



HAL
open science

All-Optical Multicast Routing in Wavelength Routed WDM Networks

Fen Zhou

► **To cite this version:**

Fen Zhou. All-Optical Multicast Routing in Wavelength Routed WDM Networks. Networking and Internet Architecture [cs.NI]. INSA de Rennes, 2010. English. NNT: . tel-00541116

HAL Id: tel-00541116

<https://theses.hal.science/tel-00541116v1>

Submitted on 29 Nov 2010

HAL is a multi-disciplinary open access archive for the deposit and dissemination of scientific research documents, whether they are published or not. The documents may come from teaching and research institutions in France or abroad, or from public or private research centers.

L'archive ouverte pluridisciplinaire **HAL**, est destinée au dépôt et à la diffusion de documents scientifiques de niveau recherche, publiés ou non, émanant des établissements d'enseignement et de recherche français ou étrangers, des laboratoires publics ou privés.

Thèse



THESE INSA Rennes
sous le sceau de l'Université européenne de Bretagne
pour obtenir le titre de

DOCTEUR DE L'INSA DE RENNES
Spécialité : *Informatique*

présentée par

Fen Zhou

ECOLE DOCTORALE

Matisse

**Routage multicast
tout optique dans
les réseaux WDM**

Thèse soutenue le 03.09.2010

devant le jury composé de :

Gérardo RUBINO

Directeur de Recherche, HDR + IRISA / INRIA Rennes / *président*

Ken CHEN

Professeur + Université de Paris 13 / *rapporteur*

Tibor CINKLER

Docens + Budapest University of Technology and Economics / *rapporteur*

David COUDERT

Chargé de Recherche, HDR + INRIA Sophia Antipolis / *examineur*

Miklos MOLNAR

Maître de Conférences, HDR + IRISA / INSA de Rennes / Co-directeur de thèse

Bernard COUSIN

Professeur + IRISA / Université de Rennes 1 / Directeur de thèse

Résumé

Dans cette thèse, nous étudions le routage multicast tout optique (AOMR) dans les réseaux WDM. Notre objectif est de trouver un ensemble de structures de diffusion, par exemple un arbre optique ou une forêt optique, pour distribuer des messages multicast vers toutes les destinations en même temps, soit en tenant compte du délai de bout en bout et du stress des liens soit en minimisant le coût total ou le budget en puissance.

En ce qui concerne l'AOMR qui tient compte à la fois du délai et du stress des liens, un algorithme efficace évitant les nœuds de branchement ne pouvant pas dupliquer la lumière dans des arbres optiques est proposé. Cet algorithme améliore le délai de bout en bout sur les arbres optiques et trouve un bon compromis entre le délai, le coût total et le stress des liens.

En ce qui concerne l'AOMR qui considère la puissance, un nouveau modèle plus précis et plus réaliste de la perte de puissance est introduit lors de la mise en œuvre d'une session multicast. Il distingue deux types de perte de puissance : la partie ponctionnée par les nœuds optiques intermédiaires pour un éventuel monitoring et la partie ponctionnée par les destinations pour la récupération des messages multicast. Basé sur ce nouveau modèle, nous proposons un calcul des arbres optiques optimisant la puissance de l'émetteur réalisé à partir d'une programmation linéaire mixte en nombres d'entiers (MILP). Pour y parvenir, un ensemble d'équations linéaires est introduit pour remplacer les équations non-linéaires induites par les coupleurs optiques.

Pour analyser les algorithmes heuristiques de l'AOMR et évaluer leurs performances, nous proposons une analyse mathématique des résultats. Dans notre analyse, nous établissons les bornes de coût des routes et les ratios d'approximation des algorithmes dans les réseaux maillés WDM pondérés et non-pondérés.

Pour le routage multicast optique de coût minimal, une nouvelle structure appelée hiérarchie optique est proposée. Il est prouvé que la structure optimale n'est pas toujours un arbre optique, mais une hiérarchie optique. Le calcul de la hiérarchie optique est modélisé sous forme d'une ILP. Ce calcul exact permet d'obtenir la solution optimale pour les petites instances. Dans les réseaux WDM à grande échelle, une heuristique efficace utilisant une stratégie de renouvellement du graphe est proposée. Les résultats de simulation justifient l'emploi de la hiérarchie optique pour l'AOMR dans les réseaux WDM avec une capacité clairsemée de duplication.

Abstract

In this thesis, we studied the all-optical multicast routing (AOMR) problem in wavelength routed WDM networks. The objective is to find a set of light structures (e.g. light-tree, or light-forest and so on) to distribute the multicast messages to all the destinations concurrently while either taking account of both the end-to-end delay and the link stress or minimizing the total cost or the power budget.

With respect to the delay and link stress sensitive AOMR, an efficient algorithm based on avoiding multicast incapable branching nodes in light-trees is proposed. This algorithm is shown to be able to improve the end-to-end delay of light-trees and to find a good tradeoff among the end-to-end delay, the link stress and the total cost.

Regarding the power-aware AOMR, a new but more accurate and realist power loss model is given for all-optical multicasting. It distinguishes two types of node tapping loss: the one tapped by intermediate optical nodes for network management and the other one tapped by destination nodes for the recovery of multicast messages. Based on this new model, the power optimal design of light-trees is formulated by a mixed-integer programming (MILP). To achieve so, a set of novel linear equations is introduced to replace the nonlinear ones induced by the light splitters.

In order to analyze the AOMR heuristic algorithms and assess their performance, light-trees computed using AOMR heuristic algorithms are evaluated mathematically by deriving the cost bounds and the approximation ratios in both unweighted and non-equally weighted WDM mesh networks.

Concerning the cost optimal AOMR, a new structure called light-hierarchy is proposed. It is proven that the optimal structure is not the light-tree but the proposed light-hierarchy. The computation of light-hierarchy is modeled as an ILP to search the optimal solution for small instance. A heuristic algorithm using a graph renewal strategy is also proposed for fast AOMR in large scale WDM networks. Simulation results strongly suggest the employment of light-hierarchy for AOMR in WDM networks with sparse splitting.

Routage multicast tout optique dans les réseaux WDM

Fen Zhou



En partenariat avec

	The logo for UMR IRISA features a stylized blue 'i' icon followed by the text 'UMR IRISA' in a blue, sans-serif font.	The logo for the China Scholarship Council is a circular emblem with a blue and white design. The text 'CHINA SCHOLARSHIP COUNCIL' is written around the bottom edge, and Chinese characters are at the top.	The logo for the University of Rennes 1 features a stylized red 'U' icon followed by the text 'UNIVERSITÉ DE RENNES 1' in a red, sans-serif font.	
--	---	--	---	--

Abstract

In this thesis, we studied the all-optical multicast routing (AOMR) problem in wavelength-routed WDM networks. The objective is to find a set of light structures, for instance a light-tree or a light-forest, to distribute the multicast messages to all the destinations concurrently while either taking account of both the end-to-end delay and the link stress or minimizing the total cost or the power budget.

With respect to the delay and link stress sensitive AOMR, an efficient algorithm based on avoiding multicast incapable branching nodes in light-trees is proposed. This algorithm is shown to be able to improve the end-to-end delay of light-trees and to find a good tradeoff among the end-to-end delay, the link stress and the total cost.

Regarding the power-aware AOMR, a new but more accurate and realist power loss model is given for all-optical multicasting. It distinguishes two types of node tapping loss : the one tapped by intermediate optical nodes for network management and the other one tapped by destination nodes for the recovery of multicast messages. Based on this new model, the power optimal design of light-trees is formulated by a mixed-integer programming (MILP). To achieve so, a set of novel linear equations is introduced to replace the nonlinear ones induced by the light splitters.

In order to analyze the AOMR heuristic algorithms and assess their performances, light-trees computed using AOMR heuristic algorithms are evaluated mathematically by deriving the cost bounds and the approximation ratios in both unweighted and non-equally weighted WDM mesh networks.

Concerning the cost optimal AOMR, a new structure called light-hierarchy is proposed. It is proven that the optimal structure is not the light-tree but the proposed light-hierarchy. The computation of light-hierarchy is modeled as an ILP to search the optimal solution for small instances. A heuristic algorithm using a graph renewal strategy is also proposed for fast AOMR in large scale WDM networks. Simulation results strongly sug-

gest the employment of light-hierarchy for AOMR in WDM networks with sparse splitting.

Key Words : All-Optical Multicast Routing (AOMR), WDM Networks, Light-tree, Light-Hierarchy

Résumé

Dans cette thèse, nous étudions le routage multicast tout optique (AOMR) dans les réseaux WDM. Notre objectif est de trouver un ensemble de structures de diffusion, par exemple un arbre optique ou une forêt optique, pour distribuer des messages multicast vers toutes les destinations en même temps, soit en tenant compte du délai de bout en bout et du stress des liens soit en minimisant le coût total ou le budget en puissance.

En ce qui concerne l'AOMR qui tient compte à la fois du délai et du stress des liens, un algorithme efficace évitant les nœuds de branchement ne pouvant pas dupliquer la lumière dans des arbres optiques est proposé. Cet algorithme améliore le délai de bout en bout sur les arbres optiques et trouve un bon compromis entre le délai, le stress des liens et le coût total.

En ce qui concerne l'AOMR qui considère la puissance, un nouveau modèle plus précis et plus réaliste de la perte de puissance est introduit lors de la mise en œuvre d'une session multicast. Il distingue deux types de perte de puissance : la partie ponctionnée par les nœuds optiques intermédiaires pour un éventuel monitoring et la partie ponctionnée par les destinations pour la récupération des messages multicast. Basé sur ce nouveau modèle, nous proposons un calcul des arbres optiques optimisant la puissance de l'émetteur réalisé à partir d'une programmation linéaire mixte en nombres d'entiers (MILP). Pour y parvenir, un ensemble d'équations linéaires est introduit pour remplacer les équations non-linéaires induites par les coupleurs optiques.

Pour analyser les algorithmes heuristiques de l'AOMR et évaluer leurs performances, nous proposons une analyse mathématique des résultats. Dans notre analyse, nous établissons les bornes de coût des routes et les ratios d'approximation des algorithmes dans les réseaux maillés WDM pondérés et non-pondérés.

Pour le routage multicast optique de coût minimal, une nouvelle structure appelée hiérarchie optique est proposée. Il est prouvé que la structure optimale n'est pas toujours

un arbre optique, mais une hiérarchie optique. Le calcul de la hiérarchie optique est modélisé sous forme d'une ILP. Ce calcul exact permet d'obtenir la solution optimale pour les petites instances. Dans les réseaux WDM à grande échelle, une heuristique efficace utilisant une stratégie de renouvellement du graphe est proposée. Les résultats de simulation justifient l'emploi de la hiérarchie optique pour l'AOMR dans les réseaux WDM avec une capacité clairsemée de duplication.

Mots Clés : Routage multicast tout optique (AOMR), Réseaux WDM, Arbre optique, Hiérarchie optique

Contents

Abstract	i
Résumé	iii
List of Figures	xiii
List of Tables	xv
I Background and Technological Context	1
1 Introduction	3
1.1 Wavelength-Routed WDM Networks	5
1.1.1 Optical Network Evolution	5
1.1.2 Wavelength-routed WDM Network Architecture	5
1.1.3 Optical Cross-Connect Devices	7
1.1.4 Sparse Splitting Configuration in WDM Networks	10
1.2 Multicast Routing in Wavelength-routed WDM Networks	11
1.2.1 All-Optical Multicast Routing	11
1.2.2 General Assumptions and System Model	13
1.3 Challenges of All-Optical Multicast Routing	15
1.3.1 Impact of Light Splitting	15
1.3.2 Impact of Wavelength Conversion	16

1.3.3	Impact of Optical Amplification	16
1.3.4	Impact of Limited Number of Wavelengths	17
1.4	Literature Review	17
1.4.1	Cost & Delay Sensitive Multicast Routing	18
1.4.2	Power-Aware Multicast Routing	21
1.5	Scope and Contributions of the Thesis	24
1.5.1	Scope	24
1.5.2	Main Contributions	25
1.6	Outline of the Thesis	27
II	Delay and Link Stress Sensitive All-Optical Multicast Routing	29
2	Avoidance of MIB Nodes in Multicast Light-trees	31
2.1	Introduction	31
2.2	Delay and Link Stress Sensitive All-Optical Multicast Routing	32
2.2.1	Useful Definitions	33
2.3	Avoidance of MIB Nodes for Multicast Routing	34
2.3.1	Construction of SPT and DijkstraPro Algorithm	35
2.3.2	Processing of the MIB nodes	38
2.3.3	Reconnection of Multicast Light-trees	41
2.4	Performance Evaluation and Simulation	44
2.4.1	Performance of the DijkstraPro Algorithm	44
2.4.2	Performance of the Avoidance of MIB Nodes Based Multicast Routing Algorithm	48
2.5	Conclusion	53
III	Power-Aware All-Optical Multicast Routing	55
3	Power-Optimal Design of Multicast Light-trees	57

3.1	Introduction	57
3.2	Power Optimal Multicast Routing in WDM Networks	59
3.2.1	Power Losses of Multicasting in WDM Networks	60
3.2.2	Design of Power Optimal Multicast Light-trees	62
3.3	MILP Formulation of Power Optimal Multicast Light-trees	62
3.3.1	Notation Tables	62
3.3.2	MILP Formulation of Power Optimal Multicast Light-trees	64
3.4	Simulation and Performance Evaluation	71
3.4.1	Simulation Configuration	71
3.4.2	Numerical Results	73
3.5	Conclusion	74
IV	Mathematical Evaluation of Multicast Light-trees	77
4	Cost Bounds and Approximation Ratios of Multicast Light-trees	79
4.1	Introduction	79
4.2	Multicast Routing with Sparse Splitting	81
4.2.1	Multicast Routing Problem	81
4.2.2	System Model	82
4.3	Cost Bounds of Multicast Light-Trees in WDM Mesh Networks	83
4.3.1	Full Light Splitting WDM Networks	83
4.3.2	Sparse Splitting WDM Networks	84
4.4	Cost Bounds of Multicast Light-Trees in WDM Rings	86
4.4.1	Multicast Light-tree in WDM Rings	86
4.4.2	Optimal Multicast Light-tree in WDM Rings	87
4.5	Approximation Ratios of the Heuristic Algorithms for Sparse Splitting Multicast Routing	88
4.5.1	Reroute-to-Source Algorithm [98]	89

4.5.2	Member-Only Algorithm [98]	91
4.6	ILP Formulation	95
4.6.1	ILP Formulation	95
4.7	Simulation and Numerical Results	99
4.7.1	Cost Bounds of Multicast Light-trees	99
4.7.2	Approximation Ratio of Multicast Light-trees	101
4.8	Conclusion	103
V	Light-Hierarchy Based All-Optical Multicast Routing	105
5	Is Light-Tree Structure Optimal for AOMR in Sparse Splitting WDM Networks?	107
5.1	Introduction	107
5.2	All-Optical Multicast Routing Problem and Motivation	108
5.3	Proposed Solutions	109
5.3.1	Graph Renewal Strategy	109
5.3.2	In Tree Distance Priority to Improve Delay and Diameter	111
5.3.3	A New Structure: Light-Hierarchy	111
5.3.4	Proposed Algorithms	113
5.4	Wavelength Assignment	113
5.5	Performance Evaluation and Simulation	114
5.5.1	Simulation Model	114
5.5.2	Performance Analysis	114
5.6	Conclusion	121
6	Light-Hierarchy: The Optimal Structure for AOMR in WDM Mesh Networks	125
6.1	Introduction	125
6.2	Cost Optimal All-Optical Multicast Routing	126

6.3	Light-Hierarchy: A New Structure for All-Optical Multicast Routing	127
6.3.1	Cross Pair Switching	127
6.3.2	Light-hierarchy Structure	127
6.4	ILP Formulation of Light-Hierarchy	130
6.4.1	ILP Formulation	131
6.5	Simulation and Performance Evaluation	135
6.5.1	Simulation Model	135
6.5.2	Light-Hierarchy versus Light-tree	136
6.6	Conclusion	137
7	Conclusion	139
7.1	Summary	139
7.2	Future Work	141
A	Résumé étendu	145
A.1	Introduction	145
A.2	L'architecture des réseaux WDM	147
A.3	Routage multicast tout optique	149
A.3.1	Présentation	149
A.3.2	Les défis de l'AOMR	150
A.4	Problématiques étudiés	152
A.5	Plan de la thèse	153
A.6	Conclusion et perspectives	160
	Bibliography	164
	Glossary	174
	Acknowledgment	179
	List of Publications	181

Autorisation de publication

183

List of Figures

1.1	A Typical Architecture of a Wavelength-Routed WDM Network [38]	6
1.2	The Architecture of a Simple OXC	8
1.3	The Architecture of a Splitter-and-Delivery (SaD) Switch [34, 91]	9
1.4	The Architecture of a Tap-and-Continue (TaC) OXC [3]	10
1.5	The Functionality Difference Between an MI and an MC Node in a Light-Tree	13
1.6	(a) Illustration of the Reroute-to-Source Algorithm (b) Illustration of the Reroute-to-Any Algorithm	20
1.7	Illustration of Centralized-Splitting Algorithm: (a) Cascade Power Loss (b) Splitting Far from the Source	23
2.1	Critical Articulation Node	33
2.2	NSF Network Topology	36
2.3	The SPT for m_1 Constructed by the Dijkstra Algorithm	36
2.4	The SPT for m_1 Constructed by Offering Higher Priority to MC <i>candidate</i> Nodes	37
2.5	The SPT after Node Adoption from Figure 2.4	37
2.6	An Example Network with CAN Nodes	39
2.7	A Shortest Path Tree for m_2	40
2.8	Processing MIB nodes Using the Critical Articulation Heuristic	40
2.9	Illustration of Two Strategies for the Reconnection of Light-Trees (a) Member-Only-Like Method (b) Connector Node Distance Priority (c) Connector & Destination Node Distance Priority	43

2.10	USA Longhaul Network	44
2.11	Link Stress vs. Multicast Group Size in (a) NSF Network (b) USA Longhaul Network	50
2.12	Average End-to-End Delay vs. Multicast Group Size in (a) NSF Network (b) USA Longhaul Network	50
2.13	Total Cost vs. Multicast Group Size in (a) NSF Network (b) USA Longhaul Network	51
2.14	Maximum End-to-End Delay vs. Multicast Group Size in (a) NSF Network (b) USA Longhaul Network	51
2.15	Link Stress against the Number of MC Nodes in (a) NSF Network (b) USA Longhaul Network	52
2.16	Average End-to-End Delay against the Number of MC Nodes in (a) NSF Network (b) USA Longhaul Network	52
2.17	Total Cost against the Number of MC Nodes in (a) NSF Network (b) USA Longhaul Network	53
2.18	Maximum End-to-End Delay against the Number of MC Nodes in (a) NSF Network (b) USA Longhaul Network	53
3.1	Illustration of Power Loss in the Light-Forest for Multicast Session $ms(s, (d_1 - d_5))$ (a) Light-Tree One (b) Light-Tree Two	61
3.2	The Increasing Tendency of <i>Power</i> against F : (a) $0.05 \leq P_{s,1}^{mW}(\lambda) \leq 10$, $0.05 \leq P_{s,2}^{mW}(\lambda) \leq 10$; (b) $1 \leq P_{s,1}^{mW}(\lambda) \leq 10$, $1 \leq P_{s,2}^{mW}(\lambda) \leq 10$	66
3.3	A 6 Nodes Mesh Network	71
4.1	An Example Sparse Splitting WDM Network	80
4.2	(a) The Best Case; (b) The Worst Case when $K < \frac{N}{2}$; (c) The Worst Case when $K \geq \frac{N}{2}$	86
4.3	The Gaps in a WDM Ring	87
4.4	Illustration of <i>Theorem 4</i>	90
4.5	Illustration of <i>Lemma 3</i>	91
4.6	Demonstration of the Worst Case of the Member-Only Algorithm	92

4.7	A Contradict Example with a Loop in the Resultant Light-Tree: (a) The Network Topology; (b) The Result	97
4.8	The Cost Bound of Multicast Light-Trees when the Number of Destinations K Varies	100
5.1	NSF Network Topology	110
5.2	For Multicast Session ms_1 , (a) Light-Tree Built by the Member-Only Algorithm; (b) Light-Tree Built Using the Hypo-Steiner Heuristic.	110
5.3	Distance Priority	111
5.4	For Multicast Session ms_3 , (a) Light-Trees Built by the Member-Only Algorithm; (b) Light-Trees Built by the Graph Renewal Strategy; (c) Light-Hierarchy Built by the Extended Graph Renewal Strategy	112
5.5	Comparison of the Link Stress in the USA Longhaul Topology when the Multicast Member (a) Ratio = 25%; (b) Ratio = 50%; (c) Ratio = 75%. . .	115
5.6	Comparison of the Average Delay in the USA Longhaul Topology when Multicast Member (a) Ratio = 25%; (b) Ratio = 50%; (c) Ratio = 75%. . .	116
5.7	Comparison of the Diameter in the USA Longhaul Topology when Multicast Member (a) Ratio = 25%; (b) Ratio = 50%; (c) Ratio = 75%.	117
5.8	Comparison of the Total Cost in the USA Longhaul Topology versus Multicast Member (a) Ratio = 25%; (b) Ratio = 50%; (c) Ratio = 75%.	118
5.9	Comparison of Throughput in (a) USA Longhaul Topology; (b) Cost-239 Topology.	121
6.1	Cross Pair Switching of an MI Node	128
6.2	Two Typical Light-Hierarchies with Cross Pair Switching	128
6.3	(a) An Example Network Topology and the Light-Hierarchy; (b) The Optimal Light-Trees for $ms(s, (d_1, d_2))$	130
6.4	(a) An Example Network Topology; (b) The False Result; (c) The Optimal Result.	133
6.5	The Weighted NSF Network	135
6.6	The Weighted European Cost-239 Network	135

List of Tables

2.1	Comparison of the Three Light-Trees in Fig. 2.9	43
2.2	Comparison of Dijkstra and DijkstraPro in the NSF Network	46
2.3	Comparison of Dijkstra and DijkstraPro in the USA Longhual Network . . .	47
3.1	Configuration of Parameters	71
3.2	Power-Optimal vs Cost-Optimal Multicast Light-Trees: $\gamma_2 = 1$ dB	72
3.3	Power-Optimal vs Cost-Optimal Multicast Light-Trees: $\gamma_2 = 3$ dB	72
4.1	Comparison of Cost Bounds in NSF Network	101
4.2	Comparison of Approximation Ratios in NSF Network	101
4.3	New Approximation Ratios of R2S and MO in NSF Network	103
6.1	Performance Comparison of LH and LT in the Weighted NSF Network. . . .	136
6.2	Performance Comparison of LH and LT in the European Cost-239 Network.	138

Part I

Background and Technological Context

Recently, great successes have been witnessed in optical networks by employing the wavelength division multiplexing (WDM) technology. Similar to the frequency division multiplexing (FDM) [18] in cellular telephical networks where each frequency is used as a communication channel, WDM is a technology that concurrently multiplexes many optical wavelengths over a single optical fiber and each of the wavelengths is viewed as a separate channel for data transmission in WDM transport networks. The state-of-art mature optical fiber is capable of carrying 160 channels in parallel with each operating at 40 Gbit/s for the total capacity of 6.4 Tbit/s or 80 channels at 100 Gbit/s in 8 Tbit/s configuration [36]. Hence, WDM is like an expandable highway, where one can simply turn on a different color of light in the same fiber to achieve higher capacity [22]. Apart from the huge bandwidth capacity provided by the optical fibers, WDM networks also have many other attractive characteristics such as low latency, low signal attenuation (about 0.2 dB/km near 1550 nm) [38, 91], low bit error rate (BER, it is typically 10^{-12} [38]), high data transparency and efficient network failure handling [38]. Due to the ability to meet rising demands of Internet services with QoS (quality of service) guarantee, WDM networking is without doubt the most efficient technique for the backbone network of Internet.

The deployment of WDM technology in the Internet infrastructure entails fast switching at the core of the networks and the enhancement of the Internet Protocol (IP) to support traffic engineering [6, 7] as well as different levels of QoS [9] for tremendous Internet traffic [70]. On one hand, regarding the fast switching, Optical-Electrical-Optical (O/E/O) conversion should be avoided to overcome the mismatch between the high bandwidth of optical fibers and the peak speed of electrical processing (a few Gbit/s) [70]. It is also referred as the well-known electro-optical bottleneck [59]. As the optical cross connects (OXC) [69, 34, 4] are becoming mature and commercially available, transparent optical networks can be realized. An OXC switch is able to switch a light signal arriving at an input fiber link to any output fiber link while retaining the same wavelength. On the other

hand, in order to achieve IP over WDM and make the best of the huge bandwidth, network traffic engineering protocols should adapt to WDM networks. For efficient communication provisions in a WDM optical network, traffic grooming protocol [5, 55, 72, 90] considering optical constraints is essential for aggregating a set of low data rate traffic streams (with kbits/s or Mbits/s) into one wavelength channel with a high data rate of Gbits/s. Besides, the routing and wavelength assignment (RWA) protocol should be developed to find paths for the communication requests and allocate a wavelength for each path so that the required network resources are minimized, or the network throughput is maximized provided a fixed number of resources.

With the dramatic increase of Internet applications, such as HDTV, distance learning, video-on-demand (VoD), video conference and software updating services, etc., multicast is the best choice for saving the limited network bandwidth. However the support of all-optical multicasting (AOM) [30] in wavelength-routed WDM networks faces a lot of challenges caused by the capacity of optical switch devices, optical amplifiers as well as the limited number of wavelengths carried in optical fibers. In this thesis, all-optical multicast routing (AOMR) [30] is investigated in sparse splitting wavelength-routed WDM networks, where only few of network nodes are capable of light splitting. The study is conducted in the connection provisioning stage [30], i.e., given that an all-optical WDM network is well dimensioned (e.g. the network topology and the nodes' configuration have already been provisioned), try to establish multicast communications with a set of optical routes while optimizing some important network resources and satisfying a certain level of QoS, such as end-to-end delay, total cost, number of wavelengths required, etc. The rest of this chapter is organized as follows:

- An introduction to the wavelength-routed WDM networks. It covers the description of the architecture of WDM backbone networks, the optical devices deployed in WDM networks as well as the concept of sparse splitting configuration.
- The definition and advantages of AOMR in wavelength-routed WDM networks.
- The challenges of supporting AOMR in wavelength-routed WDM networks.
- The state-of-art of AOMR in WDM networks.
- The scope and contributions of this thesis.
- The outline of the manuscript.

1.1 Wavelength-Routed WDM Networks

1.1.1 Optical Network Evolution

Optical networks have undergone two generations of development. In the first generation, only high capacity optical fibers are employed as transmission medium to replace the traditional copper cables. The data transmission is done in the optical domain while the switching is still performed in the electrical domain. It is called the opaque network, since a light signal is regenerated electronically at every intermediate node. Fiber distributed data interface (FDDI), synchronous optical networks (SONET) and synchronous digital hierarchy (SDH) networks are some examples of the first generation optical networks [26]. In the second generation, the WDM technology is employed. Different from the previous one, both the transmission and the switching are performed in the optical domain with the help of OXCs [69, 34, 4]. The signal is always kept in the optical domain inside the core network until arriving at the access nodes (or edges nodes) [69]. Thus, this kind of optical network is also referred to as transparent optical networks or WDM networks [26, 38].

A WDM local area network (LAN) or metropolitan area network (MAN) usually uses a star or a bus topology [38]. They usually operate in the broadcast-and-select manner [11]. In this manner, a common transmission medium is shared, and a simple broadcasting mechanism is employed for sending and receiving light signals between optical nodes. As a result, the switching or routing is not needed [33]. In contrast, a WDM wide area network (WAN) is built on the concept of wavelength routing. Considering the survivability and reliability, the mesh topology is always employed in a WDM WAN, where the network nodes are interconnected through a set of redundant point-to-point WDM links. Consequently switching (routing) is essential for data transmissions in this kind of network. A WDM WAN is more sophisticated than the broadcast-and-select WDM networks as more network functionalities are required: routing, wavelength assignment, multicasting as well as traffic grooming. Next a brief introduction is given to the architecture of the wavelength-routed WDM networks.

1.1.2 Wavelength-routed WDM Network Architecture

The typical architecture of a wavelength-routed WDM mesh network is demonstrated in Fig. 1.1. It mainly consists of access nodes (or edge nodes), OXCs as well as optical fibers.

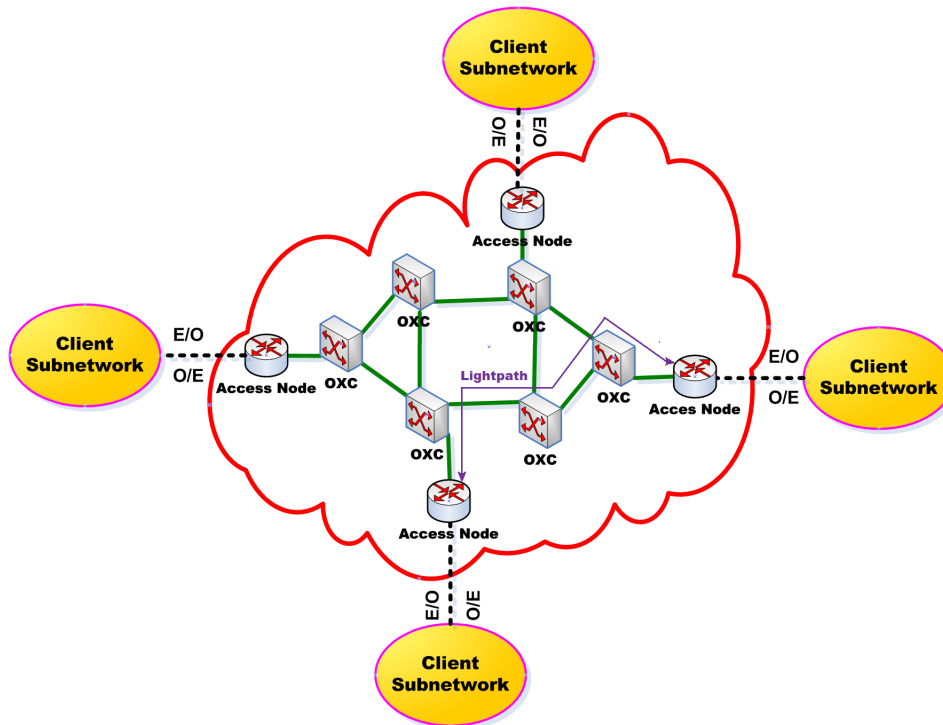

Figure 1.1: A Typical Architecture of a Wavelength-Routed WDM Network [38]

- The access nodes provide the interface between the optical core and the non-optical client subnetworks (such as IP/MPLS subnetworks, ATM subnetworks) [64]. To offer communication services for client subnetworks, an access node can act either as the source of an optical path to send light signals through optical fibers or as the destination to receive light signals from optical fibers. At the source side, an access node aggregates a set of low speed traffics and performs the E/O conversion function. Accordingly at the destination side, another access node performs the traffic deaggregation and O/E conversion.
- Meanwhile, the switching and routing functions are provided by the OXC's for supporting end-to-end communications between the access nodes. Through demultiplexing the incoming light signal, an OXC can switch each of the wavelengths at an input port to a particular output port, independent of the other wavelengths. Some particular OXC's can also switch a wavelength to several output ports simultaneously by employing a light splitter to support multicast services.
- The optical fibers carry the same set of wavelengths. They operate in WDM mode so that a high bandwidth transmission could be provided. Typically, a pair of fibers

are placed in each link for two opposite direction communications in the WDM core network.

In wavelength-routed WDM networks, the end-to-end communications between a pair of access nodes is implemented by a logical connection called lightpath [69]. A lightpath is an all-optical path between two access nodes, where only one wavelength is allocated over all the hops. Since no O/E or E/O conversion is conducted at the intermediate nodes, there is nothing in a lightpath to limit the throughput of an optical fiber. Thus, the possible bandwidth that can be utilized in a lightpath is up to as high as the capacity of a wavelength channel (i.e. about 100 Gbit/s [36]). A sample lightpath is marked as a purple arrow line in Fig. 1.1.

1.1.3 Optical Cross-Connect Devices

Relying on inherent advantages, WDM networks are capable of supporting diverse multimedia services in the Internet, such as VoIP, video conference, online community-based communications (e.g., blog, voting), etc. It broadly consists of four traffic patterns: point-to-point communication (unicast), point-to-multipoint communication (multicast), multipoint-to-point communication (MP2P) and multipoint-to-multipoint communication (MP2MP). To accommodate diverse traffic in the future Internet, the OXCs with different configurations are needed in WDM networks. As MP2P and MP2MP communications could be decomposed and realized by a set of unicast communications or multicast communications, there are two categories of OXC in wavelength-routed WDM networks: one exclusively designed for unicast and the other one supporting both unicast and multicast traffics.

For supporting unicast connections, the architecture of a simple OXC is depicted in Fig. 1.2 by [62]. An $N \times N$ simple OXC supporting W wavelengths is implemented by N wavelength demultiplexers, $W N \times N$ optical space division switches (SDSs) as well as N wavelength multiplexers. Each input port is followed by a wavelength demultiplexer while each output port is preceded by a wavelength demultiplexer. W SDSs are placed in the middle with each one responsible for a wavelength from λ_1 to λ_W . At the input port, an incoming light signal is extracted into W individual wavelengths by a multiplexer. Each λ_i is connected to its corresponding SDS. Then, the SDS reserved for λ_i switches the light signals on λ_i coming from different input ports to the designated output ports. Before going out of the OXC, the light signals on different wavelengths are combined together by the wavelength multiplexer at each outputport. Since the light signals are divided into

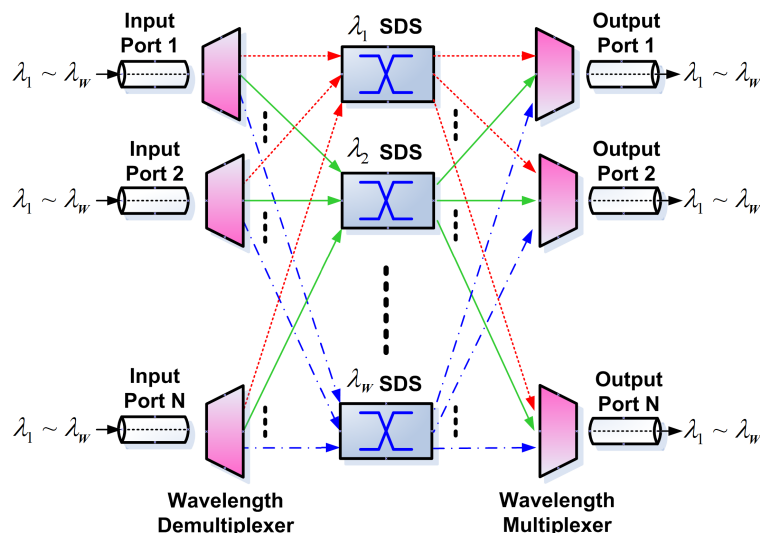

Figure 1.2: The Architecture of a Simple OXC

different wavelength layers and treated independently, a simple OXC can cross-connect the different wavelengths from one input port to any one output port. Thus, the connection pattern of each wavelength is independent of the others. Obviously, the distinct wavelength constraint has to be fulfilled on each output port. By appropriately configuring the OXCs along the physical path, logical connections (lightpaths) may be established between access nodes in the WDM network.

In order to support multicast services, an expensive optical device called light splitter should be integrated in an OXC. Thus, paper [34] proposed a splitter-and-delivery (SaD) switch to replace the optical space division switch (SDS) in the simple OXC of Fig. 1.2. A light signal will be equally split into all the outgoing ports after passing a SaD switch. An OXC employing SaD switches is also referred to as a SaD OXC. The number of SaD switches required is equal to the number of wavelengths W supported in a SaD OXC. Fig. 1.3 demonstrates the architecture of an $N \times N$ SaD switch. It consists of N light splitters, N^2 crosstalk-reducing optical gates and N^2 2×1 photonic switches. These components are well integrated on a silicon board using planar silica waveguide technology [85] so that a favorable crosstalk level less than -40dB could be achieved [34].

A significant shortcoming of the SaD OXC is that a light signal still faces splitting power loss after traversing a SaD OXC even if it only carries unicast traffic. In order to reduce the unnecessary power loss and the fabrication cost, the SaD switch is modified to a Member-Only Splitter-and-Delivery switch (MOSaD) [4]. By sharing the light splitters and

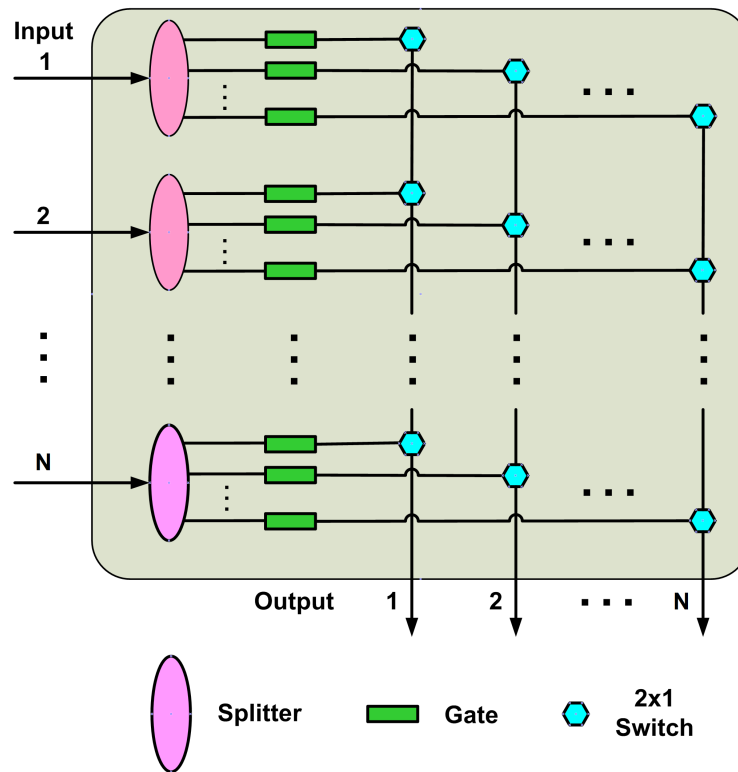

Figure 1.3: The Architecture of a Splitter-and-Delivery (SaD) Switch [34, 91]

distinguishing the unicast and the multicast traffic, MOSaD not only avoids unnecessary power loss for unicast signal but also reduces the number of light splitters.

However, SaD switches are prevented to be employed in all the OXCs due to two reasons:

- A large number of light splitters are required to implement a SaD OXC. For instance, a W wavelengths $N \times N$ SaD OXC needs $N \times W$ splitters. This makes the fabrication process of a SaD OXC difficult and expensive.
- Light splitters greatly degrade the light signal. To compensate the power loss induced by light splitters, lots of expensive optical amplifiers are consequently needed.

Thus, a low-cost OXC architecture called Tap-and-Continue (TaC) is proposed in [3] for realizing multicasting. As shown in Fig. 1.4, a TaC OXC uses a set of Tap-and-Continue Modules (TCMs) instead of light splitters. In a TCM, only a small fraction of the incoming light signal is tapped and forwarded to the local station. The remaining power of the order of 99.9% [3] is switched to the designated output port. In order to meet a certain signal to noise ratio (SNR), the tapping device should be fully programmable to provide sufficient

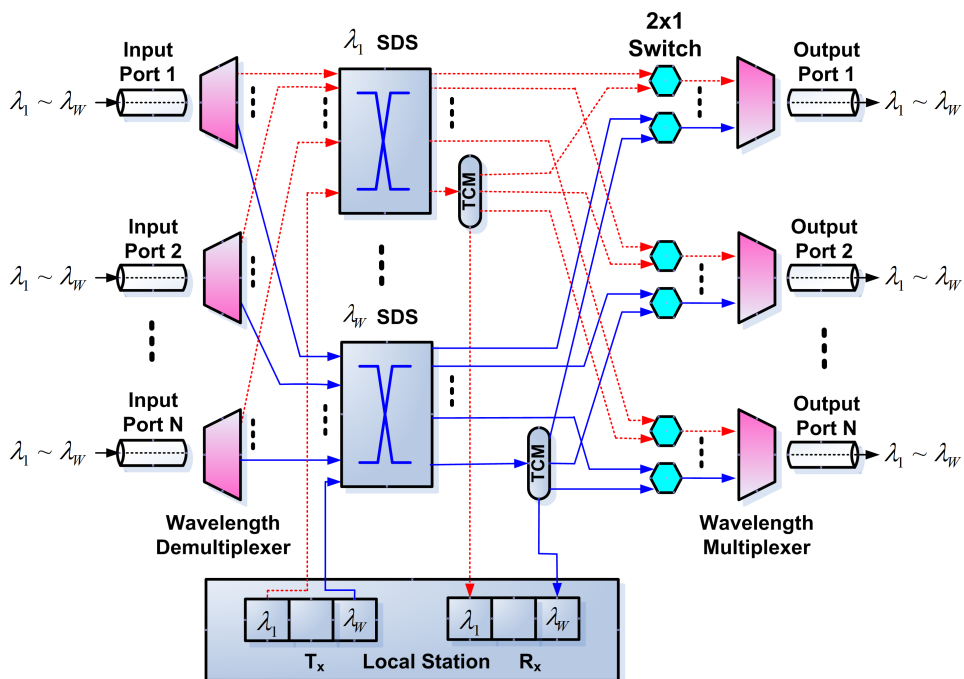

Figure 1.4: The Architecture of a Tap-and-Continue (TaC) OXC [3]

tapped signal power for the local station. By taking advantage of the TaC OXC, it is found in [3] that only about 50% of the OXCs in a WDM network need actually to be SaD OXCs, while the rest can just make use of the TaC devices.

1.1.4 Sparse Splitting Configuration in WDM Networks

According to the type of supported traffic, the OXCs in a wavelength-routed WDM network can be mainly divided into two categories:

- **Multicast Incapable OXC** (MI-OXC, or MI node). For instance the simple unicast OXC in Fig. 1.2 and the TaC OXC in Fig. 1.4.
- **Multicast Capable OXC** (MC-OXC, or MC node). E.g., the SaD OXC in Fig. 1.3 and the MOSaD OXC.

As discussed in the previous subsection, an MC-OXC is always much more expensive and complicated to fabricate than an MI-OXC. Thus, generally only few of OXCs are MC-OXCs while the rest are MI-OXCs in a WDM network, which is referred to as sparse splitting configuration [65].

In this thesis, a wavelength-routed WDM network with sparse splitting is considered, which is more realistic due to the hardware limitations of OXCs. With the advancements of the photonic devices, it is believed that adaptive splitting technologies will become mature and could be commercially used by the MC-OXCs in the near future. In this thesis, we assume that MC-OXCs are configurable, in that they can be instructed to equally split the incoming signal only into the active outgoing ports. By appropriately configuring photonic switches, each light signal resulting from the splitting operation can be switched to the desired output port. In addition, the tapping capacity is integrated in MC-OXCs to better support multicast. As far as the MI-OXCs, the cost-efficient TaC OXCs are also assumed to be employed in the studied WDM network. Moreover, all-optical wavelength converters [61, 23] and all-optical erbium-doped fiber amplifiers (EDFA) [21] are still expensive and immature [26]. As they are not widely commercially available, they will not be taken into account in this thesis.

1.2 Multicast Routing in Wavelength-routed WDM Networks

1.2.1 All-Optical Multicast Routing

The purpose of multicasting is to provide efficient communication services for applications that necessitate the simultaneous transmission of information from one source to multiple destinations, i.e. one-to-many communication [33]. Multicasting is bandwidth-efficient compared to unicasting and broadcasting. In one hand, multicasting eliminates the necessity for a source to send an individual copy of the message to each destination. In the other hand it avoids flooding the whole network by broadcasting [33]. Relying on the bandwidth efficiency, multicasting is advised for many bandwidth-driven services in the nowadays Internet, such as video-conference, shared workspace, distributed interactive simulation and software upgrading [67].

In wavelength-routed WDM networks, the network traffic is carried via different wavelengths propagated in optical fibers. The smallest transport unit is a wavelength. As no O/E/O conversion takes place in OXCs, the transmission and the duplication of data are all done in the optical domain. This is why multicasting in wavelength-routed WDM networks is also called all-optical multicasting (AOM) [30]. AOM has many potential advantages [65]. First of all, as we can know the physical topology of the WDM core network beforehand, multicasting at the WDM layer can be implemented by a more efficient mes-

sage distribution structure in terms of the bandwidth and latency. Secondly, the replication of data in WDM networks is more efficient than that in IP networks. In WDM networks, an OXC duplicates the data by directly using an optical device called light splitter, while the IP switches do it by copying the memory electronically in IP networks. The usage of light splitters also eliminates the need for buffers usually required for data duplication in the electronic domain. Finally, AOM provides a high data transparency. We do not need to care about neither the bit rate nor the coding format of the data during a multicast communication in WDM networks.

Supposing that a multicast session $ms(s, D)$ is required to distribute messages from a source s to a group of destinations D simultaneously. In order to establish this communication, a set of paths should be found to route multicast messages, i.e. resolving the multicast routing problem. In IP-based packet-switching networks, typically a multicast tree rooted at the source is constructed with branches spanning all destinations to accommodate a multicast session. Different from multicasting in the IP layer, in order to support AOM, it is desirable that the network nodes should be equipped with light splitters, which are able to split the incoming light signal to all the active outgoing ports simultaneously. This entails the network nodes to employ MC-OXCs, in brief these nodes are also named as Multicast Capable nodes (MC nodes) [53]. In WDM networks with full light splitting (all network nodes are MC nodes), the lightpath is extended to a light-tree in [71] to implement a single source based multicast communication. A light-tree is a point-to-multipoint channel on a single wavelength, which contains one continuous lightpath from the source to each destination. The goodness of introducing the light-tree not only lies at reducing the network-wide average packet hop distance but also minimizing the number of transceivers in the network. However, due to the expensive fabrication and complicated architecture of MC-OXCs, the full light splitting configuration is not practical in WDM mesh networks. Consequently, extensive studies of AOM are done in WDM networks with sparse splitting, where only few nodes are MC nodes while the other are Multicast Incapable nodes (MI nodes). The MI nodes only employ the TaC-OXCs and thus do not support light splitting. But the TaC capability enable an MI node to tap a small amount of the incoming light power for signal detection and forward the remainder to only one outgoing port. The splitting capability of a network node directly affects its nodal degree in a multicast light-tree. Fig. 1.5 ¹ shows the difference between an MI and an MC node when constructing light-trees. In this example, the source node s tries to multicast light signal to both d_1 and d_2 .

¹By default, an MI node is denoted by a rectangle while an MC node is denoted by a circle in all the figures of this thesis except those of network topologies.

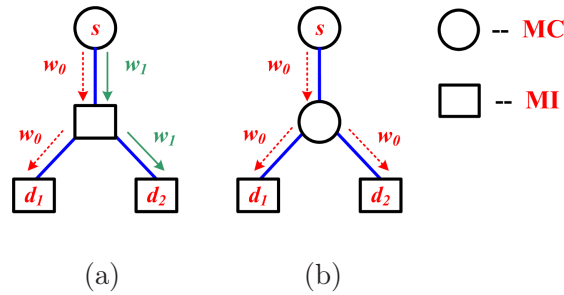

Figure 1.5: The Functionality Difference Between an MI and an MC Node in a Light-Tree

In Fig. 1.5(a) where the middle node is an MI node, two light-trees on two wavelengths w_0 and w_1 are required. As we can see, the MI node has only one outgoing branch for each wavelength and its total degree is not beyond two in a light-tree. In Fig. 1.5(b) where the middle node is an MC node, one light-tree on wavelength w_0 is enough to distribute multicast messages to both d_1 and d_2 . With the help of a light splitter, an MC node is able to split an incoming light signal into several branches concurrently. Thus, there is no limitation on the nodal degree of an MC node in a light-tree. In other words, the out degree of an MC node in a light-tree can be as big as the number of its outgoing ports. Hence, one must consider the splitting capability of network nodes when performing AOMR in sparse splitting WDM networks. As a result, the light-forest [98] concept is proposed to realize an all-optical multicast communication. A light-forest is a set of light-trees rooted at the same source node but assigned with different wavelengths. A light-forest covers all the multicast members. For instance, the light-tree on w_0 and the one on w_1 in Fig. 1.5(a) constitute a light-forest for establishing multicast session $ms(s, (d_1, d_2))$.

1.2.2 General Assumptions and System Model

A wavelength-routed WDM network with sparse splitting is studied in this thesis. MC nodes are very sparse (normally with a presence below 50%) and wavelength converters are not available in the network. The splitting capability of an MC node is assumed to be as big as the maximal nodal degree in a WDM network. A sparse splitting WDM network can be modeled by an undirected graph $G(V, E, c, d, W)$. Each node $v \in V$ is either an MI node or an MC node. Each edge $e \in E$ consists of two symmetric optical fibers for the communications of two opposite directions. Each edge $e \in E$ is associated with two weight functions $c(e)$ and $d(e)$. $c(e)$ represents the cost of fiber link e , and $d(e)$ denotes the

propagation delay in fiber link e . Both of them are additive along a lightpath $LP(u, v)$. W denotes the set of wavelengths supported in each fiber link.

Besides, as all-optical wavelength converters are still very expensive for commercial use and immature [61, 23, 26], they are supposed to be unavailable in our studied WDM network. This hardware limitation induces two typical optical layer constraints: wavelength continuity constraint and distinct wavelength constraint [60].

- **Wavelength continuity constraint.** The same wavelength should be retained over all the links in a lightpath or a light-tree in the absence of wavelength converters.
- **Distinct wavelength constraint.** Two lightpaths or light-trees can not be assigned with the same wavelength if they are not link disjoint.

These two constraints are unique in wavelength-routed WDM networks, and they should be respected when performing AOMR.

One multicast session $ms(s, D)$ is considered. Due to sparse splitting constraint, wavelength continuity constraint and distinct wavelength constraint, one light-tree may not be sufficient to cover all destinations. Assume k light-structures (light-trees or light-hierarchies²) $LS_i, 1 \leq i \leq k$ should be computed to establish a session $ms(s, D)$. Since these k light-structures are not edge disjoint, different wavelengths must be assigned for each one. Thus, link stress is defined as the maximum number of wavelengths required per link by $ms(s, D)$. It also equals the number of light-structures built.

$$Stress[ms(s, D)] = k \quad (1.1)$$

The total number of wavelength channels used (i.e., total cost) for $ms(s, D)$ can be calculated as

$$\begin{aligned} c[ms(s, D)] &= \sum_{i=1}^k c(LS_i) \\ &= \sum_{i=1}^k \sum_{e \in LS_i} c(e) \end{aligned} \quad (1.2)$$

Let $LP(s, d_j)$ be the lightpath between the source s and the destination d_j in the light-structure built for $m(s, D)$, the average end-to-end delay and the maximum end-to-end

²It is a new multicast structure which will be introduced in Chapters 5 and 6

delay can be defined as follow:

$$AverDelay[ms(s, D)] = \frac{1}{|D|} \sum_{d_j \in D} \sum_{e \in LP(s, d_j)} d(e) \quad (1.3)$$

$$MaxDelay[ms(s, D)] = \max_{d_j \in D} \sum_{e \in LP(s, d_j)} d(e) \quad (1.4)$$

1.3 Challenges of All-Optical Multicast Routing

Although AOM is beneficial, it is a challenging work to realize the multicast routing at the WDM layer. The challenges of AOMR not only arise from the multicast technique itself but also arise from distinctive characteristics of the wavelength-routed WDM networks. For an efficient multicasting in IP networks, it is the well-known Steiner problem [24] to find a multicast tree with the minimal cost. In WDM networks, the situation becomes even more critical due to wavelength routing and the hardware limitation of OXCs. It is because there is a tight coupling between the lightpath or light-tree searching and the wavelength allocation [70]. This feature makes WDM networks different from the conventional circuit-switched networks. These supplemental challenges make the design of AOMR more complicated, which thus prevent us from transplanting the IP multicasting solutions directly for AOM in WDM networks. In the following subsections, we will address several unique challengers in wavelength-routed WDM networks and discuss about their impacts on AOMR.

1.3.1 Impact of Light Splitting

The light splitting capability is a key enabling technology for multicast communications in wavelength-routed WDM networks [30]. In WDM networks with sparse splitting, the splitting fanout of network nodes varies, which affects AOMR. The splitting fanout is the maximum number of outgoing light branches supported per node for a given wavelength. It is an important parameter in the design of multicast light-trees. On one hand, it poses the constraint on the nodal degree in a light-tree. Due to this constraint, some destination nodes may not be included in the same light-tree but several ones on distinct wavelengths should be used. On the other hand, light splitters degrade the power of light signal and induce crosstalk. Consequently the quality of transmission (QoT) [31] measured in terms of SNR or BER is affected.

1.3.2 Impact of Wavelength Conversion

Wavelength converters enable an OXC to shift an incoming light signal from one wavelength to another. If converters are used, the wavelength conversion provides flexibility in the network operation and simplifies the routing problem. However, all-optical wavelength converters are still very expensive and immature [61, 23, 26]. This is why we make the assumption of no wavelength conversion in the studied WDM networks. Wavelength-routed WDM networks operate based on the concept of lightpath and light-tree [58]. In a lightpath or a light-tree, the transmitting signal is always kept in the optical format from a source node to a destination node. In the absence of wavelength conversion in OXCs, the aforementioned wavelength continuity constraint and distinct wavelength constraint [60] should be respected. It is worth noting that the wavelength continuity must be satisfied both in depth due to light propagation on a lightpath, and in breadth due to light branching in a light-tree. Wavelength channels on different fibers therefore cannot be treated independently, as it is the case for the multicasting in IP networks. Due to this constraint, the network performance in terms of the wavelength utilization and the blocking probability may be largely degraded.

1.3.3 Impact of Optical Amplification

Optical power loss in WDM networks is induced by many aspects, such as light splitting, power tapping and signal attenuation etc. When a light signal passes through an f -out power splitter, it is equally divided into f light beams and forwarded to f outgoing ports. The power of split light signal degrades a lot, as it is at most $1/f$ of that of the original one. Secondly, after traversing intermediate OXCs in a lightpath or a light-tree, a proportion of light power is always tapped for the management purpose in the control plane or for local consumption. In addition, the power loss could also be induced by the attenuation of light signals in optical fibers. In order to guarantee that the light signal received at a destination is high enough for detection and the data could be recovered correctly, optical power loss should be considered when performing AOMR. Because, the diameter of a multicast light-tree (the maximum distance from the source to the destinations) and the number of cascade light splitters in a light-tree will be affected or bounded due to the power loss. To eliminate this impact on the construction of light-trees, active optical amplification devices like erbium-doped fiber amplifier (EDFA) [21] are required to compensate the power loss. However, optical amplifiers are expensive to fabricate and introduce many problems which complicate network management such as Gain Dispersion, Gain Saturation and Noise [93].

Besides, placing amplifiers on fiber links will increase the number of potential receivers for AOM.

1.3.4 Impact of Limited Number of Wavelengths

A wavelength-routed WDM network is a multi-channel network. The number of channels depends on the number of wavelengths supported in optical fibers. Using nowadays commercially available WDM technology, an optical fiber can be divided into as many as 160 channels to provide a bandwidth of Tbits/s [36]. However, one wavelength channel is the smallest transmission unit in WDM networks. With the sparse slitting configuration, several wavelength channels may be required to fulfill a multicast communication. However two multicast sessions only can reuse the same wavelength provided that their light-trees are edge disjoint, which is the direct outcome of the wavelength continuity constraint and the distinct wavelength constraint. As the number of wavelengths in each optical fiber is limited, AOMR algorithms should be carefully designed so that as many multicast sessions as possible could be accepted concurrently in WDM core networks.

1.4 Literature Review

Recently, extensive researches in [53, 58, 94, 98, 30, 33, 65, 3, 93, 91, 89, 96, 28, 13, 12] have been done on AOMR. Many AOMR algorithms are proposed for the computation of the light-forest satisfying specific requirements. According to the metrics and constraints considered, they can be classified into two types: cost and delay sensitive multicast routing as well as power-aware multicast routing. The first type generally deals with the optimization of network resources consumed by multicast light-trees while taking the end-to-end delay into account. The latter one considers the power impairment at the WDM layer when multicasting and tries to optimize the optical power budget. As it is NP-Complete to optimize the resources for AOM [2, 35, 37, 91], a lot of integer linear programming (ILP) or mixed-integer linear programming (MILP) approaches are developed to search the optimal solution. The ILP/MILP method works well for small WDM networks with fewer multicast requests. However, they are neither time efficient nor scalable for large WDM networks. To achieve fast AOMR in large-scalable WDM networks, efficient heuristic algorithms are also developed to overcome different optical layer constraints. In the following sections, the state-of-art work on AOMR will be presented.

1.4.1 Cost & Delay Sensitive Multicast Routing

A lot of work focus on the AOMR with the consideration of wavelength channel cost and delay [53, 98, 65, 93, 96, 13, 12, 94]. Generally, the AOMR light-trees are evaluated in terms of link stress (the number of wavelengths required per link), wavelength channel cost (the number of wavelength channels used), average delay (the average hop counts from the source to the destinations) and the maximum end-to-end delay (the maximum number of hop counts from the source to the destinations). Below, some of the ILP formulation methods and related heuristic algorithms are reviewed respectively.

ILP Solutions

In order to search the cost-optimal light-trees, many ILP solutions are proposed. In [12], AOMR with delay constraints is investigated in WDM networks with heterogeneous capabilities. By setting the objective function as minimizing the weighted combination of the cost and the number of wavelengths used, a new ILP formulation method is proposed to find the optical light-forest for a single multicast session. In the formulation, whether a link is used by the lightpath from the source to a destination is regarded as variables, and it is proved that the required light-forest is the combination of all the lightpaths from the source to each destination. A significant advantage of this method is that it is very simple to determine the delay from the source to each destination by linear equations, and thus the delay constraint is very easy to impose.

In [94], multiple multicast sessions are treated entirely by developing a set of MILP formulations. Two problems are treated. The objective of the first one is to find the optimal routing and wavelength assignment strategy for multicast communications with the end-to-end delay constraint. Meanwhile the optimal placement of light splitters and wavelength converters can also be determined. In the latter one, the virtual topology design problem is formulated to minimize the congestion or the average packet hop distance. The novelty of the proposed MILP is that it uses the relationship between the delays from each spanned node to the source to avoid loops in resultant light-trees.

In [96], given a multicast communication, the ILP solution is developed for searching the loss-balanced light-forest with minimum cost. Two criteria are regarded as the feature of a loss-balanced light-forest. First, the number of destinations included in a light-tree is restricted by the optical power budget, which is also referred to as limited drop-off [35, ?]. Second, the distance from each destination to the source is bounded. The ILP formulation

in this paper is much more comprehensive. The main ILP variable is defined as whether a fiber link e on a wavelength λ is used in the light-forest. In this manner, the splitting constraint of MI nodes is very easy to express by a linear equation of ILP variables. In order to guarantee the resultant light-forest is loop-free and connected, a commodity flow constraint is developed to restrict the main ILP variables.

Heuristic Algorithms

According to the routing approaches employed, cost and delay sensitive AOMR algorithms can be broadly classified into three types: *Shortest Path Tree Based Routing* (e.g., Reroute-to-Source and Reroute-to-Any [98]), *Steiner-Based Routing* (e.g., Member-Only [98] and Virtual-Source Capacity-Priority [78]) and *Core-Based Routing* (e.g., Virtual Source-based Routing [79, 30]). Essentially, the *Shortest Path Based Routing* approach constructs multicast light-trees by using the shortest path between the source and each destination in order to minimize the per-source-destination path cost. The objective of the *Steiner-Based Routing* scheme, however, is to minimize the overall cost of multicast light-trees. The *Core-Based Routing* algorithm first connects a subset of nodes, called core nodes, which have both light splitting and wavelength conversion capacities. Multicast sessions are then established with the help of this core structure [79, 30].

- Reroute-to-Source & Reroute-to-Any [98]

In Reroute-to-Source, a multicast tree is first generated to span all destinations, for example by computing the shortest path tree with the Dijkstra algorithm. Then, it checks the light splitting capability of each branching node in the shortest path tree (SPT). Let $Deg(v)$ denote the out degree of node v in a SPT. If a branching node is a node capable of light splitting, then no modification is needed. But if it is a multicast incapable branching node (i.e., it has an out degree $Deg(v) \geq 2$ while it has no splitting capability), then only one direct child can be kept, which is chosen arbitrarily. All the other direct children (sub-trees) must be connected to the source through the shortest paths, each on a different wavelength. It is obvious that the end-to-end delay of Reroute-to-Source is minimal. However, the stress of the link is very high, because downstream branches of a multicast incapable branching node have to communicate with the source using the same shortest path but on different wavelengths. Note that there may actually be some longer paths leading to the source which are available on the same wavelength.

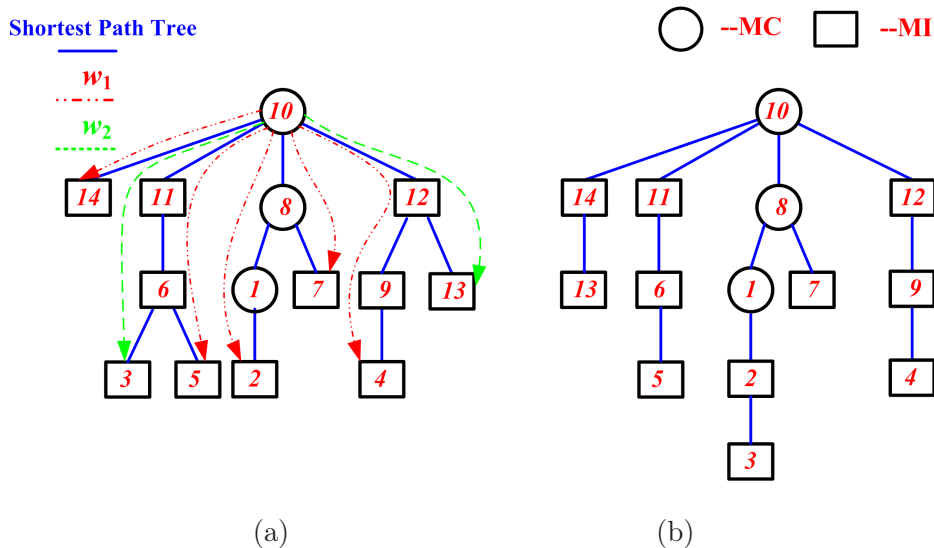

Figure 1.6: (a) Illustration of the Reroute-to-Source Algorithm (b) Illustration of the Reroute-to-Any Algorithm

In Reroute-to-Any, similarly to the previous one, a SPT is first computed for all the destinations. Then, one downstream branch of a multicast incapable branching node is kept while the others are cut off. Finally, the affected destinations are reconnected to the multicast light-tree via an MC node or a leaf MI node in the light-tree if possible. If this is impossible, they will be reconnected to the source using different wavelengths. Although its link stress and total cost are better than Reroute-to-Source, its average end-to-end delay is still not satisfactory and should be improved to take traffic with QoS requirements into account. To the best of our knowledge, no algorithm has been proposed to decide which branch of a multicast incapable branching node should be kept and what kind of reconnection algorithm can be used to reconnect the affected destinations. The example in Figs. 1.6(a)(b) illustrates the process of Reroute-to-Source and Reroute-to-Any algorithms. A multicast communication $ms(10, (1 - 14))$ is required to send messages from the source node 10 to the other 13 nodes. Nodes 1, 8 and 10 are MC nodes. The SPT is constructed in Fig. 1.6(a) and shown in blue solid lines. In this SPT, we can see that nodes 6 and 12 are MI nodes but with two direct children. Thus, one of them must be cut off from the SPT in order to respect the splitting constraint. Applying the Reroute-to-Source approach, the affected nodes 3 and 13 should connect to the source using the shortest paths on another wavelength, thus two light-trees using wavelengths w_1 (dash and dot line) and w_2 (dot line) respectively can be obtained in Fig. 1.6(a). Meanwhile, by using Re-route-to-Any

algorithm (for instance, connect node 3 to its closest node 2 and connect node 13 to its closest node 14), a light-tree in Fig. 1.6(b) may be obtained.

- Member-Only [98]

Member-Only algorithm is an adaptation of the famous Minimum Path Heuristic [82] by respecting the splitting constraint on the optical nodes. To accelerate the computation, the shortest path of each pair of nodes in the WDM network is pre-calculated and stored in a table. Then, it begins to build the multicast light-tree by connecting the destination nodes to the source node one by one just through using the shortest paths. At each step, it searches all the shortest paths from the destinations to the sub multicast light-tree already computed (to be exact, compute the shortest path to the MC nodes and the leaf MI nodes in the sub light-tree) so that the shortest paths do not traverse any non-leaf MI nodes (these MI nodes have exhausted the TaC capacity and can not connect any other nodes to the current sub light-tree) in the light-tree. If this kind of shortest paths are found, the shortest one is chosen and the corresponding nearest destination is added to the current sub light-tree by using this path. Otherwise, i.e. no such shortest path satisfying the constraints could be found, the current multicast light-tree is finished. And a new multicast light-tree on another wavelength is started from the source using the same procedure. Until all the destinations have been spanned by the computed light-trees, Member-Only algorithm terminates. According to [98], the multicast light-trees computed by Member-Only algorithm have the best total cost. However, the distance from the destination to the source is not taken into account. It is very likely that many destinations are connected to the light-tree via a node far away from the source. As a result, its average end-to-end delay is very high as shown in [98].

1.4.2 Power-Aware Multicast Routing

Multicast routing with power consideration becomes increasingly important in wavelength-routed WDM networks. A light signal suffers power loss from the light splitting during multicast communications. Besides, the attenuation coefficient of the wavelength near 1550 nm is about 0.2 dB/Km [91] in standard optical fibers. Although it is very small, it can not be ignored along a long distance route in WDM backbone networks. Furthermore, a proportion of the optical power will be tapped by the control panel or for the recovery of data after traversing intermediate OXCs, which also influences the power level at the destinations. Consequently, AOMR algorithms should be carefully designed so that the light

signal received at the destinations be maintained above the signal sensitivity threshold. Thus, next we briefly explain some ILP/MILP formulation methods and heuristic algorithms regarding the power-aware AOMR, which are proposed in [89, 91, 28, 96, 27, 75].

ILP/MILP Solutions

Modeling the power-efficient AOMR problem by MILP formulations is more complicated than that for the cost-optimal AOMR. This is because, the power level at the receiver of a network node is not always an integer but a real number. Incorporating the power issue in AOMR, MILP should be used. In addition, light splitters induce non-linear relationship between the power levels of a branching node and its children in a light-tree.

In [27], the MILP formulation is developed to minimize the total needed power gain so that all the multicast requests can be satisfied while respecting the power level constraints. For example, the total power in an optical fiber should not exceed the power upper bound, and the power level at the receiver should be high enough for detection and data recovery. The tapping loss, signal attenuation as well as the light splitting loss are taken into consideration in their model. The success of this paper is that the non-linear power relation caused by light splitters is linearized by a set of novel linear equations. However, these equations are not intelligent enough, since only the low bound of the power loss of a light splitter can be determined. If we change the objective function as minimizing the cost or number of wavelengths used (not minimizing the energy budget), the proposed equations will not work any more. In [28], instead of the previous method, the non-linear relationship is divided into several continuous intervals and each interval is approximated by a linear equation. The accuracy of the approximation depends a lot on the number of intervals divided, which is the main shortcoming of this method. In [29], the same technique in [27] is reused to resolve the optimal placement of optical amplifiers in WDM networks.

Heuristic Algorithms

As MILP is more time-consuming than ILP, fast power-aware AOMR algorithms become even more important. Here, we will review two significant ones of them.

- Centralized-Splitting Algorithm [89]

This algorithm only considers the power loss caused by light splitting. It tries to find a tradeoff between the resources utilization and the power loss when implementing AOMR.

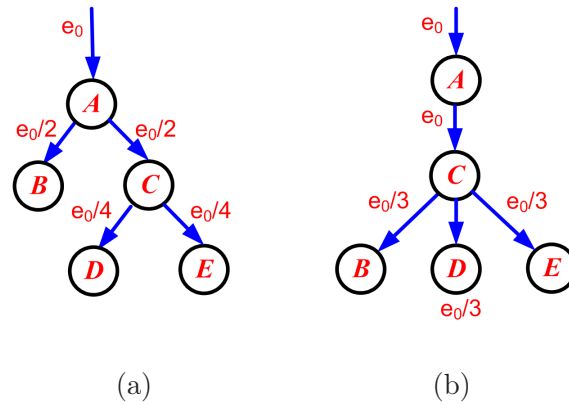

Figure 1.7: Illustration of Centralized-Splitting Algorithm: (a) Cascade Power Loss (b) Splitting Far from the Source

Initially, multicast light-trees are constructed by applying Member-Only algorithm without any consideration of the power level impairment. Then some adjustments are done in the computed light-trees according to three guidelines. First, successive MC nodes in a light-tree should be avoided, since they lead to a cascade effect on power loss (as indicated in Fig. 1.7(a)). Second, the light splitters, i.e. MC nodes, should be displaced as far from the source as possible in a light-tree. Otherwise, the effect of power loss will be propagated to all the downstream destinations of a light splitter. Finally, as the fanout of an MC node augments, the increment of the power loss caused by the light splitting is getting small. Thus, the branching MC node in a light-tree should be assigned as many fanouts as possible to make the best of splitting capacity while keeping the power loss in almost the same level. The observations of Centralized-Splitting Algorithm are illustrated in Fig. 1.7, where a light signal is diffused to A, B, C, D and E simultaneously. In Fig. 1.7(a), there are two successive MC nodes A and C in the light-tree. The power level at E dramatically degrades to $\frac{e_0}{4}$ by a cascade power loss of $\frac{3e_0}{4}$. However, if the light splitting happens at the last level of a light-tree like in Fig. 1.7(b), then the power loss will be diminished to $\frac{2e_0}{3}$.

- Balanced-Light-Tree Algorithm [91]

This algorithm takes into account both the light signal attenuation and the light splitting loss. To ensure the quality of light-trees, two constraints called source-destination power loss tolerance and inter-destination power loss variant tolerance, are imposed on the individual path from the source to each destination. To overcome these constraints, it is suggested that the multicast light-trees should be as balanced as possible. This means the

splitting ratios of any two paths from the source to two destination nodes should be within a tight range from each other. Similar to the Centralized-Splitting Algorithm, an initial multicast light-tree spanning all the group members is built by the heuristic algorithms like Minimum Path Heuristic [82]. Then, the balancing procedure is performed iteratively on the light-tree to check the power loss of each source-destination path. The main idea is to delete the destination with the maximum power loss from the light-tree, and then attempt to add it back to the light-tree via a node closer to the source. The balancing procedure continues until the maximum power loss of source-destination paths cannot be reduced. By doing so, the fairness of the power loss can be maintained among destinations. However, the shortcoming of this algorithm is that full light splitting is assumed even if is not realistic in nowadays WDM networks.

1.5 Scope and Contributions of the Thesis

1.5.1 Scope

Due to the hardware limitations of OXCs, only the sparse splitting configuration is realistic in wavelength-routed WDM networks. AOMR with sparse slitting constraint is a hot topic and extensively investigated in literature [53, 58, 94, 98, 30, 33, 65, 3, 93, 91, 89, 96, 28, 13, 12]. The end-to-end delay, link stress, total cost and power budget are important parameters which are indispensable when performing AOMR. However, it is NP-hard to compute the multicast light-trees with the minimum cost or the optimal power budget in WDM mesh networks. With respect to the delay and link stress sensitive AOMR, the heuristic algorithms proposed in literature either emphasise on the total cost or focus on the end-to-end delay constraint. Regarding the power-aware AOMR, the model of power loss when performing AOM is not accurately defined in the related work. Furthermore, the non-linear power relation induced by light splitters is still a big obstacle for formulating the power-aware AOMR by MILP. Overcoming this obstacle is very helpful to solve the optimal placement of optical amplifiers or deal the AOMR problem with physical layer impairments (PLI ³ [63, 31, 83, 76, 80]). Concerning the performance evaluation of AOMR algorithms, most of them are just done by conducting extensive simulations in literature. Nevertheless, simulation results greatly vary with topologies and with network configurations (for instance, with the weights of links). In order to guarantee the quality of multicast

³PLI involves amplifier spontaneous emission (ASE), chromatic dispersion (CD), self-phase modulation (SPM) and polarization mode dispersion (PMD) and so on.

light-trees, it is desirable that heuristic algorithms should be modeled and analyzed theoretically. Finally, although most of the AOMR heuristic algorithms compute light-trees, is the suggested light-tree (or light-forest) structure really cost-optimal? If not, what is the cost-optimal structure and how to compute it?

Thus, different from the related work, this thesis deals with the AOMR problem in the following aspects:

- How to improve the end-to-end delay of multicast light-trees while keeping the same total cost and the similar wavelength utilization (i.e. link stress).
- How to compute the power-optimal multicast light-trees? How to develop a more accurate power loss model when performing AOMR. Is there a more general or condition-free approach other than that in [27, 28] to overcome the non-linear power relation caused by light splitters in the MILP formulation?
- How to determine the cost bounds of the multicast light-trees as well as to derive the approximation ratios of AOMR heuristic algorithms mathematically?
- Is the light-tree (or light-forest) structure optimal for AOMR in WDM networks with sparse splitting configuration? If not, what is the optimal structure and how to compute the optimal multicast delivery light structure by both ILP formulation and heuristic algorithms?

1.5.2 Main Contributions

The main contributions of this thesis exactly respond to the four questions posed hereinbefore. They are briefly described below.

1. The multicast light-tree with the optimal end-to-end delay can be obtained by computing the SPT. It is found that a good trade off can be achieved between the end-to-end delay, the link stress and the total cost, by taking advantage of the good part in the SPT and avoiding the multicast incapable branching nodes in it. In addition, a distance priority heuristic is incorporated in the computation of multicast light-trees. This heuristic introduces two distance priority mechanisms while computing multicast light-trees: candidate destination node priority and candidate connect node priority. The first one concerns the distance from a source to a destination in the topology, while the latter one involves the distance from a source to a connect node in a light-tree. Simulation results show that the proposed heuristic is very helpful to improve

the end-to-end delay of multicast light-trees while retaining the same total cost and the link stress.

2. A novel and more precise power loss model is defined when performing AOMR. In addition to the common light splitting loss and light attenuation, two types of node tapping loss are distinguished and newly considered in this model. The first type is the tapping loss induced by intermediate nodes in a light-tree for control plane usage or management, while the second one is the tapping loss induced by non-leaf destinations nodes in a light-tree for decoding multicast messages and data recovery. Under this new model, the design problem of power-optimal light-trees is successfully formulated by MILP. The critical gap of the non-linear power relationship is filled by a set of novel linear equations, which is condition-free and thus could be applied directly in any MILP modeling concerning the power level impairment.

3. As the approximation ratio is one of the most important parameters for heuristic algorithms, we analyze the cost bounds of light-trees and derive the approximation ratio of some classical AOMR algorithms mathematically. In unweighted WDM networks, the cost of multicast light-trees establishing a multicast session is tightly lower limited to the number of destinations K , and strictly upper bounded to (1) $K(N - K)$ when $K < \frac{N}{2}$; (2) $\lfloor \frac{N^2}{4} \rfloor$, when $K \geq \frac{N}{2}$, where K is the number of destinations in the multicast session and N is the number of nodes in the network. Reroute-to-Source algorithm (R2S) [98] achieves an approximation ratio $\rho(R2S)$ equal to K in non-equally-weighted WDM networks, while in unweighted WDM networks $\rho(R2S)$ is inferior to (1) K , when $1 \leq K < \frac{N}{2}$; (2) $\frac{N^2}{4K}$, when $\frac{N}{2} \leq K < N$. Member-Only algorithm (MO) [98] approaches the optimal solution with a ratio $\rho(MO)$ inferior to $(K^2 + 3K)/4$ for any WDM networks. More specially in unweighted WDM networks, $\rho(MO)$ is no bigger than (1) $(K^2 + 3K)/4$, when $1 \leq K < \frac{\sqrt{16N+49}-7}{2}$; (2) $N - K$, when $\frac{\sqrt{16N+49}-7}{2} \leq K < \frac{N}{2}$; (3) $\frac{N^2}{4K}$, when $\frac{N}{2} \leq K < N$. It is also reported that if WDM network is unweighted, the approximations ratios of R2S and MO are always inferior to the diameter of the network.

4. Conventionally, the light-tree was thought to be optimal for sparse splitting AOMR. However, it is proved that if cycles are permitted in the multicast delivery structure, the total cost can still be reduced. As a result, the cost-optimal structure called light-hierarchy is discovered in this thesis. Different from the light-tree, a light hierarchy accepts cycles based on benefiting of the cross pair switching capacity of MI nodes. An ILP formulation is developed to compute the optimal light-hierarchies off-line in

WDM networks with small instances. To be practical in large scalable WDM networks, a time-efficient heuristic algorithm using link removing technique is suggested to approach the optimal solution.

1.6 Outline of the Thesis

The remainder of the dissertation is organized in a way to answer the listed questions in section 1.5 one by one successively. Generally, we can divide it into four parts: Delay and Link Stress Sensitive All-Optical Multicast Routing (Chapter 2), Power-Aware All-Optical Multicast Routing (Chapter 3), Mathematical Evaluation of Multicast Light-trees (Chapter 4), as well as Light-Hierarchy Based All-Optical Multicast Routing (Chapters 5 and 6).

In the next chapter, the problem of the delay and link stress sensitive AOMR is treated. In this chapter, a good trade off between the end-to-end delay, the link stress and the total cost is achieved by avoiding the multicast incapable branching nodes in the SPT based light-trees. In Chapter 3, a new AOMR power loss model is proposed and the power-optimal design of multicast light-trees is fulfilled by an MILP formulation. After that, the cost bounds and the approximation ratios of multicast light-trees considering sparse splitting constraint are derived in Chapter 4. Then, the light-hierarchy based AOMR is investigated in Chapters 5 and 6. Instead of the traditional light-tree solutions, light-hierarchy is invented to implement AOMR in both the heuristic way and the ILP way. Finally, this dissertation is concluded and the future work is envisaged in Chapter 7.

Part II

Delay and Link Stress Sensitive All-Optical Multicast Routing

Avoidance of MIB Nodes in Multicast Light-trees

2.1 Introduction

In wavelength-routed WDM networks, many AOMR algorithms have been proposed to minimize the total cost, but the link stress and the end-to-end delay are also important factors which should be taken into account. This is especially true for time sensitive and bandwidth intensive multicast applications such as HDTV, VoIP and Video Conference. It is known that if multicast messages are transmitted via the SPT from the source to the destinations, the end-to-end delay is minimal. Unfortunately, MC nodes are very rare (far below 50%) in a real WDM network due to their high cost and complicated architecture as mentioned in the first chapter. Thus, we can not guarantee that every branching node in a SPT is an MC node. If a SPT is directly used to establish a multicast session, then it is very likely that the branching nodes of the SPT do not coincide with MC nodes. When this is the case, different wavelengths must be used to send messages from the source to different branches of a multicast incapable branching node, and the stress on the commonly used links will be very high. If the SPT is not used, then a destination may find a longer path to the source (e.g., by connecting to a nearby MC node), which implies a bigger end-to-end delay. Thus, a tradeoff must be found between link stress and end-to-end delay in order to obtain the best general performance. In literature [98, 78, 79, 30, 106, 93], it is reported that Member-Only [98] algorithm yields the approximate minimal cost and the best link stress, while Reroute-to-Source [98] algorithm obtains the optimal delay in WDM networks with sparse splitting but without wavelength conversion.

In this chapter, an AOMR algorithm considering sparse splitting is proposed. It tries to reduce both the end-to-end delay and the link stress by avoiding multicast incapable branching nodes in multicast light-tree. The significant aspects of this proposition are: (i) a DijkstraPro algorithm with priority assignment and node adoption is introduced to construct a SPT with fewer multicast incapable branching nodes, (ii) critical-articulation and deepest-branch heuristics are used to process the multicast incapable branching nodes with the aim of reducing both link stress and end-to-end delay, (iii) a distance-based light-tree reconnection algorithm is proposed to create a set of multicast light-trees with smaller end-to-end delay while keeping the same link stress and total cost.

2.2 Delay and Link Stress Sensitive All-Optical Multicast Routing

Nowadays tremendous multicast services such as HDTV, VoIP, Video Conference and Video on Demand are widespread in Internet. They are delay sensitive and bandwidth intensive. If one multicast session uses fewer wavelengths, then more wavelengths will be available for other sessions. As the number of wavelengths is limited in an optical fiber, it is preferred to minimize the number of wavelengths used by each session. In addition, the wavelength routed WDM network is designated for Internet backbone, which interconnects diverse servers and Internet users from different states and countries. The members of a multicast session may be distributed over the world. When this is the case, although a light signal is transmitted at a very high speed, the end-to-end delay from a source to a destination can not be negligible. Generally delay-sensitive or QoS required multicast traffic in WDM networks should be satisfied with special requirements, for example minimizing the average end-to-end delay and bounding the maximum end-to-end delay. Consequently, the link stress and the delay are two important criteria for the selection of multicast light-tree in WDM networks.

However, the end-to-end delay and the link stress cannot be minimized concurrently. If the SPT is directly used for AOMR (i.e., Reroute-to-Source algorithm [98]), although its delay is optimal, the link stress is generally very high as reported in [98]. When an approximated Steiner tree is employed to build the multicast light-trees (e.g. Member-Only algorithm [98]), the link stress and total cost are good, but the end-to-end delay is very high as shown by the simulation in [98]. Thus an approach that produces a tradeoff solution needs to be found. In order to reduce the end-to-end delay, the SPT can be considered

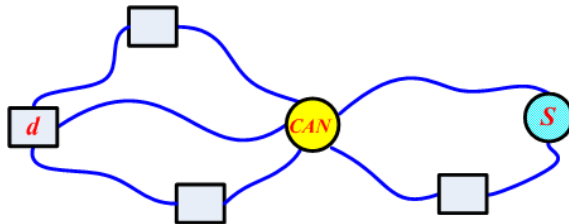

Figure 2.1: Critical Articulation Node

as a good starting point for the construction of multicast light-trees. In order to improve the link stress, the number of MIB nodes in the SPT can be reduced by making some destinations communicate with the source using longer paths. Putting this approach into practice, an AOMR algorithm based on the avoidance of MIB nodes will be proposed in the next section.

2.2.1 Useful Definitions

Before describing our algorithm, some necessary definitions are introduced below.

Definition 1: Multicast Incapable Branching node (MIB node)

An MIB node is a branching node in a light-tree which can not split (i.e., an MI node). Once an MIB node has forwarded a light signal to one of its downstream branches, it is incapable of forwarding it to another branch using the same wavelength.

Definition 2: Set MC_SET, MI_SET and D

A set of light-trees may be required by a multicast session. For a multicast light-tree LT under construction,

MC_SET: includes the MC nodes and the leaf MI nodes in LT . They may be used to span LT . Hence, nodes in MC_SET are also called connector nodes in LT .

MI_SET: includes only non-leaf MI nodes in LT which are unable to connect a new destination to LT .

D: includes unvisited multicast members which are neither joined to the current multicast light-tree LT nor to the previously constructed multicast light-trees.

Definition 3: Constrained Path (CP) and Shortest Constrained Path (SCP)

A Constrained Path $CP(u, LT)$ between a node u and a light-tree LT is defined as the shortest path $SP(u, v)$ from node u to a connector node v in LT , such that $SP(u, v)$

does not traverse any node belonging to the MI_SET of LT .

$$CP(u, LT) = \{SP(u, v) | v \in MC_SET, \text{ and } \forall x \in SP(u, v), x \notin MI_SET\} \quad (2.1)$$

Accordingly, the shortest of all possible Constrained Paths $CP_Set(u, LT)$ is called the Shortest Constraint Path $SCP(u, LT)$.

$$c[SCP(u, LT)] = \min_{CP(u, LT) \in CP_Set(u, LT)} c[CP(u, LT)] \quad (2.2)$$

There may be several $SCP(u, LT)$ from u to LT with different connector nodes v .

Definition 4: Connection Constraint Node (CCN) and Critical Articulation Node (CAN)

If node u is a CCN , there must be an intermediate node which is included in all the paths from u to the source s . This intermediate node is called the critical articulation node: $CAN(u, s)$. In other words, a CCN u cannot reach the source s without node $CAN(u, s)$.

For example, in Fig. 2.1, node CAN separates the network into two parts. Node d and source s are in different parts. Without node CAN , d is not able to communicate with s . So d is a CCN , and node CAN is the $CAN(d, s)$.

2.3 Avoidance of MIB Nodes for Multicast Routing

The avoidance of MIB nodes based AOMR algorithm can be viewed as a post-processing [106] of the SPT. Due to the presence of MIB nodes in a SPT, a single wavelength may not be sufficient to cover all destinations and thus several wavelengths may be required to accommodate the multicast group. Thus, MIB nodes should be avoided in order to decrease the link stress. If there are no MIB nodes in the SPT, then this SPT is the optimal multicast light-tree with both minimum end-to-end delay and minimum link stress. If this is not the case some processing must be done on the MIB nodes. The proposed algorithm consists of three main steps: the SPT construction step, the MIB nodes processing step and the multicast light-tree reconstruction step. In the first step, an enhanced DijkstraPro algorithm making use of priority mechanism and node adoption is introduced to construct a SPT with fewer MIB nodes and smaller link stress. In the second step the MIB nodes in the resultant SPT are processed: deepest branch and critical articulation heuristics are proposed to keep only one downstream branch of MIB nodes in an attempt to reduce both the link stress and the end-to-end delay. In the last step the distance-based light-tree reconnection algorithm (which can also reduce end-to-end delay) is applied to create the multicast light-trees.

Algorithm 1 Avoidance of MIB Nodes for Multicast Routing

Input: A multicast session $ms(s, D)$ **Output:** A set of multicast light-trees for $ms(s, D)$

- 1: Use the DijkstraPro algorithm to construct the shortest path tree SPT which is rooted at the source s and spanning all the group members.
 - 2: Use the Deepest Branch and the Critical Articulation Heuristics to process the MIB nodes in SPT.
 - 3: Use the distance based light-trees reconnection algorithm to create the required set of light-trees for $ms(s, D)$.
-

2.3.1 Construction of SPT and DijkstraPro Algorithm

First of all, a SPT rooted at the source is needed to cover all the multicast group members. Generally, Dijkstra's algorithm is employed to build the SPT. In Dijkstra's algorithm, a node is said to be labeled permanently [66] if its shortest path to the source has been found. Otherwise it is said to be tentatively labeled [66]. Initially, only the source s is permanently labeled and all the other nodes are tentatively labeled. In each iteration, the node with the shortest distance to the source among all the tentatively labeled nodes is chosen and labeled permanently. It is worth noting that in one iteration there may be several nodes that have the same shortest distance to the source, here we call them *candidate nodes* and the distance is referred to as their *level*. However, according to Dijkstra's algorithm we should label only one of the candidate nodes permanently in order to update the distances of the other nodes. The question then, is how to choose the permanently labelled candidate node? In Dijkstra's algorithm, it is chosen arbitrarily. But consider this situation: there are two candidate nodes at the same *level*; one is an MI node and another is an MC node; they share the same two adjacent nodes. If the MI *candidate* node is the first to be selected for permanent labeling then the two adjacent nodes will update their distances to the source, and thus will be connected to the source via this MI *candidate* node. The problem is that the MI *candidate* node cannot split the incoming signal to more than one outgoing port. As a result, it will become an MIB node in the SPT. Alternatively, if the MC *candidate* node is the first to be permanently labeled then when the two adjacent nodes update their distances to the source they will be connected to it via this MC *candidate* node. Subsequently, the MI candidate node is chosen to be permanently labeled. At this point, no adjacent node needs to update its distance and no adjacent node is left to be connected to the source via this MI *candidate* node. So, the risk that an MI *candidate* node will become an MIB node is reduced or even avoided. Due to the constraint on

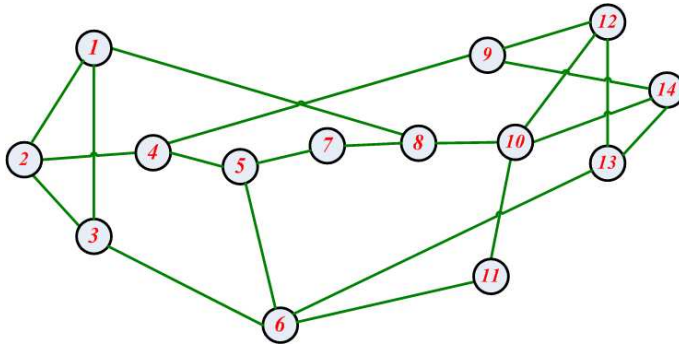
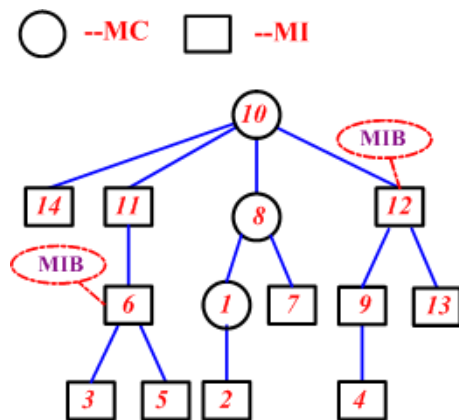

Figure 2.2: NSF Network Topology

Figure 2.3: The SPT for m_1 Constructed by the Dijkstra Algorithm

splitting capability, Dijkstra's algorithm may not yield a favorable result, but it can be improved with some modification. Hence, a DijkstraPro algorithm with priority and node adoption is presented. When building a SPT using Dijkstra's algorithm, if there are several *candidate* nodes at the same *level* in one step, the following operations are proposed:

- *Giving Higher Priority to MC Candidate Node*

The *candidate* node with multicast splitting capability (MC *candidate* node) should be given higher priority than the MI *candidate* nodes due to the fact that they can connect many destination nodes to the tree without producing an MIB node. In other words, the probability that an MI *candidate* node will be used to connect more than one destination to the tree in latter iterations is greatly reduced.

Refer to the NSF network in Fig. 2.2. Nodes 1, 8 and 10 are assumed to be MC nodes. A multicast session arrives: $m_1 = \{\text{source: } 10 \mid \text{members: } 1 \sim 14\}$. If Dijkstra's

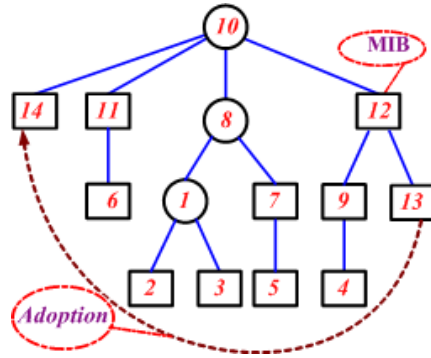

Figure 2.4: The SPT for m_1 Constructed by Offering Higher Priority to MC *candidate* Nodes

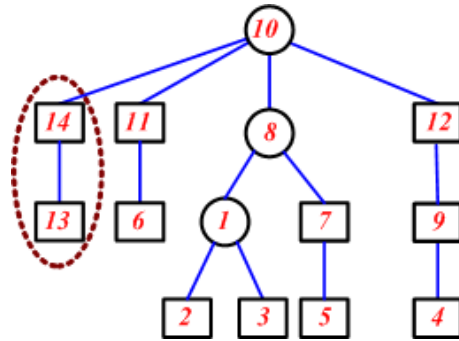

Figure 2.5: The SPT after Node Adoption from Figure 2.4

algorithm is used then we can get the shortest path tree in Fig. 2.3. There are 2 MIB nodes in this shortest path tree. We can see, however, that nodes 1, 6, 7, 9 and 13 have the same shortest distance to the source node 10. So, they can be viewed as *candidate* nodes at the same *level*. And, if node 1 (an MC node) is promoted to a higher priority and chosen first to be permanently labeled, followed by 7, 9, 13 and 6, then we can get the new shortest path tree of Fig. 2.4 which has only one MIB node.

- *Giving High Priority to MI Candidate Nodes with Smaller Degree*

If there are no MC *candidate* nodes, then an MI *candidate* node with smaller degree should be given higher priority. First, a non-source MI *candidate* node with a degree of two in the topology will never become an MIB node, and thus it can be permanently labeled before others. Second, this priority assignment may help to balance the number of direct children between MI *candidate* nodes at the same *level*. This is because if the MI *candidate* node with the highest degree is permanently labeled first, then all its

adjacent nodes (the ones farther from the source than this MI node) will connect to the SPT through it. As a result, the link stress will be very high. However, if we let some nodes connect to the SPT through an MI *candidate* node with small degree first, then the number of remaining nodes to be connected to the source through higher degree MI *candidate* nodes will be reduced. Consequently, the number of branches among MIB nodes at the same *level* will be balanced. So, this operation will help to reduce the link stress of the resultant SPT.

- *Node Adoption*

At the stage when all *candidate* nodes at the same *level* have been permanently labeled, the following situation may occur: some MI *candidate* nodes connect only two direct children to the tree (i.e., MIB *candidate* nodes) while some *candidate* nodes are leaf nodes in the created tree. Thus, the possibility arises for a leaf *candidate* node to adopt one child from an MIB *candidate* node at the same *level* when the child can reach the source through the leaf *candidate* node also. By doing this the creation of an MIB node can be avoided. Node adoption between the *candidate* nodes at the same *level* can result in a greatly reduced number of MIB nodes in a SPT or in the balancing of the load of an MIB node. Typically a destination node should be given a higher priority when determining which nodes may be adopted.

Refer to the example in Fig. 2.4. It is obvious that nodes 11, 12 and 14 have the same least distance to the source node 10, hence they can be viewed as *candidate* nodes at the same *level*. After all of them have been permanently labeled we can see that node 12 is an MIB node and node 14 is a leaf node. Note that nodes 13 or 9 can reach the source node 10 by the shortest path through both of nodes 12 and 14. Thus, one of them could be adopted by node 14, and a new SPT without one MIB node can be obtained as in Fig. 2.5.

2.3.2 Processing of the MIB nodes

Although the proposed DijkstraPro algorithm is able to produce a SPT with fewer MIB nodes and smaller link stress, some of MIB nodes can still not be avoided. Due to the fact that an MIB node must use a different wavelength to serve each of its downstream branches, the existence of MIB nodes in a SPT is the most important reason for high link stress. Thus, they should be processed. In the Reroute-to-Source algorithm [98], all downstream branches of MIB nodes are connected to the source through the reverse shortest path on different wavelengths which results in a high link stress. Although the

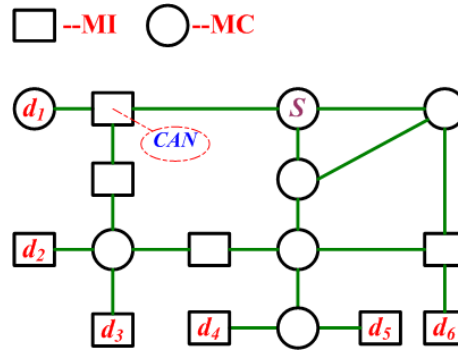

Figure 2.6: An Example Network with CAN Nodes

Reroute-to-Any algorithm is also proposed in literature [98], there is no description on which branch to be kept when processing an MIB node. In this chapter, deepest branch and critical articulation heuristics are employed to decide which branch should be kept in order to decrease the link stress and the end-to-end delay.

MIBPro

- *Critical Articulation Heuristic*

By definition, a *CCN* u can only communicate with the source through its $CAN(u, s)$. In a multicast tree, if the $CAN(u, s)$ is (unfortunately) an MIB node, then the branch containing u should be assigned a higher priority and kept when processing this MIB node. This is because there is no alternative path for u to reach the source without traversing its $CAN(u, s)$. However, destinations in the other branches may find another path to the source which will not traverse this MIB node. In fact, *CCN* and $CAN(CCN, s)$ nodes are very rare in real optical networks. However, in the case that some nodes in the network have failed they may exist, and this heuristic will be very practical. In the network of Fig. 2.6, node d_1 is a *CCN*. The shortest path tree for multicast session $m_2 = \{\text{source: } s \mid \text{destinations: } d_1, d_2, \dots, d_6\}$ is given by Fig. 2.6. We can see that $CAN(d_1, s)$ is an MIB node in the shortest path tree built for m_2 as plotted in Fig. 2.7, hence it should be processed. If node d_1 is disconnected from $CAN(d_1, s)$ and the branch leading to node d_2 and d_3 is kept, then two light-trees on two different wavelengths w_0 and w_1 are required as shown in Fig. 2.7. But if the *CCN* node d_1 is kept and the other one is cut, then only one light-tree (*or one wavelength*) is needed as shown in Fig. 2.8.

Algorithm 2 Processing of MIB nodes Using Critical Articulation and Deepest Branch Heuristics (MIBPro)

```

1: Search all the MIB nodes in the shortest path tree
2: for each MIB node do
3:   if No downstream branch contains a CCN then
4:     Keep the deepest branch
5:   else if Only one downstream branch contains a CCN, and MIB node =
     CAN(CCN, s) then
6:     Keep the branch with the CCN
7:   else if Several downstream branches contain CCN, and MIB node =
     CAN(CCNi, s), i = 1, 2, ... then
8:     Keep the deepest branch with a CCN
9:   end if
10: end for
11: Delete the downstream branches of MIB nodes which are not kept

```

2.3.3 Reconnection of Multicast Light-trees

After the MIB node processing step, the SPT is divided into a disconnected forest containing a subtree plus several separated destinations. This disconnected forest must be reconnected in order to accommodate the multicast members. A Member-Only-like [98] light-tree connection method would be a good candidate to reconnect the multicast forest. The Member-Only algorithm always adds the destination nearest to the multicast light-tree using the shortest path, but this shortest path will not use any non-leaf MI node in the light-tree. In other words, at each iteration only the destination with the shortest *SCP* is connected to the light-tree using this *SCP*. As demonstrated in [98], the Member-Only algorithm can achieve the best link stress and the minimum cost, although its end-to-end delay is very large. It is worth noting that some improvements can be made to this algorithm to reduce the end-to-end delay to some extent while obtaining the same cost and the same link stress. The example below demonstrates how end-to-end delay can be reduced.

A multicast session $m_3 = \{\text{source: } 10 \mid \text{destinations: } 6, 11, 13, 14\}$ is required in the NSF network, Fig. 2.2. We assume that the first light-tree only contains the source node 10. According to the previously described member-only-like light-tree reconnection approach, the destination with the shortest *SCP* should be added to this light-tree first. The shortest paths for node 11 and node 14 to the source have length 1. Without loss of generality, let us suppose node 14 is the first to be connected. Then, on the new light-tree,

Algorithm 3 Distance Based Light-tree Reconnection Algorithm

```

1:  $T \leftarrow$  subtree obtained after MIB process
2:  $MC\_SET \leftarrow \{MC \text{ nodes and leaf MI nodes in } T\}$ 
3:  $MI\_SET \leftarrow \{non\text{-leaf MI nodes in } T\}$ 
4:  $D \leftarrow \{destinations \text{ not in } T\}$ 
5: while ( $D \neq \Phi$ ) do
6:   repeat
7:     Find the closest destination  $d \in D$  to  $T$ , such that its shortest path to  $T$  does
       not traverse any node in  $MI\_SET$ 
8:     if there are several destinations satisfying equation 2.3 then
9:       Select the destination nearest to  $s$  in network  $G$  as  $\mathbf{d}$ 
10:    end if
11:    if there are several connector nodes for  $\mathbf{d}$  in  $MC\_SET$  satisfying equation 2.4
       then
12:      Select the connector node nearest to  $s$  in  $T$  as  $\mathbf{c}$  and choose the corre-
       sponding SCP
13:    end if
14:     $T \leftarrow T \cup SCP(\mathbf{d}, \mathbf{c})$ 
15:     $MC\_SET \leftarrow MC\_SET \cup \{\mathbf{d} \text{ and } MC\text{nodes on } SP(\mathbf{d}, \mathbf{c})\}$ 
16:     $MI\_SET \leftarrow MI\_SET \cup \{non\text{-leaf MI nodes on } SP(\mathbf{d}, \mathbf{c})\}$ 
17:     $D \leftarrow D \setminus d$ 
18:    if  $\mathbf{c}$  is an MI node then
19:       $MC\_SET \leftarrow MC\_SET \setminus \mathbf{c}$ 
20:       $MI\_SET \leftarrow MI\_SET \cup \{\mathbf{c}\}$ 
21:    end if
22:  until no destination can be added to  $T$ 
23:  return  $T$ 
24:  Begin a new tree  $T \leftarrow \{s\}$ 
25:   $MC\_SET \leftarrow \{s\}$ 
26:   $MI\_SET \leftarrow \phi$ 
27: end while

```

$$dist\{SCP(d, T)\} = \min_{d_i \in D} dist[SCP(d_i, T)] \quad (2.3)$$

$$dist\{SCP(\mathbf{d}, T)\} = dist\{SP(d, connector_i)\}, i = 1, 2, \dots \quad (2.4)$$

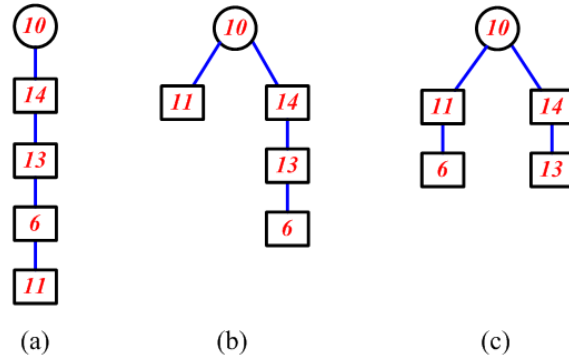

Figure 2.9: Illustration of Two Strategies for the Reconnection of Light-Trees (a) Member-Only-Like Method (b) Connector Node Distance Priority (c) Connector & Destination Node Distance Priority

Table 2.1: Comparison of the Three Light-Trees in Fig. 2.9

	Member-Only-like	Connector priority	Two priorities
Total Cost	4	4	4
Link Stress	1	1	1
Maximum Delay	4	3	2
Average Delay	2.5	1.75	1.5

we can see that both *SCPs* for nodes 11 and 13 have the same length. Also without loss of generality, suppose node 13 is then connected. After that node 6 is chosen, and finally node 11. Following these steps, the resultant multicast light-tree is given in Fig. 2.9(a). It is immediately apparent that node 11 can be connected to the light-tree via node 10 or node 6. Why do we not connect it through node 10 as in Fig. 2.9(b)? The difference is that the connector nodes have different distances to the source in the light-tree (for node 10 the distance is 0 while that for node 6 is 3). In addition, it is even more interesting to consider Fig. 2.9(c). The overall performance of the three multicast light-trees is shown in Table 2.1. All the three multicast light-trees have the same cost of 4 while having different average delays: 2.5, 1.75 and 1.5. It is also simple to determine that following the addition of node 14 to the light-tree, if node 11 is added before node 13 we can get the result in Fig. 2.9(c).

So, from this simple example we have two observations that reduce the average and maximum delay while maintaining the same cost and the same link stress. The distance priority based reconnection algorithm is developed from these observations. This algorithm

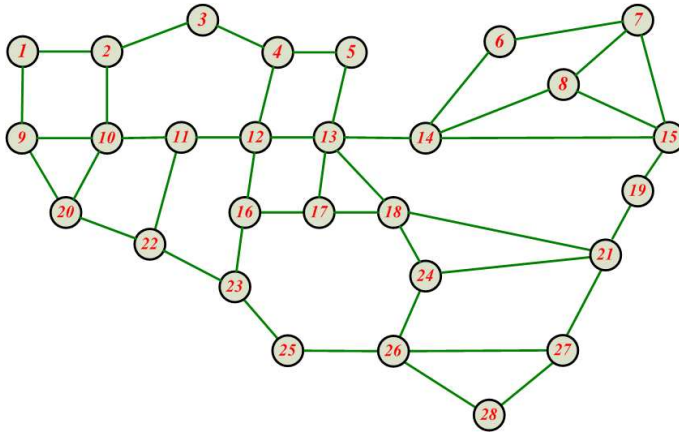

Figure 2.10: USA Longhaul Network

incorporates two different standards of priorities: the destination node distance priority and the connector node distance priority. If there are several destination nodes whose *SCPs* to the multicast light-tree have the same length, then these destination nodes should be added in the order of their distances to the source (the distances from the destination nodes to the source in the network topology): the nearer, the earlier. When a destination with the shortest *SCP* has at least two connector nodes in the sub light-tree *LT*, it is better to use the connector node nearest to the source (the distance from the connector node to the source in the multicast light-tree *LT*), otherwise its end-to-end delay will be too large.

2.4 Performance Evaluation and Simulation

To ensure the effectiveness of our proposed AOMR algorithm, two different network topologies are employed as test beds for the simulation: the 14 node NSF network in Fig. 2.2 and the 28 node USA Longhaul network in Fig. 2.10. All the links have the same cost of 1. The fact that these networks have been used as reference topologies in many papers [78, 30, 93, 101, 102, 100] is the reason for their selection.

2.4.1 Performance of the DijkstraPro Algorithm

In the simulation, the proposed DijkstraPro algorithm is compared with Dijkstra's algorithm using the following two parameters:

- N: the number of the MIB nodes in the resultant SPT.

- S: the maximum number of wavelengths required per fiber link to cover all destinations in the resultant SPT (i.e., link stress of the SPT).

In each comparison, two conditions are considered. Condition 1 only regards the source to be an MC node, while Condition 2 regards nodes with a high degree to be MC nodes. The reason for choosing these two conditions can be explained as follows. In Condition 1, as only the source is an MC node, MC *candidate* node priority is not applied. Thus, the result in Condition 1 checks the merit of the node adoption operation in the DijkstraPro algorithm. As stated in [50, 8, 1, 2, 95, 14], one efficient approach could be to place light splitters at the nodes with high degree in order to optimize the resource of WDM networks. Thus, nodes with high degree are treated as MC nodes in Condition 2. In this condition, both MC *candidate* node priority and node adoption are applied, and thus the overall performance can be verified.

In Table 2.2, we evaluate the performance of 14 SPTs rooted at each node of the NSF network. Source ID denotes the root of the SPT built. Two conditions are considered:

Condition 1 (only the source is an MC node)

The average number of MIB nodes in the SPT constructed by the DijkstraPro algorithm is 0.85 less (23%) than when applying Dijkstra's algorithm and the link stress is 0.36 smaller. This result confirms that the node adoption operation in the DijkstraPro algorithm is effective.

Condition 2 (nodes 6, 10 and the source are MC nodes)

In the NSF network, node 6 and node 10 have a high degree of 4), so they can be assumed to be MC nodes which are very useful for multicast sessions. The DijkstraPro algorithm produces a SPT with fewer MIB nodes and smaller link stress for this condition also. The average number of MIB nodes is 0.93 less (38%) and the link stress is 0.15 smaller.

In Table 2.3 we also provide the performance of 28 SPTs rooted at each node in the USA Longhaul network.

Condition 1 (only the source is an MC node)

The DijkstraPro algorithm results in 1.75 (29%) fewer MIB nodes on average than Dijkstra's algorithm, and the link stress of the SPT built by the DijkstraPro is 1.64 smaller. This signifies that the effectiveness of the node adoption operation is independent of the network topology.

Table 2.2: Comparison of Dijkstra and DijkstraPro in the NSF Network

SPT in NSF	Condition1 MC: source Members: 1 ~ 14				Condition2 MC: 6,10, and source Members: 1 ~ 14			
	Dijkstra		DijkstraPro		Dijkstra		DijkstraPro	
Source ID	N	S	N	S	N	S	N	S
1	3	4	3	3	1	2	1	2
2	4	3	3	3	3	3	2	3
3	3	4	2	4	2	2	1	2
4	4	3	3	2	4	3	3	2
5	4	4	2	3	3	2	1	2
6	3	2	3	2	3	2	3	2
7	5	5	4	4	3	3	2	2
8	4	4	2	3	3	2	1	2
9	4	3	3	3	3	3	2	3
10	3	2	1	2	2	2	1	2
11	3	4	3	4	1	2	1	2
12	4	3	4	3	2	2	1	2
13	3	4	2	4	2	2	1	2
14	4	3	4	3	2	2	1	2
<i>Average</i>	3.64	3.43	2.79	3.07	2.43	2.29	1.5	2.14

Condition 2 (nodes 10, 12~15, 18, 21, 26 and the source are MC nodes)

In the USA Longhaul network, nodes 10, 12~15, 18, 21 and 26 have a degree equal to or above 4, so they are regarded as MC nodes in this condition. the DijkstraPro algorithm can also produce a SPT with fewer MIB nodes and smaller link stress. The average number of MIB nodes is 0.78 less (46%) and the average link stress is 0.43 smaller.

Moreover, it is evident that when all the nodes in a WDM network are MC nodes, none of the SPTs constructed by the Dijkstra or the DijkstraPro algorithm will have any MIB nodes and their link stress will always be 1. So, it is obvious that when the ratio of MC nodes in the network is very high the improvement to be gained by using the DijkstraPro algorithm is not significant. But when the MC nodes are very sparse its performance is

Table 2.3: Comparison of Dijkstra and DijkstraPro in the USA Longhaul Network

SPT in Longhaul	MC: source				MC: 10,12 ~ 15, 18, 21, 26 and source			
Source	Dijkstra		DijkstraPro		Dijkstra		DijkstraPro	
ID	N	S	N	S	N	S	N	S
1	6	8	5	6	2	3	1	2
2	6	7	5	6	1	2	0	1
3	8	9	6	7	2	2	2	2
4	8	9	5	6	2	2	1	2
5	9	8	5	6	2	3	1	2
6	6	8	3	5	2	2	1	2
7	5	6	3	5	2	2	1	2
8	4	7	2	5	1	2	1	2
9	5	9	5	6	0	1	0	1
10	7	10	4	6	1	2	0	1
11	6	9	5	7	0	1	0	1
12	7	6	5	6	3	2	1	2
13	6	5	3	3	1	2	1	2
14	3	7	2	5	1	2	1	2
15	6	6	3	5	2	2	1	2
16	6	6	6	6	1	2	1	2
17	6	6	5	5	1	2	1	2
18	4	6	3	4	0	1	0	1
19	8	8	3	4	2	2	0	1
20	6	9	4	4	2	3	1	2
21	7	7	3	4	2	2	0	1
22	5	5	5	5	2	2	2	2
23	7	6	6	6	4	3	2	2
24	4	5	5	5	0	1	0	1
25	6	5	6	6	4	5	3	4
26	7	6	5	4	4	4	2	3
27	6	8	4	7	1	2	0	1
28	7	5	6	6	3	4	2	3
<i>Average</i>	6.11	7.0	4.36	5.36	1.71	2.25	0.93	1.82

much better than the Dijkstra’s algorithm, not only in terms of the number of MIB nodes but also in terms of the link stress. This justifies our introduction of the DijkstraPro algorithm in the SPT construction step for the implementation of our proposed AOMR algorithm.

2.4.2 Performance of the Avoidance of MIB Nodes Based Multicast Routing Algorithm

There is no mention in the literature for the Reroute-to-Any [98] algorithm of a technique to determine which branch of an MIB node should be cut, and which algorithm should be used to reconnect the affected destinations. In our simulation an arbitrary branch is assumed to be kept and a Member-Only-like [98] reconnection method is employed in the Reroute-to-Any algorithm.

To evaluate the performance of the proposed AOMR algorithm based on the avoidance of MIB nodes (MIBPro/MIBPro2), the following four metrics are used to measure the quality of the multicast light-trees:

- *Link stress*
- *Average end-to-end delay*
- *Maximum end-to-end delay*
- *Total cost*

In addition, each multicast session has only a single source. Each network node is selected as the source of a multicast session in turn. The destinations of a multicast group are distributed independently and uniformly through the network. For a given source and a given multicast group size, 100 random multicast sessions are generated. Hence, the result of each point in the simulation figures is the average of $100 \times |V|$ computations. In addition, Reroute-to-Source (R2S), Reroute-to-Any (R2A) and Member-Only (MO) are also implemented for comparison.

Effect of Group Size (Number of Multicast Members)

Here we study the performance of the proposed algorithm versus multicast group size. As mentioned in subsection 2.4.1, nodes with high degree have a high probability of being MC nodes [50, 8, 1, 2, 95, 14]. To simplify the simulation in this part, we regard these nodes

as MC nodes and only change the group size to evaluate the quality of light-trees built by MIBPro/MIBPro2 AOMR algorithms.

In the NSF network, nodes 6, 10, and the source are set as MC nodes. The simulation results in the NSF network are plotted in Figs. 2.11-2.14(b). As shown in Fig. 2.11(a), MIBPro achieves better link stress than R2A after the group size goes beyond four. The link stress of MIBPro2 is also much smaller than MIBPro. Figs. 2.12(a) and 2.14(a) show that the average end-to-end delay and maximum end-to-end delay of MIBPro is only second to the optimal result of R2S. As multicast group size grows the improvement of end-to-end delay returned by MIBPro compared to R2A becomes more and more significant. Moreover, while the total costs of R2A, MIBPro and MIBPro2 are almost the same, R2S results in the highest and MO results in the lowest total cost.

In the USA Longhaul network, nodes 10, 12~15, 18, 21, 26, and the source are set as MC nodes. Figs. 2.11-2.14(b) have compared the performance of those five algorithms in this topology. The link stress of the five algorithms are almost the same and very near to 1 according to Fig. 2.11(b). This is because the ratio of MC nodes is very high (32%) in this configuration. The end-to-end delay for the MIBPro algorithm is very close to the optimum (R2S). To our surprise, MIBPro obtains almost the same maximum end-to-end delay as R2S. From the point of view of the total cost, R2A, MIBPro and MIBPro2 return the same value, which is the same outcome as the NSF network example.

In both topologies the performance of R2S in terms of link stress and total cost is always the worst, while its performance in end-to-end delay is the best. Conversely the MO algorithm can achieve very good link stress and total cost, while its end-to-end delay is too large.

From the simulation results above it can be seen that the MIBPro algorithm can provide nearly the same or even slightly better link stress than R2A. Its reduction in average and maximum end-to-end delay compared to R2A becomes more obvious when the group size is large. This is because the MC node priority mechanism, node adoption and distance based reconnection do not affect the result when the group size is too small. Only when there are enough destinations can these strategies work well. Overall, however, the MIBPro algorithm achieves a good tradeoff between link stress and end-to-end delay.

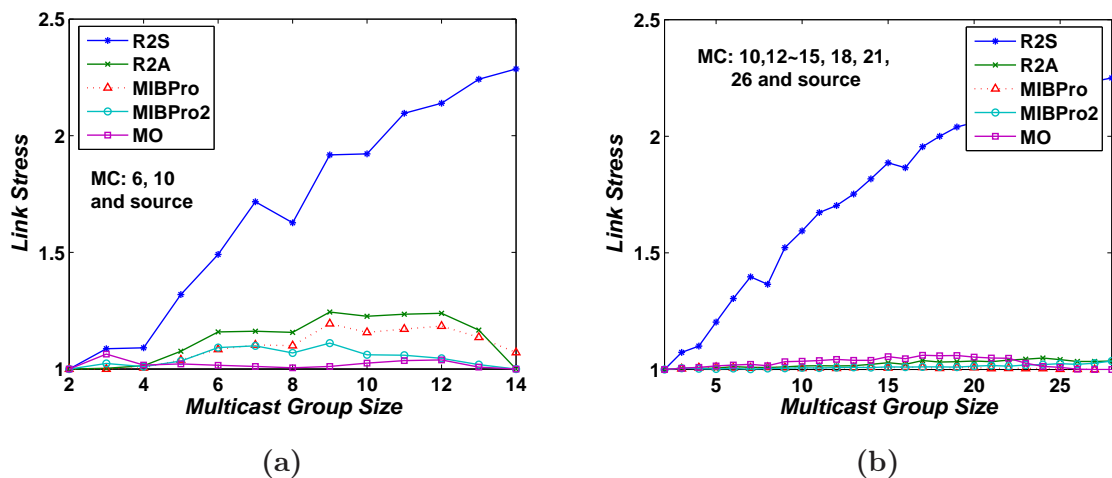

Figure 2.11: Link Stress vs. Multicast Group Size in (a) NSF Network (b) USA Longhaul Network

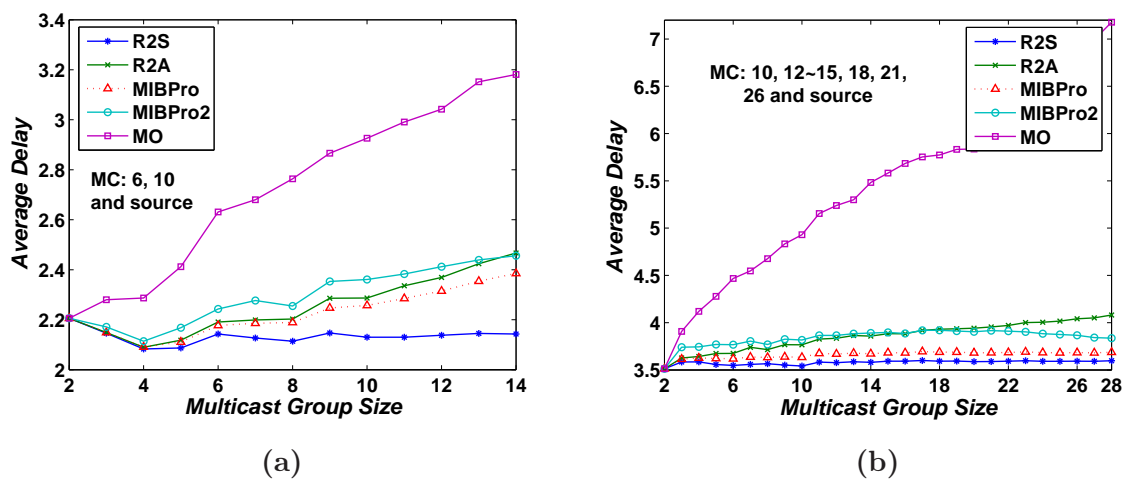

Figure 2.12: Average End-to-End Delay vs. Multicast Group Size in (a) NSF Network (b) USA Longhaul Network

Effect of Splitting Capability (Number of MC nodes)

The performance when the number of MC nodes varies have also been studied. According to the results of the previous section, MIBPro is more advantageous when the multicast group size is large. Thus, the multicast group size is set at a large value while only the number of MC nodes is changed in the simulation of this part. The MC nodes are assumed to be independently and uniformly distributed in the topology. The multicast group size is set to 12 in the 14 nodes NSF network and set to 21 in the 28 nodes USA Longhaul

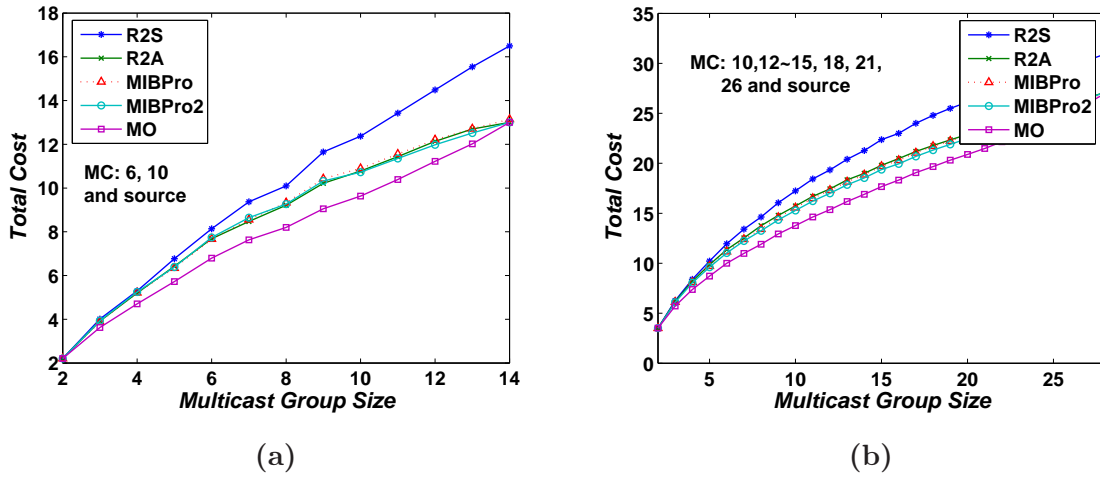

Figure 2.13: Total Cost vs. Multicast Group Size in (a) NSF Network (b) USA Longhaul Network

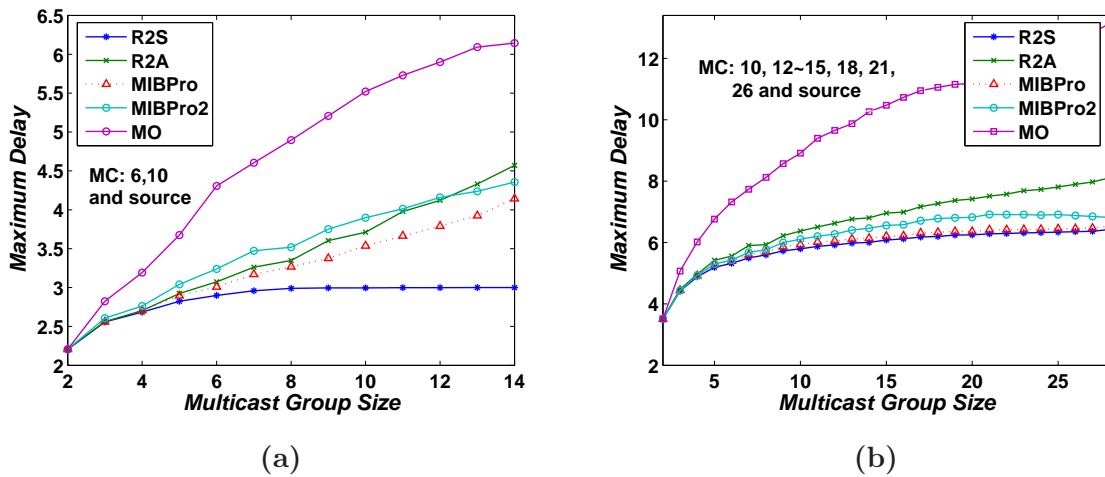

Figure 2.14: Maximum End-to-End Delay vs. Multicast Group Size in (a) NSF Network (b) USA Longhaul Network

network. The numeric results are plotted in Figs. 2.15-2.18. According to these figures, when MC nodes are sparse, (1) MIBPro achieves much better performance in terms of link stress, average end-to-end delay and maximum end-to-end delay relative to R2A while producing the same cost as R2S. (2) MIBPro2 results in both lower link stress and total cost than R2A. Its link stress is even better than MO in the Longhaul network. However, its end-to-end delay is either better or worse than R2A.

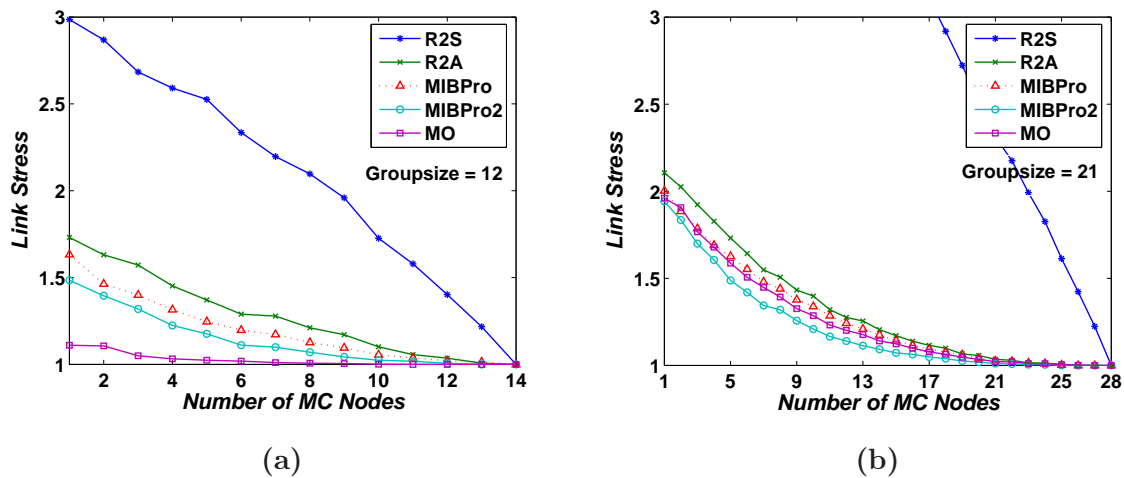

Figure 2.15: Link Stress against the Number of MC Nodes in (a) NSF Network (b) USA Longhaul Network

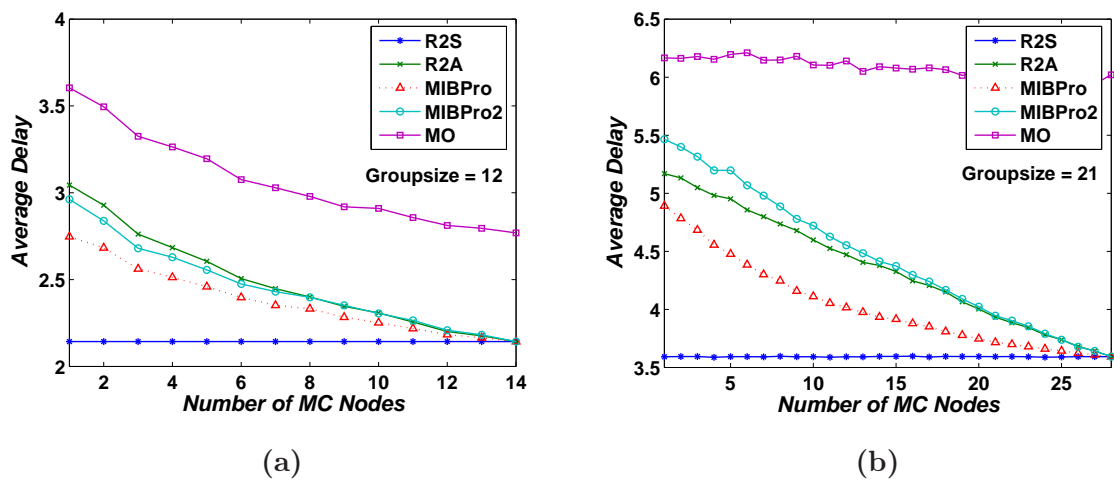

Figure 2.16: Average End-to-End Delay against the Number of MC Nodes in (a) NSF Network (b) USA Longhaul Network

These results indicate that our proposed MIBPro algorithm works well in the case of sparse splitting. When the ratio of MC nodes is large, there are fewer MIB nodes in the shortest path tree and as a result MIBPro's advantage is less significant.

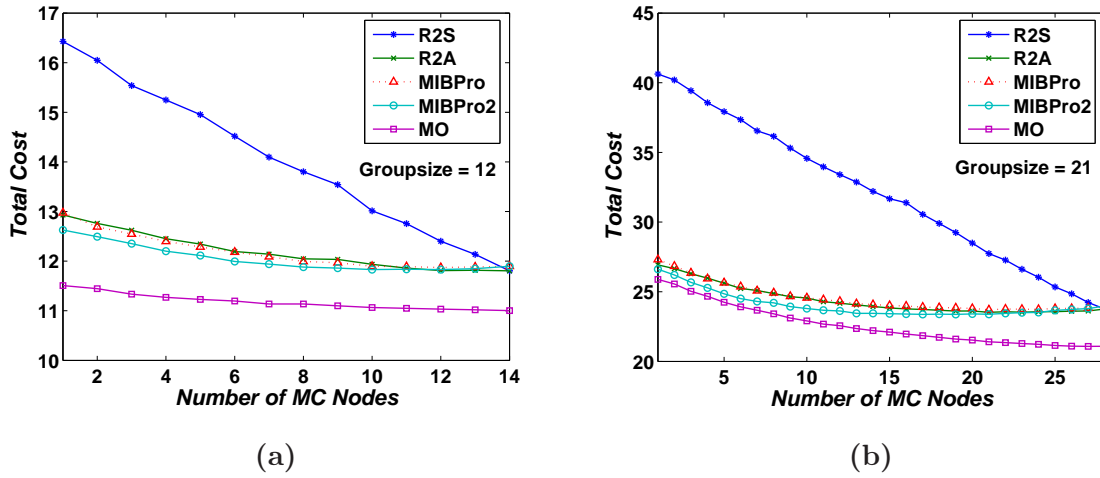

Figure 2.17: Total Cost against the Number of MC Nodes in (a) NSF Network (b) USA Longhaul Network

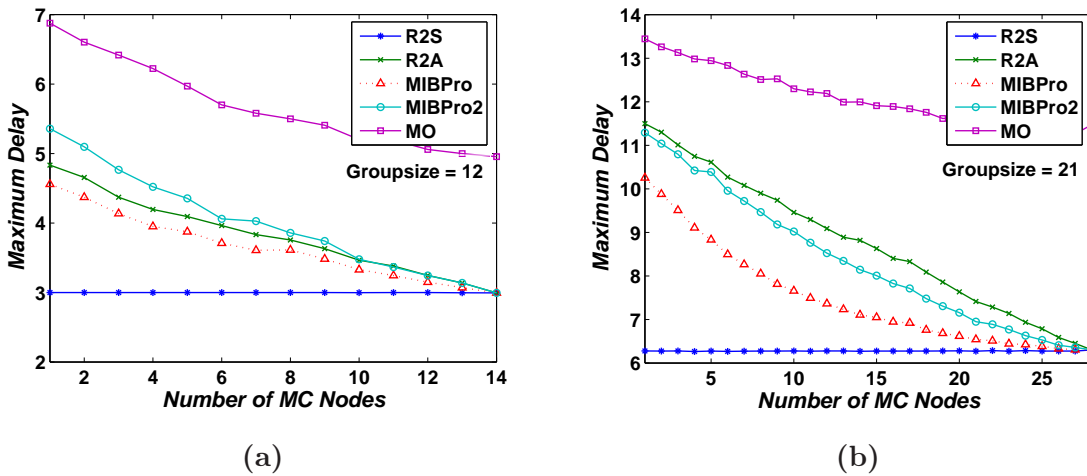

Figure 2.18: Maximum End-to-End Delay against the Number of MC Nodes in (a) NSF Network (b) USA Longhaul Network

2.5 Conclusion

Applications with QoS requirements are becoming more and more popular in the Internet. The bandwidth and the end-to-end delay are two important parameters for QoS. Hence, an AOMR algorithm based on avoidance of MIB nodes is presented for traffic with QoS requirements in WDM networks in order to decrease the link stress and the end-to-end delay. The algorithm retains the good parts of the SPT which result in optimal end-to-

end delay for at least some multicast members. In order to reduce the number of MIB nodes and the link stress in the construction of the SPT step, a DijkstraPro algorithm is presented, where a higher priority is assigned to MC *candidate* nodes and node adoption is performed between the *candidate* nodes at the same *level*. To keep one branch of MIB nodes in the SPT, critical articulation and deepest branch heuristics are introduced. Finally, the distance-based light-tree reconnection algorithm is developed to rejoin the multicast light-forest. The first part of the simulation in Section 2.4 shows that the DijkstraPro algorithm is a better tool for SPT construction in WDM networks than the traditional Dijkstra algorithm. It can really reduce the number of MIB nodes and the link stress of the SPT. Moreover, the second part of the simulation proves that the proposed MIBPro algorithm yields good performance in terms of link stress when MC nodes are very sparse. In addition, when the group size is large enough it is able to improve the average and maximum end-to-end delay dramatically giving a result very close to the optimal Reroute-to-Source algorithm solution [98]. To sum up, the proposed algorithm is a good tradeoff between the end-to-end delay, the link stress and the total cost for multicast routing in WDM networks with sparse splitting.

■ **Key points of Chapter 2** ■

- A DijkstraPro algorithm with priority assignment and node adoption is developed to compute the SPT with fewer MIB nodes and smaller link stress in sparse splitting WDM networks.
- An AOMR algorithm is proposed to find a tradeoff between the end-to-end delay, the link stress and the total cost. This algorithm consists of critical-articulation and deepest-branch heuristics for processing MIB nodes in SPT and a distance-based heuristic for reconstructing the multicast light-trees.

Part III

Power-Aware All-Optical Multicast
Routing

Power-Optimal Design of Multicast Light-trees

3.1 Introduction

Although all-optical multicasting is attractive, it poses many challenging problems in WDM networks. Optical power budget impairment is an important one of them. For a successful transmission, one must ensure that the light power arriving at the sink node should be adequate for the successful recovery of multicast messages. During a multicast communication, the light signal suffers from severe power loss induced by several basic aspects. On one hand, the integration of light splitters in an OXC is required for supporting multicasting. These programmable light splitters are capable of adaptively splitting the incoming light signal into designated outgoing links (say f) simultaneously. On the other hand, light splitting greatly degrades the light signal by dividing its power level into f equal parts. The power level of each outgoing link is at most $\frac{1}{f}$ of the original one [4]. Besides, the optical power loss also occurs when a light signal traverses a serial of network nodes to reach the sink node. Because a certain amount of the light power is tapped by each intermediate node for the purposes of the network monitoring or the network measurement and management. Moreover, the attenuation of light signal should not be ignored in long distance optical fibers. The wavelength-routed WDM network is one of the most promising candidates for the future Internet backbone. Internet connects diverse servers and provides high bandwidth communications for Internet users from different countries and continents. Thus, the light attenuation in the optical fibers connecting different cities and countries may be considerable.

In the light of above reasons, the power-aware AOMR is becoming a hot topic. It has been widely addressed in recent literature. The centralized splitting algorithm is proposed in [89] to take the power impairment into account when computing the multicast light-forest. It tries to achieve small power loss by re-constructing the light-forest established by the Member-Only algorithm [98], while still maintaining proper bandwidth, wavelength usage and delay requirement. In [91] it is found that light-trees must be as balanced as possible in order to guarantee an adequate signal quality and to scale to large destination sets. A suite of balanced light-tree heuristic algorithms are developed to compute the light-forest while considering the source-destination power loss tolerance and inter-destination power variation tolerance. Paper [28] tries to minimize the blocking probability under optical power constraints by formulating the routing and wavelength assignment of a set of multicast sessions as a Mixed-Integer Linear Programming (MILP). Only an approximate linear conversion approach is proposed to resolve the non-linear power relations ¹ caused by light splitters. The accuracy of the model depends a lot on the number of intervals used for approximating the non-linear curve. Moreover, the optimal power-aware design of all-optical multicasting for a set of concurrent multicast sessions is addressed by [27]. In this paper, the non-linear power loss was transformed and replaced by a set of linear equations. The same linearizing method is also used in the MILP formulations of [29] to solve the placement of optical amplifiers in WDM networks with multicast services. However, only the low bound of splitting loss can be determined in their equations while it will not work if we do not have an objective function corresponding to minimizing the power budget. For instance, the MILP formulation of AOMR trying to optimize the total cost while taking account of both the physical layer impairment (PLI) [31, 76, 63, 54] and the light signal power level constraint. Furthermore, the power loss model employed in [27, 91, 28] is neither accurate nor realistic, because that model ignored the power loss tapped by intermediate destination nodes in a light-tree for the recovery of multicast messages.

In this chapter, the design of all-optical multicast light-trees with minimized power loss is investigated. Optical power losses during a multicast communication, such as light splitting loss, light propagation loss, as well as two kinds of node tapping losses, are considered. We succeed to formulate the power optimal AOMR problem as an MILP by using a serial of intelligent linear equations to determine the splitting power loss. Simulation is conducted by implementing MILP in a small topology to demonstrate the power loss distribution for establishing multicast sessions. But different from the literature mentioned above, this chapter has the following contributions:

¹Refer to equation (3.1).

- A more precise and realistic power loss model is addressed during an all-optical multicast communication, i.e., two types of power tapping losses are distinguished and taken into account. The first type is tapped by intermediate nodes in a light-tree for local usage (e.g., network monitoring or network measurement and management), while the second one is tapped by non-leaf destination nodes in a light-tree for decoding multicast messages. But only the first one is considered in previous literature [27, 28, 29].
- We improve the linearizing techniques in [29] and develop a set of strictly equivalent linear equations to transform and replace the non-linear relation of splitting power loss. The proposed method is more general and condition-free for determining the exact value of the splitting power loss in a light-tree. Thus, it could be directly used in any other MILP formulations concerning the power budget (for example placement of optical amplifiers or multicast routing with physical layer impairment [31, 76, 63, 54]).
- The distribution of power loss for establishing multicast communications is obtained by conducting MILP in a sample mesh network. The power loss in the power-optimal light-tree and the cost-optimal light-tree are compared and analyzed. We give an insight into why power-optimal multicast light-trees are different from cost-optimal light-trees and derive that the optical power loss and the total cost can not be minimized simultaneously. Furthermore, important observations are also made based on the simulation results, which are very helpful for the design of fast heuristic algorithms for power-aware AOMR in large WDM networks.

3.2 Power Optimal Multicast Routing in WDM Networks

In this chapter, all-optical Erbium-Doped Fiber Amplifiers (EDFA) [21] and all-optical wavelength converters [46, 92] are not taken into consideration, since they are not widely available due to their complicated architectures and expensive fabrications. Between each pair of network nodes, two optical fibers are placed respectively for the communications of two opposite directions. The source node of a multicast session possesses adequate light emitters on each wavelength $\lambda \in W$, which is a common assumption in literature [27, 28, 26, 30, 29].

Before introducing the power-optimal AOMR problem, we should first well analyze the reasons of power loss and define the power loss model for all-optical multicast communications. It is worth mentioning that the optical power discussed below is treated in *dBm* unit except special statement.

3.2.1 Power Losses of Multicasting in WDM Networks

Based on the assumptions above, the power losses during an all-optical multicast communication are mainly induced by the following causes:

- **Splitting loss.** With the development of light splitters, a light signal can be adaptively split into arbitrary number of copies regardless of its out degree in the topology. Thus, the power loss of a light splitter m in a light-tree on wavelength λ can be express as

$$SPL_m^{dB}(\lambda) = (10 * \log_{10} f_{Out}) \text{ dB} \quad (3.1)$$

where f_{Out} equals the fanout of splitter m in the light-tree using wavelength λ . Noting that, the source node possesses sufficient light emitters on each wavelength. To avoid unnecessary power loss, a source node makes use of distinct emitters for each outgoing branch instead of employing only one emitter and splitting the light signal into different outgoing branches. Thus, the splitting loss of a source node s is always $SPL_s^{dB}(\lambda) = 0 \text{ dB}$.

- **Signal attenuation loss.** In backbone WDM networks, the attenuation of light signal is not negligible in long distance optical fibers. Near 1550 nm ², the standard fiber attenuation factor equals $\beta = 0.2 \text{ dB/km}$ [16, 91, 29, 20, 19, 15]. The fiber loss is assumed to be proportional with length in the optical fiber [16].
- **Taping loss of intermediate node for local usage.** In a light-tree, the light signal should traverse a serial of intermediate nodes to reach the destination nodes. Since TaC devices are employed all over the network, the light signal can be tapped by each intermediate node with a small proportion of power for local consumption (say $\gamma_1 \text{ dB}$, a reasonable value can be $\gamma_1 = 1 \text{ dB}$ [28, 29], which means 79.4% of the total power is forwarded to the next hop while the rest is used locally). The tapped power may be used for measurement and management in the network control plane.
- **Taping loss for the decoding of multicast messages.** If a destination node is not a leaf in a light-tree, then it will not only tap γ_1 power for local control use but also tap additional amount of signal, say $\gamma_2 \text{ dB}$. A reasonable range of this parameter can be from 1 dB to 3 dB ³ for decoding the light signal locally to recover the multicast

²Present optical fiber transmission systems generally operate in the band of 1310 nm or 1550 nm , which produce the lowest power attenuation loss [66, 15].

³ 1 dB means 20.6% of the incoming light power is tapped for the recovery of multicast messages. While 3 dB signifies that 50% is tapped.

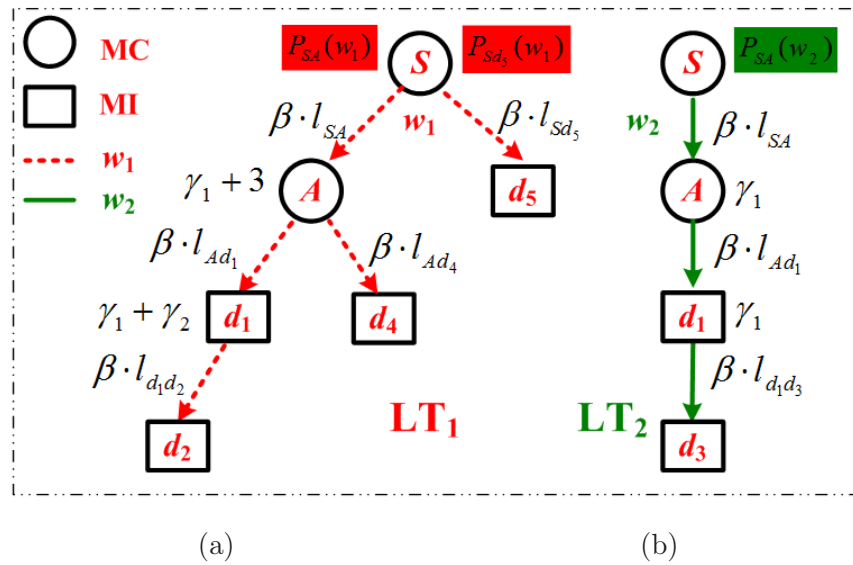

Figure 3.1: Illustration of Power Loss in the Light-Forest for Multicast Session $ms(s, (d_1 - d_5))$ (a) Light-Tree One (b) Light-Tree Two

messages. Due to sparse splitting, a destination node may be spanned in several light-trees of the same light-forest. However, it should be served only once to tap signal for the purpose of messages decoding.

To well explain the power loss for establishing a multicast communication, next we give an illustration example. For instance, a light-forest in Fig 3.1 consisting of two light-trees is computed to route multicast session $ms(s, (d_1 - d_5))$. As shown in Fig 3.1(a), light-tree LT_1 is assigned with wavelength w_1 . The source node S uses two light emitters to inject signals on wavelength w_1 with a power of $P_{SA}(w_1)$ on $link(S, A)$ and $P_{Sd_5}(w_1)$ on $link(S, d_5)$ respectively. First $P_{SA}(w_1)$ suffers a light propagation attenuation of $\beta \cdot l_{SA}$ in fiber $link(S, A)$ before arriving at node A . Then, node A taps γ_1 power for local consumption. It also produces a light splitting loss of 3 dB by splitting the light signal equally into two branches $link(A, d_1)$ and $link(A, d_4)$. When the light signal arrives at d_1 , obviously as an intermediate, node d_1 will tap γ_1 power, but as a destination node, d_1 also has to tap additional amount of signal γ_2 for decoding multicast messages. Here, we say d_1 is served in LT_1 . Finally, the light signal will continue until arriving at d_2 . And the light signal $P_{Sd_5}(w_1)$ is degraded by $\beta \cdot l_{S,d_5}$ before reaching d_5 . Concerning light tree LT_2 in Fig. 3.1(b), source S uses another light emitter to inject a light signal with power $P_{SA}(w_2)$ on wavelength w_2 . When the light signal arrives at d_3 , it is degraded by $\beta \cdot (l_{SA} + l_{Ad_1} + l_{d_1d_3}) + 2\gamma_1$. We can see that d_1 only taps γ_1 power for local consumption.

Since d_1 has already been served in LT_1 , it does not require any additional power for decoding multicast messages.

3.2.2 Design of Power Optimal Multicast Light-trees

Due to the power losses mentioned above plus the absence of EDFAs, the power budget becomes a critical issue for AOMR in WDM networks. Before establishing a multicast session, one should know at least how much energy should be emitted by the source node to guarantee the quality of signal at each sink node. And it is also favorable that AOMR should avoid unnecessary power loss and consume as little power as possible for cutting the carbon footprint of WDM networks. Generally, when a multicast session $ms(s, D)$ is required, a set of light-trees are computed to transmit the light signal from the source node s to all the destination nodes in D concurrently. Therefore, the power optimal AOMR problem is to search a set of light-trees to establish a multicast session $ms(s, D)$ while minimizing the total power budget at the source node. Meanwhile, in addition to the WDM layer constraints such as the wavelength continuity and the wavelength distinction, the quality of transmission (light signal) should be satisfied by guaranteeing a certain BER. This means that the power level of a light signal arriving at each destination should be above the sensitive threshold P_{Sen}^{dBm} of an optical receiver. However, it is NP-Complete to compute the multicast light-trees with optical power loss. This is why we formulate this problem as an MILP in the following section.

3.3 MILP Formulation of Power Optimal Multicast Light-trees

3.3.1 Notation Tables

Network Parameters:

- G : The graph of the network topology.
- V : The node set of the network G .
- E : The edge set of the network G .
- W : The set of wavelengths supported per fiber.
- λ : A wavelength, $\lambda \in W$.
- β : Light attenuation factor (dB/km).
- γ_1 : The power tapping ratio of an intermediate node for local usage (e.g, control

	and management). (dB)
γ_2	: The power tapping ratio of an intermediate destination for decoding multicast messages. (dB)
P_{Sen}^{dBm}	: Minimum detectable light power level in dBm unit of an optical receiver on each wavelength (dBm).
P_{Max}^{dBm}	: Maximum light power level on each wavelength can be emitted by an optical laser ejector (dBm).
$In(m)$: The set of nodes which has an outgoing link leading to node m .
$Out(m)$: The set of nodes which can be reached from node m .
$Deg(m)$: The in (or out) degree of node m in G , where $Deg^-(m) = Deg^+(m) = Deg(m)$.
$link(m, n)$: The directed link from node m to node n .
$e(m, n)$: The edge connecting nodes m and n in G . It consists of $link(m, n)$ and $link(n, m)$.
$l_{m,n}$: The length of the fiber link $link(m, n)$. (in km)
MC_SET	: The set of MC nodes in G .
MI_SET	: The set of MI nodes in G .
M	: Very large number.

ILP Variables:

$L_{m,n}(\lambda)$: Binary variable. Equals to 1 if multicast request $ms(s, D)$ uses wavelength λ on $link(m, n)$, equals to 0 otherwise.
$F_{m,n}(\lambda)$: Commodity flow. Denotes the number of destinations served by $link(m, n)$ on λ .
$P_m^{mW}(\lambda)$: Incoming light power in mW unit of node m on wavelength λ . (mW)
$P_m^{dBm}(\lambda)$: Incoming light power in dBm unit of node m on wavelength λ . (dBm)
$P_{s,n}^{mW}(\lambda)$: Light power in mW unit of wavelength λ emitted by source s on $link(s, n)$. (mW)
$P_{s,n}^{dBm}(\lambda)$: Light power in dBm unit of wavelength λ emitted by source s on $link(s, n)$. (dBm)
f	: Positive integer for calculating the node fanout in a light-tree.
A_f, B_f	: Binary indicators for power linearization.
$Tap_m^{dB}(\lambda)$: The tapping power of node m on λ for decoding multicast messages. (dB)
$SPL_m^{dB}(\lambda)$: Splitting power loss of MC node m on λ . (dB)

3.3.2 MILP Formulation of Power Optimal Multicast Light-trees

Problem Formulation

Given a WDM network $G(E, V, c, W)$ ⁴, a multicast session $ms(s, D)$, the set of light splitters plus their locations, and the number of wavelengths provided, the objective of the power-optimal AOMR problem is to find a light-forest for establishing multicast session $ms(s, D)$, so that

- The optical power budget required at the source node is minimized,
- The cost of the resultant light-forest is the smallest among the multicast light-forests with optimal power budget.

Hence, the objective function of our MILP formulation can be expressed as follows:

$$\text{Minimize} : \alpha_1 \cdot \text{Power} + \alpha_2 \cdot \text{Cost} \quad (3.2)$$

where,

$$\begin{aligned} \text{Power} &= \sum_{\lambda \in W} \sum_{n \in \text{Out}(s)} P_{s,n}^{mW}(\lambda) \\ &= \left(\sum_{\lambda \in W} \sum_{n \in \text{Out}(s)} 10^{\frac{1}{10} P_{s,n}^{dBm}(\lambda)} \cdot L_{s,n}(\lambda) \right) \text{dBm} \end{aligned} \quad (3.3)$$

$$\text{Cost} = \sum_{\lambda \in W} \sum_{m \in V} \sum_{n \in \text{In}(m)} l_{n,m} \cdot L_{n,m}(\lambda) \quad (3.4)$$

Noting that, in order to guarantee the required power is optimal, α_1 should satisfy $\frac{\alpha_1}{\alpha_2} \gg \text{Cost}$, so that the part Power makes the major contribution in the overall value.

In a multicast light-forest, the aggregated Power in mW of the source node is the sum of the optical power in each used branch of the source node. But it is impossible to use linear equations to express the optical signal attenuation loss, node tapping loss and splitting loss in mW , since they result in division operation between the power levels of two adjacent nodes and the number of outgoing links of nodes. Thus, it is more practical to express the power level in dBm . However, if the power of each branch is expressed as dBm , function Power will become non-linear as written in equation (3.3). In this case, the expression in equation (3.3) can not be employed if we want to compute the power optimal

⁴In brief, we use G instead in the text

light-tree by ILP/MILP. To solve this non-linear problem, linearizing methods should be employed, two of which are introduced below.

One linearizing technique may be to divide the value space of a non-linear function into several piecewise segments and then approach each segment with a linear function. In our case, the value space of each exponential function in equation (3.3) is $[P_{Sen}^{dBm}, P_{Max}^{dBm}]$. This means the power level of each branch of a source node not only should be superior to the sensitive threshold P_{Sen}^{dBm} but also should be inferior to the maximum power emitted by an optical laser ejector P_{Max}^{dBm} . However, the shortcoming of this linearizing method is that the accuracy depends directly on the number of segments used to approach the non-linear curve. Meanwhile, as the number of segments increases, the complexity and the number of constraints augment also. More details of this approach can be found in [28, 26].

Another promising linearizing method can be to find an objective function which has the same or similar monotonic characteristic as that in equation (3.3). The basic idea of this technique is explained below. The objective of the power-optimal AOMR problem is to find a light-forest which requires the minimum power budget. Thus in the MILP model, we only have to search the system status where we can get the light-forest with the minimum power budget other than the exact value of the power budget. By using an approximated objective function, we can find an approximated power-optimal light-forest. Then we can recalculate the power budget of this light-forest. For instance, source node s emits power on two branches, i.e., $Power = P_{s,1}^{mW}(\lambda) + P_{s,2}^{mW}(\lambda)$. Here, let $F = P_{s,1}^{mW}(\lambda) \cdot P_{s,2}^{mW}(\lambda)$. Then we can express $Power$ as a function of F below

$$Power = \frac{F}{P_{s,2}^{mW}(\lambda)} + P_{s,2}^{mW}(\lambda) \quad (3.5)$$

Now, suppose that F is used as the approximated objective function to find the light-forest whose $Power$ is minimal. The value space of $Power$ against F is plotted in Figs. 3.2(a)(b) when case (a): $0.05 \leq P_{s,1}^{mW}(\lambda) \leq 10$, $0.05 \leq P_{s,2}^{mW}(\lambda) \leq 10$; and case (b): $1 \leq P_{s,1}^{mW}(\lambda) \leq 10$, $1 \leq P_{s,2}^{mW}(\lambda) \leq 10$. We can find that the major tendency of $Power$ is to increase as F augments, although it is not strictly guaranteed. It is also reported that in case (b) the light-forest whose $Power$ is minimal can be better approached when F is minimized. For example, suppose the minimum F equals 5 while $Power$ achieves minimal at $F = 7.5$. The biggest possible gap of the approached $Power$ marked by double arrows in Fig. 3.2(b) is significantly smaller than that in Fig. 3.2(a). Thus, case (b) should be employed in order to obtain a better approaching result, i.e., both $P_{s,1}^{mW}(\lambda)$ and $P_{s,2}^{mW}(\lambda)$ should be no less than 1. In order to satisfy the condition of case (b) aforementioned and to better approach the

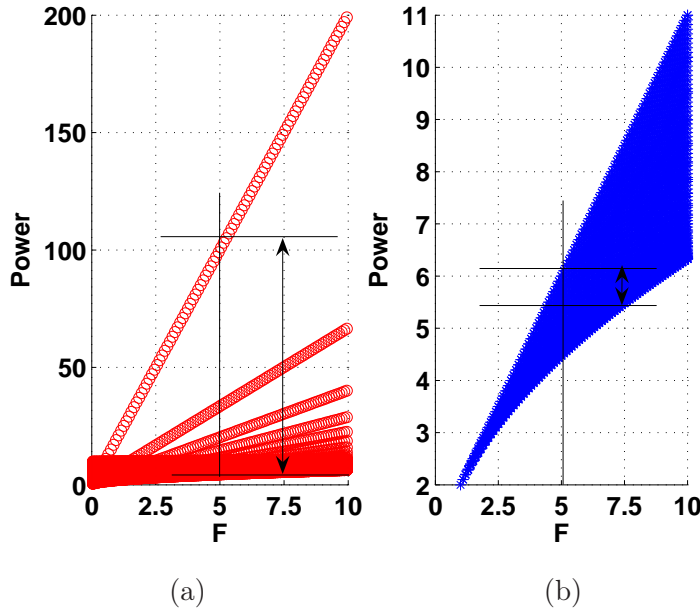

Figure 3.2: The Increasing Tendency of *Power* against *F*: (a) $0.05 \leq P_{s,1}^{mW}(\lambda) \leq 10$, $0.05 \leq P_{s,2}^{mW}(\lambda) \leq 10$; (b) $1 \leq P_{s,1}^{mW}(\lambda) \leq 10$, $1 \leq P_{s,2}^{mW}(\lambda) \leq 10$.

optimal result, equation (3.6)⁵ is used as the approximated objective function to search the light-forest whose total power *Power* is minimal. Obviously, equation (3.6) is monotonic increasing as *F* grows up.

$$\begin{aligned}
 10 \log \left(\frac{F}{P_{Sen}^{mW} \cdot P_{Sen}^{mW}} \right) &= 10 \log \left(\frac{P_{s,1}^{mW}(\lambda)}{P_{Sen}^{mW}} \cdot \frac{P_{s,2}^{mW}(\lambda)}{P_{Sen}^{mW}} \right) \\
 &= \left(P_{s,1}^{dBm}(\lambda) - P_{Sen}^{dBm} \right) + \left(P_{s,2}^{dBm}(\lambda) - P_{Sen}^{dBm} \right) \quad (3.6)
 \end{aligned}$$

Since $\frac{P_{s,1}^{mW}(\lambda)}{P_{Sen}^{mW}} \geq 1$ and $\frac{P_{s,2}^{mW}(\lambda)}{P_{Sen}^{mW}} \geq 1$ are always valid (this corresponds to case (b) mentioned above), the approaching result is improved. Consequently, this results in the subtraction of P_{Sen}^{dBm} from the optical power of each branch of the source node.

To be general for any source node, the *Power* in equation (3.2) should be replaced by the following function

$$Power = \sum_{\lambda \in W} \sum_{n \in Out(s)} \left(P_{s,n}^{dBm}(\lambda) - P_{Sen}^{dBm} \cdot L_{s,n}(\lambda) \right) \quad (3.7)$$

The employment of equation (3.7) could also be explained in this way. Instead of minimizing the total power emitted by the source, the proposed approximated objective function tries to minimize the sum of the maximum power loss (in *dBm*) on each branch of the

⁵ $P_{Sen}^{mW} = 10^{\frac{1}{10} P_{Sen}^{dBm}}$ denote the sensitive threshold of an optical receiver in *mW* unit.

source node. This means the gain required to compensate the power loss is minimal in the result light-forest. The objective function (3.2) is subject to a set of constraints, which are listed below.

Light-tree Constraints

Source Constraint:

$$\sum_{\lambda \in W} \sum_{n \in In(s)} L_{n,s}(\lambda) = 0 \quad (3.8)$$

$$1 \leq \sum_{\lambda \in W} \sum_{n \in Out(s)} L_{s,n}(\lambda) \leq |D| \quad (3.9)$$

Constraint (3.8) ensures that the light-forest of $ms(s, D)$ is rooted at the source node s . Constraint (3.9) ensures that the source node s should have at least one output link, but the total number of links going out from s should not go beyond the number of sink nodes, i.e., $|D|$.

Destination Constraint:

$$1 \leq \sum_{\lambda \in W} \sum_{n \in In(d)} L_{n,d}(\lambda) \leq |D|, \quad \forall d \in D \quad (3.10)$$

Constraint (3.10) guarantees that each destination node should be spanned at least in one light-tree, and obviously at most in $|D|$ ones.

Tree Structure Input Constraint:

$$\sum_{n \in In(m)} L_{n,m}(\lambda) \leq 1, \quad \forall \lambda \in W, \forall m \in V \text{ and } m \neq s \quad (3.11)$$

Constraint (3.11) makes sure that there is only one input link for each non-source node in a light-tree for each wavelength layer.

Sparse Splitting Constraint:

$$\sum_{n \in Out(m)} L_{m,n}(\lambda) \leq SPR \cdot \sum_{n \in In(m)} L_{n,m}(\lambda), \quad \forall \lambda \in W, \forall m \in V \text{ and } m \neq s \quad (3.12)$$

where

$$SPR = \begin{cases} 1 & \forall m \in MI_SET \\ Deg(m) - 1 & \forall m \in MC_SET \end{cases} \quad (3.13)$$

Constraint (3.12) restricts the outgoing links of MI and MC nodes. Up to $Deg(m) - 1$ outgoing links are allowed if m is an MC node, while only one outgoing link is allowed if m is an MI node.

Leaf Node Constraint:

$$\sum_{n \in \text{Out}(m)} L_{m,n}(\lambda) \geq \sum_{n \in \text{In}(m)} L_{n,m}(\lambda), \quad \forall \lambda \in W, \forall m \in V \text{ and } m \notin D \quad (3.14)$$

Constraint (3.14) indicates that non-member nodes can not be leaf nodes in the light-trees except the destination nodes.

Connectivity Constraints

In order to guarantee that the light-tree be connected and without any loop, the connectivity constraints are introduced below.

Source node:

$$\sum_{\lambda \in W} \sum_{n \in \text{Out}(s)} F_{s,n}(\lambda) = |D| \quad (3.15)$$

Constraint (3.15) ensures that the number of commodity flows emitted by the source should be equal to the number of destinations $|D|$.

Destination nodes:

$$\sum_{\lambda \in W} \sum_{n \in \text{In}(d)} F_{n,d}(\lambda) = \sum_{\lambda \in W} \sum_{n \in \text{Out}(d)} F_{d,n}(\lambda) + 1, \quad \forall d \in D \quad (3.16)$$

Although a destination may be spanned in several light-trees of the same light-forest, equation (3.16) ensures that each destination node should consume one and only one flow in the light-forest.

$$\sum_{n \in \text{In}(d)} F_{n,d}(\lambda) - 1 \leq \sum_{n \in \text{Out}(d)} F_{d,n}(\lambda), \quad \forall d \in D, \forall \lambda \in W \quad (3.17)$$

$$\sum_{n \in \text{Out}(d)} F_{d,n}(\lambda) \leq \sum_{n \in \text{In}(d)} F_{n,d}(\lambda), \quad \forall d \in D, \forall \lambda \in W \quad (3.18)$$

Equations (3.17) and (3.18) indicate the number of commodity flows either decreases by one or retains the same value after traversing a destination in the light-tree. These two constraints together with (3.16) guarantee that each destination be reachable from the source s in the resultant light-trees. Thus, the connectivity of light-trees could be assured.

Non-Member nodes:

$$\sum_{n \in \text{In}(m)} F_{n,m}(\lambda) = \sum_{n \in \text{Out}(m)} F_{m,n}(\lambda), \quad \forall m \in V \setminus (s \cup D), \forall \lambda \in W \quad (3.19)$$

Equation (3.19) guarantees that the number of flows is not dropped after traversing a non-member node.

Relationship between $L_{m,n}(\lambda)$ and $F_{m,n}(\lambda)$:

$$F_{m,n}(\lambda) \geq L_{m,n}(\lambda), \quad \forall m, n \in V, \forall \lambda \in W \quad (3.20)$$

$$F_{m,n}(\lambda) \leq |D| \cdot L_{m,n}(\lambda), \quad \forall m, n \in V, \forall \lambda \in W \quad (3.21)$$

Equations (3.20) and (3.21) show that a link should carry non-zero flow if it is used in a light-tree, and the number of flows carried by this link should not go beyond the total flows emitted by s .

Power Constraints

Due to the sparse splitting constraint, the same destination may be spanned by several light-trees of the same light-forest. However, a destination can only be served in one of them to tap the light signal for decoding multicast messages (i.e. receive the multicast messages), while it is spanned in the other ones to uniquely forward the light signal to the successor nodes. Moreover, to avoid unnecessary power loss, a source node makes use of distinct emitters to inject light signals on each of its outgoing branch instead of employing the light splitters. Thus, the power constraints are modeled as follows.

Source energy emitting constraint:

$$P_{Sen}^{dBm} \cdot L_{s,n}(\lambda) \leq P_{s,n}^{dBm}(\lambda) \leq M \cdot L_{s,n}(\lambda), \quad \forall n \in Out(s), \forall \lambda \in W \quad (3.22)$$

Regarding the power consumption, the source node does not use the splitting device. Instead, it uses different light emitters to inject light signals on each outgoing link. Constraint (3.22) ensures that s should emit light signal on $link(s, n)$ if it is used in the light-tree.

$$P_{s,n}^{dBm}(\lambda) - P_n^{dBm}(\lambda) \geq \beta \cdot l_{s,n} - (1 - L_{s,n}(\lambda)) \cdot M, \quad \forall n \in Out(s), \forall \lambda \in W \quad (3.23)$$

$$P_{s,n}^{dBm}(\lambda) - P_n^{dBm}(\lambda) \leq \beta \cdot l_{s,n} + (1 - L_{s,n}(\lambda)) \cdot M, \quad \forall n \in Out(s), \forall \lambda \in W \quad (3.24)$$

Equations (3.23) and (3.24) indicate that the signal $P_{s,n}^{dBm}(\lambda)$ is degraded by $\beta \cdot l_{s,n}$ after propagating in $link(s, n)$.

Signal detection threshold constraint:

$$P_m^{dBm}(\lambda) \geq P_{Sen}^{dBm} \cdot \sum_{n \in In(m)} L_{n,m}(\lambda), \quad \forall m \in V \text{ and } m \neq s, \forall \lambda \in W \quad (3.25)$$

$$P_m^{dBm}(\lambda) \leq M \cdot \sum_{n \in In(m)} L_{n,m}(\lambda), \quad \forall m \in V \text{ and } m \neq s, \forall \lambda \in W \quad (3.26)$$

Constraints (3.25) and (3.26) assure that the power level at each node in the light-tree is above P_{Sen}^{dBm} . We assume that P_{Sen}^{dBm} is adequate to guarantee satisfied bit error ratio (BER) for decoding multicast messages.

According to equation (3.1), the light splitting power loss makes the power level relationship between a branching node and its successor non-linear. Different from papers [27, 28, 29], in which only the low bound of the splitting power loss could be determined or only an approximated value can be obtained, here we propose a strictly accurate method to determine the exact value of the power loss of a light splitter. A set of novel equations are proposed to linearize the non-linear splitting power loss relation. Given each MC node $m \in MC_SET$, two sets of boolean indicators A_f, B_f with index $f \in [2, Deg(m) - 1]$ are introduced, i.e., $A_2, B_2, A_3, B_3, \dots, A_{Deg(m)-1}, B_{Deg(m)-1}$. For each integer f , the corresponding indicators A_f, B_f can be determined by the set of equations below.

Linearizing equations:

$$A_f - 1 \leq \frac{\sum_{n \in Out(m)} L_{m,n}(\lambda) - f + \frac{1}{2}}{M} \leq A_f \quad (3.27)$$

$$B_f - 1 \leq \frac{f - \sum_{n \in Out(m)} L_{m,n}(\lambda) + \frac{1}{2}}{M} \leq B_f \quad (3.28)$$

$$\forall m \in MC_SET, \forall \lambda \in W, \forall f \in [2, Deg(m) - 1]$$

According to equations (3.27) and (3.28), it is derived that

$$\begin{cases} A_f = 1 \text{ and } B_f = 0, & f < \sum_{n \in Out(m)} L_{m,n}(\lambda) \\ A_f = 1 \text{ and } B_f = 1, & f = \sum_{n \in Out(m)} L_{m,n}(\lambda) \\ A_f = 0 \text{ and } B_f = 1, & f > \sum_{n \in Out(m)} L_{m,n}(\lambda) \end{cases} \quad (3.29)$$

We can see only when f equals the out degree of branching node m in the light-tree, both A_f and B_f could be 1. Thus, we obtain the splitting power loss of an MC node m in equation (3.30). And equation (3.31) indicates that if m is an MI node, its splitting loss is zero.

Splitting loss:

$$SPL_m^{dB}(\lambda) = \sum_{f=2}^{Deg(m)-1} 10 \log_{10} f \cdot (A_f + B_f - 1) \quad (3.30)$$

$$\forall m \in MC_SET \text{ and } m \neq s, \forall \lambda \in W$$

$$SPL_m^{dB}(\lambda) = 0, \forall m \in MI_SET \text{ and } m \neq s, \forall \lambda \in W \quad (3.31)$$

Tapping loss for the decoding of multicast messages:

$$Tap_m^{dB}(\lambda) = \gamma_2 \cdot \left(\sum_{n \in In(m)} F_{n,m}(\lambda) - \sum_{n \in Out(m)} F_{m,n}(\lambda) \right), \quad \forall m \in D, \forall \lambda \in W \quad (3.32)$$

$$Tap_m^{dB}(\lambda) = 0, \quad \forall m \notin D, \forall \lambda \in W \quad (3.33)$$

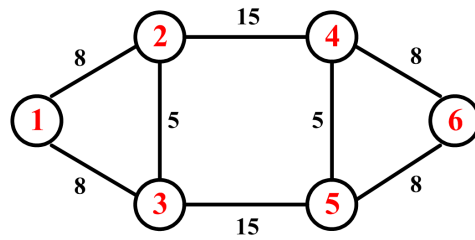

Figure 3.3: A 6 Nodes Mesh Network

Table 3.1: Configuration of Parameters

Parameters	β	γ_1	γ_2	P_{Sen}^{dBm}	M
Values	0.2 dB/km	1 dB	1 dB or 3 dB	-34 dBm	1000

For an intermediate destination node in a light-tree, the tapped signal for decoding messages can be formulated in equation (3.32). While the non-member nodes do not need to tap signal for decoding multicast messages as shown in equation (3.33).

Power level relationship:

$$P_m^{dBm}(\lambda) - P_n^{dBm}(\lambda) + (1 - L_{m,n}(\lambda)) \cdot M \geq SPL_m^{dB}(\lambda) + \beta \cdot l_{m,n} + Tap_m^{dB}(\lambda) + \gamma_1 \quad (3.34)$$

$$\forall m \in V \text{ and } m \neq s, \forall n \in Out(m), \forall \lambda \in W$$

$$P_m^{dBm}(\lambda) - P_n^{dBm}(\lambda) - (1 - L_{m,n}(\lambda)) \cdot M \leq SPL_m^{dB}(\lambda) + \beta \cdot l_{m,n} + Tap_m^{dB}(\lambda) + \gamma_1 \quad (3.35)$$

$$\forall m \in V \text{ and } m \neq s, \forall n \in Out(m), \forall \lambda \in W$$

Constraints (3.34) and (3.35) indicate the power level relationship between two adjacent nodes in the light-trees, except the source node.

3.4 Simulation and Performance Evaluation

3.4.1 Simulation Configuration

Since conducting MILP is time consuming, it is implemented in 6 nodes mesh network (refer to Fig. 3.3, all the distances are in *km* unit) by using C++ with Cplex package. Although the tested network is small, useful observations could still be found for guiding the design of power-efficient heuristic algorithm in larger-scale WDM networks. In the sample 6 nodes mesh network, only nodes 3 and 4 are configured as light splitters. Given

Table 3.2: Power-Optimal vs Cost-Optimal Multicast Light-Trees: $\gamma_2 = 1$ dB

Configuration	Sparse Splitting: 3 and 4 are MC Nodes					
Group Size	Power Optimal			Cost Optimal		
$ D $	Power Loss	Cost	Tap & SPL	Power Loss	Cost	Tap & SPL
2	5.86 dBm	23.8	18.8%	6.0 dBm	23.5	21.7%
3	8.86 dBm	32.8	26.0%	9.0 dBm	32.5	27.8%
4	11.06 dBm	36.3	34.4%	11.3 dBm	34.5	38.9%
5	12.50 dBm	44.0	29.6%	13.4 dBm	41.0	38.8%

Table 3.3: Power-Optimal vs Cost-Optimal Multicast Light-Trees: $\gamma_2 = 3$ dB

Configuration	Sparse Splitting: 3 and 4 are MC Nodes					
Group Size	Power Optimal			Cost Optimal		
$ D $	Power Loss	Cost	Tap & SPL	Power Loss	Cost	Tap & SPL
2	6.32 dBm	24.6	22.2%	6.80 dBm	23.5	30.9%
3	10.44 dBm	35.2	32.6%	11.00 dBm	32.5	40.9%
4	13.98 dBm	37.9	45.8%	14.90 dBm	34.5	53.7%
5	15.49 dBm	46.4	40.1%	17.41 dBm	41.0	52.9%

a group size $|D|$, 10 random multicast sessions are generated while each one is treated separately. The membership of each multicast session follows a uniform distribution over the topology nodes. Then, MILP formulations are executed to search the multicast light-forest with the optimal power loss and that with the optimal cost respectively. Simulation configuration parameters are listed in Table 3.1. The fiber attenuation coefficient is set to be $\beta = 0.2$ dBW/km, which is the standard value for the wavelength near 1550 nm [91, 29, 20, 19, 15]. The power tapping ratio for local consumption γ_1 is 1 dB, which is a common value referenced in [27, 29]. The tapping power for decoding multicast messages and data recovery γ_2 is set to 1 dB or 3 dB for two different configurations in the simulation. Assume the avalanche photodiode (APD) receivers is used at the destination nodes, whose sensitivity threshold P_{Sen}^{dBm} is -34 dBm when working at 2.5 Gb/s [91, 68]. In fact, the value of the sensitivity threshold P_{Sen}^{dBm} does not have any effect on the total power loss.

3.4.2 Numerical Results

Tables 3.2 and 3.3 show the average results of the same 10 multicast sessions under two different configurations of parameters. The sum of the maximum power loss on each branch of the source node (in brief the power loss) and the total cost are compared between the power-optimal multicast light-trees and the cost-optimal multicast light-trees. Tap & SPL represents the percentage of non-attenuation power loss, i.e. the node tapping loss and the splitting power loss. We set $\frac{\alpha_1}{\alpha_2} = 10000$ when computing the power-optimal multicast light-trees, while $\frac{\alpha_1}{\alpha_2} = 1/10000$ when computing the cost-optimal multicast light-trees. By setting the a value like this, we can make sure that resultant light-forests are either with the smallest cost among the power optimal ones or with the smallest power loss among the cost optimal ones. Based on the numerical results, it is observed that

- The optical power loss induced by establishing multicast sessions augments as the group size of multicast sessions grows. The power budget required to establish multicast sessions with 5 destinations is almost the twice of that for multicast sessions with 2 destinations. This result is obvious. First, more destinations will compete for the power resource as the multicast group size increases. Second, compared to small size multicast, more intermediate nodes may be traversed and more fiber links should be employed in order to span all the destinations in big size multicast sessions. Consequently, more node tapping loss and signal attenuation loss will be caused.
- The percentage of node tapping loss and splitting power loss in total power loss is relatively small for small group size multicast communications, while it is more significant for big group size multicast sessions. This can be explained as follows. As group size grows, more intermediate nodes may be used to forward the light signal to destinations. Hence the node tapping loss augments also. Besides, more light splitters are needed in order to span large size destinations. Thus, the splitting loss also increases. As a result, percentage of tapping and splitting loss becomes important for big size multicast sessions.
- Compared to power-optimal multicast light-trees, node tapping and splitting power losses lead a more important role in the total power loss of cost-optimal multicast light-trees. In order to achieve optimal cost, light splitters make it much easier for a destination node to join the light-tree with a shorter path. However, to obtain the optimal power loss, it is required that the multicast light-tree should be as balanced as possible according to literature [91]. This means that when using a light splitter

in a light-tree, the branches of the light splitter should be as symmetric as possible. Otherwise, if one branch is too short while the other one is too long, in order to ensure the power level of the leaf node in the long branch should be above P_{sen} , the power level at the leaf node in the short branch will be too much higher than P_{sen} . Then, unnecessary power will be wasted in the short branch. As a result, sometimes power optimal multicast light-trees should avoid employing light splitters in order not to produce non-balanced light-trees. Besides, as the cost is optimal, the signal attenuation power loss is smaller in cost-optimal light-trees than power-optimal light-trees. This is why the non-attenuation power loss is less significant in cost-optimal multicast light-trees.

- The cost-optimal multicast light-trees and the power optimal light-trees are different, and thus we can not optimize the total cost and the optical power budget simultaneously. In practice, a trade off could be found between them by flexibly selecting proper α_1 and α_2 .

Therefore, it is suggested that the percentage of power loss caused by node tapping and light splitting should be depressed in order to achieve power optimal multicast routing. Two approaches derived from the above discussion may be very helpful to do so. First, the number of intermediate nodes (or hop counts) in the path from the source to the destination node should be bounded. In one hand, this operation helps to forbid a long line light-tree. In the other hand, it is very helpful to limit the power differences among distinct branches in a light-tree. Thus, the tapping power loss caused by intermediate nodes could be diminished or limited in each individual source-destination path. In addition, light splitters should not be overused but sometimes should be avoided in order to construct balanced light-trees. Otherwise, unnecessary power loss will be produced if two branches of an MC node are not power symmetric.

3.5 Conclusion

The issue of optimal power budget design for all-optical multicast routing in WDM networks is addressed in this chapter. In addition to the common splitting power loss and light signal attenuation loss, the power loss during a multicast communication is more precisely modeled by introducing two types of node tapping power losses: the tapping loss of any intermediate nodes in a light-tree for local usage and the tapping loss of non-leaf destination nodes in a light-tree for decoding multicast messages. An accurate and condition-free

method is developed to transforming the non-linear power loss caused by light splitters into a set of equivalent linear equations. With the help of the proposed linearizing method, we are able to formulate the power optimal design of all-optical multicast routing problem as an MILP. Considering that MILP is time consuming, the simulation is only conducted in a small network. Despite this, useful observations could still be found. It is suggested that the hop counts in each individual source-destination path should be limited, and balanced light-tree should be computed by properly using light-splitters to optimize the overall power loss. In the future, efficient heuristic algorithm will be developed for fast power-aware multicast routing in large scalable WDM networks by taking advantage of these helpful suggestions.

■ **Key points of Chapter 3** ■

- A more precise and realist power loss model is proposed for all-optical multicasting, which newly takes two types of power tapping loss into account.
- A novel MILP formulation is proposed to model the power-optimal design of AOMR.
- A more general and condition-free method is proposed to determine the non-linear light splitting loss.
- Important observations are also made based on the simulation results, which are very helpful for the design of fast power-aware multicast routing algorithms.

Part IV

Mathematical Evaluation of
Multicast Light-trees

Cost Bounds and Approximation Ratios of Multicast Light-trees

4.1 Introduction

Finding a cost-optimal (minimum-cost) multicast light-tree or light-forest in WDM mesh networks is NP-Complete, and the situation becomes even worse when taking the sparse splitting constraint into consideration. Although many light-tree computation heuristics have been proposed recently [98, 103, 104, 102, 37], none of them has addressed the cost bounds of multicast light-trees in sparse splitting WDM networks, let alone the approximation ratios of the light-trees built by heuristics towards the optimal solution. Since the wavelength channel cost is a very important metric for the selection of the multicast light-trees, it is very critical to know both the cost bounds and the approximation ratios of the computed light-trees, which could be referenced for the planning and dimension of a WDM network. In [37], a heuristic is proposed to construct multicast light-trees with QoS guarantee and the cost upper bound of the light-trees is given. However, in [37] it is supposed that all the network nodes are equipped with costly light splitters, while it is not realistic in large WDM mesh networks due to the high cost and complex architecture of light splitters. Literature [50] also gives a cost upper bound of $\frac{N^2}{4}$ for the multicast light-trees, where N denotes the number of nodes in the network. However, the cost bound in [50] has the following two shortcomings. First it is derived on the hypothesis that the set of multicast light-trees computed for a multicast session still retain a light-tree structure in the IP layer (i.e., when all these light-trees are merged together). In fact, this hypothesis is

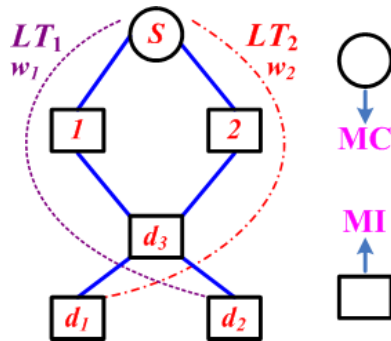

Figure 4.1: An Example Sparse Splitting WDM Network

not always held as demonstrated in the following example. A multicast session with source s and destinations d_1 , d_2 and d_3 is required in a sparse splitting optical network shown in Fig. 4.1 with solid line. Since node d_3 is an MI node, two light-trees (i.e., LT_1 (dotted line) and LT_2 (dashed line)) on two different wavelengths may be computed. As we can see the IP layer of the merged LT_1 and LT_2 are drawn in Fig. 4.1 with solid line, which is the same as the network topology. Obviously, it is not a tree but it exists a cycle. Second, the bound $\frac{N^2}{4}$ in [50] seems to be too large for small size multicast sessions, e.g., a multicast session with a source and only two destinations.

For the reasons above, in this chapter we give a much tighter bound for wavelength channel cost of multicast light-trees. It is valid for most of the multicast routing algorithms under the sparse splitting constraint, even if the IP layer of the set of multicast light-trees does not retain the tree structure (e.g, the iterative multicast routing algorithms as Member-Only [98]). Costly and complex wavelength converters are supposed to be unavailable, and an equal cost of 1 *unit hop-count cost* is assumed over all the fiber links in the network. We prove that the total cost of a multicast session is upper bounded to (1) $K(N - K)$, when $K < \frac{N}{2}$; (2) $\lfloor \frac{N^2}{4} \rfloor$, when $K \geq \frac{N}{2}$, where K is the number of destinations in the multicast session and N is the number of nodes in the network. Besides, the wavelength channel cost is lower limited to K . Moreover, in WDM rings the optimal multicast light-tree has a total cost inferior to $N - \lceil \frac{N}{K+1} \rceil$.

In fully multicast capable networks, the Shortest Path Tree algorithm approximates the optimal solution with a ratio of K , which is the number of destinations to be covered. A better heuristic named Minimum Path Heuristic [82] guarantees the result cost with a ratio of $2(1 - \frac{1}{K+1})$ [87]. However, in **sparse splitting** WDM networks, the approximation ratios of Reroute-to-Source (R2S) and Member-Only (MO) [98] algorithms are unknown although they may be considered to be some variants of SPT and MPH adapted for sparse splitting

WDM networks. Will they retain the same approximation ratios as those in fully multicast capable networks? We investigate their approximation ratios in both unweighted and non-equally-weighted WDM networks. Reroute-to-Source algorithm (R2S) [98] achieves an approximation ratio $\rho(R2S)$ equal to K in non-equally-weighted WDM networks, while in unweighted WDM networks $\rho(R2S)$ is inferior to (1) K , when $1 \leq K < \frac{N}{2}$; (2) $\frac{\lfloor \frac{N^2}{4} \rfloor}{K}$, when $\frac{N}{2} \leq K < N$. Member-Only algorithm (MO) [98] approaches the optimal solution with a ratio $\rho(MO)$ inferior to $(K^2 + 3K)/4$ for any WDM networks. More specially in unweighted WDM networks, $\rho(MO)$ is no bigger than (1) $(K^2 + 3K)/4$, when $1 \leq K < \frac{\sqrt{16N+49}-7}{2}$; (2) $N - K$, when $\frac{\sqrt{16N+49}-7}{2} \leq K < \frac{N}{2}$; (3) $\frac{\lfloor \frac{N^2}{4} \rfloor}{K}$, when $\frac{N}{2} \leq K < N$. It is also found that the approximation ratios $\rho(R2S)$ and $\rho(MO)$ are always no bigger than the diameter of network $Diam(G)$, if WDM network G is unweighted.

Moreover, cost bounds and approximation ratios of multicast light-trees in some candidate WDM backbone networks are examined through simulations. ILP formulations are proposed to find the optimal multicast light-trees. Member-Only and Reroute-to-Source [98] algorithms are also implemented in the simulation.

4.2 Multicast Routing with Sparse Splitting

4.2.1 Multicast Routing Problem

Multicast routing involves a source and a set of destinations. In sparse splitting WDM networks, a set of light-trees is employed to distribute messages from the source to all the group members simultaneously. The objective of studying multicast routing in WDM networks is to minimize the wavelength channel cost while fulfilling a multicast session. The computation of light-trees for a multicast session generally has the following principles.

- Due to sparse splitting and absence of wavelength conversion, the degree of an MI node in a light-tree cannot exceed two. In consequence some destinations cannot be included in the same light-tree. Thus, several light-trees on different wavelengths may be required for one multicast session.
- Among the light-trees built for a multicast session, one destination may be spanned (used to forward the incoming light beam to other destination nodes) by several light-trees, but it should be served (used to receive messages from the source) by only one light-tree. (e.g., d_3 in Fig. 4.1 is spanned by both LT_1 and LT_2 to forward the incoming

light beam to d_2 and d_1 respectively. Thus, it must tap the light beam only once for recovering multicast messages either in LT_1 or in LT_2).

- Since the number of wavelengths supported per fiber link is limited, the maximum number of wavelengths required and the traffic congestion in a fiber link should be taken into account during the selection of multicast light-trees. Thus, if a set of destinations D have been spanned by a light-tree LT_1 , $D \subseteq LT_1$, it is entirely useless to construct another light-tree LT_2 to serve and only serve the destinations in subset D_i , with $D_i \subseteq D$. This is because that destinations in D_i could be served directly in LT_1 . For instance, three light-trees LT_1 , LT_2 and LT_3 are computed to serve d_1, d_2, d_3 respectively, where LT_1 only contains d_1, d_2 , LT_2 only contains d_2, d_3 and LT_3 only contains d_3, d_1 . However, LT_3 , for instance, should be eliminated since d_3 is spanned in LT_2 and can be served directly in LT_2 instead of using the tree LT_3 .

4.2.2 System Model

A sparse splitting WDM network can be modeled by an undirected graph $G(V, E, c)$, in brief G . V represents the vertex-set of G , $|V| = N$. Each node $v \in V$ is either an MI or an MC node. E represents the edge-set of G , which corresponds to the fiber links between the nodes in the network. Each edge $e \in E$ is consisted of two optical fibers for opposite direction communications. And e is associated with a cost function $c(e)$. Function c is additive over the links of a lightpath $LP(u, v)$ between two nodes u and v , i.e.,

$$c(LP(u, v)) = \sum_{e \in LP(u, v)} c(e) \quad (4.1)$$

We consider a multicast session $ms(s, D)$, which requests for setting up a light distribution structure (i.e., light-forest) under optical constraint (i.e., wavelength continuity, distinct wavelength, sparse splitting and lack of wavelength conversion constraints) from the source s to a group of destinations D . Let K be the number of destinations, $K = |D|$. Without loss of generality, it is assumed that k light-trees $LT_i(s, D_i)$ are required to span all the destinations involved in multicast session $ms(s, D)$, where $i \in [1, k]$. It holds true that

$$1 \leq k \leq K \leq N - 1 \quad (4.2)$$

Although the i^{th} light-tree $LT_i(s, D_i)$ may span some destinations already spanned in the previous light-trees, D_i is used to denote exclusively the set of newly served destinations in $LT_i(s, D_i)$. Since all the destinations in D are served by k light-trees and each destination

should be served only once, we obtain

$$D = \bigcup_{i=1}^k D_i \quad (4.3)$$

These k sets of destinations D_i are disjoint, i.e.,

$$\forall i, j \in [1, k] \text{ and } i \neq j, D_i \cap D_j = \emptyset \quad (4.4)$$

Let a positive integer $K_i = |D_i|$ denote the size of the subset D_i , then we have

$$\sum_{i=1}^k K_i = |D| = K \quad (4.5)$$

The total cost of multicast session $ms(s, D)$ is defined as the wavelength channel cost of the light-trees built to serve all the destinations in set D . It can be calculated by

$$\begin{aligned} c(ms(s, D)) &= \sum_{i=1}^k c[LT_i(s, D_i)] \\ &= \sum_{i=1}^k \sum_{e \in LT_i(s, D_i)} c(e) \end{aligned} \quad (4.6)$$

4.3 Cost Bounds of Multicast Light-Trees in WDM Mesh Networks

In this section, we will study the cost bounds of light-trees in WDM networks with two different light splitting configurations: full light splitting and sparse splitting. Let $SR = N_{MC}/N$ be the ratio of MC nodes in the network, where N_{MC} is the number of MC nodes while $N = |V|$ is the number of nodes in the network G . For the full light splitting case $SR = 1$, and for the sparse splitting case $0 \leq SR < 1$. In addition, we only investigate the cost bounds in link equally-weighted WDM networks. It is assumed that all links have the same cost function

$$c(e) = 1 \text{ unit hop-count-cost} \quad (4.7)$$

Thus,

$$c(ms(s, D)) = \sum_{i=1}^k \sum_{e \in LT_i(s, D_i)} 1 \quad (4.8)$$

4.3.1 Full Light Splitting WDM Networks

In the case that all network nodes are equipped with light splitters, each node could act as a branching node in a light-tree. Hence, one light-tree is sufficient to span all the multicast

members. It is a Steiner-problem which tries to find a minimum partial spanning tree covering the source and all the multicast members. In a light-tree, there are at most N nodes when all the network nodes are spanned (i.e., when $\{v|v \in LT\} = V$), and at least $K + 1$ nodes if and only if the light-tree just contains the source and the multicast members (i.e. when $\{v|v \in LT\} = \{s\} \cup D$). So, the cost of the multicast light-tree is bounded to

$$K \leq c(ms(s, D)) \leq N - 1 \quad (4.9)$$

To minimize the total cost in full light splitting case, the Minimum Path heuristic [82] and the Distance Network heuristic [43] can be good choices, since they are guaranteed to get a light-tree with a total wavelength channel cost no more than $2(1 - \frac{1}{K+1})$ [87, 43] times that of the optimal Steiner tree. i.e.,

$$c(ms(s, D)) \leq 2(1 - \frac{1}{K+1}) \times C_{Opt} \quad (4.10)$$

where C_{Opt} denotes the wavelength channel cost of the Steiner tree.

4.3.2 Sparse Splitting WDM Networks

In the case of sparse splitting, only a subset of nodes can act as branching nodes in a light-trees. One light-tree may not be sufficient to accommodate all the group members simultaneously. Generally, several light-trees should be employed.

Lemma 1. $\forall i, j \in [1, k]$ and $i \neq j$, it exists at least a destination $d \in D_i$ served in the i^{th} light-tree such that d is not included in the j^{th} light-tree, i.e., $d \notin LT_j(s, D_j)$.

Proof. The aim of constructing the i^{th} light-tree $LT_i(s, D_i)$ is to serve the destinations in the subset D_i , and the j^{th} light-tree $LT_j(s, D_j)$ is used for serving the destinations in subset D_j . Let us suppose proof by contradiction that all the destinations in D_i are also included in $LT_j(s, D_j)$, i.e., $D_i \subseteq LT_i(s, D_i)$ and $D_i \subseteq LT_j(s, D_j)$. Then, all the destinations in set $D_i \cup D_j$ can be served by only one light-tree $LT_j(s, D_j)$ using the TaC capacity. According to the third principle of multicast light-tree computation, it is entirely useless to employ an additional light-tree to re-serve the destinations in D_i . As a result, $LT_i(s, D_i)$ can be eliminated and only $k - 1$ light-trees are required for multicast session $ms(s, D)$, which contradicts with the assumption. Hence, *Lemma 1* is proved. \square

Lemma 2. $\forall j \in [1, k]$, the cost of the j^{th} light-tree holds

$$K_j = |D_j| \leq c(LT_j(s, D_j)) \leq N - k \quad (4.11)$$

Proof. According to equation (4.4), all the k subsets of destinations D_i , $i \in [1, k]$, are disjoint. Based on *Lemma 1*, at least $k - 1$ destinations are not included in a light-tree. The number of nodes in a light-tree is consequently no more than $N - (k - 1)$. Furthermore, if no other nodes are included in the j^{th} light-tree except the source s and the destinations in D_j (i.e. $\{v | v \in LT_j(s, D_j)\} = \{s\} \cup D_j$), then the number of nodes in the j^{th} light-tree is minimal and equals $K_j + 1$. Hence, the cost bounds of a light-tree can be obtained as

$$K_j \leq c(LT_j(s, D_j)) \leq N - k \quad (4.12)$$

□

Theorem 1. *In sparse splitting and unweighted WDM networks, the total cost of the light-trees built for the multicast session $ms(s, D)$ satisfies*

$$K \leq c(ms(s, D)) \leq \begin{cases} K(N - K), & K < \frac{N}{2} \\ \lfloor \frac{N^2}{4} \rfloor, & K \geq \frac{N}{2} \end{cases} \quad (4.13)$$

Proof. According to *Lemma 2* and equation (4.6), the total cost of the light-trees built for a multicast session $ms(s, D)$ holds

$$\begin{aligned} c(ms(s, D)) &\leq \sum_{i=1}^k (N - k) \\ &\leq k(N - k) \\ &\leq -\left(k - \frac{N}{2}\right)^2 + \frac{N^2}{4} \end{aligned} \quad (4.14)$$

Regarding k is an integer and $1 \leq k \leq K$, we obtain

$$c(ms(s, D)) \leq \begin{cases} K(N - K), & K < \frac{N}{2} \\ \frac{N^2}{4}, & K \geq \frac{N}{2} \text{ and } N \text{ is even} \\ \frac{N^2 - 1}{4}, & K \geq \frac{N}{2} \text{ and } N \text{ is odd} \end{cases} \quad (4.15)$$

Moreover, according to *Lemma 2*, it is also true that

$$c(ms(s, D)) \geq \sum_{i=1}^k K_i = K \quad (4.16)$$

□

In fact the cost bounds given in *Theorem 1* are tight. In the following we give two examples to show their accuracy. It is not difficult to imagine that the case with the minimal cost appears when all and only all the destinations are involved in the light-tree computed for multicast session $ms(s, D)$, as shown in Fig. 4.2(a). That is to say $\{v | v \in LT\} = \{s\} \cup D$. It is obvious that the lower bound K is tight.

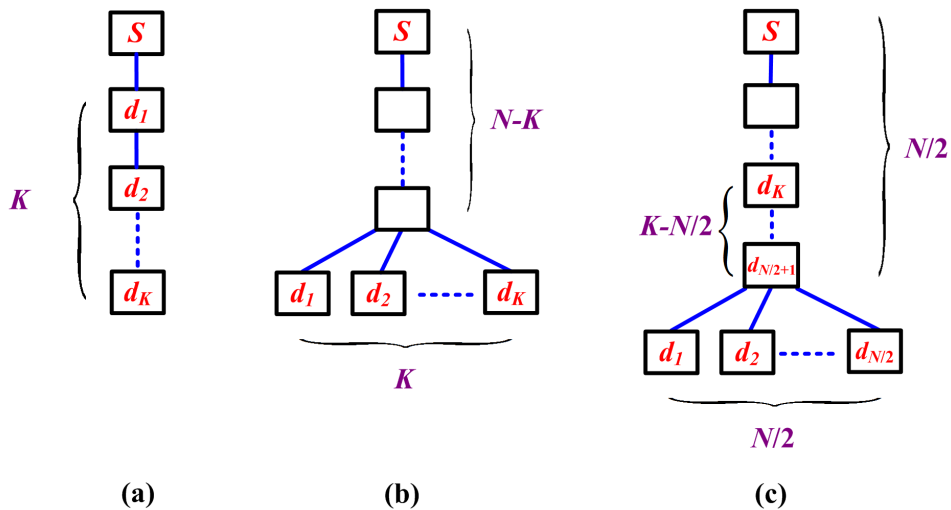

Figure 4.2: (a) The Best Case; (b) The Worst Case when $K < \frac{N}{2}$; (c) The Worst Case when $K \geq \frac{N}{2}$

The worst case depends on the relationship between K and N . In case that $K < \frac{N}{2}$, the worst case may happen when the network topology is like that in Fig. 4.2(b), where K lightpaths on different wavelengths are needed to serve K destinations to the source. Here, it is observed that the cost of the optimal light-trees equals $K(N - K)$. And when $K \geq \frac{N}{2}$, the worst case may take place in the topology of Fig. 4.2(c). In this topology, $\lfloor \frac{N}{2} \rfloor$ lightpaths from the source to each of the destinations at the bottom are required to serve all the group members. The $K - \lfloor \frac{N}{2} \rfloor$ destinations in the middle can be served in any one of them. As each lightpath has a cost of $\lceil \frac{N}{2} \rceil$, an exact total cost of $\lfloor \frac{N^2}{4} \rfloor$ should be consumed to establish the multicast session $ms(s, D)$. This example verifies the accuracy of the upper bound given in *Theorem 1*.

4.4 Cost Bounds of Multicast Light-Trees in WDM Rings

4.4.1 Multicast Light-tree in WDM Rings

In WDM rings, all the nodes are mandatorily equipped with TaC [3] capability, one light-tree is able to span all the multicast members. The multicast light-tree in a WDM ring consists of either a lightpath or two edge disjoint lightpaths originating from the same source. In an N -node WDM ring, the cost of the multicast light-tree for multicast session $ms(s, D)$ is subject to

$$K \leq c(ms(s, D)) \leq N - 1 \tag{4.17}$$

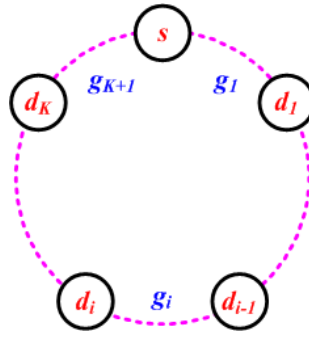

Figure 4.3: The Gaps in a WDM Ring

4.4.2 Optimal Multicast Light-tree in WDM Rings

Different from WDM mesh networks, minimizing the cost of the multicast light-tree in a WDM ring is simple. The minimum spanning tree for the multicast members is the optimal solution. Here, we use the concept gap introduced in [74, 73]. A gap is a path between two adjacent multicast members in $\{s\} \cup D$ so that no other members are involved in this path. The optimal multicast light-tree can be obtained by removing the biggest gap from the ring [74].

Theorem 2. *In an unweighted WDM ring, the cost of the optimal light-tree for multicast session $ms(s, D)$ is*

$$K \leq c(ms(s, D)) \leq N - \lceil \frac{N}{K+1} \rceil \quad (4.18)$$

Proof. Beginning from the source node s , we index the destination nodes from d_1 to d_K in the clockwise manner. Let g_1 denote the length of the gap between the source s and d_1 , g_i be the length of the i^{th} gap, i.e., the gap between d_{i-1} and d_i , and g_{K+1} be the gap between source s and d_K as shown in Fig. 4.3. In a WDM ring of N nodes, we obtain

$$\sum_{i=1}^{K+1} g_i = N \quad (4.19)$$

The cost of the optimal multicast light-tree for multicast session $ms(s, D)$ can be determined by

$$c(ms(s, D)) = N - \max_{1 \leq i \leq K+1} g_i \quad (4.20)$$

In order to obtain the cost bound of the light-tree, we have to determine the value range of $\max_{1 \leq i \leq K+1} g_i$. Note that all g_i are positive integers and satisfy equation (4.19). We obtain the following inequality

$$\max_{1 \leq i \leq K+1} g_i \geq \lceil \frac{N}{K+1} \rceil \quad (4.21)$$

This result corresponds to the case that multicast members are evenly distributed in a WDM ring. Thus we obtain

$$c(ms(s, D)) \leq N - \lceil \frac{N}{K+1} \rceil \quad (4.22)$$

Besides, if all the multicast group members stick together one by one, the optimal light-tree thus only consists of the source and the destinations. Then, we can obtain the lower bound

$$c(ms(s, D)) \geq K. \quad (4.23)$$

□

4.5 Approximation Ratios of the Heuristic Algorithms for Sparse Splitting Multicast Routing

Like the Steiner problem, it is NP-hard to find the light-trees with the optimal cost for multicast routing in sparse splitting WDM networks. This is why many heuristic algorithms have been proposed to solve this problem in polynomial time. In order to guarantee the quality of the resultant light-trees, it is imperative to determine the cost approximation ratios of the proposed heuristic solutions. Nevertheless, they have not been investigated before. In this section, we try to deduce the cost approximation ratios of two classical light-trees computation heuristics namely Reroute-to-Source (R2S) and Member-Only (MO) [98]. Define C_{Opt} as the optimal cost of the light-trees fulfilling the multicast session $ms(s, D)$, and let $\rho(\cdot)$ denote the cost approximation ratio of a heuristic solution. Specially, we discuss the approximation ratios of these algorithms in two types of WDM networks $G(V, E)$: non-equally-weighted one and unweighted one. In the first case, the link cost can be an arbitrary positive number. While in the latter case, all the link costs are set to be 1 *unit* hop-count-cost as shown in equation (4.7). At first, we study the approximation ratios in unweighted WDM networks.

Theorem 3. *Given that the WDM network $G(V, E)$ is unweighted, if an all-optical multicast routing algorithm AOMR follows the assumptions in 4.2.1 then its approximation ratio holds*

$$\rho(AOMR) \leq \begin{cases} N - K & 1 \leq K < \frac{N}{2} \\ \frac{\lfloor \frac{N^2}{4} \rfloor}{K} & \frac{N}{2} \leq K \leq N \end{cases} \quad (4.24)$$

Proof. If $G(V, E)$ is unweighted i.e., equation (4.7) is valid. As demonstrated in subsection 4.3.2, the light-forest computed by the multicast routing algorithm following the

assumptions in 4.2.1 has both a lower bound and an upper bound. Obviously, the optimal cost of light-forest should also be no less than the lower bound. Hence, the approximation ratio of the algorithm can not be greater than the value of the upper bound divided by the lower bound. According to *Theorem 1*, we obtain *Theorem 3*. It is obviously also valid for both Reroute-to-Source and Member-Only algorithms, since they respect the sparse splitting constraint and follow the aforementioned assumptions. \square

4.5.1 Reroute-to-Source Algorithm [98]

Reroute-to-Source algorithm constructs the shortest path tree rooted at the source, then it checks the splitting capacity of the branching nodes. If a branching node is an MI node, the algorithm cuts all but one downstream branch. The affected leaf destinations rejoin the light-tree along a shortest path to the source on another wavelength.

Theorem 4. *Given that the WDM network $G(V, E)$ is non-equally-weighted, the Reroute-to-Source algorithm [98] provides an approximation ratio of $\rho(R2S) = K$ for multicast routing with sparse splitting constraint.*

Proof. Let r_{max} be the cost of the shortest path from the furthest destination to the source s , i.e.

$$r_{max} = \max_{d_i \in D} c[SP(s, d_i)] \tag{4.25}$$

Obviously, we have

$$C_{Opt} \geq r_{max} \tag{4.26}$$

Hence, we obtain

$$\begin{aligned} \rho(R2S) &= c(R2S)/C_{Opt} \\ &\leq \sum_{d_i \in D} c(SP(s, d_i))/C_{Opt} \\ &\leq |D| \cdot r_{max}/r_{max} \\ &\leq K \end{aligned} \tag{4.27}$$

Next, we will show that $\rho(R2S)$ may tend to be K in a non-equally-weighted topology like Fig. 4.4, where r is a positive integer denoting the distance from s to d_1 and δ is a very small non-negative number. We can see the optimal solution for multicast communication $ms(s, d_1 - d_K)$ is the lightpath $s \rightarrow d_1 \rightarrow d_2 \dots \rightarrow d_K$, while the shortest path tree is the

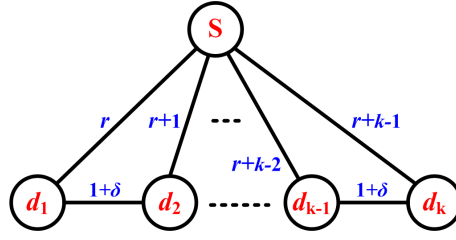

Figure 4.4: Illustration of *Theorem 4*

set of direct paths from s to each destination. Then,

$$c(R2S) = K \left(r + \frac{K-1}{2} \right) \quad (4.28)$$

$$C_{Opt} = r + (K-1)(1+\delta) \quad (4.29)$$

Thus, the approximation ratio of R2S algorithm is

$$\rho(R2S) = K \left(1 - \frac{1}{\frac{2r}{(K-1)(1+\delta)} + \frac{2(1+\delta)}{1+2\delta}} \right) \quad (4.30)$$

Since $G(V, E)$ is non-equally-weighted and K is inferior to N , r can be arbitrarily large and independent of K and N . Thus, for any $K \in (1, N)$, when $\frac{r}{N} \rightarrow \infty$ and $\delta \rightarrow 0$, we obtain $\rho(R2S) = K$. \square

However, $\rho(R2S) = K$ is not valid for all possible $1 < K < N$ in unweighted WDM networks, especially when K is very close to N . Take the same example in Fig. 4.4, if $G(V, E)$ is unweighted, r is always below $N - K$ and $\delta = 0$, thus $\frac{r}{K} \leq \frac{N-K}{K}$ will never reach ∞ when K is close to N . As a result, equation (4.30) can not tend to K any more. Hence, in this case, a tight ratio should be found when K approaches N .

Theorem 5. *Given that the WDM network $G(V, E)$ is unweighted,*

$$\rho(R2S) \leq \begin{cases} K & 1 \leq K < \frac{N}{2} \\ \frac{\lfloor \frac{N^2}{4} \rfloor}{K} & \frac{N}{2} \leq K \leq N-1 \end{cases} \quad (4.31)$$

Proof. As proved in *Theorem 4* that $\rho(R2S) \leq K$ is always true for any WDM networks. In addition, *Theorem 3* is also valid for Reroute-to-Source algorithm in unweighted graphs. By combining these two results, the proof follows. \square

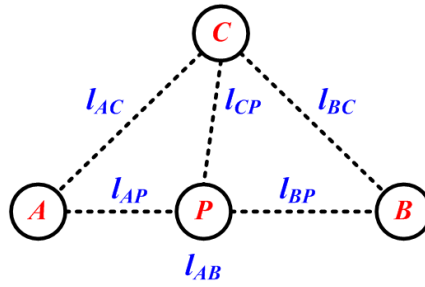

Figure 4.5: Illustration of *Lemma 3*

4.5.2 Member-Only Algorithm [98]

According to Member-Only (MO) algorithm [98], the shortest path between each pair of nodes is precalculated and stored in a table. Then, the computation of the light-trees for a multicast request is done iteratively.

At each step $i+1$, try to find the shortest paths between the destinations $d \in D$ and the connector nodes $c \in MC_SET$ of light-tree LT_i , such that they do not involve any TaC capability exhausted nodes in MI_SET . Among them, the constraint-satisfying shortest path $SP(d, c)$ with the smallest cost is selected. Then generate LT_{i+1} by adding $SP(d, c)$ to LT_i . In case that no such destination can be found, begin a new light-tree rooted at the source. Member-Only algorithm is an adjustment of the famous Minimum Path Heuristic (MPH) proposed for the Steiner problem. As mentioned in Section 4.3, MPH is able to approximate the Steiner tree with a ratio smaller than 2. However, by adjusting MPH for multicast routing under sparse splitting constraint (i.e., Member-Only algorithm), it is difficult to determine the approximation ratio. Next, we introduce *Lemma 3* before determining $\rho(MO)$. Define l_{XY} as the cost of the shortest path $SP(X, Y)$.

Lemma 3. In Fig. 4.5, suppose P is a node in the shortest path $SP(A, B)$ from node A to node B , and C is connected to P by the shortest path. We obtain

$$l_{CP} \leq \frac{1}{2}(l_{AB} + l_{AC} + l_{BC}) \quad (4.32)$$

Proof. Since node P is in $SP(A, B)$, both paths AP and BP are the shortest paths, then

$$l_{AB} = l_{AP} + l_{BP} \quad (4.33)$$

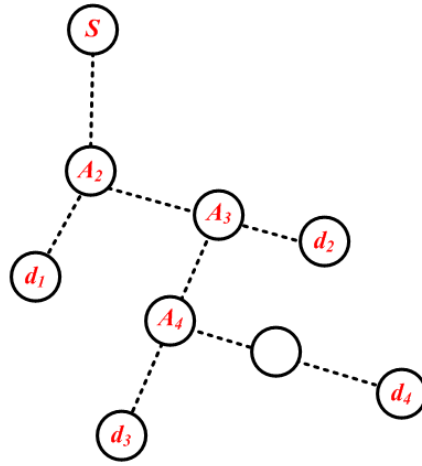

Figure 4.6: Demonstration of the Worst Case of the Member-Only Algorithm

As a result the graph in Fig. 4.5 is a distance network, where the triangle inequality is valid. Then,

$$l_{CP} \leq l_{AC} + l_{AP} \quad (4.34)$$

$$l_{CP} \leq l_{BC} + l_{BP} \quad (4.35)$$

Adding equation (4.34) to equation (4.35) gives

$$2l_{CP} \leq (l_{AP} + l_{BP}) + l_{AC} + l_{BC} \quad (4.36)$$

By substituting equation (4.33) into the above equation, *Lemma 3* follows. \square

Theorem 6. *Given any kind of WDM networks $G(V, E)$, the Member-Only algorithm provides a cost approximation ratio $\rho(MO) \leq \frac{K^2+3K}{4}$ for sparse splitting multicast routing.*

Proof. We use the proof by induction. Let l_{max} be the cost of the shortest path between the furthest two members in a multicast session $ms(s, D)$, i.e.

$$l_{max} = \max_{m_i, m_j \in s \cup D} c[SP(m_i, m_j)] \quad (4.37)$$

Member-Only algorithm starts the multicast light-tree LT from the source s and spans the light-trees iteratively. Let l_i denote the cost of the shortest path that connects the destination d_i to the current LT , and l_i^m be its upper bound. In other words, the cost of LT increases by l_i after spanning d_i , and at most l_i^m . In the following, we are trying to determine the worst case of the upper bound l_i^m for each l_i by applying the triangle

inequality in *Lemma 3*. As shown in Fig. 4.6, the nearest destination node d_1 to the source s is first added to LT . Now, the cost of LT is $l_1 \leq l_{max}$ and $l_1^m = l_{max}$. Then in the second step, the nearest destination d_2 to LT is added using the shortest path. If d_2 is spanned via d_1 or s , then obviously $l_2 \leq l_{max}$. It should be noted that the worst case appears when d_2 is spanned via an intermediate node (say A_2) in $SP(s, d_1)$. If this happens to be the case, we obtain $l_2 \leq \frac{3}{2}l_{max}$ and $l_2^m = \frac{3}{2}l_{max}$ according to *Lemma 3*. In the third step, the nearest destination d_3 is added using the shortest path. It is evident that l_3^m is the largest when d_3 is spanned via an intermediate node (say A_3) in $SP(A_2, d_2)$. This can be explained as follows. If d_3 is spanned via any member nodes (i.e., s , d_1 or d_2), then obviously $l_3 \leq l_{max}$. Otherwise, d_3 must be connected via an intermediate node in the shortest path $SP(s, d_1)$ or $SP(A_2, d_2)$. According to *Lemma 3*, $l_3 \leq \frac{3}{2}l_{max}$ if d_3 connects to LT through a node in $SP(s, d_1)$. In case that d_3 connects to LT through a node in $SP(A_2, d_2)$, the cost of $SP(A_2, d_3)$ should be calculated before using the triangle inequality. Similar to $SP(A_2, d_2)$, $c[SP(A_2, d_3)] \leq l_2^m$. Then, go back to l_3 , and we obtain:

$$\begin{aligned}
 l_3 &\leq \frac{1}{2} \left(c[SP(A_2, d_3)] + c(SP(d_2, d_3)) + l_2 \right) \\
 &\leq \frac{1}{2} (l_2^m + l_{max} + l_2) \\
 &\leq l_2^m + \frac{1}{2} l_{max}
 \end{aligned} \tag{4.38}$$

Hence,

$$l_3^m = l_2^m + \frac{1}{2} l_{max} \tag{4.39}$$

Suppose that equation (4.40) is obtained by applying *Lemma 3*

$$l_i^m = l_{i-1}^m + \frac{1}{2} l_{max} \tag{4.40}$$

Next, we try to prove that it is also true for the case of l_{i+1}^m . Since Member-Only multicast light-tree is only consisted of the shortest paths, each node in the light-tree must be in the shortest path between two member nodes or between a destination and a joint node of two shortest paths. And, l_i^m is monotonically increasing. Consequently, the worst case of l_{i+1}^m occurs when d_{i+1} connects to LT through an intermediate node in the shortest path between d_i and a joint node A_i . According to *Lemma 3*, $c[SP(A_i, d_{i+1})] \leq l_i^m$ also holds. Then, applying the triangle inequality again in the distance network of $G(A_i, d_i, d_j)$ leads

to,

$$\begin{aligned}
 l_{i+1} &\leq \frac{1}{2} \left(c[SP(A_i, d_{i+1})] + c(SP(d_i, d_{i+1})) + l_i \right) \\
 &= \frac{1}{2} (l_i^m + l_{max} + l_i) \\
 &\leq l_i^m + \frac{1}{2} l_{max}
 \end{aligned} \tag{4.41}$$

So, it is always valid for all the steps during the span of a light-tree that $l_{i+1}^m = l_i^m + \frac{1}{2} l_{max}$. Hence, we can have $l_i^m = \frac{i+1}{2} l_{max}$. Assuming k light-trees are constructed for multicast session $ms(s, D)$, and $|D_i|$ destinations are unique served in the i^{th} light-tree. This also means that $|D_i|$ steps are processed in the i^{th} light-tree. Thus, the total cost of the i^{th} light-tree is upper bounded by

$$\begin{aligned}
 c(LT_i) &= \sum_{i=1}^{|D_i|} l_i \\
 &\leq \sum_{i=1}^{|D_i|} l_i^m \\
 &\leq \frac{1}{4} (|D_i|^2 + 3|D_i|) l_{max}
 \end{aligned} \tag{4.42}$$

Then, the total cost consumed by $ms(s, D)$ using Member-Only algorithm complies

$$\begin{aligned}
 c(MO) &= \sum_{i=1}^k c(LT_i) \\
 &\leq \sum_{i=1}^k \frac{1}{4} (|D_i|^2 + 3|D_i|) l_{max} \\
 &\leq \frac{1}{4} (3|D| + \sum_{i=1}^k |D_i|^2) l_{max} \\
 &\leq \frac{1}{4} (3|D| + |D|^2) l_{max}
 \end{aligned} \tag{4.43}$$

As $C_{Opt} \geq l_{max}$, the following inequality can be obtained

$$\begin{aligned}
 \rho(MO) &= c(MO)/C_{Opt} \\
 &\leq c(MO)/l_{max} \\
 &\leq \frac{1}{4} (3K + K^2)
 \end{aligned} \tag{4.44}$$

□

Theorem 7. *Given that the WDM network $G(V, E)$ is unweighted, then*

$$\rho(MO) \leq \begin{cases} \frac{1}{4} (K^2 + 3K) & 1 \leq K < \frac{\sqrt{16N+49}-7}{2} \\ N - K & \frac{\sqrt{16N+49}-7}{2} \leq K < \frac{N}{2} \\ \frac{\lfloor \frac{N^2}{4} \rfloor}{K} & \frac{N}{2} \leq K \leq N - 1 \end{cases} \tag{4.45}$$

Proof. If $G(V, E)$ is unweighted, *Theorem 3* is valid for the Member-Only algorithm. By merging two approximation ratios in *Theorems 3* and *7*, the proof follows. \square

4.6 ILP Formulation

Since minimizing the total cost of the light-forest for a multicast session is NP-hard, the integer linear programming (ILP) method is applied to search the optimal solution.

Notations and Variables:

- W : The set of wavelengths supported per fiber.
- λ : A wavelength supported in one fiber, $\lambda \in W$.
- $In(m)$: The set of nodes leading an edge to node m .
- $Out(m)$: The set of nodes to which m is connected.
- $Deg(m)$: The degree of node m .
- $link(m, n)$: The directed link from node m to node n .
- $L_{m,n}(\lambda)$: Equals to 1 if multicast request $ms(s, D)$ uses wavelength λ on $link(m, n)$, equals to 0 otherwise.
- $U_{m,n}^d(\lambda)$: Equals to 1 if $link(m, n)$ is used on wavelength λ in the lightpath from destination d to the source s , equals to 0, otherwise.

4.6.1 ILP Formulation

The objective of the studied sparse splitting multicast routing problem is to minimize the wavelength channel cost of the light-trees built for a multicast session $ms(s, D)$. It can be expressed as follows:

$$\text{Minimize : } \sum_{\lambda \in W} \sum_{m \in V} \sum_{n \in In(m)} L_{n,m}(\lambda) \quad (4.46)$$

The objective function is subject to a set of constraints, which are listed below:

Multicast Light-tree Constraints

Source Constraints:

$$\sum_{\lambda \in W} \sum_{n \in In(s)} L_{n,s}(\lambda) = 0 \quad (4.47)$$

$$1 \leq \sum_{\lambda \in W} \sum_{n \in Out(s)} L_{s,n}(\lambda) \leq |D| \quad (4.48)$$

Constraints (4.47) and (4.48) ensure that the light-trees for multicast session $ms(s, D)$ are rooted at the source node s . In a light-tree, s must not have any input link, but should have at least one output link. And the number of outgoing links from s should not go beyond the number of sink nodes, i.e., $|D|$.

Destinations Constraints:

$$1 \leq \sum_{\lambda \in W} \sum_{n \in In(d)} L_{n,d}(\lambda) \leq |D|, \quad \forall d \in D \quad (4.49)$$

Constraint (4.49) guarantees that each destination node sinks at least one incoming light beam. Since some destinations, which act as an intermediate node in a light-tree, will forward the incoming light beam to successor destinations, a destination node d can receive at most $|D|$ light beams on all the wavelength layers. However, this constraint cannot ensure that destination d is reachable from the source s , which will be illustrated later.

Input Constraint:

$$\sum_{n \in In(m)} L_{n,m}(\lambda) \leq 1, \quad \forall \lambda \in W, \text{ and } \forall m \in V \quad (4.50)$$

Equation (4.50) indicates that each node (except the source s) in a light-tree has and only has one predecessor. Nevertheless, this constraint can not guarantee that the resultant structure is a set of light-trees, due to the fact that loops can not be avoided (refer to Fig. 4.7).

Leaf Nodes Constraint:

$$\sum_{n \in Out(m)} L_{m,n}(\lambda) \geq \sum_{n \in In(m)} L_{n,m}(\lambda), \quad \forall \lambda \in W, \forall m \in V \text{ and } m \notin D \quad (4.51)$$

Constraint (4.51) ensures that only the destination nodes can be leaf nodes in a light-tree while the non-member nodes can not.

Sparse Splitting Constraints:

$$\sum_{n \in Out(m)} L_{m,n}(\lambda) \leq R \times \sum_{n \in In(m)} L_{n,m}(\lambda), \quad \forall \lambda \in W, \forall m \in V \text{ and } m \neq s \quad (4.52)$$

where

$$\begin{cases} R = 1, & \text{if } m \text{ is an MI node} \\ R = Deg(m) - 1, & \text{if } m \text{ is an MC node} \end{cases} \quad (4.53)$$

Constraint (4.52) together with constraint (4.51) indicates the splitting capabilities of the nodes. If a node m is spanned in a light-tree, then the number of outgoing links from m is equal to 1 for an MI node and less than $Deg(m) - 1$ for an MC node. Otherwise, it must

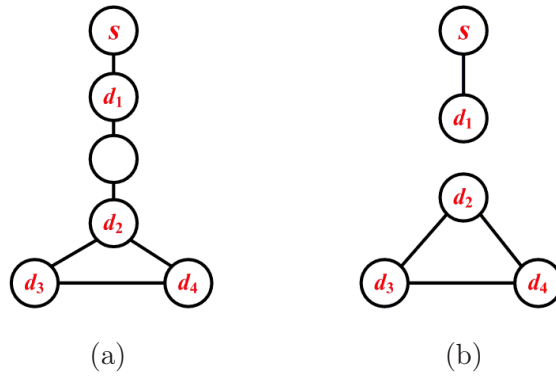

Figure 4.7: A Contradict Example with a Loop in the Resultant Light-Tree: (a) The Network Topology; (b) The Result

be 0. Only with the light-tree structure constraints developed above [96, 12], one can not guarantee that each light-tree of the resultant light-forest should be connected and loop free. An contradictory example is given next. Suppose we just employ the light-tree constraints formulation to find the light-trees for a multicast session $ms(s, (d_1 - d_4))$ in topology Fig. 4.7(a). The result in Fig. 4.7(b) uses some wavelength λ_1 , where $L_{s,d_1}(\lambda_1) = 1$, $L_{d_2,d_3}(\lambda_1) = 1$, $L_{d_3,d_4}(\lambda_1) = 1$, $L_{d_4,d_2}(\lambda_1) = 1$ and all the other variables $L_{m,n}(\lambda)$ are zero. It is true that all the constraints from (4.47) to (4.52) are satisfied in this result. Besides, the wavelength channel cost of the result is optimal. Unfortunately, this result has a loop $d_2 - d_3 - d_4 - d_2$ and three destinations are separated from the source node s . Thereby, the proposed light-trees constraints are not sufficient to guarantee the resultant light-tree structure. This is why next the destinations reachability constraints are introduced to solve these problems.

Destination Nodes Reachability Constraints

Source node:

$$\sum_{n \in In(s)} U_{n,s}^d(\lambda) = 0, \quad \forall \lambda \in W, \text{ and } \forall d \in D \quad (4.54)$$

$$1 \leq \sum_{\lambda \in W} \sum_{n \in Out(s)} U_{s,n}^d(\lambda) \leq |D|, \quad \forall d \in D \quad (4.55)$$

Similar to constraint (4.47), equation (4.54) gives the constraint that no link leading to the source will be employed to serve destinations in the light-trees.

Equation (4.55) ensures that all the destination nodes could be reached from the source node s in the light-trees. By combining equations (4.50) and (4.55), the loops can be

avoided. Still refer to the contradictory example aforementioned, the result in Fig.4.7(b) does not satisfy constraint (4.55), since destination nodes $d_2 - d_4$ can not be reached from the source node s .

Destination nodes autocorrelation:

$$\sum_{n \in \text{Out}(d)} U_{d,n}^d(\lambda) = 0, \quad \forall \lambda \in W, \text{ and } \forall d \in D \quad (4.56)$$

$$\sum_{n \in \text{In}(d)} U_{n,d}^d(\lambda) \leq 1, \quad \forall \lambda \in W, \text{ and } \forall d \in D \quad (4.57)$$

$$1 \leq \sum_{\lambda \in W} \sum_{n \in \text{In}(d)} U_{n,d}^d(\lambda) \leq |D| - 1, \quad \forall d \in D \quad (4.58)$$

Constraint (4.56) avoids the loops of destinations, such as that in Fig.4.7(b). Constraints (4.57) and (4.58) make sure that each destination has one and only one input link in a light-tree, which are equivalent to constraints (4.50) and (4.49) respectively.

Non-member nodes and destination nodes cross correlation:

$$\sum_{n \in \text{Out}(m)} U_{m,n}^d(\lambda) = \sum_{n \in \text{In}(m)} U_{n,m}^d(\lambda) \leq 1, \quad \forall \lambda \in W, \forall d \in D, \forall m \in V \text{ and } m \neq s, d \quad (4.59)$$

$$\sum_{\lambda \in W} \sum_{n \in \text{Out}(m)} U_{m,n}^d(\lambda) \leq |D|, \quad \forall \lambda \in W, \forall d \in D, \forall m \in V \text{ and } m \neq s, d \quad (4.60)$$

The distinct wavelength constraint is illustrated by equation (4.59). It ensures that one link can be used at most once on one wavelength, and will be used at most $|D|$ times to establish multicast session $ms(s, D)$ on all the wavelengths which is expressed by equation (4.60).

Relationship between $L_{m,n}(\lambda)$ and $U_{m,n}^d(\lambda)$

In order to avoid loops in the resultant light-trees, variable $U_{m,n}^d(\lambda)$ is employed to restrict variable $L_{m,n}(\lambda)$. Their relations are shown in equations (4.61) and (4.62).

$$L_{m,n}(\lambda) \leq \sum_{d \in D} U_{m,n}^d(\lambda), \quad \forall \lambda \in W, \text{ and } \forall m, n \in V \quad (4.61)$$

$$U_{m,n}^d(\lambda) \leq L_{m,n}(\lambda), \quad \forall \lambda \in W, \forall m, n \in V, \text{ and } \forall d \in D \quad (4.62)$$

4.7 Simulation and Numerical Results

In this section, simulations are conducted to compute the multicast light-trees in sparse splitting WDM mesh networks. ILP formulations are implemented by Cplex [17], while Member-Only and Reroute-to-Source are conducted in C++ with LEDA package [45]. Since the proposed cost bounds and the approximation ratios of Member-Only and Reroute-to-Source algorithms only correspond to the worst or extreme cases, they may only appear in special topologies with special configurations. Hence, here we do not mean to verify the accuracy of the proposed bounds and approximation ratios. Instead, the numerical results are obtained to just show the quality of the resultant light-trees when applying the Member-Only and Reroute-to-Source algorithms in some popular candidate WDM backbone networks like 14 nodes NSF network and 28 nodes USA Longhaul network.

4.7.1 Cost Bounds of Multicast Light-trees

Member-Only (MO) and Reroute-to-Source (R2S) algorithms are conducted in unweighted NSF network and unweighted USA Longhaul network. All the links are associated an identical cost of 1 *hop-count cost*. Since the worst case of the cost bound occurs when there is no light splitters in the network, we configure the network without light splitters. The source and multicast members are assumed to be distributed uniformly over the topology. The cost bounds of the multicast light-trees computed by MO and R2S heuristics are demonstrated in Fig. 4.8 when the multicast group size (counting the source node) $K + 1$ varies from 2 (Unicast) to the nodes number of the network (Broadcast). 5000 multicast sessions are randomly generated for a given multicast group size, meanwhile, Member-Only and Reroute-to-Source algorithms are employed to compute the multicast light-forest for each session. Among 5000 light-forests, the biggest cost of the light-forests (denoted by R2S-Max and MO-Max) and smallest cost of the light-forests (denoted by R2S-Min and MO-Min) are figured out and plotted in Fig. 4.8. The lower bound and the upper bound provided in *Theorem 1* are compared with the simulation result. According to the figure, it is observed that the proposed lower bound is covered by MO-Min since they are almost the same. The lower bound is also very near to R2S-Min. Meanwhile, we can also find that the upper bound is much bigger than the biggest costs obtained (MO-Max and R2S-Max) by the simulation. Does it mean that the proposed upper bound is too large and inexact? No! This can be explained by the fact that the simulation results depend on the simulation topology. The proposed upper bound is valid for all the algorithms which complies the

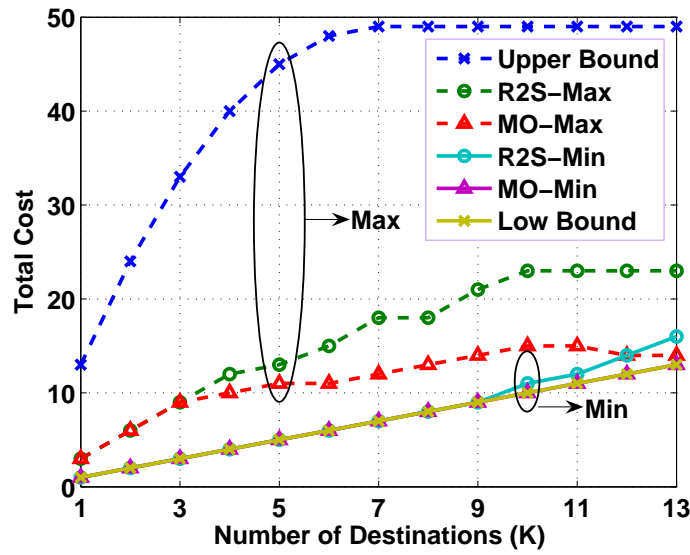

(a) NSF Network

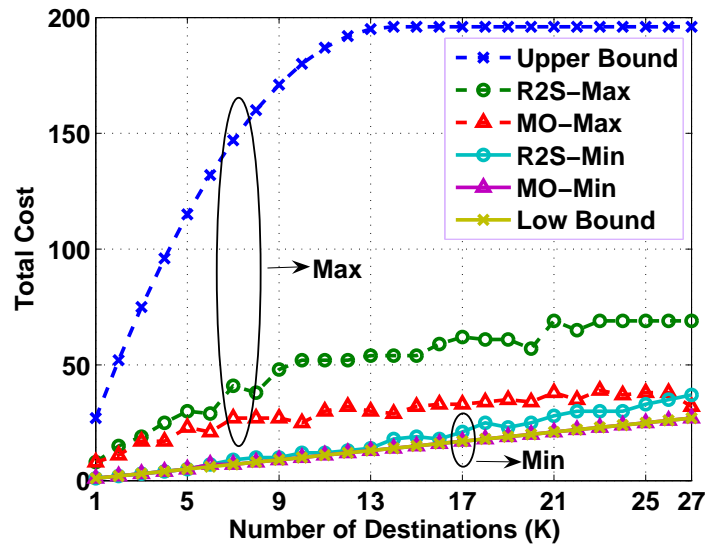

(b) Longhaul Network

Figure 4.8: The Cost Bound of Multicast Light-Trees when the Number of Destinations K Varies

three rules mentioned in section 4.2. As discussed in subsection 4.3.2, given the network topology in Fig. 4.2, both the lower bound and the upper bound are always tight.

Table 4.1: Comparison of Cost Bounds in NSF Network

$ D = K$	LB	ILP	MO	R2S	UB
2	2	3.2	3.2	3.6	24
3	3	4.5	4.6	5.2	33
4	4	5.7	5.7	6.7	40
5	5	6.7	6.9	8.2	45
6	6	8.2	8.5	9.1	48
7	7	8.3	8.5	10.9	49
8	8	8.7	9.3	11.7	49
9	9	9.6	10.1	12.3	49
10	10	10.8	11.1	15	49
11	11	11.3	11.7	17.3	48
12	12	12	12	17.3	49
13	13	13	13.1	18.9	49

Table 4.2: Comparison of Approximation Ratios in NSF Network

$ D = K$	$\rho'(\text{MO})$	$\rho(\text{MO})$	$\rho'(\text{R2S})$	$\rho(\text{R2S})$
2	2.50	1.00	2	1.13
3	4.5	1.03	3	1.16
4	7	1.00	4	1.18
5	9	1.03	5	1.23
6	8	1.04	6	1.11
7	7	1.03	7	1.32
8	6.13	1.07	6.13	1.35
9	5.44	1.06	5.44	1.29
10	4.9	1.03	4.9	1.39
11	4.45	1.04	4.45	1.54
12	4.08	1.00	4.08	1.45
13	3.77	1.01	3.77	1.46

4.7.2 Approximation Ratio of Multicast Light-trees

ILP formulations are carried out in C++ with Cplex library in the NSF network to search for the optimal light-trees for each multicast session. We set NSF network to be an equally

weighted graph, where each link has the same cost of 1 *hop – count cost*. Provided a multicast group size, 20 random sessions are generated. Hence, each cost is the average of 20 sessions with the same group size. The cost bounds (**LB** and **UB**) and the approximation ratios of the Reroute-to-Source and Member-Only algorithms are compared in tables 4.1 and 4.2. ρ' (MO) denotes the upper bound of the approximation ratio given in *Theorem 6* and ρ' (R2S) stands for the upper bound of the approximation ratio derived from *Theorem 5*, while ρ (MO) and ρ (R2S) indicate the approximation ratio obtained by $c(MO)/c(ILP)$ and $c(R2S)/c(ILP)$ respectively in the simulations. In addition, $|D| = K$ is the number of destinations in the session. As shown in table 4.1, Member-Only algorithm achieves a very near cost to the result of ILP solution. In table 4.2, it is observed that Member-Only algorithm has a better approximation ratio than Reroute-to-Source algorithm in the simulation. However, the approximation ratio gotten from the simulations is much smaller than that derived from the proof. This result can be explained as follows. First, the approximation ratio derived from the proof is the ratio of the worst case. Second, similar to the cost bound, the approximation ratio depends also on the network topology. Finally, the approximation ratios given in *Theorems 4* and *6* are not tight enough.

In fact, another important impact is the characteristic of unweighted NSF network, which plays an important role in helping Member-Only and Reroute-to-Source to get good performances. This can be explained by the following *Lemma 4*.

Lemma 4. Given that the WDM network G is unweighted, both the approximation ratios of Member-Only and Reroute-to-Source are inferior to the diameter of network $Diam(G)$.

Proof. It is trivial. Any shortest path $SP_G(\cdot)$ in the network G is always $SP_G(\cdot) \leq Diam(G)$. Both Reroute-to-Source and Member-Only algorithm exclusively make use of the shortest path in the network. Thus, the total cost $c(LF)$ of the resultant light-forest is

$$c(LF) \leq K \times Diam(G) \tag{4.63}$$

Besides, there are K destinations in session $ms(s, D)$ and G is unweighted, the optimal cost of multicast light-trees is always no less than K . Thus,

$$\rho(LF) \leq K \times Diam(G)/K = Diam(G) \tag{4.64}$$

□

It is not hard to find that the diameter of the unweighted NSF network is $Diam(NSF) = 3$. By taking *Theorems 6*, *4* and *Lemma 4* into consideration concurrently, pretty better approximation ratios $\bar{\rho}(MO)$ and $\bar{\rho}(R2S)$ can be found in Table 4.3.

Table 4.3: New Approximation Ratios of R2S and MO in NSF Network

$ D = K$	2	3	4	5	6	8	9	10	11	12	13
$\bar{\rho}(\text{MO})$	2.5	3	3	3	3	3	3	3	3	3	3
$\bar{\rho}(\text{R2S})$	2	3	3	3	3	3	3	3	3	3	3

4.8 Conclusion

Multicast routing in all-optical WDM mesh networks is an important but challenging task. It is NP-complete to minimize the wavelength channel cost consumed per multicast session under the sparse splitting constraint. Although many papers have focused on the algorithms of multicast light-trees computation, neither the cost bounds of light-trees nor the approximation ratios of heuristic algorithms have been addressed.

In this chapter, we first investigate the bounds of wavelength channel cost consumed by a multicast session in unweighted WDM networks, where an equal cost of 1 *unit hop-count cost* is associated over all the fiber links. We find that it is tightly lower limited to the number of destinations K , and strictly upper bounded to (1) $K(N - K)$ when $K < \frac{N}{2}$; (2) $\lfloor \frac{N^2}{4} \rfloor$, when $K \geq \frac{N}{2}$, where K is the number of destinations in the multicast session and N is the number of nodes in the network. Source-oriented multicast light-trees computation heuristic algorithms like Reroute-to-Source [98] and Member-Only [98] follow this cost bounds, as they respect the three principles for light-trees computation mentioned in Section 4.2. In a particular situation, where the network topology is a WDM ring, the optimal multicast light-tree can be determined by removing the biggest gap from the ring. We find that its cost is inferior to $N - \lceil \frac{N}{K+1} \rceil$.

Furthermore, some interesting results are found on the approximation ratios of some classical multicast light-trees computation algorithms in both unweighted and non-equally-weighted WDM networks. Reroute-to-Source algorithm (R2S) [98] achieves an approximation ratio $\rho(\text{R2S})$ equal to K in non-equally-weighted WDM networks, while in unweighted WDM networks $\rho(\text{R2S})$ is inferior to (1) K , when $1 \leq K < \frac{N}{2}$; (2) $\frac{\lfloor \frac{N^2}{4} \rfloor}{K}$, when $\frac{N}{2} \leq K < N$. Member-Only algorithm (MO) [98] approaches the optimal solution with a ratio $\rho(\text{MO})$ inferior to $(K^2 + 3K)/4$ for any WDM networks. More specially in unweighted WDM networks, $\rho(\text{MO})$ is no bigger than (1) $(K^2 + 3K)/4$, when $1 \leq K < \frac{\sqrt{16N+49}-7}{2}$; (2) $N - K$, when $\frac{\sqrt{16N+49}-7}{2} \leq K < \frac{N}{2}$; (3) $\frac{\lfloor \frac{N^2}{4} \rfloor}{K}$, when $\frac{N}{2} \leq K < N$. It is also reported that if WDM network is unweighted, the approximation ratios of R2S and MO are always inferior to the diameter of the network.

Simulation results illustrate that in popular candidate WDM backbone network topologies, the cost bounds and the approximation ratios of Member-Only and Reroute-to-Source heuristics are far from the worst case ones. This is due to the fact that unweighted NSF network has a very small diameter of three. In addition, the Member-Only algorithm achieves better cost than the Reroute-to-Source algorithm.

■ **Key points of Chapter 4** ■

- The tight cost bounds of multicast light-trees used for AOMR in sparse splitting WDM networks are derived.
- The approximation ratios of two heuristic AOMR algorithms are deduced mathematically in both unweighted and non-equally-weighted sparse splitting WDM networks.
- A new ILP formulation is proposed and implemented to compute the cost-optimal multicast light-trees.

Part V

Light-Hierarchy Based All-Optical
Multicast Routing

Is Light-Tree Structure Optimal for AOMR in Sparse Splitting WDM Networks?

5.1 Introduction

The main objective of multicast routing and wavelength assignment (MRWA) [30] problem is to optimize the optical network resources in terms of total cost (wavelength channel cost), link stress (maximum number of wavelengths required per fiber), optical power attenuation (impacted by the average end-to-end delay and diameter of the light-tree) as well as the network throughput. Normally, the light-tree structure [71] is thought to be optimal for all-optical multicasting. Thus, a set of light-trees (i.e. a light-forest [98]) is employed to accommodate a multicast session. Accordingly, numerous light-trees construction algorithms have been developed such as Reroute-to-Source, Member-First and Member-Only [98]. Member-Only is based on the Minimum Path Heuristic [82] and thus currently thought to achieve the best cost and link stress [30, 103, 98].

In full light splitting WDM networks, one light-tree is enough to cover all the multicast members. Thus the light-tree structure is optimal for AOM in terms of total cost and link stress. But, is the light-tree structure still optimal for AOMR in sparse splitting WDM networks? Unfortunately, the answer is no. Under sparse splitting constraint, the degree of an MI node in a light-tree is restricted by its splitting capacity. Consequently, several light-trees may be required to establish one multicast group. As a result, the quality of an

AOMR algorithm not only depends on the quality of each light-tree but also depends on the number of light-trees built for a multicast session. Given a multicast session, the more destinations a light-structure can span, the fewer light-structures a multicast session will require. Besides, it is interesting to find that an MI node with degree of 4 (or more) could be able to concurrently distribute a light signal to two downstream branches in a light-tree provided that each branch uses a different pair of input and output ports. This means that a high degree MI node may help to include more destinations in a light structure. Based on this basic idea, in our study we propose a new multicast structure called light-hierarchy to span as many destinations as possible aiming at improving the link stress and network throughput. Similar to a light-tree, only one wavelength is occupied over all the links in a light-hierarchy. But different from a light-tree, a light-hierarchy accepts cycles. The cycles in a light-hierarchy permit to traverse a 4-degree MI node twice (or more) and thus crosswise switch two signals on the same wavelengths to two destinations in the same group by using two different input and output pairs.

In this chapter, a Graph Renewal Strategy is proposed to improve the link stress of light-trees, and an In Tree Distance Priority is applied to improve the delay and diameter of light-trees. Then, the Graph Renewal Strategy is extended to compute light-hierarchies to improve the multicast performance again in terms of link stress and network throughput.

5.2 All-Optical Multicast Routing Problem and Motivation

An all-optical WDM mesh network is considered, where light splitters are very sparse and the costly wavelength converters are not available. And we assume that the same wavelength can only be used once in one optical fiber, either in the forward or in the backward direction. A multicast session $ms(s, D)$ is assumed to be required. In order to accommodate this multicast group, a light distribution structure under optical constraints (i.e., wavelength continuity, distinct wavelength [60], sparse light splitting [53] and lack of wavelength conversion) should be built to optimize the network resources such as total cost (i.e., wavelength channels cost) and the link stress (i.e., maximum number of wavelengths required per link). Furthermore, considering the QoS for the time sensitive multimedia applications, the average end-to-end delay needs to be minimized. Taking account of the signal attenuation over distance and the number of amplifiers needed, the diameter (or the height) of the light distribution structures should not be too large. And from the point of view of the network throughput, the call blocking probability (or the inverse of the number of sessions accepted) should be as small as possible. However, not all these parameters

could be optimized simultaneously. Here, we are focused on reducing the link stress and improving the network throughput.

5.3 Proposed Solutions

5.3.1 Graph Renewal Strategy

According to the Member-Only algorithm [98], during the construction of a light-tree, non-leaf MI nodes in the subtree LT (i.e., the nodes in MI_SET) have exhausted their TaC capability, and thus could not be used again to connect another destination to the subtree LT . Since they are useless for the spanning of the current light-tree, why don't we delete them from the graph? At each step, in a new graph, say G_i (generated by deleting all the non-leaf MI nodes in LT from the original graph G), we compute the shortest paths and the distances from the destinations in set D to LT . Then, add the nearest destination to LT with the shortest path in G_i . Here, we can see, it is definitely true that the shortest paths between any two nodes in the new graph G_i will not traverse any nodes in MI_SET . Hence, by computing the shortest path in the new graph, when finding the nearest destination to the subtree LT , we do not need to check whether its shortest path to LT (precisely speaking, to its connector node in MC_SET for LT) satisfies the light splitting constraint or not.

The Graph Renewal Strategy has two benefits compared to Member-Only algorithm. Firstly, the possible shortest path to connect a destination to a light-tree could be definitely computed out if it exists. Secondly, in case that the constraint-satisfied shortest path does not exist, a longer path will be used to connect a destination to the current light-tree. And this path is the shortest one among all the possible constraint-satisfied paths. But with the Member-Only algorithm, only the shortest path is used to span the light-tree and not all the possible shortest path could be enumerated for each node pair. Hence, more available paths could be found to join a destination to the current light-tree with the Graph Renewal strategy. We use the following example to explain the procedure of the Graph Renewal strategy.

Example 1: In the NSF network of Fig. 5.1, a multicast request $ms_1(s : 7, D : (4, 6))$ arrives, and only the source is an MC node. Using Member-Only algorithm, node 4 is firstly connected to node 7 using the shortest path $SP(7 - 5 - 4)$. Now, $MC_SET = \{4, 7\}$, $MI_SET = \{5\}$. Next, compute the shortest paths from node 6 to the nodes in MC_SET . Both $SP(4 - 5 - 6)$ and $SP(7 - 5 - 6)$ involve non-leaf MI node 5, thus the

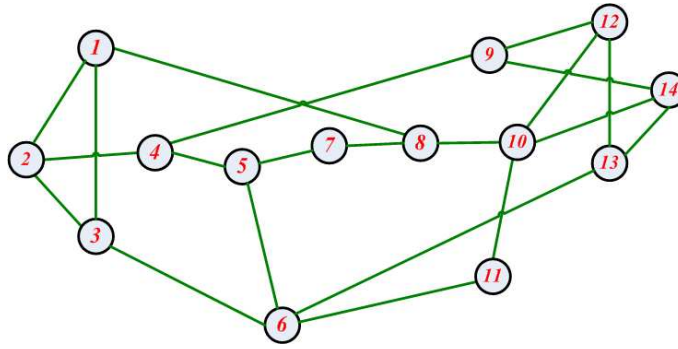

Figure 5.1: NSF Network Topology

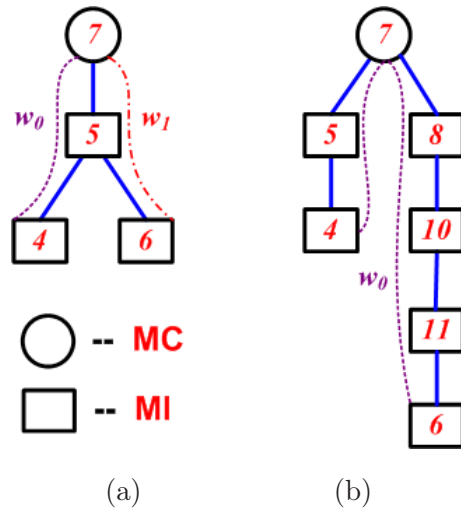

Figure 5.2: For Multicast Session ms_1 , (a) Light-Tree Built by the Member-Only Algorithm; (b) Light-Tree Built Using the Hypo-Steiner Heuristic.

span of the first light-tree LT_1 should be stopped and a new light-tree LT_2 on wavelength w_1 is required to accommodate node 6 as shown in Fig. 5.2(a). But, here if we perform the Graph Renewal Strategy (delete non-leaf MI node 5 in LT_1 from the original graph G_1 to get a new graph G_2), the shortest path $SP_{G_2}(7 - 8 - 10 - 11 - 6)$ in the new graph G_2 could be found to connect node 6. It is worth noting that $SP_{G_2}(7 - 8 - 10 - 11 - 6)$ is not the shortest path in the original graph, but it is the constraint-satisfied path with the smallest length. As demonstrated in Fig. 5.2(b), one light-tree is sufficient to cover all the multicast members, and thus only wavelength w_0 is required for $ms_1 = (s : 7, D : (4, 6))$.

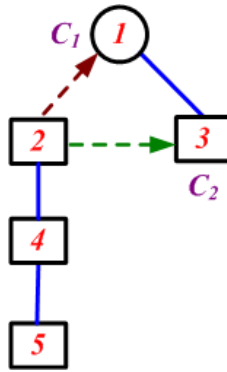

Figure 5.3: Distance Priority

5.3.2 In Tree Distance Priority to Improve Delay and Diameter

The Distance Priority proposed in [102] and Chapter 2 could be applied here to reduce the delay and diameter of light distribution structures. The nodes in MC_SET are assigned priorities according to their distances to the source in the subtree LT (that is why it is called In Tree Distance Priority). Hence, the source itself is associated with the highest priority. This priority is applied when a destination to be added is equally away from more than one connector node in MC_SET . From the point of view of the end-to-end delay and the diameter of light-trees, it is better to add a destination to LT via the connector node nearest to the source in LT .

Example 2: Multicast session $ms_2(s : 1, D : (2 \sim 5))$ request arrives at node 1 in the NSF network in Fig. 5.1. Seen from the Fig. 5.3, after the source nodes 1 and 3 are added to the subtree LT , node 2 can be connected via both connector nodes 1 and 3. Since node 1 has higher priority, node 2 is connected via it to the subtree. Then, nodes 4 and 5 are joined. With the In Tree Distance Priority, delay from source node 1 to node 2 is reduced by 1 hop (compared with connected to node 3), and the diameter of the tree is reduced by one hop. Furthermore, the delays from source to those nodes (i.e., nodes 4 and 5) which are joined to the light-tree via node 2 are also reduced. Accordingly, the average end-to-end delay will be reduced too.

5.3.3 A New Structure: Light-Hierarchy

Due to its TaC capability, an MI node is able to connect only one successor in a light-tree. However, for an MI node with high degree (at least of 4), two signals on the same wavelength from two different incoming ports can be switched to two different outgoing

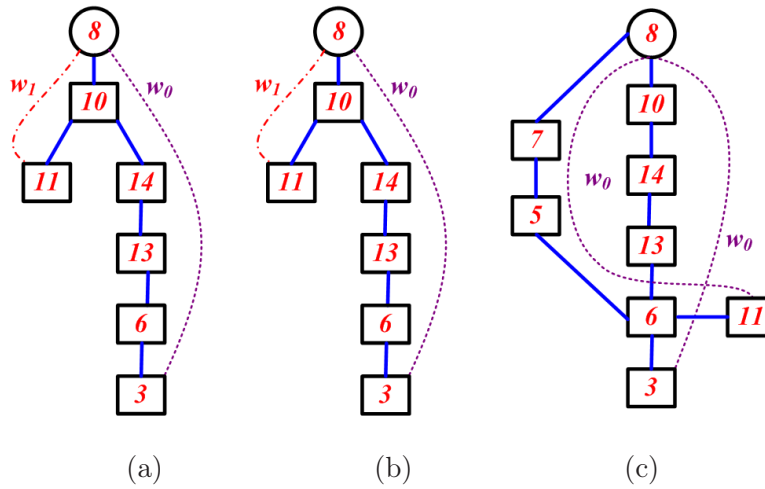

Figure 5.4: For Multicast Session ms_3 , (a) Light-Trees Built by the Member-Only Algorithm; (b) Light-Trees Built by the Graph Renewal Strategy; (c) Light-Hierarchy Built by the Extended Graph Renewal Strategy

ports without any conflict (for instance in Fig. 5.4(c), two signals on the same wavelength w_0 from the source 8 traverse MI node 6 twice through two cross paths to reach destination 3 and 11). As a result an MI node could be visited twice in the light distribution structure by making use of different input and output port pairs. In this case, the multicast structure will be no longer a light-tree, but a light-hierarchy, where cycles may exist (cf. Fig. 5.4(c)). A light-hierarchy is an extension of a light-tree, which is covered by only one wavelength. By benefiting from the particular capacity of 4-degree MI nodes, more destinations could be spanned by a light-hierarchy and fewer light-hierarchies will be required compared to light-trees. Hence the link stress could be improved. As fewer wavelengths a multicast session requires, more multicast sessions may be accepted in the network, which may lead to the improvement of network throughput also.

The light-hierarchy structure overcomes the inherent shortcoming of the light-tree structure, since a 4-degree MI node can be visited more than once in a light-hierarchy (LH). Nevertheless a link already in a sub LH cannot be used any more on the same LH . In order to compute a light-hierarchy, Graph Renewal Strategy can be employed too. But, the topology renewal operation should be modified. At iteration i , only the edges in the shortest path newly added to LH are deleted from G_i , which then generates a new graph G_{i+1} for the next iteration.

Example 3: Multicast session $ms_3(s : 8, D : (3, 6, 10, 11, 13, 14))$ is needed in the NSF network (refer to Fig. 5.1 in page 110). Only the source is an MC node. Applying

Member-Only algorithm [98], node 10 is first added to the light-tree. Since both nodes 11 and 14 have the same distance of 1 hop to node 10, there are two possibilities. On one hand, if node 14 is connected to node 10 at first, then the light-trees in Fig. 5.4(a) may be obtained by Member-Only with the adding order of nodes: 8-10-14-13-6-3, 8-10-11. The same light-trees in Fig. 5.4(b) will be obtained by Graph Renewal Strategy too with the same adding order of nodes. This is because that node 10 is deleted from graph G_1 after node 14 connects to it, and 4-degree MI node 6 is deleted from graph G_4 after node 3 connects to it. At this moment, node 11 is an isolated node in the new graph G_5 . Hence, it could not be spanned in the current light-tree and another light-tree should be built. However, with the help of the light-hierarchy, the constraint could be relaxed. To generate a new graph, only the used edges are deleted from the previous graph. 4-degree MI node 6 is still retained in the new graph and so are the edges (6-11) and (6-5). It is easy to find the path $P(8 - 7 - 5 - 6 - 11)$ for node 11 in the new graph with Dijkstra's algorithm. So, the light-hierarchy in Fig. 5.4(c) benefits from the 4-degree MI node 6. It is able to save one wavelength. On the other hand, if node 11 is assumed to be connected to node 10 earlier than 14, Member-Only algorithm still needs two wavelengths while the other two strategies require only one.

5.3.4 Proposed Algorithms

Based on the above strategies, we propose two multicast routing algorithms with two different structures in WDM networks: Graph Renewal & Distance Priority Light-Tree algorithm (GRDP-LT) and Extended Graph Renewal & Distance Priority Light-Hierarchy algorithm (GRDP-LH). The difference between them is the strategy of graph generation operation (cf. step-13 in Algorithm 4 in page 124), which corresponds to different light-structures. In a light-hierarchy, the inherent shortcoming of the light-tree structure is overcome. That is why it is able to achieve the lowest link stress (cf. Fig. 5.5).

5.4 Wavelength Assignment

The wavelength assignment problem (WAP [37]) is always accompanied with the routing problems in WDM networks. It aims to assign wavelengths to a set of routes so that the number of wavelengths required can be minimized. Hence, the strategy for WAP also greatly impacts the performance of the routing algorithms. However, it is proved in [86] that WAP is NP-complete even in simple networks like rings or trees.

In our implementation, the First-Fit [32] idea is employed. We search the wavelengths from index 1 to W (the maximum index), until we find the first wavelength index which is available on all the fiber links in a light-structure (i.e., light-tree or light-hierarchy). If and only if all the light-structures for a multicast session are assigned with a free wavelength index, this session could be accepted. Otherwise (i.e. no such wavelength index could be found), the multicast session will be blocked.

5.5 Performance Evaluation and Simulation

5.5.1 Simulation Model

From previous 3 examples, we can see the proposed algorithms work well in the NSF network (Fig. 5.1). To show its flexibility, other topologies like USA Longhaul network (cf. Fig. 2.10, 28 nodes, 7 nodes 4-degree and 1 node 5-degree) and European Cost-239 network [104, 102] (11 nodes, 4 nodes 4-degree, 6 nodes 5-degree and 1 node 6-degree) are employed as platforms for the simulations. In these topologies, without loss of generality each edge is associated with an equal cost of 1 *unit hop – count cost* and an equal delay of 1 *unit hop – count delay*. For each fiber between two neighbor nodes, the number of wavelengths supported is denoted by W . It is set to $W = 20$ for the sake of short simulation time. The members of a multicast group and the MC nodes are assumed to be uniformly distributed in the topology. When simulating the throughput of the network, the multicast group size (including the source) is generated by a random variable following a uniform distribution in the interval $[3, N - 1]$, where N is the number of nodes in the network.

5.5.2 Performance Analysis

In our simulation, five metrics are considered: link stress, average delay, diameter, total cost and network throughput. The diameter is defined as the maximum hop counts from the source to all the destinations. And the network throughput is defined as the maximum number of multicast sessions that could be accepted concurrently if the number of wavelengths in optical fibers is fixed ($W = 20$ in our case).

Initially, the GRDP-LT algorithm is compared with the famous Member-Only algorithm (MO). Since both of them produce light-trees for a multicast request, this step aims to show the performance improvement by using the proposed Graph Renewal & Distance Priority algorithm. Then, the comparison of performance is done between two different

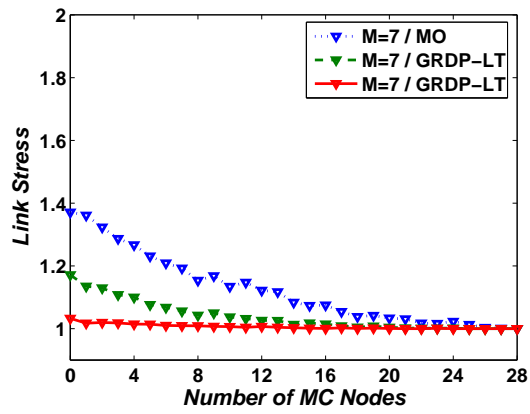

(a)

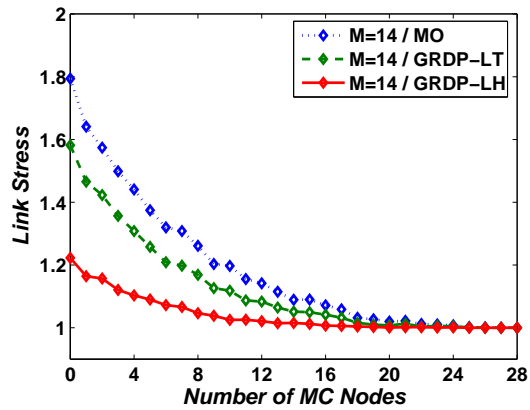

(b)

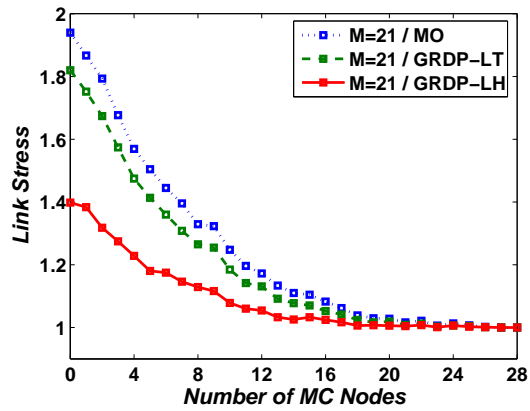

(c)

Figure 5.5: Comparison of the Link Stress in the USA Longhaul Topology when the Multicast Member (a) Ratio = 25%; (b) Ratio = 50%; (c) Ratio = 75%.

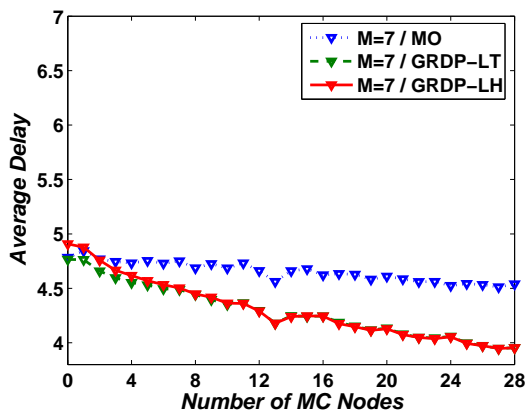

(a)

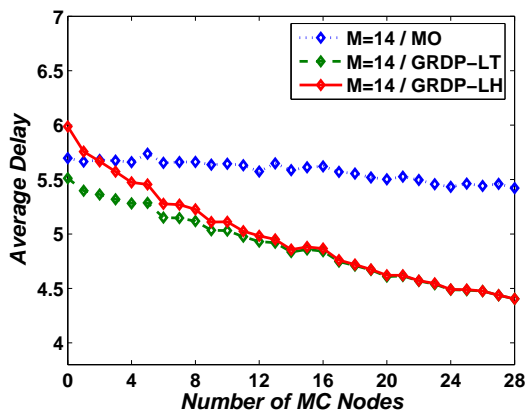

(b)

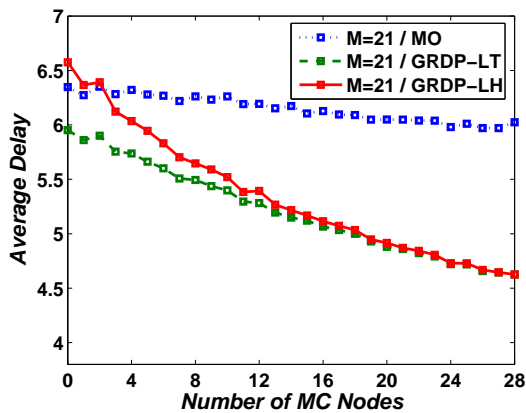

(c)

Figure 5.6: Comparison of the Average Delay in the USA Longhaul Topology when Multicast Member (a) Ratio = 25%; (b) Ratio = 50%; (c) Ratio = 75%.

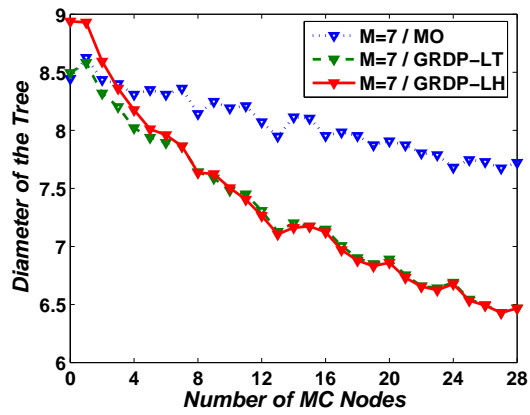

(a)

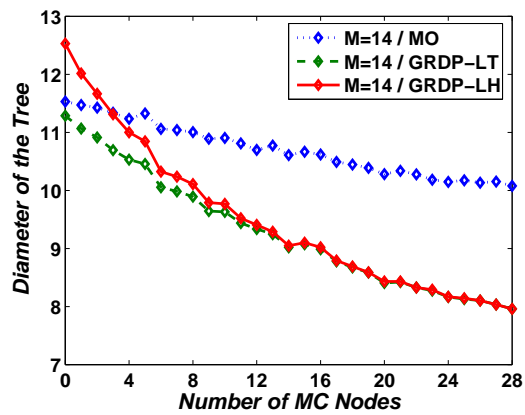

(b)

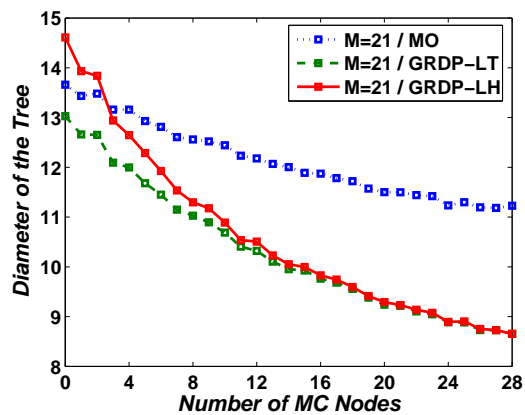

(c)

Figure 5.7: Comparison of the Diameter in the USA Longhaul Topology when Multicast Member (a) Ratio = 25%; (b) Ratio = 50%; (c) Ratio = 75%.

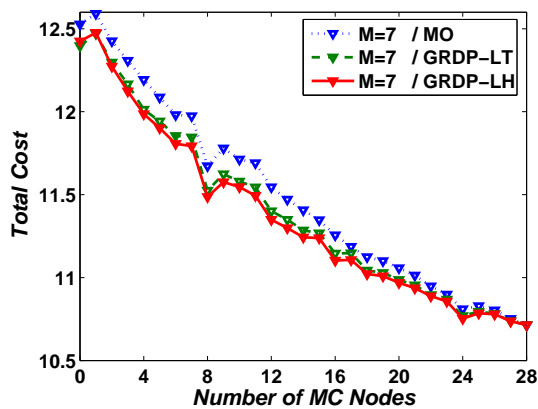

(a)

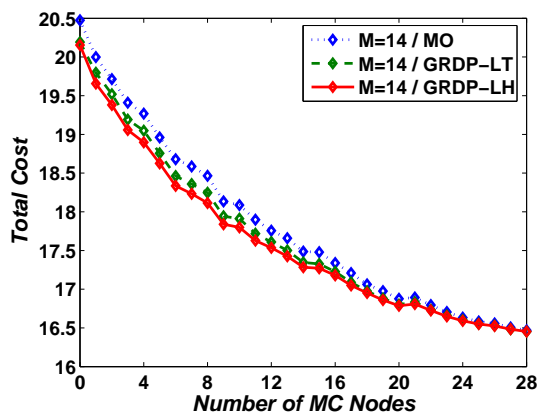

(b)

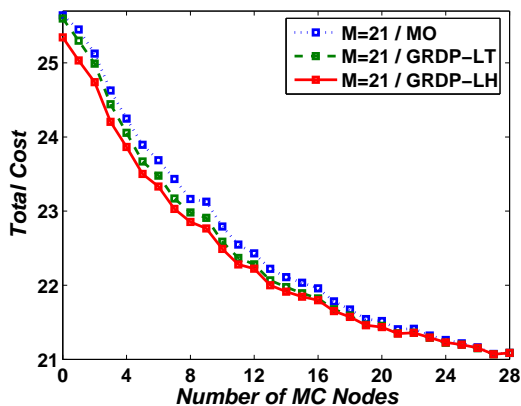

(c)

Figure 5.8: Comparison of the Total Cost in the USA Longhaul Topology versus Multicast Member (a) Ratio = 25%; (b) Ratio = 50%; (c) Ratio = 75%.

multicast structures: light-tree and light-hierarchy (using GRDP-LH algorithm). From the comparison, we will verify whether light-tree structure is still optimal in sparse splitting WDM mesh network and evaluate the quality of light-hierarchy.

MO versus GRDP-LT

In Figs. 5.5-5.9, the results of simulations in the USA Longhaul topology and the European Cost-239 topology are presented.

(i) As plot in Fig. 5.5, the link stress of GRDP-LT light-tress is always lower than MO, reduced up to 15%, 12% and 6% (calculated by $(\text{MO-GRDP})/\text{MO}$) when the group size (M , counting the source) equals to 7, 14 and 21 respectively. The reason can be explained as follows: since more available paths could be found to connect a destination to a light-tree, more destinations could be spanned in a light-tree and thus fewer light-trees are required for a multicast session.

(ii) In Figs. 5.6 and 5.7, both the average delay and the diameter of light-trees for GRDP-LT are smaller than MO. Furthermore, it is not difficult to find that the reduction of the average delay and the diameter become significant (up to 13%, 19% and 23% for average delay respectively when the group size $M=7, 14$ and 21 ; and up to 16%, 21% and 23% for diameter of light-trees respectively when $M=7, 14$ and 21), when the number of MC increases. It is because that the In Tree Distance Priority operative only when there are enough MC connector nodes for a chosen destination to join the current multicast light-tree. And, the preconditions to produce enough choices of connector MC nodes are: first the proportion of MC nodes in the network is high enough, and second there are sufficient destinations in a multicast session.

(iii) As shown in Figs. 5.8(a)(b)(c), the total cost of GRDP-LT is slightly better than MO in any situation. This is because both these two algorithms apply the Minimum Path Heuristic [82].

(iv) From the point of view of the throughput, GRDP-LT is able to stand a little more multicast sessions simultaneously than MO as shown in Figs. 5.9(a)(b).

Light-tree versus Light-hierarchy

(i) As plotted in Fig. 5.5, if there is no MC node in the network, the link stress of light-hierarchies is 0.14, 0.36 and 0.42 respectively smaller than GRDP-LT light-trees when

M=7, 14 and 21. It is very interesting to find that the light-hierarchy structure is able to reduce the link stress more and more as the number of members grows. The advantage of light-hierarchies is even more evident in the sparse light splitting case.

(ii) We can also see in the Figs. 5.6 and 5.7 before the number of MC nodes grows larger than 3 (corresponding to 10% of MC nodes), the average delay and the diameter of light-hierarchies is bigger than GRDP-LT, and even than MO. Fortunately, when the number of MC nodes is above 4, these two parameters for light-hierarchies decrease to below MO, and also approach to GRDP-LT until they reach the same value. The reason is that, when there is no MC node or the MC nodes are too sparse, in order to include more destinations in one light-hierarchy and thus to reduce the link stress, longer paths should be employed to connect destinations which cannot be connected by using the shortest path as done in Member-Only algorithm. And, in case that the proportion of MC nodes is high enough, the In Tree Distance Priority works well.

(iii) As far as the total cost indicated in Figs. 5.8(a)(b)(c), light-hierarchy structure achieves almost the same or slightly better than GRDP-LT, not even to say than MO.

(iv) Regarding throughput, up to 4.7 additional multicast sessions (an improvement of 22%) can be accepted by the light-hierarchy structure compared to GRDP-LT as plotted in Fig. 5.9(b). And whatever the number of MC nodes is, the light-hierarchy can accommodate more additional multicast sessions than both GRDP-LT and MO. Moreover, in order to study the throughput versus the number of 4-degree MI nodes in the topology, we also plot the number of multicast sessions accepted before blocking in European Cost-239 network, where all 11 nodes have a degree of at least 4. As shown in Fig. 5.9(c), the light-hierarchy structure has accepted the same number (39.5, when 50% of nodes are MC) of multicast sessions as GRDP-LT. European Cost-239 is a network with high connectivity, generally only one light-tree is enough to accommodate all multicast members with GRDP-LT algorithm. Hence, it is reasonable that GRDP-LH has the same performance as GRDP-LT in terms of throughput when all network nodes have 4 degree or above.

Is Light-tree Structure Optimal?

From the two comparisons above, we can see that although the Graph Renewal strategy could be used to improve the quality of light-trees, the improvement is limited. This limitation is mainly due to the inherent drawback of light-tree structure. With help of the light-hierarchy structure, the constraint is relaxed to delete used links. By benefiting from the at least 4-degree MI nodes, a light-hierarchy has an even bigger capacity to span more

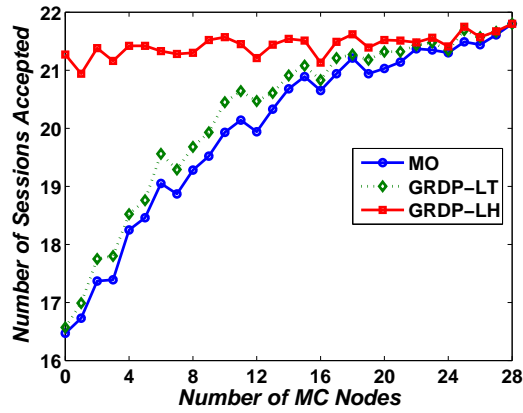

(a)

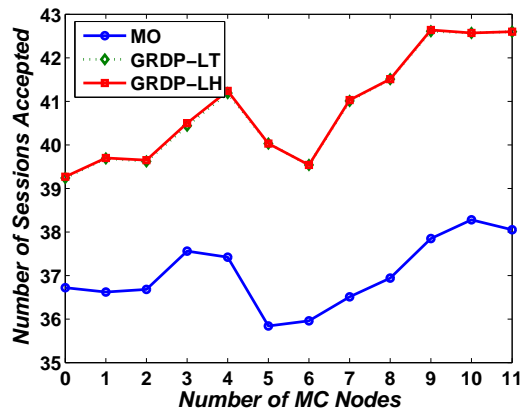

(b)

Figure 5.9: Comparison of Throughput in (a) USA Longhaul Topology; (b) Cost-239 Topology.

destinations. Thus link stress and network throughput could be greatly improved again. Based on the analysis and the numeric results, it is obvious that the light-tree structure is no longer optimal in terms of link stress and throughput, but the proposed light-hierarchy structure can be better.

5.6 Conclusion

In this chapter, a Graph Renewal Strategy is first introduced to improve the quality of light-trees, which deletes the constraint nodes from the network topology. By spanning the nearest destination with the shortest path in the renewed graph, the Graph Renewal Strategy diminishes the link stress and total cost. It also gains a higher network through-

put than the currently most efficient algorithm. Then, the In Tree Distance Priority is incorporated to reduce the average delay and the diameters of light-trees.

However, the improvement of the Graph Renewal Strategy is limited due to the inherent drawback of the light-tree structure. Thereby, a new multicast structure called light-hierarchy is proposed. A light-hierarchy is an extension of a light-tree, while it accepts cycles. With the help of the light-hierarchy structure, the constraint of nodal degree in multicasting is relaxed, and accordingly the Graph Renewal Strategy is extended to compute light-hierarchies. Simulations showed that the performance in terms of link stress and network throughput is greatly improved again by light-hierarchies, while consuming the same wavelength channel cost. Therefore, the light-tree structure is not optimal, but the light-hierarchy structure can be a better counterpart for multicast routing in sparse splitting WDM networks.

In fact the light-hierarchy proposed in this chapter is a simple version. As only one fiber is assumed in each link, the same wavelength can not be used twice in the same fiber. In the case that two optical fibers are placed in each link, the same wavelength can be employed in opposite directions concurrently. Then, the structure of light-hierarchy will become more complicated. This is why the concept of light-hierarchy is generalized in the next chapter.

■ Key points of Chapter 5 ■

- A graph renewal strategy incorporated with an 'in tree distance priority' is proposed to improve the quality of multicast light-tree.
- A simple version of light-hierarchy is introduced to overcome the inherent shortcoming of light-tree structure.
- Simulation results demonstrate the advantages of light-hierarchy in terms of link stress, total cost, and the throughput.
- With the help of the 'in tree distance priority', the light-hierarchy can also get good average delay and diameter.

Algorithm 4 Graph Renewal & Distance Priority Light-Tree Algorithm (GRDP-LT) / (GRDP-LH)

Input: A graph $G(V, E, c, W)$ and a multicast session $ms(s, D_0)$.

Output: A set of Light-structures LS_k each on a different wavelength w_k for $ms(s, D_0)$.

```

1:  $k \leftarrow 1, D \leftarrow D_0$ 
2: while ( $D \neq \emptyset$ ) do
3:    $i \leftarrow 1$  { $i$  is the serial number of a renewed graph}
4:    $G_i \leftarrow G, MC\_SET \leftarrow \{s\}, LS_k \leftarrow \{s\}$ 
5:   while ( $D$  is reachable from  $MC\_SET$  of  $LS_k$ ) do
6:     Find the nearest destination  $d_i$  to  $LS_k$ , and choose the optimal connector
       node  $c_i$  for  $d_i$ 
       1. Compute all the shortest path  $SP_{G_i}(d, c)$  in  $G_i$  from each  $d \in D$  to
           $c \in MC\_SET$ 
       2. Find the nearest destination  $d_i$  to  $LS_k$  such that
          
$$c(SP_{G_i}(d_i, c)) = \min_{d \in D, c \in MC\_SET} c(SP_{G_i}(d, c)) \quad (5.1)$$

          {Function  $c()$  is the cost of a path}
       3. Find the nearest connector node  $c_i$  to source  $s$  in  $LS_k$ , if there are several
          connector nodes satisfying equation (5.1)
7:     Add  $SP_{G_i}(d_i, c_i)$  to  $LS_k$ 
8:      $D \leftarrow D \setminus \{d_i\}$ 
9:     Add  $d_i$  and MC nodes in  $SP_{G_i}(d_i, c_i)$  to  $MC\_SET$ 
10:    if ( $c_i$  is an MI node) then
11:      Remove  $c_i$  from  $MC\_SET$ 
12:    end if
13:    Generate a new graph  $G_{i+1}$  from  $G_i$ .

```

GRDP-LT: Delete all the non-leaf MI nodes and edges in $SP_{G_i}(d_i, c_i)$ from G_i , except d if it is an MI node.

GRDP-LH: Only delete the edges in $SP_{G_i}(d_i, c_i)$ from G_i .

```

14:    $i \leftarrow i + 1$ 
15: end while
16: Assign wavelength  $w_k$  to  $LS_k$ 
17:  $k \leftarrow k + 1$  {Star a new light-structure  $LS_{k+1}$ }
18: end while

```

Light-Hierarchy: The Optimal Structure for AOMR in WDM Mesh Networks

6.1 Introduction

Based on the false assumption that MI nodes could not be traversed twice on the same wavelength, the light-tree structure was always thought to be cost-optimal for AOMR in WDM networks with sparse splitting. As proved in [37], it is a Steiner problem and NP-hard to find the light-tree with the minimized wavelength channel cost. Thus, a lot of ILP solutions are proposed for AOMR under different system models. For instance, paper [96] proposed an ILP formulation to compute the loss balanced light-trees for multicast routing with multi-drops constraints. In [12], an ILP formulation is developed to search the cost-optimal light-tree solution for AOMR under delay constraints. However paper [104] and Chapter 5 pointed out that the light-tree structure is not optimal if there are high degree (no less than 4) MI nodes in the network. By benefiting from these high degree MI nodes, link stress, network throughput and total cost can be greatly improved. Papers [3, 48] proposed the light-trail for AOMR in WDM networks without splitters. But, the so called light-trail structure does not take advantages of light splitters. Thus it is not efficient for multicasting in the case of sparse splitting configuration.

By intelligently using high degree MI nodes, Chapter 5 just presents a simple version of the light-hierarchy. In fact, if there are two fibers between a pair of nodes, any MI

node in a WDM network could be crosswise visited more than once to switch a light signal towards several destinations with only one wavelength through different input and output pairs. This capacity is called Cross Pair Switching (*CPS*). With the help of the special *CPS* capacity of MI nodes, the concept of the light-hierarchy is generalized in this chapter for cost-optimal AOMR in WDM networks with sparse splitting. Contrary to the traditional assumption, an MI node can be viewed as a special branching node, because it is able to distribute a light signal to two downstream branches in a light-tree provided that each branch uses a different pair of input and output ports. Thus, there may be some cycles in a light-hierarchy which is produced by using the *CPS* capacity of MI nodes. In this chapter we prove that the cost-optimal multicast structure in sparse splitting WDM networks is no longer a set of light-trees, but a set of light-hierarchies. Since it is also NP-Complete to compute the light-hierarchy with the minimized total cost, we formulate the light-hierarchy based cost-optimal AOMR problem as an ILP. Numerical results verified that the light-hierarchy structure could save more cost than the light-tree structure.

6.2 Cost Optimal All-Optical Multicast Routing

Costly wavelength converters are not available in our studied WDM networks. The fiber cable between any pair of neighbor nodes consists of two oppositely directed fiber links. We consider a multicast session $ms(s, D)$, which requests for setting up a set of multicast distribution light-structures (e.g., light-trees) from the source s to a group of destinations D simultaneously under the following optical constraints: (i) Wavelength Continuity Constraint. In the absence of wavelength converters, the same wavelength should be used continuously on all the links of a light-structure. (ii) Distinct Wavelength Constraint. Two light-structures should be assigned with different wavelengths unless there are edge disjoint. (iii) Sparse Splitting Constraint. Without loss of generality, assume k light-structures LS_i are computed in sequence for $ms(s, D)$, where $i \in [1, k]$, and $1 \leq k \leq |D|$. Regarding the optimization of network resources, the total cost (i.e., the wavelength channel cost consumed per multicast session) should be minimized. The total cost can be calculated by the cost sum of all the light-structures built for $ms(s, D)$.

$$\begin{aligned}
 c(ms(s, D)) &= \sum_{i=1}^k c(LS_i) \\
 &= \sum_{i=1}^k \sum_{e \in LS_i} c(e)
 \end{aligned} \tag{6.1}$$

6.3 Light-Hierarchy: A New Structure for All-Optical Multicast Routing

An MI node is only equipped with TaC capacity and thus it is incapable of light splitting. In absence of wavelength converters, the same wavelength should be retained along all the links in a light-tree. Therefore, the MI nodes were thought to be able to only act either as a leaf node or as a two degree intermediate node in a light-tree. Nevertheless, it is very interesting to find that an MI node can work as a special branching node by using Cross Pair Switching.

6.3.1 Cross Pair Switching

Since two oppositely directed optical fibers are placed between each two neighbor nodes in WDM networks, a non-terminal MI node is connected with at least two incoming links as well as two outgoing links as shown in Fig. 6.1. Assume two signals on the same wavelength w_0 come from two different lightpaths P_1 and P_2 . They enter two different input ports of an MI node. As we can see in Fig. 6.1, with the help of vacant port pairs, the MI node is able to switch these two signals into two outgoing ports without any conflict. Note that the signals are still on the same wavelength w_0 , but forwarded to different successor nodes. Here, we call it as Cross Pair Switching (*CPS*). Based on the *CPS* capacity of MI nodes, an MI node could connect two successor nodes in a light-structure (the same wavelength should be respected along all the paths in a light-structure) by making use of different input and output port pairs. In this case, an MI node can be traversed twice, then the multicast structure will be no longer a light-tree, but a light-hierarchy, where cycles may exist.

6.3.2 Light-hierarchy Structure

The concept of hierarchy is introduced in [57] to solve degree bounded and multi-constraints multicast routing problem. In sparse splitting WDM networks, the multicast structure can be a light-hierarchy with the help of Cross Pair Switching. A light-hierarchy is a set of consecutive and directed fiber links occupying the same wavelength, which is rooted from the source and terminated at the destinations. Different from a light-tree, light-hierarchy is free of the repetition of nodes while it forbids the duplicate of the same link. It can be expressed as an enumeration of nodes and links, for instance the light-hierarchy (LH) in Fig. 6.2(a) can be given by $LH = (s(l_{s1}, 1(l_{12}, 2(l_{24}, 4(l_{4d_1}, d_1))), l_{13}, 3(l_{34}, 4(l_{4d_2}, d_2))))$.

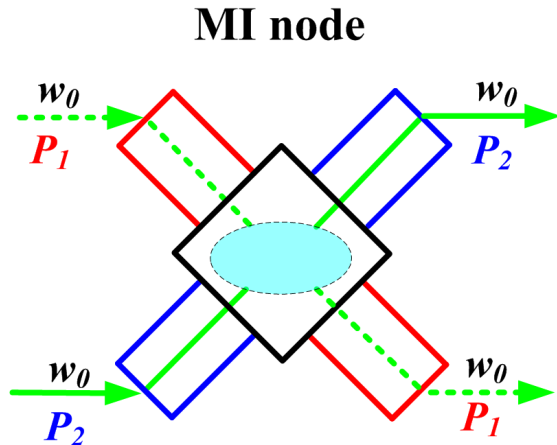

Figure 6.1: Cross Pair Switching of an MI Node

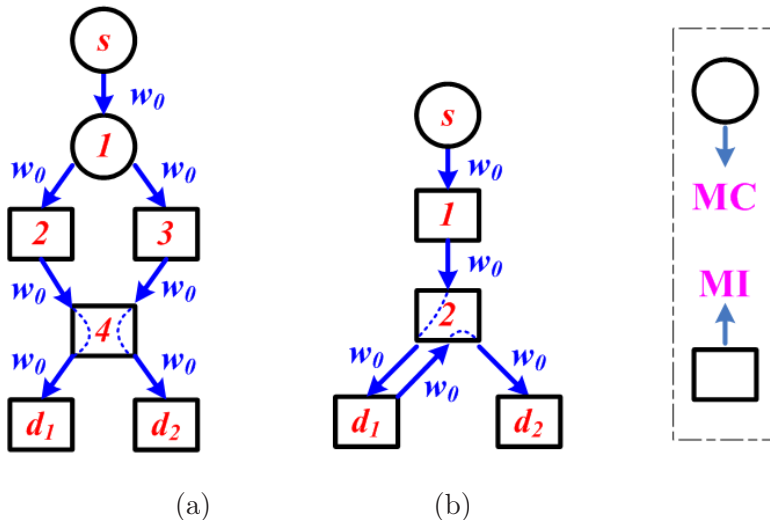

Figure 6.2: Two Typical Light-Hierarchies with Cross Pair Switching

Generally a light-hierarchy has the following characters: (a) Each link is directed and can be used only once. (b) Each link has one and only one predecessor link, except that the links coming from source have no predecessor link. (c) Cycles are permitted. (d) Only one wavelength is occupied over all the links. (e) Between each pair of nodes in a light-hierarchy, there are at most two links. Two links are only permitted in condition that they are used for opposite direction communications. (f) The number of input and output links of a node varies according to its splitting capacity. For a non-terminal MI node, multiple incoming links are allowed. However, each incoming link should correspond to distinct outgoing link. Hence, the number of input links of a non-terminal MI node should be equal to that of its output links. Besides, an MC node should have one and only

one input link. As in candidate WDM backbone networks like NSF, USA Longhaul, and European Cost-239 networks, the nodal degree is at most 6, we assume that an MC node is capable of splitting the light signal into as many outgoing branches as its nodal degree in the topology.

Two typical light-hierarchies with Cross Pair Switching are demonstrated in Fig. 6.2. Source node s multicast messages to destinations d_1 and d_2 . In Fig. 6.2(a), the light signal emitted by s is split into 2 copies by MC node 1, then these two copies enter two different incoming ports of MI node 4 and are switched to destinations d_1 and d_2 respectively. This kind of Cross Pair Switching benefits from the high degree of MI node 4 (with a degree of at least 4). While in Fig. 6.2(b) the light signal first goes out from MI node 2 to destination d_1 and returns back to it after a round trip in the edge between nodes 2 and d_1 , i.e. $link(2, d_1)$ and $link(d_1, 2)$. The light signal is then forwarded to destination d_2 . This Cross Pair Switching is based on the simultaneous usage of two oppositely directional fiber links. However, Cross Pair Switching is not always necessary, and thus the light-tree structure can also be viewed as a special light-hierarchy without Cross Pair Switching.

Theorem 8. *To minimize the wavelength channel cost for a multicast session under sparse splitting constraint, the light-tree structure is not optimal.*

Proof. Consider the topology in Fig. 6.3(a) (drawn with solid line), a multicast session $ms(s, (d_1, d_2))$ arrives. To implement this session, two light-trees should be constructed. The optimal light-forest solution (i.e., a set of light-trees) is shown in Fig. 6.3(b): $LT_1 = \{s - 1 - 2 - 3 - 5(or4) - d_1\}$ and $LT_2 = \{s - 1 - 2 - 3 - d_2\}$. The total cost of the optimal light-trees is 9. However, by using the Cross Pair Switching capability of MI node 3, a light-hierarchy (plot in dash-dot line in Fig. 6.3(a)) could be found out: $LH = \{s - 1 - 2 - 3 - 5 - d_1 - 4 - 3 - d_2\}$. As we can see, one light-hierarchy is enough to include the two destinations. The total cost of this light-hierarchy is 8, which is one smaller than that of the optimal light-trees built. We can also see that as the distance between the source s and node 3 becomes bigger, more total cost will be saved. Hence, in this case, the light-hierarchy structure outperforms the light-tree structure, thus is a better solution. \square

Theorem 9. *The cost optimal multicast routing structure for sparse splitting WDM networks is a set of light-hierarchies (at least one).*

Proof. Here we just give a simple description of the proof (please refer to [57] for the detailed proof). It is trivial that a multicast session may be established on several wavelengths.

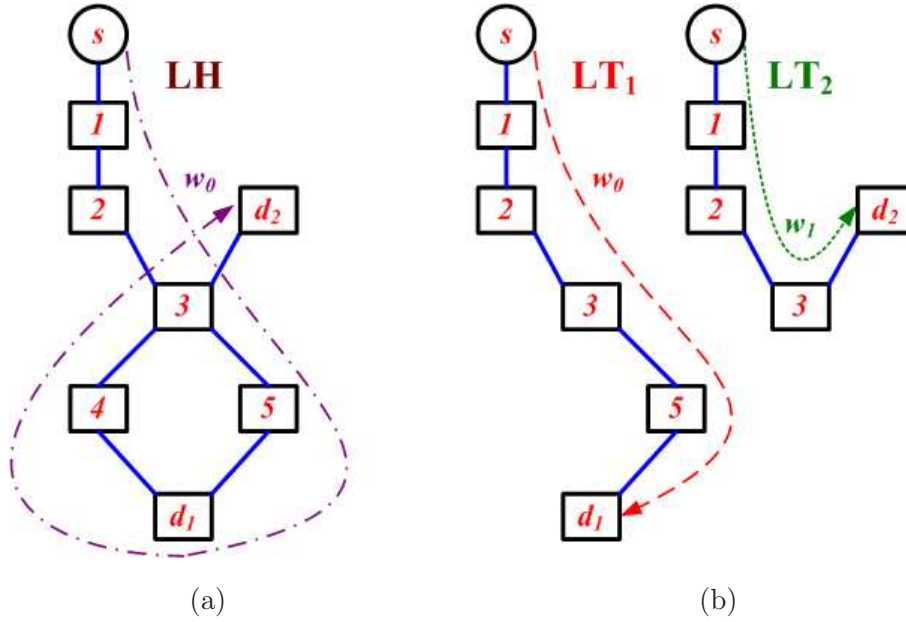

Figure 6.3: (a) An Example Network Topology and the Light-Hierarchy; (b) The Optimal Light-Trees for $ms(s, (d_1, d_2))$

Next we prove that the projection of the cost optimal structure on each used wavelength is a light-hierarchy. Consecutive links in a light-hierarchy assure its connectivity, and direction of links guarantees that the signal could propagate from the source to destinations. Hence, to prove its optimality, it is sufficient to prove that each link should have only one predecessor link in the cost optimal structure. Suppose each link in the optimal structure has two predecessor links. If one predecessor link is removed, then the connectivity and communication can still be guaranteed. Thus, it is not cost optimal and this contradicts with the assumption. So, *Theorem 9* follows. \square

6.4 ILP Formulation of Light-Hierarchy

With the help of Cross Pair Switching of MI nodes, the splitting constraint could be relaxed to some extent. Consequently more destinations may be served in one light-hierarchy. This is why the light-hierarchy structure can achieve the optimal cost. In this section, the integer linear programming (ILP) method is applied to search the cost optimal light-hierarchy solutions.

Network Parameters:

Δ	: An integer big enough such that $\Delta > W $.
λ	: A wavelength, $\lambda \in W$.
$In(m)$: The set of nodes which has an outgoing link leading to node m .
$Out(m)$: The set of nodes which can be reached from node m .
$Deg(m)$: The in (or out) degree of node m in G , where $Deg^-(m) = Deg^+(m) = Deg(m)$.
$link(m, n)$: The directed link from node m to node n .
$e(m, n)$: The edge connecting nodes m and n in G . It consists of $link(m, n)$ and $link(n, m)$.
$c_{m,n}$: The cost of the link from node m to node n .
MC_SET	: The set of MC nodes in G .
MI_SET	: The set of MI nodes in G .

ILP Variables:

$L_{m,n}(\lambda)$: Binary variable. Equals to 1 if multicast request $ms(s, D)$ uses wavelength λ on $link(m, n)$ equals to 0 otherwise.
$F_{m,n}(\lambda)$: Commodity flow. Denotes the number of destinations served by $link(m, n)$ on λ .
$w(\lambda)$: Binary variable. Equals to 1 if λ is by the light-hierarchies, equals to 0 otherwise.

6.4.1 ILP Formulation

The principle objective of our problem is minimizing the total cost for a multicast session $ms(s, D)$. Secondly, among the cost optimal light-hierarchy solutions, the one requiring the fewest wavelengths is favorable. To achieve this, a big enough integer Δ is introduced, which is superior to the number of wavelengths supported per fiber link, i.e. $\Delta > |W|$. Hence the general objective function can be expressed as follows:

$$Minimize : \Delta \cdot \sum_{\lambda \in W} \sum_{m \in V} \sum_{n \in In(m)} c_{n,m} \cdot L_{n,m}(\lambda) + \sum_{\lambda \in W} w(\lambda) \quad (6.2)$$

This objective function is subject to a set of constraints, which are listed below:

Light-Hierarchy Structure Constraints

Source Constraint:

$$\sum_{\lambda \in W} \sum_{n \in In(s)} L_{n,s}(\lambda) = 0 \quad (6.3)$$

$$1 \leq \sum_{\lambda \in W} \sum_{n \in Out(s)} L_{s,n}(\lambda) \leq |D| \quad (6.4)$$

Constraints (6.3) and (6.4) ensure that the light-hierarchies for multicast session $ms(s, D)$ are rooted at the source node s . The source s must not have any input link in a light-hierarchy, but must have at least one output link on some wavelength and the total number of links going out from s should not go beyond the number of sink nodes, i.e., $|D|$.

Destination Constraint:

$$1 \leq \sum_{\lambda \in W} \sum_{n \in In(d)} L_{n,d}(\lambda) \leq |D| - 1, \quad \forall d \in D \quad (6.5)$$

Constraint (6.5) guarantees that each destination node should be spanned in at least one but at most $|D| - 1$ light-hierarchies.

MC node Constraint:

$$\sum_{n \in In(m)} L_{n,m}(\lambda) \leq 1, \forall \lambda \in W, \forall m \in MC_SET \text{ and } m \neq s \quad (6.6)$$

$$\sum_{n \in Out(m)} L_{m,n}(\lambda) \leq Deg(m) \cdot \sum_{n \in In(m)} L_{n,m}(\lambda), \forall \lambda \in W, \forall m \in MC_SET \text{ and } m \neq s \quad (6.7)$$

Constraint (6.6) makes sure that each MC node has only one input link. This constraint together with constraint (6.7) also indicates that if and only if an MC node m is spanned in a light-hierarchy, then the number of outgoing links of m is between 1 and $Deg(m)$. Otherwise, the number of outgoing links of m must be 0.

MI node Constraint:

$$\sum_{n \in Out(m)} L_{m,n}(\lambda) \leq \sum_{n \in In(m)} L_{n,m}(\lambda), \forall \lambda \in W, \forall m \in MI_SET \text{ and } m \neq s \quad (6.8)$$

Since the number of input links is not restricted, MI nodes are enabled to make the Cross Pair Switching. According to equations (6.8) and (6.9), MI nodes are allowed to branch under the condition that the number of incoming branches equals the number of outgoing branches if they are non-member nodes. Nevertheless, the MI destination nodes may not have any outgoing branches.

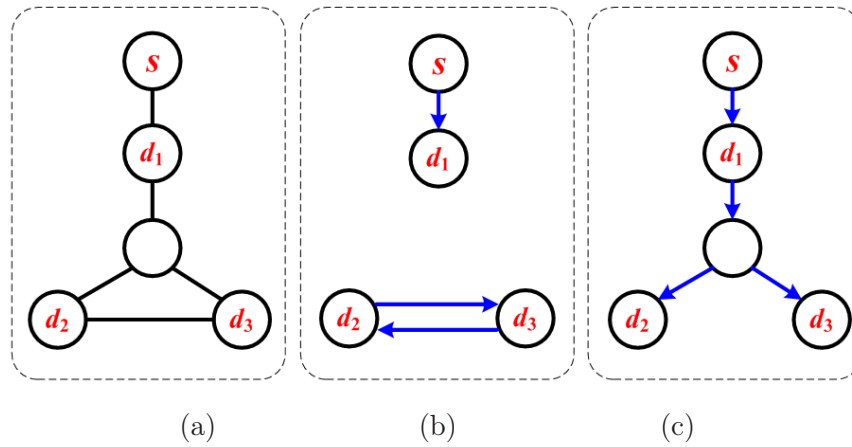

Figure 6.4: (a) An Example Network Topology; (b) The False Result; (c) The Optimal Result.

Leaf Node Constraint:

$$\sum_{n \in \text{Out}(m)} L_{m,n}(\lambda) \geq \sum_{n \in \text{In}(m)} L_{n,m}(\lambda), \forall \lambda \in W, \forall m \in V \text{ and } m \notin D \quad (6.9)$$

Constraint (6.9) ensures that only the destination nodes can be leaf nodes in the light-hierarchies while the non-member nodes can not.

Relationship between $L_{m,n}(\lambda)$ and $w(\lambda)$:

$$w(\lambda) \geq L_{m,n}(\lambda), \forall m, n \in V, \forall \lambda \in W \quad (6.10)$$

$$w(\lambda) \leq \sum_{\forall m \in V} \sum_{\forall n \in V} L_{m,n}(\lambda), \forall \lambda \in W \quad (6.11)$$

The light-hierarchy structure constraints above are not sufficient to guarantee that the resultant light-hierarchy be connected. For instance, $ms(s, (d_1 - d_3))$ is required in topology Fig. 6.4(a). By just applying the light-hierarchy structure constraints, the optimal solution is shown in Fig. 6.4(b): $L_{s,d_1}(\lambda_1) = 1$, $L_{d_2,d_3}(\lambda_1) = 1$, $L_{d_3,d_2}(\lambda_1) = 1$ while the other variables $L_{m,n}(\lambda) = 0$. Unfortunately the result is incorrect, although this result complies the light-hierarchy constraints above. This is because destinations d_2 and d_3 are not reachable from the source node 1. In [96], a commodity flow method was proposed to search the loss-balanced light-tree. Here, we apply this method to create supplementary formulations to restrain the variables $L_{n,m}(\lambda)$ in order that the continuity and the connectivity of the resultant light-hierarchy could be guaranteed.

Connectivity Constraints

To establish a multicast session, several light-hierarchies may be required. And the same destination may be spanned by several light-hierarchies. However, a destination can only be served [105] in one light-hierarchy to consume the light signal (i.e. receive the multicast messages), while it is spanned in the other light-hierarchies to uniquely forward the light signal to the successor node.

Source node:

$$\sum_{\lambda \in W} \sum_{n \in Out(s)} F_{s,n}(\lambda) = |D| \quad (6.12)$$

Constraint (6.12) indicates that the sum of the commodity flow emitted by the source should be equal to $|D|$ the number of destinations in the multicast session.

Destination nodes:

$$\sum_{\lambda \in W} \sum_{n \in In(d)} F_{n,d}(\lambda) = \sum_{\lambda \in W} \sum_{n \in Out(d)} F_{d,n}(\lambda) + 1, \forall d \in D \quad (6.13)$$

$$\sum_{n \in In(d)} F_{n,d}(\lambda) - 1 \leq \sum_{n \in Out(d)} F_{d,n}(\lambda) \leq \sum_{n \in In(d)} F_{n,d}(\lambda), \forall d \in D, \forall \lambda \in W \quad (6.14)$$

Equations (6.13) and (6.14) ensure that each destination node should consume totally one and only one flow in all the light-hierarchies. This constraint also guarantees that each destination is reachable from the source s .

Non-Member nodes:

$$\sum_{n \in In(m)} F_{n,m}(\lambda) = \sum_{n \in Out(m)} F_{m,n}(\lambda), \forall m \in V \setminus (s \cup D), \forall \lambda \in W \quad (6.15)$$

Equation (6.15) guarantees that the flow does not drop after passing a non-member node.

Relationship between $L_{m,n}(\lambda)$ and $F_{m,n}(\lambda)$:

$$F_{m,n}(\lambda) \geq L_{m,n}(\lambda), \forall m, n \in V, \forall \lambda \in W \quad (6.16)$$

$$F_{m,n}(\lambda) \leq |D| \times L_{m,n}(\lambda), \forall m, n \in V, \forall \lambda \in W \quad (6.17)$$

Equations (6.16) and (6.17) show that a link should carry non-zero flow if it is used in a light-hierarchy, and the value of this flow should not be greater than the total flow emitted by the source node.

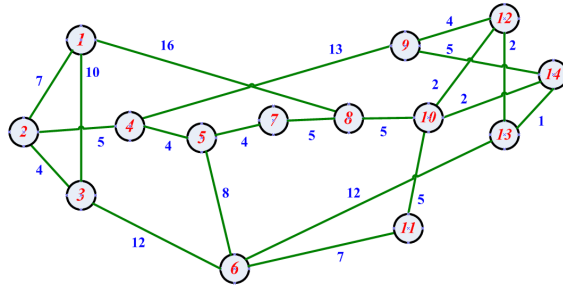

Figure 6.5: The Weighted NSF Network

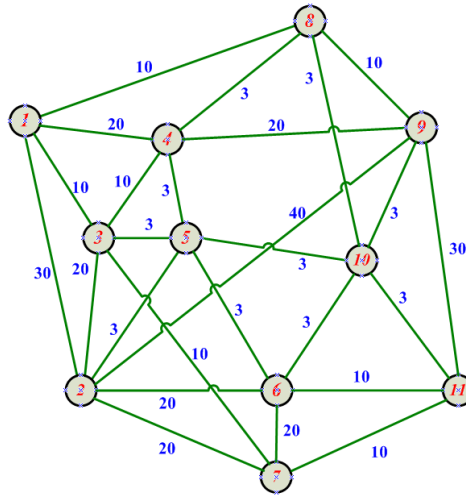

Figure 6.6: The Weighted European Cost-239 Network

6.5 Simulation and Performance Evaluation

6.5.1 Simulation Model

In order to demonstrate the advantage of the proposed light-hierarchy structure, simulation is conducted to compare it with the light-tree structures. ILP formulations are implemented in C++ with Cplex package by using the 14-nodes NSF network in Fig. 6.5 and 11-nodes European Cost-239 network in Fig. 6.6. Given a group size $|D|$, 100 random multicast sessions are generated. The membership of each multicast session follows a uniform distribution in the topology. Then, ILP formulations are executed to search the optimal light-trees and the light-hierarchies with the minimum cost for each multicast session.

Table 6.1: Performance Comparison of LH and LT in the Weighted NSF Network.

Case A: No splitters.						
<i>Size</i>	Total Cost			Wavelengths		LH
$ D $	LH	LT	\searrow	LH	LT	R(CPS)
2	2059	2079	0.96%	103	106	10/100
6	4096	4247	3.56%	107	114	35/100
9	5025	5213	3.61%	115	147	57/100
13	6237	6330	1.47%	121	156	67/100
Case B: nodes 5 and 8 are splitters (MC nodes)						
<i>Size</i>	Total Cost			Wavelengths		LH
$ D $	LH	LT	\searrow	LH	LT	R(CPS)
2	2055	2075	0.96%	103	106	11/100
6	4017	4080	1.54%	105	108	32/100
9	4898	4984	1.73%	105	112	36/100
13	6035	6035	0%	106	111	5/100

6.5.2 Light-Hierarchy versus Light-tree

To show the applicability of the light-hierarchy structure, the performances of light-hierarchy (LH) and its counterpart light-tree (LT) are simulated in both NSF network and Cost-239 network. The following metrics are taken into account:

- (1) Total cost consumed for the establishment of 100 sessions, as well as the cost saving percentage of light-hierarchy (LH) structure compared to light-tree structure (LT).
- (2) The number of wavelengths required for 100 sessions.
- (3) R(CPS), the number of light-hierarchies employing the Cross Pair Switching.

The numerical results are presented in Tables 6.1 and 6.2. Two cases are considered. Case A stands for no splitter while Case B stands for sparse splitting. Based on the simulation results, it is observed that: (a) The proposed light-hierarchy structure always achieve much lower total cost than the traditional light-tree structure. The cost can be saved up to 3.61% by 57 light-hierarchies with *CPS* in NSF network, while up to 6.27% by 81 light-hierarchies with *CPS* in Cost-239 network. Therefore, light-tree structure is not optimal from the point view of cost, but the light-hierarchy structure is optimal one. (b) In general, the absolute cost reduction by the light-hierarchy structure depends on the

number of Cross Pair Switching used, i.e. $R(\text{CPS})$. This is because that with the help of Cross Pair Switching of MI nodes a destination may connect to the light-hierarchy with less cost by using cycles. (c) Fewer wavelengths on average are required for establishing 100 multicast sessions, when the light-hierarchy method is adopted.

All of these advantages benefit from the proposed Cross Pair Switching capability of MI nodes. The light-tree structure restrains that each node should have only one input link, while the light-hierarchy structure accepts cycles rather than complying this old rule. Since the new light-hierarchy structure overcomes the inherent shortcoming of the tree structure, it is able to make the most of Cross Pair Switching by employing the incoming and outgoing link pairs of MI nodes. Therefore, more destination nodes can be served in a light-hierarchy than that in a light-tree, and thus fewer wavelengths are required by each session. With the help of the light-hierarchy structure, a destination node is more likely to connect to the nearest node (even if it is an MI node) in the light-hierarchy while it may have to lead a long way to the source node on another wavelength in order not to violate the light-tree structure. As the light-tree is a special type of light-hierarchy, the optimal light-hierarchy solution at least has the same cost as the light-tree solution in the worst cases. Once useful Cross Pair Switching node is found, the total cost is decreased. More Cross Pair Switching is used, more cost will be saved. This explains the third observation.

6.6 Conclusion

Instead of the traditional light-tree and the simple light-hierarchy proposed in the previous chapter, the concept of light-hierarchy is generalized to improve the cost of AOMR in WDM networks with sparse splitting. A light-hierarchy is a set of consecutive and directed fiber links occupying the same wavelength, which is rooted from the source and terminated at the destinations. Different from a light-tree, the light-hierarchy structure accepts the cycles introduced by the Cross Pair Switching capability of MI nodes, which enables an MI node to serve several destination nodes on the same wavelength through its different input and output pairs. Light-hierarchy structure overcomes the inherent drawback of the traditional light-tree structure, so that the splitting constraint is relaxed to some extent. This is why it outperforms the light-tree in term of cost. We proved that the optimal multicast structure for minimizing the wavelength channel cost is not a set of light-trees, but a set of light-hierarchies. ILP formulations are developed and implemented to compute

Table 6.2: Performance Comparison of LH and LT in the European Cost-239 Network.

Case A: No splitters.						
<i>Size</i>	Total Cost			Wavelengths		LH
$ D $	LH	LT	\searrow	LH	LT	R(CPS)
2	1341	1364	1.68%	100	108	22/100
5	2691	2871	6.27%	104	183	81/100
7	3580	3747	4.46%	100	223	93/100
10	5204	5336	2.47%	120	272	100/100
Case B: nodes 3 and 9 are splitters (MC nodes)						
<i>Size</i>	Total Cost			Wavelengths		LH
$ D $	LH	LT	\searrow	LH	LT	R(CPS)
2	1329	1344	1.12%	100	108	16/100
5	2685	2863	6.22%	102	183	82/100
7	3580	3747	4.46%	100	223	93/100
10	5204	5280	1.44%	100	272	100/100

the optimal light-hierarchies. Numerical results verified that the light-hierarchy structure is the cost optimal solution for AOMR with sparse splitting constraint.

■ Key points of Chapter 6 ■	
<ul style="list-style-type: none"> • The special capability of MI nodes named Cross Pair Switching (<i>CPS</i>) is introduced. • The concept of the light-hierarchy is generalized. • The light-hierarchy structure is proven cost-optimal for supporting the AOMR in WDM networks with sparse splitting. 	

7.1 Summary

In this thesis, the connection provision of all-optical multicasting (AOM) is studied in sparse splitting WDM networks. Specially, we are mainly subject to the all-optical multicast routing (AOMR) subproblem, which determines the light routing path from the source to each of the multicast session members. This subproblem is tackled in the aspects of delay consideration, power budget as well as the cost optimality. Against each aspect, either the optimal solutions (i.e., the MILP / ILP formulations) are developed for searching exact results of small instances, or the heuristic solutions are proposed for large-scale cases. Aiming at cost optimal AOMR, a new multicast structure called light-hierarchy is proposed instead of its conventional counterpart light-tree. Light-hierarchy is proven to be cost optimal for AOMR with sparse splitting constraint and more favorable in the implementation of AOM in the future wavelength-routed WDM networks.

At the beginning of the thesis, a brief introduction is given to the wavelength-routed WDM network involving the infrastructure of a WDM core network and the architecture of OXCs. Then, the necessity and challenges of supporting AOMR are presented. Related work on AOMR is also reviewed. At the end of Chapter 1, the organization and the contribution of this thesis are outlined.

In Chapter 2 the AOMR problem with the consideration of delay and link stress is treated by proposing an AOMR algorithm called MIBPro, which attempts to process the shortest path tree (SPT) so that a trade off among the delay, the link stress and the total cost could be found. In order to obtain a shortest path tree with fewer multicast incapable branching nodes (MIB), the traditional Dijkstra algorithm is replaced by a DijkstraPro algorithm with priority assignment and node adoption. Then critical-articulation and

deepest-branch heuristics are used to process MIB nodes in order to reduce both link stress and end-to-end delay. Finally, a distance priority based algorithm is proposed to reconstruct the multicast light-trees. Simulations show that DijkstraPro is able to produce 38% and 46% fewer MIB nodes in NSF network and USA Longhaul topology respectively. Besides the MIBPro algorithm is able to compute multicast light-trees with smaller end-to-end delay while keeping the same link stress and total cost.

In Chapter 3, the issue of power optimal design of AOMR is addressed. The objective is to establish a multicast session with as small energy as possible, or with as small power loss as possible. A new and more realistic power loss model is introduced. In addition to the splitting power loss and light signal attenuation, two types of node tapping loss are distinguished. One is the tapping loss of any intermediate nodes in a light-tree for local usage while the other one is the tapping loss of non-leaf destination nodes for the recovery of multicast messages. The optimal solution is given by the MILP formulations.

In Chapter 4, the quality of multicast light-trees computed by heuristic algorithms is evaluated mathematically. Not only the absolute cost bounds of multicast light-trees are derived but also the approximation ratios of some heuristic algorithms are deduced the first time in sparse splitting WDM mesh networks. Moreover, a new ILP formulation is proposed to compute the cost-optimal light-trees.

In Chapter 5 the preliminary version of light-hierarchy is introduced. By using different input and output port pairs of high degree MI nodes (no less than 4), a light-hierarchy may employ cycles to span as many destinations as possible. By comparing the light-tree and light-hierarchy computed with heuristic algorithms, it is reported that the light-hierarchy outperforms light-tree in several aspects such as cost and link stress. Besides, light-hierarchy can also help improving the network throughput, up to 22% in USA Longhaul topology.

In Chapter 6, the concept of light-hierarchy is generalized. With the help of the Cross Pair Switching capacity, an MI node is able to be traversed several times in a multicast diffusion structure. It is proven that the generalized light-hierarchy is the cost optimal structure for AOMR with sparse splitting constraint. As it is NP-complete to compute the optimal light-hierarchy, it is formulated by an ILP. In the practice side, both cost-optimal light-tree and the cost-optimal light-hierarchy are computed using ILP in the simulation. Numerical results show that with light-hierarchy the total cost can be saved up to 6.27% in European cost-239 topology and up to 3.61% in NSF network. Simulation

results verify again the cost optimality of light-hierarchy. Thus light-hierarchy could be the best candidate for AOMR in sparse splitting WDM networks.

7.2 Future Work

Lots of important issues on AOMR are covered in this thesis including theoretical and practical sides. But many issues are still open for better supporting AOMR in WDM networks. Several potential perspectives are suggested below for the future work:

- As proven in this thesis, the light-hierarchy structure is cost-optimal for AOMR in WDM network with splitting constraint. However, most of the current works only make use of the light-tree structure. The proposed light-hierarchy structure can still be generalized for multicast routing in multi-fiber WDM networks [47] as well as WDM networks with heterogenous capabilities [12]. In the multi-fiber case, each link in the network contains several fibers (more than two). Thus the same light signal is able to travel around the same link several times (the maximum value equals the number of fibers per link) without changing the wavelength, which makes the multicast structure more complicated than the one demonstrated in this thesis. In the case of WDM networks with heterogenous capabilities, there are four kinds of nodes (OXCs) in the network: MI, MC, WC (Wavelength Conversion), and WCMC (Wavelength Conversion plus Light Splitting). WC nodes only integrate wavelength converters while WCMC node is equipped with both light splitters and wavelength converters. With the help of wavelength conversion capability, the emitted light signal is able to change the wavelength easily when needed at any intermediate WC or WCMC node of a multicast diffusion structure. The wavelength continuity is not any longer a big constraint. As a result, the cost-optimal multicast structure in WDM network with heterogenous nodes is far beyond the light-tree and the current version of light-hierarchy. Then, a more general version of hierarchy [56, 58] proposed for degree bounded Steiner problem should be utilized in those two WDM networks mentioned above. The computation of this kind of complicated multicast structure is still unsolved and needs more investigation.
- In order to make the AOM model more realistic and accurate, AOM should be optimized accounting for multi-layers constraints concurrently, which is identified as impairment-aware multicast routing and wavelength assignment (IA-MRWA). The cross layer optimization of IA-MRWA should not only consider the network param-

eters (such as total cost, delay and number of wavelengths) but also the quality of transmission (QoT) [84, 31, 76, 63, 54, 44]. The QoT is measured by the BER, which involves the power budget of the source node, amplifier spontaneous emission (ASE) noise and dynamic gain, OXC insertion loss and inter-channel cross-talk. However, the consideration of QoT induces non-linear relations and thus dramatically augments the complexity of the IA-MRWA optimization. Although IA-RWA optimization has received increasing focus in recent years, most of the current work [84, 31, 76, 63, 54, 44] are only subject to the unicast traffics. The combination of multicast and IA-RWA (i.e. IA-MRWA) makes the optimization problem even more complicated and hard to resolve. Chapter 3 of this thesis give the MILP formulation of power-optimal AOMR and proposes a linearizing technique. But, the cross-talk and noise of optical devices are ignored in the model. Thus a new MILP formulation accounting for these physical impairments should be developed for off-line optimization. Besides, efficient and scalable heuristic algorithms are required to deal with the dynamic multicast traffics on-line.

- Concerning the power budget restriction of a source, each light-tree is only able to serve a limited number of multicast members, which is classified as the problem of all-optical multicast routing with limited drop-offs [49]. This problem is proven NP-Complete [49]. Although some heuristic algorithms are proposed and analyzed in [35, 25, 49, 93], only full light splitting is assumed, which is not realistic in reality. Even if [96] has formulated this problem with ILP in sparse splitting WDM network, no heuristic is proposed. Thus, the investigation of this problem under sparse splitting constraint is still required. In the theoretical side, the cost bounds of light-trees with limited drop-offs should be deduced accounting for the restriction of node degree. Besides, new efficient heuristic algorithms should also be developed to approximate the optimal solution. And, of course, the corresponding approximation ratios should be analyzed and evaluated.
- As far as the reliability and survivability in WDM networks, protection scheme is required to assure the successful implementation of multicast communications. Against the single node or link failure, lots of fast and resource efficient structures and protection concepts are proposed in the literature. For instance pre-configured cycles (p-cycles) [97, 88, 81] structure, light-tree based structure [10, 52, 77], network coding over p-cycles [41], and hybrid 1+N link protection over p-cycles [39, 40]. However, multi-domain WDM network [42, 51, 99, 81] is a new tendency, where multicast protec-

tion problem is still unresolved. Thus the design of multi-domain p-cycles protection schemes could be a new research direction in WDM networks.

A

Résumé étendu

A.1 Introduction

Récemment, de grands succès ont été constatés dans les réseaux tout optique en utilisant la technologie de multiplexage en longueur d'onde (WDM). Comparable au multiplexage en fréquence (FDM) [18] dans les réseaux cellulaires téléphoniques où chaque fréquence est utilisée comme un canal de communication, le WDM est une technologie qui multiplexe en même temps de nombreuses longueurs d'onde sur une seule fibre optique. Chacune des longueurs d'onde est considérée comme un canal distinct pour la transmission de données dans les réseaux de transport WDM. Par exemple la fibre optique actuelle est capable de transporter 160 canaux en parallèle avec une capacité de 40 Gbit/s par longueur d'onde ; ce qui donne une capacité totale de 6,4 Tbit/s [36]. Un autre exemple peut être cité où 80 canaux à 100 Gbit/s permettent de réaliser une transmission de 8 Tbit/s [36]. Par conséquence, la technologie WDM peut être vue comme une autoroute extensible, où l'on peut simplement ajouter une onde lumineuse de couleur différente dans la même fibre optique pour obtenir une capacité élevée [22]. Outre la bande passante énorme fournie par les fibres optiques, les réseaux WDM ont beaucoup d'autres caractéristiques attrayantes : une faible latence, une atténuation du signal faible (environ 0,2dB/Km en utilisant des porteuses près de 1550 nm) [38, 91], un taux d'erreur binaire bas (BER, il est généralement égal à 10^{-12} [38]), une grande transparence des données et une restauration efficace lors d'une panne du réseau [38]. De plus, les réseaux optiques sont insensibles aux bruits électro-magnétiques. En raison de sa capacité à répondre à une demande croissante de services Internet avec garantie de qualité de service (QoS), le réseau WDM est sans doute la technique la plus efficace pour réaliser les réseaux de cœur.

Le déploiement de la technologie WDM dans l'infrastructure de réseau de cœur nécessite la commutation rapide au cœur des réseaux, l'amélioration du protocole Internet (IP) en offrant l'ingénierie du trafic [6, 7], et la garantie de la qualité de service (QoS) de différents niveaux [9] pour l'énorme trafic Internet [70]. D'une part, en ce qui concerne la commutation rapide, la conversion optique-électronique-optique (O/E/O) devrait être évitée afin de pallier l'inadéquation entre la bande passante élevée des fibres optiques et la vitesse de pointe du traitement électronique (quelque Gbit/s) [70]. Ce phénomène est mentionné comme le goulot d'étranglement bien connu de l'électro-optique [59]. Comme la commutation tout optique (OXC) mûrit et que les commutateurs deviennent disponibles dans le commerce, les réseaux optiques transparents peuvent être réalisés. Un commutateur OXC est en mesure de transmettre un signal optique d'une fibre optique d'entrée vers une fibre de sortie quelconque en conservant la même longueur d'onde. D'autre part, afin de parvenir à IP sur WDM et de profiter au maximum de la bande passante dans les réseaux WDM, les protocoles utilisant l'ingénierie du trafic doivent être adaptés aux réseaux WDM. Pour avoir des communications efficaces dans un réseau WDM, l'utilisation de protocoles d'ingénierie du trafic qui tiennent compte des contraintes optiques est essentielle. Ils doivent aussi permettre l'agrégation d'un ensemble de flux de petite taille (quelques Kbit/s ou Mbit/s) dans un canal correspondant à une longueur d'onde (qui a un débit de transmission élevé de plusieurs Gbit/s). En outre, le routage et l'allocation de longueurs d'onde (Routing and Wavelength Assignment ou RWA) devront être élaborés pour trouver des routes optiques en réalisant les requêtes et pour attribuer une longueur d'onde pour chaque route avec l'objectif de maximiser le débit du réseau.

Avec l'augmentation spectaculaire des applications Internet telles que la HDTV, la formation à distance, la vidéo à la demande (VoD), la vidéo conférence et le service de mise à jour des logiciels, etc., le multicast est le meilleur choix pour économiser la bande passante du réseau. Cependant, le multicast dans un réseau WDM est confronté à un grand nombre de défis posés par la capacité limitée des dispositifs de commutation optique ou d'amplification, ainsi que par le nombre limité de longueurs d'onde fournies dans les fibres optiques. Dans cette thèse, le routage multicast tout optique (AOMR) [30] est étudié dans les réseaux WDM qui contiennent des commutateurs optiques hétérogènes, où seulement une petite partie des nœuds est capable de dupliquer la lumière entrante. Ces nœuds peuvent correspondre à un nœud de branchement d'une route multicast. L'étude est menée dans le cadre d'un réseau WDM tout optique bien dimensionné (par exemple, la topologie du réseau et la configuration des nœuds ont été conçues pour un trafic donné). On essaie d'établir des communications multicast en utilisant un ensemble d'arbres optiques (light-

trees) pour optimiser certaines ressources importantes du réseau et satisfaire un certain niveau de QoS, tels que le délai de bout en bout, le coût total, le nombre de longueurs d'onde nécessaires, etc. La suite de notre résumé est organisé comme suit

- Introduction des réseaux WDM tout optique.
- Définition de l'AOMR et les défis.
- Portée de la thèse.
- Bilan de la thèse.
- Conclusion et perspective.

A.2 L'architecture des réseaux WDM

Un réseau WDM longue distance (Wide Area Network, WAN) [33] est construit sur le concept de routage de longueur d'onde. Compte tenu de la survie et de la fiabilité nécessaires pour ce type de réseau, la topologie correspond toujours à une topologie maillée où les nœuds du réseau sont interconnectés par un ensemble de liens WDM point à point avec de la redondance. En conséquence, la commutation ou le routage sont essentiels pour les transmissions de données dans ce type de réseau. Un WAN WDM est plus sophistiqué que les réseaux de "broadcast and select" [33] car davantage de fonctionnalités sont nécessaires : le routage, l'affectation de longueur d'onde, la conversion de longueur d'onde, la multi-diffusion, ainsi que l'ingénierie du trafic. L'architecture typique d'un réseau WDM maillé est présentée à la Fig. 1.1. Elle est principalement constituée de nœuds d'accès, d'OXC et de fibres optiques.

- Les nœuds d'accès fournissent l'interface entre le cœur optique et les sous-réseaux non-optiques des clients (tels que sous-réseaux IP / MPLS, ATM) [64]. Pour offrir des services de communication pour les sous-réseaux clients, les nœuds d'accès agissent comme des sources ou des destinations des chemins optiques. Ils utilisent des émetteurs et des récepteurs optiques pour envoyer ou pour recevoir les signaux optiques provenant de la fibre optique. Du côté de la source, un nœud d'accès agrège un ensemble de trafics à basse vitesse puis exécute une conversion E/O. Du côté de la destination, le nœud d'accès effectue la désagrégation du trafic et la conversion O/E.
- Dans le cœur de réseau optique, les fonctions de commutation et de routage sont fournies par les OXC et permettent la mise en œuvre de communications de bout en

bout entre les nœuds d'accès. Grâce au démultiplexage du signal optique entrant, un OXC peut commuter chacune des longueurs d'onde d'un port d'entrée vers un port de sortie quelconque. Certains OXC particuliers peuvent également diviser une longueur d'onde entrante vers plusieurs ports de sortie à la fois grâce à un coupleur optique afin d'offrir un service multicast.

- Les fibres optiques portent le même ensemble de longueurs d'onde. Elles fonctionnent en mode WDM afin de fournir une transmission à haut débit. En général, au moins une paire de fibres est utilisée dans chaque lien du réseau afin de permettre les communications dans les deux sens.

Dans les réseaux WDM, une communication de bout en bout entre une paire de nœuds d'accès (source, destination) est mise en œuvre par une séquence de liens logiques. Cette séquence est appelée chemin optique (*lightpath*). Un chemin optique est un chemin tout optique entre deux nœuds d'accès, où une seule longueur d'onde est utilisée de bout en bout. Comme aucune conversion O/E ou E/O n'est effectuée au niveau des nœuds intermédiaires, il n'existe aucune limitation additionnelle au niveau du débit de transmission offert par la fibre optique. Ainsi, la bande passante possible qui peut être utilisée dans un chemin optique correspond à la capacité de transport d'une longueur d'onde (environ 100 Gbit/s [36]). Comme un chemin optique se comporte comme un canal transparent entre une source et une destination, l'architecture logique du réseau WDM devient très simple.

Selon le type de trafic supporté, les OXC dans un réseau WDM peuvent être principalement divisés en deux types : **Multicast Incapable** (MI-OXC, ou nœud MI) et **Multicast Capable** (MC-OXC, ou nœud MC). Les nœuds MC sont toujours beaucoup plus coûteux et compliqués à fabriquer que les autres, par exemple les OXC SaD [34] et MOSaD [4]. Ainsi, dans un réseau WDM seulement quelques nœuds sont des MC-OXC tandis que le reste sont des MI-OXC. Ce genre de réseaux est appelé réseau WDM avec capacité clairsemée de duplication (*sparse splitting*) [65]. Avec les progrès des dispositifs photoniques, nous sommes persuadés que la technologie de duplication adaptative peut être utilisée par les MC-OXC commercialisés dans un avenir proche (une duplication adaptative permet de configurer les entrées et les sorties d'une unité de duplication optique par le plan de contrôle selon les besoins de l'application). Dans cette thèse, nous supposons que le MC-OXC est configurable afin qu'il soit capable de diviser le signal lumineux entrant dans plusieurs branches arbitraires qui sont également indépendantes du degré du nœud dans la topologie. De plus, la capacité de prélèvement de puissance est intégrée dans le MC-OXC afin de mieux soutenir le multicast. Compte tenu de sa rentabilité, le dispositif

Tap-and-Continue (TaC) [3] permet de consommer une fraction du signal optique entrant pour l'usage local (par exemple un éventuel "monitoring") et de transmettre le reste du signal vers l'OXC suivant. Ainsi, il est supposé être utilisé dans tous les OXC du réseau WDM.

A.3 Routage multicast tout optique

A.3.1 Présentation

Le but du multicast est de fournir des services de communication efficaces pour les applications qui nécessitent la transmission simultanée d'information d'une source vers plusieurs destinations, c.-à-d. c'est une communication d'un-vers-plusieurs [33]. Le multicast est efficace au niveau de l'utilisation de la bande passante par rapport à la diffusion individuelle de l'information vers les destinations (on parle alors de multi-unicast) et à la diffusion (broadcast). D'une part, le multicast élimine la nécessité pour la source d'envoyer une copie individuelle de chaque message à chaque destination. D'autre part, il évite le risque d'inondation du réseau par la diffusion [33]. Ainsi, le multicast est conseillé pour de nombreux services (notamment ceux dits "bandwidth-driven") de l'Internet actuel, tels que la vidéo conférence, l'espace de travail partagé, la simulation interactive distribuée et la mise à jour automatique des logiciels [67].

Dans les réseaux WDM, le trafic du réseau est mis en œuvre via les différentes longueurs d'onde se propageant dans les fibres optiques. Une longueur d'onde est la plus petite unité de transport. Sans conversion O/E/O dans les OXC intermédiaires, la transmission et la réplique des données sont toutes effectuées dans le domaine optique. C'est pourquoi le multicast dans les réseaux WDM est aussi appelé multicast tout-optique (AOM) [30]. L'AOM a de nombreux avantages potentiels [65]. Premièrement, le multicast dans la couche WDM peut être mis en œuvre par une structure multicast plus efficace en termes de bande passante et de délai, car nous pouvons connaître la topologie physique du réseau de cœur à l'avance. Deuxièmement, la réplique de données est plus efficace que dans les réseaux IP. Dans les réseaux WDM, l'OXC reproduit des données en utilisant directement un coupleur optique tandis que dans les réseaux IP les commutateurs IP le font en recopiant le contenu de la mémoire par voie électronique. L'utilisation de coupleurs optiques élimine également la nécessité des mémoires de stockage habituellement requises pour la reproduction des données par voie électronique. Enfin, le multicast tout optique offre une transparence

élevée des données. Nous n'avons besoin de nous soucier ni du débit ni du format de codage des données au cours de la communication multicast dans les réseaux WDM.

Afin de réaliser une communication multicast, nous devons trouver une structure de routage qui contienne un ensemble de chemins pour acheminer les messages multicast aux destinations. Dans les réseaux IP avec la commutation de paquets, un arbre multicast enraciné à la source est généralement construit avec des branches couvrant toutes les destinations pour accueillir une session multicast. A la différence du multicast dans la couche IP, afin de permettre l'AOM dans les réseaux WDM, il est souhaitable que les nœuds optiques du réseau soient équipés de coupleurs optiques qui soient capables de diviser simultanément le signal optique entrant vers un certain nombre de ports de sortie. C'est à dire que les réseaux WDM permettant le multicast tout optique doivent employer des MC-OXC. Dans des réseaux WDM qui permettent la duplication sans contrainte, les nœuds sont tous MC. Dans ce cas là, similairement à un chemin optique (lightpath), un arbre optique (light-tree) unique peut être utilisé pour mettre en œuvre une session multicast. Un arbre optique, comme un chemin optique, est un canal point-à-multipoint utilisant une seule longueur d'onde. Il offre un chemin optique continu de la source à chaque destination. L'avantage de l'introduction de l'arbre optique réside non seulement dans la capacité de réduction du nombre moyen de sauts optiques, mais également dans la réduction du nombre d'émetteurs optiques au niveau de la source. Toutefois, la configuration de réseaux WDM maillés en utilisant uniquement des nœuds pouvant dupliquer la lumière n'est pas réaliste car l'architecture des MC-OXC est compliquée et leur fabrication est très coûteuse. Par conséquent, des études approfondies du routage multicast tout optique sont réalisées dans des réseaux WDM en supposant que les nœuds pouvant dupliquer la lumière sont rares : seulement une fraction des nœuds sont MC tandis que les autres sont tous MI. Les nœuds MI ne prennent pas en charge la duplication optique mais emploient un dispositif plus simple et moins coûteux qui est appelé TaC. La capacité TaC permet à un nœud MI d'exploiter une petite quantité de la puissance lumineuse d'entrée pour la détection des signaux et d'envoyer le reste à une seule sortie. La capacité de duplication affecte directement le degré nodal dans un arbre optique multicast.

A.3.2 Les défis de l'AOMR

Bien que l'AOMR soit bénéfique, le routage multicast dans la couche WDM est un travail difficile à réaliser. Les défis de l'AOMR proviennent non seulement de la technique multicast elle-même, mais aussi de caractéristiques distinctives des réseaux WDM. Pour un multicast

efficace dans les réseaux IP, trouver un arbre de recouvrement partiel avec un coût optimal correspond au problème de Steiner [24] qui est prouvé NP-difficile. Dans les réseaux WDM, la situation devient encore plus critique en raison des défis causés par le routage de longueur d'onde et les défaillances du matériel sur les dispositifs OXC. Ces défis supplémentaires compliquent la conception de l'AOMR. Ainsi, il n'est pas possible de transplanter les solutions multicast connues dans les réseaux IP directement dans les réseaux WDM. Ci-dessous, nous abordons les défis de l'AOMR qui sont propres aux réseaux WDM, et nous discutons de leurs impacts sur l'AOMR.

Impact de la conversion optique. Comme le convertisseur en longueurs d'onde est encore un dispositif rare et coûteux, il n'est pas disponible pour le moment dans le commerce. Par conséquent, dans les réseaux WDM, deux contraintes doivent être respectées. Tout d'abord, deux chemins ou arbres optiques ne peuvent pas utiliser la même longueur d'onde, s'ils partagent une fibre optique commune. Cette contrainte est appelée la contrainte de la longueur d'onde distincte [60]. De plus, la même longueur d'onde doit être conservée sur toutes les fibres optiques du chemin ou de l'arbre optique : cette contrainte est appelée la contrainte de continuité en longueur d'onde [60]. En raison de ces contraintes, les performances du réseau en termes d'utilisation de la longueur d'onde et de probabilité de blocage peuvent être largement dégradées.

Impact de la capacité de duplication du signal optique. D'une part, comme un coupleur optique n'est pas présent dans tous les nœuds du réseau, le degré du nœud dans un arbre optique multicast est limité selon sa capacité de "splitting". Cette contrainte complique la conception des algorithmes de l'AOMR. D'autre part, le coupleur optique provoque une perte de puissance. Généralement, un coupleur optique divise la puissance d'un signal optique entrant en fonction de nombre de branches de sortie et de façon équilibré sur chacune de ces branches de sortie.

Impact de l'amplification. La perte de la puissance optique dans les réseaux WDM est causée par plusieurs phénomènes, comme la duplication de la lumière dans les commutateurs (light splitting), l'atténuation de la propagation, et l'application de la technique qui prélève une partie du signal optique pour la surveillance de la qualité du signal ainsi que pour la reproduction du message multicast. Afin de garantir que le signal optique reçu à la destination soit suffisamment fort pour la détection et la reproduction des données, la perte de puissance doit être contrôlée lors de la mise en œuvre de la session multicast. Par exemple, la distance maximale de la source vers les destinations et le nombre de coupleurs optiques en cascade dans un arbre optique devront être analysés et limités. Pour compenser

la perte de puissance et pour éviter son impact sur la construction des arbres optiques, les dispositifs d'amplification tout optique (EDFA) [21] sont nécessaires dans le réseau. Toutefois, les EDFA sont coûteux à fabriquer. En plus, ils introduisent de nombreux problèmes qui compliquent la gestion de réseaux tels que le gain de dispersion, la saturation du gain et du bruit [93]. D'ailleurs, les EDFA mis sur des fibres optiques augmentent le nombre de récepteurs lumineux potentiels pour l'AOMR ce qui complique la configuration du réseau.

Le nombre limité de longueurs d'onde. Le réseau WDM est un réseau multi-canal. Le nombre de canaux correspond au nombre de longueurs d'onde prises en charge dans une fibre optique. En utilisant la technologie WDM actuellement accessible dans le commerce, une fibre optique peut être divisée en 160 canaux transmettant jusqu'à quelque Tbit/s [36]. Toutefois, un canal (correspondant à une longueur d'onde) est l'unité minimale de transmission dans les réseaux WDM. À cause de l'absence des commutateurs pouvant dupliquer la lumière, plusieurs longueur d'onde peuvent être nécessaires pour la mise en œuvre d'une session multicast. Bien que la réutilisation de longueur d'onde puisse être appliquée entre des sessions multicast, certains segments de fibre optique ne peuvent pas être utilisés par une session multicast même s'ils sont disponibles en certaines longueurs d'onde, car il faut respecter la contrainte de continuité en longueur d'onde. Comme le nombre de longueurs d'onde est limité, l'algorithme de l'AOMR doit être soigneusement conçu pour trouver des arbres optiques efficaces afin d'accepter en même temps le plus grand nombre de sessions multicast.

A.4 Problématiques étudiés

En raison des limitations du matériel optique utilisé, seul le cas des commutateurs hétérogènes pour la duplication du signal optique est réaliste dans les réseaux WDM. Le routage multicast tout optique sous la contrainte de degré de nœuds est un sujet d'actualité. Il est étudié profondément dans la littérature [53, 58, 94, 98, 30, 33, 65, 3, 93, 91, 89, 96, 28, 13, 12]. Le délai de bout en bout, le stress des lignes, le coût total et le budget de puissance sont paramètres importants qui sont indispensables lors de la mise en œuvre de session multicast. Dans la littérature, les algorithmes heuristiques concernant le routage multicast se sont focalisés soit trop sur le coût total soit trop sur le délai de bout en bout. D'ailleurs, bien que tous les algorithmes heuristiques proposent de calculer des arbres optiques pour le routage multicast tout optique, l'arbre est-il vraiment la structure de coût optimal pour le routage optique multicast? Sinon, quelle est la structure optimale? Pourquoi ne pas calculer la solution optimale si elle est différente d'un arbre optique? Du

côté de la gestion de puissance dans l'AOMR, le modèle de perte de puissance au cours de la transmission optique n'est pas défini avec précision dans les travaux liés. En outre, la relation de puissance non-linéaire causée par les coupleurs optiques est toujours un obstacle important pour la formulation MILP de la consommation d'énergie de l'AOMR. Ce type de formulation MILP peut être très utile pour résoudre le placement optimal des amplificateurs tout optique ou pour traiter l'AOMR en fonction des déficiences dans la couche physique (PLI [63, 31, 83, 76, 80]). Du point de vue de l'évaluation de la performance des algorithmes heuristiques pour l'AOMR, la plupart d'entre eux sont simplement évalués en effectuant des simulations. Néanmoins, les résultats de simulation sont très variables dans des topologies différentes. Afin de garantir la qualité des arbres optiques, il est souhaitable que l'algorithme heuristique les construisant soit modélisé et analysé théoriquement.

Ainsi, à la différence des travaux actuels, la thèse aborde le problème de l'AOMR à partir des aspects suivants :

- Comment améliorer le délai de bout en bout des arbres optiques multicast tout en gardant le même coût total et la même utilisation de longueur d'onde (c.-à-d. le même stress des liens) ?
- Comment calculer des arbres optiques multicast avec la puissance optimale? Comment modéliser précisément les pertes de puissance dans l'AOMR? Y a-t-il une approche plus générale ou sans autre condition que celle proposée par [27, 28] pour surmonter la relation non-linéaire de puissance causée par le coupleur optique dans la formulation MILP?
- Comment déterminer les bornes du coût des arbres optiques multicast? Peut-on donner des ratios d'approximation pour les algorithmes heuristiques connus de l'AOMR?
- Est-ce que l'arbre optique est la structure de coût optimal pour l'AOMR dans les réseaux WDM? Sinon, quelle est la structure optimale? D'ailleurs, comment calculer la structure optimale avec la formulation ILP et composer des algorithmes heuristiques pour des solutions approchées?

A.5 Plan de la thèse

Afin de bien répondre aux quatre questions posées dans la section précédente, cette thèse se divise en cinq parties :

1. Contexte des réseaux WDM,
2. AOMR avec considération de délai et de stress des liens,
3. AOMR en considérant la puissance optimale,
4. Évaluation mathématique de l'AOMR,
5. AOMR avec hiérarchie optique.

Les chapitres de la thèse sont organisés comme suit.

Nous commençons la thèse en introduisant les réseaux tout optique. Cette partie explique l'infrastructure du réseau de cœur WDM et l'architecture des routeurs tout optique (appelés OXC). Ensuite, on présente le problème du routage multicast tout optique (AOMR). Notre introduction énumère les éléments les plus importants sur la nécessité et les défis pour implémenter l'AOMR dans les réseaux tout optique. Nous donnons également l'état de l'art du domaine qui est suivi par le plan et les contributions majeures de la thèse.

Le chapitre 2 traite le problème AOMR sous considération du délai et du stress des liens. L'objectif de ce problème est de trouver un bon compromis entre le délai, le stress des liens et le coût total lors de la réalisation de l'AOMR. Comme l'arbre des plus courts chemins (Shortest Path Tree) assure le délai optimal pour les destinations, nous proposons de conserver une bonne partie de cet arbre et de traiter uniquement la partie responsable du plus grand stress de liens. Basé sur cette idée principale, l'algorithme MIBPro est proposé. Il comprend trois étapes. Tout d'abord, un arbre des plus courts chemins est calculé avec le moins de nœuds MIB (Multicast Incapable Branching node, nœud de branchement ne pouvant pas dupliquer la lumière). Pour cela, nous proposons l'algorithme DijkstraPro. D'une part, DijkstraPro intègre une priorité particulière pour traiter les nœuds candidats. D'autre part, il introduit la possibilité d'échanger la place des nœuds feuilles que nous appelons l'adoption de nœud dans l'algorithme de Dijkstra conventionnel. Étant donné que l'arbre ainsi calculé peut contenir des nœuds MIB, le stress du lien peut être important, car les nœuds MIB doivent utiliser au moins autant de longueurs d'onde que le nombre de branches. C'est pour cette raison que l'heuristique de l'articulation critique et la recherche de la branche la plus profonde sont ensuite proposées pour traiter les nœuds MIB. Dans un premier temps, les sous-arbres d'un nœud MIB sont déconnectés, sauf un sous-arbre. S'il y a un nœud d'articulation dans une des branches d'un nœud MIB, l'heuristique de l'articulation critique propose de conserver la branche qui contient le nœud d'articulation.

Autrement, l'heuristique de la recherche de la branche la plus profonde suggère de traiter un nœud MIB en supprimant toutes ses branches sauf la plus profonde. Finalement, cette solution permet de diminuer le délai (le diamètre des arbres obtenus). À la fin de notre proposition algorithmique, un algorithme basé sur la priorité de distance est développé pour reconnecter les destinations déconnectées aux arbres tronqués afin de réaliser la session multicast par un ensemble d'arbres optiques favorables. Les résultats numériques montrent que l'algorithme MIBPro diminue le délai tandis que le stress du lien et le coût total gardent les mêmes valeurs que les autres algorithmes, par exemple Reroute-to-Any [98].

Le chapitre 3 présente le problème de la conception de l'AOMR pour atteindre la puissance optimale de l'émetteur. Ici, on vise à établir une session multicast avec la puissance la plus petite possible, ou encore avec la perte d'énergie lumineuse optimale. Un nouveau modèle plus précis et plus réaliste de la perte de puissance est introduit lors de la mise en œuvre d'une session multicast dans un réseau tout optique. En plus de la perte de puissance due aux coupleurs et de l'atténuation du signal optique dans les fibres, le nouveau modèle distingue deux types de pertes de puissance. Le signal optique est ponctionné (nous l'appelons "tapé" dans la suite) par les nœuds optiques pour deux raisons, dont une seule est considérée dans la littérature [27, 28, 29]. D'une part, sur un chemin optique les nœuds intermédiaires tapent une partie du signal optique pour les besoins de la gestion du réseau (rendre possible une éventuelle surveillance de la qualité du signal optique). D'autre part, les nœuds de destination intermédiaires d'une session multicast doivent taper une partie du signal afin de récupérer les messages multicast. Évidemment, le problème de l'optimisation des routes multicast du point de vue de la puissance optique est un problème NP-difficile. Même s'il y a des relations non linéaires (cf. Équation 3.1) entre les niveaux de puissance de la lumière entrant des nœuds optiques, on peut modéliser le problème avec la programmation linéaire mixte en nombres d'entiers (Mixed-Integer Linear Programming ou MILP) en utilisant des techniques de linéarisation. Les relations non linéaires viennent de deux effets. Premièrement, un coupleur divise le signal lumineux entrant en autant de parties que de branches actives équilibrées. Cette division provoque alors une relation non-linéaire au niveau de la puissance entre le coupleur et ses descendants. En améliorant la technique de linéarisation se trouvant dans [29], nous proposons de calculer les pertes en dBm et d'utiliser un ensemble d'équations linéaires pour remplacer la relation non-linéaire, ce qui produit une méthode exacte et sans condition. Cette méthode pourrait être aussi utilisée pour modéliser le routage multicast tout optique en considérant la contrainte de la couche physique [31, 76, 63, 54] (IA-AOMR). La deuxième cause des effets non linéaires se présente de la façon suivante. Afin de minimiser la puissance totale, chaque branche de la source

utilise un émetteur spécifique. Le nombre d'émetteurs optiques utilisés par une source est égal au nombre de branches de cet arbre à la source. Donc, si on exprime la puissance d'un nœud en dBm , la puissance totale (en mW) de la session multicast est une somme de fonctions exponentielles de la puissance de chaque branche de la source en dBm . Pour résoudre ce problème, on a trouvé une fonction linéaire qui approche bien cette somme, et elle a le même caractère monotone dans l'intervalle qui nous intéresse. Pour la mise en œuvre et les tests du programme MILP calculant la solution optimale, nous avons opté pour une topologie maillée de 6 nœuds. Vu le temps d'exécution important du programme, ce choix nous semble raisonnable. Dans les tests, les arbres optiques avec une puissance optimale et ceux de coût optimal sont comparés et analysés ensemble. D'après les résultats de nos simulations, il est clair que la puissance optique et le coût total des routes multicast optiques ne peuvent pas être optimisés en même temps. Afin de minimiser la puissance totale, il faut limiter le nombre de nœuds dans les branches de l'arbre de la source aux destinations, ce qui donne des arbres de diamètre limité. Il est aussi intéressant de diminuer la différence entre les puissances dissipées par chaque branche d'un arbre optique. Cet équilibrage diminue l'utilisation totale de la puissance optique. De plus, les coupleurs ne doivent pas être surchargés mais ils doivent parfois être évités afin de construire des arbres optiques équilibrés. Nous avons observé qu'une perte de puissance inutile a lieu si deux branches d'un coupleur ne sont pas symétriques. Les observations obtenues dans la simulation seront très utiles pour la conception d'algorithmes heuristiques applicables dans les réseaux tout optique à grande échelle.

Le chapitre 4 présente nos travaux concernant l'évaluation mathématique des algorithmes heuristiques pour calculer des arbres optiques multicast avec un coût optimal. Même si le ratio d'approximation est une valeur très importante pour mesurer la qualité des algorithmes heuristiques, la plupart des algorithmes connus de la littérature (par exemple Reroute-to-Source et Member-Only [98]) ne sont évaluées que par des simulations. Ni la borne du coût des arbres optiques multicast construits ni le ratio d'approximation des heuristiques ne sont analysés en détails dans la littérature. C'est la raison pour laquelle nous étudions ces deux problèmes dans ce chapitre. D'abord, on examine les bornes pouvant limiter le coût des arbres optiques. Pour cette borne, il existe des résultats dans la littérature. [50] a proposé une borne $\frac{N^2}{4}$ pour l'implémentation d'une session multicast $ms(s, D)$ dans un réseau optique non-pondéré, où N indique le nombre des nœuds dans le réseau, s correspond à la source, et D est l'ensemble des destinations de la session multicast. Cette borne est très large pour une session multicast de petite taille (par exemple pour deux destinations) et une topologie de grande taille (N est grand). De plus, la preuve

est valide sous l'hypothèse que les arbres optiques obtenus correspondent encore à la structure d'un arbre dans la couche IP. Cette hypothèse n'est pas vraie pour la plupart des algorithmes heuristiques comme Member-Only [98]. Par ailleurs, la preuve est compliquée. Donc, notre objectif est de généraliser la preuve et d'améliorer la borne. Notre démarche peut être résumée comme suit. Trivialement, dans un réseau optique maillé non-pondéré, le coût des arbres optiques couvrant $ms(s, D)$ est supérieur à K , où K est le nombre de destinations ($K = |D|$). Nous précisons qu'il est inférieur à $K(N - K)$ quand la taille du groupe est petite ($K < \frac{N}{2}$), tandis qu'il est inférieur à $\lfloor \frac{N^2}{4} \rfloor$ quand la taille est grande ($K \geq \frac{N}{2}$). Les bornes proposées ici sont valides pour un ensemble d'algorithmes heuristiques bien connues incluant Reroute-to-Source et Member-Only. Nous avons aussi étudié les bornes des coûts des arbres optiques multicast optimaux dans une topologie particulière : les anneaux WDM (cf. Fig. 4.3). Les anneaux sont souvent utilisés dans le domaine optique. On définit un gap comme le nombre de sauts entre deux membres voisins du groupe multicast incluant la source. Dans les anneaux, l'arbre optique multicast optimal peut être calculé en supprimant le plus grand gap sur l'anneau. Pour la valeur minimale du coût, on obtient la borne K dans le cas où tous les membres du groupe sont des voisins directs. Le coût maximal du chemin optique couvrant un groupe multicast dans un anneau est $N - \lceil \frac{N}{K+1} \rceil$. Dans la deuxième partie de ce chapitre, nous examinons les ratios d'approximation des algorithmes Reroute-to-Source (R2S) et Member-Only (MO). Dans notre analyse, nous distinguons deux types de réseaux optiques différents : les réseaux pondérés et non-pondérés. Concernant les réseaux pondérés, nous avons prouvé que le ratio d'approximation de l'algorithme R2S est égal à $\rho(R2S) = K$, et celui de l'algorithme MO est inférieur à $\rho(MO) = (K^2 + 3K)/4$. Dans les réseaux non-pondérés, les ratios d'approximation peuvent être mieux précisés. Selon nos calculs, $\rho(R2S)$ est inférieur à K , si $1 \leq K < \frac{N}{2}$, et il est inférieur à $\frac{\lfloor \frac{N^2}{4} \rfloor}{K}$ si $\frac{N}{2} \leq K < N$. MO approche la solution optimale avec un ratio inférieur à (1) $\rho(MO) \leq (K^2 + 3K)/4$, quand $1 \leq K < \frac{\sqrt{16N+49}-7}{2}$, (2) $\rho(MO) \leq N - K$, quand $\frac{\sqrt{16N+49}-7}{2} \leq K < \frac{N}{2}$, (3) $\rho(MO) \leq \frac{\lfloor \frac{N^2}{4} \rfloor}{K}$, quand $\frac{N}{2} \leq K < N$. En plus, nous avons prouvé que les ratios d'approximation de R2S et MO sont toujours inférieurs au diamètre du réseau. Dans la suite du chapitre 4, un nouveau modèle ILP est proposé pour calculer la solution exacte (la forêt optique de coût minimal). Nous avons comparé les solutions obtenues par la programmation linéaire en nombres entiers (ILP) et celles obtenues par les algorithmes heuristiques MO et R2S. La comparaison est mise en œuvre dans la topologie "NSF network" non-pondérée. Selon les résultats numériques obtenus, on peut remarquer que les algorithmes R2S et MO montrent de bonnes performances dans "NSF network". Il est évident que les performances des heuristiques dans des

topologies particulières peuvent être meilleures que les ratios obtenus en considérant tous les cas possibles.

Le chapitre 5 présente une version préliminaire de la hiérarchie optique et contient une nouvelle analyse de l'arbre optique qui résout l'AOMR sous la contrainte de l'absence partielle de routeurs optiques pouvant dupliquer la lumière. Afin d'améliorer certaines heuristiques existantes calculant des arbres optiques, une stratégie de renouvellement du graphe topologique (GRLT) est proposée au début du chapitre. Comme l'algorithme MO, cette stratégie construit un arbre optique de façon itérative. L'idée principale de notre proposition est que lorsqu'on trouve un chemin pour une destination non encore connectée à un arbre optique déjà construit, on suggère de supprimer du graphe du réseau tous les nœuds MI (qui ne sont pas capables de dupliquer le signal optique) utilisés dans ce chemin. Dans la suite de l'algorithme, à l'itération suivante, on cherche un chemin permettant de connecter la prochaine destination à l'arbre optique dans le nouveau graphe en utilisant le chemin le plus court dans le graphe restant. Il est évident que le chemin dans le graphe réduit ne contient aucun nœud MI épuisant sa capacité de TaC. Grâce à cette stratégie, le stress des liens et le coût total sont diminués par rapport à l'algorithme MO, car MO n'utilise que les plus courts chemins dans la topologie originale. La solution GRLT peut aussi augmenter le débit du réseau par rapport à MO. Toutefois, la progression de la performance des arbres optiques construits en utilisant la stratégie de renouvellement du graphe est limitée à cause de la restriction inhérente de la structure "arbre optique". Pour construire des structures optiques plus favorables, on peut relâcher la contrainte suggérant la construction d'un arbre. Trivialement, un nœud MI avec un degré de 4 ou plus peut être traversé deux fois par le même signal multicast en utilisant une même longueur d'onde. En permettant les boucles dans la structure de la diffusion de la lumière, on utilise une autre structure plus souple que nous appelons hiérarchie optique (light-hierarchy ou LH). En utilisant la structure de hiérarchie optique, nous évitons la contrainte de construction d'arbres présente dans l'algorithme MO : cette contrainte ne permet pas de créer des boucles malgré le fait que dans certains cas les boucles peuvent être avantageuses pour le multicast optique. Ainsi, la stratégie GRLT est étendue à GRLH pour calculer des hiérarchies optiques. Dans cette stratégie, au lieu de supprimer les nœuds MI épuisant leur capacité de TaC, GRLH supprime des liens utilisés dans le graphe. De cette façon, les nœuds MI peuvent être réutilisés pour être traversés dans une direction différente: ce qui peut conduire à une diminution des coûts. Mais, GRLH risque de proposer un chemin trop long de la source vers une destination dans une hiérarchie optique. C'est pourquoi on a intégré la solution algorithmique basée sur la priorité de la distance (DP) dans les

deux heuristiques GRLT et GRLH. Cette politique de priorité permet de réduire le délai de bout en bout. Les deux algorithmes modifiés sont appelés GRDP-LT et GRDP-LH dans ce travail. Dans la simulation présentée dans le chapitre 5, nous comparons MO, GRDP-LT et GRDP-LH en termes de stress des liens, de coût total, et de débit réseau. Aux vues des résultats, nous constatons que les arbres optiques calculés par GRDP-LT sont plus performants au niveau du stress du lien et du délai que ceux construits par MO. De plus, le stress des liens peut encore être largement amélioré avec la hiérarchie optique construite par GRDP-LH. Finalement, les hiérarchies optiques augmentent le débit du réseau jusqu'à 22% dans la topologie connue comme "USA Longhaul". On conclue que la nouvelle structure hiérarchie optique est un meilleur candidat que l'arbre optique pour réaliser des sessions multicast dans un réseau tout optique où la duplication de la lumière n'est pas assurée par tous les routeurs optiques.

Dans le chapitre 6, la définition de la hiérarchie optique est généralisée. Généralement dans les réseaux optiques, il y a au moins deux fibres optiques qui sont déposées entre deux routeurs voisins. De cette façon, la même longueur d'onde peut être employée dans les directions opposées, en même temps, entre ces deux routeurs. La hiérarchie optique de la version préliminaire proposée dans le chapitre 5 ne profite que des nœuds MI avec un grand degré (au moins 4). En fait, un nœud MI quelconque a une capacité spéciale qui est appelée Cross Pair Switching (CPS, cf. Fig. 6.1). Grâce à la capacité CPS, un nœud MI arrive à faire entrer et sortir plusieurs fois le même signal optique multicast sur la même longueur d'onde en utilisant des paires de ports vacants. C'est à dire qu'un nœud (un routeur optique) peut être traversé autant de fois qu'il existe de paires d'entrée et sortie dans le nœud. Ainsi, même si un nœud MI est un nœud de branchement, il peut servir ses destinations fils en série avec une seule longueur d'onde. Une solution basée sur le parcours d'arbres pour construire un chemin optique qui aux besoins retourne plusieurs fois à des nœuds MI a été proposé dans [3]. Pour un nœud MC, le retour n'est pas nécessaire puisque la capacité de duplication du nœud n'est pas limitée. En général, un lien peut être utilisé pour propager le même signal multicast sur la même longueur d'onde simultanément dans les deux sens opposés. Cette possibilité permet aussi de diminuer le coût de la structure optique hiérarchique utilisée pour le routage multicast. En cas de contraintes sur la capacité des nœuds à dupliquer le signal optique, l'arbre optique n'est pas la structure optimale pour la mise en œuvre d'une session multicast. Les hiérarchies optiques permettant des boucles et des retours sur des nœuds sont les structures optimales. Les arbres optiques peuvent être considérés comme des cas particuliers des hiérarchies optiques. Comme pour les arbres optiques de coût minimal, le calcul de hiérarchies optiques avec un coût optimal est aussi

NP-difficile dans des réseaux optiques maillés qui limitent la possibilité de duplication du signal optique. Nous proposons la formulation ILP pour calculer la solution optimale de ce problème. Le programme ILP est implémenté dans deux topologies réputés qui sont "NSF network" (cf. Fig. 6.5) et "Cost-239" (cf. Fig. 6.6). Les résultats de la simulation montrent que le coût total est diminué de 6.27% dans la topologie "Cost-239" et de 3.61% dans la topologie "NSF network" en utilisant des hiérarchies optiques. Ainsi, les résultats numériques expriment le gain obtenu par l'utilisation des hiérarchies qui peuvent être largement utilisées dans les futurs réseaux tout optique.

A.6 Conclusion et perspectives

Dans cette thèse, nous étudions l'établissement de sessions multicast dans les réseaux WDM (AOM) dans le cas où les routeurs optiques du réseau ne contiennent que rarement des équipements permettant de dupliquer le signal optique (des "splitters"). Plus particulièrement, nous nous sommes intéressés au sous-problème du routage multicast tout optique (AOMR), lequel décide des chemins optiques (lightpaths) de la source à chaque destination de la session multicast. Différent de la littérature, ce sous-problème est traité dans la thèse en termes de délai, de stress des liens, de budget de puissance et de l'optimalité du coût. Pour chacune de ces métriques, soit la solution optimale (c'est à dire une modélisation MILP/ILP) est proposée pour rechercher les résultats exacts (cette solution est envisageable pour des topologies relativement petites), soit des algorithmes heuristiques rapides sont développés pour trouver des solutions approchées dans des réseaux optiques à grande échelle. Un des résultats principaux de nos travaux est la proposition d'une nouvelle structure : la hiérarchie optique (light-hierarchy) à la place de l'arbre optique conventionnel (light-tree). Il a été prouvé récemment que les hiérarchies optiques sont les structures optimales pour réaliser le routage multicast optique de coût optimal. Les résultats de simulation suggèrent fortement l'emploi de la hiérarchie optique pour l'AOMR dans les réseaux WDM avec capacité clairsemée de duplication.

Notre étude dans cette thèse couvre plusieurs questions parmi les questions importantes pour l'AOMR, y compris des analyses théoriques et pratiques. Mais de nombreuses questions sont encore ouvertes pour mieux soutenir l'AOMR dans les réseaux WDM. Plusieurs pistes possibles sont proposées ci-dessous pour améliorer l'analyse.

- Comme nous avons démontré dans cette thèse, la hiérarchie optique est la structure multicast de coût optimal pour la mise en œuvre de l'AOMR quand la duplication de

la lumière est limitée dans le réseau tout optique. Cependant, la plupart des travaux en cours produisent des arbres optiques pour le multicast. La structure hiérarchie optique peut encore être généralisée pour le routage multicast dans les réseaux WDM avec multi-fibres [47] ainsi que dans les réseaux WDM avec des capacités de nœuds hétérogènes [12]. Dans le cas multi-fibres, chaque lien du réseau optique contient plusieurs fibres (plus de deux). Ainsi, le même signal optique est en mesure de traverser un même lien plusieurs fois (le nombre maximale de l'aller-retour est égal au nombre de fibres entrantes ou sortantes par lien) sans changer de longueur d'onde. En conséquence, la structure multicast est plus compliquée que celle montrée dans la thèse. Dans le cas de réseaux WDM avec des capacités de nœud hétérogènes, on considère qu'il existe quatre types de nœuds (OXC) dans le réseau: MI, MC, WC (avec convertisseur de longueur d'onde) et WCMC (avec convertisseur et coupleur de longueur d'onde). Les nœuds WC sont équipés de convertisseurs en longueur d'onde alors que les nœuds WCMC sont équipés de coupleurs et de convertisseurs de longueur d'onde. Avec l'aide de la capacité de conversion en longueur d'onde, le signal optique peut être émis sur une autre longueur d'onde que sa longueur d'onde d'origine lorsque cela est nécessaire au niveau des nœuds WC ou WCMC intermédiaires d'une structure multicast. La continuité de longueur d'onde n'est plus une contrainte. En conséquence, la structure multicast de coût optimal peut être très différente des arbres optiques ou des hiérarchies optiques que nous proposons. Ainsi, les hiérarchies optiques plus générales, telles que celles proposées pour résoudre le problème de routage sous contrainte de degrés bornés [56], peuvent être utilisées avec succès dans les deux types de réseau WDM mentionnés ci-dessus. La complexité des calculs des hiérarchies optimales dans les différents réseaux est grande et la formulation des problèmes est aussi complexe. Cette recherche nécessite des investissements importants dans l'avenir.

- Afin de rendre le modèle d'AOM plus réaliste et plus précise, l'AOM doit être optimisé en respectant des contraintes de plusieurs couches en même temps, ce qui est identifié comme le problème l'IA-MRWA (Impairment-Aware Multicast Routing and Wavelength Assignment). L'optimisation multi-couches de IA-MRWA doit considérer non seulement les paramètres du réseau (tels que le coût total, le délai et le nombre de longueurs d'onde), mais aussi la qualité de la transmission (QoT) [84, 31, 76, 63, 54, 44]. La QoT est mesurée par le BER, qui implique le budget de puissance, le bruit d'émission spontanée d'amplificateur (ASE), le gain dynamique, la perte d'insertion et le cross-talk introduit par l'OXC. Toutefois, l'examen de la QoT implique des relations non-linéaires, ce qui augmente considérablement la complexité de l'optimisation IA-

MRWA. Bien que l'on peut constater une importance croissante de l'optimisation IA-RWA dans ces dernières années, la plupart des travaux actuels [84, 31, 76, 63, 54, 44] concernent uniquement le trafic unicast. La combinaison du multicast et de l'IA-RWA (c'est à dire l'IA-MRWA) rend le problème d'optimisation encore plus compliqué et difficile à résoudre. Sans doute, les formulations MILP devront être développées afin de modéliser le problème d'optimisation et de calculer les routes hors ligne pour le trafic multicast statique. En outre, des algorithmes heuristiques efficaces seront nécessaires pour traiter en ligne des demandes multicast dynamiques.

- Concernant la restriction du budget de puissance, chaque arbre optique est en mesure de servir un nombre limité de membres multicast, ce qui est connu comme le problème de l'AOM avec drop-offs limités [49]. Ce problème est prouvé NP-complet [49]. Bien que certains algorithmes heuristiques soient proposés et analysés dans les réseaux WDM, ils supposent que l'ensemble des nœuds soient capables de dupliquer le signal optique. Cette hypothèse n'est pas réaliste. Dans [96], le problème est formulé à l'aide de la programmation linéaire en nombres entiers (ILP) dans les réseaux WDM ayant des contraintes plus réalistes sur la capacité rare des nœuds pour les duplications, mais aucun algorithme heuristique n'est proposé. Ainsi, une étude plus profonde de ce problème sous la contrainte de degré est encore nécessaire. Au niveau plus théorique, il serait intéressant de trouver les bornes concernant le coût des arbres optiques avec drop-off limité et en supposant des restrictions sur le degré des nœuds. De plus, de nouveaux algorithmes heuristiques efficaces devront également être développés pour approcher la solution optimale. Et, bien sûr, les ratios d'approximation correspondants devront être analysés et évalués.
- En ce qui concerne la fiabilité et la capacité de survie des réseaux WDM, le mécanisme de protection est proposé pour assurer la mise en œuvre des communications unicast et multicast optiques fiables. Pour protéger le réseau en cas d'une seule panne d'un nœud ou d'un lien, de nombreuses structures de protection rapides et efficaces au niveau de ressources sont proposés dans la littérature. Par exemple, on peut citer : les cycles pré-configurés (p-cycles) [97, 88, 81], les protections pour les arbres optiques [10, 52, 77], les méthodes de "network coding" sur p-cycles [41] et la protection hybride du lien $1 + N$ sur p-cycles [39, 40]. Toutefois, le réseau WDM multi-domaine [42, 51, 99, 81] est une tendance nouvelle, où le problème de protection multicast n'est toujours pas résolu. Ainsi, la conception de systèmes de protection avec des p-cycles pour trafic

multicast dans des réseaux WDM multi-domaine pourrait être une nouvelle direction de recherche.

Bibliography

- [1] ALI, M. Optimization of splitting node placement in wavelength-routed optical networks. *IEEE Journal on Selected Areas in Communications*, vol. 20, no. 8 (2002), 1571–1579.
- [2] ALI, M., AND DEOGUN, J. S. Allocation of splitting nodes in all-optical wavelength-routed networks. *Photonic Network Communications*, vol. 2, no. 3 (2000), 247–265.
- [3] ALI, M., AND DEOGUN, J. S. Cost-effective implementation of multicasting in wavelength-routed networks. *IEEE/OSA Journal of Lightwave Technology*, vol. 18, no. 12 (2000), 1628–1638.
- [4] ALI, M., AND DEOGUN, J. S. Power-efficient design of multicast wavelength-routed networks. *IEEE Journal on Selected Areas in Communications*, vol. 18, no. 10 (2000), 1852–1862.
- [5] ANTONAKOPOULOS, S., AND ZHANG, L. Approximation algorithms for grooming in optical network design. In *28rd Annual Joint Conference of the IEEE Computer and Communications Societies, INFOCOM'09* (Apr. 2009), pp. 1548–1556.
- [6] AWDUCHE, D. MPLS and traffic engineering in IP networks. *IEEE Communications Magazine*, vol. 37, no. 12 (1999), 42–47.
- [7] AWDUCHE, D., MALCOLM, J., AGOGBUA, J., O'DELL, M., AND MCMANUS, J. Requirements for traffic engineering over MPLS. RFC 2702, Sep. 1999.
- [8] BILLAH, A., WANG, B., AND AWWAL, A. Topology based placement of multi-cast capable nodes for supporting efficient multicast communication in WDM optical networks. *Photonic Network Communications*, vol. 14, no. 1 (2007), 35–47.
- [9] BLAKE, S., BLACK, D., CARLSON, M., DAVIES, E., WANG, Z., AND WEISS, W. An architecture for differentiated services. RFC 2475, Dec. 1998.

- [10] BOWORNTUMMARAT, C., WUTTISITTIKULKIJ, L., AND SEGKHOONTHOD, S. Light-tree based protection strategies for multicast traffic in transport WDM mesh networks with multifiber systems. In *IEEE International Conference on Communications, ICC'04* (Jun. 2004), pp. 1791–1795.
- [11] CAI, Y., MATSUURA, M., OKI, E., KISHI, N., AND MIKI, T. Optical broadcast-and-select network architecture with centralized multi-carrier light source. *IEICE Electronics Express*, vol. 5, no. 19 (2008), 796–801.
- [12] CHEN, M.-T., LIN, B. M. T., AND TSENG, S.-S. Multicast routing and wavelength assignment with delay constraints in WDM networks with heterogeneous capabilities. *IEEE/OSA Journal of Optical Communications and Networking*, vol. 31, no. 1 (2008), 47–65.
- [13] CHEN, M.-T., TSENG, S.-S., AND LIN, B. Dynamic multicast routing under delay constraints in WDM networks with heterogeneous light splitting capabilities. *Computer Communications*, vol. 29, no. 9 (2006), 1492–1503.
- [14] CHEN, S., TEE, H. C., AND POO, G.-S. Placement of wavelength converters and light splitters in a WDM network using the generic graph model. *Computer Communications*, vol. 33, no. 7 (2010), 868–883.
- [15] CHRAPLYVY, A., TKACH, R., AND WALKER, K. Optical fiber for wavelength division multiplexing. *United States Patent 5327516* (1994).
- [16] CISCO, 2009. Introduction to optical fibers, dB, attenuation and measurements, <http://www.cisco.com/application/pdf/paws/29000>.
- [17] CPLEX, 2009. <http://www.ilog.com/products/cplex/>.
- [18] CURT, W. *Data communications and computer networks*. MA: Thomson Course Technology, Boston, 2007.
- [19] DENG., T., AND SUBRAMANIAM, S. Source power management in transparent wavelength-routed mesh networks. In *IEEE International Conference on Communications, ICC'04* (Jun. 2004), pp. 1664–1668.
- [20] DENG, T., SUBRAMANIAM, S., AND XU, J. Crosstalk-aware wavelength assignment in dynamic wavelength-routed optical networks. In *IEEE International Conference on Broadband Networks, BroadNets'04* (Oct. 2004), pp. 131–140.

- [21] DESURVIRE, E. *Erbium-doped fiber amplifiers, device and system developments*. John Wiley & Sons, Inc., New York, NY, USA, 2002.
- [22] DIXIT, S. *IP over WDM: building the next-generation optical Internet*. John Wiley & Sons, Inc., Hoboken, New Jersey, 2003.
- [23] ELMIRGHANI, J., AND MOUFTAH, H. All-optical wavelength conversion: technologies and applications in DWDM networks. *IEEE Communications Magazine*, vol. 38, no. 3 (2000), 86–92.
- [24] GAREY, M. R., AND JOHNSON, D. S. *Computers and intractability: a guide to the theory of NP-completeness*. W. H. Freeman & Co., New York, NY, USA, 1990.
- [25] GU, J., HU, X.-D., JIA, X., AND ZHANG, M.-H. Routing algorithm for multicast under multi-tree model in optical networks. *Theoretical Computer Science*, vol. 314, no. 1 (2004), 293–301.
- [26] HAMAD, A. *All optical multicasting in wavelength routing mesh networks with power considerations: design and operation*. PhD thesis, Iowa State University, Dec. 2008.
- [27] HAMAD, A., AND KAMAL, A. E. Optimal power-aware design of all-optical multicasting in wavelength routed networks. In *IEEE International Conference on Communications, ICC'04* (Jun. 2004), pp. 1796–1800.
- [28] HAMAD, A., AND KAMAL, A. E. Routing and wavelength assignment with power aware multicasting in WDM networks. In *IEEE International Conference on Broadband Networks, BroadNets'05* (Oct. 2005), pp. 31–40.
- [29] HAMAD, A., AND KAMAL, A. E. Optical amplifiers placement in WDM mesh networks for optical multicasting service support. *IEEE/OSA Journal of Optical Communications and Networking*, vol. 1, no. 1 (2009), 85–102.
- [30] HAMAD, A., WU, T., KAMAL, A. E., AND SOMANI, A. K. On multicasting in wavelength-routing mesh networks. *Computer Networks*, vol. 50, no. 16 (2006), 3105–3164.
- [31] HE, J., BRANDT-PEARCE, M., POINTURIER, Y., AND SUBRAMANIAM, S. QoT-aware routing in impairment-constrained optical networks. In *IEEE Global Telecommunications Conference, GLOBECOM'07* (Nov. 2007), pp. 2269–2274.

- [32] HE, J., BRANDT-PEARCE, M., AND SUBRAMANIAM, S. Analysis of blocking probability for First-Fit RWA in transmission impaired optical networks. In *28th Annual Joint Conference of the IEEE Computer and Communications Societies, INFOCOM'09* (Apr. 2009), pp. 1575–1583.
- [33] HE, J., CHAN, S.-H., AND TSANG, D. Multicasting in WDM networks. *IEEE Communications Surveys & Tutorials*, vol. 4, no. 1 (2002), 2–20.
- [34] HU, W., AND ZENG, Q. Multicasting optical cross connects employing splitter-and-delivery switch. *IEEE Photonics Technology Letters*, vol. 10, no. 7 (1998), 970–972.
- [35] HU, X.-D., SHUAI, T.-P., JIA, X., AND ZHANG, M.-Z. Multicast routing and wavelength assignment in WDM networks with limited drop-offs. In *23rd Annual Joint Conference of the IEEE Computer and Communications Societies, INFOCOM'04* (Mar. 2004), pp. 487–494.
- [36] INFINERA, 2009. Infinera Introduces New Line System, Sets New Standard for Capacity, <http://www.infinera.com>.
- [37] JIA, X.-H., DU, D.-Z., HU, X.-D., LEE, M.-K., AND GU, J. Optimization of wavelength assignment for QoS multicast in WDM networks. *IEEE Transactions on Communications*, vol. 49, no. 2 (2001), 341–350.
- [38] JUN ZHENG, H. T. M. *Optical WDM networks: concepts and design principles*. Wiley-IEEE Press, 2004.
- [39] KAMAL, A. GMPLS-based hybrid 1+n link protection over p-cycles: Design and performance. In *IEEE Global Telecommunications Conference, GLOBECOM'07* (Nov. 2007), pp. 2298–2303.
- [40] KAMAL, A. A generalized strategy for 1+n protection. In *IEEE International Conference on Communications, ICC'08* (May. 2008), pp. 5155–5159.
- [41] KAMAL, A. 1+n network protection for mesh networks: Network coding-based protection using p-cycles. *IEEE/ACM Transactions on Networking*, vol. 18, no. 1 (2010), 67–80.
- [42] KHALED, A., AND PATRICK, W. D. Multi-Domain WDM network structures for large-scale reconfigurable partitionable parallel computer architecture. In *SPIE Proceedings on High-Speed Fiber Networks and Channels* (1992).

- [43] KOU, L., MARKOWSKY, G., AND BERMAN, L. A fast algorithm for Steiner trees. *Acta Informatica (Historical Archive)* vol. 15, no. 2 (1981), 141–145.
- [44] KULKARNI, P., TZANAKAKI, A., MACHUKA, C., AND TOMKOS, I. Benefits of Q-factor based routing in WDM metro networks. *IEE Conference Publications*, vol. 4, no. CP502 (2005), 981–982.
- [45] LEDA, 2009. <http://www.algorithmic-solutions.com/leda/index.htm>.
- [46] LEUTHOLD, J., JOYNER, C., MIKKELSEN, B., RABYON, G., PLEUMEEKERS, J., MILLER, B., DREYER, K., AND BURRUS, C. 100 gbit/s all-optical wavelength conversion with an integrated SOA delayed-interference configuration. *Electronics Letters*, vol. 36, no. 13 (2000), 1129–1130.
- [47] LI, L., AND SOMANI, A. K. *Multifiber WDM networks*. Kluwer Academic Publishers, Norwell, MA, USA, 2001, pp. 123–149.
- [48] LI, Y., WANG, J., GUMASTE, A., XU, Y., AND XU, Y. Multicast routing in light-trail WDM networks. In *IEEE Global Telecommunications Conference, GLOBECOM'08* (Dec. 2008), pp. 1–5.
- [49] LIBESKIND-HADAS, R. Efficient collective communication in WDM networks with a power budget. In *IEEE International Conference on Computer Communications and Networks, ICCCN'00* (Aug. 2000), pp. 612–616.
- [50] LIN, H.-C., AND WANG, S.-W. Splitter placement in all-optical WDM networks. In *IEEE Global Telecommunications Conference, GLOBECOM'05* (Dec. 2005), pp. 306–310.
- [51] LIU, Q., KÖK, M., GHANI, N., AND GUMASTE, A. Hierarchical routing in multi-domain optical networks. *Computer Communications*, vol. 30, no. 1 (2006), 122–131.
- [52] LONG, L., AND KAMAL, A. Tree-based protection of multicast services in WDM mesh networks. In *IEEE Global Telecommunications Conference, GLOBECOM'09* (Dec. 2009), pp. 1–6.
- [53] MALLI, R., ZHANG, X., AND QIAO, C. Benefit of multicasting in all-optical networks. *SPIE Proceeding on All-Optical Networking* (1998), 209–220.
- [54] MANOUSAKIS, K., CHRISTODOULOPOULOS, K., AND VARVARIGOS, E. Impairment-aware offline RWA for transparent optical networks. In *28th Annual Joint Conference*

- of the *IEEE Computer and Communications, INFOCOM'09* (Apr. 2009), pp. 1557–1565.
- [55] MICHELE, MOSCARDELLI, L., SHALOM, M., AND ZAKS, S. Approximating the traffic grooming problem. *Journal of Discrete Algorithms*, vol. 6, no. 3 (2008), 472–479.
- [56] MOLNÁR, M. Hierarchies for constrained partial spanning problems in graphs. Technical report, 2008.
- [57] MOLNÁR, M. Optimisation des communications multicast sous contraintes (in french). Mémoire HDR at University of Rennes 1, Nov. 2008.
- [58] MOLNÁR, M., ZHOU, F., AND COUSIN, B. *Multicast routing in optical access networks*. Optical Access Networks and Advanced Photonics: Technologies and Deployment Strategies. Idea Group Inc (IGI), 2009, Chapter 8, pp. 162–183.
- [59] MUKHERJEE, B. *Optical communication networking*. McGraw-Hill, 1997.
- [60] MUKHERJEE, B. WDM optical communication networks: progress and challenges. *IEEE Journal on Selected Areas in Communications*, vol. 18, no. 10 (2000), 1810–1824.
- [61] NESSET, D., KELLY, T., AND MARCENAC, D. All-optical wavelength conversion using SOA nonlinearities. *IEEE Communications Magazine*, vol. 36, no. 12 (1998), 56–61.
- [62] OKAMOTO, S., WATANABE, A., AND SATO, K.-I. Optical path cross-connect node architectures for photonic transport network. *IEEE/OSA Journal of Lightwave Technology*, vol. 14, no. 6 (1996), 1410–1422.
- [63] PAVON-MARINO, P., AZODOLMOLKY, S., APARICIO-PARDO, R., GARCIA-MANRUBIA, B., POINTURIER, Y., ANGELOU, M., SOLE-PARETA, J., GARCIA-HARO, J., AND TOMKOS, I. Offline impairment aware RWA algorithms for cross-layer planning of optical networks. *IEEE/OSA Journal of Lightwave Technology*, vol. 27, no. 12 (2009), 1763–1775.
- [64] PROAKIS, J. *Wiley encyclopedia of telecommunications*. John Wiley & Sons, Inc., 2001.

- [65] QIAO, C., JEONG, M., GUHA, A., ZHANG, X., AND WEI, J. WDM multicasting in IP over WDM networks. In *IEEE International Conference on Network Protocols, ICNP'99* (Nov. 1999), pp. 89–96.
- [66] RAM MURTHY C SIVA, G. M. *WDM optical networks: concepts, design, and algorithms*. Prentice Hall- Gale, 2002.
- [67] RAMALHO, M. Intra- and inter-domain multicast routing protocols: a survey and taxonomy. *IEEE Communications Surveys Tutorials*, 3, 1 (2000), 2–25.
- [68] RAMASWAMI, R., AND SIVARAJAN, K. N. *Optical Networks*. Morgan Kaufmann Publishers, California, San Francisco, USA, 1998.
- [69] ROUSKAS, G. Optical layer multicast: rationale, building blocks, and challenges. *IEEE Network*, vol. 17, no. 1 (2003), 60–65.
- [70] ROUSKAS, G. N., AND PERROS, H. G. A tutorial on optical networks. *Advanced Lectures on Networking* (2002), 155–193.
- [71] SAHASRABUDDHE, L. H., AND MUKHERJEE, B. Light-trees: Optical multicasting for improved performance in wavelength-routed networks. *IEEE Communications Magazine*, vol. 37, no. 2 (1999), 67–73.
- [72] SALEH, M. A., AND KAMAL, A. E. Approximation algorithms for many-to-many traffic grooming in WDM mesh networks. In *29th Annual Joint Conference of the IEEE Computer and Communications Societies, INFOCOM'10* (Apr. 2010), pp. 1–9.
- [73] SCHEUTZOW, M., SEELING, P., MAIER, M., AND REISSLEIN, M. Shortest path routing in optical WDM ring networks under multicast traffic. *IEEE Communications Letters*, vol. 10, no. 7 (2006), 564–566.
- [74] SCHEUTZOW, M., SEELING, P., MAIER, M., AND REISSLEIN, M. Multicasting in a WDM-upgraded resilient packet ring. *IEEE/OSA Journal of Optical Communications and Networking*, vol. 6, no. 5 (2007), 415–421.
- [75] SHEN, G., AND TUCKER, R. S. Energy-minimized design for IP over WDM networks. *IEEE/OSA Journal of Optical Communications and Networking*, vol. 1, no. 1 (2009), 176–186.
- [76] SIAMAK, A., MIROSLAW, K., EVA, M., DAVIDE, C., SOLÉ, P. J., AND IOANNIS, T. A survey on physical layer impairments aware routing and wavelength assignment algorithms in optical networks. *Computer Networks*, vol. 53, no. 7 (2009), 926–944.

- [77] SINGHAL, N., AND MUKHERJEE, B. Protecting multicast sessions in WDM optical mesh networks. *IEEE/OSA Journal of Lightwave Technology*, vol. 21, no. 4 (2003), 884 – 892.
- [78] SREENATH, N., AND MURTHY, C. S. R. Virtual source based multicast routing in WDM optical networks. In *IEEE International Conference on Networks, ICON'00* (Nov. 2000), pp. 385–389.
- [79] SREENATH, N., AND MURTHY, C. S. R. Virtual source based multicast traffic routing in IP-over-WDM networks. *Journal of High Speed Networks*, vol. 13, no. 4 (2004), 265–281.
- [80] STRAND, J., CHIU, A., AND TKACH, R. Issues for routing in the optical layer. *IEEE Communications Magazine*, vol. 39, no. 2 (2001), 81–87.
- [81] SZIGETI, J., GYARMATI, L., AND CINKLER, T. Multidomain shared protection with limited information via MPP and p-cycles. *IEEE/OSA Journal of Optical Communications and Networking*, vol. 7, no. 5 (2008), 400–409.
- [82] TAKAHASHI, H., AND MATSUYAMA, A. An approximate solution for the steiner problem in graphs. *Math. Japonica*, vol. 24, no. 6 (1980), 573–577.
- [83] TOMKOS, I., VOGIATZIS, D., MAS, C., ZACHAROPOULOS, I., TZANAKAKI, A., AND VARVARIGOS, E. Performance engineering of metropolitan area optical networks through impairment constraint routing. *IEEE Communications Magazine*, vol. 42, no. 8 (2004), S40–S47.
- [84] TOMKOS, I., VOGIATZIS, D., MAS, C., ZACHAROPOULOS, I., TZANAKAKI, A., AND VARVARIGOS, E. Performance engineering of metropolitan area optical networks through impairment constraint routing. *IEEE Communications Magazine*, vol. 42, no. 8 (2004), 40–47.
- [85] WATANABE, A., OKAMOTO, S., KOGA, M., SATO, K., AND OKUNO, M. 8×16 delivery and coupling switch board for 320 gbit/s throughput optical path cross-connect system. *Electronics Letters*, vol. 33, no. 1 (1997), 67–68.
- [86] WILFONG, G., AND WINKLER, P. Ring routing and wavelength translation. In *Annual ACM-SIAM symposium on Discrete Algorithms, SODA '98* (Jan. 1998), pp. 333–341.

- [87] WINTER, P. Steiner problem in networks: a survey. *Networks*, vol. 17, no. 2 (1987), 129–167.
- [88] WU, B., YEUNG, K. L., AND HO, P.-H. ILP formulations for non-simple p-cycle and p-trail design in WDM mesh networks. *Computer Networks*, vol. 54, no. 5 (2010), 716–725.
- [89] WU, K.-D., WU, J.-C., AND YANG, C.-S. Multicast routing with power consideration in sparse splitting WDM networks. In *IEEE International Conference on Communications, ICC'01* (May. 2001), pp. 513–517.
- [90] XIN, C., QIAO, C., AND DIXIT, S. Traffic grooming in mesh WDM optical networks - performance analysis. *IEEE Journal on Selected Areas in Communications*, vol. 22, no. 9 (2004), 1658–1669.
- [91] XIN, Y., AND ROUSKAS, G. Multicast routing under optical layer constraints. In *23rd Annual Joint Conference of the IEEE Computer and Communications Societies, INFOCOM'04* (Mar. 2004), pp. 2731–2742.
- [92] XU, Q., ALMEIDA, V. R., AND LIPSON, M. Micrometer-scale all-optical wavelength converter on silicon. *Optics Letters*, vol. 30, no. 20 (2005), 2733–2735.
- [93] YAN, S., DEOGUN, J. S., AND ALI, M. Routing in sparse splitting optical networks with multicast traffic. *Computer Networks*, vol. 41, no. 1 (2003), 89–113.
- [94] YANG, D.-N., AND LIAO, W. Design of light-tree based logical topologies for multicast streams in wavelength routed optical networks. In *22nd Annual Joint Conference of the IEEE Computer and Communications, INFOCOM'03* (Apr. 2003), pp. 32–41.
- [95] YONG, K.-M., POO, G.-S., AND CHENG, T.-H. Optimal placement of multicast and wavelength converting nodes in multicast optical virtual private network. *Computer Communications*, vol. 29, no. 12 (2006), 2169–2180.
- [96] YU, O., AND CAO, Y. Mathematical formulation of optical multicast with loss-balanced light-forest. In *IEEE Global Telecommunications Conference, GLOBECOM'05* (Dec. 2005), pp. 1968–1972.
- [97] ZHANG, F., AND ZHONG, W.-D. p-cycle based tree protection of optical multicast traffic for combined link and node failure recovery in WDM mesh networks. *IEEE Communications Letters*, vol. 13, no. 1 (2009), 40–42.

- [98] ZHANG, X., WEI, J. Y., AND QIAO, C. Constrained multicast routing in WDM networks with sparse light splitting. *IEEE/OSA Journal of Lightwave Technology*, vol. 18, no. 12 (2000), 1917–1927.
- [99] ZHANG, X. J., IL KIM, S., AND LUMETTA, S. S. Resource provisioning for dynamic multi-domain WDM networks: effectiveness and fairness. In *IEEE International Conference on Optical Network Design and Modeling, ONDM'09* (Feb. 2009), pp. 177–182.
- [100] ZHANG, Z., AND YANG, Y. On-line optimal wavelength assignment in WDM networks with shared wavelength converter pool. *IEEE/ACM Transaction on Networking*, vol. 15, no. 1 (2007), 234–245.
- [101] ZHOU, F., MOLNÁR, M., AND COUSIN, B. Avoidance of multicast incapable branching nodes for multicast routing in WDM networks. In *IEEE International Conference on Local Computer Networks, LCN'08* (Oct. 2008), pp. 336–344.
- [102] ZHOU, F., MOLNÁR, M., AND COUSIN, B. Distance priority based multicast routing in WDM networks considering sparse light splitting. In *IEEE Singapore International Conference on Communication Systems, ICCS'08* (Nov. 2008), pp. 709–714.
- [103] ZHOU, F., MOLNÁR, M., AND COUSIN, B. Avoidance of multicast incapable branching nodes for multicast routing in WDM networks. *Photonic Network Communications*, vol. 18, no. 3 (2009), 378–392.
- [104] ZHOU, F., MOLNÁR, M., AND COUSIN, B. Is light-tree structure optimal for multicast routing in sparse light splitting WDM networks? In *IEEE International Conference on Computer Communications and Networks, ICCCN'09* (Aug. 2009), pp. 1–7.
- [105] ZHOU, F., MOLNÁR, M., COUSIN, B., AND QIAO, C. Cost bounds of multicast light-trees in WDM networks. In *IFIP International Conference on Networking, Networking'10* (May. 2010), Lecture Note in Computer Science, pp. 94–105.
- [106] ZSIGRI, A., GUITTON, A., AND MOLNÁR, M. Construction of light-trees for WDM multicasting under splitting capability constraints. In *IEEE International Conference on Telecommunication, ConTel'03* (Jun. 2003), pp. 171–175.

Glossary

Acronym	Description	Chapter
AOM	All-Optical Multicasting	1, 7
AOMR	All-Optical Multicast Routing	1, 4–7
APD	Avalanche Photodiode	3
ASE	Amplifier Spontaneous Emission	1, 7
ATM	Asynchronous Transfer Mode	1
BER	Bit Error Rate	1, 3, 7
CAN	Critical Articulation Node	2
CCN	Connection Constraint Node	2
CD	Chromatic Dispersion	1
CP	Constrained Path	2
CPS	Cross Pair Switching	6
E/O	Electrical / Optical	1
EDFA	Erbium-Doped Fiber Amplifier	1–3
FDDI	Fiber Distributed Data Interface	1
FDM	Frequency Division Multiplexing	1
GRDP	Graph Renewal Distance Priority	5
HDTV	High-Definition Television	1, 2

Acronym	Description	Chapter
IA-MRWA	Impairment-Aware Multicast Routing and Wavelength Assignment	7
IA-RWA	Impairment-Aware Routing and Wavelength Assignment	7
ILP	Integer Linear Programming	1, 4, 6, 7
IP	Internet Protocol	1
LAN	Local Area Network	1
LH	Light-hierarchy	5, 6
LT	Light-tree	2, 3, 5, 6
MAN	Metropolitan Area Network	1
MC	Multicast Capable	1–7
MI	Multicast Incapable	1–7
MIB node	Multicast Incapable Branching node	2, 7
MIBPro	MIB Processing	2, 7
MILP	Mixed-Integer Linear Programming	1, 3, 7
MO	Member-Only	2, 4, 5
MOSaD	Member-Only Splitter-and-Delivery	1
MP2MP	Multipoint-to-Multipoint	1
MP2P	Multipoint-to-Point	1
MPH	Minimum Path Heuristic	4, 5
MPLS	Multi-Protocol Label Switch	1
MRWA	Multicast Routing And Wavelength Assignment	5
O/E	Optical / Electrical	1
OXC	Optical Cross Connect	1–3, 7
PLI	Physical Layer Impairment	1
PMD	Polarization Mode Dispersion	1
QoS	Quality of Service	1, 2, 4, 5

Acronym	Description	Chapter
QoT	Quality of Transmission	1, 7
R2A	Reroute-to-Any	2, 4
R2S	Reroute-to-Source	2, 4
RWA	Routing and Wavelength Assignment	1
SaD	Splitter-and-Delivery	1
SCP	Shortest Constrained Path	2
SDH	Synchronous Digital Hierarchy	1
SDS	Space Division Switch	1
SNR	Signal to Noise Ratio	1
SONET	Synchronous Optical Networks	1
SPL	Splitting Power Loss	3
SPM	Self-Phase Modulation	1
SPT	Shortest Path Tree	1, 2, 4, 5, 7
TaC	Tap-and-Continue	1–6
TCM	Tap-and-Continue Module	1
VoD	Video-on-Demand	1
VoiP	Voice over Internet Protocol	1, 2
WAN	Wide Area Network	1
WAP	Wavelength Assignment Problem	5
WC	WC (Wavelength Conversion	7
WCMC	Wavelength Conversion plus Light Splitting	7
WDM	Wavelength Division Multiplexing	1–7

Acknowledgment

This work is supported by China Scholarship Council, University of Rennes 1, and INSA of Rennes.

I would like to thank everyone with whom I have worked. First of all, I am very grateful to my advisors Dr. Miklós Molnár and Dr. Bernard Cousin for their invaluable guidance and suggestions throughout the last three years. Then, I am very pleased to collaborate with Dr. Chunming Qiao and Dr. Mohand Yazid Saidi. Moreover, I want to thank Dr. Samer Lahour for his kind help on ILP formulations, and thank Dr. Hamza Drid for his helpful discussions on optical networks. I want also to thank Dr. Thomas Legrand for his correction on the French abstract of my thesis and his valuable discussion regarding power loss in optical networks. Their involvement and expert insights have greatly helped me to enrich this thesis.

I would like to express my sincere gratitude to my advisory committee for reading and evaluating my dissertation.

I want to express my utmost appreciation to my parents, Benchen and Chengzhi, my sisters, Shanqin, Shanping, Shanhong, and Shanhua, my brothers-in-law as well as all of my relatives for their endless love and support throughout my studies.

I would like to thank my girlfriend Ting for her marvelous love, care and encouragement throughout my graduate study.

I would like to thank my friends of INSA like Ming, Weiming, Xiao, and so on for their kind help during my stay at Rennes, especially the period of our first arrival in France, which I will never forget.

I would like to thank the Frideaus who have helped me to improve my French.

I would like to thank all the colleagues of ATNET team always with whom I took the cafe break: Ahmed, Allia, Aymen, Emna, and Siwar.

I would like to thank all the great people I met at IRISA like Zhaoguang.

Finally, I want to thank Dr. Gilles Bertrand for his wonderful thesis format.

List of Publications

Book Chapters

- MOLNÁR, M., **ZHOU, F.**, AND COUSIN, B. Section II, Chapter 8: Multicast Routing in Optical Access Networks. *Optical Access Networks and Advanced Photonics: Technologies and Deployment Strategies*. IGI Global, Greece, ISBN: 978-1-60566-707-2, (Jul. 2009).

International Journals

- **ZHOU, F.**, MOLNÁR, M., AND COUSIN, B. All-Optical Multipoint-to-Point Routing in WDM Mesh Networks. *Annals of Telecommunications*, (in revision), 2010. Springer.
- **ZHOU, F.**, MOLNÁR, M., AND COUSIN, B. Hypo-steiner heuristic for multicast routing in WDM networks. *Photonic Network Communications*, 20(1):33-42, 2010. Springer.
- **ZHOU, F.**, MOLNÁR, M., AND COUSIN, B. Avoidance of multicast incapable branching nodes in WDM networks (extended version of LCN08). *Photonic Network Communications*, 18(3):378-392, 2009. Springer.

International Conferences

- **ZHOU, F.**, MOLNÁR, M., AND COUSIN, B. AND QIAO, C. Approximation Ratios of Multicast Light-trees in WDM Networks. In *IEEE Global Communications Conference (GLOBECOM'10)*, Miami, USA (Dec. 2010), p. 1–6.

- **ZHOU, F.**, MOLNÁR, M., AND COUSIN, B. Light-hierarchy: The optimal structure for multicast routing in WDM mesh networks. In *The 15th IEEE Symposium on Computers and Communications (ISCC'10)*, Riccione, Italy (Jun. 2010), p. 1–6.
- **ZHOU, F.**, MOLNÁR, M., COUSIN B., AND QIAO, C. Cost bounds of multicast light-trees in WDM networks. In *The 9th IFIP International Conference on Networking (Networking'10)*, Chennai, India (May. 2010), Lecture Note in Computer Science, p.94–105.
- **ZHOU, F.**, MOLNÁR, M., AND COUSIN, B. Multicast routing and wavelength assignment in WDM mesh networks with sparse splitting. In *The 5th International Workshop on Traffic Management and Traffic Engineering for the Future Internet (EuroNF'09)*, Paris, France (Dec. 2009), p.17–18.
- **ZHOU, F.**, SAIDI, M. Y., MOLNÁR, M., AND COUSIN, B. Supporting multipoint-to-point communications in all-optical WDM networks. In *The 34th IEEE International Conference on Local Computer Networks (LCN'09)*, Zurich, Switzerland (Oct. 2009), p.209–212.
- **ZHOU, F.**, MOLNÁR, M., AND COUSIN, B. Is light-tree structure optimal for multicast routing in sparse light splitting WDM networks? In *The 18th IEEE International Conference on Computer Communications and Networks (ICCCN'09)*, San Francisco, USA (Aug. 2009), p.1–7.
- **ZHOU, F.**, MOLNÁR, M., AND COUSIN, B. Distance priority based multicast routing in WDM networks considering sparse light splitting. In *The 11th IEEE International Conference on Communications Systems (ICCS'08)*, Guangzhou, China (Nov. 2008), p.709–714.
- **ZHOU, F.**, MOLNÁR, M., AND COUSIN, B. Avoidance of multicast incapable branching nodes in WDM networks. In *The 33rd IEEE International Conference on Local Computer Networks (LCN'08)*, Montreal, Canada (Oct. 2008), p.336–344.

Presentations

- **ZHOU, F.**, MOLNÁR, M., AND COUSIN, B. Multicast routing in sparse splitting WDM networks. *Journées Automnales ResCom*, Strasbourg, France (Oct. 9–10, 2008).

VU :

VU :

Le Directeur de Thèse

Le Responsable de l'École Doctorale

VU pour autorisation de soutenance

Rennes, le

Le Président de l'Université de Rennes 1

VU après soutenance pour autorisation de publication :

Le Président de Jury,