



HAL
open science

Nouveaux phénotypes immunologiques et cliniques liés au déficit de la chaîne IL-12R β 1

Ludovic Ganne de Beaucoudrey

► **To cite this version:**

Ludovic Ganne de Beaucoudrey. Nouveaux phénotypes immunologiques et cliniques liés au déficit de la chaîne IL-12R β 1. Bibliothèque électronique [cs.DL]. Université Pierre et Marie Curie - Paris VI, 2008. Français. NNT : 2008PA066276 . tel-00811584

HAL Id: tel-00811584

<https://theses.hal.science/tel-00811584v1>

Submitted on 10 Apr 2013

HAL is a multi-disciplinary open access archive for the deposit and dissemination of scientific research documents, whether they are published or not. The documents may come from teaching and research institutions in France or abroad, or from public or private research centers.

L'archive ouverte pluridisciplinaire **HAL**, est destinée au dépôt et à la diffusion de documents scientifiques de niveau recherche, publiés ou non, émanant des établissements d'enseignement et de recherche français ou étrangers, des laboratoires publics ou privés.

**THESE DE DOCTORAT DE
L'UNIVERSITE PIERRE ET MARIE CURIE**

Spécialité Immunologie
(Ecole Doctorale Logique Du Vivant)

présentée par

Ludovic de BEAUCOUDREY

pour obtenir le grade de

DOCTEUR DE L'UNIVERSITE PIERRE ET MARIE CURIE

Sujet de la thèse :

**Nouveaux phénotypes immunologiques et cliniques liés au déficit
de la chaîne IL-12R β 1**

Thèse dirigée par le Professeur Jean-Laurent CASANOVA

réalisée au sein du Laboratoire de Génétique Humaine des Maladies Infectieuses

Université Paris Descartes - INSERM U550

Faculté de Médecine Necker-Enfants Malades, Paris, France

soutenue le lundi 17 novembre 2008 devant le jury composé de

Professeur Pierre NETTER	Président
Professeur Alain CALENDER	Rapporteur
Docteur Lars ROGGE	Rapporteur
Docteur Claude-Agnès REYNAUD	Examineur
Professeur Marc BONNEVILLE	Examineur

TABLE DES MATIERES

TABLE DES MATIERES	p3
LABORATOIRE DE THESE ET FINANCEMENTS	p4
RESUMES	p5
ABREVIATIONS UTILISEES	p7
LISTE DES PUBLICATIONS	p8
INTRODUCTION	p11
1. ETUDE DE PATIENTS PORTEURS DE MUTATIONS DANS LE GENE <i>IL12RB1</i>	p15
1.1. La réponse immunitaire anti-mycobactérienne	p15
1.2. Du gène <i>IL12RB1</i> à la protéine IL-12Rβ1	p16
1.3. IL-12Rβ1, IL-12 et IL-23	p18
1.4. Etat de la cohorte en 2004	p19
1.5. Recrutement des patients et méthodes employées	p20
1.6. Diversité et homogénéité observées dans le défaut complet en IL-12Rβ1	p22
1.7. Exemples d'utilisation des mutants humains <i>IL12RB1</i>	p23
1.8. Conclusions	p25
1.9. Discussion	p26
2. ETUDE DE LA POPULATION DE LYMPHOCYTES T PRODUCTEURS D'IL-17	p29
2.1. Le paradigme Th1-Th2-Th17	p29
2.2. Les Th17 chez la souris	p30
2.3. Les Th17 chez l'homme	p32
2.4. Une dissection génétique de la différenciation Th17	p33
2.5. Les différents patients utilisés	p33
2.5.1. Les mutants de la voie du TGF-β	
2.5.2. Les mutants de la voie de l'IL-1β	
2.5.3 Les mutants de la voie de l'IL-6	
2.5.4. Les mutants de la voie de l'IL-23	
2.5.5 Les autres patients	
2.6. Choix du modèle expérimental	p36
2.7. Résultats	p39
2.8. Conclusions	p40
2.9. Discussion	p42
CONCLUSIONS, PERSPECTIVES	p44
REFERENCES	p46
ARTICLES	p54

Laboratoire d'accueil

Laboratoire de Génétique Humaine des Maladies Infectieuses



Unité Mixte de Recherche Université Paris Descartes – INSERM U550
Faculté de médecine Necker-Enfants Malades
156 rue de Vaugirard
75015 Paris
France

Téléphone : 01 40 61 53 81
Fax : 01 40 61 56 88

Sous la direction de : Laurent ABEL (laurent.abel@inserm.fr)
Jean-Laurent CASANOVA (Jean-laurent.casanova@inserm.fr)

Site internet : <http://www.hgid.net>

Financements

Allocation de recherche du Ministère de l'Enseignement Supérieur
et de la Recherche (2004-2007)



Allocation de fin de thèse de la Fondation pour la Recherche Médicale
(2007-2008)



Moniteur de l'Université Paris Diderot – CIES Jussieu (2004-2007)
Service d'enseignement de Biologie Moléculaire et Cellulaire



RESUMES

Résumé en français

L'axe IL-12-IFN- γ joue un rôle important dans l'immunité anti-mycobactérienne. J'ai identifié et étudié une cohorte de 137 patients présentant un déficit autosomique récessif complet d'*IL12RB1* qui code la sous-unité $\beta 1$ des récepteurs de l'IL-12 et de l'IL-23. Ces patients sont issus de 101 familles provenant de 30 pays. Ils présentent une grande diversité génétique avec 52 allèles mutants différents. Le phénotype cellulaire avec un défaut complet de réponse à l'IL-12 est homogène chez tous les patients. Les phénotypes cliniques sont eux très hétérogènes allant de l'absence d'infection jusqu'au décès. Il s'agit en grande majorité d'infections mycobactériennes (BCG, mycobactéries environnementales et tuberculose) et/ou à salmonelles. La candidose est aussi retrouvée associée à ce défaut chez un grand nombre de patients.

L'axe IL-23-IL-17 participe à la différenciation et à l'activation des lymphocytes T CD4⁺ dits de type Th17. Les cytokines et les mécanismes contrôlant la différenciation de ces cellules sont peu connus. J'ai étudié le développement des lymphocytes producteurs d'IL-17 chez des patients porteurs de défauts génétiques affectant la voie du TGF- β (patients *TGFBR1*, *TGFBR2* et *TGFBI*), de l'IL-1 β (patients *IRAK4* et *MYD88*), de l'IL-6 (patients *STAT3*) et de l'IL-23 (patients *IL12B* et *IL12RB1*). Pour cela, j'ai quantifié la production et la sécrétion d'IL-17 dans deux modèles expérimentaux *ex vivo* et *in vitro*. Les patients *IL12B*^{-/-} et *IL12RB1*^{-/-}, et de façon plus drastique les patients *STAT3*^{-/-} présentent une diminution des lymphocytes producteurs d'IL-17, ce qui suggère l'importance de ces molécules dans la différenciation et l'expansion des cellules Th17 *in vivo*.

Mots clés en français

Génétique, Immunologie, *IL12RB1*, Mycobactérie, Salmonelle, Candida, IL-12, IFN- γ , IL-23, IL-17, *STAT3*

Résumé en anglais

The IL-12-IFN- γ axis plays an important role in the immunity against mycobacteria. I have identified and studied a cohort of patients with a complete autosomal recessive *IL12RB1* deficiency coding for the $\beta 1$ subunit of the IL-12 and IL-23 receptors. We herein report an international survey of 137 patients from 101 kindreds and 30 countries. A total of 52 *IL12RB1* mutant alleles were found. All patients had a functional complete IL-12R $\beta 1$ deficiency, most with a lack of IL-12R $\beta 1$ expression at the cell surface. Clinical phenotypes are heterogeneous from an absence of infection to the death following infection. In most cases, infection consisted in mycobacterial diseases (BCG, environmental mycobacteria and tuberculosis) and/or salmonella diseases. Candidiasis was also being frequently associated to this defect.

The IL-23-IL-17 axis seems to play a role in the differentiation and activation of the Th17 CD4⁺ T cells. The cytokines controlling the development of these cells are not well known. We addressed the question of the development of human IL-17-producing T helper cells *in vivo* by quantifying the production and secretion of IL-17 by fresh T cells *ex vivo*, and by T cell blasts expanded *in vitro* from patients with particular genetic disorders affecting TGF- β (patients *TGFB1*, *TGFBR1* and *TGFBR2*), IL-1 β (patients *IRAK4* and *MYD88*), IL-6 (patients *STAT3*), or IL-23 (patients *IL12B* and *IL12RB1*) responses. Mutations in *STAT3* and, to a lesser extent mutations in *IL12B* and *IL12RB1*, impaired the development of IL-17-producing T cells. These data suggest that these molecules play a key role in the differentiation and/or expansion of human IL-17-producing T cell populations *in vivo*.

Mots clés en anglais

Genetic, Immunology, *IL12RB1*, Mycobacteria, Salmonella, Candida, IL-12, IFN- γ , IL-23, IL-17, *STAT3*

ABREVIATIONS UTILISEES

aa	Acide Aminé
ADN	Acide Désoxyribonucléique
ARNm	Acide Ribonucléique messenger
BCG	Bacille de Calmette et Guérin
B-EBV	Lymphocytes B immortalisés par le virus d'Epstein-Barr
Blastes PHA	Lymphocytes T activés par la Phytohémagglutinine-P
<i>BTK</i>	gène codant la Bruton Tyrosine Kinase
<i>CYBB</i>	gène codant le Cytochrome B-245 Beta polypeptide (GP91phox)
ELISA	Enzyme-Linked ImmunoSorbent Assay
FACS	Fluorescent-Activating Cell Sorting
FNIII	domaine Fibronectine de type III
FOXP3	Forkhead Box P3 (facteur de transcription)
GATA3	GATA binding protein 3 (facteur de transcription)
IFN-	Interféron
IL-	Interleukine
<i>IL12A</i>	gène codant la sous-unité p35 de l'IL-12
<i>IL12B</i>	gène codant la sous-unité p40 commune de l'IL-12 et de l'IL-23
IL-12R β 1	chaîne β 1 commune des récepteurs de l'IL-12 et de l'IL-23
IL-12R β 2	chaîne β 2 du récepteur de l'IL-12
<i>IL23A</i>	gène codant la sous-unité p19 de l'IL-23
IL-23R	chaîne 2 du récepteur de l'IL-23
IRAK4	Interleukin-1 Receptor-Associated Kinase 4
IRF4	Interferon Regulatory Factor 4 (facteur de transcription)
JAK2	Janus Kinase 2
MSMD	Mendelian Susceptibility to Mycobacterial Diseases
MYD88	Myeloid Differentiation primary response gene 88
NEMO	NF- κ B Essential Modulator
NK	lymphocyte Natural Killer
OMIM	Online Mendelian Inheritance in Man
pb	Paire de Base
PBMC	Peripheral Blood Mononuclear Cells
PCR	Polymerase Chain Reaction
PHA	Phytohémagglutinine-P
PMA	Phorbol 12-Myristate 13-Acetate (ester de Phorbol)
RORC	gène RAR-related Orphan Receptor C codant la protéine ROR γ t (facteur de transcription)
RT-PCR	Reverse Transcription PCR
STAT1/3/4	Signal Transducer and Activator of Transcription-1/3/4 (facteurs de transcription)
<i>TBET/TBX21</i>	T-Box Expressed in T cells ou T-Box 21 (facteur de transcription)
TGF- β	Transforming Growth Factor β (codé par le gène <i>TGFBI</i>)
TGFBR1/2	TGF- β Receptor 1/2
Th	T « helper »
TLR	Toll-Like Receptor
Treg	lymphocyte T régulateur
TYK2	Tyrosine Kinase 2

LISTE DES PUBLICATIONS

Publications du doctorat

1. Ehlayel, M., **L. de Beaucoudrey**, F. Fike, S.A. Nahas, J. Feinberg, J.L. Casanova, and R.A. Gatti. 2008. Simultaneous presentation of 2 rare hereditary immunodeficiencies: IL-12 receptor beta1 deficiency and ataxia-telangiectasia. *The Journal of Allergy and Clinical Immunology* in press.
2. **de Beaucoudrey, L.**, A. Puel, O. Filipe-Santos, A. Cobat, P. Ghandil, M. Chrabieh, J. Feinberg, H. von Bernuth, A. Samarina, L. Janniere, C. Fieschi, J.L. Stephan, C. Boileau, S. Lyonnet, G. Jondeau, V. Cormier-Daire, M. Le Merrer, C. Hoarau, Y. Lebranchu, O. Lortholary, M.O. Chandesris, F. Tron, E. Gambineri, L. Bianchi, C. Rodriguez-Gallego, S.E. Zitnik, J. Vasconcelos, M. Guedes, A.B. Vitor, L. Marodi, H. Chapel, B. Reid, C. Roifman, D. Nadal, J. Reichenbach, I. Caragol, B.Z. Garty, F. Dogu, Y. Camcioglu, S. Gulle, O. Sanal, A. Fischer, L. Abel, B. Stockinger, C. Picard, and J.L. Casanova. 2008. Mutations in *STAT3* and *IL12RB1* impair the development of human IL-17-producing T cells. *The Journal of Experimental Medicine* 205:1543-1550.
3. Guia, S., C. Cognet, **L. de Beaucoudrey**, M.S. Tessmer, E. Jouanguy, C. Berger, O. Filipe-Santos, J. Feinberg, Y. Camcioglu, J. Levy, S. Al Jumaah, S. Al-Hajjar, J.L. Stephan, C. Fieschi, L. Abel, L. Brossay, J.L. Casanova, and E. Vivier. 2008. A role for interleukin-12/23 in the maturation of human natural killer and CD56+ T cells in vivo. *Blood* 111:5008-5016.
4. Scheuerman, O., **L. de Beaucoudrey**, V. Hoffer, J. Feinberg, J.L. Casanova, and B.Z. Garty. 2007. Mycobacterial disease in a child with surface-expressed non-functional interleukin-12Rbeta1 chains. *The Israel Medical Association Journal* 9:560-561.
5. Filipe-Santos, O., J. Bustamante, A. Chapgier, G. Vogt, **L. de Beaucoudrey**, J. Feinberg, E. Jouanguy, S. Boisson-Dupuis, C. Fieschi, C. Picard, and J.L. Casanova. 2006. Inborn errors of IL-12/23- and IFN-gamma-mediated immunity: molecular, cellular, and clinical features. *Seminars in Immunology* 18:347-361.
6. Miro, F., C. Nobile, N. Blanchard, M. Lind, O. Filipe-Santos, C. Fieschi, A. Chapgier, G. Vogt, **L. de Beaucoudrey**, D.S. Kumararatne, F. Le Deist, J.L. Casanova, S. Amigorena, and C. Hivroz. 2006. T cell-dependent activation of dendritic cells requires IL-12 and IFN-gamma signaling in T cells. *The Journal of Immunology* 177:3625-3634.
7. Tanir, G., F. Dogu, N. Tuygun, A. Ikinogullari, C. Aytekin, C. Aydemir, M. Yuksek, E.C. Boduroglu, **L. de Beaucoudrey**, C. Fieschi, J. Feinberg, J.L. Casanova, and E. Babacan. 2006. Complete deficiency of the IL-12 receptor beta1 chain: three unrelated Turkish children with unusual clinical features. *European Journal of Pediatrics* 165:415-417.
8. Mansouri, D., P. Adimi, M. Mirsaedi, N. Mansouri, S. Khalilzadeh, M.R. Masjedi, P. Adimi, P. Tabarsi, M. Naderi, O. Filipe-Santos, G. Vogt, **L. de Beaucoudrey**, J. Bustamante, A. Chapgier, J. Feinberg, A.A. Velayati, and J.L. Casanova. 2005. Inherited

disorders of the IL-12-IFN-gamma axis in patients with disseminated BCG infection. *European Journal of Pediatrics* 164:753-757

9. Moraes-Vasconcelos, D., A.S. Grumach, A. Yamaguti, M.E. Andrade, C. Fieschi, **L. de Beaucoudrey**, J.L. Casanova, and A.J. Duarte. 2005. Paracoccidioides brasiliensis disseminated disease in a patient with inherited deficiency in the beta1 subunit of the interleukin (IL)-12/IL-23 receptor. *Clinical Infectious Diseases* 41:e31-37.
10. Ozbek, N., C. Fieschi, B.T. Yilmaz, **L. de Beaucoudrey**, B. Demirhan, J. Feinberg, Y.E. Bikmaz, and J.L. Casanova. 2005. Interleukin-12 receptor beta 1 chain deficiency in a child with disseminated tuberculosis. *Clinical Infectious Diseases* 40:e55-58.
11. Feinberg, J., C. Fieschi, R. Doffinger, M. Feinberg, T. Leclerc, S. Boisson-Dupuis, C. Picard, J. Bustamante, A. Chapgier, O. Filipe-Santos, C.L. Ku, **L. de Beaucoudrey**, J. Reichenbach, G. Antoni, R. Balde, A. Alcais, and J.L. Casanova. 2004. Bacillus Calmette Guerin triggers the IL-12/IFN-gamma axis by an IRAK-4- and NEMO-dependent, non-cognate interaction between monocytes, NK, and T lymphocytes. *European Journal of Immunology* 34:3276-3284.
12. Fieschi, C., M. Bosticardo, **L. de Beaucoudrey**, S. Boisson-Dupuis, J. Feinberg, O. Filipe-Santos, J. Bustamante, J. Levy, F. Candotti, and J.L. Casanova. 2004. A novel form of complete IL-12/IL-23 receptor beta1 deficiency with cell surface-expressed nonfunctional receptors. *Blood* 104:2095-2101.

Publication en préparation

13. **de Beaucoudrey, L.**, J. Feinberg, J. Bustamante, A. Cobat, A. Samarina, L. Janni re, S. Boisson-Dupuis, Y. Rose, O. Filipe-Santos, A. Chapgier, F. Altare, C. Picard, A. Fischer, C. Rodriguez-Gallego, I. Caragol, C.A. Sigriest, J. Reichenbach, D. Nadal, K. Freceerova, Y. Boyko, B. Pietrucha, R. Bl tters-Sawatzki, J. Bernh ft, J. Freihorst, U. Baumann, O. Jeppsson, D. Richter, F. Haerynck, S. Anderson, M. Levin, D. S. Kumararatne, S. Patel, R. Doffinger, A. Exley, V. Novelli, D. Lamas, K. Scheppers, F. Mascart, C. Vermylen, D. Tuerlinckx, C. Nieuwhof, M. Pac, W. H. Haas, N.  zbek, Y. Camcioglu, F. Dogu, A. Ikinociogullari, G. Tanir, S. G lle, N. Kutuculer, G. Aksu, M. Keser, A. Somer, N. Hatipoglu, C. Aydogmus, M. S. Ehlayel, A. Al Alangari, S. Al Hajjar, S. Al Jumaah, H. Frayha, S. Al Ajiji, S. Al Muhsen, B.Z. Garty, J. Levy, P. Adimi, D. Mansouri, A. Bousfiha, J. El Baghdadi, R. Barbouche, I. Ben Mustapha, M. Bejaoui, R. Raj, K. D. Yang, X. Wang, L. Jiang, Z. Chaomin, X. Yuanyuan, Y. Xiqiang, M. Matsuoka, T. Sakai, A. Cleary, D. B Lewis, S. Holland, G. Castro, N. Ivelisse, A. King, S. Rosenzweig, J. Yancoski, L. Bezrodnik, D. Di Giovanni, M. I. Gaillard, D. de Moraes-Vasconcelos, A. J. da Silva Duarte, R. Aldana, S. Valverde Rosas, F. Javier Espinosa-Rosales, S. Pedraza, L. Abel, C. Fieschi, O. Sanal and J.L. Casanova. Revisiting human IL-12R 1 deficiency: higher penetrance, broader susceptibility, and poorer outcome.

Autres publications

14. Bustamante, J., G. Aksu, G. Vogt, **L. de Beaucoudrey**, F. Genel, A. Chapgier, O. Filipe-Santos, J. Feinberg, J.F. Emile, N. Kutuculer, and J.L. Casanova. 2007. BCG-osis and

- tuberculosis in a child with chronic granulomatous disease. *The Journal of Allergy and Clinical Immunology* 120:32-38.
15. Bustamante, J., C. Picard, C. Fieschi, O. Filipe-Santos, J. Feinberg, C. Perronne, A. Chagnier, **L. de Beaucoudrey**, G. Vogt, D. Sanlaville, A. Lemainque, J.F. Emile, L. Abel, and J.L. Casanova. 2007. A novel X-linked recessive form of Mendelian susceptibility to mycobacterial disease. *Journal of Medical Genetics* 44:e65.
 16. Chagnier, A., S. Boisson-Dupuis, E. Jouanguy, G. Vogt, J. Feinberg, A. Prochnicka-Chalufour, A. Casrouge, K. Yang, C. Soudais, C. Fieschi, O.F. Santos, J. Bustamante, C. Picard, **L. de Beaucoudrey**, J.F. Emile, P.D. Arkwright, R.D. Schreiber, C. Rolinck-Werninghaus, A. Rosen-Wolff, K. Magdorf, J. Roesler, and J.L. Casanova. 2006. Novel *STAT1* alleles in otherwise healthy patients with mycobacterial disease. *PLoS Genetics* 2:e131.
 17. Filipe-Santos, O., J. Bustamante, M.H. Haverkamp, E. Vinolo, C.L. Ku, A. Puel, D.M. Frucht, K. Christel, H. von Bernuth, E. Jouanguy, J. Feinberg, A. Durandy, B. Senechal, A. Chagnier, G. Vogt, **L. de Beaucoudrey**, C. Fieschi, C. Picard, M. Garfa, J. Chemli, M. Bejaoui, M.N. Tsoia, N. Kutukculer, A. Plebani, L. Notarangelo, C. Bodemer, F. Geissmann, A. Israel, M. Veron, M. Knackstedt, R. Barbouche, L. Abel, K. Magdorf, D. Gendrel, F. Agou, S.M. Holland, and J.L. Casanova. 2006. X-linked susceptibility to mycobacteria is caused by mutations in *NEMO* impairing CD40-dependent IL-12 production. *The Journal of Experimental Medicine* 203:1745-1759.
 18. Puel, A., J. Reichenbach, J. Bustamante, C.L. Ku, J. Feinberg, R. Doffinger, M. Bonnet, O. Filipe-Santos, **L. de Beaucoudrey**, A. Durandy, G. Horneff, F. Novelli, V. Wahn, A. Smahi, A. Israel, T. Niehues, and J.L. Casanova. 2006. The NEMO mutation creating the most-upstream premature stop codon is hypomorphic because of a reinitiation of translation. *The American Journal of Human Genetics* 78:691-701.
 19. Vogt, G., A. Chagnier, K. Yang, N. Chuzhanova, J. Feinberg, C. Fieschi, S. Boisson-Dupuis, A. Alcais, O. Filipe-Santos, J. Bustamante, **L. de Beaucoudrey**, I. Al-Mohsen, S. Al-Hajjar, A. Al-Ghoniaim, P. Adimi, M. Mirsaeidi, S. Khalilzadeh, S. Rosenzweig, O. de la Calle Martin, T.R. Bauer, J.M. Puck, H.D. Ochs, D. Furthner, C. Engelhorn, B. Belohradsky, D. Mansouri, S.M. Holland, R.D. Schreiber, L. Abel, D.N. Cooper, C. Soudais, and J.L. Casanova. 2005. Gains of glycosylation comprise an unexpectedly large group of pathogenic mutations. *Nature Genetics* 37:692-700.

INTRODUCTION

L'immunologie est l'étude des mécanismes de défense du corps contre les infections. Le système immunitaire est très complexe, spécialement chez les vertébrés, et sa fonction principale est la protection contre les microorganismes. Cependant, les infections sont la cause de décès la plus importante dans l'histoire de l'homme. Jusqu'au siècle dernier, la durée de vie moyenne était de 25 ans. L'allongement de la durée de la vie à près de 80 ans aujourd'hui résulte d'un meilleur contrôle des maladies infectieuses grâce à l'effet combiné des mesures d'hygiène, de la vaccination et des antibiotiques et non pas d'un ajustement du système immunitaire aux microbes par des mécanismes d'évolution tel que la sélection naturelle (revue dans (1)). Le système immunitaire, très efficace à l'échelle de la population dans la défense contre les agents infectieux, est beaucoup moins fiable à l'échelle de l'individu. Il ne permet pas une résistance à tous les pathogènes chez tous les individus. Une grande proportion de ces dérèglements individuels du système immunitaire est d'origine génétique. Le premier déficit immunitaire primaire décrit est l'agammaglobulinémie en 1952 par Bruton (2), dont le défaut moléculaire a été identifié en 1993 sur le gène *BTK* (3, 4). Depuis, de nombreux expérimentalistes se sont lancés dans l'étude de ces déficits et de leurs mécanismes (5). L'étude de ces nombreux cas d'erreurs innées du système immunitaire est très utile pour en comprendre le fonctionnement normal.

L'immunologie moléculaire et cellulaire a fait de grandes avancées dans ces 20 dernières années non seulement grâce aux études réalisées chez la souris mais surtout grâce à l'avènement et au développement de la biologie moléculaire. L'importance des études sur des animaux modèles tels que la souris, le rat, la drosophile ou le zebrafish n'est plus à démontrer. Ces études permettent un accès à des informations souvent inaccessibles chez l'homme. Bien que l'utilité et la complémentarité qu'offrent les modèles animaux et les études réalisées chez

l'homme pour la dissection du système immunitaire ne soient plus à démontrer, il existe des différences fondamentales entre les deux (6). En effet, les études chez l'homme sont réalisées en conditions naturelles alors que chez l'animal elles sont faites en conditions expérimentales. Une grande différence est que le fonds génétique de l'hôte et son environnement sont totalement incontrôlés chez l'homme (ce qui entraîne une grande variabilité inter- et intra-individuelle), alors qu'ils sont contrôlés chez l'animal (ce qui permet de diminuer cette variabilité). L'utilisation d'un seul ou de quelques fonds génétiques a l'avantage de diminuer la variabilité, mais peut aussi fausser d'éventuelles généralisations vers d'autres fonds de la même ou d'autres espèces. De plus, les agents infectieux utilisés chez l'animal ont rarement un tropisme naturel pour celui-ci. Les doses d'agents infectieux et la pureté de l'inoculum utilisées sont très souvent supérieures aux doses rencontrées dans la nature. Les moyens d'infection des animaux sont souvent différents des voies naturelles utilisées par les pathogènes. Notre méthode pour comprendre le système immunitaire est donc de rechercher, d'identifier et d'étudier des mutants génétiques de susceptibilité aux agents infectieux *in natura* (7).

Ces mutants naturels permettent de définir le ou les rôle(s) des fonctions atteintes en condition normale d'utilisation chez l'homme. Le syndrome de prédisposition mendélienne aux infections mycobactériennes (MSMD, OMIM 209950 (8)) est un syndrome clinique rare qui se manifeste par des infections sévères et récurrentes à des souches peu virulentes de mycobactéries, telles que le vaccin vivant du Bacille de Calmette et Guérin (BCG) ou les mycobactéries environnementales. Ce syndrome a été initialement décrit chez des enfants avec des infections disséminées par le BCG (9-12). Des infections à salmonelles sont communément retrouvées dans de nombreux cas, associées ou non à des infections mycobactériennes. A mon arrivée dans le laboratoire, des mutations de cinq gènes

autosomiques participant à l'immunité médiée par l'IFN- γ avaient été identifiées : trois gènes dont les mutations sont responsables d'un défaut de réponse à l'IFN- γ (*IFNGR1* et *IFNGR2* codant respectivement les sous-unités IFN- γ R1 et IFN- γ R2 du récepteur de l'IFN- γ , et *STAT1* codant un facteur de transcription de la voie de réponse à l'IFN- γ) ; deux autres gènes dont les mutations sont responsables d'un défaut de production d'IFN- γ (*IL12B* qui code la sous-unité IL-12p40 commune de l'interleukine (IL-)12 et de l'IL-23, et *IL12RB1* qui code la sous-unité β 1 commune des récepteurs de l'IL-12 et de l'IL-23). Des mutations de deux autres gènes situés sur le chromosome X ont été identifiés plus récemment (*NEMO* et *CYBB*) (revue dans l'article 5, Bustamante *et al*, en révision). Ces mutations définissent 13 maladies génétiques différentes (tableau 1).

Tableau 1: Etiologies génétiques du syndrome de prédisposition mendélienne aux infections mycobactériennes. 13 différentes étiologies génétiques ont été décrites dans 7 gènes et classées en fonction de: 1- leur mode de transmission autosomique (A) ou lié à l'X (X), récessif (R) ou dominant (D). 2- leur défaut fonctionnel complet (C) ou partiel (P). 3- leur niveau d'expression de la protéine mutante normale (E^+), surexprimée (E^{++}), diminuée (E^-) ou non exprimée (E^0).

Gène	Mode de transmission	Défaut fonctionnel	Conséquence protéique
<i>IL12B</i>	AR	C	E^0
<i>IL12RB1</i>	AR	C	E^0
	AR	C	E^-
<i>IFNGR1</i>	AR	C	E^+
	AR	C	E^0
	AR	P	E^+
	AD	P	E^{++}
<i>IFNGR2</i>	AR	C	E^+
	AR	C	E^0
	AR	P	E^+
<i>STAT1</i>	AD	P	E^+
<i>NEMO</i>	XR	P	E^+
<i>CYBB</i>	XR	C	E^-

J'ai eu la chance au cours de ma thèse de travailler sur deux voies de signalisation ayant comme point commun la molécule IL-12R β 1 : l'axe IL-12-IFN- γ et l'axe IL-23-IL-17. Une partie de mon travail de thèse a consisté à identifier et à décrire des patients ayant un défaut de réponse à l'IL-12 causé par des mutations dans le gène *IL12RB1*. La première partie de ce manuscrit portera donc sur l'identification de patients déficients en IL-12R β 1. Après un bref état des connaissances sur la réponse immunitaire anti-mycobactérienne et le récepteur de l'IL-12, je vous présenterai la situation de la cohorte de patients à mon arrivée, et les méthodes utilisées pour recruter de nouveaux patients. Je discuterai les résultats et les limites de cette étude de cohorte. Une autre partie de mon travail s'est portée vers une nouvelle population de cellules récemment identifiées : les lymphocytes T producteurs d'IL-17. Dans la deuxième partie de ce manuscrit, je commencerai par situer le paradigme Th1-Th2-Th17 de différenciation des lymphocytes T CD4⁺. Puis je vous décrirai un exemple d'utilisation de mutants humains dans le cadre de la dissection de la différenciation des lymphocytes T producteurs d'IL-17. Ensuite, je décrirai le modèle expérimental que nous avons choisi pour cette étude. Enfin, je discuterai les résultats que nous avons obtenus, ainsi que les avancées que nous apportons au modèle de différenciation de ces cellules. J'ai délibérément fait le choix de ne pas répéter ni rediscuter ce qui a déjà été écrit dans les publications en annexes ou dans l'article en préparation qui sont à la fin de ce document.

1. ETUDE DE PATIENTS PORTEURS DE MUTATIONS DANS LE GENE *IL12RB1*

1.1. La réponse immunitaire anti-mycobactérienne

La réponse immunitaire dirigée contre les micro-organismes intracellulaires et en particulier les mycobactéries est caractérisée par la production d'une cytokine clé : l'IFN- γ (13). La phagocytose de la mycobactérie par les macrophages ou les cellules dendritiques induit la production d'IL-12 (figure 1). L'IL-12, cytokine hétérodimérique proinflammatoire composée de deux sous-unités IL-12p40 et IL-12p35, se fixe sur son récepteur présent à la surface des lymphocytes T et NK (14). Le récepteur de l'IL-12 composé de deux sous-unités, IL-12R β 1 et IL-12R β 2 (15), permet l'activation de deux Janus kinase, JAK2 et TYK2, qui vont à leur tour activer le facteur de transcription STAT4 qui induit, entre autre, la production d'IFN- γ (16). L'IFN- γ produit va alors autoactiver les lymphocytes en se fixant à son récepteur. L'IFN- γ se fixe aussi à la surface des macrophages et des cellules dendritiques qui, via le facteur de transcription STAT1, vont activer la transcription de plus d'une centaine de gènes cibles pour permettre la destruction et l'élimination de la bactérie. L'implication de NEMO, activé par l'interaction cellule-cellule via la voie CD40-CD40L a été mise en évidence en 2006 (article 17). Plus récemment, l'impact du système NADPH oxydase dans certains types cellulaires a été démontré comme jouant un rôle important dans l'immunité anti-mycobactérienne (Bustamante *et al*, en révision).

Figure 1: Schéma de la réponse immunitaire anti-mycobactérienne. IL-12R β 1 est l'une des chaînes du récepteur de l'IL-12p70 et est importante dans l'axe IL-12-IFN- γ . Des mutations du gène *IL12B* (codant l'IL-12p40), *IL12RB1*, *IFNGR1*, *IFNGR2*, *STAT1*, *NEMO* et *CYBB* (codant la GP91phox) perturbent la réponse immunitaire et prédisposent aux infections mycobactériennes (BCG, mycobactéries environnementales et *Mycobacterium tuberculosis*). Des mutations de la voie de l'IL-12 (*IL12B* et *IL12RB1*) prédisposent aussi aux infections à salmonelles.

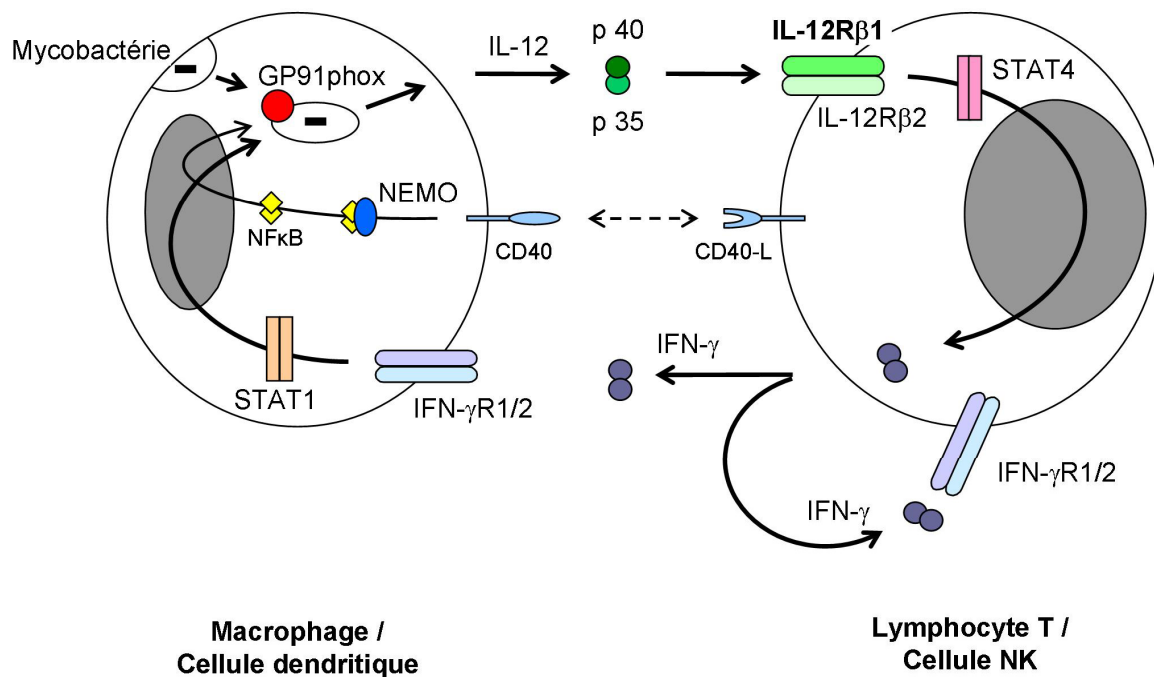

1.2. Du gène *IL12RB1* à la protéine IL-12Rβ1

La chaîne IL-12Rβ1 est codée par le gène *IL12RB1* sur le chromosome 19 en position 19p13.1 chez l'homme (17, 18) (figure 2). Ce gène permet la synthèse d'un ARNm de 2100 bases dont la très grande majorité est codante (1986 bases). IL-12Rβ1 est une protéine membranaire de 662 acides aminés avec un peptide signal (acides aminés 1 à 23), un domaine extracellulaire (aa 24-545), un domaine transmembranaire (aa 546-570) et un domaine intracellulaire (aa 571-662). C'est un membre de la famille des récepteurs gp-130 (récepteurs de cytokines de type I) dont le domaine extracellulaire est constitué de cinq domaines fibronectine de type III (FNIII) (19). Le site de fixation de la cytokine (Cytokine Binding Domain, CBD) des récepteurs de la famille des gp-130 est localisé dans les 200 acides aminés N-terminaux, et correspond aux deux premiers domaines FNIII (20, 21). Cependant dans le cas d'IL-12Rβ1 ce domaine est plus étendu (article 12). En effet, nous avons identifié un patient présentant une large délétion des exons 8 à 13 d'*IL12RB1*. Cette

mutation permet l'expression d'un récepteur délété des trois derniers domaines FNIII. Ce récepteur tronqué contient les deux premiers domaines FNIII (CBD) en phase avec le domaine transmembranaire et intracellulaire mais ne permet pas la fixation de l'IL-12.

Figure 2: D'*IL12RB1* à *IL-12Rβ1*. (A) Chez l'homme, le gène *IL12RB1* est localisé en position 19p13.1. (B) Il fait 27326 pb et est composé de 17 exons tous codants. (C) Il est à l'origine d'un transcrit de 2100 pb. (D) La protéine *IL-12Rβ1* de 662 acides aminés de long est composée d'un peptide signal (L), d'un domaine extracellulaire avec 5 domaines FNIII (FNIII 1 à 5), d'un domaine transmembranaire (TM) et d'un domaine intracellulaire (IC).

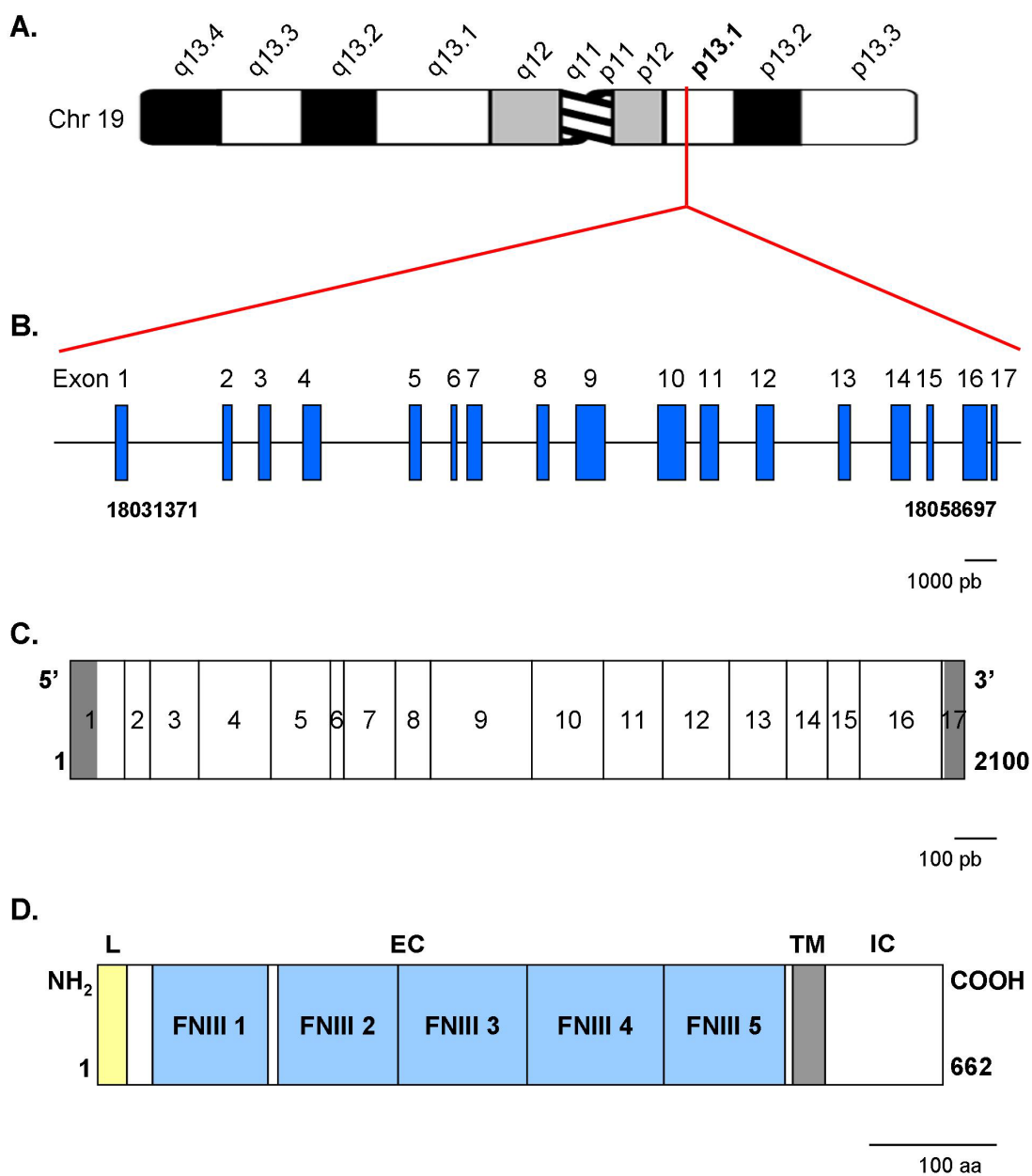

1.3. IL-12R β 1, IL-12 et IL-23

Les membres de la famille de l'IL-12 diffèrent des autres cytokines de type I par le fait qu'elles sont hétérodimériques. L'IL-12 (IL-12p70 sous sa forme active) comprend deux protéines reliées par un pont disulfure (IL-12p40 codé par le gène *IL12B* et IL-12p35 codé par le gène *IL12A*) (figure 3) (14). La sous-unité p40 est homologue à la famille des récepteurs de cytokines de type I (IL-6R α , CNTFR), alors que la sous-unité p35 est homologue aux cytokines à quatre hélices α (IL-6, GCSF). En 2000, une nouvelle protéine appelée IL-23p19 (codée par le gène *IL23A*) a été identifiée grâce à son homologie avec l'IL-6 et l'IL-12p35 (22). Cette protéine associée avec l'IL-12p40 forme l'IL-23. De plus, l'IL-12 et l'IL-23 partagent une chaîne réceptrice commune : IL-12R β 1. IL-12R β 1 s'associe avec IL-12R β 2 pour former le récepteur de l'IL-12 et avec IL-23R pour former le récepteur de l'IL-23. L'activation par l'IL-12 entraîne la phosphorylation du facteur de transcription STAT4 alors que l'activation par l'IL-23 entraîne la phosphorylation de STAT3. L'axe IL-12-IFN- γ et sa fonction sont assez bien décrits dans la littérature. Cependant, au début de ma thèse, le rôle et la fonction de l'IL-23 étaient peu décrits, mais seront relancés par la mise en évidence de l'axe IL-23-IL-17 décrit dans la deuxième partie de ce manuscrit (16, 23).

Figure 3: Voies de signalisation de l'IL-12 et de l'IL-23. La sous-unité IL-12p40 et la chaîne IL-12R β 1 sont communes aux voies de l'IL-12 et de l'IL-23. La fixation de la cytokine sur son récepteur hétérodimérique entraîne l'autophosphorylation des tyrosines kinases TYK2 et JAK2 qui vont alors phosphoryler les chaînes IL-12R β 2 et IL-23R. Les facteurs de transcription STAT vont ensuite être recrutés (STAT4 pour la voie de l'IL-12, et STAT3 pour la voie de l'IL-23), puis phosphorylés. La phosphorylation des protéines STAT va permettre leur dimérisation, puis leur translocation vers le noyau pour activer la transcription de gènes cibles.

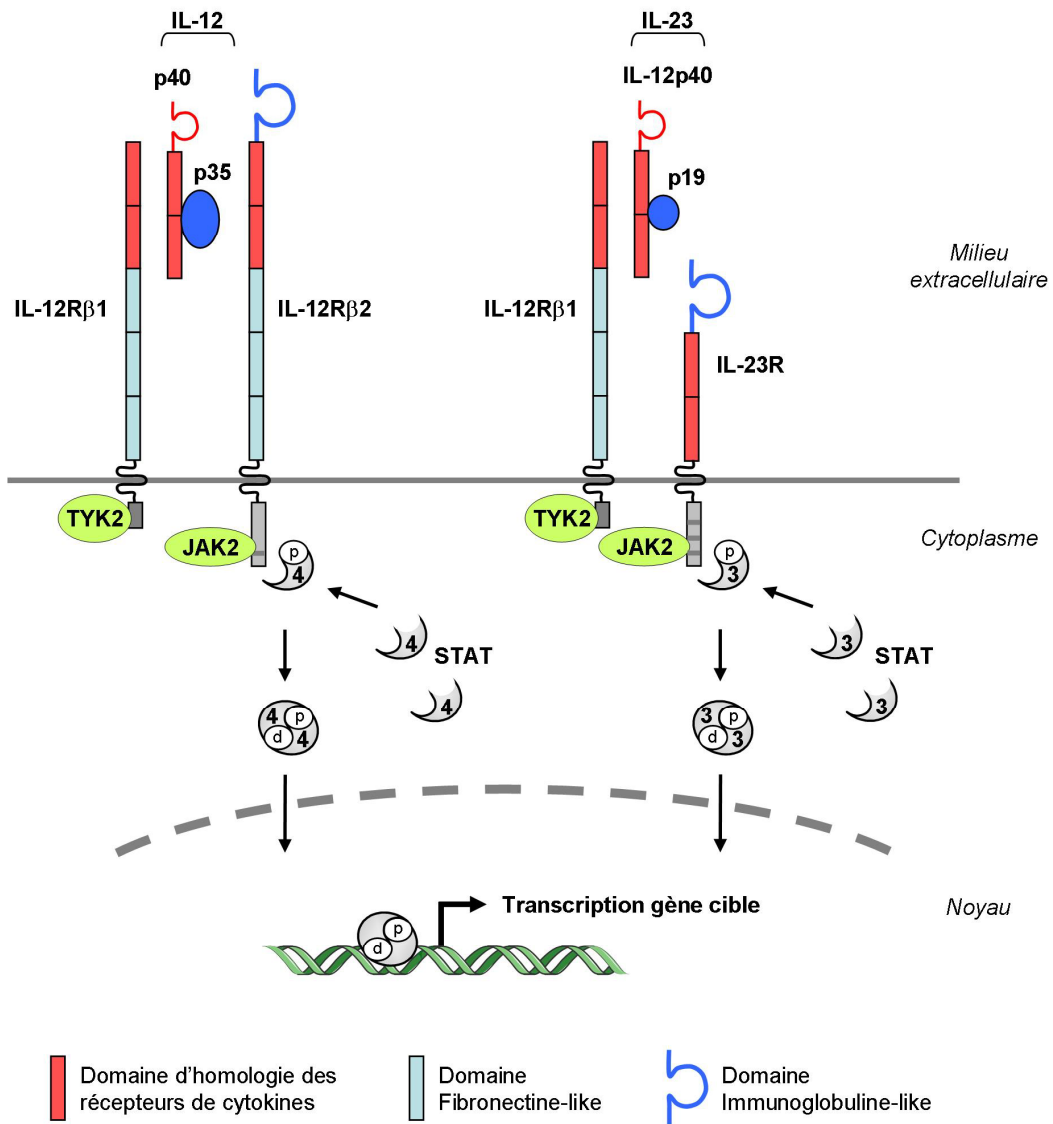

1.4. Etat de la cohorte en 2004

A mon arrivée au laboratoire, Frédéric Altare et Claire Fieschi avaient identifiés, depuis 1998, 46 patients avec un défaut complet de réponse à l'IL-12 dû à des mutations dans le gène *IL12RB1* (24-31). D'autres équipes hollandaise, japonaise, tunisienne et américaine ont aussi identifié 15 patients (32-38). L'étude de la cohorte la plus importante a été réalisée par Claire Fieschi en 2003 sur 41 patients issus de 29 familles provenant de 17 pays (27). Ces mutations ont été mises en évidence chez des patients atteints d'infections opportunistes par le BCG, des mycobactéries environnementales et des salmonelles non typhiques. Cette étude a démontré une pénétrance clinique incomplète. En effet, Claire Fieschi a mis en évidence des

patients déficients en IL-12R β 1 mais sans phénotype infectieux. La pénétrance des infections opportunistes est alors calculée parmi les frères et sœurs génétiquement atteints. Elle est estimée à 45%. Les patients IL-12R β 1 déficients étudiés ont une résistance large aux autres micro-organismes puisqu'ils ne font aucun autre type d'infections notables (virus, bactéries, champignons...). Ces patients présentent une issue qui est relativement favorable puisque le taux de mortalité parmi les patients infectés est de 15% seulement.

1.5. Recrutement des patients et méthodes employées

Les patients que nous recrutons au sein du laboratoire sont des patients présentant des mycobactérioses et/ou des salmonelloses atypiques. Ces infections sont des infections opportunistes causés par du BCG (sévères ou récurrentes, localisées ou disséminées), des mycobactéries environnementales, et des salmonelles non typhiques. Nous recrutons aussi des patients présentant des infections par des pathogènes plus virulents comme *Mycobacterium tuberculosis*. Les tuberculoses étudiées sont des maladies graves (sévères ou récurrentes), atypiques (forme miliaire ou méningite) ou disséminées. Ces patients sont recrutés grâce à un très important réseau de collaborateurs pédiatres ou immunologistes du monde entier. Dans certains cas, les médecins nous envoient par courrier express du sang hépariné du malade et de sa famille. Ce sang est alors utilisé dans le cadre d'un test sur sang total de l'axe IL-12-IFN- γ réalisé par Jacqueline Feinberg (article 11). Ce test mesure le bon fonctionnement de la boucle IL-12-IFN- γ chez les patients. En cas de réponse anormale, cela permet une orientation dans la poursuite de l'étude du patient. Les patients ayant un défaut de production d'IFN- γ en réponse à l'IL-12 dans ce test sont alors suspectés d'être porteurs d'un déficit complet en IL-12R β 1.

Je séquence alors les régions des 17 exons d'*IL12RB1* en ADN génomique, ainsi que les régions introniques flanquantes. Pour les patients dont les échantillons biologiques

n'étaient malheureusement pas accessibles, j'ai identifié leur défaut directement par séquençage. Les mutations ayant un impact sur le splice (épissage des ARN) sont confirmées et validées par l'amplification et le séquençage de l'ADN complémentaire. L'impact des mutations identifiées est validé par l'étude de l'expression de la protéine IL-12R β 1 à la surface des cellules. Ce test peut être réalisé sur des blastes T activés par la PHA ou sur des lignées de lymphocytes B transformés par l'EBV (figure 4A). Cette expérience est réalisée par cytométrie en flux à l'aide de deux anticorps reconnaissant deux épitopes différents sur le récepteur. Tous les patients étudiés n'ont pas d'expression du récepteur à la surface de leurs cellules, excepté pour une mutation qui permet l'expression à la surface d'une protéine tronquée non fonctionnelle (articles 4 et 12). Cette absence d'expression de la protéine sauvage à la surface des cellules empêche la fixation de la cytokine sur son récepteur (figure 4B). Cela entraîne un défaut de phosphorylation de STAT4 en réponse à l'IL-12, ce qui ne permet pas l'activation de la synthèse d'IFN- γ (figure 4C). Tous les patients présentent le même phénotype cellulaire.

Figure 4: Phénotype cellulaire par FACS des patients avec un déficit complet en IL-12R β 1. (A) Absence d'expression du récepteur à la surface des cellules révélée par deux anticorps anti-IL12R β 1 (24E6 et 2B10). (B) Défaut de fixation de l'IL-12 à la surface des cellules révélé par un anticorps anti-IL-12 après incubation des cellules sans ou avec IL-12. (C) Défaut de phosphorylation de STAT4 en réponse à l'IL-12 et pas à l'IFN- α révélé par un anticorps anti-phospho-STAT4.

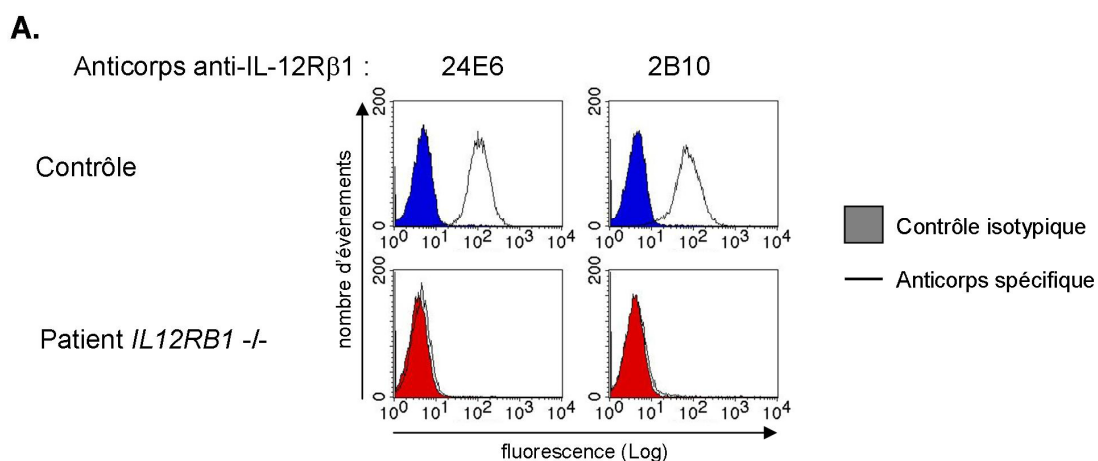

B.

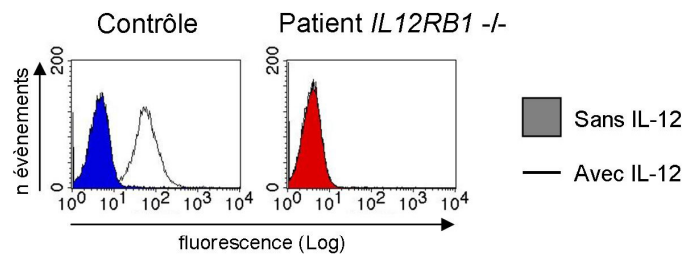

C.

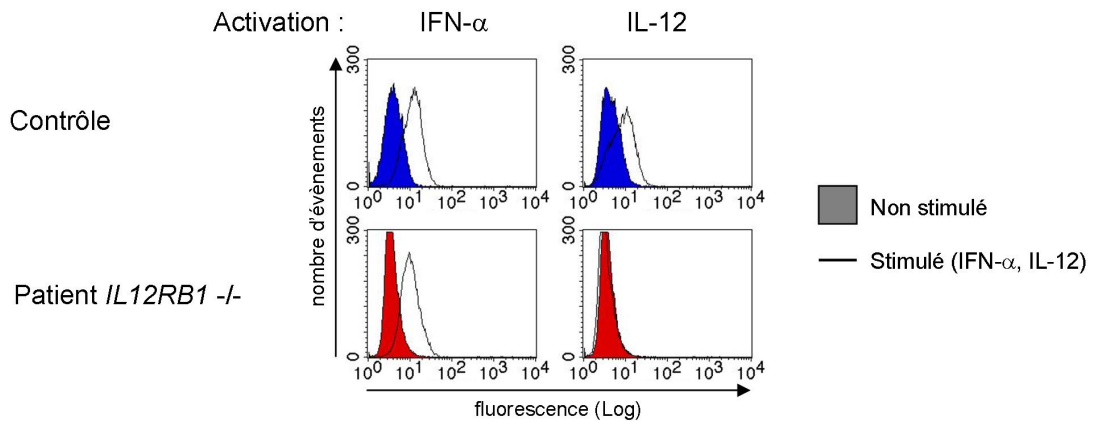

1.6. Diversité et homogénéité observées dans le défaut complet en IL-12Rβ1

La cohorte de patients déficients en IL-12Rβ1 est de 137 patients issus de 101 familles (articles 1, 4, 7, 9, 10 et article 13 en préparation qui présente les informations de l'étude sur toute la cohorte). Tout d'abord les patients présentent une grande diversité ethnique et géographique. Ils proviennent de 30 pays répartis sur toute la surface du globe. Ils présentent une grande diversité génétique avec 52 allèles délétères différents pour 101 familles. Cette diversité génétique entraîne au niveau cellulaire une très grande homogénéité avec un phénotype cellulaire complet identique chez tous les patients (figure 5). Il me semble très intéressant de noter que l'expression clinique de cette maladie est très diverse et s'étend d'une absence de phénotype clinique (patients asymptomatiques) à des formes sévères et disséminées d'infections pouvant conduire à la mort. Cependant, le spectre d'agents pathogènes semble réduit aux mycobactéries et aux salmonelles. Les patients atteints de ce syndrome sont aussi susceptibles à *Mycobacterium tuberculosis* (OMIM 607948). Nous avons

décrit les premiers cas de tuberculose mendélienne (article 10). Il n'existe pas de corrélations entre le génotype et le phénotype clinique.

Figure 5: Diversité et homogénéité observées dans l'étude du défaut complet en IL-12R β 1.

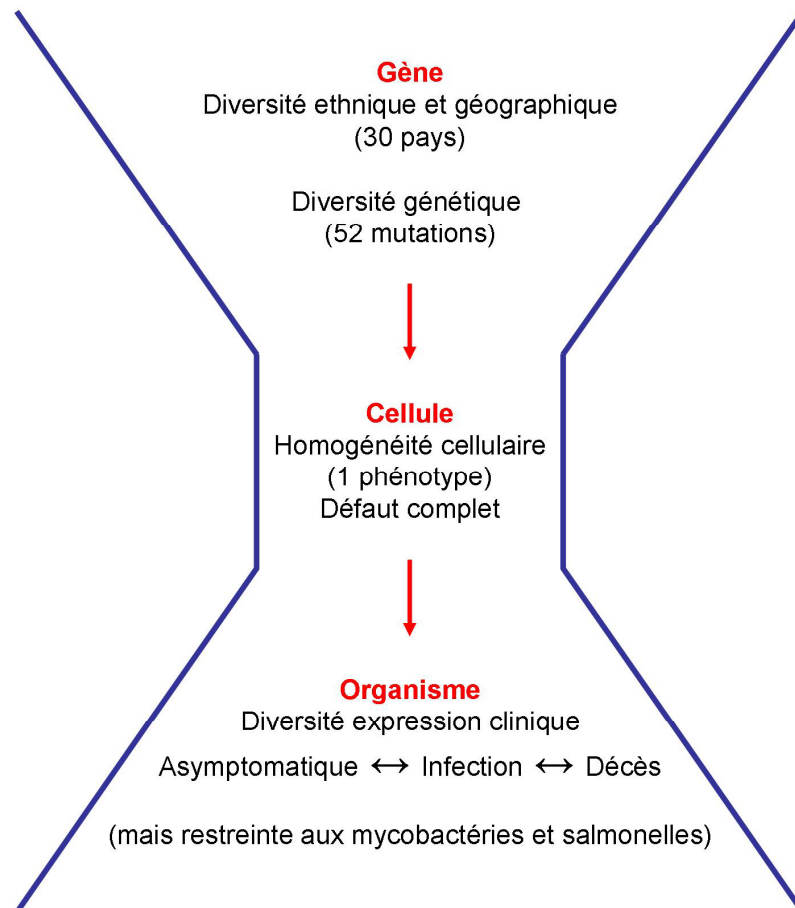

1.7. Exemples d'utilisation des mutants humains *IL12RB1*

Les mutants que nous avons identifiés peuvent servir à la dissection chez l'homme de phénotypes et de mécanismes. Ils permettent d'étudier l'impact de l'absence de réponse à l'IL-12 (et à l'IL-23). Nous avons donc collaboré avec des laboratoires plus spécialisés et intéressés par l'étude de ces phénotypes chez les patients que nous avons identifiés. Les mutants de la voie de l'IFN- γ (*IFNGR1* et *IFNGR2*), ainsi que les mutants *IL12B* et *IL12RB1* ont été utilisés pour disséquer les mécanismes d'activations des cellules dendritiques par les lymphocytes T CD4⁺ (article 6). Les études effectuées ont pu démontrer que l'activation des

cellules dendritiques se faisait par un contact physique entre les deux populations de cellules via notamment l'interaction CD40-CD40L. De plus, la signalisation via l'IL-12 des lymphocytes T était requise pour induire efficacement l'expression des molécules de costimulation ainsi que la production d'IL-12p70 par les cellules dendritiques. Cette activation passe par l'activation de la synthèse d'IFN- γ . La boucle IL-12-IFN- γ entre la cellule dendritique et le lymphocyte T doit être fonctionnelle pour activer la réponse immunitaire et amplifier le signal. Cela confirme les résultats mis en évidence au laboratoire sur l'importance des deux systèmes d'interactions cytokinique et physique (article 17).

Le rôle de l'IL-12 sur les cellules NK est assez peu connu, bien que cette cytokine a été identifiée à la base sur sa capacité à induire la cytotoxicité des cellules NK et la production d'IFN- γ (14, 39). Les mutants *IL12RB1* ont été utilisés pour l'étude des différentes populations de cellules NK ($CD3^-CD56^+$) et de lymphocytes T $CD56^+$ ($CD3^+CD56^+$) chez l'homme (article 3). Ces résultats ont permis de confirmer chez un plus grand nombre de patients déficients en IL-12R β 1 que ces cellules sont en nombre normal mais que leur fonction est altérée en terme de production d'IFN- γ et de cytotoxicité. Des expériences de compétition avec un anticorps anti-IL-12 montrent que la capacité cytotoxique de ces cellules serait dépendante d'un priming des cellules *in vivo*. La population de lymphocytes T $CD56^+$ est réduite chez les patients ayant un défaut de la voie de l'IL-12 (*IL12B* et *IL12RB1*). Cette population de cellules est équipée d'un appareil permettant la cytotoxicité, et est capable de produire de l'IFN- γ en réponse à l'IL-12. Les cellules T $CD56^+$ sont différentes des cellules NKT. Les cellules NKT sont des cellules $CD4^+$ ou $CD4^-CD8^-$ avec un TCR invariant. Les cellules T $CD56^+$ sont principalement $CD8^+TCR\alpha\beta^+$ et ont des attributs de cellules T $CD8^+$ mémoires ainsi qu'un pouvoir cytolytique (40). Leur voie de différenciation reste encore inconnue.

1.8. Conclusions

Cette maladie génétique est l'étiologie la plus fréquente du syndrome de prédisposition mendélienne aux infections mycobactériennes. Elle représente 45% des cas avec des défauts moléculaires identifiés (figure 6). Nous avons pu collecter les informations de la quasi-totalité des patients de la littérature. Cette étude a permis de poursuivre l'étude de 2003 sur un plus grand nombre de patients. Au niveau des phénotypes cliniques, nous avons confirmé la part importante de patients atteints de maladies à salmonelles (43%) bien que ces patients souffrent majoritairement de mycobactérioses (82%). Le nombre de patients ayant fait la tuberculose a augmenté (10 patients). Concernant les nouveaux phénotypes, nous avons maintenant trois patients qui ont présenté des infections à *Klebsiella pneumoniae* (Anderson *et al*, Pedraza *et al*, en préparation). Ce type d'infection devra donc être surveillé chez nos patients. Il serait intéressant de tester des patients atteints de klebsiellose pour l'axe IL-12-IFN- γ et plus spécialement un défaut complet en IL-12R β 1. Un des patients a présenté une infection à *Nocardia nova* sans infections mycobactériennes ou à salmonelles associées (Picard *et al*, en préparation). Nous avons aussi identifié un cas de paracoccidioidomycose et un cas de leishmaniose. Nous ne pouvons pas encore tirer de conclusions de ces cas isolés.

Figure 6: Répartition des défauts génétiques identifiés chez 299 patients MSMD dont les mutations entraînent un phénotype cellulaire complet (c) ou partiel (p).

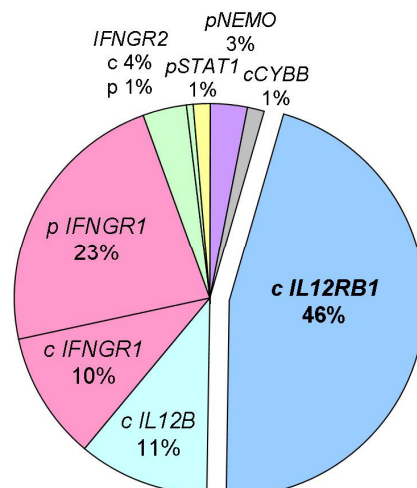

Il est très intéressant de noter que 29 patients (23%) ont présenté une infection à *Candida albicans* (Rodriguez-Gallego *et al*, en préparation). Les patients IL-12R β 1 semblent donc sensibles à la candidose. L'explication physiopathologique n'est pas encore identifiée, mais l'une des hypothèses concernant l'implication de l'axe IL-23-IL-17 sera discutée dans la deuxième partie de cette thèse. Par rapport à 2003, la pénétrance des infections opportunistes a nettement augmenté (de 45% en 2003 à 64% en 2008). La mortalité est aussi en nette augmentation (de 15% en 2003 à 28,5% en 2008). L'hypothèse du lieu de vie des patients et du niveau global du système de santé ne semble pas en cause. En effet, si nous classons les patients en groupes en fonction de leur région d'habitation (Europe, Orient, Asie, Amérique du Sud), il n'y a pas de différences significatives du taux de mortalité. En revanche, si nous étudions le taux de mortalité en fonction du type d'infection, nous pouvons remarquer que les patients atteints de mycobactérioses environnementales ont un taux de mortalité beaucoup plus élevé (52%), et les patients atteints de salmonelloses beaucoup plus bas (19%). L'effet protecteur du BCG sur la survenue de mycobactériose environnementale est confirmé sur un plus grand nombre de patients. Par contre, le BCG n'a aucun effet protecteur sur la survenue de tuberculose ou de salmonellose.

1.9. Discussion

La quasi-totalité de nos patients ont fait des infections à mycobactéries et à salmonelles. Il ne faut pas oublier que ce sont les infections mycobactériennes qui sont étudiées historiquement au laboratoire, et que l'étude des infections à salmonelles a débuté après l'observation de l'association entre les deux. Une quantité non négligeable de patients font des infections à salmonelles uniquement. Des mutations du gène *IL12RBI* peuvent donc prédisposer à un nouveau syndrome : le syndrome de « prédisposition mendélienne aux infections à salmonelles ». L'étude poussée de ces deux phénotypes entraîne donc forcément

un biais de recrutement important. Nous ne pouvons exclure que des mutations de ce gène ne soient pas associées à d'autres phénotypes infectieux. Il serait très intéressant de tester la fonctionnalité de l'axe IL-12-IFN- γ , ou de séquencer *IL12RB1* dans des cohortes de patients avec d'autres infections par des pathogènes intracellulaires (candidose, chlamydie, shigellose, légionellose, brucellose, ulcère de Buruli, nocardiose...). Dans un premier temps, il faudrait commencer par les formes atypiques de l'enfant (infections des jeunes enfants, récurrentes ou disséminées) chez des patients sans immunodéficience connue.

Cette maladie semble plus grave que dans l'étude de 2003 avec une nette augmentation de la pénétrance et de la mortalité. Ces résultats sont peut-être dus à un temps de suivi plus long et à un suivi plus approfondi des patients. Une certaine proportion non négligeable de « patients » reste tout de même asymptomatique. Nous pouvons émettre l'hypothèse que l'environnement dans lequel ils évoluent est identique à celui de leurs frères et sœurs malades qui nous ont permis d'identifier leur défaut. L'exposition serait donc sensiblement la même chez les patients symptomatiques ou non. La différence observée entre ces individus pourrait donc être génétique. L'hypothèse de gènes modificateurs, c'est-à-dire d'autres mécanismes moléculaires permettant de pallier le défaut de réponse à l'IL-12 semble intéressante. L'identification de ces gènes permettrait d'expliquer pourquoi certains patients meurent dans l'enfance de leur maladie alors que d'autres arrivent asymptomatiques à l'âge adulte, mais peut-être aussi d'expliquer les différences de sensibilité face aux différents pathogènes.

Il est assez bien établi qu'IL-12R β 1 participe à l'immunité anti-mycobactérienne essentiellement par la formation du récepteur de l'IL-12 dont l'activation permet la production d'IFN- γ . Cependant, IL-12R β 1 et l'IL-12p40 sont aussi impliquées dans

l'immunité anti-salmonelle. En effet, 50% des patients déficients en IL-12R β 1 ou IL-12p40 présentent des infections à salmonelles contre seulement 6% des patients mutés dans la voie de réponse à l'IFN- γ . Cette observation nous permet d'émettre l'hypothèse que l'immunité anti-salmonelle est IL-12R β 1/IL-12p40 dépendante, mais indépendante de la production d'IFN- γ . La découverte de l'axe IL-23-IL-17 permet de donner une voie candidate à cette hypothèse. Cependant, nous n'avons pas encore testé cette hypothèse. Mais cela pourrait aussi bien être de nouvelles voies IL-12 et/ou IL-23 dépendantes. Nous espérons un jour pouvoir identifier des mutants propres de l'IL-12 (IL-12p35 ou IL-12R β 2) et de l'IL-23 (IL-23p19 ou IL-23R) pour mieux comprendre le rôle et la fonction de chacune de ces molécules dans l'immunité anti-infectieuse. Si nous n'avons pas pu en identifier à l'heure actuelle, c'est peut-être que les phénotypes infectieux de ces patients sont différents de ceux étudiés, ou alors beaucoup moins graves et donc pas rapportés à notre laboratoire par notre réseau.

2. ETUDE DE LA POPULATION DE LYMPHOCYTES T PRODUCTEURS D'IL-17

2.1. Le paradigme Th1-Th2-Th17

Dans les années 1970, les cellules T ont été divisées en deux groupes grâce à la présence de marqueurs à la surface des cellules : CD4 et CD8. Les CD8⁺ ont un rôle de lyse des cellules (lymphocytes T cytotoxiques), et les CD4⁺ d'aide à la synthèse d'anticorps (lymphocytes T « helpers ») (revue dans (41)). En 1986, les lymphocytes T CD4⁺ ont à leur tour été divisés en deux groupes : Th1 et Th2 (42-44). Ces deux groupes de cellules existent et se distinguent par un profil différent de cytokines sécrétées après activation ainsi que par des fonctions régulatrices et effectrices différentes. Pendant plus de vingt ans, les chercheurs et les étudiants en immunologie ont travaillé avec ce paradigme de différenciation des cellules CD4⁺ « helpers » de type Th1 pour l'immunité cellulaire et de type Th2 pour l'immunité humorale. L'IL-17A est une cytokine avec des propriétés proinflammatoires qui a été mise en évidence en 1993 et dont le rôle et la fonction sont étudiés depuis quelques années (revue dans (45)). Elle appartient à la famille de l'IL-17 qui est composée de six membres (IL-17A à F). L'IL-17A (que nous appelleront IL-17 dans la suite de ce document) a été caractérisée comme étant induite par l'IL-23 dans des cellules T CD4⁺ (46, 47). Les caractéristiques moléculaires des cellules CD4⁺ productrices d'IL-17 étant différentes des caractéristiques des cellules Th1 et Th2, elles ont alors été nommées « Th17 » (47) (figure 7, tirée de (48)).

Figure 7: Schéma de différenciation des lymphocytes T CD4⁺.

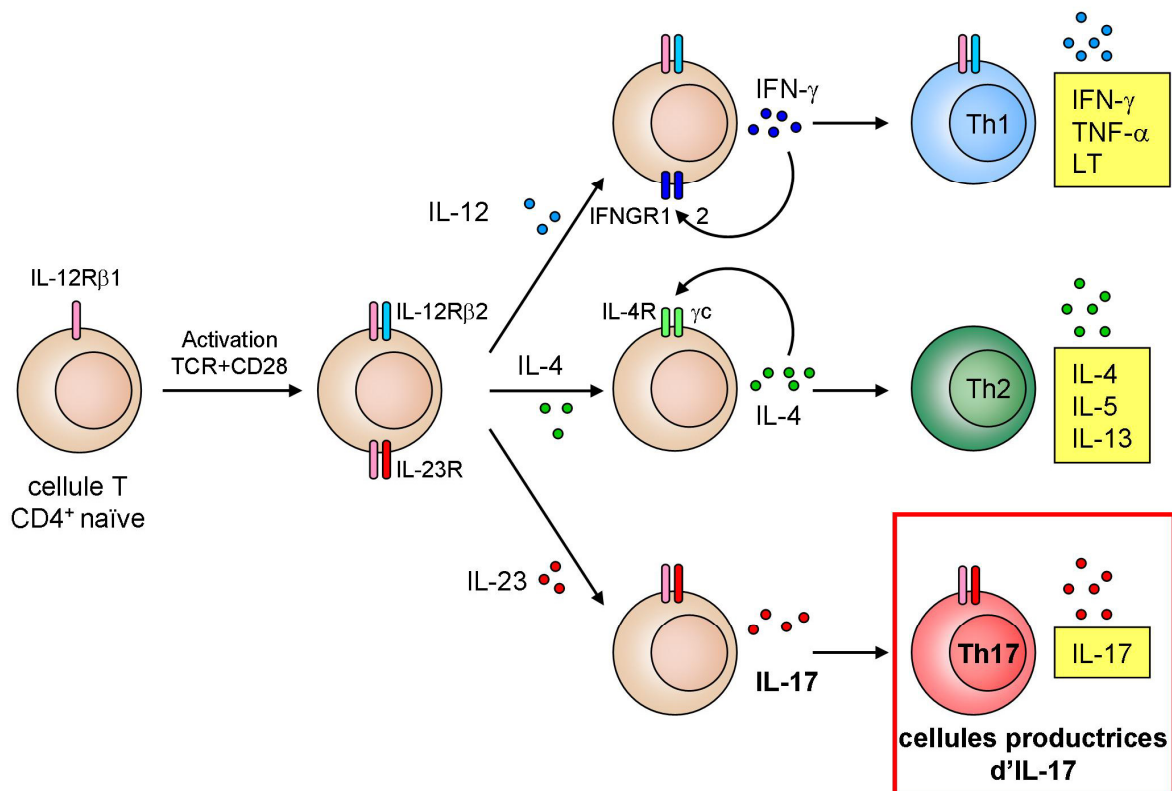

2.2. Les Th17 chez la souris

Depuis l'identification de cette population de lymphocytes, de nombreuses équipes ont étudié plus en avant les Th17 dans le modèle murin (revue dans (49, 50)). Les premiers travaux montrent que cette population est inhibée par les cytokines de type Th1 (IFN- γ) ou Th2 (IL-4) (51, 52). Le TGF- β est décrit comme étant une cytokine critique pour l'engagement des Th17 en coopération avec l'IL-6 (53-55). Les cellules T régulatrices (Treg) représentent un autre type de cellules T CD4⁺ inductibles, mais leur rôle est de réprimer la réponse immune. Ces deux populations (Th17 et Treg) bien qu'ayant des rôles opposés sont reliées par une cytokine commune : le TGF- β . Si les cellules CD4⁺ naïves sont activées par le TGF- β en coopération avec l'Acide Rétinoïque ou l'IL-2, elles se différencieront alors en Treg grâce à l'activation du facteur de transcription FOXP3 (56, 57). Au contraire, l'activation par le TGF- β en coopération avec l'IL-6 et l'IL-21 entraîne la différenciation en Th17 via le

facteur de transcription ROR γ t (58-60) (figure 8, tirée de (49)).

Figure 8: Etat des connaissances des voies de différenciation des lymphocytes T CD4⁺ chez la souris et chez l'homme.

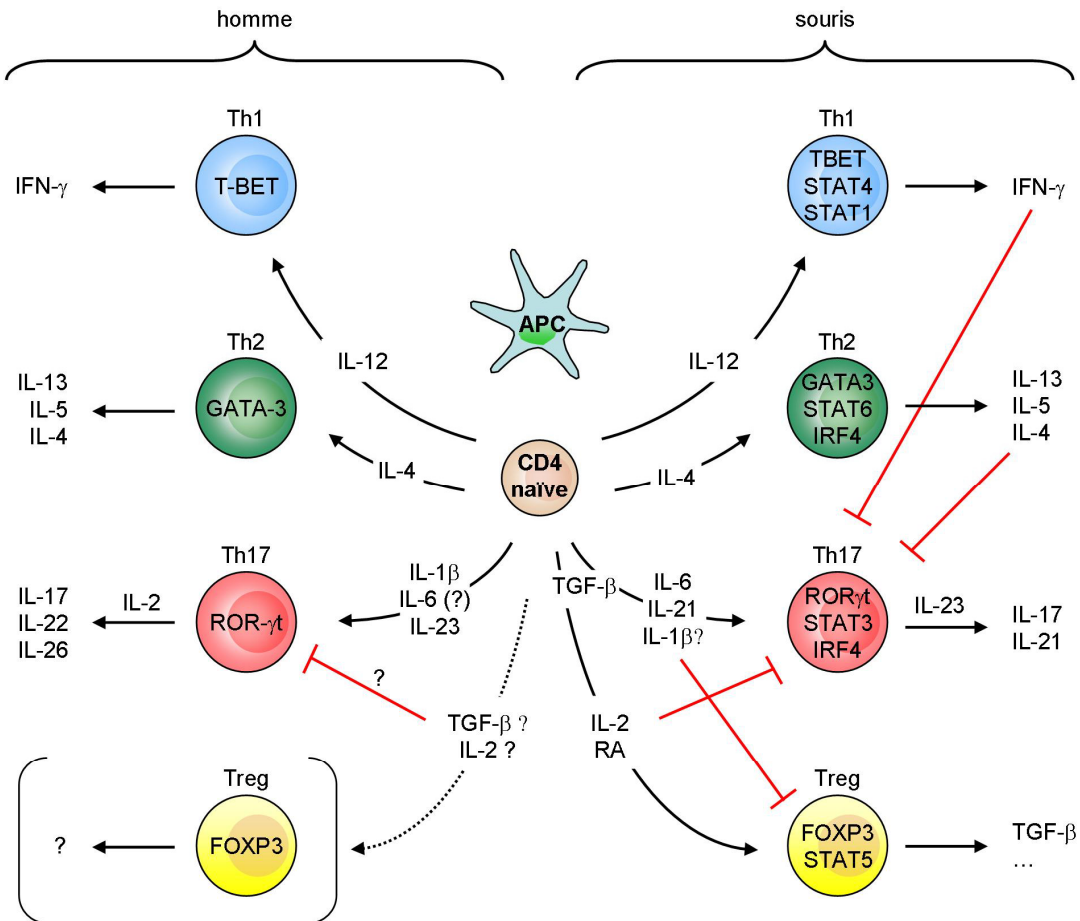

L'engagement d'une cellule dans une voie de différenciation se fait par l'action de facteurs de transcription lignages spécifiques en plus de l'action de l'environnement de cytokines. Le facteur TBET est important pour les cellules Th1 et GATA3 pour les Th2. STAT3 est décrit comme un des facteurs importants dans la différenciation Th17, certainement à cause de son implication dans la réponse à de nombreuses cytokines dont l'IL-6 (56, 61). ROR γ t serait un régulateur clé de la différenciation en Th17 (62). ROR γ t est induit

par le TGF- β et l'IL-6, et les souris *RORC*^{-/-} n'ont pas de Th17. IRF4 semble aussi jouer un rôle certainement dans l'induction de ROR γ t en plus de celui joué sur la différenciation Th2 (63). L'effet de l'IL-23 n'est pas encore résolu. Les premiers travaux montrent que l'IL-23 aurait un rôle dans l'activation de la sécrétion de l'IL-17 plus que dans leur différenciation (47). Le rôle de l'IL-1 β est peu connu, mais est avancé par certaines équipes (64). De très nombreuses études *in vivo* et *in vitro* sont réalisées chez la souris et permettent d'avoir un modèle complexe, mais qui reste néanmoins encore incomplet aujourd'hui.

2.3. Les Th17 chez l'homme

Chez l'homme, la population Th17 est peu décrite (figure 7). Les premières études ont d'abord porté sur l'identification de marqueurs phénotypiques de ces cellules (65-67). Les quatre premiers groupes qui ont étudié les voies de différenciation de ces cellules sont arrivés à des résultats contradictoires et différents du modèle murin (68-71). Ils suggèrent tous que le TGF- β n'est pas requis pour la différenciation en cellules productrices d'IL-17. Le TGF- β serait même inhibiteur dans trois études (68, 69, 71). L'IL-6 a été montrée comme ayant une activité inhibitrice de cette différenciation dans une étude (69) et redondante dans trois autres (68, 70, 71). L'IL-1 β a été identifiée comme un régulateur positif de cette population dans deux études (68, 69), tandis que l'IL-21, testée dans une étude, ne semble pas indispensable (71). Quand à l'IL-23, elle a été décrite comme ayant la capacité d'accroître le développement des cellules T productrices d'IL-17 dans les quatre études (68-71). La différenciation de ces cellules est donc mal connue et les données disponibles en 2007 ne permettent pas d'établir un modèle consensuel. Des études complémentaires viendront ensuite enrichir ce modèle en 2008 (72-76). Au vu de ces données, il nous a semblé important de voir comment nous pouvions disséquer ce modèle.

2.4. Une dissection génétique de la différenciation Th17

Depuis le début de ma thèse je souhaitais développer un projet qui utiliserait les patients *IL12RB1*^{-/-} comme des « KO naturels » pour disséquer le rôle et la fonction de cette molécule. Nous savions depuis quelques années que les patients déficients en IL-12R β 1 ont un défaut de réponse à l'IL-12 et à l'IL-23 (77). Cependant, les fonctions respectives de ces molécules étaient à mon arrivée au laboratoire assez mal connues, et étaient même décrites comme redondantes. La description de l'axe IL-23-IL-17 semble donc intéressante. L'idée simple est de trouver un modèle pour étudier les lymphocytes T producteurs d'IL-17 et de comparer les patients avec des individus contrôles. En regardant plus en avant les travaux chez la souris et chez l'homme, il semble exister en plus de l'IL-23 toute une série de molécules responsables de la différenciation et de l'activation de ces cellules : le TGF- β , l'IL-6, l'IL-1 β , STAT3 et FOXP3. Nous avons la chance dans le laboratoire d'étudier des patients porteurs de mutations dans des gènes impliqués dans ces voies, et surtout d'avoir un important réseau de collaborateurs nous permettant d'entrer en contact avec ces patients.

2.5. Les différents patients utilisés

2.5.1. Les mutants de la voie du TGF- β

Des mutations des gènes *TGFBR1* et *TGFBR2* codant le récepteur du TGF- β ont été identifiées chez des patients atteints du syndrome de Loeys-Dietz (OMIM 609192) (78, 79) (revue dans (80)). Ce syndrome de type Marfan est caractérisé par des atteintes multiples au niveau cardiovasculaire, craniofacial, squelettique, de la peau et du système oculaire. Les atteintes sont très différentes d'un patient à l'autre et parfois même au sein de la même famille. Des mutations du gène *TGFBI*, codant le TGF- β , ont été identifiées chez des patients atteints d'un syndrome de Camurati-Engelmann (OMIM 131300) (81, 82) (revue dans (83)). Ce syndrome est caractérisé par une dysplasie osseuse généralisée (formation excessive d'os)

avec un élargissement diaphysaire des os longs. Elle débute dans l'enfance. Cliniquement, ce syndrome se manifeste par des douleurs osseuses principalement au niveau des jambes, une faiblesse musculaire avec atrophie, une démarche dandinante, une fatigabilité accrue, des céphalées, des déficits des nerfs crâniens, et un retard pubertaire. Dans ces deux syndromes, la transmission est autosomique dominante, et ces mutations sont associées avec une auto-activation de la voie du TGF- β .

2.5.2. Les mutants de la voie de l'IL-1 β

Depuis 2003, il a été démontré que les patients qui ont des mutations dans le gène *IRAK4* présentent un défaut complet de réponse à l'IL-1 β (84, 85). IRAK4 est une sérine thréonine kinase présente dans les voies de signalisation des TLRs et de la superfamille de l'IL-1R. Ces patients présentent une susceptibilité restreinte aux infections par des bactéries pyogènes. La majorité des patients souffrent d'infections invasives, et souvent récurrentes, à pneumocoque (*Streptococcus pneumoniae*) ou à staphylocoque (*Staphylococcus aureus*) entraînant des manifestations variées telles que pneumonie, arthrite septique, cellulite, ostéomyélite, otite moyenne, méningite, sinusite et septicémie. Les infections par d'autres pathogènes sont très rares chez ces patients. Ces infections surviennent dans la jeune enfance (dans les deux premières années de vie majoritairement) et entraînent la mort dans la moitié des cas. Les infections deviennent de moins en moins fréquentes avec l'âge chez ces patients. En 2008, des mutations du gène *MYD88* ont été identifiées chez des patients atteints d'infections semblables et qui présentaient un défaut de réponse à l'IL-1 β sans mutation identifiée dans *IRAK4* (86). MYD88 est une molécule adaptatrice des voies de signalisation des TLRs et de l'IL-1R en amont d'IRAK4. La transmission génétique de ces deux défauts est autosomique récessive.

2.5.3 Les mutants de la voie de l'IL-6

Le syndrome Hyper-IgE (HIES) est un déficit immunitaire héréditaire de transmission autosomique dominante décrit en 1966 et également appelé syndrome de Buckley (87). Il se caractérise par des infections cutanées récurrentes à staphylocoques, des pneumopathies bactériennes et fongiques, des candidoses cutanéomuqueuses chroniques et par une augmentation importante des immunoglobulines E (IgE). Les autres manifestations cliniques associées à ce déficit immunitaire sont un eczéma, une ostéopénie, une hyperlaxité ligamentaire, un retard de la chute des dents lactéales, ainsi qu'une dysmorphie. Des mutations dominantes négatives du gène *STAT3* ont été identifiées en 2007 pour la forme autosomique dominante du syndrome (AD-HIES) (88). Il a été montré chez ces patients un défaut de réponse des cellules à l'IL-6 (ainsi qu'à l'IL-10). STAT3 est un facteur de transcription impliqué dans de très nombreuses voies de signalisation moléculaire (les membres de la famille de l'IL-6 : IL-6, IL-11, IL-27, IL-31, LIF, OSM, CNTF et cardiotrophin-1 ; les membres de la famille des IFNs : IL-10, IL-19, IL-20, IL-22, IL-24, IL-26, IFN- α/β et IFN- γ ; les membres de la famille de l'IL-2 : IL-2, IL-7, IL-9, IL-15 et IL-21 ; d'autres cytokines et hormones comme l'IL-5, IL-23, CSF3/G-CSF, EGF, CSF1, et la leptine).

2.5.4. Les mutants de la voie de l'IL-23

En plus des patients porteurs de mutations dans le gène *IL12RB1*, nous avons utilisé des patients porteurs de mutations dans le gène *IL12B* (89, 90). Ces patients souffrent du syndrome de prédisposition mendélienne aux infections mycobactériennes. Ils sont atteints d'infections à mycobactéries et à salmonelles (voir première partie de ce manuscrit, revue dans (91)). Les patients déficients en IL-12R β 1 ont un défaut de réponse à l'IL-23 et à l'IL-12, mais sont capables de produire ces cytokines. A l'opposé, les patients déficients en IL-

12p40 ne sont pas capables de produire de l'IL-23 et de l'IL-12, mais ils sont capables de répondre à ces cytokines. Sur ces derniers, nous pouvons donc compléter leur défaut, et voir l'action de ces molécules sur des cellules qui n'ont jamais été en contact avec ces cytokines. Les phénotypes cliniques de ces deux types de patients sont assez proches avec en particulier un pourcentage de patients présentant des infections à salmonelles assez élevé (environ 45%).

2.5.5 Les autres patients

Nous avons aussi étudié un patient avec des auto-anticorps anti-IL-6 (92). Ce patient a développé des infections à *Staphylococcus aureus*. Ce patient est capable de produire de l'IL-6, mais les anticorps IgG1 dirigés contre l'IL-6 présents dans son plasma neutralisent la cytokine. Les cellules sanguines de ce patient ne sont donc pas activées sous l'action de l'IL-6 *in vivo*. Cependant, *in vitro* en l'absence de sérum, ce patient peut répondre à l'IL-6. Ce patient est très intéressant pour voir l'impact du priming *in vivo* de l'IL-6. Nous avons un seul patient de ce type, ce qui ne permet donc pas de réaliser une étude statistique robuste. Nous avons aussi étudié des patients porteurs de mutations dans le gène *FOXP3* (93). Ces patients souffrent du syndrome IPEX (Immunodysregulation, Polyendocrinopathy and enteropathy, X-linked) qui est une pathologie rare survenant chez les garçons (94). Elle est caractérisée cliniquement par une diarrhée rebelle, une dermatite ichtyosiforme, un diabète sucré insulino-dépendant, une thyroïdite, une anémie hémolytique, des troubles auto-immuns et des infections graves. La transmission de la maladie est récessive liée au chromosome X. Les lourds traitements immunosuppresseurs chez ces patients, ainsi que le faible nombre de patients identifiés et testés ne nous ont malheureusement pas permis de tirer des conclusions définitives quant à l'impact de ce défaut sur la population de cellules T productrices d'IL-17.

2.6. Choix du modèle expérimental

Nous savons que chez l'homme, il est difficile de faire des études comparatives de populations cellulaires à cause de l'existence d'une grande variabilité inter- et intra-individuelle. Cette variabilité est le reflet de l'influence de la génétique et de l'environnement sur le phénotype d'intérêt. Pour pallier ces problèmes inhérents au modèle humain, il faut donc être sûr des phénotypes observés et avoir une statistique puissante, c'est-à-dire avec un nombre d'individus étudiés suffisant. Pour pouvoir tester un grand nombre d'individus, le modèle doit être le plus simple possible techniquement. Le matériel biologique dont nous pouvons disposer est constitué d'échantillons sanguins de contrôles et de patients en « faible » quantité (5 à 30 ml de sang suivant l'âge et l'état du patient). La purification des cellules sanguines se fait par une centrifugation sur gradient de ficoll. Certains papiers ont décrit les effets de l'interaction entre les monocytes et les cellules dendritiques sur la différenciation des cellules Th17 (68, 71). J'ai donc testé mes modèles avec ou sans une étape d'adhérence des PBMCs sur une flasque allongée pendant deux à trois heures dans l'étuve. Cette étape permet d'éliminer les monocytes, et de récupérer les lymphocytes « seuls ». Expérimentalement, j'obtenais un pourcentage de cellules CD3⁺IL-17⁺ plus élevé chez des contrôles après cette étape d'adhérence. J'ai donc ensuite inclus cette étape dans mon protocole expérimental.

Notre premier modèle est le modèle « *ex vivo* » (figure 9). Pour révéler la présence d'IL-17 intracellulaire, nous sommes obligés d'activer nos cellules avec la PMA-ionomycine. Sans cette activation, nous ne détectons aucune production de cytokine. Cette activation est réalisée sur la nuit pendant une période de 11 à 12 heures en présence d'un inhibiteur de sécrétion (afin de retenir les molécules produites à l'intérieur des cellules). Malheureusement, l'activation par les esters de phorbol entraîne une diminution d'expression à la surface du marqueur CD4 comme cela a été décrit depuis plus de quinze ans (95, 96). L'utilisation du

marqueur CD4 n'est donc pas possible après activation par la PMA-ionomycine. Notre choix a été de regarder la proportion de cellules CD3⁺IL-17⁺. Nous avons aussi étudié la production d'autres cytokines (IFN- γ , IL-4, IL-22) par les cellules CD3⁺. Notre deuxième modèle est un modèle de différenciation « *in vitro* ». Les PBMCs non adhérents sont mis en culture avec un anticorps anti-CD3 et un cocktail des cytokines étudiées (TGF- β , IL-23, IL-6 et IL-1 β). Du milieu contenant de l'IL-2 et les cytokines d'intérêt est ajouté au bout de trois jours. Deux jours plus tard, les cellules sont activées avec la PMA-ionomycine pour étudier par FACS la proportion de cellules IL-17⁺, IFN- γ ⁺, ou IL-22⁺. La quantité de cytokines produites est mesurée par ELISA après 48 heures d'activation.

Figure 9: Schéma du modèle expérimental pour l'étude *ex vivo* et *in vitro* des cellules T productrices d'IL-17.

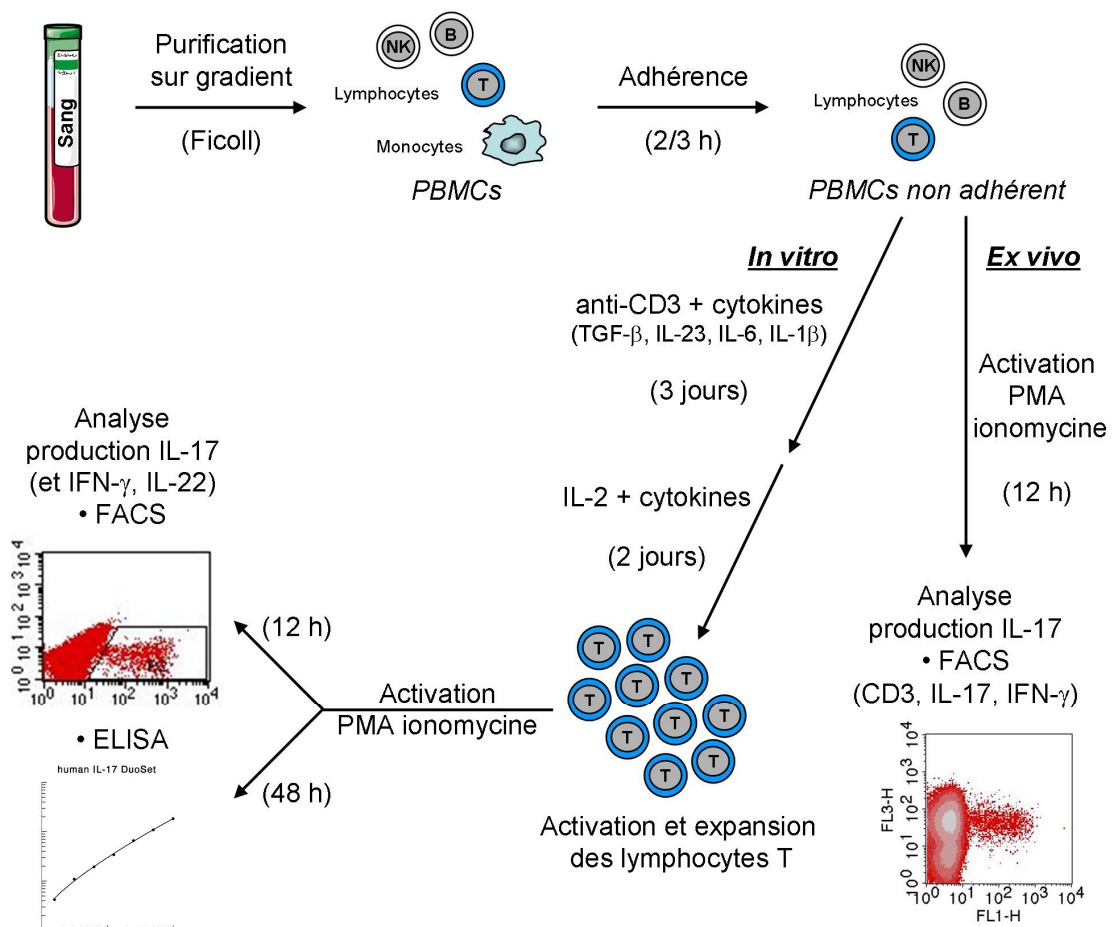

2.7. Résultats

Les résultats de cette étude sont présentés en détail dans l'article 2. Le tableau 2 présente la comparaison des différents systèmes expérimentaux que nous avons testés entre les contrôles et les groupes de patients. Le groupe de patients de la voie de l'IL-1 β (*IRAK4* et *MYD88*) présente un pourcentage de cellules T productrices d'IL-17 statistiquement comparable au groupe contrôle. En terme de production de cytokine IL-17 et IL-22, ces patients présentent une production basale d'IL-17 diminuée par rapport aux contrôles. Les patients avec des mutations gains de fonctions du TGF- β (*TGFBI*, *TGFBR1* et *TGFBR2*) ont un nombre de cellules productrices d'IL-17 et une production d'IL-17 et d'IL-22 statistiquement comparable aux contrôles. Les patients de la voie de l'IL-12 et de l'IL-23 (*IL12B* et *IL12RB1*) montrent un pourcentage de cellules productrices d'IL-17 diminué par rapport aux contrôles. Chez ces patients, la production d'IL-17 est comparable aux contrôles, mais la production d'IL-22 est statistiquement diminuée. Le groupe de patients *STAT3* est celui pour lequel le phénotype est le plus drastiquement diminué par rapport au groupe contrôle que ce soit en pourcentage de cellules productrices d'IL-17 ou en production d'IL-17 et d'IL-22. Il est intéressant de noter que notre patient avec des auto-anticorps anti-IL-6 présente un phénotype exactement comparable à celui des patients déficients en *STAT3*.

Tableau 2: Phénotypes observés dans les différents groupes de patients. Comparaison entre les phénotypes des contrôles et des patients obtenus avec notre modèle expérimental *ex vivo* et *in vitro* pour l'étude des cellules T productrices d'IL-17. La distribution des résultats observés est comparable (=), diminuée (\downarrow), ou très diminuée ($\downarrow\downarrow$) par rapport au groupe contrôle.

	Phénotype	Défaut génétique				
		<i>IRAK4</i> <i>MYD88</i>	<i>IL12B</i> <i>IL12RB1</i>	<i>TGFB1</i> <i>TGFBR1</i> <i>TGFBR2</i>	<i>STAT3</i>	auto-anticorps anti-IL-6
ex vivo	Pourcentage de PBMC CD3 ⁺ IL-17 ⁺	=	↓	=	↓↓	↓↓
	Pourcentage de blastes T IL-17 ⁺	=	↓	=	↓↓	↓↓
in vitro	Production IL-17 (non stimulé)	↓	=	=	↓↓	↓↓
	Production IL-17 (PMA-ionomycine)	=	=	=	↓↓	↓↓
	Production IL-22 (non stimulé)	=	↓	=	↓↓	NA
	Production IL-22 (PMA-ionomycine)	=	↓	=	↓↓	NA

2.8. Conclusions

STAT3 est chez l'homme un facteur primordial pour le développement des cellules productrices d'IL-17 (figure 10). Le phénotype obtenu chez le patient avec des auto-anticorps anti-IL-6 nous laisse penser que cette voie serait importante pour un priming précoce *in vivo* des cellules. L'IL-12 est un facteur inhibiteur puissant de la différenciation de ces cellules (data not shown). L'IL-23 est un facteur important pour la différenciation en cellules productrices d'IL-17, mais qui ne semble pas primordial pour la production de cette cytokine. L'IL-23 semble jouer un rôle sur la production d'IL-22. L'IL-1 β n'apparaît pas comme un facteur primordial pour la différenciation de ces cellules bien qu'il permette l'augmentation du nombre de celles-ci. L'IL-1 β semble aussi jouer un rôle dans la sécrétion basale d'IL-17. Le TGF- β ne joue pas du tout un rôle inhibiteur dans nos conditions expérimentales, ce qui a été confirmé par d'autres groupes (74-76). Dans notre modèle de différenciation, la condition qui induit le plus grand nombre de cellules productrices d'IL-17 est la condition TGF- β plus IL-

23. L'IL-22 est décrite comme étant une cytokine produite par les cellules Th17 (97). Cependant, avec un double marquage IL-17-IL-22, nous mettons en évidence qu'il existe bien des populations IL-17⁺IL22⁻ et IL-17⁺IL-22⁺ en plus de la population double positive IL-17⁺IL-22⁺. Ces deux cytokines ne sont donc certainement pas redondantes et semblent produites par des types différents de cellules. Existe-t-il une population de cellules « Th22 » ?

Figure 10: Apport de notre étude dans le modèle de différenciation des lymphocytes T producteurs d'IL-17.

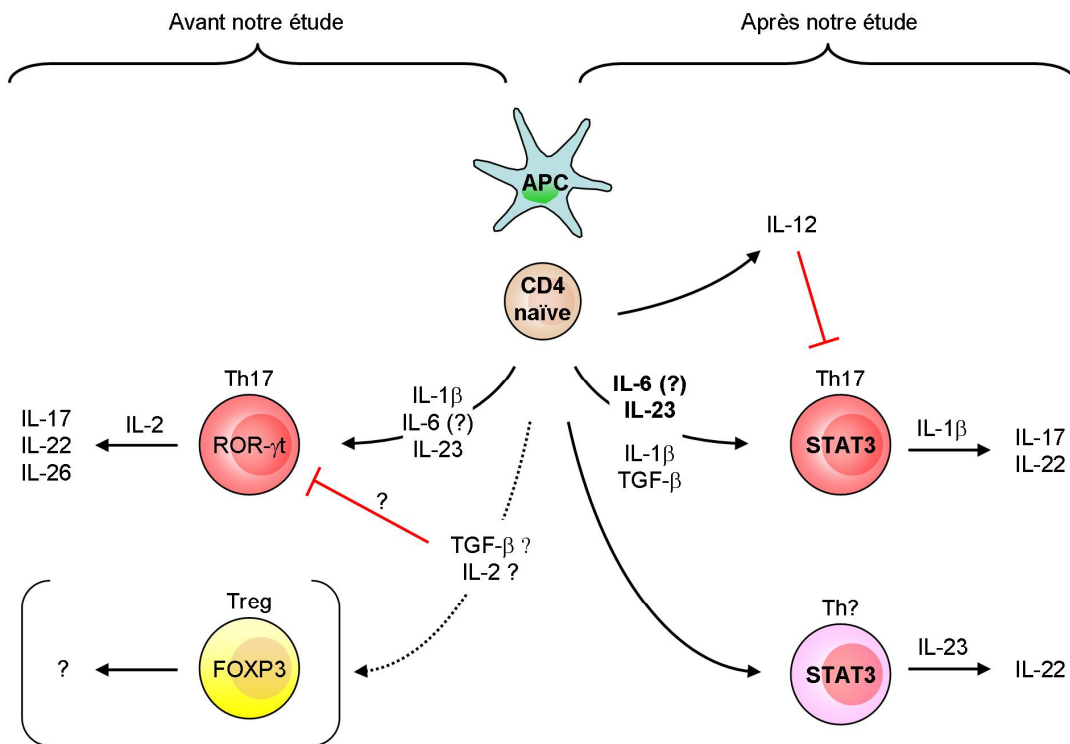

2.9. Discussion

Nous avons étudié la population de lymphocytes T producteurs d'IL-17, mais qu'en est-il de la population Th17 ? Nous avons vérifié que l'IL-17 est très majoritairement produite par les lymphocytes T CD4⁺ (90%). Cependant, il serait intéressant de savoir si cette production d'IL-17 par les autres cellules est dépendante des mêmes voies de signalisation.

Nous nous sommes heurtés à un problème récurrent dans les études chez l'homme qui est la variabilité. Nous observons chez les contrôles une variabilité très importante. Nous avons choisi une stratégie statistique, c'est-à-dire de réaliser les expériences sur un grand nombre de contrôles et de patients avec plus de 120 individus testés. De plus, nous avons choisi deux modèles expérimentaux, *ex vivo* et *in vitro*, pour pallier à cette variabilité. Nous avons obtenu les mêmes conclusions sur les patients déficients en STAT3 que deux autres groupes américain et australien (98, 99). Ces patients ont le phénotype le plus marqué probablement à cause de leur défaut de réponse à l'IL-6 et à d'autres cytokines. Les autres groupes ont réalisé ces mêmes types d'expériences à partir de CD4 naïves purifiées. Malheureusement, nous n'avions pas assez de sang pour faire ces études. Nous ne pouvions pas demander de deuxième prélèvement pour chaque patient. De plus, nous étions limités par le temps, et il n'était pas envisageable de tester autant de patients sur des cellules purifiées. Nous avons fait le choix de la puissance statistique avec un grand nombre de patients testés. De plus, notre principal apport dans le domaine a été de tester d'autres défauts génétiques.

Une des questions la plus importante à mon sens, est de savoir quelle est la fonction de la population Th17 dans l'immunité anti-infectieuse. Cette question n'est malheureusement pas encore résolue, même si nous disposons de certains éléments de réponse. La souris déficiente en IL-17R est sensible à l'infection par *Candida albicans* (100). L'infection par *Candida albicans* peut induire la production de l'ARNm de *IL17A* (100), et une production d'IL-17 (101). Les cellules T mémoires humaines spécifiques pour *Candida albicans* sont surreprésentées dans la population Th17 (65). Ce qu'il est intéressant de noter est que les patients mutés dans *STAT3* font assez communément des candidoses périphériques et cutanéomuqueuses (environ 82%) (87, 102). De plus, les patients *IL12RB1* présentent des candidoses dans une proportion non négligeable (29 patients sur 137 soit 21% des cas) (Rodriguez-

Gallego *et al*, en préparation). Ce sont des formes orales dans la plupart des cas, mais souvent récurrentes. Dans quelques cas, nous observons des formes sévères. Le point commun entre ces deux maladies distinctes est leur faible pourcentage de cellules productrices d'IL-17. L'IL-17 pourrait donc jouer un rôle dans l'immunité anti-candida.

CONCLUSIONS, PERSPECTIVES

Durant ces quatre années, nous sommes passés de l'axe IL-12/23-IFN- γ aux axes IL-12-IFN- γ et IL-23-IL-17. J'ai identifié, suivi et décrit une cohorte de patients avec un défaut complet en IL-12R β 1, molécule commune de ces deux derniers axes. L'axe IL-12-IFN- γ est important dans l'immunité anti-mycobactérienne. Cependant, des mutations de cet axe ne sont pas retrouvées chez tous les patients atteints de ce type d'infection. Nous disposons au laboratoire d'une cohorte de plus de 1000 patients avec des formes idiopathiques du syndrome MSMD. La grande majorité d'entre eux ne sont pourtant pas élucidés au plan moléculaire. Le spectre clinique de ces patients est très hétérogène allant de cas sporadiques à des formes familiales d'infections par différents pathogènes (BCG, mycobactéries environnementales, tuberculose, salmonelles...). L'âge de ces patients est aussi variable (cas pédiatriques à adultes). Afin de pouvoir générer de nouvelles hypothèses, nous avons sélectionné un panel de 22 familles consanguines dont au moins un des enfants a développé une infection sévère au BCG. Une étude par liaison génétique est réalisée dans le laboratoire afin d'identifier des régions chromosomiques puis des mutations dans de nouveaux gènes morbides impliqués dans l'immunité anti-mycobactérienne.

Nous avons identifié des patients avec un déficit complet en IL-12R β 1, mais sans phénotype infectieux. Nous pensons que l'explication est génétique et serait due à des gènes modificateurs. Par manque de temps, je n'ai malheureusement pas pu me lancer sur cette voie de recherche. Nous avons aujourd'hui un réseau de collaborateurs dans des zones où la consanguinité est très élevée (20 à 30% de mariages entre cousins germains en Turquie, Arabie Saoudite et Qatar). Il serait intéressant de tester ces familles élargies et villages pour l'intégrité de la protéine IL12R β 1 soit par le test en sang total, l'expression du récepteur, ou

simplement par génotypage afin d'enrichir le panel de porteurs asymptomatiques. Nous pourrions alors réaliser une étude de liaison par criblage complet du génome. L'identification de variations dans ces gènes modificateurs permettrait une meilleure explication de la physiopathologie de ce défaut. De plus, cela permettrait sans doute de générer de nouveaux gènes ou voies candidats.

Le rôle et la fonction différentielle de l'IL-12 et de l'IL-23 sont en train d'évoluer avec l'exploration de l'axe IL-23-IL-17. Cependant, l'impact de chacun de ces axes dans l'immunité anti-infectieuse n'est pas encore résolu, et nous ne disposons pas de mutants propres de ces cytokines (*IL12A*, *IL23A*, *IL12RB2*, *IL23R*). Beaucoup de questions restent encore ouvertes. Nous savons que les patients déficients en IL-12p40 et en IL-12R β 1 sont beaucoup plus sensibles aux salmonelles, mais nous ne savons pas de quelles molécules l'immunité anti-salmonelle est dépendante. Nous ne savons pas non plus quel est précisément le rôle de l'IL-17 dans l'immunité anti-infectieuse. L'identification de patients porteurs de mutations de l'IL-17 et/ou de son récepteur serait un atout majeur pour la compréhension de sa fonction. L'IL-17 est-elle spécifique d'un pathogène comme peut l'être l'IFN- γ vis à vis des mycobactéries ? En effet, je ne pense pas que le rôle de l'IL-17 soit aussi central que le décrivent les publications de ces derniers mois, et qu'elle soit « la » molécule clé du système immunitaire.

REFERENCES

1. Casanova, J.L., and L. Abel. 2005. Inborn errors of immunity to infection: the rule rather than the exception. *J Exp Med* 202:197-201.
2. Bruton, O.C. 1952. Agammaglobulinemia. *Pediatrics* 9:722-728.
3. Vetrie, D., I. Vorechovsky, P. Sideras, J. Holland, A. Davies, F. Flinter, L. Hammarstrom, C. Kinnon, R. Levinsky, M. Bobrow, and et al. 1993. The gene involved in X-linked agammaglobulinaemia is a member of the src family of protein-tyrosine kinases. *Nature* 361:226-233.
4. Tsukada, S., D.C. Saffran, D.J. Rawlings, O. Parolini, R.C. Allen, I. Klisak, R.S. Sparkes, H. Kubagawa, T. Mohandas, S. Quan, J.W. Belmont, M.D. Cooper, M.E. Conley, and O.N. Witte. 1993. Deficient expression of a B cell cytoplasmic tyrosine kinase in human X-linked agammaglobulinemia. *Cell* 72:279-290.
5. Ochs, H., Smith C.I.E., Puck, J. 2007. Primary Immunodeficiencies: a molecular and genetic approach. Oxford University Press, New York.
6. Casanova, J.L., and L. Abel. 2004. The human model: a genetic dissection of immunity to infection in natural conditions. *Nat Rev Immunol* 4:55-66.
7. Quintana-Murci, L., A. Alcais, L. Abel, and J.L. Casanova. 2007. Immunology *in natura*: clinical, epidemiological and evolutionary genetics of infectious diseases. *Nat Immunol* 8:1165-1171.
8. McKusick, V.A. 2007. Mendelian Inheritance in Man and its online version, OMIM. *Am J Hum Genet* 80:588-604.
9. Mimouni, J. 1951. Notre expérience de trois années de vaccination à Constantine; étude de 25 cas de complications. *Alger Médicale* 55:1138-1147.
10. Levin, M., M.J. Newport, S. D'Souza, P. Kalabalikis, I.N. Brown, H.M. Lenicker, P.V. Agius, E.G. Davies, A. Thrasher, N. Klein, and J. Blackwell. 1995. Familial disseminated atypical mycobacterial infection in childhood: a human mycobacterial susceptibility gene? *Lancet* 345:79-83.
11. Casanova, J.L., E. Jouanguy, S. Lamhamedi, S. Blanche, and A. Fischer. 1995. Immunological conditions of children with BCG disseminated infection. *Lancet* 346:581.
12. Casanova, J.L., S. Blanche, J.F. Emile, E. Jouanguy, S. Lamhamedi, F. Altare, J.L. Stephan, F. Bernaudin, P. Bordigoni, D. Turck, A. Lachaux, M. Albertini, A. Bourrillon, J.P. Dommergues, M.A. Pocardalo, F. Le Deist, J.L. Gaillard, C. Griscelli, and A. Fischer. 1996. Idiopathic disseminated bacillus Calmette-Guerin infection: a French national retrospective study. *Pediatrics* 98:774-778.
13. Bonnet, M., C. Soudais, and J.L. Casanova. 2004. The Interleukin-12/Interferon-gamma loop is required for protective immunity to experimental and natural infections by Mycobacterium. In *Susceptibility to infectious diseases : the importance of host genetics*. R. Bellamy, editor Cambridge University Press, 259-278.
14. Kobayashi, M., L. Fitz, M. Ryan, R.M. Hewick, S.C. Clark, S. Chan, R. Loudon, F. Sherman, B. Perussia, and G. Trinchieri. 1989. Identification and purification of natural killer cell stimulatory factor (NKSF), a cytokine with multiple biologic effects on human lymphocytes. *J Exp Med* 170:827-845.
15. Presky, D.H., H. Yang, L.J. Minetti, A.O. Chua, N. Nabavi, C.Y. Wu, M.K. Gately, and U. Gubler. 1996. A functional interleukin 12 receptor complex is composed of two beta-type cytokine receptor subunits. *Proc Natl Acad Sci U S A* 93:14002-14007.
16. Watford, W.T., B.D. Hissong, J.H. Bream, Y. Kanno, L. Muul, and J.J. O'Shea. 2004. Signaling by IL-12 and IL-23 and the immunoregulatory roles of STAT4. *Immunol*

- Rev* 202:139-156.
17. Chua, A.O., R. Chizzonite, B.B. Desai, T.P. Truitt, P. Nunes, L.J. Minetti, R.R. Warriar, D.H. Presky, J.F. Levine, M.K. Gately, and et al. 1994. Expression cloning of a human IL-12 receptor component. A new member of the cytokine receptor superfamily with strong homology to gp130. *J Immunol* 153:128-136.
 18. Yamamoto, K., H. Kobayashi, O. Miura, S. Hirosawa, and N. Miyasaka. 1997. Assignment of *IL12RB1* and *IL12RB2*, interleukin-12 receptor beta 1 and beta 2 chains, to human chromosome 19 band p13.1 and chromosome 1 band p31.2, respectively, by in situ hybridization. *Cytogenet Cell Genet* 77:257-258.
 19. Boulay, J.L., J.J. O'Shea, and W.E. Paul. 2003. Molecular phylogeny within type I cytokines and their cognate receptors. *Immunity* 19:159-163.
 20. Bravo, J., D. Staunton, J.K. Heath, and E.Y. Jones. 1998. Crystal structure of a cytokine-binding region of gp130. *Embo J* 17:1665-1674.
 21. Bravo, J., and J.K. Heath. 2000. Receptor recognition by gp130 cytokines. *Embo J* 19:2399-2411.
 22. Oppmann, B., R. Lesley, B. Blom, J.C. Timans, Y. Xu, B. Hunte, F. Vega, N. Yu, J. Wang, K. Singh, F. Zonin, E. Vaisberg, T. Churakova, M. Liu, D. Gorman, J. Wagner, S. Zurawski, Y. Liu, J.S. Abrams, K.W. Moore, D. Rennick, R. de Waal-Malefyt, C. Hannum, J.F. Bazan, and R.A. Kastelein. 2000. Novel p19 protein engages IL-12p40 to form a cytokine, IL-23, with biological activities similar as well as distinct from IL-12. *Immunity* 13:715-725.
 23. Langrish, C.L., B.S. McKenzie, N.J. Wilson, R. de Waal Malefyt, R.A. Kastelein, and D.J. Cua. 2004. IL-12 and IL-23: master regulators of innate and adaptive immunity. *Immunol Rev* 202:96-105.
 24. Altare, F., A. Durandy, D. Lammas, J.F. Emile, S. Lamhamedi, F. Le Deist, P. Drysdale, E. Jouanguy, R. Döffinger, F. Bernaudin, O. Jeppsson, J.A. Gollob, E. Meinel, A.W. Segal, A. Fischer, D. Kumararatne, and J.L. Casanova. 1998. Impairment of mycobacterial immunity in human interleukin-12 receptor deficiency. *Science* 280:1432-1435.
 25. Altare, F., A. Ensser, A. Breiman, J. Reichenbach, J.E. Baghdadi, A. Fischer, J.F. Emile, J.L. Gaillard, E. Meinel, and J.L. Casanova. 2001. Interleukin-12 Receptor beta1 Deficiency in a Patient with Abdominal Tuberculosis. *J Infect Dis* 184:231-236.
 26. Aksu, G., C. Tirpan, C. Cavusoglu, S. Soydan, F. Altare, J.L. Casanova, and N. Kutukculer. 2001. Mycobacterium fortuitum-chelonae complex infection in a child with complete interleukin-12 receptor beta 1 deficiency. *Pediatr Infect Dis J* 20:551-553.
 27. Fieschi, C., and J.L. Casanova. 2003. The role of interleukin-12 in human infectious diseases: only a faint signature. *Eur J Immunol* 33:1461-1464.
 28. Staretz-Haham, O., R. Melamed, M. Lifshitz, N. Porat, C. Fieschi, J.L. Casanova, and J. Levy. 2003. Interleukin-12 receptor beta1 deficiency presenting as recurrent Salmonella infection. *Clin Infect Dis* 37:137-140.
 29. Caragol, I., M. Raspall, C. Fieschi, J. Feinberg, M.N. Larrosa, M. Hernandez, C. Figueras, J.M. Bertran, J.L. Casanova, and T. Espanol. 2003. Clinical tuberculosis in 2 of 3 siblings with interleukin-12 receptor beta1 deficiency. *Clin Infect Dis* 37:302-306.
 30. Ulrichs, T., C. Fieschi, E. Nevicka, H. Hahn, M. Brezina, S.H. Kaufmann, J.L. Casanova, and K. Freceerova. 2005. Variable outcome of experimental interferon-gamma therapy of disseminated Bacillus Calmette-Guerin infection in two unrelated interleukin-12Rbeta1-deficient Slovakian children. *Eur J Pediatr* 164:166-172.
 31. Kutukculer, N., F. Genel, G. Aksu, B. Karapinar, C. Ozturk, C. Cavusoglu, J.L. Casanova, and C. Fieschi. 2006. Cutaneous leukocytoclastic vasculitis in a child with

- interleukin-12 receptor beta-1 deficiency. *J Pediatr* 148:407-409.
32. de Jong, R., F. Altare, I.A. Haagen, D.G. Elferink, T. Boer, P.J. van Breda Vriesman, P.J. Kabel, J.M. Draaisma, J.T. van Dissel, F.P. Kroon, J.L. Casanova, and T.H. Ottenhoff. 1998. Severe mycobacterial and Salmonella infections in interleukin-12 receptor-deficient patients. *Science* 280:1435-1438.
 33. Verhagen, C.E., T. de Boer, H.H. Smits, F.A. Verreck, E.A. Wierenga, M. Kurimoto, D.A. Lammas, D.S. Kumararatne, O. Sanal, F.P. Kroon, J.T. van Dissel, F. Sinigaglia, and T.H. Ottenhoff. 2000. Residual type 1 immunity in patients genetically deficient for interleukin 12 receptor beta1 (IL-12Rbeta1): evidence for an IL-12Rbeta1-independent pathway of IL-12 responsiveness in human T cells. *J Exp Med* 192:517-528.
 34. Sakai, T., M. Matsuoka, M. Aoki, K. Nosaka, and H. Mitsuya. 2001. Missense mutation of the interleukin-12 receptor beta1 chain-encoding gene is associated with impaired immunity against Mycobacterium avium complex infection. *Blood* 97:2688-2694.
 35. Elloumi-Zghal, H., M.R. Barbouche, J. Chemli, M. Bejaoui, A. Harbi, N. Snoussi, S. Abdelhak, and K. Dellagi. 2002. Clinical and genetic heterogeneity of inherited autosomal recessive susceptibility to disseminated Mycobacterium bovis bacille calmette-guerin infection. *J Infect Dis* 185:1468-1475.
 36. Lichtenauer-Kaligis, E.G., T. de Boer, F.A. Verreck, S. van Voorden, M.A. Hoeve, E. van de Vosse, F. Ersoy, I. Tezcan, J.T. van Dissel, O. Sanal, and T.H. Ottenhoff. 2003. Severe Mycobacterium bovis BCG infections in a large series of novel IL-12 receptor beta1 deficient patients and evidence for the existence of partial IL-12 receptor beta1 deficiency. *Eur J Immunol* 33:59-69.
 37. Hoeve, M.A., T. de Boer, D.M. Langenberg, O. Sanal, F.A. Verreck, and T.H. Ottenhoff. 2003. IL-12 receptor deficiency revisited: IL-23-mediated signaling is also impaired in human genetic IL-12 receptor beta1 deficiency. *Eur J Immunol* 33:3393-3397.
 38. Cleary, A.M., W. Tu, A. Enright, T. Giffon, R. Dewaal-Malefyt, K. Gutierrez, and D.B. Lewis. 2003. Impaired accumulation and function of memory CD4 T cells in human IL-12 receptor beta 1 deficiency. *J Immunol* 170:597-603.
 39. Stern, A.S., F.J. Podlaski, J.D. Hulmes, Y.C. Pan, P.M. Quinn, A.G. Wolitzky, P.C. Familletti, D.L. Stremlo, T. Truitt, R. Chizzonite, and et al. 1990. Purification to homogeneity and partial characterization of cytotoxic lymphocyte maturation factor from human B-lymphoblastoid cells. *Proc Natl Acad Sci U S A* 87:6808-6812.
 40. Pittet, M.J., D.E. Speiser, D. Valmori, J.C. Cerottini, and P. Romero. 2000. Cutting edge: cytolytic effector function in human circulating CD8+ T cells closely correlates with CD56 surface expression. *J Immunol* 164:1148-1152.
 41. Liew, F.Y. 2002. T(H)1 and T(H)2 cells: a historical perspective. *Nat Rev Immunol* 2:55-60.
 42. Coffman, R.L., and J. Carty. 1986. A T cell activity that enhances polyclonal IgE production and its inhibition by interferon-gamma. *J Immunol* 136:949-954.
 43. Mosmann, T.R., H. Cherwinski, M.W. Bond, M.A. Giedlin, and R.L. Coffman. 1986. Two types of murine helper T cell clone. I. Definition according to profiles of lymphokine activities and secreted proteins. *J Immunol* 136:2348-2357.
 44. Coffman, R.L. 2006. Origins of the T(H)1-T(H)2 model: a personal perspective. *Nat Immunol* 7:539-541.
 45. Weaver, C.T., R.D. Hatton, P.R. Mangan, and L.E. Harrington. 2007. IL-17 family cytokines and the expanding diversity of effector T cell lineages. *Annu Rev Immunol* 25:821-852.

46. Aggarwal, S., N. Ghilardi, M.H. Xie, F.J. de Sauvage, and A.L. Gurney. 2003. Interleukin-23 promotes a distinct CD4 T cell activation state characterized by the production of interleukin-17. *J Biol Chem* 278:1910-1914.
47. Langrish, C.L., Y. Chen, W.M. Blumenschein, J. Mattson, B. Basham, J.D. Sedgwick, T. McClanahan, R.A. Kastelein, and D.J. Cua. 2005. IL-23 drives a pathogenic T cell population that induces autoimmune inflammation. *J Exp Med* 201:233-240.
48. Dong, C. 2006. Diversification of T-helper-cell lineages: finding the family root of IL-17-producing cells. *Nat Rev Immunol* 6:329-333.
49. Laurence, A., and J.J. O'Shea. 2007. T(H)-17 differentiation: of mice and men. *Nat Immunol* 8:903-905.
50. Dong, C. 2008. TH17 cells in development: an updated view of their molecular identity and genetic programming. *Nat Rev Immunol* 8:337-348.
51. Harrington, L.E., R.D. Hatton, P.R. Mangan, H. Turner, T.L. Murphy, K.M. Murphy, and C.T. Weaver. 2005. Interleukin 17-producing CD4⁺ effector T cells develop via a lineage distinct from the T helper type 1 and 2 lineages. *Nat Immunol* 6:1123-1132.
52. Park, H., Z. Li, X.O. Yang, S.H. Chang, R. Nurieva, Y.H. Wang, Y. Wang, L. Hood, Z. Zhu, Q. Tian, and C. Dong. 2005. A distinct lineage of CD4 T cells regulates tissue inflammation by producing interleukin 17. *Nat Immunol* 6:1133-1141.
53. Mangan, P.R., L.E. Harrington, D.B. O'Quinn, W.S. Helms, D.C. Bullard, C.O. Elson, R.D. Hatton, S.M. Wahl, T.R. Schoeb, and C.T. Weaver. 2006. Transforming growth factor-beta induces development of the T(H)17 lineage. *Nature* 441:231-234.
54. Bettelli, E., Y. Carrier, W. Gao, T. Korn, T.B. Strom, M. Oukka, H.L. Weiner, and V.K. Kuchroo. 2006. Reciprocal developmental pathways for the generation of pathogenic effector TH17 and regulatory T cells. *Nature* 441:235-238.
55. Veldhoen, M., R.J. Hocking, C.J. Atkins, R.M. Locksley, and B. Stockinger. 2006. TGFbeta in the context of an inflammatory cytokine milieu supports de novo differentiation of IL-17-producing T cells. *Immunity* 24:179-189.
56. Laurence, A., C.M. Tato, T.S. Davidson, Y. Kanno, Z. Chen, Z. Yao, R.B. Blank, F. Meylan, R. Siegel, L. Hennighausen, E.M. Shevach, and J. O'Shea J. 2007. Interleukin-2 signaling via STAT5 constrains T helper 17 cell generation. *Immunity* 26:371-381.
57. Mucida, D., Y. Park, G. Kim, O. Turovskaya, I. Scott, M. Kronenberg, and H. Cheroutre. 2007. Reciprocal TH17 and regulatory T cell differentiation mediated by retinoic acid. *Science* 317:256-260.
58. Korn, T., E. Bettelli, W. Gao, A. Awasthi, A. Jager, T.B. Strom, M. Oukka, and V.K. Kuchroo. 2007. IL-21 initiates an alternative pathway to induce proinflammatory T(H)17 cells. *Nature* 448:484-487.
59. Nurieva, R., X.O. Yang, G. Martinez, Y. Zhang, A.D. Panopoulos, L. Ma, K. Schluns, Q. Tian, S.S. Watowich, A.M. Jetten, and C. Dong. 2007. Essential autocrine regulation by IL-21 in the generation of inflammatory T cells. *Nature* 448:480-483.
60. Zhou, L., Ivanov, II, R. Spolski, R. Min, K. Shenderov, T. Egawa, D.E. Levy, W.J. Leonard, and D.R. Littman. 2007. IL-6 programs T(H)-17 cell differentiation by promoting sequential engagement of the IL-21 and IL-23 pathways. *Nat Immunol* 8:967-974.
61. Yang, X.O., A.D. Panopoulos, R. Nurieva, S.H. Chang, D. Wang, S.S. Watowich, and C. Dong. 2007. STAT3 regulates cytokine-mediated generation of inflammatory helper T cells. *J Biol Chem* 282:9358-9363.
62. Ivanov, II, B.S. McKenzie, L. Zhou, C.E. Tadokoro, A. Lepelley, J.J. Lafaille, D.J. Cua, and D.R. Littman. 2006. The orphan nuclear receptor RORgammat directs the differentiation program of proinflammatory IL-17⁺ T helper cells. *Cell* 126:1121-

- 1133.
63. Brustle, A., S. Heink, M. Huber, C. Rosenplanter, C. Stadelmann, P. Yu, E. Arpaia, T.W. Mak, T. Kamradt, and M. Lohoff. 2007. The development of inflammatory T(H)-17 cells requires interferon-regulatory factor 4. *Nat Immunol* 8:958-966.
 64. Sutton, C., C. Brereton, B. Keogh, K.H. Mills, and E.C. Lavelle. 2006. A crucial role for interleukin (IL)-1 in the induction of IL-17-producing T cells that mediate autoimmune encephalomyelitis. *J Exp Med* 203:1685-1691.
 65. Acosta-Rodriguez, E.V., L. Rivino, J. Geginat, D. Jarrossay, M. Gattorno, A. Lanzavecchia, F. Sallusto, and G. Napolitani. 2007. Surface phenotype and antigenic specificity of human interleukin 17-producing T helper memory cells. *Nat Immunol* 8:639-646.
 66. Sato, W., T. Aranami, and T. Yamamura. 2007. Cutting edge: Human Th17 cells are identified as bearing CCR2+CCR5- phenotype. *J Immunol* 178:7525-7529.
 67. Annunziato, F., L. Cosmi, V. Santarlasci, L. Maggi, F. Liotta, B. Mazzinghi, E. Parente, L. Fili, S. Ferri, F. Frosali, F. Giudici, P. Romagnani, P. Parronchi, F. Tonelli, E. Maggi, and S. Romagnani. 2007. Phenotypic and functional features of human Th17 cells. *J Exp Med* 204:1849-1861.
 68. Acosta-Rodriguez, E.V., G. Napolitani, A. Lanzavecchia, and F. Sallusto. 2007. Interleukins 1beta and 6 but not transforming growth factor-beta are essential for the differentiation of interleukin 17-producing human T helper cells. *Nat Immunol* 8:942-949.
 69. Wilson, N.J., K. Boniface, J.R. Chan, B.S. McKenzie, W.M. Blumenschein, J.D. Mattson, B. Basham, K. Smith, T. Chen, F. Morel, J.C. Lecron, R.A. Kastelein, D.J. Cua, T.K. McClanahan, E.P. Bowman, and R. de Waal Malefyt. 2007. Development, cytokine profile and function of human interleukin 17-producing helper T cells. *Nat Immunol* 8:950-957.
 70. Chen, Z., C.M. Tato, L. Muul, A. Laurence, and J.J. O'Shea. 2007. Distinct regulation of interleukin-17 in human T helper lymphocytes. *Arthritis Rheum* 56:2936-2946.
 71. Evans, H.G., T. Suddason, I. Jackson, L.S. Taams, and G.M. Lord. 2007. Optimal induction of T helper 17 cells in humans requires T cell receptor ligation in the context of Toll-like receptor-activated monocytes. *Proc Natl Acad Sci U S A* 104:17034-17039.
 72. Lim, H.W., J. Lee, P. Hillsamer, and C.H. Kim. 2008. Human Th17 cells share major trafficking receptors with both polarized effector T cells and FOXP3+ regulatory T cells. *J Immunol* 180:122-129.
 73. Singh, S.P., H.H. Zhang, J.F. Foley, M.N. Hedrick, and J.M. Farber. 2008. Human T cells that are able to produce IL-17 express the chemokine receptor CCR6. *J Immunol* 180:214-221.
 74. Manel, N., D. Unutmaz, and D.R. Littman. 2008. The differentiation of human T(H)-17 cells requires transforming growth factor-beta and induction of the nuclear receptor RORgammat. *Nat Immunol* 9:641-649.
 75. Volpe, E., N. Servant, R. Zollinger, S.I. Bogiatzi, P. Hupe, E. Barillot, and V. Soumelis. 2008. A critical function for transforming growth factor-beta, interleukin 23 and proinflammatory cytokines in driving and modulating human T(H)-17 responses. *Nat Immunol* 9:650-657.
 76. Yang, L., D.E. Anderson, C. Baecher-Allan, W.D. Hastings, E. Bettelli, M. Oukka, V.K. Kuchroo, and D.A. Hafler. 2008. IL-21 and TGF-beta are required for differentiation of human T(H)17 cells. *Nature* 454:350-352.
 77. Parham, C., M. Chirica, J. Timans, E. Vaisberg, M. Travis, J. Cheung, S. Pflanz, R. Zhang, K.P. Singh, F. Vega, W. To, J. Wagner, A.M. O'Farrell, T. McClanahan, S.

- Zurawski, C. Hannum, D. Gorman, D.M. Rennick, R.A. Kastelein, R. de Waal Malefyt, and K.W. Moore. 2002. A receptor for the heterodimeric cytokine IL-23 is composed of IL-12Rbeta1 and a novel cytokine receptor subunit, IL-23R. *J Immunol* 168:5699-5708.
78. Loeys, B.L., J. Chen, E.R. Neptune, D.P. Judge, M. Podowski, T. Holm, J. Meyers, C.C. Leitch, N. Katsanis, N. Sharifi, F.L. Xu, L.A. Myers, P.J. Spevak, D.E. Cameron, J. De Backer, J. Hellemans, Y. Chen, E.C. Davis, C.L. Webb, W. Kress, P. Coucke, D.B. Rifkin, A.M. De Paepe, and H.C. Dietz. 2005. A syndrome of altered cardiovascular, craniofacial, neurocognitive and skeletal development caused by mutations in TGFBR1 or TGFBR2. *Nat Genet* 37:275-281.
79. Loeys, B.L., U. Schwarze, T. Holm, B.L. Callewaert, G.H. Thomas, H. Pannu, J.F. De Backer, G.L. Oswald, S. Symoens, S. Manouvrier, A.E. Roberts, F. Faravelli, M.A. Greco, R.E. Pyeritz, D.M. Milewicz, P.J. Coucke, D.E. Cameron, A.C. Braverman, P.H. Byers, A.M. De Paepe, and H.C. Dietz. 2006. Aneurysm syndromes caused by mutations in the TGF-beta receptor. *N Engl J Med* 355:788-798.
80. Ramirez, F., and H.C. Dietz. 2007. Marfan syndrome: from molecular pathogenesis to clinical treatment. *Curr Opin Genet Dev* 17:252-258.
81. Kinoshita, A., T. Saito, H. Tomita, Y. Makita, K. Yoshida, M. Ghadami, K. Yamada, S. Kondo, S. Ikegawa, G. Nishimura, Y. Fukushima, T. Nakagomi, H. Saito, T. Sugimoto, M. Kamegaya, K. Hisa, J.C. Murray, N. Taniguchi, N. Niikawa, and K. Yoshiura. 2000. Domain-specific mutations in TGFBI result in Camurati-Engelmann disease. *Nat Genet* 26:19-20.
82. Janssens, K., R. Gershoni-Baruch, N. Guanabens, N. Migone, S. Ralston, M. Bonduelle, W. Lissens, L. Van Maldergem, F. Vanhoenacker, L. Verbruggen, and W. Van Hul. 2000. Mutations in the gene encoding the latency-associated peptide of TGF-beta 1 cause Camurati-Engelmann disease. *Nat Genet* 26:273-275.
83. Janssens, K., F. Vanhoenacker, M. Bonduelle, L. Verbruggen, L. Van Maldergem, S. Ralston, N. Guanabens, N. Migone, S. Wientroub, M.T. Divizia, C. Bergmann, C. Bennett, S. Simsek, S. Melancon, T. Cundy, and W. Van Hul. 2006. Camurati-Engelmann disease: review of the clinical, radiological, and molecular data of 24 families and implications for diagnosis and treatment. *J Med Genet* 43:1-11.
84. Picard, C., A. Puel, M. Bonnet, C.L. Ku, J. Bustamante, K. Yang, C. Soudais, S. Dupuis, J. Feinberg, C. Fieschi, C. Elbim, R. Hitchcock, D. Lammas, G. Davies, A. Al-Ghonaium, H. Al-Rayes, S. Al-Jumaah, S. Al-Hajjar, I.Z. Al-Mohsen, H.H. Frayha, R. Rucker, T.R. Hawn, A. Aderem, H. Tufenkeji, S. Haraguchi, N.K. Day, R.A. Good, M.A. Gougerot-Pocidallo, A. Ozinsky, and J.L. Casanova. 2003. Pyogenic bacterial infections in humans with IRAK-4 deficiency. *Science* 299:2076-2079.
85. Ku, C.L., H. von Bernuth, C. Picard, S.Y. Zhang, H.H. Chang, K. Yang, M. Chrabieh, A.C. Issekutz, C.K. Cunningham, J. Gallin, S.M. Holland, C. Roifman, S. Ehl, J. Smart, M. Tang, F.J. Barrat, O. Levy, D. McDonald, N.K. Day-Good, R. Miller, H. Takada, T. Hara, S. Al-Hajjar, A. Al-Ghonaium, D. Speert, D. Sanlaville, X. Li, F. Geissmann, E. Vivier, L. Marodi, B.Z. Garty, H. Chapel, C. Rodriguez-Gallego, X. Bossuyt, L. Abel, A. Puel, and J.L. Casanova. 2007. Selective predisposition to bacterial infections in IRAK-4-deficient children: IRAK-4-dependent TLRs are otherwise redundant in protective immunity. *J Exp Med* 204:2407-2422.
86. von Bernuth, H., C. Picard, Z. Jin, R. Pankla, H. Xiao, C.L. Ku, M. Chrabieh, I.B. Mustapha, P. Ghandil, Y. Camcioglu, J. Vasconcelos, N. Sirvent, M. Guedes, A.B. Vitor, M.J. Herrero-Mata, J.I. Arostegui, C. Rodrigo, L. Alsina, E. Ruiz-Ortiz, M. Juan, C. Fortuny, J. Yague, J. Anton, M. Pascal, H.H. Chang, L. Janniere, Y. Rose, B.Z. Garty, H. Chapel, A. Issekutz, L. Marodi, C. Rodriguez-Gallego, J. Banchereau,

- L. Abel, X. Li, D. Chaussabel, A. Puel, and J.L. Casanova. 2008. Pyogenic bacterial infections in humans with MyD88 deficiency. *Science* 321:691-696.
87. Grimbacher, B., S.M. Holland, J.I. Gallin, F. Greenberg, S.C. Hill, H.L. Malech, J.A. Miller, A.C. O'Connell, and J.M. Puck. 1999. Hyper-IgE syndrome with recurrent infections--an autosomal dominant multisystem disorder. *N Engl J Med* 340:692-702.
 88. Minegishi, Y., M. Saito, S. Tsuchiya, I. Tsuge, H. Takada, T. Hara, N. Kawamura, T. Ariga, S. Pasic, O. Stojkovic, A. Metin, and H. Karasuyama. 2007. Dominant-negative mutations in the DNA-binding domain of STAT3 cause hyper-IgE syndrome. *Nature* 448:1058-1062.
 89. Altare, F., D. Lammas, P. Revy, E. Jouanguy, R. Döffinger, S. Lamhamedi, P. Drysdale, D. Tollner, J. Girdlestone, P. Darbyshire, M. Wadhwa, H. Dockrel, M. Salmon, A. Fischer, A. Durandy, J.L. Casanova, and D. Kumararatne. 1998. Inherited interleukin 12 deficiency in a child with bacille Calmette-Guérin and Salmonella enteritidis disseminated infection. *J Clin Invest* 102:2035-2040.
 90. Picard, C., C. Fieschi, F. Altare, S. Al-Jumaah, S. Al-Hajjar, J. Feinberg, S. Dupuis, C. Soudais, I.Z. Al-Mohsen, E. Genin, D. Lammas, D.S. Kumararatne, T. Leclerc, A. Rafii, H. Frayha, B. Murugasu, L.B. Wah, R. Sinniah, M. Loubser, E. Okamoto, A. Al-Ghonaium, H. Tufenkeji, L. Abel, and J.L. Casanova. 2002. Inherited interleukin-12 deficiency: *IL12B* genotype and clinical phenotype of 13 patients from six kindreds. *Am J Hum Genet* 70:336-348.
 91. Filipe-Santos, O., J. Bustamante, A. Chagier, G. Vogt, L. de Beaucoudrey, J. Feinberg, E. Jouanguy, S. Boisson-Dupuis, C. Fieschi, C. Picard, and J.L. Casanova. 2006. Inborn errors of IL-12/23- and IFN-gamma-mediated immunity: molecular, cellular, and clinical features. *Semin Immunol* 18:347-361.
 92. Puel, A., C. Picard, M. Lorrot, C. Pons, M. Chrabieh, L. Lorenzo, M. Mamani-Matsuda, E. Jouanguy, D. Gendrel, and J.L. Casanova. 2008. Recurrent staphylococcal cellulitis and subcutaneous abscesses in a child with autoantibodies against IL-6. *J Immunol* 180:647-654.
 93. Torgerson, T.R., A. Linane, N. Moes, S. Anover, V. Mateo, F. Rieux-Laucat, O. Hermine, S. Vijay, E. Gambineri, N. Cerf-Bensussan, A. Fischer, H.D. Ochs, O. Goulet, and F.M. Ruemmele. 2007. Severe food allergy as a variant of IPEX syndrome caused by a deletion in a noncoding region of the FOXP3 gene. *Gastroenterology* 132:1705-1717.
 94. Torgerson, T.R., and H.D. Ochs. 2007. Immune dysregulation, polyendocrinopathy, enteropathy, X-linked: forkhead box protein 3 mutations and lack of regulatory T cells. *J Allergy Clin Immunol* 120:744-750; quiz 751-742.
 95. Neudorf, S., M. Jones, S. Parker, R. Papes, and D. Lattier. 1991. Phorbol esters down-regulate transcription and translation of the CD4 gene. *J Immunol* 146:2836-2840.
 96. Baran, J., D. Kowalczyk, M. Ozog, and M. Zembala. 2001. Three-color flow cytometry detection of intracellular cytokines in peripheral blood mononuclear cells: comparative analysis of phorbol myristate acetate-ionomycin and phytohemagglutinin stimulation. *Clin Diagn Lab Immunol* 8:303-313.
 97. Zheng, Y., D.M. Danilenko, P. Valdez, I. Kasman, J. Eastham-Anderson, J. Wu, and W. Ouyang. 2007. Interleukin-22, a T(H)17 cytokine, mediates IL-23-induced dermal inflammation and acanthosis. *Nature* 445:648-651.
 98. Milner, J.D., J.M. Brenchley, A. Laurence, A.F. Freeman, B.J. Hill, K.M. Elias, Y. Kanno, C. Spalding, H.Z. Elloumi, M.L. Paulson, J. Davis, A. Hsu, A.I. Asher, J. O'Shea, S.M. Holland, W.E. Paul, and D.C. Douek. 2008. Impaired T(H)17 cell differentiation in subjects with autosomal dominant hyper-IgE syndrome. *Nature* 452:773-776.

99. Ma, C.S., G.Y. Chew, N. Simpson, A. Priyadarshi, M. Wong, B. Grimbacher, D.A. Fulcher, S.G. Tangye, and M.C. Cook. 2008. Deficiency of Th17 cells in hyper IgE syndrome due to mutations in STAT3. *J Exp Med* 205:1551-1557.
100. Huang, W., L. Na, P.L. Fidel, and P. Schwarzenberger. 2004. Requirement of interleukin-17A for systemic anti-Candida albicans host defense in mice. *J Infect Dis* 190:624-631.
101. LeibundGut-Landmann, S., O. Gross, M.J. Robinson, F. Osorio, E.C. Slack, S.V. Tsoni, E. Schweighoffer, V. Tybulewicz, G.D. Brown, J. Ruland, and C. Reis e Sousa. 2007. Syk- and CARD9-dependent coupling of innate immunity to the induction of T helper cells that produce interleukin 17. *Nat Immunol* 8:630-638.
102. Renner, E.D., S. Rylaarsdam, S. Anover-Sombke, A.L. Rack, J. Reichenbach, J.C. Carey, Q. Zhu, A.F. Jansson, J. Barboza, L.F. Schimke, M.F. Leppert, M.M. Getz, R.A. Seger, H.R. Hill, B.H. Belohradsky, T.R. Torgerson, and H.D. Ochs. 2008. Novel signal transducer and activator of transcription 3 (STAT3) mutations, reduced T(H)17 cell numbers, and variably defective STAT3 phosphorylation in hyper-IgE syndrome. *J Allergy Clin Immunol* 122:181-187.

ARTICLES

- Article 1.** Simultaneous presentation of 2 rare hereditary immunodeficiencies: IL-12 receptor beta1 deficiency and ataxia-telangiectasia. p55
- Article 2.** Mutations in *STAT3* and *IL12RB1* impair the development of human IL-17-producing T cells. p59
- Article 3.** A role for interleukin-12/23 in the maturation of human natural killer and CD56+ T cells in vivo. p80
- Article 4.** Mycobacterial disease in a child with surface-expressed non-functional interleukin-12Rbeta1 chains. p90
- Article 5.** Inborn errors of IL-12/23- and IFN-gamma-mediated immunity: molecular, cellular, and clinical features. p93
- Article 6.** T cell-dependent activation of dendritic cells requires IL-12 and IFN-gamma signaling in T cells. p109
- Article 7.** Complete deficiency of the IL-12 receptor beta1 chain: three unrelated Turkish children with unusual clinical features. p120
- Article 8.** Inherited disorders of the IL-12-IFN-gamma axis in patients with disseminated BCG infection. p124
- Article 9.** *Paracoccidioides brasiliensis* disseminated disease in a patient with inherited deficiency in the beta1 subunit of the interleukin (IL)-12/IL-23 receptor. p130
- Article 10.** Interleukin-12 receptor beta 1 chain deficiency in a child with disseminated tuberculosis. p138
- Article 11.** *Bacillus Calmette Guerin* triggers the IL-12/IFN-gamma axis by an IRAK-4- and NEMO-dependent, non-cognate interaction between monocytes, NK, and T lymphocytes. p143
- Article 12.** A novel form of complete IL-12/IL-23 receptor beta1 deficiency with cell surface-expressed nonfunctional receptors. p153
- Article en préparation.** Revisiting human IL-12R β 1 deficiency: higher penetrance, broader susceptibility, and poorer outcome. p161
- Autres articles** p199

Article 1

Simultaneous presentation of 2 rare hereditary immunodeficiencies: IL-12
receptor beta1 deficiency and ataxia-telangiectasia

Ehlayel, M., **L. de Beaucoudrey**, F. Fike, S.A. Nahas, J. Feinberg, J.L. Casanova,
and R.A. Gatti

The Journal of Allergy and Clinical Immunology
2008

Letter to the Editor

Simultaneous presentation of 2 rare hereditary immunodeficiencies: IL-12 receptor β 1 deficiency and ataxia-telangiectasia*To the Editor:*

About 150 primary immunodeficiencies (PIDs) have been described, with more than 100 genetic etiologies identified, as reviewed by Casanova and Abel.¹ Most known PIDs are rare and first manifest symptoms in infancy or early childhood. They confer predisposition to various clinical phenotypes, including infection and cancer. Most PIDs predispose affected children to infectious diseases, the nature and range of which depend on the condition. Autosomal recessive IL-12 receptor β 1 (IL-12R β 1) deficiency is the most common cause of hereditary predisposition to mycobacterial diseases and salmonellosis in otherwise healthy patients, as reviewed by Filipe-Santos et al.² Many PIDs also confer predisposition to cancer, whether because of impaired control of oncogenic viruses, impaired DNA repair, or both. The best known example is ataxia-telangiectasia (A-T), which is associated with a high rate of lymphoma and leukemia, as reviewed by Lavin et al.³ Known PIDs are typically rare, with a prevalence between 1/100,000 and 1/1,000,000 cases per live births. We report the first patient with 2 hereditary PIDs: IL-12R β 1 deficiency and A-T.

A 7-year-old Arab girl had presented in the Allergy-Immunology Clinic of Hamad Medical Corporation in Doha, Qatar, since early childhood because a sister died at age 10 years with A-T (Fig 1). She was full-term, from an uneventful pregnancy, born to healthy, first-degree cousins. At age 4 days, laboratory workup showed a low lymphocyte count but normal IgG, IgA, and IgM levels. Lymphocyte subsets revealed low proportions of CD3, CD4, and CD8. She was thus considered as a probable case of A-T. She had her immunization series except live vaccines and was given inactivated poliomyelitis vaccine.

At 14 months, she was admitted to the hospital with a 10-day fever without other symptoms. Blood cultures were positive for *Salmonella* serotype group D. She was treated with Ceftriaxone intravenously for 10 days. Blood cultures became negative after 4 days of Ceftriaxone, and the patient was discharged from the hospital. Two weeks later, the patient was readmitted with a history of a 2-day fever; she was otherwise asymptomatic. Blood culture again was positive for *Salmonella* serotype group D. She received 14 days of Ceftriaxone intravenously and was discharged with negative blood cultures. Two weeks later, she was readmitted again with a 3-day fever (40.6°C). Blood cultures were again positive for *Salmonella* serotype group D. She received a 10-day course of intravenous Ceftriaxone and Amikacin and was discharged from the hospital.

At age 22.5 months, she was admitted to the hospital with fever, limping, and a painful, swollen left knee for 4 days with limited range of motion. There was extensive oral candidiasis. No telangiectasia were noted over eyes, ears, or nose. She had bilateral, submandibular, mobile, nontender lymph nodes of 2 × 2 cm. Blood and urine cultures were negative. MRI with contrast for the left lower limb showed multiple discrete lesions in the metaphysis and diaphysis of the proximal tibia and fibula enhancing on contrast medium. She was diagnosed as having acute osteomyelitis. She received a 14-day antibiotic course of

intravenous Ceftriaxone and Cloxacillin, with oral antifungal treatment for candidiasis, and was discharged from the hospital.

At age 45 months, she was admitted to the hospital with another 4-day fever. Physical examination revealed an underweight, febrile child without ocular or cutaneous telangiectasia. There was enlargement of bilateral submandibular, nontender, mobile lymph nodes (1.5 × 2 cm). Ultrasound of the neck revealed multiple, enlarged, right-sided lymph nodes of submandibular (1.2 × 0.9 cm), intraparotid (1.5 × 1 cm), and jugulodigastric (2.1 × 0.7 cm) location. On the left side, jugulodigastric nodes measured 2.6 × 0.9 cm. Blood culture was again positive for *Salmonella* serotype group D. A 14-day course of intravenous Ceftriaxone was initiated.

The recurrent *Salmonella* infections prompted further testing for a genetic predisposition. She was proven to have IL-12R β 1 deficiency on the basis of impaired expression of IL-12R β 1 by EBV-transformed B cells by using flow cytometry with 2 antibodies that recognize different epitopes (Fig 2). She was also homozygous for the C186S (556T>A) mutation in *IL12RB1*. This mutation had been previously shown to confer IL-12R β 1 deficiency in other related kindreds of Arabic descent (families 12 and 13 in Fieschi et al⁴). She was started on IFN- γ (50 μ g/m² subcutaneously 3 times a week) and prophylactic daily oral ciprofloxacin. She has since been doing well, with no recurrence of salmonellosis over a period of more than 1 year.

At age 5.5 years, she started showing an ataxic gait similar to that of her older sister. This was accompanied by bilateral conjunctival telangiectasia and an abnormal finger-to-nose test. Serum alpha-fetoprotein was now 132 IU/mL. The diagnosis of A-T was confirmed on the basis of increased radiosensitivity of an EBV-transformed B-cell line, as described by Sun et al,⁵ lack of A-T mutated (ATM) protein by Western blotting, as described by Chun et al,⁶ and absence of ATM kinase activity, as described by Nahas et al⁷ (Fig 2). In addition, DNA sequencing revealed homozygosity for the 8395del10 mutation in the *ATM* gene. Because of the radiosensitivity noted in the patient's B-EBV cell line, 3 unrelated patients with IL-12R β 1 deficiency were also tested; all had normal colony survival responses to 1 Gy of irradiation and expressed normal levels of ATM protein. Conversely, cell lines from other, unrelated patients with A-T expressed normal levels of IL-12R β 1, as detected by flow cytometry (Fig 2).

When the patient was asymptomatic, erythrocyte sedimentation rate, C-reactive protein, C3 and C4 were normal. As for serum immunoglobulins, IgG was elevated at 2170 mg/dL, IgM was elevated at 615 mg/dL, and IgA was undetectable at <7 mg/dL. The proportions of lymphocyte subpopulations showed persistently low CD3 and elevated CD4 counts, with normal CD8 and CD19 and elevated CD3⁺CD16⁺CD56⁺.

Patients with 2 seemingly unrelated genetic disorders are extraordinarily rare experiments of nature and can be difficult to diagnose. We report the simultaneous presentation of 2 rare hereditary immunodeficiencies, A-T and IL-12R β 1 deficiency, in a child from Qatar. These diagnoses are based on both functional and genetic assays. Her EBV-B cells did not express IL-12R β 1 and were radiosensitive, thereby displaying typical cellular phenotypes for both diseases. The patient was homozygous for disease-causing mutations in *ATM* (8395del10) and *IL12RB1*

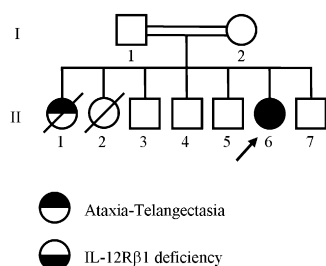

FIG 1. Family pedigree of proband (II.6). A sister (II.1) died at age 10 years with severe bronchiectasis secondary to A-T. Another sister (II.2) died at 2 months with sepsis. Parents are first-degree cousins.

(C186S). The 2 genes are located on distinct chromosomes (*IL12RB1*: 19p13.1; *ATM*: 11q23.1) and the fortuitous association of the 2 autosomal recessive syndromes was favored by parental consanguinity.

The prevalences of A-T and IL-12R β 1 deficiency in the Gulf region are unknown, but the prevalence world-wide is low for both: for A-T, about 1 in 40,000 live births, and for IL-12R β 1 deficiency, about 1 in 100,000 to 1,000,000 births. Therefore, the likelihood of the same disease affecting a random child can be estimated at approximately 1 in 4×10^9 to 1 in 4×10^{10} births. However, this estimate would be higher in ethnic groups with a higher coefficient of consanguinity or inbreeding, such as the Gulf region, as noted by Bener et al.⁸ To our knowledge, this is the first association of 2 PIDs and is almost certainly a spurious coincidence. On the other hand, our study suggests that other patients with 2 recessive diseases are likely to be diagnosed in regions of the world where consanguineous marriages are common, thus emphasizing the importance of a complete family history.

A second underlying syndrome should be considered in patients with clinical features that are not commonly associated with the primary diagnosis. For example, recurrent extraintestinal, nontyphoidal salmonellosis has never been reported in patients with A-T, as noted by Nowak-Wegrzyn et al.⁹ The IL-12R β 1 deficiency could have also caused recurrent mycobacterial disease. Likewise, ataxia and telangiectasia are not seen with IL-12R β 1 deficiency. A further compounding factor might arise if the 2 disorders were to ameliorate or aggravate one another.

The fact that the clinical features of IL-12R β 1 deficiency and A-T in our patient were so characteristic of each disorder strongly suggests that the pathogenesis of each does not intersect with the other. The course of salmonellosis was typical of IL-12R β 1 deficiency, as reviewed by Filipe-Santos et al.² Likewise, the rates of neurologic progress and the telangiectasia were characteristic of A-T. The unchanging cellular phenotypes corresponding to each of the disorders further support the conclusion of independent pathophysiologies for IL-12R β 1 deficiency and A-T. This is not surprising given that IL-12R β 1 deficiency creates a cell surface defect, whereas ATM deficiency affects primarily intranuclear signaling.

This said, it will be important to follow the patient, because IL-12 has been shown to exert antitumoral actions in the mouse model, whether directly or via the induction of IFN- γ , as noted by Elzaouk et al.¹⁰ The compounded effects of the 2 genetic deficiencies on the immune system may lead to the development of even more severe malignancy than seen in patients with A-T. Moreover, the progressive lymphopenia commonly seen in A-T may worsen the susceptibility to infections caused by

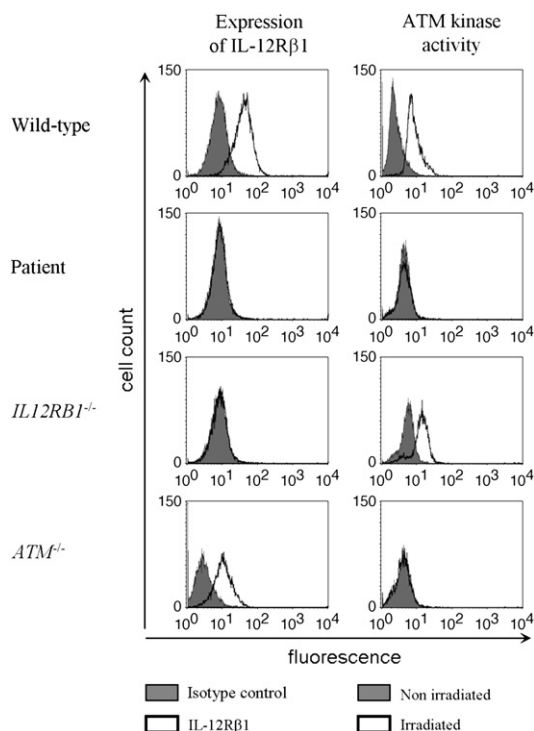

FIG 2. Expression of IL-12R β 1 protein and ATM kinase activity in response to irradiation in EBV-B cell lines derived from the patient and unrelated controls.

mycobacteria and *Salmonella* as the patient matures. Finally, diagnostic procedures involving ionizing radiation and the use of radiomimetic drugs should be avoided in patients with A-T, and this principle applies here as well. This may conflict with other clinical decisions, further complicating the patient's long-term treatment.

Mohammad Ehlajel, MD^a

Ludovic de Beaucoudrey, MSc^{b,c}

Francesca Fike, BSc^d

Shareef A. Nahas, PhD^d

Jacqueline Feinberg, PhD^{b,c}

Jean-Laurent Casanova, MD, PhD^{b,c,e}

Richard A. Gatti, MD^d

From ^athe Section of Allergy-Immunology, Department of Pediatrics, Hamad Medical Corporation, Doha, Qatar; ^bthe Laboratory of Human Genetics of Infectious Diseases, Institut National de la Santé et de la Recherche Médicale, U550, Paris, France; ^cParis Descartes University, Necker Medical School, France; ^dthe Departments of Pathology and Laboratory Medicine and Human Genetics, University of California, Los Angeles School of Medicine; and ^ethe Pediatric Hematology-Immunology Unit, Necker Hospital, Assistance Publique-Hôpitaux de Paris, Paris, France. E-mail: jean-laurent.casanova@inserm.fr.

S.A.N. and R.A.G. were supported by grants from the Ataxia-Telangiectasia Medical Research Foundation and National Institutes of Health grants (NS052528 and AI067769). The Laboratory of Human Genetics of Infectious Diseases is supported in part by grants from the Schlumberger and BNP Paribas Foundations. L.d.B. is supported by grant from the Fondation pour la Recherche Médicale as part of the PhD program of Pierre et Marie Curie University (Paris, France). J.-L.C. is an International Scholar of the Howard Hughes Medical Institute.

Disclosure of potential conflict of interest: The authors have declared that they have no conflict of interest.

REFERENCES

- Casanova JL, Abel L. Primary immunodeficiencies: a field in its infancy. *Science* 2007;317:617-9.
- Filipe-Santos O, Bustamante J, Chappier A, Vogt G, de Beaucoudrey L, Feinberg J, et al. Inborn errors of IL-12/23- and IFN-gamma-mediated immunity: molecular, cellular, and clinical features. *Semin Immunol* 2006;18:347-61.

3. Lavin MF, Gueven N, Bottle S, Gatti RA. Current and potential therapeutic strategies for the treatment of ataxia-telangiectasia. *Br Med Bull* 2007;81-2: 129-47.
4. Fieschi C, Dupuis S, Catherinot E, Feinberg J, Bustamante J, Breiman A, et al. Low penetrance, broad resistance, and favorable outcome of interleukin 12 receptor beta1 deficiency: medical and immunological implications. *J Exp Med* 2003; 197:527-35.
5. Sun X, Becker-Catania SG, Chun HH, Hwang MJ, Huo Y, Wang Z, et al. Early diagnosis of ataxia-telangiectasia using radiosensitivity testing. *J Pediatr* 2002; 140:724-31.
6. Chun HH, Sun X, Nahas SA, Teraoka S, Lai CH, Concannon P, et al. Improved diagnostic testing for ataxia-telangiectasia by immunoblotting of nuclear lysates for ATM protein expression. *Mol Genet Metab* 2003;80:437-43.
7. Nahas SA, Butch AW, Du LT, Gatti RA. Rapid-flow cytometry-based SMC1 phosphorylation assay for identification of ataxia-telangiectasia homozygotes and heterozygotes. *Clin Chem* 2008. In press.
8. Bener A, Hussain R, Teebi AS. Consanguineous marriages and their effects on common adult diseases: studies from an endogamous population. *Med Princ Pract* 2007;16:262-7.
9. Nowak-Wegrzyn A, Crawford TO, Winkelstein JA, Carson KA, Lederman HM. Immunodeficiency and infections in ataxia-telangiectasia. *J Pediatr* 2004;144: 505-11.
10. Elzaouk L, Moelling K, Pavlovic J. Anti-tumor activity of mesenchymal stem cells producing IL-12 in a mouse melanoma model. *Exp Dermatol* 2006;15:865-74.

doi:10.1016/j.jaci.2008.07.005

Article 2

Mutations in *STAT3* and *IL12RB1* impair the development of human IL-17-producing T cells

de Beaucoudrey, L., A. Puel, O. Filipe-Santos, A. Cobat, P. Ghandil, M. Chrabieh, J. Feinberg, H. von Bernuth, A. Samarina, L. Janniere, C. Fieschi, J.L. Stephan, C. Boileau, S. Lyonnet, G. Jondeau, V. Cormier-Daire, M. Le Merrer, C. Hoarau, Y. Lebranchu, O. Lortholary, M.O. Chandesris, F. Tron, E. Gambineri, L. Bianchi, C. Rodriguez-Gallego, S.E. Zitnik, J. Vasconcelos, M. Guedes, A.B. Vitor, L. Marodi, H. Chapel, B. Reid, C. Roifman, D. Nadal, J. Reichenbach, I. Caragol, B.Z. Garty, F. Dogu, Y. Camcioglu, S. Gulle, O. Sanal, A. Fischer, L. Abel, B. Stockinger, C. Picard, and J.L. Casanova

The Journal of Experimental Medicine
2008, 205:1543-1550

Mutations in *STAT3* and *IL12RB1* impair the development of human IL-17-producing T cells

Ludovic de Beaucoudrey,^{1,2} Anne Puel,^{1,2} Orchidée Filipe-Santos,^{1,2} Aurélie Cobat,^{1,2} Pegah Ghandil,^{1,2} Maya Chrabieh,^{1,2} Jacqueline Feinberg,^{1,2} Horst von Bernuth,^{1,2} Arina Samarina,^{1,2} Lucile Janni re,^{1,2} Claire Fieschi,³ Jean-Louis St phan,⁴ Catherine Boileau,⁵ Stanislas Lyonnet,^{2,6} Guillaume Jondeau,^{10,11} Val rie Cormier-Daire,^{2,6} Martine Le Merrer,^{2,6} Cyrille Hoarau,^{12,13} Yvon Lebranchu,^{12,13} Olivier Lortholary,⁷ Marie-Olivia Chandesris,⁷ Fran ois Tron,^{14,15} Eleonora Gambineri,¹⁶ Lucia Bianchi,¹⁶ Carlos Rodriguez-Gallego,¹⁷ Simona E. Zitnik,¹⁸ Julia Vasconcelos,¹⁹ Margarida Guedes,²⁰ Artur Bonito Vitor,²¹ Laszlo Marodi,²² Helen Chapel,²³ Brenda Reid,²⁴ Chaim Roifman,²⁴ David Nadal,²⁵ Janine Reichenbach,²⁶ Isabel Caragol,²⁷ Ben-Zion Garty,²⁸ Figen Dogu,²⁹ Yildiz Camcioglu,³⁰ Sanyie G lle,³¹ Ozden Sanal,³² Alain Fischer,^{2,8,33} Laurent Abel,^{1,2} Birgitta Stockinger,³⁴ Capucine Picard,^{1,2,9} and Jean-Laurent Casanova^{1,2,8}

CORRESPONDENCE

Jean-Laurent Casanova:
casanova@necker.fr

¹Laboratory of Human Genetics of Infectious Diseases, U550, Institut National de la Sant  et de la Recherche M dicale (INSERM), 75015 Paris, France

²University Paris Descartes, Necker Medical School, 75015 Paris, France

³Immunopathology Unit, Saint-Louis Hospital, Assistance Publique-H pitaux de Paris (AP-HP), 75010 Paris, France

⁴Department of Pediatrics, Saint-Etienne University Hospital, 42100 Saint-Etienne, France

⁵Laboratory of Molecular Genetics, Ambroise Par  Hospital, AP-HP, University Versailles SQY, 92100 Boulogne-Billancourt, France

⁶Department of Genetics and U781, INSERM, ⁷Department of Infectious Diseases and Tropical Medicine, Necker-Pasteur Infectiology Center, ⁸Pediatric Hematology-Immunology Unit, and ⁹Study Center of Primary Immunodeficiencies, Necker Hospital, AP-HP, 75015 Paris, France

¹⁰Marfan Multidisciplinary Outpatient Clinic, Bichat Hospital, AP-HP, 75018 Paris, France

¹¹Paris Diderot University, Bichat Medical School, 75018 Paris, France

¹²Dendritic Cells and Grafts, Unit  de Formation et de Recherche de M decine, Fran ois Rabelais University, Tours Medical School, 37000 Tours, France

¹³Allergy and Immunology Unit, Tours University Hospital, 37000 Tours, France

¹⁴U905, INSERM, Institut F d ratif de Recherche 23, 76100 Rouen, France

¹⁵Medical and Pharmaceutical School, Institute for Biomedical Research, Rouen University Hospital, 76100 Rouen, France

¹⁶Department of Pediatrics, University of Florence, 50132 Florence, Italy

¹⁷Department of Immunology, Hospital Universitario de Gran Canaria Dr. Negrin, 35010 Las Palmas de Gran Canaria, Spain

¹⁸University Children's Hospital, 1000 Ljubljana, Slovenia

¹⁹Department of Immunology and ²⁰Department of Pediatrics, General Hospital of Santo Ant nio, 4099 Porto, Portugal

²¹Department of Pediatrics, Hospital of S o Jo o, 4200 Porto, Portugal

²²Department of Infectious and Pediatric Immunology, Medical and Health Science Center, University of Debrecen, 4032 Debrecen, Hungary

²³Department of Immunology, Nuffield Department of Medicine, University of Oxford, OX3 9DU Oxford, England, UK

²⁴Division of Immunology and Allergy, Department of Pediatrics, Hospital for Sick Children, University of Toronto, M5G 1X8 Toronto, Ontario, Canada

²⁵Department of Infectious Diseases and ²⁶Department of Immunology, University Children's Hospital of Zurich, 8032 Zurich, Switzerland

²⁷Immunology Unit, Vall d'Hebron University Hospital, 08035 Barcelona, Spain

²⁸Department of Pediatrics, Schneider Children's Medical Center, 49202 Petah Tiqva, Israel

²⁹Department of Pediatric Immunology and Allergy, Ankara University School of Medicine, 06100 Ankara, Turkey

³⁰Department of Pediatrics, Infectious Diseases, Clinical Immunology, and Allergy Division, Cerrahpa a Medical School, Istanbul University, 34303 Istanbul, Turkey

³¹Department of Pediatrics, Dr. Beh et Uz Children's Research and Training Hospital, 35220 Izmir, Turkey

³²Immunology Division, Hacettepe University Children's Hospital, 06100 Ankara, Turkey

³³Normal and Pathological Development of the Immune System, U768, INSERM, 75015 Paris, France

³⁴Division of Molecular Immunology, Medical Research Council National Institute for Medical Research, NW7 1AA London, England, UK

The online version of this article contains supplemental material.

The cytokines controlling the development of human interleukin (IL) 17–producing T helper cells *in vitro* have been difficult to identify. We addressed the question of the development of human IL-17–producing T helper cells *in vivo* by quantifying the production and secretion of IL-17 by fresh T cells *ex vivo*, and by T cell blasts expanded *in vitro* from patients with particular genetic traits affecting transforming growth factor (TGF) β , IL-1, IL-6, or IL-23 responses. Activating mutations in *TGFB1*, *TGFBR1*, and *TGFBR2* (Camurati–Engelmann disease and Marfan-like syndromes) and loss-of-function mutations in *IRAK4* and *MYD88* (Mendelian predisposition to pyogenic bacterial infections) had no detectable impact. In contrast, dominant-negative mutations in *STAT3* (autosomal-dominant hyperimmunoglobulin E syndrome) and, to a lesser extent, null mutations in *IL12B* and *IL12RB1* (Mendelian susceptibility to mycobacterial diseases) impaired the development of IL-17–producing T cells. These data suggest that IL-12R β 1– and STAT-3–dependent signals play a key role in the differentiation and/or expansion of human IL-17–producing T cell populations *in vivo*.

IL-17A (IL-17) is the first of a six-member family of cytokines (IL-17A–F). IL-17 is produced by NK and T cell subsets, including helper α/β T cells, γ/δ T cells, and NKT cells, and it binds to a widely expressed receptor (1). This cytokine was first described 10 yr ago, but interest in this molecule was recently revived by the identification of a specific IL-17–producing T helper cell subset in the mouse (1). The specific development and phenotype of IL-17–producing helper T cells have been characterized in the mouse model, in which these cells have clearly been identified as a Th17 subset. The hallmarks of mouse Th17 cells include (a) a pattern of cytokine production different from those of the Th1 and Th2 subsets, with high levels of IL-17 production, often accompanied by IL-17F and IL-22; (b) dependence on TGF- β and IL-6 for early differentiation from naive CD4 T cells, followed by dependence on IL-21 and IL-23 for further expansion; and (c) dependence on at least four transcription factors for differentiation: the Th17-specific retinoic acid receptor-related orphan receptor γ t (ROR γ t) and ROR α , and the more promiscuous STAT-3 and IFN regulatory factor 4 (for review see reference 1).

Increasingly detailed descriptions of the *in vitro* and *in vivo* differentiation of the Th17 subset in mice are becoming available. In contrast, the tremendous, uncontrolled genetic and epigenetic variability of human samples has made it difficult to characterize human IL-17–producing T cells (2–13). It has proved very difficult to identify the cytokines governing the differentiation of these cells *in vitro*. The first four groups that have investigated this issue all suggested that TGF- β was not required for the differentiation of human IL-17–producing T helper cells from purified naive CD4 T cells *in vitro* (5–8). TGF- β was even found to inhibit differentiation in three studies (5, 6, 8). IL-6 was inhibitory in one study (6) and redundant in three others (5, 7, 8). In contrast, IL-23 was found to enhance the development of IL-17 T cells in all four studies (5–8) and IL-1 β was identified as a positive regulator in two studies (5, 6), whereas IL-21, which was tested in one study, was found to be redundant (8). In contrast, three recent studies showed that TGF- β is essential in this process, whereas there was more redundancy between the four ILs (11–13). *In vitro* studies using recombinant cytokines and blocking antibodies have therefore yielded apparently conflicting results, particularly if the results for human cells are compared with those for mice.

We used a novel approach to address this issue, making use of patients with various inborn errors of immunity impairing most of these cytokine signaling pathways separately to investigate the development of IL-17 T cells *in vivo*. We studied the following groups: (a) patients with autosomal-dominant developmental disorders associated with various mutations in the TGF- β pathway associated with enhanced TGF- β signaling, such as Camurati–Engelmann disease, with mutations in *TGFB1* (14), or Marfan-like syndromes, with mutations in *TGFBR1* or *TGFBR2* (15); (b) patients with autosomal-recessive susceptibility to pyogenic bacteria and loss-of-function mutations in *IRAK4* (16) or *MYD88* (unpublished data), whose cells do not respond to IL-1 β and related cytokines or to Toll-like receptors (TLRs) other than TLR3; (c) patients with autosomal-dominant hyper-IgE syndrome (AD-HIES) associated with dominant-negative mutations in *STAT3* (17, 18), whose cells respond poorly to several cytokines, including IL-6; and (d) patients with autosomal-recessive susceptibility to mycobacterial diseases and loss-of-function mutations in *IL12B* or *IL12RB1* (19), whose cells do not express or do not respond to IL-12 and IL-23 (Table S1, available at <http://www.jem.org/cgi/content/full/jem.20080321/DC1>). The role of IL-21 cannot be studied in this way, as the only known defects in this pathway (i.e., JAK3 and common γ chain deficiencies) are typically associated with a total absence of T cells (20).

RESULTS AND DISCUSSION

We used flow cytometry to investigate the percentage of IL-17–expressing blood T cells *ex vivo* in 49 healthy controls. Nonadherent PBMCs were stained for CD3, CD4, CD8, and IL-17. No IL-17–producing T cells were detected in the absence of activation (unpublished data). Upon activation with PMA-ionomycin, the percentage of CD3–positive cells producing IL-17 ranged from 0.06 to 2% (Fig. 1, A and B). The vast majority (>90%) of IL-17–positive cells were CD4–positive and CD8–negative (unpublished data). Thus, within the general population, there is considerable interindividual variability in the numbers of IL-17–producing cells present among freshly isolated T cells activated *ex vivo*. This makes it difficult to assess the impact of genetic lesions on the development of IL-17–producing T cells. We tested nine patients with null mutations in *IRAK4* or *MYD88*, whose cells were unresponsive to IL-1 β (and most TLRs and other IL-1 cytokine family members). The proportion of IL-17–producing

T cells was not significantly different from that in healthy controls, as shown by Wilcoxon tests comparing the values for each individual between the two groups (Fig. 1, A and B). We then tested 17 patients with null mutations in *IL12B* or *IL12RB1*, whose cells did not produce (for *IL12B* mutations) or did not respond (for *IL12RB1* mutations) to IL-23 (and IL-12). Interestingly, there were clearly fewer IL-17-producing T cells in these patients than in healthy controls ($P = 4.7 \times 10^{-3}$; Fig. 1, A and B). However, some patients had normal numbers of IL-17-producing T cells. In contrast, cells from patients with mildly enhanced TGF- β responses owing to mutations in *TGFB1* or *TGFB2* did not differ significantly from controls (Fig. 1 B). These results suggest that IL-1R-associated kinase 4 (IRAK-4) and MyD88 are not required for the development of IL-17-producing T cells in vivo, that TGF- β probably does not markedly inhibit this process, and that both IL-12p40 and IL-12R β 1 are required, at least in most individuals and in these experimental conditions of flow cytometry on T cells activated ex vivo.

We tested 16 patients with AD-HIES bearing mutations in *STAT3*. They displayed normal proportions of CCR6-positive CCR4-positive CD4 T cells but low proportions of CCR6-positive CCR4-negative CD4 T cells (Table S2, available at <http://www.jem.org/cgi/content/full/jem.20080321/DC1>). These patients had significantly fewer IL-17-positive T cells than controls ($P = 9.7 \times 10^{-7}$; Fig. 1, A and B). However, as observed in patients with IL-12p40 or IL-12R β 1 deficiency, some AD-HIES patients had normal proportions of IL-17-producing T cells, perhaps reflecting genetic or epigenetic heterogeneity between individuals, residual STAT-3 signaling, or both. In these experimental conditions, the huge variations in IL-17 secretion between healthy controls (from 50 to 5,000 pg/ml), as measured by ELISA, prevented rigorous comparison with the small number of patients studied (unpublished data). We did not assess other potential features of IL-17-producing T cells in the patients studied, such as the production of IL-22, a cytokine produced by Th17 cells in mice (1) and humans (5, 6), or expression of ROR γ t, a key

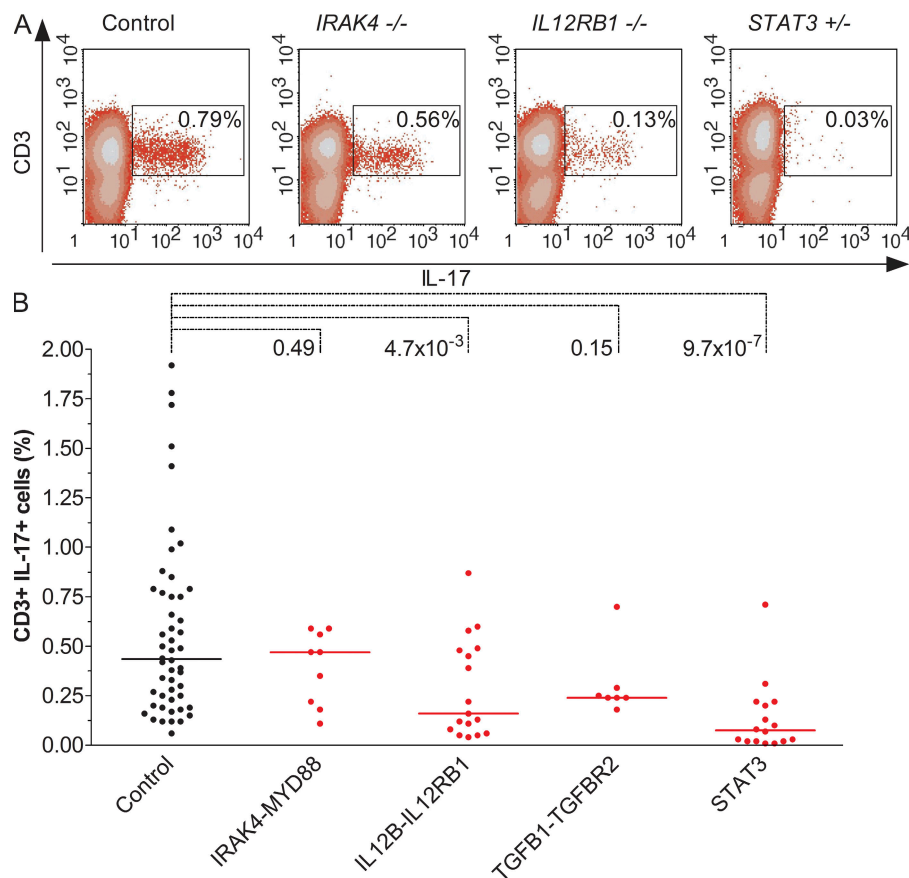

Figure 1. Identification of IL-17-producing T cells ex vivo. (A) Flow cytometry analysis of CD3 and IL-17 in nonadherent PBMCs activated with PMA-ionomycin as a representative control, an IRAK-4-deficient patient (P4), an IL-12R β 1-deficient patient (P17), and a STAT-3-deficient patient (P36; Table S1, available at <http://www.jem.org/cgi/content/full/jem.20080321/DC1>). The percentage indicated in the gate is that of IL-17- and CD3-positive cells. (B) Percentage of CD3-positive cells that were also IL-17-positive, as determined by flow cytometry of nonadherent PBMCs activated with PMA-ionomycin. Each symbol represents a value from an individual control (black circles) or patient (red circles). Horizontal bars represent medians. The p-values for Wilcoxon tests between controls ($n = 49$) and patients with mutations in *IRAK4* or *MYD88* ($n = 9$), *IL12B* or *IL12RB1* ($n = 17$), *TGFB1* or *TGFB2* ($n = 7$), and *STAT3* ($n = 16$) are indicated.

transcription factor in mouse (1) and human Th17 cells (11), as too few blood samples were available. Our results nonetheless suggest that STAT-3 is required for the differentiation of human IL-17-producing T cells in vivo, as suggested by flow cytometry analysis on ex vivo-activated T cells. We also assessed the production of IFN- γ in some patients (Fig. S1). The proportion of IFN- γ -producing T cells was found to be lower in patients with mutations in *IRAK4* and *MYD88* ($P = 1.2 \times 10^{-4}$), *IL12RB1* and *IL12B* ($P = 1.8 \times 10^{-3}$), or *STAT3* ($P = 8 \times 10^{-4}$), but not in patients with mutations in *TGFB1* or *TGFBR2* ($P = 0.11$).

No consensus has yet been reached on how to best induce the differentiation of human IL-17 T cells from naive CD4 precursors in vitro (5–8, 11–13), and only small amounts of blood from a limited number of blood samples from our patients were available. We therefore tried to induce specific IL-17 memory T cell responses using the cytokines shown to be critical for this lineage in the mouse. We evaluated IL-17 production by populations of T cell blasts expanded in vitro from PBMCs. All patients studied, in particular STAT-3-deficient patients, displayed normal proportions of CD4 and CD8 T cells (Table S3, available at <http://www.jem.org/cgi/content/full/jem.20080321/DC1>). We incubated nonadherent PBMCs from controls with OKT3 for 5 d, alone or in the presence of IL-23, IL-1 β , TGF- β , or IL-6, or a combination of these four cytokines, and then activated them with PMA-ionomycin. We did not assess the development of antigen-specific IL-17-producing T cells. There were no IL-17-positive T cells in any control or in any set of experimental conditions in the absence of activation with PMA-ionomycin, as shown by flow cytometry (unpublished data). In the absence of cytokine stimulation, the percentage of IL-17-positive T cells found in healthy controls after stimulation with PMA-ionomycin was highly variable (from 0.12 to 10%; Fig. 2 A). A statistically significant increase in the number of IL-17-producing T cells was observed after stimulation with IL-23 ($P = 7 \times 10^{-3}$) and IL-1 β ($P = 0.04$), but not after stimulation with TGF- β ($P = 0.1$) or IL-6 ($P = 0.3$), as shown by paired *t* tests (Fig. 2 and not depicted). This recall-response pattern is consistent with IL-1 β and IL-23 playing an important role in maintaining and expanding IL-17 T cell populations in mice (1) and humans (11–13).

We then investigated IL-17 production by T cell blasts from various patients in the same experimental conditions. For four patients with *IRAK-4* or *MyD88* deficiency and impaired responses to IL-1 β , the proportion of IL-17-producing cells appeared to be normal in the various experimental conditions, except in response to IL-1 β (Fig. 2). 16 patients with IL-12p40 ($n = 2$) or IL-12R β 1 ($n = 14$) deficiency were found to have much smaller proportions of IL-17-producing T cells in the absence of cytokine stimulation ($P = 7 \times 10^{-5}$; Fig. 2 A). The two IL-12p40-deficient patients, unlike the IL-12R β 1-deficient patients ($P = 5 \times 10^{-5}$), apparently responded to IL-23 in these conditions (Fig. 2 B). These data suggest that IL-23 makes a major contribution to the expansion of the IL-17 T cell population in this assay. However,

patients bearing specific IL-23(R) mutations would be required to rigorously test this hypothesis. We then tested seven patients with mutations associated with mildly enhanced TGF- β responses and found no significant differences from controls in the four conditions tested (Fig. 2).

In contrast, 14 patients with mutations in *STAT3* had almost no detectable IL-17-producing T cells in any of the four conditions tested ($P = 3.2 \times 10^{-8}$, 4.9×10^{-9} , 1.9×10^{-9} , and 3.6×10^{-9} , respectively; Fig. 2). This phenotype was clearly more pronounced than that observed with cells from IL-12p40- and IL-12R β 1-deficient patients, as the almost complete lack of IL-17-positive T cells was not complemented by IL-23, IL-1 β , or a combination of the four cytokines. T cells from the 11 patients with *STAT3* mutations studied proliferated normally in these conditions. Our results demonstrate that STAT-3 is required for the expansion of IL-17-producing T cell blasts, at least in these experimental conditions. In these conditions, all the groups of patients studied had fewer IFN- γ -producing cells than controls (Fig. S2, available at <http://www.jem.org/cgi/content/full/jem.20080321/DC1>).

Finally, we assessed the secretion of IL-17, IL-22, and IFN- γ by T cell blasts from controls and patients, with or without activation with PMA-ionomycin, as measured by ELISA (Fig. 3; and Figs. S3 and S4, available at <http://www.jem.org/cgi/content/full/jem.20080321/DC1>). Control T cell blasts cultured without recombinant cytokine produced detectable amounts of IL-17 in the absence of activation by PMA-ionomycin (mean = 137 ± 149 pg/ml; Fig. 3 A). The amounts of IL-17 secreted increased significantly ($P = 3 \times 10^{-4}$) upon activation with PMA-ionomycin (mean = $7,338 \pm 11,134$ pg/ml). However, considerable interindividual variability was observed in both sets of experimental conditions. The addition of IL-23, IL-1 β , or a combination of IL-23, IL-1 β , TGF- β , and IL-6 significantly increased the amounts of secreted IL-17 in the absence of activation with PMA-ionomycin ($P = 10^{-4}$ and 8×10^{-4} , and $P < 10^{-4}$, respectively; Fig. 3, B–D). Upon PMA-ionomycin activation, only IL-1 β significantly increased the amount of IL-17 secretion ($P = 0.04$). Four patients with *IRAK-4* or *MyD88* deficiency were tested. They displayed low levels of IL-17 secretion in the absence of activation with PMA-ionomycin in the four sets of conditions tested ($P = 4 \times 10^{-3}$, 10^{-5} , 10^{-4} , and 8×10^{-4} , respectively; Fig. 3). Upon PMA-ionomycin activation, the level of IL-17 secretion is not significantly different from the controls, except in the presence of IL-1 β ($P = 0.04$; Fig. 3). These results suggest that the Toll/IL-1R signaling pathway, and possibly the IL-1R pathway, may be involved in the secretion of IL-17 in T cell blasts. These patients produced amounts of IL-22 that were similar to the controls (Fig. S3).

T cell blasts from the 13 IL-12p40- or IL-12R β 1-deficient patients tested secreted normal amounts of IL-17 in the absence of cytokine stimulation (Fig. 3 A). The 10 patients tested produced normal amounts of IL-17 in the presence of IL-1 β (Fig. 3 C). In the presence of the four cytokines, patients with IL-12R β 1 deficiency did not secrete normal amounts of IL-17 without ($P = 2 \times 10^{-3}$) or with ($P = 10^{-3}$)

PMA-ionomycin stimulation (Fig. 3 D). In all culture conditions, cells from patients with *IL12B* and *IL12RB1* mutations secreted less IL-22 than control cells (Fig. S3). T cell blasts from all patients with mutations in the TGF- β pathway secreted normal amounts of IL-17, whereas T cell blasts from all patients with STAT-3 deficiency secreted much smaller amounts of IL-17 ($P = 8 \times 10^{-6}$, 9×10^{-7} , 9×10^{-11} , 2×10^{-7} , 10^{-8} , 3×10^{-7} , 4×10^{-9} , and 3×10^{-6} , respectively) and IL-22 in all experimental conditions (Fig. 3 and Fig. S3). These data indicate that STAT-3 is required for the maintenance and expansion of IL-17-secreting human T cell blasts and for the secretion of IL-22 by human T cell blasts, at least in these experimental conditions.

Patients with STAT-3 deficiency had the most severe IL-17 phenotype of all the patients tested, with a profound impairment of IL-17 production by T cells ex vivo and T cell blasts in vitro. This observation is consistent with findings for STAT-3-deficient mice (1, 21–24) and a recent report in hu-

mans (25). Impaired IL-6 signaling may be the key factor involved, as suggested by the results obtained for IL-6-deficient mice (1, 26, 27). However, STAT-3 is also involved in other relevant pathways, including the IL-21 and IL-23 pathways. Our data for IL-12p40- and IL-12R β 1-deficient cells suggest that IL-23 is required for the optimal development of IL-17-producing T cells. IL-23 is probably the only cytokine involved, as the patients also lacked IL-12 responses, which might be expected to enhance the development of this subset (1). This is consistent with the mouse model, in which IL-23 is required for the maintenance and expansion of these cells (1, 28, 29), and with the results of previous human studies based on the use of recombinant cytokines (5–8, 11–13). In contrast, our findings for IRAK-4- and MyD88-deficient cells do not support the notion that IL-1 β (or any of the IL-1Rs and TLRs other than, possibly, TLR3 and TLR4) is essential for the development of human IL-17-producing T cells (5, 6), consistent with the phenotype of IL-1-deficient mice (1). Finally,

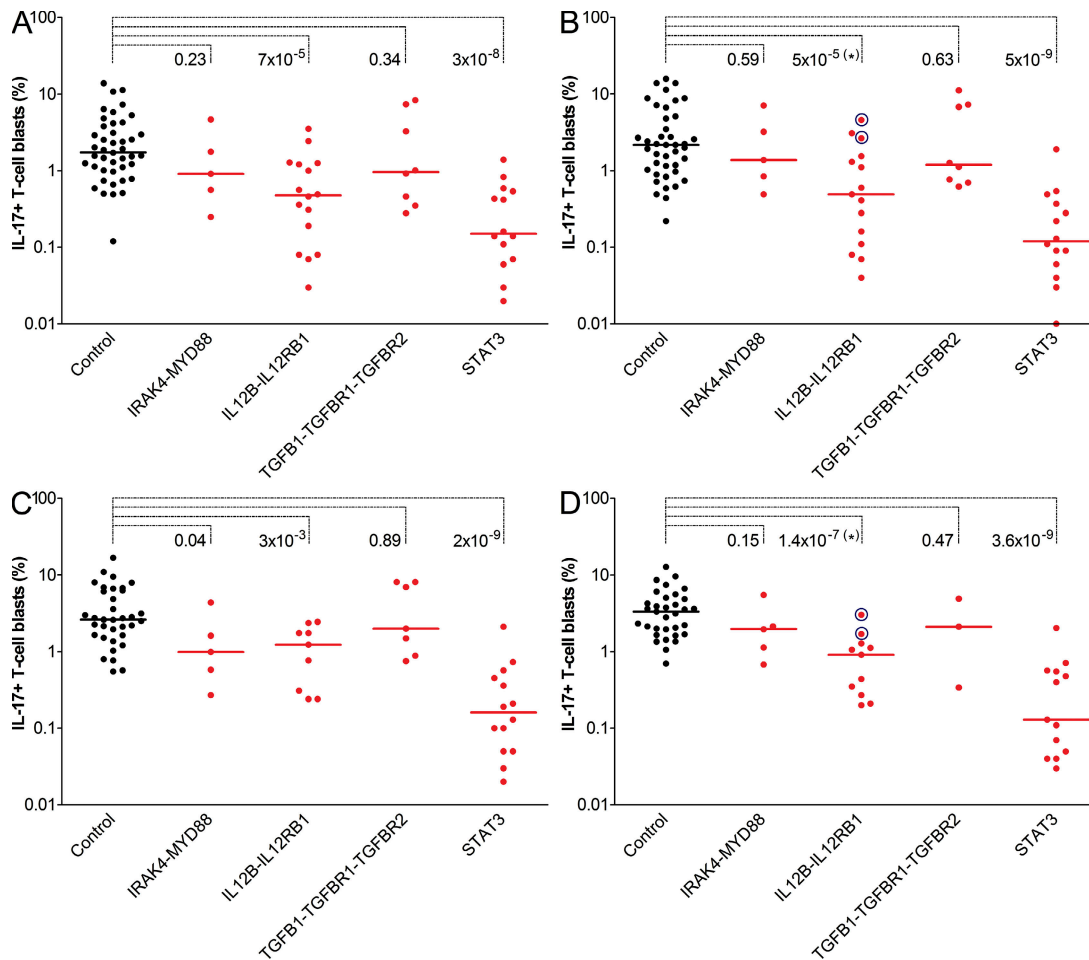

Figure 2. Identification of IL-17-expressing T cell blasts expanded in vitro. Intracellular production of IL-17 in T cell blasts activated with PMA-ionomycin for controls (black circles) and patients (red circles), as assessed by flow cytometry. The cells were cultured in different stimulation conditions: OKT3 only (A), or OKT3 with IL-23 (B), IL-1 β (C), or IL-23, IL-1 β , TGF- β , and IL-6 (D). Each symbol represents a value for an individual control or patient. Horizontal bars represent medians. In controls, stimulation with IL-23 and IL-1 β had a significant effect with respect to medium alone ($P < 0.05$). The p-values for Wilcoxon tests between each patient group and the control group are indicated. In B and D, the patients circled in blue carry *IL12B* mutations and cannot produce IL-12 and IL-23, but can respond to both cytokines. The p-value of the *IL12B-IL12RB1* group was therefore calculated only with IL-12R β 1-deficient patients (*).

the paradoxical suggestion that TGF- β may have no effect or may even inhibit the development of human IL-17-producing T cells (5–8) was neither supported nor disproved by our data for patients with mildly enhanced TGF- β responses (1).

Does our report provide any clues to the possible function of IL-17 in host defense? The mouse Th17 subset plays a key role in mucosal defense (30). IL-23- and IL-17-deficient mice are vulnerable to *Klebsiella* (31, 32). This may account for the greater susceptibility of IL-12p40- and IL-12R β 1-deficient patients than of IFN- γ R-deficient patients to both *Klebsiella* (Levin, M., and S. Pedraza, personal communication; Table S1) and the related *Salmonella* (19). However, neither *Klebsiella* nor *Salmonella* is commonly found as a pathogen in STAT-3-deficient patients despite the apparently greater defect of these patients in terms of IL-17-producing T cell development (17, 18). Mice with impaired IL-17 immunity are also susceptible to *Candida* (33–35). This may account for the peripheral candidiasis commonly seen in STAT-3-deficient patients. Interestingly, although most IL-12p40- and IL-12R β 1-deficient patients are not susceptible to *Candida* (19),

some present with peripheral candidiasis (unpublished data). Mycobacterial disease is exceedingly rare in STAT-3-deficient patients, but not in IL-12p40- and IL-12R β 1-deficient patients, in whom it results from impaired IFN- γ immunity, which is consistent with the redundancy of IL-17 in mouse primary immunity to mycobacteria (36, 37). Staphylococcal disease is the main infection seen in STAT-3-deficient patients. Mouse IL-17 seems to be involved in immunity to *Staphylococcus* (38). However, both IL-12p40- and IL-12R β 1-deficient patients are normally resistant to *Staphylococcus*. The function of human IL-17 and related cytokines in host defense therefore remains unknown. The genetic dissection of human infectious diseases should help us to attribute a function to this important cytokine in natura (39, 40).

MATERIALS AND METHODS

Patients and controls. 55 healthy, unrelated individuals of various ages from 12 countries (Argentina, Canada, Cuba, France, Germany, Israel, Portugal, Spain, Switzerland, Turkey, UK, and USA) were tested as controls. We also investigated 50 patients with mutations in *IRAK4*, *MYD88*, *IL12B*,

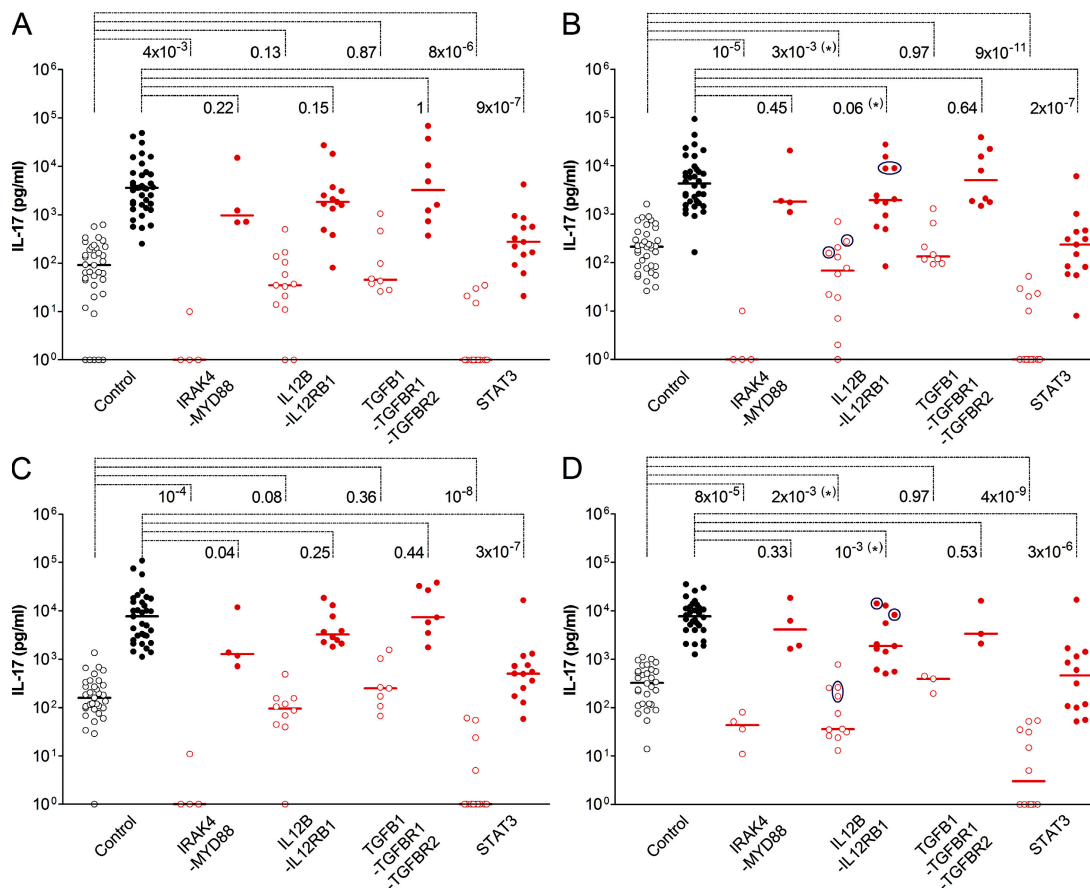

Figure 3. IL-17 secretion by T cell blasts expanded in vitro. Secretion of IL-17 by T cell blasts from controls (black circles) and patients (red circles), as measured by ELISA. Open circles represent values in the absence of stimulation, and closed circles correspond to values obtained after stimulation with PMA-ionomycin. Different stimulation conditions are shown: OKT3 only (A), or OKT3 with IL-23 (B), IL-1 β (C), or IL-23, IL-1 β , TGF- β , and IL-6 (D). Each symbol corresponds to a value obtained from an individual. Horizontal bars represent medians. The p-values for Wilcoxon tests between each patient group and the control group, either unstimulated or stimulated with PMA-ionomycin, are indicated. In B and D, patients circled in blue carry *IL12B* mutations and cannot produce IL-12 and IL-23, but can respond to both cytokines. The p-values of the *IL12B-IL12RB1* group were therefore calculated only with IL-12R β 1-deficient patients (*).

IL12RB1, *TGFB1*, *TGFBR1*, *TGFBR2*, or *STAT3* (Table S1). Our study was conducted in accordance with the Helsinki Declaration, with informed consent obtained from each patient or the patient's family, as requested and approved by the institutional review board of the Necker Medical School.

Purification and activation of nonadherent PBMCs. PBMCs were purified by centrifugation on a gradient (Ficoll-Paque PLUS; GE Healthcare) and resuspended in 10% FBS in RPMI (RPMI-10% FBS; Invitrogen). Adherent monocytes were removed by plating PBMCs in a 75-cm² horizontal culture flask and incubating them for 2–3 h at 37°C in an atmosphere containing 5% CO₂. The nonadherent cells were washed in RPMI and counted with a counter (Vi-Cell XR; Beckman Coulter). For flow cytometry, we distributed 5 × 10⁶ cells in 5 ml RPMI-10% FBS in two 25-cm² vertical culture flasks. One flask was stimulated with 40 ng/ml PMA (Sigma-Aldrich) and 10⁻⁵ M ionomycin (Sigma-Aldrich). All cells were treated with 1 μl/ml Golgiplug (BD Biosciences), a secretion inhibitor. The flasks were incubated for 12 h at 37°C under an atmosphere containing 5% CO₂. For ELISA, a 200-μl aliquot of cells at a concentration of 2.5 × 10⁶ cells/ml in RPMI-10% FBS was dispensed into each well of a 96-well plate. The cells were or were not activated with 40 ng/ml PMA and 10⁻⁵ M ionomycin. Supernatants were collected after 48 h of incubation at 37°C under an atmosphere containing 5% CO₂.

Expansion and activation of T cell blasts. Nonadherent PBMCs were dispensed into 24-well plates at a density of 2.5 × 10⁶ cells/ml in RPMI-10% FBS. All cells were activated with 2 μg/ml of an antibody against CD3 (Orthoclone OKT3; Janssen-Cilag) alone, or together with 5 ng/ml TGF-β1 (240-B; R&D Systems), 20 ng/ml IL-23 (1290-IL; R&D Systems), 25 ng/ml IL-6 (206-IL; R&D Systems), 10 ng/ml IL-1β (201-LB; R&D Systems), or combinations of these four cytokines. Plates were incubated at 37°C under an atmosphere containing 5% CO₂ for 3 d. The cells in each well were restimulated using the same activation conditions, except that the antibody against CD3 was replaced by 40 IU/ml IL-2 (Proleukin i.v.; Chiron). 1 ml of each appropriate medium was added, and we gently passed the culture up and down through a pipette to break up clumps. The culture in each well was split in two. Flow cytometry was performed on one of the duplicate wells 2 d later. The cells in this well were stimulated by incubation for 12 h with 40 ng/ml PMA and 10⁻⁵ M ionomycin plus 1 μl/ml Golgiplug at 37°C under an atmosphere containing 5% CO₂. FACS analysis was performed as described in the following section, without extracellular labeling. For ELISA analysis, cultures were allowed to differentiate under various conditions for 6 d and were then diluted 1:2 in RPMI-10% FBS supplemented with 40 IU/ml IL-2. 200 μl of cells in a 96-well plate were activated with 40 ng/ml PMA and 10⁻⁵ M ionomycin, or left unactivated. Supernatants were collected after 48 h of incubation at 37°C under an atmosphere containing 5% CO₂.

Flow cytometry. Cells were washed in cold PBS and dispensed into a 96-well plate for labeling. Extracellular labeling (for the ex vivo study only) was achieved by incubating the cells with 3 μl CD3-PECy5 in 50 μl PBS-2% FBS (BD Biosciences) for 20 min on ice. The cells were washed twice with cold PBS-2% FBS. They were fixed by incubation with 100 μl BD Cytotfix (BD Biosciences) for 30 min on ice and washed twice with BD Cytoperm (BD Biosciences), with a 10-min incubation period in BD Cytoperm on ice for the first wash. Cells were then incubated for 1 h on ice with IL-17-Alexa Fluor 488 (eBioscience) or IFN-γ-PE (BD Biosciences) at a dilution of 3 μl of antibody in 50 μl BD Cytoperm. Cells were washed twice with BD Cytoperm and analyzed with a FACScan machine and CellQuest software (both from Becton Dickinson).

Determination of cytokine levels by ELISA. IL-17, IL-22, and IFN-γ levels were determined by ELISA. We used the capture antibodies, detection antibodies, and standards supplied in the kits for IL-17 and IL-22 (Duoset; R&D Systems) and in the kit for IFN-γ (Sanquin), diluted in HPE dilution buffer (Sanquin). Milk was used for blocking, and antibody binding was detected with streptavidin poly-horseradish peroxidase (Sanquin) and TMB

microwell peroxidase substrate (KPL). The reaction was stopped by adding 1.8 M H₂SO₄. Optical density was determined with a microplate reader (MRX; ThermoLab Systems).

Statistical analysis. We first assessed differences between controls and patients (when there were more than two patients) for (a) the percentage of circulating IL-17-producing T cells, (b) the percentage of IL-17-positive T cells in vitro, and (c) the level of IL-17 production in various stimulation conditions, as assessed by ELISA. As the distribution of these three variables could not be assumed to be normal and some of the patient groups examined were very small, we used the nonparametric Wilcoxon exact test, as implemented in the NPAR1WAY module of SAS software (version 9.1; SAS Institute). A second set of tests was performed on controls only to assess the effects of different stimulation conditions on (a) the percentage of IL-17-positive T cells in vitro and (b) the level of IL-17 production, as assessed by ELISA. We used a strategy of matching, with paired *t* tests performed with the TTEST procedure of SAS software (version 9.1) to investigate the correlation between observations for different controls. For all analyses, *P* < 0.05 was considered statistically significant.

Online supplemental material. Fig. S1 shows the percentage of CD3-positive IFN-γ-positive cells, as determined by flow cytometry of nonadherent PBMCs activated with PMA-ionomycin from controls and patients. Fig. S2 shows intracellular IFN-γ production in T cell blasts activated with PMA-ionomycin from controls and patients in the various culture conditions, as assessed by flow cytometry. Fig. S3 shows the secretion of IL-22 by T cell blasts from controls and patients in the various culture conditions, as measured by ELISA. Fig. S4 shows the secretion of IFN-γ by T cell blasts from controls and patients in the various culture conditions, as measured by ELISA. Table S1 shows the genetic and clinical features of the patients studied. Table S2 shows the proportions of CCR6-positive CD4 T cells in controls and STAT-3-deficient patients. Table S3 shows the proportions of CD4 and CD8 T cells in patients. Online supplemental material is available at <http://www.jem.org/cgi/content/full/jem.20080321/DC1>.

We would particularly like to thank the patients and their families, whose trust, support, and cooperation were essential for the collection of the data used in this study. We thank N. Matamoros, F.M. Ruemmele, and F. Rieux-Laucat for their help with this study, and all members of the laboratory for helpful discussions. We thank M. Courat, C. Bidalles, M. N'Guyen, T. Leclerc, S. Fahy, and G. Brami for secretarial and technical assistance.

The Laboratory of Human Genetics of Infectious Diseases is supported by the Agence Nationale de la Recherche, the Programme Hospitalier de Recherche Clinique, the European Union (grant LHSP-CT-2005-018736), the BNP Paribas Foundation, the March of Dimes, the Dana Foundation, and the Candi'Oser Association. L. de Beaucoudrey is supported by the Fondation pour la Recherche Medicale as part of the PhD program of Pierre et Marie Curie University. J.L. Casanova is an International Scholar of the Howard Hughes Medical Institute.

The authors have no conflicting financial interests.

Submitted: 19 February 2008

Accepted: 30 May 2008

REFERENCES

- Dong, C. 2008. TH17 cells in development: an updated view of their molecular identity and genetic programming. *Nat. Rev. Immunol.* 8: 337–348.
- Acosta-Rodriguez, E.V., L. Rivino, J. Geginat, D. Jarrossay, M. Gattorno, A. Lanzavecchia, F. Sallusto, and G. Napolitani. 2007. Surface phenotype and antigenic specificity of human interleukin 17-producing T helper memory cells. *Nat. Immunol.* 8:639–646.
- Sato, W., T. Aranami, and T. Yamamura. 2007. Cutting edge: Human Th17 cells are identified as bearing CCR2+CCR5- phenotype. *J. Immunol.* 178:7525–7529.
- Annunziato, F., L. Cosmi, V. Santarlasci, L. Maggi, F. Liotta, B. Mazzinghi, E. Parente, L. Fili, S. Ferri, F. Frosali, et al. 2007.

- Phenotypic and functional features of human Th17 cells. *J. Exp. Med.* 204:1849–1861.
5. Acosta-Rodriguez, E.V., G. Napolitani, A. Lanzavecchia, and F. Sallusto. 2007. Interleukins 1beta and 6 but not transforming growth factor-beta are essential for the differentiation of interleukin 17-producing human T helper cells. *Nat. Immunol.* 8:942–949.
 6. Wilson, N.J., K. Boniface, J.R. Chan, B.S. McKenzie, W.M. Blumenschein, J.D. Mattson, B. Basham, K. Smith, T. Chen, F. Morel, et al. 2007. Development, cytokine profile and function of human interleukin 17-producing helper T cells. *Nat. Immunol.* 8:950–957.
 7. Chen, Z., C.M. Tato, L. Muul, A. Laurence, and J.J. O’Shea. 2007. Distinct regulation of interleukin-17 in human T helper lymphocytes. *Arthritis Rheum.* 56:2936–2946.
 8. Evans, H.G., T. Suddason, I. Jackson, L.S. Taams, and G.M. Lord. 2007. Optimal induction of T helper 17 cells in humans requires T cell receptor ligation in the context of Toll-like receptor-activated monocytes. *Proc. Natl. Acad. Sci. USA.* 104:17034–17039.
 9. Lim, H.W., J. Lee, P. Hillsamer, and C.H. Kim. 2008. Human Th17 cells share major trafficking receptors with both polarized effector T cells and FOXP3+ regulatory T cells. *J. Immunol.* 180:122–129.
 10. Singh, S.P., H.H. Zhang, J.F. Foley, M.N. Hedrick, and J.M. Farber. 2008. Human T cells that are able to produce IL-17 express the chemokine receptor CCR6. *J. Immunol.* 180:214–221.
 11. Manel, N., D. Unutmaz, and D.R. Littman. 2008. The differentiation of human T(H)-17 cells requires transforming growth factor-beta and induction of the nuclear receptor RORgammat. *Nat. Immunol.* 9: 641–649.
 12. Volpe, E., N. Servant, R. Zollinger, S.I. Bogiatzi, P. Hupe, E. Barillot, and V. Soumelis. 2008. A critical function for transforming growth factor-beta, interleukin 23 and proinflammatory cytokines in driving and modulating human T(H)-17 responses. *Nat. Immunol.* 9:650–657.
 13. Yang, L., D.E. Anderson, C. Baecher-Allan, W.D. Hastings, E. Bettelli, M. Oukka, V.K. Kuchroo, and D.A. Hafler. 2008. IL-21 and TGF-beta are required for differentiation of human T(H)17 cells. *Nature.* DOI:10.1038/nature07021.
 14. Janssens, K., F. Vanhoenacker, M. Bonduelle, L. Verbruggen, L. Van Maldergem, S. Ralston, N. Guanabens, N. Migone, S. Wientroub, M.T. Divizia, et al. 2006. Camurati-Engelmann disease: review of the clinical, radiological, and molecular data of 24 families and implications for diagnosis and treatment. *J. Med. Genet.* 43:1–11.
 15. Ramirez, F., and H.C. Dietz. 2007. Marfan syndrome: from molecular pathogenesis to clinical treatment. *Curr. Opin. Genet. Dev.* 17: 252–258.
 16. Ku, C.L., H. von Bernuth, C. Picard, S.Y. Zhang, H.H. Chang, K. Yang, M. Chrabieh, A.C. Issekutz, C.K. Cunningham, J. Gallin, et al. 2007. Selective predisposition to bacterial infections in IRAK-4-deficient children: IRAK-4-dependent TLRs are otherwise redundant in protective immunity. *J. Exp. Med.* 204:2407–2422.
 17. Minegishi, Y., M. Saito, S. Tsuchiya, I. Tsuge, H. Takada, T. Hara, N. Kawamura, T. Ariga, S. Pasic, O. Stojkovic, et al. 2007. Dominant-negative mutations in the DNA-binding domain of STAT3 cause hyper-IgE syndrome. *Nature.* 448:1058–1062.
 18. Holland, S.M., F.R. Deleo, H.Z. Elloumi, A.P. Hsu, G. Uzel, N. Brodsky, A.F. Freeman, A. Demidowich, J. Davis, M.L. Turner, et al. 2007. STAT3 mutations in the hyper-IgE syndrome. *N. Engl. J. Med.* 357:1608–1619.
 19. Filipe-Santos, O., J. Bustamante, A. Chappier, G. Vogt, L. de Beaucoudrey, J. Feinberg, E. Jouanguy, S. Boisson-Dupuis, C. Fieschi, C. Picard, and J.L. Casanova. 2006. Inborn errors of IL-12/23- and IFN-gamma-mediated immunity: molecular, cellular, and clinical features. *Semin. Immunol.* 18:347–361.
 20. Buckley, R.H. 2004. Molecular defects in human severe combined immunodeficiency and approaches to immune reconstitution. *Annu. Rev. Immunol.* 22:625–655.
 21. Harris, T.J., J.F. Grosso, H.R. Yen, H. Xin, M. Kortylewski, E. Albesiano, E.L. Hipkiss, D. Getnet, M.V. Goldberg, C.H. Maris, et al. 2007. Cutting edge: An in vivo requirement for STAT3 signaling in TH17 development and TH17-dependent autoimmunity. *J. Immunol.* 179:4313–4317.
 22. Wei, L., A. Laurence, K.M. Elias, and J.J. O’Shea. 2007. IL-21 is produced by Th17 cells and drives IL-17 production in a STAT3-dependent manner. *J. Biol. Chem.* 282:34605–34610.
 23. Yang, X.O., A.D. Panopoulos, R. Nurieva, S.H. Chang, D. Wang, S.S. Watowich, and C. Dong. 2007. STAT3 regulates cytokine-mediated generation of inflammatory helper T cells. *J. Biol. Chem.* 282:9358–9363.
 24. Mathur, A.N., H.C. Chang, D.G. Zisoulis, G.L. Sritesky, Q. Yu, J.T. O’Malley, R. Kapur, D.E. Levy, G.S. Kansas, and M.H. Kaplan. 2007. Stat3 and Stat4 direct development of IL-17-secreting Th cells. *J. Immunol.* 178:4901–4907.
 25. Milner, J.D., J.M. Brenchley, A. Laurence, A.F. Freeman, B.J. Hill, K.M. Elias, Y. Kanno, C. Spalding, H.Z. Elloumi, M.L. Paulson, et al. 2008. Impaired T(H)17 cell differentiation in subjects with autosomal dominant hyper-IgE syndrome. *Nature.* 452:773–776.
 26. Kimura, A., T. Naka, and T. Kishimoto. 2007. IL-6-dependent and -independent pathways in the development of interleukin 17-producing T helper cells. *Proc. Natl. Acad. Sci. USA.* 104:12099–12104.
 27. Chen, X., O.M. Howard, and J.J. Oppenheim. 2007. Pertussis toxin by inducing IL-6 promotes the generation of IL-17-producing CD4 cells. *J. Immunol.* 178:6123–6129.
 28. Langrish, C.L., Y. Chen, W.M. Blumenschein, J. Mattson, B. Basham, J.D. Sedgwick, T. McClanahan, R.A. Kastelein, and D.J. Cua. 2005. IL-23 drives a pathogenic T cell population that induces autoimmune inflammation. *J. Exp. Med.* 201:233–240.
 29. Thakker, P., M.W. Leach, W. Kuang, S.E. Benoit, J.P. Leonard, and S. Marusic. 2007. IL-23 is critical in the induction but not in the effector phase of experimental autoimmune encephalomyelitis. *J. Immunol.* 178:2589–2598.
 30. Matsuzaki, G., and M. Umemura. 2007. Interleukin-17 as an effector molecule of innate and acquired immunity against infections. *Microbiol. Immunol.* 51:1139–1147.
 31. Happel, K.I., P.J. Dubin, M. Zheng, N. Ghilardi, C. Lockhart, L.J. Quinton, A.R. Odden, J.E. Shellito, G.J. Bagby, S. Nelson, and J.K. Kolls. 2005. Divergent roles of IL-23 and IL-12 in host defense against *Klebsiella pneumoniae*. *J. Exp. Med.* 202:761–769.
 32. Ye, P., F.H. Rodriguez, S. Kanaly, K.L. Stocking, J. Schurr, P. Schwarzenberger, P. Oliver, W. Huang, P. Zhang, J. Zhang, et al. 2001. Requirement of interleukin 17 receptor signaling for lung CXC chemokine and granulocyte colony-stimulating factor expression, neutrophil recruitment, and host defense. *J. Exp. Med.* 194:519–527.
 33. Huang, W., L. Na, P.L. Fidel, and P. Schwarzenberger. 2004. Requirement of interleukin-17A for systemic anti-*Candida albicans* host defense in mice. *J. Infect. Dis.* 190:624–631.
 34. LeibundGut-Landmann, S., O. Gross, M.J. Robinson, F. Osorio, E.C. Slack, S.V. Tsoni, E. Schweighoffer, V. Tybulewicz, G.D. Brown, J. Ruland, and C. Reis e Sousa. 2007. Syk- and CARD9-dependent coupling of innate immunity to the induction of T helper cells that produce interleukin 17. *Nat. Immunol.* 8:630–638.
 35. Ouyang, W., J.K. Kolls, and Y. Zheng. 2008. The biological functions of T helper 17 cell effector cytokines in inflammation. *Immunity.* 28:454–467.
 36. Umemura, M., A. Yahagi, S. Hamada, M.D. Begum, H. Watanabe, K. Kawakami, T. Suda, K. Sudo, S. Nakae, Y. Iwakura, and G. Matsuzaki. 2007. IL-17-mediated regulation of innate and acquired immune response against pulmonary *Mycobacterium bovis* bacille Calmette-Guerin infection. *J. Immunol.* 178:3786–3796.
 37. Khader, S.A., G.K. Bell, J.E. Pearl, J.J. Fountain, J. Rangel-Moreno, G.E. Cilley, F. Shen, S.M. Eaton, S.L. Gaffen, S.L. Swain, et al. 2007. IL-23 and IL-17 in the establishment of protective pulmonary CD4+ T cell responses after vaccination and during *Mycobacterium tuberculosis* challenge. *Nat. Immunol.* 8:369–377.
 38. Schwarzenberger, P., and J.K. Kolls. 2002. Interleukin 17: an example for gene therapy as a tool to study cytokine mediated regulation of hematopoiesis. *J. Cell. Biochem. Suppl.* 38:88–95.
 39. Casanova, J.L., and L. Abel. 2007. Primary immunodeficiencies: a field in its infancy. *Science.* 317:617–619.
 40. Quintana-Murci, L., A. Alcais, L. Abel, and J.L. Casanova. 2007. Immunology in natura: clinical, epidemiological and evolutionary genetics of infectious diseases. *Nat. Immunol.* 8:1165–1171.

Mutations in *STAT3* and *IL12RB1* impair the development of human IL-17–producing T cells

Ludovic de Beauhoudrey, Anne Puel, Orchidée Filipe-Santos, Aurélie Cobat, Pegah Ghandil, Maya Chrabieh, Jacqueline Feinberg, Horst von Bernuth, Arina Samarina, Lucile Janni re, Claire Fieschi, Jean-Louis St phan, Catherine Boileau, Stanislas Lyonnet, Guillaume Jondeau, Val rie Cormier-Daire, Martine Le Merrer, Cyrille Hoarau, Yvon Lebranchu, Olivier Lortholary, Marie-Olivia Chandesris, Fran ois Tron, Eleonora Gambineri, Lucia Bianchi, Carlos Rodriguez-Gallego, Simona E. Zitnik, Julia Vasconcelos, Margarida Guedes, Artur Bonito Vitor, Laszlo Marodi, Helen Chapel, Brenda Reid, Chaim Roifman, David Nadal, Janine Reichenbach, Isabel Caragol, Ben-Zion Garty, Figen Dogu, Yildiz Camcioglu, Sanyie G lle, Ozden Sanal, Alain Fischer, Laurent Abel, Birgitta Stockinger, Capucine Picard, and Jean-Laurent Casanova

Online Supplemental Material

Journal of Experimental Medicine
Volume 205(7):1543-1550
July 2, 2008

JEM

Figure S1. Identification of IFN- γ -producing T cells *ex vivo*.

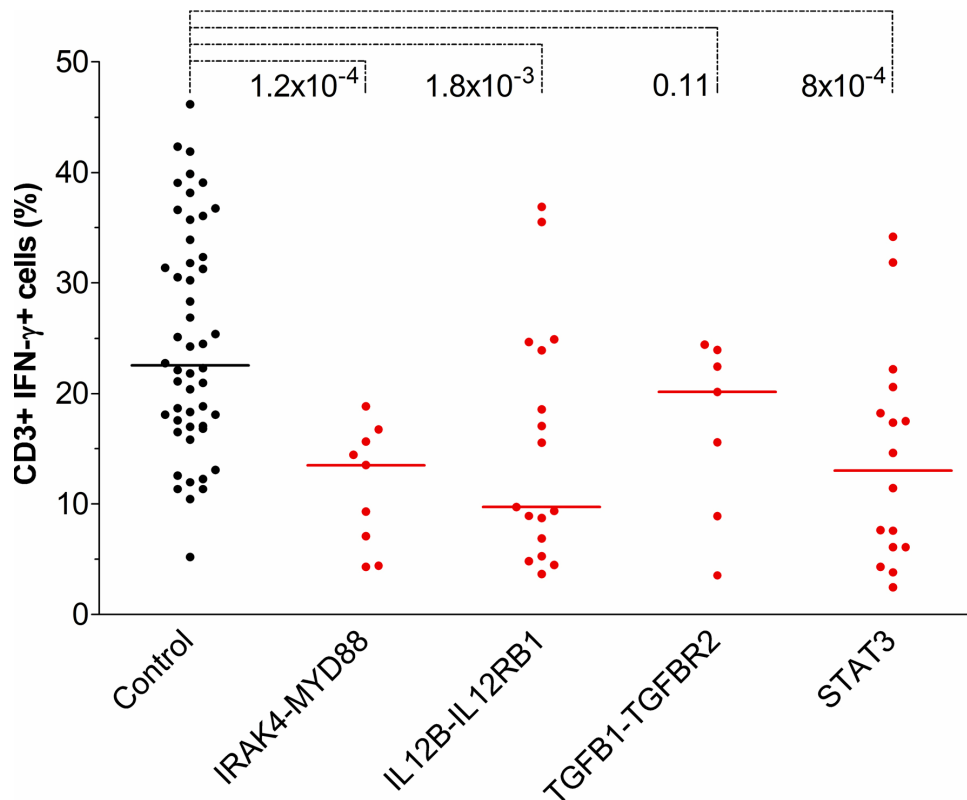

Figure S1. Identification of IFN- γ -producing T cells *ex vivo*. Percentage of CD3-positive cells producing IFN- γ , as determined by flow cytometry of nonadherent PBMCs activated with PMA-ionomycin. Each symbol represents a value for an individual control (black circles) or patient (red circles). Horizontal bars represent medians. The p-values for Wilcoxon tests between controls ($n = 49$) and patients with mutations in *IRAK4* or *MYD88* ($n = 9$), *IL12B* or *IL12RB1* ($n = 17$), *TGFB1* or *TGFB2* ($n = 7$), and *STAT3* ($n = 16$) are indicated.

Figure S2. Identification of IFN- γ -producing T cell blasts expanded *in vitro*.

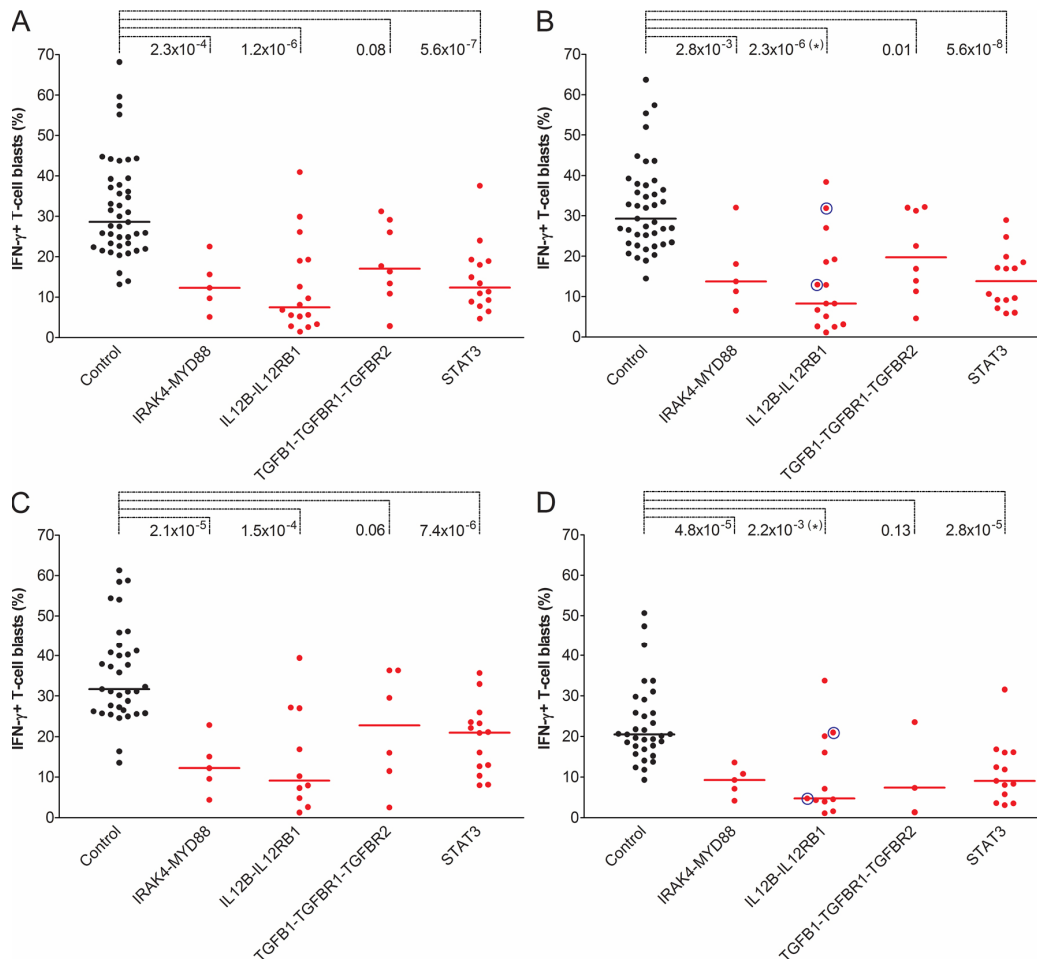

Figure S2. Identification of IFN- γ -producing T cell blasts expanded *in vitro*. Intracellular IFN- γ production in T cell blasts activated with PMA-ionomycin for controls (black circles) and patients (red circles), as detected by flow cytometry. The cells were cultured in different stimulation conditions: OKT3 only (A), or OKT3 with IL-23 (B), IL-1 β (C), or IL-23, IL-1 β , TGF- β , and IL-6 (D). Each symbol represents a value for an individual control or patient. Horizontal bars represent medians. In controls, stimulation with IL-1 β or with IL-23, IL-1 β , TGF- β and IL-6 had a significant effect with respect to medium alone ($P < 0.05$). In B and D, the patients circled in blue carry *IL12B* mutations and cannot produce IL-12 and IL-23 but can respond to both cytokines. Therefore, the p-value of the *IL12RB1-IL12B* group was calculated only with IL-12R β 1-deficient patients (*).

Figure S3. IL-22 secretion by T cell blasts expanded *in vitro*.

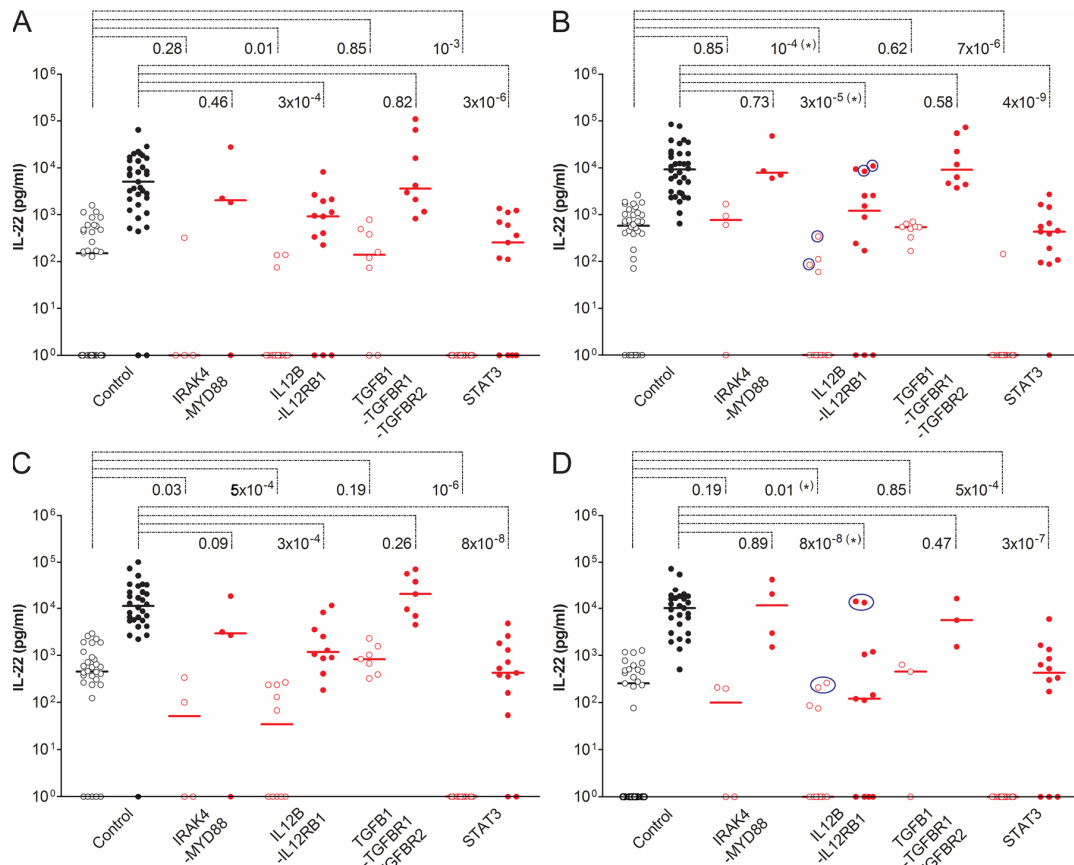

Figure S3. IL-22 secretion by T cell blasts expanded *in vitro*. Secretion of IL-22 by T cell blasts from controls (black circles) and patients (red circles), as measured by ELISA. Open circles represent values in the absence of stimulation, and closed circles correspond to the values obtained after stimulation with PMA-ionomycin. The cells were cultured in different stimulation conditions: OKT3 only (A), or OKT3 with IL-23 (B), IL-1 β (C), or IL-23, IL-1 β , TGF- β , and IL-6 (D). Each symbol corresponds to a value obtained from an individual. Horizontal bars represent medians. In B and D, patients circled in blue carry *IL12B* mutations and cannot produce IL-12 and IL-23 but can respond to both cytokines. Therefore, the p-values of the *IL12RB1-IL12B* group were calculated only with IL-12RB1-deficient patients (*).

Figure S4. IFN- γ secretion by T cell blasts expanded *in vitro*.

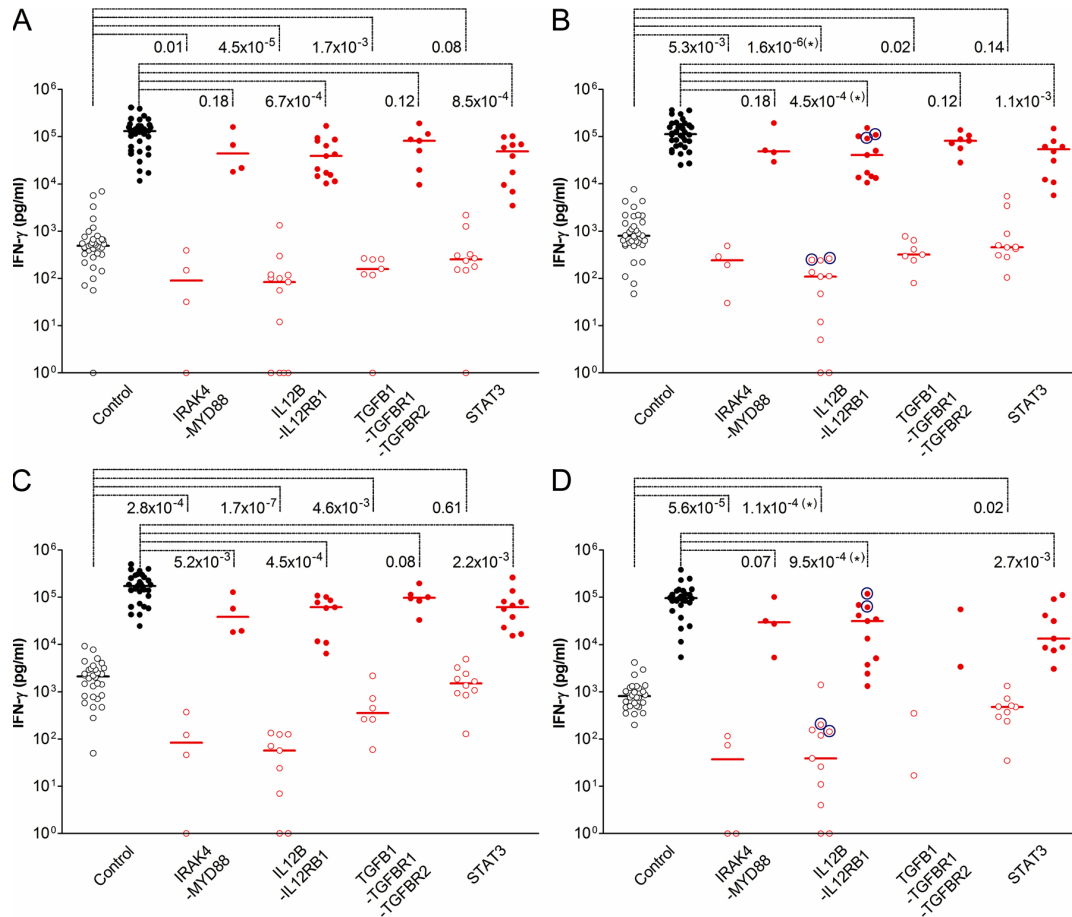

Figure S4. IFN- γ secretion by T cell blasts expanded *in vitro*. Secretion of IFN- γ by T cell blasts from controls (black circles) and patients (red circles), as measured by ELISA. Open circles represent values in the absence of stimulation, and closed circles correspond to the values obtained after stimulation with PMA-ionomycin. The cells were cultured in different stimulation conditions: OKT3 only (A), or OKT3 with IL-23 (B), IL-1 β (C), or IL-23, IL-1 β , TGF- β , and IL-6 (D). Each symbol corresponds to a value obtained from an individual. Horizontal bars represent medians. In B and D, patients circled in blue carry *IL12B* mutations and cannot produce IL-12 and IL-23 but can respond to both cytokines. Therefore, the p-values of the *IL12RB1-IL12B* group were calculated only with IL-12R β 1-deficient patients (*).

Table S1. Genetic and clinical features of the patients

Patient	Syndrome ^a	Gene	Mutations	Age (yr)	Sex	Origin	Infections					References
							<i>Pneumococcus</i>	<i>Staphylococcus</i>	<i>Salmonella</i> ^b	<i>Mycobacteria</i> ^c	<i>Candida</i>	
1	MPPBI	<i>IRAK4</i>	E402X	11	M	Spain	+	–	–	–	–	Ku et al. ^d
2	MPPBI	<i>IRAK4</i>	1-1096_40+23del	11	M	Israel	+	–	–	–	–	Ku et al.
3 ^e	MPPBI	<i>IRAK4</i>	M1V/1188+520A>G	3	F	Slovenia	–	–	–	–	–	Ku et al.
4	MPPBI	<i>IRAK4</i>	1189-1G>T/1188+520A>G	10	M	Hungary	+	–	–	–	–	Ku et al.
5	MPPBI	<i>IRAK4</i>	Q293X	33	F	UK	+	–	–	–	–	Ku et al.
6	MPPBI	<i>IRAK4</i>	Q293X	28	M	Canada	+	–	–	–	–	Ku et al.
7	MPPBI	<i>MYD88</i>	L93P/R196C	4	F	Turkey	+	–	–	–	–	unpublished data
8	MPPBI	<i>MYD88</i>	R196C	16	F	Portugal	+	–	+	–	–	unpublished data
9	MPPBI	<i>MYD88</i>	R196C	10	M	Portugal	+	+	+	–	–	unpublished data
10	MSMD	<i>IL12B</i>	297del8	7	M	Tunisia	–	–	<i>Se</i>	–	–	This report
11	MSMD	<i>IL12B</i>	297del8	24	M	Tunisia	–	–	–	–	–	This report
12	MSMD	<i>IL12RB1</i>	1791+2T>G	12	F	Spain	–	–	–	<i>Mtb</i>	–	Caragol et al. ^f
13	MSMD	<i>IL12RB1</i>	1791+2T>G	20	F	Spain	–	–	<i>Se</i>	<i>Mtb</i>	–	Caragol et al.
14	MSMD	<i>IL12RB1</i>	1791+2T>G	22	F	Spain	–	–	–	–	–	Caragol et al.
15	MSMD	<i>IL12RB1</i>	628-644dup	12	M	Turkey	–	–	–	BCG	–	Tanir et al. ^g
16	MSMD	<i>IL12RB1</i>	628-644dup	3	M	Turkey	–	–	–	–	+	Tanir et al.

17	MSMD	<i>IL12RB1</i>	Q32X	12	F	France	–	–	–	BCG	–	Fieschi et al ^h
18	MSMD	<i>IL12RB1</i>	K305X	29	F	Morocco	–	–	<i>St</i>	BCG	–	Fieschi et al.
19	MSMD	<i>IL12RB1</i>	700+362_1619-944del	11	F	Israel	–	–	–	–	–	Scheuerman et al. ⁱ
20	MSMD	<i>IL12RB1</i>	C198R	15	M	Turkey	–	–	–	BCG	–	Lichtenauer-Kaligis et al. ^j
21	MSMD	<i>IL12RB1</i>	R173P	14	M	Turkey	–	–	<i>Se</i>	–	–	This report
22	MSMD	<i>IL12RB1</i>	1745-46delinsCA/ 1483+182_1619-1073del	37	F	France	–	–	+	BCG	–	Fieschi et al.
23	MSMD	<i>IL12RB1</i>	C198R	8	F	Turkey	–	–	–	–	–	This report
24	MSMD	<i>IL12RB1</i>	C198R	4	M	Turkey	–	–	+	BCG	–	This report
25	MSMD	<i>IL12RB1</i>	Y367C	8	M	Cameroon	–	–	<i>Sd</i>	BCG	–	Fieschi et al.
26	MSMD	<i>IL12RB1</i>	1791+2T>G	24	F	Sri Lanka	–	–	–	BCG	–	Fieschi et al.
27	CE	<i>TGFB1</i>	R218C	31	F	France	–	–	–	–	–	Campos-Xavier et al. ^k
28	CE	<i>TGFB1</i>	R218C	62	F	France	–	–	–	–	–	Campos-Xavier et al.
29	CE	<i>TGFB1</i>	R218C	53	M	France	–	–	–	–	–	Campos-Xavier et al.
30	MLS	<i>TGFBR1</i>	K333Q	7	F	France	–	–	–	–	–	This report
31	MLS	<i>TGFBR2</i>	R537C	34	M	France	–	–	–	–	–	Mizuguchi et al. ^l
32	MLS	<i>TGFBR2</i>	C394W	41	F	France	–	–	–	–	–	This report
33	MLS	<i>TGFBR2</i>	C394W	14	F	France	–	–	–	–	–	This report
34	MLS	<i>TGFBR2</i>	C394W	10	F	France	–	–	–	–	–	This report
35	AD-HIES	<i>STAT3</i>	V463del	34	F	France	–	+	–	–	–	This report

36	AD-HIES	STAT3	V463del	8	M	France	+	+	-	-	+	This report
37	AD-HIES	STAT3	V463del	9	F	France	-	+	-	-	-	This report
38	AD-HIES	STAT3	K709E	17	M	France	-	+	-	-	+	This report
39	AD-HIES	STAT3	T412S	19	F	France	-	+	-	-	-	This report
40	AD-HIES	STAT3	V463del	37	F	Pakistan	-	+	-	-	+	This report
41	AD-HIES	STAT3	V463del	9	M	Pakistan	+	+	-	-	+	This report
42	AD-HIES	STAT3	K642E	36	M	France	-	+	-	-	+	This report
43	AD-HIES	STAT3	R382W	28	F	France	-	+	-	-	+	This report
44	AD-HIES	STAT3	R382Q	19	M	Turkey	-	+	-	-	+	This report
45	AD-HIES	STAT3	R382W	21	F	France	+	+	-	-	+	This report
46	AD-HIES	STAT3	R382W	16	M	Algeria	+	+	-	-	+	This report
47	AD-HIES	STAT3	R382W	23	M	France	+	+	-	-	+	This report
48	AD-HIES	STAT3	V463del	28	M	France	-	+	-	-	+	This report
49	AD-HIES	STAT3	N472D	17	M	France	-	+	-	-	+	This report
50	AD-HIES	STAT3	I665N	43	F	France	-	+	-	-	+	This report

^aShown are Mendelian predisposition to pyogenic bacterial infections (MPPBI), Mendelian susceptibility to mycobacterial diseases (MSMD), Camurati-Engelmann (CE) disease, Marfan-like syndromes (MLS), and AD-HIES.

^bInfections caused by *Salmonella enteritidis* (*Se*), *Salmonella typhimurium* (*St*), and *Salmonella dublin* (*Sd*).

^cInfections caused by Bacille Calmette-Guerin (BCG) or by *Mycobacterium tuberculosis* (*Mtb*).

^dKu, C.L., H. von Bernuth, C. Picard, S.Y. Zhang, H.H. Chang, K. Yang, M. Chrabieh, A.C. Issekutz, C.K. Cunningham, J. Gallin, et al. 2007. Selective predisposition to bacterial infections in IRAK-4-deficient children: IRAK-4-dependent TLRs are otherwise redundant in protective immunity. *J. Exp. Med.* 204:2407–2422.

^ePatient 3 suffered from invasive infection caused by *Pseudomonas aeruginosa*.

^fCaragol, I., M. Raspall, C. Fieschi, J. Feinberg, M.N. Larrosa, M. Hernandez, C. Figueras, J.M. Bertran, J.L. Casanova, and T. Espanol. 2003. Clinical tuberculosis in 2 of 3 siblings with interleukin-12 receptor beta1 deficiency. *Clin. Infect. Dis.* 37:302–306.

^gTanir, G., F. Dogu, N. Tuygun, A. Ikinciogullari, C. Aytekin, C. Aydemir, M. Yuksek, E.C. Boduroglu, L. de Beaucoudrey, C. Fieschi, et al. 2006. Complete deficiency of the IL-12 receptor beta1 chain: three unrelated Turkish children with unusual clinical features. *Eur. J. Pediatr.* 165:415–417.

^hFieschi, C., S. Dupuis, E. Catherinot, J. Feinberg, J. Bustamante, A. Breiman, F. Altare, R. Baretto, F. Le Deist, S. Kayal, et al. 2003. Low penetrance, broad resistance, and favorable outcome of interleukin 12 receptor β 1 deficiency: medical and immunological implications. *J. Exp. Med.* 197:527–535.

ⁱScheuerman, O., L. de Beaucoudrey, V. Hoffer, J. Feinberg, J.L. Casanova, and B.Z. Garty. 2007. Mycobacterial disease in a child with surface-expressed non-functional interleukin-12Rbeta1 chains. *Isr. Med. Assoc. J.* 9:560–561.

^jLichtenauer-Kaligis, E.G., T. de Boer, F.A. Verreck, S. van Voorden, M.A. Hoeve, E. van de Vosse, F. Ersoy, I. Tezcan, J.T. van Dissel, O. Sanal, and T.H. Ottenhoff. 2003. Severe *Mycobacterium bovis* BCG infections in a large series of novel IL-12 receptor beta1 deficient patients and evidence for the existence of partial IL-12 receptor beta1 deficiency. *Eur. J. Immunol.* 33:59–69.

^kCampos-Xavier, B., J.M. Saraiva, R. Savarirayan, A. Verloes, J. Feingold, L. Faivre, A. Munnich, M. Le Merrer, and V. Cormier-Daire. 2001.

Phenotypic variability at the TGF-beta1 locus in Camurati-Engelmann disease. *Hum. Genet.* 109:653–658.

^lMizuguchi, T., G. Collod-Beroud, T. Akiyama, M. Abifadel, N. Harada, T. Morisaki, D. Allard, M. Varret, M. Claustres, H. Morisaki, et al. 2004.

Heterozygous TGFBR2 mutations in Marfan syndrome. *Nat. Genet.* 36:855–860.

Table S2. Percentage of CCR6-positive CD4 T cells in controls and STAT-3–deficient patients ex vivo

Patients and controls^a	Age (yr)	CCR6⁺ CCR4⁺ CD4⁺ T cells (%)	CCR6⁺ CCR4⁻ CD4⁺ T cells (%)
P 35	7	4.4	0.5
P 36	9	5.7	0.5
P 37	34	6.7	1.1
P 38	16	8.7	7
P 46	16	8.9	1.4
Other patient ^b	7	4.7	2.4
Other patient ^b	15	3.1	0.2
Other patient ^b	21	4.9	0.5
C 1	5	7.8	1.5
C 2	7	6.8	6.5
C 3	7	6.6	8.8
C 4	7	11.1	6.2
C 5	12	16.6	15.2
C 6	13	6.8	12.2
C 7	16	8.4	18.5
C 8	unknown	8.3	11.8
C 9	unknown	10.9	20.3

^aEight STAT-3–deficient patients (P) and nine healthy controls (C) were studied.

^bThese patients, not described in Table S1, were not studied for IL-17 production.

Table S3. Percentage of CD4- and CD8-positive T cells in controls and patients ex vivo

Patient	Gene	Age (yr)	Lymphocytes ($\times 10^9$ per μl)	CD4⁺ (%)	CD8⁺ (%)
2	<i>IRAK4</i>	11	4.8	63	17
4	<i>IRAK4</i>	10	1.9	45	25
6	<i>IRAK4</i>	28	1.3	46	20
17	<i>IL12RB1</i>	12	Not done	35	19
18	<i>IL12RB1</i>	29	1.8	23	37
38	<i>STAT3</i>	17	1.3	37	21
39	<i>STAT3</i>	19	Not done	38	33
40	<i>STAT3</i>	37	2.9	41	23
41	<i>STAT3</i>	9	3.4	31	12
42	<i>STAT3</i>	36	0.8	46	20
43	<i>STAT3</i>	28	3	28	21
45	<i>STAT3</i>	21	2.6	40	34
46	<i>STAT3</i>	16	3.3	43	22
47	<i>STAT3</i>	23	1.5	35	24
49	<i>STAT3</i>	17	Not done	35	19
50	<i>STAT3</i>	43	1	39	21

Article 3

A role for interleukin-12/23 in the maturation of human natural killer and CD56⁺
T cells *in vivo*

Guia, S., C. Cognet, **L. de Beaucoudrey**, M.S. Tessmer, E. Jouanguy, C. Berger,
O. Filipe-Santos, J. Feinberg, Y. Camcioglu, J. Levy, S. Al Jumaah, S. Al-Hajjar,
J.L. Stephan, C. Fieschi, L. Abel, L. Brossay, J.L. Casanova, and E. Vivier

Blood
2008, 111:5008-5016

A role for interleukin-12/23 in the maturation of human natural killer and CD56⁺ T cells in vivo

Sophie Guia,¹⁻³ Céline Cognet,¹⁻⁴ Ludovic de Beaucoudrey,^{5,6} Marlowe S. Tessmer,⁷ Emmanuelle Jouanguy,^{5,6} Claire Berger,⁸ Orchidée Filipe-Santos,^{5,6} Jacqueline Feinberg,^{5,6} Yildiz Camcioglu,⁹ Jacob Levy,¹⁰ Suliman Al Jumaah,¹¹ Sami Al-Hajjar,¹¹ Jean-Louis Stephan,⁸ Claire Fieschi,¹² Laurent Abel,^{5,6} Laurent Brossay,⁷ Jean-Laurent Casanova,^{5,6,13} and Eric Vivier¹⁻⁴

¹Centre d'Immunologie de Marseille-Luminy, Université de la Méditerranée, Marseille, France; ²Inserm U631, Marseille, France; ³Centre National de la Recherche Scientifique (CNRS), UMR6102, Marseille, France; ⁴Hôpital de la Conception, Assistance Publique-Hôpitaux de Marseille, Marseille, France; ⁵Laboratoire de Génétique Humaine des Maladies Infectieuses, Inserm U550, Paris, France; ⁶Université Paris René Descartes, Faculté de Médecine Necker, Paris, France; ⁷Department of Molecular Microbiology and Immunology, Brown University, Providence, RI; ⁸Service de Pédiatrie, Centre Hospitalier Universitaire (CHU), St Etienne, France; ⁹Department of Pediatrics, Infectious Diseases, Clinical Immunology and Allergy Division, Cerrahpaşa Medical School, Istanbul University, Istanbul, Turkey; ¹⁰Pediatric Department, Soroka Medical Center, Faculty of Health Sciences, Ben Gurion University, Beer Sheva, Israel; ¹¹Department of Pediatrics, King Faysal Hospital and Research Center, Riyadh, Saudi Arabia; ¹²Service d'Immunopathologie, Hôpital Saint-Louis, Paris, France; and ¹³Unité d'Immuno-Hématologie, Hôpital Necker, Paris, France

Natural killer (NK) cells have been originally defined by their "naturally occurring" effector function. However, only a fraction of human NK cells is reactive toward a panel of prototypical tumor cell targets in vitro, both for the production of interferon- γ (IFN- γ) and for their cytotoxic response. In patients with *IL12RB1* mutations that lead to a complete IL-12R β 1 deficiency, the size of this naturally reactive NK cell subset is diminished, in particular for the IFN- γ production. Similar

data were obtained from a patient with a complete deficit in IL-12p40. In addition, the size of the subset of effector memory T cells expressing CD56 was severely decreased in IL-12R β 1- and IL-12p40-deficient patients. Human NK cells thus require in vivo priming with IL-12/23 to acquire their full spectrum of functional reactivity, while T cells are dependent upon IL-12/23 signals for the differentiation and/or the maintenance of CD56⁺ effector memory T cells. The susceptibil-

ity of IL-12/23 axis-deficient patients to *Mycobacterium* and *Salmonella* infections in combination with the absence of mycobacteriosis or salmonellosis in the rare cases of human NK cell deficiencies point to a role for CD56⁺ T cells in the control of these infections in humans. (Blood. 2008;111:5008-5016)

© 2008 by The American Society of Hematology

Introduction

Natural killer (NK) cells have been initially described as non-T, non-B lymphocytes that are "naturally" elicited to mediate their effector functions (ie, cytotoxicity and cytokine production) without prior sensitization.¹ Both arms of NK cell effector functions participate in the direct innate defense and in the shaping of the adaptive immune response.² In several mouse models, NK cells limit the development of tumors and microbial infections.³⁻⁵ In particular, NK cells control the early steps of mouse cytomegalovirus (MCMV) infection, both by directly killing virus-infected cells and by producing IFN- γ .⁶

The natural acquisition of NK cell effector function has recently been challenged through the demonstration that only a minor fraction of circulating human NK cells or splenic mouse NK cells is reactive toward prototypical NK cell targets in single-cell assays.⁷⁻¹³ It is thus becoming increasingly clear that NK cells are following various steps of maturation, culminating into the final effector stage.¹⁰⁻¹⁵ In mice, the production of interleukin (IL)-15 by dendritic cells is one of the factors that primes naive NK cells into effectors.^{9,13}

These results suggest that the fraction of NK cells that qualifies as effectors in vitro corresponds to the NK cells that had been exposed to in vivo priming prior to the in vitro assays. This hypothesis prompted us to determine the host genetic factors that contribute to NK cell reactivity in humans. We focused our interest on the IL-12 family of cytokines, as IL-12 had been initially identified on the basis of its ability to enhance NK cell cytotoxicity and interferon- γ (IFN- γ) production.¹⁶⁻¹⁹ A number of studies have indeed demonstrated that IL-12 affects NK cell effector function,²⁰⁻²³ especially with respect to NK cell activation by dendritic cells. IL-12 (IL-12p40:IL-12p35) and IL-23 (IL-12p40:IL-23p19) are structurally related heterodimeric cytokines that regulate cell-mediated immune responses and Th1-type inflammatory reactions.²⁴ The IL-12 receptor is composed of 2 chains, IL-12R β 1 and IL-12R β 2, the former being also part of the IL-23R.²⁴ In mice, numerous studies have shown a critical role for IL-12 in protective immunity to various pathogens.²⁵ In contrast, the description of human patients with inherited IL-12 or IL-12R deficiencies has revealed that IL-12 is redundant for human defense against most

Submitted November 14, 2007; accepted February 20, 2008. Prepublished online as *Blood* First Edition paper, March 4, 2008; DOI 10.1182/blood-2007-11-122259.

The online version of this article contains a data supplement.

The publication costs of this article were defrayed in part by page charge payment. Therefore, and solely to indicate this fact, this article is hereby marked "advertisement" in accordance with 18 USC section 1734.

© 2008 by The American Society of Hematology

Table 1. Patient characteristics

Patient	Age, y	Sex	Onset	Mutations	Historical clinic status	Experimental time clinic status
1*	25	F	Morocco	<i>IL12RB1</i> K305X	BCGite + Salmonella	Salmonella suspicion
2*†	34	F	France	[<i>IL12RB1</i> 1745]–1746insCA+1483+182-1619-1073del	BCGite + Salmonella	Asymptomatic
3*	4	F	France	<i>IL12RB1</i> Q32X	BCGite	Asymptomatic
4*	16	F	Belgium	<i>IL12RB1</i> Q32X	Asymptomatic	Asymptomatic
5	11	M	Turkey	<i>IL12RB1</i> R173P	Salmonella	Asymptomatic
6*	6	M	Israel	<i>IL12RB1</i> 700+362-1619-944del	Salmonella	Asymptomatic
7	9	M	Saudi Arabia	<i>IL12RB1</i> 1190-1G>A	BCGite + Salmonella	Salmonella
8	13	M	Saudi Arabia	<i>IL12RB1</i> 1190-1G>A	Salmonella	Salmonella
9	5	M	Tunisia	<i>IL12</i> 297del8	Salmonella	Salmonella + asymptomatic

Indicated IL-12Rβ1– or IL-12p40–deficient patients (n = 9, 13.7 ± 10 years old, M/F ratio: 5:4) were analyzed in comparison with healthy control individuals (n = 16, 26.1 ± 12.0 years old, M/F ratio: 4:12 for the phenotypic analysis; n = 13, 29.5 ± 8.4 years old, M/F ratio: 3:10 for the functional analysis).

*The patients P1, P2, P3, P4, and P6 were previously described in Fieschi et al²⁷ as 1.II.2, 19.II.1, 20.II.1, 21.II., and 10.II.1, respectively.

†The patient contracted hepatitis C virus (HCV) after a blood transfusion.

microorganisms.²⁶⁻³⁰ Noticeable exceptions include *Mycobacterium*, such as environmental *Mycobacterium*, BCG vaccines, and *M tuberculosis*, as well as *Salmonella* infections, which critically depend on IL-12/23.^{26,27} Overall, patients with mutations in molecules involved in the IFN-γ/IL-12/23–dependent pathway are affected by the syndrome of Mendelian susceptibility to mycobacterial disease (MSMD).^{26,27,30,31} This syndrome is biologically characterized by deeply impaired or absent IFN-γ production or function, and is clinically defined by the susceptibility to mycobacteriosis and salmonellosis. Here, we analyzed the phenotypic and functional features of circulating NK and NK-like CD56⁺ T cells in a group of 9 patients who present a complete IL-12Rβ1 or IL-12p40 deficiency.

Methods

Patients and controls

Peripheral blood mononuclear cells (PBMCs) were isolated by Ficoll-Hypaque density gradient centrifugation (GE Healthcare, Little Chalfont, United Kingdom) from whole blood samples obtained from healthy volunteer donors, and IL-12Rβ1– and IL-12p40–deficient patients described in Table 1. These human studies were performed and informed consent from all participating subjects was obtained in accordance with the Declaration of Helsinki.

Reagents

The following monoclonal antibodies (mAbs) were used: PE-conjugated anti-CD16 (mouse IgG1, 3G8), anti-CD25 (IgG2a, B1.49.9), anti-CD62L (IgG1, Dreg 56), anti-CD94 (IgG2a, HP-3B1), anti-CD158a,h (IgG1, EB6), anti-CD158b1/b2/j (IgG1, GL183), anti-CD158e1 (IgG1, Z27), anti-CD158i (IgG2a, FESTR172), anti-CD161 (IgG2a, 191B8), anti-NKp30 (IgG1, Z25), anti-NKp44 (IgG1, Z231), anti-NKp46 (IgG1, Bab281), anti-NKG2A (IgG2b, Z199); FITC-conjugated anti-CD3 (IgG1, UCHT1); PE-Cy5-conjugated anti-CD56 (IgG1, NKH-1); APC-conjugated anti-CD56 (NKH-1; Beckman Coulter Immunotech, Marseille, France); PE-conjugated anti-CD69 (IgG1, FN50), antiperforin (IgG2b, 27–35), anti-IFN-γ (IgG1, 4S-B3); FITC-conjugated anti-CD107a (IgG1, H4A5), anti-CD107b (IgG1, H4B4); PerCP-Cy5.5-conjugated anti-CD3 (IgG1, SK7; Becton Dickinson, Lincoln Park, NJ); purified anti-IL-12 (IgG1, 24910; R&D Systems, Minneapolis, MN), biotin-conjugated anti-CD162R (IgM, 5H10; Innate Pharma, Marseille, France); and PE-labeled streptavidin (Southern Biotechnology Associated, Birmingham, AL). Human recombinant IL-12 (219-IL) and IL-23 (1290-IL) were purchased from R&D Systems; human IL-2 (Proleukin), from Chiron (Emeryville, CA); human IL-15(200–15), from Peptidech (Rocky Hill, NJ); and human IL-18 (B003–5), from MBL (Watertown, MA).

NK cell analysis

PBMCs were analyzed by 3-color flow cytometry using a FACSCalibur cytometer (Becton Dickinson). NK cells were defined as CD3[–]CD56⁺ cells within the lymphocyte gate. Natural cytotoxicity was assessed using the MHC class I[–] human erythroleukemic K562 target cells, as well as fibroblastic hamster CHO and human HeLa target cells. Antibody-dependent cell cytotoxicity (ADCC) was assessed using the P815 mouse mastocytoma cells coated with rabbit antimouse lymphocyte antibodies (Accurate Biochemicals, Westbury, NY). NK cell effector functions were tested in a single-cell assay using CD107 mobilization and IFN-γ production, as previously described.⁷ In these assays, PBMCs were incubated for 4 hours at 37°C in the presence of GolgiStop (1/1500; Becton Dickinson), anti-CD107 mAb, and various stimuli. The effector-target ratio was 2.5:1. Cells were then washed in PBS supplemented with 2% FCS, 1 mM EDTA and stained for 30 minutes at 4°C with PerCP-Cy5.5–conjugated anti-CD3, APC-conjugated anti-CD56, and normal mouse serum 2%. After fixation in paraformaldehyde 2% and permeabilization (PermWash; Becton Dickinson), the expression of IFN-γ was detected by incubation with PE-conjugated anti-IFN-γ for 30 minutes at 4°C. As a negative control, species- and isotype-matched control mAbs were used for all stainings.

Generation of IL-2-activated NK cells

NK cell-enriched PBMCs were obtained using the RosetteSep Human NK Cell kit (StemCell Technologies, Vancouver, BC). Then, NK cells were resuspended in RPMI 10% FCS containing human IL-2 at 100 U/mL and PHA (Invitrogen, Frederick, MD) at 10 μg/mL in 96-well U-bottom plate. For expansion, NK cells needed previously irradiated (50 gray) allogeneic PBMCs at the concentration 2 × 10⁶ cells/mL. Every 2 days, the medium was replaced by RPMI 10% FCS supplemented with IL-2 100 U/mL.

Whole-blood activation by live BCG

Venous blood samples of healthy donors were collected into heparinized tubes. Blood (500 μL) was dispensed into wells of a 6-well plate for a final volume of 1 mL/well (dilution with RPMI 1640 supplemented with 100 U/mL penicillin and 100 μg/mL streptomycin). The diluted blood sample then incubated in a 2-stage procedure during 24 and 48 hours at 37°C in an atmosphere containing 5% CO₂ and under 3 conditions of activation: with medium alone, with live bacillus Calmette-Guerin (*M bovis* BCG, Pasteur substrain) at an MOI of 20 BCG/leukocytes,³² and with BCG plus IL12 (20 ng/mL; R&D Systems). Six hours before the end of activation, GolgiStop (1/1500; Becton Dickinson) was added in each well. The production of IFN-γ was detected by intracellular staining as described in “NK cell analysis” and analyzed by flow cytometry.

Statistical analysis

Graphic representation and statistical analysis of NK cell distribution were performed using GraphPad Prism software (GraphPad Software, San

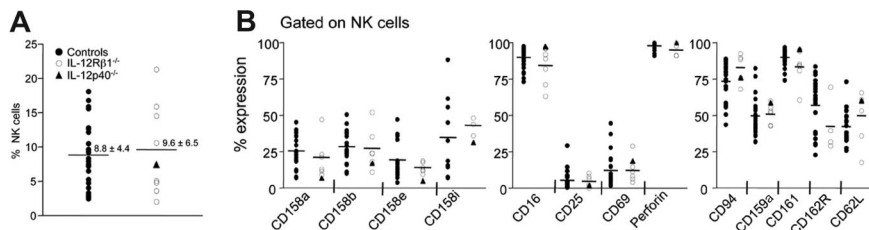

Figure 1. Normal NK cellularity and phenotype in IL-12/23 axis-deficient patients. (A) The percentages of NK cells present in peripheral blood of indicated individuals were computed from the percentages of CD3⁺CD56⁺ cells within the lymphocyte. Each dot indicates the value obtained from one individual. (B) Circulating NK cells from indicated individuals were explored for their cell surface phenotype (except for perforin, where an intracytoplasmic staining was performed). Each dot indicates the value obtained from one individual.

Diego, CA). Comparison of distributions was performed using Mann Whitney test. **P* was less than .05; ***P* was less than .01; ns indicates not significant. The statistical analysis never included the IL-12p40^{-/-} patient together with the IL-12Rβ1^{-/-} patients. Age-matched statistical analysis was performed as described in Table 1 (L.A.).

Results

NK cell phenotype in IL-12Rβ1-deficient patients

The role of IL-12 and IL-23 on human NK cells in vivo was first tested by analyzing circulating NK cell counts in a cohort of IL-12Rβ1-deficient patients presenting a complete IL-12Rβ1 deficiency (Table 1). Normal PBMC counts have been previously reported in a large cohort of IL-12Rβ1-deficient patients.²⁷ No alteration in the percentage CD3⁺CD56⁺ NK cells within PBMCs was detected here in our cohort of 8 IL-12Rβ1-deficient patients (Figure 1A). Human NK cells can be divided in 2 reciprocal subsets, based on the cell surface expression of CD56. CD56^{bright} NK cells represent a minority of blood NK cells, but are prominent in secondary lymphoid organs.³³ CD56^{bright} NK cells readily produce IFN-γ in response to proinflammatory cytokines such as IL-12, IL-18, and IL-15.^{7,34} In contrast, most circulating NK cells have a CD56^{dim} phenotype; they initiate their cytolytic and cytokine production programs upon interaction with tumor cell targets.⁷ No difference between the size of the CD56^{bright} and CD56^{dim} NK cell subsets was detected when control and IL-12Rβ1-deficient patients were compared (data not shown). The NK cell surface phenotype of IL-12Rβ1-deficient patients was also indistinguishable from that of control individuals, for the expression of MHC class I-specific receptors (killer cell Ig-like receptors: CD158/KIR, CD94, CD159a/NKG2A), of a panel of activating and cell adhesion receptors (CD16, CD161/NKR-P1, CD162R/PEN5, CD62L/L-selectin) as well as of NK cell activation markers (CD25 and CD69). Importantly, the intracytoplasmic NK cell content in perforin was comparable between control and IL-12Rβ1-deficient individuals (Figure 1B). In control individuals, CD56^{bright} NK cells expressed slightly lower cell surface levels of Nkp30 and higher levels of Nkp46 than CD56^{dim} NK cells (Figure S1A, available on the *Blood* website; see the Supplemental Materials link at the top of the online article). In IL-12Rβ1-deficient patients, a slight decrease in Nkp30 cell surface density was observed mainly on CD56^{dim} NK cells (Figure S1A,B). A minor down-regulation of Nkp46 expression was also observed (Figure S1B), but this trend did not reach statistical significance. Thus, circulating NK cells did not present gross abnormalities in counts or in their phenotype, including the repertoire of MHC class I receptors, showing that IL-12 and IL-23 are dispensable for the phenotypic development of human NK cells in vivo.

NK cell effector functions in IL-12Rβ1-deficient patients

We then analyzed NK cell effector functions using single-cell assays. We quantified the IFN-γ production and the cytotoxicity

potential (via the CD107 degranulation assay), using peripheral blood NK cells from patients and control individuals, in response to a panel of tumor cell lines. The response of patients' NK cells to the prototypical MHC class I⁻ tumor cell target K562 was diminished compared with control individuals (Figure 2A). The reduction in NK cell response was more pronounced for IFN-γ production than for the CD107 degranulation assay, as only the former reached statistical significance in these experimental settings (Figure 2B).

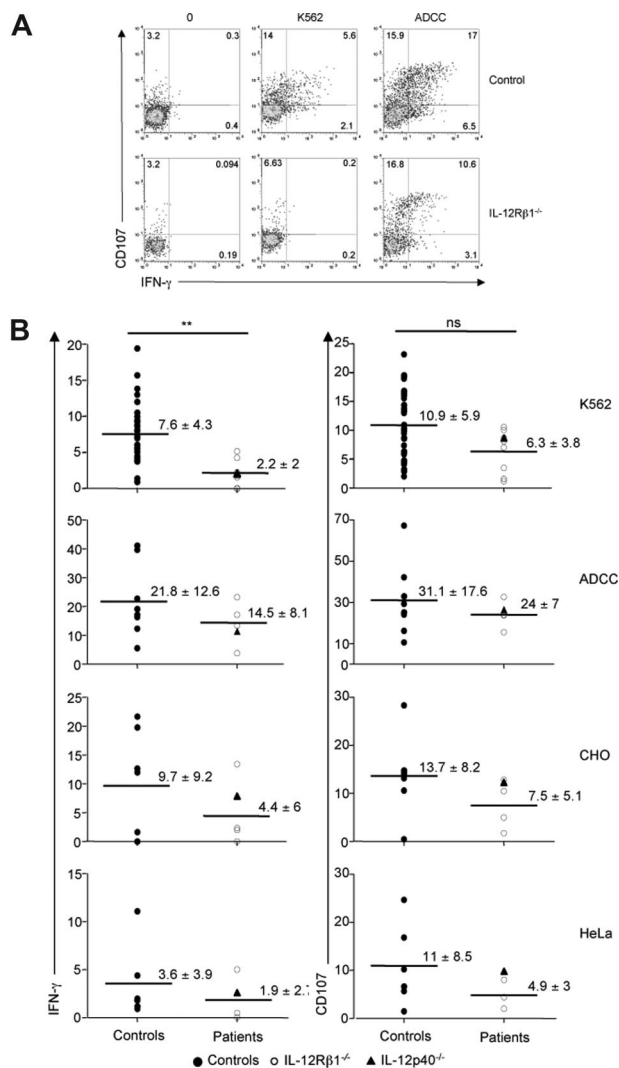

Figure 2. NK cell hyporesponsiveness in IL-12/23 axis-deficient patients. (A) A representative experiment comparing the in vitro reactivity of NK cells from healthy control individuals and IL-12Rβ1-deficient patients is shown. PBMCs were incubated for 4 hours in the presence or absence of K562 cells and assessed for CD107 and IFN-γ expression. (B) PBMCs prepared from a cohort of healthy control individuals, IL-12Rβ1-deficient patients and one IL-12p40-deficient patient were analyzed for their NK reactivity in the presence of indicated tumor cells; ADCC: antibody-coated P815 cells. Values indicate mean plus or minus SD. Each dot represents the data obtained from one individual.

A trend toward a decrease in NK cell effector function (both IFN- γ production and degranulation) was also observed in response to 2 other tumor cell lines (CHO and HeLa), as well as upon antibody-dependent cell cytotoxicity (ADCC) challenge (Figure 2B). It is likely that the small size of our cohort of IL-12R β 1-deficient patients was responsible for the fact that the decrease in NK cell reactivity did not reach statistical significance. K562, HeLa, and CHO cells are recognized by a combination of NK cell receptors including NKp30 (data not shown). However, the slight decrease in NKp30 expression observed in patients' NK cells was unlikely to be solely responsible for the decreased NK cell reactivity observed with IL-12R β 1-deficient cells. Indeed, the ADCC response of IL-12R β 1-deficient NK cells followed the same trend, but is CD16 dependent and NCR independent. In addition, no correlation could be found between the extent of NKp30 down-regulation and the reduced reactivity observed with NK cells from IL-12R β 1-deficient patients (data not shown). Therefore our data rather suggest that signaling via IL-12R β 1 partially controls critical transduction components that are downstream of and common to various NK cell activating pathways. Patients included in this study were symptomatic or asymptomatic (Table 1), and no correlation between the decrease in IFN- γ production upon K562 stimulation and the clinical status could be established (data not shown).

NK cells in an IL-12p40-deficient patient

We further tested the role of IL-12R β 1-dependent signals on NK cells by analyzing the reactivity of circulating NK cells isolated from a patient presenting a genetic deficiency in IL-12p40 (*IL12B*). NK cells from the IL-12p40-deficient patient were hyporesponsive to K562 and ADCC challenge (Figure 3). The IL-12p40-deficient patient was tested under symptomatic and asymptomatic conditions, and no correlation between the decrease in NK cell reactivity and the clinical status was detected (data not shown). As for IL-12R β 1-deficient patients, no gross abnormalities in circulating NK cell counts and phenotype were observed in the IL-12p40-deficient patient (Figure 1A,B closed triangles). The lack of other IL-12p40-deficient patients available prevented us from analyzing whether the intensity of the NK cell defect was different in IL-12p40- and IL-12R β 1-deficient patients. Nevertheless, the NK cell hyporesponsiveness in both the IL-12p40- and the IL-12R β 1-deficient patients strongly advocates for a role of IL-12/23 in the acquisition NK cell effector function (ie, in NK cell priming in vivo

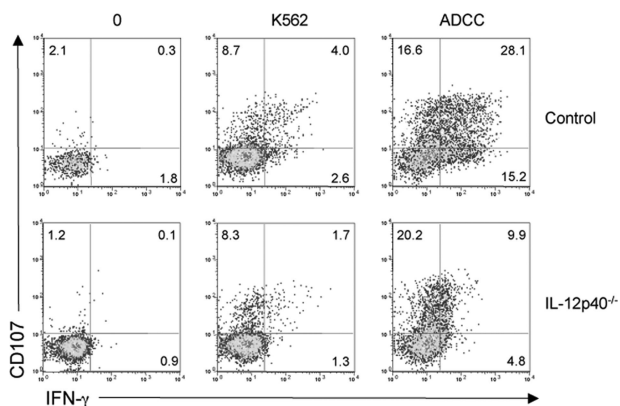

Figure 3. NK cell hyporesponsiveness in an IL-12p40-deficient patient. A representative experiment comparing the in vitro reactivity of NK cells from one control individual and one IL-12p40-deficient patient is shown. PBMCs were incubated for 4 hours in the presence or absence of K562 cells and assessed for CD107 and IFN- γ expression.

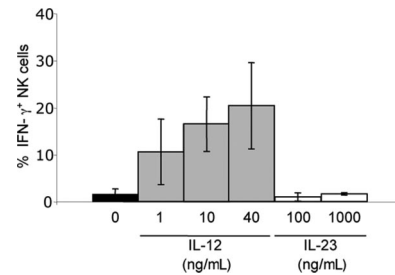

Figure 4. Differential role of IL-12 and IL-23 on IFN- γ production by NK cells in vitro. PBMCs prepared from healthy control individuals were cultured for 4 hours in vitro with the indicated concentrations of human recombinant IL-12 or IL-23, and then assayed for IFN- γ production. Results are expressed as mean plus or minus SD of 3 independent experiments.

in humans). In contrast to IL-12,²⁵ we could not detect a significant in vitro effect of IL-23 treatment on healthy NK cell IFN- γ production (Figure 4), suggesting that the decrease in NK cell IFN- γ production in IL-12R β 1-deficient patients was due to IL-12 rather than IL-23.

Role of IL-12 in NK cell priming

We then tested whether IL-12 was required during the contact between NK cells present in PBMCs and the tumor cell target or whether IL-12 was one of the factors that contributes to human NK cell priming in vivo. As shown in Figure 5, the addition of a blocking anti-IL-12 mAb during the 4-hour incubation between healthy PBMCs and K562 target cells did not influence NK cell response. The NK cell defect observed in IL-12R β 1-deficient patients was thus most likely not the consequence of a role for IL-12 during the 4-hour in vitro assay, but resulted from a role of IL-12 in vivo prior to the isolation of peripheral blood cells.

Complementation of IL-12-dependent NK cell defects

To further address the role of IL-12 in NK cell function, PBMCs prepared from the IL-12p40-deficient patient and IL-12R β 1-deficient patients were treated in vitro with recombinant human IL-12, and the reactivity of NK cells to K562 was assessed. Exogenous IL-12 complemented the defect in NK IFN- γ production of the IL-12p40-deficient patient, but not of IL-12R β 1-deficient patients, as expected (Figure 6A). By contrast, no

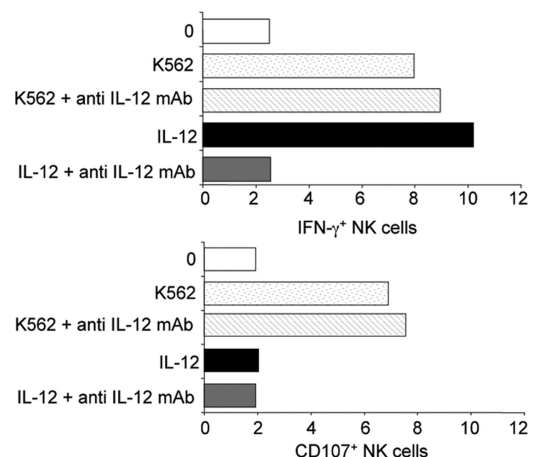

Figure 5. No detectable role for endogenous IL-12 during in vitro NK cell stimulation by K562 cells. PBMCs from healthy control individuals were incubated with K562 target cells for 4 hours at 37°C, in the presence or absence of anti-IL-12 mAb (10 μ g/mL). IFN- γ production and CD107 mobilization were assessed in a 4-hour K562 stimulation assay.

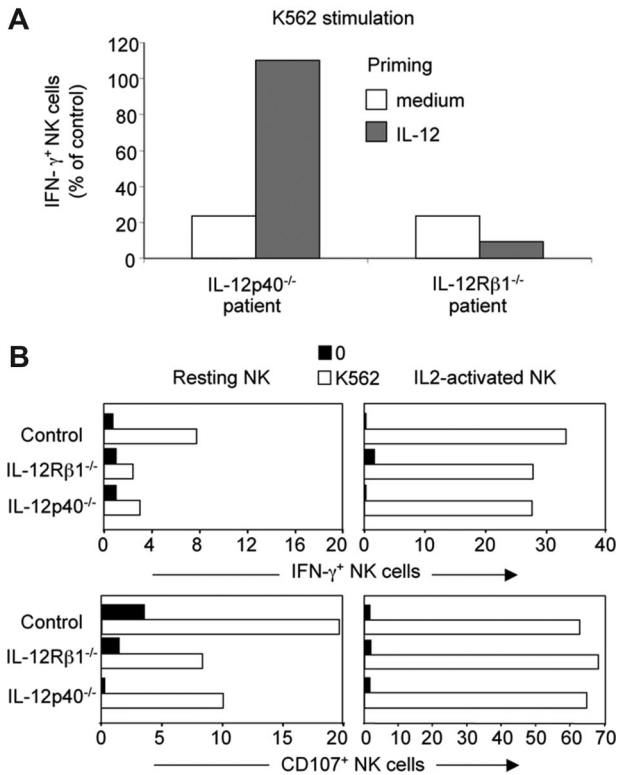

Figure 6. Complementations of the IL-12-dependent NK cell hyporesponsiveness. (A) PBMCs from one representative control individual, one representative IL-12R β 1-deficient patient, and one IL-12p40-deficient patient were cultured for 24 hours in vitro with human recombinant IL-12 (1 ng/mL), and then assayed for IFN- γ production in response to 4-hour K562 stimulation. Results are expressed as the percentage of IFN- γ ⁺ NK cells in patients normalized to the percentage of IFN- γ ⁺ NK cells in the control individual (set to 100%). (B) NK cell cultures of indicated origin (healthy controls, IL-12R β 1- and IL-12p40-deficient patients) were generated by incubating NK cell-enriched PBMCs with recombinant human IL-2 (100 U/mL) for 3 weeks. Resting NK cells or IL-2-cultured NK cells of the same individuals were then compared in parallel in a 4-hour K562 stimulation.

difference in the reactivity to K562 was observed in IL-2-cultured NK cells from control, IL-12p40-deficient, and IL-12R β 1-deficient patients (Figure 6B), showing that IL-12 played a redundant role in the priming of NK cells, when grown in IL-2.

Lack of CD56⁺ T cells in IL-12/23 axis-deficient patients

During their maturation, T cells can acquire some NK cell attributes, such as the cell surface expression of NK cell receptors.³⁵ In contrast to the lack of major NK cell phenotypic alteration in IL-12/23 axis-deficient patients, the size of the subset of T cells that expresses CD56 was severely reduced in both IL-12R β 1- and

IL-12p40-deficient patients (Figure 7A,B). The small size of the subset of CD56⁺ T cells in patients prevented us from precisely analyzing their functional characteristics in great detail. Nevertheless, in control individuals CD56⁺ T cells were mainly CD8⁺ T cells, whereas a few consisted of V α 24 invariant NKT cells and $\gamma\delta$ T cells (data not shown). The low fraction of invariant V α 24⁺ T cells in CD56⁺ T cells (from 1% to 5% of CD56⁺ T cells) is consistent with previous results,³⁶ and makes it unlikely to be responsible for the drastic reduction in the size of the CD56⁺ T-cell subset in IL-12/23 axis-deficient patients (from 4.2% \pm 2.6% to 1.6% \pm 1.5% of total lymphocytes in control individuals vs patients, respectively, Figure 7B). In control individuals, CD56⁺ T cells also included a substantial fraction of T cells expressing other NK cell phenotypic features such as KIR, CD94/NKG2A, and CD161 (Figure 8A). CD56 surface expression on T cells correlated with high intracytoplasmic perforin content (Figure 8A), consistent with previous results.³⁷ Importantly, CD56⁺ T cells were not only equipped as cytolytic effectors, but they also shared with NK cells the capacity to produce IFN- γ upon IL-12 + IL-18 treatment,³⁸ and to a lesser extent upon IL-15 stimulation (ie, in absence of TCR engagement; Figure 8B). In addition, a substantial fraction of NK cells and CD56⁺ T cells, but barely detectable CD56⁻ T cells, produced IFN- γ in vitro in presence of live BCG (Figure 8C) and in response to *Salmonella typhimurium*-infected macrophages (N. Lapaque and J. Trowsdale, personal communication, December 17, 2007). The IL-12/23 axis deficiency was also associated with a lower expression of CD161 on CD56⁺ T cells. Since the size of the CD56⁺ T-cell subset increases with aging and most of the IL-12/23 axis-deficient patients comprised infants and young adults,³⁹ a careful statistical analysis was conducted to find out whether age had a confounding effect on our results. However, the restriction of the cohort of healthy control individuals to age-matched patients still revealed a statistically significant reduction in the size of the CD56⁺ T-cell subsets in IL-12/23-deficient patients (data not shown). Thus, IL-12/23 was mandatory for the expansion of a subset of T cells, mainly CD8⁺, that presents features shared by both NK cells and effector memory T cells: cell surface expression of CD56, intracytoplasmic expression of perforin, and IFN- γ production in response to IL-12 + IL-18. IL-12/23 was critical for the final CD8⁺ T-cell maturation steps and/or for the maintenance of this CD56⁺ T-cell subset in PBMCs.

Discussion

IL-12 and IL-23 are cytokines that represent a functional bridge between the early resistance and the subsequent antigen-specific adaptive immunity.^{24,26,32,40} Here we have shown that IL-12/23 was

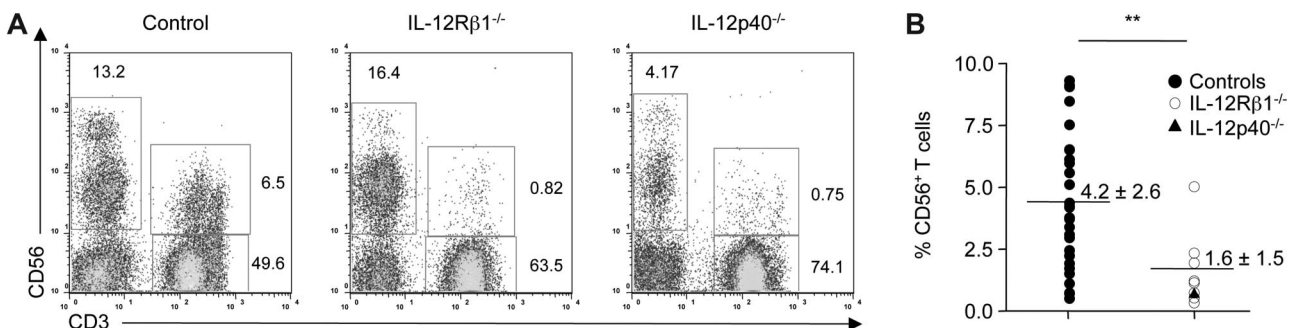

Figure 7. Reduced size of the CD56⁺ T-cell subset in IL-12/23 axis-deficient patients. (A,B) The percentages of CD56⁺ T cells present in peripheral blood of indicated individuals were computed within the total lymphocyte gate. Each dot represents the value obtained from one individual (B).

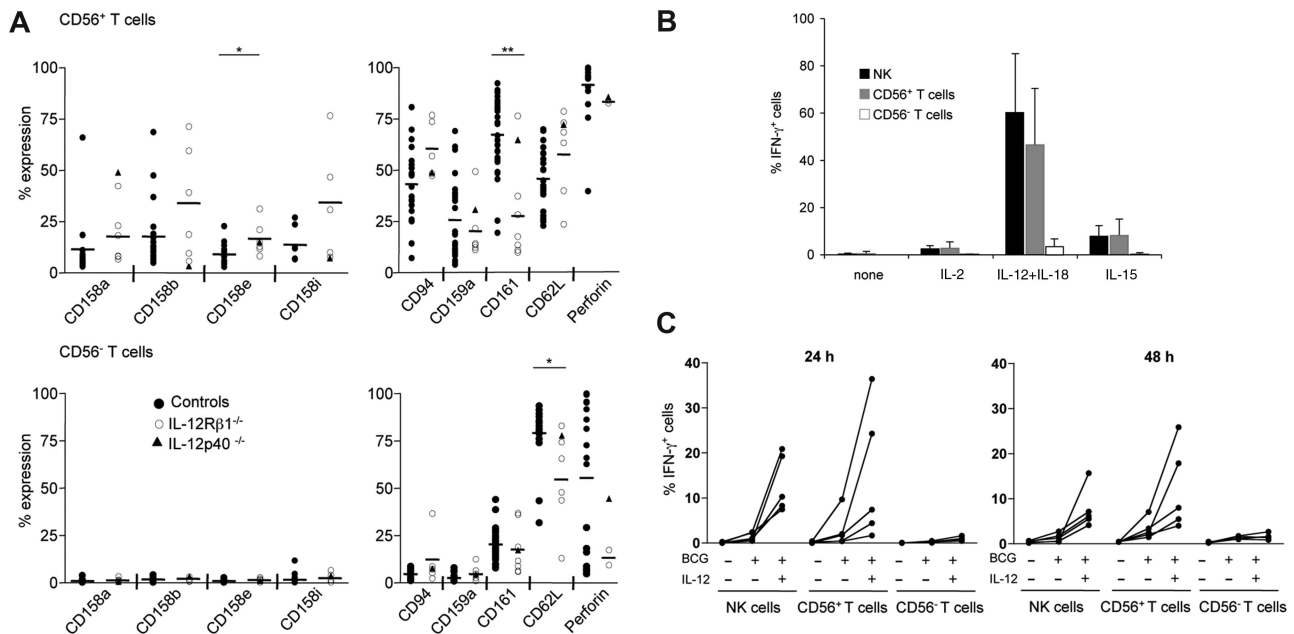

Figure 8. Altered T-cell phenotype in IL-12/23 axis-deficient patients. (A) Circulating CD56⁺ T cells (top panel) and CD56⁻ T cells (bottom panel) from indicated individuals were explored for their cell surface phenotype (except for perforin, where an intracytoplasmic staining was performed). Each dot indicates the value obtained from one individual. (B) Circulating CD56⁻ T cells, CD56⁺ T cells, and NK cells from 4 representative healthy control individuals were assayed for their IFN- γ production in response to 24-hour treatment in the presence or absence of indicated cytokines: IL-2 (50 U/mL), IL-15 (10 ng/mL), IL-18 (20 ng/mL), IL-12 (5 ng/mL). (C) Circulating CD56⁻ T cells, CD56⁺ T cells, and NK cells from 5 healthy individuals were assayed for their IFN- γ production in response to live BCG alone or BCG plus IL-12 (20 ng/mL) during 24 and 48 hours. Each line represents the response obtained with one individual.

differentially required by 2 subsets of effector lymphocytes in vivo in humans: NK cells and CD56⁺ T cells. While acting on NK cells as a priming factor, IL-12/23 was required for the differentiation and/or the maintenance of CD56⁺ effector memory T cells.

Previous observations had revealed that NK cells were present in normal numbers in IL-12R β 1-deficient patients.^{21,41} We confirmed these observations, and extended the phenotypic analysis to a large panel of receptors expressed at the NK cell surface. All described NK cells subsets develop normally in vivo in absence of IL-12 and IL-23 stimulation. In particular, we did not detect alterations in the CD56^{dim} or CD56^{bright} circulating NK cells subsets in IL-12R β 1-deficient patients, contrasting with a role for IL-12 in the maturation of CD56^{bright} NK cells, suggested earlier by in vitro experiments.⁴² Furthermore, the repertoire of Ig-like and lectin-like MHC class I receptors did not present any gross abnormalities in IL-12/23 axis-deficient patients. Thus, the variegation at the *KIR* locus, which is still poorly understood, occurs in an IL-12- and IL-23-independent manner. A defect in NK cell IFN- γ production was also reported in the pioneering description of one IL-12R β 1-deficient patient.²¹ The high variability of NK cell reactivity in vitro, combined with the large variations in peripheral NK cell counts, prompted us to complete this first characterization, by increasing the number of patients and the number of tumor cell targets, and by using single NK cell assays. We confirmed in these 4-hour short-term stimulation protocols, the low IFN- γ production by NK cells from IL-12R β 1-deficient patients in response to the prototypical MHC class I⁻ K562 tumor cells. We also showed a trend toward a broader hyporesponsiveness of NK cells for IFN- γ production and for cytotoxicity to a lesser extent to various human tumors as well as to antibody-coated target cells. This phenotype was recapitulated with NK cells from an IL-12p40-deficient patient and complemented with exogenous IL-12. Consistent with an earlier report,⁴³ we did not detect much impact of IL-23 of NK cell effector function in vitro, suggesting, but not formally proving, that IL-12 and not IL-23 was responsible for the weak reactivity of

NK cells from IL-12R β 1- and IL-12p40-deficient patients. Recent data in humans and mice point to a reappraisal of the “natural” effector function of NK cells. In mice, IL-15 and MHC class I participate in the acquisition of the full spectrum of NK cell reactivity.^{7,9-13} Thus, NK cells do not distinguish themselves from classical T and B cells by their naturally occurring reactivity with targets, but rather by the presence of a substantial fraction of primed and broadly reactive NK cells in the circulation. Yet, the factors that contribute to NK cell priming in vivo may vary between humans and mice. Indeed, we showed here that IL-12/23 is one of the NK cell priming factors in humans. In contrast, IL-12 was recently shown to be redundant for mouse NK cell priming,⁹ despite the moderate but detectable defect in NK cell antitumor cytolytic activity detected in *Il-12*- (data not shown), *Il-12rb1*-, or *Il-12rb2*-deficient mice.⁴⁴⁻⁴⁸

The size of the subset of T cells expressing surface CD56 was drastically reduced in IL-12/23 axis-deficient patients. Much confusion exists regarding the characterization and the function of the subsets of T cells that share phenotypic similarities with NK cells.^{35,49} In particular, CD56⁺ T cells have been too often referred as to NKT cells. There is, however, a consensus defining NKT cells as a subset of CD4⁺ or CD4⁻CD8⁻ T cells that express invariant TCRs, such as CD1d-restricted V α 24 T cells in humans, CD1-restricted V α 14 T cells in mice, or MR1-restricted mucosal associated invariant T (MAIT) in both species.^{50,51} CD56⁺ T cells are clearly different from aforementioned invariant NKT cells, as they are mainly CD8⁺TCR $\alpha\beta$ ⁺ cells with a high cytolytic potential in absence of in vitro maturation.³⁷ CD56⁺TCR $\alpha\beta$ ⁺ cells express a diverse TCR repertoire, which tends to oligoclonality, and the size of this subset expands with aging.³⁹ CD56⁺ T cells thus have attributes of effector memory CD8 T cells, although the precise steps of differentiation of CD56⁺ T cells from naive CD8 T cells are still unknown. In vitro data have argued for a role for IL-12 in their development and/or expansion,⁵²⁻⁵⁵ but one report disputed the

in vivo relevance of these findings for the pool of hepatic CD56⁺ T cells.⁵⁵ We also previously showed that most CD56⁺ T cells constitutively express IL-12Rβ1.⁵⁶ Similarly, IL-12 priming during primary antigenic challenge increased the population of memory CD8⁺ T cells in mice.^{57,58} Our data unambiguously show that IL-12/23 is required for the maturation of CD8⁺ T cells into circulating CD8⁺CD56⁺ T cells and/or for the maintenance of the latter in vivo in PBMCs in humans. Although IL-12/23 plays a necessary role in the determination of the size of CD56⁺ T cells, it is not sufficient. Indeed, addition of IL-12 in vitro did not lead to the induction or expansion of CD56⁺ T cells (data not shown), consistent with results obtained from the monitoring of IL-12–treated patients.⁵⁹ Along this line, TCR, IL-2, and/or IL-15 stimulations have been shown to be involved in the induction/maintenance of CD56⁺ T cells.^{55,60–62} Altogether, the presence of CD56⁺ T cells correlates with several conditions of chronic inflammation such as celiac disease⁶³ or melanoma.⁶⁴ In cirrhotic livers, a decreased number of CD56⁺ T cells may be related to their susceptibility to hepatocellular carcinoma.⁶⁵

Although we favor the possibility that IL-12/23 acts directly on NK cells and CD56⁺ T cells, the effect of IL-12/23 deficiency might be indirect (ie, function through a different cell type as opposed to directly these lymphocytes). Irrespective of this possibility, IL-12/23 is involved in the priming of NK cell effector function and in the differentiation and/or the maintenance of CD56⁺ effector memory T cells. The IL-12/IFN-γ axis is a critical molecular pathway in the susceptibility of mycobacteriosis and salmonellosis. Yet, the precise identification of the cells that produce protective IFN-γ in vivo in response to IL-12 during natural *Mycobacterium* or *Salmonella* infection in human is still lacking. In the case of *Mycobacterium*, the in vitro production of IFN-γ by whole blood cells upon live BCG stimulation is shown to be specific and sensitive to identify disease-causing genes in MSMD patients. Importantly, IFN-γ production by whole blood upon live BCG stimulation was abrogated in patients lacking NK cells or NK and T cells.³² In the same study, the production of IFN-γ by whole blood from IL-12p40– and IL-12Rβ1–deficient patients is abolished or severely reduced, respectively.³² Taken together with the strong genetic epidemiologic data showing that IFN-γ/IL-12/23 axis is critical for the protection against *Mycobacterium* and *Salmonella* in vivo in humans,³⁰ these results indicate that NK cells and T cells are the source of IFN-γ and that IL-12p40 and IL-12Rβ1 are required for this production. In the case of *Salmonella*, NK and CD56⁺ T cells produce IFN-γ in response to *Salmonella typhimurium*–infected macrophages in vitro (N. Lapaque and J. Trowsdale, personal communication, December 17, 2007). Although the NK cell hyporesponsiveness observed in IL-12/23 axis–deficient patients is moderate, the biologic consequences of this defect should not be hastily underestimated. A quantitative difference in NK cell reactivity in vitro might be translated in vivo by a delay in the early control of microbial replication and/or in the arming of the immune response (eg, myeloid cell activation as well as T- and B-cell activation by IFN-γ production). In such a situation of competition between the onset of the immune response and the development of an aggression, the consequences of a reduction and/or a postponement of the NK cell response might be more severe than intuitively thought. Moreover, the clinical consequences might be limited to certain disease conditions. For instance, MHC class I deficiency in mice leads to a targeted

deficit in the rejection of MHC class I[−] tumors or hematopoietic grafts, but does not compromise the ability of NK cells to keep in check MCMV infections.⁶⁶ However, the potential role for mouse NK cells in the control of *M tuberculosis* in vivo⁴³ is disputed.⁶⁷ Furthermore, the rare cases of true NK cell–selective deficiencies do not advocate for a role of NK cells in MSMD. No mycobacteriosis nor salmonellosis has been described in these patients, although mouse NK cells have been recently reported to control *Salmonella enterica* serovar *Typhimurium* infections.⁶⁸ The recent description of 4 children with a novel primary NK cell immunodeficiency rather showed that these patients developed Epstein-Barr virus–driven lymphoproliferative disorder or severe respiratory illnesses of probable viral etiology.⁶⁹ Other clinical reports are also consistent with a role of NK cells in defense against human herpesviral infection.⁷⁰ By contrast, few studies have analyzed the impact of CD56⁺ T cells during *Mycobacterium* or *Salmonella* infections, but the size of this T-cell subset in PBMCs is increased in both conditions.^{71,72} In the presence of live BCG and *Salmonella typhimurium*–infected macrophages in vitro, CD56⁺ T cells, but not CD56[−] T cells, appear to produce IFN-γ in absence of TCR stimulation. Thus, consistent with other reports on mouse memory CD8 T-cell subsets, a major functional feature of the subset of CD56⁺ T cells resides in their “NK-like” effector functions.⁷³ Interestingly, high counts of circulating CD56⁺ T cells at diagnosis of pulmonary tuberculosis correlated significantly with negative sputum culture after 8 weeks of treatment.⁷⁴ Taken together with their expansion in a limited set of inflammatory conditions and their high effector potential (both IFN-γ production and cytotoxicity), these data pave the way to dissect whether NK-like CD56⁺ T cells might be critical players in the protective IL-12/23/IFN-γ–dependent immune response against *Mycobacterium* and *Salmonella* in humans.

Acknowledgments

The authors thank Nicolas Lapaque and John Trowsdale (Cambridge) for sharing unpublished results, and Corinne Beziers-Lafosse (CIML) for her help in the illustrations.

This work was supported by Inserm, CNRS, the European Community (“ALLOSTEM,” E.V.), Ligue Nationale contre le Cancer (“Equipe labellisée La Ligue”), the Agence Nationale de la Recherche (“Réseau Innovation Biotechnologies” and “Microbiologie Immunologie–Maladies Emergentes”), Institut National du Cancer, Ministère de l’Enseignement Supérieur et de la Recherche, and Institut Universitaire de France.

Authorship

Contribution: S.G., C.C., J.-L.C., and E.V. designed the experiments and wrote the paper; M.S.T. and L.B. performed experiments in mice (data not shown); L.deB., E.J., C.F., J.F., O.F.-S., Y.C., J.L., J.-L.S., C.B., S.A.J., and S.A.-H. collected patient materials; and L.A. performed statistical analysis.

Conflict-of-interest disclosure: E.V. is a founder and shareholder of Innate-Pharma. All other authors declare no competing financial interests.

Correspondence: Eric Vivier, Centre d’Immunologie de Marseille-Luminy, Case 906, 13288 Marseille cedex 9, France; e-mail: vivier@ciml.univ-mrs.fr.

References

- Moretta A, Bottino C, Mingari MC, Biassoni R, Moretta L. What is a natural killer cell? *Nat Immunol.* 2002;3:6-8.
- Raulet DH. Interplay of natural killer cells and their receptors with the adaptive immune response. *Nat Immunol.* 2004;5:996-1002.
- Smyth MJ, Hayakawa Y, Takeda K, Yagita H. New aspects of natural-killer-cell surveillance and therapy of cancer. *Nat Rev Cancer.* 2002;2:850-861.
- Lodoen MB, Lanier LL. Natural killer cells as an initial defense against pathogens. *Curr Opin Immunol.* 2006;18:391-398.
- Newman KC, Riley EM. Whatever turns you on: accessory-cell-dependent activation of NK cells by pathogens. *Nat Rev Immunol.* 2007;7:279-291.
- Loh J, Chu DT, O'Guin AK, Yokoyama WM, Virgin HW. Natural killer cells utilize both perforin and gamma interferon to regulate murine cytomegalovirus infection in the spleen and liver. *J Virol.* 2005;79:661-667.
- Anfossi N, Andre P, Guia S, et al. Human NK cell education by inhibitory receptors for MHC class I. *Immunity.* 2006;25:331-342.
- Bryceson YT, March ME, Ljunggren HG, Long EO. Synergy among receptors on resting NK cells for the activation of natural cytotoxicity and cytokine secretion. *Blood.* 2006;107:159-166.
- Lucas M, Schachterle W, Oberle K, Aichele P, Diefenbach A. Dendritic cells prime natural killer cells by trans-presenting interleukin 15. *Immunity.* 2007;26:503-517.
- Yokoyama WM, Kim S. How do natural killer cells find self to achieve tolerance? *Immunity.* 2006;24:249-257.
- Raulet DH, Vance RE. Self-tolerance of natural killer cells. *Nat Rev Immunol.* 2006;6:520-531.
- Vivier E. What is natural in natural killer cells? *Immunol Lett.* 2006;107:1-7.
- Long EO. Ready for prime time: NK cell priming by dendritic cells. *Immunity.* 2007;26:385-387.
- Yokoyama WM, Kim S. Licensing of natural killer cells by self-major histocompatibility complex class I. *Immunol Rev.* 2006;214:143-154.
- Yokoyama WM. Natural killer cell immune responses. *Immunol Res.* 2005;32:317-326.
- Kobayashi M, Fitz L, Ryan M, et al. Identification and purification of natural killer cell stimulatory factor (NKSF), a cytokine with multiple biologic effects on human lymphocytes. *J Exp Med.* 1989;170:827-845.
- Stern AS, Podlaski FJ, Hulmes JD, et al. Purification to homogeneity and partial characterization of cytotoxic lymphocyte maturation factor from human B-lymphoblastoid cells. *Proc Natl Acad Sci U S A.* 1990;87:6808-6812.
- Fehniger TA, Shah MH, Turner MJ, et al. Differential cytokine and chemokine gene expression by human NK cells following activation with IL-18 or IL-15 in combination with IL-12: implications for the innate immune response. *J Immunol.* 1999;162:4511-4520.
- Walzer T, Dalod M, Robbins SH, Zitvogel L, Vivier E. Natural-killer cells and dendritic cells: "l'union fait la force." *Blood.* 2005;106:2252-2258.
- Orange JS, Biron CA. An absolute and restricted requirement for IL-12 in natural killer cell IFN- γ production and antiviral defense. *J Immunol.* 1997;156:1138-1142.
- Altare F, Lammass D, Revy P, et al. Inherited interleukin 12 deficiency in a child with bacille Calmette-Guerin and Salmonella enteritidis disseminated infection. *J Clin Invest.* 1998;102:2035-2040.
- Ferlazzo G, Pack M, Thomas D, et al. Distinct roles of IL-12 and IL-15 in human natural killer cell activation by dendritic cells from secondary lymphoid organs. *Proc Natl Acad Sci U S A.* 2004;101:16606-16611.
- Gerosa F, Gobbi A, Zorzi P, et al. The reciprocal interaction of NK cells with plasmacytoid or myeloid dendritic cells profoundly affects innate resistance functions. *J Immunol.* 2005;174:727-734.
- Trinchieri G, Pflanz S, Kastelein RA. The IL-12 family of heterodimeric cytokines: new players in the regulation of T cell responses. *Immunity.* 2003;19:641-644.
- Trinchieri G. Interleukin-12 and the regulation of innate resistance and adaptive immunity. *Nat Rev Immunol.* 2003;3:133-146.
- Fieschi C, Casanova JL. The role of interleukin-12 in human infectious diseases: only a faint signature. *Eur J Immunol.* 2003;33:1461-1464.
- Fieschi C, Dupuis S, Catherinot E, et al. Low penetrance, broad resistance, and favorable outcome of interleukin 12 receptor beta1 deficiency: medical and immunological implications. *J Exp Med.* 2003;197:527-535.
- Quintana-Murci L, Alcais A, Abel L, Casanova JL. Immunology in natura: clinical, epidemiological and evolutionary genetics of infectious diseases. *Nat Immunol.* 2007;8:1165-1171.
- Casanova JL, Abel L. Primary immunodeficiencies: a field in its infancy. *Science.* 2007;317:617-619.
- Casanova JL, Abel L. Genetic dissection of immunity to mycobacteria: the human model. *Annu Rev Immunol.* 2002;20:581-620.
- Picard C, Fieschi C, Altare F, et al. Inherited interleukin-12 deficiency: IL12B genotype and clinical phenotype of 13 patients from six kindreds. *Am J Hum Genet.* 2002;70:336-348.
- Feinberg J, Fieschi C, Doffinger R, et al. Bacillus Calmette Guerin triggers the IL-12/IFN-gamma axis by an IRAK-4- and NEMO-dependent, noncognate interaction between monocytes, NK, and T lymphocytes. *Eur J Immunol.* 2004;34:3276-3284.
- Ferlazzo G, Munz C. NK cell compartments and their activation by dendritic cells. *J Immunol.* 2004;172:1333-1339.
- Cooper MA, Fehniger TA, Caligiuri MA. The biology of human natural killer-cell subsets. *Trends Immunol.* 2001;22:633-640.
- Vivier E, Anfossi N. Inhibitory NK-cell receptors on T cells: witness of the past, actors of the future. *Nat Rev Immunol.* 2004;4:190-198.
- Ohkawa T, Seki S, Dobashi H, et al. Systematic characterization of human CD8⁺ T cells with natural killer cell markers in comparison with natural killer cells and normal CD8⁺ T cells. *Immunology.* 2001;103:281-290.
- Pittet MJ, Speiser DE, Valmori D, Cerottini JC, Romero P. Cutting edge: cytolytic effector function in human circulating CD8⁺ T cells closely correlates with CD56 surface expression. *J Immunol.* 2000;164:1148-1152.
- Stewart CA, Walzer T, Robbins SH, Malissen B, Vivier E, Prinz I. Germ-line and rearranged Tcrd transcription distinguish bona fide NK cells and NK-like gammadelta T cells. *Eur J Immunol.* 2007;37:1442-1452.
- Lutz CT, Moore MB, Bradley S, Shelton BJ, Lutgendorf SK. Reciprocal age related change in natural killer cell receptors for MHC class I. *Mech Ageing Dev.* 2005;126:722-731.
- Gately MK, Renzetti LM, Magram J, et al. The interleukin-12/interleukin-12-receptor system: role in normal and pathologic immune responses. *Annu Rev Immunol.* 1998;16:495-521.
- de Jong R, Altare F, Haagen IA, et al. Severe mycobacterial and Salmonella infections in interleukin-12 receptor-deficient patients. *Science.* 1998;280:1435-1438.
- Loza MJ, Perussia B. The IL-12 signature: NK cell terminal CD56⁺ high stage and effector functions. *J Immunol.* 2004;172:88-96.
- Feng CG, Kaviratne M, Rothfuchs AG, et al. NK cell-derived IFN- γ differentially regulates innate resistance and neutrophil response in T cell-deficient hosts infected with *Mycobacterium tuberculosis*. *J Immunol.* 2006;177:7086-7093.
- Magram J, Connaughton SE, Warrior RR, et al. IL-12-deficient mice are defective in IFN gamma production and type 1 cytokine responses. *Immunity.* 1996;4:471-481.
- Wu C, Ferrante J, Gately MK, Magram J. Characterization of IL-12 receptor beta1 chain (IL-12Rbeta1)-deficient mice: IL-12Rbeta1 is an essential component of the functional mouse IL-12 receptor. *J Immunol.* 1997;159:1658-1665.
- Takeda K, Tsutsui H, Yoshimoto T, et al. Defective NK cell activity and Th1 response in IL-18-deficient mice. *Immunity.* 1998;8:383-390.
- Wu C, Wang X, Gadina M, O'Shea JJ, Presky DH, Magram J. IL-12 receptor β 2 (IL-12R β 2)-deficient mice are defective in IL-12-mediated signaling despite the presence of high affinity IL-12 binding sites. *J Immunol.* 2000;165:6221-6228.
- Grufman P, Karre K. Innate and adaptive immunity to tumors: IL-12 is required for optimal responses. *Eur J Immunol.* 2000;30:1088-1093.
- Anfossi N, Pascal V, Vivier E, Ugolini S. Biology of T memory type 1 cells. *Immunol Rev.* 2001;181:269-278.
- Treiner E, Lantz O. CD1d- and MR1-restricted invariant T cells: of mice and men. *Curr Opin Immunol.* 2006;18:519-526.
- Bendelac A, Savage PB, Teyton L. The biology of NKT cells. *Annu Rev Immunol.* 2007;25:297-336.
- Zoll B, Lefterova P, Ebert O, Huhn D, Von Ruecker A, Schmidt-Wolf IG. Modulation of cell surface markers on NK-like T lymphocytes by using IL-2, IL-7 or IL-12 in vitro stimulation. *Cytokine.* 2000;12:1385-1390.
- Lopez RD, Waller EK, Lu PH, Negrin RS. CD58/LFA-3 and IL-12 provided by activated monocytes are critical in the in vitro expansion of CD56⁺ T cells. *Cancer Immunol Immunother.* 2001;49:629-640.
- Lin SJ, Chao HC, Yan DC. Phenotypic changes of T-lymphocyte subsets induced by interleukin-12 and interleukin-15 in umbilical cord vs. adult peripheral blood mononuclear cells. *Pediatr Allergy Immunol.* 2001;12:21-26.
- Kelly AM, Golden-Mason L, McEntee G, et al. Interleukin 12 (IL-12) is increased in tumour bearing human liver and expands CD8⁺ and CD56⁺ T cells in vitro but not in vivo. *Cytokine.* 2004;25:273-282.
- Guia S, Vivier E, André P. Phenotypic characterization of C56dim/CD56bright NK-cell subsets and IL-2-dependent human NK-cell lines. In: Mason D, ed. 7th HLDA. New York, NY: Oxford University Press; 2001:428-430.
- Chang J, Cho JH, Lee SW, Choi SY, Ha SJ, Sung YC. IL-12 priming during in vitro antigenic stimulation changes properties of CD8 T cells and increases generation of effector and memory cells. *J Immunol.* 2004;172:2818-2826.
- Lee JB, Lee KA, Chang J. Phenotypic changes induced by IL-12 priming regulate effector and memory CD8 T cell differentiation. *Int Immunol.* 2007;19:1039-1048.
- Gollob JA, Schnipper CP, Orsini E, et al. Characterization of a novel subset of CD8⁺ T cells that expands in patients receiving interleukin-12. *J Clin Invest.* 1998;102:561-575.

60. Thulesen S, Nissen MH, Odum N, Ropke C. Induction of cytotoxic CD8+CD56+ T cells from human thymocytes by interleukin-15. *J Interferon Cytokine Res.* 2001;21:905-911.
61. Jin Y, Fuller L, Carreno M, Esquenazi V, Tzakis AG, Miller J. The regulation of phenotype and function of human liver CD3+/CD56+ lymphocytes, and cells that also co-express CD8 by IL-2, IL-12 and anti-CD3 monoclonal antibody. *Hum Immunol.* 1998;59:352-362.
62. Satoh M, Seki S, Hashimoto W, et al. Cytotoxic gammadelta or alphabeta T cells with a natural killer cell marker, CD56, induced from human peripheral blood lymphocytes by a combination of IL-12 and IL-2. *J Immunol.* 1996;157:3886-3892.
63. Meresse B, Curran SA, Ciszewski C, et al. Reprogramming of CTLs into natural killer-like cells in celiac disease. *J Exp Med.* 2006;203:1343-1355.
64. Casado JG, Soto R, DelaRosa O, et al. CD8 T cells expressing NK associated receptors are increased in melanoma patients and display an effector phenotype. *Cancer Immunol Immunother.* 2005;54:1162-1171.
65. Kawarabayashi N, Seki S, Hatsuse K, et al. Decrease of CD56(+)T cells and natural killer cells in cirrhotic livers with hepatitis C may be involved in their susceptibility to hepatocellular carcinoma. *Hepatology.* 2000;32:962-969.
66. Tay CH, Welsh RM, Brutkiewicz RR. NK cell response to viral infections in beta 2-microglobulin-deficient mice. *J Immunol.* 1995;154:780-789.
67. Junqueira-Kipnis AP, Kipnis A, Jamieson A, et al. NK cells respond to pulmonary infection with *Mycobacterium tuberculosis*, but play a minimal role in protection. *J Immunol.* 2003;171:6039-6045.
68. Harrington L, Srikanth CV, Antony R, Shi HN, Cherayil BJ. A role for natural killer cells in intestinal inflammation caused by infection with *Salmonella enterica* serovar Typhimurium. *FEMS Immunol Med Microbiol.* 2007;51:372-380.
69. Eidenschenk C, Dunne J, Jouanguy E, et al. A novel primary immunodeficiency with specific natural-killer cell deficiency maps to the centromeric region of chromosome 8. *Am J Hum Genet.* 2006;78:721-727.
70. Orange JS. Human natural killer cell deficiencies. *Curr Opin Allergy Clin Immunol.* 2006;6:399-409.
71. Jason J, Buchanan I, Archibald LK, et al. Natural T, gammadelta, and NK cells in mycobacterial, *Salmonella*, and human immunodeficiency virus infections. *J Infect Dis.* 2000;182:474-481.
72. Barcelos W, Martins-Filho OA, Guimaraes TM, et al. Peripheral blood mononuclear cells immunophenotyping in pulmonary tuberculosis patients before and after treatment. *Microbiol Immunol.* 2006;50:597-605.
73. Berg RE, Forman J. The role of CD8 T cells in innate immunity and in antigen non-specific protection. *Curr Opin Immunol.* 2006;18:338-343.
74. Veenstra H, Baumann R, Carroll NM, et al. Changes in leucocyte and lymphocyte subsets during tuberculosis treatment; prominence of CD3dimCD56+ natural killer T cells in fast treatment responders. *Clin Exp Immunol.* 2006;145:252-260.

Article 4

Mycobacterial disease in a child with surface-expressed non-functional interleukin-12 Receptor beta 1 chains

Scheuerman, O., **L. de Beaucoudrey**, V. Hoffer, J. Feinberg, J.L. Casanova, and B.Z. Garty

The Israel Medical Association Journal
2007, 9:560-561

Mycobacterial Disease in a Child with Surface-Expressed Non-functional Interleukin-12R β 1 Chains

Oded Scheuerman MD¹, Ludovic de Beaucoudrey MD², Vered Hoffer MD¹, Jacqueline Feinberg MD², Jean-Laurent Casanova MD² and Ben Zion Garty MD¹

¹Department of Pediatrics B and Kipper Institute of Allergy and Immunology, Schneider Children's Medical Center of Israel, Petah Tikva, and Sackler Faculty of Medicine, Tel Aviv University, Ramat Aviv, Israel

²Laboratory of Human Genetics of Infectious Diseases, University of Paris René Descartes - INSERM U550, Necker Medical School, and Pediatric Immunology-Hematology Unit, Necker Enfants Malades Hospital, Paris, France

Key words: atypical mycobacteria, interleukin-12, interferon gamma, salmonella, deficiency

IMAJ 2007;9:560-561

Defects in the interleukin-12/interferon-gamma axis may cause selective susceptibility to intracellular pathogens such as atypical mycobacteria, bacillus Calmette-Guérin and salmonella [1]. Contrary to most other immunodeficient patients, these patients are usually not susceptible to other pathogens.

We describe a child in whom recurrent salmonella infection and chronic mycobacterial cervical lymphadenitis was found to be due to a defect in IL-12R β 1.

Patient Description

A 6 year old boy was admitted because of massive cervical lymphadenopathy of 2 months duration. Past medical history included two episodes of aspiration-confirmed *Salmonella typhimurium* cervical lymphadenitis before age 2, and one event of *Salmonella typhimurium* bacteremia. His parents are first-degree cousins of Arab descent, and he has two healthy sisters. Pregnancy and delivery were normal.

Physical examination revealed bilateral massive cervical lymphadenopathy with firm, non-tender lymph nodes of 5–6 cm diameter. Enlarged lymph nodes were also palpated in the axillae and groin. Abdominal examination yielded hepatosplenomegaly and several large firm masses in the right lower quadrant.

Laboratory findings were remarkable for high levels of C-reactive protein and erythrocyte sedimentation rate, numerous atypical lymphocytes without blasts on blood smear, and positive rheumatoid factor. Serology for Epstein-Barr virus,

cytomegalovirus, human immunodeficiency virus and toxoplasma were negative. Cervical and abdominal ultrasonography demonstrated large lymphadenopathy without liquefaction.

Fine-needle biopsy from the cervical nodes showed granuloma formation, and culture yielded *Mycobacterium avium*. Immunological workup revealed IgG 2910 mg/dl, IgM 470 mg/dl and IgA 220 mg/dl. Complement, B lymphocytes, T lymphocytes, number of natural killer cells, lymphocyte stimulation tests, NK cell function tests and neutrophil function tests were normal. However, on the basis of the clinical findings, a defect in the IL-12/IFN γ axis was suspected.

Incubation of the patient's lymphocytes with bacillus Calmette-Guérin did not yield the expected INF γ production, nor did the addition of IL-12. Genetic analysis revealed a large defect in the cDNA of the IL-12R β 1 gene (caused by a deletion of exons 8 to 13 on chromosome 1), establishing the diagnosis.

Following treatment with clarithromycin and rifampicin or rifabutin and IFN γ (50–100 μ g/day) for 1 year, the abdominal masses disappeared but the cervical lymph nodes remained enlarged; repeated aspiration from the cervical lymph nodes again yielded *Mycobacterium avium* complex. Based on the *in vitro* susceptibility tests, treatment was changed to clarithromycin, rifabutin, and cycloserin, and IFN γ 150 μ g/day.

One year later, apparently as a conse-

quence of discontinuation of treatment, the patient presented with weight loss, hepatomegaly, enormous spleen and left pleural effusion. Blood, bone marrow, and pleural fluid cultures yielded multiresistant *Mycobacterium avium* complex. The patient was treated with five anti-mycobacterial medications, corticosteroids and a high dose of IFN γ (200 mg/day), and was fed by nasogastric tube. Splenectomy was performed for the non-functional spleen and histology revealed numerous acid-fast bacilli in multiple granulomata and abscesses. The patient's clinical condition improved and he was discharged home on the same medications.

Comment

In the normal mechanism of defense against intracellular mycobacteria [Figure], IL-12 released from infected macrophages activates specific receptors on natural killer cells/T lymphocytes. In response, these cells secrete IFN γ which interacts with its specific receptors on the macrophages, starting a metabolic cascade of enhanced killing of the intracellular pathogen and further activation of the macrophages and T cells [2]. Five disease-causing autosomal genes of this axis have been identified, accounting for at least 12 disorders that result in impaired IFN γ -mediated immunity.

IL-12R β 1 deficiency, first described in 1996 [3,4], is the most frequent genetic defect of Mendelian susceptibility to mycobacterial disease. Inheritance is usually autosomal recessive [2]. Clinical features range from chronic lymphadenopathy to disseminated disease, and death. Over 80 patients have been reported worldwide

IL = interleukin

NK = natural killer
IFN = interferon

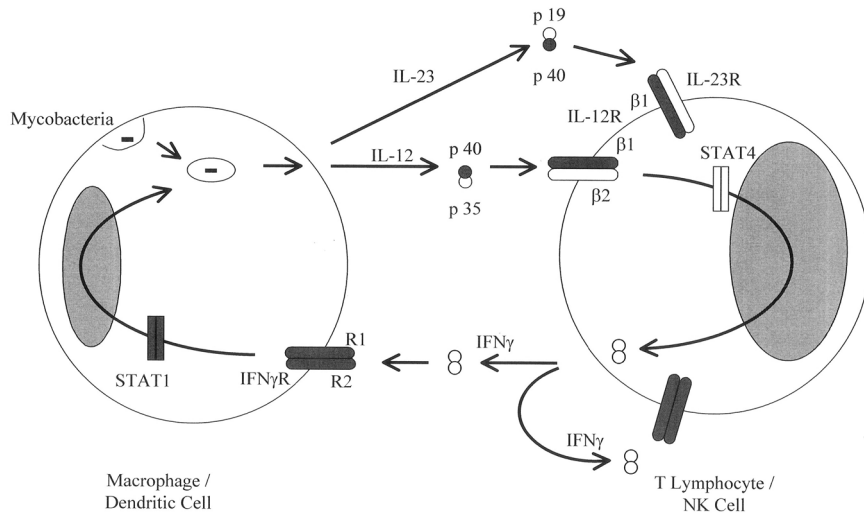

IL-12 and $\text{INF}\gamma$ axis in mycobacteria immunity: Infected macrophages release IL-12 which binds to a high affinity receptor on natural killer cells (NK) or T helper cells (TH1), or cytotoxic T cells. The receptor has two subunits ($\beta 1 + \beta 2$). The activation of the receptor results in secretion of $\text{INF}\gamma$ that adheres to a receptor on the macrophage, which also consists of two subunits. This binding to the $\text{INF}\gamma$ receptor induces intracellular events via $\text{INF}\gamma$ -responsive signal transducers and activators. Defects in any of the five genes: namely, IL-12 heterodimer (IL-12p40), IL-12-receptor (IL-12R $\beta 1$), $\text{INF}\gamma$ receptor (IFN γ R1 and IFN γ R2), or STAT-1 can cause susceptibility to intracellular pathogens, especially mycobacteria.

(our unpublished data). In most cases, the IL-12R $\beta 1$ is not found on the cell surface, because of a premature stop codon or misfolding and intracellular retention of the mutant proteins [2]. Our patient exhibited a mutation similar to that in another Israeli patient reported by Fieschi et al. [5], also of Arab/Bedouin descent. Both had a large deletion (12165 nucleotides), encompassing exons 8 to 13 of the IL-12R $\beta 1$ gene which encode the proximal NH2-terminal half of the extracellular domain that led to the surface

expression of the internally truncated receptor and its consequent inability to bind IL-12 or IL-23. Although, to the best of our knowledge, the families of these two patients were not directly related, the same mutation in the two Arab kindreds in Israel may reflect a founder effect.

In conclusion, $\text{INF}\gamma$ axis defects should be suspected in the clinical setting of chronic BCG or atypical mycobacterial infection or recurrent salmonella infection.

BCG = bacillus Calmette-Guérin

The present report indicates that IL-12R $\beta 1$ deficiency due to the surface-expression of non-functional receptors is not limited to a single family. Our evaluation also highlighted the importance of broad cellular assays and in-depth molecular investigations in certain unusual infections. The accurate diagnosis of genetic defects of the IL-12/ $\text{INF}\gamma$ axis may have therapeutic implications as exemplified by the addition of $\text{INF}\gamma$ treatment to the anti-mycobacterial agents in our patient.

References

1. Casanova JL, Abel L. Genetic dissection of immunity to mycobacteria: the human model. *Ann Rev Immunol* 2002;20:581–620.
2. Filipe-Santos O, Bustamante J, Chagrier A, et al. Inborn errors of IL-12/23- and $\text{INF}\gamma$ -mediated immunity: molecular, cellular, and clinical features. *Semin Immunol* 2006;18:347–61.
3. Newport NJ, Huxley CM, Huston S, et al. A mutation in the interferon- γ -receptor gene and susceptibility to mycobacterial infection. *N Engl J Med* 1996;335:1941–9.
4. Jouanguy E, Altare F, Lamhamedi S, et al. Interferon-gamma-receptor deficiency in an infant with fatal bacille Calmette-Guérin infection. *N Engl J Med* 1996;335:1956–61.
5. Fieschi C, Bosticardo M, de Beaucoudrey L, et al. A novel form of complete IL-12/IL-23 receptor $\beta 1$ deficiency with cell surface-expressed nonfunctional receptors. *Blood* 2004;104:2095–101. Epub 2004 Jun 3.

Correspondence: Dr. B.Z. Garty, Dept. of Pediatrics B, Schneider Children's Medical Center of Israel, Petah Tikva 49202, Israel. Phone: (972-3) 925-3681, Fax: (972-3) 925-3257 email: gartyb@clalit.org.il

Article 5

Inborn errors of IL-12/23- and IFN-gamma-mediated immunity: molecular, cellular, and clinical features

Filipe-Santos, O., J. Bustamante, A. Chagnier, G. Vogt, **L. de Beaucoudrey**, J. Feinberg, E. Jouanguy, S. Boisson-Dupuis, C. Fieschi, C. Picard, and J.L. Casanova

Seminars in Immunology
2006, 18:347-361

Review

Inborn errors of IL-12/23- and IFN- γ -mediated immunity: molecular, cellular, and clinical features

Orchidée Filipe-Santos^a, Jacinta Bustamante^a, Ariane Chapgier^a, Guillaume Vogt^a,
Ludovic de Beaucoudrey^a, Jacqueline Feinberg^a, Emmanuelle Jouanguy^a,
Stéphanie Boisson-Dupuis^a, Claire Fieschi^{a,b}, Capucine Picard^{a,c}, Jean-Laurent Casanova^{a,d,*}

^a Laboratory of Human Genetics of Infectious Diseases, University of Paris René Descartes-INSERM U 550,
Necker Medical School, 75015 Paris, France, EU

^b Laboratory of Immunology, Saint Louis Hospital, 75010 Paris, France, EU

^c Laboratory of Immunodeficiencies Study Center, Necker Hospital, 75015 Paris, France, EU

^d Pediatric Hematology-Immunology Unit, Necker Hospital, 75015 Paris, France, EU

Abstract

Mendelian susceptibility to mycobacterial diseases confers predisposition to clinical disease caused by weakly virulent mycobacterial species in otherwise healthy individuals. Since 1996, disease-causing mutations have been found in five autosomal genes (*IFNGR1*, *IFNGR2*, *STAT1*, *IL12B*, *IL12BR1*) and one X-linked gene (*NEMO*). These genes display a high degree of allelic heterogeneity, defining at least 13 disorders. Although genetically different, these conditions are immunologically related, as all result in impaired IL-12/23-IFN- γ -mediated immunity. These disorders were initially thought to be rare, but have now been diagnosed in over 220 patients from over 43 countries worldwide. We review here the molecular, cellular, and clinical features of patients with inborn errors of the IL-12/23-IFN- γ circuit.

© 2006 Elsevier Ltd. All rights reserved.

Keywords: *Mycobacterium*; Tuberculosis; Primary immunodeficiency; IFN- γ ; IL-12; IL-23

1. Introduction

Mendelian susceptibility to mycobacterial diseases (MSMD) (MIM 209950, [1]) is a rare congenital syndrome that was probably first described in 1951 in an otherwise healthy child with disseminated disease caused by bacillus Calmette-Guérin (BCG) vaccine [2]. It is defined by severe clinical disease, either disseminated or localized and recurrent, caused by weakly virulent mycobacterial species, such as BCG vaccines and non-tuberculous, environmental mycobacteria (EM), in otherwise healthy individuals [3–7]. Understandably, patients with MSMD are also susceptible to the more virulent species *Mycobacterium tuberculosis* [8–12]. Severe disease caused by non-typhoidal and, to a lesser extent, typhoidal *Salmonella* serotypes is also common—observed in nearly half the cases, including patients

who did not have any mycobacterial disease before the diagnosis of salmonellosis, or even at last follow-up [6,7,13]. The title “MSMD” is therefore misleading, and it may be more accurate to refer to the underlying genetic defects: inborn errors of the IL-12/23-IFN- γ circuit. Other infectious diseases have rarely been reported in these patients, and have mostly involved pathogens phylogenetically (e.g. *Nocardia*) or pathologically (e.g. *Paracoccidioidomycetes*) related to mycobacteria, suggesting that these infections were not coincidental. However, most of these infections occurred in single patients, making it impossible to draw definitive conclusions as to whether these infections truly reflect syndromal predisposition [14–19]. As always in human genetics, there is a need to explore both the disease-causing genotypes of patients with MSMD and the clinical phenotype of patients with known disorders of the IL-12-IFN- γ circuit.

The first genetic etiology of MSMD was described in 1996, with null recessive mutations in *IFNGR1*, encoding the IFN- γ receptor ligand-binding chain, in two kindreds [20,21]. Ten years later, distinct types of disease-causing mutations were reported in *IFNGR1* [8,20–23] and four other autosomal genes: *IFNGR2*, encoding the accessory chain of the IFN- γ receptor

Abbreviations: MSMD, Mendelian susceptibility to mycobacterial diseases; BCG, bacillus Calmette-Guérin; EM, environmental mycobacteria; IFN, interferon; IL, interleukin; Stat, signal transducer and activator of transcription; NEMO, NF- κ B essential modulator

* Corresponding author. Tel.: +33 1 40 61 56 87; fax: +33 1 40 61 56 88.

E-mail address: casanova@necker.fr (J.-L. Casanova).

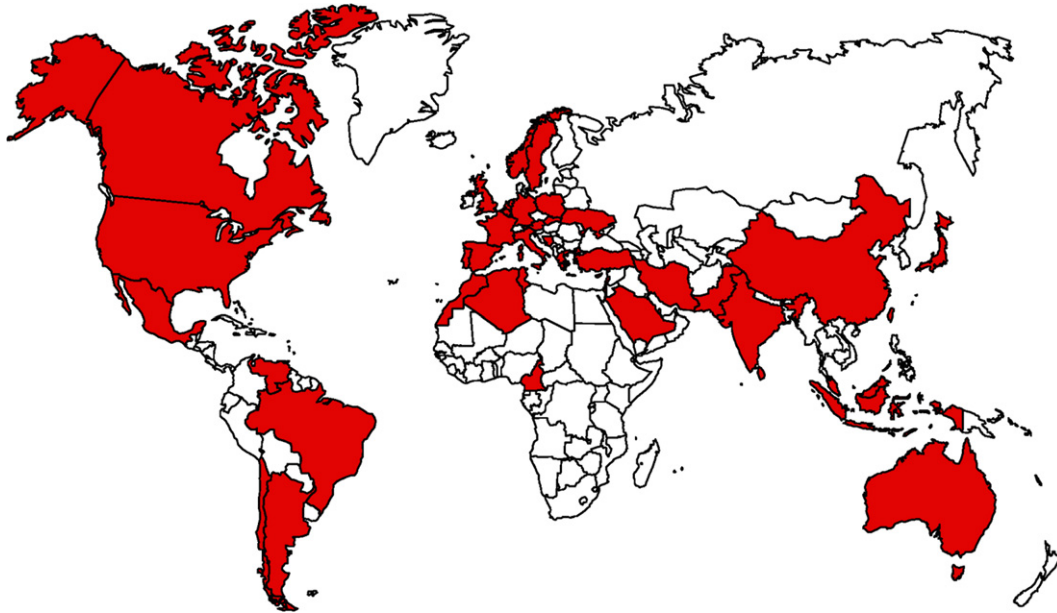

Fig. 1. Geographical origin of the kindreds with genetics defects of the IL-12/23-IFN- γ circuit. The 220 published and unpublished patients referred to in this review originate from 43 countries on five different continents: Africa (Algeria, Cameroon, Morocco, Tunisia); America (Argentina, Brazil, Canada, Chile, Mexico, United States, Venezuela); Asia (China, India, Indonesia, Iran, Israel, Japan, Lebanon, Malaysia, Pakistan, Qatar, Saudi Arabia, Sri Lanka, Taiwan, Turkey); Europe (Belgium, Bosnia, Cyprus, France, Germany, Greece, Italy, Malta, The Netherlands, Norway, Portugal, Poland, Slovakia, Spain, Sweden, United Kingdom, Ukraine); Oceania (Australia).

[24–27]; *IL12B*, encoding the p40 subunit shared by IL-12 and IL-23 [28]; *IL12RB1*, encoding the β 1 chain shared by the receptors for IL-12 and IL-23 [29–31], and *STAT1*, encoding the signal transducer and activator of transcription 1 (Stat-1) [32,33]. Specific mutations in an X-linked gene – *NEMO*, encoding the NF- κ B essential modulator (NEMO) – were also recently found [34]. The six gene products are physiologically related, as all are involved in IL-12/23-IFN- γ -dependent immunity. Defects in *IFNGR1*, *IFNGR2*, and *STAT1* are associated with impaired cellular responses to IFN- γ , whereas defects in *IL12B*, *IL12RB1* and *NEMO* are associated with impaired IL-12/IL-23-dependent IFN- γ production. Causal mutations have been found in 220 patients and 140 kindreds from 43 countries (Fig. 1). IL-12R β 1 deficiency is the most common genetic etiology of MSMD, being responsible for ~40% of cases, closely followed by IFN- γ R1 deficiency (~39%) (Fig. 2). IL-12p40 deficiency was identified in only ~9% of the patients, Stat-1 deficiency in 5%, IFN- γ R2 deficiency in 4%, and NEMO deficiency in only 3% of the cases (Fig. 2).

However, these six deficiencies are not the most clinically relevant genetic diagnoses, as there is considerable allelic heterogeneity (Figs. 3 and 4), probably greater than that for all other known primary immunodeficiencies, owing to the occurrence of MSMD-causing genes with dominant and recessive alleles (*IFNGR1*) [21,22], hypomorphic and null alleles (*IFNGR1*, *IFNGR2*) [8,24,27], null alleles with or without protein production (*IFNGR1*, *IFNGR2*, *IL12RB1*) [23,26,29–31], and alleles that affect different functional domains of the same protein (*STAT1*) [32,33]. In total, the various alleles of the six genes define 13 different genetic disorders associated with MSMD (Table 1). Additional novel types of MSMD-causing alleles may

exist for these six genes, as a null allele of *IFNGR2* was shown to be dominant *in vitro* [25], and a recessive allele of *IL12RB1* has been reported to be hypomorphic [35]. The study of MSMD and its genetic etiologies has even led to the description of a related clinical syndrome of vulnerability to mycobacterial and viral diseases, caused by null recessive alleles in *STAT1* resulting in impaired cellular responses to both IFN- γ and IFN- α/β [36,37]. Similarly, MSMD-causing mutations in *NEMO* were

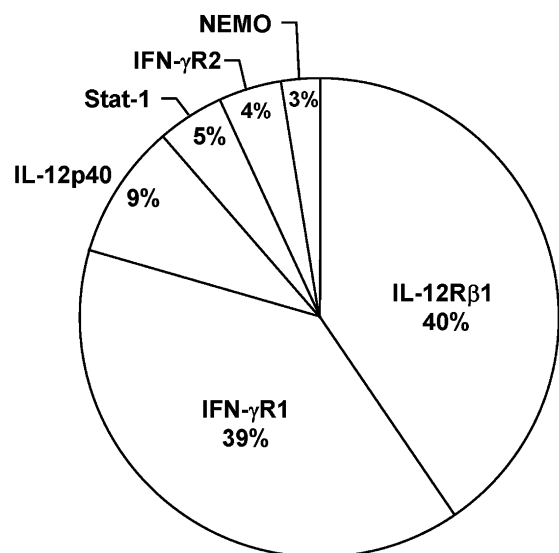

Fig. 2. Known inherited disorders of the IL-12/23-IFN- γ circuit. The genetic defects of 220 published (150) and unpublished (70) patients with MSMD. The percentage of defects in the corresponding autosomal (*IFNGR1*, *IFNGR2*, *STAT1*, *IL12B*, *IL12RB1*) and X-linked (*NEMO*) genes is indicated.

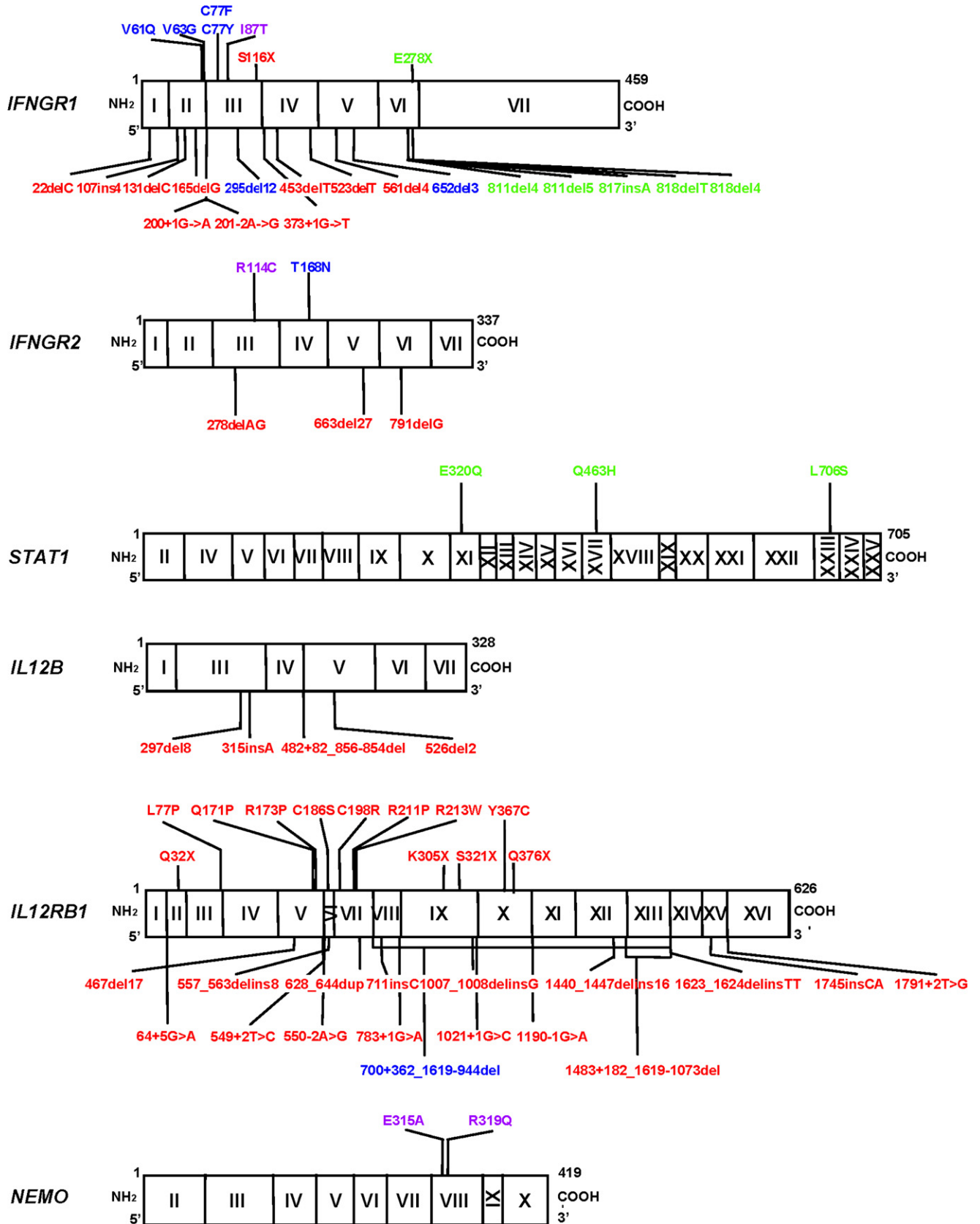

Fig. 3. Published mutations in *IFNGR1*, *IFNGR2*, *STAT1*, *IL12B*, *IL12RB1* and *NEMO*. Exons and the corresponding coding regions are represented for each gene. Exons are designated by roman numerals. Blue: recessive loss-of-function mutations associated with complete defects and surface expression of a non-functional molecule. Red: recessive loss-of-function mutations associated with a lack of expression of the protein on the cell surface. Green: dominant mutations causing partial deficiency. Purple: recessive mutations causing partial deficiency.

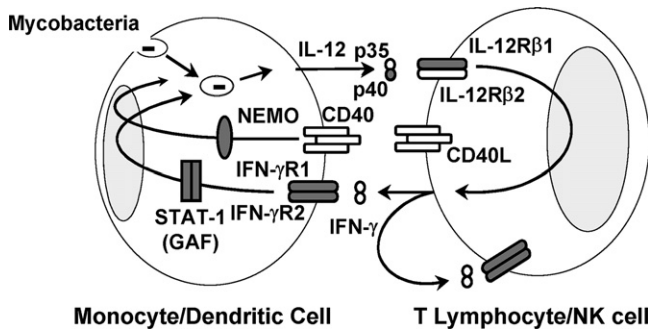

Fig. 4. MSMD-causing gene products in the IL-12/23-IFN- γ circuit. Schematic representation of cytokine production and cooperation between monocytes/dendritic cells and NK/T cells. The IL-12/23-IFN- γ loop and the CD40L-activated CD40 pathway corresponding to cooperation between T cells and monocyte/dendritic cells are crucial for protective immunity to mycobacterial infection in humans. IL-12 production is under the control of both IFN- γ and CD40-NEMO signaling. Mutant molecules in patients with MSMD are indicated in gray. Allelic heterogeneity of the five autosomal disease-causing genes results in the definition of twelve genetic disorders and specific alleles of NEMO leucine zipper (LZ) domain cause the X-linked form of MSMD, as they impair the CD40-dependent induction of IL-12. IL-23 and its receptor are not represented but may be involved in protective immunity against mycobacteria and/or salmonella.

Table 1
Genetic etiology of MSMD*

Gene	Inheritance	Defect	Protein	References
IFN- γ R1	AR	C	E+	[23]
	AR	C	E-	[20,21]
	AD	P	E+	[22]
	AR	P	E+	[8]
IFN- γ R2	AR	C	E+	[26]
	AR	C	E-	[24]
	AR	P	E+	[27]
Stat-1	AD	P	E+P-	[32]
	AD	P	E+B-	[33]
IL-12B	AR	C	E-	[15,28]
IL-12R β 1	AR	C	E+	[31]
	AR	C	E-	[29,30,99]
NEMO	XR	P	E+	[34]

* The 13 known genetic etiologies of MSMD. Modes of inheritance are either autosomal dominant (AD), autosomal recessive (AR) or X-linked recessive (XR). The functional defects are either complete (C) or partial (P). The mutant proteins are either expressed (E+) or not (E-), being not phosphorylated (P-) or not binding DNA (B-) upon IFNs stimulation.

identified only after other *NEMO* mutations had been reported to cause anhidrotic ectodermal dysplasia with immunodeficiency (EDA-ID) [38–40]. Many reviews have focused specifically on MSMD and disorders of the IL-12/23-IFN- γ circuit (Fig. 4) [6,7,13,41–58]. Ten years after identification of the first genetic etiology of MSMD, we review here the molecular, cellular, and clinical features of inborn errors of the IL-12/23-IFN- γ circuit.

2. IFN- γ R1 deficiency

IFN- γ is a pleiotropic cytokine produced principally by natural killer (NK) cells and T lymphocytes [59]. Its heterodimeric

surface receptor is ubiquitously expressed and consists of a ligand-binding chain (IFN- γ R1) and an associated chain (IFN- γ R2) [60,61]. Homodimeric IFN- γ recruits two IFN- γ R1 and two IFN- γ R2 chains, and formation of the resulting tetramer activates two constitutively associated kinases, Jak1 and Jak2, which phosphorylate IFN- γ R1, allowing the docking of Stat-1 molecules, their phosphorylation and release into the cytosol, where they form phosphorylated homodimers. These phosphorylated homodimers are translocated to the nucleus, where they drive the transcription of multiple target genes [60]. In the mouse model, IFN- γ is critical for host defenses against various infectious agents, including mycobacteria [62]. This observation, despite the broad susceptibility of mutant mice, was critical for the definition of *IFNGR1* as a candidate gene in the search for the first etiology of MSMD by linkage studies [20,21]. The *IFNGR1* gene contains seven exons (Fig. 3) encoding an extracellular IFN- γ -binding domain, a transmembrane domain and the cytoplasmic domain required for signal transduction and receptor recycling [59,61].

Inherited IFN- γ R1 deficiency was the first genetic etiology of MSMD to be identified, in 1996 [20,21]. In the last 10 years, 30 different *IFNGR1* mutations have been identified in 86 patients from 62 kindreds and 28 countries world-wide (unpublished data). Twenty-four of these mutations have been published (Fig. 3) and fall into four distinct categories defining different allelic disorders: two forms of autosomal recessive complete IFN- γ R1 deficiency, with ($n=6$, blue mutations in Fig. 3) or without ($n=11$, red mutations in Fig. 3) cell surface expression of the receptor, and two forms of partial IFN- γ R1 deficiency, which may be recessive ($n=1$, purple mutation in Fig. 3) or dominant ($n=6$, green mutations in Fig. 3). Recessive complete (RC) IFN- γ R1 deficiency was the first identified form of IFN- γ R1 deficiency [20,21]. Other kindreds have since been reported, bringing the total number of known patients to 27, in 23 kindreds from 16 countries [23,63–72]. Twenty-one causal mutations have been identified, and 17 were published including the 523delT recurrent mutation (Fig. 3). Most ($n=22$) patients are homozygous, but a few are compound heterozygous ($n=5$). Most mutations are nonsense or frameshift mutations, precluding IFN- γ R1 expression on the cell surface due to the presence of a premature termination codon before the segment encoding the transmembrane domain (Fig. 3, red mutations) [20,21,63–67,69,70]. Only six mutant alleles – all including missense mutations or in-frame deletions – encode cell surface-expressed (Fig. 3, blue mutations), dysfunctional molecules that do not recognize their natural ligand IFN- γ , despite being recognized by certain specific antibodies [23,68]. The cells of all the affected children fail to respond to IFN- γ *in vitro*, in terms of Stat-1 DNA-binding activity in EBV-transformed B cells [41,44] 10 to 30 minutes after IFN- γ stimulation, or in terms of HLA-II induction in fibroblasts [44] and the upregulation of TNF- α and IL-12 in blood cells [65,73] 24 to 74 hours after stimulation.

Complete IFN- γ R1 deficiency is a very severe condition, with an early onset of infection and a poor prognosis. Children are mostly infected by BCG and environmental mycobacteria, notably rapidly growing mycobacteria [41]. Children with disseminated disease caused by such weakly virulent environmen-

tal mycobacteria as *M. fortuitum* [23,41], *M. chelonae* [3,20], *M. smegmatis* [63,64], *M. peregrinum* [70], and *M. scrofulaceum* [72] have been reported. Salmonellosis was documented in three patients [20,21,41]. The tissue lesions typically show poorly delineated, lepromatous-like, multibacillary granulomas [74]. A few other infections have been noted, including viral infections, caused by cytomegalovirus [16] and human herpes virus 8 [17]. However, these infections occurred in single patient, making it difficult to determine whether the genetic lesion was causal. The clinical penetrance of IFN- γ R1 deficiency is complete in childhood, and the mean age at onset of first infection is 3.1 years [41]. Most of the affected children died in childhood and only four of the 22 published patients reached the age of 12 years [41]. Antibiotic treatment does not give full and sustained clinical remission and IFN- γ has no effect in the absence of a functional receptor. Hematopoietic stem cell transplantation (HSCT) was carried out in nine patients, with 12 HSCT operations, using cells donated by members of the patients' families. Four of these patients died within eight months of transplantation and two survived despite autologous reconstitution [75–78]. However, HSCT was curative in three children [75–78]. The use of a non T-cell depleted transplant from an HLA-identical sibling and fully myeloablative conditioning regimen has been shown to provide better results [75,78]. There is a high rate of graft rejection, even for transplants from an HLA-identical relative, in contrast to what is observed for patients with other genetic diseases. This high rate of rejection may be related to the high levels of IFN- γ detected in the serum of these patients, possibly impairing the development of IFN- γ R1-expressing heterologous hematopoietic cells [79]. In any event, successful clinical complementation by HSCT in humans, indicates that IFN- γ R1 deficiency is primarily a hematopoietic condition.

The specific I87T mutation (Fig. 3, purple mutation) in *IFNGR1* is the only known mutation responsible for a recessive form of partial (RP) IFN- γ R1 deficiency [8,80]. The same homozygous mutation was documented in five patients from four families from Portugal, Poland, and Chile [8,80] (unpublished data). It is not known whether the recurrence reflects a founder effect or a hotspot. Cells from these patients show a residual response to IFN- γ , in terms of both Stat-1 DNA-binding (about 25–30% GAS-binding activity) and HLA-II induction [8,44], and in terms of blood cellular responses [8,73]. RP IFN- γ R1 deficiency is associated with BCG or EM disease, but is much less severe than complete IFN- γ R1 deficiency. All known patients with RP IFN- γ R1 deficiency were alive and well at last follow-up, at ages ranging from 2 to 20 years. Interestingly, RP-IFN- γ R1 deficiency was also the first genetic etiology of MSMD to be associated with clinical tuberculosis [8], providing preliminary evidence that defects in IFN- γ -mediated immunity may predispose patients to tuberculosis, as was subsequently shown unambiguously for *M. tuberculosis*-infected children with IL-12R β 1 deficiency [12]. Patients with RP-IFN- γ R1 deficiency should be treated with antibiotics and, if needed, with recombinant IFN- γ . Given the favourable prognosis, HSCT is not indicated.

Dominant partial (DP) IFN- γ R1 deficiency typically results from a truncation in the cytoplasmic domain, resulting in the

accumulation at the cell surface of dominant-negative, non-functional IFN- γ R1 proteins [22]. The mutant molecules accumulate on the cell surface due to deletion of the recycling motif, but cannot signal, because they lack Jak-1- and Stat-1-binding domains, preventing most IFN- γ R1 dimers from functioning, and resulting in weak, but not entirely absent cellular responses to IFN- γ [22,81,82]. Up to 54 patients have been identified to date, with 22 simplex and 13 multiplex kindreds (unpublished data). Several heterozygous *IFNGR1* mutations have been reported (Fig. 3, green mutations) [16,18,22,41,81–85]. The 818del4 mutation is by far the most common dominant *IFNGR1* mutation, found in 47 patients and 28 kindreds (of 54 patients and 35 kindreds with DP IFN- γ R1 deficiency). Interestingly, this deletion was the first hotspot for small deletions identified in the human genome [22]. Small deletion hotspots have since been reported in *IFNGR1* (561del4, [69]) and other genes [86–89]. The 811del4, 813del5, 817insA, 818delT, and E278X mutations in *IFNGR1* were each found in only one patient [16,22,41,82,83].

Clinically, DP-IFN- γ R1 deficiency is less severe than RC-IFN- γ R1 deficiency [41]. The mean age at onset of mycobacterial infection is 13.4 years (range: 1.5–57 years) [41]. Patients are susceptible to BCG and environmental mycobacteria, but rapidly growing bacteria are rarely involved. Salmonellosis has been documented in only 5% of DP-IFN- γ R1-deficient patients, in contrast to what was found for IL-12R β 1-deficient patients, despite a similar life expectancy (see below) [13,41]. Other infections, each documented in only one patient, include fungal infections with species such as *Histoplasma capsulatum* [18], and viral infection with varicella zoster virus (VZV) [16]. Intriguingly, these patients typically suffer from mycobacterial osteomyelitis. A diagnosis of mycobacterial osteomyelitis, whether unifocal or multifocal, should trigger to the search of DP-IFN- γ R1 deficiency [18,41,68,81]. The prognosis is fairly good, with only two deaths among 38 patients, occurring at the ages of 17 and 27 years [41]. Patients should be treated with antibiotics and, if necessary, with recombinant IFN- γ . The high rate of mycobacterial relapses and infections with unusual mycobacterial species raise the question as to whether preventive antibiotics and/or IFN- γ should be given, at least to selected patients with the most severe clinical disease. Despite the possible occurrence of multiple and recurrent mycobacterial diseases, HSCT is not indicated.

3. IFN- γ R2 deficiency

IFN- γ R2, like IFN- γ R1, belongs to the class II cytokine receptor family [60,61]. IFN- γ R2 binds strongly to IFN- γ R1 upon stimulation with IFN- γ . The organization of the IFN- γ R2 gene resembles that of the IFN- γ R1 gene, with seven exons (Fig. 3) encoding an extracellular domain that interacts with the IFN- γ -IFN- γ R1 complex (but not itself playing a major role in ligand binding), a transmembrane domain, and a cytoplasmic domain required for signal transduction [59,61]. IFN- γ R2 is constitutively expressed at low levels, but its expression is regulated in certain cell types, with expression levels being a critical factor in IFN- γ responsiveness. Both IFN- γ R1 and IFN- γ R2 are synthesized in the endoplasmic reticulum and modified

posttranslationally, by the addition of N-linked carbohydrates during passage from the endoplasmic reticulum to the Golgi apparatus [59–61].

IFN- γ R2 deficiency is one of the rarest genetic etiologies of MSMD: only nine children have been identified, including seven children from the six families reported to date [24–27]. The first patient was reported in 1998 [24]. This child and six other patients (including two siblings) had recessive complete (RC) IFN- γ R2 deficiency [24–26]. Two forms of RC IFN- γ R2 deficiency were documented. Three patients had no detectable expression of the protein on the cell surface, due to a premature termination codon or an in-frame deletion in the coding region (Fig. 3, red mutations) resulting in intracellular protein degradation [24,26] (unpublished data). In three patients from two families, IFN- γ R2 was found to be non functional, despite surface expression (Fig. 3, blue mutation) [26]. The causal missense mutation results in the addition of a novel, pathogenic carbohydrate, but the mechanism by which this polysaccharide impairs IFN- γ R signaling is unclear. In another family, one child presented with recessive partial (RP) IFN- γ R2 deficiency, due to a homozygous R114C (Fig. 3, purple) mutation, which impaired, but did not abolish cellular responses to IFN- γ [27]. A new *IFNGR2* mutation was recently identified in a child with RP IFN- γ R2 deficiency (unpublished data). Finally, in a kindred with RC-IFN- γ R2 deficiency, the 791delG mutation that was clinically pathogenic in homozygotes was found to exert a dominant-negative effect in heterozygous cells [25]. It is unclear whether the corresponding heterozygous individuals will develop clinical disease, and whether other mutations in *IFNGR2* are dominant.

The study of IFN- γ R2 deficiency has had unexpected genetic implications, beyond the field of MSMD and even that of primary immunodeficiencies. The T168N missense mutation in IFN- γ R2 creates a new N-glycosylation site (N-X-S/T-X), resulting in the synthesis of a new polysaccharide branched to the IFN- γ R2 chain (on Asn 168) [26]. The mutant protein expressed on the cell surface has a higher molecular weight than the wild-type protein. The additional N-glycosylation of the T168N IFN- γ R2 protein was demonstrated by digesting the N-linked carbohydrate with PNGase-F or blocking the assembly of the lipid-linked oligosaccharide precursor with tunicamycin [26]. The additional N-carbohydrate was found to be necessary and sufficient to account for the pathogenic effect of the mutation. Mutant IFN- γ R2-expressing cells were even functionally complemented with PNGase F or tunicamycin or other inhibitors of maturation of N-linked glycosylation [26] (unpublished data). This provided an example of chemical complementation *in vitro* of a germline mutation, paving the way to the exploration of pharmacological treatments for inherited disorders in humans [26]. This interesting finding was also extended to other missense mutations involved in a number of other human inherited disorders. Up to 1.4% of all missense mutations described in the Human Gene Mutation Database (HGMD) are potential gain-of-glycosylation mutants [26].

Complete IFN- γ R2 deficiency seems to be as severe as complete IFN- γ R1 deficiency, with an early onset of mycobacterial disease, poorly defined and multibacillary granulomas, and a

severe outcome (three deaths among the seven affected children) [24–26] (unpublished data). HSCT seems to be the only possible cure for these patients [24–26]. Given the small number of patients identified to date, it is too soon to determine whether there are subtle clinical differences between RC-IFN- γ R1 and RC-IFN- γ R2 patients, and whether their management should therefore be tailored to the individual genetic lesion. The only child with a partial recessive form of IFN- γ R2 reported had a modest clinical phenotype, similar to that of children with RP-IFN- γ R1 deficiency [27]. Overall, the level of IFN- γ responsiveness seems to be strongly correlated to clinical phenotype, in all disorders of the IFN- γ R1 and IFN- γ R2 chains [44]. IFN- γ -mediated immunity seems to be an almost continuous trait, determining the outcome of mycobacterial invasion in humans. Patients should be offered precise molecular genetic diagnosis, making it possible to tailor the treatment to the individual.

4. Stat-1 deficiency

Signal transducer and activator of transcription-1 (Stat-1) is critical for cellular responses to type I (IFN- α/β) and type II (IFN- γ) IFNs, and to the less well characterized type III IFNs (IFN- λ) [90]. IFN- γ stimulation induces the phosphorylation and homodimerization of Stat-1 (gamma activating factors, GAF), whereas IFN- α/β stimulation specifically leads to the formation of ISGF-3 heterotrimers, composed of Stat-1, Stat-2, and IRF-9 [90]. The activation of GAF homodimers and ISGF-3 heterotrimers results in the translocation of these molecules to the nucleus, where they act as IFN-responsive gene transcription factors, binding to discrete *cis*-acting regulatory sequences in DNA: gamma activating sequences (GAS) and interferon-stimulated response elements (ISRE), respectively [60,90]. The *STAT1* gene has 25 exons (Fig. 3) and encodes a protein with four domains found in other Stats, the Src homology 2 (SH2) domain, which plays an important role in the interaction with IFN- γ R1 and other Stats, the DNA-binding (DNA-B), tail segment (TS) and the transactivator (TA) domains [91].

Germline mutations in *STAT1* were found in 2001 in patients with MSMD [32]. Ten patients with such mutations have since been described in four kindreds from three countries (Fig. 3) [32,33]. The L706S Stat-1 mutation was the first mutation discovered, in two unrelated children with MSMD [32]. This mutation impairs the nuclear accumulation of GAF but not of ISGF-3 in heterozygous cells from the patients stimulated with IFN- γ and IFN- α/β , respectively [32]. The mutation is nonetheless loss-of-function for these two phenotypes, as Stat-1-deficient stably cells transfected with the L706S mutant allele show no activation of GAF or ISGF3, due to a loss of phosphorylation at Tyr 701 [33]. Mechanistically, the L706S molecule is not phosphorylated at Tyr 701, preventing GAF activation and accounting for the negative dominance observed in heterozygous cells. It also displays no affinity for phosphorylated Stat-2, as leucine 706 is crucial for dimerization. As a result, it cannot be recruited for the formation of Stat-1/Stat-2/p48 trimers, the IFN α/β -activated ISGF3 complexes, accounting for the normal formation of ISGF3 complexes and recessivity in heterozygous cells. The L706S allele is thus deleterious for two phenotypes,

but is dominant for one (GAF activation) and recessive for the other (ISGF-3 activation), accounting for the narrow clinical phenotype, in this pure MSMD without susceptibility to viruses [32,33].

Two other mutations, E320Q and Q463H, both located in the DNA-binding domain of Stat-1, were recently found in heterozygous patients from two unrelated kindreds from Germany [33]. These mutations define a novel form of partial Stat-1 deficiency, as Tyr 701 is normally phosphorylated but the nuclear-translocated Stat-1-containing complexes do not bind correctly to GAS-DNA regulatory elements. Like L706S, the E320Q and Q463H *STAT1* alleles are dominant for IFN γ -inducing GAF-mediated anti-mycobacterial immunity, but recessive for IFN α/β -induced ISGF3-mediated anti-viral immunity, accounting for the patients' clinical phenotype of MSMD without susceptibility to viral diseases [33]. As no more than half the IFN α/β -induced ISGF-3 complexes contain a mutant Stat-1, and there is no haplo-insufficiency for this phenotype, the three mutations are recessive in heterozygous cells [33]. The dominance of the three Stat-1 mutations is accounted for by the inability of three in every four homodimers to form (L706S) or to bind normally to IFN- γ -induced-GAS elements (E320Q and Q463H). The study of these three Stat-1 mutations thus led to the description of human germline mutations deleterious for two phenotypes but dominant for one and recessive for the other [33]. In any event, children with DP-Stat-1 deficiency have relatively mild clinical disease, resembling that of children with RP-IFN- γ R1 and RP-IFN- γ R2 deficiency, and should be treated accordingly.

Other mutations in *STAT1* have been implicated in a related syndrome of susceptibility to mycobacteria and viruses, due to impaired IFN- γ - and IFN α/β -mediated immunity, respectively [36,37a,37b][36,37]. Three homozygous mutations, all located in the region encoding the SH2-domain of Stat-1, are loss-of-expression and loss-of-function, and are consequently associated with recessive complete (RC) Stat-1 deficiency and a lack of formation of both GAF and ISGF-3 complexes. This condition overlaps with, but differs from, MSMD, as the children are exposed to life-threatening viral disease [32,33,36,37a,37b]. The first two children suffered from BCG-osis, like children with severe forms of MSMD, but died of viral diseases, such of herpes simplex encephalitis, unlike children with MSMD (even those with RC-IFN- γ R1 or RC-IFN- γ R2 deficiency). The diagnosis was made post mortem in two children, for whom only EBV-transformed B cells were available. Two cousins were also recently diagnosed with this condition post-mortem (unpublished data). Finally, a fifth patient, from a third kindred, was diagnosed before hematopoietic stem cell transplantation was attempted [37]. His blood cells were shown not to respond to IFN- γ and his fibroblasts did not respond to IFN- γ and IFN α/β . He died shortly after transplantation, due to the consequences of BCG-osis. Intriguingly, he seemed to have been able to control at least some weakly virulent viruses, suggesting that Stat-1-independent mechanisms of anti-viral immunity operate in humans [37]. Complete Stat-1 deficiency defines a novel, innate, severe immunodeficiency, which should be considered in young children with severe, unexplained infectious diseases, particu-

larly, but not exclusively, mycobacterial and viral disease. HSCT should be attempted in the affected children, despite the possible involvement of non-hematopoietic cells in the development of viral diseases.

5. IL-12p40 deficiency

IL-12 comprises two disulfide-linked subunits, p35 and p40, encoded by the *IL12A* and *IL12B* genes, respectively [92,93]. The p40 subunit may also associate with the p19 subunit to form IL-23 [92,93]. IL-12 binds to a heterodimeric receptor consisting of two chains (IL-12R β 1 and IL-12R β 2) expressed on NK and T lymphocytes, and induces the production of large amounts of IFN- γ and enhances the proliferation and cytotoxic activity of NK and T cells [92,93]. IL-23 binds to a heterodimeric receptor (IL-12R β 1 and IL-23R) and induces IFN- γ and, to greater extent, IL-17 [92]. The *IL12B* gene is composed of eight exons (Fig. 3) and its mRNA is produced only in IL-12-producing antigen-presenting cells.

The first patient with IL-12p40 deficiency was reported in 1998 [28]. IL-12p40 deficiency remains the only known immunodeficiency resulting from a cytokine gene defect. In the last 8 years, 20 patients have been identified, with five different mutations in the *IL12B* gene, four of which have been published (Fig. 3) [15,28,94,95] (unpublished data). All known *IL12B* mutations are recessive and loss-of-function, resulting in recessive complete (RC) IL-12p40 deficiency with a lack of detectable IL-12p40 secretion by the patients' blood cells and EBV-transformed B cells [15,28,73]. A lack of biologically active IL-12p70 has also been reported, but IL-23 levels cannot yet be determined due to the lack of a specific antibody. The patients' cells produce only small amounts of IFN- γ *in vitro*, probably accounting for the observed susceptibility to mycobacteria [15,28,73,94].

A large homozygous deletion (g.482+82.856-854del) in the *IL12B* gene has been identified in one Pakistani and two Indian kindreds, and a frameshift insertion (315insA) has been found in four kindreds from Saudi Arabia [15] (Fig. 3). Two kindreds (three patients) from Tunisia have also been shown to carry the homozygous 297del8 *IL12B* mutation [94], and one patient from Iran has been found to carry a homozygous frameshift deletion mutation (526del2) [95] (Fig. 3). Another affected child was also recently identified in Malaysia (unpublished data). Founder effects were documented for two of the four known *IL12B* mutations. A conserved haplotype encompassing the *IL12B* gene was found to account for the recurrence of both g.482+82.856-854del and 315insA *IL12B* mutations. The two founder mutational events occurred \sim 700 years ago in the Indian subcontinent and \sim 1100 years ago in the Arabian Peninsula, respectively [15]. The g.482+82.856-854del *IL12B* mutation is a 4.6-kb frameshift deletion encompassing coding exons V and VI and resulting in the loss of 167 of the original 328 amino acids, and the addition of 45 new amino acids in the COOH-terminal region [15]. Three mutations were found within the coding region of the *IL12B* gene – one mononucleotide insertion (315insA) and two nucleotide deletions (297del8 and 526del2) – all causing a frameshift [15,28,94,95].

All IL-12p40-deficient patients vaccinated with BCG have suffered from BCG disease [15,28,94,95], and EM disease has also been described in one patient [15]. One IL-12p40-deficient patient from Saudi Arabia with BCG-osis and *S. paratyphi C* disease also had tuberculosis [15]. Moreover, half the cases were infected with *Salmonella*, often together with mycobacterial disease [13,15,28,43]. One child, who was not vaccinated with BCG, developed recurrent and disseminated infection caused by non-typhoidal *Salmonella* [15]. A similar observation was made for the more numerous IL-12R β 1-deficient patients, half of whom also suffered from salmonellosis (see below). In contrast, few cases (~6%) of *Salmonella* infection were observed among MSMD patients bearing mutations affecting the IFN- γ -signaling pathway [7,13,41], and isolated *Salmonella* infections have never yet been reported in patients with IFN- γ -signaling defects. These observations suggest that IL-12/IL-23 plays a key role in protective immunity against *Salmonella*, probably via IFN- γ -independent mechanisms. It is not clear whether IL-12, IL-23, or both are involved in immunity to *Salmonella* [13,96]. IL-12 drives IFN- γ production, whereas IL-23 seems to stimulate a unique T-cell subset to produce IL-17, at least in mice [92]. Accordingly, we recently showed that IL-12 can complement defect in the IFN- γ production of blood cells from IL12-p40-deficient patients, while IL-23 cannot (unpublished data). In any event, patients with IL-12p40 deficiency have a fairly good prognosis and should be given recombinant IFN- γ , which can be life-saving.

6. IL-12R β 1 deficiency

Functional IL-12 receptors are expressed primarily on activated T and NK cells [92,93]. The coexpression of IL-12R β 1 and IL-12R β 2 is required for high-affinity IL-12 binding and signaling. IL-12R β 1 also combines with IL-23R to constitute the IL-23R complex for IL-23 signaling [92,93]. IL-12 and IL-23 activate Janus kinase 2 (Jak2) and Tyk2, which in turn activate several Stat proteins [92,93,97]. However, IL-12 and IL-23 strongly induce the phosphorylation of Stat-4 and Stat-3, respectively [92,93,97]. The *IL12RB1* gene contains 17 exons (Fig. 3), encoding a gp130-like protein, formed by an extracellular N-terminal immunoglobulin (Ig)-like domain, a transmembrane domain, and an intracellular domain [92,93].

The first seven cases of IL-12R β 1 deficiency were published in 1998 [29,30]. Eight years later, 89 IL-12R β 1-deficient patients have been described, including 62 published cases [9–11,19,29–31,35,73,80,94,98–109] (unpublished data). IL-12R β 1 deficiency is therefore the most frequent known genetic etiology of MSMD. Forty-one mutant alleles have been identified, 29 of which have been published (Fig. 3). All mutant alleles are recessive, loss-of-function and cause recessive complete (RC) IL-12R β 1 deficiency. The mutations are diverse and include nonsense, missense, and splice mutations, microinsertions, microdeletions, microduplications and large deletions. In most cases, no IL-12R β 1 is expressed on the cell surface (Fig. 3, red mutations), with the exception of two kindreds bearing a large in-frame deletion of 12,165 nucleotides (Fig. 3, blue mutation). Despite being the largest described genetic lesion

in *IL12RB1*, this deletion paradoxically results in the surface expression of non-functional IL-12R β 1, defining a novel form of RC-IL-12R β 1 deficiency [31]. None of the patients tested respond to IL-12 and IL-23 [31,73], with the possible exception of one patient thought to present partial IL-12R β 1 deficiency [35,53]. However, there is no conclusive evidence that this patient suffers from true partial IL-12R β 1 deficiency. IL-12R β 1 was not documented on the surface of T cells and NK cells. The intracellular expression of the mutated IL-12R β 1 was shown but it was not formally demonstrated that this receptor is able to bind IL-12/IL-23 and to induce IFN- γ in response to its ligands [35].

Mycobacterial disease and salmonellosis are the most frequent infectious diseases in patients with IL-12R β 1 deficiency [13,99]. Other infectious phenotypes have been observed only rarely, in one patient each. Disseminated disease, caused by a facultative intracellular dimorphic fungus, *Paracoccidioides brasiliensis*, has been reported in one IL-12R β 1-deficient patient [19], and resembled that found in a patient with DP-IFN- γ R1 deficiency and histoplasmosis [18]. Mycobacteria, *Histoplasma*, and *Paracoccidioides* are therefore similar not only in terms of their clinical impact and pathological lesions, but also in terms of the immunological reactions they elicit. Like IL-12p40-deficient patients, about half of all the known IL-12R β 1-deficient patients have developed *Salmonella* infection, and nine patients have presented isolated (often recurrent) *Salmonella* infection [9,10,19,29–31,35,94,98,99,101,102,104–106,110]. Infectious diseases occurred before the age of 12 years in symptomatic patients, as in patients with RC-IFN- γ R1 or IFN- γ R2 deficiency. However, unlike these patients, the clinical outcome was relatively good, with only 17% deaths, and most patients surviving into adulthood. The clinical prognosis of IL-12R β 1-deficient patients is thus quite good, especially following molecular diagnosis, facilitating careful follow-up and the aggressive and prolonged treatment of infectious episodes with multiple antibiotics and recombinant IFN- γ . Abdominal surgery is often required to remove splenic and mesenteric lesions, which seem to be poorly accessible to antibiotics and IFN- γ . Finally, HSCT is not indicated in patients with IL-12R β 1 deficiency.

The penetrance of IL-12R β 1 deficiency for the case-definition phenotypes of disseminated BCG/EM and/or non-typhoidal systemic salmonellosis is low, at about 40% [99] (unpublished data). Most genetically affected siblings of index cases were found to be asymptomatic [99]. The actual ascertainment bias is therefore not as predicted when IL-12R β 1 deficiency was identified in 1998, in that the disease appears to be less severe overall than initially predicted based solely on the phenotype of the first index cases. How can we account for the interindividual variability of IL-12R β 1-deficient patients? Modifier genes may be involved, but environmental factors have been shown to be critical, as BCG vaccination confers resistance to EM disease [99]. Similarly, very few relapses of EM disease have occurred and there has been only one patient with clinical disease caused by multiple EM species (Kumararatne, personal communication). These observations strongly suggest that IL-12/23 is critical for primary, but not secondary immunity to mycobacteria. In contrast, given the long duration of salmonellosis in

patients, IL-12/23 seems to be equally important for primary and secondary immunity to *Salmonella*. Finally, it is intriguing that no p35-deficient and IL-12R β 2-deficient patient has yet been reported. This may reflect a higher rate of mutations in IL-12p40 and IL-12R β 1. Alternatively, and more likely, it may reflect the dual impact of IL-12p40 and IL-12R β 1 deficiency on both IL-12- and IL-23-mediated immunity. The clinical phenotype of patients with a pure deficit of IL-12 or IL-23, or of either receptor may be milder, overlapping, or different.

The discovery of IL-12R β 1 deficiency has had important implications beyond the study of MSMD, as it led to the discovery of the first cases of Mendelian predisposition to tuberculosis [9–12]. Indeed, children from three unrelated kindreds were found to suffer from culture-proven severe tuberculosis [9–11], providing a proof-of-principle that childhood tuberculosis can reflect a *bona fide* Mendelian predisposition, in at least a fraction of patients [12]. A child with RP-IFN γ R1 deficiency and symptomatic primary tuberculosis (without bacteriological confirmation) was reported in a previous study [8] and clinical tuberculosis has also been reported in several children with MSMD [9–12]. The three IL-12R β 1-deficient patients with tuberculosis, from Morocco, Spain, and Turkey, provide useful information, because they had no personal history of BCG or EM disease [10,99]. The patient from Morocco was investigated because her brother had IL-12R β 1 deficiency and BCG-osis; she was vaccinated three times with live BCG with no adverse effect but developed abdominal tuberculosis. The patient from Spain had disseminated tuberculosis, and she was investigated because her sister had a history of extra-intestinal non-typhoidal *Salmonella* adenitis in early childhood [10]. The patient from Turkey was investigated due to clinically severe tuberculosis, in the absence of any relevant personal or familial history. These observations raise the possibility that a substantial proportion of children world-wide suffer from disseminated tuberculosis due to a Mendelian predisposition [12,111]. This possibility is currently being investigated in population-based studies.

7. Mutations in the NEMO leucine zipper domain

The five genes involved in MSMD described above are all autosomal. *NEMO*, encoding NF- κ B essential modulator (NEMO), is an X-linked gene consisting of 10 exons (Fig. 3). NEMO is a regulatory subunit of the IKK complex that activates the canonical NF- κ B signaling pathway, thereby regulating the expression of numerous target genes [112]. Multiple receptors from several superfamilies, including that containing TNF- α R and IL-1R, can activate NF- κ B via IKK and NEMO. The IKK complex phosphorylates the NF- κ B-bound inhibitors of NF- κ B, promoting their ubiquitination and degradation, releasing NF- κ B dimers and promoting their nuclear translocation and accumulation. NEMO has no known kinase activity, but contains two coiled-coil motifs (CC1, CC2), a leucine zipper (LZ) domain and a putative zinc finger (ZF) motif thought to be involved in protein–protein interaction. The activation of the IKK complex involves NEMO trimerization, and the CC2 and LZ domains seem to be the minimal requirement for this oligomerization [113–115]. Amorphic mutations in the human X-linked *NEMO*

gene have been shown to be lethal *in utero* in male fetuses [116], whereas hypomorphic mutations in *NEMO* are associated with the syndrome of anhidrotic ectodermal dysplasia with immunodeficiency [38–40].

Two specific mutations (E315A and R319Q, Fig. 3) in the *NEMO* LZ domain were recently shown to be associated with X-linked recessive MSMD in a multiplex American kindred and in two sporadic cases from France and Germany [34]. This is the most infrequent genetic etiology of MSMD. The previously reported hypomorphic *NEMO* mutations defined three different disorders in male patients, based on developmental, infectious, and cellular phenotypes: (1) anhidrotic ectodermal dysplasia with immunodeficiency (EDA-ID) in patients with various levels of developmental abnormalities of skin appendages (hypoplasia or anodontia or conical teeth, absence or rarity of eccrine sweat glands and hypohidrosis with sparse scalp hair and eyebrows) and immunodeficiency (ID), resulting in various infections, including mycobacterial disease [38,39,117]; (2) O(L)-EDA-ID in patients with EDA-ID associated with osteopetrosis [118] and/or lymphoedema [38,119]; (3) pure ID in patients with no detectable developmental phenotype but with severe infectious diseases [120–122]. To date, excluding the six XL-MSMD patients referred to here, 43 patients bearing 25 different *NEMO* mutations have been described [38–40,116–134].

Mycobacterial diseases in (OL)-EDA-ID patients have long been documented, as eleven of these patients have developed severe mycobacterial infection, mostly caused by *M. avium*, and always in a context of coinfections with other microorganisms, of many different types, such as encapsulated bacteria. The X-linked recessive (XR) form of MSMD was first clinically described in 1991, in a multiplex kindred with disseminated *M. avium* complex infection in otherwise healthy individuals [65,135–137]. Analysis of this kindred suggested X-linked recessive inheritance of predisposition to mycobacterial infection, as all the cases were male and maternally related [135,138]. Abnormal T cell-dependent production of IL-12 was later reported, with normal IL-12 in response to microbes, providing further evidence for an underlying genetic abnormality, different from the other genetic etiologies of MSMD [136,137]. Poor IL-12 and IFN- γ production by blood cells from XR-MSMD patients was observed in response to PHA and CD3 [65,136,137]. A profound defect in IL-12 (and secondary IFN- γ) production was observed when purified monocytes were cocultured with PHA-activated T cells [34,136,137], indicating a defect in the T cell-dependent pathway of monocyte IL-12 production.

IL-12 production is positively regulated by two major pathways: a microbe-dependent, T cell-independent pathway, and a microbe-independent, T cell-dependent pathway. Microbes can directly stimulate macrophages and dendritic cells, notably, but not exclusively via the activation of Toll-like receptors (TLR), as illustrated by the potent effect of LPS on IL-12 secretion via TLR-4. The T cell-dependent pathway is largely mediated by the engagement of CD40 on antigen-presenting cells and CD40 ligand on T cells [93]. IL-12 production via the T cell-independent pathway was found to be normal when blood cells from XR-MSMD patients were stimulated with microbes

or microbial components. In this context, it is interesting that IRAK4-deficient patients [139,140] with a profound defect in the common Toll-IL1 receptor (TIR) signaling pathway, did not produce IL-12 in response to TLR stimulation and did not develop mycobacterial infections [139,140]. This suggests that the TLR-dependent production of IL-12 is redundant for protective immunity to mycobacteria. It further raises the question of which microbe-dependent pathways leading to IL-12 production are critical for protective immunity to mycobacteria. The investigation of patients with MSMD lacking a genetic etiology should provide new insight into this question.

The engagement of monocyte CD40 by CD40L-expressing T cells is required for the optimal induction of IL-12 production, suggesting that LZ-NEMO mutations may be responsible for the impairment of CD40 signaling. This was found to be the case when monocyte-derived dendritic cells (MDDC) from XR-MSMD patients were activated by CD40L; these cells showed a delayed nuclear accumulation of c-Rel, but not RelA, and strong impairment of IL-12 production [34]. E315 and R319 amino acids are structurally similar and form a highly conserved salt bridge within the LZ domain of NEMO, suggesting that mutations in these two amino acids may disturb the local plasticity of the LZ-helix of NEMO, interfering with the CD40-NEMO-NF- κ B signaling pathway [34]. CD40 signaling is not completely impaired in X-linked MSMD, as B-lymphocyte signaling seems to be intact, like several pathways in myeloid cells, accounting for the differences observed between these patients and those with complete CD40 and CD40L deficiency [141,142]. Even if some CD40L-deficient patients frequently develop localized diseases caused by BCG and severe tuberculosis [143], *CD40* and *CD40L* are not *bona fide* MSMD-causing genes, as these patients do not suffer from disseminated BCG or EM diseases. The selective impairment of CD40 signaling in monocytes and dendritic cells, and the subsequent defect in the production of IL-12 and IFN- γ thus account largely for the pathogenic effect of LZ-NEMO mutations in patients with XR-MSMD [34]. Other mechanisms are probably involved.

X-linked mycobacterial disease has been diagnosed in six patients from three unrelated kindreds. In five of these patients, no other invasive infections were documented; the remaining patient suffered from invasive disease caused by *Haemophilus influenzae b*, a Gram-negative bacterium. The *Haemophilus influenzae b* infection suggests that these NEMO mutations may not be exclusively associated with mycobacterial disease. Nevertheless, the lack of other infections in these patients is probably accounted for by their normal responses to other ligands generally requiring NF- κ B for signalling (IL-1, TLR). *M. avium* infection is the most common type of mycobacterial infection, but one of the six patients had bacteriologically proven *M. avium* and *M. tuberculosis* disease and two others probably had tuberculosis, implicating *NEMO*, like *IL12RB1*, in tuberculosis. This observation is interesting, in the context of the known higher incidence of tuberculosis in men and boys than in women and girls [144]. XR-MSMD patients seem to display some clinical heterogeneity, with a more severe course of mycobacterial disease in American than in European kindreds, although this difference may reflect age differences, the American patients

being older than the European ones. The American patients have been shown to benefit from IFN- γ therapy, suggesting that such treatment may also be beneficial to the other patients [135,138].

8. Conclusion

The genetic dissection of the molecular and cellular basis of the clinical syndrome of MSMD, over the last 10 years, has had important clinical, genetic, and immunological implications. Molecular diagnosis can now be offered to patients with MSMD, improving the prediction of individual clinical outcome and facilitating treatment based on a rational understanding of the pathogenesis of infections. IFN- γ has been a life-saving treatment in patients producing little IFN- γ , because it replaced the missing component of protective immunity. In patients lacking a functional receptor for IFN- γ , HSCT appears to be the only curative option available, despite unexpected engraftment problems in these patients. Finally, genetic counseling can now be offered to the families, whether affected by autosomal or X-linked, dominant or recessive disorders associated with MSMD. The clinical implications of these studies are likely to become more extensive in light of the recent discovery of a Mendelian predisposition to tuberculosis in patients with mutations in *IL-12R β 1* [9–11] and *NEMO* [12,34].

In immunological terms, the most surprising observation – both at the time of its initial reporting in 1996, and even more so now that major ascertainment biases have almost entirely been eliminated – is that patients with lesions in the IL-12/23-IFN- γ loop are apparently resistant to most infectious agents. Their vulnerability to mycobacteria is not surprising, as it was predicted from results obtained in the mouse model and was crucial in the identification of human mutations, together with linkage data [62]. The resistance of these patients to most infections challenges the currently prevailing immunological dogma – the Th1/Th2 paradigm – according to which IL-12 is the signature inducer cytokine and IFN- γ the signature effector cytokine of immunity to intracellular agents. The observation of resistance even to mycobacteria in IL-12p40- and IL-12R β 1-deficient patients is also intriguing. Leaving aside the possible contribution of IL-23 to the phenotype, IL-12 seems to be completely redundant for protective immunity in most individuals, at odds with the role classically attributed to this cytokine. The specific vulnerability of these patients reflects the fact that immunity to infection in man occurs in natural, as opposed to experimental, conditions [7,45,111,145]. The human model allows a genetic definition of the ecologically relevant functions of immune genes. This is important biologically, because natural selection results in genes being selected during evolution based on their function in the wild, resulting in the fitness of individuals and populations. The IL-12/23-IFN- γ circuit seems to be specifically devoted to the control of mycobacteria.

The high level of allelic heterogeneity among MSMD patients has resulted in genetic findings of more general interest, beyond the field of MSMD, and even beyond that of primary immunodeficiencies [22,26,33]. The first hotspot for small deletions was reported in *IFNGR1*, validating the consensus *cis* elements previously proposed by Krawczak and Cooper responsible for

small deletions [146]. Other small deletion hotspots have since been reported, including some in *IFNGR1* [86–89]. Mutations associated with two deleterious phenotypes but dominant for one and recessive for the other, at the cellular and clinical levels, were first discovered in *STAT1* [32,33]. Last, but not least, the discovery that human mutations include a large number of gain-of-glycosylation mutations also resulted from the study of *IFNGR2* [26]. Up to 1.4% of human missense mutations are now predicted to be gain-of-glycosylation mutations for which chemical complementation may be possible *in vitro*, and perhaps *in vivo*.

Perspectives in the field of MSMD and genetic disorders of the IL-12/23-IFN- γ loop include (i) the genetic diagnosis of more patients with MSMD, possibly revealing novel mechanisms of mutation or pathogenesis and improving definition of the clinical features of mycobacterial diseases associated with the underlying genetic disorders; it will be particularly important to study the genetically affected relatives of index cases, in particular in regions of the world where MSMD patients have not been diagnosed to date, in order to circumscribe the ascertainment bias; (ii) the identification of new clinical phenotypes associated with known genotypes, for tuberculosis in particular, but possibly also for other infectious diseases, such as histoplasmosis and paracoccidioidomycosis; again it will be important to study patients from various genetic backgrounds and exposed to diverse microbial flora; (iii) the identification of new disease-causing genes in patients with MSMD, as approximately half the known patients still lack a genetic etiology; a candidate gene approach will probably not be sufficient and a genome-wide approach will be required. We therefore expect the next 10 years to be as exciting and fruitful as the last 10 years, and that the study of MSMD will provide new fundamental and clinical insights.

Acknowledgments

We warmly thank Laurent Abel, Frédéric Altare, Rainer Döffinger, Salma Lamhamedi, and all past and present members of the laboratory who were involved in the study of patients with MSMD. We thank Michael Levin, Dinakantha Kumararatne, Steven Holland, and Joachim Roesler for friendly collaboration over the years. We thank Claire Soudais, Anne Puel, and the other members of the laboratory for helpful discussions. Needless to say, we are much indebted to the patients, their families, and their referring physicians world-wide, for their trust, patience, and collaboration over the years. O. Filipe-Santos is supported by *Fundação para a Ciência e Tecnologia*, Portugal. The laboratory is supported in part by grants from the BNP-Paribas and Schlumberger foundations, the EU grant (QLK2-CT-2002-00846), the March of Dimes, and the Agence Nationale de la Recherche. Jean-Laurent Casanova is an International Scholar of the Howard Hughes Medical Institute.

References

- [1] Hamosh A, Scott AF, Amberger JS, Bocchini CA, McKusick VA. Online Mendelian Inheritance in Man (OMIM), a knowledgebase of human genes and genetic disorders. *Nucl Acids Res* 2005;33:D514–7.

- [2] Mimouni J. Our experiences in three years of BCG vaccination at the center of the O.P.H.S. at Constantine; study of observed cases (25 cases of complications from BCG vaccination). *Alger Med* 1951;55: 1138–47.
- [3] Levin M, Newport MJ, D'Souza S, Kalabalikis P, Brown IN, Lenicker HM, et al. Familial disseminated atypical mycobacterial infection in childhood: a human mycobacterial susceptibility gene? *Lancet* 1995;345: 79–83.
- [4] Casanova JL, Jouanguy E, Lamhamedi S, Blanche S, Fischer A. Immunological conditions of children with BCG disseminated infection. *Lancet* 1995;346:581.
- [5] Casanova JL, Blanche S, Emile JF, Jouanguy E, Lamhamedi S, Altare F, et al. Idiopathic disseminated bacillus Calmette-Guérin infection: a French national retrospective study. *Pediatrics* 1996;98:774–8.
- [6] Dorman SE, Holland SM. Interferon-gamma and interleukin-12 pathway defects and human disease. *Cytokine Growth Factor Rev* 2000;11: 321–33.
- [7] Casanova JL, Abel L. Genetic dissection of immunity to mycobacteria: the human model. *Annu Rev Immunol* 2002;20:581–620.
- [8] Jouanguy E, Lamhamedi-Cherradi S, Altare F, Fondaneche MC, Tuerlinckx D, Blanche S, et al. Partial interferon-gamma receptor 1 deficiency in a child with tuberculoid bacillus Calmette-Guérin infection and a sibling with clinical tuberculosis. *J Clin Invest* 1997;100:2658–64.
- [9] Altare F, Ensser A, Breiman A, Reichenbach J, Baghdadi JE, Fischer A, et al. Interleukin-12 receptor beta1 deficiency in a patient with abdominal tuberculosis. *J Infect Dis* 2001;184:231–6.
- [10] Caragol I, Raspall M, Fieschi C, Feinberg J, Larrosa MN, Hernandez M, et al. Clinical tuberculosis in 2 of 3 siblings with interleukin-12 receptor beta1 deficiency. *Clin Infect Dis* 2003;37:302–6.
- [11] Özbek N, Fieschi C, Yilmaz BT, De Beaucoudrey L, Bikmaz YE, Casanova JL. Interleukin-12 receptor beta 1 chain deficiency in a child with disseminated tuberculosis. *Clin Infect Dis* 2005;40:55–8.
- [12] Alcais A, Fieschi C, Abel L, Casanova JL. Tuberculosis in children and adults: two distinct genetic diseases. *J Exp Med* 2005;202:1617–21.
- [13] MacLennan C, Fieschi C, Lammas DA, Picard C, Dorman SE, Sanal O, et al. Interleukin (IL)-12 and IL-23 are key cytokines for immunity against *Salmonella* in humans. *J Infect Dis* 2004;190:1755–7.
- [14] Roesler J, Kofink B, Wendisch J, Heyden S, Paul D, Friedrich W, et al. *Listeria monocytogenes* and recurrent mycobacterial infections in a child with complete interferon-gamma-receptor (IFN γ R1) deficiency: mutational analysis and evaluation of therapeutic options. *Exp Hematol* 1999;27:1368–74.
- [15] Picard C, Fieschi C, Altare F, Al-Jumaah S, Al-Hajjar S, Feinberg J, et al. Inherited interleukin-12 deficiency: IL12B genotype and clinical phenotype of 13 patients from six kindreds. *Am J Hum Genet* 2002;70: 336–48.
- [16] Dorman SE, Uzel G, Roesler J, Bradley JS, Bastian J, Billman G, et al. Viral infections in interferon- γ receptor deficiency. *J Pediatr* 1999;135:640–3.
- [17] Camcioglu Y, Picard C, Lacoste V, Dupuis S, Akcakaya N, Cokura H, et al. HHV-8-associated Kaposi sarcoma in a child with IFN γ R1 deficiency. *J Pediatr* 2004;144:519–23.
- [18] Zerbe CS, Holland SM. Disseminated histoplasmosis in persons with interferon-gamma receptor 1 deficiency. *Clin Infect Dis* 2005;41:e38–41.
- [19] Moraes-Vasconcelos D, Grumach AS, Yamaguti A, Andrade ME, Fieschi C, Beaucoudrey L, et al. *Paracoccidioides brasiliensis* disseminated disease in a patient with inherited deficiency in the beta1 subunit of the interleukin (IL)-12/IL-23 receptor. *Clin Infect Dis* 2005;41: e31–7.
- [20] Newport MJ, Huxley CM, Huston S, Hawrylowicz CM, Oostra BA, Williamson R, et al. A mutation in the interferon-gamma-receptor gene and susceptibility to mycobacterial infection. *N Engl J Med* 1996;335:1941–9.
- [21] Jouanguy E, Altare F, Lamhamedi S, Revy P, Emile JF, Newport M, et al. Interferon-gamma-receptor deficiency in an infant with fatal bacille Calmette-Guérin infection. *N Engl J Med* 1996;335:1956–61.
- [22] Jouanguy E, Lamhamedi-Cherradi S, Lammas D, Dorman SE, Fondaneche MC, Dupuis S, et al. A human *IFNGR1* small deletion hotspot

- associated with dominant susceptibility to mycobacterial infection. *Nat Genet* 1999;21:370–8.
- [23] Jouanguy E, Dupuis S, Pallier A, Döffinger R, Fondanèche MC, Lamhamedi-Cherradi S, et al. In a novel form of complete IFN γ R1 deficiency, cell-surface receptors fail to bind IFN γ . *J Clin Invest* 2000;105:1429–36.
- [24] Dorman SE, Holland SM. Mutation in the signal-transducing chain of the interferon-gamma receptor and susceptibility to mycobacterial infection. *J Clin Invest* 1998;101:2364–9.
- [25] Rosenzweig SD, Dorman SE, Uzel G, Shaw S, Scurlock A, Brown MR, et al. A novel mutation in IFN-gamma receptor 2 with dominant negative activity: biological consequences of homozygous and heterozygous states. *J Immunol* 2004;173:4000–8.
- [26] Vogt G, Chappier A, Yang K, Chuzhanova N, Feinberg J, Fieschi C, et al. Gains of glycosylation comprise an unexpectedly large group of pathogenic mutations. *Nat Genet* 2005;37:692–700.
- [27] Döffinger R, Jouanguy E, Dupuis S, Fondanèche MC, Stéphan JL, Emile JF, et al. Partial interferon gamma receptor signalling chain deficiency in a patient with bacille Calmette-Guérin and *Mycobacterium abscessus* infection. *J Infect Dis* 2000;181:379–84.
- [28] Altare F, Lammas D, Revy P, Jouanguy E, Doffinger R, Lamhamedi S, et al. Inherited interleukin 12 deficiency in a child with bacille Calmette-Guérin and *Salmonella enteritidis* disseminated infection. *J Clin Invest* 1998;102:2035–40.
- [29] Altare F, Durandy A, Lammas D, Emile JF, Lamhamedi S, Le Deist F, et al. Impairment of mycobacterial immunity in human interleukin-12 receptor deficiency. *Science* 1998;280:1432–5.
- [30] de Jong R, Altare F, Haagen IA, Elferink DG, Boer T, van Breda Vriesman PJ, et al. Severe mycobacterial and *Salmonella* infections in interleukin-12 receptor-deficient patients. *Science* 1998;280:1435–8.
- [31] Fieschi C, Bosticardo M, de Beaucoudrey L, Boisson-Dupuis S, Feinberg J, Santos OF, et al. A novel form of complete IL-12/IL-23 receptor beta1 deficiency with cell surface-expressed nonfunctional receptors. *Blood* 2004;104:2095–101.
- [32] Dupuis S, Dargemont C, Fieschi C, Thomassin N, Rosenzweig S, Harris J, et al. Impairment of mycobacterial but not viral immunity by a germline human STAT1 mutation. *Science* 2001;293:300–3.
- [33] Chappier A, Boisson-Dupuis S, Jouanguy E, Vogt G, Feinberg J, Prochnicka-Chalufour A, et al. Novel STAT1 alleles in otherwise healthy patients with mycobacterial disease. *PLoS Genetic* 2006;18:2(8).
- [34] Filipe-Santos O, Bustamante J, Haverkamp MH, Vinolo E, Ku C-L, Puel A, et al. X-linked susceptibility to mycobacteria is caused by mutations in the NEMO leucine zipper domain that impair CD40-dependent IL-12 production. *J Exp Med* 2006;203:1745–59.
- [35] Lichtenauer-Kaligis EG, de Boer T, Verreck FA, van Voorden S, Hoeve MA, van de Vosse E, et al. Severe *Mycobacterium bovis* BCG infections in a large series of novel IL-12 receptor beta1 deficient patients and evidence for the existence of partial IL-12 receptor beta1 deficiency. *Eur J Immunol* 2003;33:59–69.
- [36] Dupuis S, Jouanguy E, Al-Hajjar S, Fieschi C, Al-Mohsen IZ, Al-Jumaah S, et al. Impaired response to interferon-alpha/beta and lethal viral disease in human STAT1 deficiency. *Nat Genet* 2003;33:388–91.
- [37a] Chappier A, Wynn RF, Jouanguy E, Filipe-Santos O, Zhang S, Feinberg J, et al. Human complete Stat-1 deficiency is associated with defective type I and II IFN responses in vitro but immunity to some low virulence viruses in vivo. *J Immunol* 2006;176:5078–83.
- [37b] Novelli F, Casanova JL. The role of IL-12, IL-23 and IFN-gamma in immunity to viruses. *Cytokine Growth Factor Rev* 2004;15:367–77.
- [38] Doffinger R, Smahi A, Bessia C, Geissmann F, Feinberg J, Durandy A, et al. X-linked anhidrotic ectodermal dysplasia with immunodeficiency is caused by impaired NF-kappaB signaling. *Nat Genet* 2001;27:277–85.
- [39] Jain A, Ma CA, Liu S, Brown M, Cohen J, Strober W. Specific missense mutations in NEMO result in hyper-IgM syndrome with hypohidrotic ectodermal dysplasia. *Nat Immunol* 2001;2:223–8.
- [40] Zonana J, Elder ME, Schneider LC, Orlow SJ, Moss C, Golabi M, et al. A novel X-linked disorder of immune deficiency and hypohidrotic ectodermal dysplasia is allelic to incontinentia pigmenti and due to mutations in IKK-gamma (NEMO). *Am J Hum Genet* 2000;67:1555–62.
- [41] Dorman SE, Picard C, Lammas D, Heyne K, van Dissel JT, Baretto R, et al. Clinical features of dominant and recessive interferon gamma receptor 1 deficiencies. *Lancet* 2004;364:2113–21.
- [42] Jouanguy E, Doffinger R, Dupuis S, Pallier A, Altare F, Casanova JL. IL-12 and IFN-gamma in host defense against mycobacteria and salmonella in mice and men. *Curr Opin Immunol* 1999;11:346–51.
- [43] Fieschi C, Casanova JL. The role of interleukin-12 in human infectious diseases: only a faint signature. *Eur J Immunol* 2003;33:1461–4.
- [44] Dupuis S, Doffinger R, Picard C, Fieschi C, Altare F, Jouanguy E, et al. Human interferon-gamma-mediated immunity is a genetically controlled continuous trait that determines the outcome of mycobacterial invasion. *Immunol Rev* 2000;178:129–37.
- [45] Casanova JL, Abel L. The human model: a genetic dissection of immunity to infection in natural conditions. *Nat Rev Immunol* 2004;4:55–66.
- [46] Casanova JL, Ochs HD. Interferon γ receptor deficiency: an expanding phenotype? *J Pediatr* 1999;135:543–5.
- [47] Holland SM. Treatment of infections in the patient with Mendelian susceptibility to mycobacterial infection. *Microbes Infect* 2000;2:1579–90.
- [48] Reichenbach J, Rosenzweig S, Doffinger R, Dupuis S, Holland SM, Casanova JL. Mycobacterial diseases in primary immunodeficiencies. *Curr Opin Allergy Clin Immunol* 2001;1:503–11.
- [49] Döffinger R, Jouanguy E, Altare F, Wood P, Shirakawa T, Novelli F, et al. Inheritable defects in IL-12- and IFN γ -mediated immunity and the TH1/TH2 paradigm in man. *Allergy* 1999;54:409–12.
- [50] Remus N, Reichenbach J, Picard C, Rietschel C, Wood P, Lammas D, et al. Impaired interferon gamma-mediated immunity and susceptibility to mycobacterial infection in childhood. *Pediatr Res* 2001;50:8–13.
- [51] Rosenzweig SD, Holland SM. Defects in the interferon-gamma and interleukin-12 pathways. *Immunol Rev* 2005;203:38–47.
- [52] Ottenhoff T, Kumararatne D, Casanova JL. Novel immunodeficiencies reveal the essential role of type 1 cytokines in immunity to intracellular bacteria. *Immunol Today* 1998;19:491–4.
- [53] van de Vosse E, Hoeve MA, Ottenhoff TH. Human genetics of intracellular infectious diseases: molecular and cellular immunity against mycobacteria and salmonellae. *Lancet Infect Dis* 2004;4:739–49.
- [54] Notarangelo L, Casanova JL, Conley ME, Chapel H, Fischer A, Puck J, et al. Primary immunodeficiency diseases: an update from the International Union of Immunological Societies Primary Immunodeficiency Diseases Classification Committee Meeting in Budapest. *J Allergy Clin Immunol* 2006;117:883–96.
- [55] Altare F, Jouanguy E, Lamhamedi S, Doffinger R, Fischer A, Casanova JL. Mendelian susceptibility to mycobacterial infection in man. *Curr Opin Immunol* 1998;10:413–7.
- [56] Ottenhoff TH, Verreck FA, Lichtenauer-Kaligis EG, Hoeve MA, Sanal O, van Dissel JT. Genetics, cytokines and human infectious disease: lessons from weakly pathogenic mycobacteria and salmonellae. *Nat Genet* 2002;32:97–105.
- [57] Haverkamp MH, van Dissel JT, Holland SM. Human host genetic factors in nontuberculous mycobacterial infection: lessons from single gene disorders affecting innate and adaptive immunity and lessons from molecular defects in interferon-gamma-dependent signaling. *Microbes Infect* 2006;8:1157–66.
- [58] Wood PM, Fieschi C, Picard C, Ottenhoff TH, Casanova JL, Kumararatne DS. Inherited defects in the interferon-gamma receptor or interleukin-12 signalling pathways are not sufficient to cause allergic disease in children. *Eur J Pediatr* 2005;164:741–7.
- [59] Farrar MA, Schreiber RD. The molecular cell biology of interferon-gamma and its receptor. *Annu Rev Immunol* 1993;11:571–611.
- [60] Stark GR, Kerr IM, Williams BR, Silverman RH, Schreiber RD. How cells respond to interferons. *Annu Rev Biochem* 1998;67:227–64.
- [61] Bach E, Aguet M, Schreiber RD. The interferon gamma receptor: a paradigm for cytokine receptor signaling. *Annu Rev Immunol* 1997;15:563–91.
- [62] North RJ, Jung YJ. Immunity to tuberculosis. *Annu Rev Immunol* 2004;22:599–623.
- [63] Pierre-Audigier C, Jouanguy E, Lamhamedi S, Altare F, Rautz J, Vincent V, et al. Fatal disseminated *Mycobacterium smegmatis* infection in

- a child with inherited interferon gamma receptor deficiency. *Clin Infect Dis* 1997;24:982–4.
- [64] Altare F, Jouanguy E, Lamhamedi-Cherradi S, Fondaneche MC, Fizame C, Ribierre F, et al. A causative relationship between mutant IFN γ R1 alleles and impaired cellular response to IFN γ in a compound heterozygous child. *Am J Hum Genet* 1998;62:723–6.
- [65] Holland SA, Dorman SE, Kwon A, Pitha-Rowe IF, Frucht DM, Gerstberger SM, et al. Abnormal regulation of interferon gamma, interleukin 12, and tumor necrosis factor alpha in interferon gamma receptor 1 deficiency. *J Infect Dis* 1998;178:1095–104.
- [66] Roesler J, Kofink B, Wendisch J, Heyden S, Paul D, Lehmann R, et al. Recurrent mycobacterial and listeria infections in a child with interferon γ receptor deficiency: mutational analysis and evaluation of therapeutic options. *Exp Haematol* 1999;27:1368–74.
- [67] Cunningham JA, Kellner JD, Bridge PJ, Trevenen CL, McLeod DR, Davies HD. Disseminated bacille Calmette-Guérin infection in an infant with a novel deletion in the interferon-gamma receptor gene. *Int J Tuberc Lung Dis* 2000;4:791–4.
- [68] Allende LM, Lopez-Goyanes A, Paz-Artal E, Corell A, Garcia-Perez MA, Varela P, et al. A point mutation in a domain of gamma interferon receptor 1 provokes severe immunodeficiency. *Clin Diagn Lab Immunol* 2001;8:133–7.
- [69] Rosenzweig S, Dorman SE, Roesler J, Zelasko M, Holland SM. A novel autosomal recessive mutation defines a second mutational hotspot in the interferon gamma receptor 1 (IFNGR1) chain. *Clin Immunol* 2002;102:25–7.
- [70] Koscielniak E, de Boer T, Dupuis S, Naumann L, Casanova JL, Ottenhoff TH. Disseminated *Mycobacterium peregrinum* infection in a child with complete interferon-gamma receptor-1 deficiency. *Pediatr Infect Dis J* 2003;22:378–80.
- [71] Tsolia MN, Chappier A, Taprantzi P, Servitzoglou M, Tassios I, Spyridis N, et al. Disseminated nontuberculous mycobacterial infection in a child with interferon-gamma receptor 1 deficiency. *Eur J Pediatr* 2006;167:458–61.
- [72] Marazzi MG, Chappier A, Defilippi AC, Pistoia V, Plebani A, Dell'Acqua A, et al. Disseminated *Mycobacterium scrofulaceum* infection in a child with interferon receptor 1 deficiency. in preparation.
- [73] Feinberg J, Fieschi C, Doffinger R, Feinberg M, Leclerc T, Boisson-Dupuis S, et al. Bacillus Calmette Guérin triggers the IL-12/IFN-gamma axis by an IRAK-4- and NEMO-dependent, non-cognate interaction between monocytes, NK, and T lymphocytes. *Eur J Immunol* 2004;34:3276–84.
- [74] Emile JF, Patey N, Altare F, Lamhamedi S, Jouanguy E, Boman F, et al., Quillard J. Correlation of granuloma structure with clinical outcome defines two types of idiopathic disseminated BCG infection. *J Pathol* 1997;181:25–30.
- [75] Roesler J, Horwitz ME, Picard C, Bordigoni P, Davies G, Koscielniak E, et al. Hematopoietic stem cell transplantation for complete IFN-gamma receptor 1 deficiency: a multi-institutional survey. *J Pediatr* 2004;145:806–12.
- [76] Reuter U, Roesler J, Thiede C, Friedrich W. Correction of complete interferon-gamma receptor 1 deficiency by bone marrow transplantation. *Blood* 2002;100:4234–5.
- [77] Horwitz ME, Uzel G, Linton GF, Miller JA, Brown MR, Malech HL, et al. Persistent *Mycobacterium avium* infection following nonmyeloablative allogeneic peripheral blood stem cell transplantation for interferon-gamma receptor-1 deficiency. *Blood* 2003;102:2692–4.
- [78] Chantrain CF, Bruwier A, Brichard B, Largent V, Chappier A, Feinberg J, et al. Successful hematopoietic stem cell transplantation in a child with active disseminated *Mycobacterium fortuitum* infection and interferon-gamma receptor 1 deficiency. *Bone Marrow Transplant* 2006;38:75–6.
- [79] Fieschi C, Dupuis S, Picard C, Smith CI, Holland SM, Casanova JL. High levels of interferon gamma in the plasma of children with complete interferon gamma receptor deficiency. *Pediatrics* 2001;107:E48.
- [80] Remiszewski P, Roszkowska-Sliz B, Winek J, Chappier A, Feinberg J, Langfort R, et al. Disseminated *Mycobacterium avium* infection in a 20-year-old female with partial recessive IFN γ R1 deficiency. *Respiration* 2006;73:375–8.
- [81] Arend SM, Janssen R, Gosen JJ, Waanders H, de Boer T, Ottenhoff TH, et al. Multifocal osteomyelitis caused by nontuberculous mycobacteria in patients with a genetic defect of the interferon-gamma receptor. *Neth J Med* 2001;59:140–51.
- [82] Villella A, Picard C, Jouanguy E, Dupuis S, Popko S, Abughali N, et al. Recurrent *Mycobacterium avium* osteomyelitis associated with a novel dominant interferon gamma receptor mutation. *Pediatrics* 2001;107:E47.
- [83] Sasaki Y, Nomura A, Kusuhara K, Takada H, Ahmed S, Obinata K, et al. Genetic basis of patients with bacille Calmette-Guérin osteomyelitis in Japan: identification of dominant partial interferon-gamma receptor 1 deficiency as a predominant type. *J Infect Dis* 2002;185:706–9.
- [84] Han JY, Rosenzweig SD, Church JA, Holland SM, Ross LA. Variable presentation of disseminated nontuberculous mycobacterial infections in a family with an interferon-gamma receptor mutation. *Clin Infect Dis* 2004;39:868–70.
- [85] Smyth AE, Jackson P, Lammas D, Asghar MS, Crockard AD, Casanova JL, et al. Differential response to interferon-gamma therapy in a family with dominant negative partial interferon-gamma receptor1 deficiency. *Eur J Pediatr* 2006;165:71–2.
- [86] Lopez-Correa C, Dorschner M, Brems H, Lazaro C, Clementi M, Upadhyaya M, et al. Recombination hotspot in NF1 microdeletion patients. *Hum Mol Genet* 2001;10:1387–92.
- [87] Lebo RV, Ikuta T, Milunsky JM, Milunsky A. Rett syndrome from quintuple and triple deletions within the MECP2 deletion hotspot region. *Clin Genet* 2001;59:406–17.
- [88] Schneider KU, Sabherwal N, Jantz K, Roth R, Muncke N, Blum WF, et al. Identification of a major recombination hotspot in patients with short stature and SHOX deficiency. *Am J Hum Genet* 2005;77:89–96.
- [89] Zinn AR, Ramos P, Ross JL. A second recombination hotspot associated with SHOX deletions. *Am J Hum Genet* 2006;78:523–5.
- [90] Renauld JC. Class II cytokine receptors and their ligands: key antiviral and inflammatory modulators. *Nat Rev Immunol* 2003;3:667–76.
- [91] Imada K, Leonard WJ. The Jak-STAT pathway. *Mol Immunol* 2000;37:1–11.
- [92] Hunter CA. New IL-12-family members: IL-23 and IL-27, cytokines with divergent functions. *Nat Rev Immunol* 2005;5:521–31.
- [93] Trinchieri G. Interleukin-12 and the regulation of innate resistance and adaptive immunity. *Nat Rev Immunol* 2003;3:133–46.
- [94] Elloumi-Zghal H, Barbouche MR, Chemli J, Bejaoui M, Harbi A, Snoussi N, et al. Clinical and genetic heterogeneity of inherited autosomal recessive susceptibility to disseminated *Mycobacterium bovis* bacille Calmette-Guérin infection. *J Infect Dis* 2002;185:1468–75.
- [95] Mansouri D, Adimi P, Mirsaeidi M, Mansouri N, Khalilzadeh S, Masjedi MR, et al. Inherited disorders of the IL-12-IFN-gamma axis in patients with disseminated BCG infection. *Eur J Pediatr* 2005;164:753–7.
- [96] Happel KI, Dubin PJ, Zheng M, Ghilardi N, Lockhart C, Quinton LJ, et al. Divergent roles of IL-23 and IL-12 in host defense against *Klebsiella pneumoniae*. *J Exp Med* 2005;202:761–9.
- [97] Watford WT, Hissong BD, Bream JH, Kanno Y, Muul L, O'Shea JJ. Signaling by IL-12 and IL-23 and the immunoregulatory roles of STAT4. *Immunol Rev* 2004;202:139–56.
- [98] Aksu G, Tirpan C, Cavusoglu C, Soydan S, Altare F, Casanova JL, et al. *Mycobacterium fortuitum*-cheloniae complex infection in a child with complete interleukin-12 receptor beta 1 deficiency. *Pediatr Infect Dis J* 2001;20:551–3.
- [99] Fieschi C, Dupuis S, Catherinot E, Feinberg J, Bustamante J, Breiman A, et al. Low penetrance, broad resistance, and favorable outcome of interleukin 12 receptor beta1 deficiency: medical and immunological implications. *J Exp Med* 2003;197:527–35.
- [100] Sakai T, Matsuoka M, Aoki M, Nosaka K, Mitsuya H. Missense mutation of the interleukin-12 receptor beta1 chain-encoding gene is associated with impaired immunity against *Mycobacterium avium* complex infection. *Blood* 2001;97:2688–94.
- [101] Staretz-Haham O, Melamed R, Lifshitz M, Porat N, Fieschi C, Casanova JL, et al. Interleukin-12 receptor beta1 deficiency presenting as recurrent *Salmonella* infection. *Clin Infect Dis* 2003;37:137–40.
- [102] Cleary AM, Tu W, Enright A, Giffon T, Dewaal-Malefyt R, Gutierrez K, et al. Impaired accumulation and function of memory CD4 T

- cells in human IL-12 receptor beta 1 deficiency. *J Immunol* 2003;170:597–603.
- [103] Hoeve MA, de Boer T, Langenberg DM, Sanal O, Verreck FA, Ottenhoff TH. IL-12 receptor deficiency revisited: IL-23-mediated signaling is also impaired in human genetic IL-12 receptor beta1 deficiency. *Eur J Immunol* 2003;33:3393–7.
- [104] Ozen M, Ceyhan M, Sanal O, Bayraktar M, Mesci L. Recurrent *Salmonella bacteremia* in interleukin-12 receptor {beta}1 deficiency. *J Trop Pediatr* 2006;52:296–8.
- [105] Tanir G, Dogu F, Tuygun N, Ikinciogullari A, Aytekin C, Aydemir C, et al. Complete deficiency of the IL-12 receptor beta1 chain: three unrelated Turkish children with unusual clinical features. *Eur J Pediatr* 2006;165:415–7.
- [106] Sanal O, Turul T, De Boer T, Van de Vosse E, Yalcin I, Tezcan I, et al. Presentation of interleukin-12/23 receptor beta1 deficiency with various clinical symptoms of *Salmonella* infections. *J Clin Immunol* 2006;26:1–6.
- [107] Kutukculer N, Genel F, Aksu G, Karapinar B, Ozturk C, Cavusoglu C, et al. Cutaneous leukocytoclastic vasculitis in a child with interleukin-12 receptor beta-1 deficiency. *J Pediatr* 2006;148:407–9.
- [108] Ulrichs T, Fieschi C, Nevicka E, Hahn H, Brezina M, Kaufmann SH, et al. Variable outcome of experimental interferon-gamma therapy of disseminated bacillus Calmette-Guérin infection in two unrelated interleukin-12Rbeta1-deficient Slovakian children. *Eur J Pediatr* 2005;164:166–72.
- [109] Yu HR, Chen RF, Hong KC, Bong CN, Lee WI, Kuo HC, et al. IL-12-independent Th1 polarization in human mononuclear cells infected with varicella-zoster virus. *Eur J Immunol* 2005;35:3664–72.
- [110] Yu Z, Manickan E, Rouse BT. Role of interferon-gamma in immunity to herpes simplex virus. *J Leucoc Biol* 1996;60:528–32.
- [111] Casanova JL, Abel L. Inborn errors of immunity to infection: the rule rather than the exception. *J Exp Med* 2005;202:197–201.
- [112] Li Q, Verma IM. NF-kappaB regulation in the immune system. *Nat Rev Immunol* 2002;2:725–34.
- [113] Agou F, Ye F, Goffinont S, Courtois G, Yamaoka S, Israel A, et al. NEMO trimerizes through its coiled-coil C-terminal domain. *J Biol Chem* 2002;277:17464–75.
- [114] Agou F, Traincard F, Vinolo E, Courtois G, Yamaoka S, Israel A, et al. The trimerization domain of NEMO is composed of the interacting C-terminal CC2 and LZ coiled-coil subdomains. *J Biol Chem* 2004;279:27861–9.
- [115] Huang GJ, Zhang ZQ, Jin DY. Stimulation of IKK-gamma oligomerization by the human T-cell leukemia virus oncoprotein Tax. *FEBS Lett* 2002;531:494–8.
- [116] Smahi A, Courtois G, Vabres P, Yamaoka S, Heuertz S, Munnich A, et al. Genomic rearrangement in NEMO impairs NF-kappaB activation and is a cause of incontinentia pigmenti. The International Incontinentia Pigmenti (IP) Consortium. *Nature* 2000;405:466–72.
- [117] Ku CL, Dupuis-Girod S, Ditttrich AM, Bustamante J, Santos OF, Schulze I, et al. NEMO mutations in two unrelated boys with severe infections and conical teeth. *Pediatrics* 2005;115:615–9.
- [118] Schmid JM, Junge SA, Hossle JP, Schneider EM, Roosnek E, Seger RA, et al. Transient hemophagocytosis with deficient cellular cytotoxicity, monoclonal immunoglobulin M gammopathy, increased T-cell numbers, and hypomorphic NEMO mutation. *Pediatrics* 2006;117:e1049–56.
- [119] Dupuis-Girod S, Corradini N, Hadj-Rabia S, Fournet JC, Faivre L, Le Deist F, et al. Osteopetrosis, lymphedema, anhidrotic ectodermal dysplasia, and immunodeficiency in a boy and incontinentia pigmenti in his mother. *Pediatrics* 2002;109:e97.
- [120] Orange JS, Levy O, Brodeur SR, Krzewski K, Roy RM, Niemela JE, et al. Human nuclear factor kappa B essential modulator mutation can result in immunodeficiency without ectodermal dysplasia. *J Allergy Clin Immunol* 2004;114:650–6.
- [121] Niehues T, Reichenbach J, Neubert J, Gudowius S, Puel A, Horneff G, et al. A NEMO-deficient child with immunodeficiency yet without anhidrotic ectodermal dysplasia. *J Allergy Clin Immunol* 2004;114:1456–62.
- [122] Puel A, Reichenbach J, Bustamante J, Ku CL, Feinberg J, Doffinger R, et al. The NEMO mutation creating the most-upstream premature stop codon is hypomorphic because of a reinitiation of translation. *Am J Hum Genet* 2006;78:691–701.
- [123] Smahi A, Courtois G, Rabia SH, Doffinger R, Bodemer C, Munnich A, et al. The NF-kappaB signalling pathway in human diseases: from incontinentia pigmenti to ectodermal dysplasias and immune-deficiency syndromes. *Hum Mol Genet* 2002;11:2371–5.
- [124] Abinun M, Spickett G, Appleton AL, Flood T, Cant AJ. Anhidrotic ectodermal dysplasia associated with specific antibody deficiency. *Eur J Pediatr* 1996;155:146–7.
- [125] Mansour S, Woffendin H, Mitton S, Jeffery I, Jakins T, Kenwrick S, et al. Incontinentia pigmenti in a surviving male is accompanied by hypohidrotic ectodermal dysplasia and recurrent infection. *Am J Med Genet* 2001;99:172–7.
- [126] Aradhya S, Courtois G, Rajkovic A, Lewis R, Levy M, Israel A, et al. Atypical forms of incontinentia pigmenti in male individuals result from mutations of a cytosine tract in exon 10 of NEMO (IKK-gamma). *Am J Hum Genet* 2001;68:765–71.
- [127] Orange JS, Brodeur SR, Jain A, Bonilla FA, Schneider LC, Kretschmer R, et al. Deficient natural killer cell cytotoxicity in patients with IKK-gamma/NEMO mutations. *J Clin Invest* 2002;109:1501–9.
- [128] Nishikomori R, Akutagawa H, Maruyama K, Nakata-Hizume M, Ohmori K, Mizuno K, et al. X-linked ectodermal dysplasia and immunodeficiency caused by reversion mosaicism of NEMO reveals a critical role for NEMO in human T-cell development and/or survival. *Blood* 2004;103:4565–72.
- [129] Ku CL, Picard C, Erdos M, Jeurissen A, Bustamante J, Puel A, et al. IRAK-4 and NEMO mutations in otherwise healthy children with recurrent invasive pneumococcal disease. *J Med Genet* 2006; in press.
- [130] Jain A, Ma CA, Lopez-Granados E, Means G, Brady W, Orange JS, et al. Specific NEMO mutations impair CD40-mediated c-Rel activation and B cell terminal differentiation. *J Clin Invest* 2004;114:1593–602.
- [131] Kosaki K, Shimasaki N, Fukushima H, Hara M, Ogata T, Matsuo N. Female patient showing hypohidrotic ectodermal dysplasia and immunodeficiency (HED-ID). *Am J Hum Genet* 2001;69:664–6.
- [132] Carrol ED, Gennery AR, Flood TJ, Spickett GP, Abinun M. Anhidrotic ectodermal dysplasia and immunodeficiency: the role of NEMO. *Arch Dis Child* 2003;88:340–1.
- [133] Orange JS, Jain A, Ballas ZK, Schneider LC, Geha RS, Bonilla FA. The presentation and natural history of immunodeficiency caused by nuclear factor kappaB essential modulator mutation. *J Allergy Clin Immunol* 2004;113:725–33.
- [134] Orstavik KH, Kristiansen M, Knudsen GP, Storhaug K, Vege A, Eiklid K, et al. Novel splicing mutation in the NEMO (IKK-gamma) gene with severe immunodeficiency and heterogeneity of X-chromosome inactivation. *Am J Med Genet A* 2006;140:31–9.
- [135] Nedorost ST, Elewski B, Tomford JW, Camisa C. Rosacea-like lesions due to familial *Mycobacterium avium*-intracellular infection. *Int J Dermatol* 1991;30:491–7.
- [136] Frucht DM, Holland SM. Defective monocyte costimulation for IFN-gamma production in familial disseminated *Mycobacterium avium* complex infection: abnormal IL-12 regulation. *J Immunol* 1996;157:411–6.
- [137] Frucht DM, Sandberg DI, Brown MR, Gerstberger SM, Holland SM. IL-12-independent costimulation pathways for interferon-gamma production in familial disseminated *Mycobacterium avium* complex infection. *Clin Immunol* 1999;91:234–41.
- [138] Holland SM, Eisenstein EM, Kuhns DB, Turner ML, Fleisher TA, Strober W, et al. Treatment of refractory disseminated nontuberculous mycobacterial infection with interferon gamma. A preliminary report. *N Engl J Med* 1994;330:1348–55.
- [139] Picard C, Puel A, Bonnet M, Ku CL, Bustamante J, Yang K, et al. Pyogenic bacterial infections in humans with IRAK-4 deficiency. *Science* 2003;299:2076–9.
- [140] Yang K, Puel A, Zhang S, Eidenschenk C, Ku CL, Casrouge A, et al. Human TLR-7-, -8-, and -9-mediated induction of IFN-alpha/beta and -lambda is IRAK-4 dependent and redundant for protective immunity to viruses. *Immunity* 2005;23:465–78.
- [141] Ferrari S, Plebani A. Cross-talk between CD40 and CD40L: lessons from primary immune deficiencies. *Curr Opin Allergy Clin Immunol* 2002;2:489–94.

- [142] Etzioni A, Ochs HD. The hyper IgM syndrome—an evolving story. *Pediatr Res* 2004;56:519–25.
- [143] Levy J, Espanol-Boren T, Thomas C, Fischer A, Tovo P, Bordigoni P, Resnick I, et al. Clinical spectrum of X-linked hyper-IgM syndrome. *J Pediatr* 1997;131:47–54.
- [144] Dubos RJ, Dubos J. *The white plague; tuberculosis, man and society*. 1st ed. Boston: Little Brown; 1952.
- [145] Picard C, Casanova J, Abel L. Mendelian traits that confer predisposition or resistance to specific infections in humans. *Curr Opin Immunol* 2006;18:383–90.
- [146] Ball EV, Stenson PD, Abeyasinghe SS, Krawczak M, Cooper DN, Chuzhanova NA. Microdeletions and microinsertions causing human genetic disease: common mechanisms of mutagenesis and the role of local DNA sequence complexity. *Hum Mutat* 2005;26:205–13.

Article 6

T cell-dependent activation of dendritic cells requires IL-12 and IFN-gamma signaling in T cells

Miro, F., C. Nobile, N. Blanchard, M. Lind, O. Filipe-Santos, C. Fieschi, A. Chagnier, G. Vogt, **L. de Beaucoudrey**, D.S. Kumararatne, F. Le Deist, J.L. Casanova, S. Amigorena, and C. Hivroz

Journal of Immunology
2006, 177:3625-3634

T Cell-Dependent Activation of Dendritic Cells Requires IL-12 and IFN- γ Signaling in T Cells¹

Francesc Miro,* Cinzia Nobile,* Nicolas Blanchard,* Marianne Lind,* Orchidée Filipe-Santos,[†] Claire Fieschi,[†] Ariane Chapgier,[†] Guillaume Vogt,[†] Ludovic de Beaucoudrey,[†] Dinakantha S. Kumararatne,[‡] Françoise Le Deist,[§] Jean-Laurent Casanova,[†] Sebastian Amigorena,* and Claire Hivroz^{2*}

Patients presenting with genetic deficiencies in IFNGR1, IFNGR2, IL-12B, and IL-12RB1 display increased susceptibility to mycobacterial infections. We analyzed in this group of patients the cross-talk between human CD4⁺ T lymphocytes and dendritic cells (DCs) that leads to maturation of DC into producers of bioactive IL-12 and to activation of T cells into IFN- γ producers. We found that this cross-talk is defective in all patients from this group. Unraveling the mechanisms underlying this deficiency, we showed that IL-12 signaling in T cells is required to induce expression of costimulatory molecules and secretion of IL-12 by DCs and that IFNGR expression is required on both DCs and CD4⁺ T cells to induce IL-12 secretion by DCs. These data suggest that CD4⁺ T cell-mediated activation of DCs plays a critical role in the defense against mycobacterial infections in humans. *The Journal of Immunology*, 2006, 177: 3625–3634.

Humans with defective response to IFN- γ or IL-12 share a common vulnerability to infections due to nontuberculous mycobacteria or vaccine-associated bacille Calmette-Guérin (BCG)³ and to a lesser degree to *Salmonella* and some intracellular bacteria (1). They also display modest vulnerability to ~20% of common viruses (2, 3). This susceptibility to mycobacteria, BCG, and other intracellular opportunistic pathogens is shared by another group of patients presenting with mutations in *CD40L*, who were first described for their hyper-IgM syndrome (4–6) and have been shown to develop localized disease due to BCG and severe tuberculosis (6, 7).

CD40L/CD40 interactions, IFN- γ , and IL-12 are all major players of the cross-talk between dendritic cells (DCs) and Th cells, cross-talk that regulates the Ag-presenting functions of DCs and influences the polarization of Th1 responses and priming of CTL (8, 9) (reviewed in Ref. 10). Indeed, although the process of DC maturation, which is required for naive T cell priming (11), is initially triggered by microbial products through TLR (12), interactions of maturing DCs with various lymphocyte populations orientate the priming capacity of mature DCs. CD4⁺ Th lymphocytes have been shown to license or educate DCs to prime CTLs or to

orientate CD4⁺ T cell priming toward Th1 or Th2 responses (reviewed in Refs. 13, 14).

Mouse studies have shown that CD4⁺ T cells can be replaced by agonistic anti-CD40 Abs for the induction of CD8⁺ T cell priming (15–17), suggesting a major role for CD40-CD40L interactions in the induction of full DC maturation. In vitro, CD40-deficient DCs are partially defective for CD8⁺ T cell priming, suggesting a major, but not exclusive, role for CD40-CD40L interactions in DC licensing (18). In human models, anti-CD40 Abs, soluble trimeric CD40L, or CD40L-transfected cell lines have been shown to induce expression of costimulatory molecules (19, 20) and secretion of bioactive IL-12 by DCs (21, 22). Moreover, it has been shown that effective human CTL priming in vitro requires the presence of Ag-specific CD4 T cells and TNF- α -activated DCs (23). Thus, although the Ag-specific encounter between CD4⁺ T lymphocytes and immature or maturing DCs is generally recognized as a major step in the development of an adaptive immune response, little is known about the molecular players involved at this level.

The present study was designed to determine: 1) whether the cross-talk between CD4⁺ T cells and DCs from patients presenting with mutations in *CD40L*, *IL-12B*, *IL-12RB1*, *IFNGR1*, and *IFNGR2* was efficient; and 2) the relative contribution of T cell and DC responses to IL-12 and IFN- γ in this cross-talk.

Materials and Methods

Medium and reagents

Medium used was as follows: RPMI 1640 Glutamax, 1% pyruvate, 5 \times 10⁻⁵ M 2–2-ME, 100 U/ml penicillin, 100 μ g/ml streptomycin (Invitrogen Life Technologies), and 10% FCS (Biowest). Human rIL-4 and GM-CSF were purchased from BRUCELLS; IFN- γ from Roussel; IL-12p70, IL-23, TNF- α , and anti-IL-12 from R&D Systems; and anti-IFN- γ from BD Pharmingen. The agonist anti-human CD40 mAb (clone G28-5) was a gift from Y. Richard (Institut Paris-Sud sur les Cytokines, Clamart, France). Recombinant bacterial superantigen, toxic shock syndrome toxin 1 (TSST1), was purchased from Toxin Technology, and LPS and brefeldin A were obtained from Sigma-Aldrich.

Patients

PBMC were obtained from two unrelated patients presenting with *CD40L* mutations, resulting in a complete defect in CD40L expression (6), one

*Institut National de la Santé et de la Recherche Médicale Unité 653, Institut Curie, Paris, France; [†]Laboratory of Human Genetics of Infectious Diseases, Institut National de la Santé et de la Recherche Médicale Unité 550, Necker-Enfants Malades Medical School, Paris, France; [‡]Medical Research Council Center for Immune Regulation, The Medical School, University of Birmingham, Edgbaston, Birmingham, United Kingdom; and [§]Institut National de la Santé et de la Recherche Médicale Unité 429, Hôpital Necker-Enfants Malades, Paris, France

Received for publication March 14, 2006. Accepted for publication June 28, 2006.

The costs of publication of this article were defrayed in part by the payment of page charges. This article must therefore be hereby marked *advertisement* in accordance with 18 U.S.C. Section 1734 solely to indicate this fact.

¹ This work was financially supported by Institut National de la Santé et de la Recherche Médicale, Institut Curie, and Association pour la Recherche Contre le Cancer. F.M. is the recipient of a grant from Association pour la Recherche Contre le Cancer.

² Address correspondence and reprint requests to Dr. Claire Hivroz, Institut National de la Santé et de la Recherche Médicale Unité 653, Institut Curie, 26, Rue d'Ulm, 75248 Paris Cedex 05, France. E-mail address: claire.hivroz@curie.fr

³ Abbreviations used in this paper: BCG, bacille Calmette-Guérin; DC, dendritic cell; TSST1, toxic shock syndrome toxin 1; WT, wild type.

patient with recessive complete *IFNGR1* deficiency described previously (1) and one patient with a homozygous mutation of the *IFNGR2*-encoding gene (24), resulting in both cases in complete deficiencies in IFN- γ response, one patient with a homozygous deletion in the IL-12p40-encoding gene (25) and three unrelated patients presenting with mutations in the gene encoding IL-12R β 1 (26). This study has been approved by the Comité Consultatif de Protection des Personnes dans la Recherche Biomédicale of Necker Hospital.

DC preparation

Anti-CD14-conjugated magnetic microbeads (Miltenyi Biotec) were used to purify monocytes from controls' or patients' PBMCs. DCs were generated, as described (27), by culturing monocytes in medium supplemented with 100 ng/ml GM-CSF and 40 ng/ml IL-4 for 5 days. Populations of immature DCs obtained were 100% CD1a⁺/CD14⁻.

Sorting of CD4⁺ T cells and purification of CD45RA⁺ and CD45RO⁺ CD4⁺ T cells

After depletion of CD14⁺ cells (see above), the CD4⁺ T cell isolation kit II from Miltenyi Biotec was used to negatively select CD4⁺ T cells. Sorted CD4⁺ T cells were 97–99% CD4⁺/CD3⁺. Isolation of CD45RO⁺ memory or CD45RA⁺ naive CD4⁺ T cells was performed by incubation of CD4⁺ T cells with anti-CD45RA (Alb11; Beckman Coulter) or anti-CD45RO mAbs (UCHL1; a gift from P. Beverley, Edward Jenner Institute for Vaccine Research, Compton, U.K.), respectively, and depletion with anti-mouse IgG magnetic beads (DynaL Biotec; Invitrogen Life Technologies). The memory CD45RA⁻CD4⁺ and naive CD45RO⁻CD4⁺ T cell populations obtained were 95–98% CD45RO⁺ and CD45RA⁺, respectively.

In vitro DC activation assay

Cocultures of immature DCs and CD4⁺ T cells (5×10^4 DCs and equal number of T cells, unless otherwise stated) were performed in flat-bottom 96-well plates. In experiments addressing *trans* activation, 2×10^5 monocyte-derived DCs were cocultured with 2×10^5 T cells in 24-well plates containing cell culture inserts with a permeable membrane (0.4- μ m pore size, Transwell from BD Biosciences); several combinations of cells were used in the upper and lower well. Twenty-four hours later, cytokine pro-

duction in supernatants and expression of maturation markers by DCs and CD4⁺ T cells were analyzed.

Cytokine detection

Cytokine production was measured in the supernatants by ELISA using matched paired Abs specific for IL-12p70 (DuoSet; R&D Systems), IL-2, or IFN- γ (OptiEA; BD Biosciences). In some experiments, the cytometric bead array human inflammation kit (BD Biosciences) was used to measure inflammatory production.

FACS analysis

The following murine mAbs, anti-CD1a FITC, anti-CD14 PE, anti-CD86 FITC, anti-HLA-DR FITC, anti-CD80 PE, anti-CD83 PE, anti-CD40 PE, anti-CD4 PE, and anti-CD69 allophycocyanin, and IgG1 PE, IgG1 allophycocyanin, and IgG2a FITC isotypic controls were purchased from BD Pharmingen. Anti-TCRV β 2 FITC was from Beckman Coulter. Samples were analyzed on a FACSCalibur using the CellQuest software (BD Biosciences). Intracellular production of IFN- γ was measured by FACS. Brefeldin A (5μ g/ml) was added during the last 3 h of cocultures. Cells were then labeled with anti-CD4 mAbs coupled to FITC, fixed with 3% paraformaldehyde, and permeabilized with the CytoPerm/Wash kit from BD Biosciences before labeling with anti-IFN- γ mAb coupled to PE (Beckman Coulter).

Immunolabeling and fluorescence microscopy

After cocultures, cells were settled in RPMI 1640 onto poly(L-lysine)-coated coverslips for 15 min. After one PBS wash, cells were fixed with 3% paraformaldehyde (Carlo Erba) for 20 min and incubated for 10 min in 10 mM PBS glycine to quench free aldehyde groups. Cells were then permeabilized and labeled for 1 h by incubation with anti-IL-12p70 and anti-IFN- γ Abs diluted in PBS, 0.2% BSA (Sigma-Aldrich), 0.05% saponin (ICN Biomedicals), and secondary Abs labeled with Alexa 647-conjugated F(ab')₂ anti-species-specific Abs from Molecular Probes diluted in the same buffer. Cells were then labeled with either anti-CD1a FITC (BD Biosciences) or anti-TCRV β 2 FITC (Beckman Coulter). Coverslips were finally mounted onto glass slides using Fluoromount-G (Southern Biotechnology Associates). Fluorescence images were acquired using a Leica TCS SP2 confocal scanning microscope equipped with a 100 Å ~ 1.32 NA HCX

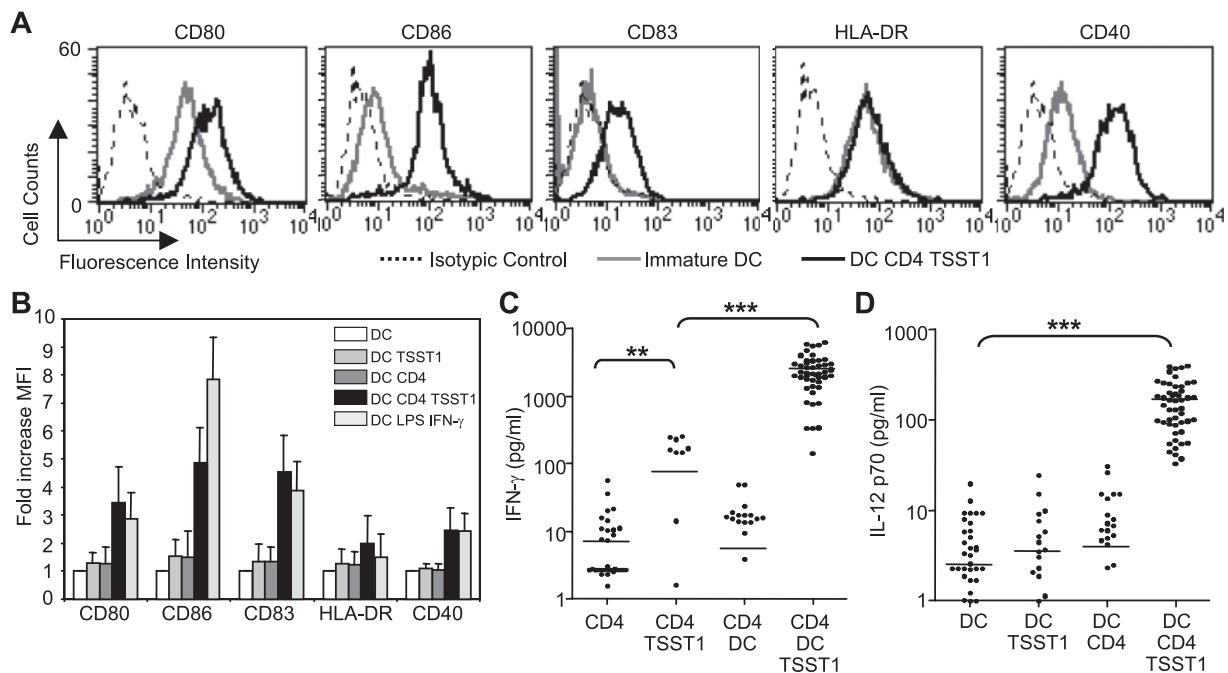

FIGURE 1. Activation of DCs by CD4⁺ T cells. Immature monocyte-derived DCs (5×10^4) were cultured for 24 h with or without CD4⁺ T cells (5×10^4) and the superantigen TSST1 (10 ng/ml) or with a combination of LPS (500 ng/ml) and IFN- γ (20 U/ml). *A* and *B*, Flow cytometric analysis of DC maturation markers. *A*, Histograms of a representative experiment. *B*, For each marker, expression was plotted as a ratio between the mean fluorescence intensity (MFI) obtained in different conditions and the MFI measured in immature DC (fold increase MFI). Data are presented as mean + SD of triplicates from 15 independent experiments performed with 11 unrelated donors. IFN- γ secretion (*C*) or IL-12p70 secretion (*D*) was measured by ELISA in supernatants from 11 and 9 individual donors, respectively. The mean of cytokine production is indicated in each column. Significant differences between the groups were assessed by Mann-Whitney's unpaired *t* test (**, $p < 0.0002$; ***, $p < 0.0001$).

PL APO oil immersion objective, and Ar and HeNe lasers emitting at wavelengths of 633 nm.

Results

T cells induce DC activation in the presence of superantigen

We set up a human model to study T cell-induced activation of immature DCs. Human monocyte-derived immature DCs and autologous or allogenic CD4⁺ T cells were purified from control donors and cocultured with or without the bacterial superantigen TSST1. Maturation of DCs was studied 24 h later, by measuring the surface expression of DC maturation markers (CD40, CD80, CD83, CD86, and HLA-DR) and the production of IL-12p70.

DC activation was not significantly induced when cultured with either TSST1 or CD4⁺ T cells alone (Fig. 1*B*). In contrast, immature DCs cocultured for 24 h in the presence of CD4⁺ T cells and TSST1 showed increased expression of CD86, CD80, CD83, and CD40. Expression of HLA-DR was not always enhanced (Fig. 1, *A* and *B*). Statistical analysis of the data demonstrated that the expression of CD80, CD86, CD83, CD40, and HLA-DR was significantly increased by coculture with T cells and TSST1. DC maturation induced by CD4⁺ T cells and TSST1 was comparable to the maturation induced by LPS + IFN- γ (Fig. 1*B*). It was reproducibly observed in 15 independent experiments with monocyte-derived DCs from 11 different donors.

Induction of CD69 expression on the T cells (data not shown) as well as production of IFN- γ (Fig. 1*C*) were observed when the CD4⁺ T cells were cultured with immature DCs and TSST1 (2536 ± 222.2 pg/ml; $n = 46$; 9 different donors). This production was 30-fold what was produced when T cells were cultured with TSST1 alone (75.90 ± 26.43 pg/ml; $n = 17$).

Finally, immature DCs produced IL-12p70 only when cocultured with TSST1 and CD4⁺ T cells (Fig. 1*D*). The mean concentration of IL-12p70 in supernatants of immature DCs cultured with TSST1 and CD4⁺ T cells was 167.5 ± 14.4 pg/ml (50 independent experiments; 11 different donors) as compared with 7927 ± 1655 pg/ml in supernatants of immature DCs activated by LPS + IFN- γ . Up-regulation of maturation markers and IL-12 production depended on the T cell number and were observed, respectively, for a DC:CD4⁺ T cell ratio of up to 25 DCs for 1 T cell and 5 DCs for 1 T cell (data not shown). IL-6, IL-8, IL-10, and TNF- α were also produced in the cocultures in the presence of TSST1 (Fig. 7); no detectable IL-4 was found in these conditions (data not shown). No significant difference in DC maturation and IL-12p70 production was observed when DCs and CD4⁺ T cells were autologous or allogenic (data not shown).

This model may be used to study the T cell-driven activation of human immature DCs.

CD4⁺ T cell-driven DC activation requires direct contact between the two cell populations

We next asked whether direct contact between human CD4⁺ T cells and immature DCs was required to induce expression of costimulatory molecules and IL-12p70 secretion by DCs. Using Transwell plates, we did not observe any phenotypic maturation of the DCs when TSST1-bearing immature DCs were seeded in the lower chamber and CD4⁺ T cells in the upper chamber (Fig. 2*A*). Therefore, direct contacts between the two cell types are required to induce DC maturation. However, DCs of the lower chamber showed moderate increased expression of CD86 and CD83, when exposed to supernatants of DCs + TSST1 + CD4 produced in the upper chamber (Fig. 2*A*).

Concerning IL-12p70 production, addition of a 24-h supernatant produced by CD4⁺ T cells + immature DCs + TSST1 did not induce IL-12p70 production by TSST1-pulsed DCs and did not

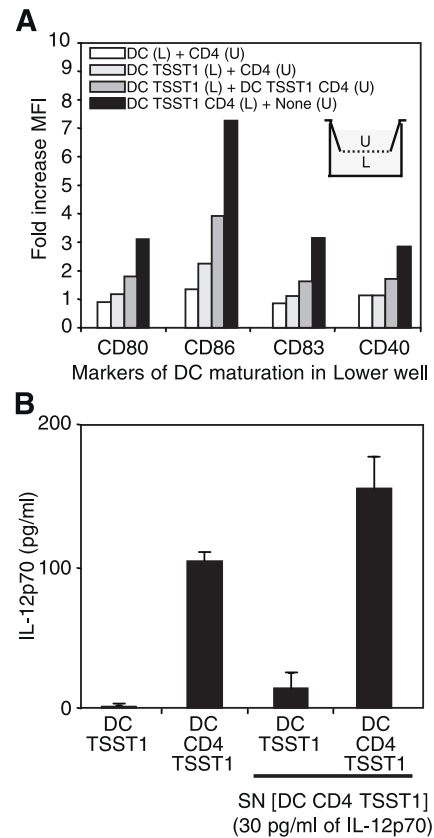

FIGURE 2. DC activation by T cells requires a direct contact between DC and CD4⁺ T cells. *A*, Immature DCs or TSST1-pulsed DCs were seeded in the lower chamber (L) of a Transwell plate, and CD4⁺ T cells, DC + TSST1 + CD4, or medium in the upper chamber (U). Expression of maturation markers by the DCs of the lower chamber was analyzed after 24 h and expressed as in Fig. 1*B*. *B*, IL-12p70 secretion was measured in 24-h supernatants of DCs pulsed with TSST1 with or without CD4⁺ T cells and compared with production of IL-12p70 by TSST1-pulsed DCs cultured for 24 h with 50 μ l of a supernatant of DC + TSST1 + CD4 containing 30 pg/ml IL-12p70. The same supernatant was added to DC + TSST1 + CD4. Data are presented as mean triplicates. One representative experiment of three is shown in *A* and *B*.

synergize with CD4⁺ T cells to induce more IL-12p70 secretion by TSST1-pulsed immature DCs (Fig. 2*B*).

We conclude that some phenotypic maturation of DCs is induced in the absence of direct contact with T cells, but that a direct contact between the two cell types is required for IL-12 production.

Memory T cells mediate T cell-driven DC activation

It has been shown previously that memory T cells induce IL-12 production by DCs (22, 28); we checked whether this was true in our model. Memory CD45RO⁺CD4⁺ T cells and naive CD45RA⁺CD4⁺ T cells were purified from control donors, and their ability to induce expression of maturation markers and secretion of IL-12p70 by DCs was compared. The same percentage (8–12%) of TSST1-specific, V β 2⁺CD4⁺ T cells was measured in the naive and memory CD4⁺ T cell populations (data not shown). However, for all the donors tested, the induction of CD69 by TSST1-pulsed immature DCs was less pronounced in naive than in memory CD4⁺ T cells (see representative experiment in Fig. 3*A*). Naive CD45RA⁺CD4⁺ T cells were less efficient at inducing CD86, CD83, and CD40 expression by DCs than memory

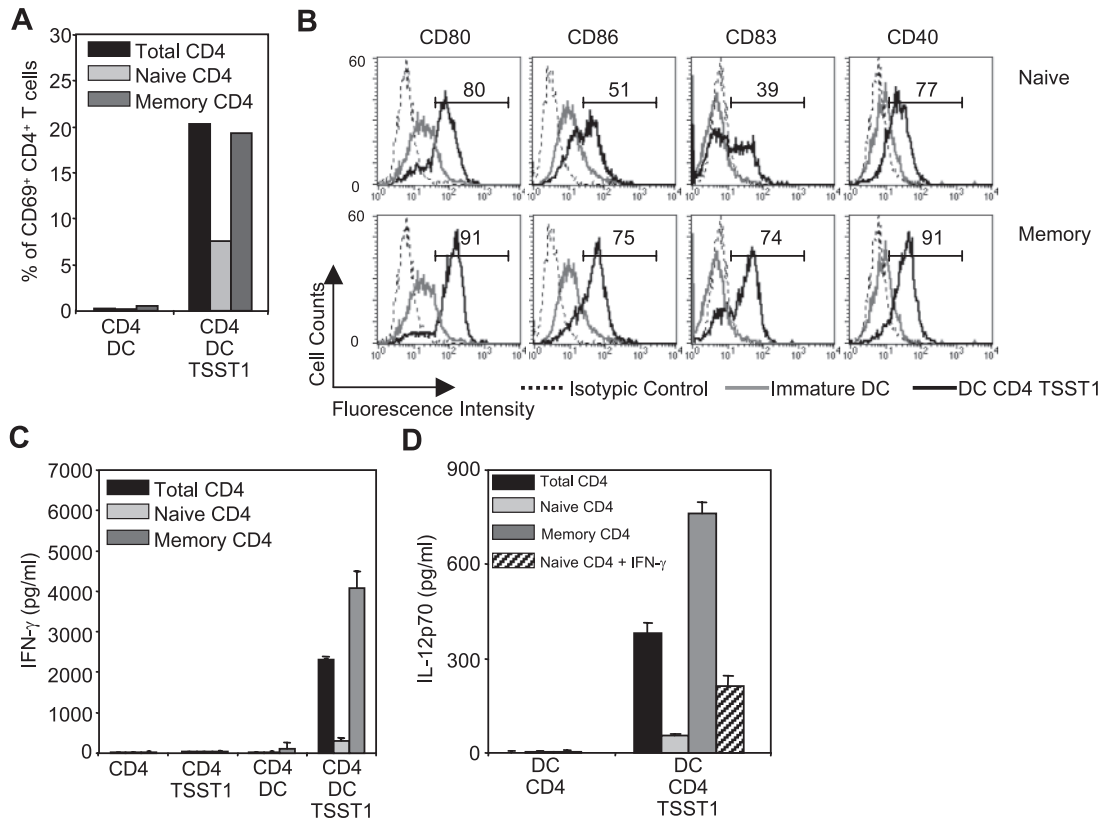

FIGURE 3. T cell-driven DC activation is mediated by memory, but not by naive T cells. Immature DCs from a control donor were cultured with allogenic purified total CD4⁺ (Total CD4), naive CD4⁺CD45RA⁺CD45RO⁻ (Naive CD4), or memory CD4⁺CD45RO⁺CD45RA⁻ (Memory CD4) T cells from the same donor at a ratio of 1:1 with or without TSST1 (10 ng/ml). *A*, CD69 expression by T cells. *B*, Expression of maturation markers by DCs cultured either with naive (*upper row*) or memory (*lower row*) CD4⁺ T cells and TSST1 for 24 h. Number above bracketed lines indicates percentage of cells in that area. Results are representative of three independent experiments. IFN- γ (*C*) or IL-12p70 (*D*) secretion in 24-h supernatants. In *D*, IL-12p70 was also measured in supernatants of naive CD4⁺ T cells + DCs + TSST1 cultured with IFN- γ (1000 U/ml). One representative experiment of three.

CD45RO⁺CD4⁺ T cells (Fig. 3*B*); they also produced lower amount of IFN- γ (25 pg/ml) than memory T cells (Fig. 3*C*).

Finally, as shown in Fig. 3*D*, naive T cells induced low levels of IL-12p70 secretion by immature DCs, which was not only due to the absence of IFN- γ in the coculture because addition of IFN- γ did not restore the IL-12p70 production to level obtained with total or memory CD4⁺ T cells (Fig. 3*D*).

These results show, in our model, that only memory CD4⁺ T cells induce DC activation and IL-12 secretion.

CD4⁺ T cell-driven DC activation requires CD40L (CD154) expression by T cells

The CD40 pathway has been shown to play an important role in eliciting costimulatory molecule expression and bioactive IL-12 secretion by DCs. To directly test the role of this pathway in our model, we used CD4⁺ T cells purified from two unrelated immunodeficient patients with complete defects in CD40L expression (6).

As shown in Fig. 4*A*, CD40L-deficient CD4⁺ T cells (CD4⁺/CD40L⁻) were efficiently activated by the TSST1-pulsed immature DCs, as witnessed by the increased expression of CD69. Moreover, CD40L-deficient CD4⁺ T cells induced increased expression of CD80, CD86, CD83, and CD40 by DCs, which was comparable to the expression induced by CD4⁺ T cells from a control donor (Fig. 4*B*). In contrast, CD40L-deficient CD4⁺ T cells from the two patients, although producing significantly higher amount of IFN- γ than in the absence of TSST1, produced 7–15 times less IFN- γ than CD4⁺ T cells from control donors (Fig. 4*C*).

Moreover, CD40L-deficient T cells did not induce any IL-12p70 production by DCs (Fig. 4*D*).

We next tested whether the absence of IL-12 production (Fig. 4*D*) was due to the low production of IFN- γ by T cells. Addition of 1000 U/ml IFN- γ to CD40L-deficient CD4⁺ T cells did not restore IL-12 production by TSST1-bearing DCs (Fig. 4*D*). In the same experiment, 40 U/ml IFN- γ increased by 4.5-fold IL-12p70 secretion induced by LPS in immature DCs (Fig. 4*D*), demonstrating the biological activity of the IFN- γ we used. These results suggested that CD40 triggering by CD40L was required for IL-12p70 production by DCs and could not be replaced by IFN- γ . To test this hypothesis, we added an activating anti-CD40 mAb to the cocultures of CD40L-deficient T cells and TSST1-pulsed immature DCs. As shown in Fig. 4*E*, addition of the anti-CD40 mAb to the cocultures containing CD40L-deficient T cells induced the secretion of IL-12p70, whereas no IL-12p70 production was induced when a control IgG was added at the same concentration (Fig. 4*E*). The IL-12p70 production observed with anti-CD40 mAb was accompanied by a markedly increased production of IFN- γ in the cocultures (data not shown), which probably explains why the addition of IFN- γ in the cocultures containing anti-CD40 mAb only moderately increased the production of IL-12p70 (Fig. 4*E*). This reciprocal activation of immature DCs and CD40L-deficient T cells leading to IL-12p70 and IFN- γ production was observed only in the presence of TSST1. Indeed, no IL-12p70 production was observed when immature DCs were cocultured with CD4⁺ T cells, the activating anti-CD40 mAb, and IFN- γ (Fig. 4*E*).

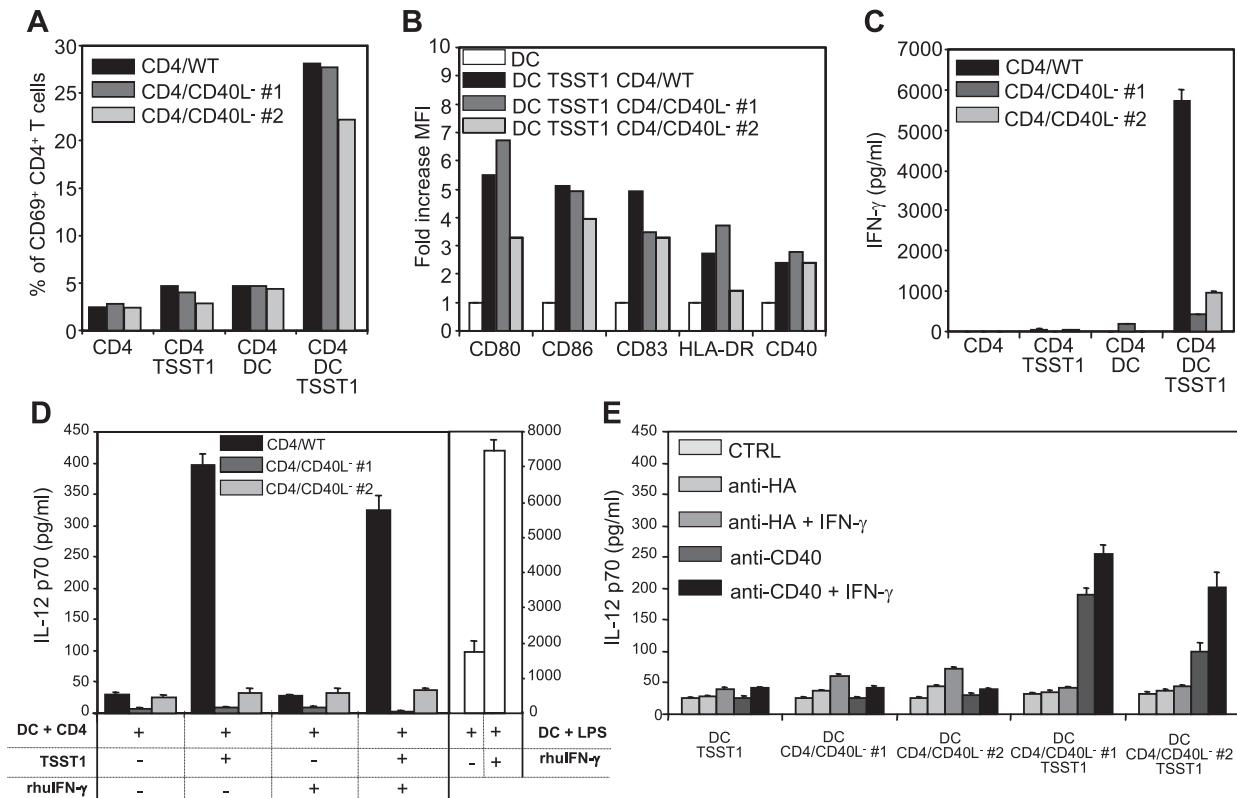

FIGURE 4. CD40L (CD154) expression by T cells is required to induce DC activation. Immature DCs were cultured as in Fig. 1 with CD4/wild-type (WT) or T cells from two CD40L deficiencies (CD4/CD40L⁻, 1 and 2). *A*, FACS analysis of CD69 expression by CD4⁺ T cells. *B*, Expression of phenotypic maturation markers in DCs is plotted as in Fig. 1*B*. IFN-γ (*C*) and IL-12p70 (*D* and *E*) secretion in supernatants (mean + SD of triplicates). *D*, Human rIFN-γ (rhuIFN-γ) at 1000 U/ml was added to cocultures of DC + CD4 and DC + CD4 + TSST1. IL-12p70 in supernatants of DCs cultured with LPS (200 ng/ml) or LPS + IFN-γ (40 U/ml). *E*, A total of 3 μg/ml anti-hemagglutinin Ab or anti-CD40 Ab was added alone or in combination with IFN-γ (1000 U/ml) to the cultures. One representative experiment of two is shown in *A–E*.

T cell-driven secretion of bioactive IL-12 by human DCs thus requires at least three signals, CD40 stimulation, IFN-γ, and antigenic stimulation of T cells.

IL-12 signaling in CD4⁺ T cells is required for T cell-induced DC activation

IL-12 is a key regulator of CD4⁺ T cell differentiation to the Th1 phenotype (8, 9), thus regulating IFN-γ production by CD4⁺ T cells. We analyzed IL-12 production by DCs in our model. As shown in Fig. 5*A* (lower panels), after coculture with CD4⁺ T cells in the presence of superantigens, anti-IL-12 Ab strongly labeled CD1a⁺ DCs' dendrites, some of which enwrapped CD4⁺ T cells. Eighty to ninety percent of the DCs, in conjugates or not, were labeled with anti-IL-12 Abs. This IL-12 labeling of DCs was never observed in the absence of superantigen (Fig. 5*A*, upper panels). A kinetic analysis of the production of IL-12p70 and IFN-γ revealed a rapid production of both IL-12p70 and IFN-γ, which are detected in the supernatants after 12 h of coculture (data not shown).

We then studied the role of IL-12 secretion by DCs in the cross-talk between CD4⁺ T cells and immature DCs by using CD4⁺ T cells from three unrelated patients presenting with mutations in *IL-12RB1*, resulting in a totally defective expression of this receptor (3). TSST1-pulsed immature DCs from normal donors induced CD69 expression in 15% of the CD4⁺/IL-12RB1⁻ T cells (data not shown) witnessing their activation. However, these activated CD4⁺/IL-12RB1⁻ T cells produced low level or no IFN-γ in coculture with TSST1-pulsed DCs (Fig. 5*B*), showing that IL-12RB1-mediated signaling is required for optimal IFN-γ production. IL-12RB1 is a common subunit for both IL-12R and IL-23R,

which binds the IL-12p40 subunit shared by these two cytokines (10). To distinguish the requirement for these two cytokines in IFN-γ secretion by T cells, we analyzed the ability of DCs derived from a patient presenting with a total defect in IL-12p40 expression (25) to induce IFN-γ production by CD4⁺ T cells from control donors. As expected, IL-12p40-deficient DCs did not secrete IL-12p70 when cocultured with TSST1 + CD4⁺ T cells from a control donor (data not shown). IL-12p40-deficient DCs induced 7 times less IFN-γ production by T cells than DCs from a control donor (Fig. 5*C*), yet they induced CD69 expression by 20–25% CD4⁺ T cells, showing T cell activation (data not shown). This result confirmed the key role of IL-12p40 in the induction of IFN-γ production by T cells. To find out the relative role of IL-12 and IL-23 in IFN-γ production by T cells, we added either IL-12p70 or IL-23 to cocultures of TSST1-pulsed IL-12p40-deficient DCs and CD4⁺ T cells and measured IFN-γ production in the supernatants. Whereas no effect of IL-12 or IL-23 was observed on CD69 expression by T cells (data not shown), IL-12p70 was able to increase by almost 3-fold the IFN-γ production by CD4⁺ T cells activated by TSST1-pulsed IL-12p40-deficient DCs, whereas IL-23 had no effect (Fig. 5*C*). These results confirm that the DC-induced IFN-γ production by human CD4⁺ T cells is strongly regulated by IL-12 and show that it is not regulated by IL-23. Moreover, addition of an anti-IL-12-blocking mAb to cocultures of control donor DC + TSST1 + control donor CD4⁺ T cells induced an inhibition of IFN-γ and TNF-α production in the cocultures (data not shown), showing that IFN-γ and TNF-α production are controlled by IL-12 in cells from control donors.

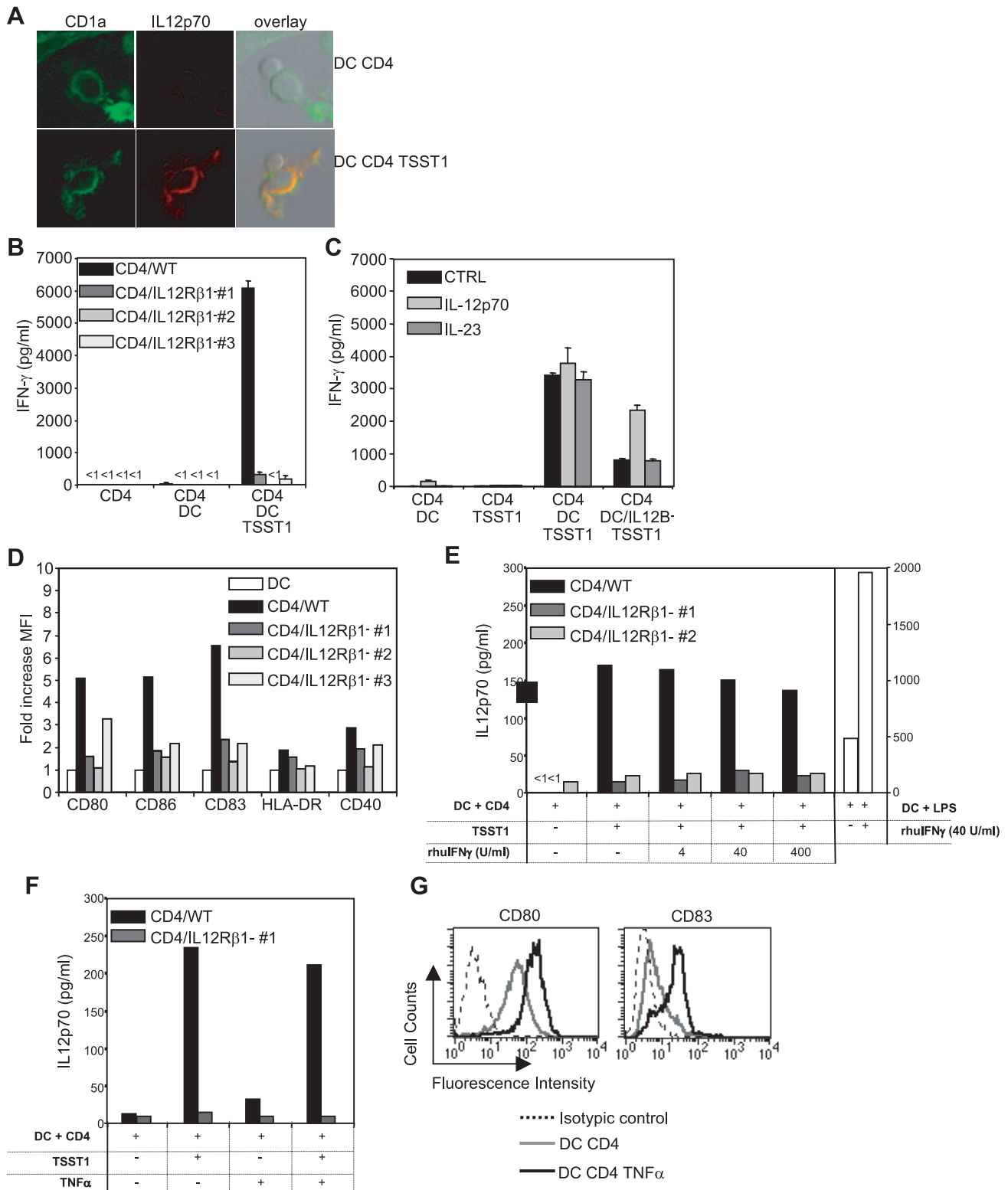

FIGURE 5. IL-12 signaling is required for T cell-dependent DC activation. *A*, Fixed cells were permeabilized and labeled with anti-IL-12p70 and CD1a Abs and visualized by confocal microscopy. *B* and *C*, IFN- γ production in 24-h supernatants of: *B*, CD4⁺ T cells from control (CD4/WT) or three IL-12R β 1-deficient patients (CD4/IL12R β 1⁻, #1–3) with or without control DCs and/or TSST1; *C*, CD4⁺ T cells from a control donor cocultured with DCs from an allogeneic control donor (DC/WT) or from an IL-12p40-deficient donor (DC/IL12B⁻). IL-12p70 (5 ng/ml), IL-23 (5 ng/ml), or medium was added at the beginning of the coculture. *D*, Expression of maturation markers in DCs from control donors cultured for 24 h in the presence of CD4⁺ T cells from allogeneic control donor (CD4/WT) or from IL-12R β 1-deficient patients presenting with a complete defect of IL-12R β 1 (CD4/IL12R β 1⁻). *E* and *F*, IL-12p70 secretion in 24-h supernatants of T cells from control donor or from two IL-12R β 1-deficient patients activated in the presence of TSST1, DC, or DC + TSST1. Various concentrations of IFN- γ (*E*) and 10 ng/ml TNF- α (*F*) were added to cocultures, and IL-12p70 secretion was measured. IL-12p70 was also measured in supernatants of DCs cultured with LPS (500 ng/ml) or LPS + IFN- γ (40 U/ml) (*E*, \square). *G*, Expression of CD80 and CD83 by DCs cultured without (gray line) or with 10 ng/ml TNF- α (black line). One representative experiment of two is shown in all panels.

We then analyzed whether IL-12 signaling in T cells plays a role in the T cell-driven DC activation. Surprisingly, CD4⁺/IL-12Rβ1⁻ T cells induced neither expression of maturation markers nor IL-12p70 production by DCs in the presence of TSST1 (maturation markers, Fig. 5D; IL-12, Figs. 5E and 7). This absence of IL-12p70 production was accompanied by an absence of production of TNF-α, IL-10, and IL-6 (Fig. 7). Because CD4⁺/IL-12Rβ1⁻ T cells produced low amount of IFN-γ and TNF-α, we added IFN-γ or TNF-α in the cocultures and measured IL-12p70 production. Addition of 4–400 U/ml (corresponding to 20–20,000 pg/ml) IFN-γ, i.e., the range of IFN-γ produced by CD4⁺ T cells from control donors activated by TSST1 and immature DCs, restored neither phenotypic maturation of DCs (data not shown) nor IL-12 production induced by CD4⁺/IL-12Rβ1⁻ T cells (Fig. 5E). Nonetheless, these concentrations of IFN-γ added to LPS-induced IL-12p70 secretion by immature DCs (Fig. 5E). Addition of

TNF-α did not restore IL-12 production induced by CD4⁺/IL-12Rβ1⁻ T cells either (Fig. 5F). In the same conditions, TNF-α induced some phenotypic maturation of DCs (Fig. 5G) as witnessed by the increase expression of CD80 and CD83; however, it did not increase the phenotypic maturation of DCs induced by CD4⁺/IL-12Rβ1⁻ T cells (data not shown).

These results show that IL-12 signaling in T cells is required to induce expression of costimulatory molecules and bioactive IL-12 secretion by DCs, and that this requirement is at least partially IFN-γ and TNF-α independent.

T cell-driven DC activation requires stimulation of both CD4⁺ T cells and DCs by IFN-γ

Results presented in Fig. 4E showed that IFN-γ controls IL-12p70 secretion by DCs. We thus better characterized the production of IFN-γ in the conjugates formed between CD4⁺ T cells and DCs.

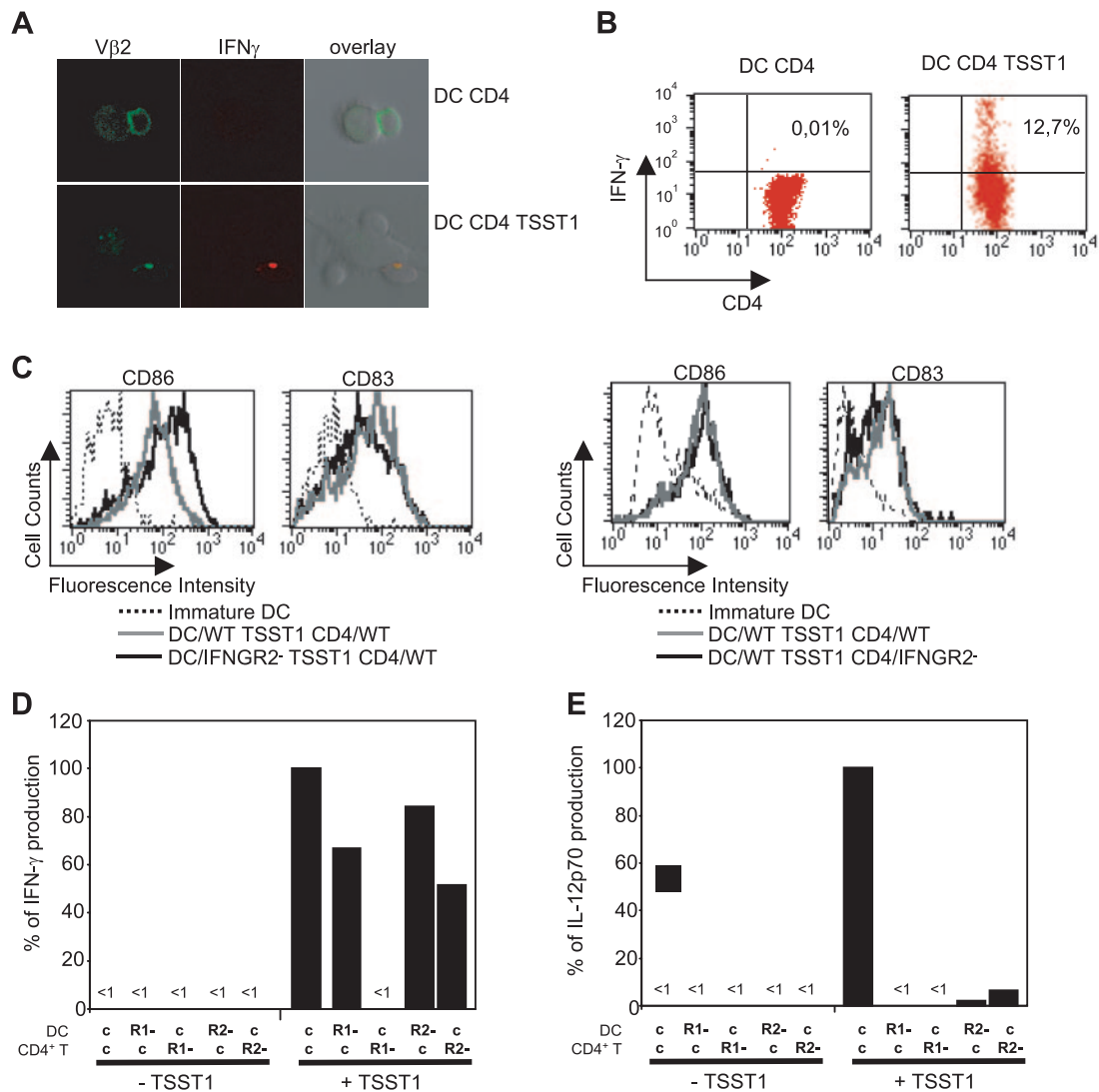

FIGURE 6. T cell-driven DC activation requires stimulation by IFN-γ of both T cells and DCs. *A*, Immature DCs were cultured for 10 h with CD4⁺ T cells without (*upper panels*) or with (*lower panels*) 10 ng/ml TSST1. Fixed cells were permeabilized and labeled with anti-IFN-γ and anti-Vβ2 Abs. *B*, FACS analysis of the IFN-γ production by CD4⁺ T cells cocultured for 10 h with TSST1-pulsed DCs (one representative experiment of three). *C*, Expression of CD86 (*left histogram*) and CD83 (*right histogram*): *left panel*, on DCs from a control (DC/WT, gray line) or on IFNGR2-deficient DCs (DC/IFNGR2⁻, black line) cocultured for 24 h with control CD4⁺ T cells and TSST1; *right panel*, on control DCs cocultured for 24 h with IFNGR2-deficient or control CD4⁺ T cells and TSST1. IFN-γ (*D*) or IL-12p70 (*E*) secretion was measured in 24-h supernatants of CD4⁺ T cells from a control donor or from two patients with a complete defect in *IFNGR1* (R1⁻) or *IFNGR2* (R2⁻) cultured with allogenic immature DCs from a control (labeled “c”), or DCs derived from the same patients (R1⁻, R2⁻) cultured with allogenic control CD4⁺ T cells (labeled “c”). Results in *C* and *D* are expressed as a percentage of cytokine production in DC/WT + CD4 + TSST1 (=100%).

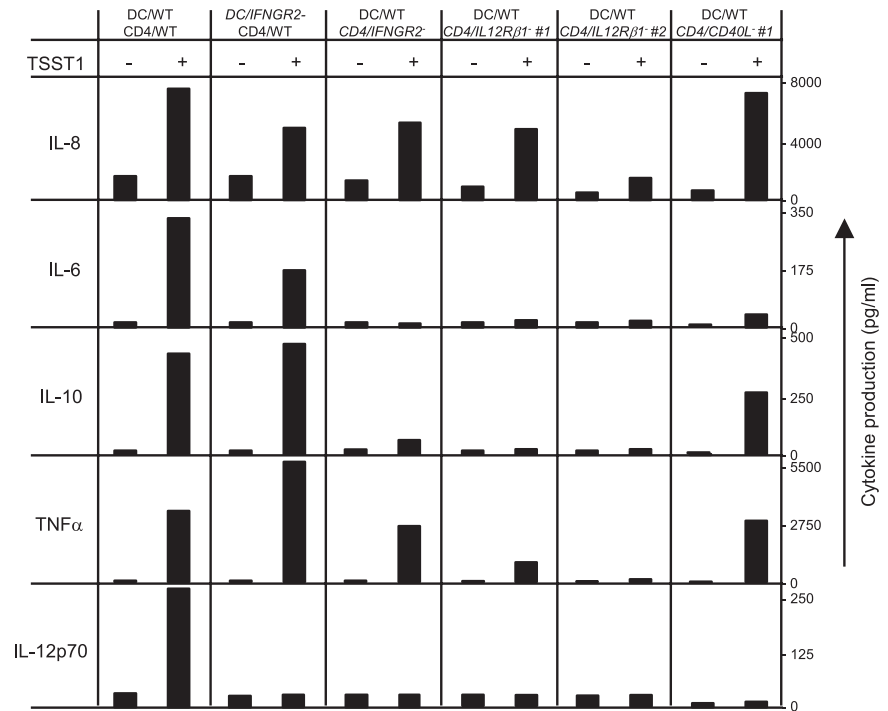

FIGURE 7. Simultaneous quantification of five cytokines using a cytometric bead array assay. IL-8, IL-6, IL-10, TNF- α , and IL-12p70 were measured using a multiplexed flow cytometric assay from 24-h supernatants of CD4⁺ T cells and DCs cocultured in presence or absence of 10 ng/ml TSST1.

Confocal analysis of immature DCs cocultured for 10 h with CD4⁺ T cells in the absence or presence of TSST1 (10 ng/ml) was performed. In the absence of TSST1, no IFN- γ labeling of T cells or DCs was observed (Fig. 6A, *upper panels*), confirming the ELISA results. In the presence of TSST1, 7–12% of the conjugates, depending on the donors, showed labeling for IFN- γ on V β 2 T cells. Only rare DCs were labeled. The IFN- γ labeling was, in most cases, polarized toward the DCs (Fig. 6A, *lower panels*). These figures corresponded to the percentage of T cells, which responded to TSST1, i.e., V β 2⁺ T cells (data not shown), and to the percentage of CD4⁺ T cells with intracellular IFN- γ labeling by FACS (Fig. 6B). These FACS analyses also confirmed that only T cells presented intracellular IFN- γ labeling. Therefore, CD4⁺ T cells secreted IFN- γ in an Ag-specific manner when interacting with immature DCs. Moreover, IFN- γ labeling is polarized toward the zone of interaction.

The role of IFN- γ in IL-12p70 secretion by DCs has been reported previously; however, the exact contribution of T cell and DC responses to IFN- γ requirement is not clearly characterized. We thus evaluated these contributions. To do so, we prepared monocyte-derived DCs and CD4⁺ T cells from two patients presenting with a total defect in IFNGR1 (1) (the IFN- γ -binding chain of the receptor) or IFNGR2 expression (24) (the accessory chain that contributes to signal transduction (29)). As shown in Fig. 6C, IFN- γ signaling was required in neither T cells nor DCs for the T cell-driven induction of CD86 and CD83 expression by DCs (*left panel* for IFNGR2-deficient DCs; *right panel* for IFNGR2-deficient CD4⁺ T cells). TSST1-pulsed DCs derived from healthy donors or from IFNGR1- and R2-deficient patients induced similar levels of IFN- γ production by control CD4⁺ T cells (Fig. 6D). IFNGR2-deficient CD4⁺ T cells were also able to secrete IFN- γ when activated with control DCs and TSST1, whereas IFNGR2-deficient T cells did not secrete any IFN- γ (Fig. 6D). These results highly suggest that IFN- γ binding to CD4⁺ T cells is required to induce IFN- γ secretion by T cells, but that IFN- γ signaling in T cells is not required. IFNGR expression by DCs or CD4⁺ T cells is not required either for IL-8, IL-10, or TNF- α production in cocultures (Fig. 7). In contrast, as shown in Fig. 6E, IFNGR1 and

IFNGR2 expression were required on both DCs and CD4⁺ T cells to induce IL-12p70 secretion by DCs.

Discussion

Patients affected by the clinical syndrome known as Mendelian susceptibility to mycobacterial disease present with specific susceptibility to live BCG vaccine, poorly virulent environmental mycobacteria, *Salmonella*, and few other intracellular pathogens (reviewed in Ref. 3). These patients have been shown to present with genetically distinct germline mutations in at least five genes, *IL12B*, *IL12RB1*, *IFNR1*, *IFNR2*, and *STAT1*, but have in common a defective IL-12/IFN- γ axis. Although known for 10 years now, the underlying mechanisms for this susceptibility to very specific intracellular pathogens are still unclear.

In this study, we specifically analyzed the T cell-driven maturation of DCs between highly purified human monocyte-derived DCs and CD4⁺ T lymphocytes from patients presenting with Mendelian susceptibility to mycobacterial disease and compared it with interactions between DCs and CD4⁺ T cells from control donors. We found out that the T cell-driven maturation of DCs is abolished in all the patients.

Although based on a human in vitro model using monocyte-derived DCs, purified CD4⁺ T cells, and recombinant superantigen, this experimental model reconstitutes a number of the known characteristics of the interactions between DCs and CD4⁺ T cells during DC licensing in vivo (in mice). These similarities include the absolute need for an Ag- and CD40-CD40L-dependent direct cell-cell contact for the induction of IL-12 secretion by DCs (30), because CD40L-deficient CD4⁺ T cells are unable to induce IL-12p70 secretion by DCs (Fig. 4). Interestingly, CD40L expression in T cells was required for the induction of IL-12p70 by human DCs, but not of other immunomodulatory cytokines (such as IL-8, IL-10, and TNF) (Fig. 7). Although CD40 plays a crucial role in the education of human DCs, anti-CD40 agonist mAbs were unable to induce IL-12p70 secretion by immature human DCs even in the presence of IFN- γ (Fig. 4). These results show that DCs require at least three signals coming from T cells, namely CD40L

expression and IFN- γ production by T cells and yet another signal, which is TCR dependent and remains to be found.

Also supporting the *in vivo* relevance of our *in vitro* model, the efficiency of CD4⁺ T cells for inducing IL-12 secretion by immature DCs is very high: one Ag-specific T cell for 125 immature DCs is sufficient to induce significant levels of IL-12 (at a ratio of total T cells:DCs of 1:5 (data not shown), and 4–5% of total purified T cells are V β 2⁺ (TSST1 responsive) with a memory phenotype). However, some of our results differ from results obtained in mice models that showed that bioactive IL-12 by DCs can be initiated by T cell-derived signals only in the presence of microbial signal (31, 32). In our study, we did not add any microbial product, and, although not completely excluded, the presence of trace amounts of endotoxins was not detected in our culture medium or in the rTSST1 (data not shown). These discrepancies in the requirement for microbial products may be due, apart from the species diversity, to several differences in the experimental models. First, we used monocyte-derived human DCs, whereas mouse splenic CD11c^{high} DCs were used. Because different DC populations can have very different functions (33), this difference may be critical. Second, we show in this study that only memory human T cells are able to induce IL-12p70 secretion by immature human DCs, whereas in the murine model only newly activated naive T cells have been tested for their ability to promote IL-12p70 production by DCs (32). Third, in this study, we used a superantigen, a polyclonal activator of T cells, whereas in the mice models, monoclonal populations of transgenic T cells were activated with their cognate MHC/peptide complex.

Using combinations of purified CD4⁺ T cells from patients and DCs from control and vice versa, we showed that T cell responses to IL-12 and IFN- γ are required to induce maturation of DCs and/or IL-12 secretion by DCs. Indeed, most studies addressing the question of the role of IL-12 and/or IFN- γ have used blocking Abs (22) or, when using patients or animals presenting with individual genetic defects in the IFN- γ /IL-12 axis, have measured the responses of mixed population of cells (PBMCs or splenocytes) (34–37). These experiments did not allow discriminating the role played by each cytokine on each cell population.

We observed that CD4⁺/IL-12 β 1R⁻ T cells were even more defective than CD4⁺/CD40L⁻ T cells in inducing DC activation. This was witnessed by the low increase in the expression by DCs of CD86, CD80, CD83, and CD40 induced by CD4⁺/IL-12 β 1R⁻ T cells and TSST1 and the absence of IL-12, but also IL-10, and TNF- α in the supernatants of DCs cultured in the same conditions (Fig. 7).

The absence of DC activation by CD4⁺/IL-12 β 1R⁻ T cells cannot be attributed to deficient T cell triggering because TSST1-pulsed immature DCs induced TCR down-regulation and expression of CD69 by CD4⁺/IL-12 β 1R⁻ T cells (data not shown). Thus, an IL-12 β 1R-dependent T cell signaling controls T cell-driven DC activation. This signal is IL-12 and not IL-23 dependent, as shown by the experiments performed with IL-12B-deficient DCs (Fig. 5C). Moreover, this signal does not depend on IFN- γ or TNF- α only, because addition of IFN- γ or TNF- α to IL-12 β 1R⁻/CD4⁺ T cell TSST1 and immature DCs does not restore IL-12p70 secretion by DCs (Fig. 5, E and F) or expression of maturation markers to levels obtained with control CD4⁺ T cells (data not shown). The absence of IL-12 secretion may be due to the low level of CD40 expression by immature DCs cocultured with IL-12 β 1R⁻/CD4⁺ T cells, a level that may be insufficient to induce triggering of DCs.

In our study, we confirm that IFN- γ signaling in DCs is required to induce production of bioactive IL-12 by DCs because IFNGR1- and IFNGR2-deficient DCs are unable to secrete IL-12 (Fig. 6).

Indeed, DCs that cannot bind IFN- γ (IFNGR1 deficient) or cannot signal through IFNGR (IFNGR2 deficient) showed an increased expression of CD83 and CD86 (Fig. 6C), but did not produce detectable amount of IL-12 (Fig. 6E). This absence of IL-12 production did not preclude IFN- γ production, which in our model was only produced by T cells. This IFN- γ may be induced by type I IFNs in an IL-12-independent manner, as already reported (38). *In vivo* the source of IFN- γ may also come from NK cells (39) or some populations of DCs (40).

We show that IFN- γ signaling is also required on the CD4⁺ T cell side for a cross-talk between CD4⁺ T cells and DCs that leads to IL-12 production. These results demonstrate that IFN- γ induces a signal in T cells that makes them competent to induce DC activation. What could be this signal? The first possibility is that the absence of functional cross-talk observed with IFNGR-deficient T cells is not due to an absence of IFN- γ secretion by these T cells because: 1) IFNGR2-deficient T cells are still able to produce IFN- γ when cocultured with DCs and superantigen (Fig. 6); 2) addition of IFN- γ in the cocultures did not restore IL-12 production by DCs (data not shown). IFNGR signaling in T cells may be required, as shown in CD4⁺ mice T cells (41), to induce IL-12R β 2 expression by T cells. IFNGRs would thus control IL-12 response of T cells, which as shown in this study is implicated in the T cell-driven DC activation. The second possibility is that IFNGR expression by T cells is important to correctly present IFN- γ to DCs. Indeed, a polarized delivery of several receptors at the immunological synapse has been shown, *i.e.*, TCR (42), CD40L, and, more recently, IFNGRs (43, 44). The directional delivery of both cytokines and their receptors at the synapse probably allows the formation of a high local concentration of cytokines, which is required for functional responses. Such mechanisms may also ensure, in the case of the T cell-driven activation of DCs, that reciprocal activation of the two cells will only happen in an Ag-dependent manner.

Immunity against intracellular pathogens such as mycobacteria strongly depends upon the induction of a Th1 CD4⁺ T cell response. Interactions of DCs with CD4⁺ Th lymphocytes have been shown to license or educate DCs to prime CTLs or to orientate CD4⁺ T cell priming toward Th1 or Th2 responses (reviewed in Refs. 13, 14). It is thus tempting to speculate that the defective cross-talk between CD4⁺ T cells and DCs in patients presenting defective response to IFN- γ or IL-12 or CD40 triggering may account for their shared vulnerability to mycobacteria, *Salmonella*, and other discrete intracellular pathogens.

Acknowledgments

We thank Clotilde Théry and Stéphanie Hugues for critical reading of the manuscript; Jeanne Wietzerbin for discussions and material; Maud Decraene for protocols; Alain Fischer for discussion and clinical material; and Salvatore Valitutti (Institut Claude de Prével, Toulouse, France) for gift of the anti-IFN- γ mAb.

Disclosures

The authors have no financial conflict of interest.

References

- Dorman, S. E., C. Picard, D. Lamm, K. Heyne, J. T. van Dissel, R. Baretto, S. D. Rosenzweig, M. Newport, M. Levin, J. Roesler, et al. 2004. Clinical features of dominant and recessive interferon γ receptor 1 deficiencies. *Lancet* 364: 2113–2121.
- Reichenbach, J., S. Rosenzweig, R. Doffinger, S. Dupuis, S. M. Holland, and J. L. Casanova. 2001. Mycobacterial diseases in primary immunodeficiencies. *Curr. Opin. Allergy Clin. Immunol.* 1: 503–511.
- Casanova, J. L., and L. Abel. 2002. Genetic dissection of immunity to mycobacteria: the human model. *Annu. Rev. Immunol.* 20: 581–620.
- DiSanto, J. P., J. Y. Bonnefoy, J. F. Gauchat, A. Fischer, and G. de Saint Basileq. 1993. CD40 ligand mutations in x-linked immunodeficiency with hyper-IgM. *Nature* 361: 541–543.

5. Korthauer, U., D. Graf, H. W. Mages, F. Briere, M. Padayachee, S. Malcolm, A. G. Ugazio, L. D. Notarangelo, R. J. Levinsky, and R. A. Kroccek. 1993. Defective expression of T-cell CD40 ligand causes X-linked immunodeficiency with hyper-IgM. *Nature* 361: 539–541.
6. Levy, J., T. Espanol-Boren, C. Thomas, A. Fischer, P. Tovo, P. Bordigoni, I. Resnick, A. Fasth, M. Baer, L. Gomez, et al. 1997. Clinical spectrum of X-linked hyper-IgM syndrome. *J. Pediatr.* 131: 47–54.
7. Alcais, A., C. Fieschi, L. Abel, and J. L. Casanova. 2005. Tuberculosis in children and adults: two distinct genetic diseases. *J. Exp. Med.* 202: 1617–1621.
8. Seder, R. A., R. Gazzinelli, A. Sher, and W. E. Paul. 1993. Interleukin 12 acts directly on CD4⁺ T cells to enhance priming for interferon γ production and diminishes interleukin 4 inhibition of such priming. *Proc. Natl. Acad. Sci. USA* 90: 10188–10192.
9. Hsieh, C. S., S. E. Macatonia, C. S. Tripp, S. F. Wolf, A. O'Garra, and K. M. Murphy. 1993. Development of TH1 CD4⁺ T cells through IL-12 produced by *Listeria*-induced macrophages. *Science* 260: 547–549.
10. Trinchieri, G. 2003. Interleukin-12 and the regulation of innate resistance and adaptive immunity. *Nat. Rev. Immunol.* 3: 133–146.
11. Steinman, R. M. 1991. The dendritic cell system and its role in immunogenicity. *Annu. Rev. Immunol.* 9: 271–296.
12. Reis e Sousa, C. 2001. Dendritic cells as sensors of infection. *Immunity* 14: 495–498.
13. Behrens, G., M. Li, C. M. Smith, G. T. Belz, J. Mintern, F. R. Carbone, and W. R. Heath. 2004. Helper T cells, dendritic cells and CTL immunity. *Immunol. Cell Biol.* 82: 84–90.
14. De Jong, E. C., H. H. Smits, and M. L. Kapsenberg. 2005. Dendritic cell-mediated T cell polarization. *Springer Semin. Immunopathol.* 26: 289–307.
15. Bennett, S. R., F. R. Carbone, F. Karamalis, R. A. Flavell, J. F. Miller, and W. R. Heath. 1998. Help for cytotoxic-T-cell responses is mediated by CD40 signalling. *Nature* 393: 478–480.
16. Schoenberger, S. P., R. E. Toes, E. I. van der Voort, R. Offringa, and C. J. Melief. 1998. T-cell help for cytotoxic T lymphocytes is mediated by CD40-CD40L interactions. *Nature* 393: 480–483.
17. Ridge, J. P., F. Di Rosa, and P. Matzinger. 1998. A conditioned dendritic cell can be a temporal bridge between a CD4⁺ T-helper and a T-killer cell. *Nature* 393: 474–478.
18. Lu, Z., L. Yuan, X. Zhou, E. Sotomayor, H. I. Levitsky, and D. M. Pardoll. 2000. CD40-independent pathways of T cell help for priming of CD8⁺ cytotoxic T lymphocytes. *J. Exp. Med.* 191: 541–550.
19. Caux, C., C. Massacrier, B. Vanbervliet, B. Dubois, C. Van Kooten, I. Durand, and J. Banchereau. 1994. Activation of human dendritic cells through CD40 cross-linking. *J. Exp. Med.* 180: 1263–1272.
20. Flores-Romo, L., P. Bjorck, V. Duvert, C. van Kooten, S. Saeland, and J. Banchereau. 1997. CD40 ligation on human cord blood CD34⁺ hematopoietic progenitors induces their proliferation and differentiation into functional dendritic cells. *J. Exp. Med.* 185: 341–349.
21. Cella, M., D. Scheidegger, K. Palmer-Lehmann, P. Lane, A. Lanzavecchia, and G. Alber. 1996. Ligation of CD40 on dendritic cells triggers production of high levels of interleukin-12 and enhances T cell stimulatory capacity: T-T help via APC activation. *J. Exp. Med.* 184: 747–752.
22. Snijders, A., P. Kalinski, C. M. Hilkens, and M. L. Kapsenberg. 1998. High-level IL-12 production by human dendritic cells requires two signals. *Int. Immunol.* 10: 1593–1598.
23. Albert, M. L., M. Jegathesan, and R. B. Darnell. 2001. Dendritic cell maturation is required for the cross-tolerization of CD8⁺ T cells. *Nat. Immunol.* 2: 1010–1017.
24. Vogt, G., A. Chappier, K. Yang, N. Chuzhanova, J. Feinberg, C. Fieschi, S. Boisson-Dupuis, A. Alcais, O. Filipe-Santos, J. Bustamante, et al. 2005. Gains of glycosylation comprise an unexpectedly large group of pathogenic mutations. *Nat. Genet.* 37: 692–700.
25. Altare, F., D. Lammass, P. Revy, E. Jouanguy, R. Doffinger, S. Lamhamedi, P. Drysdale, D. Scheel-Toellner, J. Girdlestone, P. Darbyshire, et al. 1998. Inherited interleukin 12 deficiency in a child with bacille Calmette-Guerin and *Salmonella enteritidis* disseminated infection. *J. Clin. Invest.* 102: 2035–2040.
26. Fieschi, C., S. Dupuis, E. Catherinot, J. Feinberg, J. Bustamante, A. Breiman, F. Altare, R. Baretto, F. Le Deist, S. Kayal, et al. 2003. Low penetrance, broad resistance, and favorable outcome of interleukin 12 receptor β 1 deficiency: medical and immunological implications. *J. Exp. Med.* 197: 527–535.
27. Blanchard, N., M. Decraene, K. Yang, F. Miro-Mur, S. Amigorena, and C. Hivroz. 2004. Strong and durable TCR clustering at the T/dendritic cell immune synapse is not required for NFAT activation and IFN- γ production in human CD4⁺ T cells. *J. Immunol.* 173: 3062–3072.
28. Sallusto, F., D. Lenig, R. Forster, M. Lipp, and A. Lanzavecchia. 1999. Two subsets of memory T lymphocytes with distinct homing potentials and effector functions. *Nature* 401: 708–712.
29. Pestka, S., S. V. Kotenko, G. Muthukumar, L. S. Izotova, J. R. Cook, and G. Garotta. 1997. The interferon γ (IFN- γ) receptor: a paradigm for the multichain cytokine receptor. *Cytokine Growth Factor Rev.* 8: 189–206.
30. Sporri, R., and C. Reis e Sousa. 2005. Inflammatory mediators are insufficient for full dendritic cell activation and promote expansion of CD4⁺ T cell populations lacking helper function. *Nat. Immunol.* 6: 163–170.
31. Schulz, O., A. D. Edwards, M. Schito, J. Aliberti, S. Manickasingham, A. Sher, and C. Reis e Sousa. 2000. CD40 triggering of heterodimeric IL-12 p70 production by dendritic cells in vivo requires a microbial priming signal. *Immunity* 13: 453–462.
32. Sporri, R., and C. Reis e Sousa. 2003. Newly activated T cells promote maturation of bystander dendritic cells but not IL-12 production. *J. Immunol.* 171: 6406–6413.
33. Shortman, K., and Y. J. Liu. 2002. Mouse and human dendritic cell subtypes. *Nat. Rev. Immunol.* 2: 151–161.
34. Dorman, S. E., and S. M. Holland. 1998. Mutation in the signal-transducing chain of the interferon- γ receptor and susceptibility to mycobacterial infection. *J. Clin. Invest.* 101: 2364–2369.
35. Losana, G., L. Rigamonti, I. Borghi, B. Assenzio, S. Ariotti, E. Jouanguy, F. Altare, G. Forni, J. L. Casanova, and F. Novelli. 2002. Requirement for both IL-12 and IFN- γ signaling pathways in optimal IFN- γ production by human T cells. *Eur. J. Immunol.* 32: 693–700.
36. Feinberg, J., C. Fieschi, R. Doffinger, M. Feinberg, T. Leclerc, S. Boisson-Dupuis, C. Picard, J. Bustamante, A. Chappier, O. Filipe-Santos, et al. 2004. Bacillus Calmette Guerin triggers the IL-12/IFN- γ axis by an IRAK-4- and NEMO-dependent, non-cognate interaction between monocytes, NK, and T lymphocytes. *Eur. J. Immunol.* 34: 3276–3284.
37. Flesch, I. E., J. H. Hess, S. Huang, M. Aguet, J. Rothe, H. Bluethmann, and S. H. Kaufmann. 1995. Early interleukin 12 production by macrophages in response to mycobacterial infection depends on interferon γ and tumor necrosis factor α . *J. Exp. Med.* 181: 1615–1621.
38. Rogge, L., D. D'Ambrosio, M. Biffi, G. Penna, L. J. Minetti, D. H. Presky, L. Adorini, and F. Sinigaglia. 1998. The role of Stat4 in species-specific regulation of Th cell development by type I IFNs. *J. Immunol.* 161: 6567–6574.
39. Borg, C., A. Jalil, D. Laderach, K. Maruyama, H. Wakasugi, S. Charrier, B. Ryffel, A. Cambi, C. Figdor, W. Vainchenker, et al. 2004. NK cell activation by dendritic cells (DCs) requires the formation of a synapse leading to IL-12 polarization in DCs. *Blood* 104: 3267–3275.
40. Taieb, J., N. Chaput, C. Menard, L. Apetoh, E. Ullrich, M. Bonmort, M. Pequignot, N. Casares, M. Terme, C. Flament, et al. 2006. A novel dendritic cell subset involved in tumor immunosurveillance. *Nat. Med.* 12: 214–219.
41. Afkarian, M., J. R. Sedy, J. Yang, N. G. Jacobson, N. Cereb, S. Y. Yang, T. L. Murphy, and K. M. Murphy. 2002. T-bet is a STAT1-induced regulator of IL-12R expression in naive CD4⁺ T cells. *Nat. Immunol.* 3: 549–557.
42. Blanchard, N., V. Di Bartolo, and C. Hivroz. 2002. In the immune synapse, ZAP-70 controls T cell polarization and recruitment of signaling proteins but not formation of the synaptic pattern. *Immunity* 17: 389–399.
43. Boisvert, J., S. Edmondson, and M. F. Krummel. 2004. Immunological synapse formation licenses CD40-CD40L accumulations at T-APC contact sites. *J. Immunol.* 173: 3647–3652.
44. Maldonado, R. A., D. J. Irvine, R. Schreiber, and L. H. Glimcher. 2004. A role for the immunological synapse in lineage commitment of CD4 lymphocytes. *Nature* 431: 527–532.

Article 7

Complete deficiency of the IL-12 receptor beta1 chain: three unrelated Turkish children with unusual clinical features

Tanir, G., F. Dogu, N. Tuygun, A. Ikinciogullari, C. Aytakin, C. Aydemir, M. Yuksek, E.C. Boduroglu, **L. de Beaucoudrey**, C. Fieschi, J. Feinberg, J.L. Casanova, and E. Babacan

European Journal of Pediatrics
2006, 165:415-417

Gonul Tanir · Figen Dogu · Nilden Tuygun · Aydan Ikinciogullari · Caner Aytakin ·
Cumhur Aydemir · Mutlu Yuksek · Esin Cengiz Boduroglu ·
Ludovic de Beaucoudrey · Claire Fieschi · Jacqueline Feinberg ·
Jean-Laurent Casanova · Emel Babacan

Complete deficiency of the IL-12 receptor β 1 chain: three unrelated Turkish children with unusual clinical features

Received: 25 October 2005 / Accepted: 21 December 2005
© Springer-Verlag 2005

Complete interleukin-12 receptor β 1 deficiency is the most frequent known genetic etiology of the syndrome of Mendelian susceptibility to mycobacterial diseases (MSMD, OMIM 209950). Eleven disorders caused by different types of mutations in five different gene defects related to the IL-12 and IL-23/interferon (IFN)- γ axis have been described to date [2]. Refer to Fig. 1 for the pathways of IL-12/IL-23-dependent interferon IFN-gamma immunity. Patients with MSMD are vulnerable to the Bacillus-Calmette-Guérin (BCG) vaccine species *Mycobacterium bovis*, environmental mycobacteria and *M. tuberculosis*. Infectious diseases other than those caused by Salmonella species, the latter of which infect almost one-half of all patients, are rare [1, 3, 6]. We report here various and unusual clinical manifestations of three unrelated patients with complete IL-12R β 1 deficiency due to three different mutations in the *IL-12RB1* gene, of which two are novel (711insC, 628–644dup).

The first patient was an 1-year-old infant girl who had BCG lymphadenitis at 6 months of age and disseminated mycobacterial infection complicated with spontaneous pneumomediastinum and subcutaneous emphysema at 12 months of age. She was treated with isoniazide, rifampin, ethambutol, amikacin, clarithromycin and clofazimine. Pre-tracheal fasciotomy was undertaken for subcutaneous emphysema. A complete IL-12 receptor β 1 deficiency associated with the 711insC mutation in *IL-12RB1* was detected (Fig. 2). The patient is still in remission.

The second patient was an 19-month-old infant boy who presented with five episodes of infections attributable to Salmonella and two episodes of *Salmonella enteritidis* meningitis. There was no mycobacterial disease, including no adverse reaction to BCG immunization that was practiced at the age of 2 months. He was treated with meropenem, rIFN- γ and external ventricular drainage and then ventriculo-peritoneal shunting for hydrocephalus. Immunologic and molecular genetic examinations revealed complete IL-12R β 1 deficiency and a *IL-12RB1* 783+1G>A mutation (Fig. 2) [3].

The third patient, a 4.5-year-old boy, had fistulized BCG lymphadenitis in early childhood followed by disseminated mycobacterial infection and splenic abscess with *Salmonella bacteremia* at 44 months of age. He was treated with meropenem and with isoniazide, rifampin, ethambutol, clarithromycin and amikacin. The patient improved; however, he was lost to follow-up and has been reported to have died. DNA sequencing revealed a 628–644dup mutation in *IL-12RB1* (Fig. 2). A complete IL-12 receptor β 1 deficiency is suspected. All three patients had persistent oral moniliasis.

Among a total of 56 cases of IL-12 receptor β 1 deficiency reported in the literature, the rate of infection with BCG *M. bovis* is 73% (27/37), environmental mycobacteria 21% (22/56), non-typhoidal Salmonella species 46% (26/56) and tuberculosis 7% (4/56) [4–6]. *Paracoccidioides brasiliensis*-disseminated disease has also recently been reported in an IL-12R β 1-deficient patient. None of the 37 patients with BCG disease subsequently

G. Tanir (✉) · N. Tuygun · C. Aydemir · E. C. Boduroglu
Dr. Sami Ulus Children Health and Diseases Training
and Research Center,
Hosdere Caddesi 166/3,
Yukari Ayranci, 06550 Ankara, Turkey
e-mail: gonultanir58@yahoo.com
Fax: +90-312-3170353

F. Dogu · A. Ikinciogullari · C. Aytakin · M. Yuksek ·
E. Babacan
Department of the Pediatric Allergy and Immunology,
Ankara University School of Medicine,
Ankara, Turkey

L. de Beaucoudrey · C. Fieschi · J. Feinberg · J.-L. Casanova
Laboratory of Human Genetics of Infectious Diseases,
University of Paris Rene Descartes-INSERM U550,
Necker Medical School and Pediatric Immunology
and Hematology Unit, Necker Hospital,
Paris, France

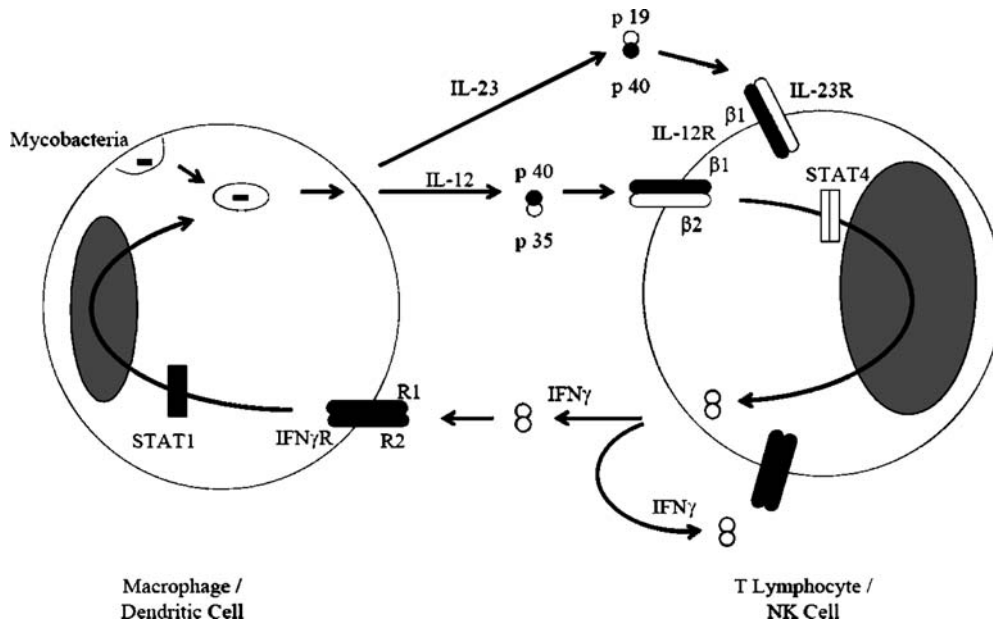
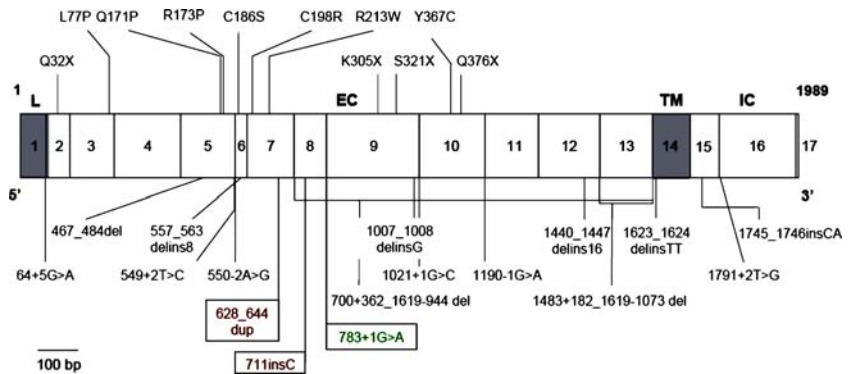

Fig. 1 Pathways of the IL-12/IL-23-dependent IFN-gamma immunity. IL-12 (consists of p35 and p40) and IL-23 (consists of IL-12 p40 and a novel protein p 19) secreted by macrophage and dendritic cells bind to their receptors consisting of a IL-12R β 1 and a second chain (IL-12R β 2, IL-23R), which are expressed on natural killer (NK) and T lymphocytes. These stimulate IFN-gamma secretion in the NK and T lymphocytes. IFN-gamma, in turn, binds to a

ubiquitous receptor, IFN-gamma R. This leads to phosphorylation of a signal transducer and activator of transcription type 1 (*STAT-1*) which, after translocation as a homodimer to the nucleus, activates IFN-gamma-inducible genes. Because IL-12R β 1 deficiency is linked by both the IL-12 and IL-23 signaling pathways through STAT4, phosphorylation and hence IFN-gamma production are impaired

Fig. 2 Structure of the *IL12RB1* gene coding region and mutations that have been described previously in patients with IL-12 β 1 deficiency and in the three new patients reported here. Coding exons are separated by vertical bars and designated by Arabic numerals. Domains: *L* P protein leader, *EC* extracellular, *TM* transmembrane, *IC* intracellular



developed environmental mycobacterial disease, whereas 12 of the 19 patients who had no BCG disease developed environmental mycobacterial disease [3–6].

Conclusion Our findings illustrate the heterogeneous clinical presentation of IL-12R β 1 deficiency, a relatively common primary immunodeficiency in Turkey. Children with unusual disease symptoms caused by BCG, environmental mycobacteria or non-typhoidal Salmonella should be investigated for IL-12R β 1 deficiency and related disorders.

References

- Altare F, Durandy A, Lammas D, Emile JF, Lamhamedi S, Le Deist F, Drysdale P, Jouanguy E, Doffinger R, Bernaudin F, Jeppsson O, Gollob JA, Meinel E, Segal AW, Fischer A, Kumararatne D, Casanova JL (1998) Impairment of mycobacterial immunity in human interleukin-12 receptor deficiency. *Science* 280:1432–1435
- Casanova JL, Abel L (2004) The human model: a genetic dissection of immunity to infection in natural conditions. *Nat Rev Immunol* 4:55–66

3. Fieschi C, Dupuis S, Catherinot E, Feinberg J, Bustamante J, Breiman A, Altare F, Baretto R, Le Deist F, Kayal S, Koch H, Richter D, Brezina M, Aksu G, Wood P, Al-Jumaah S, Raspall M, Da Silva Duarte AJ, Tuerlinckx D, Virelizier JL, Fischer A, Enright A, Bernhoft J, Cleary AM, Vermylen C, Rodriguez-Gallego C, Davies G, Blutters-Sawatzki R, Siegrist CA, Ehlayel MS, Novelli V, Haas WH, Levy J, Freihorst J, Al-Hajjar S, Nadal D, De Moraes Vasconcelos D, Jeppsson O, Kutukculer N, Frecerova K, Caragol I, Lammas D, Kumararatne DS, Abel L, Casanova JL (2003) Low penetrance, broad resistance, and favorable outcome of interleukin 12 receptor beta1 deficiency: medical and immunological implications. *J Exp Med* 197: 527–535
4. Fieschi C, Casanova JL (2003) The role of interleukin-12 in human infectious diseases: only a faint signature. *Eur J Immunol* 33:1461–1464
5. Moraes-Vasconcelos D, Grumach AS, Yamaguti A, Andrade ME, Fieschi C, de Beaucoudrey L, Casanova JL, Duarte AJ (2005) *Paracoccidioides brasiliensis*-disseminated disease in a patient with inherited deficiency in the (1 subunit of the interleukin (IL)-12/IL-23 receptor. *Clin Infect Dis* 41:31–37
6. Ozbek N, Fieschi C, Yilmaz BT, de Beaucoudrey L, Demirhan B, Feinberg J, Bikmaz YE, Casanova JL (2005) Interleukin-12 receptor beta 1 chain deficiency in a child with disseminated tuberculosis. *Clin Infect Dis* 40:e55–e58

Article 8

Inherited disorders of the IL-12-IFN-gamma axis in patients with disseminated BCG infection

Mansouri, D., P. Adimi, M. Mirsaeidi, N. Mansouri, S. Khalilzadeh, M.R. Masjedi, P. Adimi, P. Tabarsi, M. Naderi, O. Filipe-Santos, G. Vogt, **L. de Beaucoudrey**, J. Bustamante, A. Chagier, J. Feinberg, A.A. Velayati, and J.L. Casanova

European Journal of Pediatrics
2005, 164:753-757

Davood Mansouri · Parisa Adimi · Mehdi Mirsaedi
Nahal Mansouri · Soheila Khalilzadeh
Mohammad R. Masjedi · Parvaneh Adimi
Payam Tabarsi · Mohammad Naderi
Orchidée Filipe-Santos · Guillaume Vogt
Ludovic de Beaucoudrey · Jacinta Bustamante
Ariane Chapgier · Jacqueline Feinberg
Ali A. Velayati · Jean-Laurent Casanova

Inherited disorders of the IL-12-IFN- γ axis in patients with disseminated BCG infection

Received: 24 January 2005 / Accepted: 6 April 2005 / Published online: 10 August 2005
© Springer-Verlag 2005

Abstract Disseminated BCG infection is a rare complication of vaccination that occurs in patients with impaired immunity. In recent years, a series of inherited disorders of the IL-12-IFN- γ axis have been described that predispose affected individuals to disseminated disease caused by BCG, environmental *Mycobacteria*, and non-typhoidal *Salmonella*. The routine immunological work-up of these patients is normal and the diagnosis requires specific investigation of the IL-12-IFN- γ circuit. We report here the first two such patients originating from and living in Iran. The first child is two years old and suffers from complete IFN- γ receptor 2 deficiency and disseminated BCG infection. He is currently in clinical remission thanks to prolonged multiple antibiotic therapy. The other, a 28-year-old adult, suffers from IL-12p40 deficiency and presented with disseminated BCG infection followed by recurrent episodes of systemic salmonellosis. He is now doing well. A third patient of

Iranian descent, living in North America, was reported elsewhere to suffer from IL-12R β 1 deficiency. These three patients thus indicate that various inherited defects of the IL-12-IFN- γ circuit can be found in Iranian people. In conclusion we recommend to consider the disorders of the IL-12-IFN- γ circuit in all patients with severe BCG infection, disseminated environmental mycobacterial disease, or systemic non-typhoidal salmonellosis, regardless of their ethnic origin and country of residence.

Keywords BCG · Immunodeficiency · Interferon- γ · Interleukin-12 · *Salmonella*

Abbreviations IFN- γ : Interferon-gamma · IL: Interleukin · MSMD: Mendelian susceptibility to mycobacterial disease

D. Mansouri (✉) · P. Adimi · M. Mirsaedi · N. Mansouri
S. Khalilzadeh · M. R. Masjedi · P. Adimi · P. Tabarsi
A. A. Velayati
Division of Infectious Diseases and Clinical Immunology,
National Research Institute of Tuberculosis and Lung Diseases,
Shahid Beheshti University of Medical Sciences,
Niavaran (Bahonar) Avenue, Darabad, Tehran, Iran
E-mail: dmansouree@yahoo.com
Tel.: +98-21-28035509
Fax: +98-21-2285777

M. Naderi
Bou Ali Hospital, Zahedan University of Medical Sciences,
Zahedan, Iran

O. Filipe-Santos · G. Vogt · L. de Beaucoudrey
J. Bustamante · A. Chapgier · J. Feinberg · J.-L. Casanova
Laboratory of Human Genetics of Infectious Diseases,
University of Paris René Descartes, Necker Medical School,
Paris, France

Introduction

Interferon- γ (IFN- γ) is a critical cytokine produced by NK and T-cells [2]. The differentiation of T-helper cells into IFN- γ -producing cells is regulated by several cytokines, but principally interleukin-12 (IL-12). IL-12 is produced by antigen-presenting cells — particularly dendritic cells and macrophages — in response to infection [32]. IL-12 not only promotes T-helper cell differentiation, but also induces IFN- γ production in other cells, such as NK cells. Deleterious germline mutations in five genes involved in the IL-12-IFN- γ circuit have been found in human patients: *IFNGR1*, encoding the ligand-binding chain of the IFN- γ receptor (IFN- γ R1); *IFNGR2*, encoding the associated chain of the IFN- γ receptor (IFN- γ R2); *STAT1*, encoding the signal transducer and activator of transcription-1 (Stat-

1) in the IFN- γ receptor signalling pathway; *IL12B*, encoding the p40 subunit shared by IL-12 and IL-23 and *IL12RB1*, encoding the beta 1 subunit shared by the IL-12 and IL-23 receptors (IL-12R β 1).

The various types of mutation (dominant or recessive, amorphic or hypomorphic) in these five genes define up to ten distinct inherited disorders [16]. All are associated with a rare human syndrome, known as Mendelian susceptibility to mycobacterial disease (MSMD) (MIM 209950) [24]. Patients with MSMD are prone to clinical diseases caused by poorly virulent mycobacterial species such as live BCG vaccines and environmental *Mycobacteria*. They are also susceptible to develop extra-intestinal disease caused by weakly virulent non-typhoidal serovars of *Salmonella* [4, 5, 6, 11, 23,26]. Such patients are also susceptible to more virulent *Mycobacteria* and *Salmonella*, and may therefore present with severe forms of tuberculosis or typhoid fever [3].

Disseminated BCG infection is a typical clinical presentation in patients with an inherited disorder of the IL-12-IFN- γ axis, as BCG is often the first pathogen to which patients are exposed. BCG substrains are derived from *Mycobacterium bovis*. BCG vaccination is routinely carried out in most regions of the world, with up to 85% coverage of children worldwide [27]. BCG prevents severe forms of childhood tuberculosis, including miliary tuberculosis and meningitis in particular [7]; However, in rare patients, BCG vaccination results in disseminated infection involving lymph nodes, lungs, kidney, spleen and other organs. Such infections are referred to as “BCG-osis” and are considered to be the most serious complication of BCG injection, with high (71%) rates of mortality [5, 6,7].

BCG-osis invariably indicates the presence of an underlying congenital or acquired immune deficiency, such as severe combined immunodeficiency (SCID), chronic granulomatous disease (CGD), or HIV infection [31]. Patients with these conditions are also vulnerable to various other microbes. Of the remaining patients with BCG-osis, half present MSMD. About half of the known MSMD patients have been shown to present an inherited defect of the IL-12-IFN- γ axis, whereas the remaining cases remain asymptomatic. We report here the first two cases of hereditary defects in the IL-12-IFN- γ - axis diagnosed in Iran, in patients presenting with BCG-osis.

Case reports

Patient 1

A healthy boy, weighing 3.95 kg and measuring 47 cm, was born at full term. This boy was the only child of a married couple originating from and living in Iran. The mother is the maternal granddaughter of the patient's paternal grandfather's sister. The patient received routine vaccinations in Iran, including BCG at birth, OPV and DTP 1.5 months later. At the age of 38 days, the infant presented with fever, chills, bloody diarrhoea and

decreased reflexes. He was hospitalized and underwent laboratory investigations and antibacterial therapy. All culture samples (blood, stool and urine) were proved to be negative. On physical examination, the patient had a generalized cutaneous maculopapular rash, hepatosplenomegaly, and bilateral axillary lymphadenopathy.

Liver function tests were normal and the patient developed thrombocytopenia whilst febrile. Leukocyte counts increased to 29,500/m³, distributed as follows: polymorphonuclear cells (PMN)=51%, lymphocytes=27%, eosinophils=9%, and band cells=11%. TORCH study results were negative. Bone marrow evaluation showed myeloid hyperplasia and a slight decrease in the number of erythroid and megakaryocyte cells. Bone marrow staining revealed numerous acid-fast bacilli and *Mycobacterium bovis* (BCG) sensitive to isoniazid, rifampin, ethambutol and streptomycin was cultured.

The patient was treated at the age of two months (weight=3.8 kg; height=47 cm) with a regimen consisting of: isoniazid, rifampin, ethambutol, streptomycin associated with steroids (1 mg/kg/day). Clinical symptoms were incompletely resolved after two months of treatment. We therefore tapered corticosteroid doses and initiated a new antibiotic regimen of isoniazid, rifampin, clarithromycin and ofloxacin. Corticosteroids were discontinued at the age of six months. Splenectomy and lymphadenopathy resection were performed at the age of 12 months to reduce microbial burden. Smears of spleen and lymph node aspirates revealed numerous acid-fast bacilli, despite long-term treatment but culture results were negative, suggesting a possible inhibitory effect of the new antibiotic regimen. The child is now 34 months old, is still treated with drugs and has normal physical growth (weight=14.4 kg; height=93.5 cm), and a completely normal physical examination. All serological tests for *Brucella*, *Salmonella*, *Toxoplasma*, *Treponema pallidum*, *Leishmania*, and for IgM against HSV1, HSV2 and CMV were negative.

Immunological assessments, including the measurement of serum IgG, IgM, IgA, IgE, and complement levels, and the nitroblue tetrazolium test (NBT) tests gave normal results. Flow cytometry analysis of peripheral blood B lymphocytes (CD19), T lymphocytes (CD3), T-cell subpopulations (CD4, CD8), natural killer cells (CD56), and adhesion molecules (CD11a, CD11b, CD11c, CD18) on the surface of neutrophils, monocytes, lymphocytes and co-stimulatory molecules (CD28, CD80, CD86) on T-cells and macrophages, gamma interferon receptor 1 (CD119) on monocytes, all were normal. Serological assays and PCR for HIV, HCV, HBV were negative. The lymphocyte transformation test (LTT) was within normal limits for mitogens, *Candida* and PPD. Investigation of the IL-12-IFN- γ axis by means of a recently developed whole-blood assay [14] revealed a lack of IL-12 secretion by blood cells in response to BCG plus IFN- γ . Sequencing of the *IFNGR1*, *IFNGR2*, and *STAT1* genes revealed that the patient was homozygous for a missense mutation in *IFNGR2* (T168N). The par-

ents were heterozygous for this mutation, which was not found in 100 healthy controls tested. The pathogenic effects of this mutation were shown to be due to the creation of a novel N-glycosylation site in IFN- γ R2. The receptors were expressed on the cell surface, defining a novel form of IFN- γ R2 deficiency. These data unambiguously demonstrated the presence of an autosomal recessive, complete IFN- γ R2 deficiency in this patient.

Patient 2

A 28-year-old man was admitted with a cough and excessive sputum production, which began six months earlier. His parents were cousins and he had five brothers and three sisters. One of his brothers died 12 years ago, at the age of five years, from severe acute gastroenteritis. One of his sisters died three years ago, at the age of 29 years, from acute abdomen. The patient's parents and his other siblings are in good health. The patient received all the routine vaccinations carried out in Iran. He was vaccinated with BCG at the age of seven years, and four months later presented fistulous enlarged bilateral lymphadenopathies of the axillary and cervical regions. *M. bovis* BCG was isolated from the discharging sinuses. Axillary and cervical lymph nodes were excised on two occasions, at the ages of eight and 17 years, and on both occasions histological examination revealed widespread macrophage and polymorphonuclear infiltration in the dermis and lymph nodes without granuloma formation, suggestive of necrotizing lymphadenitis, with a negative result of staining for acid-fast bacilli. The patient received several courses of long-term antituberculosis therapy, and responded reasonably well. He also suffered from bilateral upper lobe pneumonia, which responded to treatment with ceftriaxone, eight months before his last admission. On admission, the patient presented enlarged lymph nodes at the same places described, pleural effusion on the right side and a maculopapular rash covering the lower extremities.

The Erythrocyte sedimentation rate was 105 mm/h and the haemoglobin concentration had decreased to 8.6 g/dl. Platelets, leukocytes, reticulocyte count and haemoglobin electrophoresis were normal. Chest X-ray film and lung CT scan demonstrated a loculated pleural effusion at the right costophrenic angle. A abdominal CT scan with contrast revealed mild hepatosplenomegaly with enlarged para-aortic lymphadenopathies. Ultrasound-guided paracentesis of pleural fluid was performed: the fluid was cloudy and turbid in appearance, and displayed marked inflammation (protein concentration: 7.8 g/dl; WBC: high, with 100% neutrophils; sugar concentration <20 mg/dl; RBC: high; LDH >10000 IU/l; pH: 7.09; ADA: 427 IU/l). Gram-negative bacilli were seen on direct examination of the pleural fluid and *Salmonella gallinarum*, a subspecies of *Salmonella enteritidis*, was cultured. Skin biopsy revealed neutrophilic dermatosis. The patient was treated with a combination of two antibiotics — ceftriaxone plus cip-

rofloxacillin — and by chest drainage. He recovered completely but suffered another episode of *Salmonella* infection, manifesting as sepsis, one year later. The bacterium involved in this episode was not serotyped. Interferon-gamma treatment was recently initiated to prevent recurrent infections. The patient, now aged 29 years, is in clinical remission. The serological tests for *Brucella*, *Salmonella*, *Leishmania*, *Toxoplasma*, *Treponema pallidum*, and IgM against HSV1, HSV2 and CMV were negative.

Normal results were obtained in all immunological tests including flow cytometry for CD3+, CD4+ CD8+, CD19+, CD56+, CD11a+, CD11b+, CD11c+, CD18+, CD28+, CD80+, CD86 and CD119+ molecules, neutrophil chemotaxis, NBT, serum immunoglobulin and complement levels. PPD tests, serologic assays and PCR for HIV, HCV, and HBV were negative. Investigation of the IL-12-IFN- γ axis with a recently developed whole-blood assay [14] revealed a lack of IL-12 production by blood cells in response to stimulation with live BCG plus IFN- γ . Sequencing of the *IL12B* gene revealed that the patient was homozygous for a missense mutation in *IL12B* (g526–528delCT). The parents were heterozygous for this mutation, which was not found in 100 healthy controls tested. This mutation exerts its pathogenic effect by creating a premature stop codon in *IL12B*. These data clearly demonstrated that the patient suffers from an autosomal recessive, complete IL-12p40 deficiency, resulting in a lack of IL-12p70 and probably a lack of IL-23.

Discussion

To our knowledge, these cases of hereditary defects in the IL-12 - IFN- γ axis are the first to be reported in patients from Iran. One American child of Iranian descent has been reported to suffer from IL-12R β 1 deficiency [9,15]. Three distinct genetic disorders have thus been identified in three patients of Iranian descent, with mutations in *IL12RB1*, *IL12B*, and *IFNGR2*. These data suggest that other genetic disorders of the IL-12-IFN- γ axis are likely to be identified in Iranian patients, provided that patients with BCG-osis or invasive disease caused by environmental *mycobacteria* or non-typhoid *Salmonella* are investigated. This report should encourage both Paediatricians and Internists to consider a diagnosis of inherited defects of the IL-12-IFN- γ axis in selected Iranian patients. It indicates that such patients are indeed identified if such a diagnosis is contemplated, suggesting the presence of undiagnosed patients in many countries worldwide in which such genetic disorders have not been reported. For example, a patient from Cameroon was diagnosed with IL-12R β 1 deficiency following transfer to a hospital in Switzerland [15]. Patients in the countries bordering Iran, such as Iraq and Afghanistan, probably remain undiagnosed due to the lack of appropriately trained clinicians and immunologists.

Our first case, with IFN- γ R2 deficiency, is also important because this patient is the first to be reported with documented disseminated BCG infection associated with IFN- γ R2 deficiency. The other two patients with complete IFN- γ R2 deficiency suffered from environmental mycobacteriosis [10,29]. By analogy with other IFN- γ R2-deficient patients and the larger number of patients with complete IFN- γ R1 deficiency [12], this patient probably has a poor prognosis, despite his current clinical remission. More advanced treatment procedures, such as bone marrow transplantation or gene therapy, might improve the prognosis of such patients in the future. This patient's defect was recently corrected in vitro, by biochemical means, using inhibitors of N-glycosylation, raising the possibility of a novel treatment in vivo.

The second patient also ran a classical course, as IL-12p40 deficiency is known to be relatively benign [1, 13, 22,28]. Our patient presents a novel mutation in *IL12B*, indicating that IL-12 deficiency is not restricted geographically and that the spectrum of mutations is not as limited as previously thought [28]. The patient suffered chronic infection with a reasonably good outcome. We suggest that the overall prognosis of such cases is good, with broad resistance, low penetrance of the mutation and a favourable outcome regarding of infection [7]. The production of small amounts of IFN- γ (1%–10% of normal), perhaps induced by cytokines such as IL-18 and IL-27, partly compensates for the lack of IL-12- and IL-23-mediated induction [17, 19, 20, 23, 25,31]. In patients with this condition, aggressive antibiotic therapy and IFN- γ injections are likely to control infections, particularly those caused by *mycobacteria* and *Salmonella* species [6]. Finally, although pleural empyema due to *Salmonella enteritidis* has been documented in immunocompromised patients, particularly those with AIDS, tuberculosis, and cancers [8, 18, 30,33], it has not been reported in patients suffering from MSMD. Pleural effusion due to *Salmonella gallinarum*, which causes typhoid in poultry, does not seem to have been reported elsewhere, in any patient [21].

We conclude that defects in the IL-12-IFN- γ axis may cause disseminated BCG infection and invasive salmonellosis in Iranian patients. This group of hereditary disorders should be considered in the evaluation of such patients, particularly in countries like Iran, where BCG vaccination is part of the national health programme and outbreaks of non-typhoid gastroenteritis are common. Patients with severe BCG infections and extra-intestinal non-typhoidal salmonellosis should be investigated for the IL-12-IFN- γ circuit.

References

- Altare F, Lammas D, Revy P, Jouanguy E, Doffinger R, Lamhamedi S (1998) Inherited interleukin 12 deficiency in a child with bacille Calmette-Guérin and *Salmonella enteritidis* disseminated infection. *J Clin Invest* 102: 2035–2040
- Boehm U, Klamp T, Groot M, Howard JC (1997) Cellular responses to IFN-gamma. *Ann Rev Immunol* 15: 749–795
- Caragol I, Raspall M, Fieschi C, Feinberg J, Larrosa MN, Hernandez M, Figueras C, Bertran JM, Casanova JL, Espanol T (2003) Clinical tuberculosis in 2 of 3 siblings with interleukin-12 receptor beta1 deficiency. *Clin Infect Dis* 37: 302–306
- Casanova JL, Blanche S (1996) Idiopathic disseminated bacillus Calmette-Guérin infection: a French national retrospective study. *Pediatrics* 98: 774–778
- Casanova JL, Abel L (2002) Genetic dissection of immunity to *Mycobacteria*: the human model. *Annu Rev Immunol* 20: 581–620
- Casanova JL, Mansoori D, Fieschi C, Picard C, Dupuis S (2002) Inherited disorders of the IL12- IFN gamma axis: mendelian predisposition to mycobacterial disease in man. *Tanaffos (Respiration)* 1(4): 9–25
- Castro-Rodriguez JA, Gonzalez R, Girardi G (1997) Osteitis caused by Bacille Calmette Guérin vaccination: an emergent problem in Chile? *Int J Tuberc Lung Dis* 1: 417–421
- Cistulli PA, Barnes DJ (1991) *Salmonella* empyema in a patient with lymphoma. *Aust NZ J Med* 21:246–247
- Cleary AM, Tu W, Enright A, Giffon T, Dewaal-Malefyt R, Gutierrez K, Lewis DB (2003) Impaired accumulation and function of memory CD4 T cells in human IL-12 receptor beta 1 deficiency. *J Immunol* 170(1): 597–603
- Dorman SE, Holland SM (1998) Mutation in the signal-transducing chain of the interferon-gamma receptor and susceptibility to mycobacterial infection. *J Clin Invest* 101: 2364–2369
- Dorman SE, Holland SM (2000) Interferon-gamma and interleukin-12 pathway defects and human disease. *Cytokine Growth Factor Rev* 11(4): 321–333
- Dorman SE, Picard C, Lammas D, Heyne K, van Dissel JT, Baretto R, Rosenzweig S, Newport M, Roesler J, Kumararante D, Casanova JL, Holland SM (2004) Clinical features of dominant and recessive IFN-gamma receptor 1 deficiencies. *Lancet* 364: 2113–2121
- Eloumi-Zghal H, Barbouche MR, Chemli J, Bejaoui M, Harbi A, Snoussi N, Abdelhak S, Dellagi K (2002) Clinical and genetic heterogeneity of inherited autosomal recessive susceptibility to disseminated *Mycobacterium bovis* bacille calmette-guérin infection. *J Infect Dis* 185: 1468–1475
- Feinberg J, Fieschi C, Doffinger R, Feinberg M, Leclerc T, Boisson-Dupuis S, Picard C, Bustamante J, Chappier A, Filipe-Santos O, Ku CL, de Beaucoudrey L, Reichenbach J, Antoni G, Balde R, Alcais A, Casanova JL (2004) Bacillus Calmette Guérin triggers the IL-12/IFN-gamma axis by an IRAK-4- and NEMO-dependent, non-cognate interaction between monocytes, NK, and T lymphocytes. *Eur J Immunol* 34: 3276–3284
- Fieschi C, Dupuis S, Catherinot E, Feinberg J, Bustamante J, Breiman A, Altare F, Baretto R, Le Deist F, Kayal S, Koch H, Richter D, Brezina M, Aksu G, Wood P, Al-Jumaah S, Raspall M, Da Silva Duarte AJ, Tuerlinckx D, Virelizier JL, Fischer A, Enright A, Bernhoft J, Cleary AM, Vermynen C, Rodriguez-Gallego C, Davies G, Blutters-Sawatzki R, Siegrist CA, Ehlayel MS, Novelli V, Haas WH, Levy J, Freiherst J, Al-Hajjar S, Nadal D, De Moraes Vasconcelos D, Jeppsson O, Kutukculer N, Freceirova K, Caragol I, Lammas D, Kumararatne DS, Abel L, Casanova JL (2003) Low penetrance, broad resistance, and favorable outcome of interleukin 12 receptor beta1 deficiency: medical and immunological implications. *J Exp Med* 197: 527–535
- Fieschi C, Bosticardo M, de Beaucoudrey L, Boisson-Dupuis S, Feinberg J, Santos OF, Bustamante J, Levy J, Candotti F, Casanova JL (2004) A novel form of complete IL-12/IL-23 receptor beta1 deficiency with cell surface-expressed nonfunctional receptors. *Blood* 104(7): 2095–2101
- Flynn JL, Chan J, Triebold KJ, Dalton DK, Stewart TA, Bloom BR (1993) An essential role for IFN-gamma in resistance to *Mycobacterium tuberculosis* infection. *J Exp Med* 178: 2249–2250

18. Gill GV, Holden A (1996) A malignant pleural effusion infected with *Salmonella enteritidis*. *Thorax* 51: 104–105
19. Guide VSH, Holland SM (2002) Host susceptibility factors in mycobacterial infection, genetic and body morphotype. *Inf Dis Clin North Am* 10: 103–181
20. Kawakami KY, Koguchi Y, Qureshi MH et al (2000) IL-18 contributes to host resistance against infection with *Cryptococcus neoformans* in mice with defective IL-12 synthesis through induction of IFN-gamma production by NK cells. *J Immunol* 165: 941–947
21. Kumar A, Srinivasan S (2001) Pleural empyema due to group B *Salmonella* in a child with diarrhea. *Indian Pediatrics* 38: 186–189
22. Maclennan C, Fieschi C, Lammas DA, Picard C, Dorman SE, Sanal O, Maclennan JM, Holland SM, Ottenhoff TH, Casanova JL, Kumararatne DS (2004) Interleukin (IL)-12 and IL-23 are key cytokines for immunity against *Salmonella* in humans. *J Infect Dis* 190: 1755–1757
23. Mastroeni P, Menager N (2003) Development of acquired immunity to *Salmonella*. *J Med Microbiol* 52: 435–459
24. McKusick VA (1998) Mendelian inheritance in man. Johns Hopkins University Press, Baltimore
25. Muller U, Kohler G (2001) IL-12 independent IFN- γ production by T cells in experimental Chagas disease is mediated by IL-18. *J Immunol* 167: 3346–3353
26. Newport MJ, Huxley CM, Huston S, Hawrylowicz CM, Oostra BA, Williamson R (1996) A mutation in the IFN-gamma receptor gene and susceptibility to mycobacterial infection. *N Engl J Med* 335: 1941–1949
27. Notarangelo L, Casanova JL, Fischer A, Puck J, Rosen F, Seger R, Geha R (2004) International Union of Immunological Societies Primary Immunodeficiency Diseases Classification Committee. Primary immunodeficiency diseases: an update. *J Allergy Clin Immunol* 114: 677–687
28. Picard C, Fieschi C, Altare F, Al-Jumaah S, Al-Hajjar S, Feinberg J, Dupuis S, Soudais C, Al-Mohsen IZ, Genin E, Lammas D, Kumararatne DS, Leclerc T, Rafii A, Frayha H, Murugasu B, Wah LB, Sinniah R, Loubser M, Okamoto E, Al-Ghonaïum A, Tufenkeji H, Abel L, Casanova JL (2002) Inherited interleukin-12 deficiency: IL12B genotype and clinical phenotype of 13 patients from six kindreds. *Am J Hum Genet* 70: 336–348
29. Rosenzweig SD, Dorman SE, Uzel G, Shaw S, Scurlock A, Brown MR, Buckley RH, Holland SM (2004) A novel mutation in IFN-gamma receptor 2 with dominant negative activity: biological consequences of homozygous and heterozygous states. *J Immunol* 173: 4000–4008
30. Suzuki H, Okamura T (1996) A case of empyema caused by *Salmonella enteritidis* in a patient with sequel of pulmonary tuberculosis. *J Jap Assoc Infect Dis* 70: 383–385
31. Talbot EA, Perkins MD, Silva SF, Fronthingham R (1997) Disseminated Bacille Calmette-Guerin disease after vaccination: case report and review. *Clin Infect Dis* 24: 1139–1146
32. Trinchieri G (2003) Interleukin-12 and the regulation of innate resistance and adaptive immunity. *Nat Rev Immunol* 3: 133–146
33. Wolday D, Seyoum B (1997) Pleural empyema due to *Salmonella paratyphi* in a patient with AIDS. *Trop Med Intern Health* 2: 1140–1142

Article 9

Paracoccidioides brasiliensis disseminated disease in a patient with inherited deficiency in the beta1 subunit of the interleukin (IL)-12/IL-23 receptor

Moraes-Vasconcelos, D., A.S. Grumach, A. Yamaguti, M.E. Andrade, C. Fieschi,
L. de Beaucoudrey, J.L. Casanova, and A.J. Duarte

Clinical Infectious Diseases
2005, 41:e31-37

Paracoccidioides brasiliensis Disseminated Disease in a Patient with Inherited Deficiency in the β 1 Subunit of the Interleukin (IL)-12/IL-23 Receptor

Dewton de Moraes-Vasconcelos,^{1,2} Anete S. Grumach,^{1,2} Augusto Yamaguti,³ Maria Elisa B. Andrade,³ Claire Fieschi,⁴ Ludovic de Beaucoudrey,⁴ Jean-Laurent Casanova,⁴ and Alberto J. S. Duarte²

¹Primary Immunodeficiencies Outpatient Unit and ²Laboratory of Investigation in Dermatology and Immunodeficiencies, Department of Dermatology, University of São Paulo Medical School, and ³Hospital of the São Paulo State Public Servants "Francisco Morato de Oliveira," São Paulo, Brazil; and ⁴Pediatric Immunology-Hematology Unit and Laboratory of Human Genetics of Infectious Diseases, University of Paris René Descartes, Necker-Enfants Malades Medical School, Paris, France

(See the article by Zerbe and Holland on pages e38–41)

Background. *Paracoccidioides brasiliensis* is a facultative intracellular dimorphic fungus that causes paracoccidioidomycosis (PCM), the most important deep mycosis in Latin America. Only a small percentage of individuals infected by *P. brasiliensis* develop clinical PCM, possibly in part because of genetically determined interindividual variability of host immunity. However, no primary immunodeficiency has ever been associated with PCM.

Methods. We describe the first patient, to our knowledge, with PCM and a well-defined primary immunodeficiency in the β 1 subunit of the interleukin (IL)-12/IL-23 receptor, a disorder previously shown to be specifically associated with impaired interferon (IFN)- γ production, mycobacteriosis, and salmonellosis.

Results. Our patient had a childhood history of bacille Calmette-Guérin disease and nontyphoid salmonellosis and, at the age of 20 years, presented to our clinic with a disseminated (acute) form of PCM. He responded well to antifungal treatment and is now doing well at 24 years of age.

Conclusions. This unique observation supports previous studies of PCM suggesting that IL-12, IL-23, and IFN- γ play an important role in protective immunity to *P. brasiliensis*. Tuberculosis and PCM are thus not only related clinically and pathologically, but also by their immunological pathogenesis. Our study further expands the spectrum of clinical manifestations of inherited defects of the IL-12/IL-23-IFN- γ axis. Patients with unexplained deep fungal infections, such as PCM, should be tested for defects in the IL-12/IL-23-IFN- γ axis.

During the past 10 years, the molecular basis of the syndrome of Mendelian susceptibility to mycobacterial disease (MIM209950) was determined in a number of patients [1–3]. Mutations of the genes encoding the ligand-binding chain (R1) [4, 5] and associated chains (R2) [6] of the IFN- γ receptor, the β 1 subunit of the IL-12 receptor (IL-12R β 1) [7, 8], the p40 subunit of IL-12 (IL-12p40) [9], and signal transducer and activator of transcription type 1 (STAT-1) [10, 11] have been recognized. The severity of clinical disease was found to correlate with the extent of failure to either

produce or respond to IFN- γ . Patients with a complete deficiency of IFN- γ R1, IFN- γ R2, or STAT-1 lack cellular responses to IFN- γ and have early-onset and life-threatening infections caused by poorly pathogenic mycobacteria and salmonellae. Milder and often curable diseases due to these pathogens are seen in patients with partial IFN- γ R1, IFN- γ R2, and STAT-1 deficiencies and in patients who lack IL-12p40 (shared by IL-12 and IL-23; hereafter, "IL-12/IL-23p40") or IL-12R β 1 (shared by the IL-12 and IL-23 receptors; hereafter, "IL-12/IL-23R β 1").

The latter 2 disorders result in normal responses to IFN- γ but abnormal IL-12-dependent and IL-23-dependent production of IFN- γ . Up to 19 patients with IL-12/IL-23p40 deficiency [3, 9, 12, 13] and 54 with IL-12/IL-23R β 1 deficiency [7, 8, 13–20] have been described. Salmonellosis, another well-known feature of the syndrome of Mendelian susceptibility to mycobacterial disease [21, 22], is particularly common in pa-

Received 24 January 2005; accepted 14 April 2005; electronically published 15 July 2005.

Reprints or correspondence: Dr. Dewton de Moraes-Vasconcelos, Instituto de Medicina Tropical, Av. Dr. Enéas de Carvalho Aguiar, 500, prédio 2, 3º Andar, Bairro: Cerqueira César, São Paulo, São Paulo 05403-000 Brazil (dmvascon@usp.br).

Clinical Infectious Diseases 2005;41:e31–7

© 2005 by the Infectious Diseases Society of America. All rights reserved.
1058-4838/2005/4104-00E1\$15.00



Figure 1. Radiograph showing the sequelae of *Salmonella enterica* serotype Typhimurium osteoarticular infection. The radiograph shows extensive destruction of the head and neck of the femur and also of the acetabulum of the ilium.

tients with IL-12/IL-23p40 and IL-12/IL-23R β 1 deficiency [3, 23]. Additional unusual infectious diseases have not been reported.

Paracoccidioidomycosis (PCM) is a deep mycosis caused by the dimorphic fungus *Paracoccidioides brasiliensis*, which is endemic in certain regions of South America [24]. *P. brasiliensis* naturally undergoes a complex transformation from inhaled environmental conidia into the pathogenic yeast form in the human lungs. According to the current classification, 2 main clinical forms of PCM are distinguished: the acute or juvenile form (AF) and the chronic or adult form (CF) [25]. The CF affects mainly males, who show a high frequency of pulmonary, skin, and mucosal involvement. The lesions affect only few tissues/organs and are associated with tuberculoid granulomas containing a small number of fungi [26]. The AF is characterized by the widespread involvement of the reticuloendothelial system, including lymph nodes, spleen, liver, and bone marrow. The lesions are disseminated and associated with necrotizing host cells and abundant fungal cells.

An intriguing feature of *P. brasiliensis* infection is that not all infected individuals develop disease. In areas of endemicity in Brazil, *P. brasiliensis* infects 10%–40% of the population, as detected by serological testing, whereas the incidence of CF and AF PCM is probably less than 1% and 0.1% of infected individuals, respectively. Interestingly, patients with HIV infection are more prone to develop a severe form of PCM, with features

of the 2 polar forms of the disease, mainly due to reactivation of latent foci but often resembling the AF of PCM [27]. Nevertheless, despite the increasing number of known primary immunodeficiencies and their improved diagnosis in Brazil, no patient with PCM associated with primary immunodeficiency was reported in the medical literature. This leaves open the question of whether a genetic predisposition may account for PCM clinical disease in the general population. Herein, we describe the first patient with clinical PCM disease and a primary immunodeficiency affecting the IL-12/IL-23–IFN- γ axis.

CASE REPORT

Our patient is a 24-year-old man of Portuguese descent. He is the first son of a nonconsanguineous couple and was born in a small city in the inlands of São Paulo State, Brazil. After bacille Calmette-Guérin (BCG) vaccination as a newborn, he presented to the hospital at 7 months of age with a cervical adenopathy caused by *Mycobacterium bovis* BCG. The infection resolved after a 6-month course of rifampin, isoniazid, and ethambutol. At 2 years of age, he presented with relapses of lymphadenitis, which responded only partially to multiple antibiotic treatments. At the age of 6 years, disseminated disease caused by *Salmonella enterica* serotype Typhimurium was diagnosed with multiple lymphadenitis, arthritis of the right hip, and osteomyelitis of the right ilium and femur. This infection

lasted 7 years and led to osteoarticular sequelae (figure 1). At 20 years of age, after a period of 7 years without symptoms, he developed persistent fever and abdominal pain with disseminated lymphadenopathy and hepatosplenomegaly (figure 2). Biopsy of an abdominal lymph node showed a juvenile (acute) form (AF) of paracoccidioidomycosis, supported by high titers of serum antibodies to *P. brasiliensis* antigens (figure 3). The infection was controlled by trimethoprim-sulfamethoxazole (160 mg trimethoprim and 800 mg sulfamethoxazole twice per day). At the time of writing, the patient is 24 years of age and is healthy after completion of a 5-year course of therapy.

Findings of laboratory analysis conducted during AF PCM showed mild leukopenia (3400 cells/mm³) and moderate lymphopenia (600 cells/mm³); normal serum IgM levels (41 mg/dL), low serum IgA and IgG levels (37 mg/dL and 533 mg/dL, respectively), and elevated IgE levels (383 IU/L); test results that were positive for IgG antibody to cytomegalovirus and negative for IgM antibody to cytomegalovirus, rubella, and *Toxoplasma gondii*; and serological test results that were negative for Epstein-Barr virus and positive for *P. brasiliensis*. Lymphocyte phenotyping showed depletion of CD4⁺ T cells before and after treatment of PCM (figure 4). Evaluation of the lympho-

proliferative capacity of the patient's T lymphocytes before therapy showed normal stimulation indexes for phytohemagglutinin and pokeweed mitogen and a decreased stimulation index for the anti-CD3 monoclonal antibody (figure 5). In contrast, the antigen-specific T cell proliferation in vitro was depressed for all of the following antigens that were tested: *Candida* metabolic antigen (CMA), tetanus toxoid, *Mycobacterium tuberculosis* purified protein derivative, and the 43-kD glycoprotein from *P. brasiliensis* (gp43). Improvement of the antigen-specific responses was verified after initiation of treatment, revealing a normal stimulation index for CMA. The rate of IL-2 secretion induced by phytohemagglutinin and CMA and gp43 antigens was low, and the rate of IFN- γ secretion induced by CMA and gp43 was high (figure 6).

A mutation in the gene encoding IL-12R β 1 was suspected by single-strand conformational polymorphism and was identified as a homozygous missense mutation resulting in substitution of leucine for phenylalanine at amino acid 77 [17]. The mutation is recessive and associated with loss of function resulting in complete IL-12/IL-23R β 1 deficiency, with no detectable surface expression of the receptors. The patient's parents are heterozygous for this mutation. One his 2 siblings, a

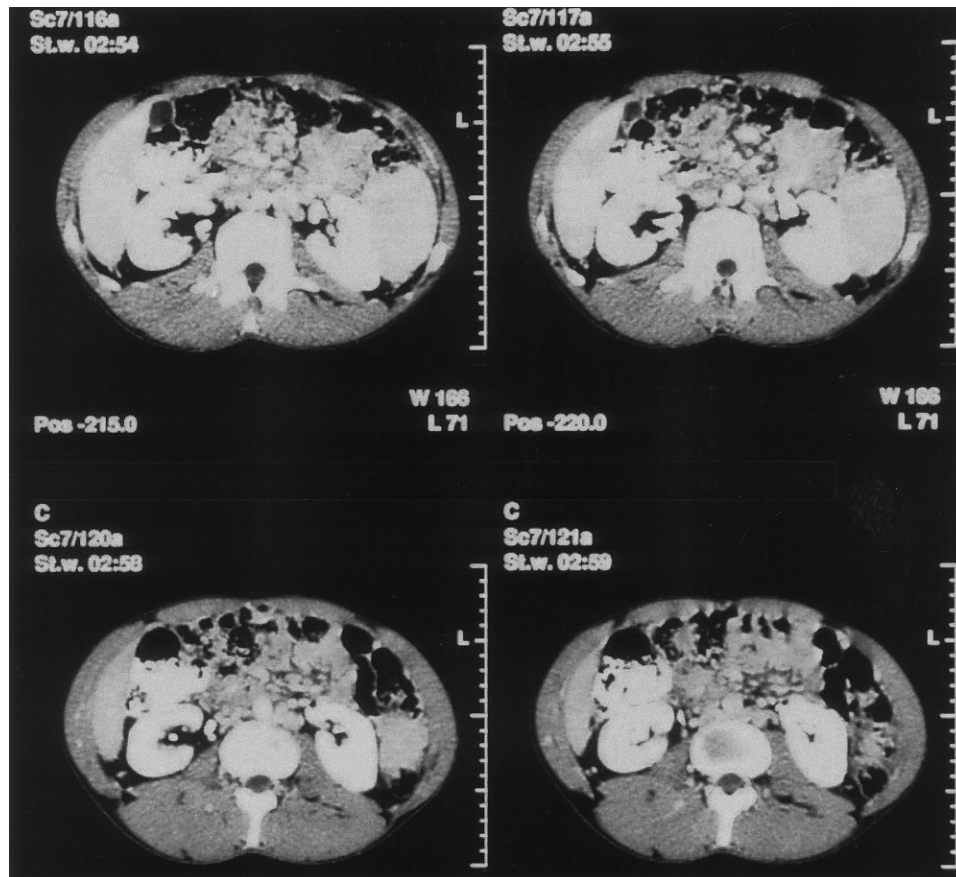

Figure 2. Axial CT of the abdomen during *Paracoccidioides brasiliensis* disseminated infection. It is important to note the extensive intra-abdominal lymphadenomegaly.

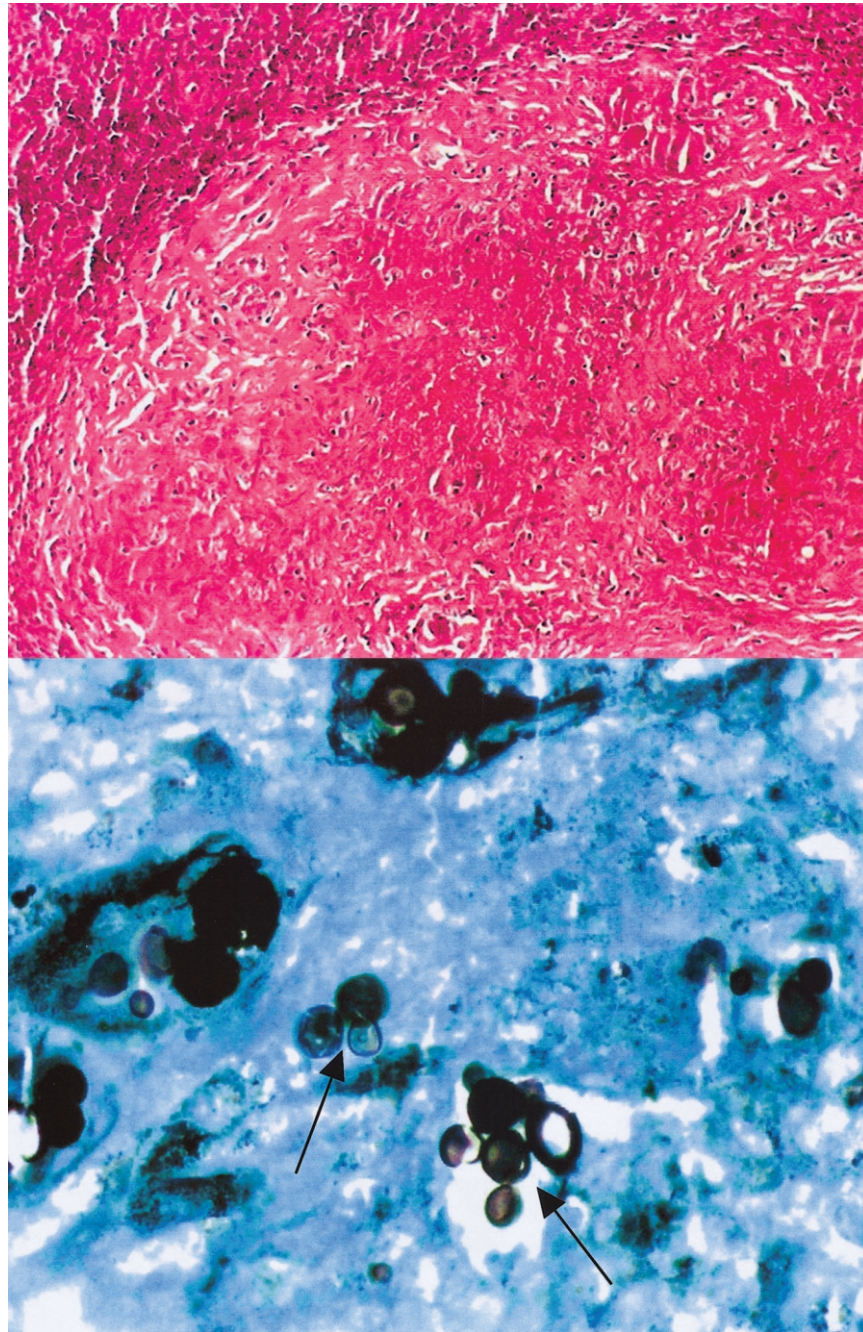

Figure 3. Histopathologic characteristics of an affected lymph node biopsy specimen. *Top*, Hematoxylin-eosin–stained specimen showing granuloma with extensive areas of necrosis (original magnification, $\times 100$). *Bottom*, Grocott-stained specimen showing multiple fungal structures inside the granuloma, with characteristic budding (arrows; original magnification, $\times 400$).

20-year-old brother, is heterozygous for the gene encoding IL-12R β 1, and the other, a 14-year-old sister, has 2 wild-type *IL12RB1* alleles [17]. Both siblings were vaccinated with BCG without adverse reaction and, at the time of writing, are healthy.

DISCUSSION

We herein describe the first patient with PCM disease and a well-defined primary immunodeficiency—inherited IL-12/IL-

23R β 1 deficiency. This is also the first patient from a PCM-endemic country to be described with a defect of the IL-12/IL-23–IFN- γ axis. This association may be coincidental, because this is the first and only known case of PCM associated with a defect in the IL-12/IL-23–IFN- γ axis. Moreover, although the patient developed an acute (disseminated) form of PCM, there was a prompt and full response to therapy with oral trimethoprim-sulfamethoxazole, which is usually indicated

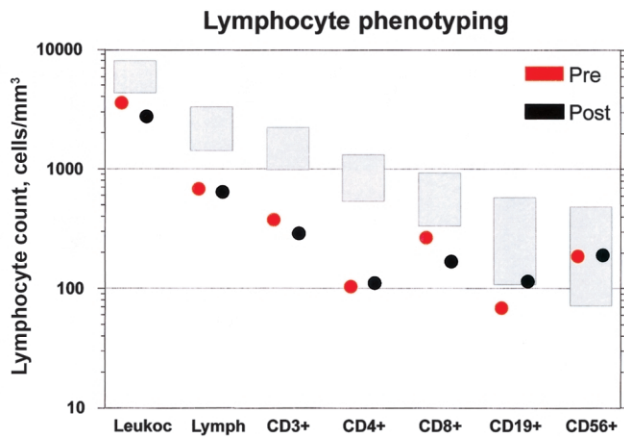

Figure 4. Lymphocyte counts for patient before (red circles) and 6 months after (black circles) the beginning therapy. Data are presented as absolute total leukocyte counts (Leukoc), lymphocyte counts (Lymph), T cell counts (CD3⁺), helper T cell counts (CD4⁺), cytotoxic T cell counts (CD8⁺), B cell counts (CD19⁺), and NK cell counts (CD3⁻CD56⁺). Gray boxes, range of normal values [39].

for milder cases of PCM. On the other hand, the characteristics of *P. brasiliensis* infection suggest that PCM in our patient was not fortuitous but, rather, a consequence of the IL-12/IL-23R β 1 defect. Indeed, there is a striking clinical and histological resemblance between PCM and mycobacterial diseases, particularly tuberculosis [29]. Although phylogenetically distant, the infectious agents of this 2 diseases invade the host via the respiratory tract, persist within macrophages, cause granuloma formation, and disseminate within the reticuloendothelial system. This study illustrates the importance of the microbial environment in the clinical presentation of primary immunodeficiencies [30].

The studies of IFN- γ knockout mice established the crucial role of IFN- γ in PCM [31]. This research showed that IFN- γ is essential for the resistance and survival of *P. brasiliensis*-infected mice. Furthermore, mice deficient in IFN- γ receptor were also highly susceptible to *P. brasiliensis* intratracheal infection, with increased morbidity and mortality [32]. It is interesting that dissemination of the infection was not observed in association with murine deficiencies in IFN- α or IFN- β receptors [33]. IL-12 knockout mice also demonstrated that IL-12 is of paramount importance in host defense against *P. brasiliensis* [34]. Our present study is thus consistent with the findings in animal models of PCM, which, in turn, suggest that the association of human IL-12R β 1 deficiency and PCM is not fortuitous.

Patients with PCM often show a suppression of IFN- γ secretion in response to *P. brasiliensis* antigens, contributing to the inability to restrict the dissemination of *P. brasiliensis* [35]. The importance of these immune functions is underscored by the potent secretion of IFN- γ depicted by healthy sensitized

subjects who live in areas of endemicity and have positive paracoccidioidin skin test results. As a result, these individuals probably develop an efficient immune response that prevents the onset of the disease. Previous studies showed a preferential secretion of IL-4, IL-5, and IL-10 in patients with AF PCM [36]. These mediators associated with low IFN- γ levels were correlated with a more severe manifestation of the disease. Intermediate immune responses were observed in patients with CF PCM, whose IFN- γ and IL-10 production did not differ from that observed in the group with AF PCM, although IL-4 and IL-5 levels were significantly lower.

Furthermore, in our laboratory, G. Benard and colleagues demonstrated that patients with either AF or CF PCM showed diminished IL-12 secretion in response to gp43, the main *P. brasiliensis* antigenic component [37]. Addition of IL-12 markedly enhanced the mean rate of gp43-elicited IFN- γ secretion by PBMCs. The addition of IL-2 resulted in an additional increase in the IFN- γ production [38], probably owing to the fact that IL-2 is crucial for the persistence of the IL-12R β 2 subunit after peptide stimulation of T cells through T cell receptor [39]. Indeed, lymphocytes exposed to gp43 obtained from patients with PCM express very low levels of the β 2-subunit, compared with cured patients (C. C. Romano and G. Benard, personal communication). Our patient did not secrete high levels of IL-10, showing a selective depression of IL-12 responsiveness without an increase of IL-4 and IL-10. This

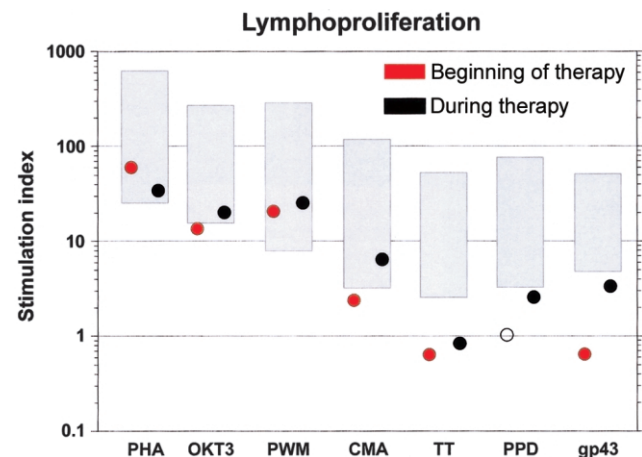

Figure 5. Proliferative response of mononuclear cells under the following stimuli: phytohemagglutinin (PHA), monoclonal antibody anti-CD3 (OKT3), pokeweed mitogen (PWM), *Candida* metabolic antigen (CMA), tetanus toxoid (TT), *Mycobacterium tuberculosis* purified protein derivative (PPD), and 43-kD glycoprotein from *Paracoccidioides brasiliensis* (gp43). Data were obtained at the beginning of the treatment course (red circles) and after 6 months of therapy (black circles) during clinical remission of the disease. Gray boxes, 95% CIs established by the analysis of a normal population studied at the Laboratory of Investigation in Dermatology and Immunodeficiencies (São Paulo, Brazil); open circle, pretreatment stimulation index not determined.

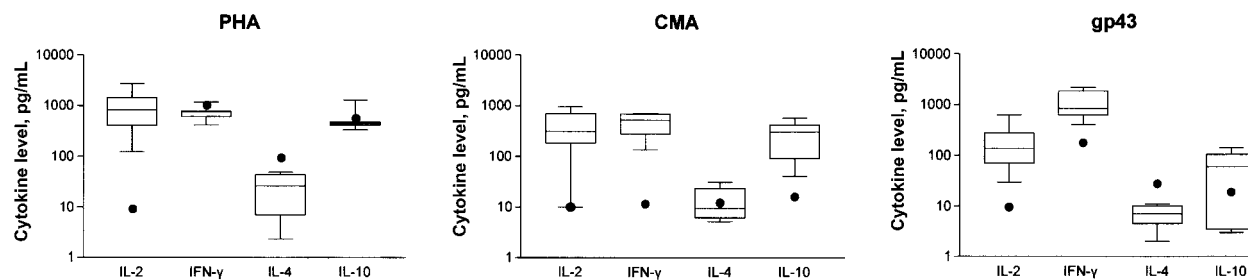

Figure 6. Production of cytokines (after 6 months of antifungal therapy and clinical remission of the infection) in response to stimulation with phytohemagglutinin for 24 h, *Candida* metabolic antigen (CMA) for 72 h, and the 43-kD glycoprotein from *Paracoccidioides brasiliensis* (gp43) for 72 h. PBMCs obtained from 1 patient (black circles) and 10 control subjects (box plots) were stimulated in culture, and supernatants were assessed for IL-2, IFN- γ , IL-4, and IL-10. Boxes, interquartile ranges; horizontal lines within boxes, median values; whiskers, maximum and minimum values.

finding could be related to a possible minor role played by IL-10, instead of IFN- γ , in the control of PCM

In conclusion, the present case report emphasizes that the diagnosis of defects of the IL-12–IFN- γ axis should not only be considered for patients with mycobacterial and/or *Salmonella* infection, but also for patients presenting with PCM or other deep mycoses. This assumption can be emphasized by the fact that an article in this issue describes an autosomal dominant negative IFN- γ R1–deficient patient from the United States who presented with disseminated histoplasmosis [40]. *Histoplasma* and *Paracoccidioides* organisms are taxonomically closely related and even belong to the same family—Onygenaceae. Their differences lie in the genus: *Ajellomyces* (*Histoplasma*) and *Paracoccidioides*. Therefore, patients who present with severe or refractory systemic mycoses may have defects in the genes of the Mendelian susceptibility to mycobacterial disease group and should be investigated for inherited disturbances of the IL-12/IL-23–IFN- γ axis.

Acknowledgments

We thank Steven M. Holland, for helpful discussions and critical reading of our manuscript, and Carla Romano and Gil Benard, for presenting some unpublished data.

Potential conflicts of interest. All authors: no conflicts.

References

- Dorman SE, Holland SM. Interferon-gamma and interleukin-12 pathway defects and human disease. *Cytokine Growth Factor Rev* **2000**; 11:321–33.
- Casanova JL, Abel L. Genetic dissection of immunity to mycobacteria: the human model. *Annu Rev Immunol* **2002**; 20:581–620.
- Fieschi C, Casanova JL. The role of interleukin-12 in human infectious diseases: only a faint signature. *Eur J Immunol* **2003**; 33:1461–4.
- Newport MJ, Huxley C, Huston S, et al. A mutation in the interferon- γ –receptor gene and susceptibility to mycobacterial infection. *N Engl J Med* **1996**; 335:1941–9.
- Jouanguy E, Altare F, Lamhamedi S, et al. Interferon- γ –receptor deficiency in an infant with fatal bacille Calmette–Guérin infection. *N Engl J Med* **1996**; 335:1956–61.
- Dorman SE, Holland SM. Mutation in the signal-transducing chain of the interferon- γ –receptor and susceptibility to mycobacterial infection. *J Clin Invest* **1998**; 101:2364–9.
- Altare F, Durandy A, Lammas D, et al. Impairment of mycobacterial immunity in human interleukin-12 receptor deficiency. *Science* **1998**; 280:1432–5.
- De Jong R, Altare F, Haagen IA, et al. Severe mycobacterial and *Salmonella* infections in interleukin-12 receptor deficient patients. *Science* **1998**; 280:1435–8.
- Altare F, Lammas D, Revy P, et al. Inherited interleukin-12 deficiency in a child with bacille Calmette–Guérin and *Salmonella enteritidis* disseminated infection. *J Clin Invest* **1998**; 102:2035–40.
- Dupuis S, Dargemont C, Fieschi C, et al. Impairment of mycobacterial but not viral immunity by a germline human STAT-1 mutation. *Science* **2001**; 293:300–3.
- Dupuis S, Jouanguy E, Al-Hajjar S, et al. Impaired response to interferon α/β and lethal viral disease in human STAT 1 deficiency. *Nat Genet* **2003**; 33:388–91.
- Picard C, Fieschi C, Altare F, et al. Inherited interleukin-12 deficiency: IL12B genotype and clinical phenotype of 13 patients from six kindreds. *Am J Hum Genet* **2002**; 70:336–48.
- Elloumi-Zghal H, Barbouche MR, Chemli J, et al. Clinical and genetic heterogeneity of inherited autosomal recessive susceptibility to disseminated *Mycobacterium bovis* bacille Calmette–Guérin infection. *J Infect Dis* **2002**; 185:1468–75.
- Aksu G, Tirpan C, Cavosuglu C, et al. *Mycobacterium fortuitum*–*chelonae* complex infection in a child with complete interleukin-12 receptor β -1 deficiency. *Pediatr Infect Dis J* **2001**; 20:551–3.
- Altare F, Ensser A, Breiman A, et al. Interleukin-12 receptor β -1 deficiency in a patient with abdominal tuberculosis. *J Infect Dis* **2001**; 184:231–6.
- Sakai T, Matsuoka M, Aoki M, Nosaka K, Mitsuya H. Missense mutation of the interleukin-12 receptor β -1 chain-encoding gene is associated with impaired immunity against *Mycobacterium avium* complex infection. *Blood* **2001**; 97:2688–94.
- Fieschi C, Dupuis S, Catherinot E, et al. Low penetrance, broad resistance, and favorable outcome of interleukin 12 receptor β 1 deficiency: medical and immunological implications. *J Exp Med* **2003**; 197: 527–35.
- Lichtenauer-Kaligis EG, de Boer T, Verreck FA, et al. Severe *Mycobacterium bovis* BCG infections in a large series of novel IL-12 receptor β 1 deficient patients and evidence for the existence of partial IL-12 receptor β 1 deficiency. *Eur J Immunol* **2003**; 33:59–69.
- Staretz-Haham O, Melamed R, Lifshitz M, et al. Interleukin-12 receptor β 1 deficiency presenting as recurrent *Salmonella* infection. *Clin Infect Dis* **2003**; 37:137–40.
- Caragol I, Raspall M, Fieschi C, et al. Clinical tuberculosis in 2 of 3

- siblings with interleukin-12 receptor β 1 deficiency. *Clin Infect Dis* **2003**; 37:302–6.
21. Casanova JL, Blanche S, Emile JF, et al. Idiopathic disseminated bacillus Calmette-Guérin infection: a French national retrospective study. *Pediatrics* **1996**; 98:774–8.
 22. Levin M, Newport MJ, D'Souza S, et al. Familial disseminated atypical mycobacterial infection in childhood: a human mycobacterial susceptibility gene? *Lancet* **1995**; 345:79–83.
 23. MacLennan C, Fieschi C, Lammas DA, et al. Interleukin (IL)–12 and IL-23 are key cytokines for immunity against *Salmonella* in humans. *J Infect Dis* **2004**; 190:1755–7.
 24. Restrepo A. The ecology of *Paracoccidoides brasiliensis*: a puzzle still unresolved. *Sabouraudia* **1985**; 23:323–4.
 25. Franco M, Montenegro MR, Mendes RP, Marques SA, Dillon NL, Mota NGS. Paracoccidoidomycosis: a recently proposed classification of its clinical forms. *Rev Soc Bras Med Trop* **1987**; 20:129–32.
 26. Del Negro G, Lacaz CS, Zamith VA, Siqueira AM. General clinical aspects: polar forms of paracoccidoidomycosis, the disease in childhood. In: Franco M, Lacaz CS, Restrepo-Moreno A, Del Negro G, eds. *Paracoccidoidomycosis*. Boca Raton, FL: CRC Press, **1994**:225–32.
 27. Benard G, Duarte AJ. Paracoccidoidomycosis: a model for evaluation of the effects of human immunodeficiency virus infection on the natural history of endemic tropical diseases. *Clin Infect Dis* **2000**; 31: 1032–9.
 28. Shearer WT, Rosenblatt HM, Gelman RS, et al. Lymphocyte subsets in healthy children from birth through 18 years of age: the Pediatric AIDS Clinical Trials Group P1009 study. *J Allergy Clin Immunol* **2003**; 112:973–80.
 29. Borges-Walmsley MI, Chen D, Shu X, Walmsley AR. The pathobiology of *Paracoccidoides brasiliensis*. *Trends in Microbiology* **2002**; 10:80–7.
 30. Casanova JL, Abel L. The human model: a genetic dissection of immunity to infection in natural conditions. *Nat Rev Immunol* **2004**; 4: 55–66.
 31. Souto JT, Figueiredo F, Furlanetto A, Pfeffer K, Rossi MA, Silva JS. Interferon- γ and tumor necrosis factor- α determine resistance to *Paracoccidoides brasiliensis* infection in mice. *Am J Pathol* **2000**; 156: 1811–20.
 32. Tabora CP. Mapeamento do epítipo de células T do antígeno principal de diagnóstico do *Paracoccidoides brasiliensis*. Indução de resposta imune protetora do tipo Th1 contra a infecção experimental no camundongo [PhD dissertation]. São Paulo, Brazil: Federal University of São Paulo, **1998**.
 33. Tabora CP, Franco MF, Reis LFL, Travassos LR. Pathology of the intratracheal infection of *Paracoccidoides brasiliensis* in IFN- γ , IFN- α , β , γ -R and IRF-1 deficient mice [abstract E-26]. In: Program and abstracts of the VIIth International Meeting on Paracoccidoidomycosis (Campos do Jordão, São Paulo, Brazil). São Paulo: Brazilian Society for Microbiology, **1999**:162.
 34. Deepe GS, Romani L, Calich VLG, et al. Knockout mice as experimental models of virulence. *Med Mycol* **2000**; 38:87–98.
 35. Benard G, Mendes-Giannini MJS, Juvenale M, Miranda ET, Duarte AJS. Immunosuppression in paracoccidoidomycosis: T cell hyporesponsiveness to two *Paracoccidoides brasiliensis* glycoproteins that elicit strong humoral immune response. *J Infect Dis* **1997**; 175:1263–7.
 36. Oliveira SJ, Mamoni RL, Musatti CC, Papiordanou PMO, Blotta MHS. Cytokines and lymphocyte proliferation in juvenile and adult forms of paracoccidoidomycosis: comparison with infected and non-infected controls. *Microbes Infect* **2002**; 4:139–44.
 37. Berzaghi R, da Silva SH, de Camargo ZP. Variable gp43 secretion by *Paracoccidoides brasiliensis* clones obtained by two different culture methods. *J Clin Microbiol* **2005**; 43:491–3.
 38. Romano CC, Mendes-Giannini MJS, Duarte AJS, Benard G. IL-12 and neutralization of endogenous IL-10 revert the in vitro antigen-specific cellular immunosuppression of paracoccidoidomycosis patients. *Cytokine* **2002**; 18:149–57.
 39. Chang JT, Segal BM, Shevach EM. Role of costimulation in the induction of IL-12/IL-12 receptor pathway and the development of autoimmunity. *J Immunol* **2000**; 164:100–6.
 40. Zerbe CS, Holland SM. Disseminated histoplasmosis in persons with interferon- γ receptor 1 deficiency. *Clin Infect Dis* **2005**; 41:e38–41.

Article 10

Interleukin-12 receptor beta 1 chain deficiency in a child with disseminated tuberculosis

Ozbek, N., C. Fieschi, B.T. Yilmaz, **L. de Beaucoudrey**, B. Demirhan, J. Feinberg, Y.E. Bikmaz, and J.L. Casanova

Clinical Infectious Diseases
2005, 40:e55-58

Interleukin-12 Receptor β 1 Chain Deficiency in a Child with Disseminated Tuberculosis

Namik Özbek,¹ Claire Fieschi,³ Bafak T. Yilmaz,¹ Ludovic de Beaucoudrey,³ Beyhan Demirhan,² Jacqueline Feinberg,³ Yunus Emre Bikmaz,¹ and Jean-Laurent Casanova^{3,4}

Departments of ¹Pediatrics and ²Pathology, Baskent University School of Medicine, Ankara, Turkey; ³Laboratory of Human Genetics of Infectious Diseases, University of Paris René Descartes–INSERM U550, Necker Medical School, and ⁴Pediatric Immunology and Hematology Unit, Necker Hospital, Paris, France

An 11-year-old girl who presented with disseminated tuberculosis associated with secondary hemophagocytosis received a diagnosis of interleukin-12 receptor β 1 chain deficiency. This diagnosis of immunodeficiency should, therefore, be considered for children with disseminated tuberculosis, even in the absence of any personal or familial history of prior infection by weakly pathogenic *Salmonella* and *Mycobacterium* species.

Mendelian susceptibility to mycobacterial disease (MIM 209950) is a rare syndrome that predisposes patients to clinical disease caused by weakly virulent mycobacterial species, such as bacille Calmette–Guérin (BCG) vaccines and nontuberculous environmental mycobacteria [1–4]. Patients are also susceptible to the more virulent species *Mycobacterium tuberculosis*, the agent of tuberculosis [5–8]. Other infectious diseases rarely occur in these patients, with the exception of nontyphoid salmonellosis. Five disease-causing autosomal genes (*IFNGR1*, *IFNGR2*, *STAT1*, *IL12B*, *IL12RB1*) have been identified, and allelic heterogeneity accounts for the existence of 10 defined disorders that result in impaired IFN- γ -mediated immunity [3, 4]. Defects in the *IFNGR1*, *IFNGR2*, and *STAT1* genes are associated with impaired cellular responses to IFN- γ , and defects in *IL12B* and *IL12RB1* are associated with impaired IL-12–dependent and IL-23–dependent production of IFN- γ . Complete defi-

ciencies of the 2 IFN- γ receptor components (IFN- γ R1 and IFN- γ R2) are associated with severe mycobacterial diseases that have an early onset. Partial IFN- γ R1, IFN- γ R2, and signal transducer and activator of transcription (STAT)–1 molecule deficiencies, like complete IL-12p40 and IL-12R β 1 deficiencies, are associated with a later onset and a better prognosis [3, 4].

IL-12R β 1 deficiency is the most common genetic etiology of Mendelian susceptibility to mycobacterial disease, with 54 patients with this syndrome in the literature [6, 8, 9–19]. The known mutations in the *IL12RB1* gene are recessive and are associated with the abolition of the response to both IL-12 and IL-23 [18, 19]. In all patients except one, no IL-12R β 1 was detectable on the cell surface. In that one patient, the mutation was associated with the surface expression of nonfunctional, internally truncated receptors [19]. Patients with IL-12R β 1 deficiency classically experience clinical disease caused by BCG, environmental mycobacteria, and nontyphoid *Salmonella* species. One patient from Morocco had abdominal tuberculosis at 18 years of age, and she received a diagnosis of IL-12R β 1 deficiency after the deficiency had been diagnosed in her younger brother, an index case patient with BCG disease and nontyphoid, extraintestinal salmonellosis [6]. In a family from Spain, a diagnosis of IL-12R β 1 deficiency was considered for a 6-year-old girl with disseminated tuberculosis, because her sister had a history of extraintestinal nontyphoid salmonellosis [8]. The patient's sister also developed pulmonary tuberculosis, despite receipt of isoniazid prophylaxis. To date, IL-12R β 1 deficiency has thus been diagnosed in a few children and teenagers with tuberculosis, on the basis of a personal or familial history of clinical disease that was caused by weakly virulent mycobacteria or *Salmonella* species. We describe a child with IL-12R β 1 deficiency and disseminated tuberculosis who had no relevant personal or familial history.

Case report. An 11-year-old girl was admitted to the hospital (Department of Pediatrics, Baskent University, Ankara, Turkey) with fever, a cervical mass with purulent discharge, abdominal pain, weakness, and night sweats. The patient was the fourth child of healthy, consanguineous parents. The patient and her parents and siblings had been vaccinated with BCG vaccine, with no adverse effect. One of the patient's sisters had died of an infection of unknown origin at the age of 1 year. An analysis of the family's medical history revealed no cases of tuberculosis, and the patient's mother and siblings had negative tuberculin skin test results. The patient's illness began 3 months before admission, with fever, anorexia, fatigue, and night sweats. Her weight and height were below the third per-

Received 9 August 2004; accepted 4 November 2004; electronically published 17 February 2005.

Reprints or correspondence: Dr. Jean-Laurent Casanova, Laboratoire de Génétique Humaine des Maladies Infectieuses, Université de Paris René Descartes–INSERM U550, Faculté de Médecine Necker, 156 Rue de Vaugirard, 75015 Paris, France (casanova@necker.fr).

Clinical Infectious Diseases 2005;40:e55–8

© 2005 by the Infectious Diseases Society of America. All rights reserved.
1058-4838/2005/4006-00E2\$15.00

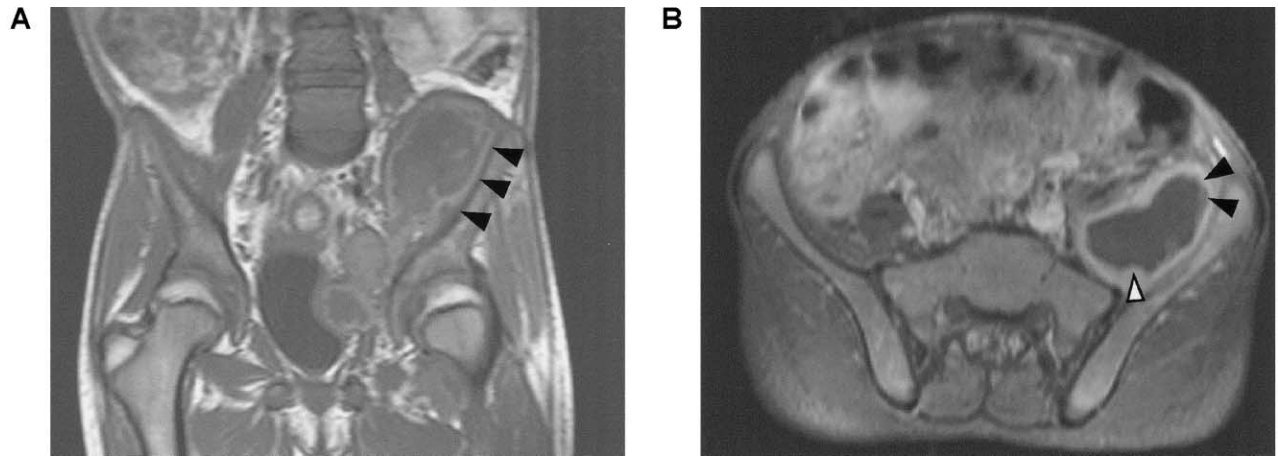

Figure 1. Frontal (A) and horizontal (B) views of MRI of the abdomen showing a large abscess (black arrow) with a thick wall (white arrow) and septum in close contact with the left hemipelvis.

centile. The patient's diphtheria-tetanus-pertussis and attenuated poliovirus vaccinations were up to date. The patient had been revaccinated with BCG vaccine after she had received a negative tuberculin skin test result at 7 years of age; no complications occurred.

Physical examination revealed fever, hepatomegaly, and bilateral packed cervical and supraclavicular lymphadenopathies—some of which were fistulized—that measured 3 cm in diameter. An intra-abdominal mass measuring 4 cm in diameter was palpable in the periumbilical area. Laboratory test results were as follows: hemoglobin concentration, 9.9 g/dL; WBC count, 21.5×10^9 cells/L; platelet count, 933×10^9 platelets/L; and serum C-reactive protein concentration, 96 mg/L. Serum levels of electrolytes, glucose, and creatinine, as well as the results of renal and liver function tests, were within normal ranges. No bacterial pathogens were detected in blood or stool cultures. No serum antibodies to herpes simplex virus, Epstein-Barr virus, cytomegalovirus, *Toxoplasma gondii*, and human herpes virus 8 were detected.

Ultrasonography of the abdomen showed multiple enlarged lymph nodes of 3 cm in diameter on the periportal, celiac, mesenteric, para-aortic, and pericaval areas. CT of the cervix, thorax, abdomen, and pelvis demonstrated multiple cervical, mediastinal, and abdominal lymphadenopathies with no detectable sign of primary infection of the lungs. MRI of the abdomen revealed the formation of an abscess in the left psoas muscle (figure 1). An increase in activity for the left hemipelvis and the lateral condyl of the femur was detected by technetium Tc 99m methylidiphosphonate scintigraphy of the skeletal system. The findings of thoracic and lumbar MRI were normal.

Biopsy of an abdominal lymph node showed tuberculoid granulomas and numerous visible acid-fast bacilli within histiocytes (figure 2). Bone marrow aspiration and biopsy showed the marrow to be hypercellular, with numerous macrophages

and marked hemophagocytosis. Liver biopsy revealed granulomatous hepatitis, with granulomas consisting of epithelioid histiocytes and multinucleated giant cells, some of which displayed emperipolesis. A culture of pus obtained from the abscess in the psoas muscle revealed *M. tuberculosis*, which was resistant to isoniazid and ethambutol. The tuberculin skin test result was positive (18 × 15 mm). The patient received a diagnosis of disseminated drug-resistant tuberculosis and secondary hemophagocytosis. Because the initial microbiological and pathologic findings suggested an atypical, multidrug-resistant mycobacterial infection, a daily regimen of rifampin, clarithromycin, ciprofloxacin, and streptomycin was initiated. The patient's fever subsided 13 days after the initiation of treatment, with improvement of the other symptoms noted. The findings of subsequently performed physical examinations were

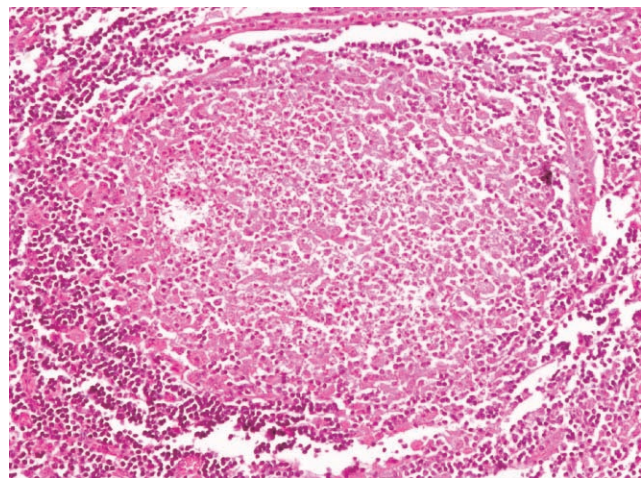

Figure 2. A well-circumscribed tuberculous granuloma in a biopsy sample of the abdominal mass (hematoxylin-eosin stain).

normal, and laboratory test results gradually returned to normal. Treatment with streptomycin was ended after 30 days. However, the patient developed a relapse of tuberculosis in the abdominal lymph nodes 8 months after treatment initiation, as was shown by signs of abdominal lymph node enlargement on an ultrasound scan and by the results of a lymph node biopsy, which revealed epithelioid histiocytes and multinucleated giant cells without acid-fast bacilli. The culture result for this biopsy specimen was negative for acid-fast bacilli and mycobacteria. Amikacin and cycloserine were added to the regimen, and the patient responded well to treatment during the 5 months after treatment initiation.

Whole blood samples were diluted, plated, and stored at 37°C, either unstimulated, stimulated with BCG alone, or stimulated with BCG and IL-12. IFN- γ was quantified in the supernatant after 48 h, as described elsewhere [20]. IFN- γ production did not increase in response to the addition of IL-12 to the test well, whereas a 1.5-log increase was observed for the wells corresponding to the control specimen and the specimen from the patient's mother (not shown). The Epstein-Barr virus-transformed B cells of the patient lacked IL-12R β 1, as shown by flow cytometry performed with 2 different antibodies (24E6 and 2B10; Pharmingen). The exon and flanking intron regions of the *IL12RB1* gene (encoding IL-12R β 1) were amplified by PCR. Direct sequencing of the PCR products revealed a homozygous mutation affecting a consensus splice site (1021 +1 G>C). This mutation results in the skipping of exon 9, as shown by cDNA-PCR. Despite the residual expression of a wild-type *IL12RB1* mRNA, blood cells and T cell blasts failed to respond to IL-12 in vitro, in terms of IFN- γ production. The patient's parents, brother, and sister were heterozygous for the mutant allele and for the wild-type allele. The patient therefore received a diagnosis of IL-12R β 1 deficiency due to a homozygous mutation in the *IL12RB1* gene. The present study was conducted according to the principles expressed in the Helsinki Declaration, and informed consent was obtained from the patient's family.

Discussion. In the present report, we describe a child with disseminated tuberculosis and inherited IL-12R β 1 deficiency. Tuberculosis in children with IL-12R β 1 deficiency appears to run a relatively unusual course, because the children described in previous reports had abdominal tuberculosis [6], disseminated tuberculosis [8, 15], or pulmonary tuberculosis, despite receipt of isoniazid prophylaxis [8]. The case reported here lends weight to the argument that a diagnosis of inherited IL-12R β 1 deficiency should be considered for children with severe, extrapulmonary tuberculosis. These children probably develop a severe form of tuberculosis soon after infection. Children with other disorders of the IL-12/IFN- γ axis are probably also prone to such severe forms of tuberculosis with early onset, as suggested by our previous description of tuberculosis in chil-

dren with partial IFN- γ R1 deficiency [5] and IL-12p40 deficiency [7].

The prevalence of tuberculosis in IL-12p40-deficient and IL-12R β 1-deficient patients is lower than that of disease due to BCG or nontuberculosis mycobacteria infection [21]. To date, only 4 of 73 patients with IL-12p40 or IL-12R β 1 deficiency have been reported to experience tuberculosis (3 [5.6%] of 54 patients with complete IL-12R β 1 deficiency and 1 [5.3%] of 19 patients with complete IL-12p40 deficiency) [21]. This may be because patients are less frequently exposed to *M. tuberculosis* than to the BCG vaccines (which have 85% coverage worldwide) and to the almost ubiquitous environmental mycobacteria. This, in turn, probably accounts for the fact that all 4 previously described case patients had a personal or familial history of clinical disease caused by weakly virulent mycobacteria or *Salmonella* species.

The patient described here is the first patient with an inherited disorder of the IL-12/IFN- γ axis and tuberculosis to be identified in the absence of any relevant personal or familial history. The 2 previous BCG inoculations had possibly protected the patient from subsequent nontuberculosis mycobacteria disease [15]. In keeping with the low penetrance of complete IL-12R β 1 deficiency for the case definition phenotype of BCG/ environmental mycobacteria clinical disease, the present report thus suggests that there may be other patients with IL-12R β 1 deficiency and tuberculosis as the sole clinical manifestation. Together with our previous reports [5–8], the present report provides strong evidence that the development of tuberculosis in the general population may be favored by a Mendelian predisposition. A diagnosis of IL-12R β 1 deficiency or of another related genetic defect [4] should thus be considered for select children with unusually severe tuberculosis, even if they have no personal or familial history of infection with weakly virulent *Mycobacterium* or *Salmonella* species.

Acknowledgments

We thank Nural Kiper, for her contribution to the management of the patient, and Laurent Abel and the members of the Laboratory of Human Genetics of Infectious Diseases, for helpful discussions. This work was supported by the Fondation Banque Nationale de Paris-Paribas, the Fondation Schlumberger, and the European Commission (grant QLK2-CT-2002-00846).

Potential conflicts of interest. All authors: no conflicts.

References

1. Levin M, Newport MJ, D'Souza S, et al. Familial disseminated atypical mycobacterial infection in childhood: a human mycobacterial susceptibility gene? *Lancet* 1995;345:79–83.
2. Casanova JL, Blanche S, Emile JF, et al. Idiopathic disseminated bacillus Calmette-Guerin infection: a French national retrospective study. *Pediatrics* 1996;98:774–8.
3. Dorman SE, Holland SM. Interferon- γ and interleukin-12 pathway

- defects and human disease. *Cytokine Growth Factor Rev* **2000**;11:321–33.
4. Casanova JL, Abel L. Genetic dissection of immunity to mycobacteria: the human model. *Annu Rev Immunol* **2002**;20:581–620.
 5. Jouanguy E, Lamhamedi-Cherradi S, Altare F, et al. Partial interferon-gamma receptor 1 deficiency in a child with tuberculoid bacillus Calmette-Guérin infection and a sibling with clinical tuberculosis. *J Clin Invest* **1997**;100:2658–64.
 6. Altare F, Ensser A, Breiman A, et al. Interleukin-12 receptor β 1 deficiency in a patient with abdominal tuberculosis. *J Infect Dis* **2001**;184:231–6.
 7. Picard C, Fieschi C, Altare F, et al. Inherited interleukin-12 deficiency: *IL12B* genotype and clinical phenotype of 13 patients from six kindreds. *Am J Hum Genet* **2002**;70:336–48.
 8. Caragol I, Raspall M, Fieschi C, et al. Clinical tuberculosis in 2 of 3 siblings with interleukin-12 receptor β 1 deficiency. *Clin Infect Dis* **2003**;37:302–6.
 9. Altare F, Durandy A, Lammas D, et al. Impairment of mycobacterial immunity in human interleukin-12 receptor deficiency. *Science* **1998**;280:1432–5.
 10. de Jong R, Altare F, Haagen IA, et al. Severe mycobacterial and *Salmonella* infections in interleukin-12 receptor-deficient patients. *Science* **1998**;280:1435–8.
 11. Verhagen CE, de Boer T, Smits HH, et al. Residual type 1 immunity in patients genetically deficient for interleukin 12 receptor β 1 (IL-12R β 1): evidence for an IL-12R β 1-independent pathway of IL-12 responsiveness in human T cells. *J Exp Med* **2000**;192:517–28.
 12. Aksu G, Tirpan C, Cavusoglu C, et al. *Mycobacterium fortuitum-chelonae* complex infection in a child with complete interleukin-12 receptor beta1 deficiency. *Pediatr Infect Dis J* **2001**;20:551–3.
 13. Sakai T, Matsuoka M, Aoki M, Nosaka K, Mitsuya H. Missense mutation of the interleukin-12 receptor β 1 chain-encoding gene is associated with impaired immunity against *Mycobacterium avium* complex infection. *Blood* **2001**;97:2688–94.
 14. Elloumi-Zghal H, Barbouche MR, Chemli J, et al. Clinical and genetic heterogeneity of inherited autosomal recessive susceptibility to disseminated *Mycobacterium bovis* bacille Calmette-Guérin infection. *J Infect Dis* **2002**;185:1468–75.
 15. Fieschi C, Dupuis S, Catherinot E, et al. Low penetrance, broad resistance, and favorable outcome of interleukin 12 receptor β 1 deficiency: medical and immunological implications. *J Exp Med* **2003**;197:527–35.
 16. Lichtenauer-Kaligis EG, De Boer T, Verreck FA, et al. Severe *Mycobacterium bovis* BCG infections in a large series of novel IL-12 receptor β 1 deficient patients and evidence for the existence of partial IL-12 receptor β 1 deficiency. *Eur J Immunol* **2003**;33:59–69.
 17. Staretz-Haham O, Melamed R, Lifshitz M, et al. Interleukin-12 Receptor β 1 deficiency presenting as recurrent salmonella infection. *Clin Infect Dis* **2003**;37:137–40.
 18. Cleary AM, Tu W, Enright A, et al. Impaired accumulation and function of memory CD4 T cells in human IL-12 receptor beta1 deficiency. *J Immunol* **2003**;170:597–603.
 19. Fieschi C, Bosticardo M, de Beaucoudrey L, et al. A novel form of complete IL-12/IL-23 receptor β 1 deficiency with cell surface-expressed nonfunctional receptors. *Blood* **2004**;104:2095–101.
 20. Feinberg J, Fieschi C, Doffinger R, et al. Bacillus Calmette Guerin triggers the IL-12/IFN-gamma axis by an IRAK-4- and NEMO-dependent, non-cognate interaction between monocytes, NK, and T lymphocytes. *Eur J Immunol* **2004**;34:3276–84.
 21. Fieschi C, Casanova JL. The role of interleukin-12 in human infectious diseases: only a faint signature. *Eur J Immunol* **2003**;33:1461–4.

Article 11

Bacillus Calmette Guerin triggers the IL-12/IFN-gamma axis by an IRAK-4- and NEMO-dependent, non-cognate interaction between monocytes, NK, and T lymphocytes

Feinberg, J., C. Fieschi, R. Doffinger, M. Feinberg, T. Leclerc, S. Boisson-Dupuis, C. Picard, J. Bustamante, A. Chapgier, O. Filipe-Santos, C.L. Ku, **L. de Beaucoudrey**, J. Reichenbach, G. Antoni, R. Balde, A. Alcais, and J.L. Casanova

European Journal of Immunology
2004, 34:3276-3284

Bacillus Calmette Guérin triggers the IL-12/IFN- γ axis by an IRAK-4- and NEMO-dependent, non-cognate interaction between monocytes, NK, and T lymphocytes

Jacqueline Feinberg¹, Claire Fieschi¹, Rainer Doffinger¹, Max Feinberg², Tony Leclerc¹, Stéphanie Boisson-Dupuis¹, Capucine Picard¹, Jacinta Bustamante¹, Ariane Chappier¹, Orchidée Filipe-Santos¹, Cheng-Lung Ku¹, Ludovic de Beaucoudrey¹, Janine Reichenbach¹, Guillemette Antoni¹, Ramatoulaye Baldé¹, Alexandre Alcaïs¹ and Jean-Laurent Casanova^{1,3}

¹ Laboratoire de Génétique Humaine des Maladies Infectieuses, Université de Paris René Descartes INSERM U550, Faculté de Médecine Necker, Paris, France, EU

² Institut National de la Recherche Agronomique, Paris, France, EU

³ Unité d'Immunologie et d'Hématologie pédiatriques, Hôpital Necker – Enfants Malades, Paris, France, EU

The IL-12/IFN- γ axis is crucial for protective immunity to *Mycobacterium* in humans and mice. Our goal was to analyze the relative contribution of various human blood cell subsets and molecules to the production of, or response to IL-12 and IFN- γ . We designed an assay for the stimulation of whole blood by live *M. bovis* Bacillus Calmette-Guérin (BCG) alone, or BCG plus IL-12 or IFN- γ , measuring IFN- γ and IL-12 levels. We studied patients with a variety of specific inherited immunodeficiencies resulting in a lack of leukocytes, or T, B, and/or NK lymphocytes, or polymorphonuclear cells, or a lack of expression of key molecules such as HLA class II, CD40L, NF- κ B essential modulator (NEMO), and IL-1 receptor-associated kinase-4 (IRAK-4). Patients with deficiencies in IL-12p40, IL-12 receptor β 1 chain (IL-12R β 1), IFN- γ R1, IFN- γ R2, and STAT-1 were used as internal controls. We showed that monocytes were probably the main producers of IL-12, and that NK and T cells produced similar amounts of IFN- γ . NEMO and IRAK-4 were found to be important for IL-12 production and subsequent IFN- γ production, while a lack of CD40L or HLA class II had no major impact on the IL-12/IFN- γ axis. The stimulation of whole blood by live BCG thus triggers the IL-12/IFN- γ axis by an IRAK-4- and NEMO-dependent, non-cognate interaction between monocytes, NK, and T lymphocytes.

Key words: Human / Primary immunodeficiency / *Mycobacterium* / Cytokines / Cellular activation

Received	15/4/04
Revised	5/8/04
Accepted	19/8/04

1 Introduction

IL-12p70, the biologically active form of IL-12, consists of two subunits – IL-12p35 and IL-12p40 – encoded by the *IL12A* and *IL12B* genes, respectively, and is produced principally by phagocytes and dendritic cells [1]. IL-12p70 is required to stimulate the production of large

[DOI 10.1002/eji.200425221]

Abbreviations: **CD40L:** CD40 ligand **IRAK-4:** IL-1R-associated kinase-4 **IL-12R β 1:** IL-12R β 1 chain **MSMD:** Mendelian susceptibility to mycobacterial disease **NEMO:** NF- κ B essential modulator **XL-EDA-ID:** X-linked anhidrotic ectodermal dysplasia with immunodeficiency **STAT-1:** Signal transducer and activator of transcription-1

amounts of IFN- γ by natural killer (NK) and T cells. Phagocytes have also been shown to respond to IL-12 and to produce IFN- γ , although generally in smaller amounts [2]. IFN- γ is a noncovalently linked homodimeric glycosylated protein. Its production is induced principally by IL-12, but also by other cytokines such as IL-1 β , IL-18, IL-23, IL-27, and TNF- α [3, 4]. The p40 subunit is also a component of IL-23, which binds to a receptor sharing a β 1 subunit with the IL-12R and shares many biological properties with IL-12. The crucial role played by the IL-12/23/IFN- γ axis in mycobacterial immunity was first demonstrated in mice [5].

Recent investigations of human patients with Mendelian susceptibility to mycobacterial disease (MSMD) have

demonstrated that the IL-12/23/IFN- γ axis is also important in human immunity to mycobacteria [6, 7]. Patients with MSMD are susceptible to disease caused by live BCG vaccine and mildly virulent environmental mycobacteria. Paradoxically, they are resistant to most others microorganisms, with the exception of *Salmonella* [6]. Several types of mutations (recessive and dominant, amorphic and hypomorphic) have been identified in five genes (*IL12B*, *IL12RB1*, *IFNGR1*, *IFNGR2*, *STAT1*), which cause ten different genetic diseases [6, 8]. Patients with IL-12p40 and IL-12R β 1 chain (IL-12R β 1) deficiency with impaired IL-12- and IL-23-mediated immunity display defects in the production of IFN- γ , whereas patients with IFN- γ R1, IFN- γ R2, and STAT-1 deficiency display an impaired response to IFN- γ .

The cooperation and relative contributions of the various blood cells subsets involved in the production of, or response to, IL-12/IL-23 and IFN- γ in response to mycobacteria are largely unknown. We dissected the cellular and molecular basis of the production of, and response to, the IL-12/IFN- γ axis, upon stimulation by live mycobacteria, in patients with a variety of well-defined primary immunodeficiencies [9]. The conditions studied included reticular dysgenesis, T- B- NK+ and T- B+ NK- SCID, NK cell deficiency, X-linked agammaglobulinemia, CGD, HIES, CD40L, HLA class II, NF- κ B essential modulator (NEMO), IL-1R-associated kinase-4 (IRAK-4), IFN- γ R1, IFN- γ R2, STAT-1, IL-12p40 and IL-12R β 1 deficiencies [8, 10–13] (see Table 1 for abbreviations). We studied the production of IL-12 and IFN- γ *in*

Table 1. Description of the three groups of patients in the study and their vulnerability to mycobacteria

Disorder ^{a)}	Abbreviation	Susceptibility ^{b)}	No.
Controls			
Internal healthy controls		–	50
Group 1: Selective cellular defects			
Kostmann's syndrome	PMN–	–	3
Bruton's disease	B–	–	2
Natural killer cell deficiency	NK–	–	1
SCID T/B	T– B–	+	4
SCID T/NK	T– NK–	+	3
Reticular dysgenesis	RD	+	1
Group 2: Defects other than MSMD without cytopenia			
XL-anhidrotic ectodermal dysplasia with immunodeficiency	XL-EDA-ID	+	2
IRAK-4 deficiency	IRAK-4	–	3
Chronic granulomatous disease	CGD	+	3
Hyper-IgE syndrome	HIES	±	2
CD40L deficiency	CD40 L	±	2
HLA class II immunodeficiency	HLA-II	–	4
Group 3: MSMD defects			
Complete IFN- γ R1 deficiency	cIFN- γ R1	+	5
Complete IFN- γ R2 deficiency	cIFN- γ R2	+	3
Partial IFN- γ R1 deficiency	pIFN- γ R1	+	10
Partial STAT-1 deficiency	pSTAT-1	+	6
Complete IL-12p40 deficiency	cIL-12p40	+	3
Complete IL-12R β 1 deficiency	cIL-12R β 1	+	33

^{a)} Group 1: Kostmann's syndrome (lack of PMN cells), Bruton's disease (lack of B cells), NK cell deficiency (lack of NK cells) [11], SCID T/B (lack of T and B cells), SCID T/NK (lack of T and NK cells) and reticular dysgenesis (lack of leukocytes). Group 2: XL-anhidrotic ectodermal dysplasia with immunodeficiency (identified *NEMO* mutation), IRAK-4 deficiency (*IRAK4* mutation with pyogen microorganisms susceptibility), autosomal or X-recessive chronic granulomatous disease (mutations in the genes encoding the NADPH oxidase subunits), hyper-IgE syndrome (gene defect not known), CD40L deficiency (mutation in the *CD40L* gene), HLA-II deficiency (mutation in transactivating factors). Group 3: complete or partial molecular deficiencies (mutation in *IFNGR1*, *IFNGR2*, *STAT1*, *IL12B*, and *IL12RB1*).

^{b)} Susceptibility to poorly virulent mycobacteria; these conditions were associated with a high risk (+), low risk (±) or no risk (–) of BCG/environmental mycobacteria disease [9].

in vitro in the blood of these patients, in response to live BCG, BCG plus IFN- γ , and BCG plus IL-12.

2 Results

2.1 Production of IL-12 and IFN- γ in whole blood from healthy controls

We compared the production of IL-12 or IFN- γ after stimulation with BCG alone, BCG plus IFN- γ , and BCG plus IL-12 in purified PBMC and diluted whole blood. We added IL-12 or IFN- γ to BCG as they are known to be potent inducers of IFN- γ and IL-12. We chose to assess both the IL-12p70 and IL-12p40 response of blood cells, as IL-12p70 is the natural cytokine, but IL-12p40 is expressed in higher amounts. We decided to use whole blood for the study, as this method was more likely to be better fitted for the purpose of this assay, being more reliable (whole blood is the most appropriate medium in which to study cytokine production *in vitro*) and taking into account the reciprocal interactions of all the blood cells. It was also quicker and easier to perform (data not shown). *In vitro* depletion of human cells would result in difficulties inherent to the depletion techniques. Antibody-mediated depletion would cause cytokine release whereas column depletion would cause a mechanical stress. From this preliminary study we found that (1) levels of IL-12 and IFN- γ production were maximal for a multiplicity of infection (MOI) of 20 BCG per leukocyte (not shown); (2) levels of IL-12p70 and IL-12p40 production in response to BCG or BCG plus IFN- γ were maximal after 12–18 h of activation; and (3) levels of IFN- γ in response to BCG alone or BCG plus IL-12 were highest after 48 h of stimulation (not shown).

Whereas PBMC counting is known to vary with age, we also determined the influence of age and gender in the 50 healthy subjects. Age and gender had no significant effect on the production of IFN- γ , IL-12p70, or IL-12p40 by controls, regardless of the type of stimulation (not shown). Among the 50 healthy controls, there was no significant correlation between the levels of blood monocytes and IL-12p40 or IL-12p70 production (not shown). We have not tested healthy children, but results for cytokine production were standardized with respect to the number of PBMC and are expressed as pg/ml/ 10^6 PBMC.

In the 50 healthy BCG-vaccinated controls analyzed, levels of IL-12p40 at 18 h were generally low without activation (mean 60 pg/ml/ 10^6 PBMC) with a 95% confidential interval of the mean ($CI_{95\%}$) ranging 0–655. Following stimulation with BCG, IL-12p40 levels increased by a factor of 5 (mean 248 pg/ml/ 10^6 PBMC,

$CI_{95\%}$ 10–2,051). Activation with BCG plus IFN- γ increased the levels of this cytokine 8 times more than stimulation with BCG (mean 2,074 pg/ml/ 10^6 PBMC, $CI_{95\%}$ 211–8,599; Figs. 1A–3A). In contrast, IL-12p70 was barely detectable following stimulation with BCG (mean 2 pg/ml/ 10^6 PBMC, $CI_{95\%}$ 0–6). The addition of IFN- γ amplified the response to BCG, resulting in 100 to 150 times more IL-12p70 production (mean 148 pg/ml/ 10^6 PBMC, $CI_{95\%}$ 7–861; (Figs. 1B–3B). IFN- γ levels at 48 h were very low in medium alone (mean 6 pg/ml/ 10^6 PBMC, $CI_{95\%}$ 0–21). In the presence of BCG, IFN- γ levels were about 700 times higher (mean 4,403 pg/ml/ 10^6 PBMC, $CI_{95\%}$ 266–21,026). The addition of IL-12 to BCG further increased IFN- γ production, to levels 17 times higher than those with BCG (mean 76,265 pg/ml/ 10^6 PBMC, $CI_{95\%}$ 18,059–223,263; Figs. 1C–3C).

We also analyzed the IL-12p40, IL-12p70, and IFN- γ production of healthy controls who had not been vaccinated with BCG ($n=8$), five of whom had been activated with a delay due to the shipment. We observed a similar range of variation to that observed for the BCG-vaccinated healthy controls. Similar responses were found for the subgroup of non-vaccinated healthy travel controls, with slightly lower values (not shown). Thus, these results for a limited cohort of non-BCG-vaccinated healthy subjects suggest that prior BCG vaccination has no effect on the results of the assay. The BCG status of the controls was shown to have no significant impact on this *in vitro* blood test. In any event, most (over 90%) of the patients we analyzed had been vaccinated with BCG.

2.2 Response of patients with selective cellular defects (group 1)

We evaluated the contributions of the various human blood cell subsets to the production of, and response to, IL-12 and IFN- γ , by analyzing six types of patients with primary immunodeficiency diseases involving various specific cellular defects (Table 1). Normal production of IL-12p40 and IL-12p70 was observed in patients lacking PMN cells ($n=2$), B cells ($n=2$), NK cells ($n=1$, analyzed twice), and in patients lacking both T and B cells ($n=4$) or both T and NK cells ($n=3$). A subnormal IL-12p70 (but not IL-12p40) production was observed for one PMN-patient and may reflect an underlying illness. Thus, B cells, NK cells, and T cells do not significantly contribute to whole-blood IL-12p40 and IL-12p70 production in response to BCG infection. More surprisingly, the contribution of PMN cells to IL-12 production [1] is not demonstrated by this blood assay.

It was not possible to check the major role of monocytes in IL-12 production in the absence of known selective

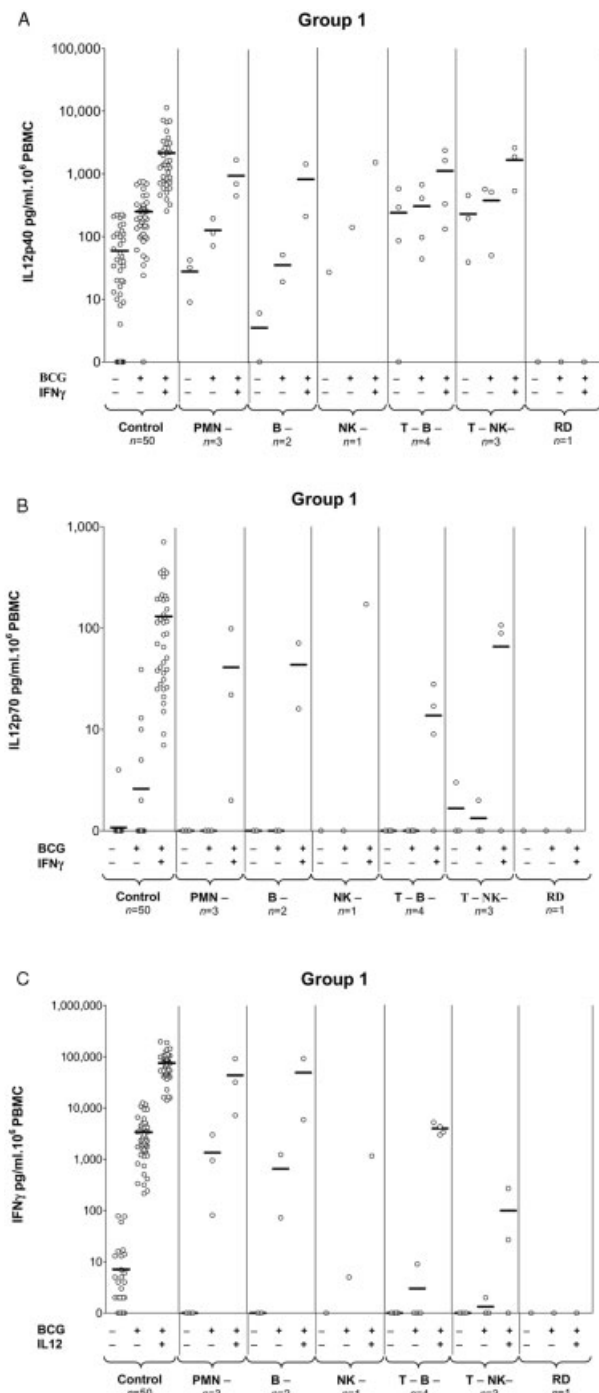

◀ Fig. 1. Cytokine production in the supernatants of whole-blood cells from patients with a lack of PMN (PMN-), B (B-), NK (NK-), T and B (T-B-), T and NK (T-NK-), or myeloid and lymphoid cells (reticular dysgenesis, RD), unstimulated or stimulated by BCG alone or BCG plus cytokine, as detected by ELISA. The amounts of cytokine secreted are normalized for 10^6 PBMC on a logarithmic scale and averages are indicated as solid bars. (A) IL-12p40 production at 18 h. (B) IL-12p70 production at 18 h. (C) IFN- γ production at 48 h. The same set of control data are replicated for each group of patient.

We then analyzed the contribution of the various cell subsets to IFN- γ production. Patients with neutropenia ($n=3$) produced IFN- γ in similar amounts to the controls in response to BCG and BCG plus IL-12. Patients lacking B cells ($n=2$) respond to stimulation with BCG alone by producing low to “normal” levels of IFN- γ . The addition of IL-12 increased IFN- γ production by a factor of about 50. In both defects, levels of IFN- γ production were similar to those in healthy controls, taking into account the individual variability of the response observed in controls.

In contrast, our patient lacking NK cells failed to produce detectable IFN- γ in response to BCG alone, but produced 1,100 pg/ml/ 10^6 PBMC IFN- γ after activation with BCG plus IL-12. SCID patients that lacked both T and B cells ($n=4$) displayed no detectable IFN- γ production after BCG activation and a low level of IFN- γ production in response to BCG plus IL-12 (mean 4,000 pg/ml/ 10^6 PBMC). Strikingly, patients lacking both T and NK cells ($n=3$) produced no detectable IFN- γ in response to BCG, and very little IFN- γ in response to BCG plus IL-12 (mean 99 pg/ml/ 10^6 PBMC). In the absence of T and NK cells, these small amounts of IFN- γ were probably produced by the patients’ monocytes, detected by this *in vitro* blood assay. Our patient with reticular dysgenesis was unable to produce IFN- γ , even after stimulation with BCG plus IL-12 (Fig. 1C). This suggests that NK and T cells are primarily responsible for the production of IFN- γ in the blood in response to live BCG. Further investigations of a larger number of patients with NK deficiency are required to determine more accurately the relative contributions of NK and T cells, which seem to be equivalent, based on the present study.

defects in monocytes. However, such a role was indirectly suggested by the study of a patient with reticular dysgenesis, who had no leukocytes and failed to produce IL-12p40 or IL-12p70 (Fig. 1A, B). Our data are consistent with the notion that monocytes are the blood cells responsible for the production of IL-12 in response to BCG *in vivo*.

2.3 Response of patients with immune defects impairing T cell/antigen-presenting cell cooperation (group 2)

We analyzed, in group 2, six primary immunodeficiency diseases (Table 1) [9, 13]. Patients with complete CGD

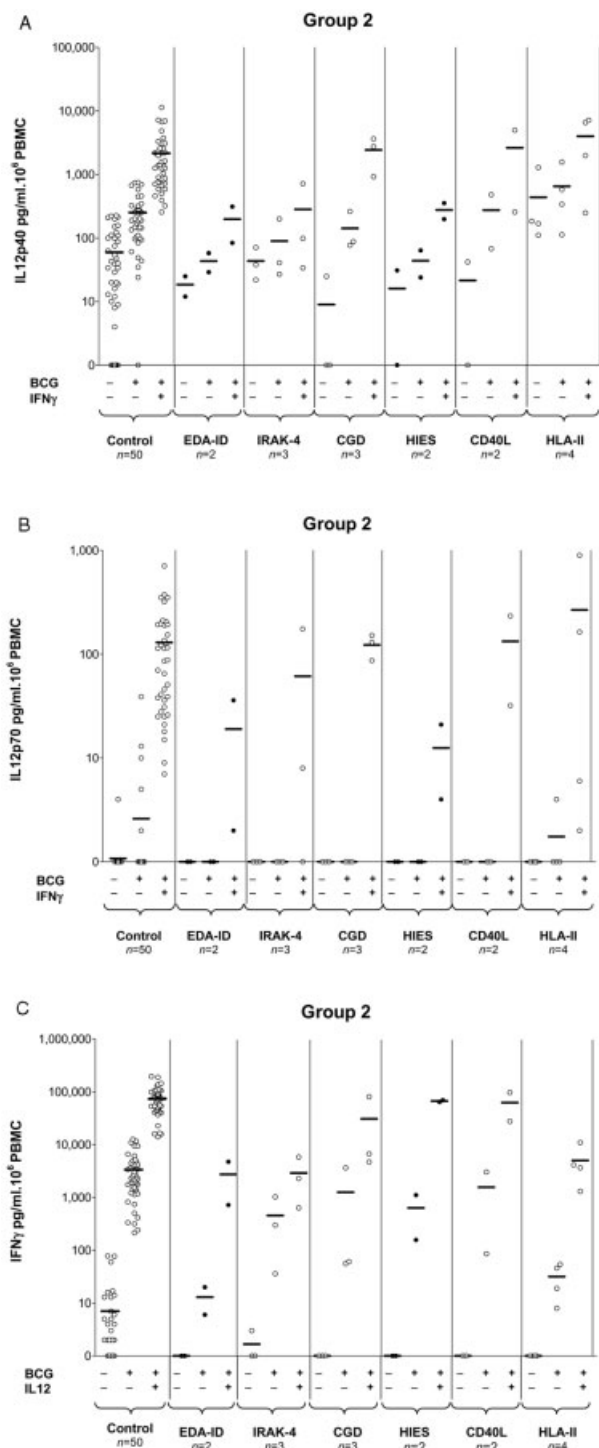

($n=3$), CD40 ligand (CD40L; $n=2$), and HLA-II ($n=4$) deficiency displayed normal induction of IL-12p40 and IL-12p70 (Fig. 2A, B), despite a high background production of IL-12p40 in some patients. Low, but detectable, levels of IL-12p40 associated with low to

◀ Fig. 2. Cytokine production in the supernatants of whole-blood cells from patients with XL-EDA-ID, IRAK-4 deficiency, CGD, HIES, a mutation in the CD40L, and HLA-II immunodeficiency, unstimulated or stimulated by BCG alone or BCG plus cytokine, as detected by ELISA. The amounts of cytokine secreted are normalized for 10⁶ PBMC on a logarithmic scale and averages are indicated as solid bars. Data for blood samples activated 24–48 h after collection are plotted as closed circles. (A) IL-12p40 production at 18 h. (B) IL-12p70 production at 18 h. (C) IFN- γ production at 48 h.

normal levels of IL-12p70 were obtained for HIES ($n=2$) and IRAK-4-deficient ($n=3$) patients, following activation with BCG or BCG plus IFN- γ . Patients with X-linked anhidrotic ectodermal dysplasia with immunodeficiency (XL-EDA-ID; $n=2$) also showed no or only a small increase in IL-12p40 production after activation with BCG. The levels of this cytokine increased by a factor of only 2 to 5 after BCG plus IFN- γ activation. The defect in IL-12 production in these patients was confirmed by no IL-12p70 detected in supernatants after activation with BCG, associated to low levels detected after BCG plus IFN- γ (Fig. 2A, B). Overall, these data indicate that the respiratory burst and CD40/CD40L interaction are not involved in the production of IL-12p40 and IL-12p70 *in vitro* after activation by BCG or BCG plus IFN- γ , whereas NEMO and IRAK-4, important triggers of NF- κ B activation, play an important role in IL-12 production in humans.

Consistent with our findings of normal levels of IL-12p40 and IL-12p70 production, patients with complete CGD ($n=3$), HIES ($n=2$) and CD40L deficiency ($n=2$) produced amounts of IFN- γ in response to live BCG and BCG plus IL-12 similar to those produced by the controls. The three patients with IRAK-4 deficiency displayed normal responses to BCG alone, but poor responses to the addition of IL-12 to BCG. Patients with HLA-II deficiency ($n=4$) produced little IFN- γ after activation with BCG, and IFN- γ production levels did not normalize following the addition of IL-12. This most likely resulted from the CD4 lymphopenia observed in HLA-II deficiency [14]. The patients with XL-EDA-ID ($n=2$) also displayed a profound defect in IFN- γ production after BCG activation, and levels of this cytokine increased little following stimulation with IL-12 plus BCG (Fig. 2C). These data indicate that the NF- κ B signaling pathway plays a major role in IFN- γ production by blood cells *in vitro* in response to infection with live BCG. The IRAK-4-deficient patients also displayed an impaired response to BCG plus IL-12 activation *in vitro*.

2.4 Response of patients with specific molecular defects resulting in impairment of the IL-12/IFN- γ axis (group 3)

IL-12p40 was quantified in patients with MSMD (MIM209950, [7]) ($n=60$). Thirty-three patients with complete IL-12R β 1 deficiency were analyzed. Basal levels of IL-12p40 production, in the absence of stimulation, and levels of this cytokine after stimulation with BCG or BCG plus IFN- γ were similar to those in healthy controls. We also generally observed an IL-12p70 response to live BCG plus IFN- γ in these patients that was similar to that in healthy subjects.

In contrast, no IL-12p40 or IL-12p70 was detected in the blood of patients with complete IL-12p40 deficiency ($n=3$), regardless of the type of stimulation. Patients with complete IFN- γ R1 ($n=5$) or IFN- γ R2 ($n=3$) deficiency displayed normal levels of IL-12p40 production following activation with BCG, but no further response was observed following the addition of IFN- γ to live BCG (similar levels or doubling at most). No IL-12p70 production in response to BCG or BCG plus IFN- γ was detected in patients with complete IFN- γ R deficiency, confirming previous reports of a complete lack of response to IFN- γ . Patients with partial IFN- γ R1 deficiency ($n=10$) or partial STAT-1 deficiency ($n=6$) displayed normal IL-12p40 production in response to BCG alone, but only a weak response to the addition of IFN- γ (increase by a factor of 1.5). Neither the patients with IL-12p40 deficiency ($n=3$) nor those with partial or complete defects in the IFN- γ pathway ($n=24$) produced detectable amounts of IL-12p70 in response to BCG plus IFN- γ (Fig. 3A, B). These data confirm that IL-12p70 production by blood monocytes in response to BCG plus IFN- γ is principally controlled by the IFN- γ R and the associated transcription factor STAT-1.

IFN- γ was quantified in whole blood in the same cohort of patients. Patients with complete IL-12R β 1 deficiency produced only small amounts of IFN- γ with BCG, and displayed a complete lack of response to IL-12 (no increase of the IFN- γ production following the addition of IL-12 to BCG). The three patients with the *IL12B* null mutation displayed no detectable IFN- γ production with BCG. Low levels of IFN- γ production were, however, detected following activation with BCG plus IL-12, probably reflecting the response of blood cells to the exogenous IL-12 added to the medium. Patients with complete IFN- γ R deficiency ($n=8$), partial IFN- γ R1 deficiency ($n=10$), or partial STAT-1 deficiency ($n=6$) produced only small amounts of IFN- γ after activation with BCG, but displayed normal increase in IFN- γ production following the addition of IL-12 to live BCG for stimulation (Fig. 3C). Thus, the production of IFN- γ by

whole blood stimulated with BCG or BCG plus IL-12 strongly depends on the IL-12 pathway, and involves both IL-12p70 and the IL-12R.

3 Discussion

Few studies of the IL-12/IFN- γ axis have been carried out in humans with PBMC or whole blood activated by live mycobacteria [15, 16]. A study reported IFN- γ production in response to stimulation with live BCG in four volunteers, completed by an *in vitro* whole-blood assay [15]. Several studies of the IL-12/IFN- γ axis have reported the activation of PBMC or whole blood by heat-killed mycobacteria or mycobacterial antigens such as PPD, ESAT6, and CFP10 ([17] and references therein). These studies aimed at describing the immune response to *M. tuberculosis* and developing diagnostic assays for tuberculosis. In a different perspective, Levin et al. [18, 19] reported a decrease in the level of TNF- α produced by PBMC in response to endotoxin plus IFN- γ /endotoxin and in levels of IFN- γ in response to mycobacterial antigens in IFN- γ R1 deficiency. Holland et al. [20] later reported a 10% decrease in IL-12p40 and IFN- γ production in response to PHA in the PBMC of two patients with MSMD due to loss-of-function mutations in IFN- γ R1. They also reported a decrease in PHA-induced IFN- γ production in a patient with a mutation affecting the extracellular domain of IFN- γ R2 [21].

However, the cellular basis of IL-12 and IFN- γ production, as well as that of the response to IL-12 and IFN- γ , upon blood stimulation by live or even dead mycobacteria, has not been determined. Whole blood cultures and stimulation by live mycobacteria enable the evaluation of the contributions and reciprocal interactions of all cell types and molecules in the sample. Our study is the first to investigate a large cohort of patients ($n=90$) with such a variety ($n=18$) of specific inherited immunodeficiencies to dissect the IL-12/IFN- γ axis at the cellular and molecular level. Our study mostly dealt with small groups of patients and we cannot exclude the possibility that inter-individual variability would somewhat change the global picture.

The normal IL-12p70 production in most patients lacking T, B, NK, or PMN cells and the lack of IL-12p70 production in the patient with reticular dysgenesis, suggest that the major blood cells responsible for IL-12p70 production in response to BCG and BCG plus IFN- γ are probably monocytes (including *bona fide* monocytes and dendritic cells), although the absence of a specific human monocyte defect or defect of monocytes/dendritic cells precludes definitive conclusions [22]. IL-12p70 production is also strongly dependent on the NF- κ B pathway, as demonstrated by the diminished IL-12

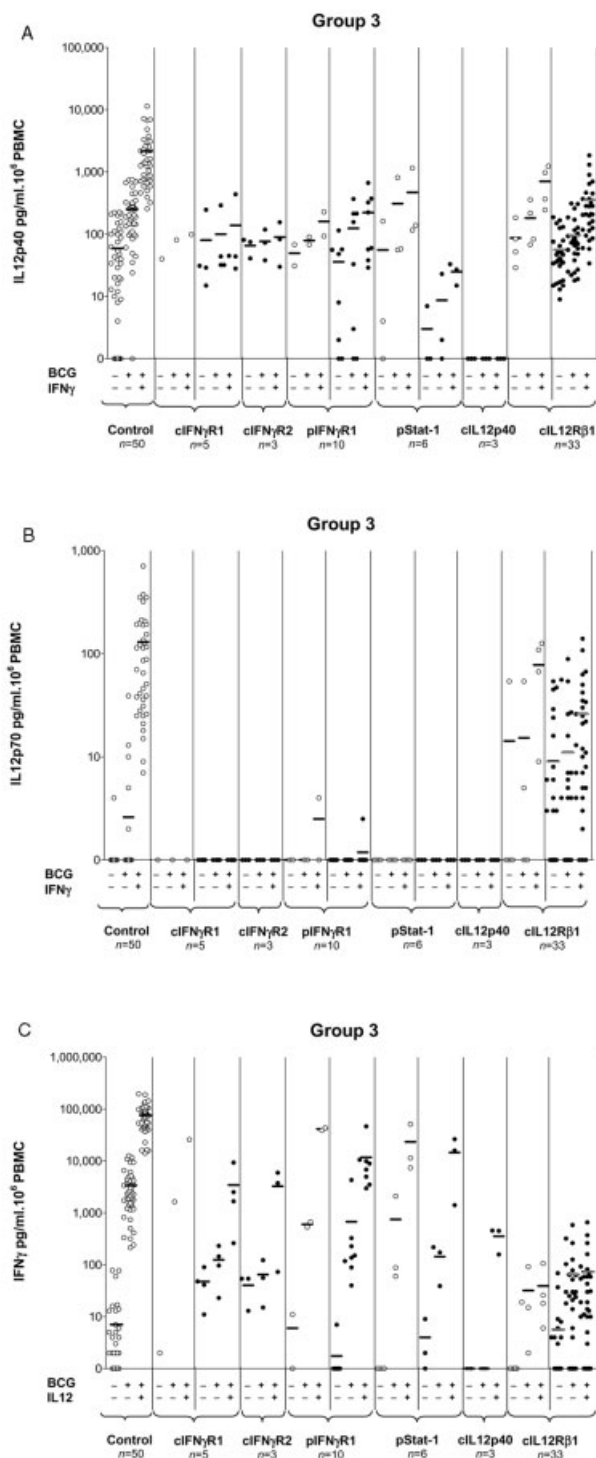

production in patients with NEMO and IRAK-4 deficiency. Our results are also consistent with IL-12 production in response to mycobacteria and IFN- γ being largely independent of molecules such as CD40L, HLA-II and of the respiratory burst. However, this IL-12 response to live BCG is controlled by the *IL12B* gene and IL-12

◀ Fig. 3. Cytokine production in the supernatants of whole-blood cells from patients with complete IFN- γ R1, complete IFN- γ R2, partial IFN- γ R1, partial STAT-1, complete IL-12p40, or complete IL-12R β 1 deficiencies, unstimulated or stimulated by BCG alone or BCG plus cytokine, as detected by ELISA. The amounts of cytokine secreted are normalized for 10^6 PBMC on a logarithmic scale and averages are indicated as solid bars. Data for blood samples activated 24–48 h after collection are plotted as closed circles. (A) IL-12p40 production at 18 h. (B) IL-12p70 production at 18 h. (C) IFN- γ production at 48 h.

production in response to BCG plus IFN- γ is heavily dependent on the presence of functional IFN- γ R1, IFN- γ R2, and STAT-1 molecules.

NK and T cells have been shown to make a major contribution to IFN- γ production in response to BCG. Patients lacking NK or T cells or both NK and T cells displayed similar profound defects in IFN- γ production following stimulation with BCG alone or BCG plus IL-12 (less pronounced than patients lacking both NK and T cells). In contrast, neither B cells nor PMN cells seem to be involved in the IFN- γ production, as demonstrated by the normal levels of IFN- γ production in this assay for patients with Kostmann's and Bruton's diseases. We were also able to suggest the importance of molecules such as IRAK-4 and NEMO which contribute to IFN- γ production, induced by IL-12 activation of NK and T cells. Similarly, the absence of other molecules, such as CD40L and components of the gp^{PHOX} complex, had no detectable effect on the IFN- γ production induced by live BCG. We confirmed with MSMD patients that IFN- γ production in response to BCG infection depends on IL-12/23 priming, and that IFN- γ production in response to BCG plus IL-12 heavily depends on the IL-12/23 pathway, particularly on the integrity of the IL-12R β 1 molecule.

This study has also significant clinical implications, as this assay can be used to identify deficient pathways in patients with high levels of susceptibility to mycobacteria, and could therefore be used to search directly for mutations. This test proved to be particularly useful for the screening of patients with MSMD or a suspicion of NEMO or IRAK-4 mutation. The known genetic etiologies of MSMD (complete IFN- γ R1 or partial IFN- γ R1 and complete IFN- γ R2 deficiencies, partial STAT-1 deficiency, complete IL-12p40 deficiency, and complete IL-12R β 1 deficiency) were successfully diagnosed at the molecular level, following an initial screening with our whole-blood assay. Furthermore, the rapid diagnosis of complete IFN- γ R1/2 deficiencies in infected patients was confirmed by

the detection of IFN- γ in the patient's serum [23]. Our blood assay appears to be specific and sensitive to successfully identify impaired pathways in the IL-12/IFN- γ circuit and guide the search for disease-causing genes in patients with MSMD.

4 Materials and methods

4.1 Subjects and patients

We compared three different groups of patients with adult local ($n=50$) healthy subjects. Mean age (standard deviation) was 34 years (6.5) for controls and 10.5 years (9) for patients. For group description see Table 1. Our study was conducted according to the principles expressed in the Helsinki Declaration, with informed consent obtained from each patient or the patient's family. The genetic defects were identified in all patients from group 3 and in some, but not all, patients from groups 1 and 2. The diagnosis criteria were clinical and immunological, following current states of knowledge [10].

Group 1 included 14 patients lacking a specific blood cell type. For description see Table 1. The SCID patients do not have detectable autologous T cells in the blood. Group 2 included 14 patients with primary immunodeficiency diseases other than MSMD (for description see Table 1). All patients with complete CGD had no detectable respiratory burst. Group 3 included 60 patients with MSMD due to recently identified molecular defects [6].

4.2 Whole-blood cultures and activation by live BCG

Venous blood samples were collected into heparinized tubes. They were diluted 1:2 in RPMI 1640 (GibcoBRL) supplemented with 100 U/ml penicillin and 100 μ g/ml streptomycin (GibcoBRL). We dispensed 6 ml of the diluted blood sample into 4 wells (1.5 ml/well) of a 24-well plate (Nunc). It was then incubated in a two-stage procedure during 18 and 48 h at 37°C in an atmosphere containing 5% CO₂/95% air, and under four different conditions of activation: with medium alone, with live BCG (*M. bovis* BCG, Pasteur® sub-strain) at an MOI of 20 BCG/leukocytes, with BCG plus IFN- γ (5,000 IU/ml; Imukin®, Boehringer Ingelheim) and with BCG plus recombinant IL-12p70 (20 ng/ml; R&D Systems®). An MOI of at least 20 in individuals without any cytopenia was used. The first incubation stage was completed after 18 h of culture, 450 μ l supernatant was collected from each culture well and frozen at -80°C. After 48 h, by the end of the second incubation stage, whole remaining volume of each well was recovered, centrifuged at 1,800 \times g for 10 min, and the supernatant was stored frozen at -80°C until analysis. For patients whose blood samples were transported from elsewhere, we also analyzed a "travel" control in parallel, when available.

4.3 Cytokines ELISA

Cytokine concentrations were analyzed by ELISA, using the human Quantikine IL-12p70 HS and IL-12p40 kits from R&D Systems and the human Pelikin™ or Pelipair IFN- γ kit from Sanquin, according to the manufacturers' guidelines. These kits were applied using matched antibody pairs. Optical density was determined using an automated MR5000 ELISA reader (Thermolab Systems).

Quantitative analysis was carried out using the non-linear four-parameter logistic (4PL) calibration model developed by O'Connell [24]. An in-house software based on Microsoft Excel® application language was developed for this purpose. Intermediate results for each cytokine are expressed in pg/ml. However, PBMC counts vary according to the subject, and are dependent on age, in particular. We therefore standardized the final results by expressing them per million PBMC, in the unit pg/ml/10⁶ PBMC. The number of PBMC was determined from blood cell counts carried out on day 0.

4.4 Statistical analysis of the data

An initial Q-plot statistical study demonstrated that cytokine data were not normally distributed for the healthy population (controls). These data were log-transformed, and the resulting distribution generally approximated a normal distribution.

The effect of gender and age on IL-12p40, IL-12p70, and IFN- γ levels under four different sets of activation conditions (no stimulation, stimulation with BCG alone, stimulation with BCG plus IFN- γ , and stimulation with BCG plus IL-12) was assessed by the means of one-way analysis of variance for gender and linear regression analysis for age. Intra-individual correlation of IL-12p40, IL-12p70, and IFN- γ values was taken into account for these analyses. All computations were made with the generalized linear model (GLM) procedure of SAS software v8.2 (SAS Institute, Cary, NC).

Acknowledgements: We would like to thank Laurent Abel and members of the laboratory of HGID as well as Stéphane Blanche, Alain Fischer and members of the Pediatric Immunology Hematology Unit for helpful discussions, Claude Frehel for advice in BCG culture and titration, Françoise Le Deist for the diagnosis of SCID, HLA-II- and CD40L-deficient patients and helpful advices, Marie-Anne Pocardalo for the diagnosis of CGD patients, and Jean Donnadiu and Françoise Valensi for the diagnosis of patients with neutropenia. We also thank all internits and pediatricians world-wide who have kindly accepted to send us blood samples from their patients, whom we also thank warmly together with their families for their participation.

References

- 1 **Trinchieri, G.**, Interleukin-12 and the regulation of innate resistance and adaptive immunity. *Nat. Rev. Immunol.* 2003. **3**: 133–146.
- 2 **Frucht, D. M., Fukao, T., Bogdan, C., Schindler, H., O'Shea, J. J. and Koyasu, S.**, IFN-gamma production by antigen-presenting cells: mechanisms emerge. *Trends Immunol.* 2001. **22**: 556–560.
- 3 **Murray, P. J.**, Defining the requirements for immunological control of mycobacterial infections. *Trends Microbiol.* 1999. **7**: 366–372.
- 4 **Trinchieri, G., Pflanz, S. and Kastelein, R. A.**, The IL-12 family of heterodimeric cytokines. New players in the regulation of T cell responses. *Immunity* 2003. **19**: 641–644.
- 5 **Flynn, J. L. and Chan, J.**, Immunology of tuberculosis. *Annu. Rev. Immunol.* 2001. **19**: 93–129.
- 6 **Casanova, J. L. and Abel, L.**, Genetic dissection of immunity to mycobacteria: the human model. *Annu. Rev. Immunol.* 2002. **20**: 581–620.
- 7 **McKusick, V. A.**, Mendelian inheritance in man. Catalogs of human genes and genetic disorders, 12th Edn. Johns Hopkins University Press, Baltimore 1998
- 8 **Fieschi, C., Bosticardo, M., De Beaucoudrey, L., Boisson-Dupuis, S., Feinberg, J., Filipe Santos, O., Bustamante, J., Levy, J., Candotti, F. and Casanova, J. L.**, A novel form of complete IL-12/IL-23 receptor beta1-deficiency with cell surface-expressed non-functional receptors. *Blood* 2004 (in press).
- 9 **Reichenbach, J., Rosenzweig, S., Döffinger, R., Dupuis, S., Holland, S. M., Casanova, J. L.**, Mycobacterial diseases in primary immunodeficiencies. *Curr. Opin. Allergy. Clin. Immunol.* 2001. **1**: 503–511.
- 10 **Ochs, H., Smith C. I. E. and Puck, J.**, Primary immunodeficiencies: a molecular and genetic approach, 2nd Edn. Oxford University Press, New York 2002
- 11 **Bernard, F., Picard, C., Cormier-Daire, V., Eidenschenk, C., Pinto, G., Bustamante, J. C., Jouanguy, E., Teillac-Hamel, D., Colomb, V., Funck-Brentano, I. et al.**, A novel developmental and immunodeficiency syndrome associated with intrauterine growth retardation and a lack of natural killer cells. *Pediatrics* 2004. **113**: 136–141.
- 12 **Doffinger, R., Smahi, A., Bessia, C., Geissmann, F., Feinberg, J., Durandy, A., Bodemer, C., Kenwrick, S., Dupuis-Girod, S., Blanche, S. et al.**, X-linked anhidrotic ectodermal dysplasia with immunodeficiency is caused by impaired NF-kappaB signaling. *Nat. Genet.* 2001. **27**: 277–285.
- 13 **Picard, C., Puel, A., Bonnet, M., Ku, C. L., Bustamante, J., Yang, K., Soudais, C., Dupuis, S., Feinberg, J., Fieschi, C. et al.**, Pyogenic bacterial infections in humans with IRAK-4 deficiency. *Science* 2003. **299**: 2076–2079.
- 14 **Klein, C., Lisowska-Grospierre, B., LeDeist, F., Fischer, A. and Griscelli, C.**, Major histocompatibility complex class II deficiency: clinical manifestations, immunologic features, and outcome. *J. Pediatr.* 1993. **123**: 921–928.
- 15 **van Crevel, R., van der Ven-Jongekrijg, J., Netea, M. G., de Lange, W., Kullberg, B. J. and van der Meer, J. W.**, Disease-specific *ex vivo* stimulation of whole blood for cytokine production: applications in the study of tuberculosis. *J. Immunol. Methods* 1999. **222**: 145–153.
- 16 **Gooding, T. M., Kemp, A. S., Robins-Browne, R. M., Smith, M. and Johnson, P. D.**, Acquired T-helper 1 lymphocyte anergy following infection with *Mycobacterium ulcerans*. *Clin. Infect. Dis.* 2003. **36**: 1076–1077.
- 17 **Vankayalapati, R., Wizel, B., Weis, S. E., Klucar, P., Shams, H., Samten, B. and Barnes, P. F.**, Serum cytokine concentrations do not parallel *Mycobacterium tuberculosis*-induced cytokine production in patients with tuberculosis. *Clin. Infect. Dis.* 2003. **36**: 24–28.
- 18 **Levin, M., Newport, M. J., D'Souza, S., Kalabalikis, P., Brown, I. N., Lenicker, H. M., Agius, P. V., Davies, E. G., Thrasher, A., Klein, N. et al.**, Familial disseminated atypical mycobacterial infection in childhood: a human mycobacterial susceptibility gene? *Lancet* 1995. **345**: 79–83.
- 19 **Newport, M. J., Huxley, C. M., Huston, S., Hawrylowicz, C. M., Oostra, B. A., Williamson, R. and Levin, M.**, A mutation in the interferon-gamma-receptor gene and susceptibility to mycobacterial infection. *N. Engl. J. Med.* 1996. **335**: 1941–1949.
- 20 **Holland, S. M., Dorman, S. E., Kwon, A., Pitha-Rowe, I. F., Frucht, D. M., Gerstberger, S. M., Noel, G. J., Vesterhus, P., Brown, M. R. and Fleisher, T. A.**, Abnormal regulation of interferon gamma, interleukin 12, and tumor necrosis factor alpha in interferon gamma receptor 1 deficiency. *J. Infect. Dis.* 1998. **178**: 1095–1104.
- 21 **Dorman, S. E. and Holland, S. M.**, Mutation in the signal-transducing chain of the interferon-gamma receptor and susceptibility to mycobacterial infection. *J. Clin. Invest.* 1998. **101**: 2364–2369.
- 22 **Geissmann, F., Jung, S. and Littman, D. R.**, Blood monocytes consist of two principal subsets with distinct migratory properties. *Immunity* 2003. **19**: 71–82.
- 23 **Fieschi, C., Dupuis, S., Picard, C., Smith, C. I., Holland, S. M. and Casanova, J. L.**, High levels of interferon gamma in the plasma of children with complete interferon gamma receptor deficiency. *Pediatrics* 2001. **107**: E48.
- 24 **O'Connell, M., Belanger, B. and Haaland, P.**, Calibration and assay development using the four-parameter logistic model. *Chemometrics and Intelligent Laboratory Systems* 1993. **20**: 97–114.

Correspondence: Jacqueline Feinberg or Jean-Laurent Casanova, Laboratoire de Génétique Humaine des Maladies Infectieuses, Université René Descartes INSERM U550, Faculté de Médecine Necker, 156 rue de Vaugirard, F-75015 Paris, France, EU
 Fax: +33-1-4061-5688
 e-mail: feinberg@necker.fr or casanova@necker.fr

Rainer Doffinger's present address: Department of Clinical Biochemistry and Immunology, Addenbrookes Hospital, Cambridge, UK

Article 12

A novel form of complete IL-12/IL-23 receptor beta1 deficiency with cell surface-expressed nonfunctional receptors

Fieschi, C., M. Bosticardo, **L. de Beaucoudrey**, S. Boisson-Dupuis, J. Feinberg, O. Filipe-Santos, J. Bustamante, J. Levy, F. Candotti, and J.L. Casanova

Blood
2004, 104:2095-2101

A novel form of complete IL-12/IL-23 receptor β 1 deficiency with cell surface-expressed nonfunctional receptors

Claire Fieschi, Marita Bosticardo, Ludovic de Beaucoudrey, Stéphanie Boisson-Dupuis, Jacqueline Feinberg, Orchidée Filipe Santos, Jacinta Bustamante, Jacov Levy, Fabio Candotti, and Jean-Laurent Casanova

Complete interleukin-12/interleukin-23 receptor β 1 (IL-12R β 1) deficiency is the most frequent known genetic etiology of the syndrome of Mendelian susceptibility to mycobacterial disease. The patients described to date lack IL-12R β 1 at the surface of their natural killer (NK) and T cells due to *IL12RB1* mutations, which either interrupt the open reading frame or disrupt protein folding. We describe a patient with a large in-frame deletion of 12165 nucleotides (nt) in *IL12RB1*, encompassing exons 8 to 13 and resulting in the surface expression of nonfunctional IL-12R β 1. These 6 exons encode the proximal

NH₂-terminal half of the extracellular domain downstream from the cytokine-binding domain. Five of 6 monoclonal anti-IL-12R β 1 antibodies tested recognized the internally truncated chain on the cell surface. However, IL-12 and IL-23 did not bind normally to the patient's IL-12R β 1-containing respective heterodimeric receptors. As a result, signal transducer and activator of transcription-4 (STAT4) was not phosphorylated and interferon- γ (IFN- γ) production was not induced in the patient's cells upon stimulation with even high doses of IL-12 or IL-23. The functional defect was com-

pletely rescued by retrovirus-mediated IL-12R β 1 gene transfer. Thus, the detection of IL-12R β 1 on the cell surface does not exclude the possibility of complete IL-12R β 1 deficiency in patients with mycobacteriosis or salmonellosis. Paradoxically, the largest *IL12RB1* mutation detected is associated with the cell surface expression of nonfunctional IL-12R β 1, defining a novel genetic form of IL-12R β 1 deficiency. (Blood. 2004;104:2095-2101)

© 2004 by The American Society of Hematology

Introduction

Mendelian susceptibility to mycobacterial disease (MSMD) (Mendelian Inheritance in Man, MIM209950; Online Mendelian Inheritance in Man [OMIM]: <http://www.ncbi.nlm.nih.gov/Omim/>)¹ is a rare syndrome predisposing affected individuals to infectious diseases caused by poorly virulent mycobacteria, such as bacille Calmette-Guérin (BCG) vaccines and environmental mycobacteria (EM), and poorly virulent *Salmonella* strains, such as nontyphoidal “minor” serovars. Patients are also susceptible to infections caused by the more virulent *Mycobacterium tuberculosis* and typhoidal “major” *Salmonella* serotypes.^{1,2} Unlike patients with “classic” immunodeficiencies, these patients are otherwise quite healthy and only rarely suffer from other unusually severe bacterial, viral, fungal, or parasitic diseases.^{2,3} The spectrum of infections is narrow, but the spectrum of severity is broad—from disseminated BCG disease in infancy to localized environmental mycobacterial disease in the elderly. Moreover, whereas some sporadic and most familial cases seem to involve autosomal recessive heredity, the syndrome has been found to segregate in an autosomal dominant^{4,5}

or X-linked recessive⁶ pattern in other families, further suggesting genetic heterogeneity.

Five disease-causing autosomal genes have been identified since 1996,^{7,8} and allelic heterogeneity accounts for the existence of 9 defined disorders, all of which result in impaired interferon- γ (IFN- γ)–mediated immunity.^{1,2} Null recessive mutations in the IFN- γ receptor ligand-binding chain (IFN- γ R1)–encoding gene (*IFNGR1*) abolish either receptor expression^{7,8} or the binding of surface-expressed receptors to IFN- γ .^{9,10} Partial recessive¹¹ and dominant⁴ IFN- γ R1 deficiencies have also been described. Different recessive mutations in the gene encoding the IFN- γ signaling chain (IFN- γ R2), *IFNGR2*, are responsible for complete¹² or partial¹³ IFN- γ R2 deficiency. A dominant mutation in *STAT1* is responsible for partial signal transducer and activator of transcription-1 (STAT-1) deficiency and defines the remaining disease in which cellular responses to IFN- γ are impaired.⁵ Complete recessive STAT-1 deficiency is a related but distinct disorder involving susceptibility to both mycobacteria and viruses, due to the impairment of IFN- γ – and IFN- α/β –mediated immunity.¹⁴

From the Laboratory of Human Genetics of Infectious Diseases, University of Paris René Descartes (Institut National de la Santé et de la Recherche Médicale [INSERM] U550), France, EU; Necker Medical School, Paris, France, EU; Disorders of Immunity Section, Genetics and Molecular Biology Branch, National Human Genome Research Institute, National Institutes of Health, Bethesda, MD; Division of Pediatrics, Soroka Medical Center and Faculty of Health Sciences, Ben Gurion University, Beer Sheva, Israel; and Pediatric Immunology and Hematology Unit, Necker Hospital, Paris, France, EU.

Submitted February 23, 2004; accepted May 3, 2004. Prepublished online as *Blood* First Edition Paper, June 3, 2004; DOI 10.1182/blood-2004-02-0584.

Supported by the Fondation pour la Recherche Médicale (FRM) (C.F.), the Fondation Banque National de Paris (BNP)–Paribas, the Fondation

Schlumberger, and European Commission grant QLK2-CT-2002-00846.

The online version of the article contains a data supplement.

Reprints: Jean-Laurent Casanova, Laboratoire de Génétique Humaine des Maladies Infectieuses, Université de Paris René Descartes-INSERM U550, Faculté de Médecine Necker, 156 rue de Vaugirard, 75015 Paris, France, Union Européenne; e-mail: casanova@necker.fr.

The publication costs of this article were defrayed in part by page charge payment. Therefore, and solely to indicate this fact, this article is hereby marked “advertisement” in accordance with 18 U.S.C. section 1734.

© 2004 by The American Society of Hematology

In about half of all patients with MSMD and a well-defined genetic disorder, cellular responses to IFN- γ are normal, but the interleukin-12 (IL-12)– and interleukin-23 (IL-23)–dependent production of IFN- γ is severely impaired. Nineteen children homozygous for null mutations in *IL12B*, encoding the p40 subunit of IL-12 and IL-23, have been identified.^{15–17} Null recessive *IL12RB1* mutations have been identified in 54 other patients with IL-12 and IL-23 receptor β 1 chain deficiency.^{17–28} Patients with IL-12 p40 and IL-12R β 1 deficiency share a number of common clinical characteristics: low penetrance of genetic susceptibility to mycobacteriosis and salmonellosis; high proportion of extraintestinal salmonellosis among symptomatic patients; broad resistance to other microorganisms; and a favorable clinical outcome.^{29,30} From a molecular point of view, 53 of 54 known patients with complete IL-12R β 1 deficiency^{17–26,28} have no detectable IL-12R β 1 on the cell surface, due to mutations that either interrupt the open reading frame (ORF) (nonsense and frameshift mutations) or disrupt folding of the protein (missense mutations). We report here the molecular investigation of a patient with complete IL-12R β 1 deficiency despite the presence of IL-12R β 1 at the cell surface.

Patients, materials, and methods

The patient

The patient (P) is a 6-year-old boy born to first-cousin parents of Bedouin origin living in Israel (Figure 1). He was not inoculated with BCG and was first seen at the age of 12 months with disseminated *Salmonella enteritidis* disease (septicemia and multiple adenitis). Between the ages of 1 and 3 years, the patient suffered 8 recurrences of systemic *Salmonella* infection, with the same serovar implicated on each occasion. The detailed clinical and bacteriologic features of these infections have been reported elsewhere,²⁷ and this patient was patient 10.II.3 in a previous study²⁶ in which his genotype was described. The negative control (C–) used in this study was also previously described (patient 20.II.1²⁶) and is homozygous for a nonsense mutation resulting in a premature stop in the ORF (Q32X).

Our study was approved by the Institutional Review Board of the Université de Paris René Descartes. Informed consent was obtained from the patient's family according to the Declaration of Helsinki.

Cell culture and stimulation

Epstein-Barr virus–transformed lymphoblastoid cell lines (EBV-B cell lines) were cultured as previously described.¹⁶ Peripheral blood mononuclear cells (PBMCs) were cultured in RPMI 1640 supplemented with 10% heat-inactivated pooled human AB serum and activated by incubation with phytohemagglutinin-P (PHA) (Bacto, Becton Dickinson, Heidelberg, Germany) for 72 hours to generate PHA-activated T cells. PHA–T-cell blasts were restimulated every 48 hours with IL-2 (40 IU/mL) (Chiron, Amsterdam, The Netherlands) and cultured in Panserine 401 (Pan Biotech, Aidenbach, Germany) with 10% heat-inactivated pooled human AB serum and 2 mM L-glutamine. For cytokine stimulation, we plated 0.5×10^6 PHA–T-cell blasts in complete medium in each well of a 48-well plate on day 6 and added IL-23 and IL-12p70 (both from R&D Systems, Minneapolis, MN) at various concentrations to a final volume of 500 μ L. As a positive control for activation, PHA–T-cell blasts were stimulated with 10^{-7} M phorbol myristate acetate (PMA) (Sigma-Aldrich, St Louis, MO) and 10^{-5} M ionomycin. Supernatants were harvested after 48 hours.

ELISA and cell surface flow cytometry

Cell culture supernatants were assayed for IFN- γ by enzyme-linked immunosorbent assay (ELISA), according to the kit manufacturer's recommendations (Peliklin Compact, CLB, Amsterdam, The Netherlands). IFN- γ concentration was calculated per 1 million PHA–T-cell blasts. For flow cytometry, PHA–T-cell blasts and/or EBV-transformed B cells were first incubated with an IL-12R β 1–specific mouse immunoglobulin G1 (IgG1)

monoclonal antibody (mAb) (24E6), an IL-12R β 1–specific rat IgG2a mAb (2B10), or matched isotypic control mAbs; then with a biotinylated rat anti–mouse Ab or a biotinylated mouse anti–rat Ab; and finally with streptavidin-phycoerythrin (streptavidin-PE) (all reagents were from Pharmingen, San Diego, CA). Mouse antibodies B101, B103, and 12RB44 were all generously provided by the Genetics Institute (Andover, MA). One additional commercial mAb—an anti–human IL-12R β 1 mAb (clone 69310 coupled to R-phycoerythrin from R&D Systems)—and a matched isotype control were tested for IL-12R β 1 staining. The cells were fixed by incubation in 4% paraformaldehyde for 30 minutes and were then stained. All washing and incubation steps were performed in the presence of 0.1% saponin (Sigma-Aldrich). Signals were analyzed with a FACScan and the Cellquest software (Becton Dickinson Immunocytometry Systems, San Jose, CA).

Fluorescent IL-12/IL-23 binding and phospho-STAT4 detection

IL-12p70 or IL-23 fluorescence binding experiments were performed as follows: 400 000 day 6 PHA–T-cell blasts were incubated in 20 μ L phosphate-buffered saline (PBS) with (or without) 50 ng IL-12p70 or 100 ng recombinant human IL-23 (rhIL-23) (R&D Systems) for 30 minutes at 4°C and then with mouse anti–IL-12p40-p70 IgG1, biotinylated rat anti–mouse IgG1, and finally with streptavidin-PE (all reagents and antibodies were from Pharmingen). Phospho-STAT4 detection by flow cytometry was adapted from Uzel et al³¹: PHA–T-cell blasts were either left unstimulated or stimulated by IFN- α (10^5 U/mL during 30 minutes) or IL-12 (100 ng/mL during 15 minutes) at 37°C. Cells were then fixed with 4% paraformaldehyde (PFA) in PBS, followed by 100% methanol fixation while vortexing, permeabilized with saponin, and stained with rabbit polyclonal anti-STAT4 Ab or rabbit polyclonal antiphospho-STAT4 Ab (both from Zymed, South San Francisco, CA) (or matched isotype control), followed by goat anti–rabbit Alexa Fluor 488 (Molecular Probes, Eugene, OR). Signals were analyzed with a FACScan using Cellquest software (Becton Dickinson).

Retroviral-mediated gene transfer

The retroviral vector, MND–IL-12R β 1 (myeloproliferative sarcoma virus enhancer, negative control region deleted, dl587 rev primer-binding site substituted), was constructed using the MND–X–IRES–EGFP vector (a gift from Dr D. B. Kohn, Children's Hospital, Los Angeles, CA) and by replacing the internal ribosome entry site–enhanced green fluorescent protein (IRES–EGFP) fragment with human IL-12R β 1 cDNA (gift from Dr J. J. O'Shea, National Institute of Arthritis and Musculoskeletal and Skin Diseases [NIAMS], National Institutes of Health [NIH], Bethesda, MD). Infectious retroviral particles were generated using the PG13 cell line³² as previously described.³³ Retroviral supernatant stocks were produced by incubating producer cells in Dulbecco modified Eagle medium (DMEM) (Life Technologies, Bethesda, MD), 10% fetal bovine serum (FBS) for 72 hours at 32°C. PHA–T-cell blasts (1×10^6 /mL) were incubated for 24 hours in fibronectin-coated plates (20 μ g/mL Retronectin, Takara Bio, Shiga, Japan) preloaded with retroviral supernatant. The transduction procedure was repeated the following day. After 48 to 72 hours, cells were stained with anti–human IL-12R β 1 (24E6 or 2B10), stimulated with IFN- α and IL-12, followed by intracellular flow cytometry phospho-STAT4 detection or stimulated with increasing doses of IL-12. In this last case, supernatants were harvested after 48 hours, and IFN- γ was measured by ELISA (hIFN- γ Quantikine kit; R&D Systems).

DNA and RNA extraction, cDNA synthesis, and PCR amplification

Genomic DNA and total RNA were extracted from EBV-transformed B cells or T-cell blasts as previously described.¹⁶ RNA was reverse transcribed in the presence of oligo(dT) with Superscript II reverse transcriptase (Invitrogen Life Technologies, Paisley, United Kingdom).¹⁶ The *IL12RB1* cDNA, coding exons, and flanking intron regions were amplified using pairs of primers and polymerase chain reaction (PCR) conditions available in Table S1 of the supplementary material (at the *Blood* website, see the Supplemental Table link at the top of the online article).

Sequencing

PCR was carried out with pairs of intron primers flanking each *IL12RB1* exon, under conditions available upon request. PCR products were sequenced by dideoxynucleotide termination with nested primers (Table S1) and the ABI PRISM dGTP BigDye Terminator Cycle Sequencing Kit (Applied Biosystems, Courtaboeuf, France). PCR products were sequenced on an ABI Prism 3100 apparatus and analyzed with Sequencing Analysis software (Applied Biosystems).

Results

A large in-frame deletion in *IL12RB1*

We previously reported a patient for whom we were unable to amplify exons 8 to 13 of *IL12RB1* (10.IL.2²⁶). The sequencing of introns 7 and 13 made it possible to identify the genomic breakpoints of a large deletion of 12165 nucleotides (12165 nt), and the mutation was designated 700 + 362_1619-944 del³⁴ (the deletion occurred beginning 362 nucleotides [nt] 3' of exon 7, which ends at nt 700, and ending 944 nucleotides 5' of nt 1619, which is the first nucleotide of exon 14). The patient was homozygous for this mutation, inherited from his 2 heterozygous parents. No other mutations of *IL12RB1* were found. Amplification of the *IL12RB1* ORF from cDNAs produced from both an EBV-transformed B-cell line and PHA-T-cell blasts yielded a fragment of lower molecular weight than was obtained for the control (not shown). Sequencing showed that exon 7 was directly spliced to exon 14 (Figure 1). Exon 1 encodes the signal peptide, and exon 14 encodes the IL-12Rβ1 transmembrane domain. The aberrant mRNA detected is in frame, contains no novel codon, and is predicted to result in the production of a 356-amino acid protein with an internally truncated extracellular domain but intact transmembrane and intracellular domains. In comparison, the wild-type (WT) protein contains 662 amino acids (Figure 1). The putative mature mutant protein (following cleavage of the signal peptide) would thus lack 306 (59%) of the 521 extracellular amino acids and sequences corresponding to 6 of the 12 exons encoding the mature extracellular domain.

Detection of an IL-12Rβ1 chain by intracellular staining

By Northern blot analysis, we detected a transcript with a lower molecular weight than the WT transcript, although their molecular amounts as determined by PhosphorImager (Molecular Dynamics,

Sunnyvale, CA) quantification were equal (not shown). Because the deletion was in frame, we first tried to detect a mutant receptor chain by intracellular flow cytometry (fluorescence-activated cell sorter [FACS]) analysis. Staining of day 5 PHA-T-cell blasts with the mouse IgG1 anti-IL-12Rβ1 mAb 24E6 resulted in the detection of an intracellular chain in P, although staining was less intense than in the positive control (C+), with this chain not detected in cells from the negative control (C-) (not shown). Staining with rat IgG2a anti-IL-12Rβ1 mAb 2B10 was negative in C+, C-, and P (not shown). We also assessed the intracellular staining of IL-12Rβ1 with 4 other mAbs: clearly positive results were obtained for C+ and P with clones B101, 12RB44, and 69310, whereas the signal obtained with clone B103 was weak in C+, and no signal was detected in P (not shown). These results were confirmed by the intracellular staining of EBV-transformed B-cell lines, although the signal was less intense for both C+ and P in these cell lines (not shown). The mutant receptor encoded by the *IL12RB1* allele in P, who carries the large 700 + 362_1619-944 deletion, can therefore be detected by flow cytometry in 2 types of cell, EBV-transformed B cells and PHA-T-cell blasts, with 4 of the 5 mAbs that stained the wild-type IL-12Rβ1 chain.

A detectable IL-12Rβ1 chain on the cell surface

Because intracellular IL-12Rβ1 was detectable in P, we used FACS analysis to investigate IL-12Rβ1 expression on the cell surface. IL-12Rβ1 was present in large amounts on the surface of PHA-T-cell blasts on day 5 in C+, as shown by staining with all 6 mAbs tested, including 3 commercially available (clones 24E6, 2B10, 69310) mAbs. PHA-T-cell blasts from P also tested positive with 5 of the 6 mAb tested (clones 24E6, B101, B103, 12RB44, 69310). No signal was obtained with the 2B10 mAb in P (Figure 2). Similar results were found when staining EBV-B cells of C+, P, and C- (not shown). The 700 + 362_1619-944 del *IL12RB1* allele therefore encodes a detectable surface-expressed IL-12Rβ1 chain in our patient. Remarkably, none of the other 53 patients with IL-12Rβ1 deficiency described to date^{17-26,28} were found to express detectable levels of these receptors at the cell surface. In contrast, IL-12Rβ1 was present in large amounts at the cell surface in P and was detected with 5 of the 6 mAbs tested, including 2 of the 3 commercially available mAbs. With the 5 mAbs, the level of surface expression of the mutant IL-12Rβ1 chain detected is reduced. This may be due to an impaired surface expression of the protein or to an

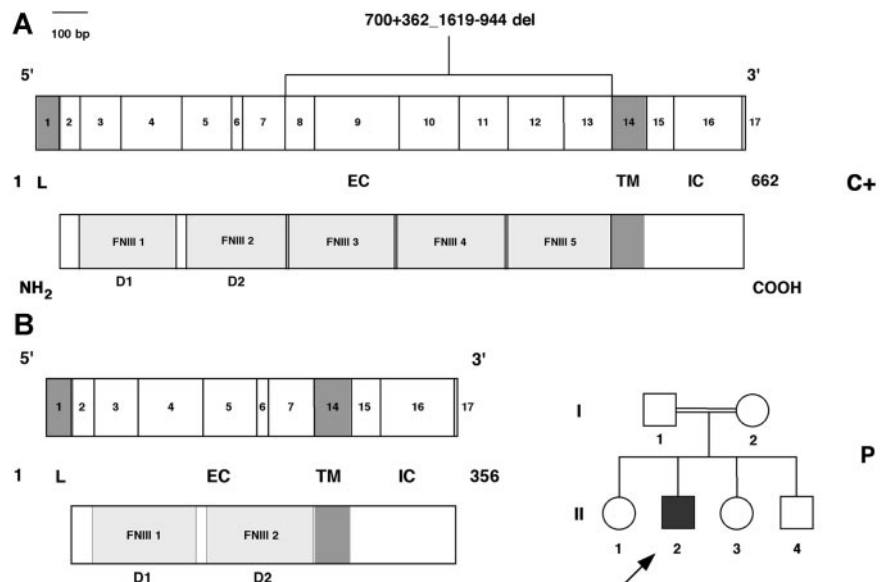

Figure 1. A large in-frame deletion in *IL12RB1*. (A) Schematic representation of the wild-type IL-12Rβ1 chain containing 17 coding exons (Arabic numerals) encoding 662 amino acids, with a peptide leader sequence (L), extracellular domain (exons 2 to 13, EC), transmembrane domain (exon 14, TM), and an intracellular, cytoplasmic domain (exons 15 to 17, IC). The mutation found in P is also indicated (700 + 362_1619-944 del). The mature IL-12Rβ1 chain contains 5 fibronectin III (FNIII) domains shown in the bottom row in light gray. (B) Schematic representation of the mutant protein, lacking the sequences encoded by 6 of the exons (8 to 13) in the wild-type gene. The mutant protein contains 356 amino acids and only the first 2 FNIII domains of the extracellular domain but has intact transmembrane and intracellular domains. In the family tree, the patient is indicated by an arrow.

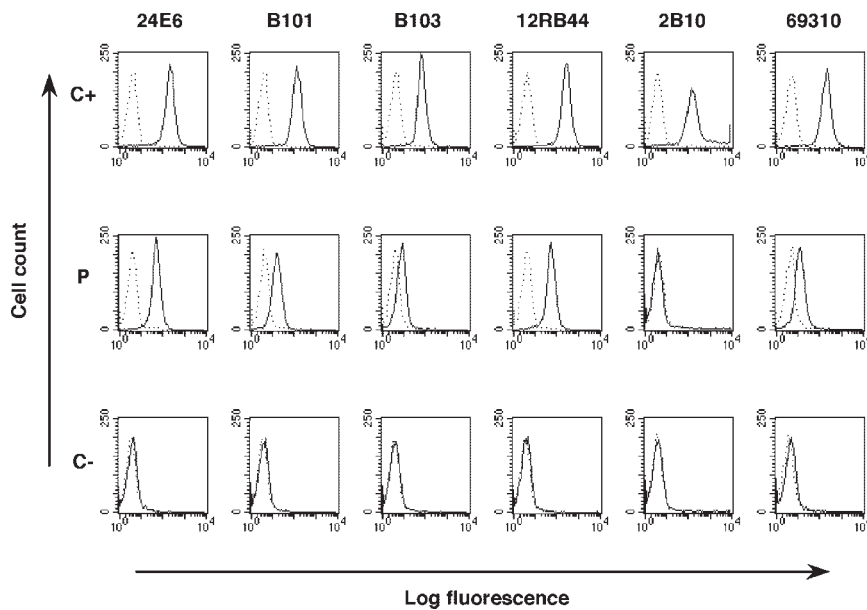

Figure 2. IL-12R β 1 chain detected at the cell surface by FACS analysis. PHA-T-cell blasts from a positive control (C+), the patient (P), and a negative control (C-) were stained with various purified mouse monoclonal antibodies (24E6, B101, B103, 12RB44), rat mAb (2B10), or matched isotype control, followed by biotinylated matched Ab and phycoerythrin-conjugated streptavidin. IL-12R β 1 clone 69310, directly conjugated to R-PE, was compared with a matched conjugated isotype control. Specific signals are represented as plain lines; matched isotype controls are represented as dotted lines.

abnormal conformation of the molecule, as suggested by the various levels of expression found using different mAbs.

A lack of phosphorylated STAT4 upon IL-12 stimulation

STAT4 is a major transducer of the signals mediated by IL-12.^{35,36} It is phosphorylated by the activated Janus kinases TYK2 and JAK2 upon the binding of IL-12 to its heterodimeric receptor (IL-12R β 1 and IL-12R β 2). Homodimers of phosphorylated STAT4 (P-STAT4) are formed and translocate to the nucleus, where they induce *IFNG* and other target genes. We thus tried to detect STAT4 phosphorylation following the stimulation of PHA-T-cell blasts, by means of intracellular FACS, as previously described.³¹ In unstimulated PHA-T-cell blasts from C+, C-, and P, no P-STAT4 was detected, whereas unphosphorylated STAT4 was clearly present (not shown). Following 30 minutes of stimulation with IFN- α , P-STAT4 was detected in PHA-T-cell blasts from C+, C-, and P, with no change in the total amount of STAT4 present (not shown). Following stimulation with IL-12, P-STAT4 was detected in PHA-T-cell blasts from C+ but not in those from P and C- (Figure 3). Thus, despite the presence of IL-12R β 1 at the cell surface, P cells did not respond to IL-12, as detected by STAT4 phosphorylation, a critical early activation event.

A lack of IFN- γ secretion in response to IL-12

We then investigated the impact of the *IL12RB1* mutation on a more distal and equally crucial event—the induction of IFN- γ —by stimulating whole blood with BCG alone or BCG plus IL-12.²⁶ By ELISA, no IFN- γ was induced by IL-12 in P cells, in contrast to what was observed in C+ (not shown), implying that peripheral T and natural killer (NK) cells do not respond to IL-12. Indeed, we have shown in another study that IFN- γ is secreted by both NK and T cells in this assay (J.F., in preparation). We then stimulated PHA-T-cell blasts from P, C+, and C- with various doses of IL-12 (1 pg/mL to 100 ng/mL) (Figure 4A). PHA-T-cell blasts from C+ produced large amounts of IFN- γ in response to IL-12, with a dose-dependent response up to 10 ng/mL, where a plateau was reached. In contrast, cells from P, like PHA-T-cell blasts from C-, did not respond to even high doses of IL-12, ruling out a partial defect with residual signaling in P. The cells from the patient's mother, who is heterozygous for the large deletion and expresses both wild-type and mutant receptors, as detected by flow cytometry,

showed a normal response to IL-12, ruling out a dominant negative effect of the mutant allele for IL-12 responsiveness (not shown). Homozygosity for 700 + 362_1619-944 del is thus associated with a cellular phenotype of complete IL-12R β 1 deficiency, as shown by early (STAT4 phosphorylation) and late (IFN- γ induction) events in both NK and T cells *ex vivo* and in PHA-T-cell blasts *in vitro*.

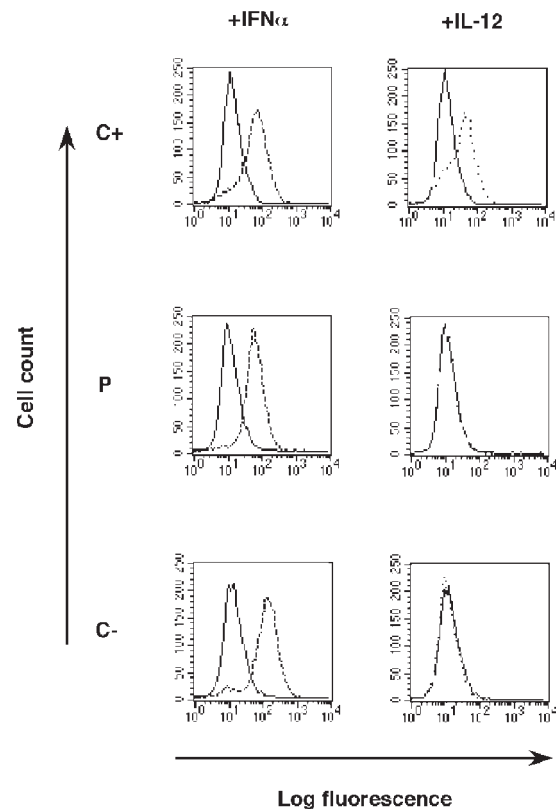

Figure 3. Lack of phosphorylated STAT4 upon IL-12 stimulation, as shown by FACS analysis. PHA-T-cell blasts from a positive control (C+), a negative control (C-), and the patient (P) were left unstimulated (plain line) or were stimulated (dotted line) with IFN- α (10^5 U/mL) (left) for 30 minutes or with IL-12 (100 ng/mL) (right) for 15 minutes. Cells were fixed by PFA and methanol, permeabilized with saponin, and stained with a phospho-STAT4 rabbit polyclonal Ab (Zymed) (or matched isotype control), followed by goat anti-rabbit Alexa Fluor 488 (Molecular Probes).

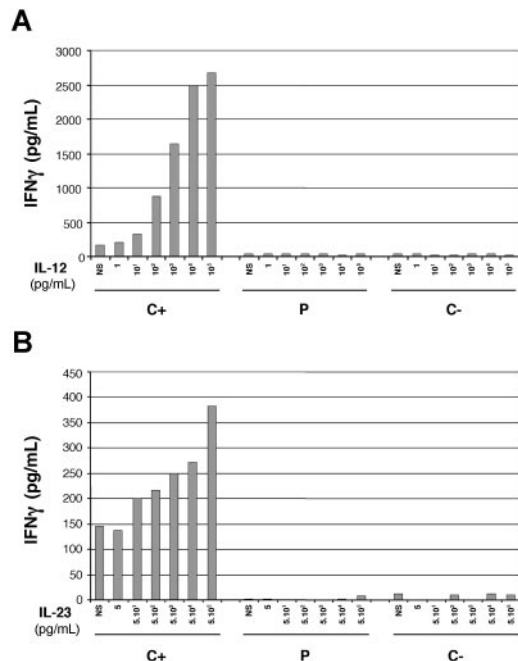

Figure 4. Lack of IFN-γ production in response to IL-12 and IL-23. PHA-T-cell blasts from a positive control (C+), a negative control (C-), and the patient (P) were plated in 24-well plates and were left unstimulated (NS) or were stimulated with increasing concentrations of IL-12 for 48 hours (A) or IL-23 for 72 hours (B). Supernatants were harvested, and IFN-γ was quantified by ELISA.

A cellular phenotype of complete IL-23R deficiency

IL-12Rβ1 binds to the IL-23R chain to generate the heterodimeric receptor for a recently described cytokine, IL-23, that is composed of the p19 specific subunit and the p40 subunit that also forms part of IL-12.³⁷⁻³⁹ Several patients with IL-12Rβ1 deficiency due to a lack of surface receptor expression were previously shown not to respond to IL-23.^{25,40} We therefore stimulated PHA-T-cell blasts with various doses of IL-23 (5 pg/mL to 500 ng/mL). Cells from C+ produced IFN-γ in a dose-dependent manner in response to IL-23 (although less than in response to IL-12), whereas cells from P and C- did not respond to even high concentrations of IL-23 (Figure 4B). Cells from P therefore respond neither to IL-12 nor to IL-23 (Figure 4). P thus displays complete IL-12 and IL-23 receptor deficiency despite the presence of detectable IL-12Rβ1 at the cell surface.

The absence of cytokine binding to IL-12Rβ1 molecules at the cell surface

We investigated the reasons for the lack of response to IL-12 and IL-23 in P despite the presence of the IL-12Rβ1 chain at the cell surface. We performed fluorescence binding assays to assess the binding of IL-12 and IL-23 to PHA-T-cell blasts. A mAb specific for IL-12p40 was added to PHA-T-cell blasts after their incubation with large doses of recombinant IL-12 or IL-23. IL-12 and IL-23 binding was detectable by FACS analysis in most cells from C+, indicating that this antibody recognizes both IL-12 (p40-p35) and IL-23 (p40-p19). As expected, in the absence of cell surface IL-12Rβ1 in C-, there was no detectable binding of IL-12. Similarly, no IL-12 binding was detected in P either (Figure 5). Thus, although our assay does not exclude the possibility that IL-12 binds to P cells with a low affinity, the cell surface IL-12R heterodimers comprising mutant IL-12Rβ1 molecules in P did not bind normally their natural ligand, IL-12. C- displayed residual binding of IL-23, indicating that IL-23 binds to the IL-23R chain in the absence of IL-12Rβ1 (Figure 5). Moreover, P showed similar levels of IL-23 binding to C- whereas C+ displayed much higher levels of binding, indicating that the heterodimeric IL-23 receptors

comprising mutant IL-12Rβ1 chains in P were impaired in their ability to normally recognize IL-23 and that the weak binding to IL-23R was not sufficient to trigger stimulation. Despite residual binding of IL-23 (and possibly of IL-12 to an even lower extent), complete IL-12 and IL-23 receptor defects in P therefore result at least in part from the impairment of IL-12 and IL-23 binding to heterodimers comprising the mutant IL-12Rβ1 chains at the cell surface. Our data do not exclude the possibility that the mutant IL-12Rβ1 chains do not interact normally with other signaling components, further contributing to the functional cytokine receptor defect.

IL-12Rβ1 expression and function are restored by retroviral transduction

We checked that the lack of response to IL-12 was truly caused by the *IL12RB1* genotype, and not by a defect in another receptor chain or signaling molecule, by complementing the cellular defect by means of retrovirus-mediated transfer. We demonstrated that STAT4 was phosphorylated and activated in response to IFN-α but not to IL-12 in P. The transduction of T-cell blasts from P with a retrovirus encoding WT IL-12Rβ1 restored normal IL-12Rβ1 expression, as detected by the 2B10 mAb, which did not recognize the mutant chain (Figure 6A). The expression of a WT IL-12Rβ1 chain was accompanied by the restoration of STAT4 phosphorylation upon the IL-12 stimulation of transduced T cells, as shown by intracellular FACS analysis (not shown). WT IL-12Rβ1 expression not only restored STAT4 phosphorylation but also the ability of T-cell blasts to respond to IL-12 in terms of IFN-γ production (Figure 6B). The complete lack of response to IL-12 documented in P despite the presence of IL-12Rβ1 molecules at the cell surface is

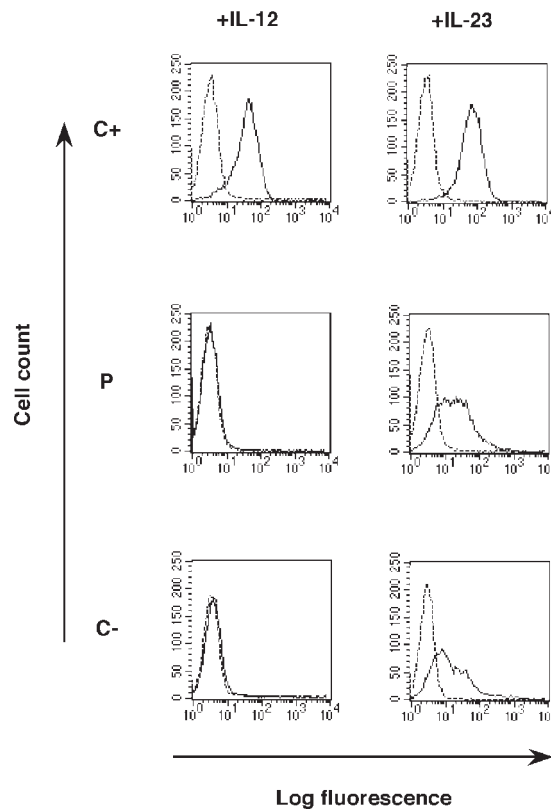

Figure 5. Lack of cytokine binding to the surface of PHA-T-cell blasts. PHA-T-cell blasts from a positive control (C+), a negative control (C-), and the patient (P) were incubated without (dotted line) or with (plain line) IL-12p70 or IL-23 for 30 minutes at 4°C. The PHA-T-cell blasts were then incubated with a purified mouse anti-IL-12 p40 antibody, followed by a biotinylated anti-mouse antibody, and antibody binding was detected by incubation with PE-conjugated streptavidin.

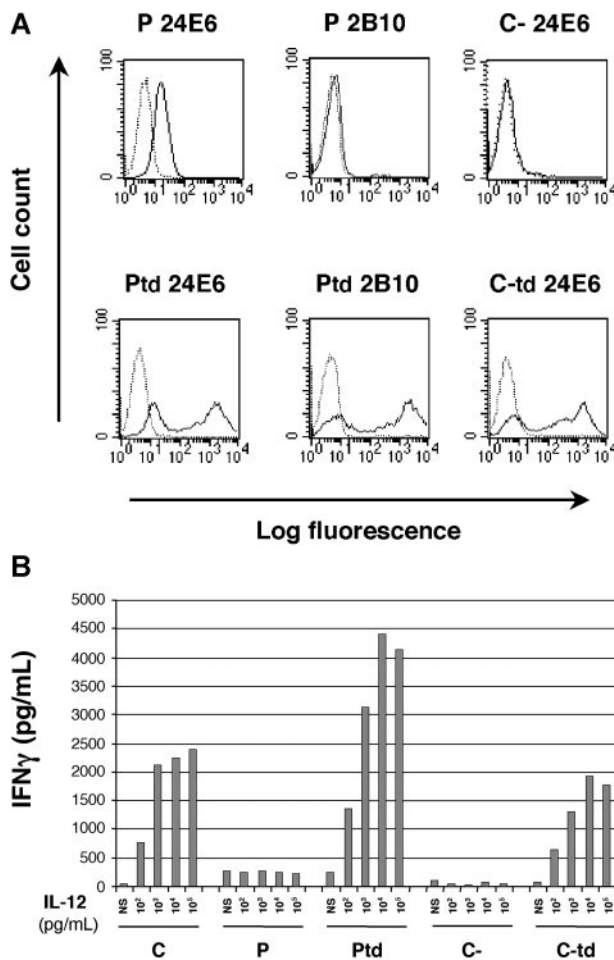

Figure 6. Correction of the patient's IL-12R β 1 defect by retroviral-mediated gene transfer. (A) PHA-T-cell blasts from the patient (P), a negative control (C-), MND-IL-12R β 1-transduced PHA-T-cell blasts from the patient (Ptd), or the negative control (C-td) were stained with anti-IL-12R β 1 mAb (24E6 or 2B10, plain line) or matched isotype control (dotted line). (B) IFN- γ production in response to IL-12. PHA-T-cell blasts from the patient (P), a negative control (C-), and MND-IL-12R β 1-transduced PHA-T-cell blasts from the patient (Ptd) or the negative control (C-td) were plated in 24-well plates and were either left unstimulated (NS) or were stimulated with increasing concentrations of IL-12 for 48 hours. Supernatants were harvested, and IFN- γ was quantified by ELISA.

therefore due to the absence of surface IL-12R β 1 molecules able to bind IL-12 normally.

Discussion

IL-12R β 1 deficiency is the most frequent genetic defect responsible for the syndrome of MSMD, with 54 patients from 16 countries reported to date.¹⁷⁻²⁸ All patients except the patient reported here lack IL-12R β 1 at the surface of all cells examined, due to mutations creating a premature stop codon in the coding region or to disrupting protein folding and stability. We describe here a patient with a large in-frame deletion of 12165 nt, which results in the surface expression of internally truncated IL-12R β 1 chains, as documented by flow cytometry with 5 of the 6 mAbs tested. Impaired binding of IL-12 and IL-23 to their surface-expressed heterodimeric receptors, including IL-12R β 1, accounts at least in part for the complete absence of response to both cytokines. The abnormal conformation of the receptor may also affect its interaction with other signaling molecules. This patient thus defines a novel genetic form of complete IL-12R β 1 deficiency.

A similar situation had been found for complete IFN- γ R1 deficiency, caused by the lack of surface receptors,^{1,2,7,8} or surface-expressed nonfunctional receptors.^{9,10} However, the mutations in the latter patients were much smaller, consisting of short in-frame deletions or missense mutations.^{9,10}

What molecular lessons can we learn from this experiment of nature? The mutant IL-12R β 1 protein is stable, expressed on the cell surface, and lacks the proximal half of the extracellular domain. The wild-type IL-12R β 1 chain is a member of the glycoprotein (gp) 130 family of receptors (type I cytokine receptor), the extracellular domain of which contains 5 fibronectin type III (FNIII) domains, each about 100 amino acids long.⁴¹ An FNIII domain contains 7-stranded β -sandwich motifs organized in an antiparallel manner.⁴² In IL-12R β 1, the first 2 FNIII domains consist essentially of the translation products of exons 2 to 7 (Figure 1). In our patient, who lacks exons 8 to 13, the 3 C-terminal FNIII domains are removed by the large deletion. The truncated protein is stable, probably because the first 2 FNIII domains are intact, and the remaining 3 are completely lacking. Consistent with this view, another IL-12R β 1-deficient patient (19.II.26) lacking IL-12R β 1 surface expression bears another in-frame deletion, encompassing only exon 13 (1483 + 182-1619-1073 del). The protein generated from the 1483 + 182-1619-1073 del allele is not stable, probably due to the disruption of only half of the fifth FNIII domain—normally encoded by exons 12 and 13.

The cytokine-binding domain of receptors of the gp 130 family is located in the 200 N-terminal amino acids of the mature chain and consists, more precisely, of the first 2 FNIII domains, which are linked by a short proline-rich hinge, allowing an 80-degree elbow for the binding of the ligand.^{42,43} These 2 FNIII domains are also called "hematopoietin receptor domains",⁴¹ or the "cytokine-binding homology region" (CHR).⁴³ The first N-terminal FNIII domain (D1) contains 3 amino acids forming the CXW motif (CSW in IL-12R β 1). The second N-terminal FNIII domain (D2) contains the SWXS motif (SWKS in IL-12R β 1). Both motifs are signatures of the gp 130 family of cytokine receptors.⁴¹ Horsten et al⁴⁴ have demonstrated that D1 and D2 are necessary and sufficient for the binding of IL-6 to gp130. In our patient, however, despite the integrity of these 2 FNIII domains, the recognition and binding of IL-12 is profoundly impaired. The difference between the 2 situations may be due to the different receptors involved (IL-6R and IL-12R) and possibly to IL-12 being itself a "truncated" receptor that may need to interact not only with the CHR of its receptor but also with other IL-12R β 1 FNIII domains. Alternatively, IL-12R β 1 CHR folding may be influenced by extracellular residues outside the CHR itself.

The impact of the (700 + 362_1619-944 del) mutation on IL-12R β 1-specific Ab recognition was much less pronounced than that on cytokine binding. Indeed, the deletion of 6 exons from *IL12RB1* is consistent not only with receptor expression at the cell surface but also with receptor recognition by 5 of the 6 available IL-12R β 1-specific antibodies. This study therefore makes it possible to map the epitopes of some anti-human IL-12R β 1 antibodies. The 5 mAbs that bound (clones 24E6, B101, B103, 12RB44, 69310) were probably generated against the first 2 FNIII domains (the CHR). The 5 epitopes located in the IL-12 recognition site are not significantly altered by the large (700 + 362_1619-944 del) deletion, which respects the first 2 FNIII domains. However, the low levels of receptor expression detected with these mAbs may result from an abnormal conformation of the receptor. Moreover, one epitope (recognized by 2B10) either maps outside the CHR or, if it is located within the CHR, is conformational and strictly

depends on residues located in the other 3 FNIII domains, which are lacking in our patient.

Our report highlights the lack of correlation between the *IL12RB1* genotype and IL-12Rβ1 expression: Paradoxically, the 700 + 362_1619-944 del mutation is the largest deletion described in *IL12RB1* and the only known mutation allowing cell surface expression. Whereas a small *IL12RB1* genomic lesion, such as a missense mutation, may be responsible for the lack of protein at the cell surface due to misfolding and degradation,^{21-24,26} a very large deletion of 12165 nt, encompassing half the exons encoding the extracellular domain, can lead to the presence of detectable receptors at the cell surface. This report also demonstrates that a diagnosis of IL-12Rβ1 deficiency should not be excluded solely on the basis of a conserved surface expression on flow cytometry. The clinical implications of these findings are important for individual

patients. Therapeutic options can best be tailored to the patient, on a rational basis, if accurate molecular diagnosis is achieved. Indeed, recombinant IFN-γ administration can save the lives of IL-12Rβ1-deficient patients. Our report thus stresses the importance of in-depth molecular diagnostic investigation in patients with MSMD.

Acknowledgments

We thank the patients and their families for their trust, the members of the Laboratory of Human Genetics of Infectious Diseases for helpful discussions, Dr Dominique Recan for the EBV transformation of B cells, and Betty Cazeau and Marianne O'Donnell from the Genetics Institute (Andover, MA) for providing 3 mAbs (B101, B103, 12RB44).

References

- Casanova JL, Abel L. Genetic dissection of immunity to mycobacteria: the human model. *Annu Rev Immunol.* 2002;20:581-620.
- Dorman SE, Holland SM. Interferon-gamma and interleukin-12 pathway defects and human disease. *Cytokine Growth Factor Rev.* 2000;11:321-333.
- Jouanguy E, Döffinger R, Dupuis S, Pallier A, Altare F, Casanova JL. IL-12 and IFN-γ in host defense against mycobacteria and salmonella in mice and men. *Curr Opin Immunol.* 1999;11:346-351.
- Jouanguy E, Lamhamedi-Cherradi S, Lammas D, et al. A human IFNGR1 small deletion hotspot associated with dominant susceptibility to mycobacterial infection. *Nat Genet.* 1999;21:370-378.
- Dupuis S, Dargemont C, Fieschi C, et al. Impairment of mycobacterial but not viral immunity by a germline human STAT1 mutation. *Science.* 2001;293:300-303.
- Frucht DM, Sandberg DI, Brown MR, Gerstberger SM, Holland SM. IL-12-independent costimulation pathways for interferon-γ production in familial disseminated Mycobacterium avium complex infection. *Clin Immunol.* 1999;91:234-241.
- Jouanguy E, Altare F, Lamhamedi S, et al. Interferon-gamma-receptor deficiency in an infant with fatal bacille Calmette-Guérin infection. *N Engl J Med.* 1996;335:1956-1961.
- Newport MJ, Huxley CM, Huston S, et al. A mutation in the interferon-gamma receptor gene and susceptibility to mycobacterial infection. *N Engl J Med.* 1996;335:1941-1949.
- Jouanguy E, Dupuis S, Pallier A, et al. In a novel form of IFN-gamma receptor 1 deficiency, cell surface receptors fail to bind IFN-gamma. *J Clin Invest.* 2000;105:1429-1436.
- Allende LM, Lopez-Goyanes A, Paz-Artal E, et al. A point mutation in a domain of gamma interferon receptor 1 provokes severe immunodeficiency. *Clin Diagn Lab Immunol.* 2001;8:133-137.
- Jouanguy E, Lamhamedi-Cherradi S, Altare F, et al. Partial interferon-gamma receptor 1 deficiency in a child with tuberculoïd bacillus Calmette-Guérin infection and a sibling with clinical tuberculosis. *J Clin Invest.* 1997;100:2658-2664.
- Dorman SE, Holland SM. Mutation in the signal-transducing chain of the interferon-gamma receptor and susceptibility to mycobacterial infection. *J Clin Invest.* 1998;101:2364-2369.
- Döffinger R, Jouanguy E, Dupuis S, et al. Partial interferon gamma receptor signaling chain deficiency in a patient with bacille Calmette-Guérin and Mycobacterium abscessus infection. *J Infect Dis.* 2000;181:379-384.
- Dupuis S, Jouanguy E, Al-Hajjar S, et al. Impaired response to interferon-alpha/beta and lethal viral disease in human STAT1 deficiency. *Nat Genet.* 2003;33:388-391.
- Altare F, Lammas D, Revy P, et al. Inherited interleukin 12 deficiency in a child with bacille Calmette-Guérin and Salmonella enteritidis disseminated infection. *J Clin Invest.* 1998;102:2035-2040.
- Picard C, Fieschi C, Altare F, et al. Inherited interleukin-12 deficiency: IL12B genotype and clinical phenotype of 13 patients from six kindreds. *Am J Hum Genet.* 2002;70:336-348.
- Eloumi-Zghal H, Barbouche MR, Chemli J, et al. Clinical and genetic heterogeneity of inherited autosomal recessive susceptibility to disseminated Mycobacterium bovis bacille calmette-guérin infection. *J Infect Dis.* 2002;185:1468-1475.
- Altare F, Durandy A, Lammas D, et al. Impairment of mycobacterial immunity in human interleukin-12 receptor deficiency. *Science.* 1998;280:1432-1435.
- de Jong R, Altare F, Haagen IA, et al. Severe mycobacterial and Salmonella infections in interleukin-12 receptor-deficient patients. *Science.* 1998;280:1435-1438.
- Verhagen CE, de Boer T, Smits HH, et al. Residual type 1 immunity in patients genetically deficient for interleukin 12 receptor beta1 (IL-12Rbeta1): evidence for an IL-12Rbeta1-independent pathway of IL-12 responsiveness in human T cells. *J Exp Med.* 2000;192:517-528.
- Aksu G, Tirpan C, Cavusoglu C, et al. Mycobacterium fortuitum-chelonae complex infection in a child with complete interleukin-12 receptor beta 1 deficiency. *Pediatr Infect Dis J.* 2001;20:551-553.
- Altare F, Ensser A, Breiman A, et al. Interleukin-12 receptor beta1 deficiency in a patient with abdominal tuberculosis. *J Infect Dis.* 2001;184:231-236.
- Sakai T, Matsuoka M, Aoki M, Nosaka K, Mitsuya H. Missense mutation of the interleukin-12 receptor beta1 chain-encoding gene is associated with impaired immunity against Mycobacterium avium complex infection. *Blood.* 2001;97:2688-2694.
- Lichtenauer-Kaligis EG, De Boer T, Verreck FA, et al. Severe Mycobacterium bovis BCG infections in a large series of novel IL-12 receptor beta1 deficient patients and evidence for the existence of partial IL-12 receptor beta1 deficiency. *Eur J Immunol.* 2003;33:59-69.
- Cleary AM, Tu W, Enright A, et al. Impaired accumulation and function of memory CD4 T cells in human IL-12 receptor beta1 deficiency. *J Immunol.* 2003;170:597-603.
- Fieschi C, Dupuis S, Catherinot E, et al. Low penetrance, broad resistance, and favorable outcome of interleukin 12 receptor beta1 deficiency: medical and immunological implications. *J Exp Med.* 2003;197:527-535.
- Staretz-Haham O, Melamed R, Lifshitz M, et al. IL 12 receptor beta1 deficiency presenting as recurrent Salmonella infection. *Clin Infect Dis.* 2003;37:137-140.
- Caragol I, Raspall M, Fieschi C, et al. Clinical tuberculosis in two of three siblings with interleukin-12 receptor beta1 deficiency. *Clin Infect Dis.* 2003;37:302-306.
- Fieschi C, Casanova JL. The role of interleukin-12 in human infectious diseases: only a faint signature. *Eur J Immunol.* 2003;33:1461-1464.
- Casanova JL, Abel L. The human model: a genetic dissection of immunity to infection in natural conditions. *Nat Rev Immunol.* 2004;4:55-66.
- Uzel G, Frucht DM, Fleisher TA, Holland SM. Detection of intracellular phosphorylated STAT-4 by flow cytometry. *Clin Immunol.* 2001;100:270-276.
- Miller AD, Garcia JV, von Suhr N, Lynch CM, Wilson C, Eiden MV. Construction and properties of retrovirus packaging cells based on gibbon ape leukemia virus. *J Virol.* 1991;65:2220-2224.
- Candotti F, Johnston JA, Puck JM, Sugamura K, O'Shea JJ, Blaese RM. Retroviral-mediated gene correction for X-linked severe combined immunodeficiency. *Blood.* 1996;87:3097-3102.
- den Dunnen JT, Antonarakis SE. Nomenclature for the description of human sequence variations. *Hum Genet.* 2001;109:124-124.
- Kaplan MH, Sun YL, Hoey T, Grusby MJ. Impaired IL-12 responses and enhanced development of Th2 cells in Stat4-deficient mice. *Nature.* 1996;382:174-177.
- Thierfelder WE, van Deursen JM, Yamamoto K, et al. Requirements for Stat4 in interleukin-12-mediated responses of natural killer and T cells. *Nature.* 1996;382:171-174.
- Oppmann B, Lesley R, Blom B, et al. Novel p19 protein engages IL-12p40 to form a cytokine, IL-23, with biological activities similar as well as distinct from IL-12. *Immunity.* 2000;13:715-725.
- Parham C, Chirica M, Timans J, et al. A receptor for the heterodimeric cytokine IL-23 is composed of IL-12Rbeta1 and a novel cytokine receptor subunit, IL-23R. *J Immunol.* 2002;168:5699-5708.
- Trinchieri G. Interleukin-12 and the regulation of innate resistance and adaptive immunity. *Nat Rev Immunol.* 2003;3:133-146.
- Hoeve MA, de Boer T, Langenberg DM, Sanal O, Verreck FA, Ottenhoff TH. IL-12 receptor deficiency revisited: IL-23-mediated signaling is also impaired in human genetic IL-12 receptor beta1 deficiency. *Eur J Immunol.* 2003;33:3393-3397.
- Boulay JL, O'Shea JJ, Paul WE. Molecular phylogeny within type I cytokines and their cognate receptors. *Immunity.* 2003;19:159-163.
- Bravo J, Heath JK. Receptor recognition by gp130 cytokines. *EMBO J.* 2000;19:2399-2411.
- Bravo J, Staunton D, Heath JK, Jones EY. Crystal structure of a cytokine-binding region of gp130. *EMBO J.* 1998;17:1665-1674.
- Horsten U, Schmitz-Van de Leur H, Mullberg J, Heinrich PC, Rose-John S. The membrane distal half of gp130 is responsible for the formation of a ternary complex with IL-6 and the IL-6 receptor. *FEBS Lett.* 1995;360:43-46.

Article en préparation

Revisiting human IL-12R β 1 deficiency:
higher penetrance, broader susceptibility, and poorer outcome

Ludovic de Beaucoudrey, Jacqueline Feinberg, Jacinta Bustamante, Aurélie Cobat, Arina Samarina, Lucile Jannière, Orchidée Filipe-Santos, Ariane Chapgier, Stéphanie Boisson-Dupuis, Yoann Rose, Frédéric Altare, Capucine Picard, Alain Fischer, Carlos Rodriguez-Gallego, Isabel Caragol, Claire-Anne Sigriest, Janine Reichenbach, David Nadal, Klara Frecerova, Yaryna Boyko, Barbara Pietrucha, Renate Blütters-Sawatzki, Jutta Bernhöft, Joachim Freihorst, Ulrich Baumann, Olle Jeppsson, Darko Richter, Filomeen Haerynck, Suzanne Anderson, Michael Levin, Dinanthaka S. Kumararatne, Smita Patel, Rainer Doffinger, Andrew Exley, Vas Novelli, David Lamas, Kinda Scheppers, Françoise Mascart, Christiane Vermylen, David Tuerlinckx, Chris Nieuwhof, Malgorzata Pac, Walther H. Haas, Namik Özbek, Yildiz Camcioglu, Figen Dogu, Aydan Ikinciogullari, Gonul Tanir, Saniye Gülle, Necil Kutuculer, Guzide Aksu, Melike Keser, Ayper Somer, Nevin Hatipoglu, Cigdem Aydogmus, Mohammad S. Ehlayel, Abdullah Al Alangari, Sami Al Hajjar, Suliman Al Jumaah, Husn Frayha, Sulaiman Al Ajiji, Saleh Al Muhsen, Ben Zion Garty, Jacob Levy, Parisa Adimi, Davood Mansouri, Aziz Bousfiha, Jamila El Baghdadi, Ridha Barbouche, Imen Ben Mustapha, Mohammed Bejaoui, Slim Abdelmoula, Salem Kachboura, Jalel Chemli, Zohra Fitouri, Revathi Raj, Kuender D. Yang, Xiaochuan Wang, Liping Jiang, Zhu Chaomin, Xie Yuanyuan, Yang Xiqiang, Masao Matsuoka, Tatsunori Sakai, Aileen Cleary, David B Lewis, Steven Holland, Gabriela Castro, Natera Ivelisse, Ana Codoceo, Alejandra King, Sergio Rosenzweig, Judith Yancoski, Liliana Bezrodnik, Daniela Di Giovanni, Maria Isabel Gaillard, Dewton de Moraes-Vasconcelos, Alberto José da Silva Duarte, Ruth Aldana, Saul Valverde Rosas, Francisco Javier Espinosa-Rosales, Sigifredo Pedraza, Laurent Abel, Claire Fieschi, Ozden Sanal and Jean-Laurent Casanova

**Revisiting human IL-12R β 1 deficiency:
higher penetrance, broader susceptibility, and poorer outcome**

de Beaucoudrey, L., J. Feinberg, J. Bustamante, A. Cobat, A. Samarina, L. Janni re, S. Boisson-Dupuis, Y. Rose, O. Filipe-Santos, A. Chapgier, F. Altare, C. Picard, A. Fischer, C. Rodriguez-Gallego, I. Caragol, C.A. Sigriest, J. Reichenbach, D. Nadal, K. Frecerova, Y. Boyko, B. Pietrucha, R. Bl tters-Sawatzki, J. Bernh ft, J. Freihorst, U. Baumann, O. Jeppsson, D. Richter, F. Haerynck, S. Anderson, M. Levin, D. S. Kumararatne, S. Patel, R. Doffinger, A. Exley, V. Novelli, D. Lamas, K. Scheppers, F. Mascart, C. Vermylen, D. Tuerlinckx, C. Nieuwhof, M. Pac, W. H. Haas, N.  zbek, Y. Camcioglu, F. Dogu, A. Ikinogullari, G. Tanir, S. G lle, N. Kutuculer, G. Aksu, M. Keser, A. Somer, N. Hatipoglu, C. Aydogmus, M. S. Ehl yel, A. Al Alangari, S. Al Hajjar, S. Al Jumaah, H. Frayha, S. Al Ajiji, S. Al Muhsen, B.Z. Garty, J. Levy, P. Adimi, D. Mansouri, A. Bousfiha, J. El Baghdadi, R. Barbouche, I. Ben Mustapha, M. Bejaoui, R. Raj, K. D. Yang, X. Wang, L. Jiang, Z. Chaomin, X. Yuanyuan, Y. Xiqiang, M. Matsuoka, T. Sakai, A. Cleary, D. B Lewis, S. Holland, G. Castro, N. Ivelisse, A. King, S. Rosenzweig, J. Yancoski, L. Bezrodnik, D. Di Giovanni, M. I. Gaillard, D. de Moraes-Vasconcelos, A. J. da Silva Duarte, R. Aldana, S. Valverde Rosas, F. Javier Espinosa-Rosales, S. Pedraza, L. Abel, C. Fieschi, O. Sanal and J.L. Casanova.

Address all correspondence to Jean-Laurent Casanova: Laboratory of Human Genetics of Infectious Diseases, Paris Descartes University – INSERM U550, Necker Enfants-Malades Medical School, 156 rue de Vaugirard, 75015 Paris, France. Phone: 33 1 40 61 56 87; Fax: 33 1 40 61 56 88. Email: jean-laurent.casanova@inserm.fr

Running title: Human interleukin-12 receptor deficiency.

Abstract

First discovered in 1998, autosomal recessive, complete IL-12R β 1 deficiency is the most common genetic etiology of the syndrome of Mendelian predisposition to mycobacterial disease and the first described genetic etiology of pediatric tuberculosis. In 2003, a study of 41 cases suggested that IL-12R β 1 deficiency shows low penetrance, broad resistance, and favorable outcome. We herein report an international survey of 137 patients from 101 kindreds and 30 countries. Among the 101 index cases, the first infection occurred at ages 2 week-31,7 years and consisted in mycobacterial disease in 75 cases, caused by BCG (n = 64), environmental mycobacteria (n = 8) and *M. tuberculosis* (n = 3). Some presented first with non-typhoidal, extra-intestinal salmonellosis (n = 22). Up to 72% of the known genetically affected siblings of index cases were clinically affected (n = 26), with only 10 remaining asymptomatic. However 54 of the 164 siblings were not genotyped. Among the 127 symptomatic patients, recurrences of infection were rare (n = 40) and concerned mostly salmonellosis (n = 34). Up to 27% (n = 34) of patients had both salmonellosis and mycobacteriosis. BCG or EM disease strongly protected from subsequent EM disease. Other infectious diseases occurred, most in single or few patients (klebsiellosis, leishmaniasis, paracoccidioidomycosis, candidiasis). Only two-third of the patients (88 = 69%) survived, now aged 0.7-46.4 years. Altogether, these data corroborate the previous description of IL-12R β 1 deficiency, which is characterized by childhood-onset mycobacteriosis and salmonellosis with only rare recurrent or multiple infections. It also refines its clinical picture, with somewhat higher clinical penetrance, broader vulnerability to infections, and less favorable outcome than previously thought.

Introduction

Mendelian Susceptibility to Mycobacterial Diseases (MSMD, MIM 209950) is a clinical syndrome predisposing otherwise healthy individuals to infectious diseases caused by poorly virulent mycobacteria, such as bacillus Calmette-Guérin (BCG) vaccines and environmental mycobacteria (EM) (1). Since 1996, mutations in six genes defined thirteen genetic etiologies of MSMD (reviewed in (2)). Defects were found in five autosomal genes, which encoded either chain of the IFN- γ receptor (*IFNGR1* and *IFNGR2*), the signal transducer and activator of transcription factor 1 (*STAT1*), the p40 subunit of IL-12 and IL-23 (*IL12B*), and the β 1 chain shared by the IL-12 and IL-23 receptors (*IL12RB1*), and one X-linked gene coding for nuclear factor- κ B essential modulator (*NEMO*) (2). These defects all result in impaired IFN- γ mediated immunity. The allelic heterogeneity is such that mutations in six genes define thirteen distinct genetic traits, a given gene being possibly associated with recessive or dominant inheritance, complete or partial defect, and loss of expression or expression of non-functional molecules. Patients with MSMD are also susceptible to the more virulent species *Mycobacterium tuberculosis*, and IL-12R β 1 deficiency was even the first identified Mendelian genetic etiology of pediatric tuberculosis in children normally resistant to BCG and EM (3-6). The patients are also susceptible to *Salmonella* infections, in less than half of the cases (2, 7). A few other infections were diagnosed, albeit often in single patients with any of or even the combination of the aforementioned genetic traits, making it difficult to draw firm conclusions as to whether their pathogenesis is related to the underlying genetic defect(s).

The most common genetic etiology of MSMD is autosomal recessive IL-12R β 1 deficiency, first reported in 1998 (8, 9). NK and T cells from the patients do not respond to IL-12 and produce low levels of IFN- γ . The first large series of patients was reported in 2003, with 41 patients from 29 unrelated families in 17 countries (10). This survey resulted in the

description of key clinical features of IL-12R β 1 deficiency, when compared with other genetic etiologies of MSMD such as IFN- γ R1 deficiency (11). Five features of IL-12R β 1 deficiency were of specific clinical and immunological interest. First, infectious diseases typically first appeared in childhood, with no adult onset of disease. Second, recurrence of mycobacterial disease was rare, with BCG and EM disease protecting from EM disease. Third, there was incomplete clinical penetrance, with up to 45% of asymptomatic affected siblings. Fourth, the patients showed broad resistance to infectious agents, with a phenotype largely dominated by mycobacterial disease and salmonellosis. Fifth, there was a favorable outcome, with an overall mortality of only 15%. By now, individual case reports and small series have brought up the number of patients described in the literature to 71 (3-5, 12-45). There is a need to further reduce the ascertainment bias, in particular to assess the potential impact of the genetic background and microbial flora on the clinical phenotype, in order to draw better clinical and immunological conclusions from the study of this disorder. We herein describe the molecular, cellular, and clinical features of an international series of 137 patients with complete IL-12R β 1 deficiency.

Patients and methods

Subjects and kindreds.

We investigated patients and their families with disseminated and/or recurrent mycobacterial or atypical salmonella diseases history. Our study was conducted in accordance with the Helsinki Declaration, with informed consent obtained from each patient or patient's family, as requested and approved by the institutional review boards of the various institutions involved, including the Necker Medical School.

Whole-blood activation

Venous blood samples were collected into heparinized tubes and sent at room-temperature by express mail. Blood is diluted 1/2 in RPMI 1640 medium (Invitrogen) supplemented with 100 U/ml penicillin and 100 μ g/ml streptomycin (Invitrogen). 1 ml per

well of a 24 wells plate were activated under four conditions: with medium alone, with live BCG (*Mycobacterium bovis* BCG, Pasteur strain) either at 20:1 multiplicity of infection, with BCG more IFN- γ (5000 UI/ml, Imukin Boheringer Ingelheim), or with BCG more IL-12p70 (20 ng/ml, R&Dsystems) (40). Supernatants were collected between 12 and 18 hours, and the remaining volume is collected after 48 hours, centrifuged at 1800 g for 5 minutes. All the supernatants were stored at -20°C until analysis.

Determination of cytokine levels by ELISA

IL-12p40, IL-12p70 levels (12/18 hours supernatant) and IFN- γ levels (48 hours supernatants) were determined by ELISA. We used the capture antibodies, detection antibodies and standards supplied in the R&D Systems kits for IL-12p40 and IL-12p70 (DuoSet DY1240 and Quantikine HS120) and in the Sanquin kit for IFN- γ (M9333), diluted in HPE dilution buffer (M1940, Sanquin). Milk was used for blocking and antibody binding was detected with streptavidin poly-HRP (M2032, Sanquin) and TMB microwell peroxidase substrate (50-76-00, KPL). The reaction was stopped by adding H₂SO₄ (1.8 M). Optical density was determined with an MRX microplate reader (Thermolab Systems). Quantitative analysis involving a non-linear four parameter logistic (4PL) calibration model was made by an in-house software based on the Microsoft Excel application language developed for this purpose (gift from Max Feinberg). Intermediate results for each cytokine are expressed in pg/ml/10⁶ PBMC.

Cell culture

Epstein-Barr virus-transformed lymphoblastoid cell lines (EBV-B cell lines) were cultured RPMI 1640 (Invitrogen) supplemented with 10% heat-inactivated Foetal Bovine Serum (FBS) (Invitrogen). To generate PHA activated T-cells, peripheral blood mononuclear cells (PBMCs) were purified by centrifugation on a Ficoll-Paque Plus gradient (GE Healthcare), resuspended in RPMI-10% FBS and activated with phytohemagglutinin-P (PHA, Becton Dickinson) for 72 to 96 hours. PHA-T-cell blasts were restimulated every 48 hours with IL-2 (50 IU/ml, Proleukin i.v. from Chiron) and cultured in Panserin 401 (Pan Biotech) with 10% FBS and 2 mM L-glutamine (Invitrogen) at 2×10^5 cells/ml. All cells were incubated at 37°C, under an atmosphere containing 5% CO₂.

Flow cytometry

PHA-T-cell blasts or EBV-B cells were washed in PBS and dispensed into a 96-well plate for labeling. The cells were incubated with an anti-IL-12R β 1 antibody (1/100e of 556064 and/or 559253 from BD Biosciences) or a matched isotypic control (555746 and/or 555840 from BD Biosciences) for 20 minutes in PBS-2% FBS on ice. The cells were then washed twice with cold PBS-2% FBS. Cells were then incubated for 20 minutes on ice with anti-mouse- or anti-rat-Alexa Fluor 488 (A-11029 or A-11006 from Invitrogen) Cells were washed twice with PBS-2% FBS and analyzed with a FACScan machine and the Cellquest software (Becton Dickinson).

Genetic analysis

Human genomic DNA was isolated from pellet of PBMC purification, whole blood or cell lines. The cells were lysed in extraction buffer (10 mM Tris, 0.1 M EDTA, 0.5% SDS, and 10 mg/ml proteinase K) overnight at 37°C. The DNA was isolated by phenol/chloroform extraction, precipitated in isopropanol and ethanol and resuspended in TE 10:1 (10 mM Tris, 1 mM EDTA, pH 7.6). RNA was isolated from EBV-B cells or PHA-T cell blats with Trizol reagent (Invitrogen) according to the manufacturer's instructions. RNA was reverse transcribed by oligo-dT with Superscript II reverse transcriptase (Invitrogen). The first-strand cDNA was then stored at -20°C. PCR amplification was performed using AmpliTaq DNA polymerase (Applied Biosystems) and the GeneAmp PCR system 9700 (Applied Biosystems). Primers and conditions used for PCR amplification of the coding exons, including the flanking intronic sequences, or the cDNA of *IL12RB1* are available on request. Amplified PCR products were controlled by gel electrophoresis in a 1% agarose gel and were purified by centrifugation through Sephadex G-50 Superfine resin (Amersham GE) on filter plates multiscreen MAHV-N45 (Millipore). PCR products were sequenced by dideoxynucleotide termination with the BigDye terminator kit v1.1 (Applied Biosystems) and the PCR primers. Sequencing products were purified by centrifugation through Sephadex G-50 Superfine resin and analysed on an ABI Prism 3100 or 3130xl apparatus (Applied Biosystems). Sequences files and chromatograms were analyzed with GENALYS Software from CNG, France (46).

Statistical methods

The proportion of infection free, survival and penetrance were estimated by the Kaplan-Meier method for all type of infection and according to infection type. Curves were compared using the log-rank test. Clinical penetrance of IL-12R β 1 deficiency was assessed

after excluding all probands. All calculations and curves were performed with the survival package of the R software.

Results

Identification of 137 patients carrying two IL12RB1 mutant alleles

We sequenced the 17 *IL12RB1* coding exons and flanking intron regions in patients with severe mycobacterial disease (MSMD and severe tuberculosis) and/or systemic salmonellosis (non-typhoidal and typhoidal) referred to our laboratory. We identified 101 unrelated index cases from 30 countries with two *IL12RB1* mutant alleles (Table 1; Figure 1 and 2). There were a total of 52 mutant alleles (Table 1; Figure 3). The patients were homozygous (n = 86) or more rarely compound heterozygous (n = 12) for nonsense (n = 11), missense (n = 15), and splice (n = 10) mutations, small insertions (n = 3), small deletions (n = 7), large deletions (n = 2), and deletions/insertions (n = 4). All predicted splice mutations had a major impact on the *IL12RB1* mRNA structure, with a lack of detectable full-length mRNAs, as determined by RT-PCR (data not shown). Systematic investigation of most relatives, siblings in particular, led to a suspicion of IL-12R β 1 deficiency in up to 137 cases. Up to 25 siblings of index cases died including 17 of unknown or unrelated cause and eight of BCG-osis (26.II.1, 62.II.1, 73.II.1 and 73.II.1, 81.II.1), *M. avium* disease (4.II.1), disseminated tuberculosis (65.II.1) and salmonellosis (*S. enteritidis*, 30.II.5) (Table 1). They probably carried the disease-associated *IL12RB1* genotype. Among the 164 surviving siblings, 54 were not genotyped and up to 28 were homozygous or compound heterozygous for the corresponding mutations (Figure 1). Altogether, up to 137 individuals from 101 kindreds had proven (n = 129) or probable (n = 8) IL-12R β 1 deficiency. Up to 159 parents were genotyped and all were found to be heterozygous except one mother (47.I.2) who was found to be homozygous for the familial mutation.

Abolished cellular responses to IL-12

Up to 65 IL-12R β 1-deficient patients (47 index cases and 18 relatives were investigated for their blood IL-12/IFN- γ circuit. We measured the production of IFN- γ by whole blood, in response to stimulation with BCG alone (partly resulting from BCG-dependent, endogenous IL-12 production) and BCG plus exogenous, recombinant IL-12, as previously described (10, 40). All patients tested had an abolished response to IL-12 in this assay (Figure 4). In particular, there was no increased production of IFN- γ upon stimulation with BCG plus IL-12, when compared with BCG alone. The cellular phenotype of all patients tested is therefore uniform, with functional complete IL-12R β 1 deficiency. At odds with a few previous report, we did not detect any residual IL-12 responses in patient 64.II.1 carrying the C186S mutation (16). We then assessed IL-12R β 1 expression on the surface of T cell blasts and/or EBV-B cells by flow cytometry with two specific antibodies that recognize distinct epitopes on the extracellular domain of IL-12R β 1. No IL-12R β 1 molecules were detected on the surface of cells from the 90 patients tested, except for four patients from two Israeli families (kindreds 10 and 43) carrying the same mutation, as previously described (18). This truncated, cell surface-expressed protein is non-functional and causes complete IL-12R β 1 deficiency. Interestingly, the 15 missense *IL12RB1* mutations detected, unlike the 4 missense SNPs, were both loss-of-expression and loss-of-function.

Presenting clinical features of 101 index cases

We studied the age of onset and the nature of the first infectious diseases in 101 index cases with IL-12R β 1 deficiency. They developed infections caused by weakly virulent microorganisms (BCG, EM and non typhoidal *Salmonella*) (n = 97) or by more virulent microorganisms (*Mycobacterium tuberculosis*) (n = 3). One patient developed a *Nocardia nova* infection (97.II.2). The first infections occurred at 2 weeks-31.7 years (mean 2.8 years).

Most cases presented with BCG infection (64 among 84 BCG-vaccinated index cases). Eight of them presented with EM diseases and three of them suffered from *M. tuberculosis* infection. Salmonellosis was the first infection diagnosed in 22 cases. Two patients presented with two different infections simultaneously (patients 17.II.2 and 68.II.1); they suffered from EM and Salmonella diseases. We need to complete the clinical data for two patients.

Presenting clinical features of 28 genetically affected siblings

We have identified two *IL12RB1* null alleles causing complete IL-12R β 1 deficiency in 28 relatives (27 brothers or sisters and one mother). The defect was also probable in 8 siblings deceased of chronic infection. Among the 36 genetically affected siblings, 10 displayed no overt infectious phenotype. This asymptomatic group presented with the same cellular phenotype than their clinically affected IL-12R β 1-deficient siblings. Among these ten patients, two were vaccinated with BCG and did not develop any BCG disease. As first infection, fourteen other genetically affected parents developed BCG disease (among 22 BCG-vaccinated), four had environmental mycobacteriosis, three tuberculosis and four salmonellosis. One patient presented with two infections at the same time (BCG diseases and salmonellosis in patient 40.II.1). Altogether, the infectious phenotype was comparable to that of the index cases. The age of infection in these 28 patients did not differ either from that of index cases (mean 1.6 years, range 1 week-8 years). Their age was also comparable (mean 7.8 years, range 1.2-28 years). The remarkable observation is that ten patients had no overt phenotype, although being aged 0.7-21.5 years.

Incomplete clinical penetrance

Interestingly, 10 of the 36 IL-12R β 1-deficient (whether proven or suspected) siblings or parents were completely free of unusual infections at their last follow-up visit (mean

duration of follow-up: 12.6 years, range: 0.7-21.5 years). These asymptomatic patients have been identified because they are related (siblings or parents) to the index cases. To estimate the clinical penetrance of the defect, we used the 26 symptomatic (follow-up from 1.2 to 28 years, mean = 7.8 years) and the 10 asymptomatic siblings (follow up from 0.7 to 21.5 years, mean = 12.6 years). Overall, the penetrance of infections was estimated to be 78% (confidence interval 95%: 51-90%) when calculated with survival analysis techniques to account for differences in follow-up period (Figure 6). The penetrance of opportunistic infections (BCG, EM and salmonella diseases) was estimated to be 64% (confidence interval 95%: 41-78%). The BCG disease penetrance among vaccinated is 61% (confidence interval 95%: 31-78%), EM penetrance is 14% (confidence interval 95%: 0-25%), salmonella penetrance is 35% (confidence interval 95%: 12-52%). The penetrance of tuberculosis was estimated to be 28% (confidence interval 95%: 0-55%). These figures are somewhat higher than in the previous series. However, up to 54 (34%) of asymptomatic siblings were not genotyped. In contrast, all symptomatic siblings were considered to be IL-12R β 1-deficient, even when they were not genotyped. In 2003, only X% of siblings had not been genotyped. It is therefore difficult to conclude that the penetrance is higher than expected.

Mycobacterial diseases in the 137 patients

Mycobacterial diseases were the most frequent infections (Figure 5), as they were diagnosed in 104 of 127 infected patients (82%). We first analyzed the individuals who developed case-definition opportunistic infections caused by weakly virulent mycobacteria. BCG was the leading pathogen, as up to 106 patients were vaccinated with live BCG, 81 of whom have developed BCG disease (localized, n = 19; disseminated, n = 57; not known, n = 5). In contrast, only 23 patients developed EM diseases due to *M. avium* (n = 13), *M. triplex* (n = 1), *M. chelonae* (n = 2), *M. genavense* (n = 2), *M. simiae* (n = 1), *M. bovis* (n = 1).

Remarkably, only two patients suffered from two or more EM infections (4.II.1 and 7.II.5). More virulent mycobacterial infections were also diagnosed in IL-12R β 1-deficient patients, especially due to *M. tuberculosis*. Ten cases of tuberculosis were documented (Figure 5). Interestingly, in line with previous reports, tuberculosis was the only infectious disease in five patients (2.II.1, 24.II.3, 31.II.2, 65.II.1, 93.II.1). Three of them suffered also from BCG disease, one from EM disease and another from salmonellosis.

Salmonellosis in the 127 patients

Salmonellosis occurred in up to 54 of 127 patients and was the only infectious disease in 20 patients; the remaining 34 patients developed salmonellosis with mycobacteriosis. Non-typhoidal *Salmonella* were documented among 53 patients, including *S. enteritidis* (n = 23), *S. typhimurium* (n = 10), *S. dublin* (n = 3), *S. enteritica* (n = 1), *S. portland* (n = 1), *S. hadar* (n = 1), *S. group B* (n = 5) or *S. group D* (n = 10). Only one patient suffered from typhoid fever (patient 84.II.1), caused by *S. typhi* and *S. paratyphi*. *Salmonella* infection was found in 43% of the 127 infected IL-12R β 1-deficient patients. Three deaths were attributable to salmonellosis. Up to 8 patients suffered from salmonellosis caused by multiple groups of serotypes (3.II.1, 9.II.3, 30.II.6, 56.II.2, 67.II.4, 74.II.1, 79.II.2 and 84.II.1). Among the total of 127 symptomatic patients, up to 40 patients (31%) had multiple infections (Figure 5). Most (n = 37) had only two infections. Up to 32 patients had both salmonellosis and mycobacteriosis (80% of the multiple infected patients). Only nine of 127 patients had two different types of mycobacterial disease. Five patients have developed two opportunistic types of mycobacterial diseases with EM and BCG diseases. Three patients had salmonellosis and two mycobacterial infections (patients 8.II.2, 40.II.2 and 56.II.2). The four other made one opportunistic mycobacterial disease (3 BCG and 1 EM) with tuberculosis.

Infections caused by agents other than mycobacteria and salmonella

One patient did not develop mycobacterial or salmonella diseases but presented with *Nocardia nova* infection (patient 97.II.2), consistent with the phylogenetic and biochemical proximity of Mycobacteria and Nocardia. Interestingly, up to 29 patients have developed muco-cutaneous disease caused by *Candida albicans* (23%). The large majority of patients had recurrent oral thrush, often occurring when the patients were off all antibiotics treatment. The detailed clinical features of candidiasis in IL-12R β 1-deficient patients will be reported elsewhere. One patient developed recurrent visceral leishmaniasis (77.II.2) (27), one disseminated *Paracoccidioides brasiliensis* (29.II.1) (20), and one disseminated histoplasmosis (57.II.1). Most bacterial infections were benign, except for three patients who were infected by *Klebsiella pneumoniae* (70.II.2, 86.II.1 and 97.II.2), and another who developed sepsis and meningitis due to *Citrobacter freundii* (36.II.4). The occurrence of Klebsiellosis may be related to the susceptibility to Salmonella, as the two species are phylogenetically and biochemically very close. There were no unusually severe fungal, bacterial or viral infections in our 127 symptomatic patients.

Clinical outcome of IL-12R β 1-deficient patients

The mortality rate among symptomatic patient was 31% (39 out of 127 infected patients). This rate is more important than the 15% previously reported (10). Among the 39 patients, most died due to BCG-osis (n = 21), and fewer due to EM disease (n = 9), tuberculosis (n = 2), or salmonellosis (n = 3). One patient died due to oesophageal carcinoma (patient 30.II.6) (Rodriguez-Gallego *et al*, submitted) and three of unknown causes. The global mortality, including asymptomatic patients, is increased, at 28.5% (compared with 15% in a previous report).

Age of onset of infections among the 127 patients

We focused our analysis on the 127 symptomatic patients (101 index cases and 26 siblings). The age of the first onset of infection is during the first infancy with a mean at 2.8 years (range: 1 week-31.7 years) (Figure 6). In most cases the first infection is due to the vaccination with live BCG (BCG-it is or BCG-osis). It occurred from 2 weeks to 10.1 years with a mean of 8.6 months of age (from 1 week to 3.2 years after vaccination, with a mean at 4.8 months after vaccination). In nearly all cases, (95%) BCG disease occurred in the first year of life after vaccination. Salmonella (range: 3 months to 30.5 years, mean 4.4 years) and EM (range 1 week to 31.7 years, mean 6.4 years) diseases occurred around at the same period of life. For tuberculosis, the age of onset is later. *M. tuberculosis* infection occurred from 2.5 to 31 years with a mean of 11.3 years. BCG disease is the first infection in 78 cases (61%), EM in 12 (9%), *M. tuberculosis* in 6 (5%) and *Salmonella* in 26 cases (20%). Three of them have a mycobacterial infection and a salmonella infection at the same time as first (BCG n = 1, EM n = 2). In 95% of the cases, symptoms appeared during infancy, before age 1 year in BCG-vaccinated individuals and before age 5 years in the others. However, there were some patients who developed their first symptomatic infection at a relatively advance age (2 weeks).

Impact of BCG vaccination and EM disease on other mycobacterial diseases

Up to 40 patients among the 127 (31%) have had multiple infections (Figure 5). Up to 29 patients presented with BCG disease as their first infection (72%). We determined the impact of BCG vaccination and disease on the clinical phenotype of the 127 patients. BCG disease strongly protects from subsequent EM diseases (Figure 6). Only 5 of 81 patients with BCG diseases developed EM diseases. Only 7 of the 25 patients resistant to BCG (BCG inoculation without BCG disease) suffered from EM diseases with late onset of the diseases.

In contrast, up to 11 of the 26 patients (42%) who had not been vaccinated with BCG suffered from EM diseases, with early onset of the disease. The difference in age at onset of EM disease between the three groups of patients was highly significant ($p = 6 \times 10^{-4}$, Figure 6). This difference was most particularly important if patients with BCG disease were compared with patients not inoculated with BCG ($p = 1.7 \times 10^{-4}$). The difference between patients resistant to BCG and non-vaccinated patients was not statistically significant ($p = 0.09$). Finally, the difference in incidence of EM disease between BCG inoculated (with or without BCG disease) and non-vaccinated patients was highly significant ($p = 3.6 \times 10^{-4}$). This observation made for EM diseases was not true for the onset of tuberculosis ($p = 0.48$). The comparison of the age of onset of salmonella diseases was not statistically significant between this three groups ($p = 0.30$).

Discussion

We herein report 137 patients with IL-12R β 1 deficiency. The patients originate from 30 countries on four continents and comprise individuals from various ethnic groups (e.g. Europeans, Africans, Arabs, Chinese...). Consistent with the geographic and ethnic heterogeneity, there is substantial genetic heterogeneity, with up to 52 mutant alleles in 101 kindreds. In all but two kindreds from Israel (18, 28), the patients suffer from IL-12R β 1 deficiency without surface expression of the receptor. In all patients, the cells do not respond to both IL-12 and IL-23, defining a complete form of IL-12R β 1 deficiency. A diagnosis of partial, as opposed to complete, IL-12R β 1 deficiency was proposed by other investigators in a child homozygous for mutation C186S but these findings were not confirmed here in a patient carrying the same mutation (16). Likewise, an IL-12R β 1-independent T cell response to IL-12 was proposed by the same investigators, but these findings were not confirmed in our assays (37). In all patients tested, including patients with IL-12R β 1 expression on the cell surface,

there was no detectable cellular response to IL-12 in our whole blood assay (40). In any event, the high number of kindreds diagnosed, in various ethnic groups, with various mutant alleles, strongly suggests that IL-12R β 1 deficiency will be diagnosed in many other families world-wide, especially with increased awareness of the clinical features of MSMD and IL-12R β 1 deficiency. The present study is expected to contribute to this process.

Interestingly, the uniform cellular phenotype is associated with a substantial heterogeneity of the clinical phenotype, ranging from early death in infancy to an asymptomatic course until adulthood. Mycobacterial infections remain the vast majority of infections: up to 76% of symptomatic patients suffered from one or another type of mycobacterial disease. The high proportion of mycobacterial diseases, BCG and EM disease in particular, may reflect an ascertainment bias as patients with MSMD are primarily studied for the IL-12R β 1 chain. We also report five cases with tuberculosis as their sole clinical manifestation (3-5). The *IL12RB1* gene can be considered as the first tuberculosis Mendelian susceptibility gene. The prevalence of tuberculosis in IL-12R β 1-deficient patients is lower than that of disease due to BCG or EM infection. This may be because patients are less frequently exposed to *M. tuberculosis* than to the BCG vaccines (which have 85% coverage world-wide) and the almost ubiquitous EM. This also is less likely to be due to the possibility that a first mycobacterial infection might protect from tuberculosis. There are however 2 patients with BCG-osis and TB.

Salmonellosis is the second most common infection, found in 43% of symptomatic IL-12R β 1-deficient patient. It is the only infection for 37% of those cases (20/54) and 16% of the symptomatic and 15% of all patients. The remaining patients suffered from both mycobacteriosis and salmonellosis. It is clear from our study that IL-12R β 1 deficiency should be considered in patients with a pure phenotype of salmonellosis, extra-intestinal non-typhoidal salmonellosis in particular (typhoid fever was only diagnosed in one patient).

Infections other than those caused by mycobacteria and salmonella are also increasingly diagnosed. Leishmaniasis, paracoccidioidomycosis, and nocardiosis were diagnosed in one patient each. The three organisms are intra-macrophagic pathogens, consistent with the plausible role of IL-12R β 1 deficiency in the pathogenesis. Moreover, a child with nocardiosis was previously reported to suffer from IL-12p40 deficiency (47). Klebsiellosis was diagnosed in three patients. The natural history of these intra-cellular infections suggests that IL-12R β 1 deficiency is involved but more cases need to be diagnosed to confirm this hypothesis. Surprisingly, mild forms of chronic mucocutaneous candidiasis were diagnosed in up to 29 patients (Rodriguez-Gallego *et al*, in preparation). Interestingly, in the last few years, IL-12R β 1 was implicated in the human IL-23-IL-17 axis (48-51), previously described in mouse model (reviewed in (52, 53)). Mice with impaired IL-17 immunity are also susceptible to *Candida* (54, 55). Moreover, mouse IL-17 has, paradoxically, been shown to impair immunity to *Candida* in certain experimental conditions (56, 57). The actual function of human IL-23-IL-17 axis in host defense remains unknown but it has been demonstrated that patient with IL-12R β 1 deficiency have an impaired development of IL-17-producing T cells (45). This relatively high proportion of patient with this clinical course may reflect an impact of IL-12 or IL-23 on the immunity against *Candida*. As the IL-12-IFN- γ axis was described for anti-mycobacteria immunity, perhaps the IL-23-IL-17 axis could be involved in the anti-candida or the anti-salmonella immunity in humans. Genetic dissection of immunity against *Salmonella* or *Candida* could help us to understand this clinical specificity of IL-12R β 1-deficient patients. In any event, the infectious phenotype of IL-12R β 1-deficient patients appears to be broader than initially thought.

We also confirm that the penetrance of MSMD in IL-12R β 1 deficiency is not complete, whether for BCG or EM disease. The penetrance of salmonellosis is also incomplete, although it is difficult to define which patients have been exposed to *Salmonella*.

This is even more pronounced for tuberculosis, as only a small fraction of patients were probably exposed to *M. tuberculosis*. We also confirm that IL-12R β 1 deficiency is a disease of childhood onset. When compared with our 2003 survey, the higher number of patients (137 against 41) results in a penetrance of MSMD increased from x% to 49% and that of MSMD plus salmonellosis from 45 to 64%. If we include tuberculosis, the global penetrance raised to 78%. Altogether, even healthy siblings of probands, and their more distant relatives in consanguineous kindreds, should be investigated. We further confirm that the prognosis of IL-12R β 1 deficiency is quite good. However, consistent with the higher penetrance, the outcome is not nearly as good as that observed in 2003 with fewer patients. The overall mortality rate of IL-12R β 1-deficient patients now reaches up to 28.5%, against 15% in 2003. It does not seem to correlate with the country of origin, but the type of infection has a detectable impact, with EM disease being associated with a poor prognosis. Among 81 BCG-infected patients, 24 died (30%); among 23 EM-infected patients, 12 died (52%); among 10 patients with tuberculosis, 3 died (30%); and among 54 patients with Salmonellosis, only 10 died (19%). The outcome improved with age, with no death after age 38 years. Most (??) patients are currently healthy off all treatment. Overall, IL-12R β 1 deficiency is often but not always symptomatic, presents typically in childhood, is lethal in up to a third of the patients, especially in patients with EM disease, and its prognosis seems to improve with age.

Legends to table and figures

Table 1: Genetic and clinical features of the patients with IL-12R β 1 deficiency.

Figure 1: Pedigrees of 101 families with IL-12R β 1 deficiency. Each kindred are designated by a capital number (1–101), each generation by a roman numeral (I–II), and each individual by an Arabic numeral (from left to right). Symbols are partitioned in two parts by a

horizontal line: the upper part indicates infections with Mycobacteria (in black, patients with BCG-osis or atypical mycobacteriosis; in gray, patients with tuberculosis); the lower part in black indicates infections with salmonella. The probands are indicated by an arrow. Individuals whose genetic status could not be evaluated are indicated by the symbol “E?”. Asymptomatic individuals carrying two mutant *IL12RB1* alleles are represented by a vertical line.

Figure 2: Kindred’s origin. Geographical origin’s of the 137 patients with complete IL-12R β 1 deficiency. They are originated from 30 countries (Argentina, Belgium, Bosnia and Herzegovina, Brazil, Cameroon, Chile, China, Cyprus, France (continental and Martinique), Germany, India, Iran, Israel, Japan, Morocco, Mexico, Netherlands, Pakistan, Poland, Qatar, Saudi Arabia, Slovakia, Spain (continental and Canaries), Sri Lanka, Taiwan, Tunisia, Turkey, United Kingdom, Ukraine and Venezuela).

Figure 3: Mutated alleles in IL12RB1 genes. Schematic representation of the coding region of the IL-12R β 1 chain containing 17 coding exons encoding a 662 amino acids protein, with a peptide leader sequence (exon1, L), extracellular domain (exons 2 to 13, EC), transmembrane domain (exon 14, TM) and an intracellular cytoplasmic domain (exons 15 to 17, IC). Missense mutations are noted in parm, nonsense in red, complex in sienna. Splicing mutations are noted in blue, and large deletions are in green.

Figure 4: Impaired cellular response to interleukin-12. Production of IFN- γ by whole blood cells from 38 healthy “local” positive controls (fresh blood), from 49 healthy “travel” positive controls and from 65 patients, either unstimulated (-) or stimulated with BCG alone or with BCG plus recombinant IL-12p70. The horizontal bars represent the

median of the values.

Figure 5: Repartition of the clinical phenotype of the IL-12R β 1-deficient patients. Each patient is classified according to mycobacterial infections (in red, BCG for BCG disease, EM for EM disease, Mtb for tuberculosis) and salmonella infections (in green, salmonella for salmonella disease).

Figure 6: Epidemiological features of IL-12R β 1 deficiency. First onset (A) and outcome (B) of infectious diseases in 119 deficient patients, according to infections: BCG (broken blue line), EM (broken gray line), M. tuberculosis (broken green line), Salmonella (broken red line), and all 4 infections (solid black line). (C) Onset of BCG disease among patients. (D) Variations in onset of EM disease among the 124 deficient patients, who had been vaccinated with BCG and suffered BCG disease (broken red line, n = 80), who had been vaccinated with BCG without developing BCG disease (resistance to BCG, broken blue line, n = 25), or who had not been vaccinated with BCG (solid black line, n = 27). Penetrance of infectious diseases (E) and opportunistic case-definition infectious diseases (F) in 31 of the 36 IL-12R β 1-deficient siblings (excluding all probands).

Legends to supplementary figures

Supplementary figure 1: Repartition of clinical phenotypes of IL-12R β 1-deficient patients. (A) Global repartition of clinical phenotypes. (B) Repartition of salmonella disease. (C) Repartition of mycobacterial diseases. (D) Repartition of non vaccinated, resistant to BCG, and BCG diseases.

Supplementary figure 2: Penetrance of clinical phenotypes in the IL-12R β 1-deficient

siblings (excluding all probands). (A) Penetrance of BCG diseases in vaccinated deficient siblings. (B) Penetrance of EM diseases in deficient siblings. (C) Penetrance of tuberculosis in deficient siblings. (D) Penetrance of salmonella disease in 36 deficient siblings.

Supplementary figure 3: Variations in onset of EM (A) diseases and tuberculosis (B) among the 132 deficient patients, who had been vaccinated with BCG and suffered BCG disease (broken red line, n = 80), who had been vaccinated with BCG without developing BCG disease (resistance to BCG, broken blue line, n = 25), or who had not been vaccinated with BCG (solid black line, n = 27).

Acknowledgements

We would particularly like to thank the patients and their families, whose trust, support, and cooperation were essential for collection of the data used in this study. We thank all the members of the Laboratory of Human Genetics of Infectious Diseases for helpful discussions and critical reading of our manuscript. We thank Martine Courat, Catherine Bidalled, Michele N'Guyen, Tony Leclerc, Maya Chrabieh, Sylvanie Fahy and Guy Bami for secretarial and technical assistance. We thank Jérôme Flatot and Max Feinberg for computational assistance. The Laboratory of Human Genetics of Infectious Diseases is supported by ANR, PHRC, EU (LHSP-CT-2005-018736), BNP Paribas Foundation, the Dana Foundation, and the March of Dimes. Ludovic de Beaucoudrey is supported by the *Fondation pour la Recherche Médicale* as part of the PhD program of Pierre et Marie Curie University (Paris, France). Jean-Laurent Casanova was an International Scholar of the Howard Hughes Medical Institute. The authors have no conflicting financial interests.

Web Resources

The URLs for data presented herein are as follows:

GENALYS Software: <http://software.eng.fr>

GenBank: <http://www.ncbi.nlm.nih.gov/Genbank/>

Online Mendelian Inheritance in Man (OMIM): <http://www.ncbi.nlm.nih.gov/Omim>

References

1. Casanova, J.L., and L. Abel. 2002. Genetic dissection of immunity to mycobacteria: the human model. *Annu Rev Immunol* 20:581-620.
2. Filipe-Santos, O., J. Bustamante, A. Chapgier, G. Vogt, L. de Beaucoudrey, J. Feinberg, E. Jouanguy, S. Boisson-Dupuis, C. Fieschi, C. Picard, and J.L. Casanova. 2006. Inborn errors of IL-12/23- and IFN-gamma-mediated immunity: molecular, cellular, and clinical features. *Semin Immunol* 18:347-361.
3. Altare, F., A. Ensser, A. Breiman, J. Reichenbach, J.E. Baghdadi, A. Fischer, J.F. Emile, J.L. Gaillard, E. Meinl, and J.L. Casanova. 2001. Interleukin-12 Receptor beta1 Deficiency in a Patient with Abdominal Tuberculosis. *J Infect Dis* 184:231-236.
4. Caragol, I., M. Raspall, C. Fieschi, J. Feinberg, M.N. Larrosa, M. Hernandez, C. Figueras, J.M. Bertran, J.L. Casanova, and T. Espanol. 2003. Clinical tuberculosis in 2 of 3 siblings with interleukin-12 receptor beta1 deficiency. *Clin Infect Dis* 37:302-306.
5. Özbek, N., C. Fieschi, B.T. Yilmaz, L. de Beaucoudrey, Y.E. Bikmaz, J. Feinberg, and J.L. Casanova. 2005. Interleukin-12 receptor beta 1 chain deficiency in a child with disseminated tuberculosis. *Clin Infect Dis* 40:e55-58.
6. Alcais, A., C. Fieschi, L. Abel, and J.L. Casanova. 2005. Tuberculosis in children and adults: two distinct genetic diseases. *J Exp Med* 202:1617-1621.
7. MacLennan, C., C. Fieschi, D.A. Lammas, C. Picard, S.E. Dorman, O. Sanal, J.M. MacLennan, S.M. Holland, T.H. Ottenhoff, J.L. Casanova, and D.S. Kumararatne. 2004. Interleukin (IL)-12 and IL-23 are key cytokines for immunity against *Salmonella* in humans. *J Infect Dis* 190:1755-1757.
8. Altare, F., A. Durandy, D. Lammas, J.F. Emile, S. Lamhamedi, F. Le Deist, P. Drysdale, E. Jouanguy, R. Döffinger, F. Bernaudin, O. Jeppsson, J.A. Gollob, E. Meinl, A.W. Segal, A. Fischer, D. Kumararatne, and J.L. Casanova. 1998. Impairment of mycobacterial immunity in human interleukin-12 receptor deficiency. *Science* 280:1432-1435.
9. de Jong, R., F. Altare, I.A. Haagen, D.G. Elferink, T. Boer, P.J. van Breda Vriesman, P.J. Kabel, J.M. Draaisma, J.T. van Dissel, F.P. Kroon, J.L. Casanova, and T.H. Ottenhoff. 1998. Severe mycobacterial and *Salmonella* infections in interleukin-12 receptor-deficient patients. *Science* 280:1435-1438.
10. Fieschi, C., S. Dupuis, E. Catherinot, J. Feinberg, J. Bustamante, A. Breiman, F. Altare, R. Baretto, F. Le Deist, S. Kayal, H. Koch, D. Richter, M. Brezina, G. Aksu, P. Wood, S. Al-Jumaah, M. Raspall, A.J. Da Silva Duarte, D. Tuerlinckx, J.L. Virelizier, A. Fischer, A. Enright, J. Bernhoft, A.M. Cleary, C. Vermeylen, C. Rodriguez-Gallego, G. Davies, R. Blutters-Sawatzki, C.A. Siegrist, M.S. Ehlayel, V. Novelli, W.H. Haas, J. Levy, J. Freiherst, S. Al-Hajjar, D. Nadal, D. De Moraes Vasconcelos, O. Jeppsson, N. Kutukculer, K. Freceirova, I. Caragol, D. Lammas, D.S. Kumararatne, L. Abel, and J.L. Casanova. 2003. Low penetrance, broad resistance, and favorable outcome of interleukin 12 receptor beta1 deficiency: medical and immunological implications. *J Exp Med* 197:527-535.
11. Dorman, S.E., C. Picard, D. Lammas, K. Heyne, J.T. van Dissel, R. Baretto, S.D. Rosenzweig, M. Newport, M. Levin, J. Roesler, D. Kumararatne, J.L. Casanova, and S.M. Holland. 2004. Clinical features of dominant and recessive interferon gamma receptor 1 deficiencies. *Lancet* 364:2113-2121.
12. Sakai, T., M. Matsuoka, M. Aoki, K. Nosaka, and H. Mitsuya. 2001. Missense mutation of the interleukin-12 receptor beta1 chain-encoding gene is associated with impaired immunity against *Mycobacterium avium* complex infection. *Blood* 97:2688-2694.
13. Aksu, G., C. Tirpan, C. Cavusoglu, S. Soydan, F. Altare, J.L. Casanova, and N. Kutukculer. 2001. *Mycobacterium fortuitum-chelonae* complex infection in a child with complete interleukin-12 receptor beta 1 deficiency. *Pediatr Infect Dis J* 20:551-553.
14. Elloumi-Zghal, H., M.R. Barbouche, J. Chemli, M. Bejaoui, A. Harbi, N. Snoussi, S. Abdelhak, and K. Dellagi. 2002. Clinical and genetic heterogeneity of inherited autosomal recessive susceptibility to disseminated *Mycobacterium bovis* bacille calmette-guerin infection. *J Infect Dis* 185:1468-1475.
15. Cleary, A.M., W. Tu, A. Enright, T. Giffon, R. Dewaal-Malefy, K. Gutierrez, and D.B. Lewis.

2003. Impaired accumulation and function of memory CD4 T cells in human IL-12 receptor beta 1 deficiency. *J Immunol* 170:597-603.
16. Lichtenauer-Kaligis, E.G., T. de Boer, F.A. Verreck, S. van Voorden, M.A. Hoeve, E. van de Vosse, F. Ersoy, I. Tezcan, J.T. van Dissel, O. Sanal, and T.H. Ottenhoff. 2003. Severe Mycobacterium bovis BCG infections in a large series of novel IL-12 receptor beta1 deficient patients and evidence for the existence of partial IL-12 receptor beta1 deficiency. *Eur J Immunol* 33:59-69.
 17. Staretz-Haham, O., R. Melamed, M. Lifshitz, N. Porat, C. Fieschi, J.L. Casanova, and J. Levy. 2003. Interleukin-12 receptor beta1 deficiency presenting as recurrent Salmonella infection. *Clin Infect Dis* 37:137-140.
 18. Fieschi, C., M. Bosticardo, L. de Beaucoudrey, S. Boisson-Dupuis, J. Feinberg, O.F. Santos, J. Bustamante, J. Levy, F. Candotti, and J.L. Casanova. 2004. A novel form of complete IL-12/IL-23 receptor {beta}1 deficiency with cell surface-expressed nonfunctional receptors. *Blood* 104:2095-2101.
 19. Ulrichs, T., C. Fieschi, E. Neviccka, H. Hahn, M. Brezina, S.H. Kaufmann, J.L. Casanova, and K. Freceerova. 2005. Variable outcome of experimental interferon-gamma therapy of disseminated Bacillus Calmette-Guerin infection in two unrelated interleukin-12Rbeta1-deficient Slovakian children. *Eur J Pediatr* 164:166-172.
 20. Moraes-Vasconcelos, D., A.S. Grumach, A. Yamaguti, M.E. Andrade, C. Fieschi, L. de Beaucoudrey, J.L. Casanova, and A.J. Duarte. 2005. Paracoccidioides brasiliensis disseminated disease in a patient with inherited deficiency in the beta1 subunit of the interleukin (IL)-12/IL-23 receptor. *Clin Infect Dis* 41:e31-37.
 21. Yu, H.R., R.F. Chen, K.C. Hong, C.N. Bong, W.I. Lee, H.C. Kuo, and K.D. Yang. 2005. IL-12-independent Th1 polarization in human mononuclear cells infected with varicella-zoster virus. *Eur J Immunol* 35:3664-3672.
 22. Sanal, O., T. Turul, T. De Boer, E. Van de Vosse, I. Yalcin, I. Tezcan, C. Sun, L. Memis, T.H. Ottenhoff, and F. Ersoy. 2006. Presentation of interleukin-12/-23 receptor beta1 deficiency with various clinical symptoms of Salmonella infections. *J Clin Immunol* 26:1-6.
 23. Rosenzweig, S.D., J. Yancoski, A. Bernasconi, S. Krasovec, B.E. Marciano, L. Casimir, G. Berberian, N. Simboli, M. Rousseau, and G. Calle. 2006. Thirteen years of culture-positive M. bovis-BCG infection in an IL-12Rbeta1 deficient patient: treatment and outcome. *J Infect* 52:e69-72.
 24. Kutukculer, N., F. Genel, G. Aksu, B. Karapinar, C. Ozturk, C. Cavusoglu, J.L. Casanova, and C. Fieschi. 2006. Cutaneous leukocytoclastic vasculitis in a child with interleukin-12 receptor beta-1 deficiency. *J Pediatr* 148:407-409.
 25. Tanir, G., F. Dogu, N. Tuygun, A. Ikinogullari, C. Aytekin, C. Aydemir, M. Yuksek, E.C. Boduroglu, L. de Beaucoudrey, C. Fieschi, J. Feinberg, J.L. Casanova, and E. Babacan. 2006. Complete deficiency of the IL-12 receptor beta1 chain: three unrelated Turkish children with unusual clinical features. *Eur J Pediatr* 165:415-417.
 26. Ozen, M., M. Ceyhan, O. Sanal, M. Bayraktar, and L. Mesci. 2006. Recurrent Salmonella bacteremia in interleukin-12 receptor beta1 deficiency. *J Trop Pediatr* 52:296-298.
 27. Sanal, O., G. Turkkani, F. Gumruk, L. Yel, G. Secmeer, I. Tezcan, A. Kara, and F. Ersoy. 2007. A case of interleukin-12 receptor beta-1 deficiency with recurrent leishmaniasis. *Pediatr Infect Dis J* 26:366-368.
 28. Scheuerman, O., L. de Beaucoudrey, V. Hoffer, J. Feinberg, J.L. Casanova, and B.Z. Garty. 2007. Mycobacterial disease in a child with surface-expressed non-functional interleukin-12Rbeta1 chains. *Isr Med Assoc J* 9:560-561.
 29. Lee, P.P., L.P. Jiang, X.C. Wang, K.W. Chan, W.W. Tu, and Y.L. Lau. 2008. Severe mycobacterial infections in two pairs of Chinese siblings with interleukin-12 receptor beta1 deficiency. *Eur J Pediatr* 167:231-232.
 30. Ehlayel, M., L. de Beaucoudrey, F. Fike, S.A. Nahas, J. Feinberg, J.L. Casanova, and R.A. Gatti. 2008. Simultaneous presentation of 2 rare hereditary immunodeficiencies: IL-12 receptor beta1 deficiency and ataxia-telangiectasia. *J Allergy Clin Immunol*
 31. Lachaux, A., B. Descos, I. Loras-Duclaux, G. Souillet, D. Floret, J. Brunet, J. Freney, and M. Hermier. 1988. [Recurrent infections caused by Salmonella typhimurium]. *Arch Fr Pediatr*

- 45:337-339.
32. Jeppsson, O., B. Petrini, J. Andersson, N. Heurlin, and G. Malm. 1988. Defective handling of mycobacteria. *Lancet* 2:570.
 33. Levin, M., M.J. Newport, S. D'Souza, P. Kalabalikis, I.N. Brown, H.M. Lenicker, P.V. Agius, E.G. Davies, A. Thrasher, N. Klein, and et al. 1995. Familial disseminated atypical mycobacterial infection in childhood: a human mycobacterial susceptibility gene? *Lancet* 345:79-83.
 34. Tuerlinckx, D., C. Vermylen, B. Brichard, J. Ninane, and G. Cornu. 1997. Disseminated Mycobacterium avium infection in a child with decreased tumour necrosis factor production. *Eur J Pediatr* 156:204-206.
 35. Sanal, O., G. Morgan, A. Gocmen, V. Novelli, N. Klein, I. Tezcan, F. Ersoy, A.I. Berkel, and L. Yel. 2000. Isolated cutaneous response to granulocyte-monocyte colony stimulating factor in fatal idiopathic disseminated Bacillus-Calmette-Guerin infection. *Eur J Pediatr* 159:149-152.
 36. Costa, F.F., G. Castro, J. Andrade, R. Jesus Ade, R.P. de Almeida, and C.M. Nascimento-Carvalho. 2006. Resistant Mycobacterium bovis disseminated infection. *Pediatr Infect Dis J* 25:190.
 37. Verhagen, C.E., T. de Boer, H.H. Smits, F.A. Verreck, E.A. Wierenga, M. Kurimoto, D.A. Lammas, D.S. Kumararatne, O. Sanal, F.P. Kroon, J.T. van Dissel, F. Sinigaglia, and T.H. Ottenhoff. 2000. Residual type 1 immunity in patients genetically deficient for interleukin 12 receptor beta1 (IL-12Rbeta1): evidence for an IL-12Rbeta1-independent pathway of IL-12 responsiveness in human T cells. *J Exp Med* 192:517-528.
 38. Verreck, F.A., T. de Boer, M. Hoeve, J.T. van Dissel, O. Sanal, M. Kurimoto, and T.H. Ottenhoff. 2002. Human host defense and cytokines in mycobacterial infectious diseases: interleukin-18 cannot compensate for genetic defects in the interleukin-12 system. *Clin Infect Dis* 35:210-212.
 39. Hoeve, M.A., T. de Boer, D.M. Langenberg, O. Sanal, F.A. Verreck, and T.H. Ottenhoff. 2003. IL-12 receptor deficiency revisited: IL-23-mediated signaling is also impaired in human genetic IL-12 receptor beta1 deficiency. *Eur J Immunol* 33:3393-3397.
 40. Feinberg, J., C. Fieschi, R. Doffinger, M. Feinberg, T. Leclerc, S. Boisson-Dupuis, C. Picard, J. Bustamante, A. Chappier, O. Filipe-Santos, C.L. Ku, L. de Beaucoudrey, J. Reichenbach, G. Antoni, R. Balde, A. Alcais, and J.L. Casanova. 2004. Bacillus Calmette Guerin triggers the IL-12/IFN-gamma axis by an IRAK-4- and NEMO-dependent, non-cognate interaction between monocytes, NK, and T lymphocytes. *Eur J Immunol* 34:3276-3284.
 41. Wood, P.M., C. Fieschi, C. Picard, T.H. Ottenhoff, J.L. Casanova, and D.S. Kumararatne. 2005. Inherited defects in the interferon-gamma receptor or interleukin-12 signalling pathways are not sufficient to cause allergic disease in children. *Eur J Pediatr* 164:741-747.
 42. Miro, F., C. Nobile, N. Blanchard, M. Lind, O. Filipe-Santos, C. Fieschi, A. Chappier, G. Vogt, L. de Beaucoudrey, D.S. Kumararatne, F. Le Deist, J.L. Casanova, S. Amigorena, and C. Hivroz. 2006. T cell-dependent activation of dendritic cells requires IL-12 and IFN-gamma signaling in T cells. *J Immunol* 177:3625-3634.
 43. de Boer, T., J.T. van Dissel, T.W. Kuijpers, G.F. Rimmelzwaan, F.P. Kroon, and T.H. Ottenhoff. 2008. Influenza virus vaccination induces interleukin-12/23 receptor beta 1 (IL-12/23R beta 1)-independent production of gamma interferon (IFN-gamma) and humoral immunity in patients with genetic deficiencies in IL-12/23R beta 1 or IFN-gamma receptor I. *Clin Vaccine Immunol* 15:1171-1175.
 44. Guia, S., C. Cagnet, L. de Beaucoudrey, M.S. Tessmer, E. Jouanguy, C. Berger, O. Filipe-Santos, J. Feinberg, Y. Camcioglu, J. Levy, S. Al Jumaah, S. Al-Hajjar, J.L. Stephan, C. Fieschi, L. Abel, L. Brossay, J.L. Casanova, and E. Vivier. 2008. A role for interleukin-12/23 in the maturation of human natural killer and CD56+ T cells in vivo. *Blood* 111:5008-5016.
 45. de Beaucoudrey, L., A. Puel, O. Filipe-Santos, A. Cobat, P. Ghandil, M. Chrabieh, J. Feinberg, H. von Bernuth, A. Samarina, L. Janniere, C. Fieschi, J.L. Stephan, C. Boileau, S. Lyonnet, G. Jondeau, V. Cormier-Daire, M. Le Merrer, C. Hoarau, Y. Lebranchu, O. Lortholary, M.O. Chandris, F. Tron, E. Gambineri, L. Bianchi, C. Rodriguez-Gallego, S.E. Zitnik, J. Vasconcelos, M. Guedes, A.B. Vitor, L. Marodi, H. Chapel, B. Reid, C. Roifman, D. Nadal, J. Reichenbach, I. Caragol, B.Z. Garty, F. Dogu, Y. Camcioglu, S. Gulle, O. Sanal, A. Fischer, L. Abel, B. Stockinger, C. Picard, and J.L. Casanova. 2008. Mutations in *STAT3* and *IL12RB1* impair the development of human IL-17-producing T cells. *J Exp Med* 205:1543-1550.

46. Takahashi, M., F. Matsuda, N. Margetic, and M. Lathrop. 2003. Automated identification of single nucleotide polymorphisms from sequencing data. *J Bioinform Comput Biol* 1:253-265.
47. Picard, C., C. Fieschi, F. Altare, S. Al-Jumaah, S. Al-Hajjar, J. Feinberg, S. Dupuis, C. Soudais, I.Z. Al-Mohsen, E. Genin, D. Lammas, D.S. Kumararatne, T. Leclerc, A. Rafii, H. Frayha, B. Murugasu, L.B. Wah, R. Sinniah, M. Loubser, E. Okamoto, A. Al-Ghonaum, H. Tufenkeji, L. Abel, and J.L. Casanova. 2002. Inherited interleukin-12 deficiency: *IL12B* genotype and clinical phenotype of 13 patients from six kindreds. *Am J Hum Genet* 70:336-348.
48. Chen, Z., C.M. Tato, L. Muul, A. Laurence, and J.J. O'Shea. 2007. Distinct regulation of interleukin-17 in human T helper lymphocytes. *Arthritis Rheum* 56:2936-2946.
49. Wilson, N.J., K. Boniface, J.R. Chan, B.S. McKenzie, W.M. Blumenschein, J.D. Mattson, B. Basham, K. Smith, T. Chen, F. Morel, J.C. Lecron, R.A. Kastelein, D.J. Cua, T.K. McClanahan, E.P. Bowman, and R. de Waal Malefyt. 2007. Development, cytokine profile and function of human interleukin 17-producing helper T cells. *Nat Immunol* 8:950-957.
50. Acosta-Rodriguez, E.V., G. Napolitani, A. Lanzavecchia, and F. Sallusto. 2007. Interleukins 1beta and 6 but not transforming growth factor-beta are essential for the differentiation of interleukin 17-producing human T helper cells. *Nat Immunol* 8:942-949.
51. Evans, H.G., T. Suddason, I. Jackson, L.S. Taams, and G.M. Lord. 2007. Optimal induction of T helper 17 cells in humans requires T cell receptor ligation in the context of Toll-like receptor-activated monocytes. *Proc Natl Acad Sci U S A* 104:17034-17039.
52. Stockinger, B., and M. Veldhoen. 2007. Differentiation and function of Th17 T cells. *Curr Opin Immunol* 19:281-286.
53. Dong, C. 2008. TH17 cells in development: an updated view of their molecular identity and genetic programming. *Nat Rev Immunol* 8:337-348.
54. Huang, W., L. Na, P.L. Fidel, and P. Schwarzenberger. 2004. Requirement of interleukin-17A for systemic anti-*Candida albicans* host defense in mice. *J Infect Dis* 190:624-631.
55. LeibundGut-Landmann, S., O. Gross, M.J. Robinson, F. Osorio, E.C. Slack, S.V. Tsoni, E. Schweighoffer, V. Tybulewicz, G.D. Brown, J. Ruland, and C. Reis e Sousa. 2007. Syk- and CARD9-dependent coupling of innate immunity to the induction of T helper cells that produce interleukin 17. *Nat Immunol* 8:630-638.
56. Zelante, T., A. De Luca, P. Bonifazi, C. Montagnoli, S. Bozza, S. Moretti, M.L. Belladonna, C. Vacca, C. Conte, P. Mosci, F. Bistoni, P. Puccetti, R.A. Kastelein, M. Kopf, and L. Romani. 2007. IL-23 and the Th17 pathway promote inflammation and impair antifungal immune resistance. *Eur J Immunol* 37:2695-2706.
57. Cooper, A.M. 2007. IL-23 and IL-17 have a multi-faceted largely negative role in fungal infection. *Eur J Immunol* 37:2680-2682.

Table1 : Familial, genetical, geographical and clinical features of patients with IL-12Rβ1 deficiency.

Kindred	Code	Mutation	Origin	Death	Age	BCG ^a	EM ^b	Mtb ^c	Salmonella ^d	Candida ^e
1	II.2	K305X	Morocco	alive	29	D	-	-	<i>Stm</i>	NA
2	II.3	R213W	Morocco	alive	17	D	-	-	<i>Sen</i>	NA
	II.1	R213W	Morocco	alive	28	R	-	<i>Mtb</i>	-	NA
3	II.3	Y367C	Cameroon	alive	8	D	-	-	<i>Sd, Sh</i>	-
4	II.1	1623_1624delinsTT	Cyprus	alive	39	R	<i>Ma, Mt, Mg</i>	-	<i>Se</i>	-
4	II.3	1623_1624delinsTT	Cyprus	alive	27	R	-	-	<i>S. spp</i>	-
	II.2	NA	Cyprus	deceased	7	R	<i>Ma</i>	-	-	-
5	II.3	783+1G>A	Turkey (Kurdes)	alive	22	D	-	-	-	-
	II.4	783+1G>A	Turkey (Kurdes)	alive	17	nv	-	-	-	-
6	II.2	783+1G>A	Turkey (Kurdes)	alive	20	D	-	-	<i>Se</i>	-
	II.3	783+1G>A	Turkey (Kurdes)	alive	15	D	-	-	-	-
7	II.5	R173P	Turkey	deceased	17	R	<i>Ma, Mfc</i>	<i>Mtb</i>	-	<i>Ca</i>
8	II.2	R173P	Turkey	alive	15	D	<i>Mc</i>	-	<i>Se</i>	-
9	II.3	557-563delins8	Turkey	alive	18	D	-	-	<i>Se, Stm</i>	<i>Ca</i>
10	II.2	700+362_1619-944del	Israel	alive	10	nv	-	-	<i>SD</i>	<i>Ca</i>
11	II.2	1190-1G>A	Saudi Arabia	alive	8	D	-	-	-	-
12	II.2	C186S	Qatar	alive	12	D	-	-	<i>Se</i>	-
	II.6	C186S	Qatar	deceased	3	D	-	-	-	-
13	II.5	C186S	Qatar	alive	10	R	<i>M. spp</i>	-	<i>SD</i>	-
	II.7	C186S	Qatar	alive	8	R	<i>M. spp</i>	-	<i>S. spp</i>	-
14	II.2	1791+2T>G	Iran	alive	14	nv	-	-	<i>Se</i>	-
15	II.2	S321X	Pakistan	alive	24	D	-	-	<i>Se</i>	-
16	II.1	1791+2T>G	Sri Lanka	alive	24	D	-	-	-	-
17	II.2	Q32X/1623_1624delinsT	France	alive	14	nv	<i>Mg</i>	-	<i>Stm</i>	NA
	II.1	Q32X/1623_1624delinsT	France	alive	19	R	-	-	-	NA
18	II.1	Q376X	France	alive	31	R	-	-	<i>Sd</i>	<i>Ca</i>
19	II.1	[1745-46delinsCA + 1483+182_1619-1073del]	France	alive	37	D	-	-	<i>S. spp, Sd</i>	<i>Ca</i>
20	II.1	Q32X	France	alive	12	D	-	-	-	NA
21	II.2	Q32X	Belgium	deceased	7	nv	<i>Ma</i>	-	<i>Se</i>	<i>Ca</i>
	II.1	Q32X	Belgium	alive	22	nv	-	-	-	NA
22	II.1	1623_1624delinsTT	Germany	deceased	4	nv	<i>Ma</i>	-	-	NA
23	II.1	1623_1624delinsTT	Germany	alive	15	D	-	-	<i>Se</i>	-
	II.2	1623_1624delinsTT	Germany	alive	12	nv	-	-	-	-
24	II.2	1791+2T>G	Spain	alive	19	nv	-	<i>Mtb</i>	<i>Se</i>	-
24	II.1	1791+2T>G	Spain	alive	22	nv	-	-	-	-
	II.3	1791+2T>G	Spain	alive	12	nv	-	<i>Mtb</i>	-	-
25	II.1	1791+2T>G	Spain	deceased	8	nv	<i>Ma</i>	-	<i>Se</i>	<i>Ca</i>
26	II.4	549+2T>C	Bosnia Herzegovina	alive	12	nv	<i>M. spp</i>	-	-	-
	II.1	NA	Bosnia Herzegovina	deceased	4	D	-	-	-	-
27	II.2	[1442_1149delins16 + Q171P]	Slovakia	deceased	2	D	-	-	-	-
28	II.3	[1007_1008delinsG + Q171P]	Slovakia	alive	9	D	-	-	-	-
29	II.1	L77P	Brazil	alive	30	D	-	-	<i>Stm</i>	-
30	II.5	NA	Spain	deceased	7	NA	-	-	<i>Se</i>	<i>Ca</i>
	II.6	1791+2T>G	Spain	deceased	30	nv	-	-	<i>Se, Sp</i>	<i>Ca</i>
31	II.2	1021+1G>C	Turkey	alive	15	R	-	<i>Mtb</i>	??	-
32	II.8	1791+2T>G	Mexico	alive	34	R	-	-	<i>SB</i>	-
33	II.2	[1623_1624delinsTT + 65delCTGC]	Belgium	deceased	14	nv	<i>Ma</i>	-	-	-
34	II.1	C196Y/1483+182_1619-1073del	France	alive	28	R	-	-	<i>Stm</i>	NA
35	II.2	[I369T + 1623_1624delinsTT]	Poland	alive	4	D	-	-	-	-

36	II.3	Y88X	Saudi Arabia	alive	12	D	-	-	SD	-
	II.4	Y88X	Saudi Arabia	alive	6	D	-	-	SD	-
37	II.6	C186S	Qatar	alive	8	R	-	-	SD	-
38	II.1	R173P	Turkey	alive	14	R	-	-	Se	-
39	II.2	711insC	Turkey	deceased	2	D	-	-	-	Ca
40	II.1	628-644dup	Turkey	alive	11	D	-	-	S. spp	-
	II.2	628-644dup	Turkey	deceased	5	D	Ma	-	S. spp	Ca
	II.5	628-644dup	Turkey	alive	3	D	-	-	-	Ca
41	II.3	1336delC	Saudi Arabia	deceased	4	D	-	-	-	-
	II.2	1336delC	Saudi Arabia	alive	8	D	-	-	-	-
42	II.2	783+1G>A	Turkey	deceased	3	R	-	-	Se	Ca
43	II.2	700+362_1619-944del	Israel (arabic)	deceased	9	nv	Ma	-	Stm	-
	II.1	700+362_1619-944del	Israel (arabic)	alive	12	nv	-	-	-	-
	II.3	700+362_1619-944del	Israel (arabic)	deceased	2	nv	Ma	-	-	-
44	NA	R486X	Turkey	alive	NA	D	NA	NA	NA	NA
45	II.1	NA	Mexico	deceased	4	D	-	-	-	Ca
	II.2	1791+2T>G	Mexico	alive	2	nv	-	-	-	-
	II.3	1791+2T>G	Mexico	alive	1	nv	-	-	-	-
46	II.4	1791+2T>G	Iran	alive	9	D	-	-	-	-
47	I.2	580+1G>A	Iran	alive	NA	NA	-	-	-	NA
	II.2	580+1G>A	Iran	alive	4	D	-	-	-	-
48	II.1	[983_999del + R173W]	Brazil	alive	6	D	-	-	-	-
49	II.1	Y88X	Saudi Arabia	alive	3	D	-	-	-	-
50	II.1	783+1G>A	Turkey	deceased	2	D	-	-	-	Ca
51	II.1	1791+2T>G	Brazil	deceased	2	D	-	-	-	-
52	II.2	Y88X	Saudi Arabia	alive	5	D	Ms	-	-	-
53	II.3	R173W	Venezuela	alive	14	R	-	-	Se	Ca
54	II.1	K305X	Morocco	deceased	15	D	-	Mtb	-	-
56	II.2	[1189+2T>A + 1791+2T>G]	Ukraine	alive	9	D	M. spp	-	Stm, Se	-
57	II.1	R521X	India	alive	7	D	-	Mtb	-	-
58	II.1	R211P	Taiwan	alive	24	R	-	-	Se	-
59	II.1	R173W	Poland	alive	17	D	-	-	Se	-
60	II.1	1791+2T>G	Mexico	alive	15	D	Mb?	-	-	-
	II.5	1791+2T>G	Mexico	deceased	3	D	Mb?	-	-	-
62	II.1	NA	China	deceased	1	D	-	-	-	-
	II.2	1791+2T>G	China	alive	2	D	-	-	-	-
63	II.1	[169delA + C62G]	Chile	deceased	2	D	-	-	-	-
64	II.2	C198R	Turkey	alive	4	D	-	-	S. spp	-
	II.1	C198R	Turkey	alive	8	R	-	-	-	-
65	II.1	NA	China	deceased	11	R	-	Mtb	-	-
	II.2	Q285X	China	deceased	2	D	-	-	-	-
66	II.1	R521X	Iran	alive	8	D	-	-	-	-
67	II.4	1190-1G>A	Saudi Arabia	alive	9	R	-	-	SD, Se H	-
	II.2	1190-1G>A	Saudi Arabia	alive	13	D	-	-	Stm H	Ca
68	NA	Q376X	Netherlands	deceased	0	nv	Ma	-	SB	-
69	II.1	[E67X + 1623_1624delinsTT]	Argentina	alive	3	D	-	-	-	-
70	II.1	1623_1624delinsTT	United Kingdom	deceased	6	nv	MAIc	-	-	-
71	II.1	E480X	Ukraine	alive	12	D	-	-	Stm	-
	II.2	E480X	Ukraine	alive	3	D	-	-	Stm	-
73	II.6	R175W	Turkey	alive	3	D	-	-	-	-
	II.3	NA	Turkey	deceased	4	D	-	-	-	NA
	II.4	NA	Turkey	deceased	5	D	-	-	-	NA

74	II.1	R175W	Turkey	alive	6	R	-	-	<i>Se, SB</i>	-
76	II.1	1765delG	Martinique	alive	32	NA	-	-	<i>SD</i>	-
77	II.1	467_484del	Turkey	deceased	5	D	-	-	-	-
	II.2	467_484del	Turkey	alive	7	R	-	-	<i>SD</i>	-
78	II.2	C198R	Turkey	alive	15	D	-	-	-	-
79	II.1	783+1G>A	Turkey	deceased	4	D	-	-	-	<i>Ca</i>
	II.2	783+1G>A	Turkey	alive	10	R	<i>M. spp</i>	-	<i>SB, SD</i>	<i>Ca</i>
81	II.1	NA	Turkey	deceased	4	D	-	-	-	-
	II.2	783+1G>A	Turkey	alive	10	nv	-	-	<i>SD</i>	-
82	II.1	783+1G>A	Turkey	deceased	7	D	-	-	-	<i>Ca</i>
	II.2	783+1G>A	Turkey	deceased	4	D	-	-	-	<i>Ca</i>
83	II.1	783+1G>A	Turkey	alive	6	D	-	-	-	-
84	II.1	R173P	Turkey	alive	17	D	-	-	<i>Se, St, Spt</i>	-
86	NA	R486X	Mexico	deceased	NA	NA	<i>NA</i>	<i>NA</i>	<i>NA</i>	<i>NA</i>
87	II.5	Y88X	Saudi Arabia	alive	6	R	-	-	<i>SB</i>	-
	II.6	Y88X	Saudi Arabia	alive	1	D	-	-	-	-
88	II.7	C186S	Qatar	alive	1	D	-	-	-	-
89	II.1	64+2T>G	Turkey	alive	4	D	-	-	-	<i>Ca</i>
90	II.5	1425delC	Turkey	alive	3	D	-	-	<i>Se</i>	<i>Ca</i>
91	II.1	783+1G>A	Turkey	alive	4	D	-	-	-	<i>Ca</i>
92	NA	G569D	Iran	alive	NA	NA	<i>NA</i>	<i>NA</i>	<i>NA</i>	<i>NA</i>
93	NA	T355del	Iran	alive	34	R	-	<i>Mtb</i>	-	<i>NA</i>
94	NA	1791+2T>G	Saudi Arabia	NA	NA	NA	<i>NA</i>	<i>NA</i>	<i>NA</i>	<i>NA</i>
95	II.1	64+2T>G	Turkey	alive	2	D	-	-	-	-
96	II.1	Q32X	United Kingdom	alive	47	D	-	-	-	-
97	II.2	1791+2T>G	Turkey	alive	1	nv	-	-	-	-
98	II.1	1623_1624delinsTT	Argentina	alive	5	D	-	-	-	-
99	II.2	W531X	Argentina	alive	10	D	-	-	-	-
100	II.1	[1623_1624delinsTT + DelEx4]	Argentina	alive	8	D	-	-	-	-
101	II.3	1623_1624delinsTT	Argentina	alive	20	D	-	-	-	-
102	II.2	R213W	Japan	deceased	38	R	<i>Ma</i>	-	-	-
103	II.4	64+2T>G	Tunisia	alive	11	D	-	-	-	<i>Ca</i>
104	II.1	NA	Tunisia	deceased	1	D	-	-	-	<i>Ca</i>
105	II.1	NA	Tunisia	alive	28	R	<i>M. spp</i>	-	-	<i>Ca</i>
106	II.1	550-2A>G	Tunisia	deceased	8	D	-	-	<i>S.spp</i>	-
107	II.1	64+5G>A	Tunisia	alive	2	D	-	-	-	<i>Ca</i>

a. BCG, Bacille Calmette-Guérin ; D, Disseminated BCG infection ; R, Resistant, no adverse reaction to BCG vaccination ; nv, Not Vaccinated with BCG ; NA, information not available.

b. *Ma*, *Mycobacterium avium* ; *Mt*, *M. triplex* ; *Mg*, *M. genevense* ; *Mfc*, *M. fortuitum-chelonae* complex ; *Mc*, *M. chelonae* ; *Msp*, patient who respond well to empirical mycobacterial treatment without identification of species ; *Ms*, *M. simiae* ; *MAIc*, *M. avium-intracellulare* complex.

c. *Mtb*, *M. tuberculosis*.

d. *Stm*, *Salmonella typhimurium* ; *Sen*, *S. enteritica* ; *Sd*, *S. Dublin* ; *Sh*, *S. hadar* ; *Se*, *S. enteritidis* ; *Sp*, *S. Portland* ; *SB*, *S. group B* ; *SD*, *S. group D* ; *Se H*, *Se group H* ; *Stm H*, *Stm group H* ; *St*, *S. typhi* ; *Spt*, *S. paratyphimurium*.

e. *Ca*, *Candida albicans*.

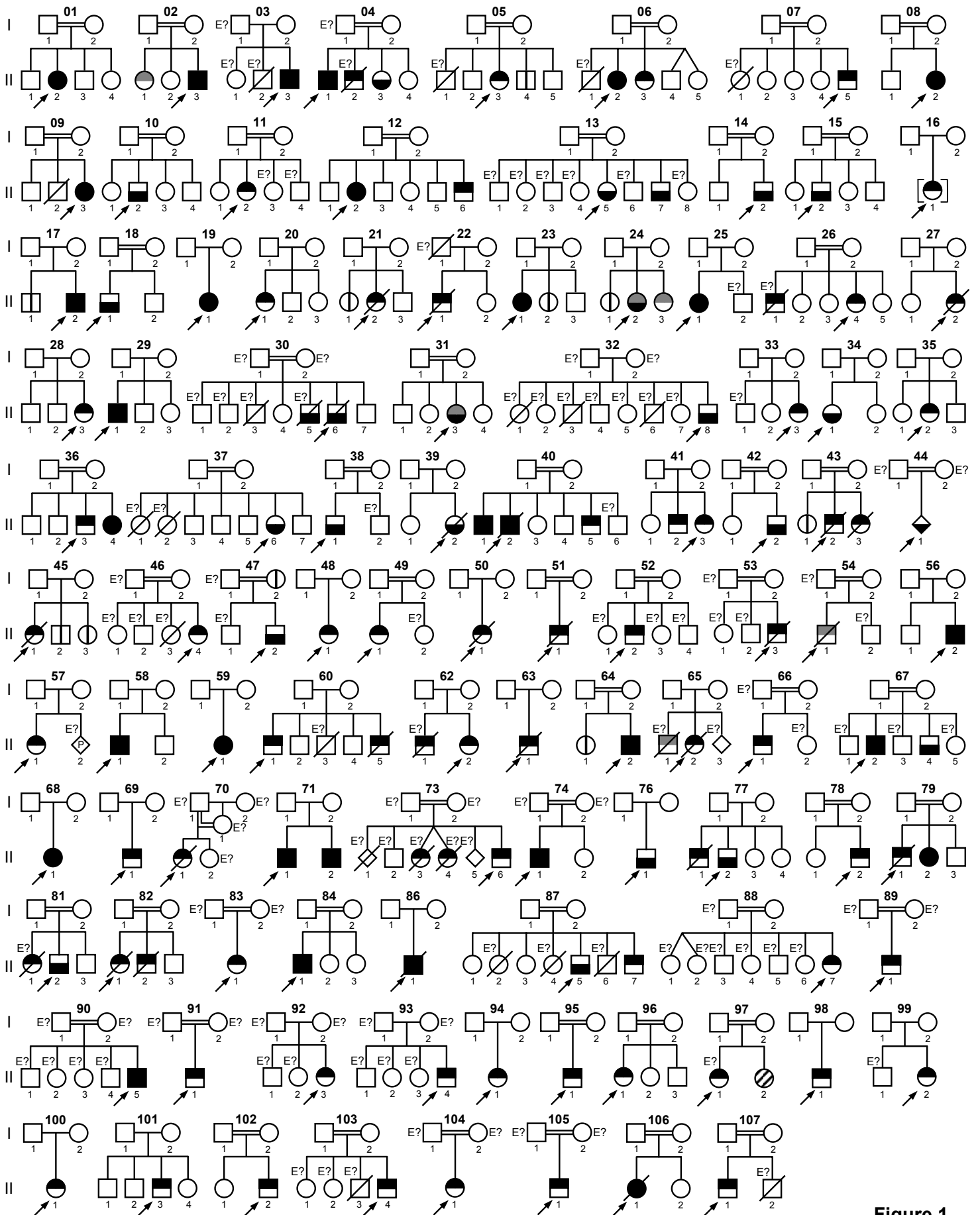

Figure 1

Figure 2



Figure 3

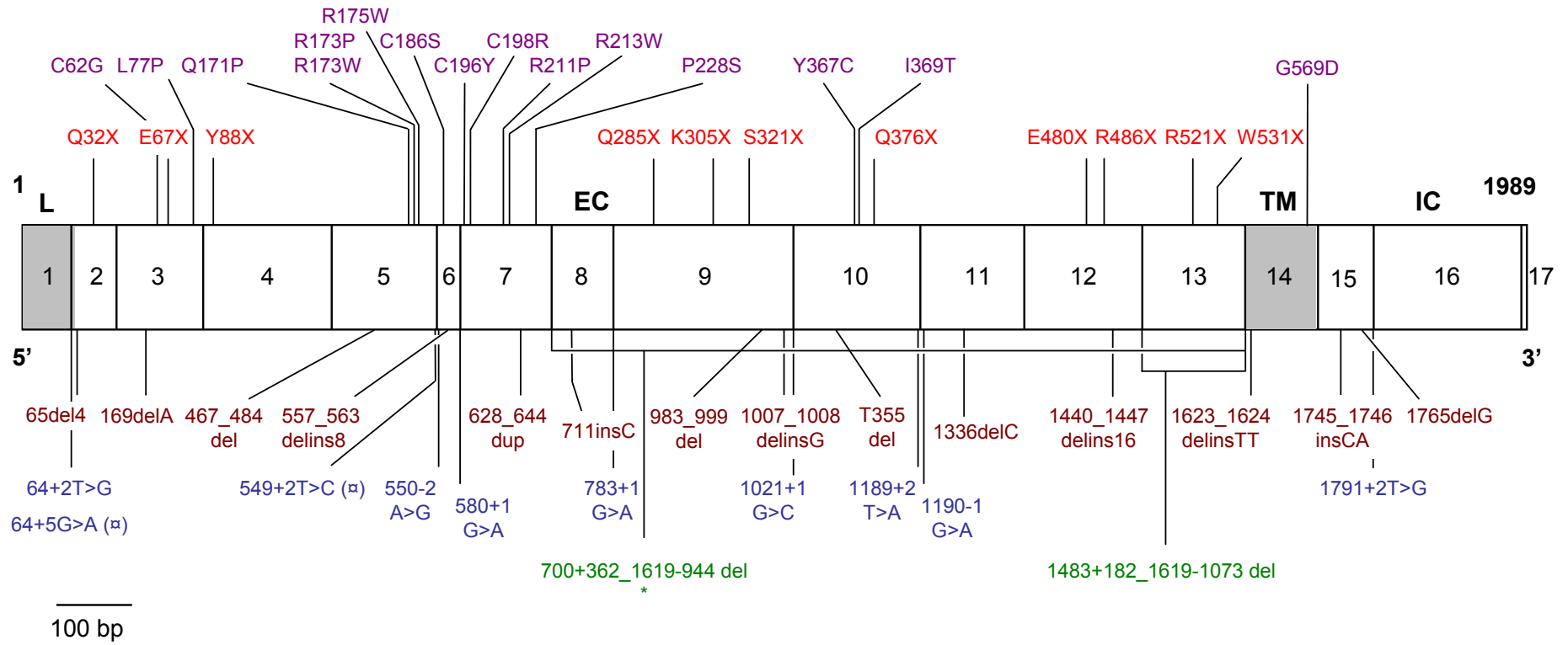

Figure 4

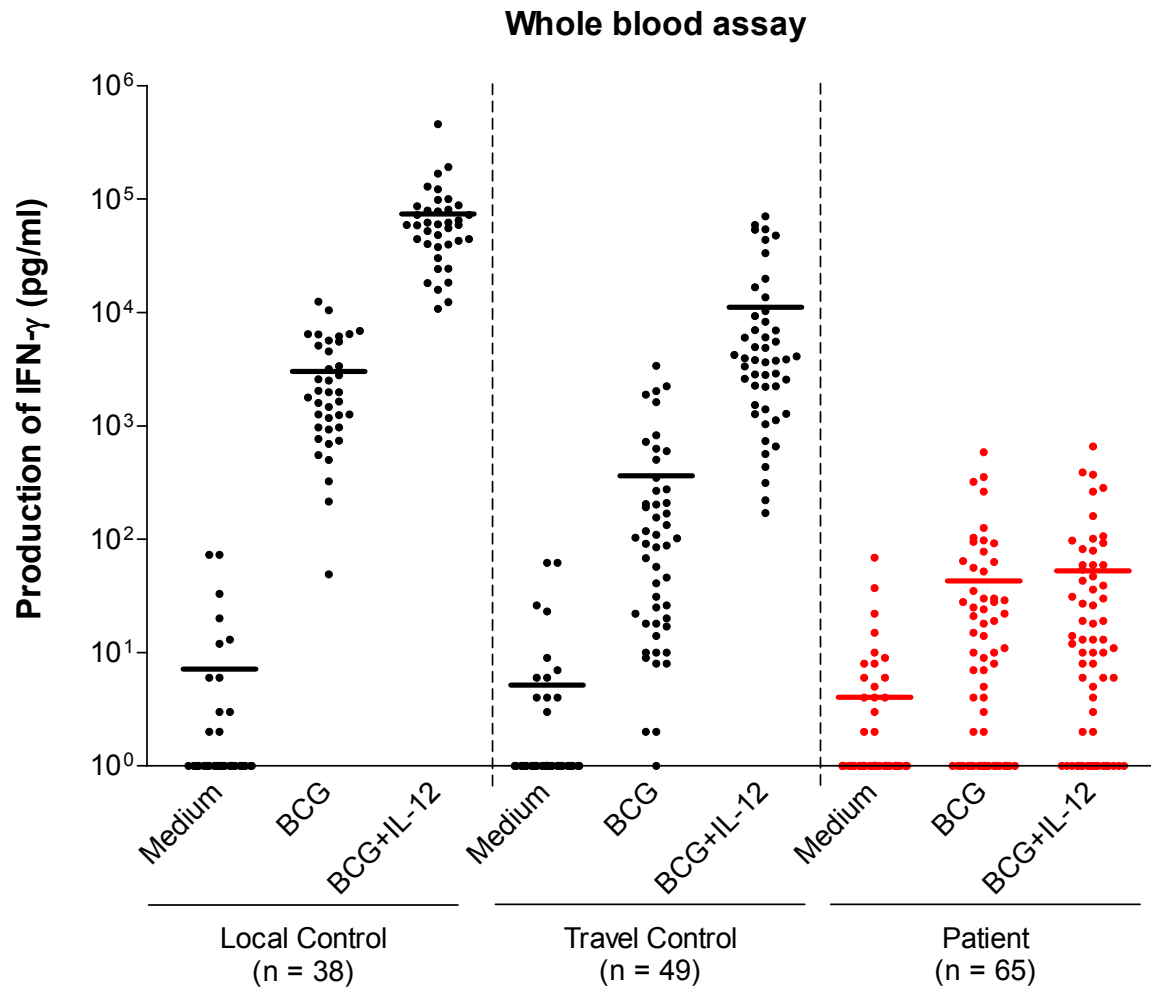

Figure 5

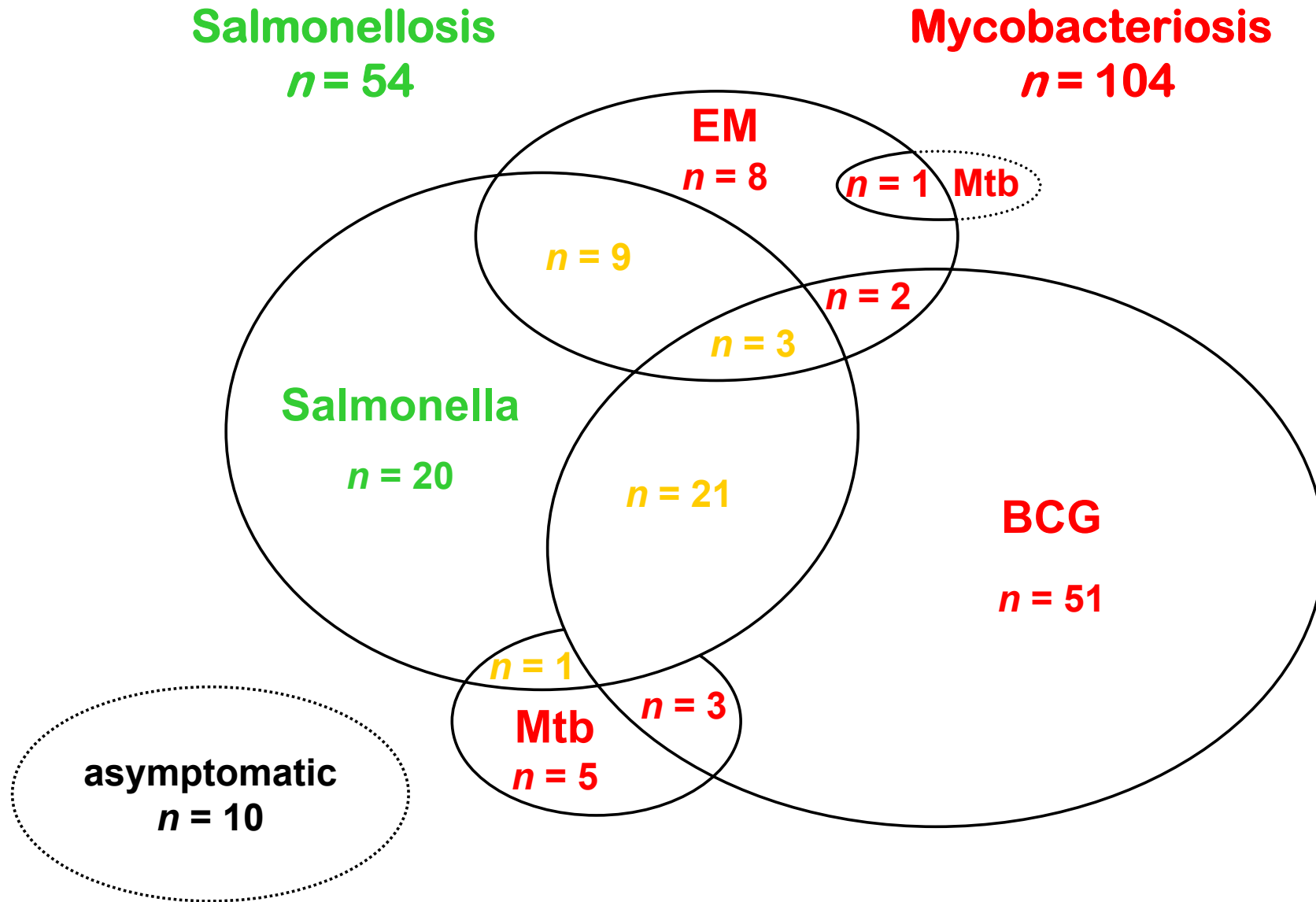

Figure 6

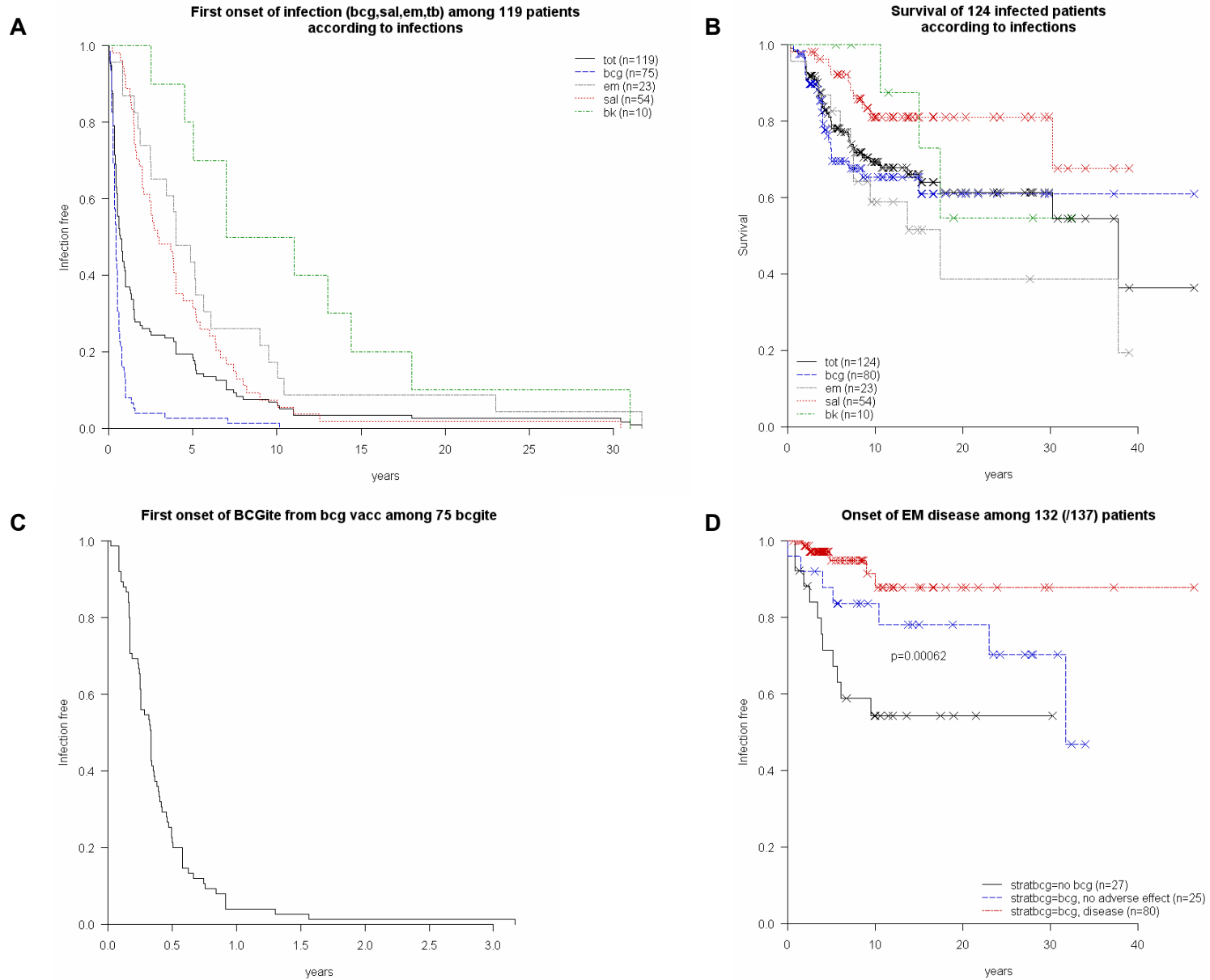
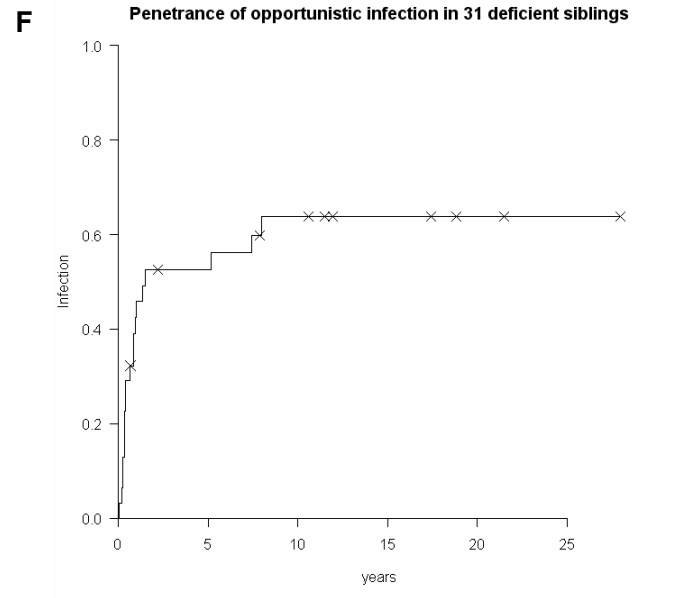
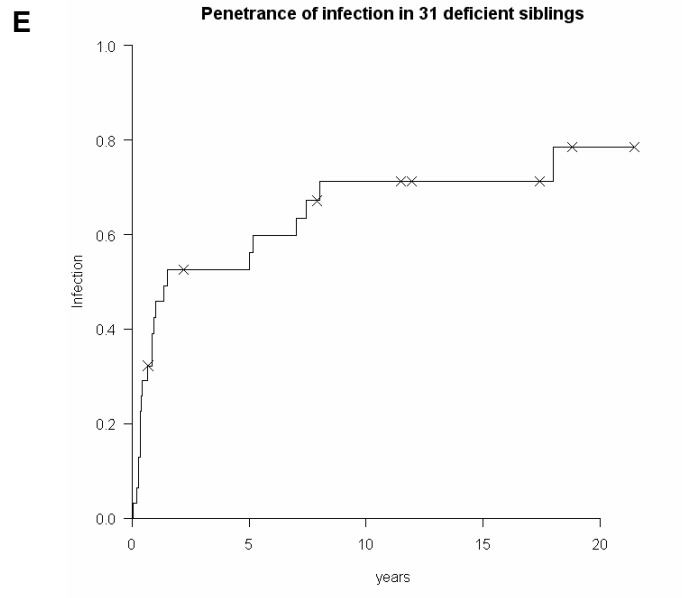

Figure 6



Supplementary figure 1

A

Repartition of clinical phenotype among IL-12RB1-deficient patients (134 / 137)

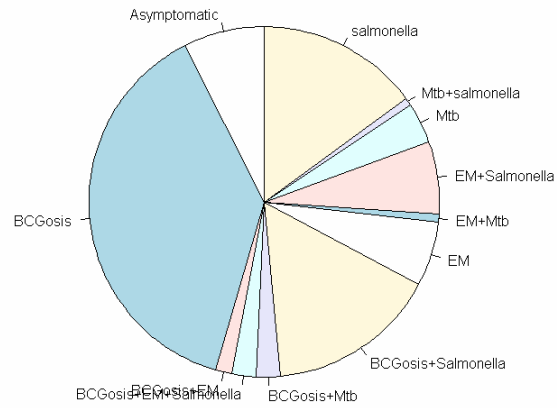

B

Repartition of salmonellosis among IL-12RB1-deficient patients (134 / 137)

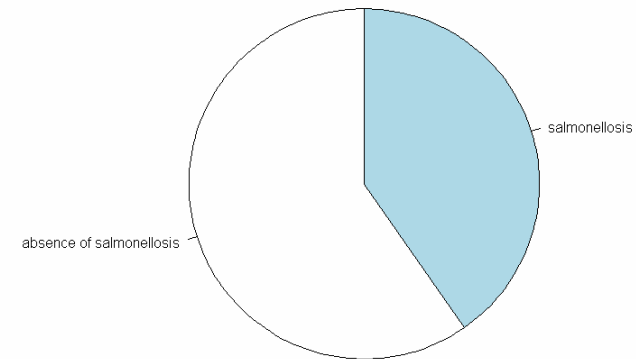

C

Repartition of mycobacteriosis among IL-12RB1-deficient patients (134 / 137)

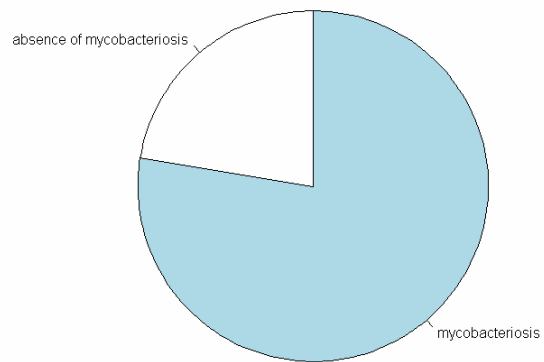

D

Repartition of BCGosis among vaccinated IL-12RB1-deficient patients (106 vaccinated / 132)

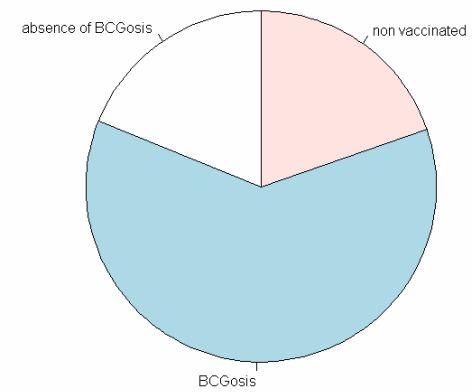

Supplementary figure 2

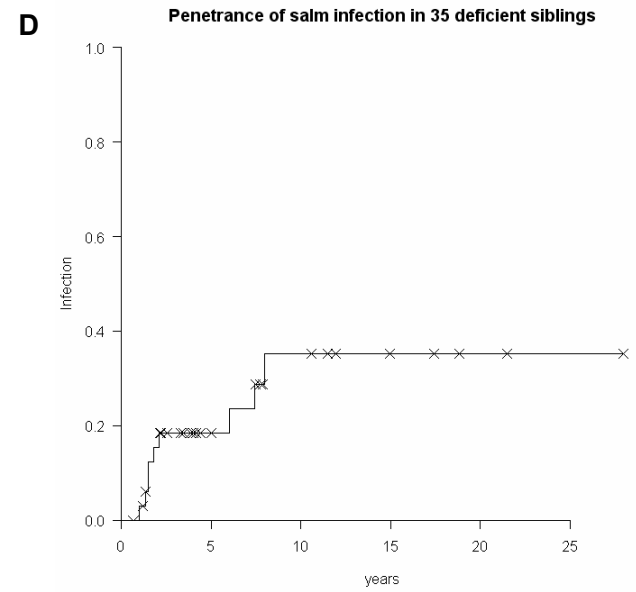
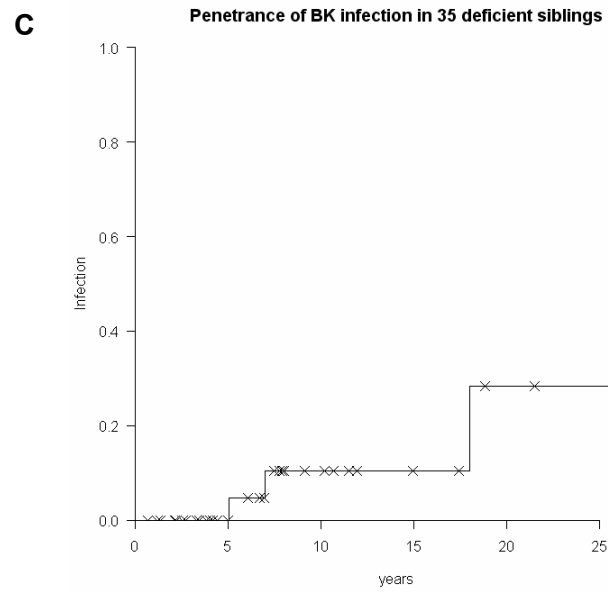
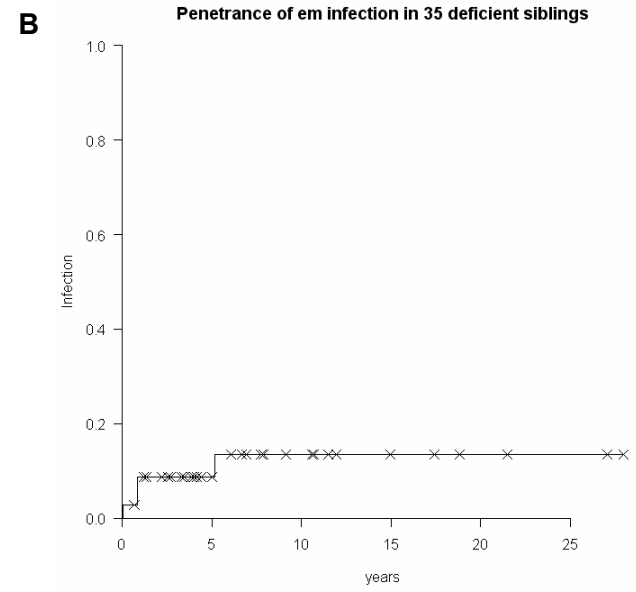
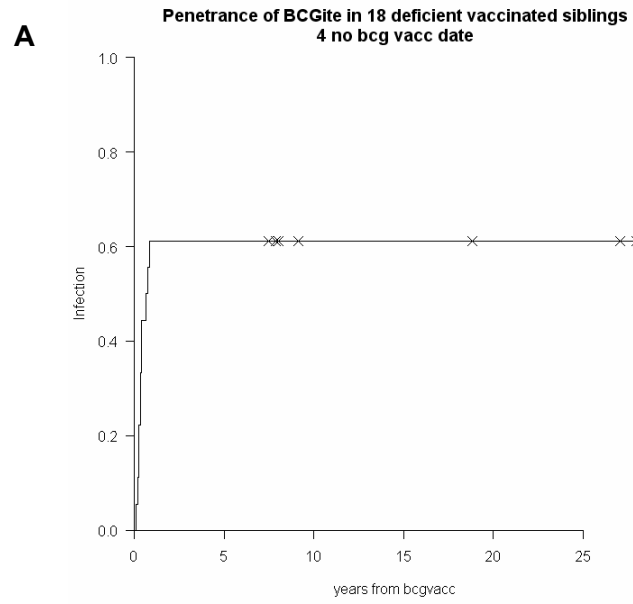

Supplementary figure 3

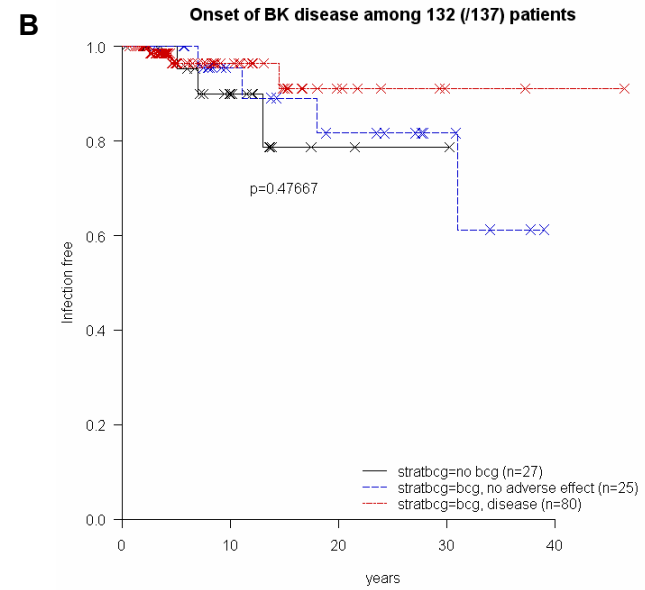
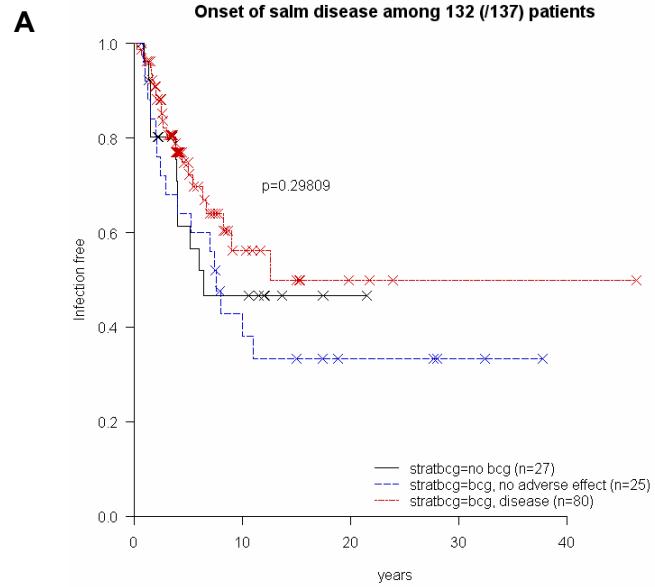

Autres articles

Case study

BCG-osis and tuberculosis in a child with chronic granulomatous disease

Jacinta Bustamante, MD, PhD,^{a,b} Guzide Aksu, MD,^c Guillaume Vogt, PhD,^{a,b}
 Ludovic de Beaucoudrey, MS,^{a,b} Ferah Genel, MD,^c Ariane Chappier, MS,^{a,b}
 Orchidée Filipe-Santos, PhD,^{a,b} Jacqueline Feinberg, PhD,^{a,b} Jean-François Emile,
 MD, PhD,^d Necil Kutukculer, MD,^c and Jean-Laurent Casanova, MD, PhD^{a,b,e}

Paris and Boulogne, France, and Bornova-Izmir, Turkey

A few known primary immunodeficiencies confer predisposition to clinical disease caused by weakly virulent mycobacteria, such as BCG vaccines (regional disease, known as BCG-itis, or disseminated disease, known as BCG-osis), or more virulent mycobacteria, such as *Mycobacterium tuberculosis* (pulmonary and disseminated tuberculosis). We investigated the clinical and genetic features of a 12-year-old boy with both recurrent BCG-osis and disseminated tuberculosis. The patient's phagocytic cells produced no O₂⁻. A hemizygous splice mutation was found in intron 5 of *CYBB*, leading to a diagnosis of X-linked chronic granulomatous disease. Chronic granulomatous disease should be suspected in all children with BCG-osis, even in the absence of nonmycobacterial infectious diseases, and in selected children with recurrent BCG-itis or severe tuberculosis. (J Allergy Clin Immunol 2007;120:32-8.)

Key words: BCG, tuberculosis, chronic granulomatous disease

The patient was born in 1994 to a nonconsanguineous Turkish family living in Turkey. He was vaccinated with *Mycobacterium bovis* BCG at birth. Three months later,

From ^athe Laboratory of Human Genetics of Infectious Diseases, Institut National de la Santé et de la Recherche Médicale U550, and ^bthe University Paris René Descartes, Necker Medical School, Paris; ^cthe Faculty of Medicine, Department of Pediatrics, Ege University, Bornova-Izmir; ^dthe Pathology Department, Institut National de la Santé et de la Recherche Médicale U602, Assistance Publique-Hopitaux de Paris Ambroise Paré Hospital, Boulogne; and ^ethe Pediatric Hematology-Immunology Unit, Necker Hospital, Paris.

J. Bustamante was supported by Fondation Schlumberger, Mycobacterial infection in neonates and infants project (NEOTIM) EEA05095KKA, and the Institut National de la Santé et de la Recherche Médicale. This work was supported by Fondation Banque Nationale de Paris-Paribas, Fondation Schlumberger, Institut Universitaire de France, European Union (EU) grant QLK2-CT-2002-00846, and NEOTIM-EU grant LSHP-CT-2005-018736. J.-L. Casanova is an International Scholar of the Howard Hughes Medical Institute.

Disclosure of potential conflict of interest: The authors have declared that they have no conflict of interest.

Received for publication January 28, 2007; revised April 12, 2007; accepted for publication April 18, 2007.

Available online June 4, 2007.

Reprint requests: Jean-Laurent Casanova, MD, PhD, Laboratory of Human Genetics of Infectious Diseases, University of Paris René Descartes-INSERM U550, Necker Medical School, 156 rue de Vaugirard, 75015 Paris, France, EU. E-mail: casanova@necker.fr.

0091-6749/\$32.00

© 2007 American Academy of Allergy, Asthma & Immunology

doi:10.1016/j.jaci.2007.04.034

Abbreviations used

CGD: Chronic granulomatous disease

EM: Environmental mycobacteria

MSMD: Mendelian susceptibility to mycobacterial diseases

NADPH: Nicotinamide dinucleotide phosphate

PMA: Phorbol 12-myristate 13-acetate

PMN: Polymorphonuclear neutrophil

TST: Tuberculin skin test

he developed progressive regional axillary lymphadenopathy. He was treated with antibiotics for 3 months with a favorable response. At the age of 13 months, the patient was admitted to the hospital with abdominal distension. Physical examination revealed ascites and hepatomegaly. A computerized tomography scan of the abdominal region was performed, which confirmed the clinical findings. Liver tissue biopsy revealed an infiltration of mononuclear cell into the portal spaces. Cultures of liver material obtained by needle biopsy, blood, and urine were negative for bacteria, fungi, and acid-fast organisms. BCG-osis was suspected, and the patient received antituberculous treatment with isoniazid, rifampin, and streptomycin for 4 months. The patient made a full clinical recovery.

At the age of 4 years, the patient presented with a high fever and cough. Gastric aspirates tested negative by culture for acid-fast bacilli, but PCR tests for *Mycobacterium tuberculosis* complex were positive. His chest x-ray showed no infiltrates in the lungs. A tuberculin skin test (TST) with purified protein derivative was strongly positive, producing a weal 23 mm × 24 mm. The medical history of the patient's family was analyzed, and no cases of tuberculosis were detected. It was not possible to discriminate between a recurrence of BCG-osis or a primary tuberculosis. The patient was prescribed isoniazid, rifampin, and pyrazinamide therapy for 9 months. He recovered fully.

At the age of 6 years, the patient underwent surgery for a hepatic cystic lesion. Liver histology showed hepatic abscess. No acid-fast bacilli were detected, and biopsy cultures for bacteria, mycobacteria, and fungi were negative. The patient received antituberculous medication

ELECTRONIC LETTER

A novel X-linked recessive form of Mendelian susceptibility to mycobacterial disease

Jacinta Bustamante, Capucine Picard, Claire Fieschi, Orchidée Filipe-Santos, Jacqueline Feinberg, Christian Perronne, Ariane Chappier, Ludovic de Beaucoudrey, Guillaume Vogt, Damien Sanlaville, Arnaud Lemainque, Jean-François Emile, Laurent Abel, Jean-Laurent Casanova

J Med Genet 2007;44:e65 (<http://www.jmedgenet.com/cgi/content/full/44/2/e65>). doi: 10.1136/jmg.2006.043406

Background: Mendelian susceptibility to mycobacterial disease (MSMD) is associated with infection caused by weakly virulent mycobacteria in otherwise healthy people. Causal germline mutations in five autosomal genes (*IFNGR1*, *IFNGR2*, *STAT1*, *IL12RB1*, *IL12B*) and one X-linked (*NEMO*) gene have been described. The gene products are physiologically related, as they are involved in interleukin 12/23-dependent, interferon γ -mediated immunity. However, no genetic aetiology has yet been identified for about half the patients with MSMD.

Methods: A large kindred was studied, including four male maternal relatives with recurrent mycobacterial disease, suggesting X-linked recessive inheritance. Three patients had recurrent disease caused by the bacille Calmette–Guérin vaccine, and the fourth had recurrent tuberculosis. The infections showed tropism for the peripheral lymph nodes.

Results: Known autosomal and X-linked genetic aetiologies of MSMD were excluded through genetic and immunological investigations. Genetic linkage analysis of the X-chromosome identified two candidate regions, on Xp11.4–Xp21.2 and Xq25–Xq26.3, with a maximum LOD score of 2.

Conclusion: A new X-linked recessive form of MSMD is reported, paving the way for the identification of a new MSMD-causing gene.

Mendelian susceptibility to mycobacterial disease (MSMD, MIM 209950) is a rare syndrome^{1,2} involving predisposition to clinical disease caused by poorly virulent mycobacterial species, such as bacille Calmette–Guérin (BCG) vaccines^{3,4} and non-tuberculous, environmental mycobacteria.⁵ The patients are also vulnerable to the more virulent *Mycobacterium tuberculosis*.^{6–11} Typically, patients are not particularly prone to other infections, except salmonellosis, which affects less than half the cases. MSMD is clinically heterogeneous, and outcome is correlated with the type of histological lesions present.¹² It was initially believed that MSMD was inherited as an autosomal recessive trait as a rule,^{3–5}

until X-linked recessive inheritance patterns were reported in one multiplex kindred.^{13,14}

Five disease-causing autosomal genes (*IFNGR1*, *IFNGR2*, *STAT1*, *IL12RB1* and *IL12B*) have been found.^{2,15} *IFNGR1* and *IFNGR2* encode the interferon (IFN) γ R1 and IFN γ R2 chains of the receptor for IFN γ , a pleiotropic cytokine secreted by natural killer and T lymphocyte cells. *STAT1* encodes signal transducer and activator of transcription 1 (Stat 1), an essential molecule in the IFN γ R signalling pathway. *IL12B* encodes the p40 subunit of interleukin (IL) 12 and IL23, two cytokines secreted by macrophages and dendritic cells. Finally, *IL12RB1* encodes the β 1 chain shared by the receptors for IL12 and IL23, expressed in natural killer and T cells. Mutations in *IFNGR1*, *IFNGR2* and *STAT1* impair cellular responses to IFN γ , and mutations in *IL12B* and *IL12RB1* impair the production of IFN γ . The five MSMD-causing autosomal genes are thus immunologically related. A high degree of allelic heterogeneity at these five loci accounts for the existence of at least 12 known distinct genetic disorders including autosomal dominant *IFNGR1* deficiency.^{2,15–19}

Familial X-linked recessive MSMD was clinically described in 1994.^{13,21} Four males in two generations of a non-consanguineous family developed disseminated mycobacterial complex infection.^{20,21} The patients' monocytes showed impaired IL12 production on phytohaemagglutinin (PHA) activation, even though their T cells were intrinsically able to produce IFN γ on stimulation by control monocytes.¹³ Together with S M Holland, we recently identified the molecular genetic basis of XR-MSMD in this American kindred and in two other unrelated families from France and Germany.¹⁴ Surprisingly, specific mutations affecting the leucine zipper domain (LZD) of nuclear factor- κ B essential modulator (NEMO)^{22–26} were found in the three kindreds. We describe here a large French kindred with a new X-linked recessive form of MSMD (XR-MSMD).

Case reports and family data

Figure 1 shows the pedigree. All members of the kindred live in France and are of French descent. Informed consent was obtained from all the family members (fig 1A).

Patient 1 (P1, III-4) was born in 1953 and was not vaccinated with BCG in infancy. He remained healthy until the age of 10 years, at which time he presented with symptomatic primary tuberculosis of the lungs, with a positive tuberculosis skin test (Mantoux skin test) indicating delayed-type hypersensitivity to tuberculous purified protein derivative. He was treated with isoniazid for 12 months and recovered. At 34 years of age, he

Key points

- Mendelian susceptibility to mycobacterial disease (MSMD) is characterised by clinical disorders caused by poorly virulent mycobacteria in otherwise healthy people.
- Mutations in *NEMO* leucine zipper domain are associated with X-linked recessive MSMD.
- We have reported a novel form of X-linked recessive-MSMD.

Abbreviations: BCG, bacille Calmette–Guérin; EBV, Epstein–Barr virus; IFN, interferon; LOD, logarithm of odds; LZD, leucine zipper domain; MSMD, Mendelian susceptibility to mycobacterial disease; NEMO, nuclear factor- κ B essential modulator; PBMC, peripheral blood mononuclear cells; Stat 1, signal transducer and activator of transcription 1; XR-MSMD, X-linked recessive MSMD

Novel *STAT1* Alleles in Otherwise Healthy Patients with Mycobacterial Disease

Ariane Chappier¹, Stéphanie Boisson-Dupuis¹, Emmanuelle Jouanguy^{1,2}, Guillaume Vogt¹, Jacqueline Feinberg¹, Ada Prochnicka-Chalufour³, Armanda Casrouge¹, Kun Yang^{1,2}, Claire Soudais¹, Claire Fieschi^{1,4}, Orchidée Filipe Santos¹, Jacinta Bustamante¹, Capucine Picard^{1,5}, Ludovic de Beaucoudrey¹, Jean-François Emile⁶, Peter D. Arkwright⁷, Robert D. Schreiber⁸, Claudia Rolinck-Werninghaus⁹, Angela Rösen-Wolff¹⁰, Klaus Magdorf⁹, Joachim Roesler¹⁰, Jean-Laurent Casanova^{1,2,11*}

1 Laboratory of Human Genetics of Infectious Diseases, University of Paris René Descartes, INSERM U550, Necker Medical School, Paris, France, European Union, **2** French-Chinese Laboratory of Genetics, Ruijin Hospital, Shanghai II University, Shanghai, People's Republic of China, **3** Laboratory of MNR of Biomolecules, CNRS URA2185, Pasteur Institute, Paris, France, European Union, **4** Service of Clinical Immunology, Saint Louis Hospital, Paris, France, European Union, **5** Center for the Study of Immunodeficiencies, Necker Hospital, Paris, France, European Union, **6** Department of Pathology, Ambroise Paré Hospital, Boulogne, France, European Union, **7** University of Manchester, Manchester, United Kingdom, **8** Department of Pathology and Immunology, Washington University, Saint Louis, Missouri, United States of America, **9** Department of Pediatric Pneumology and Immunology, Charité, Humboldt University of Berlin, Berlin, Germany, **10** Department of Pediatrics, University Clinic Carl Gustav Carus, Dresden, Germany, **11** Pediatric Immunology Hematology Unit, Necker Hospital, Paris, France, European Union

The transcription factor signal transducer and activator of transcription-1 (STAT1) plays a key role in immunity against mycobacterial and viral infections. Here, we characterize three human *STAT1* germline alleles from otherwise healthy patients with mycobacterial disease. The previously reported L706S, like the novel Q463H and E320Q alleles, are intrinsically deleterious for both interferon gamma (IFNG)-induced gamma-activating factor-mediated immunity and interferon alpha (IFNA)-induced interferon-stimulated genes factor 3-mediated immunity, as shown in *STAT1*-deficient cells transfected with the corresponding alleles. Their phenotypic effects are however mediated by different molecular mechanisms, L706S affecting *STAT1* phosphorylation and Q463H and E320Q affecting *STAT1* DNA-binding activity. Heterozygous patients display specifically impaired IFNG-induced gamma-activating factor-mediated immunity, resulting in susceptibility to mycobacteria. Indeed, IFNA-induced interferon-stimulated genes factor 3-mediated immunity is not affected, and these patients are not particularly susceptible to viral disease, unlike patients homozygous for other, equally deleterious *STAT1* mutations recessive for both phenotypes. The three *STAT1* alleles are therefore dominant for IFNG-mediated antimycobacterial immunity but recessive for IFNA-mediated antiviral immunity at the cellular and clinical levels. These *STAT1* alleles define two forms of dominant *STAT1* deficiency, depending on whether the mutations impair *STAT1* phosphorylation or DNA binding.

Citation: Chappier A, Boisson-Dupuis S, Jouanguy E, Vogt G, Feinberg J, et al. (2006) Novel *STAT1* alleles in otherwise healthy patients with mycobacterial disease. *PLoS Genet* 2(8): e131. DOI: 10.1371/journal.pgen.0020131

Introduction

Mendelian susceptibility to mycobacterial disease (MSMD) is characterized by the occurrence of clinical disease caused by weakly virulent mycobacteria in otherwise healthy individuals (reviewed in [1,2]). This syndrome covers a broad range of clinical phenotypes, reflecting the diversity of environmental and host factors involved, notably the underlying genetic lesions. The five genes known to cause this syndrome are involved in IL12/23-dependent interferon gamma (IFNG)-mediated immunity. Two genes control the production of IFNG: *IL12B*, encoding the p40 subunit of IL12 and IL23, and *IL12RB1*, encoding the β_1 chain of the IL12 and IL23 receptors (IL12RB1). Three genes control the response to IFNG: *IFNGR1* and *IFNGR2*, encoding the IFNG receptor (IFNGR) chains, and *STAT1*, encoding the signal transducer and activator of transcription-1 (STAT1). Allelic heterogeneity results in a total of 11 inherited disorders (Table 1): recessive complete IL12p40 [3,4] and IL12RB1 deficiency with [5] or without [6–8] surface-expressed receptors, recessive complete IFNGR1 deficiency with [9] or without [10,11] surface-expressed receptors, dominant [12] or recessive [13] partial IFNGR1 deficiency, recessive complete IFNGR2 deficiency with [14] or without [15] surface-expressed

receptors, recessive partial IFNGR2 deficiency [16], and dominant partial *STAT1* deficiency [17]. Complete IFNGR1 and IFNGR2 deficiencies run a more severe clinical course than the other defects, which are associated with residual IFNG-mediated immunity [1,2,18,19].

The binding of homodimeric IFNG to its tetrameric receptor leads to the activation of constitutively associated

Editor: Veronica van Heyningen, MRC Human Genetics Unit, United Kingdom

Received: April 19, 2006; **Accepted:** July 5, 2006; **Published:** August 18, 2006

DOI: 10.1371/journal.pgen.0020131

Copyright: © 2006 Chappier et al. This is an open-access article distributed under the terms of the Creative Commons Attribution License, which permits unrestricted use, distribution, and reproduction in any medium, provided the original author and source are credited.

Abbreviations: BCG, bacille Calmette-Guérin; EBV, Epstein-Barr virus; EMSA, electrophoretic mobility shift assay; GAF, gamma-activating factor; GAS, gamma-activating sequence; HSV, herpes simplex virus; IFNA, interferon alpha; IFNG, interferon gamma; ISGF3, interferon-stimulated genes factor 3; ISRE, IFNA sequence response element; JAK, Janus kinase; MSMD, Mendelian susceptibility to mycobacterial disease; *STAT1*, signal transducer and activator of transcription-1; SV40, simian virus 40; VSV, vesicular stomatitis virus; WT, wild-type

* To whom correspondence should be addressed. E-mail: casanova@necker.fr

© These authors contributed equally to this work.

X-linked susceptibility to mycobacteria is caused by mutations in NEMO impairing CD40-dependent IL-12 production

Orchidée Filipe-Santos,¹ Jacinta Bustamante,¹ Margje H. Haverkamp,^{10,12} Emilie Vinolo,² Cheng-Lung Ku,¹ Anne Puel,¹ David M. Frucht,¹¹ Karin Christel,¹ Horst von Bernuth,¹ Emmanuelle Jouanguy,¹ Jacqueline Feinberg,¹ Anne Durandy,³ Brigitte Senechal,⁹ Ariane Chapgier,¹ Guillaume Vogt,¹ Ludovic de Beaucoudrey,¹ Claire Fieschi,^{1,13} Capucine Picard,^{1,4} Meriem Garfa,⁵ Jalel Chemli,¹⁴ Mohamed Bejaoui,¹⁵ Maria N. Tsolia,¹⁷ Necil Kutukculer,¹⁸ Alessandro Plebani,¹⁹ Luigi Notarangelo,¹⁹ Christine Bodemer,⁶ Frédéric Geissmann,⁹ Alain Israël,⁸ Michel Véron,² Maike Knackstedt,²⁰ Ridha Barbouche,¹⁶ Laurent Abel,¹ Klaus Magdorf,²⁰ Dominique Gendrel,²¹ Fabrice Agou,² Steven M. Holland,¹⁰ and Jean-Laurent Casanova^{1,7}

¹Laboratory of Human Genetics of Infectious Diseases, University of Paris René Descartes–Institut National de la Santé et de la Recherche Médicale (INSERM) U 550, Necker Medical School; ²Laboratory of Enzymatic Regulation of Cellular Activities, URA 2185 Centre National de la Recherche Scientifique (CNRS), Pasteur Institute; ³Laboratory of Normal and Pathologic Development of the Immune System, INSERM U768, ⁴Center for the Study of Primary Immunodeficiencies, ⁵Laboratory of Confocal Microscopy, ⁶Dermatology Unit, and ⁷Pediatric Hematology–Immunology Unit, Necker Hospital; ⁸Laboratory of Molecular Signaling and Cellular Activation, URA 2582 CNRS, Pasteur Institute; and ⁹INSERM, Laboratory of Mononuclear Phagocyte Biology, Avenir Team, Necker Enfants Malades Institute, 75015 Paris, France
¹⁰Laboratory of Clinical Infectious Diseases, National Institutes of Health and ¹¹Laboratory of Cell Biology, Division of Monoclonal Antibodies, Center for Drug Evaluation and Research, Food and Drug Administration, Bethesda, MD 20892
¹²Department of Infectious Diseases, Leiden University Medical Center, 2300 Leiden, Netherlands
¹³Laboratory of Immunology, Saint Louis Hospital, 75010 Paris, France
¹⁴Department of Pediatrics, Sahloul Hospital, 4054 Sousse, Tunisia
¹⁵National Center for Bone Marrow Transplantation and ¹⁶Department of Immunology, Pasteur Institute, 1002 Tunis, Tunisia
¹⁷Second Department of Pediatrics, University of Athens School of Medicine, P. and A. Kyriakou Children's Hospital, 115 27 Athens, Greece
¹⁸Department of Pediatrics, Ege University, 35100 Izmir, Turkey
¹⁹Department of Pediatrics and Institute for Molecular Medicine Angello Nocivelli, University of Brescia, 25121 Brescia, Italy
²⁰Department of Pediatric Pulmonology and Immunology, Charité, Campus Virchow Klinikum, 13353 Berlin, Germany
²¹Department of Pediatrics, St. Vincent de Paul Hospital, 75014 Paris, France

Germline mutations in five autosomal genes involved in interleukin (IL)–12–dependent, interferon (IFN)– γ –mediated immunity cause Mendelian susceptibility to mycobacterial diseases (MSMD). The molecular basis of X-linked recessive (XR)–MSMD remains unknown. We report here mutations in the leucine zipper (LZ) domain of the NF– κ B essential modulator (NEMO) gene in three unrelated kindreds with XR–MSMD. The mutant proteins were produced in normal amounts in blood and fibroblastic cells. However, the patients' monocytes presented an intrinsic defect in T cell–dependent IL–12 production, resulting in defective IFN– γ secretion by T cells. IL–12 production was also impaired as the result of a specific defect in NEMO– and NF– κ B/c–Rel–mediated CD40 signaling after the stimulation of monocytes and dendritic cells by CD40L–expressing T cells and fibroblasts, respectively. However, the CD40–dependent up–regulation of costimulatory molecules of dendritic cells and the proliferation and immunoglobulin class switch of B cells were normal. Moreover, the patients' blood and fibroblastic cells responded to other NF– κ B activators, such as tumor necrosis factor– α , IL–1 β , and lipopolysaccharide. These two mutations in the NEMO LZ domain provide the first genetic etiology of XR–MSMD. They also demonstrate the importance of the T cell– and CD40L–triggered, CD40–, and NEMO/NF– κ B/c–Rel–mediated induction of IL–12 by monocyte–derived cells for protective immunity to mycobacteria in humans.

CORRESPONDENCE

Jean-Laurent Casanova:
casanova@necker.fr

Abbreviations used: EM, environmental mycobacteria; LZ, leucine zipper; MDDC, monocyte–derived dendritic cell; MSMD, Mendelian susceptibility to mycobacterial diseases; NEMO, NF– κ B essential modulator; XR, X-linked recessive.

O. Filipe-Santos and J. Bustamante contributed equally to this work.
S.M. Holland and J.-L. Casanova contributed equally to this work.

The *NEMO* Mutation Creating the Most-Upstream Premature Stop Codon Is Hypomorphic Because of a Reinitiation of Translation

Anne Puel,^{1,*} Janine Reichenbach,^{1,*†} Jacinta Bustamante,¹ Cheng-Lung Ku,¹ Jacqueline Feinberg,¹ Rainer Döffinger,^{1,‡} Marion Bonnet,^{1,§} Orchidée Filipe-Santos,¹ Ludovic de Beaucoudrey,¹ Anne Durandy,² Gerd Horneff,^{6,||} Francesco Novelli,^{1,¶} Volker Wahn,^{6,#} Asma Smahi,³ Alain Israel,⁵ Tim Niehues,⁶ and Jean-Laurent Casanova^{1,4}

¹Laboratoire de Génétique Humaine des Maladies Infectieuses, INSERM U550, Faculté de Médecine Necker-Enfants Malades, ²Développement Normal et Pathologique du Système Immunitaire, INSERM U429, ³Unité de Recherches sur les Handicaps Génétiques de l'Enfant, INSERM U393, and ⁴Unité d'Immunologie et d'Hématologie Pédiatriques, Hôpital Necker-Enfants Malades, and ⁵Unité de Signalisation Moléculaire et Activation Cellulaire, URA 2582 Centre National de la Recherche Scientifique, Institut Pasteur, Paris; and ⁶Pädiatrische Immunologie und Rheumatologie, Zentrum für Kinderheilkunde, Heinrich Heine Universität, Düsseldorf, Germany

Amorphic mutations in the NF- κ B essential modulator (*NEMO*) cause X-dominant incontinentia pigmenti, which is lethal in males in utero, whereas hypomorphic mutations cause X-recessive anhidrotic ectodermal dysplasia with immunodeficiency, a complex developmental disorder and life-threatening primary immunodeficiency. We characterized the *NEMO* mutation *110_111insC*, which creates the most-upstream premature translation termination codon (at codon position 49) of any known *NEMO* mutation. Surprisingly, this mutation is associated with a pure immunodeficiency. We solve this paradox by showing that a Kozakian methionine codon located immediately downstream from the insertion allows the reinitiation of translation. The residual production of an NH₂-truncated *NEMO* protein was sufficient for normal fetal development and for the subsequent normal development of skin appendages but was insufficient for the development of protective immune responses.

The human *IKBKG* locus is located on chromosome Xq28 and encodes *NEMO*. Amorphic *NEMO* mutations are associated with a complete lack of NF- κ B activation via the classical pathway. They are responsible for incontinentia pigmenti (IP), an X-linked dominant disorder that is lethal in hemizygous males in utero and is characterized by abnormalities in ectoderm-derived tissues, including the skin, eyes, CNS, and teeth, in heterozygous females. About 85% of patients with IP who have *NEMO* mutations carry a complex rearrangement of the *NEMO* gene that results in a frameshift deletion

of exons 4–10 and encodes a putative truncated protein consisting of the first 133 N-terminal amino acids. A number of other IP-causing mutations have been identified in exons 2–10, including mutations associated with premature stop codons (Smahi et al. 2000; Aradhya et al. 2001*b*; Fusco et al. 2004). Blood leukocytes and fibroblasts expressing the mutated X-chromosome are selectively eliminated around the time of birth, leading to skewed X-inactivation in female carriers (Parrish et al. 1996).

Other *NEMO* mutations are hypomorphic, since they

Received October 3, 2005; accepted for publication January 13, 2006; electronically published February 15, 2006.

Address for correspondence and reprints: Dr. Jean-Laurent Casanova, Laboratoire de Génétique Humaine des Maladies Infectieuses, Université de Paris René Descartes-INSERM U550, Faculté de Médecine Necker-Enfants Malades, 156 Rue de Vaugirard, 75015 Paris, France. E-mail: casanova@necker.fr

* Both of these authors contributed equally to this work.

† Present affiliation: Zentrum der Kinderheilkunde und Jugendmedizin, Klinikum der Johann Wolfgang Goethe-Universität, Frankfurt, Germany.

‡ Present affiliation: Department of Clinical Biochemistry and Immunology, Addenbrookes Hospital, Cambridge, United Kingdom.

§ Present affiliation: Department of Pathology, New York University School of Medicine, New York.

|| Present affiliation: Department of Pediatrics, Asklepios Clinic Sankt Augustin, Sankt Augustin, Germany.

¶ Present affiliation: Centro Oncologico Ematologico Subalpino, Centro Ricerche Medicina Sperimentale, Ospedale San Giovanni Battista, Torino, Italy.

Present affiliation: Immunodeficiency Center of the Charité, Department of Pediatric Pulmonology and Immunology, Humboldt University, Berlin.

Am. J. Hum. Genet. 2006;78:691–701. © 2006 by The American Society of Human Genetics. All rights reserved. 0002-9297/2006/7804-0015\$15.00

Gains of glycosylation comprise an unexpectedly large group of pathogenic mutations

Guillaume Vogt¹, Ariane Chapgier¹, Kun Yang^{1,2}, Nadia Chuzhanova^{3,4}, Jacqueline Feinberg¹, Claire Fieschi^{1,5}, Stéphanie Boisson-Dupuis¹, Alexandre Alcais¹, Orchidée Filipe-Santos¹, Jacinta Bustamante¹, Ludovic de Beaucoudrey¹, Ibrahim Al-Mohsen⁶, Sami Al-Hajjar⁶, Abdulaziz Al-Ghoniaim⁶, Parisa Adimi⁷, Mehdi Mirsaiedi⁷, Soheila Khalilzadeh⁷, Sergio Rosenzweig^{8,17}, Oscar de la Calle Martin⁹, Thomas R Bauer¹⁰, Jennifer M Puck¹¹, Hans D Ochs¹², Dieter Furthner¹³, Carolin Engelhorn¹⁴, Bernd Belohradsky¹⁴, Davood Mansouri⁷, Steven M Holland⁸, Robert D Schreiber¹⁵, Laurent Abel¹, David N Cooper⁴, Claire Soudais¹ & Jean-Laurent Casanova^{1,2,16}

Mutations involving gains of glycosylation have been considered rare, and the pathogenic role of the new carbohydrate chains has never been formally established. We identified three children with mendelian susceptibility to mycobacterial disease who were homozygous with respect to a missense mutation in *IFNGR2* creating a new N-glycosylation site in the IFN γ R2 chain. The resulting additional carbohydrate moiety was both necessary and sufficient to abolish the cellular response to IFN γ . We then searched the Human Gene Mutation Database for potential gain-of-N-glycosylation missense mutations; of 10,047 mutations in 577 genes encoding proteins trafficked through the secretory pathway, we identified 142 candidate mutations (~1.4%) in 77 genes (~13.3%). Six mutant proteins bore new N-linked carbohydrate moieties. Thus, an unexpectedly high proportion of mutations that cause human genetic disease might lead to the creation of new N-glycosylation sites. Their pathogenic effects may be a direct consequence of the addition of N-linked carbohydrate.

Mendelian susceptibility to mycobacterial disease (MSMD; OMIM 209950) is a rare syndrome that confers predisposition to illness caused by moderately virulent mycobacterial species, such as *Bacillus Calmette-Guérin* (BCG) vaccines and nontuberculous environmental mycobacteria, and by the more virulent *Mycobacterium tuberculosis*¹. Other types of microorganism rarely cause severe clinical disease in individuals with MSMD, with the exception of *Salmonella*, which infects <50% of these individuals. The demonstration that this condition was associated in some affected individuals with deficiency of interferon γ receptor ligand-binding chain (IFN γ R1) provided the first evidence for a genetic etiology^{2,3}. Subsequent studies identified mutations in the genes encoding IFN γ R2 (ref. 4), the interleukin-12 p40 (IL-12p40) subunit shared by IL-12 and IL-23 (ref. 5), the IL-12R β 1 subunit shared by the IL-12 and IL-23 receptors^{6,7}, and the signal transducer and activator of transcription-1 (Stat-1)⁸. Allelic

heterogeneity at these five disease-associated autosomal gene loci is responsible for ten known disorders, all of which involve impaired function of the IL-12/23-IFN γ circuit⁹⁻¹⁵. Complete Stat-1 deficiency is associated with a related but more severe syndrome of vulnerability to mycobacterial and viral infections due to an impaired cellular response to both IFN γ and IFN α/β ¹⁶.

IFN γ R2 deficiency is the most infrequent of the inherited forms of MSMD: only three children with MSMD have been reported, two with complete IFN γ R2 deficiency^{4,17} and one with partial IFN γ R2 deficiency¹⁴. By contrast, 22 individuals are known to have complete IFN γ R1 deficiency, and 38 are known to have partial IFN γ R1 deficiency¹⁵. Here we report four children with complete IFN γ R2 deficiency, from three unrelated families. One of these children has an in-frame microdeletion in the gene *IFNGR2* such that the encoded protein does not reach the cell surface normally. The other three

¹Laboratory of Human Genetics of Infectious Diseases, University of Paris René Descartes INSERM U550, Necker Medical School, 156 rue de Vaugirard, 75015 Paris, France. ²French-Chinese Laboratory of Genomics and Life Sciences, Ruijin Hospital, Shanghai Second Medical University, Shanghai, China. ³Biostatistics and Bioinformatics Unit and ⁴Institute of Medical Genetics, Cardiff University, Cardiff CF14 4XN, UK. ⁵Department of Immunopathology, Saint Louis Hospital, 75010 Paris, France. ⁶Pediatric Infectious Diseases and Immunology Units, Department of Pediatrics, King Faisal Specialist Hospital & Research Centre, Riyadh, Saudi Arabia. ⁷National Research Institute of Tuberculosis and Lung Diseases, Shaheed Beheshti University of Medical Sciences, Dar-Abad, 19556 Tehran, Iran. ⁸Laboratory of Clinical Infectious Diseases, National Institutes of Health, Bethesda, Maryland 20892, USA. ⁹Service of Immunology, Hospital de la Santa Creu i Sant Pau, Barcelona, Spain. ¹⁰National Cancer Institute and ¹¹National Human Genome Research Institute, National Institutes of Health, Bethesda, Maryland 20892, USA. ¹²Department of Pediatrics, University of Washington, Seattle, Washington 98109, USA. ¹³Department of Pediatrics, Klinikum Wels, 4600 Wels, Austria. ¹⁴Department of Pediatrics, Hospital for Sick Children, 80337 München, Germany. ¹⁵Department of Pathology and Immunology, Washington University, Saint Louis, Missouri 63110, USA. ¹⁶Pediatric Immunology & Hematology Unit, Necker Hospital, 75015 Paris, France. ¹⁷Present address: Servicio de Inmunología, Hospital Garrahan, Buenos Aires, Argentina. Correspondence should be addressed to J.-L.C. (casanova@necker.fr).