



HAL
open science

Impacts environnementaux de l'industrialisation et du commerce international en Chine : cas de l'émission industrielle de SO₂

Jie He

► **To cite this version:**

Jie He. Impacts environnementaux de l'industrialisation et du commerce international en Chine : cas de l'émission industrielle de SO₂. Economies et finances. Université d'Auvergne - Clermont-Ferrand I, 2005. Français. NNT : . hal-00015396

HAL Id: hal-00015396

<https://theses.hal.science/hal-00015396>

Submitted on 8 Dec 2006

HAL is a multi-disciplinary open access archive for the deposit and dissemination of scientific research documents, whether they are published or not. The documents may come from teaching and research institutions in France or abroad, or from public or private research centers.

L'archive ouverte pluridisciplinaire **HAL**, est destinée au dépôt et à la diffusion de documents scientifiques de niveau recherche, publiés ou non, émanant des établissements d'enseignement et de recherche français ou étrangers, des laboratoires publics ou privés.

Université d'Auvergne Clermont 1
Faculté des Sciences Economiques et de Gestion
Centre d'Etudes et de Recherches sur le Développement International (CERDI)
Institut de Recherches sur l'Economie Chinoise (IDREC)

**THE IMPACTS OF INDUSTRIALIZATION AND INTERNATIONAL
TRADE ON CHINA'S ENVIRONMENT:
THE CASE OF INDUSTRIAL SO₂ EMISSION**

Thèse pour le Doctorat en Sciences Economiques
Présentée et soutenue publiquement le 24 novembre 2005

par

JIE HE

Membres du jury :

M. Jaime de Melo (Rapporteur)

Professeur à l'Université de Genève

M. Patrick Guillaumont (Directeur de thèse)

Professeur à l'Université d'Auvergne
Clermont 1, CERDI

M. Alain de Janvry (Directeur de thèse)

Professeur à l'Université de Californie à
Berkeley

L'Université d'Auvergne Clermont 1 n'entend donner aucune approbation ni improbation aux opinions émises dans les thèses. Ces opinions doivent être considérées comme propres à leurs auteurs.

Table of Content

ACKNOWLEDGEMENT	9
INTRODUCTION.....	11
0.1. Limits in traditional economic analysis and its extension and development since 1960s	11
0.2. Internalization of market failure caused by environmental externality, new concept of equity: the development in environmental economics	14
0.3. Sustainable development, globalization and developing countries	16
0.4. Topic and structure of this dissertation.....	20
CHAPTER 1. EVOLUTION OF CHINA’S ECONOMIC AND ENVIRONMENTAL SITUATION SINCE ECONOMIC REFORM	23
1.1. China’s economic reform success	23
1.2. Evolution in China’s environmental situation during economic reform years.....	27
1.3. Potential cost of pollution for Chinese economy	30
1.4. China’s Green GDP.....	33
PART 1. ENVIRONMENT AND ECONOMIC GROWTH: RE-ESTIMATE THE ENVIRONMENTAL KUZNETS CURVE IN CHINA’S CASE	35
CHAPTER 2. IS THE HYPOTHESIS OF THE ENVIRONMENTAL KUZNETS CURVE CONFIRMED IN CHINA’S CASE?.....	37
2.1 The idea and the genesis of the hypothesis of “Environmental Kuznets Curve”	37
2.2 Different policy interpretation on the EKC hypothesis.....	38
2.3 A simple review and comparison on the existing EKC empirical analysis.....	40
2.4 Country-specific EKC analyses: Is it really necessary for the developing countries to follow the EKC obtained from international experience?	57
2.5 EKC revisit on China’s industrial SO ₂ emission case.....	61
2.6 Conclusion.....	75
CHAPTER 3 STRUCTURAL DETERMINANTS OF INDUSTRIAL SO ₂ EMISSION.....	77
3.1. Structural explanation for the existence of EKC—demask the “black-box”	77
3.2. Review of China’s economic growth and industrialisation process and their impact on emission: one introduction descriptive	84
3.3. Economic determinants for industrial SO ₂ emission density—a structural model and the decomposition step	91
3.4. Conclusion.....	101
CHAPTER 4. ANOTHER DECOMPOSITION ANALYSIS ON SCALE, COMPOSITION AND TECHNIQUE EFFECT BASED ON DIVISIA INDEX DECOMPOSITION METHOD: A NON-PARAMETRIC METHOD.....	103
4.1. Literature review on the existing decomposition analyses.....	103
4.2. A simple introduction on the Divisia index decomposition method.....	105
4.3. Divisia index decomposition analysis adapted to China’s provincial level data ...	109
4.4. Conclusion.....	123
PART 2. INTERNATIONAL TRADE AND ITS IMPACT ON INDUSTRIAL SO₂ EMISSION IN CHINA	125
CHAPTER 5. ENVIRONMENTAL IMPACT OF INTERNATIONAL TRADE THROUGH COMPOSITION EFFECT: THE ROLE OF CAPITAL, LABOR AND ENVIRONMENTAL REGULATIONS.....	127
5.1. Literature review on the trade-environment relationship: a mixed conclusion.....	127

5.2. The principal problems in the existing trade-environment nexus analyses based on developing countries' experiences	132
5.3. Evolution of the specialization situation for some China's industrial sectors.....	133
5.4. Structural model—determining environmental impact of international trade through composition effect.....	135
5.5. Conclusion.....	160
Appendix 5.1. The structural model estimation—the environmental role of trade (the relative K/L and relative per capita income involved in interactive terms with trade intensity).....	162
CHAPTER 6. ENVIRONMENTAL IMPACT OF INTERNATIONAL TRADE THROUGH SCALE, COMPOSITION AND TECHNIQUE EFFECT: AN ANALYSIS BASED ON THE DIVISIA DECOMPOSITION RESULTS	167
6.1. Graphical illustration on the trade's impact on scale and technique effect.....	168
6.2. Tracing the trade-related scale, composition and technique effect—an empirical analysis based on the Divisia decomposition results.....	174
6.3. Conclusion.....	184
Appendix 6.1. The estimation results for the decomposed composition effect with both time effects and time trend removed.....	186
Appendix 6.2. A detailed introduction on the synthetic composition indicator	188
CHAPTER 7. ENVIRONMENTAL IMPACT OF INTERNATIONAL TRADE THROUGH SCALE, COMPOSITION AND TECHNIQUE EFFECT: AN ANALYSIS BASED ON A SIMULTANEOUS SYSTEM	189
7.1. The links between trade and emission: The system of simultaneous equations.....	189
7.2. Econometric analysis	195
7.3. Conclusion.....	203
PART 3. SUSTAINABILITY OF CHINA'S ECONOMIC GROWTH.....	205
CHAPTER 8. ECONOMIC COST OF CHINA'S NEW DE-SULFUR POLICY DURING HER GRADUAL ACCESSION TO WTO—A SYNTHETIC ANALYSIS ON CHINA'S TRADE-ENVIRONMENT RELATIONSHIP BASED ON A CALCULABLE GENERAL EQUILIBRIUM MODEL	207
8.1 China's current pollution control policies	209
8.2. Model Specification.....	210
8.3. Policy scenarios	216
8.4. Trade-environment nexus analysis.....	217
8.5. Decomposition analysis.....	229
8.6. Conclusion and policy discussion	234
Appendix 8.1. Production Nesting Structure.....	239
Appendix 8.2. Principal assumptions on the key model elasticity	240
Appendix 8.3. Several supplementary tables.....	241
Appendix 8.4. Model Specification.....	244
CHAPTER 9. INDUSTRIALIZATION, ENVIRONMENT AND HEALTH: THE IMPACTS OF INDUSTRIAL SO ₂ EMISSION ON PUBLIC HEALTH IN CHINA	261
9.1. Literature review on the existing pollution-health nexus studies for China's case	261
9.2. A simple theoretical model describing the pollution-health nexus	263
9.3. Data details	266
9.4. Econometrical analysis	269
9.5. Threshold analysis on the impact of industrial SO ₂ emission on health situation..	272
9.6. Conclusion.....	274
CONCLUSION AND POLICY IMPLICATIONS	275
REFERENCE	281

Table list

Table 0.1. Comparison in some fundamental economic and environmental indicators between developed and developing countries	19
Table 1.1. The significant improvement in people's living standard.....	23
Table 1.2. The economic cost related to China's air and water pollution.....	33
Table 2.1 EKC empirical analyses based on SO ₂ pollution case.....	41
Table 2.2. Statistic description on the data used in EKC analysis	67
Table 2.3. Industrial SO ₂ emission per capita	68
Table 2.4. Industrial SO ₂ emission density	70
Table 2.5. Provincial per capita GDP, geographical area statistics and emission density	71
Table 2.6. Correlation between emission densities, per capita emission and population density	73
Table 2.7. Total industrial SO ₂ emission EKC reduced model.....	74
Table 3.1. Relationship between per capita GDP and Industrial SO ₂ intensity.....	94
Table 3.2. Structural model and decomposition results (Industrial SO ₂ emission density)	98
Table 4.1. Total and annual average changes in industrial SO ₂ emission and the decomposed contributions from different structural determinants	113
Table 4.2. The combination of the impact of income growth on EKC formation (Estimation from the decomposed Divisia scale, composition and technique effect)	119
Table 4.3. The combination of the impact of income growth on EKC formation—distinguishing between 3 cities and 26 provinces	120
Table 5.1 ACT (1998) structural model: trade-environment nexus request (dependant variable: industrial SO ₂ emission density, 29 provinces, 1992-2003)	150
Table 5.2 ACT (1998) structural model: trade-environment nexus request (dependant variable: total industrial SO ₂ emission, 29 provinces, 1992-2003)	151
Table 5.3. Scale, composition, technique and trade elasticity.....	155
Table A.5.1.1. ACT (1998) structural model: trade-environment nexus request.....	162
Table A.5.1.2. ACT (1998) structural model: trade-environment nexus request.....	164
Table 6.1. The impact of international trade in the decomposed Scale effect (Reduced-form).....	176
Table 6.2. The impact of international trade in the decomposed composition effect (reduced-form)	177
Table 6.3. The impact of international trade in the decomposed technique effect (reduced-form).....	178
Table 6.4. Trade's impact on industrial SO ₂ emission—Channel 1: enlargement of the industrial production scale	179
Table 6.5. Trade's impact on industrial SO ₂ emission—Channel 2: transformation of industrial composition	180
Table 6.6. Trade's impact on industrial SO ₂ emission—Channel 2: transformation of industrial composition (New composition indicator).....	181
Table A.6.1. Estimation results for the decomposed composition effect with both time effects and time trend removed.....	186
Table A.6.2. Trade's impact on industrial SO ₂ emission—Channel 2: transformation of industrial composition	187
Table 7.1. Statistical description of the data	196
Table 7.2. The simultaneous model estimation results	200
Table 8.1. Evolution of China's SO ₂ pollution levy system in the 1990s.....	209

Table 8.2. Energy induced SO ₂ emissions.....	211
Table 8.3. Conversion factor and emission rate per monetary unit of energy input	212
Table 8.4. The related exogenous variable evolution in simulations	216
Table 8.5. Macroeconomic changes	219
Table 8.6. Structure of production in 1997 and 2000.....	220
Table 8.7. Structure of energy consumption in 1997 and variation in 2000 with respect to 1997	221
Table 8.8. Principal simulation results for Business as Usual (BaU) scenario	223
Table 8.9. Decomposition of change in SO ₂ emission (reference: 1997, Divisia method)	231
Table 8.10. Sensitivity test (Open+Desulfur scenario)	237
Table A.8.1. The expected tariff reduction schedule in China (percents change from 2000)	241
Table A.8.2. Energy input intensity changes under the four policy scenarios: coal and Oil (Percentage changes in 2005 from the reference)	242
Table 9.1 Selected studies on the relationship between air pollution and public health in China....	262
Table 9.2. Data statistical characters	269
Table 9.3. Impacts of industrial SO ₂ emission density on public health situation (2SLS)	270
Table 9.4 Threshold analysis on the impacts of SO ₂ emission on public health (TSLS).....	273

Figure list

Figure 0.1 The End-Means Spectrum	13
Figure 0.2. Remarkable globalization tendency in developing economies.....	20
Figure 1.1 Evolution of some major macroeconomic indicators	25
Figure 1.2. Evolution of regional disparities among Chinese provinces (1985-2000)	26
Figure 1.3. Evolution of air pollution concentration indicators in Chinese cities	29
Figure 1.4 China's Green GDP per capita.....	34
Figure 2.1. Micro theoretical foundation for EKC formation.....	49
Figure 2.2 Global EKC vs. Individual countries' EKC.....	54
Figure 2.3 Evolution of income-pollution relationship under the existence of the pollution- discharging channel from developed to developing country through international trade	55
Figure 2.4 The inversed C curve	57
Figure 2.5 A simple cross-country correlation between per capita SO ₂ emission and per capita GDP	62
Figure 2.6 Evolution of SO ₂ emission in China during economic reform period.....	63
Figure 2.7 Evolution of real industrial GDP and industrial SO ₂	65
Figure 2.8 Regional disparity changes on per capita industrial SO ₂ emission	65
Figure 2.9 Estimated EKC for per capita industrial SO ₂ emission and.....	69
the actual location of 29 provinces in 2003.....	69
Figure 2.10 EKC estimations for the industrial SO ₂ emission density	72
Figure 3.1. Structural determinants for EKC formation.....	82
Figure 3.2. Several policy implications for EKC formation	83
Figure 3.3. Growth rate of Chinese total and industrial economy	85
Figure 3.4. Evolution of Ratio of industrial GDP in total GDP	85
Figure 3.5 Correlation between scale effect and industrial SO ₂ emission	86
Figure 3.6. Evolution of the ratio of heavy/light industry.....	86
Figure 3.7. Evolution of the proportion of polluting industries in total industrial economy	87
Figure 3.8. Evolution in the numbers of complaining letters and visits concerning environmental degradation problems	88
Figure 3.9. Evolution of the number staff working in environment protection institutions	90
Figure 3.10. Evolution of the ratio of industrial SO ₂ abatement.....	91
Figure 3.11. Correlation between GDPPC and industrial SO ₂ emission intensity.....	95
Figure 4.1. Divisia Decomposition results	115
Figure 4.2. Decomposition results on national level (1991-2001).....	116
Figure 4.3. Structural determinants for EKC formation—China's case	121
Figure 4.4. Structural determinants for EKC formation—China's case	122
Figure 5.1. Evolution of the specialization degree of the selected industries	134
Figure 5.2. Production patterns under autarky	137
Figure 5.3. Production pattern changes under trade liberalization: Traditional endowment- based comparative advantage.....	139
Figure 5.3bis. Production patterns changes under trade liberalization: Traditional endowment- based comparative advantages—the decomposition.....	141

Figure 5.4. Production patterns changes under trade liberalization: Traditional endowment-based comparative advantage dominating Pollution Haven hypothesis	142
Figure 5.4bis. Production patterns changes under trade liberalization: Traditional endowment-based comparative advantage dominating Pollution Haven hypothesis—the decomposition	144
Figure 5.5. Production patterns changes under trade liberalization: Traditional endowment-based comparative advantage dominated by Pollution Haven hypothesis.....	145
Figure 5.5bis. Production patterns changes under trade liberalization: Traditional endowment-based comparative advantage dominated by Pollution Haven hypothesis—the decomposition.....	146
Figure 5.6. Actual K/L and per capita GDP situation of the 29 Chinese provinces (2003)...	154
Figure 5.7. Provincial-specific trade elasticities (model (5), table 5.2 and 5.3, Fixed effect results)	157
Figure 5.8. Evolution of the relationship between industrial SO ₂ emission and its determinants	158
Figure 6.1. Production pattern changes under trade liberalization: Factor-endowment comparative advantage dominates pollution haven comparative advantage; the South benefits from technology progress in both production and pollution abatement activities	168
Figure 6.2. Production pattern changes under trade liberalization: Factor-endowment comparative advantage dominated by pollution haven comparative advantages, the South benefiting from technology progress in both production and pollution abatement activities.....	170
Figure 6.3. Production pattern changes under trade liberalization (decomposition) :Factor-endowment comparative advantage dominates pollution haven comparative advantages, the South benefiting from technology progress in both production and pollution abatement activities.....	172
Figure 6.4. Production pattern changes under trade liberalization (decomposition): Factor-endowment comparative advantage dominated by pollution haven comparative advantages, the South benefiting from technology progress in both production and pollution abatement activities....	173
Figure 7.1 Illustration of the different Channels of trade's impact on pollution.....	194
Figure 7.2 Different Channels of the impacts of trade on pollution	202
Figure 8.1. The price effects of different policies	225
Figure 8.2. Output and SO ₂ emission intensity changes (%)	226
Figure 8.3. Trade structure changes under different policy scenarios (%)	228

Acknowledgement

The preparation work for this dissertation, from the thesis selection at very beginning to the last step of page setup, has lasted for almost four years. This is an unforgettably rich and inspirational experience, which has not only allowed me to accumulate my research skills and broaden analytical horizons, but also provided me with the opportunity to recognise my strength and weakness and clarified my preference for future career orientation.

However, this dissertation could not have been completed today without the precious helps and supports from numerous persons that I would like to thank here.

My thankfulness goes first of all to Professor Patrick Guillaumont. As the very first person suggesting me to choose the environmental economics field as my dissertation topic, many of his pertinent insights in development topics have largely enriched my research. I would like to thank him for his kindness of accepting to be my dissertation supervisor, and for his continuous support and encouragement all along the four-year's Ph.D program.

Thanks also give to my co-director, Professor Alain de Janvry of University of California at Berkeley. His wise advices on the initial idea of this dissertation and on how to efficiently organize the research work benefited greatly the progress of this dissertation. The inspirations from some of the discussion with him also enabled me to deepen the analytical perspective in some chapters. I would equally thank Madame Elisabeth Sadoulet for her availability to my questions and emails and for her pertinent suggestions.

Special thanks go to Professor David Roland-Holst of Mills College and University of California at Berkeley for generous sharing of the prototype China CGE model and 1997 China's SAM and his continuous instructive suggestions. His guidance is a critical factor in leading me into the apprenticing of the policy-based CGE modelling skills. Without his helps, the research work in the chapter 8 would not have been supported by the "Doctoral Fieldwork Award" of EEPSEA (Economic and Environmental Program of South-East Asia) of IDRC (International Development Research Centre) and it would not neither, has been published by China Economic Review.

I would also like to thank Professor Jaime de Melo of University of Geneva. As a student majoring in international economics from the very beginning university education, I always found his insights in international economics brilliant and inspiring for my own research. I thank him for his interest and attention paid to my research progress and for his availability in answering my emails and questions.

Another special "thank you" goes to Dr. Hua Wang of the World Bank. As the very first professional collaborator, his rich field work experiences in China's environmental problems and his brilliant idea on the future development of the contingent valuation (CV) method inspired me a lot about my potential future research topics. I would also like to thank him for having accorded me the opportunity to work as consultant in the World Bank. This precious working experience will continue in benefiting me in the future.

I am also greatly indebted to many professors and researchers of CERDI: Monsieur Jean-Louis Arcand, Madame Martine Audibert, Monsieur Jean-Francois Brun, Monsieur Stephen Calipel,

Monsieur Jean-Louis Combes, Madame Sylvie Demurger, Professor Sylviane Guillaumont Jeanneney, Madame Ping Hua, Professor Jacky Mathonnat, Professor Patrick Plane and Professor Marie-Francoise Renard. They have not only unfolded before me the different interesting aspects of development economics issues and econometrical techniques by their carefully-prepared courses, but also spent their precious time to read, comment my papers and answer my questions.

Thanks are equally given to the participants of the various workshops and conferences that I have attended for their helpful suggestions and constructive advices. Here another special thanks goes to Ian Coxhead of University of Wisconsin at Madison for his patience and helpful critics given to the three different versions of the technique report prepared for EEPSEA project.

I would also like to thank "Teilhard de Chardin" Program of Ministry of Foreign Affairs of French government and EEPSEA/IRDC for their financial supports and CERDI for numerous allowances provided for my international and national conference participation.

I would also like to give my gratitude to Monsieur Patrick Doger for his availability and consideration in assuring the necessary facilities for our studies. Gratefulness also goes to Martine Bouchut, Jacqueline Reynard, Annie Cohade and all the personals and students of CERDI. Owing to their kindness, my six year's studies in CERDI will always bring back to me pleasant memory.

Please permit me expressing my profound gratitude to my families: first, my parents and grand parents for their unselfish understanding on my dream to further exploring my academic potential and for their sacrifice never expecting reciprocate, and second the family of my husband, their acceptance of me as a family member without reservation makes me find back the family's affections and warmth that I have been lacked during all these years' student life far from my parents. Finally, I would like to thank my husband, Thomas Poder, though younger than me, his maturity and mental strength has been the indispensable supports during the long-march preparation work of this dissertation, which requires not only good physical and intelligent conditions, but also the possession of constantly strong psychological forces. The large amount of time that he has spent in reading my chapters and correcting the grammar and even logical mistakes in my sentences always makes me feel deeply indebted to him.

Opening for another time this dissertation, registered between the words and sentences, is the last 1500 days and nights that marked by the sadness and happiness, doubt and dedication, tears and laughter, give and receive ... Thousands of thanks can not express my gratefulness at this special moment, so please permit me to use this Chinese song to conclude this acknowledgement.

奉献

长路奉献给远方，玫瑰奉献给爱情，我拿什么奉献给你，我的爱人
白云奉献给草场，江河奉献给海洋，我拿什么奉献给你，我的朋友
白鸽奉献给蓝天，星光奉献给长夜，我拿什么奉献给你，我的小孩
雨季奉献给大地，岁月奉献给季节，我拿什么奉献给你，我的爹我

Give

Long road given to horizon, rose given to love, what can I give to you, my lover?
White cloud given to ranch, river given to ocean, what can I give to you, my friends?
White Pigeon given to blue sky, star given to long night, what can I give to you, my children?
Rain given to land, time given to season, what can I give to you, my parents?

Introduction

“Nor is there much satisfaction in contemplating the world with nothing left to the spontaneous activity of nature; with every rood of land brought into cultivation, which is capable of growing food for human beings; every flowery waste or natural pasture ploughed up, all quadrupeds or birds which are not domesticated for man’s use exterminated as his rivals for good, every hedgerow or superfluous tree rooted out, and scarcely a place left where a wild shrub or flower could grow without being eradicated as a weed in the name of improved agriculture. (Mill, 1871, p.331)

0.1. Limits in traditional economic analysis and its extension and development since 1960s

“The 20th century has been extraordinarily successful for the human species—perhaps too successful.”(World Watch Institute, 1984) The whole economy system, benefiting from industrialization and technology progress, has exploded to more than 20 times its size in 1900. Living standard has largely improved. Daily intake of calories per capita shows the general increasing tendency in both the developed and developing worlds. The proportion of people in poverty also decreased during the last 50 years. The remarkable material enrichment catalyzed rapid mortality rate decrease and at the same time the extension of the average live expectancy by over 20 years, which in turn fostered the “explosion” of population growth. During the last contrary, the total population living in the world has increased from 1 billion to 6 billions.¹ The people living in our days should generally feel happier than their ancestors. However, this might not be the case. The comments from Sismondi more than one hundred years ago on the unrestrained economic activity during the British industrial revolution still seems incredibly

¹ Data source: UNPD (2001, 1999, 1998a, 1998b), FAO (2001), World Bank (1999, 2001).

appropriate to describe the phenomena of “increasing of income and decreasing of happiness” that confuses our human beings today.

“In this astonishing country, which seems to be submitted to a great experiment for the instruction of the rest of the world, I have seen production increasing whilst enjoyments were diminishing. The mass of the nation here, no less than philosophers, seems to forget that the increase of wealth is not the end in political economy, but its instrument in procuring the happiness of all. I sought for this happiness in every class, and I could nowhere find it.”
(Sismondi, 1847, pp205)

Why our happiness reduces as we are getting rich? We can use the Ends-Means Spectrum of Daly and Townsend (1993) to explain it. Traditional economic analyses have described the economic process as one circulation of goods and services between various economic agents, producers, consumers, investors, etc. In this circle, labor, capital and primary commodities are mobilized from household and turned into intermediate products and final consumer goods through producers' activities and finally oriented to their respective usage. Simultaneously, a flow of money in the opposite direction is observed as the counterpart of exchange. However, the “origins of labor and primary commodities, as well as the destination of these final products beyond the action of consumption, remained very much a mystery in traditional economic models” (Cole, 2000). Implicitly, the traditional economic analysis equalizes maximization of material richness to maximization of happiness and assumes that economic growth is only confined by the availability of the intermediate means, whose supply and demand and economic values can be traced from market system. One exception in the pre-classical economists is the ‘Physiocrate’, who regarded ‘land’ as the mysterious but also the most original source of labor and primary commodities and therefore the final explanation for economic growth. The contribution of Daly and Townsend is to combine the economic activities into a more integral total ends-means spectrum as shown in Figure 0.1, where the “ultimate end is that with reference to which intermediate ends are directed.” We derive the goodness from the ultimate end but not “from any instrumentals relation to any other end”. At the opposite end of the spectrum is the ultimate means, which consists of low entropy matter-energy.¹ All the intermediate categories are means with respect

¹ The term “entropy” comes from the entropy law, which is also known as the Second Law of Thermodynamics of Georgescu-Reogen (1973). According to Rees (1990), the meaning of the Second Law is that, “in any closed isolated system, available energy and matter are continuously and irrevocably degraded to the unavailable state.” Therefore, “the Second Law is actually the ultimate regulator of economic activity”. Daly (1973) states that, entropy may be considered to be a measure of the unavailable energy within a closed thermodynamic system.

to the ultimate end, or end with respect to the ultimate means. For Daly, “humanity’s ultimate economic production is to use the Ultimate Means *wisely* in the service of the Ultimate End,” where the economic activities are only a ‘middle range’. (Daly and Townsend, 1993, p.21) Daly’s interpretation on the Ends-Means spectrum actually indicates the two principal sources of human beings’ unhappiness. The first is our blindness in using intermediate ends to measure happiness, which is, in reality, obtained from the satisfaction of our ultimate ends. The second comes from our ignorance about the precious value of the ultimate means, which is actually the fundamental wealth and source of our happiness.

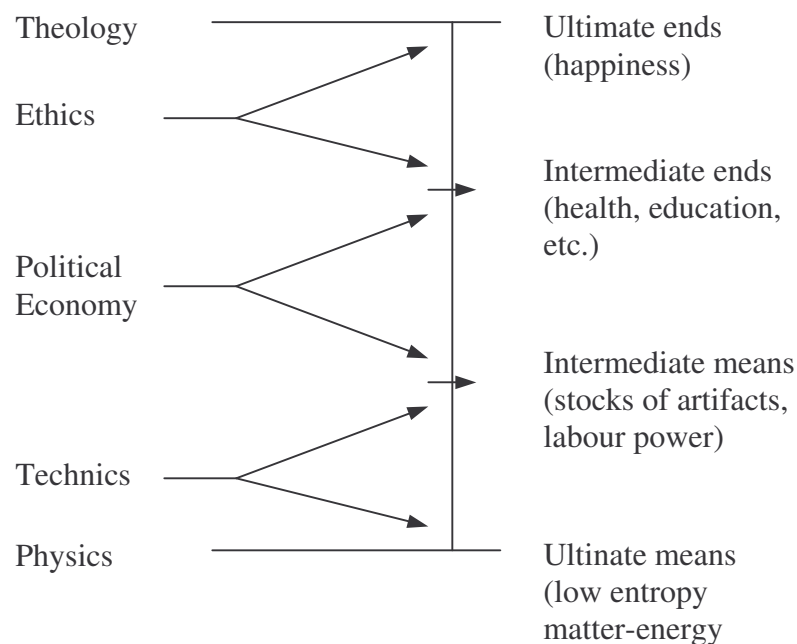

Figure 0.1 The End-Means Spectrum

(Source: Daly and Townsend, 1993)

The Ends-Means spectrum of Daly and Townsend also reveals the fundamental limits of the conventional economic analysis. “It has naturally not dealt with ultimates or absolutes, which are found only at the extremes, and has falsely assumed that the middle-range pluralities, relativities and substitutabilities among competing ends and scarce means were representative of the whole spectrum”. “Absolute limits are absent from the economists’ paradigm because absolute are encountered only in confrontation of the ultimate poles of the spectrum, which have been excluded from the focus of their attention.” (Daly and Townsend, 1993, p.21)

For example, if a piece of coal is available, or free energy for us, therefore we say that we have low entropy. Once this piece of coal is used, the energy is now bound and hence we have high entropy.

The development of economics, however, has not economized its efforts in enlarging its scope and analytical reaches towards the both extreme ends. The rapidly amplified development economics can be considered as the efforts to approach the distance from the intermediate ends to the ultimate end. According to UNDP (1995), “development is a form of change in social processes and institutions broadening the set of options that people have to improve their livelihoods and determine their futures”, which in turn can facilitate the obtaining of more justice, social acceptance, equity and finally more happiness. Meanwhile, the environmental economics also started to investigate the distance between the intermediate means and the ultimate means by considering circulation between them as being embedded in natural processes within ecosystems characterized by flows and stocks of non-renewable and renewable resources. As said Dasmann et al. (1973), “all economic development takes place within the natural ecosystems ...Development brings about very varying degrees of modification, but always remains subject to the ecological limitations which operate within natural systems.”

0.2. Internalization of market failure caused by environmental externality, new concept of equity: the development in environmental economics

The incapability of the economic analysis to include the environmental dimension is due to its ignorance of the potential value of natural resource and environmental quality and the negative externality caused by natural resource depletion and environmental pollution on economy's growth capacity. Therefore, the initial development in environmental economics starts from internalizing these environmental externalities. This is the so-called traditional approach that applies economic concepts to environment using a set of models and techniques rooted within the standard neoclassical mainstream of economic thoughts. In this approach, the value of the natural resources is reflected from its role as an instrument for economic growth: a source of raw materials, a set of sinks for absorbing and recycling the wastes issuing from production activities, and a provider of essential life supports for the re-establishment of labor forces.¹ Another approach is called the ecological approach, which takes a different perspective. “Rather than applying economic concepts to the environment, ecological economics seeks to place economic activities in the context of biological and physical system that support all human activities”. (Harris, 2002) Under this approach, the environment and natural resource has an intrinsic value that is generally much higher than the

¹ Opschoor et al (1999).

value presumed in the traditional approaches. To maintain their original level not only means the maintenance of the sources of economic growth but the sustainability of the harmony of the ecological system as a whole.

During the long march of human beings' self-development, the ignorance of the real value of natural resources has resulted in its general over-consumption in both production and consumption activities. The situation has extremely deteriorated in the 20th century with unprecedented rapid economic growth. Observing the fast disappearance of most of the non-renewable resources and the dangers coming from the irreversibility of some climate deteriorations, many scholars expressed their worries about the sustainability of this remarkable economic "prosperity" of the last century in the future. Kenneth Boulding (1966) indicated the fact that our economic growth history until these days is actually a 'cowboy economy', where the natural resource has been blindly assumed unlimited. In this economy, the measure of success is the volume of production, which is supposed to be maximized. Observing the danger from the steadily increased production level, both in terms of reducing finite resource stocks and in terms of environmental pollution, the cowboy-style economic growth process in our time is actually depriving the same right of the future generations in pursuing their own economic growth, social development and happiness. From an equity point of view, it is necessary to transform the 'cowboy economy' to a 'spaceman economy', where the earth becomes a "single spaceship, without unlimited reservoirs of anything".

The Limit to Growth (Meadows et al. 1972), the report of Club of Rome further dramatized our future situation. In analyzing the future economic growth, this report made assumptions: (1) the physical, economic or social relationship that has historically governed the development of the world system is kept effectively unchanged; and (2) population and industrial capital would continue to grow exponentially and but the supply of both food and non-renewable resource keep as the same as today. With these assumptions, this report concluded that our production system will collapse and that the halt of our economic growth will happen before 2100 (Cole, 2000).

The fears of the growth limit has transformed into the research for the possibility of a 'sustainable development' since the advent of 1980s. Among its over 70 various definitions, the most generally accepted definition for the term of 'sustainable development' comes from the Brundtland Commission Report (*Our Common Future*, World Commission on Environment and Development, WCED, 1987): "A process of change in which the exploration of resources, the direction of investment and the orientation of technological development and institutional change are all compatible and satisfy current human needs and

aspirations without jeopardizing the future (generation's) potential for satisfying their needs.” This definition actually enlarges the concepts of ‘equity’. Compared to the traditional development economics that aims at improving the equity between developing and developed countries in the same epoch, the sustainable development idea adds into its economic analysis the time dimension and aims at establishing and maintaining the equity between the people of different generations.

The implication of the sustainable development can be categorized into two schools. The ‘weak’ sustainable development requires the total utility obtained from economic growth by different generations to stay the same. This actually implicates the necessity to maintain the same level of *aggregate capital stock*. Any fall in the stock of natural capital can be compensated by an appropriate increase in the man-made capital, since their utilitarian value in the objective of economic growth, according to the traditional environmental economic approach, is the same. In contrast, the ‘strong’ sustainable development, parallel to the ecological economic approach, requires a non-decreasing stock of the natural capital. Therefore, simply maintaining the level of *aggregate capital stock* as suggested by the ‘weak’ sustainable development cannot meet this standard.

0.3. Sustainable development, globalization and developing countries

The concerns about the sustainability of development, when it was firstly advocated, was not predominant in developing countries. For these countries, the first and foremost problems were, and are directly related to ‘poverty and very lack of development’ of their society—the problem assumed to be overcome by development and growth firstly (Founex Report, 1971). However, though absolute poverty situation “in the past 50 years has fallen more than that in the previous 500 years” (World Bank, 1998; UNDP, 1997), the relative inequality between the developing and developed world has been increased. The relationship between the richest 20% of all the nations in the world and the poorest 20%, in terms of GDP per capita, has increased from around 30:1 in 1960 to 61:1 in 1991, and to 78:1 in 1994. (UNDP, 1996, 1999) Since the statistics show that economic growth and development after the Second World War have benefited both developed and developing countries and many developing countries experienced even higher growth rate than their developed counter partners, part of the true causes of this increased inequality between developing and developed countries are actually related to environmental and resource aspects. For example, during last fifty years, over sixty percent of population growth happened in only 12 developing countries. The rapid overpopulation burden in some developing countries,

although not the only cause, did intensify the difficulties in maintaining and improving living standard and social welfare. Moreover, rapid population growth can also reduce per capita abundance of environmental and natural resources and intensify the pollution burden related to both production and consumption. These two aspects will in turn impoverish the sustainability of economic growth in these countries. Therefore, environmental concerns are potentially very important factors for developing countries' poverty reduction and living standard improvement process.

Table 1 compares some most recent statistics in living standard, per capita natural resource abundance, average energy and pollution intensity between the developed and developing worlds. For most of the indicators, the contrasts are remarkable. Whilst the general lower living standard in the developing country reminds us of the rights of these developing countries in growth and development, their already low starting-point for natural resource abundance also reveals the necessity to search for a more sustainable development path. This idea is further supported by the statistic comparison between the developing and developed worlds in their per capita pollution emission and energy intensity. If the energy use and CO₂ emission are assumed to be intensified during economic growth, the current small numbers of the developing countries actually predict that developing countries' energy use and CO₂ emission will obviously increase by multiples if they totally copy the economic growth mode of developed countries. This actually means very serious environment deterioration tendency for both the developing countries and the whole world. Therefore, searching for a more energy independent, less polluting and even "decoupling" economic growth mode is almost an obligation for these following-up countries.

The ever-strengthening globalization tendency since 1980s has involved the developing economy deeper and deeper into the world economy system, the three panels of figure 0.2 indicate the remarkable rapid increase of export ratio, FDI annual inflow in developing countries and the obvious industrialization tendencies in certain Asian economies. This integration tendency further complicates the obligation of the developing countries in searching for a cleaner economic growth process. Being an economic instrument helpful in increasing economic efficiency and stability, trade reform may also play a disturbing role in developing countries' pursuit of sustainable development. Although the comparative advantage of a developing country may eventually reflect its actual higher pollution assimilation capacity or its relatively richer endowment of certain natural resources, as suggested by "pollution haven" hypothesis, we could not eliminate the possibility that some developing countries, in order to realize faster economic growth, might decide to specialize in

certain pollution-intensive industries by (either initiatively or passively) reducing their environmental regulation stringency. Facing the tendency that 'the industries most heavily reliant on environmental resources and most heavily polluting are growing most rapidly in developing countries.' (WCED,1987), many scholars already express their fears that the integration of world economy will increase the dependency of the entire world's economic growth and its pursuit of happiness on the natural resources and environmental capital of the developing world.

Therefore, the developing countries are actually coming to the center of the sustainable development discussion. Though globalization can facilitate the economic growth in developing countries, this approaching of the income levels between the developing and developed worlds, if obtained at the cost of environment quality of the developing countries, will double the scarification supported by the future generations in developing countries. Under this circumstance, they are deprived from its well-being not only by the current generation in the developing countries that pursuing economic growth, but also by and the future generation of the developed countries, whose welfare is safeguarded as their ancestors choose to pursuing their happiness by utilizing the natural resource of the developing world.

Fortunately, globalization does not only mean environmental dangers for the developing world. Dynamic and structural theoretical analyses already reveal the possibility for the developing countries' sustainable development task to benefit from globalization. Some economists indicate the openness-fueled income growth can reinforce public demand for a better environment, which will in its turn encourage environmental improvement tendency in developing countries. Others believe globalization can facilitate inflow of advanced production and pollution abatement technologies, which is a supply-side factor to encourage environment improvement in developing countries. Moreover, for the developing countries whose resource-endowment-based comparative advantages actually resides in less-polluting sectors, participating the world production system will be helpful in reducing their pollution burden related to economic growth process. Finally, the competition pressures coming from the world market may also encourage domestic producers to invest more in pollution abatement activities and therefore to reinforce their pollution abatement efficiency.

Table 0.1. Comparison in some fundamental economic and environmental indicators between developed and developing countries

1. Living standard					
Indicators	GDPPC	Per capita meat consumption	Per capita calorie supply	Population density	
Unit	USD(1995 price)	kg/person	kilocalories/person/day	people/Km²	
Developed	20792.253	58.900	3281.200	23.200	
Developing	1327.219	33.800	2665.200	59.700	
Contrast	15.666	1.743	1.231	0.389	
2. Natural resource abundance					
Indicators	Per capita Arable and permanent cropland	Per person forest area	Per capita actual renewable water resources	Fuel export ratio	
Unit	hectare/person	hectare/person	m³/person annually (2004)	%	
Developed	0.486	1.310	11513.800	5.000	
Developing	0.187	0.412	7761.700	14.200	
Contrast	2.601	3.181	1.483	0.352	
3. Energy and pollution intensity of economic activities					
Indicators	Per capita CO₂ emissions	Per capita coal and coal products consumption	Per capita crude oil, natural gas liquids and petroleum products consumption	Per capita geothermal, solar, wind and wave energy consumption	Per capita total energy consumption
Unit	tons/person	tons /person¹	tons /person¹	tons /person¹	Kg /person²
Developed	0.011	1.009	1.658	0.023	4590.1
Developing	0.002	0.213	0.273	0.004	832.5
Contrast	6.083	4.735	6.074	5.161	5.514

Data source:

Development Data Group, The World Bank. World Development Indicators, each year, Washington, D.C.: The World Bank.

Food and Agriculture Organization of the United Nations (FAO), FAOSTAT on-line statistical service (FAO, Rome, 2004). Available online at: <http://apps.fao.org>.

International Energy Agency (IEA) (2004), Energy Balances of OECD Countries (2003 Edition) and Energy Balances of non-OECD Countries (2003 Edition). Electronic database available online at:

<http://data.iaea.org/ieastore/default.asp>. Paris: Organization for Economic Cooperation and Development (OECD).

Population Division of the Department of Economic and Social Affairs of the United Nations Secretariat, 2004. World Population Prospects: The 2002 Revision. New York: United Nations. Available on-line at

<http://www.un.org/esa/population/ordering.htm>

International Energy Agency (IEA), 2004. CO₂ Emissions from Fossil Fuel Combustion (2003 Edition). Electronic database available online at: <http://data.iaea.org/ieastore/default.asp>. Paris: Organization for Economic Cooperation and Development (OECD).

National Institute for Public Health (RIVM) and Netherlands Organization for Applied Scientific Research (TNO). 2001. The Emission Database for Global Atmospheric Research (EDGAR) 3.2. Acidifying Gases:

SO₂ (Sulfur dioxide): Aggregated Emissions 1990/1995. Electronic database available online at: <http://arch.rivm.nl/env/int/coredata/edgar/>. The Netherlands: RIVM.

Population Division of the Department of Economic and Social Affairs of the United Nations Secretariat. 2004. World Urbanization Prospects: The 2003 Revision. Urban and Rural Areas Dataset (POP/DB/WUP/Rev.2003/Table A.7), dataset in digital form. Available on-line at <http://www.un.org/esa/population/ordering.htm>. New York: United Nations.

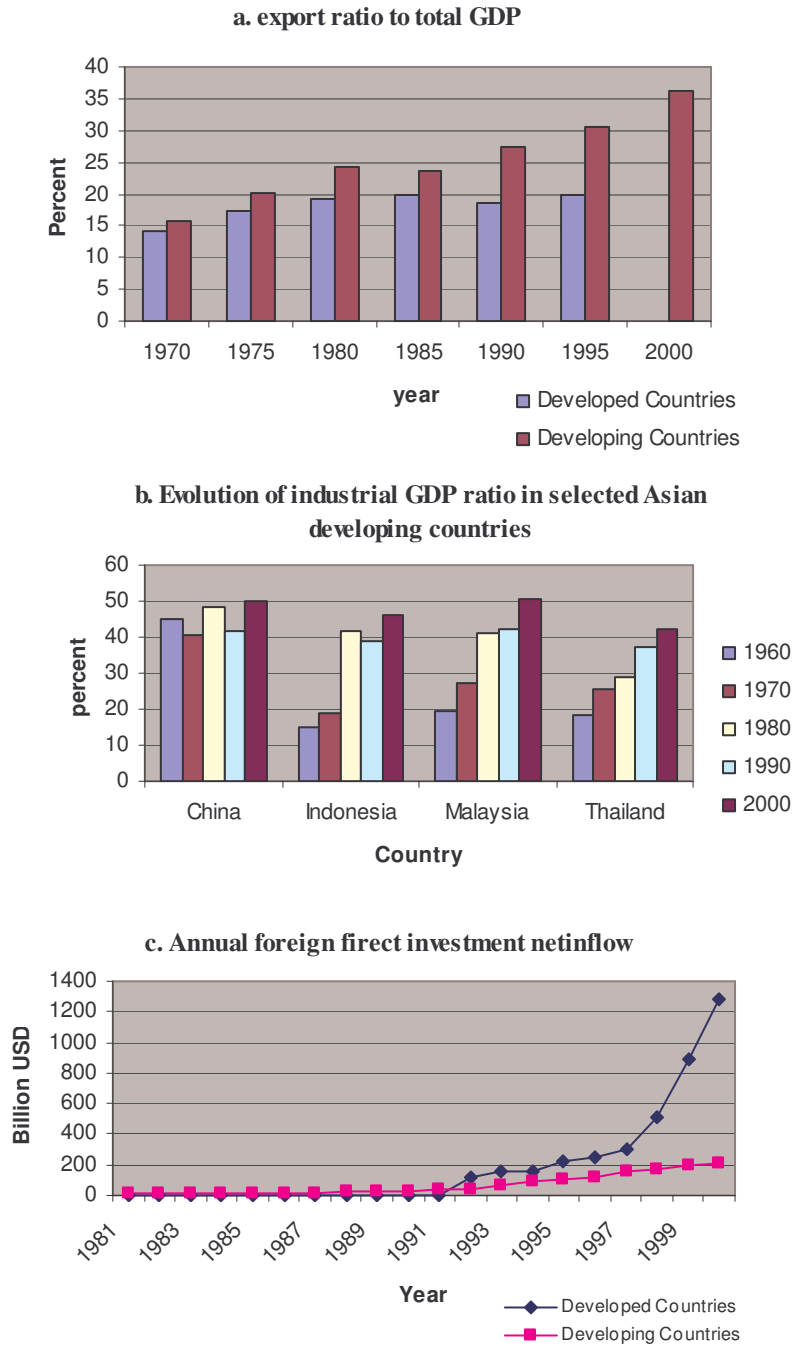

Figure 0.2. Remarkable globalization tendency in developing economies

Source: World Development Indicators (various years)

0.4. Topic and structure of this dissertation

To sum up, for a developing country, the necessity of sustainable development is a challenge much heavier than that for a developed country. This is because, firstly, degradation of its currently environmental assets can directly reduce its future economic growth and social improvement capacity. In addition, given its already quite serious condition, compared to 100 years ago, the global environmental quality is more sensitive to the pollution coming from developing countries' economic activities. Furthermore, for a developing country, under

globalization tendency, the variation of its environmental capital stock will also be influenced or even dominated by the socio-economic spillovers from developed countries. Therefore, whether and how the developing world can benefit from the already-achieved technological progress in production and pollution abatement activities and institutional development to fight against the potential pollution deterioration danger in its pursuit for a better life is actually the central question for both development and environmental economics.

In this dissertation, we will take China, the biggest developing country as an example. After a brief review of its last 25 years' experiences in economic growth, industrialization, commercial openness and air pollution situation and more technical analyses on its growth-environment and openness-environment nexus, we would like to answer the following questions. What kind of roles do economic growth, industrialization and international trade play in China's environmental situation determination? How will the environment deterioration result in economic cost and future growth capacity reduction to the Chinese economy. Is there any possibility for China to fulfill its economic growth objective without exerting too serious environmental deterioration? How could China's experiences and lessons inspire other developing countries to improve their environmental management? How can the developing economies benefit from the cooperation with their developed counterparts in both technology and regulation aspects, to realize a more sustainable development process? Only after being able to answer these questions, the developing countries will be able to fulfil their development objective and accomplish their obligations in protecting our common precious environmental capital.

This dissertation is composed of three parts. Part 1 discusses China's growth-environment nexus. In this part, we start from an Environmental Kuznets Curve analysis based on China's provincial level industrial SO₂ emission panel data. Next, to "demask" the reduced-form income-pollution relationship, we investigate the role of the three structural determinants of emission, the scale, composition and technique effects, in a structural model. In the third step, we further employ the Divisia Index Decomposition method to decompose the variation of industrial SO₂ emission into the contribution from the three effects, and then check the potential correlation of these contributions with China's economic growth. Part II focuses on trade-environment relationship. The trade-environment nexus in China will be firstly investigated by a simple estimation in which only the trade-related composition effect is analyzed through the multiplicative terms in an ACT-style (Antweiler, Copeland and Taylor, 2001) model. Considering the trade can also exert its impacts on pollution through scale and technique effects and the correlation between them, we further check the trade's

impact on industrial SO₂ emission by employing the Divisia decomposition results and a simultaneous system model, in which the potential environmental impact of trade through all the three aspects are investigated. The third part of this dissertation discusses the possibility for China to realize a sustainable economic growth and its necessary conditions. This part of analyses consist of a Calculable General Equilibrium (CGE) model which projects and compares the potential environmental impact of economic growth and international trade during 2001-2005 and a simple study on the potential feedback effect of pollution on China's economic sustainability.

Chapter 1. Evolution of China's economic and environmental situation since economic reform

1.1. China's economic reform success

China should be considered as a successful case in the developing world, her economic success during the last 27 years (1978-2005) has been remarkable. With an average annual economic growth rate of 9% and over 11.5% in several industrial sectors, China's national economic strength has been largely enhanced. Its per capita GDP at the end of 2003 was 7 times of that at the beginning of the reform in 1978.

Table 1.1. The significant improvement in people's living standard

Item	Unit	1989	2003	Variations(%)
Urban				
Annual per capital disposable income	Yuan	1374	8472	616.59
Annual per capita consumption expenditure	Yuan	1211	6511	537.65
Household's Engle coefficient	%	54.5	37.1	68.07
Per capita living space	m ²	13.5	23.7	175.56
Ratio of access of tap water	%	47.4	86.2	181.86
Ratio of access to natural gas	%	17.8	76.7	430.90
Number of color TV per 100 household	Set	51.5	130.5	253.40
Percentage of household expenditure on health care	(%)	1.3	7.3	561.54
Rural				
Annual per capital disposable income	Yuan	602	2622	435.55
Annual per capita consumption expenditure	Yuan	535	1943	363.18
Household's Engle coefficient	%	54.8	45.6	83.21
Per capita living space	m ²	17.2	27.2	158.14
Ratio of access of tap water	%	--	--	--
Ratio of access to natural gas	%	--	--	--
Number of color TV per 100 household	Set	3.6	67.8	1883.33
Percentage of household expenditure on health care	(%)	3.1	6.0	193.55
Number of students per 10000 population				
College and university	persons	18.5	86.3	466.49
Secondary school	persons	448	763	170.31

Data source: China Statistic Yearbook (2004).

Parallel to income growth are the significant living standard improvement and the notable public health amelioration, which are well documented in Table 1.1. During 1978-2003, the final consumption expenditure increased over 5 times, average living space was almost doubled and the energy consumption was almost quadrupled. Accompanying the increases in the household medical care expenditures, the infantile mortality rate reduced from 47 per thousand in 1975 to 28.4 per thousand in 2000 and during the same period, the average life expectancy increased from 64 years to 71.4 years.¹

China's significant economic success is also characterized by rapid industrialisation and openness policies. When the ratio of primary industry's GDP has undergone important decrease from 28.1% in 1978 to only 14.6% at the end of 2003, the secondary and tertiary industries, on contrary, experienced their unprecedented rapid expansion. The industrialisation and diversification in economic composition significantly reduced the vulnerability of Chinese economy with respect to external shocks. The competitiveness of some Chinese products, especially those whose production processes intensively use labour forces are from now on world widely recognized. The accession to WTO since 2001 further reinforces China's integration process to the world economy. In 2003, her annual total volume of export and import attains 120 times of that in 1979, in which over 90% are manufactured goods. The market-oriented economic reform is also turning China into one of the most attractive destinations for foreign direct investment (FDI) around the world. According to OECD (2004), after entering into the new millennium, contrary to the decreasing tendency in FDI inflows in many OECD economics due to their sluggish macroeconomic performance, China became world biggest FDI recipient with an annual inflow of FDI amount to about 53.5 billions US dollars, largely higher than that to Germany (47 billions USD) and to the United State (40 billions USD) at the same year. During last 25 years, China has received totally almost 500 billions USD foreign direct investment.² Regarding the generally believed optimistic perspective on China's economic growth in the following years, both scholars and Chinese government forecast a maintaining or even a further increasing tendency for the both openness indicators in the near future.

Figure 1.1 summarizes some details in the evolution of China's economic growth, industrialization and openness situation during the 25 years' reform. All the four indicators reported in the figure share an obvious increasing tendency. Another common character

¹ The data on growth, living standard improves and other amelioration situation in Chinese economy and society are calculated by author according to the statistic published in China Statistic Yearbook and the data furnished by China's Ministry of Health.

² China Statistic Yearbook, 2004.

between the variation trajectories of the four indicators is the obvious dividing point in year 1992, with the growth tendency in the post-1992 period showing evident acceleration with respect to that in the pre-1992 period. This dividing point corresponds to the milestone of China's economic reform—the beginning of the third stage of China's economic reform, which is characterized by the formalization of the role of market forces in the “socialist economy with Chinese characteristics” in the clarion call of Deng Xiaoping and the start of a major changes in the directions of many economic policies.

Figure 1.1 Evolution of some major macroeconomic indicators

(Source: China Statistic Yearbook, various years)

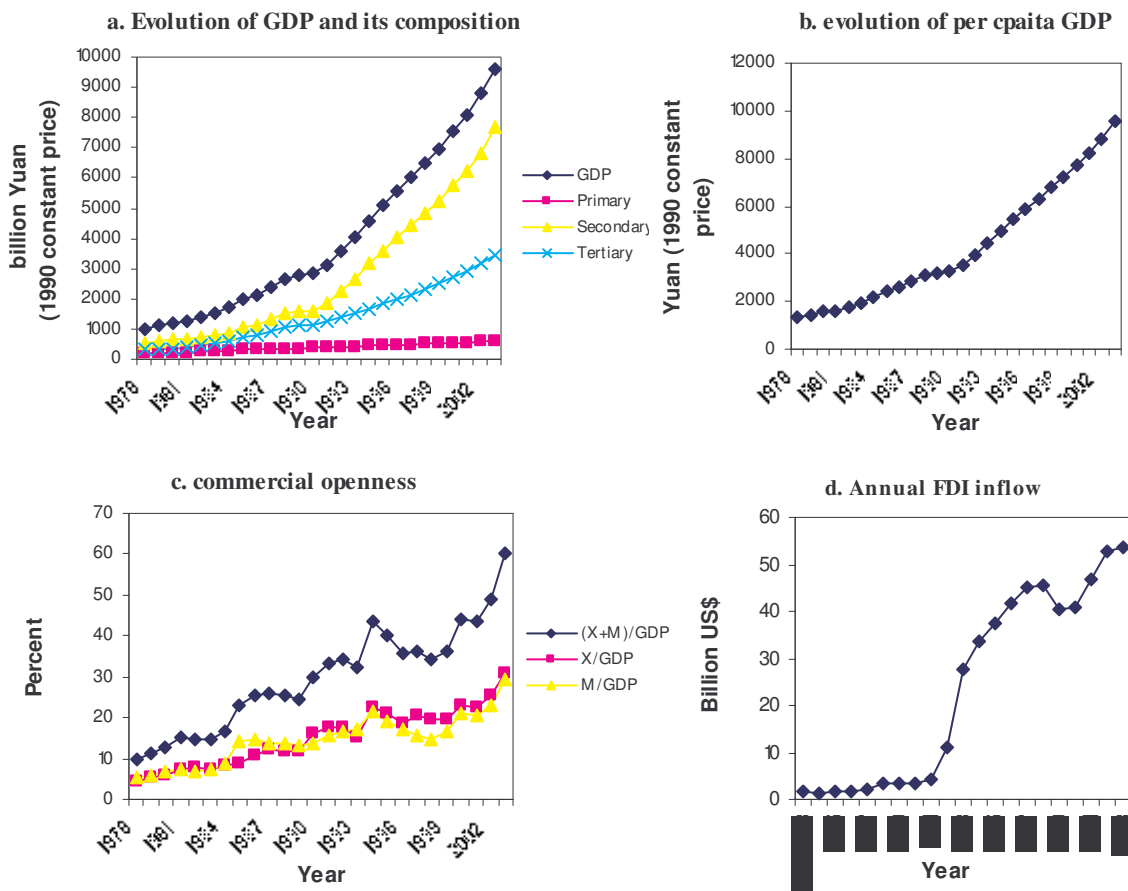

This worldwide-known economic success, however, did not benefit different Chinese regions in a homogenous way. Besides the obvious gaps between urban and rural regions in the living standard indicators reported in table 1.1, significant disparities in both income and economic opportunities between provinces also appeared since the beginning of 1990s and were continuously enlarged.

Inspired by Démurger (2001), we compile the related data, calculate and illustrate the evolution of the degree of regional disparities in per capita GDP, openness degree and composition transformation situation in the Figure 1.2 by the Lorenz-style curves. Obviously,

income, international trade intensity and industrial composition transformation all showed obvious increasing regional disparity, especially after 1990, the FDI capital stock, however displayed a reducing one, which might be explained by the recently proposed preferential policies to encourage the FDI inflow to the central and west provinces.

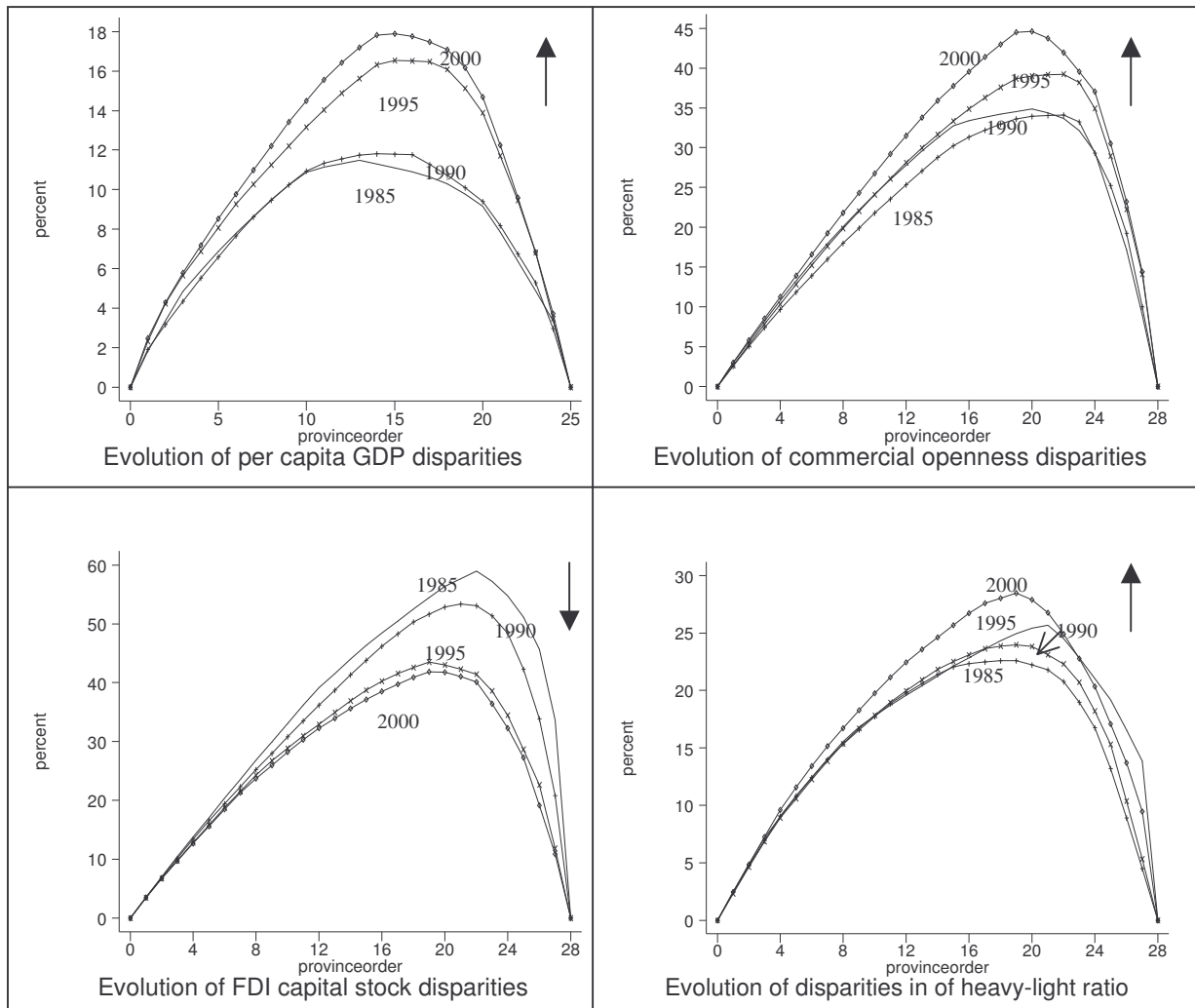

Figure 1.2. Evolution of regional disparities among Chinese provinces (1985-2000)

Note:

1. The curves illustrated in the figure measure the difference between the Lorenz curve and the 45° line, so that a higher curve represents a higher degree of disparity.
2. Due to data availability Tibet is excluded from the figure. As Hainan province was originally a region in Guangdong province until 1987, to avoid the data incoherence problem in Lorenz curve comparison during the time; we add its data since 1988 back to Guangdong province. Therefore we have 28 provinces in the figure. In the panel showing the per capita GDP disparity, we further exclude Beijing, Tianjin, Shanghai, the three municipalities directly under the control of central government since the income differential between them and the other provinces is too big. Démurger (2001) has made the same arrangement.
5. Commercial openness degree is measured by $(\text{export} + \text{import}) / \text{GDP}$, the FDI capital stock is divided by GDP to get rid of the disturbance from the economy size difference between provinces. The heavy-light ratio is the output ratio of heavy industry to light industry, an indicator reflecting the industrial composition.
6. Data source: China Statistic Yearbook and Almanac of China's Foreign Economic Relations and Trade (various issues).

Existing literatures gave different explanation for these regional disparities. (Bao et al., 2002; Démurger, 2001; Fu, 2004; Hu, 2002 and Cai et al., 2002) They believe these disparities are firstly due to the preferential government policies, geographical location, and

infrastructure development in the coastal provinces and urban areas. At the same time, the limited linkage of the economy of the landlocked central and western provinces with the economic growth engines as international trade and foreign direct investment also partially explain their relatively slower economic growth. Finally, the economic growth of the eastern and southern coastal provinces, to some extent, is also fueled and financed by the rural-to-urban, west-to-east, south-to-north labor mobility, which is actually at the cost of the economic growth potential of the inland and rural regions.

1.2. Evolution in China's environmental situation during economic reform years

Owing to its remarkable economic reform success, China has often been described as the future leading economy power of the world. However, the possibility for this hypothesis actually depends on the sustainability of China's high-speed economic growth. If China's economic growth during the last 25 years resulted from intensive intermediary consumption, and from scarification of environmental quality, or in other words, if its current economic growth "miracle" is realized by *borrowing* growth capacity from the future, its economic growth will not be sustainable.

Has China's recent economic success been obtained by respecting its environment? Numerous observations tell us that it might not have been the case. Covered by its economic victory, China's environment has actually been considerably deteriorated.

1.2.1. Disappearance of cultivation lands and forest

China is a country relatively poor in cultivation land and forest. Being a country represents 22% of the world total population, China possesses only 7% of world total cultivation lands. Its per capita forest possession and natural prairie are only 1/5 and 1/2 of the world averages respectively. However, during the economic reform, we still note continuous diminution of cultivation land and forests induced by economic activities. For example, by an expansion speed of 2 million hectares per year, up to 2002, the area of the land suffering the erosion problem, principally due to the abusive pasturage has attained 37.1% of the total surface of Chinese territory.

Another main cause for the reduction of arable land and forest area is urbanization and industrialization tendency. On the one hand, the enriched urban population demands more living surface and green land, which unavoidably pushes further the frontier of the cities and occupies the original farmland. On the other hand, the increasing urban-rural income gap also

attracts the rural labor forces to settle down in the urban regions in search for “a better life”. This rural-urban migrant population not only leaves their farmland abandoned, but also further reinforces the necessity for the cities to expand. We observe that from 1982 to 2000, the ratio of urban population increased by 16%, while at the same time, the number of counties declined from 2664 to 2053. The expansion of urban region also induced massive construction of roads and railways to facilitate the communication between regions.¹ During the 25 years’ economic growth, China’s length of Highways has doubled and that of the railway has increased by 42%. This results in additional farmland and forest area reduction.

1.2.2. Air quality deterioration

China’s openness and economic success also seemed accompanied by obvious pollution problems. Air pollution situation in the urban area started deteriorating quickly since the first decade of economic reform. At the end of 1990s, some Chinese cities had the highest air pollution concentration indicators in the world. 2/3 of Chinese cities failed to meet the air quality standard established by China’s Environment Protection Agency (EPA), which actually left more than ¾ of the urban population exposed in very polluted air. In general, northern cities have more serious particulate pollution as coal is intensively used for heating and heavy industrial boilers, while southern cities have serious sulfur dioxide pollution problem. Figure 1.3 illustrates the annual average sulfur dioxide (SO₂), Nitrogen Oxide (NO_x) and Total Suspending Particulates (TSP) concentration indicators in year 1991 and 2001 for 12 geographically representative Chinese cities. Although some air quality improvement has been realized during 1990s owing to the reinforcement of environmental protection efforts of the related administrative agency, the SO₂ and TSP concentration indicators in most of the cities still stay significantly above the World Health Organization (WHO) guidelines for developing countries.²

¹ Data mentioned in this section are compiled by the author from different sources. World Bank (1997), China Statistic Yearbook (various years), etc.

² World Bank (1997), pp.10.

Figure 1.3. Evolution of air pollution concentration indicators in Chinese cities
 (Data source: China Environmental Statistic Yearbook)

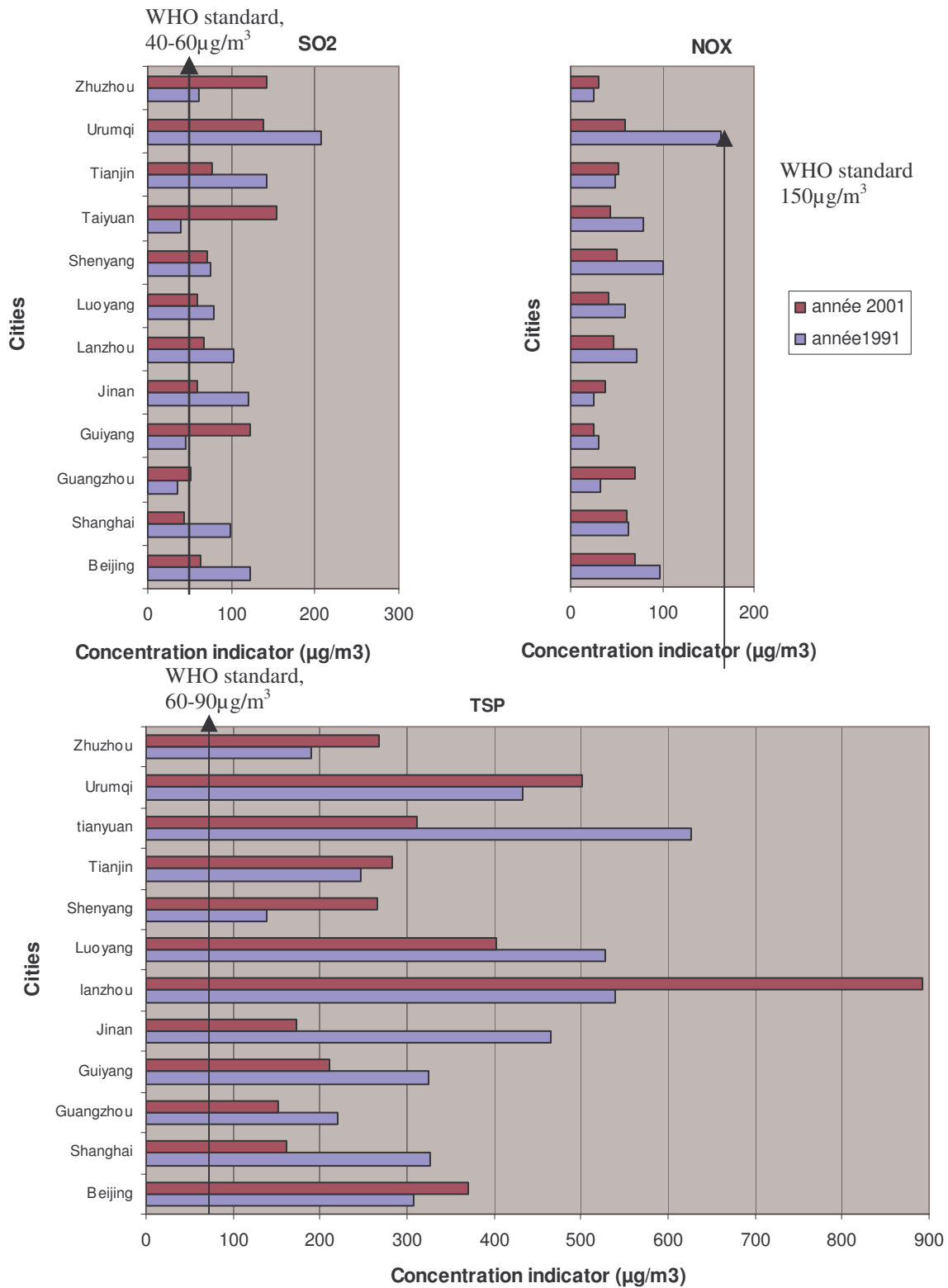

1.2.3. Water quality degradation

Originally, China is a country relatively poor in water access. The per capita water access is only 1/3 of the world average. However, under the pressure of accelerating industrial development and urbanization process, since 1980s, the quality of limited China's surface and ground water resources was significantly deteriorated. China's environmental agency categorizes the water quality into 5 categories. The water meeting the requirement of grade 1, 2 and 3 permits direct utilization as potable sources. The water reaching the requirement of grade 4 is restricted to the industrial use and the water attaining the condition of grade 5 can be used for irrigation. In 2002, in the seven main river basins of China, only 29.1% of the 741 key monitored sections met the water quality standard for Grade I-III, compared to 55% in year 1990; 30.0% of the sections met Grade IV or V standards, compared to 45% in year 1991. The water quality of the rest 40.9% of the sections was worse than Grade V standards.¹

The water quality deterioration further accentuated China's water shortage problem, especially in some large northern cities. In 1995, over 270 Chinese cities suffered water shortage problems. For more than 70 cities among them, the water shortage problem is principally due to the fact that their raw water source has been contaminated by the pollution from both production and/or consumption activities.²

1.3. Potential cost of pollution for Chinese economy

Traditional economic analysis ignores the environment cost induced by economic activities. In its point of view, China's economic success should simply be measured by gross national or domestic product (GDP). However, economic growth in China during the last quarter of the 20th century obviously incurred non-negligible cost on its natural resource capital.

1.3.1. Cost related to population density increase in urban regions

The reduction of the surface of forest and prairie has engendered serious desertification problem in many northern provinces in China. The decreasing arable land surface reduced China's agriculture production capacity and encumbered its alimentary dependence vis-à-vis foreign countries. In some provinces, when large number of peasants pour into urban regions, the fast increase in population density can provoke big difficulties for the urban regions' sanitary system and trigger the dissemination of some serious infectious diseases. The SARS

¹ SEPA (2003, 1991).

² World Bank (1997).

(Severe Acute Respiratory Syndrome), an atypical pneumonia of unknown aetiology, recognized and rapidly spread in a large part of Chinese territory at the beginning of 2003 was such an example.

1.3.2. Cost related to air pollution

The potential cost of air pollution on public health in some Chinese cities has been discussed and examined in numerous studies. Xu et al. (1994, 1995) on the case of Beijing and Shenyang, World Bank (1996) on the case of Chongqing and Peng et al. (2001) on the case of Shijiazhuang and Changsha all found significant positive correlation between the incidence of respiratory diseases and that of the air pollution concentration indicators such as suspending particulate matters (PM₁₀ and PM_{2.5}). Imagining that current average air pollution concentration situation of the whole country is equal to that of Beijing and that 80% of the Chinese population is exposed to the polluted air, World Bank (1997) calculated the potential cost alleviation in physical damages if China met its class-2 air quality standard.¹ Their calculation shows that over 178 000 premature deaths and 346 000 cases of Respiratory hospital admissions can be avoided if China's atmosphere can be improved.

Another major phenomenon derived from air pollution is the acid rain, which originates principally from two air pollutants: sulfur dioxide (SO₂) and nitrogen oxide (NO_x). After emit into the atmosphere and mixed with moisture in the air, the two air pollutants will produce sulphuric acid and nitric acid. These acid gas, firstly staying in the atmosphere and collected into clouds, will be released toward the earth when it rains, snows and fogs etc. At the beginning of 1980s, the acid rain phenomenon was essentially concentrated in some southwest provinces as Guizhou and Sichuan, whose coal reserves contain high tenor of sulfur. During the economic reform, with increase of related air pollution emission, the zone of acid rain has enlarged to 13 provinces and covers both the eastern coastal, inland southwest and inland north regions. Due to their relative humid climate, it is the south provinces that suffer the most from the acid rain problem. According to some Chinese scholars, the direct economic loss due to the acid rain in the 11 southern provinces accounts up to 4 billion Yuan (1988 constant price) of which the crop and the forest carry the most. If we also include the

¹ Chinese ambient air quality standard gives a 3-class air pollution situation assessment guidelines for the following concentration problems: sulphur dioxide, total suspended particulates, PM₁₀, carbon monoxide, nitrogen oxides, ozone and lead. This guideline is actually comparable to those of the World Health Organization. The class 2 air quality standard is actually the intermediate objective, whose most target values for concentration indicator are very close to that proposed by WHO.

potential loss in the ecological value in the forest and land stroked by the acid rain, this loss can be 2-8 times higher.¹

Another important source of pollution induced by the increase in concentration of carbon dioxide (CO₂) and NO_x in the atmosphere is the Greenhouse effect, which is supposed to possess the capacity in changing the global climate and to engender the destruction of aquatic and land ecosystem by producing a net warming of the earth's surface. Although it is not China's solo responsibility for the Greenhouse Gas (GHG) emission, facing the ascending trend in global temperature, some Chinese scholars predicted the further increase in the GHG (including CO₂, Methane, NO_x, etc.) around the world will result in continuous temperature ascending. This will in turn accelerate the vaporization speed of the water contained in earth and engender hurricanes and other forms of climate alias more frequently and finally affect China's rice, wheat, cotton and other crops' production. The rise of the temperature will also accelerate the melting of Arctic glacier and result in the rise of sea level. If as suggested, the sea level increased by 1 meter, it would not only flood an important part of Chinese territory, but also deprive China from its most developed regions like Shanghai and Guangdong, both located on the coast.²

1.3.3. Cost related to water pollution

Owing to its relatively well elaborated water adduction system, the disease related to the insalubrious of the polluted water is less spread in China than many other developing countries. But with the increase of the population living in the urban regions and acceleration of industrialization, the used-water treatment becomes a heavier and heavier task for many Chinese cities. The relatively backward water re-treatment system, combined with the problem of raw water shortage, actually explains the reappearance of some faeces-related contagious diseases after having disappeared from China for 30 years.

1.3.4. Pollution cost summary

Table 2.1 listed some economic cost valuation results related to the potential damages caused by China's air and water pollution problem compiled by World Bank (1997). Neglecting difference in the principles of the two valuation methods used in this calculation,

¹ Source: <http://zhengjian.org/zj/articles/2004/2/8/25610.html>.

² World Bank (1997).

we note that the actual environmental pollution problem generally causes important cost for Chinese economy, at least 3.5% of the total GDP.¹

Table 1.2. The economic cost related to China's air and water pollution

(million US\$, Source : World Bank (1997))

Problem	Willingness-to-pay valuation	Human capital valuation
Urban air pollution	32 343	11 271
Premature death	10 684	1 597
Morbidity	21 659	9 674
Restricted activity days	3 842	3 842
Chronic bronchitis	14 092	2 107
Other health effects	3 725	3 725
Indoor air pollution	10 648	3 711
Premature death	3 517	526
Morbidity	7 131	3 185
Lead exposure (children)	1 622	270
Water pollution	3 930	3 930
Health care costs	1 988	1 988
Agriculture and fishery losses	1 159	1 159
Water shortages	783	783
Acid rain	5 046	5 046
Crop and forest damage	4 364	4 364
Materials damage	271	271
Ecosystem damage	411	411
Total	53 589	24 228
Percentage of GDP	7.7%	3.5%

1.4. China's Green GDP

The green national accounting offers us a new measurement for the welfare equivalent income for the purpose of making comparison over time under the analytical angle of sustainable development (Vincent, 2000). In this system, the net national product (NNP) can be obtained by deducting from gross national product (GNP) "the portion of output which is used up in the production process, i.e. the level of man-made capital which is lost through 'wear and tear'" (Cole, 2000, pp.59.). Then, from NNP, we further remove the depreciation of natural capital and the destruction of natural resource to obtain the Green NNP. The equation of calculation similar to Pearce (1993) is as the following.

$$Green\ NNP = GNP - D_m - D_n - D_{estr_n}$$

¹ The principle of the willingness-to-pay valuation method is to ask the representative individuals how much he is willing to pay in order to avoid the damages mentioned in the table 1.2. Here, we extrapolate for the China's case the WTP studies done in US after adjusting the amount of payment according to income difference between the two countries. While the human capital valuation method is only focus on the individual's potential income loss caused by the interested pollution problems, which is absolutely lower than that estimated by Willingness-To-Pay method since the intrinsic values of health of both human body and ecosystem have not been considered in this method.

Here, D_m is the depreciation of the man-made capital, D_n is the depreciation of natural capital, which is measured by costs of replacing such depreciation with renewable substitutes according to Pearce, and $Destr_n$ is the destruction of natural capital.

Following the same reasoning of the calculation function for Green NNP, we can easily derive the Green GDP for China by employing the estimated economic cost related to air and water pollution listed in Table 1.2. Under this condition, Green GDP=GDP-economic cost related to pollution. Simply assuming that during 1980-2002, the average economic cost related to air and water pollution problems in China takes the value of 7.7% or 3.5%, we illustrate in the Figure 1.4 the evolution of China's Green GDP per capita during its 25 years' economic reform. Clearly, although the magnitude of reduction in per capita GDP due to the environmental cost is not very big, with the economic growth and the increase of income level, the deduction caused by the environmental cost becomes more and more obvious.

Figure 1.4 China's Green GDP per capita

(Based on the valuation result of Table 1.1, Yuan, 1990 constant price)

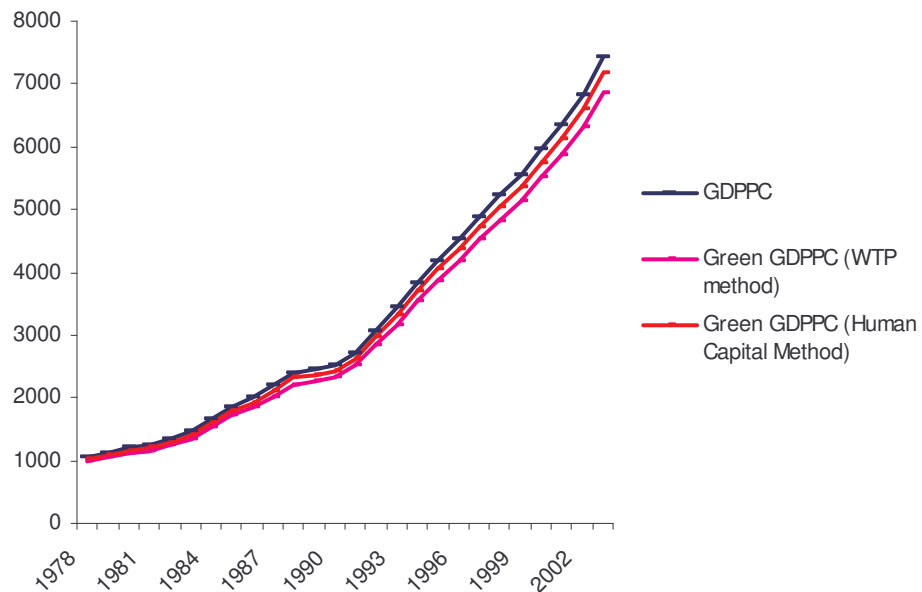

**PART 1. ENVIRONMENT AND ECONOMIC GROWTH: RE-ESTIMATE
THE ENVIRONMENTAL KUZNETS CURVE IN CHINA'S CASE**

Chapter 2. Is the hypothesis of the Environmental Kuznets Curve confirmed in China's case?

Facing the obvious environmental quality degradation during last 25 years, China starts to concern about its environmental issue. However, different from those living in developed countries, Chinese people's desire for a better environment is actually combined with their ambition of earning a higher income and leading a better material life. Will China be able to sustain its economic growth without running into resource constraints that will encumber future economic growth? Whether there exists a sustainable development path for China to enjoy economic success and preserve environmental quality at the same time? We will try to answer this question by studying the hypothesis of "Environmental Kuznets Curve" in China's case.

2.1 The idea and the genesis of the hypothesis of "Environmental Kuznets Curve"

For some "limit of growth" proponents as Georgescu-Roegen (1971) and Meadows et al. (1972), the growing economic activity requires more and more energy and material inputs, and generates more and more waste by-products. These will then undermine the "carry capacity" of the biosphere and result in degradation of environmental quality. The degraded stock of natural resources would eventually put economic activity itself at risk and cease the future growth potential. Therefore, to save the environment and economy, economic growth must cease and the world must make a transition to its steady state.

Different from this extreme pessimistic hypothesis, Environmental Kuznets Curve (EKC) assumes the relationship between various indicators of environmental degradation and per capita income to be depicted by an inverted U curve. This means the environment degradation indicators, firstly reinforced with economic growth, will be decoupled from economic growth trends and bended downwards after income level attains certain critically high level.

The genesis of the Environmental Kuznets Curve can be traced back to the Kuznets curve named by Kuznets (1955), who originally hypothesized the relationship between

inequality in income distribution and income growth to follow an inverted U curve. Since the early 1990s, this inverted U curve re-gained academic attention. In the path breaking studies of Grossman and Krueger (1991) on the potential environmental impacts of NAFTA, the Shafik and Bandyopadhyay (1992) as the background study for the *1992 World Development Report* and Panayotou (1993) as a part of a study for the International Labour Organization, the common conclusion all revealed the existence of inverted-U relationship between some pollution indicators and income per capita from cross-country analyses. Panayotou (1993) first coined this inverted-U relationship as Environmental Kuznets Curve (EKC) given its resemblance to Kuznets' inverted-U relationship between income inequality and economic development.

2.2 Different policy interpretation on the EKC hypothesis

Different economists, however, derive totally different policy interpretation from the inverted-U relationship between pollution variation and income growth. At the extreme of optimists, Beckerman (1992) argues that the easiest way to realize environmental improvement is keep the original economic growth path and endure the transient environment deterioration. Believing both the demand and supply capacity for better environment to increase with income, he concludes that, "the strongest correlation between the incomes and the extent to which environmental protection measures are adopted demonstrates that in the long run, the surest way to improve your environment is to becomes rich". In his very controversial book *the Sceptical Environmentalist*, Lomborg (2001) also describes our future as a "beautiful world". After making the comparison in both environmental and economic aspects of the world during the last 100 years, he concludes this world "is basically headed in the right direction and that we can help to steer this development process by insisting on reasonable prioritisation (the economic growth)".(p. 350-352) Barlett (1994) goes even farther in his claims about environment and growth nexus. For him, the environmental regulation, as policy tools reducing economic growth, will actually reduce the environmental quality.

At the other extreme end, the pessimists explain the formation of this inverted-U curve by trade liberalization that redistributes the polluting industries between countries of different income level. "Whereas *certeteris paribus* openness might be expected to reduce environmental damage in both developing and developed countries, trade itself likely to increase impacts in developing countries and reduce them in the developed countries and this may be another explanation for the EKC relationship". (Suri and Chapman, 1998)

The hypothesis of “pollution haven” further emphasizes this interpretation: the developing countries have comparative advantages in polluting sectors as their relatively lower income level cannot support as stringent environmental regulation as their richer trade-partners. Under trade liberalisation, there is a tendency for the pollution-intensive industries to move offshore from the developed countries and relocated in the developing countries where the pollution control stringency is less severe. If the famous inverted-U curve observed from the cross-country experience is formed by this static mechanism, the decrease in the environmental degradation in the developed countries is actually compensated by the pollution increase in the developing countries. Under this circumstance, the overall environment quality of the world may even risks more damage, as the developing countries generally possess less efficient pollution abatement technologies. Ekins (1997) further points out that if the pollution reduction in the developed countries is realized by discharging the pollution burden to the less developing countries, a such opportunity may not available for today’s least developed countries. Therefore, advocating EKC hypothesis will actually impede the realization of sustainable development in both the developing countries and the whole world.

More economists put forward a neutral view on the EKC hypothesis and believe the found inverted U curve captures only the ‘net effect’ of income on environment, in which “income growth is used as an omnibus variable representing a variety of underlying influences, whose separate effect are obscured”. (Panayotou, 2003) In this perspective, the linkage from income growth to alleviation of environmental deterioration is *not* automatic. To understand the mysterious mechanisms accompanied and masked by economic growth, many authors regard the inverted-U relationship as a “stylised” fact and spending their “demystifying” efforts in proposing and verifying the underlying structural explanations for it: efficiency increase in production, consumption and pollution abatement; institutional development; improvements in market and institution efficiency; strengthened public consciences on the negative effects of pollution on health; increasing willingness-to-pay for pollution abatement with income; and transformation of economic structure from dominated by industrial sectors to the one dominated by tertiary sectors.¹ From their point of view, the economic growth is neither necessary nor “sufficient factor to induce environmental improvement in general”.² This actually reminds us the turning point between economic growth and environmental degradation obtained from cross-country experience is not a must-

¹ More details are discussed in Panayotou (1997), Stern (2004) and Dinda (2004).

² Arrow et al. (1995, p.92)

to-be condition. For some pollution case, it is actually possible to realize situation improvement even in the countries whose actual income level is still low.

2.3 A simple review and comparison on the existing EKC empirical analysis

Once the statistics on environmental quality becomes available, the EKC hypothesis is a reduced-form correlation between environmental indicator and income level easy to test econometrically. From the beginning of 1990s, the compilation and publication of concentration and emission data by the Global Environmental Monitoring System (GEMS), the World Bank (World Development Indicator), the World Resource Institute (WRI), the OECD and United Nation activated the unprecedented academic enthusiasm on EKC hypothesis investigation. Since the first paper of Grossman and Krueger (1991), over 100 papers have addressed this topic from different angles and many of them did confirm the existence of EKC from the cross-country international experiences during the last 30 years.

If the EKC can be considered as a statistical artefact that summarizing the pollution indicator and income per capita in a two-dimensional diagram, in a strict econometrical perspective, this reduced-form correlation, ignoring the underlying real causality between the two indicators, risks to be “spurious” and far from being “optimal”. The general critics confronted by most of the EKC studies are the incoherence and incomparability in the forms and turning points of the pollution-income relationship found in different studies. (Wilson, 2002, Ekins, 1997 and Stern and Common, 2001)

2.3.1 Great instability in the EKC analyses based on international experiences

Table 2.1 summarizes in chronological order 27 EKC studies analysing the sulphur dioxide (SO₂) pollution case. SO₂ is the air pollution indicator most discussed in EKC literatures and we generally believe it is the local air pollution indicator having the highest possibility to follow the inverted U trajectory during income growth. (Stern, 2004; Cole et al., 2003; Selden and Song, 1994)

Table 2.1 EKC empirical analyses based on SO₂ pollution case

Authors	EKC form	Turning point ¹	Countries, periods ²	Emis/ Conc	Func. form	Other variables	Estimation methods	Interesting findings	Data source
Grossman and Krueger (1991)	N curve	Peak: \$5000 Trough: \$14000 (1985 USD)	27-52 cities in 14-32 countries, 1977, 1982, 1988	Conc.	Level, Cubic	Site dummy, population density, time trend, trade intensity, communist country dummy	Panel data (Random effect)	First paper discussing the pollution-income relationship	GEMS
Panayotou (1993)	Inverted U	\$3137 (1990 USD, nominal exchange rate)	30 countries, 1982-1994	Emis.	Log., square	Population density	OLS	First paper coined the pollution-income relationship by Environmental Kuznets Curve	GEMS
Shafik (1994)	Concentration: Inverted U Emission: increasing relationship	Concentration: \$8000 (1990 USD PPP)	149 counties, 1961-1986	Emis. and Conc.	Log., cubic	Time trend, site dummy	OLS	Concentration indicators are more easily to show inverted U curve with income growth.	World Bank
Grossman and Krueger (1994)	Inverted U curve	Peak: \$4053, trough: \$14000	Numerous cities in 30 countries in 1977, 1982, 1988	Conc.	Level, cubic	Population density, site dummy, time trend	Panel data estimator random effect		GEMS
Selden and Song (1994)	Inverted U curve	OLS: no results FE: \$8916-8709 RE: \$10500 (1985 USD)	30 countries (22 high-income, 6 middle-income and 2 low-income countries), 1973-1975, 1979-1981, 1982-1984	Emis.	Level, square	Population density and period fixed effect	Panel data estimators (pooling, fixed and random effect)	Although find EKC, the authors believe the total emission will not decrease in very long term, as most of the population are living in the relatively poor countries	GEMS, WRI
Shukla and Parikh (1996)	Monotonically negative relationship	--	City-level cross-country data,	Conc.	Level, square	City population, squared city population		The inverted U relationship is found between city population and pollution	WRI
Cole et al. (1997)	Inverted U curve,	Log: \$6900 Level: \$5700	11 OECD countries, 1970-1992	Emis.	level & Log., square	Trade intensity, time trend	GLS, random effect	Including other factors has little impact on EKC form	OECD
Panayotou (1997)	Inverted U before and U curve after structural determinants included	Inverted U: \$5000 U curve: though: \$27528	30 developing and developed countries, 1982-1994	Conc.	Level, cubic	Growth rate, population density, quality of institution, scale effect, composition effect, time trend,	Unbalanced panel of cross-section panel data (Fixed and random effect)	Inclusion of the structural determinants can change the form of EKC. Paper offers more policy implication to EKC hypothesis	GEMS
Carson et al. (1997)	Monotonically decreasing relationship	--	US, 1990	Emis.	Linear form	Population density, percentage of urban population	OLS for cross-country data	It is more interesting to see percentage change instead of absolute change of emission in EKC studies as different initial pollution situation induce difficulties of different level in pollution reduction	US

Table 2.1 EKC empirical analyses based on SO₂ pollution case (continue)

Authors	EKC form	Turning point ¹	Countries, periods ²	Emis/C onc	Func. form	Other variables	Estimation methods	Interesting findings	Data source
De Bruyn et al. (1998)	EKC is not generally fit for all the countries	--	4 countries, Netherlands, UK, USA and Western Germany, between 1960-1993	Emis.	Growth rate	Composition changes, energy price, economic growth path,	OLS, each country separately estimated	EKC does not generally fit for all countries, each country has its own technological, structural, energy price and economic growth path, so specific emission situation	Netherland, UK, USA, Western Germany
Gale and Mendez (1998)	Monotonically decreasing	--	Re-estimate the GK (1994), same database but restricted in 1979, 34 cities in 25 countries	Conc.	Level, cubic	City economic scale, the relative importance of city population, relative factor abundances (capital, labour and land), trade policy, time trend	OLS	Pollution-income relationship becomes monotonically decreasing after the other structural factors included into estimation	GEMS
Kaufman et al. (1998)	U-curve	OLS: \$11577 FE: \$12500 RE: \$12175	23 countries (13 developed, 10 developing countries) 1974-1989, ***	Conc.	Level, square	Economic activity density, iron steel export ratio and time effect	Cross-country OLS, panel data estimator (fixed and random effect)	Paper Indicates the asymmetric characters of the relationship between income and pollution before and after the turning points. As the other factors as fuel mix might not following same evolution trend in the developing countries as in developed ones.	UN
Torras and Boyce (1998)	N curve	Peak: \$3306 with and \$3890 without inequality, Trough: \$14034 with and \$15425 without inequality	18-52 cities in 19-42 countries, 1977-1991 (Almost same database as GK, 1994)	Conc.	Level, cubic	GINI, literacy, political right and civil liberty, Urbanization, location specific dummy (residence, commercial, industrial regions), population density	OLS	The inclusion of income inequality into the estimation function generally reduces the turning point of EKC	GEMS
List and Gallet (1999)	Inverted U or N	General system inverted U: \$16828, cubic: 15502 Individual EKC for different states: \$1162-\$22462	US data, 1929-1994, 48 states	Emis.	Level, square/cubic	No other determinants considered since the environment-income coefficient is state-specific	Random coefficient panel data model	Inverted U or N according to the estimation function form, each state has its own EKC form and turning points	US
Perman and Stern (1999)	Each country has its EKC curve, monotonically increasing or U curve are very often	--	74 countries (25 developed and 49 developing countries), 1960-1990	Emis.	Level, square		Take care of the time series characters of the data, cointegration	Study is based on a dynamic model in which the EKC form is included as a long run stable relationship into the cointegration vector of each country	A.S.L. and Association

Table 2.1 EKC empirical analyses based on SO₂ pollution case (continue)

Authors	EKC form	Turning point ¹	Countries, periods ²	Emis/C onc	Func. form	Other variables	Estimation methods	Interesting findings	Data source
Barrett and Graddy (2000)	N curve	Peak: \$4200 Trough: \$12500	Same database as GK (1994): 27-52 cities in 14-32 countries, 1977, 1982, 1988	Conc.	Level, cubic, lagged income included	Civil liberty dummy, site dummy, time effect, population density, site dummy and time trend	Random effect, GLS, panel data	The inclusion of civil freedom dummy only influences the height of the EKC Almost same results as GK (1994) (1985USD PPP)	GEMS
Bradford et al. (2000)	Inverted U or N curve	Inverted-U: \$3055 N: Peak: \$1891, Trough: \$1531250	Same database of GK (1994), Numerous cities in 26 countries, 1977,1982 and 1988,	Conc.	New model	Time effect and technology	Panel data estimator (fixed and random effect)	Inverted U or N curve depending on the polynomial order of Y included	GEMS
Dinda et al. (2000)	U curve	Trough: \$12500 (1985 USD)	39 cities in 33 countries, 3 period, 1979-1982, 1983-1986 and 1987-1990, 6 low-income, 11 middle-income and 16 high-income countries	Conc.	Level and Log., square	Sectoral composition (capital abundance, K/L), growth rate and time effect, distinguishing site characters (commercial, residential, etc.)	OLS according to different area and least absolute error method	Study includes the scale, composition and technique effects defined by Grossman (1995) into estimation of EKC curve	World Development Report, world Bank, 1992
Harbaugh et al. (2000)	Inversed S curve	Peak: \$13741-\$20081 Bottom: \$7145-\$9142	GK (1994) database+10 years' more data (1971-1976 before and 1989-1992 after)+25 new cities	Conc.	Level, cubic	Site dummy and time trend	Panel data estimator (Fixed and Random effect)	The changes in data sample, both in time and country dimension, can have important influence on the EKC estimation results.	GEMS
Gangadharan and Valenzuela (2001)	Insignificant inverse S curve or N curve	Trough: \$939 Peak: \$12038	51 countries (29 developing and 22 OECD countries) China included	Emis.	Level, cubic	Population density, literacy rate and income inequality	Reduced form from a two equation system, TSLS	Paper discusses the potential feedback effect of pollution on people's health situation	WDI
Heerink et al. (2001)	Inverted U curve	\$1929 without and \$2233 with GINI	Shafik (1994) database, only 33 countries are included due to inequality data	Urban Conc.	Log., square	Income inequality (GINI), believe reduction in inequality increase the turning point of EKC	Cross-country data. OLS	Increase in income inequality might improve environmental quality	
Stern and Common (2001)	Global sample: monotonically increasing. High-income subsample: inverted U curve	Whole sample: \$29360 OECD only: \$48920 Non-OECE only: \$303133	73 countries for 31 years, (1960-1991) (24 developed and 49 developing countries),	Emis.	Log., square	Time fixed effect	Panel data estimator (Fixed and random effect)	Paper mentioned the potential sensitivity of the EKC form with respect to country sample in the database. The relatively low turning points found by many EKC studies might be due to the fact that only the rich OECD countries were included in the estimation data sample. Turning point becomes very much larger when developing countries included	A.S.L. and Association

Table 2.1 EKC empirical analyses based on SO₂ pollution case (continue)

Authors	EKC form	Turning point ¹	Countries, periods ²	Emis/ Conc	Func. form	Other variables	Estimation methods	Interesting findings	Data source
Roca et al. (2001)	Monotonically decreasing	--	1973-1996, Spain	Emis.	Log.	Share of nuclear power and coal in total primary energy	Time series method, co-integration	The EKC hypothesis is generally weakened when additional variables are added besides income.	Spain
Egli (2002)	No inverted-U curve found	--	West Germany, 1966-1998	Emis.	Level, square	Trade, structure and growth rate	Error correction model, GLS	Believe the EKC to be a long-run relationship.	Federal Republic Germany
Cole and Elliott (2003)	Inverted U or N curve	Global data: FE: \$5367-\$7483 RE: \$8406-11168 Only OECD: \$5431-\$10521	26 countries, 5 year period average data from 1975-1990	Emis.	Level, cubic	Trade impact, relative capital abundance (K/L), multiplicative terms between trade and other determinants of emission, GINI, literacy rate	Panel data estimator (Fixed and random effect),	Trade's impact on EKC differs from country, since each country has different comparative advantage and environmental regulation situation. Sample difference does not influence the estimation results. Author believes EKC is a robust relationship; trade only plays marginal impact on it.	
Halos (2003)	EKC is not rejected by A-B GMM, but rejected in the random coefficient model	Random coefficient model: Total: \$2850-6230, OECD: \$9239-9181, Non OECD: \$908178-343689 A-B GMM: Global: \$4381 OECD: \$5648 Non-OECD: \$3439	73 OECD and non-OECD countries for 31 years (1960-1990), same database as Stern and Common (2001)	Emis.	Log., square	Electricity tariff, debt per capita, trade, political right and other listed in Agras and Chapman (1999)	Random coefficient panel data model, Arellano and Bond GMM estimator	Results are totally different from Stern and Common (2001) by using different methods. Choice of econometrical method is crucial in the extraction of turning point and associated policy implications. The coefficients are significantly different between rich and poor countries samples	A.S.L. and Association
Milimet et al. (2003)	Inverted-U curve	\$8000	48 US state, 1929-1994	Emis.	Undefined func. form	none	Semi-parametrical PLR model	The location of the peak of EKC is quite sensitive to modelling assumptions	US
Cole (2004)	Inverted U	\$3742 without and \$5426 with dirty import and export factors included in estimation,	1980-1997, 18 OECD countries	Emis.	Log, cubic	Net export as a proportion of consumption, country and time specific effect, share of manufacturing sector in GDP, share of dirty export of non-OECD countries in total export and share of dirty import from non-OECD countries, trade intensity	Fixed effect, panel data	Author cannot exclude the possibility that the displacement and migration of dirty industries do not contribute to the formation of inverted U curve	OECD

Note: 1. All the turning points are transformed to the 1985 USD calculated from the parity of purchasing power. (The transformation information between dollars of different year is from WDI, 2002)

2. Most of the databases used in EKC literatures include China in their sample.

However, among the 27 studies listed in the table, only 15 find supportive evidences for the EKC hypothesis. The number of studies providing other curve forms for the relationship between SO₂ and economic growth increases during the time. Even among the paper supporting the EKC hypothesis, their conclusion about the location of the turning points of the inverted-U curve shows very large discrepancies. Detailed comparison between papers reveals the possible explanation for these discrepancies may be the high sensitivity of these inverted-U curves with respect to the choice of time period, country sample, estimation functions and methods.

a. The sensitivity of EKC form with respect to time period choices in estimation

The sensitivity of EKC form with respect to sample choices can be firstly observed from time dimension. Using exactly the same estimation function form and the same database as Grossman and Krueger (1991), Harbaugh et al. (2000) found that the simple prolongation of the database by another 10 years can change the estimated pollution-income relationship into an inverse-S form. This finding reminds us to be cautious in projecting future pollution-income trajectory by the environment improvement realized during some historical periods. Some necessary and sufficient conditions resulting in the downward bending trend of pollution facing income growth might not exist anymore with time passing by.

b. The sensitivity of the EKC form to the choice of country samples

The instability of the EKC form is also observed between the studies including different countries samples in their database. One example is Stern and Common (2001) vs. Selden and Song (1994). Using only the 22 OECD countries' data, Selden and Song (1994) found an EKC with turning point at about \$8000-\$10000. Stern and Common (2001) enlarge the database to 73 countries, with most of the new data coming from developing world. Their conclusion reveals that "turning point (of EKC) becomes quite higher when data of developing countries are included or separately estimated". If their OECD sub-sample still reproduces similar EKC turning point (\$9181) as that in Selden and Song (1994), the global and non-OECD countries samples actually reveal much higher turning points: \$54199 (global) and \$343689 (non-OECD). Several other pairs of comparison in Table 2.1 confirm the sensitivity of EKC form in this aspect, such as the two studies based on US state level data—Carson et al. (1997) vs. List and Gallet (1999) and the other two focusing on a part of OECD and developing countries—Cole et al. (1997) vs. Kaufman et al. (1998). This finding actually reminds us the infeasibility in extrapolating the environment-income experience

obtained from developed countries to predict that for developing countries. The latter are frequently proven to have more difficulties in improving their pollution-income trajectory.

c. The sensitivity of the EKC form with respect to environmental measurements

Another source of sensitivity is related to the measures of environmental indicators. The “measures of the environmental degradation fall in two general categories: emission of the pollutants and environmental concentrations of pollutants”. (Kaufman et al., 1998, p210) These two measurements illustrate different aspects of environmental degradation situation and neither of them can offer us a comprehensive description on environment. “Emission directly measures the amount of pollutants generated by economic activities during a period without regarding to the size of the area into which the pollutants are emitted”. It is actually a flow measurement for the polluting capacity of economy activities. “The concentration measures the quality of pollutants per unit area without regarding to the activity that emitted them”, which is more like a stock measurement describing the final result of the encounter between emission, abatement efforts of the economy and the auto-purification capacities of the nature. As concentration is a more direct environmental quality indicator and has more direct impact on productivity and public health situation, Selden and Song (1994) believe it should be more easier to obtain an inverted U curve for concentration than for emission indicators. The EKC studies listed in Table 2.1 confirm this proposition, especially the most previous studies in which the estimation methods, etc. have not yet played a significant role in changing the estimation results.

d. Sensitivity of the EKC form with respect to the different econometrical strategies

Aiming at improve econometrical efficiency, more recent EKC studies heavily invest in estimation methods. Their efforts can be classified into four categories. The first category aims at revealing country-specification in environment-income relationship. This strategy evolves from the very first simple cross-section OLS estimation that supposes the environment-income relationship to be an internationally homogenous correlation (Panayotou, 1993 and Shafik, 1994), to the panel data estimator which includes group specific effect into estimation to capture the country-specific heights in EKC, and finally to the random coefficient panel data model which permits country-specific coefficient for income and income square term (List and Gallet, 1999; Halos, 2003). The estimation efficiency improvements are generally accompanied by the decrease of coherence in environment-income relationship between countries and by the loss of prediction power of the one-form-

fit-for-all EKC curve obtained from international experiences. The second category aims at “demystifying” the EKC hypothesis (Panayotou, 1997). These group of studies focus on investigating the underlying structural factors covered by income growth, such as structural transformation, population density, technological progress, institutional development, inequality, etc. As mentioned in many of these studies, inclusion of the other factors into does affect the simple environment-income correlation predicted by EKC hypothesis, therefore enhances the instability in the form and turning point of EKC. (Cole 2003; Cole 2004; Roca et al. 2001; Heerink et al., 2001; Barrett and Graddy, 2000; Gale and Mendez, 1998; Kaufman et al., 1998 and Torras and Boyce, 1998, Panayotou, 1997, etc.) The third group of authors regards pollution indicator and income level as two time series originally sharing the same monotonically increasing trend. It explains the decoupling between these two series by the domination of the technical progress in pollution abatement to economic scale enlargement that leads pollution to increase. (De Bruyn et al., 1998 and Perman and Stern, 2003) The last type of econometrical strategy focuses on the potential estimation bias caused by the predetermined estimation function as either square or cubic form. By simply comparing the estimation results obtained from different function form or employing more rigorous statistical method as semi- or non-parametrical models, these studies find the decision to include or not the cubic income term largely determines the location of the EKC turning point. (Bradford et al., 2000; Milimet et al., 2003)

e. Other factors can also affect the forms of EKC

The turning point sensitivity of EKC hypothesis can also be explained by the economic sources of pollution. Dinda et al. (2000) distinguish the pollution concentration data in residential regions from that in commercial regions, and find the turning point of the EKC in the residential regions are much higher than that in the commercial regions. This is because to separate the utility increase obtained from consumption from the disutility related to pollution increase that also issues from increased consumption is more difficult.

We may also find different EKC turning points when the interested pollution indicators are reflecting the average environment situation of the whole country and when they only illustrate the environmental situation in urban areas. Considering many EKC studies are based on the GEMS data collected in cities of 30 countries all over the world, Selden and Song (1994) indicate that the turning points revealed by these studies might be lower than that revealed by the EKC showing the relationship of national average environmental evolution

with income growth, because it is in the urban regions that we firstly start environment quality control activities.

2.3.2. Weakness in the current EKC analyses

The great instability and incomparability observed in the previous EKC analyses actually reveals several aspects' weakness.

1) Incoherence between the theoretical assumptions of micro-foundation and the reality

Most of the micro-foundation theoretical analyses succeed in explaining the formation of EKC as an automatic tendency once per capita income level attains certain critical level. (Lopèz, 1994; Antel and Heidebrink, 1995; Kriström and Rivera, 1995; Selden and Song, 1995; McConnell, 1997; Andreoni and Levinson, 1998, Munashinghe, 1999 and Antweiler et al., 2001) One common idea of these theoretical models is to base their reasoning on utility maximisation problem of a representative consumer. This utility function is supposed to contain two components: the utility coming from consumption of normal good C and the disutility caused by pollution, P. It can be expressed as,

$$\begin{aligned} \text{Max}_C U &= U(C, P(C)) \\ U'_C > 0, U''_C < 0, U'_P < 0, U''_P > 0, P'_C > 0, P''_C < 0. \end{aligned} \quad (2.1)$$

Consumption of the normal good C can, on one hand, increase the utility, but on the other hand, decrease it since production and/or consumption of the normal good arises pollution problem. For a representative consumer, utility maximisation requires to equalise the marginal utility of the last unit of normal goods consumption U'_C to the marginal disutility of pollution U'_P caused by the emission related to this last unit of consumption. Presented in equation (2.2), this reasoning is called Samuelson Rule.

$$U'_C + U'_P = 0 \quad (2.2)$$

Now, the basic idea of the utility maximization of a representative consumer can be illustrated in Figure 2.1. Before the consumption attains the consumption level C^* where marginal utility of consumption equal to marginal disutility of pollution, the increase of consumption brings more marginal utility than disutility. Therefore, with income growth, the consumer prefers to continue increasing his consumption level and suffer the necessary utility decrease caused by pollution. As there is no pollution abatement activity at this moment, we observe a positive relationship between economic growth and pollution as shown in the lower panel of Figure 2.1.

However, this positive income-pollution relationship will only be valid when the consumption level is below C^* or when income is lower than Y^* . Beyond these, the utility maximization objective will make the investment in pollution abatement activities necessary measures. The following consumption increase will be less than the income growth, with another part of income growth used in pollution abatement activities. Owing to the costly pollution abatement activities, the consumption and income growth will be able to decoupled from pollution increase, and at this time, the inverted-U curve between income growth and pollution is formed.

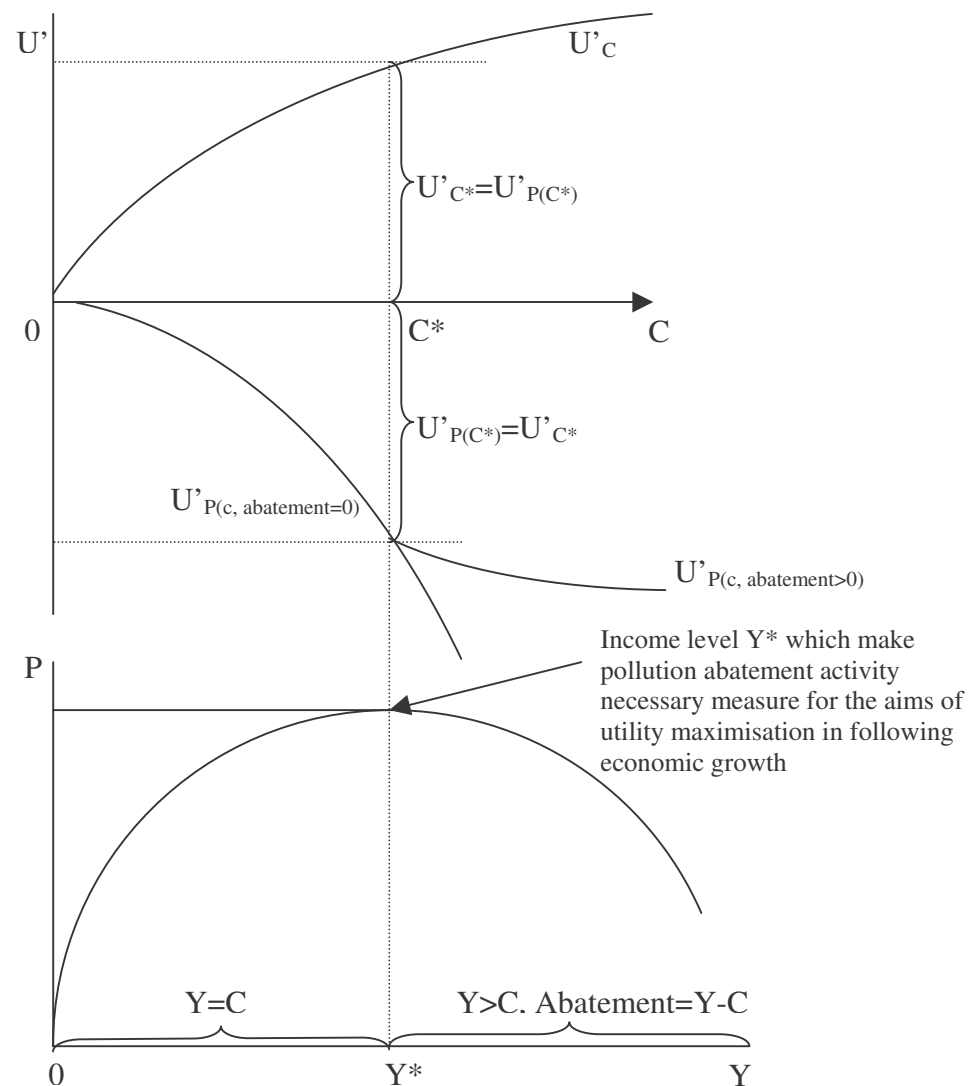

Figure 2.1. Micro theoretical foundation for EKC formation

Different theoretical analyses employ different way to express the pollution abatement activities in their models. Selden and Song (1995) describe pollution abatement investment as direct income split flow toward pollution abatement activities, while Lopèz (1994) embodies the pollution reduction in the process of substitution of the polluting factors by the

conventional production factors as capital or labor.¹ Their common idea that the pollution abatement activity is not free is actually at the core for explaining the automatic formation of the inverted U relationship.

Although theoretical explanations implicate the automatic decoupling between economic growth and environmental deterioration as a rational dynamic track for economies, this implication is actually conditional on the following three underlying assumptions—the increasing marginal disutility from pollution with income growth; the increasing availability of the abatement technology with economic development, and finally the existence of a efficient institutional system that guarantees function of the economy to following the neoclassical reasoning. Unfortunately, the validity of all the three assumptions is not the same between countries. They are actually further conditional on many other concrete characteristics of an economy.

Firstly, income growth may not necessarily provoke marginal disutility from pollution to increase. It actually depends on whether the information on pollution situation can be completely disclosed to the public and whether the negative impact of the pollutant is understood by them. However, the realisation of the both conditions does not necessarily depend on economic growth. For the pollutants whose existence cannot be easily detected without the help of necessary equipment or whose negative impact has not yet been proven by scientific studies, marginal disutility related to it may not necessarily increase with income growth. Hilton and Levinson (1998) found that the diminution of the lead emission from vehicle uses was actually triggered by the scientific discover showing the dangers of the increasing atmospheric lead concentration to children's intelligence development but not by income growth. Bimonte (2002) also confirms the importance of the pollution formation accessibility in the formation of the inverted-U curve.

Secondly, even if the pollution information disclosure system can promptly inform the current pollution situation to the public, in reality, this cannot yet guarantee the formation of the inverted U EKC. This can be explained from the following two aspects. On one hand, the assumed automatic link from the increased pollution disutility to pollution control policy adjustment can be undermined by either government failure or social structure characteristics. Barrett (2000) points out the environmental quality of one country does not only “depend on its prosperity”, but also “on the capacity of the citizens to acquire environment information, to assemble and organize, and to give voice to their preference for environmental quality” and

¹ The capital and labor transferred into pollution abatement activities present the opportunity cost for producer since if not used in pollution abatement activities, these factors can be used to increase production quantity.

on whether “its government has incentives to satisfy these preferences by changing policy, perhaps the most powerful incentive being the desire to get elected or re-elected.” For the countries having relatively low civil and political freedoms, their population might be lack of the capacity to manifest their dissatisfaction about environmental quality. For the government, the inexistence of the sense of urgency for the re-election possibility might also reduce its incentive to respond actively to the public demand for a better environment. On the other hand, even the government acts like an efficient social planner and keeps the maximization of social welfare as its objective, the link between disutility of pollution and the environment control policy adjustment may still be distorted. As indicated in Torras and Boyce (1998), although the negative effect of pollution is normally distributed in an average fashion among the people, the distribution of the power for social decision might not be carried out in the same way. This unbalanced social decision power distribution may have the tendency to exaggerate the benefit from the pollution-generating production activity obtained by the people having larger social decision power while overlook the pollution disutility suffered by the people having less power in social decisions. This can actually retarded the development of pollution control activities and therefore postpones the appearance of the turning point of EKC. Using the income inequality as an approximation for the distribution situation of the social decision power, both Torras and Boyce (1998) and Bimonte (2002) found that greater income inequality is associated with more pollution.

Finally, even if the both previous conditions are satisfied, some other institutional defections may still prevent the appearance of pollution-income decoupling tendency. For example, the pollution control policies may be undermined by the incompetence in pollution monitoring and policy enforcement. Take the example of China, as its pollution monitoring and control policies are only efficiently applied in the large-scale state own enterprises (SOE), but its market-oriented economic reform catalysts remarkable growth in the ratio of the small scale private economy, the increase of its nominal stringency of pollution control policies during 1990s does not necessarily means important improvement of its overall pollution control capacity of the government. Moreover, the reaction of the polluters to the reinforced pollution control policies also depends on their technological supply capacity, which is not only conditional on absolute income level but also on the current institutional situation of a country. Magnani (2000) investigates the determinants of the research and development investment on pollution abatement in different countries and concludes that for the poor countries, inequality is another important impediment factor for technology progress in pollution abatement activities besides the absolute income level. Bhattarai and Hammig

(2001) also indicate the critical role of some institution and macro policies as exchange rate regime, debt policy, interest rate policy and black market premium, etc. in affecting the investment decision of government in pollution abatement research and development.

From all the three aspects, we can see that simple income growth is neither the necessary nor the sufficient condition for the appearance of the decoupling tendency between deterioration of environmental quality and economic growth. For different countries with different institutional and structural characteristics, the potential difference in their income-pollution relationship can be very big.

(2) Weakness of the EKC hypothesis from assumptions in the empirical analyses

Besides the deficiencies in the theoretical EKC analyses due to their naïve assumptions about the perfect economic and institutional efficiency, the weakness of the current EKC analyses can also be found from their empirical assumptions.

a. Potential simultaneity between economic growth and pollution

The EKC hypothesis implicitly assumes the unidirectional causality from economic growth to pollution and ignores the possible simultaneity and “feedback” effect from the pollution to economic growth capacity. Coondoo and Dinda (2002) tested the causality between income and emission of CO₂. Their conclusion showed that different countries have different causality direction between income and pollution. Excepts for the very limited number of countries in the South America, Oceania and Japan, whose causality only runs from income to emission as supposed by the EKC hypothesis, for most of the developed countries in North America and Western Europe, the causality is from emission to income, while for most of the developing countries, the causality is actually bi-directional. Therefore, given the “economy and its environment are jointly determined” (Perrings, 1987), it is inappropriate to estimate a single equation model that assumes unidirectional causality from economy to environment. (Stern, 1998)

b. Confusions between the single-country's dynamic processes and the observed cross-country static relationship

The original EKC hypothesis describes the essential dynamic trajectory of environmental situation evolution facing economic growth for a single country. However, given the constraints in data availability on both environment and economic aspects, most of the empirical EKC analyses use the cross-country database to carry out their investigation on this relationship. From a strict econometrical point of view, the inverted-U curve found by

these analyses only give static description about the environmental situation in the countries of different income levels at the same time points. To equalize this static descriptive curve to the dynamic income-pollution trajectory in a single country, we need one supplementary assumption—countries included in the same sample should follow the same income-pollution trajectory. If this assumption is valid, we can regard the low income and bad environmental situation of a developing country in 1990s as those of a developed countries 50 or 100 years ago when it had the similar income level and the high income and good environment situation of a developed country in 1990s as the future income and environment situation of a developing country after it accomplishes its development process. However, De Bruyn et al. (1998) indicate that “there is nothing to expect that each countries in the sample will move along such an estimated (cross-country static) EKC path”. Figure 2.2 explains this idea.

Starting from the reduced-form estimation function most often used in EKC literatures as equation (2.3), we know the curvature of the inverted-U *EKC* obtained from international experience (called global EKC afterwards) will be measured by the two coefficients for the income terms and its turning point will be equal to $-(\alpha_1/2\alpha_2)$. The height of the global EKC is determined by the linear time trends α_3T (T is the time trend variable) and the country specific constant α_0 .

$$E_{it} = \alpha_0 + \alpha_1 Y_{it} + \alpha_2 Y_{it}^2 + \alpha_3 T + \varepsilon_{it} \quad (2.3)$$

Following this reasoning, in each period, an inverted U global EKC can be imagined as a snapshot showing the actual location of income and pollution situation of all the countries in the sample during this period, purged the country specific constant. To obtain a country-specific dynamic EKC (*ind EKC*), we only need to link all the points belonging to the same country during different periods together. In panel a of Figure 2.2, we assume a common negative time trend shared by all the countries, so global EKCs shift downwards over time. We use the global EKC named T1, T2, T3 and T4 in figure 2.1 to show the four global EKC in time order. For one country A, if its location on the general EKC at different moments are indicated by the black points, its individual EKC curve can be actually traced by a bold curve linking the four points together. At a simple glance, we see that although both the global and individual EKC are inverted-U curves, the turning point of the individual EKC (I^*) is actually different from that of the global EKC (I_g).¹

Following, De Bruyn et al. (1998) indicate that, it is also possible for the form of individual EKC to shows other form even if the global EKC keep the same inverted U form.

¹ Similarly, if we suppose the global EKC to shift upwards during the time, we will find the individual EKC to have a higher turning point than that predicted by the global EKCs.

One possible example is illustrated in the panel b of Figure 2.2. In this panel, we relax the assumption of common negative linear time trends, so the 4 global EKC are no longer shifting downwards over time. Due to some external shock (such as very cold and long winter), we suppose the global EKC for the period 4 to shift above the EKC for period 2 and 3. Under this circumstance, although the global EKC may always keep the inverted U form, the dynamic individual EKC will increase monotonically with income growth.

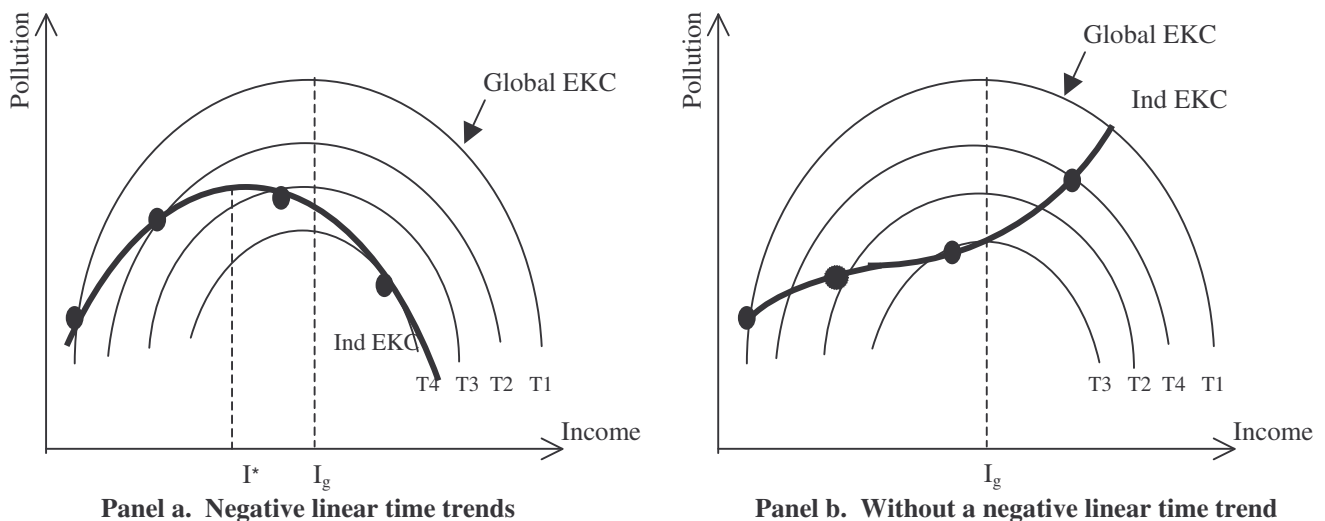

Figure 2.2 Global EKC vs. Individual countries' EKC

c. Trade liberalisation challenges the local characteristic of the negative effect of pollution in a country

Another underlying assumption of the EKC hypothesis is that the inverted-U curve relationship is only “valid for pollutants involving local short-term costs (for example, sulfur, particulates and fecal coliforms), but not for the accumulation of stocks of waste or for pollutants involving long-term and more dispersed (or transboundary) costs (such as CO_2)”. (Arrow et al., 1995, pp.92) This is because the negative impacts of local pollution are easier to be internalised in its origin country, which manifests the necessity to carry out pollution control measures. Come to the global pollution case, given its negative impact is generally dispersed averagely all over the world, the pollution origin country prefers “free-riding” in this case as the marginal cost to reduce the pollution is normally much higher than the marginal benefit that it can harvest from the total pollution reduction results.

The advent of the trade liberalisation tendency since 1980s, by endowing the separability between production and consumption, is actually blurring the distinctions between the global and local pollution cases. Some authors suspects that under trade liberalisation, unlimited transboundary exchanges of goods and services permit the rich

developed countries to dislocate their polluting industries' production towards the developing country and to keep their original consumption product-mix by importing the goods of these industries from there. (Lucas et al., 1992; Arrow et al., 1995, Stern et al., 1996; Rothman, 1998 and Suri and Chapman, 1998, etc.) By doing this, the developed countries actually succeed in maintaining their original consumption utility and discharging the necessary pollution burden to the less developed countries—a very similar situation as what happens in the global pollution case, where the “real” pollution emitters benefit the integral of the utility increase but only suffer very small portion of the negative consequences issuing from this pollution. Diwan and Shafik (1992) indicated this point—“the availability of technologies that delink local and global pollution eliminated many of the automatic benefits for the global environment from addressing local concerns. The north can now achieve improvements in local environmental quality while continuing to impose negative externalities internationally”. Or as Pearce and Wardford (1993) indicate that, “it is perfectly possible for a single nation to secure sustainable development—in the sense of not depleting its own stock of natural capital assets—at the cost of procuring unsustainable development in another country.”

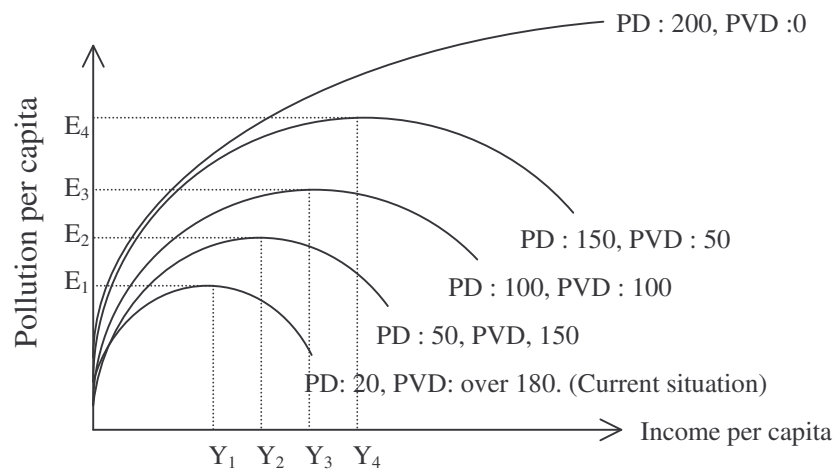

Figure 2.3 Evolution of income-pollution relationship under the existence of the pollution-discharging channel from developed to developing country through international trade

Note: numbers behind PVD and PD indicates numbers of developing and developed countries in different moment.

Under this circumstance, the decrease of pollution in the developed countries is actually “compensated” by pollution increase in the developing countries. If the inverted U curve is really the results of this process, it will only be a transient phenomenon that can be observed in this specific time period with a specific country samples. As the time passing by, more and more developing countries will realise income growth and material live enrichments and become pollution-burden discharger, while fewer and fewer countries stay at the end of pollution burden receivers. Under this circumstance, the pollution discharging channel

functioning through trade liberalisation will become more and more insufficient and lead the turning point of the inverted-U EKC to become both higher and further. In the extreme situation, when the least developed country also accomplishes its economic growth process, there will be no more pollution receiver. At that moment, each country has to take care of its own polluting goods production. As generally consumption is positively correlated with income level, in this extreme case, the final income-pollution relationship will become an monotonically increasing trend. The following Figure 2.3 illustrates this idea. PD means the developed countries and PVD means the developing countries.¹

d. Is the sensitivity of EKC estimation linked to some historical coincidence?

Besides weakness of EKC analyses related to cross-country estimation, some authors also suspects the formation of the dynamic inverted U curve relationship for a single country is due to the specific historical events that catalysed the development of the forces in demand and/or supply for a better environment. Unruh and Moomaw (1998) investigate the relationship between income growth and CO₂ emission situation in France, Finland and USA during 1950-1990. They found although these countries followed different environmental impact trajectory during income growth process, the downward bending of their emission evolution all happened during 1970s when the oil crisis pushed the oil price to skyrocket. Robert and Grimes (1997), using a much larger database including both developing and developed countries, also found the inverted U shape reached statistical significance briefly in the early 1970s and retook the increasing trends since 1982. Under this circumstance, if the historical events did not averagely affect all the countries to the same extent, EKC analyses focusing on different individual country will surely results in different results.

e. Explanation for EKC instability from the dynamic attributes of the environmental resource stock

Starting his reasoning from the evolution of environmental resource stock, Tisdell (2001) describes the situation under which EKC hypothesis cannot guarantee a sustainable development procedure. Under this situation, an economy may have potential dangers to exhaust the assimilation capacity of its environment before reaching the predicted income level for the turning point to appear. If that is the case, the maximal level of pollution predicted by EKC trajectory will be higher than the threshold of carry capacity of the

¹ Cole (2004) actually provides an empirical evidence for this idea based on the experience of the OECD countries during 1980-1997, in which the 'simple' EKC have relatively lower turning points than the EKC estimated after the dirty import from non-OECD countries and the dirty export to from non-OECD countries as a proportion of their total consumption are also included in the estimation function. (pp.78)

ecosystem. Once the threshold is reached, the environmental change can depresses income sharply and stymies economic growth. As illustrated in Figure 2.4, for this economy, its income-pollution relationship will show a reversed C curve as the reduced assimilation capacity of the ecosystem can have a negative “feedback” impact on the economy’s growth capacity.

Therefore, the form of income-pollution relationship should also depend on the dynamic evolution of the assimilation capacity and the environmental quality stock of the individual country, a one-form-fit-all EKC hypothesis does not reflect the aspect’s reality. As today’s developing countries generally possess a worse initial environment condition than that possessed by their rich forerunner 100 years ago, for them, to attenuate environmental pressure during economic growth process actually requires more pollution abatement efforts. This might be another reason to explain why Selden and Song (1995) conclude in their paper that the EKC turning points have the tendency to increase when more developing countries are included into database.

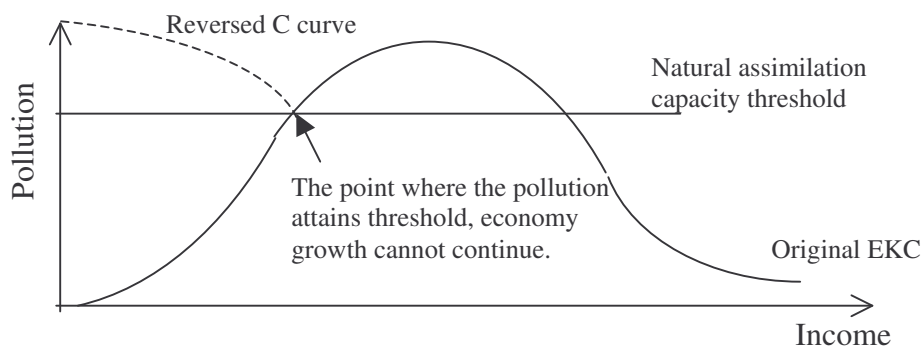

Figure 2.4 The inverted C curve

2.4 Country-specific EKC analyses: Is it really necessary for the developing countries to follow the EKC obtained from international experience?

The idea that the inverted U shaped EKC found from international historical experience is not an optimal or standardized trajectory and should not necessarily be followed by all the countries actually reveals the hopes and challenges for the developing countries to realise sustainable development.

Let’s first look at the challenges. Staying at relatively low level of income nowadays, how the developing countries choose their income-pollution trajectory will critically affect future worldwide environmental quality. The EKC hypothesis generally predict the improvement environmental situation to happen after per capita income attains the range of 4000-8000 USD (1985 price, PPP). Although the lower bound of the turning point approaches

to the current world mean income level in year 2001, only 21% of the world population living in relatively rich countries has attained this income level.¹ If the EKC hypothesis is valid, that means almost four-fifths world population and all developing countries are currently staying on the increasing track of inverted-U curve. If a general improvement tendency can only happen after the 80% of world population accomplish economic growth process, this actually predicts very dismal future for the global environmental situation. Moreover, if the current trade liberalisation tendency really works as a pollution discharging channel for richer developed countries, the developing world might need to attain even higher income level to realize the harmony between economic growth and environmental protection. In this case, we suspects the potential turning point to be even higher than that revealed by current EKC literatures. In addition, even if the turning point of EKC could be attained, we actually have no concrete idea about the maximum pollution level corresponding to this turning point, which might be already too high to save the ecosystem's assimilation capacities from being destructed. Finally, as most of EKC estimations investigate the relationship between per capita income and per capita emission, the achievement of the turning point in this environmental indicator does not necessarily means immediate reduction of the total emission. The SO₂ emission projection made in Stern et al. (1996), following the EKC estimate of Panayotou (1993), predicted that, world-average per capita SO₂ emission will attains its highest level around year 2025. However, at that time, the decreasing of the per capita emission will not to be accompanied immediately by the reduction of total emission volume, as according to UN and World Bank, the rapid population expansion in developing countries can still overwhelm the emission reduction tendency expressed in per capita terms. Stern et al. (1996) believe the total emission will continue increasing until 2050. Under this circumstance, if there does exist a threshold for carry capacity of the ecosystem as described in Tisdell (2002), the strategy to simply follow the international EKC experience, to endure the pollution increase and to wait for the advent of the harmony between economic growth and pollution reduction will be unrealistic and even dangerous for the whole human being.

Given the already achieved technical progress in the developed countries and the reinforced institutional consentience all over the world for environment quality control, is these any possibility for the developing countries to, as suggested by Munashinghe (1999), "tunnel through" or "leapfrog" past the periods of increasing environmental impact and

¹ Calculated by author according to statistic information from World Development Indicator (2003).

resource use, so as to avoid paying too much environmental cost during their economic growth process?

To answer this question requires us to base our analysis on country-specific case, since the potential resolution for each country should be very different. Actually, the existing analysis effort in distinguishing the countries specific income-pollution trajectory was not rare in the previous EKC empirical analysis. They can be categorized into three groups.

For the paper belonging to the first group, they still accept the inverted U curve as an artefact for the dynamic environment-income relationship of a single economy, but they suspect the credibility of the simple extrapolation from the international experience to individual country's dynamic process, given the "heterogeneous structural, technical characters between countries" (Stern, 1996). So they choose to enrich the original reduced-form EKC by adding all kinds of other country-specific pollution determinant factors besides the income and squared income terms in cross-country EKC estimation function. These determinant factors include industrial structure, technical progress, openness degree, income distribution, population density and political and institutional development, etc.¹ Although the inclusion of these other determinants does distinguish part of pollution variation causality away from income growth, as these country-specific characteristics can only switch the EKC up- or downward, but leave the turning point and the basic form of EKC curve solely determined by income changes, different countries still share the common income-pollution relationship and the common turning points.

The second group of authors also base their estimation on international or regional panel data, but they employ the multi-function system estimation method for panel data that permits attributing country-specific random coefficients to the income and squared income terms (List and Gallet, 1999; Koope and Tole, 1999 and Halkos, 2003). Common conclusion of their studies indicates the remarkable difference between countries (or states) in their EKC form and turning points. However, given the complicity of the estimation method itself, these studies were not able to offer concrete explanation on how these country-specific EKC is concretely determined by the country-specific structural or technical characteristics.

Facing the two aspects of limits in the country-specific EKC studies based on international panel data, Stern et al. (1996) believed that the EKC obtained from the international experiences is only useful as a "descriptive statistic", they advocated that, "a more fruitful approach to the analysis of the relationship between economic growth and

¹ Detailed surveys on the other pollution determinants included into EKC analyses can be found in the most recent EKC surveys of Dinda (2004) and Stern (2004).

environmental impact would be the examination of the historical experience of individual countries, using econometric and also qualitative historical analysis". Responding to this proposition, numerous analyses discussing the EKC existence in specific country case come up. Some papers regress the EKC relationship from the country's time series data. However, since most of the available environmental data started since 1960s, given the relatively limited income variation range that can happen during 30 years, to capture both increasing and decreasing phases of pollution variation is relatively difficult. We find only three studies confirming the EKC hypothesis with relatively long historical data series of a single country. They are Roca et al (2001) on the case of Spain (1973-1996), Friedl and Getzner (2003) on Austria (1960-1999) and Lindmark (2002) on Sweden (1870-1997). Besides confirming the big difference in their country-specific EKC form and turning point, these papers also reveals the advent timing of decoupling between pollution and income was actually determined by some country specific characters as technical progress, structural evolution or the external shocks like the oil crisis happened during the investigated time periods.

There are also several country-level studies focusing on some developing countries' experience. Their strategy to surmount the data availability constraint in the time dimension is to make use of the regional disparity in economic growth and environmental quality in the same country to carry out regional level panel data estimation. Compared to the studies based on cross-country experience, these studies are more interesting as they directly focus on developing countries and their assumption on the common trajectory for income-pollution relationship are more acceptable given the larger similarity in regional institutional, technical or structure characteristics. Their analyses also avoid the critics like the omission of countries and the data incomparability on cross-country level.¹ These studies revealed very countries-specific income-pollution relationships, which are in fact incomparable with most of the inverted-U curve confirmed by cross-country experiences. Vincent (1997) employs the state-level panel data in Malaysia from late 1970 till early 1990 and de Groot et al. (2004) analyze China's provincial level air, wastewater and solid waste data from 1982-1997, they both find that different pollution indicators follow totally different evolution trajectories during economic growth and the pollution-income relationships obtained from cross-country studies poorly predict their trends. For example, Vincent (1997) concludes that the concentration indicator of some pollutants predicted to decline (according to international experience) actually increased (TSP and ammoniacal nitrogen) while others that were predicted to

¹ As indicated in Stern (2004) the choice of the exchange rate to deflate the per capita income in different countries can largely influence the estimated turning point.

increase actually decreased (BOD). De Groot et al. (2004) obtain an ever decreasing trend for industrial wastewater while increasing trends for both the industrial waste gas and waste solid during China's last two decades' economic growth process.

2.5 EKC revisit on China's industrial SO₂ emission case

From my knowledge, until now, there exist only two papers talking about China's economic growth and environmental pollution relationship. One is the Auffhammer (2002), which focuses on CO₂ emission problem and another is the de Groot et al. (2004). Although the CO₂ emission in Auffhammer (2004) was actually extrapolated from the waste gas emission data that is also used in Groot et al. (2004), and that both paper take care of the dynamic characters of the income-pollution relationship, their results are actually incomparable due to the fact that the two papers are interested in different aspects of the income-pollution relationship and they employed different empirical methods. de Groot et al. (2004) focus more on the differences between provinces while Auffhammer (2002) is more interested in obtaining the precise province-specific technological progress speed, which can then help him to obtain a better prediction for the future CO₂ emission situation. In addition, since both papers mainly concentrate on the pure relationship between income and pollution, their auxiliary attempts in understanding the structural determination factors for China's environmental situation is very limited. Therefore, in this dissertation, I will try to re-visit the EKC hypothesis for China's case from a more structural perspective in hoping to fill up this analytical blank.

2.5.1 Comparison between China's actual situations with that predicted by the previous EKC analyses

Although the last 25 years economic reform success has remarkably increased Chinese people's income level and living standard, China is still a low-income country. In 2003, her per capita GDP, tripled with respect to that of 1978, is only about 944 USD according to the official exchange rate and 2387 USD according to the purchase power parity at 1985 constant price. Chinese people's desire for a better environment is actually combined with their ambition of earning a higher income and leading a better material life.

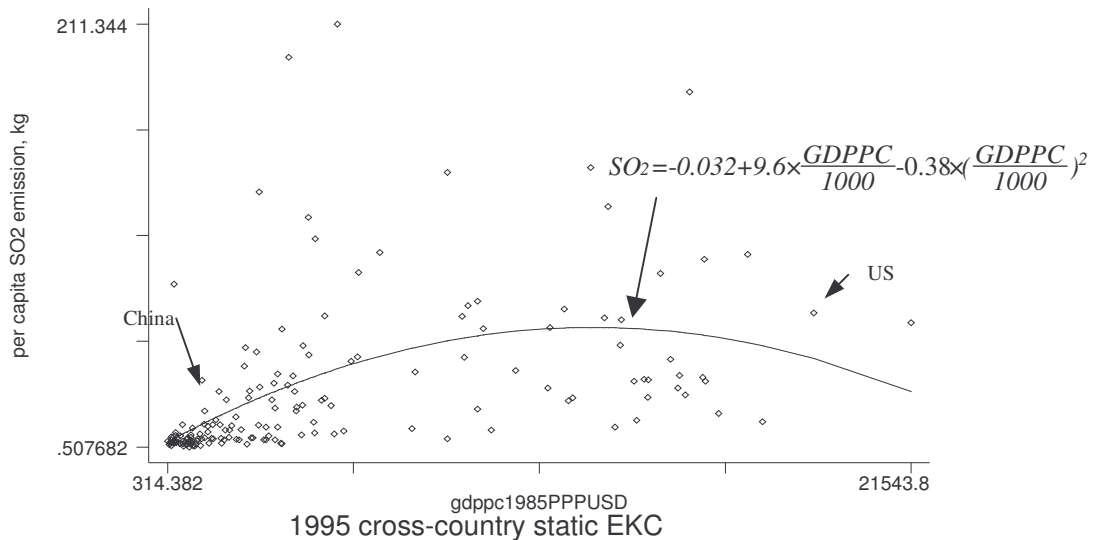

Figure 2.5 A simple cross-country correlation between per capita SO₂ emission and per capita GDP

(Data source: SO₂ emission data come from National Institute for Public Health (RIVM) and Netherlands Organization for Applied Scientific Research (TNO). 2001. Electronic database available online at: <http://arch.rivm.nl/env/int/coredata/edgar/>. The Netherlands: RIVM. GDPPC data are obtained from World Development Indicator, their value are measured by 1985 constant price of USD (PPP).

Figure 2.5 reported the cross-country distribution situation of per capita SO₂ emission and per capita income for 178 countries in year 1995. The actual locations of China and United States are indicated. Clearly, China is in fact located to the lower-end of the income spectrum. If obliged to follow the EKC trajectory predicted by cross-country experience, Chinese people seems still need to suffer continuous environment deterioration problems until their per capita income attains the turning points of these cross-country EKC (\$12464 as in Figure 2.5 or \$4400-\$7100 according to the general findings of EKC literatures).¹ Moreover, as shown in Figure 2.5, China actually locates above the inverted U curve, this actually means it having a worse environmental performance compared to the average cross-country experience at that time point.² Considering this situation, will the country-specific EKC for China predict even worse pollution situations? Or as said Stern et al. (1991) that, the global EKC is a “misspecification” and China actually has its own specific income-pollution relationship trajectory which reveals more optimistic pollution trajectory? In hoping of replying these questions, we will focus on China’s industrial SO₂ emission case to re-estimate the EKC hypothesis.

¹ Original data from Dugupta et al. (2002) are on 1990 constant price. Author made the some price transformation from 1990 constant price to 1985 constant price to facilitate the comparison.

² This might be due to China’s unbalanced energy endowment structure that shows obvious domination of coal reserves, whose combustion generally discharges more pollution than the other energies as natural gas or oil.

2.5.2 Why do we choose to investigate China's industrial SO₂ emission?

The choice of China's provincial level industrial emission to carry out our analysis is due to two considerations. Firstly, SO₂ is the pollution case mostly studied in EKC literatures, given its 'local pollution' characteristic, many authors also regard it as the pollution case having the biggest possibility to illustrate an inverted-U evolution trajectory during income growth. Concentrating on this pollution case will facilitate us to compare our estimation results with those found by the precious studies. Secondly, since 1978, China's SO₂ emission quickly increased with economic growth and becomes one of the most important atmosphere pollution sources. The deterioration of the acid rain situation and increasing of the prevalence of respiratory diseases in Chinese population, causing each year non-ignorable economic growth loss, are principally caused by this pollution problem.¹

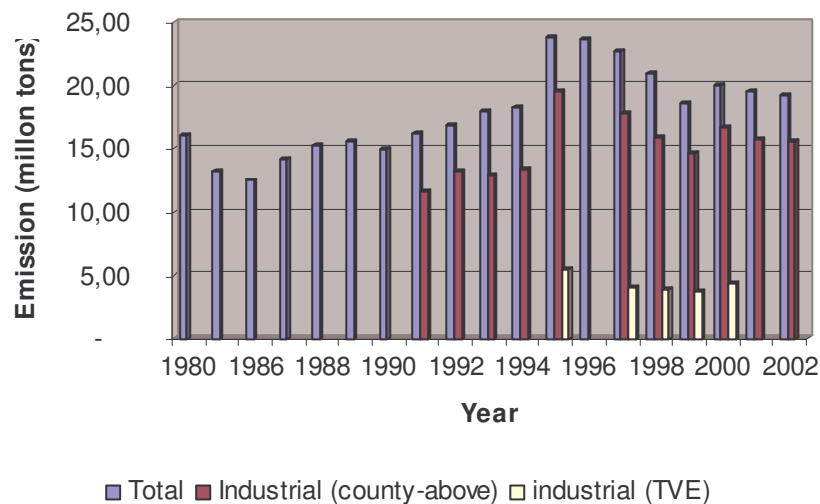

Figure 2.6 Evolution of SO₂ emission in China during economic reform period

Data Sources: China Energy Databook 5.0 and 6.0 and China's Environment Statistics Yearbook

Why do we choose to only concentrate on industrial SO₂ emission? The first reason is that among the total SO₂ emission, industrial production activities is always the largest source. Figure 2.6 shows that SO₂ emission coming from industrial sectors always occupied almost $\frac{3}{4}$ of the total SO₂ emission during the first half of 1990's and the SO₂ emission variation in each year was also principally caused by the variation in the emission coming from industrial sectors. The part of emission from other sources stayed relatively stable. Secondly, by focusing on industrial SO₂ emission, we will be able to make further use of the detailed SO₂ emission and energy consumption data on industrial sectoral level. This will be a

¹ World Bank (1999).

necessary follow-up step in the following chapters for our investigation on the determination role of industrial composition and technique progress in SO₂ emission variation.

2.5.3 Several improvement incidences in China's industrial SO₂ emission evolution

Before starting EKC analysis on China's industrial SO₂ emission case, we can firstly get some idea about the evolution of SO₂ emission and industrial economic growth during the last 15 years' economic reform through China's national level data. Although figure 2.5 reveals relatively gloomy situation for China's environmental performance, dynamic comparison during 1990s shows that China actually made obvious progress in its pollution control activities and this improvement tendency still continues today.

Figure 2.7 reveals the evolution of China's total industrial GDP and that of industrial SO₂ since 1991. Although both indicators increased during the time, the increase speed of industrial GDP is obviously faster than that of industrial SO₂ emission. This actually signifies a decreasing trend in industrial SO₂ emission intensity, which is shown in the panel b of the figure. Clearly, in China's industrialization process, environmental cost for one unit of product decreases consistently during the time.

We have already discussed in Chapter 1 the increasing regional disparity on some economic aspects between Chinese provinces by several Lorenze-style curves. In figure 2.8, we make a similar illustration to show how the disparity between provinces in the aspects of industrial SO₂ emission evolved during 1990s. Opposite to the general increasing tendency in the disparity of economic aspects, the regional disparities in industrial SO₂ emission seemed to reduce since 1992. This convergence tendency in the provinces' industrial SO₂ pollution should be owing to the heterogeneous pollution control policies applied in different regions, with the regions suffering more pollution problem exerting more stringent control severity.

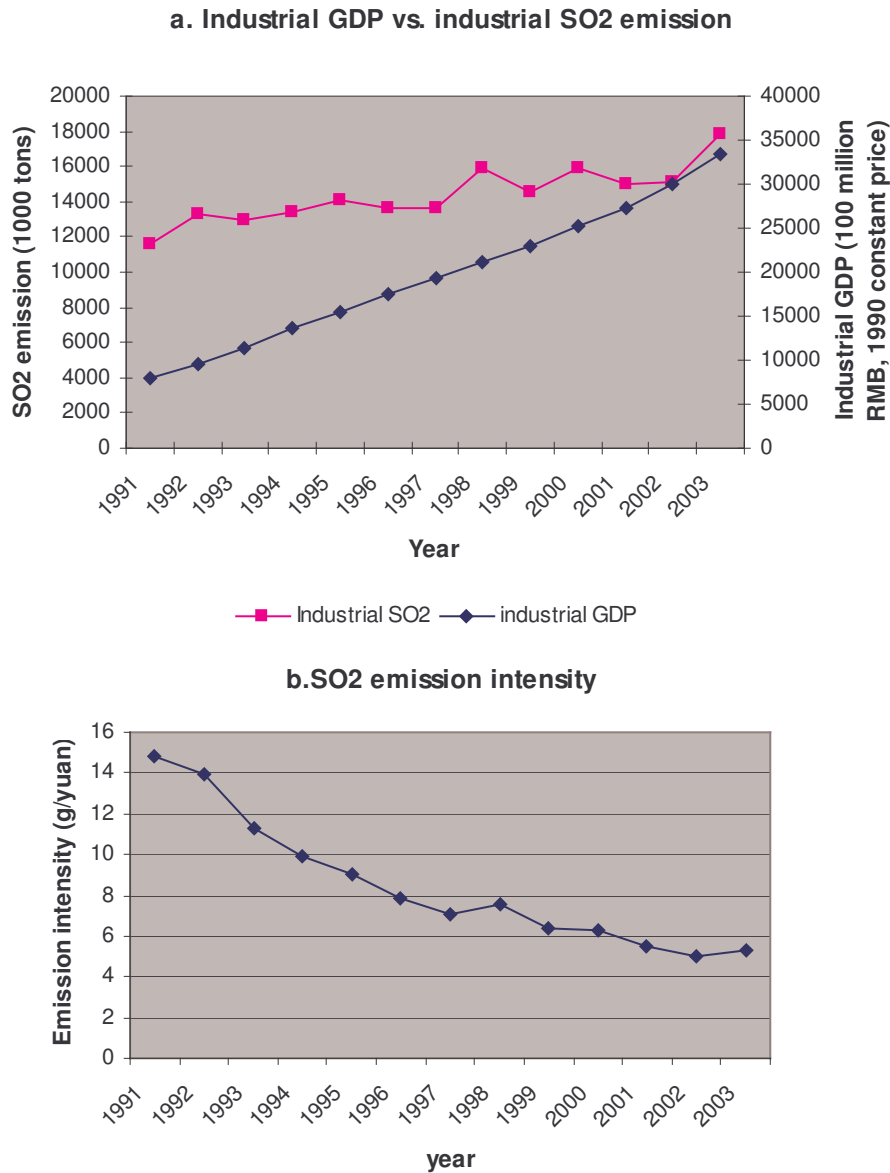

Figure 2.7 Evolution of real industrial GDP and industrial SO₂
 (Data source: China Statistical Yearbook and China Environment Yearbook, various years)

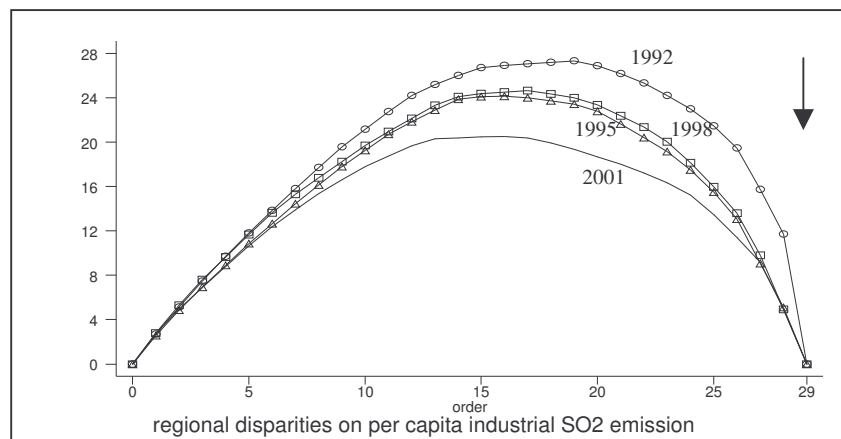

Figure 2.8 Regional disparity changes on per capita industrial SO₂ emission

2.5.4 Empirical analysis: is there an EKC for the case of industrial SO₂ emission in China?

As China's SO₂ emission case has shown several improvement signals, what will be the its country-specific EKC? Does it exist an inverted U relationship between economic growth and SO₂ emission evolution, at which income level will happen the decoupling between economic growth and pollution increase? Is this China-specific EKC curve coherent to those found from international experience? To answer these questions, in this section, we carry out an EKC estimation based on a panel data set of China's 29 provinces during 1992-2003.

(1) The construction of environmental indicator

Besides using per capita industrial SO₂ emission as dependant variable in our estimation, we also check the existence of inverted U curve for another environmental indicator called emission density. Emission density is calculated by dividing annual industrial SO₂ emission with the surface of the corresponding province. There are double interests in analysing this environmental indicator. Firstly, as geographical area of each province is constant during years, this indicator preserves the principal characteristic of total industrial SO₂ emission for each province, which is the central interest of this dissertation since ultimate environmental quality and assimilation capacity of the ecosystem are actually determined by total volume of emission. Secondly, emission density in a province can also be rewrite as the product of per capita emission and population density (see equation 2.4). As the same quantity of emission cause more health problem in a province if population are more condensed, the evolution of emission density can actually extrapolate some characteristics of pollution concentration indicator.

$$\frac{Emission}{Area} = \frac{Emission}{Population} \times \frac{Population}{Area} = \frac{Emission}{Population} \times Population\ density \quad (2.4)$$

(2) The existence of EKC —“reduced form” analysis

Table 2.2 sums up the statistics for all the data used in the emission determination analysis through chapter 2-5. Given this panel database covers 29 provinces during the most important economic reform period 1992-2003, we distinguish wide value spectrum for both pollution and economic indicators, which is the necessary condition for robust EKC estimates. We first look at the existence of an “inverted U” relationship between per capita industrial SO₂ emission and income per capita. In this step, we employ a simple reduced-form estimation function as equation (2.5), which directly connects per capita industrial SO₂ emission ($so2pc_{it}$) to GDP per capita ($GDPPC_{it}$).

$$so2pc_{it} = X_i + \beta_t + \alpha_1 GDPPC_{it} + \alpha_2 (GDPPC_{it})^2 + \alpha_3 t + \varepsilon_{it} \quad (2.5)$$

Table 2.2. Statistic description on the data used in EKC analysis

Variable	Variable definition	Unit	Obs.	Mean	Std. Dev.	Min	Max
so2pc	Annual industrial emission per capita	kg/person	348	13.225	8.173	2.331	58.914
so2den	Annual industrial SO ₂ emission density	g/m ²	348	5.608	10.629	0.021	69.836
so2int	Annual industrial SO ₂ emission intensity	g/yuan	348	13.061	13.911	1.598	137.816
GDPPC	Per capita real GDP	Yuan/person	348	4145.761	2932.655	913.6758	19053.71
K/L	Capital Abundance per labour	Yuan/person	348	62477.85	58781.88	4883.607	302040.8
Scale	Industrial GDP density	Yuan/m ²	348	1.300	3.661	0.003	32.254
Open	Openness degree ((X+M)/GDP)	Percent	348	28.132	33.657	4.006	192.843
Popden	Population density	Persons/km ²	348	360.742	431.866	5.917	2759.878

All the variables measured in value are converted into the yuan of 1990 constant price.

The index i and t represent province and year respectively. X_i signifies the immeasurable constant province-specific effect. β_t are the time-specific intercepts, which is used to account for the common stochastic shocks to all the provinces in each period. A time trend t is further included to capture the common tendency in the dynamic evolution of the SO₂ emission. The main EKC estimation results for per capita industrial SO₂ emission are reported in Table 2.3. We employ both random and fixed effect estimators for panel data. The Simple Model columns report the estimates based directly on equation (2.3) and the AD(1,0) columns list the results in which the first order serial-correlation problem within each province is corrected by including the instrumented lagged dependant variable $so2pc_{it-1}$ on the right-hand side of the regression function.¹ To test the possible re-increasing trends of EKC after the dichotomy between economic growth and pollution increase appears, we also regress the cubic EKC

¹ The instrumentation method employed here is developed by Balestra-Nerlove (1966) for the “fixed effect of the dynamic linear penal model”. More details are in P. Sevestre and A. Trognon (1996, pp??).

model. Different from the estimation based on international experience, our estimation results show relatively good stability given the model and estimation method changes. Though the cubic model predicts a re-increasing trend for per capita industrial SO₂ emission after the per capita GDP attains 20000-25000 Yuan, the location of its peak turning point corresponds well to that found by squared model. Both model predict the dichotomy between China's per capita economic growth and per capita industrial SO₂ emission to happen when its per capita GDP attains 9000-9500 Yuan (1990 constant price).

Table 2.3. Industrial SO₂ emission per capita

	Simple Model: Squared		AR(1,0): Squared		Simple Model: Cubic		AD(1,0): Cubic	
	RE	FE	RE	FE	RE	FE	RE	FE
GDPPC (1/1000)	2.090 (4.04)***	2.159 (4.49)***	1.339 (2.72)***	1.523 (2.89)***	3.573 (3.13)***	4.529 (3.50)***	4.199 (4.01)***	5.699 (3.51)***
GDPPC² (1/1000) ²	-0.117 (5.41)***	-0.122 (6.41)***	-0.075 (3.48)***	-0.083 (3.52)***	-0.270 (2.52)**	-0.349 (2.99)***	-0.349 (3.73)***	-0.463 (3.28)***
GDPPC³ (1/1000) ³					0.005 (1.45) ^o	0.007 (2.04)**	0.008 (2.84)***	0.012 (2.74)***
so₂pc_{t-1}			0.670 (4.34)***	0.621 (4.09)***			0.500 (3.72)***	0.472 (3.75)***
trend	-0.090 (0.67)	-0.095 (0.48)	0.180 (1.49) ^o	0.145 (1.24)	-0.248 (1.44) ^o	-0.379 (1.59) ^o	-0.143 (0.91)	-0.366 (1.99)**
Constant	9.556 (5.38)***		0.329 (0.14)		7.254 (3.04)***		-2.043 (0.72)	
R-squared	0.0059	0.1716	0.1028	0.3029	0.0076	0.1810	0.0601	0.3156
F test		4.88		9.26		4.82		9.09
AR(1)	1.6996	1.4437	1.5158	1.5297	1.7017	1.4448	1.5410	1.5475
Breusch-pagan		1269.76 (0.000)		1290.93 (0.000)		1241.11 (0.000)		1265.77 (0.000)
Hausman		63.80 (0.000)		1.50 (1.000)		1.45 (1.000)		6.61 (0.949)
Province Turning point (Peak)	8931.62 (1057)	8848.36 (883)	8926.67 (1338)	9174.70 (954)	8803.51 (12894)	9081.50 (10926)	8909.64 (9307)	9618.82 (13117)
Province Turning point (Trough)	--	--	--	--	26634.08 (37377)	22825.79 (26706)	18542.61 (18932)	17084.25 (22866)
Observations	348	348	319	319	348	348	319	319
Provinces	29	29	29	29	29	29	29	29

Note:

- Absolute value of z statistics in parentheses. ^o significant at 15%, * significant 10%, ** significant 5%, *** significant 1%.
- The standard error of the turning point is indicated in the parenthesis below. They are calculated by Delta method. See Greene (2002, pp. 913-914) for details.
- FE means fixed effect, and RE means random effect.
- AR (1) is the Durbin-Watson statistics for first order serial correlation. Breusch-Pagan is used to test the group specific effect. Hausman test is used to compare the efficiency between fixed and random panel data estimator.
- The instrumentation method employed in AD (1,0) model for SO₂PC_{t-1} is developed by Balestra-Nerlove (1966) for the "fixed effect of the dynamic linear penal model". More details are in P. Sevestre and A. Trognon (1996, pp??).

The estimated EKC are also depicted in figure 2.9. The actual locations of the 29 provinces in year 2003 are also indicated in the figure. Excepts for the several provinces whose per capita income level has surpassed the estimated turning point, most of them still stays on the increasing track of the EKC in year 2003. Following the assumption of EKC

hypothesis, our estimation results actually anticipate more pollution problem in most of the provinces in the coming future.

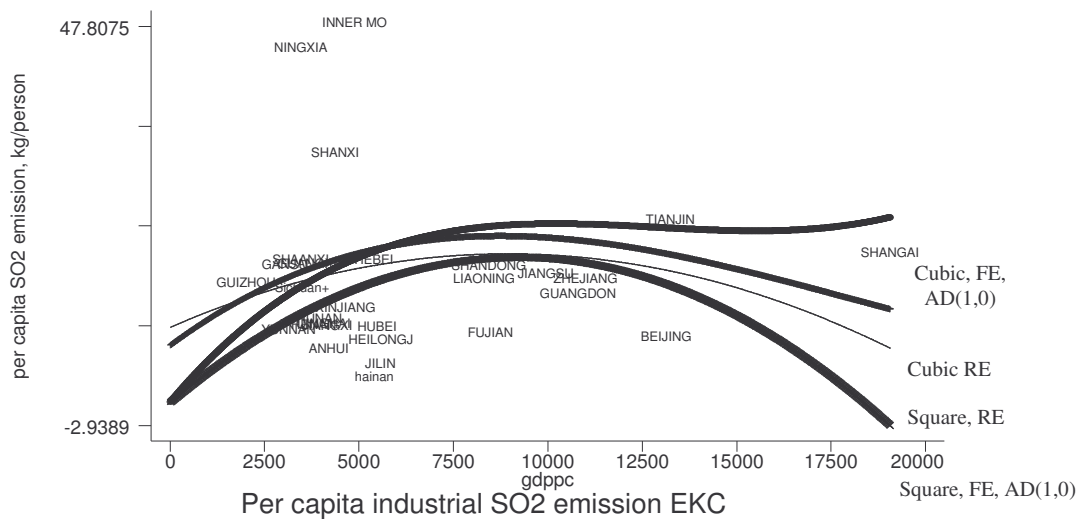

Figure 2.9 Estimated EKC for per capita industrial SO₂ emission and the actual location of 29 provinces in 2003

Following we estimate EKC hypothesis for the case of industrial SO₂ emission density. In this step, we will estimate a simple EKC model (eq. 2.6) that is very similar to that for per capita SO₂ emission case. As we have seen in equation (2.4) that emission density can be regarded as the product of per capita emission with population density, we also add population density as a supplementary explanation in estimation function.

$$so2den_{it} = X_i + \beta_t + \alpha_1 GDPPC_{it} + \alpha_2 (GDPPC_{it})^2 + \gamma denpop_{it} + \alpha_3 t + \varepsilon_{it} \quad (2.6)$$

The estimation results based on this function are reported in Table 2.4. Although the per capita emission seems to peak in China at the income level of 9000 yuan, the estimations on the industrial SO₂ emission density seem unable to support the EKC hypothesis. In the three estimation based on the whole sample of the 29 provinces, neither the squared nor cubic EKC estimation model obtains significant income coefficients. We only find a significantly positive coefficient (0.391) for income term in the linear income-pollution model. Does this means economic growth will unavoidably lead the emission density to increase in China?

Table 2.4. Industrial SO₂ emission density

	Whole Sample			26 provinces		3 cities	Combined model	
	FE	FE	FE	FE	AB	FE	FE	AB
GDPPC (1/1000)	0.935 (1.50) ^o	0.420 (1.01)	0.391 (2.45)**	2.305 (4.63)***	2.372 (2.30)**	4.055 (2.05)*	1.085 (1.38)	2.310 (2.14)**
GDPPC ² (1/1000) ²	-0.051 (0.78)	-0.004 (0.16)		-0.333 (4.71)***	-0.309 (2.35)**	-0.075 (1.26)	-0.123 (1.08)	-0.198 (2.18)**
GDPPC ³ (1/1000) ³	0.002 (0.62)			0.017 (4.85)***	0.015 (2.52)**		0.007 (1.18)	0.008 (2.58)***
City×GDPPC							2.055 (1.17)	2.006 (3.65)***
City×GDPPC ²							-0.133 (1.27)	-0.103 (3.22)***
SO ₂ den _{t-1}	0.057 (0.28)	0.087 (0.40)	0.036 (0.30)	0.172 (1.64) ^o	0.116 (0.72)		0.055 (0.34)	-0.019 (0.14)
popden	-0.022 (2.62)***	-0.021 (2.50)**	-0.023 (5.90)***	0.023 (5.68)***	0.018 (2.82)***	-0.019 (3.22)***	-0.022 (2.87)***	-0.024 (5.92)***
trend	-0.031 (0.41)	0.030 (0.37)	0.033 (0.61)	-0.158 (3.46)***	-0.175 (1.79)	-1.743 (2.11)**	-0.011 (0.17)	-0.207 (1.21)
R-squared	0.5420	0.5420	0.5403	0.5011		0.8338	0.5522	
F test	21.70	23.33	25.05	16.40		6.81	19.80	
AR(1)	1.9831	1.9907	1.9768	1.4745	-2.96 (0.0031)	2.5005	2.0349	-1.75 (0.0803)
AR(2)					1.36 (0.1745)			0.84 (0.4011)
Breuch-pagan	765.33 (0.000)	854.17 (0.000)	943.16 (0.000)	1163.54 (0.000)		13.41 (0.0003)	574.83 (0.000)	
Hausman	138.11 (0.000)	152.86 (0.000)	400.86 (0.000)	15.37 (0.000)		--	180.36 (0.000)	
Sagan					18.24 (1.000)			21.00 (1.000)
Province Turning point (Peak)	--	52500 (277071)	--	--	--	--	--	--
Province Turning point (Trough)	--	--	--	--	--	--	--	--
City Turning point (Peak)	--	52500 (277071)	--			27033.33 (7614)	--	--
Observations	319	319	319	286	260	36	319	290
Province	29	29	29	26	26	3	29	29

▪ Absolute value of z statistics in parentheses, ^o significant at 15%, * significant 10%, ** significant 5%, *** significant 1%.

▪ The standard error of the turning point is indicated in the parenthesis below.

▪ In the spline model, we distinguish the coefficient of income terms between cities and province. The income coefficients for province are those before the simple GDPPC terms. But to obtain coefficients of income term for 3 cities, we need to add the GDPPC and GDPPC×city together.

▪ AB means Arellano-Bond (1991) dynamic GMM estimator for fixed-effect panel data. In this estimation method, the statistic value of AR(2) denotes the second order serial correlation

Table 2.5. Provincial per capita GDP, geographical area statistics and emission density

Province	GDPPC (Yuan, 1990 price)	Surface (km ²)	SO2 density (kg/km ²)
SHANGAI	19054	6200	50.909
TIANJIN	13242	11302	20.366
BEIJING	13133	16814	6.781
ZHEJIANG	11000	101792	6.948
GUANGDONG	10799	177806	5.929
JIANGSU	9944	102578	11.488
FUJIAN	8482	121471	2.413
SHANDONG	8436	153126	10.058
LIAONING	8303	145803	4.371
HEILONGJIANG	5587	473414	0.603
JILIN	5572	188000	0.630
HUBEI	5482	191389	2.836
HAINAN	5405	33977	0.661
HEBEI	5394	187964	6.357
INNER MONGOLIA	4889	1204642	0.945
XINJIANG	4647	1635210	0.137
SHANXI	4376	156120	6.619
ANHUI	4196	139510	2.906
JIANGXI	4152	166758	2.349
QINGHAI	4052	779141	0.065
HUNAN	3947	210151	3.195
HENAN	3799	166867	5.404
GUANGXI	3637	230512	3.603
SICHUAN	3483	566553	2.936
SHAANXI	3466	204996	3.176
NINGXIA	3463	66027	3.913
YUNNAN	3139	392215	0.971
GANSU	3028	455099	0.969
GUIZHOU	2016	176253	3.235

As the emission density is an indicator consisting of two factors: the province's total annual emission quantity as the numerator and the province surface as denominator, the reason for which emission density does not support EKC hypothesis may reside in these two factors. Let's first look into the province surface. In table 2.5, following decreasing order of per capita GDP, we list the income level, geographical surface and industrial SO₂ emission density data in year 2003 for each of the 29 provinces. Interestingly, all the three indicators for the three municipalities directly under central government, Shanghai, Beijing and Tianjin, are very different from those of the other 26 provinces. Possessing relatively higher per capita income level, these three cities actually have the smallest geographical areas among 29 provinces. Therefore, their SO₂ density levels are naturally much higher than that of other provinces. The same conclusion can also be obtained from the panel a. of figure 2.10, from which we can see that almost all the observations for the 26 provinces are actually concentrated in the lower-left part of the diagram and the several exceptional points in the

higher-right part belongs to the three municipalities. Whether the linear positive relationship between SO_2 density and income is simply caused by the participation of the exceptional observations of the three cities?

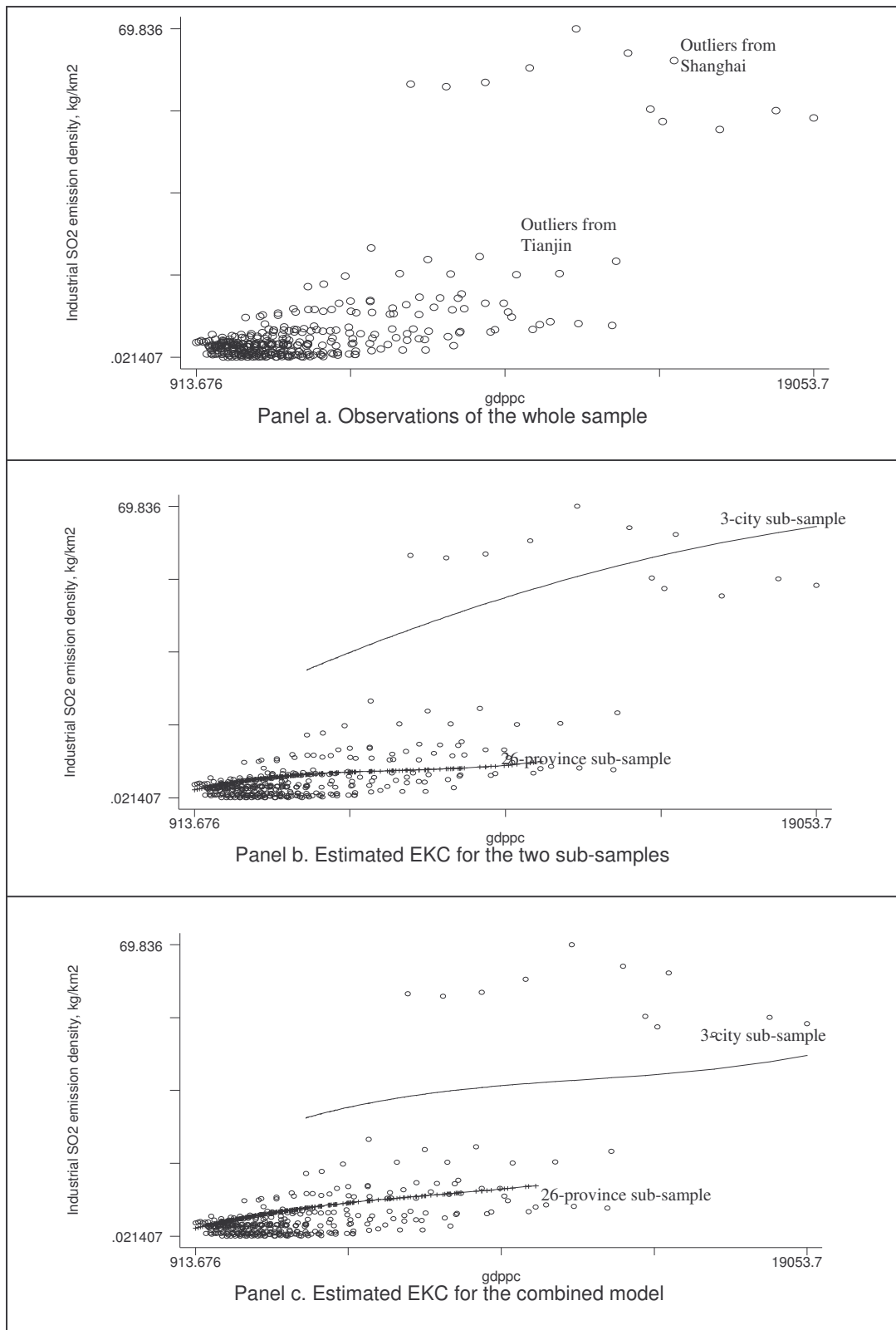

Figure 2.10 EKC estimations for the industrial SO_2 emission density

To test this possibility, we divide the database into two sub-samples: 26 provinces and 3 cities and redo the estimation. The results are also reported in Table 2.4 and their graphical illustrations are given in the panel b and c of Figure 2.10. In this step, we use both the method of Balestra-Nerlove (1966) and first-difference General Methods of Moments (GMM) for linear, dynamic panel data proposed by Arellano and Bond (1991) to deal with the serial correlation problems. Out of our expectation, the estimates for both the sub-samples of 26 provinces and that of the 3 cities still predict increasing tendency for China's industrial SO₂ emission density during economic growth process.¹

The last two columns of Table 2.4 report the estimates of a combined model, in which a spline structure is used to allow the estimation basing on the whole database but at the same time to distinguish the potential income coefficient differences between the 26 provinces and the 3 cities.² The advantage of this model is to avoid potential estimation bias caused by only focusing on partial data sample. Once more, the combined model confirms the common increasing tendency for the industrial SO₂ density. Furthermore, it seems the emission density's increasing trends for the 26 provinces follows very similar track as that for the 3 cities, excepts the absolute emission density level is much higher in the 3 big cities. This can be seen from panel c of figure 2.10, where the graphical presentation actually shows almost parallel evolution tendencies for SO₂ emission density in the 26 provinces and the 3 cities.

Table 2.6. Correlation between emission densities, per capita emission and population density

	so2den	so2pc	popden
so2den	1.0000		
so2pc	0.4083	1.0000	
popden	0.9374	0.2379	1.0000

The co-existence of the inverted U curve for per capita industrial SO₂ emission and the monotonically increasing tendency for industrial SO₂ emission density actually reminds us the possible role played by population expansion. Therefore in table 2.6, we analyze firstly the simple correlation coefficients of industrial SO₂ emission density with respect to per capita industrial SO₂ emission and population density. The very large correlation coefficient (0.94) between SO₂ density and population density reveals the closer causality between them. Given

¹ The division of the database does not need to be explicitly between provinces and big cities. We also estimate emission density's EKC model for the sub-samples of 26 provinces+Beijing, 26 provinces+Beijing+Tianjin. The estimation results are very similar to those obtained from sub-sample of the 26 provinces.

² Although the estimation results of the 3-city sample actually predict an inverted-U curve for industrial SO₂ emission density. As its turning point corresponds to a very high income level: 27033 yuan, which is actually much higher than the maximum income level appearing in the actual database, so for the three cities, the estimated SO₂ density actually shows a ever-increasing trends under the available income range.

the geographical dimension of each province is time-invariable, the correlation between SO₂ density and population density to some extent reflects the correlation between the variation in total industrial SO₂ emission and provincial population growth. Following this reasoning, the divergence in the evolution trajectory of industrial SO₂ density and that of the per capita SO₂ emission is actually similar to that mentioned in Stern et al. (1996): although the per capita emission peaks relatively early, the total volume of emission will continue increasing under the pressure of population expansion. This finding is further confirmed by the EKC estimation results for the total industrial SO₂ emission reported in table 2.7, which generally predict increasing trends for total industrial SO₂ emission evolution in both the 26 provinces and the 3 cities.

Table 2.7. Total industrial SO₂ emission EKC reduced model

	Whole sample		26 provinces		3 cities		Combined model	
	RE	FE	RE	FE	RE	FE	RE	FE
GDPPC	91.306	101.129	335.081	334.236	77.556	158.464	353.002	347.223
(1/1000)	(2.20)**	(2.07)**	(4.03)***	(2.97)***	(1.54) ^o	(5.84)***	(4.53)***	(3.20)***
GDPPC²	-7.024	-7.777	-49.068	-50.251	-2.989	-8.477	-51.168	-51.710
(1/1000) ²	(1.87)*	(1.90)*	(4.18)***	(3.43)***	(0.66)	(4.89)***	(4.64)***	(3.63)***
GDPPC³	0.158	0.178	2.610	2.623	0.055	0.185	2.705	2.689
(1/1000) ³	(1.31)	(1.49)	(4.29)***	(3.65)***	(0.43)	(4.21)***	(4.71)***	(3.81)***
City×GDPPC							-267.903	-278.504
							(3.50)***	(3.16)***
City×GDPPC²							45.878	47.510
							(4.13)***	(3.53)***
City×GDPPC³							-2.592	-2.599
							(4.57)***	(3.76)***
trend	2.686	4.292	-13.391	-8.586	-32.136	-43.197	-15.349	-10.255
	(0.43)	(0.69)	(1.59) ^o	(0.85)	(6.52)***	(6.59)***	(1.95)*	(1.07)
SO_{2t-1}		-0.001		0.353				0.341
		(0.01)		(2.37)**				(2.45)**
Constant	290.328		31.867		-72.339		-0.305	
	(2.93)***		(0.24)		(0.44)		(0.00)	
R-squared	0.0060	0.2628	0.0386	0.3570	0.8250	0.8241	0.0821	0.3535
F test		5.54		7.95	23.74	18.38		
AR(1)	1.1586	1.0145	1.2215	1.1233	2.1826	2.2386	1.2278	1.1502
Breuch-pagan	1640.98		1409.14		104.05		1564.57	
	(0.000)		(0.000)		(0.000)		(0.000)	
Hausman	1.55		0.97				1.70	
	(1.000)		(1.000)				(1.000)	
Province Turning point (Peak)	9626	9797	--	--			--	--
	(21693)	(21166)						
Province Turning point (Trough)	20010	19330	--	--			--	--
	(44421)	(40689)						
City Turning point (Peak)	9626	9797			--	--	--	--
	(21693)	(21166)						
City Turning point (Trough)	20010	19330			--	--	--	--
	(44421)	(40689)						
Observations	348	319	312	286	36	36	348	319
Province	29	29	26	26	3	3	29	29

▪ Absolute value of z statistics in parentheses. ^o significant at 15%, * significant 10%, ** significant 5%, *** significant 1%.

▪ The standard error of the turning point is indicated in the parenthesis below.

2.6 Conclusion

In this chapter, we first made a review of literature on both the EKC-related theoretical and empirical analyses. Although the inverted-U form relationship seems to be relatively easy to prove by both the microeconomic theories and cross-country panel data estimation. The divergence between the theoretical assumptions and country reality, the great sensitivity of the estimated EKC form with respect to country sample, time period, estimation method and function form choice actually deepen our doubt about the existence of one-for-fit-all EKC experience for all the countries.

The possibility of country-specific correlation dynamism between economic growth and pollution actually gives China both hopes and challenges to realize its objective of sustainable development. The estimated China-specific EKC curve predicts the turning point for the dichotomy between economic growth and per capita industrial SO₂ emission to appear when China's per capita GDP attains 9000 yuan, about 2750 USD, which is actually much lower than that found from the international experiences (4400-7100 USD).¹ However, given China's fast population expansion speed, the decreasing trends in the per capita emission will not bring an immediate reduction in total industrial SO₂ emission. At present, our EKC estimates for both industrial SO₂ density and total industrial SO₂ emission predict a quite gloomy future for the sustainability of China's economic growth.

¹ Both the two turning point in USD are 1985 constant price. The conversion between 1990 CNY and 1985 USD is computed by author according to related price index in World Development Indicator (2003).

Chapter 3 Structural determinants of industrial SO₂ emission

Although the EKC analyses in last chapter can not dispel our worries about the continuously deteriorating industrial SO₂ pollution situation in China, the relatively earlier turning point found in the per capita SO₂ emission experience with respect to that obtained from international experience is still a positive signal. If China's last 10 years' economic growth was accompanied by less emission increase than that expected from international experience, it deserves to carry out a structural analysis to understand the underlying determinants for it. Therefore, in this chapter, we will investigate the potential structural determinants of pollution and therefore de-masque the EKC "black-box" and turn it to a policy implication tools.

3.1. Structural explanation for the existence of EKC—demask the "black-box"

Most theoretical explanations for EKC formation base their reasoning on the demand-side factor. These analyses generally consider the decoupling of economic growth and environmental deterioration as the result of the trade-off between utility from normal good consumption and disutility caused by pollution. However, demand-side causes are only the necessary conditions for the appearance of EKC turning point. Without satisfying certain supply-side conditions, such as technological capacities in pollution abatement or production process and the de-pollution trends in industrial structure transformation, a simple rise of public demand for a better-environment may only lead economic growth to a halt and cannot realize a win-win result. As this dissertation is interested in industrial SO₂ emission situation in a developing country, whose most important objective is still to enrich its population at the

moment, the analyses on the supply-side emission determination factors are actually more appropriate.

3.1.1. Grossman decomposition

More or less, based on macroeconomic foundation, some theoretical analyses have already involved in their discussion the supply-sides pollution determinants and explored the structural explanation for the formation of EKC. The most widely accepted supply-side pollution determinants are those proposed by Grossman (1995), which regarded pollution as a by-product of production activities. According to him, the final total emission results can be calculated by equation (3.1).

$$E_t = Y_t \sum_{j=1}^n I_{j,t} S_{j,t} \quad (3.1)$$

Where E_t means the emission in year t . $j=1,2,\dots,n$ represents the different sectors in the economy, Y_t is the total GDP in year t , it can also be presented by the sum of value added of the n sectors, so $Y_t = \sum Y_{j,t}$. $I_{j,t}$ is the emission intensity, the average quantity of pollution emitted for each unit of product in sector j , so $I_{j,t} = E_{j,t}/Y_{j,t}$. $S_{j,t} = Y_{j,t}/Y_t$, it represents the ratio of the value added of sector j in total GDP. According to this equation, total emission can be considered as product of the total value added of economy Y_t and the average sectoral emission intensity weighted by the ratio of each sector's GDP in total economy $\sum_j (I_{j,t} S_{j,t})$.

If we make total differentiation with respect to time and then divide the whole equation by total emission results, E , we reproduce the Grossman decomposition in equation (3.2).

$$\hat{E} = \hat{Y} + \sum_j e_j \hat{S}_j + \sum_j e_j \hat{I}_j \quad (3.2)$$

Where $e_j = E_j/E$ represents the ratio of emission from sector j in total economy and $\hat{X} = (dX/dt)/X_t, X \in \{E, I, S, Y\}$. This decomposition defines the famous three determinants of emission. \hat{Y} denotes the scale effect, which is expected to be a pollution-increasing factor. "All else equal, an increase in output means an equiproportionate increase in pollution". The composition effect is represented by \hat{S}_j , the changes in S_j over time represent the influence on emission of a change in the composition of economic activities. All else equal, if the sectors with high emission intensities grow faster than sectors with low emission intensities, the composition changes will result in a upwards pressure on emission, so that total emission will grow at a faster rate than income. \hat{I}_j represents the technique effect. The decrease in sector

emission intensities, as the results of the use of more efficient production and abatement technologies, can reduce emission increasing pressure given the same quantity of economic growth and fixed industrial composition mix.

3.1.2. A graphical illustration on how the structural determinants of emission affect the form of EKC

The Grossman decomposition offers us a dynamic version for the formation of EKC during one country's economic growth process, in which the supply-side factors (scale expansion, composition transformation and technique progress), catalyzed or affected by the increasing public demand for a better environment, collectively determine the appearance timing of the decoupling between economic growth and environment deterioration tendency.

A concrete graphical illustration on this structural formation of the inverted U curve can be derived by borrowing the emission determination model of Antweiler et al.(ACT,2001), though this model initially is not designed to explain the formation of EKC.

In ACT model, the determination function for emission is written as

$$z = x\{1 - \lambda a[\theta(\tau^*(I))]\} \quad (3.3).$$

Where z is emission. The products of the economy can be categorized into non-polluting and polluting ones, where we use x to present the total output whose production processes arise pollution problems and y to denote all the product that do not pollute. By adjusting the measurement unit, x can also be used to directly present the level of total pollution that should have been emitted by the economy. I is per capita income. The optimal emission tax τ^* is determined by the neoclassical reasoning of Samuelson Rule, so it is equal to the marginal disutility of pollution in order to guarantee social utility maximization. immediately we know that τ^* is a positive function of per capita income, that is $\tau^{*'}(I) > 0$.¹ θ represents producer's decision in pollution abatement facing the optimal emission tax rate τ^* .² Normally, the pollution abatement effort increases with τ^* , that means $\theta'(\tau^*) > 0$. λ denotes the actual technology situation in abatement activities. As $\lambda a[.]$ describes the ratio of abated emission for each unit of product x , the pollution for one unit of product x finally emit to

¹ Higher income means higher sensitivity to pollution problem, therefore exigency for strict environment control policy measures.

² Antweiler et al. (2001) assume that only the product of polluting sector can be used in pollution reduction activities. This is a realistic assumption. Because if we suppose pollution can be easily abated by the non-polluting products, it will be unnecessary for us to worry about environment degradation problem, since under this condition, we are actually assuming the economy to have auto-purification capacity.

environment is actually equal to $\{1-\lambda a[\cdot]\}$.¹ Therefore, in this equation, the final emission level z is collectively determined by the increasing forces from production expansion in output x and the decreasing forces from the reinforcement of pollution abatement, $\{1-\lambda a[\theta(\tau^*(I))]\}$.

Following, by further supposing product y as numeraire and the price of x to be p , we further decompose the polluting sector output x in equation (3.3) into two factors: the whole production scale $S=y+px$, consisting of both polluting and non-polluting products, and the ratio of polluting product x to total production scale, x/S , which will be used to denote the composition characteristic of the economy.² This adjustment is illustrated in equation (3.4).

$$z=S\frac{\chi}{S}\{1-\lambda a[\theta(\tau^*(I))]\}=S\frac{\chi}{I+p\chi}\{1-\lambda a[\theta(\tau^*(I))]\} \quad (3.4)$$

As EKC analysis is actually interested in the potential correlation between emission z and per capita income I , and $I=S/\text{pop}$, where pop means population of the economy, we can make further adjustment and obtain equation (3.5).

$$z=\text{pop}\times I\times\frac{\chi}{I+p\chi}\{1-\lambda a[\theta(\tau^*(I))]\} \quad (3.5)$$

Making derivative of final emission z with respect to per capita income I , we can obtain an expression for the slope of the relationship between emission and per capita income as equation (3.6).³

$$\frac{\partial z}{\partial I}=\underbrace{I\frac{\chi}{I+p\chi}\{1-\lambda a[\theta(\tau^*(I))]\}}_{\text{Scale}}+\underbrace{\frac{\partial}{\partial I}\left(\frac{\chi}{I+p\chi}\right)\times I\times\{1-\lambda a[\theta(\tau^*(I))]\}}_{\text{composition}}-\underbrace{I\times\frac{\chi}{I+p\chi}\times\lambda a'\theta'\tau^*I}_{\text{technique}}\times\text{pop} \quad (3.6)$$

The first term in the right-hand side of the equation (3.6) corresponds to the scale effect. It reveals that during economic growth process, the variation of total emission caused by production scale change is actually equal to $\frac{\chi}{I+p\chi}\{1-\lambda a[\theta(\tau^*(I))]\}\times\text{pop}$. As supposed in Grossman (1995), *all else equal*, it should be a constant positive relationship. The second term

¹ Pollution abatement technology enjoys the decreasing return to the scale characteristic, $a'(\theta)>0$, $a''(\theta)<0$.

² As $x/S=x/(y+px)$, if we suppose $\chi=x/y$, x/S can also be represented by $\chi/(1+p\chi)$. In the original model of ACT (2001), they use χ instead of x/S to indicate the composition situation. However, if we fix the relative price p , χ will be positively correlated to $x/S=\chi/(1+p\chi)$. As this simple graphical illustration will not involve price changes, we therefore use $\chi/(1+p\chi)$ to extrapolate the industrial composition situation of the economy in this chapter.

³ Since per capita income $I=S/\text{pop}$, the determination function for the per capita emission: $\frac{z}{\text{pop}}=I\times\frac{\chi}{I+p\chi}\{1-\lambda a[\theta(\tau^*(I))]\}$. Correspondingly, the scale, composition and technique effect for per capital

emission z/pop are $\frac{\chi}{I+p\chi}\{1-\lambda a[\theta(\tau^*(I))]\}$, $\frac{\partial}{\partial I}\left(\frac{\chi}{I+p\chi}\right)\times I\times\{1-\lambda a[\theta(\tau^*(I))]\}$ and $I\times\frac{\chi}{I+p\chi}\times\lambda a'\theta'\tau^*$ respectively.

$\frac{\partial \left(\frac{\chi}{I+p\chi}\right)}{\partial I} \times I \times \{1-\lambda a[\theta(\tau^*(I))]\} \times pop$ represents the composition effect. As $\{1-\lambda a[\theta(\tau^*(I))]\} > 0$ and we believe the ratio of polluting output in total economy (χ/S) follows a first increasing and then decreasing trajectory with income growth process, or more concretely from less-polluting agriculture to pollution industry and finally back to less polluting service industry, with the highest ratio appears when heavy industry occupies the most important proportion in the economy, it is reasonable to suppose the composition effect follows an inverted U curve with income growth, *all else equal*. The third term describes the *absolute* value of the technique effect. Given $a'(\theta) > 0$ and $\tau^*(I) > 0$, the term $I \times \frac{\chi}{I+p\chi} \times \lambda a'(\theta) \theta' \tau^* \times pop$ predicts a positive linear relationship between income growth and the impact of technique effect on emission. Therefore, all else equals, with economic growth, we should observe an enhancing pollution reduction impact owing to technique effect.

The idea of equation (3.6) to decompose the relationship between emission (z) and income growth (I) into the contribution from the three structural determinants result in the graphical explanation for EKC formation as Figure 3.1. The upper panel of this figure describes the evolution of the slope contribution from the three effects during income growth. Corresponding to our discussion, we use an inverted U curve to represent the composition effect, and an increasing straight line to express the technique effect and a horizontal straight line to represent the scale effect, whose height is equal to $\frac{\chi}{I+p\chi} \{1-\lambda a[\theta(\tau^*(I))]\} \times pop$.¹

The lower panel of figure 3.1 traces the corresponding emission-income relationship, which is the final results of force contrasts between the pollution-reducing technique effect and the two pollution-increasing factors: scale and composition effect. From figure 3.1, we see the pollution-increasing contribution from the combined scale+composition effect is firstly higher than the pollution-reducing contribution of technique effect. This predicts the positive slopes for emission-income curve. The domination situation of the pollution-increasing factor will only be reversed when the income level attains Y_0^* , where the increasing straight line describing the technique effect intersects with the inverted U form combined scale+composition effect. Beyond Y_0^* , as the pollution-reducing impact of

¹ Under the assumption of a closed economy, since all the technical progress needs to be realized by the country itself, we suppose the increasing straight line representing technique effect to start from the origin 0 or some income level larger than 0 for the case in which technique progress in pollution abatement activities requires high fixed cost. This assumption, however, is valid for a country capable to benefit technical progress from the other countries, in this case, the technique effect might start from some negative income value and has a positive intersect with the vertical axis.

technique effect will overwhelm the pollution-increasing impact of composition and scale effect, we will observe a negative correlation relationship between emission increase and income growth. Like this, we obtain an inverted U EKC curve displayed in lower panel with the turning point located at the income level Y_0^* .

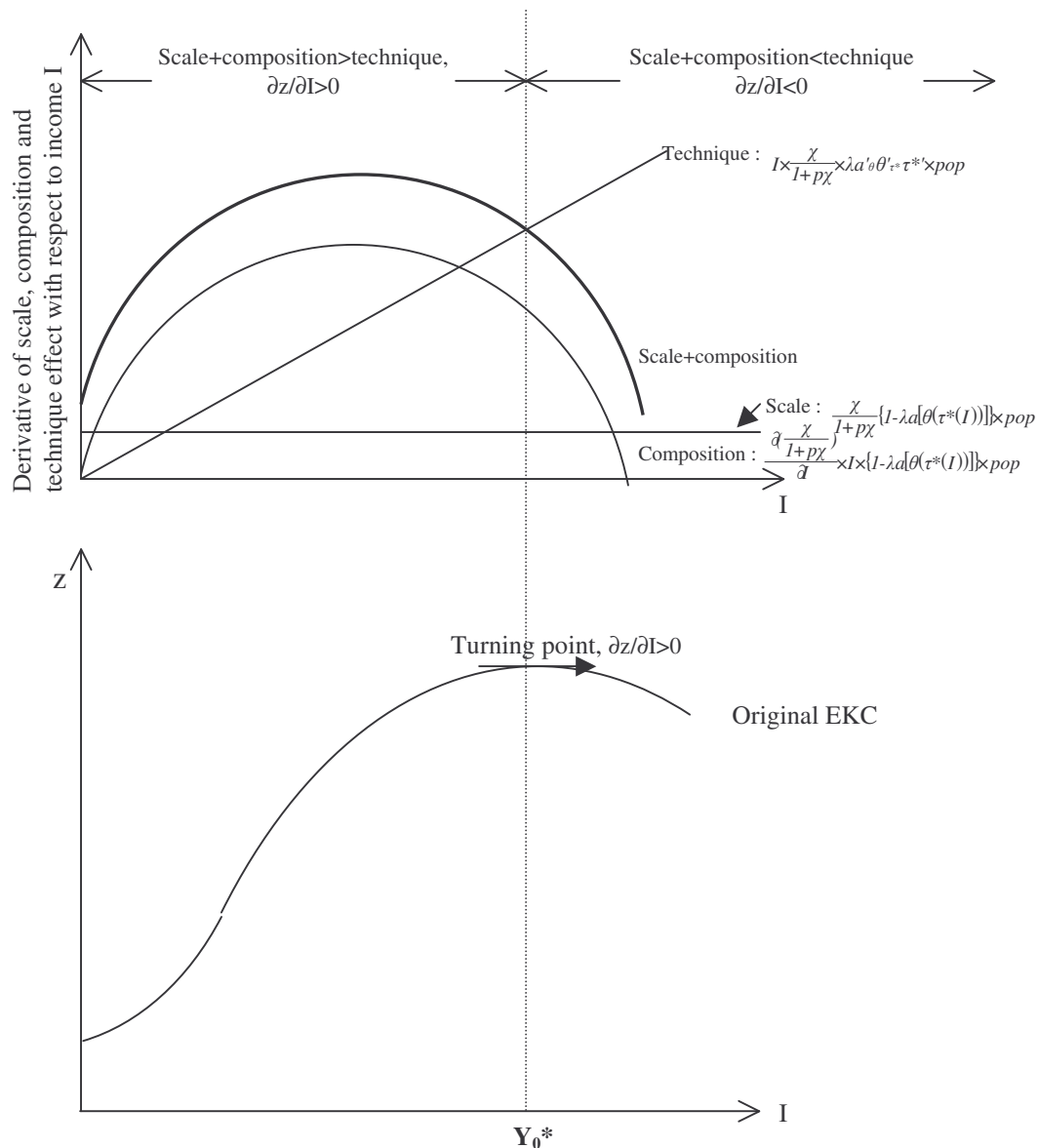

Figure 3.1. Structural determinants for EKC formation

Besides shedding light on how the inverted U EKC curve can be formed under the collaboration of the three structural factors, a more important usage of the graphical illustration is to give concrete policy implication on how to reduce the height and/or turning point of the EKC curve by affecting scale, composition and technique effect. Figure 3.2 gives some examples. For a developing country, facing already achieved technical progress by the forerunner developed countries; the advantage as a latecomer permits it to start its economic

growth process with a relatively higher technological level. Under this circumstance, given the unchanged value for the responsiveness of pollution control policy to income growth τ^*_1 and for the responsiveness of the producer's abatement decision to the emission control policy $\theta^*_{\tau^*}$, an exogenously driven efficiency improvement in pollution abatement activities will lead the value of $\lambda a'_\theta$ to increase, so we can expect reinforcement in the technique effect. This reinforced technique effect can be expressed in the figure as an upward spinning of the increasing straight line representing the technique effect. Obviously, the reinforced technique effect will cross with the scale+composition inverted U curve in a lower income level Y_1^* . Given all other factor keeping constant, we expect a new inverted-U curve named EKC_1 with a lower turning point and also a lower height in the bottom panel.

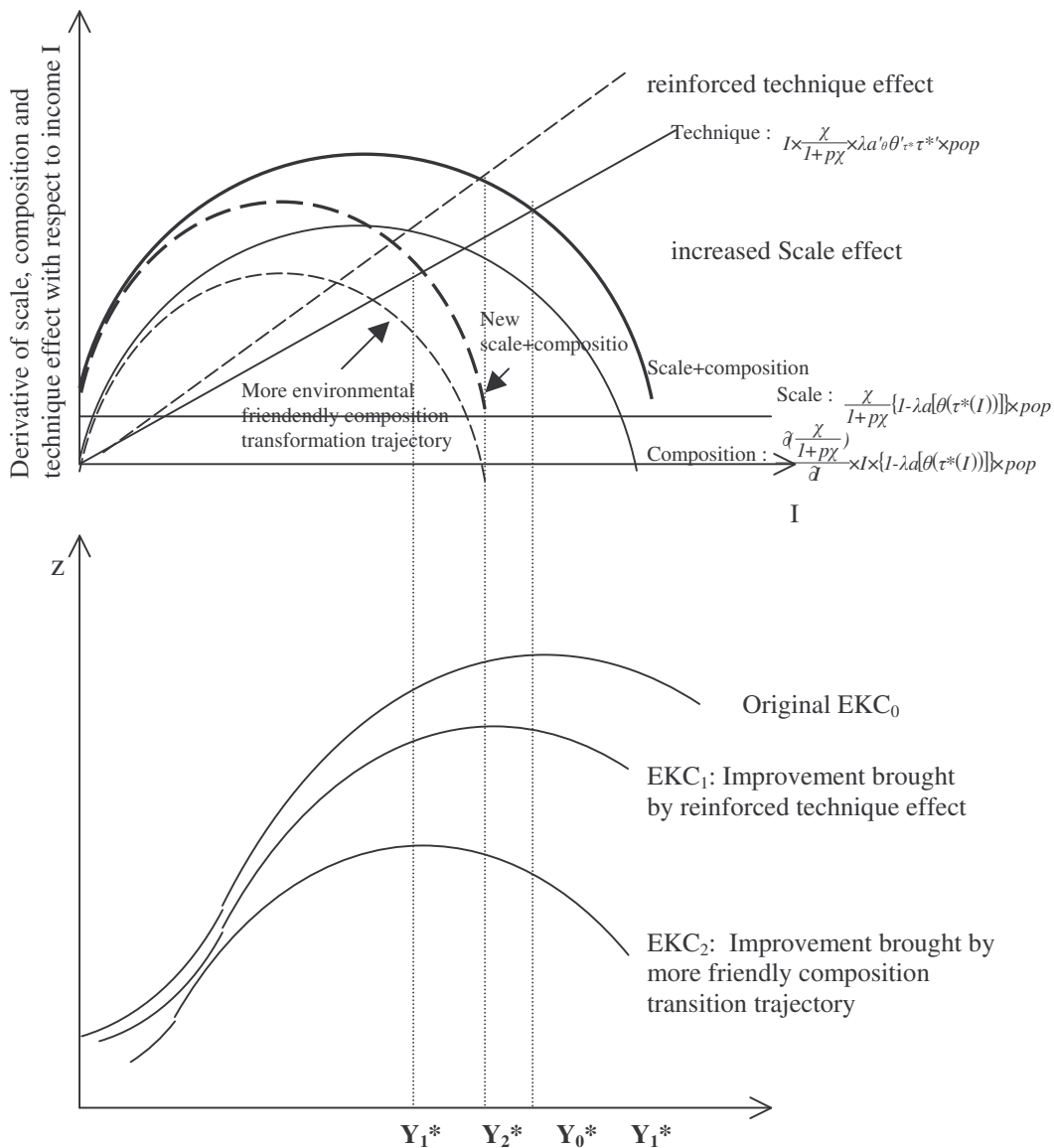

Figure 3.2. Several policy implications for EKC formation

Another policy implication focuses on composition effect. If there are different industrial structure transformation trajectories, for a developing country, it might be possible to use certain industrial guidance policy to avoid the development of some heavy-polluting industries and encourage some less polluting ones, so as to realize a more rapid composition transformation trajectory from firstly agricultural-dominated to industry-dominated and finally service-dominated structure. Under this circumstance, we can expect a new inverted U composition effect to shift inwards and has less important height and width. Therefore the technique effect will intersect with the new scale +composition combination curve at some lower income level Y_2^* and the new emission-income relationship (EKC_2) determined by them will have lower height and a lower turning point.

3.2. Review of China's economic growth and industrialisation process and their impact on emission: one introduction descriptive

Knowing the importance of the structural and technical characteristics of an economy in formation of EKC, in this section, we will make a review on the evolution of the scale, composition and technique effects' evolution in China's industrial economy during 1990s.

3.2.1. Rapid expansion of Chinese economy and its industrial sectors: several evidences for the scale effect

Already mentioned in Chapter 1, since 1978, Chinese economic reform have realized impressive economic growth results. The growth rates for both real GDP and real industrial GDP during 1990s are reported in figure 3.3. Both of them, after attaining their highest growth rate, stabilized since 1993 at about 8% (GDP) and 10% (industrial GDP) and retook the increasing trends since 2000. Showing the same evolution tendency, the relatively higher growth rate of industrial GDP actually reveals the potential domination role of industry in Chinese economy.

Rapid industrialization quickly increased the proportion of industrial sector in total economy. Figure 3.4 reports the evolution of the ratio of industrial GDP in total Chinese GDP during 1978-2003. Starting from 40% at the beginning of economic reform, this ratio has attained over 70% in 2003, with the most rapid increase happening after year 1990.

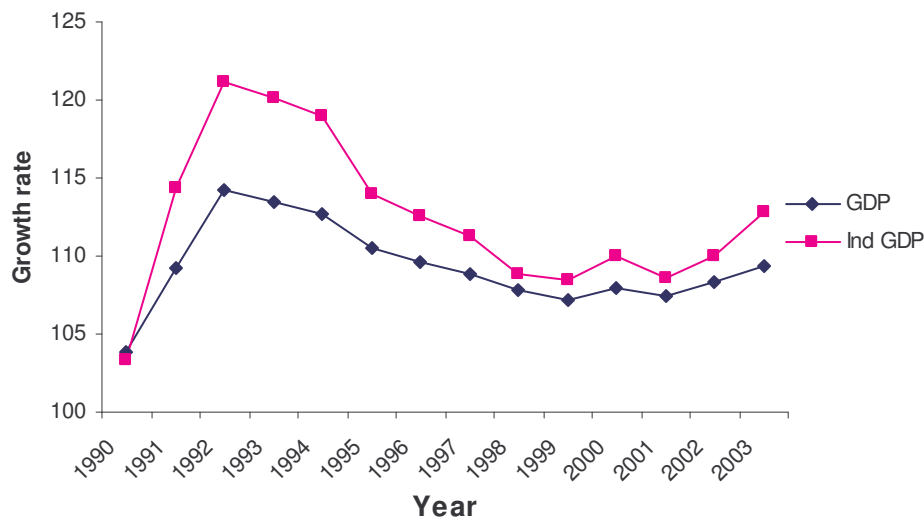

Figure 3.3. Growth rate of Chinese total and industrial economy
 Data Source: China Statistic Yearbook (Various issues)

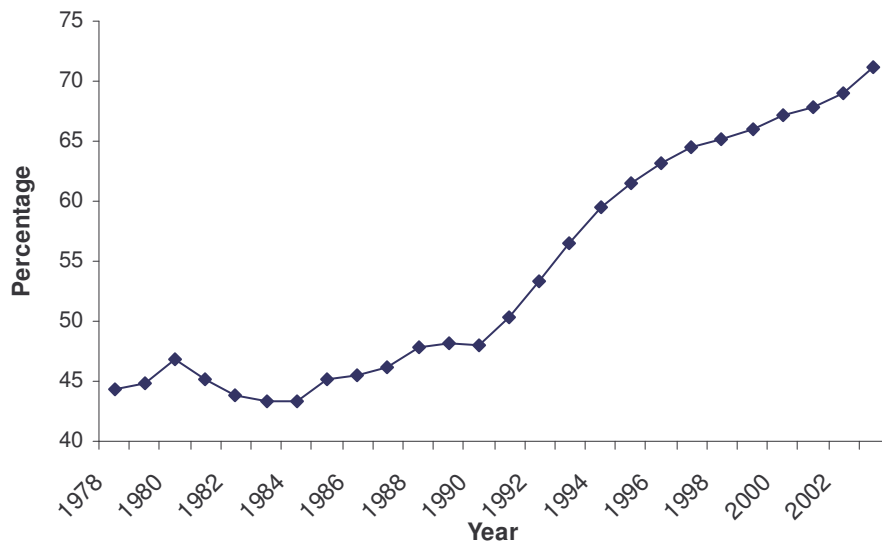

Figure 3.4. Evolution of Ratio of industrial GDP in total GDP
 Data sources: China Statistic Yearbook (2004)

Given the discussion on the scale effect in the last section, we suspect this fast industrialization process in China should have resulted in increasing SO₂ emission problem. This suggestion is confirmed by the figure 3.5, in which the plot figure using detailed provincial-level panel data from 1992-2003 shows an obvious positive correlation between industrial SO₂ emission and real industrial GDP.

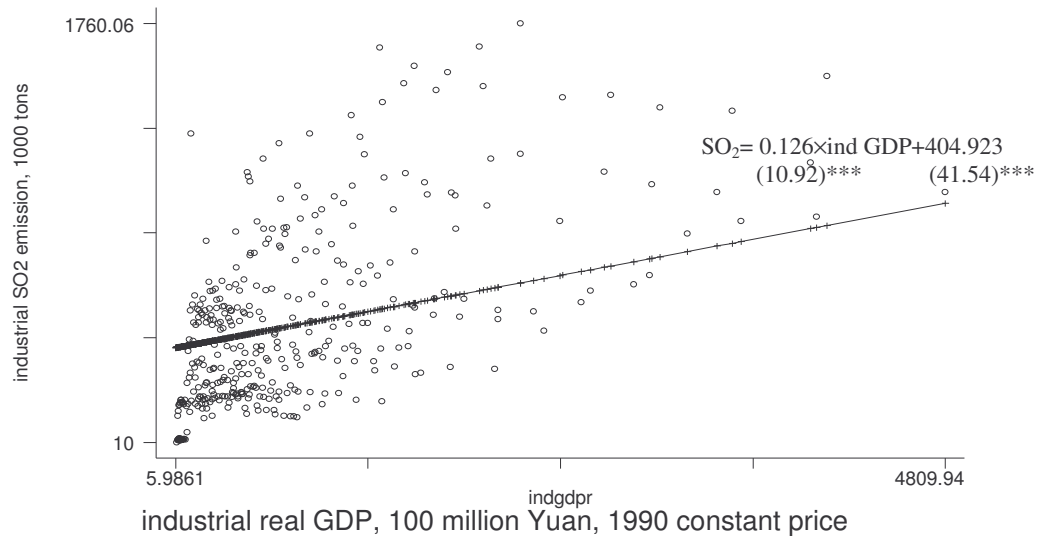

Figure 3.5 Correlation between scale effect and industrial SO₂ emission

Data sources: China Statistic Yearbook (1993-2004), the estimation result is based on fixed-effect estimator method

3.2.2. Internal changes in industry: evidences for the composition effect

As our analysis will focus on industrial SO₂ emission, the composition effect that we discuss here will be the proportion of different industrial sectors instead of the traditional composition effect that covers the transition from primary, secondary to tertiary sectors. From policy implication point of view, we also believe it to be more fruitful to concentrate on the internal structural variation of the industrial sector. This is because the industrialization process is the biggest pollution source during a country's economic development process. For a developing country, to understand how to adjust the composition of industrial sectors of different emission intensities and therefore to reduce the potential pollution burden accompanying its industrialization process should be an important and feasible policy measure for the realisation of sustainable development.

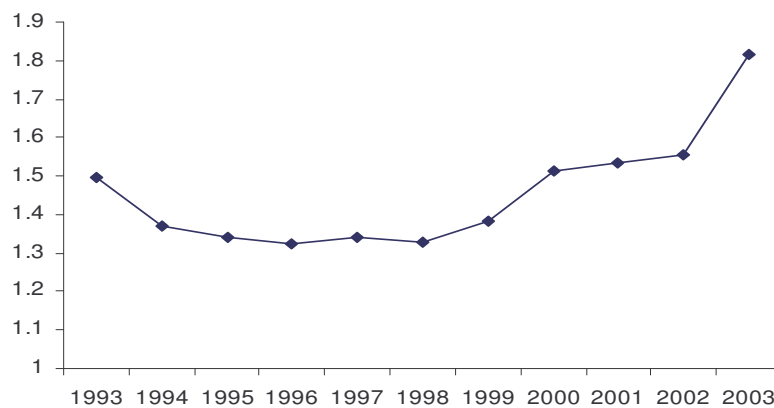

Figure 3.6. Evolution of the ratio of heavy/light industry

Data source: China Statistic Yearbook (1994-2004)

Industrialisation process has already bring important internal composition changes in China's industry economy. Figure 3.6 firstly reports the obvious increasing tendency in the ratio of heavy industries' output with respect to that of light industry in China during 1993-2003, especially for the last five years.

According to the classification for the polluting industries of Dasgupta, Wang and Wheeler (1997), we also report the ratio of the six most polluting industrial sectors to total industrial GDP during the period of 1992-2003 in figure 3.7.¹ To our surprise, although the ratio of heavy industry with respect to light industry has significantly increased in the last several years, the output ratio of the most polluting sector in total industrial economy was stabilized at about 1/3 during the same period. This contrast actually reminds us the fact that heavy industry is not necessarily polluting industries.

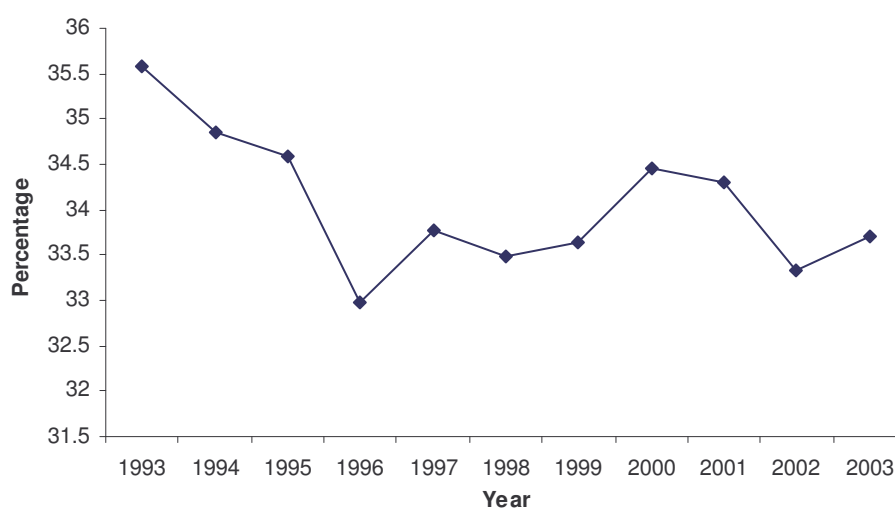

Figure 3.7. Evolution of the proportion of polluting industries in total industrial economy
Data source: China Statistic Yearbook (1994-2004)

3.2.3. Several evidences concerning the technique effect in Chinese industrial sectors

Did China's rapid economic growth and living standard improvement during the last 25 years facilitate the improvement of its environmental regulation efficiency and therefore reinforce its technique effect? We will check the different aspects of China's technique effect in this subsection.

¹ The original five most polluting industrial sectors in China, according to the classification given in Dasgupta, Wang and Wheeler (1997) is (from the most polluting to least polluting): chemical industry, paper-making industry, nonferrous metal industry, ferrous metal industry and finally the non-metal mineral industry. Given the electricity generation in China, principally using coal in its production, is often considered as the industrial sector having most heavily SO₂ pollution problem, we also include it into the category of polluting industries.

a. Reinforced public conscience on environment quality

Although the awakening of the public conscience on environmental quality can be traced back to discovery of the potential public health risk related to pollution in the beginning of 1970s. Disturbed by the political activities in early 1970s, handicapped by the low efficient education and propagation capacity at the beginning of the economic reform and blinded by the high enthusiasm for obtaining a better living standard during 1980s, public conscience for environmental quality has not receive its deserved development until 1990s.

Once the income growth and improvement of living standard attains the necessary level, obvious reinforcement of public conscience for better environmental quality started to appear. Figure 3.8 reports the evolution of the number of visits and number of complaint letters related to environmental problem received by China's environmental protection agencies in each year during 1991-1998. Clearly, during the last 15 years, both manifestation methods have been more often used by Chinese citizens, especially the direct visit. This increasing initiative public demand for a better environment is actually an important demand-side catalyst for the technique effect.

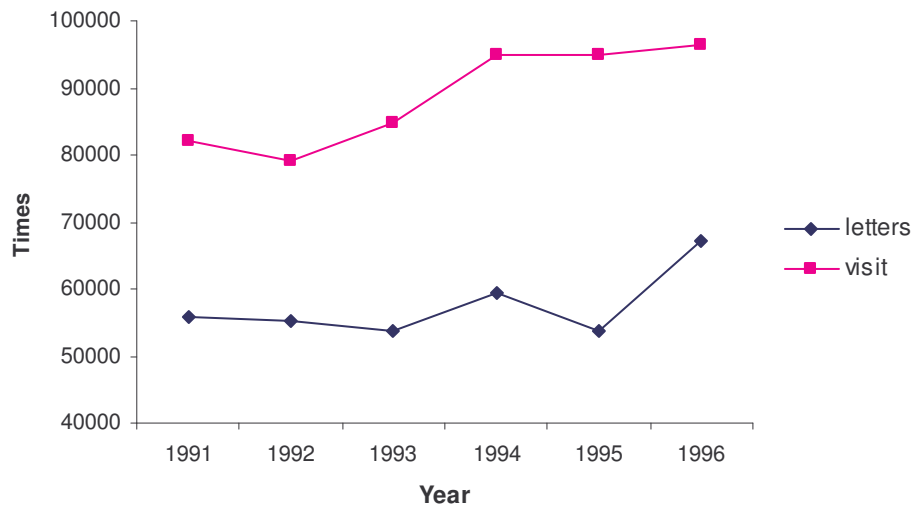

Figure 3.8. Evolution in the numbers of complaining letters and visits concerning environmental degradation problems

Data source: China Statistic Yearbook (1994-1999)

b. Regulation and institutional development in the field of environment protection

Development in China's environmental regulation and institution actually started as early as 1970s. The first organisation taking care of the wastewater utilisation and recycling was created in 1971. Environmental protection was introduced into country's administration agenda in 1973. The State Environment Protection Agency (SEPA) was found in 1974. From

1973 to 1978, a series of policies concerning environmental protection has been formulated.¹ On 1978, the famous article n°11 has been added into China's Constitution, which emphasize the obligation for the state to "protect and improve the environment, in order to prevent pollution and other forms of public perils". The promulgation of the Environment Law during the 11th National People's Congress (NPC) in 1979 was, during that epoch, an important milestone signifying the construction of the legal system aiming at environmental protection.

The revision of the Chinese Constitution in 1982 further enlarged the legal concept of environmental protection and included the exploration and utilisation of natural resources into regulation. During the following five years, numerous laws concerning the protection of marine environment, the prevention of water and air pollution have been promulgated. This period was also characterized by the formulation of the numerous regulations aiming at precisising and improving the environment management capacity by both the State Council and SEPA. The content of these regulation covers the management of the emission levy system, the construction and maintenance of the pollution-accident alert system and the establishment of the monitoring system aiming at small-size village and township enterprises.

However, the promulgation of the different laws and regulations did not signify their application, meant even less for environmental protection achievement. Although environment protection is certainly a desirable objective, during the first ten years' economic reform, it was economic growth and improvement of people's living standard the prior preoccupation for Chinese government.

During 1990s, the relationship between economic growth and environment protection in Chinese government's strategy became more complex. On one hand, Chinese economic growth entered a new phase, the transformation from planning to market economy offered China more growth vitality. On the other hand, the accentuation of environmental degradation provoked rapid increase in the public conscience for a better environment and reinforced the pressures from international community requiring China to take more efficient pollution control initiatives. Corresponding to the situation changes, the evolution of pollution control policies after 1990 was characterised not only by the simple diversification of laws aiming at prevention and protection, but also by the actual application of some control regulations. The signature of Chinese government on the international convention "Environment and Development" ratified by United Nation in Rio de Janeiro in 1992 and the ten environment and development measures registered in Agenda 21 (Chinese White-Cover Book) were

¹ Among these policies, some are continuously applied until today, such as the system of « three-simultaneous » and the system of « elimination before the bottom data ».

generally considered by the scholars as the two important milestones illustrating the increasing of the weight of environment protection in China's development strategies. Several empirical analyses, such as Dasgupta and Wheeler (1997) and Wang (2000), also confirmed the responsive environmental institution construction and their improved operational efficiency during this period.

Figure 3.9 reports the rapid increase in the total and the scientific staffs employed in the administrative and monitoring establishments of SEPA during 1990s. Aware of the potential inappropriateness to equalize the staff number increase to actual institution development, by this indicator, we only expect to illustrate a restricted view on the on-going institutional development in environmental protection aspects in China during the last 15 years.

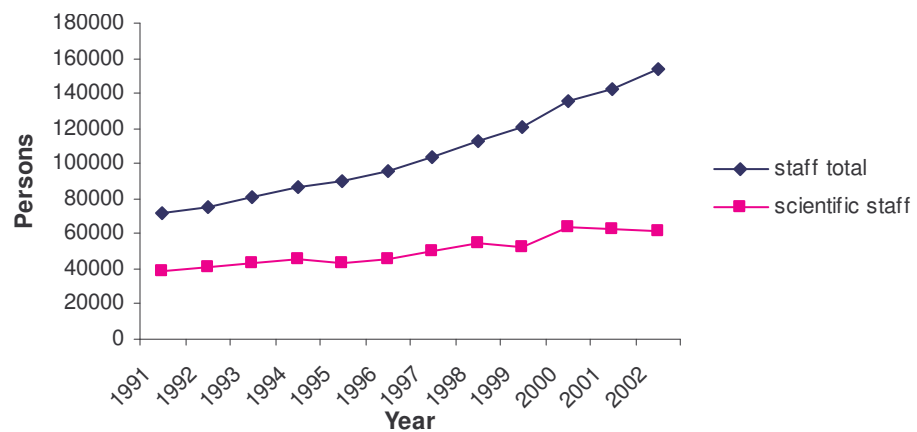

Figure 3.9. Evolution of the number staff working in environment protection institutions

Data source: China Statistic Yearbook (1994-2003)

c. Accomplishment of industrial SO₂ emission abatement

Responding to the ever-increasing public environment conscience and the reinforced environmental regulation and institution development, China's industrial sectors seems to have accomplished obvious progress in industrial SO₂ emission abatement achievement. Figure 3.10 illustrates the evolution of China's industrial SO₂ emission abatement activities during last 15 years. From this figure, we can distinguish that since 1994, parallel to the reinforced public consciences and institutional and regulation efforts, both the scale and relative proportion of pollution abatement with respect to total SO₂ emission show obvious increasing tendency. This actually confirms the conclusion in Wang and Wheeler (1999) and Wang (2000), which emphasized the obvious sensitivity of the emission intensity in some industrial sectors with respect to the currently applied pollution levy system, although the

latter still stays at a relatively lower level compared to the optimal rate proposed by the neoclassical efficiency maximization reasoning.

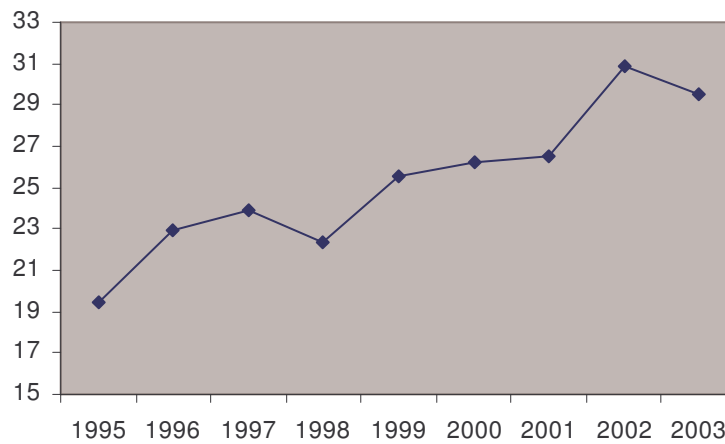

Figure 3.10. Evolution of the ratio of industrial SO₂ abatement

Data sources : China Environment Yearbook (1995-2004)

3.3. Economic determinants for industrial SO₂ emission density—a structural model and the decomposition step

The evolution of China's industrial scale, composition and technique characteristics reveals in front of us a China experiencing rapid industrialisation and composition transformation process and gaining technical efficiency at the same time. To obtain a more systematic relationship of industrial SO₂ emission with respect to the three aspects' characteristics, in this section, we will carry out a structural form econometrical analysis.

3.3.1. The structural model

(1) Grossman decomposition adaptation to our provincial level panel data

If we agree that emission is a by-product of production, according to Grossman (1995), the industrial SO₂ emission in each province *i* during period *t* can be written as a product of its three determinants as in equation (3.7).

$$SO_{2,it} = Y_{it} \sum_j \left(\frac{Y_{j,it}}{Y_{it}} \times \frac{SO_{2j,it}}{Y_{j,it}} \right) \quad (3.7).$$

The index $j=1, \dots, n$ signifies different industrial sectors. Y_{it} presents the total industrial GDP in province *i* during period *t* and $SO_{2,it}$ signifies the total industrial SO₂ emission of the same province. $Y_{j,it}$ means the GDP created in industrial sector *j* of province *i* during period *t* and $SO_{2j,it}$ is the corresponding sector-level SO₂ emission.

Following chapter 2, our structural form estimation will still mainly concentrate on the determination of industrial SO₂ density in each province. Therefore, we divide the time-invariable provincial surface (area_i) on both side of the equation (3.7) and obtain

$$\frac{SO_{2,it}}{area_i} = \frac{Y_{it}}{area_i} \sum_j \left(\frac{Y_{j,it}}{Y_{it}} \times \frac{SO_{2j,it}}{Y_{j,it}} \right). \quad (3.8)$$

The term $(SO_{2,it}/area_i)$ is therefore the industrial SO₂ density in province i during period t, and the first terms on the right-hand side of equation $(Y_{it}/area_i)$ becomes the industrial activity density. $(Y_{j,it}/Y_{it})$ gives the proportion of product of sector j in total industrial product of province i. Finally, the term $(SO_{2j,it}/Y_{j,it})$ calculates the sector-specific pollution intensity. If we suppose sector specific emission intensity $(SO_{2j,it}/Y_{j,it})$ can be represented by provincial-level average emission intensity $(SO_{2,it}/Y_{it})$ adjusted by a sector-specific emission efficiency indicator $e_{i,jt}$, so $\frac{SO_{2j,it}}{Y_{j,it}} = \frac{SO_{2,it}}{Y_{it}} \times e_{i,jt}$, equation (3.8) can be transformed into

$$\frac{SO_{2,it}}{area_i} = \underbrace{\frac{Y_{it}}{area_i}}_{scale} \times \underbrace{\sum_j \left(\frac{Y_{j,it}}{Y_{it}} \times e_{j,it} \right)}_{Composition} \times \underbrace{\frac{SO_{2,it}}{Y_{it}}}_{Technique}. \quad (3.9)$$

The three structural determinants of emission are easier to distinguish in equation (3.9). The term $(Y_{it}/area_i)$ corresponds to scale effect. A higher industrial activity density normally means higher emission density given other factors staying constant. The inclusion of the sector-specific efficiency indicators $e_{j,it}$ permit us to distinguish the other two effects. Firstly, with the aid of this efficiency indicator, we are able to include the provincial-level average SO₂ emission intensity directly in the formation of SO₂ emission density, which is actually an ideal measurement for the technique effect. We expect a negative correlation between this terms and the industrial SO₂ emission density. Secondly, this sector-specific emission efficiency indicator can also directly involve with the proportion of different sectors in total industry to form the composition effect term $\sum_j \left(\frac{Y_{j,it}}{Y_{it}} \times e_{j,it} \right)$. If at period t, the emission intensity of different sectors stay at their original level $e_{j,it-1}$, but the proportion of the polluting sectors, whose emission intensity is higher than provincial average level, so $e_{j,it-1} > 1$, increases in total industrial economy, we will obtain a new composition effect term at period t

as $\sum_j \left(\frac{Y_{j,it}}{Y_{it}} \times e_{j,it-1} \right)$, which is actually larger than $\sum_j \left(\frac{Y_{j,it-1}}{Y_{it-1}} \times e_{j,it-1} \right)$. This in turn explains the composition-related increase in emission with respect to that at period t-1.¹

(2) Relationship between Industrial SO₂ emission intensity and income: can we use per capita GDP to extrapolate technique effect?

To transform the decomposition function (3.9) into an estimable model, we face one difficulty. Although both the scale and composition effect can be directly measured by economic statistic indicators in estimation function, for technique effect, if we keep using the provincial level average industrial SO₂ emission intensity as its measurement, we risk to encounter estimation bias related to endogeneity problem since the industrial SO₂ emission, under this circumstance, appears actually in both sides of equation. To avoid this problem, we need to find an economic indicator that is closely related to technique effect but does not involve industrial SO₂ emission in its measurement.

Among the previous empirical structural analysis on pollution determination, Selden and Song (1994) and Panayotou (1997) use per capita GDP as an extrapolation for technique effect in their paper. Whether per capita GDP can also be served as a good approximate for technique effect? In this section, let's first check the direct relationship between per capita GDP and provincial level average industrial SO₂ emission intensity. The estimation results are in reported table 3.1. To distinguish potential coefficient difference between the 3 big cities and the 26 provinces, in this step, like those in chapter 2, estimates also consist of four parts.

¹ One point need to be indicate is that equation (3.8) is actually an identity equation, therefore the term of composition effect $\sum_j \left(\frac{Y_{j,it}}{Y_{it}} \times e_{j,it} \right) = 1$ in each period. To derive its contribution in total emission or emission density, here we actually use comparative static principle—all the reasoning is actually based on the hypothesis that “all else equal”. All else equal, if the ratio of the relatively more polluting industrial sectors in total industrial economy increases, we will have $\sum_j \left(\frac{Y_{j,it}}{Y_{it}} \times e_{j,it} \right) = \sum_j \left(\frac{Y_{j,it}}{Y_{it}} \times e_{j,it-1} \right) > \sum_j \left(\frac{Y_{j,it-1}}{Y_{it-1}} \times e_{j,it-1} \right)$, therefore

$\sum_j \left(\frac{Y_{j,it}}{Y_{it}} \times e_{j,it-1} \right) > 1$. This in turn leads the total emission to increase.

Table 3.1. Relationship between per capita GDP and Industrial SO2 intensity

	Whole Sample		26 provinces		3 cities		Combined model	
	RE	FE	RE	FE	RE	FE	RE	FE
GDPPC (1/1000)	-12.114 (10.36)***	-11.903 (6.95)***	-22.812 (9.13)***	-22.547 (6.54)***	-1.627 (7.00)***	-1.508 (11.03)***	-12.466 (10.35)***	-13.195 (6.72)***
GDPPC ² (1/1000) ²	1.212 (7.80)***	1.187 (6.00)***	3.490 (6.75)***	3.457 (5.80)***	0.048 (4.71)***	0.039 (7.14)***	1.191 (6.89)***	1.393 (5.29)***
GDPPC ³ (1/1000) ³	-0.037 (6.40)***	-0.036 (5.33)***	-0.170 (5.42)***	-0.169 (5.25)***			-0.028 (3.30)***	-0.042 (3.47)***
City×GDPPC							1.626 (0.95)	-3.392 (1.09)
City×GDPPC ²							-0.217 (1.60) ^o	0.085 (0.45)
Constant	40.593 (14.02)***		53.864 (13.35)****		15.883 (13.09)***		41.403 (13.60)***	
R-squared	0.3574	0.3114	0.3694	0.3680	0.8449	0.8935	0.3619	0.3246
F test		47.63		54.92		130.03		30.19
AR(1)	1.4631	0.8541	1.5364	0.9034	1.7203	1.8035	1.4824	0.8768
Breuch-pagan	729.53 (0.000)		683.40 (0.000)		18.44 (0.000)		733.72 (0.000)	
Hausman	1.19 (0.7563)		0.93 (0.8190)				2.15 (0.8287)	
Province Turning point (P)	13901.28 (8384)	13869.77 (9709)	8231.33 (7502)	8238.38 (5141)			25251.25 (12520)	15332.45 (11804)
Province Turning point (T)	7802.18 (5013)	7853.56 (5978)	5420.73 (4902)	5398.82 (7712)			6944.50 (4123)	6856.59 (5489)
City Turning point (P)	13901.28 (8384)	13869.77 (9709)			--	--	13695.00 (31163)	14315.97 (--)
City Turning point (T)	7802.18 (5013)	7853.56 (5978)			16947.92 (1424)	19333.33 (1029)	9370.18 (23099)	9231.41 (--)
Observations	348	348	312	312	36	36	348	348
Provinces	29	29	26	26	3	3	29	29

- Absolute value of z statistics in parentheses, ^o significant at 15%, * significant at 10% ** significant at 5%; *** significant at 1%. Absolute value of z statistics in parentheses.
- The standard error of the turning point is indicated in the parenthesis below.

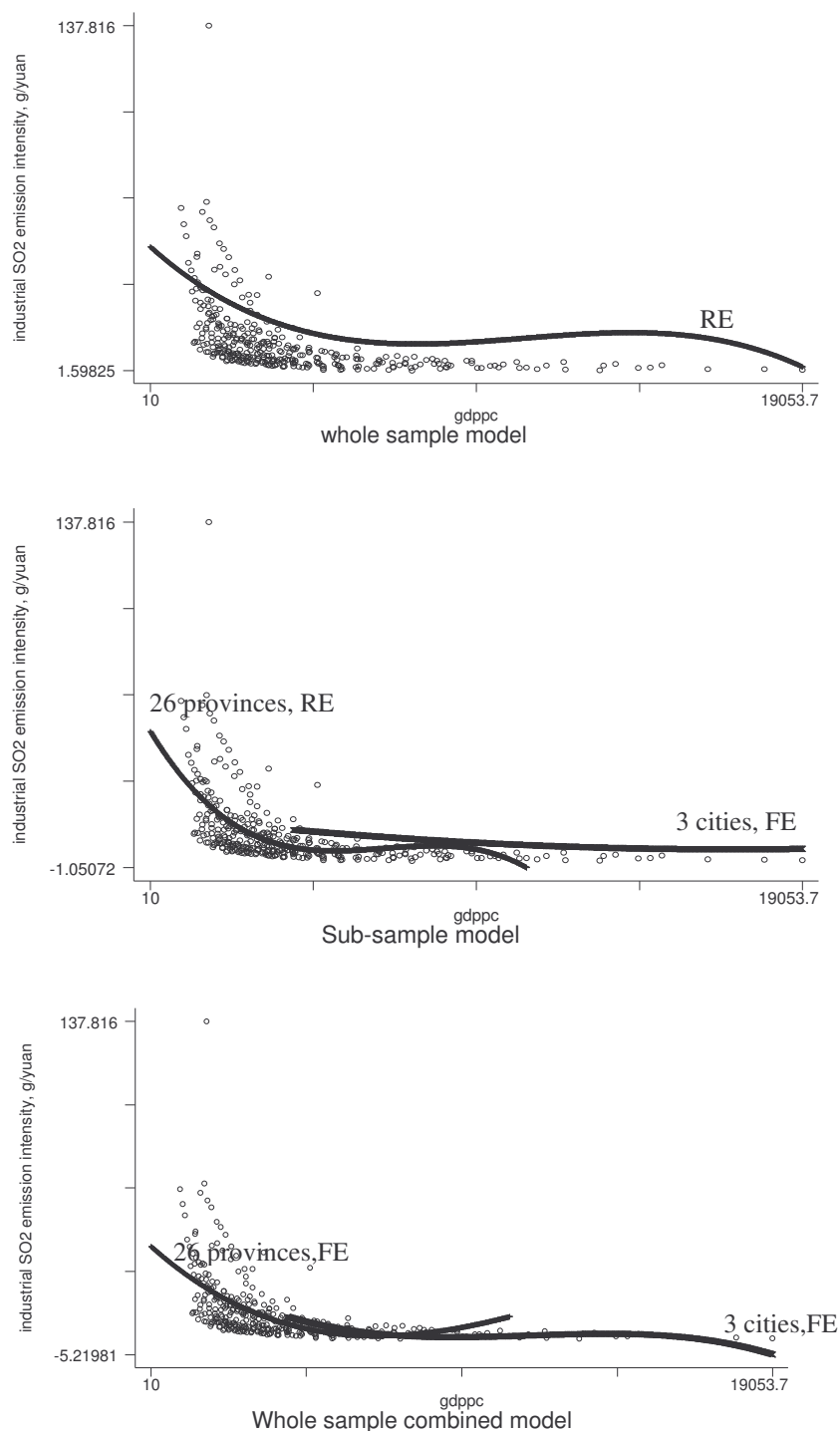

Figure 3.11. Correlation between GDPPC and industrial SO₂ emission intensity

Figure 3.11 gives the corresponding graphical demonstrations for the estimated relationships. In all the four estimations, a common decreasing tendency in industrial SO₂ intensity with respect to income growth can be easily found. Although this relationship shows slight fluctuations at the border income level of some samples, we believe in a general sense, per capita income growth generally lead a negative correlation with respect to industrial SO₂ emission intensity, therefore can be served as a good extrapolation for abatement

technological progress tendency. This finding reminds us the similar conclusion of Hettige et al (2000, p460) and confirms that of Selden and Song (1995), Panayotou (1997) and Cole and Elliott (2003).

(3) The structural estimation function

As we know the relationship between emission intensity $\frac{SO_{2,it}}{Y_{it}}$ and GDPPC is a negative and almost linear one, by carefully choosing measurement unit, in equation (3.9), we can directly replace average emission intensity by $GDPPC_i$ for each province.

$$\frac{SO_{2,it}}{area_i} = \underbrace{\frac{Y_{it}}{area_i}}_{scale} \times \underbrace{\sum_j \left(\frac{Y_{j,it}}{Y_{it}} \times e_{j,it} \right)}_{Composition} \times \underbrace{GDPPC_i}_{Technique} \times \nu \quad (3.10)$$

Therefore, different from EKC hypothesis, we find in equation (3.10) that per capita GDP is only one determinant for SO_2 emission density besides the scale ($Y_{jt}/area_j$) and composition $\sum_i (Y_{i,jt}/Y_j \times e_{i,jt})$ effects. In this new structural determination function, per capita income growth is only considered as one of the pollution-reduction factors, which acts collectively with scale enlargement and composition transformation to finally determine the emission results, but not the solo factor that leads pollution evolution to form the inverted U form curve.¹

Based on the equation (3.10), we can obtain the final estimation function used in this chapter to investigate the structural determination of emission.

$$SO_{2it} = \alpha_i + \eta_t + \beta GDPPC_{it} + \gamma Scale_{it} + \theta Composition_{it} + \eta popden_{it} + Z_{jt}' \phi + \rho t + \varepsilon_{jt} \quad (3.11)$$

Besides using $GDPPC$ to measure the technique effect in estimation function, we use provincial total industrial GDP divided by the surface of the same province to measure the scale effect ($Scale_{it}$). We expect a positive coefficient for it. The original construction of composition effect according to equation (3.10) requires us to possess the detailed sector-specific emission intensity and value added data. However, though sectoral-level value added data are actually available in China's publicly published industrial statistics, we do not have

¹ Cole and Elliott (2003) use emission per capita as the dependant variables in their investigation of the structural determinants of EKC. However, given the dependant variable is per capita emission, they are obliged to use per capita GDP to capture both the technique and scale effect. Compared to their paper, the advantages for us to use industrial SO_2 emission density as dependant variables are actually two folds. On one hand, by only concentrating on SO_2 emission from industrial production, the scale effect can be clearly distinguished from technique effect since the former is measured by total industrial GDP and the latter is measured per capita GDP. On the other hand, using the intensity of industrial SO_2 emission as dependant variable also helps us to reduce the potential correlation between total industrial GDP and per capita GDP, since the former is now deflated by the geographical surface of the province and the latter by population size.

the sectoral specific emission intensity data. This means we still need an approximate for composition effect for our estimation. Considering this structural model is very similar to that proposed by ACT (2001), we decide to following their example and to use capital abundance ratio $(K/L)_{it}$ to describe composition effect for each province. An implicit assumption of this composition effect extrapolation is a sector whose production procedure uses more intensively capital should has more pollution problem.¹ Therefore, for this variable, a positive efficient is expected. As we will employ panel data estimator for this equation, we also permit both provincial-specific and time-specific effect. For the correspondence to Chapter 1, the estimations for emission density all include the population density terms. Considering the possible non-linear relationship between industrial SO₂ emission density and its determinants, we include higher order polynomial terms of the three emission determinant factors when necessary.

3.3.2. Estimation results of the structural model

The estimation results based on equation (3.11) are reported in Table 3.2. For the technique effect measured by per capita income GDPPC, we keep using the spline combined function form and only gradually delete the insignificant polynomial income terms during estimation process. Therefore, in this step, we still distinguish the potential difference in the coefficients of income terms between provinces and cities.

The inclusion of the structural and scale characteristics into the determination of industrial SO₂ emission density obviously increases the whole model's explanation power; the adjusted R² value increases from 0.50 (see table 2.4) to 0.62. The more satisfactory statistic values for the auto-correlation test also reveals the potential serial correlation problem in the previous EKC analyses owing to the omitted variables. The positive coefficient before scale effect confirms our expectation, a higher industrial activities density does predict in a higher industrial SO₂ emission density. However, the significant but negative coefficient obtained for the capital abundance ratio $(K/L)_{jt}$ is actually contrary to our original anticipation and the general conclusion obtained from international experience. According to our result, a province having higher industrial capital abundance ratio should have *lower* SO₂ emission density.

¹ The same hypothesis has already be widely used in the similar analyses as Copeland and Taylor (1994, 1997), ACT (2001) and Cole and Elliott (2003).

Table 3.2. Structural model and decomposition results (Industrial SO₂ emission density)

Variables	FE	AB	FE	AB	FE	AB
GDPPC (1/1000)	-0.506 (0.57)	-1.020 (1.43)	-0.462 (1.75)*	0.124 (0.26)	-0.160 (1.23)	-0.455 (1.68)*
GDPPC ² (1/1000) ²	0.025 (0.21)	0.096 (1.40)	0.019 (1.19)	-0.033 (1.07)		
GDPPC ³ (1/1000) ³	-0.000 (0.05)	-0.006 (2.41)**				
City×GDPPC	2.469 (1.94)*	2.465 (1.96)**	2.528 (3.14)***	3.462 (2.54)**	2.331 (2.86)***	3.869 (2.71)***
City×GDPPC ²	-0.150 (1.90)*	-0.120 (1.58) ^o	-0.154 (3.29)***	-0.178 (2.32)**	-0.138 (2.96)***	-0.207 (2.60)***
K.L (1/10000)	-0.147 (6.03)***	-0.154 (2.15)**	-0.146 (6.22)***	-0.151 (1.95)*	-0.145 (6.18)***	-0.154 (2.04)**
Scale	1.416 (3.29)***	2.383 (4.57)***	1.407 (4.11)***	2.068 (3.08)***	1.411 (4.14)***	2.065 (3.05)***
Popden	-0.034 (5.52)***	-0.049 (10.71)***	-0.034 (5.53)***	-0.046 (9.83)***	-0.034 (5.56)***	-0.046 (9.66)***
trend	0.254 (2.79)***	0.344 (2.84)***	0.250 (5.02)***	0.213 (2.15)**	0.207 (5.75)***	0.301 (3.50)***
SO ₂ den _{t-1}		-0.258 (3.52)***		-0.223 (3.40)***		-0.218 (3.40)***
R-squared	0.6167		0.6167		0.6158	
F test	25.41		26.90		28.48	
AR(1)	2.1021	-1.61 (0.1082)	2.0903	-1.60 (0.1093)	2.0776	-1.60 (0.1096)
AR(2)		0.18 (0.8610)		0.35 (0.7276)		0.38 (0.7016)
Breuch-pagan	88.78 (0.000)		101.56 (0.000)		109.09 (0.000)	
Hausman	1981.25 (0.000)		1752.54 (0.000)		1588.17 (0.000)	
Sagan		19.77 (1.000)		18.91 (1.000)		22.06 (1.000)
Observations	348	290	348	290	348	290
Provinces	29	29	29	29	29	29

▪ ^o significant at 15%, * significant at 10%** significant at 5%; *** significant at 1%. Absolute value of z statistics in parentheses.

▪ The standard error of the turning point is indicated in the parenthesis below.

▪ FE means fixed-effect estimator for panel data. AB represents Arellano-Bond (1991) dynamic GMM estimator for fixed-effect panel data.

This contrary-to-intuition result may be due to the fact that the capital-abundance ratio, being a pertinent extrapolation for the composition effect when analysis focus covers the whole economy, may lose its pertinence when the analysis is concentrated only in the industrial sector. Here is our explanation. The pollution performance of *whole* economy structure and the *total* capital-abundance level may follow similar evolution trajectory when economy starts from less capital-intensive and less pollution-intensive agriculture-dominated structure, then experiences the industrialization procedures that leads both capital intensity and pollution intensity to increase and finally arrives the post-industry structure whose

production process returns to be low capital-intensive and low pollution intensive style. However, once our attention is focused only in the industrial sectors, less polluting industries might not necessarily be the sectors possessing less capital abundance ratio, the example is the information industries. Moreover, in the relatively early stage of industrialization procedure, though the less polluting light industries may generally possess relatively lower capital abundance ratio, for the enterprises in the same industry, higher capital abundance ratio may mean better technology efficiency, therefore means less pollution problems. Dinda et al (2000) also indicate the potential ambiguity in using capital abundance as measurement for environmental performance of the industrial composition, since the “capital intensive sector could also be more likely to be clean technology owner”.

Concerning the technique effect, the spline estimation function still reveals different results between the 26 provinces and the 3 cities. Although the expected negative correlation between GDPPC and SO₂ emission density is confirmed for the 26 provinces, for the 3 cities, the inclusion of scale and composition effect into the structural estimation function only partially decomposes the combined correlation between emission density and per capita income growth proposed by EKC hypothesis. The coefficients obtained for the income terms still predict an inverted U curve for this EKC-style relationship, but with the turning point reducing to the range of 7900-8400 yuan according to the estimation methods. Although this divergence between provinces and big cities can be partially explained by their structural differences, where the industrial production in the 3 cities might be more consumption-led than that in the 26 provinces. These results also warn us the constrained decomposition efficiency of our current structural model. We suspect the potential efficiency loss in this structural model to come principally from two aspects, one is that we still forget some structural determinants that should be included into the estimation model and another is the inappropriate extrapolation for the composition effect by the industrial capital abundance ratio $(K/L)_{it}$.

For the reason of comparison, we also apply the structural determination model to the case of total industrial SO₂ emission. The estimation results are reported in table 3.3. Although the decomposition effect is relatively less efficient than that for the industrial emission density case, we are still satisfied with the stability of the estimate results. The results based on total industrial SO₂ emission case also confirm the positive scale effect and the unexpected negative composition effect as those in emission density case. The low efficiency of our decomposition efforts in the total industrial SO₂ emission case can be traced from the coefficients for the technique effect. Although the involvement of scale and

composition effect in estimation can partially take away explanation power of the per capita GDP in total industrial SO₂ emission, where the new relationship between per capita GDP and total emission becomes the inverted U curve instead of the ever-increasing trends found in chapter 2, our decomposition structural function is obviously lack of some other emission determination factors, this is actually revealed by the low value of the auto-correlation test.

Table 3.3. Structural model and decomposition results
(Total industrial SO₂ emission)

	Structural model	
	RE	FE
GDPPC (1/1000)	170.706 (2.35)**	228.012 (2.04)**
GDPPC² (1/1000)²	-35.019 (3.34)***	-37.462 (2.86)***
GDPPC³ (1/1000)³	1.743 (3.14)***	1.872 (3.12)***
City×GDPPC	-154.380 (2.42)**	-178.999 (1.96)*
City×GDPPC²	34.064 (3.39)***	34.124 (2.75)***
City×GDPPC³	-1.777 (3.30)***	-1.820 (3.12)***
K/L (1/10000)	-6.368 (1.66)	-3.287 (0.87)
Scale	2.096 (6.21)***	1.065 (2.27)**
trend	2.475 (0.32)	-1.663 (0.14)
so2_{t-1}		0.262 (3.40)***
Constant	227.421 (2.08)**	-7.117 (0.04)
R-squared	0.4863	0.4300
F test		13.67
AR(1)	1.3298	1.2583
Breuch-pagan		1098.43 (0.000)
Hausman		417.4 (0.000)
Province Turning point (Peak)	3204 (2531)	4697 (5020)
Province Turning point (Trough)	10191 (6759)	8644 (9228)
City Turning point (Peak)	6376 (35561)	9411 (39593)
City Turning point (Trough)	--	33383 (129414)
Observations	348	319
Provinces	29	29

▪ ° significant at 15%, * significant at 10%** significant at 5%; *** significant at 1%. Absolute value of z statistics in parentheses.

▪ The standard error of the turning point is indicated in the parenthesis below.

3.4. Conclusion

In this chapter, we first made a simple graphical analysis on the potential structural determinants for emission and their roles in the formation of EKC curve. Following, with the help of a similar decomposition idea as Grossman (1995), we derived a structural determination function. In this structural model, per capita GDP, an extrapolation measure for the technique effect, is only one of the emission determinants besides the scale and composition effects. Although the reduced-form estimation function obtained from original EKC hypothesis suggests an ever-increasing correlation between economic growth and industrial SO₂ emission density in the last chapter, the estimation results of this chapter shows that income growth should be considered as a pollution-reducing factors given its significantly negative correlation with industrial SO₂ emission intensity. The estimation results from the structural model confirm this finding, especially for the 26 Chinese provinces.

However, estimation results of this chapter also reveals the potential efficiency defection of our decomposition structural model, since we can only partially decompose the negative technique effect for the emission density case of the 3 big cities and for the total industrial SO₂ emission case. We suspect two possible sources of efficiency loss: the inappropriate use of capital abundance ratio (K/L) as the extrapolation measure for composition effect or the ignorance of other important structural emission determinant factors.

Chapter 4. Another decomposition analysis on scale, composition and technique effect based on Divisia index decomposition method: a non-parametric method

Facing the low efficiency of the structural emission determination model discussed in the chapter 3, we will tempt to carry out a decomposition analysis for the three emission determinants: scale, composition and technique effects in this chapter by the Divisia index decomposition method. Although identifying the ultimate sources of emission and its variation is probably a task beyond the scope of this non-parametric decomposition analysis and the decomposition method itself does not directly reveal the causal effects behind the EKC hypothesis, it can offer us more detailed information about province-specific contribution of the three emission determination factors in industrial SO₂ emission variation during the last decades.

4.1. Literature review on the existing decomposition analyses

Although different in their concrete decomposition methods, most of the existing emission determination decomposition analyses share the following three common characters. Firstly, as the mathematical expression for the contribution of one determinant in total emission changes is the continuous derivative of pollution with respect to this determinant factor, the common rationale of the decomposition analyses is to find appropriate mathematical transformation to adapt the continuous characteristic of the mathematical derivative to the discrete nature of the statistical economy and emission data actually available in the reality. Secondly, the efficiency of the decomposition analyses generally depends more heavily on the availability of the detailed data on emission and economic structure than the reduced-form EKC analysis or the structural model developed in chapter 3. Due to the stringent data requirement, most of the previous decomposition attempts are based

their analyses on the experience of developed countries, whose complete statistical system permits the collection of the detailed emission, output mix and input mix data on both the national and sectoral level. Finally, the structures of these decomposition models all follow more or less the decomposition idea of Grossman (1995). Although different in their degree of precision, the structural factors included into their analyses can always be easily categorised into the scale, composition and technique effects.

Sharing the above common points, the existing decomposition studies on the emission determination factors can actually be categorized into two groups according to their concrete decomposition methods. The first group bases on “fixed-weight” decomposition method. The representative studies in this group are Selden et al. (1999) and Bruvoll and Medin (2003), which investigate the structural determinants for the variations of various emission cases in United States (1970-1990) and Norway (1980-1996), respectively. The second group of studies employs the Adaptive-Weighting Divisia (AWD) decomposition methods that were frequently used in energy literatures. The representative paper to this group of studies is Bruyn (1997), which employed this method to decompose the changes in the emission/output ratio changes between 1980 and 1990 for West Germany and Netherlands into technological and structural variations.

The similarity and difference between these two decomposition rationales can be explained by the following equations. Starting from the Grossman decomposition (1995) as equation (3.1), if we divide the both side of equation (3.1) by Y_t —total income of the economy, so we get an equation as (4.1). This equation suggests the emission intensity U_t to depend on its structural ($S_{j,t}$) and technique ($I_{j,t}$) characters.

$$U_t = \frac{E_t}{Y_t} = \sum_{j=1}^n I_{j,t} S_{j,t} \quad (4.1)$$

Differentiating equation (4.1) with respect to time gives the following continuous decomposition function.

$$U'_t = \sum_j I_{j,t} S'_{j,t} + \sum_j S_{j,t} I'_{j,t} \quad (4.2)$$

The similarity between the two decomposition methods, as mentioned above, is to adapt this continuous decomposition function into a discrete approximation since the actual statistic data are generally reported by annual base. However, the divergence between these two methods also starts here. AWD method insists in adjusting the weigh during the time. While the fixed-weigh method suggests to keep the initial weight in the calculation for the following period. This difference can be explained as in equation (4.3).

$$\text{AWD method: } U_t - U_0 = \underbrace{\sum_j [I_{j,0} + \alpha(I_{j,t} - I_{j,0})](S_{j,t} - S_{j,0})}_{\text{structure}} + \underbrace{\sum_j [S_{j,0} + \beta(S_{j,t} - S_{j,0})](I_{j,t} - I_{j,0})}_{\text{technique}}$$

(α, β are generally supposed to be 0.5)

$$\text{Fixed-weight method: } U_t - U_0 = \underbrace{\sum_j I_{j,0}(S_{j,t} - S_{j,0})}_{\text{structure}} + \underbrace{\sum_j S_{j,0}(I_{j,t} - I_{j,0})}_{\text{technique}} \quad (4.3)$$

Owing to the connectedness characteristic, fixed-weight method can always assure the sum of the individual effects to be equal to the total changes. In contrast, the AWD method, like most of other decomposition approach, may produce some residual effect that has no clear economic interpretations. However, to employ the fixed-weight decomposition method, a supplementary assumption is needed. That is, the proportion of contributions from structural and technique effect in total emission evolution will always equal to their original weight. So this decomposition effort actually aims at providing *a fortiori* evidence—either structural or technique effect's changes alone will be sufficient to cause emission intensity U to turn down in the absence the other effect. This actually diverges from the original intention of the decomposition analysis, which is to investigate the *actual, unique and path-dependent* contribution from structural (technique) effect in the evolution of the emission/output ratio in conjunction with the historically happened progress in the technique (structural) effect. Furthermore, We will see in the following analysis that, the unexplainable residual effect in the AWD method can actually be constrained to very small value by employing appropriate decomposition function form. Therefore, in our decomposition analysis of this chapter, we prefer to use the AWD method.

4.2. A simple introduction on the Divisia index decomposition method

4.2.1. The origin of Divisia index

The AWD decomposition method obtains its inspiration from the Divisia index—a continuous time index number formula due to François Divisia (1925). This index has already been widely used in theoretical discussions of data aggregation and the measurement of technical change. It is defined with respect to the time paths of set variables. For example, at given period t , the prices $[P_1(t), P_2(t), P_3(t), \dots, P_N(t)]$ and commodities $[X_1(t), X_2(t), X_3(t), \dots, X_N(t)]$. Total expenditure on this group of commodities is given by:

$$Y(t) = P_1(t)X_1(t) + P_2(t)X_2(t) + P_3(t)X_3(t) + \dots + P_N(t)X_N(t). \quad (4.4)$$

Using dots over variables to indicate derivatives with respect to time, the total differentiation of (4.4) yields:

$$\frac{\dot{Y}(t)}{Y(t)} = \sum_{i=1}^N \frac{P_i(t)X_i(t)}{Y(t)} \frac{\dot{P}_i(t)}{P_i(t)} + \sum_{i=1}^N \frac{P_i(t)X_i(t)}{Y(t)} \frac{\dot{X}_i(t)}{X_i(t)}. \quad (4.5)$$

The first summation of the right-hand side of (4.5) defines the Divisia index of prices and the second defines the Divisia quantity index. Both indexes are weighted averages of the growth rates of the individual $P_i(t)$ and $X_i(t)$, where the weights are the components' shares in total expenditures: $\frac{P_i(t)X_i(t)}{Y(t)}$. The sum of equation (4.5) thus defines the rate of change of the aggregate price and quantity indexes. The levels of these indexes are obtainable by line integration over the trajectory followed by the individual prices and quantities over the time interval $[0, T]$. For the quantity index, the line integral has the following form:¹

$$I_q(0, T) = \exp \left\{ \int_0^T \left[\sum_{i=1}^N \frac{P_i(t)X_i(t)}{Y(t)} \frac{\dot{X}_i(t)}{X_i(t)} \right] dt \right\}. \quad (4.6)$$

We note that the Divisia index is defined using time as a continuous variable. This is actually not appropriate for empirical analysis, where the data on both price and quantity typically refer to discrete points in time.

To resolve this problem, we need to approximate the continuous variables of equation (4.5) with their discrete time counterparts. The approach of Törnqvist (1936) suggests approximating the growth rate of prices and quantities by logarithmic differences and the continuous weights by two periods arithmetic averages. So the Törnqvist approximation to the growth rate of the Divisia quantity index can then be written as:

$$\sum_{i=1}^N 0.5 \left[\frac{P_{i,t}X_{i,t}}{Y_t} + \frac{P_{i,t-1}X_{i,t-1}}{Y_{t-1}} \right] \ln \left(\frac{X_{i,t}}{X_{i,t-1}} \right) \quad (4.7)$$

Equally, the Divisia price index can be calculated as:

$$\sum_{i=1}^N 0.5 \left[\frac{P_{i,t}X_{i,t}}{Y_t} + \frac{P_{i,t-1}X_{i,t-1}}{Y_{t-1}} \right] \ln \left(\frac{P_{i,t}}{P_{i,t-1}} \right) \quad (4.8)$$

Comparing equation (4.7) and (4.8) with equation of AWD method described in (4.3), we can know the Törnqvist approximation for the Divisia index decomposition method is exactly the AWD method.

¹ For more discussion of Divisia integrals, see Richter (1966) and Hulten (1973).

4.2.2. Application of Divisia index decomposition method in energy economics

As the rationale of the Divisia index decomposition method is to provide a way of obtaining the contribution ratio of each determinant factor in the total changes by using the factors' variations alone without direct knowledge of the actual determination function, this method has been widely employed in the decomposition analyses on aggregate energy intensity of manufacturing industries. (Ang, 1994, 1995).

Given the direct link between energy combustion and pollutant emission, during the last decades, this decomposition method was also extended into the analyses on the contributions of the structural changes and the efficiency improvement in energy input usage in emission intensity variation. Torvanger (1991) and Greening et al. (1997, 1998) on the case of OECD countries, Alcántara and Roca (1995) on the case of Spain, and finally Lin and Chang (1996) on the case of Taiwan are good examples.

Besides the Törnqvist approximation principle or AWD principle, based on the original Divisia index decomposition method, several other approximation principles have also been developed, such as Laspeyres, the simple average Divisia, etc. Greening et al. (1997, 1998) made a comparative analysis between the different principles and their conclusion suggests the AWD exhibits the smallest residual terms with the least variation. Therefore, in this section, we will only introduce the application of this decomposition method in the energy economics.¹

If the total emission from production activities can be expressed by the following identity function.

$$Z_t = \sum_i \sum_j U_{ij,t} \left(\frac{E_{ij,t}}{E_{i,t}} \right) \left(\frac{E_{i,t}}{Y_{i,t}} \right) \left(\frac{Y_{i,t}}{Y_t} \right) Y_t \quad (4.9)$$

t : suffix indicating the periods..

i : suffix indicating the sectors.

j : suffix indicating the different energy types.

Z_t : total emission.

Y_t : total economic output.

$Y_{i,t}$: output in sector i .

$(Y_{i,t}/Y_t)$: output share of sector i .

$E_{i,t}$: energy consumption in sector i .

$(E_{i,t}/Y_{i,t})$: energy intensity in sector i .

$E_{ij,t}$: consumption of energy j in sector i .

$(E_{ij,t}/E_{i,t})$: consumption share of energy j in sector i .

¹ For more discussion on the differences and links between these different decomposition indices, see Ang (1994, 1995, 1997) and Greening et al. (1997, 1998).

$U_{ij,t}$: average emission effluent rate of fuel j in sector i , given by emission per unit of energy use.

Let $R_{tot}=Z_{t+1}/Z_t$, a measure of the fractional change in the aggregate emission intensity from year t to year $t+1$, we can define it as the product of the fractional changes of its determinant factors.

$$R_{tot}=R_{eme}\times R_{fsh}\times R_{str}\times R_{scl}\times R_{rsd} \quad (4.10)$$

R_{eme} : contribution from the fractional variation in energy- and sector-specific emission effluent rate.

R_{fsh} : contribution from the fractional variation in the sector-specific energy-structure.

R_{str} : contribution from the fractional variation in the sectoral structure.

R_{scl} : contribution from the economic scale enlargement.

R_{rsd} : the residual effect that has no clear economic explanations.

Following the procedure described in Ang (1994), equation (4.10) can lead to the following Divisia index decomposition:

$$\begin{aligned} R_{eme} &= \exp\left\{ \sum_i \sum_j [w_{ij,t} + \alpha_{ij}(w_{ij,t+1} - w_{ij,t})] \ln(U_{ij,t+1}/U_{ij,t}) \right\} \\ R_{fsh} &= \exp\left\{ \sum_i \sum_j [w_{ij,t} + \beta_{ij}(w_{ij,t+1} - w_{ij,t})] \ln\left[\left(\frac{E_{ij,t+1}}{E_{i,t+1}}\right) / \left(\frac{E_{ij,t}}{E_{i,t}}\right)\right] \right\} \\ R_{str} &= \exp\left\{ \sum_i \sum_j [w_{ij,t} + \gamma_{ij}(w_{ij,t+1} - w_{ij,t})] \ln\left[\left(\frac{Y_{i,t+1}}{Y_{t+1}}\right) / \left(\frac{Y_{i,t}}{Y_t}\right)\right] \right\} \\ R_{scl} &= \exp\left\{ \sum_i \sum_j [w_{ij,t} + \theta_{ij}(w_{ij,t+1} - w_{ij,t})] \ln(Y_{t+1}/Y_t) \right\} \\ R_{rsd} &= \frac{R_{tot}}{R_{eme}\times R_{fsh}\times R_{str}\times R_{scl}} \end{aligned} \quad (4.11)$$

Here $w_{ij,t}$ is the share of emission arising from consumption of energy j in sector i , that means $w_{ij,t}=(Z_{ij,t}/Z_t)$. $\alpha_{ij}, \beta_{ij}, \gamma_{ij}, \theta_{ij}$ are parameters with values varying from 0 to 1. Assigning these values is equivalent to define specific integral paths in the Divisia indices. By suggesting all of them to be equal to 0.5, $\alpha_{ij}=\beta_{ij}=\gamma_{ij}=\theta_{ij}=0.5$, this index decomposition method is actually the form of Divisia-Törnqvist index.

From the 5 equations grouped in (4.11) we learn that the Divisia index decomposition method actually has a strict requirement on the data availability. Not only the total emission Z_t , total output Y_t , sectoral output mix ($Y_{i,t}/Y_t$) and sectoral energy input mix ($E_{ij,t}/E_{i,t}$) are necessary, the precision of the decomposition also requires the existence of the sectoral level energy-specific emission effluent rate $U_{ij,t}$.

4.3. Divisia index decomposition analysis adapted to China's provincial level data

Although Chinese Industrial Economic Statistic Yearbook and China Energy Databook 6.0 provide detailed energy input mix on national level and detailed sectoral output mix on both national and provincial level for the period of 1990s, we do not possess the related emission effluent rate for the different energy inputs during the same period. Given the current data condition, neither a national nor a provincial level complete Divisia index decomposition analysis is feasible. But fortunately, the national-wide average emission intensities for different industrial sectors are reported annually since 1991, with the help of this data series, it is still possible for us to carry out a relatively “incomplete” decomposition analysis to investigate the role of scale enlargement, product structure changes and technical progress in industrial SO₂ emission variation on both national and provincial levels.

4.3.1. Necessary adaptation of the original Divisia index decomposition to Chinese data

Suppose industrial SO₂ emission in province i in year t can be expressed as

$$SO_{2it} = Y_{it} \times \sum_j \left(\frac{Y_{jit}}{Y_{it}} \times \frac{SO_{2jit}}{Y_{jit}} \right). \quad (4.12).$$

Where Y_{it} indicates corresponding industrial product and SO₂ means industrial emission. Also, $i=1,2,3,\dots,n$. and $t=0,1,2,3,\dots,T$, represent province and time, respectively.

We can express provincial and national average level emission intensity in sector j as $I_{jt} = \frac{SO_{2jt}}{Y_{jt}}$ and $I_{jit} = \frac{SO_{2jit}}{Y_{jit}}$, respectively. For the proportion of sector j in total industrial product, its national and provincial level situation is represented by $S_{jt} = \frac{Y_{jt}}{Y_t}$ and $S_{jit} = \frac{Y_{jit}}{Y_{it}}$.

Due to the data constraint, we only have national level average sectoral emission intensity I_{jt} . Therefore, we need an efficiency deflator e_{jit} for each sector j of province i to construct the following identity equation.

$$SO_{2it} = Y_{it} \times \sum_{j=1}^n \left(\frac{Y_{jit}}{Y_{it}} \times \frac{SO_{2jit}}{Y_{jit}} \right) = Y_{it} \times \sum_{j=1}^n (S_{jit} \times I_{jt} \times e_{jit}), \text{ with } e_{jit} = \frac{SO_{2jit}/Y_{jit}}{SO_{2jt}/Y_{jt}}. \quad (4.13)$$

For simplification, we suppose all the industrial sectors in the same province share the same emission intensity deflator e_{it} , that means

$$e_{it} = \frac{\sum_{j=1}^n (S_{jit} \times I_{jit})}{\sum_{j=1}^n (S_{jit} \times I_{jt})} = \frac{SO_{2it}}{Y_{it} \times \sum_{j=1}^n (S_{jit} \times I_{jt})}. \quad (4.14)$$

Replacing e_{it} into (4.13) and combining (4.14), we have a new expression for the industrial SO_2 emission in province i during period t as

$$SO_{2it} = Y_{it} \times e_{it} \times \sum_{j=1}^n S_{jit} \times I_{jt} = Y_{it} \times e_{it} \times \sum_{j=1}^n (S_{jit} \times \frac{I_{jt}}{I_{it}} \times I_{it}) = Y_{it} \times e_{it} \times I_{it} \times \sum_{j=1}^n (S_{jit} \times e_{jt}). \quad (4.15)$$

Therefore its fractional variation during period t can be written as,

$$\frac{SO_{2it}}{SO_{2it-1}} = \frac{Y_{it}}{Y_{it-1}} \times \frac{e_{it}}{e_{it-1}} \times \frac{I_{it}}{I_{it-1}} \times \frac{\sum_{j=1}^n (S_{jit} \times e_{jt})}{\sum_{j=1}^n (S_{jit-1} \times e_{jt-1})}. \quad (4.16)$$

Applying Divisia index decomposition method introduced in last section to equation (4.16) and following Törnqvist continuous hypothesis, we have,

$$\frac{SO_{2it}}{SO_{2it-1}} = \frac{Y_{it}}{Y_{it-1}} \times \frac{e_{it}}{e_{it-1}} \times \frac{I_{it}}{I_{it-1}} \times \exp\left(\sum_{j=1}^n \frac{S_{jit} \times e_{jt} \times \ln\left(\frac{S_{jit}}{S_{jit-1}}\right)}{\sum_{k=1}^n (S_{kit} \times e_{kt})}\right) \times \exp\left(\sum_{j=1}^n \frac{S_{jit} \times e_{jt} \times \ln\left(\frac{e_{jt}}{e_{jt-1}}\right)}{\sum_{k=1}^n (S_{kit} \times e_{kt})}\right). \quad (4.17)$$

Transforming the rolling base year specification in (4.17) into fixed base year specification with the reference as the original year 0 and changing the equation (4.17) into logarithmic form, we have,¹

$$\begin{aligned} \ln\left(\frac{SO_{2it}}{SO_{2i0}}\right) &= \ln\left(\frac{Y_{it}}{Y_{i0}}\right) + \ln\left(\frac{e_{it}}{e_{i0}}\right) + \ln\left(\frac{I_{it}}{I_{i0}}\right) + \int_{t=1}^T \sum_{j=1}^n \frac{S_{jit} \times e_{jt}}{\sum_{k=1}^n (S_{kit} \times e_{kt})} \times \frac{d\ln(S_{jit})}{dt} \times dt \\ &+ \int_{t=1}^T \sum_{j=1}^n \frac{S_{jit} \times e_{jt}}{\sum_{k=1}^n (S_{kit} \times e_{kt})} \times \frac{d\ln(e_{jt})}{dt} \times dt. \end{aligned} \quad (4.18)$$

A more applicable equation that we will use in decomposition step is

$$\begin{aligned} \ln\left(\frac{SO_{2it}}{SO_{2i0}}\right) &= \ln\left(\frac{Y_{it}}{Y_{i0}}\right) + \ln\left(\frac{e_{it}}{e_{i0}}\right) + \ln\left(\frac{I_{it}}{I_{i0}}\right) + \sum_{t=1}^T \sum_{j=1}^n [(w_{jit} + \alpha(w_{jit} - w_{jit-1})) \times \ln\left(\frac{S_{jit}}{S_{jit-1}}\right)] \\ &+ \sum_{t=1}^T \sum_{j=1}^n [(w_{jit} + \beta(w_{jit} - w_{jit-1})) \times \ln\left(\frac{e_{jt}}{e_{jt-1}}\right)] + \text{residuals}_i. \end{aligned} \quad (4.19)$$

Where $w_{jit} = \frac{S_{jit} \times e_{it}}{\sum_{k=1}^n (S_{kit} \times e_{kt})}$. We equally suppose $\alpha = \beta = 0.5$.

We call the first terms $\ln\left(\frac{Y_{it}}{Y_{i0}}\right)$ on the right-hand side of the equation (4.19) as scale effect, the sum of the terms $\ln\left(\frac{e_{it}}{e_{i0}}\right)$ and $\sum_{t=1}^T \sum_{j=1}^n [(w_{jit} + \alpha(w_{jit} - w_{jit-1})) \times \ln\left(\frac{S_{jit}}{S_{jit-1}}\right)]$ as structure effect

¹ Please note that $\frac{SO_{2jt}}{SO_{2j0}} = \frac{SO_{2jt}}{SO_{2jt-1}} \times \frac{SO_{2jt-1}}{SO_{2jt-2}} \times \dots \times \frac{SO_{2j1}}{SO_{2j0}}$.

and the sum of $\ln(\frac{I_{it}}{I_{i0}})$ and $\sum_{t=1}^T \sum_{j=1}^n [(w_{jit} + \alpha(w_{jit} - w_{jit-1})) \times \ln(\frac{e_{jt}}{e_{jt-1}})]$ as technique effect. Although this decomposition can not reach the depth of sector-specific energy consumption structure and their efficiency, the explicit decomposition of the total emission variation into contribution from the production scale enlargement, composition transformation and technical progress will offer us a clearer idea about the actual role of played by three structural factors in industrial SO₂ emission determination.

4.3.2. Data and assumptions

This adjusted Divisia index decomposition method is then applied to a database compiled by myself from China Industrial Economic Statistic Yearbook (1992-2002), China Statistic Yearbook (1992-2002) and China Energy Databook, 5.0 and 6.0. For each province, we have detailed value added data for 13 industrial sectors whose sum accounts up to over 98% of the province's total industrial GDP.¹ The 13 sectors are: total mining, food, beverage and tobacco, textile and leather, paper-making and printing, total power except coal, chemical materials, pharmaceutical, chemical fiber, nonmetal product, metal processing and smelting, metal products, machinery and finally, other industry. This detailed sectoral level value added data in each province are then combined with provincial level industrial SO₂ emission data and the national level average SO₂ emission intensity data for the corresponding 13 industrial sectors.

In most of the traditional Divisia decomposition analyses that are applied to emission studies, the authors often choose to follow the “bottom-up” logic, according to which the final total emission was often an estimated value obtained by multiplying the consumption of individual energies by their corresponding emission coefficients. And these emission coefficients were generally directly borrowed from some estimation based on developed countries' experiences, such as OECD (1991) or Torvanger (1991). However, in this chapter, as our aim is to get a better understanding on the determination mechanism of the variation of total industrial SO₂ emission, we choose to follow the “top-down” logic and carry out a direct decomposition analysis from the actually reported total industrial SO₂ emission statistics.

Furthermore, considering the potential purity divergence between the energies in different countries that are officially categorized into the same type and the potential emission effluent rate differences related to different combustion technologies, we also doubt about the

¹ The data for 1996 and 1998 are not officially published due to the adjustment of China's statistic system. Therefore, we use the linear extrapolation to get smooth time series for the value added for each sector in these two years.

pertinence to directly extrapolate one country's emission result according to the emission effluent rate estimated from another one. Consequently, another advantage of our "top-down"-style decomposition method is, by simply stripping the scale and composition effect from the actually happened total emission variation, to guarantee us with a more general but also more credible technique effect.

4.3.3. Decomposition result

Table 4.1 displays the total variation of industrial SO₂ emission in year 2001 with respect to that of 1991 and the contributions from the three effects computed according to the equation (4.19). Although there are always some unexplainable residuals, by employing the AWD combined with the rolling base year index decomposition method, we actually get relatively small residuals.

Table 4.1 provides the decomposition results expressed in both total and annual average percentage change forms. Corresponding to the findings in chapter 2, during the last ten years, industrial SO₂ emission generally experienced an increasing tendency in most of the provinces, except Beijing, Liaoning, Heilongjiang, Shanghai and Jianxi. On national level, the total industrial SO₂ emission in year 2001 has increased by 30% with respect to that of 1991. We equally observe big regional difference in SO₂ emission variation; especially from the annual average percentage changes. With the national average level stays at about 3% per year, some provinces' annual average percentage changes have surpassed 5%, such as Guangdong, Hainan, Henan, Shanxi, Fujian, Sichuan, Fujian and Zhejiang.

The decomposition result revealing the most important contributor in industrial SO₂ emission is industrial production scale enlargement. Varying from 11% to almost 22%, the industrial SO₂ emission increase caused by scale effect seems to follow remarkable average percentage changes each year in all the provinces.

Table 4.1. Total and annual average changes in industrial SO₂ emission and the decomposed contributions from different structural determinants

Region	Changes (2001 vs. 1991, 1991=1)					Annual average percentage changes (percent per year)			
	SO ₂	Scale	Composition	Technique	Residual	SO ₂	Scale	Composition	Technique
CHINA	0.304	1.566	0.196	-1.450	-0.008	3.091	16.957	1.981	-13.501
BELJING	-0.508	1.321	-0.388	-1.432	-0.009	-4.957	14.121	-3.804	-13.345
TIANJIN	0.280	1.677	0.107	-1.465	-0.038	2.844	18.257	1.072	-13.631
HEBEI	0.393	1.717	0.123	-1.435	-0.012	4.005	18.729	1.241	-13.367
SHANXI	0.570	1.259	0.851	-1.552	0.012	5.868	13.416	8.880	-14.372
INNER MONGOLIA	0.098	1.322	0.234	-1.451	-0.007	0.981	14.130	2.372	-13.510
LIAONING	-0.275	1.148	0.090	-1.506	-0.007	-2.714	12.161	0.902	-13.977
JILIN	0.115	1.374	0.255	-1.508	-0.006	1.152	14.725	2.579	-13.995
HEILONGJIANG	-0.005	1.338	0.293	-1.638	0.003	-0.048	14.315	2.969	-15.109
SHANGAI	-0.125	1.476	-0.264	-1.331	-0.006	-1.242	15.908	-2.609	-12.462
JIANGSU	0.212	1.697	-0.107	-1.363	-0.016	2.141	18.493	-1.062	-12.739
ZHEJIANG	0.491	1.790	0.124	-1.412	-0.011	5.036	19.604	1.245	-13.168
ANHUI	0.086	1.394	0.051	-1.352	-0.007	0.864	14.958	0.509	-12.647
FUJIAN	0.526	1.914	-0.034	-1.340	-0.015	5.400	21.095	-0.340	-12.537
JIANGXI	-0.078	1.121	0.272	-1.460	-0.011	-0.777	11.862	2.762	-13.587
SHANDONG	0.112	1.862	-0.278	-1.461	-0.010	1.122	20.463	-2.746	-13.596
HENAN	0.617	1.699	0.438	-1.514	-0.005	6.365	18.519	4.476	-14.052
HUBEI	0.096	1.491	0.007	-1.388	-0.013	0.965	16.078	0.066	-12.961
HUNAN	0.160	1.164	0.402	-1.405	-0.001	1.614	12.344	4.101	-13.108
GUANGDONG	0.776	1.968	0.297	-1.476	-0.012	8.071	21.754	3.012	-13.726
GUANGXI	0.262	1.204	0.495	-1.430	-0.008	2.653	12.798	5.077	-13.321
HAINAN	0.657	1.634	0.605	-1.583	0.000	6.787	17.754	6.234	-14.637
SICHUAN	0.529	1.258	0.675	-1.403	-0.001	5.429	13.407	6.980	-13.089
GUIZHOU	0.382	1.163	0.737	-1.515	-0.003	3.893	12.329	7.654	-14.055
YUNNAN	0.387	1.415	0.555	-1.576	-0.007	3.943	15.202	5.706	-14.583
SHAANXI	0.061	1.327	0.287	-1.549	-0.004	0.615	14.189	2.912	-14.349
GANSU	0.119	1.203	0.416	-1.498	-0.002	1.196	12.784	4.245	-13.915
QINGHAI	0.169	1.452	0.217	-1.504	0.005	1.706	15.626	2.195	-13.968
NINGXIA	0.341	1.518	0.366	-1.555	0.013	3.470	16.389	3.728	-14.404
XINJIANG	0.166	1.735	0.071	-1.637	-0.003	1.677	18.952	0.715	-15.103

Note: Total change of SO₂ is equal to the sum of the contribution from the changes in scale, composition and technique effect and the residual. Note that the residuals obtained from the AWD rolling based year decomposition method are generally very small.

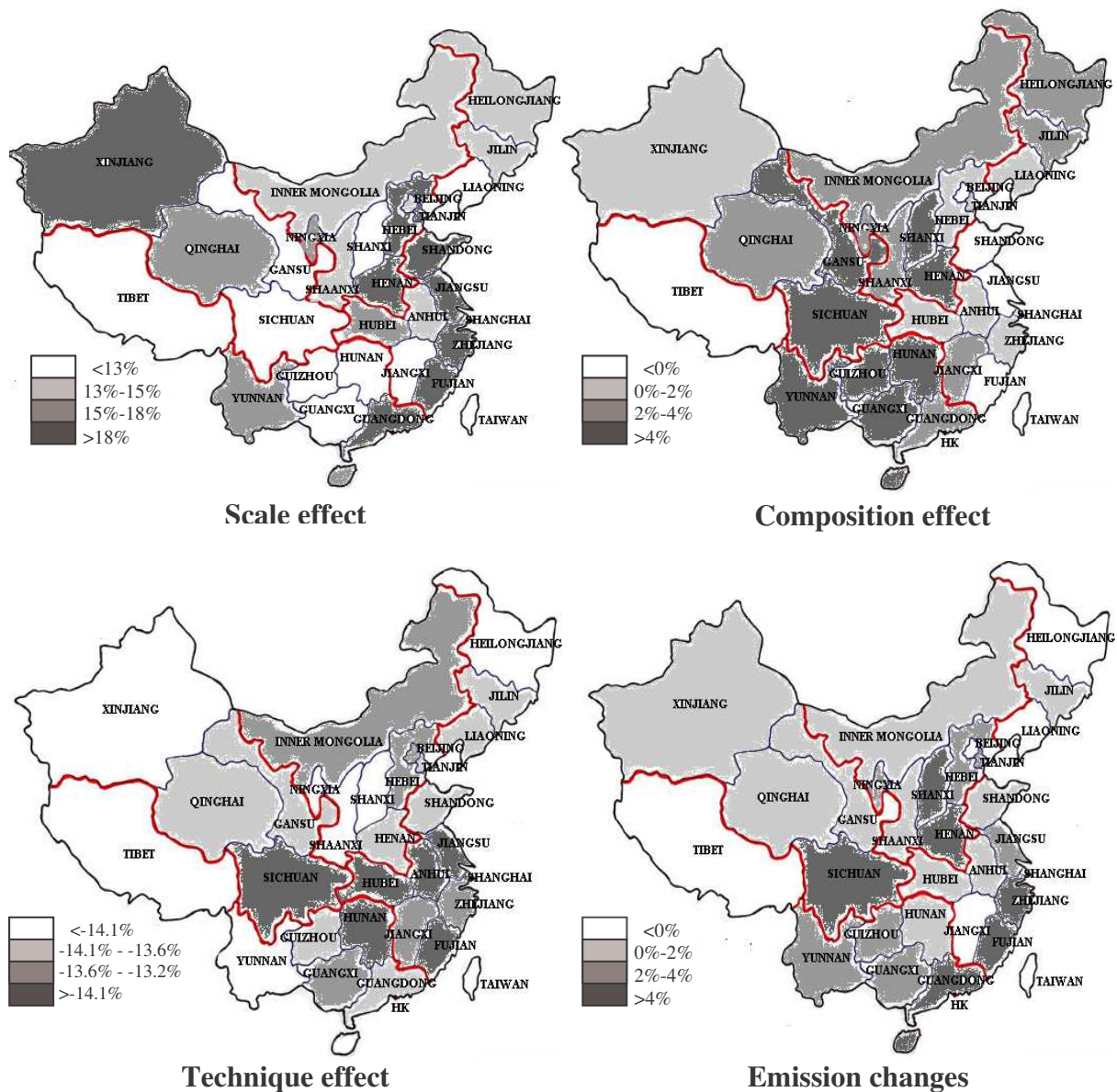

Figure 4.1. Divisia Decomposition results
(Annual average percentage changes)

The general positive numbers associated with the composition effect reveals the second pollution-increasing factor for most of Chinese provinces—a not surprising finding for a country in its early phase of industrialization process. There are only five exceptions, Beijing, Shanghai, Jiangsu, Fujian and Shandong, whose total composition effect appeared to be emission-reducing factor. As all the five provinces are located in the east coast of China and their prosperous economic growth are all benefiting from high degree of commercial and capital openness. We suspect the emission reduction contribution from composition effect in these five provinces is actually due to their participation into global production division system, in which, China, abundantly endowed with cheap labor forces, possesses actually comparative advantages in the relatively less polluting industries as textile, electronic

equipment, etc. This idea can be better represented by the panel of composition effect in Figure 4.1, in which the pollution increase caused by composition effect is gradually reinforced when we move from east coastal provinces to those located in the central and west China.

Although less remarkable than that in the scale or composition effect, the regional disparity in the technique effect illustrated in Figure 4.1 indicates that it is the inland provinces, especially those in the northwest, northeast part of China, that have the most important pollution-reducing technique effect. This seemingly surprising finding can actually be explained by the fact that the current pollution control mechanisms in China are only applied to the large-scale state-own and collective enterprises. During the economic reform, the rise of the proportion of private economy is generally represented by the small-scale private enterprises that generally concentrate in coastal provinces. The polluting activities of these private enterprises are actually out of the control of China's current pollution regulation systems. Facing the benefits from enlarged domestic market owing to income growth and/or from the enlarged international demand through export, the rapid expansion of the small-scale private economy in the coastal provinces is actually canceling the technique effect improvement in these provinces owing to income growth and institutional development.

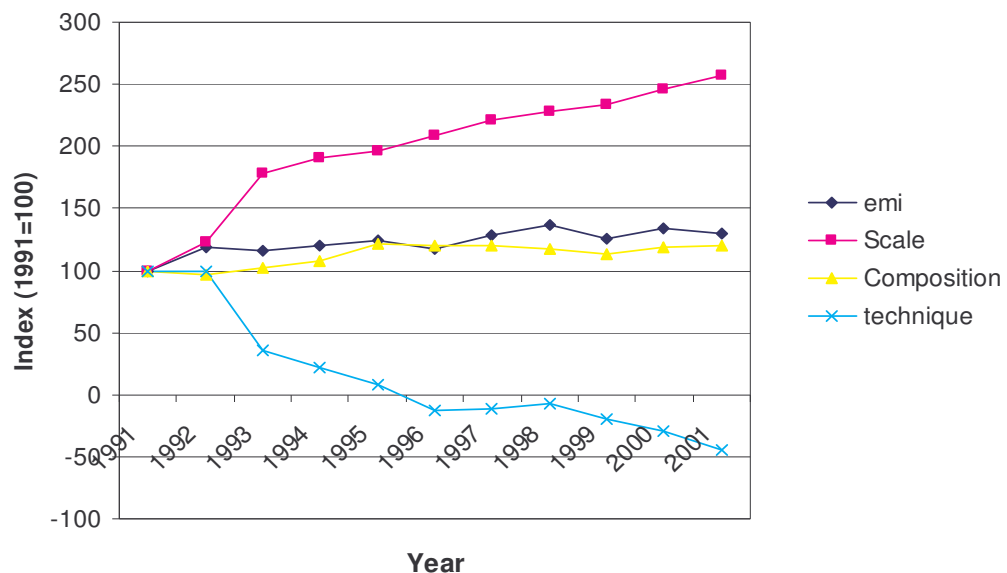

Figure 4.2. Decomposition results on national level (1991-2001)

Figure 4.2 plots the detailed annual dynamic evolution of the national level industrial SO₂ emission and its three contribution factors. Similar to the conclusion in Selden et al.

(1999) and Bruvoll and Medin (2001), our decomposition results also emphasize the technique effect as the most important SO₂ emission reducing factor. Given the relatively small values of the composition effect, it seems the principal mutual cancellation effect actually exists between pollution-increasing scale effect and the pollution-reducing technique effect.

4.3.4. EKC-revisit: the correlation between the decomposed scale, composition and technique effect and per capita GDP

In Figure 3.1 of chapter 3, we illustrate how the three structural determinants of pollution, during income growth process, can work together to form the inverted U form of EKC in a general case. With the decomposed results of the contribution of scale, composition and technique effects in the total industrial SO₂ emission, we can now check whether China's reality corresponds to this general tendency.

- a. Econometrical strategy and normalization of the variation index into the actual emission changes in quantity

From eq. (4.19), we saw the Divisia index decomposition methods actually reasons on percentage change basis with reference to the original industrial emission level. Its contribution is to decompose the percentage change in industrial SO₂ emission, $\ln(SO_{2i,t}/SO_{2i,0})$, into the contribution from scale enlargement $\ln(\frac{Y_{it}}{Y_{i0}})$, composition

transformation $\ln(\frac{e_{it}}{e_{i0}}) + \sum_{t=1}^T \sum_{j=1}^n [(w_{jit} + \alpha(w_{jit} - w_{jit-1})) \times \ln(\frac{S_{jit}}{S_{jit-1}})]$ and technique progress

$$\ln(\frac{I_{it}}{I_{i0}}) + \sum_{t=1}^T \sum_{j=1}^n [(w_{jit} + \alpha(w_{jit} - w_{jit-1})) \times \ln(\frac{e_{jt}}{e_{jt-1}})] .$$

However, our econometrical analysis actually requires the scale, composition and technique effect to be expressed in quantity of emission changes instead of the percentage changes. Therefore, as the first step, we need to normalize the decomposition results for the three effects. The normalization process is illustrated in equation (4.20)-(4.22). In this step, we simply use the total SO₂ emission variation in each year with respect to the reference original year 0 as the base value and attribute this value to the three effects according to their contribution shares.

$$\Delta SO_{2,i,t, scale} = \frac{\ln(Y_{i,t}/Y_{i,0})}{\ln(SO_{2,i,t}/SO_{2,i,0})} \times (SO_{2,i,t} - SO_{2,i,0}) \quad (4.20)$$

$$\Delta SO_{2,i,t,composition} = \frac{\ln\left(\frac{e_{it}}{e_{i0}}\right) + \sum_{t=1}^T \sum_{j=1}^n [(w_{jit} + \alpha(w_{jit} - w_{jit-1})) \times \ln\left(\frac{S_{jit}}{S_{jit-1}}\right)]}{\ln(SO_{2,i,t}/SO_{2,i,0})} \times (SO_{2,i,t} - SO_{2,i,0}) \quad (4.21)$$

$$\Delta SO_{2,i,t,technique} = \frac{\ln\left(\frac{I_{it}}{I_{i0}}\right) + \sum_{t=1}^T \sum_{j=1}^n [(w_{jit} + \alpha(w_{jit} - w_{jit-1})) \times \ln\left(\frac{e_{jt}}{e_{jt-1}}\right)]}{\ln(SO_{2,i,t}/SO_{2,i,0})} \times (SO_{2,i,t} - SO_{2,i,0}) \quad (4.22)$$

b. Estimation results and discussion

From the normalized Divisia decomposition result, we know that,

$$\Delta SO_{2i,t} = SO_{2i,t} - SO_{2i,1990} = \Delta SO_{2i,t,scale} + \Delta SO_{2i,t,composition} + \Delta SO_{2i,t,technique}. \quad (4.23)$$

Therefore, we have,

$$SO_{2i,t} = SO_{2i,1990} + \Delta SO_{2i,t,scale} + \Delta SO_{2i,t,composition} + \Delta SO_{2i,t,technique} \quad (4.24)$$

If we regard the original emission level $SO_{2i,1990}$ as province-specific constant, equation (4.24) reveals the feasibility to obtain an EKC-style relationship between SO_2 emission and per capita GDP by separately regressing the industrial SO_2 emission variations caused by the three effects on GDPPC and then add them together. Following this reasoning, the turning point of EKC curve for SO_2 emission is reached when,

$$\frac{dSO_{2i,t}}{dGDPPC_{i,t}} = \frac{dSO_{2i,t,scale}}{dGDPPC_{i,t}} + \frac{dSO_{2i,t,composition}}{dGDPPC_{i,t}} + \frac{dSO_{2i,t,technique}}{dGDPPC_{i,t}} = 0 \quad (4.25)$$

Therefore, our econometrical strategy is to firstly use per capita GDP of each province as independent variable to explain the industrial SO_2 emission variations contributed by each of the three effects separately. Following, we will be able to calculate the derivatives of the three effects with respect to per capita GDP and to locate the potential turning point where the sum of the three derivatives is equal to zero.

Table 4.2. The combination of the impact of income growth on EKC formation (Estimation from the decomposed Divisia scale, composition and technique effect)

	Scale effect				Composition effect				Technique Effect			
	Model 1		Model 2		Model 1		Model 2		Model 1		Model 2	
	RE	FE	RE	FE	RE	FE	RE	FE	RE	FE	RE	FE
gdppc_{jt}(1/1000)	316.344 (4.27)***	521.300 (3.50)***	416.444 (10.71)***	423.092 (9.04)***	-29.206 (4.56)***	-41.208 (5.51)***	52.010 (4.39)***	80.674 (6.77)***	-208.325 (3.16)***	-370.426 (2.67)***	-480.815 (12.39)***	-495.784 (10.57)***
gdppc_{jt}²(1/1000)²	-24.839 (3.05)***	-42.567 (3.14)***	-35.004 (5.96)***	-34.630 (5.87)***			-3.281 (4.02)***	-4.503 (6.20)***	19.640 (2.65)***	33.741 (2.73)***	45.976 (7.83)***	46.074 (7.90)***
gdppc_{jt}³(1/1000)³	0.662 (2.16)**	1.230 (2.79)***	1.006 (4.05)***	0.981 (4.39)***					-0.571 (2.03)**	-1.023 (2.57)**	-1.448 (5.83)***	-1.432 (6.45)***
trend	22.282 (2.31)**	-5.891 (0.34)			26.485 (7.45)***	30.482 (6.49)***			-50.164 (5.87)***	-28.051 (1.62) ^o		
y1993	171.291 (4.74)***	163.697 (3.36)***			14.539 (0.60)	14.381 (0.67)			-183.153 (5.40)***	-177.108 (3.53)***		
y1994	152.484 (4.38)***	139.721 (3.56)***			24.489 (1.05)	24.307 (1.18)			-170.462 (5.21)***	-160.308 (3.89)***		
y1995	112.325 (3.31)***	97.903 (2.94)***			69.341 (3.07)***	69.128 (3.46)***			-164.732 (5.18)***	-153.259 (4.38)***		
y1996	95.347 (2.85)***	79.757 (2.72)***			64.898 (2.92)***	64.756 (3.03)***			-168.725 (5.38)***	-156.328 (4.85)***		
y1997	79.008 (2.36)**	63.130 (2.19)**			-1.255 (0.06)	-1.162 (0.06)			-93.954 (2.99)***	-81.344 (2.78)***		
y1998	81.863 (2.42)**	67.835 (2.11)**			21.959 (0.97)	22.197 (0.99)			-47.719 (1.50) ^o	-36.587 (1.25)		
y1999	15.367 (0.44)	9.736 (0.31)			2.337 (0.10)	1.613 (0.07)			-16.484 (0.51)	-11.962 (0.40)		
y2000	28.639 (0.79)	30.053 (0.77)			19.585 (0.80)	17.635 (0.59)			-11.300 (0.33)	-12.296 (0.34)		
Constant	-511.370 (3.66)***		-536.411 (5.29)***		-4.074 (0.13)		-73.801 (2.05)**		398.442 (3.29)***		657.271 (7.13)***	
Obs	290	290	290	290	290	290	290	290	290	290	290	290
Number of prov.	29	29	29	29	29	29	29	29	29	29	29	29
R²	0.08	0.65	0.06	0.60	0.19	0.28	0.03	0.15	0.17	0.69	0.05	0.62
Breusch-Pagan	945.20 (0.000)		795.39 (0.000)		362.92 (0.000)		219.43 (0.000)		885.57 (0.000)		624.25 (0.000)	
Hausman	16.64 (0.1637)		0.00 (1.000)		3.28 (0.9740)		93.67 (0.000)		9.04 (0.6995)		0.00 (1.0000)	

▪ Absolute value of z statistics in parentheses, ^o significant at 15%, * significant 10%, ** significant 5%, *** significant 1%.

Table 4.3. The combination of the impact of income growth on EKC formation—distinguishing between 3 cities and 26 provinces*(Estimation from the decomposed Divisia scale, composition and technique effect)*

	Scale effect		Composition effect		Technique effect	
	RE	FE	RE	FE	RE	FE
gdppc_{jt} (1/1000)	142.120 (7.52)***	147.547 (4.75)***	118.665 (5.39)***	164.852 (6.38)***	-74.045 (4.14)***	-77.395 (2.63)***
gdppc_{jt}² (1/1000)²			-11.109 (4.54)***	-14.524 (5.06)***		
gdppc_{jt}×city (1/1000)	-130.698 (7.99)***	-136.497 (5.66)***	-77.952 (3.76)***	-139.180 (4.99)***	87.354 (5.67)***	94.180 (4.23)***
gdppc_{jt}²×city (1/1000)²			8.934 (3.79)***	13.033 (4.46)***		
trend	29.723 (4.46)***	28.384 (3.45)***			-55.357 (8.72)***	-54.792 (5.98)***
y1993	185.390 (5.44)***	185.413 (3.61)***			-193.397 (5.86)***	-193.384 (3.74)***
y1994	176.785 (5.41)***	176.840 (4.07)***			-187.921 (5.95)***	-187.939 (4.27)***
y1995	142.777 (4.51)***	142.948 (3.84)***			-186.348 (6.08)***	-186.495 (4.90)***
y1996	129.106 (4.14)***	129.336 (3.98)***			-192.581 (6.39)***	-192.815 (5.51)***
y1997	112.154 (3.60)***	112.385 (3.66)***			-117.396 (3.89)***	-117.692 (3.80)***
y1998	110.921 (3.50)***	111.182 (3.35)***			-68.431 (2.23)**	-68.798 (2.31)**
y1999	36.745 (1.12)	37.103 (1.22)			-31.398 (0.99)	-31.636 (1.05)
y2000	46.086 (1.35)	46.585 (1.30)			-23.286 (0.70)	-23.380 (0.66)
Constant	-200.519 (2.52)**	-208.186 (2.33)**	-175.201 (3.84)***	-259.721 (6.04)***	167.786 (2.46)**	170.897 (1.99)**
Observations	290	290	290	290	290	290
Number of province	29	29	29	29	29	29
R-squared	0.007	0.67	0.27	0.21	0.30	0.69
Breusch-Pagan		979.17 (0.000)		211.55 (0.000)		885.68 (0.000)
Hausman	0.80 (1.000)		2.85 (0.5834)		0.89 (1.000)	

▪ Absolute value of z statistics in parentheses, ° significant at 15%, * significant 10%, ** significant 5%, *** significant 1%.

The estimation results are given in Table 4.2. For both the scale and technique effect estimation, further inclusion of the time-specific effect and trend is helpful in increasing the explicative power without affecting the coefficients of per capita GDP. But the situation for the composition effect is somewhat different. Although the inclusion of the time-specific effect and trends does increase the explicative power of the estimation function, their participation obviously disturbs the sign and significance of the coefficients for per capita income terms. This might be due to the fact that although both the scale and technique effects

show obvious variation tendency during the time, the evolution of the composition effect during the time seems to be more irregular. Therefore, for composition effect, we will base our discussion on the model in which the time-specific effect and trend are both excluded.

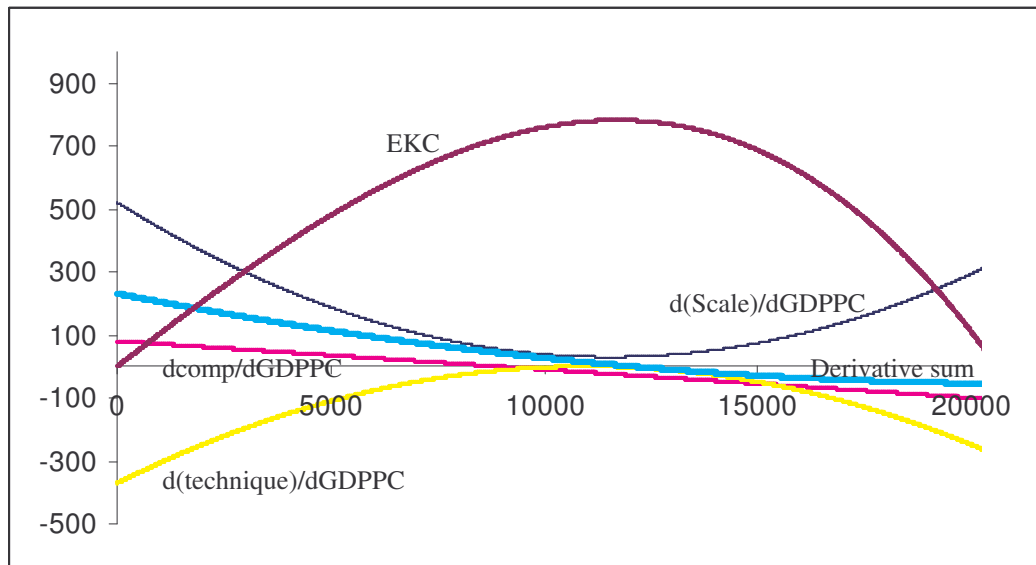

Figure 4.3. Structural determinants for EKC formation—China's case

(based on estimation results in Table 4.2. Model 1 for scale and technique effect, model 2 for composition effect)

Following the idea of the EKC formation mechanism depicted in figure 3.1, we illustrate in Figure 4.3 China's actual EKC formation mechanism. In this figure, the curves denoting the three effects are actually their derivative with respect to GDPPC (based on estimated relationships in table 4.2). The curve denoted as *derivative sum* gives the sum of the three derivatives, it therefore indicates the location of the potential EKC turning points by its intersection with the GDPPC-axis.

Corresponding to the direct EKC estimation results in Table 2.3 of chapter 2, the turning point of EKC indicated by the intersection of derivative sum curve and GDPPC-axis is around 10000 yuan. However, the relationship of the derivatives of three effects with per capita income seems to be more complicated than that depicted in chapter 3. Both the derivatives of scale and technique effects change their evolution direction when the income reaches 10000 yuan, which is exactly the upper-end of the income range for the 26 provinces.

This actually reminds us the necessity to distinguish the 3 cities from the 26 provinces in our estimation. Therefore, we distinguish the coefficients for the income terms between provinces and cities by running this time the fixed-effect spline estimation for each decomposed effect. The estimation results are reported in Table 4.3 and the graphical illustration of the estimation results are in figure 4.4.

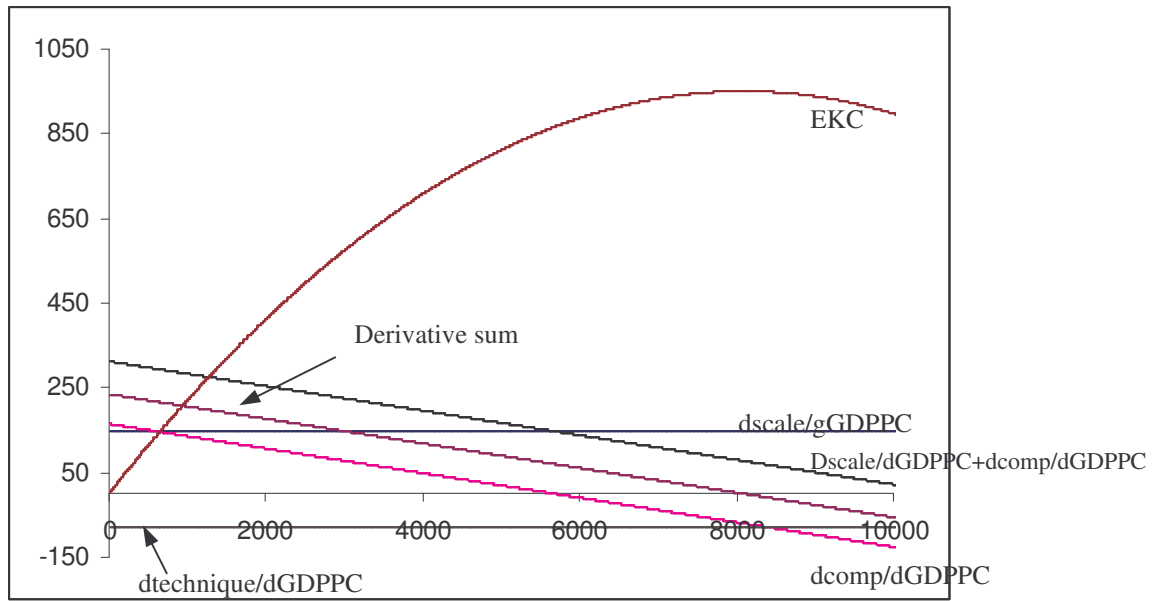

Panel a. 26 provinces

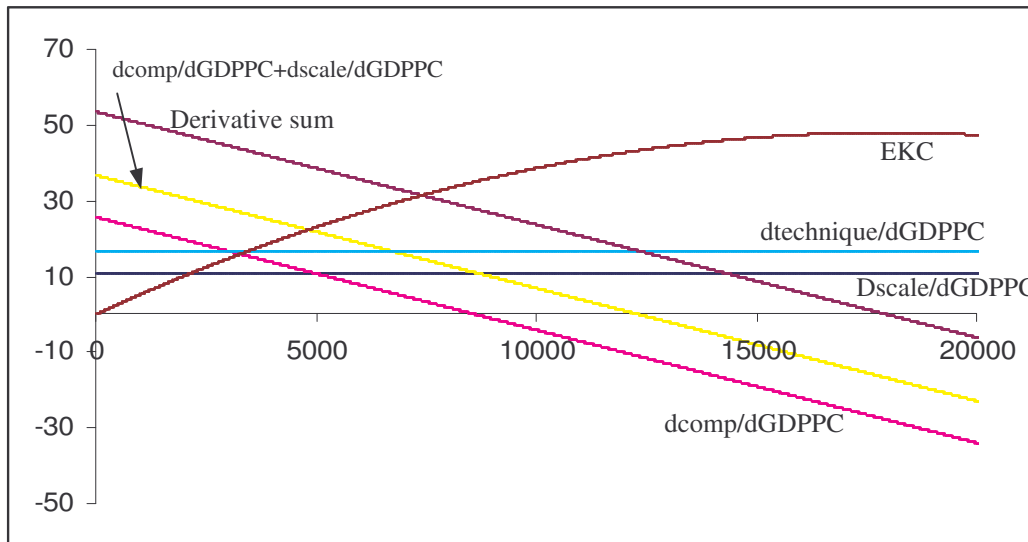

Panel b. Three cities

Figure 4.4. Structural determinants for EKC formation—China's case

(Based on the spline model's estimation results in Table 4.3)

Distinguishing the EKC formation mechanism of the 26 provinces from that for the 3 cities improves the correspondence between the results obtained from this chapter and the general mechanism depicted in Figure 3.1. Moreover, this effort also reveals completely different EKC formation mechanism for these two groups. For the 26 provinces, it is the pollution-reducing technique effect finally overwhelms the pollution-increasing scale and composition effects when income level attains 8000 yuan. While for the 3 cities, their final pollution reduction tendency starting from income level of 18000 yuan is actually achieved by their composition transformation towards less pollution sectors. As the derivative-sum-determined EKC turning points for the 26 provinces and the 3 cities are both located on the

upper-end of their income range, for most of the observations in the database, their income-pollution relationship still keeps the increasing trend.¹

4.4. Conclusion

In this chapter, we introduced and adjusted the traditional Divisia index decomposition method and employed it to Chinese data. By deepening our analysis insight into the detailed 13 industrial sectors in each province, the Divisia decomposition method revealed more concrete contribution of industrial scale enlargement, composition transformation and technical progress in industrial SO₂ emission changes for each province during 1991-2001.

The decomposition results confirmed the estimation finding of both reduced-form and structural models about an ever-increasing tendency in total industrial SO₂ emission during the last decade. Besides the contribution from the rapid expansion in industrial production scale, we find that the industrial composition transformation process also plays as pollution-increasing factor in most of Chinese provinces. Only several richest provinces whose industrialization largely benefited from their advantageous geographical location and openness policy have been the exceptions.

Accompanying scale enlargement, the economic growth in each province also catalyzed the technique effect, a pollution-reducing factor. We distinguished smaller regional disparity for the technique effect than that for the scale or composition effect. Geographical illustration shows that inland provinces (especially those in the north) had moderately larger technique effect than the richer coastal provinces.

Coherent to most of previous emission decomposition studies, our findings show the scale and technique effects as the two most important emission variation contributors, but in opposite directions. This actually leads the final changes in SO₂ emission to be determined by the combination of the composition effect with the left impact from the mutual cancellation between scale and technique effect.

The Divisia decomposition results also permit us to test how the three structural determinants of EKC—scale, composition and technique effect evolve with income growth and how their evolutions can finally determine the decoupling of the pollution increase from economic growth process. The good correspondence between the turning points of the simple EKC estimation in Chapter 2 and those determined by the sum of the derivatives of the three

¹ These findings are actually quite close to what we found in table 2.4 for both the province and city groups, although in chapter two, the final turning points did not appear in the sample's income range. We can regard this as another indicator for the good decomposition efficiency of our Divisia method.

effects reveals the good efficiency of the Divisia decomposition method. Our estimation results in this step reveal once again the potential differences in EKC formation mechanism between the 26 provinces and the 3 big cities directly under the control of the central government. Given their current industrialization tendency, in short- and medium-term, the 26 provinces will depend heavily on the reinforcement of their pollution abatement efficiency to finally realize the decoupling of industrial SO₂ emission from their economy growth. While for the 3 big cities, the realization of the inverted-U EKC curve actually depends on the composition transformation which expulses the pollution-intensive industrial activities gradually out of their territories.

PART 2. INTERNATIONAL TRADE AND ITS IMPACT ON INDUSTRIAL SO₂ EMISSION IN CHINA

The Divisia decomposition analysis carried out in the last chapter has shed lights on the necessity to include the openness characteristic of a province into the determination analysis about its industrial SO₂ emission. Given China's last ten years' remarkable economic growth success was marked by a significant increase of openness degree in both the commercial trade and foreign direct investment and that China's accession to the WTO from 2002 anticipates an even deeper openness tendency in the near future, we believe that it will also be important to understand the potential relationship between emission and openness.

Chapter 5. Environmental impact of international trade through composition effect: the role of capital, labor and environmental regulations

If commercial liberalisation allows profit-hunting producers to overpass the market frontier of a country and push further their limit of production specialisation to benefit from the relative production cost differentiations between countries, what will be the impact of trade liberalization on the environmental quality in these countries? Similar to the production division process happening in commercial liberalization, will international trade equally facilitate the new international pollution division? For the developing countries, enjoying benefits in income growth and economic prosperity from commercial liberalization, will they also face more pollution problems? Given the deep and complex impacts that international trade can have on export and import countries through production and consumption channels, this question has obviously no simple answer.

5.1. Literature review on the trade-environment relationship: a mixed conclusion

In Part 1, trade has been used as a pessimistic explanation for the EKC formation. This explanation is actually based on the famous “pollution haven” hypothesis. (Pethig, 1976; Chichilnisky, 1994; Copeland and Taylor, 1994) According to this hypothesis, under trade liberalization process, developed countries will lose their competitiveness in the polluting sectors and it will be their counterpart in the developing countries to pick up these market shares as their production faces less restrictive environmental regulations. Therefore, the relatively lax environmental regulation can actually be considered as a “comparative advantage” for the developing countries and we expect the developing economies to be

gradually specialized in the polluting industries and finally to turn into a “pollution haven” for the polluting industries’ production.

The “racing to the bottom” (Revesz, 1992) or “stuck in the mud” (Zasky, 1997) hypotheses are two dynamic-version extensions of the “pollution-haven” hypothesis. “Racing to the bottom” hypothesis expects the developing countries, facing the possibility to enhance their competitiveness by applying less restrictive environmental regulation, will have no motivation to improve their environmental standard. While for the developed countries, the pressures from the loss of competitiveness in certain strategic industries and the accentuated structural unemployment problems will also urge them to lower their environmental regulation strictness. Therefore, Revesz (1992) suggests that under trade liberalization, the countries of different environmental standard will have the intention to converge their environmental regulation to the lowest standard. The “stuck in the mud” hypothesis is less pessimistic. Instead of allowing the environmental standard to reverse, Zasky (1997) only suggests the possible stagnation state for environmental regulation progress. On one hand, the constraints of loss of competitiveness induced by globalization retard the capacities and the willingness of all nation-states to take any unilateral measure, which imposes additional costs for good environment management on domestic producers (similar to the prisoner-dilemma problem). On the other hand, the pressures of convergence of environmental protection policies means that the action to improve the environmental standards can only be applied in step with primary competitors. Therefore, the net results of the environmental regulation, under the reasoning of Zasky (1997) is that, firstly, the market becomes the primary drivers for environmental performance changes and secondly, the environmental managers are pressured to maintain the state-quo or change it only incrementally.

Whilst the reasoning of all the three hypotheses is intuitively plausible, the gloomy prospects for the trade-environment nexus predicted by them has not be echoed by the empirical evidences. The evidence of the low-regulation pollution haven are mixed. Only a restricted number of studies provide some supportive evidence for “pollution haven” hypothesis.¹ More studies fail to prove the “Pollution Haven” Hypothesis. This includes most of the studies analyzing location decision of US firms facing environmental regulation differences between countries or regions (Bartik, 1985, 1988, 1989; Leonard, 1988; Friedman et al., 1992; Levison, 1992; Wheeler and Mody, 1992, etc.) and many papers focusing directly on the potential relationship between international trade, environmental regulation and

¹ Robinson (1988), Low and Yeat (1992); Hettige et al. (1992), Birdsall and Wheeler (1997), Suri and Chapman (1998), Xing and Kolstad (2002), Friedl and Getzner (2003) and Cole (2004).

environmental quality. Kalt (1998) analyzes the potential correlation between the changes in export across 78 industrial categories during 1967-1977 and the changes in environmental compliance costs in the same period, he only finds statistically insignificant inverse relationship. Aiming at finding the contribution of the environment quality control policy in the net export of the 5 most polluting products in 23 OECD countries, Tobey (1990) only obtain unsatisfactory results. None of Jaffe et al. (1995), Janicke et al. (1997) and Van Beers and van den Bergh (1997) find evidences suggesting that the stringency of a country's environmental regulations influences its trade in dirty products. Grether and de Melo (1995) compare the evolution in the indices of average revealed comparative advantage (RCA) of the polluting products in 53 countries during 1965-1990. Although the common decreasing tendency in RCA between the developed countries confirms these countries were losing their specialization in polluting industries' production, the various RCA evolution trajectories found for the developing countries fails to provide convincing evidence that suggests taking-up the polluting industries' production and becoming "pollution haven" to be a unavoidable tendency for the developing countries. Eskeland and Harrison (1997) analyze four developing countries: Côte d'Ivoire, Morocco, Mexico and Venezuela, and find none of these countries attracted the specialization of dirty industries under globalization tendency. Gale and Mendez (1998), by employing the same cross-country database as Grossman and Krueger (1991, 1994), only detect ambiguous influence of a country's trade policy on its environmental quality indicators. Focusing on the potential trade's impact on composition effect, Antweiler et al. (2001), followed by Cole et al. (2005), also conclude that "either positive or negative, the environmental impact of trade should be small".

Some studies even proved the contrary stories. The conclusion of Sharfik and Bandyopadhyay (1992) supposes opener is a country's trade regime, the cleaner are the production process it employs. Grossman and Krueger (1991) firstly suppose the countries to use relaxed environmental regulation to keep competitiveness, while their results proved the contrary fact for the SO₂ case. Wheeler (2002) discovers the negative correlation between the time series of pollution indicators in urban areas of China, Brazil and Mexico and that of their degree of openness.

Apart from the measurement and definition problems existing in both environmental regulation stringency and trade flows, most of authors explain the ambiguity in the trade-environment relationship by the complexity of the relationship itself.

First, Copeland and Taylor (1994, 1997) and Antweiler et al. (2001) remind us the comparative advantage of a country is actually determined by two aspects of characteristics of

an economy. One is the country's natural factor endowment and the other is the environmental regulation strictness. Although the relatively low income in a developing country prevents it from carrying out as strict environmental regulation as its developed trade partners, whether this developing country will turn into a "pollution haven" also depends on its factor endowment situation. Supposing pollution-intensive sectors are generally capital-intensive, Copeland and Taylor (1994, 1997) conclude that a developing country will be specialized in polluting industries only if its pollution compliance cost advantage is large enough to overcome its capital cost markup with respect to its developed trade-partners. However, compared to the cost of the classical production factors such as capital and labor, environmental regulation compliance cost might not be a critical cost factor for most of private firms. Various studies based on developed country's firm-level data find the total factor productivity decline caused by strict environmental regulations often stays modest. (Denison, 1979, Gray, 1987, Haveman and Christiansen, 1981, etc) This suggests that pollution control cost differentiation between countries may not be a primary determinant for global production specialization, that is why Jaffe et al. (1995) believe that the lion's share of pollution-intensive product's production is still in the developed countries and the increase of the production in developing countries might be due to their own demand growth.

Second, the original "pollution haven" hypothesis follows a static reasoning logic that is analogical to the comparative advantage perspective. However, we should also take care of the dynamic characteristics of the trade-environment relationship. The hypothesis of Porter is actually one of the supply-side dynamisms that contribute to cancel-off the "pollution haven" advantages existing in developing countries. According to this hypothesis, stringent environmental regulation can also encourage efficiency innovation and make production procedure more environment-friendly (Porter and Linde, 1995; Xepapadeas and Zeeuw, 1999). This dynamic technical progress can further induce a 'negative cost', which will benefit productivity reinforcement owing to the cleaned environment. (Jaffe et al., 1995) Following this reasoning, production specialization due to environmental regulation stringency differential is actually unnecessary in the long run.

Third, the dynamism canceling the "pollution haven" advantages in developing countries can also be traced from demand side. Under globalization tendency, an enterprise needs not only to minimize production cost, but also to keep their environmental performance, since more and more consumers start to include producer's environmental image into their purchase decision. Therefore, even this enterprise decides to dislocate its production to developing countries; it may keep respecting the environmental standard of its

origin country. Moreover, less emission serves also as a signal to the investors that the production techniques employed by the enterprise are efficient, therefore enhance their expectation on the liability of the enterprise, and facilitate the enterprise to attract more investment from capital market. (Dasgupta, Laplante and Mamingi, 1997) Therefore, for the enterprises in some polluting industries, keeping good environmental performance is also sufficient condition for their survive in the intense market competitions.

Fourth, the insignificance of the “pollution haven” hypothesis can also be explained by the potentially reversed causality between trade and pollution phenomena. From the point of view of the developed countries, the ‘racing-to-the-bottom’ hypothesis reveals this possibility. According to this hypothesis, trade liberalisation can create pressures on the developed countries’ governments and urges them to lower their environmental standard (Revesz, 1992). This in fact reduces the pollution compliance cost difference between developing and developed countries by lowering the higher-end level.¹ This reversed causality may also exist in developing countries. If some of international exporters in these countries, as described in last paragraph, voluntarily keep higher environmental efficiency, this will reinforce competition in the domestic market and urge the other firms in the same sectors to enhance production efficiency and improve pollution abatement activities. In the long run, we can expect the reinforcement of environmental efficiency for the whole economy, which actually reduces the environmental regulation compliance cost differentials between the rich and poor countries by lifting the lower-end level.

Fifth, several studies based on the historical experiences of developing countries indicate that as income increases with the deepening of commercial liberalization, the environmental regulation, strongly correlated with income level, can also be improved with trade expansion. Therefore, as concluded by Mani and Wheeler (1997), the “pollution-haven” should only be a transient phenomenon, therefore the difference in environmental regulation stringency between developed and developing countries will also have the tendency to converge under the commercial liberalization process.

Finally, the formation of the global production specialization also depends on many of other factors that are more and more often discussed in the “pollution-haven” literatures. These include the dependence of many polluting heavy industries on home markets (Cole,

¹ As an extension of this hypothesis, Levinson and Taylor (2003) and Ederington and Minier (2003) have discussed the potential estimation bias in the empirical studies that simply focus on the uni-direction relationship from environmental regulation strictness to the net import in the developed countries. Both paper find that, US environmental regulations, once their endogeneity with respect to international trade get controlled, do affect US trade patterns.

2004), the importance of the geographical location in international merchandise and service exchanges (Smarzynska and Wei, 2001; Fredriksson et al. 2003), the mask effect on “pollution haven” hypothesis caused by the other tax breaks benefits and infrastructure subsidies offered by domestic government to the enterprises under restrict environmental regulation control (Keller and Levinson, 1999), the difference in the impacts of the reinforced environmental regulation on an already-existing enterprises from those on a newly appearing enterprises due to the sunk cost and fixed cost already invested (Keller, 1996; Keller and Levinson, 1999 and List and Co, JEEM), and finally the other institutional, technical or political factors which also have important influence on the production efficiency, such as corruption, poor infrastructure and uncertain or unreliable legislations, etc. (Smarzynska and Wei, 2001) Clearly, the environmental regulation compliance cost is only one factor among many others which has the capacity to affect the formation of the global production division. Without employing appropriate analytical method, it will be hard to get a thorough understanding on the trade-environment nexus.

5.2. The principal problems in the existing trade-environment nexus analyses based on developing countries' experiences

Although most of the authors has indicated the impact of international trade on environment that is actually exerted through different channels and depends on certain technical, structural and institutional characteristics of the economy, parallel to the EKC analysis, we do believe it is useful and even necessary to carry out country-specific trade-environment analysis. However, until now, no country-specific study focusing on a particular developing country's experience has been done yet.

Given data availability constraints, to my knowledge, most of the existing trade-environment nexus studies are in fact based either on mirror trade data from United State or OECD countries (Eskeland and Harrison, 1997; Keller and Levinson, 1999 and Cole, 2004a, 2004b, etc.). The principal problem of these mirror data analyses is the credibility of the mirror-reflection—whether the increase in net import of pollution-intensive products in certain developed countries means absolutely that their environmental load is displaced toward the developing world? In his paper examining the environmental load displacement possibility inside NAFTA, Cole (2004b) indicates that although he found clear evidence of US environmental load displacement over period 1974-2001 and US import from Mexico

have grown more rapidly than domestic consumption pattern during the same period, no evidence is found to suggest that NAFTA is increasing displacement to Mexico.

There are also some studies basing their analysis on the cross-country panel data. Most of them only include some of the developing countries and only focus on the relationship between the trade volumes of the “five most polluting industries” and the related environmental regulation stringencies. (Cole, 2004a, etc.) However, given the potential difference in technical level, the same product might be produced by different techniques in different countries, therefore to categorize the industries in one country according to their environmental performance in another country largely reduce the credibility of these studies, especially as most of these studies has use some developed countries as the reference country, which show clearly technological differences from the developing countries in analysis. Moreover, the correspondence efficiency of this extrapolation also closely depends on the aggregation degree of the industry classification; we generally believe the extrapolation efficiency reduces when the classification’s aggregation degree gets higher.

China is actually an ideal case for country-specific trade-environmental nexus analysis. On one hand, China’s openness policy since 1978 has induced a rapid integration of Chinese economy into world market. From figure 1.1 of chapter 1, we already saw important increase in trade intensity (sum of export and import over total GDP) during the years of reform. And on the other hand, China environment situation has also obviously deteriorated during the same period. Furthermore, both China’s international trade evolution and industrial SO₂ emission are also marked by important regional disparities (c.f. Figure 1.2 and 2.7), which guarantees the necessary data quality for an efficient panel data estimation analysis.

5.3. Evolution of the specialization situation for some China’s industrial sectors

In this introductory section, we use two specialization measures widely used in related literatures to give a simple description on the specialization situation of some industrial sectors in China. The first is the net import, expressed as a share of each industry’s value added, so that for an industry j during period t , its net export indicator can be calculated as $NETX_{jt}=(X_{jt}-M_{jt})/VA_{jt}$, where X and M denote the export and import and VA means the value added. Increasing $NETX_{jt}$ for a specific industry implies the export are increasing relative to import, hence it maybe inferred that specialization is increasing in this industry. The second specialization measure is the Michealy Index (Michealy, 1962), which is defined

as $Michealy_{jt} = \frac{X_{jt}}{\sum_j X_{jt}} - \frac{M_{jt}}{\sum_j M_{jt}}$. Michealy index ranges from positive one to minus one, a

positive (negative) value means China is specialized (under-specialized) in that industry.

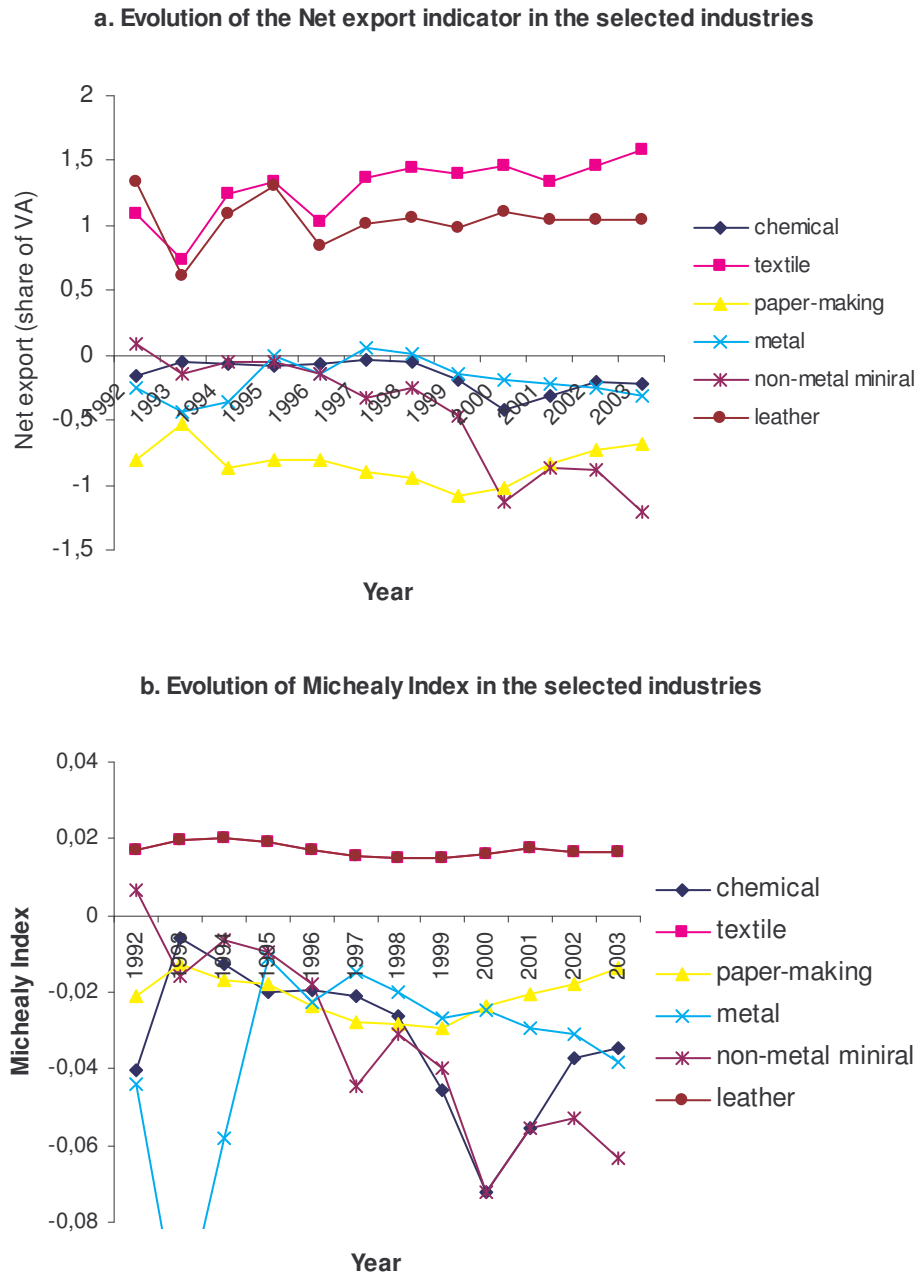

Figure 5.1. Evolution of the specialization degree of the selected industries

The two panels of Figure 5.1 summarize the evolution of these two specialization indicators for the four most polluted industries according to the classification of Dasgupta et al. (1997): chemical, paper-making, metal and nonmetal mineral products and the two light industries: textile and leather products. The main observation from this figure seems to offer

opposite evidence for the “pollution haven” hypothesis. All the four polluting industries generally show negative specialization indicators and for the net export indicator, all the four industries even show a common decreasing tendency. This actually implies the reduction of specialization degree in these pollution-intensive industries during the last ten years in China. On contrary, for the two light industries, we always observe positive specialization indicators. Moreover, their ever-increasing Net export indicators reveal that China was actually following a specialization process orientating toward these less-polluting light industries.

Considering the potential efficiency problems in the existing trade-environment nexus analyses indicated in section 5.2, we know the simple introductive description based on specialization indicator of selected sectors is far from a convincing conclusion about the actual role played by international trade in the determination of China’s industrial SO₂ emission. In the following three sections, we will employ separately three different structural analytical methods to explore the detailed relationship between trade and industrial SO₂ emission in China.

5.4. Structural model—determining environmental impact of international trade through composition effect

5.4.1. Graphical illustration of the structural model of Antweiler, Copeland and Taylor (2001) and Copeland and Taylor (2003)

The general equilibrium model of Antweiler, Copeland and Taylor (2001) can be considered as the most complete theoretical investigation efforts in trade-environment relationship till these days. According to this model, influence of trade on pollution depends on a country’s comparative advantage, whose situation is collectively determined by the standard factor endowment—measured by the relative capital abundant with respect to labor, and the environmental regulation strictness—a institutional indicator largely influenced by country’s real income level. This model is further developed in Copeland and Taylor (2003).

a. General assumptions

Following Copeland and Taylor (2003), we divide the world into two regions—North and South—who together determine world price. Each region is composed of many identical countries, that is, they have the same preference and technologies. Both regions produce two goods x and y . Good x generates pollution during its production and good y does not. By choosing y to be numeraire (so that $p_y=1$), we denote the domestic relative price of good x by

p . There are two primary factors, capital and labor (K and L), with market returns r and w . x is capital intensive and y is labor intensive. That means for any w and r , the capital/labor ratio in x is higher than y ($K_x/L_x > K_y/L_y$). They further suppose that generally more capital-intensive sector is also more polluting, so the production process of x emits pollution but that of y does not. Therefore x industry jointly produces two outputs—good x and emission z . Copeland and Taylor (2003) suppose x industry can allocate a fraction θ of its inputs to abatement activities to reduce the emission intensity $e=z/x$. So that we have $z=\varphi(\theta)F(K_x, L_x)=\varphi(\theta)x$, and technology feasibility requires $0\leq\theta\leq 1$, $\varphi(0)=1$ and $\varphi(1)=0$ and $d\varphi/d\theta<0$. The choice of the fraction of input θ used in pollution abatement to an endogenous choice of x industry's producer facing the stringency of the environmental regulation τ^* practiced in his country, so $z=\varphi(\theta(\tau^*))x$, normally $\theta'_{\tau^*}>0$. The latter is, in its turn, an endogenous utility-maximizing policy variable of the pseudo-government with respect to per capita income level $I=(px+y)/N=(rK+wL)/N$, here N is the population. So we have $z=\varphi[\theta(\tau^*(I))]$ x . Under equilibrium condition, according to the utility-maximization objective of the pseudo government, the optimal environmental regulation stringency, more concretely the emission tax τ^* should be equal to the marginal disutility caused by pollution. As generally we believe the disutility caused by the same level of pollution to increase as people getting richer, so we have $\tau^{*'}_I>0$, $\tau^{*''}_I>0$.

We suppose three differences between these two regions. First, the North possesses absolutely more capital and labor than the South. If we use K_N and L_N to denote the capital and labor endowment in North and K_S and L_S to denote those in South, we actually suppose $K_N>K_S$ and $L_N>L_S$. Secondly, in relative term, the North is endowed with more capital than the South, so $K_N/L_N>K_S/L_S$. Finally, two regions have same population N . Therefore the income level in North should be higher than South, this in turn results in the assumption that the North practice more stringent environmental regulation than the South, so $\tau_N>\tau_S$.¹

Bearing these assumptions in mind, we now start graphical illustration to see how trade liberation changes the pollution situation in the two regions according to ACT (2001).

b. Production patterns in the two regions under autarky

¹ The richer total labor force resource in the North can be comprehended as a result of higher education, therefore, even the population sizes are the same in the two regions, as the North population generally have higher education level, their productivity can be higher than the people living in the South, so in term of effective labor force, the North is richer than the South.

industry by distinguishing the potential ($PF_{N0, \text{potential}}$) and net ($PF_{N0, \text{net}}$) production possibilities in the North. The potential production frontier is the production probabilities for the economy if no abatement is undertaken, while the net production frontier, relating to the maximum level of net output of x that can be produced for a given output of y and for a given emission tax rate, τ , is actually an innermost curve with respect to the $PF_{N0, \text{potential}}$. We equally know the horizontal distance between the potential and net production frontier is a fixed fraction of the whole horizontal distance from potential production frontier to the y -axis, and this fixed fraction is equal to $\theta = x_a / (x_a + x)$, excepts for their intersections with y -axis, where the output x is zero.

The bottom panel of figure 5.2 depicts the emission results of the production activities of the two regions. Since in our analysis, South applies no emission tax, therefore, by carefully choosing the unit for product x , we can illustrate the output-emission relationship in this region as by a 45° straight line $z=x$. While for the North, the allocation of a part of input into the abatement activities in industry x has two effects on its emission result. Firstly, it reduces the total output of x , therefore reduces the potential quantity of pollution. At the same time, as a fraction of input is used in abatement activities, the emission intensity will also be smaller than 1. Therefore, we need to use a new straight line in the bottom panel $z=e_0x$ to denote the output-emission relationship for the North, note that $0 < e_0 < 1$. Graphically, this means to rotate counterclockwise the 1 to 1 emission-output curve used for the South.

In autarky, each of regions produces both goods to satisfy domestic demand. Their production decision about the (x, y) combination in each country is actually determined by the contingent point of their utility indifference curves (U_{S0} and $U_{N0, \text{potential}}$) with the production frontier (PF_{S0} and $PF_{N0, \text{potential}}$), which are point A and B in Figure 5.2, respectively. This contingent point also determines the relative prices of x with respect to y (p_{N0} and p_{S0}) in each region, which is equal to the slope of either the production frontier or the utility indifference curve at the contingent point. When the North applies pollution control policies, we suppose the production point becomes D in $PF_{N, \text{net}}$.¹ Figure 5.2 equally tells us that given the factor endowment differences, the relative price of x with respect to y is higher in the South. So it is the North that has the comparative advantage in x product. Although the application of the

¹ For the illustration convenience in the following figures, we also use the straight line (OQ) to present the relative consumption situation in the South under different trade situations. Under different trade situation, this straight line will start from origin point and go through the point representing the consumption pattern. Therefore under autarky, OQ_A curve goes through the consumption point A, so its slope actually represents the relative consumption situation of y with respect that of x , it is equal to y_{S0}/x_{S0} in figure 5.3. We will always use the suffix letter to follow the OQ in nomination of the relative consumption curve, and the suffix will be each time the same letter that we use to represent the actual consumption pattern.

pollution control policy in the North reduce the relative price gap between the North and South to some extent ($P_{N0,potential} < P_{N0,net} < P_{S0}$), the situation described in figure 5.2 predicts the North to conserve its comparative advantage in x sector.

c. International trade based on factor endowment differences between regions

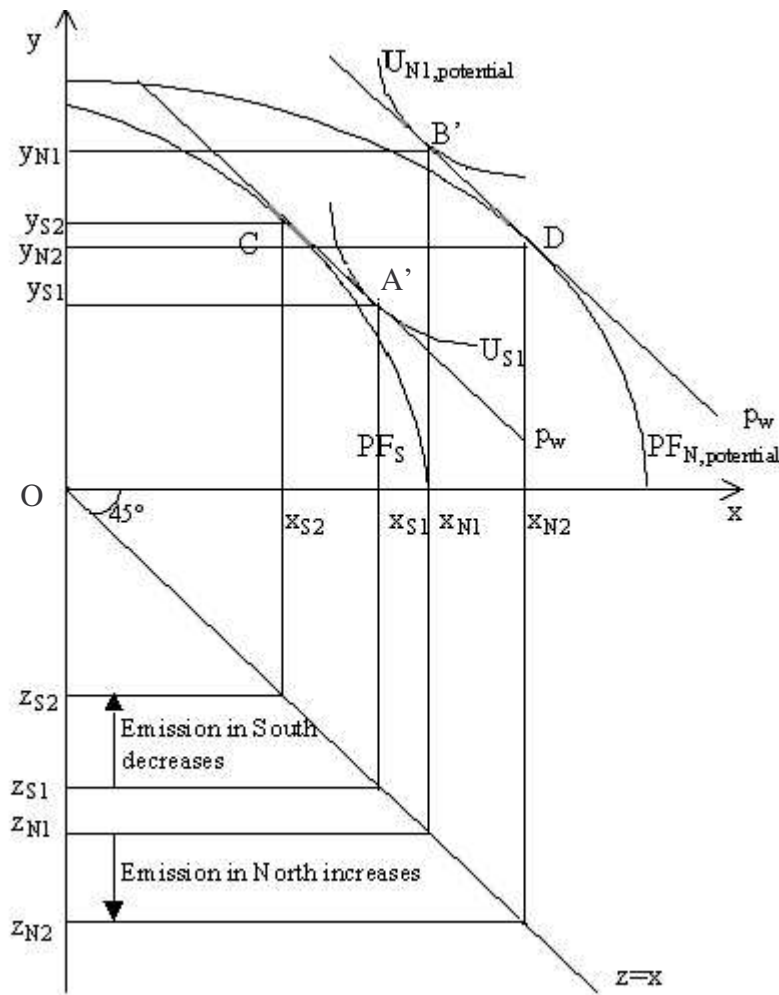

Figure 5.3. Production pattern changes under trade liberalization: Traditional endowment-based comparative advantage

For illustration convenience, let's first neglect the pollution control policy difference between North and South and focus on the production pattern changes caused by factor-endowment-based international trade. If now both regions open their markets, a product reallocation happens between the two regions. The factor-endowment-difference-based international trade push both regions to be more specialized in the sectors where they possess comparative advantages, therefore the South, having the comparative advantage in y production, acts as a exporter of y and the North, instead, export x to South. The new relative price in the world market (p_w) will locate some level between the initial price of South and

that of North. This new relative price determines the new production patterns (C and D) for the South and North and also their consumption patterns (A' and B'). Therefore, under the new situation, North exports $(x_{S2}-x_{S1})$ quantity of good x to the south and receiving the import of good y of $(y_{S2}-y_{S1})$ quantity from the South at the same time. The world market clears up.

Both regions gain from the trade. This gain can be presented by the utility indifference curve $U_{N1,potential}$ and U_{S1} . Contingent with the straight line denoting the world price curve p_w , they are slightly higher than the original $U_{N0,potential}$ and U_{S0} . Since both countries produces more the goods whose prices are relatively more expensive, this gain can also be traced from the slight income changes.

Environmental situation change is depicted in the lower panel of the figure 5.3. As the natural factor endowment decides the North to be exporter of the polluting goods x. International trade actually transfer a part of environmental burden from the South to the North, whose quantity is indicated in the figure as $(z_{N2}-z_{N1})=(z_{S2}-z_{S1})$.

Following we decompose in Figure 5.3.bis the trade-induced pollution changes into three effect (Scale, Composition and Technique effects) as done in ACT (2001). As this dissertation is interested in China's environmental problems related to international trade, we only concentrate on the decomposition for the South. For the illustration convenience, in all the decomposition figures, we will use a series of straight lines named OQ_x to present the relative production situation in the South under different trade situations, here the suffix letter x is changeable according to different trade situation, it will be each time the same letter that we use to represent the actual production pattern. Under different trade situation, this straight line will start from origin point and go through the point representing the consumption pattern in the South. The relative production curve under autarky is OQ_A , which goes through the production point A. Similarly, for the case of factor-endowment-difference-based trade liberalization, the relative production curve should be OQ_C , which goes through the production point C. The relative production situations are presented by the slope of these lines. In figure 5.3bis, it is equal to y_{S0}/x_{S0} under autarky and y_{S2}/x_{S2} under trade liberalization.

In this figure, the autarky production pattern in the South is still indicated by point A and the autarky relative price is denoted by p_{S0} . C indicates the new output situation under free trade and p_w is the world market price. The pollution situation under autarky and international trade are indicated by z_{S0} and z_{S2} in the bottom panel. The dashed straight line p_{S0p} parallel to the initial relative price p_{S0} in the South passes through the new output point c, it gives a real value measurement for the new output of the South under free trade at the base

polluting industry x . However, international trade only transfers pollution burden between countries, but lead the total world emission stays unchanged, that means $z_{S0}+z_{N0}=z_{S2}+z_{N2}$.

d. International trade based on both factor endowment comparative advantage and pollution haven hypothesis

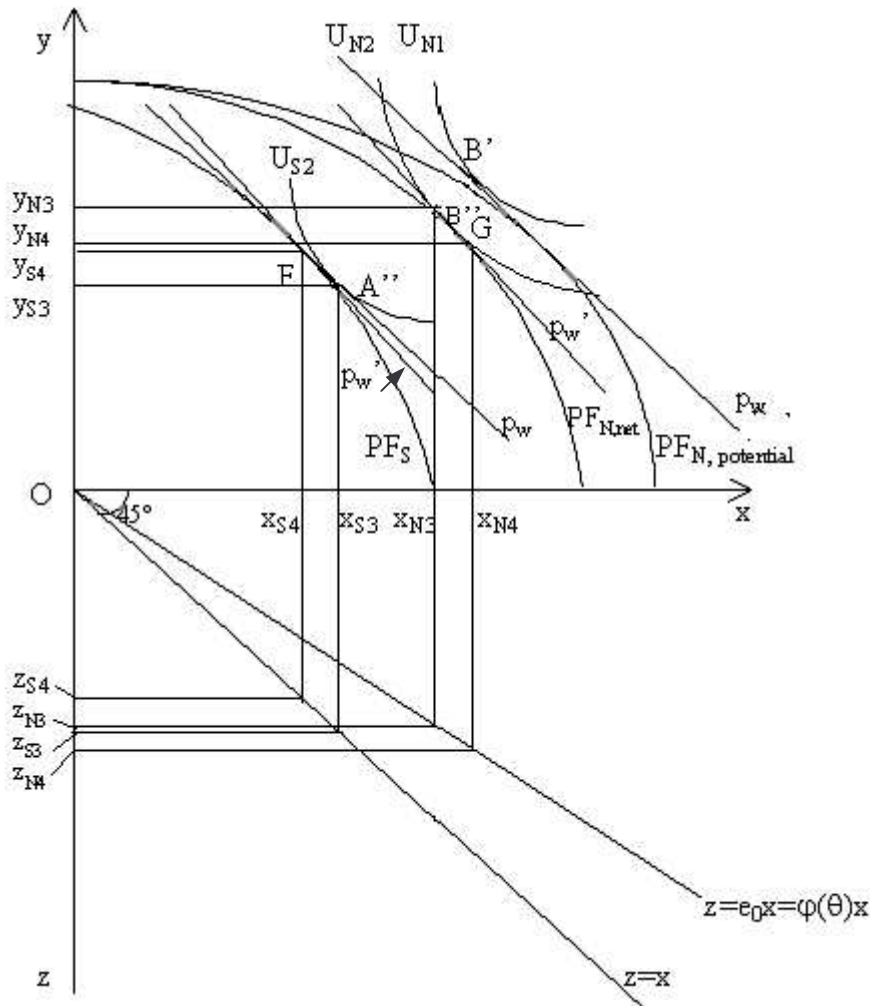

Figure 5.4. Production patterns changes under trade liberalization: Traditional endowment-based comparative advantage dominating Pollution Haven hypothesis

Now we include another part of assumption mentioned in sector b—the north practice some pollution control policies while the South does not. According to Copeland and Taylor (1994, 1997 and 2003), as the countries belonging to the North generally have higher emission tax, they should lose some of their comparative advantage in the polluting sector x . However, as the final trade patterns between North and South is actually determined by the force-contrast between the factor-endowment-based comparative advantage and the “pollution-haven”-hypothesis-based comparative advantage, we need to discuss the potential trade-pattern changes under two different conditions. One is when the traditional endowment-

based comparative advantage dominates Pollution Haven hypothesis and another is when the traditional endowment-based comparative advantage is dominated by pollution-control-policy-based comparative advantage.

Figure 5.4 illustrates the trade pattern changes under the condition that traditional endowment-based comparative advantage dominates the pollution haven advantage in the South. This is in fact a following figure of Figure 5.2. Under this case, the inward shift of the net production frontier of the North ($PF_{N,net}$) is not very large, so compared to PF_S , the $PF_{N,net}$ is still more skew to the x-axis. Therefore, although the total comparative advantage of the North in x industry decrease to some extent, the North is still relatively more specialized in x industry and its autarky relative price of x is still lower than that of the South. But the practice of pollution control policy in North will reduce its supply of x to the world market to some extends when both regions open their market. This in turn will lead world market relative price to increase to p_w' , which is depicted in figure 5.4 as a straight line with steeper slope than that of p_w (c.f. figure 5.3). At this new world market equilibrium, the North produces at point G and consumes at B'' and the South produces at F and consumes at A''. The South still exports ($y_{S4}-y_{S3}$) quantity of y to the North and receives ($x_{N4}-x_{N3}$) quantity of x imported, but the inter-regional exchange of both goods turns out to be less than that obtained in figure 5.3.

What are the pollution changes in both regions? Comparing figure 5.4 with 5.3 shows that once the trade patterns is under the influences of both comparative advantage characteristics, but the pollution haven hypothesis is less important than the endowment comparative advantage, the pollution reduction that the South can benefit from international trade will be smaller ($z_{S0}-z_{S4}) < (z_{S0}-z_{S2})$. On contrary for the North, owing to both the improved pollution abatement activities and the less deepening industrial specialization in the polluting industry x, it will suffer less pollution problems than in situation described in figure 5.3, that means ($z_{N4}-z_{N0}) < (z_{N2}-z_{N0})$. Furthermore, as partial pollution burden in the South is transferred to the North, where some pollution abatement activities are carried out, we expect the total world pollution to decrease. So ($z_{N4}+z_{S4}) < (z_{N0}+z_{S0})$.

Following, we decompose the total pollution changes in the South caused by trade liberalization in figure 5.4bis. Under this new condition, the total pollution reduction in the South resulting from trade liberalization ($z_{S4}-z_{S0}$) can now be decomposed into four parts. The first two parts are ($z_{S0} \rightarrow z_{ST}$) and ($z_{ST} \rightarrow z_{S2}$). They respectively correspond to the production pattern changes in the South under trade liberalization caused by its factor endowment characters, ($A \rightarrow E$) and ($E \rightarrow C$). These two parts are exactly the same as those in figure 5.3bis. However, these two parts of pollution reduction are actually cancelled off by the two part of

pollution increasing results in the South related to its potential comparative advantages as a pollution haven. These two parts are represented in figure 5.4bis as $(z_{S2} \rightarrow z_{ST'})$ and $(z_{ST'} \rightarrow z_{S4})$. They correspond respectively to the composition transformation that oriented toward x industry ($C \rightarrow H$) and scale changes ($H \rightarrow F$) that caused by world relative price changes.

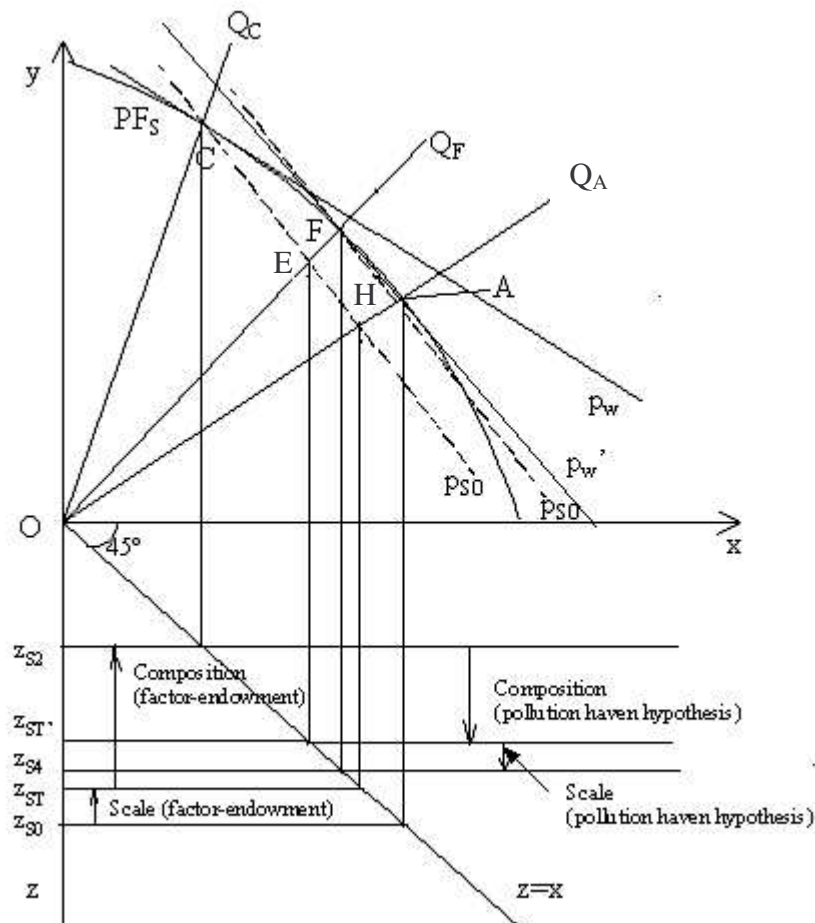

Figure 5.4bis. Production patterns changes under trade liberalization: Traditional endowment-based comparative advantage dominating Pollution Haven hypothesis—the decomposition

As the decomposed scale effect in both figures 5.3bis and 5.4bis are actually based on monetary unit measurement, but not on real scale changes, the most important conclusion that we can derive from these decomposition analyses based on ACT (2001) model is that, it is actually composition effect of each country that eventually determine the trade-environment relationship. This is why Cole and Elliott (2003) re-nominates the model of ACT (2001) as a determination mechanism for the composition effect and uses a cross-country panel data to re-estimate this model in aim of investigating the determination role of capital, labor and environmental regulations in the composition effect transformation.

Now let's look into the case where the pollution haven comparative advantage of the South overwhelms its factor endowment comparative advantage. Under this circumstance, the

horizontal contraction in the North's net production frontier should be large enough to finally realize a $PF_{N,net}$ skewed even more toward the y-axis than the production frontier of the South, PF_S . Under this case, the comparative advantage reverse happens. Even if North is more competitive in x production from the perspective of factor-endowment situation, its significantly stricter pollution control policies actually prevent it from specializing in this polluting industry. Therefore when both regions open their market, we expect the world relative price of x to increase to p_w'' , and $p_w'' > p_w' > p_w$. The South, although relatively richer in labor endowment, will find it is more profitable to specialized in x industry, given its high world relative price.

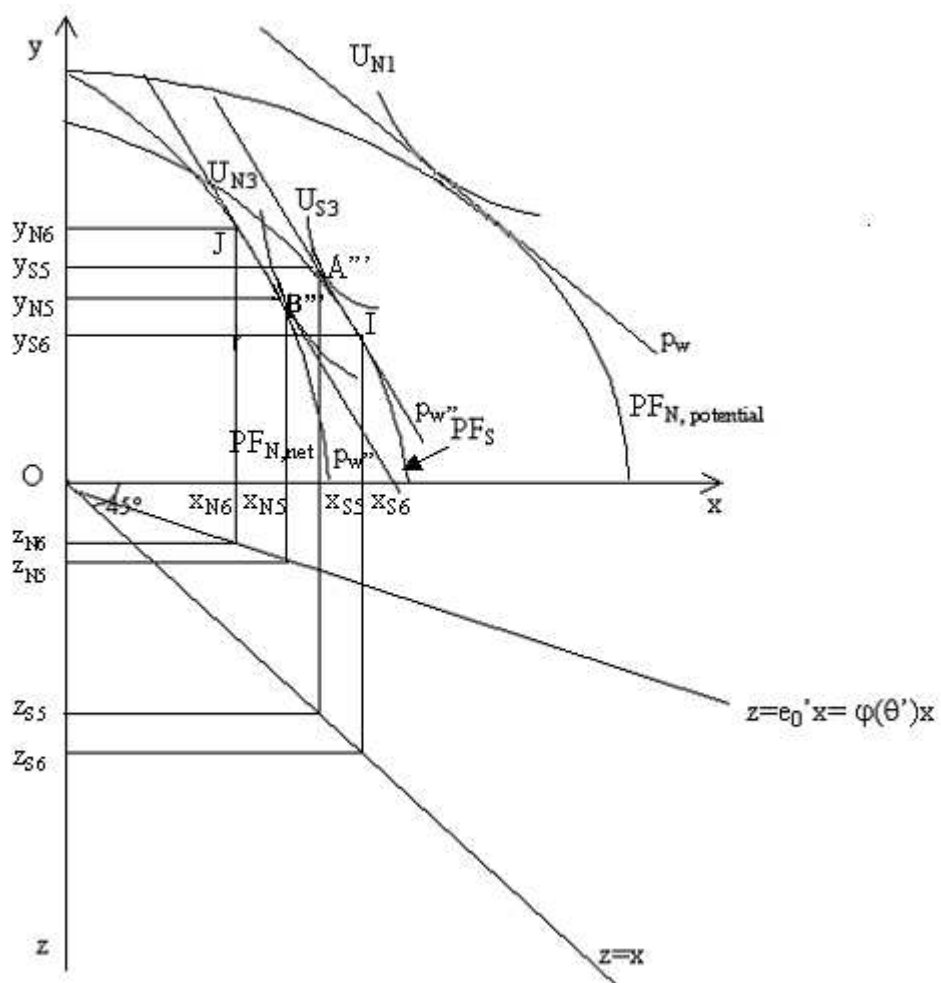

Figure 5.5. Production patterns changes under trade liberalization: Traditional endowment-based comparative advantage dominated by Pollution Haven hypothesis

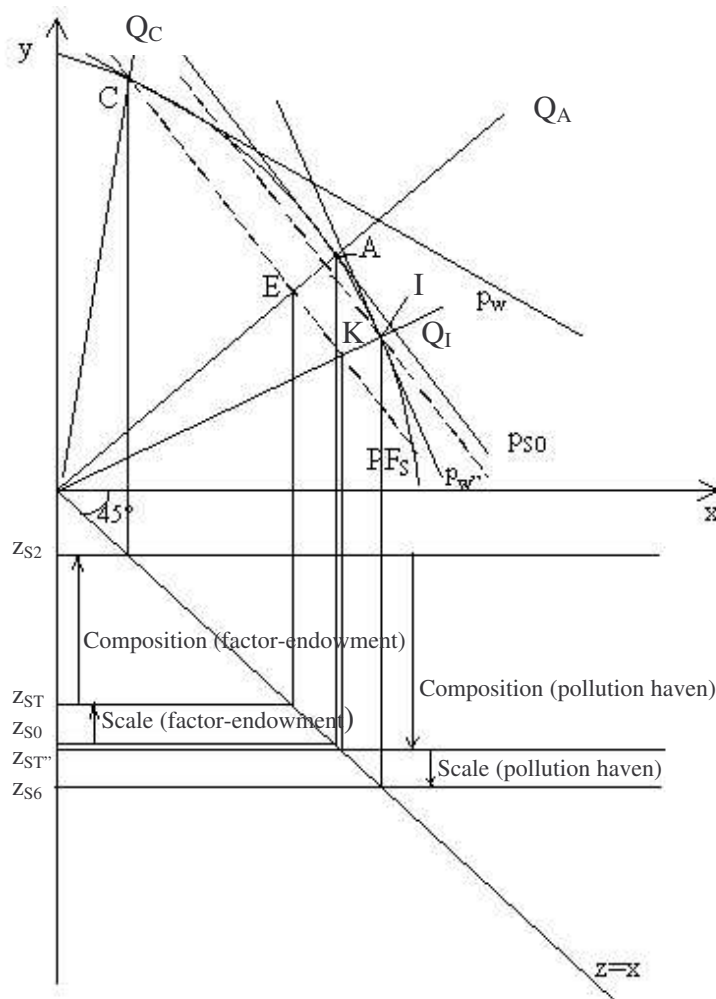

Figure 5.5bis. Production patterns changes under trade liberalization: Traditional endowment-based comparative advantage dominated by Pollution Haven hypothesis—the decomposition

We illustrate this situation in figure 5.5, where both the new production and consumption point for both countries are indicated in their respective production frontiers. As the pollution haven comparative advantage becomes dominating, reverse of comparative advantage happens between North and South, the South produce at I and consumes at A''' and the North produces at J and consumes at B'''. South will exports $(x_{S6}-x_{S5})$ quantity of pollution good x and imports from the North $(y_{N6}-y_{N5})$ quantity of cleaner good y. Concerning pollution situation, opposite to the situation illustrated in figure 5.4, the comparative advantage reversal between North and South due to very restrict pollution control policy in the North actually lead the pollution in the South to increase, since at this time, the pollution burden is transferred from the more pollution-efficient region (North) to less efficient region (South). The situation for the total pollution in the world stays, however, at the moment, an

ambiguous situation. Though the pollution burden transformation from more efficient northern countries to less efficient southern countries generally predicts an increase tendency for total pollution. Whether world total pollution will increase or not in this two-regions two-products framework also depends on the final total production quantity of x after trade.¹

The trade's environmental impact decomposition analysis for this comparative advantage reversal case is given in figure 5.5bis. Different from figure 5.5bis, here the pollution-decreasing contribution from composition and monetary scale effects based on factor-endowment comparative advantage is totally canceled off by the pollution-increasing composition and scale effects resulting from "pollution haven" hypothesis. Therefore the total pollution in South is going to increase from z_{S0} to z_{S6} .

5.4.2. Empirical trade-environmental nexus analysis based on ACT (2001) model—the composition effect

a. Estimation model

The decomposition analyses in figure 5.4bis and 5.5bis actually provide us with a concrete illustration for the conclusion of Copeland and Taylor (1994, 1997, 2003) and ACT (2001). According to these two figures, international trade can actually affect emission in a southern country as China through the composition effect from the following two aspects. On one hand, as a low-income country, the "pollution haven" hypothesis suggests China to specialize in some pollution-intensive industries; on the other hand, considering China's extremely rich endowment in labor forces, traditional comparative advantage hypothesis also suggests its industrial structure to specialize in the less polluting labor-intensive industries. The total effect of trade on environment in China actually depends on the force contrast between its factor endowment $(K/L)_{jt}$ and its environmental regulation strictness.

In this section, we therefore employ the empirical model of ACT (1998, 2001) to check trade's impacts on industrial SO_2 emission situation in the 29 Chinese provinces. The estimation function can be illustrated by equation (5.1).

$$SO_{2jt} = \alpha_j + \eta_t + \beta GDPPC_{jt} + \gamma Scale_{jt} + \theta (K/L)_{jt} + Z_{jt}' \varphi + \rho t + \varepsilon_{jt} \quad (5.1)$$

$$+ \gamma_0 open_{jt} + \gamma_1 open_{jt} \times (K/L)_{jt} + \gamma_2 open_{jt} \times (K/L)_{jt}^2 + \gamma_3 open_{jt} \times GDPPC_{jt} + \gamma_4 open_{jt} \times GDPPC_{jt}^2$$

¹ From a more realistic point of view, we believe the characteristics of the multilateral international trade and the flexible mobility of capital between nations of our days actually guarantee the total production of the polluting goods to stay the same level as that before trade liberalization or even higher. That is why some authors believe international trade is a transient reason for the formation of Environmental Kuznets Curve but finally lead the total world pollution to increase, an idea also discussed in the figure 2.2 of chapter 2 of this dissertation.

Obviously, this equation is an extended version of the estimation function (3.10) used for the investigation of the structural determinants of the industrial SO₂ emission. The five supplementary terms included to investigate the environmental impact of trade are regrouped in the second line of (5.1).

The simple trade intensity variable ($open_{jt}$), measured by the ratio of the sum of export and import over total GDP $((X+M)/GDP)$ is included to trace the potential direct impact of trade on industrial SO₂ emission.¹ Following ACT (2001), we also include the multiplicative terms of trade intensity ($open_{jt}$) with the capital-labor abundance ratio $(K/L)_{jt}$ and per capita income $GDPPC_{jt}$ to capture the interaction between the factor-abundance and pollution haven motive in determination of the composition effect in China's trade liberalization process during last decade.

To capture the force-contrast between the pollution-haven-based and the traditional factor-endowment-based comparative advantages in industrial composition determination under trade liberalization, as in ACT (2001), we also interact the quadratic per capita income $GDPPC_{jt}^2$ and quadratic capital-labor ratio $(K/L)_{jt}^2$ into with trade intensity ratio in eq. (5.1). As explained in ACT (1998), because the theory does not tell at what point further increases in the capital-abundance ratio raise pollution (via composition effect) or when increases in per capita income finally lower pollution (via composition effect), we prefer to adopt this flexible approach in our estimation. As a consequence, we expect the interacted quadratic in capital-labor abundance ratio with trade intensity to imply a positive impact of further openness on SO₂ emission for high capital/labor ratio but a negative effect for lower levels. This corresponds to the situation illustrated in figure 5.4 that, regardless of the other characteristics of the North, if its capital-labor abundance ratio is sufficiently higher than the South, it must export polluting good X. Alternatively, if the capital/labor ratio of the South is relatively enough lower with respect to the North, it must import the polluting x good. Therefore, the partial estimation results for these two interacted terms of capital/labor abundance ratio with trade actually reflects the factor endowment comparative advantage hypothesis.

Similarly, we expect the interacted quadratic per capita income to imply a negative impact of further openness on SO₂ emission for high incomes but a positive effect for lower incomes. This actually corresponds to the figure 5.5 that, for the North, if its income per capita is sufficiently high, it must import polluting good x. Alternatively, for the South, if its income per capita is sufficiently low, even it is abundant in labor force, it turns into x

¹ The same measurement for the trade intensity has also been used in Agras and Chapman (1999) and Suri and Chapman (1998), ACT (1998, 2001) and Cole and Elliott (2003).

exporter. This partial estimation result related to the two interacted terms between per capita income and trade intensity actually reflects the pollution haven hypothesis.

The reasons that we simply use provincial-level absolute capital-labor abundance ratio and provincial-level absolute per capita income in the trade-related multiplicative terms, but not as ACT (2001) and Cole and Elliott (2003) to use relative K/L and relative income with respect to the sample average K/L and income is due to the consideration that we are actually interested in the international trade of each Chinese province with the all other *foreign countries*. Therefore, for each province, it is actually the differences between its K/L and income and those of the world average (China excluded) that decided their comparative advantages. However, since in each year, this world average is actually the same for all the provinces, including them will only change the scale of the multiplicative terms' coefficients. Therefore, it is not necessary to make this arrangement in our estimation. However, considering China's relatively faster economic growth rate, we believe it will still be interesting to make this arrangement for a comparison since the difference between the world average (China excluded) and Chinese provinces in both capital-abundance ratio and per capita income should decrease with time.¹

b. Estimation results

Following chapter 3, we run the estimation for both the industrial SO₂ emission density and total industrial SO₂ emission. The results for SO₂ emission density are shown in table 5.1 and those for total emission are in table 5.2. The only difference in estimation functions used in table 5.1 from those used in table 5.2 is the additional inclusion of the population density terms in the former, a mathematical arrangement already explained in chapter 2.

Let's first look at the results for the emission density. In all the columns, the inclusion of trade intensity variables in estimation does not affect the good coherence of the estimated coefficients for the 3 structural determinants of emission, the scale, technique and composition effects with respect to those obtained in EKC structural model estimation in chapter 3. This reveals good stability of roles of the three effects in emission determination. Scale effect keeps its around-1 positive coefficient. While the capita-labour abundance ratio, as an approximating measure of composition effect, continues to have the counter-assumption but significant negative coefficients.

¹ This comparison is reported in the annex of this chapter. As we expect, the inclusion of the relative terms of K/L and income does not change the principal estimation results.

Table 5.1 ACT (1998) structural model: trade-environment nexus request (dependant variable: industrial SO₂ emission density, 29 provinces, 1992-2003)

	Model (1)		Model (2)		Model (3)		Model (4)	
	FE	AB	FE	AB	FE	AB	FE	AB
GDPPC (1/1000)	-0.165 (1.32)	-0.460 (1.80)	-0.554 (3.03)***	-0.916 (2.93)***	-0.491 (2.49)**	-0.598 (1.94)*	-0.480 (2.85)***	-0.611 (1.98)**
City×GDPPC	2.308 (2.68)***	3.785 (2.39)**	2.482 (2.49)**	3.893 (1.85)*				
City×GDPPC²	-0.136 (2.72)***	-0.201 (2.23)**	-0.137 (2.30)**	-0.196 (1.53) ^o				
K.L (1/10000)	-0.143 (6.24)***	-0.148 (1.88)*	-0.094 (3.15)***	-0.089 (1.12)	-0.087 (2.66)***	-0.046 (0.52)	-0.084 (3.04)***	-0.035 (0.40)
Scale	1.391 (3.67)***	1.995 (2.48)**	1.325 (3.22)***	2.024 (3.73)***	1.021 (2.75)***	1.301 (6.41)***	1.004 (3.02)***	1.308 (6.33)***
Open	0.003 (0.24)	0.006 (0.44)	-0.012 (0.77)	-0.016 (0.70)	-0.035 (1.86)*	-0.066 (2.13)**	-0.035 (1.89)*	-0.067 (2.14)**
Open×K/L			-0.003 (1.47)	-0.003 (1.47)	-0.0016 (0.80)	-0.00095 (0.72)	-0.0014 (1.92)*	-0.00094 (0.83)
Open×(K/L)²			0.000013 (0.23)	0.000036 (0.53)	8.94×10 ⁻⁶ (0.14)	4.32×10 ⁻⁶ (0.13)		
Open×GDPPC			0.007 (1.36)	0.008 (0.71)	0.016 (3.15)***	0.022 (2.68)***	0.016 (3.18)***	0.022 (2.80)***
Open×GDPPC²			-0.0002 (0.35)	-0.0002 (0.39)	-0.001 (2.22)**	-0.001 (3.53)***	-0.001 (2.19)**	-0.001 (3.72)***
Popden	-0.034 (5.53)***	-0.046 (8.37)***	-0.034 (4.88)***	-0.045 (12.03)***	-0.033 (4.38)***	-0.039 (14.50)***	-0.033 (4.66)***	-0.039 (15.75)***
trend	0.207 (5.71)***	0.300 (3.50)***	0.261 (5.08)***	0.366 (4.26)***	0.228 (4.26)***	0.215 (2.80)***	0.224 (5.56)***	0.214 (2.69)***
SO₂den_{t-1}		-0.209 (3.43)***		-0.187 (3.94)***		-0.095 (1.11)		-0.095 (1.12)
R-squared	0.6160		0.6442		0.6147		0.6146	
F test	26.82		24.44		23.85		25.18	
AR(1)	2.0730	-1.60 (0.1091)	2.1947	-1.56 (0.1199)	2.1635	-1.56 (0.1180)	2.1594	-1.56 (0.1179)
AR(2)		0.45 (0.6488)		0.63 (0.3271)		0.35 (0.7245)		0.35 (0.7271)
Breuch-pagan	111.86 (0.000)		159.92 (0.000)		158.65 (0.000)		190.62 (0.000)	
Hausman	1445.61 (0.000)		1141.57 (0.000)		802.06 (0.000)		888.81 (0.000)	
Sagan		18.91 (1.000)		14.08 (1.000)		16.47 (1.000)		16.31 (1.000)

Note: Arellano and Bond (1991) dynamic GMM estimation method is not used in these table due to their significant incapability in removing the serial correlation between the time serials of the same group.

Table 5.2 ACT (1998) structural model: trade-environment nexus request (dependant variable: total industrial SO2 emission, 29 provinces, 1992-2003)

	Model (1)		Model (2)		Model (3)		Model (4)		Model (5)	
	RE	FE, AD(1,0)	RE	FE, AD(1,0)	RE	FE, AD(1,0)	RE	FE, AD(1,0)	RE	FE, AD(1,0)
GDPPC (1/1000)	183.588 (2.49)**	229.828 (1.95)*	184.733 (2.44)**	274.854 (2.47)**	-76.980 (4.27)***	-54.161 (2.19)**	-76.798 (4.27)***	-61.667 (2.53)**	-36.165 (3.08)***	-39.383 (3.49)***
GDPPC² (1/1000)²	-37.061 (3.45)***	-38.933 (2.77)***	-37.165 (3.26)***	-44.656 (3.44)***						
GDPPC³ (1/1000)³	1.862 (3.25)***	1.986 (3.08)***	1.771 (2.83)***	2.154 (3.65)***						
City×GDPPC	-149.057 (2.39)**	-165.956 (1.68)*	-158.326 (2.52)**	-221.906 (2.04)**	44.242 (2.98)***	21.015 (1.04)	44.132 (2.98)***	26.967 (1.34)		
City×GDPPC²	34.517 (3.46)***	34.059 (2.55)**	34.389 (3.44)***	38.683 (2.93)***						
City×GDPPC³	-1.845 (3.39)***	-1.887 (3.01)***	-1.724 (3.12)***	-1.947 (3.33)***						
K.L (1/10000)	-6.370 (1.66)*	-3.222 (0.84)	-4.925 (1.07)	1.301 (0.30)	-7.721 (1.69)*	-4.374 (1.11)	-7.489 (1.71)*	-5.094 (1.48)	-11.127 (2.62)***	-6.795 (1.72)*
Scale	2.156 (6.36)***	1.120 (2.34)**	2.087 (5.80)***	0.928 (2.00)**	2.044 (5.61)***	1.007 (1.87)*	2.040 (5.63)***	1.167 (2.18)**	1.262 (4.69)***	0.805 (2.48)**
Open	-0.801 (0.96)	-0.472 (0.92)	-1.609 (0.95)	-3.263 (2.47)**	-0.511 (0.42)	-1.123 (1.27)	-0.584 (0.50)	-0.888 (0.98)	-1.074 (0.92)	-1.020 (1.00)
Open×K/L			-0.131 (0.93)	-0.031 (0.39)	-0.124 (0.91)	-0.063 (0.60)	-0.104 (1.24)	-0.125 (1.95)*	-0.021 (0.27)	-0.085 (1.57) ^o
Open×(K/L)²			0.001 (0.35)	-0.001 (0.53)	0.001 (0.19)	-0.001 (0.50)				
Open×GDPPC			0.428 (0.91)	0.743 (2.11)**	0.245 (1.14)	0.386 (2.07)**	0.246 (1.14)	0.431 (2.37)**	0.191 (0.89)	0.370 (1.97)*
Open×GDPPC²			-0.015 (0.51)	-0.032 (1.60) ^o	-0.010 (1.09)	-0.013 (2.18)**	-0.010 (1.12)	-0.014 (2.36)**	-0.004 (0.50)	-0.010 (1.39)
trend	1.157 (0.15)	-0.831 (0.07)	0.731 (0.09)	-7.298 (0.63)	23.924 (5.24)***	24.587 (4.68)***	23.791 (5.32)***	26.162 (5.14)***	19.560 (4.62)***	23.745 (5.59)***
so2_{t-1}		0.239 (2.45)**		0.318 (4.02)***		0.220 (2.45)**		0.138 (1.58)		0.105 (1.13)
Constant	226.271 (2.10)**	8.649 (0.05)	231.180 (2.17)**	-59.524 (0.35)	556.442 (9.74)***	408.893 (5.47)***	555.921 (9.71)***	452.017 (6.19)***	537.461 (8.94)***	454.552 (6.53)***
R-squared	0.5117	0.4217	0.4797	0.4607	0.4605	0.4004	0.4612	0.3905	0.3865	0.3783
F test		11.69		11.20		13.34		12.32		12.15
AR(1)	1.3307	1.2527	1.3500	1.3395	1.3375	1.2364	1.3375	1.2108	1.3080	1.1947
Breuch-pagan		983.99 (0.000)		885.21 (0.000)		871.80 (0.000)		894.56 (0.000)		1070.78 (0.000)
Hausman		77.25 (0.000)		132.36 (0.000)		226.63 (0.000)		214.31 (0.000)		58.51 (0.000)

Following table 3.2 and 3.3, we keep using spline model for the technique effect in estimation. Although the spline structure still distinguishes the income-pollution relationship divergences between provinces and cities even after all the five trade-related terms are included, the significance of the coefficients for the two multiplicative terms between per capita GDP and city dummy obviously decrease when the trade-related terms are included. At the same time, the five trade-related terms show a collective significance of a F-test value of 4.7 for fixed effect (FE) estimation and 10.91 for Arellano-Bond (AB) dynamic GMM estimation. Is there any possibility that the multi-collinearity between the trade-related terms and the city-specific technique effect reduces the coefficients significance for the trade-related terms? To test this possibility, in model (3), we remove spline structure for the technique effect in estimation. The result shows that, with total explicative power of the model keeps unchanged, all the trade-relative terms become significant once the splien structure for the technique effect is removed from the estimation function. We regard this as an implication that trade characteristic of the provincial economy helps to accomplish the structural decomposition of EKC that we discussed in chapter 3. After the inclusion of the five trade-related terms, we finally succeed in obtaining a general negative coefficient for per capita GDP, which measures the pure technique effect.

Concerning the role of trade in industrial SO₂ emission. Though staying insignificant in model (1), the trade intensity terms, once collectively included with the other trade-related multiplicative terms, seems to have a significant pollution reduction impact. This finding actually corresponds to the findings of ACT (2001) and Cole and Elliott (2003) based on international experiences. The estimation results for the interactive terms between trade and comparative advantage characteristics also confirms the theoretical expectation of ACT (2001) and our graphical illustration, with the exception of the non-significant trade-(K/L)² multiplicative term. For a province, if its K/L ratio stays lower than 890 000 Yuan/person according to FE estimation or 41667 Yuan/person in Arellano-Bond estimator, it will find pollution falling in response to trade liberalization. While for a province whose per capita GDP is lower than 8000 Yuan according to fixed effect estimation or 11 000 Yuan according to GMM dynamic estimation, an increase in trade openness will be accompanied by an increase in its industrial SO₂ emission density, since their comparative advantage in dirty production deepens.

Figure 5.6 reports the combination situation of the K/L ratio and per capital GDP for the 29 Chinese provinces in year 2003. The horizontal and vertical lines denoted as FE and AB delimitate the K/L-per capita GDP diagram into four zones, which represents the four possible

combination situations between the factor-endowment comparative advantage and pollution haven motive. Clearly, all the 29 Chinese provinces actually possess obvious comparative advantages in less polluting labor-intensive industries.¹ For most of them, their relatively low income level also endows them some advantages in some polluting industries. Only the three cities according to the Arellano-Bond estimation or the eight richest provinces and cities (Shanghai, Beijing, Tianjin, Guangdong, Zhejiang, Jiangsu, Fujian, Shandong and Liaoning) according to FE estimation has surpassed the phases of the force-contrast between the factor-based and pollution-haven-based comparative advantage.

Although the coefficients are relatively less significant, the estimation results for the total industrial SO₂ emission reported in table 5.2 are very coherent to those for emission density. As in the emission density case, the inclusion of trade intensity does not affect the stability of the coefficients for scale, composition and technique effect. The simple trade intensity term is also proven to be an emission-reducing factor for total industrial SO₂ emission. Moreover, from the estimation results, we also observe similar force-contrast patterns between the factor-endowment comparative advantage and pollution haven hypothesis in different provinces. The high coherence between the results obtained from estimation based on different pollution measurements actually reveals the good stability of the ACT (2001) structural model.

¹ This is also the reason why we fail to obtain a significant coefficient for the interacted trade-(K/L)² term.

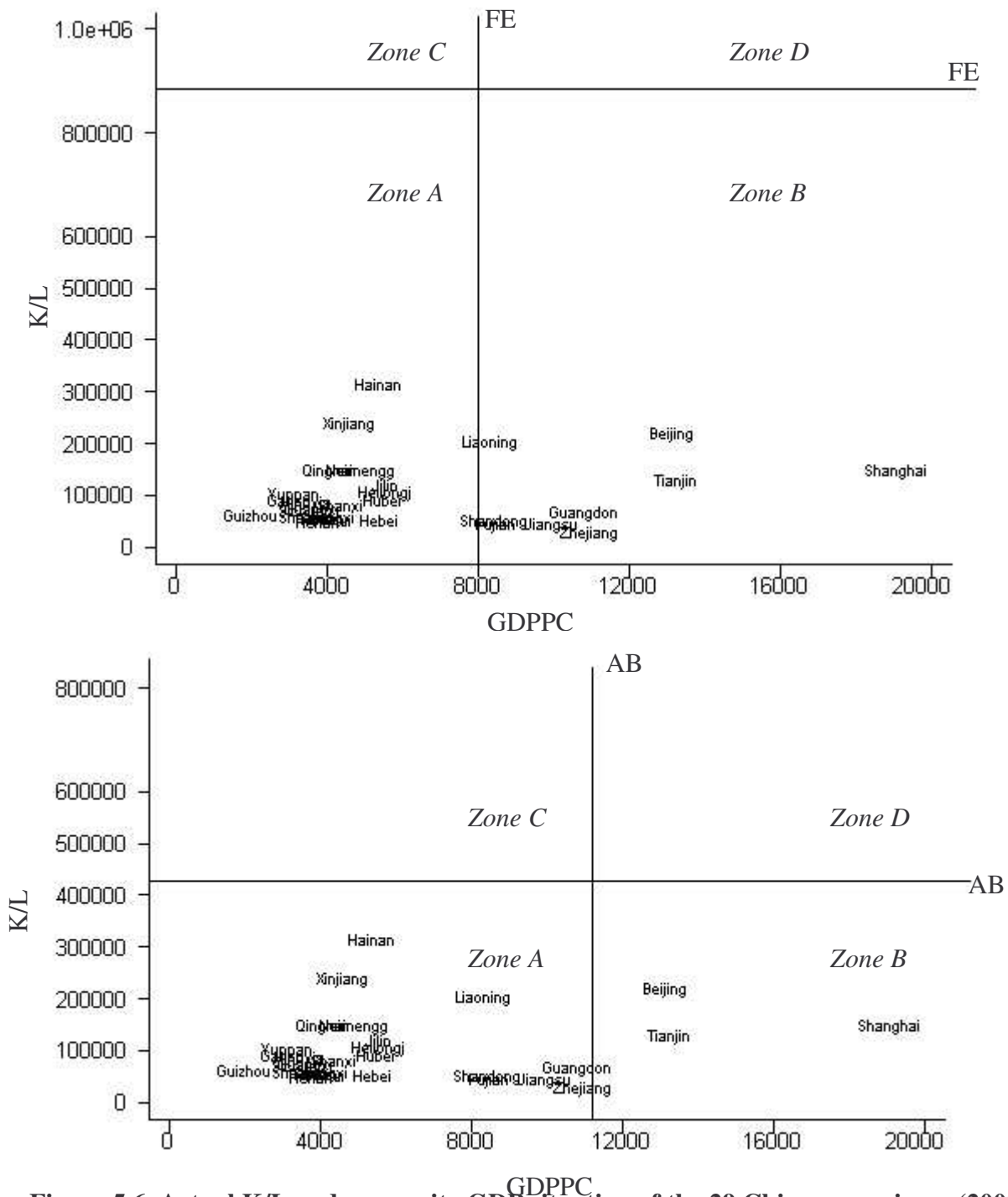

Figure 5.6. Actual K/L and per capita GDP situation of the 29 Chinese provinces (2003)

Zone A: Pollution haven comparative advantage cancelled out by factor-endowment comparative advantage in cleaner industry
 Zone B: Factor-endowment comparative advantages in cleaner industry reinforced by pollution haven comparative disadvantage
 Zone C: Pollution haven comparative advantage reinforced by factor-endowment comparative advantage in polluting industry
 Zone D: Factor-endowment comparative advantages in polluting industry cancelled out by pollution haven comparative disadvantage

Table 5.3. Scale, composition, technique and trade elasticity

	Industrial SO ₂ emission density							
	Fixed effect				Arellano-Bond GMM dynamic fixed effect			
	Scale	Composition	Technique	Trade	Scale	Composition	Technique	Trade
Elasticity	0.233	-0.137	-0.146	0.049	0.470	-0.107	-0.262	0.002
Stand. Err.	0.000***	-0.001***	-0.001***	-0.001***	0.030**	0.149	0.141	0.054*
Max	0.233	-0.138	-0.147	0.048	0.499	0.039	-0.124	0.055
Min	0.232	-0.136	-0.145	0.049	0.441	-0.252	-0.400	-0.051

	Total industrial SO ₂ emission							
	Fixed effect				Random effect			
	Scale	Composition	Technique	Trade	Scale	Composition	Technique	Trade
Elasticity	0.002	-0.113	-0.255	-0.010	0.003	-0.146	-0.262	-0.027
Stand. Err.	0.001***	0.075*	0.078*	0.039**	0.001***	0.092*	0.080*	0.053*
Max	0.003	-0.040	-0.178	0.028	0.005	-0.055	-0.183	0.025
Min	0.001	-0.187	-0.332	-0.049	0.002	-0.236	-0.340	-0.080

▪ *** indicates significance at 1% confidence level. ** indicates significance at 5% confidence level. * indicates significance at 10% confidence level.

▪ Elasticities are evaluated at the average of the independent variables.

Since we use the interacted terms between different emission determinants in our estimation, to understand the actual role of each individual factor in emission determination, as ACT (2001) and Cole and Elliott (2003), we need to calculate the elasticity of each emission determinant factor. The elasticity calculation is based on the Delta method and the estimation result of Model (5) in Table 5.1 and 5.2.¹ We choose the sample average value for each emission determinant to carry out the calculation. For the limit of space, in this chapter, we only report the national-level average scale, composition, technique and trade elasticity for both industrial SO₂ emission density and total emission. The magnitude of the elasticities seems reasonable. For the same emission determinant, the difference in estimation method does not affect the direction of its elasticity, although the fixed effect estimator supplies obviously more significant elasticity results.

For both the emission density and total emission cases, we find positive and significant scale effect elasticities, but it seems the scale effect plays a more significant role in emission density than in total emission. Without exception, we obtain negative composition elasticities for both emission indicators, this corresponds to the findings that the capital/labor ratio increase in China should be regarded as a pollution-reducing factor. The magnitude of the negative elasticities for the technique effect in both emission cases are particularly large, which implies the rapid technical progress in pollution abatement activities in China's industrial sector. The only divergence in the elasticity results between emission density and total emission cases happens in the aspect of trade intensity. Although trade intensity seems to be a negative factor for emission density variation, we find positive trade elasticities for total

¹ The calculation of the elasticities is based on Delta method (Greene, 1997, pp280).

industrial SO₂ emission. However, the value of these trade elasticities, similar to the findings in ACT (2001), “no matter positive or negative”, are all very close to zero. This actually indicates the weak influence of trade in emission determination.

We present in the four panels in Figure 5.7 the plots of the provincial-specific trade elasticity against income or capital/labor abundance ratio using the FE estimation results of model (5) in table 5.2 and 5.3. Although it seems more provinces possess positive trade intensity elasticity, corresponding to the elasticity calculated at national average level, for most provinces, their trade elasticity distribution is around zero. As provinces are different in their comparative advantage characteristics, we suggest that trade liberalization has not the same relationship with industrial emission in all the provinces. The sign of the relationship should depend on a province's factor-endowment and technical characteristics. According to ACT (2001), under trade liberalization, the simple pollution haven hypothesis suggests the poor provinces to have more possibility to specialize in dirty goods and richer provinces, on contrary, to have more possibility to specialize in clean goods. Therefore, given the same level of trade intensity increase, we should anticipate higher trade elasticity for the poorer provinces. However, the relationships shown in the two income-elasticity panels are in fact, definitely nonnegative—it is actually high-income provinces that have a comparative advantage in polluting industries. This contrary-to-intuition result is also found in the empirical analysis of ACT (2001).

The two lower-panels in Figure 5.7 show the potential relationship between trade intensity elasticity and capital/labor abundance ratio. Although traditional comparative advantage theory suggests the provinces having relatively larger capital stock to specialize in capital-intensive sectors, the obvious negative relationship between trade elasticity and capital/labor abundance ratio found in China's experience reveals for another time that higher capital/labor abundance ratio is actually related to cleaner production.

This elasticity analysis is actually based on an “all else equal” assumption. However, as the estimation function includes the interacted terms between some determinants, for each province, the sign and magnitude of its elasticity for one emission determinant at a given time also depends on the value of the other emission determinants that appear collectively in the related interacted terms.

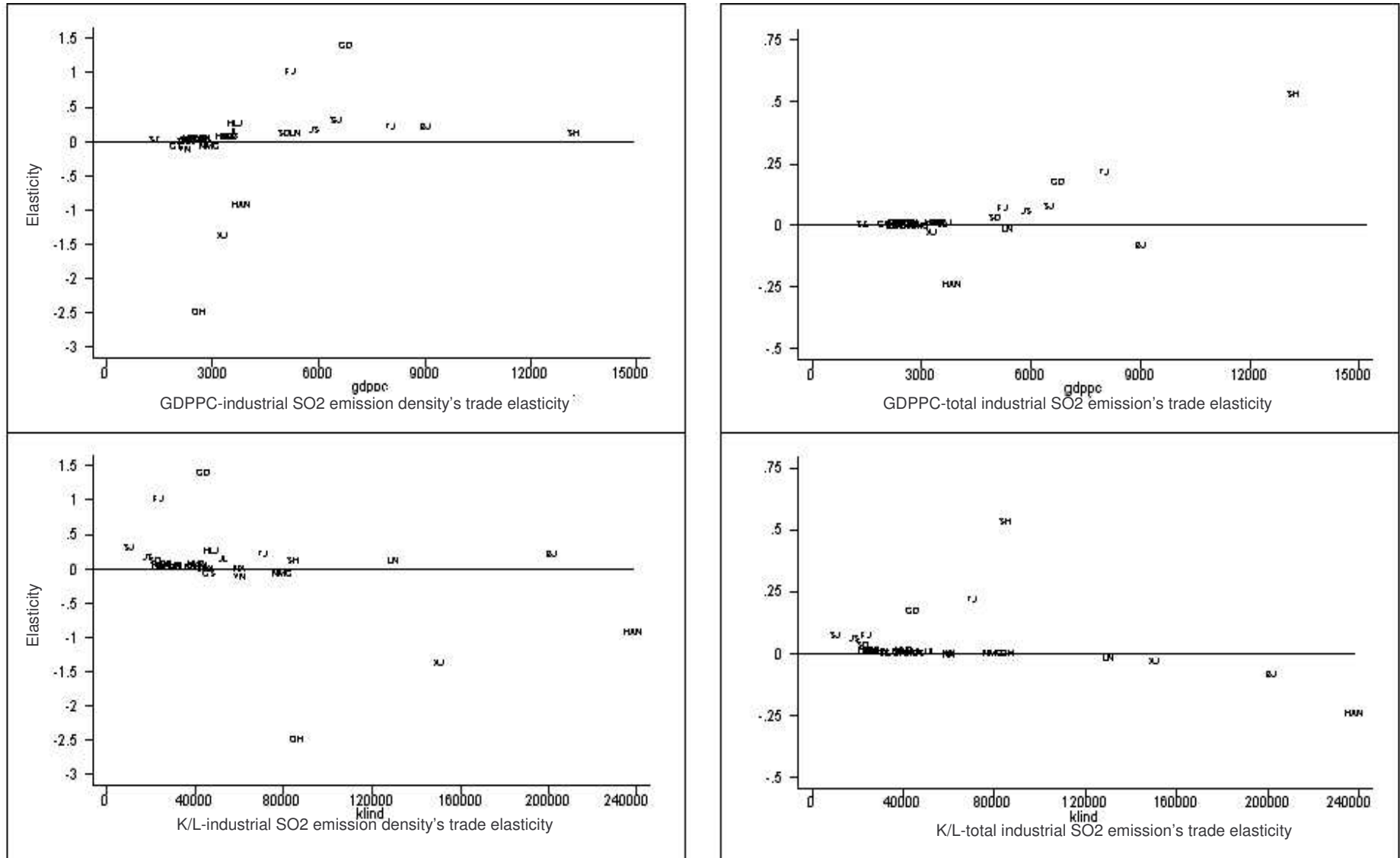

Figure 5.7. Provincial-specific trade elasticities (model (5), table 5.2 and 5.3, Fixed effect results)

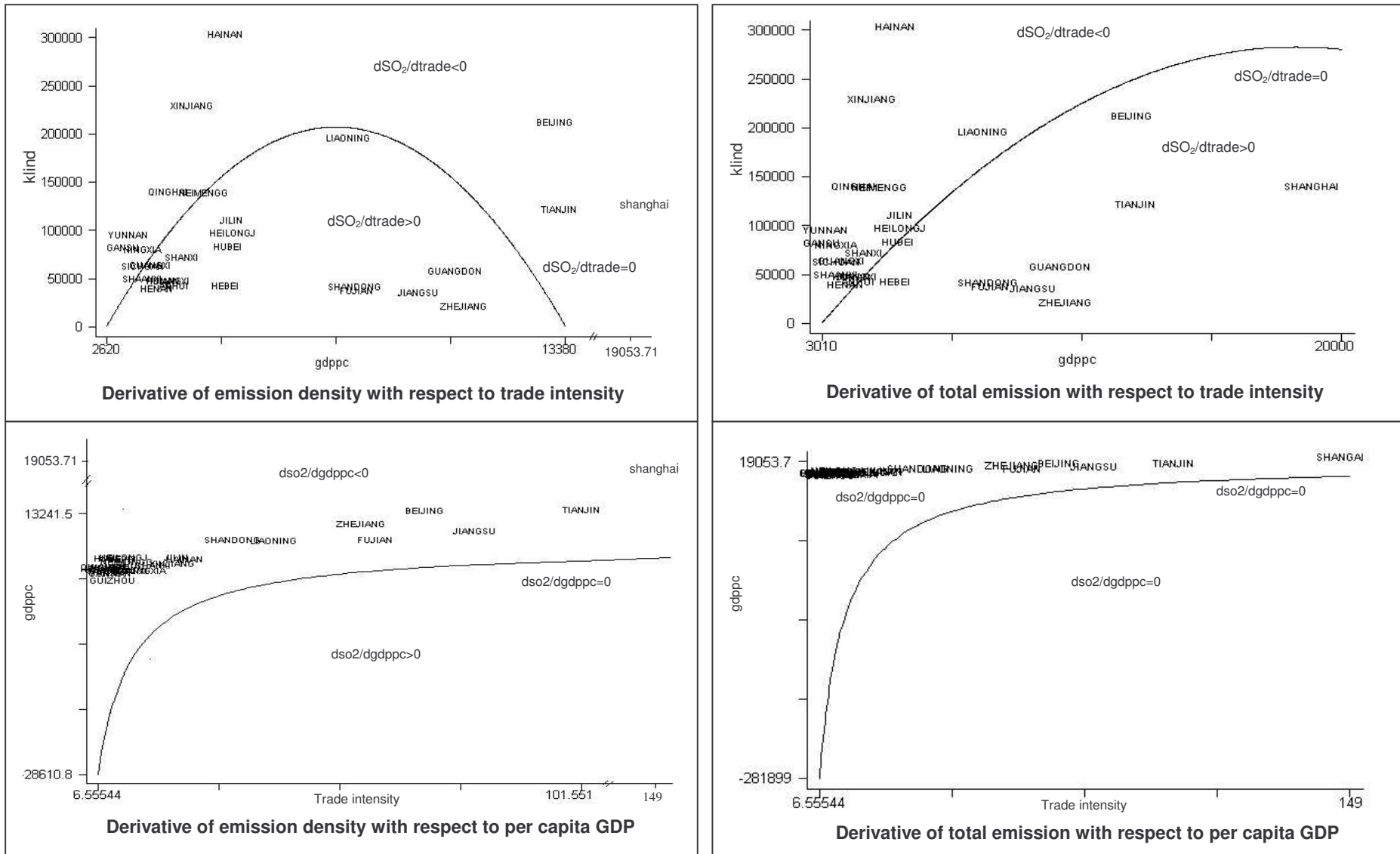

Figure 5.8. Evolution of the relationship between industrial SO₂ emission and its determinants

To further clarify the complex relationship between industrial SO₂ emission and its economic determinants, we plot the derivative of industrial SO₂ emission with respect to the each emission determinants that are involved in the interacted terms against their respective interactive determinant in Figure 5.8. All the derivatives are calculated from the fixed effect estimation result of the Model (5) in table 5.2 and 5.3. The curve indicated in each panel of figure 5.8 depicts all the possible combinations between the two interacted determinants that assure the derivative of the emission indicator to be zero. With the aid of this curve, the diagram can be divided into two parts, in one part the increase of the interested determinant will lead emission to increase and in the other part, the increase of the interested determinant will lead emission to decrease. By denoting the actual location of all the 29 provinces in 2003 in these diagrams, we will be able to get a quick idea about the actual role played by each emission determinant in each province given its current economic characteristics.

The two panels on the left-hand side of Figure 5.8 belong to the case of industrial SO₂ emission density and the two on the right depict the evolution of the derivative of total industrial SO₂ emission with respect to the interested determinants. As the estimation results for both emission indicators suggest the increase in capital/labor abundance ratio will always lead emission indicators to decrease, no matter what will be the value of trade intensity, we will not illustrate the evolution of emission derivative with respect capital/labor abundance ratio in figure 5.8.

The inverted U curves depicted in the two upper panels indicate the combination condition between per capita GDP and capital/labour abundance ratio that assure the derivative of emission density with respect to trade intensity to be equal to zero, that means $d(\text{SO}_2 \text{ indicator})/d(\text{trade intensity})=0$. Obviously, the inverted U dividing curve found for industrial SO₂ emission density (left) is relatively smaller than that for total emission (right), which actually implies that to attain the zone where income growth and openness development collectively reduce the emission problem should be a harder task for total emission case. Comparing the actual location of the 29 provinces with the dividing curve, we can see that over 2/3 of the provinces still face a positive emission derivative with respect to trade intensity given their current per capita GDP and capital/labour ratio combination. For these provinces, to realize environment-friendly openness process (that means to stay in outside of the inverted U curve), their economic growth needs to be accompanied by a faster capital accumulation. This can be explained by the following two reasons. First, although China is still a low-income country, her extremely rich labour-forces endowment is still a dominating factor for its comparative advantage. Therefore under trade liberalisation process,

the labour-intensive export-oriented industries will expand more rapidly than the pollution-intensive industries. Second, as our estimation results repeatedly assign negative coefficient to capital/labour abundance ratio, given China's relatively low capital endowment, we suspect the K/L ratio to be more like a technical indicator than an industrial composition indicator. Given these two reasons, we believe that under trade liberalization process, capital accumulation will be more likely to be devoted to technology updating in labour-intensive export-oriented sectors than to be used to foster expansion of the pollution-intensive sectors.

The two lower panels of figure 5.8 illustrate the evolution of the emission derivative with respect to per capita GDP given the different combination of per capita GDP and trade intensity. Here the dividing curves assuring the derivative of emission with respect to per capita GDP to be zero come out to be an upward border for both emission indicators. This actually indicates that, for Chinese provinces, to keep an environment-friendly economic growth process, they actually need to assure certain growth rate in their trade intensity. Given China's rapid openness process during the last decades, we can see that all the provinces have actually meet this requirement, so that for all of the provinces, at least in year 2003, their economic growth is already accompanied by emission reduction result.

5.5. Conclusion

In this chapter, we firstly use the production frontier and necessary decomposition analyses to graphically illustrate the theoretical idea of ACT (2001), which suppose trade's impact on pollution for an economy actually depends on the interaction between its comparative advantage based on actual factor-endowment and that based on its relative income level with respect its trade-partner. As Cole and Elliott (2003), we finally agree that the theoretical analysis of ACT (2001) can actually be regarded as an explanation for the trade's impact on emission via composition effect.

Based the same estimation function of ACT (2001), we study the role of international trade intensity $((X+M)/GDP)$ in determination of industrial SO_2 emission (both density and total volume) in China using the Chinese provincial level panel data during 1992-2003. Our principal results confirm the theoretical analysis of ACT (2001). We find that for the role of trade, besides a significantly negative direct impact, its indirect impacts on emission also go through the composition effect. This indirect impact actually depends on the current capital/labour abundance ratio and the actual income level of a province. Although we traced some supportive evidence for the "pollution haven" hypothesis, given China's extremely rich endowment in labor force, it seems trade liberalisation actually plays an environment-

friendly role in China (via composition effect), since under trade liberalization, China is more likely to specialize in less-polluting labor intensive industries' production. However, Coherent to the conclusion of ACT (1998, 2001) and Cole and Elliott (2003), the relatively small values of trade elasticity calculated in this paper also reveal that international trade only plays a relatively small role in the determination of industrial SO₂ emission.

As ACT (2001) estimation function includes the interacted terms between some independent determinants, for each province, the sign and magnitude of the relationship between one emission determinant and industrial SO₂ emission at a given time also depends on the value of the other emission determinants that appear collectively in the interacted terms. Therefore in the last step of this section, we illustrate graphically how the relationship between emission and one emission determinant (defined as derivative of emission with respect to the interested emission determinant) is conditional on the value of the other emission determinants. We find that for most provinces, a negative trade's impact on emission is actually due to its relatively low capital/labour abundance ratio with respect to its actual income level. To change this situation, for many provinces, their economic growth should be accompanied by faster capital accumulation, which can then be used to update the production technology and therefore reduce the pollution. We equally find that a higher economic growth rate should also be accompanied by higher trade intensity. This confirm, for another time, the environment-friendly role of international trade in China via composition effect—higher trade intensity can relax the dependency of China's economic growth on the development of its domestic heavy industries, therefore avoid the pollution problem which is traditionally related to a standard economic development process.

Appendix 5.1. The structural model estimation—the environmental role of trade (the relative K/L and relative per capita income involved in interactive terms with trade intensity)

Table A.5.1.1. ACT (1998) structural model: trade-environment nexus request
(dependant variable: industrial SO₂ emission density, independent variables: relative K/L and relative per capita income are introduced into the interactive terms with trade intensity)

	Model (1)	Model (2)	Model (3)	Model (4)
	FE	FE	FE	FE
GDPPC (1/1000)	-0.165 (1.32)	-0.438 (2.64)***	-0.429 (2.36)**	-0.431 (2.53)**
City×GDPPC	2.308 (2.68)***	2.764 (2.57)**		
City×GDPPC ²	-0.136 (2.72)***	-0.160 (2.41)**		
K.L (1/10000)	-0.143 (6.24)***	-0.114 (4.68)***	-0.096 (3.31)***	-0.097 (3.72)***
Scale	1.391 (3.67)***	1.268 (2.98)***	1.079 (2.59)***	1.084 (2.73)***
Open	0.003 (0.24)	-0.002 (0.07)	-0.051 (1.82)*	-0.051 (1.87)*
Open×R.K/L		-0.060 (0.68)	-0.037 (0.40)	-0.041 (1.50)
Open×(R.K/L) ²		-0.025 (0.25)	-0.006 (0.05)	
Open×R.GDPPC		0.013 (0.24)	0.125 (2.63)***	0.126 (2.62)***
Open×R.GDPPC ²		0.009 (0.33)	-0.041 (1.83)*	-0.041 (1.83)*
Trend	0.207 (5.71)***	0.246 (5.43)***	0.213 (4.50)***	0.213 (5.35)***
Popden	-0.034 (5.53)***	-0.034 (5.30)***	-0.034 (4.96)***	-0.034 (5.10)***
R² adjusted	0.62	0.64	0.61	0.61
F test	26.82	24.28	23.13	24.43
Trade F test		4.45		
AR(1)	2.07	2.19	2.13	2.13
Breuch-pagan	111.86 (0.000)	112.95 (0.000)	96.91 (0.000)	129.97 (0.000)
Hausman	1441.16 (0.000)	51.88 (0.000)	1214.05 (0.000)	1396.01 (0.000)
Observations	348	348	348	348
Groups	29	29	29	29

We do not report AB results due to the unsatisfactory efficiency of its instrumentation step.

R.KL means the relative capital abundance ratio with respect to world average level and R.GDPPC means the relative per capita GDP with respect to world average level. The data about the world average K/L and GDPPC of each year is compiled by author from World Development Indicator Following are their statistic descriptions.

Variable	Obs	Mean	Std. Dev.	Min	Max
rk lind	348	0.182	0.164	0.018	0.786
rgd	348	0.630	0.425	0.154	2.622

Table A.5.1.2. ACT (1998) structural model: trade-environment nexus request*(Dependant variable: total industrial SO₂ emission, Independent variables: relative K/L and relative per capita income are introduced into the interactive terms with trade intensity)*

	Model (1)		Model (2)		Model (3)		Model (4)		Model (5)	
	RE	FE, AD(1,0)	RE	FE, AD(1,0)	RE	FE, AD(1,0)	RE	FE, AD(1,0)	RE	FE, AD(1,0)
GDPPC (1/1000)	239.442 (2.97)***	254.357 (1.97)**	236.439 (2.92)***	245.518 (2.11)**	-13.273 (0.87)	-13.275 (0.83)	-21.246 (1.59)	-20.628 (1.63) ^o	-18.113 (1.37)	-22.348 (1.78)*
GDPPC² (1/1000)²	-36.158 (3.14)***	-39.088 (2.44)**	-32.504 (2.71)***	-33.935 (2.36)**						
GDPPC³ (1/1000)³	1.930 (3.18)***	2.103 (2.80)***	1.451 (2.23)**	1.578 (2.35)**						
CityxGDPPC	-189.606 (2.52)**	-176.597 (1.69) ^o	-227.760 (2.92)***	-302.642 (2.78)***	-12.117 (1.06)	-13.911 (1.18)				
CityxGDPPC²	34.112 (3.03)***	33.843 (2.27)**	36.178 (3.18)***	42.736 (3.01)***						
CityxGDPPC³	-1.971 (3.32)***	-2.019 (2.79)***	-1.833 (3.08)***	-2.044 (3.19)***						
K.L (1/10000)	-15.731 (4.26)***	-8.764 (2.05)**	-16.405 (4.03)***	-4.522 (0.86)	-20.314 (5.16)***	-14.643 (3.22)***	-21.078 (5.48)***	-14.593 (3.53)***	-19.459 (5.26)***	-16.237 (4.59)***
Scale	19.367 (1.32)	11.445 (1.15)	13.970 (0.88)	2.992 (0.26)	5.470 (0.35)	-11.970 (0.94)	4.821 (0.30)	-14.959 (1.17)	-1.432 (0.09)	-13.663 (1.20)
Open	-0.660 (0.72)	-0.577 (0.90)	0.347 (0.15)	0.404 (0.19)	-1.462 (0.85)	-1.282 (0.98)	-1.373 (0.80)	-1.608 (1.25)	-1.886 (1.12)	-1.822 (1.28)
OpenxR.K/L			-10.109 (1.52)	-2.474 (0.64)	-9.848 (1.52)	-4.835 (1.05)	-11.527 (1.84)*	-3.704 (0.82)	-3.059 (1.10)	-2.451 (1.20)
Openx(R.K/L)²			9.853 (1.18)	0.359 (0.08)	11.222 (1.36)	4.833 (0.88)	12.322 (1.51)	3.799 (0.65)		
OpenxR.GDPPC			-1.163 (0.27)	-2.097 (0.49)	3.877 (1.66)	2.270 (1.02)	4.462 (1.97)**	2.725 (1.36)	4.079 (1.80)*	3.431 (1.76)*
OpenxR.GDPPC²			1.909 (0.99)	1.959 (1.03)	-0.812 (0.89)	-0.015 (0.02)	-1.025 (1.15)	-0.205 (0.29)	-0.902 (1.02)	-0.424 (0.61)
trend	2.743 (0.32)	1.974 (0.15)	1.985 (0.23)	-2.055 (0.16)	25.595 (5.32)***	26.739 (4.75)***	27.939 (6.54)***	28.368 (6.04)***	26.374 (6.35)***	29.728 (6.71)***
so2_{t-1}		0.186 (2.29)**		0.303 (3.45)***		0.078 (1.07)		0.113 (1.89)*		0.009 (0.18)
Constant	204.999 (1.64) ^o		220.365 (1.74)*		559.272 (7.89)***		568.485 (7.64)***		559.086 (7.64)***	

Table A.5.1.2 (continue). ACT (1998) structural model: trade-environment nexus request

R² adjusted	0.23	0.37	0.22	0.41	0.21	0.35	0.19	0.35	0.19	0.34
F test		8.05		7.85		7.75		7.74		7.87
Trade-related F test			12.30 (0.000)	2.34 (0.04)						
AR (1)		1.17		1.36		1.16		1.18		1.16
Breush-Pagan		1561.19 (0.000)		1383.21 (0.000)		1374.41 (0.000)		1565.77 (0.000)		1556.14 (0.000)
Hausman	1.69 (1.000)		4.92 (1.000)		3.88 (1.000)		1.66 (1.000)		1.76 (1.000)	
Observations	348	319	348	319	348	319	348	319	348	319
Groups	29	29	29	29	29	29	29	29	29	29

R.KL means the relative capital abundance ratio with respect to world average level and R.GDPPC means the relative per capita GDP with respect to world average level. The data about the world average K/L and GDPPC of each year is compiled by author from World Development Indicator (2004).

Chapter 6. Environmental impact of international trade through scale, composition and technique effect: an analysis based on the Divisia decomposition results

The ACT model only reveals the potential environmental role of international trade that is exerted through the composition effect. Various theories indicate other channels through which trade can exert its impacts on environment. Trade can affect production scale. Besides the production scale enlargement effect benefiting directly from the enlarged demand from the world market, some economic growth theories further include the positive externality and technology spillover effect related to trade into production function. (Feder, 1983; de Melo and Robinson, 1990 and Rodrigo and Thorbecke, 1997) Trade can also affect technique effect. Hypothesis of Porter (Porter and Linde, 1995; Xepapadeas and Zeeuw, 1998) believes that in the long run, participating in international trade will encourage developing countries' domestic producers to update and innovate their production technologies.¹ Copeland and Taylor (2003) also indicate the potential endogeneity of all the three emission determinants—the scale, composition and technique effects—with respect to international trade and the necessity to check the trade-environment relationship from a general equilibrium point of view.

Following these considerations, in this section, our investigation in the trade-environment relationship will also go one step further. At the first time, we will continue using graphical illustration to explain how trade liberalization can change the scale and technique effect and how these effects' changes can join the already discussed composition effect change to finally change total emission result. Then, by employing the Divisia index

¹ The international trade's environmental impact via technique effect can be explained from both and supply and demand sides. From the supply side, international trade facilitates the access to advanced technology for the producers in developing countries, and from the demand side, intensified competition from world market also makes technology adoption or improvement necessary measure for domestic producers to keep their world market share.

decomposition results that we have reported in Chapter 4, we will check whether the causality between trade intensity and the emission changes that decomposed into the contribution from scale, composition and technique effects is actually coherent to our suggestions.

6.1. Graphical illustration on the trade's impact on scale and technique effect

The graphical illustration in this section follows the same idea of chapter 5. Therefore, the world is still composed of two regions North and South. Each region consists of many identical countries having the same preference and technologies. Both regions produce two goods x and y , where x is more polluting and more capital-intensive than y .

6.1.1. Including trade-related scale and technique effect changes into graphical illustration

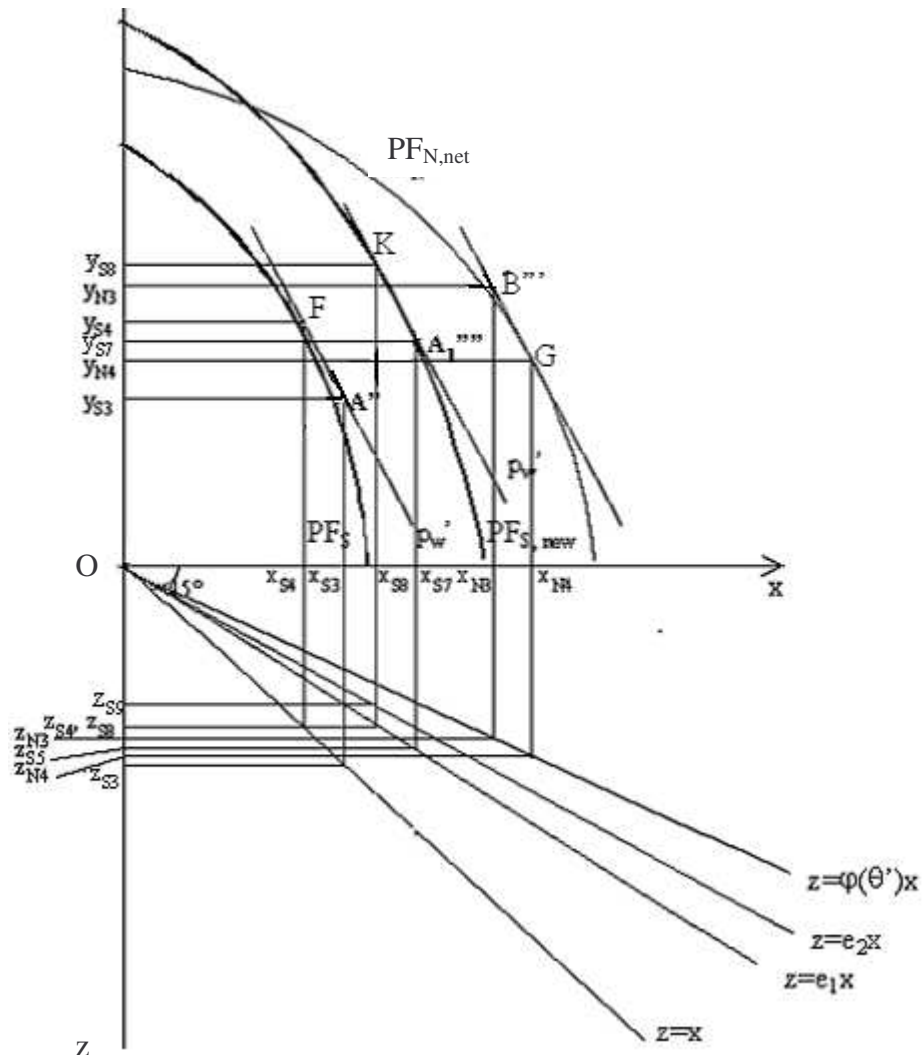

Figure 6.1. Production pattern changes under trade liberalization: Factor-endowment comparative advantage dominates pollution haven comparative advantage; the South benefits from technology progress in both production and pollution abatement activities

Come back to figure 5.4. We still assume the “pollution-haven”-based comparative advantage in the South is not large enough to reverse the factor-endowment comparative advantage; the South will still be an exporter of the cleaner product y . If in addition, we assume international trade can enlarge the South’s production scale owing to the positive spillover effect either in terms of advanced technology or reinforced competition. This can be represented by an outward expansion of the production frontier given the unchanged factor endowment. Therefore, we can obtain a new figure 6.1, in which the new trade-catalyzed production frontier for the South is now presented by $PF_{S,new}$. By supposing the participation in world market competition produces positive spillover effect in an average way on the whole Southern economy, we can depict the $PF_{S,new}$ as an extended curve parallel to PF_S .

What happens under this new circumstance? Given the South’s production frontier to be stretched outwards in a proportional way, we further suppose the income growth due to this productivity increase will also lead the consumption for both goods in the South to increase in a proportional way. As the production pattern in the South is more specialized in y industry, we expect this trade-related positive spillover will in its turn lead the relative price of x in world market to slightly increase. However, given both x and y are normal goods, this relative price increase will generally be very small. To concentrate on the more important pollution changes coming from production side, we will ignore this slight consumption-led price change.¹ So we presume the world market price to still stay at p_w , the North still produces at G and consumes at B'' (c.f. figure 5.4), but the South produces now at K and consumes at A_1''' . As both world price and production patterns in the two regions stay unchanged, the North will continue importing $(y_{N4}-y_{N3})$ of y from the South and exporting $(x_{N4}-x_{N3})$ quantity of x . Consequently, for the South, it will also continue to export $(y_{S6}-y_{S5})$ quantity of y and import $(x_{S6}-x_{S5})$ quantity of x . Here, we have $(y_{S6}-y_{S5})=(y_{S4}-y_{S3})$ and $(x_{S6}-x_{S5})=(x_{S4}-x_{S3})$.

What is the emission result under this new condition? With income growth in the South, we expect public demand for a better environment to be reinforced. At the same time, as the higher output quantity in the South is actually produced from the same quantity of input as before, following the assumption that emission is directly related to input use, we can also expect production efficiency improvement and therefore the reduction of emission intensity in the South. Hence, both the demand (public demand increase) and supply (production efficiency increase) side provide condition for the pollution intensity in the South to decrease. Correspondingly in the lower-panel of figure 6.1, we distinguish a new production-emission

¹ Moreover, based on a small country hypothesis, if the positive spillover effect only happens in some of the Southern country, they will not be capable in changing the world market price, so this simplification assumption also brings some reality to our discussion.

relation $z=e_1x$, where $e_1 < 1$, so we have $z_{S4}=z_{S6}=x_{S4}=e_1x_{S6}$, with $e_1=x_{S4}/x_{S6}$. Furthermore, according to Porter hypothesis, facing the intensified market competition, domestic producers in the South can also have incentive to realize additional technological progress in pollution abatement activities, therefore, we can also expect some supplementary emission intensity reduction, that means, in figure 6.1, $z_{S7}=e_2x_{S6}$, and $0 < e_2 < e_1 < 1$, $z_{S7} < z_{S6}$.

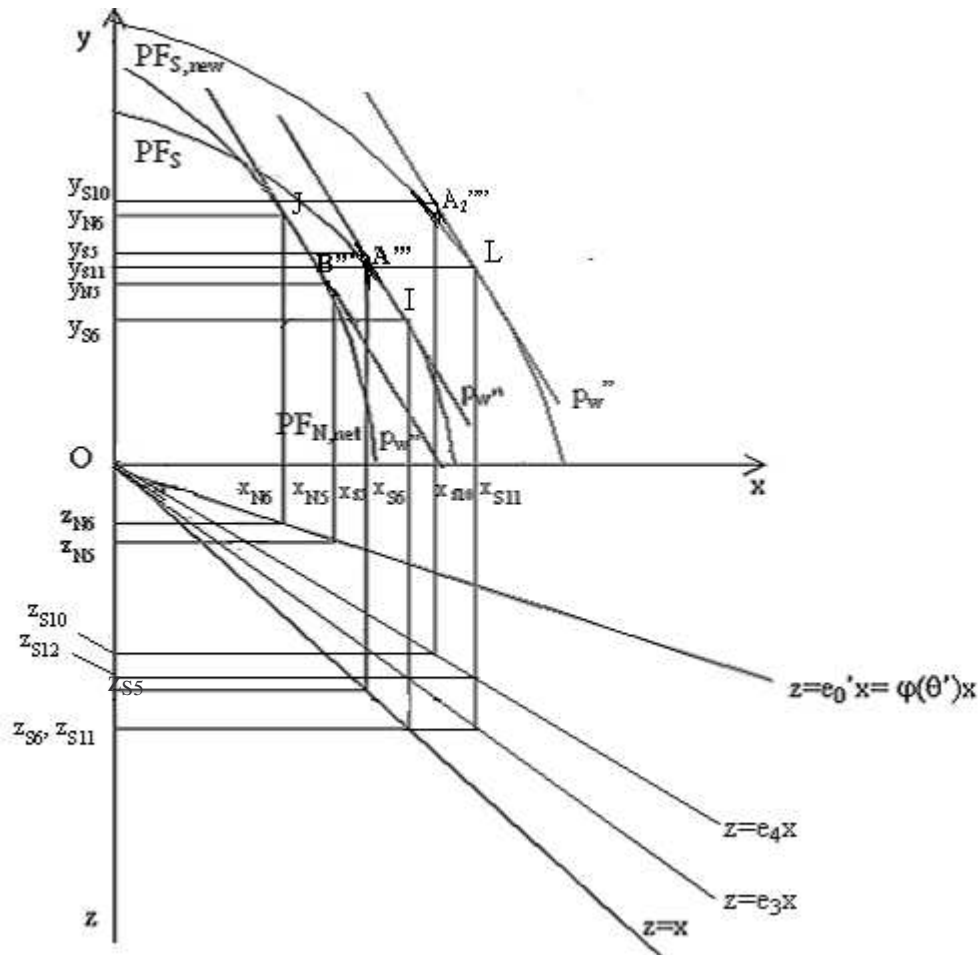

Figure 6.2. Production pattern changes under trade liberalization: Factor-endowment comparative advantage dominated by pollution haven comparative advantages, the South benefiting from technology progress in both production and pollution abatement activities

Parallel to figure 6.1, we illustrate production and consumption patterns' changes and the corresponding pollution evolution for the case where “pollution haven” motive overwhelms factor-endowment comparative advantages in the South in figure 6.2. As the South, in this case, becomes exporter of the polluting goods x , the scale enlargement and technological progress in this economy related trade actually help to reduce the pollution burden discharged from the North and therefore lead total world pollution to reduce. Correspondingly, we can see from figure 6.2 that although the output of x in the South is higher after the technique and scale impact of trade are included, ($x_{S11} > x_{S6}$), since both the

production and pollution abatement efficiency are enhanced, the final pollution situation is also improved. Therefore we can see from figure 6.2 that the final pollution z_{S12} is smaller than that in figure 5.4 (z_{S6}).

Although the graphical illustration helps to explain in a very simple way the impact of international trade on pollution through three different channels, we should still bear in mind the following several points when deriving conclusions from these graphical analyses. Firstly, for simplification reason, we only assume the trade can averagely enlarge the production scale of the Southern economy. However, de Melo and Robinson (1990) indicate the export-oriented sectors may be able to benefit more from the positive spillover effect as the reinforced competition acts more directly on these sectors. Following their reasoning, the $PF_{S,new}$ should show a disproportional outward stretching that give more production scale expansion in y industry. Under this circumstance, the world relative price will change, follows the production, consumption patterns and final pollution results in both countries. But according to experiences from the graphical analysis of this chapter, we believe the price-change-related production and consumption changes are generally small, so this simplification should not affect the capability of our analysis to reflect the reality.

Secondly, for the production-emission relationship, following ACT (2003), we simply suppose emission to be directly related to input use. However, this simple two-factor production model actually neglects all the other sources of emission during the production process, especially for the intermediate inputs such as energy. Although given the necessary technological progress, it is possible for the South to produce more output using the same quantity of capital and labor, capital and labor; it is difficult to believe the employment of the intermediary inputs as energy for one unit of goods can be reduced in the same way. Including the perspective of energy usage into consideration, we expect the emission reduction result can be less than proportional to the production efficiency improvement in labor and capital.

Thirdly, another implication used in graphical analysis is that the consumption of both normal goods x and y to be linearly correlated to income level. However, in reality, the marginal utility obtained from consuming the normal goods is generally decreasing with income and quantity of consumption. Moreover, there is no guarantee for the same marginal utility evolution between x and y as we supposed in the model. Therefore, if these potential marginal utility characteristics are allowed into our analysis, we expect more complicated changes in both consumption and production pattern and world relative price.

6.1.2. Decomposition analyses

The decomposition analyses corresponding to the two trade liberalization cases introduced in section a are illustrated in Figure 6.3 and 6.4.

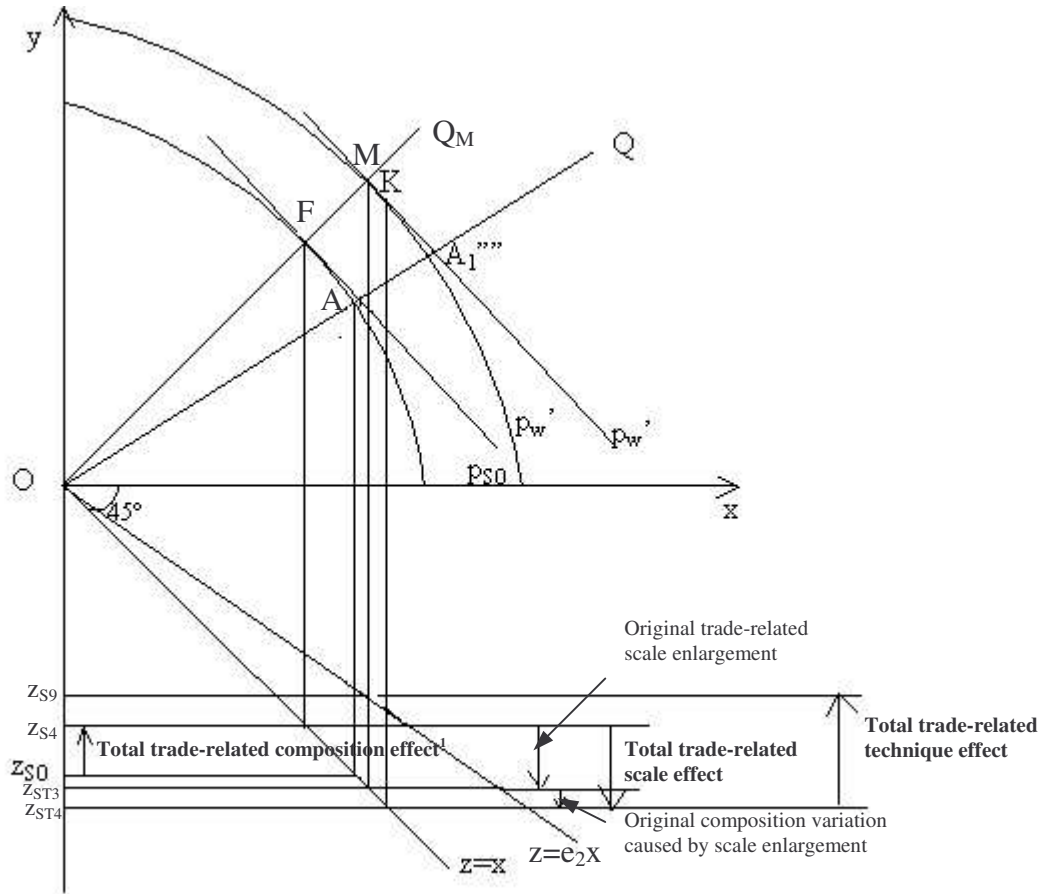

Figure 6.3. Production pattern changes under trade liberalization (decomposition) :Factor-endowment comparative advantage dominates pollution haven comparative advantages, the South benefiting from technology progress in both production and pollution abatement activities

Note: Here the total trade-related composition effect includes the scale and composition effect that we have decomposed in detail in Figure 5.4bis. Since the price-variation-related scale effect is relatively small, following Cole and Elliott (2003), we include it into the total trade-related composition effect. The same definition is also used for the total trade-related scale effect.

Let's firstly look the case where factor-endowment based comparative advantage dominates the pollution haven comparative advantage in the South. This is illustrated in Figure 6.3. From now on, we use the "total trade-related composition effect" to denote the trade-related pollution changes that we have already carefully analyzed and decomposed in the chapter 5.¹ So the emission variation ($z_{S4} - z_{S0}$) related to the total production pattern changes ($A \rightarrow F$) is now called the total composition effect. The trade-related scale enlargement ($F \rightarrow K$), in its turn, can be decomposed to pure scale enlargement ($F \rightarrow M$) and a slight composition transformation ($M \rightarrow K$), whose corresponding pollution variation are

¹ By doing so, we are actually including the small pollution variations caused by price-unit-led scale effect changes.

($z_{S4} \rightarrow z_{ST3}$) and ($z_{ST3} \rightarrow z_{ST4}$), respectively. Considering the composition transformation caused by scale enlargement is relatively small, for the reason of simplification, we include it into the total trade-related scale effect, which lead the emission to increase from z_{S4} to z_{ST4} . Finally, owing to the trade-related technologic progress in pollution abatement activities, the straight line representing the emission-production relationship $z=x$ will rotate counter-clockwise to $z=e_2x$, which reduces the emission intensity for one unit of output. This brings the trade-related technique effect, which leads the final pollution result to reduce from z_{ST4} to z_{S9} . Therefore, for the South, if its rich endowment in labor forces dominates in its comparative advantage determination, the total emission should decrease from z_{S0} to z_{S9} . This total emission reduction can be decomposed into the trade-related impacts through the three famous channels: scale enlargement, composition changes and technical progress, where the pollution reduction contributed by composition transformation and technical progress collectively cancel off the pollution increase related to scale enlargement.

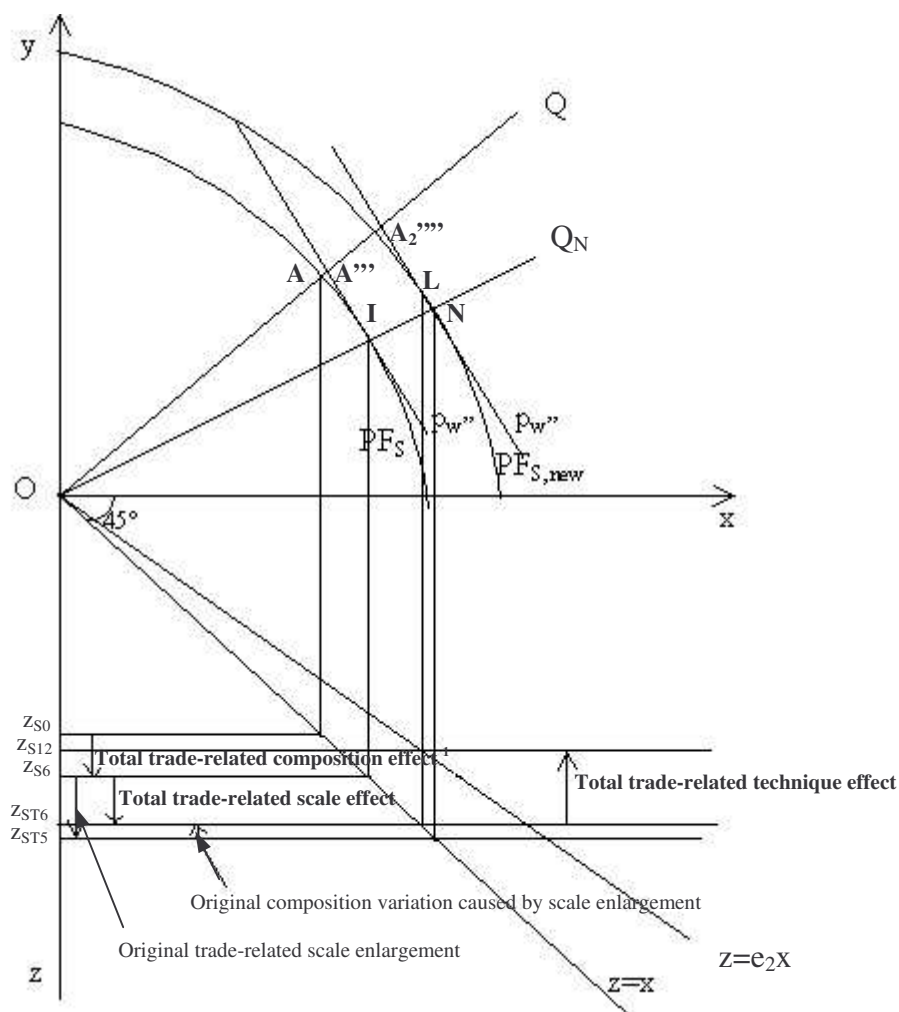

Figure 6.4. Production pattern changes under trade liberalization (decomposition): Factor-endowment comparative advantage dominated by pollution haven comparative advantages, the South benefiting from technology progress in both production and pollution abatement activities

Note: Here the total trade-related composition effect includes the scale and composition effect that we have decomposed in detail in Figure 5.5bis. The same definition is also used for the total trade-related scale effect.

Figure 5.12 depicts the decomposition results for the case where the pollution haven hypothesis overwhelms the factor-endowment-based comparative advantage in the South. Without going into more details, we find as the pollution haven hypothesis dominates in the determination of international production specialization, the South will finally find its emission to increase from z_{S0} to z_{S12} . This emission increase can also be decomposed into the three effects related to trade liberalization, where the pollution reduction benefiting from trade-related technique effect is not large enough to cancel off the pollution increasing scale and composition effects.¹

6.2. Tracing the trade-related scale, composition and technique effect—an empirical analysis based on the Divisia decomposition results

In Chapter 4, under the help of the detailed industrial level GDP and emission data in each province, we succeed in decomposing the variations in industrial SO₂ emission in each province into the contribution from scale enlargement, composition transformation and technical progress in pollution abatement activities. This decomposed information can actually be used in this section to trace the trade-related scale, composition and technique effect.

Our empirical strategy in this section is relatively simple. As the variations in industrial SO₂ emission related to international trade can be considered as a final combination of the three partial changes caused by scale, composition and technique effects, the objective of this section is to trace the indirect environmental role of trade through its separate impacts on the emission variations that are contributed by scale enlargement, composition transformation and technical progress.

Our investigation is carried out in two steps. In the first step, we regress the reduced-form estimation function, which relates trade intensity ratio directly to each of the three partial emission changes. In the second step, we regress the partial emission changes directly on their corresponding effects, which are measured respectively by industrial GDP, capital/labor abundance ratio and per capita GDP, by the Two Stage Least Square (2SLS) estimator. In this step, trade's impact on emission via the three effects is actually captured by the first stage of the 2SLS estimation, in which we use trade liberalization degree as instruments for the scale, composition and technique effects. Although in the second step, the three effects are not

¹ Surely, if the South has the technique effect which is large enough to cancel off the potential emission increase related to scale enlargement and composition transformation, it will be possible to it to find its total emission to reduce. The theoretical analysis does not exclude this possibility.

the endogenous variables with respect to their corresponding emission changes, the 2SLS estimator actually enables us to separately analyze the impact of trade on the scale, composition and technique effect and how the three effects, in their turns, affect the total emission results. Multiplying the coefficients of the structural determinants obtained in the second-stage 2SLS estimation with the trade's coefficient found by the first stage instrumentation estimation, we can give a more direct description on how the trade intensity variation affects emission through each of the three channels.

Detailed reduced-form estimation results for the three effects are reported in table 6.1, 6.2 and 6.3. Tables 6.4-6.7 list the 2SLS structural estimation results.

As a general character often observed in Asian countries' industrialization histories is that they often use foreign exchanges obtained from export to finance the import of machinery and equipment that used to support the development of some strategic heavy industries. If their export growth is stimulated by the demand from the world market, their import activity is more policy-oriented. Considering the possible difference in the role of export and import in economy and pollution, in the estimation carried out in this section, besides the $(X+M)/GDP$, we also check the emission determination role of export and import separately.¹

We firstly include the export and import intensity (X/GDP and M/GDP) separately in the emission determination model B. Suspecting it might be the stock of the imported equipment and machinery instead of the annual import flow that has the capacity to affect the economic structure in China, we further replace in model C the import intensity (M/GDP) by the variable $Mstock$, which measures the employment of the stock of the imported equipment and machinery in total economy.² This openness measurement is inspired by the CGE production model of de Melo and Robinson (1990), in which the positive externality of the international trade on developing economy is describe through both the increasing export activities and the accumulation of the stock of imported machinery and equipment that increases the total effective capital.

These simple reduced-form estimations provide us with some reasonable results. Corresponding to the econometrical analysis in the previous sections, the reduced-form estimation model confirms that international trade (both export and import) generally plays emission-increasing role through scale effect but emission decreasing role via composition and technique effects. However, a common point among the three tables of reduced-form

¹Agras and Chapman (1999) did the same arrangement in their paper.

²Due to data unavailability, we use the stock of imported manufacture goods as an approximation for the stock of imported equipment and machinery goods. This data series is compiled by author according to the provincial level statistical report in Almanac of China's Foreign Economic Relationship and Trade (1984-2001).

estimation results is the unsatisfactory significance for all the three sets of trade intensity measures. This actually reminds us the underlying complexity of the trade-emission relationship.

Table 6.1. The impact of international trade in the decomposed Scale effect (Reduced-form)

	Model A		Model B		Model C	
	RE	FE	RE	FE	RE	FE
(X+M)/GDP (%)	2.155 (1.64)*	3.293 (1.66)*				
X/GDP (%)			4.746 (1.48) ^o	5.631 (1.53) ^o	3.214 (1.27)	5.962 (2.00)**
M/GDP (%)			0.061 (0.02)	1.650 (0.72)		
Mstock					0.019 (4.47)***	0.019 (6.45)***
y1993	188.343 (4.95)***	190.313 (3.36)***	195.788 (5.01)***	196.876 (3.42)***	195.887 (5.27)***	202.453 (3.54)***
y1994	160.962 (4.31)***	153.414 (3.35)***	163.272 (4.35)***	154.469 (3.38)***	173.741 (4.86)***	167.072 (3.70)***
y1995	129.408 (3.63)***	124.570 (3.12)***	128.835 (3.60)***	123.501 (3.10)***	139.096 (4.03)***	133.672 (3.46)***
y1996	124.511 (3.59)***	124.939 (3.52)***	126.406 (3.63)***	126.600 (3.56)***	132.545 (3.94)***	134.254 (3.89)***
y1997	110.482 (3.18)***	112.266 (3.29)***	105.908 (3.01)***	108.594 (3.19)***	112.797 (3.36)***	112.169 (3.49)***
y1998	113.933 (3.20)***	118.420 (3.08)***	109.917 (3.05)***	115.547 (3.00)***	114.424 (3.35)***	117.031 (3.30)***
y1999	34.776 (0.95)	38.628 (1.06)	33.196 (0.90)	37.749 (1.04)	36.895 (1.05)	40.237 (1.22)
y2000	30.386 (0.80)	29.736 (0.72)	29.208 (0.77)	28.733 (0.69)	34.090 (0.93)	32.774 (0.88)
trend	66.121 (14.87)***	65.924 (9.07)***	66.160 (14.83)***	65.933 (9.11)***	60.307 (13.42)***	60.001 (8.53)***
Constant	-45.802 (0.53)		-53.572 (0.63)		-31.907 (0.39)	
R-squared	0.13	0.59	0.14	0.59	0.16	0.62
Breusch-Pagan		964.31 (0.000)		915.19 (0.000)		928.66 (0.000)
Hausman	1.67 (0.9983)		24.36 (0.0113)		2.73 (0.9938)	
Observations	290	290	290	290	290	290
Number of province	29	29	29	29	29	29

Absolute value of z statistics in parentheses, ^o significant at 15%, * significant 10%, ** significant 5%, *** significant 1%.

Table 6.2. The impact of international trade in the decomposed composition effect (reduced-form)¹

	Model A		Model B		Model C	
	RE	FE	RE	FE	RE	FE
(X+M)/GDP (%)	-0.845 (1.48) ^o	-0.933 (1.10)				
X/GDP (%)			-1.056 (0.60)	-2.100 (1.30)	-1.103 (0.90)	-2.009 (1.33)
M/GDP (%)			-0.653 (0.42)	-0.081 (0.06)		
Mstock					-0.004 (1.28)	-0.004 (1.28)
y1993	13.459 (0.54)	13.305 (0.59)	12.838 (0.50)	10.011 (0.44)	11.611 (0.46)	9.381 (0.41)
y1994	30.535 (1.26)	31.124 (1.45)	30.261 (1.24)	30.461 (1.41)	26.430 (1.09)	28.515 (1.35)
y1995	73.452 (3.14) ^{***}	73.829 (3.50) ^{***}	73.453 (3.13) ^{***}	74.289 (3.51) ^{***}	70.748 (3.02) ^{***}	72.412 (3.48) ^{***}
y1996	64.926 (2.83) ^{***}	64.893 (2.95) ^{***}	64.768 (2.82) ^{***}	64.058 (2.89) ^{***}	63.273 (2.77) ^{***}	62.586 (2.84) ^{***}
y1997	-2.806 (0.12)	-2.946 (0.15)	-2.395 (0.10)	-1.054 (0.05)	-2.436 (0.11)	-2.346 (0.12)
y1998	18.050 (0.77)	17.700 (0.75)	18.440 (0.78)	19.232 (0.80)	19.219 (0.83)	18.252 (0.78)
y1999	1.237 (0.05)	0.937 (0.04)	1.412 (0.06)	1.448 (0.06)	1.722 (0.07)	0.521 (0.02)
y2000	24.811 (0.99)	24.862 (0.78)	24.875 (0.99)	25.395 (0.80)	24.104 (0.96)	24.465 (0.77)
trend	16.904 (5.76) ^{***}	16.920 (5.13) ^{***}	16.899 (5.75) ^{***}	16.912 (5.11) ^{***}	17.975 (5.89) ^{***}	18.181 (5.26) ^{***}
Constant	-38.733 (1.18)		-38.362 (1.15)		-46.210 (1.36)	
Observations	290	290	290	290	290	290
Number of province	29	29	29	29	29	29
R-squared	0.13	0.22	0.13	0.22	0.12	0.23
Breusch-Pagan		378.22 (0.000)		368.04 (0.000)		386.64 (0.000)
Hausman	0.01 (1.000)		0.84 (1.000)		0.41 (1.000)	

Absolute value of z statistics in parentheses, ^o significant at 15%, * significant 10%, ** significant 5%, *** significant 1%.

¹ For the aim of correspondence to the empirical analyses in chapter 4, in the appendix of this chapter, we report both the reduced-form and 2SLS estimation results for the decomposed composition effect without time trend and time-specific effects.

Table 6.3. The impact of international trade in the decomposed technique effect (reduced-form)

	Model A		Model B		Model C	
	RE	FE	RE	FE	RE	FE
(X+M)/GDP (%)	-1.108 (0.97)	-2.403 (1.54) ^o				
X/GDP (%)			-2.248 (0.78)	-3.142 (1.16)	-1.259 (0.56)	-3.798 (1.54) ^o
M/GDP (%)			-0.128 (0.05)	-1.903 (0.88)		
Mstock					-0.006 (2.08)**	-0.006 (3.32)***
y1993	-195.069 (5.60)***	-197.312 (3.58)***	-198.383 (5.54)***	-199.374 (3.57)***	-197.630 (5.62)***	-203.626 (3.64)***
y1994	-179.870 (5.26)***	-171.278 (3.81)***	-181.127 (5.27)***	-171.530 (3.80)***	-186.233 (5.50)***	-179.951 (4.01)***
y1995	-179.199 (5.48)***	-173.691 (4.49)***	-179.076 (5.46)***	-173.310 (4.48)***	-183.868 (5.62)***	-178.725 (4.65)***
y1996	-189.633 (5.96)***	-190.120 (5.23)***	-190.478 (5.95)***	-190.641 (5.23)***	-192.705 (6.05)***	-194.152 (5.35)***
y1997	-115.594 (3.63)***	-117.626 (3.58)***	-113.474 (3.51)***	-116.501 (3.53)***	-116.483 (3.66)***	-115.778 (3.62)***
y1998	-68.716 (2.11)**	-73.824 (2.26)**	-66.773 (2.02)**	-72.975 (2.22)**	-68.709 (2.12)**	-71.001 (2.27)**
y1999	-30.218 (0.90)	-34.603 (1.06)	-29.395 (0.87)	-34.368 (1.05)	-30.944 (0.93)	-33.923 (1.07)
y2000	-16.385 (0.47)	-15.644 (0.42)	-15.875 (0.45)	-15.392 (0.41)	-18.048 (0.52)	-16.755 (0.46)
trend	-72.767 (17.85)***	-72.542 (10.13)***	-72.790 (17.78)***	-72.543 (10.12)***	-70.028 (16.33)***	-69.859 (9.70)***
Constant	96.409 (1.36)	130.467 (1.57) ^o	99.088 (1.41)	133.944 (1.59) ^o	84.729 (1.24)	118.781 (1.51) ^o
Observations	290	290	290	290	290	290
Number of provcode	29	29	29	29	29	29
R-squared		0.66		0.66		0.66
Breusch-Pagan		881.22 (0.000)		826.00 (0.000)		810.74 (0.000)
Hausman	2.25 (0.9940)		4.83 (0.9394)		2.09 (0.9982)	

Absolute value of z statistics in parentheses, ^o significant at 15%, * significant 10%, ** significant 5%, *** significant 1%.

Table 6.4. Trade's impact on industrial SO₂ emission—Channel 1: enlargement of the industrial production scale

	Simple		2SLS					
			Model A		Model B		Model C	
	RE	FE	RE	FE	RE	FE	RE	FE
Ind. GDP	0.481	0.480	0.421	0.595	0.268	0.350	0.280	0.296
	(16.69)***	(8.52)***	(2.59)***	(1.66)*	(2.34)**	(1.72)*	(6.13)***	(6.22)***
y1993	186.420	186.415	186.192	186.848	185.619	185.926	185.663	185.725
	(6.87)***	(4.36)***	(6.99)***	(3.32)***	(6.34)***	(3.33)***	(6.36)***	(3.34)***
y1994	176.830	176.825	176.632	177.201	176.134	176.401	176.173	176.226
	(6.80)***	(4.94)***	(6.92)***	(3.68)***	(6.28)***	(3.69)***	(6.30)***	(3.80)***
y1995	144.485	144.467	143.740	145.882	141.868	142.870	142.012	142.213
	(5.73)***	(4.77)***	(5.79)***	(3.48)***	(5.21)***	(3.48)***	(5.24)***	(3.59)***
y1996	132.457	132.429	131.353	134.526	128.580	130.065	128.794	129.091
	(5.34)***	(4.99)***	(5.36)***	(3.62)***	(4.79)***	(3.63)***	(4.83)***	(3.77)***
y1997	116.792	116.762	115.570	119.082	112.502	114.145	112.738	113.067
	(4.71)***	(4.66)***	(4.71)***	(3.37)***	(4.19)***	(3.32)***	(4.23)***	(3.50)***
y1998	117.905	117.865	116.332	120.851	112.384	114.498	112.687	113.111
	(4.67)***	(4.34)***	(4.64)***	(3.10)***	(4.11)***	(3.05)***	(4.15)***	(3.21)***
y1999	42.062	42.016	40.223	45.508	35.606	38.079	35.961	36.457
	(1.62) ^o	(1.85)*	(1.55) ^o	(1.21)	(1.26)	(1.06)	(1.29)	(1.12)
y2000	40.271	40.244	39.180	42.316	36.441	37.908	36.651	36.945
	(1.48) ^o	(1.73)*	(1.46)	(0.99)	(1.24)	(0.90)	(1.26)	(0.99)
trend	28.169	28.290	33.003	19.115	45.137	38.639	44.204	42.901
	(7.19)***	(5.94)***	(2.48)**	(0.68)	(4.64)***	(2.33)**	(8.87)***	(5.66)***
Constant	-103.628	-103.267	-89.187	-130.678	-52.938	-72.350	-55.724	
	(1.93)*	(1.84)*	(1.07)	(1.12)	(0.74)	(0.84)	(0.89)	
Obs.	290	290	290	290	290	290	290	290
Group #	29	29	29	29	29	29	29	29
R-squared		0.79	0.60	0.60	0.56	0.59	0.56	0.57
Breusch-Pagan	934.48	(0.000)						
Hausman	0.02	(1.000)						
Iden. test			0.014	0.030	3.70	0.94	32.24	26.10
			(1.000)	(1.000)	(0.9599)	(0.9999)	(0.0003)***	(0.0036)***
Trade elasticity of decomposed emission changes caused by industrial production scale enlargement								
(X+M)/GDP			0.152	0.193				
X/GDP					0.164	0.194	0.104	0.123
M/GDP					-0.035	-0.039		
Mstock							0.060	0.064
First-stage coefficient for the international trade instruments (on ind. GDP_{it})								
(X+M)/GDP (%)			6.160	5.534				
			(3.05)***	(1.36)				
X/GDP (%)					20.580	18.669	11.897	14.056
					(4.48)***	(2.04)**	(4.20)***	(3.23)***
M/GDP (%)					-4.536	-3.808		
					(1.21)	(0.68)		
Mstock							0.067	0.067
							(14.41)***	(16.14)***

The detailed calculation equation for elasticity of export intensity ratio for decomposed scale effect is as following,

$$\frac{d(\text{scale effect})}{d(X/GDP)} = 14.056 \times \frac{X/GDP}{\text{ind. GDP}} \times 0.296 \times \frac{\text{ind. GDP}}{SO_2} = 14.096 \times 0.296 \times \frac{X/GDP}{SO_2} = 0.123$$
Here 14.096 and 0.296 are the coefficients obtained for export intensity in the instrumentation estimation and for industrial GDP in the second-stage fixed-effect estimation result of model C, respectively. The $\bar{X/GDP}$, $\overline{\text{ind. GDP}}$ and $\overline{SO_2}$ mean the sample average value of X/GDP, industrial GDP and the decomposed industrial SO₂ emission variation related to the scale effect. The elasticity of trade for the other two decomposed emission changes is calculated in the same way.

Absolute value of z statistics in parentheses, ^o significant at 15%, * significant 10%, ** significant 5%, *** significant 1%.

Table 6.5. Trade's impact on industrial SO₂ emission—Channel 2: transformation of industrial composition

	Simple		2SLS					
			Model A		Model B		Model C	
	RE	FE	RE	FE	RE	FE	RE	FE
(K/L) _{jt}	-8.243	-13.964	-36.451	55.539	-7.206	27.082	-14.541	110.327
(1/10000)	(2.65)***	(4.28)***	(1.33)	(1.10)	(0.70)	(0.66)	(0.51)	(1.86)*
y1993	12.615	11.015	4.723	30.461	12.906	22.499	22.499	10.853
	(0.51)	(0.51)	(0.16)	(1.13)	(0.51)	(0.87)	(0.87)	(0.37)
y1994	18.570	14.155	-3.200	67.795	19.371	45.833	45.833	13.710
	(0.78)	(0.68)	(0.09)	(1.58) ^o	(0.76)	(1.21)	(1.21)	(0.39)
y1995	61.228	55.237	31.689	128.019	62.314	98.220	98.220	54.633
	(2.63)***	(2.62)***	(0.81)	(2.23)**	(2.42)**	(2.01)**	(2.01)**	(1.37)
y1996	55.298	48.394	21.261	132.260	56.550	97.923	97.923	47.699
	(2.41)**	(2.13)**	(0.50)	(2.06)**	(2.16)**	(1.79)*	(1.79)*	(1.11)
y1997	-12.353	-19.899	-49.557	71.769	-10.985	34.237	34.237	-20.659
	(0.54)	(0.96)	(1.11)	(1.04)	(0.41)	(0.59)	(0.59)	(0.45)
y1998	17.662	15.081	4.938	46.433	18.130	33.597	33.597	14.821
	(0.77)	(0.65)	(0.17)	(1.48) ^o	(0.76)	(1.19)	(1.19)	(0.51)
y1999	1.588	-0.154	-6.999	21.004	1.904	12.341	12.341	-0.329
	(0.07)	(0.01)	(0.24)	(0.72)	(0.08)	(0.45)	(0.45)	(0.01)
y2000	23.786	23.409	21.930	27.982	23.854	26.110	26.110	23.371
	(0.96)	(0.76)	(0.76)	(0.87)	(0.95)	(0.81)	(0.81)	(0.82)
trend	21.242	24.355	36.588	-13.456	20.678	2.025	2.025	24.668
	(6.33)***	(5.80)***	(2.40)**	(0.49)	(3.27)***	(0.09)	(0.09)	(1.56) ^o
Constant	-34.216		57.244		-37.580		-148.752	
	(1.10)		(0.60)		(0.87)		(1.08)	
Obs.	290	290	290	290	290	290	290	290
Group #	29	29	29	29	29	29	29	29
R-squared	0.10	0.25	0.03	0.22	0.10	0.22	0.08	0.23
Breusch-Pagan		397.41						
		(0.000)						
Hausman	4.23							
	(0.9366)							
Overiden.			1.10	0.064	0.01	0.45	0.05	0.95
			(0.9998)	(1.000)	(1.000)	(1.000)	(1.000)	(0.9999)
<i>Trade elasticity of decomposed emission changes caused by industrial composition transformation</i>								
(X+M)/GDP			-0.427	-0.481				
X/GDP					0.214	0.007	-0.124	-0.456
M/GDP					-0.266	-0.204		
Mstock							0.032	-0.123
<i>First-stage coefficient for the international trade instruments (on (K/L)_{jt})</i>								
(X+M)/GDP (%)			0.023	-0.017				
			(2.12)**	(0.79)				
X/GDP (%)					-0.115	0.001	0.033	-0.016
					(3.43)***	(0.03)	(1.36)	(0.55)
M/GDP (%)					0.147	-0.030		
					(4.91)***	(0.73)		
maccunew							-0.00008	-0.00004
							(1.10)	(0.95)

Absolute value of z statistics in parentheses, ^o significant at 15%, * significant 10%, ** significant 5%, *** significant 1%.

Table 6.6. Trade's impact on industrial SO₂ emission—Channel 2: transformation of industrial composition (New composition indicator)

	Simple		2SLS					
			Model A		Model B		Model C	
	RE	FE	RE	FE	RE	FE	RE	FE
Comp. indicator	4.239 (1.96)**	3.953 (1.58) ^o	18.857 (1.55) ^o	37.506 (1.10)	12.360 (1.02)	-3.011 (0.28)	20.090 (1.70)*	15.870 (1.13)
y1993	11.980 (0.48)	12.178 (0.54)	1.835 (0.06)	-11.107 (0.35)	6.344 (0.24)	17.011 (0.73)	0.979 (0.03)	3.907 (0.16)
y1994	23.513 (0.98)	23.608 (1.13)	18.619 (0.69)	12.375 (0.50)	20.794 (0.84)	25.940 (1.23)	18.206 (0.69)	19.618 (0.94)
y1995	55.553 (2.28)**	56.518 (2.67)***	6.215 (0.13)	-56.728 (0.49)	28.143 (0.60)	80.023 (1.95)*	2.053 (0.04)	16.294 (0.33)
y1996	54.315 (2.31)**	55.053 (2.41)**	16.628 (0.41)	-31.454 (0.35)	33.378 (0.86)	73.008 (2.11)**	13.448 (0.34)	24.327 (0.61)
y1997	-9.234 (0.40)	-8.711 (0.42)	-35.968 (1.07)	-70.075 (1.07)	-24.086 (0.75)	4.026 (0.14)	-38.223 (1.16)	-30.507 (0.99)
y1998	13.377 (0.57)	13.917 (0.59)	-14.221 (0.41)	-49.431 (0.71)	-1.955 (0.06)	27.066 (0.82)	-16.550 (0.49)	-8.583 (0.26)
y1999	-4.504 (0.19)	-3.923 (0.15)	-34.164 (0.94)	-72.004 (0.96)	-20.982 (0.61)	10.207 (0.28)	-36.666 (1.03)	-28.105 (0.77)
y2000	24.262 (0.97)	24.266 (0.76)	24.033 (0.87)	23.740 (0.75)	24.134 (0.95)	24.375 (0.76)	24.013 (0.88)	24.079 (0.75)
trend	13.058 (3.75)***	13.308 (3.66)***	0.298 (0.03)	-15.980 (0.54)	5.969 (0.55)	19.387 (2.00)**	-0.778 (0.07)	2.905 (0.23)
Constant	-135.632 (2.83)***		-393.197 (1.82)*		-278.724 (1.30)		-414.925 (1.97)**	
Obs.	290	290	290	290	290	290	290	290
Group #	29	29	29	29	29	29	29	29
R-squared	0.13	0.23	0.09	0.22	0.11	0.20	0.08	0.15
Breusch-Pagan		384.14 (0.000)						
Hausman	0.08 (1.000)							
Overiden.			1.49 (0.9990)	0.35 (1.000)	0.47 (1.000)	0.17 (1.000)	0.85 (0.9973)	0.76 (1.000)
<i>Trade elasticity of decomposed emission changes caused by industrial composition transformation</i>								
(X+M)/GDP			-0.423	-0.478				
X/GDP					0.131	-0.070	-0.140	0.139
M/GDP					-0.351	-0.080		
Mstock							-0.112	-0.089
<i>First-stage coefficient for the international trade instruments (on new composition indicator)</i>								
(X+M)/GDP (%)			-0.044 (3.19)***	-0.025 (0.69)				
X/GDP (%)					0.041 (0.85)	0.090 (1.42)	-0.027 (0.83)	0.034 (0.72)
M/GDP (%)					-0.113 (2.64)***	0.106 (1.94)*		
maccunew							-0.0002 (2.81)***	-0.0002 (3.40)***

Absolute value of z statistics in parentheses, ^o significant at 15%, * significant 10%, ** significant 5%, *** significant 1%. Detailed introduction for the new composition indicator is available in appendix of this chapter.

Table 6.7. Trade's impact on industrial SO₂ emission—Channel 3: technique progress

	Simple		2SLS					
	RE	FE	Model A		Model B		Model C	
			RE	FE	RE	FE	RE	FE
(GDPPC) _{jt}	-208.325	-370.426	-23.472	-70.937	-25.719	-66.396	-41.469	-53.494
(1/1000)	(3.16)***	(2.67)***	(0.89)	(1.54) ^o	(0.98)	(1.59) ^o	(1.97)**	(5.91)***
(GDPPC) _{jt} ²	19.640	33.741						
(1/1000) ²	(2.65)***	(2.73)***						
(GDPPC) _{jt} ³	-0.571	-1.023						
(1/1000) ³	(2.03)**	(2.57)**						
y1993	-183.153	-177.108	-193.458	-194.080	-193.487	-194.020	-193.694	-193.916
	(5.40)***	(3.53)***	(5.46)***	(3.56)***	(5.46)***	(3.56)***	(5.39)***	(3.57)***
y1994	-170.462	-160.308	-187.574	-188.294	-187.608	-188.225	-187.847	-188.105
	(5.21)***	(3.89)***	(5.52)***	(4.04)***	(5.52)***	(4.05)***	(5.46)***	(4.09)***
y1995	-164.732	-153.259	-184.327	-185.170	-184.367	-185.089	-184.647	-184.948
	(5.18)***	(4.38)***	(5.60)***	(4.65)***	(5.60)***	(4.66)***	(5.53)***	(4.70)***
y1996	-168.725	-156.328	-189.494	-190.056	-189.521	-190.002	-189.707	-189.908
	(5.38)***	(4.85)***	(5.85)***	(5.23)***	(5.85)***	(5.25)***	(5.77)***	(5.29)***
y1997	-93.954	-81.344	-113.675	-113.307	-113.657	-113.342	-113.535	-113.404
	(2.99)***	(2.78)***	(3.51)***	(3.51)***	(3.51)***	(3.51)***	(3.46)***	(3.54)***
y1998	-47.719	-36.587	-63.883	-62.942	-63.838	-63.032	-63.526	-63.189
	(1.50) ^o	(1.25)	(1.94)*	(2.03)**	(1.94)*	(2.03)**	(1.90)*	(2.05)**
y1999	-16.484	-11.962	-27.882	-30.743	-28.017	-30.469	-28.967	-29.990
	(0.51)	(0.40)	(0.82)	(0.96)	(0.82)	(0.95)	(0.84)	(0.96)
y2000	-11.300	-12.296	-20.830	-28.539	-21.195	-27.802	-23.753	-26.511
	(0.33)	(0.34)	(0.58)	(0.74)	(0.59)	(0.73)	(0.66)	(0.72)
trend	-50.164	-28.051	-65.141	-49.334	-64.393	-50.847	-59.148	-53.494
	(5.87)***	(1.62) ^o	(6.70)***	(3.19)***	(6.64)***	(3.59)***	(7.23)***	(5.91)***
Constant	398.442		112.987		117.361		148.029	
	(3.29)***		(1.40)		(1.45)		(1.94)*	
Obs.	290	290	290	290	290	290	290	290
Group #	29	29	29	29	29	29	29	29
R-squared	0.17	0.69	0.20	0.61	0.19	0.62	0.16	0.63
Breusch-Pagan		885.57 (0.000)						
Hausman	9.04 (0.6995)							
Overiden.			1.48 (0.9990)	2.90 (0.9837)	1.74 (0.9980)	2.98 (0.9820)	7.10 (0.7100)	8.36 (0.5933)
<i>Trade elasticity of decomposed emission changes caused by technical progress</i>								
(X+M)/GDP			-0.064	-0.153				
X/GDP					-0.050	-0.125	-0.092	-0.110
M/GDP					-0.022	-0.033		
Mstock							-0.014	-0.019
<i>First-stage coefficient for the international trade instruments (on GDPPC_{jt})</i>								
(X+M)/GDP (%)			0.043 (8.30)***	0.034 (3.09)***				
X/GDP (%)					0.061 (4.61)***	0.059 (3.04)***	0.069 (7.13)***	0.064 (3.74)***
M/GDP (%)					0.028 (2.56)**	0.016 (1.20)		
Mstock							0.0001 (7.73)***	0.0001 (4.20)***

Absolute value of z statistics in parentheses, ^o significant at 15%, * significant 10%, ** significant 5%, *** significant 1%.

Table 6.4-6.7 report the indirect environmental role of international trade on emission going through its three structural determinants. In the six columns related to 2SLS structural model, we separately use the three trade intensity measures as instruments for this production scale measurement. The first-stage instrumentation estimation results are reported in the bottom of the table.

Let's first look at the results concerning the environmental role of trade through production scale enlargement impact in table 6.4. Good coherence between the results of the second-stage 2SLS estimation and those in the reduced-form model can be easily observed in this table. In two to three cases, the changes in the trade intensity measurement and estimation methods do not affect the coefficients of the trade variables. The only exception is the model B, where we only prove the significant positive coefficients for export intensity. As the Hausman specification test indicates the best instrumentation efficiency to be in Model C, in which we use X/GDP and $Mstock/GDP$ to instrument industrial GDP. We believe this result actually confirms the assumption of the CGE model of de Melo and Robinson (1990) on its production function—the growth of domestic economy benefits the positive spillover effect from both the export intensity increase and the accumulation in the imported equipment and machinery. Therefore, we will base our following discussion on the result of model C. To sum up, the estimation results in both table 6.1 and 6.4 generally confirm the positive causality between the trade intensity (either total trade intensity or annual export intensity and the stock of imported machinery and equipment), the industrial production scale, and the decomposed industrial emission variation related to scale effect. This conclusion is also expressed in the table 6.4 by the positive trade elasticity of the decomposed scale effect.

The estimations for the decomposed composition effect do not obtain such a good coherence. Although the capital/labor abundance ratio starts to have positive coefficients after being instrumented by the trade intensity variables (c.f. fixed effect estimation results in table 6.5), most of these positive coefficients still suffer from low significance.

As already discussed in Chapter 3, the low explanation power of capital/labor abundance indicator as a composition effect measurement may be due to the fact that this indicator measures at the same time the technical efficiency of the economy in pollution abatement activities, to overcome the ambiguity of this simple composition effect measurement, we make use of the detailed value added data of 13 industrial sectors in each province to construct a synthetic composition indicator for each provinces as following,

$$\Omega_{it} = \sum_j \left(\frac{Y_{jit}}{Y_{it}} \times I_{j,0} \right)$$

$$Y_{jit}$$
 signifies the detailed value added in industrial sector j of province i at

time t and $I_{j,0}$ is the initial national average SO_2 emission intensity for each of the 13 sectors in year 1991.¹ As the sum of value added of the 13 industrial sectors generally counts up to 98% of the total provincial industrial GDP each year, we are confident about the representative capability of this synthetic indicator as the measurement for the general environmental performance of the industrial composition. Keller and Levinson (2002) also use the same expression to measure industry composition of each state in order to adjust the measurement for state pollution abatement costs. The 2SLS structural model estimation results based on this new composition effect measurement are listed in table 6.6. The new synthetic composition indicator does improve the reliability of the estimation results. The expected positive coefficients are obtained for both the simple and structural estimations. However, most of these positive coefficients are still insignificant and the trade intensity variables also show low instrumentation efficiency. We therefore fail to capture significant impact of trade in the China's industrial composition transformation.

The estimation results obtained for the decomposed emission variations related to technique effect are relatively more satisfactory (c.f. figure 6.7). As expected, per capita GDP is a pertinent approximation for the technique effect, especially when collectively instrumented by the trade intensity indicators X/GDP and $M\text{stock}$. In this estimation result, the positive GDPPC coefficient shows the highest significance. The estimation proves an obvious environment-friendly role for international trade through technique effect. This conclusion is revealed in table 6.7 by the unanimous negative trade elasticity.

6.3. Conclusion

In this chapter, we further enlarge our analysis angle on the potential environmental role of international trade for China. Besides the trade-related pollution impact via composition effect, we further analysed the other two channels through which international trade can exert its impact on environment. One is the trade-related production scale enlargement effect and another is trade-related technology progress in pollution abatement activities.

Using the Divisia index decomposition results of chapter 4 as dependant variables, in this section, we separately investigate the potential relationship between the trade intensity indicators and the three parts of emission variation caused scale enlargement, composition transformation and technical progress through both a reduced-form model and a structural model estimated by 2SLS method. This simple econometrical strategy clarified the

¹ More discussion about the advantages and deficiencies of this synthetic composition effect measurement is included in the appendix.

relationship of trade with both scale and technique effects. We prove the significant role of the trade as a positive factor in production scale enlargement, and an active catalyst for the technological progress in pollution control activities but failed to derive a clear conclusion for the role of trade on China's industrial composition transformation, though the analysis in the chapter 5 implied an environment-friendly role for trade through its impact on composition transformation.

Although the new synthetic composition indicators helped to reduce the confusion existing in the original composition effect measurement--capital/labor abundance ratio, the 2SLS estimation strategy of this section was not able to impart a satisfactory conclusion about the actual role played by international trade in composition transformation. We suspect this difficulty to come from the complicity of the trade-composition relationship itself. As composition transformation under trade liberalisation, as discussed in ACT (2001) is actually determined, not only by the actually openness degree, but also by the final results of the force-contrast between the pollution haven comparative advantage that further depends on the actual income level and the Ricardian comparative advantage determined by factor endowment situation. While both income growth and factor endowment (especially the capital accumulation process accompanying the trade liberalisation process) are also subject to the impact of trade liberalisation. Without considering the potential correlation between the trade-related technique effect and the trade-related composition effect, we still risk to obtain biased conclusion for the potential role of trade on pollution that exerts through the composition effect. Therefore, to obtain a better understanding for the nexus between trade, industrial composition transformation and the resulted emission variations requires us to employ a more structured estimation method which enables us to take care of the three indirect channels through which international trade exerts its impact on emission at the same time. This requirement actually calls for the use of the simultaneous system estimator, which permits investigating on the complicated correlation relationship in different levels between various endogenous and exogenous variables by a series of equation that will be estimated at the same time.

Appendix 6.1. The estimation results for the decomposed composition effect with both time effects and time trend removed

Table A.6.1. Estimation results for the decomposed composition effect with both time effects and time trend removed

	Model A		Model B		Model C	
	RE	FE	RE	FE	RE	FE
(X+M)/GDP (%)	-0.758 (1.34)	-0.637 (1.04)				
X/GDP (%)			0.782 (0.44)	0.830 (0.53)	-1.578 (1.29)	-0.393 (0.27)
M/GDP (%)			-2.094 (1.32)	-1.664 (1.73)*		
Mstock					0.004 (1.32)	0.004 (2.37)**
Constant	74.228 (2.81)***	70.931 (3.90)***	70.954 (2.65)***	64.503 (3.21)***	69.792 (2.57)**	52.807 (2.60)***
Observations	290	290	290	290	290	290
Number of province	29	29	29	29	29	29
R-squared	0.02	0.0014	0.04	0.0031	0.02	0.0078
Breusch-Pagan		287.46 (0.000)		280.66 (0.00)		293.44 (0.000)
Hausman	0.02 (0.8903)		0.20 (0.9042)		0.50 (0.7792)	

Table A.6.2. Trade's impact on industrial SO₂ emission—Channel 2: transformation of industrial composition

	Simple				2SLS											
	K/L		Comp. indicator		Model A				Model B				Model C			
	RE	FE	RE	FE	RE	FE	RE	FE	RE	FE	RE	FE	RE	FE	RE	FE
(K/L) _{jt}	5.210	9.106			-193.271	15.140			-38.355	15.096			13.691	14.770		
(1/10000)	(2.10)**	(3.93)***			(0.24)	(1.04)			(1.03)	(1.79)*			(1.25)	(2.31)**		
Comp. Indicator			10.582	11.113			13.750	10.232			9.220	6.019			18.210	15.056
			(6.73)***	(6.12)***			(1.28)	(1.04)			(1.49)	(1.62) ^o			(1.61) ^o	(2.30)**
Constant	23.912		-197.184	-209.778	1,153.238		-272.266		271.787		-164.912		-24.343		-377.938	
	(0.92)		(4.59)***	(4.80)***	(0.25)		(1.06)		(1.27)		(1.11)		(0.36)		(1.40)	
Obs.	290	290	290	290	290	290	290	290	290	290	290	290	290	290	290	290
Group #	29	29	29	29	29	29	29	29	29	29	29	29	29	29	29	29
R-squared	0.001	0.034	0.08	0.08	0.001	0.02	0.08	0.08	0.001	0.02	0.08	0.08	0.0002	0.02	0.08	0.08
Breusch-Pagan	298.73		344.74													
	(0.000)		(0.000)													
Hausman	5.35		1.09													
	(0.0207)		(0.2966)													
Overiden.					0.06	0.06	0.09	0.00	1.38	0.14	0.05	0.64	0.63	0.33	0.46	0.14
					(0.8055)	(0.8047)	(0.7662)	(0.9544)	(0.2398)	(0.7124)	(0.8262)	(0.4219)	(0.4264)	(0.5649)	(0.4969)	(0.7061)
<i>Trade elasticity of decomposed emission changes caused by industrial composition transformation</i>																
(X+M)/GDP					-0.394	-0.324	-0.378	-0.323								
X/GDP									0.406	0.206	0.383	0.345	-0.095	-0.107	-0.352	0.165
M/GDP									-0.579	-0.418	-0.552	-0.398				
Mstock													0.099	0.124	0.102	0.084
<i>First-stage coefficient for the international trade instruments (on (K/L)_{jt})</i>																
(X+M)/GDP (%)					0.004	-0.042	-0.054	-0.062								
					(0.25)	(1.46)	(2.52)**	(1.73)*								
X/GDP (%)									-0.041	0.053	0.161	0.222	-0.027	-0.028	-0.075	0.453
									(0.96)	(1.12)	(2.56)**	(3.33)***	(0.93)	(0.62)	(1.69)*	(0.77)
M/GDP (%)									0.060	-0.110	-0.238	-0.263				
									(1.59) ^o	(2.12)**	(4.34)***	(4.87)***				
Mstock													0.00026	0.0003	0.0002	0.0002
													(4.07)***	(3.12)***	(2.23)**	(3.32)***

Absolute value of z statistics in parentheses, ^o significant at 15%, * significant 10%, ** significant 5%, *** significant 1%.

Appendix 6.2. A detailed introduction on the synthetic composition indicator

The original idea for the construction of this synthetic composition indicator is due to the unsatisfactory estimation results of the composition indicator—(K/L), the capital abundance ratio in industrial sector. We believe a efficient composition measurement must include both the detailed production structure and the emission performance of each industrial sector that actually exist in industrial economy.

Inspired by the equation (3.9) of the decomposition reasoning in chapter 3,

$$\frac{SO_{2,it}}{area_i} = \underbrace{\frac{Y_{it}}{area_i}}_{scale} \times \underbrace{\sum_j \frac{Y_{j,it}}{Y_{it}}}_{Composition} \times \underbrace{e_{j,it}}_{Technique} \times \frac{SO_{2,it}}{Y_{it}} \quad (3.9)$$

where $e_{j,it}$ is the emission efficiency indicator for each sector j of province i , we define the synthetic composition indicator by fixing the emission efficiency indicator $e_{j,it}$ to equal to the I_{j0} —the national level average emission intensity of each industrial sector j at base year 1990, so $e_{j,it} = I_{j,1990}$. Therefore, for a province i in each t , we can construct an indicator as $\Omega_{it} = \sum_j \frac{Y_{j,it}}{Y_{it}} \times I_{j,1990}$. In this indicator, as the sector-

specific emission intensity is fixed at the initial level, for each province, its variations during the time actually reveals the changes of the ratio of the different industrial sectors. Therefore, when the ratio of a relatively more polluting sector experiences an increase during period 1, we can expect an increase in this indicator, so $\Omega_{it} > \Omega_{i0}$. Therefore, we use this indicator as a synthetic composition index.

For each province, this indicator is actually constructed by combining the detailed value added data of the 13 industrial sectors of each province in different years with the sector-specific emission intensity in base year. The 13 industrial sectors are total mining industry, food and beverage, textile, paper, total power industry, chemical materials, pharmacy, fiber, non-metal products, metal processing and smelting, metal products, machinery and the other industry, these data comes from China Industrial Economic Statistic Yearbook (1989-2002), and their total value added accounts up to 98% of the total industrial VA in each province. Therefore we are quite confident on the representation capacity of this indicator.

We are, however, not the first authors using this indicator in emission-related analysis. Keller and Levinson (2002) also use the same expression to measure industry composition of each state in order to adjust the measurement for state pollution abatement costs.

Although this indicator captures the composition effect changes due to the variation of the proportion of different sectors in total industrial economy, it ignores, in fact the potential emission efficiency differences between the same industrial sectors in different provinces. Moreover, it is also different from the decomposed composition effect by the Divisia method, where both the sectoral proportion changes and the general technological progress in emission efficiency are both considered. (c.f. the AWD or Törnqvist principle introduced in chapter 4)

Chapter 7. Environmental impact of international trade through scale, composition and technique effect: an analysis based on a simultaneous system

In order to get a better understanding on the environmental impacts of international trade in China, in this chapter, we construct a four-equation simultaneous system. In this model, the emission is firstly determined by the three economic determinants, scale (economy's production scale), composition (pollution performance of industrial composition), technique (environmental abatement efforts) effects and also directly by trade openness degree. The following three equations capture the potential endogeneity of the three pollution determinants with respect to international trade. With the help of this system, we expect to obtain clearer understanding on the indirect impact of trade on emission going through the three economic determinants and to reveal the potential interaction between the three effects that affect the environmental role of trade through composition effect in the last section. Following the estimation results of the last section, export and import will be separately included into the model. This simultaneous system is then tested by the same panel data set of 29 Chinese provinces that we used all along this dissertation.

7.1. The links between trade and emission: The system of simultaneous equations

A direct inspiration of the system used in this paper comes from Dean (1998). In her paper she studied the relationship between international trade and industrial wastewater emission in China by a simpler simultaneous system. Her model supposes that international trade increases pollution through "pollution haven" effect, but trade also contributes to China's economy growth, which in turn reduces emission since higher income strengthens

public exigency for a better environment. Following similar reasoning, we construct our 4-equation simultaneous system, which is represents in equations (7.1)-(7.4)

$$(7.1) E_{it} = e(Y_{it}, \Omega_{it}, \tau_{it}, EX_{it}, EM_{it})$$

$$(7.2) Y_{it} = A_i(EX_{it})^\varphi \left[(K_{it} \times EM_{it}^\psi)^\alpha L_{it}^\beta \right]$$

$$(0 < \alpha < 1, 0 < \beta < 1, EX_{it} = \left(\frac{X_{it}}{GDP_{it}} \right), \varphi > 0, EM_{it} = \left(1 + \frac{\Delta KM_{it}}{KM_{it0}} \right), \Delta KM_{it} = \sum_{T=t_0}^{t-1} M_{iT}, KM_{it0} = \sum_{T=0}^{t_0} M_{iT}, \psi > 0)$$

$$(7.3) \Omega_{it} = z(EX_{it}, EM_{it}, Y_{it})$$

$$(7.4) \tau_{it} = t(Y_{it}, denpop_{it}, EX_{it}, EM_{it})$$

(*i*: Indicator for different province, *t*: Indicator for difference years, $t_0=1992$)

E_{it} : emission

X_{it} : total export

Y_{it} : scale effect

GDP_{it} : total GDP

Ω_{it} : composition effect

ΔKM_{it} : variation of stock of imported machinery and equipment since base year t_0

τ_{it} : technique effect

$A_i(EX_{it})$: total factor productivity parameter

M_{it} : total annual import of machinery and equipment

EX_{it} : export externality

K_{it} : total capital stock employed in production

$denpop_{it}$: population density

EM_{it} : import externality

KM_{it0} : initial stock of imported machinery and equipment in year t_0

L_{it} : total labor employed in production

Equation (7.1) describes the economic determinants for industrial SO₂ emission. We include scale effect (Y_{it}), composition effect (Ω_{it}) and technique effect (τ_{it}) into this equation. All else equal, we expect a positive coefficient scale effect; a positive coefficient for Composition effect, measured by the synthetic indicator that is introduced in chapter 6; and a negative coefficient for the technique effect. We also include export and import terms in this function in hoping to capture some of their direct impact on emission.

Besides the direct role of export and import described in the emission determination function, their indirect impacts on emission going through their effect on the scale, composition and technique characteristics of an economy are captured by the equation (7.2)-(7.4).

The impacts of international trade on economic scale are captured by a de Melo-Robinson style production function in equation (7.2). In this function, both export and import growth can result in production scale enlargement through their positive spillover effect. The externality of export is captured by the term $A_i \times (X_{it}/GDP_{it})^\varphi$ with $\varphi > 0$, which supposes higher export intensity increases total factor productivity of the whole economy by enhancing the competition pressure faced by domestic producer. The externality of import acts differently

from that of export. Instead of supposing the import externality to increase productivity of capital and labor in an average way, basing on the general characteristics among the East Asian Newly Industrializing Economies (NIE's), we assumed faster accumulation of imported

machinery and equipment $KM_{it} = \sum_{T=1}^{t-1} M_{iT}$ can increase the effectiveness of capital stock K_{it}^e

used in economy. This idea is expressed as $K_{it}^e = K_{it} \times \left(\frac{KM_{it}}{KM_{it0}}\right)^\psi = K_{it} \times \left(1 + \frac{\sum_{T=t_0}^{t-1} M_{iT}}{KM_{it0}}\right)^\psi$ in the production function (7.2). KM_{it0} is the initial stock of the imported equipment in the base year t_0 and $\sum_{T=t_0}^{t-1} M_{iT}$ is the accumulation of machinery and equipment imports since the base year t_0 .

The capital productivity gains from the accumulation of imported technologies are captured

by the positive parameter ψ . As $\left(1 + \frac{\sum_{T=t_0}^{t-1} M_{iT}}{KM_{it0}}\right)^\psi \geq 1$, with higher import-related externality elasticity ψ , the accumulation of the imported equipment can result in a higher effective capital stock, which will then contribute in total production growth.

Indirect impact of trade on pollution through composition transformation is captured by composition determination function (7.3), where both the export and import indicators are included as independent variables. As the final role of international trade in composition transformation in an economy is determined by the force contrast between its “pollution haven” comparative advantage and its natural endowment situation, we expect the sign of export’s coefficient to reveal the actual composition transformation impact induced by export growth. The consideration for the role of import on composition transformation is, however, different from the suggestion of Copeland and Taylor (2003). Because we use the accumulation of imported machinery and equipment as the measurement for import. As many of its Asian neighbors, most of the machinery and equipment imported in China are used in aims to support the development of some strategic heavy industrial sectors. Therefore, we suspect the equipment and machinery import may play a positive role on the pollution performance of the industrial composition, so $z_{EM} > 0$. As Wang and Wheeler (1996), World Bank (2000) indicated that “China’s levy system has been working much better than that has been supposed” due to her complaining citizens acting in an informal way. Considering the public demand for the better environment is positively correlated to economic growth. In this function we also include economic growth Y_{it} to measure the impact of *informal* pollution control efforts on the orientation of new production capacity towards less polluting sectors. We expect a negative coefficient for this variable, $z_y < 0$.

The equation (7.4) describes the determination of technique effect as suggested in the neo-classical theories. (Selden and Song, 1995; Lopèz, 1994) Here we consider four potential determinants for technique effect. The first is economy growth (Y_{it}), which seizes technical progress in pollution abatement encouraged by the increasing public demand for better environment as they getting richer, so we expect $t_y > 0$. Given the same income level, higher population density intensifies the marginal damage of pollution, which in turn urges technical innovation in pollution abatement activity to progress. Therefore, we include population density into this equation and expect $t_{DENPOP} > 0$. The possible impact of export on technique effect can be expected differently according to two different hypotheses. The “racing to bottom” hypothesis supposes the competition pressures from world market may force Chinese government to relax its environmental regulation stringency, which will in turn discourage the investment of the producers in pollution abatement activities, in this case $t_{EXP} < 0$. However, supplying world market makes it necessary for China's domestic producers to meet stricter international environment norm, which can encourage the investment in pollution abatement activities, so $t_{EXP} > 0$. As the impact of export on technique effect expected by these two hypotheses tells totally different stories, its final impact on technique effect will be revealed by its estimation coefficient. Given the finding in chapter 6, we expect this coefficient to come out as positive. The impact of machinery and equipment import on technique effect is more difficult to predict. On one hand, as imported machinery and equipment generally embody advanced production technologies, their participation in production may reduce the necessity to additionally invest in abatement activities. In this case, we expect the negative coefficient. On the other hand, the accumulation of the import machinery and equipment may also facilitate the investment in the foreign equipment and machinery designated for pollution abatement; so we can also expect a positive coefficient for import indicator. As the estimation analysis in the last section (c.f. table 6.7) seems to describe the stock of imported equipment and machinery as a positive determinant for technique effect, we also expect a positive coefficient for it in this simultaneous system analysis.

Following we make total differentiation to the four equations and divide each of them by its corresponding dependant variable. So we get a new simultaneous system (7.1*)-(7.4*).

$$\begin{aligned}
 (7.1^*) \quad \frac{\dot{E}_{it}}{E_{it}} &= e_y \times \frac{\dot{Y}_{it}}{Y_{it}} + e_\tau \times \frac{\dot{\tau}_{it}}{\tau_{it}} + e_\Omega \times \frac{\dot{Q}_{it}}{Q_{it}} + e_{EX} \times \frac{\dot{EX}_{it}}{EX_{it}} + e_{EM} \times \frac{\dot{EM}_{it}}{EM_{it}} \\
 &= \eta_{E,Y} \times \frac{\dot{Y}_{it}}{Y_{it}} + \eta_{E,\Omega} \times \frac{\dot{Q}_{it}}{Q_{it}} + \eta_{E,\tau} \times \frac{\dot{\tau}_{it}}{\tau_{it}} + \eta_{E,EX} \times \frac{\dot{EX}_{it}}{EX_{it}} + \eta_{E,EM} \times \frac{\dot{EM}_{it}}{EM_{it}} \\
 &\quad (+) \quad (+) \quad (-) \quad (?) \quad (?) \\
 (7.2^*) \quad \frac{\dot{Y}_{it}}{Y_{it}} &= \varphi \times \frac{\dot{EX}_{it}}{EX_{it}} + \alpha \times \frac{\dot{K}_{it}}{K_{it}} + \alpha\psi \times \frac{\dot{EM}_{it}}{EM_{it}} + \beta \times \frac{\dot{L}_{it}}{L_{it}}
 \end{aligned}$$

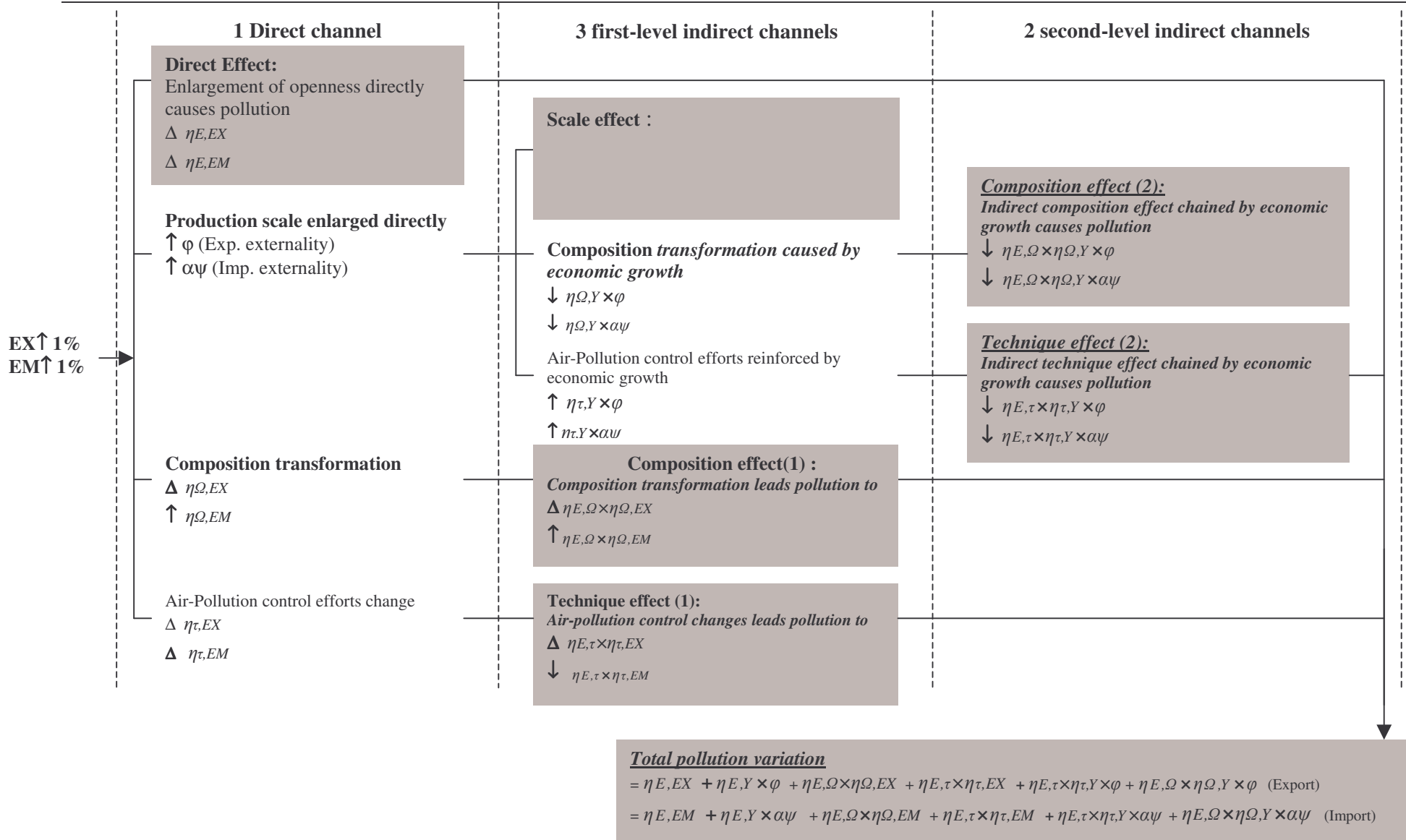

Figure 7.1 Illustration of the different Channels of trade's impact on pollution

$$\begin{aligned}
 (7.5) \quad \frac{\partial E}{\partial EX} &= \underbrace{\eta_{E,EX}}_{\substack{\text{direct effect} \\ (?)}} + \underbrace{\eta_{E,Y} \times \varphi}_{\substack{\text{Scale effect} \\ (+)}} + \underbrace{\eta_{E,\tau} \times \eta_{\tau,EX}}_{\substack{\text{Technique effect} \\ (-)}} + \underbrace{\eta_{E,\tau} \times \eta_{\tau,Y} \times \varphi}_{\substack{\text{Indirect technique effect} \\ \text{chained by} \\ \text{economic growth} \\ (-)}} + \underbrace{\eta_{E,\Omega} \times \eta_{\Omega,EX}}_{\substack{\text{Composition effect} \\ (?)}} + \underbrace{\eta_{E,\Omega} \times \eta_{\Omega,Y} \times \varphi}_{\substack{\text{Indirect composition effect} \\ \text{chained by} \\ \text{economic growth} \\ (-)}} \\
 &\qquad\qquad\qquad \underbrace{\hspace{10em}}_{\substack{\text{Technique effect} \\ (-)}} \qquad\qquad\qquad \underbrace{\hspace{10em}}_{\substack{\text{Composition effect} \\ (?)}}
 \end{aligned}$$

$$\begin{aligned}
 (7.6) \quad \frac{\partial E}{\partial EM} &= \underbrace{\eta_{E,EM}}_{\substack{\text{direct effect} \\ (?)}} + \underbrace{\eta_{E,Y} \times \alpha \psi}_{\substack{\text{Scale effect} \\ (+)}} + \underbrace{\eta_{E,\tau} \times \eta_{\tau,EM}}_{\substack{\text{Technique effect} \\ (-)}} + \underbrace{\eta_{E,\tau} \times \eta_{\tau,Y} \times \alpha \psi}_{\substack{\text{Indirect technique effect} \\ \text{chained by} \\ \text{economic growth} \\ (-)}} + \underbrace{\eta_{E,\Omega} \times \eta_{\Omega,EM}}_{\substack{\text{Composition effect} \\ (?)}} + \underbrace{\eta_{E,\Omega} \times \eta_{\Omega,Y} \times \alpha \psi}_{\substack{\text{Indirect composition effect} \\ \text{chained by} \\ \text{economic growth} \\ (-)}} \\
 &\qquad\qquad\qquad \underbrace{\hspace{10em}}_{\substack{\text{Technique effect} \\ (-)}} \qquad\qquad\qquad \underbrace{\hspace{10em}}_{\substack{\text{Composition effect} \\ (?)}}
 \end{aligned}$$

All the six trade-emission nexus can be further grouped into direct, first- and second-level indirect channels and illustrated in Figure 7.1. The direct channel reveals the direct relationship between trade and emission. The three first-level indirect channels reflect the indirect emission variation induced by the direct trade-related changes in the three structural effects. The two second-level indirect channels trace the emission variation resulting from the indirect composition and technique changes induced by trade-led economic growth. To calculate the total impact of trade on emission, we only need to add all these different aspects together.

We use gray-color cases to indicate all trade-related emission variations impacts in the graphic. Compared with the single equation estimation models used in the last two sections, this simultaneous model is able to enrich and deepen our investigation angle and to offer us a structural description on the nexus between trade and the environment with several different levels. Therefore, we hope to get more satisfactory estimation results from it.

7.2. Econometric analysis

7.2.1. Data choice for some of the independent variables

As all the variables used in this simultaneous model's estimation will be in their growth rate, we therefore re-report the data statistics description in table 7.1.

Table 7.1. Statistical description of the data

Variables	Corresponding Data	Obs.	Ave.	Sta. Dev.	Min.	Max.
Endogenous Variables (in level)						
E	Annual industrial SO ₂ emission, 1000 tons	261	494.49	363.01	16.68	1760.06
Y	Real industrial GDP, 10 ⁹ Yuan, 1990 price	261	70.10	65.90	2.72	353.00
Ω	Synthetic industrial composition indicator	261	24.27	5.53	13.02	44.25
τ	Average levy rate on industrial SO ₂ emission	261	0.059	0.039	0.011	0.247
Endogenous Variables (in growth ratio)						
\dot{E}/E		232	0.025	0.155	-0.337	0.688
\dot{Y}/Y		232	0.120	0.047	-0.059	0.344
$\dot{\Omega}/\Omega$		232	0.041	0.128	-0.254	0.705
$\dot{\tau}/\tau$		232	0.095	0.666	-0.849	8.077
Exogenous Variables (in level)						
K	Industrial Capital stock, 10 ⁹ Yuan, 1990 price	261	128.000	125.000	12.200	776.000
L	Staffs and workers employed in industrial sector	261	344.68	249.78	19.60	1002.00
EX	Export intensity with respect to total GDP (X/GDP)	261	8.77	15.51	0.21	96.13
EM	Ratio of stock of imported manufacturing good to its base year value (KM _t /KM ₁₉₉₂)	261	5.847	4.326	1.158	30.279
$denpop$	Population density per km ²	261	357.04	421.29	5.99	2700.20
Exogenous Variables (in growth ratio)						
\dot{K}/K		232	0.042	0.041	-0.034	0.176
\dot{L}/L		232	-0.022	0.065	-0.300	0.127
\dot{EX}/EX		232	0.090	0.282	-0.461	1.369
\dot{EM}/EM		232	0.284	0.177	0.057	1.309
$\dot{denpop}/denpop$		232	0.012	0.024	-0.099	0.189

Note: (1) Due to lack of data, Tibet is excluded from the sample, all the other provinces have 9 observations (1993-2001).

(2) The total industrial capital stock is calculated by the permanent inventory method by using real value of fixed investment data (on the constant price of 1990) of each province in each year deflated by the corresponding fixed investment price index. More details about the permanent inventory method are in Wu (1999).

(3) The capital stock used in industrial air pollution treatment is calculated from simple accumulation of the real value of the investment in industrial air pollution treatment (on constant price of year 1990) deflated by fixed investment price index. Data source: China Environment Yearbook (1987-1997), China Environmental Statistic Yearbook (1998-2002).

(4) The export data is on the total provincial economy level instead of industrial sector level. Given what we interested in the externality of export and its impact on pollution through the pollution determinants, we do not think to use the corresponding industrial level data will be necessary for the objective of this paper.

(5) The provincial level annual imported manufactured goods stock is compiled by author according to the provincial level statistical report in Almanac of China's Foreign Economic Relationship and Trade (1984-2001).

(6) The construction of the composition effect is based on detailed industrial sectors' statistics provided in Chinese Industrial Economic Statistics Yearbook from 1985 till 2002.

(7) The other data comes from China Statistic Yearbook (1985-2004).

Although the scale effect is still measured by the industrial GDP, to capture the evolution of the environmental performance of composition effect for each province, we use the synthetic indicator that we have already introduced to some estimations of the last section,

$\Omega_{it} = \sum_j \left(\frac{Y_{jit}}{Y_{it}} \times e_{j,0} \right)$. To use this indicator is, on one hand, due to its obviously higher efficiency in summarizing the heterogeneous emission performance of different industries belonging to the same economy; on the other hand, also an obligatory choice concerning to the construction of this simultaneous system. Because this system requires composition effect to be endogenous variable but at the same time the production factors as capital and labor to be exogenous ones. Using capital abundance (K/L) to measure composition effect obviously does not meet this exigency.

The measurement for technique effect in this system is also different from that used in previous sections. This is because in the original arrangement of the simultaneous system, we planned to verify the potential causality between economic growth and the technical efforts of producer in pollution abatement by using economic growth as a explanation variable for technique effect. However, simply using per capita GDP as measurement for technique effect risks to arise estimation bias given the strong correlation existing between per capita GDP and the total industrial GDP. To resolve this problem, we will use the total capital stock employed in air pollution abatement activity to directly measure the current pollution abatement technique effort in each province.

7.2.2. The empirical method

Based on a simultaneous model and provincial level panel data, our empirical analysis needs to take care of three potential estimation biases. The first and second come from the dynamic panel data characteristics of our database. On one hand, to capture the time-invariable specific effect, we need to employ fixed effect estimator for each province. On the other hand, we also need to take care of the potential serial correlation inside of each province. Both considerations require us to employ dynamic GMM estimator proposed by Blundell and Bond (1998) for each equation.

This is a new development from Anderson and Hsiao (1982) and Arellano and Bond (1991). This method proposes to include to the right-hand side of each function the one-period lagged dependant variable to remove the first-order serial correlation in the residuals. At the same time, to deal with the time-invariable fixed effect, it uses first-difference transformation as suggested by Arellano and Bond (1991). Therefore the actual estimation function form for each equation becomes $y_{it} - y_{i,t-1} = \rho(y_{i,t-1} - y_{i,t-2}) + (x'_{it} - x'_{i,t-1})\beta + (\varepsilon_{it} - \varepsilon_{i,t-1})$, where y_{it} signifies the dependant variable and x_{it} indicates the vector of independent variables. ε_{it} is the residual. While the serial-correlation and fixed effect are both cancelled out in this new

estimation function, the difference of the lagged endogenous variable ($y_{i,t-1}-y_{i,t-2}$) is obviously correlated with the error term ($\varepsilon_{it}-\varepsilon_{i,t-1}$), since $y_{i,t-1}-y_{i,t-2}=\rho(y_{i,t-2}-y_{i,t-3})+(x'_{i,t-1}-x'_{i,t-2})\beta+(\varepsilon_{i,t-1}-\varepsilon_{i,t-2})$. So $E(dy_{i,t-1}d\varepsilon_{it})\neq 0$, the estimator will be biased. Arellano and Bond (1991) suggests to use all the available additional moments restrictions to enlarges the set of instruments, which means the instruments for the lagged endogenous variables ($y_{i,t-1}-y_{i,t-2}$) is enlarged to $y_{i,t-2}, y_{i,t-3}, y_{i,t-4}, \dots, y_{i1}$.

The principal development of Blundell and Bond (1998) compared to Arellano and Bond (1991) is their new innovation in the instrumentation method and its suggestions to further make use of the additional level information besides the differences. "This combination of the moment restrictions for differences and levels results in the so-called GMM-system-estimator by Arellano and Bond".(Behr, 2003) Concretizing to the estimation functions in this paper, this estimation method means for each of the four equations, we use both first-difference and level function form in estimation by confining the coefficient for the same variable to be the same in both the first-difference and level function. The lagged endogenous variable ($y_{i,t-1}-y_{i,t-2}$) in first difference function will be instrumented by the level moment $y_{i,t-2}, y_{i,t-3}, \dots, y_{i2}, y_{i1}$ and the lagged endogenous variable $y_{i,t-1}$ will be instrumented by difference moments ($y_{i,t-2}-y_{i,t-3}$), ($y_{i,t-3}-y_{i,t-4}$), ..., ($y_{i,2}-y_{i,1}$).

The preoccupation for the third bias is related to the simultaneous system. facing the intercorrelation between the endogenous variables in this system, we suspect the existence of correlation between the residuals of different functions, which means $cov(\varepsilon_i, \varepsilon_j) \neq 0$, $i \neq j$, i and j indicate different equations in the system. The existence of this correlation can make the separate single-equation estimation results biased. Therefore, we need to use the traditional Generalized Method of Moment (GMM) estimator for simultaneous system, which controls the covariance matrix of the four residuals of the system as a whole by instrumenting all the endogenous variables by all the exogenous variables available in the system.

However, there does not exist an already-made econometrical package that combines the traditional GMM estimator for simultaneous system with the Blundell-Bond GMM-system estimator for dynamic panel data. Luckily, the instrumentation method developed by Balestra and Nerlove (1966) and Sevestre and Trognon (1996) indicate a compatible way to carry out the Blundell-Bond-style instrumentation step separately, which allows us to finally combine the special instrumentation method of Blundell-Bond (1998) with the traditional GMM estimator for the whole system together.

The concrete estimation is actually carried out in two steps. In the first step, following Sevestre and Trognon (1996), we separately instrument each of the four lagged dependant variables of the simultaneous system, in both the level and first difference terms, year by year, on cross-province level, by all of its available moments of instruments. In the second step, we included the instrumented lagged dependent variables as exogenous variables into their corresponding estimation functions to carry out the GMM estimation for simultaneous system, where the system endogenous variables are then instrumented by all the exogenous variable of the system. In practice, we actually estimate both the first difference and level function for each of the four equations by restricting the coefficients for the same variables to be the same.

7.2.3. Estimation results for the simultaneous equation system

Table 7.2 gives the system estimation results. The overall fit of the system is satisfactory. Most coefficients show expected signs and high significance. The specification test of Hausman (1978) proves the orthogonality conditions of the instruments used for the lagged endogenous variables on equation-level are respected. And the J-statistic also proves the efficiency of the instrumentation used for the whole system. Adding the lagged dependant variables to the right side of the equation also successfully removes the first-order serial correlation problem in most equations. The tiny inter-equation residual covariance shows the high efficiency of the GMM estimator for the simultaneous system.

The first column illustrates the estimation results for the economic determination of SO₂ emission. The signs and the significance of all the three economic determinants for industrial SO₂ emission confirm the theoretical anticipation of Grossman decomposition. Especially for the synthetic composition indicator, which for the first obtain a significantly positive coefficient in this dissertation. The attempt to separately detect the impacts of import and export on emission already shows for the second time its efficiency. In the direct emission determination function, we find significant but opposite signs for export and import. Export seems to exert direct deterioration impact on emission. Estimation result shows if the annual export ratio to GDP increases by 1%, the total emission will increase by 0.119%. On contrary, the acceleration in imported manufactured goods accumulation seems to be an environment-friendly factor, 1% increase in its accumulation with respect to the base value of year 1992 will lead industrial SO₂ emission to reduce by 0.434%.

Table 7.2. The simultaneous model estimation results

(GMM for simultaneous system, Fixed effect, 29 provinces during 9 years, 203 observations)

Variables	\dot{E}_{it}/E_{it}	Scale effect	Composition effect	Technique effect
		\dot{Y}_{it}/Y_{it}	$\dot{\Omega}_{it}/\Omega_{it}$	$\dot{\tau}_{it}/\tau_{it}$
Lagged \dot{E}_{it}/E_{it}	-0.436*** (0.000)			
Lagged \dot{Y}_{it}/Y_{it}		0.708*** (0.000)		
Lagged $\dot{\Omega}_{it}/\Omega_{it}$			-0.245*** (0.000)	
Lagged $\dot{\tau}_{it}/\tau_{it}$				0.483*** (0.000)
\dot{Y}_{it}/Y_{it}	2.201*** (0.005)		-0.279** (0.019)	0.600*** (0.000)
$\dot{\Omega}_{it}/\Omega_{it}$	2.173*** (0.000)			
$\dot{\tau}_{it}/\tau_{it}$	-1.171** (0.014)			
\dot{K}_{it}/K_{it}		0.273*** (0.000)		
\dot{L}_{it}/L_{it}		0.030 (0.211)		
\dot{EX}_{it}/EX_{it}	0.119*** (0.007)	0.021*** (0.000)	-0.073*** (0.002)	0.042*** (0.004)
\dot{EM}_{it}/EM_{it}	-0.434*** (0.007)	0.035** (0.031)	0.292*** (0.000)	0.009 (0.592)
$\dot{denpop}_{it}/denpop_{it}$				0.269*** (0.000)
Hausman (first-difference)	17.99 (0.006)	25.71 (0.000)	13.82 (0.008)	4.94 (0.432)
Hausman (level)	9.46 (0.149)	6.84 (0.233)	1.47 (0.832)	0.31 (0.997)
Autocorrelation ($\hat{\rho}$)	-0.540*** (0.000)	-0.557*** (0.000)	-0.415*** (0.000)	-0.177** (0.013)
J-statistic (System identification)		0.622		
Residual covariance		2.76E-18		

Notes : (1) *** indicates the significance of 99%, ** indicates the significance of 95% and * means significance of 90%.

(2) As the fixed effect of each province is removed by the first-difference transformation and the serial correlation between the observations for the same province is also controlled by the inclusion of instrumented lagged dependant variables to the right-hand side of the equations, the simultaneous system in this paper is estimated by the cross-section GMM estimator for system of equations, the heteroskedasticity is corrected by the White's heteroskedasticity consistent covariance matrix.

(3) The equation-level identification test is the Hausman test, which verifies the validity of the instruments used for the lagged dependant variables.

(4) Autocorrelation test is from Woodridge (2002), P282-283. It is a simple test for potential serial correlation problem in first-difference fixed effect estimation based on the simple regression on T-2 time periods of the following equation: $\hat{e}_{it} = \hat{\rho}\hat{e}_{it-1} + error_{it}$, $t=3,4,\dots,T$; $i=1,2,\dots,N$. When the value of the coefficient $\hat{\rho}$ approaches to -0.5, it will warrant computing the robust variance matrix for the first-difference estimator.(5) The J-statistic serves to verify the validity of all the instruments used in simultaneous system GMM estimator. Multiplying the J-statistic with observation number $126.27=0.622 \times 203$ derives an approximation for Chi-2 value, which can then be used in Sargan test statistic. Given the number of the instruments used in this system counts up to 236 (the instruments for lagged dependant variables are also included), the probability for this Chi-2 value to be smaller than the critical value 183.79 is 1.

The estimation result for production function confirms the positive externality for both export and import. The parameter for export externality in total factor productivity φ is found

to be 0.021. While the parameter for import externality ψ is approach to 0.125.¹ Compared to the export and import externality elasticities (generally supposed to be equal to 0.1) that were used in several related CGE studies on Asian countries' case (de Melo and Robinson (1990) for South Korea and Rodrigo and Thorbecke (1996) for Indonesia), the import externality elasticity estimated from China's industrial economy shows good coherence, but the estimated export externality seems to be lower.

The negative coefficient before export variable in composition equation confirms the domination role of factor endowment comparative advantages in the composition determination impact of export. With 1% of increase in export/GDP ratio, the pollution performance of the composition effect improves by 0.073%. We equally find a significantly positive coefficient for import. This actually confirms the generally believed fact that Chinese government is using import as a technical support for its heavy industry development strategy. The positive coefficient that we find for the economic growth variable (Y_{it}) also confirms the tendency for the industrial composition to become cleaner with economic growth. This is actually defined in our model as the composition transformation related to the reinforcement of informal air pollution control.

The last column of Table 7.2 shows the potential determinants for China's technique effect. As we anticipated, the stronger pollution control effort is positively correlated with economic growth and population density increase. 1% of increase in the industrial production growth rate leads to a 0.6%'s increase in the strength of pollution control and 1%'s increase in population density also urges the technique effect to rise by 0.269%. This finding actually provides an explanation for the relatively earlier appearance of EKC turning point in China's case that we observed in chapter 2. Come to the trade's impact on technique effect, only export shows a significant positive coefficient 0.042. This finding actually confirms the hypothesis that facing the external competition is a positive factor which encourages the producers to invests in pollution abatement activities. We equally find a positive coefficient for import term, although it is not significant. This actually reveals the fact that the accumulation of imported equipment and machinery actually facilitates the introduction of the advanced pollution abatement technologies to China.

¹ The parameter for the externality of import can not be obtained directly from the estimation results, actually the coefficient before the import term is actually $\alpha\psi$. So $\psi = \alpha\psi / \alpha = 0.035 / 0.273 = 0.125$.

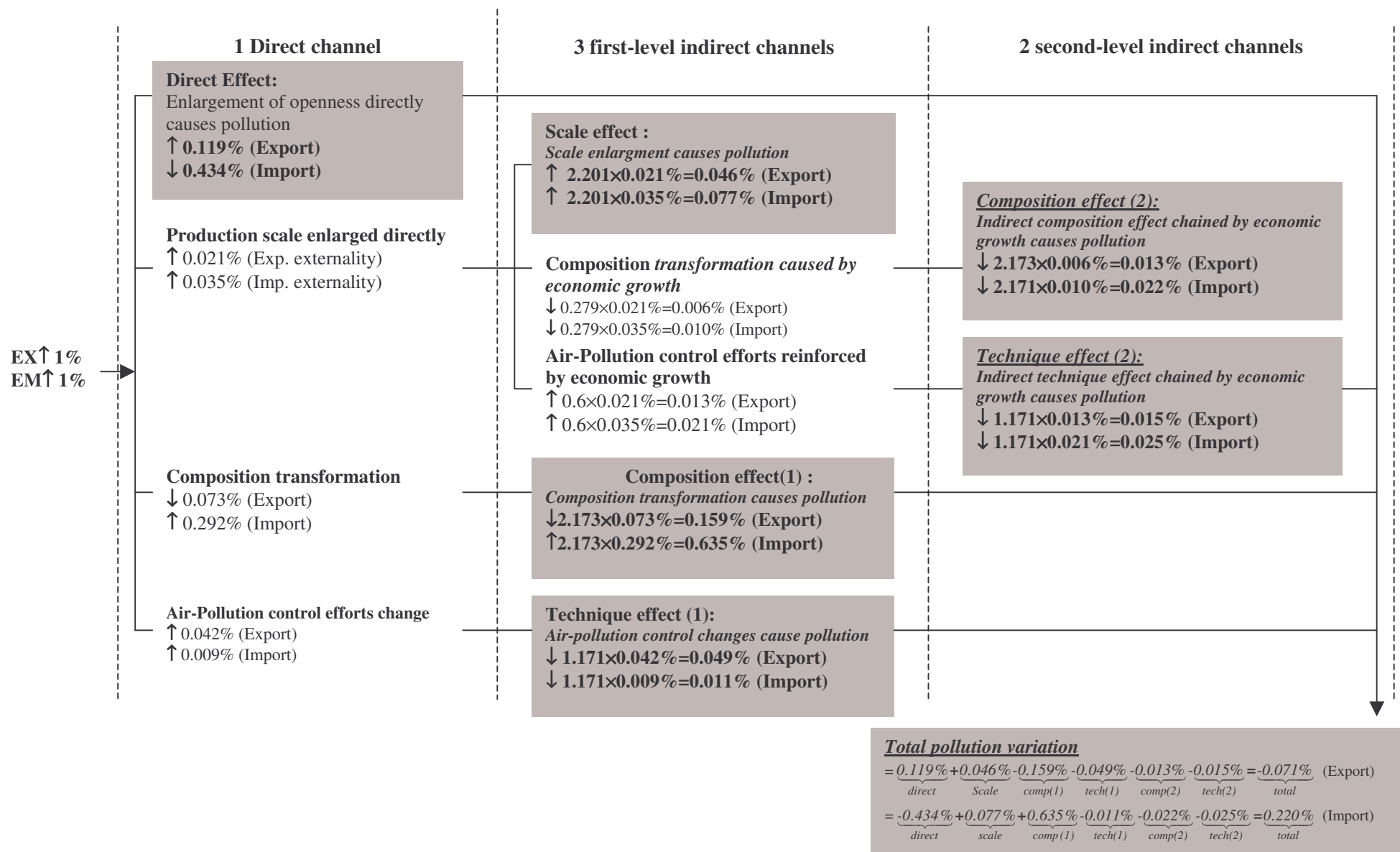

Figure 7.2 Different Channels of the impacts of trade on pollution

Figure 7.2 concretize the figure 7.1 by using the estimated coefficients in Table 7.2. Except both play positive role in production scale enlargement, export and import exert very different impact in both composition and technique effect. We find the final results for the environmental impacts of export and import to be completely opposite. With 1%'s increase in export/GDP ratio, the total percentage change in industrial SO₂ emission realized by all the 6 channels is a negative number, -0.071%, while the overall SO₂ emission variation resulting from 1%'s increase in imported manufactured goods accumulation is, on contrary a positive number, 0.22%. Totally speaking, export is an environment-friendly factor but this is not the case for import. From figure 7.2 we see that, the total emission reduction impact issuing from export is actually owing to the domination of emission reduction result contributed by technique and composition effects. For import, its environment-unfriendly role should be explained by the emission-increasing impact of scale and composition effects.

7.3. Conclusion

Recognizing the potential endogeneity of the three economic determinants of industrial SO₂ emission with respect to international trade and the underlying interaction between them, in this section, we constructed a simultaneous model, in which the impacts of trade on industrial production scale, industrial composition and environment protection efforts and the interactions between the three effects can be structurally captured. With the aid of this model, we get a implicate idea on the real environmental impact of export and import, separately.

The estimation result, corresponding to the related empirical literatures as ACT (2001), proves that the total impact of international trade on China's industrial SO₂ emission is relatively small. We found totally opposite role of export and import on industrial SO₂ emission determination. With 1%'s increase in export intensity to total GDP, the industrial SO₂ will *reduce* by 0.071%, while if imported manufactured goods stock increases by 1%, the industrial SO₂ will on contrary *increase* by 0.22%.

Our result equally revealed the significant externality played by export and import on Chinese industrial economy. We did not find the "pollution haven" evidence for the commercial openness case of China. The pollution-increasing tendency revealed from China's industrial composition is in fact caused by her industry development strategy that uses import as an instrument to facilitate the introduction of the advanced foreign equipment and machinery to some strategic heavy industries. Participation in the international production division system, by guiding Chinese economy to specialize in less polluting labor-intensive sectors where its comparative advantages reside, actually helps China to alleviate the potential

pollution increase that her strategic industrial development process presumes. Concerning the technique effect, we do not find proof for “racing to the bottom” hypothesis. Facing the intensified competition from world market and benefiting from the facilitated technology import process, China’s technical effort in pollution abatement is actually reinforced.

PART 3. SUSTAINABILITY OF CHINA'S ECONOMIC GROWTH

In part 1 and 2 of this dissertation we separately discussed the relationship of China's environment quality with its economic growth and international trade. These two groups of studies conclude that while China's economic growth and industrialization process are still exerting negative impact on its environment, international trade, whose impact on environment stays very complicated from structural point of view, only plays very small improving impact. Facing the future economic growth, industrialization process and the unchangeable globalization tendency, we are naturally very interested in the sustainability of China's economic growth. Will the pursuit for a better live and more stable economic structure will endanger China's long-term growth capacity? What will be the environmental cost that we need to pay? If the environment deterioration comes out to be a unavoidable tendency if China keeps following its current industrial and economic policies, what will be the potential cost? What will be the cost reduction contributed by a more opened economic development process? And finally, what will be the impact of this environmental cost on the future economic growth capacity of China? To answer some of these questions, in this part, we will firstly carry out a synthetic analysis based on a Calculable General Equilibrium Model (CGE). In this model, the relationship between trade, economic growth and environment during 2001-2005 will be parameterized according to the estimation results obtained from the previous chapters and the potential environmental cost during this period will be numerized and decomposed, from which the force-contrast between the environmental impact of economic growth and international trade will be illustrated. Following, we will studies the potential feedback effect from the industrial SO₂ emission on public health situation in China in the last chapter of this dissertation. This study will help us to get some perspective on China's future economic growth capacity loss related to its current pollution problem.

Chapter 8. Economic cost of China's new de-sulfur policy during her gradual accession to WTO—a synthetic analysis on China's trade-environment relationship based on a Calculable General Equilibrium model

Entering the new century, China's economy and environment face unprecedented challenges and opportunities. On one hand, according to the related articles in GATT (1994), from the beginning of 2002, China begins to gradually implement her commitments related to the WTO accession. Large reductions in tariffs, subvention and gradual phasing out of the NTBs are expected over the next 15 years, with the most important changes scheduled to happen during the first 10 years. This further deepening openness process will unavoidably affect China's economic growth, structure transformation and technological progress and equally her environmental situation. On the other hand, in June 2001, China's National Environment Protection Agency (NEPA) called for a further reduction of total annual SO₂ emission by 10% nation wide and 20% in the two control zones (Acid-Rain Control Zone and SO₂ Emission Control Zone) by the year 2005 based on the SO₂ emission volume of the year 2000.¹ Since the openness policy and the new de-sulfur policy were actually implemented during the same period (2001-2005), it undoubtedly offers us a perfect policy background to analyze the trade-environment nexus for China's case.

Given the future SO₂ emission ceiling fixed by the new de-sulfur policy is based on the emission level of year 2000, to attain the new de-sulfur policy's objective, China needs to reduce, both the original SO₂ emission growth caused by the "Business as Usual" economy growth and the further industrial SO₂ emission variation caused by its accession to WTO. If China's SO₂ emission will, as predicted by the conclusion of Part 2, reduce under the new trade

¹ *Beijing Environment, Science and Technology update*, 14, June 2002.

liberalization process, we should expect the new de-sulfur policy to be less costly for the economy growth under the on-coming openness process.

To carry out such a country-specific trade-environment study for China requires us to take into account, the complexity of Chinese economy as much as possible. During the last eight years, based on the 1996 pioneer prototype computable general equilibrium (CGE) trade-environment model developed by OECD Development Center —the Trade and Environment Equilibrium Analysis model (TEQUILA), a series of studies focusing on the trade-environment relationship for developing countries have emerged. Examples include Beghin et al (1997) on Mexico, van der Mensbrugge et al. (1998), Beghin et al (1999, 2002) on Chile, etc. These studies, though similar in their modeling method manage to capture the trade-environment nexus through both scale and composition aspects, project quite different trajectory for the trade-environment nexus for countries. This actually reveals the importance of one country's economic and structural characters in determining the role of trade liberalization in environment protection.

In this chapter, we will apply the recent prototype of a Real China's Computable General Equilibrium Model of Roland-Holst and van der Mensbrugge (2002). Based on this prototype, we further attribute substitutability between different energy inputs and link pollution emission directly to energy intermediary consumption in the production as done in the TEQUILA model. This model, however, is different from the TEQUILA model. Instead of directly using the estimated input-based effluents intensities (Dessus et al., 1994) obtained by matching input data from the social accounting matrix of United States to the corresponding IPPS pollution data developed by the World Bank (Martin et al., 1991), we use the actual SO₂ emission and fuel energy (coal, oil and natural gas) input data in the 18 Chinese industrial sectors to econometrically estimate China's own energy-specific SO₂ emission coefficients. To capture trade's impact on pollution through technical and efficiency aspects, we also include the positive trade-externality into the model through both export and import as in de Melo and Robinson (DMR, 1990). At the same time, considering China's important position as a large exporter of wearing apparel, textile, leather and electronic equipment goods, we also consider the "large country" hypothesis for China in the world market of these goods.

This CGE model is then calibrated into a detailed SAM of 55 sectors of China for the year 1997. There will be four policy scenarios. The Business as Usual (BaU) scenario assumes the Chinese economy will continue under the current situation. To measure the potential economic cost of the new de-sulfur policy, the Desulfur scenario is carried out in which we apply simply the new de-sulfur policy. In the OPEN scenario, only the foreseen gradual tariff

reduction promises during 2002-2005 in China are included. Finally, in the Desulfur+Open scenario, the new de-sulfur policy is implemented along with the new openness process. To seize the different channels through which trade exerts impacts on environment, we further employ the Divisia index decomposition method to reveal the actual contribution of the different economic determinants in SO₂ emission evolution under different policy application.

8.1 China's current pollution control policies

Before going to the details explanation about the CGE model, we need to simply introduce China's current pollution control policies, which is actually a central aspect for both the model construction and policy scenario design in this chapter.

Table 8.1. Evolution of China's SO₂ pollution levy system in the 1990s

(Data source: Cao (1999) and China's Environment Statistic Yearbook, 1991-2001)

Levy rate based on energy consumption (1997)				Average SO ₂ Charge in national level ²	
Province	Charge Rate (Yuan/ton)	Scope of Application ¹	Total Charge in 1997 (10 ⁶ Yuan)	Year	(Yuan/ton)
Guangdong Province	200	Coal and oil	58.52	1993	1.10
Guizhou province	200	Coal	15.97	1994	4.23
Chongqing City	5 yuan/ton coal	Coal	7.34	1995	5.17
Yibin City	180	Coal	7.36	1996	6.20
Nanning City	200	Coal	8.45	1997	7.36
Liuzhou City	200	Coal	na	1998	24.63
Guilin City	200	Coal	na	1999	46.37
Yichang City	200	Coal	11.43	2000	38.90
Qingdao City	200	Coal	39.41		
Hangzhou City	180	Coal	9.19		
Changsha City	200	Coal	3.89		

Note: ¹ Energies in industrial and commercial usage.

² We use the total SO₂ charge revenue divided by the total SO₂ emission quantity to get the national level average SO₂ emission levy rate.

The current SO₂ pollution control system implemented in China is the so-called "Total Emission Quantity Control (TEQC)" system. Under this system, the polluters, principally industrial and commercial enterprises, are asked to pay for their pollution emission *exceeding the relevant national or local pollution standard*, and "the original pollution levy rules also stipulated 80% of the levy revenue to be used to fund pollution prevention measures".¹ This system was applied first in 1993 in two provinces and nine cities. At the beginning, the implemented emission levy rates were very low (only 1.01 Yuan/ton of SO₂ emitted at average national level).² Although Table 8.1 shows that the strictness of the emission levy policy was reinforced during 1990s and its application areas were enlarged into more provinces (Hebei in

¹ Calculated by author according to the available emission and emission levy revenue data.

² Cao et al (1999).

1995 and Shaanxi in 1996), this policy still did not seem to be efficient enough to urge producers to exercise effective emission abatement activities. As the levy rate “in some cases is only 25% of the pollution control cost”,¹ many polluters may prefer to pay levy charge instead of taking measures to abate their emission. Therefore, a large part of pollution reduction observed in the last ten years should be credited to the pollution abatement initiatives of Chinese environmental regulation authority which was funded by over 80% of the revenue collected by the pollution levy system. Clearly, reinforcing levy system efficiency and strengthening polluters' voluntary abatement initiatives, we expect to observe more progress in pollution reduction.

From the beginning of 1998, SEPA went further in their de-sulfur program and defined the cities and provinces suffering most from SO₂ pollution and acid rain problems into two special zones (Acid-Rain Control Zone and SO₂ Pollution Control Zone). In these zones, more stringent pollution control strategies were applied. Since these two zones emit almost two thirds of the national total SO₂ emission, strengthening pollution control in these two zones actually signifies a significant increase in total SO₂ control stringency. Correspondingly, we see from Table 1 the average SO₂ emission levy rate was tripled in 1998.

The plan to reduce total SO₂ emission by another 10% (20% in the two special pollution control zones) in 2001-2005 is a measure to further reinforce the environmental protection strictness initiated by SEPA. Taking as serious this newly established emission control standard (10% less with respect to 2000's real emission level), under the traditional “total emission control” levy system, by how much should we raise the levy rate in order to activate the initiative private pollution abatement activity? How will the side-by-side trade liberalization policy influence the necessary pollution levy rate? How will the influenced levy rate lead structure and total economy growth to change? We will try to answer these questions in our analysis.

8.2. Model Specification

The CGE model used in this chapter is composed of production, income distribution and consumption, other final consumption (investment, government and export service), government revenue and savings, trade, domestic supply and demand, market equilibrium, macro close rules and dynamics sections. It is then calibrated into China's recent 1997 SAM.² The whole economy is divided into 55 sectors: 14 agriculture sectors, 29 industrial sectors, one

¹ Wang (1996).

² Source: Roland-Holst and van der Mensbrugge (2002).

construction sector and 11 service sectors. The energy industries are composed of four sectors: coal mining, oil and coke, natural gas and electricity generation.

The production technology is specified so that each economic sector combines capital, labor, natural resources, land, electricity, fossil fuel and other normal intermediate inputs in production. We use a 6-layered nested constant elasticity of substitution (CES)-Leontief production function to design the production of a specific product. The production nesting is shown in the appendix 8.1.

We suppose that only the energy combustions in production activities emit SO₂ pollution. Inspired by Beghin et al.(1996) and Yang (2001), the production specification further distinguishes the energy input bundle from other normal intermediate inputs and endows the former with continuous substitutability. In light of the differing emission properties of, e.g. fossil fuels and electricity, we specify CES decomposition between electricity and a fossil fuels bundle (coal, oil, natural gas) by assuming greater substitutability between fuels than with respect to electricity.¹ This energy-substitutability arrangement will enable us to be free from the rigid energy input ratio in each unit of product and realize the substitution possibility both inside the energy bundle and between the energy bundle and other traditional production factors. This arrangement will help us to seize producer's energy structure adaptation strategy when facing strengthened pollution control policy and to avoid rigid proportional output reductions. Due to data limitation, we cannot distinguish the pollution abatement activities in the available SAM data, so we currently suppose there are no end-of-pipe pollution abatement efforts in production.

Table 8.2. Energy induced SO₂ emissions

Dependant variables: Industrial SO₂ emission (ton), panel data estimator (1991-1998, 18 sectors)

Explicative Var. ¹	Random Effect (RE)		Fixed Effect (FE)	
	Coefficient	T-value	Coefficient	T-value
Coal	0.0181581	5.17***	0.0184979	5.12***
Oil, petrol and coke	0.0099582	1.40*	0.011331	1.51*
Gas	-0.0083825	-0.88	-0.0098472	-0.99
Year	-5830.464	-0.63	-6596.19	-0.70
Constant	1.20×10 ⁷	0.64	1.35×10 ⁷	0.72
Breusch-Pagan test		479.02		
Hausman test	0.47			
R ² adjusted	0.2254		0.2254	
Num. of Group		18		
Num. of obs.		144		

Note: ¹ the energy usage is measured in physical units, that is to say, TCE (tons of coal equivalence).

The emission rates we use to impute SO₂ pollution from energy use in production were obtained by direct estimation from Chinese industrial data. Using panel data detailing emissions and energy use for 18 sectors (representing over 98% of the total Chinese industrial

¹ Yang (2001) has made a similar arrangement for the energy substitution.

production) from 1991-1998, we obtained the estimates shown in Table 8.2.¹ The most significant relationship is between coal combustion and SO₂ emissions, and a less important, but still significant correlation exists between oil and SO₂ emission. The insignificant negative coefficients for natural gas input support the conventional intuition that natural gas is not a significant threat to the environment. Since the Hausman test suggests the superiority for random effect estimator, we use RE estimation result in our analysis.

As the energy data used in these estimates are measured in physical units – TCE (tons of coal equivalence), we need to further transform them into emission ratios for per monetary units of energy input that is used in 1997 SAM. To get the necessary conversion factors, we divide the corresponding value of total consumption for each type of energy inputs in all the manufacturing sectors in 1997 SAM by the total energy input consumption for the whole manufacturing sector in physical unit in the same year recorded in the panel database. This procedure is shown schematically in equation (8.1).² The conversion factor from physical to monetary unit for emission rates of each energy input is given in Table 8.3.

Table 8.3. Conversion factor and emission rate per monetary unit of energy input

	Conversion factor (Inverse of energy price, CET tons/million USD)	Energy price (USD/ton CE, 1997 price)	SO ₂ emission rate of the energy valued at million USD (Tons of emission/million USD)
Coal	35925.483	27.84	652.339
Oil, petrol and coke	3858.622	259.16	39.421
Gas	19417.549	51.50	0

Note: Physical intermediary energy consumption data for total industry come from China's Energy Databook 5.0, LBL and the monetary intermediary energy consumption data are from the 1997 SAM (Roland-Holst and van der Mensbrugge, 2002).

$$\underbrace{\frac{SO_2 \text{ emission}}{\text{energy}(\text{monetary})}}_{\text{Emission rate for each monetary unit of energy}} = \underbrace{\frac{SO_2 \text{ emission}}{\text{energy}(\text{physical})}}_{\text{Emission rate for each physical unit of energy}} \times \underbrace{\frac{\text{energy}(\text{physical})}{\text{energy}(\text{monetary})}}_{\text{Conversion factor}} \quad (8.1)$$

We can now derive SO₂ emissions for each sector by using the emission rate per monetary unit's energy and the detailed energy input consumption information furnished by SAM 1997 according to equation (8.2). The SO₂ emission from the total economy is calculated from equation (8.3). Here the index j refer to different sectors.

$$SO_2_j = 652.339 \times \text{Coal}_j + 39.421 \times \text{Oil}_j + 0 \times \text{gas}_j + 0 \times \text{Electricity}_j \quad (8.2)$$

¹ This is not the same data source as that we used in constructing the synthetic industrial composition indicator. The panel data used in this estimation are actually on national level.

² It is transformed from CNY by PPP exchange rate 1 USD=4.078 CNY (1997 price). The PPP exchange rate is from Roland-Holst and Van der Mensbrugge (2002).

$$SO_2 = \sum_j SO_{2j} \quad (8.3)$$

Because of data constraints, the present model has only one household group. Each household's consumption decision is characterized by the Linear Expenditure System (LES), after a fixed share of the income transferred in remittances and another fixed proportion going to savings. Other domestic demand includes government final consumption, investment and the volume of services exported in international trade and transport activities. Unlike household demand, the other final demand for different goods is determined by their constant proportions with respect to the aggregated institutional income (revenue, savings and total consumption aggregate, respectively), information need to be calibrated from 1997 SAM.

The model assumes imperfect substitution between goods of differing origin and destination in trade. We use two-stage Armington (CES) function form to determine demand composition between domestic and imported goods from different origins.¹ On the supply side, domestic production is allocated across different markets by a two-stage constant elasticity of transformation (CET) specification. The trade distortions against export and import flows are specified as export taxes (or subsidies) and ad valorem tariffs and/or NTB (with calibrated premia) imposed by government, differing between different markets and assumed to be exogenous.

We assume domestic product demand achieves equality with domestic product supply by adjustment of domestic market prices. The import and the export in most sectors are assumed to follow the small country assumption, facing perfectly elastic import supply and export demand in the world market; their world prices remain constant. But we allow the large country hypothesis for certain products in which China possesses very important influence in the world market, such as textile, wearing apparel, leather goods and electronic equipment. For these sectors, profit maximization decisions of producers depend on the trade-off between export volume and export price that are endogenously determined by foreign markets' demand having finite price elasticity.

All factor markets, labor, capital, land, energy, and other specific resources are supposed to clear in equilibrium. Since the current data do not permit us to distinguish between labors of different skill levels, we assume labor to be perfectly mobile between sectors, determining a unique equilibrium wage. We suppose capital to be allocated with a CET specification across different sectors according to real rental rate differences. Land supply is fixed in the aggregate; the land allocation between different sectors follows a CET arrangement analogous to capital.

¹ More information in the elasticity of substitution the Armington elasticity and the constant elasticity of transformation (CET) for each product are in the Appendix 8.2.

Some resources are employed uniquely in specific sectors, such as mines for the coal mining sector, etc. In the model, we assume zero-mobility for these resources and that their supply varies with their price relative to the general price index.

Government revenue comes from a variety of fiscal instruments: production tax, intermediate consumption tax, income tax, final consumption tax, valued added tax, import tariff, net export tax (or subsidy), emission tax, and transfers from foreign countries. Its expenditure consists of government consumption, transfers to households, enterprises, and to the rest of world. The residual of revenue over expenditure constitutes government's saving.

In the model we consider all the tax rates as exogenously specified policy instruments, with initial values calibrated from the baseline SAM. Treatment of the emission tax is somewhat special since this tax is not accounted for separately in the original SAM. To include this policy instrument into model specification and SAM, we divide the statistically recorded data of 1997 total SO₂ emission charges by total SO₂ pollution in all the *industrial and service* sectors, calculated from equation (8.2). This imputation yields a "national-wide average SO₂ levy rate", about 22.22 Yuan per ton of SO₂ emission. Next, we transform this average SO₂ emission rate into the energy-specific SO₂ emission tax rate by multiplying it by effluent rates for different energy sources. This energy-specific SO₂ emission tax rate will then enable us to calculate SO₂ emission levy revenue from each industrial and service sector for the year 1997.

In the macro closure, we assume the government fiscal balance is exogenous, with the real value of government savings staying constant and with the surplus of government revenue being redistributed to households in lump-sum fashion. Investment is driven endogenously in the model from the total savings coming from household, enterprise, government and the rest of world. The trade balance is also supposed to be endogenous, as is the balance of payments, since we recognize a fixed exchange rate system for Chinese currency RMB.

Traditional CGE models can capture simple aggregate efficiency gains from removing trade and other price distortions.¹ But the estimation results in last chapter confirms that in China, as in most of other East Asia countries, its expanding trade confers a variety of growth externalities. To seize this possible externality from trade in the Chinese economy, we also go a little further to specify a de Melo-Robinson-style positive growth externality in domestic productivity arising from trade (through both exports and imports).

Therefore, we construct a CES production function as equation (8.4), which is very similar to the production function that we used in simultaneous system of chapter 7.

¹ See comments in De Melo and Robinson (1990) and Rodrigo and Thorbecke (1997).

$$Y_j = AT_j \left[a_K (\lambda_K \times K_j)^\rho + a_{ene} (\lambda_{ene} \times ENE_j)^\rho + a_L (\lambda_L \times L_j)^\rho \right]^{1/\rho} \quad (8.4)$$

Y_j is the product. a_x is the share parameter, ρ is CES exponent related to elasticity of substitution between production factors. λ_j represents the endogenous productivity factor.¹ The term

$$AT_j = \overline{AT}_j \left(\frac{\overline{E}_k}{E_{k,t-1}} \right)^\varphi \text{ with } \overline{AT}=1$$

shows the productivity shift due to the externality coming from an increase in export volume with respect to the preceding year, where the E_k denotes export volume for product k (from sector j) and the index t-1 refers to the preceding year.² DMR (1990) choose 0.1-0.3 for the externality parameter φ in their research on Korea. Based on the estimation results from the simultaneous system, we decide to choose here a fairly small value of 0.1 for φ .³

To capture the external effect from the imported machinery and equipment, we further modify the production function as equation (8.5).

$$Y_j = AT_j \left[a_K (\lambda_K \times BT \times K_j)^\rho + a_{ene} (\lambda_{ene} \times ENE_j)^\rho + a_L (\lambda_L \times L_j)^\rho \right]^{1/\rho} \quad (8.5)$$

Here, corresponding to chapter 6, we add term BT in this function, represents the externality resulting from the stock of imported advanced machinery and equipment to the total effective capital stock. Mathematically, this import-externality shift parameter is given by

$$BT = \overline{BT} \times \left(1 + \frac{\sum M_{hp,t}}{\sum_{hp,T=0}^t \sum M_{hp,T}} \right)^\psi.$$

It is constructed in the same way as the import indicators that we used for in simultaneous model. Here $M_{hp,t}$ is the import of machinery and equipment product in period t, suffix *hp* signifies all the machinery and equipment goods, and we know $\overline{BT}=1$. Here the externality from imported machinery is exerted in an average way on the whole economy—it will lead the volume of *effective* capital of the economy to averagely increase by BT times, so

¹ The value of λ is firstly fixed at 1 for the origin year 0. Its values for the following years are then computed in the first dynamic recursive Business as Usual simulation of the model according to the supposed exogenous economic growth rate.

² Index k and j actually refer to the same sector. Since k is used to indicate product and j is to indicate sector.

³ Instead of using the actually estimated elasticity of export externality from chapter 6, which is equal to 0.021 is due to consideration about the discrepancy in variable measurement between the simultaneous and the CGE models. In the simultaneous model, we use the growth rate of the annual total export ratio to total GDP as measurement of export while the CGE model that we used in this chapter follows more original production function of de Melo and Robinson (1990), in which the export externality on the production of each sector only comes from the increase of the export from the industrial sector itself.

for each sector, we have $BT \times K_j \geq K_j$. Based on the estimation results from chapter 5, the externality parameter ψ is supposed to be 0.1.¹

8.3. Policy scenarios

The first recursive dynamic simulation carried out in this study is to find the necessary endogenous productivity growth path for production factors used in industrial and service sectors such that the “Business as Usual” (BaU) GDP growth trajectory can be realized.² The business as usual trajectories for the growth of GDP, population and labor forces during 1997-2001 is reported in Table 8.4. Most of these data comes from the official projection of United Nation, the World Bank and the Chinese government itself. In this simulation, all policy instruments are held exogenous and constant, except SO₂ emission tax rate, which is permitted to evolve during 1997-2000 to capture the already achieved pollution control enforcement during these years. The capital depreciation rate is 5%.

Table 8.4. The related exogenous variable evolution in simulations

Exogenous variables	Year	Annual growth rate	Exogenous variables	Year	Annual growth rate
GDP (percent)	1997	8.8	Labor Force (1/1000)	1997	10.89
	1998	7.8		1998	14.79
	1999	7.1		1999	10.72
	2000	8.0		2000	9.68
	2001	7.3		2001	13.04
	2002-05	7.0		2002-05	10.00
Population (1/1000)	1997	10.06	Productivity growth trajectory <i>Reference: preceding year</i>	1997	1.0000
	1998	9.14		1998	1.0306
	1999	8.18		1999	1.0349
	2000	7.58		2000	1.0310
	2001	6.95		2001	1.0417
	2002-05	7.00		2002	1.0346
				2003	1.0348
				2004	1.0364
			2005	1.0380	

Note: For the expected growth rate of the three exogenous variables (Population, Labor and GDP), the recently published 2003 *China's Statistic Yearbook* gives their actual growth rates during the year 2002. Labor force: 10.12%, Population 6.45% and GDP 8.0%. Our expectation is very close to the actually achieved level.

Once the necessary productivity growth path is obtained, we can start our simulation analysis. The Business as Usual (BaU) scenario is in fact the simulation in the reverse direction to the first simulation requires. In this scenario, supposing that all policy instruments stay constant, we only use the calibrated factor productivity growth rate as exogenous parameters to re-find the supposed BaU economic growth trajectory. To measure the economic cost of the

¹ Rodrigo and Thorbecke (1997) chose the same value for this elasticity in their study on Indonesia case.

² Here, we suppose that only the productivity of labor and capital in the industrial and service sectors is endogenous and changeable during the time, but those for the agricultural sectors and those for land and sector-specific natural resource are always fixed to their original value 1. We also assume that energy inputs to enjoy the same productivity growth rate as capital and labor.

new de-sulfur policy, the Desulfur scenarios adds the 10% SO₂ emission reduction objective to the BaU scenario. We assume this policy will be achieved gradually during 2001 to 2005 (about 2%’s reduction each year) with the aid of endogenous SO₂ emission levy rate. The Open scenario measures possible economic and SO₂ emission changes under China’s gradual accession to WTO. The Uruguay Round of Multilateral negotiation requires China to gradually reduce tariff levels by 30-36% in different sectors and totally eliminate export taxes except for some specific merchandise. The tariff reduction schedule from 2001 to 2005 for the 55 sectors is given in Appendix 8.3. Due to data constraints, we suppose a uniform reduction trajectory for the export tax in all sectors by 50% each year with respect to preceding year, implying a total reduction of export tax by 93.75% at the end of year 2005. We further impose a sizeable trade shock on China’s economy that assumes some exogenous improvement of terms of trade for China’s export owing to its WTO integration. This is expressed in simulation as increases in the world export price faced by Chinese exporters by 1% each year during 2002-2005.¹ Finally, the policy scenario Desulfur+Open combines the two policies.

8.4. Trade-environment nexus analysis

8.4.1 Economic and pollution evolution from 1997 to 2000

Before going into the detailed results of the four simulations, let’s first check the simulated results during 1997-2000 to verify the reality-coherence of the model. According the simulation results in table 8.5, China’s gross output, absorption and real disposable income all grew by about 25% during 1997-2000, these data correspond well to their actual growth achievements of 28.46%, 23.02% and 24.25%, respectively.² The simulation shows investment growth (41.09%) was faster than real GDP growth, as were industrial gross output (29.26%) and export (27.43%). These are also coherent to their actual values, which are 32.03%, 29.39% and 31% respectively. Simulation results also reveals that, due to reinforced pollution control policy, China’s economic growth has been achieved by less than 1 to 1 proportional pollution increase, total SO₂ emission during 1997-2000 grew much slower (10.53%). This is also close to the actual number for this variable, 8.8%. This de-sulfur result could be explained by the

¹ This favorable trade shock is added due to the consideration that with the domestic market more open to the world, China’s products will be more favorable than before in the world market. Some items in the agreement of China’s WTO accession do reflect this possibility.

² All the actual growth achievement of the macroeconomic factors in 1997-2000 is calculated by the author according to the officially published data in China’s Statistic Yearbook (1998-2003).

parallel slower energy consumption growth, especially for coal (only 4.63% vs. -10% in reality) and electricity (12.83% vs. 17% in reality).¹

Detailed changes in economic and energy consumption structure during 1997-2000 are reported in table 8.6 and 8.7. As a typical industrializing country, over 58% of China's production output came from industrial sectors during this period, which is also very close to its actual situation. Within industrial sectors, except the traditional light industries as textile, wearing apparel and leather products still keeping their significant share in total industrial production, some newly emerging industries as chemical products, ferrous metals, electronic equipment and other machinery and equipment sectors also experienced obvious growth.

Industrial sectors have the highest trade intensity. Corresponding to the conclusion of part 2, China's comparative advantage obviously stayed in the traditional or emerging labor-intensive industries such as textile, wearing apparel, leather goods and electronic equipment sectors. The significant import ratios in some natural resource-intensive sectors (as oil and petroleum, food, ferrous metal) and technique-intensive sectors (as chemical products, motor vehicle and other machinery and equipment sectors) manifest China's natural resource and technology constraint.

Table 8.7 shows energy consumption and SO₂ emission situation in some sectors during 1997-2000. Since we suppose SO₂ emission coming directly from energy consumption, the sectors having the highest SO₂ share are generally the sectors consuming most intensively coal in their production activities, such as electricity generation, chemical products, ferrous metals and other mineral product sectors. Oil, another important source of SO₂ emission, is mainly used in oil and petroleum, chemical products, electricity and some transportation service sectors.

¹ The relatively large difference in coal consumption growth between simulation result and the actual official statistics might be due to the missing energy consumption statistics caused by China's statistic system reform. Since this year, official industrial statistics include only the state-owned enterprises and the non-state-owned above designated size industrial enterprises. The new statistical system actually ignores the statistics data of the small coal-mining enterprises, which are very widespread in China. The under-valuation of coal consumption can also explain the exaggeration in electricity consumption increase. See Sinton (2001) For more discussion.

Table 8.5. Macroeconomic changes

Items	Real value							Comparison (% changes to reference)				
	Unit	1997	2000	BaU (2005)	Desulfur (2005)	Lib (2005)	Desulfur+Lib (2005)	2000 (vs 1997)	BAU (vs 2000)	vs BAU Desulfur	Lib	Desulfur+Lib
Real GDP	10 ⁹ US\$	854.69	1073.61	1524.13	1509.64	1535.55	1520.10	25.61	41.96	-0.95	0.75	-0.26
Aggregate output	10 ⁹ US\$	2280.77	2859.59	3949.34	3914.08	3946.91	3909.08	25.38	38.11	-0.89	-0.06	-1.02
Industry	10 ⁹ US\$	1337.69	1729.16	2514.21	2478.94	2513.18	2474.91	29.26	45.40	-1.40	-0.04	-1.56
Private consumption	10 ⁹ US\$	414.09	517.96	692.02	688.80	702.20	698.65	25.08	33.60	-0.47	1.47	0.96
Investment	10 ⁹ US\$	310.00	437.37	650.73	646.69	659.31	655.02	41.09	48.78	-0.62	1.32	0.66
Export	10 ⁹ US\$	235.93	300.64	454.86	447.33	524.41	515.70	27.43	51.30	-1.66	15.29	13.38
Industry	10 ⁹ US\$	209.51	269.08	402.08	394.68	468.16	459.55	28.43	49.43	-1.84	16.43	14.29
Import	10 ⁹ US\$	245.26	312.62	479.37	474.64	571.52	565.62	27.46	53.34	-0.99	19.22	17.99
Industry	10 ⁹ US\$	214.69	267.60	389.42	387.71	484.76	482.23	24.64	45.52	-0.44	24.48	23.83
Absorption	10 ⁹ US\$	830.61	1061.85	1449.27	1442.01	1468.03	1460.19	27.84	36.49	-0.50	1.29	0.75
Real disposable income	10 ⁹ US\$	750.34	935.12	1242.08	1236.63	1259.83	1253.77	24.63	32.83	-0.44	1.43	0.94
Per capita	US\$	606.95	736.07	943.69	939.54	957.17	952.57	21.27	28.21	-0.44	1.43	0.94
Total wage bill	10 ⁹ US\$	388.59	508.35	707.13	696.51	735.41	723.77	30.82	39.10	-1.50	4.00	2.35
Trade balance	10 ⁹ US\$	24.08	28.31	34.39	30.78	34.24	30.03	17.57	21.48	-10.50	-0.44	-12.68
Total SO2 emission	10 ⁶ tons	8.26	9.13	11.00	8.21	11.18	8.21	10.53	20.48	-25.36	1.64	-25.36
Industry	10 ⁶ tons	7.36	8.04	9.55	6.91	9.71	6.90	9.24	18.78	-27.64	1.68	-27.75
Total coal input	10 ⁹ US\$	9.28	9.71	10.68	6.77	10.82	6.68	4.63	9.99	-36.61	1.31	-37.45
Industry	10 ⁹ US\$	8.79	9.16	10.06	6.31	10.20	6.23	4.21	9.83	-37.28	1.39	-38.07
Total oil input	10 ⁹ US\$	56.01	70.93	102.40	96.18	104.61	97.62	26.64	44.37	-6.07	2.16	-4.67
Industry	10 ⁹ US\$	41.28	52.40	75.81	70.96	77.53	72.03	26.94	44.68	-6.40	2.27	-4.99
Total gas input	10 ⁹ US\$	1.11	1.29	1.60	1.74	1.63	1.78	16.22	24.03	8.75	1.87	11.25
Industry	10 ⁹ US\$	1.08	1.26	1.57	1.71	1.60	1.74	16.67	24.60	8.92	1.91	10.83
Total electricity input	10 ⁹ US\$	31.10	35.09	42.70	45.83	43.67	47.03	12.83	21.69	7.33	2.27	10.14
Industry	10 ⁹ US\$	26.21	29.44	35.84	38.83	36.65	39.86	12.32	21.74	8.34	2.26	11.22
Emission tax (1997)	US\$ /	0.00545	0.00545	0.00545	0.00545	0.00545	0.00545	0.00	0.00	0.00	0.00	0.00
Emission tax (2000)	US\$ /		0.028816	0.028816	0.028816	0.028816	0.028816		0.00	4.11	0.00	4.11
Emission tax (2001)	US\$ /			0.028816	0.30	0.028816	0.30			941.09	0.00	941.09
Emission tax (2002)	US\$ /			0.028816	0.63	0.028816	0.66			2086.29	0.00	2190.39
Emission tax (2003)	US\$ /			0.028816	1.01	0.028816	1.09			3405.00	0.00	3682.62
Emission tax (2004)	US\$ /			0.028816	1.47	0.028816	1.62			5001.33	0.00	5521.88
Emission tax (2005)	US\$ /			0.028816	2.04	0.028816	2.25			6979.40	0.00	7708.16
Price wedge on coal		0.03%			104%		113%					
Price wedge on oil		0.0021%			7.4%		8.0%					

Table 8.6. Structure of production in 1997 and 2000

Sector	Share in Gross output (%)		Export/output (%)		Import/domestic sales (%)	
	1997	2000	1997	2000	1997	2000
Agriculture	11.53	12.06	2.34	0.93	3.18	4.86
Manufacturing	58.65	58.43	15.66	15.57	15.99	15.63
Coal	0.50	0.42	10.95	9.96	0.89	0.95
Oil	2.46	2.48	6.69	10.08	16.39	13.04
Gas	0.07	0.06	17.05	20.14	0.00	0.00
Electricity	1.54	1.21	0.61	1.55	0.02	0.01
Mining	1.41	1.49	2.15	1.85	7.92	8.62
Bovine cattle, sheep	0.10	0.09	3.15	2.42	13.34	15.35
Other meat products	0.55	0.51	9.67	4.46	8.66	13.50
Vegetable oils and fats	0.48	0.44	4.91	4.02	30.63	33.35
Dairy products	0.05	0.04	4.17	4.99	21.79	19.92
Processed rice	1.65	1.54	0.82	0.56	0.83	1.03
Sugar	0.03	0.02	21.75	14.74	39.44	46.41
Other food products	1.57	1.42	12.16	9.43	8.02	9.37
Beverages and tobacco	1.78	1.81	2.62	2.13	4.16	4.69
Textiles	5.00	4.82	17.47	16.30	20.11	19.54
Wearing apparel	2.17	2.04	48.61	45.21	9.31	9.42
Leather products	1.69	1.43	54.94	49.47	14.99	16.97
Wood	0.96	0.98	19.13	17.55	8.70	9.21
Paper prod., publishing	1.75	1.73	4.14	4.11	16.57	16.64
Chem. Prod., rub. plast.	6.78	6.87	10.57	12.56	20.26	18.43
Other mineral products	4.58	4.69	5.01	5.21	3.78	3.69
Ferrous metals	3.16	3.27	5.97	6.33	13.28	12.86
Other metal	1.27	1.34	8.12	8.76	19.39	18.63
Metal products	2.43	2.49	12.47	12.92	6.55	6.40
Motor vehicles	1.50	1.52	3.84	4.46	12.88	11.86
Other trans. equipment	1.15	1.20	12.81	13.10	17.66	17.44
Electronic equipment	3.07	3.05	44.79	42.03	45.32	44.28
Other mach. and equip.	8.27	8.59	16.45	17.19	23.22	22.66
Other manufactures	2.51	2.71	39.08	41.35	7.51	7.12
Water	0.18	0.17	0.23	0.37	0.66	0.49
Construction	9.22	9.78	0.26	0.22	0.72	0.79
Services	20.60	19.73	4.20	4.79	4.38	4.32
Total	100.00	100.00	10.34	10.17	10.71	10.62

Table 8.7. Structure of energy consumption in 1997 and variation in 2000 with respect to 1997

	Coal intensity (TCE/million USD)		Oil intensity (TCE/million USD)		Gas intensity (TCE/million USD)		Electricity intensity (1000 kwh/million USD)		Share of SO ₂ Emission (%)		SO ₂ intensity (ton/million USD)	
	1997	Δ2000	1997	Δ2000	1997	Δ2000	1997	Δ2000	1997	Δ2000	1997	Δ2000
Agriculture	21.16	2.18	36.09	6.44	0.05	0.01	0.24	0.03	2.40	0.28	0.75	0.11
Manufacturing	235.96	-45.65	119.07	-2.13	15.70	-1.58	0.63	-0.08	89.10	-0.99	5.50	-0.85
Coal	2.37	-0.22	0.12	0.00	0.03	0.00	0.00	0.00	0.01	0.00	0.04	0.00
Oil	1.05	-0.16	1664.13	-111.47	0.03	0.00	0.00	0.00	11.56	2.15	17.02	-1.14
Gas	1053.06	-127.77	324.32	-9.38	2392.50	-140.22	0.00	0.00	0.41	0.00	22.44	-2.42
Electricity	5274.95	-1044.90	466.91	-53.10	166.36	-23.43	8.07	-1.36	42.88	-4.94	100.57	-19.52
Mining	63.42	-4.78	9.21	0.20	1.66	-0.02	0.59	-0.02	0.48	0.06	1.25	-0.08
Bovine cattle, sheep	67.83	-26.50	6.95	-2.27	0.39	-0.14	0.46	-0.17	0.04	-0.02	1.30	-0.50
Other meat products	8.82	-1.78	0.96	-0.11	0.05	-0.01	0.06	-0.01	0.03	-0.01	0.17	-0.03
Vegetable oils and fats	113.93	-31.63	8.25	-1.66	1.46	-0.33	0.45	-0.11	0.29	-0.07	2.15	-0.59
Dairy products	68.91	-17.91	7.54	-1.37	0.40	-0.08	0.46	-0.11	0.02	0.00	1.33	-0.34
Processed rice	84.22	-20.03	6.04	-0.95	1.08	-0.20	0.34	-0.07	0.72	-0.17	1.59	-0.37
Sugar	42.63	-23.21	3.25	-1.62	0.55	-0.28	0.17	-0.09	0.01	0.00	0.81	-0.44
Other food products	21.92	-9.05	1.74	-0.61	0.28	-0.10	0.09	-0.03	0.18	-0.07	0.42	-0.17
Beverages and tobacco	66.44	-11.54	3.06	-0.27	1.23	-0.14	0.25	-0.04	0.61	-0.04	1.24	-0.21
Textiles	40.87	-6.75	3.60	-0.28	4.21	-0.44	0.32	-0.04	1.08	-0.05	0.78	-0.13
Wearing apparel	10.61	-1.23	1.77	-0.04	0.95	-0.05	0.08	-0.01	0.13	0.00	0.21	-0.02
Leather products	8.53	-1.34	2.39	-0.16	0.53	-0.05	0.07	-0.01	0.08	-0.02	0.18	-0.03
Wood	60.76	-7.01	5.82	-0.13	1.38	-0.07	0.25	-0.02	0.31	0.01	1.16	-0.13
Paper prod., publishing	106.06	-12.86	8.05	-0.23	0.35	-0.02	0.53	-0.05	0.97	0.01	2.01	-0.24
Chem. Prod., rub. plast.	198.62	-31.69	243.89	-17.35	48.96	-4.87	0.91	-0.11	11.42	0.79	6.10	-0.75
Other mineral products	327.96	-36.03	33.84	-0.55	4.56	-0.21	0.61	-0.05	7.96	0.58	6.30	-0.66
Ferrous metals	372.44	-44.61	44.67	-1.22	17.17	-0.98	1.31	-0.11	6.29	0.50	7.22	-0.82
Other metal	109.36	-15.71	22.55	-1.21	8.87	-0.73	1.53	-0.17	0.78	0.06	2.22	-0.30
Metal products	25.29	-2.80	4.37	-0.07	2.97	-0.14	0.38	-0.03	0.34	0.03	0.50	-0.05
Motor vehicles	34.62	-5.00	7.02	-0.38	1.50	-0.12	0.26	-0.03	0.29	0.01	0.70	-0.09
Other trans. equipment	25.11	-2.77	4.23	-0.07	1.30	-0.06	0.28	-0.02	0.16	0.01	0.50	-0.05
Electronic equipment	4.13	-0.62	1.46	-0.09	2.13	-0.19	0.06	-0.01	0.08	0.00	0.09	-0.01
Other mach. and equip.	32.75	-3.61	5.05	-0.08	3.10	-0.14	0.13	-0.01	1.48	0.14	0.65	-0.07
Other manufactures	36.70	-5.04	4.07	-0.19	3.96	-0.30	0.20	-0.02	0.49	0.05	0.71	-0.09
Water	15.23	-2.74	25.29	-2.36	0.34	-0.04	4.18	-0.59	0.03	0.00	0.53	-0.07
Construction	5.41	-0.30	4.95	0.22	0.68	0.01	0.08	0.00	0.38	0.06	0.15	0.00
Services	23.19	-3.38	98.56	1.38	0.84	-0.09	0.16	-0.02	8.12	0.65	1.43	-0.05
Total	146.11	-24.20	94.75	0.95	9.45	-0.69	0.44	-0.04	100.00	0.00	3.62	-0.43

Table 8.7 illustrates a general declining tendency for SO₂ emission intensity in many industrial and service industries during 1997-2000. This could be explained by their energy intensity declines, especially in the coal and oil use. The most important sulfur reduction was also achieved in the most SO₂-polluting sectors, like electricity generation sector, whose SO₂ emission reduction was about -19.42%. However, since the China experienced very important economic growth during the same period, the total volume of SO₂ emission and energy consumption still increased. (See table 8.5).

8.4.2. Empirical results of the four policy scenarios

a. BaU scenario

The BaU scenario presents the most likely trajectory for economic growth, SO₂ emission variation and industrial structure transformation in China given its current policies. According to this scenario, as shown in Table 8.5, China's real GDP will grow by another 42%, with a environmental cost of 20% increases in SO₂ emission. The coal consumption intensity will further decrease and this coal use decline will be compensated by increases in the consumption of other energies, whose expected consumption show relatively larger growth than coal.

Table 8.8 reports the principal structural changes in Chinese economy in BaU scenario. Under the same industrial policies, China's most important output increase during 2001-2005 will be in the industrial sector (45.40%). However, contrary to our expectation, except for the electronic equipment sector, the most important expansion will not happen in the labor-intensive sectors, but in some heavy industries, as metal, machinery, motor vehicle, other transportation equipment and chemical products sectors. This actual reveals and confirms our suspicion about China's "heavilization" intention in its current industrial development strategy. This intention can be further traced from China's producer tax structure, conveyed by SAM, which gives more priority to the development of some raw material and energy industries.

The changes in export and import structure and in market price equally reveal this "heavilization" tendency. On one hand, obvious export increases and import reductions are expected in most of heavy industries. On the other hand, the general market price for these products will also diminish, showing the actual advantages that they benefit from the industrial policies.

Table 8.8. Principal simulation results for Business as Usual (BaU) scenario

	SO ₂ emission				
	Output changes (%)	intensity changes (%)	Export change (%)	Import change (%)	Market price change (%)
Agriculture	8.32	20.88	-61,77	3,95	38.66
Manufacturing	45.40	-26.66	49,43	-1,84	0.49
Coal	12.21	-14.19	-10,65	8,60	6.37
Oil	71.45	-20.49	177,74	-12,78	-11.73
Gas	38.77	-23.90	63,45	-13,74	-5.13
Electricity	41.95	-40.30	285,84	-57,75	-22.74
Mining	53.18	-20.54	31,27	0,92	3.63
Bovine cattle, sheep	-33.70	-27.35	-82,01	6,40	28.79
Other meat products	-4.48	-22.15	-68,25	4,88	25.50
Vegetable oils and fats	9.76	-37.46	-23,32	-0,07	6.06
Dairy products	1.27	-37.34	-29,41	2,70	7.58
Processed rice	8.93	-30.38	-65,70	5,57	32.97
Sugar	-40.09	-25.70	-77,11	8,12	12.24
Other food products	-2.45	-40.06	-59,18	4,02	22.30
Beverages and tobacco	31.79	-34.62	-17,57	1,87	11.92
Textiles	37.16	-32.32	23,07	0,16	-0.21
Wearing apparel	33.88	-22.64	20,44	1,71	1.36
Leather products	-10.65	-18.14	-28,24	2,45	12.87
Wood	45.28	-26.40	28,67	1,72	3.33
Paper prod., publishing	41.88	-25.98	33,96	0,18	1.25
Chem. Prod., rub. plast.	54.26	-28.58	79,02	-8,46	-3.50
Other mineral products	53.06	-26.40	64,07	-4,16	-1.76
Ferrous metals	58.49	-28.11	71,29	-9,19	-1.80
Other metal	63.09	-32.61	76,92	-6,06	-1.82
Metal products	54.53	-26.01	64,15	-1,94	-1.62
Motor vehicles	56.22	-31.56	84,84	-0,69	-3.85
Other trans. equipment	59.23	-26.95	68,51	0,19	-1.35
Electronic equipment	50.30	-31.17	38,50	0,66	-1.14
Other mach. and equip.	58.95	-26.88	71,15	0,27	-1.74
Other manufactures	66.88	-37.09	78,74	1,09	-2.78
Water	58.96	-33.49	186,74	-8,44	-13.73
Construction	51.06	-12.30	34,40	1,26	2.95
Services	40.72	-5.80	82,98	-0,40	5.88
Total	38.11	-17.58	51,30	-1,66	-0.40

Fortunately, this “heavilization” tendency seems not to be accompanied by pollution *intensity* increase. Our simulation results show that, even without further pollution control policies, given the expected technique progress, the tendency for SO₂ emission *intensity* is to decrease. This is reflected by the generally important decrease in the SO₂ emission *intensity* in almost all the industrial and service sectors. This result should be attributed to the energy substitution process shown in Tables 8.5 and Appendix 8.4.

b. Other three policy scenarios

The principal macroeconomic indicators’ changes under the other policy scenarios are also reported in Table 8.5.

Similar to the studies of Mexico (Beghin et al., 1997 and 1998), the new de-sulfur objective, when applied alone on Chinese economy, will only induce small foregone for Chinese real GDP growth (-0.95%). The main contribution to pollution reduction will come from energy

composition transformation from coal intensive to gas and electricity intensive. As the most important polluters are concentrated in industrial sectors, the gross output and export of the industrial sectors will face relatively more loss than the average level of the whole economy.

Contrary to our expectation, China's accession to WTO seems to only bring modest economic growth (0.75% for real GDP). The most prevalent impact of trade liberalization is to enlarge export and import share in Chinese economy. Without a further policy to control SO₂ pollution, trade liberalization, however, will lead SO₂ emission to increase by 1.64% with respect to the BaU scenario. This actually reflects an *increase* of SO₂ emission intensity by 0.89%.¹ The GDP and emission variation differences are larger in industry, with a slight reduction of total output of -0.06%, the 1.68% increase in SO₂ emission from industrial production means an actual increase of SO₂ emission intensity by 1.74%. Clearly, opposite to the description as an environment-friendly factor for Chinese economy, the trade liberalization policy related to WTP accession will *slightly deteriorate* China's SO₂ pollution problem.

Similar to Beghin et al. (1997 and 1998), for most of the macroeconomic indicators, their variations under Open+Desulfur policy are quite close to the additive of their separate variations under Open and Desulfur scenario (except for export and import). But this additive situation cannot be applied to the energy consumption case. In Table 8.5, we observe that both the reduction in coal and oil consumption and the increase in gas and electricity uses under the combined scenario are somewhat higher than the additive sum of the two scenarios of separated policy. This actually reveals the fact that policy combination will further facilitate the substitution between the polluting (coal, oil) and less polluting (gas, electricity) energies.

To achieve the 10% SO₂ reduction objective in 2005, under the Desulfur scenario, the necessary endogenous emission levy rate needs to increase by about 150% each year and finally attains 2.04 USD per Kg of SO₂ in 2005 (1997 US\$). This levy rate needs to grow a bit faster when the de-sulfur policy is implemented together with trade liberalization promises, and to reach 2.25 USD per kg of SO₂ in 2005.^{2,3} Compared to the original emission levy rate in the benchmark year 1997 (Table 8.6), the increase in emission levy rate pushed by new desulfur policy will bring a much more important ad valorem wedge to energy price. For example, the price wedge caused by emission tax in 2005 will be about 113% for coal and about 8.0% for oil in the Desulfur+Open scenario.

¹ The 0.89%'s increase in SO₂ emission intensity is calculated by subtracting the 0.75% increase in real GDP from the total SO₂ emission increase, since $SO_2 \text{ emission intensity} = SO_2 \text{ emission} / \text{real GDP}$.

² This is equal to 8.34 Yuan per Kg SO₂ according to PPP exchange rate: 1 US\$=4.07691Yuan.

³ The magnitude of these necessary emission levy rates is similar to those found in Bighin et al. (1997, 1998) for Mexico and Chile.

8.4.3. Discussion on the detailed structure and price changes in the four scenarios

Figure 8.1 shows the detailed market price changes in different sectors due to pollution control and trade liberalization policies. This is actually an intermediate step for us to understand the changes in the output and pollution structure. As the application of the new de-sulfur policy will bring an ad valorem wedge of 104% (113%) on coal price under the Desulfur (combined Desulfur+Open) policy, this important increase in coal price will in turn decrease demand for coal. The final equilibrium coal price will be 83% (94%) higher than the original price. This higher coal price will in its turn encourage producers to substitute coal with other cleaner energies. The increase in the demand for oil, gas and electricity will then lead the market prices of these less-polluting energies to rise. Following this general price increase tendency for all the energy products, the production cost and price of the products whose production process needs more energy as inputs, such as electricity, chemical products, ferrous metal, other metal, metal products and the mineral products, etc., will also rise. These will then reduce the competitiveness of the sectors producing these products. The production factors originally used in these sectors will then be released back into the economy and become available for the less energy-intensive sectors at lower prices. As a result, we can observe the general price decrease tendency in the sectors as textile, apparel, leather product and electronic equipment.

Figure 8.1. The price effects of different policies¹

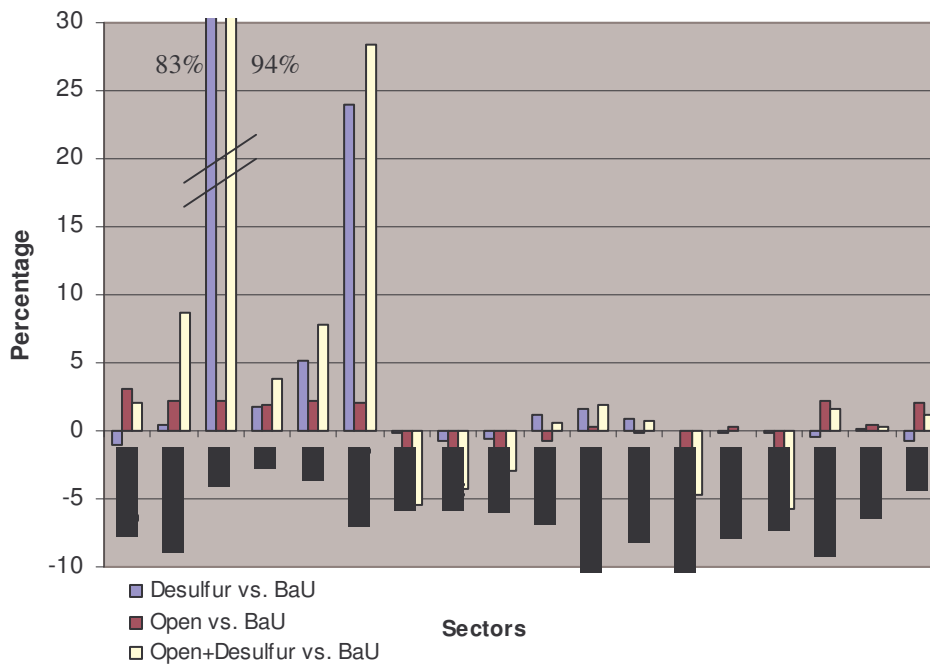

¹ Due to space limitations, we just report the most important industrial sectors in the following figures. More detailed tables with simulation results for all 55 sectors are available upon request.

According to Figure 8.1, the price structure changes under trade liberalization process seems very similar to that under the de-sulfur policy, although their causality mechanisms are not the same. Under the new trade liberalization process, the sectors that benefit more from productivity improvement are generally the sectors having stronger export capacity. Coincidentally, in China, the labor-intensive industrial sectors that possess comparative advantages in world market are also the sectors whose production processes use relatively less energy and emit less pollution.

Another supportive evidences for the compatibility between the de-sulfur and openness policies in their impact on China's industrial structure specialization and pollution reduction can be find from the price structure of the combination scenario. Where the price differences between the polluting and less-polluting sectors are generally more remarkable than those in either of the two separate policy scenarios. Comparing the price structure of the three scenarios, we can also see that the price reduction effect in the less-polluting sectors is principally owing to the trade liberalization process, while the price increase effects in the polluting sectors are mainly caused by the de-sulfur policy.

Figure 8.2. Output and SO₂ emission intensity changes (%)

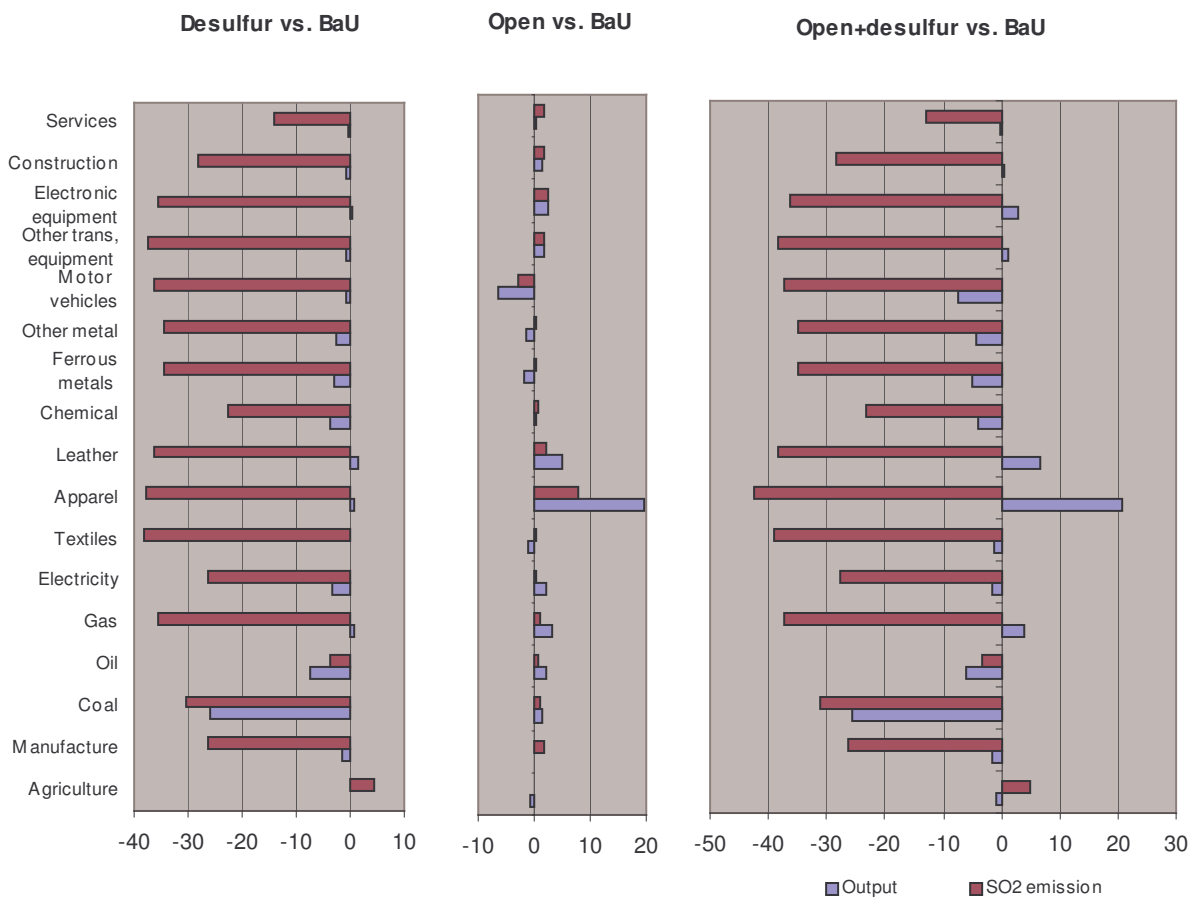

Figure 8.2 illustrates the changes in output and SO₂ emission of some industrial sectors under the three policy scenarios with respect to BaU. Given the price structure changes, in all the three policy scenarios, the original “heavilization” tendency will be impeded. Besides the three energy sectors, coal, oil and electricity, whose output reduction should be explained by the reduction in intermediary consumption demand, the most important production reduction with respect to the BaU scenario actually happens in the energy-intensive industries as chemical products, ferrous metal, other metal, and metal product.

Under the Open scenario, the changes in price structure also forecast significant reductions in many disadvantageous capital-intensive heavy industrial sectors (other motor vehicle, -6.42%, other metal, -1.55%, ferrous metals, -1.64%, etc.). At the same time, the Open scenario anticipates a 19.81% increase in wearing apparel sectors, 2.42% increase for electronic equipment and 4.99% for leather production with respect to the BAU scenario. The actual reduction in the textile sector’s output should be explained by the domination of price consideration in producer’s profit-maximization decision when facing the downward sloping demand curve of the world market under the large country hypothesis.

The compatibility between the Open and Desulfur policies observed from the price structure changes also induces more remarkable industrial structure changes under this policy-combination scenario. From Figure 8.2 we can easily distinguish larger output increases in wearing apparel (20.87%), leather production (6.71%) and electricity equipment (2.83%) sectors with respect to those in Open scenario. Meanwhile, due to the reinforcement in pollution control, the product ratio decrease in the polluting heavy industry sectors, such as the ferrous metal, other metal and chemical sectors, is also more remarkable.

The dark-colored bars in Figure 8.2 reflect SO₂ emission changes. To attain the 10% SO₂ reduction objective, the new desulfur policy will cause SO₂ emission intensity to decrease in an average way in all industrial sectors (by about -37%). The simple presence of trade liberalization will instead lead the pollution intensity of most industrial sectors to increase slightly, but not in an even fashion. The curious out-of-proportion SO₂ emission intensity increases in many export-oriented sectors, such as wearing apparel (7.8%), electronic equipment (2.51%) and leather products (2.07%) reveal the fact that the sectors possessing a comparative advantage will produce with higher pollution intensity under trade liberalization. This phenomenon might be due to the improvement of trade terms of these export sectors, which reduces the relative cost of the pollution tax faced by the producers. Or as that found in chapter 4, the stricter pollution control policies are actually applied in some capital-intensive heavy industries where exists more large-scale enterprises. This is actually the reason for which we failed to capture a clear-cut and

significant environmental impact of trade in chapter 6 when we employ the trade intensity to explain the decomposed composition effect. Clearly, the contrary-intuitive SO₂ emission increase result obtained from the Open scenario is in fact the final result of production structure variations and uneven pollution intensity changes in different sectors.

Combining trade and pollution reduction policy seems to be a good remedial measure for the slight SO₂ intensity increase case in the most important export sectors. On the one hand, the Chinese economy can harvest the fruits of liberalization and enlarge the production scale in certain advantageous sectors. On the other hand, new pollution control policy can also impose more exigent requirements on pollution reduction performance, especially to the export-oriented sectors, whose pollution performance risk to increase the most under liberalization. Correspondingly, in figure 8.3, we see the most significant pollution reduction achievement will happens in most export-oriented sectors (textile, -39.02%, wearing apparel, 42.45%, leather product, -38.44%, electronic equipment, -36.12%).

Figure 8.3. Trade structure changes under different policy scenarios (%)

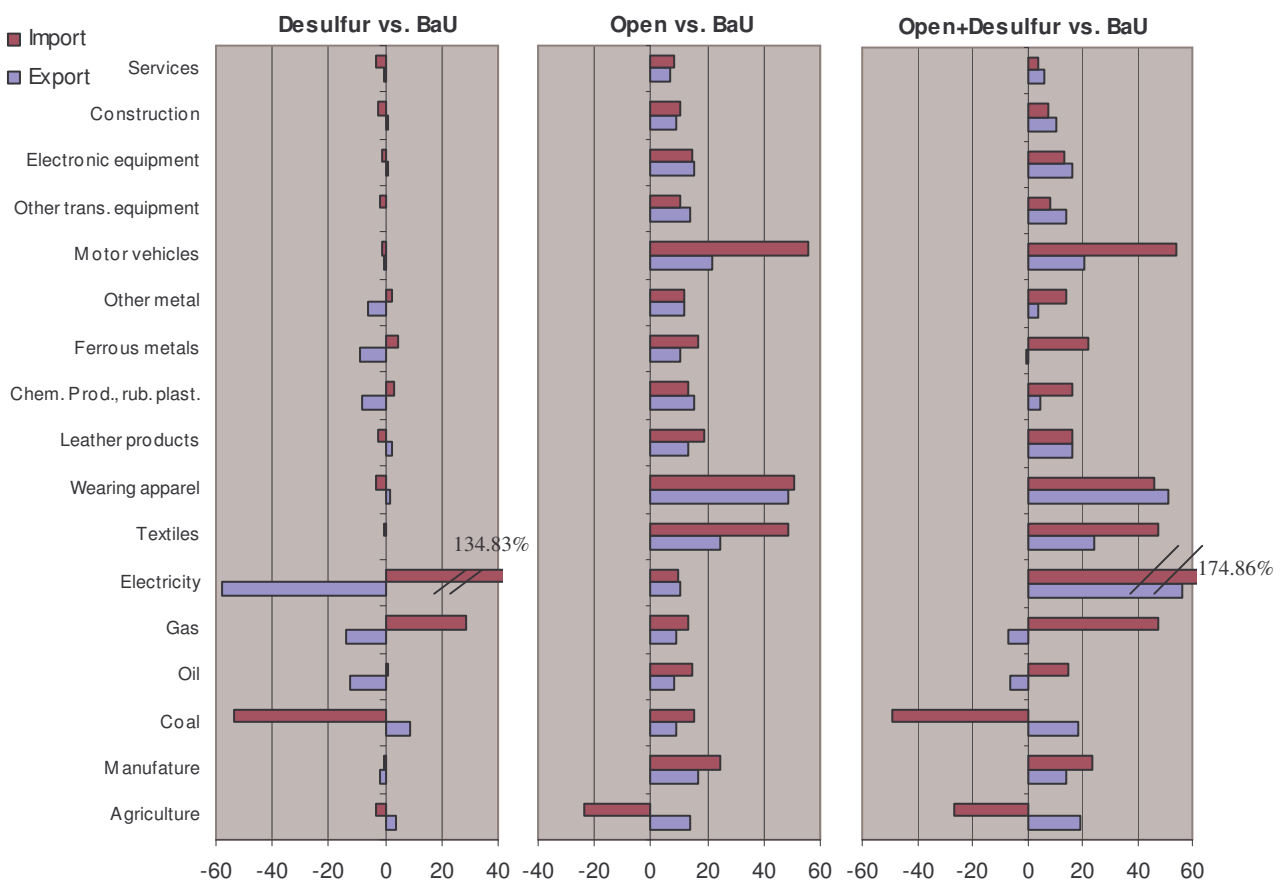

The fact that output ratios of most of the heavy and SO₂-intensive sectors are to decrease in both the Open and Open+Desulfur scenarios prove for another time the absence of the “pollution haven” hypothesis in China’s case. As suggested in the conclusion of part 2, China’s traditional

comparative advantage in relatively cleaner labor-intensive sectors actually dominates over its environmental comparative advantage as a low-income “pollution haven” for polluting sectors. The new finding from this chapter is that, if we would like to consider trade liberalization as a factor to deteriorate China’s environment, it works actually from relaxing the pollution tax pressure faced by the export sectors rather than from leading China’s industrial composition transformation to specialized in polluting sectors.

The detailed trade variations for the different policy scenarios are shown in figure 8.3. Due to energy composition changes under new de-sulfur policy; we observe an increase in net coal export from China and the contrary tendency for the other three cleaner energies. The clean energy import is further increased (47.91% for gas and 174.86% for electricity) under the combined policy scenario. This actually reveals the contribution of liberalization in relaxing domestic supply constraints of these energies by opening clean energy supply from the world market. Overall, the dependence of the Chinese economy on the imported cleaner energy will increase due to the emission control policy, but the simulated results also show the decrease in trade surplus related to energy import will be relatively small. The total trade surplus under the two scenarios that include the desulfur policy will remain stable at about 30 billions US\$. Obviously, China’s export has enough capability to finance its energy import.

8.5. Decomposition analysis

Since our CGE model distinguishes production and emission changes in each economic sector, and different channels of technical progress are also included in the production function, these actually offer us an opportunity to calculate the contribution of scale, composition and technique effects on SO₂ emission variation by the Divisia index decomposition method. Starting from production function (8.5), the emission determination function of sector j can actually be expressed as equation (8.6).

$$SO_{2,jt} = \sum_f \left(\frac{\varphi_f \lambda \times AT \times BT \times X_{f,j}}{X_j} \right) \times \left(\frac{X_j}{\sum_j X_j} \right) \times \sum_j X_j \quad (8.6)$$

φ_f is the estimated and supposed-to-be-constant SO₂ emission rate of energy f . $\sum_j X_j$ indicates the scale effect. $\frac{X_j}{\sum_j X_j}$ captures the composition changes. $\sum_f \left(\frac{\varphi_f \lambda \times AT \times BT \times X_{f,i}}{X_i} \right)$ reveals

the different channels through which the technical effect affect SO₂ emission, in which we can distinguish three different channels: the increase of total factor productivity indicated by λ (neutral *technique effect*), the expansion of the trade externality indicated by AT and BT

(externality effect), and the substitution of polluting energies by less- or non-polluting energies indicated by $X_{f,i}$ (substitution effect). Starting from equation (8.6), the Divisia index decomposition method can decompose the changes of total SO₂ emission under each scenario into variation of those five determinants as equation (8.7).

$$\begin{aligned}
 \ln(SO_{2,jt}/SO_{2,j0}) = & \left\{ \sum_f 0.5 \times \left(\frac{X_{f,jt} \times \varphi_f}{\sum_f (X_{f,jt} \times \varphi_f)} + \frac{X_{f,j0} \times \varphi_f}{\sum_f (X_{f,j0} \times \varphi_f)} \right) \left[\ln \left(\frac{\sum X_{jt}}{\sum X_{j0}} \right) \right] \right\} & \text{(Scale)} \\
 & + \left\{ \sum_f 0.5 \times \left(\frac{X_{f,jt} \times \varphi_f}{\sum_f (X_{f,jt} \times \varphi_f)} + \frac{X_{f,j0} \times \varphi_f}{\sum_f (X_{f,j0} \times \varphi_f)} \right) \left[\ln \left(\frac{\frac{X_{jt}}{\sum X_{jt}}}{\frac{X_{j0}}{\sum X_{j0}}} \right) \right] \right\} & \text{(Composition)} \\
 & + \left\{ \sum_f 0.5 \times \left(\frac{X_{f,jt} \times \varphi_f}{\sum_f (X_{f,jt} \times \varphi_f)} + \frac{X_{f,j0} \times \varphi_f}{\sum_f (X_{f,j0} \times \varphi_f)} \right) \left[\ln \left(\frac{\lambda_{j0}}{\lambda_{jt}} \right) \right] \right\} & \text{(Technique)} \\
 & + \left\{ \sum_f 0.5 \times \left(\frac{X_{f,jt} \times \varphi_f}{\sum_f (X_{f,jt} \times \varphi_f)} + \frac{X_{f,j0} \times \varphi_f}{\sum_f (X_{f,j0} \times \varphi_f)} \right) \left[\ln \left(\frac{AT_{j0} \times BT_0}{AT_{jt} \times BT_t} \right) \right] \right\} & \text{(Externality)} \\
 & + \left[\sum_f 0.5 \times \left(\frac{X_{f,jt} \times \varphi_f}{\sum_f (X_{f,jt} \times \varphi_f)} + \frac{X_{f,j0} \times \varphi_f}{\sum_f (X_{f,j0} \times \varphi_f)} \right) \times \ln \left(\frac{\frac{X_{f,jt} \times \lambda_{jt} \times AT_{jt} \times BT_t}}{X_{jt}}}{\frac{X_{f,j0} \times \lambda_{j0} \times AT_{j0} \times BT_0}}{X_{j0}}} \right) \right] & \text{(Substitution)} \quad (7)
 \end{aligned}$$

The decomposition results for the four policy scenarios are reported in Table 8.9. In all four scenarios, the most important contribution in SO₂ emission increase comes from scale expansion, in which the single electricity generation sector occupies very large percentage point. Though the composition effect will further exacerbate this pollution deterioration tendency, which can be traced from the generally large positive numbers listed in the composition effect columns, the relatively smaller numbers appearing in the two desulfur-related scenarios show the fact that the industrial structure transformation under the desulfur policy does partially limit the SO₂ emission growth potential. Concerning to the contribution from technical effect, besides the slight differences in the trade externality effect caused by trade volume variation under different scenarios, it is the neutral technique and energy substitution effects that make the major contribution for SO₂ emission reduction. Without the new desulfur policy, the most important SO₂ reduction force comes from technological progress. As for the two scenarios where the desulfur objective is imposed, the most important role in SO₂ reduction is played by energy substitution procedure.¹

¹The detailed variations of energy input use on sectoral level are furnished in the Appendix.

Table 8.9. Decomposition of change in SO₂ emission (reference: 1997, Divisia method)

Sector	BaU							Desulfur						
	Effect						ΔEmission	Effect						ΔEmission
	Scale	Composition	Externality	Technique	Substitution	Residual		Scale	Composition	Externality	Technique	Substitution	Residual	
Agriculture	138.28	-92.44	-3.05	0.00	74.36	0.01	117.16	139.44	-92.32	-3.11	0.00	87.88	0.00	131.89
Manufacturing	4586.78	968.12	-132.82	-2314.04	-917.85	-0.51	2189.68	3814.30	642.80	-107.51	-1956.29	-2825.46	-13.56	-445.70
Coal	0.27	-0.18	-0.01	-0.14	0.03	0.00	-0.02	0.18	-0.22	0.00	-0.09	-0.16	0.00	-0.29
Oil	751.70	451.38	-16.58	-379.24	126.51	0.00	933.78	693.04	335.74	-15.47	-355.45	66.60	0.05	724.52
Gas	21.08	-0.25	-0.47	-10.63	-0.53	-0.01	9.19	16.75	0.34	-0.37	-8.59	-13.73	-0.14	-5.75
Electricity	1938.41	-19.40	-42.76	-977.93	-919.67	-0.25	-21.60	1609.99	-87.85	-35.93	-825.73	-1710.51	-8.10	-1058.13
Mining	28.33	8.03	-0.63	-14.29	3.86	-0.01	25.29	21.60	5.92	-0.48	-11.08	-15.79	-0.15	0.03
Bovine cattle, sheep	0.92	-1.57	-0.02	-0.46	-1.22	0.00	-2.36	0.77	-1.29	-0.02	-0.40	-1.69	0.00	-2.62
Other meat products	0.92	-0.94	-0.02	-0.46	-0.32	0.00	-0.83	0.74	-0.74	-0.02	-0.38	-0.91	0.00	-1.31
Vegetable oils and fats	10.13	-6.19	-0.22	-5.11	-8.29	0.00	-9.68	8.28	-5.11	-0.18	-4.25	-13.19	-0.04	-14.49
Dairy products	0.63	-0.42	-0.01	-0.32	-0.54	0.00	-0.65	0.51	-0.33	-0.01	-0.26	-0.87	0.00	-0.97
Processed rice	27.01	-17.57	-0.60	-13.63	-15.02	0.00	-19.81	21.58	-13.84	-0.48	-11.07	-30.77	-0.09	-34.67
Sugar	0.13	-0.27	0.00	-0.06	-0.25	0.00	-0.46	0.11	-0.23	0.00	-0.06	-0.31	0.00	-0.48
Other food products	5.21	-4.50	-0.11	-2.63	-7.28	0.00	-9.31	4.26	-3.62	-0.10	-2.19	-9.71	-0.02	-11.37
Beverages and tobacco	27.68	-2.57	-0.61	-13.97	-10.27	0.00	0.26	21.74	-1.84	-0.49	-11.15	-26.83	-0.07	-18.63
Textiles	51.28	-0.46	-1.46	-25.87	-14.15	-0.01	9.34	39.85	0.18	-1.15	-20.44	-46.50	-0.20	-28.27
Wearing apparel	6.31	-0.70	-0.18	-3.18	-0.07	0.00	2.17	4.92	-0.42	-0.14	-2.52	-4.32	-0.04	-2.53
Leather products	3.07	-3.41	-0.07	-1.55	-0.53	0.00	-2.49	2.50	-2.71	-0.06	-1.28	-2.47	-0.02	-4.04
Wood	16.43	2.23	-0.50	-8.29	-0.72	0.00	9.15	12.74	1.97	-0.40	-6.54	-11.59	-0.07	-3.88
Paper prod., publishing	50.24	3.25	-1.56	-25.35	-3.03	-0.01	23.55	38.94	2.79	-1.24	-19.97	-36.05	-0.18	-15.70
Chem. Prod, rub. plast.	634.83	211.08	-26.06	-320.27	-42.81	-0.05	456.72	532.42	151.33	-20.29	-273.07	-303.50	0.27	87.16
Other mineral products	445.77	128.19	-17.62	-224.89	-0.96	-0.07	330.42	346.07	98.82	-13.39	-177.49	-285.93	-1.93	-33.86
Ferrous metals	358.97	136.83	-14.75	-181.10	-10.82	-0.06	289.07	277.32	97.05	-10.62	-142.23	-232.59	-1.70	-12.76
Other metal	44.38	20.92	-1.86	-22.39	-5.43	-0.01	35.61	34.45	15.53	-1.40	-17.67	-31.73	-0.27	-1.09
Metal products	19.10	5.87	-0.76	-9.64	0.23	0.00	14.80	14.65	4.50	-0.58	-7.51	-12.52	-0.11	-1.58
Motor vehicles	15.86	5.49	-0.69	-8.00	-2.01	0.00	10.63	12.28	4.32	-0.54	-6.30	-11.94	-0.10	-2.28
Other trans. equipment	9.13	3.56	-0.38	-4.61	0.11	0.00	7.81	7.02	2.82	-0.29	-3.60	-5.97	-0.05	-0.08
Electronic equipment	4.02	0.93	-0.13	-2.03	-0.61	0.00	2.18	3.18	0.82	-0.11	-1.63	-3.03	-0.03	-0.79
Other mach. and equip.	85.29	32.77	-3.54	-43.03	0.98	-0.02	72.45	65.50	26.00	-2.77	-33.59	-55.97	-0.46	-1.30
Other manufactures	28.17	15.45	-1.20	-14.21	-4.75	0.00	23.45	21.63	12.40	-0.94	-11.09	-22.72	-0.13	-0.85
Water	1.48	0.57	-0.03	-0.75	-0.26	0.00	1.02	1.28	0.48	-0.03	-0.66	-0.77	0.00	0.30
Construction	23.31	5.97	-0.51	-11.76	7.73	0.00	24.73	19.14	5.08	-0.43	-9.82	-5.26	-0.05	8.66
Services	469.06	49.39	-10.35	-236.64	137.78	0.06	409.30	423.20	48.72	-9.44	-217.05	6.18	1.87	253.47
Total	5217.43	931.04	-146.73	-2562.45	-697.98	-0.44	2740.87	4396.09	604.28	-120.49	-2183.15	-2736.66	-11.73	-51.68

Table 8.9. (Continued) Decomposition of change in SO₂ emission (reference: 1997, Divisia method)

Sector	Open							Desulfur+Open						
	Effect						ΔEmission	Effect						ΔEmission
	Scale	Composition	Externality	Technique	Substitution	Residual		Scale	Composition	Externality	Technique	Substitution	Residual	
Agriculture	137.54	-95.36	-3.28	0.00	75.89	0.01	114.80	138.79	-95.28	-3.36	0.00	90.43	0.00	130.59
Manufacturing	4621.33	1070.89	-142.99	-2334.09	-865.79	-0.52	2348.83	3800.50	700.25	-114.77	-1953.83	-2874.15	-15.27	-457.26
Coal	0.27	-0.18	-0.01	-0.14	0.04	0.00	-0.01	0.18	-0.22	0.00	-0.09	-0.16	0.00	-0.30
Oil	762.27	486.76	-18.19	-385.00	139.73	0.00	985.57	697.77	357.52	-16.87	-358.72	73.12	0.05	752.88
Gas	21.55	1.04	-0.51	-10.88	-0.03	-0.01	11.15	16.84	1.27	-0.41	-8.66	-14.17	-0.16	-5.29
Electricity	1961.65	59.93	-46.82	-990.77	-912.45	-0.26	71.28	1610.49	-30.84	-38.93	-827.95	-1747.46	-9.25	-1043.94
Mining	28.25	7.58	-0.67	-14.27	4.17	-0.01	25.05	21.22	5.45	-0.51	-10.91	-16.28	-0.16	-1.19
Bovine cattle, sheep	0.90	-1.62	-0.02	-0.45	-1.20	0.00	-2.39	0.75	-1.32	-0.02	-0.39	-1.68	0.00	-2.65
Other meat products	0.89	-1.02	-0.02	-0.45	-0.31	0.00	-0.91	0.71	-0.80	-0.02	-0.36	-0.90	0.00	-1.38
Vegetable oils and fats	9.71	-7.30	-0.23	-4.90	-8.17	0.00	-10.90	7.88	-6.00	-0.19	-4.05	-13.08	-0.04	-15.48
Dairy products	0.61	-0.47	-0.01	-0.31	-0.53	0.00	-0.70	0.49	-0.36	-0.01	-0.25	-0.87	0.00	-1.01
Processed rice	26.59	-18.90	-0.63	-13.43	-14.65	0.00	-21.03	21.03	-14.72	-0.51	-10.81	-30.90	-0.10	-36.01
Sugar	0.12	-0.29	0.00	-0.06	-0.23	0.00	-0.47	0.10	-0.25	0.00	-0.05	-0.29	0.00	-0.49
Other food products	4.86	-5.36	-0.12	-2.45	-7.09	0.00	-10.17	3.96	-4.31	-0.10	-2.04	-9.47	-0.02	-11.97
Beverages and tobacco	26.29	-6.23	-0.63	-13.28	-10.77	0.00	-4.63	20.48	-4.67	-0.50	-10.53	-27.08	-0.07	-22.36
Textiles	51.10	-1.36	-1.65	-25.81	-13.42	-0.01	8.85	39.21	-0.41	-1.29	-20.16	-47.16	-0.22	-30.03
Wearing apparel	7.16	1.57	-0.26	-3.62	0.80	0.00	5.65	5.47	1.41	-0.21	-2.81	-4.37	-0.05	-0.55
Leather products	3.17	-3.24	-0.08	-1.60	-0.43	0.00	-2.17	2.54	-2.52	-0.06	-1.31	-2.52	-0.02	-3.90
Wood	16.53	2.30	-0.52	-8.35	-0.33	0.00	9.63	12.65	2.05	-0.42	-6.50	-11.80	-0.08	-4.10
Paper prod., publishing	48.72	-1.64	-1.41	-24.61	-3.28	-0.01	17.78	37.34	-1.03	-1.11	-19.20	-36.65	-0.19	-20.84
Chem. Prod, rub. plast.	638.53	218.86	-27.88	-322.50	-31.92	-0.05	475.04	529.26	150.80	-21.54	-272.09	-306.91	0.41	79.92
Other mineral products	448.10	130.32	-18.54	-226.32	8.72	-0.07	342.21	342.87	98.70	-13.93	-176.27	-291.73	-2.18	-42.53
Ferrous metals	356.27	125.60	-15.47	-179.94	-6.96	-0.06	279.43	271.20	85.28	-11.01	-139.42	-236.90	-1.89	-32.75
Other metal	44.02	19.58	-1.99	-22.23	-5.04	-0.01	34.33	33.70	14.13	-1.47	-17.33	-32.24	-0.30	-3.51
Metal products	19.32	6.27	-0.83	-9.76	0.79	0.00	15.79	14.59	4.75	-0.63	-7.50	-12.75	-0.12	-1.66
Motor vehicles	15.07	3.41	-0.73	-7.61	-2.65	0.00	7.49	11.56	2.66	-0.56	-5.94	-12.33	-0.10	-4.72
Other trans. equipment	9.31	3.94	-0.41	-4.70	0.46	0.00	8.60	7.05	3.09	-0.32	-3.62	-6.05	-0.06	0.08
Electronic equipment	4.12	1.14	-0.15	-2.08	-0.43	0.00	2.59	3.21	0.99	-0.12	-1.65	-3.04	-0.03	-0.64
Other mach. and equip.	85.35	32.23	-3.82	-43.11	2.46	-0.02	73.10	64.67	25.40	-2.96	-33.24	-57.15	-0.52	-3.80
Other manufactures	29.12	17.39	-1.34	-14.71	-2.83	0.00	27.62	22.00	13.75	-1.04	-11.31	-22.56	-0.15	0.69
Water	1.49	0.58	-0.04	-0.75	-0.23	0.00	1.04	1.27	0.48	-0.03	-0.66	-0.77	0.01	0.30
Construction	23.65	6.64	-0.56	-11.95	8.57	0.00	26.35	19.22	5.60	-0.46	-9.88	-5.26	-0.05	9.16
Services	473.61	56.71	-11.30	-239.21	152.05	0.06	431.92	424.88	55.44	-10.27	-218.43	12.10	2.12	265.85
Total	5256.13	1038.89	-158.14	-2585.25	-629.29	-0.45	2921.89	4383.39	666.01	-128.86	-2182.14	-2776.88	-13.19	-51.66

Comparing Open scenario to BaU scenario reveals how trade influences SO₂ emission. Scale enlargement under trade liberalization will lead SO₂ emission to increase slightly with respect to the BaU scenario. This corresponds to the trade-related scale effect. According to the simulation results, some desulfur contribution related to international trade can be traced from composition transformation. However, this trade-related composition effect, owing to its relatively small impact, is found to be cancelled out by the rise of the importance of electricity and oil sectors in the whole economy.^{1,2} The increased export and import activity under trade liberalization policy can also bring some supplementary contribution in SO₂ reduction with respect to BaU. However, without additionally pollution control policy, trade liberalization does not really contribute to emission reduction through energy substitution channel. Combining the different aspects together, we obtain a total SO₂ pollution increase of 180,000 tons under the Open scenario vs. BaU.

The comparison between the Desulfur and Open+Desulfur columns explains how trade liberalization helps to make the new desulfur objective less costly, and how the new desulfur objective induces trade to show more pollution reduction capability. Firstly, the co-existence of trade liberalization and de-sulfur policy can reduce the potential cost of the desulfur objective paid by economic growth. This is reflected by the less important scale reduction under Desulfur+Open scenario. Secondly, with the intervention of the trade liberalization process, the emission reduction originally contributed by scale reduction under Desulfur scenario can now be accomplished by the composition transformation and larger technical effect, which is composed of larger trade externality and more significant energy substitution effect.³

8.6. Conclusion and policy discussion

The fact that China's WTO accession promise and its de-sulfur policies will be implemented simultaneously during 2001 to 2005 offers us a perfect policy background to analyze the trade-pollution nexus in China. In this paper, with the aid of a CGE model, we tried

¹ Simple calculation can clarify this point in Table 9. If we put aside the energy sectors' composition variation, the actual composition effect for the Open scenario will be 491.34 K tons, which is smaller than that of the BaU scenario, of 499.49 K tons. The difference between the composition effect of open scenario and that of BaU reflects the pollution reduction contribution of trade liberalization coming from composition transformation.

² The expansion of the energy sectors, especially for the electricity and oil sector, can be explained, on one hand by the increase of input demand from production procedure due to energy substitution process, and on the other hand, by the increase of the final demand for luxury goods, such as electronic equipment and private vehicles. According to the simulation results, with income growth during 1997-2005, final demand for electronic equipment and transportation will be both doubled.

³ In table 8.9, under the combined scenario, supplementary energy substitution contribution to SO₂ reduction from trade liberalization is 8.37 and the supplementary trade externality contribution is about 40.22.

to reveal the actual role of trade in China's environmental situation by combining these two policies into model construction and simulation.

This model parameterised the multiple aspects of the trade-pollution and growth-pollution nexus in China and made explicit numerical comparisons on the magnitude of the environmental impact of trade with respect to that from China's total economic growth. Our result shows that given China's special natural resource endowment situation (rich coal deposits) and its current industrialization strategy, its future economic growth process will turn out to be very polluting, even in the presence of significant technological progress in factor productivity. According to the BaU scenario simulation, the potential SO₂ emission will increase by 33.17% from 2001 to 2005.

The specialization under trade liberalization will encourage the industrial composition to lean towards less polluting labor-intensive sectors. In addition, the positive externality of trade will also contribute to SO₂ emission reductions. We did not find proof for the "pollution haven" hypothesis. However, due to the relaxing of the pollution control intention in some export-oriented sectors, the increase in total production scale and the expansion in some energy sectors accompanying economic growth, in total, the environmental impact of trade, is actually "negative". The supplementary increase of SO₂ purely caused by China's WTO accession is about 1.64%.

Although seemingly ambitious, the new de-sulfur policy will only induce very small loss in economic growth. Real GDP growth will only decrease by -0.95% vis-à-vis BaU scenario. Most of the pollution reduction will be achieved by energy substitution process.

The combination of the trade liberalization and pollution control policies seems to give China more flexibility in adapting its economic growth to the new de-sulfur objective. The presence of trade liberalization has several advantages:

Accelerates industrial composition transformation towards less polluting labor-intensive sectors;

Enlarges clean energy supply by importing them from other countries and offers domestic producers more capacity to deepen their energy substitution procedure;

Reinforces the contribution of positive trade externality in raising energy input's productivity.

And at the same time, the new pollution control policy, by imposing a much higher emission tax (2.25 US\$/Kilo), will also encourage producers, especially those in export-oriented sectors, to reduce their energy consumption.

Combining all these aspects together, we find that the total economic loss due to the new de-sulfur policy will be limited to only -0.26% under the presence of trade liberalization, which

is remarkably lower than that in Desulfur scenario. Our results, in fact, show a good coordination between these two policies.

Our simulation results seem to describe an optimistic future for China's de-sulfur perspective. In reality, interpreting the model's results for policy decisions requires us to bear in mind the following points:

1. China is still quite an imperfect market with frequent government interferences (e.g. recent policies to support domestic auto industry development and banning new power plants in cities located in the sulfur control zone). The perfectly competitive market suggested in this model might not reflect the total reality of Chinese economy.

2. The model in this paper is actually based on some simplifying and central assumptions. One of them is to assume that inter-fuel switching is one important contributor to SO₂ reductions. The potential economic cost of the de-sulfur policy, according to this model, seems to depend on the inter-energy substitutability. Given China's limited oil and gas supply and heavy reliance on coal, the potential "technology barrier" for this inter-fuel substitution might be more important than what we expected. This is especially true for heavy industries where energy intensities are generally high. Since we chose 0.7 for elasticity of substitution between fuel and non-fuel energy bundles and 0.9 for inter-fuel energy substitution, and considering the relatively short time dimension of 5 years in this paper, whether lower energy substitution elasticity will bring significantly higher economic cost for the new de-sulfur policy remains to be tested.

To check the sensitivity of the selected model arrangement for the substitutability between energies, we further run several simulations with lower energy substitution elasticity. The relative variations of the principal economic indicators obtained from this sensitivity check are listed in Table 6.10. Though as expected, the economic cost of the de-sulfur policy will be somewhat higher, we do not observe important economic cost increases caused by the changes in substitution elasticity. The supplementary economic cost coming from the lowest substitution elasticity is about -1.12% for real GDP with respect to that in the original simulation, which means a total economic cost of -1.38% $(-1.12\%+0.26\%)=-1.38\%$ for the de-sulfur policy. Even higher stability is found in per capita disposable income, which stays at almost the same level under the three inter-energy substitution elasticity arrangements. The good stability of the model can be explained by the Divisia index decomposition results. Although the lower substitutability reduces emission abatement capacity of the energy substitution process, facing the even higher price hike caused by more rigid energy input mix, the industrial composition transformation will take more flexible adaptation. Therefore, the share of the labor-intensive industries will show an even larger increase in total economy.

Table 8.10. Sensitivity test (Open+Desulfur scenario)

	Units	0.7-0.9 (Original assumption)	0.5-0.7 (Moderately low elasticity)	0.3-0.5 (Very low elasticity)
1. Macroeconomic factors				
Real GDP	10 ⁹ US\$	1520.10	1511.39	1503.02
Aggregate output	10 ⁹ US\$	3909.08	3875.90	3848.44
Industry	10 ⁹ US\$	2474.91	2453.97	2425.77
Export	10 ⁹ US\$	515.70	521.05	516.06
Import	10 ⁹ US\$	565.62	535.60	532.79
Real disposable income	10 ⁹ US\$	1253.77	1251.13	1247.50
Per capita	US\$	952.57	950.56	947.80
2. SO₂ emission determinants:				
Scale effect	K tons	4383.39	4323.95	4274.00
Composition effect	K tons	666.01	531.37	191.34
Externality effect	K tons	-128.86	-127.45	-126.15
Technique effect	K tons	-2182.14	-2186.82	-2191.49
Substitution effect	K tons	-2776.88	-2581.15	-2192.80
Residual	K tons	-13.19	-11.38	-6.58
3. Energy consumption				
Total coal input	10 ⁹ TCE	0.24	0.25	0.26
Industry	10 ⁹ TCE	0.22	0.23	0.24
Total oil input	10 ⁹ TCE	0.38	0.36	0.34
Industry	10 ⁹ TCE	0.28	0.26	0.24
Total gas input	10 ⁹ TCE	0.03	0.03	0.03
Industry	10 ⁹ TCE	0.03	0.03	0.03
Total electricity input	10 ¹² kwh	1517.19	1525.90	1428.80
Industry	10 ¹² kwh	1285.88	1289.75	1195.88
4. Necessary emission tax evolution				
Emission tax (1997)	US\$	0.00545	0.00545	0.00545
Emission tax (2000)	US\$	0.028816	0.028816	0.028816
Emission tax (2001)	US\$	0.30	0.57	0.92
Emission tax (2002)	US\$	0.66	1.06	1.62
Emission tax (2003)	US\$	1.09	1.68	2.48
Emission tax (2004)	US\$	1.62	2.46	3.54
Emission tax (2005)	US\$	2.25	3.37	4.75

3. Except for the inter-energy substitution, other methods such as before-combustion coal cleaning technologies that decrease the sulfur content ratio of the coal, the cleaner combustion technologies that change the emission effluent ratio of energies and finally the end-of-pipe controlling measures that reduce total emission at the end of combustion procedures may also reduce SO₂ emissions. However, due to data constraints, we have not been able to consider other methods of reducing SO₂ emission in the model specification. Although the econometrically estimated energy-specific emission rate might reflect some original contribution of the above-mentioned de-sulfur technologies, the time-invariable emission rate used in our dynamic recursive simulations actually ignores the dynamism of the emission rate, which may benefit from all these aspects of de-sulfur efforts. Therefore, the emission levy rate growth path suggested by our model might be exaggerated and the simulated economic cost for the new de-sulfur policy might be even smaller.

4. Given the limited domestic oil and gas reserves, switching away from coal to the other cleaner energies means China will largely depend on the expansion of crude oil and natural gas supply from foreign sources. According to the International Energy Agency (IEA) and the Chinese government, in 2003, China's oil imports has already accounted for over 30% of the country's total annual commercial energy supply, and it had since then replaced Japan and became the world's second largest consumer of crude oil just after the USA. IEA considered China to be the "main driver of global oil demand growth". Facing the inelastic situation of world crude oil supply, we expect Chinese demand to be a primary driver of global oil prices, which might make China's inter-energy switching process and the new de-sulfur policy more costly.

5. Although the simulation results from this chapter predict relatively small economic cost for the new de-sulfur policy. The central condition that determines the success of this policy is whether Chinese government will be capable or not to apply the suggested new emission tax rate, and whether the currently institutional foundation will be enough efficient to monitor and implement it. If these conditions could not be met, we suspect the future industrialization and trade liberalization will bring even more environment deterioration to China, even the "pollution haven" hypothesis is not applicable to China's case.

Appendix 8.1. Production Nesting Structure

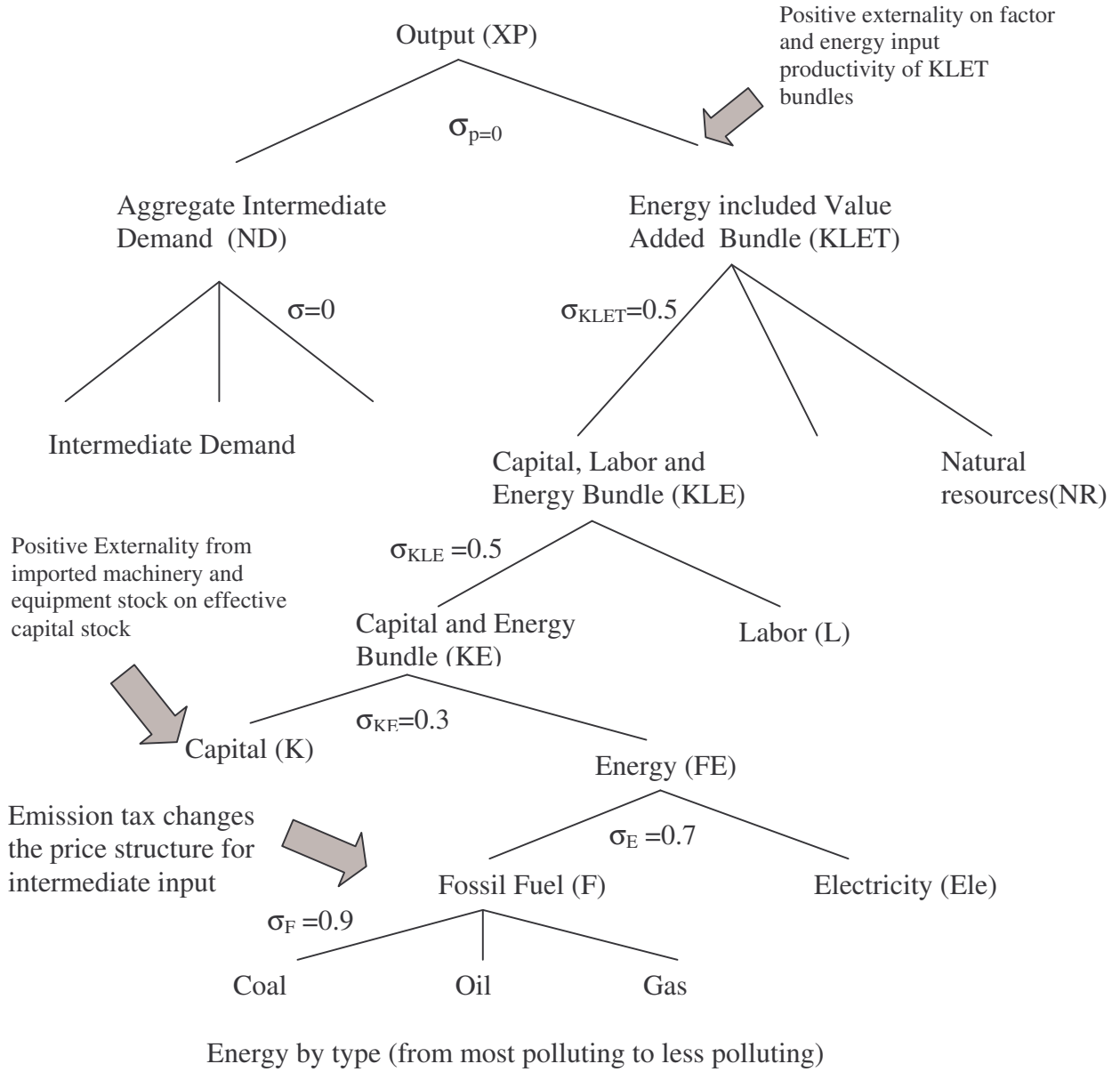

Appendix 8.2. Principal assumptions on the key model elasticity

The substitution elasticity between intermediate consumption and the traditional and energy factors are furnished in Appendix 1.

Household income elasticities in consumption of different goods are obtained from D. Roland-Holst and D. Van der Mensbrugghe (2002), which come originally from the GTAP database.

Both the Armington elasticities between domestic and aggregate import demand and that between import demands across different origins are assumed to be 4.0. For the top-level transformation elasticity between the domestic market and aggregate exports and that between exports across different destinations, we also assume them to be 4.0. Most of the choices of the elasticity follow the existing literatures.

The export demand elasticity for the textile, wearing apparel, leather products and electronic equipments are all supposed to be 6.0.

The export-externality elasticity is supposed to be 0.1 and the same for that of the imported equipment and machinery stock.

Appendix 8.3. Several supplementary tables

Table A.8.1. The expected tariff reduction schedule in China (percents change from 2000)

Sectors	2000	2001	2002	2003	2004	2005
Paddy rice	100	80.94	46.96	46.96	32.32	32.322
Wheat	100	93.75	93.75	93.75	93.75	693.75
Cereal grains, n.e.s.	100	98.31	96.61	94.92	93.22	93.22
Vegetables and fruits	100	11.11	11.11	11.11	11.11	177.78
Oil seeds	100	88.98	77.97	66.95	55.93	55.93
Sugar cane and sugar beet	100	11.11	11.11	11.11	11.11	177.78
Plant-based fibers	100	11.11	11.11	11.11	11.11	177.78
Crops, n.e.s.	100	89.04	78.08	68.49	58.22	58.22
Bovine cattle, sheep and goats.	100	97.22	94.44	93.06	90.28	90.28
Animal products n.e.s.	100	97.22	94.44	93.06	90.28	90.28
Raw milk	100	90.99	81.98	72.97	63.96	63.96
Wool, silk-worm cocoons	100	90.99	81.98	72.97	63.96	63.96
Forestry	100	68.00	64.00	60.00	60.00	60.00
Fishing	100	68.00	64.00	60.00	60.00	60.00
Coal	100	90.48	85.71	83.33	83.33	80.95
Oil	100	76.32	76.32	76.32	76.32	76.32
Gas	100	76.32	76.32	76.32	76.32	76.32
Electricity	100	76.32	76.32	76.32	76.32	76.32
Other minerals	100	90.48	85.71	83.33	83.33	80.95
Bovine, sheep and horse meat	100	90.29	80.58	70.87	61.65	55.83
Other meat products	100	90.29	80.58	70.87	61.65	55.83
Vegetable oils and fats	100	90.29	80.58	70.87	61.65	55.83
Dairy products	100	90.29	80.58	70.87	61.65	55.83
Processed rice	100	90.29	80.58	70.87	61.65	55.83
Sugar	100	90.29	80.58	70.87	61.65	55.83
Other food products	100	90.29	80.58	70.87	61.65	55.83
Beverage and tobacco	100	84.82	69.65	54.47	39.30	38.13
Textiles	100	88.89	66.67	55.56	44.44	33.33
Wearing Apparel	100	83.33	83.33	66.67	50.00	50.00
Leather products	100	100.00	100.00	100.00	50.00	50.00
Wood products	100	80.43	63.04	50.00	39.13	36.96
Paper products and publishing	100	80.43	63.04	50.00	39.13	36.96
Chemical, rubber and plastic	100	93.75	87.50	81.25	75.00	68.75
Other mineral products	100	86.49	72.97	67.57	62.16	59.46
Ferrous metals	100	86.49	72.97	67.57	62.16	59.46
Other metals	100	86.49	72.97	67.57	62.16	59.46
Metal products	100	86.49	72.97	67.57	62.16	59.46
Motor vehicles and parts	100	84.00	68.00	58.00	48.80	41.20
Other transport equipment	100	76.19	76.19	73.81	71.43	71.43
Electronic equipment	100	66.67	33.33	24.24	24.24	24.24
Other machinery and equipment	100	80.00	62.50	55.00	52.50	52.50
Other Manufactures	100	93.75	87.50	81.25	75.00	68.75
Water	100	93.75	87.50	81.25	75.00	68.75
Services and construction (11 sectors)	100	90.00	80.00	65.07	50.00	50.00

Note: ¹ Data source: Wang (2002).

Table A.8.2. Energy input intensity changes under the four policy scenarios: coal and Oil (Percentage changes in 2005 from the reference)

Sector	Coal				Oil			
	BAU	DESULFUR	OPEN	Open+Desulfur	BAU	DESULFUR	OPEN	Open+Desulfur
	Change from 2000	Change from BAU	Change from BAU	Change from BAU	Change from 2000	Change from BAU	Change from BAU	Change from BAU
Agriculture	11.72	10.36	0.05	10.99	29.81	-0.33	0.20	-0.04
Manufacturing	-35.62	-35.85	1.44	-36.51	-0.72	-5.00	2.30	-3.43
Coal	-14.75	-31.52	1.13	-32.44	2.94	0.86	1.30	1.97
Oil	-43.65	-42.11	0.57	-44.17	-20.46	-3.64	0.73	-3.35
Gas	-27.15	-43.53	1.20	-46.06	-6.90	0.15	1.37	1.38
Electricity	-41.25	-29.34	0.44	-30.94	-22.98	22.03	0.60	24.61
Mining	-22.50	-41.27	0.51	-42.24	1.21	2.25	0.67	3.03
Bovine cattle, sheep	-27.76	-40.55	0.20	-40.28	-20.77	6.68	0.35	7.17
Other meat products	-22.98	-41.51	0.11	-40.49	-9.82	3.73	0.26	4.00
Vegetable oils and fats	-38.02	-36.06	-1.22	-35.52	-25.00	12.18	-1.08	10.77
Dairy products	-38.07	-40.58	-0.69	-40.47	-26.6	5.14	-0.54	4.62
Processed rice	-30.98	-39.68	0.21	-39.92	-16.83	6.42	0.37	7.02
Sugar	-25.98	-40.01	-1.56	-35.30	-19.83	8.31	-1.43	5.59
Other food products	-40.54	-40.00	-2.94	-38.38	-30.20	6.19	-2.81	2.78
Beverages and tobacco	-35.11	-38.53	-2.02	-38.31	-17.57	8.03	-1.87	5.91
Textiles	-33.30	-40.88	0.52	-41.87	-14.45	4.05	0.68	5.02
Wearing apparel	-24.50	-42.67	7.77	-48.91	-4.65	1.46	7.98	10.25
Leather products	-20.00	-43.84	2.04	-46.85	-7.42	0.06	2.21	2.36
Wood	-27.60	-40.52	1.24	-41.58	-6.24	4.83	1.40	6.66
Paper prod., publishing	-26.92	-39.66	-0.26	-39.27	-6.05	5.90	-0.11	5.83
Chem. Prod., rub. plast.	-37.73	-42.21	0.75	-43.57	-16.58	-1.01	0.91	-0.34
Other mineral products	-27.77	-38.82	1.08	-39.85	-5.04	6.85	1.25	8.54
Ferrous metals	-29.73	-38.07	0.44	-38.65	-6.37	6.92	0.60	7.77
Other metal	-35.25	-40.08	0.25	-40.85	-12.05	3.75	0.41	4.29
Metal products	-28.24	-42.07	1.40	-43.39	-5.32	1.21	1.56	2.87
Motor vehicles	-34.04	-42.11	-2.71	-42.48	-11.87	1.32	-2.56	-1.22
Other trans. equipment	-29.19	-42.08	1.94	-43.54	-5.59	1.61	2.11	3.90
Electronic equipment	-34.94	-44.20	2.48	-45.77	-14.00	-1.44	2.65	1.14
Other mach. and equip.	-28.95	-41.86	0.77	-42.97	-5.36	2.03	0.93	3.13
Other manufactures	-38.59	-41.33	3.90	-41.95	-15.31	3.34	4.07	7.91
Water	-44.08	-43.01	0.77	-44.28	-23.23	-1.13	0.94	-0.26
Construction	-20.87	-44.76	1.54	-46.34	2.76	-3.16	1.71	-1.73
Services	-32.71	-45.25	0.99	-46.67	3.67	-5.65	2.04	-4.13
Total	-28.11	-35.69	1.41	-36.37	6.27	-5.19	2.21	-3.65

Table A. 8.2 (Continue). Energy input intensity changes under the four policy scenarios: gas and electricity

(Percentage changes in 2005 from the reference)

Sector	Gas				Electricity			
	BAU	DESULFUR	OPEN	Open+Desulfur	BAU	DESULFUR	OPEN	Open+Desulfur
	Change from 2000	Change from BAU	Change from BAU	Change from BAU	Change from 2000	Change from BAU	Change from BAU	Change from BAU
Agriculture	25.78	-4.36	0.17	-4.40	15.44	1.41	1.70	3.22
Manufacturing	-20.16	10.04	1.84	12.42	-23.66	9.74	2.30	12.78
Coal	-4.28	4.80	1.01	6.05	-9.28	0.11	2.66	2.21
Oil	-29.93	1.05	0.45	1.48	-33.08	3.31	2.12	5.49
Gas	-15.16	5.47	1.08	7.00	-19.38	6.90	2.74	10.35
Electricity	-30.44	28.28	0.32	31.19	-35.11	22.82	1.97	27.18
Mining	-8.47	7.55	0.39	8.39	-13.93	4.39	2.00	6.69
Bovine cattle, sheep	-23.63	12.42	0.08	12.79	-25.37	7.68	1.62	9.65
Other meat products	-15.19	9.24	0.00	9.27	-18.43	4.90	1.51	6.54
Vegetable oils and fats	-30.32	18.05	-1.33	16.24	-33.79	12.10	0.14	12.09
Dairy products	-31.28	10.71	-0.79	9.97	-34.10	6.33	0.72	7.20
Processed rice	-22.61	12.03	0.1	12.57	-26.39	6.31	1.66	8.33
Sugar	-22.33	14.17	-1.67	10.39	-23.97	8.39	-0.37	6.90
Other food products	-34.42	11.83	-3.04	7.67	-37.13	6.40	-1.68	4.22
Beverages and tobacco	-24.73	13.70	-2.12	11.15	-29.78	6.71	-0.67	5.97
Textiles	-22.15	9.52	0.4	10.57	-26.93	5.27	2.00	7.75
Wearing apparel	-12.76	6.83	7.62	17.26	-17.18	4.33	9.68	16.00
Leather products	-12.56	5.40	1.91	8.19	-15.05	4.21	3.65	8.66
Wood	-14.96	10.35	1.12	12.37	-20.35	5.71	2.75	9.09
Paper prod., publishing	-14.57	11.44	-0.37	11.17	-20.10	5.87	1.15	7.17
Chem. Prod., rub. plast.	-25.22	4.00	0.63	4.78	-28.52	5.41	2.28	7.92
Other mineral products	-14.32	12.41	0.96	14.27	-19.97	7.90	2.59	11.16
Ferrous metals	-15.90	12.4	0.32	13.26	-21.51	8.65	1.91	11.01
Other metal	-21.52	9.09	0.13	9.64	-26.45	7.15	1.73	9.27
Metal products	-14.67	6.48	1.28	8.35	-19.74	4.22	2.93	7.59
Motor vehicles	-20.92	6.61	-2.82	3.66	-25.65	4.51	-1.35	3.15
Other trans. equipment	-15.23	6.93	1.82	9.52	-20.48	4.31	3.50	8.37
Electronic equipment	-22.55	3.77	2.35	6.70	-26.61	3.84	4.04	8.52
Other mach. and equip.	-14.99	7.37	0.65	8.59	-20.33	4.68	2.26	7.40
Other manufactures	-24.81	8.78	3.77	13.81	-30.47	5.20	5.48	11.55
Water	-31.74	3.97	0.66	4.95	-34.86	5.60	2.30	8.37
Construction	-6.89	1.91	1.42	3.55	-10.69	2.98	3.09	6.41
Services	-26.00	1.45	1.00	2.61	-26.11	2.83	2.80	5.92
Total	-13.78	9.39	1.87	11.75	-16.4	8.20	2.33	11.16

Appendix 8.4. Model Specification

A. Model specification

1. Production

1.1 Top level of production nesting

$$ND_j = \alpha_j^{nd} \left(\frac{PX_j}{PND_j} \right)^{\sigma_j^p} XP_j$$

$$KLET_j = \alpha_j^{klet} \left(\frac{PX_j}{PKLET_j} \right)^{\sigma_j^p} XP_j$$

$$PX_j = (\alpha_j^{nd} PND_j^{1-\sigma_j^p} + \alpha_j^{klet} PKLET_j^{1-\sigma_j^p})^{(1/(1-\sigma_j^p))}$$

$$PP_j = PX_j (1 + \xi^p \tau_j^p)$$

1.2 Second level of production nesting: intermediate input and KLET bundle

$$AT_j = \begin{cases} \overline{AT} \left(\frac{XET_j}{XET_{j,-1}} \right)^\eta, & \text{if } XET_j > XET_{j,-1} \text{ and } j \in ip, \overline{AT} = 1 \\ 1, & \text{if } E_j < E_{j,-1} \text{ or } j \in np \end{cases}$$

$$BT = \overline{BT} \left(\frac{XMT_{hp,t}}{\sum_{hp} \sum_{t=0}^{presnet} XMT_{hp,t}} \right)^\psi, \text{ if } \sum_{hp} XMT_{hp,t} > 0, \overline{BT} = 1$$

or

$$BT = \overline{BT}, \text{ if } \sum_{hp} XMT_{hp,t} > 0$$

$$XAP_{nd,j} = \alpha_j^{nd} ND_j$$

$$PND_j = \sum_{nd} \alpha_j^{nd} (1 + \tau_{nd,j}^{pc}) PA_{nd,j}$$

$$TD_j = \alpha_j^{td} \left(\frac{PKLET_j}{RENT_j (1 + \tau_j^{td})} \right)^{\sigma_j^{klet}} (\lambda_j^t \times AT_j)^{(\sigma_j^{klet} - 1)} KLET_j$$

$$NRD_j = \alpha_j^{nrd} \left(\frac{PKLET_j}{PNR_j} \right)^{\sigma_j^{klet}} (\lambda_j^{nr} \times AT_j)^{(\sigma_j^{klet} - 1)} KLET_j$$

$$KLE_j = \alpha_j^{kle} \left(\frac{PKLET_j}{PKLE_j} \right)^{\sigma_j^{klet}} KLET_j$$

$$PKLET_j = \left[\alpha_j^{ld} \left(\frac{RENT_j(1+\tau_j^{td})}{\lambda_j \times AT_j} \right)^{1-\sigma_j^{klet}} + \alpha_j^{nrd} \left(\frac{PNR_j(1+\tau_j^{nrd})}{\lambda_j^{nr} \times AT_j} \right)^{1-\sigma_j^{klet}} + \alpha_j^{kle} PKLE_j^{1-\sigma_j^{klet}} \right]^{1/(1-\sigma_j^{klet})}$$

1.3 Third level of production nesting: labor demand and KLE bundle

$$LD_j = \alpha_j^{ld} \left(\frac{PKLE_j}{WAGE_j(1+\tau_j^{ld})} \right)^{\sigma_j^{kle}} (\lambda_j^l \times AT_j)^{(\sigma_j^{kle}-1)} KLE_j$$

$$KE_j = \alpha_j^{ke} \left(\frac{PKLE_j}{PKE_j} \right)^{\sigma_j^{kle}} KLE_j$$

$$PKLE_j = \left[\alpha_j^{ld} \left(\frac{WAGE_j(1+\tau_j^{ld})}{\lambda_j^l \times AT_j} \right)^{1-\sigma_j^{kle}} + \alpha_j^{ke} (PKE)^{1-\sigma_j^{kle}} \right]^{\frac{1}{1-\sigma_j^{kle}}}$$

1.4 Fourth level of production nesting: capital demand and energy bundle

$$KD_j = \alpha_j^{kd} \left(\frac{PKE_j}{rate_j(1+\tau_j^{kd})} \right)^{\sigma_j^{ke}} (\lambda_j^k \times AT_j \times BT)^{\sigma_j^{ke}-1} KE_j$$

$$ENE_j = \alpha_j^{ene} \left(\frac{PKE_j}{PENE_j} \right)^{\sigma_j^{ke}} KE_j$$

$$PKE_j = \left[\alpha_j^{kd} \left(\frac{RATE(1+\tau_j^{kd})}{\lambda_j^k \times AT_j \times BT} \right)^{\sigma_j^{ke}-1} + \alpha_j^{ene} PENE^{\sigma_j^{ke}-1} \right]^{\frac{1}{1-\sigma_j^{ke}}}$$

1.5 Fifth level of production nesting: electricity demand and fossil fuel bundle

$$ELE_j = \alpha_j^{ele} \left(\frac{PENE_j}{PA_{ele,j}(1+\tau_{ele,j}^{pc})} \right)^{\sigma_j^{ene}} (\lambda_j^{ele} \times AT_j)^{\sigma_j^{ene}-1} ENE_j$$

$$FUEL_j = \alpha_j^{fuel} \left(\frac{PENE_j}{PFUEL_j} \right)^{\sigma_j^{ene}} ENE_j$$

$$PENE_j = \left[\alpha_j^{ele} \left(\frac{PA_{ele}(1+\tau_{ele,j}^{pc})}{\lambda_j^{ele} \times AT_j} \right)^{\sigma_j^{ene}-1} + \alpha_j^{fuel} PFUEL^{\sigma_j^{ene}-1} \right]^{\frac{1}{1-\sigma_j^{ene}}}$$

1.6 Sixth level of production nesting: Fossil Fuel demand

$$FUEL_{f,j} = \alpha_j^f \left(\frac{PFUEL_j}{PA_{f,j}(1+\tau_{f,j}^{pc} + v_f t_{poll})} \right)^{\sigma_j^{fuel}} (\lambda_j^f \times AT_j)^{\sigma_j^{fuel}-1} FUEL_j$$

$$PFUEL_j = \left[\sum_f \left(\frac{\alpha_j^f PA_{f,j} (1 + \tau_{f,j}^{pc} + \nu_f t_{poll})}{\lambda_j^f \times AT_j} \right)^{\sigma_j^{fuel} - 1} \right]^{\frac{1}{1 - \sigma_j^{fuel}}}$$

1.7 Commodity aggregation

$$PP_j = P_k$$

$$X_k = \sum_{j \in k} XP_j$$

2. Income distribution

2.1 Factor income

$$LY = \sum_j WAGE_j LD_j$$

$$KY = \sum_j RATE_j KD_j$$

$$TY = \sum_j RENT_j TD_j$$

$$NRY = \sum_j PNR_j NRD_j$$

2.2 Profit distribution

$$TR_{KE} = \varphi_{k,e} KY$$

$$TR_{KH} = \varphi_{k,h} KY$$

$$TR_{KE} = \varphi_{k,f} KY$$

2.3 Corporate income re-distribution

$$YE = \varphi_{k,e} TR_{KE} + \overline{TRGE} + \overline{TRFE} \cdot \overline{ER}$$

$$YDE = \left[(1 - \kappa_e)(YE - \overline{TRGE}) + \overline{TRGE} \right]$$

$$SE = seYDE$$

$$TR_{EH} = \varphi_{e,h} YDE$$

$$TR_{EF} = \varphi_{e,f} YDE$$

2.4 Household income distribution

$$YH = LY + TY + NRY + TR KH + TR EH + \overline{TR GH} + \overline{TR FH} \overline{ER}$$

$$YDH = (1 - \xi^h \kappa_h)(YH - \overline{TR GH}) + \overline{TR GH}$$

$$TR HF = \phi_{h,f} YDH$$

3. Domestic final demand

3.1 Household's demand structure

$$SH = sh \times YDH$$

$$XAH_k = pop \theta_k + \frac{\mu_k}{(1 + \tau_k^{hc}) PA_k} \left((1 - \phi_{k,f} - sh) YDH - \sum_{kk} (1 + \tau_{kk}^{hc}) PA_{kk} pop \theta_{kk} \right)$$

$$CPI = \frac{\sum_k (1 + \tau_k^{hc}) PA_k XAH_{k,0}}{\sum_k (1 + \tau_{k,0}^{hc}) PA_{k,0} XAH_{k,0}}$$

3.2 Government final goods expenditure

$$XAG_k = a_k^g \overline{XG}$$

$$YG = \sum_k (XAG_k \cdot (1 + \tau_k^{gc}) PA_k)$$

$$PG = \frac{YG}{\overline{XG}} = \sum_k a_k (1 + \tau_k^{gc}) PA_k$$

3.3 Exports of international trade and transport services

$$XATRDMG = a_k^{trdmg} \overline{XTRDMG}$$

$$YTRDMG = \sum_k (XATRDMG_k (1 + \tau_k^{trdmgc}) PA_k)$$

$$PTRDMG = \frac{YTRDMG}{\overline{XTRDMG}} = \sum_k a_k^{trdmgc} (1 + \tau_k^{trdmgc}) PA_k$$

3.4 Investment

$$XAINV_k = a_k^{inv} XINV$$

$$PINV = \sum_k a_k^{inv} (1 + \tau_k^{inv}) PA_k$$

$$INV = PINV.XINV$$

4. Trade

4.1 Top level Armington nesting

$$XA_k = \sum_j XAP_{k,j} + XAH_k + XAG_k + XAINV_k + XATRDMG_k$$

$$XDD_k = \alpha_k^{dd} \left(\frac{PA_k}{PDD_k} \right)^{\sigma_k^c} XA_k$$

$$XMT_k = \alpha_k^{mt} \left(\frac{PA_k}{PMT_k} \right)^{\sigma_k^c} XA_k$$

$$PA_k = \left[\alpha_k^{dd} PDD_k^{1-\sigma_k^c} + \alpha_k^{mt} PMT_k^{1-\sigma_k^c} \right]^{\frac{1}{1-\sigma_k^c}}$$

4.2 Second level Armington nesting

$$PM_{r,k} = \overline{ER.WMP}_{r,k} (1 + \tau_{r,k}^m)$$

$$XM_{r,k} = \alpha_{r,k}^m \left(\frac{PMT_k}{PM_{r,k}} \right)^{\sigma_k^m} XMT_k$$

$$PMT_k = \left[\sum_r \alpha_{r,k}^m PM_{r,k}^{1-\sigma_k^m} \right]^{\frac{1}{1-\sigma_k^m}}$$

4.3 Top level of CET nesting

$$PE_{k,r} (1 + \tau_{k,r}^x) = \overline{ER.WPEV}_{k,r}$$

$$XDS_k = \gamma_k^{ds} \left(\frac{PDS_k}{P_k} \right)^{\sigma_k^p} X_k$$

$$XET_k = \gamma_k^{et} \left(\frac{PET_k}{P_k} \right)^{\sigma_k^p} X_k$$

$$P_k = \left[\gamma_k^{ds} PDS_k^{1+\sigma_k^p} + \gamma_k^{et} PET_k^{1+\sigma_k^p} \right]^{\frac{1}{1+\sigma_k^p}}$$

4.4 Second level of CET nesting

$$XE_{k,r} = \gamma_{k,r}^x \left(\frac{PE_{k,r}}{PET_k} \right)^{\sigma_k^x} XET_k$$

$$PET_k = \left[\sum_r \gamma_{k,r}^x PE_{k,r}^{1+\sigma_k^x} \right]^{\frac{1}{1+\sigma_k^x}}$$

$$ED_{k,r} = \alpha_{k,r}^e \left(\frac{\overline{WPE}_{k,r}}{WPEV_{k,r}} \right)^{\eta_{k,r}^e} \quad \text{if } \eta_{k,r}^e \neq \infty \text{ (Large country hypothesis)}$$

$$WPEV_{k,r} = \overline{WPE}_{k,r} \quad \text{if } \eta_{k,r}^e = \infty \text{ (Small country hypothesis)}$$

5. Market Equilibrium

5.1 Good market equilibrium

$$XDD_k = XDS_k$$

5.2 Factor market equilibrium

a. Labor Market

$$LS = \alpha^{ls} \left(\frac{ewage}{PLEV} \right)^{\omega^l}$$

$$LS = \sum_j LD_j$$

$$wage_j = \phi_j^l ewage$$

b. Capital market

$$TKS^e = \overline{BT} \left(1 + \frac{\sum_{hp} XMT_{hp}}{\sum_{hp} \sum_{t=0}^{present} XMT_{hp,t}} \right)^{\psi} TKS$$

$$KS_j = \gamma_j^k \left(\frac{rate_j}{PTK} \right)^{\omega^k} TKS^e$$

$$PTK = \left[\sum_j \gamma_j^k rate_j^{1+\omega^k} \right]^{\frac{1}{1+\omega^k}}$$

$$KS_j = KD_j$$

c. Land Market

$$TS_j = \gamma_j^t \left(\frac{rent_j}{PLAND} \right)^{\omega^t} LAND$$

$$PLAND = \left[\sum_j \gamma_j^t rent_j^{1+\omega^t} \right]^{\frac{1}{1+\omega^t}}$$

$$TS_j = TD_j$$

d. Specific Natural Resource Market

$$NRS_j = \gamma_j^{nr} \left(\frac{PNR_j}{PLEV} \right)^{\omega^{nr}}$$

$$NRD_j = NRS_j$$

6. Macro Closure

6.1 Government Account

$$\begin{aligned} YG = & \underbrace{\sum_k \sum_j \tau_{k,j}^{pc} PA_k XAP_{k,j}}_{\text{Sale tax on intermediate consumption}} + \underbrace{\sum_h \tau_k^{hc} PA_k XAH_k}_{\text{Household consumption tax}} + \underbrace{\sum_k \tau_k^{gc} PA_k XAG_k}_{\text{Government consumption tax}} \\ & + \underbrace{\sum_k \tau_k^{invc} PA_k XAINV_k}_{\text{Investment consumption tax}} + \underbrace{\sum_k \sum_r \tau_{k,r}^x PE_{k,r} XE_{k,r}}_{\text{export tax}} + \text{tariff} + \underbrace{\sum_j \tau_j^{pp} PX_j XP_j}_{\text{production tax}} \\ & + \underbrace{\kappa^h (YH - TRGH)}_{\text{Household's income tax}} + \underbrace{\kappa^e (YE - TRGE)}_{\text{Enterprise's income tax}} + \underbrace{\sum_j \tau_j^{ld} wage_j LD_j}_{\text{Labor factor tax}} + \underbrace{\sum_j \tau_j^{kf} rate_j KD_j}_{\text{Capital factor tax}} \\ & + \underbrace{\sum_j \tau_j^{ld} rent_j TD_j}_{\text{Land tax}} + \underbrace{\sum_j \tau_j^{nrd} PNR_j NRD_j}_{\text{Specific natural resource tax}} + \underbrace{\sum_j t_{poll} SO_{2j}}_{\text{Emission tax}} + \overline{ER.TR FG} \end{aligned}$$

$$EXPG = YG + \overline{TRGH} + \overline{TRGE} + \overline{TRGF.ER}$$

$$SG = YG - EXPG$$

$$\overline{RSG} = SG / PLEV$$

6.2 Investment account

$$INV = SH + SG + SE + \overline{SF} \cdot \overline{ER}$$

6.3 Aggregate price index

$$PLEV = \frac{\sum_k PA_k XA_{k,0}}{\sum_k PA_{k,0} XA_{k,0}}$$

6.4 Balance of payment

$$\begin{aligned} Bop = & \sum_k \sum_r \overline{WPE}_{k,r} XE_{k,r} + Y \overline{TR DMG} + \overline{TR FG} + \overline{TR FH} + \overline{TR FE} + \overline{SF} \\ & - \sum_r \sum_k \overline{WPM}_{r,k} XM_{r,k} - \frac{\overline{TR HF} + \overline{TR EF} + \overline{TR KF}}{\overline{ER}} - \overline{TR FG} \end{aligned}$$

7. Macroeconomic identity

$$\begin{aligned} GDPMP = & \sum_k (1 + \tau_k^{hc}) PA_k XAH_k + \sum_k (1 + \tau_k^{gc}) PA_k XAG_k + \sum_k (1 + \tau_k^{invc}) PA_k XAINV_k \\ & + ER \sum_k \sum_r \overline{WPE}_{k,r} XE_{k,r} - \sum_k \sum_r PM_{r,k} XM_{r,k} \end{aligned}$$

$$\begin{aligned} RGDPMP = & \sum_k (1 + \tau_{k,0}^{hc}) PA_{k,0} XAH_k + \sum_k (1 + \tau_{k,0}^{gc}) PA_{k,0} XAG_k + \sum_k (1 + \tau_{k,0}^{invc}) PA_{k,0} XAINV_k \\ & + ER_0 \sum_k \sum_r \overline{WPE}_{k,r,0} XE_{k,r} - \sum_k \sum_r PM_{r,k,0} XM_{r,k} \end{aligned}$$

$$PGDPMP = GDPMP / RGDPMP$$

$$GDPPFC = \sum_j wage_j LD_j + \sum_j rate_j KD_j + \sum_j rent_j TD_j + \sum_j PNR_j NRD_j$$

$$GDPFC = \sum_j wage_{j,0} LD_j + \sum_j rate_{j,0} KD_j + \sum_j rent_{j,0} TD_j + \sum_j PNR_{j,0} NRD_j$$

$$PGDPFC = GDPFC / RGDPFC$$

8. Emission equation

$$SO_{2f,j} = \overline{v}_f XAP_{f,j}$$

$$SO_{2j} = \sum_f SO_{2f,j}$$

$$TSO_2 = \sum_j SO_{2j}$$

9. Growth equations

$$RGDPMP = (1 + g^y) RGDPMP_{-1}$$

$$\lambda_{ip}^l = (1 + \overline{\gamma^{kle}} + \chi_{ip}^l) \lambda_{ip,-1}^l$$

10. Dynamic equations for exogenous variables

$$\lambda_{ip}^k = (1 + \overline{\gamma^{kle}} + \chi_{ip}^{klt}) \lambda_{ip,-1}^k$$

$$\lambda_{ip}^f = (1 + \overline{\gamma^{kle}} + \chi_{ip}^f) \lambda_{ip,-1}^f$$

$$\lambda_{ip}^{ele} = (1 + \overline{\gamma^{kle}} + \chi_{ip}^{ele}) \lambda_{ip,-1}^{ele}$$

$$\lambda_{np}^l = (1 + \overline{\gamma^l}) \lambda_{np,-1}^l$$

$$\lambda_{np}^k = (1 + \overline{\gamma^k}) \lambda_{np,-1}^k$$

$$\lambda_{np}^f = (1 + \overline{\gamma^f}) \lambda_{np,-1}^f$$

$$\lambda_{np}^{ele} = (1 + \overline{\gamma^{ele}}) \lambda_{np,-1}^{ele}$$

$$\overline{\lambda_j^l} = \overline{\lambda_{j,-1}^l}$$

$$\overline{\lambda_j^{nr}} = \overline{\lambda_{j,-1}^{nr}}$$

$$pop = (1 + \overline{g^{pop}}) pop_{-1}$$

$$LAND = (1 + \overline{g^t}) LAND_{-1}$$

$$\alpha^{ls} = (1 + \overline{g^l}) \alpha^{ls}_{-1}$$

$$\gamma_j^{nr} = (1 + \overline{g^{nr}}) \gamma_{j,-1}^{nr}$$

$$K sup = (1 - \delta) K sup_{-1} + INV$$

$$TKS = (TKS_0 / K sup_0) K sup$$

B. Model Variables and parameters

Indices used in the model

<i>j</i>	Production activities
<i>k (or kk)</i>	Commodities
<i>f</i>	Fossil fuel energies
<i>ele</i>	electricity
<i>nd</i>	Intermediate consumptions
<i>np</i>	Exogenous factor productivity growth sectors
<i>ip</i>	Endogenous factor productivity growth sector
<i>hp</i>	Machinery and equipment industrial sectors

a. Endogenous variables

Production

<i>ND_j</i>	Demand for aggregate intermediate demand bundle
<i>KLET_j</i>	Demand for value added and energy input bundle
<i>PX_j</i>	Unit cost of production
<i>PP_j</i>	Producer price
<i>AT_j</i>	Export externality productivity shifter
<i>BT</i>	Productivity shifter coming from the externality of Imported machinery and equipment
<i>XAP_{nd,j}</i>	Intermediate demand for goods and services
<i>PND_j</i>	Price of aggregate intermediate demand bundle
<i>KLE_j</i>	Demand for capital-labor-energy bundle
<i>TD_j</i>	Demand for aggregate land bundle
<i>NRD_j</i>	Demand for sector-specific resource
<i>PKLET_j</i>	Price of value added and energy input bundle
<i>LD_j</i>	Demand for labor factor
<i>KE_j</i>	Demand for capital/energy input bundle
<i>PKLE_j</i>	Price of capital-labor-energy bundle
<i>KD_j</i>	Demand capital factor
<i>ENE_j</i>	Demand for aggregate energy bundle
<i>PKE_j</i>	Price of capital and aggregate energy input bundle
<i>ELE_j</i>	Demand for electricity input
<i>FUEL_j</i>	Demand for aggregate fossil fuel energy bundle
<i>PENE_j</i>	Price for aggregate energy bundle
<i>XAP_{f,j}</i>	Demand for fossil fuel energy input
<i>PFUEL_j</i>	Price for aggregate fossil fuel energy input bundle
<i>P_k</i>	Aggregate producer price of commodity <i>k</i>
<i>XP_j</i>	Aggregate sector output (of activity <i>j</i>)

Income distribution

<i>LY</i>	Aggregate net labor remuneration
<i>KY</i>	Aggregate after-tax capital income
<i>TY</i>	Aggregate after-tax land income
<i>NRY</i>	Aggregate after-tax income from sector-specific resource
<i>TRKE</i>	Capital income transferred to enterprises
<i>TRKH</i>	Capital income transferred to households
<i>TRKF</i>	Capital income transferred abroad
<i>YE</i>	Corporate income
<i>YDE</i>	Corporate disposable income
<i>SE</i>	Corporate retained earnings
<i>TREH</i>	Corporate earnings transferred to households

<i>TREF</i>	Corporate earnings transferred abroad
<i>YH</i>	Aggregate household income
<i>YDH</i>	Disposable income net of taxes and transfers
<i>TRHF</i>	Household transfers abroad

Domestic demand variables

<i>SH</i>	Household savings
<i>XAH_k</i>	Household demand for goods and services
<i>CPI</i>	Household-specific consumer price index
<i>XAG_k</i>	Government final demand for goods and services
<i>YG</i>	Government final demand aggregate expenditure level
<i>PG</i>	Aggregate price for total government final demand
<i>XATRDMG_k</i>	Demand for export of trade and transportation services
<i>YTRDMG</i>	Export of trade and transportation services demand aggregate expenditure level
<i>PTRDMG</i>	Aggregate price of total demand for export of trade and transportation services
<i>XAINV_k</i>	Investment final demand for goods and services
<i>PINV</i>	Aggregate price for total investment final demand
<i>INV</i>	Investment final demand aggregate expenditure level

Trade

<i>XA_k</i>	Economy-wide demand for Armington good
<i>XDD_k</i>	Domestic demand for domestic production
<i>XMT_k</i>	Domestic demand for aggregate imports
<i>PA_k</i>	Price of Armington good
<i>PM_{r,k}</i>	Domestic tariff-inclusive price of imports by region of origin
<i>XM_{r,k}</i>	Sectoral import volume by region of origin
<i>PMT_k</i>	Price of aggregate import bundle
<i>PE_{k,r}</i>	Producer price of exports by region of destination
<i>XDS_k</i>	Domestic output sold domestically
<i>XET_k</i>	Aggregate export supply
<i>X_k</i>	Aggregate output
<i>XE_{k,r}</i>	Export supply by region of destination
<i>PET_k</i>	Price of aggregate exports
<i>ED_{k,r}</i>	Demand for exports by region of destination
<i>WPEV_{k,r}</i>	Price of the export demand by region of destination (large country hypothesis)

Market equilibrium**Goods market equilibrium**

<i>PDD_k</i>	Price of domestic goods sold domestically
------------------------	---

Factor market equilibrium

<i>LS</i>	Labor supply
<i>ewage</i>	Equilibrium wage rate
<i>wage_j</i>	Sector specific wage rate
<i>TKS^e</i>	Effective aggregate capital supply
<i>KS_j</i>	Sectoral capital supply
<i>PTK</i>	Economy-wide aggregate rate of return to capital
<i>rate_j</i>	Sectoral rate of return to capital by type
<i>TS_j</i>	Sectoral land supply
<i>PLAND</i>	Economy-wide aggregate rate of return to land
<i>rent_j</i>	Sectoral rate of return to land
<i>NRS_j</i>	Sectoral supply of sector-specific factor
<i>PNR_j</i>	Price of sector-specific factor

Macro Closure**Government account**

<i>YG</i>	Government total revenue
<i>EXPG</i>	Government total expenditure

SG Government savings

Investment account

INV Total expenditure on investment

Aggregate price index

PLEV Aggregate price level

Macroeconomic identity

GDPMP Nominal GDP at market price

RGDPMP Real GDP at market price

PGDPMP GDP at market price deflator

GDPFC Nominal GDP at factor cost

RGDPFC Real GDP at factor cost

PGDPFC GDP at factor cost deflator

Emission

SO_{2fj} Emission of SO₂ from each fossil fuel energy f combusted in sector j

SO_{2j} Emission of SO₂ from sector j

TSO₂ Total emission of SO₂

b. Key model elasticities

Production elasticities

σ_j^p Substitution elasticity between intermediate consumption and capital-labor-energy-land-natural resource bundles

σ_j^{klet} Substitution elasticity between capital-labor-energy bundle and land, natural resource

σ_j^{kle} Substitution elasticity between capital-energy bundle and labor

σ_j^{ke} Substitution elasticity between capital and energy bundles

σ_j^{ene} Substitution elasticity between electricity-fossil fuel energy bundles

σ_j^{fuel} Substitution elasticity between the fossil fuels

η Export externality elasticity with respect to export growth

ψ Import externality elasticity with respect to growth in imported machinery stocks

Demand elasticities

μ_k Based household income elasticities

Trade elasticities

σ_k^c Armington elasticities between domestic and aggregate import demand

σ_k^m Armington elasticities between import demand across different origins

σ_k Top-level transformation elasticity between the domestic market and aggregate exports

σ_k^x Transformation elasticity of exports across different destinations

$\eta_{k,r}^e$ Price elasticity of World demand for export by regions of destinations

Factor market elasticities

ω^l Labor supply elasticity with respect to wage level

ω^k Transformation of capital across different sectors

ω^l Transformation of land across different sectors

ω^{nr_j} Natural resource supply elasticity with respect to price

Emission factors

v_f Energy specific emission rate

c. Calibrated parameters

Production

α_j^{nd} CES share parameter for intermediate consumption bundle

α_j^{klt}	CES share parameter for capital-labor-energy-land-natural resource bundle
$a_{nd,j}$	Leontief coefficients for intermediate demand
α_j^d	CES share parameter for land demand
α_j^{nr}	CES share parameter for sectoral specific natural resource demand
α_j^{kle}	CES share parameter for capital-labor-energy bundle
α_j^l	CES share parameter for labor demand
α_j^{ke}	CES share parameter for capital-energy bundle
α_j^{kd}	CES share parameter for capital demand
α_j^{ene}	CES share parameter for energy bundle
α_j^{ele}	CES share parameter for electricity demand
α_j^{fuel}	CES share parameter for fossil fuel energy bundle
α_j^f	CES share parameter for fossil fuel demand

Saving behaviors

sh	Household savings rate
se	Entreprise savings rate

Income distribution parameters

$\varphi_{k,e}$	Enterprise share of after-tax capital income
$\varphi_{k,h}$	Household share of after-tax capital income
$\varphi_{k,f}$	Rest of world share of after-tax capital income
$\varphi_{e,h}$	Household share of after-tax enterprise income
$\varphi_{e,f}$	Rest of world share of after-tax capital income
$\varphi_{h,f}$	Rest of world share of after-tax household income

Demand parameters

θ_k	Household minimum consumption parameter
a_k^g	Commodity share parameter for government consumption
a_k^{inv}	Commodity share parameter for investment consumption
a_k^{trdmg}	Commodity share parameter for exported trade and transportation services

Trade parameters

α_k^{dd}	Domestic share parameter in top-level Armington CES
α_k^{mt}	Import share parameter in top-level Armington CES
$\alpha_{r,k}^n$	Regional share parameter in second-level Armington CES
$\alpha_{k,r}^e$	Export demand shift parameter by region of destination
γ_k^{ds}	Domestic share parameter in top-level CET
γ_k^{er}	Export share parameter in top-level CET
$\gamma_{k,r}^r$	Regional share parameter in second-level CET

Factor market parameters

ϕ_j	Inter-sectoral wage differential parameters
α^s	Labor supply shift parameter
γ_j^k	Capital allocation share parameters between sectors
γ_j^l	Land allocation share parameters between sectors
γ_j^{nr}	Specific natural resource allocation share parameter between sectors

d. Exogenous variables**Growth factors**

g^y	Real GDP growth rate
$Ksup$	Aggregate non-normalized capital stock
TKS	Aggregate normalized capital stock
$LAND$	Aggregate land supply
pop	Total population
g^{pop}	Population growth rate
g^{ls}	Labor supply growth rate
g^{nr}	Natural resource supply growth rate

g^l	Land supply growth rate
δ	Capital depreciation rate
γ^{le}	Capital, labor and energy factor productivity growth factor (endogenous factor growth sectors)
λ_{ip}^l	Labor productivity discrepancy shifter (endogenous factor growth sectors)
λ_{ip}^k	Capital productivity discrepancy shifter (endogenous factor growth sectors)
λ_{ip}^f	Fossil fuel productivity discrepancy shifter (endogenous factor growth sectors)
λ_{ip}^{ele}	Electricity productivity discrepancy shifter (endogenous factor growth sectors)
γ_{np}^l	Labor factor productivity growth factor (exogenous factor growth sectors)
γ_{np}^k	Capital factor productivity growth factor (exogenous factor growth sectors)
γ_{np}^f	Fossil fuel energy factor productivity growth factor (exogenous factor growth sectors)
γ_{np}^{le}	Capital, labor and energy factor productivity growth factor (endogenous factor growth sectors)
λ_{ip}^l	Labor productivity for sectors with endogenous factor productivity growth shifter
λ_{ip}^k	Capital productivity for sectors with endogenous factor productivity growth shifter
λ_{ip}^f	Fuel energy productivity for sectors with endogenous factor productivity growth shifter
λ_{ip}^{ele}	Electricity productivity for sectors with endogenous factor productivity growth shifter
λ_{np}^l	Labor productivity for sectors with exogenous factor productivity growth shifter
λ_{np}^k	Capital productivity for sectors with exogenous factor productivity growth shifter
λ_{np}^f	Fuel energy productivity for sectors with exogenous factor productivity growth shifter
λ_{np}^{ele}	Electricity productivity for sectors with exogenous factor productivity growth shifter
λ_j^l	Land productivity growth factor
λ_j^{nr}	Natural resource productivity growth factor

Trade price

$\overline{WPE}_{k,r}$	Export price index of competitors
$WPM_{r,k}$	World price of import by region of origin
ER	Exchange rate

Fiscal variables

RSG	Real government saving
XG	Aggregate government consumption in volume
τ_j^p	Producer's tax
$\tau_{k,j}^{pc}$	Producer's intermediate consumption tax
τ_j^d	Labor input tax
τ_j^{kd}	Capital input tax
τ_j^{ld}	Land input tax
τ_j^{nrd}	Sectoral specific natural resource input tax
ξ^i	Household's income tax adjustment factor
κ^h	Household's income tax
κ^e	Enterprise income tax
$\tau_{k,r}^x$	Export tax by region of destination
$\tau_{r,k}^m$	Import tariff by region of origin
τ_k^{hc}	Household consumption tax
τ_k^{gc}	Government consumption tax
τ_k^{invc}	Investment final consumption tax
τ_k^{trdmg}	Tax on export of trade and transportation services
t_{poll}	Emission tax
$TRGH$	Government transfer to households
$TRGE$	Government transfer to enterprises

Miscellaneous exogenous variables

$TRGF$	Government transfer to foreign countries
--------	--

<i>TRFG</i>	Foreign transfer received by government
<i>TRFH</i>	Foreign transfer to household
<i>TRFE</i>	Part of enterprise income coming from foreign countries
<i>SF</i>	Foreign saving
<i>XTRDMG</i>	Aggregate exports of transportation service in volume

e. Key model elasticities

Production elasticities

σ_j^p	Substitution elasticity between intermediate consumption and capital-labor-energy-land-natural resource bundles
σ_j^{klet}	Substitution elasticity between capital-labor-energy bundle and land, natural resource
σ_j^{kle}	Substitution elasticity between capital-energy bundle and labor
σ_j^{ke}	Substitution elasticity between capital and energy bundles
σ_j^{ene}	Substitution elasticity between electricity-fossil fuel energy bundles
σ_j^{fuel}	Substitution elasticity between the fossil fuels
η	Export externality elasticity with respect to export growth
ψ	Import externality elasticity with respect to growth in imported machinery stocks

Demand elasticities

μ_k	Based household income elasticities
---------	-------------------------------------

Trade elasticities

σ_k^c	Armington elasticities between domestic and aggregate import demand
σ_k^m	Armington elasticities between import demand across different origins
σ_k^{ds}	Top-level transformation elasticity between the domestic market and aggregate exports
σ_k^x	Transformation elasticity of exports across different destinations
$\eta_{k,r}^e$	Price elasticity of World demand for export by regions of destinations

Factor market elasticities

ω^l	Labor supply elasticity with respect to wage level
ω^k	Transformation of capital across different sectors
ω^d	Transformation of land across different sectors
ω_j^{nr}	Natural resource supply elasticity with respect to price

Emission factors

v_j	Energy specific emission rate
-------	-------------------------------

f. Calibrated parameters

Production

α_j^{nd}	CES share parameter for intermediate consumption bundle
α_j^{klet}	CES share parameter for capital-labor-energy-land-natural resource bundle
$a_{nd,j}$	Leontief coefficients for intermediate demand
α_j^d	CES share parameter for land demand
α_j^{nrd}	CES share parameter for sectoral specific natural resource demand
α_j^{kle}	CES share parameter for capital-labor-energy bundle
α_j^l	CES share parameter for labor demand
α_j^{ke}	CES share parameter for capital-energy bundle
α_j^d	CES share parameter for capital demand
α_j^{ne}	CES share parameter for energy bundle
α_j^{le}	CES share parameter for electricity demand
α_j^{fuel}	CES share parameter for fossil fuel energy bundle
$\alpha_{f,j}$	CES share parameter for fossil fuel demand
$\frac{AT}{BT}$	Original export externality's productivity shifter factor
$\frac{BT}{AT}$	Original import externality's productivity shifter factor

Saving behaviors

sh	Household savings rate
sc	Enterprise savings rate

Income distribution parameters

$\varphi_{k,e}$	Enterprise share of after-tax capital income
$\varphi_{k,h}$	Household share of after-tax capital income
$\varphi_{k,f}$	Rest of world share of after-tax capital income
$\varphi_{e,h}$	Household share of after-tax enterprise income
$\varphi_{e,f}$	Rest of world share of after-tax capital income
$\varphi_{h,f}$	Rest of world share of after-tax household income

Demand parameters

θ_k	Household minimum consumption parameter
α_k^g	Commodity share parameter for government consumption
α_k^{inv}	Commodity share parameter for investment consumption
α_k^{trdms}	Commodity share parameter for exported trade and transportation services

Trade parameters

α_k^{dd}	Domestic share parameter in top-level Armington CES
α_k^{mt}	Import share parameter in top-level Armington CES
$\alpha_{r,k}^m$	Regional share parameter in second-level Armington CES
$\alpha_{k,r}^e$	Export demand shift parameter by region of destination
γ_k^{ds}	Domestic share parameter in top-level CET
γ_k^{et}	Export share parameter in top-level CET
$\gamma_{k,r}^x$	Regional share parameter in second-level CET

Factor market parameters

ϕ_j	Inter-sectoral wage differential parameters
α^s	Labor supply shift parameter
γ_j^k	Capital allocation share parameters between sectors
γ_j^l	Land allocation share parameters between sectors
γ_i^{nr}	Specific natural resource supply shifter parameter

Chapter 9. Industrialization, Environment and Health: the impacts of industrial SO₂ emission on public health in China

Among the discussions on sustainable development, the effect of air pollution on health is a frequently mentioned topic. Though economy growth favorites improvement of living condition and therefore benefits public health amelioration, if economy growth is achieved with important pollution cost, negative effect from pollution on public health will in the long run reduce growth capacity.

The previous chapters seem to describe mixed situation for China's current and future pollution situation. Although many factors have the capacity to help China improve its environmental quality, the successful application of these positive roles depends on the validness of some critical institutional conditions. If the worst scenario to be realized in China, that means Chinese government fails to met these conditions therefore, the air quality in China will face even serious deterioration tendency. How much potential cost will this deteriorating tendency of pollution mean to China's economic growth sustainability? To answer this question, in this chapter, we will investigate the potential causality between regional industrial SO₂ emission density and ratio of population suffering chronicle diseases in China during 1990s.

9.1. Literature review on the existing pollution-health nexus studies for China's case

Facing obvious deteriorating tendency in China's air pollution situation during the last decade, many authors started to investigate the potential relationship between air pollution and public health in China. Among these studies, different health indicators (mortality, acute

diseases and chronicle diseases, etc), different air quality indicators (concentration of SO₂, NO_x, Suspending particles, etc.) and different analysis methods (Does-Response¹, temporary series analyses, etc.) have been used. In Table 9.1, we list some of them whose analysis focuses are very similar to ours.

Table 9.1 Selected studies on the relationship between air pollution and public health in China

Authors	Methods	Place	Period	Health Indicator	Air quality indicator	Results
Xu et al (1994)	Poisson regression in logarithms form by controlling effects of temperature, humidity and of date and weekday	Two residential districts in Beijing	1989	Daily mortality in these two district of Beijing (statistic ratio)	Concentration indices of SO ₂ and TSP	SO ₂ : significantly negative effect on health. TSP: insignificantly negative effect on health.
Xu et al (1995)	Temporal series analysis	One hospital in Beijing	n.a	Outpatients' visits for acute diseases, classified according to the type of diseases (Statistic ratio)	Concentration indices of SO ₂ and TSP	SO ₂ and TSP: both significantly positive with respect to the outpatients' visits.
Xu et al (1995)	Temporal series analysis by controlling effect of temperature, humidity, and of date and weekday.	Shenyang	1992	Daily Mortality classified according to different death causes (statistic ratio)	Concentration indices of SO ₂ and TSP	Mortality is positively correlated to the concentration degree of SO ₂ and TSP.
Peng et al (2001)	Spatial Models to "detailize" the concentration indices of pollutants, especially the suspending particles. Does-Response method.	Shijiazhuang and Changsha	1995	Data on mortality and morbidity obtained from epidemiological and official statistic studies.	Concentration indices of SO ₄ and other particles estimated from SO ₂ emission data by spatial model.	Significant correlation between health situation and SO ₂ emission.

Different in analytical perspectives and methods, most of these studies prove a positive causality between air pollution and the deterioration of public health indicators. Compared with the studies based on other foreign countries, these Chinese-case studies generally share two particularities. On one hand, the causality between TSP (Total Suspending Particles) concentration increase and public health deterioration that is very often observed from the other countries' experience is not always confirmed by Chinese data. On the other hand, as China is particularly endangered by SO₂ emission problem, the studies investigating China's case often detect a positive relationship between SO₂ pollution and public health situation deterioration, which is relatively rare in the other countries.

¹ According to Ostro (1996), the estimation function of Does-Response method is: $d(H)=R*Population*d(A)$. Where $d(H)$ is variation of the risk for people to fall ill. R is change rate of the Does and Response in function. Here Population indicates the population exposed to risk. And $d(A)$ is the changes in air pollution situation, which is considered to be the risk in the analysis.

These two aspects of differences, however, are not contradictory. Because SO₂ emission is in fact a very important source for the formation of tiny particles, especially for that of the tiny airborne particles—SO₄, the component of the suspending particles most commonly found in China's atmosphere. Peng et al (2001) use the precise data on geographical location of the principal SO₂ emission sources in Shijiazhuang and Changsha,¹ to estimate the precised concentration indices of SO₄ and other particles in different areas of these two cities with the help of a spatial model. Then they use these estimated pollution concentration indicators to explain the difference in public health situation between the different areas. The significant relationship between the estimated pollution concentration indicator and the public health situation found in their study actually confirms the closed link between SO₂ emission, tiny suspending particles concentration and the public health situation in China.

9.2. A simple theoretical model describing the pollution-health nexus

Although from a medical point of view, the estimation method employed by most of the existing pollution-health nexus studies based on China's case are very pertinent, by focusing their attention on the data samples coming from the same single city or district, these studies generally neglect the potential health impact of some macroeconomic characters. One good example is the per capita GDP of an economy, which is, on one hand, an important determinant for supply and demand of public medical and health services, and on the other and, the “fruits” of air pollution deterioration, whose creation process has been described in many new growth theories as the main reasons for the air pollution deterioration problem in an economy. Therefore, for an analysis with a perspective of sustainable development as ours, to include the trade-off between current economic growth opportunity, public health situation deterioration and finally the future growth capacity reduction is more than necessary.

Therefore, in this section, we will try to explain the relationship between air pollution and health by a system of 3 equations as shown in equation (9.1)-(9.3). In this system, we use proportion of population suffering from pollution-related diseases as public health indicator. We assume both pollution and economic growth to be public health determinants. At the same time, pollution is also considered as a production factor, just like labor and capital.

$$\text{Chronicle diseases} = d(\text{GDPPC}, \text{Pollution}, \text{Education}, \text{Social Security}, \text{time}) \quad (9.1)$$

$$\text{GDPPC} = f(y(K, L), \text{pollution}) / L = (K_p^\beta / L^\beta)^\alpha \times [(K_e / L) \times \text{pollution}]^{1-\alpha} = Y_{pi}^\alpha \times [(K_e / L) \times \text{pollution}]^{1-\alpha} \quad (9.2)$$

$$\text{Education} = e(\text{GDPPC}, G) \quad (9.3)$$

¹ Such as large central boilers and factories, in which the coal are combustion activities are concentrated.

with:

Chronicle diseases: indicator for public health situation

GDPPC: per capita GDP

Pollution: pollution indicator

Education: level of education received by the population

Social security: ratio of the coverage of social security system on people's medical expenditure

K: capital

L: labor

K_p: capital used in production activities

K_e: capital used in pollution abatement activities

Y_{pi}: per capita income

G: the other exogenous variables explaining population's education level.

Equation (9.1) describes public health determination. We consider it to depend on the following factors.

First, per capita gross domestic production of economy (*GDPPC*). Considering to the supply and demand channels through which *GDPPC* increase can facilitate the development of medical and health services, we believe it to be a preventing factor for public health status deterioration.

Second, air pollution (*Pollution*) indicator. Generally we believe the increase in air pollution can bring more risks to people's health situation.

Third, population's average education level (*Education*). By receiving education, we reinforce our consciences on the function of our bodies and on how to take care of ourselves in cases of slight sickness, in this perspective, education level should be a pro-health factor. However, it is also possible that, by obtaining more consciences on the mechanism of our bodies, we becomes more sensible to feel (subjectively) ill, especially in the case of chronicle diseases. Therefore, currently, we cannot determine the clear role of education on health.

Fourth, social security system (*social security*). This is also an ambiguous determinant for public health situation. In an objective perspective, a good social security system offers population a good coverage for medical expenditure, therefore helps the people in maintaining the necessary health care even their original income status does not permit them to do so, therefore, we should export a better social security system to be followed by a better health situation. However, in a subjective perspective, good medical expenditure coverage may also encourage people to consult doctors more frequently and to be more easily to feel sick. Its final coefficient will be determined by our estimation.

Fifth, the technological progress, which is denoted by (*time*) in the equation (1). Facing the rapid technological progress and ever-deepening openness process, Chinese people are currently living in a transition period. In this period, the new modes of live, ideas, even social values are under rapid transformation, especially those of the generation most active in our epoch. We expect to capture some of these changes and their influence on public health situation by the time trend. We expect with the time passing by, technical progress and changes in ideas and living mode to promote amelioration in the health situation of population. For this reason, a negative sign is expected for this determinant.

Equation (9.2) illustrates a growth model, which includes environment quality as production factor. By doing so, we actually consider air pollution as an indispensable factor for production. Intermediate consumption of natural resource for each unit of product can be reduced owing to technical progress, but we can never totally cut off the direct links between production and its negative impact on environment.

Given this consideration, evidently, equation (9.1) ignores the potential correlation existing between pollution and GDPPC. Without controlling it, we risk to get biased estimation results. Moreover, Equation (9.1) only considers the static impact of pollution on public health situation. As we already know that China's industrial SO₂ emission intensity experienced an obvious decreasing trend the year 1990's, we are equally interested in understanding, with economic growth, how pollution control activities can dynamically reduce the negative impacts of pollution on public health.

Inspired by Musu (1994), we suppose the production function also invest one part of capital in pollution control activities. Therefore we distinguish the productive capital (K_p) from the capital distributed to pollution control activities (K_e) in our production function. The characteristics of Cobb-Douglas function permit us to further assume that pollution needed for one unit of product's production reduces with the increase in capitalistic ratio of pollution control activities, (K_e/L).

Equation (9.3) seizes the possible correlation between the health determinant factor *Education* and economy development level that is measured by GDPPC and the other exogenous characters of the population included in G.

Starting from this simple system of equations, we can derive the following reduced-form estimation function.

$$\text{chronicle diseases} = d(Y_{pt}, \text{pollution}, t, \text{pollution} \times (K_e/L), \text{Education}, \text{social security}) \quad (9.4)$$

(-) (+) (-) (-) (?) (?)

From a more structural point of view, equation (9.4) describes the relationship between public health, pollution and economic growth somewhat different from Equation (9.1). The impact of pollution on health situation now consists of two terms: *Pollution* and *Pollution* \times (K_e/L). The variable *Pollution* captures the direct effect of pollution increase on public health situation. While (*Pollution* \times *time*) seizes the dynamic reduction of the negative effect of pollution on public health situation contributed by pollution increase, which is the strengthened pollution control activities with income growth.

A more concrete explanation for this dynamic reduction of the negative effect of pollution on public health situation contributed by pollution increase is as following. As pollution intensity declines with economic growth, to produce one unit more GDPPC will require a marginal increase in pollution less than that for the previous unit of GDPPC. Consequently, the effect of amelioration on public health situation coming from economic growth should accelerate during time. As this dynamic improvement effect from economic growth is different from the static impact of GDPPC on health that has already explained in the equation (1), the reduced-form estimation function eq. (4) actually offers us an opportunity to distinguish them. Therefore in equation (4), the dynamic effect is captured by (*Pollution* \times *time*) and the static effect is measured by per capita income Y_{pc} .

Considering there are two endogenous variables with respect to GDPPC in this estimation function, which are (K_e/L) and *Education*, we will use Two Stage Least Square (TSLS) method to carry out our estimation.

9.3. Data details

9.3.1. Dependent variable: Proportion of population suffering from chronicle diseases

Considering the pollution impacts on health situation, which is more possibly to be negligible in short run, but to be accumulated and manifested in the long run, we will use the number of persons having chronicle diseases for 1000 persons in each region as health indicator. This is actually the aggregated data in the two synthetic reports of the two "Survey on National Health Service", organized by China's Ministry of Health on June 1993 and 1998.¹ The aim of these two surveys is to obtain information on population's health situation in different regions, to understand their demand for volume and different types of health services, and to have a thoroughly and precise knowledge on the spatial repartition of the health services and their efficiency. The data used in this paper is from the household survey

¹ These two reports and the related data are available in the website: <http://www.moh.gov.cn/statisitique>.

part.¹ For this part of survey, three or four counties (or districts in the cities) that can represent different development level inside of each province were chosen. In each county (district), 600 families (more than 2000 persons) have been chosen in a random way to answer the questionnaire. Therefore, we believe the aggregate data on the county (district) level to have a good representation for the health situation of each county (district). Another attractive point of this database is that, over the 89 counties included into our sample, 2/3 are actually the rural regions. Therefore we expect to obtain some clearer conclusions on the pollution-health nexus in rural regions, which is rarely discussed in the previous studies.²

9.3.2. Independent variables

a. Pollution: annual industrial SO₂ emission density

Considering that SO₂ emission is the principal source of the suspending particles and that over 70% of the SO₂ emission in China comes from industrial production, our estimation will focus on the potential health impact coming directly from the emission generated by industrial production activities. However, we only possess annual industrial SO₂ emission data on provincial level. To obtain an indicator for air quality in each province, we make the following extrapolation: we firstly calculate the quantity of annual industrial SO₂ emission in each county according to the ratio of its annual industrial product in its province and then divide it by the geographical area of this county. In addition, since both survey have been done in the middle of the year (the second half of June in year 1993 and 1998), naturally, the calculation of the annual industrial SO₂ emission should cover the second half of the precedent year and the first half of the survey year. Therefore, the calculation can be expressed as equation (9.5).

$$\text{industrial SO}_2 \text{ emission density}_{i,j,t} = \frac{\left(\frac{(SO_{2,j,t-1} + SO_{2,j,t})}{2} \times \frac{Y_{ind,i,j,t}}{Y_{ind,j,t}} \right)}{\text{Area}_{i,j,t}} \quad (9.5)$$

Where the Y_{ind} represents industrial product. Index i signifies county i . Index j signifies province j , and index t represents year t .

¹ Each of the two surveys consists of two parts: household survey on health situation of population and health service establishments survey on health service quality and efficiency. However, sample choice for the second part has not followed the same methods neither the same repertory as the household survey. Therefore, we cannot use the second part of the survey data in our analysis and introduce regional health service quality indicators into our estimation.

² There are originally 92 counties investigated in the survey. The three counties taken out from estimation are from Tibet whose industrial emission data are not available.

b. The other independent variables

The series of per capita income level (Y_{pt}) is obtained from the *Survey on National Health Services*; it is expressed in current price. We choose the percentage of persons possessing superior diploma in the interrogated population (*Higher*) to describe the education level in each county.¹ This series of data also comes from the Survey. Given the endogeneity of this variable in the system, we instrument it, by per capita GDP, which is further decomposed into per capita income level (Y_{pc}) and $\text{pollution} \times (K/L)$, and by the following population characters: per capita average living surface, ratio of population unmarried, percentage of population employed and urban population ratio in each county.²

The information on the organization of social security system also comes from the Survey. Given there exist different types of social security coverage, we choose the percentage of persons support themselves their medical expenditure (*Self-funded*) to describe the non-covered degree of the social security system in each county (district).

Neither the health service survey nor the other available county-level data sources does not, however, provide us with the data about the capital stock that used in pollution abatement activities, K_e . Therefore, we decide to replace the capitalistic ratio (K/L) by time trend (*time*). The implicit assumption for this extrapolation is that, as the capital stock used in pollution control activities increases with economic growth and that in China, per capita GDP shows a significant increasing tendency during time, we can suppose that as time passing by, the investment in pollution control activities grows.

For the time trend (t), we assume the pollution control activities did not start until year 1980, when China began its economic reforms. Consequently, we define $t=0$ for year 1980, so $t=12.5$ for June of year 1993 when the first survey was carried out and $t=17.5$ for June of year 1998 when the second survey took place.³

¹ The reason made us not to have chosen the ratio of the people possessing secondary or superior education diploma is due to two considerations. Firstly, the secondary education should not be enough to furnish people sufficient knowledge on the function of our mechanism and on how to take care of us in case of slight illness. Secondly, given China's current education policy demands a 9-year obligatory education for all the new generation, to some degree, the proportion of the population possessing a secondary diploma is more like a demographical structure indicator for a region. This means a high secondary diploma ratio may reflect in fact a high proportion of population of age 20-30. Given younger population normally have fewer propensities to suffer chronicle diseases, inclusion of the percentage of people having secondary diploma into the education indicator may cause some unnecessary ambiguity in our estimation results.

² Living surface can be considered as a measurement for richness level of a household, richer a household is, more capacity it will have to finance for higher education. Equally, unmarried and employed people are more possible to have more education. Finally, concentration of urban population in a county can be considered as an important indicator for urbanization level. High urbanization level also favorites the development of higher education.

³ The sensibility test shows that change of the beginning year for $t=0$ will not cause our estimation results to change.

9.3.3. Control variables

After over twenty years of economic reform, Chinese economy shows great disparity between regions. Large divergence in the economic structure between different regions has come up. While the inland provinces have generally be chosen as the heavy industry center due to the military strategies during Mao's epoch, coastal provinces are more specialized in labor-intensive light industries. To control the potential difference in the pollution-health relationship between costal and inland provinces, we will include the ratio of heavy industry's product in total industrial economy on provincial level (*Heavy*) as a control variable.

Table 9.2. Data statistical characters

Variable	Unit	Obs.	Mean	Std. Dev.	Min	Max
Dependent Var.						
Chronicle Diseases	Persons over 1000	180	155.237	89.310	30.180	608.607
Independent Var.						
SO2	μg/km ²	175	18.290	38.600	0.00004	294.723
SO2×time	μg/km ²	175	268.094	541.393	0.001	3684.032
self-funded	Percent	180	71.331	33.851	0.049	99.900
Y	1000 Yuans (current price)	180	1.859	1.404	0.175	7.829
heavy	percent	182	59.217	12.717	32.948	88.318
higher	percent	180	1.564	2.980	0.000	14.540

Summarizing up all the dependent and independent variables, we have the exact estimation function that we will use in our econometrical analysis as equation (9.6). The statistic characters of the related variables are reported in Table 9.2.

$$Chronicle\ diseases = f(Y^{(?)}, SO2^{(+)}_t, SO2^{(-)}_{\times t}, Edu^{(-)}(Y, SO2_{\times t}, G), heavy^{(+)}, Self\ funded^{(?)}) \quad (9.6)$$

9.4. Econometrical analysis

The results of our estimation are reported in Table 9.3. The first four columns record the estimation results based on single year data. In this step, similar to many previous studies, we consider only the direct and static impact of pollution on public health. Obviously, the results are unsatisfactory for both years. More curiously, the coefficients of industrial SO₂ emission density change the sign between 1993 and 1998. If we still feel comfortable to agree that in 1991, increase in SO₂ emission density causes chronicle disease ratio in population to rise, it seems less reasonable for us to accept that in 1998, increase in SO₂ emission can bring this chronicle diseases ratio to fall.

Following, we estimate our reduced-form function obtained from the structural theoretical system. In this estimation, we combine the two years' data to look for the potential dynamic attenuation tendency in the negative effect of pollution on public health. The related

results are shown in the last two columns of Table 9.3. Generally speaking, the result gives better explication power. For the first time, we obtain a significantly negative sign for SO_2 emission, which implies the negative role it plays on public health situation. An increase of $1 \mu g/m^2$ of industrial SO_2 emission density seems to causes 2-3 persons to have chronicle diseases over 1000. Equally speaking, given industrial SO_2 emission density increases $1 \mu g/m^2$, the probability to suffer chronicle diseases for a person will increase by 0.2-0.3%. Corresponding to our theoretical model, our estimation results also provide supportive evidence that this negative impact of pollution is actually reducing during the time. This is actually revealed by the negative coefficient before the multiplicative term $SO_2 \times t$.

Table 9.3. Impacts of industrial SO_2 emission density on public health situation (2SLS)

	Number of persons suffering chronicle diseases for each 1000 persons					
	Sub-sample (1993)		Sub-sample (1998)		Whole sample (1993+1998)	
	(2)	(4)	(6)	(8)	(10)	(12)
SO_2	0.040** (0.009)	0.046** (0.000)	-0.029 (0.363)	-0.024 (0.394)	2.883*** (0.000)	2.351*** (0.003)
t					-9.220** (0.021)	-13.438*** (0.003)
$SO_2 \times t$					-0.184*** (0.002)	-0.146** (0.013)
Higher ^a	6.252 (0.508)	6.193 (0.510)	31.784*** (0.003)	27.526*** (0.001)	16.232*** (0.008)	13.923** (0.016)
Y_{pc}^b	46.819 (0.148)	97.116* (0.065)	-23.054 (0.285)	11.716 (0.600)	5.361 (0.653)	29.437* (0.078)
Y_{pc}^2		-17.700 (0.138)		-3.740 (0.211)		-2.950* (0.065)
Self-funded	-0.367 (0.167)	-0.288 (0.243)	-0.505 (0.166)	-0.448 (0.163)	-0.450** (0.036)	-0.394* (0.057)
Heavy	1.966*** (0.008)	1.909*** (0.009)	0.164 (0.806)	0.488 (0.347)	1.190*** (0.002)	1.356*** (0.000)
Constant	-27.028 (0.625)	-1.213 (0.985)	176.493* (0.067)	99.306 (0.201)	217.513*** (0.000)	241.592*** (0.000)
R-squared	0.5417	0.5483	0.2730	0.425	0.594	0.610
F	32.58	33.61	9.250	10.000	48.140	50.090
Normality		21.09 (0.000)		8.39 (0.015)		41.87 (0.000)
Obs. number		86		88		174

Note : a. Higher, the indicator for education level is an endogenous variables, we use the following variables to instrument it : so_2 , $time$, $SO_2 \times time$, $self-funded$, Y , $Heavy$ and $Aveareap$ (per capita average living surface), $unmarried$ (percent of population unmarried in total population), $employed$ (percent of population employed in total population) and $Urban-pop$ (ratio of urban population in total population in each county). The first three variables are obtained from the Survey and the last one comes from « China County-level Data on Provincial Economic Yearbooks and « China's county-level economic statistics 2000», which is actually the data in year 1999.

b. Three counties located in Tibet are taken out from our estimation due to the lack of data for industrial pollution situation.

c. The line headed by « Normality » show the statistic value of the normality test on dependent variables.

To see the total effect of pollution on public health situation in each year, we need to combine the simple term SO_2 and the multiplicative terms of $SO_2 \times time$ together. This combination shows that, in 1993, the derivative of the health status with respect to industrial

SO₂ emission density is equal to $d(\text{diseases})/d(\text{SO}_2)=2.351-0.146\times 12.5=0.526$, which suggests a total negative role for pollution in public health determination. While in 1998, this derivative value becomes $d(\text{diseases})/d(\text{SO}_2)=2.351-0.146\times 17.5=-0.204$. This simple calculation shows that, although in year 1998, the negative effect of pollution still exerted on public health situation; this negative role has been totally cancelled by the positive effect sourcing of pollution on health status that comes from progress in technology used in pollution control activity. This finding also gives us a feasible explanation for the puzzling sign-changing results for SO₂ variable in the sub-sample estimation for each separate year.

We look now at the other determinants for public health. Firstly, the per capita income, (Y_{pc}). Instead of the anticipated linear positive relationship, the impact of per capita income growth on public health should be described by an inverted U curve. The ratio of chronicle diseases in population will firstly increase with income growth and this tendency will be reversed after per capita income attains 4988 Yuan. This inverted-U curve relationship actually reveals the fact that the health situation improvement can only be realized after people's living condition attains certain critical level.

The coefficients found for the education indicator *Higher* and social security indicator *Self-funded* are, however, contrary to our precious expectation. Our estimation results seems to attribute higher education level and higher coverage degree of social security system as negative factor for public health improvement. These anti-logical finding might be due to the subjective characters of the health indicators that we choose in this paper. To collect data on chronicle diseases ratio in population, the original question in the Survey is that, *during the last six months, have you had the chronicle diseases examined and confirmed by doctors?* Clearly, for someone who supports himself the consultation fee and other medical expenditures or one person having less knowledge on the function of his body, it will be less possible for him to visit a doctor for health problems seemingly (subjectively) little acute. Consequently, the probability of this person to be examined by doctors will be smaller; even smaller will be the change for them to be detected as having chronicle diseases.¹

¹ This deficiency in the measurement of the public health situation, however, does not affect the credibility of the estimation result of the pollution-health relationship, although we mind need to bear in mind that the actual negative impact of pollution on public health might be higher than that revealed by our estimation results.

9.5. Threshold analysis on the impact of industrial SO₂ emission on health situation

Accepting the health-damaging effect of pollution, we should at the same time agree that human being possesses the capacity to stand minor air pollution problem without falling ill. World Health Organization (WHO) also indicates that for developing countries, the acceptable SO₂ concentration standard is 60 µg/m³, obvious health damage should come up after this upper-end bound is surpassed.

Is it also necessary for our empirical analysis to pay attention to the potential estimation bias related to this pollution-health relationship threshold? From Table 9.2, we see that the disparities in industrial SO₂ emission density between the 89 counties are actually very big. The minimal industrial SO₂ emission density is only 0.00004 µg/m², while the highest density attains to 294.723 µg/m². According to this, our estimation results in the table 9.3 may suffers form bias, which has the tendency to attenuate the actual negative impact of pollution on public health. We therefore in this section check the existence of the threshold for industrial SO₂ emission density in its impact on public health.

To look for this potential threshold, we firstly sort out our sample according to their industrial SO₂ emission density level in a decreasing order, then start regression by only including the counties possessing the highest emission density at the first time. If the coefficient for both SO₂ and SO₂×t stays significant, we move downwards in the list of the county and adding in to our regress each time one more county that has the highest emission density among those not yet included into the estimation. We continue enlarging our estimation sample until the coefficients for SO₂ and SO₂×time terms becomes both insignificant. We therefore define the emission density of the finally included observation that keeps the significance of pollution terms as the. With the aid of this method, we find the threshold for the impact of China's industrial SO₂ emission density on the ratio of chronicle disease to be 8 µg/m².

Using this threshold, we can divide our database into two sub-samples, whose emission density are respectively above and below the threshold, then we redo the same estimations as those in table 9.3 for these two sub-samples, separately. The results are reported in the first two columns in Table 9.4. Obviously, we only find the negative effect of industrial SO₂ emission in the over-threshold sub-sample. However, it seems the magnitude of the negative impact of emission on public health stays at almost the same level as that found from the whole sample. Clearly, the stability of our estimation are not affected by the rearrangement of

the database. Furthermore, the strategy to divide the whole sample into two according to the threshold value does not show its superiority in explication power. On contrary, observing the F-statistic of Chow which tests the structure change equal to only 0.606, we are afraid simply dividing the database according to the critical threshold level will instead result in loss of explanation power of our model.

Table 9.4 Threshold analysis on the impacts of SO₂ emission on public health (TSLs)

Independent Var.	Number of persons suffering chronicle diseases for 1000 persons		
	Sub-sample (SO ₂ =8μg/m ²)		Whole sample (spline model)
	SO ₂ >8μg/m ²	SO ₂ <8μg/m ²	
SO ₂	2.183* (0.082)	19.497 (0.532)	
Time	4.894 (0.786)	-17.948*** (0.005)	-12.166** (0.018)
SO ₂ ×time	-0.128 (0.182)	-1.232 (0.501)	
(over-threshold)×SO ₂			2.461*** (0.002)
(over-threshold)×SO ₂ ×time			-0.153** (0.012)
(below-threshold)×SO ₂			13.733 (0.668)
(below-threshold)×SO ₂ ×time			-0.890 (0.634)
Higher ^a	23.766** (0.014)	6.342 (0.553)	14.463** (0.025)
Incomepc ^b	-54.161 (0.277)	61.119* (0.083)	28.833* (0.077)
Incomepc ²	3.40 (0.318)	-5.44 (0.532)	-3.000* (0.070)
Self_fun	-0.094 (0.787)	-0.290 (0.208)	-0.374** (0.024)
Heavy	-0.411 (0.783)	1.723*** (0.000)	1.320*** (0.002)
Constant	189.339 (0.141)	242.131*** (0.000)	223.298*** (0.000)
R ²	0.4995	0.3664	0.6091
F	21.65	9.50	38.50
F test for SO ₂ and SO ₂ ×time ^c	6.34	0.38	
F value (Chow test) ^d	0.606		2.385
Number of observations ^b	54	120	174

Note : a. Higher, the indicator for education level is an endogenous variables, we use the following variables to instrument it : *so2*, *time*, *SO₂×time*, *self-funded*, *Y*, *Heavy* and *Aveareap* (per capita average living surface), *unmarried* (percent of population unmarried in total population), *employed* (percent of population employed in total population) and *Urban-pop* (ratio of urban population in total population in each county). The first three variables are obtained from the Survey and the last one comes from «China County-level Data on Provincial Economic Yearbooks and «China's county-level economic statistics 2000», which is actually the data in year 1999.

b. Three counties located in Tibet are taken out from our estimation due to the lack of data for industrial pollution situation.

c. F test is for the co-significance of the two terms: SO₂ and SO₂ × time.

d. Chow test is to test the structure change possibility in estimation function according to the value of certain independent variables. (Johnston, 1987, pp207)

Therefore, following, we employ the spline model to re-estimate the reduced-form equation (6). In the model, coming back to the whole sample, we distinguish the coefficients for emission density terms by multiplying them with the dummy variables *over-threshold*

(equal to 1 if $SO_2 > 8 \mu g/m^2$, and equal to 0 if $SO_2 < 8 \mu g/m^2$) and the *below-threshold* (equal to 1 if $SO_2 < 8 \mu g/m^2$, and equal to 0 if $SO_2 > 8 \mu g/m^2$).

The estimation results are reported in the third column of Table 9.4. This spline model clearly helps us to obtain higher explanation power in our estimation. Moreover, the Chow test also proves the necessity to distinguish the health impact of emission density between these two samples in estimation. When the industrial SO_2 emission density is greater than $8 \mu g/m^2$, the coefficients for SO_2 and $SO_2 \times time$ terms are both significant. Correspond to the last section, the direction of the total role of SO_2 also changes sign between 1993 (0.5485) and 1998 (-0.2165). However, when SO_2 emission density is below the threshold, both terms related to SO_2 comes out to be insignificant.

The coefficients for the other independent variables also show good coherence with respect to those in Table 9.3. We find, as previous, the relationship between income and chronicle diseases ratio keep following inverted U curve, and increase in income will not bring health situation amelioration until income attains 4805 yuans/person.

9.6. Conclusion

In this paper, we firstly constructed a structural system to explain the relationship between air pollution and public health situation. In this model, we consider not only the direct and static impact of pollution on public health situation, but also tried to capture the dynamic attenuation tendency in this impact accompanied by economic growth. Following, this model is examined by the county-level aggregated data from the two national surveys organized by China's MOH in 1993 and 1998.

Our estimation results firstly prove the potential negative impact of industrial SO_2 emission density on public health situation, which is measured in this study by the ratio of chronicle disease per 1000 persons. It seems the negative impact of emission density on public health is found to be significant after emission density reach or surpass the threshold of $8 \mu g/m^2$. Following, our estimation results seem to suggest the negative impact of pollution on health will be gradually repaired by the fruits of economic growth. However, we should bear in mind that this is actually a very optimistic conclusion, whether such a conclusion can be possible or not in China depends closely on the validity of the implicit assumption that the de-sulfur effort will automatically increase with income growth. More precisely, as we use the time trend to represent the increasing tendency of the stock of capital used in pollution reduction activities, the validity of this conclusion actually depends on whether technological efforts in pollution abatement in China can really increase continuously during the time.

Conclusion and policy implications

The objective of this dissertation has been to study the potential relationship between economic growth, trade liberalization and environment in China, in the aims of identifying the possibility, the sufficient and necessary conditions for China to realize its sustainable development. We started our discussion by a reduced-form Environmental Kuznets Curve analysis (chapter 2), which revealed a seemingly optimistic image for the relationship between China's economic growth and its per capita industrial SO₂ emission evolution. However, this "per capita"-based Environmental Kuznet Curve did not guarantee a similar trajectory for total industrial SO₂ emission. Although our EKC analysis predicted a turning point at about 9000 yuan (1990 price) for the case of per capita industrial SO₂ emission, the evolution of total industrial SO₂ emission seems to continue its increasing tendency. To understand the underlying reasons for the increasing tendency in total SO₂ emission, we carried out two structural analyses, in which the structural determinants of SO₂ emission are decomposed either parametrically (chapter 3) or non-parametrically (chapter 4) into scale, composition and technique effects. We found that, the per capita income, acting as an omnibus variable representing all the three aspects of underlying structural determinants, only impart a "net-effect" of income growth on environment. The real reason for the ever-increasing trend of total industrial SO₂ emission in China is actually due to the domination of pollution-increasing impact of scale enlargement over the pollution-reducing contribution from technical progress, combined with a province-specific composition transformation which exerts slight pollution-increasing impact in most of the Chinese provinces, given their current industrialization process.

The second part of this dissertation further amplified our decomposition efforts by giving particularly attention to the emission determination role of international trade.

Previously redeemed by some pessimistic economists as a channel for the richer developed countries to discharge their pollution burdens to their poorer trade-partners, international trade has been considered as a static explanation for the formation of the inverted-U-shaped growth-pollution relationship. Nevertheless, all three analyses carried out in this part, by investigating the different channels through which international can exerts impact on the three determinants of emission, have not been able to provide supportive evidence for the “pollution haven” hypothesis in China. As China’s factor-endowment-based comparative advantages are much attractive than its potential as a “pollution haven”, the conclusion of chapter 5 believes trade liberalization can reduce the pollution burden of China’s industrialization process by deviating its industrial composition transformation towards less polluting labor-intensive sectors. But the actual role of trade is more complicated than that and in chapter 6, we further confirmed its positive impact in both scale enlargement and technical progress. The analysis based on a simultaneous system in chapter 7 permit us to combine these three aspects’ indirect impact of international trade on emission into the same structural model and its estimation results reveals the total role of export in China to be environment-friendly while that for import (measured by the accumulation of imported machinery and equipments) to be pollution-enhancing.

By relating emission results directly to production activities and energy combustion, the CGE model analysis in Part 3 offers us an opportunity to parameterise multiple aspects of trade-pollution and growth-pollution nexus and obtain an explicit numerical comparison between the magnitude of environmental impact of trade and that from economic growth. This analysis reveals that, compared to the scale effect resulting from rapid economic expansion in China, the actual pollution-reduction result owing to trade liberalization, unfortunately, very insufficient. The most important contribution in pollution reduction actually comes from efficiency improvement in energy uses and depends largely on the existence of a flexible energy substitution process.

Facing the mixed situation for China’s future environmental situation, we investigated in the last chapter of this dissertation the potential feedback effect from pollution to China’s further growth capacity. Our analysis reveals a significant negative impact of industrial SO₂ emission on public health after the industrial SO₂ emission density attains the critical threshold of 8μg/m³. After this threshold, each 1μg/m³ increase in SO₂ emission density will increase the probability for one person to suffer chronicle diseases by 0.241%. Fortunately, this chapter seems also to reveals some possible dynamism through which the significant negative impact of industrial SO₂ emission on public health status can be gradually reduced

with economic growth. But to realize this dynamism, China need to realise a more-than-proportion investment increase in de-sulfur technologies with respect to its economic growth rate in the coming years.

To sum up, the analyses carried out in this dissertation actually indicate both the opportunities and challenges for China's pursuit for a sustainable development path. Given the current environmental deterioration tendency that accompanies its remarkable economic growth achievement, China is actually endangering its economic suitability. But the structural determination mechanism for industrial SO₂ emission also reality also preserves for China some opportunities to make up for these dangers, such as to combine a stricter pollution control policy with trade liberalization measures as proposed in the CGE analysis, or to ensure more intense technology investment activities in pollution abatement activities as proposed in chapter 9.

However, whether these measures and policies can be correctly and promptly put into execution and whether they can finally bring effective pollution reduction results, will in their turn, depend on the existence of both the sufficient technological capacity and the efficient institution and market system (the necessary condition) in China.

The sufficient technological capacity can be considered as a necessary condition. Without it, blindly enhancing pollution control strictness or intensifying investment process in pollution abatement activities will only distort economic agents' decision and result in unnecessary efficiency loss.

The efficient institution and market system should be regarded as a sufficient condition. Without these systems' normal functioning, the expected price signals of the stricter pollution control policy cannot be produced in the economy. Even the correct price signal can be obtained, it might still be difficult for it to exert correct influence on economic agents' decision and finally to realize the expected pollution reduction result. Obviously, the pursuit for a sustainable development in China equally calls for the necessary reform in both economic and institutional systems. Without the cooperation from these aspects, Chinese economy may still stays far away from her country-specific sustainable development trajectory.

Being a supply-side factor, the condition on the technological capacity is relatively easier to be satisfied in China given its ever-increasing economic strength and rapid technological progress all over the world. The difficulties related to the satisfaction of the institutional and market system reform will be much more difficult. The success in putting forward the construction of these system requires efficient information dissemination about

potential negative impact of pollution on human health, prompt disclosure of the pollution performance information to citizens, increasing sensitivity of government decision-making process to public demand, and finally, good intention of government agency on improving the policy implementation and monitoring efficiency. Considering the demand for a better environment relates closely to personal utility or interests of each citizen and observing the already existing important informal pollution control system in China (World Bank, 2000), we believe the pursuit for a more sustainable development trajectory will also facilitate the construction and improvement of the institution and market systems.

As one of the most important aspects of pollution problem in China, the industrial SO₂ emission, however, is far from being able to representing China's total environmental situation. All kinds of other emission problems that have not be really discussed in this dissertation, such as other air pollution emission, wastewater discharging, solid waste depositing, natural resource depletion, etc. actually act together with industrial SO₂ emission to determine the total environmental quality in China. Without a careful census on all the different aspects of pollution problems and a thorough understanding about the actual situation and future dynamism of ecological system's assimilative capacity, even the future economic growth can be dichotomised from industrial SO₂ emission increase, we are still unable to say that China is realized its sustainable development. Given the big differences in economic, structural, demographical, and natural condition characteristics, each region may has its most urgent pollution problems. Such as for the "cancer-village" in Zhejiang, their most urgent task to close down the small township and village enterprises (TVE) polluting the drinking water sources, while for some regions of Inner Mongolia, it will be how to preserve the natural pasture from desertification. However, the logic about the necessity of the efficient economic, political and institutional systems in supporting an efficient pollution-reduction result is actually applicable to all the different kinds of pollution abatement objectives.

The institutional and political intervention from a careful government will be even more important after the proportion of consumption-related pollution starts to increase. The inseparability between pollution and consumption will make people handicapped in reducing their consumption for the aim of environmental protection. As the rate of the household possessing a private vehicle is still low in China, given its rapid economic growth tendency, very important pollution increase related to vehicle use can be expected for the future 30 years. Under this case, the intervention from the government will be even more essential.

The existence of the efficient institutional and economic system is also indispensable condition for the active and convincing international cooperation in reducing the Green House

Gas (GHG) emission. Being the world second largest GHG emitter, to possess more transparent decision-making process and more efficient policy-application conditions can enhance other countries' confidence on China's resolution and efficiency in its GHG reduction objectives, therefore encourage the other countries to fulfil their own obligation and finally contribution to a more optimistic future for our planet.

Reference

- Agras, J. and D. Chapman (1999), 'A dynamic approach to the Environmental Kuznets Curve hypothesis'. *Ecological Economics* 28(2): 267-277.
- Anderson, D., Cavendish, W., 2001. *Dynamic Simulation and Environmental Policy Analysis: Beyond Comparative Statics and the Environmental Kuznets Curve*. *Oxford Economic Papers* 53, 721-746.
- Anderson, T. and C. Hsiao (1982), 'Formulation and estimation of dynamic models using panel data', *Journal of Econometrics* 18: 67-82.
- Ang, B.W., Pandiyan, G., 1997. Decomposition of energy-induced CO₂ emissions in manufacturing, *Energy Economics* 19, 363-374.
- Antweiler, W., B. R. Copeland and M.S. Taylor (2001), 'Is Free Trade Good for The Environment?', *American Economic Review*, 91(4): 877-908.
- Antweiler, W., Copeland, B. R., Taylor, M.S., 2001. Is Free Trade Good for The Environment?, *American Economic Review* 91(4), 877-908.
- Arellano, M. and O. Bover (1995). 'Another Look at the Instrumental Variable Estimation of Error-Components Models', *Journal of Econometrics*, 68: 29-51.
- Arellano, M. and S.R. Bond (1991), 'Some Tests of Specification for panel Data: Monte Carlo Evidence and an Application to Employment Equations', *Review of Economics Studies*. 58: 277-297.
- Audibert, M., Mathonnat, J., & Chen, N. (2000). Does external openness influences the infant mortality rates? An econometric investigation for the Chinese provinces. *Health and System Science*, 2000(4), 65-90.
- Audibert, M., Mathonnat, J., Henry, M., & Nzeyimana, I. (1999). Rôle du paludisme dans l'efficacité technique des producteurs de coton du nord de la Côte-d'Ivoire. *Revue d'Economie du Développement*, 1999(4), 121-148.
- Balestra, P. and M. Nerlove (1966), 'Pooling Cross-Section and Time Series Data in the Estimation of a Dynamic Model: The Demand for Natural Gas', *Econometrica*, 34: 585-612.
- Baltagi, B.H. (1995), *Econometric Analysis of Panel Data*, Wiley and Sons, Ltd, West Sussex, England, 304pp.
- Bao, D., G.H.Chang, J.D. Sachs and W.T. Woo (2002). Geographic factors and China's regional development under market reform, 1978-1998. *China Economic Review*, 13:89-111.
- Beghin, J., Bowland, B., Déssus, S., Roland-Holst, D. (1999). Trade, Environment, and Public Health in Chile: Evidence from an Economy-wide Model, in P.G. Fredriksson (ed). *Trade, Global Policy, and the Environment*, World Bank, 1999, 35-54.
- Beghin, J., Dessus, S., Roland-Holst, D., Van der Mensbrugghe, D. (1996). *General Equilibrium Modelling of Trade and the Environment*. Technical paper No. 116, OECD.
- Beghin, J., Dessus, S., Roland-Holst, D., Van der Mensbrugghe, D. (2002). Trade Integration, Environmental Degradation, and Public Health in Chile: Assessing the Linkage. *Environment and Development Economics* 7, 241-267.
- Beghin, J., Dessus, S., Roland-Holst, D., Van der Mensbrugghe, D. (1997). The Trade and Environment Nexus in Mexican Agriculture: A General Equilibrium Analysis. *Agricultural Economics* 17, 115-131. Beijing Environment, Science and Technology update, 14, June, 2002.
- Behr, A. (2003), 'A Comparison of Dynamic Panel Data Estimators: Monte Carlo Evidence and an Application to the Investment Function'. Discussion paper 05/03. Economic Research Centre of the Deutsche Bundesbank.
- Blundell, R. and S.R. Bond (1998), 'Initial Conditions and Moment Restrictions in Dynamic Panel Data Models', *Journal of Econometrics*, 87: 115-143.
- Boulding, K.E. (1966). *The Economics of the Coming Spaceship Earth*. From Environmental Quality in a Growing Economy. Washington, D.C.: John Hopkins Press.
- Cai, F., D. Wang and T. Du, (2002). Regional disparity and economic growth in China: the impact of labor market distortions. *China Economic Review*, 13: 197-212.
- Cao, D., Yang, J., Ge, C., 1999. SO₂ Charge and Taxation Policies in China: Experiment and Reform, in (OECD eds.). *Environmental Taxes: Recent Developments in China and OECD Countries*, OECD, 233-257.
- Cole, M.A. (2000). *Trade Liberalisation, Economic Growth and the Environment*. Edward Elgar, Cheltenham, UK and Northampton, MA. USA. 144pp.

- Cole, M.A. (2004), 'Trade, the pollution haven hypothesis and the environmental Kuznets curve: examining the linkages', *Ecological Economics*, 48(1): 71-81.
- Cole, M.A. and R. J. R. Elliott (2003), 'Determining the trade-environment composition effect: the role of capital, labor and environmental regulations', *Journal of Environmental Economics and Management*, 46(3): 363-383.
- Copeland, B. and M. S. Taylor, (1997), 'A Simple Model of Trade, Capital Mobility and the Environment', NBER, No. 5898, Cambridge, MA, 304pp.
- Copeland, B. and M. S. Taylor (1994), 'North-South Trade and the Environment', *The Quarterly Journal of Economics*, 109(3): 755-787.
- Copeland, B.R. and M.S. Taylor (2003), *Trade and the Environment: Theory and Evidence*, Princeton and Oxford: Princeton University Press.
- Daly, H.E. and K.N. Townsend (1993). *Valuing the Earth: Economics, Ecology, Ethics*. Cambridge, MA: MIT Press.
- Daly, H.E.. (1973). *Towards A Steady-State Economy*. New York: W. H. Freeman.
- Dasgupta S., M. Huq, D. Wheeler and C. Zhang (1996), 'Water Pollution abatement by Chinese industry: Cost Estimates and Policy Implications', Working paper, No. 1630, the World Bank, Washington, DC.
- Dasgupta, S and D. Wheeler (1997), 'Citizen Complaints as Environmental Indicators : Evidence From China', Policy Research Working Paper, No. 1704, the World Bank, Washington, DC.
- Dasgupta, S. and al. (1995). *Environmental Regulation and Development: A Cross-Country Empirical Analysis*, Policy Research Working Paper, Numéro 1448, World Bank.
- Dasgupta, S. and al. (2000). *Industrial Environmental Performance in China*, Policy Research Working Paper, Numéro 2285, World Bank.
- Dasgupta, S., B. Laplante, N. Mamingi and H. Wang (2000), 'Industrial Environmental Performance in China', Policy Research Working Paper, No. 2285, the World Bank, Washington, DC.
- Dasgupta, S., H. Wang and D. Wheeler (1997). *Surviving Success: Policy Reform and the Future of Industrial Pollution in China*, PRDEI, August, 1997.
- Dasmann, R.F., Milton, J.P. and Freeman, P.H. (1973), *Ecological Principles for Economic Development*, London and New York: John Wiley & Sons, Ltd.
- David W. Pearce and R. Kerry Turner (1990). 'Environmental and the Developing countries', In *Economics of Natural Resources and the Environment*, Chapter 22. New York & London: Harvester Wheatsheaf, 342-359
- De Melo, J., and S. Robinson (1990), 'Productivity and Externalities: Models of Export-led Growth', Memo. 90.10, University of Geneva, Geneva.
- De Melo, J., Robinson, S., 1990. Productivity and Externalities: Models of Export-led Growth. Memo. 90.10, University of Geneva.
- Dean, J. M. (1998), Testing the Impact of Trade Liberalization on the Environment: theory and evidence, in Fredriksson. In P. G. Fridriksson (eds.) *Trade, Global policy and Environment*, Chapter 4, 55-63, World Bank, Washington, 1998.
- Démurger, S. (2001). Infrastructure Development and Economic Growth: An Explanation for Regional Disparities in China? *Journal of Comparative Economics*, 29: 95-117.
- Dessus, S. Bussolo, M., 1998. Is There a Trade-off Between Trade Liberalization and Pollution Abatement? A Computable General Equilibrium Assessment Applied to Costa Rica. *Journal of Policy Modeling* 20, 11-31.
- Dessus, S., Roland-Holst, D., Van der Mensbrugge, D., 1994. Input-based Pollution Estimates for Environmental Assessment in Developing Countries, Technical papers, No. 101, OECD.
- FAO (2001). FAO database, accessed in 2001: <http://apps.fao.org>.
- Feder, G. (1983), 'On exports and economic growth', *Journal of Development Economics*, 12(1-2): 59-73.
- Fu, X. (2004). Limited linkage from growth engines and regional disparities in China. *Journal of Comparative Economics*, 32: 148-164.
- Gangadharan, L., & Valenzuela, M. R. (2001), Interrelationships between income, health and the environment: extending the Environmental Kuznets Curve hypothesis. *Ecological Economics*, 36, 513-531.
- Georgescu-Roegen, N. (1973). The Entropy Law and the Economic Problem. In Daly, H.E. (ed), *Towards a Steady-State Economy*. New York: W. H. Freeman.
- Goulder, L. H., 1995. Environmental taxation and "double-dividend": a reader's guide. *International Tax and Public Finance* 2, 157-183.
- Greene, W. H. (2000), *Econometric Analysis*, International Edition, (Version IV), New York University: Prentice-Hall International Inc.
- Grether, J. M., De Melo, J., Commerce, environnement et relations Nord-sud: les enjeux et quelques tendances récentes, *Revue de Economie du Développement*. *Revue d'économie de développement* 4, 69-102.
- Grossman, G. (1995). Pollution and growth: What do we know? Goldin and Winter (eds.). *The Economics of Sustainable Development*, Cambridge University Press, 1995.

- Grossman, G. and A. Krueger (1991), 'Environmental Impacts of A North American Free Trade Agreement', NBER, Working Paper No. 3914, Cambridge, MA.
- Grossman, G. and A. Krueger (1994). Economic Growth and The Environment, NBER, Working Paper no. 4634.
- Grossman, G. M. and A. B. Krueger (1993), 'Environmental impacts of a North American Free Trade Agreement, in The U. S. –Mexico Free Trade Agreement', in P. Garber ed., Cambridge, MA: MIT Press.
- Grossman, G., 1995. Pollution and growth: What do we know? In Goldin and Winter (eds.). *The Economics of Sustainable Development*, Cambridge University Press, 1995.
- Guillaumont Jeanneney, S., Hua, P., 2001. How does real exchange rate influence income inequality between urban and rural areas in China? *Journal of Development Economics* 64, 529-545.
- Guillaumont Jeanneney, S., Hua, P., 2002. The Balassa–Samuelson effect and inflation in the Chinese provinces. *China Economic Review* 13, 134-160.
- Guillaumont, P., 1985. *Economie du Developpement*. Tome 1-3, PUF, Paris.
- Guillaumont, S., & Hua, P. (1999), Taux de change réel, industrialisation rurale et biais urbain en Chine. *Revue d'Economie du Développement*, Numéro spécial « Economie chinoise : croissance et disparités, 1999(1-2), 131-157.
- Hansen, A. C., & Selte, H. (2000), Air pollution and Sick-leaves: A Case Study Using Air Pollution Data from Oslo. *Environmental and Resource Economics*, 16, 31-50.
- Harris, J.M. (2002). *Environmental and Natural Resource Economics: A Contemporary Approach*. Houghton Mifflin Company, Boston and New York. (Good text book)
- Hausman, J. (1978), 'Specification Tests in Econometrics', *Econometrica*, 46: 1251-1271.
- He, J. (2003). 'Economic Determinants for China's Industrial SO₂ Emission: Reduced vs. Structural form and the role of international trade', mimeo, CERDI, Université d'Auvergne, Clermont-Ferrand, France.
- He, J. (2004). *Estimation on Economic Cost of China's New De-sulfur Policy During Her Gradual Accession to WTO: The Case of Industrial SO₂ Emission*, EEPSEA/IRDC research report.
- He, J. (2005). Estimation on Economic Cost of China's New De-sulfur Policy during Her Gradual Accession to WTO: The Case of Industrial SO₂ Emission. *China Economic Review*, forthcoming.
- Heil, M. K. and T. M. Selden, (2000), 'Carbon Emission and Economic Development: Future Trajectories Based on Historical Experience'. *Environment and Development Economics*, 6: 63-83.
- Hettige, H., M. Mani and D. Wheeler, (2000). Industrial pollution in economic development: the environmental Kuznets curve revisited, *Journal of Development Economics*, vol. 62, pp.445-478.
- Hettige, H., R. E. B. Lucas and D. Wheeler (1992), 'The Toxic Intensity of Industrial Production: Global Patterns, Trends, and Trade Policy', *American Economic Review*, 82(2): 478-481.
- Hou, W. (1990). The environmental crisis in China and the case for environmental history studies, *Environmental History Review*, vol. 14(1-2). pp. 151-158.
- Hu, D. (2002). Trade, rural-urban migration, and regional income disparity in developing countries: a spatial general equilibrium model inspired by the case of China. *Regional Science and Urban Economics*, 32: 311-338.
- International Bank for Restructure and Development (IBRD, 1992). *Development and Environmen: World Development Report*, World Bank, Oxford University Press.
- Johnston, J. (1987), *Econometric Method*, (Third Edition). Singapore: McGraw-Hill International Editions, Economies series.
- Judson, R.A., and A.L. Owen. (1996). 'Estimating Dynamic Panel Data Models: A Practical Guide For Macroeconomists'. Federal Reserves Board of Governors, Washington, DC.
- Keller, W. and A. Levinson, (1999). 'Pollution Abatement Costs and Foreign Direct Investment Inflow to U.S. States'. NBER. Working Paper no. 7369, Cambridge, MA.
- Keller, W. and A. Levinson, (2001). 'Pollution Abatement Costs and Foreign Direct Investment Inflow to U.S. States'. *The Review of Economics and Statistics*, LXXXIV (4): 691-703.
- Lawrence Berkeley National Laborarory, 2001. *China Energy Databook*, 5.0, Berkeley, 2001.
- Lee, H., Roland-Holst, D., 1997. The Environment and Welfare Implications of Trade and Tax Policy. *Journal of Development Economics* 52, 65-82.
- Lopez, R. (1994), 'The Environment as a Factor of production: The Effects of Economic Growth and Trade Liberalisation', *Journal of Environmental Economics and Management*, 27: 163-184.
- Lucas, R. E., Wheeler, B.D., Hettige, H., 1992. Economic Development, Environmental Regulation and the International Migration of Toxic Industrial pollution : 1960-1988. P. Low (Ed). *International Trade and the Environment*, World Bank, Discussion paper No. 159, Washington, DC.
- Lucas, R. E., B.D. Wheeler, and H. Hettige (1992), 'Economic Development, Environmental Regulation and the International Migration of Toxic Industrial pollution: 1960-1988', P. Low ed., *International Trade and the Environment*, Discussion paper No. 159, the World Bank, Washington, DC.

- Mani, M. and D. Wheeler, (1997). 'In Search of Pollution Havens? Dirty Industries in the World Economy, 1965-1995'. In: Proceedings of the OECD Conference on Foreign Investment and the Environment (1999), The Hague, Netherland.
- Matyas, L. and P. Sevestre, (1992). *The Econometrics of Panel Data : Handbook of Theory and Applications*, Kluwer Academic Publishers, 552pp.
- Meadows, D.H., Meadow, D.L., Randers, J., and Behrens, W., (1972). *The Limit to Growth*. Universe Books, New York.
- Mensbrugge, D. V., Roland-Holst, D., Dessus, S., Beghin, J., 1998. The interface between growth, trade, pollution and natural resource use in China: evidence from an economy wide model. *Agricultural Economics* 19, 843-860.
- Mill, J.S. (1871). *Principles of Political Economy*, Longman.
- Ministry of Foreign Economic Relationship and Trade (1984-2001). *Almanac of China's Foreign Economic Relations and Trade*. Beijing, China.
- Musu, I. (1994), *On Sustainable Endogenous Growth*. Fondazione Eni Enrico Mattei, Document de Travail, E.E.E N° 11.94.
- OECD, 2004. Trends and Recent Developments in Foreign Direct Investment. June 2004. OECD, Paris.
- Opschoor, J(Hans). B., Kenneth, Button and Peter Nijkamp (1999), eds. *Environmental Economic and Development. Environmental analysis and Economic Policy*, 5. An Elgar Reference Collection. Cheltenham, UK, Northampton, MA. USA.
- Ostro, B., (1996), *A Methodology for Estimating Air Pollution Health Effect*. Technical Report WHO/EHG/96.5, World Health Organization, Geneva.
- Pearce, D.W. (1993). *Blueprint Three: Measuring Sustainable Development*. London: Earthscan.
- Peng, C., Wu, X., Liu, G., Johnson, T., Shah, J., & Guttikunda, S. (2001). Urban Air Quality and Public Health in China, *Proceedings of CED 2001 Annual Meeting*, June 27-28, 2001, Xiamen, China.
- Pethig, R., 1976. Pollution, Welfare, and Environmental Policy in the Theory of Comparative Advantage. *Journal of Environmental Economics and Management* 2, 160-169.
- Porter, M.E. and C. van der Linde, (1995). 'Toward A New Conception of the Environment-Competitiveness Relationship', *Journal of Economic Perspective*, 9: 97-118.
- Qiang, J., Zhang, K., 1998. China's Desulfurization Potential. *Energy Policy* 26, 345-351.
- Ramon Lopèz (1992). In Patrick Low (ed.), *International Trade and the Environment: An overview*, Chpt.9, Discussion Paper 159, Washington, DC: World Bank, pp.137-155.
- Rees, W.E. (1990). The Ecology of Sustainable Development. *The Ecologist*, 20(1):18-23.
- Reveze, R.L. (1992). 'Rehabilitating Interstate-Competition: Rethinking the "Racing to the Bottom"'. *New York University Law Review*, 67: 1210-1254
- Rock, M. T., 1996. Pollution Intensity of GDP and Trade Policy: Can the World Bank Be Wrong? *World Development* 24, 471-479.
- Rogrigo, G. C., and E. Thorbecke, (1997), 'Sources of Growth: A Reconsideration and General Equilibrium Application to Indonesia', *World Development*, 25(10): 1609-1625.
- Rogrigo, G.C., Thorbecke, E., 1997. Sources of Growth: A Reconsideration and General Equilibrium Application to Indonesia. *World Development* 25, 1609-1625.
- Roland-Holst, D., Van der Mensbrugge, D., 2002. Prototype Specification for a Real Computable General Equilibrium Model of China, Date of current version: Oct. 21, 2002.
- Sadoulet, E., De Janvry, A., 1995, *Quantitative Development Policy Analysis*. The John Hopkins University Press, Paris and Baltimore.
- Schubert, K., & Zagamé, P. (1998), *L'environnement: Une nouvelle dimension de l'analyse économique*. Paris : Librairie Vulbert.
- Schults, T. P., & Tansel, A. (1997), Wage and labor supply effects of illness in Côte d'Ivoire and Ghana: instrumental variable estimates for days disabled. *Journal of Development Economics*, 53, 251-286.
- Selden T. M. and D. Song (1994). Environmental Quality and Development: Is there a Kuznets Curve for Air Pollution Emission? *Journal of Environmental Economics and Management*, Vol. 27, pp147-162.
- Selden, Thomas M. and D. Song, (1995). Neoclassical Growth, the J Curve for Abatement, and the Inverted U curve for Pollution, *Journal of Environmental Economics and Management*, Vol. 29, pp 162-168.
- SEPA(State Environmental Protection Agency, PRC) (1986-1997), *China Environmental Yearbook*. Beijing: China Statistical Publishing House.
- SEPA(State Environmental Protection Agency, PRC) (1998-2002), *China Environmental Statistic Yearbook*. Beijing.
- Sevestre, P. and A. Trognon (1996), 'Dynamic Linear Models'. in L. Matyas and P. Sevestre eds., *The Econometrics of Panel Data*, Chapter 7, Kluwer Academic Publishers.
- Shen, L., 1997. Speech make at the Clean Coal Initiative Conference, World Bank.

- Shen, M. and M. Yang, (2002). Economic growth vs. environment protection: a survey data report of Chinese urban elites environmental awareness, Ch. 10, Proceeding of "Environment and our sustainability in the 21st Century: Understanding and cooperation between developed and developing countries, University of Nagoya.
- Sinton, J. E., 2001. Accuracy and reliability of China's energy statistics. *China Economic Review* 12, 373-383.
- Tobey, J. A., 1990. The effect of domestic environmental policies on patterns of world trade: An empirical test. *Kyklos* 43, 191-209.
- Sismondi, J. (1847). *New Principles of Political Economy*. Chapman.
- SSB(State Statistical Bureau, PRC) (1984-2004), *China Statistical Yearbook*, Beijing: China Statistical Publishing House.
- SSB(State Statistical Bureau, PRC) (1986-1997), *China Industrial Economics Statistics Yearbook*. Beijing: China Statistical Publishing House.
- SSB(State Statistical Bureau, PRC) (1989-2004). *China Statistical Yearbook*, China Statistical Publishing house, Beijing.
- Suri, V. and D. Chapman, (1998). 'Economic growth, trade and energy: implications for the environmental Kuznets curve', *Ecological Economics*, 25(2): 195-208.
- UNDP (1995). *Human Development Report 1995*. UN Development Program. Oxford: Oxford Economic Press.
- UNDP (1996). *Human Development Report 1996*. UN Development Program. Oxford: Oxford Economic Press.
- UNDP (1997). *Human Development Report 1997*. UN Development Program. <http://www.undp.org/hdro/97.htm>.
- UNDP (1999). *Human Development Report 1996*. UN Development Program. Oxford: Oxford Economic Press.
- UNPD (1998a). *World Population projections to 2150*. United Nations Department of Economic and Social Affairs, Population Division. New York: United Nation Publications. <Http://www.undp.org/popin/wdtends/execsum.htm>.
- UNPD (1998b). *Historic World Population Figures*. United Nations Department of Economic and Social Affairs, Population Division.
- UNPD (1999). *World Population Prospects: The 1998 vision*. Volume I. Comprehensive Tables; Volume II: Sex and Age. United Nations Department of Economic and Social Affairs, Population Division. New York: United Nations Publication.
- UNPD (2001). *World Population Prospects: The 2000 Revision*. Annex Tables. <Http://www.un.org/esa/population/wpp2000at.pdf>.
- Van der Mensbrugge, D., Roland-Holst, D., Dessus, S., Beghin, J., 1998. The Interface Between Growth, Trade, Pollution and Natural Resource Use in Chile: Evidence from an Economy-wide Model. *Agricultural Economics* 19, 87-97.
- Vincent, J.R. (2000). Green accounting: from theory to practice. Introduction to the Special Issue. *Environmental and Development Economics*, 5(1-2):1-13.
- Wang H. (2000), 'Pollution Charges, Community Pressure, and Abatement Cost of Industrial Pollution in China', Policy Research Working Paper, No. 2337, the World Bank, Washington, DC.
- Wang, (1996). Taxation and Environment in China: Practice and Perspectives, in OECD ed. *Environmental Tax : Recent Development in China and OECD Countries*.
- Wang, H. and D. Wheeler (1996), 'Pricing Industrial Pollution in China: An Econometric Analysis of the Levy System', Policy Research Working Paper, No. 1644, the World Bank, Washington, DC.
- Wang, H. and D. Wheeler, (2000). *Endogenous Enforcement and Effectiveness of China's Pollution Levy System*, Policy Research Working Paper, no. 2337, World Bank.
- Wang, J., (2002). 'Environmental pollution and legal controls during the Opening-up and reform in China: From the point of an Environmental law professor', Ch.3 in Proceeding of Environment and our sustainability in the 21st Century: Understanding and cooperation between developed and developing countries, University of Nagoya, Japan.
- Wang, Z. (2002). The Impact of China's WTO accession on Patterns of World Trade. *Journal of Policy Modeling* 5298, 1-42.
- Wolf, C. (2001), Urban air pollution and health: an ecological study of chronic rhinosinusitis in Cologne, Germany. *Health & Place*. 8(2), 129-139.
- Woodridge, J.M. (2002). *Econometric Analysis of Cross-Section and Panel Data*. Cambridge: MIT Press, 740pp.
- World Bank (1996a). *China: Chongqing Industry pollution control and reform project*, Staff Appraisal Report, Washington DC.
- World Bank (1996b). *China: Issues and Options in Health Financing*, China and Mongolia Department, Washington, DC.
- World Bank (1997), *China's Environment in the New Century: Clear Water, Blues Skies*. World Bank, Washington, DC.
- World Bank (1997). *China 2020: Clear Water, Blue Skies*, Washington D.C.: the World Bank.

- World Bank (1997). *China 2020: Development Challenges in the New Century*, Washington D. C.: the World Bank.
- World Bank (1998a). Poverty Reduction and the World Bank: Progress in Fiscal 1996 and 1997. http://www.worldbank.org/html/extdr/pov_red/default.htm.
- World Bank (1999), *Greening Industry: New roles for communities, markets and government*. Oxford University Press.
- World Bank (1999). World Development Indicators 1999. <http://www.worldbank.org/data/wdo/home.html>.
- World Bank (2000), *Greening Industry: New roles for communities, markets and governments*, Oxford University Press, 150pp.
- World Bank (2001). World Development Report 2000/2001: Attacking Poverty. Washington, DC: World Bank. <http://www.worldbank.org/html/extpb/annrep/down.htm>.
- World Bank, 1996. China : Chongqing Industry pollution control and reform project, Staff Appraisal Report, Washington DC.
- World Commission on Environment and Development (WCED, 1987). *Our Common Future*, Oxford and New York: Oxford University Press.
- Worldwatch Institute (1984). *State of the World 1984: A Worldwatch Institute Report on Progress Toward a Sustainable Society (State of the World)*, W W Norton & Co Inc, 272pp.
- Wu, Y., 1999. 'Productivity and Efficiency in China's Regional Economics', In Tsu-Tan Fu et al. (Editors), *Economic Efficiency and Productivity Growth in the Asian-Pacific Region*, Edward Elgar Publishing, 351pp.
- Xepapadeas, A. and A. de Zeeuw, (1999). 'Environmental Policy and Competitiveness: The Porter Hypothesis and the Composition of Capital'. *Journal of Environmental Economics and Management*, 37: 165-182.
- Xie, J., (1996). Humanity and nature: a review of development and environmental degradation of contemporary China, *The Sinosphere Journal*, Autumn, 1996.
- Xu, X. & Johnson, T. (1997), *Air Pollution and Its Health Effect in Chongqing, China*. World Bank Report, Washington, DC, July.
- Xu, X. & Wang, L. (1993), Association of Indoor and Outdoor Particulate Level with Chronic Respiratory Illness. *American Review of Respiratory Diseases*, **148**, 1516-1522.
- Xu, X. and al. (1994). Air Pollution and Daily Mortality in Residential Area of Beijing, China, *Archives of Environmental Health*, vol. 49(4), pp216-222.
- Xu, X. and L. Wang, (1993). Association of Indoor and Outdoor Particulate Level with Chronic Respiratory Illness, *American Review of Respiratory Diseases*, No. 148, pp1516-1522.
- Xu, X. and T. Johnson, (1997). *Air pollution and its health effect in Chongqing, China*, World Bank Report, Washington, DC, juillet, 1997.
- Xu, X., B. Li and H. Huang (1995). Air pollution and Unscheduled Hospital Outpatient and Emergency Room Visits. *Environmental Health perspectives*, Vol.103, No. 3, pp286-289, mars, 1995.
- Xu, X., Gao, J., Dockery, D. W., Chen, Y., 1994. Air Pollution and Daily Mortality in Residential Area of Beijing, China. *Archives of Environmental Health* 49, 216-222.
- Xu, X., Li, B. L., Huang, H. Y., 1996. Air Pollution and Unscheduled Hospital outpatient and Emergency Room Visits. *Environmental Health Prospective*.
- Xu, X., Li, B., & Huang, H. (1995), Air pollution and Unscheduled Hospital Outpatient and Emergency Room Visits. *Environmental Health perspectives*, **103**(3), 286-289.
- Xu, X, Gao, J., Dockery, D., & Chen, Y. (1994), Air Pollution and Daily Mortality in Residential Area of Beijing, China. *Archives of Environmental Health*, **49**(4), 216-222.
- Yang, H-Y, 2001. Trade Liberalisation and Pollution: A General Equilibrium Analysis of Carbon Dioxide Emissions in Taiwan. *Economic Modelling* 18, 435-454.
- Yang, J. Benkovic, S., 2002. The Feasibility of Using Cap and Trade to Achieve Sulfur Dioxide Reductions in China. *The Sinosphere Journal* 4, 10-14.
- Zarsky, L., (1997), 'Stuck in the Mud? Nation-States, Globalization and the Environment', in OECD eds., *Globalization and Environment Study: OECD Economics Division*, Paris, OECD.
- Zuidema, T. & Nentjes, A. (1997), Health Damage of Air Pollution: An examination of a Does-Response Relationship for the Netherlands. *Environmental and Resources Economics*, **9**, 291-308.