



HAL
open science

Contributions to the Methodologies and Technologies for the Intelligent Control-Maintenance-technical Management Systems (ICMMS) in Hydropower Plants

Yongqian Liu

► **To cite this version:**

Yongqian Liu. Contributions to the Methodologies and Technologies for the Intelligent Control-Maintenance-technical Management Systems (ICMMS) in Hydropower Plants. Automatic. Université Henri Poincaré - Nancy I, 2002. English. NNT: . tel-00003396

HAL Id: tel-00003396

<https://theses.hal.science/tel-00003396>

Submitted on 18 Sep 2003

HAL is a multi-disciplinary open access archive for the deposit and dissemination of scientific research documents, whether they are published or not. The documents may come from teaching and research institutions in France or abroad, or from public or private research centers.

L'archive ouverte pluridisciplinaire **HAL**, est destinée au dépôt et à la diffusion de documents scientifiques de niveau recherche, publiés ou non, émanant des établissements d'enseignement et de recherche français ou étrangers, des laboratoires publics ou privés.



CNRS UMR 7039

Faculté des Sciences
UFR Sciences Techniques Mathématiques
Informatique Automatique
Ecole Doctorale IAEM Lorraine
DFD Automatique

Université Henri Poincaré – Nancy I

School of Hydropower and Digitalization
Engineering

Université Huazhong des Sciences et
Technologies (HUST) – Wuhan - Chine

THESE en co-tutelle entre l'UHP et HUST

Présentée en vue de l'obtention des titres de

Docteur de l'Université Henri Poincaré, Nancy I - Spécialité Production Automatisée
Docteur de l'Université de HUST – Spécialité "Hydropower Engineering"

par

Yongqian LIU

**Contributions to the Methodologies and Technologies for the Intelligent
Control-Maintenance-technical Management Systems (ICMMS) in
Hydropower Plants**

**Contribution à l'automatisation des systèmes intégrés et à intelligence
distribuée de Contrôle, Maintenance et Gestion Technique (ICMMS) pour les
centrales hydroélectriques**

Soutenance publique prévue le 18 Avril 2002 à Pékin – Université de Tsinghua – devant la commission d'examen:

Membres du Jury :

Rapporteurs:	Guy DOUMEINGTS	Professeur à l'Université de Bordeaux I
	Dexin CHEN	Professeur à l' Institut Chinois d'Ingénierie Hydro-électrique de Zhengzhou (North China Institute of Water Conservancy and Hydropower - Chine)
Directeur de Thèse à HUST:	Luqing YE	Professeur à l'Université Chinoise de HUST
Directeur de thèse à l'UHP:	Gérard MOREL	Professeur à l'Université Henri Poincaré – Nancy I
Examineurs:	Benoit IUNG	Maître de Conférences à l'Université Henri Poincaré – Nancy I
	Zhoahui LI	Professeur à l'Université Chinoise de HUST

ACKNOWLEDGEMENT

This Thesis was completed under a Thesis co-supervision agreement between Huazhong University of Science and Technology, Wuhan, China and Université Henri Poincaré, Nancy 1, France. I want to express my gratitude to all those who gave me the possibility to complete this thesis.

Firstly, I would like to express my sincere gratitude to the Supervisors of my Thesis, Professor YE Luqing and Professor Gérard MOREL. Their excellent guidance and in-depth thought directed me to complete the Thesis, and will continue to inspire me in my future career.

Prof. Guy Doumeingts, Prof. Chen Dexin and Prof. Jiang Jinping, the reviewers of this Thesis, also have my full gratitude. Their fruitful suggestions and constructive criticism encouraged me in improving the Thesis a lot.

My special thanks should be given to the Associate Director of this Thesis, Associate Professor Benoît IUNG for all his indispensable help during the whole doctoral studying process, on both research and administration. I would like to appreciate Associate Director of this Thesis, Professor Li Zhaohui, for his direct guidance and fruitful suggestions.

I am grateful to my colleagues in China, Dr. Wang Shengtie, Dr. Yu Ren, Dr. Zhang Yonggang, Dr. Cheng Yuanchu, Mr. Chen Qiming, Dr. Fu Chuang, Mr. Li Zhengrong, Mr. Lin Zehai, Mr. Huang Weihua, Miss Xiong Fengxia, Mr. Liang Hongzhu, Mr. Liu Xiuliang, and Mr. Meng Anbo, for their fruitful discussions and corporation.

I am grateful to my French colleagues, Dr. Jean-Baptiste LEGER, Dr. Eric NEUREUTHER, Dr. Patrick LAMBOLEY, Jean-Christophe BLAISE, Dr. David MOREL, Miss Maryse DRIQUERT, and Mr. Michel BRAUCOURT, for their help during my studying in France.

I am also grateful to Mr. Jack Haslam, expert in Maintenance, for his fruitful discussions and advice.

Finally, without the support and love of my wife Li Fenhua and my daughter Liu Yuan, and without the encouragements of my parents, there would have been no Thesis of me at all.

摘 要

智能控制—维护—管理集成系统（ICMMS）将目前生产过程自动化中控制、维护、技术管理三个相对孤立的领域集成为一个协调的系统。应用系统科学的基本原理和有关企业集成的方法论，本文提出了面向生产过程的建模方法论和水电厂自动化系统 ICMMS 参考模型。从能量转换的角度看，水力发电过程的结构是不变的，因此用面向过程方法建立起来的水电厂模型具有很高的稳度和重用性。本文提出的参考模型抓住了水电厂的相似性和不变性特点，功能模块能够在 ICMMS 中自然、方便地重新分布，并保证了系统成员之间的协调。

为了实现水电厂智能控制—维护—管理集成系统，本文提出了混合型智能自动化系统（HSAS）。该系统既采用全分布式的系统结构体系，又能够将基于现场总线的和传统的现场设备集成在一起。

在技术管理领域，水电机组的整体性能评估方法和实现系统目前是一个空白。然而，设备的性能评估是 ICMMS 中不可缺少的部分。本文建立了关于水电机组性能评估的概念、指标、准则和方法论体系。提出了水电机组经济性能评估的算法并开发了相应的软件。该软件可以对水电机组的运行管理水平、维护状态等方面进行定量评估。实际案例的研究表明了这种方法的有效性。

在维护领域，对状态监测给出了清晰的定义，对水电厂状态监测的相关技术进行了全面的分析和总结，提出了 ICMMS 参考模型下水电厂状态监测系统的集成框架。基于本文提出的水电机组的状态评估，提出了经济性能维护（EBM）的维护策略，并用案例说明了该策略的实施。

在控制领域，应用 H_{∞} 理论中的干扰抑制方法（DAA），提出了一种设计水轮机调速器的设计方法，并进行了仿真验证。

最后，探讨了自动化系统集成中的哲学思想。回顾系统论、自动化学科发展历史的基础上，总结了系统科学和自动化系统的发展规律，提出了“以不变应万变”的自动化系统建模与集成的思想。

关键词：系统集成，水力发电，水力发电机组，性能评估，经济性能维护，状态监测，系统工程

RESUMÉ

Les travaux présentés contribuent à un des enjeux majeurs de l'Entreprise Etendue liée au domaine de la production d'énergie électrique. L'objectif est de maintenir en dynamique la qualité des services rendus par les processus de production. Ces travaux ont ainsi pour objet, en se référant au cadre de modélisation d'Entreprise GERAM, de proposer une méthodologie réutilisable pour l'automatisation intégrée des centrales hydroélectriques. Ces dernières étant structurellement des systèmes stables, cette méthodologie est basée sur une approche orientée processus et aboutit au développement de modèles pérennes et réutilisables. Le point central de cette méthodologie consiste en la définition d'un modèle de référence ICMMS (Intelligent Control-Maintenance-technical Management Systems) formalisant la connaissance générique, de niveau terrain, applicable à l'automatisation de toute centrale hydroélectrique. La mise en œuvre de ce modèle de référence conduit à la proposition d'une architecture HSAS (Hybrid Smart Automation System) qui intègre en un tout cohérent sur les points de vue Contrôle, Maintenance et Gestion Technique, les différents composants d'automatisation distribués, supportés par des actionneurs, capteurs, ou contrôleurs conventionnels de niveau terrain.

Par rapport à cette architecture, les concepts innovants de "Surveillance Conditionnelle" pour l'îlot Maintenance et d' "Atténuation de Perturbations" pour l'îlot Contrôle sont définis et étudiés afin d'être intégrés au système ICMMS. De plus, nous proposons, pour la Gestion Technique, des concepts, critères et outils pour l'évaluation de performances des HGU's (Hydroelectric Generating Units). Cette contribution est basée sur la définition d'un système d'évaluation des performances économiques utilisant des descripteurs quantitatifs mesurant l'état d'efficacité, le niveau de gestion de l'exploitation et l'état de maintenance de ces unités. Une nouvelle stratégie en lien avec la maintenance, intitulée EBM (Economic performance Based Maintenance), est ainsi formalisée. L'ensemble de nos propositions est validée sur une étude de cas.

MOTS CLES: Automatisation, Ingénierie Système, Intégration, Intelligence, Evaluation de Performances, Centrales Hydroélectriques.

ABSTRACT

Based on the principles of system thought and related enterprise integration methodologies, a process oriented methodology and ICMMS (Intelligent Control-Maintenance-technical Management Systems) reference model for hydropower plants are proposed. Because the structures of the hydropower generating process are unchanging from the point of view of energy conversion, the methodology employs the process-oriented approaches to model the hydropower plants, and the models constructed through this methodology are stable and reusable. The proposed Reference Model grasps the similarities and unchangeabilities of the hydropower plants. Therefore, the redistribution of the function modules inside the system can be done in a natural and easy way, while the synergies among the components of the system are guaranteed.

To implement the ICMMS in hydropower plants, HSAS (Hybrid Smart Automation System) is proposed in which the conventional controllers and fieldbus based components are integrated under fully distributed system architecture.

In the technical management domain, the performance evaluation methods and implementation system is a lacuna item to the HGUs (Hydroelectric Generating Units). However, it is indispensable for ICMMS. A system of concepts, indexes, criteria and methodologies for the performance evaluation on HGUs is established. An economic performance evaluation algorithm and software for HGUs is presented, with which the efficiency state, level of operation management and the maintenance state of an HGU can be measured through qualitative indexes. A real test case study illustrated effectiveness of the method. Based on this method, a new maintenance strategy, EBM (Economic performance Based Maintenance) is proposed and illustrated through a case study.

In the maintenance domain, the concept of Condition Monitoring is clearly defined, and related technologies for hydropower plants are summarized and analyzed. The condition monitoring system is integrated into the ICMMS under the Reference Model proposed above.

As a contribution to the control domain, based on the DAA (Disturbance Attenuation Approach) of H_∞ theory, a new method to design hydraulic turbine governors is proposed.

Finally, some philosophical thoughtlets of the author for the system integration are presented.

Keywords: System Integration, Hydropower, hydroelectric generating unit, Performance Evaluation, Economic Performance Based Maintenance, Condition Monitoring, System Engineering.

CONTENTS

CHAPTER 1: INTRODUCTION	1
1.1 DEVELOPMENT OF THE AUTOMATION SYSTEMS FOR HYDROPOWER PLANTS.....	3
1.2 CURRENT SITUATIONS AND PROBLEMS TO BE RESOLVED IN THE AUTOMATION SYSTEMS FOR HPS	6
1.3 CURRENT SITUATIONS IN ENTERPRISE INTEGRATION.....	7
1.3.1 BRIEF INTRODUCTION TO ENTERPRISE INTEGRATION.....	8
1.3.2 ENTERPRISE INTEGRATION LEVELS.....	9
1.4 CURRENT SITUATIONS IN AUTOMATION INTEGRATION: CMMS/IAMS AND MES	10
1.5 NEW AUTOMATION INTEGRATION TRENDS FOR HP	11
1.5.1 THE INTEGRATION LEVELS IN A PLANT OF PROCESS INDUSTRY.....	11
1.5.2 AUTOMATION SYSTEM INTEGRATION FOR HP	12
1.6 OBJECTIVES AND STRUCTURES OF THE THESIS.....	14
1.6.1 OBJECTIVES OF THE THESIS	14
1.6.2 STRUCTURE OF THE THESIS	15
 CHAPTER 2: AN ICMMS REFERENCE MODEL FOR HYDROPOWER PLANTS	 19
2.1 INTRODUCTION	19
2.1.1 PROBLEM STATEMENT	19
2.1.2 REFERENCE MODELS.....	21
2.1.3 ARRANGEMENT OF THIS CHAPTER	21
2.2 GERAM.....	22
2.3 ENTERPRISE/CONTROL SYSTEM INTEGRATION STANDARDS	24
2.4 THE CHARACTERS OF HYDROPOWER PLANTS.....	26
2.4.1 THE COMMON FEATURES OF HYDROPOWER PLANTS	26
2.4.2 THE MOST CHANGEABLE PARTS OF A HP: AUTOMATION SYSTEMS	28
2.5 THE FUNCTIONAL ANALYSIS OF ICMMS FOR HPS.....	30
2.6 A ICMMS REFERENCE MODEL FOR HYDROPOWER PLANTS.....	32
2.7 SUMMARY	39
 CHAPTER 3: THE IMPLEMENTATION ARCHITECTURES OF ICMMS FOR HYDROPOWER PLANTS.....	 43
3.1 INTRODUCTION	43
3.2 STATE OF THE ART ON THE AUTOMATION SYSTEMS FOR HP	44
3.3 CURRENT PROBLEMS	45
3.4 INTELLIGENT CONTROL-MAINTENANCE-TECHNICAL MANAGEMENT SYSTEMS (ICMMS) FOR HPS	46

3.5 THE HYBRID SMART AUTOMATION SYSTEMS FOR HYDROELECTRIC GENERATING UNITS	50
3.5.1 FIELDBUS-BASED CONTROL SYSTEMS(FCS) FOR HYDRO GENERATING UNITS	50
3.5.2. HSAS (HYBRID SMART AUTOMATION SYSTEM) FOR HYDROELECTRIC GENERATING UNITS.....	51
3.6 SUMMARY	54
CHAPTER 4: PERFORMANCE EVALUATION METHODOLOGIES FOR HYDROELECTRIC GENERATING UNITS	56
4.1 INTRODUCTION	57
4.2 THE CRITERIA AND METHODS TO EVALUATE THE OVERALL PERFORMANCE OF HGUS	60
4.2.1 THE COMPREHENSIVE PERFORMANCE EVALUATION INDEXES IN THE LIFECYCLE OF HGU.....	60
4.2.2 THE PERFORMANCE INDEX MATRIX AND OVERALL PERFORMANCE INDEXES OF HGUS.....	61
4.3 THE ECONOMIC PERFORMANCE CRITERIA AND EVALUATING METHOD FOR HGUS.....	63
4.3.1 THE IMPORTANCE RELATED TECHNOLOGIES OF ECONOMIC PERFORMANCE FOR HGUS.....	63
4.3.2. THE ESTABLISHMENT OF THE ECONOMIC PERFORMANCE INDEX SYSTEM AND EVALUATION CRITERIA	64
4.3.3 THE ENERGY FLOW ANALYSIS FOR HGU	65
4.3.4 THE OVERALL EFFICIENCY OF AN HGU η_s	66
4.3.5 IDEAL EFFICIENCY OF HGU: η_{si}	67
4.3.6 REACHABLE EFFICIENCY OF HGU η_{sr}	68
4.3.7 OPERATIONAL EFFICIENCY OF HGU η_{so}	68
4.3.8 THE ECONOMIC EVALUATION CRITERIA FOR THE MAINTENANCE AND OPERATION MANAGEMENT OF HGU	69
4.4 IMPLEMENTATION OF THE ECONOMIC PERFORMANCE EVALUATION FOR HGUS.....	69
4.4.1 THE IMPLEMENTATION SCHEME UNDER ICMMS REFERENCE MODELS	69
4.4.2 AN ECONOMIC PERFORMANCE EVALUATION SYSTEM AND TESTING RESULTS	70
4.5 A NEW MAINTENANCE STRATEGY: EBM (ECONOMIC PERFORMANCE BASED MAINTENANCE)	74
4.5.1 INTRODUCTION.....	74
4.5.2 EBM IN ICMMS.....	75
4.5.3 THE EFFECTIVENESS OF EBM FOR HYDROPOWER PLANTS	77
4.6 SUMMARY	79

CHAPTER 5: CONDITION MONITORING SYSTEMS FOR

HYDROPOWER PLANTS	83
5.1 INTRODUCTION	83
5.1.1 IMPORTANCE OF CONDITION MONITORING SYSTEMS FOR HYDROPOWER PLANTS.....	83
5.1.2 OBJECTIVES OF THIS CHAPTER	84
5.2 THE CONCEPT AND FUNCTIONS OF CONDITION MONITORING	84
5.2.1 CONCEPT OF CONDITION MONITORING	84
5.2.2 THE FUNCTIONS OF A CONDITION MONITORING SYSTEM	85
5.3 CURRENT SITUATION AND PROBLEMS FOR THE CM OF HGUS	86
5.3.1 CONDITION MONITORING TECHNOLOGIES IN HYDROPOWER PLANTS	86
5.3.2 THE DIAGNOSIS AND PROGNOSIS TECHNOLOGIES.....	89
5.3.3 CURRENT PROBLEMS IN THE CM SYSTEMS FOR HGUS	89
5.4 THE REFERENCE MODELS OF CONDITION MONITORING SYSTEM FOR HYDRO ELECTRICAL GENERATING UNITS	90
5.4.1 TWO POSSIBLE SOLUTIONS TO THE INTEGRATION OF THE CM SYSTEMS FOR HYDROPOWER PLANTS.....	90
5.4.2 THE REFERENCE MODELS FOR THE CONDITION MONITORING SYSTEMS OF HYDROPOWER PLANTS	91
5.5 SUMMARY²	92

CHAPTER 6: CONTRIBUTIONS TO THE CONTROL DOMAIN OF

ICMMS: DAA.....	95
6.1 INTRODUCTION	95
6.2. MODEL OF HYDRAULIC TURBINE GOVERNING SYSTEM.....	97
6.3 DAA-BASED DESIGN METHOD FOR THE HYDRAULIC TURBINE GOVERNORS.....	99
6.3.1. MODEL DEVELOPMENT FOR A HYDRAULIC TURBINE GOVERNING SYSTEM	99
6.3.2. DAA-BASED CONTROL ALGORITHM FOR HYDRAULIC TURBINE GOVERNORS	100
6.4. SIMULATION AND RESULTS	101
6.5 SUMMARY	104

CHAPTER 7: SEVERAL PHILOSOPHICAL THOUGHTLETS ON THE AUTOMATION SYSTEMS INTEGRATION

7.1 THE DEVELOPMENT TRACES OF SYSTEM SCIENCE	109
7.2 THE DEVELOPMENT PROCESS OF THE AUTOMATION SYSTEMS.....	111
7.3 PHILOSOPHY OF SYSTEM INTEGRATION FOR HYDROPOWER PLANTS	

.....	112
7.4 SUMMARY	113
CHAPTER 8: CONCLUSIONS AND PERSPECTIVES.....	117
8.1 CONCLUSIONS	117
8.2 PERSPECTIVES	119
REFERENCES	123
LIST OF PUBLICATIONS DURING DOCTORAL STUDY	134

CHAPTER 1: Introduction

CHAPTER 1: INTRODUCTION

君子性非异也，善假与物也。——荀子

Gentlemen are not unique in nature from others; despite they are good at utilizing the power of natures. ---Xunzi

It has been an important indication of mankind's civilization process that utilizes any types of power to help or totally replace the human labour since the beginning of the human history. Water resources are so important to human beings that they are essential living conditions for survival, so most of the ancient civilization sites were located along the rivers. Hydropower is one of the oldest forms of natural energy that our ancestors harnessed, and using waterpower to generate electricity represents more than one century of technology, which is almost as old as the invention of the electricity generating.

However, how to make the hydroelectric generating process safer, more reliable and more efficient is still an active research field, in which there are still spaces for improvement. The automation system for hydropower plant is the neural centre of the plant and the most rapidly developing field in the hydroelectrical engineering. This thesis aims to contribute a little to this end.

1.1 DEVELOPMENT OF THE AUTOMATION SYSTEMS FOR HYDROPOWER PLANTS

Hydropower has the following advantages.

- Renewable;
- Clean;
- Easy to store;

- Fast and flexible for load regulation;
- Low cost.

Therefore, the hydropower has being given high priority in the global energy development strategies. In developed countries, over 80% of reserve waterpower has been harnessed whereas much less waterpower has been utilized in the developing countries. There are 6.76×10^5 MW waterpower reserves in the rivers in China, from which 3.78×10^5 MW power capacity of hydroelectric generating units can be installed, and annual electric energy can reach 1.92×10^{12} kWh. Therefore, China is the world NO.1 in water energy reservation, but the development rate was only 16.5% by the end of 1998 [Zhou Dabing 1999].

As the economy grows rapidly, the demand for electric energy increases at a very high speed, and the scale of hydropower projects under construction has remained large in the past decades in China. Now one third of world hydroelectric projects under construction is in China. The Three Gorges Hydropower Plant, with 18,200 MW of installed capacity, is the biggest power plant mankind ever built. Therefore, Hydroelectrical Engineering research has great application background in China.

The automation system is the “neural” system for the whole HP, because the system connects all the electrical and mechanical equipments of the plant into a system that controls, operates, diagnoses, manages these equipments, and makes them work in order and harmony. These equipments include hydropower generating units, auxiliary facilities and equipments (like governing systems, excitation systems, water supply systems, oil systems, pressure air systems, etc.), fire fighting equipments, sluice gate driving systems, safety measurement and supervision systems for hydraulic structures etc. For the huge HP like The Three Gorges Hydropower Plant, its automation system is of great importance because of the particularities and the unique role of the power plant in the nationwide electric power systems.

The automation systems in HP have been developed dramatically in the past 40 years. Table 1 shows the development history of automation systems for HP [Yu 2000a]:

Table 1 the development of automation systems for HP

Periods	Functions & development levels	System Architectures	Hardware	Software
1960s	Control +	Centralized	Conventional components based: Relays, Electron tubes, transistors, etc.	Non
	TM -			
	Maintenance -			
1970s	Control +	Centralized	Small computer	Assembly
	TM ⊕			
	Maintenance -			
1980s	Control +	Hierarchical and distributed	Microcomputers	Assembly Advanced
	TM +			
	Maintenance ⊕			
1990s	Control +	Open	Field bus +	Visualized Graphic modulated
	TM +	Evolvment	Ethernet +	
	Maintenance +	Network	Internet +	
	CMMS-IAMS ⊕	Intelligent	Intelligent field devices +	

In Table 1, to show the development levels, “+” indicates for developed, “⊕” indicates for the beginning, and “-” indicates for not developed. Like the automation systems in any manufacturing or process industry enterprises, the automation system in HP can be divided into three functional domains: Control, Technical Management (TM), and Maintenance, from the functional point of view.

1.2 CURRENT SITUATIONS AND PROBLEMS TO BE RESOLVED IN THE AUTOMATION SYSTEMS FOR HPS

The influence of IT (Information Technology) on all aspects of our society is enormous. From above analysis, it can be seen that IT plays a key role in the automation systems for hydropower plants. As the rapid development of the computer and network technologies, the industrial automation technologies change with each passing day. In past decade, there has been much big advancement in the area of HP automation. The following are some main points of it:

- Distributed and hierarchical control systems are widely used in automation systems for HP [Fang 2000][Zhang 1999] [Danial et al. 2000].
- As the number and the types of automation devices increase, the quantity of field data increases sharply, and the complexity of the automation systems mounts up.
- As the automation technologies changes fast, the pace of extension and upgrade for the automation devices and systems speed up. The contents of ‘Automation system for HP’ has enriched from supervision, control, protection, etc. into three big functional domains, i.e. Control, Maintenance, and Technical management [Ye et al. 2000] [Yu et al. 1999] [Yu et al. 2001]

However, some new problems emerge:

- A. Different types of automation devices and systems are relatively closed and isolated from each other. The main subsystems of HP automaton include Local Control Unit, Governing system, Excitation control system, protection systems for the main equipment, and automation system for the common auxiliary systems, are relatively closed to each other. Even in the same subsystem, their monitoring devices are isolated. For example, for the hydro turbine, the devices for monitoring vibration, efficiency and cavitation are relatively isolated. Nevertheless, the HGU (Hydroelectric Generating Unit) is a dynamic system, which involves several physical processes: hydraulic, mechanical and electrical, etc. There are many correlations among the system components. If these correlations are omitted, some general characteristics of the systems can’t be indicated. This also causes overlapping investment, communication barriers, data inconsistency, information collision among the systems, and makes them very difficult to work together in harmony.

- B. The economic indexes (efficiency of the unit, electric power price, energy consumption inside the plant, man and material cost, etc.) are either unavailable or dis-organized. Technical management system for real-time production planning, scheduling and decision making is under development.
- C. MMI (Man Machine Interface) is still under development. The operator concerns about some general state information like the overall operation conditions of the unit, the degradation of the unit, possibility potential failures, necessity of maintenance, etc. However, these pieces of information are not available yet.
- D. The quantity of field data has been increasing sharply. In the next four years, it is predicted that the field data will increase 10 to 30 times [Xu et al. 2000]. Therefore, it becomes an increasingly urgent task to face the problems of ‘**data explosion**’, well organize the field data, and extract the useful information from it.
- E. Automation products and their standards upgrade faster and faster, and this makes the lifecycle of the automation products shorter, wastes a lot of money and resources. There are many such lessons in the automation systems for HP in China and abroad [Lung 1992] [Ye et al. 2000].
- F. There are many international standardization projects on automation system integration, and some progresses have been achieved, such as ISA-dS95 [ISA-dS95 1999]. However, most of the standards are still in the draft stages, and the applications of standards have not reached a satisfactory level [Chen et al. 2001]. This makes the integration, maintenance, and reengineering of the automation systems for HP very difficult and costly.

1.3 CURRENT SITUATIONS IN ENTERPRISE INTEGRATION

Above listed problems are correlated with each other, and it is not a good approach that the problems are solved one by one independently. Thus, the comprehensive and formal approaches are necessary for solving these problems. Enterprise Integration is a new discipline that can be applied for this purpose.

Therefore, it's necessary to study the achievements in enterprise integration, and apply these achievements to define and seek the possible solutions for the problems in automation systems of HP.

1.3.1 BRIEF INTRODUCTION TO ENTERPRISE INTEGRATION

Enterprise Integration (EI) consists in breaking down organizational barriers to improve synergy within the enterprise so that business goals are achieved in a more productive and efficient way [Vernadat 2000].

Enterprise Modeling (EM) is the art of externalizing enterprise knowledge which adds value to the enterprise or needs to be shared. It consists of making models of the structure, behavior and organization of the enterprise. EM is the precondition for EI [Vernadat 2000].

Enterprise is a system, which has the characters of Wholeness, Correlation, and Evolution. When the environment (including market, technologies etc.) changes, enterprises must adapt themselves to the environment for surviving. In a system the ‘order’ or ‘organization’ of their components is crucial to the overall performance of the system, i.e., ‘1’ + ‘1’ usually not equal to ‘2’, especially when the system is complex. Modern enterprises have been evolved into very complex systems. The complexities are represented in:

- Fast changing environment drives the enterprises changing fast;
- Varieties and numbers of the components increased;
- Fast growing influences of modern science and technologies, especially the IT.

In the development history of this discipline, many paradigms were proposed: CIM (Computer Integrated Manufacturing) [Harrington 1974], JIT (Just-In-Time), Lean Manufacturing, Concurrent Engineering, Networked Engineering, and Enterprise Integration (EI), etc. [Vernadat 2000]. The Chinese scholars proposed a new paradigm: CIMS: Computer Integrated Manufacturing System [Li 1994], and later was evolved into Contemporary Integrated Manufacturing System [Wu et al. 1999], which emphasizes the modelling optimization and coordination. At the same time, many modelling methodologies were proposed, most internationally recognized of them are:

- IDEF (ICAM Definition Method) [Mayer 1991];
- GRAI-GIM (GRAI Integrated Methodology) [Doumeingts 1995];
- CIMOSA (CIM Open System Architecture) [AMICE 1993] [Vernadat 1996] [Vernadat 1998];

- PERA (Purdue Enterprise Reference Architecture) [Williams 1994].
- GERAM (Generalized Enterprise Reference Architecture and Methodology) is a generalization of CIMOSA, GIM and PERA [IFIP-IFAC Task Force 1999].

All those paradigms and methodologies have enriched the knowledge about enterprise modelling and integration. Nevertheless, they are diversified and some of them are overlapping or evolving in contents. In order to achieve the final goals of enterprise integration, “Integration of all knowledge”, i.e., standardization is the only way out. Many international organizations have been working on this matter for many years. Although most of them are still in draft phases, some standards can be applied to direct the enterprise modelling and integration process. David Chen and François Vernadat surveyed the standardization on enterprise modelling and integration in [Chen et al. 2001].

1.3.2 ENTERPRISE INTEGRATION LEVELS

To simplify problems of enterprise modelling and integration, an enterprise is divided into several hierarchical levels. According to PERA, enterprise can be divided into 6 levels, which is shown in Fig. 1 [From PERA web site].

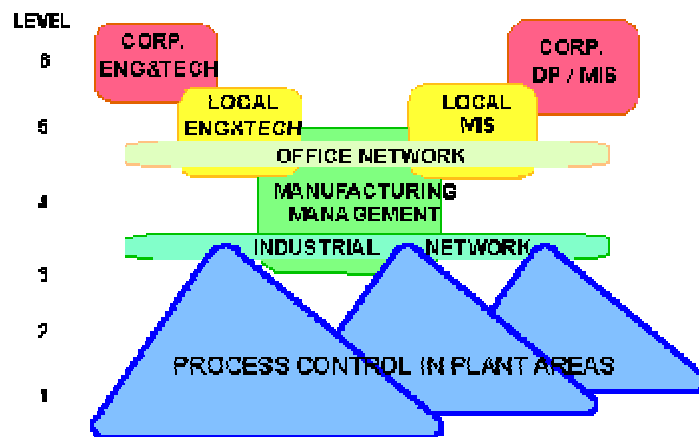

Fig. 1 PERA architecture for enterprise

In CIMOSA, enterprise integration problems are classified into three levels: physical system integration, application integration and business integration, which are shown in Fig. 2 [Vernadat 2000].

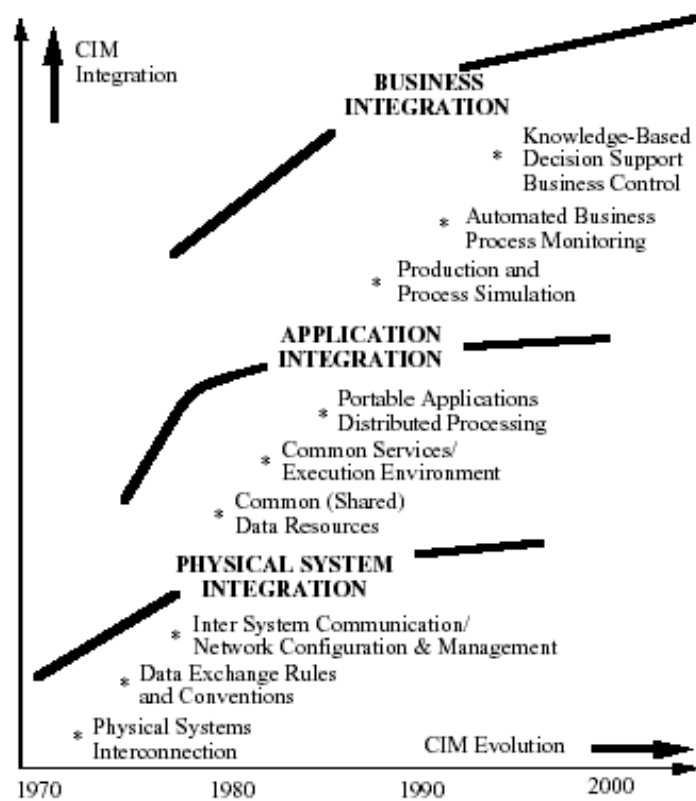

Fig. 2 Enterprise Integration levels [Vernadat 2000]

In Chinese 863/CIMS subject, the enterprise integration is also catalogued into three groups: information integration, process integration (Concurrent Engineering), and enterprise integration (Agile Manufacturing) [Wu 1997] [Wu 1999].

1.4 CURRENT SITUATIONS IN AUTOMATION INTEGRATION: CMMS/IAMS AND MES

In manufacturing enterprises, there is a gap between the real time world of the manufacturing process and the transactional world of the business administrations [KroczeK 1999]. In order to execute the business strategies in the manufacturing process, and represent the state of the production process in the forms that can be easily 'understood' by the operators and the entities in the business level, there should be interfaces between the Business level and Process level. MES (Manufacturing Execution System) is just for this purpose. Therefore, MES is to master the synchronic evolution of the process (material/energy) flows with the diachronic 'state-oriented' supervision and management by operators through information flows (discrete views) representing the continuous flows [D. Galara 1998]. ISA-dS95 defines the interfaces between enterprise activities and control activities [ISA-dS95 1999].

To realize MES functions, there should be intelligence in both process and business levels. In the process level of the manufacturing enterprises, this goal can be implemented by CMMS (integrated Control, Maintenance and technical Management System) and IAMS (Intelligent Actuation and Measurement System), which are the new paradigms for plant automation system integration and implementation [Morel et al. 1994] [IUNG 1992]. They are the results from several European projects: ESPRIT II-DIAS (Distributed Intelligent Actuation and Sensors), ESPRIT III PRIAM (Prenormative Requirements for Intelligent Actuation and Measurement), ESPRIT III EIAMUG (European Intelligent Actuation and Measurement User Group), ESPRIT IV IAM-PILOT (Intelligent Actuation and Measurement Pilot) [Petin 1995] [Neunreuther 1998] [Leger 1999] [Morel et al. 1997] and EIAM-IPE [Ye et al. 1999].

CMMS and IAM are two aspects of the same system. CMMS means to integrate the three isolated automation islands at the plant level using system thought. IAMS emphasizes the intelligence distribution among fields components to ensure the interoperability and openness. CMMS ensures the synergy among the automation function modules, while the IAMS provides the implementation architecture and technology for CMMS. Therefore, CMMS and IAM contradict in appearance, but agree in nature.

Through the EU-China join project EIAM-IPE, CMMS and IAM were synthesized and developed into ICMMS (Intelligent Control-Maintenance-Management System)[Wang 1999][Zhang 1999][Ye et al. 2000].

1.5 NEW AUTOMATION INTEGRATION TRENDS FOR HP

1.5.1 THE INTEGRATION LEVELS IN A PLANT OF PROCESS INDUSTRY

According to the way of processing material, the production industry processes are usually classified into continuous processes and discrete processes. Most of the enterprise integration efforts, especially the CIM or CIMS, are mainly dedicated to discrete manufacturing process. However, most of the results in CIM or CIMS can be applied in process industries. A new concept CIPS is proposed, which apply the CIMS paradigms in process industry [Rao et al. 1994] [Chai et al. 1999] [Xiong et al. 2000][Mo et al. 1999]. The hierarchical levels of CIPS are different in above-mentioned references, but they can be unified by a common reference framework, like the hierarchical PERA structure for process industries [Williams 1988].

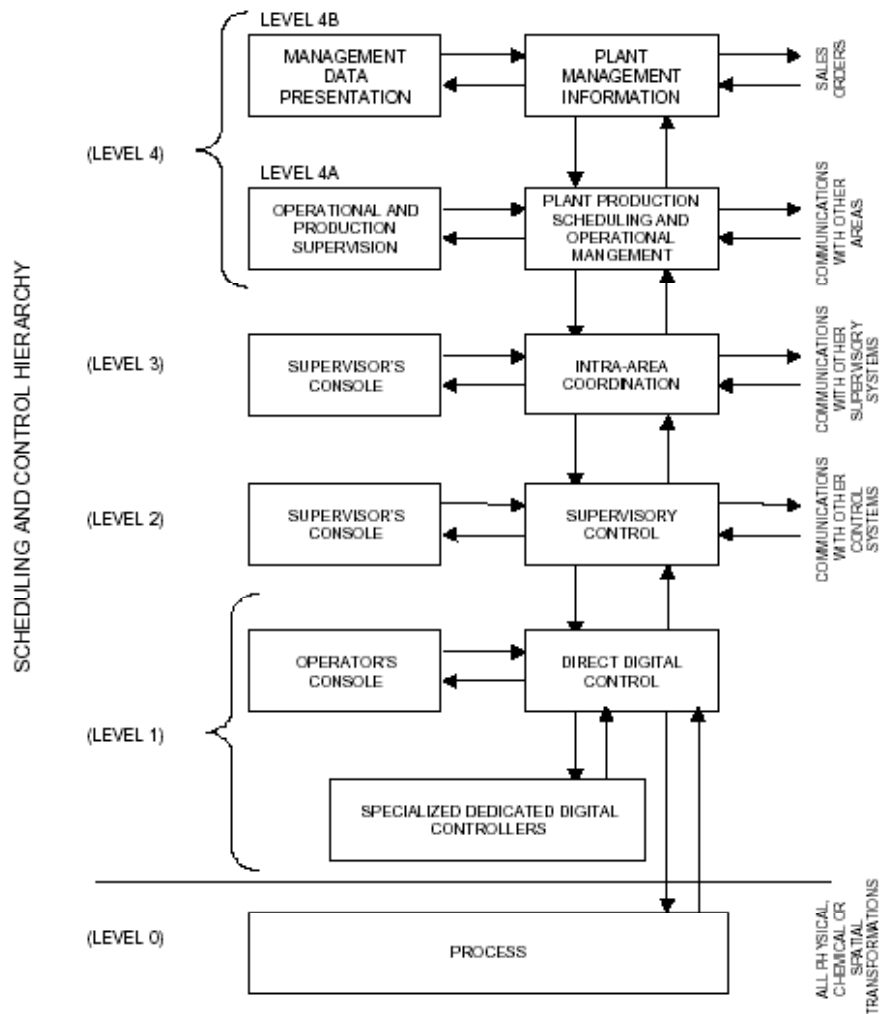

Fig. 3 Hierarchical Computer Control System Structure For An Industrial Plant (Continuous Process Such As Petrochemicals) [Williams 1988]

1.5.2 AUTOMATION SYSTEM INTEGRATION FOR HP

Hydropower generating is a typical class of process industries, and has the common features of them. In addition, hydroelectric power also has its unique characters:

- The natural conditions constrain the structures, installed capacities, operation approaches, and other technical aspects of the hydropower plants
- Its raw material: Hydraulic power is dependent on the river flow, which can only be regulated to some extent.
- The product: electrical energy can be stored directly in large scale.
- The production, transmission, distribution, sale and consumption of the product are

completed in the same time.

➤ ...

To adapt these particularities, the generalized models and approaches in enterprise modelling and integration are not sufficient. It's necessary to construct the reference models for HP. For an independent HP, there is no need for Level 5 under PERA. Considering the organizational characters of the HP, level 2 and level 3 can be merged in this Thesis (Fig. 4).

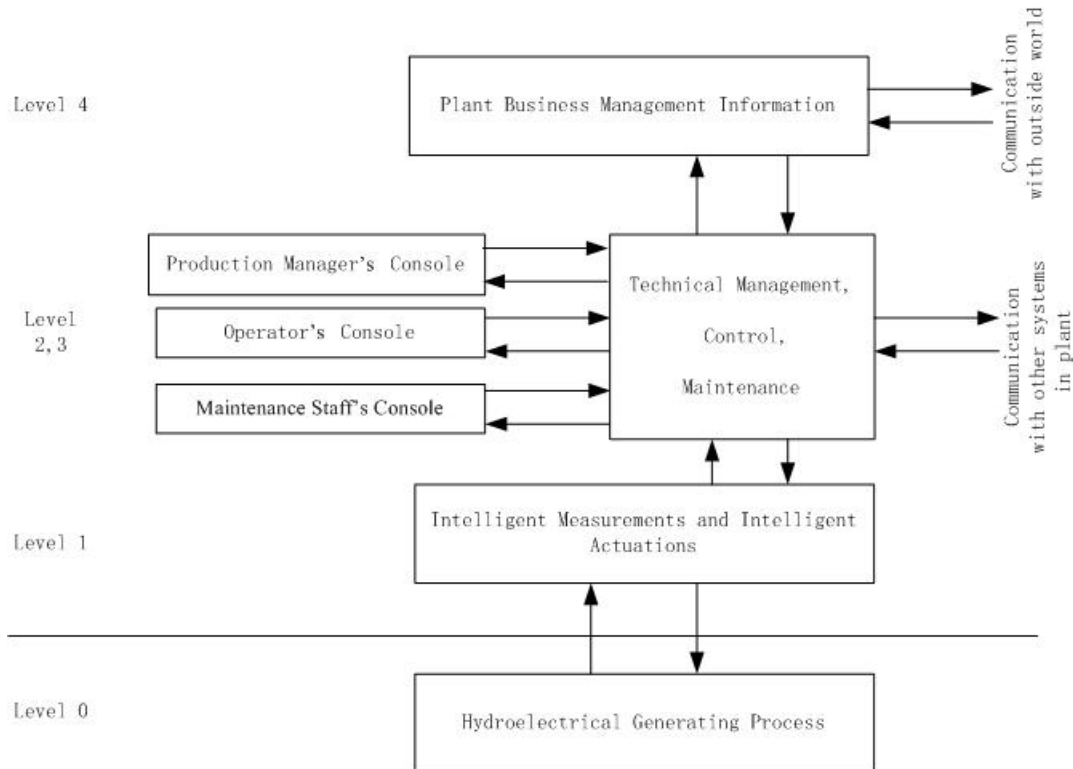

Fig. 4 PERA based hierarchical structure for the automation systems of HP

Recent years, integrated methodologies technologies are increasingly popular in the automation system integration for HP. Some principles and methodologies in enterprise integration and enterprise modelling are applied in HP. CMMS/IAMS has been applied in HP and some achievements are obtained. In REMAFEX project, the remote maintenance for the facilities in HP is realized using CMMS/IAMS principles [Leger1999]. Based on CMMS/IAMS, ICMMS for HP is proposed [Wang 1999] [Ye et al. 2000].

In this Thesis, the main scopes for studying are focused on the automation integration at the process level and its interfaces with the business level.

1.6 OBJECTIVES AND STRUCTURES OF THE THESIS

1.6.1 OBJECTIVES OF THE THESIS

Based on the research results of other scholars worldwide, the Thesis wants to contribute the integration methodologies and related technologies to solve these problems for HP automation systems through the system thought.

The main objectives of the Thesis can be summarized in the following aspects:

- A. Modelling: According to the characters of the hydropower plants and the principles in enterprise integration and modelling, propose an integration methodology and Reference Model of ICMMS for HP;
- B. Implement architecture: Under the proposed Reference model, use the IAM and fieldbus technologies, propose an implementation architecture for the ICMMS of hydropower plants;
- C. Technical Management Domain: Propose the criteria and methodologies to evaluate the performance of the Hydroelectric Generating Units, present its implementation schemes;
- D. Maintenance domain: Under the proposed reference model, present integrated solutions for the condition monitoring systems of Hydropower Plants; and propose a new maintenance strategy, EBM (Economic performance Based Maintenance);
- E. Philosophy of automation system integration: Summarize the philosophical thoughtlets of automation system integrations perceived by the author.

1.6.2 STRUCTURE OF THE THESIS

The structure of the Thesis is shown in Fig. 5.

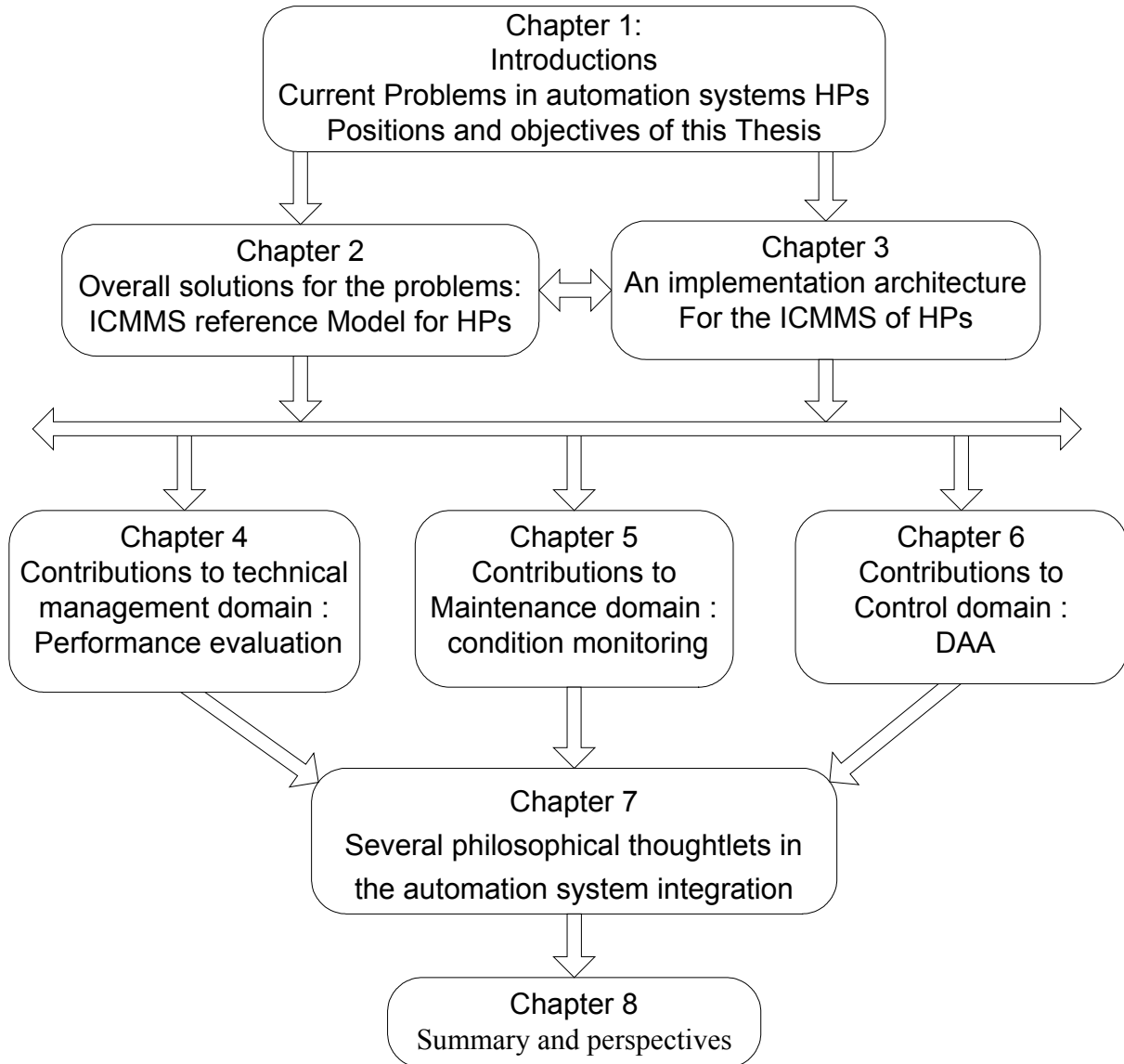

Fig. 5 Structure of the Thesis

CHAPTER 2: An ICMMS Reference Model for the Hydropower Plants

CHAPTER 2: AN ICMMS REFERENCE MODEL FOR HYDROPOWER PLANTS

There's nothing new under the sun. --The Bible.

世上无新事。 --《圣经》

From the viewpoints of system thought and system engineering, any enterprise is a system that has the properties of wholeness, correlation and evolution [Xu 2000]. Presently most problems in the automation systems for HP (Hydropower Plants) can be classified within these three aspects. That is to say, these problems can be summarized into: how to organize the resources and knowledge, and make all of the components in the HP work in harmony. Modelling is so important that it is a necessary process for system integration today. In this Chapter, based on the methodologies and technologies in enterprise modelling, and the main Characters of HPs, a new reference model for ICMMS of HPs is proposed. The features of the methods and the framework are summarized.

2.1 INTRODUCTION

2.1.1 PROBLEM STATEMENT

Originally, the Enterprise Integration appeared as a big problem in manufacturing sectors when the information technologies were widely applied and made the manufacturing enterprises too complex to handle through traditional methodologies. Then the CIM [Harrington 1974] and CIMS [Li 1994] were born; and later experienced fast development. For hydropower plants, there are some differences comparing with ordinary manufacturing enterprises. The application of enterprise integration in HPs has a bit delay time after those in manufacturing enterprises. Nevertheless, the enterprise integration is becoming a noticeable

problem for the automation systems of HPs today, as IT infiltrates anywhere in this world.

From Section 1.2 of Chapter 1, six aspects of problems for the automation systems of HP are listed. Most of them are not unique, and the root causes of these problems are common to all enterprises today: “Change”.

“Change” is selected as a “key word” in enterprise engineering for following reasons:

- Demands from market are changing;
- Technologies are changing. Among them the IT is the most influential one;
- Society is changing.

To face these challenges, the enterprises must change themselves in almost all aspects:

- Organization;
- People;
- Ways of working and doing business for each staff;
- Technologies;
- ...

However, some things remain not changed:

- To maximize the social and economic benefits;
- To satisfy the customs’ requirements;
- To protect the environment;
- ...

All these “changes” and “unchanged” may induce many problems. For example, the SCADA of a HP is replaced by a new one with computerized components, while the turbine governing system either remains the conventional one or is not compatible to the new SCADA system. A new discipline was born to tackle this problem: **Enterprise Engineering**, which organizes all knowledge that is needed to identify the need for change in enterprises and to carry out that change expediently and professionally [IFIP-IFAC Task Force 1999].

There are many Enterprise Engineering/Integration methodologies. The most popular of them are IDEF (ICAM Definition Method) [Mayer 1991]; GRAI-GIM (GRAI Integrated

Methodology) [Doumeingts 1995]; CIMOSA (CIM Open System Architecture) [AMICE 1993] [Vernadat 1996] [Vernadat 1998]; and PERA (Purdue Enterprise Reference Architecture) [Williams 1994], which were to organize all the enterprise integration knowledge and serve as a guide in enterprise integration programs. However, it is impossible to integrate the models constructed by different methodologies or tools.

So IFAC/IFIP Task Force on Architectures for Enterprise Integration was established. Based on GRAI/GIM, CIMOSA, and PERA, the Task Force has developed an overall definition of a generalized architecture. The proposed framework was entitled ‘GERAM’ (Generalized Enterprise Reference Architecture and Methodology). GERAM is about those methods, models and tools that are needed to build and maintain the integrated enterprise, be it a part of an enterprise, a single enterprise or a network of enterprises (virtual enterprise or extended enterprise).

2.1.2 REFERENCE MODELS

Reference Models or Partial Enterprise Models (reusable, paradigmatic, typical models) are the models that capture the characteristics common to many enterprises within or across one or more industrial sectors. Reference models may cover the whole or parts of a typical enterprise [IFIP-IFAC Task Force 1999]. Clearly, the reference models are helpful for the modelling process.

HP has its own features. Is it possible to establish a modelling stereotype (Reference Model) that captures the common characters of HPs? This Chapter propose an ICMMS reference model for HPs supported by Partial Enterprise Models defined in GERAM, and other system engineering methods.

2.1.3 ARRANGEMENT OF THIS CHAPTER

This Chapter is to establish a reference model for the automation system of HPs, which covers the automation integration at the process level and its interfaces with the business level.

To give an overall picture of an enterprise modelling, the GERAM is introduced briefly in Section 2.2. The ISA-dS95.01-1999: Enterprise – Control System Integration (Part 1) is introduced in Section 2.3. Then, based on these standards, methodologies and the characters of HPs, an ICMMS reference model is proposed and analyzed in the following sections.

2.2 GERAM

Fig. 6 shows the framework components of GERAM [IFIP-IFAC Task Force 1999]. All the components are defined and described in the GERAM.

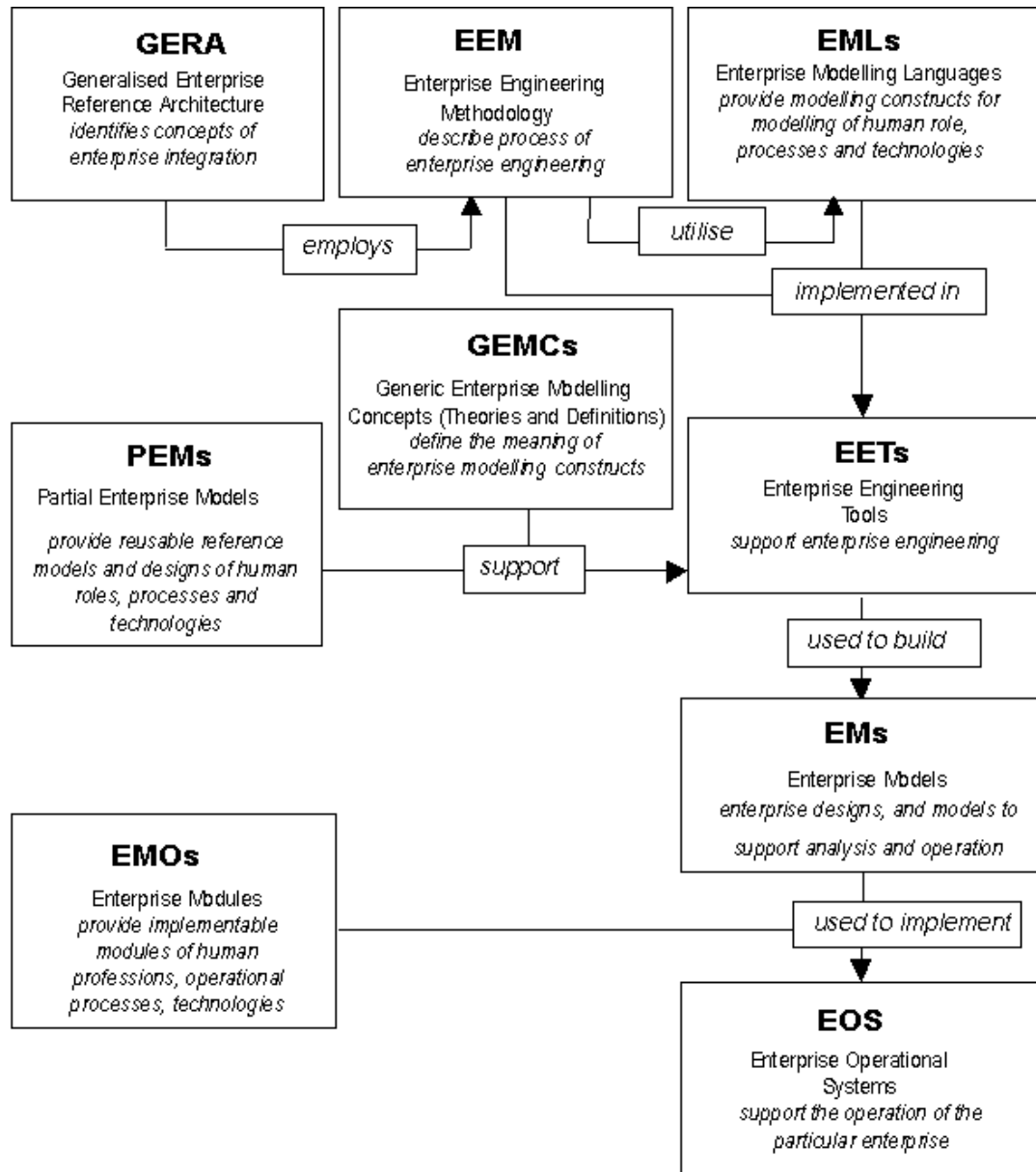

Fig. 6 GERAM framework components [IFIP-IFAC Task Force 1999]

The GERA Modelling Framework is shown clearly in Fig. 7 (The left hand side represents the reference models, and the right hand side the resulting particular enterprise models).

GERAM has following four major features:

- GERAM is defined through a pragmatic approach providing a generalised framework for describing the components needed in all types of enterprise engineering/enterprise integration processes;
- GERAM is intended to facilitate the unification of methods of several disciplines used in the change process, such as methods of industrial engineering, management science, control engineering, communication and information technology, i.e. to allow their combined use, as opposed to segregated application.
- GERAM framework unifies the two distinct approaches of enterprise integration, those based on product models and those based on business process design. It also offers new insights into the project management of enterprise integration and the relationship of integration with other strategic activities in an enterprise.
- An important aspect of enterprise engineering is the recognition and identification of feedback loops on various levels of enterprise performance as they relate to its products, mission and meaning. To achieve such feedback with respect to both the internal and the external environment, performance indicators and evaluation criteria of the corresponding impact of change on process and organisation are required. The continuous use of these feedback loops will be the prerequisite for the continuous improvement process of the enterprise operation and its adaptation to the changes in the relevant market, technology and society

The concept of PEMs or Reference Models is very useful in enterprise modelling to increase modelling process efficiency. The reference models may be in the form of: Human Role Models, Process Models or Technology Models [IFIP-IFAC Task Force 1999].

There are many common characters for HPs, so the construction of a reference models for HPs is feasible and useful for the modelling.

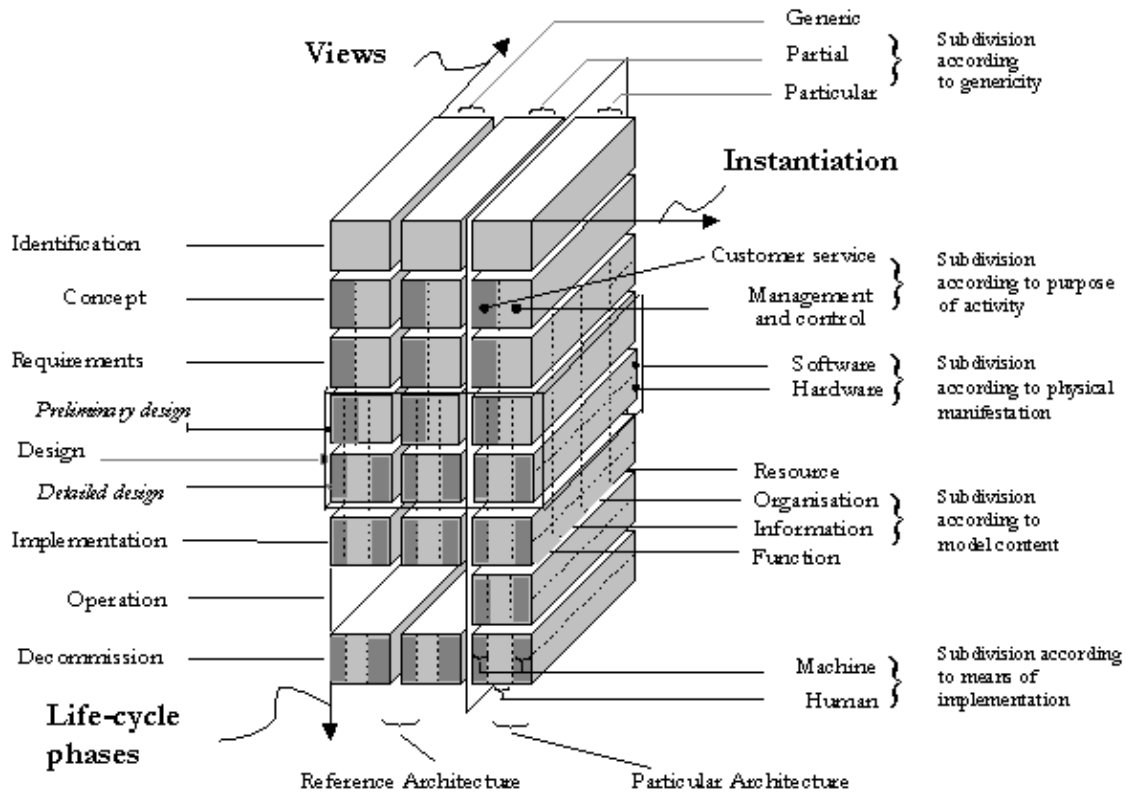

Fig. 7 The GERA Modelling Framework [IFIP-IFAC Task Force 1999]

2.3 ENTERPRISE/CONTROL SYSTEM INTEGRATION STANDARDS

Among the standardization on the system integration at process level, ISA-dS95 is the most matured one, although it is still at the draft stage. It provides standard models and terminology for defining the interfaces between an enterprise's business systems and its manufacturing control systems.

ISA-dS95.01-1999 (Enterprise – Control System Integration, Part 1) defines the interface content between manufacturing control functions and other enterprise functions. The interfaces considered are the interfaces between levels 3 and 4 of the hierarchical model defined by this standard (Fig. 8).

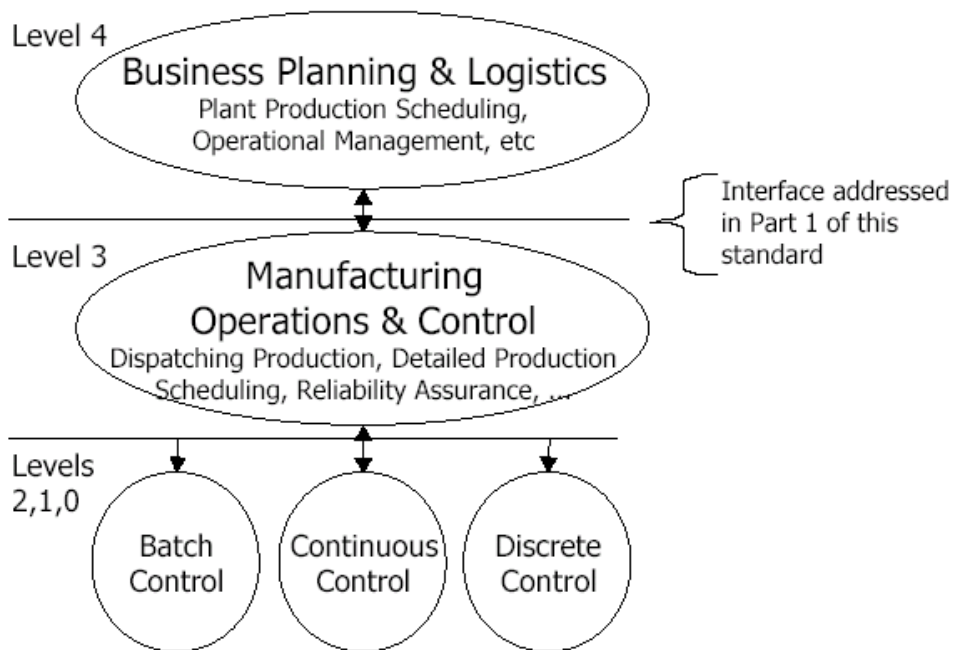

Fig. 8 The Function Hierarchy [ISA-dS95 1999]

The scope of Part 1 is limited to [ISA-dS95 1999]:

- a definition of the scope of the manufacturing operations & control domain,
- a definition of the organization of physical assets of an enterprise involved in manufacturing, and
- a definition of the functions associated with the interface between control functions and enterprise functions,

a definition of the information which is shared between control functions and enterprise functions.

2.4 THE CHARACTERS OF HYDROPOWER PLANTS

From system engineering point of view, a HP, like any other enterprises, is a system. It exchanges energy, material and information with its environment.

2.4.1 THE COMMON FEATURES OF HYDROPOWER PLANTS

To establish the PEMs of the HPs, the similarities should be figured out.

- The energy flow relations: Fig. 9 shows the energy flow of a HP. In fact, this figure also reveals the ultimate goal of a hydropower plant: Convert the hydraulic energy into electric energy under the constraints of the water system and the electric power system. These relations are always the same to every hydropower plant in this world. The raw material of a HP is the hydraulic power, while the finished product of a HP is electricity. Therefore, the variables to measure the quantity and quality of the product are the same too.

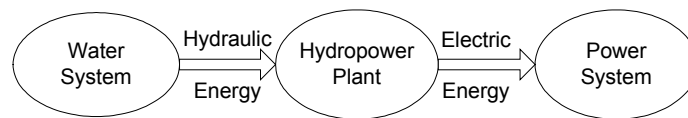

Fig. 9 The energy flow of a Hydropower Plant

- The components, functions and organization structures of the main facilities for production in a hydropower plant are the same. Fig. 10 reflects the main facilities for the hydroelectric power generating process in typical HP. The arrows represent the material and energy flow between the components.

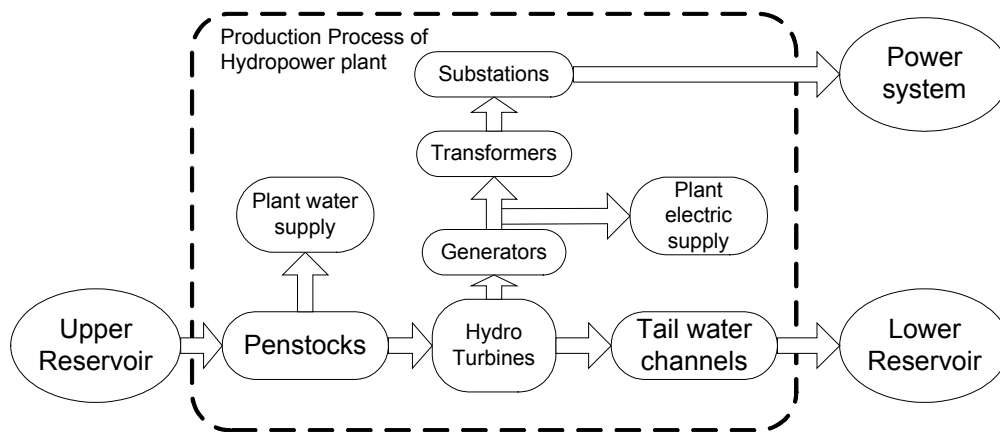

Fig. 10 The production process of a Hydropower Plant

Although there may be some formation changes, the physical principles and functions of the main facilities for the HP are similar:

Upper reservoirs: to accumulate the hydraulic energy of the river flow;

Penstocks: to channel the water from reservoirs to turbines;

Hydro turbines: to convert the hydraulic energy of the water into the mechanical energy of the runner;

Tail Water Channels: to channel the water from turbines to the lower reservoirs;

Generators: to convert the mechanical energy into electrical energy;

Transformers: to transform the voltage and the current of the electricity;

Substations: to distribute the electrical energy to the power lines of the power systems;

...

For a century, scientists and engineers have been studying their static and dynamic behaviours in Fluid Dynamics, Mechanical Engineering, Electrical Engineering, etc. Usually these behaviours can be described in groups of equations. Some of the equations are deduced from the physics, while some of them are from the model tests or prototype tests.

Hydro turbines, for example, the types may be Frances, Kaplan, Pelton or others, but their functions are always the same: Converting the hydraulic power into the mechanical power.

The basic equations are similar:

$$\begin{cases} P_t = g\rho\eta_t Q_t H_t \\ \eta_t = f(\alpha, H_t, Q_t) \\ \dots \end{cases} \quad (1)$$

P_t : Output power of the turbine (W);

Q_t : Flow rate of the turbine (m^3/s);

H_t : Net water head of the turbine (m);

η_t : Efficiency of the turbine;

α : Opening of the turbine vanes;

ρ : Density of flow fluid , for clean water, $\rho=1000 \text{ Kg/m}^3$;

g : Local gravity acceleration. Its standard value is 9.81 m/s^2 .

2.4.2 THE MOST CHANGEABLE PARTS OF A HP: AUTOMATION SYSTEMS

From the technical views, the automation systems are the most changeable components of the HPs. The reasons are summarized as followings:

- The business environments of the HPs are changing, for example the change from regulated to deregulated electric market;
- Technologies are changing, especially IT;
- The organization, operation and management of the HP is always changing;
- The qualifications, responsibilities and number of the staffs are changing.

Fig. 11 shows the relations of them.

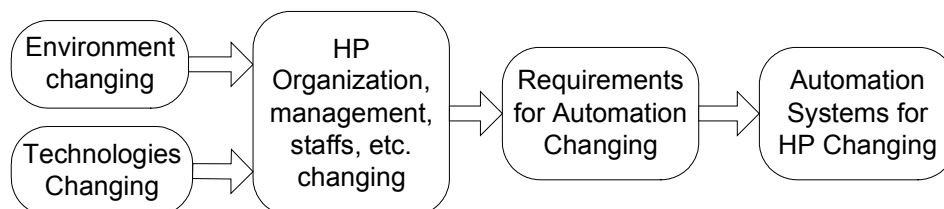

Fig. 11 the reasons for the changing of automation system for HPs

From Fig. 12, the three components (Facilities, People and Information Systems) of a

hydropower plants and their positions in the whole plant are described. The original goal of automation was to replace part or full of human labours. That means the automation system is the closest part of the facilities to human. Human roles are always changing in an enterprise, so the automation system in a plant is changing endlessly.

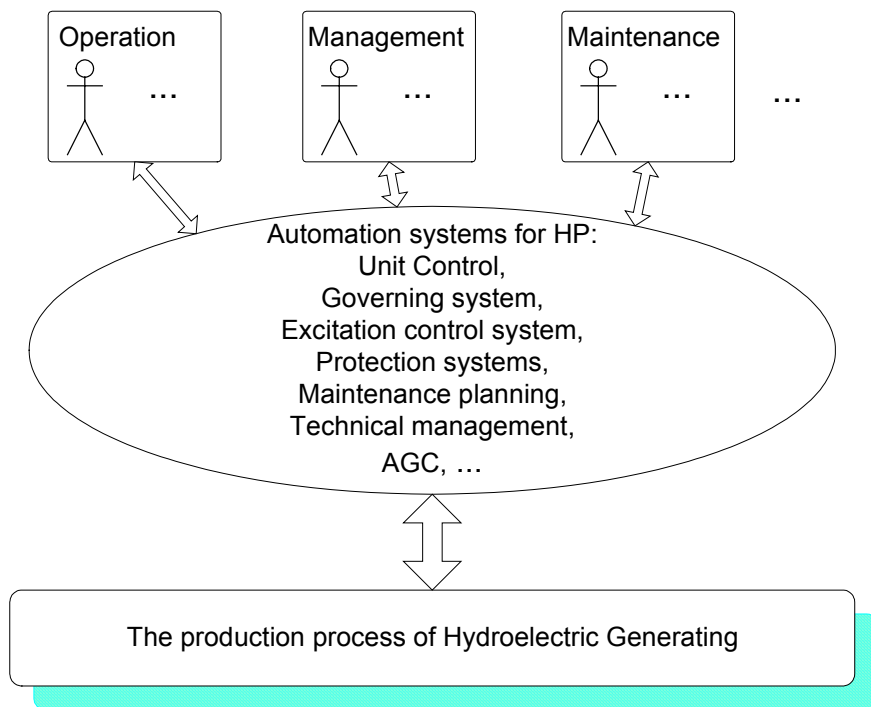

Fig. 12 The functional position of the automation systems in HPs.

Each member of staff is an autonomous intelligent agent; he/she interacts with some parts of the automation system according to his/her responsibilities and authorities. These functional parts were formed into relatively independent automation ‘Islands’. Since the roles of the staff and the automation technologies are always in the changing process, the coordination among those ‘islands’ is very difficult, so the risks of conflicts and faults are introduced.

Therefore, the major goal for automation system in HP today is to ensure the synergy among these automation modules. This goal could be achieved through correctly distributing the functions, well organizing the modules, and handling the changes in a professional way. To solve this problem, the systemic thinking and approach are necessary. One of the measures is to establish a common reference model and therefore make the change in a formal and unified way. ICMMS is proposed to this end.

2.5 THE FUNCTIONAL ANALYSIS OF ICMMS FOR HPS

From above analysis, it can be seen that the functions of automation system for HP are changeable, especially under deregulated electricity market. This problem can't be avoided because HPs can't change the environment. Hence, the automation system should adapt themselves to the environment changes.

We can't stop the changing of function requirements, but we can make the way of this changing in an ordered way. ICMMS is a solution to this end. System thought is the fundamental principle of the methodology.

Although the functions are always changing, some things don't change much:

- In a HP, there are mainly three kinds of staff for production: Operators, Maintenance staff and production managers. Maybe there are some overlapping functions of a person, but this division is relatively steady.
- The functions requirements for automation systems of a HP can be divided into three domains: Control, maintenance and technical management.

Currently the automation systems at the plant level are not integrated. These systems are relatively independent, which can be classified into three types by functional view: automatic control systems, maintenance systems and technical management systems. These three types of systems are divided according to their functions and the users:

- The main functions of control subsystems are: to accept the instructions from the operator, to control the production process, to monitor the parameters of production process, to protect the safety of staffs and machineries. The users of these systems are operators.
- The main functions of maintenance subsystems are: to monitor the conditions, to make the maintenance decision, to make the maintenance plans, to manage the spare parts, to diagnosis the faults, the test the equipment. The main users of the systems are maintenance staffs.
- The main functions of technical management subsystems are: to coordinate the actions among operators and maintenance staffs, to assess the situation of the process and equipment, to evaluate the economic performance of the equipment, to evaluate the overall economic aspects of the process, to optimize the operation and maintenance activities so as to obtain maximum economic benefits. Main users are production managers.

Although the three domains are closely linked and no function can be realized by a single domain, these functions are divided in the three domains to simplify the integration and use of the automation system. In general, control is concerned with safety, stability, productivity of the production process, while maintenance is concerned with reliability and availability of the process facilities, and technical management is for scheduling the plant production resources, and maximizing the overall social and economic benefits of the production process.

Currently those three subsystems are relatively independent and isolated. The information isolation among them is the barrier for communication and coordination, and even causes faults and accidents. This problem can be solved by ICMMS. Fig. 13 shows the main components of the ICMMS for HPs.

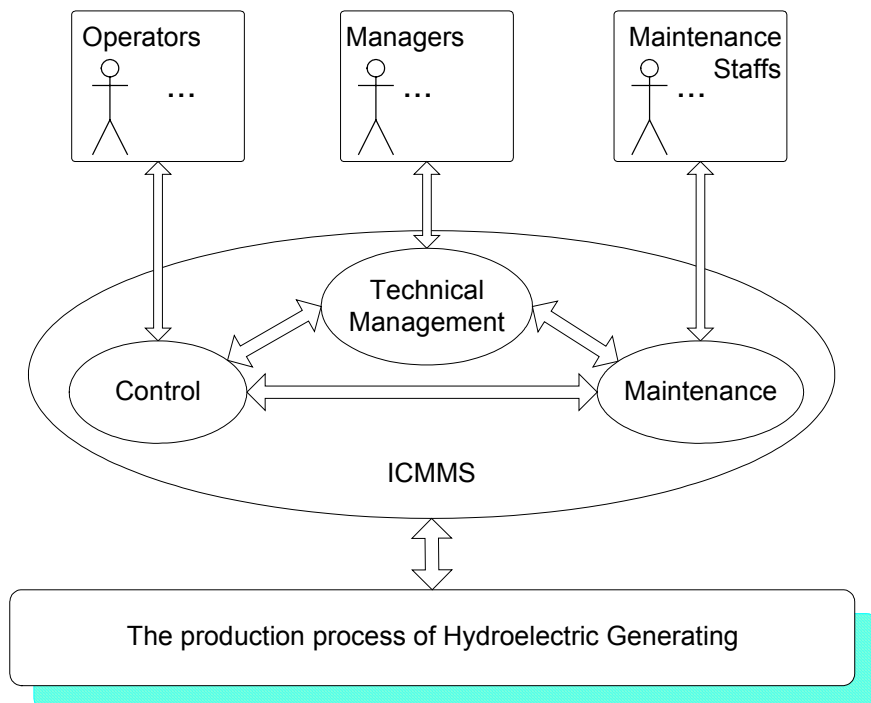

Fig. 13 Function domains of automation system for HP

Under ICMMS, the three main fields of industrial automation, Control, Maintenance, and Management are integrated into a system from the system engineering viewpoints. The key points of ICMMS can be summarized into four words: **Integration, Distribution, Intelligent, and Open.**

Integration: three functional domains of the automation should be considered as a whole, in order to realize the fluent communication and harmonic coordination among the system domains.

Distribution: the system implementation should adopt a distributed architecture and

distribute the functions into the subsystems, thereby achieve the flexibility, openness and reliability of the system.

Intelligent: to distribute the integrated functions, all the components of the ICMMS should have the abilities of communication, decision-making and self-adapting, i.e. the subsystems of the ICMMS should be intelligent.

Open: to ensure the longevity of the system, the system should be open. For automation system, open is a combination of data connectivity and hardware and software portability. Openness can be measured from 5 aspects: extensibility, interoperability, portability, scalability, and modularity.

To achieve the full objectives of the ICMMS, there are both technological and academic problems to be solved. Some application studies and real implementation results showed the encourage future of ICMMS.

2.6 A ICMMS REFERENCE MODEL FOR HYDROPOWER PLANTS

Enterprise itself is an “organic system”, which has the properties: autonomous, dynamic, goal-oriented, reactive, proactive, etc. To build a “perfect” reference framework to model all those properties is not an easy task. Maybe it is impossible. However, a useful solution is better than no solutions at all. GERAM is a good solution towards finding the right direction.

In GERAM, like in any other enterprise modelling methodologies, the enterprise models are decomposed into many “blocks” to simplify the problems. Consequently, enterprise is decomposed and not integrated in the process of enterprise integration.

Under the GERA (Generalised Enterprise Reference Architecture) of GERAM, there are three kinds of concepts to decompose an enterprise:

- A) Human oriented concepts: to describe the roles of humans as an integral part of the organisation and operation of an enterprise and to support humans during enterprise design, construction and change;
- B) Process oriented concepts for the description of the business processes of the enterprise;
- C) Technology oriented concepts for the description of the business process supporting technology involved in both enterprise operation and enterprise engineering efforts

(modelling and model use support).

Examples of enterprise reference architectures are provided by ARIS, CIMOSA, GRAI/GIM, IEM, and PERA. ENV 40003 defines a general Framework for Enterprise Modelling. ISO DIS 14258 defines Rules and Guidelines for Enterprise Models [IFIP-IFAC Task Force 1999].

Comparing with the common manufacturing enterprises, the hydropower plants have these characters:

- The production, transmission and sale of their products (Electric Energy) are in the same time;
- The organizations of the enterprise are different, for example, there is no department for new products development, the marketing and sales department is different from other manufacturing enterprises;
- The structures of the hydroelectric generating process remain unchanged due to the technical and natural constrains.

Therefore, it is not necessary to use much generalized reference architectures to model the HPs, and PEMs is a good solution to simplify the modelling process for HPs.

A Hydropower plant can be decomposed into three types entities: Humans (or human groups), the automation systems, and the hydroelectric generating process.

Obviously, those three types of components work together as a whole system. They play different roles in the plant:

- Since hydroelectric generating is the ultimate goal of the whole power plant, so the process is the protagonist of the power plant. Other two should work for the process;
- The humans observe the conditions, think and give orders to the automation system; hence, the humans are the leaders of the plant.
- Humans observe and manipulate the generating process through the automation systems. Therefore, the automation systems are the extensions of the eyes, hands and brains of the humans. In addition, the automation systems have some intelligent functions, so they are also senior assistants or consultants to the humans.

Fig. 14 shows these relations. The modelling framework for the hydro power plants can be

based on those analysis: Three types of entities: Human, Process, and automation.

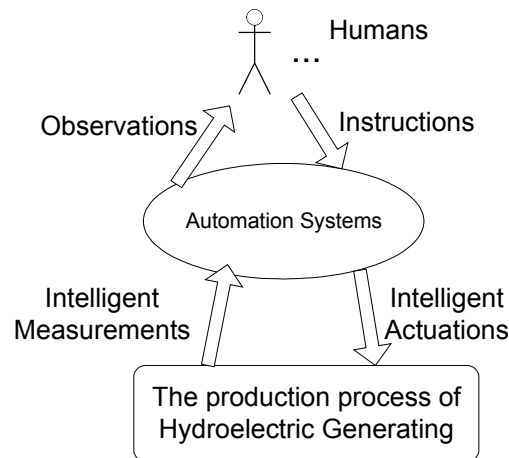

Fig. 14 The relations of the Humans, automation systems and the generating process

In this chapter, a reference model of ICMMS for Hydropower Plants is proposed (Fig. 15). The ICMMS is decomposed into following parts:

- 1) Knowledge repository: process models, tools, know-how, expert knowledge, etc. The process models are established through objected oriented methodologies. The Control, Technical Management and Maintenance modules take this repository as a knowledge and information support agent. The variables and characters of the process facilities are updated by the Control, Technical Management and Maintenance modules.
- 2) Control: accept the instructions from the operator, make the generating process and related auxiliary process under expected conditions, and protect the safety of the facilities and human staffs. For example, turbine governing systems, excitation control systems, unit sequences control, control systems for the auxiliary systems, isolators and breakers control, unit and transformer protection systems, etc. The objects to be controlled are the facilities of the process. Therefore, the process to be selected as the foundation is a right choice.
- 3) Maintenance: condition monitoring; assess the safety conditions of the process, prognosis, diagnosis, maintenance scheduling, spare parts management, maintenance help to staffs, etc.
- 4) Technical management: coordinate the actions of control and maintenance, economic efficiency evaluation, optimal load dispatching, etc.

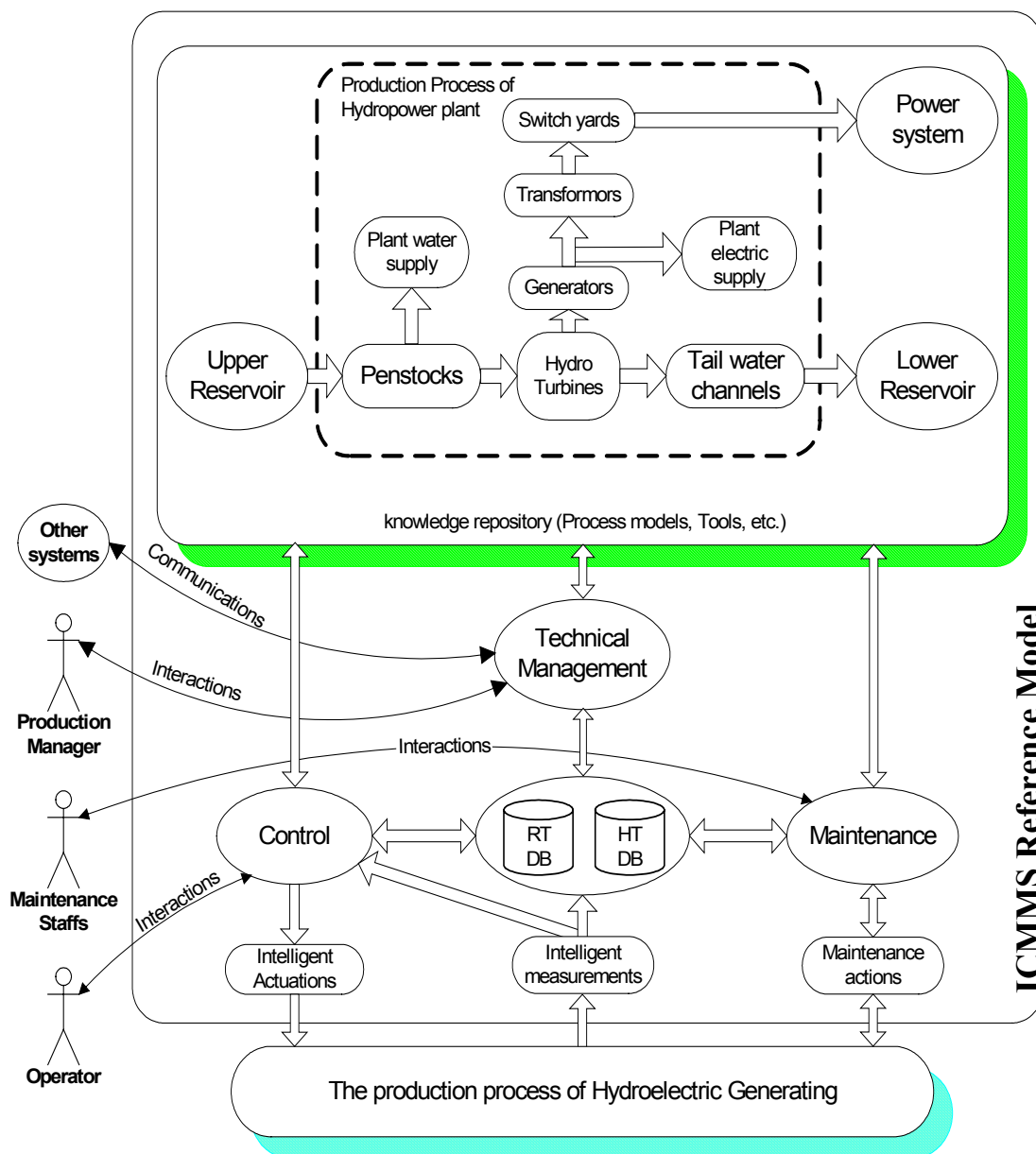

Fig.15 the reference model of ICMMS for Hydropower Plants

- 5) Intelligent measurements: sensing the physical variables of the production process, pre-processing the signals (isolation, compensation, filtering, A/D, etc.), validating the data, making the data into useful information, and sending it to the database. In this reference model, some of the data are directly sent to the control modules to meet the strict real-time requirements for those data. In implementation, some maintenance functions are also imbedded in an intelligent measurement device [IUNG et al. 1994].
- 6) Intelligent Actuations: follow the instructions from the control modules; transfer the signal into strong forces to manipulate the process. Intelligent actuators may embed some

intelligent control and maintenance functions [IUNG et al. 1994].

- 7) Databases: from the temporal view, two types of databases are needed: real time databases and history database. In the deployment view, the database may be centralized or distributed.

In order to ensure the reusability of the reference model, the least changeable parts of the plants, the main facilities of the hydroelectric generating process are selected as the foundations for all automation activities. Under this reference model, the process is modelled through object-oriented method. The main facilities of the process, like Water turbines, Generators, Transformers, Reservoirs, Breakers, Penstocks, Tail Water Channels, and Auxiliary Equipment... are all selected as objects which static and dynamic behaviours can be described. To illustrate the method, a Class Diagram for the main facilities of the generating process in Hydropower Plant is shown in Fig. 16.

Each Class may have several subclasses to express different types the equipment. In this figure, three most common Hydro Turbines, Francis, Kaplan and Pelton turbines are listed in the diagram as the subclasses of Hydro Turbine. An instance of a turbine can be described as an object; the parameters and state variables can be listed as the attributes of the turbine. Table 2 show a example of Francis turbines.

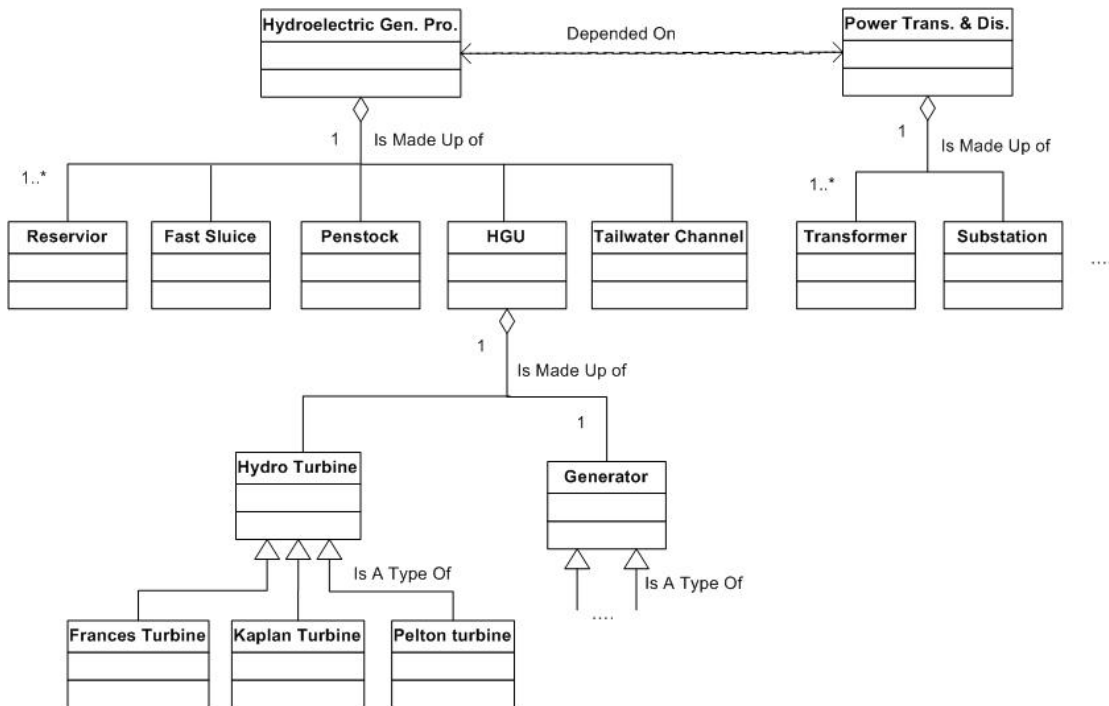

Fig. 16 UML Class Diagram of the main generating process for Hydropower Plants

Table 2 List of the attributes of a Francis turbine

Attributes	Name	Unit	Meaning
Variables	H_t	m	Head of the turbine
	P_t	W	Output power of the turbine
	Q_t	m^3/s	Flow rate through the turbine
	n	$r.p.m.$	Speed of the runner
	a	%	Opening of the Guide Vanes
	Eff_t	%	Efficiency of the turbine

Parameters	D_l	m	Nominal diameter of the runner
	H_r	m	Rated Head of the turbine
	Q_r	m^3/s	Rated Flow rate through the turbine
	a_0	%	Rated opening of the Guide Vanes
	Eff_0	%	Rated Efficiency of the turbine

The relations of the attributes, e.g. equations, can be defined in the operations of the object. Some complex dynamic relations among objects can be modelled through an association class [Rumbaugh 1999] [Booch 1999].

When the Control, maintenance or technical management modules read or update the information concerning the turbine, they can communicate with the hydro turbine object.

The features of this new reference model for HPs:

- Process oriented modelling methods. The structures of the Hydroelectric Generating process are unchangeable after the HPs put into use, and the topologies of the HPs are similar to most of the HPs. Hence the process model can simplify the integration process of the automation systems.
- The function modules can be easily distributed or redistributed among three domains. Because the models, databases and knowledge bases are organized based on the process, they needn't be changed when the locations of the function modules change.
- All modules of the system are constructed on the common and firm structured process models, the synergies of the system agents are guaranteed.

- Since the reference model is process oriented, the object oriented modelling methods and languages, such as UML, can be applied to describe all the ICMMS development process. This is helpful to increase the reusability of the models, and software and hardware components.
- This reference model and related methodologies are proposed under the constraints of hydropower plants. To the enterprises on other trades, it can't be used directly.
- This reference model grasps the unchanged aspects of the plants to cope with changeable aspects. This methodology is just the same as "Unchanging is the best way to deal with changing" in the philosophy. The methodology may have some inspiring help to cope with the enterprise integration problems for other trades.

Important comments:

On the one hand, the main idea of ICMMS is to integrate the three islands of automation into a synergetic system, on the other hand, the functions of the automation system are divided into three domains. Clearly, there are some conflicts between these two aspects. For example, the functions that are shared by two, even three domains, should be positioned in which domain?

According to the ICMMS reference models proposed here, the production process is the centre and main role of the power plant, the men are the leader of the plant, and the ICMMS is the intermediate between the men and the process. Therefore, the function domains should be divided according to the men who need the functions the most. In addition, the function modules can be shared by the two or three domains.

Under the process oriented reference models, the process models are shared among the three domains, and the physical or functional locations of function modules are very easy to changed. Therefore, the function contents of the three domains can be adjusted with small efforts.

For these reasons, the exact functions of the three function domains in the ICMMS of hydropower plants haven't been fixed in this Thesis. The Condition monitoring is mainly a problem in the maintenance domain, but some of its functions are needed more in the control domains. Therefore, the function modules of the condition monitoring are delegated into the three domains, but they can work together as a system. This concept is very similar to the Dynamic Federation the CIMS, and the MAS (Multi Agent System) in Artificial Intelligence.

2.7 SUMMARY

The main objective of this chapter is to propose a suitable reference model for the integration of the Automation systems for Hydropower Plants.

- 1) GERAM is introduced briefly. GERAM is an international initiative in enterprise engineering, and many important enterprise engineering methodologies are included. Through GERAM, most of the famous enterprise engineering methods can be understood. Hydropower plants have many features of their own, so Partial Enterprise Models can simplify the Hydropower Plants integration remarkably.
- 2) ISA-dS95.01-1999 (Enterprise – Control System Integration, Part 1) is introduced briefly. Among the standardization on the system integration at process level, ISA-dS95 is the most matured one, although it is still at the draft stage. It provides standard models and terminology for defining the interfaces between an enterprise's business systems and its manufacturing control systems.
- 3) The characters of the Hydropower Plants are analyzed and revealed. The most important characters for hydropower plants integration are their similarities and unchanging aspects:
 - Energy flows;
 - Process structures;
 - Main components of the hydroelectric generating process;
 - According to the responsibilities, there are three groups of people on the production level in a power plant: production managers, operators, and maintenance staffs.

The changeable aspects of a hydropower plants are:

- People, their organization and responsibilities;
 - Function requirements, function distributions, structures, technologies of Automation systems.
- 4) Because the users can be grouped into three, the function domains of the automation system for Hydropower Plants can be organized into three accordingly: Control, Maintenance and technical Management. In addition, the three domains should be coordinated to work as a single system, and the intelligence should be embedded into all domains, hence the ICMMS for Hydropower plants is proposed. The main features of

ICMMS are discussed.

- 5) Based on process-oriented method, a new reference model for the ICMMS of hydropower plants is proposed. The reference model grasps the similarities and unchangeabilities of the hydropower plants, and this makes the redistribution of the function modules inside the ICMMS an easy task, guarantees the synergies among the components of the ICMMS.
- 6) The reference model grasps the unchanged aspects of the plants to cope with changeable challenges. This methodology is just the same as “Unchanging is the best way to deal with changing” in the philosophy. The methodology may have some inspiring helps to cope with the enterprise integration problems for other trades.

CHAPTER 3:

The implementation architectures of ICMMS for the Hydropower Plants

CHAPTER 3: THE IMPLEMENTATION ARCHITECTURES OF ICMMS FOR HYDROPOWER PLANTS

不管白猫黑猫，抓住老鼠就是好猫。——邓小平

The cat that catches mouse is a good cat, whether it's white or black.

---- Deng Xiaoping

3.1 INTRODUCTION

In ICMMS, all functions from three domains are integrated, but some of those intelligent functions should be distributed into the field devices to ensure the flexibility of system structures and openness of the automation components. So the enabling technologies for ICMMS are Fieldbus and IAM (Intelligent Actuation and Measurement) technologies. This means that the integration and distribution should be handled carefully to realize the ICMMS.

In this chapter, a FCS (Fieldbus Control System) based ICMMS architecture is proposed. Under this architecture, all field devices are intelligent and confirm to the fieldbus protocols. This architecture is open, fully distributed and integrated; so it represents the future development trend for ICMMS. However, most of the controllers, sensors and actuators in HPs are still not intelligentized yet. Therefore FCS can't be implemented from the technical view today.

For the sake of current technical feasibility and future development, a new type of automation systems for HP, HSAS (Hybrid Smart Automation System), for the automation systems of HP is proposed in this chapter. The overall structure of this system is based on fully distributed Fieldbus architecture. Not only the Fieldbus-based IAM components, but also the traditional automation devices can be integrated into this system. So the HSAS is a fully distributed and realizable solution for the automation system of HP.

To illustrate this architecture, a HSAS solution for large-scaled hydropower generating units is also presented, and its features include integrated, distributed, open, and intelligent.

3.2 STATE OF THE ART ON THE AUTOMATION SYSTEMS FOR HP

The automation systems for HP commonly being used mainly include following types of subsystems:

- Supervisory control systems: HGUs (Hydroelectric Generating Units), auxiliary equipment systems, common systems, hydraulic structures, fire-extinguishing systems, air-condition and ventilation systems etc.;
- Protection systems and fault recording systems for HGUs, transformers, and other important equipment;
- Measurement and report, such as the temperatures, pressures, flow rates, current, voltages, etc.;
- Technical Management Systems, such as optimal load scheduling systems, shift records of the staffs, etc.;
- Others; such as Maintenance management.

The main structural features of current automation systems for HP are [Fang 2000]:

- Hierarchical control architectures: Local unit control, Plant control, Cascade dispatch centre scheduling (optional), and Power system dispatch centre scheduling (optional);
- Distributed computer systems,
- Layered network structure.

For the generating units level, the subsystems (such as turbine governors, excitation regulators, measuring and recording devices, etc.) are tending to be interconnected through a Fieldbus, and form a field level network.

Fig. 17 is a typical structure of automation systems for HP currently used. There are several subsystems: governing systems, excitation systems, measuring and recording systems for generating units, etc. Each subsystem has its own I/O channels with the process, but there are few direct communications or interconnections between those subsystems. Here, another features should be noticed is that the protection systems are independent from the supervisory control system.

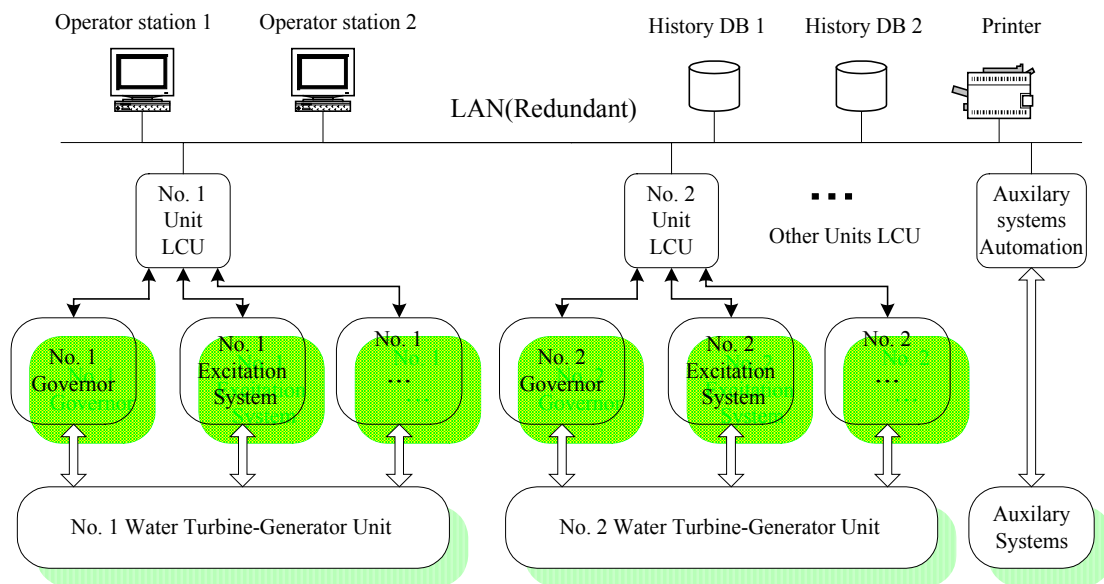

Fig. 17 Conventional Automation System for Hydro Power Plant

3.3 CURRENT PROBLEMS

As the technologies for HP automation are fast developing, the complexity of the systems is increasing quickly, and it becomes very important to coordinate all the subsystems. Here list some main problems currently existing:

- There are no system integration frameworks and standards for the whole HP, so the automation systems lack the openness. Because the standards for interfaces and communication protocols have not unified, the subsystems are relatively closed and isolated, and it is difficult to exchange information among them. These make the system integration, maintenance, retrofitting difficult; and raise the operation cost, lower the reliability, and hinder the lift of the lifetime for the automation systems.
- The state variables of the generating units measured by scattered instruments, it is very difficult to ensure the data with time consistency, comparability, real-time, and integrality. Thus it is difficult to assess the overall status of the whole generating unit, and to support the CBM (Condition Based Maintenance).
- The methodologies, standards for equipment status assessment are waiting to be consummated.
- There is little real-time technical information concerning the economic indexes, status for the Hydro Power Generating Units. The technical management system is badly needed to

provide production-scheduling support for the management staff.

- For a power plant operating in a deregulated electric power market, the availability, efficiency, safety, etc. must remain in high levels to gain the high overall economic benefits. These bring some new and higher requirements for the automation systems for HP.

3.4 INTELLIGENT CONTROL-MAINTENANCE-TECHNICAL MANAGEMENT SYSTEMS (ICMMS) FOR HPS

All above-mentioned problems can be summarized into 4 words: **Integration**, **Open**, **Distribution**, and **Intelligence**, which are among the hottest topics in research and development on industry automation.

Integration refers that all problems of an automation system should be perceived and solved from an entire, relational viewpoint. Those problems include all the aspects of an industrial automation system in the lifecycle, such as analysis, design, construction, operation, maintenance, retrofitting, decommission, recycling, etc. Similar to Computer Integrated Manufacturing System (CIMS) for the manufacturing industry, Computer Integrated Process System (CIPS) is proposed [Rao et al. 1994][Chai et al. 1999].

Open is a combination of data connectivity and hardware and software portability. Openness can be measured from 5 aspects: extensibility, interoperability, portability, scalability, and modularity [Gary et al. 1999] [Jonson 1999].

Distribution means the system structure is distributed, and some processing functions, which were performed by the central controller before, are distributed into field devices. In order to make the field measurement and actuation components intelligent, and establish the distributed automation systems, the European Union funded several projects (DIAS, PRIAM, etc.) under the ESPRIT, and a EU-China joint project (EIAM-IPE)[Morel et al. 1997][Petin et al. 1998].

Intelligence refers that systems have some kinds of intelligent characters such as perception, recognition, reasoning, decision-making, learning, adapting, etc. [Lin et al. 1996]. In the fully distributed systems, all the modules should be intelligent; also, the modules must conform to a unified framework to ensure the openness of the systems. Fig. 18 shows an intelligent reference model of intelligent components [IUNG et al. 1994] [Ye et al. 2000]. The

components receive orders and measurement information from the external world, process the information, and output corresponding orders for actuation and submit the state report. Internal intelligent process can be divided into four intelligent modules: Object Analysis, Behaviour Analysis, State & Fault Analysis, and Decision Analysis.

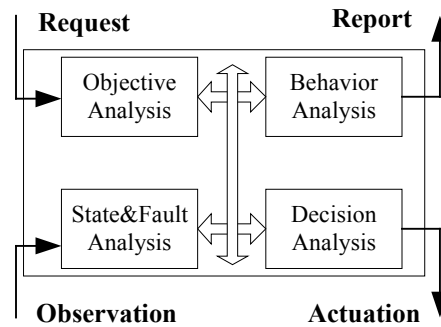

Fig.18 Intelligent Reference Model

Integration, Open, Distribution, and Intelligence are associated and supplemented each other. Only the distributed systems can realize open and integration and only the systems that are integrated and distributed can realize openness. The intelligence is the precondition for the other three performances. ICMMS (Intelligent Control Maintenance and technical Management System) is formed through the integration of these four aspects. In ICMMS, the systemic views are employed to model and integrate distributed automation system as a whole. The study of ICMMS includes methodologies, CASE (Computer Aided Software Engineering) Tools, and implementation technologies, etc. From the functional view, the production process automation system can be subdivided into three parts: Control, Maintenance, and technical Management. These three parts should be integrated together as an organic system, to avoid the functional and information collisions. The kernel part is the information integration and its standardization. [Morel et al. 1996][Ye et al. 1995].

The precondition to realize ICMMS is the sound information infrastructure of the system. The useful information can be exchanged reliably and timely among the subsystems of a layered and distributed system, and among the components of subsystems. IAMS (Intelligent Actuation and Measurement) systems are suitable choices to meet this demand. Fieldbus provides a very good information exchange media for different IAMS modules, like IA (Intelligent Actuation), IM (Intelligent Measurement), C (Control), M (Maintenance), TM (Technical Management), etc. [Fu et al. 2001 [Wang et al. 1999][Dai et al. 2000]].

Fig. 19 shows an implementation architecture of ICMM automation system for Hydropower Plants. From system implementation point of view, the automation systems for hydropower

plants can be divided into three layers: Field Net, Production Net, and Business Net.

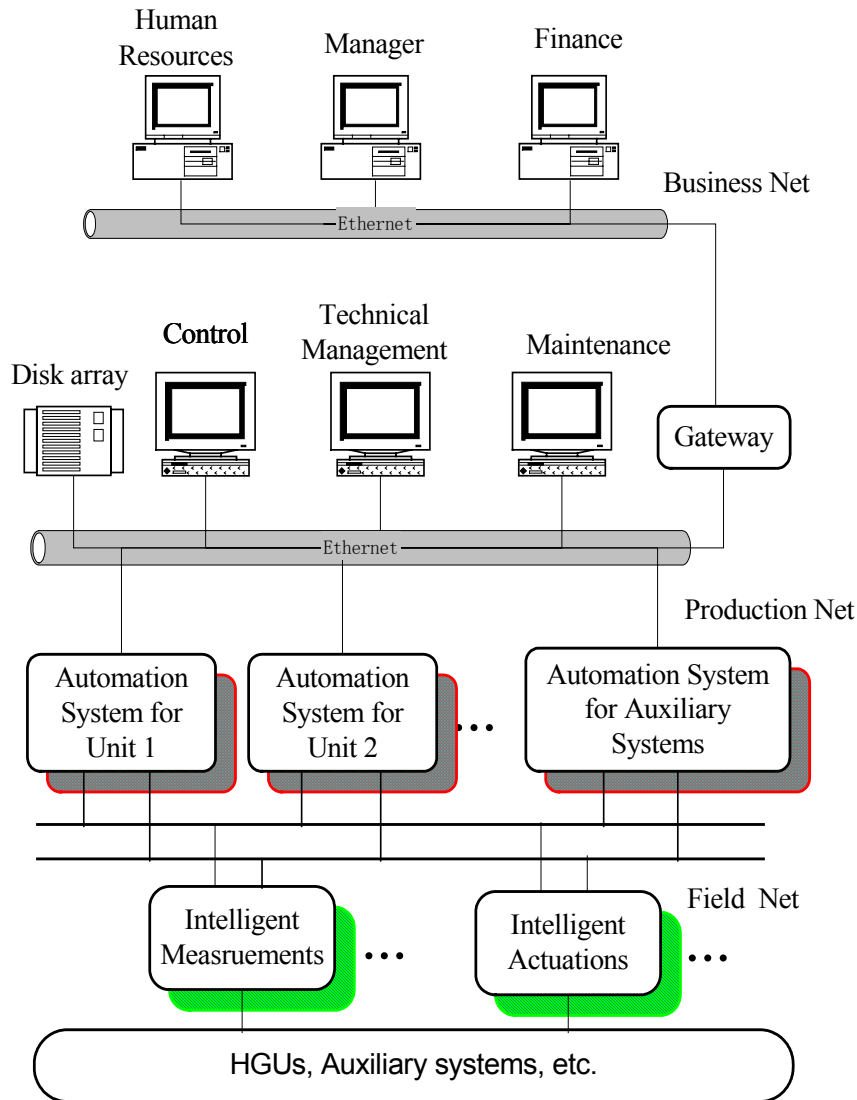

Fig. 19 ICMMS System For Hydro Power Plants

Field Net is directly connected with the production processes; it includes IM, IA, and IPU (Intelligent Processing Unit, such as Excitation control processing unit, turbine regulation processing unit, auxiliary equipment control unit, etc.). All IMs, IAs, IPUs are interconnected and exchange information through Fieldbus, so all the devices should follow the fully distributed fieldbus standards.

Here the functions of a traditional governor are performed through following parts:

IMs: Frequency measurement unit, upper and lower reservoir water level measurement units, guide vane opening measurement units, blade angle measurement units (for Kaplan Turbines), etc.

IAs: Electrical-hydraulic converter, hydraulic servomechanism for guide vanes, hydraulic servomechanism for runner blades (for Kaplan Turbines), etc.

IPUs: Turbine control unit, including the startup control, shutdown control, speed and load regulation, operation modes transfer and other modules.

There are communication modules inside each unit to act as the network protocols.

Therefore, there are fundamental changes for the structures of traditional automation devices like governors, excitation regulators, and so on. Through Fieldbus, IM, IA, IPU are integrated into a fully distributed field level net. The EU project PREIAM has shown the advantages of this type of automation network [Petin 1995]. Main advantages are high consistency, reliability, operability, openness and flexibility. This architecture will be the future trend.

Production Net: refers to the control, maintenance, and technical management for the power plant. It is the production central nerve of the whole power plant. On this level, the Ether net has become the trend. Among these three domains, the control domain has been developed and matured, the maintenance domain is still underdevelopment but receives more and more attentions, but there are very few research and development on the technical management domain. Utilizing the ICMMS methodologies, these three subsystems can be integrated and developed as a whole.

Business Net: functions as the management information system of the whole plants. The managers can use this network to schedule the production, manage the human resources, manage the finance, and make the logistic support. Managers obtain the production information from the production net and send the production instructions to the production net. Gateway is installed between the business net and the production net to increase the security of the production net. Currently the level of network has been developed rapidly.

From above-mentioned analysis, the field net and the maintenance subsystem of the production net is the major difficult problems for the ICMMS in the automation systems for hydropower plants. For the key part of the field net, automation systems for hydroelectric generating units, a solution is presented here.

3.5 THE HYBRID SMART AUTOMATION SYSTEMS FOR HYDROELECTRIC GENERATING UNITS

3.5.1 FIELDBUS-BASED CONTROL SYSTEMS (FCS) FOR HYDRO GENERATING UNITS

Fieldbus is a kind of bi-directional and multi branch communication network that connects intelligent field devices and automation systems. The main features of fieldbus are high reliability, fully distributed, and openness, etc. The rapid development of the fieldbus shows its advances and bright future.

Fieldbus-based Control Systems (FCS) has been a research hot spot in recent years [20]. The characters of FCS are, all measurement and actuation devices are digitalized and intelligentized, then connected to fieldbus directly, all field controllers are also directly linked to the fieldbus, and form a real fully distributed network system.

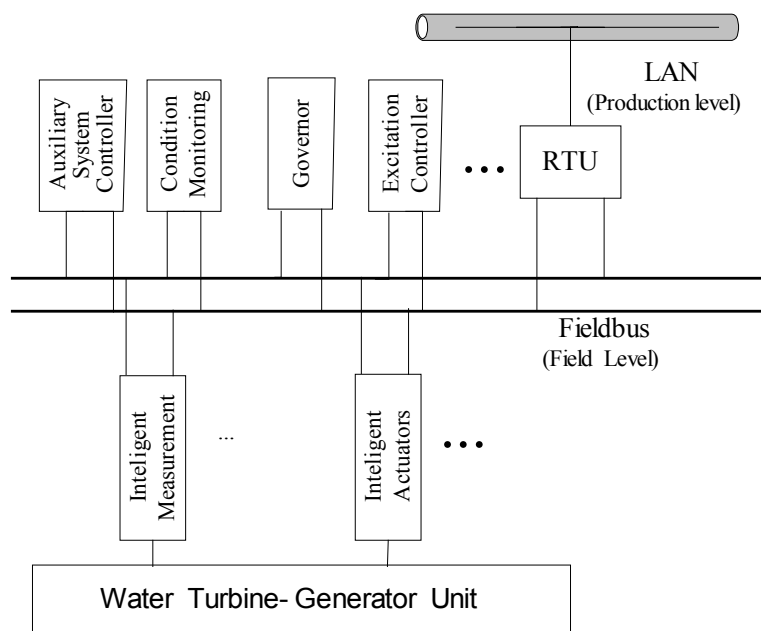

Fig. 20 FCS Based Automation System for Water Turbine-Generator Units

Fig. 20 is a FCS solution for the automation system of hydro generating unit. Intelligent devices, which are directly linked to the fieldbus, are used to measure all physical variables, such as pressures, temperatures, dispositions, vibrations, flow rates, current, voltage, frequency, etc. All the actuators, like hydraulic servo systems, driving motors, automatic valves, phase controllers, also are intelligent devices that conform to the fieldbus protocols.

Any controllers that need the physical variables obtain the information from the fieldbus, and they send the instructions to the actuators through fieldbus.

From the structural view, this system is really reliable and open. However, all the field devices must be intelligent and conform to the international standards, in order to realize a fully distributed FCS for the automation systems of hydro generating units. This is not an easy task that can be achieved by one step. The international standards on fieldbus (IEC61158) was passed and published in 2000 after 10 years hot debates. The products conform to this standard are under research and development. For very important production process like large scaled HGUs, the requirements for the reliability of their automation systems are very high. So a certain period is needed to test the product and make it mature.

How to apply both the advantages of FCS and the maturity of traditional field devices, and construct a field net for the automation systems of hydro power plants? To find a solution, HSAS (Hybrid Smart Automation System) is proposed in this paper.

3.5.2. HSAS (HYBRID SMART AUTOMATION SYSTEM) FOR HYDROELECTRIC GENERATING UNITS

Fig. 21 shows the architecture of HSAS (Hybrid Smart Automation System) for Water Turbine-Generator Units, which structure is between the hierarchical supervisory control systems and FCS.

The ICMMS should has following functions from the function integration view:

- **Control:** governing, excitation, turbine-generator operation automation, auxiliary system automation, etc.
- **Maintenance:** protection, condition monitoring and recording, operation zones limit, faults diagnosis, predictive maintenance, maintenance planning and scheduling, spare parts management, etc.

Technical Management: the integration and coordination between control and maintenance, efficiency monitoring, operation condition optimization, cost calculation, statistics and report for all kind of technical and economic indexes, operation log, staff shift scheduling and recording, etc.

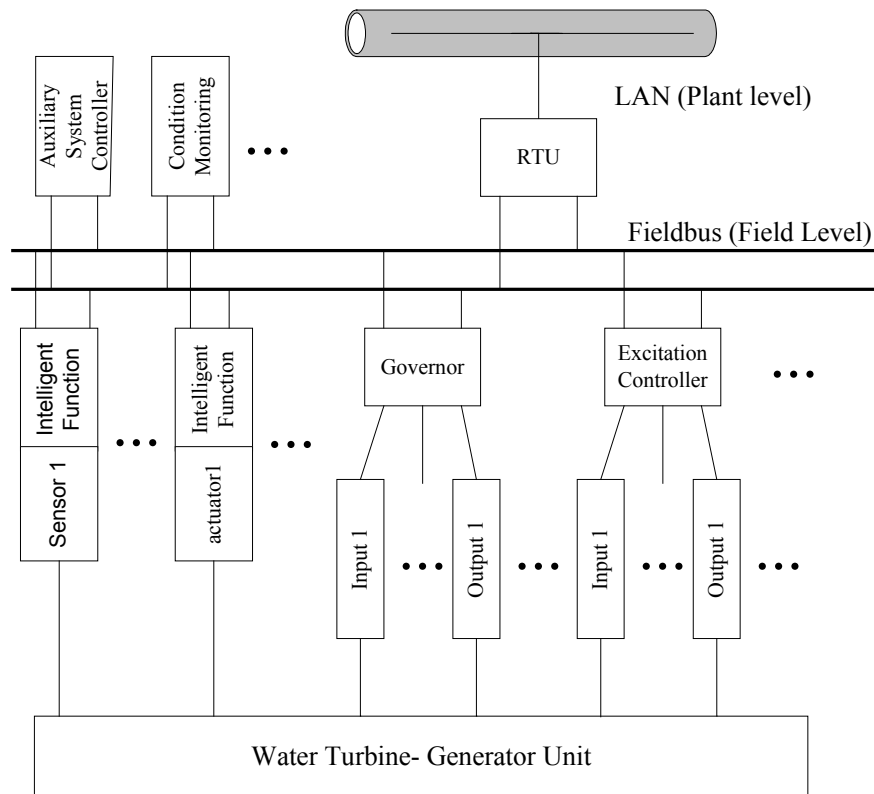

Fig.21 HSAS Based ICMMS for Water Turbine-Generator Unit

When there are no matured products available for some devices, the relevant traditional products can be modified into intelligent components to conform the fieldbus protocols through introducing the intelligent software and hardware interface modules. Then these intelligent components and other available intelligent field components can be connected and integrated into a fieldbus network. The word ‘Hybrid’ means some traditional and reliable devices, such as governor and excitation controllers, and the intelligent fieldbus complied components are integrated into a fieldbus based control system. Because the functions of HSAS are not restricted in the functions of conventional SCADA system, and include the maintenance and technical management domain, ‘smart automation system’ is used instead of ‘control system’.

For the conventional control devices, for example, turbine governors and excitation regulators, there are two ways to reconstruct them into Fieldbus complied intelligent devices:

A. To the governors that have been put into operation, reconstruction methods are:

- i. **Hardware:** developing and installing a communication adaptor.

- ii. **Software:** adding relevant communication modules in the governors. The information sent to the field net: rotating speed of the units, shift of servo mechanism, water head, turbine working conditions information, status information of governing systems, etc. The instruction information obtained from the field net by governors: set point of speed, set point for power output, startup or shutdown instructions (normal or emergency), increase or decrease the load, opening limit, setting control parameters, etc.
- B. For the newly designed governors for large scaled hydro generating units, redundant controllers structure is recommended (see Fig. 22). Both Controller A and Controller B have communication adaptors and load relevant communication programs. Here the fieldbus not only functions as communication media, but also provides a reliable and no shock switching over channel between the two controllers.

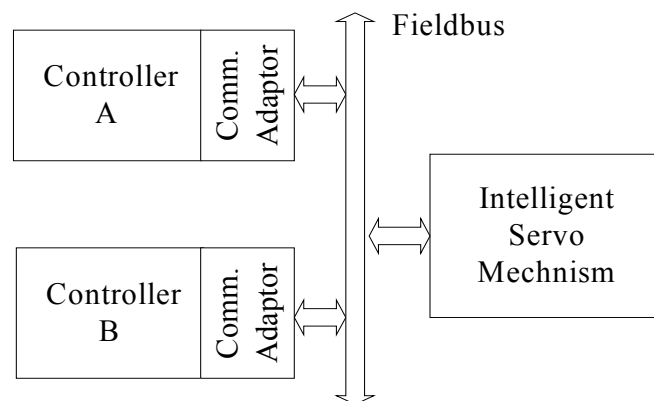

Fig.22 Connecting redundant governors to Fieldbus

The main features of HSAS shown in Fig. 21 are:

- Fully distributed Fieldbus architecture (FCS) is employed, which provides a very good foundation for system extension, upgrade, and reuse of the system components. This is a fundamental advancement to the traditional supervisory control systems.
- The well-tried traditional devices and technologies can be utilized. So HSAS is currently feasible in technology, requires only short period for the research and development, low cost, and easy to be accepted by users.
- Many intelligent components are formed through adding intelligent software (or

hardware) modules to traditional devices, and are, therefore easy to learn and use. The information from field is enriched and this provides very good foundation for maintenance and technical management.

- HSAS accords with the development trends for automation systems. In the future when some components need to be upgrade, only these components are replaced without changing the system structure. So the overall lifetime of the systems will be prolonged a great deal.
- When all traditional components in HSAS are replaced with fully distributed fieldbus components, HSAS will evolve into FCS. So the transition process towards FCS is smooth.

HSAS not only has fully distributed system structure of FCS and solves the problems of information exchange, but also is compatible with traditional supervisory control equipments (such as governors, regulators, measurement devices, etc.) and makes full use of available equipments and technologies. Currently this is feasible architecture for automation systems.

3.6 SUMMARY

- Current situation and existing problems in automation systems for hydro power plants are discussed. A type of ICMMS for HP is presented, and its functions are summarized.
- Based on fieldbus and IAM technologies, a FCS for hydroelectric generating units is presented.
- In consideration of both current technical feasibility and future development trends, Hybrid Smart Automation System (HSAS) is proposed. As an example, a HSAS solution for the automation systems of water turbine-generator units is presented.

Fieldbus based automation systems are the development trends for the future automation systems at field net level. But standards and technologies are in the growing up process at present, and fully distributed FCS is still being developed. Combining the traditional field devices with field bus technologies, HSAS may become a feasible system architecture for water turbine-generator units in recent period

CHAPTER 4: Performance evaluation methodologies for hydroelectric generating units

CHAPTER 4: PERFORMANCE EVALUATION METHODOLOGIES FOR HYDROELECTRIC GENERATING UNITS

"Les grands hommes font leur propre pedestal;
l'avenir se charge de la statue". --- Victor Hugo

大人物只做自己的宝座，而未来将铸成塑像。
——维克多●雨果

4.1 INTRODUCTION

In the technical management domain of ICMMS, the overall performance evaluation for the production process is a very important aspect. Through this function module, the production managers can understand the history and present states of the overall performance for each piece of equipment or the whole production process, and forecast the future trends. Therefore, this module is vital to help the managers mine the useful information from the “**exploded**” data “**ocean**”, and make right decisions for operation and maintenance scheduling at the right time.

To achieve above objectives, following conditions should be met:

- 1) The condition information and models for the equipment and process can be accessed by the technical management systems;
- 2) The performance evaluation criteria are correctly defined;
- 3) The performance evaluation methods are established.

Under the process oriented reference model of ICMMS proposed in Chapter 2, the validated condition information can be accessed through the production information databases, and the

models of the process or equipment can be accessed through the knowledge repository. So the condition 1) can be met.

Condition 2) and 3) haven't been satisfied yet. There are very few researches on the performance evaluation methodologies available for the hydropower plants. Prof. Ye proposed an integral criterion for appraising the overall quality of a computer-based hydro turbine governing system [Ye et al. 1995]. However, until now there haven't been reports on the overall performance evaluation criteria and methodologies for the whole hydropower generating process.

HGUs (Hydroelectric Generating Units) are the main pieces of equipment in a hydropower plant, and their performances play the vital role for the whole plant. As the original research in the field of overall performance evaluation for hydropower plants, this chapter selects the HGUs as the objects to be studied. The objectives of this chapter are:

- a) Define the problems of studying in the performance evaluations for the hydropower plants;
- b) Propose the criteria and methodologies for evaluating the overall performance of the HGUs;
- c) Taking the economic performance of the HGUs as an example to validate the methodologies;
- d) Based on the economic performance evaluation methodologies, propose a new maintenance strategy: EBM (Economic performance Based Maintenance) and illustrate its effectiveness.

Nomenclature

ΔH	Total hydraulic losses of the hydraulic system, m
CEM	Criterion of Efficiency Maintenance
COE	Criterion of Operation Efficiency
g	local gravity acceleration, varies from different geographic locations. Its standard value is 9.81 m/s^2
H	gross head of the HGU at t , m
P_o	power output to the electric power system, kw
Q	Total inflow at t , m^3/s
η_g	efficiency of generator
η_{ga}	actual efficiency of the generator
η_{gd}	designed efficiency of generator;
η_{ta}	efficiency that considers the energy losses in the penstock, electricity and water used inside the plant currently
η_{td}	designed efficiency that considers the energy losses in the penstock, electricity and water used inside the plant
η_s	overall efficiency of HGU
η_{si}	ideal efficiency of HGU
η_{so}	operational efficiency of HGU
η_{sr}	reachable efficiency of HGU
η_t	efficiency of turbine
η_{ta}	actual efficiency of the turbine under current conditions
η_{td}	designed efficiency of turbine
ρ	density of flow, for clean water, $\rho = 1000 \text{ Kg/m}^3$

4.2 THE CRITERIA AND METHODS TO EVALUATE THE OVERALL PERFORMANCE OF HGUS

To measure or evaluate something, firstly the indexes, methods, criteria, etc. should be stated clearly.

4.2.1 THE COMPREHENSIVE PERFORMANCE EVALUATION INDEXES IN THE LIFECYCLE OF HGU

According to GERAM, the life-cycle for any enterprise or any of its entities can be divided into 7 phases: Identification, Concept, Requirement, Design, Implementation, Operation, and Decommissioning [IFIP-IFAC Task Force 1999]. As for the HGU, its lifecycle can be divided into Requirement, Design, Installation, Operation and maintenance, and Decommissioning. The inherent characters of an HGU are decided in the first two phases, while installation, operation and maintenance are the determinant factors for the actual characteristics evolvement and the lifetime. Decommissioning phase includes the activities like recycling, preservation, transfer, disbanding, disassembly, or disposal of whole or parts of the HGU at the end of its useful life in operation. Fig. 23 Show the entity lifecycle in GERA.

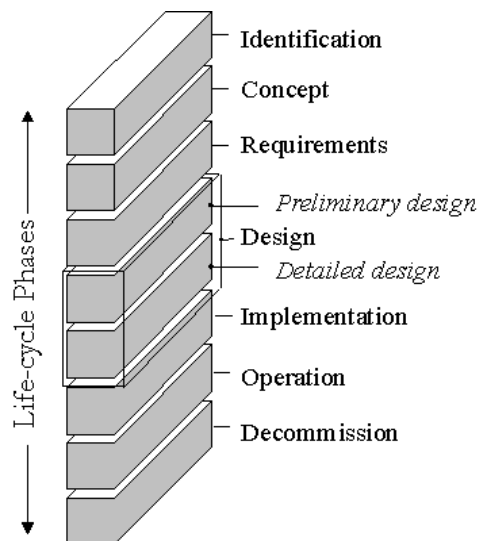

Fig. 23 GERA Life-cycle phases for any enterprise or entity [IFIP-IFAC Task Force 1999]

In the ICMMS reference model for hydropower plant proposed in chapter 2, the performance evaluation modules belong to the technical management domains (Fig. 15). These modules should be based on the hydroelectric generating process models.

It's very useful for automation, operation and maintenance to describe and evaluate this process of changing in depth. The installation, operation and maintenance are selected as the study phase for performance evaluation in this paper. To evaluate the characteristics (mainly includes energy, cavitation, stability, etc.) of the HGU, three types of indexes are proposed in this paper: Ideal Performance Indexes J_i , Reachable Performance Indexes J_r and Operational Performance Indexes J_o .

Definition 1: The **Ideal Performance Indexes** of HGU J_i are the designed performance indexes that should be reached while the new HGU is put into use, and all the designed conditions are satisfied.

They are the optimal characteristics of a new HGU, and the main references for SAT (Site Acceptance Test) to assess the quality of designing, manufacturing, installing, and adjusting. These indexes can be calculated from the model characteristics provided by the manufacturer, the actual hydraulic, electric and mechanic parameters of the hydropower plant.

Definition 2: The **Reachable Performance Indexes** of HGU J_r are the maximum performance indexes when the HGU in the operation during certain period.

These types of indexes reflect the actual performance state of the HGU. On the one hand, the indexes evolve over the operating time increases. On the other hand, they represent the maintenance state of the HGU to some degree. Through maintenance actions, the reachable indexes can be restored totally or partially to the ideal performance state. J_r can be obtained through online monitoring from the automation system of the HGU, or scheduled performance field-testing.

Definition 3: The **Operational Performance Indexes** of HGU J_o are the actual performance indexes when the HGU operates during certain period.

This category of indexes reflects the actual operation management level of the HGU. They can be calculated from the operational log data of the HGU.

Obviously, $J_i \geq J_r \geq J_o$

4.2.2 THE PERFORMANCE INDEX MATRIX AND OVERALL PERFORMANCE INDEXES OF HGUS

The overall performance of a HGU generally includes following aspects:

➤ From the technical point view: Safety, Economic, Stability, Reliability, Quality (of the

product), etc.

- From the states view: Ideal Performance, Reachable Performance r and Operational Performance.

From these two aspects, the overall performance index matrix can be establish, which is shown in Table 3.

Table 3 The performance index matrix for HGU

Views States	Safety	Economic	Reliability	Quality	Stability	J_{ov}
Ideal	$J(1,1)$	$J(1,2)$	$J(1,3)$	$J(1,4)$	$J(1,5)$	J_i
	$W(1)$	$W(2)$	$W(3)$	$W(4)$	$W(5)$	
Reachable	$J(2,1)$	$J(2,2)$	$J(2,3)$	$J(2,4)$	$J(2,5)$	J_r
	$W(1)$	$W(2)$	$W(3)$	$W(4)$	$W(5)$	
Operational	$J(3,1)$	$J(3,2)$	$J(3,2)$	$J(3,4)$	$J(3,5)$	J_o
	$W(1)$	$W(2)$	$W(3)$	$W(4)$	$W(5)$	

Here, the value of the matrix elements $J(m,n)$ may be the accurate numbers or fuzzy logic defined numbers.

In this table, the meaning of rows has been defined, which represent the states of the HGU. The columns represent the technical views, could be any aspects that are interesting to the managers. In table 3, the author listed five interesting aspects: Safety, Economic, Stability, Reliability, Quality, but other compositions are also possible. Take the turbine as an example; its performance may be measured through three aspects: energy indexes (efficiency, output power etc.), stability indexes (vibration, swing, pressure pulsation etc.), and cavitation indexes, etc.

Definition 4 The Overall Performance Indexes Vector of HGU J_{ov} is defined as:

$$J_{OV} = \begin{bmatrix} J_i \\ J_r \\ J_o \end{bmatrix} = J \bullet W \quad (4.1)$$

Matrix W is the weight Vector:
$$\sum_{i=1}^5 W(i)=1 \quad (4.2)$$

By comparing and analyzing these indexes, the overall performance of HGU can be evaluated. If the long time data and documentary records of the indexes are accumulated, the evolvement process of the performance can be presented. These are very helpful for the long time planning for the operation and maintenance of the power plants.

4.3 THE ECONOMIC PERFORMANCE CRITERIA AND EVALUATING METHOD FOR HGUS

4.3.1 THE IMPORTANCE RELATED TECHNOLOGIES OF ECONOMIC PERFORMANCE FOR HGUS

Hydroelectric power generating is a clean, renewable, and economic way of energy production. Every single kwh of hydropower makes sense, because this means a bit reduction of fossil or nuclear fuel burning. The hydraulic energy is a valuable natural resource, and heightening the efficiency of hydropower production is a long-term goal in the field of hydropower engineering because it greatly contributes to the economy and environment. Usually the rated efficiency of a large generator is above 98%, the efficiency of the water turbine is the key element to the overall efficiency of an HGU. A study on a hydropower plant in Malaysia shows that one percent turbine efficiency improvement can bring 1.25% increased earnings of the whole power plant [AL-Zubaidy 1997].

In the past, the economic efficiency of hydro power plants did not receive enough attention because of the price of the hydro electric power, load dispatching, partial interest, and development history, etc. There is great potential in it. Recent years the deregulated electric power market has been the trends in China and abroad. Under the electric power market, the price for hydropower will increase to a reasonable level, and utilization efficiency for hydraulic energy will be increasingly important to the hydro power plants that operate as independent power generating companies.

Measuring the large flow has been the main technical barrier for the online monitoring of the efficiency of HGU. Fortunately, there have been some big progresses in this field and the efficiency measurement for prototype water turbine becomes increasingly popular [Zheng 1997] [Liu 200]. The online efficiency monitoring has been a feasible technology.

There are mainly three categories of factors that influence the economic efficiency of an

HGU:

- a) It is the fundamental factor for the high efficiency of the whole power plant that a water turbine with high efficiency is selected according to the real hydraulic conditions during the design phase.
- b) After the HGU is put into use, the operation conditions and health state are very important factors influencing the real efficiency of the unit.
- c) The reliability and maintenance spending also play important roles on the economic interest of the plant.

Usually the factors of the first category are given a lot of thought, while the rest two categories haven't been considered highly enough. There haven't been comprehensive methods and quantitative index systems to assess the economic performance through the lifecycle of the HGU from the viewpoint of engineering economics.

As the complexity of automation systems increases, it becomes increasingly difficult to exchange information, coordinate the functions, and standardize the systems. Intelligent Control Maintenance and technical Management System (ICMMS) is the development trend to solve these problems [Morel 1996][Ye 1995][Ye 2000][Yu 2001]. Under the ICMMS integration framework, the HGU performance evaluation system is a vital part of technical management subsystem and plays an important role on the integration of the whole ICMMS.

Therefore, an economic performance evaluation method for HGU is proposed in this paper. In part 2, several new concepts are proposed and defined, the qualitative indexes and criteria for evaluating the performance of HGUs are constructed, and corresponding formulae are presented. Analyzing and calculating method based on these indices is described. The performance evaluation process of this method is illustrated through a real case study in part 3, and part 4 is the summary and prospect of this method.

4.3.2. THE ESTABLISHMENT OF THE ECONOMIC PERFORMANCE INDEX SYSTEM AND EVALUATION CRITERIA

For thermal power generating units, their economic performance is measured through 'coal consume per kwh' or 'heat rate' [Yang 2000], while there are few criteria to assess the economic performance of HGU in a standard way. Comparing with the thermal power units, HGU has following features in economic performance:

- Hydraulic energy is not only related to the volume of water flow, but also depends on water head, density and gravity acceleration of the site.
- The efficiency, vibration, cavitation and other characteristics of HGU change evidently under different water heads.
- The HGU of large capacity is often responsible for the peak load and frequency regulation in an electric power system, so its load variation scope is large and its startup and shutdown processes appear frequently.

It's not sufficient to measure the economic performance of the HGU if only the “volume of water consumed per kwh” is used. Therefore, the authors propose an index system and criteria to assess the economic performance of HGU.

Energy performance is the direct index to measure the economic benefits of the HGU, and is selected as an example to illustrate the method and indexes system proposed by this paper. Thus, the energy conversion process is analyzed in the following section.

4.3.3 THE ENERGY FLOW ANALYSIS FOR HGU

Fig. 24 shows the diagram of energy flow of an HGU with single penstock. From this diagram, the function of each piece of pertinent equipment in the energy flow can be seen clearly. The energy flow analysis is an effective means to assess the efficiency characteristics and actual operational management, analyze in depth the effect of each components on the overall efficiency of the HGU, and define the proper technical management mechanism.

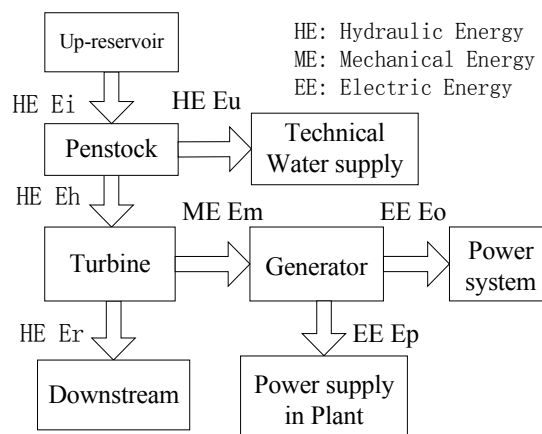

Fig. 24 Energy flow of an HGU

In Fig. 24, E_i (Joule) is the water energy inputted to HGU during the period from t_1 to t_2 .

$$Ei = \int_{t1}^{t2} g \rho H Q dt \quad (4.3)$$

E_u is the hydraulic energy lost due to the technical water supply system (such as the water supply for cooling, guibearing, fire fighting, etc.) for the HGU. Q_u is the flow, ΔH_{ps} represents the hydraulic loses in the penstock, then:

$$E_u = \int_{t1}^{t2} g \rho (H - \Delta H_{ps}) Q_u dt \quad (4.4)$$

E_h : the hydraulic energy flowed into the turbine from $t1$ to $t2$; Q_t is the flow rate of turbine,

$$Q_t = Q - Q_u \quad (4.5)$$

$$E_h = \int_{t1}^{t2} g \rho (H - \Delta H_{ps}) Q_t dt \quad (4.6)$$

E_r : the remained energy after the water flow out from the draft tube during the time from $t1$ to $t2$.

E_o : the output electric energy of the HGU from $t1$ to $t2$.

$$E_o = 1000 \int_{t1}^{t2} P_o dt \quad (4.7)$$

E_p : the electric energy used by the power plant from $t1$ to $t2$. This includes the electric power consumed by the auxiliary systems especially for the HGU and the share of this unit in the common systems of the power plant.

E_m : the mechanical energy that turbine transferred to the generator from $t1$ to $t2$.

$$E_m = E_h - E_r = \int_{t1}^{t2} g \rho \eta_t (H - \Delta H) Q_t dt \quad (4.8)$$

$E_o + E_p$ is the electric energy output by the generator.

$$E_o + E_p = \int_{t1}^{t2} g \rho \eta_t \eta_g (H - \Delta H) Q_t dt \quad (4.9)$$

Here η_g is related to the load and the power factor. Nevertheless, it changes moderately in the common operating zones and is usually treated as a constant.

4.3.4 THE OVERALL EFFICIENCY OF AN HGU η_s

Definition 5: During the period (from $t1$ to $t2$), the **overall efficiency** of the HGU η_s is defined as the ratio between electric energy outputted to the power system and the hydraulic energy used by the HGU during this period time

$$\eta_s = \frac{E_o}{E_i} = \frac{1000 \int_{t1}^{t2} P_o dt}{\int_{t1}^{t2} g \rho Q H dt} \quad (4.10)$$

P_o , H are the conventional monitoring parameters of a modern hydropower plant, so measurement of Q is the key to calculate η_s . Measuring the large fluid flow has been a difficult problem. However, there have been some big progresses in recent years. Currently there are mainly the following methods to measure the flow rate in hydropower plants:

- Using velocity meters;
- Water hammer method;
- Ultrasonic flow measurement;
- Measuring the differential pressure in the spiral casing;
- Thermodynamic methods.

Among these methods, the ultrasonic and differential pressure methods can be used for real-time monitoring purpose. So it can be seen that online measuring and calculating η_s have been the feasible technologies today.

The ultimate goal of an HGU is to convert the hydraulic energy into electrical energy. η_s reflects the real efficiency of this conversion process. It also implies the quality of operation management, maintenance organization and so on. Thus, it may be employed as an index for assessing the technical economic benefit of an HGU.

4.3.5 IDEAL EFFICIENCY OF HGU: η_{si}

Based on definition 1 and 5, an ideal energy performance index can be inferred: **Ideal Efficiency** of HGU η_{si} . It can be defined as the optimal overall efficiency of the HGU under certain conditions (such as water head), when the HGU and its auxiliary equipment and facilities are in the designed status.

$$\eta_{si} = \text{Max} \left(\frac{\int_{t1}^{t2} \eta_{td} \eta_{gd} \eta_{ld} g \rho Q H dt}{\int_{t1}^{t2} g \rho Q H dt} \right) \quad (4.11)$$

When the water head of the plant is constant, the ideal efficiency of an HGU appears on certain steady operating points.

$$\eta_{si} = \eta_{tdx} \eta_{gdx} \eta_{ldx} \quad (4.12)$$

Here, η_{tdx} , η_{gdx} , η_{ldx} are the efficiencies on this steady operation point.

It should be mentioned that the optimal efficiencies of turbine, generator, hydraulic system, etc. are never in the same operation point, so the ideal efficiency of the HGU must be less than the product of the maximum efficiencies of the HGU components. This conclusion is consistent with the calculation results of the case followed ahead.

4.3.6 REACHABLE EFFICIENCY OF HGU η_{sr}

From definition 2 and 5, a reachable energy performance index can be inferred: **Reachable Efficiency** of HGU η_{sr} . It can be defined as the maximum overall efficiency of the HGU under certain conditions (such as water head), when the HGU and its auxiliary equipment and facilities are in current status.

$$\eta_{sr} = \text{Max} \left(\frac{\int_{t_1}^{t_2} \eta_{ta} \eta_{ga} \eta_{la} g \rho Q H dt}{\int_{t_1}^{t_2} g \rho Q H dt} \right) \quad (4.13)$$

Similarly, when the water head of the plant is constant, the reachable efficiency of an HGU appears on certain steady operation point.

$$\eta_{sr} = \eta_{tao} \eta_{gao} \eta_{lao} \quad (4.14)$$

Here, η_{tao} , η_{gao} , η_{lao} are the efficiencies on this steady operation point.

4.3.7 OPERATIONAL EFFICIENCY OF HGU η_{so}

From definition 3 and 5, **Operational Efficiency** η_{so} , an operational energy index of an HGU can be defined:

$$\eta_{so} = \frac{\int_{t_1}^{t_2} \eta_{to} \eta_{go} \eta_{lo} g \rho Q H dt}{\int_{t_1}^{t_2} g \rho Q H dt} \quad (4.15)$$

η_{to} , η_{go} are the efficiencies of hydro turbine, generator at t . η_{lo} is the generating efficiency that considers the hydraulic losses in the hydraulic system, electricity used inside the plant and technical water supply system. In real operation situation, the operation point of the HGU is time varying, so η_{so} is the weighted average from t_1 to t_2 .

4.3.8 THE ECONOMIC EVALUATION CRITERIA FOR THE MAINTENANCE AND OPERATION MANAGEMENT OF HGU

Criterion 1: the **Criterion of Efficiency Maintenance (CEM)** is defined as the ratio of Reachable Efficiency η_{sr} and Ideal Efficiency of HGU η_{si} in certain evaluating period (may be a day, a month, or a year). Higher **CEM** indicates higher maintenance level.

$$CEM = \frac{\eta_{sr}}{\eta_{si}} \quad (4.16)$$

Obviously, $0 < CEM \leq 1$. **CEM** represents the nearness of the currently reachable efficiency and the ideal efficiency. It reflects the maintenance state of an HGU from the viewpoint of efficiency. Using **CEM**, the economic benefit losses caused by the performance degradation of an HGU can be figured out, thus it provides the decision-making support for refurbishment and maintenance planning of HGU.

Criterion 2: the **Criterion of Operation Efficiency (COE)** is defined as the ratio of Operational Efficiency η_{so} and the Reachable Efficiency η_{sr} of an HGU in certain evaluating period. Higher **COE** indicates higher operation management level.

$$COE = \frac{\eta_{so}}{\eta_{sr}} \quad (4.17)$$

Similarly, $0 < COE \leq 1$. This criterion reflects difference between the real and reachable efficiency levels of operation scheduling and management. It can be used to calculate the electric power losses due to the operation management, and to assess the potential economic benefits for improving operation management.

4.4 IMPLEMENTATION OF THE ECONOMIC PERFORMANCE EVALUATION FOR HGUS

To show the implementation of the proposed economic evaluation methods, two schemes are presented in this section: the economic performance evaluation module under the ICMMS reference models, and special software that can work with conventional automation systems for the hydropower plants.

4.4.1 THE IMPLEMENTATION SCHEME UNDER ICMMS REFERENCE MODELS

From the reference model proposed in chapter 2, the economic performance can be realized

with a module in the technical domain of the ICMMS. Fig. 25 shows the functions and the objects that interact with the module.

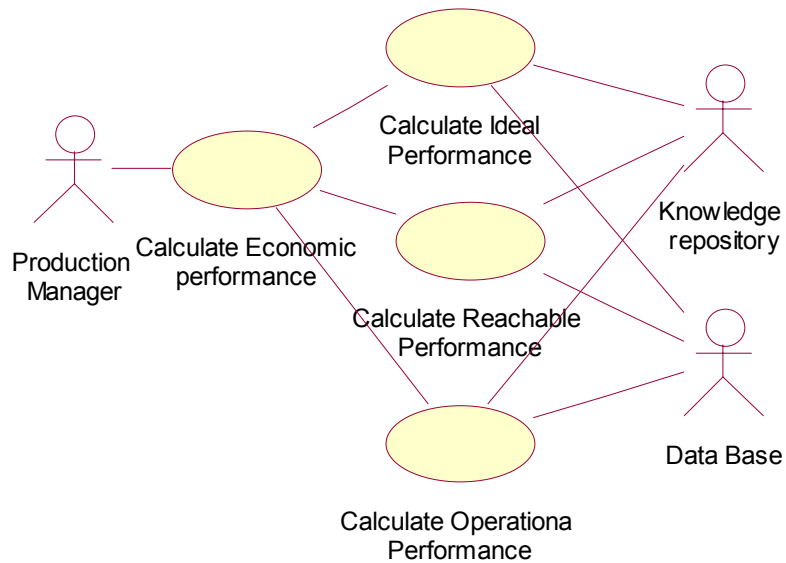

Fig. 25 UML use case for the economic evaluation module under ICMMS reference modules

4.4.2 AN ECONOMIC PERFORMANCE EVALUATION SYSTEM AND TESTING RESULTS

Based on above-mentioned index and criterion system, an economic performance evaluation system for HGU is constructed in this paper. Fig. 26 is the architecture of this system. To explain the principles of the system, a case study for energy performance evaluation is illustrated below. Table 4 shows the essential parameters of the No.1 HGU of a hydropower plant on the Yellow River in China.

Table 4 Essential parameters of an HGU

Turbine type	Generator output	Rated turbine output	Rated flow	Rated head	Maximum head	Minimum head
Francis HL240-LJ-410	45MW	45.36MW	138m ³ /s	38m	39.5m	37m

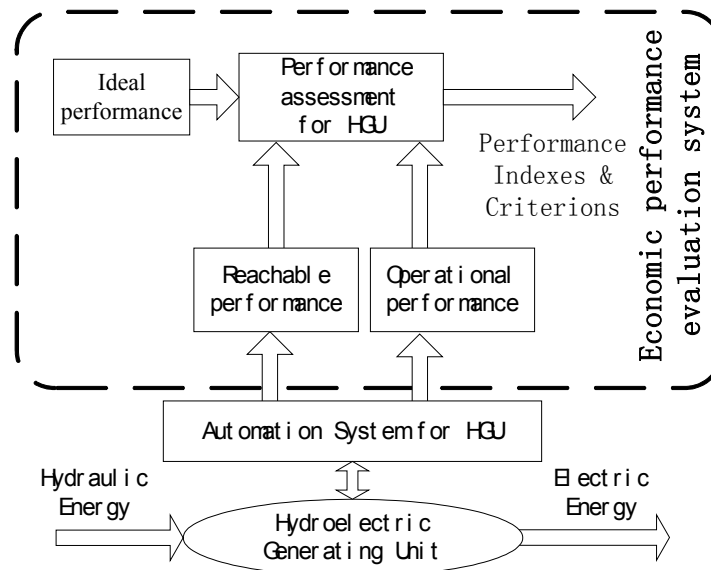

Fig. 26 Performance evaluation system for HGU

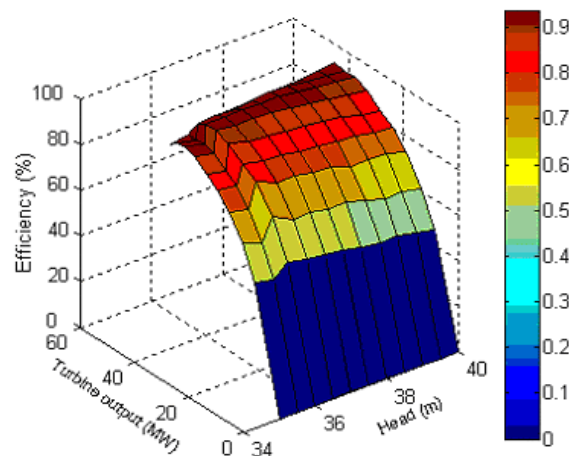

Fig. 27 Designed efficiency characteristic of the prototype turbine

This HGU was put into use in 1966. The designed efficiency surface is shown in Fig. 27. When the overhaul was completed in February 1998, a field test was carried out. Then other two field tests followed in April 2000 and October 2000, respectively. These three field tests were carried out under the same condition and with the same method, so they have the comparability. Fig. 28 shows the designed efficiency curve and the efficiency curves of the three tests under water head of 38 m. According to the real situation of the power plant and the reservoir, this hydraulic turbine usually operates around this water head. Fig. 29 shows a typical daily load diagram of this HGU.

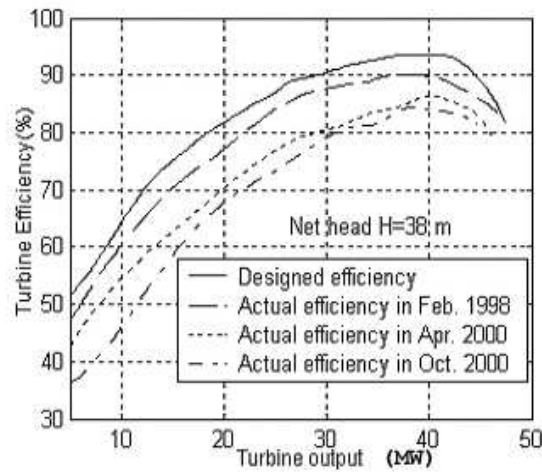

Fig. 28 The Actual Efficiency Evolvement of the Turbine

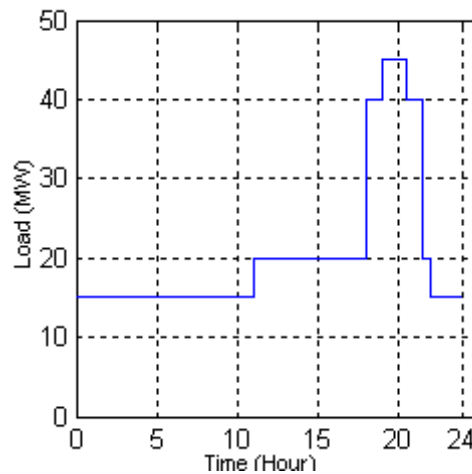

Fig. 29 A typical daily load diagram

According to above-mentioned method, a *Matlab*[®]-based program is developed. The economic performance evaluation results for this HGU were listed in Table 5.

Table 5 the calculation results of performance evaluation

	Electric Energy Output (MWH)	Hydraulic Energy (MWH)	Water (Mm ³)	η_{si} (%)	η_{sr} (%)	η_{so} (%)	CEM	COE
Design(1966)	492.5	648.9283	6.2156	86.99	86.99	75.89	1	0.8724
Feb. 1998	492.5	668.5059	6.4021	86.99	85.43	73.67	0.9821	0.8623
Apr. 2000	492.5	731.4000	6.9998	86.99	81.91	67.34	0.9416	0.8221
Oct. 2000	492.5	762.8796	7.2963	86.99	79.93	64.56	0.9188	0.8077

Cause the electric power used and the technical water supply inside the plant change very

little when the load of an HGU changes, those two factors are omitted in this case; therefore these calculation results are precise enough to represent the real state.

From results shown in Table 5, following conclusions can be reached for the economic performance of this HGU, from operational, maintenance, and designed aspects.

- The overall efficiency of the HGU on this day was far below (more than 10%) its reachable efficiency, that is to say the *COE* was rather low. The reason was that the HGU operated under the low efficiency for long time. Through optimizing the load scheduling, there was big efficiency potential to be improved. The production manager should inform the operator to improve the load scheduling.
- *CEM* reflected the difference between the reachable efficiency and the ideal efficiency of the HGU, and it had no direct link to the operation conditions. In 1966 when the HGU was put into use, *CEM* was around 1. *CEM* of this unit was recovered to 0.98 when a overhaul was completed in February 1998. Then *CEM* decreased gradually as the operation hours increased. If the long term *CEM* is recorded, and taking into account the price of the runner and the spends for an overhaul, then the reliable qualitative economic decision can be made for the repair and refurbishment of the turbine or generator. This is very important for CBM (Condition Based Maintenance). Based on this ideal, a new maintenance strategy, EBM (Economic performance Based Maintenance) is proposed in the next section of this chapter.
- In the energy flow model, the hydraulic loses in the penstock was taken into account, so the peak efficiency of the HGU and the peak efficiency of the turbine do not appear at the same operating point, especially for the long penstock or long tail water system. Because the linear hydraulic loses is proportional to the square of flow rate. In AGC (Automatic Generation Control) or economic optimal load dispatching software, the hydraulic loses must be modelled by the function of flow rate. This principle is very easily omitted by many engineers and operators in hydropower plants. If the automation systems of the hydropower plant are based on the ICMMS reference models proposed in Chapter 2, and all the components inside the ICMMS share the same process models (including the energy flow models), than this factor can be taken into account spontaneously.

4.5 A NEW MAINTENANCE STRATEGY: EBM (ECONOMIC PERFORMANCE BASED MAINTENANCE)

Lacking the links with the economic performance of the equipment is a major obstacle for disseminating some advanced maintenance strategies in industries. In this chapter, a new maintenance strategy, EBM (Economic performance Based Maintenance), is proposed under the ICMMS reference model. In EBM, the role of economic performance is paid special attentions through economic efficiency evaluation, cost-benefits analysis, operation and maintenance performance evaluation, and other means. Concrete data from two large scale HPs (Hydropower Plants) are analyzed to show the usages of EBM.

4.5.1 INTRODUCTION

According to a survey and review conducted by an IEEE/PES Task Force [IEEE/PES 2001], “Maintenance at fixed interval is the most frequently used approach, often augmented by additional corrections. Newer “as needed”-type methods, such as RCM, are increasingly considered for application in North America, but methods based on mathematical models are hardly ever used or even considered...”. What obstacles hindered the wide application of the advanced maintenance strategies in the industry? The authors agreed with the opinions of Chris Staller [Staller 1999] and Darren Witherwick [Witherwick 1999], Jean-Baptiste Leger [Leger 1999], and Luqing Ye [Ye et al. 2000], that there are two categories of reasons:

- Three main functional domains of the industry automation systems: Control, Maintenance, and technical Management, are isolated islands, and lack of communication and coordination;
- There are very few operational evaluation methods to assess the economic aspects of equipment and its maintenance activities, such as the operating efficiency performance, maintenance costs and its economic return analysis. As Chris Staller said: “a Condition Monitoring Program cannot become a successful Condition Based Maintenance practice unless the links to the operation are made and the financial metrics determined”[Staller 1999].

To the problems of the first category, an integrated system ICMMS was proposed to integrate the three islands and make them work together in harmony [Leger 1999][Ye et al 2000][Morel et al. 1996][Yu et al. 2001].

For the problems of the second category, some new maintenance strategies have considered the financial factors to some extent. In TPM (Total Productivity Maintenance) [Shirose 1992][Li 2000], and CEM (Cost Effective Maintenance) [Li 1999], some economic factors are taken into account even though not adequate. Those strategies are established for the manufacturing industries, and some of the concepts and approach can be applied in the maintenance for process industries.

However, the process industries have their own characters, compare with the manufacturing sectors. For example, the efficiency of some key equipment plays a significant role in the overall economic and social benefits for many process industrial companies, such as power generation industry, petrochemical industry, metallurgical industry, etc. There haven't been any concrete maintenance approaches to meet this requirement.

To fill this gap, EBM is proposed under the framework of ICMMS. This strategy is the extension of the CEM, its principal ideals are

- The maintenance decision and scheduling should be based on their coupling relations with control and technical management domains under the framework of ICMMS.
- The ultimate goal of the any activities of a company, including maintenance, is to maximize the economic and social benefits of company. The economic aspects related to the efficiency of the equipment, which is paid little attention, should be taken into account.

When the efficiency of the equipment decreased, and this incurred economic loss is higher than the cost for the maintenance actions (minor maintenance, overhaul, or retrofitting), the maintenance action should be taken even when there are no fault or security threads. This is a fundamental feature that EBM differs from other maintenance strategies, which are based on the fault diagnosis and prognosis.

4.5.2 EBM IN ICMMS

EBM is similar to CEM in which they consider the economic cost and benefits. The unique feature of EBM, compare to other maintenance strategies, indwells the linkages of the maintenance with the operation through economic performance.

The objectives of maintenance strategies are to maintain the equipment in high reliability,

availability, longevity, low maintenance cost, ... But there is no maintenance strategy in which links the maintenance activity with the operation efficiency of the equipment, and integrate these links with the overall economic performance of the plant.

Despite the cost and effective analysis of maintenance in CEM, the economic losses due to efficiency decrease are considered in EBM. When the efficiency of the equipment decreased, and this incurred economic loss is higher than the cost for the maintenance actions (minor maintenance, overhaul, or retrofitting), then the maintenance action should be taken even when there are no fault or security threads.

The main modules that may be used by EMB include: Online or offline monitoring & evaluating of the technical and economic efficiency of the equipment; Calculating the economic losses incurred by the efficiency degradation according to operation logs; Calculating and analyzing the cost of any possible maintenance actions for the efficiency uplifting; Analyzing the constraints to the maintenance from the point of view of control and technical management systems; and Maintenance decision-making and scheduling module.

Fig. 30 is the use case of an EBM subsystem under ICMMS, in which shows the function blocks of EBM and relations of them.

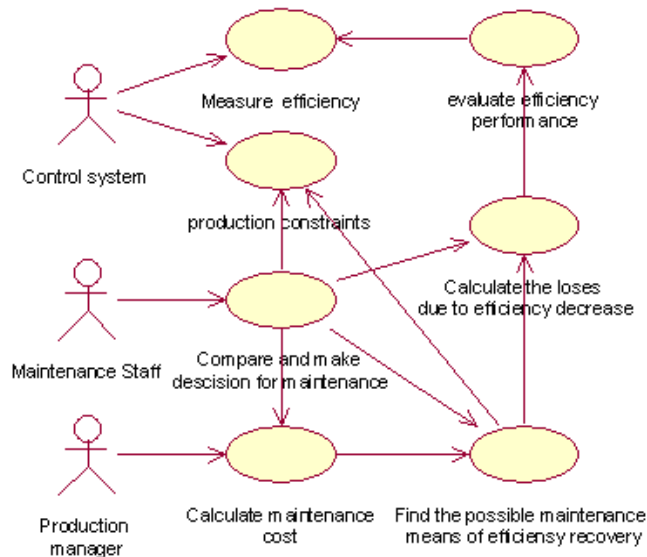

Fig. 30 Use case of an EBM subsystem under ICMMS

Fig. 31 shows the sequence reaction diagram of EBM under ICMMS. From this diagram, the sequence of reactions and communications among EBM modules are clearly displayed.

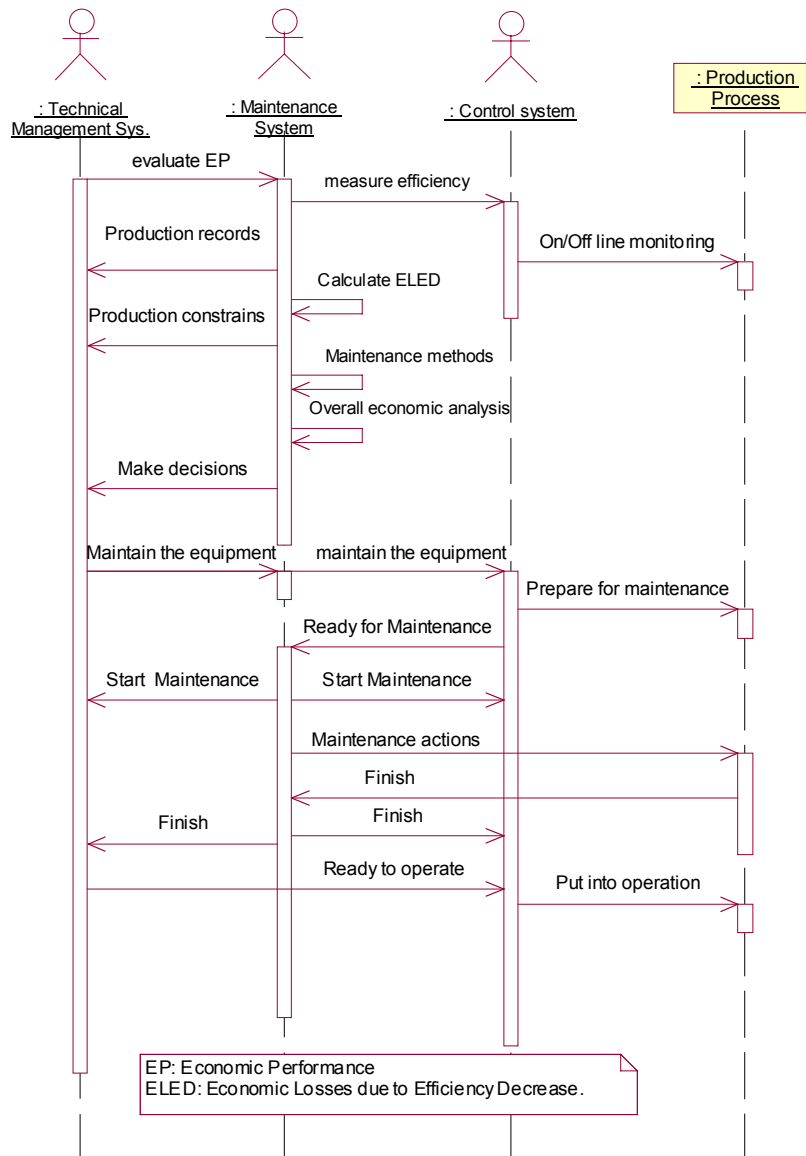

Fig. 31 Sequence reaction diagram of EBM under ICMMS

4.5.3 THE EFFECTIVENESS OF EBM FOR HYDROPOWER PLANTS

The effectiveness of EBM lies in the idea that improve the overall economic benefits of the hydropower generating process through evaluate the overall economic performance of the HGU and related maintenance and operation costs.

From the case described in section 4.4.2 of this chapter, the overall economic efficiency can be analyzed based on the evaluation results.

- Operation aspects: The overall efficiency of the HGU on this typical day was far below (more than 10%) its reachable efficiency, that is to say the *COE* was rather low. The reason was that the HGU operated under the low efficiency for long time. Through optimizing the load scheduling, there was a big efficiency potential to be improved.
- Maintenance Aspects: *CEM* reflected the difference between the reachable efficiency and the ideal efficiency of the HGU, and it had no direct link to the operation conditions. In 1966 when the HGU was put into use, *CEM* was around 1. *CEM* of this unit was recovered to 0.98 when an overhaul was completed in February 1998. Then *CEM* decreased gradually as the operation hours increased.
- Maintenance action to improve the economic efficiency and related costs:
 - a) Overhaul, the efficiency can be reached no more than the levels in 1998, 2-4% improvement (Fig. 27). Each overhaul costs 900, 000 RMB.
 - b) Replace the turbine runner with a new one made of stainless steel. The present technology can ensure the maximum efficiency 94.9%, almost 9% higher than the efficiency in Oct. 2000. Also, will enlarge the output to 50MW, and improve the anti-cavitation and anti-abrasion capabilities and sharply decrease the maintenance costs. Costs of this action: around 4 million RMB.

Through the economic analysis, a refurbishment maintenance decision was made at the end of 2000. In 2001, a new turbine runner replaced the old one. This maintenance cost can be returned within two years. Apparently, this maintenance action is very successful.

The efficiency improvement is very large through replacing the runner in this example. In fact, the optimal runner refurbishment should have been taken long time ago when the economic loss due to the efficiency decrease reached the critical point. In this case, the replacement of the runner should have been taken far before the end of 2000 to avoid extra efficiency losses and maintenance cost. However, this decision should be supported by the condition monitoring, economic performance evaluating, and EBM decision-making modules. Long time monitoring data is also necessary to make the right decision at the right time.

This case is another good example to prove that the maintenance should be integrated with the control and technical management systems.

4.6 SUMMARY

As automation systems bring us more useful information of the production processes, they also may give use too many technical data that are difficult to understand even for experts. How to mine the useful information of the production process from this “data ocean” is a very practical problem. The author proposes a methodology to mine the overall performance information for the production managers in the hydropower plants. Main contributions of this chapter can be summarized:

- a) Based on the analysis of the current situations, the problems for the performance evaluation for hydropower plants are picked up and abstracted from the academic and engineering viewpoints. Thus open a new research field in the automation system engineering for hydropower plants;
- b) Some important concepts for the performance evaluation on HGUs, such as Ideal Performance, Reachable Performance, Operational Performance, Overall Efficiency, Index of Efficiency Maintenance, Index of Operational Efficiency, are proposed and defined.
- c) Based on the analysis of the energy flow of an HGU, a method and related formulas to calculate the energy indexes of the unit are presented. A method and corresponding indexes and criteria to assess the economic performance for HGU are proposed in this paper. Through the energy flow models of the HGU, the formulae and method to calculate the energy indexes are presented. The efficiency state, the level of operation management, and the maintenance state of an HGU can be measured through these qualitative indexes. A real test case illustrated effectiveness of the method.
- d) Based on above mentioned economic performance evaluation methodologies, a new maintenance strategy: EBM (Economic performance Based Maintenance) is proposed and illustrated through a case study.

After finished this chapter, the author have some points to be mentioned here:

- There are very few data available for the long time efficiency field tests for HGUs. But they are very important materials to study the performance of HGUs, and help the managers, operators and maintenance staffs in decision-making. The author wants to thank Mr. LIU Xiuliang, Senior Engineer at Gansu Institute of Electrical Test and Research in China, for his contributions of many years field-testing data.

- The focus aspect is mainly on the efficiency in this paper. However, the comprehensive performance and conditions of an HGU include many other aspects, such as cavitation, vibration, swing, temperature, etc. The method and thought presented in this paper can be employed to study these aspects, thus a new way is paved to assess the comprehensive performance and monitoring the condition of the HGU.
- It will be a hot research area that make full use of the advanced measurement technologies (such as flow, vibration, cavitation, swing, pressure pulsation, partial discharge, etc.), to assess the performance and the condition of HGU in full scale, and provide validated information for the control, maintenance and technical management of HGU. This area involves the science and technologies in hydraulic, mechanical, electrical, automation, etc. Therefore, the study is cross disciplinary, and should be organized in a systemic way.
- This study limited on the unit level, so analysis is based on the load diagram of the unit. If the plant level is considered, the performance evaluation could have more contents and involve more aspects of the technical management, such as the optimal load diagram of a day, month or year. However, the approach proposed in this chapter can be applied as the components of the performance evaluation on the plant level.

CHAPTER 5: Condition monitoring systems for hydropower plants

CHAPTER 5: CONDITION MONITORING SYSTEMS FOR HYDROPOWER PLANTS

智慧的花朵常常开放在痛苦思索的枝头上。
——中国谚语

The wisdom flowers often blossom out on the branches of
the painful thought. ---Chinese Proverb

5.1 INTRODUCTION

5.1.1 IMPORTANCE OF CONDITION MONITORING SYSTEMS FOR HYDROPOWER PLANTS

CM (Condition Monitoring) is one of the most important parts in maintenance domain, because it provides validated information, decision-support tools of the process, which is necessary for the implementations of advance maintenance strategies. In addition, the CM system provides process condition information services to the technical management systems and control systems. Therefore, CM is indispensable to all three domains of ICMMS.

Presently the industrial companies spare no effort to raise their competitive powers in the market through increasing the reliability and availabilities, and decreasing the maintenance related costs and losses for their equipment. The maintenance strategies of those companies are transferring from the preventive maintenance dominated towards CBM (Condition Based Maintenance) or Predictive Maintenance dominated [Leger 1999]. Consequently, the condition monitoring attracts great attentions from the research and development on automation engineering. There are many important advances in CM in recent years. Since the strict requirements for high reliability, availability on the facilities in power plants, especially the generating units, the online CM systems are increasingly applied widely in power plants.

Condition monitoring systems, especially the online condition monitoring systems, need some cost for establishments. This cost can be returned by the increased productivity and benefits.

For the power generating facilities, the return rate for such cost is enormous: for the high speed rotating machineries, like gas turbines or steam turbines, the return can reach 17/1 or even more. In Pehrul power plant in USA, the installed capacity is 1000 MW, annual production value is 100 million dollars (electricity price is 0.015 \$/KWH). According to the reliability analysis, the whole system may have 14 times of fault incurred breakdown each year. After the installation of a CM system, which cost 300 thousand dollars, half of these faults can be detected before the failures occurred. If each repair action to restore needs 3 days, the loss is over 100 million dollars. This means only one day less breakdown could balance all the cost of the CM system [Huang 2000].

Generally speaking, the CM technologies in Hydropower plants lag behind those in thermal power plants and nuclear power plants [Travé-Massuyès 1997] [Deb 2000] [Wang 2001]. But the demands for CM systems for the Hydropower Plants increase as the capacity and importance of the plants increase. In Three Gorges Hydropower Plant in China, the unit output is 700 MW, that means that one hour unscheduled shutdown of a single HGU could incur 700, 000 KWHs of electrical energy loss. Hence the condition monitoring systems of HGUs are so important that they are necessary part for large HGUs.

5.1.2 OBJECTIVES OF THIS CHAPTER

In this chapter, the state of arts for the CM systems of HGUs is surveyed briefly. The current problems are proposed. To clear the confusing understanding of the condition monitoring concept in hydropower plant, the author propose a definition for Condition Monitoring, and introduced the functions and related technologies for Condition Monitoring systems for hydropower plant. Under the ICMMS reference model proposed in the chapter 2, a condition monitoring system for HGUs is presented in this chapter.

5.2 THE CONCEPT AND FUNCTIONS OF CONDITION MONITORING

5.2.1 CONCEPT OF CONDITION MONITORING

CM (Condition Monitoring) is not a new concept. But what are the contents of a condition monitoring system? There is no unified definition for it. Because different groups have different understandings, and the concept evolves with the development of the related technologies. Some people take the condition monitoring as the activities that monitoring the process parameters, while others give the condition monitoring broader contents. Therefore,

it's necessary to give a clear definition for this concept.

Definition 1. Condition Monitoring for a facility is defined as the following activities: to sense, measure, and acquire the data of the physical variables of the facility; to process, analyze and interpret the data; and to obtain the useful information about the current state and future trends of the functions, performances, and health of the facility.

This is a broad definition for CM, which also includes the analyses of those parameters, including condition assessment, prediction, faults prognoses and diagnoses.

5.2.2 THE FUNCTIONS OF A CONDITION MONITORING SYSTEM

According to the definition 1, the main functions of a condition monitoring system should have two levels from the information abstraction viewpoints: parameter monitoring and information processing:

- A. Parameter monitoring: get the validated information of the process.
 - a) Sensing: convert the physical variable into electrical, optical, image and other signals which are easy to be transmitted, processed and interpreted. Some time, special exciting signals are added for measurement;
 - b) Filtering and isolating: get rid of the disturbance signals;
 - c) Digitalization: convert the signals into digits;
 - d) Pre-processing: compensate, validate data, and transform them into relative values.
 - e) Basic dynamic analysis: according to the history data of the variable, analyze the History-Present-Future trends.
 - f) Interpretation: according to the physical or chemical principles of the process, interpret the meaning of some data. For example, the limits warning of the parameters.
- B. Information processing: process the information in depth, get the “finished information products”, and give the users of CM system decision-support services.
 - a) Assess the operation performances of the facility: Economic Performances (i.e. Efficiency of a process), Safety (i.e. the stability of a HGU), Reliability, etc.

- b) Assess the health conditions: Assess the overall health conditions qualitatively or quantitatively for the facility.
- c) Faults diagnoses: When faults appear, detect the fault mode, causes, locations and effectives, i.e. FMECA (Fault Mode and Effect Analysis).
- d) Predict the future conditions (Forecasting/Prognosis): Predict the future trends of the conditions; predict the possible performance degradation and faults.

Two points should be mentioned here:

- Above definition of CM concept and the functions of CM system is just the author personal view. The purpose is to give a clear scope for studying. According to the real situations, there may be some modifications. Even for the same CM system, there may be some evolvments of the functions according to practical experiences and technological advancement.
- Commonly CM is considered as a part of maintenance domain [Iung 1997]. But this is changeable. In this thesis, the functions domains are divided according to three kinds of users of the ICMMS: Operators, Maintenance Staffs and Production Managers. A function belong to which domains is depends on its user. For example, the online monitoring of some important process parameters is part of the concerns of the operators, while some other parameters, which are not important to the operators, may important to maintenance staffs. Hence, some functions of the CM systems in ICMMS may be common to both or all three users. The process-oriented approach is employed to integrate the ICMMS for hydropower plants in this Thesis, and the structures of the hydroelectric energy production process are unchanged. All the functions are identified through the process they related, so the migrations of the users are not big problems.

5.3 CURRENT SITUATION AND PROBLEMS FOR THE CM OF HGUS

5.3.1 CONDITION MONITORING TECHNOLOGIES IN HYDROPOWER PLANTS

According to the materials authors have [Liu 1995][Lloyd 1999], the process variables in HPs to be monitored and related technologies are summarized in Table 6.

Table 6 Condition Monitoring technologies in hydropower plants

No.	Variable	Equipment	Principles	Current state
1	Power	Generator (Active and reactive)	Transformers.	Ready
2	Current	Stator and rotator of the generator, Excitation, etc.	Transformers.	Ready
3	Voltages	Stator and rotator of the generator, Excitation, etc.	Transformers	Ready
4	Temperatures	Guide bearing, Thrust bearing, stator of the generator, the coolers for generator (temperatures of the coolers and cooling water), air temperature in the Generator, etc.	Resistance, thermal couple.	Ready
5	Fluid levels	Upper reservoir, tail water, drainage systems, oil level in bearings and pressure oil systems, etc.	Pressure sensing, Ultrasonic wave, floater, etc.	Ready
6	Rotating speed	HGUs	Transformer, electro-optical censoring, etc.	Ready
7	Pressures	Water pressure at Spiral Cases, Coping, and Draft tubes of the turbines; Cooling water pressures, Oil pressure in the pressure oil tanks, Air pressure in the pressure air systems, etc.	Pressure sensors	
8	Flow	Flow rate of the turbines, technical water supply systems, etc.	Pressure deference in the spiral case, Ultra sonic, magnetic flow meters, etc.	Ready, accuracy need to be improved
9	Efficiency	Turbines	Calculated value.	Key factor if the flow measurement.
10	Shift	The shift of the servomotors of the turbines, axial shift of the main shaft, Air gaps in the generator, thickness of the oil film on the thrust bearings, etc.	Inductance, Capacity, Current vertex, etc.	Ready

Table 6 Condition Monitoring technologies in hydropower plants(Continued)

No.	Variable	Equipment	Principles	Current state
11	Vibration	Brackets, and Stator of the generator, Coping of the turbine.	Current vertex, Mechanical, etc.	Ready, but some problems unsolved.
12	Swings	Guide bearings of the generator, Turbine guide bearing.	Mainly Current vertex	Ready
13	Noise	Turbine, generator.	Sound sensor	Ready
14	Pressure pulse	Water pressure pulse in Draft tube, Coping, and entrance of the spiral case.	Pressure sensors	Ready
15	Isolation	The windings of the Stator	Partial Discharge, Capacity.	Ready
16	Oil contaminate d by water	The oil tanks of guide bearings and thrust bearings, etc.	Capacity	Ready
17	Force	Hydraulic thrust of the turbine	Pressure sensor	Ready
18	Torque	Main shaft.	Resistance	Lab ready, field online under development
19	Current in axis	Main axis.	Transformer	Ready
20	Cavitation	Turbine	Accelerate sensors to measure the noise in the runner chamber, etc.	Under development

All above-mentioned variables can be monitored online. As the important supplements to the online monitoring systems, here are also some offline monitoring technologies that are used in hydropower plant. They are:

- Oil analysis, through analyzing the debris in the lubricating oil, the wear and tear of the mechanical parts are inspected. Filter Debris Analysis has been applied as an online condition monitoring approaches in airplanes [Fisher 2000];
- Ultra sonic, acoustic emission, current vortex, and other non-destructive detection technologies for cracks or other faults for turbine blades or other mechanical parts;

To conclude above detailed analysis about the technologies on the CM of HPs:

- Most of the process parameters in hydropower plants can be measured directly or indirectly measured by sensors.
- Some of the items are still under developing. Such as the Cavitation measurement, the capture of low or very low frequency (less than 1Hz) vibration signals for HGUs.

5.3.2 THE DIAGNOSIS AND PROGNOSIS TECHNOLOGIES

As the condition monitoring technologies progress, there are more and more field data are available. This increases the possibilities of faults detection and forecasting. Recent years, diagnosis and prognosis are becoming active areas in studying, and some encouraging results achieved. Generally, the methods for diagnosis and prognosis can be classified into three categories:

- Model-based approaches, The model may be physical [Kozłowski 2001] or statistics models [Ray 1996];
- Knowledge rule-based one, such as expert system [Chande 1998] or fuzzy logic system [Liu 1996];
- Learning-based one, for instance, Artificial Neural Network [Liu 1997] [Brotherton 2000] or Data Mining [King 1995].

The cognition of the failure mechanism and available information is different in different conditions, so the special diagnosis and prognosis methods applied to special equipment, which may be one of the above or combination of them [Vilim 2001].

5.3.3 CURRENT PROBLEMS IN THE CM SYSTEMS FOR HGUS

Last ten years is a fast growing period for the online condition monitoring for HGUs. During this period, CM technologies for hydropower plants have achieved breakthroughs in most aspects of the process parameters monitoring. Presently, most of the important process parameters can be monitored online.

However, the CM system for the HGUs is just in its growing up ages, and many problems remain to be solved:

- Most of the condition monitoring facilities in HGUs are scattered devices that have few information exchanges among them, and each device only deals with a specific type of

problems, even though some times they are called systems. For example, Vibration and Swing monitoring system for HGU, Temperature monitoring system, Flow measurement systems, Cavitation monitoring system, etc.

- There are very few methodologies and standards to assess the overall conditions of the process. Consequently the results of the condition monitoring systems are just more “digits” to the users, and make the “data explosion” problem even worse in some cases. These “digits” are “raw materials” that waiting to be processed into “finished information products”.
- Since the pieces of condition monitoring information from different devices are not timely synchronized, it is very difficult to make some general conclusions on the conditions of the HGU. Taking hydro turbine vibration monitoring as an example, the vibration altitudes and frequency of the turbine can be monitored, but the exact operating points of this turbine at that time are monitored by the control system, and there are no synchronized and direct communications between the two systems. Because the same vibration altitude or frequency is interpreted quite differently: it is over the warning limit to one turbine operation point, while it is just normal to another operation point.

These problems on the condition monitoring systems for HGU can be summarized into two types of problems: **systemic integration** and **overall conditions assessment methodologies**.

5.4 THE REFERENCE MODELS OF CONDITION MONITORING SYSTEM FOR HYDRO ELECTRICAL GENERATING UNITS

5.4.1 TWO POSSIBLE SOLUTIONS TO THE INTEGRATION OF THE CM SYSTEMS FOR HYDROPOWER PLANTS

To the problems of CM for HGU presented above, there are two possible solutions, from authors view:

- Establishing one or several relatively independent Condition Monitoring systems, the CM system may share some sensors with the control systems, but no interactions between them [Lloyd 1999] [Wang 2001]. Most of the conditions monitoring systems are developed this way presently.
- Under the ICMMS reference model for hydropower plants, condition information of a

production process is necessary to all users of its automation system, though they have different requirements for the information. Hence the condition monitoring is process centred, and the condition functions are delegated to the Control, Maintenance and Technical Management domains.

The first solution is the advancement to the scattered instruments condition monitoring for the hydropower plants. But it is very difficult to coordinate the condition monitoring systems with other parts of the plant automation systems, such as control system, maintenance systems.

In the second solution, all the automation functions, including condition monitoring functions, are centred on the same production process model, and this ensures the communications and synergies among different function modules. In fact, the condition monitoring system is a virtual one as a “system”, cause all its modules are distributed into different automation domains. The authors expect this solution be the future development trend in condition monitoring for the hydropower plants.

5.4.2 THE REFERENCE MODELS FOR THE CONDITION MONITORING SYSTEMS OF HYDROPOWER PLANTS

Under ICMMS reference model proposed in Chapter 2 of this Thesis, two principles should be held to establish the models of condition monitoring systems of HPs:

- The electric generating process oriented. This means that all condition monitoring information should be organized according to the process they reflect. Only this principle is upheld can the condition monitoring systems keep long live and work in harmony with the three kinds of users. Because the responsibilities of the three users may redistribute, while the hydroelectric generating process usually remains unchanged. In the proposed reference model in Chapter 2, this principle is satisfied by all three domains share a common process models.
- Condition monitoring system is a part of maintenance domain. But some pieces of condition information or functions (services) may be shared or even positioned in other two domains: Control and Maintenance. The principle for functional domains division is that the functions modules should be always delegated to those who need most.

Based on the reference model proposed in Chapter 2, a reference model for the condition monitoring system in hydropower plants is presented in Fig. 32.

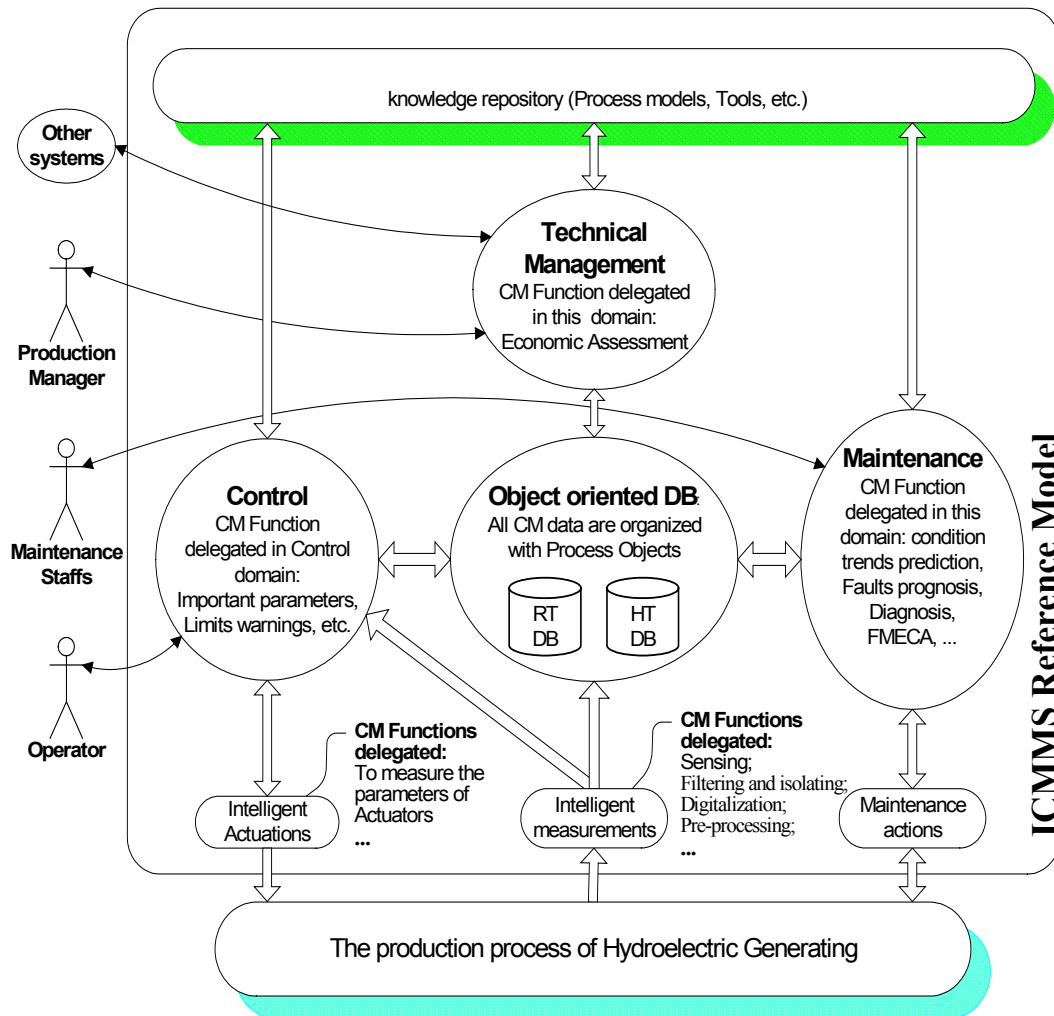

Fig. 32 The reference model of the condition monitoring system for Hydropower Plant

5.5 SUMMARY

- The concept of Condition monitoring is clearly defined, including the scopes and the functions.
- Related technologies for condition monitoring of hydropower plants are summarized and analyzed. The present problems for condition monitoring are presented and synthesized. System integration is the key aspect of them.
- Two possible solutions are presented for the integration of the Condition Monitoring Systems in Hydropower: The establishment of relatively independent Condition Monitoring systems or integrate the condition monitoring system into the ICMMS. The reference model to implement the condition monitoring in ICMMS is presented.

**CHAPTER 6:
Contributions to the control
domain of ICMMS: DAA**

CHAPTER 6: CONTRIBUTIONS TO THE CONTROL DOMAIN OF ICMMS: DAA

知人者智，自知者明。
胜人者有力，自胜者强。——老子

Who understands the world is learned;

Who understands the self is enlightened.

Who conquers the world has strength;

Who conquers the self has adamancy. —Laotze

Under ICMMS reference model proposed in chapter 2, the three domains of the automation systems for hydropower plants are integrated through process-oriented approach. One of the most important functions in the control domain for the HGU is to control the hydro turbine. This Chapter contribute a new approach for the turbine control in HP.

Based on the DAA (Disturbance Attenuation Approach) of H_∞ theory, a new method to design hydraulic turbine governors is proposed. The designed system is robustly stable and the disturbance acting on the system can be effectively attenuated. This method can be applied to both linear and non-linear systems [Liu 2000].

6.1 INTRODUCTION

In an electric power system, large hydraulic turbine generating units usually run as the main sources for regulating the active power generation and controlling the system frequency, because of their fast and economical load regulation characteristics. The hydraulic turbine governors are the kernel devices to realise these functions.

As the rapid development of electronics and computer technology, microcomputer-based hydraulic turbine governors are widely used. Generally, they are composed of two parts: the microcomputer-based controller and the hydraulic servomechanism. Comparing with the traditional governors, the modern hydraulic governors can have much more functions because

the microcomputer-based controller can realise various control algorithms. Many new algorithms, such as Adaptive Algorithm [Li et al. 1992] [Ye et al. 1990] [Jovanovic 1995] [Ye et al. 1983] [Ye 1984], Neural Network, Genetic Algorithm [Wrate et. al. 1997], Fuzzy Logic [Jing et al. 1998], Optimal Control [Schniter et al. 1995], have been introduced in this field in recent years, but the most popular algorithms actually being used today are still the PID and PID-based algorithms. Nowadays the capacity of the power systems and the unit output of the turbine grow larger and larger, consequently the stability and dynamic performance of the turbine governing system become more and more difficult to manage. So it is still a useful topic to study the algorithm with robust stability, and good dynamic performance for hydraulic turbine governors.

In the past decade, H_∞ theory has gained much development [Doyle et al. 1989] [Francis 1987] [Marinescu and Bourles 2000], but there are very few practical design applications based on this theory [Abrishamchian and Barmish 1996]. In this paper, based on the Disturbance Attenuation Approach (DAA) of H_∞ theory [Isidori et al. 1992] [Van der Schafer 1992][Zasadzinski et al. 1998], we propose a new way to design hydraulic turbine governors. This method has the following advantages:

- (1) It can be used as a standard approach for hydraulic turbine governor systems design, and is suitable for both linear and nonlinear hydraulic turbine models.
- (2) The designed systems are robustly stable.
- (3) The disturbances on the systems can be effectively attenuated.

However, the price paid for this strong robustness of the designed governor is the conservativeness on the performance of the system. Fortunately, this shortcoming is minor and can be practically neglected when “small disturbance” occurs; in hydroelectric engineering a load disturbance is called “small” if it is less than 5% of the rated load, which is the usual case for discussing the performance of the turbine governing system.

To apply this method, we establish a practical model of a hydraulic turbine governing system in Section 6.2. In Section 6.3, we transform the model into the standard form of DAA and propose a DAA-Based design method for hydraulic turbine governor. In order to test the effectiveness of this method, a practical hydraulic turbine governor is designed by this method and simulation result is presented in Section 6.4. Section 6.5 is our conclusions and prospective.

6.2. MODEL OF HYDRAULIC TURBINE GOVERNING SYSTEM

In the ICMMS reference models (Fig. 15), all the process models are established in the knowledge repository part. The modern hydraulic turbine governing systems can be divided into three parts:

- (1) Microcomputer-based controller: this is the heart of the control system, which generates the control strategies and communicates with the other systems.
- (2) Hydraulic servomechanism: functions as an actuator, amplifies the control signals and drives the guide vanes.
- (3) The process to be controlled (including water system, hydraulic turbine generating units, and power system).

Fig. 33 shows the schematic diagram of the system. The static, dynamic models of these components should be established separately, using process-oriented approach. Those models may be in different forms: equations, tables, curves, ANN (Artificial Neuron Networks), etc. [Shen 1988] [Zhang 1988]. Then the mathematical models of the whole turbine governing system are constructed according to the topologic links of the components.

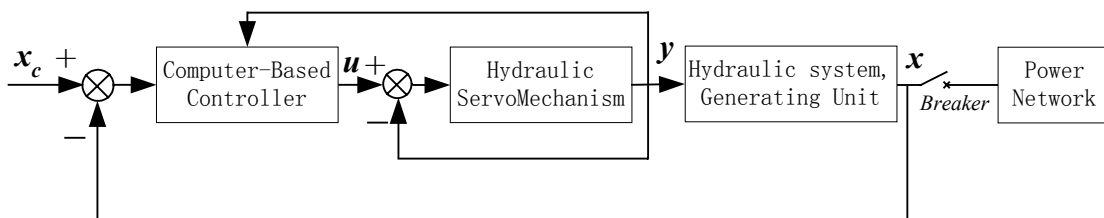

Fig. 33 The schematic diagram of the turbine governing system

For the computer-based controller, the other two parts can be regarded as the system to be controlled. Fig 34 depicts the structural diagram of this controlled system with an auxiliary hydraulic servo. In this model, we further assume that the time constants of the guiding valve and the auxiliary servo can be neglected, and the water hammer in the system is rigid.

The physical meaning of the parameters used in Fig. 33 are defined in the following:

- b_λ : the local feedback factor of the auxiliary servo,
- e_n : the comprehensive self-balance factor of the hydraulic generation units,

- T_a : the inertia time constant of the hydraulic generation units,
 T_y : the inertia time constant of the hydraulic servo,
 T_w : the inertia time constant of the water flow in the hydraulic power system,
 y : the relative value of the displacement of the hydraulic servo,
 h : the relative value of the change of water head,
 x : the relative value of the change of turbine running speed, and

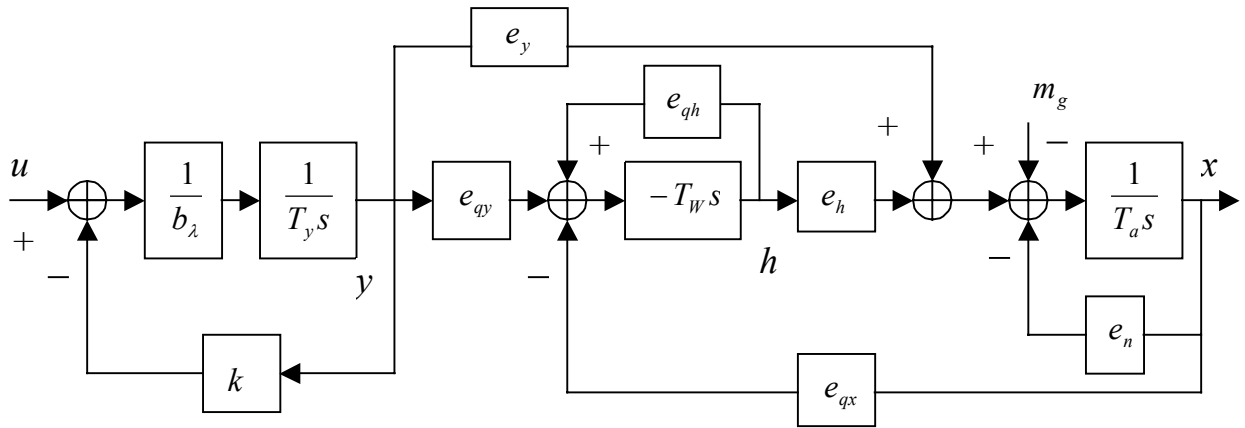

$e_{qh}, e_{qy}, e_{qx}, e_y, e_h$: the transformation factors of water turbine.

Fig. 34 The structural diagram of the controlled system

By selecting $y, h,$ and x as the state variables, i.e., $X_1 = [y \ h \ x]^T$, we can express the state variable equations of the system as

$$\dot{X}_1 = A_1 X_1 + B_1 u + C m_g \quad (6.1)$$

where the control input u and the disturbance input m_g are scalars. The elements of matrix A_1 and vectors B_1, C are:

$$\begin{aligned}
 a_{11} &= -\frac{k}{b_\lambda T_y} & a_{12} &= 0 & a_{13} &= 0 \\
 a_{21} &= \frac{k e_{qy}}{e_{qh} b_\lambda T_y} & a_{22} &= -\frac{1}{T_w e_{qh}} & a_{23} &= \frac{e_n e_{qx}}{e_{qh} T_a} \\
 a_{31} &= \frac{e_y}{T_a} & a_{32} &= \frac{e_h}{T_a} & a_{33} &= -\frac{e_n}{T_a} \\
 b_1 &= \frac{1}{b_\lambda T_y} & b_2 &= -\frac{e_{qy}}{e_{qh} b_\lambda T_y} & b_3 &= 0 \\
 c_1 &= 0 & c_2 &= -\frac{e_{qx}}{e_{qh} T_a} & c_3 &= -\frac{1}{T_a}
 \end{aligned}$$

In general, the load disturbance m_g involves two parts, i.e., $m_g = m_{g0} + w$. The term m_{g0} represents the step change part of the load disturbance and $w \in L_2$ is the oscillation part [Van der Schafer 1992].

6.3 DAA-BASED DESIGN METHOD FOR THE HYDRAULIC TURBINE GOVERNORS

A design method for the hydraulic turbine governors via DAA is presented in this section. The attention will be concentrated on the procedures of applying DAA to the design of a hydraulic turbine governor.

6.3.1. MODEL DEVELOPMENT FOR A HYDRAULIC TURBINE GOVERNING SYSTEM

Before applying the DAA to a system, we have to transform a given system model into the standard form defined in DAA. By doing so, we introduce a new input v and express u in terms of it,

$$u = -\frac{a_{11}}{b_1}y + \frac{1}{b_1}v \quad (6.2)$$

After substituting equation (6.2) into equation (6.1), we have

$$\dot{X}_1 = A_2 X_1 + B_2 v + C_0 + Cw \quad (6.3)$$

where,

$$A_2 = \begin{bmatrix} 0 & 0 & 0 & 0 \\ a_{21} - \frac{b_2 a_{11}}{b_1} & a_{22} & a_{23} \\ a_{31} & a_{32} & a_{33} \end{bmatrix}$$

$$B_2 = \begin{bmatrix} 1 \\ \frac{b_2}{b_1} \\ 0 \end{bmatrix}$$

and

$$C_0 = C m_{g0}.$$

In order to control the frequency of the electricity at a high precision, the relative value of the running speed deviation x should be zero when the system reaches its steady states. That is

to say, the steady states of the system should satisfy

$$A_2 X_{10} = -C_0 \quad (6.4)$$

To remove the steady state values from the state vector we define

$$X = X_1 - X_{10}, \quad (6.5)$$

then the perturbed model of equation (6.3) can be represented by

$$\dot{X} = A_2 X + B_2 v + Cw \quad (6.6)$$

This is the standard form to be used in DAA.

6.3.2. DAA-BASED CONTROL ALGORITHM FOR HYDRAULIC TURBINE GOVERNORS

In the real world, to minimise both the control energy consumption and the state errors we have to choose the controlled output Z (in another word, penalty) as a vector $Z(X, v) = [X^T \quad v]^T$. Therefore, the Hamilton Functional of the system described in equation (6.6) can have the form

$$H(X, P, v, w) = P^T (A_2 X + B_2 v + Cw) + X^T X + v^2 - \gamma^2 w^2 \quad (6.7)$$

where $P \in R^3$ [Doyle et al. 1989] [Isidori et al. 1992] [Van der Schafer 1992]. According to the well-developed DAA, the saddle of Hamilton Functional should be at

$$v^*(X, P) = -\frac{1}{2} B_2^T P$$

$$w^*(X, P) = \frac{1}{2\gamma^2} C^T P$$

As usual, the Lyapunov functional should be chosen as

$$V(X) = X^T W X \quad (6.8)$$

where W is a symmetrically positive defined matrix. If we select matrix W to satisfy

$$H(X, P, v^*, w^*)(\gamma) \leq 0 \quad (6.9)$$

where $P = V_x = \frac{dV}{dX} = 2WX$, then

$$v = -B_2^T W X \quad (6.10)$$

Using equations (6.2) and (6.5), the DAA control algorithm for the system described in equation (1) is given by

$$u = -\frac{a_{11}}{b_1} y + \frac{1}{b_1} v = -\frac{a_{11}}{b_1} y - \frac{1}{b_1} [B_2^T W (X_1 - X_{10})] \quad (6.11)$$

or in a more concise form

$$u = u^*(X_1, W) = -\left[\begin{array}{ccc} \frac{a_{11}}{b_1} & 0 & 0 \end{array} \right] + \frac{1}{b_1} B_2^T W X_1 + \frac{1}{b_1} B_2^T W X_{10} \quad (6.12)$$

The above developed control law has the following properties:

- (1) The closed loop system for system (6.1) becomes

$$\dot{X}_1 = [A_1 - B_1 \left(\begin{array}{ccc} \frac{a_{11}}{b_1} & 0 & 0 \end{array} \right) - \frac{1}{b_1} B_1 B_2^T W] X_1 + \frac{1}{b_1} B_1 B_2^T W X_{10} + C m_g \quad (6.13)$$

This system is asymptotically stable at X_{10} .

- (2) The impact of disturbance w on the controlled output Z can be attenuated,

$$\int_{t_0}^T Z^T(X_1, v) Z(X_1, v) dt \leq \gamma^2 \int_{t_0}^T w^2 dt \quad (6.14)$$

where t_0 is the initial time and $T \geq t_0$.

6.4. SIMULATION AND RESULTS

To illustrate the effectiveness of the DAA control algorithm in equation (6.12), we simulate the performance of a practical hydraulic turbine governing system which structure is shown in

$$\begin{array}{lll} b_\lambda=0.2 & k=0.04 & \\ e_n=1.0 & e_h=1.46 & e_y=0.74 \\ e_{qh}=0.491 & e_{qx}=0 & e_{qy}=0.789 \\ T_a=6.67 & T_y=0.1 & T_w=1.62 \end{array}$$

Fig. 34 with the following parameter values

The disturbance is simulated in the form: $m_g = m_{g0} + w$,

Where: $w = a e^{-\beta t} \sin(\alpha t)$ with $a = 0.03$, $\beta = 0.5$, $\alpha = 5$.

For the convenience of solving the Riccati equation, chose $\gamma = 2$.

Four different cases are carried out using the software package *Simulink* in *Matlab*[®], and their results are shown in Fig. 35-38.

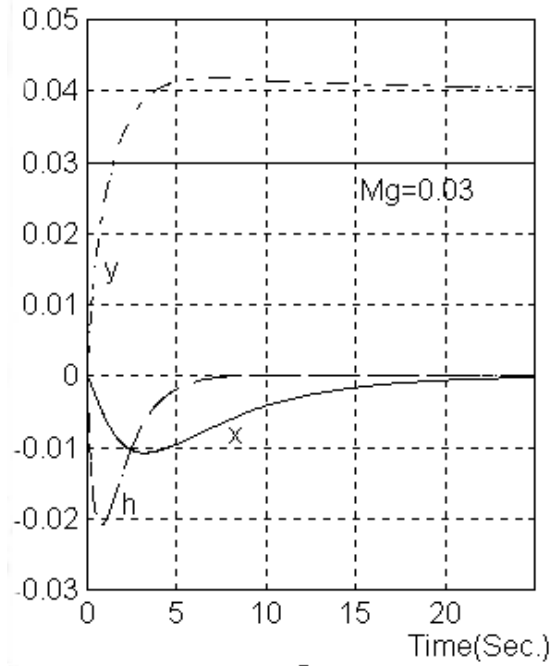

Fig. 35 The case of 3% step change of load disturbance

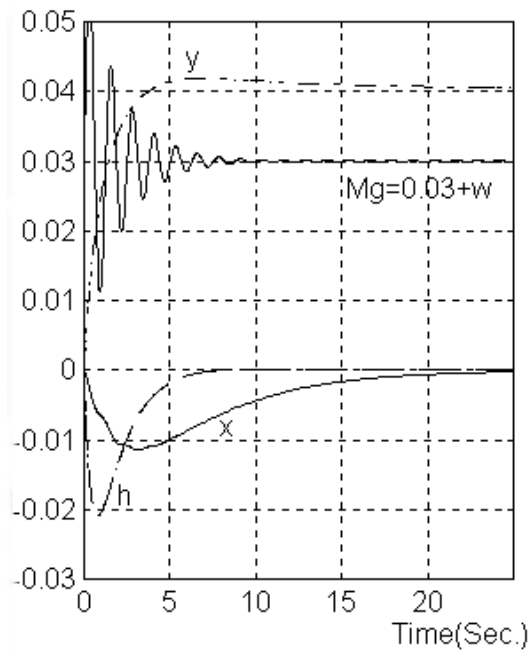

Fig. 36 The case of 3% step change plus weakening oscillation of load disturbance

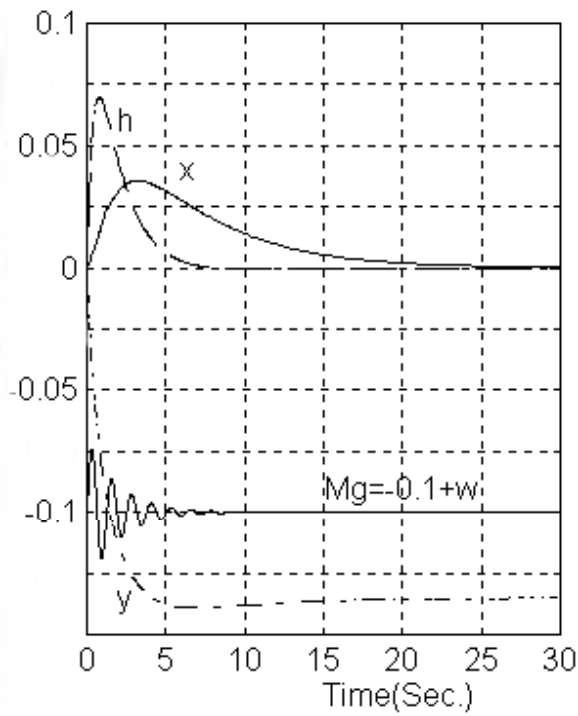

Fig. 37 The case of -10% step change of load disturbance

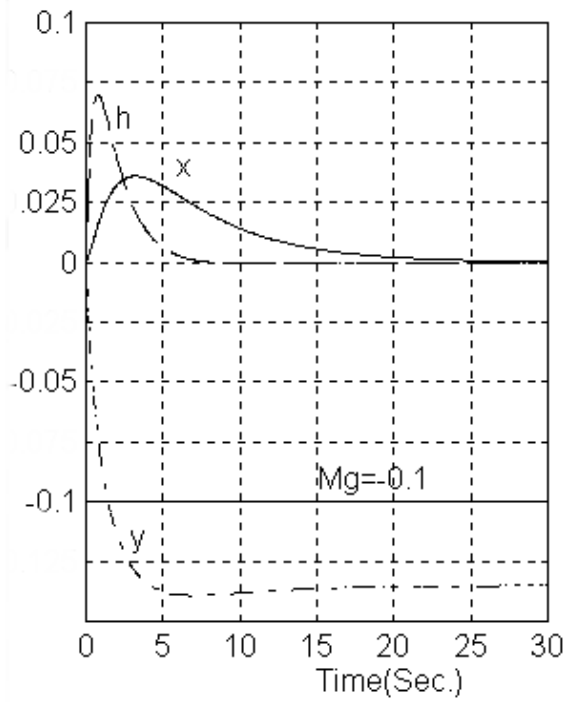

Fig. 38 The case of -10% step change plus weakening oscillation of load disturbance

Compare Fig. 35 and Fig. 36, we can see that the dynamic response is almost the same when a weakening oscillation disturbance $w = a e^{-\beta t} \sin(\alpha t)$ with $a = 0.03$, $\beta = 0.5$, $\alpha = 5$ is added a small step change 0.03 to the system. In both cases the disturbance is effectively attenuated and the surge time short. From Fig. 37 and Fig. 38, we can see the disturbances is also been effectively attenuated, but the surge time is a bit longer when the step change is large. Many other forms of disturbances have been simulated, and the results are similar.

These simulations suggest that the designed system has a strong robustness. When the disturbance is small, the system also has good dynamic response. However, the surge time is a bit long when the disturbance is large.

6.5 SUMMARY

- In this Chapter, the DAA method has been applied to the design of the control law of a practical linear hydraulic turbine governing system. The designed controller is strongly robust and can effectively attenuate all kinds of disturbances w , which belong to $L_2(0, T)$. However, the penalty for the robustness is the conservativeness of the control effect. The simulation results show that the system achieved satisfactory control effect if the scale of disturbance is small; otherwise, the system does not act fast enough and behaves conservatively.
- This example shows the process-oriented integration method, applied in the reference model in Fig. 15 of chapter 2, can be applied to control domain too. In the governing system modelling, its components, such as the turbine, generator, power system, servomechanism, etc. are modelled, then the whole governing system models are constructed according to the topology of the system. The models of those components and the process can be shared by the whole system members, for example, the excitation system in control domain, the economic performance evaluation system in technical management domain.
- As a part of the control system, the turbine control system (governing system) has the links not only with other control subsystems, but also with some modules of the technical management domains and maintenance domains. For example, when the sensible control strategies are applied to raise the quality of electric energy, the actions of the governing systems will be much more frequent, then the hydraulic servomechanism and related

parts will be worn faster, also the efficiency of the turbine will decrease [Fei 2001]. This means the possibility of faults will be increased, the MTBF will be shortened, and the costs for maintenance will be increased. Therefore, the control strategies are also related maintenance and technical management. The integrated solutions, which are emphasized in ICMMS, are just on the correct direction to solve these problems.

**CHAPTER 7:
SEVERAL PHILOSOPHICAL
THOUGHTLETS ON THE
AUTOMATION SYSTEMS INTEGRATION**

CHAPTER 7: SEVERAL PHILOSOPHICAL THOUGHTLETS ON THE AUTOMATION SYSTEMS INTEGRATION

道法自然。--老子

The Way is from Nature. --Lao Tze

The highest abstraction of the world is philosophy, which abstracts and generalizes all the human perceptions for the world. For thousands of years and by the efforts of billions of human beings, the human beings still haven't had and will not have a unified philosophy, because the minds of the human are diversified forever. However, one thing is clear, the experiences of searching for the truth are helpful for finding new truth, especially in the fields of science research.

During his doctoral studying, the author perceived some thoughtways in system integrations. They are not systematic thoughts, but may be useful for the automation system integrators on methodologies. This chapter is to present those thoughtlets.

7.1 THE DEVELOPMENT TRACES OF SYSTEM SCIENCE

What means "Systemic approaches" or "system thought"? The "system thought" has become a common recognition among majorities of the system science researchers: a "system" should be perceived from three aspects: Wholeness, Correlation, Evolution [Xu 2000]. The process to reach this short abstraction is very long: more than two thousands years. Studying this development process is helpful not only to understand the system thought its self, but also to find the rules of the science development.

Like any other important thoughts, the system concept was originated from social or natural practicing works of the human beings.

The great philosopher in ancient Greece, Heraclitus (b.c. 500), maintained that the world is the wholeness that includes everything, and strife and change are natural conditions of the universe. During the Warring States (b.c. 403 to 211) Period in China, the famous doctor,

BIAN Que diagnosed the patients through the comprehensive approaches according to their complexions, sounds, appearances, etc., and utilized acupuncture, Chinese herb medicines, massage, and other therapies systemically. Since then the traditional Chinese medicines take the human body as a whole system that the all parts are closely related, and opposed “when the head aches, just cure the head; when foot aches, just cure the foot”, which omitted those correlations. In the same period, Li Bin, a gifted expert on water conservancy, designed and constructed the great water conservancy project, Du Jiang Yan. In this project, many subprojects were closely coupled on hydraulic, sediment, etc., and all these relationships were handled so successfully in a systemic way that the project is still function normally today.

The ancient system concepts strengthened the importance of the wholeness, but were mainly based on the experiences, and lacked of scientific supports and understanding of the details of the nature. Hence these thoughts were not complete and in depth.

In the 15th century, the science sprang up in many fields, such as mechanics, physics, chemistry, astronomy, biology, etc. People divided the science into many subjects, studied the details of each subject. Many big advances in science were achieved during this time. But those separated ways of observing the system were introduced into philosophy, and metaphysics prevailed.

In the 19th century, there were some major breakthroughs in science, especially the discoveries on energy conversion, cells, and evolution. The man’s understanding over the nature and social world advanced in big steps. In philosophy, the wholeness, correlation and evolution were described clearly to observe the world. The system thought was developed to the qualitative descriptions.

In the 20th century, the development of the science and technology reached the fastest speed. The system thought had grown into the qualitative analysis stage, with the supports from mathematics and the computer related technologies.

According to above analysis, the development traces of the human knowledge and understanding to the system science are shown in Fig. 39.

From the Figure, following rules are revealed:

- The volume of human knowledge increases with the time, though there may be some differences in the growing speed;
- The level of human understanding on the system science (three aspects: wholeness,

correlation, evolution) increases with time in general trend. But there was an exception period, approximately from 15th century to 18th century, when the metaphysics philosophy prevailed and the system science stagnated even a bit retrogressed, although the human knowledge increased very quickly in that period.

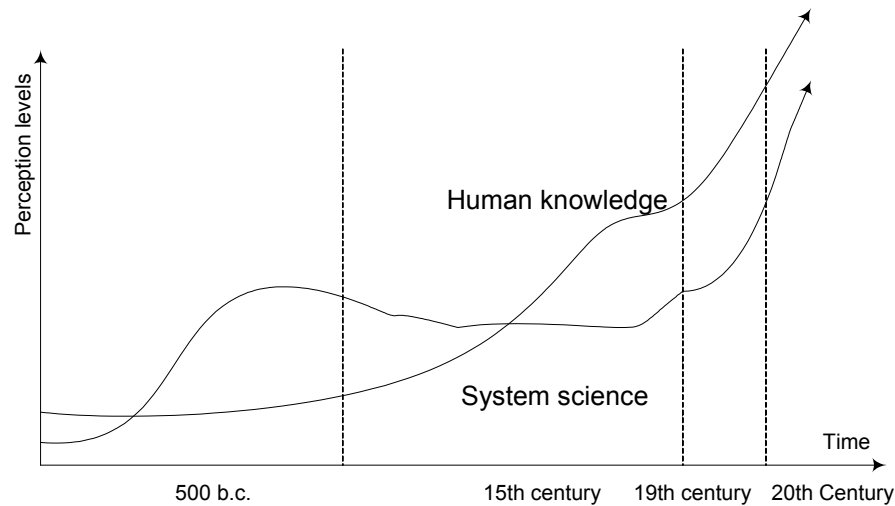

Fig. 39 the development traces of the system science and human knowledge

7.2 THE DEVELOPMENT PROCESS OF THE AUTOMATION SYSTEMS

One of the major differences between men and apes are that men can make and use tools. Automation systems are the highest-level tools that men use to produce some things, and from this viewpoint, the primary tools are the origins of today automation systems.

But the automation systems really began in the 19th century when the industrial revolution started. Its development process can be described in Fig. 40.

The automation levels and the problems of the automation systems have following characters:

- The automation level increases with time. In the field of hydropower plant automation, there were fully automatic plants in Europe ten years ago. Now there are more demands for the automation, such as tele-maintenance, condition monitoring, etc.
- As the automation level increases, the complexity and the amount of the data are increasing at a straight high speed. As the environment is changing fast, the demands for changing increases. These problems are too complex to handle with the traditional automation methodologies. That is why the system integration engineering becomes a hot

field.

- It is very difficult to increase the automation level markedly, if the problems of system integration solved correctly.

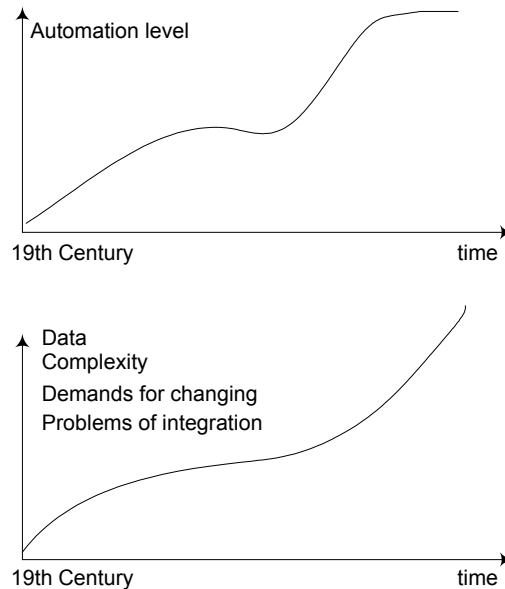

Fig. 40 The development process of automation systems

Compare the Fig. 40 with Fig. 39; there are some very similar features, although the periods are not the same. At the beginning stages, the systems are not so complex, and it nature can be understood by experiences knowledge. When the system grown up and the volume of knowledge or information grow faster than the philosophy, there will be stagnation stages.

The development of the software engineering also has the similar features [Shao et al. 1998].

From above analysis, it can be seen that presently the integration philosophy for enterprises should be progressed to promote the advances in automation systems.

7.3 PHILOSOPHY OF SYSTEM INTEGRATION FOR HYDROPOWER PLANTS

There are always conflicts inside any system, like any thing in the world. When the conflicts are handled in balance, the system is in harmony. The development of any systems is the process of conflicts handling, so the conflicts are the propel force for systems.

In the system integration for the hydropower plants, there are following conflicts today, but

not restricted to:

- Conflicts among the three function domains;
- Function integration versus structuring distribution;
- Changing market versus the unchanged equipment;
- The generalization versus the particularities for modelling;
- ...

There will never be a perfect and universal solution to solve all the conflicts. When the old conflicts are solved, the new conflicts will emerge. However, we can find some reasonable or optimal solutions.

In hydropower plant, there are three types of agents: Man, main process and automation system (Fig. 14 in chapter 2). Among them, the process is the most unchangeable part. So the process oriented methodology is proposed in chapter 2 to establish the ICMMS reference model. And this methodology and reference models are proved as reasonable solutions for hydropower plants.

Although above methodology restricted in hydropower plants, it contributes some rules in the philosophy of the enterprise integration: the models of the enterprises should be based on the relatively unchanged objects in order to ensure the flexibility and longevity of the enterprises models.

In philosophy, this rule can be expressed by an old Chinese saying: “Keep unchanging is the best way to cope with changing”.

7.4 SUMMARY

Some thoughtlets of the author for the system integration are presented.

- There are some similarities among the development of the people’s understanding of the nature. The system thought is just essential for the system integration;
- To face the changing environment, enterprise should be flexible to adapt the changing. To cope with this challenge, the enterprise reference models should be based on the unchangeable objects or aspects.
- The process-oriented method is reasonable to construct the reference models for

hydropower plants. The philosophy inside it is “Keeping unchanging is the best way to cope with changing”.

CHAPTER 8: CONCLUSIONS AND PERSPECTIVES

CHAPTER 8: CONCLUSIONS AND PERSPECTIVES

路漫漫其修远兮，吾将上下而求索。——屈原

The road is tortuous and long, I will keep pursuing the truth
throughout the universe. ---Qu Yuan

8.1 CONCLUSIONS

An integrated solution towards the Intelligent Control-Maintenance-technical Management Systems (ICMMS) in Hydropower Plants is proposed in this Thesis. The main contributions of this Thesis can be concluded in the following points:

- 1) As a specific category of enterprises in process industries, all hydropower plants share some common characters. According to these characters, using the principles and methodologies of enterprise integration and modelling, a new methodology and an ICMMS Reference Model for the hydropower plants are proposed. The methodology employs the process-oriented approaches to model the hydropower plants, and the models constructed through this methodology are stable and reusable, because the power generating process is very stable. The proposed ICMMS Reference Model grasps the similarities and unchangeabilities of the hydropower plants, and this makes the redistribution of the function modules inside the system an easy task, guarantees the synergies among the components of the ICMMS.
- 2) HSAS (Hybrid Smart Automation System), a feasible scheme to implement the ICMMS in hydropower plants, is proposed. In ICMMS, distributed IAM (Intelligent Actuation And Measurement), opened communication networks and other enabling technologies are needed. However, some of the technologies haven't been available yet. The proposed HSAS integrates the conventional controllers and fieldbus based components under a fully distributed system architecture.

- 3) Performance evaluation methodologies for HGU are proposed. In ICMMS, the performance evaluation is indispensable in the technical management domain. However, the performance evaluation methods and implement system are still lacunae to Hydroelectric Generating Units. In this Thesis, some important concepts, indexes, criteria and methodologies for the performance evaluation on HGUs are proposed. Based on the analysis of the energy flow of an HGU, a method and related formulas to calculate the energy indexes of the unit are presented. A method and corresponding indexes and criteria to assess the economic performance for HGU are proposed. The efficiency state, the level of operation management, and the maintenance state of an HGU can be measured through these qualitative indexes. A real test case illustrated effectiveness of the method.
- 4) Based on above mentioned economic performance evaluation methodologies, a new maintenance strategy: EBM (Economic performance Based Maintenance) is proposed and illustrated through a case study.
- 5) Under the ICMMS Reference Model, the condition monitoring is a very important part in maintenance domain. In this Thesis, the concept of Condition Monitoring is clearly defined, and related technologies for hydropower plants are summarized and analyzed. The condition monitoring system is integrated into the ICMMS under the Reference Model proposed above.
- 6) As a contribution to the control domain, based on the Disturbance Attenuation Approach of H_∞ theory, a new method to design hydraulic turbine governors is proposed. The simulation results shows that the designed system is robustly stable and the disturbance acting on the system can be effectively attenuated. This method can be applied to both linear and non-linear systems.
- 7) Some philosophical thoughtlets of the author for the system integration are presented. There are some similarities among the development of the people's understanding of the nature world. The system thought is essential for the system integration. To face the changing environment, enterprise should be flexible to adapt the changing. To cope with this challenge, the enterprise reference models should be based on the unchangeable objects or aspects. The process-oriented method is reasonable to construct the reference models for hydropower plants. The philosophy inside it is "Keeping unchanging is the best way to cope with changing".

8.2 PERSPECTIVES

When the old problems are solved, new problems will appear. This is the way in which the history of the science and technologies always run. From the development process view, the automation systems for hydropower plants presently enter a stage when supporting technologies have been advanced but the systemic cognition lag behind. So the author expects the system thought, i.e. wholeness, correlation and evolution ways of thinking, will prevail in the system integration studying. The author only achieves a little bit to this end. Following study aspects are expected:

- In the field of system modelling, based on the proposed methodology and reference model in this Thesis, establish a model library for the ICMMS in hydropower plants. This will be very helpful to construct and reconstruct for the automation system in hydropower plant;
- Condition monitoring is a hotspot now and in the near future in hydropower plants. More attentions will be paid on the condition assessment, diagnosis and prognosis;
- Performance evaluation is new topic for the hydropower plants. There will be more progresses on the methodologies, criteria and integration with other systems in the performance evaluation.

References

REFERENCES

- [Abrishamchian and Barmish 1996] Mehdi Abrishamchian and B. Ross Barmish, Reduction of robust stabilization problems to standard H^∞ problems for classes of systems with structured uncertainty, *Automatica*, Vol. 32, No. 8, pp. 1101-1115, 1996.
- [AL-Zubaidy 1997] S. AL-Zubaidy, Andrew Right, Performance investigation of a hydroelectric power station at Batang Ai-Sarawak, *International Journal of Energy Research*, Vol. 21, 1405-1412, 1997.
- [AMICE 1993] AMICE, CIMOSA: Open System Architecture for CIM, 2nd extended and revised version. Springer-Verlag, Berlin, 1993.
- [Booch 1999] Grady Booch, James Rumbaugh, Ivar Jacobson, *The Unified Modeling Language User Guide*, Addison Wesley Longman, 1999.
- [Brotherton 2000] Brotherton T, Jahns G, Jacobs J, Wroblewski D. Prognosis of faults in gas turbine engines, *IEEE Proceedings of Aerospace Conference*, 2000, Vol.16, pp163~171.
- [Chai et al. 1999] Tianyou Chai, Xinyu Zhao, Xinli Zhao, A 2-Dimensional Architecture for Process Industry, *Proceedings of 14 World Congress of IFAC*, July 1999, Beijing, 109~113.
- [Chande 1998] Chande P K, Tokekar S V. Expert-based maintenance: a study of its effectiveness, *IEEE Transactions on Reliability*, 1998, Vol.47, No.1, pp53~58.
- [Chen et al. 2001] David Chen, Francois Vernadat, *Standardisation On Enterprise Modelling And Integration: Achievements, On-Going Works And Future Perspectives*, Proc. 10th IFAC Symposium on Information Control in Manufacturing (INCOM'01), Vienna, 2001.
- [Dai et al. 2000] Dai Xiaohui, Wei Wei, Wang Yu, Implementation of monitoring system of thermal generator based on Profibus in power plant, *Automation of Electric Power Systems*, Aug. 2000, pp.51-54.
- [Danial et al. 2000] Danial Ladang, Jean-Marie Tarin, Distributed Control System for the Aolvay-Jemepe Cogeneration Power Plant, *Proc. of IFAC Symposium on Power Plants & Power Systems Control 2000*, Brussels, Belgium, April 26-29, 2000.

[Deb 2000] Somnath Deb, Sudipto Ghoshal, Venkata N. Malepati, and David L. Kleinman, Tele-diagnosis: Remote monitoring of large-scale systems, 0-7803-5846-5/00/ © 2000 IEEE.

[Doumeingts 1995] G. Doumeingts, B. Vallespir, A methodology supporting design and implementation of CIM systems including economic evaluation. In Optimization Models and Concepts in Production Management, Gordon & Breach Science Publishers, New York, 1995. pp. 307-331.

[Doumeingts 1998] G. Doumeingts, B. Vallespir, D. Chen, Decisional Modelling using the GRAI Grid, in P. Bernus, K. Mertins and G. Schmidt, Handbook on Architectures of Information Systems, Springer-Verlag., (1998). pp313-338.

[Doyle et al. 1989] J. C. Doyle, K. Glover, P. P. Khargonekar, B. A. Francis, "State-space solution to standard H_2 and H_∞ control problems," IEEE Trans. on Automatic Control, Vol.34, No.8, August 1989.

[Fang 2000] Fang Huiqin, Discussion on the cascade dispatch and complex control of Three Gorges-Gezhouba Hydropower Plants, Automation of Electric Power Systems, Feb. 25, 2000, Vol. 24, No.4, pp14-18. (In Chinese).

[Fei 2001] Fei Xiuyu, Analysis of the effects of AGC operation on hydropower generating unit, Zhejiang electric power, 2001, No.4, pp16-18. (In Chinese)

[Fisher 2000] Gary Fisher, Aiden Donahue, Filter debris analysis as a first-line condition monitoring tool, Lubrication Engineering, Feb. 2000, pp18-22.

[Francis 1987] B. A. Francis, A course in H_∞ control theory, New York: Springer-Verlag, 1987.

[Fu et al. 2001] Fu Chuang, Chen Yuanchu, Li Zhengrong, Ye Luqing, The development and realization on Profibus-FMS communication programs under Windows, Industrial Control Computer, Jan., 2001, pp22-24. (In Chinese)

[Gary et al. 1999] Gary A. Mintchell, Open Systems mean freedom of choice in manufacturing, Control Engineering, Sept. 1999.

[Harrington 1974] Joseph Harrington, Computer Integrated Manufacturing, 1974.

[Huang 2000] Huang Yaluo, Huang Shuhong, Peng Zhongze, Condition Based Maintenance for Power Generating Equipment, China Electrical Power Press, Beijing, 2000. ISBN 7-5083-0349-0. (In Chinese)

[IEEE/PES 2001] Task Force, Risk and Probability Applications Subcommittee under

IEEE/PES, The Present Status of Maintenance Strategies and the Impact of Maintenance on Reliability, IEEE Transactions On Power Systems, Vol. 16, No. 4, November, 2001.

[IFIP-IFAC Task Force 1999] IFIP-IFAC Task Force, GERAM (version 1.6.3), March 1999, <http://www.cit.gu.edu.au/~bernus/taskforce/geram/versions/geram1-6-3>.

[ISA-dS95 1999] Instrument Society of America, Enterprise-Control-System Integration, ISA dS95.01-1999

[Isidori et al. 1992] A. Isidori, A. Astolfi, "Disturbance attenuation and H_∞ -control via Measurement feedback in nonlinear systems," IEEE Trans. on Automatic Control, Vol.37, No.9, Sept. 1992.

[IUNG 1992] Benoit Iung, Intelligence distribuée dans les processus industriels complexes, PhD Thesis, University of Henri Poincare, Nancy 1, 1992. Nancy, France. (French)

[IUNG et al. 1994] Benoit Iung, J. Pinoteau, Gerard Morel, Specifications of the PRIAM Tool, Deliverable 6.1 of the ESPRIT Project 6188, January 1994.

[IUNG et al. 1997] Benoit Iung, Jean-Baptiste Leger, Improvement of the PRIMA-WP4 generic Equipment Monitoring Model to propose a generic predictive maintenance model, PRIMA-REMAFEX Collaboration, Ref. REMAFEX-PRIMA002, December 1997.

[Jing et al. 1998] JING Lei, YE Luqing, "An Intelligent Discontinuous Control Strategy for Hydroelectric Generating Unit," IEEE Trans. on Energy Conversion, Vol.13, No.1, March 1998.

[Jonson 1999] Dick Johnson, Open Systems in process control: Are they the answer?, Control Engineering, Sept. 1999.

[Jovanovic 1995] S. Jovanovic, Intelligent Adaptive Turbine Controller, March 1995, Vol. 10, No. 1, pp195.

[King 1995] King B, Steward A P, Tait J I. Towards automated knowledge acquisition for process plant diagnosis, IEE Colloquium on Knowledge Discovery in Databases, 1995: 3/1~3/4

[Kozlowski 2001] Kozlowski J D, Byington C S, Garga A K, Watson M J, Hay W A. Model-based predictive diagnostics for electrochemical energy sources. IEEE Proceedings of Aerospace Conference, 2001, Vol. 6, pp3149 ~3164.

[Kroczek 1999] B. Kroczek, Integrated Data Flow from Shop Floor to the Business

Administration, Proc. Of the China Network for Integration in Manufacturing Workshop, Oct. 5th-7th, 1999, Karlsruhe, Germany, pp. 149-252.

[Leger 1999] Jean-Baptiste Leger, Contribution Methodologique a la Maintenance Provisionnelle des Systemes Industriels de Production: Proposition d'un Cadre Formel de Modelisation, PhD Thesis, University of Henri Poincare, Nancy 1, April 1999. Nancy, France. (French)

[Li 1994] Li Bohu, The provisional Constitution, Standards, Building Guide of CIMS, Weapon Industry Press, Beijing, 1994.

[Li 1999] Li Baowen, New thinking and new models for equipment management, China Machine Press, Beijing, 1999, ISBN 7-111-01757-9. (In Chinese)

[Li 2000] Li Baowen, TPM from concept to practice, China Metallurgy Press, Beijing, 2000, ISBN 7-5024-2666-3. (In Chinese)

[Li et al. 1992] LI Zhaohui, YE Luqing, WEI Shouping and O. P. Malik, "Fault tolerance aspects of a high reliable microprocessor-based water turbine governor," IEEE Trans. on Energy Conversion, Vol. 7, No. 1, March 1992.

[Lin et al. 1996] Lin Yaorui, Ma Shaoping, Introduction to Artificial Intelligence, Beijing: Tsinghua University Press, July, 1996. (In Chinese).

[Lin et al. 2000] Lin Ruiquan, Shao Gongwei, A network integrative distributed control system with fieldbus control system. China Instrumentation, Jan. 2000, pp. 8-11. (in Chinese)

[Lloyd 1999] Blake Lloyd, Condition monitoring for hydro generators, 0-7803-5569-5/99/ © 1999 IEEE.

[Liu et al. 1995] Liu Wanjing, Cao Hongen, Operation condition monitoring for hydroelectric units, Water Resources and Hydropower Technologies, No. 5, 1995, pp11-14. (In Chinese).

[Liu et al. 1996] Liu J N K, Sin K Y. Fuzzy knowledge system for machine maintenance, Australian and New Zealand Conference on Intelligent Information Systems, 1996, pp245~248

[Liu et al. 1997] Liu J N K, Sin K Y. Fuzzy neural networks for machine maintenance in mass transit railway system, IEEE Transactions on Neural Networks, 1997, Vol.8, No.4, pp932~941.

[Liu et al. 2000] Liu Xiuliang, Application of ultrasonic flow measurement technologies on

the testing of hydroelectric generating units in China, *Journal of Hydro Power Plant Automation*, supplement edition, 2000. (In Chinese)

[Liu et al. 2000] Liu Yongqian, Tong Songlin and Ye Luqing, Design method for hydraulic turbine governors via disturbance attenuation approach, *Power Plants and Power Systems Control 2000*, Editor: Waha JP, ISBN:0-08-043252-2, pp297-301, 2000. Elsevier Science BV, Amsterdam.

[Marinescu and Bourles 2000] Bogdan Marinescu, Henri Bouries, Robust state-predictive control with separation property: A reduced-state design for control systems with non-equal time delays, *Automatica*, Vol.36, pp555-562, 2000.

[Mayer 1991] R. Mayer, *Wholistic, Design, Engineering, and Manufacture*, Texas A&M University, College Station, TX 77843, USA, 1991.

[Mo et al. 1999] Mo Yiwei, Xiao Deyun, A Model-driven Approach to information Integration in Continuous Process Industries, *Proceedings of 14th World Congress of IFAC*, Beijing, 1999.

[Morel et al. 1994] G. Morel, B. Iung, D. Galara, F. Russo, Prototyping a subconcept of Computer Integrated Manufacturing Engineering (CIME): the integrated Control, Maintenance and Technical Management System (CMMS), *International Journal on Intelligent Actuation and soft Computing-Trends in R&D and Applications*, TSI Press Series, Vol. 2, 1994, pp. 25-30.

[Morel et al. 1997] G. Morel, B. Iung. Balancing between Integration and Distribution Paradigms: the Modelling Process of the European CMMS-IAMS Projects. *Proceedings of the ICEIMT'97 Conference - Workshop 3*. Burnel, Belgium, 1997, 11 ~ 13.

[Neunreuther 1998] Eric Neunreuther, *Contribution a la Modélisation des Systèmes Intègres de Production a Intelligence distribuée: application a la distribution du contrôle et de la gestion technique sur les équipements de terrain*, PhD Thesis, University of Henri Poincare, Nancy 1, October 1998, Nancy, France. (French)

[Petin 1995] Jean-Francois Petin, *Contribution méthodologique a l'Actionnement et la Mesure Intelligents: application au project ESPRIT III-PRIAM No. 6188*, PhD Thesis, University of Henri Poincare, Nancy 1, October 1998, Nancy, France. (French)

[Petin et al. 1998] Jean-Francois Petin, Benoit Iung, Gerard Morel, Distributed intelligent actuation and Measurement (IAM) system within an integrated shop-floor organization,

Computer in Industry, Vol. 37, 1998, pp197-211.

[Rao et al. 1994] Rao M., Wang Q., Yuan L., ad Zao M., CIPS Architecture and Implementation, Conference on Computer Integrated Manufacturing in the Process Industries, 1994, pp248-267.

[Ray 1996] Ray A, Tangirala S, Stochastic modelling of fatigue crack dynamics for on-line failure prognostics, IEEE Trans. on Control Systems Technology, 1996,Vol. 4, No.4, pp443–451.

[Rumbaugh 1999] James Rumbaugh, Ivar Jacobson, Grady Booch, The Unified Modelling Language Reference Manual, Addison Wesley Longman, 1999.

[Schniter et al. 1995] P. Schniter, et al., Efficiency Based Optimal Control of Kaplan Hydrogenerators, June 1995, Vol. 10, No. 2, pp348.

[Shao et al. 1998] Shao Weizhong, Yang Fuqing, Object Oriented System Analysis, Beijing: Tsinghua University Press, January, 1998. (In Chinese).

[Shen 1988] Shen Zongshu, Zhang Yongchuan, The stability and control of the hydroelectric generating units, Huazhong University of Science and Technology Press, 1998, ISBN 7-5609-0015-1. (In Chinese)

[Shirose 1992]Kunio Shirose, TPM for Workshop Leaders, English edition translated by Bruce Talbot, Productivity Press, Portland, Oregon, USA, 1992, ISBN 0-915299-92-5.

[Staller 1999]Chris Staller, Condition Based Maintenance - What is the condition of Condition Based Maintenance? Condition Monitoring Newsletter, January 1999.

[Travé-Massuyès 1997] Louise Travé-Massuyès, Robert Milne, Gas-Turbine Condition Monitoring Using Qualitative Model-Based Diagnosis, IEEE Expert, 1997, pp22-31.

[Van der Schafer 1992] A. J. Van der Schafer,“ L_2 -gain analysis of nonlinear systems and nonlinear state feedback control,” IEEE Trans. on Automatic Control, AC37, 1992.

[Vernadat 1996] F.B. Vernadat, Enterprise Modeling and Integration: Principles and Applications, Chapman & Hall, London, 1996.

[Vernadat 1998] F.B. Vernadat, The CIMOSA Languages, in P. Bernus, K. Mertins and G. Schmidt, Handbook on Architectures of Information Systems, Springer-Verlag., (1998). pp. 243-264.

-
- [Vernadat 1998] F.B. Vernadat, The CIMOSA Languages. In (P. Bernus, K. Mertins and G. Schmidt, eds.) Handbook of Information Systems, Springer-Verlag, Berlin, 1998, pp. 243-263.
- [Vernadat 2000] F.B. Vernadat, Enterprise Modelling and Integration: Current status and research perspectives, Management and Control of Production and Logistics 2000, IFAC, PERGAMON, ISBN: 0 08 043621 8, May 2001, Volume 2.
- [Vilim 2001] Vilim R B, Garcia H E, Chen F W, An identification scheme combining first principle knowledge, neural networks, and the likelihood function. IEEE Transactions on Control Systems Technology, 2001, 9(1): 186~199
- [Wang 1999] Wang Shentie, Intelligent Control-Maintenance-Management System and Its Application for Hydropower Stations, PhD thesis, Huazhong University of Science and Technology, 1999. (In Chinese)
- [Wang 2001] WANG Hai, Research on condition monitoring diagnosis and comprehensive test analyzing system for hydropower generator units, PhD thesis, Huazhong University of Science and Technology, 2001. (In Chinese)
- [Wang et al. 1999] Wang Shentie, YE Luqing, O.P. Malik, Intelligent Networked (N+M) Fault Tolerant Systems for Hydropower Station, International Journal Hydroelectric Energy, Mar. 1999, Vol. 17 No. 1, pp.66-72.
- [Williams 1988] T.J. Williams, A Reference Model for Computer Integrated Manufacturing (CIM), A Description From the Viewpoint of Industrial Automation, Minutes, CIM Reference Model Committee, International Purdue Workshop on Industrial Computer Systems, Purdue University, West Lafayette, IN (1988), the complete document is available on the World Wide Web under the following URL: <http://www.pera.net/Pera/PeraReferenceModel/ReferenceModel.html>.
- [Williams 1994] T.J. Williams, The Purdue Enterprise Reference Architecture, Computers in Industry, 24 (2-3), 141-158, 1994.
- [Williams 1994] Williams, T.J., "The Purdue Enterprise Reference Architecture" , Computers in Industry, Vol. 24, No. 2-3, pp. 141-158., 1994.
- [Witherwick 1999] Darren Witherwick, Condition monitoring compares, contrasts offshore equipment performance. Oil & Gas Journal; Vol.97; pp.64-66; ISSN 00301388; Tulsa; Feb 15, 1999.

[Wrate et. al. 1997] C. A. Wrate, et. al., Hydrogenerator System Identification Using Genetic Algorithm, March 1997, Vol. 12, No. 1, pp60.

[Wu 1997] Wu Cheng, The Information Technology and the Development Of Enterprises: Strategies for Chinese Manufacturing Enterprises, Computer in Manufacturing Systems, Vol.3, No.3, pp. 3-7.

[Wu et al. 1999] Cheng Wu, Bohu Li, Manufacturing System Automation in China: Contemporary Integrated Manufacturing, Proceedings of 14th World Congress of IFAC, Beijing, 1999.

[Xiong et al. 2000] Xiong Gang, Timo R. Nyberg, The Theories And Technologies In CIPS, Management and Control of Production and Logistics 2000, IFAC, PERGAMON, ISBN: 0 08 043621 8, May 2001.

[Xu 2000] XU Guozhi, System Science, Shanghai Science and Education Press, 2000, ISBN 7-5428-2355-8.

[Xu et al. 2000] Xu Aidong, Wang Hong, Yang Zhijia, Industry Automation Based on Ethernet, Information and Control, Apr. 2000, Vol.29, No.2, 182-186. (In Chinese)

[Yang 2000] YANG Yong-ping, LIU Tong, GUO Min-ren, and LIU Wen-yi, A study on the performance evaluation index for a coal-fired power generation unit, Proceedings of the CSEE, Vol. 20, No.2, Feb. 2000. (In Chinese)

[Ye 1984] YE Luqing, "Model reference multivariable optimal control and its realisation with microprocessor," Proceedings of Mini and Microcomputers and their Applications, Bari, Italy, June 1984.

[Ye et al. 1983] YE Luqing, Serge Maurin, "Multivariable adaptive control and how achieve it with microprocessor," Proceedings of ACI83 Applied Control and Identification, Copenhagen, July 1983.

[Ye et al. 1990] YE Luqing, WEI Shouping, LI Zhaohui, "An intelligent self-improving control strategy and its microprocessor-based implementation for application to hydro-turbine governing system", Can. J. Elect. & Comp. Eng., Vol. 15, No.4, 1990.

[Ye et al. 1995] Ye Luqing et al., An Integral Criterion Appraising the Overall Quality of a Computer-Based Hydro turbine Generating System, IEEE Trans. on Energy Conversion, Vol.10, No.2, June 1995, pp.376-381.

[Ye et al. 1999] Ye Luqing, Li Zhaohui, Jacques Pinoteau, Gerard Morel, Benoit Iung, CMMS/IAMS European-China co-operation through EIAM-IPE Project, Proc. Of the China Network for Integration in Manufacturing Workshop, Oct. 5th-7th, 1999, Karlsruhe, Germany, pp. 221-226.

[Ye et al. 2000] Ye Luqing, Li Zhaohui, Liu Yongqian, Zhang Yonggang, Intelligent Control-Maintenance-Management System and Its Application on Hydropower plants, Management and Control of Production and Logistics 2000, IFAC, PERGAMON, ISBN: 0 08 043621 8, May 2001, Volume 2, pp.609-614.

[Yu 2000a] Yu Ren, Theory and its application of predictive maintenance under the framework of intelligent control-maintenance-technical management system, PhD Thesis, Huazhong University of Science and Technology, Sept. 2000, Wuhan, China. (In Chinese)

[Yu et al. 1999] Yu Ren , Ye Luqing, Zhang Yonggang , Intelligent Control-Maintenance-technical Management System (ICMMS) and its application in power system, Automation of Electric Power Systems, Dec., 1999, Vol. 23, No.23, pp50-53. (In Chinese)

[Yu et al. 2001] Yu Ren, Zhang Yonggang, Ye Luqing, Li Zhaohui, The analysis and design method of maintenance system in intelligent control-maintenance-technical management system (ICMMS) and its application, Proceedings of Chinese Society for Electrical Engineering, Vol. 21 No.4, Apr. 2001, pp60-65. (In Chinese)

[Zasadzinski et al. 1998] M. Zasadzinski, E. Richard, M. F. khelfi and M. Darouach, Disturbance attenuation and trajectory tracking via a reduced-order output feedback controller for robot manipulators, Automatica, Vol. 34, No. 12, pp. 1539-1546, 1998.

[Zhang 1988] Zhang Changqi, The principles and the mathematical models of hydraulic turbines, Huazhong University of Science and Technology Press, 1998, ISBN 7-5609-0084-4. (In Chinese)

[Zhang 1999] Zhang Runshi, Integrated automation scheme of modern hydropower station, Automation of Electric Power Systems, November, 1999, Vol. 23, No.22, pp50-53. (In Chinese)

[Zhang 1999] Zhang Yonggang, Intelligent Control-Maintenance-Management System and Its Application on Electric Power Dispatching System and Hydroelectric Governing System, PhD thesis, Huazhong University of Science and Technology, 1999. (In Chinese)

[Zheng 1997] Zheng Qingshun, Test of Turbine Efficiency and Economic Benefit, Yunnan Water Power, Vol. 47, 91-96, 1997(2). (In Chinese)

[Zhou 1999] Zhou Dabing, Hold the opportunities and work initiatives to boost the cause of hydropower development in China: Speech on the Hydropower Development Seminar by the China State Electrical Power Company, Guizhou Water Power, Dec. 1999, Special edition, Vol.12, pp2-10. (In Chinese)

LIST OF PUBLICATIONS DURING DOCTORAL STUDY

LIST OF PUBLICATIONS DURING DOCTORAL STUDY

Published:

1. LIU Yongqian, Tong Songlin and Ye Luqing, “*Design Method for Hydraulic Turbine Governors via Disturbance Attenuation Approach.*” Power Plants and Power Systems Control 2000, Editor: Waha JP, ISBN:0-08-043252-2, pp297-301, 2000. Elsevier Science BV, Amsterdam. (In English)
2. LIU Yongqian, YE Luqing, Benoit IUNG, Xiuliang Liu, Yuanchu Cheng, Gerard Morel, Cuangfu, “An economic performance evaluation method for hydroelectric generating units”, ”, Energy Conversion and Management, Vol. 44, No.6, pp. 797-808, April. 2003 , Elsevier Science, (ISSN: 0196-8904), (in English)
3. Yongqian LIU, Luqing Ye, Yuanchu Cheng, Benoit IUNG, Gerard MOREL, Zhaohui Li, “*Hybrid Smart Automation System for Hydro Power Plants*, Automation of Electric Power Systems (电力系统自动化英文增刊), Vol.26 Supplement 2002, pp.104-109, October 2002, ISSN 1000-1026, CODEN DXZIE9.(in English)
4. Liu Yongqian, Ye Luqing, Tong Songlin, “*Disturbance Attenuation Approach to Design Water Turbine Governor.*” Journal of Hydraulic Engineering (水利学报), ISSN 0559-9350, CODEN SLHPBI, pp. 50-54, Vol. 4, Apr 1999. (In Chinese).
5. LIU Yongqian, YE Luqing, B. IUNG, CHENG Yuanchu, FU Chuang, G. MOREL, LIU Xiuliang, “*Economic Performance Based Maintenance and Its Application in Hydroelectric Generating Units*”, pp. 105-113, Proceedings of 1st CENNET Workshop on Digital Manufacturing and Business, Beijing, April 14-15, 2002. (In English)
6. Liu Yongqian, Chen Dexin, Jan Vojtek, “*A Numerical Method and Code to Express 3D Twisty Blade Surfaces in Turbomachinery.*” Acta Polytechnica, ISSN 1210-2709, CODEN ACPOEZ, pp. 43-54, Vol.36, No.3, 1996. (In English)
7. LIU Yongqian, YE Luqing, CHEN Yuanchu, B. IUNG, G. MOREL, LI Zhaohui, “*A New*

-
- System Integration Architecture for Hydro Power Plants*”, pp. 165-172, Proceedings of 1st CENNET Workshop on Digital Manufacturing and Business, Beijing, April 14-15, 2002. (In English)
8. Ye Luqing, Li Zhaohui, Liu Yongqian, Zhang Yonggang, “*Intelligent Control-Maintenance-Management System and Its Application on Hydropower plants*”, Management and Control of Production and Logistics 2000, IFAC, PERGAMON, ISBN: 0-08-043621-8, May 2001, Vol. 2, pp.609-614. (In English)
 9. CHENG Yuanchu, LIU Yongqian, “*Universal Approach and Windows-Based Software Platform to Simulate Water Transients in Hydro Power Plants*”, XXIX IAHR Congress Proceedings, Theme D Beijing, Tsinghua University Press, ISBN 7-302-0476, Vol. II pp531-537, Sept. 200. (In English)
 10. Jean-Baptiste Leger, Yongqian Liu, “*CASIP: The information Technologies Applied to Safety of Industry Plants*”, Proceedings of 1st CENNET Workshop on Digital Manufacturing and Business, pp140-147, April 14-15, 2002, Beijing, China. (in English)
 11. CHENG Yuanchu, LIU Yongqian, XU Hangke, “*The Application of PLC on the Automatic Control for Hydropower Unit*”, Programmable Controller & Factory Automation, ISSN 1606-5123, No. 3 pp43-45, 2001. (In Chinese)
 12. Li Fenhua, Liu Yongqian, “*A New Singularity Method for Flow Analysis in Hydraulic Machinery Runners.*” Journal of the North China Institute of Water Conservancy and Hydroelectrical Power (华北水利水电学院学报), ISSN 1002-5058, pp. 28-33, Vol.18, No. 4, Dec 1997. (In Chinese)
 13. Fu Chuang, Ye Luqing, Yu Ren, Liu Yongqian. “*Study of predictive maintenance in Intelligent Control-Maintenance-Management System*” (智能控制-维护-管理系统(ICMMS)中预知维护的研究), “Automation of Electric Power System (电力系统自动化), Vol. 26, No. 4, pp45-50. (In Chinese)
 14. CHENG Yuanchu, LIU Yongqian, Xu Hanke, PLC-based controller for the automatic control of Pelton turbine generator units (基于 PLC 的冲击式水轮发电机组自动控制), No. 5, 2002, Journal of Water Power (水力发电) (In Chinese)

Accepted:

15. Chuang Fu, Luqing Ye, Ren Yu, Yongqian Liu, and Benoit. Iung, Predictive Maintenance in Intelligent-Control-Maintenance-Management System for Hydroelectric Generating Unit, accepted by IEEE trans. on Energy Conversion. (In English)
16. CHENG Yuanchu, YE Luqing, LIU Yongqian, FU Chuang, LI Zengrong, “Design of the Micro controller-based Governor for Hydro Turbine and Its Intelligent Control Strategy”, accepted by International Journal of Power and Energy Systems. (In English)
17. Fu Chuang, Ye Luqing, Liu Yongqian, Cheng Yuanchu, “Intelligent Control-Maintenance-Management System (ICMMS) based on Multi-agent”, accepted by Control and Decision (控制与决策), ISSN 1001-0920. (In Chinese)

Monsieur LIU Yongqian

DOCTORAT de l'UNIVERSITE HENRI POINCARÉ, NANCY 1
en PRODUCTION AUTOMATISEE

VU, APPROUVÉ ET PERMIS D'IMPRIMER

Nancy, le 27 MAI 2002 n°671

Le Président de l'Université

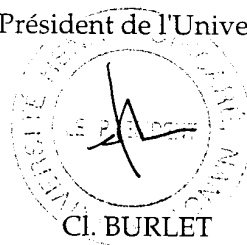

RESUME

Les travaux présentés contribuent à un des enjeux majeurs de l'Entreprise Étendue liée au domaine de la production d'énergie électrique. L'objectif est de maintenir en dynamique la qualité des services rendus par les processus de production. Ces travaux ont ainsi pour objet, en se référant au cadre de modélisation d'Entreprise GERAM, de proposer une méthodologie réutilisable pour l'automatisation intégrée des centrales hydroélectriques. Ces dernières étant structurellement des systèmes stables, cette méthodologie est basée sur une approche orientée processus et aboutit au développement de modèles pérennes et réutilisables. Le point central de cette méthodologie consiste en la définition d'un modèle de référence ICMMS (Intelligent Control-Maintenance-technical Management Systems) formalisant la connaissance générique, de niveau terrain, applicable à l'automatisation de toute centrale hydroélectrique. La mise en œuvre de ce modèle de référence conduit à la proposition d'une architecture HSAS (Hybrid Smart Automation System) qui intègre en un tout cohérent sur les points de vue Contrôle, Maintenance et Gestion Technique, les différents composants d'automatisation distribués, supportés par des actionneurs, capteurs, ou contrôleurs conventionnels de niveau terrain.

Par rapport à cette architecture, les concepts innovants de "Surveillance Conditionnelle" pour l'îlot Maintenance et d'"Atténuation de Perturbations" pour l'îlot Contrôle sont définis et étudiés afin d'être intégrés au système ICMMS. De plus, nous proposons, pour la Gestion Technique, des concepts, critères et outils pour l'évaluation de performances des HGU (Hydroelectric Generating Units). Cette contribution est basée sur la définition d'un système d'évaluation des performances économiques utilisant des descripteurs quantitatifs mesurant l'état d'efficacité, le niveau de gestion de l'exploitation et l'état de maintenance de ces unités. Une nouvelle stratégie en lien avec la maintenance, intitulée EBM (Economic performance Based Maintenance), est ainsi formalisée. L'ensemble de nos propositions est validée sur une étude de cas.

MOTS CLES

Automatisation, Ingénierie Système, Intégration, Intelligence, Evaluation de Performances, Centrales Hydroélectriques, Maintenance basée sur la Performance économique, Surveillance conditionnelle.

ABSTRACT

Based on the system thought and GERAM, a methodology and ICMMS (Intelligent Control-Maintenance-technical Management Systems) reference model for hydropower plants are proposed. Because the structures of the hydropower generating process are unchanging, the methodology employs the process-oriented approaches to model the hydropower plants, and the models constructed through this methodology are stable and reusable. The proposed Reference Model grasps the similarities and unchangeabilities of the hydropower plants, therefore the redistributing of the function modules inside the system can be done in a natural and easy way, while the synergies among the components of the system are guaranteed. To implement the ICMMS in hydropower plants, HSAS (Hybrid Smart Automation System) is proposed in which integrates the conventional controllers and fieldbus based components under fully distributed system architecture.

In the maintenance domain, the concept of Condition Monitoring is clearly defined, and related technologies for hydropower plants are summarized and analyzed. The condition monitoring system is integrated into the ICMMS under the Reference Model proposed above.

In the technical management domain, the performance evaluation methods and implement system is a lacuna item to the HGU (Hydroelectric Generating Units), however it is indispensable for ICMMS. Some important concepts, indexes, criteria and methodologies for the performance evaluation on HGUs are proposed. An economic performances evaluation system for HGUs is proposed, with which the efficiency state, the level of operation management, and the maintenance state of an HGU can be measured through qualitative indexes. A real test case illustrated effectiveness of the method. Based on this method, a new maintenance strategy, EBM (Economic performance Based Maintenance) is proposed and illustrated through a case study. As a contribution to the control domain, a new method, DAA (Disturbance Attenuation Approach), is proposed to design hydraulic turbine governors. Finally, some philosophical thoughtlets of the author for the system integration are presented.

KEYWORDS

System Integration, Hydropower, hydroelectric generating unit, Performance Evaluation, Economic Performance Based Maintenance, Condition Monitoring, System Engineering.