



HAL
open science

L'Hafnium dans les zones de subduction: Bilan isotopique des flux entrant et sortant

Jean-Christophe Marini

► **To cite this version:**

Jean-Christophe Marini. L'Hafnium dans les zones de subduction: Bilan isotopique des flux entrant et sortant. Géochimie. Université Joseph-Fourier - Grenoble I, 2004. Français. NNT: . tel-00006357

HAL Id: tel-00006357

<https://theses.hal.science/tel-00006357>

Submitted on 30 Jun 2004

HAL is a multi-disciplinary open access archive for the deposit and dissemination of scientific research documents, whether they are published or not. The documents may come from teaching and research institutions in France or abroad, or from public or private research centers.

L'archive ouverte pluridisciplinaire **HAL**, est destinée au dépôt et à la diffusion de documents scientifiques de niveau recherche, publiés ou non, émanant des établissements d'enseignement et de recherche français ou étrangers, des laboratoires publics ou privés.

Université Joseph Fourier – Grenoble I
Observatoire des Sciences de la Terre de Grenoble

Année 2004

Thèse
Pour l'obtention du diplôme de doctorat en Sciences de la Terre

Présentée par
Jean-Christophe Marini

L'Hafnium dans les zones de subduction : bilan isotopique des flux entrant et sortant

Soutenue le 7 mai 2004 devant le jury composé de

Henriette Lapierre
Nadine Mattielli
Pierre Schiano
John Ludden
Dalila Ben Othman
Catherine Chauvel

Président du Jury
Rapporteur
Rapporteur
Examineur
Invité
Directeur de thèse

Remerciements

Ce travail de thèse a été soutenu de manière quotidienne, souvent à bout de bras, par de nombreuses personnes plus que bienveillantes : Bien sûr par l'ensemble de ma famille, en particulier, Bernard, Dorothee, Nathalie, Claude et Gilles Marini; Thomas, Florence et Mariano Gomez. Au laboratoire, un MERCI Infini à Vincent De Andrade (l'homme aux élastiques et meilleur compagnon de bureau qui puissent exister - pour répondre à ses remerciements de DEA), Ivan Vlastelic et sa Super Petite Famille, Marion Carpentier et Mikaël Attal. Si ce travail a une quelconque petite valeur, elle est due à ces personnes.

L'Amitié profonde accordée par beaucoup d'autres personnes fût absolument indispensable : Bénédicte, Thierry, Alexis et Chloé Champel-Duffait, Bardhyl Muceku, Thomas Saucède, Bruno Kieffer, Ananta Gajurel, Florence Revol, Rodolphe Pinon (Grand Manitou des ordinateurs), François Chauvet et Hugues Genty.

Merci à Carole Roberge, Sandra Nicod, Séverine Ruellan, Isabelle Perbet, Gilles Brocard, Arnaud Agranier, Chaker Raddadi, Julien Beltramo, Alexandre Narros, Florence Bastien, Agnès Samper, Damien Mollex, Philippe Monjoie, Éric Lewin, François et Claudie Senebier, Claudine Meugniot, Pascale Talour, Marc Mamberti, Yann Rolland, Marcelo Garcia-Godoy, Crélia Padron, Andréa Amortégui, James Allibon, Jérémie Van Nelle et Dorian Besançon, Tous Ceux croisés durant ces trois ans et demi pour leurs attentions, leur aide, leur soutien et leur sympathie.

Enfin merci à Catherine Chauvel pour avoir proposé et encadré ce travail et à l'ensemble des autres membres du Jury : Henriette Lapierre, Nadine Mattielli, Pierre Schiano, Dalila Ben Othman et John Ludden, pour avoir accepté de l'évaluer.

Mille Excuses si des personnes ont été involontairement oubliées dans ces remerciements.

Table des matières

Résumé	I
Abstract	II
Introduction	1
CHAPITRE I : Compositions isotopiques de l'Hafnium des matériaux terrestres : Corrélations avec les compositions isotopiques du Néodyme et intérêts dans l'étude des zones de subduction	6
CHAPITRE II : Compositions isotopiques de l'Hafnium et du Néodyme du flux entrant dans la zone de subduction d'Izu-Mariannes (Leg ODP 185, Sites 801 et 1149).....	18
<i>Article : Hf-Nd isotopic budget of altered oceanic crust and sediments subducted at the Izu-Mariana margin (ODP Leg 185, Sites 801 and 1149). Implications for the recycling of subducted materials into the Izu-Mariana arc and the earth's deep mantle.....</i>	<i>21</i>
CHAPITRE III : Compositions isotopiques de l'Hafnium des laves d'arcs insulaires	
<u>Partie A</u> : Arc de Luzon	69
<i>Article : Hf isotope compositions of northern Luzon arc lavas suggest involvement of pelagic sediments in their source</i>	<i>71</i>
<u>Partie B</u> : Île de Java (arc de la Sonde)	101
<i>Article : Evolution temporelle des compositions isotopiques de l'Hf des laves d'arc de Java.....</i>	<i>103</i>
CHAPITRE IV : Synthèse des résultats principaux	128

N.B. La présentation sous forme d'articles en préparation pour publication nous a conduit à placer les références bibliographiques à la fin de chaque chapitre

Résumé

Les zones de subduction représentent les principaux sites d'échanges de matière entre la croûte et le manteau terrestre. Les magmas d'arcs insulaires produits au niveau des zones de subduction correspondent à un flux de matière sortant du manteau qui s'ajoute aux croûtes des arcs. En contrepartie, les croûtes océaniques altérées et les piles sédimentaires associées qui sont absorbées au niveau des zones de subduction correspondent à un flux de matière réintégrant le manteau terrestre. Nous avons examiné ces échanges de masse entre la croûte et le manteau terrestre en utilisant les compositions isotopiques de deux éléments en traces : l'Hafnium et le Néodyme.

Tout d'abord nous avons mesuré les compositions isotopiques de l'Hafnium et du Néodyme de la croûte basaltique altérée et de la pile sédimentaire entrant dans la zone de subduction d'Izu-Mariannes afin de préciser l'origine de ces deux éléments dans les matériaux qui retournent vers le manteau. Les budgets de l'Hafnium et du Néodyme de la croûte basaltique altérée n'ont pas été modifiés par les processus hydrothermaux et restent identiques aux compositions d'une croûte océanique non-altérée. Les budgets de l'Hafnium et du Néodyme de la pile sédimentaire sont dominés par des apports provenant de l'eau de mer. Pour la zone de subduction d'Izu, nous avons ensuite comparé la masse de Néodyme injectée dans le manteau lors de la subduction des sédiments avec la masse de Néodyme sortant du manteau lors de la remontée des magmas jusqu'à la croûte de l'arc. Ces deux taux sont d'un ordre de grandeur comparable. Dans la zone de subduction d'Izu, il n'existe donc pas un grand déséquilibre entre les flux de Néodyme entrant et sortant. Enfin la croûte basaltique et les sédiments actuellement subduits au niveau de la zone d'Izu-Mariannes ne sont probablement pas équivalents aux anciennes croûtes et sédiments recyclés dans la source des laves de points chauds.

Nous avons mesuré les compositions isotopiques de l'Hafnium des laves de l'arc de Luzon et de l'île de Java (arc de la Sonde) afin d'examiner les caractéristiques du flux sortant des zones de subduction. Les compositions isotopiques de l'Hafnium des laves d'arc de Luzon et de Java apparaissent très radiogéniques par rapport à leurs compositions isotopiques du Néodyme. Ces compositions semblent conditionnées par des sédiments océaniques qui contaminent la source et qui possèdent aussi des compositions isotopiques de l'Hafnium très radiogéniques par rapport à leurs compositions isotopiques du Néodyme. Les laves d'arcs insulaires sont de plus caractérisées par des anomalies négatives en Niobium et Tantale, deux éléments en traces proches de l'Hafnium. Ces anomalies négatives semblent en premier lieu causées par une rétention de ces deux éléments dans une phase minérale résiduelle au niveau des matériaux de la plaque subduite.

Mots clés : Zones de Subduction, compositions isotopiques de l'Hafnium et du Néodyme, Arcs insulaires, Croûte Océanique Altérée, Sédiments Océaniques, Recyclage, Anomalies en Nb-Ta.

Abstract

Subduction zones are the primary regions of exchanges between the crust and the mantle of Earth. Magmas derived from mantle, erupted in island arcs contribute to crust growth whereas altered oceanic crusts and overlying sediments subducted at convergent margins are recycled back toward the earth's mantle. We analyze these mass exchanges between the crust and the mantle using Hafnium and Neodymium isotopes.

First, we have measured the Hafnium and Neodymium isotopic compositions of the altered basaltic crust and overlying sedimentary pile subducting at the Izu-Mariana trench. Hafnium and Neodymium isotopes of the altered basaltic crust consumed at the Mariana trench are equivalent to the isotopic budget of unaltered Pacific MORB and have not been modified by hydrothermal alteration and interaction with seawater. Isotopic compositions of sediments subducted at the Izu trench indicate that the primary source of Hafnium and Neodymium for these materials is the overlying Pacific seawater. In the Izu subduction zone, we have compared the Neodymium entering flux by sediment subduction with the Neodymium output flux by eruption of arc lavas. These input and output fluxes are of the same order and consequently no large disequilibria exist for the Neodymium mass balance. Finally, the altered basaltic crust and sedimentary pile subducted today at the Izu-Mariana margin are probably not equivalent to ancient oceanic crusts and sediments recycled into mantle plumes.

We have measured Hafnium isotopes of lavas from the Luzon arc and from Java Island (Sunda arc) in order to examine the isotopic composition of arc lavas, which are the major output flux of subduction zones. Luzon and Java arc lavas have Hafnium isotopic compositions highly radiogenic in comparison to their Neodymium isotopic ratios. Such compositions reflect the contribution in their source of oceanic sediments with highly radiogenic Hafnium isotopes. In island arc lavas, Niobium and Tantalum, two trace elements from the Hafnium group, are in depleted concentrations in comparison to other trace element. These negative Niobium and Tantalum anomalies appear caused by retention of these elements by a residual mineral in the subducting materials.

Keywords: Subduction zones, Hafnium and Neodymium isotopes, volcanic arcs, altered oceanic crust, oceanic sediments, recycling, Nb-Ta anomalies.

Introduction

Introduction

Les zones de subduction représentent des régions clés de la dynamique terrestre. Sur près de 30000 km de longueur, elles permettent l'absorption de la lithosphère océanique et son retour vers le manteau en contrebalançant ainsi l'accrétion de cette lithosphère qui intervient au niveau des dorsales medio-océaniques. La subduction de la lithosphère océanique est généralement associée à un magmatisme qui s'exprime en surface par l'apparition d'un arc volcanique sur la plaque continentale ou océanique sus-jacente à la subduction. Les magmas produits à l'aplomb des zones de subductions présentent une série de caractéristiques pétrographiques et géochimiques qui les distinguent pleinement des magmas produits au niveau des points chauds et des rides médio-océaniques (Gill, 1981; Thorpe, 1982). Tout d'abord leur composition moyenne en éléments majeurs, légèrement enrichie en silice et en alcalins, a été dénommée composition andésitique. Ensuite au niveau de leurs compositions en éléments en traces, ces magmas sont principalement caractérisés par un déficit des concentrations en Niobium et Tantale par rapport aux éléments en traces comparables (Perfit et al., 1980; Pearce, 1982). Ces compositions géochimiques des magmas de zones de subductions apparaissent très proches de la composition moyenne de la croûte continentale (Taylor et McLennan, 1985). La similitude entre les magmas d'arcs volcaniques et la composition de la croûte continentale ont conduit Taylor (1967; 1977) puis Taylor et McLennan (1985; 1995) à considérer que les zones de subduction constituaient des régions où actuellement la croûte continentale était extraite du manteau terrestre. Les arcs volcaniques représentent ainsi des ensembles juvéniles de croûte destinés à évoluer vers des ensembles matures et à s'ajouter à la masse continentale présente à la surface de la Terre.

Cependant au niveau des zones de convergence, la subduction ne concerne pas uniquement la lithosphère océanique mais aussi les couches sédimentaires qui se sont déposées sur celle-ci

durant son trajet depuis la dorsale jusqu'à la fosse de subduction (Von Huene et Scholl, 1991; Rea et Ruff, 1996). Les éléments constituant ces sédiments océaniques proviennent pour partie de l'érosion mécanique et chimique des masses continentales (Hay, 1998). La subduction de ces sédiments correspond donc à un retour de matériaux continentaux vers le manteau de la Terre. D'un point de vue géochimique, les zones de subduction représentent donc des régions d'échanges de matière entre deux des principaux réservoirs terrestres, en permettant l'extraction de la croûte continentale à partir du manteau mais aussi en autorisant le retour du matériel crustal vers ce même manteau (Armstrong, 1968; Armstrong, 1981; White, 1989; Armstrong, 1991; Von Huene et Scholl, 1993; Plank et Langmuir, 1998). Les zones de subductions représentent en outre des lieux d'interactions entre le manteau et les enveloppes fluides de la Terre (l'océan et l'atmosphère). En effet, les croûtes basaltiques et les sédiments constituant la partie supérieure des lithosphères océaniques contiennent d'importantes proportions d'eau. Leur subduction permet donc vraisemblablement un recyclage de l'eau océanique vers le réservoir mantellique (Ito, et al., 1983; Gillet, 1993). Enfin le dégazage des laves au niveau des arcs volcaniques correspond pour partie à un flux de matière entre le manteau et l'atmosphère terrestre (Marty et Tolstikhin, 1998).

Cette perspective du rôle fondamental des zones de subductions dans la dynamique des réservoirs géochimiques de la Terre repose pour partie sur le comportement du Niobium et du Tantale puisque ce sont les proportions de ces deux éléments qui permettent de rapprocher chimiquement les magmas des zones de subduction des matériaux de la croûte continentale. Niobium et Tantale sont deux éléments appartenant au groupe géochimique des éléments à faibles rayons ioniques et fortes valences (nommés groupe des "High Field Strength Elements" dans les publications en langue anglaise). L'étude détaillée du comportement de ces éléments dans les zones de subduction apparaît donc capitale afin

d'appréhender les processus de génération des magmas d'arcs et d'échanges entre la croûte et le manteau.

Notre travail est consacré à l'étude des compositions isotopiques de l'Hafnium, un élément appartenant au groupe des éléments à faibles rayons ioniques et fortes valences. La désintégration radioactive β^- de l'isotope 176 du Lutétium en isotope 176 de l'Hafnium permet l'utilisation de la composition isotopique de l'Hafnium comme traceur géochimique (Patchett et Tatsumoto, 1980; Patchett, 1983a; Patchett, 1983b). Nous avons mesuré les compositions isotopiques de l'Hafnium et du Néodyme dans des sédiments et des basaltes de croûte océanique récoltés au front d'une zone de subduction ainsi que les compositions isotopiques de l'Hafnium de laves d'arcs insulaires intra-océaniques afin d'atteindre cinq objectifs :

- 1) Tout d'abord, la mesure des compositions isotopiques de l'Hafnium et du Néodyme dans les sédiments et les croûtes océaniques absorbées au niveau des zones de subduction complètent les données de Staudigel et al. (1995) et Plank et Langmuir (1998) concernant le budget isotopique des croûtes océaniques et piles sédimentaires subduites. Ces données permettent de préciser les sources des terres rares et des éléments du groupe de l'Hafnium dans les matériaux retournant vers le manteau.
- 2) De telles mesures sur le flux entrant dans les zones de subductions peuvent ensuite être comparées aux données sur les laves émises dans les arcs volcaniques qui représentent le principal flux de matière sortant des zones de subductions. Ceci permet une estimation du bilan des échanges intervenant dans ces régions.
- 3) Enfin les compositions isotopiques des matériaux consommés au niveau des fosses de subductions pourront être comparées aux compositions des laves de points chauds qui représentent un échantillonnage du manteau profond de la Terre. Cette démarche permet

d'apporter quelques contraintes sur un possible recyclage des ensembles subduits dans le manteau profond.

- 4) Les mesures sur les compositions isotopiques de l'Hafnium dans les laves d'arcs complètent les données préexistantes dans la littérature et permettent un examen des corrélations entre les compositions isotopiques de l'Hafnium et du Néodyme mais aussi des corrélations entre ces compositions isotopiques et les compositions en éléments traces dans les roches d'arcs intra-océaniques.
- 5) Ces données sur les laves d'arcs peuvent nous permettre d'apporter ensuite des contraintes sur les causes du déficit en Niobium et Tantale par rapport aux autres éléments traces dans ces roches.

Nos travaux ont été réalisés sur trois zones de subductions intra-océaniques : La subduction d'Izu-Bonin-Mariannes, la subduction de Luzon-Taiwan et la subduction de la Sonde. Notre étude s'articule autour de trois manuscrits en cours de préparation pour publication : Tout d'abord les compositions isotopiques de l'Hafnium et du Néodyme des ensembles subduits ont été mesurées sur des échantillons provenant des Sites de forages 801 et 1149 du programme "Ocean Drilling Program" qui se localisent au front de la fosse d'Izu-Mariannes. Ensuite les compositions isotopiques de l'Hafnium des laves d'arcs ont été mesurées sur les laves de l'arc de Luzon puis sur les laves de l'île de Java (arc de la Sonde).

Références Bibliographiques :

- Armstrong, R. L. (1968): A model for the evolution of strontium and lead isotopes in a dynamic Earth. *Reviews of Geophysics*, Vol. 6, p. 175-199.
- Armstrong, R. L. (1981): Radiogenic isotopes: The case for crustal recycling on a near-steady-state no-continental-growth Earth. *Philosophical Transactions of the Royal Society of London. A*, Vol. 301, p. 443-472.
- Armstrong, R. L. (1991): The persistent myth of crustal growth. *Australian Journal of Earth Sciences*, Vol. 38, p. 613-630.

-
- Gill, J. B. (1981): *Orogenic andesites and plate tectonics*. Springer-Verlag, New York, 330 p.
- Gillet, P. (1993): L'eau du manteau terrestre. *La Recherche*, Vol. 255, p. 676-685.
- Hay, W. W. (1998): Detrital sediment fluxes from continents to oceans. *Chemical Geology*, Vol. 145, p. 287-323.
- Ito, E., D. M. Harris, et al. (1983): Alteration of oceanic crust and geologic cycling of chlorine and water. *Geochimica et Cosmochimica Acta*, Vol. 47, p. 1613-1624.
- Marty, B. et I. N. Tolstikhin (1998): CO₂ fluxes from mid-ocean ridges, arcs and plumes. *Chemical Geology*, Vol. 145, p. 233-248.
- Patchett, P. J. (1983a): Hafnium isotope results from mid-ocean ridges and Kerguelen. *Lithos*, Vol. 16, p. 47-51.
- Patchett, P. J. (1983b): Importance of the Lu-Hf isotopic system in studies of planetary chronology and chemical evolution. *Geochimica et Cosmochimica Acta*, Vol. 47, p. 81-91.
- Patchett, P. J. et M. Tatsumoto (1980): Hafnium isotope variations in oceanic basalts. *Geophysical Research Letters*, Vol. 7(12), p. 1077-1080.
- Pearce, J. A. (1982): Trace element characteristics of lavas from destructive plate boundaries. in *Andesites: Orogenic Andesites and Related Rocks*. R. S. Thorpe (Ed.). John Wiley, New York, p. 525-548.
- Perfit, M. R., D. A. Gust, et al. (1980): Chemical characteristics of island-arc basalts: Implications for mantle sources. *Chemical Geology*, Vol. 30, p. 227-256.
- Plank, T. et C. H. Langmuir (1998): The chemical composition of subducting sediment and its consequences for the crust and mantle. *Chemical Geology*, Vol. 145, p. 325-394.
- Rea, D. K. et L. J. Ruff (1996): Composition and mass flux of sediment entering the world's subduction zones: Implications for global sediment budgets, great earthquakes, and volcanism. *Earth and Planetary Science Letters*, Vol. 140, p. 1-12.
- Staudigel, H., G. R. Davies, et al. (1995): Large scale isotopic Sr, Nd and O isotopic anatomy of altered oceanic crust: DSDP/ODP sites 417/418. *Earth and Planetary Science letters*, Vol. 130, p. 169-185.
- Taylor, S. R. (1967): The origin and growth of continents. *Tectonophysics*, Vol. 4, p. 17-34.
- Taylor, S. R. (1977): Island arc models and the composition of the continental crust. in *Island Arcs, Deep Sea Trenches, and Back-Arc Basins*. M. Talwani et W. C. Pitman III (Eds). AGU, Washington D.C., Maurice Ewing Ser., Vol. 1, p. 325-335.
- Taylor, S. R. et S. M. McLennan (1985): *The Continental Crust: Its Composition and Evolution*. Blackwell Scientific, Boston, Mass., 312 p.
- Taylor, S. R. et S. M. McLennan (1995): The geochemical evolution of the continental crust. *Reviews of Geophysics*, Vol. 33(2), p. 241-265.
- Thorpe, R. S. (1982): *Andesites: Orogenic Andesites and Related Rocks*. John Wiley, New York, 724 p.
- Von Huene, R. et D. W. Scholl (1991): Observations at convergent margins concerning sediment subduction, subduction erosion, and the growth of continental crust. *Reviews of Geophysics*, Vol. 29, p. 279-316.
- Von Huene, R. et D. W. Scholl (1993): The return of sialic material to the mantle indicated by terrigenous material subducted at convergent margins. *Tectonophysics*, Vol. 219, p. 163-175.
- White, W. M. (1989): Geochemical evidence for crust-to-mantle recycling in subduction zones. in *Crust/Mantle Recycling at Convergence Zones*. S. R. Hart et L. Gullen (Eds). Kluwer Academic, Hingham, Mass., p. 43-58.
-

CHAPITRE I

Compositions isotopiques de l'Hafnium des matériaux terrestres : Corrélations avec les compositions isotopiques du Néodyme et intérêts dans l'étude des zones de subduction

CHAPITRE I : Compositions isotopiques de l'Hafnium des matériaux terrestres : Corrélations avec les compositions isotopiques du Néodyme et intérêts dans l'étude des zones de subduction

A) Compositions isotopiques des éléments traces

Les roches terrestres contiennent la totalité des éléments chimiques connus à l'état naturel. Une petite dizaine de ces éléments, désignés par le terme d'éléments majeurs, constituent généralement plus de 99% de la masse des matériaux terrestres. Il s'agit du Silicium, de l'Oxygène, de l'Aluminium, du Fer, du Calcium, du Magnésium, du Manganèse, du Sodium, du Potassium et du Titane. L'ensemble des autres éléments chimiques naturels (environ 80 éléments) forment généralement moins de 1% de la masse des échantillons terrestres. Ces éléments ont été regroupés sous le terme d'éléments traces.

Parmi les éléments traces des roches terrestres, quelques nucléides proviennent d'une désintégration radioactive d'autres éléments traces. Ces processus de désintégrations ont trouvé deux applications importantes en Sciences de la Terre. Tout d'abord, les réactions de désintégrations radioactives à longues périodes, avec des constantes de désintégrations λ de l'ordre de 10^{-9} à 10^{-12} an⁻¹, sont utilisées comme chronomètre pour déterminer l'âge des échantillons géologiques.

Ces systèmes de désintégrations radioactifs à longues périodes sont, de plus, utilisés pour étudier la pétrogenèse des roches terrestres. Cette application concerne principalement les systèmes ⁸⁷Rb-⁸⁷Sr, ¹⁴⁷Sm-¹⁴³Nd, ²³⁸U-²⁰⁶Pb, ²³⁵U-²⁰⁷Pb, ²³²Th-²⁰⁸Pb et ¹⁷⁶Lu-¹⁷⁶Hf. L'utilisation de ces systèmes en pétrogenèse des roches est permise par les répartitions différentes des

éléments pères et des éléments fils dans les différents réservoirs terrestres. En effet durant l'individualisation des divers ensembles de la Terre solide (le noyau, le manteau et la croûte continentale), les éléments radioactifs n'ont pas été distribués en proportions équivalentes à leurs éléments fils. Ainsi, si l'on considère un couple isotopique Père/Fils, certains réservoirs terrestres présenteront une proportion élevée d'élément radioactif alors que d'autres réservoirs présenteront au contraire une proportion faible de l'élément père par rapport à l'élément radiogénique. Ces distributions hétérogènes des éléments pères et fils ont entraîné au cours du temps, avec la désintégration des éléments radioactifs, des compositions isotopiques variées pour les éléments radiogéniques dans les différents ensembles de la Terre. Une mesure des rapports isotopiques des éléments radiogéniques permet donc de déterminer de quel réservoir proviennent les roches terrestres. En outre un échantillon provenant d'un mélange de deux sources présentera des rapports isotopiques intermédiaires entre ces deux sources. Les rapports isotopiques permettent donc aussi d'établir une éventuelle origine complexe des matériaux terrestres. Ce principe d'utilisation des rapports isotopiques d'éléments traces afin de déterminer la source de matériaux est mis en application dans ce mémoire par l'étude des compositions isotopiques de l'Hafnium et de ces relations avec les compositions isotopiques du Néodyme.

B) Le couple isotopique $^{176}\text{Lu} - ^{176}\text{Hf}$

Le système Lu-Hf est basé sur la désintégration radioactive de l'isotope 176 du Lutétium en isotope 176 de l'Hafnium selon une radioactivité de type β^- . La demie-vie de l'isotope ^{176}Lu a été évaluée à 35,9 milliards d'années ce qui représente une constante de désintégration de $1,93 \times 10^{-11} \text{ ans}^{-1}$ (Sguigna et al., 1982). Le système Lu-Hf présente des applications en géochronologie pour la datation d'échantillons météoritiques, de roches terrestres anciennes et de minéraux enrichies en Lutétium comme le Grenat (Patchett et Tatsumoto, 1980a; Patchett

et Tatsumoto, 1980c; Pettingill et Patchett, 1981; Duchêne et al., 1997; Blichert-Toft et al., 1999a). Cependant les fractionnements que subissent Lutétium et Hafnium durant les processus de magmatogenèse permettent aussi l'application du système Lu-Hf aux questions de pétrogenèse des roches terrestres (Patchett et Tatsumoto, 1980b; Patchett et al., 1981; Patchett, 1983a; Patchett, 1983b).

C) Compositions isotopiques de l'Hafnium de la croûte et du manteau terrestre

Lors des processus de fusion partielle des matériaux terrestres, Lutétium et Hafnium ne présentent pas des comportements identiques. Ces deux éléments sont au contraire généralement fractionnés lors des phénomènes de fusion (Patchett et al., 1981). Ainsi les magmas produits par fusion des matériaux terrestres présentent généralement des rapports Lu/Hf inférieurs au matériel source. À l'opposé le résidu solide de la fusion possède un rapport Lu/Hf supérieur au matériel source. L'Hafnium est ainsi considéré comme un élément plus incompatible que le Lutétium au cours des processus de magmatogenèse (Hofmann, 1988). Ce fractionnement que subissent Lutétium et Hafnium durant la génération des magmas a permis l'individualisation sur Terre de deux ensembles principaux aux rapports Lu/Hf distincts : La croûte continentale et le manteau supérieur appauvri (Patchett et al., 1981; Patchett, 1983b; Hofmann, 1988; Hofmann, 1997). La croûte continentale générée par fusion du manteau primitif de la Terre a hérité d'un rapport Lu/Hf inférieur à ce dernier (Taylor et McLennan, 1985; McLennan, 2001). En complément, le manteau supérieur, considéré comme le résidu laissé par l'extraction de la croûte doit posséder un rapport Lu/Hf supérieur au manteau primitif (Patchett et Tatsumoto, 1980b; Patchett et al., 1981; Patchett, 1983b; Salters et Hart, 1989; Salters et Hart, 1991; Hofmann, 1997; Chauvel et Blichert-Toft, 2001). Le fractionnement entre Lutétium et Hafnium durant la différenciation de la croûte et

du manteau terrestre se rapproche du fractionnement subit par le couple Sm-Nd. En effet dans ce système, le Néodyme qui est l'élément radiogénique de ce couple est également plus incompatible que le Samarium, son élément père (Hofmann, 1988; Hofmann, 1997 et références citées dans ces articles).

Les rapports Lu/Hf et Sm/Nd distincts de la croûte et du manteau supérieur de la Terre ont entraînés au cours du temps le développement de compositions isotopiques distinctes dans ces deux réservoirs géochimiques par désintégration radioactive des nucléides ^{176}Lu et ^{147}Sm en isotopes ^{176}Hf et ^{143}Nd (Patchett et al., 1981; Patchett, 1983b; Vervoort et Patchett, 1996a; Vervoort et al., 1996b; Vervoort et Blichert-Toft, 1999a et références citées dans ces articles). L'évolution de ces compositions isotopiques peuvent être représentées par l'étude des rapports $^{176}\text{Hf}/^{177}\text{Hf}$ et $^{143}\text{Nd}/^{144}\text{Nd}$ (les nucléides ^{177}Hf et ^{144}Nd étant des isotopes stables de l'Hafnium et du Néodyme). Comme le montre la figure A, les basaltes de rides medio-océaniques (dénommés MORB pour "Mid Ocean Ridge Basalts") provenant du manteau supérieur présentent des rapports $^{176}\text{Hf}/^{177}\text{Hf}$ et $^{143}\text{Nd}/^{144}\text{Nd}$ supérieurs aux rapports du manteau primitif. À l'opposé les granites continentaux analysés par Vervoort et Patchett (1996a) affichent des rapports $^{176}\text{Hf}/^{177}\text{Hf}$ et $^{143}\text{Nd}/^{144}\text{Nd}$ inférieurs aux rapports du manteau primitif. Les compositions isotopiques de l'Hafnium et du Néodyme permettent donc de préciser l'origine continentale ou mantellique des matériaux terrestres et peuvent être utilisés comme traceurs de la source des roches magmatiques.

D) Compositions isotopiques de l'Hafnium des laves de points chauds et d'arcs volcaniques

Parmi les roches magmatiques rencontrées à la surface terrestre deux cas particuliers doivent être distingués : Les laves de points chauds (dénommés OIB pour "Oceanic island Basalts") et les laves des arcs volcaniques (dénommés IAV pour "Island Arc Volcanics").

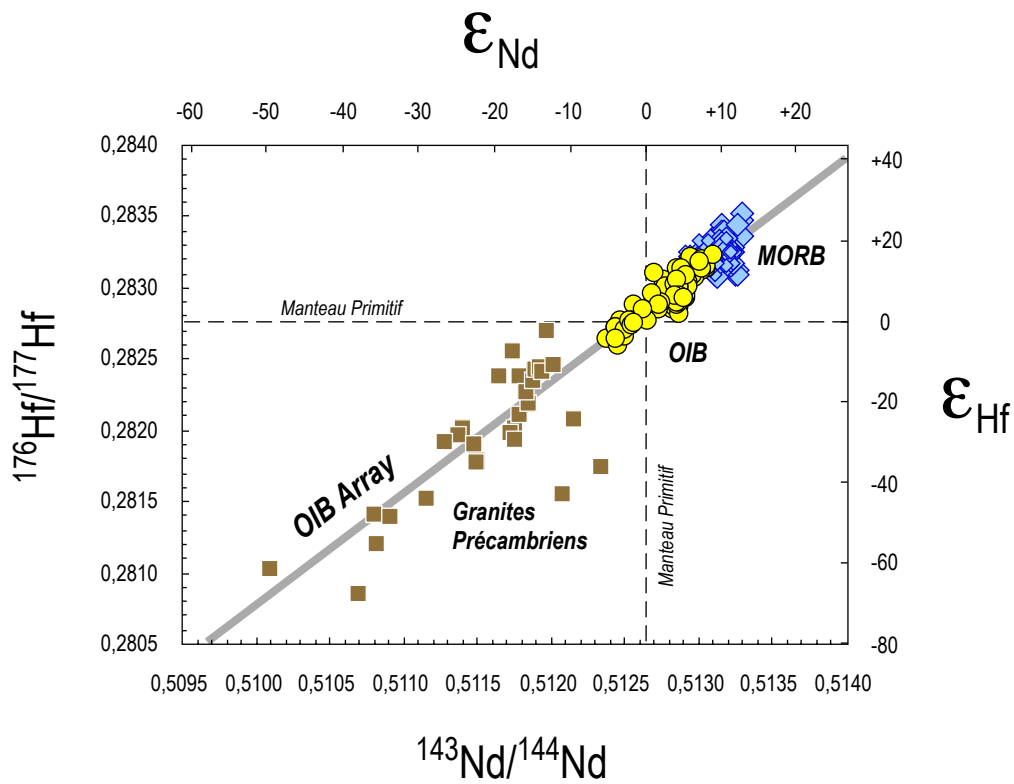

Figure A: Diagramme $^{176}\text{Hf}/^{177}\text{Hf}$ versus $^{143}\text{Nd}/^{144}\text{Nd}$ des MORB, OIB et des Granites de la Croûte Continentale. Données des MORB et OIB d'après Patchett et Tatsumoto, 1980b; Patchett, 1983a; Stille et al., 1983; Stille et al., 1986; Salters et Hart, 1991; Chauvel et al., 1992; Salters, 1996; Salters et White, 1998; Blichert-Toft et Albarède, 1999b; Blichert-Toft et al., 1999c et Chauvel et Blichert-Toft, 2001. L' "OIB Array" représente la droite de corrélation entre les compositions isotopiques de l'Hf et du Nd des OIB calculée par Vervoort et al., 1999b. Données des Granites Précambriens d'après Vervoort et Patchett, 1996a. Composition isotopique de l'Hf du Manteau Primitif d'après Blichert-Toft et Albarède, 1997.

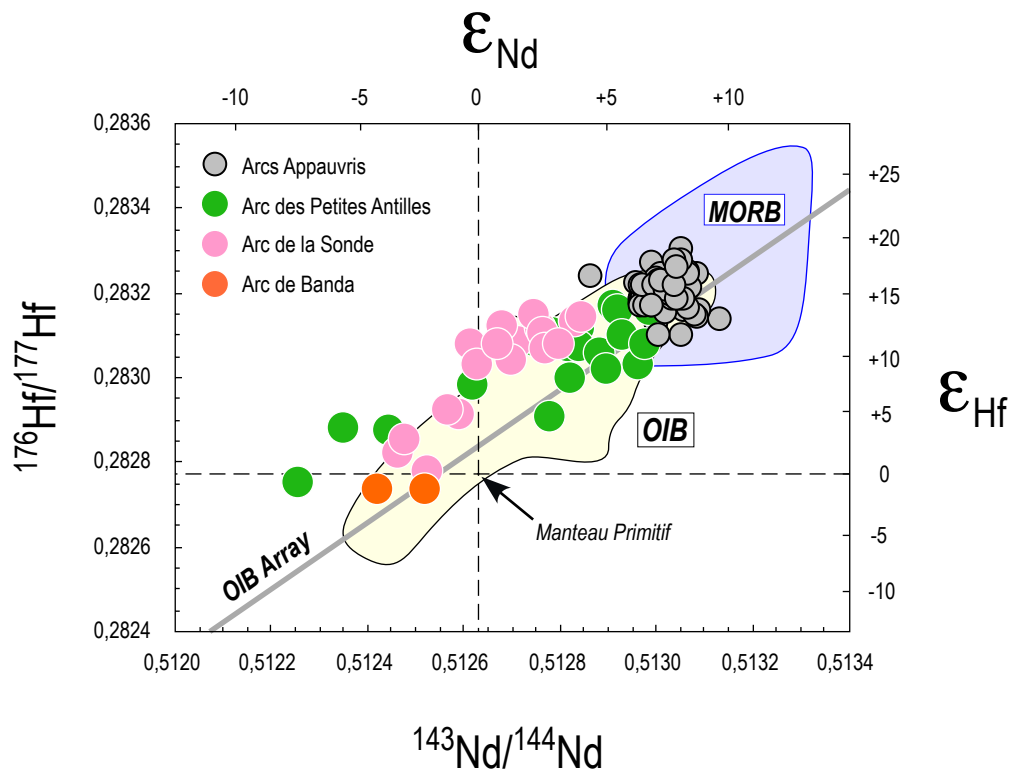

Figure B: Diagramme $^{176}\text{Hf}/^{177}\text{Hf}$ versus $^{143}\text{Nd}/^{144}\text{Nd}$ des laves actuelles des arcs intra-océaniques. Données de White et Patchett, 1984; Pearce, 1999 et Woodhead et al., 2001. Le terme "Arcs appauvris" regroupe les arcs d'Izu-Mariannes, de Nouvelle Bretagne, des Kermadec et des Aléoutiennes qui sont isotopiquement proches des MORB. Les champs des MORB et OIB ainsi que l' "OIB Array" ont été dessinés d'après les références citées dans la figure A.

Tout d'abord les OIB présentent des compositions isotopiques de l'Hafnium et du Néodyme intermédiaires entre les compositions des MORB et les compositions des matériaux continentaux (figure A). Ces laves de points chauds sont caractérisées par une très bonne corrélation entre les rapports $^{176}\text{Hf}/^{177}\text{Hf}$ et les rapports $^{143}\text{Nd}/^{144}\text{Nd}$. Elles permettent ainsi de définir une droite de corrélation entre les compositions isotopiques de l'Hf et du Nd qui est dénommée "OIB Array " (Vervoort et al., 1999b). Plusieurs hypothèses ont été proposées par différents auteurs pour rendre compte de la disposition de laves de points chauds le long d'une corrélation dans l'espace $^{176}\text{Hf}/^{177}\text{Hf}$ *versus* $^{143}\text{Nd}/^{144}\text{Nd}$. Parmi ces différentes hypothèses, plusieurs auteurs ont suggérés que la source des points chauds résulte d'un mélange entre un manteau similaire au manteau source des MORB et des composants présentant des rapports isotopiques de l'Hafnium et du Néodyme peu radiogéniques. Ces composants peu radiogéniques sont généralement identifiés comme des sédiments et des croûtes océaniques recyclés dans le manteau terrestre (Patchett et al., 1984; Chauvel et al., 1992; Salters et White, 1998; Blichert-Toft et al., 1999c).

Les seules mesures des compositions isotopiques de l'Hafnium des laves d'arcs volcaniques (IAV) ont été réalisées par White et Patchett (1984), Woodhead (1989), Salters et Hart (1991), Vroon et al. (1998), Pearce et al. (1999), Woodhead et al. (2001). Ces données ont été reportées dans la figure B. La plupart des laves d'arcs volcaniques (laves d'arc des Mariannes, d'Izu, des Aléoutiennes, des Kermadec et de Nouvelle Bretagne) ont des compositions isotopiques de l'Hafnium et du Néodyme équivalent aux basaltes de rides medio-océaniques (MORB). Seuls les échantillons provenant de deux arcs intra-océaniques, l'arc des Petites Antilles et l'arc de la Sonde-Banda, présentent des compositions isotopiques moins radiogéniques que les MORB (figure B). Enfin les compositions isotopiques de

l'Hafnium des arcs reposant sur une croûte continentale, par exemple l'arc volcanique des Andes, n'ont jusqu'à présent pas été mesurées.

Les compositions isotopiques de l'Hafnium des arcs intra-océaniques ont été étudiées par les différents auteurs précédemment cités avec pour principal objectif la détermination du comportement des éléments du groupe de l'Hafnium dans les zones de subduction. En effet, le manteau source des arcs insulaires semble contaminé par des composants provenant des matériaux subduits (Gill, 1981; Hawkesworth et al., 1993; Hawkesworth et al., 1994 et références citées dans ces articles). Ces composants contribuant à la source des laves d'arcs peuvent correspondre à des fluides aqueux ou à des liquides silicatés provenant de la déshydratation ou de la fusion des matériaux en subduction (Hawkesworth et al., 1993; Hawkesworth et al., 1994; Turner et al., 1996; Elliott et al., 1997; Class et al., 2000 et références citées dans ces articles). Les études expérimentales menées sur des basaltes et des sédiments ont démontrées que les éléments du groupe de l'Hafnium présentent de faibles affinités pour les fluides aqueux libérés par les réactions de déshydratation (Tatsumi et al., 1986; Ayers et Egglar, 1995; Brenan et al., 1995; Adam et al., 1997; Ayers et al., 1997; Kogiso et al., 1997; Stalder et al., 1998; Johnson et Plank, 1999). Au contraire les éléments du groupe de l'Hafnium présentent une bonne compatibilité vis à vis de liquides silicatés produits par fusion des matériaux subduits (Johnson et Plank, 1999). En conséquence l'étude du comportement de l'Hafnium dans les laves d'arcs peut permettre en premier lieu de préciser la nature aqueuse ou silicaté des liquides qui contribuent à la source des arcs (Pearce et al., 1999).

Cependant d'après plusieurs auteurs, les compositions isotopiques de l'Hafnium des laves d'arcs volcaniques apparaissent aussi contrôlées par les compositions isotopiques des sédiments océaniques subduits (White et Patchett, 1984; Vroon et al., 1998; Pearce et al., 1999; Woodhead et al., 2001). Par conséquent l'étude des compositions isotopiques de

l'Hafnium des arcs insulaires nécessite aussi un examen des compositions isotopiques des sédiments océaniques.

E) Compositions isotopiques de l'Hafnium des sédiments océaniques

Les compositions isotopiques de l'Hafnium des sédiments océaniques ont été déterminées durant les études de White et al. (1986), Godfrey et al. (1997), Albarède et al. (1998), Pearce et al. (1999), Vervoort et al. (1999b), David et al. (2001). Ces travaux permettent de distinguer deux grands groupes de sédiments océaniques au niveau de leurs rapports isotopiques de l'Hafnium et de leurs corrélations avec les rapports isotopiques du Néodyme (figure C). Tout d'abord les sédiments détritiques (terrigènes et volcanogènes) qui correspondent à des argiles et des sables provenant de l'érosion de roches préexistantes se répartissent le long d'une corrélation nommée le "Terrestrial Array" par Vervoort et al. (1999b). Cette corrélation des sédiments détritiques est très proche de la corrélation Hf-Nd observée pour les laves de points chauds (nommée "OIB Array"). Au contraire, les nodules polymétalliques et les croûtes de Fe-Mn des grands fonds océaniques possèdent des compositions isotopiques de l'Hafnium très radiogéniques par rapport à leurs composition isotopiques du Néodyme. Dans la figure C, ces sédiments se placent donc au-dessus des sédiments détritiques et du "Terrestrial Array". D'après White et al. (1986), Godfrey et al. (1997), Albarède et al. (1998), David et al. (2001), ces compositions isotopiques des nodules et croûtes de Fe-Mn doivent refléter des compositions isotopiques de l'Hafnium particulièrement radiogéniques des eaux océaniques.

La distinction entre sédiments détritiques et nodules et croûtes de Fe-Mn que l'on peut opérer au niveau de leurs compositions isotopiques peut aussi être effectuée au niveau de leur rapport Lu/Hf comme démontré par Patchett et al. (1984). En effet, parmi les sédiments, les

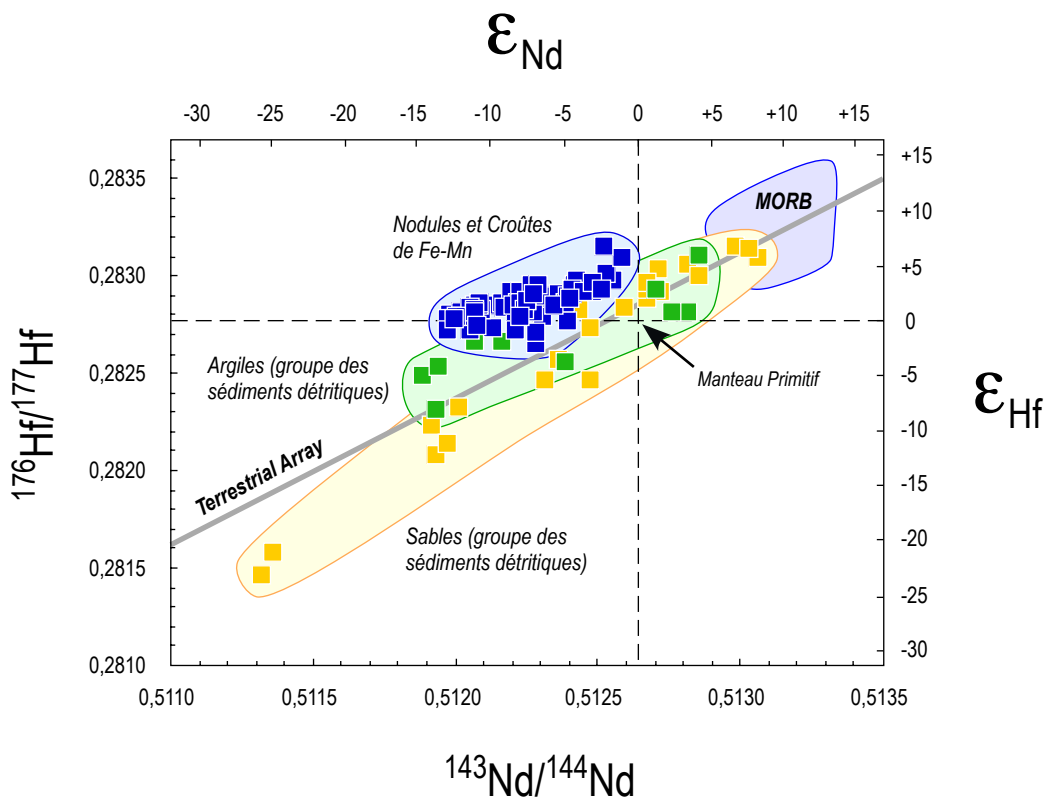

Figure C: Diagramme $^{176}\text{Hf}/^{177}\text{Hf}$ versus $^{143}\text{Nd}/^{144}\text{Nd}$ des sédiments océaniques. Données de White et al., 1986; Ben Othman et al., 1989; McLennan et al., 1990; Godfrey et al., 1997; Albarède et al., 1998; Pearce et al., 1999; Vervoort et al., 1999b; David et al., 2001. Le "Terrestrial Array" représente la droite de corrélation entre les compositions isotopiques de l'Hf et du Nd de l'ensemble des matériaux terrestres calculée par Vervoort et al., 1999b. Le champ des MORB a été dessiné d'après les références citées dans la figure A.

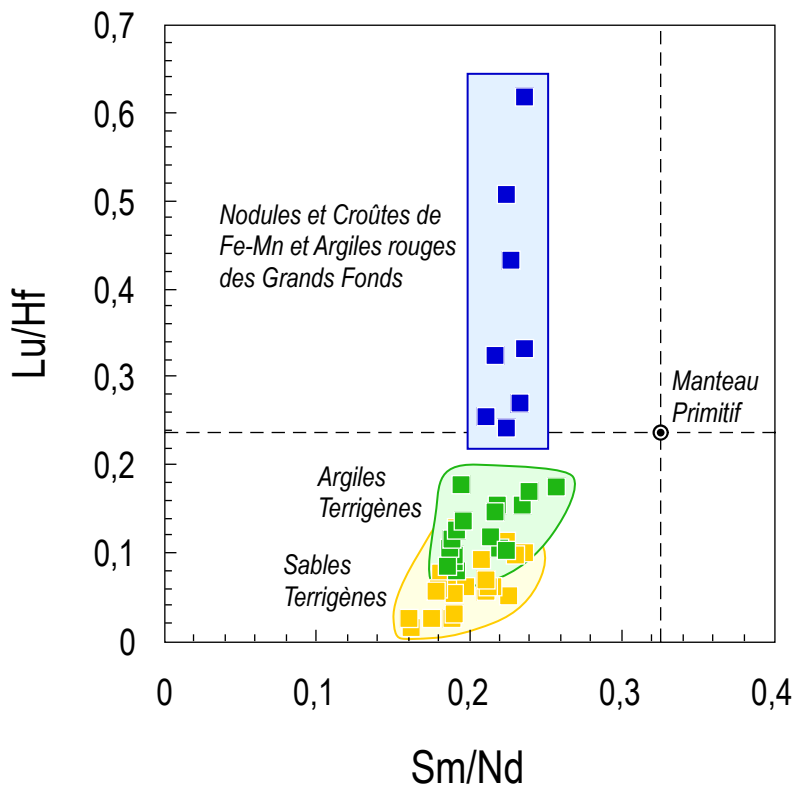

Figure D: Diagramme Lu/Hf versus Sm/Nd des sédiments océaniques d'après Patchett et al., 1984. Dans le groupe des sédiments détritiques seuls les sables et argiles terrigènes ont été analysés. Les sables et argiles volcanogènes qui s'intègrent aussi dans le groupe des sédiments détritiques n'ont pas été considérés dans cette étude. Composition du Manteau Primitif d'après Hofmann, 1988.

sables terrigènes possèdent généralement des rapports Lu/Hf particulièrement faibles (figure D). Les argiles terrigènes présentent des rapports Lu/Hf en moyenne plus élevés que les sables. Enfin les nodules et croûtes de Fe-Mn ainsi que quelques argiles des grands fonds océaniques possèdent des rapports Lu/Hf particulièrement élevés. Cette distinction entre ces 3 types de sédiments ne concerne que leurs rapports Lu/Hf et ne s'observe pas au niveau de leurs rapports Sm/Nd (figure D). D'après Patchett et al. (1984), ce fractionnement du rapport Lu/Hf dans le système sédimentaire résulte de la forte résistance du zircon aux processus d'altérations chimiques. En effet dans les matériaux constituant la croûte continentale, l'Hafnium se trouve en grande partie concentré dans le zircon. La forte résistance de ce minéral aux processus d'hydrolyse limite le transfert de l'Hafnium vers les argiles terrigènes formées à partir de l'altération chimique de roches continentales. De plus cette résistance du zircon limite aussi le transfert de l'Hafnium vers les sédiments formés par précipitation chimique d'éléments en solution comme les nodules et croûtes de Fe-Mn. En conséquence seuls les sables terrigènes engendrés par l'érosion mécanique de roches continentales ne présentent pas de déficit en Hafnium.

Dans le système sédimentaire l'Hafnium subit donc un fractionnement très important : Tout d'abord le groupe des sédiments détritiques et les nodules et croûtes de Fe-Mn présentent des corrélations différentes entre leurs compositions isotopiques de l'Hafnium et du Néodyme. De plus ces deux groupes de sédiments se distinguent aussi au niveau de leurs rapports Lu/Hf.

F) Intérêts des compositions isotopiques de l'Hafnium dans l'étude des zones de subduction

Nous pouvons dégager trois intérêts majeurs pour la mesure des compositions isotopiques de l'Hafnium et l'étude de leur corrélations avec les compositions isotopiques du Néodyme dans les zones de subductions:

-Premièrement la comparaison des compositions isotopiques de l'Hafnium des laves d'arcs et des matériaux subduits permet d'établir si les éléments du groupe de l'Hafnium sont transférés depuis la plaque en subduction jusqu'à la source des arcs volcaniques. La composition aqueuse ou silicatée des fluides qui contaminent la source des arcs peut ainsi être précisée. Ce point permet ultérieurement d'apporter des contraintes sur les causes du déficit de certains éléments du groupe de l'Hf dans les laves d'arcs.

-Deuxièmement la diversité des compositions isotopiques de l'Hafnium et du Néodyme dans les sédiments océaniques permet de préciser quel type de sédiments contribue à la source des laves d'arcs. L'Hafnium constitue donc un excellent traceur de la contribution des sédiments à la source des arcs insulaires.

-Enfin comme l'on démontré Patchett et al. (1984), Salters et White (1998) et Blichert-Toft et al. (1999c), la diversité des compositions isotopiques de l'Hafnium et du Néodyme dans les sédiments océaniques permet d'utiliser les corrélations Hf-Nd comme traceur du recyclage de sédiments au niveau de la source des points chauds. L'Hafnium constitue donc aussi un traceur des matériaux sédimentaires recyclés dans le manteau profond de la Terre.

Références Bibliographiques :

Adam, J., T. H. Green, et al. (1997): Trace element partitioning between aqueous fluids, silicate melts and minerals. *European Journal of Mineralogy*, Vol. 9, p. 569-584.

-
- Albarède, F., A. Simonetti, et al. (1998): A Hf-Nd isotopic correlation in ferromanganese nodules. *Geophysical Research Letters*, Vol. 25(20), p. 3895-3898.
- Ayers, J. C., S. K. Dittmer, et al. (1997): Partitioning of elements between peridotite and H₂O at 2.0-3.0 GPa and 900-1100°C, and application to models of subduction zone processes. *Earth and Planetary Science Letters*, Vol. 150, p. 381-398.
- Ayers, J. C. et D. H. Eggler (1995): Partitioning of elements between silicate melt and H₂O-NaCl fluids at 1.5 and 2.0 GPa pressure: Implications for mantle metasomatism. *Geochimica et Cosmochimica Acta*, Vol. 59, p. 4237-4246.
- Ben Othman, D., W. M. White, et al. (1989): The geochemistry of marine sediments, island arc magma genesis, and crust-mantle recycling. *Earth and Planetary Science Letters*, Vol. 94, p. 1-21.
- Blichert-Toft, J. et F. Albarède (1997): The Lu-Hf isotope geochemistry of chondrites and the evolution of the mantle-crust system. *Earth and Planetary Science Letters*, Vol. 148, p. 243-258.
- Blichert-Toft, J., F. Albarède, et al. (1999a): Lu-Hf isotope systematics of garnet pyroxenites from Beni Bousera, Morocco: Implications for basalt origin. *Science*, Vol. 283, p. 1303-1306.
- Blichert-Toft, J. et F. Albarède (1999b): Hf isotopic compositions of the Hawaii Scientific Drilling Project core and the source mineralogy of Hawaiian basalts. *Geophysical Research Letters*, Vol. 26(7), p. 935-938.
- Blichert-Toft, J., F. A. Frey, et al. (1999c): Hf isotope evidence for pelagic sediments in the source of Hawaiian basalts. *Science*, Vol. 285, p. 879-882.
- Brenan, J. M., H. F. Shaw, et al. (1995): Mineral-aqueous fluid partitioning of trace elements at 900°C and 2.0 GPa: Constraints on the trace element chemistry of mantle and deep crustal fluids. *Geochimica et Cosmochimica Acta*, Vol. 59(16), p. 3331-3350.
- Chauvel, C. et J. Blichert-Toft (2001): A hafnium isotope and trace element perspective on melting of the depleted mantle. *Earth and Planetary Science Letters*, Vol. 190, p. 137-151.
- Chauvel, C., A. W. Hofmann, et al. (1992): HIMU-EM: The French Polynesian connection. *Earth and Planetary Science Letters*, Vol. 110, p. 99-119.
- Class, C., D. M. Miller, et al. (2000): Distinguishing melt and fluid subduction components in Umnak Volcanics, Aleutian Arc. *Geochemistry, Geophysics, Geosystems*, Vol. 1, papier n° 1999GC000010.
- David, K., M. Frank, et al. (2001): The Hf isotope composition of global seawater and the evolution of Hf isotopes in the deep Pacific Ocean from Fe-Mn crusts. *Chemical Geology*, Vol. 178, p. 23-42.
- Duchêne, S., J. Blichert-Toft, et al. (1997): The Lu-Hf dating of garnets and the ages of the Alpine high-pressure metamorphism. *Nature*, Vol. 387, p. 586-589.
- Elliott, T., T. Plank, et al. (1997): Element transport from slab to volcanic front at the Mariana arc. *Journal of Geophysical Research*, Vol. 102(B7), p. 14991-15019.
- Gill, J. B. (1981): *Orogenic andesites and plate tectonics*. Springer-Verlag, New York. 330 p.
- Godfrey, L. V., D.-C. Lee, et al. (1997): The Hf isotopic composition of ferromanganese nodules and crusts and hydrothermal manganese deposits: Implications for seawater Hf. *Earth and Planetary Science Letters*, Vol. 151, p. 91-105.
- Hawkesworth, C. J., K. Gallagher, et al. (1993): Mantle and slab contributions in arc magmas. *Annual Review of Earth and Planetary Sciences*, Vol. 21, p. 175-204.
- Hawkesworth, C. J., K. Gallagher, et al. (1994): Destructive plate margin magmatism: Geochemistry and melt generation. *Lithos*, Vol. 33, p. 169-188.
-

-
- Hofmann, A. W. (1988): Chemical differentiation of the Earth: The relationship between mantle, continental crust, and oceanic crust. *Earth and Planetary Science Letters*, Vol. 90, p. 297-314.
- Hofmann, A. W. (1997): Mantle geochemistry: the message from oceanic volcanism. *Nature*, Vol. 385, p. 219-229.
- Johnson, M. C. et T. Plank (1999): Dehydration and melting experiments constrain the fate of subducted sediments. *Geochemistry, Geophysics, Geosystems*, Vol. 1, papier n° 1999GC000014.
- Kogiso, T., Y. Tatsumi, et al. (1997): Trace element transport during dehydration processes in the subducted oceanic crust: 1. Experiments and implications for the origin of ocean island basalts. *Earth and Planetary Science Letters*, Vol. 148, p. 193-205.
- McLennan, S. M. (2001): Relationships between the trace element composition of sedimentary rocks and upper continental crust. *Geochemistry, Geophysics, Geosystems*, Vol. 2, papier n° 2000GC000109.
- McLennan, S. M., S. R. Taylor, et al. (1990): Geochemical and Nd-Sr isotopic composition of deep-sea turbidites: crustal evolution and plate tectonic associations. *Geochimica et Cosmochimica Acta*, Vol. 54, p. 2015-2050.
- Patchett, P. J. (1983a): Hafnium isotope results from mid-ocean ridges and Kerguelen. *Lithos*, Vol. 16, p. 47-51.
- Patchett, P. J. (1983b): Importance of the Lu-Hf isotopic system in studies of planetary chronology and chemical evolution. *Geochimica et Cosmochimica Acta*, Vol. 47, p. 81-91.
- Patchett, P. J., O. Kouvo, et al. (1981): Evolution of continental crust and mantle heterogeneity: Evidence from Hf isotopes. *Contributions to Mineralogy and Petrology*, Vol. 78, p. 279-297.
- Patchett, P. J. et M. Tatsumoto (1980a): Lu-Hf total-rock isochron for the eucrite meteorites. *Nature*, Vol. 288, p. 571-574.
- Patchett, P. J. et M. Tatsumoto (1980b): Hafnium isotope variations in oceanic basalts. *Geophysical Research Letters*, Vol. 7(12), p. 1077-1080.
- Patchett, P. J. et M. Tatsumoto (1980c): A routine high-precision method for Lu-Hf isotope geochemistry and chronology. *Contributions to Mineralogy and Petrology*, Vol. 75, p. 263-267.
- Patchett, P. J., W. M. White, et al. (1984): Hafnium/rare earth element fractionation in the sedimentary system and crustal recycling into the Earth's mantle. *Earth and Planetary Science Letters*, Vol. 69, p. 365-378.
- Pearce, J. A., P. D. Kempton, et al. (1999): Hf-Nd element and isotope perspective on the nature and provenance of mantle and subduction components in Western Pacific arc-basin systems. *Journal of Petrology*, Vol. 40(11), p. 1579-1611.
- Pettingill, H. S. et P. J. Patchett (1981): Lu-Hf total-rock age for the Amîtsoq gneisses, West Greenland. *Earth and Planetary Science Letters*, Vol. 55, p. 150-156.
- Salters, V. J. M. (1996): The generation of mid-ocean ridge basalts from the Hf and Nd isotope perspective. *Earth and Planetary Science Letters*, Vol. 141, p. 109-123.
- Salters, V. J. M. et S. R. Hart (1989): The hafnium paradox and the role of garnet in the source of mid-ocean-ridge basalts. *Nature*, Vol. 342, p. 420-422.
- Salters, V. J. M. et S. R. Hart (1991): The mantle sources of ocean ridges, islands and arcs: the Hf-isotope connection. *Earth and Planetary Science Letters*, Vol. 104, p. 364-380.
- Salters, V. J. M. et W. M. White (1998): Hf isotope constraints on mantle evolution. *Chemical Geology*, Vol. 145, p. 447-460.
- Sguigna, A. P., A. J. Larabee, et al. (1982): The half-life of ^{176}Lu by a γ - γ coincidence measurement. *Canadian Journal of Physics*, Vol. 60, p. 361-364.
-

-
- Stalder, R., S. F. Foley, et al. (1998): Mineral-aqueous fluid partitioning of trace elements at 900-1200°C and 3.0-5.7 GPa: New experimental data for garnet, clinopyroxene, and rutile, and implications for mantle metasomatism. *Geochimica et Cosmochimica Acta*, Vol. 62(10), p. 1781-1801.
- Stille, P., D. M. Unruh, et al. (1983): Pb, Sr, Nd and Hf isotopic evidence of multiple sources for Oahu, Hawaii basalts. *Nature*, Vol. 304, p. 25-29.
- Stille, P., D. M. Unruh, et al. (1986): Pb, Sr, Nd, and Hf isotopic constraints on the origin of Hawaiian basalts and evidence for a unique mantle source. *Geochimica et Cosmochimica Acta*, Vol. 50, p. 2303-2319.
- Tatsumi, Y., D. L. Hamilton, et al. (1986): Chemical characteristics of fluid phase released from a subducted lithosphere and origin of arc magmas: Evidence from high pressure experiments and natural rocks. *Journal of Volcanology and Geothermal Research*, Vol. 29, p. 293-309.
- Taylor, S. R. et S. M. McLennan (1985): *The Continental Crust: Its Composition and Evolution*. Blackwell Scientific, Boston, Mass. 312 p.
- Turner, S. P., C. J. Hawkesworth, et al. (1996): U-series isotopes and destructive plate margin magma genesis in the Lesser Antilles. *Earth and Planetary Science Letters*, Vol. 142, p. 191-207.
- Vervoort, J. D. et P. J. Patchett (1996a): Behavior of hafnium and neodymium isotopes in the crust: Constraints from Precambrian crustally derived granites. *Geochimica et Cosmochimica Acta*, Vol. 60(19), p. 3717-3733.
- Vervoort, J. D., P. J. Patchett, et al. (1996b): Constraints on early Earth differentiation from hafnium and neodymium isotopes. *Nature*, Vol. 379, p. 624-627.
- Vervoort, J. D. et J. Blichert-Toft (1999a): Evolution of the depleted mantle: Hf isotope evidence from juvenile rocks through time. *Geochimica et Cosmochimica Acta*, Vol. 63(3/4), p. 533-556.
- Vervoort, J. D., P. J. Patchett, et al. (1999b): Relationships between Lu-Hf and Sm-Nd isotopic systems in the global sedimentary system. *Earth and Planetary Science Letters*, Vol. 168, p. 79-99.
- Vroon, P. Z., G. Nowell, et al. (1998): HFSE mobility at the slab-wedge interface: Hafnium-isotope evidence from the east Sunda-Banda arc. *Mineralogical Magazine*, Vol. 62A, p. 1617-1618.
- White, W. M. et P. J. Patchett (1984): Hf-Nd-Sr isotopes and incompatible element abundances in island arcs: implications for magma origins and crust-mantle evolution. *Earth and Planetary Science Letters*, Vol. 67, p. 167-185.
- White, W. M., P. J. Patchett, et al. (1986): Hf isotope ratios of marine sediments and Mn nodules: evidence for a mantle source of Hf in seawater. *Earth and Planetary Science Letters*, Vol. 79, p. 46-54.
- Woodhead, J. D. (1989): Geochemistry of the Mariana arc (western Pacific): Source composition and processes. *Chemical Geology*, Vol. 76, p. 1-24.
- Woodhead, J. D., J. M. Hergt, et al. (2001): Hafnium isotope evidence for 'conservative' element mobility during subduction zone processes. *Earth and Planetary Science Letters*, Vol. 192, p. 331-346.

CHAPITRE II

***Compositions isotopiques de l'Hafnium
et du Néodyme du flux entrant dans la
zone de subduction d'Izu-Mariannes
(Leg ODP 185, Sites 801 et 1149)***

CHAPITRE II : Compositions isotopiques de l'Hafnium et du Néodyme de la croûte océanique altérée et de la pile sédimentaire entrant dans la zone de subduction d'Izu-Mariannes (Leg ODP 185, Sites 801 et 1149)

Notre travail sur la composition isotopique de l'Hafnium et du Néodyme des matériaux absorbés au niveau des zones de subduction porte sur les échantillons récoltés au cours du Leg ODP 185. Ce travail est présenté sous la forme d'un manuscrit en préparation pour la revue *Geochemistry, Geophysics, Geosystems (G³)*. Le Leg ODP 185 réalisé en 1999 dans la partie Ouest de l'océan Pacifique a permis d'échantillonner la croûte basaltique altérée qui est absorbée au niveau de la fosse des Mariannes ainsi que la pile sédimentaire qui est subduite au niveau de l'arc d'Izu. Un des principaux objectifs de cette campagne ODP est de déterminer les compositions chimiques et isotopiques globales de la croûte et de la colonne sédimentaire entrant dans la zone de subduction d'Izu-Mariannes. Comme expliqué par Plank, Ludden, Escotia et al., 2000 (*Proc. ODP, init. Repts., Vol. 185*), ce travail est réalisé par différentes équipes chargées chacune de réaliser différentes analyses sur un jeu d'échantillons communs. Nous apportons pour notre part les compositions isotopiques de l'Hafnium et du Néodyme de ces échantillons communs. L'interprétation de nos données isotopiques a été réalisée en utilisant les compositions des éléments majeurs et des éléments en traces déterminées par Kelley et al., 2003 (*Geochem., Geophys., Geosyst., Vol. 4: 8910, doi:10.1029/2002GC000435*) et Plank et al., (manuscrit en préparation, 2004).

Les échantillons provenant de la croûte basaltique altérée du puit 801C présentent des compositions de l'Hafnium et du Néodyme équivalentes aux compositions des basaltes non altérés de la dorsale du Pacifique. Le budget isotopique de l'Hafnium et du Néodyme ne

semble donc pas modifié lors des processus d'altération hydrothermale de haute et basse température qui affectent les croûtes océaniques.

Les sédiments récoltés au niveau du Site 1149 présentent des rapports isotopiques du Néodyme semblables aux rapports mesurés dans la colonne d'eau de l'océan Pacifique. Ces compositions indiquent que la principale source de Néodyme dans les sédiments du Site 1149 sont les eaux du Pacifique. Cet apport de Néodyme depuis la colonne d'eau s'effectue par l'intermédiaire d'une précipitation de phosphates authigènes.

Les compositions isotopiques de l'Hafnium des sédiments du Site 1149 varient de manière progressive le long de la pile sédimentaire. Ces compositions semblent contrôlées par des phases minérales alumino-silicatées. Les sédiments du bas de la colonne présentent des rapports $^{176}\text{Hf}/^{177}\text{Hf}$ peu radiogéniques qui traduisent l'apport de phases alumino-silicatées d'origine continentale. Les compositions isotopiques de l'Hafnium évoluent ensuite progressivement vers des compositions plus radiogéniques comparables aux compositions isotopiques de l'eau de mer du Pacifique. Cette évolution est probablement permise par la précipitation de minéraux alumino-silicatées authigènes.

Nos données nous permettent de proposer une estimation globale de la composition isotopique de la pile sédimentaire subduite au niveau de la fosse d'Izu. Les compositions isotopiques globales de l'Hafnium et du Néodyme de la pile sédimentaire reflètent principalement la contribution de l'eau de mer du Pacifique. La source continentale d'Hafnium identifiée dans les sédiments du bas de la pile n'est qu'une source secondaire à l'échelle de la colonne sédimentaire.

Nous avons ensuite utilisé nos données pour estimer la masse de Néodyme qui est absorbé au niveau de la fosse d'Izu lors de la subduction de la pile sédimentaire. Ce taux de Néodyme entrant dans la zone de subduction semble d'un ordre de grandeur comparable à la masse de Néodyme contenu dans les laves émises dans l'arc volcanique d'Izu. Dans la zone de

subduction d'Izu, le bilan de masse du Néodyme entre le flux entrant et le flux sortant semble donc proche de l'équilibre.

Enfin nous avons utilisé les compositions globales de la croûte basaltique altérée du puit 801C et de la pile sédimentaire du Site 1149 pour examiner si ces matériaux absorbés au niveau des zones de subduction étaient recyclés dans la source des laves de points chauds. La participation de tels matériaux à la source des points chauds nécessite un excellent mélange des sédiments et des croûtes basaltiques avant leur contribution aux panaches mantelliques. Cependant les croûtes et sédiments océaniques actuelles ne sont peut-être pas représentatifs des sédiments et croûtes anciennes qui participent à la source des laves de points chauds.

**Hf-Nd isotopic budget of altered oceanic crust and
sediments subducted at the Izu-Mariana margin
(ODP Leg 185, Sites 801 and 1149). Implications for
the recycling of subducted materials into the Izu-
Mariana arc and the earth's deep mantle**

Jean-Christophe Marini and Catherine Chauvel

LGCA, Université Joseph Fourier, Maison des Géosciences, BP 53, F-38041 Grenoble Cedex 09, France (jcmarini@ujf-grenoble.fr; cchauvel@ujf-grenoble.fr)

Terry Plank and Katherine A. Kelley

Department of Earth Sciences, Boston University, 685 Commonwealth Ave., Boston, Massachusetts 02215 USA (tplank@bu.edu; kelleyk@bu.edu)

John N. Ludden

INSU/SDU – CNRS, 3 rue Michel-Ange, BP 287, 75766 Paris Cedex 16, France (john.ludden@cnrs-dir.fr)

Hubert Staudigel

Institute of Geophysics and Planetary Physics, Scripps Institution of Oceanography, University of California, San Diego, La Jolla, California 92093, USA (hstaudigel@ucsd.edu)

Abstract

In a subduction zone two major mass fluxes could be defined: First an input flux corresponding to the subduction of altered oceanic crust and associated sedimentary pile toward the earth's mantle and secondly an output flux represented by the transfer of magmas from the upper mantle to the overlying volcanic arc. The chemical and isotopic compositions of subducted altered oceanic crusts and sediments remain poorly constrained in comparison to magmas erupted along volcanic arcs. The ODP Leg 185 has been lead in Western Pacific with the primary objective of sampling the altered basaltic basement and the entire sedimentary pile subducting at the Izu-Mariana margin. We report here the Hf and Nd isotopic compositions of these materials. Hf and Nd isotopes of altered basaltic crust sampled at Hole 801C are strictly equivalent to the isotopic compositions of unaltered Pacific MORB and remain totally unchanged during hydrothermal alteration. Hf and Nd isotopic compositions of sediments collected at Site 1149 indicate that the primary source of REE and HFSE in such materials is the overlying Pacific seawater. However continental areas seem predominantly contribute to the Hf isotopic budget of the older sediments. The Site 1149 sedimentary pile has a bulk ϵ_{Nd} value of -5.9 and an ϵ_{Hf} about $+4.4$ with bulk Nd and Hf concentrations respectively of 26.2 ppm and 1.76 ppm. In the Izu subduction zone this Nd input flux with the Site 1149 sediments is of the order of the Nd output flux in arc lavas. Finally the Hole 801C altered basaltic crust and Site 1149 sediments subducted today at the Izu-Mariana trench are probably not representative of ancient oceanic materials recycled in mantle plumes.

Introduction

Subduction zones appear as privileged exchange sites between the earth's mantle and the external geochemical reservoirs of the earth (the crust, the oceans and the atmosphere). Indeed in volcanic arcs supply of magmas originating from the mantle contributes to crustal growth

and deliver volatile elements to the atmosphere. In return at convergent margins the earth's mantle is refertilized by subduction of altered oceanic crust and sediments that contain elements derived from the crust and seawater (Armstrong, 1968; Armstrong, 1991; Von Huene and Scholl, 1991; Von Huene and Scholl, 1993; Plank and Langmuir, 1998).

Calculations of these mass transfers occurring between the mantle and the superficial reservoirs of the earth at subduction zones require a precise evaluation of the global chemical and isotopic composition of the arc magmas and a global evaluation of the chemical and isotopic composition of the subducting materials. In 1999 the ODP Leg 185 has been lead in Western Pacific with the primary objective of sampling a complete section of the altered basaltic crust and overlying sedimentary pile subducting in the intra-oceanic Izu-Bonin-Mariana arc system (Plank et al., 2000). The altered basaltic crust has been drilled at Hole 801C, east of the Mariana arc and the sedimentary pile subducting at the Izu trench arc has been sampled at Site 1149.

We have analyzed the Hole 801C basaltic samples and the sediments collected at Site 1149 for Nd and Hf isotopes. Comparing the Nd and Hf isotopic compositions of the altered basaltic crust with the isotopic compositions of fresh Pacific MORB permit to determine the behavior of the rare earth elements (REE) and high field strength elements (HFSE) during alteration of oceanic crusts before their return into the mantle. On other hand Nd and Hf isotopic compositions of the Site 1149 sediments are fundamental for determining the sources of REE and HFSE in sediments absorbed in intra-oceanic subduction zones.

At a regional scale, numerous authors have demonstrated that the elemental and isotopic compositions of the Izu-Mariana lavas suggest a contribution of subducted materials to their source (Hole et al., 1984; Woodhead and Fraser, 1985; Woodhead et al., 1987; Lin et al., 1990; Lin, 1992; Elliott et al., 1997; Taylor and Nesbitt, 1998; Pearce et al., 1999). At a more large-scale level the geochemical and isotopic compositions of oceanic island basalts (OIB)

seem indicate that the materials absorbed at convergent margins are ultimately recycled into the earth's deep mantle (Hofmann and White, 1982; Weaver, 1991a; Weaver, 1991b; Chauvel et al., 1992; Lassiter and Hauri, 1998; Blichert-Toft et al., 1999a; Chauvel and Hémond, 2000). The Hf and Nd isotopic compositions of the altered basaltic crust and overlying sedimentary pile drilled during Leg 185 constitute first essential data to quantified the contribution of subducted materials to the Izu-Mariana arc source. These Hf and Nd isotopic compositions permit secondly to investigate the possible involvement of such modern basaltic crusts and pelagic sediments to the sources of oceanic island basalts.

Lithological description and sampling of the Western Pacific altered basaltic crust and sedimentary pile

a) The altered basaltic crust drilled at Hole 801C

Hole 801C (18°38.5'N, 156°21.6'E) is located in the Pigafetta Basin (figure 1) at about 950 km east of the Mariana trench. This Hole was initiated in 1989 during the ODP Leg 129 with the principal objective of sample the oldest part of the Pacific crust and the overlying jurassic to modern sediments (Lancelot et al., 1990). It was next deepened in 1999 during the ODP Leg 185 in order to sample a more complete section of the altered oceanic crust (Plank et al., 2000). The addition of the ODP Legs 129 and 185 represent a drilling of 474 m in this Western Pacific altered oceanic crust. Eight major sequences with different petrological, mineralogical and geochemical characteristics have been distinguished in the basaltic crust. An uppermost first sequence of alkalic basalts and dolerites (about 20m thick) and lower sequences of typical MORB with tholeiitic composition including massive flows or pillows associated with breccias, volcanoclastic material and silicic hydrothermal deposits (Lancelot et al., 1990; Floyd and Castillo, 1992a; Plank et al., 2000; Barr et al., 2002). The Ar-Ar radiometric age of the top alkalic basalts is about 157 Ma and the radiometric ages of the

MORB are ranging from 162 to 171 Ma (Pringle, 1992; Koppers et al., 2003). The basaltic materials from Hole 801C are usually altered by low temperature hydrothermalism and interaction with seawater, from highly altered interpillow materials to more preserved massive flows but also totally unaltered volcanic glasses (Alt et al., 1992; Plank et al., 2000; Fisk and Kelley, 2002; Talbi and Honnorez, 2003).

As explained by Plank et al. (2000) and Kelley et al. (2003) in order to evaluate the large scale chemical and isotopic compositions of the altered oceanic crust, the ODP Leg 185 shipboard scientific party opt for create a set of composites samples by mixing of powders of the various lithologies (massive flows, pillows, breccias, volcanoclastic materials and hydrothermal deposits) according their respective proportions in the Hole. The detailed procedure followed for the fabrication of the composite samples is detailed in Plank et al. (2000). At all fourteen composites representative of the flows and pillows units, of the breccias and volcanoclastics sediments units or representative of the global composition of a part or of the entire basaltic column have been created. Major and trace element compositions of these Hole 801C composites have been measured by Kelley et al. (2003) and stable isotopes have been published by Alt (2003). Our Hf and Nd isotopic compositions have also been performed on these composites samples.

b) The sedimentary pile drilled at Site 1149

The sedimentary cover subducted at the Mariana trench has been drilled and sampled during several DSDP and ODP campaigns (especially during the ODP Leg 129) and is now one off the most well-known sedimentary pile absorbed in a subduction zone (Plank and Langmuir, 1998). At the opposite the sedimentary pile subducted in the Izu-Bonin region, north of the Mariana arc, was largely unsampled. In consequence during the ODP leg 185 this sediments cover has been entirely drilled at Site 1149 (31°20.1'N, 143°21.8'E see figure 1).

In the Izu-Bonin region the sedimentary cover of the Pacific crust has a thickness about 410m and includes various lithologic units (figure 2):

-Unit I has a thickness about 118 m and it consists of a mixture of clay minerals, siliceous planktonic microfossils (essentially diatoms and radiolarians) and volcanic ash. The paleomagnetic data indicate an age of this unit from late Miocene (about 6.5 Ma) to late Pleistocene (younger than 0.2 Ma).

-Unit II (including subunits IIA and IIB) has a thickness about 62 m, it is constituted almost exclusively of pelagic clays. However in the upper part defined as the subunit IIA, some ash layers are present. The lowest part of the unit II has been namely subunit IIB and is entirely composed of pelagic clays. The transition between subunit IIB and unit III is constituted by zeolites (zeolitic clays). The age of the unit II remains unknown in lack of paleomagnetic or biostratigraphic data.

-Unit III is composed of biogenic siliceous deposits: radiolarian cherts and radiolarian porcelanite. Some claystones have also been recovered essentially in the uppermost and in the lower part of this unit. The thickness of unit III is about 103 m and its age deposition is unknown.

-Unit IV (thickness 126 m) is characterized by a mixture of radiolarian cherts and porcelanite with calcareous sediments (marlstone and chalk). An isolated ash-rich level is meanwhile present in the core 16R1 at the top of this unit. Nannofossils preserved in marls and chinks permit biostratigraphic datations of these materials from late Valanginian (133 Ma) to late Hauterivian (126 Ma).

Selected discrete samples have been collected along the entire Site 1149 sedimentary column from unit I to unit IV (Plank et al., 2000). The major and trace element compositions of this communal set of samples have been measured by Plank et al. (manuscript in preparation,

2004) and we report here the Hf and Nd isotopic compositions of these sediments. Such sampling procedure permit to identify some Hf and Nd isotopic variations along the sedimentary pile and also permit a estimation of the global composition of the sedimentary cover using the calculation procedure described by Plank and Langmuir (1998).

Analytical Procedure

The Hf isotopic compositions of Hole 801C composites and Site 1149 sediments have been determined using the procedure of Blichert-Toft et al. (1997a). The Hf separation has been performed in Grenoble and the isotopic composition has been measured using a VG Plasma 54 in Lyon. The analytical procedure for Hf separation of Blichert-Toft et al. (1997a) has been highly efficient for most of the Hole 801C composites and Site 1149 sediments however the Hf separation has failed for two particular sample groups:

- 1) The Hf separation has been unsuccessful for cherts and porcelanites collected at Site 1149. For these samples Hf has not been efficiently separated from heavy rare earth elements (HREE) during the chemical procedure stage. In consequence the measurement of the $^{176}\text{Hf}/^{177}\text{Hf}$ isotopic ratio of these samples on the P54 has been disturbed by isobaric interferences at mass 176 caused by Yb and Lu.
- 2) The Hf chemical separation has also been poorly efficient for Ca-rich samples such as the marl and chalk present in the Site 1149 sedimentary pile but also for two Hole 801C composites: 801SED and 0-110VCL containing calcareous interpillow sediments. For these samples after chemical separation the Hf recovery was extremely low and often insufficient for analyze at the P54.

In the analytical procedure of Blichert-Toft et al. (1997a) the chemical separation of Hf and HREE is achieved by addition of concentrated HF to the solid residue after sample dissolution. REE precipitate then into Ca-Mg fluoride salts while Hf bring into supernatant solution. The solid is next centrifuged and leached additionally two times with concentrated HF. For most rock samples this procedure permit to recover more than 90% of Hf in the supernatant solution whereas virtually 100% of REE are trapped into the Ca-Mg fluoride salts (Blichert-Toft et al., 1997a; Yokoyama et al., 1999). However Blichert-Toft (2001) has revealed that this procedure is inadequate for separate Hf from REE in Mg-rich samples (such as komatiites or picrites) because during the fluorides precipitation stage Hf is also entrained together with REE inducing low Hf recovery in the supernatant. Such concentration of Hf into fluorides salts is probably due to high partition coefficient of Hf with respect to Mg-rich fluorides (Blichert-Toft, 2001).

The low Hf recovery after chemical separation on Ca-rich samples suggests that a comparable process of Hf precipitation occurs during HF leaching of Ca-rich materials. At the opposite the low proportions of Ca in Site 1149 cherts and porcelanites (CaO% usually lower than 1%) could explain why HREE do not completely precipitate into the fluoride salts during HF leaching of these materials. In order to validate these preliminary conclusions we have performed some experiments on the Zr, Hf and REE partitioning during HF leaching and fluorides precipitation in Ca-rich and Ca-depleted samples. We have first selected 3 rock samples on the basis of their major element compositions (Table 1): A basalt from the Sunda arc (sample 80J102) moderately enriched in CaO (CaO = 8.38%), a limestone from the southeastern France (sample 287C) containing a high proportion of CaO (50.61% of CaO) and finally an andesite from the Sunda arc namely PC6B with an especially low CaO percentage (0.7% of CaO). These three samples show relatively low proportions of MgO (3.8%, 0.6% and 5.24% of MgO for respectively samples 80J102, 287C and PC6B) and this

element could therefore not imply HFSE precipitation during HF leaching as demonstrated by Blichert-Toft (2001) for Mg-rich samples.

Powders of the three samples were dissolved in savillex capsules with a HF:HNO₃ mixture at about 140°C for 48h and ultimately evaporated. The residues have been next leached 3 times with concentrated HF using the procedure of Blichert-Toft et al. (1997a). Finally the HF supernatant solutions and the Ca-Mg fluoride salts have been prepared for ICP-MS analysis with the exception of the fluorides formed during leaching of the Ca-rich sample because this residue has been strongly resistant to acid digestion performed before ICP-MS analysis. Percentages of REE, Zr and Hf recovered in each fraction are reported in Table 1 and plotted in figure 3. For the sample moderately enriched in Ca (namely 80J102) the observed REE, Hf and Zr partitioning between Ca-Mg fluorides salts and HF supernatant is equivalent to the results of Blichert-Toft et al. (1997a). More than 97% of Zr and Hf remain concentrated in HF supernatant (figure 3a) whereas always more than 95% of REE are concentrated in the fluoride precipitate (with the exception of Ce perhaps due to oxidation of Ce(III) to Ce(IV)). In the case of the Ca-rich sample (sample 287C) the fluoride salts could not have been analyzed but only 2.2% of Zr and 0.9% of Hf have been recovered in HF supernatant solution (Table 1). This result demonstrates that during HF leaching of Ca-rich matrix, Zr and Hf are preferentially concentrated into fluoride residue probably because Zr and Hf have drastically more elevated partition coefficient for Ca-rich fluorides in comparison to Ca-poor fluorides. Figure 3b reveals finally that HF leaching of Ca-depleted samples produces another distinctive distribution of REE, Zr and Hf between fluoride precipitate and HF supernatant solution. For Ca-depleted matrix Zr and Hf are almost exclusively concentrated in the HF supernatant (more than 99% of Zr and Hf) but REE show a progressively fractionation from LREE preferably concentrated in the fluoride salt (with the exception of Ce) to HREE rather diluted in HF solution (59.1% of Yb recovered in supernatant and 40.9% recovered in

residue). Such fractionation implies a progressively decreasing partition coefficient from LREE to HREE with respect to Ca-depleted fluoride salts.

Our experiments demonstrate therefore that the proportion of Ca in sample matrix is a fundamental constraint for the HFSE and REE distribution between fluoride salts and supernatant solution during HF leaching. In the case of moderately Ca-rich matrix, HFSE are preferentially concentrated in supernatant solution whereas REE precipitate in fluorides salts. But during HF leaching of highly Ca-rich sample, HFSE and REE precipitate together in the fluoride residue. Finally for Ca-depleted samples HFSE remain in solution whereas LREE and HREE are fractionated between fluoride salts and HF supernatant solution. In consequence the HF leaching procedure of Blichert-Toft et al. (1997a) could not been used for separation of Hf from REE in Ca-rich and Ca-depleted sample rocks.

We have therefore modified the original protocol of Blichert-Toft et al. (1997a) for Hf purification from Ca-rich and Ca-depleted samples. These modified procedures are detailed in figure 4 together with the original protocol. For Ca-rich samples the HF leaching and fluoride precipitation step is replaced by cation-exchange column composed of DOWEX-AGx12 resin and calibrated by Revillon (2000). However this modified protocol for Ca-rich samples has not be successful for two Hole 801C composites enriched in Ca (801 SED and 0-110 VCL) because during sample dissolution using HF:HNO₃ mixture Ca rich fluorides salts have precipitate entraining probably REE and Hf. These fluorides were next highly resistant to acid digestion before column loading and consequently the Hf recovery after chemical separation was extremely low. We recommend therefore that dissolution of Ca-rich samples does not have to be achieved using concentrated HF but better using lithium metaborate fusion as described in Le Fèvre and Pin (2001). Finally in the modified procedure for Ca-depleted samples we have performed a HF leaching step in order to separated Hf and LREE, but the

remaining HREE have been next separated from Hf using cation-exchange column composed of AG50W-X8 resin (figure 4).

REE were recovered from fluoride residue left after HF leaching or after cation-exchange column (figure 4). Nd has been next isolated using Eichrom® HDEHP-coated teflon resin for Nd isotopic composition measurement.

JMC-475 Hf standard has been used for calibration of the P54 during Hf isotopic analysis. The average measured $^{176}\text{Hf}/^{177}\text{Hf}$ ratio was 0.282163 ± 11 (1σ , 32 runs). Two different standard have been used for calibration during Nd analysis: a first JMC standard has given an average $^{143}\text{Nd}/^{144}\text{Nd}$ ratio of 0.512238 ± 7 (1σ , 12 runs) and a La Jolla standard which give an average $^{143}\text{Nd}/^{144}\text{Nd}$ ratio of 0.511858 ± 10 (1σ , 8 runs). Hf and Nd blanks where measured by ICP-MS and were always lower than 80 pg for Hf and 235 pg for Nd.

Results

Hole 801C basaltic Composites

The Hf and Nd isotopic compositions of Hole 801C composites are reported in Table 2 together with their present day and initial ϵ_{Hf} and ϵ_{Nd} values. The different lithologies (massive flows, pillows, breccias, volcanoclastic materials and hydrothermal deposits) mixed for fabrication of each composite are also indicate in footnotes. The initial Hf and Nd isotopic compositions of Hole 801C samples have been plotted in figure 5 together with the Hf and Nd isotopic compositions of present day middle oceanic ridge basalts (MORB) and oceanic island basalts (OIB). This figure shows that composites constituted by mixing of tholeiitic samples, in particular the composite sample 801SUPER representative of the global composition of the altered tholeiitic crust have initial Hf and Nd isotopic composition equivalent to the present day Pacific MORB.

On other hand the 3 composites composed of alkalic materials (Composites 801 TAB type All, type VCL and type FLO) plot in the OIB field and present initial Hf and Nd isotopic ratios identical to the Hawaiian and Rurutu samples.

Site 1149 sedimentary samples

The measured Hf and Nd isotopic ratios of Site 1149 sediments are reported in Table 3. Paleomagnetic and biostratigraphic dating of samples of respectively units I and IV from Plank et al. (2000) have been used for calculation of their initial $\epsilon_{\text{Hf}(i)}$ and $\epsilon_{\text{Nd}(i)}$ values. For units IIA, IIB and III sediments however ages remain unknown in lack of magnetostratigraphic or biostratigraphic record. Meanwhile the sedimentation rate during deposition of these units was particularly slow (about 1.4 m/Ma) and seem have not radically varied through time in comparison to the sedimentation rates calculated in units I and IV which have notably fluctuated from 7 m/Ma to 34 m/Ma (Plank et al., 2000). In order to estimate their initial Hf and Nd isotopic compositions we have therefore calculate the ages and of samples collected in units IIA, IIB and III as a function of their depth assuming a constant sedimentation rate of 1.4 m/Ma.

The initial Hf and Nd isotopic compositions of Site 1149 samples are plotted along the sedimentary column in figure 6. $\epsilon_{\text{Nd}(i)}$ values are generally restrained in a small range from -8 to -5 with the exception of samples 7H4 140-150, 10H3 140-150 and 16R1 93-98 that show significant more radiogenic Nd isotopic compositions (from -3 to -1.6).

The Hf isotopic compositions appear more contrasted: sediments from the units I, IIA, and from the upper part of unit III have positive $\epsilon_{\text{Hf}(i)}$ values whereas samples collected in the deeper part of the sedimentary pile show negative $\epsilon_{\text{Hf}(i)}$ values with the important exception of sample 16R1 93-98 and 29R1 28-35 ($\epsilon_{\text{Hf}} = +6.4$ and $+12$ respectively). Site 1149 sediments have been next plotted in a $\epsilon_{\text{Hf}(i)}$ vs. $\epsilon_{\text{Nd}(i)}$ diagram together with the different categories of

oceanic sediments (figure 7). Firstly this figure reveals that the Site 1149 pelagic sediments plot on the Fe-Mn crusts and nodule field above the “terrestrial array” defined by Vervoort et al. (1999). This diagram permits additionally to highlight a Hf isotopic evolution along the sedimentary column with no significant change of the Nd isotopes: $\epsilon_{\text{Hf(i)}}$ value shown an progressive increase from the unit IV samples (with negative values) toward units I and IIA with the more radiogenic Hf isotopic compositions. Samples 7H4, 10H3 (from unit I) and 16R1 (from unit IV) with distinctively higher ϵ_{Nd} values do not plot along this sub-vertical large scale trend and appear correspond to punctual modification of the Nd isotopic ratios.

Discussion

Hf and Nd isotopic compositions of Hole 801C composites

Hole 801C composites constituted by tholeiitic materials (composites 801-MORB-0-110, 801-MORB-110-220, 801-MORB-220-420 and 801 SUPER) present initial Hf and Nd isotopic compositions entirely equivalent to the present-day Hf and Nd isotopic ratios of Pacific N-MORB, determined by analysis of unaltered glasses and fresh basalts collected along the Pacific middle oceanic ridge (figure 5). Such initial Hf and Nd isotopic ratios of composite samples are consistent with the previous geochemical and isotopic studies on tholeiitic discrete samples that have demonstrated that Hole 801C tholeiitic units are composed of typical Pacific N-MORB (Castillo et al., 1992; Floyd and Castillo, 1992a; Hauff et al., 2003). Table 2 shows also that no discrimination can be achieved between the composites from the upper part of the tholeiitic section (composites 801-MORB-0-110), from the medium part of the tholeiitic section (composites 801-MORB-110-220) and from the deeper tholeiitic units (composites 801-MORB-220-420). The initial Hf and Nd isotopic compositions seem therefore not varied with depth along the Hole 801C crust.

801-TAB-0-50 composites constituted by alkali materials have $\epsilon_{\text{Hf}(i)}$ and $\epsilon_{\text{Nd}(i)}$ values lower than the tholeiitic composites and plot in the OIB field. These initial Hf and Nd isotopic ratios appear also as expected compositions for igneous materials identified as oceanic island basalts (OIB) in preceding works of Castillo et al. (1992), Floyd and Castillo (1992a) and Hauff et al. (2003).

The unmodified initial Hf and Nd isotopic compositions of Hole 801C tholeiitic composites in comparison to unaltered Pacific N-MORB and the preserved isotopic compositions of alkali composites demonstrate that the global Hf and Nd isotopic budget of altered basaltic crust remain totally unchanged during hydrothermal and low temperature alteration processes. Derivation of the measured Hf and Nd isotopic ratios from the initial compositions appears exclusively caused by internal radioactive decay since eruption of these lavas. This result is consistent with the previous study of Staudigel et al. (1995) which have demonstrated that the Nd isotopes of oceanic crusts are not modified by hydrothermal alteration.

A more detailed examination of the Hf and Nd isotopes of Hole 801C composites (Table 2) reveals that the initial isotopic ratios of the three composites type “All” constituted by mixing of massive flows, pillows, volcanoclastic and interflows materials are not ranging between the isotopic compositions of type “FLO” and “VCL” samples (composed respectively by flows and pillows and by volcanoclastic and interflows sediments). For example sample 801-MORB-220-420 type “All” present $\epsilon_{\text{Nd}(i)}$ and $\epsilon_{\text{Hf}(i)}$ values lower than Composites MORB-220-420 “FLO” and MORB-220-420 “VCL”. In addition 801 SUPER composite composed by mixing of all the materials present in the tholeiitic crust have the lowest $\epsilon_{\text{Hf}(i)}$ value among the tholeiitic samples. Likewise the isotopic compositions of sample 801-TAB-0-50 type “All” seem not correspond to a mixing between the alkali flows and alkali volcanoclastic materials. However as reported in figure 5 the reproducibility of the Hf and Nd isotopic ratios of the standard solutions analyzed during isotopes measurements and the reproducibility of the Sm,

Nd, Lu and Hf concentrations used for calculations of the $\epsilon_{\text{Nd}(i)}$ and $\epsilon_{\text{Hf}(i)}$ values permit to estimate uncertainty of about ± 0.65 unit for the $\epsilon_{\text{Nd}(i)}$ values and about ± 1 unit for the $\epsilon_{\text{Hf}(i)}$ values. Such uncertainty upon the initial isotopic compositions of Hole 801C composites seem indicate that the distinctions between isotopic compositions of the tholeiitic samples are not significant. Similarly considering such uncertainty, composite 801-TAB-0-50 type “All” appear not significantly distinct from the two other alkali composites.

The Nd isotopic compositions and REE budget of Site 1149 sediments

The initial Nd isotopic compositions of Site 1149 sediments remain remarkably constant along the whole sedimentary pile ($\epsilon_{\text{Nd}(i)}$ comprise between -4 to -6.6) and appear roughly independent of sample lithology. Only three sample: 7H4 140-150, 10H3 140-150 from unit I and 16R1 93-98 from the top of unit IV have distinctively more radiogenic $\epsilon_{\text{Nd}(i)}$ values ranging from -3 to -1 (figure 6).

These Nd isotopic compositions help to constraint the major sources of REE in Site 1149 sediments. First figure 7 shows that these initial Nd isotopic ratios are equivalent to the present-day Nd isotopic compositions of hydrogenetic Fe-Mn crusts and nodules. In a Sm/Nd versus $\epsilon_{\text{Nd}(i)}$ diagram (figure 8) Site 1149 samples plot next on in the North Pacific Seawater field seawater determined by Piepgras and Jacobsen (1988) and Shimizu et al. (1994) by straight analysis of water samples. Finally trace element compositions performed by Plank et al. (manuscript in preparation, 2004) indicate that Site 1149 sediments have generally negative Ce anomalies in comparison to other LREE similarly to the oceanic water pattern (Goldberg et al., 1963; Elderfield and Greaves, 1982; Piepgras and Jacobsen, 1992; Bertram and Elderfield, 1993; Shimizu et al., 1994). The Nd isotopes and the trace elements compositions of Site 1149 sediments seem therefore argue that the Nd isotopic budget and the REE pattern of these samples are primary derived from the overlying Pacific seawater.

A major consequence of such result is that in sediments collected at Site 1149 the REE must be primary hosted in authigenic minerals precipitating in the sedimentary pile from seawater through chemical or biochemical processes. According previous studies several groups of authigenic minerals could host large proportions of REE in oceanic sediments: Authigenic alumino-silicate phases such authigenic zeolites or clays (Piper, 1974a; Piper, 1974b), Fe-Mn oxydes (Palmer, 1985; Shaw and Wasserburg, 1985; Palmer and Elderfield, 1986) or phosphate minerals (Elderfield et al., 1981; Toyoda et al., 1990; Plank and Langmuir, 1998). In order to determine in which authigenic phases are sequestrated REE, we have plot in figure 9 the Nd concentration firstly as a function of Al_2O_3 (%) and K_2O (%) as proxies of alumino-silicate proportions, next as a function of the MnO percentage considering this latter as representative of the Fe-Mn oxydes content and lastly as a function of P_2O_5 (%) as a proxy of the phosphate amount. According to this figure the Nd concentration appear well correlated to the P_2O_5 percentage and consequently the authigenic minerals hosting almost of REE in Site 1149 sediments seem be P-rich minerals probably phosphates.

Among the Site 1149 sediments, samples 7H4 140-150, 10H3 140-150 and 16R1 93-98 have Sm/Nd ranging from 0.2 to 0.25 equivalent to the other Site 1149 samples but present notably higher $\epsilon_{\text{Nd}(t)}$ values (figure 8). The distinct Nd isotopic compositions suggest that the Nd budget of these three samples is not exclusively derived from seawater. Smear-slides data of Site 1149 sediments by Plank et al. (2000) indicate that these three samples contain between 10% to 15% of volcanic ashes (volcanic glasses and fragments). In figure 8, the shift of these three samples from other Site 1149 sediments could be explained by supply of volcanic materials with radiogenic Nd isotopic compositions derived from oceanic islands or volcanic arcs. According to Plank et al. (2000) ashes involved in unit I samples (such samples 7H4 140-150 and 10H3 140-150) are originated from the Western Pacific volcanic arcs (as the Izu-

Mariana arc) since unit I sediments are first remarkably depleted in Nb and moreover the deposition of ashes in unit I during Neogene is synchronous with the Site 1149 approach of the Izu-Mariana and Japan arcs. At the opposite volcanic ashes included in sample 16R1 93-98 at the top of the unit IV are probably not derived from Western Pacific arcs. This sample has been dated from the uppermost Hauterivian (about 126 Ma) by A. Bartolini (Unpublished data) and at this time the ODP Site 1149 was located in the central region of the Pacific Superocean, largely distant from Peri-Pacific volcanic arcs (see Coffin et al., 2000 and Bartolini and Larson, 2001 for a paleogeographic reconstruction of the Pacific Plate). In figure 10 the Th/Nb ratio of sample 16R1 93-98 have moreover a remarkably low Th/Nb about 3.3 contrasting with other Site 1149 sediments. Such ratio appears analogous to those of MORB and OIB. In the Western Pacific region several volcanic units dated from the upper Hauterivian have been identified: first sills of alkalic dolerites sampled at Site 800A have been dated from 126 Ma by Pringle (1992). Secondly some submarine volcanoes of the Magellan seamount line were also active at about 120 Ma (Smith et al. 1989). Finally thick volcanoclastics units deposited from Hauterivian to Aptian-Albian are present in the Sites 800 and 801 sediment piles (Lancelot et al., 1990; Lees et al., 1992). All these volcanic materials have been identified as OIB by numerous authors (Smith et al., 1989; Staudigel et al., 1991; Castillo et al., 1992; Floyd et al., 1992b; Lees et al., 1992) and have been plotted in figure 8 and 10. The low Th/Ta ratio and the synchronism between the hauterivian OIB and supply of volcanic ashes in sample 16R1 93-98 suggest that the igneous materials involved in this sediment were erupted during this intraplate volcanic event.

In conclusions the Nd isotopic compositions and Sm/Nd ratios indicate that in Site 1149 sediments the primary source of REE is the overlying Pacific Seawater via precipitation of authigenic phosphates. In sample containing ashes the Nd isotopic composition appear

resulting from a mixing between the seawater source and volcanic components derived from volcanic arcs or from oceanic island volcanism.

The Hf isotopic compositions and HFSE budget of Site 1149 sediments

Contrary to the Nd isotopic compositions the Hf isotopic compositions vary in a large range along the Site 1149 sedimentary column from $\epsilon_{\text{Hf}(i)} = -5.4$ to $\epsilon_{\text{Hf}(i)} = +12$ (figure 6). These variations suggest that several sources contribute to the Hf isotopic budget. In order to distinguish the various origins of HFSE in Site 1149 sediments we have plotted the Ta/Hf, Zr/Hf and Th/Ta ratios in function of the $\epsilon_{\text{Hf}(i)}$ values in figure 11. This figure shows that the initial Hf isotopic compositions are correlated with evolutions of the Ta/Hf and Zr/Hf ratios: the negative $\epsilon_{\text{Hf}(i)}$ values of sediments from unit IV are associated with high Ta/Hf and Zr/Hf ratios (excepted for sample 16R1 93-98 and 29R1 28-35). At the opposite samples from unit I and subunit IIA have positive $\epsilon_{\text{Hf}(i)}$ values associated with lower Ta/Hf and Zr/Hf (Ta/Hf comprise between 0.11 to 0.25 and Zr/Hf about 35). Other Site 1149 units have $\epsilon_{\text{Hf}(i)}$, Ta/Hf and Zr/Hf intermediary between the unit IV and units I and IIA sediments.

Additionally to these elemental and isotopic evolutions figure 12 indicate that the Hf concentration seems correlated with the Al_2O_3 and K_2O percentage. Consequently in Site 1149 sediments the HFSE budget appears primary controlled by alumino-silicate minerals probably zeolites or clay minerals which are the most abundant alumino-silicates in Pacific pelagic sediments (Goldberg and Arrhenius, 1958; Piper, 1974a; Piper, 1974b).

The Hf isotopic compositions, the Ta/Hf and Zr/Hf ratios permit to identify different sources of HFSE along the Site 1149 sedimentary pile.

The HFSE budget of unit IV sediments

The elevated Zr/Hf and Ta/Hf ratios associated with negative $\epsilon_{\text{Hf}(i)}$ values measured in unit IV samples (excepted for samples 16R1 93-98 and 29R1 28-35) reflect primarily the chemical and isotopic compositions of the aluminosilicate minerals hosting Hf and other HFSE in these sediments. The low initial Hf isotopic ratios point to three potential sources for such aluminosilicate phases: first numerous authors have demonstrated that continental dusts derived from Asia and transported by eastward winds constitute important components in Pacific sediments (Rea and Janecek, 1981; Rea et al., 1985; Leinen, 1987; Olivarez et al., 1991; Nakai et al., 1993; Jones et al., 1994; Asahara et al., 1995; Weber et al., 1996; Asahara et al., 1999; Pettke et al., 2000). Consequently aluminous minerals involved in unit IV sediments could be eolian Asia-derived grains. Secondly Olivarez et al. (1991), Zhou and Kyte (1992), Kyte et al. (1993), Nakai et al. (1993), Jones et al. (1994) and Asahara et al. (1999) have demonstrated that andesitic materials derived from peri-Pacific volcanic arcs are also significant constituents of Pacific sediments. Aluminosilicate phases identified in unit IV could therefore also be originating from volcanic arcs. Finally in the Pacific Ocean some scarce oceanic islands have negative ϵ_{Hf} values such volcanics erupted at the Pitcairn hotspot (Salters and White, 1998; Eisele et al., 2002). The aluminosilicate minerals determining the HFSE budget of unit IV sediments could consequently also derive from such oceanic island.

In figure 11, Site 1149 sediments have been plotted together with the Asian materials (after the data of Taylor et al., 1983; Kyte et al., 1993; Gallet et al., 1996; Jahn et al., 2001; McLennan, 2001 and Pettke et al., 2002) and with the Pitcairn lavas composition (data of Eisele et al., 2002). Concerning the andesitic source White and Patchett (1984), Pearce et al. (1999) and Woodhead et al. (2001) have established that lavas collected in Western Pacific intra-oceanic arcs (Kermadec, New Britain, Izu-Mariana and Aleutian arcs) present always highly radiogenic Hf isotopic compositions (ϵ_{Hf} about +15). The west Pacific arcs can not therefore be the source of the aluminous minerals present in unit IV sediments. A potential

source for these materials with low ϵ_{Hf} values are the Western American continental arcs such the Andean arc but any Hf isotopic composition has been published for this region. In consequence in figure 11 we have only indicate the average Th/Ta, Ta/Hf and Zr/Hf ratios of the Andean magmatic rocks calculated using the Andean Arc Precompiled File of the GEOROC database (MPI-Mainz).

Figure 11a and 11b reveals that Sediments from unit IV have Hf isotopic compositions equivalent to the Asian dusts and Pitcairn lavas but Ta/Hf and Zr/Hf ratios intermediary between these two components. In figure 11c however the unit IV sediments have Th/Ta distinctively higher than the Pitcairn volcanics (excepted sample 16R1 93-98). These Th/Ta ratios of unit IV sediments suggest therefore that the HFSE budget of these materials can not derive from OIB. In consequence the Th/Ta and $\epsilon_{\text{Hf(i)}}$ values indicate rather that the aluminosilicate minerals controlling the HFSE budget of unit IV sediments are probably derived from continental areas (such Asia) or continental volcanic arcs (such Andean arc). Meanwhile the higher Ta/Hf and Zr/Hf ratios of unit IV samples in comparison to these source regions remain unexplained (figures 11a and 11b).

Two samples from unit IV, 16R1 93-98 and 29R1 28-35 present distinctively radiogenic Hf isotopic compositions ($\epsilon_{\text{Hf(i)}} = +6.4$ and $+12$ respectively). First, sample 29R1 28-35 is a calcareous marl collected at the bottom of the sedimentary pile few centimeters above the basaltic crust. Their $\epsilon_{\text{Hf(i)}}$, Ta/Hf and Zr/Hf ratios appear equivalent to the MORB endmember (figures 11a and 11b). Plank et al. (2000) have moreover demonstrated that at Site 1149, sediments deposited just above the basaltic crust present important enrichments in metalliferous elements (especially in Mn and Fe) and seem include elements derived from mid oceanic hydrothermal vents. The Hf isotopes suggest also that this sample contain hydrothermally-derived HFSE. However figure 11c reveal that sample 29R1 28-35 have

especially high Th/Ta ratio (about 26.3) poorly compatible with MORB compositions. In consequence the source of HFSE in the sediments deposited just above the basaltic crust remains unclear.

Finally sample 16R1 93-98 present remarkably low Th/Ta ratios equivalent to OIB (figure 11c) which indicate that the HFSE budget of this sediment reflect supply of oceanic island derived ashes as it Nd isotopic budget.

The HFSE budget of unit III and subunit IIB sediments

In comparison to unit IV, unit III and subunit IIB sediments present an evolution of their Hf isotopes from negative $\epsilon_{\text{Hf}(i)}$ to positive $\epsilon_{\text{Hf}(i)}$ values associated with decrease of their Ta/Hf and Zr/Hf (figure 11). Such evolution argues for a progressive modification of the source of HFSE during sedimentation of these materials.

Two hypothesis could be proposed for explaining the shift of the units III and IIB samples in comparison to the unit IV sediments (figure 11): first the modern Pacific seawater present an average ϵ_{Hf} value from +5 to +7 (after the data of Godfrey et al., 1997, Albarède et al., 1998, Lee et al., 1999 and David et al., 2001 on the Pacific Fe-Mn crusts and nodules). The derivation toward positive values could therefore reflect increasing precipitation of authigenic minerals from the overlying seawater. Secondly the shift of units III and IIB sediments toward positive ϵ_{Hf} value could be caused by supply of materials originating from Western Pacific volcanic arcs (such the Izu-Mariana arc) with radiogenic Hf isotopic compositions (figures 11a and 11b).

According to Plank et al. (2000) in units III and IIB sediments no volcanic materials have been recognized. But on other hand an authigenic clay mineral namely palygorskite have been clearly identify by X-ray diffractometry (Plank et al., 2000). In consequence the evolution of the Hf isotopic composition is probably caused by increasing supply of authigenic alumino-

silicates precipitating from seawater. The HFSE budget of unit III and subunit IIB sediments result therefore from a mixing between HFS elements originating from a continental source mixed with HFS elements derived from Pacific seawater.

The HFSE budget of unit I and subunit IIA sediments

Unit I and subunit IIA samples have the more radiogenic Hf isotopic compositions ($\epsilon_{\text{Hf}(i)}$ values comprise between +5.9 to +10.3) associated with the lowest Ta/Hf and Zr/Hf ratios among the Site 1149 sediments (figures 11a and 11b). 4 samples of these units have approximately similar $\epsilon_{\text{Hf}(i)}$ values ranging from +5.9 to +7.1 (samples 1H1 140-150, 4H2 140-150, 10H3 140-150 and 14H2 140-150). These initial Hf isotopic compositions are strictly equivalent to the ϵ_{Hf} values of Pacific seawater determined by analysis of Fe-Mn crusts and nodules (figure 11). The HFSE budget of these samples appears therefore controlled by the overlying Pacific seawater. This conclusion is reinforced by the chemical composition of interstitial waters studied by Plank et al. (2000). Indeed in units I and II interstitial waters are depleted in silica, Sr^{2+} and K^+ whereas increasing concentrations of the Na^+ , Li^+ and NH_4^+ have been reported. Such modifications seem reflect effects of cation exchanges between solid particles and interstitial waters and suggest high rate of authigenic clay precipitation in these sediments. Moreover Mn-micronodules are current in some unit I cores (Plank et al., 2000) and agree also for intensive precipitation of authigenic phases during deposition of these sediments.

Finally sediment 7H4 140-150, an ash-rich layer from unit I present initial Hf isotopic composition and Ta/Hf and Zr/Hf ratios shifted toward the Izu-Mariana arc lavas (figures 11a and 11b). Volcanic materials involved in this sample appear therefore also constitute a major source of HFSE.

In summary the Hf isotopic compositions reveal that various sources contribute to the HFSE budget of Site 1149 sediments. Continental areas (cratonic regions or continental arcs) and Pacific seawater are probably the two major sources of HFSE but intra-oceanic arcs (for sample 7H4 140-150), oceanic islands (for sample 16R1 93-98) and perhaps hydrothermal venting (for sample 29R1 28-35) contribute also to the HFSE budget of these materials.

Calculation of the bulk composition of Site 1149 sedimentary pile

Our measured Hf and Nd isotopes on discrete sediments associated with the trace element analysis of Plank et al., (manuscript in preparation, 2004) permit an evaluation of the global composition of the Site 1149 sedimentary pile. Indeed Plank and Langmuir (1998) have demonstrated that for sedimentary rocks the geochemical composition is related to the sediment lithology. In each sedimentary unit constituted by comparable sediments, analysis of a limited number of samples permits therefore to evaluate the average composition of the whole unit. Afterwards an estimation of the bulk composition of a sedimentary pile could be achieved by combination of the average compositions of the different units.

The sedimentary pile drilled at Site 1149 has been initially divided in five lithological units or subunits (see figure F17 in Plank et al., 2000). However trace elements analysis and Hf and Nd isotopes have revealed that some distinctive layers could be identified in these large units. First the transition between subunit IIB and unit III is constituted by about 10 meters thick zeolitic clays highly enriched in REE in comparison to other unit III or subunit IIB samples (Plank et al., manuscript in preparation, 2004). In consequence these REE-rich layer has been considered for calculations as a distinct lithological unit. Secondly in unit IV, samples 16R1 93-98 and 29R1 28-35 present distinctively radiogenic Hf isotopic compositions in comparison to the negative ϵ_{Hf} values of the other unit IV sediments (Table 3). These two samples have therefore also been considered separately from other unit IV sediments.

In a first time using the Hf and Nd isotopes and concentrations measured on discrete samples we have calculated the average isotopic compositions of each sedimentary unit (Table 4). Next using the mixing equation of Langmuir et al. (1978), these average compositions have been combined with the thickness and density of each unit for calculate the global composition of the Site 1149 sedimentary pile. This bulk isotopic and trace element composition is reported in Table 4 and plotted together with the discrete samples in figure 13.

The Site 1149 sedimentary column have a present-day negative ϵ_{Nd} of -5.9 but a positive ϵ_{Hf} value about +4.4 and plot in the Fe-Mn crusts and nodules field, above the “terrestrial array” defined by Vervoort et al. (1999). These global Hf and Nd isotopic compositions lead to several conclusions. First the bulk ϵ_{Nd} value about -5.9 of Site 1149 sedimentary pile is strictly equivalent to the Nd isotopic composition of the deep Pacific seawater (Piepgras and Jacobsen, 1988; Shimizu et al., 1994). This isotopic composition demonstrate that the almost exclusively source of REE for the sedimentary column is the overlying seawater. The positive ϵ_{Hf} of +4.4 indicate that the Hf budget of the sedimentary pile is primary dominated by the upper units (units I, IIA, IIB and zeolitic clay layer) that have more radiogenic ϵ_{Hf} values and are enriched in Hf in comparison to the deeper units (Table 4). Such positive ϵ_{Hf} indicates moreover that the predominant source of HFSE for the Site 1149 sedimentary pile is the Pacific seawater. The continental HFSE source identified in the deeper sediments represents only a secondary contribution for the global HFSE budget.

The bulk Sm/Nd, Nd/Hf and Lu/Hf ratios of the sedimentary pile have been also noted in Table 4 and plotted in figure 14. The Nd/Hf (about 14.9) and the Lu/Hf ratio (about 0.255) are largely higher than the earth primitive mantle ratios after the data of Hofmann (1988) (Nd/Hf = 4.44 and Lu/Hf = 0.238). These elevated ratios demonstrate that Site 1149 sediments are enriched in REE in comparison to the HFSE probably since the important precipitation of

REE from seawater into phosphate minerals. On contrary the bulk Sm/Nd = 0.214 of the sedimentary pile is lower than the primitive mantle ratio (Sm/Nd = 0.325 after Hofmann, 1988) and suggest that the LREE are enriched comparatively to MREE (mid REE). Enrichment in LREE is also a major characteristic of the seawater pattern (Elderfield and Greaves, 1982; Piepgras and Jacobsen, 1992; Shimizu et al., 1994). The low Sm/Nd calculated for the Site 1149 sedimentary pile appears therefore reflect the predominant contribution of seawater to the REE budget. In figure 14 the bulk Lu/Hf ratio has been reported in function of Sm/Nd together with the sediment data of Patchett et al. (1984). This figure shows that the Site 1149 sedimentary pile have trace elements compositions equivalent to deep sea red clays and Fe-Mn crusts and nodules. Site 1149 sedimentary column appears in consequence largely distinct from the GLOSS (Global Subducting sediments) proposed by Plank and Langmuir (1998) which is principally dominated by terrigenous materials.

An estimation of the bulk Hf and Nd isotopes of the Western Pacific sedimentary cover has been already performed by White et al. (1986) and Woodhead (1989) by analysis of the composite sample 452-C from the DSDP Site 452, located in front of the Mariana arc (figure 1). As show in figure 13 the calculated bulk Hf and Nd isotopic compositions of Site 1149 sedimentary pile are remarkably similar to the isotopic ratios of Site 452 composite ($^{143}\text{Nd}/^{144}\text{Nd} = 0.512410$ and $^{176}\text{Hf}/^{177}\text{Hf} = 0.282900$). The Hf and Nd isotopic compositions of the sedimentary pile subducting at the Izu trench seem therefore represent a common composition for the Western Pacific sedimentary cover. However at DSDP Site 452 in front of the Mariana arc and at ODP Site 1149 in front of the Izu arc the sedimentary columns do not comprise significant proportions of volcanoclastic sediments (Hussong et al., 1982; Plank et al., 2000). The West Pacific ODP reference Sites 800, 801 and 802 (figure 1) include on contrary thick volcanoclastic units in their sedimentary sections (Lancelot et al., 1990; Lees et

al., 1992) that probably substantially influence their bulk Hf and Nd isotopic budget. The global Hf and Nd isotopic compositions of DSDP Site 452 and ODP Site 1149 should therefore be considered as representative of Pacific sedimentary columns without important amount of volcanogenic materials.

Recycling of the Site 1149 sediments into the Izu arc lavas

The ODP Site 1149 has been drilled in front of the central part of the Izu arc in order to establish a reference site for the sedimentary pile subducting at the Izu trench (Plank et al., 2000). In this central segment of the Izu arc volcanic activity appears simultaneously occur in three juxtaposed zones (Honza and Tamaki, 1985; Taylor, 1992; Hochstaedter et al., 2000): In the volcanic front where are located the emerged islands, in an immerged extensional zone adjoining the volcanic front and in the Western Seamounts region bounding the Shikoku back-arc Basin. Elemental and isotopic compositions of lavas erupted in these areas have been studied by numerous authors (Notsu et al., 1983; Ikeda and Yuasa, 1989; Fryer et al., 1990; Hochstaedter et al., 1990a; Hochstaedter et al., 1990b; Tatsumi et al., 1992; Taylor and Nesbitt, 1998; Hochstaedter et al., 2000; Hochstaedter et al., 2001; Schmidt, 2001). The primary conclusion of these studies is that volcanic rocks from these three zones have distinct geochemical and isotopic compositions and could therefore not result from melting of a uniform source. An illustration of the complex processes occurring in the Izu arc is given in figure 15 where the Izu arc lavas present highly variable Hf/Nd ratios but seem not result from a simple binary mixing between a MORB like mantle and the Site 1149 sediments. Hochstaedter et al. (2001) have proposed that these across-arc variations result from numerous contamination steps by the subducted materials (sediments and altered basaltic crust) and multiple depletion stages by melting affecting the arc source. The specific

contribution of Western Pacific sediments into the Izu arc source has been clearly demonstrated using Pb isotopes by Hochstaedter et al. (2001) and Schmidt (2001).

In complement to these previous works the bulk Hf and Nd isotopic compositions of the Site 1149 sedimentary pile constitute fundamental data for evaluate the proportions of trace elements derived from the subducted sediments involved in arc lavas. Hochstaedter et al. (2001) using the data of Hickey-Vargas (1991; 1998) have evaluated the ϵ_{Nd} value of the unmodified subarc mantle to about +8.7. On other hand lavas from the central section of the Izu arc (from latitude about 30°N to 33°N) have ϵ_{Nd} values ranging from +9.4 to +6.7 after the data of Taylor and Nesbitt (1998) and Hochstaedter et al. (2001). Considering that the Site 1149 sedimentary pile present a bulk ϵ_{Nd} value of -5.9, a elementary mass balance calculation between the subarc mantle and the Site 1149 bulk composition indicate that between of 0% to 14% of Nd included in the arc lavas is derived from the subducted sediments. The Nd isotopic ratios of some Izu lavas occasionally more radiogenic than the mantle endmember are interpreted by Hochstaedter et al. (2001) as resulting from a contribution to the source of fluids derived from the subducted basaltic crust. In such case the percentage of Nd derived from the sedimentary pile will be higher than the proportions calculated above. These Nd percentages have therefore to be considered as minimum proportions of Nd recycling from the sedimentary pile.

In the central segment of the Izu arc any Hf isotopic compositions have been measured. Only four Hf isotopic ratios have been published by White and Patchett (1984) and Pearce et al. (1999) for the northern volcanoes of the Izu arc (about latitude 35°N). These ratios ranging from 0.283190 ($\epsilon_{Hf} = +14.8$) to 0.283280 ($\epsilon_{Hf} = +18$) appear not significantly distinct from Pacific MORB (ϵ_{Hf} of Pacific MORB ranging from +10 to +20). In consequence the percentage of Hf derived from the sedimentary pile in the Izu volcanics appears arduous to

estimate. Two propositions could explicate such apparent no derivation of the Izu lavas from the MORB end-member: first as demonstrated by Pearce et al. (1999), Hf from the subducted materials seems not efficiency recycled into the Izu arc probably because the low Hf solubility in dewatering fluids. Secondly as we calculated previously the Site 1149 sedimentary pile present notably radiogenic Hf isotopic composition (bulk $\epsilon_{\text{Hf}} = +4.4$). In consequence if only few percents of Hf in arc lavas are derived from subducted sediments the isotopic compositions will not be significantly modified by such input. For example considering that the subarc mantle have an ϵ_{Hf} value about +15 (average value measured in Pacific MORB) and assuming that about 10% of Hf included in the Izu lavas are derived from the subducted sediments (analogously to the 0% to 14% of Nd derived from sediments) then the ϵ_{Hf} of the arc lavas will be only decreased toward +13.9 which is not distinctly from Pacific MORB composition.

Comparison between the Nd input and output fluxes and Mass balance calculation in the Izu arc

Our calculated bulk composition of the Site 1149 sedimentary pile associated with physical and geochemical data available today in literature permit preliminary estimations of the trace element input and output fluxes in the Izu subduction zone. These calculations constitute indispensable steps for evaluations of the mass transfers between the continental crust and mantle reservoirs in such subduction zone.

We concentrated only on the Nd sedimentary input and volcanic output fluxes in the central part of the Izu arc (from latitude about 30°N to 33°N) located forward the Site 1149 (latitude 31°N). First in table 5 we have compiled the magmatic addition rate of the Izu arc determined by Dimalanta et al. (2002) with the average Nd concentration of the central Izu arc lavas. These data permit to evaluate a Nd volcanic output rate ranging from 880 to 1900 kg/km/a. In addition in the previous paragraph we have calculated that the minimum percentage of Nd

derived from the sediments in the Izu lavas is comprise between 0% to 14%. This implies that at minimum from 0 to 266 kg/km/a of the Nd output flux are originated from the subducted sediments. On other hand we use the average Nd concentration of 26.2 ppm of the Site 1149 sedimentary pile to evaluate the Nd input rate with the sediments to about 1080 kg/km/a (Table 5). These results have been reported in figure 16a; they permit to estimate a maximum Nd recycling rate into the deep mantle of 1080 to 814 kg/km/a. The major conclusion highlighted by figure 16a is that the Nd input rate with the sediments is of the order of the volcanic output flux. This is primary caused by the elevated concentration of Nd in Site 1149 sediments (26.2 ppm) in comparison to the average Nd concentration in Izu arc lavas (from 5 to 10 ppm).

According to Armstrong (1968 and 1991) subduction zones are the primary regions of exchanges between the continental crust and the mantle reservoirs. Two major fluxes could be defined in a subduction zones: First elements are transferred from the mantle reservoir to the arc crust by supply of magmas. These elements from the mantle reservoir are transferred toward the arc crust from three components: from the subarc mantle, from the subducted basaltic crust but also from the subducted sediments which could on part derive from the mantle reservoir (for example volcanogenic sediments). This first flux is combined with recycled elements from the continental crust (almost included in sediments) to generate the total volcanic output. The second major flux in subduction zones is a return of materials originating from the continental crust into the earth's deep mantle. These elements are almost totally comprise in sediments but a minor fraction could also be included in the altered basaltic crust. For example the Sr isotopes of altered basaltic crust appear modified in comparison to unaltered MORB (Staudigel et al., 1995) and imply that a fraction of the Sr

budget of the altered basaltic crust is derived from an enriched source probably the seawater and consequently at least for a part from the continental crust which contribute to seawater Sr.

At Site 1149 the Nd isotopes of altered MORB samples published by Hauff et al. (2003) appear strictly equivalent to unaltered Pacific MORB ($\epsilon_{Nd(i)}$ about 10.3) suggesting that the Nd budget of this subducting basaltic crust is exclusively derived from the mantle reservoir and have not been modified by seawater interaction. For the Nd mass balance the altered basaltic crust appears therefore as a pure mantellic endmember. In consequence a quantification of the Nd exchanges between the mantle and crust reservoirs require only an evaluation of the continentally derived Nd included in the sedimentary pile. The Nd isotopes of Site 1149 sediments indicate that the REE budget of these materials is derived from Pacific seawater. According to various authors the REE budget of Pacific seawater results from a mixing between contributions from the crust and the mantle (Piepgras et al., 1979; Piepgras and Wasserburg, 1980; Goldstein and Jacobsen, 1987; Shimizu et al., 1994). We choose to evaluate the proportion of continentally derived Nd in Site 1149 sediments resolving a mass balance calculation between crust contribution and mid oceanic ridge input. This procedure does not consider however the hotspots or volcanic arcs contributions to the Pacific seawater because the bulk isotopic compositions of these end-members seem arduous to establish. According to Goldstein et al. (1984) and Gallet et al. (1998) products of continental erosion have an average ϵ_{Nd} value to about -11 . On other hand Pacific MORB have an average ϵ_{Nd} value about $+10$. The ϵ_{Nd} of -5.9 of Site 1149 sediments suggest therefore that about 75% of their Nd budget derive from the crust and 25% from the mantle reservoir. This result permits to estimate the mass fluxes occurring between the mantle and the crust in the Izu arc (figure 16b). Two principal conclusions appear in the light of this figure: In first pelagic sediments formed distant from any continents, such the Site 1149 sediments, contain although large

proportions of continentally derived REE and contribute therefore also to crustal recycling into the mantle. This is due to the high proportion of continentally derived REE in the seawater. Secondly according to figure 16b in the Izu arc the maximum rate of continental Nd cycled back into the deep mantle is lower than the rate of mantellic Nd transferred toward the arc crust. The mass balance between the crust and the mantle in the Izu arc appears therefore as a gain of Nd for the crust reservoir. However the maximum Nd recycling rate into the deep mantle (810-610 kg/km/a) could be approximately equivalent to the minimum Nd flux from the mantle to the arc crust (880 kg/km/a). In consequence equilibrated exchanges between the mantle and the crust in the Izu arc could not be totally precluded.

Long term isotopic evolution of the Hole 801C basaltic crust and Site 1149 sedimentary pile

Numerous authors have proposed that the altered basaltic crusts and associated sedimentary columns absorbed at subduction zones are ultimately recycled into the earth's deep mantle and probably next contribute to mantle plumes sources of the OIB (Hofmann and White, 1982; Weaver, 1991a; Weaver, 1991b; Chauvel et al., 1992; Lassiter and Hauri, 1998; Blichert-Toft et al., 1999a; Chauvel and Hémond, 2000). The Hole 801C tholeiitic crust (represented by the composite 801 SUPER) and the overlying alkali basalts (represented by the composite 801 TAB 0-50 type "All") but also the sedimentary pile drilled at Site 1149 represent typical examples of the materials consumed today at the Western Pacific intra-oceanic subduction zones. However the isotopic compositions of Hole 801C basalts and Site 1149 sediments could not be straightly used for examine the potential contribution of such components into hot spots because the recycled materials involved in modern OIB source are supposed aged of several thousand millions years (Chauvel et al., 1992). In consequence their initial Hf and Nd isotopic ratios were probably not equivalent to those of present day oceanic basalts and sediments primary because of ^{176}Lu and ^{147}Sm radioactive decay through time.

In a preliminary approach ancient oceanic basalts and sediments could be regarded as derived from similar sources to those of modern oceanic crusts and associated sediments. We attempt therefore to estimate the Hf and Nd isotopic compositions of ancient subducted materials using the isotopic ratios of Hole 801C basalts and Site 1149 sediments. Two calculations steps have been performed: First we calculated the initial $\epsilon_{\text{Hf}(i)}$ and $\epsilon_{\text{Nd}(i)}$ of ancient basalts and sediments assuming that the source of these materials (primary the depleted mantle for the basalts; the seawater and the continental crust for the sediments) have been differentiated from a chondritic primitive mantle since 4.5 Ga and have next conserved constant Lu/Hf and Sm/Nd ratios through time. These initial isotopic ratios have been secondly corrected using the Sm/Nd and Lu/Hf ratios of the Hole 801C composites and Site 1149 sediments in order to calculate the theoretical present day compositions of such ancient oceanic materials. The results have been plotted in figure 17 together with the GLOSS dominated by terrigenous sediments. This diagram shows firstly that if ancient oceanic basalts and sediments were comparable to modern oceanic crusts and sediments these components will have actually highly distinct compositions in the ϵ_{Hf} vs. ϵ_{Nd} space. Ancient tholeiitic crust and pelagic sediments would not plot along the Hf-Nd “OIB array”, only the GLOSS and alkali basalts would approximately plot along this correlation. Such contrasted long term Hf and Nd isotopic evolutions and divergence from the OIB array are primary induced by the highly distinctive Sm/Nd and Lu/Hf ratios of the tholeiitic basalts, alkali basalts, terrigenous and pelagic sediments (figure 14).

In contrast with these materials the Hf and Nd isotopic ratios of modern OIB appear well correlated and they all plot on a Hf-Nd “OIB array” (Patchett and Tatsumoto, 1980; Patchett, 1983; Patchett et al., 1984; Salters and White, 1998; Vervoort et al., 1999). According to Patchett et al. (1984), Salters and White (1998) and Vervoort et al. (1999) such well

correlated Hf and Nd isotopic ratios in modern OIB compared to the divergent long term evolution of subducted materials imply that the recycled components do not contribute separately to hot spots sources. These authors have proposed that if recycled oceanic basalts and sediments contribute to OIB sources they are imperatively mixed at a constant rate to produce a homogenous component located at the non-radiogenic termination of the OIB array. For example Patchett et al. (1984) have calculate that to produce a endmember located at the end of the OIB array a mixing between terrigenous sediments and deep sea red clays is required in a constant ratio 1.2 to 1. The result remain approximately equivalent if the Patchett's deep sea red clays are substituted by the Site 1149 sediments since this sedimentary pile have trace element ratios equivalent to red clays (figure 14).

However alternative explanations could be proposed for the relatively uniform Hf-Nd correlation of OIB in comparison to the long term divergence of subducted materials. First Plank and Langmuir (1998) have proposed that the enrichment in REE comparatively to Hf identified in the deep sea red clays, Site 1149 sediments and some other pelagic sediments is restricted to Phanerozoic times (from 540 Ma to present). Indeed the REE supply in such materials is caused by phosphate precipitation that seems greatly improved by biological processes (Elderfield and Pagett, 1986; Toyoda et al., 1990). Consequently if pelagic sediments involved in modern OIB were formed during Archean or Proterozoic they have probably not elevated Lu/Hf ratios and would be perhaps not basically distinct from terrigenous sediments and the present day GLOSS composition.

Additionally, in various papers Jacob et al. (1994), Jacob and Foley (1999) and Foley et al. (2003) have proposed that ancient oceanic crust were not constituted by N-MORB but by more magnesian and trace elements depleted basalts comparable to picrites or komatiites. The present-day Hf and Nd isotopic ratios of precambrian komatiites, magnesian and tholeiitic

basalts analyzed by Blichert-Toft and Arndt (1999c) have been plotted in figure 17. Among these ancient basalts the Barberton Greenstone belt and Ottawa islands samples plot approximately around the present day OIB array, thus if ancient oceanic crust were comparable to these rocks they are actually isotopically not highly distinct from the OIB array. Meanwhile some ancient basalts, in particular the 2.7 Ga old komatiites (Munro-type), do not plot along this mantle array because of their actual highly radiogenic Nd isotopic compositions (figure 17).

In summary modern basalts and sediments absorbed at subduction zones would present long term Hf and Nd isotopic evolution notably divergent from the Hf-Nd OIB array. On contrary ancient oceanic basalts and sediments have perhaps long term isotopic evolution possibly more condensed around the OIB array. In such case contribution of recycled basalts and sediments to the OIB sources do not require extremely constant mixing of these materials.

Conclusions

Our Hf and Nd isotopic study about the Site 1149 sediments and Hole 801C basaltic composites lead to several major conclusions:

- 1) Concerning the analytical aspect we have demonstrated that the Ca content is a primordial factor controlling the HFSE and REE partition between fluoride salts and supernatant during HF leaching of natural sample rocks. The procedure of Blichert-Toft et al. (1997a) for Hf and REE separation using concentrated HF could not be applied for Ca-depleted or Ca-highly enriched samples such as cherts and calcareous sediments. For these sample types Hf and REE separation using cation-exchange columns are preferable.

- 2) The Hf and Nd isotopes of Hole 801C composites representative of the large scale composition of the Hole 801C altered basaltic crust are equivalent to unaltered basalts and appear totally unaffected by hydrothermal and low temperature alteration.
- 3) The Hf and Nd isotopic compositions of Site 1149 sediments are largely decoupled since in these materials REE and HFSE have not strictly same origins and are not hosted in same phases. Nd isotopes suggest that the major source of REE in these materials is the Pacific seawater. REE have precipitate from seawater into authigenic phosphates. The Hf isotopic compositions suggest that the HFSE budget of Site 1149 sediments derive from continental areas and seawater. Such supply of HFSE is controlled by sedimentation of detrital and authigenic alumino-silicate phases.
- 4) The bulk Hf and Nd isotopic composition of the Site 1149 sedimentary pile reflect the predominance of the seawater contribution to the REE and HFSE budget.
- 5) The bulk isotopic compositions of Site 1149 sediments could be used to estimate the minimum percentage of Nd derived from the subducted sediments in the Izu arc lavas from 0% to 14%. These results permit also preliminary estimations of the Nd fluxes in this arc. The first conclusion of these calculations is that the Nd input flux with sediments in the Izu subduction zone is of the same order of the Nd volcanic output.
- 6) The bulk Hf and Nd isotopes of Hole 801C composites and Site 1149 sediments has been used for examine the potential contribution of oceanic basalts and sediments to the hot spot sources. These materials have highly distinct long term isotopic evolutions in consequence they have to be imperatively well mixed to explain the present-day Hf-Nd OIB array. However modern oceanic basalts and sediments collected at Hole 801C and Site 1149 are perhaps not representative of ancient oceanic materials stored in the earth's mantle.

References

- Albarède, F., A. Simonetti, et al. (1998): A Hf-Nd isotopic correlation in ferromanganese nodules. *Geophysical Research Letters*, Vol. 25(20), p. 3895-3898.
- Alt, J. C. (2003): Stable isotopic composition of upper oceanic crust formed at a fast spreading ridge, ODP Site 801. *Geochemistry Geophysics Geosystems*, Vol. 4(5), paper n° 8908, doi:10.1029/2002GC000400.
- Alt, J. C., C. France-Lanord, et al. (1992): Low-temperature hydrothermal alteration of jurassic ocean crust, Site 801. in *Proceedings of the Ocean Drilling Program, Scientific Results*. R. L. Larson, Y. Lancelot and al. (Eds). Ocean Drilling Program, College Station, Tex. Vol. 129, p. 415-427.
- Armstrong, R. L. (1968): A model for the evolution of strontium and lead isotopes in a dynamic Earth. *Reviews of Geophysics*, Vol. 6, p. 175-199.
- Armstrong, R. L. (1991): The persistent myth of crustal growth. *Australian Journal of Earth Sciences*, Vol. 38, p. 613-630.
- Asahara, Y., T. Tanaka, et al. (1995): Asian continental nature of $^{87}\text{Sr}/^{86}\text{Sr}$ ratios in north central Pacific sediments. *Earth and Planetary Science Letters*, Vol. 133, p. 105-116.
- Asahara, Y., T. Tanaka, et al. (1999): Provenance of the north Pacific sediments and process of source material transport as derived from Rb-Sr isotopic systematics. *Chemical Geology*, Vol. 158, p. 271-291.
- Barr, S. R., S. Révillon, et al. (2002): Determining the inputs to the Mariana Subduction Factory: Using core-log integration to reconstruct basement lithology at ODP Hole 801C. *Geochemistry Geophysics Geosystems*, Vol. 3(11), paper n° 8901, doi:10.1029/2001GC000255.
- Bartolini, A. and R. L. Larson (2001): Pacific microplate and the Pangea supercontinent in the Early to Middle Jurassic. *Geology*, Vol. 29(8), p. 735-738.
- Ben Othman, D., W. M. White, et al. (1989): The geochemistry of marine sediments, island arc magma genesis, and crust-mantle recycling. *Earth and Planetary Science Letters*, Vol. 94, p. 1-21.
- Bertram, C. J. and H. Elderfield (1993): The geochemical balance of rare earth elements and neodymium isotopes in the oceans. *Geochimica et Cosmochimica Acta*, Vol. 57, p. 1957-1986.
- Blichert-Toft, J., C. Chauvel, et al. (1997a): Separation of Hf and Lu for high-precision isotope analysis of rock samples by magnetic sector-multiple collector ICP-MS. *Contributions to Mineralogy and Petrology*, Vol. 127, p. 248-260.
- Blichert-Toft, J. and F. Albarède (1997b): The Lu-Hf isotope geochemistry of chondrites and the evolution of the mantle-crust system. *Earth and Planetary Science Letters*, Vol. 148, p. 243-258.
- Blichert-Toft, J., F. A. Frey, et al. (1999a): Hf isotope evidence for pelagic sediments in the source of Hawaiian basalts. *Science*, Vol. 285, p. 879-882.
- Blichert-Toft, J. and F. Albarède (1999b): Hf isotopic compositions of the Hawaii Scientific Drilling Project core and the source mineralogy of Hawaiian basalts. *Geophysical Research Letters*, Vol. 26(7), p. 935-938.
- Blichert-Toft, J. and N. T. Arndt (1999c): Hf isotope compositions of komatiites. *Earth and Planetary Science Letters*, Vol. 171, p. 439-451.
- Blichert-Toft, J. (2001): On the Lu-Hf isotope geochemistry of silicate rocks. *Geostandards Newsletter*, Vol. 25(1), p. 41-56.
- Castillo, P. R., P. A. Floyd, et al. (1992): Isotope geochemistry of Leg 129 basalts: Implications for the origin of the widespread cretaceous volcanic event in the Pacific. in *Proceedings of the Ocean Drilling Program, Scientific Results*. R. L. Larson, Y.

- Lancelot and al. (Eds). Ocean Drilling Program, College Station, Tex. Vol. 129, p. 405-413.
- Chauvel, C. and J. Blichert-Toft (2001): A hafnium isotope and trace element perspective on melting of the depleted mantle. *Earth and Planetary Science Letters*, Vol. 190, p. 137-151.
- Chauvel, C. and C. Hémond (2000): Melting of a complete section of recycled oceanic crust: Trace element and Pb isotopic evidence from Iceland. *Geochemistry Geophysics Geosystems*, Vol. 1, paper n° 1999GC000002.
- Chauvel, C., A. W. Hofmann, et al. (1992): HIMU-EM: The French Polynesian connection. *Earth and Planetary Science Letters*, Vol. 110, p. 99-119.
- Coffin, M. F., L. A. Lawver, et al. (2000): *The Plates Project 2000 atlas of plate reconstructions (750 Ma to present day)*. University of Texas, Plates Project Progress Report n°250, Austin, p. 89 p.
- David, K., M. Frank, et al. (2001): The Hf isotope composition of global seawater and the evolution of Hf isotopes in the deep Pacific Ocean from Fe-Mn crusts. *Chemical Geology*, Vol. 178, p. 23-42.
- Dimalanta, C., A. Taira, et al. (2002): New rates of western Pacific island arc magmatism from seismic and gravity data. *Earth and Planetary Science Letters*, Vol. 202, p. 105-115.
- Eisele, J., M. Sharma, et al. (2002): The role of sediment recycling in EM-1 inferred from Os, Pb, Hf, Nd, Sr isotope and trace element systematics of the Pitcairn hotspot. *Earth and Planetary Science Letters*, Vol. 196, p. 197-212.
- Elderfield, H. and M. J. Greaves (1982): The rare earth elements in seawater. *Nature*, Vol. 296, p. 214-219.
- Elderfield, H., C. J. Hawkesworth, et al. (1981): Rare earth element geochemistry of oceanic ferromanganese nodules and associated sediments. *Geochimica et Cosmochimica Acta*, Vol. 45, p. 513-528.
- Elderfield, H. and R. Pagett (1986): Rare earth elements in ichthyoliths: Variations with redox conditions and depositional environment. *Science of the Total Environment*, Vol. 49, p. 175-197.
- Elliott, T., T. Plank, et al. (1997): Element transport from slab to volcanic front at the Mariana arc. *Journal of Geophysical Research*, Vol. 102(B7), p. 14991-15019.
- Fisk, M. and K. A. Kelley (2002): Probing the Pacific's oldest MORB glass: mantle chemistry and melting conditions during the birth of the Pacific Plate. *Earth and Planetary Science Letters*, Vol. 202, p. 741-752.
- Floyd, P. A. and P. R. Castillo (1992a): Geochemistry and petrogenesis of jurassic ocean crust basalts, Site 801. in *Proceedings of the Ocean Drilling Program, Scientific Results*. R. L. Larson, Y. Lancelot and al. (Eds). Ocean Drilling Program, College Station, Tex. Vol. 129, p. 361-388.
- Floyd, P. A., J. A. Winchester, et al. (1992b): Geochemistry and petrography of cretaceous sills and lava flows, Sites 800 and 802. in *Proceedings of the Ocean Drilling Program, Scientific Results*. R. L. Larson, Y. Lancelot and al. (Eds). Ocean Drilling Program, College Station, Tex. Vol. 129, p. 345-359.
- Foley, S. F., S. Buhre, et al. (2003): Evolution of the Archaean crust by delamination and shallow subduction. *Nature*, Vol. 421, p. 249-252.
- Fryer, P., B. Taylor, et al. (1990): Petrology and geochemistry of lavas from the Sumisu and Torishima backarc rifts. *Earth and Planetary Science Letters*, Vol. 100, p. 161-178.
- Gallet, S., B.-M. Jahn, et al. (1998): Loess geochemistry and its implications for particle origin and composition of the upper continental crust. *Earth and Planetary Science Letters*, Vol. 156, p. 157-172.

- Gallet, S., B.-M. Jahn, et al. (1996): Geochemical characterization of the Luochuan loess-paleosol sequence, China, and paleoclimatic implications. *Chemical Geology*, Vol. 133, p. 67-88.
- Godfrey, L. V., D.-C. Lee, et al. (1997): The Hf isotopic composition of ferromanganese nodules and crusts and hydrothermal manganese deposits: Implications for seawater Hf. *Earth and Planetary Science Letters*, Vol. 151, p. 91-105.
- Goldberg, E. D. and G. O. S. Arrhenius (1958): Chemistry of Pacific pelagic sediments. *Geochimica et Cosmochimica Acta*, Vol. 13, p. 153-212.
- Goldberg, E. D., M. Koide, et al. (1963): Rare-earth distributions in the marine environment. *Journal of Geophysical Research*, Vol. 68(14), p. 4209-4217.
- Goldstein, S. J. and S. B. Jacobsen (1987): The Nd and Sr isotopic systematics of river-water dissolved material: Implications for the sources of Nd and Sr in seawater. *Chemical Geology*, Vol. 66, p. 245-272.
- Goldstein, S. L., R. K. O'Nions, et al. (1984): A Sm-Nd isotopic study of atmospheric dusts and particulates from major river systems. *Earth and Planetary Science Letters*, Vol. 70, p. 221-236.
- Hauff, F., K. Hoernle, et al. (2003): Sr-Nd-Pb composition of Mesozoic Pacific oceanic crust (Site 1149 and 801, ODP Leg 185): Implications for alteration of ocean crust and the input into the Izu-Bonin-Mariana subduction system. *Geochemistry Geophysics Geosystems*, Vol. 4(8), paper n° 8913, doi:10.1029/2002GC000421.
- Hickey-Vargas, R. (1991): Isotope characteristics of submarine lavas from the Philippine Sea: Implications for the origin of arc and basin magmas of the Philippine tectonic plate. *Earth and Planetary Science Letters*, Vol. 107, p. 290-304.
- Hickey-Vargas, R. (1998): Origin of the Indian Ocean-type isotopic signature in basalts from Philippine Sea plate spreading centers: An assessment of local versus large-scale processes. *Journal of Geophysical Research*, Vol. 103(B9), p. 20963-20979.
- Hochstaedter, A. G., J. B. Gill, et al. (1990a): Volcanism in the Sumisu Rift, I. Major element, volatile, and stable isotope geochemistry. *Earth and Planetary Science Letters*, Vol. 100, p. 179-194.
- Hochstaedter, A. G., J. B. Gill, et al. (1990b): Volcanism in the Sumisu Rift, II. Subduction and non-subduction related components. *Earth and Planetary Science Letters*, Vol. 100, p. 195-209.
- Hochstaedter, A. G., J. B. Gill, et al. (2000): Across-arc geochemical trends in the Izu-Bonin arc: Constraints on source composition and mantle melting. *Journal of Geophysical Research*, Vol. 105(B1), p. 495-512.
- Hochstaedter, A. G., J. B. Gill, et al. (2001): Across-arc geochemical trends in the Izu-Bonin arc: Contributions from the subducting slab. *Geochemistry Geophysics Geosystems*, Vol. 2, paper n° 2000GC000105.
- Hofmann, A. W. (1988): Chemical differentiation of the Earth: The relationship between mantle, continental crust, and oceanic crust. *Earth and Planetary Science Letters*, Vol. 90, p. 297-314.
- Hofmann, A. W. and W. M. White (1982): Mantle plumes from ancient oceanic crust. *Earth and Planetary Science Letters*, Vol. 57, p. 421-436.
- Hole, M. J., A. D. Saunders, et al. (1984): Subduction of pelagic sediments: Implications for the origin of Ce-anomalous basalts from the Mariana Islands. *Journal of the Geological Society of London*, Vol. 141, p. 453-472.
- Honza, E. and K. Tamaki (1985): The Bonin arc. in *The Ocean Basins and Margins, vol. 7, The Pacific Ocean*. A. E. M. Nairn and S. Uyeda (Eds). Plenum, New York, p. 459-502.
- Hussong, D. M., S. Uyeda, et al. (1982): Site 452: Mesozoic Pacific Ocean basin. *Initial Reports of the Deep Sea Drilling Project*, Vol. 60, p. 77-93.

- Ikeda, Y. and M. Yuasa (1989): Volcanism in nascent back-arc basins behind the Shichito Ridge and adjacent areas in the Izu-Ogasawara arc, northwest Pacific: Evidence for mixing between E-type MORB and island arc magmas at the initiation of back-arc rifting. *Contributions to Mineralogy and Petrology*, Vol. 101, p. 377-393.
- Jacob, D. E. and S. F. Foley (1999): Evidence for Archean ocean crust with low high field strength element signature from diamondiferous eclogite xenoliths. *Lithos*, Vol. 48(1-4), p. 317-336.
- Jacob, D. E., E. Jagoutz, et al. (1994): Diamondiferous eclogites from Siberia: Remnants of Archean oceanic crust. *Geochimica et Cosmochimica Acta*, Vol. 58(23), p. 5191-5207.
- Jahn, B.-M., S. Gallet, et al. (2001): Geochemistry of the Xining, Xifeng and Jixian sections, Loess Plateau of China: eolian dust provenance and paleosol evolution during the last 140 Ka. *Chemical Geology*, Vol. 178, p. 71-94.
- Jones, C. E., A. N. Halliday, et al. (1994): Neodymium isotopic variations in North Pacific modern silicate sediment and the insignificance of detrital REE contributions to seawater. *Earth and Planetary Science Letters*, Vol. 127, p. 55-66.
- Kelley, K. A., T. Plank, et al. (2003): Composition of altered oceanic crust at ODP Sites 801 and 1149. *Geochemistry Geophysics Geosystems*, Vol. 4(6), paper n° 8910, doi:10.1029/2002GC000435.
- Koppers, A. A. P., H. Staudigel, et al. (2003): High-resolution $^{40}\text{Ar}/^{39}\text{Ar}$ dating of the oldest oceanic basement basalts in the western Pacific basin. *Geochemistry Geophysics Geosystems*, Vol. 4(11), paper n° 8914, doi:10.1029/2003GC000574.
- Kyte, F. T., M. Leinen, et al. (1993): Cenozoic sedimentation history of the central North Pacific: Inferences from the elemental geochemistry of core LL44-GPC3. *Geochimica et Cosmochimica Acta*, Vol. 57, p. 1719-1740.
- Lancelot, Y., R. L. Larson, et al. (1990): *Proceedings of the Ocean Drilling Program, Initial Reports, Vol. 129*. Ocean Drilling Program, College Station, Tex. 488 p.
- Langmuir, C. H., R. D. Vocke, et al. (1978): A general mixing equation with applications to icelandic basalts. *Earth and Planetary Science Letters*, Vol. 37, p. 380-392.
- Lassiter, J. C. and E. H. Hauri (1998): Osmium-isotope variations in Hawaiian lavas: Evidence for recycled oceanic lithosphere in the Hawaiian plume. *Earth and Planetary Science Letters*, Vol. 164, p. 483-496.
- Lee, D.-C., A. N. Halliday, et al. (1999): Hafnium isotope stratigraphy of ferromanganese crusts. *Science*, Vol. 285, p. 1052-1054.
- Lees, G. J., G. Rowbotham, et al. (1992): Petrography and Geochemistry of graded volcanoclastic sediments and their clasts, Leg 129. in *Proceedings of the Ocean Drilling Program, Scientific Results*. R. L. Larson, Y. Lancelot and al. (Eds). Ocean Drilling Program, College Station, Tex. Vol. 129, p. 137-152.
- Le Fèvre, B. and C. Pin (2001): An extraction chromatography method for Hf separation prior to isotopic analysis using multiple collection ICP-Mass spectrometry. *Analytical Chemistry*, Vol. 73(11), p. 2453-2460.
- Leinen, M. (1987): The origin of paleochemical signatures in North Pacific pelagic clays: Partitioning experiments. *Geochimica et Cosmochimica Acta*, Vol. 51, p. 305-319.
- Lin, P.-N. (1992): Trace element and isotopic characteristics of western Pacific pelagic sediments: Implications for the petrogenesis of Mariana Arc magmas. *Geochimica et Cosmochimica Acta*, Vol. 56, p. 1641-1654.
- Lin, P.-N., R. J. Stern, et al. (1990): Nd- and Sr-isotopic compositions of lavas from the northern Mariana and southern Volcano arcs: implications for the origin of island arc melts. *Contributions to Mineralogy and Petrology*, Vol. 105, p. 381-392.

- McLennan, S. M. (2001): Relationships between the trace element composition of sedimentary rocks and upper continental crust. *Geochemistry, Geophysics, Geosystems*, Vol. 2, paper n° 2000GC000109.
- McLennan, S. M., S. R. Taylor, et al. (1990): Geochemical and Nd-Sr isotopic composition of deep-sea turbidites: crustal evolution and plate tectonic associations. *Geochimica et Cosmochimica Acta*, Vol. 54, p. 2015-2050.
- Nakai, S., A. N. Halliday, et al. (1993): Provenance of dust in the Pacific Ocean. *Earth and Planetary Science Letters*, Vol. 119, p. 143-157.
- Notsu, K., N. Isshiki, et al. (1983): Comprehensive strontium isotope study of Quarternary volcanic rocks from the Izu-Ogasawara arc. *Geochemical Journal*, Vol. 17, p. 289-302.
- Olivarez, A. M., R. M. Owen, et al. (1991): Geochemistry of eolian dust in Pacific pelagic sediments: Implications for paleoclimatic interpretations. *Geochimica et Cosmochimica Acta*, Vol. 55, p. 2147-2158.
- Palmer, M. R. (1985): Rare earth elements in foraminifera tests. *Earth and Planetary Science Letters*, Vol. 73, p. 285-298.
- Palmer, M. R. and H. Elderfield (1986): Rare earth elements and neodymium isotopes in ferromanganese oxide coatings of Cenozoic foraminifera from the Atlantic Ocean. *Geochimica et Cosmochimica Acta*, Vol. 50, p. 409-417.
- Patchett, P. J. (1983): Hafnium isotope results from mid-ocean ridges and Kerguelen. *Lithos*, Vol. 16, p. 47-51.
- Patchett, P. J. and M. Tatsumoto (1980): Hafnium isotope variations in oceanic basalts. *Geophysical Research Letters*, Vol. 7(12), p. 1077-1080.
- Patchett, P. J., W. M. White, et al. (1984): Hafnium/rare earth element fractionation in the sedimentary system and crustal recycling into the Earth's mantle. *Earth and Planetary Science Letters*, Vol. 69, p. 365-378.
- Pearce, J. A., P. D. Kempton, et al. (1999): Hf-Nd element and isotope perspective on the nature and provenance of mantle and subduction components in Western Pacific arc-basin systems. *Journal of Petrology*, Vol. 40(11), p. 1579-1611.
- Pettke, T., A. N. Halliday, et al. (2000): Dust production and deposition in Asia and the north Pacific Ocean over the past 12 Myr. *Earth and Planetary Science Letters*, Vol. 178, p. 397-413.
- Pettke, T., D.-C. Lee, et al. (2002): Radiogenic Hf isotopic compositions of continental eolian dust from Asia, its variability and its implications for seawater Hf. *Earth and Planetary Science Letters*, Vol. 202, p. 453-464.
- Piegras, D. J. and S. B. Jacobsen (1988): The isotopic composition of neodymium in the North Pacific. *Geochimica et Cosmochimica Acta*, Vol. 52, p. 1373-1381.
- Piegras, D. J. and S. B. Jacobsen (1992): The behavior of rare earth elements in seawater: Precise determination of variations in the North Pacific water column. *Geochimica et Cosmochimica Acta*, Vol. 56, p. 1851-1862.
- Piegras, D. J. and G. J. Wasserburg (1980): Neodymium isotopic variations in seawater. *Earth and Planetary Science Letters*, Vol. 50, p. 128-138.
- Piegras, D. J., G. J. Wasserburg, et al. (1979): The isotopic composition of Nd in different ocean masses. *Earth and Planetary Science Letters*, Vol. 45, p. 223-236.
- Piper, D. Z. (1974a): Rare earth elements in ferromanganese nodules and other marine phases. *Geochimica et Cosmochimica Acta*, Vol. 38, p. 1007-1022.
- Piper, D. Z. (1974b): Rare earth elements in the sedimentary cycle: A summary. *Chemical Geology*, Vol. 14, p. 285-304.
- Plank, T. and C. H. Langmuir (1998): The chemical composition of subducting sediment and its consequences for the crust and mantle. *Chemical Geology*, Vol. 145, p. 325-394.

- Plank, T., J. N. Ludden, et al. (2000): *Proceedings of the Ocean Drilling Program, Initial Reports, Vol. 185*. Ocean Drilling Program, College Station, Tex. (CD-ROM).
- Pringle, M. S. (1992): Radiometric ages of basaltic basement recovered at Sites 800, 801, and 802, Leg 129, Western Pacific Ocean. in *Proceedings of the Ocean Drilling Program, Scientific Results*. R. L. Larson, Y. Lancelot and al. (Eds). Ocean Drilling Program, College Station, Tex. Vol. 129, p. 389-404.
- Rea, D. K. and T. R. Janecek (1981): Mass accumulation rates of non-authigenic inorganic crystalline (eolian) component of deep sea sediments from the western Mid-Pacific Mountains. in *Initial Report of the Deep Sea Drilling Project*. Deep Sea Drilling Project Hole 463, Vol. 62, p. 653-659.
- Rea, D. K., M. Leinen, et al. (1985): Geologic approach to the long-term history of atmospheric circulation. *Science*, Vol. 227, p. 721-725.
- Revillon, S. (2000): *Origine et composition du Plateau Océanique Caraïbe*. Ph. D. University of Rennes. Mémoires Géosciences Rennes, 358 p.
- Salters, V. J. M. (1996): The generation of mid-ocean ridge basalts from the Hf and Nd isotope perspective. *Earth and Planetary Science Letters*, Vol. 141, p. 109-123.
- Salters, V. J. M. and S. R. Hart (1991): The mantle sources of ocean ridges, islands and arcs: the Hf-isotope connection. *Earth and Planetary Science Letters*, Vol. 104, p. 364-380.
- Salters, V. J. M. and W. M. White (1998): Hf isotope constraints on mantle evolution. *Chemical Geology*, Vol. 145, p. 447-460.
- Schmidt, A. (2001): *Temporal and spatial evolution of the Izu island arc, Japan, in terms of Sr-Nd-Pb isotope geochemistry*. Ph. D. University of Kiel, 81 p.
- Shaw, H. F. and G. J. Wasserburg (1985): Sm-Nd in marine carbonates and phosphates: Implications for Nd isotopes in seawater and crustal ages. *Geochimica et Cosmochimica Acta*, Vol. 49, p. 503-518.
- Shimizu, H., K. Tachikawa, et al. (1994): Cerium and neodymium isotope ratios and REE patterns in seawater from the North Pacific Ocean. *Geochimica et Cosmochimica Acta*, Vol. 58, p. 323-333.
- Smith, W. H. F., H. Staudigel, et al. (1989): The Magellan seamounts: Early Cretaceous record of the south Pacific isotopic and thermal anomaly. *Journal of Geophysical Research*, Vol. 94(B8), p. 10501-10523.
- Staudigel, H., G. R. Davies, et al. (1995): Large scale isotopic Sr, Nd and O isotopic anatomy of altered oceanic crust: DSDP/ODP sites 417/418. *Earth and Planetary Science letters*, Vol. 130, p. 169-185.
- Staudigel, H., K.-H. Park, et al. (1991): The longevity of the South Pacific isotopic and thermal anomaly. *Earth and Planetary Science Letters*, Vol. 102, p. 24-44.
- Stille, P., D. M. Unruh, et al. (1983): Pb, Sr, Nd and Hf isotopic evidence of multiple sources for Oahu, Hawaii basalts. *Nature*, Vol. 304, p. 25-29.
- Stille, P., D. M. Unruh, et al. (1986): Pb, Sr, Nd, and Hf isotopic constraints on the origin of Hawaiian basalts and evidence for a unique mantle source. *Geochimica et Cosmochimica Acta*, Vol. 50, p. 2303-2319.
- Talbi, E. H. and J. Honnorez (2003): Low-temperature alteration of mesozoic oceanic crust, Ocean Drilling Program Leg 185. *Geochemistry Geophysics Geosystems*, Vol. 4(5), paper n° 8906, doi:10.1029/2002GC000405.
- Tatsumi, Y., M. Murasaki, et al. (1992): Across-arc variation of lava chemistry in the Izu-Bonin arc: Identification of subduction components. *Journal of Volcanology and Geothermal Research*, Vol. 49, p. 179-190.
- Taylor, B. (1992): Rifting and the volcanic-tectonic evolution of the Izu-Bonin-Mariana arc. in *Proceedings of the Ocean Drilling Program, Scientific Results*. B. Taylor, K. Fujioka and al. (Eds). Ocean Drilling Program, College Station, Tex. Vol. 126, p. 627-651.

- Taylor, R. N. and R. W. Nesbitt (1998): Isotopic characteristics of subduction fluids in an intra-oceanic setting, Izu-Bonin arc, Japan. *Earth and Planetary Science Letters*, Vol. 164, p. 79-98.
- Taylor, S. R., S. M. McLennan, et al. (1983): Geochemistry of loess, continental crustal composition and crustal model ages. *Geochimica et Cosmochimica Acta*, Vol. 47, p. 1897-1905.
- Toyoda, K., Y. Nakamura, et al. (1990): Rare earth elements of Pacific pelagic sediments. *Geochimica et Cosmochimica Acta*, Vol. 54, p. 1093-1103.
- Vervoort, J. D., P. J. Patchett, et al. (1999): Relationships between Lu-Hf and Sm-Nd isotopic systems in the global sedimentary system. *Earth and Planetary Science Letters*, Vol. 168, p. 79-99.
- Von Huene, R. and D. W. Scholl (1991): Observations at convergent margins concerning sediment subduction, subduction erosion, and the growth of continental crust. *Reviews of Geophysics*, Vol. 29, p. 279-316.
- Von Huene, R. and D. W. Scholl (1993): The return of sialic material to the mantle indicated by terrigenous material subducted at convergent margins. *Tectonophysics*, Vol. 219, p. 163-175.
- Weaver, B. L. (1991a): The origin of ocean island basalt end-member compositions: trace element and isotopic constraints. *Earth and Planetary Science Letters*, Vol. 104, p. 381-397.
- Weaver, B. L. (1991b): Trace element evidence for the origin of ocean-island basalts. *Geology*, Vol. 19, p. 123-126.
- Weber, E. T., R. M. Owen, et al. (1996): Quantitative resolution of eolian continental crustal material and volcanic detritus in North Pacific surface sediment. *Paleoceanography*, Vol. 11(1), p. 115-127.
- White, W. M. and P. J. Patchett (1984): Hf-Nd-Sr isotopes and incompatible element abundances in island arcs: implications for magma origins and crust-mantle evolution. *Earth and Planetary Science Letters*, Vol. 67, p. 167-185.
- White, W. M., P. J. Patchett, et al. (1986): Hf isotope ratios of marine sediments and Mn nodules: evidence for a mantle source of Hf in seawater. *Earth and Planetary Science Letters*, Vol. 79, p. 46-54.
- Woodhead, J. D. (1989): Geochemistry of the Mariana arc (western Pacific): Source composition and processes. *Chemical Geology*, Vol. 76, p. 1-24.
- Woodhead, J. D. and D. G. Fraser (1985): Pb, Sr and ¹⁰Be isotopic studies of volcanic rocks from the Northern Mariana Islands. Implications for magma genesis and crustal recycling in the Western Pacific. *Geochimica et Cosmochimica Acta*, Vol. 49, p. 1925-1930.
- Woodhead, J. D., R. S. Harmon, et al. (1987): O, S, Sr, and Pb isotope variations in volcanic rocks from the Northern Mariana Islands: implications for crustal recycling in intra-oceanic arcs. *Earth and Planetary Science Letters*, Vol. 83, p. 39-52.
- Woodhead, J. D., J. M. Hergt, et al. (2001): Hafnium isotope evidence for 'conservative' element mobility during subduction zone processes. *Earth and Planetary Science Letters*, Vol. 192, p. 331-346.
- Yokoyama, T., A. Makishima, et al. (1999): Evaluation of the coprecipitation of incompatible trace elements with fluoride during silicate rock dissolution by acid digestion. *Chemical Geology*, Vol. 157, p. 175-187.
- Zhou, L. and F. T. Kyte (1992): Sedimentation history of the South Pacific pelagic clay province over the last 85 million years inferred from the geochemistry of deep sea drilling project Hole 596. *Paleoceanography*, Vol. 7(4), p. 441-465.

Table 1 Trace element distributions after HF leaching of Ca-moderately enriched, Ca-highly enriched and Ca-depleted samples.

Sample Rock Type Location	80J102 ^a Basalt Sunda arc	287C ^b Limestone SE France	PC6B ^a Andesite Sunda arc	
CaO%	8.38	50.61	0.70	
MgO%	3.80	0.60	5.24	
Element ^c	Fluoride (%)	Supernatant (%)	Fluoride (%)	Supernatant (%)
La	93.4	6.6	89.5	10.5
Ce	71.5	28.5	6.2	93.8
Pr	95.8	4.2	86.5	13.5
Nd	96.2	3.8	84.7	15.3
Sm	96.8	3.2	74.7	25.3
Zr	3.7	96.3	0.6	99.4
Hf	3.6	96.4	1.0	99.0
Eu	95.8	4.2	68.2	31.8
Gd	94.9	5.1	61.9	38.1
Tb	96.9	3.1	55.2	44.8
Dy	97.1	2.9	50.5	49.5
Ho	97.1	2.9	47.0	53.0
Er	97.1	2.9	43.7	56.3
Yb	96.3	3.7	40.9	59.1
Lu	96.4	3.6	39.4	60.6

^aCaO and MgO compositions after Polvé and Maury, Unpublished data.

^bCaO and MgO compositions after Nicod and Chauvel, Unpublished data.

^cDetermined by ICP-MS (VG Plasma Quad, University of Grenoble). Analytical precision is $\pm 5\%$.

Table 2 Hf and Nd isotopic compositions of Hole 801C Composites

Composites ^a	Type	$^{143}\text{Nd} / ^{144}\text{Nd} \pm 2\sigma_{\text{in}}^{\text{b}}$	$^{147}\text{Sm}/^{144}\text{Nd}^{\text{c}}$	$\epsilon_{\text{Nd}}^{\text{d}}$	$\epsilon_{\text{Nd(t)}}^{\text{e}}$	$^{176}\text{Hf} / ^{177}\text{Hf} \pm 2\sigma_{\text{in}}^{\text{b}}$	$^{176}\text{Lu}/^{177}\text{Hf}^{\text{c}}$	$\epsilon_{\text{Hf}}^{\text{d}}$	$\epsilon_{\text{Hf(t)}}^{\text{e}}$
801-TAB-0-50	FLO	0.512845 ± 13	0.1306	+4.0	+5.4	0.282979 ± 7	0.0094	+7.3	+9.9
801-TAB-0-50	VCL	0.512848 ± 9	0.1334	+4.1	+5.4	0.283019 ± 6	0.0134	+8.7	+10.9
801-TAB-0-50	All	0.512896 ± 6	0.1315	+5.0	+6.3	0.282973 ± 5	0.0101	+7.1	+9.6
801-MORB-0-110	FLO	0.513154 ± 32	0.2157	+10.1	+9.7	0.283206 ± 6	0.0293	+15.3	+15.8
801-MORB-0-110	All	0.513081 ± 10	0.2143	+8.6	+8.3	0.283201 ± 5	0.0325	+15.2	+15.3
801-MORB-110-220	FLO	0.513128 ± 9	0.2115	+9.6	+9.2	0.283171 ± 6	0.0273	+14.1	+14.8
801-MORB-110-220	VCL	0.513080 ± 6	0.2067	+8.6	+8.4	0.283219 ± 9	0.0368	+15.8	+15.4
801-MORB-110-220	All	0.513103 ± 7	0.2113	+9.1	+8.8	0.283194 ± 8	0.0291	+14.9	+15.4
801-MORB-220-420	FLO	0.513154 ± 8	0.2110	+10.1	+9.8	0.283172 ± 7	0.0283	+14.1	+14.7
801-MORB-220-420	VCL	0.513157 ± 5	0.2102	+10.1	+9.8	0.283201 ± 5	0.0283	+15.2	+15.7
801-MORB-220-420	VCL ^f	0.513159 ± 4	0.2102	+10.2	+9.9				
801-MORB-220-420	All	0.513132 ± 7	0.2118	+9.6	+9.3	0.283161 ± 6	0.0285	+13.8	+14.3
801	SUPER	0.513118 ± 6	0.2111	+9.4	+9.1	0.283164 ± 7	0.0294	+13.9	+14.3

^aTAB, top alkali basalts; MORB, mid-ocean ridge tholeiites; FLO, less altered flows and pillows; VCL, highly altered volcanoclastics; SUPER, all site 801 tholeiite.

^bNormalized for mass fractionation to $^{146}\text{Nd}/^{144}\text{Nd}=0.7219$ and $^{176}\text{Lu}/^{177}\text{Hf}=0.7325$.

^c $^{147}\text{Sm}/^{144}\text{Nd}$ and $^{176}\text{Lu}/^{177}\text{Hf}$ have been calculated using trace element data of Kelley et al., 2003.

^d ϵ_{Nd} and $\epsilon_{\text{Nd(t)}}$ have been calculated using $^{176}\text{Lu}/^{177}\text{Hf}_{\text{CHUR}}=0.282772$ after Blichert-Toft and Albarède, 1997b and $^{147}\text{Sm}/^{144}\text{Nd}_{\text{CHUR}}=0.512638$.

^e ϵ_{Hf} and $\epsilon_{\text{Hf(t)}}$ have been calculated using alkali materials age of 157Ma and tholeiitic materials age of 167Ma after Pringle, 1992, $^{176}\text{Lu}/^{177}\text{Hf}_{\text{CHUR(0)}}=0.0332$ after Blichert-Toft and Albarède, 1997b and $^{147}\text{Sm}/^{144}\text{Nd}_{\text{CHUR(0)}}=0.1967$.

^fComplete duplicate analysis.

Table 3 Hf and Nd isotopic compositions of Site 1149 sediments

Sample	Depth (mbsf) ^a	Unit	Dissolution	Protocol ^b	$^{143}\text{Nd} / ^{144}\text{Nd} \pm 2\sigma_m^c$	ϵ_{Nd}^d	$\epsilon_{\text{Nd}(t)}^e$	$^{176}\text{Hf} / ^{177}\text{Hf} \pm 2\sigma_m^c$	ϵ_{Hf}^d	$\epsilon_{\text{Hf}(t)}^e$
1149A 1H1 140-150	1.40	I		BT 97	0.512369 ± 10	-5.2	-5.2	0.282966 ± 8	+6.9	+6.9
1149A 1H1 140-150 ^f	1.40	I	in Parr Bomb	BT 97				0.282964 ± 5	+6.8	+6.8
1149A 4H2 140-150	26.10	I		BT 97	0.512307 ± 5	-6.5	-6.4	0.282939 ± 9	+5.9	+5.9
1149A 4H2 140-150 ^f	26.10	I		BT 97	0.512271 ± 6	-7.2	-7.2			
1149A 7H4 140-150	57.60	I		BT 97	0.512557 ± 6	-1.6	-1.6	0.283063 ± 8	+10.3	+10.3
1149A 10H3 140-150	84.60	I		BT 97	0.512483 ± 4	-3.0	-3.0	0.282973 ± 4	+7.1	+7.1
1149A 10H3 140-150 ^f	84.60	I		BT 97	0.512507 ± 5	-2.6	-2.5			
1149A 14H2 140-150	121.10	IIA		BT 97	0.512291 ± 11	-6.8	-6.6	0.282960 ± 6	+6.6	+6.7
1149A 18H3 140-150	160.40	IIB	in Parr Bomb	BT 97				0.282816 ± 8	+1.6	+1.6
1149A 18H3 140-150 ^f	160.40	IIB	in Parr Bomb	BT 97				0.282791 ± 4	+0.7	+0.7
1149A 20X1 140-150	171.20	IIB-III		BT 97	0.512342 ± 5	-5.8	-5.4	0.282936 ± 5	+5.8	+3.7
1149B 6R1 38-42	199.08	III	in Parr Bomb	Ca-Depl	0.512308 ± 6	-6.4	-5.8	0.282873 ± 8	+3.6	+2.2
1149B 12RCC 0-5	245.40	III	in Parr Bomb	Ca-Depl	0.512294 ± 5	-6.7	-5.8	0.282761 ± 3	-0.4	-1.4
1149B 16R1 93-98	283.23	IV		BT 97	0.512519 ± 6	-2.3	-1.1	0.282954 ± 6	+6.4	+8.0
1149B 17R1 14-17	292.14	IV		BT 97	0.512248 ± 12	-7.6	-6.3	0.282677 ± 4	-3.4	-2.7
1149B 17R1 14-17 ^f	292.14	IV		BT 97				0.282678 ± 3	-3.3	-2.7
1149B 18R1 41-43	302.01	IV		BT 97	0.512269 ± 5	-7.2	-5.9	0.282692 ± 5	-2.8	-3.1
1149B 20R1 25-35	321.15	IV		BT 97	0.512267 ± 7	-7.2	-5.8			
1149B 22R1 20-25	340.30	IV		BT 97	0.512240 ± 8	-7.8	-6.5	0.282671 ± 23	-3.6	-3.3
1149B 25R1 19-23	368.89	IV	in Parr Bomb	Ca-Rich				0.282715 ± 9	-2.0	-5.4
1149B 27R1 49-55	388.09	IV		Ca-Rich	0.512282 ± 12	-6.9	-5.5			
1149B 28R1 52-56	397.62	IV		BT 97	0.512353 ± 77	-5.6	-4.1			
1149B 28R2 48-66	398.90	IV		BT 97	0.512312 ± 24	-6.4	-4.9			
1149B 29R1 28-35	407.08	IV		BT 97				0.283244 ± 49	+16.7	+12.0

^ambsf, meters below surface seafloor.^bProtocol used for Hf separation: BT 97, original protocol of Blichert-Toft et al., 1997a; Ca-Depl and Ca-Rich, Protocols for Ca-depleted and Ca enriched samples described in Fig. 4.^cNormalized for mass fractionation to $^{146}\text{Nd}/^{144}\text{Nd}=0.7219$ and $^{179}\text{Hf}/^{177}\text{Hf}=0.7325$.^d ϵ_{Nd} and ϵ_{Hf} have been calculated using $^{176}\text{Hf}/^{177}\text{Hf}_{\text{Chond}}=0.282772$ after Blichert-Toft and Albarede, 1997b and $^{143}\text{Nd}/^{144}\text{Nd}_{\text{Chond}}=0.512638$.^e $\epsilon_{\text{Nd}(t)}$ and $\epsilon_{\text{Hf}(t)}$ have been calculated for Unit I and IV sediments using paleomagnetic and biostratigraphic ages reported by Plank et al., 2000. Approximative ages of samples from units II and III were determined by linear extrapolation from ages of unit I and IV samples using a constant sedimentation rate of 1.44 m/Ma. $^{179}\text{Lu}/^{177}\text{Hf}_{\text{Chond}}=0.0332$ after Blichert-Toft and Albarede, 1997b and $^{147}\text{Sm}/^{144}\text{Nd}_{\text{Chond}}=0.1967$.^fComplete duplicate analysis.

Table 4 Hf and Nd bulk isotopic compositions and trace element ratios for the Site 1149 sedimentary pile

Unit	Mass % ^a	¹⁴³ Nd/ ¹⁴⁴ Nd ^b	ϵ_{Nd} ^c	¹⁷⁶ Hf/ ¹⁷⁷ Hf ^b	ϵ_{Hf} ^c	Nd (ppm) ^d	Sm (ppm) ^d	Lu (ppm) ^d	Hf (ppm) ^d	Sm/Nd	Nd/Hf	Lu/Hf
Site 1149	100.0	0.512336	-5.9	0.282897	+4.4	26.2	5.60	0.448	1.76	0.214	14.9	0.255
Unit I	30.2	0.512423	-4.2	0.282987	+7.6	21.5	4.72	0.414	2.62	0.220	8.2	0.158
Subunit IIA	6.5	0.512291	-6.8	0.282960	+6.6	26.5	5.90	0.521	3.05	0.223	8.7	0.171
Subunit IIB	4.3			0.282816	+1.6	59.4	13.3	0.994	4.14	0.224	14.3	0.240
Zeolitic clay layer	2.2	0.512342	-5.8	0.282936	+5.8	193.5	44.0	3.19	4.47	0.227	43.3	0.714
Unit III	24.4	0.512296	-6.7	0.282779	+0.2	30.5	6.34	0.531	1.38	0.208	22.1	0.385
Sample 16R1 93-98	0.04	0.512519	-2.3	0.282954	+6.4	37.9	7.44	0.541	5.24	0.196	7.2	0.103
Unit IV	32.2	0.512277	-7.0	0.282680	-3.3	11.5	2.17	0.142	0.48	0.189	24.0	0.296
Sample 29R1 28-35	0.2			0.283244	+16.7	20.1	3.74	0.332	0.55	0.186	36.5	0.604

^aThe mass % represent the proportion of each unit in the global mass of the sedimentary pile. It has been calculated combining the thickness and the grain density of each unit.

^bThe isotopic composition of each unit has been calculated using the isotopic compositions and the Nd and Hf concentrations of discrete samples analyzed in each unit. The bulk composition of the Site 1149 sedimentary pile has been calculated combining the isotopes, trace element compositions and mass % of each unit using the mixing equation of Langmuir et al., 1978.

^c ϵ_{Hf} and ϵ_{Nd} have been calculated using $^{176}Hf/^{177}Hf_{CHUR}=0.282772$ after Blichert-Toft and Albarede, 1997b and $^{143}Nd/^{144}Nd_{CHUR}=0.512638$.

^dTrace element data used for calculations after Plank et al. (manuscript in preparation, 2004).

Table 5 Volcanic output and sediment input fluxes in the Izu subduction zone

	Output Flux	Sediment Flux
Volume ($\times 10^{-5}$ km ³ /km/a)	6.3 to 6.8 ^a	2.87 ^c
Density (g/cm ³)	2.8	1.86 ^d
wt% water		23 ^d
Total dry flux ($\times 10^8$ kg/km/a)	1.764 to 1.904	0.411
Average Nd (ppm)	5 to 10 ^b	26.2 ^e
Nd flux (kg/km/a)	880 to 1900	1080
0% to 14% of recycled Nd in arc lavas (kg/km/a)	0 to 266	

^aData of Dimalanta et al., 2002.

^bAverage values of data of Taylor and Nesbitt, 1998 and Hochstaedter et al., 2001.

^cCalculated with a subduction rate of 7 cm/a and a sediment thickness of 410 m.

^dData of Plank and Langmuir, 1998.

^edata from this study.

Figures captions

Figure 1 Map of the Western Pacific region with locations of ODP Sites 800, 801, 802, 1149 and DSDP Site 452 (modified from Plank et al., 2000).

Figure 2 Lithostratigraphic column of Site 1149 with locations of samples analyzed for Hf and Nd isotopes (modified from Plank et al., 2000). The transition between subunit IIB and unit III is constituted by Zeolitic clays highly enriched in REE in comparison to other Site 1149 sediments (Plank et al., manuscript in preparation, 2004). They have been considered as a distinct unit in this study.

Figure 3 REE, Zr and Hf distributions between supernatant and fluoride salts after HF leaching of (a) Ca-moderately enriched sample and (b) Ca-depleted sample.

Figure 4 Original protocol of Blichert-Toft et al. (1997a) for Hf separation as represented in Blichert-Toft (2001) together with the protocols for Ca-depleted and Ca-rich samples used during this study. P54 is the MC-ICP-MS model built by VG.

Figure 5 $\epsilon_{\text{Hf}(i)}$ vs. $\epsilon_{\text{Nd}(i)}$ diagram of composites from Hole 801C. At the upper right corner these data are presented with their uncertainty of about ± 0.65 unit for the $\epsilon_{\text{Nd}(i)}$ values and about ± 1 unit for the $\epsilon_{\text{Hf}(i)}$ values. MORB and OIB data are from Patchett and Tatsumoto (1980); Patchett (1983); Stille et al. (1983); Stille et al. (1986); Salters and Hart (1991); Chauvel et al. (1992); Salters (1996); Salters and White (1998); Blichert-Toft et al. (1999a); Blichert-Toft and Albarède (1999b); Chauvel and Blichert-Toft (2001).

Figure 6 $\epsilon_{\text{Nd}(i)}$ and $\epsilon_{\text{Hf}(i)}$ values of Site 1149 sediments plotted in function of their depth along the sedimentary pile.

Figure 7 $\epsilon_{\text{Hf}(i)}$ vs. $\epsilon_{\text{Nd}(i)}$ diagram of Site 1149 sediments together with Fe-Mn crusts and nodules and other oceanic sediments (principally terrigenous and volcanogenic clays and sands). Samples 7H4 140-150, 10H3 140-150 and 16R1 93-98 with distinctively more elevated $\epsilon_{\text{Nd}(i)}$ values have been annotated. Fe-Mn crusts and nodules and other sediments data are from White et al. (1986); Ben Othman et al. (1989); McLennan et al. (1990); Godfrey et al. (1997); Albarède et al. (1998); Pearce et al. (1999); Vervoort et al. (1999); David et al. (2001). “Terrestrial array” defined by Vervoort et al. (1999). MORB data sources as in figure 5.

Figure 8 Sm/Nd vs. $\epsilon_{\text{Nd}(i)}$ diagram of Site 1149 sediments together with the Pacific Seawater field, Izu-Mariana arc lavas, Site 800A alkali dolerites and OIB from Magellan seamounts. Trace element data of Site 1149 sediments in this and other diagrams are from Plank et al. (manuscript in preparation, 2004). The Pacific Seawater field has been drawn after the data of Piegras and Jacobsen (1988) and Shimizu et al. (1994). Izu-Mariana arc lavas are from White and Patchett (1984); Woodhead (1989); Elliott et al. (1997); Pearce et al. (1999); Woodhead et al. (2001). Site 800A dolerites data are from Castillo et al. (1992) and Floyd et al. (1992b). Magellan seamounts data are from Staudigel et al. (1991).

Figure 9 Nd vs. $\text{Al}_2\text{O}_3\%$, $\text{K}_2\text{O}\%$, $\text{MnO}\%$ and $\text{P}_2\text{O}_5\%$ of Site 1149 sediments after the data of Plank et al. (manuscript in preparation, 2004). Colors of the various units as in figure 6.

Figure 10 Th/Ta vs. $\epsilon_{\text{Nd}(i)}$ diagram of Site 1149 sediments together with the Izu-Mariana arc lavas and Site 800A alkali dolerites. Data sources as in figure 8.

Figure 11 (a) Ta/Hf vs. $\epsilon_{\text{Hf(i)}}$, (b) Zr/Hf vs. $\epsilon_{\text{Hf(i)}}$ and (c) Th/Ta vs. $\epsilon_{\text{Hf(i)}}$ diagram of Site 1149 sediments together with Izu-Mariana arc lavas, eolian dusts from Asia collected in sedimentary core LL44-GPC3 and Pitcairn lavas. Samples 7H4 140-150, 16R1 93-98 and 29R1 28-35 with distinctively more elevated $\epsilon_{\text{Hf(i)}}$ values have been annotated. Only average trace element ratios of China loess and Andean arc lavas have been indicated since no Hf isotopes have been published for these materials. Hf isotopic range of Pacific Fe-Mn crusts and nodules have been only indicated (range noted Pac. Fe-Mn) since no complete trace element data have been published on crusts and nodules analyzed for Hf isotopes. Data sources of the Izu-Mariana arc lavas as in figure 8 (excepted Elliott et al., 1997). Data of Asian dusts are from Kyte et al. (1993) and Pettke et al. (2002) and data of Pitcairn lavas are from Eisele et al. (2002). Average trace element data of China loess have been calculated by McLennan (2001) after the data of Taylor et al. (1983); Gallet et al. (1996); Jahn et al. (2001). References used for calculation of trace element ratios of Andean arc lavas are too numerous to be cited here but are available upon request. Pacific Fe-Mn crusts and nodules range has been drawn after the data of Godfrey et al. (1997); Albarède et al. (1998); David et al. (2001).

Figure 12 Hf vs. $\text{Al}_2\text{O}_3\%$, $\text{K}_2\text{O}\%$, $\text{MnO}\%$ and $\text{P}_2\text{O}_5\%$ of Site 1149 sediments after the data of Plank et al. (manuscript in preparation, 2004). Colors of the various units as in figure 6.

Figure 13 ϵ_{Hf} vs. ϵ_{Nd} diagram of Site 1149 sediments together with Fe-Mn crusts and nodules and other oceanic sediments. Hf and Nd isotopes of composite from DSDP Site 452 sedimentary pile are from White et al. (1986) and Woodhead (1989). Other data sources as in figure 7.

Figure 14 Lu/Hf vs. Sm/Nd diagram where the bulk composition of Site 1149 sediments, composites 801 Super and 801 TAB All (representative respectively of the Hole 801C tholeiitic section and alkali section) and the Global Subducting Sediments (GLOSS) have been plotted together with various sediment types. Sediments data are from Patchett et al. (1984). Trace element data of composites 801 Super and 801 TAB All are from Kelley et al. (2003). GLOSS after Plank and Langmuir (1998) and CHUR after the data of Hofmann (1988).

Figure 15 Hf/Nd vs. ϵ_{Nd} diagram of Site 1149 sediments together with lavas from the three zones of the central section of the Izu arc (from latitude 30°N to 33°N). Dashed arrow represents theoretical mixing between a mantle endmember and the Site 1149 bulk composition. Izu arc data are from Taylor and Nesbitt (1998); Hochstaedter et al. (2001). ϵ_{Nd} value of +8.7 for the unmodified subarc mantle has been calculated by Hochstaedter et al. (2001) using the data of Hickey-Vargas (1991; 1998).

Figure 16 (a) Comparison of the total Nd input flux in sediments with the Nd volcanic output flux. (b) Comparison of the flux of Nd derived from the continental crust (annotated “continental Nd input flux”) with the Nd volcanic output flux. The Nd recycling rates from the sediments toward the arc crust should be considered as minimum fluxes. In consequence the Nd recycling fluxes into the deep mantle should be considered as maximum values. After Hauff et al. (2003) the Nd isotopic compositions of altered MORB sampled at Site 1149 are strictly equivalent to unaltered Pacific MORB in consequence it appear arduous to discriminate the contribution of the altered basaltic crust from the subarc mantle contribution to the Nd volcanic output flux. These two contributions have therefore been considered together as a mantellic flux.

Figure 17 ϵ_{Hf} vs. ϵ_{Nd} diagram showing the present day MORB and OIB fields together with the “OIB array” and Precambrian basalts. Field in grey represent the uncertainty of the OIB array. Lines with tick marks represent the present-day composition of Site 1149 sediments, GLOSS, 801 TAB All and 801 Super composites with different sedimentation or eruption ages. Numbers on tick marks are the ages of these materials. Each tick marks on these lines are separated from 0.5 Ga. The Nd isotopic composition of modern GLOSS (age = 0 Ga) is from Plank and Langmuir (1998). It Hf isotopic composition has not been evaluated by these authors but the GLOSS is largely dominated by terrigenous sediments. In consequence the Hf isotopic composition of GLOSS has been located in the “terrestrial array” of Vervoort et al. (1999) because according to these last authors terrigenous materials all plot along this array. Trace elements data sources used for GLOSS, 801 TAB All and 801 Super composites as in figure 14. “OIB array” is from Vervoort et al. (1999). Precambrian komatiites, magnesian and tholeiitic basalts data are from Blichert-Toft and Arndt (1999c). MORB and OIB fields after the references cited in figure 5.

Figure 1

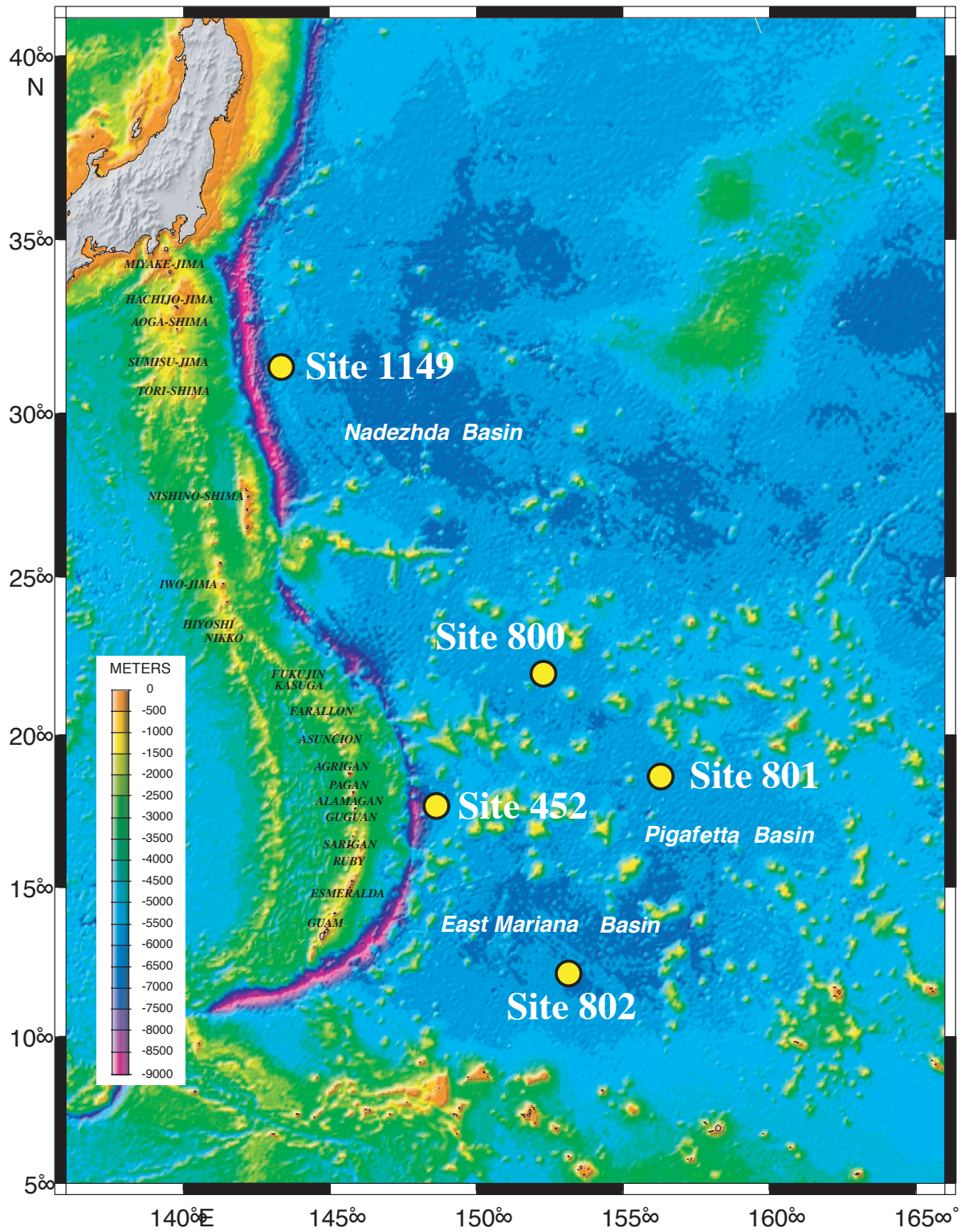

Figure 2

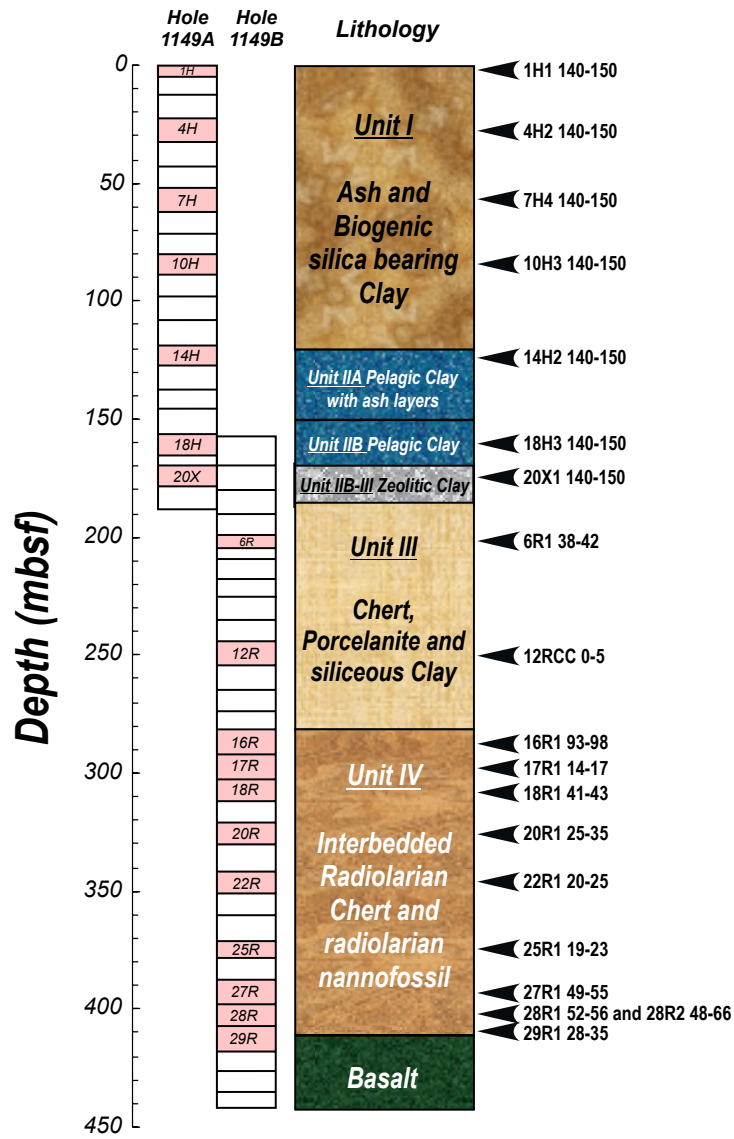
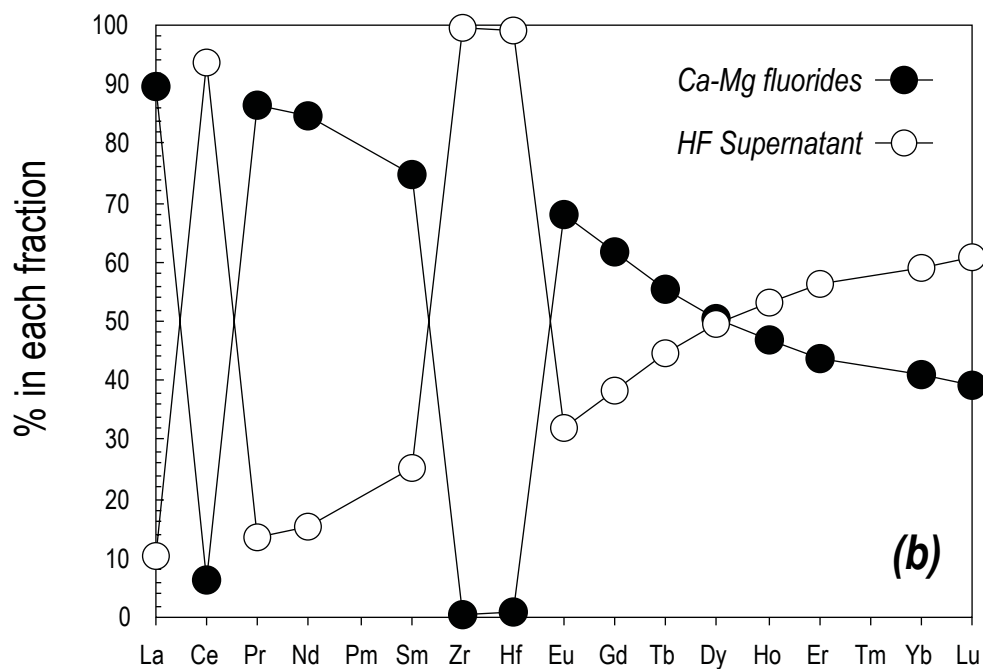
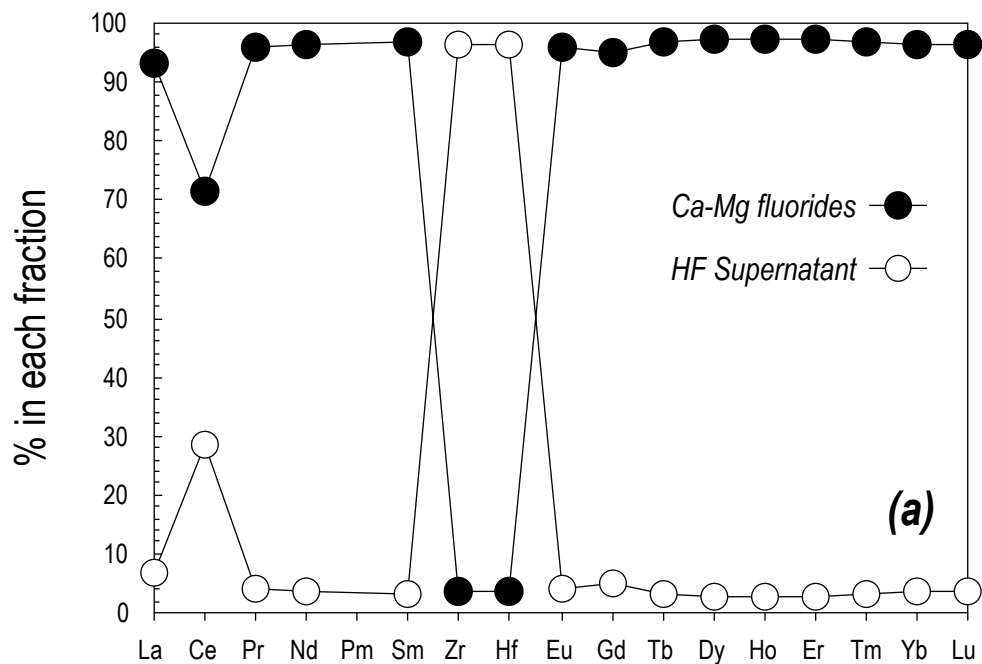

Figure 3



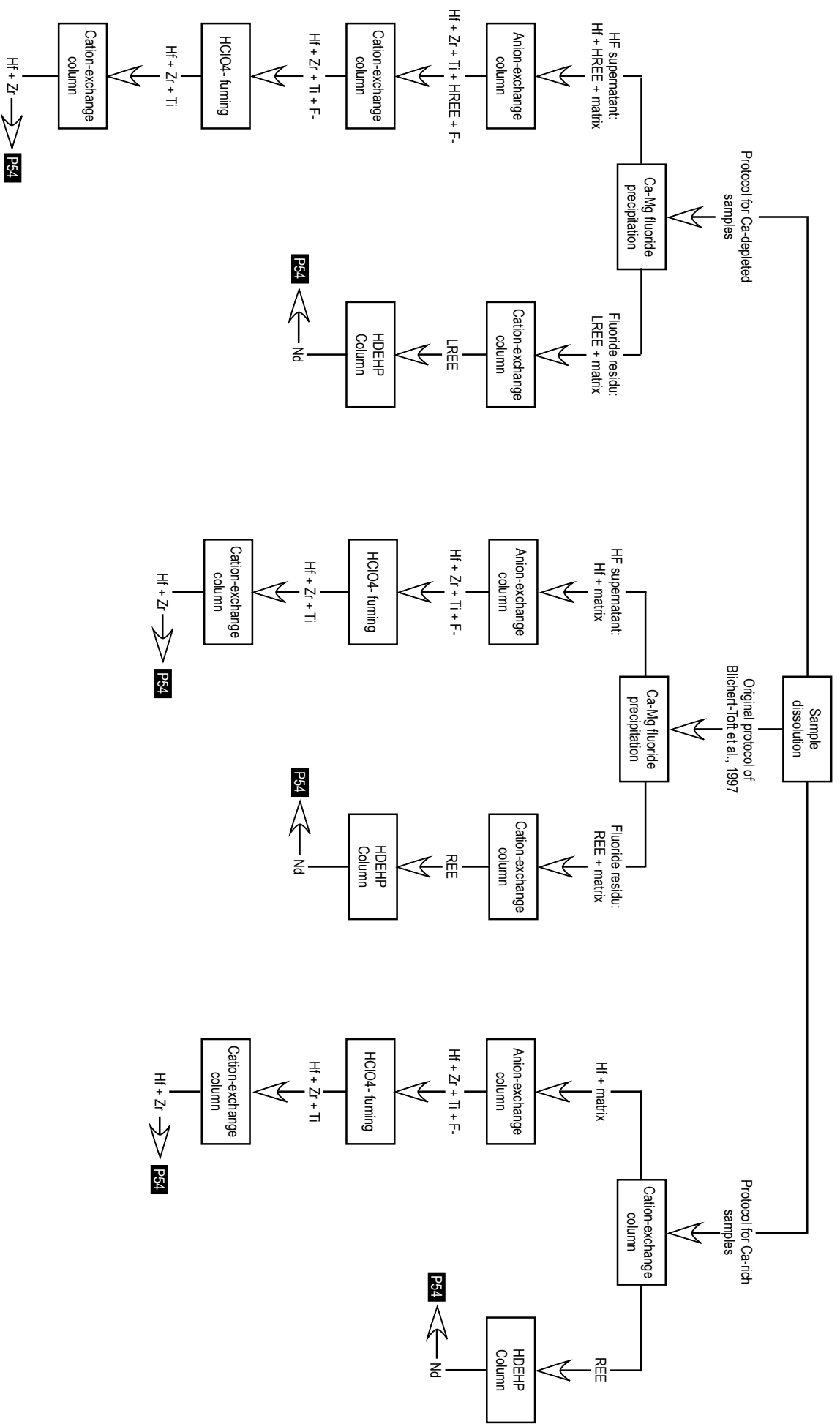

Figure 4

Figure 5

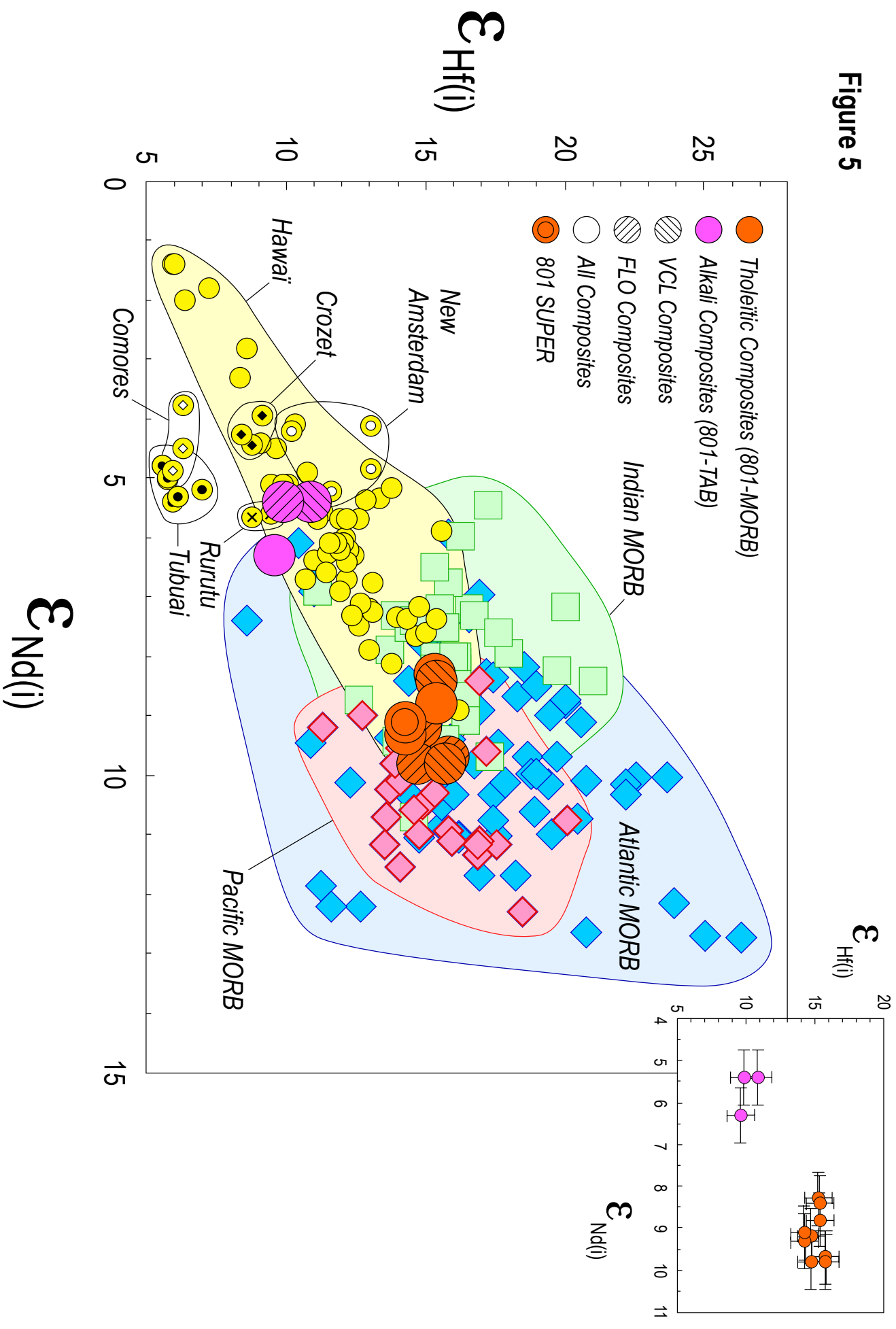

Figure 6

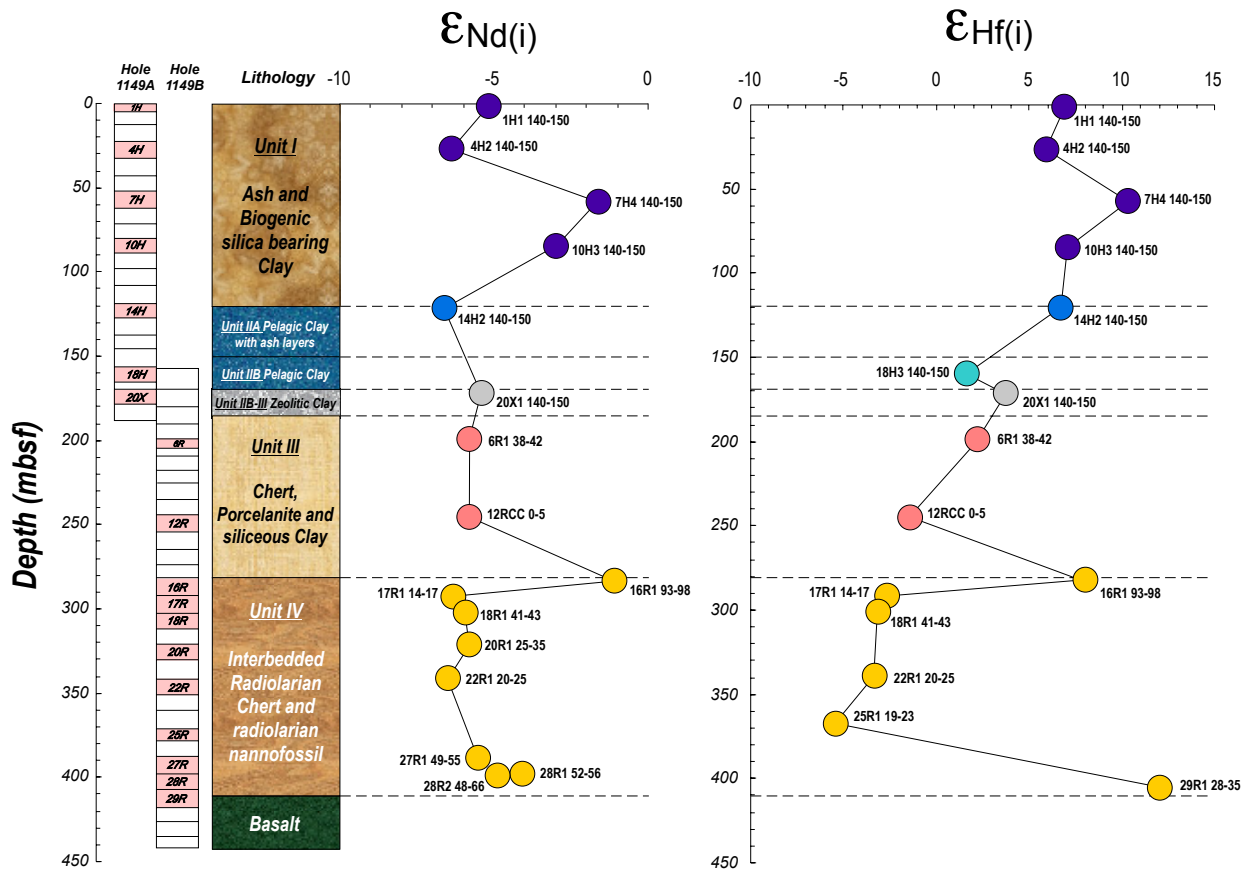

Figure 7

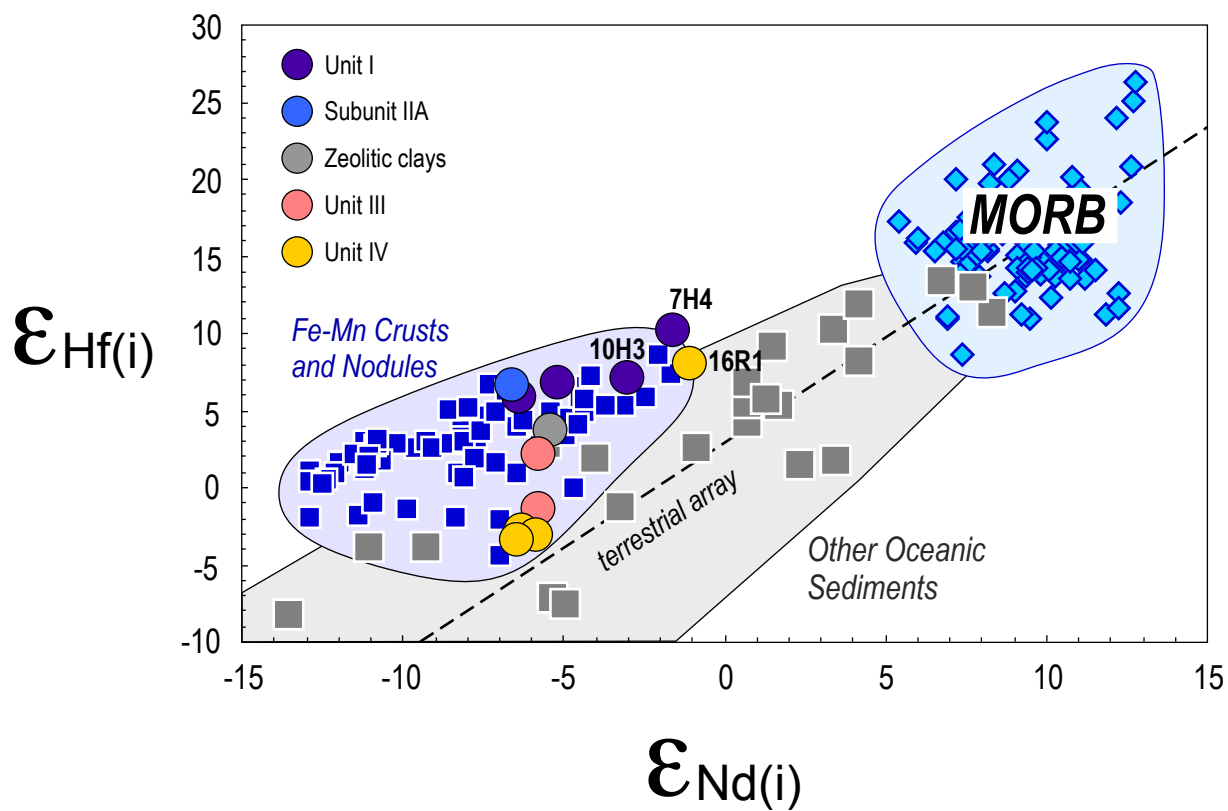

Figure 8

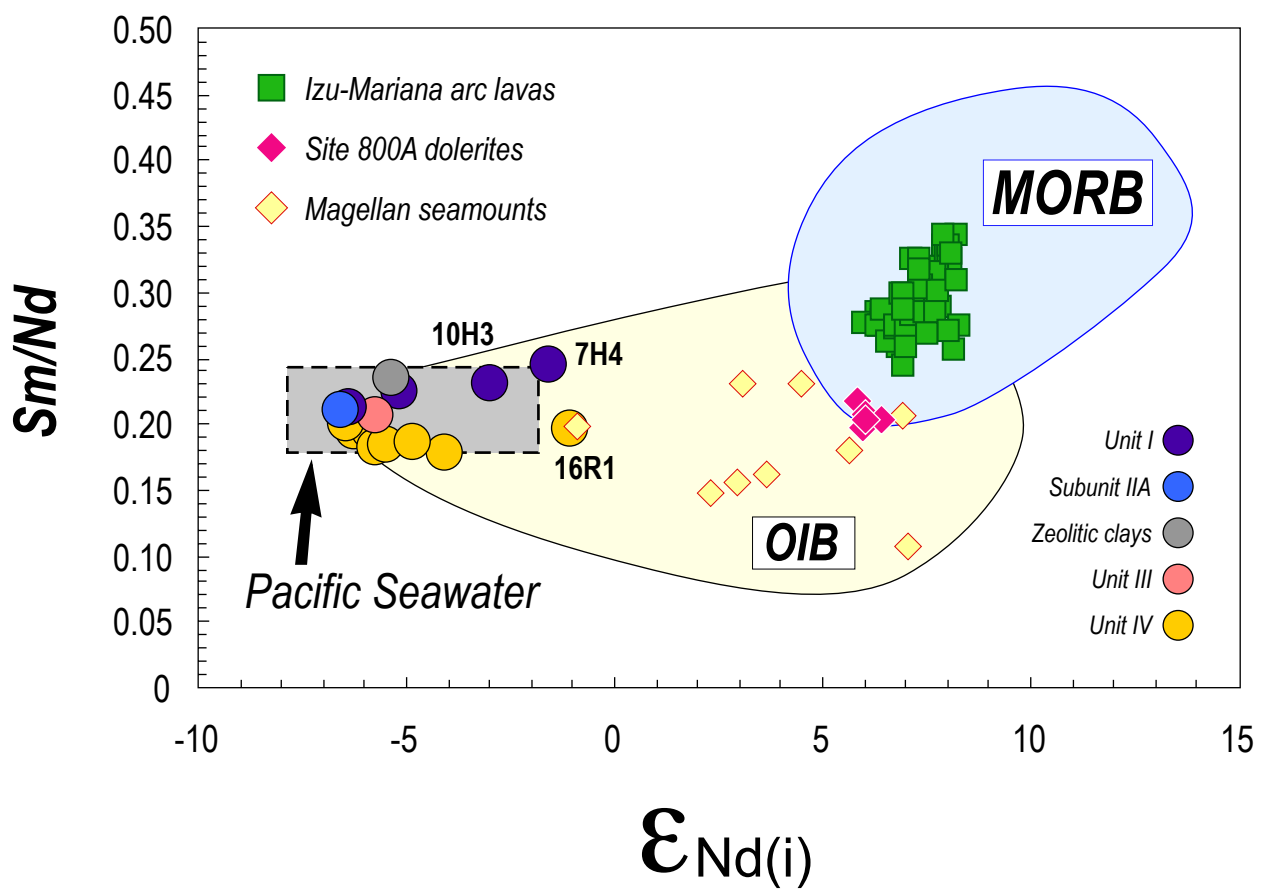

Figure 9

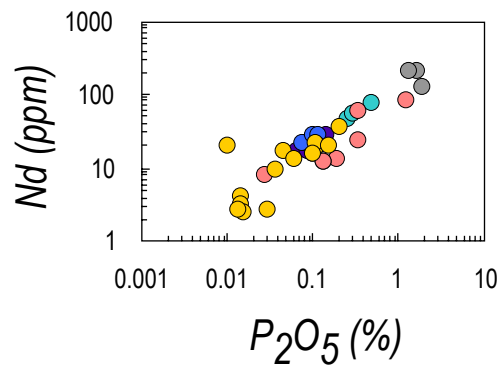
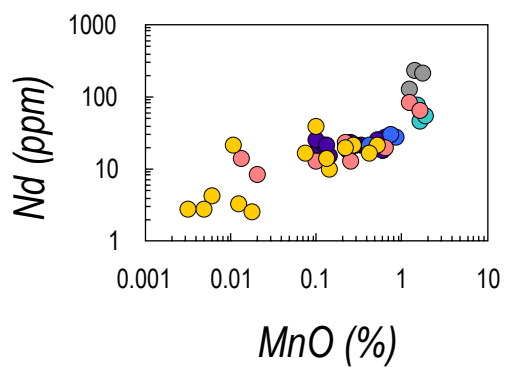
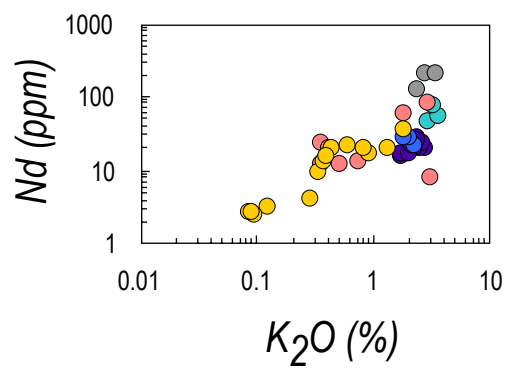
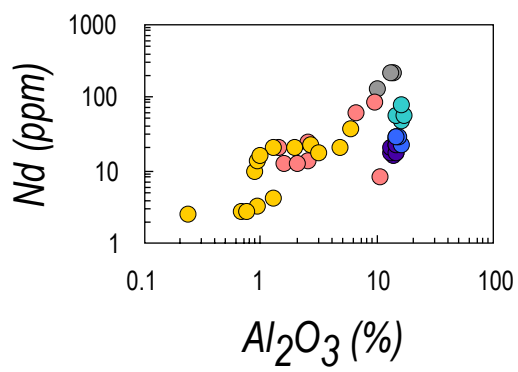

Figure 10

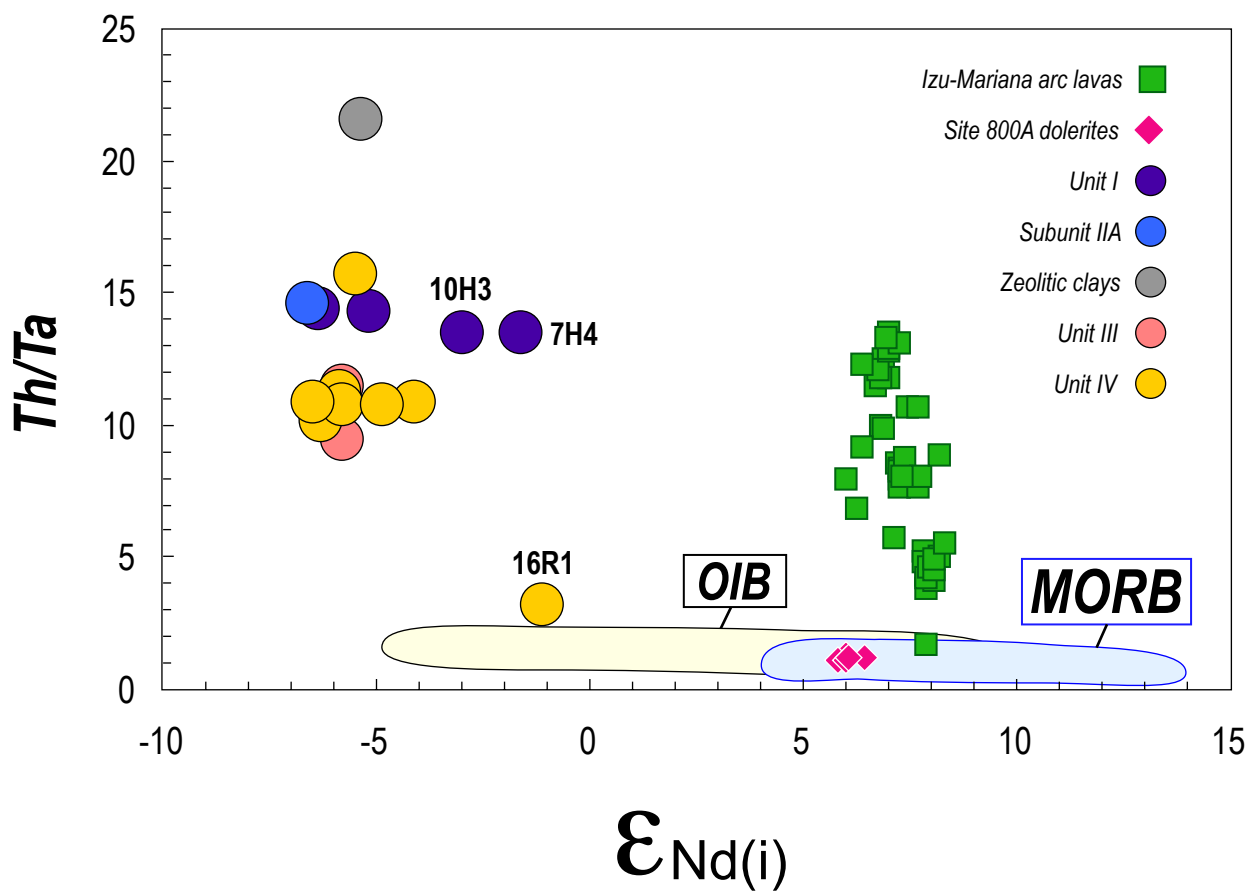
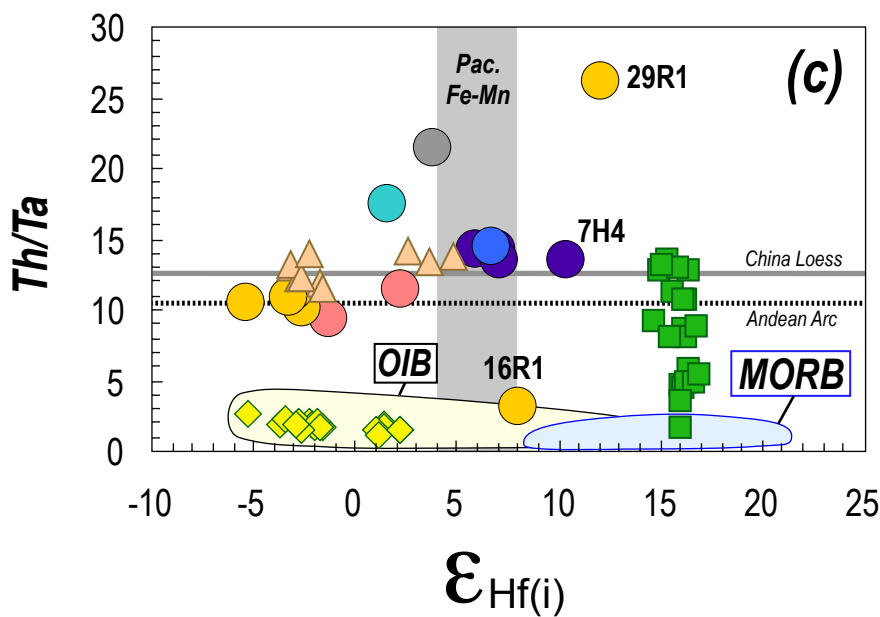
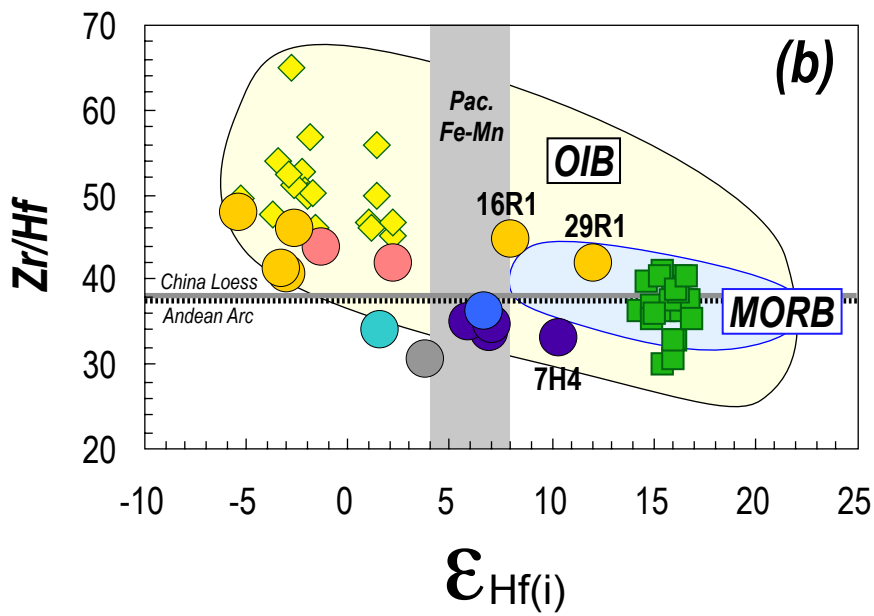
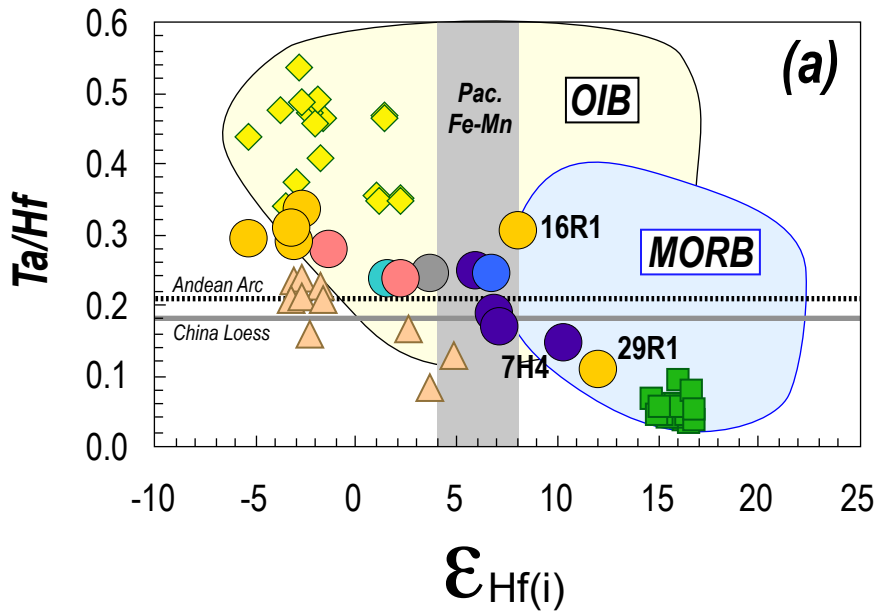

Figure 11



- Izu-Mariana arc lavas
- ▲ Asian Dust from
- ◆ Pitcairn lavas
- Unit I
- Subunit IIA
- Subunit IIB
- Zeolitic clays
- Unit III
- Unit IV

Figure 12

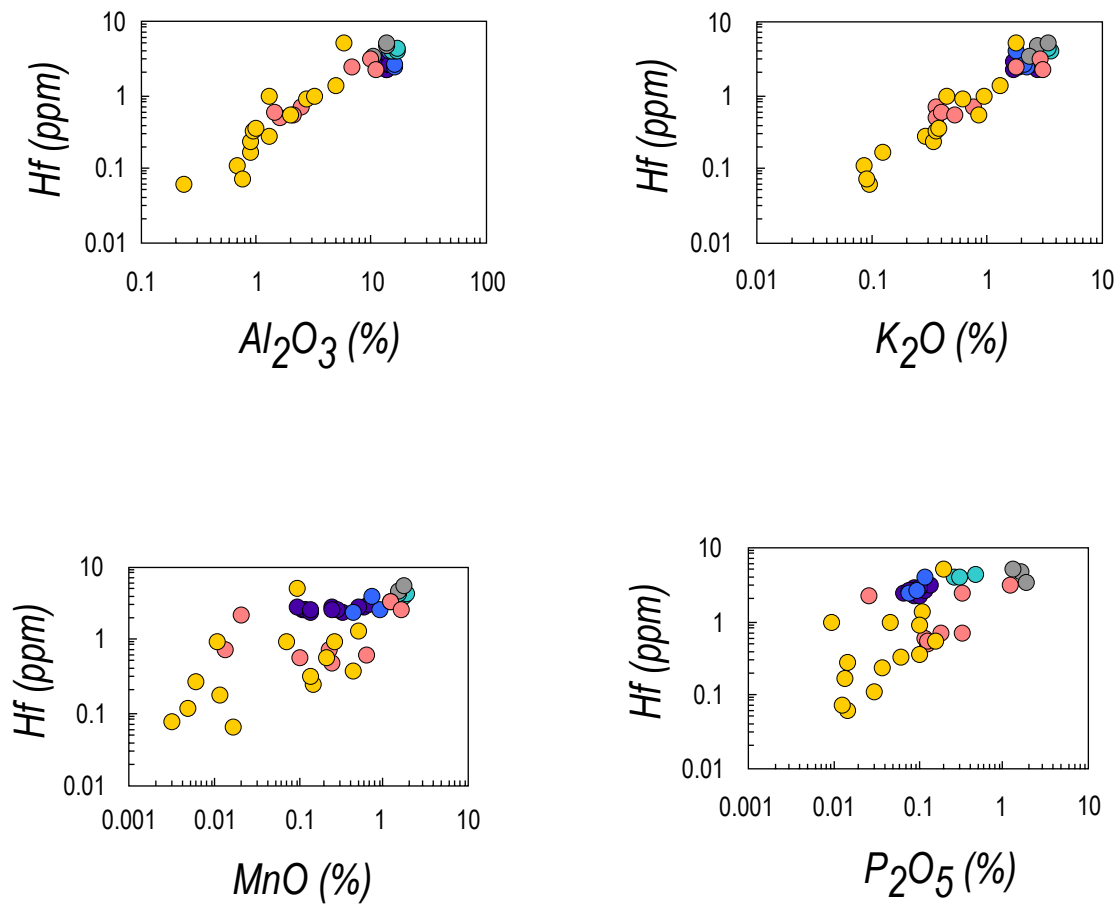

Figure 13

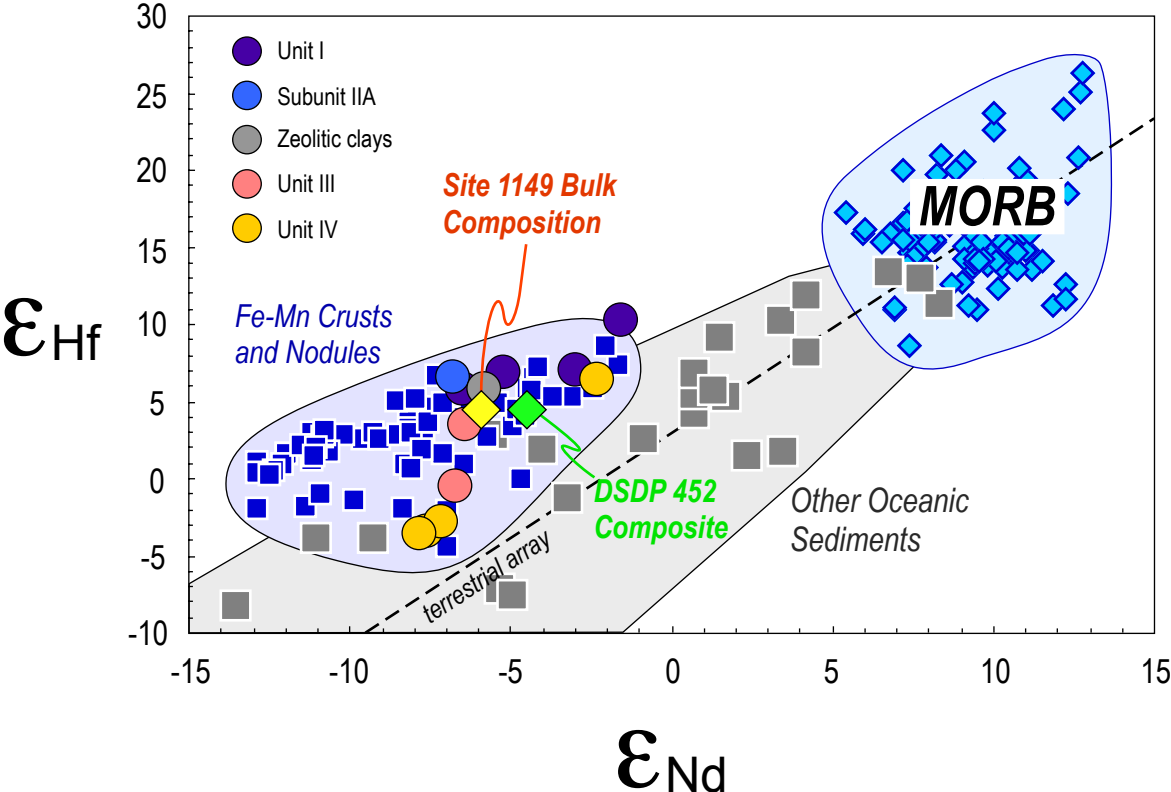

Figure 14

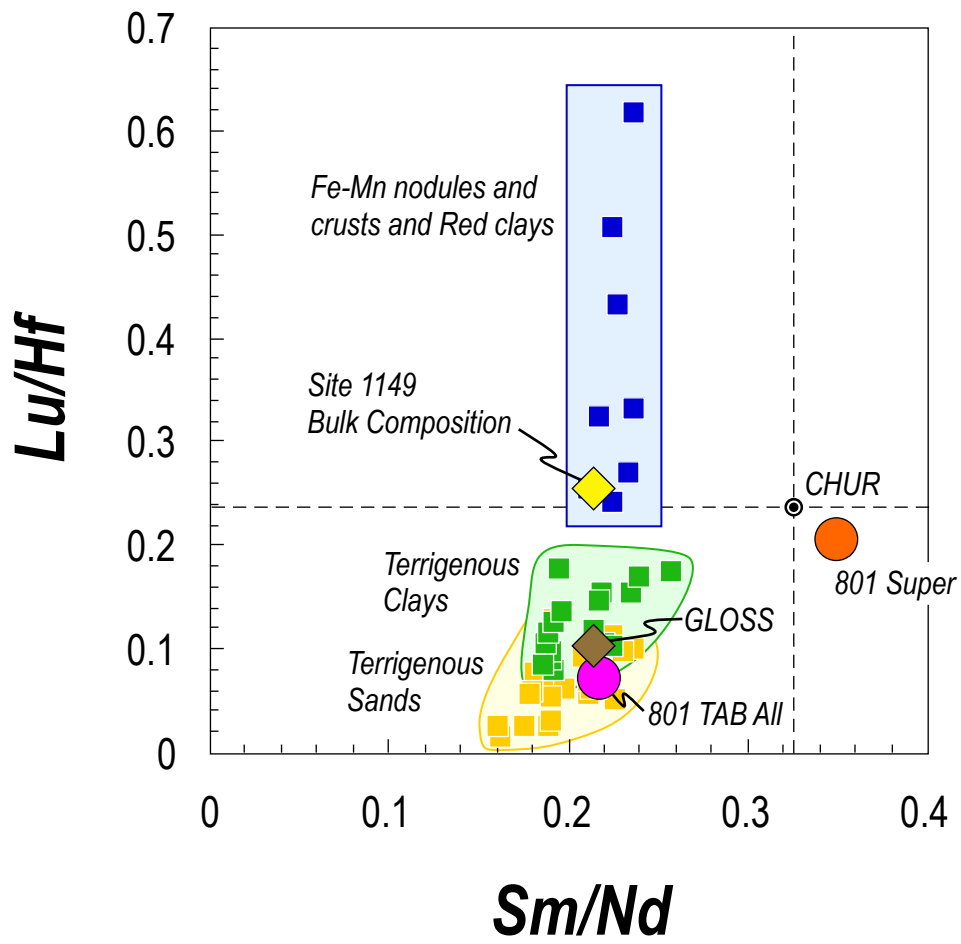

Figure 15

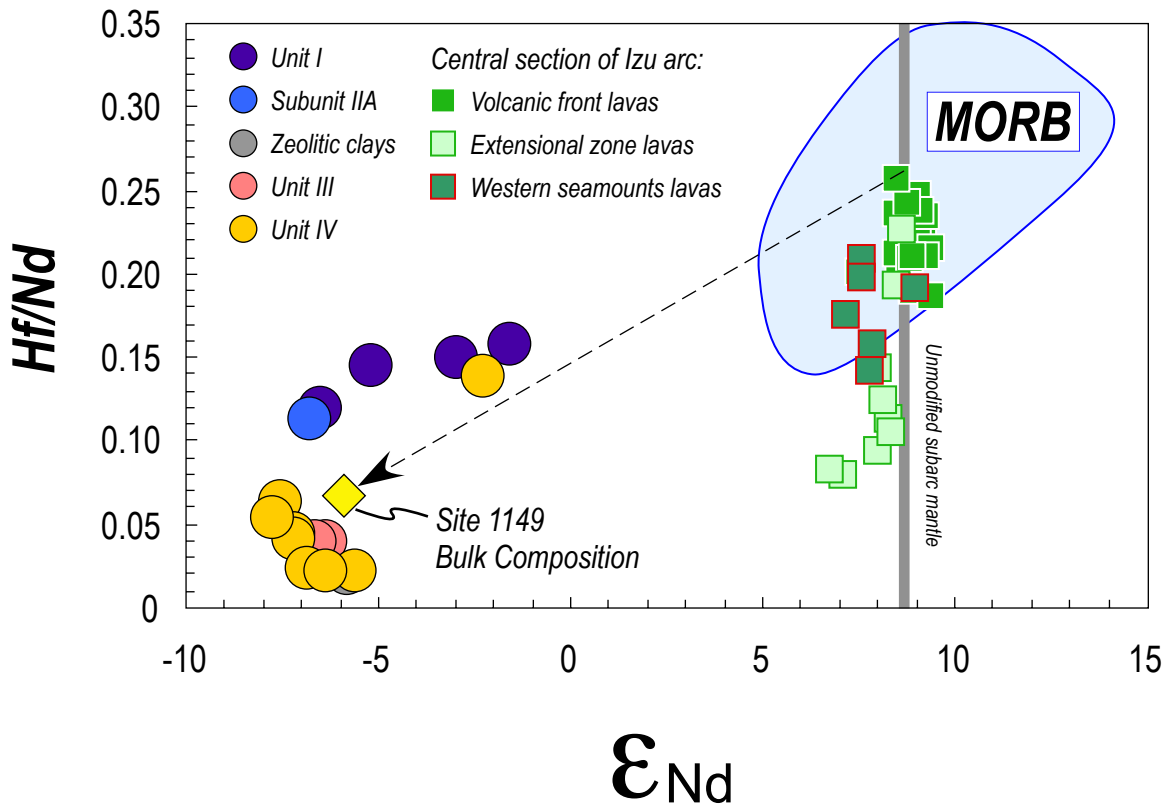

Figure 16

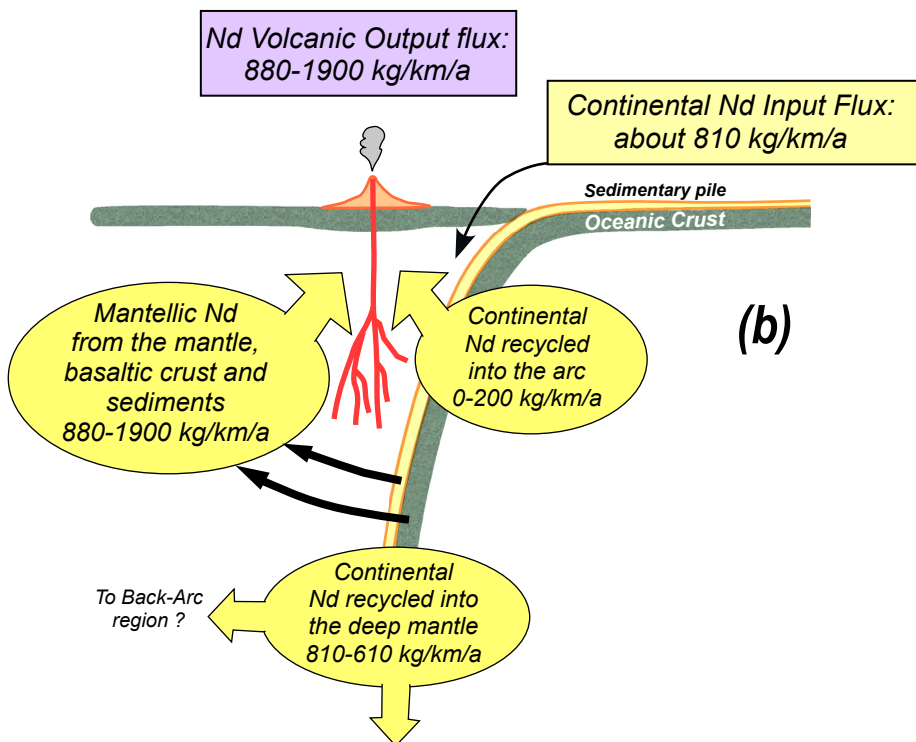
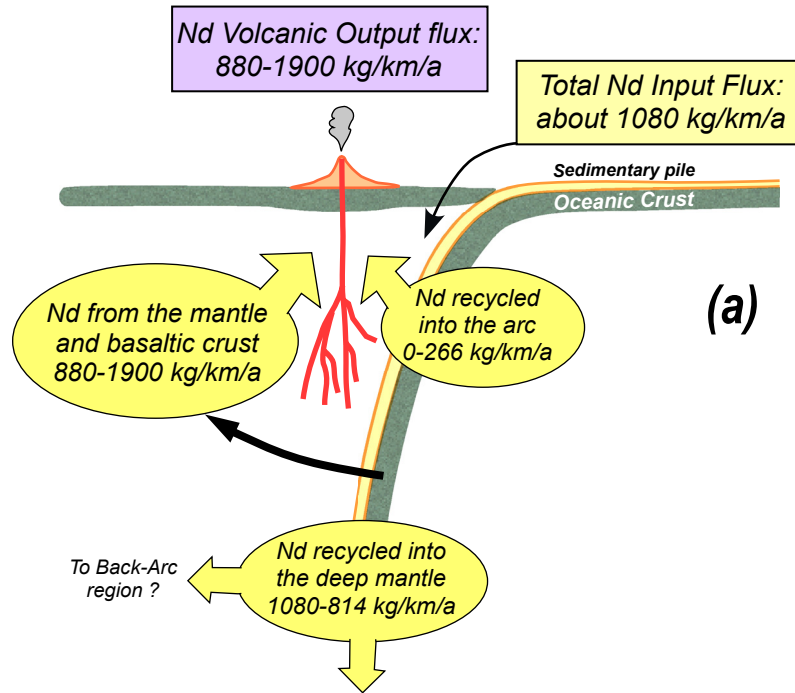
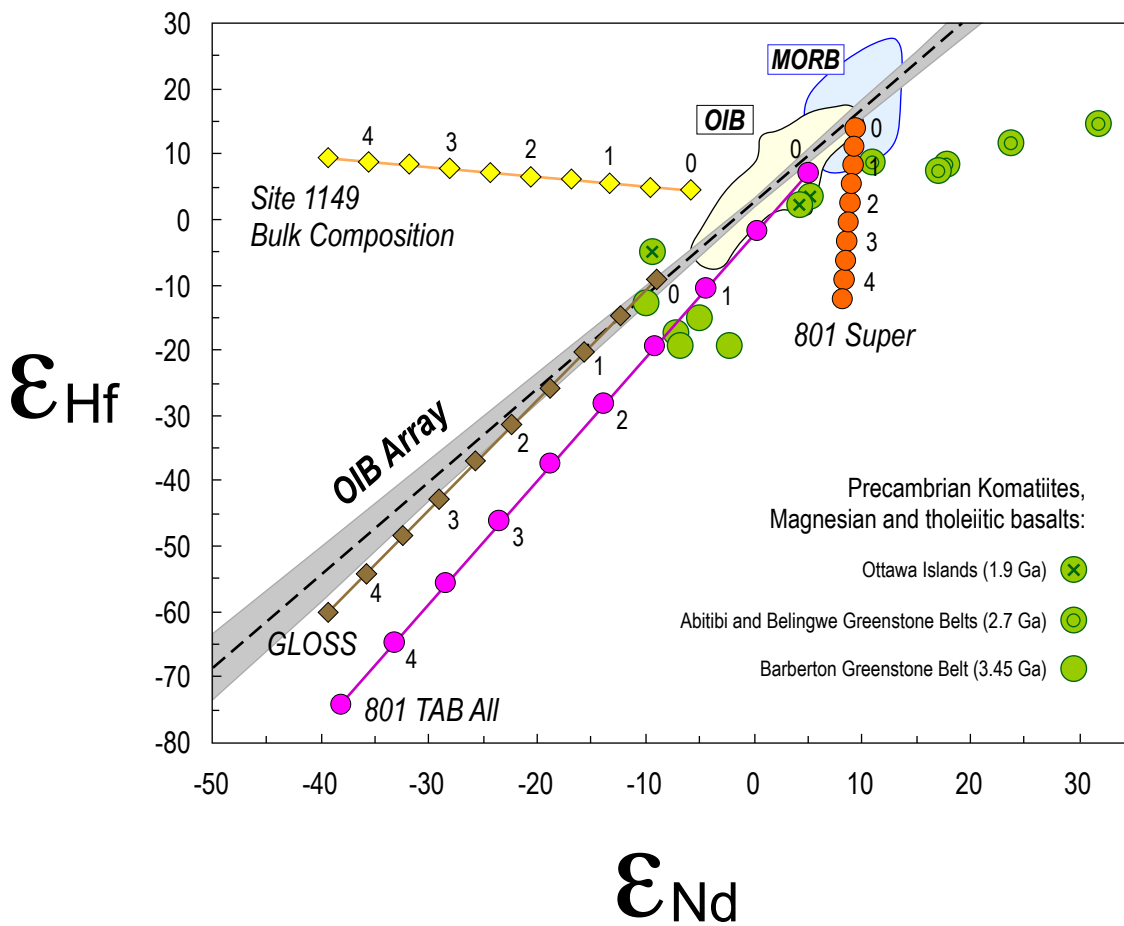

Figure 17



CHAPITRE III

Compositions isotopiques de l'Hafnium des laves d'arcs insulaires

CHAPITRE III - Partie A

Arc de Luzon

CHAPITRE III - Partie A : Arc de Luzon

Notre étude de la composition isotopique de l'Hafnium des laves de l'arc de Luzon se présente sous la forme d'un manuscrit soumis à la revue *Contributions to Mineralogy and Petrology*. Le principal objectif de ce travail est tout d'abord de compléter les données précédemment publiées sur les compositions isotopiques de l'Hafnium des laves d'arcs insulaires puis d'explorer les différentes interprétations pouvant expliquer les corrélations entre les compositions isotopiques de l'Hafnium et du Néodyme dans les laves de Luzon.

Les échantillons de l'arc de Luzon présentent généralement des compositions de l'Hafnium très radiogéniques par rapport à leurs compositions isotopiques du Néodyme. Ces compositions des laves de Luzon apparaissent distinctes des compositions isotopiques des autres arcs intra-océaniques. L'île de Batan constitue une exception par rapport aux autres îles de l'arc de Luzon puisque ces compositions isotopiques peu radiogéniques du Néodyme sont corrélées avec des compositions peu radiogéniques de l'Hafnium. Les compositions des laves de Batan se rapprochent de celles des autres arcs intra-océaniques.

L'analyse des corrélations entre le rapport des concentrations Sm/Hf et les rapports isotopiques de l'Hafnium démontre que les laves de l'arc de Luzon peuvent être divisées en trois groupes géographiques : Les laves du Nord, les laves de Batan et les laves de la partie Sud de notre zone d'étude. Chacun de ces groupes montre une corrélation linéaire entre les rapports Sm/Hf et les rapports isotopiques de l'Hafnium. De telles relations démontrent que la source de chaque groupe de laves est constituée par un mélange d'uniquement deux composants. Nous avons utilisé les corrélations linéaires entre les rapports d'éléments traces et les compositions isotopiques de l'Hafnium et du Néodyme pour calculer les hyperboles de mélange des trois groupes de laves de l'arc de Luzon dans l'espace ϵ_{Hf} versus ϵ_{Nd} . Ces hyperboles indiquent que la source des laves des groupes Nord et Sud est un manteau de type

MORB contaminé par des sédiments pélagiques dont les compositions isotopiques de l'Hafnium sont très radiogéniques par rapport à leurs compositions isotopiques du Néodyme. L'hyperbole de mélange de Batan indique que la source des laves de cette île résulte d'un mélange entre un manteau préalablement modifié qui a ensuite subi une nouvelle contamination par des argiles terrigènes.

Dans l'arc de Luzon, les compositions isotopiques de l'Hafnium et leurs corrélations avec les compositions isotopiques du Néodyme semblent donc contrôlées par le type de sédiment qui contamine la source. Au niveau des arcs volcaniques des Petites Antilles, de la Sonde et de Banda, les corrélations entre les compositions isotopiques de l'Hafnium et du Néodyme apparaissent aussi conditionnées par la composition isotopique des sédiments qui contribuent à la source des laves.

Hf isotope compositions of northern Luzon arc lavas suggest involvement of pelagic sediments in their source

Jean-Christophe Marini¹, Catherine Chauvel¹ and René C. Maury²

¹ : LGCA, Université Joseph Fourier, Maison des Géosciences, BP 53, F-38041 Grenoble Cedex 09, France

² : IUEM, Université de Bretagne Occidentale, Place N. Copernic, F-29280 Plouzané, France

Corresponding author: Catherine Chauvel, E-mail: Catherine.C Chauvel@ujf-grenoble.fr

Tel.: 33 (0)4 76 63 59 12; Fax: 33 (0)4 76 51 40 58

Words counts: Abstract: 163 words, text + Figures captions: ≈8421 words

Abstract

New Hf isotopic compositions for island arc basalts from the Luzon arc (Philippines) define a remarkable sub-horizontal trend in Hf-Nd isotopic space with a small range of ϵ_{Hf} (+5 to +17) associated with a large variation in ϵ_{Nd} (-7 to +8). The data plot above and barely overlap the terrestrial array defined by oceanic basalts and continental crust. Mixing hyperbola passing through the data intersect fields for depleted mantle and pelagic sediments suggesting that these two components formed the source of the Luzon arc lavas. An exception is the Batan Island where the low ϵ_{Nd} ratios are associated with low ϵ_{Hf} values. A mixing hyperbola fitting the Batan samples suggests that their mantle source was modified by subducted material prior to contamination by terrigenous clays.

The relationship between Nd and Hf isotopic compositions in the Luzon volcanics show that the type of sediment subducted under an island arc is a determining factor in the control of the two isotopic systems in island arc environments.

Introduction

Subduction zones are important sites of the Earth surface because they are regions where continental crust is extracted from the mantle. Petrological and geochemical studies show that island arc lavas have compositions that approach that of average continental crust (Taylor and McLennan, 1985; Taylor and McLennan, 1995) but differ significantly from those of lavas at mid-ocean ridges or in oceanic islands such as Hawaii. Possible explanations for the close similarities between the compositions of continental crust and island arcs are not yet fully developed but they can be separated into two distinct categories: (a) The distinctive chemical characteristics of both arcs and the continental crust (negative Nb-Ta anomalies and enrichment of the LILE) is a primary feature unique to magma formation in subduction zones. These features are bequeathed to the continental crust as island arcs are accreted and reworked during crust-forming processes. (b) The chemical characteristics of arc magmas are secondary, being inherited from sediments of continental origin. The continental signature is transmitted from subducted sediment to the mantle source of arc magmas as the sediments dehydrate or partially melt during the subduction process. It is very likely that both explanations are valid; the continental signature was created initially in ancient subduction zones, then recycled each

time a new subduction zone forms. The critical question is the relative importance of the two processes in modern subduction zones. While the presence of ubiquitous and large negative Nb anomalies in arcs showing otherwise little to no involvement of sediments in their source argue in favor of specific fractionation processes during arc lava formation (Elliott et al., 1997; McCulloch and Gamble, 1991), other studies have demonstrated that the composition of subducted sediments strongly influences the composition of the island arc basalts (McDermott et al., 1993; Plank and Langmuir, 1993; Vroon et al., 1995; Vroon et al., 1993; White and Dupré, 1986). The question remains therefore open.

Because Hf is a high field strength element (HFSE) and Nd is a rare earth element (REE), they behave differently during sedimentary processes. Hf is concentrated in zircon which is deposited as a detrital component, typically in coarser-grained terrigenous sediments; Nd is present mainly in clay minerals which are deposited in finer-grained sediments or in chemical precipitates. Detrital sediments therefore have high Hf/Nd and low Lu/Hf ratios which leads to non-radiogenic Hf isotope ratios while pelagic sediments and Fe-Mn crusts and nodules have low Hf/Nd and high Lu/Hf which generate more radiogenic Hf with time (Albarède et al., 1998; Ben Othman et al., 1989; David et al., 2001; Godfrey et al., 1997; Patchett et al., 1984; Vervoort et al., 1999; White et al., 1986). The Hf-Nd isotopic array of arc lavas will therefore depend on the type of sediment subducted under the arc. Similarly, the process responsible for the addition of sediments to the source of arc lavas will affect the Nd-Hf isotopic relationship. Because Nd is more soluble than Hf in aqueous fluids, dehydration of sediments and/or basaltic crust will favor Nd input relative to Hf while bulk melting should transfer both elements in relatively unchanged proportions (Hawkesworth et al., 1993a; Hawkesworth et al., 1993b; Hawkesworth et al., 1994; McCulloch and Gamble, 1991; Pearce et al., 1999; Saunders et al., 1991; Tatsumi et al., 1986). This process also has consequences on the Nd-Hf isotopic array in the arc lavas. In summary, both the contribution to the arc source of a subducted material with variable Nd-Hf isotopic compositions, and the various processes affecting the REE and HFSE in subduction zones are potential causes of Nd-Hf geochemical and isotopic variations in arc lavas.

Very few studies have focussed on the Hf isotopic compositions of island arc basalts (Pearce et al., 1999; Salters and Hart, 1991; Vroon et al., 1998; White and Patchett, 1984; Woodhead et al., 2001) and much understanding of the processes occurring under the arcs can be gained by further work. The Luzon arc is an excellent site to evaluate Nd-Hf isotopic systematics in arcs because this arc displays a very large range of Nd isotopic compositions (Defant et al., 1989; Defant et al., 1990; Fourcade et al., 1994; McDermott et al., 1993). This suggests that

Hf isotopic compositions should also vary widely. Previous authors have suggested the involvement of different types of sediments in the source, terrigenous sediments in the opinion of McDermott et al. (1993) and pelagic sediments for Fourcade et al. (1994). Various mechanisms for the transfer of the sedimentary component from slab to wedge were also suggested: aqueous fluid transfer for Maury et al. (1992) and siliceous melts for Bau and Knittel (1993), Maury et al. (1998), Prouteau et al. (1999), Sajona et al. (2000) and Schiano et al. (1995). Combining Hf isotopic compositions with previously published trace-element and Nd isotope data should therefore help constrain the source composition and the processes involved in the formation of the Luzon arc.

Geological setting

The Luzon arc extends from Luzon, the northernmost island of the Philippines archipelago to Taiwan in the West Pacific (Fig. 1). It includes many active or dormant volcanoes distributed over about 1200 km between Taiwan and Mindoro Islands and it formed through the eastward subduction of the South China Sea beneath the Luzon plate (Hayes and Lewis, 1984; Huang et al., 1997; Stephan et al., 1986; Teng, 1990). The subduction of the South China oceanic lithosphere is limited in the north by the collision between the arc and the Chinese continental platform and in the south by the Mindoro collision zone.

The basement of the volcanoes is exposed in Luzon Island where it consists of Cretaceous ophiolites overlain by volcanoclastic sediments (Pubellier et al., 1996). No old continental crust basement has been described in our study area in the northern part of the Luzon arc. We selected 19 basalts, basaltic andesites and andesites from the islands of Lutaao, Lanshu, Batan, Babuyan, Calayan and Camiguin in the northern part of the Luzon arc and from Mount Cagua and Baguio volcanoes on Luzon island. Their ^{40}K - ^{40}Ar radiometric ages, determined on whole rock samples by Defant et al. (1990), Maury et al. (1998) and Richard et al. (1986a and 1986b), range from 5.7 Ma to 1480 years B.P. (Table 1).

Previous work

Several recent papers have concentrated on the petrologic, geochemical and isotopic characteristics of volcanics from the northern part of the Luzon arc (Chen et al., 1990; Defant

et al., 1989; Defant et al., 1990; Fourcade et al., 1994; Jacques, 1987; Maury et al., 1998; McDermott et al., 1993; Richard et al., 1986a; Richard et al., 1986b; Vidal et al., 1989). These studies show that basalts and andesites from the Luzon arc have major element compositions ranging from low-K tholeiites to high-K calc-alkaline lavas. They also display a large variety of trace element patterns, ranging from nearly flat patterns in the arc tholeiites to patterns strongly enriched in large ion lithophile elements (LILE) and light rare earth elements (LREE) in the high-K calc-alkaline volcanics. Their Sr, Nd and Pb isotopic compositions are also highly variable (Chen et al., 1990; Defant et al., 1989; Defant et al., 1990; McDermott et al., 1993; Vidal et al., 1989). For example in a $^{143}\text{Nd}/^{144}\text{Nd}$ versus $^{87}\text{Sr}/^{86}\text{Sr}$ diagram (Fig. 4 of McDermott et al., 1993) the Luzon volcanics range from values close to those of MORB ($^{87}\text{Sr}/^{86}\text{Sr} = 0.703$ and $^{143}\text{Nd}/^{144}\text{Nd} = 0.5131$) in the arc tholeiites to enriched compositions ($^{87}\text{Sr}/^{86}\text{Sr} = 0.706$ and $^{143}\text{Nd}/^{144}\text{Nd} = 0.5123$) in the calc-alkaline lavas.

Analytical procedure

On the basis of published Nd isotopic compositions (Defant et al., 1990; Fourcade et al., 1994; McDermott et al., 1993), we selected 19 samples and analysed them for Hf isotopes. Chemical separation was carried out in Grenoble following the procedure described by Blichert-Toft et al. (1997) and measurements were performed using the VG Plasma 54 in Lyon. Blanks were negligible relative to the amount of Hf present in the samples and the average measured $^{176}\text{Hf}/^{177}\text{Hf}$ ratio for the standard JMC 475 was 0.282165 ± 10 (1σ , 17 runs). The Hf isotopic compositions are reported in Table 1.

Some trace element concentrations for our samples were published by Defant et al. (1990) and McDermott et al. (1993) but data were not complete. We therefore measured trace element concentrations by ICP-MS in Grenoble. The analytical procedure followed that described by Barrat et al. (1996) with minor modifications. BHVO was used for calibration of the machine and reported concentrations are relative to the BHVO composition given in Table 1.

Results

A - Hf isotopic composition of the Luzon volcanics

Lavas from the Luzon arc have $^{176}\text{Hf}/^{177}\text{Hf}$ ratios ranging from 0.283251 ($\epsilon_{\text{Hf}} = +16.9$) to 0.282693 ($\epsilon_{\text{Hf}} = -2.8$) (Table 1). The arc tholeiites have the most radiogenic Hf isotopic compositions whereas the high-K calc-alkaline lavas have the lowest ϵ_{Hf} values. These Hf isotopic compositions are very different from those measured in other volcanic rocks. For example, in an ϵ_{Hf} versus ϵ_{Nd} diagram, even samples with low ϵ_{Nd} values have radiogenic Hf isotopic ratios (Fig. 2). The data therefore define a subhorizontal trend that is quite distinct from the array defined by all other terrestrial samples (Fig. 2), including MORB, OIB, continental crust and other island arcs (Patchett and Tatsumoto, 1980; Salters and Hart, 1991; Vervoort et al., 1999; White and Patchett, 1984).

The only samples that do not fall in the subhorizontal field are the Batan island volcanics. These samples have low ϵ_{Hf} (-3 to -1) associated to low ϵ_{Nd} (-5 to -2), values comparable to those reported by White and Patchett (1984) for the Banda arc (Fig. 2).

B - Trace element composition of the Luzon volcanics

Measured trace element concentrations are listed in Table 1 and plotted in Fig. 3. The new data confirm the geochemical features measured previously. The Luzon rocks show a large range of trace element concentrations, from arc tholeiites moderately enriched in LILE and LREE to high-K calc-alkaline lavas strongly enriched in LILE and LREE relative to HREE. They are also characterized by strong depletions in Nb and Ta relative to the neighbouring incompatible trace elements. These depletions increase from arc tholeiites which have La/Nb ratios of about 2 to high K calc-alkaline samples with La/Nb ratios of 11 (see also Fig. 3). A positive Pb anomaly is present in all trace element patterns and it translates into low Ce/Pb ratios of 2.3 to 6.7, values that are much lower than the Ce/Pb ratio of about 25 found in MORB and OIB.

Additional features of Luzon arc lavas are illustrated in Figure 4. Three groups can be identified when Hf isotopic compositions are used in conjunction with Sm/Hf, Pb/Hf and Sr/Hf ratios:

- Lavas from volcanoes in the southern part of the study area (Baguio, Cagua, Camiguin, Calayan + sample Bb 39 for Babuyan) have highly radiogenic Hf isotopic compositions (ϵ_{Hf} from +13 to +17) combined with a large range of Sm/Hf ratios (between 1 and 2.1) and a relatively small range of Nd/Hf (3.5 to 8.9).

- Lavas from the northern part of the arc (Lutao and Lanshu islands) have lower ϵ_{Hf} values (between +5 and +11) and they show a restricted range of Sm/Hf ratios (1.1 to 1.6). Their Nd/Hf ratios vary from 4.9 to 14.6.
- Batan Island defines a third group with the lowest ϵ_{Hf} values and a restricted range of Sm/Hf and Nd/Hf ratios (1.1 to 1.6 and 6.4 to 8.3 respectively, see Fig. 4a).

The trace element signature of Luzon lavas have some other interesting characteristics. As shown in Fig. 5, samples from the northern and southern island groups display significant Ce negative anomalies that correlate with the Hf isotopic compositions. In contrast, Batan lavas, which have the lowest Hf isotopic compositions of our data set display no significant Ce anomalies.

Discussion

A- Contamination of the mantle source or assimilation within the arc crust?

The Luzon arc volcanics have Sr, Nd and Pb isotopic compositions that extend from isotopic ratios close to MORB to isotopic ratios close to continental material (Chen et al., 1990; Defant et al., 1989; Defant et al., 1990; Fourcade et al., 1994; McDermott et al., 1993; Vidal et al., 1989). These features are commonly attributed to variable proportions of sedimentary material in the mantle source rather than to the assimilation of wall rocks during magma ascent through the arc crust. We believe that the compositions of Luzon volcanics are not solely due to crustal contamination for the following reasons:

- 1) When the Luzon arc started to form in the Middle Miocene (≈ 20 Ma ago), it was located on the Philippines oceanic plate far away from any continental detrital source (Hall et al., 1995; Lee and Lawver, 1995). The basement of the arc consists therefore of oceanic crust and it is not covered by a thick pile of continental sediments (Defant et al., 1990).
- 2) McDermott et al. (1993) showed that the lavas with the lowest ϵ_{Nd} are also the most magnesian. This is the opposite of what could be expected during assimilation and fractionation processes within the crust. In addition, the $\delta^{18}\text{O}$ values measured on various

Luzon arc lavas (Chen et al., 1990; Fourcade et al., 1994) indicate little crustal assimilation.

- 3) The presence of mantle xenoliths in some Batan lavas (Richard et al., 1986b) suggests a rapid ascent of the magmas through the arc crust and argues against contamination during magma ascent.

Consequently, the enriched signature of the lavas cannot be attributed to contamination by the arc crust and its origin has to be found in the source region.

B- Mixing processes in the arc source

Numerous studies have demonstrated that the chemical and isotopic compositions of arc lavas reflect contamination of their mantle source by the materials recycled through the subduction zone (Gill, 1981; Hawkesworth et al., 1993a and references therein). The arc source corresponds to a mixture of multiple components: the subarc mantle and materials coming from the subducted basaltic crust and overlying sediments (e.g., Class et al., 2000; Ellam and Hawkesworth, 1988; Elliott et al., 1997; Hawkesworth et al., 1993a; Turner et al., 1996).

In the Luzon arc, the Sr, Nd and Pb isotopic compositions of the volcanic rocks show clearly that sedimentary material is present in their source (Chen et al., 1990; Defant et al., 1989; Defant et al., 1990; Fourcade et al., 1994; McDermott et al., 1993; Vidal et al., 1989). This suggestion is confirmed and reinforced by the Ce anomalies shown in Fig. 5. Similar negative Ce anomalies were also reported for the Mariana arc lavas where they were cited as decisive evidence for the involvement of sedimentary materials in the source of the lavas (Elliott et al., 1997; Hole et al., 1984; Lin, 1992; Woodhead, 1989). The presence of similar negative Ce anomalies in the Luzon arc volcanics implies that sediments were also present in the source of Luzon lavas, but this does not preclude that, as suggested by some authors, other components from the subducted basaltic crust could also have contaminated the mantle wedge under the arc (Maury et al., 1998; Maury et al., 1992; McDermott et al., 1993; Prouteau et al., 1999; Sajona et al., 2000; Schiano et al., 1995).

Using the relationship between Nd and Hf isotopic compositions and the trace element data, we should be able to better constrain both the number and the origin of the components involved in the genesis of the lavas. Figures 4a, b and c provide crucial information about the mixing processes. Because Sm, Sr, Pb and Hf have similar geochemical behaviour during arc

lava genesis, two-component mixing defines lines while more complex mixtures create clouds in such diagrams. The number of end-members involved in lava genesis can therefore be evaluated. In Figure 4a where Sm/Hf is plotted as a function of Hf isotopic composition, the northern, southern and Batan lavas are distributed along three distinct linear arrays. This distribution provides constraints on the contamination processes occurring under the arc: each section of arc (the northern part, the southern part and Batan Island) appears to result from a simple binary mixture of two end-members.

In order to investigate the nature and origin of the mixing processes occurring in Luzon and provide explanations to the unusual Hf isotopic compositions of the Luzon arc lavas, information about the composition of the subducted materials appears critical.

C- Composition of the South China Sea oceanic crust and sediments.

The basaltic crust of the South China Sea has never been sampled by drilling or dredging. Tu et al. (1992) reported geochemical analyses of basalts from the region, but these samples are from oceanic island that erupted on the seafloor and cannot be taken as representative of the oceanic crust. The South China seafloor is covered by a 1500-3000m thick sedimentary pile (Hayes and Lewis, 1984; Jinmin, 1994) that was drilled during ODP Leg 184 in 1999 (location shown on Fig. 1). Its lithological composition corresponds to a simple combination of clays derived from the Chinese continental platform and calcareous nannofossil oozes (Prell et al., 1999). ϵ_{Nd} measured on the terrigenous-hemipelagic clay fraction range from -7.7 to -13.3 (Clift et al., 2002; Li et al., 2003). However, the calcareous fraction, which represents 10% to 60% of the sedimentary material, was not analyzed and the bulk composition of the sediment is difficult to evaluate.

Geochemical data representing the uppermost meters of the sedimentary pile are available for piston-cores sampled along the subduction trench (Figure 1) (Chen et al., 1990; McDermott et al., 1993). In the northern part of the arc, their ϵ_{Nd} values vary between -8 and -12 (Chen et al., 1990; McDermott et al., 1993) and are similar to the range reported for the clay fraction of the ODP Leg 184 samples. In the central part of the South China Sea, which is located farther away from the Chinese continental input, the Nd isotopic compositions are more radiogenic with an ϵ_{Nd} value of -0.4 (McDermott et al., 1993). Unfortunately, no Hf isotopic compositions were measured on any of the South China Sea sediments.

Fourcade et al. (1994) suggested that the sediments currently on the sea floor in front of the Luzon arc are not necessarily identical to the sediments involved in the source of the Luzon arc lavas because the Nd/Sr ratio of the sedimentary material inferred to have contaminated the source differs from that of the presently subducting sediments. These authors suggest that the sedimentary material in the source was pelagic rather than the lithogenous-hemipelagic clay and calcareous ooze mixture currently in the sedimentary pile overlying the South China Sea basaltic crust.

D. Constraints on the mixing processes provided by Hf and Nd isotopes

Because Hf isotopic compositions are not available for the subducted material, and because the sediments present today on top of the South China Sea oceanic crust might not be representative of those in the Luzon arc source, another approach has to be used to constrain the nature and origin of the components in the sources of the Luzon arc lavas. We therefore choose to use the relationships between trace element ratios and Nd and Hf isotopic compositions to constrain the form and position of the mixing arrays in $\epsilon_{\text{Hf}}-\epsilon_{\text{Nd}}$ isotope space.

While ϵ_{Nd} and ϵ_{Hf} values are identical in arc volcanics and in their source, the trace-element ratios are often modified during partial melting and/or fractional crystallisation. For example, it has been shown that Nd is more incompatible than Hf not only during the mantle melting that produces MORB and OIB (Chauvel and Blichert-Toft, 2001; Hofmann, 1988; Sun and McDonough, 1989) but also during the formation of island arc basalts (Pearce et al., 1999). The Nd/Hf ratio measured on lavas is not necessarily the source ratio. In contrast, Sm has been demonstrated to have about the same compatibility as Hf during formation of the vast majority of magmas, and the Sm/Hf ratio appears unchanged during magma formation (Blichert-Toft and Albarède, 1999; Blichert-Toft et al., 1999b; Chauvel and Blichert-Toft, 2001; Hofmann, 1988; Sun and McDonough, 1989). It can therefore be used, together with ϵ_{Nd} and ϵ_{Hf} values, to evaluate source compositions.

In Fig. 4a, each of the three Luzon arc groups (northern islands, southern islands and Batan island) defines a linear relationship between Sm/Hf and ϵ_{Hf} . Because mixing arrays are straight lines in a ratio vs. ratio plot when the denominator is the same for the two ratios (e.g. Langmuir et al., 1978), this relationship suggests that each group could result from simple mixing of only two end-members. When Hf/Nd is plotted as a function of ϵ_{Nd} , as in Figure 6, the situation is more complicated. The simple mixing relation is perturbed because Nd is

slightly more incompatible than Hf (or Sm) during partial melting. Hf/Sm is therefore a better proxy to the source compositions than Hf/Nd and it is for this reason that we used it in Figure 7. Theoretically, the mixing arrays in Figure 7 are not straight lines but hyperbola but their curvature is very limited if the Sm/Nd ratios of the end-members are similar. Figure 8 shows that for each of the three island groups, Sm/Nd varies by a factor of less than 2.

In Figure 7, the correlation coefficients are not as good as for the Sm/Hf versus ϵ_{Hf} relationship (Figure 4a) (0.81, 0.61 and 0.84 instead of 0.96, 0.91 and 0.72), probably because of scatter that we attribute to changes of Sm/Nd ratios during partial melting. However, the mixing arrays can be approximated as straight lines and we can use them to characterize the source compositions of the lavas.

The equations defining the three linear arrays in Figures 4a and 7 are given in the Figures and can be combined to derive the relationship between $^{176}\text{Hf}/^{177}\text{Hf}$ and $^{143}\text{Nd}/^{144}\text{Nd}$ in Figure 9. For each island group, a mixing hyperbola can be calculated :

$$\epsilon_{\text{Hf}} = -\left(\frac{1}{0.0032 \cdot \epsilon_{\text{Nd}} + 0.083}\right) + 21.72 \text{ for the Northern islands (1)}$$

$$\epsilon_{\text{Hf}} = -\left(\frac{1}{0.0088 \cdot \epsilon_{\text{Nd}} + 0.124}\right) + 21.60 \text{ for the Southern islands (2)}$$

$$\text{and } \epsilon_{\text{Hf}} = \left(\frac{1}{-0.0054 \cdot \epsilon_{\text{Nd}} + 0.034}\right) - 19.85 \text{ for Batan volcanics (3)}$$

Figure 9 shows clearly that the arrays for the northern and southern islands are similar while the curvature of the Batan island array is in the opposite direction. Because each array in Fig. 9 is a hyperbola, the asymptotic values can be used to constrain the isotopic compositions of the end-members. Reference to Figure 9 shows that the radiogenic end-members of the northern and southern islands cannot have ϵ_{Hf} values higher than +21.7 and +21.6, respectively (Fig. 9), while for Batan Island the ϵ_{Nd} value of the radiogenic end-member cannot be greater than +6.3. The non-radiogenic end-members of the northern and southern islands cannot have ϵ_{Nd} values lower than -25.9 and -14.1, respectively, while for Batan Island, the non-radiogenic end-member must have an ϵ_{Hf} value higher than -19.9 (Fig. 9).

E. Potential origins for the radiogenic end-members

In Figure 9, the mixing arrays of the northern and southern islands are seen to pass through the MORB field, which suggests that the radiogenic end-members of these two groups could be normal MORB-like mantle. However, these two radiogenic end-members cannot be identical and must have different ϵ_{Hf} ratios because the two mixing hyperbolas do not intersect in the MORB field. Using Figure 4a, the ϵ_{Hf} values of the radiogenic end-members for the northern and southern islands can be shown to differ by 3 to 5 epsilon units because the Sm/Hf ratio of the depleted mantle source must remain realistic. It cannot be lower than about 0.4, the extremely low value reported by Murton et al. (1992) for Western Pacific boninites and is most probably no higher than normal depleted MORB mantle.

The northern and southern islands of the Luzon arc therefore have slightly different mantle sources, the southern group of islands having a depleted mantle component with a more radiogenic Hf isotopic composition than the northern group.

For Batan Island, the situation is different because the mixing curve does not pass through the MORB field and the hyperbola has an ϵ_{Nd} asymptotic value of +6.3 (Fig. 9). In addition, the correlation between ϵ_{Hf} and Sm/Hf for the Batan volcanics indicates that the radiogenic end-member has a Sm/Hf ratio higher than that of MORB (Figure 4a). These two constraints suggest that the radiogenic end-member for Batan Island is not the depleted mantle source of normal MORB. Chen et al. (1990) suggested that the source could be enriched mantle, like the source of some oceanic island basalts but McDermott et al. (1993) showed that Pb isotopes provide no evidence for the involvement of such an enriched source. As an alternative, we suggest that the radiogenic end-member of the Batan lavas could be a depleted mantle source already contaminated by subducted materials. The relatively low ϵ_{Nd} ($\approx +6$) and the elevated Sm/Hf ratio of this modified mantle suggest that the component added to the depleted mantle was at least partly derived from sedimentary materials and not only from a basaltic crust with MORB characteristics.

F. The unradiogenic end-members

The unradiogenic end-members of the three Luzon groups are inferred to represent fluids or siliceous melts derived from the subducted sediments and from the basaltic crust. The compositions of these components lie on the three mixing hyperbolas but their exact locations

are not well constrained. Little isotopic information on the South China Sea sediments is available in the literature, and the only published data were reported by Chen et al. (1990), Clift et al. (2002), Li et al. (2003) and McDermott et al. (1993) who measured the ϵ_{Nd} values of terrigenous clays and reported values ranging from -8 to -13. They did not measure the ϵ_{Nd} values of the nannofossil oozes that are mixed with the terrigenous-hemipelagic clays and represent 10 to 60% of the sedimentary pile (Clift et al., 2002; Li et al., 2003). Palmer and Elderfield (1985 and 1986) measured the Nd isotopic composition of similar oozes in the Atlantic ocean and demonstrated that these samples register the composition of seawater. Since seawater in the Western Pacific and South China Sea has ϵ_{Nd} values of -6 to -4 (Albarède and Goldstein, 1992; Li et al., 2003; Piepgras and Jacobsen, 1988), we can assume that the nannofossil oozes should have the same Nd isotopic composition. The ϵ_{Nd} value of the South China Sea nannofossil oozes should therefore be significantly less negative than the ϵ_{Nd} value of -8 to -13 reported for the clay fraction, and the average Nd isotopic composition of the sediment pile should be at least as radiogenic as the clay fraction.

On the other hand, fluids derived from the subducted basaltic crust should have a radiogenic Nd isotopic composition close to that of MORB, with an ϵ_{Nd} of +10. As a consequence, the range of isotopic composition reported for South China Sea clays ($\epsilon_{Nd} = -8$ to -13) should represent the minimum ϵ_{Nd} values for the unradiogenic end-members since all other subducted materials, calcareous nannofossil oozes and basaltic crust, have more positive ϵ_{Nd} values. This range is reported in Figure 9 and should be considered as the lowest possible value for the subducted material.

Fourcade et al. (1994) suggested that the Sr-Nd isotopic compositions of the Luzon lavas required a contribution from pelagic sediments with compositions different from those of sediments now in the ocean basin. In other areas such sediments have ϵ_{Nd} values of about -2 to -8 (Ben Othman et al., 1989; Godfrey et al., 1997), values that are higher than the ϵ_{Nd} of -8 to -13 of present day South China clays.

In summary, it appears that the Nd isotopic ratios reported for clays from the South China Sea represent minimum values for the material recycled into the subduction zone and involved in the source of lavas under the Luzon arc. The Hf isotopic composition of the subducted material remains unknown since no local sediments were analyzed.

The three mixing arrays shown on Figure 9 can be used to constrain the compositions of the enriched component that mixed with peridotite in the mantle wedge and by consequence its possible origin.

The mixing hyperbola defined by the northern islands place strong constraints on the composition of the enriched end-member since the lavas with the lowest ϵ_{Nd} values (-6.7) are located close to the field of South China Sea sediments in Figure 9 and the curvature of the mixing array is not strong. The thickened segment on the mixing hyperbola in Figure 9 illustrates possible combinations of ϵ_{Hf} and ϵ_{Nd} for the enriched end-member: ϵ_{Hf} from -2.4 to +5.5 and ϵ_{Nd} from -13 to -7. The unradiogenic end-member of the northern islands therefore plots above the Hf-Nd terrestrial array of Vervoort et al. (1999) with a composition similar to values reported for Fe-Mn crusts and nodules (see Figure 9). However, two factors argue against involvement of such sediments in the source of the lavas:

- even though Fe-Mn crusts have been reported by Li et al. (2003) in the central part of the South China Sea, the monotonous, 900m thick sedimentary pile drilled during Leg ODP 184 does not contain any ferromanganese crust and such deposits cannot constitute a significant component of the South China Sea sedimentary cover.
- Fe-Mn crusts and nodules have high Nd/Hf ratios ranging from 14 to 35 (Ben Othman et al., 1989; Godfrey et al., 1997), ratios that are incompatible with the Nd/Hf ratios of 7 to 11 calculated for the unradiogenic end-member using the mixing relationships.

Recently, Marini et al. (2003) reported unusual Hf-Nd isotopic compositions for Pacific pelagic sediments. These materials, which consist of clay minerals (including authigenic clays) and siliceous microfossils, have Hf-Nd isotopic compositions similar to those of Fe-Mn crusts and nodules and plot above the Hf-Nd terrestrial array (see Fig. 9). These pelagic clays also have Nd/Hf ratios ranging between 7 and 14, the values required for the unradiogenic end-member of the Northern Luzon islands. In addition, involvement of pelagic materials would help explain the negative Ce anomalies that characterize lavas from the northern islands (Fig. 5) since such anomalies are typical of biogenous and hydrogenous pelagic sediments (Ben Othman et al., 1989; Elderfield and Greaves, 1981; Elderfield et al., 1981; Lin, 1992; Palmer, 1985; Palmer and Elderfield, 1986; Shimizu and Masuda, 1977; Toyoda et al., 1990). The involvement of such pelagic sediments in the source of the northern islands could therefore account for both the Hf-Nd isotopic compositions and the trace element characteristics of the lavas.

For the southern islands, the composition of the unradiogenic end-member is more difficult to constrain because the mixing hyperbola shown in Figure 9 is almost vertical when it

approaches the ϵ_{Nd} values of South China Sea sediments. Isotopic compositions as diverse as those of Fe-Mn crusts, pelagic sediments and lithogenous sediments could all, in principle, explain the mixing array. However, if we combine the isotopic constraints with those from the trace elements, we can restrict the type of subducted material that was involved in the source of the southern islands. Because of the curvature of the mixing array in Figure 9, the position in the array of the unradiogenic end-member has strong implications for its Nd and Hf contents. If the enriched end-member fell on the terrestrial array, it must have had an elevated Nd/Hf ratio of about 25 to 30. This is much higher than values reported for sediments with similar Hf and Nd isotopic compositions (see for example, Ben Othman et al., 1989; McLennan et al., 1990; Pearce et al., 1999; Vervoort et al., 1999; White et al., 1986) who report Nd/Hf values between 0.7 to 14). Dehydration of subducted sediments could produce aqueous fluids with high Nd/Hf ratios because Hf is particularly insoluble in aqueous liquids compared to Nd (Stalder et al., 1998). However such fluids would also fractionate other element ratios, in particular the U/Th ratio (Hawkesworth et al., 1997a; Hawkesworth et al., 1997b; Turner et al., 1996). Fig. 10 shows clearly not only that the Luzon arc lavas do not have elevated U/Th ratios but also that for each island group a trend of decreasing U/Th ratios is associated with a decrease of ϵ_{Hf} values. This is the opposite of what would be expected for fluid produced by dehydration of subducted materials. It can be concluded that fluids produced by dehydration of either subducted sediments or the basaltic oceanic crust are unlikely candidates for the unradiogenic end-member of the southern islands mixing array.

Elevated Nd/Hf ratios can also result from rutile fractionation during melting or dehydration of sediments since experimental studies show that Hf is much more compatible than Nd in rutile compared with fluids or silicate melts (Brenan et al., 1994; Foley et al., 2000; Stalder et al., 1998). The presence of residual rutile beneath the Mariana and Aleutian arcs has already been proposed by Elliott et al. (1997) and Class et al. (2000) to explain the relationship between Nb and Th in those arcs; they did not, however, consider the effect of its fractionation on the Nd/Hf ratio. If rutile fractionates during melting of a sedimentary component, the resulting liquid should have elevated Th/Nb, La/Nb and Nd/Hf associated with low ϵ_{Hf} . This is exactly what is seen in Figure 11 where, in samples from the northern and southern Luzon islands, a decrease in Hf isotopic ratios correlates with an increase in Th/Nb and La/Nb ratios. The increase of Th/Nb and La/Nb ratios is a measure of the magnitude of the Nb-Ta anomalies in the Luzon lavas trace element patterns (Figure 3) which become deeper as the

concentrations of the most incompatible elements increase. Such behaviour cannot be attributed to the involvement of aqueous fluids with extremely low Nb contents because, as mentioned above and shown in Figure 10, the variations of U/Th argue against such an interpretation. Neither can the large negative Nb anomalies that characterize the Luzon lavas be due to the involvement of Nb-poor sedimentary materials because most Luzon arc lavas have Th/Nb and La/Nb ratios higher than common sediments (Fig. 11). Consequently, the Nb anomalies are most likely to be due to preferential retention of Nb in a residual HFSE-rich phase like rutile. The retention of such a phase during partial melting could therefore explain the high Nd/Hf ratios inferred for the unradiogenic end-member. However, residual rutile cannot explain the systematic negative Ce anomalies found in the southern Luzon volcanics (Figure 5) and this leads us to consider an alternative explanation for the origin of the unradiogenic end-member of the southern island mixing array.

As for the northern islands of the arc, the enriched end-member could lie above the “terrestrial array” and be located in the field of Fe-Mn crust and nodules in Fig. 9. It would then need to have a much lower Nd/Hf ratio, of about 12. As we argued for the northern islands group, not only Fe-Mn crust and nodules are not common in the South China Sea but they are also characterized by very high Nd/Hf ratios between 14 and 35 (Ben Othman et al., 1989; Godfrey et al., 1997). Both factors argue against their involvement in the arc source. The relatively low Nd/Hf calculated for the unradiogenic end-member, together with the systematic negative Ce anomaly of the southern lavas (see Figure 5) point instead to the involvement of pelagic sediments similar to those invoked for the northern Luzon lavas.

For Batan island, the situation is different because in Figure 9 the mixing array is curved in the opposite direction to that of the other islands. The unradiogenic end-member of the mixing array is constrained to have an ϵ_{Nd} value between -13 and -5 and an ϵ_{Hf} of -10 to -3 (Fig. 9). It cannot have had a negative Ce anomaly (see Figure 5) and its U/Th ratio must have been lower than 0.15 (Figure 10). Unlike the cases considered previously, the Nd/Hf ratio of this end-member cannot be calculated using the curvature of the hyperbola because the nature and composition of the radiogenic component of Batan island is not well constrained. All we know is that it is not ordinary depleted mantle, as discussed earlier. In Figure 9, the Batan Island mixing hyperbola lies below the field of Fe-Mn crust and nodules but passes through the field of lithogenous-hemipelagic clays. It follows that lithogenous-hemipelagic clays similar to

those drilled in the South China Sea during ODP leg 184 could contribute to the source of Batan lavas.

In summary, our new Hf isotopic measurements, when combined with other isotopic and trace element data, provide useful constraints on the nature of the sources involved in the genesis of the Luzon arc volcanics. The relationship between Sm/Hf and Hf isotopic compositions (Fig. 4a) demonstrates that three different geographic groups can be distinguished along the Luzon arc. For each group, the REE and Hf characteristics of the lavas results from simple mixing between only two end-members. The mixing arrays that characterize the northern and southern islands indicate that the sources located under the islands consist of MORB-like depleted mantle contaminated by liquids derived from sedimentary material with radiogenic Hf isotopes, negative Ce anomalies, elevated Th/U and very low Ce/Pb ratios. These characteristics are best attributed to pelagic clays. For Batan Island, the situation is slightly different since mixing occurs between contaminated or metasomatised depleted mantle and an unradiogenic component derived from lithogenous-hemipelagic clays.

Our new Hf isotopic results reinforce the conclusions reached by previous workers about the control of lava composition by the type and amount of subducted sediment (Defant et al., 1989; Defant et al., 1990; Fourcade et al., 1994; McDermott et al., 1993). In particular, the correlation between the amplitude of negative Ce anomalies and Hf isotope ratios is a strong argument in favour of an authigenic origin for the sediment in the source of the lavas. Such sediments differ from the lithogenous-hemipelagic clays and calcareous nannofossil oozes that are presently being subducted at the trench but they are consistent with the suggestion made by Fourcade et al. (1994) to explain the Sr-Nd array. In addition, the relationships between REE and Hf, and in particular between Sm/Hf and the Hf isotopic ratio (Fig. 4a), show that fluid from subducted basaltic crust does not represent a discrete end-member. Although the subducted basaltic crust no doubt contributes to the REE and HFSE budget of the Luzon source, this contribution is always combined, and probably overwhelmed by the sedimentary contribution. Indeed, the significantly negative ϵ_{Nd} values of the three identified unradiogenic end-members of the mixing arrays imply that fluids liberated by the basaltic crust cannot play a major role in the Hf and Nd isotopic budget of the Luzon volcanics. Most of the REE and HFSE that is transported from the slab into the source of the arc lavas originates from fluids or silicate melts derived from subducted sediments.

G- How does Luzon compare with other oceanic island arcs?

The Lesser Antilles and Sunda-Banda arcs share with the Luzon arc a large range of ϵ_{Nd} values, from compositions similar to those of MORB to very non-radiogenic values (Fig. 2). However, in ϵ_{Nd} vs ϵ_{Hf} space (Fig. 2) data from the three arcs have different slopes. The Luzon arc is characterized by high Hf isotope ratios and the Lesser Antilles arc has the lowest ϵ_{Nd} values. The Sunda-Banda arc lies in an intermediate position and is characterized by two fields, the most radiogenic having Nd and Hf isotopes like the Luzon volcanics and the least radiogenic being similar to the Lesser Antilles (Figure 2).

We attribute the difference between the Lesser Antilles, Sunda-Banda and Luzon to differences in the type of sediments involved in the source of the lavas. The subduction of terrigenous sediments from the Guiana craton beneath the Lesser Antilles explains the Sr-Nd isotopes of these lavas (White and Dupré, 1986; White et al., 1985) and can also account for their low ϵ_{Hf} values. In the case of the Luzon arc, we attribute the radiogenic Hf isotopic composition to a contribution of pelagic sediments. Finally, in the Sunda-Banda arc, the Hf isotopic compositions indicate that different types of sediments contribute to the source. Pelagic sediments could be involved in the source of lavas with radiogenic Hf isotopic compositions whereas terrigenous-hemipelagic sediments could be present in the source of lavas with low ϵ_{Hf} and ϵ_{Nd} . Both types of sediments have been recognized in the sedimentary pile present in front of the Sunda-Banda trench. Vroon et al. (1995) reported that terrigenous sediments from the Australian continent were subducted at the Banda trench and Plank and Langmuir (1998) have identified pelagic clays and terrigenous materials at DSDP Sites 211 and 261 and at ODP Site 765 in front of the Java-Sunda trench. Pelagic sediments dominate in the central part of the arc, on the crust subducting beneath Java and Bali, but the proportion of terrigenous sediments from Australia increases to the east in the region of Banda (Vroon et al., 1995).

-H- Implications

Subduction zones are key regions to address the general question of continental crust growth (e.g., Armstrong, 1968; Armstrong, 1991; McCulloch and Bennett, 1994; Reymer and

Schubert, 1984). In a subduction zone, juvenile crust is created and old crustal material is recycled in the mantle: the net growth rate can be defined as the total flux of new material, minus the flux of recycled material. Evaluation of the net flux can be done in different ways, the most accurate being to establish a quantitative budget for the concentrations or ratios of key trace elements and isotopes. However, such calculations are extremely difficult to make and beyond the scope of this paper. A semi-quantitative approach can be made by comparing the composition of island arc lavas with an estimate of the composition of the subducted components (Plank and Langmuir, 1993) which could include pelagic and detrital sediments, as well as fresh and altered oceanic crust. In order to evaluate the net growth rate of continental crust, the concentrations of trace elements in each component, as well as the fractionation of these elements during fluid transport and partial melting, must be taken into account.

Our new isotopic and trace elements data on the Luzon arc contribute to the general question in the following way. We show that three main components contribute to the source of the arc lavas: the mantle wedge, pelagic or detrital sediments and a less well constrained mixture of sediments and oceanic crust. The contribution of pelagic sediments is clearly illustrated by the relationship between Nd and Hf isotopic compositions; this is probably the only geochemical tool able to clearly distinguish pelagic sediments from detrital sediments. Our new trace element data also show that some key trace element ratios differ in the island arc lavas and in the components subducted under the arc. More specifically, the La/Nb ratio of the volcanic rocks is too high to be explained solely by mixing mantle wedge, subducted sediments and oceanic crust. It appears that Nb was fractionated from La during fluid transfer or magma formation. The probable cause of this fractionation, as suggested most recently by Class et al., (2000) and Elliott et al. (1997), is the retention of rutile or another Nb-bearing mineral during magma genesis.

In summary, significant recycling of material in the form of pelagic sediments is required by the Nd-Hf isotopic data, but this is not the only process that influences the compositions of lavas from the Luzon arc. The formation of new island arc crust results of the combined effects of the type of material subducted under the arc and the processes occurring during fluid transfer and magma formation.

Conclusions

Lavas from the Luzon arc have remarkable Hf isotopic compositions. In Hf-Nd isotopic space, data from the arc form a subhorizontal trend distinct from those of the other intra-oceanic arcs: especially at low Nd isotope ratios, the Hf isotopic compositions of the Luzon lavas are unusually radiogenic. The only exception is Batan Island where the Hf-Nd isotopic correlation is more normal and similar to that of the Lesser Antilles and Banda arcs. The relationship between Hf isotopic compositions and Sm/Hf ratios defines three different groups of islands along the Luzon arc. The northern group includes Luta and Lanshu islands, the southern group Babuyan, Calayan, Camiguin, Cagua and Baguio islands and the third group the island of Batan.

The trace-element and isotopic compositions of each group can be explained in terms of simple binary mixing between two end-members. The northern and southern Luzon islands result from mixing between a depleted mantle source and an unradiogenic component derived dominantly from pelagic sediments.

Under Batan Island, the radiogenic component is not normal depleted mantle but a source already contaminated by material from a subducting slab. The non-radiogenic component resembles lithogenous-hemipelagic clays of the type present today on the South China sea floor. More generally, the correlation between Nd and Hf isotopic compositions in arc lavas seems to be controlled by the nature of the sediments involved in the source. While in Luzon pelagic sediments explain best the subhorizontal isotopic array, in other arcs such as the Lesser Antilles and the Sunda-Banda arc, the Nd-Hf isotopic array is controlled by terrigenous sediments from a continental source

Acknowledgements: This work benefited of valuable help from Janne Blichert-Toft and Philippe Telouk while using the Plasma 54 in Lyon. Discussions with Terry Plank, Nicholas Arndt and Mireille Polvé contributed to major improvements in the manuscript. Very careful and pertinent reviews by Chris Hawkesworth, Julian Pearce, an anonymous reviewer and Alex Halliday helped us produce a more thorough and balanced interpretation of our data with respect to an earlier version of the paper.

References

- Albarède, F. and Goldstein, S.L., 1992. World map of Nd isotopes in sea-floor ferromanganese deposits. *Geology*, 20: 761-763.
- Albarède, F., Simonetti, A., Vervoort, J.D., Blichert-Toft, J. and Abouchami, W., 1998. A Hf-Nd isotopic correlation in ferromanganese nodules. *Geophysical Research Letters*, 25(20): 3895-3898.
- Armstrong, R.L., 1968. A model for the evolution of strontium and lead isotopes in a dynamic Earth. *Review of Geophysics*, 6: 175-199.
- Armstrong, R.L., 1991. The persistent myth of crustal growth. *Australian Journal of Earth Sciences*, 38: 613-630.
- Barrat, J.A. et al., 1996. Determination of rare earth elements in sixteen silicate reference samples by ICP-MS after Tm addition and ion exchange separation. *Geostandards Newsletter*, 20: 133-139.
- Bau, M. and Knittel, U., 1993. Significance of slab-derived partial melts and aqueous fluids for the genesis of tholeiitic and calc-alkaline island-arc basalts: Evidence from Mt. Arayat, Philippines. *Chemical Geology*, 105: 233-251.
- Ben Othman, D., White, W.M. and Patchett, P.J., 1989. The geochemistry of marine sediments, island arc magma genesis, and crust-mantle recycling. *Earth and Planetary Science Letters*, 94: 1-21.
- Blichert-Toft, J. and Albarède, F., 1997. The Lu-Hf isotope geochemistry of chondrites and the evolution of the mantle-crust system. *Earth and Planetary Science Letters*, 148: 243-258.
- Blichert-Toft, J. and Albarède, F., 1999. Hf isotopic compositions of the Hawaii Scientific Drilling Project core and the source mineralogy of Hawaiian basalts. *Geophysical Research Letters*, 26(7): 935-938.
- Blichert-Toft, J., Chauvel, C. and Albarède, F., 1997. Separation of Hf and Lu for high-precision isotope analysis of rock samples by magnetic sector-multiple collector ICP-MS. *Contributions to Mineralogy and Petrology*, 127: 248-260.
- Blichert-Toft, J., Frey, F.A. and Albarède, F., 1999a. Hf isotope evidence for pelagic sediments in the source of Hawaiian basalts. *Science*, 285: 879-882.
- Blichert-Toft, J., Gleason, J.D., Télouk, P. and Albarède, F., 1999b. The Lu-Hf isotope geochemistry of shergottites and the evolution of the Martian mantle-crust system. *Earth and Planetary Science Letters*, 173: 25-39.
- Brenan, J.M., Shaw, H.F., Phinney, D.L. and Ryerson, F.J., 1994. Rutile-aqueous fluid partitioning of Nb, Ta, Hf, Zr, U and Th: Implications for high field strength element depletions in island-arc basalts. *Earth and Planetary Science Letters*, 128: 327-339.
- Chauvel, C. and Blichert-Toft, J., 2001. A hafnium isotope and trace element perspective on melting of the depleted mantle. *Earth and Planetary Science Letters*, 190: 137-151.
- Chauvel, C., Hofmann, A.W. and Vidal, P., 1992. HIMU-EM: The French Polynesian connection. *Earth and Planetary Science Letters*, 110: 99-119.
- Chen, C.-H., Shieh, Y.-N., Lee, T., Chen, C.-H. and Mertzman, S.A., 1990. Nd-Sr-O isotopic evidence for source contamination and an unusual mantle component under Luzon Arc. *Geochimica et Cosmochimica Acta*, 54: 2473-2483.
- Class, C., Miller, D.M., Goldstein, S.L. and Langmuir, C.H., 2000. Distinguishing melt and fluid subduction components in Umnak Volcanics, Aleutian Arc. *Geochemistry, Geophysics, Geosystems*, 1: Paper number 1999GC000010.

- Clift, P., Lee, J.I., Clark, M.K. and Blusztajn, J., 2002. Erosional response of South China to arc rifting and monsoonal strengthening; a record from the South China Sea. *Marine Geology*, 184: 207-226.
- David, K., Frank, M., O'Nions, R.K., Belshaw, N.S. and Arden, J.W., 2001. The Hf isotope composition of global seawater and the evolution of Hf isotopes in the deep Pacific Ocean from Fe-Mn crusts. *Chemical Geology*, 178: 23-42.
- Defant, M.J., Jacques, D., Maury, R.C., Boer, J.D. and Joron, J.-L., 1989. Geochemistry and tectonic setting of the Luzon arc, Philippines. *Geological Society of America Bulletin*, 101: 663-672.
- Defant, M.J. et al., 1990. The geochemistry and tectonic setting of the northern section of the Luzon arc (the Philippines and Taiwan). *Tectonophysics*, 183: 187-205.
- Elderfield, H. and Greaves, M.J., 1981. Negative cerium anomalies in the rare earth element patterns of oceanic ferromanganese nodules. *Earth and Planetary Science Letters*, 55: 163-170.
- Elderfield, H., Hawkesworth, C.J., Greaves, M.J. and Calvert, S.E., 1981. Rare earth element geochemistry of oceanic ferromanganese nodules and associated sediments. *Geochimica et Cosmochimica Acta*, 45: 513-528.
- Ellam, R.M. and Hawkesworth, C.J., 1988. Elemental and isotopic variations in subduction related basalts: Evidence for a three component model. *Contributions to Mineralogy and Petrology*, 98: 72-80.
- Elliott, T., Plank, T., Zindler, A., White, W.M. and Bourdon, B., 1997. Element transport from slab to volcanic front at the Mariana arc. *Journal of Geophysical Research*, 102(B7): 14991-15019.
- Foley, S.F., Barth, M.G. and Jenner, G.A., 2000. Rutile/melt partition coefficients for trace elements and an assessment of the influence of rutile on the trace element characteristics of subduction zone magmas. *Geochimica et Cosmochimica Acta*, 64(5): 933-938.
- Fourcade, S., Maury, R.C., Defant, M.J. and Dermott, F.M., 1994. Mantle metasomatic enrichment versus arc crust contamination in the Philippines: Oxygen isotope study of Batan ultramafic nodules and northern Luzon arc lavas. *Chemical Geology*, 114: 199-215.
- Gill, J.B., 1981. *Orogenic andesites and plate tectonics*, New York, 330 pp.
- Godfrey, L.V. et al., 1997. The Hf isotopic composition of ferromanganese nodules and crusts and hydrothermal manganese deposits: Implications for seawater Hf. *Earth and Planetary Science Letters*, 151: 91-105.
- Hall, R., Ali, J.R., Anderson, C.D. and Baker, S.J., 1995. Origin and motion history of the Philippine Sea Plate. *Tectonophysics*, 251: 229-250.
- Hawkesworth, C.J., Gallagher, K., Hergt, J.M. and McDermott, F., 1993a. Mantle and slab contributions in arc magmas. *Annual Review of Earth and Planetary Sciences*, 21: 175-204.
- Hawkesworth, C.J., Gallagher, K., Hergt, J.M. and McDermott, F., 1993b. Trace element fractionation processes in the generation of island arc basalts. *Philosophical Transactions of the Royal Society of London. A*, 342: 179-191.
- Hawkesworth, C.J., Gallagher, K., Hergt, J.M. and McDermott, F., 1994. Destructive plate margin magmatism: Geochemistry and melt generation. *Lithos*, 33: 169-188.
- Hawkesworth, C.J., Turner, S.P., McDermott, F., Peate, D.W. and Calsteren, P.V., 1997a. U-Th isotopes in arc magmas: Implications for element transfer from the subducted crust. *Science*, 276: 551-555.

- Hawkesworth, C.J., Turner, S.P., Peate, D.W., McDermott, F. and Calsteren, P.V., 1997b. Elemental U-Th variations in island arc rocks: Implications for U-series isotopes. *Chemical Geology*, 139: 207-221.
- Hayes, D.E. and Lewis, S.D., 1984. A geophysical study of the Manila trench, Luzon, Philippines 1. Crustal structure, gravity, and regional tectonic evolution. *Journal of Geophysical Research*, 89(B11): 9171-9195.
- Hofmann, A.W., 1988. Chemical differentiation of the Earth: the relationship between mantle, continental crust, and oceanic crust. *Earth and Planetary Science Letters*, 90: 297-314.
- Hole, M.J., Saunders, A.D., Marriner, G.F. and Tarney, J., 1984. Subduction of pelagic sediments: Implications for the origin of Ce-anomalous basalts from the Mariana Islands. *Journal of the Geological Society of London*, 141: 453-472.
- Huang, C.-Y. et al., 1997. Tectonic evolution of accretionary prism in the arc-continent collision terrane of Taiwan. *Tectonophysics*, 281: 31-51.
- Jacques, D., 1987. Géologie et pétrologie de l'archipel Babuyan et des Monts Tabungon et Cagua, Nord Luzon, Philippines: Implications magmatologiques et géodynamiques, Université de Bretagne Occidentale, Brest, 233 pp.
- Jinmin, W., 1994. Evaluation and models of Cenozoic sedimentation in the South China Sea. *Tectonophysics*, 235: 77-98.
- Langmuir, C.H., Vocke, R.D., Hanson, G.N. and Hart, S.R., 1978. A general mixing equation with applications to Icelandic basalts. *Earth and Planetary Science Letters*, 37: 380-392.
- Lee, T.-Y. and Lawver, L.A., 1995. Cenozoic plate reconstruction of Southeast Asia. *Tectonophysics*, 251: 85-138.
- Li, X.-H. et al., 2003. Geochemical and Nd isotopic variations in sediments of the South China Sea: A response to Cenozoic tectonism in SE Asia. *Earth and Planetary Science Letters*, 211: 207-220.
- Lin, P.-N., 1992. Trace element and isotopic characteristics of western Pacific pelagic sediments: Implications for the petrogenesis of Mariana Arc magmas. *Geochimica et Cosmochimica Acta*, 56: 1641-1654.
- Marini, J.-C. et al., 2003. Hf-Nd isotopic budget of subducting oceanic crust and sediments. *Geophysical Research Abstracts*, 5: EAE-A-00622.
- Maury, R.C. et al., 1998. Temporal geochemical trends in northern Luzon arc lavas (Philippines): Implications on metasomatic processes in the island arc mantle. *Bulletin de la Société Géologique de France*, 169(1): 69-80.
- Maury, R.C., Defant, M.J. and Joron, J.-L., 1992. Metasomatism of the sub-arc mantle inferred from trace elements in Philippine xenoliths. *Nature*, 360: 661-663.
- McCulloch, M.T. and Bennett, V.C., 1994. Progressive growth of the Earth's continental crust and depleted mantle: Geochemical constraints. *Geochimica et Cosmochimica Acta*, 58: 4717-4738.
- McCulloch, M.T. and Gamble, J.A., 1991. Geochemical and geodynamical constraints on subduction zone magmatism. *Earth and Planetary Science Letters*, 102: 358-374.
- McDermott, F., Defant, M.J., Hawkesworth, C.J., Maury, R.C. and Joron, J.-L., 1993. Isotope and trace element evidence for three component mixing in the genesis of the North Luzon arc lavas (Philippines). *Contributions to Mineralogy and Petrology*, 113: 9-23.
- McLennan, S.M., 2001. Relationships between the trace element composition of sedimentary rocks and upper continental crust. *Geochemistry, Geophysics, Geosystems*, 2: Paper number 2000GC000109.
- McLennan, S.M., Taylor, S.R., Culloch, M.T.M. and Maynard, J.B., 1990. Geochemical and Nd-Sr isotopic composition of deep-sea turbidites: crustal evolution and plate tectonic associations. *Geochimica et Cosmochimica Acta*, 54: 2015-2050.

- Murton, B.J., Peate, D.W., Arculus, R.J., Pearce, J.A. and Laan, S.R.V.d., 1992. Trace-element geochemistry of volcanic rocks from Site 786: The Izu-Bonin forearc. *Proceedings of the Ocean Drilling Program Scientific Results*, 125: 211-235.
- Palmer, M.R., 1985. Rare earth elements in foraminifera tests. *Earth and Planetary Science Letters*, 73: 285-298.
- Palmer, M.R. and Elderfield, H., 1985. Variations in the Nd isotopic composition of foraminifera from Atlantic Ocean sediments. *Earth and Planetary Science Letters*, 73: 299-305.
- Palmer, M.R. and Elderfield, H., 1986. Rare earth elements and neodymium isotopes in ferromanganese oxide coatings of Cenozoic foraminifera from the Atlantic Ocean. *Geochimica et Cosmochimica Acta*, 50: 409-417.
- Patchett, P.J., 1983. Hafnium isotope results from mid-ocean ridges and Kerguelen. *Lithos*, 16: 47-51.
- Patchett, P.J. and Tatsumoto, M., 1980. Hafnium isotope variations in oceanic basalts. *Geophysical Research Letters*, 7(12): 1077-1080.
- Patchett, P.J., White, W.M., Feldmann, H., Kielinczuk, S. and Hofmann, A.W., 1984. Hafnium/rare earth element fractionation in the sedimentary system and crustal recycling into the Earth's mantle. *Earth and Planetary Science Letters*, 69: 365-378.
- Pearce, J.A., Kempton, P.D., Nowell, G.M. and Noble, S.R., 1999. Hf-Nd element and isotope perspective on the nature and provenance of mantle and subduction components in Western Pacific arc-basin systems. *Journal of Petrology*, 40(11): 1579-1611.
- Piepgras, D.J. and Jacobsen, S.B., 1988. The isotopic composition of neodymium in the North Pacific. *Geochimica et Cosmochimica Acta*, 52: 1373-1381.
- Plank, T. and Langmuir, C.H., 1993. Tracing trace element from sediment input to volcanic output at subduction zones. *Nature*, 362: 739-742.
- Plank, T. and Langmuir, C.H., 1998. The chemical composition of subducting sediment and its consequences for the crust and mantle. *Chemical Geology*, 145: 325-394.
- Prell, W.L., Wang, P., Blum, P. and al., e., 1999. Leg 184 Preliminary report-South China Sea. *Proceedings of the Ocean Drilling Program*: 102.
- Prouteau, G., Scaillet, B., Pichavant, M. and Maury, R.C., 1999. Fluid-present melting of ocean crust in subduction zones. *Geology*, 27(12): 1111-1114.
- Pubellier, M., Quebral, R., Aurelio, M. and Rangin, C., 1996. Docking and post-docking tectonics in the southern Philippines. In: R. Hall and D. Blundel (Editors), *Tectonic evolution of SE Asia*. Geological Society of America Special Publication, pp. 511-523.
- Reymer, A. and Schubert, G., 1984. Phanerozoic addition rates of the continental crust and crustal growth. *Tectonics*, 3: 63-77.
- Richard, M., Bellon, H., Maury, R.C., Barrier, E. and Juang, W.-S., 1986a. Miocene to recent calc-alkalic volcanism in eastern Taiwan: K-Ar ages and petrography. *Tectonophysics*, 125: 87-102.
- Richard, M. et al., 1986b. Geology of Mt. Iraya volcano and Batan island, Northern Philippines. *Philippines Bulletin of Volcanology*, 3: 1-27.
- Sajona, F.G. et al., 2000. Slab melt as metasomatic agent in island arc magma mantle sources, Negros and Batan (Philippines). *The Island Arc*, 9: 472-486.
- Salters, V.J.M., 1996. The generation of mid-ocean ridge basalts from the Hf and Nd isotope perspective. *Earth and Planetary Science Letters*, 141: 109-123.
- Salters, V.J.M. and Hart, S.R., 1991. The mantle sources of ocean ridges, islands and arcs: the Hf-isotope connection. *Earth and Planetary Science Letters*, 104: 364-380.
- Salters, V.J.M. and White, W.M., 1998. Hf isotope constraints on mantle evolution. *Chemical Geology*, 145: 447-460.

- Saunders, A.D., Norry, M.J. and Tarney, J., 1991. Fluid influence on the trace element compositions of subduction zone magmas. *Philosophical Transactions of the Royal Society of London. A*, 335: 377-392.
- Schiano, P. et al., 1995. Hydrous, silica-rich melts in the sub-arc mantle and their relationship with erupted arc lavas. *Nature*, 377: 595-600.
- Shimizu, H. and Masuda, A., 1977. Cerium in chert as an indication of marine environment of its formation. *Nature*, 266: 346-348.
- Stalder, R., Foley, S.F., Brey, G.P. and Horn, I., 1998. Mineral-aqueous fluid partitioning of trace elements at 900-1200°C and 3.0-5.7 GPa: New experimental data for garnet, clinopyroxene, and rutile, and implications for mantle metasomatism. *Geochimica et Cosmochimica Acta*, 62(10): 1781-1801.
- Stephan, J.F. et al., 1986. Geodynamic evolution of the Taiwan-Luzon-Mindoro belt since the late Eocene. *Tectonophysics*, 125: 245-268.
- Stille, P., Unruh, D.M. and Tatsumoto, M., 1983. Pb, Sr, Nd and Hf isotopic evidence of multiple sources for Oahu, Hawaii basalts. *Nature*, 304: 25-29.
- Stille, P., Unruh, D.M. and Tatsumoto, M., 1986. Pb, Sr, Nd, and Hf isotopic constraints on the origin of Hawaiian basalts and evidence for a unique mantle source. *Geochimica et Cosmochimica Acta*, 50: 2303-2319.
- Sun, S.-S. and McDonough, W.F., 1989. Chemical and isotopic systematics of oceanic basalts: Implications for mantle composition and processes. In: A.D. Saunders and M.J. Norry (Editors), *Magmatism in the Ocean Basins*. Geological Society Special Publication, London, pp. 313-345.
- Tatsumi, Y., Hamilton, D.L. and Nesbitt, R.W., 1986. Chemical characteristics of fluid phase released from a subducted lithosphere and origin of arc magmas: Evidence from high pressure experiments and natural rocks. *Journal of Volcanology and Geothermal Research*, 29: 293-309.
- Taylor, S.R. and McLennan, S.M., 1985. *The Continental Crust: Its Composition and Evolution*, Boston, Mass., 312 pp.
- Taylor, S.R. and McLennan, S.M., 1995. The geochemical evolution of the continental crust. *Reviews of Geophysics*, 33(2): 241-265.
- Teng, L.S., 1990. Geotectonic evolution of late Cenozoic arc-continent collision in Taiwan. *Tectonophysics*, 183: 57-76.
- Toyoda, K., Nakamura, Y. and Masuda, A., 1990. Rare earth elements of Pacific pelagic sediments. *Geochimica et Cosmochimica Acta*, 54: 1093-1103.
- Tu, K. et al., 1992. Magmatism in the South China Basin 1. Isotopic and trace-element evidence for an endogenous Dupal mantle component. *Chemical Geology*, 97: 47-63.
- Turner, S.P. et al., 1996. U-series isotopes and destructive plate margin magma genesis in the Lesser Antilles. *Earth and Planetary Science Letters*, 142: 191-207.
- Vervoort, J.D., Patchett, P.J., Blichert-Toft, J. and Albarède, F., 1999. Relationships between Lu-Hf and Sm-Nd isotopic systems in the global sedimentary system. *Earth and Planetary Science Letters*, 168: 79-99.
- Vidal, P., Dupuy, C., Maury, R. and Richard, M., 1989. Mantle metasomatism above subduction zones: Trace-element and radiogenic isotope characteristics of peridotite xenoliths from Batan Island (Philippines). *Geology*, 17: 1115-1118.
- Vroon, P.Z., Bergen, M.J.V., Klaver, G.J. and White, W.M., 1995. Strontium, neodymium, and lead isotopic and trace-element signatures of the East Indonesian sediments: provenance and implications for Banda Arc magma genesis. *Geochimica et Cosmochimica Acta*, 59(12): 2573-2598.

- Vroon, P.Z., Bergen, M.J.V., White, W.M. and Varekamp, J.C., 1993. Sr-Nd-Pb isotope systematics of the Banda arc, Indonesia: combined subduction and assimilation of continental material. *Journal of Geophysical Research*, 98(B12): 22349-22366.
- Vroon, P.Z., Nowell, G., Hoogewerff, J.A. and Bergen, M.J.v., 1998. HFSE mobility at the slab-wedge interface: Hafnium-isotope evidence from the east Sunda-Banda arc. *Mineralogical Magazine*, 62A: 1617-1618.
- White, W.M. and Dupré, B., 1986. Sediment subduction and magma genesis in the Lesser Antilles: isotopic and trace element constraints. *Journal of Geophysical Research*, 91(B6): 5927-5941.
- White, W.M., Dupré, B. and Vidal, P., 1985. Isotope and trace element geochemistry of sediments from the Barbados Ridge-Demerara Plain region, Atlantic Ocean. *Geochimica et Cosmochimica Acta*, 49: 1875-1886.
- White, W.M. and Patchett, P.J., 1984. Hf-Nd-Sr isotopes and incompatible element abundances in island arcs: implications for magma origins and crust-mantle evolution. *Earth and Planetary Science Letters*, 67: 167-185.
- White, W.M., Patchett, P.J. and Othman, D.B., 1986. Hf isotope ratios of marine sediments and Mn nodules: evidence for a mantle source of Hf in seawater. *Earth and Planetary Science Letters*, 79: 46-54.
- Woodhead, J.D., 1989. Geochemistry of the Mariana arc (western Pacific): Source composition and processes. *Chemical Geology*, 76: 1-24.
- Woodhead, J.D., Hergt, J.M., Davidson, J.P. and Eggins, S.M., 2001. Hafnium isotope evidence for 'conservative' element mobility during subduction zone processes. *Earth and Planetary Science Letters*, 192: 331-346.

GROUP	Northern	Northern	Northern	Northern	Northern	Northern	Batan	Batan	Batan	Batan	Batan	Batan	Trans-N-S
LOCATION	Lulao	Lulao	Lulao	Lulao	Lanshu	Lanshu	Batan	Batan	Batan	Batan	Basalle	Batan	Babuyan
ROCK TYPE	Andesite	Andesite	Andesite	Duplicate	Bas. andesite	Bas. andesite	Bas. andesite	Bas. andesite	Andesite	Bas. andesite	Bas. andesite	Bas. andesite	Andesite
SAMPLE	TW 36	TW 40	Duplicate TW 40 ^a	TW 41	TW 31	TW 32	B 3m	B 10	B 2	B 80	B 88	B 20	
K-Ar Age (Ma)	1.88 ± 0.28	2.94 ± 0.15	2.88 ± 0.15	3.86 ± 0.2	5.45 ± 0.27	1480 ± 50 years	2370 ± years	1.09 ± 0.08	2.30 ± 0.35	0.76 ± 0.04	1.68 ± 0.09		
Co (ppm)	16.9	15.5	14.5	9.75	13.6	19.1	18.6	19.2	18.2	33.3	22.1	21.6	
Rb	63.2	59.2	56.2	39.1	18.8	18.8	114	107	65.9	27.7	113	36.8	
Sr	2622	2743	2606	600	582	232	641	953	1366	492	587	301	
Y	16.4	14.0	13.3	11.7	16.0	16.2	19.6	22.2	14.5	14.4	19.6	17.4	
Zr	224	203	195	82.0	88.4	77.3	195	237	143	82.3	253	87.8	
Nb	17.0	14.9	14.6	4.21	2.27	1.72	9.74	11.8	6.40	3.61	13.9	3.19	
Cs	7.51	7.45	7.79	1.12	0.74	0.50	8.69	9.05	2.75	1.32	3.61	0.77	
Ba	1594	1524	1473	425	282	186	701	826	549	288	657	222	
La	169	164	162	20.5	15.1	10.6	38.6	48.6	29.5	12.7	34.1	15.9	
Ce	282	271	266	39.1	30.2	20.5	81.6	103	61.4	29.0	80.3	32.6	
Pr	25.8	24.5	24.7	4.53	3.72	2.50	9.69	12.2	7.74	3.91	10.5	4.19	
Nd	77.6	72.4	70.5	16.2	14.5	9.65	36.2	45.8	31.6	16.9	40.6	16.7	
Sm	8.73	7.75	7.43	2.89	2.84	2.13	6.17	7.96	5.81	3.51	6.81	3.60	
Eu	1.72	1.55	1.54	0.85	0.85	0.66	1.44	1.87	1.30	0.92	1.45	0.97	
Gd	4.19	3.68	3.76	2.38	2.69	2.14	4.24	5.38	4.47	2.81	4.41	3.09	
Tb	0.52	0.46	0.44	0.34	0.41	0.35	0.58	0.69	0.49	0.41	0.59	0.46	
Dy	2.61	2.25	2.25	1.90	2.54	2.25	3.13	3.62	2.54	2.44	3.26	2.71	
Ho	0.52	0.43	0.45	0.40	0.55	0.51	0.65	0.72	0.50	0.50	0.66	0.58	
Er	1.55	1.33	1.27	1.16	1.60	1.60	1.92	2.08	1.23	1.42	1.93	1.59	
Yb	1.51	1.34	1.30	1.16	1.48	1.54	1.84	1.89	1.21	1.36	1.85	1.60	
Lu	0.24	0.21	0.22	0.19	0.25	0.26	0.30	0.30	0.17	0.21	0.29	0.26	
Hf	5.31	4.97	4.81	2.25	2.38	2.00	4.81	5.76	3.83	2.24	6.34	2.34	
Ta	0.93	0.85	0.87	0.27	0.14	0.11	18.0	0.66	0.35	0.20	0.78	0.19	
Pb	52.8	74.5	71.9	11.0	4.96	6.35	21.5	19.0	12.0	7.30	15.3	10.1	
Th	87.4	85.2	83.7	7.48	4.82	3.29	21.5	24.4	9.07	4.94	34.3	5.03	
U	15.7	15.5	14.6	1.59	1.20	0.83	3.99	4.48	2.20	0.92	5.38	1.06	
¹⁴³ Nd / ¹⁴⁴ Nd	0.512295	0.512316	0.512299	0.512259	0.512735	0.512641	0.51248	0.51255	0.51251	0.512552	0.51239	0.51256	
ϵ_{Nd}	-6.7	-6.3	-6.3	-0.9	+1.9	+0.1	-3.1	-1.7	-2.5	-1.7	-4.8	-1.5	
¹⁷⁶ Hf / ¹⁷⁷ Hf	0.282925	0.282942	0.283001	0.283004	0.283064	0.283074	0.282804	0.282798	0.282786	0.282895	0.282693	0.283085	
2 σ	0.000007	0.000016	0.000011	0.000018	0.000007	0.000007	0.000016	0.000015	0.000013	0.000008	0.000015	0.000010	
ϵ_{Hf}	+5.4	+6.0	+8.1	+10.3	+10.7	+1.1	+0.9	+0.5	+4.3	-2.8	+11.1		

Table 1 K-Ar ages, trace element, Nd and Hf isotopic data of Luzon arc lavas. K-Ar ages and Nd isotopic data noted in italic are from Richard et al. 1986a, 1986b; Defant et al. 1990; McDermott et al. 1993; Fourcade et al. 1994 and Maury et al. 1998. Trace element and Hf isotopic compositions were analysed during this study.
 ϵ_{Hf} values were calculated with $(^{176}\text{Hf} / ^{177}\text{Hf})_{\text{CHUR}} = 0.282772$ after Blichert-Toft and Albarede 1997.
^aComplete duplicate analysis

GROUP	Southern	Southern	Southern	Southern	Southern	Southern	Southern	Southern	Southern	Southern	Southern	Values used to calculate sample concentration
LOCATION	Babuyan	Calayan	Calayan	Camiguin	Camiguin	Camiguin	Camiguin	Caigua	Caigua	Caigua	Baguio	Baguio
ROCK TYPE	Basalle	Andesite	Bas. andesite	Andesite	Andesite	Bas. andesite	Bas. andesite	Bas. andesite	Bas. andesite	Bas. andesite	Basalle	Basalle
SAMPLE	B839	Cl 1	Cl 16	Cm 5	Duplicate Cm 5 ^a	Cm 54	Cm 54	Ca 9	Ca 26	Ca 26	47 A	Duplicate 47 A ^a
K-Ar Age (Ma)	1.74 ± 0.14	5.33 ± 0.23	5.68 ± 0.38	0.69 ± 0.1	0.74 ± 0.06	0.64 ± 0.19	Inf. to 10000 yrs	2.9				BHVO
Co (ppm)	30.2	22.1	26.5	19.4	19.9	18.3	14.0	18.6	30.1	45.0		
Rb	17.9	3.65	4.81	21.3	21.8	31.5	28.4	25.1	19.7	9.20		
Sr	378	183	215	746	754	507	634	529	519	399		
Y	14.7	19.8	19.8	16.2	16.6	19.8	20.0	19.5	28.0	28.0		
Zr	48.0	74.1	67.0	69.5	71.7	97.2	63.8	62.9	101	184		
Nb	1.78	1.64	1.94	2.38	2.43	3.17	4.32	3.47	3.8	19.7		
Cs	1.11	0.03	0.20	0.65	0.68	2.39	1.49	1.52	0.49	0.0967		
Ba	179	53.3	55.5	287	296	325	501	406	249	132.86		
La	10.6	4.06	4.13	11.0	11.3	21.6	14.7	11.8	13.0	15.5		
Ce	22.5	10.2	10.0	23.3	23.8	43.1	27.5	22.2	27.5	38.0		
Pr	2.99	1.53	1.46	2.99	3.08	5.32	3.39	2.98	4.10	5.45		
Nd	12.1	7.18	7.13	12.4	12.7	20.7	13.8	12.2	18.4	24.7		
Sm	2.80	2.08	2.16	2.64	2.67	4.03	3.03	2.91	4.53	6.17		
Eu	0.85	0.66	0.73	0.81	0.88	1.14	0.95	0.95	1.40	2.06		
Gd	2.64	2.54	2.61	2.71	2.82	3.75	3.27	2.95	4.89	6.22		
Tb	0.39	0.45	0.47	0.40	0.42	0.55	0.49	0.47	0.73	0.95		
Dy	2.40	2.81	2.79	2.44	2.52	3.13	2.95	2.96	4.34	5.25		
Ho	0.52	0.66	0.64	0.54	0.55	0.65	0.66	0.67	0.95	1.00		
Er	1.47	1.96	1.98	1.62	1.67	1.95	2.02	1.95	2.63	2.56		
Yb	1.39	1.89	1.85	1.57	1.67	1.90	1.97	1.91	2.40	1.98		
Lu	0.23	0.29	0.28	0.25	0.25	0.28	0.29	0.31	0.37	0.278		
Hf	1.35	2.06	1.77	1.91	1.97	2.49	1.81	1.71	2.70	4.49		
Ta	0.10	0.10	0.12	0.14	0.16	0.17	0.24	0.21	0.21	1.21		
Pb	7.45	1.74	1.92	3.49	3.53	7.05	7.52	5.82	4.61	2.055		
Th	2.93	0.74	0.71	2.77	2.87	6.35	3.98	3.16	2.59	1.247		
U	0.58	0.32	0.21	0.71	0.72	1.26	1.02	0.95	0.81	0.41		
¹⁴³ Nd / ¹⁴⁴ Nd	0.51258	0.51306	0.512977	0.51302	0.512778	0.51264	0.51287	0.512937	0.512937	0.512937		
ε _{Nd}	-1.1	+8.2	+6.6	+7.5	+2.7	0.0	+4.5	+5.8				
¹⁷⁶ Hf / ¹⁷⁷ Hf	0.283145	0.283242	0.283251	0.283226	0.283186	0.283178	0.28317	0.283189	0.283155			
2 σ	0.000011	0.000025	0.000008	0.000011	0.000018	0.000011	0.000016	0.000015	0.000016			
ε _{Hf}	+13.2	+16.6	+16.9	+16.1	+14.6	+14.4	+14.1	+14.7	+13.5			

LOCATION	Lulao	Lulao	Lulao	Lanshu	Lanshu	Batan	Batan	Batan	Batan	Batan
ROCK TYPE	Andesite	Andesite	Andesite	Bas. andesite	Bas. andesite	Bas. andesite	Bas. andesite	Andesite	Basalte	Bas. andesite
SAMPLE	TW 36	TW 40	TW 41	TW 31	TW 32	B 3m	B 10	B 42	B 80	B 88
SiO ₂ (wt%)	55.3	56.2	60.2	54.5	53.1	53.6	54.0	59.1	51.9	52.2
TiO ₂	0.61	0.54	0.52	0.82	0.73	0.95	0.97	0.95	0.81	1.12
Al ₂ O ₃	18.1	18.45	18.9	18.9	16.85	19.85	18.36	16.98	15.57	18.64
Fe ₂ O ₃	6.34	5.64	2.31	5.56	8.33			5.85	9.13	8.67
MnO	0.13	0.11	0.07	0.10	0.15	0.17	0.16	0.09	0.16	0.16
MgO	4.20	4.17	2.31	4.56	6.42	3.58	3.63	3.59	7.90	3.82
CaO	7.41	7.03	6.95	9.54	9.32	8.21	8.29	6.64	11.13	8.84
Na ₂ O	3.56	3.66	3.71	3.40	3.06	3.47	3.55	3.86	2.57	3.33
K ₂ O	1.90	1.99	1.48	1.11	1.02	2.27	2.11	2.69	1.11	2.51
P ₂ O ₅	0.34	0.25	0.11	0.05	0.04	0.45	0.45	0.35	0.15	0.40
LOI	1.18	1.43	0.76	0.92	0.30	0.22	0.34	0.03	0.19	-0.04
H ₂ O	0.28	0.27	0.63	0.62	0.23	0.50	1.45	0.06	0.37	0.16
Total	99.35	99.74	100.2	99.99	99.11			100.19	100.99	99.81
⁸⁷ Sr / ⁸⁶ Sr	0.706102	0.706013	0.70483	0.704313	0.705452	0.70476	0.70445	0.70393	0.70396	0.70545
2σ	0.000006	0.000009		0.000008	0.000006					
²⁰⁸ Pb / ²⁰⁴ Pb	18.424	18.429	18.412	18.298	18.394	18.455	18.298	18.36	18.351	18.378
²⁰⁷ Pb / ²⁰⁴ Pb	15.639	15.637	15.611	15.573	15.622	15.64	15.538	15.558	15.571	15.594
²⁰⁶ Pb / ²⁰⁴ Pb	38.845	38.83	38.698	38.561	38.781	38.834	38.492	38.516	38.515	38.661
δ ¹⁸ O	+6.91	+6.48	+7.92	+6.61	+6.39	+6.51		+6.11	+5.97	+6.15

Appendix: Major elements, Sr, Pb and O isotopic data of the Luzon arc lavas analysed for Hf isotopic compositions. Data from Richard et al. 1986a, 1986b; Vidal et al. 1989; Defant et al. 1990; McDermott et al. 1993; Fourcade et al. 1994 and Maury et al. 1998.

LOCATION	Babuyan Andesite B220	Babuyan Basalte B339	Calayan Andesite CI 1	Calayan Bas. andesite CI 16	Camiguin Andesite Cm 5	Camiguin Bas. andesite Cm 54	Cagua Bas. andesite Ca 9	Cagua Bas. andesite Ca 26	Baguio Basalte 47 A
SiO ₂ (wt%)	55.7	51.3	57.7	55.5	58.25	53.8	55.2	53.3	48.5
TiO ₂	0.83	0.81	0.81	0.91	0.74	1.05	0.92	1.05	1.29
Al ₂ O ₃	17.67	18.38		16.9		18.48			19.25
Fe ₂ O ₃	7.88	9.75		8.26		6.78			11.18
MnO	0.14	0.17		0.16		0.14			0.16
MgO	4.01	5.21		5.17		4.26	2.73	3.59	4.19
CaO	8.46	10.66		9.60		9.10		10.5	10.5
Na ₂ O	3.39	2.72		3.06		3.37		3.06	3.06
K ₂ O	1.21	0.74	0.49	0.37	1.19	1.45	1.32	1.12	1.07
P ₂ O ₅	0.10	0.10		0.10		0.20			0.20
LOI	0.25	0.0	0.45	0.17	0.23	1.26			0.62
H ₂ O	0.24	0.15		0.13		0.22			0.28
Total	99.88	99.16		100.33		100.11			100.3
⁸⁷ Sr / ⁸⁶ Sr	0.704565	0.70448	0.7037	0.703707	0.70327	0.704078	0.70386	0.70395	0.703774
2σ	0.000007			0.000019		0.000009			0.000008
²⁰⁸ Pb / ²⁰⁴ Pb	18.531	18.515		18.274	18.37	18.5	18.502	18.569	18.348
²⁰⁷ Pb / ²⁰⁴ Pb	15.614	15.621		15.554	15.543	15.609	15.574	15.615	15.532
²⁰⁶ Pb / ²⁰⁴ Pb	38.837	38.782		38.348	38.425	38.731	38.645	38.804	38.343
δ ¹⁸ O	+7.02	+6.13	+6.86	+6.98	+6.7	+7.3			+6.69

Figure Captions

Figure 1 Location map of the Luzon arc. Black dots indicate the locations of the studied volcanic islands in the northern part of the arc (segments 1,2 and 3 from Defant et al. (1989 and 1990)). Volcanoes in the southern part of the arc (for example segment 4, which includes Mt Pinatubo and Taal) have been omitted for clarity as they are not studied here. Also shown are the locations of the Lamont-Doherty sediment cores analysed by Chen et al. (1990), McDermott et al. (1993) and the ODP sites 1144 to 1148 (Leg 184) where the clays analysed by Clift et al. (2002) and Li et al. (2003) were sampled.

Figure 2 ϵ_{Hf} vs. ϵ_{Nd} diagram showing data for the Luzon arc together with the fields of the other oceanic arcs (data from Pearce et al. (1999), White and Patchett (1984) and Woodhead et al. (2001)). The “Depleted arcs” term is used to group the Marianas, Izu, New Britain, Aleutians and Kermadec arcs which have isotopic compositions close to MORB. Fields for MORB and OIB were drawn using literature data (Blichert-Toft and Albarède, 1999; Blichert-Toft et al., 1999a; Chauvel and Blichert-Toft, 2001; Chauvel et al., 1992; Patchett, 1983; Patchett and Tatsumoto, 1980; Salters, 1996; Salters and Hart, 1991; Salters and White, 1998; Stille et al., 1983; Stille et al., 1986).

Figure 3 Trace element patterns of the Luzon arc lavas normalized to the primitive mantle values of Hofmann (1988).

Figure 4 (a) Sm/Hf vs. ϵ_{Hf} diagram of the Luzon arc lavas. On the basis of relations between Sm/Hf and the ϵ_{Hf} ratios, three distinct groups can be identified in the Luzon arc: the northern group, the southern group and Batan Island. Babuyan Island is located at the boundary between the northern and southern groups. One sample of this island (Bb 39) is included in the southern group but another sample, Bb 20, has a composition intermediate between the two groups. (b) and (c) Pb/Hf and Sr/Hf vs. ϵ_{Hf} diagram of the Luzon arc lavas showing the same three Luzon groups. The primitive mantle and MORB values in this and other diagrams are from Hofmann (1988).

Figure 5 Ce/Ce* vs. ϵ_{Hf} diagram for the Luzon arc lavas. The northern and southern groups have negative Ce anomalies whose magnitude correlates with their ϵ_{Hf} ratios. These anomalies

are comparable to those in the Marianas arc lavas (Pearce et al., 1999; White and Patchett, 1984; Woodhead et al., 2001). Batan samples do not have significant Ce anomalies.

Figure 6 Hf/Nd vs. ϵ_{Nd} diagram for the Luzon arc lavas. The data scatter around linear arrays because of the combined effects of mixing and melting which both change the Hf/Nd ratio (see text for further explanation). The range of the present day South China Sea sediments has been drawn using the data of Chen et al. (1990), Clift et al. (2002), McDermott et al. (1993) and Li et al. (2003).

Figure 7 Hf/Sm vs. ϵ_{Nd} diagram for the Luzon arc lavas. For the northern, southern and Batan lavas the Hf/Sm ratios show approximate linear correlations with the ϵ_{Nd} values (see text for discussion). Data sources as in Figure 6.

Figure 8 Sm/Nd vs. ϵ_{Nd} diagram showing that the Sm/Nd ratio of each group of lavas does not change by more than a factor of two. Data source as in Figure 6.

Figure 9 ϵ_{Hf} vs. ϵ_{Nd} diagram showing the mixing hyperbolas of the three Luzon lavas groups, together with the oceanic sediments. On each hyperbola, the ranges of the non radiogenic end-members are indicated by thick strokes. Lithogenous sediment data and Fe-Mn crusts and nodules field are from Albarède et al. (1998), Ben Othman et al. (1989), David et al. (2001) Godfrey et al. (1997), Pearce et al. (1999), Vervoort et al. (1999) and White et al. (1986). The present day South China Sea sediment range is from Chen et al. (1990), Clift et al. (2002), Li et al. (2003) and McDermott et al. (1993). The field for Site 1149 Pacific pelagic sediments is from Marini et al. (2003). These sediments are mixtures of clay minerals, volcanic ash and siliceous nanofossils, and have Hf and Nd isotopic compositions similar to those of Fe-Mn crusts and nodules. The “terrestrial array” is from Vervoort et al. (1999) and the MORB field has been drawn using the same references as in Fig. 2.

Figure 10 U/Th vs. ϵ_{Hf} diagram for Luzon arc lavas. The U/Th ratios of the lavas do not increase as ϵ_{Hf} decreases showing that the non radiogenic components of the source do not have high U/Th ratios.

Figure 11 (a) Th/Nb vs. ϵ_{Hf} and (b) La/Nb vs. ϵ_{Hf} diagrams for Luzon arc lavas, together with compositions of lithogenous sediments (McLennan et al., 1990; Pearce et al., 1999; Vervoort et al., 1999) and the average upper continental crust value (McLennan, 2001). The increasing Th/Nb and La/Nb ratios cannot be explained by involvement of HFSE-depleted aqueous fluids because there is no associated increase in U/Th ratios (see Fig. 10). Nor can the involvement of sediments from continental crust explain the data because the northern and southern Luzon lavas have HFSE anomalies that are often bigger than in detrital sediments. Consequently these diagrams suggest that Nb is retained in the source in a residual HFSE rich mineral such as rutile.

Figure 1

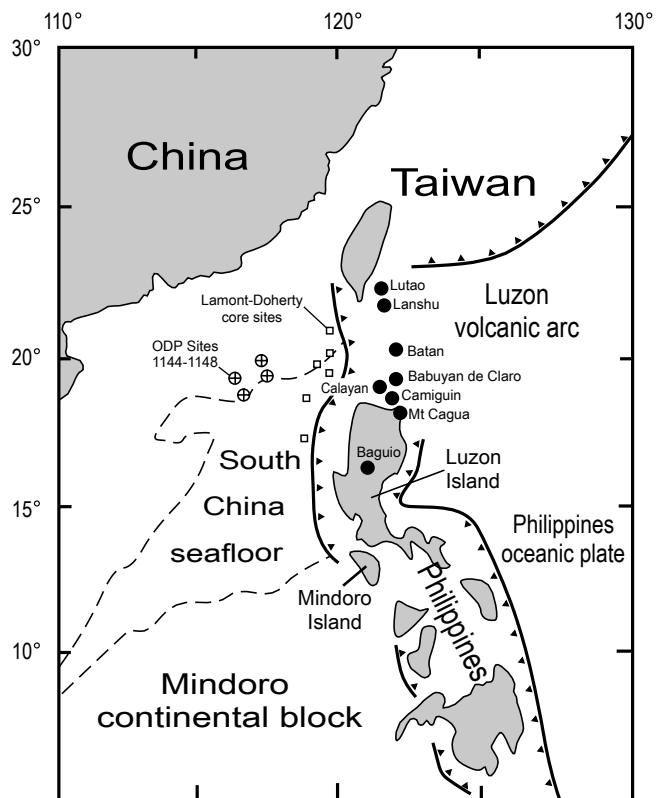

Figure 2

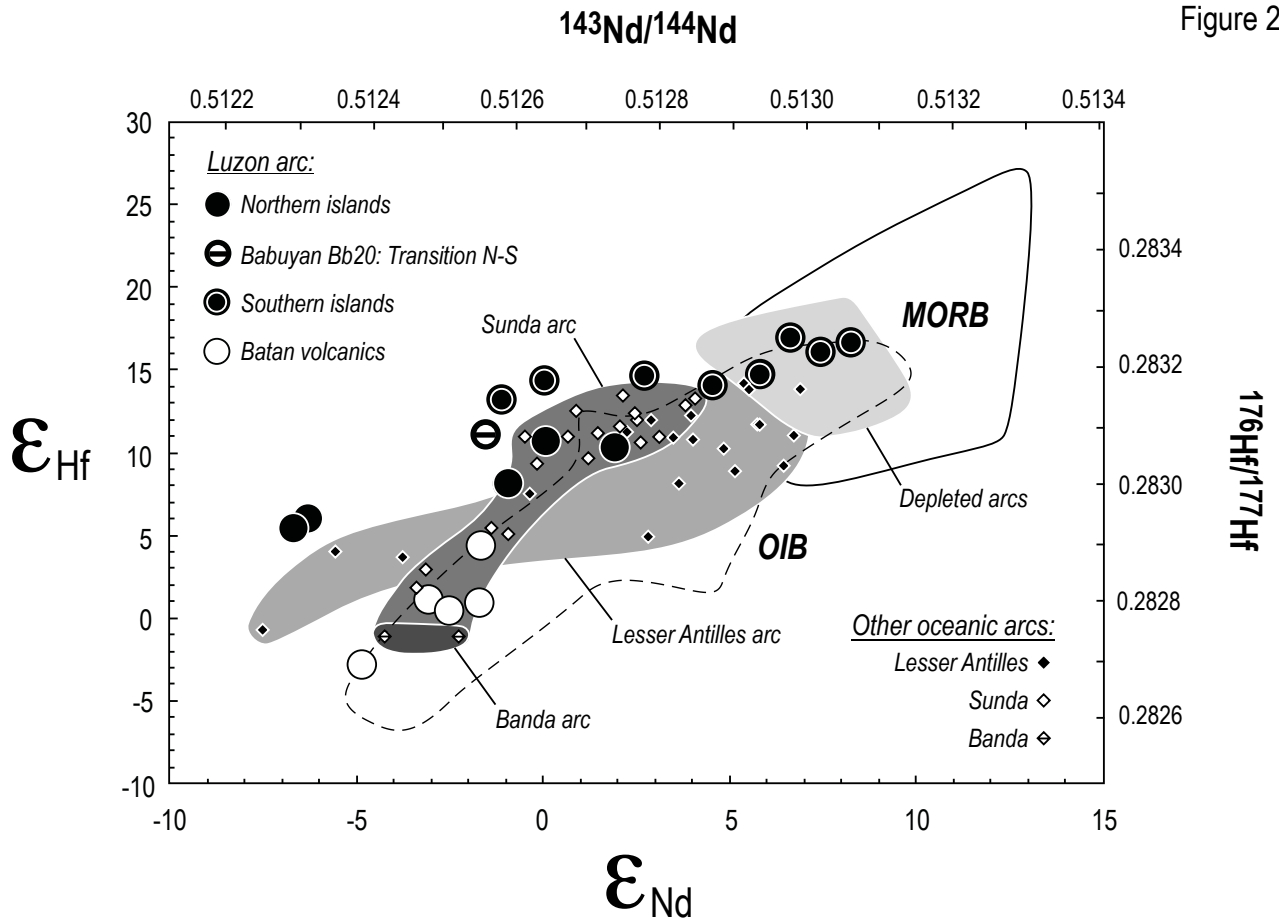
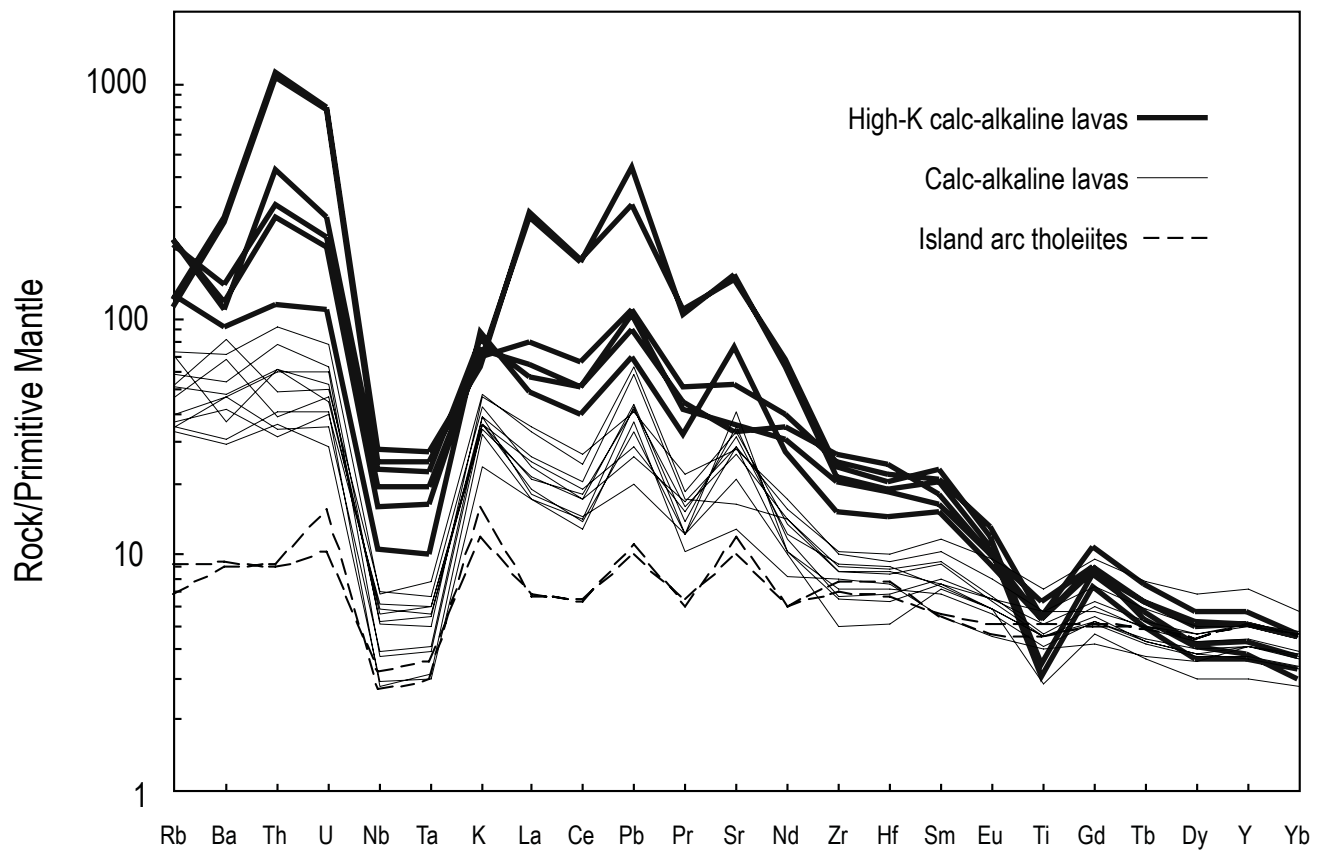

Figure 3



$^{176}\text{Hf}/^{177}\text{Hf}$

Figure 4a

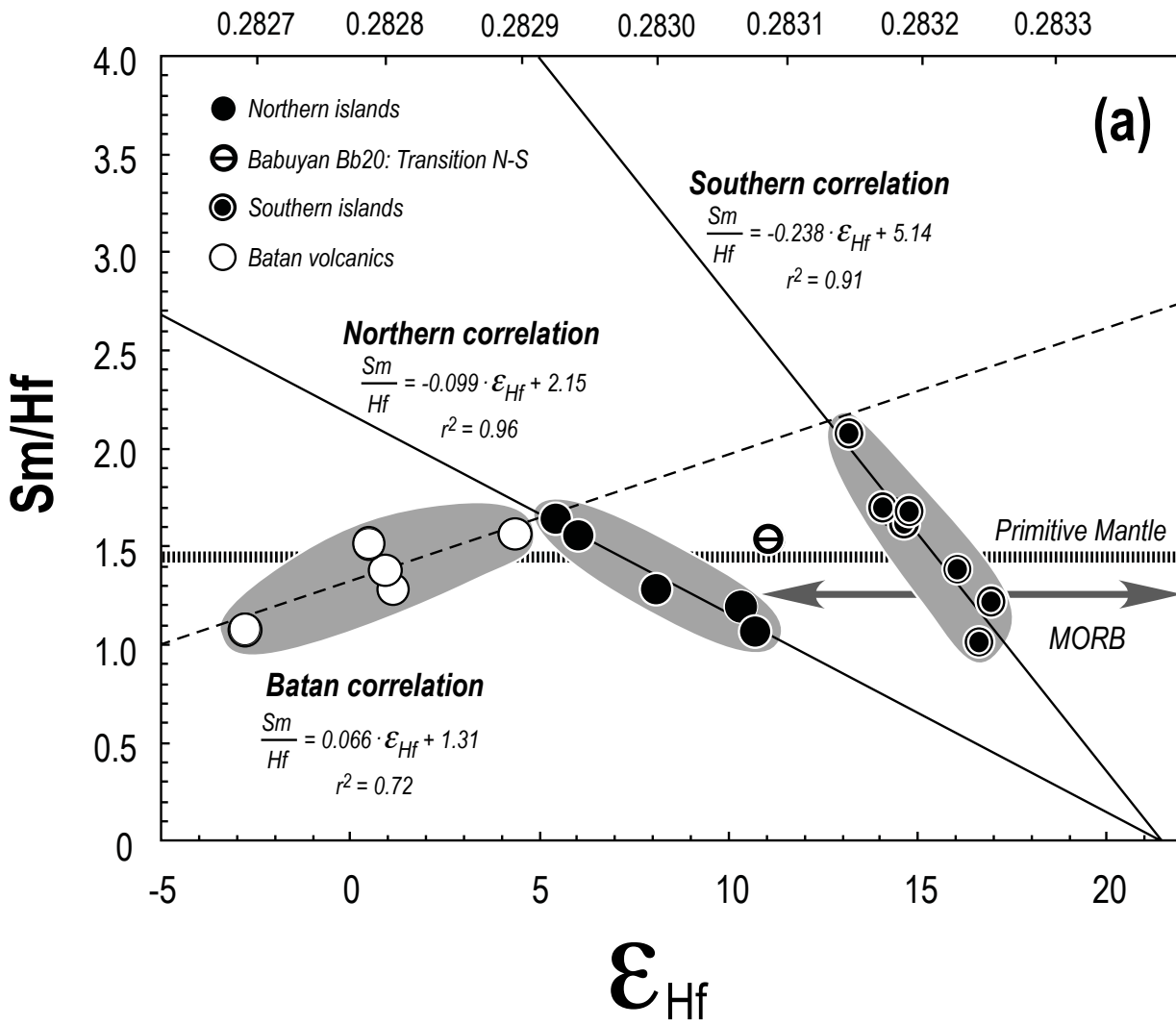

Figure 4b

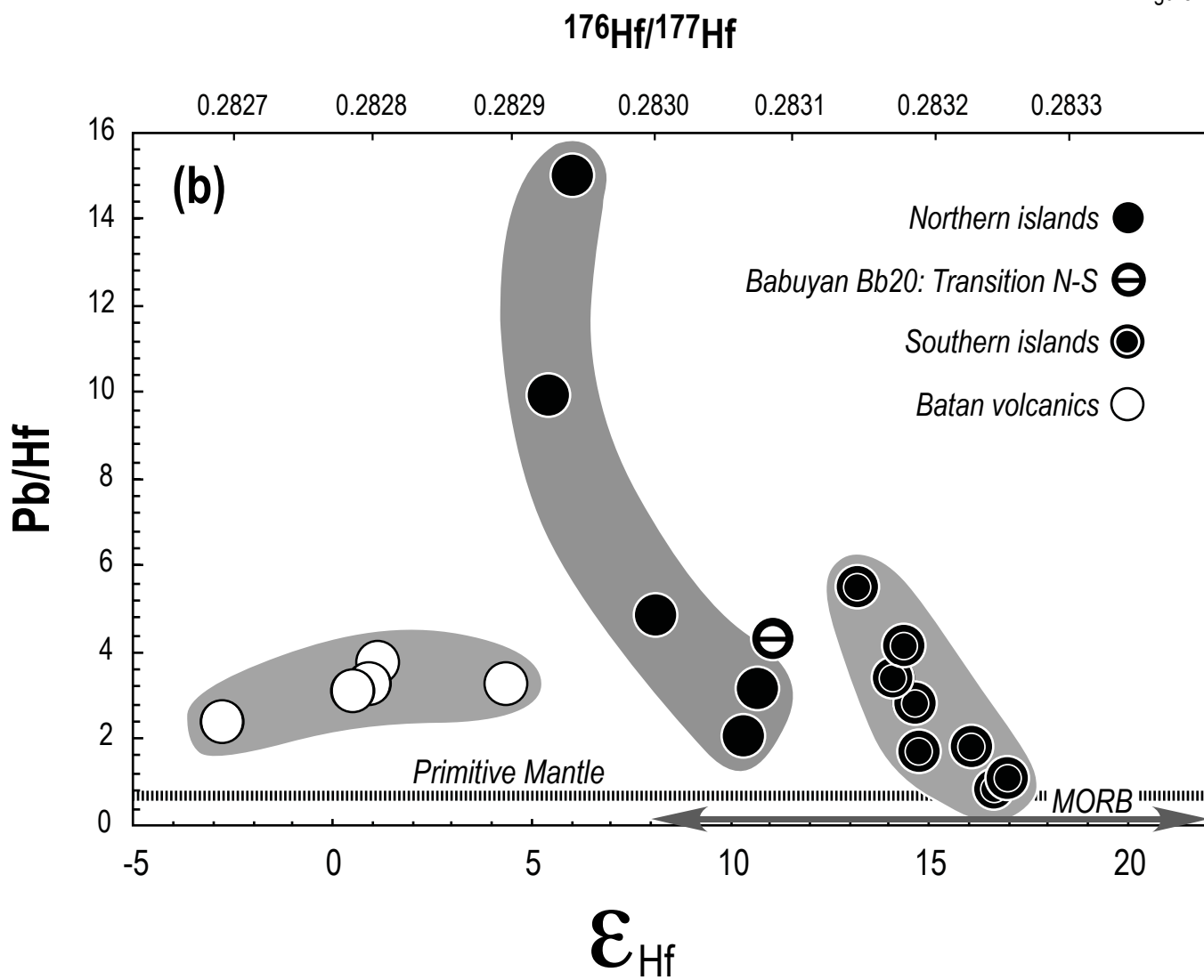
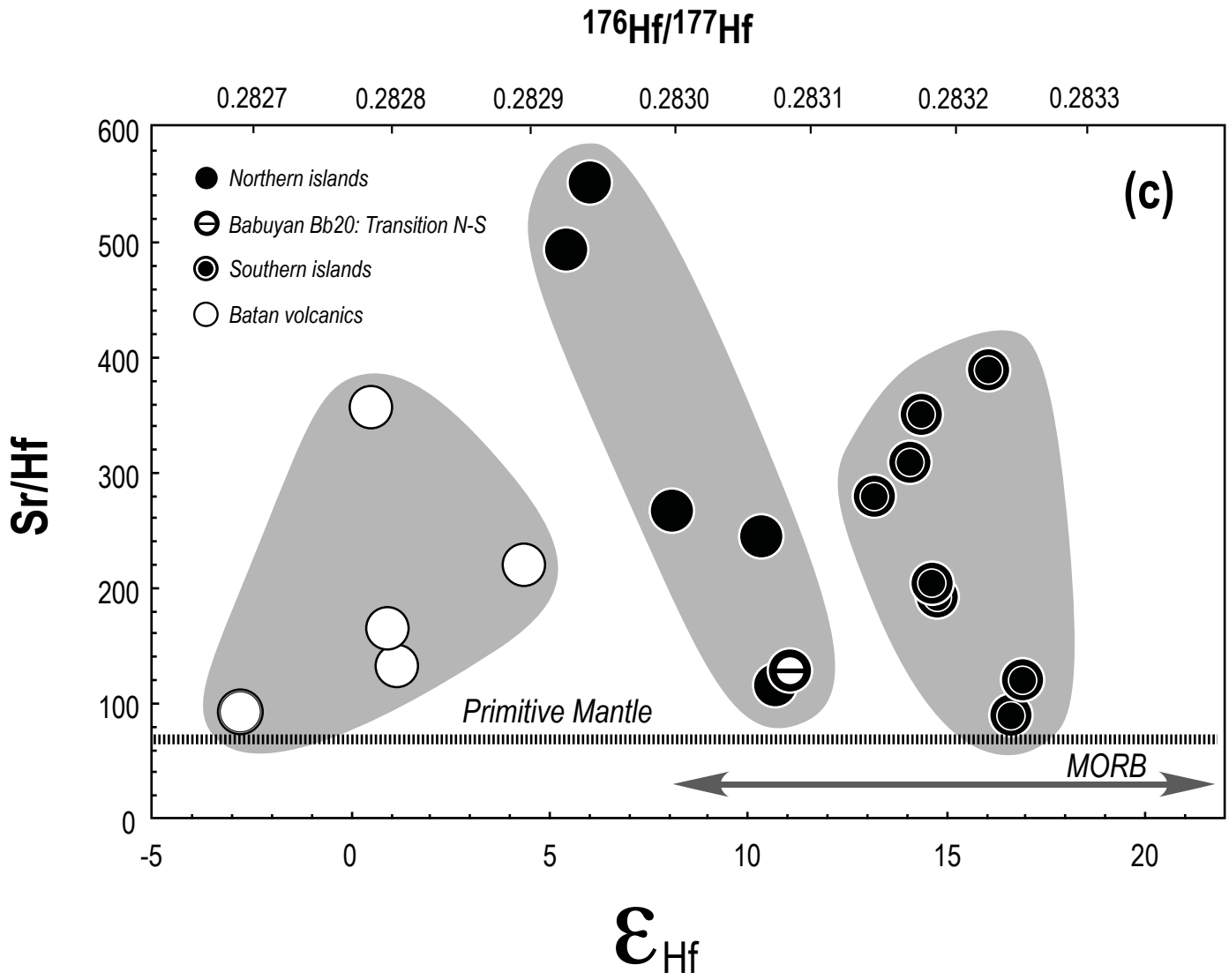
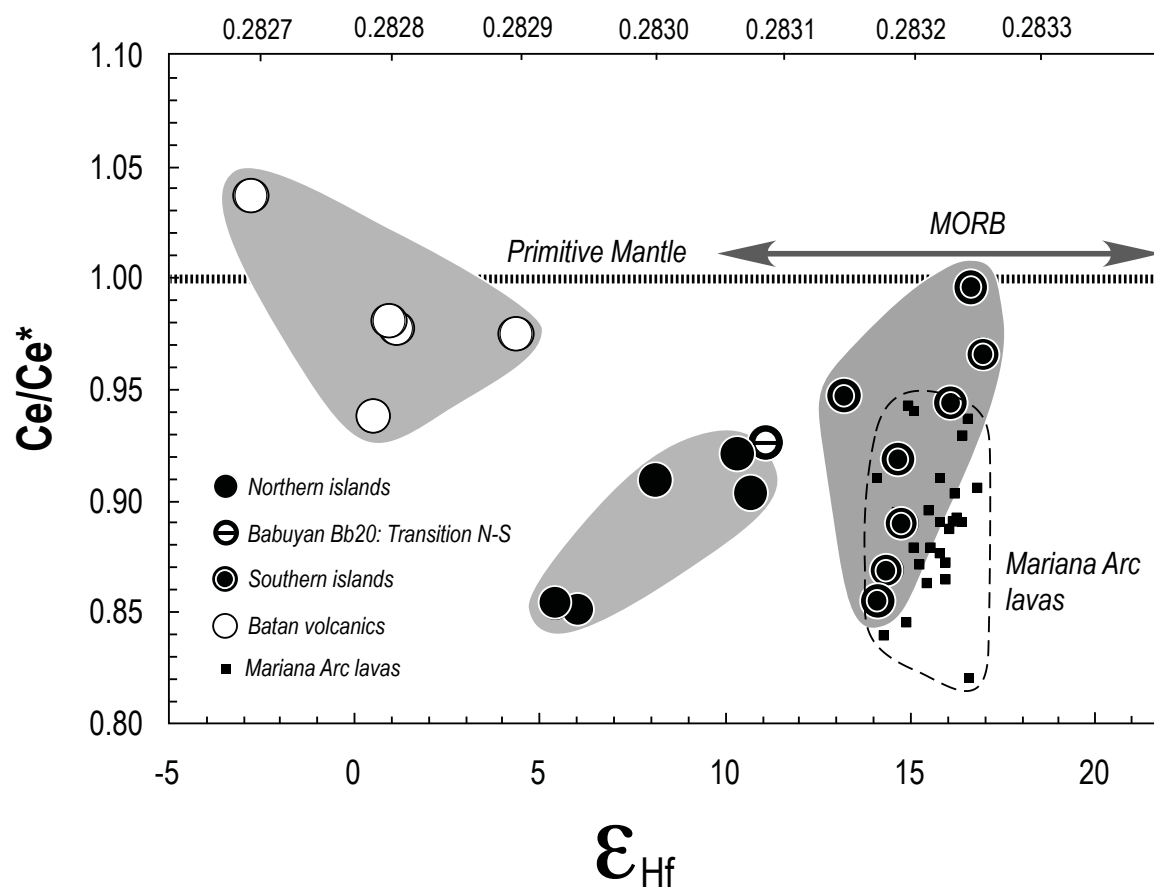

Figure 4c



$^{176}\text{Hf}/^{177}\text{Hf}$

Figure 5



$^{143}\text{Nd}/^{144}\text{Nd}$

Figure 6

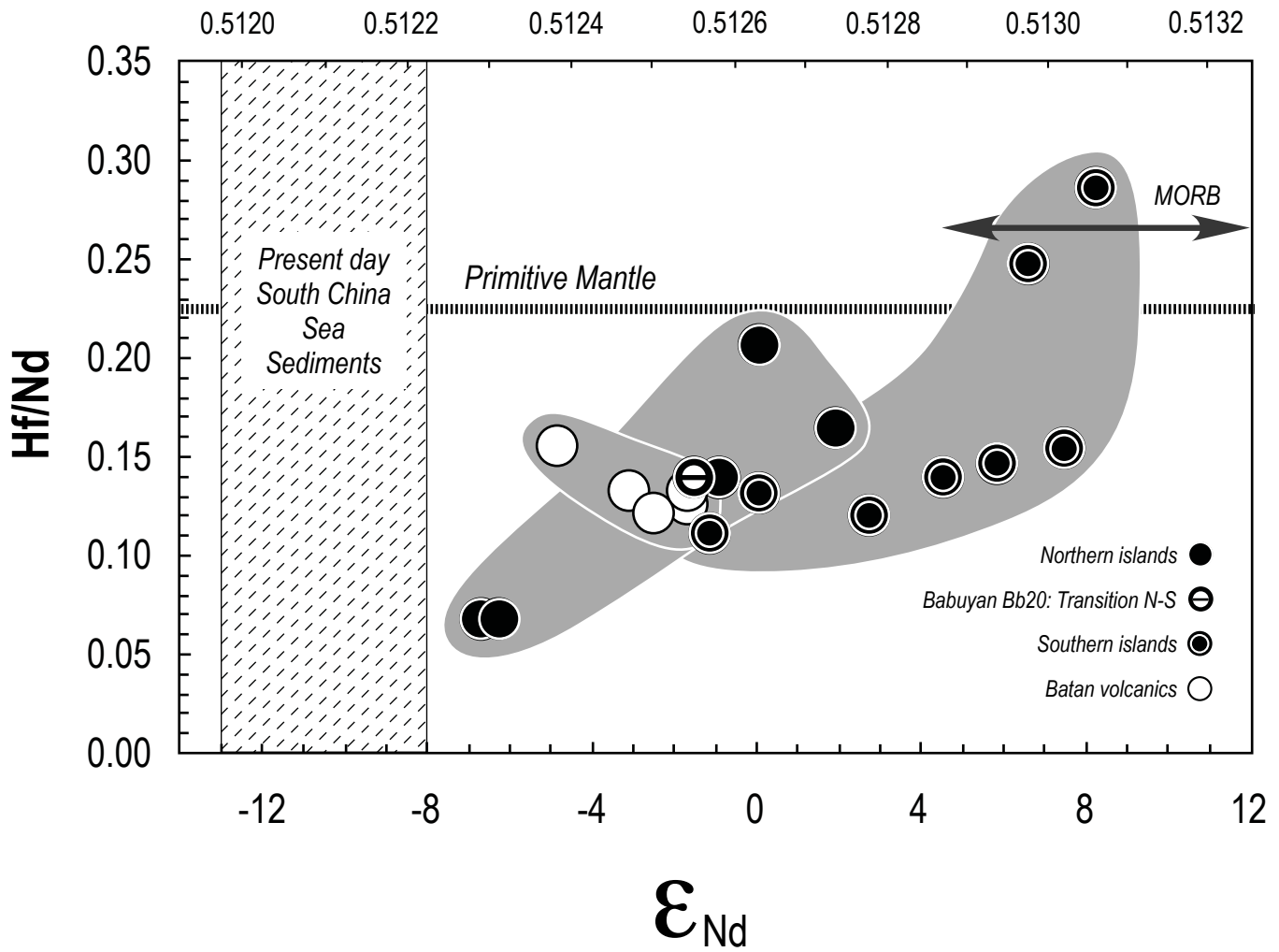

$^{143}\text{Nd}/^{144}\text{Nd}$

Figure 7

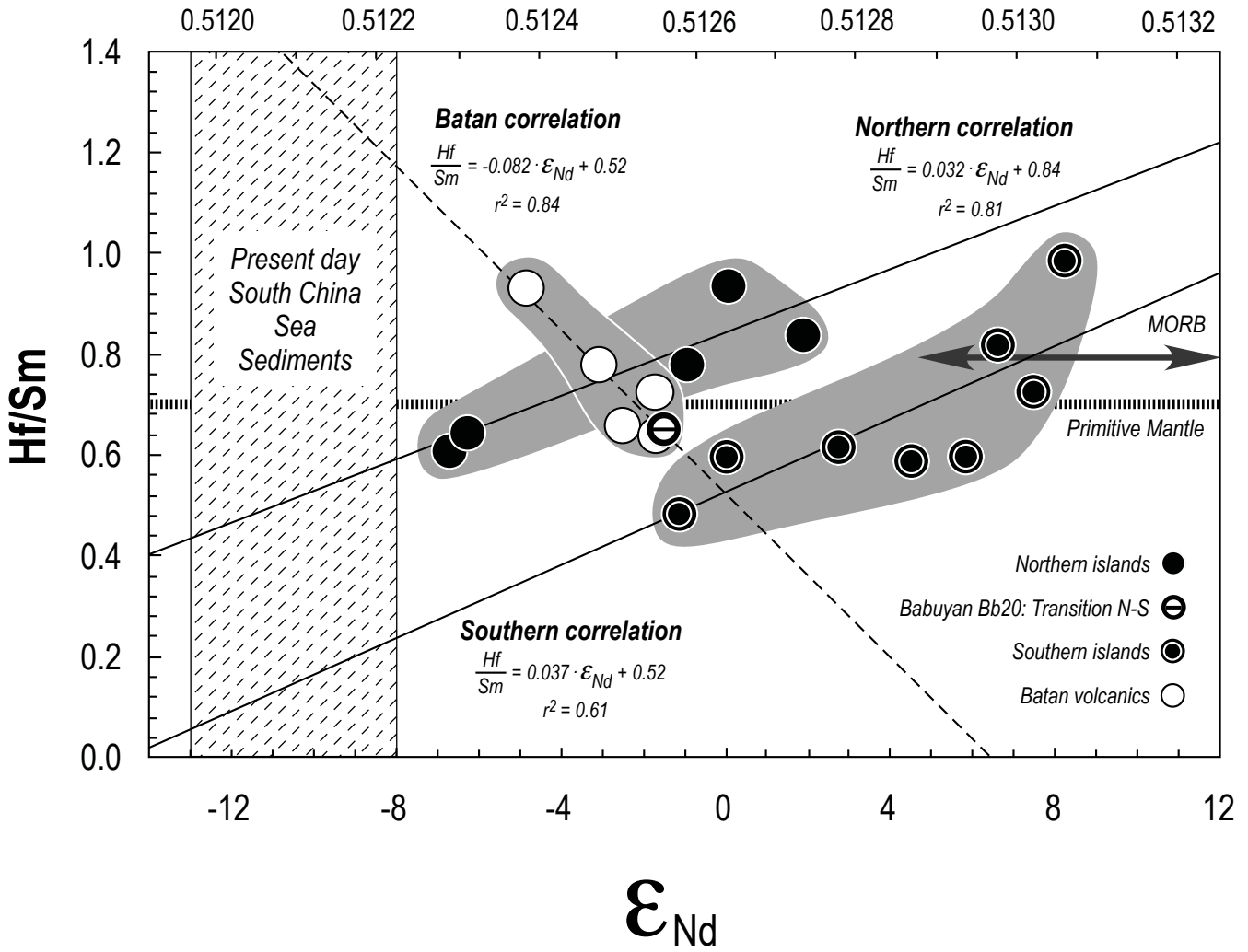

Figure 8

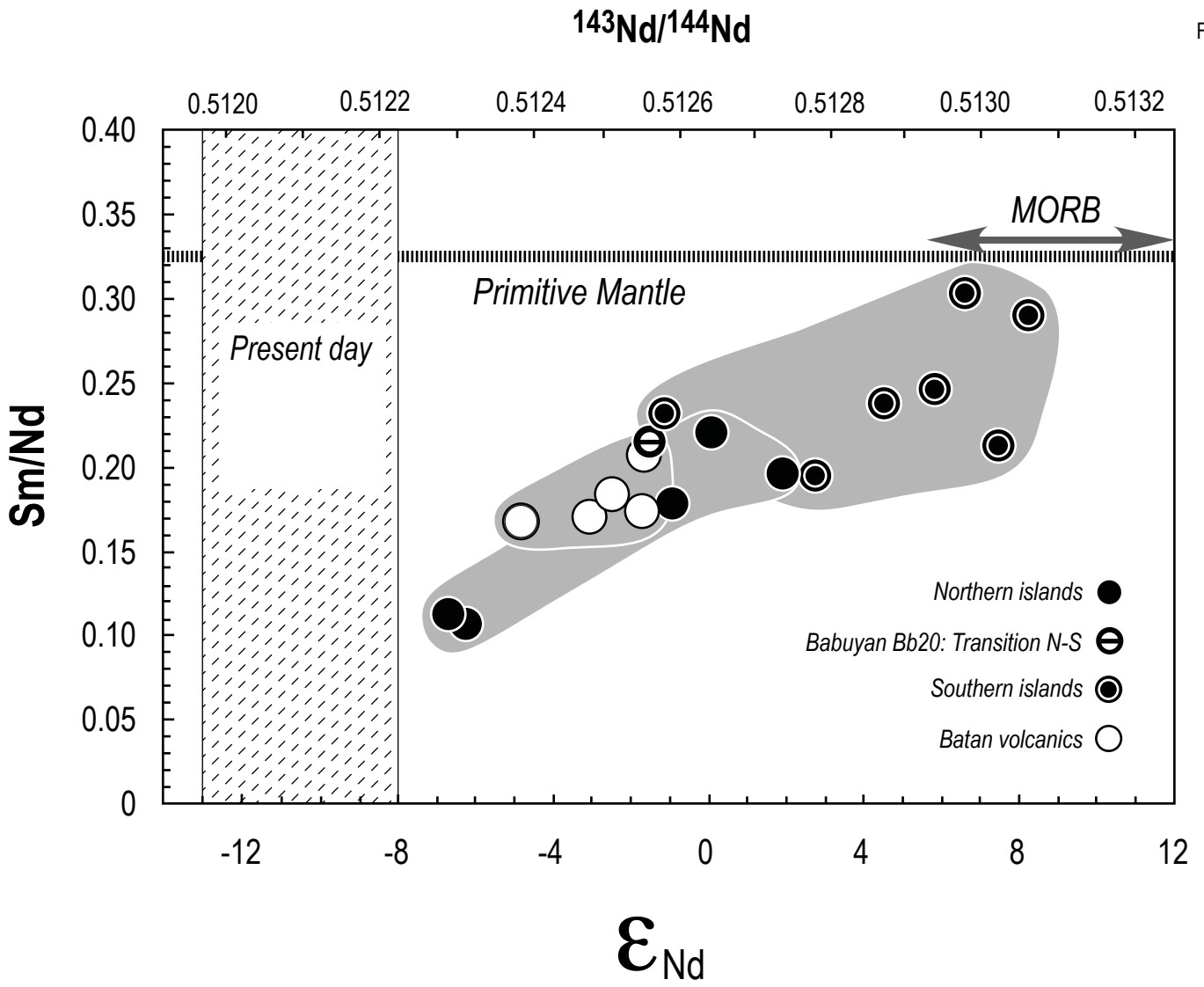
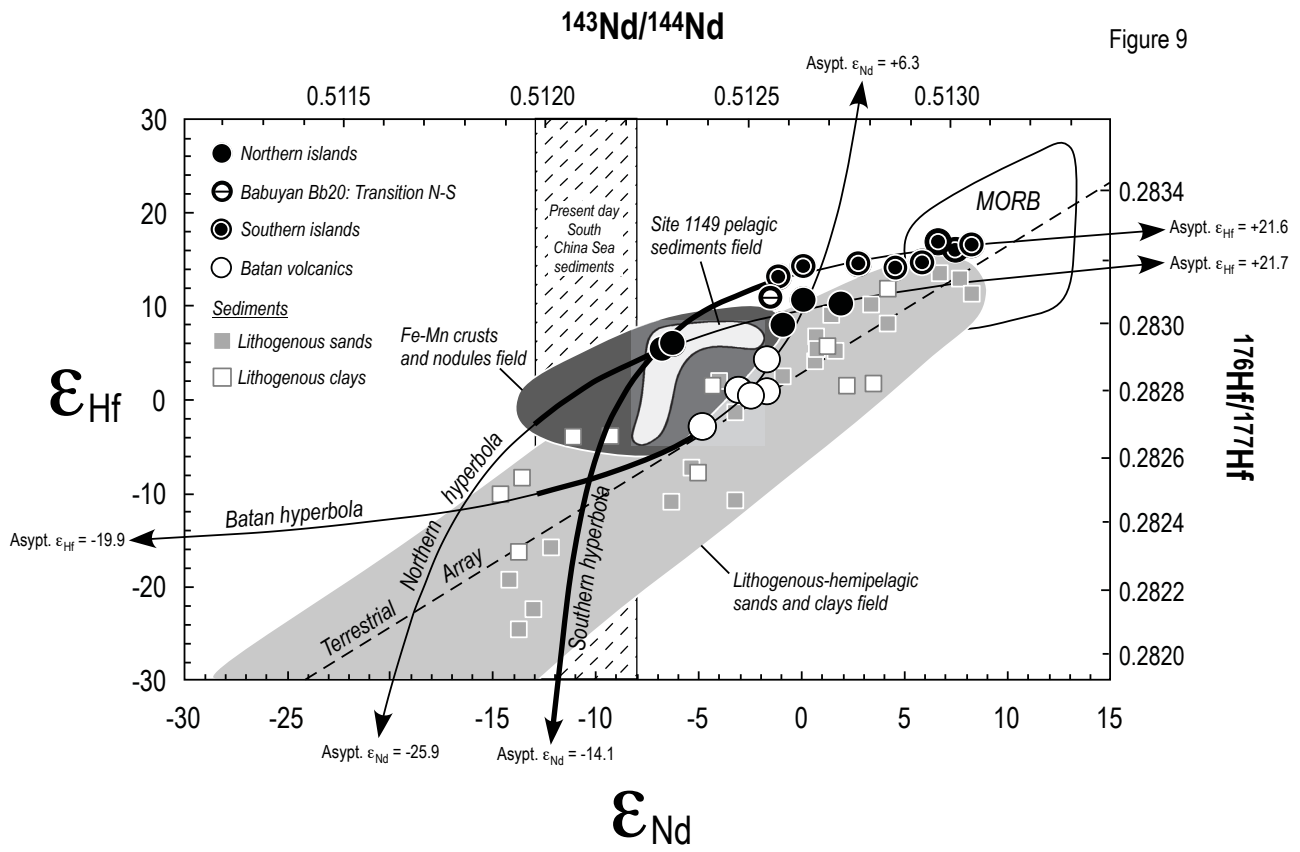
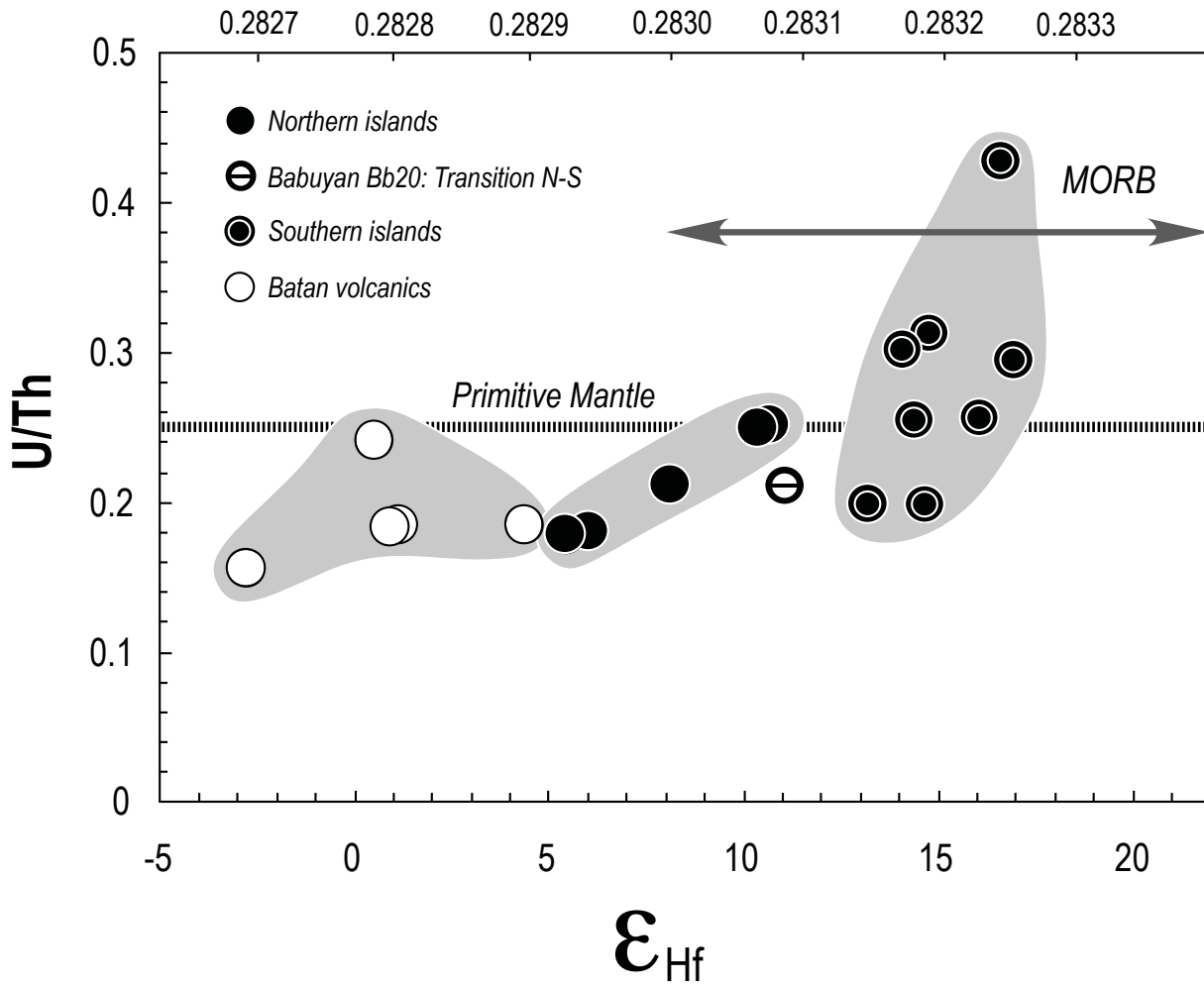

Figure 9



$^{176}\text{Hf}/^{177}\text{Hf}$

Figure 10



$^{176}\text{Hf}/^{177}\text{Hf}$

Figure 11a

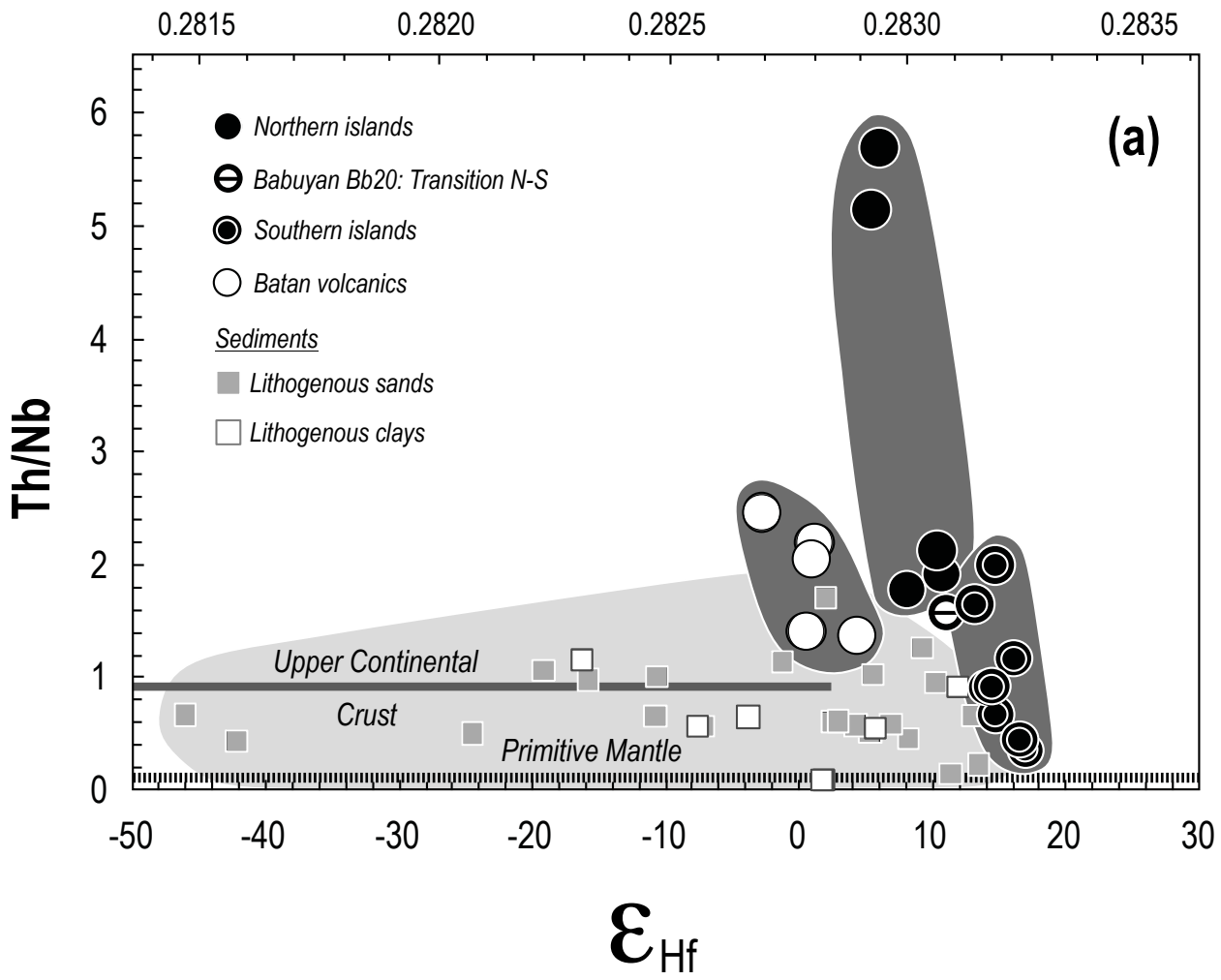
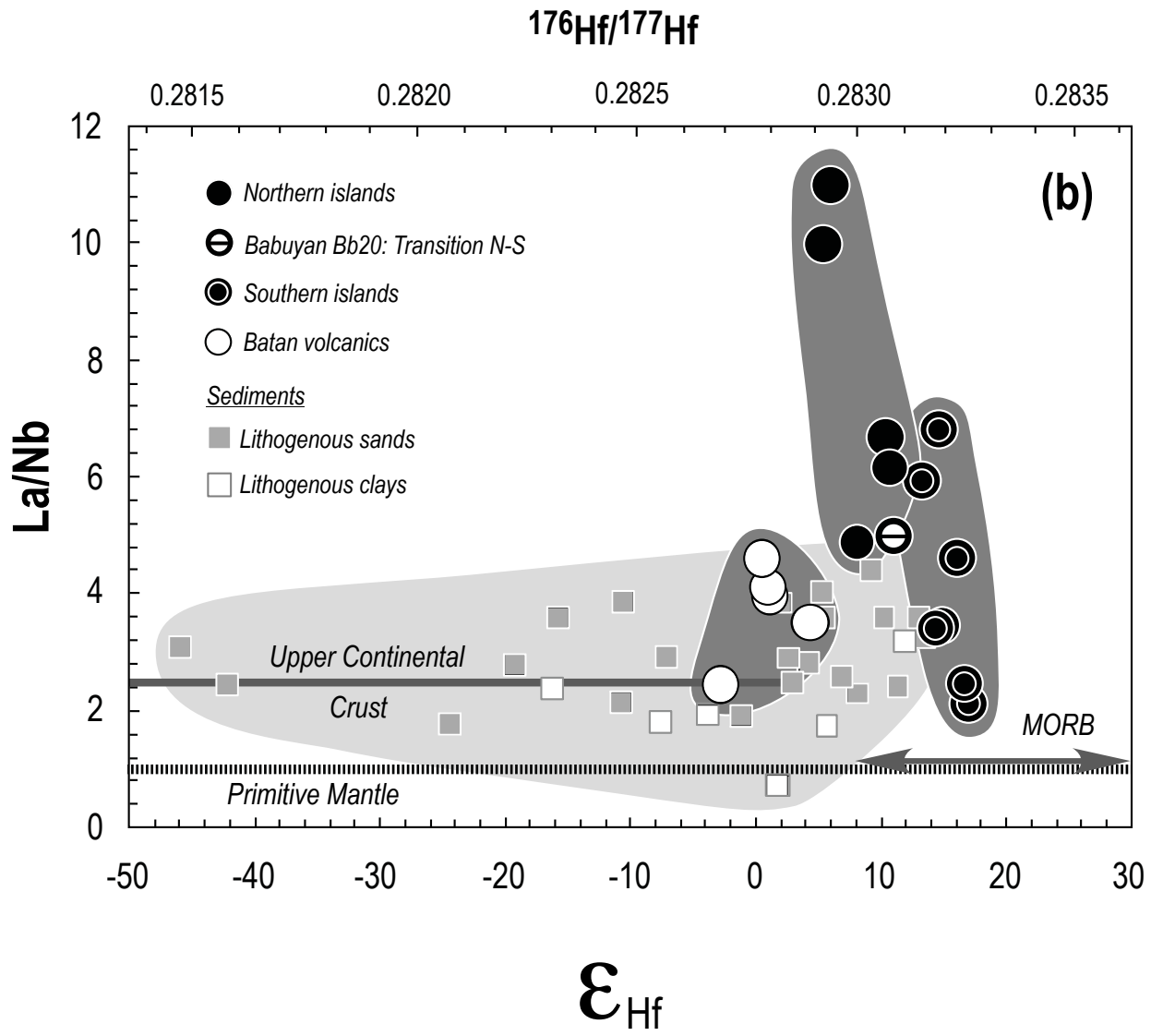

Figure 11b



CHAPITRE III - Partie B

Île de Java (arc de la Sonde)

CHAPITRE III - Partie B : Île de Java (arc de la Sonde)

Notre travail sur les compositions isotopiques de l'Hafnium des laves de Java est présenté sous la forme d'un manuscrit destiné à être intégré dans une publication en préparation par Mireille Polvé. L'île de Java connaît un volcanisme actif depuis plusieurs dizaines de millions d'années qui s'intègre dans le magmatisme de l'arc de la Sonde. L'objectif des travaux de M. Polvé et de ses collaborateurs est de déterminer l'évolution des compositions chimiques et isotopiques du volcanisme de l'île de Java sur plus de 40 Ma. Un échantillonnage de laves âgées de 1,3 Ma à 42,7 Ma a été réalisé à cette fin. Les compositions en éléments majeurs et en éléments traces ainsi que les compositions isotopiques du Strontium et du Néodyme de ces roches ont été déterminées par Anne-Claude Abraham en 1993. Nous apportons ici les compositions isotopiques de l'Hafnium et tentons d'analyser leurs corrélations avec les compositions isotopiques du Néodyme.

Les compositions isotopiques des laves de Java ne semblent pas contrôlées par des processus d'assimilation de matériaux durant la traversée de la croûte de l'arc. Les rapports isotopiques des échantillons de Java apparaissent contraints par des phénomènes de contamination de la source. D'après Abraham (1993), les compositions isotopiques du Néodyme évoluent au cours du temps vers des rapports de moins en moins radiogéniques et indiquent une contribution de sédiments à la source des laves de Java. Nous pouvons confirmer cette conclusion par l'étude des anomalies négatives en Cérium par rapport aux autres Terres Rares légères qui soulignent aussi l'apport de matériaux sédimentaires.

Les sédiments subduits actuellement au niveau de la fosse de Java ne présentent pas d'anomalie négative en Cérium et ne sont donc pas identiques aux sédiments qui contaminent la source des laves.

Contrairement aux compositions isotopiques du Néodyme, les rapports isotopiques de l'Hafnium restent constants au cours du temps et ne reflètent pas une contamination de la source. Nous proposons que la contamination de la source des laves de Java soit causée par des sédiments biogéniques (calcaires pélagiques ou radiolarites) qui présentent des rapports Nd/Hf élevés et des compositions isotopiques de l'Hafnium peu différentes du manteau source. Cette contribution de sédiments biogéniques permet de rendre compte de la non-évolution des rapports isotopiques de l'Hafnium associée à une modification des rapports isotopiques du Néodyme.

Évolution temporelle des compositions isotopiques de l'Hf des laves d'arc de Java

Jean-Christophe Marini, Catherine Chauvel, Mireille Polvé et René C. Maury

Travail destiné à être intégré dans une publication en préparation par Mireille Polvé

Introduction

Au cours de son histoire, un arc volcanique peut connaître une évolution de la nature des produits émis. Ce phénomène est particulièrement bien décrit au niveau de l'arc d'Izu-Bonin-Mariannes où les plus anciennes laves de l'arc, âgées de 50 à 45 Ma, correspondent principalement à des boninites et tholéïtes d'arc alors que depuis 35 Ma ce sont des tholéïtes d'arc et des laves calco-alcalines qui sont principalement émises (Taylor, 1992). Cette évolution s'est accompagnée d'une modification des compositions chimiques des laves mais aussi d'une évolution des compositions isotopiques de l'Hf et du Nd identifiée par Pearce et al. (1999).

Lors de notre étude des compositions isotopiques de l'Hf des laves de l'arc de Luzon nous nous sommes uniquement intéressés aux variations spatiales de ce rapport isotopique le long de l'arc. Les variations temporelles de la composition isotopique de l'Hf n'ont pas été examinées car l'échantillonnage ne couvre que la partie récente de l'activité de l'arc de Luzon (depuis 6 Ma jusqu'à nos jours).

Afin de déterminer si des modifications de la composition isotopique de l'Hf interviennent communément dans l'histoire d'un arc volcanique, à l'image de l'arc d'Izu-Bonin-Mariannes, nous avons mesuré les rapports isotopiques de l'Hf d'une série d'échantillons provenant de l'arc de la Sonde. Ces échantillons permettent d'examiner l'évolution des compositions isotopiques des laves sur plus de 40 Ma, de comparer ensuite ces mesures aux compositions des laves actuellement produites au niveau de cet arc puis de contraindre les causes des évolutions isotopiques au cours du temps.

Contexte géologique : l'arc de la Sonde

L'arc volcanique de la Sonde limite la partie SE de l'Indonésie. Il s'étend sur plus de 4000 km entre le NW de l'île de Sumatra et l'île de Flores à l'Est (figure 1a). Cet arc s'est

constitué en réponse à la subduction de la croûte océanique indienne sous la plaque eurasiatique. À son extrémité Est, la subduction océanique est actuellement interrompue dans la région du Timor par la collision entre la marge continentale australienne et la croûte océanique supportant l'arc de la Sonde (Hutchison, 1982). À l'Est du Timor un volcanisme d'arc se poursuit ensuite le long de la subduction de Banda. À l'extrémité Ouest, au niveau de Sumatra, la subduction de la croûte océanique indienne s'effectue de manière oblique à la fosse et aboutit plus au Nord à la mise en place d'un système de décrochement entre la croûte Indienne et le craton de la Sonde (zone de décrochement d'Andaman). Cette zone de décrochement marque la terminaison de la subduction océanique. Dans la partie centrale de l'arc, au front de l'île de Java, la subduction perpendiculairement à la fosse s'effectue à une vitesse d'environ 7 cm/an (Hamilton, 1979; Jarrard, 1986; Widiyantoro et Hilst, 1996; Widiyantoro et Hilst, 1997).

L'arc volcanique de la Sonde repose sur une croûte composite. Sur l'île de Sumatra, l'arc s'est édifié sur une portion de croûte continentale mature appartenant au craton de la Sonde (Van Bemmelen, 1949; Katili, 1975). Dans sa partie centrale, au niveau de Java, l'arc repose sur une croûte d'épaisseur intermédiaire (Curry et al., 1977; Jarrard, 1986). Enfin à son extrémité Est, dans la région de l'île de Flores, le substratum de l'arc est une croûte peu épaisse d'origine océanique (Hamilton, 1979).

Les laves produites au Quaternaire dans l'arc de la Sonde appartiennent principalement à des séries calco-alcalines et calco-alcalines hautement potassiques dénommées séries "calc-alkaline High-K" dans les publications en langue anglaise (Whitford et al., 1979). Cependant des laves de nature tholéitiques ou shoshonitiques ont aussi été produites durant les phases d'activités récentes. L'arc de la Sonde est principalement caractérisé par des variations importantes des caractéristiques géochimiques des laves en fonction de leur position géographique : Tout d'abord la composition des laves dépend de la distance par rapport à la

fosse. La proportion de K_2O augmente ainsi clairement avec la profondeur du plan de Benioff (Hutchison, 1976; Whitford et Nicholls, 1976; Whitford et al., 1979; Nicholls et al., 1980; Hutchison, 1982; Wheller et al., 1987; Stolz et al., 1990; Edwards et al., 1993; Hoogewerff et al., 1997). En complément Whitford (1975) et Van Bergen et al. (1993) ont démontré que les compositions des laves évoluent en outre de manière progressive le long de l'arc volcanique. De nombreuses causes ont été proposées afin d'expliquer les variations chimiques longitudinales et transversales le long de l'arc de la Sonde : Des variations du taux de fusion de la source des laves, des variations de la composition des constituants de la source, et des variations du taux d'assimilation durant la remontée des magmas vers la surface (Whitford, 1975; Whitford et al., 1979; Hilton et al., 1992; Van Bergen et al., 1993; Gasparon et al., 1994; Hoogewerff et al., 1997; Turner et Foden, 2001; Gertisser et Keller, 2003). L'arc de la Sonde apparaît donc comme une région où la composition géochimique des laves produites est en partie dépendante de leur site d'échantillonnage. Afin de proposer une reconstitution de l'évolution géochimique de cet arc, un échantillonnage spécifique a donc été réalisé.

Échantillonnage et procédure analytique

L'étude de l'évolution géochimique des laves de la Sonde au cours du temps nécessite en premier lieu de s'affranchir des variations chimiques transversales et longitudinales reconnues dans cet arc. Plusieurs campagnes d'échantillonnages ont été menées par M. Polvé, R. Maury et R. Soeria-Atmadja dans la partie centrale de l'île de Java, sur un segment restreint d'environ 500 km le long de l'arc volcanique afin de limiter d'éventuelles variations chimiques longitudinales (figure 1b). La position de ces laves par rapport à la fosse de subduction au moment de leur mise en place apparaît par contre difficile à préciser en raison de phénomènes d'érosion ou d'accrétion tectoniques qui peuvent intervenir au niveau d'une fosse de subduction au cours du temps (Von Huene et Scholl, 1991).

Les échantillons proviennent de coulées massives et de divers formes d'intrusions (dykes ou sills). Les études pétrographiques de ces roches ont été réalisées par Priadi (1989), Soeria-Atmadja et al. (1991) et Sutanto (1993). Des datations $^{40}\text{K}/^{40}\text{Ar}$ de cette série d'échantillons ont été effectuées par Bellon et al. (1989) et Soeria-Atmadja et al. (1991). Les âges de ces laves s'étendent de 43 Ma à 1 Ma. Ces laves récoltées dans d'anciennes coulées et d'anciens dykes, necks et sills mis à l'affleurement par l'érosion ont donc été regroupées sous le terme de volcanisme ancien ou volcanisme tertiaire de Java par opposition aux laves quaternaires et historiques qui se rencontrent sous forme de volcans actifs ou encore préservés de l'érosion. Enfin Abraham (1993) sous la responsabilité de M. Polvé a sélectionné 14 échantillons basaltiques à andésitiques parmi les moins altérés afin de déterminer leurs compositions en éléments majeurs, en éléments traces ainsi que les compositions isotopiques du Sr et du Nd. Les mesures de la composition isotopique du Pb sont en cours de réalisation par M. Polvé. Nous apportons ici la composition isotopique de l'Hf pour 12 de ces échantillons.

Les mesures de la composition isotopique de l'Hf ont été réalisées selon la procédure de Blichert-Toft et al. (1997a). Les étapes de séparation chimiques ont été effectuées à Grenoble puis les mesures des rapports isotopiques sur un spectromètre multicollecteurs P54 à Lyon. Lors du passage au spectromètre de masse, les échantillons contenaient des proportions d'Yb et de Lu supérieures aux proportions généralement obtenues lors de l'application du protocole de Blichert-Toft et al. (1997a) (Tableau 1). Ces proportions anormalement importantes de terres rares lourdes résultent probablement d'un défaut de centrifugation lors d'une étape de la procédure de séparation chimique. La présence d'Yb et de Lu en proportions significatives dans les solutions de passage au spectromètre multicollecteurs peut entraîner des interférences au niveau de la masse 176 car Hf, Yb et Lu possèdent chacun un isotope de masse atomique 176. Les mesures du rapport isotopique $^{176}\text{Hf}/^{177}\text{Hf}$ des laves de l'arc de la Sonde doivent en conséquence être considérées comme potentiellement altérées par interférences de masse. Nos

données ne peuvent donc pas être utilisées pour décrire des évolutions fines de la composition de l'Hf dans les échantillons de l'arc de la Sonde en attendant la duplication de nos mesures. Seules les grandes tendances dans l'évolution des rapports isotopiques de l'Hf seront donc considérées ici.

Lors de ces mesures de rapports isotopiques de l'Hf le standard JMC 475 a été utilisé pour calibrer les gains des différents détecteurs. Ce standard a fourni un rapport isotopique moyen durant la séance de mesures de $0,282164 \pm 10$ (1σ sur 8 mesures). Les blancs d'Hf étaient toujours inférieurs à 60 pg ce qui est négligeable par rapport aux 400 à 600 ng d'Hf utilisés pour l'analyse des échantillons de roches.

Résultats

Les rapports isotopiques de l'Hf des laves de l'île de Java sont reportées dans le Tableau 1 avec les valeurs actuelles de l' ϵ_{Hf} ainsi que les valeurs initiales $\epsilon_{\text{Hf}(i)}$ corrigées en fonction de l'âge de l'échantillon. Les rapports isotopiques actuels et initiaux du Sr et du Nd obtenus par Abraham (1993) y sont aussi indiqués.

Les compositions isotopiques initiales des laves de Java ont été reportées dans la figure 2 en fonction de l'âge de l'échantillon avec les compositions des laves actuelles de la partie centrale de l'île de Java disponibles dans la littérature. En utilisant uniquement ses données, acquises sur les laves anciennes de Java, Abraham (1993) a montré que les compositions isotopiques du Sr ne variaient pas en fonction de l'âge des échantillons. Au contraire les rapports isotopiques initiaux du Nd semblent diminuer au cours du temps. Ces résultats peuvent être confirmés en comparant les données d'Abraham (1993) aux compositions des laves quaternaires de Java (figure 2a et 2b). Les compositions isotopiques du Sr des laves tertiaires de Java sont tout à fait comparables aux compositions des laves quaternaires. Au contraire les laves les plus anciennes présentent des $\epsilon_{\text{Nd}(i)}$ sensiblement supérieurs aux valeurs

ϵ_{Nd} des laves actuelles. L'échantillon JM36 âgé de 1,33 Ma semble constituer une exception parmi les laves tertiaires de Java puisqu'il présente des compositions isotopiques du Sr nettement plus radiogéniques que les autres échantillons anciens et que les laves actuelles de l'arc. Les compositions de cette roche ne peuvent donc pas être considérées comme représentative d'une évolution global du volcanisme de Java.

Les compositions isotopiques de l'Hf des laves anciennes de l'île de Java ont été placées dans la figure 2c. Les valeurs de l' $\epsilon_{Hf(i)}$ restent comprises entre +11,4 et +17,2 et ne semblent pas corrélées avec l'âge des échantillons. Les compositions isotopiques de l'Hf des laves anciennes de Java semblent donc être restées approximativement constantes au cours du temps. Au niveau des isotopes de l'Hf l'échantillon JM36 constitue de nouveau une exception parmi le volcanisme tertiaire de Java avec un rapport $\epsilon_{Hf(i)}$ de +5.

Par ailleurs, d'après la figure 2c les compositions isotopiques initiales des laves anciennes de Java semblent généralement plus radiogéniques que les compositions des laves actuelles analysées par White et Patchett (1984), Woodhead et al. (2001). Cependant ce résultat est peut-être la conséquence d'interférence de masse lors de nos mesures de la composition isotopique de l'Hf des laves tertiaires de Java. Ce résultat ne sera donc pas exploité ici dans l'attente d'une duplication de nos mesures.

Enfin dans l'espace $\epsilon_{Hf(i)}$ versus $\epsilon_{Nd(i)}$ les échantillons anciens de Java se superposent pour partie aux laves quaternaires de l'arc de la Sonde (figure 3). Les compositions isotopiques de l'Hf des roches de Java sont donc en position intermédiaire entre le champ des Petites Antilles et le champ de l'arc de Luzon. Toutefois les rapports isotopiques du Nd fortement radiogéniques déterminés par Abraham (1993) pour les laves les plus anciennes de Java associées à nos mesures des rapports isotopiques de l'Hf démontrent que les échantillons d'âge supérieur à 24 Ma se positionnent dans le champ des basaltes de ride medio-océaniques

(MORB). De telles compositions n'ont par contre jamais été rapportées pour les laves actuelles de l'arc de la Sonde qui présentent toujours des rapports ϵ_{Nd} toujours inférieurs au MORB.

Discussion

Les compositions isotopiques de l'Hf ne semblent donc pas évoluer au cours du temps dans les laves d'arc de l'île de Java. Au contraire les rapports isotopiques du Nd présentent une diminution vers des rapports moins radiogéniques depuis les échantillons les plus anciens jusqu'aux laves actuellement émises. Au niveau des laves d'arc de Java il existe donc un découplage entre les variations des isotopes du Nd et la constance des rapports isotopiques de l'Hf. Nous nous proposons d'examiner tout d'abord les différentes hypothèses permettant de rendre compte de l'évolution des compositions isotopiques du Nd. Puis, dans un second temps nous pouvons considérer plusieurs solutions afin d'expliquer pourquoi les compositions de l'Hf n'évoluent pas parallèlement aux compositions du Nd.

L'évolution des rapports isotopiques du Nd

La dérive que connaissent les rapports isotopiques du Nd des laves de Java traduit en premier lieu la contribution d'un composant dont les compositions du Nd sont faiblement radiogéniques. De tels rapports isotopiques faiblement radiogéniques suggèrent qu'il peut s'agir d'un composant crustal et/ou sédimentaire. La participation de ce composant peut alors intervenir à deux niveaux distincts : Tout d'abord des sédiments entraînés lors de la subduction de la croûte océanique indienne peuvent contaminer le manteau source des laves de Java. Ensuite une assimilation de divers matériaux peut intervenir lors de la remontée des magmas à travers la croûte de l'île de Java.

Les processus d'assimilation de matériaux crustaux semblent intervenir de manière significative dans l'arc de la Sonde essentiellement au niveau de l'île de Sumatra où l'arc repose sur une croûte continentale mature (Gasparon et al., 1994; Gasparon et Varne, 1998). Dans les autres segments de l'arc où l'arc repose sur une croûte océanique ou intermédiaire, respectivement dans les régions de Flores et de Java les processus d'assimilation semblent plus limités (Turner et Foden, 2001; Gertisser et Keller, 2003). D'après ces auteurs, les processus d'assimilation des matériaux encaissants par les magmas de la Sonde doivent s'accompagner d'une différenciation de ces derniers par cristallisation fractionnée (processus d'Assimilation par Cristallisation Fractionnée désignés par le sigle AFC). Cependant les travaux de Turner et Foden (2001) et Gertisser et Keller (2003) ont montré que pour les laves actuelles de la zone de Java et de Flores les compositions isotopiques du Nd n'étaient pas corrélées avec des variations des teneurs en SiO₂. Par conséquent, les rapports isotopiques du Nd ne semblent pas conditionnés par des processus d'AFC. Une démonstration identique peut être effectuée avec les données acquises par Abraham (1993) sur les laves anciennes de Java. Comme montré dans la figure 4, les $\epsilon_{Nd(i)}$ des laves tertiaires de Java ne montrent pas de corrélation avec les pourcentages en SiO₂ et MgO. L'évolution des rapports isotopiques du Nd au cours du temps ne peut donc pas être attribuer à une assimilation croissante de matériaux appartenant à la croûte sous jacente à l'arc. L'évolution des isotopes du Nd doit alors refléter une contribution de sédiments à la source des laves d'arc de Java. Cette hypothèse de contamination de la source des magmas de Java a été aussi précédemment retenue par Turner et Foden (2001) et Gertisser et Keller (2003) pour les laves quaternaires et par Abraham (1993) pour les laves tertiaires.

Nous pouvons confirmer la participation de sédiments océaniques par l'examen du comportement du Ce par rapport aux autres terres rares légères dans les laves tertiaires de Java en utilisant les données d'Abraham (1993). Certains types de sédiments océaniques sont

en effet caractérisés par la présence d'anomalies négatives en Ce par rapport au La et au Nd (Shimizu et Masuda, 1977; Elderfield et Greaves, 1981a; Elderfield et al., 1981b; Palmer, 1985; Palmer et Elderfield, 1986; Ben Othman et al., 1989; Toyoda et al., 1990; Lin, 1992). Cette anomalie peut se retrouver dans les magmas d'arcs dont la source est contaminée par de tels sédiments. L'exemple le plus explicite restant les laves de l'arc d'Izu-Mariannes où les anomalies négatives en Ce traduisent une contribution de sédiments pélagiques à la source de ces magmas (Hole et al., 1984; Woodhead, 1989; Lin, 1992; Elliott et al., 1997). Le rapport Ce/Ce* des laves tertiaires de Java a été reporté dans la figure 5a en fonction de l'âge des échantillons. D'après cette figure, les plus anciennes laves ne présentent pas d'anomalies en Ce par rapport aux autres terres rares légères puis des anomalies négatives de plus en plus marquées se développent au cours du temps. Les évolutions parallèles des compositions isotopiques initiales du Nd et des anomalies en Ce au cours du temps suggèrent une corrélation entre ces deux caractéristiques géochimiques que nous avons reporté dans la figure 5b.

Les évolutions conjointes des isotopes du Nd et des rapports Ce/Ce* peuvent premièrement refléter une contribution de plus en plus importante au cours du temps de sédiments océaniques à la source des laves de Java. C'est l'hypothèse qui avait été retenue par Abraham (1993) en proposant que le pourcentage de sédiments participant à la source des laves passe de 0,7% pour les plus anciennes laves à 2,2% pour les laves les plus récentes. Cependant l'évolution des rapports isotopiques du Nd et des anomalies en Ce peut aussi indiquer une modification de la composition des sédiments subduits au cours de l'histoire de l'arc. L'examen des données géochimiques concernant la composition des sédiments subduits au niveau de la fosse de Java apparaît donc capital pour tenter de déterminer si les évolutions chimiques et isotopiques des laves de Java résultent d'une simple augmentation de la

proportion de sédiments ou d'une modification progressive de la nature des sédiments subduits.

Composition des sédiments océaniques de la région de Java

Les sédiments océaniques présents actuellement au front de l'île de Java sont relativement bien connus grâce deux forages profonds réalisés durant les Leg 22 et 27 du programme "Deep Sea Drilling Project" (DSDP) et à une série de carottage superficiels effectués par le Lamont-Doherty. Les Sites DSDP 211 et 261 ainsi que les sites de prélèvement des carottes superficielles sont indiqués dans la figure 1.

Le Site de forage 211 est considéré comme le site de référence pour la pile sédimentaire absorbée au niveau de Java (Plank et Langmuir, 1998). Trois grandes unités y ont été reconnues depuis le sommet jusqu'à la base du forage : Une unité supérieure constituée par des radiolarites et des argiles d'âge Pliocène à Quaternaire, une unité intermédiaire constituée de sables et d'argiles terrigènes appartenant au delta sous marin du Nicobar (âge Pliocène) et enfin une unité inférieure d'argiles du Crétacé. Le Site DSDP 261 est localisé au front de la région de Flores dans la partie Est de la subduction de la Sonde (figure 1). La succession lithologique semble assez proche de celle décrite au niveau du Site 211. L'unité supérieure à radiolarites et l'unité inférieure d'argiles du Crétacé sont aussi présentes. Seuls les sables et argiles terrigènes de l'unité II ne sont plus présents et sont remplacés par des turbidites carbonatées provenant du plateau continental australien. Les compositions chimiques et isotopiques des piles sédimentaires des Sites 211 et 261 ont été estimées par Plank et Langmuir (1998). Le rapport $^{87}\text{Sr}/^{86}\text{Sr}$ de ces deux colonnes sédimentaires est proche de 0,717 et la valeur moyenne de l' ϵ_{Nd} de ces sédiments est égale à $-9,3$.

Les carottes sédimentaires du Lamont-Doherty ont été échantillonnées dans la zone avant-arc de l'île de Java, au nord de la fosse de subduction (figure 1). Ces sédiments ne font donc pas

partie de la pile sédimentaire entraînée en subduction. Les compositions isotopiques du Sr et du Nd de ces matériaux ont été mesurées par Ben Othman et al. (1989) et Romeur (1991) et apparaissent nettement distinctes des compositions globales des Sites DSDP 211 et 261. En effet, les rapports $^{87}\text{Sr}/^{86}\text{Sr}$ de ces roches variant de 0,708 à 0,709 sont moins radiogéniques que les rapports de la pile sédimentaire subduite au niveau de la fosse. De plus les valeurs ϵ_{Nd} de $-2,6$ à $-3,1$ mesurées par Ben Othman et al. (1989) ne sont pas équivalentes aux ϵ_{Nd} de $-9,3$ des colonnes sédimentaires des Sites 211 et 261. Ces compositions isotopiques des carottes échantillonnées dans la partie avant arc de l'île de Java indique l'apport de matériaux plus juvéniles dans ces sédiments provenant probablement de l'érosion de l'arc de Java. En conséquence nous ne pouvons considérer ces carottes sédimentaires de la zone avant-arc de Java comme représentatives des sédiments subduits au niveau de la fosse.

Les compositions globales de la colonne sédimentaire des Sites 211 et 261 a été reportée dans les figures 2, 3 et 5. Ces sédiments ont des ϵ_{Nd} actuels d'environ $-9,3$ et pourraient rendre compte des compositions isotopiques de moins en moins radiogéniques des laves de Java. Cependant comme le montre la figure 5a les sédiments de la colonne subduite ne présentent généralement pas d'anomalie négative en Ce. Cette observation indique que les sédiments que se trouvent actuellement au front de la fosse de Java ne sont absolument pas équivalents aux sédiments qui contaminent la source de l'arc.

Les sédiments contribuant à la source des laves de Java doivent obligatoirement correspondre à des matériaux possédant une anomalie négative en Ce. Parmi les différentes catégories de sédiments océaniques, les sédiments détritiques, terrigènes ou volcanogènes (sables, silts et argiles) ne présentent pas d'anomalies en Ce par rapport aux autres Terres Rares légères (McLennan et al., 1990; Plank et Langmuir, 1998). Les sédiments

hydrogénétiques (croûtes et nodules de Fe-Mn) possèdent généralement des anomalies positives en Ce qui se traduisent par des rapports Ce/Ce* supérieurs à 1 (Piper, 1974a; Piper, 1974b; Elderfield et al., 1981b; Amakawa et al., 1991). Enfin les sédiments biogéniques (calcaires, radiolarites, diatomites, argilites siliceuses) présentent couramment des anomalies négatives en Ce qui s'expriment par des rapports Ce/Ce* inférieurs à 1 (Shimizu et Masuda, 1977; Palmer, 1985; Palmer et Elderfield, 1986; Ben Othman et al., 1989; Toyoda et al., 1990; Lin, 1992). Les anomalies négatives en Ce des laves de Java suggèrent en conséquence que les sédiments contaminant leur source appartiennent au groupe des sédiments biogéniques, seuls matériaux sédimentaires présentant de tels anomalies.

L'examen des données géochimiques concernant les sédiments de la région de Java nous permet donc de préciser quel type de sédiment contribue actuellement à la source des laves de Java mais ne nous permet pas de déterminer si l'évolution des compositions isotopiques du Nd et des rapports Ce/Ce* au cours du temps est causé par une augmentation de la contribution sédimentaire ou une modification du type de sédiment.

Découplage entre les compositions isotopiques de l'Hf et du Nd

À l'inverse des compositions isotopiques du Nd et des rapports Ce/Ce* qui semblent indiquer une contribution sédimentaire à la source, les compositions isotopiques de l'Hf des laves de Java ne connaissent pas d'évolution au cours du temps (figure 2) et reste généralement équivalentes aux compositions des MORB (ϵ_{Hf} des MORB compris de +8 à +25). Nous pouvons proposer deux hypothèses pour rendre compte de ce découplage entre les compositions isotopiques de l'Hf et du Nd :

- a) Tout d'abord la non-évolution des compositions de l'Hf peut résulter d'une rétention de l'Hf dans les matériaux de la plaque subduite, sans transfert de cet élément vers la source magmatique de l'arc.
- b) Deuxièmement les compositions isotopiques de l'Hf très radiogéniques des laves de Java peuvent résulter d'une contribution de sédiments dont la composition isotopique de l'Hf est relativement radiogénique et peu différente de la composition du manteau source.

1) Hypothèse du non-transfert de l'Hf vers la source mantellique de l'arc de Java

De très nombreuses études expérimentales de déshydratation et de fusion ont été menées sur des matériaux sédimentaires et basaltiques afin de préciser le comportement des différents éléments chimiques lors de la subduction des croûtes océaniques et des piles sédimentaires associées (Tatsumi et al., 1986; Brenan et al., 1994; Ayers et Egger, 1995; Brenan et al., 1995; Adam et al., 1997; Ayers et al., 1997; Kogiso et al., 1997; Stalder et al., 1998; Johnson et Plank, 1999). Un des principaux résultats de ces études concerne les éléments du groupe des HFSE (High Field Strength elements). Les éléments de ce groupe présentent en effet des coefficients de partage faibles vis à vis des fluides aqueux libérés par déshydratation des matériaux subduits en comparaison des autres groupes d'éléments chimiques (Large Ion Lithophile Elements : LILE et Rare Earth Elements : REE). Ces conclusions apportées par les études expérimentales semblent confirmées lors d'études concernant des exemples naturels, en particulier l'arc d'Izu-Mariannes où l'Hf ne semble pas être transféré par des fluides aqueux depuis les matériaux subduits jusqu'à la source de l'arc (Pearce et al., 1999).

Au niveau de l'arc de Java, la non-évolution des compositions isotopiques de l'Hf peut donc aussi résulter du non-transfert de cet élément lors de la déshydratation des matériaux subduits.

Au contraire, d'après les données de (Johnson et Plank, 1999), le Nd est l'élément du groupe

des terres rares le plus compatible vis à vis des fluides aqueux. Son évolution isotopique serait ainsi autorisée par de tels agents de transport entre les matériaux subduits et la source magmatique. Cependant ce comportement différentiel entre le Nd et l'Hf devrait aussi concerner d'autres couples d'éléments chimiques. En particulier une déshydratation des matériaux subduits devrait entraîner un découplage entre l'U considéré comme extrêmement compatible vis à vis de fluides aqueux et le Th possédant de faibles coefficients de partage vis à vis de ces mêmes fluides (Turner et al., 1996; Hawkesworth et al., 1997a; Hawkesworth et al., 1997b). Le rapport U/Th des laves de Java a été reporté en fonction de l'âge des échantillons dans la figure 6. Ce rapport reste généralement inférieur à la valeur des MORB ($U/Th_{MORB}=0,38$ d'après Hofmann, 1988) et connaît une diminution générale au cours du temps depuis les laves les plus anciennes jusqu'aux laves quaternaires. Cette évolution est exactement à l'inverse de ce qui est attendu en cas de contamination par déshydratation des matériaux subduits et implique que les éléments les plus réfractaires vis à vis de fluides aqueux, comme le Th, sont transférés vers la source magmatique de Java. En conséquence la non-évolution des compositions isotopiques de l'Hf ne semble pas pouvoir être attribuée au non-transfert de cet élément vers la source des laves.

2) Hypothèse d'une contribution de sédiments dont la composition isotopique de l'Hf est fortement radiogénique

La constance des compositions isotopiques de l'Hf des laves tertiaires et quaternaires de Java et leur faible différence par rapport aux compositions des MORB peuvent résulter d'une contribution de sédiments dont les compositions isotopiques de l'Hf sont peu différentes de la composition mantellique. En effet, les travaux sur les compositions isotopiques des sédiments océaniques ont montrés que les sédiments hydrogénétiques (croûtes et nodules de Fe-Mn, sédiments alumino-silicatés authigéniques) et les sédiments biogéniques

(cherts et radiolarites) présentent des rapports isotopiques de l'Hf relativement radiogéniques (ϵ_{Hf} de -5 à +10) associées à des ϵ_{Nd} toujours négatifs (-1 à -13) (d'après les données de White et al., 1986; Ben Othman et al., 1989; Godfrey et al., 1997; Albarède et al., 1998; Vervoort et al., 1999; David et al., 2001; Marini et al., en préparation, 2004). Une contamination du manteau source par ce type de sédiment peut rendre compte des compositions isotopiques des laves de Java. Nous en fournissons une illustration dans la figure 3 où nous avons représenté une courbe de mélange entre un pôle mantellique de type MORB et un échantillon de radiolarites du Site ODP 1149 (Pacifique Ouest). Cette hyperbole de mélange présente tout d'abord une convexité importante qui s'explique par le rapport Nd/Hf très élevé que possèdent les radiolarites en comparaison du rapport Nd/Hf du pôle mantellique (figure 3). Cette courbe démontre ensuite que pour de faibles pourcentages de sédiments, la contamination d'un manteau source par de sédiments biogéniques engendre un mélange dont les compositions isotopiques du Nd sont bien distinctes de la composition des MORB alors que les compositions isotopiques de l'Hf restent relativement proches de ces derniers. Pour exemple, une participation de 5% de matériel sédimentaire à la source des laves entraînerait une diminution de l' ϵ_{Hf} à +13,8, ce qui reste proche du pôle mantellique que nous avons placé à $\epsilon_{\text{Hf}} = +15$. La contribution de sédiments possédant des rapports isotopiques de l'Hf fortement radiogéniques (par rapport à leurs compositions du Nd) et des rapports Nd/Hf élevés (en comparaison du pôle mantellique) permet donc de rendre compte du découplage entre les évolutions des compositions isotopiques de l'Hf et du Nd dans l'arc de Java. De telles caractéristiques associées aux anomalies négatives en Ce correspondent vraisemblablement à des sédiments de type biogéniques (calcaires, radiolarites ou diatomites).

Conclusions

Notre étude de l'évolution des compositions isotopique de l'Hf des laves d'arc de Java au cours du temps nous conduit à proposer quatre principales conclusions :

- 1) Les compositions isotopiques de l'Hf des laves de Java ne semblent pas avoir évoluer de manière significative depuis plus de 40 Ma.
- 2) Les compositions isotopiques du Nd qui évoluent vers des valeurs de moins en moins radiogéniques et les anomalies négatives en Ce qui deviennent de plus en plus importantes au cours du temps indiquent une contribution de sédiments à la source des laves de Java.
- 3) Les sédiments présents actuellement au front de l'île de Java ne correspondent pas aux matériaux qui participent à la source des laves car ils ne possèdent pas d'anomalie négative en Ce.
- 4) La constance des compositions isotopiques de l'Hf au cours du temps et les anomalies négatives en Ce des laves suggèrent une contribution de sédiments biogéniques à leur source.

Références Bibliographiques :

- Abraham, A.-C. (1993): *Evolution géochimique (éléments traces et isotopes) du magmatisme d'arc au cours du temps: exemple de Java*. Mémoire de DEA, Université Paul Sabatier, Toulouse, 33 p.
- Adam, J., T. H. Green, et al. (1997): Trace element partitioning between aqueous fluids, silicate melts and minerals. *European Journal of Mineralogy*, Vol. 9, p. 569-584.
- Albarède, F., A. Simonetti, et al. (1998): A Hf-Nd isotopic correlation in ferromanganese nodules. *Geophysical Research Letters*, Vol. 25(20), p. 3895-3898.
- Amakawa, H., J. Ingri, et al. (1991): Isotopic compositions of Ce, Nd and Sr in ferromanganese nodules from the Pacific and Atlantic Oceans, the Baltic and Barents Seas, and the Gulf of Bothnia. *Earth and Planetary Science Letters*, Vol. 105, p. 554-565.
- Ayers, J. C., S. K. Dittmer, et al. (1997): Partitioning of elements between peridotite and H₂O at 2.0-3.0 GPa and 900-1100°C, and application to models of subduction zone processes. *Earth and Planetary Science Letters*, Vol. 150, p. 381-398.
- Ayers, J. C. et D. H. Eggler (1995): Partitioning of elements between silicate melt and H₂O-NaCl fluids at 1.5 and 2.0 GPa pressure: Implications for mantle metasomatism. *Geochimica and Cosmochimica Acta*, Vol. 59, p. 4237-4246.

- Bellon, H., R. C. Maury, et al. (1989): Chronologie ^{40}K - ^{40}Ar du volcanisme tertiaire de Java Central (Indonésie): mise en évidence de deux épisodes distincts de magmatisme d'arc. *Comptes Rendus de l'Académie des Sciences de Paris*, Vol. 309, p. 1971-1977.
- Ben Othman, D., W. M. White, et al. (1989): The geochemistry of marine sediments, island arc magma genesis, and crust-mantle recycling. *Earth and Planetary Science Letters*, Vol. 94, p. 1-21.
- Blichert-Toft, J., C. Chauvel, et al. (1997a): Separation of Hf and Lu for high-precision isotope analysis of rock samples by magnetic sector-multiple collector ICP-MS. *Contributions to Mineralogy and Petrology*, Vol. 127, p. 248-260.
- Blichert-Toft, J. et F. Albarède (1997b): The Lu-Hf isotope geochemistry of chondrites and the evolution of the mantle-crust system. *Earth and Planetary Science Letters*, Vol. 148, p. 243-258.
- Blichert-Toft, J. et F. Albarède (1999a): Hf isotopic compositions of the Hawaii Scientific Drilling Project core and the source mineralogy of Hawaiian basalts. *Geophysical Research Letters*, Vol. 26(7), p. 935-938.
- Blichert-Toft, J., F. A. Frey, et al. (1999b): Hf isotope evidence for pelagic sediments in the source of Hawaiian basalts. *Science*, Vol. 285, p. 879-882.
- Brenan, J. M., H. F. Shaw, et al. (1994): Rutile-aqueous fluid partitioning of Nb, Ta, Hf, Zr, U and Th: Implications for high field strength element depletions in island-arc basalts. *Earth and Planetary Science Letters*, Vol. 128, p. 327-339.
- Brenan, J. M., H. F. Shaw, et al. (1995): Mineral-aqueous fluid partitioning of trace elements at 900°C and 2.0 GPa: Constraints on the trace element chemistry of mantle and deep crustal fluids. *Geochimica and Cosmochimica Acta*, Vol. 59(16), p. 3331-3350.
- Chauvel, C. et J. Blichert-Toft (2001): A hafnium isotope and trace element perspective on melting of the depleted mantle. *Earth and Planetary Science Letters*, Vol. 190, p. 137-151.
- Chauvel, C., A. W. Hofmann, et al. (1992): HIMU-EM: The French Polynesian connection. *Earth and Planetary Science Letters*, Vol. 110, p. 99-119.
- Curry, J. R., G. G. Shor, et al. (1977): Seismic refraction and reflection studies of crustal structure of the eastern Sunda and western Banda arcs. *Journal of Geophysical Research*, Vol. 82, p. 2479-2489.
- David, K., M. Frank, et al. (2001): The Hf isotope composition of global seawater and the evolution of Hf isotopes in the deep Pacific Ocean from Fe-Mn crusts. *Chemical Geology*, Vol. 178, p. 23-42.
- Edwards, C. M. H., M. Menzies, et al. (1991): Evidence from Muriah, Indonesia, for the interplay of supra-subduction zone and intraplate processes in the genesis of potassic alkaline magmas. *Journal of Petrology*, Vol. 32(3), p. 555-592.
- Edwards, C. M. H., J. D. Morris, et al. (1993): Separating mantle from slab signatures in arc lavas using B/Be and radiogenic isotope systematics. *Nature*, Vol. 362, p. 530-533.
- Elderfield, H. et M. J. Greaves (1981a): Negative cerium anomalies in the rare earth element patterns of oceanic ferromanganese nodules. *Earth and Planetary Science Letters*, Vol. 55, p. 163-170.
- Elderfield, H., C. J. Hawkesworth, et al. (1981b): Rare earth element geochemistry of oceanic ferromanganese nodules and associated sediments. *Geochimica and Cosmochimica Acta*, Vol. 45, p. 513-528.
- Elliott, T., T. Plank, et al. (1997): Element transport from slab to volcanic front at the Mariana arc. *Journal of Geophysical Research*, Vol. 102(B7), p. 14991-15019.
- Gasparon, M., D. R. Hilton, et al. (1994): Crustal contamination processes traced by helium isotopes: Examples from the Sunda arc, Indonesia. *Earth and Planetary Science Letters*, Vol. 126, p. 15-22.

- Gasparon, M. et R. Varne (1998): Crustal assimilation vs subducted sediment input in west Sunda arc volcanics: an evaluation. *Mineralogy and Petrology*, Vol. 64, p. 89-117.
- Gerbe, M.-C., A. Gourgaud, et al. (1992): Mineralogical and geochemical evolution of the 1982-1983 Galunggung eruption (Indonesia). *Bulletin of Volcanology*, Vol. 54, p. 284-298.
- Gertisser, R. et J. Keller (2003): Trace element and Sr, Nd, Pb and O isotope variations in medium-K and high-K volcanic rocks from Merapi volcano, Central Java, Indonesia: Evidence for the involvement of subducted sediments in Sunda arc magma genesis. *Journal of Petrology*, Vol. 44(3), p. 457-489.
- Godfrey, L. V., D.-C. Lee, et al. (1997): The Hf isotopic composition of ferromanganese nodules and crusts and hydrothermal manganese deposits: Implications for seawater Hf. *Earth and Planetary Science Letters*, Vol. 151, p. 91-105.
- Hamilton, W. (1979): *Tectonics of the Indonesian region*. U.S. Geological Survey, Professional Papers, N° 1078, 345 p.
- Hawkesworth, C. J., S. P. Turner, et al. (1997a): U-Th isotopes in arc magmas: Implications for element transfer from the subducted crust. *Science*, Vol. 276, p. 551-555.
- Hawkesworth, C. J., S. P. Turner, et al. (1997b): Elemental U-Th variations in island arc rocks: Implications for U-series isotopes. *Chemical Geology*, Vol. 139, p. 207-221.
- Hilton, D. R., J. A. Hoogewerff, et al. (1992): Mapping magma sources in the east Sunda-Banda arcs, Indonesia: Constraints from helium isotopes. *Geochimica and Cosmochimica Acta*, Vol. 56, p. 851-859.
- Hofmann, A. W. (1988): Chemical differentiation of the Earth: The relationship between mantle, continental crust, and oceanic crust. *Earth and Planetary Science Letters*, Vol. 90, p. 297-314.
- Hole, M. J., A. D. Saunders, et al. (1984): Subduction of pelagic sediments: Implications for the origin of Ce-anomalous basalts from the Mariana Islands. *Journal of the Geological Society of London*, Vol. 141, p. 453-472.
- Hoogewerff, J. A., M. J. Van Bergen, et al. (1997): U-series, Sr-Nd-Pb isotope and trace-element systematics across an active island arc-continent collision zone: implications for element transfer at the slab-wedge interface. *Geochimica and Cosmochimica Acta*, Vol. 61(5), p. 1057-1072.
- Hutchison, C. S. (1976): Indonesian active volcanic arc: K, Sr and Rb variation with depth to the Benioff zone. *Geology*, Vol. 4, p. 407-408.
- Hutchison, C. S. (1982): Indonesia. in *Andesites*. R. S. Thorpe (Ed.). John Wiley, New York. p. 207-224.
- Jarrard, R. D. (1986): Relations among subduction parameters. *Reviews of Geophysics*, Vol. 24, p. 217-284.
- Johnson, M. C. et T. Plank (1999): Dehydration and melting experiments constrain the fate of subducted sediments. *Geochemistry, Geophysics, Geosystems*, Vol. 1, papier n° 1999GC000014.
- Katili, J. A. (1975): Volcanism and plate tectonics in the Indonesian island arcs. *Tectonophysics*, Vol. 26, p. 165-188.
- Kogiso, T., Y. Tatsumi, et al. (1997): Trace element transport during dehydration processes in the subducted oceanic crust: 1. Experiments and implications for the origin of ocean island basalts. *Earth and Planetary Science Letters*, Vol. 148, p. 193-205.
- Lin, P.-N. (1992): Trace element and isotopic characteristics of western Pacific pelagic sediments: Implications for the petrogenesis of Mariana Arc magmas. *Geochimica and Cosmochimica Acta*, Vol. 56, p. 1641-1654.

- McLennan, S. M., S. R. Taylor, et al. (1990): Geochemical and Nd-Sr isotopic composition of deep-sea turbidites: crustal evolution and plate tectonic associations. *Geochimica and Cosmochimica Acta*, Vol. 54, p. 2015-2050.
- Nicholls, I. A., D. J. Whitford, et al. (1980): Variation in the geochemistry of mantle sources for tholeiitic and calc-alkaline mafic magmas, western Sunda volcanic arc, Indonesia. *Chemical Geology*, Vol. 30, p. 177-199.
- Palmer, M. R. (1985): Rare earth elements in foraminifera tests. *Earth and Planetary Science Letters*, Vol. 73, p. 285-298.
- Palmer, M. R. et H. Elderfield (1986): Rare earth elements and neodymium isotopes in ferromanganese oxide coatings of Cenozoic foraminifera from the Atlantic Ocean. *Geochimica and Cosmochimica Acta*, Vol. 50, p. 409-417.
- Patchett, P. J. (1983): Hafnium isotope results from mid-ocean ridges and Kerguelen. *Lithos*, Vol. 16, p. 47-51.
- Patchett, P. J. et M. Tatsumoto (1980): Hafnium isotope variations in oceanic basalts. *Geophysical Research Letters*, Vol. 7(12), p. 1077-1080.
- Pearce, J. A., P. D. Kempton, et al. (1999): Hf-Nd element and isotope perspective on the nature and provenance of mantle and subduction components in Western Pacific arc-basin systems. *Journal of Petrology*, Vol. 40(11), p. 1579-1611.
- Piper, D. Z. (1974a): Rare earth elements in ferromanganese nodules and other marine phases. *Geochimica and Cosmochimica Acta*, Vol. 38, p. 1007-1022.
- Piper, D. Z. (1974b): Rare earth elements in the sedimentary cycle: A summary. *Chemical Geology*, Vol. 14, p. 285-304.
- Plank, T. et C. H. Langmuir (1998): The chemical composition of subducting sediment and its consequences for the crust and mantle. *Chemical Geology*, Vol. 145, p. 325-394.
- Priadi, B. (1989): *Pétrologie, géochimie et géochronologie du volcanisme Tertiaire de Java (Indonésie)*. Mémoire de DEA, Université de Bretagne Occidentale, Brest.
- Romeur, M. (1991): *Séries magmatiques arc et arrière-arc de la Sonde: nature des sources impliquées (éléments en trace et isotopes Sr-Nd-Pb)*. Thèse de l'Université de Bretagne Occidentale, Brest.
- Salters, V. J. M. (1996): The generation of mid-ocean ridge basalts from the Hf and Nd isotope perspective. *Earth and Planetary Science Letters*, Vol. 141, p. 109-123.
- Salters, V. J. M. et S. R. Hart (1991): The mantle sources of ocean ridges, islands and arcs: the Hf-isotope connection. *Earth and Planetary Science Letters*, Vol. 104, p. 364-380.
- Salters, V. J. M. et W. M. White (1998): Hf isotope constraints on mantle evolution. *Chemical Geology*, Vol. 145, p. 447-460.
- Shimizu, H. et A. Masuda (1977): Cerium in chert as an indication of marine environment of its formation. *Nature*, Vol. 266, p. 346-348.
- Soeria-Atmadja, R., R. C. Maury, et al. (1991): The tertiary magmatic belts in Java. *The Silv. Jub. Inst. of Sci.*, Vol. September 17-19, p. 98-121.
- Stalder, R., S. F. Foley, et al. (1998): Mineral-aqueous fluid partitioning of trace elements at 900-1200°C and 3.0-5.7 GPa: New experimental data for garnet, clinopyroxene, and rutile, and implications for mantle metasomatism. *Geochimica and Cosmochimica Acta*, Vol. 62(10), p. 1781-1801.
- Stille, P., D. M. Unruh, et al. (1983): Pb, Sr, Nd and Hf isotopic evidence of multiple sources for Oahu, Hawaii basalts. *Nature*, Vol. 304, p. 25-29.
- Stille, P., D. M. Unruh, et al. (1986): Pb, Sr, Nd, and Hf isotopic constraints on the origin of Hawaiian basalts and evidence for a unique mantle source. *Geochimica and Cosmochimica Acta*, Vol. 50, p. 2303-2319.

- Stolz, A. J., R. Varne, et al. (1990): Magma source components in an arc-continent collision zone: the Flores-Lembata sector, Sunda arc, Indonesia. *Contributions to Mineralogy and Petrology*, Vol. 105, p. 585-601.
- Sun, S.-S. et W. F. McDonough (1989): Chemical and isotopic systematics of oceanic basalts: Implications for mantle composition and processes. in *Magmatism in the Ocean Basins*. A. D. Saunders and M. J. Norry (Eds). Geological Society Special Publication, London. Vol. 42, p. 313-345.
- Sutanto (1993): *Evolutions géochimiques et géochronologiques du magmatisme tertiaire de Java*. Mémoire de DEA, Université de Bretagne Occidentale, Brest.
- Tatsumi, Y., D. L. Hamilton, et al. (1986): Chemical characteristics of fluid phase released from a subducted lithosphere and origin of arc magmas: Evidence from high pressure experiments and natural rocks. *Journal of Volcanology and Geothermal Research*, Vol. 29, p. 293-309.
- Taylor, B. (1992): Rifting and the volcanic-tectonic evolution of the Izu-Bonin-Mariana arc. in *Proceedings of the Ocean Drilling Program, Scientific Results*. B. Taylor, K. Fujioka et al. (Eds), Ocean Drilling Program, College Station, Tex. Vol. 126, p. 627-651.
- Toyoda, K., Y. Nakamura, et al. (1990): Rare earth elements of Pacific pelagic sediments. *Geochimica and Cosmochimica Acta*, Vol. 54, p. 1093-1103.
- Turner, S. P. et J. Foden (2001): U, Th and Ra disequilibria, Sr, Nd and Pb isotope and trace element variations in Sunda arc lavas: predominance of a subducted sediment component. *Contributions to Mineralogy and Petrology*, Vol. 142, p. 43-57.
- Turner, S. P., C. J. Hawkesworth, et al. (1996): U-series isotopes and destructive plate margin magma genesis in the Lesser Antilles. *Earth and Planetary Science Letters*, Vol. 142, p. 191-207.
- Van Bemmelen, R. W. (1949): *The Geology of Indonesia. Vol. 1A: General Geology*. Government Printing Office. The Hague.
- Van Bergen, M. J., P. Z. Vroon, et al. (1993): Geochemical and tectonic relationships in the east Indonesian arc-continent collision region: implications for the subduction of the Australian passive margin. *Tectonophysics*, Vol. 223, p. 97-116.
- Vervoort, J. D., P. J. Patchett, et al. (1999): Relationships between Lu-Hf and Sm-Nd isotopic systems in the global sedimentary system. *Earth and Planetary Science Letters*, Vol. 168, p. 79-99.
- Von Huene, R. et D. W. Scholl (1991): Observations at convergent margins concerning sediment subduction, subduction erosion, and the growth of continental crust. *Reviews of Geophysics*, Vol. 29, p. 279-316.
- Wheller, G. E., R. Varne, et al. (1987): Geochemistry of Quaternary volcanism in the Sunda-Banda arc, Indonesia, and three-component genesis of island-arc basaltic magmas. *Journal of Volcanology and Geothermal Research*, Vol. 32, p. 137-160.
- White, W. M. et P. J. Patchett (1984): Hf-Nd-Sr isotopes and incompatible element abundances in island arcs: implications for magma origins and crust-mantle evolution. *Earth and Planetary Science Letters*, Vol. 67, p. 167-185.
- White, W. M., P. J. Patchett, et al. (1986): Hf isotope ratios of marine sediments and Mn nodules: evidence for a mantle source of Hf in seawater. *Earth and Planetary Science Letters*, Vol. 79, p. 46-54.
- Whitford, D. J. (1975): Strontium isotopic studies of the volcanic rocks of the Sunda arc, Indonesia, and their petrogenetic implications. *Geochimica and Cosmochimica Acta*, Vol. 39, p. 1287-1302.
- Whitford, D. J. et I. A. Nicholls (1976): Potassium variation in lavas across the Sunda arc in Java and Bali. in *Volcanism in Australasia*. R. W. Johnson (Ed.). Elsevier, Amsterdam. Vol. , p. 63-75.

- Whitford, D. J., I. A. Nicholls, et al. (1979): Spatial variations in the geochemistry of quaternary lavas across the Sunda arc in Java and Bali. *Contributions to Mineralogy and Petrology*, Vol. 70, p. 341-356.
- Whitford, D. J., W. M. White, et al. (1981): Neodymium isotopic composition of Quaternary island arc lavas from Indonesia. *Geochimica and Cosmochimica Acta*, Vol. 45, p. 989-995.
- Widiyantoro, S. et R. V. d. Hilst (1996): Structure and evolution of lithospheric slab beneath the Sunda arc, Indonesia. *Science*, Vol. 271, p. 1566-1570.
- Widiyantoro, S. et R. V. d. Hilst (1997): Mantle structure beneath Indonesia inferred from high-resolution tomographic imaging. *Geophysical Journal International*, Vol. 130, p. 167-182.
- Woodhead, J. D. (1989): Geochemistry of the Mariana arc (western Pacific): Source composition and processes. *Chemical Geology*, Vol. 76, p. 1-24.
- Woodhead, J. D., J. M. Hergt, et al. (2001): Hafnium isotope evidence for 'conservative' element mobility during subduction zone processes. *Earth and Planetary Science Letters*, Vol. 192, p. 331-346.

Tableau 1 Compositions isotopiques de l'Hf, du Nd et du Sr des laves de Java

Echantillon	Âge (Ma) ^a	$^{176}\text{Hf}/^{177}\text{Hf}$ ^b	$\pm 2\sigma_m$	ϵ_{Hf} ^c	$\epsilon_{\text{Hf}(t)}$ ^d	Signal ^{176}Yb (Volts) ^e	Signal ^{176}Lu (Volts) ^e	$^{143}\text{Nd}/^{144}\text{Nd}$ ^f	ϵ_{Nd} ^g	$\epsilon_{\text{Nd}(t)}$ ^g	$^{87}\text{Sr}/^{86}\text{Sr}$ ^f	$^{87}\text{Sr}/^{86}\text{Sr}$ ^f
JM36	1.33	0.282913	± 11	+5,0	+5,0	0.0017218	0.0000504	0.512507	-2,6	-2,5	0.706833	0.706817
KRK45	7.90	0.283259	± 6	+17,2	+17,2	0.0029339	0.0000805					
WT28A	8.74	0.283240	± 4	+16,6	+16,6	0.0031498	0.0000951	0.512850	+4,1	+4,2	0.705661	0.705636
WT28A ⁱ	8.74	0.283236	± 5	+16,4	+16,5	0.0028630	0.0000896					
JM61	13.69	0.283092	± 3	+11,3	+11,4	0.0073984	0.0002463	0.512740	+2,0	+2,1	0.704325	0.704311
PN8	17.64	0.283148	± 4	+13,3	+13,4	0.0033420	0.0000879	0.512810	+3,4	+3,5	0.704145	0.704108
80J102	22.60	0.283166	± 4	+13,9	+14,1	0.0000627	0.0000024	0.512851	+4,2	+4,3	0.704512	0.704458
BY52	24.25	0.283205	± 4	+15,3	+15,4	0.0024684	0.0000648	0.512978	+6,6	+6,7	0.704372	0.704198
KRS31A	26.52	0.283212	± 4	+15,6	+15,8	0.0031473	0.0000682					
BY48	33.15	0.283173	± 3	+14,2	+14,2	0.0000728	0.0000021	0.513060	+8,2	+8,2	0.704401	0.704289
KRS30	37.55	0.283207	± 5	+15,4	+15,7	0.0031599	0.0000775					
KRS29	39.82	0.283244	± 5	+16,7	+17,0	0.0109800	0.0003008					
PC6B	42.73	0.283173	± 3	+14,2	+14,6	0.0001134	0.0000034	0.513013	+7,3	+7,3	0.705260	0.705240

^a Âges K-Ar d'après Bellon et al., 1989 et Soeria-Atmadja et al., 1991.

^b Rapports isotopiques normalisés à $^{179}\text{Hf}/^{177}\text{Hf} = 0,7325$.

^c ϵ_{Hf} calculé avec $^{176}\text{Hf}/^{177}\text{Hf}_{\text{CHUR}} = 0,282772$ d'après Blichert-Toft et Albarède, 1997b.

^d $\epsilon_{\text{Hf}(t)}$ calculé avec $^{176}\text{Lu}/^{177}\text{Lu}_{\text{CHUR}} = 0,0332$ d'après Blichert-Toft et Albarède, 1997b.

^e Les signaux ^{176}Yb et ^{176}Lu notés en italiques doivent être considérés comme suffisamment élevés pour potentiellement induire des interférences sur les rapports isotopiques $^{176}\text{Hf}/^{177}\text{Hf}$. Ces rapports isotopiques de l'Hf doivent donc être confirmés par duplication des analyses. En général l'application du protocole de Blichert-Toft et al., 1997a pour la séparation entre Hf et Terres Rares permet d'obtenir des signaux en ^{176}Yb inférieurs à 0,001 volts et des signaux ^{176}Lu inférieurs à 0,00004 volts lors du passage au spectromètre de masse.

^f Données d'Abraham, 1993.

^g ϵ_{Nd} et $\epsilon_{\text{Nd}(t)}$ calculés avec $^{143}\text{Nd}/^{144}\text{Nd}_{\text{CHUR}} = 0,512638$ et $^{147}\text{Sm}/^{144}\text{Nd}_{\text{CHUR}} = 0,1967$.

ⁱ Duplication complète de l'analyse précédente.

Légende des figures

Figure 1 (a) Carte régionale de la zone de subduction de la Sonde. Les volcans constituant les arcs volcaniques de la Sonde et de Banda n'ont pas pu être représentés individuellement. Les axes volcaniques de la Sonde et de Banda ont donc été indiqués par des pointillés épais. Les Sites 211 et 261 forés durant les Leg 22 et 27 du DSDP y sont indiqués de même que les Sites de carottages du Lamont-Doherty dont les échantillons ont été analysés par Ben Othman et al. (1989) et Romeur (1991). (b) Carte de l'île de Java montrant la localisation des échantillons étudiés.

Figure 2 Diagrammes (a) $^{87}\text{Sr}/^{86}\text{Sr}_{(i)}$, (b) $\epsilon_{\text{Nd}(i)}$ et (c) $\epsilon_{\text{Hf}(i)}$ en fonction de l'âge des échantillons de Java. Les compositions isotopiques du Sr et du Nd dans cette figure et dans toutes les suivantes et les compositions en éléments majeurs et en éléments en traces des tertiaires laves de Java dans toutes les figures suivantes proviennent des travaux d'Abraham (1993). Les âges des laves anciennes de Java dans cette figure et dans toutes les figures suivantes ont été déterminés par Bellon et al. (1989) et Soeria-Atmadja et al. (1991). Les compositions des laves actuelles de Java dans cette figure et dans toutes les figures suivantes sont tirées des publications suivantes : Whitford (1975); Whitford et al. (1979); Whitford et al. (1981); White et Patchett (1984); Edwards et al. (1991); Gerbe et al. (1992); Edwards et al. (1993); Turner et Foden (2001); Woodhead et al. (2001); Gertisser et Keller (2003). Seules les compositions des laves actuelles de la partie centrale de l'île de Java ont été placées dans ces figures et dans toutes les suivantes. Les échantillons des autres zones de l'île de Java et des autres segments de l'arc de la Sonde n'ont pas été considérés car l'arc présente des variations longitudinales des compositions des laves. Les compositions de la pile sédimentaire subduite au niveau de la fosse de Java dans cette figure et dans toutes les figures suivantes ont été estimées par Plank et Langmuir (1998).

Figure 3 Diagramme $\varepsilon_{\text{Hf}(i)}$ *versus* $\varepsilon_{\text{Nd}(i)}$ des tertiaires laves de Java comparées aux compositions des laves actuelles de l'arc de la Sonde et aux champs de variations des autres arcs intra-océaniques d'après les données de White et Patchett (1984), Pearce et al. (1999), Woodhead et al. (2001) et Marini et al. (en préparation, 2004). Le terme "Arcs appauvris" regroupe les arcs d'Izu-Mariannes, de Nouvelle Bretagne, des Kermadec et des Aléoutiennes qui sont isotopiquement proches des MORB. Les champs de variations des MORB et OIB ont été dessinés d'après les données de Patchett et Tatsumoto (1980), Patchett (1983), Stille et al. (1983), Stille et al. (1986), Salters et Hart (1991), Chauvel et al. (1992), Salters (1996), Salters et White (1998), Blichert-Toft et Albarède (1999a), Blichert-Toft et al. (1999b) et Chauvel et Blichert-Toft (2001). L'échantillon de radiolarite 6R1 a été choisi comme représentatif des sédiments biogéniques présentant des rapports isotopiques de l'Hf relativement radiogéniques en comparaison des sédiments détritiques, des rapports Nd/Hf élevés en comparaison du manteau appauvri et d'importantes anomalies négatives en Ce par rapport aux autres Terres Rares légères (Ce/Ce^* de l'échantillon 6R1 égale à 0,5). Compositions chimiques et isotopiques de la radiolarite 6R1 d'après Plank et al. (en préparation, 2004) et Marini et al. (en préparation, 2004).

Figure 4 Diagramme $\varepsilon_{\text{Nd}(i)}$ *versus* (a) $\text{SiO}_2(\%)$ et (b) $\text{MgO}(\%)$ des laves tertiaires de Java. Les sources des données de cette figure sont énumérées dans la légende de la figure 2. Les valeurs $\varepsilon_{\text{Nd}(i)}$ ne montrent aucune corrélation avec les pourcentages en SiO_2 ou MgO . En conséquence l'évolution des compositions isotopiques du Nd au cours du temps ne peut pas être attribuée à des processus d'Assimilation par Cristallisation fractionnée.

Figure 5 Diagramme Ce/Ce* en fonction (a) de l'âge des échantillons et (b) de la valeur $\epsilon_{Nd(i)}$ des laves tertiaires de Java. Les sources des données de cette figure sont énumérées dans la légende de la figure 2. Les échantillons de Java montrent une diminution progressive du rapport Ce/Ce* ce qui correspond à un accroissement du déficit en Ce par rapport aux autres Terres Rares légères au cours du temps. Méthode de calcul du rapport Ce/Ce* : $Ce/Ce^* = (3 \times Ce_n) / (2 \times La_n + Nd_n)$. La normalisation des concentrations en La, Ce et Nd a été effectuée en utilisant les concentrations de la chondrite C1 d'après Sun et McDonough (1989).

Figure 6 Diagramme U/Th en fonction de l'âge des échantillons de Java. Les sources des données de cette figure sont énumérées dans la légende de la figure 2. Si l'on excepte l'échantillon BY48 les laves de Java montrent une diminution générale du rapport U/Th au cours du temps ce qui indique que les éléments les plus incompatibles vis à vis des fluides aqueux comme le Th ne sont pas découplés des éléments les plus compatibles vis à vis de ces mêmes fluides. La contamination du manteau source de l'arc de Java ne semble donc pas uniquement réalisée par des fluides aqueux mais nécessite aussi la contribution d'agents capables d'assurer le transport du Th jusqu'à la source des laves. Ces agents correspondent probablement à des liquides silicatés provenant de la fusion des matériaux subduits. De plus cette fusion doit en premier lieu concerner les sédiments subduits puisque la contamination de la source de l'arc est corrélée à une anomalie négative en Ce (voir figure 5).

(Blichert-Toft and Albarède, 1997b)

Figure 1

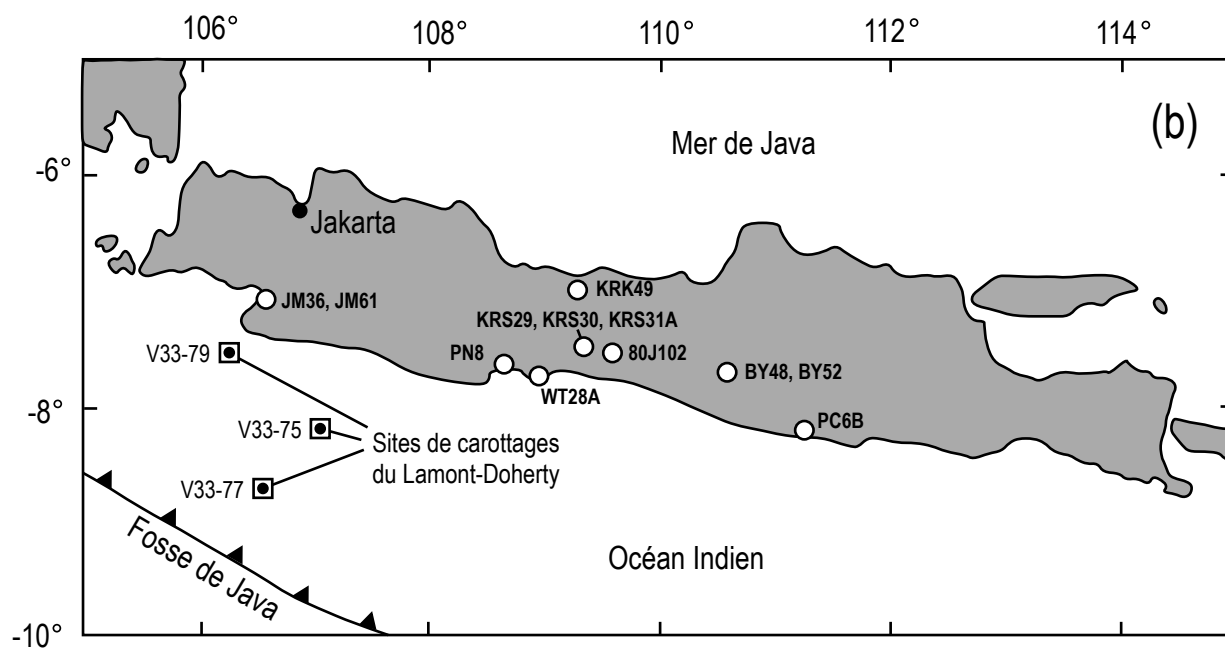
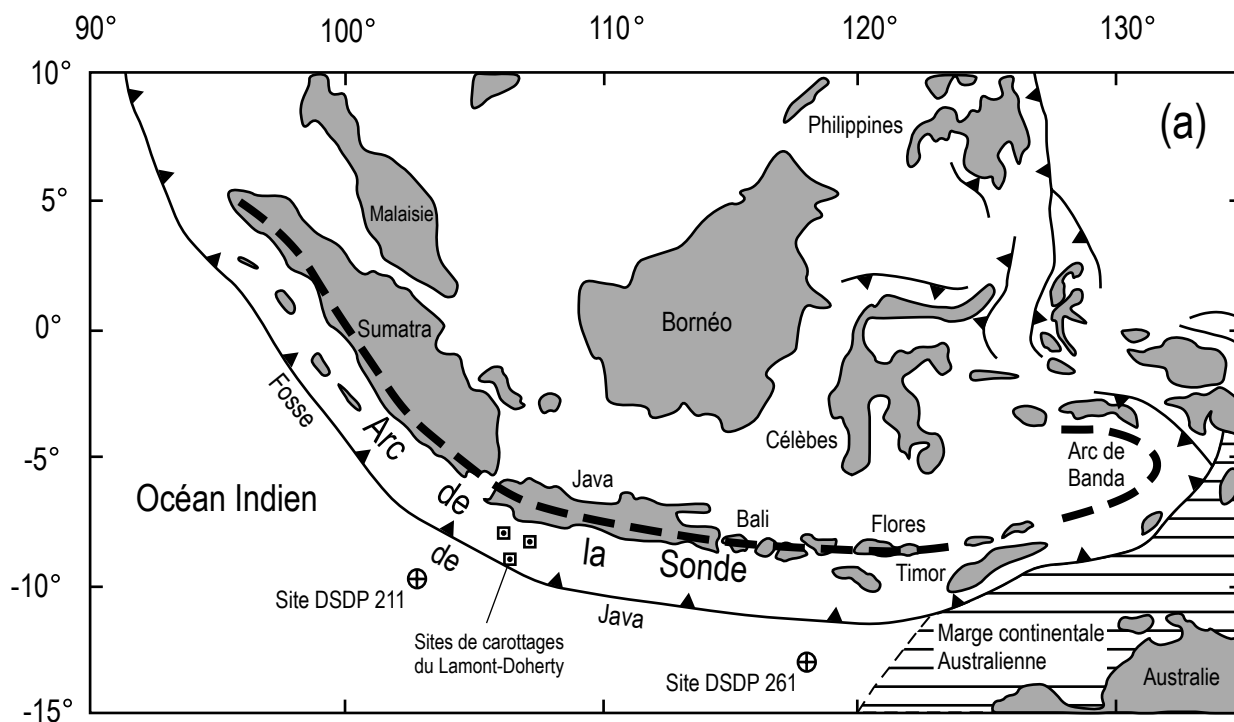

Figure 2

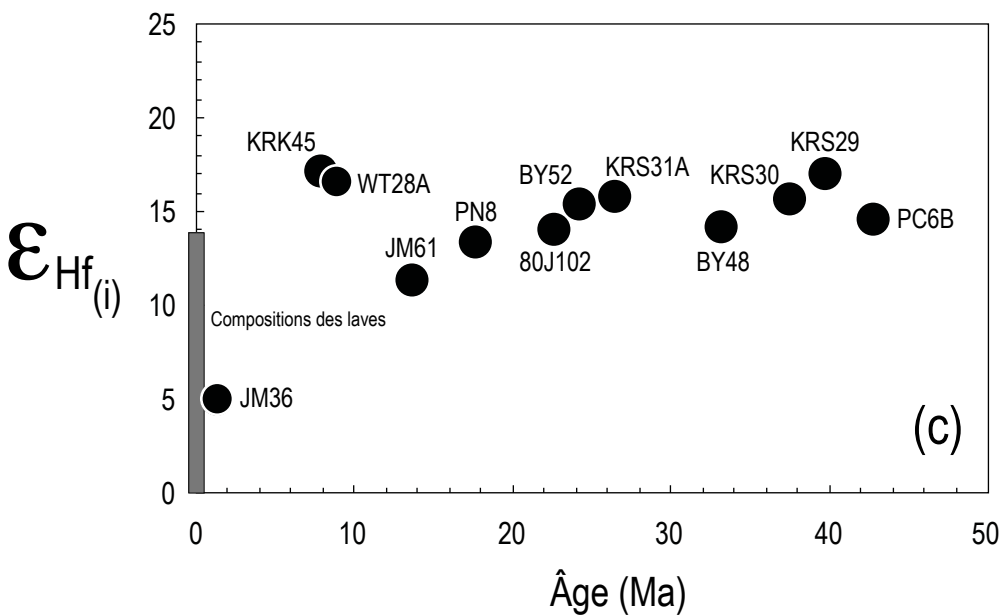
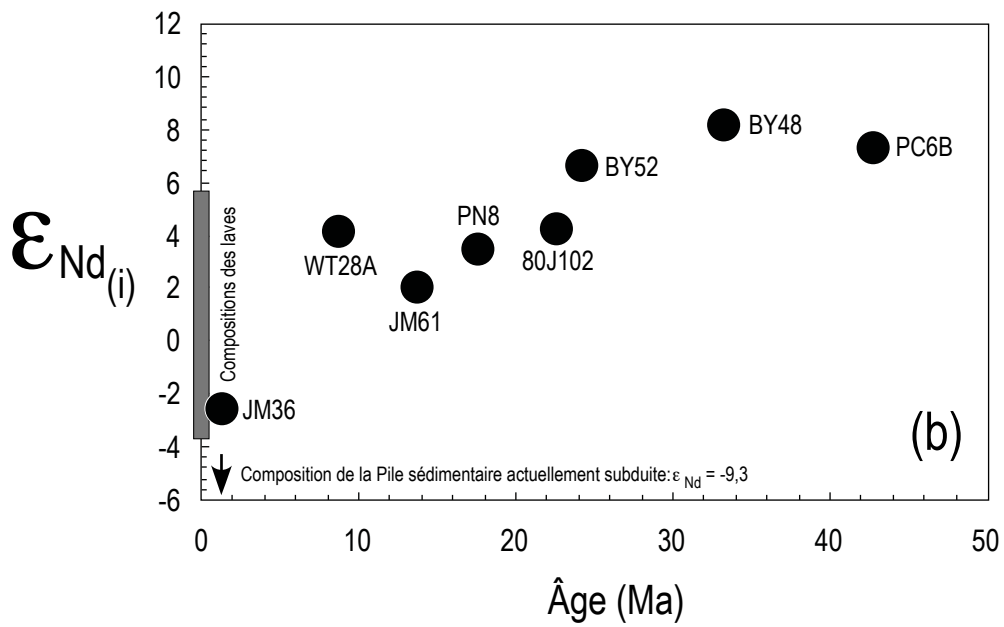
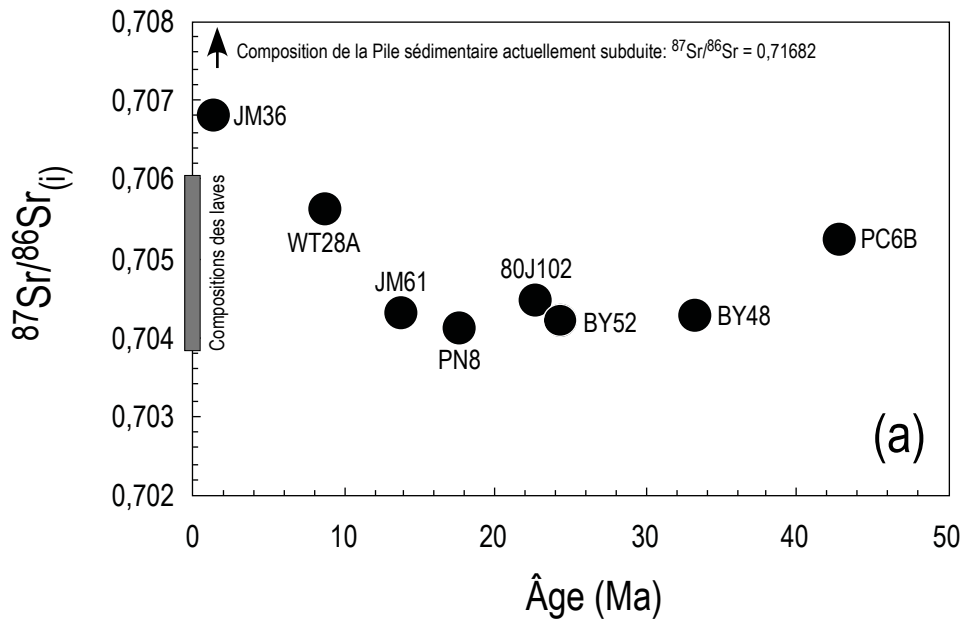
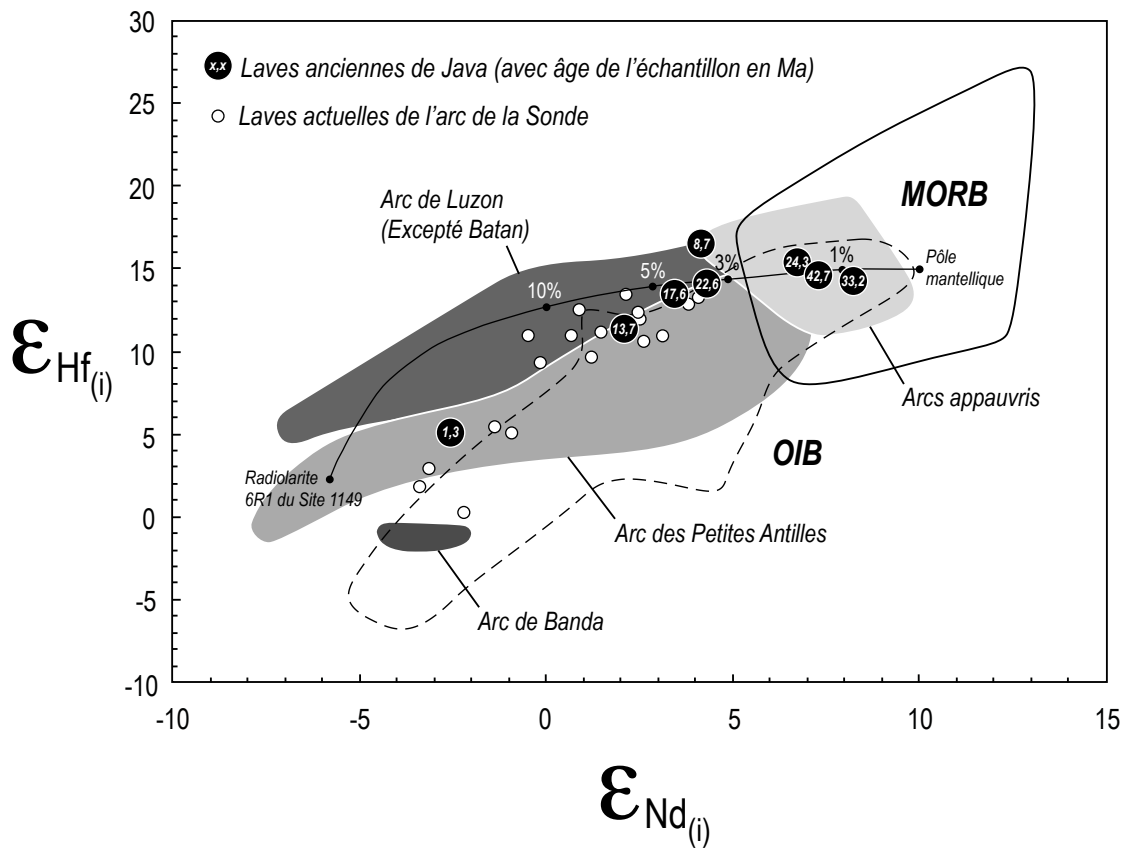

Figure 3



Données utilisées pour tracer la courbe de mélange entre le pôle mantellique et l'échantillon de radiolarite 6R1 du Site ODP 1149

	ϵ_{Nd}	ϵ_{Hf}	Nd/Hf
Pôle mantellique	+10	+15	3,2
Radiolarite 6R1	-5,8	+2,2	25

Figure 4

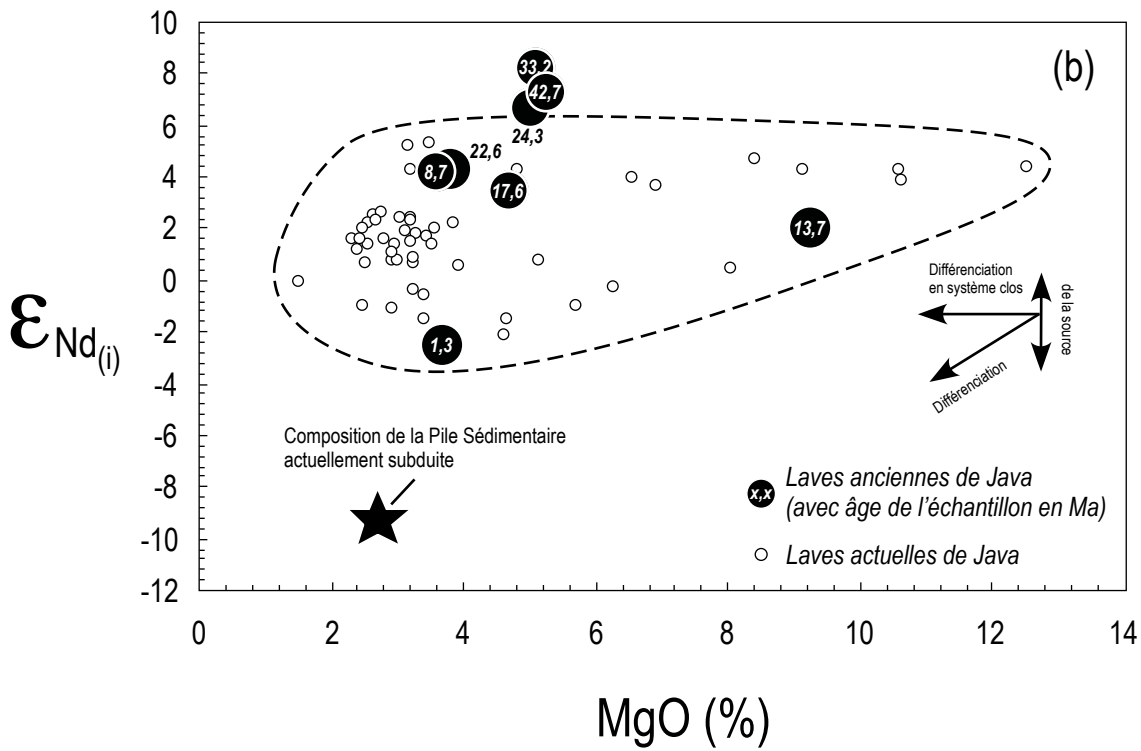
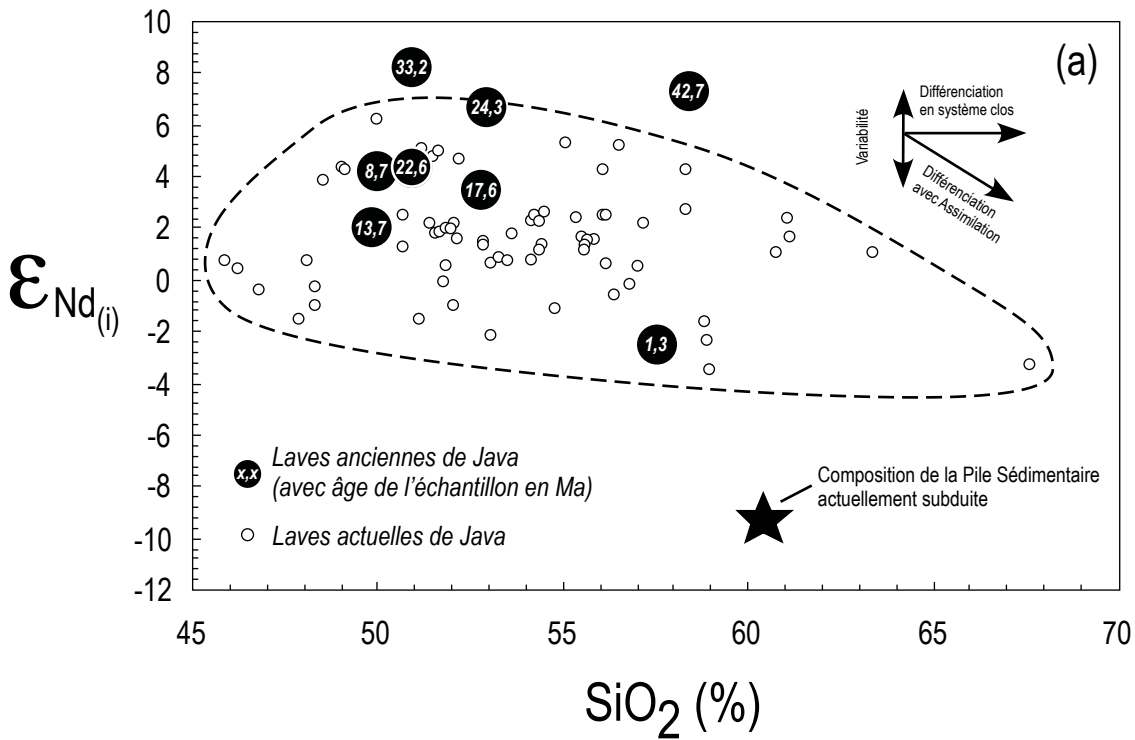

Figure 5

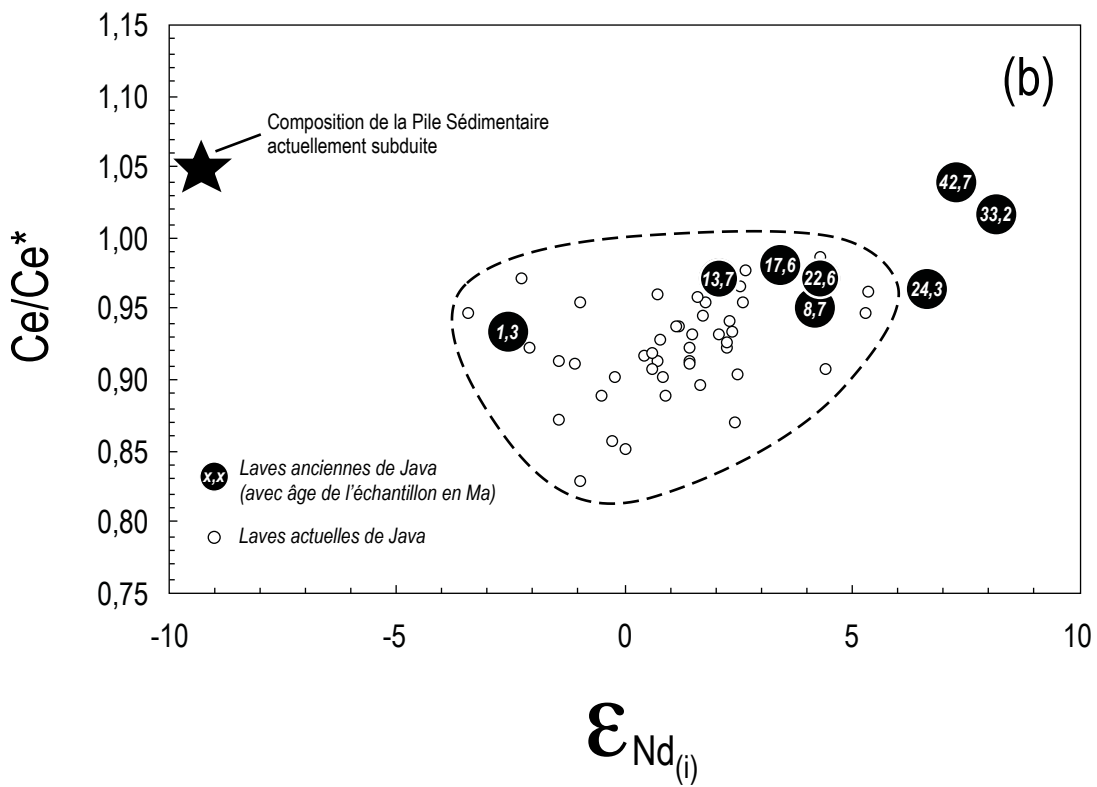
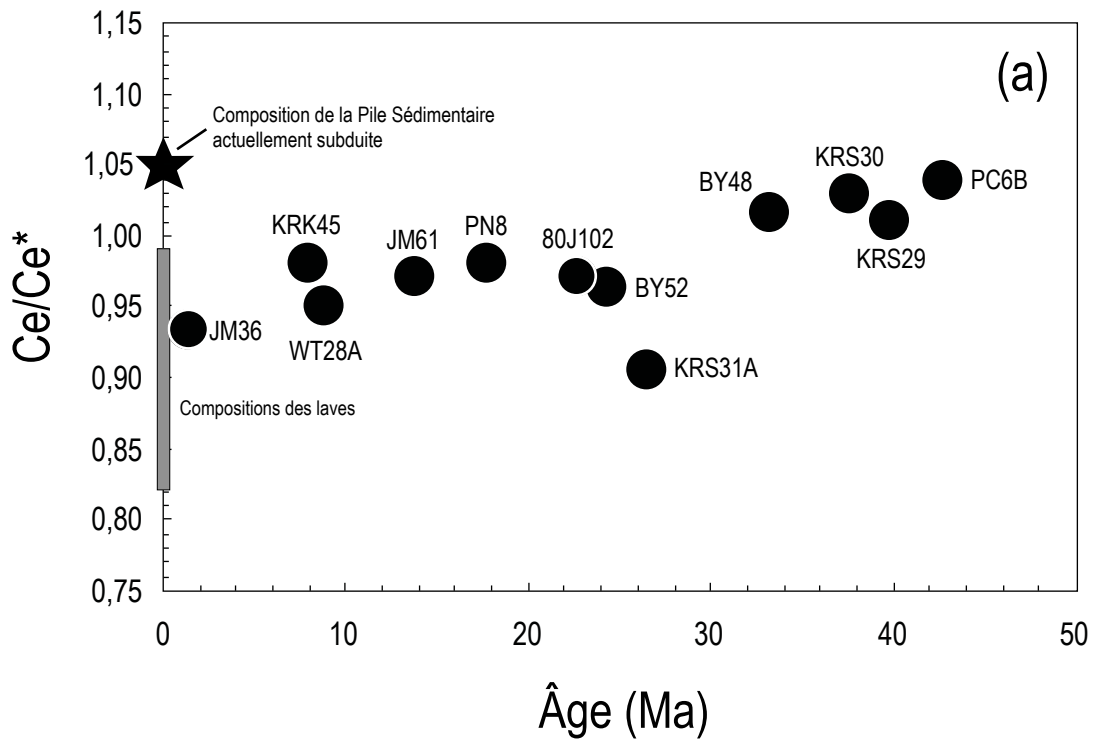
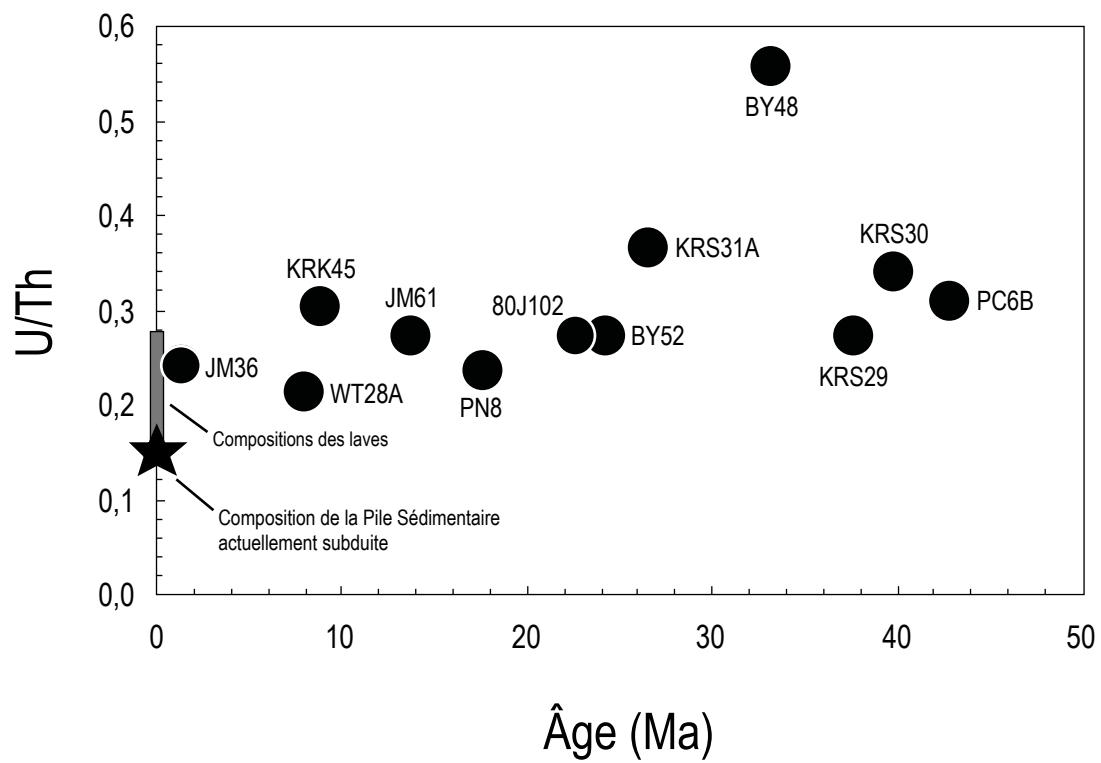

Figure 6



CHAPITRE IV

Synthèse des résultats principaux

CHAPITRE IV : Synthèse des résultats principaux

Nos travaux sur les compositions isotopiques de l'Hafnium des échantillons provenant d'une croûte océanique altérée, des sédiments de grands fonds océaniques et des laves d'arcs insulaires nous conduisent à proposer plusieurs conclusions majeures :

Tout d'abord, nos mesures sur les échantillons composites du forage ODP 801C et du Site 1149 ont permis de déterminer les compositions isotopiques globales de l'Hafnium et du Néodyme de la croûte basaltique altérée absorbée au niveau de la fosse des Mariannes et de la pile sédimentaire subduite au niveau de l'arc d'Izu :

La croûte basaltique altérée du forage 801C présente des compositions isotopiques de l'Hafnium et du Néodyme équivalentes aux compositions des basaltes non-altérés de la dorsale du Pacifique. Le budget des Terres Rares et des éléments du groupe de l'Hafnium ne semble donc pas modifié lors de l'altération hydrothermale de haute et basse température de la croûte océanique et de son interaction avec l'eau de mer.

Les sédiments du Site 1149 présentent des compositions isotopiques de l'Hafnium et du Néodyme similaires aux compositions des croûtes et des nodules de Fe-Mn. Certains sédiments des grands fonds océaniques (radiolarites, argilites siliceuses et certaines argiles pélagiques) possèdent donc des compositions isotopiques équivalentes à la composition de l'eau de mer. Ce résultat s'explique par une précipitation du Néodyme et de l'Hafnium dans des phases minérales authigènes. Le Néodyme et les autres éléments du groupe des Terres Rares précipitent dans des phosphates alors que les éléments du groupe de l'Hafnium se concentrent dans des phases alumino-silicatés authigènes (zéolithes ou minéraux argileux).

Nos données permettent une estimation du flux de Néodyme entrant dans la zone de subduction d'Izu par subduction de la pile sédimentaire. Ce flux semble du même ordre de

grandeur que le flux de Néodyme sortant dans l'arc volcanique d'Izu. Pour cette zone de convergence, il n'y a donc pas un grand déséquilibre entre le flux de matière entrant et le flux de matière sortant. Ce résultat sur le bilan de masse du Néodyme dans la zone d'Izu démontre que les zones de subduction absorbant des sédiments pélagiques sont aussi des régions de recyclage de la croûte continentale vers le manteau au même titre que les zones de subduction absorbant des sédiments terrigènes comme la zone de subduction des Petites Antilles (White et Dupré, 1986).

Enfin nous avons utilisé nos données sur la croûte basaltique du forage 801C et les sédiments du Site 1149 afin de vérifier si le recyclage d'anciennes croûtes et sédiments océaniques dans le manteau profond de la Terre pouvaient rendre compte des compositions isotopiques des laves de points chauds. La contribution d'anciennes croûtes et sédiments océaniques équivalents aux croûtes et sédiments actuels implique un mélange en proportions fixes de ces matériaux avant leur contribution à la source des points chauds. Cependant les possibles modifications de la composition des croûtes basaltiques au cours de l'histoire de la Terre (depuis des croûtes archéennes aux compositions komatiitiques jusqu'aux croûtes tholeiitiques actuelles) et les modifications de la composition des sédiments avec le développement biologique (développement des sédiments biogéniques et des phases minérales biochimiques) rendent peut-être les croûtes et sédiments océaniques actuels non-représentatifs des matériaux anciennement subduits.

Nos mesures sur les laves de l'arc de Luzon et de l'île de Java complètent notablement les précédentes études concernant les compositions isotopiques de l'Hafnium des laves d'arcs volcaniques réalisées par White et Patchett (1984), Salters et Hart (1991), Vroon et al. (1998), Pearce et al. (1999), Woodhead et al. (2001). Ces données associées à nos mesures ont été rassemblées dans la figure A. Elles permettent aujourd'hui d'affirmer que les laves d'arcs

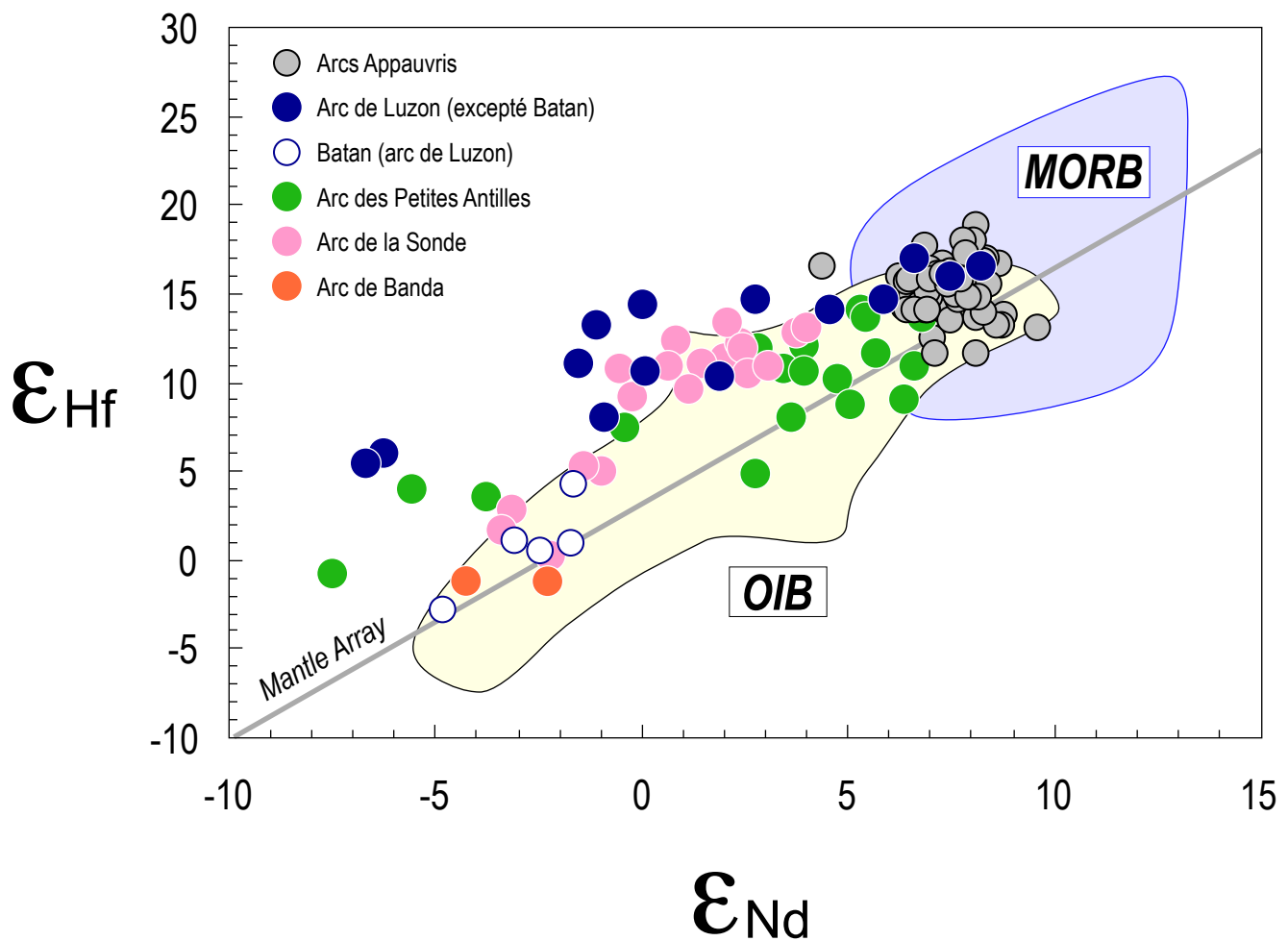

Figure A: Diagramme ϵ_{Hf} versus ϵ_{Nd} des laves actuelles des arcs intra-océaniques.

Données de White et Patchett, 1984; Pearce, 1999; Woodhead et al., 2001 et Marini et al., en preparation, 2004. Le terme "Arcs appauvris" regroupe les arcs d'Izu-Mariannes, de Nouvelle Bretagne, des Kermadec et des Aléoutiennes qui sont isotopiquement proches des MORB. Les champs des MORB et OIB ont été dessinés d'après les données de Patchett et Tatsumoto, 1980; Patchett, 1983; Stille et al., 1983; Stille et al., 1986; Salters et Hart, 1991; Chauvel et al., 1992; Salters, 1996; Salters et White, 1998; Blichert-Toft et Albarède, 1999a; Blichert-Toft et al., 1999b et Chauvel et Blichert-Toft, 2001. Le "Mantle Array" représente la droite de corrélation entre les compositions isotopiques de l'Hf et du Nd des OIB et des MORB et a été calculée par Vervoort et al., 1999.

insulaires se positionnent pour leur très grande majorité au-dessus du "Mantle Array" défini par Vervoort et al. (1999) dans l'espace ϵ_{Hf} versus ϵ_{Nd} . Les laves d'arcs volcaniques se distinguent donc des laves de points chauds par des compositions isotopiques de l'Hafnium plus radiogéniques pour des compositions isotopiques du Néodyme équivalentes. Nos travaux sur les arcs de Luzon et de Java nous permettent d'affirmer que ces compositions isotopiques de l'Hafnium sont conditionnées par la contamination de leurs sources par des sédiments présentant aussi des compositions isotopiques de l'Hafnium très radiogéniques par rapport à leurs compositions isotopiques du Néodyme. De tels sédiments se positionnent donc également au dessus du "Mantle Array" dans l'espace ϵ_{Hf} versus ϵ_{Nd} et appartiennent aux groupes des sédiments pélagiques déposés sur les grands fonds océaniques.

Nos travaux sur les laves d'arcs ont aussi porté sur les causes du déficit en Niobium et Tantale par rapport aux autres éléments en traces. Trois grandes hypothèses ont été proposées dans la littérature pour rendre compte des anomalies négatives en Niobium et Tantale dans les spectres des magmas d'arcs : Tout d'abord une contamination de la source des arcs par des fluides aqueux incapables à transporter Niobium et Tantale depuis les matériaux subduits jusqu'au manteau source (Tatsumi et al., 1986; Tatsumi, 1989; McCulloch et Gamble, 1991; Saunders et al., 1991; Hawkesworth et al., 1993; Hawkesworth et al., 1994; Brenan et al., 1995; Keppler, 1996). Deuxièmement la rétention de Niobium et Tantale par une phase résiduelle dans les matériaux de la plaque en subduction (Brenan et al., 1994; Elliott et al., 1997; Turner et al., 1997; Stalder et al., 1998; Class et al., 2000; Foley et al., 2000). Enfin une contamination du manteau source par des sédiments présentant un déficit des proportions en Niobium et Tantale peut aussi contribuer à l'apparition d'anomalies négatives au niveau de ces deux éléments dans les spectres des laves d'arcs (Class et al., 2000).

L'apport de fluides aqueux à la source des laves d'arcs insulaires peut être identifiée par l'analyse du rapport U/Th. En effet, comme détaillé par Hawkesworth et al. (1997), les fluides

aqueux permettent un transfert de l'Uranium depuis les matériaux subduits jusqu'à la source des laves d'arcs mais ne permettent pas le transfert du Thorium. En conséquence la contribution de fluides aqueux s'accompagne d'un fractionnement entre Uranium et Thorium et se traduit par une élévation du rapport U/Th au niveau des laves d'arcs (Hawkesworth et al., 1997). À l'opposé, une contamination de la source des laves d'arcs par des magmas silicatés provenant de la fusion des matériaux subduits n'entraîne pas d'augmentation du rapport U/Th. Nos données combinant les compositions isotopiques de l'Hafnium et les rapports U/Th des laves d'arc de Luzon ainsi que les données de White et Patchett (1984), Pearce et al. (1999), Woodhead et al. (2001) concernant d'autres arcs intra-océaniques sont reportés dans la figure B1. Cette figure démontre que les arcs dont les laves ont des rapports isotopiques de l'Hafnium proche des MORB (les arcs des Mariannes, des Aléoutiennes et des Kermadec) présentent des rapports U/Th parfois très élevés. De tels rapports U/Th peuvent être interprétés comme reflétant la participation de fluides aqueux à la source de ces arcs. À l'opposé, les arcs de Luzon, de la Sonde et des Petites Antilles possèdent des rapports U/Th diminuant avec les valeurs ϵ_{Hf} . Une telle évolution indique probablement la contribution de magmas silicatés provenant des sédiments à la source des laves. Cependant, comme le démontre la figure B2, l'ensemble des laves de ces différents arcs présentent des rapports La/Nb tout à fait comparables. La totalité des laves d'arcs insulaires possèdent donc toutes des déficits similaires en Niobium et Tantale, quelle que soit la composition aqueuse ou silicatée des liquides qui contaminent la source. Les anomalies négatives en Niobium et Tantale par rapport aux autres éléments traces dans les laves d'arcs insulaires ne semblent donc pas au premier ordre contrôlées par la contribution de fluides aqueux.

De plus, d'après les données de McLennan et al. (1990) et Plank et al. (en préparation, 2004), les différents groupes de sédiments océaniques (terrigenes, volcanoclastiques, biogéniques) présentent des rapports La/Nb généralement compris entre 0,8 et 12 ce qui est équivalent aux

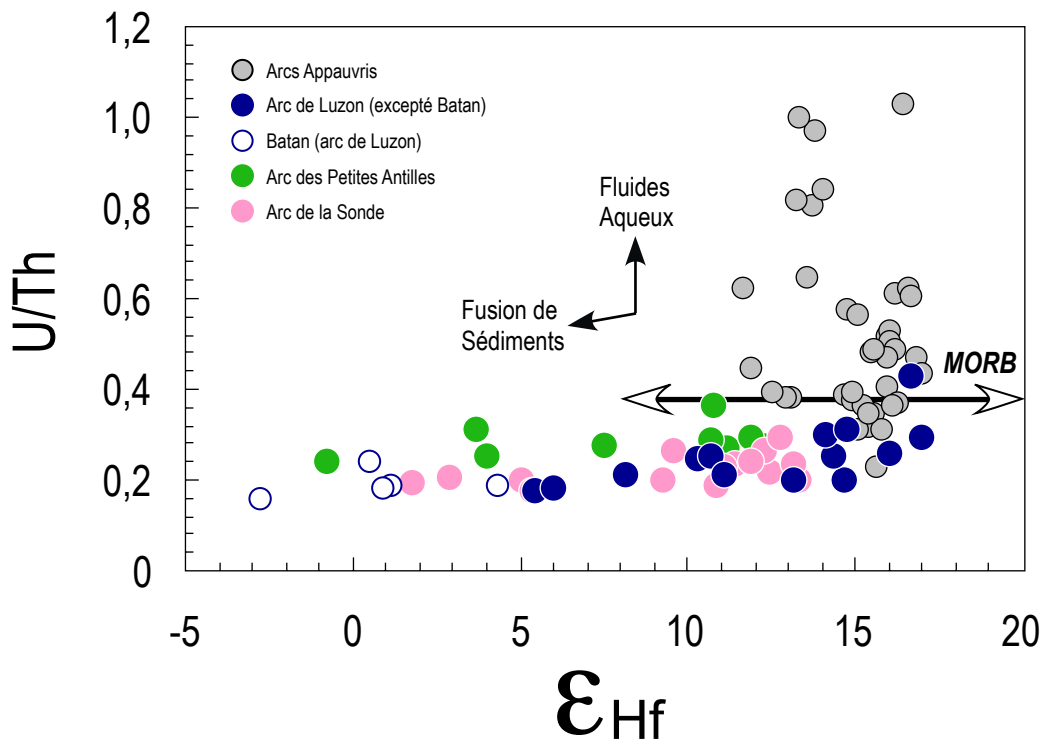

Figure B1: Diagramme U/Th versus ϵ_{Hf} des laves actuelles des arcs intra-océaniques.

Données de Pearce et al., 1999; Woodhead et al., 2001 et Marini et al., en préparation, 2004. Le terme "Arcs appauvris" regroupe les arcs d'Izu-Mariannes, de Nouvelle Bretagne, des Kermadec et des Aléoutiennes qui sont isotopiquement proches des MORB. L'enrichissement en U des laves de ces arcs indique probablement l'apport de fluides aqueux à la source. Au contraire dans les arcs de Luzon, de la Sonde et des Petites Antilles, la diminution des rapports U/Th et des rapports isotopiques de l'Hf indique la contribution de sédiments probablement par fusion de ces derniers. Rapport U/Th des MORB d'après Hofmann, 1988.

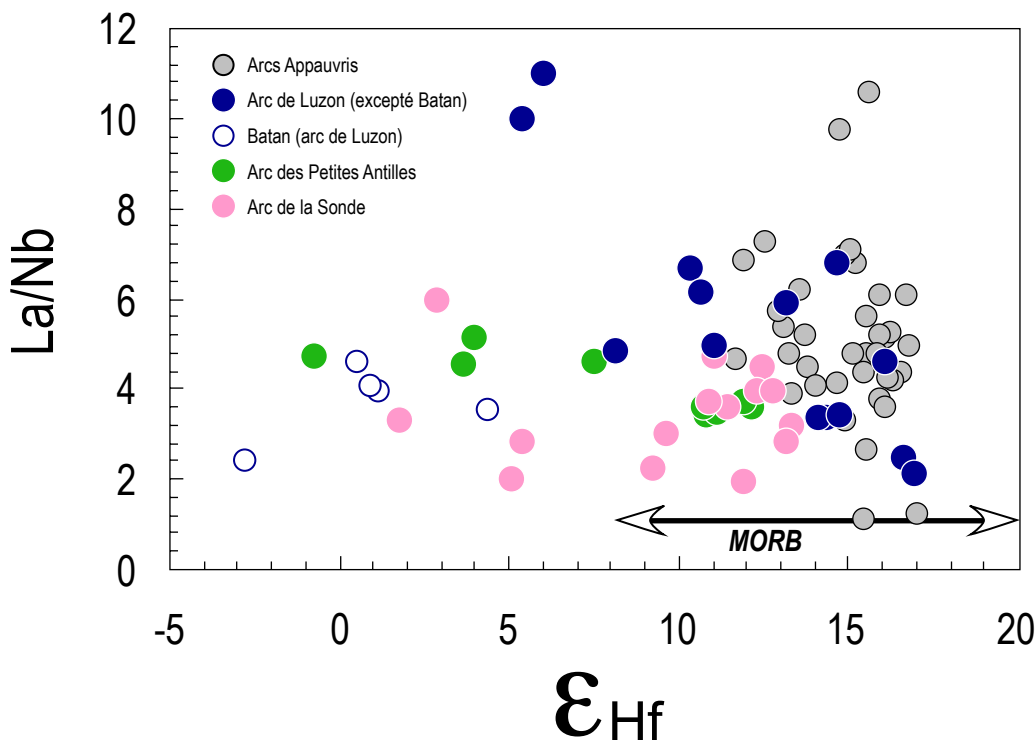

Figure B2: Diagramme La/Nb versus ϵ_{Hf} des laves actuelles des arcs intra-océaniques.

Sources des données identiques à la figure B1. Cette figure montre que les laves des différents arcs ont des déficits comparables en Nb et Ta. Les sédiments océaniques n'ont pas été représentés mais les données de McLennan et al., 1990 et Plank et al., en préparation, 2004, indiquent que ces matériaux présentent des rapports La/Nb variant généralement de 0,8 à 12 comparables aux rapports La/Nb des laves d'arcs.

rapports La/Nb des laves d'arcs (figure B2). Par conséquent si le déficit en Niobium et Tantale des laves est exclusivement causé par le déficit en Niobium et Tantale des sédiments océaniques alors la source des magmas d'arcs doit être composée d'une proportion de près de 100% de sédiments. Cette hypothèse ne peut être retenue car la composition en éléments majeurs des sédiments, en particulier leur faibles teneurs en MgO et leurs fortes teneurs en Silice, ne permet pas d'obtenir par fusion des liquides magmatiques de composition basaltique ou andésitique (Johnson et Plank, 1999). Par conséquent nous pouvons conclure que le déficit en Niobium et Tantale des laves d'arcs insulaires est en premier lieu causé par une rétention de ces éléments dans une phase minérale résiduelle. Pour différents auteurs, la rétention de ces deux éléments serait occasionnée par du rutile résiduel au niveau des matériaux subduits (Brenan et al., 1994; Elliott et al., 1997; Turner et al., 1997; Stalder et al., 1998; Class et al., 2000; Foley et al., 2000) et non pas au niveau du manteau source (Green et Pearson, 1986; Ryerson et Watson, 1987; Woodhead et al., 1993). L'intervention de fluides aqueux et le déficit en Niobium et Tantale des sédiments ne sont que des causes secondaires des anomalies négatives en Niobium et Tantale par rapport aux autres éléments traces dans les laves d'arcs.

Références Bibliographiques :

- Blichert-Toft, J. et F. Albarède (1999a): Hf isotopic compositions of the Hawaii Scientific Drilling Project core and the source mineralogy of Hawaiian basalts. *Geophysical Research Letters*, Vol. 26(7), p. 935-938.
- Blichert-Toft, J., F. A. Frey, et al. (1999b): Hf isotope evidence for pelagic sediments in the source of Hawaiian basalts. *Science*, Vol. 285, p. 879-882.
- Brenan, J. M., H. F. Shaw, et al. (1994): Rutile-aqueous fluid partitioning of Nb, Ta, Hf, Zr, U and Th: Implications for high field strength element depletions in island-arc basalts. *Earth and Planetary Science Letters*, Vol. 128, p. 327-339.
- Brenan, J. M., H. F. Shaw, et al. (1995): Mineral-aqueous fluid partitioning of trace elements at 900°C and 2.0 GPa: Constraints on the trace element chemistry of mantle and deep crustal fluids. *Geochimica et Cosmochimica Acta*, Vol. 59(16), p. 3331-3350.
- Chauvel, C. et J. Blichert-Toft (2001): A hafnium isotope and trace element perspective on melting of the depleted mantle. *Earth and Planetary Science Letters*, Vol. 190, p. 137-151.

-
- Chauvel, C., A. W. Hofmann, et al. (1992): HIMU-EM: The French Polynesian connection. *Earth and Planetary Science Letters*, Vol. 110, p. 99-119.
- Class, C., D. M. Miller, et al. (2000): Distinguishing melt and fluid subduction components in Umnak Volcanics, Aleutian Arc. *Geochemistry, Geophysics, Geosystems*, Vol. 1, papier n° 1999GC000010.
- Elliott, T., T. Plank, et al. (1997): Element transport from slab to volcanic front at the Mariana arc. *Journal of Geophysical Research*, Vol. 102(B7), p. 14991-15019.
- Foley, S. F., M. G. Barth, et al. (2000): Rutile/melt partition coefficients for trace elements and an assessment of the influence of rutile on the trace element characteristics of subduction zone magmas. *Geochimica et Cosmochimica Acta*, Vol. 64(5), p. 933-938.
- Green, T. H. et N. J. Pearson (1986): Ti-rich accessory phase saturation in hydrous mafic-felsic compositions at high P, T. *Chemical Geology*, Vol. 54, p. 185-201.
- Hawkesworth, C. J., K. Gallagher, et al. (1993): Trace element fractionation processes in the generation of island arc basalts. *Philosophical Transactions of the Royal Society of London. A*, Vol. 342, p. 179-191.
- Hawkesworth, C. J., K. Gallagher, et al. (1994): Destructive plate margin magmatism: Geochemistry and melt generation. *Lithos*, Vol. 33, p. 169-188.
- Hawkesworth, C. J., S. P. Turner, et al. (1997): Elemental U-Th variations in island arc rocks: Implications for U-series isotopes. *Chemical Geology*, Vol. 139, p. 207-221.
- Hofmann, A. W. (1988): Chemical differentiation of the Earth: The relationship between mantle, continental crust, and oceanic crust. *Earth and Planetary Science Letters*, Vol. 90, p. 297-314.
- Johnson, M. C. et T. Plank (1999): Dehydration and melting experiments constrain the fate of subducted sediments. *Geochemistry, Geophysics, Geosystems*, Vol. 1, papier n° 1999GC000014.
- Keppler, H. (1996): Constraints from partitioning experiments on the composition of subduction-zone fluids. *Nature*, Vol. 380, p. 237-240.
- McCulloch, M. T. et J. A. Gamble (1991): Geochemical and geodynamical constraints on subduction zone magmatism. *Earth and Planetary Science Letters*, Vol. 102, p. 358-374.
- McLennan, S. M., S. R. Taylor, et al. (1990): Geochemical and Nd-Sr isotopic composition of deep-sea turbidites: crustal evolution and plate tectonic associations. *Geochimica et Cosmochimica Acta*, Vol. 54, p. 2015-2050.
- Patchett, P. J. (1983): Hafnium isotope results from mid-ocean ridges and Kerguelen. *Lithos*, Vol. 16, p. 47-51.
- Patchett, P. J. et M. Tatsumoto (1980): Hafnium isotope variations in oceanic basalts. *Geophysical Research Letters*, Vol. 7(12), p. 1077-1080.
- Pearce, J. A., P. D. Kempton, et al. (1999): Hf-Nd element and isotope perspective on the nature and provenance of mantle and subduction components in Western Pacific arc-basin systems. *Journal of Petrology*, Vol. 40(11), p. 1579-1611.
- Ryerson, F. J. et E. B. Watson (1987): Rutile saturation in magmas: Implications for Ti-Nb-Ta depletion in island-arc basalts. *Earth and Planetary Science Letters*, Vol. 86, p. 225-239.
- Salters, V. J. M. (1996): The generation of mid-ocean ridge basalts from the Hf and Nd isotope perspective. *Earth and Planetary Science Letters*, Vol. 141, p. 109-123.
- Salters, V. J. M. et S. R. Hart (1991): The mantle sources of ocean ridges, islands and arcs: the Hf-isotope connection. *Earth and Planetary Science Letters*, Vol. 104, p. 364-380.
- Salters, V. J. M. et W. M. White (1998): Hf isotope constraints on mantle evolution. *Chemical Geology*, Vol. 145, p. 447-460.
-

-
- Saunders, A. D., M. J. Norry, et al. (1991): Fluid influence on the trace element compositions of subduction zone magmas. *Philosophical Transactions of the Royal Society of London. A*, Vol. 335, p. 377-392.
- Stalder, R., S. F. Foley, et al. (1998): Mineral-aqueous fluid partitioning of trace elements at 900-1200°C and 3.0-5.7 GPa: New experimental data for garnet, clinopyroxene, and rutile, and implications for mantle metasomatism. *Geochimica et Cosmochimica Acta*, Vol. 62(10), p. 1781-1801.
- Stille, P., D. M. Unruh, et al. (1983): Pb, Sr, Nd and Hf isotopic evidence of multiple sources for Oahu, Hawaii basalts. *Nature*, Vol. 304, p. 25-29.
- Stille, P., D. M. Unruh, et al. (1986): Pb, Sr, Nd, and Hf isotopic constraints on the origin of Hawaiian basalts and evidence for a unique mantle source. *Geochimica et Cosmochimica Acta*, Vol. 50, p. 2303-2319.
- Tatsumi, Y. (1989): Migration of fluid phases and genesis of basalt magmas in subduction zones. *Journal of Geophysical Research*, Vol. 94, p. 4697-4707.
- Tatsumi, Y., D. L. Hamilton, et al. (1986): Chemical characteristics of fluid phase released from a subducted lithosphere and origin of arc magmas: Evidence from high pressure experiments and natural rocks. *Journal of Volcanology and Geothermal Research*, Vol. 29, p. 293-309.
- Turner, S. P., C. J. Hawkesworth, et al. (1997): $^{238}\text{U}/^{230}\text{Th}$ disequilibria, magma petrogenesis, and flux rates beneath the depleted Tonga-Kermadec island arc. *Geochimica et Cosmochimica Acta*, Vol. 61, p. 4855-4884.
- Vervoort, J. D., P. J. Patchett, et al. (1999): Relationships between Lu-Hf and Sm-Nd isotopic systems in the global sedimentary system. *Earth and Planetary Science Letters*, Vol. 168, p. 79-99.
- Vroon, P. Z., G. Nowell, et al. (1998): HFSE mobility at the slab-wedge interface: Hafnium-isotope evidence from the east Sunda-Banda arc. *Mineralogical Magazine*, Vol. 62A, p. 1617-1618.
- White, W. M. et B. Dupré (1986): Sediment subduction and magma genesis in the Lesser Antilles: isotopic and trace element constraints. *Journal of Geophysical Research*, Vol. 91(B6), p. 5927-5941.
- White, W. M. et P. J. Patchett (1984): Hf-Nd-Sr isotopes and incompatible element abundances in island arcs: implications for magma origins and crust-mantle evolution. *Earth and Planetary Science Letters*, Vol. 67, p. 167-185.
- Woodhead, J. D., S. Eggins, et al. (1993): High field strength and transition element systematics in island arc and back-arc basin basalts: evidence for multi-phase melt extraction and a depleted mantle wedge. *Earth and Planetary Science Letters*, Vol. 114, p. 491-504.
- Woodhead, J. D., J. M. Hergt, et al. (2001): Hafnium isotope evidence for 'conservative' element mobility during subduction zone processes. *Earth and Planetary Science Letters*, Vol. 192, p. 331-346.

L'Hafnium dans les zones de subduction : bilan isotopique des flux entrant et sortant

Les zones de subduction représentent les principaux sites d'échanges de matière entre la croûte et le manteau terrestre. Les magmas d'arcs insulaires produits au niveau des zones de subduction correspondent à un flux de matière sortant du manteau qui s'additionne aux croûtes des arcs. En contrepartie, les croûtes océaniques altérées et les piles sédimentaires associées qui sont absorbées au niveau des zones de subduction correspondent à un flux de matière réintégrant le manteau terrestre. Nous avons examiné ces échanges de masse entre la croûte et le manteau terrestre en utilisant les compositions isotopiques de deux éléments en traces : l'Hafnium et le Néodyme.

Tout d'abord nous avons mesuré les compositions isotopiques de l'Hafnium et du Néodyme de la croûte basaltique altérée et de la pile sédimentaire entrant dans la zone de subduction d'Izu-Mariannes afin de préciser l'origine de ces deux éléments dans les matériaux qui retournent vers le manteau. Les budgets de l'Hafnium et du Néodyme de la croûte basaltique altérée n'ont pas été modifiés par les processus hydrothermaux et restent identiques aux compositions d'une croûte océanique non-altérée. Les budgets de l'Hafnium et du Néodyme de la pile sédimentaire sont dominées par des apports provenant de l'eau de mer. Pour la zone de subduction d'Izu, nous avons ensuite comparé la masse de Néodyme injectée dans le manteau lors de la subduction des sédiments avec la masse de Néodyme sortant du manteau lors de la remontée des magmas jusqu'à la croûte de l'arc. Ces deux taux sont d'un ordre de grandeur comparable. Dans la zone de subduction d'Izu, il n'existe donc pas un grand déséquilibre entre les flux de Néodyme entrant et sortant. Enfin la croûte basaltique et les sédiments actuellement subduits au niveau de la zone d'Izu-Mariannes ne sont probablement pas équivalents aux anciennes croûtes et sédiments recyclés dans la source des laves de points chauds.

Nous avons mesuré les compositions isotopiques de l'Hafnium des laves de l'arc de Luzon et de l'île de Java (arc de la Sonde) afin d'examiner les caractéristiques du flux sortant des zones de subduction. Les compositions isotopiques de l'Hafnium des laves d'arc de Luzon et de Java apparaissent très radiogéniques par rapport à leurs compositions isotopiques du Néodyme. Ces compositions semblent conditionnées par des sédiments océaniques qui contaminent la source et qui possèdent aussi des compositions isotopiques de l'Hafnium très radiogéniques par rapport à leurs compositions isotopiques du Néodyme. Les laves d'arcs insulaires sont de plus caractérisées par des anomalies négatives en Niobium et Tantale, deux éléments en traces proches de l'Hafnium. Ces anomalies négatives semblent en premier lieu causées par une rétention de ces deux éléments dans une phase minérale résiduelle au niveau des matériaux de la plaque subduite.

Mots clés : Zones de Subduction, compositions isotopiques de l'Hafnium et du Néodyme, Arcs insulaires, Croûte Océanique Altérée, Sédiments Océaniques, Recyclage, Anomalies en Nb-Ta.
