



HAL
open science

Classification des composantes connexes des strates de l'espace des modules des différentielles quadratiques

Erwan Lanneau

► **To cite this version:**

Erwan Lanneau. Classification des composantes connexes des strates de l'espace des modules des différentielles quadratiques. Mathématiques [math]. Université Rennes 1, 2003. Français. NNT : . tel-00007204v2

HAL Id: tel-00007204

<https://theses.hal.science/tel-00007204v2>

Submitted on 28 Oct 2004

HAL is a multi-disciplinary open access archive for the deposit and dissemination of scientific research documents, whether they are published or not. The documents may come from teaching and research institutions in France or abroad, or from public or private research centers.

L'archive ouverte pluridisciplinaire **HAL**, est destinée au dépôt et à la diffusion de documents scientifiques de niveau recherche, publiés ou non, émanant des établissements d'enseignement et de recherche français ou étrangers, des laboratoires publics ou privés.

THÈSE

Présentée

DEVANT L'UNIVERSITÉ DE RENNES I

pour obtenir

le grade de DOCTEUR DE L'UNIVERSITÉ DE RENNES I

Mention Mathématiques et Applications

par

Erwan LANNEAU

Institut de Recherche Mathématique de Rennes

École Doctorale MATISSE

U.F.R. de Mathématiques

TITRE DE LA THÈSE :

**Classification des composantes connexes des strates
de l'espace des modules des différentielles quadratiques**

Soutenue le 5 décembre 2003 devant la Commission d'Examen

COMPOSITION DU JURY :

M. Pierre Arnoux	Université de la Méditerranée	
M. Dominique Cerveau	Université de Rennes 1	Président du jury
M. Yves Guivarc'h	Université de Rennes 1	
M. Pascal Hubert	Université de la Méditerranée	
M. Maxim Kontsevich	I.H.É.S.	Rapporteur
M. Anton Zorich	Université de Rennes 1	Directeur

Remerciements

Je voudrais avant tout exprimer ma reconnaissance à Anton Zorich qui a dirigé mes premiers pas en recherche. J'ai beaucoup apprécié d'avoir une grande autonomie quant aux choix de mes thèmes de recherche et à l'organisation de mon travail. Je tiens à le remercier pour les orientations scientifiques qu'il m'a suggérées ainsi que pour les nombreuses discussions (nocturnes !) au tableau. Je tiens à le remercier pour toutes les expérimentations informatiques qui ont guidées mon intuition dans ce travail.

Je tiens aussi à remercier Pascal Hubert qui m'a beaucoup appris grâce aux multiples discussions que nous avons pu avoir et à tous ses conseils.

Je suis très honoré que Maxim Kontsevich et Howard Masur aient accepté la charge d'être rapporteur. Je suis également très honoré que Maxim Kontsevich ait accepté de faire partie de mon jury.

Je remercie profondément Pierre Arnoux pour l'intérêt qu'il a porté à mes travaux, et d'avoir accepté de faire partie de mon jury. Je remercie Dominique Cerveau, Yves Guivarc'h et Pascal Hubert, qui ont bien voulu également faire partie de mon jury.

Je tiens à saluer l'ensemble des membres de l'équipe Géométrie Analytique de Rennes pour l'agréable ambiance durant les deux premières années de cette thèse. Merci aussi aux organisateurs et participants du séminaire Pampers.

Je tiens aussi à saluer l'équipe DAC de Luminy à Marseille de m'avoir accueilli depuis plus d'un an. Je remercie l'ensemble des thésards de Luminy pour cette ambiance de travail chaleureuse. Je remercie aussi François, Pascal, Pierre, Sébastien, Serge... pour les discussions aussi bien mathématiques que extra-mathématiques. Merci également à tous les participants du "célèbre" séminaire volley...

Je voudrais remercier encore une fois Anton Zorich, Howard Masur, Pascal Hubert et Alex Eskin pour avoir organisé ce fabuleux colloque au CIRM en Juillet 2003. Cela a été un moment très agréable et enrichissant de rencontres et de discussions avec les plus grands spécialistes dans ce domaine. En particulier, je voudrais remercier Howard Masur qui m'a fait le grand honneur de m'inviter à faire un exposé.

J'exprime aussi ma reconnaissance à mes professeurs qui, au cours de ma scolarité, ont su me communiquer leur soif de savoir et le goût des mathématiques.

Merci aussi à Samuel Lelièvre, qui a partagé mon bureau et surtout qui a partagé multiples conversations, voyages, aventures...

Ces remerciements seraient incomplets si je ne remerciais pas toute ma famille pour leur soutien moral et leurs encouragements dans les moments durs. Merci à mon père de m'avoir transmis le goût pour les mathématiques.

Merci enfin à Magali dont le soutien et les encouragements de tous les jours ont permis l'aboutissement de cette thèse. Merci pour sa patience et sa présence qui ont su donner tout le charme à ces années.

Introduction

Dans cette thèse, nous étudions la dynamique du flot géodésique de Teichmüller. L'origine de cette question provient de l'étude d'une classe très importante de systèmes dynamiques : celle des échanges d'intervalles. Dans des travaux classiques, Masur et Veech en 1982 relient la dynamique de ces échanges d'intervalles avec celle du flot géodésique de Teichmüller sur l'espace des modules des courbes complexes. L'espace des phases de ce flot peut être vu comme l'espace des modules des différentielles quadratiques sur une surface. Ces espaces sont naturellement stratifiés par le type des singularités des formes et cette stratification est préservée par l'action de ce flot. Des résultats classiques affirment que ces strates sont des orbifolds complexes et sont non-vides et non-connexes en "général".

La motivation du travail développé dans cette thèse est donnée par le résultat fondamental, démontré indépendamment par Masur et par Veech (1982), qui affirme que le flot géodésique de Teichmüller agit de façon ergodique sur chaque composante connexe de chaque strate, par rapport à la mesure orbifoldique, qui est de masse finie.

Cette question de classification peut-être vue comme une question de dynamique ou de topologie. En accord avec les travaux de Rauzy (1979), ce problème peut aussi être abordé d'un point de vue purement combinatoire à travers les classes de Rauzy.

Kontsevich et Zorich ont décrit les composantes connexes d'une partie de ces strates ; les strates de l'espace des modules des différentielles Abéliennes \mathcal{H}_g . Nous donnons dans cette thèse la description complète des composantes connexes des strates de l'espace "complémentaire" \mathcal{Q}_g . En particulier, nous utilisons alternativement les trois points de vue.

Par ailleurs, la structure spin est un des invariants dont se servent Kontsevich et Zorich pour classer les composantes. Ici nous donnons une formule explicite pour le calcul de cette structure spin (d'une différentielle quadratique dans notre contexte) en terme uniquement des singularités de la strate. Ceci contredit une conjecture de Kontsevich—Zorich sur la classification des composantes connexes non-hyperelliptiques de \mathcal{Q}_g par cette structure spin. En utilisant cette formule, nous donnons une application dans le contexte des billards dans un polygone rationnel.

Préliminaires

Une différentielle quadratique sur une surface de Riemann S est le carré d'une section du faisceau des germes de 1-formes holomorphes. Si U est un ouvert de S et z une coordonnée locale sur U , alors toute 1-forme $\omega \in \Omega_S(U)$ peut s'écrire comme $\omega = f(z)dz$ pour f une fonction analytique sur U ; similairement, toute différentielle quadratique peut s'écrire comme $f(z)dz^2 = f(z)(dz)^2$. Pour ceux qui ne veulent pas utiliser la structure

de faisceau, ce qui sera le cas ici, nous pouvons voir une différentielle quadratique ψ sur S comme n'importe quel atlas $\{(U_i, z_i)\}$ avec une collection d'expressions $f_i(z_i)dz_i^2$, où le terme "différentielle" signifie comment les fonctions de transitions f_i et f_j sont reliées sur $U_i \cap U_j$:

$$f_j(z_j) \left(\frac{dz_j}{dz_i} \right)^2 = \psi(z_i)$$

Nous aurons besoin de considérer des différentielles quadratiques méromorphes à pôles simples. Si S est une surface de Riemann et $P \subset S$ est un ensemble discret, nous considérerons des différentielles quadratiques, holomorphes sur $S \setminus P$, et ayant des pôles simples en tout point de P . Si S est compacte alors P est fini et on peut voir que $\int_S |\psi| < \infty$, car

$$\int_{\mathbb{D}} \frac{1}{|z|} dx dy = 2\pi < \infty \quad \text{où } \mathbb{D} \text{ est le disque unité } |z| = 1$$

(ici la métrique $\int_S |\psi| < \infty$ est localement définie par $|f_i(z)| dx dy$).

Le quotient de deux différentielles quadratiques est une fonction méromorphe sur S qui doit avoir autant de zéros et de pôles, comptés avec multiplicité. Il s'ensuit que toute différentielle quadratique non nulle doit avoir le même nombre de zéros et de pôles, qui doit être le double du nombre de zéros d'une 1-forme holomorphe. Comme une 1-forme s'annule exactement $2g - 2$ fois sur une surface de genre g , une différentielle quadratique possède exactement $4g - 4$ zéros et pôles, comptés avec multiplicité.

Dans la suite, on utilisera souvent la géométrie de telles différentielles quadratiques. En particulier la donnée d'une telle différentielle induit un feuilletage particulier sur la surface : un *feuilletage mesuré*. Nous pouvons décrire cela de la manière suivante.

Pour tout point $p \in S \setminus P$ tel que $\psi(p) \neq 0$ i.e. pour tout point régulier de ψ , il existe une coordonnée locale z sur un voisinage U de p dans lequel $\psi = dz^2$. On peut voir cela comme suit : soit U une coordonnée locale telle que $\psi = f(w)dw^2$; quitte à réduire U , on peut supposer qu'il existe une racine carrée analytique de $f(w)$ dans U (car $f(0) \neq 0$). Maintenant posons

$$z(y) = \int_p^y (f(w))^{1/2} dw$$

Cette application satisfait clairement aux conditions.

Nous appellerons de telles coordonnées des *coordonnées naturelles* pour ψ . Il est clair que ces coordonnées sont uniques (à translation et au signe près). Ainsi, en dehors des singularités de ψ , S a localement la structure d'une pièce de papier, en fait un papier linéaire, puisque la direction horizontale ne dépend pas du choix des coordonnées naturelles. Remarquons qu'il n'y a pas de direction donnée sur les droites horizontales. On peut facilement voir qu'il est possible d'orienter le feuilletage horizontal si et seulement si la différentielle quadratique ψ est globalement le carré d'une 1-forme holomorphe ω . Nous emploierons aussi le terme différentielle *abélienne* pour désigner ω .

Ainsi la surface de Riemann hérite d'une métrique Euclidienne. Le Théorème de Gauss—Bonnet affirme que la seule surface compacte Euclidienne orientable est le tore. Donc il doit y avoir de la courbure concentrée aux singularités de ψ , c'est-à-dire aux pôles

et aux zéros. Comme ci-dessus, pour une singularité p de ψ , il existe une coordonnée locale z sur un ouvert U de p pour laquelle

$$\psi = z^k dz^2$$

Donc la surface S a localement la structure d'un cône Euclidien au voisinage des singularités de ψ . L'angle du cône est $(k+2)\pi$ où $k > 0$ est le degré du zéro de ψ ($k = -1$ si le zéro est un pôle). Dans un voisinage d'un point singulier, on peut trouver des coordonnées polaires (r, θ) telle que la métrique s'écrive

$$ds^2 = dr^2 + (crd\theta)^2$$

où c est un demi-entier ($2c \in \mathbb{N}$). Nous dirons que la métrique a des singularités de type conique avec un angle de $2\pi c$ (ici $2c = k+2$). La courbure κ au point singulier est définie par la formule

$$\kappa = 2\pi - 2\pi c$$

* * *

Ces surfaces arrivent naturellement dans l'étude des Systèmes Dynamiques. Nous donnons ici deux exemples fondamentaux.

Pour le premier exemple, notons par P un polygone dans \mathbb{R}^2 . Le flot du billard est donné par le mouvement d'un point avec les règles usuelles de réflexion de l'optique géométrique sur le bord ∂P de P . L'orbite d'un élément pour ce flot (flot géodésique) est donné par un point $x \in P$ et une direction $\theta \in \mathbb{R}/2\pi\mathbb{Z}$ sur le fibré unitaire tangent de P . Les orbites de ce flot ne sont pas continues quand elles rencontrent le bord de P . Nous voulons réfléchir les trajectoires par rapport aux bords. Si e_i est un côté de P et $\rho_i : S^1 \rightarrow S^1$ représente la réflexion par rapport au côté e_i (partie linéaire seulement) alors nous identifions (p, v) avec $(p, \rho_i(v))$ pour chaque $p \in e_i$.

Soit $\Gamma \subset O(2)$ le groupe engendré par les parties linéaires des réflexions par rapport aux côtés. Nous sommes intéressés seulement par le cas où Γ est fini ; dans ce cas le polygone est dit rationnel. Une définition équivalente est de demander, lorsque P est simplement connexe, que tous les angles de P soient des multiples rationnels de π . Le cas des billards irrationnels est pour le moment presque complètement ouvert. Par exemple, pour un billard polygonal quelconque (même dans un triangle), on ne sait toujours pas s'il existe une trajectoire périodique.

Pour un billard rationnel, il existe une construction classique (voir [MaTa] pour un "survey" agréable sur les billards rationnels) qui donne lieu à une surface plate \tilde{S}_g^2 de genre g i.e. une surface de Riemann munie d'une différentielle abélienne. Nous rappelons cette construction.

Soit $P \subset \mathbb{C}$ et Γ comme ci-dessus. Prenons $|\Gamma|$ copies disjointes de P , chacune étant l'image de P par un élément de Γ . Pour chaque copie P_c de P et chaque réflexion $r \in \Gamma$, collons chaque côté E_c de P_c au côté $r(E_c)$ de $r(P_c)$. Quand le groupe Γ est fini, le résultat est une surface de Riemann \tilde{S}

$$\tilde{S} = \left(\bigsqcup_{\gamma \in \Gamma} \gamma(P) \right) / \sim$$

où \sim est la relation d'équivalence décrite ci-dessus. La forme dz sur chaque copie $\gamma(P)$, $\gamma \in \Gamma$, induit une 1-forme holomorphe $\tilde{\omega}$ sur \tilde{S} . Il est facile de vérifier que les singularités de $\tilde{\omega}$ sont situées aux sommets des copies de P . Ainsi un billard rationnel définit une surface plate \tilde{S} avec une différentielle quadratique holomorphe $\tilde{\psi} = \tilde{\omega}^2$. On peut facilement calculer le genre de la surface en fonction des angles de la table de billard. Ainsi, nous pouvons donc voir l'ensemble des billards rationnels comme une sous-famille de l'ensemble des différentielles quadratiques. Bien sûr, cette inclusion est stricte.

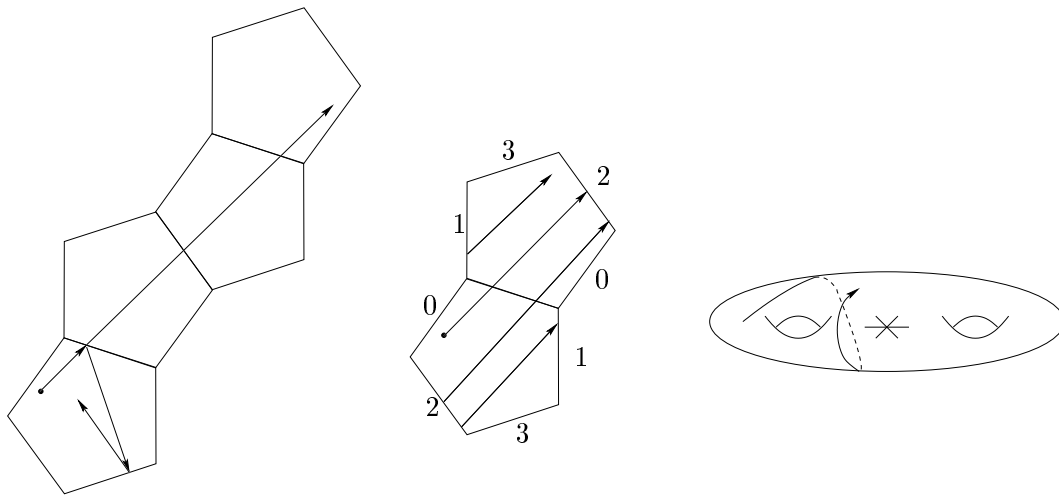

Une trajectoire dans le billard dans un pentagone qui se développe sur la surface invariante. Ici on obtient une surface de Veech de genre 2.

Pour le deuxième exemple fondamental, considérons un intervalle I sur une surface de translation S , transverse au feuilletage vertical. Supposons de plus que ce feuilletage soit minimal. Alors l'application de premier retour de Poincaré $T : I \rightarrow I$ est un échange d'intervalles i.e. une application bijective avec un nombre fini de points de discontinuités, telle que la dérivée de T est égale à $+1$ presque partout. De telles applications sont complètement déterminées par le nombre d'intervalles de continuités de T et par la permutation qui décrit comment ces intervalles sont échangés sur I .

Réciproquement, pour tout échange d'intervalles T , on peut construire une différentielle abélienne ω sur une surface S et un intervalle horizontal I sur cette surface S tel que l'application de premier retour du flot vertical induit par ω sur I donne précisément l'application initiale T . Remarquons que la minimalité du flot implique ici que la permutation sous-jacente soit irréductible. Nous présentons en Appendice une construction due à Masur (voir [Ma1]) pour obtenir une telle surface à partir d'un échange d'intervalles. Il existe aussi une construction classique due à Veech (voir [V1]) connue sous le nom de "Zippered Rectangles".

* * *

Nous avons vu que les surfaces avec une structure de droites parallèles et les surfaces munies d'une différentielle quadratique (avec au plus des pôles simples) définissent les mêmes objets. Nous allons donner une description supplémentaire de ces structures via la

théorie des feuilletages mesurés, introduite par Thurston (voir [FaLaPo] et [Th]).

Un feuilletage mesuré (\mathcal{F}, μ) est un feuilletage \mathcal{F} avec une mesure de probabilité μ invariante et transverse. C'est à dire une mesure définie sur l'ensemble des arcs transverses au feuilletage \mathcal{F} et qui est invariante. Une telle mesure est dite invariante si pour deux arcs γ et η , qui sont homotopes avec extrémités fixes dans deux feuilles de \mathcal{F} , nous avons

$$\mu(\gamma) = \mu(\eta)$$

Il est clair qu'une différentielle quadratique induit une paire de feuilletages mesurés transverses : le feuilletage vertical et le feuilletage horizontal. En fait, nous avons la réciproque : étant donné *deux* feuilletages mesurés transverses, disons \mathcal{F}_1 et \mathcal{F}_2 , on peut toujours construire une différentielle quadratique ψ qui les réalise : le feuilletage horizontal de ψ (respectivement vertical) est \mathcal{F}_1 (respectivement \mathcal{F}_2).

Si nous avons seulement *un* unique feuilletage mesuré, nous devons avoir quelques propriétés supplémentaires pour l'existence d'une différentielle quadratique qui le réalise comme feuilletage horizontal. En particulier il existe des contres exemples à l'existence d'une différentielle quadratique qui réalise un feuilletage mesuré comme feuilletage horizontal (voir [HuMa], voir aussi en Appendice).

Nous avons le critère suivant qui est le "dual" d'un Théorème de Hubbard et Masur (voir [HuMa], voir aussi [Cala] et [KoZo])

Théorème. *Un feuilletage mesuré orientable sur une surface de Riemann est le feuilletage horizontal d'une différentielle abélienne dans une structure complexe si et seulement si tout cycle obtenu comme une union de lien de selles et de séparatrices dans la direction positive n'est pas homologue à zéro.*

* * *

Notons par (k_1, \dots, k_n) l'ordre des singularités de ψ . Nous avons vu que $\sum k_i = 4g - 4$. Localement, dans un ouvert simplement connexe d'un point non singulier, en prenant la racine carré, nous pouvons présenter une différentielle quadratique comme le carré d'une différentielle abélienne. Mais globalement, ce n'est pas le cas en général. C'est précisément le cas quand le feuilletage horizontal correspondant est orienté. S'il existe au moins un zéro de ψ d'ordre impair (ou au moins un pôle) alors ψ n'est clairement pas le carré d'une 1-forme holomorphe. Mais si toutes les singularités de ψ sont de degré pair, il existe des obstructions (holonomie de la métrique) pour que ψ soit globalement le carré d'une 1-forme.

Notons par $\mathcal{H}\mathcal{Q}_g$ l'espace des modules des paires (S_g^2, ψ) , où S_g^2 est une surface de Riemann de genre g et ψ une différentielle sur S . Nous déclarons que deux différentielles ψ_1 et ψ_2 sur S_1 et S_2 sont équivalentes s'il existe un homéomorphisme f de S_1 sur S_2 qui envoie des points singuliers sur les points singuliers avec le même ordre et qui a la même forme que les fonctions de transitions au voisinage des autres points. Remarquons que cela implique que f est un difféomorphisme sur le complémentaire des singularités de ψ_1 .

On peut voir que cela est équivalent à la condition suivante :

$$f^* \psi_1 = \psi_2$$

Dans une formulation analogue, nous demandons qu'il existe un homéomorphisme f de S_1 sur S_2 , qui est un difféomorphisme dans le complémentaire des singularités et tel que f est affine dans les cartes canoniques définies par ψ_1 et ψ_2 .

L'espace des modules $\mathcal{H}\mathcal{Q}_g$ est naturellement stratifié par le type des singularités des formes. En utilisant les notations de Veech, nous notons par $\mathcal{Q}(k_1, \dots, k_n; \varepsilon) \subset \mathcal{Q}_g$ la strate des différentielles quadratiques $[S_g^2, \psi] \in \mathcal{Q}_g$ avec les singularités du type (k_1, \dots, k_n) , où $k_i \in \{-1, 0, 1, 2, \dots\}$ et où $\varepsilon = +1$ si la différentielle ψ est globalement le carré d'une différentielle abélienne et $\varepsilon = -1$ sinon. Remarquons que $\varepsilon = +1$ implique que tous les k_i sont nécessairement pairs.

Nous considérerons aussi l'espace des modules des différentielles abéliennes (ou de manière équivalente, l'espace des modules des différentielles quadratiques qui sont le carré de différentielles abéliennes). Nous notons ces espaces par \mathcal{H}_g , et si \vec{k} est un vecteur dans \mathbb{N}^n avec $\sum k_i = 2g - 2$, nous notons par $\mathcal{H}(k_1, \dots, k_n)$ la strate correspondante. Il y a un isomorphisme naturel de la strate $\mathcal{H}(k_1, \dots, k_n)$ dans la strate $\mathcal{Q}(2k_1, \dots, 2k_n; +1)$. Ceci motive la convention suivante :

Convention.

- Nous notons par \mathcal{Q}_g l'espace des modules des paires (S_g^2, ψ) , où S_g^2 est une surface de Riemann de genre g et ψ une différentielle quadratique *qui n'est pas globalement le carré d'une 1-forme holomorphe*.
- En accord avec les notations ci-dessus, nous posons :

$$\mathcal{Q}(k_1, \dots, k_n) := \mathcal{Q}(k_1, \dots, k_n; -1)$$

pour dénoter les strates de l'espace modulaire \mathcal{Q}_g .

Dans toute cette thèse, nous considérerons uniquement les différentielles quadratiques qui ne sont pas globalement le carré d'une 1-forme holomorphe ; sauf mention explicite du contraire.

Pour g fixé, l'union des ces strates est l'espace modulaire tout entier $\mathcal{H}\mathcal{Q}_g = \mathcal{Q}_g \cup \mathcal{H}_g$ au dessus de l'espace de Teichmüller \mathcal{T}_g .

C'est une partie classique de la théorie de Teichmüller que l'espace de Teichmüller \mathcal{T}_g est une variété complexe et que $\mathcal{H}\mathcal{Q}_g$ s'identifie naturellement au fibré cotangent de l'espace modulaire $\mathcal{M}_g = \mathcal{T}_g/\text{Mod}(g)$, où $\text{Mod}(g)$ désigne le groupe modulaire en genre g .

Les strates ne sont pas fermées en général dans l'espace $\mathcal{Q}_g \cup \mathcal{H}_g$ (seule la strate minimale $\mathcal{Q}(4g - 4)$ l'est). Ceci parce que l'on peut obtenir une suite de surfaces dans une strate qui dégénèrent en une surface pincée (on peut contracter plusieurs zéros ou "liens de selles" ensembles).

On peut obtenir une exhaustion de compacts dans chaque strate en considérant les surfaces qui ont des longueurs de géodésiques bornées inférieurement :

$$\mathcal{QD}(\varepsilon) = \{[S, \psi], \text{longueur de chaque feuille fermée sur } S \geq \varepsilon\}$$

Il est bien connu que les strates ont une structure d'orbifold modelées par le premier groupe de cohomologie. Nous décrirons cette structure plus tard en détail. Comme le groupe modulaire $\text{Mod}(g)$ n'agit pas librement, ces strates n'ont évidemment pas une structure lisse. Masur et Veech ont calculé précisément la dimension de telles strates :

Théorème (H. Masur; W. Veech).

Chaque strate $\mathcal{H}(k_1, \dots, k_n)$ est une orbifold complexe de dimension

$$\dim_{\mathbb{C}} \mathcal{H}(k_1, \dots, k_n) = 2g + n - 1$$

Chaque strate $\mathcal{Q}(k_1, \dots, k_n)$ est une orbifold complexe de dimension

$$\dim_{\mathbb{C}} \mathcal{Q}(k_1, \dots, k_n) = 2g + n - 2$$

Une remarque très importante qui joue un rôle crucial dans cette théorie est que le groupe $\mathrm{SL}(2, \mathbb{R})$ agit sur ces espaces \mathcal{Q}_g et \mathcal{H}_g par transformation linéaire dans les coordonnées canoniques, en préservant chaque strate. Si un point $[S, \psi]$ est présenté par un atlas de coordonnées canoniques $\{(U_i, z_i)\}$, et $A \in \mathrm{SL}(2, \mathbb{R})$ est une matrice, alors $\{(U_i, Az_i)\}$ définit une nouvelle famille de coordonnées canoniques pour la différentielle quadratique $(S, A\psi)$. Nous déclarons que :

$$A \cdot [S, \psi] := [S, A\psi]$$

Nous requérons que A envoie les singularités de ψ aux singularités de $A\psi$ en préservant l'ordre.

On considère en particulier les trois sous-groupes (à un paramètre) de $\mathrm{SL}(2, \mathbb{R})$ qui ont un intérêt spécial

$$g_t = \begin{pmatrix} e^{t/2} & 0 \\ 0 & e^{-t/2} \end{pmatrix}, \quad r_\theta = \begin{pmatrix} \cos \theta & \sin \theta \\ -\sin \theta & \cos \theta \end{pmatrix}, \quad h_s = \begin{pmatrix} 1 & s \\ 0 & 1 \end{pmatrix}$$

en référence respectivement au flot géodésique, circulaire et horocyclique.

Le flot géodésique g_t sur une différentielle quadratique (S, ψ) a pour effet d'étirer le long des trajectoires horizontales de ψ par un facteur e^t et de contracter le long des trajectoires verticales par e^t .

Le flot circulaire r_θ sur une différentielle quadratique (S, ψ) a pour effet de changer la direction canonique définie par ψ par un facteur d'angle θ . Remarquons que ce flot laisse la métrique invariante.

Il est clair que la définition implique que cette action préserve chaque strate. Par ailleurs, il est possible de définir une mesure μ_0 qui est $\mathrm{SL}(2, \mathbb{R})$ -invariante et absolument continue par rapport à la structure orbifoldique définie sur chaque strate.

Un résultat classique, obtenu indépendamment par Masur et par Veech, affirme que ce flot agit ergodiquement sur chaque composante connexe de chaque strate (voir [Ma1] et [V1]) :

Théorème (Masur; Veech). [1982]

Le volume d'une strate normalisée (surfaces plates d'aire 1) est finie par rapport à la mesure μ_0 .

Le flot géodésique de Teichmüller g_t agit ergodiquement sur chaque composante connexe de chaque strate par rapport à la mesure μ_0 .

Motivés par ce résultat, nous sommes intéressés par la classification de l'ensemble des composantes connexes des strates, c'est-à-dire l'ensemble des composantes ergodiques du flot géodésique. Il est bien connu que ces strates sont non vides, excepté 4 cas exceptionnels

en petit genre (voir [MaSm]), et non connexes en général. Néanmoins, Veech a montré qu'il n'y a qu'un nombre fini de composantes connexes pour chaque strate. En particulier, en utilisant la théorie des *Zippered Rectangles* (voir [V1]), Veech montre que l'ensemble des composantes connexes des strates des *différentielles abéliennes* est en bijection avec l'ensemble des *classes de Rauzy étendues*. Avec cette description, Veech prouve que la strate $\mathcal{H}(4)$ possède 2 composantes connexes et P. Arnoux prouve que la strate $\mathcal{H}(6)$ possède trois composantes connexes.

Cette classification est très importante dans l'étude de certaines classes de Systèmes Dynamiques. L'étude de ce flot géodésique a beaucoup d'applications. En genre 1, l'espace de Teichmüller \mathcal{T}_g , munit de sa métrique de Teichmüller, est isométrique au demi plan supérieur \mathbb{H}^2 munit de sa métrique hyperbolique standard. L'étude de l'action de g_t sur $\mathcal{H}_{g=1}$ coïncide avec l'étude standard du flot géodésique sur la surface modulaire $\mathrm{PSL}(2, \mathbb{Z}) \backslash \mathbb{H}^2$.

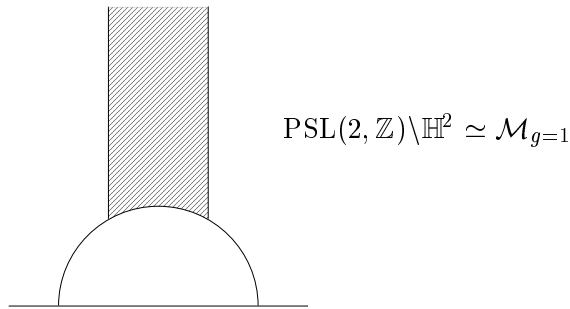

Ainsi, dans le cas particulier du genre 1, le Théorème de Masur et de Veech peut être reformulé comme le résultat classique, attribué à Hedlund (1935), qui affirme que le flot géodésique agit de manière ergodique sur la surface modulaire par rapport à la mesure de Liouville. En particulier, cette théorie bien connue est reliée à la théorie classique des fractions continues.

En genre plus grand, le flot géodésique est relié aux applications linéaires par morceaux : les échanges d'intervalles, et à l'induction de Rauzy. Pour une liste (incomplète) d'auteurs qui ont étudié cela, nous référons à Arnoux, Keane, Rauzy, Veech, Zorich...

Dans les papiers [EsMa], [EsMaZo], A. Eskin, H. Masur et A. Zorich décrivent les propriétés asymptotiques sur les surfaces plates génériques dans une composante connexe donnée d'une strate de l'espace des modules des différentielles *abéliennes*. Ils comptent les géodésiques fermées de longueurs bornées. A. Eskin and A. Okounkov (voir [EsOk]) ont calculé le volume (par rapport à μ_0) de toutes ces strates (normalisées).

Dans ce contexte, un travail est en cours : Eskin et Okounkov (voir [EsOk2]) utilisent nos résultats pour obtenir des résultats similaires dans le cadre des différentielles quadratiques.

Enfin, en accord avec la correspondance entre l'ensemble des composantes connexes et des classes de Rauzy étendues, cette classification donne une description complète pour l'ensemble des classes de Rauzy étendues. Ces classes ont été calculées en petit genre par A. Zorich (voir [Zo1] et [Zo2]).

Résultats connus

Kontsevich et Zorich (voir [KoZo]) ont obtenu une classification complète des composantes connexes pour toutes les strates des différentielles abéliennes. En particulier, ils ont montré qu'il y a au plus trois composantes connexes et que cette borne supérieure est atteinte pour la strate minimale $\mathcal{H}(2g-2)$ et pour la strate $\mathcal{H}(2k, 2k)$. Ils utilisent deux invariants pour obtenir une telle classification : l'invariant d'hyperellipticité et l'invariant de structure spin. La structure spin est l'invariant qui permet de classer toutes les composantes connexes non hyperelliptiques de toutes les strates (voir plus tard pour les définitions). Ici nous présentons les deux résultats principaux pour cette classification :

Théorème (Kontsevich, Zorich). *Toutes les composantes connexes d'une strate des différentielles abéliennes sur une courbe de genre $g \geq 4$ sont décrites par la liste suivante :*

La strate $\mathcal{H}(2g-2)$ a trois composantes connexes : une hyperelliptique, $\mathcal{H}^{hyp}(2g-2)$, et deux autres composantes : $\mathcal{H}^{even}(2g-2)$ et $\mathcal{H}^{odd}(2g-2)$ correspondant aux structures spin paire et impaire.

La strate $\mathcal{H}(2l, 2l)$, pour $l \geq 2$, a trois composantes connexes : une hyperelliptique, $\mathcal{H}^{hyp}(2l, 2l)$, et deux autres composantes : $\mathcal{H}^{even}(2l, 2l)$ et $\mathcal{H}^{odd}(2l, 2l)$.

Toutes les autres strates de la forme $\mathcal{H}(2l_1, \dots, 2l_n)$, où tout $l_i \geq 1$, ont deux composantes connexes : $\mathcal{H}^{even}(2l_1, \dots, 2l_n)$ et $\mathcal{H}^{odd}(2l_1, \dots, 2l_n)$, correspondant aux structures spin paire et impaire.

La strate $\mathcal{H}(2l-1, 2l-1)$, $l \geq 2$, a deux composantes connexes une des deux, $\mathcal{H}^{hyp}(2l-1, 2l-1)$, est hyperelliptique, l'autre $\mathcal{H}^{nonhyp}(2l-1, 2l-1)$ pas.

Toutes les autres strates des différentielles abéliennes sur une courbe de genre $g \geq 4$ sont non vides et connexes.

Il faut aussi considérer la liste des composantes connexes dans les cas de petits genres $1 \leq g \leq 3$, où il y a des composantes qui manquent en comparaison au cas général.

Théorème (Kontsevich, Zorich). *L'unique strate en genre 1, $\mathcal{H}(0)$ est connexe.*

L'espace des modules des différentielles abéliennes sur une courbe de genre $g = 2$ contient deux strates : $\mathcal{H}(1, 1)$ et $\mathcal{H}(2)$. Chacune d'entre elles est connexe et coïncide avec sa composante connexe hyperelliptique.

Chaque strate $\mathcal{H}(2, 2)$, $\mathcal{H}(4)$ de l'espace des modules des différentielles abéliennes sur une courbe de genre 3 a deux composantes connexes : une hyperelliptique, et l'autre possédant la structure spin impaire.

Les autres strates en genre 3 sont connexes.

Plan de la thèse

Dans cette thèse, nous donnons la description complète des composantes connexes de toutes les strates de l'espace des modules \mathcal{Q}_g des différentielles quadratiques. En particulier nous montrons qu'il y a au plus 2 composantes connexes et que ce nombre est atteint pour les *strates hyperelliptiques* et pour quelques strates exceptionnelles. Les constructions des composantes connexes hyperelliptiques et le fait que cela produit des familles de strates non connexes donne lieu à un article (voir [La1] et l'Appendice).

En outre, nous montrons que pour l'espace des modules des différentielles quadratiques (qui ne sont pas globalement le carré d'une 1-forme holomorphe), la structure spin est

constante sur chaque strate. De plus, nous donnons une formule explicite pour déterminer la parité de cette structure spin, connaissant le type des singularités (k_1, \dots, k_n) de la strate. Ceci contredit une conjecture de Kontsevich—Zorich qui affirme que la structure spin distingue les composantes non hyperelliptiques d’une strate $\mathcal{Q}(k_1, \dots, k_n)$. Cela donne lieu à un article (voir [La2] et l’Appendice).

* * *

Tout au long de cette thèse, nous notons par (S, ψ) une surface de demie translation avec une holonomie non triviale dans une strate $\mathcal{Q}(k_1, \dots, k_n)$ en genre g à n singularités. Nous supposons que l’aire de la surface S , par rapport à la métrique plate définie par ψ , est finie. De manière équivalente, la forme ψ a au plus des pôles simples, c’est à dire $k_i \geq -1$ pour tout i . Nous ne considérons pas les points marqués, donc $k_i \neq 0$. La classification dans le cas particulier où $k_i = 0$ pour certains i coïncide avec notre classification. Le Théorème de Gauss—Bonnet implique :

$$\sum_{i=1}^n k_i = 4g - 4$$

Dans le Chapitre 6 de cette thèse, nous prouvons le résultat de classification suivant :

Théorème Principal 1. *Fixons le genre $g \geq 5$. Considérons les familles de strates suivantes :*

$$\begin{aligned} \mathcal{F}_2 &= \{ \mathcal{Q}(4(g-k) - 6 ; 4k + 2) & | & 0 \leq k \leq g - 2 \} \\ \mathcal{F}_3 &= \{ \mathcal{Q}(4(g-k) - 6 ; 2k + 1 ; 2k + 1) & | & 0 \leq k \leq g - 1 \} \\ \mathcal{F}_4 &= \{ \mathcal{Q}((2(g-k) - 3 ; 2(g-k) - 3 ; 2k + 1 ; 2k + 1) & | & -1 \leq k \leq g - 2 \} \end{aligned}$$

dans l’espace des modules des différentielles quadratiques \mathcal{Q}_g . Alors nous avons :

- Toutes les strates listées dans la famille ci-dessus ont exactement 2 composantes connexes ; une hyperelliptique — l’autre non.
- Toutes les autres strates de l’espace modulaire \mathcal{Q}_g sont connexes.

En petit genre, il y a quelques exceptions pour la classification : il y a quelques composantes qui manquent par rapport au cas général. Il y a aussi quelques composantes additionnelles exceptionnelles. Tout d’abord, certaines strates peuvent être vides :

Théorème (Masur et Smillie). *Considérons un vecteur (k_1, \dots, k_n) tel que tous les $k_i \in \mathbb{N} \cup \{-1\}$. Supposons que $\sum k_i = 0 \pmod{4}$ et $\sum k_i \geq -4$. Alors la strate correspondante $\mathcal{Q}(k_1, \dots, k_n)$ est non-vide, excepté dans les 4 cas particuliers suivants :*

$$\mathcal{Q}(\emptyset), \mathcal{Q}(1, -1) \text{ (en genre } g = 1) \quad \text{et} \quad \mathcal{Q}(4), \mathcal{Q}(1, 3) \text{ (en genre } g = 2)$$

Le Théorème suivant donne la classification des composantes connexes pour les strates de l’espace des modules en genre $g = 0, \dots, 4$:

Théorème Principal 2. *Fixons le genre $0 \leq g \leq 4$. Alors :*

- *En genre 0 et 1 toutes les strates de \mathcal{Q}_g sont connexes.*
- *En genre 2 toutes les strates sont connexes exceptées les deux strates*

$$\mathcal{Q}(-1, -1, 6) \text{ et } \mathcal{Q}(-1, -1, 3, 3)$$

pour lesquelles nous avons exactement 2 composantes connexes ; une hyperelliptique — l'autre non.

- *En genre 3, les strates qui contiennent une composante hyperelliptique ont exactement 2 composantes connexes ; une hyperelliptique — l'autre non.*

Il existe 3 strates particulières

$$\mathcal{Q}(-1, 9) \quad \mathcal{Q}(-1, 3, 6) \quad \mathcal{Q}(-1, 3, 3, 3)$$

qui ont 2 composantes connexes ; une adjacente à la strate minimale $\mathcal{Q}(8)$ — l'autre non.

Toutes les autres strates en genre 3 sont connexes.

- *En genre 4, les strates qui contiennent une composante hyperelliptique ont exactement 2 composantes connexes ; une hyperelliptique — l'autre non.*

La strate minimale $\mathcal{Q}(12)$ possède exactement 2 composantes connexes.

Toutes les autres strates en genre 4 sont connexes.

Stratégie de la preuve

La preuve de ces résultats utilise une combinaison d'idées venant de la dynamique, de la géométrie algébrique et de la combinatoire des classes de Rauzy et des permutations généralisées. Nous décomposons la démonstration générale en trois étapes comme suit.

Tout d'abord, il y a trois séries à un paramètre de strates correspondantes aux courbes complexes hyperelliptiques. Ces strates sont non-connexes : elles possèdent une composante connexe hyperelliptique et une composante connexe non-hyperelliptique.

Ensuite nous montrons la dichotomie suivante : excepté trois cas particulier en genre 3, toute composante connexe est soit hyperelliptique soit attachée à la strate minimale ; c'est à dire la strate $\mathcal{Q}(4g-4)$. Afin de prouver ceci, nous montrons que toutes composante non-hyperelliptique, excepté 3 cas particuliers en genre 3, possède une surface avec un lien de selle de multiplicité 1 que l'on peut "écraser". Ainsi toute composante non-hyperelliptique est adjacente à une strate de dimension plus petite, et donc par récurrence à la strate minimale. Cette preuve est basée sur la combinatoire et la dynamique des feuilletages mesurés.

La dernière étape est consacrée à la strate minimale. Nous montrons qu'elle est connexe pour le genre $g \geq 5$ et, en utilisant un résultat de Kontsevich—Zorich sur la connexité locale, que toute strate attachée à cette strate minimale l'est aussi. Nous procédons par récurrence sur le genre des surfaces. On montre directement que la strate $\mathcal{Q}(16)$ en genre 5 est connexe, et de manière récursive pour $g \geq 5$, que la strate minimale de genre g est connexe en utilisant l'argument de chirurgie "bubbling a handle".

Plan de la preuve

Les Chapitres 1 et 2 sont principalement consacrés à l'étude et à la géométrie des différentielles quadratiques : nous donnons le background nécessaire en terme de feuilletages mesurés induits par une différentielle quadratique. Les surfaces sont considérées comme des surfaces Euclidiennes avec des singularités coniques ou comme des surfaces munies d'une paire de feuilletages mesurés transverses. Dans ce langage, nous avons la notion de feuilles.

Nous appelons une *séparatrice* (*separatrix*) une feuille qui contient un point singulier. Un *lien de selle* (*saddle connection*) est une séparatrice compacte homéomorphe à un segment : un lien de selle entre deux selles *différentes*.

Une *boucle de séparatrice* (*separatrix loop*) est une séparatrice compacte homéomorphe à un cercle : un lien de selle qui part d'une selle et revient à la *même* selle.

Dans la dernière section du Chapitre 1, nous obtenons une construction (basée sur une construction de Hubbard et Masur (voir [HuMa]) et sur une idée de Kontsevich) qui produit un invariant topologique : les *composantes connexes hyperelliptiques*.

Le nombre maximal de composantes connexes des strates est 2. Ce nombre est atteint pour les familles de strates pour lesquelles nous possédons un invariant : une composante peut être hyperelliptique ou non. Ce nombre est aussi atteint pour quelques strates exceptionnelles en genre 3 et 4. En utilisant ces invariants et des propriétés géométriques des feuilletages mesurés, nous montrons que les strates listées dans le Théorème 1 ont au moins deux composantes connexes. Ceci donne lieu à un article (voir [La1]). Nous distinguons les composantes exceptionnelles plus tard en utilisant des propriétés combinatoires, à savoir les classes de Rauzy. Pour notre programme de classification, nous montrons dans la suite que toutes les autres strates sont connexes et que les strates ci-dessus ont au plus deux composantes connexes.

Dans le Chapitre 1 nous donnons deux constructions “classiques” de surfaces de demi translation. La première (“breaking up a singularity”) donne une méthode de construction de différentielles quadratiques avec beaucoup de singularités en “éclatant” un zéro de la différentielle initiale. La seconde (“bubbling a handle”) nous permet de construire une différentielle quadratique en genre $g + 1$ en partant d'une différentielle quadratique sur une surface de genre g . Nous terminons ce Chapitre en introduisant une construction de revêtement double ramifié. Cette construction nous permet d'obtenir les *composantes connexes hyperelliptiques*.

Dans le second Chapitre, nous présentons tous les outils que nous allons utiliser dans la preuve. En particulier, nous prouvons un résultat de densité (dans toute strate) de l'ensemble de différentielles de type Jenkins—Strebel à un cylindre. De plus, nous proposons un moyen de coder ces formes en utilisant la notion de “permutations généralisées”. Le codage de telles formes n'est pas unique mais une permutation détermine uniquement le type des singularités et aussi le type topologique de la strate sous-jacente. En particulier, on montre plusieurs résultats en utilisant les propriétés de ces objets combinatoires. En ce sens, les “permutations généralisées” sont l'outil principal pour notre programme de classification. Dans le Chapitre 3, en utilisant cette notion de permutations, nous donnons des représentants explicites pour chaque composante connexe.

Dans le Chapitre 4, nous présentons le premier résultat principale pour la preuve de la classification. Nous y étudions l’adjacence des strates. Nous montrons que toute composante connexe non-hyperelliptique d’une strate possède une surface plate qui peut se dégénérer en contractant un lien de selle pour donner une surface de Riemann non-singulière dans une strate de dimension plus petite. En ce sens, on obtient une description précise de l’adjacence des strates. En utilisant cette description, nous concluons que toute composante connexe d’une strate en genre $g \geq 5$ est soit hyperelliptique, soit adjacente à la strate *minimale* $\mathcal{Q}(4g - 4)$.

Dans la dernière section du Chapitre 4, nous donnons quelques résultats sur la connexité locale des strates au voisinage de la strate minimale. Nous en déduisons que pour une strate fixée, le nombre de composantes connexes non-hyperelliptiques est borné par le nombre de composante connexe de la strate minimale correspondante. Ceci nous donne une borne supérieure sur le nombre de composantes connexes : il y a au plus $\#\pi_0(\mathcal{Q}(4g - 4)) + 1$ composantes connexes dans chaque strate.

Le Chapitre 5 est consacré à l’étude de la strate minimale $\mathcal{Q}(4g - 4)$. Nous y montrons qu’elle est connexe à partir du genre $g \geq 5$. Nous procédons par induction sur le genre g des surfaces. L’étape d’induction est la chirurgie “bubbling a handle” décrite au Chapitre 1. Nous montrons que l’on peut toujours trouver, dans chaque composante connexe de $\mathcal{Q}(4g - 4)$, une surface de demie-translation qui est obtenue par la chirurgie “bubbling a handle” sur une surface de la strate $\mathcal{Q}(4(g - 1) - 4)$ en genre $g - 1$. En d’autres termes, nous pouvons “oublier” une anse pour abaisser le genre des surfaces. La preuve est basée sur la combinatoire des permutations généralisées.

Dans le Chapitre 6 nous montrons les deux principaux résultats de cette thèse ; c’est-à-dire les Théorème 1 et Théorème 2. Nous montrons que toute composante connexe qui n’est ni hyperelliptique, ni un des 3 cas particuliers donnés dans le Chapitre 3, est adjacente à la strate minimale $\mathcal{Q}(4g - 4)$. Ceci nous donne une borne supérieure sur le nombre de composantes connexes non-hyperelliptique: il y a au plus $\#\pi_0(\mathcal{Q}(4g - 4))$ composantes non-hyperelliptiques. Le Théorème 1 est alors une conséquence directe du résultat du Chapitre 5 (connexité de la strate minimale en genre plus grand que 5) et de la description des composantes connexes hyperelliptiques (voir [La1]). La suite de la preuve en petit genre est complètement similaire : nous distinguons plusieurs cas suivant le nombre et la parité des singularités de la strate.

Structure spin

En Appendice, nous donnons la définition de la *structure spin* sur une courbe complexe. Dans l’espace des modules des différentielles abéliennes, la structure spin est l’invariant basique qui permet de classifier les composantes connexes non-hyperelliptiques.

En utilisant le point de vue géométrique de cette structure spin, nous montrons le Théorème 3 qui contredit une conjecture de Kontsevich—Zorich qui affirme que la structure spin distingue les composantes connexes hyperelliptiques des strates de l’espace des modules \mathcal{Q}_g . En outre, nous donnons une formule explicite pour calculer la parité de cette structure spin, connaissant seulement le type des singularités de la forme. Nous montrons les deux Théorèmes suivants correspondants aux résultats énoncés (voir aussi [La2]) :

Théorème Principal 3. *La parité de la structure spin d'une différentielle quadratique ψ , qui n'est pas le carré d'une 1-forme holomorphe, est indépendante du choix de ψ dans une strate $\mathcal{Q}(k_1, \dots, k_l)$ donnée.*

Utlisant la construction explicite du revêtement des orientations, nous claculons explicitement la parité de cette structure spin en terme uniquement du type des singularités des formes :

Théorème Principal 4. *Soit ψ une différentielle quadratique méromorphe sur une surface de Riemann S avec le type de singularités $\mathcal{Q}(k_1, \dots, k_l)$. Soit n_{+1} le nombre de zéros de ψ de degré $k_i = 1 \pmod{4}$, et soit n_{-1} le nombre de zéros de ψ de degré $k_j = 3 \pmod{4}$. En outre, nous supposons que tous les degrés des zéros restants satisfont $k_r = 0 \pmod{4}$. Avec ces conditions, la struture spin de $\hat{\omega}$ sur \hat{S} le revêtement double associé, a un sens. Alors la parité de la structure spin déterminée par ψ est donné par :*

$$\Phi(\psi) = \left[\frac{|n_{+1} - n_{-1}|}{4} \right] \pmod{2}$$

où les crochets dénotent la partie entière.

En utilisant cette formule, nous donnons une application dans le contexte des billards rationnels.

Contents

1	Surgeries and branched coverings	23
1.1	Breaking up a singularity	23
1.1.1	Local construction	23
1.1.2	Global construction	25
1.2	Bubbling a handle	25
1.2.1	A particular construction	25
1.2.2	Local construction	26
1.2.3	Global construction	27
1.3	Branched coverings	27
1.3.1	Orientating double covering	27
1.3.2	Orientating double covering and homological group	28
1.3.3	Construction	29
1.3.4	Hyperelliptic connected components	29
2	Tools	33
2.1	Jenkins—Strebel surfaces	33
2.1.1	Completely periodic foliations	33
2.1.2	Cohomological coordinates	34
2.1.3	Density results	35
2.2	Generalized permutations	38
2.2.1	A definition	40
2.2.2	Admissible vectors	41
2.2.3	Suspension over a generalized permutation	41
2.2.4	Irreducibility	42
2.2.5	A geometric property	46
2.2.6	Irreducibility and weakly irreducibility	46
2.2.7	Cyclic order	46
2.3	\hat{H} omologous saddles connections	47
2.3.1	Canonical double covering and homological group	47
2.3.2	\hat{H} omologous saddles connections	47
2.3.3	Multiplicity	48
2.4	Properties of surgeries of Chapter 1	48
2.4.1	Properties of “breaking up a singularity”	48
2.4.2	Properties of “bubbling a handle”	51
2.5	Two fundamentals observations	53
2.5.1	“Breaking up a singularity”	53

2.5.2	“Bubbling a handle”	54
3	Representative elements	57
3.1	Hyperelliptic connected components	57
3.1.1	Representative elements	57
3.1.2	Hyperelliptic strata in low genera	59
3.2	Irreducible connected components	60
3.2.1	The stratum $\mathcal{Q}(-1, 9)$	60
3.2.2	The stratum $\mathcal{Q}(-1, 3, 6)$	60
3.2.3	The stratum $\mathcal{Q}(-1, 3, 3, 3)$	61
3.2.4	The minimal stratum $\mathcal{Q}(12)$	61
4	Adjacency	63
4.1	Flat surfaces and “Breaking up a singularity”	64
4.1.1	Multiplicity one and “Breaking up a singularity”	64
4.1.2	Exceptionnal cases	64
4.2	Main result of this Chapter	65
4.2.1	Sketch of the proof	66
4.2.2	Proof of the main result of this Chapter	67
4.3	Refinement of the main result	78
4.4	Adjacency of strata	78
4.4.1	Adjacency	78
4.4.2	Local connectedness	79
5	The Minimal Stratum $\mathcal{Q}(4g - 4)$	81
5.1	Simple cylinder and the minimal stratum	81
5.1.1	Formulation of the statement	82
5.1.2	Sketch of the proof	82
5.1.3	Proof of the main result of this section	83
5.2	Connectedness of the minimal stratum	89
5.2.1	Initialization of the induction: genera $g = 3, 4, 5$	89
5.2.2	Induction on the genus g	92
6	General Classification	93
6.1	Paths inside the moduli space	93
6.1.1	Case of hyperelliptic connected components	93
6.1.2	Case of irreducible connected components	94
6.2	Main Theorem 1	95
6.3	Main Theorem 2	96
7	Appendix	99
7.1	Spin Structure	99
7.1.1	Spin Structure Defined by an Abelian Differential	99
7.1.2	Parity of a spin structure	99
7.1.3	Spin structure on a deformed curve	100
7.1.4	Spin Structure Defined by a Quadratic Differential	100
7.2	Suspension over an interval exchange map	100

7.2.1	Zippered rectangles (After Veech)	100
7.2.2	Second construction (After Masur)	101
7.3	Rauzy classes	102
7.4	Examples of measured foliations on surfaces	103
7.4.1	An Example of arithmetic surfaces	103
7.4.2	Measured foliations and transverse measured foliations	104

Chapter 1

Surgeries and branched coverings

In this Chapter, we describe some “classical” constructions of half translation surfaces (see also [EsMaZo], [MaZo] and [KoZo]). We also use an analogous construction of the “orientating” double ramified covering associated to a quadratic differential (see [HuMa]). Constructions are geometric and use only the point of view of measured foliations on S . In the last section of this Chapter, we give a construction of a double ramified covering and deduce an invariant to distinguish the connected components: hyperellipticity.

1.1 Breaking up a singularity

In this section, we want to “break up a singularity” of order k_1 into two singularities of orders l and r with $r + l = k_1$. According to the parity of l and r , the surgery that we propose is local or global.

1.1.1 Local construction

Breaking up a singularity into two singularities

In this section, we consider the two cases where l and r are even or k_1 is odd. The surgery we will describe is local (see Figure 1.1). We have

Lemma 1. *Consider a surface in $\mathcal{Q}(k_1, \dots, k_n)$. Choose $l, r \in \{-1, 1, 2, 3, 4, \dots\}$, as follows*

- *if k_1 is odd, $l + r = k_1$; and l, r any.*
- *if k_1 is even, $l + r = k_1$; and l, r even.*

For any $\psi_0 \in \mathcal{Q}(k_1, k_2, \dots, k_n)$ and for any sufficiently small $\varepsilon > 0$ (depending on ψ_0) it is possible to construct a deformation $\psi \in \mathcal{Q}(l, r, k_2, \dots, k_n)$ of ψ_0 such that the corresponding flat metric would have a horizontal saddle connection of length ε joining the singularities P_1 and P_2 of orders l and r .

The deformation can be chosen to be local: the flat metric does not change outside of a small neighborhood of the zero of multiplicity k_1 .

Proof of Lemma 1. See references in Annexes (see also [La1]). □

Breaking up a singularity into three singularities

Next, we will see that for breaking up an even zero into two odd zeroes, the construction is global. Nevertheless we can extend the last construction to obtain another local one: we “break up a zero” into *three* zeroes (see Figure 1.2)

Lemma 2. *Consider a surface in $\mathcal{Q}(k_1, \dots, k_n)$. Choose $l, r, s \in \{-1, 1, 2, 3, 4, \dots\}$ with $l + r + s = k_1$ and l, r, s any. For any $\psi_0 \in \mathcal{Q}(k_1, k_2, \dots, k_n)$ and for any sufficiently small $\varepsilon > 0$ (depending on ψ_0) it is possible to construct a deformation $\psi \in \mathcal{Q}(l, r, s, k_2, \dots, k_n)$ of ψ_0 such that the corresponding flat metric would have two horizontal saddle connection of length ε joining the singularities P_1, P_2 and P_2, P_3 of orders l, r, s correspondingly.*

The deformation can be chosen to be local: the flat metric does not change outside of a small neighborhood of the zero of multiplicity k_1 .

Proof of Lemma 2. See references in Annexes (see also [La1]). □

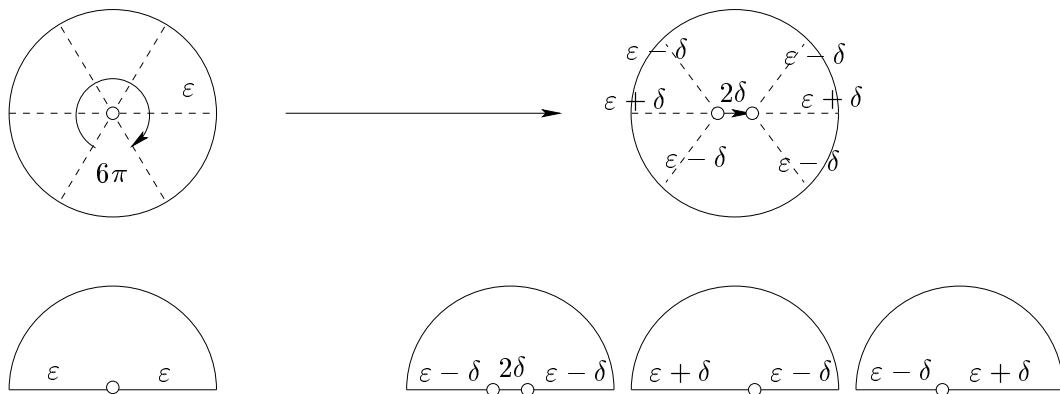

Figure 1.1: Breaking up a zero of order 4 into two zeros of orders 2. Note that the surgery is local: we do not change the flat metric outside of the neighborhood of the zero.

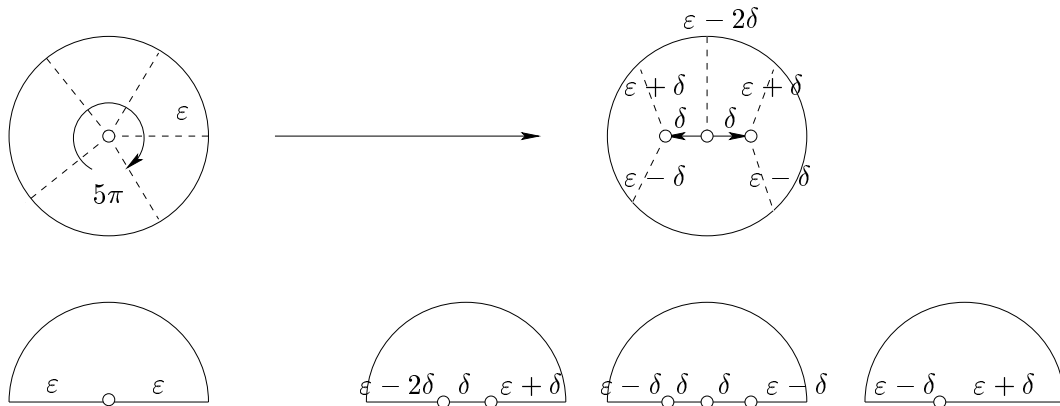

Figure 1.2: Breaking up a zero of order 3 into three zeros of orders 1. Note that the surgery is local: we do not change the flat metric outside of the neighborhood of the zero.

1.1.2 Global construction

In this section, we consider “breaking up a singularity” in two cases where l and r are odd (then k_1 is even).

The surgery is *global*. We use section 1.2.3 to obtain a flat surface S' with an additional handle. We required that the angle between the two new sectors is $n_1 = l + 2$ ($n_2 = r + 2$ if we consider the complementary angle). Now let us “erase” this handle to obtain a flat surface, also denoted by S' , with a boundary component. The boundary of the new surface S' is exactly union of two separatrix loops γ_1 and γ_2 of length ε . We cut this surface along the point P_1 to obtain a flat surface with a boundary homeomorphic to a circle. Then we identify the two geodesics segments γ_i by an isometry. We obtain a compact Riemann surface, also denoted by S' . We can explicitly describe this surgery in terms of the flat metric so S' is also a flat surface. The types of singularities of S and S' coincide except that instead of P_1 we obtain two singularities Q_1 and Q_2 . Conical angle around these points are n_1 and n_2 . So the resulting flat surface satisfy the desired conditions: two “new” zeroes of order $l = n_1 - 2$ and $r = n_2 - 2$. Note that we have

$$k_1 = n_1 + n_2 - 4 = (n_1 - 2) + (n_2 - 2) = l + r$$

1.2 Bubbling a handle

Let S be a half translation surface with non-trivial holonomy. Let $P_1 \in S$ be a point of multiplicity k_1 with respect to the flat metric ($k_1 = 0$ if P_1 is a regular point, $k_1 = -1$ if P_1 is a pole and $k_1 > 0$ if P_1 is a zero). We want to construct a half translation surface S' in genus $g + 1$ starting with S in genus g . We first give a construction in a special case and then we describe this surgery in full generality.

1.2.1 A particular construction

Construction

Let $\theta \in \mathbb{S}^1$ denote a direction on S . In this direction, we choose a separatrix γ which contains the point P_1 . Let $Q \in \gamma$ be a point at distance at most ε from P_1 with $\varepsilon < \varepsilon_0$. Here we suppose that $[S, \psi] \in \mathcal{QD}(\varepsilon_0)$ (see Introduction for definition of these sets). So there are no singular points in the geodesic segment $]P_1; Q[$. Then we cut the flat surface S along this segment $[P_1; Q]$. The resulting surface, denoted by S' , is a flat surface with a boundary component. By construction, the boundary is homeomorphic to a circle \mathbb{S}^1 : the union of two saddle connections between the two singularities P_1 and Q on S' . We identify these two points. The quotient surface, still denoted by S' , is also a half translation surface with a boundary component homeomorphic to a bouquet of two circles: γ_1 and γ_2 . The lengths of each of these two separatrix loops is ε . Then we consider a straight metric cylinder \mathcal{C} of perimeter ε . We glue the top boundary component of this cylinder to γ_1 and the bottom component to γ_2 . The resulting surface is a non-singular closed flat surface. We obtain on S' a measured foliation \mathcal{F}' . By construction, holonomy of the two foliations \mathcal{F} of S in the direction θ and \mathcal{F}' on S' coincide; that is \mathcal{F} is oriented if and only if \mathcal{F}' also. Moreover, the surface S' possesses the same type of singularities as S for all singular points different from $P_1 = Q$. In this particular point the conical angle in terms of the flat metric

is $(k_1 + 2 + 4)\pi$ so the corresponding differential ψ' has a zero of order $k_1 + 4$. With our notation in terms of strata, if $[S, \psi] \in \mathcal{Q}(k_1, k_2, \dots, k_n)$ then $[S', \psi'] \in \mathcal{Q}(k_1 + 4, k_2, \dots, k_n)$.

Parameter space

We can calculate the parameters for the above surgery; that is the parameters space. The parameters responsible for the cylinder are the height h and the twist ϕ . The parameters responsible for the direction and the cutting on S are θ and the length ε of the geodesic segment $[P_1, Q]$. In other words, we have

$$(\{\theta \in \mathbb{S}^1\} \times \{0 < \varepsilon < \varepsilon_0\}) \times (\{0 < h < h_0\} \times \{\phi \in \mathbb{S}^1\}) = \mathbb{D}^2 \times \mathbb{D}^2$$

We would like to extend this construction which will give us an additional discrete parameter: the angle between the two “new” sectors. In the previous construction, angle between the two separatrix loops γ_1 and γ_2 are 2π (or $(k_1 + 2)\pi$ if we consider the complementary angle).

Let n_1 and n_2 satisfy $n_1 + n_2 = k_1 + 4$. In section 1.2.2 and 1.2.3 we are going to construct a flat surface S' with a simple cylinder by “bubbling” a handle such that the angle of this handle is $n_1\pi$ (or $n_2\pi$ if we consider the complementary angle) in the flat metric.

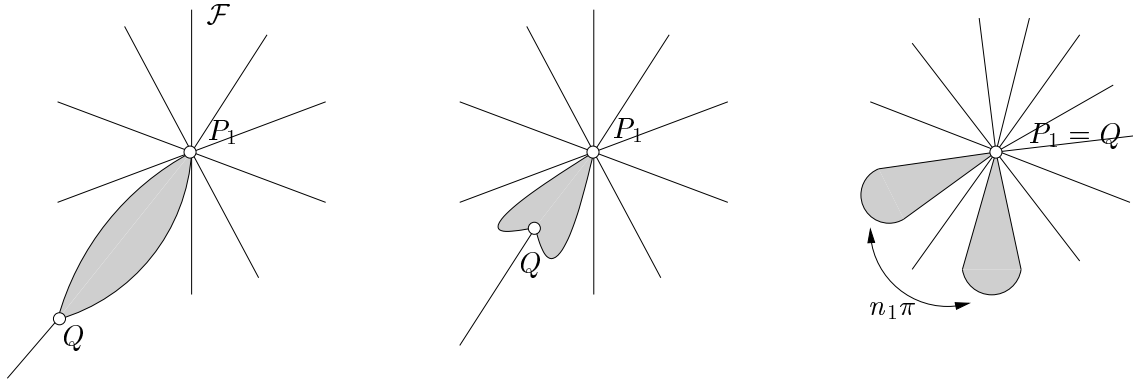

Figure 1.3: Here the construction of “bubbling a handle” at a zero of order 8. The angle between the two new sectors is $n_1\pi$ with $n_1 = 2$.

1.2.2 Local construction

In this section, we consider “bubbling a handle” in two cases where n_1, n_2 are even or k_1 is odd. In these two cases, it is easy to generalize the previous construction. We can break the zero of order k_1 into two zeroes of orders $n_1 - 2$ and $n_2 - 2$ (see previous section 1.1.1). We can do it by a local construction: the flat metric does not change outside of a small neighborhood of the zero of multiplicity k_1 (see Lemma 1). Then we cut the resulting surface along the saddle connection between these two zeroes. We identify the zeroes to obtain a flat surface S' with a boundary component which is exactly the union of two separatrix loops of angle n_1 . Note that the surgery is local.

1.2.3 Global construction

In this section, we consider “bubbling a handle” in the case where the angles between the two new sectors are $n_1\pi$ and $n_2\pi$ with n_1 and n_2 odd.

In this case, the construction is *global*. We refer to [MaZo] for details of this construction.

Remark 1. The two above surgeries are related. In the local construction, we can think of the parameters space as one punctured complex disc times a discrete parameter for the surgery “breaking up a singularity”. For the surgery “bubbling a handle”, there is an additional parameter: a punctured complex disc for the additional metric cylinder.

Remark 2. Using these surgeries, we obtain the following fact: there are some components of the stratum $\mathcal{Q}(k_1, k_2, k_3, \dots, k_n)$ which are “accessible” by a surgery “breaking up a singularities” on a surface inside the stratum $\mathcal{Q}(k_1 + k_2, k_3, \dots, k_n)$. For the case “bubbling a handle”, we have an analogous fact: there are some components of the stratum $\mathcal{Q}(k_1, \dots, k_i + 4, \dots, k_n)$ which are “accessible” by a surgery “bubbling a handle” on a surface inside the stratum $\mathcal{Q}(k_1, \dots, k_i, \dots, k_n)$.

In Chapter 4 and Chapter 3, we classify all components in all strata which contain a half-translation surface constructs by one of these two surgeries. This classification allows us to describe in details the *adjacency* of the strata.

1.3 Branched coverings

The main result of this section is the construction of four one-parameters family of strata which are not connected. This invariant which is used is the notion of *hyperelliptic* connected component. First we describe a classical construction of the “orientating double covering” (see [HuMa]). Then we construct the hyperelliptic components and prove the announced statement. We refer to [La1] for details and proofs.

1.3.1 Orientating double covering

Proposition. *Let S_g^2 be a Riemann surface and let ψ be a quadratic differential on it.*

Then there exists a canonical (ramified) double covering $\pi : \hat{S}_g^2 \rightarrow S_g^2$ such that $\pi^\psi = \hat{\omega}^2$, where $\hat{\omega}$ is an Abelian differential on \hat{S}_g^2 .*

Moreover, the images $P \in S_g^2$ of ramification points of the covering π are exactly the singularities of odd degrees of ψ . The covering $\pi : \hat{S}_g^2 \rightarrow S_g^2$ is the minimal (ramified) covering such that the quadratic differential π^ψ becomes the square of an Abelian differential on \hat{S}_g^2 .*

Note that the surface \hat{S} is connected if and only if ψ is not the global square of an Abelian differential.

Proof of the Proposition. Consider an atlas $(U_i, z_i)_i$ on $\hat{S}_g^2 = S_g^2 \setminus \{\text{singularities of } \psi\}$ where we punctured all zeros and poles of ψ . We assume that all the charts U_i are connected and simply-connected. The quadratic differential ψ can be represented in this atlas by a

collection of holomorphic functions $f_i(z_i)$, where $z_i \in U_i$, satisfying the relations:

$$f_i(z_i(z_j)) \cdot \left(\frac{dz_i}{dz_j} \right)^2 = f_j(z_j) \quad \text{on } U_i \cap U_j$$

Since we have punctured all singularities of ψ any function $f_i(z_i)$ is nonzero at U_i . Consider two copies U_i^\pm of every chart U_i : one copy for every of two branches $g_i^\pm(z_i)$ of $g^\pm(z_i) := \sqrt{f_i(z_i)}$ (of course, the assignment of “+” or “-” is not canonical). Now for every i identify the part of U_i^+ corresponding to $U_i \cap U_j$ with the part of one of U_j^\pm corresponding to $U_j \cap U_i$ in such way that on the overlap the branches would match

$$g_i^+(z_i(z_j)) \cdot \frac{dz_i}{dz_j} = g_j^\pm(z_j) \quad \text{on } U_i^+ \cap U_j^\pm$$

Apply the analogous identification to every U_i^- . We get a Riemann surface with punctures provided with a holomorphic 1-form $\hat{\omega}$ on it, where $\hat{\omega}$ is presented by the collection of holomorphic functions g_i^\pm in the local charts. It is an easy exercise to check that filling the punctures we get a closed Riemann surface \hat{S}_g^2 , and that $\hat{\omega}$ extends to an Abelian differential on it. We get a canonical (possibly ramified) double covering $\pi : \hat{S}_g^2 \rightarrow S_g^2$ such that $\pi^* \psi = \hat{\omega}^2$.

By construction the only points of the base S_g^2 where the covering might be ramified are the singularities of ψ . In a small neighborhood of zero of even degree $2k$ of ψ we can chose coordinates in which ψ is presented as $z^{2k}(dz)^2$. In this chart we get two distinct branches $\pm z^k dz$ of the square root. Thus the zeros of even degrees of ψ and the marked points are the regular points of the covering π . However, it easy to see that the covering π has a ramification point over any zero of odd degree and over any simple pole of ψ . \square

1.3.2 Orientating double covering and homological group

Let $[S, \psi] \in \mathcal{Q}(k_1, \dots, k_n)$ be a point. Consider the orientating (or canonical) double covering $\pi : \hat{S} \rightarrow S$ described in the above construction such that the pull-back $\pi^* \psi = \hat{\omega}^2$ becomes the global square of an Abelian differential $\hat{\omega}$ on \hat{S} . Let τ be the natural involution of \hat{S} interchanging the points in the fibers of π . Let $\hat{P}_1, \dots, \hat{P}_r \in \hat{S}$ be the *true* zeros of $\hat{\omega}$. Since by construction $\tau^* \hat{\omega} = -\hat{\omega}$, the set $\{\hat{P}_1, \dots, \hat{P}_r\}$ is sent to itself by the involution τ . Consider the induced involution

$$\tau^* : H^1(\hat{S}, \{\hat{P}_1, \dots, \hat{P}_r\}; \mathbb{C}) \rightarrow H^1(\hat{S}, \{\hat{P}_1, \dots, \hat{P}_r\}; \mathbb{C})$$

of the relative cohomology group. The vector space $H^1(\hat{S}, \{\hat{P}_1, \dots, \hat{P}_r\}; \mathbb{C})$ splits into direct sum

$$H^1(\hat{S}, \{\hat{P}_1, \dots, \hat{P}_r\}; \mathbb{C}) = V_1 \oplus V_{-1}$$

of invariant and anti-invariant subspaces of the involution τ^* . We have already seen that $[\hat{\omega}] \in V_{-1}$.

In Chapter 2, we will use these groups to describe locally the structure of the strata. In particular, a small neighborhood of $[\hat{\omega}]$ in the anti-invariant subspace V_{-1} gives local coordinates charts of a regular point $[S, \psi]$ (not a fixed point for a elliptic element of the modular group Γ_g) inside the stratum $\mathcal{Q}(k_1, \dots, k_n)$.

1.3.3 Construction

Here we present a construction of a natural mapping of the strata induced by a ramified covering of the fixed combinatorial type.

Let S_g^2 be a Riemann surface and let ψ_0 be a quadratic differential on it which is not a square of an Abelian differential. Let (k_1, \dots, k_n) be its singularity pattern. We do not exclude the case when some of k_i are equal to zero: by convention this means that we have some marked points.

Let $\pi : \tilde{S}_g^2 \rightarrow S_g^2$ be a (ramified) covering such that the image of any ramification point of π is a marked point, or a zero, or a pole of the quadratic differential ψ_0 . Fix the *combinatorial type* of the covering π : the degree of the covering, the number of critical fibers and the ramification index of the points in every critical fiber. Consider the induced quadratic differential $\pi^*\psi_0$ on \tilde{S}_g^2 ; let $(\tilde{k}_1, \dots, \tilde{k}_m)$ be its singularity pattern.

Deforming slightly the initial point $[M_g^2, \psi_0] \in \mathcal{Q}(k_1, \dots, k_n)$ we can consider a ramified covering over the deformed Riemann surface of the same combinatorial type as the covering π . This new covering would have exactly the same relation between the position and types of the ramification points and the degrees and position of singularities of the deformed quadratic differential. This means that the induced quadratic differential $\pi^*\psi$ would have the same singularity pattern $(\tilde{k}_1, \dots, \tilde{k}_m)$ as $\pi^*\psi_0$. Thus we get a local mapping

$$\begin{aligned} \mathcal{Q}(k_1, \dots, k_n) &\rightarrow \mathcal{Q}(\tilde{k}_1, \dots, \tilde{k}_m) \\ [S_g^2, \psi] &\mapsto (\tilde{S}_g^2, \pi^*\psi) \end{aligned}$$

Note that in general the corresponding *global* mapping is multi-valued. See [La1] for details and proofs for this construction.

Using this construction, we prove

Proposition 1. *The mapping*

$$\mathcal{Q}(k_1, \dots, k_n) \rightarrow \mathcal{Q}(\tilde{k}_1, \dots, \tilde{k}_m) \tag{1.1}$$

is locally an embedding.

Note that the image of above mapping belongs to the set of quadratic differential which is not the global square of an Abelian differential.

Proof of the Proposition 1. We use the *cohomological coordinates* (see section 2.1.2) in the neighborhood of $[S, \psi] \in \mathcal{Q}(k_1, \dots, k_n)$ and in the neighborhood of its image $[\tilde{S}, \tilde{\psi}] \in \mathcal{Q}(\tilde{k}_1, \dots, \tilde{k}_m)$, where $\tilde{\psi} = \pi^*\psi$. These coordinates linearize the mapping, and the proof becomes an exercise in algebraic topology. See the Annexes for details of the proof (see also [La1]). \square

1.3.4 Hyperelliptic connected components

In [La1], we classify all combinatorial types of strata such that the dimension of the two orbifolds $\mathcal{Q}(k_1, \dots, k_n)$ and $\mathcal{Q}(\tilde{k}_1, \dots, \tilde{k}_m)$ in the above Proposition coincide. For the strata $\mathcal{Q}(\tilde{k}_1, \dots, \tilde{k}_m)$ we get exactly the list $\mathcal{F}_2 \sqcup \mathcal{F}_3 \sqcup \mathcal{F}_4$ given by Main Theorem 1.

Moreover, the genus of surfaces in the corresponding strata $\mathcal{Q}(k_1, \dots, k_n)$ is always zero. Next, we present an explicitly construction of the list \mathcal{F}_4 . We will use the following

Proposition 2 (Kontsevich). *Any stratum $\mathcal{Q}(k_1, \dots, k_n)$ with $\sum k_i = -4$ is connected.*

Proof of the Proposition. Since there is only one complex structure on \mathbb{CP}^1 we can work in the standard atlas on $\mathbb{CP}^1 = \mathbb{C} \cup (\mathbb{C}^* \cup \infty)$. In this atlas, we can easily find quadratic differentials $f(z)(dz)^2$ with any prescribed singularities at any prescribed points (with the evident condition on the zeros, $\sum k_i = -4$) just by choosing an appropriate rational function $f(z)$. The space of configurations of points on a sphere is connected; this implies the statement of the Proposition. \square

Here, we present an explicitly construction of the list \mathcal{F}_4 . Let us consider the following example. Let us apply Construction 1.3.3 in the following particular case. Consider a meromorphic quadratic differential ψ on \mathbb{CP}^1 having the singularity pattern $(2(g-k) - 3, 2k+1, -1^{2g+2})$, where $k \geq -1$, $g \geq 1$ and $g-k \geq 2$. Consider a ramified double covering π over \mathbb{CP}^1 having ramification points over $2g+2$ poles of ψ , and no other ramification points. We obtain a hyperelliptic Riemann surface \tilde{M} of genus g with a quadratic differential $\pi^*\psi$ on it. Obviously, the induced quadratic differential $\pi^*\psi$ has the singularity pattern $(2(g-k) - 3, 2(g-k) - 3, 2k+1, 2k+1)$. Thus we get a local mapping

$$\mathcal{Q}(2(g-k) - 3, 2k+1, -1^{2g+2}) \rightarrow \mathcal{Q}(2(g-k) - 3, 2(g-k) - 3, 2k+1, 2k+1),$$

where $k \geq -1$, $g \geq 1$ and $g-k \geq 2$. Using formula on the dimension of the strata (see Introduction) we get

$$\begin{aligned} \dim_{\mathbb{C}} \mathcal{Q}(2(g-k) - 3, 2k+1, -1^{2g+2}) &= 2 \cdot 0 + (2g+4) - 2 = 2g+2 \\ \dim_{\mathbb{C}} \mathcal{Q}(2(g-k) - 3, 2(g-k) - 3, 2k+1, 2k+1) &= 2g+4 - 2 = 2g+2 \end{aligned}$$

The dimensions of the strata coincide. Above Proposition imply that the mapping is non-degenerate. Since the stratum $\mathcal{Q}(2(g-k) - 3, 2k+1, -1^{2g+2})$ is connected, as any other stratum on \mathbb{CP}^1 by Proposition 2 the image of the mapping in the stratum $\mathcal{Q}(2(g-k) - 3, 2(g-k) - 3, 2k+1, 2k+1)$ is also connected.

We obtain an open set on the stratum $\mathcal{Q}(2(g-k) - 3, 2(g-k) - 3, 2k+1, 2k+1)$ which is invariant by the $\mathrm{SL}(2, \mathbb{R})$ -action. By ergodicity of the geodesic flow the image of the mapping

$$\mathcal{Q}(2(g-k) - 3, 2k+1, -1^{2g+2}) \rightarrow \mathcal{Q}(2(g-k) - 3, 2(g-k) - 3, 2k+1, 2k+1)$$

gives us a full measure set in the corresponding connected component of the stratum

$$\mathcal{Q}(2(g-k) - 3, 2(g-k) - 3, 2k+1, 2k+1).$$

Thus we obtain a whole connected component of these stratum. We call it the *hyperelliptic* connected component and denote it by

$$\mathcal{Q}^{hyp}(2(g-k) - 3, 2(g-k) - 3, 2k+1, 2k+1).$$

Note that the singularities data of this stratum belongs to the list \mathcal{F}_4 .

Similarly to the previous case we can easily check coincidence of the dimensions of the strata

$$\mathcal{Q}(2(g-k) - 3, 2k, -1^{2g+1}) \rightarrow \mathcal{Q}(2(g-k) - 3, 2(g-k) - 3, 4k+2),$$

with $k \geq 0$, $g \geq 1$ and $g - k \geq 1$ and

$$\mathcal{Q}(2g - 2k - 4, 2k, -1^{2g}) \rightarrow \mathcal{Q}(4(g - k) - 6, 4k + 2)$$

with $k \geq 0$, $g \geq 2$ and $g - k \geq 2$.

The images of these mappings give us connected components in the strata

$$\mathcal{Q}(2(g - k) - 3, 2(g - k) - 3, 4k + 2).$$

and

$$\mathcal{Q}(4(g - k) - 6, 4k + 2).$$

Definition 1. The connected components constructed above are called the *hyperelliptic components* and denoted by:

1. $\mathcal{Q}(2(g - k) - 3, 2k + 1, -1^{2g+2}) \rightarrow \mathcal{Q}^{hyp}(2(g - k) - 3, 2(g - k) - 3, 2k + 1, 2k + 1)$, where $k \geq -1$, $g \geq 1$, $g - k \geq 2$. The corresponding double covering has ramification points over $2g + 2$ poles of meromorphic quadratic differential on \mathbb{CP}^1 .
2. $\mathcal{Q}(2(g - k) - 3, 2k, -1^{2g+1}) \rightarrow \mathcal{Q}^{hyp}(2(g - k) - 3, 2(g - k) - 3, 4k + 2)$, where $k \geq 0$, $g \geq 1$ and $g - k \geq 1$. The corresponding double covering has ramification points over $2g + 1$ poles and over the zero of degree $2k$ of meromorphic quadratic differential on \mathbb{CP}^1 .
3. $\mathcal{Q}(2g - 2k - 4, 2k, -1^{2g}) \rightarrow \mathcal{Q}^{hyp}(4(g - k) - 6, 4k + 2)$, where $k \geq 0$, $g \geq 2$ and $g - k \geq 2$. The corresponding double covering has ramification points over all singularities of the quadratic differential on \mathbb{CP}^1 .

In Main Theorem 1, we have denoted above families of strata by $\mathcal{F}_2 \sqcup \mathcal{F}_3 \sqcup \mathcal{F}_4$.

The Theorem below proves that there are no other connected components which can be obtained using a similar construction.

Theorem 1. *Let $\mathcal{Q}(k_1, \dots, k_n)$ be a stratum in the moduli space of meromorphic quadratic differentials and let $\pi : \hat{S} \rightarrow S$ be a covering of finite degree $d > 1$. Consider the mapping*

$$\mathcal{Q}(k_1, \dots, k_n) \rightarrow \mathcal{Q}(\tilde{k}_1, \dots, \tilde{k}_m)$$

induced by the covering π (see Construction 1.3.3). Suppose that the image stratum is not a stratum of squares of Abelian differentials, and suppose that the mapping is neither of one of the three types corresponding to hyperelliptic components. Then

$$\dim_{\mathbb{C}} \mathcal{Q}(k_1, \dots, k_n) < \dim_{\mathbb{C}} \mathcal{Q}(\tilde{k}_1, \dots, \tilde{k}_m)$$

Proof. See [La1]. □

Remark 3. Hyperelliptic connected components of the type \mathcal{F}_4 was first discovered by M. Kontsevich.

In [La1], we proved that all of those strata (which contain an hyperelliptic component) are not connected in genera higher than 3. We show, using the geometry of measured foliation that it necessarily exists a non-hyperelliptic component. Namely, we have the following

Corollary 1. *Let us fix $g \geq 3$. Let us consider the following families of strata*

$$\begin{aligned} \mathcal{F}_2 &= \{ \mathcal{Q}(4(g-k) - 6 ; 4k + 2) & | & 0 \leq k \leq g - 2 \} \\ \mathcal{F}_3 &= \{ \mathcal{Q}(4(g-k) - 6 ; 2k + 1 ; 2k + 1) & | & 0 \leq k \leq g - 1 \} \\ \mathcal{F}_4 &= \{ \mathcal{Q}((2(g-k) - 3 ; 2(g-k) - 3 ; 2k + 1 ; 2k + 1) & | & -1 \leq k \leq g - 2 \} \end{aligned}$$

Then all strata listed in the above families are not connected: there is one hyperelliptic connected component and at least one non-hyperelliptic connected component.

In the next of this thesis, we are going to prove that, in genera higher than 5, any connected component is either hyperelliptic or attached to the minimal stratum. This will prove Main Theorem 1.

Chapter 2

Tools

In this Chapter, we remind key results on the moduli space and on the geometry of half translation surfaces. We propose a way to encode particular flat surfaces: the Jenkins—Strebel forms with one cylinder. We refer to [DoHu], [HuMa] and [KoZo].

2.1 Jenkins—Strebel surfaces

An important class of quadratic differentials is given by Jenkins—Strebel differentials. In this section, we explain these particular forms and we present some results about the density in the moduli space. In addition, we propose a natural way to encode such forms.

2.1.1 Completely periodic foliations

Let Γ be the critical graph of (S, ψ) for the horizontal foliation, that is the union of all separatrices in the horizontal direction. We want to study a particular class of flat surfaces: the one where Γ is compact.

Proposition 3. *Γ is compact if and only if the horizontal measured foliation of ψ is completely periodic; that is in the horizontal direction, any leaf is compact.*

Proof of the Proposition. If Γ is compact, one can define an ε -neighborhood of Γ :

$$\Gamma(\varepsilon) = \{P \in S ; d(P, \Gamma) < \varepsilon\}$$

for all $\varepsilon > 0$ (d is defined by the flat metric). Now let us consider $P \in S \setminus \Gamma$. We choose ε small enough such that $P \notin \Gamma(\varepsilon)$. Let us consider the (horizontal) leaf γ through P . The distance of P from $\Gamma(\varepsilon)$ is positive thus

$$d(Q, \Gamma(\varepsilon)) > 0 \quad \text{for all points } Q \in \gamma$$

If the leaf γ is non compact then it is dense in a minimal component and so $d(\gamma, \Gamma(\varepsilon)) = 0$ which leads to a contradiction.

Thus any regular leaf is compact and so the foliation is completely periodic. □

In this case, we say that the form ψ is of type Jenkins—Strebel.

Example 1. A very large class of these forms is given by Veech surfaces in a periodic direction, and, in particular, by arithmetics surfaces.

Recall that an arithmetic translation surface (endow with an Abelian differential) is a ramified covering over the two torus with only one critical value. In an equivalent way, the group generated by absolutes and relatives periods is a lattice in \mathbb{C} . A Theorem of Gutkin and Judge (see [GuJu]) asserts that this condition is also equivalent to the fact that the Veech group is commensurable to $\mathrm{PSL}(2, \mathbb{Z})$ (and so as consequence it is a lattice).

An arithmetic translation surface (endowed with a quadratic differential) is a surface such that the orientating double covering is an arithmetic surface.

2.1.2 Cohomological coordinates

It is a well-known part of the Teichmüller theory that \mathcal{T}_g is a complex manifold and $\mathcal{H}\mathcal{Q}_g$ is the cotangent bundle over the modular space $\mathcal{M}_g = \mathcal{T}_g/\mathrm{Mod}(g)$. Here we describe this structure in the case of the principal stratum: the stratum $\mathcal{Q}(1, \dots, 1) = \mathcal{Q}(1^{4g-4})$. We recall that the dimension of this stratum is

$$\dim_{\mathbb{C}} \mathcal{Q}(1, \dots, 1) = 2 \cdot \dim_{\mathbb{C}} \mathcal{T}_g = 6g - 6 \quad (2.1)$$

We refer to [DoHu] for details. For a Riemann surface S endowed with a quadratic differential ψ which is not the global square of an Abelian differential, recall that we note by \hat{S}_ψ the connected Riemann surface which is the double cover of S and $\pi : \hat{S} \rightarrow S$ the projection. Let $\hat{\omega} = \sqrt{\pi^* \psi}$ be one of the two square roots (see section 1.3.1 for the notations).

Let $[S, \psi] \in \mathcal{Q}_g$ be a point in the total space with only simple zeroes. The Riemann surface \hat{S} has a natural involution and so the various homology and cohomology spaces attached to it. The vector space $H^0(S; \Omega^{\otimes 2})$ can be identified with $H^0(\hat{S}; \Omega)^-$ with the identification

$$u \mapsto \hat{u} = \sqrt{\pi^* u}$$

This allows us to define the following map

$$\begin{aligned} \phi_\psi : H^0(S; \Omega^{\otimes 2}) &\rightarrow \mathrm{Hom}(H_1(\hat{S})^-; \mathbb{R}) \\ u \mapsto \phi_\psi(u)(\hat{\gamma}) &= \mathrm{Re} \int_{\hat{\gamma}} \hat{u} \end{aligned}$$

This map ϕ_ψ is an \mathbb{R} -isomorphism. Now we want to parametrized locally the principal stratum. Let $[S_0, \psi_0] \in \mathcal{Q}(1, \dots, 1)$ be a quadratic differential with only simples zeroes and let U be a simply-connected open neighborhood of ψ_0 inside the principal stratum. With these considerations, we can identify

$$H_1(\hat{S}_\psi)^- \text{ and } H_1(\hat{S}_{\psi_0})^- \text{ for all } \psi \in U \quad (2.2)$$

We define the map $\chi : U \rightarrow \mathrm{Hom}(H_1(\hat{S}_{\psi_0})^-; \mathbb{R})$ by $\chi(\psi) = \phi_\psi(\psi)$, thus $\chi(\psi)(\gamma) = \mathrm{Re} \int_{\gamma_\psi} \omega_\psi$, where γ_ψ is the cycle on \hat{S}_ψ corresponding to γ with equation (2.2).

Proposition (Douady, Hubbard). *The map χ is \mathbb{R} -analytic and its derivative at ψ_0 is $\frac{1}{2} \phi_{\psi_0}$.*

Proof of the Proposition. To compute the value of the derivative on $u \in T_{\psi_0} = H^0(S; \Omega^{\otimes 2})$ evaluated at $\hat{\gamma} \in H_1(\hat{S}_{\psi_0})^-$, one must find the derivative at 0 of the function

$$t \mapsto \Re \int_{\hat{\gamma}(t)} \omega_{\psi_0+tu} \quad (2.3)$$

where $\hat{\gamma}(t)$ is the cycle in $H_1(\hat{S}_{\psi_0+tu})$ corresponding to $\hat{\gamma}$ (see equation (2.2)). One may suppose that $\hat{\gamma}$ is a loop on \hat{S}_{ψ_0} which is the double cover of a saddle connection γ on S between the two zeroes P_1 and P_2 (see [La2]). The function (2.3) can be rewritten

$$t \mapsto 2\Re \int_{P_1(t)}^{P_2(t)} \sqrt{\psi_0 + tu}$$

where $P_1(t)$ and $P_2(t)$ are the zeroes of $\psi_0 + tu$ near P_1 and P_2 . The derivative of this integral gives the result. □

Using the implicit function Theorem we have the following

Corollary. *The map χ is open in a neighborhood of ψ_0 . In addition, the moduli space $\mathcal{Q}(1, \dots, 1)$ inherit of the structure of a complex orbifold of dimension $6g - 6$.* □

Using the cohomology group with *relative* periods, we have the following classical result

Theorem (H. Masur; W. Veech).

Any stratum $\mathcal{H}(k_1, \dots, k_n)$ is a complex orbifold of dimension

$$\dim_{\mathbb{C}} \mathcal{H}(k_1, \dots, k_n) = 2g + n - 1$$

Any stratum $\mathcal{Q}(k_1, \dots, k_n)$ is a complex orbifold of dimension

$$\dim_{\mathbb{C}} \mathcal{Q}(k_1, \dots, k_n) = 2g + n - 2$$

In the case of the principal stratum, above formula corresponds to the formula (2.1) with $n = 4g - 4$. The general formula is obtained by subtracting a dimension any time a zero is collapsed to higher order.

2.1.3 Density results

Jenkins—Strebel forms

Locals coordinates, which were introduced independently by Masur and by Veech, show that arithmetics surfaces play the role of rational points inside the moduli space. More precisely, a stratum is locally modeled by the cohomology group $H^1(S; \text{singularities}; \mathbb{C})$. Taking points given by

$$H^1(S; \text{singularities}; \mathbb{Q} \oplus i\mathbb{Q}),$$

we obtain immediately the following

Lemma 3. *Jenkins—Strebel differentials are dense in each stratum of the moduli space.*

Proof. Obviously, a form whose absolutes and relatives periods are rational is a Jenkins—Strebel form. \square

Douady and Hubbard proved something stronger: the Jenkins—Strebel differentials are dense on each Riemann surface (see [DoHu]) not just in a stratum.

The complement of $\Gamma(\psi)$ in S is a disjoint union of *maximal* periodic components for the horizontal foliation. These components are isometric to vertical metric straight cylinders, foliated by regular horizontal leaves. A simple computation on the Euler characteristic, using these cylinders, shows that the maximal numbers of such cylinders is $3g - 3$, and it is obtain only by quadratic differentials having simple zeroes. By considering a thinner triangulation we obtain

Proposition 4. *Let S be a half translation surface and ψ the associated quadratic differential (here we do not suppose that the holonomy is non-trivial). We denote by E_v the number of zeroes of ψ of even multiplicity and by $2O_d$ the number of zeroes (or poles) of ψ of odd multiplicity. Let g be the genus of the surface. Let us assume that the horizontal foliation is completely periodic. Then the maximal number of cylinders is*

$$g - 1 + E_v + O_d$$

and this upper bound is sharp.

Lemma 3 gives us a density result for the Jenkins—Strebel differential in each stratum. We can also ask if the set of Jenkins—Strebel differentials with *exactly* r cylinders is dense in the moduli spaces (where r is any integer in $\{1, \dots, g - 1 + E_v + O_d\}$). H. Masur proved a result of this type for the principal stratum (see [Ma3])

Theorem 2 (Masur). *Let r be an integer with $1 \leq r \leq 3g - 3$. The set of Jenkins—Strebel differential with exactly r cylinders is dense inside the principal stratum $\mathcal{Q}(1, \dots, 1)$ of genus g .*

Jenkins Strebel forms with one cylinder

We would like to extend this result (in the case of $r = 1$) for *all* strata. The proof is geometric and use an idea of M. Kontsevich and A. Zorich in the particular case where the form ψ is the global square of an Abelian differential ω on S .

Theorem 3. *Let $\mathcal{Q}(k_1, \dots, k_n)$ be a stratum. Then the set of quadratic differentials such that the horizontal foliation is completely periodic, and decompose the surface into a unique straight metric cylinder, is dense in each connected component of this stratum.*

We stress that we formulate this statement for each connected component. There is now such additional difficulty since for the principal stratum it is obviously connected.

Proof of Theorem 3. We follow the main idea given by the proof of the equivalent result in the case of Abelian differentials. First of all, let us prove that there exists an half translation surface, in each connected component, such that the horizontal foliation is completely periodic and decomposes the surface into a unique cylinder.

Let $[S, \psi]$ be a point in a given connected component. Without loss of generality, we may suppose that the surface $(\hat{S}, \hat{\omega})$ over (S, ψ) is an arithmetic surface; that is a ramified covering over the standard torus. The vertical foliation on S is completely periodic and decompose the surface into many (horizontal) cylinders \mathcal{C}_i . Let us consider γ a closed regular curve, transversal to this foliation, of the following type. The surface S is a ramified covering $\pi : S \rightarrow \mathbb{T}^2$. Obviously, the measured foliation in a given direction θ on S is given by the lift under the map π of the standard linear foliation on the two-torus \mathbb{T}^2 in the direction θ . We consider a foliation on \mathbb{T}^2 in the direction $\theta = \frac{1}{q}$ with q arbitrary large. The lift of this foliation allows us to obtain a closed regular geodesic γ on S , transversal to the vertical foliation of ψ , such that γ does not contains any singularity of ψ . In addition, we can choose γ such that its length is arbitrary large with respect to the flat metric defined by ψ .

The closed loop γ cuts vertical sides of cylinders \mathcal{C}_i (that is the set of vertical saddle connections and separatrix loops) many times. By construction, $\partial\mathcal{C}_i \setminus \gamma$ is a disjoint union of vertical intervals. We can always choose γ long enough to obtain there is at most one singularity of ψ in each vertical interval. Now we want to modify slightly the transverse structure to obtain a periodic horizontal foliation with only one cylinder. We do this as follow.

We cut the surface along the vertical critical graph $\Gamma(\psi)$ of ψ and also along γ . We obtain a finite union of parallelogram R_i . The set of horizontal sides is a part of γ and the set of vertical sides is a part of the set of separatrix loops and saddle connections (for the vertical foliation induced by ψ). By construction, in each vertical side of R_i , there is at most one singularity of ψ .

Let us construct a new foliation as follow. We conserve all horizontal parameters and we change vertical parameters in the following way: we declare that the length of any vertical side of R_i is 1 for all i . In addition, if there is a singularity located on a vertical side, we declare that it is located on the middle of this side. With our above consideration, there is no contradiction. Finally we obtain a new set of parallelogram R'_i endowed with the natural metric dz^2 .

Let (S', ψ') be the flat surface construct from the new rectangles R'_i with the corresponding identifications of vertical and horizontal sides given by gluing described above. We obtain a flat surface with the same singularities data of ψ .

The surface S and S' are topologically the same. One can see that by construction the vertical critical graph $\Gamma(\psi)$ and $\Gamma(\psi')$ on S coincide. We just have change absolute and relative periods of the form ψ . The subvariety of quadratic differentials sharing the same vertical foliation is connected and depends continuously on the suitable of deformations of the vertical foliation (see [HuMa] and [V1]). Thus it implies the two points $[S, \psi]$ and $[S', \psi']$ belongs to the same connected component. One can see that, by construction, the horizontal foliation on S' induced by ψ' is completely periodic and decomposes the surface into one cylinder, which prove the first assertion.

Now let us prove the second assertion: the set of such forms is dense in each connected component. We denote by $\pi : \hat{S} \rightarrow S$ the orientating double covering and $\omega^2 = \pi^*\psi$. By direct corollary of the main result of Veech and Masur (see [Ma1] and [V1]), without loss of generality, we may assume that the vertical foliation of ω on \hat{S} is periodic and the horizontal foliation of ω is uniquely ergodic. By construction the corresponding loop

$\hat{\gamma}$ on \hat{S} is transverse to the vertical foliation. Always by construction, the corresponding form $\omega' = \pi^*\psi'$ is obtained as the corresponding element of $\hat{\gamma} \in H_1(S, \mathbb{R})$ by the Poincaré duality. Thus:

$$\int_{\rho} \Re(\omega) \approx \frac{1}{|\hat{\gamma}|} \#(\rho \cap \hat{\gamma}) \approx \frac{1}{|\hat{\gamma}|} \int_{\rho} \Re(\omega')$$

for any path ρ transverse to the vertical foliation induced by ω' . According to the cohomological coordinates, choosing γ sufficiently long, we can make $\psi'/|\gamma|$ arbitrary close to the initial form ψ .

This achieves the proof of the Theorem. \square

Remarks on the directional flow

There are several results concerning dynamics of $e^{i\theta}\psi$ with fixed ψ and variable $\theta \in \mathbb{S}^1$. In particular we have the following well-known result, which should be attributed to Katok and Keane

Proposition. *Let ψ be a quadratic differential on S . Then we have*

$$\mu(\{\theta \in \mathbb{S}^1 \mid \text{such that } \mathcal{F}_{\theta} \text{ is minimal}\}) = 1$$

where μ denotes the normalized Lebesgue measure on the circle.

Proof of the Proposition. The set of direction such that there exists a compact separatrix is countable. See Masur—Tabachnikov [MaTa]. \square

Proposition above shows that completely periodic directions are “rare”. Moreover, for a generic translation surface there is no θ such that the directional flow \mathcal{F}_{θ} is periodic (see [Ma2]).

Surfaces having completely periodic direction producing a single cylinder are even more rare (for the measure). Say, an arithmetic surface which has many completely periodic directions may have no one-cylinder decompositions. We present an example in the Appendix of an arithmetic surface for which any periodic decomposition produces at least two cylinders.

2.2 Generalized permutations

In the previous section, we have shown that the set of Jenkins—Strebel differentials with one cylinder is dense in each connected component. We want now to study the geometry of such surfaces. In all of this section, let (S, ψ) denote a flat surface such that the horizontal foliation is periodic and decompose the surface into only one cylinder.

We cut S along the critical graph $\Gamma(\psi)$ of ψ (note that this graph is compact so it makes sense). We obtain a vertical straight metric cylinder $\text{Cyl}(S)$, such that the boundary components are represented by a union of saddle connections; by construction each saddle connection is presented twice on the boundary of $\text{Cyl}(S)$. To reconstruct our surface S , we identify these pairs of intervals in the following way: let γ^1, γ^2 denote intervals corresponding to the saddle connection γ . If intervals γ^1, γ^2 are present in the same side of $\text{Cyl}(S)$, we identify them by a central symmetry, otherwise we identify them by a translation. The quotient surface $\text{Cyl}(S)/\sim$ is a half translation surface, affinely equivalent

to S . The form ψ is the image of the form dz^2 on $\text{Cyl}(S)$ which is compatible with the equivalence relation (note that in the case of Abelian differential, identifications are only translations so, the form dz is compatible with the equivalence relation and we obtain a *global* 1–form on $\text{Cyl}(S)/\sim$). Endpoints of intervals produce singular points on S for ψ . The action of the horocyclic flow

$$h_t = \begin{pmatrix} 1 & t \\ 0 & 1 \end{pmatrix}, \quad t \in \mathbb{R}$$

on S preserves the cylinder and twists the boundary. Action of $\text{PSL}(2, \mathbb{R})$ is continuous on the strata, so we can assume that in each connected component there exists a surface as above with a vertical saddle connection γ . Now we cut S along Γ and γ to obtain a metric rectangle $\text{Rec}(S) = [0; l] \times [0; h]$; where l is the length of a horizontal regular leaf and h is the length of the vertical saddle connection γ with respect to the transverse measure. Recall that the two horizontal sides of this rectangle, that is $[0; l] \times 0$ and $[0; l] \times h$, are a disjoint union of intervals. We can encode identifications of gluing of these intervals by a “permutation” as follows: we attribute to each interval a number between 1 to r with the property that we put the same number on two intervals if and only if they are equivalent by \sim . We obtain a (generalized) permutation π . We will give a formal definition later. Note that, as above, if $\psi = \omega^2$ for ω a global 1–form on S then π is a “true” permutation from the group \mathcal{S}_r and the coding of intervals is given by the first return map of the vertical *flow* on a regular horizontal leaf.

Thus to each connected component, we can associated a “generalized” permutation. Of course, this construction is not canonical and we obtain a family of permutations, depending the choice of surface, direction and twist. Conversely, given a permutation π , we can suspend a continuous family of flat surfaces over π as follows.

Let π be an arbitrary (generalized) permutation. Let $\text{Rec} = [0; l] \times [0; 1]$ be a Euclidian rectangle endowed with the form dz^2 . Choose a partition of the top and of the bottom boundary of R into a finite number of intervals (given by the number of elements of π). Let λ_i denote the length of these intervals. We suppose that the vector λ is admissible for π (see below for a formal definition). We construct the surface $S := S(\pi, \lambda)$ by the same way as above: we identify horizontal intervals between them with respect to the combinatorics of π (see Fig 2.1). Parameters of this construction are the length of the intervals. Using this remark, we can prove the following

Lemma 4. *The family of surfaces $S(\pi, \lambda)$ belongs to the same connected component for all admissible vectors λ .*

Proof of the Lemma. Note that the length λ_i of the intervals correspond to the absolute and to the relative periods of the corresponding form ψ on S . Thus the Lemma is a direct consequence of the local description using the cohomological coordinates. \square

This construction implies a simple fact: we can encode the set of connected component by using generalized permutations. In particular, such permutation determines completely the type of singularities and so a stratum. In addition, above Lemma proves that it also determines the connected component of the stratum. The set of generalized permutations, for a fix stratum is obviously finite. This gives an independent proof of the following

Theorem (Veech). *The set of connected components of a stratum $\mathcal{Q}(k_1, \dots, k_n)$ in the moduli space \mathcal{Q}_g of meromorphic quadratic differentials is finite.*

In the next, we will use this remark to show the connectedness for some strata in low genera; surfaces where the combinatorics is very simple. More precisely, we prove that the strata $\mathcal{Q}(-1, 5)$, $\mathcal{Q}(2, 2)$ and $\mathcal{Q}(8)$ are connected (see section 3.1.2).

Now we give the formal definition of a generalized permutation. In section 2.2.5 we describe a correspondence between dynamical properties of the vertical foliation on the surface $S(\pi, \lambda)$ and combinatorics properties of the permutation π , namely the notion of *irreducibility*.

2.2.1 A definition

We first give a practical definition and then we give a formal definition which is obviously equivalent.

Consider the multi-set $X = \{1, 1, 2, 2, \dots, k, k\}$ where each element $1, 2, \dots, k, k$ is taken with a multiplicity two. A *generalized permutation* is an ordered partition of X into two ordered multi-sets, $X = Y_1 \sqcup Y_2$. In the present thesis we shall always consider only those generalized permutations, for which each of Y_1, Y_2 contains at least one entry of multiplicity two. Y_1 and Y_2 are not necessarily of the same cardinality. Usually we present a generalized permutation by a tabular:

Example 2.

$$\pi = \begin{pmatrix} 1 & 2 & 3 & 4 & 3 & 5 & 4 \\ 6 & 6 & 1 & 5 & 2 & & \end{pmatrix}$$

This tabular represents a permutation of type $r = 7$ and $l = 5$ where $r = \text{card}(Y_1)$, $l = \text{card}(Y_2)$ and $k = (r + l)/2$.

One can check that suspension over this generalized permutation gives surfaces in the stratum $\mathcal{Q}(-1, 9)$ (see Figure 2.1).

Now, let us give a formal definition equivalent to the above definition.

Let r, l be non negative integers. A *generalized permutation* π is an involution without fix points of the set $\{1, \dots, r, r + 1, \dots, r + l\}$.

This notion is justified by the fact that a “true” permutation π_1 of the group \mathcal{S}_r is a generalized permutation with $r = l$ and

$$\begin{aligned} \pi(i) &= r + \pi_1^{-1}(i), & i \leq r \\ \pi(i) &= \pi_1(i - r), & i > r \end{aligned}$$

In the present thesis, we required the following technical condition which is the dual of the condition in the first given definition

$$\text{there exists } i \leq r \text{ and } j \geq r + 1 \text{ such that } \pi(i) \leq r \text{ and } \pi(j) \geq r + 1$$

This condition comes from the geometry of the surface: there is at least two pairs of interval on each horizontal side of the cylinder which are identify by a central symmetry. Note that this correspond to measured foliations which are non-orientable.

2.2.2 Admissible vectors

Let π denote a generalized permutation of type (r, l) . We say that $\lambda \in \mathbb{R}_+^{r+l}$ is an admissible vector (for π) if

$$\begin{cases} \lambda_i = \lambda_{\pi(i)} \text{ for all } i = 1, \dots, r+l \\ \sum_{i=1}^r \lambda_i = \sum_{j=1}^l \lambda_{r+j} \end{cases}$$

Some times, we normalize the last expression to 1. Geometrically $\sum_{i=1}^r \lambda_i$ is the perimeter of the cylinder, so when the height of the cylinder is chosen to be 1, the area of the flat surface $S(\pi, \lambda)$ in terms of the metric defined by ψ is 1.

Note that for the “true” permutations π of the group \mathcal{S}_r , the vector

$$(\lambda_1, \dots, \lambda_r, \lambda_{\pi(1)}, \dots, \lambda_{\pi(r)})$$

is admissible for any $\lambda_i > 0$. Thus the set of admissible vectors in this case is the simplex Δ of \mathbb{R}_+^r .

In the general case, the set of admissible vectors is a simplicial cone of dimension $(r+l)/2 - 1$: we have an additional equation given by the length of intervals which are presented twice on the same boundary

$$\sum_{\substack{i \leq r \\ \pi(i) \leq r}} \lambda_i = \sum_{\substack{j > r+1 \\ \pi(j) \geq r+1}} \lambda_j \quad (2.4)$$

There is no cancellations of terms in the last equation.

2.2.3 Suspension over a generalized permutation

Let π be a generalized permutation and λ an admissible vector for π . We denote by p (perimeter) the quantity

$$p := \sum_{i=1}^r \lambda_i = \sum_{j=1}^l \lambda_{r+j}$$

Let $\text{Rec} = [0; p] \times [0; 1]$ be a Euclidian rectangle endowed with the form dz^2 . Consider the partition of the two horizontal sides of Rec in intervals of length λ_i . Now identify these horizontal intervals with respect the combinatorics of π in the following way. If two intervals are presented twice on a side, we identify them by a centrally symmetry and else we identify them by a translation. Identify also the two vertical sides between them by a translation.

The resulting space is a Riemann surface, denoted by $S := S(\pi, \lambda)$ endowed with a natural quadratic differential $\psi = dz^2$. We call the flat surface $S := S(\pi, \lambda)$ the *suspension* over the element (π, λ) .

Notation. The surface $S = S(\pi, \lambda)$ decomposes into a single cylinder in the horizontal direction. By construction we always have, in the vertical direction, a separatrix on this surface. We denote it by $\gamma(\pi) \subset S$.

In our main program of classification, we want to show that in each connected component, one can find a saddle connection which we can collapse it to a point. In the next sections, we will give sufficient conditions for the vertical saddle connection $\gamma(\pi)$ is “contractible”, namely the notion of irreducibility.

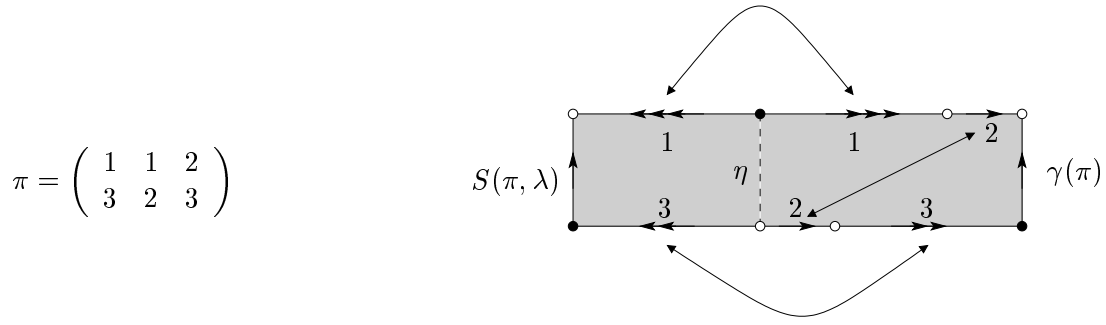

Figure 2.1: A suspension over a permutation π with an appropriate admissible vector λ . The resulting point $[S(\pi, \lambda), dz^2]$ belongs in the stratum $\mathcal{Q}(-1, -1, 2)$. The white bullets correspond to the poles and the black bullets to the unique zero of the differential.

2.2.4 Irreducibility

We want to have a notion of irreducibility analogous to that for “true” permutations. Here we first give the notion of *weak reducibility* and then the definition of the *irreducibility* for a generalized permutation.

These notions are related to the dynamics of the vertical foliation of the corresponding quadratic differential obtained by suspension.

The weak irreducibility

We say that π is *weakly reducible* if there exists $1 \leq i_0 < r$ and $r + 1 \leq j_0 < r + l$ such that we have one of the three following decomposition cases

- $\pi(\{1, \dots, i_0\}) = \{r + 1, \dots, j_0\}$
- $\pi(\{i_0 + 1, \dots, r + 1\}) = \{j_0 + 1, \dots, r + l\}$
- For all $i \leq i_0$, if $\pi(i) \geq r + 1$ then $\pi(i) \leq j_0$ else $\pi(i) > i_0$.
For all $r + 1 \leq j \leq j_0$, if $\pi(j) \leq r$ then $\pi(j) \leq i_0$ else $\pi(j) > j_0$.

We say that π is *weakly irreducible* if there does not exist such $i_0 < r$, $j_0 < r + l$. We can check that this condition is equivalent to the classical condition of irreducibility for “true” permutations in the group \mathcal{S}_r : $\pi\{1, \dots, k\} \neq \{1, \dots, k\}$ for all $1 \leq k < r$.

For instance, the permutation in Example 2 is weakly irreducible.

The above permutation

$$\left(\begin{array}{ccc|ccc} 1 & 2 & 3 & 4 & 3 & 5 \\ 6 & 1 & 2 & 6 & 5 & 4 \end{array} \right)$$

is weakly reducible with corresponding $i_0 = 3$ and $j_0 = 9$. We note by a vertical line the corresponding “invariant” multi-set.

Remark 4. Let us consider the surface $S(\pi, \lambda)$. We normalize the length of the separatrix $\gamma(\pi)$ to 1. Obviously, the condition of weak irreducibility of π is equivalent to the following fact: there exists a full Lebesgue measure set of admissible vectors λ such that all vertical separatrices η (different from $\gamma(\pi)$) on the flat surface $S(\pi, \lambda)$, if any, verifies

$$|\eta| \geq 2$$

In other words, if π is weakly reducible then for all λ , there exist a vertical separatrix η , different from $\gamma(\pi)$, of length 1.

Proof of Remark 4. It is obvious. \square

Our main goal is to obtain a combinatorial condition which implies a stronger statement of above Remark 4. We want to obtain

$$|\eta| \geq 3 \text{ for any vertical separatrix } \eta$$

This leads to the discussion of the condition Irred_2 and the notion of *irreducibility*.

The condition Irred_2

This notion is a little bit technical to present. We give in the next section a geometric interpretation. It is related to the length of the vertical separatrices.

We say that π does not satisfy the condition Irred_2 if there exist a decomposition of π into the following way (up to a permutation of lines of π):

We can decompose the ordered multi-set Y_1 (respectively Y_2) into three ordered multi-sets

$$Y_1', Y_1'', Y_1''' \text{ (respectively } Y_2', Y_2'', Y_2''')$$

such that the permutation is as follow (in terms of tabular)

$$\pi = \left(\begin{array}{c|c|c} Y_1' & Y_1'' & Y_1''' \\ Y_2' & 1 & Y_2'' \\ \hline & Y_2'' & 1 \\ & Y_2''' & \end{array} \right)$$

with

$$\left\{ \begin{array}{l} \forall i \in Y_1' \begin{cases} \pi(i) \in Y_2 \Rightarrow \pi(i) \in Y_2' \\ \pi(i) \in Y_1 \Rightarrow \pi(i) \in Y_1''' \end{cases} \\ \forall i \in Y_1'' \begin{cases} \pi(i) \in Y_2 \Rightarrow \pi(i) \in Y_2'' \\ \pi(i) \in Y_1 \Rightarrow \pi(i) \in Y_1'' \end{cases} \\ \forall j \in Y_2' \begin{cases} \pi(j) \in Y_1 \Rightarrow \pi(j) \in Y_1' \\ \pi(j) \in Y_2 \Rightarrow \pi(j) \in Y_2''' \end{cases} \\ \forall j \in Y_2'' \begin{cases} \pi(j) \in Y_1 \Rightarrow \pi(j) \in Y_1'' \\ \pi(j) \in Y_2 \Rightarrow \pi(j) \in Y_2'' \end{cases} \end{array} \right.$$

Example 3. The following permutation does not satisfy the condition Irred_2

$$\left(\begin{array}{cccccc} 1 & 2 & 2 & 3 & 3 & 1 \\ 0 & 0 & & & & \end{array} \right)$$

We have a decomposition as above given by $Y_1' = \{1\}$, $Y_1'' = \{2, 2, 3, 3\}$, $Y_1''' = \{1\}$ and $Y_2' = \{0\}$, $Y_2'' = \emptyset$, $Y_2''' = \{0\}$.

The permutation in Example 2 satisfy the condition Irred_2 .

Using this notion, we have a statement analogous to Remark 4 on the length of the vertical separatrices:

Proposition 5. *Let us consider the surface $S(\pi, \lambda)$. We normalize the length of the separatrix $\gamma(\pi)$ to 1. Then the following conditions are equivalents:*

- π satisfy the condition Irred_2 .
- there exists a full Lebesgue measure set of admissible vectors λ such that all vertical separatrices η (different from $\gamma(\pi)$) on the flat surface $S(\pi, \lambda)$, if any, verifies

$$|\eta| \neq 2$$

Proof of Proposition 5. Obviously, if π does not satisfy the condition Irred_2 then for all λ , there exists a vertical separatrix of length 2. Now let us prove that this condition is sufficient.

Let π be a generalized permutation. We are going to prove that for an admissible vector λ , if $\frac{\lambda_i}{\lambda_j} \notin \mathbb{Q}$, for any $i \neq j$ and if there exists a vertical separatrix of length 2, then the permutation will not satisfy the condition Irred_2 .

So let us assume that there exists a closed vertical separatrix η of length 2. We obtain (up to a permutation of sides of the cylinder) one of the following two cases Figure 2.2 and Figure 2.3.

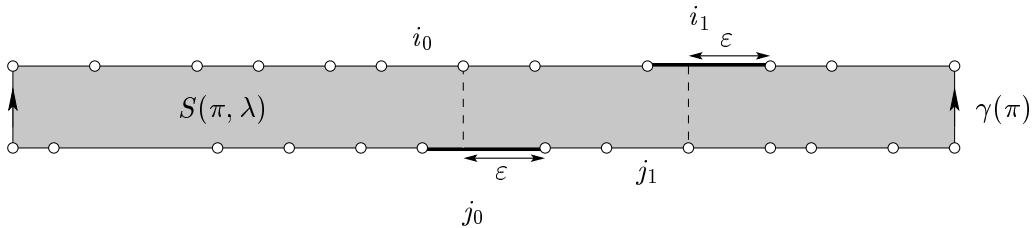

Figure 2.2: A separatrix of length 2 (here the canonical separatrix $\gamma(\pi)$ has length 1). The two corresponding intervals of length λ'_{j_0} and λ_{i_1} numbered by j_0 and i_1 are glued by a translation.

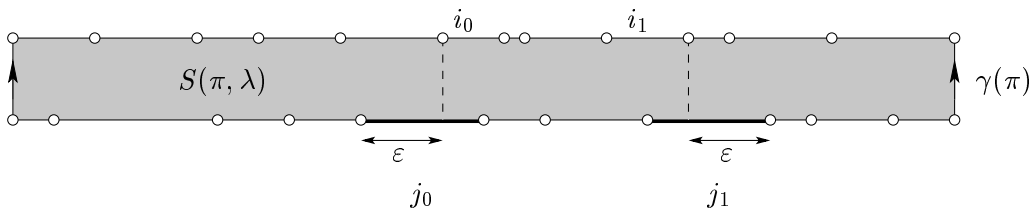

Figure 2.3: A separatrix of length 2 (here the canonical separatrix $\gamma(\pi)$ has length 1). The two corresponding intervals of length λ'_{j_0} and λ'_{j_1} numbered by j_0 and j_1 are glued by a centrally symmetry.

To fix the notations, we denote by λ_i the length of the intervals on the upper horizontal part of the cylinder and by λ'_j the length of the intervals on the lower horizontal part of

the cylinder. In addition, we have a linear relation on the λ_i and λ'_i given by the perimeter of the cylinder (see Equation 2.4). With these notations, we have for the first case:

$$\lambda_{i_1} = \lambda'_{j_0}$$

and for the second case

$$\lambda'_{j_0} = \lambda_{j_1}$$

Now, for each case, we get two equations given by the fact that there exists a vertical separatrix of length 2 (see Figures 2.2 and 2.3 for details). For the first case, we get:

$$\sum_{i=1}^{i_0} \lambda_i = \sum_{j=1}^{j_0} \lambda'_j - \varepsilon \quad \text{and} \quad \sum_{i=1}^{i_1} \lambda_i - \varepsilon = \sum_{j=1}^{j_1} \lambda'_j$$

which gives by adding these two formulas

$$2 \sum_{i=1}^{i_0} \lambda_i + \sum_{i=i_0+1}^{i_1} \lambda_i = 2 \sum_{j=1}^{j_0} \lambda'_j + \sum_{j=j_0+1}^{j_1} \lambda'_j \quad (2.5)$$

And for the second case, we get:

$$\sum_{i=1}^{i_0-1} \lambda_i = \sum_{j=1}^{j_0-1} \lambda'_j + \varepsilon \quad \text{and} \quad \sum_{i=1}^{i_1} \lambda_i = \sum_{j=1}^{j_1} \lambda'_j - \varepsilon$$

which gives by adding these two formulas

$$2 \sum_{i=1}^{i_0-1} \lambda_i + \sum_{i=i_0}^{i_1} \lambda_i = 2 \sum_{j=1}^{j_0-1} \lambda'_j + \sum_{j=j_0+1}^{j_1-1} \lambda'_j + 2\lambda'_{j_0} \quad (2.6)$$

In order to prove the Proposition, recall that the λ_i and λ'_j are independents over \mathbb{Q} . First we remark that Equation (2.5) is not satisfy: the coefficient of λ_{i_1} and λ'_{j_0} is different.

Secondly, Equation (2.6) must be trivial (that is we must obtain $0 = 0$). Comparing the coefficients on the length of the intervals and using relation (2.4) we get that π does not satisfy the condition Irred_2 .

Proposition 5 is proved. \square

Irreducibility

Definition 2. We say that π is *irreducible* if π is weakly irreducible and satisfies the condition Irred_2 .

There is obviously many generalized permutations which are weakly irreducible but does not satisfy the condition Irred_2 ; for instance the permutation of Example 3.

In Chapter 3 we consider a particular class of generalized permutations for which the condition Irred_2 is a consequence of the weak irreducibility.

2.2.5 A geometric property

We want to use the notion of irreducibility of a generalized permutation π to obtain some properties on the vertical foliation on the surface $S(\pi, \lambda)$ for specific λ . By construction, we always have a vertical separatrix $\gamma(\pi)$ on the surface S . We normalize its length to 1. The next Proposition is obviously the consequence of Remark 4 and Proposition 5.

Proposition 6. *Let π be an irreducible permutation. Let us normalize the length of the canonical vertical separatrix $\gamma(\pi)$ to 1 on the corresponding surface $S = S(\pi, \lambda)$ obtained by suspension over π . Then there exists a full Lebesgue measure set of admissible vectors λ such that all vertical separatrices η , different from $\gamma(\pi)$, on the flat surface $S(\pi, \lambda)$, if any, verifies*

$$|\eta| \geq 3$$

Proof of Proposition 6. The proof is obvious using Remark 4 and Proposition 5: the length of any separatrix is an integer different from 1 and 2 for a full Lebesgue measure set. \square

This condition is related to the notion of multiplicity of a separatrix (see section 2.3.3 below). We will prove that, under this condition, the vertical saddle connection $\gamma(\pi)$ can be collapsed to a point.

For “true” permutations, irreducibility coincides with the classical definition. Moreover the Keane condition implies the i.d.o.c. property for the corresponding interval exchange map as soon as all λ_i are independents over \mathbb{Q} (see [Ke]). Thus for “true” permutations, we obtain that vertical critical leaves satisfy $|\eta| = \infty$, except for the canonical vertical separatrix $\gamma(\pi)$.

2.2.6 Irreducibility and weakly irreducibility

Here we present a class of permutations for which the irreducibility is a consequence of the weakly irreducibility.

Condition (*). Let π be a generalized permutation. We suppose that there exist only one index $i_0 \leq n$ (respectively $j_0 \geq n + 1$) such that $\pi(i_0) \leq n$ (respectively $\pi(j_0) \geq n + 1$).

We can translate this combinatorics condition in terms of flat surfaces. Let S denote the flat surface obtained by suspension over π with an arbitrary admissible vector. Then one can see that the above condition is equivalent to the following one:

there exists *exactly* two separatrix loops γ_1 and γ_2 such that for all other separatrix loop η , the two corresponding intervals η^1 and η^2 are not in the same horizontal side of the straight cylinder $S \setminus \Gamma(\psi)$.

Obviously, if π satisfy the condition (*) then the weak irreducibility imply the irreducibility.

2.2.7 Cyclic order

We always assume that the elements of the submultisets Y_1 and Y_2 of a generalized permutation (for the first Definition) are organized in the natural cyclic order. Say, for the permutation of Example 2 we have $1 \mapsto 2 \mapsto \dots \mapsto 4 \mapsto$ and $6 \mapsto 6 \mapsto 1 \mapsto 5 \mapsto 2 \mapsto$. We defined a natural equivalence relation on the set of generalized permutation by rotating

elements of the multi-set Y_1 and Y_2 . For example, permutation of Example 2 is equivalent to the following one

$$\pi \sim \begin{pmatrix} 5 & 4 & 1 & 2 & 3 & 4 & 3 \\ 5 & 2 & 6 & 6 & 1 & & \end{pmatrix} = \begin{pmatrix} 1 & 2 & 3 & 4 & 5 & 2 & 4 \\ 1 & 5 & 6 & 6 & 3 & & \end{pmatrix}$$

Note that this relation does not preserve the condition of irreducibility but by construction, it preserves the stratum and also the connected component. This combinatorial transformation corresponds to the action of the horocyclic flow on the suspension $S(\pi, \lambda)$: it preserves the cylinder and twist the boundary.

2.3 \hat{H} omologous saddles connections

2.3.1 Canonical double covering and homological group

Let S be a half translation surface with non-trivial holonomy. We denote by $\hat{\pi} : \hat{S} \rightarrow S$ the standard orientating double covering (see section 1.3.1). Let γ be a *compact separatrix* on S . We consider γ^+ and γ^- the two lifts of γ by $\hat{\pi}$. We choose an orientation of γ . So, according to this choice, we can define

$$\hat{\gamma} = [\gamma^+] - [\gamma^-]$$

($\hat{\gamma}$ is well defined up to a sign). If P_i denote singularities of ψ on S and \hat{P}_i singularities of $\hat{\pi}^*\psi = (\hat{\omega})^2$ on \hat{S} , we note by $H_1^+(\hat{S}, \{\hat{P}_i\}, \mathbb{C})$ the first homological group invariant with respect to the involution and $H_1^-(\hat{S}, \{\hat{P}_i\}, \mathbb{C})$ the first homological group anti-invariant with respect to the involution (see section 1.3.2). By definition:

$$\hat{\gamma} \in H_1^- / \pm$$

2.3.2 \hat{H} omologous saddles connections

We say that two closed loops γ and η are *\hat{h} omologous* if corresponding loops $\hat{\gamma}$ and $\hat{\eta}$ on \hat{S} are proportional in the group H_1^- . Note that this definition does not depend of choice of orientation of cycles neither choice of direction on S . Moreover, γ and η do not need to be closed. For instance, we can have a saddle connection (homeomorphic to a segment) which is \hat{h} omologous to a separatrix loop (homeomorphic to a circle). The following Proposition gives a necessary condition for two separatrices to be \hat{h} omologous (see [MaZo] for details)

Example 4. In Figure 2.1, one can see that the vertical saddle connection $\gamma(\pi)$ and the vertical separatrix loop η are \hat{h} omologous. More precisely, we have

$$[\widehat{\gamma(\pi)}] = [\hat{\eta}]$$

Proposition 7. *If γ and η are two \hat{h} omologous separatrices (saddle connection or separatrix loop), then they are parallel and their length satisfy (with respect to the transverse measure)*

$$\frac{|\gamma|}{|\eta|} \in \left\{ 1, 2, \frac{1}{2} \right\}$$

Proof of Proposition 7. See [MaZo]. □

2.3.3 Multiplicity

Multiplicity of a separatrix

Let γ be a separatrix. We say that γ has multiplicity n if there exists *exactly* n different separatrices homologous to γ . In the next, we are interested to obtain separatrices of multiplicity 1.

Multiplicity of a simple cylinder

Here we give the Definition of a simple cylinder.

Definition 3. Let S be a flat surface. Let us assume that S possesses a cylinder (in the horizontal direction). We say that this cylinder is *simple* if each boundary component of it is a single compact separatrix

A classical way to obtain simple cylinders on a surface is the construction “bubbling a handle” at a singularities (see Figure 1.2).

We say that the simple cylinder has multiplicity n if the the multiplicity of the corresponding separatrix is n .

2.4 Properties of surgeries of Chapter 1

In this section, we give some properties concerning constructions described in Chapter 1. We denote by (S, ψ) a flat surface in the stratum $\mathcal{Q}(k_1, \dots, k_n)$. We will consider the two surgeries “break up a singularity” and “bubbling a handle” on a point P_i on S of order k_i for the quadratic differential ψ . We want to give necessary and sufficient conditions, in terms of homology, to obtain surfaces by the surgery “break up a singularity” and “bubbling a handle”.

2.4.1 Properties of “breaking up a singularity”

Multiplicity 1 and surgery “breaking up a singularity”

Let S' be constructed from S by “breaking up” the zero $P \in S$ into two zeroes $P_1 \in S'$ and $P_2 \in S'$. The saddle connection γ , between P_1 and P_2 on S' , can be chosen arbitrary small with respect to the other. In particular, Proposition 7 imply that

$$\text{mult}(\gamma) = 1$$

Reciprocally, it is possible to show that if a surface S' , with two zeroes P'_1 and P'_2 , possesses a saddle connection γ , between these two points, of multiplicity 1 then it is possible to “collapse” this saddle to a point to obtain a non-degenerated Riemann surface. In other word this surface is obtained from a surface in a lower dimensionnal stratum, by “breaking up” a zero P into the two zeroes P'_1 and P'_2 .

We first present an informal argument how to collapse a saddle connection of multiplicity one. Then we give the general statement.

How to collapse a saddle connection ?

Let us assume that we have obtained a surface $S(\pi, \lambda)$ such that the vertical saddle connection $\gamma(\pi)$ has multiplicity 1. Recall that it is the case for a full Lebesgue measure set of λ when the generalized permutation is irreducible. For simplicity, we assume that this surface is in the stratum $\mathcal{Q}(k, 4g - 4 - k)$; the general case is similar.

The surface has two conical singularities of angle $(k + 2)\pi$ and $(4g - 2 - k)\pi$. So there are precisely $4g$ intervals on the horizontal sides of the corresponding rectangle. Let us deform slightly these horizontal intervals of the rectangle to obtain a polygon in \mathbb{C} (see Figure 2.4). The continuous deformation family belongs to a fix connected component. We can compute complex parameters responsible for this deformation: there are $4g$ intervals which are identifying one-to-one, so it produces $2g$ complex parameters. There is also the vertical parameter. In addition, we have a restriction given by the equation on the length of the perimeter of the cylinder. So we obtain

$$2g + 1 - 1 = 2g \text{ complex parameters}$$

According to Masur and Veech, the complex dimension of the orbifold $\mathcal{Q}(k, 4g - 4 - k)$ is

$$\dim_{\mathbb{C}} \mathcal{Q}(k, 4g - 4 - k) = 2g + 2 - 2 = 2g$$

So we obtain a small open set inside this stratum.

For each surfaces in this open set, there exists a saddle connection of multiplicity one. Thus we can present, by deformation of theses surfaces in this particular connected component, a polygon with a “small” vertical saddle connection (see Figure 2.4).

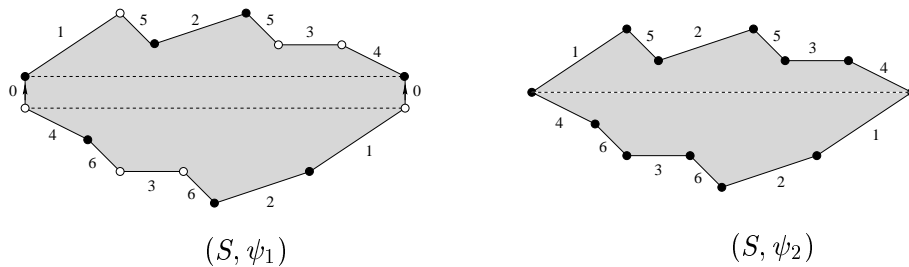

Figure 2.4: Let us consider the following two polygons in \mathbb{R}^2 . We make identifications on the boundary according to the number of intervals by the following way: we identify the corresponding intervals 5 and 6 by a centrally symmetry. We identify the corresponding intervals 0, 1, 2, 3, 4 by a translation. The resulting spaces are Riemann surfaces S of genus 3. The form dz^2 is compatible with identifications so it induces two quadratic differentials ψ_1 and ψ_2 on S . For the polygon on the left, one can check that the white bullet give a zero with conical angle of 6π and the black bullet give a zero with conical angle of 6π . In other word, we obtain a point $[S, \psi_1]$ inside the stratum $\mathcal{Q}(4, 4)$. With the same type of arguments, $[S, \psi_2] \in \mathcal{Q}(8)$. One can see that we can collapse the vertical saddle connection numbered 0 on S to a single point. The resulting surface is the non-degenerated flat surface (S, ψ_2) .

One can easily see that we can collapse the vertical saddle connection $\gamma(\pi)$ to a point to obtain a regular Riemann surface endowed with a flat metric with a single conical

singularity of angle $(4g - 2)\pi$; that is a zero, for the corresponding quadratic differential, of degree $4g - 4$.

Now, we give a precise announced and proof of the above result.

Proposition 8. *Let $[S', \psi'] \in \mathcal{Q}(k_1, \dots, k_n)$ be a flat surface with multiplicity 1 saddle connection between the two different singularities P_i and P_j . Then there exists a flat surface $[S, \psi] \in \mathcal{Q}(k_1, \dots, \hat{k}_i, \dots, \hat{k}_j, \dots, k_n, k_i + k_j)$ such that we can “break up” the zero of order $P_i + P_j$ on S into two zeroes of order P_i and P_j to obtain the surface (S', ψ') .*

Here, the notation $(k_1, \dots, \hat{k}_i, \dots, k_n)$ stands for the list where we forgot the index k_i .

Proof of Proposition 8. We present a proof of this result in the case where the surgery is local that is k_i and k_j are not both odd. For instance, we consider the case where k_i and k_j are even. For the general case we refer to [MaZo].

Let us assume that (S, ψ) has a multiplicity 1 saddle connection. This property is defined in terms of the homology of S thus, the cohomological coordinates imply that this property is true in a small open set of $[S, \psi]$ inside the corresponding stratum. This property is also stable by the geodesic flow, so ergodicity of this flow give us a full measure set of surfaces with a saddle connection of multiplicity 1, inside the connected component.

In other words, we can assume that the saddle connection which has multiplicity 1 has length ε and all other separatrices (in the same direction) have length at least $\varepsilon + 1$. Now let us consider a metric neighborhood U of the two points P_i and P_j on S . That is the reunion of $k_i + k_j + 2$ half Euclidian discs. This is possible with assumption on the parity of k_i and k_j (we present such neighborhood in Figure 1.1).

The length of this saddle connection can be chosen arbitrary small with respect to the other thus we can assume that there is no other separatrix in U . Now we can take this open set U and construct locally a single zero of order $k_i + k_j$ (see Lemma 1). The resulting surface (S', ψ') satisfy to the Proposition.

Proposition 8 is proved. □

Lift of paths

We consider the surgery “breaking up a singularity” at the point P_i . Let us denote the resulting surface (S', ψ') in the corresponding stratum $\mathcal{Q}(k_1, \dots, l, r, \dots, k_n)$ with $k_i = l + r$. We suppose in addition that l and r are not odd at the same time. There are many ways to break up the singularity into two singularity of order l and r . One can see that the surgery is local: the flat metric does not change outside of a small neighborhood of the singularity P_i . Hence all surfaces (S', ψ') obtained by breaking up the zero P_i of order k_i into two zeroes of order l and r belong to the same connected component. Moreover, this construction allows us to obtain a fiber bundle

$$\mathcal{Q}(k_1, \dots, l, r, \dots, k_n) \rightarrow \mathcal{Q}(k_1, \dots, k_n)$$

with fibers homeomorphic to a product of two complex discs. Thus we have

Proposition 9. *Let $[S', \psi'] \in \mathcal{Q}(k_1, \dots, l, r, \dots, k_n)$ be as above.*

Let $\rho : [0, 1] \rightarrow \mathcal{Q}(k_1, \dots, k_n)$ be any continuous path with $\rho(0) = [S, \psi]$. Then we can construct a continuous path $\rho' : [0, 1] \rightarrow \mathcal{Q}(k_1, \dots, l, r, \dots, k_n)$ with $\rho'(0) = [S', \psi']$ by breaking up the singularity P_i of the flat surface $\rho(t)$.

We will reformulate these results in terms of adjacency and local connectedness in Chapter 4.

2.4.2 Properties of “bubbling a handle”

Multiplicity 1 and simple cylinder

We consider the surgery “bubbling a handle” at the point P_i . Let us denote the resulting surface (S', ψ') in the corresponding stratum $\mathcal{Q}(k_1, \dots, k_i + 4, \dots, k_n)$. We suppose in addition that the angle between the two new sectors is not odd if k_i is even (see Chapter 1 for details). One can prove easily the following two Propositions. Essentially, it is a direct corollary of the previous Proposition in terms of the surgery “breaking up a singularity”.

Let $[S, \psi] \in \mathcal{Q}(4g - 4)$ be a point with $g \geq 3$. Let S' be construct from S by “bubbling a handle” to the *unique* zero of S . By construction, the separatrix loop γ , which is the boundary component of the additional cylinder, can be chosen arbitrary small with respect to the other (see section 1.2). Thus Proposition 7 imply that

$$\text{mult}(\gamma) = 1$$

Reciprocally, it is possible to show that if a surface S' in the minimal stratum of genus g , possesses a simple cylinder of multiplicity 1, then it is possible to “shrink” this cylinder. In other word this surface is obtain from a surface in the minimal stratum of genus $g - 1$, by “bubbling a handle” at the unique zero of the differential.

How to shrink a simple cylinder ?

It is easy to see that the two constructions “bubbling a handle” and “breaking up a singularity” are related. Using this relation and Proposition 8, we easily prove

Proposition 10. *Let $[S', \psi'] \in \mathcal{Q}(4g - 4)$ be a flat surface with a simple cylinder of multiplicity 1. Then there exists a flat surface $[S, \psi] \in \mathcal{Q}(4(g - 1) - 4)$ such that we can “bubbling a handle” at the unique zero of ψ on S to obtain the surface (S', ψ') .*

Proof of Proposition 10. In Figure 2.5 we give the relation between the two above constructions. Then Proposition 10 is a direct corollary of Proposition 8. \square

Lift of paths

Proposition 11. *Let $[S'_1, \psi'_1], [S'_2, \psi'_2]$ be two points in the stratum $\mathcal{Q}(k_1, \dots, k_i + 4, \dots, k_n)$. Suppose that these surfaces are obtained by “bubbling a handle” at the same zero P_i of a surface $[S, \psi]$ in $\mathcal{Q}(k_1, \dots, k_n)$. In addition let us assume the angle between the new sectors is the same in the two constructions.*

Then $[S'_1, \psi'_1]$ and $[S'_2, \psi'_2]$ belong to the same connected component of the stratum $\mathcal{Q}(k_1, \dots, k_i + 4, \dots, k_n)$.

The following Proposition is a direct corollary of the Proposition 9

Proposition 12. *Let $\rho : [0, 1] \rightarrow \mathcal{Q}(k_1, \dots, k_n)$ be any continuous path with $\rho(0) = [S, \psi]$. Then we can construct a continuous path $\rho' : [0, 1] \rightarrow \mathcal{Q}(k_1, \dots, k_i + 4, \dots, k_n)$ with $\rho'(0) = [S', \psi']$ by “bubbling a handle” at the singularity P_i along the path ρ .*

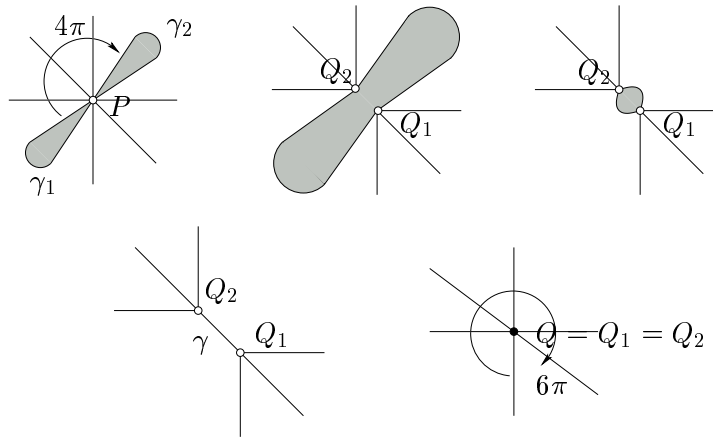

Figure 2.5: On the left, the diagram represent a simple cylinder “attached” to a zero of order 8. We cut the surface along this cylinder to obtain two homologous separatrix loops γ_1, γ_2 . We can deform the flat metric to obtain a flat surface with two singularities. The degree of these saddles depends of the degree of the initial zero and the angle between γ_1 and γ_2 . Here we have a zero of order 8 and the angle between the sector is 4π . Thus we obtain two zeroes of order 2. If the initial simple cylinder has multiplicity 1, then the multiplicity of the saddle connection γ is 1. Applying Proposition 8, we can collapse this saddle connection to a point. The resulting surface is a non-singular Riemann surface. At the point P , the differential has a zero of order 4.

The map \oplus

We want to describe precisely properties of the surgery “bubbling a handle”. In this section we formalize this notion. For our main classification program, we need to consider only two strata but all results can easily be generalized when constructions are local.

Let $\mathcal{Q}(-1, 4g - 3)$ be a stratum in genus $g \geq 2$. Let \mathcal{C} be a connected component of this stratum and $[S, \psi] \in \mathcal{C}$ be a point. We construct the flat surface (S', ψ') from (S, ψ) by the surgery “bubbling a handle” at the *unique zero* of ψ with corresponding parameters: arbitrary continuous parameters and discrete parameter s (angles between the two new sectors). By Proposition 12, the connected component $\mathcal{C}' \subseteq \mathcal{Q}(-1, 4g + 1)$ which contains the point $[S', \psi']$ does not depends of $[S, \psi]$ inside \mathcal{C} . Moreover, Proposition 11 asserts that for s fix, the component \mathcal{C}' does not depends of choice of continuous parameters. In other word, we have as an immediately corollary

Lemma 5. *With above notations, the following map*

$$\begin{aligned} \oplus : \pi_0(\mathcal{Q}(-1, 4g - 3)) \times \mathbb{N} &\rightarrow \pi_0(\mathcal{Q}(-1, 4g + 1)) \\ (\mathcal{C}, s) &\mapsto \mathcal{C} \oplus s := \mathcal{C}' \end{aligned}$$

is well defined for all $g \geq 2$.

Here $\pi_0(E)$ denote the set of connected component of the topological space E .

Remark 5. In Appendix, we give an example of a flat surface in the stratum $\mathcal{Q}(2, 6)$ and we present two ways to obtain surfaces from our initial surface using the surgery “bubbling a handle” on the zero of order 6. The angle between the two additional sectors in the two constructions is 3π . Thus we obtain two points inside the stratum $\mathcal{Q}(2, 10)$. The surgery is not local. We describe one way to obtain a point inside the hyperelliptic connected component of the stratum $\mathcal{Q}(2, 10)$ and one way to obtain a point inside the non-hyperelliptic connected component.

In this sense, the map \oplus does not extend when the surgery is not local

Nevertheless, a consequence of Theorem 6 is that this map is also well defined for the minimal stratum. Namely, the following Lemma holds

Lemma 6. *With the above notation, the following map*

$$\begin{aligned} \oplus : \pi_0(\mathcal{Q}(4g - 4)) \times \mathbb{N} &\rightarrow \pi_0(\mathcal{Q}(4g)) \\ (\mathcal{C}, s) &\mapsto \mathcal{C} \oplus s := \mathcal{C}' \end{aligned}$$

is well defined for all $g \geq 3$.

Note that in the two above Lemma the corresponding angle between the two new sectors is chosen modulo $2g$ hence we can fix $s \in \{1, \dots, 2g\}$.

We can easily prove the following properties for the map \oplus

Property. *Let us fix \mathcal{C} a connected component of a stratum in genus $g \geq 5$. The map \oplus satisfy the three following properties*

- \oplus is commutative “on the right”: $\mathcal{C} \oplus s_1 \oplus s_2 = \mathcal{C} \oplus s_2 \oplus s_1$ for all s_1, s_2 .
- $\mathcal{C} \oplus s_1 \oplus s_2 = \mathcal{C} \oplus (s_2 - 2) \oplus (s_1 + 2)$ if $s_2 \geq 3$
- $\mathcal{C} \oplus s_1 \oplus s_2 = \mathcal{C} \oplus (s_2 - 4) \oplus s_1$ if $s_2 - s_1 \geq 4$

Proof. The proof is obvious using the description in terms of diagrams. □

2.5 Two fundamentals observations

Here we present two fundamentals observations. We give some conditions on a generalized permutation π such that the suspended flat surface $S(\pi, \lambda)$ is obtain by one of the two surgeries “breaking up a singularity” or “bubbling a handle”) on a zero on a surface.

2.5.1 “Breaking up a singularity”

Here we translate the surgery “breaking up a singularity” in terms of the combinatorics of the generalized permutation.

Let π be a generalized permutation. Recall that for an admissible vector λ , there is a canonical separatrix $\gamma(\pi)$ on the flat surface $S = S(\pi, \lambda)$ (see above construction in section 2.2). By Proposition 6 and property of homologous separatrix of Proposition 7, one can easily deduced the following

Corollary 2. *Let π be a generalized permutation. We consider the half-translation surface $S = S(\pi, \lambda)$. If π is irreducible then there exists a full Lebesgue measure set of λ such that the corresponding separatrix $\gamma(\pi)$ on S satisfies*

$$\text{mult}(\gamma(\pi)) = 1$$

Proposition 13. *Let us assume that the vertical separatrix $\gamma(\pi)$ on $S(\pi, \lambda)$ is a saddle connection. Let also assume that π is irreducible.*

Then the surface S is obtained by the surgery “breaking up a singularity” on a surface in a lower dimensional stratum.

In Chapter 4, we calculate all components which contain above surface. That is, we will show any connected component (in genus greater than 4) is either hyperelliptic or attached to the minimal stratum. Surprisingly, the answer is quite difficult and we find that some component, in small genera, is not hyperelliptic neither adjacent to the minimal stratum.

2.5.2 “Bubbling a handle”

In the following, we will use the practical notation:

Notation. Let π be a generalized permutation of the set $\{1, \dots, n+m\}$. Let also assume that it satisfies $\pi(1) = n+1$. Then we denote by $\hat{\pi}$ the *restricted* generalized permutation of the set $\{\hat{1}, 2, \dots, n, \widehat{n+1}, n+2, n+m\}$; where \hat{i} says that we forgot the corresponding element i . In notation of tabular, this gives

$$\pi = \begin{pmatrix} 0 & A \\ 0 & B \end{pmatrix} \quad \text{and} \quad \hat{\pi} = \begin{pmatrix} A \\ B \end{pmatrix}$$

Clearly, the surface $S(\pi, \lambda)$, with π as above, possesses a simple cylinder in the vertical direction (see also Figure 2.6).

Thus, using Corollary 2 one can deduced easily the following

Proposition 14. *Let us consider a flat surface $S(\pi, \lambda) \subset \mathcal{Q}_g(4g-4)$. Let also assume that $\hat{\pi}$ is irreducible.*

Then the surface S is obtained by the surgery “bubbling a handle” on a surface in a the stratum $\mathcal{Q}_{g-1}(4g-8)$.

In terms of Lemma 6, this Proposition asserts that the map

$$\oplus : \pi_0(\mathcal{Q}_{g-1}(4g-8)) \times \mathbb{N} \rightarrow \pi_0(\mathcal{Q}_g(4g-4))$$

is surjective for all $g \geq 4$.

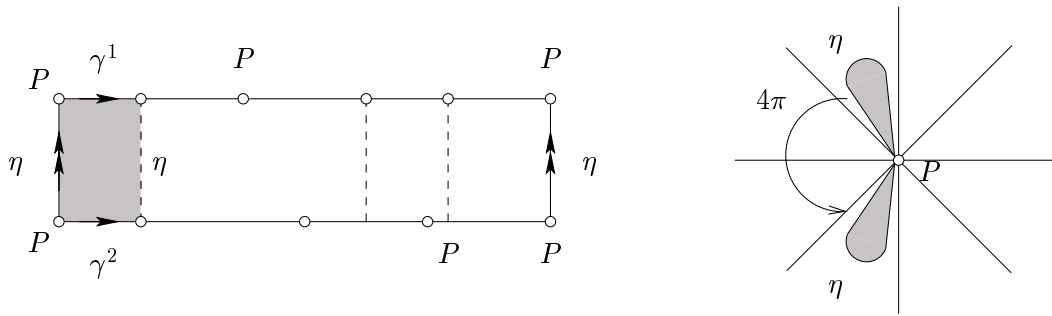

Figure 2.6: Here on the left, the figure represents a flat surface of the form $S(\pi, \lambda)$. In the vertical direction, one can easily see that there is a simple cylinder. The boundary component of this cylinder is $\gamma(\pi)$. On the figure on the right, we have represented the diagram of the vertical foliation on S . In this example, the angle of this cylinder is 4π (or 6π is we consider the complementary angle). If the generalized permutation $\hat{\pi}$ is irreducible, one can choose lengths of horizontal parameters in the way that $\gamma(pi)$ has multiplicity 1. In this case this surface is obtained from a surface in genus $g - 1$, where $g = \text{genus}(S)$, by “bubbling a handle” (see Figure 1.3).

In Chapter 3, we calculate all components of the minimal stratum which contain above surface. That is, we will show that any connected component (in genus greater than 4) is accessible by considering the surgery “bubbling a handle” on a surface in a lower genus stratum.

Chapter 3

Representative elements

In this Chapter, we give a “bestiary” of half-translations surfaces. We present the surfaces (S, ψ) in terms of generalized permutations. Recall that, in order to prove our classification result, the second step is that any connected component, except 3 particular cases, is either hyperelliptic or attached to the minimal stratum.

Here we give a family of representative elements of any hyperelliptic connected component. We also give a representative element of the three particular case discussed above: we call it the *irreducible* connected component.

On the last section, we use these elements to obtain some properties on the adjacency inside the moduli space \mathcal{Q}_g .

3.1 Hyperelliptic connected components

We want to construct representatives elements for hyperelliptic connected components. Let us fix r and l arbitrary non-negative integers. We consider the generalized permutation $\Pi_1(r, l)$ given by Figure 3.1.

$$\Pi_1(n, m) = \begin{pmatrix} 0_1 & 1 & \dots & r & 0_1 & l+1 & \dots & r+l \\ r+l & \dots & r+1 & 0_2 & r & \dots & 1 & 0_2 \end{pmatrix}$$

Figure 3.1: A permutation of type (r, l) . For instance, when $r = 4$ and $l = 0$, it corresponds to the stratum $\mathcal{Q}(-1, -1, 3, 3)$.

3.1.1 Representative elements

We would like to identify the stratum which contains surfaces construct by suspension over the permutation $\Pi_1(n, m)$. It depends of the parity of the two integers r and l . More precisely, we have

Lemma 7. *Let (S, ψ) be the surface given by $S(\Pi_1(r, l), \lambda)$ for an admissible vector λ . If r and l are odd then S has two singularities. If r and l have different parities then S has three singularities. If r and l are even then S has four singularities. The following tabular*

give the type of singularities in terms of r and l

r	l	stratum which contain $[S, \psi]$
$2k + 1$	$2(g - k) - 3$	$\mathcal{Q}(4k + 2, 4(g - k) - 6)$
$2k + 2$	$2(g - k) - 3$	$\mathcal{Q}(2k + 1, 2k + 1, 4(g - k) - 6)$
$2k + 2$	$2(g - k) - 2$	$\mathcal{Q}(2k + 1, 2k + 1, 2(g - k) - 3, 2(g - k) - 3)$

Proof of the Lemma. It is obvious by direct computation of the type of singularities. \square

According to Chapter 1, the above strata contain an hyperelliptic connected component. We can ask if these points, defined by $[S(\Pi_1(r, l)), \psi]$, belong in this hyperelliptic component. This is done by the following

Lemma 8. *For any λ , surfaces $S(\Pi_1(r, l), \lambda)$ belong to the hyperelliptic connected components of the corresponding stratum.*

Proof of Lemma 8. Here we present the proof in the first case; that is r and l are odd. The other are similar. Take $r = 2k + 1$ and $l = 2(g - k) - 3$. We consider the rectangle

$$R = \left[-\frac{r+l}{2} - 1; \frac{r+l}{2} + 1 \right] \times \left[-1, 1 \right]$$

We denote by $\tau : R \rightarrow R$ the involution of R given by $\tau(x, y) = (-x, -y)$. Obviously, τ induces a *global* involution on the surface $S_0 = S(\Pi_1(r, l), \lambda)$. We denote still it by τ . By Lemma 7, $[S_0, \psi_0]$ belongs to the stratum $\mathcal{Q}(4k + 2, 4(g - k) - 6)$.

Recall that the hyperelliptic component of this stratum is, by definition, the image of the map

$$\begin{aligned} \mathcal{Q}(2k, 2(g - k) - 4, -1^{2g}) &\rightarrow \mathcal{Q}(4k + 2, 4(g - k) - 6) \\ [\mathbb{P}^1, dz^2] &\mapsto [S, \pi^* dz^2] \end{aligned}$$

In order to prove that $[S_0, \psi_0]$ belongs to the hyperelliptic component, we have to construct a double ramified covering $\pi : \mathbb{P}^1 \rightarrow S_0$ such that $\pi^* dz^2 = \psi_0$.

Let us count the number of fixed point of the map τ :

- There are $r + l$ fixed points of τ on the horizontal sides of R located at the middle of the intervals (precisely at the middle of separatrix loops).
- There is a fixed point located at the middle of the vertical side.
- There is a fixed point located at the point $(0, 0)$.
- There are 2 fixed points which corresponds to the two zeroes of ψ_0 .

Thus the total number of fixed points of τ on S_0 :

$$n + m + 1 + 1 + 2 = 2k + 1 + 2(g - k) - 3 + 4 = 2g + 2$$

The Riemann—Hurwitz formula imply that the genus of $S/(x \sim \tau(x))$ is zero. Let us consider the projection map

$$\pi : S_0 \rightarrow \mathbb{P}^1$$

It is easy to check that above covering gives the announced statement.

Lemma 8 is proved. \square

Remark 6. We can also construct other representative elements for hyperelliptic connected components. For instance we can prove, using the same way, that surfaces $S(\Pi_2(r, l), \lambda)$, with $\Pi_2(r, l)$ given by the permutation of Figure 3.2, belong to the hyperelliptic connected component of the corresponding stratum (which depends also of the values of r and l).

$$\Pi_2(n, m) = \begin{pmatrix} 1 & \dots & r & 1 & \dots & r \\ r+1 & \dots & r+l & r+1 & \dots & r+l \end{pmatrix}$$

Figure 3.2: A permutation of type (r, l) . For instance, when $r = 4$ and $l = 1$, it corresponds to the stratum $\mathcal{Q}(-1, -1, \mathbf{6})$.

Here we present a result which is a corollary of a general result proved in Chapter 4.

Corollary 3. *Let $[S, \psi]$ be a point in an hyperelliptic connected component. Suppose that in the horizontal direction, the surface decompose into one cylinder. Let π denote the corresponding generalized permutation (well defined up to the cyclic order). Then there exists non-negatives integers r, l and $i \in \{1, 2\}$ such that*

$$\pi = \Pi_i(r, l)$$

3.1.2 Hyperelliptic strata in low genera

Here we present, as a consequence of these combinatorics objects, an independent combinatorics proof of the following Theorem of Masur and Smillie (see [MaSm]):

Theorem. *The following strata are empty*

$$\mathcal{Q}(\emptyset), \mathcal{Q}(1, -1) \text{ (in genus } g = 1) \quad \text{and} \quad \mathcal{Q}(4), \mathcal{Q}(1, 3) \text{ (in genus } g = 2)$$

Proof of the Theorem. Let us assume that the stratum $\mathcal{Q}(4)$ is non-empty. By “breaking up a singularity” at the unique zero of a point in this stratum, we obtain a point in a non-hyperelliptic component of the stratum $\mathcal{Q}(2, 2)$ (see Chapter 4). Now we prove that this stratum is connected and equals to its hyperelliptic component which leads to a contradiction.

We can calculate all generalized permutations (up to a cyclic order) which produced by suspension flat surfaces in the stratum $\mathcal{Q}(2, 2)$. We obtain only two permutations (up to a cyclic order) which are

$$\pi_1 = \begin{pmatrix} 1 & 2 & 1 & 3 \\ 4 & 3 & 4 & 2 \end{pmatrix} \quad \pi_2 = \begin{pmatrix} 1 & 2 & 1 & 2 \\ 3 & 4 & 3 & 4 \end{pmatrix}$$

According to Lemma 8, these two permutations give rise to surfaces in the component $\mathcal{Q}^{hyp}(2, 2)$. So it proves $\mathcal{Q}(2, 2)$ is connected and hence the stratum $\mathcal{Q}(4) = \emptyset$.

We can proceed with the by the same way for the strata $\mathcal{Q}(1, -1)$ and $\mathcal{Q}(1, 3)$ by considering respectively the connected hyperelliptic strata $\mathcal{Q}(-1, -1, 2)$ and $\mathcal{Q}(1, 1, 2)$. \square

3.2 Irreducible connected components

3.2.1 The stratum $\mathcal{Q}(-1, 9)$

Let $[S_0, \psi_0] \in \mathcal{Q}(-1, 9)$ be the *particular* flat surface defined by Figure 3.3. See also Figure 3.4 which present a suspension over the corresponding permutation. We call the *irreducible connected component* $\mathcal{Q}^{irr}(-1, 9)$, the component of $\mathcal{Q}(-1, 9)$ which contains this point.

$$\begin{pmatrix} 0 & 1 & 2 & 3 & 4 & 0 \\ 4 & 3 & 2 & 5 & 1 & 5 \end{pmatrix}$$

Figure 3.3: This permutation gives rise by suspension flat surfaces with two singularities for the metric, of angle π and 11π . In other words, it produces a continuous family of points inside the stratum $\mathcal{Q}(-1, 9)$.

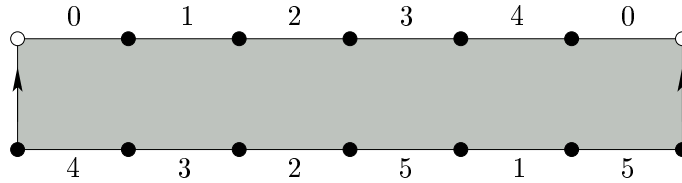

Figure 3.4: Let us consider the following polygon in \mathbb{R}^2 . We make identifications on the boundary according to the number of intervals. If two intervals are in the same boundary component, we identify them by a centrally symmetry and else we identify them by a translation. We also identify the two vertical by a translation. The resulting surface is a Riemann surface S of genus 3. The form dz^2 is compatible with identifications so it induce a quadratic differential ψ on S . One can check that the white bullet give a pole for the differential and black bullets give a single zero with conical angle of 11π . So in other word, we obtain a point $[S, \psi]$ inside the stratum $\mathcal{Q}(-1, 9)$. Here $[S, \psi]$ belongs to the component $\mathcal{Q}^{irr}(-1, 9)$.

3.2.2 The stratum $\mathcal{Q}(-1, 3, 6)$

Let $[S_1, \psi_1] \in \mathcal{Q}(-1, 3, 6)$ be the *particular* flat surface defined by Figure 3.5. We call the *irreducible connected component* $\mathcal{Q}^{irr}(-1, 3, 6)$, the component of $\mathcal{Q}(-1, 3, 6)$ which contains this point.

$$\begin{pmatrix} 0 & 1 & 2 & 3 & 4 & 5 & 0 \\ 5 & 4 & 3 & 2 & 6 & 1 & 6 \end{pmatrix}$$

Figure 3.5: This permutation gives rise by suspension flat surfaces with three singularities for the metric, of angle π , 3π and 8π . In other words, it gives points inside the stratum $\mathcal{Q}(-1, 3, 6)$.

3.2.3 The stratum $\mathcal{Q}(-1, 3, 3, 3)$

Let $[S_2, \psi_2] \in \mathcal{Q}(-1, 3, 3, 3)$ be the *particular* flat surface defined by Figure 3.6. We call the *irreducible connected component* $\mathcal{Q}^{irr}(-1, 3, 3, 3)$, the component of $\mathcal{Q}(-1, 3, 3, 3)$ which contains this point.

$$\begin{pmatrix} 0 & 1 & 2 & 3 & 4 & 5 & 6 & 0 \\ 6 & 5 & 3 & 2 & 7 & 4 & 1 & 7 \end{pmatrix}$$

Figure 3.6: This permutation gives rise by suspension flat surfaces with three singularities for the metric of angles 5π and one singularity of angle π . In other words, it gives points inside the stratum $\mathcal{Q}(-1, 3, 3, 3)$.

3.2.4 The minimal stratum $\mathcal{Q}(12)$

We denote by $\mathcal{Q}^I(12)$ the connected component of the stratum $\mathcal{Q}(12)$ which contain the surface $[S_3, \psi_3]$ given in Figure 3.7. We call $\mathcal{Q}^{II}(12)$ the connected component of $\mathcal{Q}(12)$ which contain the surface $[S_4, \psi_4]$ given in Figure 3.8.

We can check that the vertical foliation gives a diagram of separatrices with a handle of angle 2π for the first surface and a handle of 6π for the second surface. Using notations of Chapter 2, we have

$$\mathcal{Q}^I(12) := \mathcal{Q}(8) \oplus 2$$

and

$$\mathcal{Q}^{II}(12) := \mathcal{Q}(8) \oplus 6$$

$$\begin{pmatrix} 1 & 2 & 3 & 4 & 2 & 5 & 6 \\ 1 & 4 & 5 & 7 & 6 & 7 & 3 \end{pmatrix}$$

Figure 3.7: This permutation gives rise by suspension flat surfaces with only one singularity for the metric. The conical singularity has angle 14π . In other words, it gives point inside the stratum $\mathcal{Q}(12)$. We call $\mathcal{Q}^I(12)$ the connected component which contain this point.

$$\begin{pmatrix} 1 & 2 & 3 & 4 & 3 & 5 & 6 \\ 1 & 5 & 7 & 4 & 2 & 6 & 7 \end{pmatrix}$$

Figure 3.8: This permutation gives rise by suspension flat surfaces with only one singularity for the metric. The conical singularity has angle 14π . In other words, it gives point inside the stratum $\mathcal{Q}(12)$. We call $\mathcal{Q}^{II}(12)$ the connected component which contain this point.

In Chapter 4, we present a proof for the description of connected component which contains a multiplicity one saddle connection. The statement of our result is that any non-hyperelliptic and any non-irreducible component is attached to the minimal stratum.

Chapter 4

Adjacency

In Chapter 1, we have describe some connected components inside

a particular stratum $\mathcal{Q}(k_1, k_2, k_3, \dots, k_n)$ which are “accessible” by the surgery “breaking up a singularity” on a surface in the stratum $\mathcal{Q}(k_1 + k_2, k_3, \dots, k_n)$. In general, it is not true for all connected components. In this Chapter, we want to classify all component of such type: those which possess a surface with a saddle connection between two singularities which we can “collapse” it to a point. The problem is not trivial: given a generic surface with a saddle connection, if we collapse this saddle, the resulting surface could be a degenerated Riemann surface and we do not consider this type of surfaces for our problem. In other words, we do not consider the compactification of the Modular spaces. In Figure 4.1 we present an example of a collapse of a saddle connection which leads to a degenerated surface.

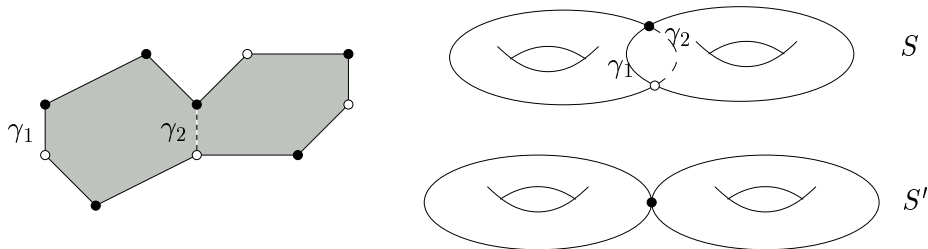

Figure 4.1: Let us consider the following polygon in \mathbb{R}^2 given by the figure on the left. We make identifications on the boundary, according to the number of the intervals, by translation. The form dz induces a holomorphic 1–form on the quotient surface. Obviously, we obtain a point $[S, \omega]$ inside the stratum $\mathcal{H}(1, 1)$. The saddle connection γ_1 is homologous to γ_2 . Thus if we deform the flat metric to collapse γ_1 to a point, the resulting surface S' would be a degenerated surface.

First, we give some examples of connected components which are *not* accessible by “breaking up a zero” on a surface in a lower strata. That is, component \mathcal{C} for which for any flat surface $[S, \psi]$ in \mathcal{C} , and for any saddle connection on S , if we collapse this saddle connection to a point, the resulting surface would be a degenerated Riemann surface. Then classify all components which contain a surface with a “contractible” saddle connection.

4.1 Flat surfaces and “Breaking up a singularity”

4.1.1 Multiplicity one and “Breaking up a singularity”

Here we recall the necessary and sufficient conditions in terms of homology to obtain surfaces by the surgery “break up a singularity” (see section 2.4.1).

Let S' be constructed from S by “breaking up” the zero $P \in S$ into two zeroes $P_1 \in S'$ and $P_2 \in S'$. The saddle connection γ , between P_1 and P_2 on S' , can be chosen arbitrary small with respect to the other. In particular, Proposition 7 imply that

$$\text{mult}(\gamma) = 1$$

Reciprocally, if a surface S' , with two zeroes P_1 and P_2 , possesses a saddle connection γ , between these two points, of multiplicity 1 then it is possible to “collapse” this saddle to a point to obtain a non-degenerated Riemann surface. In other word this surface is obtained from a surface in a lower dimentionnal stratum, by “breaking up” a zero P into the two zeroes P_1 and P_2 .

4.1.2 Exceptionnal cases

Here we describe some connected components which does not contain any flat surface with a *saddle connection* of multiplicity 1 (between two different zeroes).

Hyperelliptic connected components

Proposition 15. *Let $[S, \psi] \in \mathcal{Q}^{hyp}(4(g - k) - 6, 4k + 2)$ be a point in the hyperelliptic connected component of the stratum $\mathcal{Q}(4(g - k) - 6, 4k + 2)$. Then any saddle connection on S has multiplicity at least 2.*

Proof. Let $[S, \psi] \in \mathcal{Q}^{hyp}(4(g - k) - 6, 4k + 2)$ be a flat surface.

By construction, there is a canonical element in the affine group of S : the hyperelliptic involution

$$\tau \in \text{Aff}(S, \psi)$$

Suppose that γ is a saddle connection on S between the two different zeroes of ψ . Then $\tau(\gamma)$ is also a saddle connection. It is clear that $\tau(\gamma) \neq \gamma$: by construction (see 1.3.3), τ fixes the two distinct zeroes and τ is different from the identity map. One can see that $[\hat{\gamma}] = [\tau(\hat{\gamma})]$ on the orientating canonical double covering \hat{S} . In other word, γ and $\tau(\gamma)$ are two different homologous saddle connection. Thus we have

$$\text{mult}(\gamma) \geq 2 \quad \text{for any saddle connection } \gamma \text{ on } S$$

Proposition 15 is proved. □

In this terms, there is no surface in this hyperelliptic connected component which is constructed from a surface in the minimal stratum $\mathcal{Q}(4g - 4)$ by breaking up the zero into two zeroes.

Obviously, we can prove a similar statement for the hyperelliptic connected component $\mathcal{Q}^{hyp}(-1, -1, 4g - 2)$

Proposition 16. *Let $[S, \psi] \in \mathcal{Q}^{hyp}(-1, -1, 4g - 2)$ be a point in the hyperelliptic connected component of the stratum $\mathcal{Q}(-1, -1, 4g - 2)$. Then any saddle connection on S , between the zero and a pole, has multiplicity at least 2.*

The genus 2

According to [MaSm], the stratum $\mathcal{Q}(4)$ is empty. Thus we have obviously a similar result for the strata $\mathcal{Q}(-1, 5)$ and $\mathcal{Q}(2, 2)$. Note that the last stratum is contained in the list of Proposition 15: $\mathcal{Q}(2, 2) = \mathcal{Q}^{hyp}(4(g-k) - 6, 4k + 2)$ with $g = 2$ and $k = 0$.

Proposition 17. *Let $[S, \psi] \in \mathcal{Q}(-1, 5)$ be a point. Then any saddle connection on S has multiplicity at least 2.*

Notation

Let us denote by $[S_0, \psi_0] \in \mathcal{Q}(-1, 9)$ the particular flat surface (see Fig 3.3). We call irreducible connected component $\mathcal{Q}^{irr}(-1, 9)$ the connected component of $\mathcal{Q}(-1, 9)$ which contains this point.

In Appendix, using Rauzy classes, we prove a similar statement on the multiplicity of saddle connections on surfaces in the irreducible component $\mathcal{Q}^{irr}(-1, 9)$. In this Chapter, we will not use this result. The proof that we will present in the next fails for this particular component. That explains why we consider this choice.

4.2 Main result of this Chapter

In this section, we want to prove that, except the above described particular connected components, all other possess a surface with a multiplicity 1 saddle connection; that is a saddle connection which we can “collapse” to a point.

For the hyperelliptic connected component $\mathcal{Q}^{hyp}(4(g-k) - 6, 4k + 2)$, the hyperelliptic connected component $\mathcal{Q}^{hyp}(-1, -1, 4g - 2)$ and the stratum $\mathcal{Q}(-1, 5)$ it is a *necessarily* condition (see Propositions 15, 16 and 17).

For the irreducible connected component $\mathcal{Q}^{irr}(-1, 9)$ the proof which we are going to describe fails in this special case. In Appendix, we will see that in fact, this component satisfy a property as above: *any* saddle connection (between the zero and the pole) of any half-translation surface in this particular component has multiplicity at least 2.

Theorem 4. *Let \mathcal{C} be a connected component of a stratum $\mathcal{Q}(k_1, \dots, k_n)$ in genus $g \geq 1$ with $n \geq 2$. We assume that \mathcal{C} is not one of the following list of component*

- *hyperelliptic connected components $\mathcal{Q}^{hyp}(4(g-k) - 6, 4k + 2)$ and $\mathcal{Q}^{hyp}(-1, -1, 4g - 2)$.*
- *$\mathcal{C} \notin \pi_0(\mathcal{Q}(-1, 5))$.*
- *irreducible component $\mathcal{Q}^{irr}(-1, 9)$.*

Then there exists a flat surface M in a lower dimensionnal stratum that $\mathcal{Q}(k_1, \dots, k_n)$ and a surgery “breaking up a singularity” at a singular point $P \in M$ such that the resulting surface $[S, \psi]$ belongs inside the given component \mathcal{C}

The proof of this result is based on the combinatorics of the unique cylinder given in a completely periodic direction. The main remark is that two homologous separatrices are always parallel and their lengths are equal or differ by a factor 2 (see Proposition 7). We are going to show that we can always found a saddle connection of length arbitrary small with respect to the length of other parallel separatrix, if any.

4.2.1 Sketch of the proof

Remark on the multiplicity

In order to proof the Theorem, according to Proposition 8, we have to construct a surface $[S, \psi] \in \mathcal{C}$ with a multiplicity 1 saddle connection between two different singularities (not two poles).

In section 2.3, we have shown that two homologous saddle connections γ and η are always parallel and satisfy $\frac{|\gamma|}{|\eta|} = 1, 2$ or $1/2$.

We are going to construct a surface, in each connected component given by the Theorem, with a saddle connection γ of length 1 and such that

$$|\gamma_i| \geq 3 \text{ for all vertical separatrices } \gamma_i \text{ parallel to } \gamma$$

which will imply $\text{mult}(\gamma) = 1$.

Combinatorics of one cylinder decomposition

We consider a Jenkins—Strebel differential (S, ψ) with one cylinder for the horizontal foliation; that is horizontal foliation is completely periodic and the complement of the critical graph of ψ in S is connected.

By density, (see Theorem 3), we can consider such forms without loss of generality. So Let $S(\pi, \lambda)$ be a surface in \mathcal{C} with an arbitrary generalized permutation π . In the horizontal direction, we denote by $R(S)$ the corresponding rectangle. Recall that the vertical side of this rectangle is a separatrix denoted by $\gamma(\pi)$ of ψ .

For a horizontal separatrix γ , we denote by γ^1 and γ^2 the two corresponding intervals on the horizontal side of $R(S)$. Recall that if these two intervals are presented twice in the same horizontal side of the rectangle then we glue them by a centrally symmetry and else we glue them by a translation. The quotient surface, $R(S)/\sim$, is affinely equivalent to our initial flat surface (S, ψ) .

We will use the two fundamental obvious remarks. We suppose that γ is a horizontal *saddle connection*, between two *distinct* zeroes, and η is a horizontal separatrix (not necessarily a saddle connection).

Fundamental Remark 1. *If γ^1, γ^2 are in two different horizontal sides of the rectangle $R(S)$ then we have no conditions on the horizontal parameter $|\gamma^1| = |\gamma^2| = |\gamma|$ (see equation (2.4)). So we can choose the length of γ in the flat metric, arbitrary small with respect to the other length of horizontal separatrices. Thus we have*

$$\text{mult}(\gamma) = 1$$

Fundamental Remark 2. *If all intervals γ^1, γ^2 and η^1, η^2 are in a same horizontal side then we have only one linear relation on the length of γ : the rectangle is a metric rectangle so the length of the two horizontal sides must coincide. Thus we obtain (see equation (2.4))*

$$|\gamma^1| + |\gamma^2| + |\eta^1| + |\eta^2| + \dots = \dots$$

There is no cancellation of terms in the left part given by the length of the saddle connection γ and the separatrix η . In particular, we can choose $|\gamma^1| + |\gamma^2| + |\eta^1| + |\eta^2|$ arbitrary small

and hence $|\gamma^1| = |\gamma^2| = |\gamma|$ arbitrary small with respect to the other length of horizontal separatrices. Thus we have

$$\text{mult}(\gamma) = 1$$

Note that in the case of Abelian differentials, all gluing are translations so Fundamental Remark 1 holds every time and hence the corresponding statement for Abelian differentials is trivial.

Now, if one of the two Fundamental Remarks holds, the Theorem is proved. Thus Let us assume that it is not the case. Hence we obtain some restrictions on the combinatorics of the permutation π . We will study these restrictions.

Next we consider the vertical foliation on the surface $S(\pi', \lambda)$ with $\pi' \sim \pi$ for the cyclic order (see section 2.2.7). Or in an equivalent way, we study the action of the horocyclic flow on the point $[S(\pi, \lambda), \psi]$. Our result is that there always exist a nice twist parameter such that the canonical vertical saddle connection $\gamma(\pi')$ has multiplicity 1.

This proof fails for some kinds of combinatorics of permutations: such permutations are then completely determined. By direct computation (see Chapter 3) we check that they correspond to hyperelliptic curves in a hyperelliptic connected component or to exceptional case listed in genera 2 and 3. These cases correspond to surfaces of section 4.1.2.

4.2.2 Proof of the main result of this Chapter

We decompose the proof into several cases. Recall that n denote the number of the singularities. First we consider the general case $n \geq 4$. Then we prove the case $n = 3$. Finally we conclude by the holomorphic case $n = 2$ and the meromorphic case; that is the stratum $\mathcal{Q}(-1, 4g - 3)$; which is more technical.

Proof in the particular case where $n \geq 4$

Let (S, ψ) be a Jenkins—Strebel differential with only one (vertical) cylinder for the horizontal foliation. Let $\text{Cyl}(S)$ be this cylinder. We denote the boundary component of $\text{Cyl}(S)$ by I and J . We have a decomposition of this boundary into a disjoint union of intervals given by the cutting of the critical graph of ψ on S .

First of all, it necessarily exists a zero, say P_1 , of the differential ψ and a saddle connection γ between this zero P_1 and another singularity P_i for $i \geq 2$, say P_2 . One can see this in the following way. Assumption of the genus $g \geq 1$ imply that there exists a zero P , say located in I . If there is no saddle connection starting of this zero then the endpoints of intervals located in I give precisely the zero P . Now $n \geq 4$, thus it exists another singularities, necessarily located in J . It is easy to see that there exists at last one zero P_1 on J and hence one saddle connection γ attached to this zero.

Up to a permutation, we assume that $\gamma^1 \subset I$. If $\gamma^2 \subset J$ then we have done by Fundamental Remarks 1. Thus let us assume that

$$\gamma^1, \gamma^2 \subset I$$

Then let P_3 be a singularity different from P_1 and P_2 . If $P_3 \in I$ then it necessarily exists a saddle connection α between P_3 and a singularity P_i such that $\alpha^1 \subset I$. In this case, we

have also done by one of the two Fundamental Remarks 1 or 2 corresponding respectively to the case where $\alpha^2 \subset J$ or I . So we can assume that for *all* singularities P_i different from P_1 and P_2 we have $P_i \in J$ (see Figure 4.2).

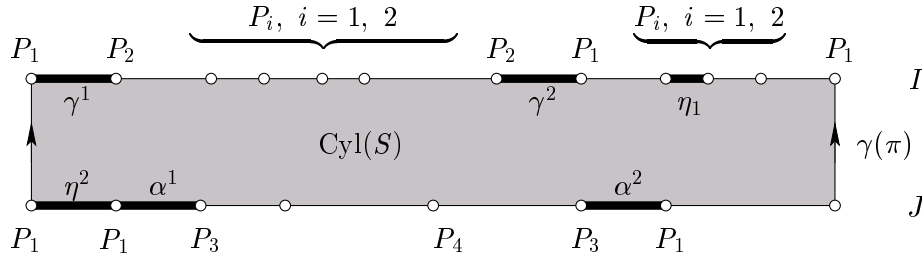

Figure 4.2: An example of a decomposition of a Jenkins—Strebel differential with one (vertical) cylinder (for the horizontal direction).

The point P_1 is a zero so there must exist a separatrix η which contains P_1 and with $\eta^1 \subset I$. If $\eta^2 \subset I$ the Theorem holds by Fundamental Remark 2. Thus we can assume that $\eta^2 \subset J$. We refer to Figure 4.2 for details.

Recall that $n \geq 4$ so there exists a saddle connection α between P_3 and P_1 such that $\alpha^1 \subset J$. If $\alpha^2 \subset I$ then $P_3 \in I$ which contradicts assumptions so $\alpha^2 \subset J$. We conclude by the fact that $n \geq 4$. Thus there exists P_4 different from P_i for $i = 1, 2, 3$ with $P_4 \in J$. It necessarily exists a saddle connection ζ between P_4 and another singularity. Now by a direct checking, one can see that ζ has multiplicity one.

The proof for the case $n = 3$ is similar to the previous one with a refinement.

Proof in the particular case where $n = 3$

As above, let us assume that (S, ψ) is a Jenkins—Strebel differential with only one vertical cylinder $\text{Cyl}(S)$.

We can apply the above argument to obtain the following dichotomy: **either** there exists a *zero* P_1 of ψ and a *saddle connection* γ between P_1 and a singularity P_2 of ψ (precisely as above) **or** the quadratic differential possesses exactly two poles and one zero. Moreover in this last situation we have for the combinatorics of the corresponding permutation, the following description

$$\begin{pmatrix} \cdots & \cdots \\ 0 & 0 \end{pmatrix}$$

Now we will discuss these two cases.

Our goal is to prove that if $[S(\pi, \lambda), \psi] \notin \mathcal{Q}(-1, -1, 4g - 2)$ then one can find a multiplicity 1 vertical saddle connection on (S, ψ) . For the particular stratum $\mathcal{Q}(-1, -1, 4g - 2)$, we will show that we also have this result except in only two cases. In these two particular cases, the corresponding generalized permutation π is completely determined and equal to (up to a cyclic order) $\Pi_1(r, l)$ or $\Pi_2(r, l)$ for adequate values of r and l (see Section 3.1). In Chapter 3 we have proved that all surfaces construct by suspension over these particular

permutations belong to the hyperelliptic connected component $\mathcal{Q}^{hyp}(-1, -1, 4g - 2)$ which will give the proof. Now let us discuss details.

Let us assume that the first case discussed above arise, that is γ is a saddle connection between the zero P_1 and a singularity P_2 of ψ . By the same type of argument discussed in the case $n \geq 4$, one can see that either we obtain a multiplicity one saddle connection or the permutation π possesses a prescribed combinatorial type. Namely, the following Lemma holds

Lemma. *Let \mathcal{C} be a connected component of a stratum $\mathcal{Q}(k_1, k_2, k_3)$ in genus $g \geq 1$. Then either there exists in \mathcal{C} a flat surface $[S, \psi]$ with a multiplicity 1 saddle connection γ between two different singularities (not two poles) or the singularity pattern is exactly $(k_1, k_2, k_3) = (-1, -1, 4g - 2)$ and there exists a surface $[S(\pi, \lambda), \psi] \in \mathcal{C}$ such that π is given by one of the two following type*

$$\pi = \begin{pmatrix} 1 & \dots & r & 0_1 & 0_1 \\ 0_2 & 0_2 & \pi(1) & \dots & \pi(r) \end{pmatrix} \quad \text{or} \quad \pi = \begin{pmatrix} \dots & \dots \\ 0 & 0 \end{pmatrix}$$

□

It remains to prove the Theorem for $n = 3$ to consider the two permutations given by the above Lemma. Now we will consider the *vertical* on the surface.

We will prove that if π is different (up to a cyclic order) from the two particular permutations $\Pi_i(r, l)$, for $i = 1$ and 2 , then we always have a cyclic order on π such that the corresponding *saddle connection* $\gamma(\pi)$ on S has multiplicity 1. The way to obtain this is Corollary 2; that is, if π is irreducible then the vertical separatrix $\gamma(\pi)$ has multiplicity 1. We will show that there exists in the class of π an irreducible permutation such that the corresponding vertical separatrix is a saddle connection except when π is equivalent to Π_i for $i = 1, 2$.

Case 1. Let us consider the first permutation

$$\pi \sim \begin{pmatrix} 2 & \dots & r & 0_1 & 0_1 & 1 \\ 0_2 & \pi(1) & \pi(2) & \dots & \pi(r) & 0_2 \end{pmatrix}$$

Note that π satisfy the condition (*) thus it is sufficient to obtain a weakly irreducible generalized permutation in the class of π (see Chapter 2).

The above generalized permutation is weakly reducible if and only if $\pi(r) = 1$. We can repeat this process to prove that either there exists an weakly irreducible permutation in the class of π or we have

$$\pi(i) = r - i + 1$$

Obviously, the last condition correspond to $\pi \sim \Pi_1(r, 0)$

Case 2. It remain to finish the proof for $n = 3$ to consider the second permutation of the Lemma. Recall that the corresponding suspension $S = S(\pi, \lambda)$ is in the stratum $\mathcal{Q}(-1, -1, 4g - 2)$ so for any permutations in the class of π for the cyclic order *on the first line*, the corresponding separatrix $\gamma(\pi)$ on S is a saddle connection between the zero and one of the two poles. We will prove that there always exists an irreducible permutation equivalent to π , unless π is the particular permutation given by $\pi = \Pi_2(r, 1)$. In this last

case, the surface is hyperelliptic and belongs to the hyperelliptic connected component of the stratum $\mathcal{Q}(-1, -1, 4g - 2)$ (see Chapter 3).

First of all, we prove that there always exist a permutation equivalent to π which is weakly irreducible, unless π is the particular permutation given by $\Pi = \pi_2(r, 1)$.

If π is weakly reducible then we have the following decomposition

$$\left(\begin{array}{c|c} A & B \\ \hline 0 & 0 \end{array} \right)$$

We rewrite $A = (1 \ A_2)$ and $B = (B_1 \ 1 \ B_2)$. Then π is equivalent to the following generalized permutation

$$\pi \sim \left(\begin{array}{cccccc} 1 & B_2 & 1 & A_2 & B_1 & \\ 0 & & & & 0 & \end{array} \right)$$

This last permutation is weakly reducible if and only if $B_1 = \emptyset$. In this case, we can repeat this process with the new set A for A_2 and the new set B for B_2 . Thus either we obtain a weakly irreducible generalized permutation or $A = B = (1 \ 2 \ \dots \ r)$. In the last case we have $\pi = \Pi_2(r, 1)$.

To achieve the proof, it remain to show that if π is weakly reducible then we can obtain an irreducible permutation in the class of π for the cyclic order. This is done with the same type of argument as above. This gives the Theorem for $n = 3$.

Remark 7. We have shown that there always exists a surface, in a non-hyperelliptic connected component of the stratum $\mathcal{Q}(k_1, k_2, k_3)$, which possesses a multiplicity one saddle connection. But we have no control on the multiplicity of the saddles attached to this saddle connection. It is easy to have a refinement of the precedent proof to obtain a more precise result. We announced such statement in the next section.

Proof in the holomorphic case $n = 2$

Let P_1, P_2 be the two different zeroes of ψ on the Jenkins—Strebel surface $S = S(\pi, \lambda)$. Obviously, we have the following dichotomy: **either** there is no saddle connection between P_1 and P_2 **or** there is at least one saddle connection on the surface (for the horizontal foliation).

We can apply the same type of argument in the discussion of the case $n = 3$ to see that in the second case, we obtain a multiplicity one horizontal saddle connection or the permutation π must obey to some combinatorics restrictions. We can summarize this into the following

Lemma. *Let \mathcal{C} be a connected component of a stratum $\mathcal{Q}(k_1, k_2)$ in genus $g \geq 1$ with any $k_1, k_2 > 0$ and $k_1 + k_2 = 4g - 4$.*

Then either there exists a flat surface $[S, \psi] \in \mathcal{C}$ with a multiplicity 1 saddle connection between the two different zeroes or there exists a surface $[S(\pi, \lambda), \psi] \in \mathcal{C}$ such that the combinatorics of π is given by one of the two following type (corresponding of the two above case of the dichotomy)

$$\pi = \left(\begin{array}{cccccc} 0_1 & 1 & \dots & r & 0_1 & r+1 & \dots & r+l \\ 0_2 & \sigma_1(1) & \dots & \sigma_1(r) & 0_2 & \sigma_2(r+1) & \dots & \sigma_2(r+l) \end{array} \right)$$

or

$$\pi = \left(\begin{array}{c} A \\ B \end{array} \right) \quad \text{and} \quad \pi(A) = A, \pi(B) = B$$

where σ_1 is a “true” permutation of the set $\{1, \dots, r\}$ and σ_2 is a “true” permutation of the set $\{r+1, \dots, r+l\}$.

□

Thus the proof of the Theorem in the holomorphic case $n = 2$ is reduced to considering these two permutations. As in the case $n = 3$, one can prove, using the notion of cyclic order and irreducibility, that there exists a surface $S(\pi', \lambda)$, with $\pi' \sim \pi$, and having a multiplicity one saddle connection. The proof fails in two cases: it corresponds to the case (up to a cyclic order) where

$$\pi = \Pi_i(r, l) \quad \text{for } i = 1 \text{ or } 2$$

In Chapter 3, we prove have seen that these surfaces are hyperelliptic and belong to the hyperelliptic connected component $\mathcal{Q}^{hyp}(k_1, k_2)$. Thus it achieves the proof of the Theorem in the case $n = 2$ and where all singularities are non-negatives.

Here we adrese the proof of the first case. The idea is essentially the same to the one given previously in the case $n = 3$ (for the stratum $\mathcal{Q}(-1, -1, 4g - 2)$). The generalized permutation π is equivalent to the following one:

$$\left(\begin{array}{cccccccc} 0_1 & 1 & \dots & r & 0_1 & r+1 & \dots & r+l \\ \sigma_1(r) & 0_2 & \sigma_2(r+1) & \dots & \sigma_2(r+l) & 0_2 & \sigma_1(1) & \dots & \sigma_1(r-1) \end{array} \right)$$

First the corresponding separatrix loop $\gamma(\pi)$ on the surface $S(\pi, \lambda)$ obtained by suspension over this permutation is a saddle connection. Then one can easily see that this permutation is weakly irreducible, and so irreducible, if and only if we have

$$\sigma_1(r) = 1$$

Repeating this process, we obtain that either there exists a cyclic order such that the vertical saddle connection $\gamma(\pi)$ has multiplicity 1 or we have

$$\sigma_1(i) = r - i + 1 \quad \text{for } i = 1, \dots, r$$

and

$$\sigma_2(j) = 2r + l - j + 1 \quad \text{for } j = r + 1, \dots, r + l$$

namely, these last conditions are equivalent to

$$\pi = \Pi_2(r, l)$$

Proof in the meromorphic case $n = 2$

Let us consider the stratum $\mathcal{Q}(k_1, \dots, k_n) = \mathcal{Q}(-1, 4g - 3)$ in genera higher than 3. In this case, the situation is more complicated. In particular we found a connected component in the stratum of genus 3 for which there are *no* surfaces with a saddle connection of multiplicity 1.

First we will prove a result less general than the Theorem: one can find a saddle connection or a simple cylinder of multiplicity one. Then we prove the

Theorem. *Let $\mathcal{C} \subseteq \mathcal{Q}(4g - 3, -1)$ be a connected component. Suppose that $g \geq 4$. Then there exists a flat surface $[S, \psi] \in \mathcal{C}$ and a saddle connection γ on S , between the pole and the zero of ψ , such that*

$$\text{mult}(\gamma) = 1$$

In the particular case of the genus $g = 3$, we also have the result with an additional assumption that is $\mathcal{C} \neq \mathcal{Q}^{irr}(-1, 9)$.

In order to prove this result, we will consider the two following Propositions. Recall that a simple cylinder is a maximal straight cylinder such that each boundary component of this cylinder is a single separatrix. A simple cylinder has multiplicity 1 if the corresponding separatrix on the boundary has multiplicity 1 (see Chapter 3 and Figure 2.5).

Proposition 18. *Let $\mathcal{C} \subseteq \mathcal{Q}(4g - 3, -1)$ be a connected component with $g \geq 3$. Then there exists a flat surface $[S, \psi] \in \mathcal{C}$ with one of the two following properties*

- *There exists a saddle connection γ on S of multiplicity one.*
- *There exists a multiplicity one simple cylinder on S (using notations of section 2.4.2, we have $\mathcal{C} = \mathcal{C}' \oplus s$ with $s \in \{1, \dots, 2g\}$ and $\mathcal{C}' \subset \mathcal{Q}(-1, 4(g - 1) - 3)$).*

The first assertion of this Proposition is the result of the Theorem. So it remains to obtain the Theorem in full generalities to consider the second assertion. It is given by the following

Proposition 19.

- *Any connected component of $\mathcal{Q}(-1, 13)$ possesses a flat surface $[S, \psi]$ with a saddle connection of multiplicity one.*
- *Let $\mathcal{C}_0 = \mathcal{Q}(-1, 5)$ be the unique connected component of the stratum $\mathcal{Q}(-1, 5)$. Let $s \in \{1, 2, 4\}$ be an integer. Then there exists a flat surface $[S, \psi] \in \mathcal{C}_0 \oplus s$ with a saddle connection γ on S of multiplicity one.*

Note that we have by construction

$$\mathcal{C}_0 \oplus 3 = \mathcal{Q}^{irr}(-1, 9)$$

which explain why we do not consider the case $n = 3$.

Proof of the Theorem. If there exists a flat surface $[S, \psi] \in \mathcal{C} \subseteq \mathcal{Q}(-1, 4g - 3)$ ($g \geq 4$) with a saddle connection of multiplicity 1 then there also exist a flat surface $[S', \psi'] \in \mathcal{C} \oplus s$ with a saddle connection of multiplicity 1 by “bubbling a handle” on S .

Thus the Theorem follows immediately from Propositions 18 and 19. □

Proof of Proposition 18. The proof of the Proposition is based on the combinatorics of generalized permutations. Let us suppose that $[S, \psi]$ is a Jenkins-Strebel differential inside the connected component $\mathcal{C} \subseteq \mathcal{Q}(-1, 4g - 3)$. We can suppose, without loss of generality, that the surface S decomposes into only one cylinder for the horizontal foliation given by $\mathfrak{Sm}(\psi)$. Let π denote the corresponding generalized permutation which encodes the gluing

of the horizontal intervals of the horizontal sides of the cylinder $S \setminus \Gamma(\psi)$. Suppose that we have a horizontal saddle connection γ and a separatrix loop η such that the corresponding intervals γ^i and η^i for $i = 1, 2$ are in a *same* boundary component. Then we can choose an admissible vector λ with the corresponding length of γ arbitrary small. Thus the surface $S = S(\pi, \lambda)$ satisfies to the first property. In other word, if π is not described by the following permutation (up to a cyclic order)

$$\pi = \left(\begin{array}{cccccc} 0 & 1 & \dots & n & 0 \\ A & & & & & \end{array} \right) \quad \text{with} \quad \pi(\{1, \dots, n\}) \subset A$$

Proposition 18 holds. So we can assume that π is equal to the upper permutation. We are going to consider the cyclic order on π to obtain a suspension $S = (\pi', \lambda)$ with a saddle connection of multiplicity one or a simple cylinder of multiplicity one. One can remark that the separatrix γ constructed on $S(\pi, \lambda)$ is a saddle connection for all cyclic order on the elements of the set A . In addition, if π is irreducible, there exists a dense set of λ such that γ has multiplicity 1.

First we consider some permutations π' in the class of π such that the surface $S(\pi', \lambda)$ has a simple cylinder. To fix the notations, we denote by

$$\pi \sim \sigma = \left(\begin{array}{c|cccccc} 1 & 2 & \dots & n & 0 & 0 \\ 1 & \dots & \dots & \dots & \dots & \dots \end{array} \right)$$

The vertical measured foliation on $S(\sigma, \lambda)$ has a vertical simple cylinder. The boundary of this cylinder is the separatrix loop γ . By Corollary 2, there exists a dense set of λ such that the multiplicity of γ is 1 if and only if the restricted permutation $\hat{\sigma}$ is irreducible. In addition, in this particular case, it is easy to see that if $\hat{\sigma}$ is weakly irreducible but not irreducible then there exists $\sigma_1 \sim \sigma$ such that $\hat{\sigma}_1$ is irreducible.

Let us assume that $\hat{\sigma}$ is weakly reducible. We have one of the two possibilities for the combinatorics of σ

$$\sigma = \left(\begin{array}{c|ccc|cccc} 1 & 2 & \dots & k & k+1 & \dots & n & 0 & 0 \\ 1 & A_1 & k & A_2 & & & B & & \end{array} \right)$$

or

$$\sigma = \left(\begin{array}{c|ccc|c} 1 & 2 & \dots & n & 0 \\ 1 & & A & & B \end{array} \right)$$

One can see that the first permutation is equivalent (with respect to the element k) to a permutation as in Proposition 23. So in this case, we have the result: there exists a simple cylinder of multiplicity one. It remain to consider the second permutation. We have $\sigma(B) \subseteq A$. Let us denote $A = (A_1 \ r \ A_2)$ with $\sigma(A_2) \subseteq B$ and $r \leq n$. With these notations, the permutation σ is equivalent to the following one

$$\sigma \sim \left(\begin{array}{c|cccccccc} r & r+1 & \dots & n & 0 & 0 & 1 & 2 & \dots & r-1 \\ r & A_2 & B & 1 & A_1 & & & & & \end{array} \right)$$

Fact. If $r \neq n$ then the above permutation satisfy assumptions of Proposition 23. So we obtain a simple cylinder of multiplicity one.

Thus let us consider the particular case where $r = n$.

$$\pi = \begin{pmatrix} 0 & 1 & \dots & n & 0 \\ n & A_2 & B & 1 & A_1 \end{pmatrix} \quad \text{with} \quad \pi(A_2) \subseteq B$$

One can see that the vertical separatrix γ is a saddle connection. Thus Corollary 2 imply that if $\pi' \sim \pi$ (for the cyclic order on the second line) is irreducible then the Proposition holds: γ has multiplicity one.

Fact. The permutation π is weakly reducible if and only if we have $A_2 = \emptyset$ and $A_1 = (C B')$ with $B' = \pi(B)$ and $C = (\pi(2) \dots \pi(n-1))$.

In other words we have proved the following Lemma

Lemma. *Let $\mathcal{C} \subseteq \mathcal{Q}(4g-3, -1)$ be a connected component with $g \geq 3$. Let $[S, \psi] \in \mathcal{C}$ be a Jenkins-Strebel form with one cylinder for the horizontal foliation. Then the surface (S, ψ) satisfies one of the two properties given by Proposition 18 or the corresponding permutation for the combinatorics of the boundary component of the cylinder $S \setminus \Gamma(\psi)$ is given by the following one (up to a cyclic order)*

$$\pi = \begin{pmatrix} 0 & 1 & \dots & n & 0 \\ n & B & 1 & C & B' \end{pmatrix}$$

with $\pi(B) = B'$ and $C = (\pi(2) \dots \pi(n-1))$.

□

So we have reduced the proof of Proposition 18 to the particular type of permutations of above Lemma. We consider the two cases following the values of n : $n \geq 2$ and $n = 1$. In the first case, we show that there exists $\pi' \sim \pi$ (for the cyclic order on the second line) such that π' is irreducible. So it implies the Proposition. The case $n = 1$ is more technical. This correspond to the two following Lemma.

Lemma. *Let $n \geq 2$ be an integer. Let π be the following generalized permutation*

$$\pi = \begin{pmatrix} 0 & 1 & \dots & n & 0 \\ n & B & 1 & C & B' \end{pmatrix}$$

with $\pi(B) = B'$ and $C = (\pi(2) \dots \pi(n-1))$. We assume the technical condition that the genus g of the surface satisfy

$$\text{genus}(S(\pi, \lambda)) \geq 3$$

Then there exists a permutation $\pi' \sim \pi$ (for the cyclic order on the second line) such that π' is irreducible.

Proof of the Lemma. Suppose that $n \geq 3$. Then we have $n-1 \neq 1$. Let us denote $C = (C_1 \ n-1 \ C_2)$. With these notations, π is equivalent to

$$\pi \sim \pi' = \begin{pmatrix} 0 & 1 & \dots & \dots & n-1 & n & 0 \\ n-1 & C_2 & B' & n & B & 1 & C_1 \end{pmatrix}$$

It is easy to see that this permutation is weakly irreducible.

Suppose that $n = 2$. Let us denote $B' = (B'' \ 3)$ with $\pi(3) \in B$. With these notations we obtain

$$\pi \sim \pi' = \begin{pmatrix} 0 & 1 & 2 & 0 \\ 3 & B'' & 2 & B & 1 \end{pmatrix}$$

This permutation is weakly reducible if and only if $B'' = \emptyset$. This last condition is always satisfied else we obtain a particular flat surface with a simple pole and a zero of order 5. The surface has genus 2 which is a contradiction.

To finish the proof, it is easy to see that if π is weakly irreducible and not reducible, we can always find a permutation in the class of π which is irreducible.

The Lemma is proved. \square

To finish the proof of the Proposition, it remains to consider the case $n = 1$.

Lemma. *Let π be a generalized permutation given by*

$$\pi = \begin{pmatrix} 0 & 1 & 0 \\ B & 1 & B' \end{pmatrix}$$

with $\pi(B) = B'$. Then one of the two following affirmations holds

- *There exists a permutation $\pi' \sim \pi$ (for the cyclic order on the second line) such that π' is irreducible.*
- *Combinatorics of the permutation π is given by $B = B' = (2 \ 3 \ \dots \ n)$.*

Moreover, in the last case, there exists $\pi' \sim \pi$ and an admissible vector λ such that the vertical foliation on $S(\pi', \lambda)$ is completely periodic. In addition the surface decomposes (in this direction) into exactly $g - 1$ cylinders. One of these cylinders is a simple cylinder and it has multiplicity 1.

This achieves the proof of Proposition 18. \square

Proof of the Lemma. Let us denote B and B' by $B = (2 \ B_2)$ and $B' = (B'_1 \ 2 \ B'_2)$. Thus

$$\pi \sim \begin{pmatrix} 0 & 1 & 0 \\ 2 & B'_2 & 2 & B_2 & 1 & B'_1 \end{pmatrix}$$

One can see that this permutation is weakly reducible if and only if $B'_1 = \emptyset$. The Lemma follows by induction with $B = B_2$ and $B' = B'_2$.

To finish the proof it remains to show for the second affirmation that we have a vertical periodic decomposition into exactly $g - 1$ cylinders. Let us consider the following generalized permutation π' , which is equivalent to π

$$\pi \sim \pi' = \begin{pmatrix} 0 & & & & 1 & & & & 0 \\ 3 & 4 & \dots & n & 2 & 3 & 4 & \dots & n & 1 & 2 \end{pmatrix}$$

We consider the Jenkins—Strebel surface $S = S(\pi', \lambda)$ with the admissible vector λ given by

$$\lambda_0 = \left((n-1)\alpha ; \alpha ; (n-1)\alpha ; \underbrace{\alpha ; \dots ; \alpha}_{2n-1 \text{ times}} \right) \quad \text{for any } \alpha \in \mathbb{R}^+ \quad (4.1)$$

Now let us prove Proposition 19 to establish the Theorem in the meromorphic case $n = 2$.

First we prove the following

Lemma 9. *The stratum $\mathcal{Q}(-1, 5)$ is connected.*

Proof. The proof is completely analogous to the proof of the connectedness of the stratum $\mathcal{Q}(8)$ (see Lemma 16). \square

Proof of Proposition 19. Let us prove the second point of the Proposition; that is the result for the stratum $\mathcal{Q}(-1, 9)$. We want to prove that all connected component of this stratum of the form $\mathcal{Q}(-1, 5) \oplus s$ with $s = 1, 2, 4$ has a surface with a saddle connection of multiplicity one. Let us consider the two following permutations

$$\sigma_1 = \begin{pmatrix} 0 & 1 & 2 & 3 & 4 & 0 \\ 4 & 5 & 3 & 5 & 2 & 1 \end{pmatrix} \quad \sigma_2 = \begin{pmatrix} 0 & 1 & 2 & 3 & 4 & 0 \\ 3 & 5 & 2 & 4 & 5 & 1 \end{pmatrix}$$

We consider $\lambda = (1, \dots, 1)$ an admissible vector for σ_i . We consider the cyclic order for σ_1 with respect to the elements 3 and 1. It is easy to see that the two corresponding surfaces $S(\sigma, \lambda)$ are respectively in $\mathcal{Q}(-1, 5) \oplus 1$ and $\mathcal{Q}(-1, 5) \oplus 4$. In addition, the second permutation with the cyclic order with respect to the element 2 give an element in $\mathcal{Q}(-1, 5) \oplus 2$. We finish the proof by the following remark. The action of the horocyclic flow on these two points

$$h_1([S(\sigma_1, \lambda), \psi_1]) \quad \text{and} \quad h_1([S(\sigma_2, \lambda), \psi_2])$$

give surfaces with a saddle connection of multiplicity 1.

Second, we prove the result for the stratum $\mathcal{Q}(-1, 13)$. We want to prove that all connected component of this stratum has a surface with a saddle connection of multiplicity one.

By Proposition 18 it remain to consider all connected component of this stratum which contain a surface with a simple cylinder of multiplicity one; that is all component of the form $\mathcal{C} \oplus s$ with $\mathcal{C} \subset \mathcal{Q}(-1, 9)$. We have proved that all component of the stratum $\mathcal{Q}(-1, 9)$, except the irreducible component, has the a surface with a saddle connection of multiplicity one. So it is sufficient to prove the Proposition for all component of the form

$$\mathcal{Q}^{irr}(-1, 9) \oplus s \quad \text{for all } s = 1, \dots, 6$$

Recall that $\mathcal{Q}^{irr}(-1, 9) = \mathcal{Q}(-1, 5) \oplus 3$. Moreover all components $\mathcal{Q}(-1, 5) \oplus s$ with $s = 1, 2, 4, 5$ possess a flat surface with a saddle connection of multiplicity one. Using property of the map \oplus , one can see that

$$\mathcal{Q}(-1, 9)^{irr} \oplus s = \mathcal{Q}(-1, 5) \oplus s \oplus 3$$

Thus the Proposition holds for $s = 1, 2, 4, 5$. We can reduce the case $s = 6$ to the case $s = 3$

$$\mathcal{Q}(-1, 9)^{irr} \oplus 6 = \mathcal{Q}(-1, 5) \oplus 6 \oplus 3 = \mathcal{Q}(-1, 9)^{irr} \oplus 3$$

We finish the proof for the case $s = 3$ by using the second property of the map \oplus

$$\mathcal{Q}(-1, 5) \oplus 3 \oplus 3 = \mathcal{Q}(-1, 5) \oplus 1 \oplus 5$$

This achieve the proof of Proposition 19. \square

4.3 Refinement of the main result

In the previous section, we have shown that there always exists a surface, in a connected component given in the assumptions of Theorem 4, which possesses a multiplicity one saddle connection of multiplicity one. But we have no control of the multiplicity of the singularities attached to this saddle connection. Here we can prove a stronger result in the special cases of $n = 3$ and $n = 4$. The proof is just a refinement of the proof of the Theorem 4.

Corollary 4. *Let \mathcal{C} be a connected component of the stratum $\mathcal{Q}(k_1, k_2, k_3)$. We suppose that \mathcal{C} is not hyperelliptic when it makes a sense. We choose a particular degree of singularity, say k_1 for instance $((k_1, k_2, k_3)$ is consider as an unordered set). Then there exists a flat surface $[S, \psi] \in \mathcal{C}$ and an index $i_0 \in \{2, 3\}$ such that S possesses a multiplicity one saddle connection between the two distinct singularities $P_1 \in S$ of order k_1 and $P_{i_0} \in S$ of order k_{i_0} .*

For strata with four singularities, we have

Corollary 5. *Let \mathcal{C} be a connected component of the stratum $\mathcal{Q}(k_1, k_2, k_3, k_4)$. We suppose that \mathcal{C} is not hyperelliptic when it make sense. We choose two particulars degree of singularities, say k_1 and k_2 for instance $((k_1, k_2, k_3, k_4)$ is consider as an unordered set). Then there exists a surface $[S, \psi] \in \mathcal{C}$ and index $i_0 \in \{1, 2\}$ and $j_0 \in \{3, 4\}$ such that S possesses a multiplicity one saddle connection between the two distinct singularities $P_{i_0} \in S$ of order k_{i_0} and $P_{j_0} \in S$ of order k_{j_0} .*

4.4 Adjacency of strata

In this section we study the *adjacency* of the strata. We translate Theorem 4 in terms of the description of the adjacency. We also give some description on the local connectedness in a neighborhood of the minimal stratum and of some particular strata.

4.4.1 Adjacency

Let $\mathcal{C}' \subseteq \mathcal{Q}(l_1, \dots, l_r)$ be a connected component and

$$k_i = \sum_{j=r_i+1}^{r_{i+1}} l_j \quad \text{for } i = 1, \dots, n \quad (4.2)$$

with $0 = r_1 < r_2 < \dots < r_n < r_{n+1} = r$. By definition, we say that \mathcal{C}' is adjacent to \mathcal{C} if

$$\mathcal{C} \subset \overline{\mathcal{C}'}$$

where $\overline{\mathcal{C}'}$ denote the closure inside the moduli space \mathcal{Q}_g .

We have the following criterion

Proposition 20. *Let $[S, \psi] \in \mathcal{C}$. Suppose that we “break up a singularity” of ψ into two singularities on S . We obtain a flat surface S' . Let \mathcal{C}' be the connected component which contains this point $[S', \psi']$. Then*

$$\mathcal{C} \subset \overline{\mathcal{C}'}$$

It follows by induction

Corollary 6. *Let $\mathcal{Q}(l_1, \dots, l_r)$ be a stratum and \mathcal{C} be a connected component of the stratum $\mathcal{Q}(k_1, \dots, k_r)$. Suppose that vectors (l_1, \dots, l_r) and (k_1, \dots, k_r) are related by formula (4.2). Then there exists a connected component $\mathcal{C}' \subset \mathcal{Q}(l_1, \dots, l_r)$ which is adjacent to \mathcal{C} .*

We can deduce from Theorem 4 and local description of local coordinates (see Chapter 2) that we have a precise description of adjacency. More precisely, we have

Proposition 21. *Let $\mathcal{C} \subset \mathcal{Q}(k_1 + k_2, k_3, \dots, k_n)$ be a connected component. Suppose that we have a component $\mathcal{C}' \subset \mathcal{Q}(k_1, k_2, k_3, \dots, k_n)$ adjacent to \mathcal{C} . Then there exists a flat surface $[S, \psi] \in \mathcal{C}$ such that we can “break up the singularity” P on S of order $k_1 + k_2$ into two singularities of order k_1 and k_2 to obtain a surface $[S', \psi'] \in \mathcal{C}'$.*

Now we can translate Corollaries 4 and 5 and Theorem 4 in terms of adjacency:

Theorem 5. *Any component in a stratum in genus $g \geq 4$ is either hyperelliptic or adjacent to a lower dimensional stratum.*

We use this description in Chapter 6 in order to prove Main Theorem 1. In Chapter 6 we will prove a stronger result; that is the following dichotomy holds: any component in a stratum in genus $g \geq 4$ is either hyperelliptic or adjacent to the minimal stratum.

4.4.2 Local connectedness

In general, we can “break up a singularity” P into different ways (see Chapter 1). When the surgery is local and when there is many zero of order $k = \text{order}(P)$, we can break the zero into many ways to obtain different surfaces and so different connected components. For example, in Appendix we construct *two* connected components \mathcal{C}'_1 and \mathcal{C}'_2 inside the stratum $\mathcal{Q}(2, 3, 3)$ and a connected component \mathcal{C} inside the stratum $\mathcal{Q}(2, 6)$ such that $\mathcal{C} \subset \overline{\mathcal{C}'_1} \sqcup \overline{\mathcal{C}'_2}$.

Here we first give some trivial conditions to obtain the local connectedness in a neighborhood of some special strata. Then, we cite a direct corollary of a result of Kontsevich—Zorich concerning the local connectedness in a neighborhood of the minimal stratum.

Local surgeries

We present the following result obtained as a direct corollary of the *local* constructions of Lemma 1 and Lemma 2:

Proposition 22. *Let $[S, \psi] \in \mathcal{C} \subset \mathcal{Q}(k_1, \dots, k_n)$ be an arbitrary point. We consider the stratum $\mathcal{Q}(l, r, k_2, \dots, k_n)$ with $l + r = k_1$. Suppose that $l + r = k_1 \neq k_i$ for all $i \geq 2$ and l, r are not both odd. Then there exists an arbitrary small neighborhood U of $[S, \psi]$ in the whole space \mathcal{Q}_g such that*

$$U \cap \mathcal{Q}(l, r, k_2, \dots, k_n)$$

is non-empty and connected.

We have the same type of result for the stratum $\mathcal{Q}(l, r, s, k_2, \dots, k_n)$ with $l + r + s = k_1 \neq k_i$ for all $i \geq 2$ and l, r, s any.

Local connectedness in the neighborhood of the minimal stratum

Following Kontsevich—Zorich (see [KoZo]), we have:

Theorem 6 (Kontsevich, Zorich). *Let $p \in \mathcal{Q}(4g-4)$ be a point in the minimal stratum. Then there exist an arbitrary small neighborhood $U(p)$ of p in the whole space \mathcal{Q}_g such that*

$$U(p) \cap \mathcal{Q}(k_1, \dots, k_n)$$

is non-empty and connected for any k_i with the condition $\sum k_i = 4g - 4$.

We can reformulate the above result in terms of adjacency:

Theorem. *Let $\mathcal{Q}(k_1, \dots, k_n)$ be an arbitrary stratum in genus g . Then there are at most s connected components of this stratum which are adjacent to the minimal stratum $\mathcal{Q}(4g-4)$, where s denote the number of component of the minimal stratum.*

Chapter 5 is devoted to show the connectedness of the minimal stratum in genera higher than 5. Thus, according to above result, Main Theorem 1 is reduced to prove the dichotomy: any component in a stratum in genus $g \geq 5$ is either hyperelliptic or adjacent to the minimal stratum. This is done in Chapter 6.

Chapter 5

The Minimal Stratum $\mathcal{Q}(4g - 4)$

This Chapter is devoted to a particular type of strata, the so-called *minimal* stratum $\mathcal{Q}(4g - 4)$ in genus g . Our goal is to prove that it is connected for all genera $g \geq 5$. The proof is based on induction on $g \geq 3$. The step of induction is given by the following fact: in each connected component of the minimal stratum in genus higher than 4, there exists a flat surface for which we can “erase” a handle. The initialization of the induction is reduced to the proof of the connectedness of the stratum $\mathcal{Q}_{g=5}(16)$, which we establish by a direct argument. The main result of this Chapter is the following

Theorem 7. *Any connected components of the stratum $\mathcal{Q}(4g - 4)$ is describe by the following list:*

- *The stratum $\mathcal{Q}(8)$ in genus 3 is connected.*
- *The stratum $\mathcal{Q}(12)$ in genus 4 possesses two components — corresponding to $\mathcal{Q}^I(12)$ and $\mathcal{Q}^{II}(12)$.*
- *Any other stratum $\mathcal{Q}(4g - 4)$, in genera $g \geq 5$, is connected.*

Here, we prove the above result in a weakly version: for the case $g = 4$: we will show that the stratum possesses *at most* two connected components.

In Appendix, using combinatorics on Rauzy classes, we proved that the stratum $\mathcal{Q}(12)$ is not connected thus it proves the Main classification Theorem for the minimal strata.

In a first section we show the step for the induction. In a second section we prove the main statement.

5.1 Simple cylinder and the minimal stratum

Recall that the minimal stratum $\mathcal{Q}(4g - 4)$ in genus g is non-empty for all genera $g \geq 3$. In Chapter 1, we have described a surgery to “bubbling a handle” on a flat surface. This shows that there are some connected components of $\mathcal{Q}(4g - 4)$ which are “accessible” from a surface in the stratum $\mathcal{Q}(4(g - 1) - 4)$ by “bubbling a handle” at the unique zero of the differential. As in Chapter 4, we would like to classify all connected components of this type. This will give us the step for our main induction. First we give some restrictions to obtain such property. Then, we prove that all connected components in genera higher than 4 are “accessible” by this surgery on a half-translation surface of lower genus. Namely, we will show the

Theorem 8. *Let \mathcal{C} be a connected component of the stratum $\mathcal{Q}(4g - 4)$ in genus $g \geq 4$. Then there exists a flat surface $[S, \psi] \in \mathcal{Q}(4g - 8)$ and an angle parameter s such that the surgery “bubbling a handle” at the unique singularity of ψ in S (with discrete parameter s) gives rise to surfaces belonging in the component \mathcal{C} .*

In other terms, using notations of section 2.4.2, above statements says that the map

$$\begin{aligned} \oplus : \pi_0(\mathcal{Q}_{g-1}(4g - 8)) \times \mathbb{N} &\rightarrow \pi_0(\mathcal{Q}_g(4g - 4)) \\ (\mathcal{C}, s) &\mapsto \mathcal{C} \oplus s := \mathcal{C}' \end{aligned}$$

is onto. Recall that up to consider the complementary angle, s can be choose in $\{1, \dots, 2g - 2\}$.

First we give an independent geometric proof of an analogous result of Kontsevich—Zorich in the particular case of Abelian differential. Then we give the proof in full generality.

5.1.1 Formulation of the statement

According to section 2.4.2, above Theorem is equivalent to the following one:

Theorem. *Let \mathcal{C} be a connected component of the stratum $\mathcal{Q}(4g - 4)$ in genus $g \geq 4$. Then there exists a flat surface $[S, \psi] \in \mathcal{C}$ such that S possesses a multiplicity 1 simple cylinder.*

According to [MaSm], the stratum $\mathcal{Q}(4)$ is empty so that *no* surface in the stratum $\mathcal{Q}(8)$, in genus 3, is obtained from a surface in lower genus by “bubbling a handle”. In other words, for all points $[S, \psi]$ in the minimal stratum $\mathcal{Q}(8)$, if S possesses a simple cylinder, and if $[\gamma]$ denote the separatrix loop which is the boundary of this cylinder, then

$$\text{mult}(\gamma) \geq 2$$

This explain why the genus in the assumptions of the Theorem is assumed to be greater or equal than 4.

As in Chapter 4, the proof of this result is based on the combinatorics of the cylinders given in a completely periodic direction. First we present the idea on the proof. Next we give an independent proof of an analogous result of Kontsevich—Zorich in the particular case of Abelian differential. Then we give the complete proof of above result.

5.1.2 Sketch of the proof

Let (S, ψ) be a point such that the horizontal foliation decompose the surface into a unique cylinder. We denote by π the corresponding generalized permutation. We have to show that (S, ψ) has a multiplicity one simple cylinder.

We recall the main idea discussed in section 2.5.2. Let us assume that π has the following form

$$\pi = \begin{pmatrix} 0 & A \\ 0 & B \end{pmatrix}$$

Then the vertical foliation on $S(\pi, \lambda)$ produces a simple cylinder.

Moreover, if $\hat{\pi}$ is irreducible then one can see that this cylinder has multiplicity 1.

Then we show we can always find a twist on the element of π such that this is done which gives the result. For the next, we restrict the proof of the Theorem to the proof of a combinatorics Proposition.

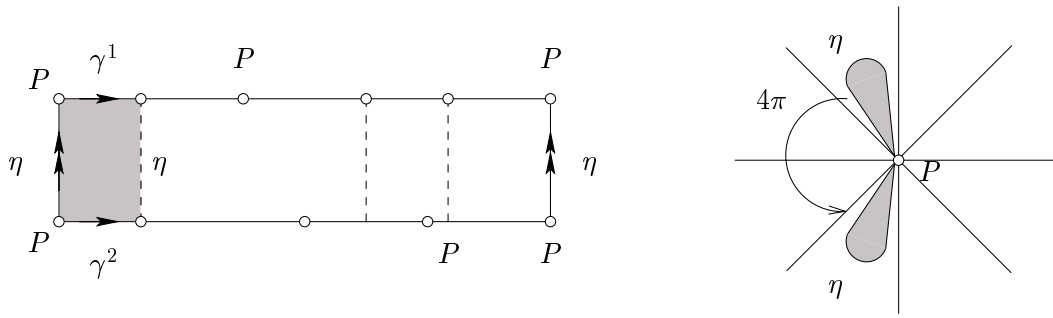

Figure 5.1: Here on the left, the figure represents a flat surface of the form $S(\pi, \lambda)$. In the vertical direction, we can easily see that there is a simple cylinder. The boundary component of this cylinder is η . On the figure on the right, we have represented the diagram of the vertical foliation on S . In this example, the angle of this cylinder is 4π (or 6π is we consider the complementary angle). If the generalized permutation $\hat{\pi}$ is irreducible, one can choose lengths of horizontal parameters in the way that η has multiplicity 1. In this case this surface is obtain from a surface in genus $g - 1$, if $g = \text{genus}(S)$, by “bubbling a handle” (see Figure 1.3).

5.1.3 Proof of the main result of this section

Proof of the main result versus Abelian differentials

In this section we give a proof of the existence of surfaces with a simple cylinder in each connected component of the minimal stratum of *Abelian differentials* $\mathcal{H}(2g - 2)$.

Theorem 9. *Let \mathcal{C} be a connected component of the minimal stratum $\mathcal{H}(2g - 2)$ with $g \geq 2$. Then there exists a surface $[S', \omega'] \in \mathcal{C}$ with a one simple simple cylinder; that is (S', ω') is obtained from a surface (S, ω) in the minimal stratum $\mathcal{H}(2(g - 1) - 2)$ by “bubbling a handle” at the unique zero of the differential ω .*

This result was first proved by Kontsevich and Zorich. Here we give an independent geometric proof using the combinatorics of surfaces with one cylinder. In particular, this proof does not use the notion of Rauzy classes.

We first show a combinatorial Proposition in order to prove the Theorem

Proposition 23. *Let π be a “true” permutation of the group \mathcal{S}_r . We assume that the suspended surface has no marked point that is $\pi(i + 1) \neq \pi(i) + 1$ for all $i = 1, \dots, r$ with the “dummy” condition $\pi(r + 1) := \pi(1)$. Let us also assume that the genus of the surface is greater than 2. It implies in particular that $r \geq 4$.*

Then there exists a permutation π_1 in the class of π for the cyclic order with $\pi_1(1) = 1$ and such that $\hat{\pi}_1$ is irreducible.

Now assuming above Proposition, one can prove the Theorem:

Proof of Theorem 9. Let \mathcal{C} be a connected component of the minimal stratum $\mathcal{H}(2g - 2)$ with $g \geq 2$. Let us take a Jenkins—Strebel surface (S, ω) inside this component.

According to Proposition 23, we can assume that the permutation π which encode the gluing of horizontal sides of the cylinder $S \setminus \Gamma(\omega)$ satisfy

$$\pi(1) = 1 \quad \text{and} \quad \hat{\pi} \text{ is irreducible}$$

Thus Remark 2.5.2 imply that there exists on S a simple cylinder in the vertical direction. In addition $\hat{\pi}$ is irreducible. Applying Corollary 2, we obtain a full Lebesgue measure set of admissible vectors λ such that $S(\pi, \lambda) \in \mathcal{C}$ possesses a multiplicity one simple cylinder (in the vertical direction).

Theorem 9 is proved. \square

Proof of Proposition 23. Let π be a permutation of the set $\{1, \dots, r\}$ with $r \geq 4$. We can always assume, up to a cyclic order, that $\pi(1) = 1$. If $\hat{\pi}$ is irreducible then the Proposition holds with $\pi_1 = \pi$. Thus let us assume that the restrict permutation $\hat{\pi}$ is reducible. Then by definition there exist $2 \leq i_0 < r$ such that

$$\pi(\{2, \dots, i_0\}) = \{2, \dots, i_0\}$$

Let us consider the following new set: $\pi(i_0 + 1, \dots, r) = (A_1 \ r \ A_2)$. With these notations, we have

$$\pi \sim \pi_1 = \begin{pmatrix} r & 1 & 2 & \dots & i_0 & i_0 + 1 & \dots & r - 1 \\ r & A_2 & 1 & \pi(2) & \dots & \dots & \pi(i_0) & A_1 \end{pmatrix}$$

It is easy to see that $A_2 \neq \emptyset$: else the corresponding flat surface $S(\pi_1, \lambda)$ will possess a marked point and we do not consider such flat surfaces. Thus, with this condition, if $\hat{\pi}_1$ is reducible, it is easy to see that the corresponding invariant set $\pi(\{1, \dots, i'_0\}) = \{1, \dots, i'_0\}$ will satisfies the condition $i'_0 \geq i_0 + 1 > i_0$. The set $\{0, \dots, r\}$ is finite, thus the Proposition holds by repeating finitely many times this process.

Proposition 23 is proved. \square

Proof of the main result

We want to prove an analogous result of Proposition 23 on the combinatorics of generalized permutations. The proof is a little technical. First we show a combinatorial Proposition, analogous to Proposition 23, under the technical assumption that permutations π satisfy condition (*) (see section 2.2.6). Then we prove Theorem 8.

Proposition 24. *Let $\pi = \begin{pmatrix} A \\ B \end{pmatrix}$ such that π satisfy the condition (*). In particular we have $\#A = \#B$. Moreover we assume that the flat surface $S = S(\pi, \lambda)$ has no marked points. Let us also assume that $\#A \geq 7$. This imply in particular that the genus of the flat surface $S = S(\pi, \lambda)$ satisfies*

$$\text{genus}(S) = g \geq 4$$

Then π is equivalent (with respect to the cyclic order) to

$$\pi \sim \left(\begin{array}{c|c} 0 & A' \\ \hline 0 & B' \end{array} \right)$$

where $\hat{\pi} = \begin{pmatrix} A' \\ B' \end{pmatrix}$ is irreducible.

We forgot for the moment the proof of the Proposition in order to show the Theorem assuming Proposition 24.

Proof of Theorem 8. Let \mathcal{C} be a connected component of the stratum $\mathcal{Q}(4g - 4)$. If there exists $[S(\pi, \lambda), \psi] \in \mathcal{C}$ such that $\hat{\pi}$ is irreducible then, applying the proof of Theorem 9 we have done. Now the proof of Theorem 8 in full generality is reduced to the two following Lemmas. \square

Lemma 10. *Let \mathcal{C}_0 be a connected component of the minimal stratum $\mathcal{Q}(4g - 4)$. Then there exists a sequence of connected components \mathcal{C}_i for $i = 1, \dots, t$ ($t \geq 0$) of this stratum and a sequence of connected components \mathcal{C}^j for $j = 1, \dots, t$ of the stratum $\mathcal{Q}(k_j, 4g - 4 - k_j)$ (with k_j even) such that*

$$\mathcal{C}_i \cup \mathcal{C}_{i+1} \subset \overline{\mathcal{C}^{i+1}} \quad \text{for all } i = 0, \dots, t - 1$$

In addition, there exists a flat surface $S = S(\pi, \lambda)$ with $[S, \psi] \in \mathcal{C}_t$ and π satisfy the condition ().*

Lemma 11. *Let \mathcal{C}_0 be a connected component of the minimal stratum $\mathcal{Q}(4g - 4)$. Suppose that there exists a component \mathcal{C}_1 of the minimal stratum and a component \mathcal{C} of the stratum $\mathcal{Q}(k, 4g - 4 - k)$ (k even) with*

$$\mathcal{C}_0 \cup \mathcal{C}_1 \subset \overline{\mathcal{C}}$$

Let us also assume that there exists a flat surface $[S, \psi] \in \mathcal{C}_1$ with a simple cylinder of multiplicity 1. Then there also exist a flat surface $[\hat{S}, \hat{\psi}] \in \mathcal{C}_0$ with a simple cylinder of multiplicity 1.

Proof of Lemma 10. Let $[S(\pi, \lambda), \psi] \in \mathcal{C}_0$ be a point. If π satisfies the condition (*) then the Lemma holds. If not, there exists two separatrices γ and η such that γ^i and η^i are present twice in a same side of the cylinder $S \setminus \Gamma(\psi)$. Then, using representatives elements (see Chapter 3), we can break up the unique zero into two zeroes by adding a saddle connection ζ such that ζ^1 and ζ^2 are not in a same side of the cylinder. Applying Remark 2, we can collapse the saddle connection γ to a point to obtain a new surface in the component $\mathcal{C}_1 \subset \mathcal{Q}(4g - 4)$. Now let us remark that the “transition” surface belongs to a component \mathcal{C}^1 of a stratum with two singularities. We have

$$\mathcal{C}_0 \cup \mathcal{C}_1 \subset \overline{\mathcal{C}^1}$$

Repeating inductively this process, Lemma 10 holds. \square

Proof of Lemma 11. Its follows from Proposition 11. \square

Proof of Proposition 24. First of all note that, under the condition (*), a permutation which is weakly irreducible is irreducible.

Recall that a generalized permutation is an ordered partition of $X = \{1, \dots, n + m\}$ into two ordered sets, $X = Y_1 \sqcup Y_2$. In the present thesis we shall always consider only those generalized permutations, for which each of Y_1, Y_2 contains at least one entry of multiplicity two. The permutation satisfy the condition (*) that is each set Y_1, Y_2 contains *exactly* one entry of multiplicity two. Up to re-labeling, we can suppose for the next that the two particular elements are 1 in Y_1 and 2 in Y_2 .

In order to prove this result, we use the representations of π by a tabular. Let π be a generalized permutation of the set $\{1, \dots, n + m\}$. We can always assume, up to a cyclic order, that $\pi(1) = n + 1$. If $\hat{\pi}$ is irreducible then the Proposition holds with $\pi_1 = \pi$. Thus let us assume that the restrict permutation $\hat{\pi}$ is reducible. According to the definition of weakly reducibility, we have a decomposition of $\hat{\pi}$ into the following way

$$\pi = \begin{pmatrix} 0 & A & C \\ 0 & B & D \end{pmatrix}$$

The reducibility of $\hat{\pi}$ involves one of the three following decomposition cases:

1. $\pi(A) = B$
2. $\pi(C) = D$
3. For all $i \in A$, if $i \neq 1$ then $\pi(i) \in B$ else $\pi(i) \in C$.
For all $j \in B$, if $j \neq 2$ then $\pi(j) \in A$ else $\pi(j) \in D$.

In addition, we assume that this decomposition is minimal: we do not have a decomposition into sets A', B', C', D' which are strictly include into the set A, B, C, D . This condition, in the case of “true” permutation, is equivalent to say that i_0 is minimal.

Obviously, in the type (1) and (2) of reducibility we have the result: this is simply the idea discuss in the proof of Proposition 24. The type (1) is a direct consequence of this remark. We can reduce the type (2) to the type (1) as follow. Let us denote the two sets $A = (A_1 \ 3)$ and $B = (B_1 \ 3 \ B_2)$. With this considerations the generalized permutation π is equivalent to the following one

$$\pi \sim \begin{pmatrix} 3 & C & 0 & A_1 \\ 3 & B_2 & D & 0 & B_1 \end{pmatrix}$$

This last one can be reducible but then it is necessarily of type (1).

Thus it remain to consider the type (3) of reducibility of $\hat{\pi}$.

Recall that π , so all permutations equivalent to π , satisfy the condition (*). The generalized permutation $\hat{\pi}$ is reducible and we have

$$1 \in A \text{ and } \pi(1) \in C \quad 2 \in B \text{ and } \pi(2) \in D$$

Let us consider the two sets $C = (C_1 \ 1 \ C_2)$ and $D = (D_1 \ 2 \ D_2)$. With these notations, we have

$$\pi = \left(\begin{array}{cc|ccc} 0 & A & C_1 & 1 & C_2 \\ 0 & B & D_1 & 2 & D_2 \end{array} \right)$$

There is the following dichotomy: either the two sets C_2 and D_2 are empty or one of them is non-empty (say C_2 up to a permutation of lines). In the last case, we can consider the algorithm given in the proof of Proposition 23 to obtain either the result or a permutation with a more restricted combinatorics.

Using this procedure, it is easy to prove that either there is a permutation π_1 in the class of π for the cyclic order such that $\hat{\pi}_1$ is irreducible or the combinatoric of π is given by one of the two following type of permutation (up to a permutation of lines)

$$\left(\begin{array}{cc|cc} 0 & A & C & 1 \\ 0 & B & D & 2 \end{array} \right) \quad \text{and} \quad \left(\begin{array}{cc|ccc} 0 & A & C & 1 & 3 \\ 0 & B & D & 3 & 2 \end{array} \right)$$

Obviously, if the two sets C and D are non-empty, we can repeat this algorithm to obtain either a permutation in the class of π for which the Proposition holds or a permutation with a very restricted combinatorics. Namely, the following Lemma holds

Lemma. *Let π be a generalized permutation which satisfy assumptions of Proposition 24.*

Then either π is equivalent to π_1 and π_1 satisfy to Proposition 24 or the combinatorics of π is given by one of the four following type of permutations

$$\left(\begin{array}{cc|c} 0 & A & 1 \\ 0 & B & 2 \end{array} \right) \left(\begin{array}{cc|cc} 0 & A & 3 & 1 \\ 0 & B & 3 & 2 \end{array} \right) \left(\begin{array}{cc|cc} 0 & A & 3 & 1 \\ 0 & B & 2 & 3 \end{array} \right) \left(\begin{array}{ccc|ccc} 0 & A & & 4 & 3 & 1 \\ 0 & B & & 4 & 2 & 3 \end{array} \right)$$

□

In order to prove Proposition 24, it remains to consider these four type of permutations above. We will consider only the second case. The others are similar and it is an easy exercise.

The main idea is to describe the structure of the sets A et B . For the next of the proof, we will use the same notations not to have too many variables. Namely, we use the notation A, B, C, D to describe the sets A, B .

Let us denote $A = (A_1 \ 1 \ A_2)$ and $B = (B_1 \ 2 \ B_2)$. Not to have too many notations, we declare that A stands for A_1 , B stands for B_1 and C stands for A_2 , D stands for B_2 .

Lemma 12. *Let π be a generalized permutation of the following form*

$$\left(\begin{array}{cccc|cc} 0 & A & 1 & C & 3 & 1 \\ 0 & B & 2 & D & 3 & 2 \end{array} \right)$$

Let us suppose that $\#A + \#C \geq 3$.

Then $\pi \sim \pi_1$ and the generalized permutation $\hat{\pi}_1$ is irreducible.

Proof of Lemma 12. By assumption on the minimality of the decomposition, we have one of the two sets C and D which is non-empty; else $\pi(A) = B$ which contradicts the fact on the minimal invariant set.

Up to a permutation of the lines, we can assume that $C \neq \emptyset$. Let us consider $C = (C_1 \ 4)$ with $\pi(4) \in B \cup D$. For the next of the proof we will forget the index 1; that is C stand for C_1 to simplify the notations.

We will consider the two following cases: the case where $\pi(4) \in B$ and the case where $\pi(4) \in D$.

Case 1. For the first one, we denote the two sets B_1 and B_2 by $B = (B_1 \ 4 \ B_2)$. Thus the permutation π is equivalent to the following one

$$\pi \sim \pi_1 = \left(\begin{array}{cccc|ccc} 4 & 3 & 1 & 0 & A & 1 & C \\ 4 & B_2 & 2 & D & 3 & 2 & 0 & B_1 \end{array} \right)$$

Obviously, the permutation $\hat{\pi}_1$ is reducible if we have $B_2 = D = \emptyset$. On the other hand, if one of the two sets B_2 or D is non-empty, the permutation $\hat{\pi}_1$ can be reducible but the corresponding decomposition is of type (1) and so the Lemma holds. For the case where $B_2 = D = \emptyset$, one can see that π is equal to

$$\pi = \left(\begin{array}{cccc|c|cc} 0 & A & 1 & C & 4 & 3 & 1 \\ 0 & B & 4 & 2 & & 3 & 2 \end{array} \right)$$

(B stands for B_1).

Assumptions on π implies that $\#B \geq 2$. So we can write $B = (B_1 \ 5)$ with $\pi(5) \in A \cup C$. If $\pi(5) \in C$ then we decompose the set C by $C = (C_1 \ 5 \ C_2)$. Obviously, $C_2 \neq \emptyset$: we do not consider surfaces with marked points. Thus, using the same remarks as above, by considering the cyclic order with respect to 5, we obtain the result. If $5 \in A$, we obtain the same conclusion using the fact that $C \neq \emptyset$: it is a consequence of the assumption on the minimality of the invariant set.

Case 2. For the second case, recall that we have $\pi(4) \in D$. We note $D = (D_1 \ 4 \ D_2)$ with $D_2 \neq \emptyset$. Thus the permutation π is equivalent to the following one

$$\pi \sim \pi_2 = \left(\begin{array}{cccccc} 4 & 3 & 1 & 0 & A & 1 & C \\ 4 & D_2 & 3 & 2 & 0 & B & 2 & D_1 \end{array} \right).$$

Obviously, the permutation $\hat{\pi}_2$ is reducible if we have $\pi_2(D_2) \subseteq A$. On the other hand, if we does not have this condition, the permutation $\hat{\pi}_2$ can be reducible but the corresponding decomposition is of type (1) and so the Lemma holds.

Thus, to finish the proof of this case and so the Lemma it remain to consider the case where $\pi_2(D_2) \subseteq A$ and π is equal to

$$\pi = \left(\begin{array}{cccccc} 0 & A & 1 & C & 4 & 3 & 1 \\ 0 & B & 2 & D_1 & 4 & D_2 & 3 & 2 \end{array} \right).$$

As above, D_2 is non-empty and so we can write $D_2 = (D_2 \ 5)$ and $A = (A_1 \ 5 \ A_2)$. Let π_3 be the generalized permutation in the class of π for the cyclic order with respect to the element 5. By direct computation, one can see that if $\hat{\pi}_3$ is reducible, it is of type (1).

This achieve the proof of Lemma 12. \square

In order to prove Proposition 24, it remain to prove the three following Lemma. Proof are analogous to the above so we left them in exercise.

Lemma 13. *Let π be a generalized permutation of the form*

$$\left(\begin{array}{cccc|c} 0 & A & 1 & C & 1 \\ 0 & B & 2 & D & 2 \end{array} \right)$$

Let us suppose that $\#A + \#C \geq 4$. Then $\pi \sim \pi_1$ with π_1 holds for Proposition 24.

\square

Lemma 14. *Let π be a generalized permutation of the form*

$$\left(\begin{array}{cccc|cc} 0 & A & 1 & C & 3 & 1 \\ 0 & B & 2 & D & 2 & 3 \end{array} \right)$$

Then $\pi \sim \pi_1$ with π_1 holds for Proposition 24.

\square

Lemma 15. *Let π be a generalized permutation of the form*

$$\left(\begin{array}{cccc|ccc} 0 & A & 1 & C & 4 & 3 & 1 \\ 0 & B & 2 & D & 4 & 2 & 3 \end{array} \right)$$

Then $\pi \sim \pi_1$ with π_1 holds for Proposition 24.

□

Clearly, Proposition 24 follow from the Lemma which classify the type of combinatorics of π and from Lemma 12, 13, 14 and 15 Thus it achieve the proof of Proposition 24. □

5.2 Connectedness of the minimal stratum

Now we are ready to prove the main statement announced at the beginning of this Chapter; that is Theorem 7. We first prove directly that the stratum $\mathcal{Q}_{g=5}(16)$, and inductively on g , we show that the stratum $\mathcal{Q}(4g - 4)$ for $g \geq 5$ is also connected. The step of induction is given by the previous section.

5.2.1 Initialization of the induction: genera $g = 3, 4, 5$

The genus $g = 3$

First we prove

Lemma 16. *The stratum $\mathcal{Q}(8)$ is connected.*

Proof of Lemma 16. The proof of this Lemma is just based on a calculus.

Let (S, ψ) be a Jenkins—Strebel surface of genus 3, with a unique zero, which is decomposed into a unique cylinder for the horizontal foliation. So that, there is a unique conical singularity on S with a conical angle of 10π . We are going to see that there are few possibilities for the combinatorics of the gluing for the set of horizontal separatrix loops.

Let us denote by π the corresponding generalized permutation. Obviously, there is two possibilities for π : either the number of elements of Y_1 and Y_2 are the same or it is different. We call the set of generalized permutations which satisfy the first condition the class \mathcal{S}_1 and the set of second type of permutations the class \mathcal{S}_2 .

Moreover using the fact that $[S, \psi] \in \mathcal{Q}(8)$, one can see by direct computation for permutations in \mathcal{S}_1 we have $\#Y_1 = Y_2 = 5$ and for permutations in \mathcal{S}_2 we have $\#Y_1 = 7$, $\#Y_2 = 4$ (up to a permutation of lines).

Now we can identify all permutations in the class \mathcal{S}_1 and \mathcal{S}_2 up to the cyclic order and a re-labeling of lines. We find 4 generalized permutations in the class \mathcal{S}_1 and 3 generalized permutations in the class \mathcal{S}_2 (see the following list which gives representatives elements)

$$\begin{pmatrix} 5 & 3 & 5 & 2 & 4 \\ 1 & 2 & 1 & 3 & 4 \\ 5 & 4 & 5 & 2 & 3 \\ 1 & 2 & 1 & 3 & 4 \\ 5 & 4 & 5 & 3 & 2 \\ 1 & 2 & 1 & 3 & 4 \\ 5 & 3 & 5 & 3 & 4 \\ 1 & 2 & 1 & 2 & 4 \end{pmatrix} \quad \begin{pmatrix} 5 & 2 & 5 & 3 & 4 & 2 \\ 1 & 3 & 1 & 4 & & \\ 3 & 5 & 4 & 2 & 5 & 2 \\ 1 & 3 & 1 & 4 & & \\ 5 & 3 & 2 & 5 & 4 & 2 \\ 1 & 3 & 1 & 4 & & \end{pmatrix}$$

We proceed as in the proof of Proposition 19. At the present time, we have just proved that there is at most 7 connected components inside the stratum $\mathcal{Q}(8)$. Now, we consider surfaces $S(\pi, \lambda_0)$ with $\pi \in \mathcal{S}_2$ and with an appropriate admissible vector λ_0 equals to

$$\lambda_0 = (1, 1, 1, 1, 1, 1, 2, 1, 2, 1)$$

We consider the vertical foliation on all surfaces $S = S(\pi, \lambda_0)$ for $\pi \in \mathcal{S}_2$.

One can see that this foliation is completely periodic and decomposes the surface into only one (horizontal) cylinder. Moreover the corresponding permutation, which encodes gluing of the vertical separatrix loop, is contained (up to a cyclic order and a change of lines) in the class \mathcal{S}_1 . Thus it proves that there is at most 4 connected components inside the stratum $\mathcal{Q}(8)$.

Now let us consider all surfaces $S(\pi, \lambda_1)$ with $\pi \in \mathcal{S}_1$ with the admissible vector λ_1 equals to

$$\lambda_1 = (1, 1, 1, 1, 1, 1, 1, 1, 1)$$

Obviously, these surfaces are arithmetics surfaces: the corresponding orientating double covering is a ramified covering over the two-torus with only 1 critical value. We conclude by the fact that all of these arithmetics surfaces belongs in the same $\text{PSL}(2, \mathbb{Z})$ -orbit.

Lemma 16 is proved. □

Now we will consider the two cases corresponding to the strata in genera $g = 4$ and $g = 5$.

The genus $g = 4$

Proof of Theorem 7 in the case $g = 4$. Here we prove that the stratum $\mathcal{Q}(12)$, in genus 4, has at most two components. More precisely, using notations of Chapter 3, we show

$$\mathcal{Q}(12) = \mathcal{Q}^I(12) \cup \mathcal{Q}^{II}(12)$$

In Appendix, we give an argument, namely Rauzy Classes, to show that this union is a *disjoint* union.

Let \mathcal{C}_0 be the unique connected component of the stratum $\mathcal{Q}(8)$ (see Lemma 16). Then, Theorem 8, imply that any component \mathcal{C} of the stratum $\mathcal{Q}(12)$ is of the following form

$$\mathcal{C} = \mathcal{C}_0 \oplus s \text{ with } s = 1, \dots, 2g = 6$$

We recall that by definition, $\mathcal{Q}^I(12) = \mathcal{C}_0 \oplus 2$ and $\mathcal{Q}^{II}(12) = \mathcal{C}_0 \oplus 6$. Let us denote σ_1 the generalized permutation given by Figure 3.7 and σ_2 the generalized permutation given by Figure 3.8. We denote by (S_1, ψ_1) (respectively (S_2, ψ_2)) the suspended flat surfaces over σ_1 (respectively σ_2) and the admissible vector

$$\lambda_0 = (1, 1, 1, 1, 1, 1, 1)$$

With our notations, we have

$$[S_1, \psi_1] \in \mathcal{Q}^I(12) \quad \text{and} \quad [S_2, \psi_2] \in \mathcal{Q}^{II}(12)$$

In the next we consider the cyclic order on permutations σ_1 and σ_2 . Our goal is to present a nice twist on these permutations to obtain a flat surface which possesses (in the vertical direction) a simple cylinder of multiplicity 1 with an angle $k\pi$ ($k = 1, \dots, 6$).

First, we consider the cyclic order on σ_1 with respect to the element 5; that is

$$\sigma_1 = \begin{pmatrix} 1 & 2 & 3 & 4 & 2 & 5 & 6 \\ 1 & 4 & 5 & 7 & 6 & 7 & 3 \end{pmatrix} \sim \sigma_1' = \begin{pmatrix} 5 & 6 & 1 & 2 & 3 & 4 & 2 \\ 5 & 7 & 6 & 7 & 3 & 1 & 4 \end{pmatrix}$$

By direct computation, we see that $S' = S(\sigma_1', \lambda_0)$ possesses (in the vertical direction) a simple cylinder of multiplicity 1. In addition, this cylinder has angle 4π , with respect to the flat metric. In particular, S' and S_1 belongs to the same connected components. In other terms we have proved that

$$\mathcal{C}_0 \oplus 4 = \mathcal{C}_0 \oplus 2 = \mathcal{Q}^I(12)$$

In an equivalent way, using the generalized permutation σ_2 and the cyclic order with respect to the element 5, we show

$$\mathcal{C}_0 \oplus 3 = \mathcal{C}_0 \oplus 6 = \mathcal{Q}^{II}(12)$$

To finish the prove, of the Theorem (in the case $g = 4$) it remains to consider the value 1π and 5π of s . Let us consider the following generalized permutation

$$\sigma = \begin{pmatrix} 1 & 2 & 3 & 4 & 5 & 6 & 5 \\ 1 & 4 & 7 & 3 & 7 & 2 & 6 \end{pmatrix}$$

By direct checking, the cyclic order on σ with respect to the element 1 gives rise to a flat surface with a simple cylinder of multiplicity 1 with an angle of 4π .

For the cyclic order with respect to the element 3 we obtain a cylinder with an angle of π .

For the cyclic order with respect to the element 2 we obtain a cylinder with an angle of 5π .

In others terms

$$\mathcal{C}_0 \oplus 4 = \mathcal{C}_0 \oplus 1 = \mathcal{C}_0 \oplus 5$$

which achieve the proof of Theorem 7 in the case $g = 4$. \square

The genus $g = 5$

Proof of Theorem 7 in the case $g = 5$. Let \mathcal{C}_0 be the unique connected component of the stratum $\mathcal{Q}(8)$ (see Lemma 16). Let $\mathcal{C}_1 = \mathcal{C}_0 \oplus 2 \oplus 2$ be a component of $\mathcal{Q}_{g=5}(16)$.

Our goal is to prove that the stratum $\mathcal{Q}(16)$ is connected. Recall that

$$\mathcal{C}_0 \oplus 2 = \mathcal{Q}^I(12) \quad \text{and} \quad \mathcal{C}_0 \oplus 6 = \mathcal{Q}^{II}(12)$$

Using Theorem 8 we obtain that for any component \mathcal{C}' of the stratum $\mathcal{Q}(16)$, there exists s_0 such that $\mathcal{C}' = \mathcal{C} \oplus s_0$ with \mathcal{C} equals to one of the two components $\mathcal{Q}^I(12)$, $\mathcal{Q}^{II}(12)$ of $\mathcal{Q}(12)$.

Using the properties of the map \oplus (see Chapter 2), one can easily proved that

$$\mathcal{C}_0 \oplus 2 \oplus s = \mathcal{C}_0 \oplus 6 \oplus s = \mathcal{C}_1 \text{ for all } s = 1, \dots, 8$$

which will prove Theorem 7 in the case $g = 5$. \square

5.2.2 Induction on the genus g

Here we prove Theorem 7 in the full generality. The proof is based inductively on the genus g of the surfaces. We use the main result of the previous section (see section 5.1) to obtain the step of induction. We have shown that we can always find a surface, in each connected component of the minimal stratum, with a multiplicity one simple cylinder. Then the Theorem follows from properties of the map \oplus (see section 2.4.2). Now let us discuss details of the proof.

Proof of Theorem 7 in the case $g \geq 6$. Let us fix $g \geq 6$. Let us assume that Theorem 7 is proved for all genera $5 \leq g' < g$ and let us prove it for the genus g ; that is let us prove that the minimal stratum $\mathcal{Q}(4g - 4)$ is connected. Recall that the initialization of the induction is given by section 5.2.1.

Now $g - 1 \geq 5$ so that the minimal stratum in genus $g - 1$ is connected by assumption. Let $\mathcal{C}_0 = \mathcal{Q}(4(g - 1) - 4)$ be the connected component of this stratum. We denote by $\mathcal{C}_1 \subseteq \mathcal{Q}(4g - 4)$ the component obtained by “bubbling a handle” on a surface of \mathcal{C}_0 :

$$\mathcal{C}_1 = \mathcal{C}_0 \oplus 1$$

By Theorem 8, the map

$$\begin{aligned} \oplus : \pi_0(\mathcal{Q}_{g-1}(4g - 8)) \times \mathbb{N} &\rightarrow \pi_0(\mathcal{Q}_g(4g - 4)) \\ (\mathcal{C}, s) &\mapsto \mathcal{C} \oplus s := \mathcal{C}' \end{aligned}$$

is onto. But the stratum $\mathcal{Q}(4(g - 1) - 4)$ is connected and s can be chosen in $\{1, \dots, 2g - 2\}$ (up to consider the complementary angle). Thus we obtain a surjective map

$$\oplus : \{1, \dots, 2g - 2\} \rightarrow \pi_0(\mathcal{Q}_g(4g - 4))$$

Our goal is to show $\mathcal{C}_0 \oplus s = \mathcal{C}_1$ for any s which will prove the Theorem.

Always by Theorem 8, there exists r_0 such that

$$\mathcal{C}_0 = \mathcal{C}'_0 \oplus r_0$$

with \mathcal{C}'_0 a component of the stratum $\mathcal{Q}(4(g - 2) - 4)$ (which is non-empty because $g - 2 \geq 3$). Recall that the stratum $\mathcal{Q}(4(g - 1) - 4)$ is connected so we also have

$$\mathcal{C}'_0 \oplus r = \mathcal{C}_0 \quad \text{for any } r \tag{5.1}$$

Using above equation (5.1) and properties of the map \oplus , we conclude that

$$\mathcal{C}_0 \oplus r = \mathcal{C}'_0 \oplus s \oplus r = \mathcal{C}'_0 \oplus r \oplus s = \mathcal{C}_0 \oplus s \quad \text{for any } r, s$$

Taking $r = 1$, we obtain the desired relation.

Theorem 7 is proved. □

Chapter 6

General Classification

In this Chapter, we give the complete description of the set of connected component of any stratum inside the moduli space of quadratic differentials. This corresponds to Main Theorem 1 and Main Theorem 2. First of all, we consider the description of components in genera higher than 5 which corresponds to the “general” case. Then we describe the list of component in small genera; that is $1 \leq g \leq 4$, where some components are missing in comparison to the general case and some “exceptional” components appear.

The scheme of the proof is the following. It uses results of Chapter 4 and Chapter 5. In the general case ($g \geq 5$), the minimal stratum $\mathcal{Q}(4g - 4)$ is non-empty (see [MaSm]). We show that any connected component of an arbitrary stratum in genus g is either hyperelliptic or adjacent to the minimal stratum. Then Theorem 6 gives an upper bound on the number of non-hyperelliptic component on each stratum. We conclude using the complete description of the set of hyperelliptic component (see [La1]).

In order to proof Main Theorem 2, we essentially follow the same way as above but it is more technical. We consider several case depending the multiplicities of the singularities.

6.1 Paths inside the moduli space

In this section, we describe precisely the adjacency of some strata of the moduli spaces. We show that a non-hyperelliptic (or non-irreducible) connected component which is adjacent to a hyperelliptic connected component or an irreducible connected component is also adjacent to a non-hyperelliptic (or non-irreducible) connected component. For proving this fact, we give some explicit continuous path inside the whole moduli space by using explicit permutations.

6.1.1 Case of hyperelliptic connected components

Case of two singularities

We have construct a surface in the hyperelliptic connected component of the stratum $\mathcal{Q}(4k + 2, 4(g - k) - 6)$ using the permutation $\Pi_1(2k + 1, 2(g - k) - 3)$ (see Chapter 3). Here we explicitly present a continuous locally deformation of this surface inside the stratum $\mathcal{Q}(k_1, k_2, 4(g - k) - 6)$ with $k_1 + k_2 = 4k + 2$ and k_1, k_2 any even integers. We first prove a combinatorial Lemma and then the main statement.

Lemma 17. *Let a be an even integer with $2 \leq a \leq r + 1$. We choose $r = 2k + 1$ and $l = 2(g - k) - 3$. We consider the half translation surface (S, ψ) given by suspension over the following generalized permutation*

$$\pi_1(r, l, a) = \begin{pmatrix} 0_1 & 0_3 & 1 & \dots & r & 0_1 & r+1 & \dots & r+l \\ r+l & \dots & r+1 & 0_2 & r & \dots & a & 0_3 & a-1 & \dots & 1 & 0_2 \end{pmatrix}$$

Then

$$[S, \psi] \in \mathcal{Q}(a - 2, 4k + 4 - a, 4(g - k) - 3)$$

Proof. It is obvious. □

Then we have the following

Proposition 25. *Let $[S, \psi] \in \mathcal{Q}^{hyp}(k, k')$ be a point (necessarily $k = k' = 2$ modulo 4). Let k_i be any even positives integers with $k_1 + k_2 = k$. Then there exists a continuous path $\rho : [0, 1] \rightarrow \mathcal{Q}_g$ of $[0, 1]$ into the whole space \mathcal{Q}_g with $4g - 4 = k + k'$ such that*

- $\rho(0) = [S, \psi]$
- $\rho(t) \in \mathcal{Q}(k_1, k_2, k')$ for all $0 < t < 1$.
- $\rho(1) \in \mathcal{Q}(k, k') \setminus \mathcal{Q}^{hyp}(k, k')$.

Proof. Taking $a = k_1 + 2$ and applying Lemma 17, the statement follows. □

Case of three singularities

We can prove similar results for hyperelliptic strata with three and four singularities by using explicit representatives elements with corresponding generalized permutations.

6.1.2 Case of irreducible connected components

We prove similar results for irreducible connected components. More precisely, we prove that if a connected component \mathcal{C} , which is non-hyperelliptic and non-irreducible, is adjacent to the irreducible connected component of the stratum $\mathcal{Q}(-1, 9)$ then it is also adjacent to the minimal stratum. Namely, we have

Proposition 26. *Let $[S, \psi] \in \mathcal{Q}^{irr}(-1, 9)$ be a point. Let k_1, k_2 be any integers with $k_1 \in \{-1, 1, 2, 4\}$ and $k_1 + k_2 = 9$. Then there exists a continuous path $\rho : [0, 1] \rightarrow \mathcal{Q}_{g=3}$ of $[0, 1]$ into the whole space such that*

- $\rho(0) = [S, \psi]$
- $\rho(t) \in \mathcal{Q}(-1, k_1, k_2)$ for all $0 < t < 1$.
- $\rho(1) \in \mathcal{Q}(-1, 9) \setminus \mathcal{Q}^{irr}(-1, 9)$.

Proof. We use explicit generalized permutations as Lemma 17. □

We also have an analogous result for stratum $\mathcal{Q}(-1, 3, 3, 3)$.

6.2 Main Theorem 1

Let us fix $g \geq 5$. In this section, we prove that any non-hyperelliptic connected component in any stratum in \mathcal{Q}_g is adjacent to the minimal stratum. Note that this restriction on the set of non-hyperelliptic connected component is necessary (see Proposition 15).

Proposition 27. *Let us fix $n \geq 2$. Let $\mathcal{C} \subset \mathcal{Q}(k_1, \dots, k_n)$ be a connected component of a stratum in genus $g \geq 5$. We assume that \mathcal{C} is not an hyperelliptic connected component (when it has a sense). Then there exists $\mathcal{C}_0 \subseteq \mathcal{Q}(4g - 4)$ a connected component such that*

$$\mathcal{C}_0 \subset \bar{\mathcal{C}}$$

Now, assuming above Proposition, we are ready to prove our Main result:

Proof of Main Theorem 1. Let $\mathcal{Q}(k_1, \dots, k_n)$ be an arbitrary stratum in genus $g \geq 5$. If $n = 1$ then the Main Theorem follows from Theorem 7. So let us assume that $n \geq 2$. By Proposition 27, the set of non-hyperelliptic components of this stratum is adjacent to the minimal one. Using Theorem 7 and Theorem 6 we conclude that there is at most 1 non-hyperelliptic component.

Thus any stratum which have no hyperelliptic component is connected and any stratum which have a hyperelliptic component has at most two components.

We conclude by the fact that in genera higher than 5, any stratum which contains an hyperelliptic component is non-connected (see [La1]).

Main Theorem 1 is proved. □

It remains to obtain the main classification result in genera higher than 5 to prove Proposition 27.

Proof of Proposition 27. We consider several cases, following the different values of n , the number of singularities. First we prove the Proposition in the particular cases $n = 2, 3, 4$. Then we prove it in the general case $n \geq 5$.

First of all, let us remark that the case $n = 2$ is given by Theorem 5.

Then let us consider the stratum $\mathcal{Q}(k_1, k_2, k_3)$. We consider different cases following the parity of k_i . Note that the case of the stratum $\mathcal{Q}(-1, -1, 4g - 2)$ is also given by Theorem 5. Let \mathcal{C} be a connected component of this stratum.

First, let us assume that (up to a permutation of k_i) k_2, k_3 are odd and k_1 even. If \mathcal{C} is non-hyperelliptic, Corollary 4 implies that this component is adjacent to a component of the stratum $\mathcal{Q}(k_1 + k_i, k_j)$ with $\{k_i, k_j\} = \{k_2, k_3\}$. According to Theorem 1 this stratum have not a hyperelliptic component (k_j is odd) so Theorem 5 implies that \mathcal{C} is adjacent to the minimal stratum.

Secondly, let us assume that all k_i are even. We choose $k_1 = \max\{k_i\}$. Corollary 4 implies that this component is adjacent to a component of the stratum $\mathcal{Q}(k_1 + k_i, k_j)$ with $\{k_i, k_j\} = \{k_2, k_3\}$. If this stratum has not a hyperelliptic component, we have done. If not then we can assume that \mathcal{C} is adjacent to a hyperelliptic component (if not, we have also done). Proposition 25 and Proposition 22 show that we can joint this hyperelliptic

component to a non-hyperelliptic component through the component \mathcal{C} which conclude the proof in the case $n = 3$.

The proof of Proposition 27 in the case $n = 4$ is similar to the previous one.

Now let us prove the Proposition for all $n \geq 5$. According to [La1], a stratum $\mathcal{Q}(k_1, \dots, k_n)$ which contains an hyperelliptic connected component must satisfy $n \leq 4$. Thus if we prove the Proposition for $n = 5$, by transitivity of the property adjacency, we have done for *all* arbitrary values of $n > 5$.

The proof for $n = 5$ follows of the main result of Chapter 4. Recall that we have proved (see Theorem 5) any component is either hyperelliptic or adjacent to a lower dimensional stratum.

Let \mathcal{C} be a connected component of the stratum $\mathcal{Q}(k_1, \dots, k_5)$. We choose $k_1 = \max\{k_i\}$. So \mathcal{C} is adjacent to a connected component of the stratum

$$\mathcal{Q}(k_1 + k_i, k_2, \dots, \hat{k}_i, \dots, k_5) \quad (6.1)$$

Now, if this stratum has not an hyperelliptic connected component, \mathcal{C} is adjacent to a non-hyperelliptic connected component and so the result follows from the study of the case $n = 4$. If the stratum (6.1) contains a hyperelliptic connected component then in the stratum $\mathcal{Q}(k_1, \dots, k_5)$, there exists a zero of order $k_1 + k_i$. Recall that k_1 has been defined by the max of all k_i thus it implies that $k_i = -1$.

Now, using Theorem 4, we conclude that \mathcal{C} is adjacent to a connected component of the stratum

$$\mathcal{Q}(k_1 - 1 + k_j, k_2, \dots, \hat{k}_j, \dots, k_5)$$

This stratum has no a hyperelliptic component so \mathcal{C} is adjacent to the minimal stratum. Proposition 27 is proved. \square

6.3 Main Theorem 2

It remains to prove Main Theorem 2 to establish the complete classification of components of the strata. Here we consider particular small values of g . The genus $g = 0$ is given by Proposition 2. So we treat cases $g = 1, 2, 3, 4$. For genera 3 and 4, we prove an analogous Proposition of the previous section on the adjacency of the strata. There is some additional condition: some “exceptionnal” components comparing to the general case.

Proposition 28. *Let n be greater or equals 2. Let $\mathcal{C} \subset \mathcal{Q}(k_1, \dots, k_n)$ be a connected component of a stratum in genus $g = 3$ or 4. We assume that \mathcal{C} is not an hyperelliptic component neither one of the three components given by the list*

$$\mathcal{Q}^{irr}(-1, 9) \quad \mathcal{Q}^{irr}(-1, 3, 6) \quad \mathcal{Q}^{irr}(-1, 3, 3, 3) \quad \text{in genus } g = 3$$

Then there exists $\mathcal{C}_0 \subseteq \mathcal{Q}(4g - 4)$ a connected component such that

$$\mathcal{C}_0 \subset \bar{\mathcal{C}}$$

Note that as above, Main Theorem 2 in genera 3 and 4 follows from above Proposition. There is some additional cases to discuss providing to the fact that $\mathcal{Q}(12)$ is not connected.

Proof of Proposition 28. The proof is similar to the proof of Proposition 27. Particulars cases follow from Proposition 26. \square

Proof of Main Theorem 2. The proof in the case $g = 3, 4$ is given by Proposition 28. Here we just consider the two last cases, that is genus 1 and genus 2.

In genus 1, the projection of a Teichmüller disc of a point in the moduli space of curves is the whole space $\mathbb{H}^2/\mathrm{PSL}(2, \mathbb{Z})$. Thus it is sufficient to prove that the stratification given by the type of singularities on the set of meromorphic quadratics differentials on a *particular* surface is connected. For instance, one can consider the standard torus \mathbb{C}/\mathbb{Z}^2 . Obviously, the space of meromorphic quadratics differentials on the two torus is one-to-one with the space of doubly periodic meromorphic functions on the complex plane (doubly periodic with respect to the lattice \mathbb{Z}^2). It is a classical result that the stratification given by the type of singularities produces connected strata.

The minimal stratum in genus 2 does not exist; that is *all* quadratic differential on a curve of genus 2 with a single zero is automatically the global square of an Abelian differential. Nevertheless, we can prove a result analogous to Proposition 27: any connected components of any stratum of the moduli space $\mathcal{Q}_{g=2}$ different from

$$\mathcal{Q}^{hyp}(-1, -1, 6) \quad \text{and} \quad \mathcal{Q}^{hyp}(-1, -1, 3, 3)$$

is adjacent to one of the two following strata

$$\mathcal{Q}(-1, 5) \quad \text{or} \quad \mathcal{Q}(2, 2)$$

There is finitely many cases to consider. Using results on local connectedness and explicit paths between the strata (see Chapter 4), we can prove that all strata which are adjacent to one of the two above components are connected. In [La1], we prove that that $\mathcal{Q}(-1, -1, 6)$ and $\mathcal{Q}(-1, -1, 3, 3)$ are not connected thus it follows that they possess precisely two components. Main Theorem 2 is proved. \square

Chapter 7

Appendix

7.1 Spin Structure

The invariant, that classifies non-hyperelliptic connected components of the moduli spaces of Abelian differentials with prescribed singularities, is the *parity of the spin structure* (see [KoZo]). We show that in the case of quadratic differentials the spin structure is constant on every stratum where it is defined. This disproves a conjecture of Kontsevich—Zorich that it classifies the non-hyperelliptic connected components of the moduli spaces of quadratic differentials with prescribed singularities. Moreover we give an explicit formula for the parity of the spin structure.

7.1.1 Spin Structure Defined by an Abelian Differential

We remind first the algebraic-geometric definition of the *spin structure* given by an Abelian differential, see M. Atiyah [At]; see also [KoZo]; see D. Johnson [Jo] for a topological definition.

Let ω be a 1-form with only even singularities. There are 2^{2g} solutions of the equation $2D = K(\omega)$ in the divisor group where $K(\omega)$ is the canonical divisor determined by ω . A spin structure is the choice of D in the Picard group $\text{Pic}(S)$ of S . For an Abelian differential with only even zeros, one can write

$$K(\omega) = 2k_1P_1 + \cdots + 2k_nP_n$$

With these notation, we declare that the spin structure defined by the form ω on the complex curve S is just the divisor $D = k_1P_1 + \cdots + k_nP_n$. Thus a point $[S, \omega]$ gives *canonically* a spin structure.

7.1.2 Parity of a spin structure

The dimension of the linear space $|D|$ may have quite different values for different choice of D . For example, in genus 1, the dimension of the space given by the three solutions different from 0 have non-zero dimension. We declare that the dimension modulo 2 of this linear space is the parity of the spin structure D and we denote it by $\Phi(D)$. On a curve of genus $g \geq 1$, M. Atiyah [At] proved that there are $2^{g-1}(2^g + 1)$ odd structure spin and $2^{2g} - 2^{g-1}(2^g + 1)$ even structure spin.

7.1.3 Spin structure on a deformed curve

According the result of M. Atiyah [At] and D. Mumford [Mu], the dimension of the linear space $|D(\omega)|$ modulo 2 is invariant under continuous deformations of the Abelian differential ω inside the corresponding stratum, and hence, it is constant for every connected component of any stratum, where it is defined.

7.1.4 Spin Structure Defined by a Quadratic Differential

Let $\hat{\pi} : \hat{S} \rightarrow S$ be the orientating covering. We denote by $\hat{\omega}^2 = \hat{\pi}^*\psi$ the pull-back. The parity of spin structure of ψ is the parity of the spin structure determined by ω

$$\Phi(\psi) \stackrel{\text{Def}}{=} \Phi(\hat{\omega})$$

One can see that the parity of the spin-structure is well defined.

According to these notations, we have

Main Theorem 4. *Let ψ be a meromorphic quadratic differential on a Riemann surface S with singularity pattern $\mathcal{Q}(k_1, \dots, k_l)$. Let n_{+1} be the number of zeros of ψ of degrees $k_i = 1 \pmod{4}$, let n_{-1} be the number of zeros of ψ of degrees $k_j = 3 \pmod{4}$, and suppose that the degrees of all the remaining zeros satisfy $k_r = 0 \pmod{4}$.*

Then the parity of the spin structure defined by ψ is given by

$$\Phi(\psi) = \left[\frac{|n_{+1} - n_{-1}|}{4} \right] \pmod{2}$$

where square brackets denote the integer part.

Proof of 4. See [La2]. □

7.2 Suspension over an interval exchange map

7.2.1 Zippered rectangles (After Veech)

Having an interval exchange transformation $T : I \rightarrow I$ one can “suspend” a flat surface S endowed with an Abelian differential ω over T . Here we present the idea of such “suspension”; one can find all the details in the paper of W.A.Veech [V1]. See also a nice Figure of this construction in [KoZo].

Place the interval I horizontally in the plane \mathbb{C} . Place a rectangle R_i over each subinterval $I_i \subset I$; the rectangle R_i has the width $\lambda_i = |I_i|$ and some altitude h_i . Later on we shall pose some restrictions on the altitudes. Glue the top horizontal side of rectangle R_i to the interval $T(I_i)$ at the base. There are still no identifications between the vertical sides of the rectangles, so we get a Riemann surface with several “holes”; each boundary component is a union of the vertical sides of the rectangles. Now start “zipping” the holes. If the altitudes h_i of the rectangles, and the altitudes a_i till which we “zipper” the rectangles obey some linear equations and inequalities (see [V1]), then we manage to eliminate all the holes. The Riemann surface thus constructed has natural flat structure with cone-type singularities;

the complex structure, coming from the initial complex structure on the plane \mathbb{C} , extends to the conical points. The Abelian differential ω is locally represented as dz , where z is the standard coordinate in \mathbb{C} .

As we already mentioned the altitudes h_i , and a_i obey some linear relations; it is proved in [V1] that the family of solutions is always nonempty. This family has dimension $m = 2g + k - 1 = \dim H^1(S_g, \{\text{zeroes of } \omega\})$, which coincides with the number m of subintervals under exchange, $\pi \in \mathcal{S}_m$.

7.2.2 Second construction (After Masur)

Here we present a nice construction, due to Masur (see [Ma1]), analogous to the previous one. Having an interval exchange transformation $T : I \rightarrow I$ one can “suspend” flat surface S endowed with an Abelian differential ω over T .

Recall that an irreducible permutation π is a permutation of the set $\{1, \dots, n\}$ such that

$$\pi(\{1, \dots, k\}) \neq \{1, \dots, k\} \quad \text{for all } k < n$$

Obviously, this condition is equivalent to

Lemma. *The permutation π is irreducible if and only if*

$$\sum_{i=1}^k (\pi(i) - i) > 0 \quad \text{for all } 1 \leq k < n \quad (7.1)$$

Let T be an interval exchange transformation on the segment $I = (0; 1)$ with corresponding parameters (π, λ) . Let us assume that π is irreducible and $\sum \lambda_i = 1$. We consider the $2n$ -gon in \mathbb{R}^2 given by its vertex (the segment I is located on the horizontal axe)

$$(0, 0) \quad \left(\sum_{i=1}^k \lambda_i ; \sum_{i=1}^k (\pi(i) - i) \right) \quad (1, 0)$$

and

$$\left(\sum_{i=1}^k \lambda_i ; \sum_{i=1}^k (\pi^{-1}(i) - i) \right)$$

According to formula (7.1), the polygon is well defined. We denote it by $P(\pi, \lambda)$. Thus we have the following obvious

Lemma. *The opposite edges of the polygon $P(\pi, \lambda)$ are parallel and of equal lengths.*

We can glue by translation all edges to obtain a Riemann surface S endowed with an Abelian differential $\omega = dz$. The singularities are located at the vertices of the polygon. One can see that the first return map of the vertical flow of ω on the interval $(0; 1)$ on S gives the initial transformation T .

Remark 9. This construction has been rediscovered by Veech in the hyperelliptic case.

7.3 Rauzy classes

In this section, using combinatorics, namely, Rauzy classes, we present some particular non-connected strata (see [Zo1] and [Zo2] for details). These strata are precisely those exceptional strata which are non-connected and which do not possess an hyperelliptic component. Permutations given in this section are different from permutations presents in Chapter 2. Permutations in Chapter 2 encode the gluing of the horizontal sides of a straight metric cylinder. In this section, all permutations are considered as the coding of the “first return map” of the minimal vertical foliation on a transversal. In our cases, our foliation is not oriented, thus we must pass to the double covering to obtain a notion of flow. The main result of this section is to prove

Proposition. *The four following strata*

$$\begin{aligned} \text{in genus 3 : } & \mathcal{Q}(-1, 9) & \mathcal{Q}(-1, 3, 6) & \mathcal{Q}(-1, 3, 3, 3) \\ \text{in genus 4 : } & \mathcal{Q}(12) \end{aligned}$$

are not connected.

Proof of the Proposition. The proof used combinatorics on Rauzy classes. For each above stratum, we consider a flat surface. The “first return map” on an interval inside this particular surface produces an linear involution, parametrized by a collection of intervals and a generalized permutation (see [DaNo]). We denote this permutation by π_1 . Then we compute the *extend Rauzy class* $\mathcal{R}(\pi_1)$ corresponding to π_1 and we give an explicit element π_2 such that $\pi_2 \notin \mathcal{R}(\pi_1)$ and an explicit surface in the same initial stratum such that the “first return map” on a transversal gives an linear involution, parametrized by the permutation π_2 .

For instance, we treat the last case: the stratum $\mathcal{Q}(12)$. The us consider the two following permutations

$$\pi_1 = \begin{pmatrix} 8 & 4 & 1 & 6 & 3 & 7 & 2 & 6 \\ 7 & 5 & 1 & 3 & 5 & 8 & 2 & 4 \end{pmatrix} \quad \pi_2 = \begin{pmatrix} 8 & 4 & 1 & 6 & 3 & 2 & 6 & 7 \\ 7 & 5 & 1 & 3 & 5 & 2 & 4 & 8 \end{pmatrix}$$

Using an analogous construction of Veech, namely Zippered Rectangles, (see section 7.2), we can check that flat surfaces (S_1, ψ_1) and (S_2, ψ_2) given by suspension over these two permutations are flat surfaces inside the stratum $\mathcal{Q}(12)$. Moreover we can choose the length of the corresponding horizontal intervals to be 1 to obtain surfaces with a vertical simple cylinder of multiplicity 1. By direct computation of angle of this cylinder, we obtain (according to the notation of Chapter 3)

$$[S_1, \psi_1] \in \mathcal{Q}^I(12) \quad \text{and} \quad [S_2, \psi_2] \in \mathcal{Q}^{II}(12)$$

By direct computation of the corresponding Rauzy classes, one can see that

$$\pi_2 \notin \mathcal{R}(\pi_1)$$

In particular, this prove that $\mathcal{Q}^I(12)$ and $\mathcal{Q}^{II}(12)$ are two *disjoint* connected components of the stratum $\mathcal{Q}(12)$.

We can prove the same fact for special strata in genus 3. For example, for the stratum $\mathcal{Q}(-1, 9)$ we consider the two permutations

$$\pi_3 = \begin{pmatrix} 2 & 6 & 5 & 4 & 7 & 7 & 3 \\ 1 & 6 & 3 & 4 & 2 & 5 & 1 \end{pmatrix} \quad \pi_4 = \begin{pmatrix} 7 & 2 & 4 & 5 & 1 & 5 & 6 \\ 7 & 3 & 3 & 4 & 1 & 2 & 7 \end{pmatrix}$$

We can check that the second permutation give rise surfaces inside the irreducible connected component $\mathcal{Q}(-1, 9)^{irr}$ of the stratum $\mathcal{Q}(-1, 9)$ (the vertical foliation give rise to a simple cylinder with an angle of 6π).

Stratum	Irreducible component	Non-irreducible component
$\mathcal{Q}(-1, 9)$	$\begin{pmatrix} 7 & 2 & 4 & 5 & 1 & 5 & 6 \\ 6 & 3 & 3 & 4 & 1 & 2 & 7 \end{pmatrix}$	$\begin{pmatrix} 2 & 6 & 5 & 4 & 7 & 7 & 3 \\ 1 & 6 & 3 & 4 & 2 & 5 & 1 \end{pmatrix}$
$\mathcal{Q}(-1, 3, 6)$	$\begin{pmatrix} 1 & 1 & 2 & 3 & 2 & 3 & 4 & 5 \\ 4 & 6 & 5 & 6 & 7 & 8 & 7 & 8 \end{pmatrix}$	$\begin{pmatrix} 1 & 2 & 2 & 3 & 4 & 3 & 4 & 5 \\ 6 & 1 & 7 & 8 & 6 & 7 & 5 & 8 \end{pmatrix}$
$\mathcal{Q}(-1, 3, 3, 3)$	$\begin{pmatrix} 1 & 1 & 2 & 3 & 4 & 5 & 6 & 7 & 6 \\ 7 & 8 & 5 & 8 & 2 & 4 & 9 & 3 & 9 \end{pmatrix}$	$\begin{pmatrix} 1 & 1 & 2 & 3 & 2 & 3 & 4 & 5 & 6 \\ 4 & 7 & 8 & 9 & 7 & 8 & 6 & 5 & 9 \end{pmatrix}$
$\mathcal{Q}(12)$	$\begin{pmatrix} 8 & 4 & 1 & 6 & 3 & 7 & 2 & 6 \\ 7 & 5 & 1 & 3 & 5 & 8 & 2 & 4 \end{pmatrix}$	$\begin{pmatrix} 8 & 4 & 1 & 6 & 3 & 2 & 6 & 7 \\ 7 & 5 & 1 & 3 & 5 & 2 & 4 & 8 \end{pmatrix}$

Table 7.1: Special strata.

In the tabular 7.1 we have present generalized permutations (in terms of Rauzy) which produces surfaces in the “special” stratum. For each stratum, one can check that the Rauzy classes are disjoint, which prove the Proposition.

□

7.4 Examples of measured foliations on surfaces

7.4.1 An Example of arithmetic surfaces

[Private communication with M.Schmoll]

For this section, we refer to [Sc2]. Let us consider the standard 2-torus $S = \mathbb{C}/\mathbb{Z}^2$. We also consider the following set P of points inside S

$$(0, 0) \quad (1/2, 1/2) \quad (1/2, 0) \quad (0, 1/2)$$

The Veech group of S is $SL(2, \mathbb{Z})$. Obviously, the set P is preserved by the Dehn-Twist and by the rotation thus the Veech group of the flat surface with *marked points* (S, P) is still $SL(2, \mathbb{Z})$. In the vertical direction, the surface decompose into two cylinders, thus also in all periodic direction (there is only 1 cusp for the Teichmüller disc). One can consider a ramified covering

$$\pi : S_1 \longrightarrow S$$

of arbitrary degree such that the set consisting of critical values is equal to the set P . Then the flat surface $(S_1, \omega = \pi^* dz)$ is a translation surface with no marked points. By construction it is an arithmetic surface. One can check that in all periodic direction, there is a decomposition into at least two straight cylinders (In any direction the number of cylinders on S_1 is at least the number of cylinders on S in the same direction).

7.4.2 Measured foliations and transverse measured foliations

In this section, we present an example of a measured foliation, on a surface of genus 2, with four simple zeroes which does not admit a transverse measured foliation. Note that this example does not enter in our context (see [HuMa]).

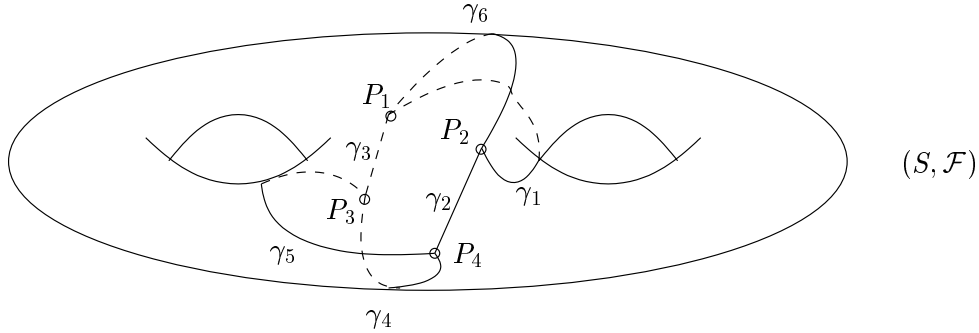

Figure 7.1: A measured foliation \mathcal{F} on a Riemann surface of genus 2. This foliation has four simple zeroes: at each singularity P_i , there are three emanating saddle connections.

The measured foliation given in Figure 7.1 does not admit a transverse measured foliation.

Proof. Let us assume that there is a transverse measured foliation \mathcal{F}' to \mathcal{F} . Then there exist also a transverse measure for \mathcal{F}' ; that is a measure defined on leaves of \mathcal{F} . We denote by l_i the length of the saddle connections γ_i with respect to this measure. In the direction of \mathcal{F} , the surface decomposes into two metric cylinders. In comparing the perimeter of each cylinder, we obtain

$$l_1 + l_6 = l_1 + l_2 + l_3 + l_4 \quad \text{for the first cylinder}$$

$$l_4 + l_5 = l_2 + l_3 + l_5 + l_6 \quad \text{for the second cylinder}$$

We conclude that $l_2 = l_3 = 0$ which leads to a contradiction (the length of a leaf is strictly positive). \square

Note that the measured foliation \mathcal{F}_1 obtained by collapsing the two saddle connections γ_2, γ_3 to a point possesses two zeroes of order 2. Obviously there exist a transverse foliation to \mathcal{F}_1 . Thus it determines a point inside the stratum $\mathcal{H}(1, 1)$.

Bibliography

- [At] M. Atiyah, *Riemann surfaces and spin structures*, Ann. Sci. École Norm. Sup. **4** (1971), 47–62.
- [Cala] E. Calabi, *An intrinsic characterization of harmonic 1-forms*, Global Analysis, Papers in Honor of K.Kodaira, (D.C.Spencer and S.Iyanaga, ed.), (1969), 101–117.
- [Calt] K. Calta, *Veech surfaces and complete periodicity in genus 2*, (2003), to appear.
- [DaNo] C. Danthony, A. Nogueira *Measured foliations on nonorientable surfaces*. Ann. Sci. École Norm. Sup. **23**, (1990).
- [DoHu] A. Douady, J. Hubbard, *On the density of Strebel differentials*, Inventiones Mathematicae, **30**, (1975), 175–179.
- [EsMa] A. Eskin, H. Masur, *Asymptotic formulas on flat surfaces*, Ergodic Theory and Dynamical Systems, **21:2**, (2001), 443–478.
- [EsMaZo] A. Eskin, H. Masur, A. Zorich, *Moduli Spaces of Abelian Differentials: The Principal Boundary, Counting Problems and the Siegel—Veech Constants*, (2003), to appear.
- [EsOk] A. Eskin, A. Okounkov. *Asymptotics of number of branched coverings of a torus and volumes of moduli spaces of holomorphic differentials*, Inventiones Mathematicae, **145:1**, (2001), 59–104.
- [EsOk2] A. Eskin, A. Okounkov. *Volumes of moduli spaces of quadratic differentials*, in progress.
- [FaLaPo] A. Fathi, F. Laudenbach, V. Poenaru. *Travaux de Thurston sur les surfaces*, Astérisque, **66–67**, (1979).
- [GuJu] E. Gutkin, C. Judge. *Affine mappings of translation surfaces: geometry and arithmetic*. Duke Math. J., **103** no. 2, (2000), 191–213.
- [HuLe] P. Hubert, S. Lelièvre, *Square tiled surfaces*, preprint, (2003).
- [HuMa] J. Hubbard, H. Masur, *Quadratic differentials and foliations*, Acta Math. **142** (1979), 221–274.
- [Jo] D. Johnson. *Spin structures and quadratic forms on surfaces*, J. London Math. Soc. (2) **22** (1980), 365–373.

- [Ka] A. B. Katok. *Invariant measures of flows on oriented surfaces*, Soviet Math. Dokl., **14**, (1973), 1104–1108.
- [KaZe] A. Katok, A. Zemlyakov. *Topological transitivity of billiards in polygons*. Math. Notes, **18**, (1975), 760–764.
- [Ke] M. Keane. *Interval exchange transformations*, Math. Z. **141** (1975), 25–31.
- [KeMaSm] S. Kerckhoff, H. Masur, J. Smillie. *Ergodicity of Billiard Flows and Quadratic Differentials*. Ann. of Math., **124**, (1986), 293–311.
- [Ko] M. Kontsevich, *Lyapunov exponents and Hodge theory*. “The mathematical beauty of physics” (Saclay, 1996), (in Honor of C. Itzykson) 318–332, Adv. Ser. Math. Phys., **24**, World Sci. Publishing, River Edge, NJ, (1997).
- [KoZo] M. Kontsevich, A. Zorich, *Connected components of the moduli spaces of Abelian differentials*, Inventiones Mathematicae, (2003), to appear.
- [La1] E. Lanneau, *Hyperelliptic connected components of the moduli spaces of quadratic differentials*, Comment. Math. Helv., (2003), to appear.
- [La2] E. Lanneau, *Spin structure of quadratic differentials*, (2003), submitted.
- [Ma1] H. Masur, *Interval exchange transformations and measured foliations*, Ann of Math. **115** (1982) 169–200.
- [Ma2] H. Masur, *Closed trajectories for quadratic differentials with an application to billiards*, Duke Math. J. **53** (1986) 307–314.
- [Ma3] H. Masur, *The Jenkins-Strebel differentials with one cylinder are dense*, Comment. Math. Helv. **54** (1979) 179–184.
- [MaSm] H. Masur, J. Smillie, *Hausdorff dimension of sets of nonergodic foliations*, Ann. of Math. **134**, (1991), 455–543.
- [MaTa] H. Masur, S. Tabachnikov, *Rational billiards and flat structures*, Handbook of dynamical systems, **Vol. 1A**, North-Holland, Amsterdam, (2002), 1015–1089.
- [MaZo] H. Masur, A. Zorich, *Moduli Spaces of quadratic differentials: The Principal Boundary, Counting Problems and the Siegel–Veech Constants*, in progress.
- [Mc2] C. McMullen, *Billiards and Teichmüller curves on Hilbert modular surfaces*, **16**, (2003), 857–885.
- [Mc2] C. McMullen, *Teichmüller geodesics of infinite complexity*, Acta. Math., (2003), to appear.
- [Mi] J. Milnor, *Remarks concerning spin manifolds*, *Differential and Combinatorial Topology*, (in Honor of Marston Morse), Princeton, (1965).
- [Mu] D. Mumford. *Theta-characteristics of an algebraic curve*, Ann. scient. Éc. Norm. Sup., **2** (1971), 181–191.

- [Ra] G. Rauzy, *Echanges d'intervalles et transformations induites* Acta Arith., **34** (1979), 315–328.
- [Si] Ya. G. Sinai, *Introduction to ergodic theory. Preliminary Informal Notes of University Courses and Seminars in Mathematics.*, Mathematical Notes, Princeton University Press, (1976), 1–144.
- [Sc1] M. Schmoll, *On the asymptotic quadratic growth rate of saddle connections and periodic orbits on marked flat tori*, Geom. Funct. Anal. **12** (2002), 622–649.
- [Sc2] M. Schmoll, *Private communications*, (2002).
- [St] K. Strebel, *Quadratic differentials*. Springer-Verlag, (1984).
- [Th] W.P. Thurston, *On the geometry and dynamics of diffeomorphisms of surfaces* Bull. Amer. Math. Soc., **19** (1988), 417–431.
- [V1] W. A. Veech, *Gauss measures for transformations on the space of interval exchange maps* Ann. of Math., **115** (1982), 201–242.
- [Ve2] W. Veech, *The Teichmüller geodesic flow*, Ann. of Math. **124** (1986), 441–530
- [Ve3] W. Veech. *Moduli spaces of quadratic differentials*. J. D'Analyse Math., **55**, (1990), 117–171.
- [Ve4] W. Veech. *Teichmüller curves in moduli space. Eisenstein series and an application to triangular billiards*, Invent. Math., **97**, (1990), 117–171.
- [Ve5] W. Veech, *Siegel measures*, Ann. of Math. **148** (1998), 895–944
- [Zo] A. Zorich, *Square tiled surfaces and Teichmüller volumes of the moduli spaces of Abelian differentials*, in collection “Rigidity in Dynamics and Geometry”, M. Burger, A. Iozzi (Editors), Springer Verlag, 2002, 459–471.
- [Zo1] A. Zorich, *Computer experiments*.
- [Zo2] A. Zorich, *Extend Rauzy Class*, preprint.