



HAL
open science

Étude mathématique de quelques équations cinétiques collisionnelles

Clément Mouhot

► **To cite this version:**

Clément Mouhot. Étude mathématique de quelques équations cinétiques collisionnelles. Mathématiques [math]. Ecole normale supérieure de lyon - ENS LYON, 2004. Français. NNT: . tel-00008338v2

HAL Id: tel-00008338

<https://theses.hal.science/tel-00008338v2>

Submitted on 24 Feb 2005

HAL is a multi-disciplinary open access archive for the deposit and dissemination of scientific research documents, whether they are published or not. The documents may come from teaching and research institutions in France or abroad, or from public or private research centers.

L'archive ouverte pluridisciplinaire **HAL**, est destinée au dépôt et à la diffusion de documents scientifiques de niveau recherche, publiés ou non, émanant des établissements d'enseignement et de recherche français ou étrangers, des laboratoires publics ou privés.

ÉCOLE NORMALE SUPÉRIEURE DE LYON
UNITÉ DE MATHÉMATIQUES PURES ET APPLIQUÉES

N° attribué par la bibliothèque 1014EINISL10129131

THÈSE

pour obtenir le grade de

DOCTEUR DE
L'ÉCOLE NORMALE SUPÉRIEURE DE LYON

Spécialité : Mathématiques

présentée et soutenue publiquement

par

Clément MOUHOT

le 25 Novembre 2004

Titre :

ÉTUDE MATHÉMATIQUE DE QUELQUES ÉQUATIONS
CINÉTIQUES COLLISIONNELLES

Directeur de thèse :

Cédric VILLANI

Jury

M. Eric CARLEN,	Rapporteur
M. Jean DOLBEAULT,	Président du jury
M. François GOLSE,	Rapporteur
M. Benoît PERTHAME,	Examineur
M. Cédric VILLANI,	Directeur de thèse

Remerciements

Tout d'abord je tiens à remercier Cédric Villani pour le sujet qu'il m'a proposé, ses nombreux conseils et les questions fructueuses qu'il m'a soumises. Ce fut un honneur de pouvoir faire mes premiers pas en recherche au contact d'un tel mathématicien.

Je souhaite remercier Éric Carlen et François Golse qui m'ont fait un grand honneur en acceptant d'être rapporteurs de cette thèse et en montrant de l'intérêt pour mon travail. Je remercie Jean Dolbeault, qui a accepté de faire partie de mon jury, pour son soutien et ses encouragements. Je suis enfin honoré de compter Benoît Perthame parmi les membres de mon jury.

Parmi les nombreux scientifiques qui m'ont beaucoup apporté, Laurent Desvillettes a joué un rôle particulier, et je lui adresse tous mes remerciements pour le soutien et la disponibilité qu'il m'a témoignés.

Je remercie les mathématicien(ne)s avec qui j'ai pu effectuer ou commencer des collaborations ces trois années, en particulier Céline Baranger, Stéphane Mischler pour ses encouragements et l'intérêt qu'il a montré pour mes travaux, Lorenzo Pareschi avec qui j'ai pu entamer l'étude des méthodes numériques pour les équations cinétiques lors de mes séjours à Ferrare. Un grand merci à Francis Filbet, pour sa gentillesse, son soutien, et ses efforts pour m'apprendre quelques rudiments sur les simulations numériques ! Je remercie également Thierry Gallay pour ses encouragements, et les discussions éclairantes que nous avons eues sur la théorie spectrale. Je remercie María José Cáceres, José Antonio Carrillo et le laboratoire de Grenade, Lukas Neuman, Christian Schmeiser et le laboratoire de Vienne, Giuseppe Toscani et le laboratoire de Pavie pour les échanges et collaborations scientifiques que j'ai pu entreprendre avec eux. C'est également l'occasion de remercier les organisateurs du réseau européen de recherche HYKE, qui m'a permis d'effectuer des échanges scientifiques au cours de cette thèse. Je remercie Marc, Pauline, Magali et toute l'équipe de l'ACI "Nouvelles interfaces des mathématiques". Enfin je remercie Alexander Bobylev, Laurent Boudin, David Levermore, Xuguang Lu, Francis Nier, Laure Saint-Raymond, Bruno Sévenec, Bernt Wennberg et bien d'autres pour les discussions scientifiques que nous avons pu avoir.

Je remercie mes compagnons thésards, passés ou présents, David, François, Matthieu et Aurélien, ainsi que Stéphane et Julien pour leur aide et leur disponibilité, et toute l'UMPA, les secrétaires, les ingénieurs et les chercheurs.

Pour terminer, plein de mercis à ma famille pour son soutien, merci à Pierre, Brigitte, Etienne, Philomène, Arnaud, la petite dernière Louise, Betty, Clémence et Pauline, plein de mercis à tou(te)s mes ami(e)s, et enfin merci à Manue pour tout !

Table des matières

Chapitre 1. Introduction	9
1.1 La théorie cinétique	13
1.2 Étude de la régularité en théorie cinétique classique	33
1.3 Quantification du retour à l'équilibre thermodynamique	50
1.4 Étude des collisions inélastiques	66
1.5 Étude numérique	78
1.6 Perspectives	85
1.7 Annexe : notations	87
I. Étude de la régularité	
Chapitre 2. Regularity theory for the spatially homogeneous Boltzmann equation with cut-off	91
2.1 Introduction	93
2.2 Preliminary estimates on the collision operator	99
2.3 Regularity of the gain operator	104
2.4 Propagation of L^p estimates	118
2.5 Propagation of smoothness and singularity via the Duhamel formula	124
2.6 Application to a problem of long-time behavior	132
2.7 Weaker integrability conditions	135
2.8 Appendix: Some facts from interpolation theory and harmonic analysis	137
Chapitre 3. About L^p estimates for the spatially homogeneous Boltzmann equation	143

3.1	Introduction	145
3.2	Functional estimates on the collision operator	148
3.3	Application to the flow of the equation	159
3.4	Behavior for large times	162
Chapitre 4. Quantitative lower bounds for the full Boltzmann equation in the torus		165
4.1	Introduction	167
4.2	Functional toolbox	177
4.3	Proof of the lower bound in the cutoff case	187
4.4	Proof of the lower bound in the non-cutoff case	194
4.5	Application to the existing Cauchy theories	203
 II. Théorie quantitative du retour vers l'équilibre		
Chapitre 5. Explicit spectral gap estimates for the linearized Boltzmann and Landau operators with hard potentials		211
5.1	Introduction	213
5.2	The Boltzmann linearized operator	221
5.3	The Landau linearized operator	229
Chapitre 6. Explicit coercivity estimates for the linearized Boltzmann and Landau operators		237
6.1	Introduction and main results	239
6.2	The linearized Boltzmann operator	246
6.3	The linearized Landau operator	258
Chapitre 7. Rate of convergence to equilibrium for the spatially homogeneous Boltzmann equation with hard potentials		267
7.1	Introduction	269
7.2	Properties of the linearized collision operator	281
7.3	Localization of the spectrum	297
7.4	Trend to equilibrium	304

III. Étude des gaz granulaires

Chapitre 8. Cooling process for inelastic Boltzmann equations for hard spheres, Part I: The Cauchy problem 323

- 8.1 Introduction and main results 325
- 8.2 Estimates in Orlicz spaces 335
- 8.3 Proof of the Cauchy theorem for non-coupled collision rate . . 342
- 8.4 Proof of the Cauchy theorem for coupled collision rate 351
- 8.5 Study of the cooling process 361
- 8.6 Appendix: Some facts about Orlicz spaces 367

Chapitre 9. Cooling process for inelastic Boltzmann equations for hard spheres, Part II: Self-similar solutions and tail be- havior 371

- 9.1 Introduction and main results 373
- 9.2 Regularity property of the collision operator 383
- 9.3 Regularity study in the rescaled variables 393
- 9.4 Self-similar solutions and tail behavior 401
- 9.5 Perspectives 410

IV. Étude numérique

Chapitre 10. Fast algorithms for computing the Boltzmann col- lision operator 415

- 10.1 Introduction 417
- 10.2 Carleman-like representation and approximation of the colli-
sion operator 421
- 10.3 Fast spectral algorithm for a class of collision kernels 430
- 10.4 Fast DVM's algorithm for a class of collision kernels 440
- 10.5 Conclusions 447
- 10.6 Appendix: Remarks on admissible collision kernels and an
extension to the “non-decoupled” case 447

Bibliographie 449

Liste de Figures

1.1	Géométrie de la collision binaire	19
1.2	Spectre de $L_{\mathcal{B}}$ pour les potentiels durs ou les molécules Maxwelliennes ($\gamma \geq 0$) avec b non localement intégrable ($\nu \in [0, 2[$) et spectre de $L_{\mathcal{L}}$ pour les potentiels durs ou les molécules Maxwelliennes ($\gamma \geq 0$)	56
1.3	Spectre de $L_{\mathcal{B}}$ pour les potentiels mous ($\gamma < 0$) avec b non localement intégrable ($\nu \in [0, 2[$) et spectre de $L_{\mathcal{L}}$ pour les potentiels mous ($\gamma < 0$)	56
1.4	Géométrie de la collision binaire inélastique (avec $O = (v + v_*)/2$ et $u = v - v_*$)	69
1.5	Géométrie de la collision binaire inélastique pour un coefficient normal de restitution ϵ : $\Omega O = (1 - \epsilon) u /2$ et $\Omega v' = (1 + \epsilon) u /2$	70
2.1	Decomposition of the solution	130
3.1	Geometry of binary collisions	149
4.1	Spreading property of Q^+	181
5.1	Spectrum of the collision operator for strictly hard potential with angular cutoff	216
5.2	Spectrum of the collision operator for Maxwell's molecules with angular cutoff	217
5.3	Spectrum of the collision operator for soft potentials with angular cutoff	217
5.4	Introduction of an intermediate collision A	223
5.5	Introduction of an intermediate collision B	226
5.6	Introduction of an intermediate collision C	231
7.1	Spectrum of \mathcal{L} in L^1	304
9.1	Carleman representation for granular gases	383

10.1 Geometry of the collision $(v, v_*) \leftrightarrow (v', v'_*)$ 423

Préambule

On s'intéresse dans cette thèse aux équations issues de la théorie cinétique collisionnelle, et en particulier à l'équation de Boltzmann. Les applications de cette théorie sont nombreuses : physique des gaz raréfiés, physique des plasmas, physique des milieux granulaires, dynamique des galaxies, trafic routier... De plus cette théorie fournit, pour des modèles statistiques mésoscopiques hors équilibre, un cadre analytique pour l'étude des mécanismes de retour vers l'équilibre thermodynamique liés à l'irréversibilité.

Cependant la théorie mathématique qualitative et quantitative des solutions de ces équations reste très parcellaire, principalement à cause de la complexité de l'opérateur non-linéaire intégral exprimant le processus de collision. Le but de cette thèse est de contribuer à la compréhension des propriétés de ces solutions.

Le premier chapitre, introductif, présente le sujet et résume les résultats obtenus. Les chapitres suivants correspondent chacun à un article. Ils sont divisés en quatre parties, suivant les préoccupations suivantes :

1. *Étude de la régularité (partie I)* : Dans les chapitres 2 et 3, nous considérons les solutions spatialement homogènes de l'équation de Boltzmann, pour lesquelles l'étude se concentre sur l'opérateur de collision. Dans le chapitre 2, nous effectuons une étude de régularité détaillée des modèles d'interaction à courte portée. Dans le chapitre 3, nous donnons des résultats sur l'intégrabilité des solutions dans le cas d'interactions à longue portée. Dans le chapitre 4, nous considérons les solutions spatialement non homogènes, pour lesquelles les effets du transport libre et des collisions se combinent. Nous quantifions la positivité de la distribution de particules d'un gaz évoluant dans un tore, en montrant, sous des conditions de régularité, des bornes inférieures qui décroissent exponentiellement à l'infini.
2. *Quantification du retour vers l'équilibre (partie II)* : Dans le chapitre 5, nous proposons une méthode géométrique pour obtenir des estimations explicites sur le trou spectral des opérateurs de Boltzmann et Landau

linéarisés pour les potentiels durs ou les sphères dures. Dans le chapitre 6, nous prouvons des inégalités de coercivité explicites qui généralisent les estimations de trou spectral. Dans le chapitre 7, nous démontrons la convergence exponentielle vers l'équilibre avec taux explicite pour l'équation de Boltzmann spatialement homogène, pour des interactions de type sphères dures ou plus généralement pour les potentiels durs avec troncature angulaire de Grad.

3. *Étude des mécanismes de collision dissipatifs (partie III)* : Nous étudions l'évolution d'un gaz de sphères dures inélastiques. Dans le chapitre 8 nous effectuons une étude de Cauchy pour différents types physiques d'inélasticité. Dans le chapitre 9 nous étudions, pour des inélasticités avec coefficient normal de restitution constant, le comportement asymptotique, en prouvant en particulier l'existence de profils auto-similaires avec queue de distribution « sur-peuplée ».
4. *Étude numérique par méthode déterministe de l'opérateur de Boltzmann (partie IV)* : Dans cette partie nous utilisons une semi-discrétisation de l'intégrale de collision pour proposer des algorithmes rapides basés sur des méthodes spectrales ou discrétisées en vitesses (chapitre 10).

Liste des travaux rassemblés dans la thèse

- Chapitre 2 : article [150], en collaboration avec Cédric Villani, paru à *Archive for Rational Mechanics and Analysis* (2004).
- Chapitre 3 : article [69], en collaboration avec Laurent Desvillettes, à paraître dans *Annales de l'IHP, Analyse Non-Linéaire*.
- Chapitre 4 : article [146], à paraître dans *Communications in Partial Differential Equations*.
- Chapitre 5 : article [15], en collaboration avec Céline Baranger, à paraître dans *Revista Matemática Iberoamericana*.
- Chapitre 6 : article [145], soumis.
- Chapitre 7 : article [147], soumis.
- Chapitre 8 : article [141], en collaboration avec Stéphane Mischler et Mariano Rodriguez Ricard, soumis.
- Chapitre 9 : article [140], en collaboration avec Stéphane Mischler, soumis.
- Chapitre 10 : article [148], en collaboration avec Lorenzo Pareschi, soumis, qui a donné lieu également à la note [149], parue aux *Comptes-rendus de l'Académie des Sciences* (2004).

Introduction

Cette thèse est consacrée à l'étude mathématique des équations de la théorie cinétique. Parmi celles-ci, l'équation de Boltzmann¹ joue un rôle particulier, à la fois pour des raisons historiques et mathématiques. En effet, c'est la plus ancienne équation de la théorie cinétique, elle concentre une grande partie des difficultés typiques de cette théorie, et c'est l'un des rares modèles cinétiques pour lequel il existe, sous certaines restrictions, des théorèmes rigoureux permettant de le déduire des équations fondamentales de la dynamique microscopique sur les particules². C'est pourquoi la majorité de cette thèse se concentrera sur cette équation. Dans ce chapitre, nous débuterons par une brève introduction mathématique à la théorie cinétique dans la section 1.1. Pour ne pas alourdir cette section, la théorie linéarisée des équations de Boltzmann et Landau, les modèles cinétiques de gaz granulaire et les méthodes numériques en théorie cinétique seront introduits dans les sections 1.3, 1.4 et 1.5 de l'introduction qui leur sont consacrées, où nous détaillerons les résultats obtenus dans ces directions. Nous n'aborderons pas dans cette thèse les aspects quantiques ou relativistes de la théorie cinétique (pour une introduction à ces modèles dans le cas spatialement homogène, nous renvoyons par exemple à l'article de revue récent [83]).

Les notations des différents espaces fonctionnels utilisés sont réunies à la fin de ce chapitre, en section 1.7.

¹Établie par Ludwig Boltzmann (1844–1906) en 1872, après des travaux précurseurs de James Clerk Maxwell (1831–1879) dans les années 1860.

²Voir la discussion ci-dessous.

Sommaire

1.1	La théorie cinétique	13
1.1.1	Mécanique des fluides et théorie cinétique	13
1.1.2	Description cinétique des interactions	15
1.1.3	Physique de la collision	17
1.1.4	L'opérateur de collision de Boltzmann	20
1.1.5	L'équation de Boltzmann	21
1.1.6	Types d'interaction et noyaux de collision	24
1.1.7	Limite de collision rasante	26
1.1.8	Problèmes mathématiques liés à ces modèles	29
1.2	Étude de la régularité en théorie cinétique classique	33
1.2.1	Vue d'ensemble et difficultés	33
1.2.2	Étude des collisions pour des interactions à courte portée (Chapitre 2)	35
1.2.3	Étude des collisions pour des interactions à longue portée (Chapitre 3)	41
1.2.4	Étude de l'effet combiné transport + collisions sur la positivité (Chapitre 4)	44
1.3	Quantification du retour à l'équilibre thermodynamique	50
1.3.1	Historique et difficultés du problème	50
1.3.2	La théorie linéarisée	53
1.3.3	Estimations explicites de trou spectral (Chapitre 5)	57
1.3.4	Estimations explicites de coercivité (Chapitre 6) .	61
1.3.5	Taux de retour vers l'équilibre en spatialement homogène (Chapitre 7)	64
1.4	Étude des collisions inélastiques	66
1.4.1	Les gaz granulaires	66
1.4.2	Étude de Cauchy (Chapitre 8)	71
1.4.3	Étude asymptotique et profils auto-similaires (Chapitre 9)	75
1.5	Étude numérique	78

1.5.1	Les méthodes numériques pour les modèles cinétiques collisionnels	78
1.5.2	Méthodes déterministes rapides pour l'intégrale de collision de Boltzmann (Chapitre 10)	82
1.6	Perspectives	85
1.6.1	Théorie de Cauchy et régularité	85
1.6.2	Retour vers l'équilibre	85
1.6.3	Gaz granulaires	86
1.6.4	Méthodes numériques	86
1.7	Annexe : notations	87

1.1 La théorie cinétique

1.1.1 Mécanique des fluides et théorie cinétique

La *mécanique classique des fluides* repose sur les lois fondamentales de la dynamique ou **équations de Newton**. D'une part l'application de ces lois à un ensemble de n particules en interaction (où $n \sim 10^{24}$ est de l'ordre du nombre d'Avogadro) aboutit à un système hamiltonien dans l'espace des phases des positions et vitesses de chaque particule $\Omega^n \times (\mathbb{R}^N)^n$ (où $\Omega \subset \mathbb{R}^N$ est le domaine de l'espace où évoluent les particules, et $N \geq 1$ est la dimension d'espace). D'autre part l'application de ces lois aux éléments infinitésimaux de volume d'un fluide aboutit aux **équations hydrodynamiques** : les équations d'Euler³ pour un fluide non visqueux et les équations de Navier-Stokes⁴ pour un fluide visqueux.

Entre le niveau de description microscopique associé aux équations sur les trajectoires des particules et le niveau de description macroscopique associé aux équations hydrodynamiques, la théorie cinétique fournit un niveau de description intermédiaire, ou **mésoscopique** du fluide (nous renvoyons par exemple à l'introduction de l'article de revue [16] pour une discussion plus approfondie de ces différentes échelles de description). Le niveau de description cinétique est fondamental pour différentes raisons. Étant donné le nombre de particules mises en jeu, le système hamiltonien associé est inaccessible à l'étude analytique aussi bien que numérique. La théorie cinétique permet alors de réduire considérablement le nombre de degrés de liberté par rapport au système hamiltonien décrivant les trajectoires de chaque particule. Cependant, contrairement à la description macroscopique, la théorie cinétique permet d'intégrer aux équations d'évolution les caractéristiques de la dynamique moléculaire (par exemple les équations d'état d'un fluide ou encore les coefficients de transport ne peuvent être dérivés des modèles hydrodynamiques). Également elle permet l'étude de fluides qui ne sont pas à l'**équilibre thermodynamique local** : cette hypothèse est nécessaire pour établir les modèles hydrodynamiques, elle signifie que dans chaque élément infinitésimal de volume de fluide, les vitesses des particules se répartissent selon une courbe gaussienne, ce qui permet de définir les grandeurs thermodynamiques standards (densité, vitesse et température du fluide). Comme exemple de fluides hors de l'équilibre thermodynamique local on peut citer les écoulements très rapides dans un gaz raréfié (comme dans la couche limite

³Établies dans le cas d'un fluide incompressible par Leonhard Euler (1707–1783) en 1755.

⁴Établies par Claude-Louis Navier (1785–1836) en 1821 et George Stokes (1819–1903) en 1845.

qui se forme autour d'une fusée lorsqu'elle entre dans la haute atmosphère). Ajoutons que les modèles cinétiques ont été amplement validés par les expériences et les simulations numériques (voir par exemple [56]). Enfin la théorie cinétique suscite également un intérêt plus théorique. Au Congrès International des Mathématiciens de 1900 était posé le *Sixième Problème de Hilbert*⁵. Ce problème est la question de savoir si l'on peut axiomatiser la mécanique, et en particulier si l'on peut déduire les équations de la mécanique des fluides à partir d'un modèle microscopique gouverné par les équations de Newton. Hilbert proposait alors d'utiliser comme « étape intermédiaire » de cette limite l'équation de Boltzmann.

Le passage formel du système hamiltonien décrivant les trajectoires des particules à la description cinétique se fait de la façon suivante : on commence par traduire les équations gouvernant les trajectoires en une seule équation d'évolution sur la densité de probabilité jointe $f(t, x^1, \dots, x^n, v^1, \dots, v^n)$ de toutes les particules sur l'espace $\Omega^n \times (\mathbb{R}^N)^n$. Cette équation est appelée **équation de Liouville**. On en déduit la hiérarchie d'équations BBGKY sur les marginales de cette densité de probabilité. Dans la limite d'un grand nombre de particules, pour un fluide suffisamment peu dense, et en faisant l'hypothèse qu'à la limite les densités de probabilité jointes des différentes particules se « découplent » (hypothèse dite de *chaos moléculaire*), le système limite se réduit à une équation d'évolution sur le densité de probabilité d'une seule particule $f = f(t, x, v)$. Cette stratégie, connue aujourd'hui sous le nom de limite de Boltzmann-Grad, a pu être justifiée rigoureusement pour la limite d'un système de particules vers l'équation de Boltzmann, au moins dans certains cas (voir [124]). Nous renvoyons également à [58, Chapitres 2 et 4] pour une discussion plus approfondie sur ce point.

La vision probabiliste de cette densité de probabilité réduite $f = f(t, x, v)$ est la suivante : l'état microscopique complet du fluide est inaccessible et bien trop détaillé pour de nombreuses applications. On cherche alors à décrire quelque chose de plus simple : imaginons que toutes les particules soient numérotées et qu'au temps t on en sélectionne une au hasard, qui ait pour position x et vitesse v . Ainsi en tirant des numéros de particules au hasard, on obtient des points aléatoires dans l'espace des phases $\Omega \times \mathbb{R}^N$. La fonction f est alors la densité de la probabilité de ce point aléatoire au cours du temps.

À partir de cette densité de probabilité on peut reconstruire les **observables** du système de particules (c'est-à-dire les grandeurs thermodynamiques que l'on peut effectivement mesurer) en intégrant la densité de probabilité sur l'espace des vitesses contre des fonctions tests. On définit ainsi la **densité locale** $\rho(t, x)$, la **vitesse macroscopique locale** $u(t, x)$, et la **température**

⁵David Hilbert (1862–1943).

locale $T(t, x)$ par les formules

$$(1.1.1) \quad \rho(t, x) = \int_{\mathbb{R}^N} f(t, x, v) dv, \quad u(t, x) = \frac{1}{\rho} \int_{\mathbb{R}^N} v f(t, x, v) dv,$$

$$(1.1.2) \quad T(t, x) = \frac{1}{N\rho} \int_{\mathbb{R}^N} |u - v|^2 f(t, x, v) dv.$$

Nous utiliserons également l'**énergie cinétique locale** $\mathcal{E}(t, x)$

$$\mathcal{E}(t, x) = \int_{\mathbb{R}^N} |v|^2 f(t, x, v) dv.$$

Nous pouvons résumer schématiquement la place de la théorie cinétique au sein de la mécanique des fluides de la façon suivante :

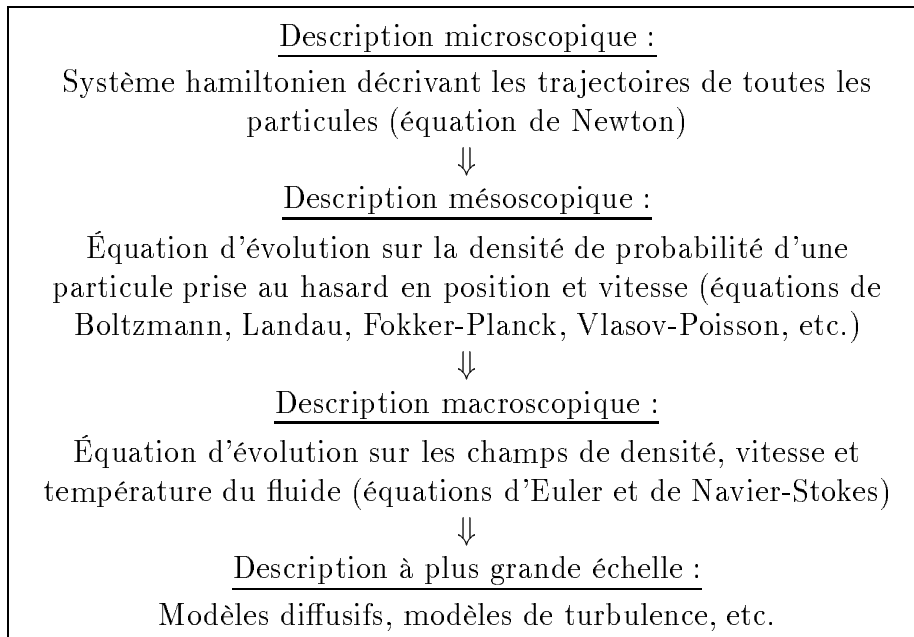

Par la suite, nous ne reviendrons plus sur la justification de la théorie cinétique et nous adopterons une démarche plus phénoménologique.

1.1.2 Description cinétique des interactions

Comme on vient de le voir, l'objet d'étude de la théorie cinétique est une équation d'évolution sur la densité de probabilité $f = f(t, x, v)$. En l'absence d'interaction entre les particules et le milieu extérieur et entre les particules elles-même, cette équation est l'**équation du transport libre**

$$(1.1.3) \quad \frac{\partial f}{\partial t} + v \cdot \nabla_x f = 0.$$

Classiquement, on considère les cas où le milieu extérieur agit sur les particules *via* un champ de force F_{ext} , ce qui conduit à l'**équation de Vlasov linéaire**

$$(1.1.4) \quad \frac{\partial f}{\partial t} + v \cdot \nabla_x f + F_{ext}(x) \cdot \nabla_v f = 0,$$

ou bien *via* un opérateur de collision *linéaire* modélisant les collisions des particules avec le milieu ambiant supposé au repos, ce qui conduit à des **modèles cinétiques de « scattering »**⁶. Par la suite nous ne considérerons pas le cas d'une interaction entre les particules et le milieu extérieur.

La modélisation des interactions entre les particules dépend principalement de la portée de l'interaction. Ainsi si l'interaction est à très longue portée elle est plutôt modélisée par un **champ moyen**, alors que des interactions dont la portée est suffisamment courte pour qu'on puisse les considérer comme localisées en espace sont plutôt modélisées par un **opérateur de collision**. Aux échelles intermédiaires, les deux approches peuvent être complémentaires, le terme de collision étant alors vu comme une correction en temps grand du terme de champ moyen.

Une équation cinétique de type champ moyen prend la forme

$$(1.1.5) \quad \frac{\partial f}{\partial t} + v \cdot \nabla_x f - \nabla_x \Psi \cdot \nabla_v f = 0, \quad \Psi(t, x) = \psi *_x \rho$$

où $\psi = \psi(x)$ est un potentiel d'interaction entre les particules, et $\rho = \rho(t, x)$ est la densité locale de particules (l'équation est donc non-linéaire). Un cas célèbre est l'**équation de Vlasov-Poisson** utilisée en physique des plasmas, pour laquelle le potentiel d'interaction est donné par les lois d'interaction coulombienne :

$$\psi(x) = \frac{e^2}{4\pi\epsilon_0|x|}$$

où e est la charge d'une particule, et ϵ_0 est la perméabilité du vide. Notons que les modèles de type champ moyen sont réversibles (c'est-à-dire que les équations restent inchangées par le changement de variable $(t, x, v) \rightarrow (-t, x, -v)$).

Lorsque les interactions entre particules sont modélisées par un opérateur de collision, l'équation cinétique prend la forme

$$(1.1.6) \quad \frac{\partial f}{\partial t} + v \cdot \nabla_x f = C(f).$$

⁶Ces modèles sont utilisés en physique pour le transport de neutrons et le transfert radiatif par exemple, voir [52, Chapitre IV, Section 3].

L'opérateur de collisions $C(f)$ dépend de la physique de la collision et du type d'interaction (et en premier lieu de la portée de l'interaction) entre les particules. Ces points seront discutés dans les deux sous-sections suivantes.

C'est l'occasion ici d'introduire une classe fondamentale d'interaction qui fournit aussi une échelle de mesure de la portée de l'interaction : nous appellerons **interaction en loi de puissance inverse d'ordre s** une interaction qui découle d'un potentiel d'interaction $\psi(x)$ de la forme

$$\psi(x) = \frac{C}{|x|^{s-1}}$$

avec $s \in [2, +\infty]$ (notons que s désigne traditionnellement la puissance de la force d'interaction et non du potentiel lui-même). Le cas $s = 2$ correspond aux interactions coulombiennes, le cas $s = +\infty$ correspond formellement aux interactions de contact de type **sphères dures** (qui correspondent à l'image intuitive du billard). Une analyse d'échelle dans [31] montre que

- pour $s > 3$, le terme de collision domine le terme de champ moyen,
- pour $s < 3$, le terme de collision est négligeable devant le terme de champ moyen.

Le cas limite $s = 3$ est appelé **interaction de Manev**.

Dans cette thèse nous nous intéresserons uniquement aux **modèles cinétiques collisionnels**, pour lesquels l'interaction entre les particules est modélisée uniquement par un opérateur de collision. Remarquons que ce choix est pleinement justifié pour des interactions en loi de puissance inverse d'ordre $s > 3$, mais que, dans le cas $s \in [2, 3]$, l'approche collisionnelle continue à jouer un rôle important puisque le terme de collision devient non négligeable en temps grand même lorsque le terme de champ moyen domine.

1.1.3 Physique de la collision

Nous décrivons ici les hypothèses sur les collisions qui sont à l'origine de la dérivation heuristique de l'opérateur de Boltzmann *élastique* pour les gaz raréfiés⁷. Nous reviendrons par la suite sur les collisions inélastiques. Précisons que le terme *collision* est pris dans un sens plus large que son usage courant. Il désigne ici le processus au cours duquel des particules deviennent très proches de sorte que leurs trajectoires sont fortement déviées en un court intervalle de temps.

⁷Plus précisément, nous considérons des gaz raréfiés contenant une seule espèce, supposée monoatomique. Pour les généralisations au cas de mélanges de plusieurs espèces, et/ou d'espèces polyatomiques, nous renvoyons à l'article de revue récent [57, Sections 16 et 17].

- (i) Nous supposons que les interactions se font uniquement de façon **binnaire** entre les particules. Ceci suppose implicitement que nous supposons le gaz suffisamment dilué pour pouvoir négliger les effets des interactions impliquant plus de deux particules.
- (ii) Nous supposons que les collisions sont **localisées** en espace et en temps. Mathématiquement cela signifie que les collisions se produisent en un point x et un instant t . Physiquement cela suppose implicitement que la durée typique d'une collision est négligeable devant l'échelle de temps et que les quantités mesurant la taille d'une collision, comme le paramètre d'impact⁸, sont négligeables devant l'échelle d'espace.
- (iii) Nous supposons que les collisions sont **élastiques** : la quantité de mouvement et l'énergie cinétique sont préservées lors de la collision. Si v', v'_* désignent les vitesses avant la collision, et v, v_* les vitesses après la collision, nous obtenons les relations suivantes (rappelons que toutes les particules sont ici supposées avoir la même masse) :

$$\begin{cases} v' + v'_* = v + v_* \\ |v'|^2 + |v'_*|^2 = |v|^2 + |v_*|^2. \end{cases}$$

- (iv) Nous supposons les collisions **microréversibles**, comme conséquence du fait que les lois de la dynamique microscopique lors de la collision sont réversibles. Cela signifie que la probabilité pour que les vitesses (v', v'_*) soient transformées en (v, v_*) lors d'une collision est égale à la probabilité pour que les vitesses (v, v_*) soient transformées en (v', v'_*) lors d'une collision.
- (v) Enfin nous faisons l'hypothèse de **chaos moléculaire** de Boltzmann : juste avant les collisions, les vitesses des particules en collision ne sont pas corrélées. Cette hypothèse introduit donc l'asymétrie passé-futur dans l'équation, puisque le résultat des collisions est bien sûr d'augmenter les corrélations dans le système de particules au cours du temps. Physiquement, cette hypothèse est liée à la dilution du gaz, car elle suppose que chaque particule ne subit qu'un faible nombre de collisions.

La géométrie de la collision, imposée par les lois de conservation, est résumée dans la figure 1.1. L'angle θ qui apparaît sur cette figure est appelé **angle de déviation**. Le vecteur $v - v_*$ est appelé **vitesse relative**. Il y

⁸C'est-à-dire la distance la plus petite qui serait réalisée entre les deux particules si elles n'interagissaient pas.

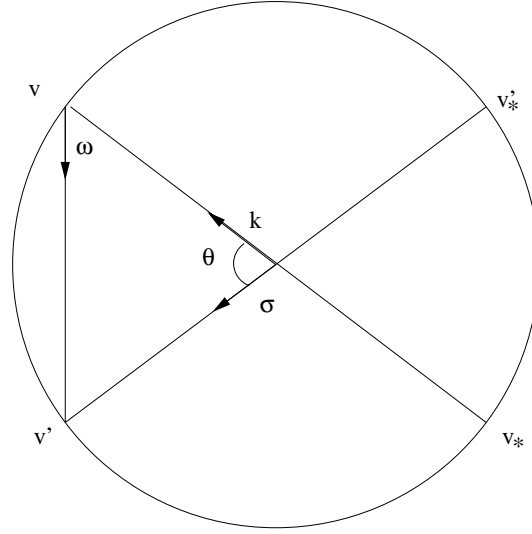

Figure 1.1: Géométrie de la collision binaire

a $2N$ degrés de liberté pour fixer les vitesses post-collisionnelles, et les lois de conservation fixent seulement $N + 1$ degrés de liberté. Pour paramétrer l'ensemble des collisions possibles il faut donc se donner $N - 1$ degrés de liberté. Les paramétrisations les plus classiques sont :

1. Déterminer v' et v'_* en fonction de v, v_* qui décrivent \mathbb{R}^N , et du vecteur unitaire $\sigma = (v' - v'_*)/|v' - v'_*|$ (voir la figure 1.1) qui décrit \mathbb{S}^{N-1} . Nous désignerons cette paramétrisation comme la « **représentation σ** » de la collision. Les formules correspondantes sont

$$\begin{cases} v' = \frac{v + v_*}{2} + \frac{|v - v_*|}{2}\sigma \\ v'_* = \frac{v + v_*}{2} - \frac{|v - v_*|}{2}\sigma. \end{cases}$$

2. Déterminer v' et v'_* en fonction de v, v_* qui décrivent \mathbb{R}^N , et du vecteur unitaire $\omega = (v - v')/|v - v'|$ (voir la figure 1.1) qui décrit \mathbb{S}^{N-1} . Nous désignerons cette paramétrisation comme la « **représentation ω** » de la collision. Les formules correspondantes sont

$$\begin{cases} v' = v + ((v_* - v) \cdot \omega)\omega \\ v'_* = v_* - ((v_* - v) \cdot \omega)\omega. \end{cases}$$

3. Déterminer v_* en fonction de v, v' qui décrivent \mathbb{R}^N , et v'_* qui décrit l'hyperplan orthogonal au vecteur $v - v'$ et passant par v . Nous désignerons

cette paramétrisation comme la « **représentation de Carleman** »⁹ de la collision. La formule correspondante est simplement

$$v_* = v' + v'_* - v.$$

1.1.4 L'opérateur de collision de Boltzmann

En partant des cinq hypothèses ci-dessus, Boltzmann établit en 1872 (voir [36]) l'opérateur de collision suivant (que nous écrivons en utilisant la représentation σ des collisions)

$$(1.1.7) \quad Q_{\mathcal{B}}(f, f)(t, x, v) := \int_{\mathbb{R}^N \times \mathbb{S}^{N-1}} B(|v - v_*|, \cos \theta) (f' f'_* - f f_*) dv_* d\sigma.$$

Nous avons adopté la convention de notation classique : $f' := f(t, x, v')$, $f'_* := f(t, x, v'_*)$, $f_* := f(t, x, v_*)$. La fonction B est le **noyau de collision**. Elle est positive, et dépend uniquement du module de la vitesse relative et du cosinus de l'angle de déviation. Elle est reliée à la section efficace de collision Σ par la formule $B = |v - v_*| \Sigma$.

L'opérateur (1.1.7) est obtenu par un bilan d'apparition et disparition de particules dans l'espace des vitesses sous l'effet des collisions au point x et au temps t , sous les hypothèses précédentes. L'hypothèse (i) se traduit par le fait que l'opérateur est bilinéaire, l'hypothèse (ii) se traduit par le fait que l'opérateur est local en temps et en espace, l'hypothèse (iii) est implicite dans la paramétrisation de la collision, l'hypothèse (iv) se traduit par la forme particulière du noyau de collision (qui doit être invariant lorsqu'on intervertit les rôles joués par (v, v_*) et (v', v'_*)), enfin l'hypothèse (v) se traduit par le fait que la densité de probabilité jointe des deux particules qui collisionnent est donnée par la densité du produit tensoriel des probabilités, soit le produit des densités de probabilités, et elle est implicite dans l'écriture de l'opérateur.

Les propriétés microscopiques des collisions ont des conséquences au niveau macroscopique sur les observables : les lois de conservation microscopiques lors de la collision se traduisent ainsi par des lois de conservation sur les premiers moments de la densité de probabilité. Les changements de variables unitaires $(v, v_*, \sigma) \rightarrow (v_*, v, -\sigma)$ et $(v, v_*, \sigma) \rightarrow (v', v'_*, k)$ (le vecteur unitaire k est défini par $k = (v - v_*)/|v - v_*|$, voir la figure 1.1) laissent invariant le noyau de collision. Ils permettent d'obtenir formellement, pour une fonction

⁹Cette représentation de la collision fut introduite par Carleman dans [45], nous y reviendrons plus en détail par la suite.

test $\varphi = \varphi(v)$:

$$(1.1.8) \quad \int_{\mathbb{R}^N} Q_{\mathcal{B}}(f, f) \varphi(v) dv = \frac{1}{2} \int_{\mathbb{R}^N \times \mathbb{R}^N \times \mathbb{S}^{N-1}} B(|v - v_*|, \cos \theta) f f_* (\varphi' + \varphi'_* - \varphi - \varphi_*) dv dv_* d\sigma.$$

Si l'on cherche les fonctions tests qui annulent cette quantité pour toute distribution f , on est conduit à résoudre l'équation fonctionnelle

$$(1.1.9) \quad \forall (v, v_*, \sigma) \in \mathbb{R}^N \times \mathbb{R}^N \times \mathbb{S}^{N-1}, \quad \varphi(v') + \varphi(v'_*) - \varphi(v) - \varphi(v_*) = 0.$$

On vérifie immédiatement que les fonctions

$$\varphi(v) = 1, \quad v_1, \dots, v_N, \quad |v|^2,$$

appelées **invariants de collision**, sont solutions de cette équation¹⁰. On en déduit que

$$(1.1.10) \quad \forall \varphi \in \text{Vect} \{1, v_1, \dots, v_N, |v|^2\}, \quad \int_{\mathbb{R}^N} Q_{\mathcal{B}}(f, f) \varphi(v) dv = 0.$$

D'autre part, en utilisant les mêmes changements de variables que précédemment, la formulation duale (1.1.8) de l'opérateur peut être symétrisée en

$$(1.1.11) \quad \int_{\mathbb{R}^N} Q_{\mathcal{B}}(f, f) \varphi(v) dv = -\frac{1}{4} \int_{\mathbb{R}^N \times \mathbb{R}^N \times \mathbb{S}^{N-1}} B(|v - v_*|, \cos \theta) (f' f'_* - f f_*) (\varphi' + \varphi'_* - \varphi - \varphi_*) dv dv_* d\sigma.$$

Cette formule montre formellement que

$$(1.1.12) \quad \mathcal{D}_{\mathcal{B}}(f) := - \int_{\mathbb{R}^N} Q_{\mathcal{B}}(f, f) \log f dv = \frac{1}{4} \int_{\mathbb{R}^N \times \mathbb{R}^N \times \mathbb{S}^{N-1}} B(|v - v_*|, \cos \theta) (f' f'_* - f f_*) \log \frac{f' f'_*}{f f_*} dv dv_* d\sigma \geq 0.$$

1.1.5 L'équation de Boltzmann

Nous pouvons maintenant écrire l'**équation de Boltzmann** :

$$(1.1.13) \quad \frac{\partial f}{\partial t} + v \cdot \nabla_x f = Q_{\mathcal{B}}(f, f).$$

¹⁰On montre également (voir [58, p. 36–42]), sous des hypothèses très générales, que les invariants de collision sont les seules solutions de cette équation.

Cette équation d'évolution doit être complétée par la donnée d'une condition initiale

$$\forall x \in \Omega, v \in \mathbb{R}^N, \quad f(0, x, v) = f_0(x, v),$$

ainsi que la donnée de conditions au bord sur $\partial\Omega$. Les exemples les plus couramment utilisés sont :

- A. Le cas de l'espace tout entier $\Omega = \mathbb{R}^N$, où la seule « condition de bord » est une condition d'intégrabilité à l'infini.
- B. Le cas du tore $\Omega = \mathbb{T}^N$, où la condition de bord se réduit à une condition de périodicité.
- C. Le cas d'un ouvert convexe régulier Ω avec l'une des trois conditions suivantes (ou encore un mélange de ces conditions) :

– **Réflexion spéculaire** :

$$\begin{aligned} \forall t \in \mathbb{R}_+, x \in \partial\Omega, v \in \mathbb{R}^N, \\ f(t, x, R_x v) = f(t, x, v), \quad R_x v = v - 2(v \cdot n_x) n_x \end{aligned}$$

où n_x est le vecteur normal unitaire *sortant* de la surface $\partial\Omega$ au point x .

– Condition de « **bounce-back** » :

$$\forall t \in \mathbb{R}_+, x \in \partial\Omega, v \in \mathbb{R}^N, \quad f(t, x, -v) = f(t, x, v).$$

– **Diffusion Maxwellienne** :

$$\begin{aligned} \forall t \in \mathbb{R}_+, x \in \partial\Omega, v \in \mathbb{R}^N ; v \cdot n_x < 0, \\ f(t, x, v) = \left(\int_{\{v \cdot n_x > 0\}} f(t, x, v) (v \cdot n_x) dv \right) \frac{e^{-\frac{|v|^2}{2T_p}}}{(2\pi)^{\frac{N-1}{2}} T_p^{\frac{N+1}{2}}} \end{aligned}$$

où T_p est la température de la paroi.

Le confinement dans un tore est souvent utilisé dans les études mathématiques car il permet d'avoir un domaine d'espace borné mais sans les complications d'un bord (les propriétés asymptotiques, par exemple, sont très différentes pour un domaine borné et un domaine non borné). Néanmoins ce modèle n'est pas seulement une simplification mathématique, puisque le cas d'une boîte avec réflexion spéculaire peut se réduire au cas du tore (voir [58, Chapitre 7, Section 6]).

En intégrant en espace l'équation des conservations locales (1.1.10), on voit que tout ces modèles conservent formellement la **masse totale** :

$$\frac{d}{dt} \int_{\Omega} \rho(t, x) dx = 0.$$

Dans les cas de l'espace tout entier, d'un tore, ou de conditions de bord de type « bounce-back » ou réflexion spéculaire, on obtient formellement la conservation de l'**énergie totale** :

$$\frac{d}{dt} \int_{\Omega} \left(\rho(t, x) \frac{|u(t, x)|^2}{2} + N \rho(t, x) \frac{T(t, x)}{2} \right) dx = 0.$$

Enfin dans les cas de l'espace tout entier ou du tore, on obtient formellement la conservation de la **quantité de mouvement totale** :

$$\frac{d}{dt} \int_{\Omega} \rho(t, x) u(t, x) dx = 0.$$

On déduit également formellement de la discussion précédente le célèbre **Théorème H** de Boltzmann (nous nous restreignons aux cas de l'espace tout entier, du tore, ou de conditions de bord de type « bounce-back » ou réflexion spéculaire). Introduisons l'entropie¹¹ de la solution f :

$$S(f) = - \int_{\Omega \times \mathbb{R}^N} f \log f dx dv.$$

L'équation (1.1.12) montre formellement que

$$\frac{dS(f)}{dt} = \int_{\Omega} \mathcal{D}_{\mathcal{B}}(f) dx \geq 0.$$

De plus une distribution f telle que

$$\mathcal{D}_{\mathcal{B}}(f)(t, x) = 0$$

en un point $(t, x) \in \mathbb{R}_+ \times \Omega$, vérifie, d'après la positivité de l'intégrande et la discussion sur les solutions de l'équation (1.1.9), que $\log f(t, x, \cdot)$ est une combinaison linéaire des invariants de collision. Cela implique :

$$\forall v \in \mathbb{R}^N, \quad f(t, x, v) = M(\rho, u, T)(v) = \frac{\rho}{(2\pi T)^{N/2}} \exp \left\{ -\frac{|u - v|^2}{2T} \right\},$$

¹¹Qui est au signe près la « fonctionnelle H » qu'utilisait Boltzmann pour formuler son théorème.

où $\rho(t, x)$, $u(t, x)$, $T(t, x)$ sont respectivement la densité locale, la vitesse macroscopique locale et la température locale de f au point (t, x) , définies par les équations (1.1.1, 1.1.2).

La distribution $M(\rho, u, T)$ est appelée **distribution Maxwellienne**. On dit alors que la fonction f est à l'**équilibre thermodynamique local** au point (t, x) . Les équations hydrodynamiques sont obtenues en fermant formellement le système des moments de la densité de probabilité f par une hypothèse d'équilibre thermodynamique local. Lorsque l'on recherche les états équilibres *globaux*, il faut étudier les distributions partout à l'équilibre thermodynamique local $M(x, v)$ qui résolvent l'équation

$$\forall x \in \Omega, v \in \mathbb{R}^N, \quad v \cdot \nabla_x M = 0.$$

La résolution de cette équation dépend de la dimension du domaine, de sa géométrie, et des conditions aux limites. Dans le cas d'un tore $\Omega = \mathbb{T}^N$ ou d'une boîte sans axe de symétrie avec conditions de réflexion spéculaire ou « bounce-back », la solution est donnée par une distribution Maxwellienne $M(v)$ indépendante de x , uniquement déterminée par sa masse totale, sa quantité de mouvement totale et son énergie totale.

Le théorème *H* est lié à l'irréversibilité de l'équation de Boltzmann : le changement de variable $(t, x, v) \rightarrow (-t, x - v)$ transforme l'équation en

$$\frac{\partial f}{\partial t} + v \cdot \nabla_x f = -Q_{\mathcal{B}}(f, f),$$

et pour cette nouvelle équation (non physique), l'entropie des solutions décroît au cours du temps :

$$\frac{dS(f)}{dt} = - \int_{\Omega} \mathcal{D}_{\mathcal{B}}(f) dx \leq 0.$$

1.1.6 Types d'interaction et noyaux de collision

Dans l'opérateur de Boltzmann, l'information physique sur le type d'interaction est contenue dans le noyau de collision B . Le cas le plus important¹² est le cas des **sphères dures**, pour lequel en dimension $N = 3$,

$$B(|v - v_*|, \cos \theta) = K |v - v_*|, \quad K > 0.$$

Ce cas correspond formellement au cas $s = +\infty$ d'une interaction en loi de puissance inverse d'ordre s . Pour $s \in [2, +\infty[$, on obtient le découplage

$$B(|v - v_*|, \cos \theta) = \Phi(|v - v_*|) b(\cos \theta),$$

¹²En effet, c'est le seul cas où la dérivation physique du noyau de collision est entièrement explicite, c'est le seul cas qui a été dérivé rigoureusement à partir de systèmes de particules, et enfin c'est de loin le cas physique où la théorie mathématique est la plus avancée.

où Φ et b sont des fonctions positives et localement intégrables sauf éventuellement respectivement en 0 et en 1. Nous appellerons Φ le **noyau de collision cinétique** et b le **noyau de collision angulaire**. La dérivation physique fournit les formules suivantes en dimension $N = 3$ (voir [52, Chapitre 2, Section 5]) :

$$\begin{cases} \Phi(|z|) = |z|^\gamma, & \gamma = \frac{s-5}{s-1}, \\ \sin^{N-2} \theta b(\cos \theta) \underset{\theta \rightarrow 0}{\sim} K \theta^{-1-\nu}, & \nu = \frac{2}{s-1}. \end{cases}$$

Le noyau de collision angulaire b est défini implicitement. Mis à part le cas des sphères dures, il n'est explicité que dans un seul autre cas, celui des interactions coulombiennes $s = 2$, pour lequel il est donné par la formule de Rutherford

$$b(\cos \theta) = \frac{K}{\sin^4 \theta/2}.$$

On parle usuellement de **potentiels durs** lorsque $\gamma > 0$ (soit $s > 5$ en dimension $N = 3$), de **potentiels mous** lorsque $\gamma < 0$ (soit $s < 5$ en dimension $N = 3$), et de **molécules Maxwelliennes** lorsque B est indépendant de la vitesse relative, i.e. $\gamma = 0$ (soit $s = 5$ en dimension $N = 3$).

Le seul cas physique pour lequel le noyau de collision B est localement intégrable est le cas des sphères dures. Dans tous les autres cas, l'intégrale de B sur la sphère $\sigma \in \mathbb{S}^{N-1}$ est infinie. Ceci a conduit Grad (voir [108]) à introduire l'hypothèse simplificatrice connue aujourd'hui sous le nom de **troncature angulaire de Grad** :

$$(1.1.14) \quad \int_{\mathbb{S}^{N-1}} b(k \cdot \sigma) d\sigma := |\mathbb{S}^{N-2}| \int_0^\pi b(\cos \theta) \sin^{N-2} \theta d\theta < +\infty.$$

Lorsque cette hypothèse est vérifiée, il est possible de décomposer l'opérateur de collision en partie positive et partie négative $Q_B = Q_B^+ - Q_B^-$ de façon évidente. Cette hypothèse correspond à une troncature des interactions à longue portée.

Du point de vue physique, les noyaux de collisions ci-dessus sont classés selon la portée de l'interaction qu'ils modélisent. Du point de vue mathématique, il y a plusieurs phénomènes à distinguer :

- Le comportement du noyau de collision pour les grandes vitesses relatives est lié à la décroissance à l'infini de la solution f .

- La singularité en $\theta \sim 0$ du noyau de collision est liée aux propriétés de régularisation (en vitesse) de l'opérateur de collision.
- Enfin, le dernier point est le plus mal compris encore à l'heure actuelle : le comportement (singulier ou non) du noyau de collision pour les petites vitesses relatives semble avoir une influence sur les phénomènes de régularité et de retour à l'équilibre.

Les deux premiers points peuvent être résumés par le parallèle suivant : dans l'équation intégral-différentielle de Boltzmann, le noyau de collision cinétique joue le rôle des coefficients dans une équation aux dérivées partielles classique, et le noyau de collision angulaire donne l'ordre (fractionnaire) de dérivation en vitesse. Le cas des molécules Maxwelliennes correspond dans ce parallèle au cas d'un opérateur de dérivation en vitesse à coefficients constants¹³.

1.1.7 Limite de collision rasante

Le cas des interactions coulombiennes $s = 2$ est un cas limite en terme de singularité du noyau de collision, il correspond, en dimension $N = 3$, à $\gamma = -3$ et $\nu = 2$. Dans ce cas, il n'est plus possible de donner un sens à l'équation de Boltzmann (voir [189, Annexe I, Appendice]). Cependant, par une procédure asymptotique formelle, Landau¹⁴ établit en 1936 l'**opérateur de Landau-Coulomb**, défini par

$$Q_{\mathcal{L}}(f, f)(t, x, v) = \nabla_v \cdot \left(\int_{\mathbb{R}^N} \mathbf{A}(v - v_*) [f_*(\nabla f) - f(\nabla f)_*] dv_* \right),$$

où $\mathbf{A}(z) = |z|^2 \Phi(z) \mathbf{P}(z)$, $\mathbf{P}(z)$ est le projecteur orthogonal sur z^\perp , i.e.

$$(\mathbf{P}(z))_{i,j} = \delta_{i,j} - \frac{z_i z_j}{|z|^2}$$

et (en dimension $N = 3$) $\Phi(|z|) = |z|^{-3}$. On parlera plus généralement d'**opérateur de Landau** (ou opérateur de **Fokker-Planck-Landau**) lorsque la fonction Φ est une fonction puissance plus générale. Contrairement à l'opérateur de Boltzmann, cet opérateur peut être défini pour les interactions coulombiennes. Il est utilisé en physique des plasmas, c'est-à-dire

¹³Nous verrons par la suite que ce parallèle avec les équations aux dérivées partielles peut réellement être un support pour l'intuition. Par exemple les « lemmes de compensation » peuvent être comparés à des intégrations par parties et permettent de traiter la dérivation en vitesse contenue dans l'opérateur de collision lorsque le noyau de collision n'est pas localement intégrable (voir le chapitre 3).

¹⁴Lev Davidovitch Landau (1908–1968).

des gaz de particules partiellement ou totalement ionisées, et dans lesquels l'interaction prépondérante est souvent l'interaction coulombienne entre les particules chargées.

Plus généralement le phénomène sous-jacent à cette asymptotique formelle est la **limite de collision rasante**. Celle-ci est maintenant bien comprise suite aux travaux [13, 63, 66, 186, 5]. On appelle « collision rasante » une collision pour laquelle l'angle de déviation θ est proche de 0. Intuitivement, plus la portée de l'interaction est grande, plus la proportion de collisions qui sont rasantes devient importante. Si toutes les collisions deviennent rasantes on obtient alors l'opérateur de Landau.

Mathématiquement on se donne une suite de noyaux de collision B_ε telle que dans la limite $\varepsilon \rightarrow 0$, la partie angulaire b_ε se concentre asymptotiquement uniquement sur les collisions rasantes de la façon suivante :

$$\left\{ \begin{array}{l} \forall \theta_0 > 0, \quad b_\varepsilon(\cos \theta) \xrightarrow{\varepsilon \rightarrow 0} 0 \text{ uniformément sur } \theta \in [\theta_0, \pi] \\ \mu_\varepsilon := |\mathbb{S}^{N-2}| \int_0^\pi b_\varepsilon(\cos \theta) (1 - \cos \theta) \sin^{N-2} \theta \, d\theta \xrightarrow{\varepsilon \rightarrow 0} \mu \in (0, +\infty). \end{array} \right.$$

Alors l'opérateur de Boltzmann associé tend vers l'opérateur de Landau, dont la fonction Φ dans la définition de \mathbf{A} ci-dessus est donnée par le noyau de collision cinétique de l'opérateur de Boltzmann. Par analogie avec l'opérateur de Boltzmann, nous pouvons donc parler d'opérateurs de Landau avec potentiels durs, mous ou molécules Maxwelliennes, selon le comportement de Φ , même si leur signification physique n'est pas aussi clairement établie que celle de l'opérateur de Landau-Coulomb dans le cas coulombien. Dans le cas de l'opérateur de Landau, nous appellerons noyau de collision la fonction Φ .

Les propriétés de l'opérateur de Boltzmann discutées ci-dessus sont héritées par l'opérateur de Landau. Le changement de variables unitaire $(v, v_*) \rightarrow (v_*, v)$ laisse le noyau de collision invariant. Il permet d'obtenir formellement, pour une fonction test $\varphi(v)$:

$$(1.1.15) \quad \int_{\mathbb{R}^N} Q_{\mathcal{L}}(f, f) \varphi(v) \, dv = \int_{\mathbb{R}^N \times \mathbb{R}^N} f_* (\nabla_v f)^T \mathbf{A}(v - v_*) [(\nabla_v \varphi)_* - (\nabla_v \varphi)] \, dv \, dv_*.$$

Si l'on cherche les fonctions tests qui annulent cette quantité pour toute distribution f , on est conduit à résoudre l'équation fonctionnelle

$$(1.1.16) \quad \forall (v, v_*) \in \mathbb{R}^N \times \mathbb{R}^N, \quad (\nabla_v \varphi)(v_*) - (\nabla_v \varphi)(v) \text{ colinéaire à } (v - v_*).$$

On vérifie immédiatement que les invariants de collision

$$\varphi(v) = 1, v_1, \dots, v_N, |v|^2$$

sont solutions de cette équation¹⁵. On en déduit que

$$(1.1.17) \quad \forall \varphi \in \text{Vect} \{1, v_1, \dots, v_N, |v|^2\}, \quad \int_{\mathbb{R}^N} Q_{\mathcal{L}}(f, f) \varphi(v) dv = 0.$$

D'autre part, en utilisant le même changement de variables que précédemment, on obtient

$$(1.1.18) \quad \mathcal{D}_{\mathcal{L}}(f) := - \int_{\mathbb{R}^N} Q_{\mathcal{L}}(f, f) \log f dv = \\ \frac{1}{2} \int_{\mathbb{R}^N \times \mathbb{R}^N} f f_* \left(\frac{\nabla_v f}{f} - \frac{(\nabla_v f)_*}{f_*} \right)^T \mathbf{A}(v-v_*) \left(\frac{\nabla_v f}{f} - \frac{(\nabla_v f)_*}{f_*} \right) dv dv_* \geq 0.$$

La positivité de cette quantité provient du fait que la matrice $\mathbf{A}(z)$ est définie positive pour tout $z \in \mathbb{R}^N$.

Nous pouvons alors écrire l'équation de Landau :

$$(1.1.19) \quad \frac{\partial f}{\partial t} + v \cdot \nabla_x f = Q_{\mathcal{L}}(f, f).$$

Cette équation d'évolution doit être complétée par la donnée d'une condition initiale et de conditions au bord de la même façon que pour l'équation de Boltzmann. L'équation des conservations locales (1.1.17) implique formellement les mêmes lois de conservations globales sur la distribution que dans le cas de l'équation de Boltzmann et on déduit formellement de (1.1.18) et de la discussion des solutions de (1.1.16) que cette équation vérifie également le théorème H : l'entropie $S(f)$ de la solution f vérifie

$$\frac{dS(f)}{dt} = \int_{\Omega} \mathcal{D}_{\mathcal{L}}(f) dx \geq 0,$$

et une distribution f telle que

$$\mathcal{D}_{\mathcal{L}}(f)(t, x) = 0$$

en un point $(t, x) \in \mathbb{R}_+ \times \Omega$ vérifie que $\log f(t, x, \cdot)$ est une combinaison linéaire des invariants de collision, ce qui implique que $f(t, x, \cdot)$ est une distribution Maxwellienne, c'est-à-dire que la distribution f est à l'équilibre

¹⁵À nouveau, sous des hypothèses très générales, les invariants de collision sont les seules solutions de cette équation (voir [58, p. 36–42]).

local au point (t, x) . La discussion sur la recherche d'équilibre global est exactement similaire au cas de l'équation de Boltzmann.

L'opérateur de Landau est une simplification **diffusive** de l'opérateur de Boltzmann (le terme « diffusif » se rapportant à la variable de vitesse). La géométrie de la collision est considérablement simplifiée, puisque les cercles de collision (voir la figure 1.1) sont « écrasés » sur des droites. Il est possible d'effectuer des simplifications diffusives encore plus importantes de l'opérateur de collision pour des interactions à longues portées, ce qui conduit à perdre complètement trace de la géométrie des collisions tout en conservant les lois de conservations locales et le théorème H . L'exemple le plus célèbre est l'**opérateur de Fokker-Planck**, qui sort du cadre de notre étude.

1.1.8 Problèmes mathématiques liés à ces modèles

La première étape de l'étude mathématique des propriétés de ces modèles consiste en l'étude du problème de Cauchy. Malheureusement, et malgré des progrès récents très importants, cette étape est loin d'être achevée. Elle dicte les cadres pour des études plus précises des solutions. Parmi les problèmes pertinents les concernant, mentionnons par exemple l'étude de la régularité et des singularités (apparition ou non de régularité, géométrie de la propagation des singularités, comportement au cours du temps de l'amplitude des singularités, etc.), l'étude de bornes inférieures ou supérieures sur la solution (et leur lien éventuel avec le(s) état(s) limite(s)), l'étude du comportement en temps grand (existence d'état(s) limite(s), convergence), l'étude de régimes limites (régimes fluides, diffusifs, etc.), et les méthodes de calcul numérique de ces solutions. Nous reviendrons en détail sur ces différentes questions au cours des sections suivantes.

Pour situer le cadre de notre étude, nous donnons rapidement ici une idée des différentes théories de Cauchy parcellaires existantes.

A. Cadre des solutions spatialement homogènes. C'est historiquement le premier cadre de Cauchy qui a été construit pour l'équation de Boltzmann dans les années 1930 par Carleman [44, 45], dans le cas des sphères dures. Depuis, de très nombreux travaux ont permis d'étendre ces premiers résultats au cas des potentiels durs avec troncature angulaire de Grad, sous des hypothèses physiquement acceptables sur la donnée initiale¹⁶. Mentionnons par exemple l'article récent de Mischler et Wennberg [144], qui démontre l'existence et l'unicité dans l'espace des distributions positives dont l'énergie cinétique est finie et ne croît pas au cours du temps.

¹⁶Nous n'essayons pas ici de retracer une bibliographie de cette question. Le lecteur intéressé pourra se reporter à l'article de revue très détaillé [191].

Une solution spatialement homogène est une solution $f = f(t, v)$ qui ne dépend pas de la variable d'espace. L'équation de Boltzmann homogène devient alors

$$(1.1.20) \quad \frac{\partial f}{\partial t} = Q_{\mathcal{B}}(f, f), \quad t \geq 0, \quad v \in \mathbb{R}^N.$$

La simplification apportée par cette hypothèse est considérable :

- Le terme de transport disparaît, ce qui simplifie analytiquement l'équation.
- Il n'y a plus de problèmes liés au domaine spatial et aux conditions de bord à considérer.
- Plus profondément, la réduction de taille de l'espace fonctionnel rend la non-linéarité de l'opérateur de collision bien moins difficile à traiter : les lois de conservation et le théorème H suffisent à définir correctement l'opérateur dans L^1 et, dans la plupart des cas, l'utilisation soignée des lois de conservation permet d'obtenir des estimations de type sous-linéaire sur celui-ci.

Ceci explique le succès qu'a connu l'étude des solutions spatialement homogènes. Néanmoins malgré l'ampleur de la simplification effectuée, plusieurs arguments soutiennent la pertinence de cette approche :

- Tout d'abord, l'opérateur de collision étant local en la variable d'espace et l'équation de Boltzmann étant encore très mal comprise, il paraît naturel d'étudier séparément le problème des collisions comme un premier pas pour « diviser les difficultés ».
- De plus cette séparation entre les processus de transport pur et de collision pur est effectivement mise en pratique dans les schémas numériques de type « splitting », et la compréhension de l'équation spatialement homogène est liée à la justification théorique de ces schémas.
- Par ailleurs, la propriété d'homogénéité en espace est une propriété stable, comme le montre l'étude [11], ce qui la rend physiquement pertinente. Il est également naturel de s'attendre à ce que les propriétés obtenues dans un cadre homogène soient encore vraies pour des solutions faiblement inhomogènes.
- Enfin une dernière motivation pour l'étude du cas homogène peut être la compréhension de la convergence vers l'équilibre local, comme un premier pas vers l'étude des limites hydrodynamiques (voir la discussion dans l'introduction de [48]).

Mentionnons une simplification supplémentaire courante de l'équation : l'hypothèse des **molécules pseudo-Maxwelliennes**, qui consiste à supposer le noyau de collision B indépendant de la vitesse relative et vérifiant la troncature angulaire de Grad. Sous cette hypothèse (non physique), une théorie semi-explicite de l'équation de Boltzmann spatialement homogène basée sur la transformation de Fourier a pu être construite. Nous renvoyons le lecteur à l'article de synthèse de l'un des principaux acteurs de cette théorie [24].

La théorie spatialement homogène reste toutefois incomplète à l'heure actuelle. Principalement, l'équation pour des noyaux de collision présentant des singularités (pour les petits angles de déviation ou les petites vitesses relatives) est encore mal comprise. Par exemple pour les interactions à longue portée (lorsque le noyau de collision n'est pas localement intégrable), malgré des avancées récentes concernant le problème d'existence dans les cas très singuliers (voir [107], [186]), et le problème d'unicité dans le cas Maxwellien (voir [180]), une question qui reste ouverte est l'unicité pour des noyaux de collision non localement intégrables généraux¹⁷.

B. Théorie perturbative. Le théorème H suggère que les solutions de l'équation de Boltzmann convergent asymptotiquement vers un équilibre global. Il est donc naturel d'étudier les petites variations autour de cet état stationnaire. Hilbert [116] puis Grad [108] ont posé les fondements de cette théorie.

Si l'équilibre est une distribution Maxwellienne M , disons de masse 1, vitesse macroscopique 0 et température 1, le cadre adéquat de linéarisation est l'étude des variations autour de M dans l'espace $L^2(M^{-1})$. Autrement dit, si l'on note $f = M(1 + h)$, cela revient à étudier h dans l'espace $L^2(M)$. Dans cette espace de Hilbert, l'**opérateur de Boltzmann linéarisé** s'écrit

$$L_B h = M^{-1} [Q_B(M, Mh) + Q_B(Mh, M)]$$

et il est auto-adjoint négatif. Dans ce cadre perturbatif, l'étude de Cauchy et l'étude de la convergence vers l'équilibre global M se réduisent alors à une étude de stabilité, qui est reliée au spectre de l'opérateur

$$-v \cdot \nabla_x + L_B.$$

Nous reviendrons en détails sur cet aspect dans la section 1.3.

Cette théorie a permis de construire les premières solutions régulières globales de l'équation de Boltzmann (voir les travaux fondateurs de Ukai [183,

¹⁷Un travail est en cours en collaboration avec Laurent Desvillettes pour résoudre ce problème dans le cas des potentiels durs.

184]), et d'étudier la vitesse de convergence vers l'équilibre global (en particulier Ukai a donné le premier résultat de convergence exponentielle vers l'équilibre global en spatialement inhomogène, pour un gaz de sphères dures dans le tore, dont la preuve reste toutefois non constructive). Ce cadre a également permis de donner les premières justifications rigoureuses des limites hydrodynamiques, voir par exemple [76] ou les nombreuses références données dans [191, Chapitre 1, Section 5.4]. Dans le cas spatialement homogène, Arkeryd a démontré le premier résultat de convergence exponentielle vers l'équilibre sans condition perturbative, pour un gaz de sphères dures, dans [10]. Son résultat s'appuie sur la théorie linéarisée de l'opérateur de Boltzmann et des outils de compacité. Il ne requiert pas de condition de petitesse sur la solution mais ne fournit aucune information explicite sur la vitesse de convergence.

Cet exemple n'est pas un cas isolé : un inconvénient majeur de la théorie linéarisée du point de vue de la pertinence physique est son caractère non constructif. Par exemple, dans le cas spatialement homogène, le spectre de l'opérateur de collision n'est pas connu de manière explicite, sauf dans le cas des molécules Maxwelliennes. C'est un des buts de cette thèse (voir la partie II) que de donner de nouveaux outils perturbatifs constructifs ainsi que des méthodes constructives pour relier les théories linéarisées aux théories non-linéaires.

C. Théorie des solutions « petites ». Des solutions régulières en temps petit ont été construites pour la première fois par Kaniel et Shinbrot [120], et des solutions globales « proches du vide » dans l'espace tout entier ont été construites par Illner et Shinbrot [119]. Ce dernier résultat a été amélioré par Goudon [105, 106] grâce à des idées de monotonie : la propagation de bornes par en-dessus et par en-dessous par des « Maxwelliennes voyageuses ».

D. Théorie des solutions renormalisées. C'est la célèbre théorie de DiPerna et Lions, initiée par l'article fondateur [75]. Cette théorie est actuellement, en spatialement inhomogène, la seule théorie de solutions globales en temps sans condition de perturbation ou de petitesse. Les deux ingrédients essentiels sont l'usage d'un procédé de renormalisation qui rend l'opérateur de collision sous-linéaire, et l'utilisation des propriétés fines de régularité de l'équation (celle de l'opérateur de collision en vitesse, et celles de l'opérateur de transport en espace) pour obtenir des résultats de compacité. Le centre de la théorie est un résultat de stabilité.

Cette théorie est très robuste et a pu être étendue à différents types d'interaction, à des variantes de l'équation de Boltzmann, et au cas de domaines avec conditions de bords. Néanmoins des questions fondamentales restent ouvertes : l'unicité et la régularité de ces solutions (en particulier la

conservation de l'énergie totale et la non-explosion de la densité locale). Il est possible de comparer¹⁸ le rôle joué par la théorie des solutions renormalisées en théorie cinétique à celui joué par la théorie des solutions de Leray en mécanique des fluides pour l'équation de Navier-Stokes. Plusieurs liens profonds peuvent en effet être mis en évidence : la propriété d'« unicité fort-faible » (si une solution forte existe alors la solution renormalisée / de Leray coïncide avec la solution forte), la ressemblance entre l'estimation de production d'entropie pour l'équation de Boltzmann et l'estimation de dissipation d'énergie pour les solutions de Leray, et enfin le théorème récent de limite hydrodynamique des solutions renormalisées de l'équation de Boltzmann vers les solutions de Leray de l'équation de Navier-Stokes dans [104] (voir aussi l'article de revue [190]).

E. Théorie monodimensionnelle. Dans certains problèmes de modélisation ayant des symétries¹⁹, il est naturel de supposer que la distribution ne dépend que d'une seule coordonnée en espace. Dans ce cas, la non-linéarité de l'opérateur de collision peut être compensée en partie par les propriétés dispersives de l'opérateur de transport et des solutions sans renormalisation ont été construites dans [9] et [55, 53].

Les contributions de cette thèse se situent dans le cadre spatialement homogène, à l'exception du chapitre 4, qui travaille dans un cadre spatialement inhomogène, pour des solutions possédant des bornes de régularité *a priori* (ces solutions existent par exemple près de l'équilibre ou en temps petit).

1.2 Étude de la régularité en théorie cinétique classique

1.2.1 Vue d'ensemble et difficultés

Comme nous l'avons vu, la théorie de la régularité pour l'équation de Boltzmann est encore très largement incomplète. On peut séparer les difficultés en trois catégories :

- (i) l'action de l'opérateur de collision sur la variable de vitesse ;
- (ii) le flot du transport libre, dont l'apparente simplicité est trompeuse ;
- (iii) le mélange des deux effets précédents !

¹⁸Comme le fait Lions en parlant de sa théorie dans [130].

¹⁹Voir par exemple [56].

Les points (i) et (ii) ont connu des avancées importantes ces deux dernières décennies. Pour l'étude de l'opérateur de transport et de ses propriétés en vue de l'application à l'équation de Boltzmann, nous renvoyons par exemple à l'article de revue récent [165]. L'étude de l'action de l'opérateur de collision sur la variable vitesse peut être menée en premier lieu sur l'équation spatialement homogène. Avant de discuter plus en détail le point (i), mentionnons que le point (iii) est encore de loin le plus mal compris. Les propriétés dispersives de l'opérateur de transport transfèrent en quelque sorte la régularité de la variable vitesse vers la variable de position. Dans certains cas particuliers (solutions proches du vide posées dans tout l'espace), il est possible de montrer en un certain sens (voir [38]) que les singularités sont transportées le long des caractéristiques de l'opérateur de transport tout en décroissant en amplitude sous l'effet de l'opérateur de collision. Paradoxalement, le mélange des effets de transport et de collision semble mieux compris en ce qui concerne la théorie explicite du retour vers l'équilibre (voir [73, 70] et en particulier la discussion éclairante sur l'approche de l'équilibre global par oscillation autour de la variété d'équilibre local).

Passons au point (i). Il est nécessaire de distinguer deux types de propriétés de l'opérateur de collision sur la variable vitesse : son action sur la régularité de la distribution et son action sur sa décroissance à l'infini. D'après les travaux récents, nous pouvons donner une première image grossière de son action sur la régularité de la distribution selon la portée de l'interaction (ne figurent pas dans ce schéma les effets encore mal compris d'une singularité du noyau de collision pour les petites vitesses relatives qui se produit dans le cas des potentiels mous).

Interactions à courte portée :

Modèles : sphères dures, ou troncature angulaire de Grad.
Comportement *hyperbolique* (les singularités sont propagées).
Effets de mélange : l'amplitude des singularités décroît.

↓

Interactions à longue portée :

Modèles : noyaux de collision non localement intégrables.
Comportement *parabolique* (régularisation instantannée).
Intermédiaire entre un laplacien fractionnaire (d'ordre relié à l'exposant de la singularité angulaire) et un opérateur de collision.

↓

Interactions à très longue portée :

Modèles : approximations diffusives de l'opérateur de Boltzmann
(opérateur de Landau, Fokker-Planck, etc.).
Comportement *parabolique* (structure de type *dérive-diffusion*).

L'action de l'opérateur de collision sur la décroissance à l'infini de la distribution est mesurée par l'étude de l'évolution des moments de la distribution, définis par (nous nous restreignons au cas spatialement homogène)

$$M_k(t) = \int_{\mathbb{R}^N} f(t, v) |v|^k dv$$

pour $k \geq 0$.

Dans le cas des potentiels durs ($\gamma > 0$), l'opérateur de collision a un effet « parabolique » sur la variable fréquence associée aux vitesses : tous les moments apparaissent instantanément et sont propagés uniformément (voir par exemple [67, 198, 200]). Les outils principaux pour démontrer ces résultats sont l'étude des inéquations différentielles satisfaites par ces moments et les **inégalités de Povzner** (voir [168]). Avec ces mêmes outils il est possible également montrer la propagation de moments « exponentiels », voir [25, 32], et également leur apparition dans certains cas (voir le chapitre 8, Proposition 8.3).

Dans le cas des molécules Maxwelliennes ($\gamma = 0$), l'opérateur de collision a un effet « hyperbolique » sur la variable fréquence associée aux vitesses : les moments sont « exactement propagés uniformément » et il n'y a pas d'apparition. Par contre ils vérifient un système récursif infini et il est possible de démontrer à partir de ce système qu'ils convergent asymptotiquement vers leur valeur à l'équilibre (voir [118]).

Dans le cas des potentiels mous ($\gamma < 0$), il y a à nouveau stricte propagation et pas d'apparition, mais il n'existe pas de résultat de borne uniforme sur les moments. Le meilleur résultat qui existe est un résultat de croissance au plus polynomial, démontré dans [67] puis amélioré dans [182].

Détaillons maintenant les résultats obtenus dans cette thèse.

1.2.2 Étude des collisions pour des interactions à courte portée (Chapitre 2)

Dans le chapitre 2 on se place dans le cadre de l'équation de Boltzmann spatialement homogène pour des interactions à courte portée. Les hypothèses principales faites sur le noyau de collision sont les suivantes :

(H1) Le noyau de collision adopte la forme produit

$$B(|v - v_*|, \cos \theta) = \Phi(|v - v_*|) b(\cos \theta).$$

(H2) $b \geq 0$ n'est pas identiquement nulle et vérifie une hypothèse forte de troncature angulaire de Grad (qui implique (1.1.14))

$$\|b\|_{L^2(\mathbb{S}^{N-1})}^2 := |\mathbb{S}^{N-2}| \int_0^\pi b(\cos \theta)^2 \sin^{N-2} \theta d\theta < +\infty.$$

(H3) $\Phi \geq 0$ vérifie $\Phi(0) = 0$, Φ est γ -Hölder sur \mathbb{R}_+ ($\gamma \in]0, 2[$), et $\Phi(|z|) \geq K |z|^\gamma$ pour une certaine constante $K > 0$.

Principalement ces hypothèses incluent le cas des noyaux de type

$$(1.2.21) \quad B(|v - v_*|, \cos \theta) = |v - v_*|^\gamma b(\cos \theta)$$

avec $\gamma \in]0, 2[$ (potentiel dur) et b borné, et elles intègrent le cas physique des sphères dures $B = K |v - v_*|$.

La théorie de Cauchy, dans ce cadre, est optimale (voir [144]) : dès que la donnée initiale f_0 vérifie

$$(1.2.22) \quad \int_{\mathbb{R}^N} f_0(v) (1 + |v|^2) dv < +\infty,$$

il existe une unique solution dans la classe des distributions positives d'énergie cinétique décroissante au sens large, et cette solution vérifie les lois de conservation²⁰. C'est toujours cette solution que nous considérons dans ce chapitre. Comme rappelé précédemment il y a propagation uniforme et apparition de tous les moments (avec constantes explicites). Enfin, en plus du théorème H qui assure une borne uniforme $L \log L$ lorsque la donnée initiale vérifie $S(f_0) < +\infty$, des bornes uniformes sur les normes L^p ($p > 1$) qui sont bornées initialement ont également été obtenues par Carleman [44, 45] et Arkeryd [8] dans le cas $p = +\infty$, puis par Gustafsson [111, 112] dans le cas $1 < p < +\infty$, par une interpolation non-linéaire entre les théories L^1 et L^∞ . Les bornes fournies par les preuves de Carleman et Arkeryd dans le cas L^∞ sont constructives, alors que cela ne semble pas être le cas pour les bornes obtenues par Gustafsson dans le cas $1 < p < +\infty$.

Le but de ce chapitre est de compléter ces résultats. D'une part nous revisitons la théorie L^p ($1 < p < +\infty$) pour obtenir des **estimées quantitatives** tout en affaiblissant les hypothèses. D'autre part, nous étudions en détail les phénomènes de **propagation de régularité** et **propagation de singularités**, qui sont les principales conséquences de la troncature angulaire de Grad.

Notre étude est basée sur la propriété fondamentale de « régularité de l'opérateur de gain », c'est-à-dire sur le fait que la partie $Q_{\mathcal{B}}^+$ de l'opérateur de collision a un effet régularisant. Ce phénomène a été découvert par Lions [130, 131], puis étudié par Wennberg [199], Bouchut et Desvillettes [37], et Lu [134]. Il est également réminiscent des propriétés de compacité obtenues

²⁰Notons que sans la condition d'énergie cinétique décroissante au sens large, des solutions parasites ont été construites dans [201].

par Grad [109] sur l'opérateur de gain linéarisé²¹. En partant de la méthode de [199] nous donnons une preuve légèrement généralisée et surtout avec des constantes entièrement explicites.

Il est naturel d'étudier la régularité en vitesse dans un cadre L^p ($p > 1$), car les propriétés de régularité du terme de gain semblent dégénérer pour $p = 1$. En l'état actuel des connaissances en effet, aucun résultat de régularisation ne couvre le cas $p = 1$ (ce qui est cohérent avec les résultats théoriques sur la transformée de Radon de [177]). Le meilleur résultat obtenu (voir par exemple [130]), sous des hypothèses de troncature et régularisation du noyau ($B \in C_c^\infty(\mathbb{R}_+,] - 1, 1[)$), est du type

$$Q_{\mathcal{B}}^+ : L^1 \times L^p \longrightarrow W^{(N-1)(1-1/p), p}$$

pour $1 < p \leq 2$, et, dans le cas $p = 1$, seulement²²

$$Q_{\mathcal{B}}^+ : L^1 \times L^1 \longrightarrow L^1 \quad \text{compact.}$$

Cette dégénérescence de la propriété de régularité en une propriété de compacité dans le cas $p = 1$ est suffisante pour les applications à la construction de solutions renormalisées (voir [130, 131]), mais suggère de commencer l'étude de régularité par la propagation de bornes L^p .

Nous donnons d'abord un théorème qui résume (parfois sans entrer dans tous les détails techniques ou sans donner forcément les énoncés optimaux) les propriétés de régularité de l'opérateur de gain, en incluant notre contribution.

Théorème 1.1. *Soit $\eta \in \mathbb{R}_+$. L'opérateur de gain vérifie les propriétés suivantes :*

- (i) **(Inégalités de type convolution)** *Si B vérifie les hypothèses (H1)-(H2)-(H3) de cette sous-section, alors pour tout $p \in [1, +\infty]$ et $s \in \mathbb{N}$, il existe une constante $C_{B,p,s} > 0$ explicite dépendant uniquement de la dimension N , du noyau de collision B et de s telle que pour toute fonction $f \in W_{\eta+\gamma}^{s,p} \cap W_{\eta+\gamma}^{s,1}$,*

$$\|Q_{\mathcal{B}}^+(f, f)\|_{W_{\eta}^{s,p}} \leq C_{B,p,s} \|f\|_{W_{\eta+\gamma}^{s,p}} \|f\|_{W_{\eta+\gamma}^{s,1}}.$$

²¹Voir également les estimations de régularité sur l'opérateur de gain linéarisé dans le chapitre 7 qui précisent les propriétés de compacité découvertes par Grad.

²²Notons que le résultat de compacité de $Q_{\mathcal{B}}^+$ dans L^1 a été amélioré dans le cas de « l'opérateur de gain itéré » $Q_{\mathcal{B}}^+(Q_{\mathcal{B}}^+(\cdot, \cdot), \cdot)$ dans [144, 1]. Nous nous servons ici de cette propriété pour obtenir des résultats de décomposition en partie régulière et partie singulière (voir ci-dessous) pour des données initiales seulement L^1_2 , dans le cas des sphères dures.

- (ii) **(Théorème de Lions)** Si $B \in C_c^\infty(\mathbb{R}_+,]-1, 1[)$, alors il existe une constante $C_B > 0$ explicite dépendant uniquement de la dimension N et du noyau de collision B telle que pour toutes fonctions $f \in L_\eta^1$, $g \in H_\eta^s$

$$\begin{cases} \|Q_B^+(g, f)\|_{H_\eta^{s+(N-1)/2}} \leq C_B \|g\|_{H_\eta^s} \|f\|_{L_\eta^1} \\ \|Q_B^+(f, g)\|_{H_\eta^{s+(N-1)/2}} \leq C_B \|g\|_{H_\eta^s} \|f\|_{L_\eta^1}. \end{cases}$$

Cette inégalité se traduit en une inégalité de « gain d'intégrabilité » par injection de Sobolev et interpolation avec les inégalités de convolution du point (i) (avec $s = 0$), voir le corollaire 2.2.

- (iii) **(Théorème de Bouchut-Desvillettes-Lu)** Si B vérifie (1.2.21) avec $b \in L^2(\mathbb{S}^{N-1})$, alors il existe une constante $C_B > 0$ explicite dépendant uniquement de la dimension N et du noyau de collision B telle que pour tout $s \geq 0$, et pour toutes fonctions $f, g \in L_{\eta+\gamma}^1 \cap H_{\eta+\gamma+1}^s$,

$$\|Q_B^+(g, f)\|_{H_\eta^{s+(N-1)/2}} \leq C_B \left(\|g\|_{H_{\eta+\gamma+1}^s} \|f\|_{H_{\eta+\gamma+1}^s} + \|g\|_{L_{\eta+\gamma}^1} \|f\|_{L_{\eta+\gamma}^1} \right).$$

- (iv) **(Inégalités de type compacité précisée)** Si B vérifie les hypothèses (H1)-(H2)-(H3) de cette sous-section et $s \in \mathbb{N}$, $w > 0$, alors il existe des constantes $C_{B,s,w} > 0$ et $\kappa > 0$ dépendant uniquement du noyau de collision B , de la dimension N et de s et w , telles que pour toutes fonctions $f \in W_{\eta+\gamma+w}^{s,1} \cap H_\eta^s$,

$$\|Q_B^+(f, f)\|_{H_\eta^s} \leq C_{B,s,w} \varepsilon^{-\kappa} \|f\|_{H_\eta^{s'}} \|f\|_{L_\eta^1} + \varepsilon \|f\|_{H_{\eta+\gamma}^s} \|f\|_{W_{\eta+\gamma+w}^{s,1}}$$

pour tout $\varepsilon > 0$, avec $s' = \max\{s - (N-1)/2, 0\}$.

De la même façon, sous les mêmes hypothèses sur B , on obtient en terme d'intégrabilité, pour $p \in]1, +\infty[$,

$$\|Q_B^+(f, f)\|_{L_\eta^p} \leq C_{B,p,w} \varepsilon^{-\kappa} \|f\|_{L_\eta^q} \|f\|_{L_\eta^1} + \varepsilon \|f\|_{L_{\eta+\gamma}^p} \|f\|_{L_{\eta+\gamma+w}^1}$$

pour tout $\varepsilon > 0$, où $q \in]1, p[$ ne dépend que de p et de la dimension N .

- (v) **(Inégalités de régularité pour des noyaux physiques)** Si B vérifie les hypothèses (H1)-(H2)-(H3) de cette sous-section et $s \in \mathbb{N}$ et $w > 0$, alors il existe $\alpha \in]0, (N-1)/2[$ et $C_{B,s,w} > 0$ dépendant uniquement du noyau de collision B et de w et s , telles que pour toutes fonctions $f \in W_{\eta+\gamma+w}^{s,1} \cap H_{\eta+\gamma}^s$,

$$\|Q_B^+(f, f)\|_{H_\eta^{s+\alpha}} \leq C_{B,s,w} \|f\|_{H_{\eta+\gamma}^s} \|f\|_{W_{\eta+\gamma+w}^{s,1}}.$$

Le point (i) est démontré par Gustafsson [111, 112]. Nous en redonnons une preuve qui généralise légèrement le résultat et surtout qui est plus simple grâce à des outils de dualité dans le corollaire 2.1. Nous verrons également une autre preuve au chapitre 3 qui permet (voir le chapitre 8) de généraliser ces inégalités aux espaces de Orlicz. Le point (ii) est démontré pour la première fois dans [130, 131], puis d'une autre manière dans [199]. La preuve repose sur les propriétés de régularisation des intégrales sur des surfaces mobiles. En partant de la preuve simplifiée de [199] basée sur la transformée de Radon, nous avons explicité les constantes (voir le théorème 2.2). Le point (iii) est démontré dans [37, 134]. Les points (iv) et (v) sont démontrés dans les théorèmes 2.3, 2.4 et 2.6. Les outils utilisés sont des découpages adaptés de $Q_{\mathcal{B}}^+$ combinés avec des résultats simples d'analyse harmonique.

En ce qui concerne les bornes L^p et $W^{s,p}$, nous démontrons (voir les théorèmes 2.7 et 2.8) le

Théorème 1.2. *Soit B un noyau de collision vérifiant les hypothèses (H1)-(H2)-(H3) de cette sous-section, $p \in]1, +\infty[$, et f_0 une donnée initiale positive dans $L_2^1 \cap L^p$. Alors la solution de l'équation de Boltzmann spatialement homogène associée vérifie*

$$\frac{d \|f\|_{L^p}^p}{dt} \leq C_+ \|f\|_{L^p}^{p(1-\theta)} - K_- \|f\|_{L^{\gamma/p}}^p$$

où $\theta \in]0, 1[$ dépend uniquement de la dimension, et $C_+, K_- > 0$ dépendent de B et de la masse, l'énergie cinétique et l'entropie de f_0 . Par conséquent nous en déduisons la propagation uniforme de la norme L^p . De plus des estimations a priori similaires avec des poids démontrent l'apparition et la propagation uniforme de tous les moments L_η^p ($\eta \in \mathbb{R}_+$). Plus généralement des estimations a priori similaires sur les dérivées de la distribution permettent d'obtenir des résultats de propagation uniforme dans tous les $W^{s,p}$, $s \in \mathbb{N}$.

Ce résultat redémontre en l'améliorant le résultat non constructif de propagation uniforme des bornes L^p de Gustafsson [111, 112] et le généralise à tous les espaces de Sobolev. L'idée principale de la preuve est la combinaison des estimations de type compacité précisée en terme d'intégrabilité sur $Q_{\mathcal{B}}^+$ avec des bornes par en-dessous sur le terme de perte $Q_{\mathcal{B}}^-$, et l'utilisation des résultats sur la propagation uniforme des moments L^1 .

Sur la base de cette étude de propagation de régularité, nous démontrons un résultat nouveau sur la décroissance de l'amplitude des singularités. Ce résultat était conjecturé par les physiciens (voir [56]). Remarquons qu'il est

facile de se convaincre à partir de la représentation de Duhamel

$$f(t, v) = f_0(v) e^{-\int_0^t Lf(s, v) ds} + \int_0^t Q_B^+(f, f)(s, v) e^{-\int_s^t Lf(\tau, v) d\tau} ds$$

$$:= f^{\text{sing}} + f^{\text{reg}},$$

où $Lf = \|b\|_{L^1(\mathbb{S}^{N-1})}(\Phi * f)$, que les singularités sont effectivement propagées et que la distribution n'est jamais plus régulière que la donnée initiale. Néanmoins nous montrons (voir les théorèmes 2.10 et 2.13) le

Théorème 1.3. *Soit B un noyau de collision vérifiant les hypothèses (H1)-(H2)-(H3) de cette sous-section et f_0 une donnée initiale positive dans $L_2^1 \cap L^2$. Alors la solution f de l'équation de Boltzmann spatialement homogène associée vérifie, pour $s \geq 0$, $q \geq 0$ arbitrairement grands, et $\tau > 0$ arbitrairement petit, que pour tout $t \geq \tau$, f se décompose en $f = f^S + f^R$ (« S » désigne « smooth » et « R » désigne « remainder »), avec f^S positive et*

$$\begin{cases} \sup_{t \geq \tau} \|f_t^S\|_{H_q^s \cap L_2^1} < +\infty, \\ \forall t \geq \tau, \forall k > 0, \exists \lambda = \lambda(k) > 0; \quad \|f_t^R\|_{L_k^1} = O(e^{-\lambda t}). \end{cases}$$

Toutes les constantes sont explicites en fonction de la masse, l'énergie cinétique et la norme L^2 de f_0 , ainsi que τ . Dans le cas particulier des sphères dures, l'hypothèse sur la donnée initiale peut être relaxée à $0 \leq f_0 \in L_2^1$, et le même résultat est vrai, avec des constantes explicites dépendant uniquement de la masse, l'énergie cinétique de f_0 , et τ .

L'idée de la preuve est de combiner :

- a. les résultats de propagation uniforme de régularité précédents ;
- b. un résultat de stabilité dans L^1 (qui énonce que les flots partant de deux données initiales différentes s'éloignent au plus de manière exponentielle) ;
- c. l'utilisation itérée du découpage fourni par la représentation de Duhamel en une partie « singulière » f^{sing} dont la régularité est la même que la donnée initiale mais qui décroît exponentiellement dans L^1 , et une partie « régulière » f^{reg} , qui est plus régulière que la donnée initiale grâce aux propriétés de régularité de Q_B^+ .

Il faut alors prendre la partie régulière de la représentation de Duhamel comme donnée initiale et commencer un nouveau flot, et ceci à des temps bien choisis (voir la figure 2.1). Cette méthode est réminiscente de la décomposition en sommes de Wild dans le cas Maxwellien. Elle se rapproche d'un

équivalent non-linéaire de cette décomposition pour les potentiels durs avec troncature angulaire.

Mentionnons que les outils développés dans les théorèmes 1.1, 1.2 et 1.3 se généralisent en partie à l'équation de Boltzmann pour les gaz granulaires, voir le chapitre 9.

Le résultat de décroissance exponentielle des singularités au cours du temps du théorème 1.3 permet ensuite d'appliquer à des solutions non régulières des résultats sur la convergence asymptotique vers l'équilibre démontrés dans le cas régulier. En fait il permet en principe d'étendre à des solutions non régulières tout résultat sur le comportement asymptotique vrai pour des solutions régulières et à un terme exponentiellement décroissant près. Ainsi nous démontrons (voir les théorèmes 2.12 et 2.13) le

Théorème 1.4. *Soit B un noyau de collision vérifiant les hypothèses (H1)-(H2)-(H3) de cette sous-section et f_0 une donnée initiale positive dans $L^1_2 \cap L^2$, associée à l'équilibre Maxwellien noté M . Alors la solution f de l'équation de Boltzmann spatialement homogène associé vérifie*

$$\|f_t - M\|_{L^1} = O(t^{-\infty}),$$

ce qui signifie : pour tout $n > 0$, il existe une constante $C_n > 0$ telle que

$$\|f_t - M\|_{L^1} \leq C_n t^{-n}.$$

Toutes les constantes sont explicites en fonction de la masse, l'énergie cinétique et la norme L^2 de f_0 . Dans le cas particulier des sphères dures, l'hypothèse sur la donnée initiale peut être relaxée à $0 \leq f_0 \in L^1_2$, et le même résultat est vrai, avec des constantes explicites dépendant uniquement de la masse et l'énergie cinétique de f_0 .

Le résultat de convergence en $O(t^{-n})$ pour tout $n > 0$ avait été démontré dans [192] sous des hypothèses de régularité très fortes sur la solution (essentiellement $H^s_{q(n)}$ avec $s(n)$ et $q(n)$ tendant vers $+\infty$ lorsque n tend vers $+\infty$). Nous appliquons ici ce résultat à la partie régulière de la décomposition ci-dessus, ce qui permet de supprimer toute hypothèse de régularité.

1.2.3 Étude des collisions pour des interactions à longue portée (Chapitre 3)

Dans le chapitre 3, on se place dans le cadre de l'équation de Boltzmann spatialement homogène pour des interactions à longue portée. Plus précisément on suppose :

(H1) Le noyau de collision adopte la forme produit

$$B(|v - v_*|, \cos \theta) = |v - v_*|^\gamma b(\cos \theta)$$

avec $\gamma \in [0, 1]$.

(H2) $b \geq 0$ n'est pas identiquement nulle et

$$\begin{cases} b \in L_{\text{loc}}^\infty([-1, 1[), \\ \sin^{N-2} \theta b(\cos \theta) \underset{\theta \rightarrow 0}{\sim} K \theta^{-1-\nu}, \end{cases}$$

avec $\nu \in]-\infty, 2[$.

Ce cadre inclut le cas des lois d'interaction en puissance inverse pour les potentiels durs (avec ou sans troncature angulaire).

Sous ces hypothèses la théorie de Cauchy est encore incomplète. Lorsque le noyau de collision est localement intégrable ($\nu < 0$), l'existence et l'unicité sont démontrées dans la classe des distributions positives de masse et énergie cinétique finie, qui ne font pas croître l'énergie cinétique au cours du temps (voir [6, 144]). Lorsque le noyau de collision n'est pas localement intégrable, le premier résultat d'existence est celui d'Arkeryd [7] en dimension $N = 3$ lorsque $\gamma > -1$ et $\nu < 1$. Cette restriction a été levée dans les travaux [107] et [186] (voir également la remarque dans [3, Section 7]). Nos hypothèses sur le noyau de collision sont incluses dans celles de [186] par exemple. L'unicité reste une question ouverte pour les noyaux de collision non localement intégrables, sauf dans le cas particulier des molécules Maxwelliennes (voir [180]). Nous considérerons ici les solutions construites dans [186].

Dans ce chapitre nous étendons la théorie des bornes L^p aux noyaux non localement intégrables, en prouvant de nouvelles estimées *a priori* sur l'opérateur de collision par des méthodes élémentaires.

Nous démontrons (voir le théorème 3.1) le

Théorème 1.5. *Soit B un noyau de collision vérifiant les hypothèses (H1)-(H2) de cette sous-section, $p \in]1, +\infty[$ et $q \in \mathbb{R}$ tel que*

(i) $q \in \mathbb{R}_+$ si $\nu < 0$ (noyau intégrable),

(ii) $pq > 2$ si $\nu \in [0, 1[$,

(iii) $pq > 4$ si $\nu \in [1, 2[$

et f_0 une donnée initiale positive dans $L^1_{\max(p,2)q+2} \cap L^p_q$. Alors

- A.** il existe une solution (faible) de l'équation de Boltzmann spatialement homogène associée, dans $L^\infty([0, +\infty); L^p_q(\mathbb{R}^N))$ (la borne est explicite) ;
- B.** de plus si $\gamma > 0$, cette solution peut être construite dans $L^\infty((\tau, +\infty); L^p_r(\mathbb{R}^N))$ pour tout $\tau > 0$ et $r > q$ (avec des bornes explicites qui explosent de manière au pire polynomiale en $\tau \sim 0$).

Mentionnons que pour les noyaux de collision non localement intégrables, ce théorème peut certainement être amélioré. En effet, dans ce cas le comportement parabolique de l'opérateur permet une apparition de régularité et donc, par injection de Sobolev, une apparition de bornes L^p . Dans le cas de l'opérateur de Landau, ceci a été effectivement démontré (voir [71]). Dans le cas de l'opérateur de Boltzmann ceci a été démontré sous une hypothèse non physique de potentiels durs « régularisés », voir [74]. Des travaux sont en cours, en collaboration avec Laurent Desvillettes, dans cette direction.

La méthode de preuve est basée sur trois ingrédients principaux :

- a.** L'utilisation de l'inégalité de Young, avec un paramètre libre que nous ajustons en fonction de l'angle de déviation θ de la collision.
- b.** Le changement de variable pré-postcollisionnel unitaire $(v, v_*, \sigma) \rightarrow (v', v'_*, k)$, et le changement de variable

$$\begin{aligned} \int_{\mathbb{R}^N \times \mathbb{S}^{N-1}} B(|v - v_*|, \cos \theta) F(v') dv d\sigma \\ = \int_{\mathbb{R}^N \times \mathbb{S}^{N-1}} \frac{1}{\cos^N(\theta/2)} B\left(\frac{|v - v_*|}{\cos(\theta/2)}, \cos \theta\right) F(v) dv d\sigma. \end{aligned}$$

associé aux « lemmes de compensation » (voir [3, Section 3, preuve du Lemme 1]).

- c.** Un découpage de l'opérateur de collision en une partie avec troncature angulaire et une partie sans troncature, et l'utilisation pour la partie tronquée des estimées du chapitre 2.

Les points **a** et **b** permettent de prouver des estimations *a priori* du type (voir le corollaire 3.1)

$$\int_{\mathbb{R}^N} Q_{\mathcal{B}}(g, f)(v) f^{p-1}(v) \langle v \rangle^{pq} dv \leq C_{p,N,\gamma}(b) \|g\|_{L^1_{pq+\gamma}} \|f\|_{L^p_{q+\gamma/p}}^p$$

avec

$$C_{p,N,\gamma}(b) = \text{cst}(p, N, \gamma) \left(\int_{\mathbb{S}^{N-1}} b(\cos \theta) (1 - \cos \theta) d\sigma \right),$$

et où $\text{cst}(p, N, \gamma)$ est une constante explicite dépendant de p , N et γ . Combinées avec les estimations du chapitre 2, elles constituent le coeur de la preuve.

La restriction imposée à l'exposant de poids q dans le théorème 1.5 n'est pas simplement technique dans notre preuve. En effet comme suggéré dans [3], l'opérateur de collision sans troncature angulaire se comporte comme un Laplacien fractionnaire d'ordre $\nu/2$, et nous utilisons en fait les deux changements de variable du point \mathbf{b} de la même façon que des intégrations par partie, pour reporter la dérivation contenue dans l'opérateur sur le poids. Ceci explique que la condition sur le poids dépende de l'ordre ν de la singularité angulaire. De plus, cette stratégie de preuve montre l'utilité pour l'intuition du parallèle avec les équations aux dérivées partielles.

1.2.4 Étude de l'effet combiné transport + collisions sur la positivité (Chapitre 4)

Dans le chapitre 4, on se place dans le cadre de l'équation de Boltzmann posée dans le tore ($\Omega = \mathbb{T}^N$). Les hypothèses mises sur le noyau de collision sont les suivantes :

(H1) B adopte la forme produit

$$B(|v - v_*|, \cos \theta) = \Phi(|v - v_*|) b(\cos \theta).$$

(H2) La partie cinétique Φ vérifie soit

$$\forall z \in \mathbb{R}, \quad c_\Phi |z|^\gamma \leq \Phi(z) \leq C_\Phi |z|^\gamma$$

soit (*noyau lissé pour les petites vitesses relatives*)

$$\begin{cases} \forall |z| \geq 1, & c_\Phi |z|^\gamma \leq \Phi(z) \leq C_\Phi |z|^\gamma \\ \forall |z| \leq 1, & c_\Phi \leq \Phi(z) \leq C_\Phi \end{cases}$$

pour des constantes $c_\Phi, C_\Phi > 0$ et $\gamma \in]-N, 1]$.

(H3) La partie angulaire b est une fonction continue sur $\theta \in]0, \pi]$, strictement positive sur $\theta \in]0, \pi[$, et telle que

$$b(\cos \theta) \sin^{N-2} \theta \underset{\theta \rightarrow 0}{\sim} b_0 \theta^{-1-\nu}$$

pour une constante $b_0 > 0$ et $\nu \in]-\infty, 2[$.

Ce cadre couvrent tous les noyaux de collisions classiques, en particulier les noyaux de collision associés à des lois d'interaction en puissance inverse (avec ou sans troncature angulaire) et le cas des sphères dures.

Les travaux pour quantifier la stricte positivité de la distribution de particules débutent avec le papier fondateur de Carleman [44]. Ce dernier démontre, pour les sphères dures en dimension $N = 3$, que les solutions spatialement homogènes et radialement symétriques en v qu'il construit dans $L_6^\infty(\mathbb{R}_v^N)$ (les premières solutions mathématiques de l'équation de Boltzmann) vérifient une borne inférieure du type

$$\forall t \geq t_0 > 0, \forall v \in \mathbb{R}^3, \quad f(t, v) \geq C_1 e^{-C_2 |v|^{2+\varepsilon}},$$

pour tout $t_0 > 0$ et $\varepsilon > 0$. Les constantes $C_1, C_2 > 0$ sont uniformes lorsque $t \rightarrow +\infty$, et dépendent de t_0, ε et d'estimées sur la solution. Ce résultat ne fut pas amélioré jusqu'au papier de Pulvirenti et Wennberg [169]. Dans ce dernier les auteurs prouvent, pour les potentiels durs avec troncature angulaire en dimension $N = 3$, que les solutions spatialement homogènes construites dans $L_2^1(\mathbb{R}_v^N) \cap L \log L(\mathbb{R}_v^N)$ (voir [6, 144]) vérifient une borne inférieure de la forme

$$\forall t \geq t_0 > 0, \forall v \in \mathbb{R}^3, \quad f(t, v) \geq C_1 e^{-C_2 |v|^2},$$

pour tout $t_0 > 0$. À nouveau $C_1, C_2 > 0$ sont uniforme lorsque $t \rightarrow +\infty$ et dépendent de t_0 et d'estimées sur la solution.

Ces deux résultats reposent sur une propriété fondamentale d'étalement de l'opérateur de gain, couplée (dans le cas de [169]) à des estimées de non-concentration sur l'opérateur de gain itéré. Cette propriété d'étalement peut être rapprochée des propriétés de mélanges associées à la régularité de l'opérateur de gain (voir le chapitre 2). Ces outils sont le point de départ de notre étude. Mentionnons également que l'étude de borne inférieure pour les équations cinétiques a également été abordée par des méthodes probabilistes (voir [92, 94, 93]), ou par des méthodes de type principe du maximum (voir [71, 99]), toujours dans le cas des solutions spatialement homogènes.

Les contributions de ce chapitre sont :

- (i) une méthode pour généraliser ces estimations aux solutions dépendant de la variable d'espace ;
- (ii) une méthode de découpage de l'opérateur de collision pour généraliser ces estimations aux noyaux de collision non localement intégrables ;
- (iii) l'implémentation de ces preuves pour tous les types d'interaction, y compris pour les noyaux de collision admettant une singularité pour les petites vitesses relatives (comme dans le cas des potentiels mous) ;

- (iv) une discussion détaillée de la connexion entre ces estimations *a priori* et les théories de Cauchy parcellaires existantes.

Nous adoptons en effet ici un point de vue *a priori*, qui permet de traiter la question de la borne inférieure indépendamment de celle de l'obtention des bornes de régularité nécessaires sur la solution, que nous n'aborderons pas. Ce point de vue doit être compris comme une approche unifiée des différentes théories de Cauchy, en même temps qu'une façon d'obtenir des résultats *a priori* lorsqu'aucune théorie de Cauchy n'existe, ou bien lorsque les solutions construites sont trop faibles.

L'étude de bornes inférieures sur la distribution est motivée d'abord, bien sûr, par la compréhension qualitative de l'équation, mais aussi par l'émergence récente d'outils d'étude de la convergence vers l'équilibre basés sur des estimations de production d'entropie, qui requièrent de manière générale ce type de borne (voir par exemple [181, 182, 72, 192, 73, 70]).

Nous introduisons maintenant les observables dont nous aurons besoin sur la solution. Considérons une fonction $f = f(t, x, v) \geq 0$ sur $[0, T) \times \Omega \times \mathbb{R}^N$. Nous définissons sa **densité locale**

$$\rho_f(t, x) := \int_{\mathbb{R}^N} f(t, x, v) dv,$$

son **énergie locale** (i.e. le moment local d'ordre 2)

$$e_f(t, x) := \int_{\mathbb{R}^N} f(t, x, v) |v|^2 dv,$$

son moment local d'ordre $\tilde{\gamma}$

$$e'_f(t, x) := \int_{\mathbb{R}^N} f(t, x, v) |v|^{\tilde{\gamma}} dv$$

(où $\tilde{\gamma}$ est la partie positive de $(2 + \gamma)$), son **entropie locale**

$$h_f(t, x) := - \int_{\mathbb{R}^N} f(t, x, v) \log f(t, x, v) dv,$$

sa **norme L^p locale** ($p \in [1, +\infty[$)

$$l_f^p(t, x) := \|f(t, x, \cdot)\|_{L^p(\mathbb{R}_v^N)},$$

et sa **norme $W^{2, \infty}$ locale**

$$w_f(t, x) := \|f(t, x, \cdot)\|_{W^{2, \infty}(\mathbb{R}_v^N)}.$$

Nous définissons alors les bornes uniformes suivantes sur ces observables :

$$\left\{ \begin{array}{ll} \varrho_f := \inf_{(t,x) \in [0,T] \times \Omega} \rho_f(t,x), & E_f := \sup_{(t,x) \in [0,T] \times \Omega} (e_f(t,x) + \rho_f(t,x)), \\ E'_f := \sup_{(t,x) \in [0,T] \times \Omega} e'_f(t,x), & H_f := \sup_{(t,x) \in [0,T] \times \Omega} |h_f(t,x)|, \\ L_f^p := \sup_{(t,x) \in [0,T] \times \Omega} l_f^p(t,x), & W_f := \sup_{(t,x) \in [0,T] \times \Omega} w_f(t,x). \end{array} \right.$$

Les hypothèses sur la solution sont :

(H4) Si $\nu < 0$, et Φ lissée ou $\gamma \geq 0$ (sphères dures, potentiels durs ou molécules Maxwelliennes avec troncature angulaire, potentiels mous lissés avec troncature angulaire), nous supposons que

$$\varrho_f > 0, \quad E_f < +\infty, \quad H_f < +\infty.$$

(H5) Si $\gamma \in (-N, 0)$ avec Φ non lissé (singularité de Φ pour les petites vitesses relatives), nous supposons de plus

$$L_f^{p_\gamma} < +\infty$$

$$\text{avec } p_\gamma > \frac{N}{N+\gamma}.$$

(H6) Si $\nu \in [0, 2)$ (singularité de b), nous supposons de plus

$$W_f < +\infty, \quad E'_f < +\infty$$

Dans l'énoncé qui suit, une *solution généralisée* renvoie à la définition 4.1 du chapitre 4 lorsque le noyau de collision est localement intégrable et à la définition 4.2 du chapitre 4 lorsque le noyau de collision n'est pas localement intégrable. Nous démontrons (voir les théorèmes 4.1 et 4.2) le

Théorème 1.6. *Soit B un noyau de collision vérifiant les hypothèses (H1)-(H2)-(H3) de cette sous-section, et $f = f(t, x, v)$ une solution généralisée de l'équation de Boltzmann sur $[0, T[$, $T \in]0, +\infty]$, qui vérifie l'hypothèse (H4) de cette sous-section et telle que*

- (i) *si Φ n'est pas lissée et $\gamma < 0$, alors f vérifie également l'hypothèse (H5) de cette sous-section.*
- (ii) *si $\nu \in [0, 2[$, alors f vérifie également l'hypothèse (H6) de cette sous-section.*

Alors

- A.** Si $\nu < 0$, pour tout $\tau \in]0, T[$ il existe des constantes $\rho > 0$ et $\theta > 0$ dépendant de $\tau, \varrho_f, E_f, H_f$ (et $L_f^{p\gamma}$ si Φ n'est pas lissée et $\gamma < 0$), telles que pour tout $t \in [\tau, T[$ la solution f est bornée ponctuellement par en-dessous par la distribution Maxwellienne uniforme de densité ρ et température θ , i.e.

$$\forall t \in [\tau, T[, \text{ pour presque tout } (x, v) \in \Omega \times \mathbb{R}^N,$$

$$f(t, x, v) \geq \rho \frac{e^{-\frac{|v|^2}{2\theta}}}{(2\pi\theta)^{N/2}}.$$

- B.** Si $\nu \in [0, 2[$, pour tout $\tau \in]0, T[$ et pour tout exposant K tel que

$$K > 2 \frac{\log\left(2 + \frac{2\nu}{2-\nu}\right)}{\log 2},$$

il existe des constantes $C_1 > 0$ et $C_2 > 0$ dépendant de $\tau, K, \varrho_f, E_f, E'_f, H_f, W_f$ (et $L_f^{p\gamma}$ si Φ n'est pas lissée et $\gamma < 0$), telles que

$$\forall t \in [\tau, T), \text{ pour presque tout } (x, v) \in \Omega \times \mathbb{R}^N,$$

$$f(t, x, v) \geq C_1 e^{-C_2 |v|^K}.$$

De plus dans le cas $\nu = 0$, il est possible de prendre $K = 2$ (borne inférieure Maxwellienne).

Notons que cette propriété d'« apparition immédiate » de borne inférieure strictement positive peut surprendre à première vue si l'on a l'image d'un processus de collision entre un nombre fini de particules. En effet, même si la distribution initiale de particules est à support compact en vitesse, les particules « remplissent » immédiatement tout l'espace \mathbb{R}^N des vitesses. En fait c'est une conséquence du fait que l'équation de Boltzmann est un modèle mathématique idéalisé qui correspond à une limite d'un système de particules lorsque leur nombre tend vers l'infini.

Les ingrédients de la preuve sont les suivants :

- a.** Une représentation de la solution par une formule de Duhamel écrite le long des caractéristiques.
- b.** Une propriété de non-concentration sur l'opérateur de gain itéré qui permet d'obtenir l'apparition de « plateaux de minoration » en vitesse le long des caractéristiques.

c. Une propriété d'étalement de l'opérateur de gain qui permet par itération infinie d'obtenir des bornes exponentiellement décroissantes sur tout l'espace des vitesses le long des caractéristiques.

d. Dans le cas de noyaux non localement intégrables pour lesquels le découpage de l'opérateur de collision en partie gain et partie perte n'a plus de sens, nous découpons l'opérateur en une partie avec troncature angulaire qui vérifie les propriétés b. et c. ci-dessus uniformément en le paramètre de troncature, et une partie sans troncature angulaire mais qui peut être rendue petite dans L^∞ grâce aux estimations de régularité sur la solution.

Les points **b** et **c** étaient déjà présents dans les travaux [169] dans le cas spatialement homogène. Nous redétaillons néanmoins ces estimations pour expliciter les constantes et montrer qu'elles peuvent être rendues indépendantes de la caractéristique que l'on regarde (voir les lemmes 4.2 et 4.3 du chapitre 4).

Les applications possibles de ce théorème *a priori* sont les suivantes :

Ce théorème couvre le cas des solutions spatialement homogènes. Il contient les résultats précédents [44, 169]. Il s'applique également (théorème 4.3) aux solutions spatialement homogènes dans le cas de potentiels mous lissés avec troncature angulaire (traités par exemple par la théorie de [6]) ou encore (théorème 4.4) aux solutions construites dans [74] pour des potentiels durs lissés sans troncature angulaire. Ce sont les premiers résultats de borne inférieure exponentielle pour des solutions de l'équation de Boltzmann sans troncature angulaire.

Dans le cas non spatialement homogène, ce théorème s'applique aux solutions régulières construites dans un cadre perturbatif, par exemple dans [183] pour les sphères dures, ou plus récemment dans [110] pour les potentiels mous avec troncature angulaire (voir le théorème 4.5). Plus généralement il peut être vu comme un résultat *a priori* sur les solutions renormalisées. Par exemple, dans le cas d'un gaz de sphères dures dans le tore, sa contraposée énonce que si la distribution f s'annule en un point (x, v) de l'espace des phases (au sens d'une borne inférieure essentielle), alors nécessairement soit la densité locale ρ_f doit s'annuler en un point x du tore (au sens d'une borne inférieure essentielle), soit l'énergie locale e_f ou l'entropie locale h_f doivent diverger en un point x du tore (au sens d'une borne supérieure essentielle).

Un travail est en cours pour généraliser le théorème 1.6 au cas d'un ouvert Ω convexe, borné et régulier avec condition de réflexion spéculaire ou condition de « bounce-back » au bord.

1.3 Quantification du retour à l'équilibre thermodynamique

1.3.1 Historique et difficultés du problème

Ce problème est intimement lié à la théorie de Boltzmann puisqu'une des motivations de Boltzmann était de construire un modèle mathématique rigoureux pour les phénomènes de production d'entropie associés à l'irréversibilité en thermodynamique. En pratique le théorème H est le point de départ de l'étude analytique des phénomènes de production d'entropie en théorie cinétique. La motivation de cette étude est fondamentale : d'une part fournir une base mathématique claire au second principe de la thermodynamique pour un modèle de mécanique statistique hors équilibre thermodynamique très largement validé par l'expérience ; d'autre part valider le modèle de Boltzmann pour l'étude de la convergence vers l'équilibre en prouvant qu'il converge effectivement vers l'équilibre thermodynamique en un temps physiquement raisonnable.

Le théorème H dans sa forme initiale comprend deux parties : la décroissance de la fonctionnelle H (i.e. l'opposé de l'entropie physique) et le fait que les seuls extrema de cette fonctionnelle sont les distributions Maxwelliennes (ce dernier point est aussi connu sous le nom de « lemme de Gibbs »). Depuis les années 1930 et les travaux de Carleman, nous savons construire des solutions mathématiques rigoureuses de l'équation de Boltzmann, au moins dans certains cas particuliers. Le **problème du retour à l'équilibre** consiste à montrer que la solution converge (en un sens à préciser) asymptotiquement vers l'équilibre thermodynamique qui lui est associé (nous ne considérerons que des cas où cet équilibre existe et est unique). Le **problème du retour à l'équilibre quantifié** consiste à prouver la convergence tout en quantifiant la vitesse de convergence.

Des résultats de convergence vers l'équilibre obtenus par des méthodes de compacité non constructives sont apparus bien avant les premiers résultats quantifiés. Quel est alors l'intérêt de préciser la vitesse de convergence ? Prouver la convergence vers l'équilibre thermodynamique est une avancée considérable, mais ne peut être considérée comme satisfaisant tant que les résultats restent basés sur des arguments non constructifs. Comme le suggérait implicitement Boltzmann dans ses arguments contre les critiques de sa théorie basées sur le théorème de récurrence de Poincaré, l'équation de Boltzmann n'est plus valide pour les très grands temps. En effet, l'hypothèse de non-corrélation des particules avant collision n'est vraie que lorsque chaque particule ne collisionne que $O(1)$ fois par unité de temps (hypothèse de

chaos moléculaire, obtenu pour des régime de gaz dilués). On peut donc s'attendre à ce que le temps de validité de l'équation de Boltzmann soit de l'ordre de $O(n)$ unité de temps, où n est le nombre de particules. C'est le temps au bout duquel chaque particule a collisionné avec une fraction non négligeable des autres particules et les effets de corrélation ne peuvent plus être négligés (voir également la discussion dans [191, Chapitre 1, Section 2.5]). Ceci donne un temps de validité fini, de l'ordre du nombre d'Avogadro, c'est-à-dire 10^{24} . Il est donc crucial d'obtenir des informations quantitatives sur le taux de convergence, pour pouvoir comparer l'échelle du temps de convergence à l'échelle du temps de validité. Ajoutons que les arguments constructifs donnent une meilleure compréhension qualitative du modèle, et permettent par exemple de mieux comprendre la dépendance du taux de convergence par rapport aux paramètres du modèle.

On peut résumer les principales étapes de l'histoire de l'étude de la convergence vers l'équilibre ainsi (nous n'essayons pas de dresser une bibliographie exhaustive) :

Les premiers résultats sont des convergences fortes ou faibles dans L^1 , dans le cadre spatialement homogène, obtenus par des arguments de compacité, voir par exemple Carleman [44] (ou plus tard Arkeryd [6]).

Dans les années 1950, Ikenberry et Truesdell [118] démontrent, dans le cadre spatialement homogène et pour les molécules Maxwelliennes, la relaxation exponentielle de tous les moments qui existent initialement vers leur valeur à l'équilibre, en explicitant le taux de convergence.

Dans les années 1960, Grad [109] démontre l'existence d'un trou spectral (en vitesse) pour l'opérateur de collision linéarisé pour les potentiels durs ou Maxwelliens (et les sphères dures). Ce résultat est non constructif, car il est basé sur le théorème de Weyl sur les perturbations compactes du spectre essentiel, mais suscite énormément de travaux. En particulier il ouvre la voie à la construction de solutions perturbatives en inhomogène, et, pour ces solutions, à l'étude de la convergence vers l'équilibre (voir par exemple [183, 184]) ou à l'étude de la limite hydrodynamique (voir par exemple [76]). Il permet d'obtenir les premiers résultats de convergence exponentielle vers l'équilibre, même si le taux reste non constructif. Il est important de noter que le cadre fonctionnel dans lequel est étudié l'opérateur de collision est $f \in L^2(M^{-1})$ où M est la distribution Maxwellienne à l'équilibre, cadre qui est bien plus petit que l'espace physique L^1 , et pour lequel il n'existe aucun résultat de Cauchy, même en spatialement homogène avec molécules Maxwelliennes et troncature angulaire. Une théorie linéarisée non-constructive similaire a également été construite par la suite pour les potentiels mous, voir [41, 42, 103].

Dans le même cadre fonctionnel $f \in L^2(M^{-1})$ et dans le cas particulier des molécules Maxwelliennes, les travaux de Wang-Chang et Uhlenbeck [194] et Bobylev [24] permettent d'obtenir une diagonalisation explicite de l'opérateur de collision linéarisé en exploitant ses propriétés de symétrie et la transformation de Fourier. Ceci permet de préciser la valeur du trou spectral de l'opérateur linéarisé en spatialement homogène pour les molécules Maxwelliennes.

À la fin des années 1980, en se basant sur les résultats de Grad et des arguments de compacité, Arkeryd [10] démontre, dans le cadre des solutions spatialement homogènes avec potentiels durs et troncature angulaire, le premier résultat de convergence exponentielle vers l'équilibre (dans L^1) sans hypothèse perturbative sur la solution. Ce résultat reste cependant fortement non constructif. Il est étendu au cas des espaces L^p ($1 < p < +\infty$) par Wennberg [196, 197].

Au début des années 1990 émerge une nouvelle approche basée sur la quantification du théorème H avec les travaux fondateurs [46, 47] puis les travaux [181, 182, 192, 150]. Plus précisément l'idée est d'obtenir une inégalité du type

$$-\frac{dH(f|M)}{dt} \geq \Theta(H(f|M))$$

où $H(f|M) = S(M) - S(f)$ et Θ est une fonction strictement positive sur \mathbb{R}_+ . La **conjecture de Cercignani** est l'inégalité suivante :

$$(1.3.23) \quad -\frac{dH(f|M)}{dt} \geq K_f H(f|M)$$

pour une certaine constante K_f qui dépend d'estimations de régularité et décroissance sur f (conjecture sous forme faible) ou indépendante de f (conjecture sous forme forte). Cette inégalité fournirait en fait immédiatement la convergence exponentielle avec taux donné par K_f , mais il a été démontré ([28]) que cette conjecture était fautive (dans ses formes fortes et faibles) même pour des fonctions infiniment régulières et vérifiant une décroissance polynomiale arbitrairement grande. Néanmoins la conjecture de Cercignani est « presque vraie » (voir [192, 150]) : pour tout $\varepsilon > 0$, sous certaines hypothèses de régularité et décroissance polynomiale sur la solution, on a

$$\mathcal{D}(f) \geq K_f^\varepsilon H(f|M)^{1+\varepsilon},$$

ce qui permet d'obtenir une convergence « presque exponentielle », soit en $O(t^{-\frac{1}{\varepsilon}})$ pour tout $\varepsilon > 0$. Pour une vue d'ensemble de cette approche, nous renvoyons aux articles de revue récents [185, 12].

Finalement, dans le cas des molécules Maxwelliennes en spatialement homogène, des outils spécifiques au cas Maxwellien (essentiellement la convergence des moments ainsi que des métriques adaptées basées sur la transformation de Fourier) ont permis d'obtenir des résultats de convergence avec taux explicites et optimaux (voir [48, 49]).

Mentionnons que dans le cas des solutions renormalisées de DiPerna et Lions, les seuls résultats existants sont des convergences faibles de la distribution pour des suites de temps tendant vers l'infini, voir par exemple [130, 131].

Il est possible de se représenter la théorie par théorème H quantifié comme une théorie de « trou spectral non-linéaire ». Elle est bien plus puissante que la théorie linéarisée puisqu'elle ne nécessite pas d'hypothèse perturbative sur les solutions du problème non-linéaire et travaille directement dans l'espace physique L^1 . Néanmoins elle semble impuissante à fournir directement la convergence exponentielle dans L^1 , alors que, pour les potentiels durs avec troncature angulaire par exemple, elle est attendue au vu des résultats non constructifs de [10]. De plus, le trou spectral existe dans ce cas alors que la conjecture de Cercignani n'est pas vérifiée. Cette considération est le point de départ de cette partie : le but est de fournir d'une part des résultats de trou spectraux constructifs dans l'espace linéarisé $L^2(M^{-1})$, et d'autre part de fournir des outils constructifs pour relier la théorie linéarisée dans $L^2(M^{-1})$ à la théorie non-linéaire dans L^1 , pour obtenir la convergence exponentielle explicite. Le but final est le théorème 7.1 du chapitre 7 qui répond à la question dans le cas spatialement homogène.

1.3.2 La théorie linéarisée

On désigne par $M = M(v)$ la distribution Maxwellienne à l'équilibre autour de laquelle on effectue la linéarisation. Soit $m = m(v)$ une fonction strictement positive mesurable, on définit la linéarisation \mathcal{L}_m associée au poids m par la formule

$$\mathcal{L}_m(g) = m^{-1} [Q_{\mathcal{B}}(mg, M) + Q_{\mathcal{B}}(M, mg)].$$

Dans le cas particulier $m = M$, on parle simplement de l'**opérateur de Boltzmann linéarisé**, défini par

$$\begin{aligned} L_{\mathcal{B}}(h) &= M^{-1} [Q_{\mathcal{B}}(Mh, M) + Q_{\mathcal{B}}(M, Mh)] \\ &= \int_{\mathbb{R}^N \times \mathbb{S}^{N-1}} B(|v - v_*|, \cos \theta) M(v_*) [h'_* + h' - h_* - h] dv_* d\sigma. \end{aligned}$$

L'opérateur $\mathcal{L}_m(g)$ correspond à la linéarisation autour de M avec une perturbation g du type $f = M + mg$. Parmi tous les choix possibles pour m ,

le cas $m = M$ est particulier puisque $L_{\mathcal{B}}$ est alors auto-adjoint sur l'espace $L^2(M)$. C'est pourquoi c'est souvent le seul considéré.

De la même façon, on définit l'**opérateur de Landau linéarisé** (nous ne l'utiliserons qu'avec le poids classique $m = M$)

$$L_{\mathcal{L}}h(v) = M(v)^{-1} \nabla_v \cdot \left(\int_{v_* \in \mathbb{R}^N} \mathbf{A}(v - v_*) [(\nabla h) - (\nabla h)_*] M M_* dv_* \right),$$

qui est auto-adjoint sur $L^2(M)$.

Pour un opérateur linéaire $T : \mathcal{B} \rightarrow \mathcal{B}$ sur un espace de Banach \mathcal{B} , défini sur le domaine dense $\text{Dom}(T) \subset \mathcal{B}$, on rappelle les définitions et notations suivantes :

- $N(T) \subset \mathcal{B}$ désigne le noyau de T ;
- l'**ensemble résolvant** de T désigne l'ensemble des nombres complexes ξ tels que $T - \xi$ est bijectif de $\text{Dom}(T)$ sur \mathcal{B} , d'inverse borné ;
- $\Sigma(T) \subset \mathbb{C}$ désigne le **spectre** de T , c'est-à-dire l'ensemble complémentaire de l'ensemble résolvant dans \mathbb{C} ;
- $\Sigma_d(T) \subset \Sigma(T)$ désigne le **spectre discret** de T , c'est-à-dire l'ensemble des valeurs propres isolées au sein du spectre et de multiplicité finie ;
- $\Sigma_e(T) \subset \Sigma(T)$ désigne le **spectre essentiel** de T , c'est-à-dire le complémentaire du spectre discret dans le spectre ($\Sigma_e(T) = \Sigma(T) \setminus \Sigma_d(T)$) ;
- pour un opérateur auto-adjoint sur un Hilbert, et lorsque $\Sigma(T) \subset \mathbb{R}_-$ (opérateur négatif), on dit que T possède un **trou spectral** lorsque la distance entre 0 et $\Sigma(T) \setminus \{0\}$ est non nulle, et le trou spectral désigne cette distance.

C'est un fait classique de la théorie de l'opérateur de Boltzmann linéarisé $L_{\mathcal{B}}$ qu'avec les changements de variables unitaires $(v, v_*, \sigma) \rightarrow (v_*, v, -\sigma)$ et $(v, v_*, \sigma) \rightarrow (v', v'_*, k)$ on obtient

$$\langle h, L_{\mathcal{B}}h \rangle_{L^2(M)} = -\frac{1}{4} \int_{\mathbb{R}^N \times \mathbb{R}^N \times \mathbb{S}^{N-1}} B(|v - v_*|, \cos \theta) \left[h'_* + h' - h_* - h \right]^2 M M_* dv dv_* d\sigma \leq 0.$$

Ceci implique que l'opérateur est négatif et que donc son spectre est inclus dans \mathbb{R}_- . Le noyau de L_B est

$$(1.3.24) \quad N(L_B) = \text{Vect} \{1, v_1, \dots, v_N, |v|^2\}.$$

Ces deux propriétés correspondent à la version linéarisée du théorème *H*. Les estimations de type trou spectral correspondent à des versions linéarisées des estimations (1.3.23) reliant l'entropie relative à la production d'entropie. De la même façon, pour l'opérateur de Landau linéarisé $L_{\mathcal{L}}$, on obtient

$$\langle h, L_{\mathcal{L}} h \rangle_{L^2(M)} = -\frac{1}{2} \int_{\mathbb{R}^N} \int_{\mathbb{R}^N} \Phi(v - v_*) |v - v_*|^2 \|\mathbf{P}(v - v_*) [(\nabla h) - (\nabla h)_*]\|^2 M M_* dv_* dv \leq 0.$$

Ceci implique que l'opérateur est négatif et que donc son spectre est inclus dans \mathbb{R}_- , et son noyau est également

$$N(L_{\mathcal{L}}) = N(L_B) = \text{Vect} \{1, v_1, \dots, v_N, |v|^2\}.$$

Nous résumons maintenant l'état des connaissances sur la géométrie du spectre de L_B et $L_{\mathcal{L}}$, en fonction du noyau de collision (les traits continus correspondent au spectre essentiel et les points isolés correspondent au spectre discret). Le noyau de collision est supposé prendre la forme

$$B(|v - v_*|, \cos \theta) = |v - v_*|^\gamma b(\cos \theta)$$

avec

$$\sin^{N-2} \theta b(\cos \theta) \underset{\theta \rightarrow 0}{\sim} \theta^{-1-\nu}, \quad \nu \in]-\infty, 2[$$

dans le cas de L_B , et simplement

$$\Phi(|v - v_*|) = |v - v_*|^\gamma$$

dans le cas de $L_{\mathcal{L}}$. La figure 5.1 donne le spectre de L_B pour les potentiels durs ($\gamma > 0$) avec b localement intégrable ($\nu < 0$). La figure 5.2 donne le spectre de L_B pour les molécules Maxwelliennes ($\gamma = 0$) avec b localement intégrable ($\nu < 0$). La figure 5.3 donne le spectre de L_B pour les potentiels mous ($\gamma < 0$) avec b localement intégrable ($\nu < 0$). Ces figures sont issues de résultats qu'on peut trouver dans [52, Chapitre 4, Section 6] et [41]. De plus, au vu des résultats du chapitre 6 concernant le cas ($\gamma > 0, \nu > 0$) pour L_B et la diagonalisation explicite dans le cas $\gamma = 0$ (valide sans troncature angulaire),

on obtient la géométrie de la figure 1.2 dans le cas $\gamma \geq 0, \nu \in]0, 2[$ pour L_B , ou $\gamma \geq 0$ pour $L_{\mathcal{L}}$. Il est alors naturel de conjecturer la même géométrie dans le cas $(\gamma \geq 0, \nu = 0)$ pour L_B (où le noyau de collision est encore non localement intégrable et l'opérateur correspond à une dérivée logarithmique en terme de régularisation). Enfin, à partir du cas $(\gamma < 0, \nu < 0)$ (figure 5.3) et en prenant la limite sur une troncature de b , on est conduit à conjecturer la géométrie de la figure 1.3 (non démontrée pour le moment) dans le cas $(\gamma < 0, \nu \in [0, 2[)$ pour L_B , et $\gamma < 0$ pour $L_{\mathcal{L}}$.

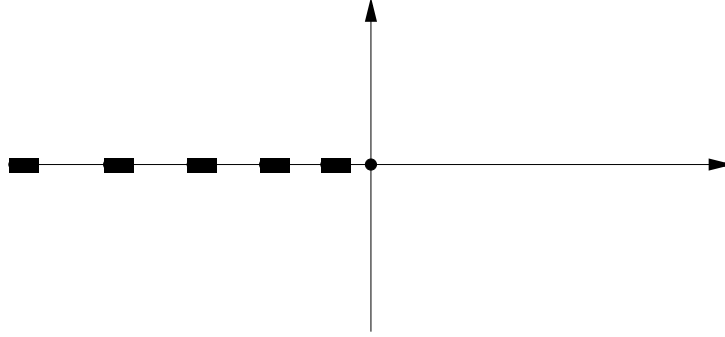

Figure 1.2: Spectre de L_B pour les potentiels durs ou les molécules Maxwelliennes ($\gamma \geq 0$) avec b non localement intégrable ($\nu \in [0, 2[$) et spectre de $L_{\mathcal{L}}$ pour les potentiels durs ou les molécules Maxwelliennes ($\gamma \geq 0$)

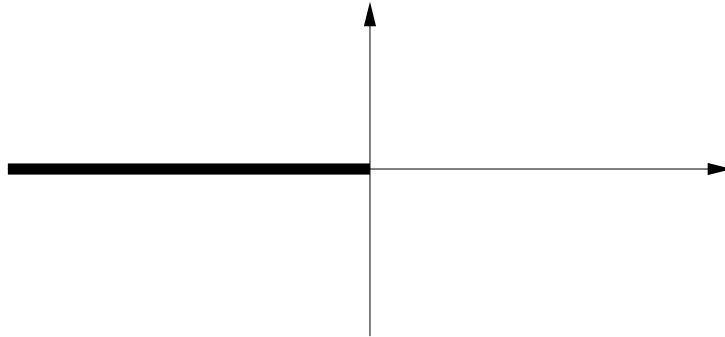

Figure 1.3: Spectre de L_B pour les potentiels mous ($\gamma < 0$) avec b non localement intégrable ($\nu \in [0, 2[$) et spectre de $L_{\mathcal{L}}$ pour les potentiels mous ($\gamma < 0$)

Dans le cas $(\gamma > 0, \nu < 0)$, il existe $c_0 > 0$ tel que le spectre est composé d'une partie essentielle $] -\infty, c_0]$ et d'une infinité de valeurs propres discrètes sur l'intervalle $] -c_0, 0]$, qui s'accablent uniquement en $-c_0$. Dans le cas

($\gamma = 0, \nu < 0$), il existe $c_1 > 0$ tel que le spectre est composé d'une partie essentielle $\{-c_1\}$ et d'une infinité de valeurs propres discrètes sur l'intervalle $]-c_1, 0]$, qui s'accroissent uniquement en $-c_1$. Dans le cas ($\gamma < 0, \nu < 0$), il existe $c_2 > 0$ tel que le spectre est composé d'une partie essentielle $[-c_2, 0]$, et de valeurs propres discrètes sur l'intervalle $]-\infty, -c_2[$, qui s'accroissent uniquement en $-c_2$. Dans le cas ($\gamma \geq 0, \nu \in [0, 2[$) (ou seulement $\gamma \geq 0$ pour l'opérateur de Landau linéarisé), le spectre est composé uniquement de valeurs propres discrètes sur l'intervalle $]-\infty, 0]$, qui forment une suite infinie tendant vers $-\infty$. Dans le cas ($\gamma < 0, \nu \in [0, 2[$) (ou seulement $\gamma < 0$ pour l'opérateur de Landau linéarisé), le spectre est composé uniquement d'une partie essentielle $]-\infty, 0]$. En conclusion, pour cette classe de noyaux de collision l'existence d'un trou spectral est équivalente à $\gamma \geq 0$.

1.3.3 Estimations explicites de trou spectral (Chapitre 5)

Dans le chapitre 5, le but est d'obtenir des estimations explicites sur le trou spectral des opérateurs de Boltzmann et Landau linéarisés dans tous les cas décrits ci-dessus où il existe (i.e. $\gamma \geq 0$). Nous adoptons ici pour le noyau de collision B le cadre général suivant :

(H1) B adopte la forme produit

$$B(|v - v_*|, \cos \theta) = \Phi(|v - v_*|) b(\cos \theta).$$

(H2) La partie cinétique Φ est bornée inférieurement à l'infini :

$$\exists R \geq 0, c_\Phi > 0 ; \forall r \geq R, \Phi(r) \geq c_\Phi.$$

(H3) La partie angulaire b vérifie

$$c_b = \inf_{\sigma_1, \sigma_2 \in \mathbb{S}^{N-1}} \int_{\sigma_3 \in \mathbb{S}^{N-1}} \min\{b(\sigma_1 \cdot \sigma_3), b(\sigma_2 \cdot \sigma_3)\} d\sigma_3 > 0.$$

L'hypothèse (H3) couvre tous les cas physiques. Quant à l'hypothèse (H2) elle couvre le cas des potentiels durs, des sphères dures et des molécules Maxwelliennes. Dans le cas de l'opérateur de Landau linéarisé, les hypothèses sur le noyau de collision Φ se réduisent à (H2).

La méthode de Grad (dont on peut trouver une présentation très claire dans [58]) peut être aisément généralisée à ces hypothèses. La forme de Dirichlet étant monotone par rapport au noyau de collision, on peut toujours

supposer le noyau tronqué angulairement quitte à minorer la forme de Dirichlet. L'idée de la preuve est alors de décomposer l'opérateur L_B en une partie multiplicative dont on calcule le spectre (composé uniquement d'une partie essentielle] $-\infty, -c_0]$ pour un certain $c_0 > 0$) plus une partie compacte, et d'utiliser le théorème de Weyl pour les opérateurs auto-adjoints, qui énonce qu'une perturbation auto-adjointe compacte d'un opérateur auto-adjoint ne modifie pas son spectre essentiel. Le reste du spectre est alors nécessairement constitué de valeurs propres discrètes, qui ne peuvent se trouver que sur l'intervalle $] -c_0, 0]$ du fait que l'opérateur est négatif. Une méthode similaire a été appliquée à l'opérateur de Landau linéarisé, voir [62] (voir également [128] pour des variantes relativistes ou quantiques de l'opérateur de Landau linéarisé).

Ici au contraire nous partons des estimations explicites du cas Maxwellien (voir [194, 24]) et nous les étendons aux hypothèses ci-dessus en travaillant uniquement sur la forme de Dirichlet et sans utiliser de théorème abstrait de théorie spectrale. En effet, la méthode de Grad permet d'obtenir la géométrie complète du spectre, mais ne fournit aucune information sur la taille du trou spectral, et ne repose pas sur un argument physique. Nous proposons une méthode géométrique qui travaille sur l'opérateur de collision global, sans décomposition gain/perte, et basée sur un argument physique. Cette méthode retrouve tous les résultats précédents sur l'existence de trou spectral, et fournit des estimations explicites qui sont nouvelles dans tous les cas où le noyau de collision dépend du module de la vitesse relative. Nous démontrons (voir les théorèmes 5.1 et 5.2 du chapitre 5) le

Théorème 1.7. *Soit B un noyau de collision vérifiant les hypothèses (H1)-(H2)-(H3) de cette sous-section (respectivement un noyau de collision Φ vérifiant l'hypothèse (H2) de cette sous-section dans le cas de l'opérateur linéarisé de Landau). Alors*

- (i) *La forme de Dirichlet de l'opérateur linéarisé de Boltzmann avec noyau de collision B vérifie*

$$\forall h \in L^2(M), \quad -\langle h, L_B h \rangle_{L^2(M)} \geq -C_{\Phi,b}^{B_0} \langle h, L_B^0 h \rangle_{L^2(M)},$$

où L_B^0 est l'opérateur de Boltzmann linéarisé avec noyau de collision $B_0 \equiv 1$, et

$$C_{\Phi,b}^{B_0} = \left(\frac{c_\Phi c_b e^{-4R^2}}{32 |\mathbb{S}^{N-1}|} \right)$$

avec R , c_Φ et c_b définis dans les hypothèses (H2)-(H3) de cette sous-section.

(ii) Nous en déduisons les estimations suivantes sur le trou spectral de l'opérateur linéarisé de Boltzmann :

$$\forall h \in L^2(M), \quad -\langle h, L_B h \rangle_{L^2(M)} \geq C_{\Phi, b}^{\mathcal{B}_0} \lambda_0^{\mathcal{B}_0} \|h - \Pi(h)\|_{L^2(M)}^2$$

où $\lambda_0^{\mathcal{B}_0} > 0$ désigne le trou spectral de l'opérateur de Boltzmann linéarisé avec noyau de collision $B_0 \equiv 1$, qui vaut en dimension $N = 3$ (voir [24])

$$\lambda_0^{\mathcal{B}_0} = \pi \int_0^\pi \sin^3 \theta \, d\theta = \frac{4\pi}{3}.$$

Dans le cas particulier $B \geq |v - v_*|^\gamma$ ($\gamma > 0$), on trouve par exemple, après calcul, l'estimation suivante sur le trou spectral $S_\gamma^{\mathcal{B}_0}$ correspondant (en dimension $N = 3$)

$$S_\gamma^{\mathcal{B}_0} \geq \frac{\pi (\gamma/8)^{\gamma/2} e^{-\gamma/2}}{24}.$$

(iii) La forme de Dirichlet de l'opérateur linéarisé de Landau avec noyau de collision Φ vérifie

$$\forall h \in L^2(M), \quad -\langle h, L_{\mathcal{L}} h \rangle_{L^2(M)} \geq -C_{\Phi}^{\mathcal{L}^a} \langle h, L_{\mathcal{L}}^0 h \rangle_{L^2(M)}$$

où $L_{\mathcal{L}}^0$ est l'opérateur de Landau linéarisé avec noyau de collision $\Phi_0 \equiv 1$, et

$$C_{\Phi}^{\mathcal{L}^a} = \left(\frac{c_{\Phi} \beta_R}{8 \alpha_N} \right)$$

où

$$\alpha_N = \int_{\mathbb{R}^{N-1}} e^{-|V|^2} \, dV, \quad \beta_R = \int_{\{V \in \mathbb{R}^{N-1} \mid |V| \geq 2R\}} e^{-|V|^2} \, dV.$$

(iv) Nous en déduisons les estimations suivantes sur le trou spectral de l'opérateur de Landau linéarisé :

$$\forall h \in L^2(M), \quad -\langle h, L_{\mathcal{L}} h \rangle_{L^2(M)} \geq C_{\Phi}^{\mathcal{L}^a} \lambda_0^{\mathcal{L}^a} \|h - \Pi(h)\|_{L^2(M)}^2$$

où $\lambda_0^{\mathcal{L}^a} > 0$ désigne le trou spectral de l'opérateur linéarisé de Landau avec noyau de collision $\Phi_0 \equiv 1$, qui vérifie en dimension $N = 3$

$$\lambda_0^{\mathcal{L}^a} \geq 2\pi.$$

Dans le cas particulier $\Phi \geq |v - v_*|^\gamma$ ($\gamma > 0$), on trouve par exemple après calcul l'estimation suivante sur le trou spectral $S_\gamma^{\mathcal{L}^a}$ correspondant (en dimension $N = 3$)

$$S_\gamma^{\mathcal{L}^a} \geq \frac{\pi (\gamma/8)^{\gamma/2} e^{-\gamma/2}}{4}.$$

L'idée de la preuve est d'utiliser la monotonie de la forme de Dirichlet pour essayer de la contrôler par la forme de Dirichlet du cas Maxwellien. La difficulté vient des régions où le noyau de collision s'annule. On peut se représenter la forme de Dirichlet comme la somme de la quantité

$$q_C = [h' + h'_* - h - h_*]^2$$

sur l'ensemble des collisions C , pondérée par le noyau de collision. Si lorsque se produit une collision $C_0 : (v, v_*) \rightarrow (v', v'_*)$ dans une région du domaine d'intégration où le noyau de collision s'annule, on peut trouver deux collisions C_1 et C_2 produisant les mêmes vitesses pré et post-collisionnelles, et telles que

$$q_{C_1} + q_{C_2} \geq K q_{C_0}$$

pour une certaine constante absolue $K > 0$, alors on peut remplacer la collision. L'idée est alors d'effectuer ce remplacement avec des collisions venant de régions du domaine d'intégration où le noyau de collision ne s'annule pas.

Plus précisément, le point de départ est l'inégalité suivante, qui apparaissait déjà dans [50, théorème 2.4] dans le contexte des modèles granulaires : pour toute fonction $\xi = \xi(x)$ sur \mathbb{R}^N ,

$$\begin{aligned} \int_{\mathbb{R}^N} \int_{\mathbb{R}^N} |\xi(x) - \xi(y)|^2 |x - y|^\gamma M(x) M(y) dx dy \\ \geq K_\gamma \int_{\mathbb{R}^N} \int_{\mathbb{R}^N} |\xi(x) - \xi(y)|^2 M(x) M(y) dx dy \end{aligned}$$

où $\gamma \geq 0$, et

$$K_\gamma = \frac{1}{4 \int_{\mathbb{R}^N} M} \inf_{x, y \in \mathbb{R}^N} \int_{\mathbb{R}^N} \min \{|x - z|^\gamma, |z - y|^\gamma\} M(z) dz.$$

La preuve de cette inégalité repose sur l'existence d'une inégalité « de type triangulaire » pour la fonction de deux variables intégrée : ici $F(x, y) = |\xi(x) - \xi(y)|^2$ vérifie

$$F(x, y) \leq 2F(x, z) + 2F(z, y).$$

La difficulté principale dans le cas de l'opérateur de Boltzmann est d'isoler un couple de variables dans le domaine d'intégration telles que la quantité q_C ci-dessus vérifie une inégalité « de type triangulaire ». Dans le cas du traitement des annulations de la partie angulaire b , les deux variables du domaine d'intégration à considérer sont $(v - v_*)/|v - v_*|$ et $(v' - v'_*)/|v' - v'_*|$ sur \mathbb{S}^{N-1} , et le couple de vitesses intermédiaires à introduire est décrit dans la figure 5.4. Dans le cas du traitement des annulations de la partie cinétique Φ (pour $v \sim v_*$), les deux variables du domaine d'intégration à considérer sont $v \cdot \omega$ et $v' \cdot \omega$ (où $\omega = (v' - v)/|v' - v|$, voir la figure 1.1), et le couple de vitesses à introduire est décrit dans la figure 5.5. Les estimations sur l'opérateur de Landau linéarisé (points (iii) et (iv) du théorème 1.7) sont ensuite obtenues par limite de collision rasante.

1.3.4 Estimations explicites de coercivité (Chapitre 6)

Dans le chapitre 6, le but est d'obtenir des estimations explicites de coercivité sur les opérateurs de Boltzmann et Landau linéarisés, qui généralisent les estimations de type trou spectral. Plus précisément nous montrons que la forme de Dirichlet prise sur une fonction h permet de contrôler h dans un espace fonctionnel qui dépend du noyau de collision. Ces estimations de coercivité coïncident avec les estimations de trou spectral dans le cas de molécules Maxwelliennes avec troncature angulaire, et sont strictement plus fortes que ces estimations pour les potentiels durs avec ou sans troncature angulaire, et les sphères dures. Dans les cas où l'opérateur linéarisé n'admet pas de trou spectral, les potentiels mous avec ou sans troncature angulaire, ces estimations de coercivité jouent le rôle d'estimations de trou spectral généralisées au sens propre. Des premières estimations non constructives dans ce sens dans le cas des potentiels mous avaient été obtenues dans [41, 42, 103]. La contribution de ce chapitre est de donner une méthode constructive pour l'obtention de ces estimées, et de les généraliser à tout type de noyau et à l'opérateur de Landau linéarisé, en particulier en obtenant des contrôle de type Sobolev pour l'opérateur de Boltzmann linéarisé avec noyaux non localement intégrables ou pour l'opérateur de Landau linéarisé.

Nous adoptons ici pour le noyau de collision B le cadre général suivant :

(H1) Dans le cas de l'opérateur de Boltzmann linéarisé, B adopte la forme produit

$$B(|v - v_*|, \cos \theta) = \Phi(|v - v_*|) b(\cos \theta)$$

où Φ et b sont des fonctions positives.

(H2) La partie cinétique Φ vérifie

$$\forall r \geq 0, \quad \Phi(r) \geq C_\Phi r^\gamma,$$

avec $\gamma \in (-N, 1]$ dans le cas de l'opérateur linéarisé de Boltzmann, et $\gamma \in [-N, 1]$ dans le cas de l'opérateur linéarisé de Landau, et pour une constante $C_\Phi > 0$.

(H3) La partie angulaire b vérifie le contrôle par en-dessous suivant lorsque B est localement intégrable

$$C_b = \inf_{\sigma_1, \sigma_2 \in \mathbb{S}^{N-1}} \int_{\sigma_3 \in \mathbb{S}^{N-1}} \min\{b(\sigma_1 \cdot \sigma_3), b(\sigma_2 \cdot \sigma_3)\} d\sigma_3 > 0.$$

et le contrôle par en-dessous plus précis suivant lorsque B n'est pas localement intégrable

$$\forall \theta \in (0, \pi], \quad \sin^{N-2} \theta b(\cos \theta) \geq c_b \theta^{-1-\nu},$$

pour des constantes $c_b > 0$ et $\nu \in [0, 2[$.

Ces hypothèses couvrent essentiellement tous les noyaux de collisions utilisés, en particulier les noyaux de type sphères dures ou dérivant d'une interaction en puissance inverse. Dans le cas de l'opérateur de Landau linéarisé, les hypothèses sur le noyau de collision Φ se réduisent à (H2).

Nous démontrons alors (voir les théorèmes 6.1, 6.2 et 6.3 du chapitre 6) le

Théorème 1.8. *Soit B un noyau de collision vérifiant les hypothèses (H1)-(H2)-(H3) de cette sous-section (respectivement un noyau de collision Φ vérifiant l'hypothèse (H2) de cette sous-section dans le cas de l'opérateur linéarisé de Landau). Alors*

(i) **(L'opérateur de Boltzmann linéarisé)** *Si le noyau de collision est localement intégrable, on obtient*

$$\forall h \in L^2(M), \quad -\langle h, L_B h \rangle_{L^2(M)} \geq C_\gamma^{\mathcal{B}} \|h - \Pi(h)\|_{L^2((\nu)^\gamma M)}^2,$$

où $C_\gamma^{\mathcal{B}} > 0$ est une constante explicite dépendant de γ , C_Φ , C_b , et de la dimension N . Dans le cas où le noyau de collision n'est pas localement intégrable, on a

$$\forall h \in L^2(M), \quad -\langle h, L_B h \rangle_{L^2(M)} \geq C_{\gamma, \alpha}^{\mathcal{B}} \|h - \Pi(h)\|_{L^2((\nu)^\gamma M) \cap H_{\text{loc}}^{\nu/2}}^2,$$

où $C_{\gamma, \nu}^{\mathcal{B}} > 0$ est une constante explicite dépendant de γ , ν , C_Φ , C_b , c_b et de la dimension N (pour la définition de ν , voir l'hypothèse (H3) ci-dessus).

(ii) (**L'opérateur de Landau linéarisé**) *On obtient*

$$\forall h \in L^2(M), \quad -\langle h, L_{\mathcal{L}}h \rangle_{L^2(M)} \geq C_{\gamma}^{\mathcal{L}} \|h - \Pi(h)\|_{H^1((\nu)^{\gamma}M)}^2,$$

où $C_{\gamma}^{\mathcal{L}} > 0$ est une constante explicite dépendant de γ , C_{Φ} , et de la dimension N .

Remarquons qu'une conséquence immédiate de ces estimations est que l'opérateur $L_{\mathcal{B}}$ (resp. l'opérateur $L_{\mathcal{L}}$) est à résolvante compacte lorsque $\gamma > 0$ et $\nu > 0$ (resp. $\gamma > 0$). Ceci découle en effet de l'application du théorème de Rellich-Kondrachov et cela implique que le spectre est alors purement discret (voir la figure 1.2 et les sous-sections 6.2.3 et 6.3.1).

Les ingrédients de la preuve sont les suivants :

- a. L'idée générale est se ramener aux estimations explicites obtenues d'une part dans [194, 24] dans le cas Maxwellien, d'autre part dans [15] dans le cas des potentiels durs.
- b. Pour obtenir le bon poids algébrique pour les potentiels durs, nous utilisons un argument inspiré des travaux de Grad [109] et qui avait déjà été utilisé dans [17] : nous décomposons l'opérateur entre une partie multiplicative qui vérifie toujours les estimations de coercivité recherchées, et une partie non-locale qui est continue dans l'espace $L^2(M)$ grâce aux propriétés de mélange.
- c. Pour obtenir le bon poids algébrique pour les potentiels mous, nous décomposons la forme de Dirichlet selon les valeurs de la vitesse relative. En utilisant des estimations techniques sur la partie non-locale cela nous permet de reconstituer le poids dans le terme à contrôler. La preuve des points b. et c. est similaire pour l'opérateur de Landau linéarisé, en utilisant en plus une inégalité de Poincaré adaptée.
- d. Pour obtenir les contrôles dans les normes de Sobolev locales pour l'opérateur de Boltzmann linéarisé avec noyau de collision non localement intégrable, nous nous inspirons des travaux [132, 188, 3] dans le cas non linéarisé. Nous introduisons une décomposition adaptée entre une partie qui vérifie des estimations de coercivité de type Laplacien et une partie continue (grâce aux « lemmes de compensation », voir [3]). La structure de cette décomposition se lit plus clairement après limite de collision rasante sur l'opérateur de Landau linéarisé mais est également présente dans l'opérateur de Boltzmann linéarisé.

1.3.5 Taux de retour vers l'équilibre en spatialement homogène (Chapitre 7)

D'une part l'article [10] (plus les résultats sur l'apparition et la propagation des moments, voir [200]) démontre de manière non constructive que les solutions spatialement homogènes (dans L_2^1) de l'équation de Boltzmann avec noyau de collision de type sphères dures convergent exponentiellement vite vers l'équilibre, sans information sur le taux de convergence et les constantes. D'autre part l'article [150] montre un résultat explicite de convergence vers l'équilibre avec vitesse $O(t^{-\infty})$ pour ces mêmes solutions. Dans le chapitre 7, nous complétons ces résultats, dans le cadre des interactions de type potentiels durs avec troncature angulaire et dans le cas spatialement homogène, en montrant la convergence exponentielle vers l'équilibre par des arguments constructifs (avec un taux et des constantes explicites), et en montrant que le spectre de l'opérateur linéarisé L_B gouverne effectivement le comportement asymptotique de la solution, comme il était conjecturé dans [48].

Nous adoptons le cadre général suivant pour le noyau de collision B :

(H1) B adopte la forme produit

$$B(|v - v_*|, \cos \theta) = \Phi(|v - v_*|) b(\cos \theta),$$

avec Φ et b des fonctions positives.

(H2) La partie cinétique Φ vérifie

$$\Phi(z) = C_\Phi z^\gamma$$

avec $\gamma \in (0, 1]$.

(H3) La partie angulaire b vérifie

$$\forall \theta \in [0, \pi], \quad b(\cos \theta) \leq C_b.$$

Cette hypothèse implique en particulier la troncature angulaire de Grad. Nous supposons de plus que la fonction b est croissante et convexe sur $] -1, 1[$.

Ce cadre inclut les sphères dures et les potentiels durs avec l'hypothèse de troncature angulaire forte et les hypothèses techniques sur b ci-dessus. Sous ces hypothèses, la théorie de Cauchy est bien posée dans l'espace des distributions positives de L_2^1 qui ne font pas croître l'énergie (voir [144]). Nous travaillerons avec ces solutions. Également, dans cette sous-section, nous

ne considérerons pas l'opérateur de Landau linéarisé, et nous noterons donc $L = L_B$ sans risque de confusion.

Rappelons que, pour une donnée initiale f_0 , nous notons M la Maxwellienne à l'équilibre. Nous introduisons la **fréquence de collision** associée

$$\nu(v) = \int_{\mathbb{R}^N \times \mathbb{S}^{N-1}} B(|v - v_*|, \cos \theta) M(v_*) dv_* d\sigma$$

qui, sous les hypothèses ci-dessus, est une fonction uniformément minorée par un $\nu_0 > 0$, et vérifiant

$$\forall v \in \mathbb{R}^N, \quad C_1(1 + |v|) \leq \nu(v) \leq C_2(1 + |v|)$$

avec $C_1, C_2 > 0$. Nous démontrons alors (voir les théorèmes 7.1 et 7.2) le

Théorème 1.9. *Soit B un noyau de collision vérifiant les hypothèses (H1)-(H2)-(H3) de cette sous-section. Alors*

- (i) *Soit $\lambda \in]0, \nu_0[$ le trou spectral de l'opérateur linéarisé L_B . Soit une donnée initiale $0 \leq f_0 \in L_2^1 \cap L^2$. Alors la solution $f = f(t, v)$ de l'équation de Boltzmann spatialement homogène avec noyau de collision B et donnée initiale f_0 vérifie : pour tout $0 < \mu \leq \lambda$, il existe une constante $C > 0$, explicite en fonction de B , la masse, l'énergie cinétique et la norme L^2 de f_0 , de μ et d'une borne inférieure sur $\nu_0 - \mu$, telle que*

$$\|f_t - M\|_{L^1} \leq C e^{-\mu t}.$$

Dans le cas particulier des sphères dures, l'hypothèse « $f_0 \in L_2^1 \cap L^2$ » peut être affaiblie en « $f_0 \in L_2^1$ », et le même résultat est vrai avec une constante $C > 0$, explicite en fonction de B , la masse et l'énergie cinétique de f_0 , de μ et d'une borne inférieure sur $\nu_0 - \mu$

- (ii) *On considère la linéarisation \mathcal{L}_m avec $m(v) = \exp[-a|v|^s]$, $a > 0$, $s \in]0, 2[$. Alors le spectre $\Sigma(\mathcal{L}_m)$ de \mathcal{L}_m est égal au spectre $\Sigma(L)$ de L . De plus les vecteurs propres de \mathcal{L}_m associés à une valeur propre discrète sont donnés par ceux de L associés à la même valeur propre discrète, multipliés par $m^{-1}M$.*

Remarquons que l'on déduit de [15] l'estimation

$$\lambda \geq c_b C_\Phi \frac{(\gamma/8)^{\gamma/2} e^{-\gamma/2} \pi}{24}$$

sur λ dès que b vérifie le contrôle

$$\frac{1}{|\mathbb{S}^{N-1}|} \inf_{\sigma_1, \sigma_2 \in \mathbb{S}^{N-1}} \int_{\sigma_3 \in \mathbb{S}^{N-1}} \min\{b(\sigma_1 \cdot \sigma_3), b(\sigma_2 \cdot \sigma_3)\} d\sigma_3 \geq c_b > 0.$$

Après calcul, on obtient par exemple

$$\lambda \geq \pi / (48\sqrt{2}e) \approx 0.03.$$

pour les sphères dures. Cette borne inférieure permet d'obtenir avec le théorème 1.9 un résultat de convergence exponentielle entièrement explicite, avec un taux non optimal mais raisonnable du point de vue physique.

L'idée générale de la preuve du point (i) est d'établir des estimations explicites de décroissance exponentielle au cours du temps sur le semi-groupe d'évolution de \mathcal{L}_m , avec $m(v) = \exp[-a|v|^s]$. Ces estimations permettent d'obtenir un taux de convergence exponentielle explicite lorsque la solution est proche de l'équilibre pour la distance $L^1(\exp[a|v|^s])$ (et que la partie linéaire \mathcal{L}_m domine). Parallèlement la théorie non-linéaire basée sur l'étude de la production d'entropie (théorème 1.4), couplée à des estimations de propagation et apparition de normes $L^1(m^{-1})$ pour s assez petit (voir le lemme 7.8), est utilisée pour obtenir un temps explicite au bout duquel la solution entre dans le voisinage de l'équilibre où les effets linéaires dominent. Les estimations de décroissance sur le semi-groupe de \mathcal{L}_m sont obtenues en montrant que le spectre de \mathcal{L}_m est le même que celui de L et que l'on peut relier explicitement la norme de la résolvante de \mathcal{L}_m à celle de L , ce qui permet d'obtenir une estimation de sectorialité explicite. L'étude du spectre est compliquée par l'absence de structure hilbertienne, elle est basée sur un mélange des méthodes de Grad pour localiser le spectre essentiel et une idée inspirée des travaux de Gallay et Wayne [97, 98] sur l'équation de Navier-Stokes : il est possible de montrer que l'équation aux valeurs propres pour l'opérateur \mathcal{L}_m implique que les vecteurs propres appartiennent en fait à l'espace plus petit associé à la linéarisation de L .

1.4 Étude des collisions inélastiques

1.4.1 Les gaz granulaires

Par gaz granulaires, ou plus généralement milieux granulaires on entend ici un système de particules en interaction en très grand nombre, qui dissipent de l'énergie au cours de cette interaction. L'utilisation de modèles de Boltzmann (avec interaction de type sphères dures) pour décrire les flots dilués et rapides de gaz granulaires commence avec l'article de physique [113], et

s'est ensuite développée dans une importante littérature physique durant les vingt dernières années. L'étude de ces régimes de systèmes granulaires est motivée par leurs propriétés physiques surprenantes (avec les phénomènes de « gel » au niveau cinétique, et formation de « clusters » au niveau hydrodynamique), leur utilisation pour dériver les équations hydrodynamiques des fluides granulaires, et leur intérêt pour les simulations numériques.

Le phénomène de « gel » décrit le fait qu'en chaque point de l'espace, la dissipation d'énergie lors des collisions amène toutes les particules à adopter la vitesse macroscopique locale. Il peut être étudié sur l'équation spatialement homogène. Le mécanisme de formation de « clusters »²³ est le suivant : lorsque la densité locale augmente en un point du domaine, le nombre de collisions augmente en ce point, ce qui fait diminuer la température locale par les effets de dissipation lors des collisions ; la pression locale diminue donc ce qui amène une migration des particules vers cette zone ; tout ceci a pour effet une nouvelle augmentation de densité locale au point. Ce phénomène d'auto-entraînement suggère une instabilité de l'équation d'évolution par rapport aux fluctuations de la densité locale, et la possibilité que cette dernière se concentre.

Du point de vue mathématique, ces modèles font donc apparaître des phénomènes nouveaux de concentrations (en vitesse et en espace) par rapport aux modèles élastiques. Ceci est la source de leurs propriétés physiques surprenantes, mais aussi de nouvelles difficultés mathématiques. En effet, pour les modèles élastiques, les bornes L^1 et $L \log L$ restent uniformément bornées au cours du temps (aussi bien pour les solutions homogènes que pour les solutions renormalisées en inhomogène), ce qui interdit la concentration en temps fini ou asymptotiquement. Pour les modèles inélastiques au contraire, ce n'est plus le cas en général, et la distribution peut tendre vers une masse de Dirac en temps fini ou asymptotiquement. La raison mathématique sous-jacente est la perte du théorème H et des propriétés de non-concentration (en x et v) qu'il imposait. Mentionnons que certains des problèmes de concentration posés par les modèles inélastiques rejoignent ceux du modèle semi-classique de Boltzmann-Bose (voir les travaux mathématiques récents [137, 133, 83]). Pour ce modèle, il existe encore une version modifiée du théorème H , mais la nouvelle fonctionnelle entropie est sous-linéaire et non plus sur-linéaire (contrairement au modèle semi-classique de Boltzmann-Fermi). Elle ne prévient donc plus la concentration. Toutefois en un sens, la situation est pire pour les matériaux granulaires, puisqu'il n'y a plus du tout de fonctionnelle de Lyapunov connue, ce qui, pour le moment, reste un obstacle majeur dans l'étude asymptotique des solutions.

²³Voir par exemple la discussion physique et les simulations numériques dans [102].

L'étude mathématique des gaz granulaires est assez récente, avec les travaux [79, 78, 18, 179, 20, 27, 29, 100, 32]. La majorité de ces études se restreint au cas spatialement homogène, qui permet d'étudier le phénomène de « gel » et contient déjà des difficultés importantes²⁴. On peut distinguer à première vue deux types de problèmes : l'obtention de résultats de Cauchy et de propagation de régularité d'une part, et l'étude éventuelle de profils asymptotiques qui précisent la convergence vers la masse de Dirac d'autre part, avec en particulier l'existence de queue de distribution « surpeuplée », c'est-à-dire décroissant moins vite que la distribution Maxwellienne. Cependant ces deux problèmes sont reliés, et l'étude du comportement asymptotique est liée en grande partie à l'étude de régularité d'une équation auxiliaire proche de l'équation de Boltzmann (voir le chapitre 9).

L'objet de cette partie est l'étude des sphères dures inélastiques dans le cadre spatialement homogène. D'une part, nous donnons des résultats de Cauchy sous des hypothèses très générales et physiquement réalistes sur le noyau de collision (qui permettent en particulier de traiter des milieux granulaires pour lesquels le « gel » se produit en temps fini). D'autre part, nous étudions, pour des sphères dures avec coefficients normaux de restitution constants, le comportement asymptotique de la solution (et en particulier l'existence de profils auto-similaires).

Avant de décrire les résultats, décrivons brièvement la physique de la collision inélastique. Parmi les cinq hypothèses (i) à (v) de la sous-section 1.1.3 nous modifions les hypothèses (iii) et (iv) de la façon suivante : la collision de deux particules de vitesses pré-collisionnelles v et v_* est inélastique, ce qu'on peut schématiser ainsi

$$\{v\} + \{v_*\} \xrightarrow{B} \{v'\} + \{v'_*\} \quad \text{avec} \quad \begin{cases} v' + v'_* = v + v_* \\ |v'|^2 + |v'_*|^2 < |v|^2 + |v_*|^2 \end{cases}$$

où B est le noyau de collision qui dicte les fréquences d'apparition des vitesses post-collisionnelles v' et v'_* . On paramètre alors les vitesses post-collisionnelles possibles par une variable z dans la boule unité $B(0, 1) \subset \mathbb{R}^N$.

²⁴Dans le cas spatialement inhomogène, on peut mentionner les solutions petites ou en temps petit construites dans [18] pour un modèle simplifié, ou encore le travail [84] pour des modèles de type Enskog, qui sont des modifications de l'équation de Boltzmann où l'opérateur de collision n'est plus local en espace pour tenir compte de la taille des particules.

Les formules deviennent

$$\begin{cases} v' = \frac{v + v_*}{2} + z \frac{|v_* - v|}{2} \\ v'_* = \frac{v + v_*}{2} - z \frac{|v_* - v|}{2}, \end{cases}$$

ce qui peut être résumé dans la figure 1.4. Pour couvrir tous les modèles

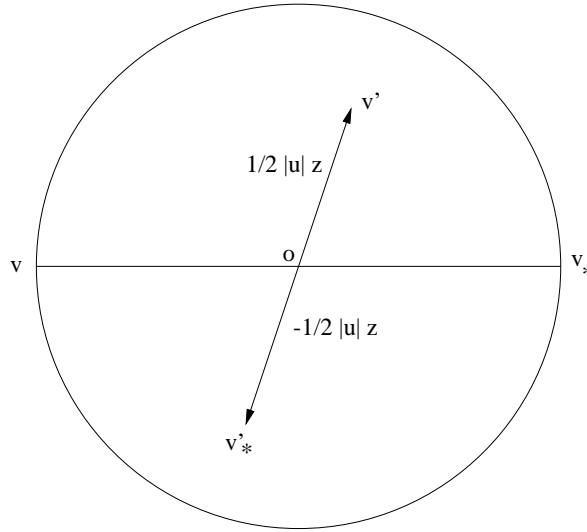

Figure 1.4: Géométrie de la collision binaire inélastique (avec $O = (v + v_*)/2$ et $u = v - v_*$)

physiques, le plus simple est de prendre un noyau de collision $B = B(\mathcal{E}, u; dz)$ sous la forme d'une mesure sur la boule $B(0, 1)$, qui dépend de l'énergie cinétique de la distribution \mathcal{E} et la vitesse relative $u := v - v_*$. Ceci traduit l'observation physique que l'inélasticité varie dans les milieux granulaires en fonction de la température et/ou la vitesse relative (en particulier dans la plupart des cas elle diminue lorsque la température ou la vitesse relative diminue). Le cas où B est proportionnel à $\delta_{z=0}$ correspond au cas des **collisions collantes**.

La collision n'est plus réversible à cause de la dissipation d'énergie, et il faut maintenant noter différemment les vitesses « passé » v', v'_* qui peuvent donner les vitesses v, v_* lors d'une collision, et les vitesses « futur » v, v_* qui peuvent émerger de v, v_* lors d'une collision.

Au sein de cette classe de modèle on distingue le cas particulier où « la composante normale de la vitesse relative est conservée lors du choc ». Le

mot « normal » s'entend ici par rapport à la direction de l'impact, c'est-à-dire $\omega = (v - v')/|v - v'|$. On a alors

$$(v' - v'_*) \cdot \omega = -\epsilon(v - v_*) \cdot \omega$$

$$(v' - v'_*) - [(v' - v'_*) \cdot \omega] \omega = (v - v_*) - [(v - v_*) \cdot \omega] \omega$$

et on appelle $e \in [0, 1]$ le **coefficient normal de restitution**. On retrouve le cas d'une collision élastique pour $e = 1$ et le cas d'une collision collante pour $e = 0$. La mesure B se concentre alors sur la sphère

$$\mathcal{C}_{u,e} = \frac{1 - e}{2} \frac{v - v_*}{|v - v_*|} + \frac{1 + e}{2} \mathbb{S}^{N-1}$$

et on paramètre les vitesses post-collisionnelles par un vecteur unitaire $\sigma \in \mathbb{S}^{N-1}$ tel que

$$z = \frac{1 - e}{2} \frac{v - v_*}{|v - v_*|} + \frac{1 + e}{2} \sigma,$$

ce qui est résumé dans la figure 1.5. L'observation physique montre qu'en

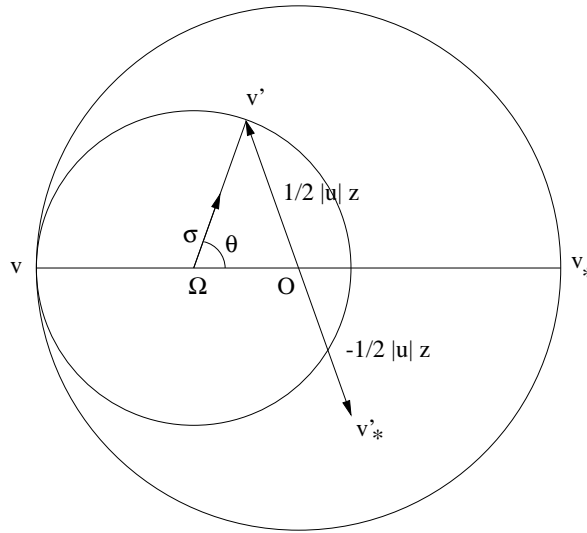

Figure 1.5: Géométrie de la collision binaire inélastique pour un coefficient normal de restitution ϵ : $\Omega O = (1 - \epsilon)|u|/2$ et $\Omega v' = (1 + \epsilon)|u|/2$

général le coefficient e dépend de la température de la distribution et de la vitesse relative, même s'il est peut être considéré comme constant en première approximation.

Nous pouvons maintenant introduire l'équation de Boltzmann spatialement homogène pour les sphères dures inélastiques :

$$(1.4.25) \quad \frac{\partial f}{\partial t} = Q_{\mathcal{I}}(f, f)$$

où l'opérateur de collision $Q_{\mathcal{I}}$ est défini sous forme duale par

$$\langle Q_{\mathcal{I}}(f, f), \varphi \rangle = \int_{\mathbb{R}^N \times \mathbb{R}^N} f_* f \int_D (\varphi(v') - \varphi(v)) B(\mathcal{E}, u; dz) dv dv_*.$$

Les modifications du modèle au niveau microscopique ont les conséquences suivantes au niveau des observables : il y a toujours conservation de la masse et de la quantité de mouvement, mais l'énergie cinétique \mathcal{E} est seulement décroissante : on définit la fonctionnelle de dissipation d'énergie cinétique

$$\frac{d}{dt} \mathcal{E}(t) = -\frac{1}{2} \int_{\mathbb{R}^N \times \mathbb{R}^N \times D} f f_* (1 - |z|^2) |u|^2 B(\mathcal{E}, u; dz) dv dv_* =: -D(f) \leq 0.$$

On définit le taux de dissipation

$$\beta(\mathcal{E}, u) := \frac{1}{4} \int_D (1 - |z|^2) b(\mathcal{E}, u; dz) \geq 0,$$

ce qui permet d'écrire

$$D(f) := \int_{\mathbb{R}^N} \int_{\mathbb{R}^N} f f_* |u|^3 \beta(\mathcal{E}, u) dv dv_*.$$

Si le taux de dissipation ne s'annule que quand l'énergie cinétique est nulle, le seul état d'équilibre de l'équation est une masse de Dirac déterminée par la masse et la quantité de mouvement de la donnée initiale. Ceci amène à définir le **temps de vie** T_c de la distribution par

$$T_c := \inf\{T \geq 0, \mathcal{E}(t) = 0 \forall t > T\} = \sup\{S \geq 0, \mathcal{E}(t) > 0 \forall t < S\}.$$

1.4.2 Étude de Cauchy (Chapitre 8)

Dans le chapitre 8, le but est de construire des solutions pour des modèles de milieux granulaires spatialement homogènes de type Boltzmann, sous des hypothèses générales et physiquement réalistes. Pour $x \in \mathbb{R}^N$, nous noterons $\hat{x} = x/|x|$.

Nous adoptons le cadre suivant. Tout d'abord nous énonçons les hypothèses de base :

(H1) B adopte la forme produit (noyau de type sphères dures)

$$B = B(\mathcal{E}, u; dz) = |u| b(\mathcal{E}, u; dz),$$

avec $u = v - v_*$ et b mesure finie sur $B(0, 1)$ pour tout \mathcal{E}, u .

(H2) b vérifie la propriété de symétrie

$$b(\mathcal{E}, u; dz) = b(\mathcal{E}, -u, -dz).$$

(H3) Pour tout $\varphi \in C_c(\mathbb{R}^N)$ la fonction

$$(v, v_*, \mathcal{E}) \mapsto \int_D \varphi(v') b(\mathcal{E}, u; dz)$$

est continue.

(H4) Il existe une fonction continue $\alpha :]0, \infty[\rightarrow]0, \infty[$ telle que

$$\forall u \in \mathbb{R}^N, \mathcal{E} > 0, \quad \alpha(\mathcal{E}) = \int_D b(\mathcal{E}, u; dz).$$

(H5) Pour tout $\mathcal{E} > 0$, il existe une fonction $j_{\mathcal{E}}(\varepsilon) \geq 0$, tendant vers 0 quand $\varepsilon \rightarrow 0$, telle que

$$\forall \varepsilon > 0, u \in \mathbb{R}^N, \quad \int_{\{\hat{u} \cdot z \in [-1, 1] \setminus [-1+\varepsilon, 1-\varepsilon]\}} b(\mathcal{E}, u; dz) \leq \alpha(\mathcal{E}) j_{\mathcal{E}}(\varepsilon)$$

pour tout $\varepsilon > 0$ and $u \in \mathbb{R}^N$, et cette convergence est uniforme en \mathcal{E} lorsque \mathcal{E} décrit un compact de $]0, +\infty[$.

Dans le cas où le noyau de collision dépend effectivement de l'énergie cinétique de la distribution (couplage fortement non-linéaire), nous ferons l'hypothèse supplémentaire suivante pour obtenir l'unicité :

(H6) La mesure b se concentre sur la sphère $\mathcal{C}_{u,e}$ décrite ci-dessus, avec un coefficient normal de restitution $e :]0, \infty[\rightarrow [0, 1]$, $\mathcal{E} \mapsto e(\mathcal{E})$ qui dépend uniquement de l'énergie cinétique, et $\alpha = \alpha(\mathcal{E})$ et $e = e(\mathcal{E})$ localement Lipschitz sur $]0, +\infty[$. Cette mesure est supposée absolument continue par rapport à la mesure de Hausdorff sur la sphère et s'écrit donc

$$b(\mathcal{E}, u; dz) = \delta_{\{z = (1-e)\hat{u}/2 + (1+e)\sigma/2\}} \tilde{b}(\mathcal{E}, |u|, \hat{u} \cdot \sigma) d\sigma$$

où $d\sigma$ est la mesure de Hausdorff, et \tilde{b} est une fonction mesurable positive.

Dans l'étude du processus de « gel », nous supposons toujours au moins (comportement réellement inélastique) :

(H7) La fonction $\beta(\mathcal{E}, u)$ est continue sur $]0, +\infty[\times \mathbb{R}^N$ et vérifie

$$\forall u \in \mathbb{R}^N, \mathcal{E} > 0, \quad \beta(\mathcal{E}, u) > 0.$$

Pour démontrer qu'il n'y a pas de perte asymptotique d'énergie cinétique à l'infini nous ferons l'une des deux hypothèses suivantes :

(H8) Pour tout $\mathcal{E}_0, \mathcal{E}_\infty \in]0, \infty[$ (avec $\mathcal{E}_0 \geq \mathcal{E}_\infty$), on a

$$\forall u \in \mathbb{R}^N, \quad \beta(\mathcal{E}, u) \geq \psi(|u|) \quad \forall \mathcal{E} \in (\mathcal{E}_\infty, \mathcal{E}_0),$$

avec $\psi \in C(\mathbb{R}_+, \mathbb{R}_+)$ tel que pour tout $R > 0$,

$$\forall u \in \mathbb{R}^N, |u| > R/2, \quad \psi(|u|) \geq \psi_R |u|^{-1}$$

pour un certain $\psi_R > 0$.

(H9) La mesure b se concentre sur la sphère $\mathcal{C}_{u,e}$ décrite ci-dessus, avec $e :]0, \infty[\times]0, \infty[\rightarrow]0, 1]$, $(\mathcal{E}, |u|) \mapsto e(\mathcal{E}, |u|)$ des fonctions continues. Cette mesure est supposée absolument continue par rapport à la mesure de Hausdorff sur la sphère et s'écrit donc

$$b(\mathcal{E}, u; dz) = \delta_{\{z=(1-e)\hat{u}/2+(1+e)\sigma/2\}} \tilde{b}(\mathcal{E}, |u|, \hat{u} \cdot \sigma) d\sigma$$

où $d\sigma$ est la mesure de Hausdorff, et \tilde{b} est une fonction mesurable positive, telle que pour tout \mathcal{E} et $|u|$ fixés, $\tilde{b}(\mathcal{E}, |u|, \cdot)$ est croissante et convexe sur $] -1, 1[$.

On voit que ces hypothèses couvrent les cas d'un coefficient normal de restitution constant ou qui dépend de l'énergie cinétique et/ou de la vitesse relative, mais également des modèles plus généraux comme des variantes multi-dimensionnelles de ceux introduits dans [179]. De plus elles permettent de traiter des caractéristiques physiques intéressantes comme une inélasticité qui croît ou décroît lorsque la vitesse relative ou l'énergie cinétique décroissent. En particulier, nos hypothèses couvrent le cas de gaz granulaires admettant un processus de « gel » en temps fini, comme le montre le théorème qui suit.

Les solutions sont ici définies au sens des distribution (voir la définition 8.1 du chapitre 8). Nous démontrons alors (voir les théorèmes 8.1 et 8.2 du chapitre 8) le

Théorème 1.10. *Soit B un noyau de collision vérifiant les hypothèses (H1) à (H5) de cette sous-section, et une donnée initiale $0 \leq f_{\text{in}} \in L^1_3$ que l'on peut supposer sans restriction de masse 1 et quantité de mouvement 0. Alors*

- (i) *Si le noyau de collision B est indépendant de l'énergie cinétique, l'équation (1.4.25) admet une unique solution $0 \leq f \in C(\mathbb{R}_+; L^1_2) \cap L^\infty_{\text{loc}}(\mathbb{R}_+; L^1_3)$. Cette solution vérifie les lois de conservation sur la masse et la quantité de mouvement, et son énergie cinétique décroît. Son temps de vie T_c est infini, et si on suppose en plus (H7) et (H8), ou (H7) et (H9), on a*

$$(1.4.26) \quad \mathcal{E}(t) \rightarrow 0 \text{ et } f(t, \cdot) \xrightarrow{t \rightarrow T_c} \delta_{v=0} \text{ dans } M^1(\mathbb{R}^N)\text{-faible} *$$

où M^1 désigne l'espace des mesures de probabilité sur \mathbb{R}^N .

- (ii) *Dans le cas général où le noyau de collision dépend de l'énergie cinétique, il existe au moins une solution maximale $0 \leq f \in C([0, T_c]; L^1_2) \cap L^\infty(0, T_c; L^1_3)$ avec $T_c \in]0, +\infty]$, qui vérifie les lois de conservation sur la masse et la quantité de mouvement et dont l'énergie cinétique décroît. De plus si $T_c < +\infty$ ou bien si on suppose en plus (H7) et (H8), ou (H7) et (H9), on a le comportement asymptotique (1.4.26). Enfin cette solution est unique si on fait l'hypothèse supplémentaire (H6) et $f_{\text{in}} \in BV_4 \cap L^1_3$.*

- (iii) *On donne les critères partiels suivants sur le temps de vie :*

- *Si α est borné au voisinage de $\mathcal{E} = 0$ et $j_\mathcal{E}$ converge vers 0 quand $\varepsilon \rightarrow 0$ uniformément au voisinage de $\mathcal{E} = 0$, alors $T_c = +\infty$.*
- *Si β est majorée par une fonction croissante β_0 qui ne dépend que de l'énergie et $f_{\text{in}} e^{a_\eta |v|^\eta} \in L^1$ avec $\eta \in]1, 2]$, $a_\eta > 0$, alors $T_c = +\infty$.*
- *Si $\beta(\mathcal{E}, u) \geq \beta_0 \mathcal{E}^\delta$ avec $\beta_0 > 0$ et $\delta < -1/2$, alors $T_c < +\infty$.*

Les ingrédients des preuves sont les suivants :

- a. De nouvelles estimations sur l'opérateur de collision dans les espaces de Orlicz. Celles-ci généralisent les estimations de type convolution dans les espaces de Lebesgue (prouvées par Gustafsson [111] dans le cas élastique, et étendues dans le cas inélastique avec coefficient normal de restitution constant dans [100]). Elles démontrent que le semi-groupe d'évolution est borné dans les espaces de Orlicz (avec une borne dépendant du temps en général). Leur preuve est uniquement basée sur l'inégalité de Young et un découpage de l'opérateur de gain.
- b. Des versions fines des estimations basées sur les inégalités de Povzner pour obtenir l'apparition et la propagation des moments L^1 , inspirées de [32].
- c. Le théorème du point fixe de Schauder combiné à un résultat de stabilité

faible fourni par les estimées dans les Orlicz pour construire des solutions du problème couplé.

d. Une étude précise de la fonctionnelle de dissipation d'énergie cinétique pour obtenir le comportement asymptotique sur la distribution et l'énergie cinétique.

1.4.3 Étude asymptotique et profils auto-similaires (Chapitre 9)

Dans le chapitre 9 on restreint l'étude aux modèles de Boltzmann granulaires spatialement homogènes pour des noyaux de collision de type sphères dures inélastiques avec coefficient normal de restitution constant. On se place dans le cadre suivant :

(H1) B ne dépend pas de l'énergie cinétique et adopte la forme produit (noyau de type sphères dures)

$$B = B(u; dz) = |u| b(u; dz).$$

(H2) b est une mesure finie qui se concentre sur la sphère $\mathcal{C}_{u,e}$ décrite ci-dessus, avec un coefficient normal de restitution $e \in]0, 1[$ constant. Cette mesure s'écrit

$$b = \delta_{\{z=(1-e)\hat{u}/2+(1+e)\sigma/2\}} \tilde{b}(\hat{u} \cdot \sigma) d\sigma$$

où $d\sigma$ est la mesure de Hausdorff, et \tilde{b} est une fonction mesurable positive, avec $\sigma \rightarrow \tilde{b}(\hat{u} \cdot \sigma)$ d'intégrale 1 sur la sphère \mathbb{S}^{N-1} , et \tilde{b} croissante et convexe sur $] -1, 1[$.

Ces hypothèses couvrent principalement le cas des sphères dures inélastiques avec coefficient normal de restitution constant e (i.e. \tilde{b} constant). On voit de plus qu'elles rentrent dans le cadre des hypothèses du point (i) du théorème 1.10 ci-dessus (y compris les hypothèses supplémentaires (H7) et (H9)) : le problème est bien posé dans $C(\mathbb{R}_+, L_2^1) \cap L_{\text{loc}}^\infty(\mathbb{R}_+, L_3^1)$, le temps de vie est infini et les solutions vérifient le comportement asymptotique (1.4.26).

Dans ce cadre, l'article [113] conjecturait un comportement de la température en $O(t^{-2})$, sur la base d'une analyse des variables auto-similaires (ce qui est connu aujourd'hui sous le nom de **loi de Haff**). Par la suite d'autres travaux physiques, comme [78] par exemple, ont avancé des arguments pour l'existence de profils auto-similaires décroissant en $e^{-|v|}$. Le but de ce chapitre est de prouver mathématiquement ces conjectures.

Introduisons tout d'abord les variables auto-similaires et l'équation d'évolution associée. Nous supposons sans restriction que la solution f de l'équation (1.4.25) est centrée (c'est-à-dire de quantité de mouvement nulle) et nous cherchons une fonction g reliée à f par une formule du type

$$f(t, v) = K(t) g(T(t), V(t, v)),$$

où K, T, V sont des fonctions à déterminer. On impose ensuite la conservation de la masse, et l'annulation des termes multiplicatifs dans l'équation sur g , en utilisant la propriété d'homogénéité suivante de l'opérateur de collision :

$$Q_{\mathcal{I}}(g(\lambda \cdot), g(\lambda \cdot))(v) = \lambda^{-(N+1)} Q_{\mathcal{I}}(g, g)(\lambda v).$$

Des calculs immédiats donnent comme choix possible

$$K(t) = (c_0 + c_1 t)^3, \quad T(t) = \frac{1}{c_1} \ln \left(1 + \frac{c_0}{c_1} t \right) \quad V(t, v) = (c_0 + c_1 t)v$$

pour des constantes $c_0, c_1 > 0$ à fixer. La fonction g est alors solution de l'équation d'évolution

$$(1.4.27) \quad \frac{\partial g}{\partial t} = Q_{\mathcal{I}}(g, g) - c_1 \nabla_v \cdot (vg).$$

Ce nouveau problème d'évolution conserve la masse, et tout état stationnaire $G(v)$ de (1.4.27) fournit une solution auto-similaire

$$F(t, v) = (c_0 + c_1 t)^3 G((c_0 + c_1 t)v)$$

du problème de départ (1.4.25). À translation et homothétie près, on peut toujours se ramener à $c_0 = c_1 = 1$.

Nous démontrons alors (voir les théorèmes 9.1 et 9.2 du chapitre 9) le

Théorème 1.11. *Concernant les profils auto-similaires on a*

- (i) *Pour toute valeur de la masse $\rho > 0$, il existe un profil auto-similaire G centré de masse ρ :*

$$0 \leq G \in L^1_2, \quad Q_{\mathcal{I}}(G, G) = \nabla_v \cdot (vG), \quad \int_{\mathbb{R}^N} G \begin{pmatrix} 1 \\ v \end{pmatrix} dv = \begin{pmatrix} \rho \\ 0 \end{pmatrix}.$$

- (ii) *De plus tout profil auto-similaire G dans L^p avec $p > 1$ est C^∞ et peut être construit radialement symétrique et tel que*

$$\forall v \in \mathbb{R}^N, \quad a e^{-b|v|} \leq G(v) \leq A e^{-B|v|}$$

pour des constantes $a, b, A, B > 0$.

On se donne une donnée initiale ($\rho > 0$)

$$0 \leq f_{\text{in}} \in L^1_3 \cap L^p, p > 1, \quad \int_{\mathbb{R}^N} f_{\text{in}} \begin{pmatrix} 1 \\ v \end{pmatrix} dv = \begin{pmatrix} \rho \\ 0 \end{pmatrix}.$$

(iii) L'unique solution $f \in C(\mathbb{R}_+, L^1_2) \cap L^\infty_{\text{loc}}(\mathbb{R}_+, L^1_3)$ de l'équation (1.4.25) vérifie en variables auto-similaires :

- Soient $s \geq 0$, $q \geq 0$ arbitrairement grands et $\tau > 0$ arbitrairement petit. Alors, pour tout $t \geq \tau$, g se décompose en $g = g^S + g^R$, avec g^S positif, et

$$\begin{cases} \sup_{t \geq \tau} \|g_t^S\|_{H^s_q \cap L^1_2} < +\infty \\ \forall t \geq \tau, \forall k > 0, \exists \lambda = \lambda(k) > 0; \quad \|g_t^R\|_{L^1_k} = O(e^{-\lambda t}). \end{cases}$$

- Pour tout $\tau > 0$ et $s < 1/2$, il existe des constantes explicites $a, b, A, B > 0$ telles que

$$\forall t \geq \tau, \forall v \in \mathbb{R}^N, \quad \liminf_{t \rightarrow +\infty} g(t, v) \geq a e^{-b|v|}$$

et

$$\forall t \geq \tau, \quad \int_{\mathbb{R}^N} g(t, v) e^{-B|v|^s} dv \leq A.$$

(iii) Le point (ii) peut être traduit sur f dans les variables d'origine. Il implique en particulier la décroissance algébrique des singularités de f dans L^1 au cours du temps, et également que f vérifie la loi de Haff au sens suivant :

$$\forall t \geq \tau, \quad m t^{-2} \leq \mathcal{E}(t) \leq M t^{-2}$$

pour des constantes $m, M > 0$.

Toutes les constantes de ce théorème peuvent être explicitées en fonction de la masse, l'énergie cinétique et la norme L^p de f_{in} , et τ .

Les ingrédients des preuves sont les suivants :

- La propriété de régularisation de Lions sur la partie gain Q^{\pm}_I de l'opérateur de collision, que nous démontrons dans le cas inélastique pour un coefficient normal de restitution constant. Nous établissons une représentation de Carleman adaptée pour les gaz granulaires puis nous suivons une méthode proche de celle de [199, 150]. Nous déduisons de ce résultat la propagation

uniforme de borne L^p , $p > 1$, pour le problème (1.4.27) en variables auto-similaires.

b. Les outils de type « somme de Wild non-linéaire » développés dans [150] pour la preuve du théorème 1.3, appliqués à l'équation d'évolution en variables auto-similaires.

c. À nouveau des estimations basées sur les inégalités de Povzner pour obtenir l'apparition et la propagation uniforme des moments L^1 sur la solution en variables auto-similaires.

d. Un résultat d'analyse fonctionnel de type point fixe, qui énonce qu'un semi-groupe d'évolution continu $(S_t)_{t \geq 0}$ sur un espace de Banach, stabilisant un convexe compact non vide au cours du temps et tel que S_t est continu pour tout $t \geq 0$, possède un état stationnaire. Nous utilisons la propagation uniforme des bornes L^p , $p > 1$, en variables auto-similaires, pour construire un compact stable au sens de la topologie faible.

e. Les méthodes de type principe du maximum utilisées dans [100, 99] et les méthodes de [169, 146] pour l'obtention de bornes inférieures.

Notre étude montre en fait que l'identification de variables auto-similaires est un outil puissant à la fois pour la recherche de profils auto-similaires, mais également pour l'étude fine de la régularité. De plus, certaines propriétés asymptotiques, comme l'existence de profils auto-similaires, peuvent se déduire de l'étude de régularité au moyen de théorèmes abstraits d'analyse fonctionnelle.

1.5 Étude numérique

1.5.1 Les méthodes numériques pour les modèles cinétiques collisionnels

La simulation numérique des solutions des équations cinétiques collisionnelles est d'une grande importance pour les applications, que ce soit en dynamique des gaz raréfiés (voir [58]), en physique des plasmas (voir [63]), en physique des milieux granulaires (voir [18, 19]), en physique des semi-conducteurs (voir [138]), etc.

Cependant deux difficultés principales se posent pour la construction de schémas numérique utilisables en pratique : d'une part la complexité de l'opérateur intégral de collision, dont les variables d'intégration décrivent une variété non plate de dimension $2N - 1$ (i.e. $\mathbb{R}^N \times \mathbb{S}^{N-1}$), et d'autre part la taille de l'espace des phases en position et vitesse, qui impose rapidement des tailles de données impraticables.

C'est pourquoi la classe de méthodes numériques la plus populaire, et de loin la plus utilisée dans les application d'ingénierie, est l'approche probabiliste de **Monte-Carlo**. Le principe de ces **méthodes particulières** est de simuler l'évolution des particules sous l'action du transport libre et de collisions aléatoires. Les exemples les plus connus sont les schémas de Bird [22] et Nanbu [152]. Ces méthodes présentent l'avantage de ne jamais évaluer l'opérateur de collision, puisque le processus de collision déterministe sur la densité de probabilité réduite $f = f(t, x, v)$ est remplacé par un processus de collision aléatoire sur un ensemble de « particules numériques » (le nombre de « particules numériques » étant bien plus faible que le nombre de particules physiques). Ceci permet une forte réduction de la complexité du schéma numérique mais également, ainsi que nous allons le voir, cela évite d'avoir à tronquer artificiellement l'espace des vitesses (il n'y a pas de discrétisation de l'espace de vitesse, qui peut devenir arbitrairement grand). Également ces méthodes préservent les lois de conservation, sont faciles à implémenter et très robustes. Leur coût, enfin, est linéaire en le nombre de « particules numériques ». Cependant, leur précision reste faible et les résultats peuvent présenter des fluctuations importantes. Pour remédier à ces problèmes, il est nécessaire d'augmenter le nombre de particules et de moyenner les résultats, ce qui devient très coûteux pour des gaz loin de l'équilibre global, ou près du régime fluide. Ainsi ces méthodes sont très puissantes pour obtenir rapidement la solution stationnaire à l'équilibre global, mais semblent inutilisables par exemple pour obtenir le taux de convergence vers l'équilibre. De plus elles ne permettent pas de reconstruire la densité de probabilité f autrement que très grossièrement, ce qui peut être se révéler un défaut important dans des situations comme les flots granulaires ou le comportement à l'infini en v de f est une caractéristique que l'on cherche à observer (voir [87] par exemple).

Ces limitations des méthodes particulières ont motivé la recherche de **méthodes déterministes**. Le principe des méthodes déterministes est de travailler réellement sur la densité de probabilité f et l'équation de Boltzmann, et d'effectuer une discrétisation en vitesse et en espace. Nous n'aborderons pas ici les méthodes de résolution en temps. Pour éviter d'avoir des conditions impraticables sur le pas de temps pour les faibles nombres de Knudsen, celles-ci sont généralement basées sur des schémas implicite ou des schémas dits « relaxés » (voir par exemple [88]). Dans le cas spatialement inhomogène, les résolutions du terme transport et du terme de collision sont traitées séparément par le schéma de splitting d'ordre 2 de Strang (voir [178]). Ceci permet de réduire l'étude numérique du terme de collision au cas spatialement homogène.

Pour le traitement du terme de transport nous distinguerons principalement deux types de méthodes : d'une part les méthodes ENO et WENO

issues des schémas numériques pour les systèmes hyperboliques (voir [174]), et d'autres part les méthodes de volumes finis positives et conservant le flux (voir [91]). Le principe des premières méthodes est un schéma de type différences finies où les coefficients dépendent d'estimations sur la « régularité discrète locale » de la donnée. Elles sont donc d'ordre élevé loin des singularités, et très stable près des singularités. En contrepartie ces méthodes sont relativement diffusives et ne préservent pas la positivité et les lois de conservations. Quant aux secondes méthodes, elles sont construites de telle sorte à préserver la positivité et les lois de conservation en égalant les flux entre les cellules d'espace. Elles sont moins diffusives et plus stables globalement, mais moins adaptées pour traiter de fortes singularités. Nous renvoyons à l'article [90] pour une comparaison des différentes méthodes de résolution de l'équation de transport, qui inclut également d'autres approches comme les méthodes semi-lagrangiennes ou les méthodes spectrales.

Pour le traitement du terme de collision (on se place donc maintenant dans le cadre spatialement homogène), les méthodes les plus populaires en dynamique des gaz raréfiés furent pendant longtemps basées sur les **modèles discrétisés en vitesses** de l'équation de Boltzmann, voir [40, 139, 33, 60, 156, 171]. Le principe est de discrétiser la variable vitesse sur une grille régulière et de construire un mécanisme de collision discret sur les points de la grille, qui préserve les principales propriétés physiques. Ces méthodes sont donc conservatives et stables (elles préservent la positivité et la norme L^1 de la distribution), et évitent toute fluctuation dans les résultats. Cependant leur coût est de l'ordre de $O(n^{2N+a})$ où n est le nombre de points dans chaque direction de la grille en vitesse et a est un nombre qui varie selon les méthodes mais qui est de l'ordre de 1. De plus, leur précision semble assez pauvre. Les résultats théoriques [155, 154, 156] démontrent des convergences en $O(n^{-r})$ avec $0 < r < 1$ et les études numériques suggèrent au mieux une précision d'ordre 2. Ces méthodes restent donc essentiellement limitées à des simulations avec un petit nombre de points de discrétisation et à des études numériques de propriétés qualitatives. Mentionnons toutefois que les modèles discrétisés en vitesses ont leur intérêt propre, qui a d'ailleurs motivé leur étude dès les années 1970, alors que les premiers résultats de consistance entre ces modèles et l'équation de Boltzmann ne datent que de la fin des années 1980 (nous renvoyons à l'article [26] pour une discussion historique plus précise).

Enfin récemment une nouvelle classe de méthode a émergé, basée sur une discrétisation des modes de Fourier associés à l'espace des vitesses. Elle s'inspire d'une part des outils (développés dans [24] par exemple) pour l'analyse de l'opérateur de collision par transformée de Fourier, et d'autre part des méthodes spectrales développées pour la mécanique des fluides (voir

[43] par exemple). Le premier article sur ces **méthodes spectrales** de type Fourier-Galerkin est [159]. Des généralisations furent ensuite étudiées [160, 161], et la méthode a été appliquée à des situations spatialement inhomogènes [89] (en la couplant avec les méthodes décrites ci-dessus pour le terme de transport), à l'équation de Landau [86, 162], à l'équation de Boltzman pour des noyaux non localement intégrables [164], aux gaz granulaires [151, 87]. L'intérêt de ces méthodes est leur grande simplicité et leur grande précision, ou **précision spectrale**, c'est-à-dire en « $O(n^{-\infty})$ » où l'exposant est relié à la régularité de la solution, et n désigne le nombre de modes de Fourier dans chaque direction. Elles conservent la masse mais pas la quantité de mouvement ni l'énergie cinétique. Cependant ces dernières lois de conservation sont également approximées avec une précision spectrale, et l'efficacité du schéma compense en grande partie ces pertes de conservativité exacte. Le coût de ces schémas spectraux est en $O(n^{2N})$. Mentionnons que des méthodes proches basées sur la transformée de Fourier rapide (mais qui ne semblent pas avoir la précision spectrale) ont été développées dans [23, 34].

Un problème majeur des méthodes déterministes de façon générale est la nécessité d'utiliser un domaine de discrétisation borné dans l'espace des vitesses. Physiquement ce domaine est \mathbb{R}^N et (voir le chapitre 4) la propriété d'être à support compact n'est pas préservée par l'opérateur de collision²⁵, qui « étale » le support (par un facteur $\sqrt{2}$ dans le cas élastique par exemple). Par conséquent si le support numérique reste constant au cours du temps, il est nécessaire d'imposer des conditions numériques non physiques au bord du domaine. Il y a principalement deux stratégies :

- A. Supprimer les collisions binaires qui conduisent à des couples de vitesses post-collisionnelles hors du domaine numérique. Cela signifie une baisse du nombre de collisions et donc du nombre de conditions à satisfaire pour être un invariant local (c'est-à-dire une fonction $\varphi = \varphi(v)$ qui résout l'équation (1.1.9) sur le domaine numérique), soit une possible augmentation du nombre d'invariants locaux de collision. On vérifie cependant simplement qu'il est possible de « garder assez de collisions » pour que le schémas n'hérite pas d'invariants locaux parasites. Cependant cette troncature oblige à modifier le noyau de collision d'une manière qui ne dépend pas seulement de la vitesse relative mais également de la position dans le domaine en vitesse. De ce fait elle brise la structure de type convolution de l'opérateur de collision. Cette ap-

²⁵Sauf dans des cas très particuliers, comme par exemple pour des gaz granulaires mono-dimensionnels, voir [151] par exemple.

proche est le point de départ de la plupart des modèles discrétisés en vitesses.

- B. Une autre possibilité est de rajouter des collisions non physiques en périodisant la distribution f et l'opérateur de collision sur le domaine numérique. Cette approche implique la perte des invariants locaux non périodiques, i.e. la quantité de mouvement et l'énergie cinétiques, qui ne vérifient pas l'équation (1.1.9) pour les nouvelles collisions ajoutées. Le schéma n'est donc plus conservatif, sauf en ce qui concerne la masse²⁶. Cependant les propriétés de type convolution de l'opérateur sont préservées et peuvent donc être exploitées pour la construction de schémas rapides. Cette périodisation est le point de départ des méthodes spectrales.

La justification numérique de ces deux approches est la décroissance rapide de la distribution f en vitesse qui permet, en choisissant un domaine numérique assez grand, de négliger les deux approximations faites. Dans les travaux numériques que nous présentons nous adoptons la seconde approche, ce qui signifie que les schémas ne sont plus exactement conservatifs et que nous devons tenir compte des erreurs d'« aliasing » (voir [43] pour une discussion de différentes techniques de « desaliasing »). Notre but est en effet d'exploiter la structure particulière de type convolution de l'opérateur de collision pour construire des schémas numériques rapides.

1.5.2 Méthodes déterministes rapides pour l'intégrale de collision de Boltzmann (Chapitre 10)

D'une part, dans la limite de collision rasante (opérateur de Landau) ou dans la limite quasi-élastique (opérateur de type *friction*), des travaux (respectivement [162] et [151]) ont montré que les méthodes spectrales pouvaient être calculées par des algorithmes rapides en $O(n^N \log_2 n)$ au lieu de $O(n^{2N})$. Cette réduction de la complexité de la méthode provient d'un découplage des « kernel modes » (voir ci-dessous). Il est possible formellement d'étendre ces algorithmes rapides à des asymptotiques « intermédiaires » de limite de collision rasante ou de limite quasi-élastique mais ces dernières ne sont pas clairement justifiables, y compris du point de vue numérique (en particulier des problèmes d'instabilité se posent).

²⁶En fait si la donnée initiale est paire en vitesse, cette propriété est conservée au cours du temps, et la quantité de mouvement est conservé car la fonction $\varphi(v) = v$ est un invariant *global*, c'est-à-dire une fonction $\varphi = \varphi(v)$ qui résout l'équation (1.1.8) pour cette classe de distributions, sans nécessairement résoudre point par point l'équation (1.1.9).

D'autre part les travaux [23, 34] ont montré l'intérêt des représentations de type Carleman pour l'utilisation de la transformée de Fourier rapide et la construction d'algorithmes rapides. Dans ces articles les auteurs construisent des schémas rapides en mêlant les approches par différences finies et par décomposition de type Fourier-Galerkin. La conservativité de ces schémas est maintenue mais leur précision reste faible (d'ordre inférieur à 2 d'après les simulations numériques).

En partant de ces deux types de contributions, le but du chapitre 10 est de construire, pour une classe d'interactions qui inclut le cas physique des sphères dures en dimension $N = 3$, des algorithmes spectraux rapides pour le calcul de l'équation de Boltzmann. Ces algorithmes gardent une précision spectrale et ne présentent pas de perte supplémentaire de conservativité par rapport aux algorithmes spectraux classiques. Nous nous bornons ici à donner le principe des méthodes spectrales et l'idée centrale qui permet d'obtenir une réduction du coût de calcul, sans rentrer dans les détails techniques.

Considérons une périodisation sur le domaine $\mathcal{D}_T = [-T, T]^d$ en vitesse. Il est nécessaire d'effectuer une troncature de l'opérateur de collision pour imposer que le domaine d'intégration sur lequel il est défini ne couvre qu'une période (cette troncature ne modifie toutefois pas l'invariance par translation du noyau de collision). Nous noterons cet opérateur tronqué $Q_{\mathcal{B}}^R$. Pour simplifier les notations nous prenons $T = \pi$ et nous utilisons une seule lettre pour désigner les multi-indices.

La distribution f est approximée par la série de Fourier tronquée

$$\begin{cases} f_n(v) = \sum_{k=-n}^n \hat{f}_k e^{ik \cdot v}, \\ \hat{f}_k = \frac{1}{(2\pi)^N} \int_{\mathcal{D}_\pi} f(v) e^{-ik \cdot v} dv \end{cases}$$

où $n \in \mathbb{N}$ désigne le nombre de modes de Fourier dans chaque direction de la discrétisation, et les \hat{f}_k désignent les coefficients de Fourier de f . Puis nous projetons l'équation

$$\frac{\partial f}{\partial t} = Q_{\mathcal{B}}^R(f, f)$$

sur \mathbb{P}^n , l'espace vectoriel de dimension $(2n+1)^N$ des polynômes trigonométriques de degré au plus n dans chaque direction :

$$\frac{\partial f_n}{\partial t} = \mathcal{P}_n Q_{\mathcal{B}}^R(f_n, f_n),$$

où \mathcal{P}_n désigne la projection orthogonale sur \mathbb{P}^n dans $L^2(\mathcal{D}_\pi)$. On obtient alors le système d'équations différentielles ordinaires suivant :

$$(1.5.28) \quad \hat{f}'_k(t) = \sum_{\substack{l, m=-n \\ l+m=k}}^n \hat{\beta}(l, m) \hat{f}_l \hat{f}_m, \quad k = -n, \dots, n,$$

où les $\hat{\beta}(l, m)$ sont les « **kernel modes** ». Lorsqu'on utilise une troncature $Q_{\mathcal{B}}^R$ basée sur la représentation de Carleman, ils sont donnés par la formule

$$(1.5.29) \quad \hat{\beta}(l, m) = \int_{x \in \mathcal{B}_R} \int_{y \in \mathcal{B}_R} \tilde{B}(x, y) \delta(x \cdot y) [e^{il \cdot x} e^{im \cdot y} - e^{im \cdot (x+y)}] dx dy.$$

La résolution de ce système d'équations nécessite le calcul et le stockage des $O(n^{2N})$ « kernel modes » une fois pour toute, puis $O(n^{2N})$ opérations à chaque pas.

Néanmoins la formule (1.5.28) montre que dès que les « kernel modes » vérifient une décomposition du type

$$\hat{\beta}(l, m) = \sum_{p=1}^A \alpha_p(l) \alpha'_p(m),$$

la somme dans (1.5.28) se décompose en A produits de convolution discrets. Ceux-ci peuvent alors être calculés par l'algorithme de Cooley et Tukey [59], et le coût global de l'évaluation du système d'équations différentielles à chaque pas de temps devient alors $O(A n^N \log_2 n)$.

Le point crucial est donc d'obtenir une décomposition des « kernel modes » qui découple les deux arguments l et m . Le principe des méthodes spectrales rapides que nous proposons est alors d'intégrer les composantes radiales de x et y dans la formule (1.5.29) et d'utiliser la règle de quadrature des rectangles pour discrétiser l'intégration en l'un des deux vecteurs unitaires $x/|x|$ ou $y/|y|$. La distribution étant périodique, il est possible de montrer que cette semi-discrétisation de l'opérateur est consistante et spectralement précise (voir le théorème 10.4). De plus elle préserve les symétries de l'opérateur de collision, et en particulier n'introduit pas de perte supplémentaire de conservativité. Enfin l'implémentation du schéma est parallélisable (ce qui réduit le coût théorique à $O(n^N \log_2 n)$) et adaptative (il est possible de modifier le paramètre A au cours du temps ou bien selon la position dans le domaine spatial, selon la précision souhaitée).

Mentionnons enfin que les mêmes idées (périodisation et recherche de structure de convolution discrète) ont pu être appliquées également aux modèles discretisés en vitesses (voir la section 10.4 du chapitre 10).

1.6 Perspectives

1.6.1 Théorie de Cauchy et régularité

Dans le cas de l'équation de Boltzmann spatialement homogène, deux problèmes principaux restent à traiter. D'une part l'unicité et la régularité de la solution pour des noyaux de collisions non localement intégrables, par exemple dans un premier temps pour les potentiels durs. D'autre part l'étude de l'évolution au cours du temps des bornes sur les moments et la régularité de la solution pour les potentiels mous, éventuellement avec troncature angulaire dans un premier temps. Dans le cas de l'équation de Landau spatialement homogène, les potentiels mous restent mal compris. En particulier une question serait de savoir si l'équation de Landau-Coulomb propage effectivement la régularité de la solution (voir la discussion dans [191, Chapitre 5, Section 1.3]). Dans le cas de l'équation de Boltzmann spatialement inhomogène, plusieurs pistes se dégagent : l'obtention d'une théorie de solutions perturbatives avec bornes des régularité explicites (dans l'esprit des travaux récents de Guo [110] et en utilisant les bornes de coercivité explicites du chapitre 6), la poursuite de la stratégie d'étude de la régularité sous des hypothèses *a priori* sur les champs hydrodynamiques engagée dans le chapitre 4, l'étude de la propagation des singularités et de leur décroissance en amplitude, l'étude de l'influence de la géométrie du domaine (et de ses propriétés de convexité ou non-convexité) sur le développement de singularités, etc.

1.6.2 Retour vers l'équilibre

Les chapitres 5, 6, 7 suscitent les pistes possibles suivantes. Tout d'abord plusieurs questions restent ouvertes en ce qui concerne l'étude spectrale de l'opérateur linéarisé dans l'espace d'auto-adjonction $f \in L^2(M^{-1})$: obtenir une estimée de coercivité qui contrôle une norme de régularité globale et non plus locale dans le cas de noyaux non localement intégrables, montrer la compacité de la résolvante dans le cas non localement intégrable « limite » $\nu = 0$, prouver la géométrie du spectre de la figure 1.3 pour les potentiels mous sans troncature angulaire, obtenir des informations sur la forme des fonctions propres pour les sphères dures ou les potentiels durs avec troncature angulaire, quantifier la dépendance du spectre par rapport au noyau de collision, etc. En ce qui concerne l'obtention de taux explicites de convergence vers l'équilibre, le chapitre 7 couvre le cas des potentiels durs avec troncature angulaire, et des études restent à mener pour obtenir des taux explicites pour les autres interactions. Par ailleurs la décroissance exponentielle du semi-groupe de l'opérateur de collision linéarisé dans l'espace L^1 avec

poids exponentiellement croissant obtenue dans le chapitre 7 pose la question de savoir si la conjecture de Cercignani pourrait être vérifiée pour des distributions dans un tel espace (ce qui n'est pas exclu par les contre-exemples de [28]). Enfin l'obtention de taux de convergence exponentielle explicites dans le cas spatialement inhomogène (pour des interactions de type sphères dures par exemple) sans condition perturbative (en supposant des bornes de régularité *a priori* sur la solution) reste ouverte, et nécessite probablement de nouveaux outils.

1.6.3 Gaz granulaires

Tout d'abord le chapitre 8 suscite de nombreuses améliorations possibles pour lever certaines des hypothèses techniques des théorèmes, en particulier sur les conditions pour obtenir l'unicité, la convergence de l'énergie cinétique vers 0 ou encore un temps de vie infini. Le chapitre 9 quant à lui gagnerait à être étendu à des noyaux de collision plus généraux. Plus fondamentalement les questions ouvertes sont l'unicité du profil auto-similaire, et la convergence éventuelle de la solution vers un profil auto-similaire (i.e. au sens d'une convergence vers une solution stationnaire en variables auto-similaires). En l'absence de fonction de Lyapunov connue, une possibilité serait une étude perturbative linéarisée autour du profil. Par ailleurs, la stabilité ou l'instabilité de l'homogénéité spatiale reste ouverte²⁷ et, dans le cas spatialement inhomogène, la construction de solutions renormalisées restent également ouverte, du fait de l'absence de théorème *H*.

1.6.4 Méthodes numériques

L'application des méthodes spectrales rapides décrites dans le chapitre 2 à des simulations spatialement homogènes et inhomogènes est en cours [85]. Par ailleurs, il serait intéressant d'étendre les algorithmes spectraux rapides à des modèles granulaires ou des modèles de semi-conducteurs. Sur le plan théorique, la consistance des méthodes spectrales est connue, mais la stabilité (et donc la convergence) reste ouverte. Enfin les méthodes déterministes pourraient être utilisées pour obtenir des renseignements sur des problèmes encore inaccessibles à l'étude analytique, comme l'étude des oscillations lors de la relaxation vers l'équilibre, ou bien la dépendance du taux de relaxation en fonction de la forme du domaine, etc.

²⁷Aucune étude linéarisée dans l'esprit de [11] n'existe en inélastique, et des arguments physiques, comme dans [102], penchent en faveur de l'instabilité de l'homogénéité spatiale.

1.7 Annexe : notations

Soit une fonction mesurable $f : \mathbb{R}^d \rightarrow \mathbb{R}$, avec $d \geq 1$. On note

$$\langle \cdot \rangle = \sqrt{1 + |\cdot|^2}.$$

Soit $p \in [1, +\infty[$, $q \in \mathbb{R}$ et $m : \mathbb{R}^d \rightarrow \mathbb{R}$ une fonction strictement positive mesurable. Alors

- On définit l'espace $L^p(m)$ par la norme

$$\|f\|_{L^p(m)}^p = \int_{\mathbb{R}^d} |f(y)|^p m(y) dy,$$

et l'espace $L^\infty(m)$ par la norme

$$\|f\|_{L^\infty(m)} = \sup_{y \in \mathbb{R}^d} |f(y)| m(y)$$

(le « sup » désigne la borne supérieure essentielle).

- Dans le cas particulier d'un poids en puissance, on définit l'espace L_q^p par la norme

$$\|f\|_{L_q^p}^p = \int_{\mathbb{R}^d} |f(y)|^p \langle y \rangle^{pq} dy,$$

et l'espace L_q^∞ par la norme

$$\|f\|_{L_q^\infty} = \sup_{y \in \mathbb{R}^d} |f(y)| \langle y \rangle^q.$$

- Plus généralement, on définit pour $s \in \mathbb{N}$, l'espace $W^{s,p}(m)$ par la norme

$$\|f\|_{W^{s,p}(m)}^p = \sum_{|k| \leq s} \int_{\mathbb{R}^d} |\partial^k f(y)|^p m(y) dy,$$

avec $\partial^k = \partial^{k_1} / \partial_{y_1}^{k_1} \cdots \partial^{k_N} / \partial_{y_N}^{k_N}$, et l'espace $W^{s,\infty}(m)$ par la norme

$$\|f\|_{W^{s,\infty}(m)} = \sum_{|k| \leq s} \sup_{y \in \mathbb{R}^d} |\partial^k f(y)| m(y).$$

- Dans le cas particulier d'un poids en puissance, on définit l'espace $W_q^{s,p}$ par la norme

$$\|f\|_{W_q^{s,p}}^p = \sum_{|k| \leq s} \int_{\mathbb{R}^d} |\partial^k f(y)|^p \langle y \rangle^{pq} dy,$$

et l'espace $W_q^{s,\infty}$ par la norme

$$\|f\|_{W_q^{s,\infty}} = \sum_{|k|\leq s} \sup_{y\in\mathbb{R}^d} |\partial^k f(y)| \langle y \rangle^q.$$

• Dans le cas particulier $p = 2$, on note $H^s(m) = W^{s,2}(m)$ et $H_q^s = W_q^{s,2}$, et les définitions peuvent être étendues par interpolation à $s \geq 0$. Également nous avons la norme équivalente suivante sur H_q^s pour tout $s \geq 0$:

$$\|f\|_{H_q^s}^p = \|\mathcal{F}(f\langle \cdot \rangle^q)\|_{L^2}^2$$

où $\mathcal{F}(f\langle \cdot \rangle^q)$ désigne la transformée de Fourier de la fonction $y \mapsto f(y) \langle y \rangle^q$.

• On définit $L \log L$ l'espace de Orlicz associé à la fonction convexe $\phi : \mathbb{R} \rightarrow \mathbb{R}_+, X \mapsto (1 + |X|) \log(1 + |X|)$, c'est-à-dire l'ensemble des $f : \mathbb{R}^d \rightarrow \mathbb{R}$ mesurables telles que

$$\int_{\mathbb{R}^d} \phi(|f(y)|) dy < +\infty.$$

C'est un espace de Banach, pour plus de détails, nous renvoyons à la section 8.6 du chapitre 8.

• On définit l'espace BV_q des fonctions à variations bornées avec poids en puissance d'ordre q comme l'ensemble des limites de suites de $W_q^{1,1}$ dans $\mathcal{D}'(\mathbb{R}^d)$ l'espace des distributions sur \mathbb{R}^d , pour la convergence faible $W_q^{1,1}$. Pour $f \in BV_q$, la norme est donnée par

$$\|f\|_{BV_q} = \|f\|_{L_q^1} + \int_{\mathbb{R}^d} \langle y \rangle^q |dm_f|(y)$$

où dm_f désigne la dérivée de f au sens des distributions (associée à une mesure sur \mathbb{R}^d), et $|dm_f|$ sa variation totale.

Partie I

Étude de la régularité

Regularity theory for the spatially homogeneous Boltzmann equation with cut-off

Article [150], en collaboration avec Cédric Villani, paru à
Archive for Rational Mechanics and Analysis.

ABSTRACT: We develop the regularity theory of the spatially homogeneous Boltzmann equation with cut-off and hard potentials (for instance, hard spheres), by (i) revisiting the L^p theory to obtain constructive bounds, (ii) establishing propagation of smoothness and singularities, (iii) obtaining estimates on the decay of the singularities of the initial datum. Our proofs are based on a detailed study of the “regularity of the gain operator”. An application to the long-time behavior is presented.

Contents

2.1	Introduction	93
2.2	Preliminary estimates on the collision operator	99
2.2.1	Some convolution-like inequalities on Q^+	100
2.2.2	A lower bound on Q^-	104
2.3	Regularity of the gain operator	104
2.3.1	A splitting of Q^+	105
2.3.2	Regularity and integrability for a smooth collision kernel	107
2.3.3	Regularity and integrability for a non-smooth collision kernel	113
2.4	Propagation of L^p estimates	118
2.4.1	Main result	118
2.4.2	Generalization: propagation of H^k estimates for $k \in \mathbb{N}$	121
2.5	Propagation of smoothness and singularity via the Duhamel formula	124
2.5.1	Preliminary estimates	124
2.5.2	Propagation of regularity	127
2.5.3	The decomposition theorem	128
2.6	Application to a problem of long-time behavior	132
2.7	Weaker integrability conditions	135
2.8	Appendix: Some facts from interpolation theory and harmonic analysis	137
2.8.1	Convolution inequalities in weighted spaces	137
2.8.2	Riesz-Thorin interpolation	138
2.8.3	Regularity of a sum $H_k^s + H_k^{s+\beta}$	138
2.8.4	A simple estimate on pseudo-differential operators	140

2.1 Introduction

This paper is devoted to the study of qualitative properties of solutions to the spatially homogeneous Boltzmann equation with cut-off and hard potentials. In this work, we shall obtain new, quantitative bounds on the norms of the solutions in Lebesgue and Sobolev spaces. Before we explain our results and methods in more detail, let us introduce the problem in a precise way.

The spatially homogeneous Boltzmann equation describes the behavior of a dilute gas, in which the velocity distribution of particles is assumed to be independent of the position; it reads

$$\frac{\partial f}{\partial t} = Q(f, f), \quad v \in \mathbb{R}^N, \quad t \geq 0,$$

where the unknown $f = f(t, v)$ is a time-dependent probability density on \mathbb{R}^N ($N \geq 2$) and Q is the quadratic Boltzmann collision operator, which we define by the bilinear form

$$Q(g, f) = \int_{\mathbb{R}^N \times \mathbb{S}^{N-1}} B(|v - v_*|, \cos \theta) (g'_* f' - g_* f) dv_* d\sigma.$$

Here we have used the shorthand $f' = f(v')$, $g_* = g(v_*)$ and $g'_* = g(v'_*)$, where

$$\begin{cases} v' = \frac{v + v_*}{2} + \frac{|v - v_*|}{2} \sigma, \\ v'_* = \frac{v + v_*}{2} - \frac{|v - v_*|}{2} \sigma \end{cases}$$

stand for the pre-collisional velocities of particles which after collision have velocities v and v_* . Moreover $\theta \in [0, \pi]$ is the deviation angle between $v' - v'_*$ and $v - v_*$, and B is the Boltzmann collision kernel (related to the cross-section $\Sigma(v - v_*, \sigma)$ by the formula $B = \Sigma|v - v_*|$), determined by physics. On physical grounds, it is assumed that $B \geq 0$ and that B is a function of $|v - v_*|$ and $\cos \theta = (\sigma \cdot (v - v_*))/|v - v_*|$.

In this paper we shall be concerned with the case when B is **locally integrable**, an assumption which is usually referred to as *Grad's cut-off assumption* (see [108]). The main case of application is that of hard-sphere interaction, where (up to a normalization constant)

$$(2.1.1) \quad B(|v - v_*|, \cos \theta) = |v - v_*|.$$

We shall study more general kernels than just (2.1.1), but, in order to limit the complexity of statements, we shall assume that B takes the simple product form

$$(2.1.2) \quad B(|v - v_*|, \cos \theta) = \Phi(|v - v_*|) b(\cos \theta), \quad \cos \theta = \left\langle \frac{v - v_*}{|v - v_*|}, \sigma \right\rangle.$$

Let us state our assumptions in this context:

- We use Grad's cut-off assumption, which takes here the simple form

$$(2.1.3) \quad \int_0^\pi b(\cos \theta) \sin^{N-2} \theta d\theta < +\infty.$$

- It is customary in physics and in mathematics to study the case when Φ behaves like a power law $|v - v_*|^\gamma$, and it is traditional to distinguish between hard potentials ($\gamma > 0$), Maxwellian potentials ($\gamma = 0$), and soft potentials ($\gamma < 0$). Here we shall concentrate on **hard potentials**, and more precisely we shall assume that Φ behaves like a positive power of $|v - v_*|$, in the following sense: There exists a $\gamma \in (0, 2)$ such that

$$(2.1.4) \quad \Phi(0) = 0 \quad \text{and} \quad C_\Phi \equiv \|\Phi\|_{C^{0,\gamma}(\mathbb{R}_+)} < +\infty.$$

Here $C^{0,\gamma}(\mathbb{R}_+)$ is the γ -Hölder space on \mathbb{R}_+ , i.e.,

$$\|\Phi\|_{C^{0,\gamma}(\mathbb{R}_+)} = \sup_{r,s \in \mathbb{R}_+, r \neq s} \frac{|\Phi(r) - \Phi(s)|}{|r - s|^\gamma}.$$

- In addition to (2.1.3) we shall assume a polynomial control on the convergence of the angular integral: there exists $\delta > 0$ such that

$$(2.1.5) \quad \left| \int_0^\pi b(\cos \theta) \sin^{N-2} \theta d\theta - \int_\varepsilon^{\pi-\varepsilon} b(\cos \theta) \sin^{N-2} \theta d\theta \right| \leq C_b \varepsilon^\delta.$$

Remark: The goal of this assumption is to simplify the computations and bounds which will be derived. Of course, the L^1 integrability of the angular cross-section implies that the left-hand side in (2.1.5) goes to 0 as $\varepsilon \rightarrow 0$, and almost all the results in the present paper remain true under this sole assumption.

- Finally, we shall impose a lower bound on the kernel B , in the form

$$(2.1.6) \quad \int_{\mathbb{S}^{N-1}} B(|v - v_*|, \cos \theta) d\sigma \geq K_B |v - v_*|^\gamma \quad (K_B > 0, \quad \gamma > 0).$$

For a kernel in product form, as in (2.1.2), this assumption means that b is (almost everywhere) not identically zero and Φ satisfies

$$(2.1.7) \quad \forall z \in \mathbb{R}^N, \quad \Phi(|z|) \geq K_\Phi |z|^\gamma$$

for some $K_\Phi > 0$.

Remarks:

1. Our assumptions imply that Φ is bounded from above and below by constant multiples of $|v - v_*|^\gamma$. In fact, to establish the subsequent L^p estimates on Q^+ , it is sufficient to treat this case: since the gain operator behaves in a monotone way with respect to the collision kernel, the general estimates follow immediately.

2. It would also be easy to generalize our results to the case in which B is a finite sum of products of the form (2.1.2), but much more tedious to do the same for a general B , even if no conceptual difficulty should arise.

The Cauchy problem for hard and Maxwellian potentials is by now fairly well understood (see for example [44, 45], [6], [144], [24]), while soft potentials still remain more mysterious (see [7], [107], [186] for partial results).

For hard potentials with $0 < \gamma < 2$, the following results are known:

- **Existence and uniqueness** of a solution as soon as the initial datum f_0 satisfies

$$(2.1.8) \quad \int_{\mathbb{R}^N} f_0(v) (1 + |v|^2) dv < +\infty.$$

This uniqueness statement in fact holds in the class of solutions with non-increasing kinetic energy, and the solution satisfies the conservation laws

$$\forall t \geq 0, \quad \int_{\mathbb{R}^N} f(t, v) \begin{pmatrix} 1 \\ v \\ |v|^2 \end{pmatrix} dv = \int_{\mathbb{R}^N} f_0(v) \begin{pmatrix} 1 \\ v \\ |v|^2 \end{pmatrix} dv.$$

This strong uniqueness result is due to Mischler and Wennberg [144]. We note that spurious solutions with increasing kinetic energy can be constructed, see [201].

- **Boltzmann's H -theorem:** let

$$H(f) = \int_{\mathbb{R}^N} f \log f \, dv,$$

then

$$\frac{d}{dt} H(f(t, \cdot)) \leq 0.$$

In particular, if $H(f_0) < +\infty$, then

$$\forall t \geq 0, \quad H(f(t, \cdot)) \leq H(f_0).$$

- **Moment bounds** (see [168], [67], [198, 200], [144]): if f_0 satisfies (2.1.8), then

$$\forall s \geq 2, \quad \forall t_0 > 0, \quad \sup_{t \geq t_0} \int_{\mathbb{R}^N} f(t, v) (1 + |v|^s) \, dv < +\infty.$$

In words, all moments are bounded for positive times, uniformly as t goes to infinity. This effect has been studied at length in the literature, and is strongly linked to the behavior of the collision kernel as $|v - v_*| \rightarrow +\infty$. Some explicit bounds are available [67, 200].

- **Positivity estimates** (see [44], [169]): without further assumptions, it is known that

$$\begin{aligned} \forall t_0 > 0, \exists K_0, A_0 > 0; \quad t \geq t_0 \\ \implies \quad \forall v \in \mathbb{R}^N, \quad f(t, v) \geq K_0 e^{-A_0 |v|^2}. \end{aligned}$$

This means that there is an immediate appearance of a Maxwellian lower bound (the particles immediately fill up the whole velocity space). Again the bounds here are explicit.

- **L^p bounds:** L^p estimates ($p > 1$) have been obtained by several authors: Carleman [44, 45] and Arkeryd [8] for $p = +\infty$, then Gustafsson [111, 112] for $1 < p < +\infty$. The bounds given by Carleman and Arkeryd are constructive, while this does not seem to be the case for Gustafsson's one, obtained by an intricate nonlinear interpolation procedure.

Our goal in this work is to complete the picture, while staying in the framework of hard potentials with cut-off, by

- revisiting the L^p theory ($1 < p < +\infty$) and obtain **quantitative estimates** together with improved results (holding true under physically relevant assumptions);
- studying in detail the phenomena of **propagation of smoothness** and **propagation of singularities**, which are certainly the main physical consequences of Grad's cut-off assumption.

Unlike Gustafsson's proof, our method does not use the L^∞ theory, nor nonlinear interpolation; it is entirely based on the important property of "regularity of the gain operator", namely the fact that the positive part of the Boltzmann collision operator

$$Q^+(g, f) = \int_{\mathbb{R}^N} \int_{\mathbb{S}^{N-1}} B(|v - v_*|, \cos \theta) g'_* f' d\sigma dv_*$$

has a regularizing effect. This phenomenon was discovered by Lions [130, 131], and later studied by Wennberg [199], Bouchut and Desvillettes [37], and Lu [134]. On one hand we shall use some of the results in [37], but on the other hand we shall also need some fine versions of the regularization property which do not appear in the above-mentioned references, and this is why we shall devote a whole section to the study of this regularization effect. This part should be of independent interest for researchers in the field, since the Q^+ regularity is the basis of the study of propagation of regularity for the Boltzmann equation in general, including the full, spatially inhomogeneous Boltzmann equation. Wennberg's work [199] will be the starting point of our investigation.

Since the pioneering papers [130, 131] it was known that the Q^+ regularity was useful for smoothness issues; we shall show here that it is also very powerful for establishing L^p bounds, as was first suggested in [182]. In this reference, the case of smoothed soft potentials was considered; here we shall adapt the strategy to the case of hard potentials, which will turn out to be much more technical. Our subsequent study of propagation of smoothness will use these L^p bounds as a starting point, in the case $p = 2$.

Interpolation will play an important role in our estimates, but it will only be linear interpolation, applied to the bilinear Boltzmann operator with one frozen argument (typically, $f \mapsto Q(g, f)$).

Our main results can be summarized as follow: under assumptions (2.1.3)–(2.1.6)

- if the initial datum lies in L^p , then the solution is bounded in L^p , uniformly in time;

- if the initial datum is smooth (say in some Sobolev space), then the solution is smooth, uniformly in time;
- if the initial datum is not smooth, then the solution is not smooth either. However, it can be decomposed into the sum of a smooth part (with arbitrary high degree of smoothness) and a non-smooth part whose amplitude decays exponentially fast.

All this will be quantified and stated precisely in Sections 2.4 and 2.5. The L^p propagation result is an improvement of already known results, in the sense that we do not need an extra L^p -moment condition on the initial datum; the other results are new. As an application, we shall establish some new estimates on the rate of convergence to thermodynamical equilibrium as time goes to infinity. Although these estimates are obtained as a consequence of our regularity study, they will hold true even for non-smooth solutions.

The plan of the present paper is as follows. First, in Section 2.2, we give some simple estimates on the collision operator in various functional spaces. These estimates will be obtained by simple duality arguments; some of them were essentially well known even if maybe not in the particular form which we give. Then in Section 2.3 we begin our fine study of the regularity of Q^+ . It is only in Section 2.4 that we start looking at *solutions* of the Boltzmann equation; in this section we show that if the initial datum lies in L^p ($1 < p < +\infty$) then the solution is bounded in L^p uniformly in time (also we prove that a phenomenon of “appearance of L^p moments” occurs, like in the case $p = 1$). In Section 2.5, the main result is a decomposition theorem of the solution into the sum of a smooth part (having arbitrary high degree of smoothness) and a non-smooth part whose amplitude decays exponentially fast. As a preliminary we shall also prove propagation of smoothness, and thus rather precisely tackle the phenomena of propagation of singularities together with exponential decay. Finally, in Section 2.6 we give an application to the study of long-time behavior of the solution: the decomposition theorem allows us to apply estimates for a very smooth solution obtained by [192], in order to prove rapid convergence to global equilibrium.

The whole paper is essentially self-contained, apart from a few simple auxiliary estimates for which precise references will be given, and from known existence and uniqueness results, which we here admit. Some facts from linear interpolation theory and harmonic analysis, used within the proofs, will be recalled in an appendix, in Section 2.8.

2.2 Preliminary estimates on the collision operator

Let us first introduce the functional spaces which will be used in what follows. Throughout the paper we shall use the notation $\langle \cdot \rangle = \sqrt{1 + |\cdot|^2}$ and we shall denote by “cst” various constants which do not depend on the collision kernel B . Whenever multi-indices are needed we shall use the common notation $x^\nu = x_1^{\nu_1} \cdots x_N^{\nu_N}$, $\partial^\nu = \partial_1^{\nu_1} \cdots \partial_N^{\nu_N}$, where $\partial_i = \partial/\partial x_i$, and $\binom{\nu}{\mu} = \binom{\nu_1}{\mu_1} \cdots \binom{\nu_N}{\mu_N}$. We shall use weighted Lebesgue spaces L_k^p ($p \geq 1$, $k \in \mathbb{R}$) defined by the norm

$$\|f\|_{L_k^p(\mathbb{R}^N)} = \left(\int_{\mathbb{R}^N} |f(v)|^p \langle v \rangle^{pk} dv \right)^{1/p}$$

with the convention

$$\|f\|_{L_k^\infty(\mathbb{R}^N)} = \sup_{v \in \mathbb{R}^N} [|f(v)| \langle v \rangle^k] .$$

We shall also use weighted Sobolev spaces $W_k^{s,p}(\mathbb{R}^N)$; when $s \in \mathbb{N}$ they are defined by the norm

$$\|f\|_{W_k^{s,p}(\mathbb{R}^N)} = \left(\sum_{|\nu| \leq s} \|\partial^\nu f\|_{L_k^p}^p \right)^{1/p} .$$

Then the definition is extended to positive (real) values of s by interpolation. In particular, we shall denote $W_k^{s,2}$ by H_k^s ; note that this is a Hilbert space.

We shall make frequent use of the translation operators τ_h defined by

$$\forall v \in \mathbb{R}^N, \quad \tau_h f(v) = f(v - h).$$

The translation operation does not leave the weighted norms invariant. Instead, we have the following estimates:

$$\|\tau_h f\|_{L_{k_1+k_2}^p} \leq \langle h \rangle^{|k_2|} \|f\|_{L_{k_1}^p} .$$

Finally, we introduce the H functional:

$$H(f) = \int_{\mathbb{R}^N} f \log f dv.$$

For nonnegative functions in L_2^1 , $H(f)$ is finite if and only if f belongs to the Orlicz space $L \log L$ (often used in kinetic theory) defined by the convex function $\phi(X) = (1 + |X|) \log(1 + |X|)$.

2.2.1 Some convolution-like inequalities on Q^+

In this subsection we prove some estimates on Q^+ in Lebesgue and Sobolev spaces. In the case of Lebesgue spaces, they are essentially contained in [111, 112]; but our method, based on duality, provides somewhat simpler proofs.

We shall establish two different types of estimates: for the bilinear Boltzmann collision operator on one hand, and for the quadratic operator on the other hand. To establish the bilinear estimates, we shall impose an additional assumption on the angular kernel: *no frontal collision should occur*, i.e., $b(\cos \theta)$ should vanish for θ close to π :

$$(2.2.9) \quad \exists \theta_b > 0; \quad \text{supp } b(\cos \theta) \subset \{\theta / 0 \leq \theta \leq \pi - \theta_b\}.$$

This additional assumption will not be needed, on the other hand, for the quadratic estimates, i.e., the estimates on $Q^+(f, f)$. Indeed, $Q^+(f, g) = \tilde{Q}^+(g, f)$ if \tilde{Q}^+ is a Boltzmann gain operator associated with the kernel $\tilde{b}(\cos \theta) = b(\cos(\pi - \theta))$. In particular, $b(\cos \theta)$ and $[b(\cos \theta) + b(\cos(\pi - \theta))]1_{\cos \theta \geq 0}$ define the same quadratic operator Q^+ , and the latter satisfies (2.2.9) automatically. We note that $Q^+(g, f)$ and $Q^+(f, g)$ will not necessarily satisfy the same estimates, since assumption (2.2.9) is not symmetric. To exchange the roles of f and g , we will therefore be led to introduce the assumption that no grazing collision should occur, i.e.,

$$(2.2.10) \quad \exists \theta_b > 0; \quad \text{supp } b(\cos \theta) \subset \{\theta / \theta_b \leq \theta \leq \pi\}.$$

Theorem 2.1. *Let $k, \eta \in \mathbb{R}$, $s \in \mathbb{R}_+$, $p \in [1, +\infty]$, and let B be a collision kernel of the form (2.1.2), satisfying the assumption (2.2.9). Then, the following estimates hold:*

$$(2.2.11) \quad \|Q^+(g, f)\|_{L^p_\eta(\mathbb{R}^N)} \leq C_{k, \eta, p}(B) \|g\|_{L^1_{|k+\eta|+|\eta|}(\mathbb{R}^N)} \|f\|_{L^p_{k+\eta}(\mathbb{R}^N)},$$

$$(2.2.12) \quad \|Q^+(g, f)\|_{W^{s, p}_\eta(\mathbb{R}^N)} \leq C_{k, \eta, p}(B) \|g\|_{W^{[s], 1}_{|k+\eta|+|\eta|}(\mathbb{R}^N)} \|f\|_{W^{s, p}_{k+\eta}(\mathbb{R}^N)},$$

where $C_{k, \eta, p}(B) = \text{cst } (\sin(\theta_b/2))^{\min(\eta, 0) - 2/p'} \|b\|_{L^1(\mathbb{S}^{N-1})} \|\Phi\|_{L^\infty_{-k}}$. If on the other hand assumption (2.2.9) is replaced by assumption (2.2.10), then the same estimates hold with $Q^+(g, f)$ replaced by $Q^+(f, g)$.

Corollary 2.1. *Let $k, \eta \in \mathbb{R}$, $p \in [1, +\infty]$, and let B be a collision kernel of the form (2.1.2). Then the following estimates hold:*

$$\|Q^+(f, f)\|_{L^p_\eta(\mathbb{R}^N)} \leq C_k(B) \|f\|_{L^1_{|k+\eta|+|\eta|}(\mathbb{R}^N)} \|f\|_{L^p_{k+\eta}(\mathbb{R}^N)},$$

$$(2.2.13) \quad \|Q^+(f, f)\|_{W^{s, p}_\eta(\mathbb{R}^N)} \leq C_k(B) \|f\|_{W^{[s], 1}_{|k+\eta|+|\eta|}(\mathbb{R}^N)} \|f\|_{W^{s, p}_{k+\eta}(\mathbb{R}^N)},$$

where $C_k(B) = \text{cst } \|b\|_{L^1(\mathbb{S}^{N-1})} \|\Phi\|_{L^\infty_{-k}}$.

Remarks:

1. Of course, if B satisfies assumption (2.1.4), then $C_k(B)$ is finite as soon as $k \geq \gamma$.

2. No regularity is needed on the collision kernel here.

3. In the particular case $\eta \geq 0$, it is possible to obtain slightly better weight exponents in Theorem 2.1 and Corollary 2.1. We can indeed use the inequality

$$|v|^2 \leq |v'|^2 + |v'_*|^2$$

to split the weight on the two arguments of Q^+ and get

$$\|Q^+(g, f)\|_{L_\eta^p} \leq \text{cst} \|Q^+(G, F)\|_{L^p}$$

where $F(v) = f(v)\langle v \rangle^\eta$ and $G(v) = g(v)\langle v \rangle^\eta$. When $\eta \geq 0$, the conclusion of Theorem 2.1 thus becomes

$$\|Q^+(g, f)\|_{L_\eta^p(\mathbb{R}^N)} \leq C_{k,\eta,p}(B) \|g\|_{L_{k+\eta}^1(\mathbb{R}^N)} \|f\|_{L_{k+\eta}^p(\mathbb{R}^N)},$$

and

$$\|Q^+(g, f)\|_{W_\eta^{s,p}(\mathbb{R}^N)} \leq C_{k,\eta,p}(B) \|g\|_{W_{k+\eta}^{[s],1}(\mathbb{R}^N)} \|f\|_{W_{k+\eta}^{s,p}(\mathbb{R}^N)}.$$

4. As we said above, the corollary is obtained from the theorem upon replacing $b(\cos \theta)$ by $[b(\cos \theta) + b(-\cos \theta)]1_{0 \leq \theta \leq \pi/2}$. We note that in the case of a hard-sphere collision kernel, the physically relevant regime is $\cos \theta \leq 0$, so our trick to reduce to $\cos \theta \geq 0$ should just be considered as a mathematical convenience (which could have been avoided by choosing different conventions; however there is some other motivation for our present conventions).

Proof of Theorem 2.1. By duality,

$$\|Q^+(g, f)\|_{L_\eta^p} = \sup \left\{ \int Q^+(g, f)\psi \ ; \ \|\psi\|_{L_{-\eta}^{p'}} \leq 1 \right\}.$$

We apply the well-known pre/post-collisional change of variables, namely $(v, v_*, \sigma) \rightarrow (v', v'_*, (v - v_*)/|v - v_*|)$, which has a unit Jacobian, to obtain

$$\int_{\mathbb{R}^N} Q^+(g, f)\psi \, dv = \int_{\mathbb{R}^N \times \mathbb{R}^N} g_* f \left(\int_{\mathbb{S}^{N-1}} B(|v - v_*|, \sigma) \psi(v') \, d\sigma \right) \, dv \, dv_*$$

for all $\|\psi\|_{L^p_{-\eta}} \leq 1$. Let us define the linear operator S by

$$S\psi(v) = \int_{\mathbb{S}^{N-1}} B(|v|, \sigma) \psi\left(\frac{v + |v|\sigma}{2}\right) d\sigma.$$

Then

$$(2.2.14) \quad \int_{\mathbb{R}^N} Q^+(g, f)\psi dv = \int_{\mathbb{R}^N} g(v_*) \left(\int_{\mathbb{R}^N} f(v) (\tau_{v_*} S(\tau_{-v_*} \psi))(v) dv \right) dv_*.$$

We shall study the operator S in weighted L^1 and L^∞ norms. For brevity we denote $v^+ = (v + |v|\sigma)/2$. By use of the inequality

$$\sin\left(\frac{\theta_b}{2}\right) |v| \leq |v^+| \leq |v|$$

which is a consequence of (2.2.9), we find

$$(2.2.15) \quad \|S\psi\|_{L^\infty_{-k-\eta}} \leq \text{cst} (\sin(\theta_b/2))^{\min(\eta, 0)} \|b\|_{L^1(\mathbb{S}^{N-1})} \|\Phi\|_{L^\infty_{-k}} \|\psi\|_{L^\infty_{-\eta}}.$$

Next, we turn to the L^1 estimate. First,

$$\begin{aligned} \|S\psi\|_{L^1_{-k-\eta}} &= \int_{\mathbb{R}^N} \int_{\mathbb{S}^{N-1}} \Phi(|v|) \langle v \rangle^{-k-\eta} b(\cos \theta) |\psi(v^+)| d\sigma dv \\ &\leq (\sin(\theta_b/2))^{\min(\eta, 0)} \|\Phi\|_{L^\infty_{-k}} \\ &\quad \times \int_{\mathbb{R}^N} \int_{\mathbb{S}^{N-1}} b(\cos \theta) |\psi(v^+)| \langle v^+ \rangle^{-\eta} d\sigma dv \end{aligned}$$

The change of variable $v \rightarrow v^+$ is allowed because b has compact support in $[0, \pi - \theta_b]$, and its Jacobian is $2^{N-1} \cos^2 \theta/2$. By applying it we find

$$\begin{aligned} \|S\psi\|_{L^1_{-k-\eta}} &\leq \text{cst} (\sin(\theta_b/2))^{\min(\eta, 0)} \|\Phi\|_{L^\infty_{-k}} \\ &\quad \times \int_{\mathbb{R}^N \times \mathbb{S}^{N-1}} b(\cos \theta) |\psi(v^+)| \langle v^+ \rangle^{-\eta} dv d\sigma \\ &\leq \text{cst} (\sin(\theta_b/2))^{\min(\eta, 0)} \|\Phi\|_{L^\infty_{-k}} \\ &\quad \times \int_{\mathbb{R}^N \times \mathbb{S}^{N-1}} b(\cos \theta) |\psi(v^+)| \langle v^+ \rangle^{-\eta} \frac{2^{N-1}}{\cos^2 \theta/2} dv^+ d\sigma \\ (2.2.16) \quad &\leq \text{cst} (\sin(\theta_b/2))^{\min(\eta, 0)-2} \|b\|_{L^1(\mathbb{S}^{N-1})} \|\Phi\|_{L^\infty_{-k}} \|\psi\|_{L^1_{-\eta}}. \end{aligned}$$

By the Riesz-Thorin interpolation theorem (see Section 2.8), from inequalities (2.2.15) and (2.2.16) we deduce

$$\|S\psi\|_{L^p_{-k-\eta}} \leq C_{k, \eta, p'}(B) \|\psi\|_{L^p_{-\eta}}, \quad 1 \leq p \leq \infty,$$

where $C_{k,\eta,p'}(B) = \text{cst} (\sin(\theta_b/2))^{\min(\eta,0)-2/p} \|b\|_{L^1(\mathbb{S}^{N-1})} \|\Phi\|_{L_{-k}^\infty}$. Plugging this inequality in (2.2.14), we find

$$\begin{aligned}
 \left| \int_{\mathbb{R}^N} Q^+(g, f) \psi \, dv \right| &\leq \int_{\mathbb{R}^N} dv_* |g_*| \left(\int_{\mathbb{R}^N} dv |f| |(\tau_{-v_*} S(\tau_{v_*} \psi))(v)| \right) \\
 &\leq \int_{\mathbb{R}^N} dv_* |g_*| \|f\|_{L_{k+\eta}^p} \|\tau_{-v_*} S(\tau_{v_*} \psi)\|_{L_{-k-\eta}^{p'}} \\
 &\leq \|f\|_{L_{k+\eta}^p} \int_{\mathbb{R}^N} |g_*| \langle v_* \rangle^{k+\eta} \|S(\tau_{v_*} \psi)\|_{L_{-k-\eta}^{p'}} \, dv_* \\
 &\leq C_{k,\eta,p}(B) \|f\|_{L_{k+\eta}^p} \int_{\mathbb{R}^N} |g_*| \langle v_* \rangle^{k+\eta} \|\tau_{v_*} \psi\|_{L_{-\eta}^{p'}} \, dv_* \\
 &\leq C_{k,\eta,p}(B) \|f\|_{L_{k+\eta}^p} \|\psi\|_{L_{-\eta}^{p'}} \int_{\mathbb{R}^N} |g_*| \langle v_* \rangle^{k+\eta+|\eta|} \, dv_* \\
 &\leq C_{k,\eta,p}(B) \|f\|_{L_{k+\eta}^p} \int_{\mathbb{R}^N} |g_*| \langle v_* \rangle^{k+\eta+|\eta|} \, dv_* \\
 &\leq C_{k,\eta,p}(B) \|f\|_{L_{k+\eta}^p} \|g\|_{L_{|k+\eta+|\eta|}^1}.
 \end{aligned}$$

This concludes the proof of (2.2.11).

We now turn to the proof of (2.2.12). It is based on the formula

$$(2.2.17) \quad \nabla Q^\pm(g, f) = Q^\pm(\nabla g, f) + Q^\pm(g, \nabla f)$$

which is an easy consequence of the bilinearity and the Galilean invariance property of the Boltzmann operator, namely $\tau_h Q(g, f) = Q(\tau_h g, \tau_h f)$. From (2.2.17) it is easy to deduce a Leibniz formula for derivatives of Q^+ at any order, and equation (2.2.12) easily follows for any $s \in \mathbb{N}$. Indeed, whenever $s \in \mathbb{N}$ we can apply Theorem 2.1 to each term of the Leibniz formula for $\partial^\nu Q^+(g, f)$ and find

$$\begin{aligned}
 \|Q^+(g, f)\|_{W_\eta^{s,p}}^p &= \sum_{|\nu| \leq s} \|\partial^\nu Q^+(g, f)\|_{L_\eta^p}^p \\
 &= \sum_{|\nu| \leq s} \sum_{\mu \leq \nu} \binom{\nu}{\mu} \|Q^+(\partial^\mu g, \partial^{\nu-\mu} f)\|_{L_\eta^p}^p \\
 &\leq C_{k,\eta,p}(B) \sum_{|\nu| \leq s} \sum_{\mu \leq \nu} \binom{\nu}{\mu} \|\partial^\mu g\|_{L_{|k+\eta+|\eta|}^1}^p \|\partial^{\nu-\mu} f\|_{L_{k+\eta}^p}^p \\
 &\leq C_{k,\eta,p}(B) \|g\|_{W_{|k+\eta+|\eta|}^{s,1}}^p \|f\|_{W_{k+\eta}^{s,p}}^p.
 \end{aligned}$$

Then the general case of (2.2.12) is obtained by use of the Riesz-Thorin interpolation theorem, with respect to the variable f . \square

2.2.2 A lower bound on Q^-

We shall use the following estimates on Q^- .

Proposition 2.1. *Assume that the collision kernel B satisfies (2.1.6). Then, for all $f \in L^1_2$ with $H(f) < +\infty$, there exists a constant $K(f)$, only depending on a lower bound on $\int f dv$, and upper bounds on $\int f|v|^2 dv$ and $H(f)$, such that*

$$(2.2.18) \quad Q^-(f, f) \geq K(f) f(v) (1 + |v|)^\gamma.$$

Similarly, if in the right-hand side of (2.1.6) the term $|v - v_*|^\gamma$ is replaced by $\min(|v - v_*|^\gamma, 1)$, then the conclusion (2.2.18) should be replaced by

$$(2.2.19) \quad Q^-(f, f) \geq K(f) f(v).$$

This result is well known: see for instance [8, Lemma 4], or [72, Lemma 6].

2.3 Regularity of the gain operator

It is known from the works of Lions [130, 131] that, under adequate assumptions on the collision kernel B , the gain operator $Q^+(g, f)$ acts like a regularizing operator on each of its components when the other one is frozen. In this section we shall establish various versions of this regularizing effect. The results will of course depend on the assumptions imposed on B .

The proof in [130] was very technical; it relied on Fourier integral operators, and the theory of generalized Radon transform (integration over a moving family of hypersurfaces), which was studied in detail by Sogge and Stein at the end of the eighties [175, 176, 177]. Later Wennberg [199] simplified the proof by using the Carleman representation [44] of Q^+ , and classical Fourier transform tools. Both authors prove functional inequalities which are roughly speaking of the type

$$(2.3.20) \quad \|Q^+(g, f)\|_{H^{(N-1)/2}} \leq C \|f\|_{L^2} \|g\|_{L^1}.$$

A slightly different family of inequalities was obtained by much simpler means in independent papers by Bouchut and Desvillettes [37] and Lu [134]: they established functional inequalities of the type

$$(2.3.21) \quad \|Q^+(f, f)\|_{H^{(N-1)/2}} \leq C \|f\|_{L^2}^2.$$

For our purposes in the next section, inequalities of type (2.3.21) will not be sufficient, and we shall need the full strength of inequalities of type (2.3.20).

On the other hand, formulas of the type of (2.3.21) will be sufficient for our regularity study later in the paper.

The precise variants of (2.3.20) which will be used below cannot be found in [199], so we shall re-establish them from scratch. Our proof follows essentially the idea of Wennberg [199], and our main contributions will be to make the constants depend more explicitly on the features of the collision kernel, to extend the results to weighted Sobolev spaces of arbitrary order and arbitrary weight, and to extend the range of admissible collision kernels, allowing a possible deterioration of the exponents of regularization. It would also be possible to adapt the proofs by Sogge and Stein, which are more systematic; but it would be much more tedious to keep track of the constants.

2.3.1 A splitting of Q^+

We shall first prove the regularity property on the gain operator when the collision kernel is very smooth. Then we shall include the non-smooth part of the kernel, at the price of deteriorating the exponents, by an interpolation procedure with the convolution-like inequalities of Section 2.2. This interpolation is not needed for the proof of propagation of the L^p bound but will be useful for the study of the propagation of singularity/regularity performed in Section 2.5. This calls for an appropriate splitting of the collision kernel, and therefore of the gain operator.

Let us consider a collision kernel $B = \Phi b$ satisfying the general assumptions (2.1.3)–(2.1.6). Let $\Theta : \mathbb{R} \rightarrow \mathbb{R}_+$ be an even C^∞ function such that

$$\begin{cases} \text{supp } \Theta \subset (-1, 1), \\ \int_{\mathbb{R}} \Theta dx = 1 \end{cases}$$

and $\tilde{\Theta} : \mathbb{R}^N \rightarrow \mathbb{R}_+$ be a radial C^∞ function such that

$$\begin{cases} \text{supp } \tilde{\Theta} \subset B(0, 1) \\ \int_{\mathbb{R}^N} \tilde{\Theta} dx = 1. \end{cases}$$

Introduce the regularizing sequences

$$\begin{cases} \Theta_m(x) = m \Theta(mx) & (x \in \mathbb{R}), \\ \tilde{\Theta}_n(x) = n^N \tilde{\Theta}(nx) & (x \in \mathbb{R}^N). \end{cases}$$

We shall use these mollifiers to split the collision kernel into a smooth and a non-smooth part. As a convention, we shall use subscripts S for “smooth”

and R for “remainder”. First, we set

$$\begin{cases} \Phi_{S,n} = \tilde{\Theta}_n * (\Phi \mathbb{1}_{\mathbb{A}_n}), \\ \Phi_{R,n} = \Phi - \Phi_{S,n}, \end{cases}$$

where \mathbb{A}_n stands for the annulus

$$\mathbb{A}_n = \left\{ x \in \mathbb{R}^N ; \frac{2}{n} \leq |x| \leq n \right\}.$$

Similarly, we set

$$\begin{cases} b_{S,m} = \Theta_m * (b \mathbb{1}_{\mathbb{I}_m}), \\ b_{R,m} = b - b_{S,m}, \end{cases}$$

where \mathbb{I}_m stands for the interval

$$\mathbb{I}_m = \left\{ x \in \mathbb{R} ; -1 + \frac{2}{m} \leq |x| \leq 1 - \frac{2}{m} \right\}$$

(here b is understood as a function defined on \mathbb{R} with compact support in $[-1, 1]$). Finally, we set

$$Q^+ = Q_S^+ + Q_R^+,$$

where

$$(2.3.22) \quad Q_S^+(g, f) = \int_{\mathbb{R}^N \times \mathbb{S}^{N-1}} \Phi_{S,n}(|v - v_*|) b_{S,m}(\cos \theta) g'_* f' dv_* d\sigma$$

and

$$Q_R^+ = Q_{RS}^+ + Q_{SR}^+ + Q_{RR}^+$$

with the obvious notation

$$\begin{cases} Q_{RS}^+(g, f) = \int_{\mathbb{R}^N} dv_* \int_{\mathbb{S}^{N-1}} d\sigma \Phi_{R,n} b_{S,m} g'_* f', \\ Q_{SR}^+(g, f) = \int_{\mathbb{R}^N} dv_* \int_{\mathbb{S}^{N-1}} d\sigma \Phi_{S,n} b_{R,m} g'_* f', \\ Q_{RR}^+(g, f) = \int_{\mathbb{R}^N} dv_* \int_{\mathbb{S}^{N-1}} d\sigma \Phi_{R,n} b_{R,m} g'_* f'. \end{cases}$$

2.3.2 Regularity and integrability for a smooth collision kernel

In this subsection we shall prove the regularity property of the gain operator under the assumption that both Φ and b are smooth and compactly supported:

$$(2.3.23) \quad \Phi \in C_0^\infty(\mathbb{R}^N \setminus \{0\}), \quad b \in C_0^\infty(-1, 1).$$

The assumption (2.3.23) is obviously satisfied by the smooth part Q_S^+ of the gain operator in the decomposition above. Thus, the results in this section will apply to the mollified operator Q_S^+ in (2.3.22). Our main result in this subsection is the

Theorem 2.2. *Let $B(|v-v_*|, \cos \theta) = \Phi(|v-v_*|)b(\cos \theta)$ satisfy the assumption (2.3.23). Then, for all $s \in \mathbb{R}^+$, $\eta \in \mathbb{R}$,*

$$(2.3.24) \quad \begin{cases} \|Q^+(g, f)\|_{H_\eta^{s+\frac{N-1}{2}}} \leq C_{\text{reg}}(s, B) \|g\|_{H_\eta^s} \|f\|_{L_{2|\eta|}^1}, \\ \|Q^+(f, g)\|_{H_\eta^{s+\frac{N-1}{2}}} \leq C_{\text{reg}}(s, B) \|g\|_{H_\eta^s} \|f\|_{L_{2|\eta|}^1}, \end{cases}$$

where the constant $C_{\text{reg}}(s, B)$ only depends on s and on the collision kernel, see formulas (2.3.27) and (2.3.28).

Remark: Of course assumption (2.3.23) is left invariant under the change $\theta \rightarrow \pi/2 - \theta$, and therefore the estimates in (2.3.24) are symmetric under exchange of f and g .

Proof of Theorem 2.2. We shall proceed in three steps, following the method of Wennberg [199]. We shall make use of the elementary Lemma 2.4 in Section 2.8 to explicitly control an error term disregarded in [199].

Step 1: The Carleman representation. The idea of Carleman representation (see [44, 45]) is to parametrize Q^+ by the variables v' and v'_* instead of v_* and σ . This change of variable leads to

$$Q^+(g, f) = \int_{\mathbb{R}^N} dv' \int_{E_{v, v'}} dv'_* \frac{\Phi(|v-v_*|)b(\cos \theta)}{|v-v'|^{N-1}} g'_* f',$$

where $E_{v, v'}$ denotes the hyperplane orthogonal to $v-v'$ and containing v . Since $|v-v'|/|v-v_*| = \sin(\theta/2)$, we can parametrize the kernel by

$$\frac{\Phi(|v-v_*|)b(\cos \theta)}{|v-v'|^{N-1}} = \mathcal{B}(v-v_*, |v-v'|),$$

where

$$\mathcal{B}(v_1, |v_2|) = \frac{\Phi(|v_1|) b \left(1 - 2 \left(\frac{|v_2|}{|v_1|} \right)^2 \right)}{|v_2|^{N-1}}.$$

The fact that \mathcal{B} is radial according to the first variable will not be used in the next step, but will prove to be useful in Step 3 where some modified versions of the collision kernel will be needed.

Following [199], we define, for $w \in \mathbb{S}^{N-1}$ and $r, s \in \mathbb{R}$,

$$R_{w,r}g(s) = \int_{w^\perp} \mathcal{B}(z + sw, r) g(z + sw) dz,$$

where w^\perp denotes the hyperplane orthogonal to w going through the origin (this is a weighted Radon transform). Then, for $y \neq 0$ we set

$$\begin{aligned} Tg(y) &= [R_{y/|y|,|y|}] g(|y|) \\ &= \int_{y+y^\perp} \mathcal{B}(z, y) g(z) dz. \end{aligned}$$

By an easy computation,

$$Q^+(g, f) = \int_{\mathbb{R}^N} f(v') (\tau_{v'} \circ T \circ \tau_{-v'}) g(v) dv'$$

(this is the last formula in [199, Section 2]). Thus it becomes clear that regularity estimates on the Radon transform T will result in regularity estimates on Q^+ . More precisely, a careful use of Fubini and Jensen theorems leads to

$$\|Q^+(g, f)\|_{H_\eta^{s+\frac{N-1}{2}}}^2 \leq \|f\|_{L^1} \int_{\mathbb{R}^N} |f(v')| \left\| (\tau_{-v'} \circ T \circ \tau_{v'}) g(v) \right\|_{H_\eta^{s+\frac{N-1}{2}}}^2 dv',$$

and we see that

$$\|Q^+(g, f)\|_{H_\eta^{s+\frac{N-1}{2}}} \leq C_{\text{reg}}(s, B) \|f\|_{L^1_{2|\eta|}} \|g\|_{H_\eta^s},$$

if we define $C_{\text{reg}}(s, B)$ as the best constant in the inequality

$$(2.3.25) \quad \|Tg\|_{H_\eta^{s+\frac{N-1}{2}}} \leq C \|g\|_{H_\eta^s}.$$

Step 2: Estimates of radial derivatives of T . We now start to establish (2.3.25). As we shall see in the next step, it suffices to study the regularity with respect to the modulus of the relative velocity variable, because the angular derivatives can be controlled by the radial ones. We shall work in spherical coordinates and write $Tg(rw) = R_{w,r}g(r)$ ($r > 0, w \in \mathbb{S}^{N-1}$). We introduce the “radial Fourier transform”, \mathcal{RF} , and the Fourier transform in \mathbb{R}^N , \mathcal{F} , by the formulas

$$\mathcal{RF}f(\rho w) = \frac{1}{(2\pi)^{1/2}} \int_{\mathbb{R}} e^{i\rho r} f(rw) dr,$$

$$\mathcal{F}f(\xi) = \frac{1}{(2\pi)^{N/2}} \int_{\mathbb{R}^N} e^{iv \cdot \xi} f(v) dv.$$

In particular,

$$\mathcal{RF}[\langle r \rangle^\eta Tg](\rho w) = \frac{1}{(2\pi)^{1/2}} \int_{\mathbb{R}} dr e^{i\rho r} \langle r \rangle^\eta \int_{w^\perp} dz \mathcal{B}(z + rw, r) g(z + rw).$$

Let $u = z + rw$. By Fubini’s theorem and some simple computations,

$$\mathcal{RF}[\langle r \rangle^\eta Tg](\rho w) = (2\pi)^{\frac{N-1}{2}} \mathcal{F}[g(\cdot) \mathcal{B}(\cdot, |(\cdot, w)|) \langle (\cdot, w) \rangle^\eta](\rho w).$$

By this we can estimate the $H_\eta^{s+\frac{N-1}{2}}$ norm according to the radial variable. Let us define for some function f

$$\|f\|_{H_\eta^{s+\frac{N-1}{2}}(\mathbb{S}^{N-1} \times \mathbb{R})}^2 = \int_{\mathbb{S}^{N-1}} dw \int_{\mathbb{R}} d\rho \langle \rho \rangle^{2(s+\frac{N-1}{2})} \left| \mathcal{RF}[\langle r \rangle^\eta f](\rho w) \right|^2.$$

Then

$$\begin{aligned} & \|Tg\|_{H_\eta^{s+\frac{N-1}{2}}(\mathbb{S}^{N-1} \times \mathbb{R})}^2 \\ &= \int_{\mathbb{S}^{N-1}} dw \int_{\mathbb{R}} d\rho \langle \rho \rangle^{2(s+\frac{N-1}{2})} \left| \mathcal{RF}[\langle r \rangle^\eta Tg](\rho w) \right|^2 \\ &= (2\pi)^{N-1} \int_{\mathbb{S}^{N-1}} dw \int_{\mathbb{R}} d\rho \langle \rho \rangle^{2(s+\frac{N-1}{2})} \left| \mathcal{F}[g(\cdot) \mathcal{B}(\cdot, |(\cdot, w)|) \langle (\cdot, w) \rangle^\eta](\rho w) \right|^2. \end{aligned}$$

We change variables to get back to Euclidean coordinates, and find

$$\|Tg\|_{H_\eta^{s+\frac{N-1}{2}}(\mathbb{S}^{N-1} \times \mathbb{R})}^2 = (2\pi)^{N-1} \int_{\mathbb{R}^N} \langle \xi \rangle^{2s+N-1} |\xi|^{-(N-1)}$$

$$\times \left| \mathcal{F} \left[g(\cdot) \mathcal{B} \left(\cdot, \left| \left(\cdot, \frac{\xi}{|\xi|} \right) \right| \right) \left\langle \left(\cdot, \frac{\xi}{|\xi|} \right) \right\rangle^\eta \right] (\xi) \right|^2 d\xi.$$

Now we cut this expression into two parts: for $|\xi| > 1$, the inequality $|\xi|^2 > 1/2(1 + |\xi|^2)$ implies that the right-hand side is bounded from above by

$$\begin{aligned} & (8\pi)^{N-1} \int_{|\xi|>1} \langle \xi \rangle^{2s} \left| \mathcal{F} \left[g(\cdot) \mathcal{B} \left(\cdot, \left| \left(\cdot, \frac{\xi}{|\xi|} \right) \right| \right) \left\langle \left(\cdot, \frac{\xi}{|\xi|} \right) \right\rangle^\eta \right] (\xi) \right|^2 \\ & + (2\pi)^{N-1} 2^{s+\frac{N-1}{2}} \left(\int_{\mathbb{B}^N} \frac{d\xi}{|\xi|^{N-1}} \right) \\ & \times \sup_{|\xi| \leq 1} \left| \mathcal{F} \left[g(\cdot) \mathcal{B} \left(\cdot, \left| \left(\cdot, \frac{\xi}{|\xi|} \right) \right| \right) \left\langle \left(\cdot, \frac{\xi}{|\xi|} \right) \right\rangle^\eta \right] (\xi) \right|^2, \end{aligned}$$

where \mathbb{B}^N stands for the ball of radius 1.

Then, on one hand Lemma 2.4 implies

$$\begin{aligned} & \int_{|\xi|>1} \langle \xi \rangle^{2s} \left| \mathcal{F} \left[g(\cdot) \mathcal{B} \left(\cdot, \left| \left(\cdot, \frac{\xi}{|\xi|} \right) \right| \right) \left\langle \left(\cdot, \frac{\xi}{|\xi|} \right) \right\rangle^\eta \right] (\xi) \right|^2 \\ & \leq \|g\|_{H_\eta^s}^2 \left\| \mathcal{B} \left(x, \left| \left(x, \frac{y}{|y|} \right) \right| \right) \frac{\left\langle \left(x, \frac{y}{|y|} \right) \right\rangle^\eta}{\langle x \rangle^\eta} \right\|_{L_y^\infty(H_x^S)}^2, \end{aligned}$$

where $S = s + \lfloor N/2 \rfloor + 1$. On the other hand, for each $|\xi| \leq 1$,

$$\begin{aligned} & \left| \mathcal{F} \left[g(\cdot) \mathcal{B}(\dots) \left\langle \left(\cdot, \frac{\xi}{|\xi|} \right) \right\rangle^\eta \right] (\xi) \right| \\ & = \left| \frac{1}{(2\pi)^{N/2}} \int_{\mathbb{R}^N} e^{-i\xi \cdot x} g(x) \mathcal{B}(\dots) \left\langle \left(x, \frac{\xi}{|\xi|} \right) \right\rangle^\eta dx \right|. \end{aligned}$$

Hence, by the Cauchy-Schwarz inequality,

$$\begin{aligned} & \left| \mathcal{F} \left[g(\cdot) \mathcal{B}(\dots) \left\langle \left(\cdot, \frac{\xi}{|\xi|} \right) \right\rangle^\eta \right] (\xi) \right| \\ & \leq \frac{1}{(2\pi)^{N/2}} \|g\|_{L_\eta^2} \sup_{w \in \mathbb{S}^{N-1}} \left\| \mathcal{B}(x, |(x, w)|) \frac{\langle (x, w) \rangle^\eta}{\langle x \rangle^\eta} \right\|_{L^2(\mathbb{R}_x^N)}. \end{aligned}$$

Adding up the previous inequalities, we conclude that

$$\begin{aligned} & \|Tg\|_{H_\eta^{s+\frac{N-1}{2}}(\mathbb{S}^{N-1} \times \mathbb{R})} \\ (2.3.26) \quad & \leq \text{cst}(N, s) \|g\|_{H_\eta^s} \sup_{w \in \mathbb{S}^{N-1}} \left\| \mathcal{B}(x, |(x, w)|) \frac{\langle (x, w) \rangle^\eta}{\langle x \rangle^\eta} \right\|_{H^S(\mathbb{R}_x^N)}. \end{aligned}$$

Step 3: Corollary: estimates of the angular derivatives of T . Here we show how to get estimates on the *angular* derivatives of Tg thanks to the estimates on the radial derivatives. We first require the exponent $s+(N-1)/2$ to be integer, so that the $H_{\eta}^{s+(N-1)/2}$ norm can be computed in terms of norms of derivatives. Then,

$$\begin{aligned} \frac{\partial(Tg)}{\partial y_i}(y) &= \sum_j \frac{\partial w_j(y)}{\partial y_i} \frac{\partial}{\partial w_j} R_{w,s}g(s) + \frac{\partial s(y)}{\partial y_i} \left[\frac{\partial}{\partial s} R_{w,r}g(s) \right]_{s=r} \\ &\quad + \frac{\partial r(y)}{\partial y_i} \left[\frac{\partial}{\partial r} R_{w,r}g(s) \right]_{s=r}, \end{aligned}$$

where

$$w(y) = \frac{y}{|y|}, \quad r(y) = s(y) = |y|,$$

and higher-order variants of this formula can obviously be obtained by differentiating at arbitrary order. Let us assume that $\text{supp}(\Phi) \subset [\alpha, +\infty)$ and $\text{supp}(b) \subset [\varepsilon, 1]$ ($\alpha > 0$ and $0 < \varepsilon < 1$). Then $\text{supp}(\mathcal{B}) \subset [\alpha, +\infty) \times [\varepsilon\alpha, +\infty)$, and we can easily establish that

$$\left| \frac{\partial^\nu w_j(y)}{\partial y^\nu} \right| \leq \frac{\text{cst}(N)}{(\alpha\varepsilon)^{|\nu|}}, \quad \left| \frac{\partial^\nu s(y)}{\partial y^\nu} \right|, \quad \left| \frac{\partial^\nu r(y)}{\partial y^\nu} \right| \leq \frac{\text{cst}(N)}{(\alpha\varepsilon)^{|\nu|-1}}$$

in the support of \mathcal{B} .

Our second tool is the following property of the Radon transform: it can be rewritten

$$\begin{aligned} R_{w,r}g(s) &= \int_{w^\perp} g(z + sw)\mathcal{B}(z + sw, r) dz \\ &= \int_{\mathbb{R}^N} g(u)\mathcal{B}(u, r)\delta(w \cdot u - s) du, \end{aligned}$$

where δ is the Dirac mass at 0 on \mathbb{R} . Thus

$$\begin{aligned} \frac{\partial}{\partial w_j} R_{w,r}g(s) &= \int_{\mathbb{R}^N} g(u)\mathcal{B}(u, r)u_j \delta'(w \cdot u - s) du \\ &= -\frac{\partial}{\partial s} \int_{\mathbb{R}^N} g(u)\mathcal{B}(u, r)u_j \delta(w \cdot u - s) du \\ &= -\frac{\partial}{\partial s} \tilde{R}_{w,r}(g)(s), \end{aligned}$$

where $\tilde{R}_{w,r}$ is defined by the new kernel $\mathcal{B}(u, r)u_j$. Thus the angular derivative $\frac{\partial}{\partial w_j} R_{w,r}g(s)$ can be obtained from the estimate (2.3.26) of Step 2, upon

replacing the collision kernel by another one, only differing by a factor of u_j . The same holds true for all order derivatives.

To conclude with the regularization property of T , it is enough to notice that the derivatives along r are already taken into account above, and to use the above-mentioned commutation property for the angular derivatives. We conclude that equation (2.3.25) holds true with

$$(2.3.27) \quad C_{\text{reg}}(s, B) = \frac{\text{cst}(s, N)}{(\alpha\varepsilon)^{s+\frac{N-1}{2}}} \sup \left\{ \left\| \mathcal{B}(x, |(x, w)|) x^\nu \frac{\langle (x, w) \rangle^\eta}{\langle x \rangle^\eta} \right\|_{H^{s-|\eta|}(\mathbb{R}^N_x)} \right. \\ \left. |\nu| \leq s + \frac{N-1}{2}; \quad w \in \mathbb{S}^{N-1} \right\}.$$

This concludes the proof of (2.3.25) when $s + (N-1)/2$ is an integer. The general case follows by the Riesz-Thorin interpolation theorem again. \square

Order of the constant according to the convolution parameters. The computation of an upper bound on the constant $C_{\text{reg}}(s, B)$ for the collision kernel $\Phi_{S,n} b_{S,m}$ according to the mollifying parameters m and n is tedious but straightforward. It is easy to obtain a polynomial bound in the form

$$(2.3.28) \quad C_{\text{reg}}(s, B) \leq \text{cst}(s, N) m^{a+s+b} n^{a'+s+b'} \|1_{\mathbb{I}_m} b\|_{L^1(\mathbb{S}^{N-1})} \\ \leq \text{cst}(s, N) m^{a+s+b} n^{a'+s+b'} \|b\|_{L^1(\mathbb{S}^{N-1})},$$

where a, a', b, b' stand for some constant depending only the dimension N and γ .

We conclude this section with the following corollary of Theorem 2.2, which translates the gain of regularity into a gain of integrability.

Corollary 2.2. *Let us consider a collision kernel B satisfying the smoothness assumption (2.3.23). Then, for all $p \in (1; +\infty)$, $\eta \in \mathbb{R}$,*

$$\begin{cases} \|Q^+(g, f)\|_{L_\eta^q} \leq C_{\text{int}}(p, \eta, B) \|g\|_{L_\eta^p} \|f\|_{L_{2|\eta|}^1}, \\ \|Q^+(f, g)\|_{L_\eta^q} \leq C_{\text{int}}(p, \eta, B) \|g\|_{L_\eta^p} \|f\|_{L_{2|\eta|}^1}, \end{cases}$$

where the constant $C_{\text{int}}(p, \eta, B)$ only depends on the collision kernel, p and η , and $q > p$ is given by

$$q = \begin{cases} \frac{p}{2 - \frac{1}{N} + p(\frac{1}{N} - 1)} & \text{if } p \in (1; 2], \\ pN & \text{if } p \in [2; +\infty). \end{cases}$$

Remark: Just as C_{reg} , the constant $C_{\text{int}}(m, n)$ depends on the mollifying parameters in a polynomial way. Note that the constant $C_{\text{int}}(p, \eta, B)$ in Corollary 2.2 no longer depends on the weight exponent η in the quadratic case (just as in Section 2.2).

Proof. The proof is almost obvious. When $p = 2$, it is a direct consequence of Theorem 2.2 with $s = 0$, and the Sobolev injection $H_\eta^{(N-1)/2} \hookrightarrow L_\eta^{2N}$ (with a constant only depending on N). The general case follows by a Riesz-Thorin interpolation between this estimate and the convolution-like inequalities in Theorem 2.1. \square

2.3.3 Regularity and integrability for a non-smooth collision kernel

In this subsection we extend the regularity of Q^+ to general non-smooth kernels. There are at least two strategies for that, which will lead to slightly different results. We shall first give a general result of “gain of integrability/regularity”, in a form which is remindful of the classical Povzner inequalities used to study the L^1 -moment behavior (besides it will play the same role in the proof of propagation of L^p moments).

Decomposition approach. The following inequality will turn out to be the most appropriate for our study of propagation of integrability. We state it only in its quadratic version, the bilinear version would be slightly more intricate but easy to write down as well.

Theorem 2.3. *Let B be a collision kernel satisfying assumptions (2.1.3)–(2.1.5). Then, for all $p > 1$, $k > \gamma$ and $\eta \geq -\gamma$, there exist constants C and κ , and $q < p$ (q only depending on p and N), such that for all $\varepsilon > 0$, and for all measurable f ,*

$$\|Q^+(f, f)\|_{L_\eta^p} \leq C\varepsilon^{-\kappa} \|f\|_{L_\eta^q} \|f\|_{L_{2|\eta|}^1} + \varepsilon \|f\|_{L_{\gamma+\eta}^p} \|f\|_{L_{k+2\eta_+}^1}.$$

This estimate expresses a “mixing” property of the Q^+ operator: the dominant norm $L_{\gamma+\eta}^p$ appears with a constant ε as small as desired; and for the rest, we can lower both the Lebesgue exponent and its weight. This property is of course consistent with the compactness properties of Q^+ , and in complete contrast with the properties of the loss term Q^- .

Proof of Theorem 2.3. We split Q^+ as $Q_S^+ + Q_{RS}^+ + Q_{SR}^+ + Q_{RR}^+$ and we shall estimate each term separately. From the beginning we assume, without loss of

generality, that the angular kernel $b(\cos \theta)$ has support in $[0, \pi/2]$. Remember that the truncation parameters n (for the kinetic part) and m (for the angular part) are implicit in the decomposition of Q^+ .

By Corollary 2.2, there exists a constant $C_{\text{int}}(m, n)$, blowing up polynomially as $m \rightarrow \infty$, $n \rightarrow \infty$, such that

$$\|Q_S^+(f, f)\|_{L_\eta^p} \leq C_{\text{int}}(m, n) \|f\|_{L_\eta^q} \|f\|_{L_{2|\eta|}^1},$$

for some $q < p$, namely

$$(2.3.29) \quad q = \begin{cases} \frac{(2N-1)p}{N+(N-1)p} & \text{if } p \in (1; 2N], \\ \frac{p}{N} & \text{if } p \in [2N; +\infty) \end{cases}$$

(the roles of p and q are exchanged here with respect to Corollary 2.2.)

Next, we shall take advantage of the fact that $b_{R,m}$ has a very small mass (assumptions (2.1.3) and (2.1.5)), and write, using Corollary 2.1 with $k = \gamma$,

$$\|Q_{RR}^+(f, f)\|_{L_\eta^p} \leq C m^{-\delta} \|f\|_{L_{|\gamma+\eta|+|\eta|}^1} \|f\|_{L_{\gamma+\eta}^p},$$

for some constant C only depending on C_Φ . A similar estimate holds true for $\|Q_{SR}^+\|_{L_\eta^p}$. Since $\gamma + \eta \geq 0$, we can write $|\gamma + \eta| + |\eta| = \gamma + 2\eta_+$, where $\eta_+ = \max(\eta, 0)$.

It remains to estimate the term Q_{RS}^+ . For this we shall consider separately large and small velocities, and write $f = f_r + f_{rc}$, where

$$\begin{cases} f_r = f 1_{\{|v| \leq r\}}, \\ f_{rc} = f 1_{\{|v| > r\}}. \end{cases}$$

On the one hand, we use Theorem 2.1, and pick a $k > \gamma$, in order to ensure that $\|\Phi_{R,n}\|_{L_{-k}^\infty}$ goes to 0 as $n \rightarrow \infty$. Thanks to the Hölder assumption (2.1.4), it can easily be proved that

$$\|\Phi_{R,n}\|_{L_{-k}^\infty} \leq \text{cst } n^{-(\min(\gamma, k-\gamma))}.$$

It follows that

$$\begin{aligned} \|Q_{RS}^+(f, f_r)\|_{L_\eta^p} &\leq C \|f\|_{L_{|k+\eta|+|\eta|}^1} \|f_r\|_{L_{k+\eta}^p} \|\Phi_{R,n}\|_{L_{-k}^\infty} \\ &\leq C \|f\|_{L_{|k+\eta|+|\eta|}^1} r^{k-\gamma} \|f\|_{L_{\gamma+\eta}^p} n^{\gamma-k} \\ &\leq C \left(\frac{r}{n}\right)^{k-\gamma} \|f\|_{L_{k+2\eta_+}^1} \|f\|_{L_{\gamma+\eta}^p} \end{aligned}$$

(here $\theta_b = \pi/2$ thanks to the symmetrization).

Remark: This is the only place where we use a regularity estimate on Φ .

On the other hand, the support of $b_{S,m}$ lies a positive distance ($O(1/m)$) away from 0, so (2.2.10) holds true with $\theta_b = \text{cst } m^{-1}$. Thus we can apply Theorem 2.1 with f and g exchanged, to find

$$\|Q_{RS}^+(f, f_{rc})\|_{L_\eta^p} \leq C m^\beta \|f_{rc}\|_{L_{|\gamma+\eta|+|\eta|}^1} \|f\|_{L_{\gamma+\eta}^p},$$

where $\beta = \max(-\eta, 0) + 2/p'$ and C depends only on C_Φ . Since we assume $\gamma + \eta \geq 0$, this can also be bounded by

$$C m^\beta r^{\gamma-k} \|f\|_{L_{k+\eta+|\eta|}^1} \|f\|_{L_{\gamma+\eta}^p} = C m^\beta r^{\gamma-k} \|f\|_{L_{k+2\eta_+}^1} \|f\|_{L_{\gamma+\eta}^p}.$$

To sum up, we have obtained

$$\begin{aligned} \|Q^+(f, f)\|_{L_\eta^p} &\leq C_1(m, n) \|f\|_{L_\eta^q} \|f\|_{L_{2|\eta|}^1} \\ &\quad + C \left[m^{-\delta} + \left(\frac{r}{n}\right)^{k-\gamma} + \frac{m^\beta}{r^{k-\gamma}} \right] \|f\|_{L_{k+2\eta_+}^1} \|f\|_{L_{\gamma+\eta}^p}. \end{aligned}$$

The conclusion follows by choosing first m large enough, then r , then n . \square

We turn to another similar theorem in which the emphasis is laid on regularity rather than integrability and whose proof is quite similar.

Theorem 2.4. *Let B be a collision kernel satisfying assumptions (2.1.3)–(2.1.5). Then, for all $s > 0$, $k > \gamma$ and $\eta \geq -\gamma$, there exist constants C and κ , and $0 \leq s' < s$ ($s' = \max(s - \frac{N-1}{2}, 0)$) only depending on s and N), such that for all ε , and for all measurable f ,*

$$\|Q^+(f, f)\|_{H_\eta^s} \leq C \varepsilon^{-\kappa} \|f\|_{H_\eta^{s'}} \|f\|_{L_{2|\eta|}^1} + \varepsilon \|f\|_{H_{\gamma+\eta}^s} \|f\|_{W_{k+2\eta_+}^{[s],1}}.$$

Proof of Theorem 2.4. The proof follows the same path as the previous one. The term Q_S^+ is estimated by Theorem 2.2, the terms Q_{SR}^+ and Q_{RR}^+ are estimated by Theorem 2.1. For the remaining term Q_{RS}^+ , we also estimate separately large and small velocities. But this time, the splitting $f = f_r + f_{rc}$ should be

$$\begin{cases} f_r = f \chi_r, \\ f_{rc} = f - f_r, \end{cases}$$

where χ_r is a C^∞ function with bounded derivatives and such that $\chi_r = 1$ on $|v| \leq r$ and $\text{supp } \chi_r \subset B(0, r+1)$. The end of the proof is straightforward. \square

Bouchut-Desvillettes approach. The first way to get a regularity result for the full kernel is to use the method of Bouchut and Desvillettes [37]. Hence it is possible to extend Theorem 2.1 in [37] into the following

Theorem 2.5. *Let $B(|v - v_*|, \cos \theta) = \Phi(|v - v_*|) b(\cos \theta)$ be a collision kernel such that Φ satisfies the assumption (2.1.4) and b satisfies*

$$(2.3.30) \quad \|b\|_{L^2(\mathbb{S}^{N-1})} < +\infty$$

in the sense that $\int_0^\pi b(\cos \theta)^2 \sin^{N-1} \theta d\theta < +\infty$. Then for all $s \geq 0$ and $\eta \geq 0$,

$$\|Q^+(g, f)\|_{H_\eta^{s+\frac{N-1}{2}}} \leq C_{\text{BD}} \left[\|g\|_{H_{\eta+\gamma+1}^s} \|f\|_{H_{\eta+\gamma+1}^s} + \|g\|_{L_{\eta+\gamma}^1} \|f\|_{L_{\eta+\gamma}^1} \right],$$

where C_{BD} only depends on N and on $\|b\|_{L^2(\mathbb{S}^{N-1})}$.

Remarks:

1. Of course assumption (2.3.30) is stronger than (2.1.3); it is however still reasonable in the context of cut-off hard potentials (in particular for hard spheres, in which b is just a constant).

2. The inequality here is not adapted to our study of integrability, but will be useful for our study of regularity. Moreover, the proof is simpler than the proof of Theorem 2.6 below.

Interpolation approach. The second way towards a regularity result for the full kernel is to combine Theorem 2.1 and Theorem 2.2 and make an explicit interpolation. By this we can prove

Theorem 2.6. *Let B be a collision kernel satisfying assumptions (2.1.3) – (2.1.5). Then for all $k > \gamma$ and $\eta \geq -\gamma$, there exists $\alpha > 0$, depending only on B , such that for all $s \geq 0$ and $\eta \in \mathbb{R}$*

$$\|Q^+(f, f)\|_{H_\eta^{s+\alpha}} \leq C \|f\|_{W_{k+2\eta+}^{[s],1}} \|f\|_{H_{\gamma+\eta}^s}$$

for some constant C which only depends on s and B .

Proof of Theorem 2.6. Let us take $s \in \mathbb{R}_+$ and $\eta \in \mathbb{R}$. We have the following estimates on the four parts of the decomposition of Q^+ (by symmetrization the angular part of the collision kernel is supposed to be zero for $\theta \geq \pi/2$).

• For the smooth part, Theorem 2.2 gives

$$\|Q_S^+(f, f)\|_{H_\eta^{s+\frac{N-1}{2}}(\mathbb{R}^N)} \leq C_1 \|f\|_{L_{2|\eta|}^1} \|f\|_{H_\eta^s(\mathbb{R}^N)},$$

where $C_1 = C_{\text{reg}}(m, n)$ blows up polynomially as $m \rightarrow \infty$, $n \rightarrow \infty$.

- To control the effect of small deviation angles, we use again Corollary 2.1, and the dependence of the constant on $\|b_{R,n}\|$ to ensure it goes to zero; we obtain as in the proof of Theorem 2.3

$$\|Q_{SR}^+(f, f), Q_{RR}^+(f, f)\|_{H_\eta^s} \leq C_2 \|f\|_{W_{\gamma+2\eta+}^{[s],1}} \|f\|_{H_{\gamma+\eta}^s},$$

where $C_2 = \text{cst}(N) \|b_R\|_{L^1(\mathbb{S}^{N-1})} \|\Phi\|_{L_\infty^\gamma}$, which thanks to assumption (2.1.5) can be bounded from above by $\text{cst}(C_B, N)m^{-\delta}$.

- To control the effect of singularities of the kinetic kernel and high velocities, we use again Theorem 2.1 and pick a $k > \gamma$. As in the proof of Theorem 2.4, we prove

$$\|Q_{RS}^+(f, f)\|_{H_\eta^s} \leq C_3 \|f\|_{W_{k+2\eta+}^{[s],1}} \|f\|_{H_{\gamma+\eta}^s},$$

where

$$C_3 = C \left[m^{-\delta} + \left(\frac{r}{n}\right)^{k-\gamma} + \frac{m^\beta}{r^{k-\gamma}} \right],$$

which goes to 0 polynomially according to the parameter m when we set r then n as well-chosen functions of m .

To sum up, we know that for all $m \geq 1$, we can decompose Q^+ as $Q^+ = Q_{S,m}^+ + Q_{R,m}^+$ (remember n is now set as a function of m), with the estimates

$$\begin{cases} \|Q_{S,m}^+(f, f)\|_{H_\eta^{s+\frac{N-1}{2}}} \leq C_1 \|f\|_{L_{2|\eta|}^1} \|f\|_{H_\eta^s}, \\ \|Q_{R,m}^+(f, f)\|_{H_\eta^s} \leq (C_2 + C_3) \|f\|_{W_{k+2\eta+}^{[s],1}} \|f\|_{H_{\gamma+\eta}^s}. \end{cases}$$

By applying Theorem 2.14 in the Appendix, we can conclude that

$$\|Q^+(f, f)\|_{H_\eta^{s+\alpha}} \leq C \|f\|_{W_{k+2\eta+}^{[s],1}} \|f\|_{H_\eta^s}$$

for some $0 < \alpha < (N-1)/2$ depending on the exponents of polynomial control for each term. This concludes the proof. \square

Remark: Some closely related results can be found in [199], the goal is however different: in this reference the author searches for sufficient conditions on the collision kernel B , to ensure that the $H^{(N-1)/2}$ bound still holds true. Here on the contrary we allow general collision kernels, but, as a natural price to pay, the regularization which we obtain is in general strictly less than a gain of $(N-1)/2$ derivatives.

2.4 Propagation of L^p estimates

In this section we are interested in the propagation of L^p integrability of the solutions of Boltzmann's equation and its derivatives. Our proofs will be based on a differential inequality approach. Most of the hard work has been done in the functional study of the previous section, and the proofs will be much less technical now. The bounds that we establish here will later serve as the first step for our study of propagation of regularity via a semigroup approach.

2.4.1 Main result

Theorem 2.7. *Let $B(|v - v_*|, \cos \theta) = \Phi(|v - v_*|) b(\cos \theta)$ satisfy assumptions (2.1.3)–(2.1.6), let $1 < p < +\infty$ and let f_0 be a nonnegative function in $L^1_2 \cap L^p(\mathbb{R}^N)$. Then, the unique solution f of the Boltzmann equation with initial datum f_0 satisfies the estimates*

$$(2.4.31) \quad \frac{d \|f\|_{L^p}^p}{dt} \leq C_+ \|f\|_{L^p}^{p(1-\theta)} - K_- \|f\|_{L^p_{\gamma/p}}^p$$

for some constants $C_+, K_- > 0$, $\theta \in (0, 1)$ which only depend on p , N , B , on upper bounds on $\|f\|_{L^1_2}$ and $H(f)$, and on a lower bound on $\|f\|_{L^1}$.

In particular, there is an explicit constant $C_p(f_0)$, only depending on B , on an upper bound on $\|f_0\|_{L^1_2} + \|f_0\|_{L^p}$, and on a lower bound on $\|f_0\|_{L^1}$, such that

$$\forall t \geq 0, \quad \|f(t, \cdot)\|_{L^p} \leq C_p(f_0).$$

Moreover, for any $t > 0$ and any $\eta > 0$, it is known that $f(t, \cdot) \in L^p_\eta(\mathbb{R}^N)$. More precisely, for any $t_0 > 0$,

$$\sup_{t \geq t_0} \|f(t, \cdot)\|_{L^p_\eta} < +\infty.$$

Once again this bound can be computed in terms of B , an upper bound on $\|f_0\|_{L^1_2} + \|f_0\|_{L^p}$, a lower bound on $\|f_0\|_{L^1}$, and a lower bound on t_0 .

Proof of Theorem 2.7. Here we shall just be content with establishing the necessary *a priori* estimates. The proof of the theorem follows from standard approximation arguments, known results on the unique solvability of the Boltzmann equation, with bounds in, say, weighted L^∞ if the initial datum also satisfies such bounds (see the references indicated in Section 2.1).

Let f be a solution to the Boltzmann equation, supposed to be in $C^1(\mathbb{R}_t, L^p)$. Also, since the solution is differentiable in L^p ,

$$\frac{1}{p} \frac{d \|f\|_{L^p}^p}{dt} = \int f^{p-1} Q^+(f, f) dv - \int f^{p-1} Q^-(f, f) dv.$$

By Proposition 2.1,

$$(2.4.32) \quad - \int f^{p-1} Q^- dv \leq -K \int f^p (1 + |v|)^\gamma dv \leq -K_0 \|f\|_{L_{\gamma/p}^p}^p.$$

On the other hand, by Hölder's inequality,

$$\begin{aligned} \int f^{p-1} Q_S^+(f, f) dv &\leq \left[\int f^p \right]^{\frac{p-1}{p}} \left[\int (Q_S^+)^p \right]^{\frac{1}{p}} \\ &= \|f\|_{L^p}^{p-1} \|Q_S^+(f, f)\|_{L^p} \end{aligned}$$

and

$$\begin{aligned} \int f^{p-1} Q_R^+(f, f) dv &= \int (f \langle v \rangle^{\gamma/p})^{p-1} \frac{Q^+}{\langle v \rangle^{\frac{\gamma}{p'}}} \\ &\leq \left[\int (f \langle v \rangle^{\gamma/p})^p \right]^{\frac{p-1}{p}} \left[\int (Q_R^+ \langle v \rangle^{-\gamma/p'})^p \right]^{\frac{1}{p}} \\ &= \|f\|_{L_{\gamma/p}^p}^{p-1} \|Q_R^+(f, f)\|_{L_{-\gamma/p'}^p}. \end{aligned}$$

By using the estimates on Q_S^+ and Q_R^+ proved in Theorem 2.3 with $\eta = -\gamma/p'$, $k = 2$ and $\varepsilon = K_0/(2\|f\|_{L_2^1})$, we can find a constant C , depending on $\|f\|_{L_2^1}$, such that

$$\int f^{p-1} Q^+(f, f) dv \leq C \|f\|_{L^q} \|f\|_{L^1} \|f\|_{L^p}^{p-1} + \varepsilon \|f\|_{L_2^1} \|f\|_{L_{\gamma/p}^p},$$

where q is defined by (2.3.29). Combining this with elementary Lebesgue interpolation and the conservation of mass and energy, we deduce that there exists a $\theta \in (0, 1)$, only depending on N and p , and a constant C_0 , only depending on N , p , B and $\|f_0\|_{L_2^1}$, such that

$$\begin{aligned} \int f^{p-1} Q^+(f, f) dv &\leq C_0 \|f\|_{L^p}^{1-p\theta} \|f\|_{L^p}^{p-1} - \frac{K_0}{2} \|f\|_{L_{\gamma/p}^p}^p \\ &\leq C_0 \|f\|_{L^p}^{p(1-\theta)} - \frac{K_0}{2} \|f\|_{L_{\gamma/p}^p}^p. \end{aligned}$$

This together with (2.4.32) concludes the proof of the differential inequality (2.4.31) with $C_+ = C_0$ and $K_- = K_0/2$.

From this differential inequality we see that the time-derivative of $\|f(t, \cdot)\|_{L^p}^p$ is bounded by a constant, and therefore $f(t, \cdot)$ lies in L^p for all times. Moreover, if $\|f(t, \cdot)\|_{L^p}$ ever becomes greater than $(C_+/K_-)^{1/(p\theta)}$, it follows from (2.4.31) that $(d/dt)\|f(t, \cdot)\|_{L^p} \leq 0$. Since $\|f\|_{L^p} \geq \|f\|_{L^p}$, we conclude that

$$C_p(f_0) := \max \left[\|f_0\|_{L^p}; \left(\frac{C_+}{K_-} \right)^{\frac{1}{p\theta}} \right]$$

is a uniform upper bound for $\|f(t, \cdot)\|_{L^p}$.

Next, for all $\eta \geq 0$, a similar argument leads to the *a priori* differential inequality

$$(2.4.33) \quad \frac{d\|f\|_{L_\eta^p}^p}{dt} \leq C_+ \|f\|_{L_\eta^p}^{p(1-\theta)} - K_- \|f\|_{L_{\eta+\gamma/p}^p}^p,$$

where C_+, K_- now depend on the entropy and on some $\|f\|_{L_s^1}$ norm for s large enough (depending on η). We deduce that $\|f\|_{L_\eta^p}$ norms are propagated, uniformly in time, if the initial datum possesses L^1 moments of high enough order. Let $t_0 > 0$ be arbitrarily small; for $t \geq t_0$, we know that all the quantities $\|f(t, \cdot)\|_{L_s^1}$ are bounded, uniformly in time, for all s , and these inequalities therefore hold true with uniform constants as soon as $t \geq t_0$.

We next turn to the property of moment generation, i.e., the proof that L_η^p norms are automatically bounded for positive times. These results are the analogue of the well-known results of L^1 -moment generation for hard potential with cut-off (see for instance [200, Theorem 4.2]). Let $t_0 > 0$ be arbitrarily small. Integrating the inequality (2.4.31) in time from 0 to t_0 , we obtain

$$\int_0^{t_0} \|f(s, \cdot)\|_{L_{\gamma/p}^p}^p \leq \frac{C_+}{K_-} \int_0^{t_0} \|f(s, \cdot)\|_{L^p}^{p-\theta} + \frac{1}{K_-} \left(\|f_0\|_{L^p}^p - \|f(t_0, \cdot)\|_{L^p}^p \right),$$

which implies

$$\int_0^{t_0} \|f(s, \cdot)\|_{L_{\gamma/p}^p}^p ds < +\infty$$

and thus

$$\forall t_0 > 0, \quad \exists t_1 \in (0, t_0); \quad \|f(t_1, \cdot)\|_{L_{\gamma/p}^p}^p < +\infty.$$

Besides, the estimate (2.4.33) for $\eta = \gamma/p$ gives the propagation of the $L_{\gamma/p}^p$ norm starting from time $t_1 > 0$. Since for $t \geq t_1$, the L_s^1 norms of f are

uniformly bounded, the argument can be iterated to prove by induction (integrating in time the weighted inequality (2.4.33)) that

$$\forall \eta \geq 0, \forall t > 0, \quad \|f(t, \cdot)\|_{L^p_\eta} < +\infty.$$

The above argument is slightly formal since we worked with quantities which are not *a priori* finite. It can however be made rigorous and quantitative in the same manner as in [200]. \square

Remark: The property of moment generation in L^p could also be proved directly, without induction, by using the idea of Wennberg [200] of comparison to a Bernoulli differential equation. Using the same estimates on Q_R^+ and Q^- as in (2.4.33), convolution-like inequality (2.2.11) on Q_S^+ , and Hölder's inequality, gives

$$\frac{d \|f\|_{L^p_\eta}^p}{dt} \leq C_+ \|f\|_{L^p_\eta}^p - \frac{K_-}{C_p(f_0)} \|f\|_{L^p_\eta}^{p(1+\lambda)},$$

where $\lambda = \frac{2}{\eta}$ and $C_p(f_0)$ stands for the uniform bound on the L^p norm of the solution. It gives an explicit bound on the L^p moments of the form

$$\forall t > 0, \quad \|f(t, \cdot)\|_{L^p_\eta} \leq \left[\frac{A}{B(1 - e^{-A\lambda t})} \right]^{-\frac{2}{\gamma}},$$

where A, B depend on $C_p(f_0)$ and an upper bound on the L^1 moment of the solution of high enough order. Notice that these bounds are not optimal: for example, $\|f\|_{L^p_{\gamma/p}}^p$ has to be integrable as a function of t , as $t \rightarrow 0^+$, as can be seen from our *a priori* differential inequality.

2.4.2 Generalization: propagation of H^k estimates for $k \in \mathbb{N}$

Here we follow the same strategy on the differentiated equation in order to get uniform bounds in Sobolev spaces H^k for $k \in \mathbb{N}$. This method seems to fail for spaces H^k with k non-integer, because fractional derivatives do not behave “bilinearly” with respect to the collision operator. Moreover we state our results only for “power law” kinetic collision kernels. This restriction is made for convenience, and can probably be relaxed at the price of some more work.

Theorem 2.8. *Let $B(|v - v_*|, \cos \theta) = |v - v_*|^\gamma b(\cos \theta)$ ($\gamma \in (0, 2)$) satisfy assumptions (2.1.3), (2.1.5), (2.1.6) and (2.3.30), let $\eta \in \mathbb{R}$, and let f_0 be a nonnegative function in $L^1_{\frac{1}{2}}$. Then the unique solution f of the Boltzmann equation with initial datum f_0 satisfies, for any multi-index ν , the estimate*

$$\frac{d}{dt} \|\partial^\nu f\|_{L^2_\eta}^2 \leq C_+ \|\partial^\nu f\|_{L^2_\eta} - K_- \|\partial^\nu f\|_{L^2_{\eta+\gamma/2}}^2$$

for some constants $C_+, K_- > 0$, which depend on p, N, B , on upper bounds on $\|f_0\|_{L^1_{\frac{1}{2}}} + H(f_0)$, on a lower bound on $\|f_0\|_{L^1}$ and on $L^2_{\eta+1+\gamma}$ norms on derivatives of f of order strictly less than $|\nu|$.

In particular for any $k \in \mathbb{N}$, there is an explicit constant $C_k(f_0)$, only depending on B , on an upper bound on $\|f_0\|_{L^1_{\frac{1}{2}}} + \|f_0\|_{H^k_{k(1+\gamma)}}$, and on a lower bound on $\|f_0\|_{L^1}$, such that

$$\forall t \geq 0, \quad \|f(t, \cdot)\|_{H^k} \leq C_k(f_0).$$

Moreover, for any $t > 0$ and any $\kappa > 0$, it is known that $f(t, \cdot) \in H^\kappa(\mathbb{R}^N)$. More precisely, for any $t_0 > 0$,

$$\sup_{t \geq t_0} \|f(t, \cdot)\|_{H^\kappa} < +\infty.$$

This bound can be computed in terms of B , an upper bound on $\|f_0\|_{L^1_{\frac{1}{2}}} + \|f_0\|_{H^k}$, a lower bound on $\|f_0\|_{L^1}$, and a lower bound on t_0 .

Proof of Theorem 2.8. Again we only prove the *a priori* differential inequality: let us consider a given partial derivative $\partial^\nu f$ of f ,

$$\begin{aligned} \frac{1}{2} \frac{d \|\partial^\nu f\|_{L^2_\eta}^2}{dt} &= \int \partial^\nu f \partial^\nu Q^+(f, f) \langle v \rangle^{2\eta} dv - \int \partial f \partial Q^-(f, f) \langle v \rangle^{2\eta} dv \\ &= \int \partial^\nu f \partial^\nu Q^+ \langle v \rangle^{2\eta} dv - \int (\partial^\nu f)^2 A * f \langle v \rangle^{2\eta} dv \\ &\quad - \sum_{0 < \alpha \leq \nu} \binom{\nu}{\alpha} \int \partial^\nu f \partial^{\nu-\alpha} f \partial^\alpha (A * f) \langle v \rangle^{2\eta} dv, \end{aligned}$$

where $A(z) = \|b\|_{L^1(\mathbb{S}^N)} \Phi(z) = \text{cst} |z|^\gamma$ here. For the first term we apply the regularity Theorem 2.5 : since $(N-1)/2 \geq 1$, it implies

$$\|\partial^\nu Q^+(f, f)\|_{L^2_\eta} \leq C_{\text{BD}} \left[\|f\|_{L^1_{\eta+\gamma}} \|f\|_{L^1_{\eta+\gamma}} + \|f\|_{H^{\nu'}_{\eta+\gamma+1}} \|f\|_{H^{\nu'}_{\eta+\gamma+1}} \right],$$

where ν' is a multi-index satisfying $|\nu'| < |\nu|$, and thus

$$\int \partial^\nu f \partial^\nu Q^+(f, f) \langle v \rangle^{2\eta} dv \leq C_1 \|\partial^\nu f\|_{L^2_\eta}$$

with C_1 depending on the $L_{\eta+\gamma+1}^2$ norm on derivatives of f of order strictly lower than ν and the $L_{\eta+\gamma}^1$ norm of f .

By Proposition 2.1, the second term is bounded by

$$(2.4.34) \quad - \int (\partial f)^2 A * f \langle v \rangle^{2\eta} dv \leq -K_0 \|\partial f\|_{L_{\eta+\gamma/2}^2}^2.$$

Finally for the third and last term, we split A in $A_S + A_R$ where, for $j \in \mathbb{N}$,

$$A_S = \left(\tilde{\Theta}_j * 1_{|v| \geq 2/j} \right) A, \quad A_R = A - A_S$$

(notice that here we only need to isolate the singularity at zero relative velocity).

For the smooth part,

$$\|\partial^\alpha(A_S * f)\|_{L^\infty} = \|(\partial^\alpha A_S) * f\|_{L^\infty} \leq \|\partial^\alpha A_S\|_{L_{-(\gamma-1)+}^\infty} \|f\|_{L_{(\gamma-1)+}^1}$$

($\|\partial^\alpha A_S\|_{L_{-(\gamma-1)+}^\infty} < +\infty$ since $|\alpha| \geq 1$) and thus

$$\begin{aligned} \int \partial^\nu f \partial^{\nu-\alpha} f \partial^\alpha(A_S * f) \langle v \rangle^{2\eta} dv &\leq C \|f\|_{L_{(\gamma-1)+}^1} \|\partial^\nu f\|_{L_\eta^2} \|\partial^{\nu-\alpha} f\|_{L_\eta^2} \\ &\leq C_2 \|\partial^\nu f\|_{L_\eta^2} \end{aligned}$$

with C_2 depending on on the L_η^2 norm on derivatives of f of order strictly less than $|\nu|$ and the $L_{(\gamma-1)+}^1$ norm of f .

For the remainder term,

$$\|\partial^\alpha(A_R * f)\|_{L^\infty} = \|A_R * (\partial^\alpha f)\|_{L^\infty} \leq \|A_R\|_{L^2} \|\partial^\alpha f\|_{L^2}$$

and thus

$$\int \partial^\nu f \partial^{\nu-\alpha} f \partial^\alpha(A_R * f) dv \leq C_3 \|\partial^\nu f\|_{L^2}$$

if $\alpha < \nu$, with C_3 depending on the L^2 norm on derivatives of f of order strictly lower than ν and the L^1 norm of f , or

$$\int \partial^\nu f \partial^{\nu-\alpha} f \partial^\alpha(A_R * f) dv \leq C_3 \|\partial^\nu f\|_{L^2}^2$$

if $\alpha = \nu$, with C_3 depending on the L^2 norm of f . In the second case, as C_3 goes to zero when j goes to infinity, this term can be damped by the second one, thanks to (2.4.34). This shows that

$$\frac{1}{2} \frac{d \|\partial^\nu f\|_{L^2}^2}{dt} \leq C_+ \|\partial^\nu f\|_{L^2} - K_- \|\partial^\nu f\|_{L_{\gamma/2}^2}^2$$

and the proof is complete.

Then the proof of propagation of the H^k norm is made by induction. The proof of moments appearance is made first by propagating the $H_{-k(\gamma+1)}^k$ norm, then using interpolation with the L^1 moments. \square

Remark: To get $W^{k,p}$ bounds when p is different from 2, the strategy above could still apply, although with more complications. The idea would be to prove an *a priori* differential inequality similar to (2.4.31) on each derivative. Use the decomposition $Q^+ = Q_S^+ + Q_R^-$. To deal with the regular part now use Corollary 2.2 instead of Theorem 2.5 on each term of the Leibniz formula; and to deal with the remainder part use estimate (2.2.13), together with the rough estimate

$$\|f\|_{L_\eta^1} \leq C(\varepsilon) \|f\|_{L_{\eta+N/p'+\varepsilon}^p}$$

for $\varepsilon > 0$. Moreover the weight exponent in the assumptions becomes much higher.

2.5 Propagation of smoothness and singularity via the Duhamel formula

The aim of this section is to study the propagation of smoothness and singularity for the solutions of the Boltzmann equation. Throughout the section, we shall consider a given collision kernel B , satisfying assumptions (2.1.3)–(2.1.6), (2.3.30).

2.5.1 Preliminary estimates

From now on, explicit computations become rather long and we shall try to be as synthetical as possible; so we will not keep track of exact constants. However, all the proofs remain completely explicit and there would be no conceptual difficulty in extracting exact constants.

Our results below are based on two kinds of estimates. First, a result of stability in L^1 for the solution of the Boltzmann equation with cut-off and hard potential. Secondly, some smoothness estimates on the Duhamel representation formula.

Stability estimate. The stability result in L^1 which we use is an immediate consequence of the estimates in [198] and in [111]. We do not search here for an optimal version. We shall use the shorthand $f_t = f(t, \cdot)$.

Lemma 2.1. *Let f, g be two solutions of the Boltzmann equation belonging to $L^1_{2+\gamma} \cap L \log L$. Then there exists a constant $C > 0$, only depending on B , such that for all $0 \leq k \leq 2$ and $t > 0$*

$$\frac{d}{dt} \|f_t - g_t\|_{L^1_k} \leq C \|f_t - g_t\|_{L^1_k} \|f_t + g_t\|_{L^1_{k+\gamma}}.$$

In particular, as $\|f_t + g_t\|_{L^1_{k+\gamma}}$ is bounded uniformly with respect to t thanks to the assumption, the following stability estimate holds:

$$\|f_t - g_t\|_{L^1_k} \leq \|f_0 - g_0\|_{L^1_k} e^{C_{\text{stab}} t},$$

where C_{stab} only depends on B , $\|f_0\|_{L^1_{k+\gamma}}$ and $\|g_0\|_{L^1_{k+\gamma}}$.

Regularity estimates on the Duhamel representation. Next, we introduce the well-known Duhamel representation formula for the Boltzmann equation: for all $t \geq 0$, $v \in \mathbb{R}^N$,

$$(2.5.35) \quad f(t, v) = f_0(v) e^{-\int_0^t Lf(s, v) ds} + \int_0^t Q^+(f, f)(s, v) e^{-\int_s^t Lf(\tau, v) d\tau} ds,$$

where Lf stands for $A * f$ and $A(z) = \|b\|_{L^1(\mathbb{S}^N)} \Phi(|z|)$. This formula is well adapted to the study of smoothness issues because it expresses the solution in terms of the initial datum and the regularizing operators Q^+ and L .

For $s \leq t$, we set

$$F(s, t, v) = \int_s^t Lf(\tau, v) d\tau, \quad G(s, t, v) = e^{-F(s, t, v)}.$$

We shall prove several estimates on these functions. We look for uniform (with respect to time) estimates, which leads us to allow a “loss” on the weight exponent.

Proposition 2.2. *Let $\alpha, \beta > 0$ be such that $A \in H^\alpha_{-\beta}$. Let $\alpha' = \min(\alpha, (N-1)/2)$, and let $\delta = \beta + \gamma + 1$. Then, there is a constant C_{duh} such that for all $k, \eta \geq 0$,*

$$(2.5.36) \quad \left\| \int_0^t Q^+(f, f)(s, \cdot) G(s, t, \cdot) ds \right\|_{H^\eta_{k+\alpha'}} \leq C_{\text{duh}} \sup_{0 \leq \tau \leq t} \|f(\tau, \cdot)\|_{H^{\eta+\delta}^{[k+\alpha]+2}},$$

and

$$(2.5.37) \quad \|f_0(\cdot) G(0, t, \cdot)\|_{H^k_\eta} \leq C_{\text{duh}} e^{-K't} \|f_0(\cdot)\|_{H^{k+\beta}_\eta} \sup_{0 \leq \tau \leq t} \|f(\tau, \cdot)\|_{H^{k-\alpha'}_\beta}^{[k]},$$

with $0 < K' < K$ where $K > 0$ is the constant in (2.2.18).

Remark: Under our general assumptions, a possible choice of α, β is $\alpha = \gamma$, $\beta = N/2 + \gamma + \varepsilon$, $\varepsilon > 0$. For $\Phi(|z|) = |z|^\gamma$, it would be possible to take $\alpha = \gamma + N/2 - \varepsilon$, for any $\varepsilon > 0$.

Proof of Proposition 2.2. We start with some preliminary estimates on L , F and G . As a consequence of Cauchy-Schwarz inequality, we find that for all $k \geq 0$,

$$\|Lf\|_{W_{-\beta}^{k+\alpha, \infty}} \leq C_1 \|f\|_{H_\beta^k}.$$

It follows that

$$\|F(s, t, \cdot)\|_{W_{-\beta}^{k+\alpha, \infty}} \leq C_1 \sqrt{t-s} \left(\int_s^t \|f(\tau, \cdot)\|_{H_\beta^k}^2 d\tau \right)^{1/2}.$$

Combining this with the estimate (2.2.19), in the form $Lf \geq K$, we deduce that

$$\begin{aligned} \|G(s, t, \cdot)\|_{W_{-\beta}^{k+\alpha, \infty}} &\leq C_1 \sqrt{t-s} e^{-K(t-s)} \left(\int_s^t \|f(\tau, \cdot)\|_{H_\beta^k}^2 d\tau \right)^{\frac{[k+\alpha]}{2}} \\ (2.5.38) \qquad \qquad \qquad &\leq C_2 e^{-K'(t-s)} \sup_{s \leq \tau \leq t} \|f(\tau, \cdot)\|_{H_\beta^k}^{[k+\alpha]} \end{aligned}$$

with $0 < K' < K$.

Now we use the following simple lemma to exchange a time integral and a $H_P^S(\mathbb{R}_v^N)$ norm:

Lemma 2.2. *Let $Z(s, v)$ be a function on $\mathbb{R}_+ \times \mathbb{R}^N$ and $S, P \in \mathbb{R}$, then for any $\lambda > 0$,*

$$\left\| \int_0^t Z(s, \cdot) ds \right\|_{H_P^S} \leq \frac{1}{\sqrt{\lambda}} \left(\int_0^t e^{\lambda(t-s)} \|Z(s, \cdot)\|_{H_P^S}^2 ds \right)^{1/2}.$$

This lemma is an immediate consequence of the Cauchy-Schwarz inequality with the weight $e^{\lambda(t-s)/2}$, after passing to Fourier variables. The choice of the exponential function is arbitrary; we used it because it is convenient for what follows.

As a consequence, we have (recall that $\alpha' = \min(\alpha, (N-1)/2)$)

$$\begin{aligned} &\left\| \int_0^t Q^+(f_s, f_s) G(s, t, \cdot) ds \right\|_{H_\eta^{k+\alpha'}} \\ &\leq C \left(\int_0^t e^{K'(t-s)} \left\| Q^+(f_s, f_s) G(s, t, \cdot) \right\|_{H_\eta^{k+\alpha'}}^2 ds \right)^{1/2} \\ &\leq C \left(\int_0^t e^{K'(t-s)} \|Q^+(f_s, f_s)\|_{H_{\eta+\beta}^{k+\alpha'}}^2 \|G(s, t, \cdot)\|_{W_{-\beta}^{k+\alpha', \infty}}^2 ds \right)^{1/2}. \end{aligned}$$

At this stage we apply Theorem 2.5 and estimate (2.5.38), to get a bound like

$$\begin{aligned}
 & C \left[\int_0^t e^{K'(t-s)} \|f_s\|_{H_{\eta+\beta+\gamma+1}^k}^4 e^{-2K'(t-s)} \left(\sup_{s \leq \tau \leq t} \|f(\tau, \cdot)\|_{H_{\beta}^k}^{[k+\alpha]} \right)^2 ds \right]^{1/2} \\
 & \leq C \left(\int_0^t e^{-K'(t-s)} ds \right)^{1/2} \sup_{0 \leq s \leq t} \|f(s, \cdot)\|_{H_{\eta+\beta+\gamma+1}^k}^{[k+\alpha]+2} \\
 & \leq C \sup_{0 \leq s \leq t} \|f(s, \cdot)\|_{H_{\eta+\beta+\gamma+1}^k}^{[k+\alpha]+2}.
 \end{aligned}$$

This concludes the proof of (2.5.36).

The proof of (2.5.37) is performed in a similar way, using estimate (2.5.38) with $s = 0$. \square

2.5.2 Propagation of regularity

As soon as we have uniform bounds on L^2 moments, the Duhamel representation (2.5.35) together with Proposition 2.2 imply some uniform bound on f in Sobolev spaces, provided that the initial datum itself belongs to such a space. With respect to the method used for proving Theorem 2.8, the improvement here is that we are able to treat H^s regularity for any $s \in \mathbb{R}_+$. Here is a precise theorem, definitely not optimal.

Theorem 2.9. *Let $0 \leq f_0 \in L_2^1$ be an initial datum with finite mass and kinetic energy, and let f be the unique solution preserving energy. Then for all $s > 0$ and $\eta \geq \beta$, there exists $w(s) > 0$ (explicitly $w(s) = \delta[s/\alpha']$) such that*

$$f_0 \in H_{\eta+w}^s \implies \sup_{t \geq 0} \|f(t, \cdot)\|_{H_{\eta}^s} < +\infty.$$

Remark: This theorem is not so strong as the decomposition theorem below, because of the strong moment assumption. It is quite likely that the restriction on w could be relaxed with some more work. A sufficient condition for this moment assumption to be automatically satisfied, is that all the L^1 moments of f_0 be finite. Of course we know that for $t \geq t_0$, this is always the case; but this is *a priori* not sufficient to conclude. Nevertheless it gives by interpolation the following result: under the same assumptions, as soon as $f_0 \in H_{\eta}^s$, f_t belongs to H_{η}^s for any $t > 0$. The constant is explicit, is uniformly bounded for $t > t_0$ for any t_0 , and blows up like an inverse power law of t_0 as $t_0 \rightarrow 0^+$.

Proof of Theorem 2.9. Let $n \in \mathbb{N}$ be such that $n\alpha' \geq s$ ($n = \lceil s/\alpha' \rceil$). Let $w(s) = \delta \lceil s/\alpha' \rceil$. The proof is made by an induction comprising n steps, proving successively that f is uniformly bounded in $H_{\eta + \frac{n-i}{n}w}^{i\alpha'}$ for $i = 0, 1, \dots, n$. The above-mentioned argument is used in each step.

Let us write the induction. The initialization for $i = 0$, i.e., f uniformly bounded in $L_{\eta+w}^2$ is proved by Theorem 2.7 and the more general equation (2.4.33). Now let $0 < i \leq n$ and suppose the assumption is satisfied for all $0 \leq j < i$. Then Proposition 2.2 implies

$$\|f_0(\cdot)G(0, t, \cdot)\|_{H_{\eta + \frac{n-i}{n}w}^{i\alpha'}} \leq C_2 e^{-K't} \|f_0(\cdot)\|_{H_{\eta + \frac{n-i}{n}w + \beta}^{i\alpha'}} \sup_{0 \leq \tau \leq t} \|f(\tau, \cdot)\|_{H_{\beta}^{\lceil i\alpha' \rceil}}.$$

We know from the previous subsection that

$$\left\| \int_0^t Q^+(f, f)(s, \cdot) G(s, t, \cdot) ds \right\|_{H_{\eta + \frac{n-i}{n}w}^{i\alpha'}} \leq C_3 \sup_{0 \leq \tau \leq t} \|f(\tau, \cdot)\|_{H_{\eta + \frac{n-i}{n}w + \delta}^{\lceil i\alpha' \rceil + 2}}.$$

Moreover as $\beta \leq \delta \leq w/n$ and $i \geq 1$,

$$\begin{aligned} \beta &\leq \eta + \frac{n - (i - 1)}{n}w, \\ \eta + \frac{n - i}{n}w + \delta &\leq \eta + \frac{n - (i - 1)}{n}w, \end{aligned}$$

and thus, using the induction assumption for $i - 1$, f is uniformly bounded in $H_{\eta + \frac{n-i}{n}w}^{k\alpha'}$ and the proof is complete. \square

2.5.3 The decomposition theorem

Here we shall give a precise meaning to the idea that the Boltzmann equation with cut-off propagates both smoothness and singularities, but makes the amplitude of the singular part go to zero as time t goes to infinity. For this purpose, we shall look for some iterated versions of the Duhamel representation (2.5.35).

Theorem 2.10. *Let $0 \leq f_0 \in L_2^1 \cap L^2$ and f be the unique energy-preserving solution of the Boltzmann equation with initial datum f_0 , and let $s \geq 0$, $q \geq 0$ be arbitrarily large. Let $\tau > 0$ be arbitrarily small. Then, for all $t \geq \tau$, f can be written $f^S + f^R$, where f^S is nonnegative, and*

$$\begin{cases} \sup_{t \geq \tau} \|f_t^S\|_{H_s^1 \cap L_2^1} < +\infty, \\ \forall t \geq \tau, \forall k > 0, \exists \lambda = \lambda(k) > 0; \quad \|f_t^R\|_{L_k^1} = O(e^{-\lambda t}). \end{cases}$$

All the constants in this theorem can be computed in terms of the mass, energy and L^2 norm of f_0 , and τ .

Remark: The idea of such a decomposition is reminiscent of Wild sums in the case of Maxwellian molecules. Also partial results in this direction were obtained in [199] and [1]. In these cases the gain of regularity in the second term of the Duhamel formula was iterated just once (or twice in [1] for a gain of integrability), and thus the regularity was limited to $H^{(N-1)/2}$ essentially. For hard potentials the obstacle to iterating the Duhamel formula as in the Maxwellian case is the strong non-linearity of the decomposition. Here we bypass this difficulty by the strategy of starting new flows at each step of the iteration.

Proof of Theorem 2.10. We first note that moment estimates imply bounds in L_k^1 for all $k \geq 0$, and therefore the only problems are the gain of regularity for the smooth part and the exponential decrease for the remainder part.

The idea of the proof is a use of the Duhamel formula to decompose the flow associated with the equation into two parts, one of which is more regular than the initial datum, while the amplitude of the other decreases exponentially fast with time. We shall use this repeatedly to progressively increase the smoothness: after a while, we start again a new flow having the smooth part of the previous solution as initial datum. And so on. Of course, each time we start a new flow, we shall depart from the true solution, since the initial datum is not the real solution. However, we can use the stability theorem (Lemma 2.1) to control the error.

The times at which we start the new flows are chosen in such a way that the decay of the non-smooth part (measured by the constant C_{dec}) balances the divergence of the solutions (measured by the constant C_{stab}). The idea is summarized in Fig. 2.1. Each node of the tree corresponds to a time where we start a new solution of the Boltzmann equation, taking for initial data the “smooth part” of the previous solution. In the aim to achieve the goal of balancing the effect of the divergence of the solutions thanks to the exponential decaying of the first term in the Duhamel formula, it is necessary that the decomposition tree ends precisely at the time t we are looking for a decomposition of the solution. Note that for different t , the functions f_t^S constructed below *do not belong to the same flow*.

Let us implement this idea more precisely. By Theorem 2.7, we have a uniform L^2 bound on the solution f , and for a given $t_0 > 0$, we also know that all the L^2 moments are uniformly bounded (see Section 2.4). Let $n \geq 1$, be thought of as the number of times we wish to apply the semigroup; we choose n in such a way that $n\alpha' > k$, where k is the degree of smoothness

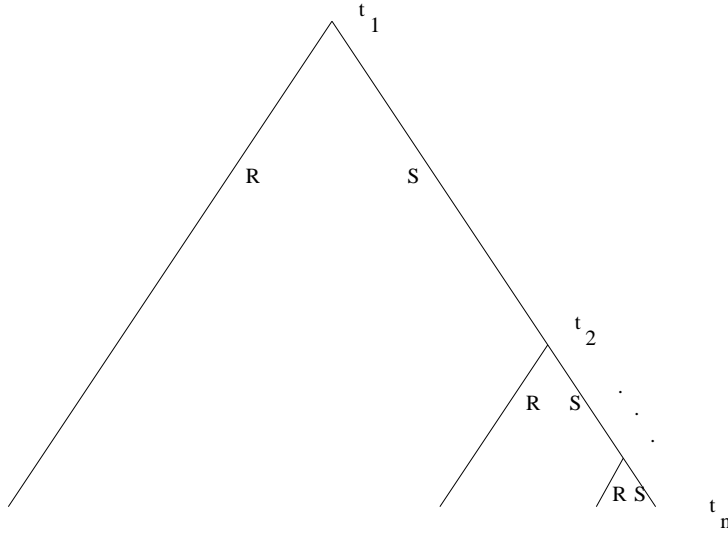

Figure 2.1: Decomposition of the solution

which we are looking for, and α' is the degree of regularization appearing in Proposition 2.2. Let $\tau' \in (0, \tau)$ be arbitrary, say $\tau' = \tau/2$. Let us set $t_n = t \geq \tau$, $t_{-1} = \tau'$, and define inductively (forwards) t_i for $0 \leq i \leq n - 1$ by

$$t_i = t_{i-1} + \mu(t_n - t_{i-1}),$$

where $\mu \in (0, 1)$ satisfies

$$(2.5.39) \quad \mu > \frac{C_{\text{stab}}}{C_{\text{stab}} + K'}$$

(K' is the constant of exponential decrease in (2.5.37)). Let us denote by f_0, f_1, \dots, f_n the solutions constructed as explained above: $f_0 = f$ is the solution we are studying, f_1 is the solution for $t \geq t_0$ of the Boltzmann equation starting from the “initial datum”

$$\int_0^{t_0} Q^+(f_0, f_0)(s, \cdot) e^{-\int_s^{t_0} Lf_0} ds$$

at time t_0 , f_2 is the solution for $t \geq t_1$ of the Boltzmann equation starting from

$$\int_0^{t_1-t_0} Q^+(f_1, f_1)(s, \cdot) e^{-\int_s^{t_1-t_0} Lf_1} ds$$

at time t_1 , etc. More generally, for $2 \leq i \leq n-1$, f_{i+1} is the solution for $t \geq t_i$ of the Boltzmann equation starting at

$$\int_0^{t_i-t_{i-1}} Q^+(f_i, f_i)(s, \cdot) e^{-\int_s^{t_i-t_{i-1}} Lf_i ds}$$

at time t_i . Of course this sequence is well defined, since at each node, the “smooth” part of the solution that we take as a new initial data is nonnegative, lies in $L_2^1 \cap L^2$ and has all its L^2 moments bounded.

The n -times iteration of estimate (2.5.36) together with the theorem of propagation of regularity 2.9 easily implies a bound on the $H^{n\alpha'}$ norm on $f_n(t_n, \cdot)$ which is uniform in $t_n \geq \tau$, and only depends on τ' , n , and on the mass, energy and L^2 moments of f . So let us set

$$f^S(t_n, \cdot) \equiv f_n(t_n, \cdot)$$

and

$$f^R(t_n, \cdot) \equiv f(t_n, \cdot) - f^S(t_n, \cdot).$$

This construction can be made for all $t_n \geq \tau$; thus our decomposition is well defined for all $t \geq \tau$. It remains to prove that f^R is exponentially decaying as $t \rightarrow \infty$. For this we write

$$\begin{aligned} \|f_t^R\|_{L^1} &= \|f_{t_n}^R\|_{L^1} \\ &\leq \sum_{i=0}^{n-1} \|f_{t_n}^{i+1} - f_{t_n}^i\|_{L^1} \\ &\leq \sum_{i=1}^n e^{C_{\text{stab}}(t_n-t_i)} \|f_{t_i}^{i+1} - f_{t_i}^i\| \\ &\leq C \sum_{i=1}^n e^{C_{\text{stab}}(t_n-t_i)} e^{-K'(t_i-t_{i-1})} \\ &\leq C \sum_{i=1}^n e^{(1-\mu)^{i-1}(t_n-t_0)(C_{\text{stab}}(1-\mu)-K'\mu)} \\ &\leq C \sum_{i=1}^n e^{(1-\mu)^{n-1}(t_n-\tau')(C_{\text{stab}}(1-\mu)-K'\mu)} \\ &\leq Cn e^{-(t_n-\tau')(1-\mu)^{n-1}(K'\mu-C_{\text{stab}}(1-\mu))} \end{aligned}$$

which gives the result: if we set

$$0 < C_{\text{dec}} < (1-\mu)^{n-1} (K'\mu - C_{\text{stab}}(1-\mu))$$

which is possible thanks to (2.5.39), we have

$$\|f_t^R\|_{L^1} \leq C e^{-C_{\text{dec}} t}.$$

On the other hand, f_t^R has all its L_k^1 norms bounded, for all k . By elementary interpolation, it follows that all these L_k^1 norms are decaying exponentially fast (the same holds true for all L_k^p norms, whenever $p < 2$). \square

2.6 Application to a problem of long-time behavior

Let us now show an application of Theorem 2.10. Here we shall extend a result proved for very smooth solutions, into a result which applies without a smoothness assumption.

We start with the following statement, which is an immediate corollary of the main results in [192].

Theorem 2.11. *Let $B(|v - v_*|, \cos \theta) = \Phi(|v - v_*|) b(\cos \theta)$ satisfy assumptions (2.1.4), (2.1.6) and (2.3.30), together with the stronger lower-bound assumption*

$$(2.6.40) \quad b(\cos \theta) \geq b_0 > 0.$$

Let f_0 be a nonnegative function in $L_2^1(\mathbb{R}^N)$. Without loss of generality, assume that

$$\int_{\mathbb{R}^N} f_0(v) \begin{pmatrix} 1 \\ v \\ |v|^2 \end{pmatrix} dv = \begin{pmatrix} 1 \\ 0 \\ N \end{pmatrix},$$

and denote by

$$M(v) = \frac{e^{-|v|^2}}{(2\pi)^{N/2}}$$

the associated Maxwellian equilibrium. Let f be an energy-preserving solution of the Boltzmann equation with initial datum f_0 , satisfying

$$(2.6.41) \quad \forall s \geq 0, \forall k \geq 0, \quad C_{s,k} \equiv \sup_{t \geq t_0} \|f_t\|_{H_k^s} < +\infty,$$

and

$$\forall t \geq t_0, \quad f(t, v) \geq K_0 e^{-A_0 |v|^{q_0}}$$

for some time $t_0 > 0$ and some positive constants K_0, A_0, q_0 . Then,

$$\|f_t - M\|_{L^1} = O(t^{-\infty}),$$

in the sense that for all $\varepsilon > 0$ there exists a constant C_ε , explicitly computable in terms of the above constants, and depending on f only via t_0, K_0, A_0, q_0 and an upper bound on $C_{k,s}$ for k and s large enough, such that

$$(2.6.42) \quad \|f_t - M\|_{L^1} \leq C_\varepsilon t^{-1/\varepsilon}.$$

Remarks:

1. Assumption (2.6.40) is satisfied by the hard-spheres kernel, and can be considered as satisfactory for hard potentials with cut-off (since they are satisfied by non-cutoff potentials). Kernels like $|v - v_*|^\gamma$ ($0 < \gamma < 2$) satisfy all the above assumptions.

2. Note that Theorem 2.11 and Theorem 2.12 in the sequel are quantitative, which explains their interest even if exponential convergence to equilibrium has been proven by non-constructive approaches: see [10] for the proof in the L^1 setting, and [197] for the extension to the L^p setting.

It is equivalent to require (2.6.41) or to require uniform bounds in all H^k norms and in all L_s^1 norms. Therefore, we see that known results of appearance of moments and Maxwellian lower bound for hard potentials cover all the assumptions needed for this theorem, except the H^k bounds. If we apply the propagation result of Theorem 2.9, we conclude that the conclusion (2.6.42) holds true as soon as the initial datum f_0 lies in all weighted Sobolev spaces. However, the decomposition theorem of the previous paragraph will lead us to a much stronger conclusion.

Theorem 2.12. *Let f_0 satisfy the same assumptions as in Theorem 2.11 and B satisfy (2.1.3)–(2.1.6), (2.3.30) together with (2.6.40). Further assume that $f_0 \in L^2(\mathbb{R}^N)$. Then the conclusion of Theorem 2.11 holds true:*

$$\|f_t - M\|_{L^1} = O(t^{-\infty}).$$

Proof of Theorem 2.12. First of all, let us pick a $t_0 > 0$. We know that the solution f_t satisfies a Maxwellian lower bound and moment estimates, uniformly as $t \geq t_0$.

Let $\varepsilon > 0$ be arbitrary, and let k, s be such that C_ε in Theorem 2.11 only depends on a uniform upper bound on $\|f\|_{H_s^k}$. Let us make the decomposition of Theorem 2.10 with $\tau = 1$ and s . Then we know that

$$f_t = f_t^S + f_t^R \quad \forall t \geq 1.$$

Let $t_1 \geq 1$ be an intermediate time, to be chosen later. Let us introduce \tilde{f}_t , the solution of the Boltzmann equation starting from $f_{t_1}^S$ at $t = t_1$, and \tilde{M} , the Maxwellian distribution associated with $\tilde{f}_{t_1} = f_{t_1}^S$. Since $f_{t_1}^S$ is bounded in $H^k \cap L_s^1$ by Theorem 2.10, \tilde{f}_t is uniformly bounded in $H^k \cap L_s^1$, and has a Maxwellian lower bound for $t \geq t_2 > t_1$, where t_2 can be chosen arbitrarily (so let us say $t_2 = t_1 + 1$). After rescaling space (to reduce to the case where f has unit mass, zero average velocity and unit temperature), Theorem 2.11 implies

$$\|\tilde{f} - \tilde{M}\|_{L^1} = O((t - t_1)^{-\frac{1}{\varepsilon}})$$

with explicit constants which do not depend on t_1 (they only depend on the τ in the decomposition).

Now, thanks to the properties of the decomposition,

$$\begin{aligned} \|f_t^R\|_{L_s^1} &= O(e^{-C_{\text{dec}}(t-\tau)}) \\ &= O(e^{-C_{\text{dec}}(t-1)}) = O(e^{-C_{\text{dec}}t}). \end{aligned}$$

Moreover,

$$\begin{aligned} \|M - \tilde{M}\|_{L^1} &= O(e^{-C_{\text{dec}}(t_1-\tau)}) \\ &= O(e^{-C_{\text{dec}}(t_1-1)}) = O(e^{-C_{\text{dec}}t_1}). \end{aligned}$$

Indeed, a simple computation shows that $\|\tilde{M} - M\|_{L^1}$ can be bounded in terms of $\|f - \tilde{f}\|_{L_s^2}$, which in turn can be estimated in terms of $\|f_{t_1}^R\|_{L_s^2}$.

Next, the stability Lemma 2.1 implies

$$\|f_t - \tilde{f}_t\| \leq C e^{C_{\text{stab}}(t-t_1)} \|f_{t_1} - \tilde{f}_{t_1}\|_{L_s^1}.$$

On the whole, we find

$$\begin{aligned} \|f_t - M\|_{L^1} &\leq \|f_t - \tilde{f}_t\|_{L^1} + \|\tilde{f}_t - \tilde{M}\|_{L^1} + \|\tilde{M} - M\|_{L^1} \\ &\leq C \left(e^{C_{\text{stab}}(t-t_1)} e^{-C_{\text{dec}}t_1} + (t - t_1)^{-\frac{1}{\varepsilon}} + e^{-C_{\text{dec}}t_1} \right). \end{aligned}$$

It remains to choose $t_1 \gg (t - t_1)$ in order to compensate for the exponential divergence allowed by the stability Lemma 2.1. More precisely, if

$$C_{\text{stab}}(t - t_1) = \frac{C_{\text{dec}}}{2} t_1, \quad \text{i.e.} \quad t_1 = \frac{C_{\text{stab}}}{C_{\text{dec}}/2 + C_{\text{stab}}} t$$

then

$$\|f_t - M\|_{L^1} \leq C \left(e^{-C_{\text{stab}}(t-t_1)} + (t-t_1)^{-\frac{1}{\varepsilon}} + e^{-2C_{\text{stab}}(t-t_1)} \right)$$

and so

$$\|f_t - M\|_{L^1} \leq C(t-t_1)^{-\frac{1}{\varepsilon}} \leq C't^{-\frac{1}{\varepsilon}}.$$

This holds for ε arbitrarily small, and the theorem is proved. \square

2.7 Weaker integrability conditions

A natural question is whether the two main results of this paper, the decomposition Theorem 2.10 and the Theorem 2.12 of convergence to equilibrium, extend to solutions with weaker integrability conditions. A first step could be $L^1_2 \cap L^p$ with $1 < p < 2$. A physically relevant assumption would be $L^1_2 \cap L \log L$. But since Mischler and Wennberg [144] have proved the existence and unicity under the sole L^1_2 assumption, the optimal assumption would be only $f_0 \in L^1_2$ (i.e., no entropy condition).

It turns out that in the particular case of a hard-sphere collision kernel we can extend our results to general L^1_2 data, using results of [144] and [1]. A careful study of the iterated gain term $Q^+(Q^+(g, f), h)$ is done in [144] in order to prove non-concentration of the solution. This non-concentration is used to obtain the weak compactness by the Dunford-Pettis theorem and prove the existence of a solution with no entropy condition. This study is refined in [1], where this iterated gain term is estimated in Lebesgue spaces. Therefore Abrahamsson is able to prove [1, Lemma 2.1]

$$\forall 1 \leq p < 3, \quad \|Q^+(Q^+(g, f), h)\|_{L^p} \leq C \|f\|_{L^1_2} \|g\|_{L^1_2} \|h\|_{L^1_2}$$

with an explicit constant C . He deduces a decomposition theorem [1, Proposition 2.1] from which we can extract

Lemma 2.3 (Abrahamsson's decomposition). *Let $B(|v - v_*|, \cos \theta) = |v - v_*|$, and let $f_0 \in L^1_2$ be a nonnegative initial datum with finite kinetic energy. Let f be the unique solution (with non-increasing energy) of the Boltzmann equation with collision kernel B and initial datum f . Let $q \geq 0$ be arbitrarily large and $\tau > 0$ arbitrarily small. Then f can be decomposed as $f = f^S + f^R$, where $f^S \in L^\infty([\tau, +\infty); L^2_q \cap L^1_2)$ and, for all $k \geq 0$, there is $\lambda = \lambda(k) > 0$ such that $\|f^R\|_{L^1_k} = O(e^{-\lambda t})$. All the constants in this lemma can be computed explicitly in terms of the mass and energy of f_0 .*

We explain how to connect this result to our method in order to get optimal assumptions on the initial data in the hard-sphere case, and then we make some remarks on possible extensions for general hard potentials with cut-off.

Thus for hard spheres we have

Theorem 2.13. *Let $B(|v - v_*|, \cos \theta) = |v - v_*|$ and $0 \leq f_0 \in L^1_2$. Let f be the unique energy-preserving solution of the Boltzmann equation with initial datum f_0 , and let $s \geq 0$, $q \geq 0$ be arbitrarily large. Let $\tau > 0$ be arbitrarily small. Then, for all $t \geq \tau$, f can be written $f^S + f^R$, where f^S is nonnegative, and*

$$\begin{cases} \sup_{t \geq \tau} \|f_t^S\|_{H^s_q \cap L^1_2} < +\infty, \\ \forall t \geq \tau, \forall k > 0, \exists \lambda = \lambda(k) > 0; \quad \|f_t^R\|_{L^1_k} = O(e^{-\lambda t}). \end{cases}$$

Moreover the conclusion of Theorem 2.11 holds true:

$$\|f_t - M\|_{L^1} = O(t^{-\infty}).$$

All the constants in this theorem can be computed in terms of τ , q , s , and the mass and energy of f_0 .

Proof of Theorem 2.13. First let us prove the decomposition part of the theorem. We follow the same strategy of tree decomposition as in Theorem 2.10. It is enough to take the decomposition of Lemma 2.3 at the first step of the tree: f_1 takes the smooth part of decomposition of Lemma 2.3 as initial data at time t_0 . Then we have to adjust the constants in the proof: take n , the number of steps, such that $(n + 1)\alpha' \geq k$ (one step more) and take

$$\mu < \frac{C_{\text{stab}}}{C_{\text{stab}} + K''},$$

where $K'' = \min\{K', \lambda\}$ (λ is the rate of exponential decrease in the decomposition of Lemma 2.3). The rest of the proof is identical to that of Theorem 2.10. Then with the decomposition result in hand, we can prove the “almost exponential” convergence to equilibrium exactly the same way as in Theorem 2.12. \square

Remarks:

1. Note that except for the physically relevant case of hard spheres, the cut-off assumption is unphysical for general hard potentials interactions. Besides, non-cutoff collision operators are known to have a regularizing effect

(see for instance [3]). The optimality of the integrability condition is thus less important for general hard- potential interactions than it is for hard spheres.

2. For general hard potentials with cut-off (with $0 \leq \gamma \leq 1$), the result of Abrahamsson on the iterated gain term becomes

$$\|Q^+(Q^+(g, f), h)\|_{L^p} \leq C_{p,q,r,\gamma} \left(\|f\|_{L^1_2}, \|g\|_{L^1_2}, \|h\|_{L^1_2}, \|f\|_{L^q}, \|g\|_{L^r}, \|b\|_{L^\infty} \right)$$

for any $p \in [1, 3/(2 - \gamma))$ and q, r, γ satisfying $1/q + 1/r < (5 + \gamma)/3$. It is likely that an improvement of this result in order to allow $q = r = 1$ in this estimate would allow us to extend Lemma 2.3 and thus Theorem 2.13 to general hard potentials with cut-off. However it seems that this question leads to serious technical difficulties.

3. Nevertheless a possible strategy to extend Theorem 2.10 to initial data in $L^1_2 \cap L^p$ with any $p > 1$ could be the following. In the same spirit as the tree decomposition in Theorem 2.10, we could iterate the Duhamel formula, but now increase the Lebesgue integrability at each step (using Theorem 2.6 for $s = 0$, translated into a gain of integrability thanks to the Sobolev injections coupled with some interpolation). As soon as the L^2 integrability is reached, we could start the decomposition tree of Theorem 2.10 in order to increase regularity, connecting the two decompositions in the same spirit as in the proof of Theorem 2.13.

2.8 Appendix: Some facts from interpolation theory and harmonic analysis

The goal of this appendix section is to recall some classical results about linear interpolation theory and also to give the proof of some elementary results used here, in order to make this paper almost self-contained.

2.8.1 Convolution inequalities in weighted spaces

Proposition 2.3. *Let $\eta \in \mathbb{R}$, then*

$$\|f * g\|_{L^\eta_r} \leq \|f\|_{L^p_{|\eta|}} \|g\|_{L^q_\eta}$$

for all $p, q, r \geq 1$ such that $\frac{1}{r} + 1 = \frac{1}{p} + \frac{1}{q}$.

Proof of Proposition 2.3. The proof of this proposition is similar to the standard proof of the usual Young's inequality. \square

2.8.2 Riesz-Thorin interpolation

Proposition 2.4. *Let $\theta \in [0, 1]$, $p_1, p_2, p \in [1, +\infty]$ such that $1/p = \theta/p_1 + (1 - \theta)/p_2$, $k_1, k_2, k \in \mathbb{R}$ such that $k = \theta k_1 + (1 - \theta)k_2$, $q_1, q_2, q \in [1, +\infty]$ such that $1/q = \theta/q_1 + (1 - \theta)/q_2$, $l_1, l_2, l \in \mathbb{R}$ such that $l = \theta l_1 + (1 - \theta)l_2$, and let T be a continuous operator from $L_{k_1}^{p_1}$ into $L_{l_1}^{q_1}$ and from $L_{k_2}^{p_2}$ into $L_{l_2}^{q_2}$. Then its restriction to C_0^∞ functions extends to a continuous operator from L_k^p into L_l^q with the following bound on its norm:*

$$\|T\|_{L_k^p \rightarrow L_l^q} \leq \|T\|_{L_{k_1}^{p_1} \rightarrow L_{l_1}^{q_1}}^\theta \|T\|_{L_{k_2}^{p_2} \rightarrow L_{l_2}^{q_2}}^{1-\theta}.$$

Corollary 2.3. *Let $\theta \in [0, 1]$, $s_1, s_2, s \in \mathbb{R}$ such that $s = \theta s_1 + (1 - \theta)s_2$, and $t_1, t_2, t \in \mathbb{R}$ such that $t = \theta t_1 + (1 - \theta)t_2$. If T is a continuous operator from H^{s_1} into H^{t_1} and from H^{s_2} into H^{t_2} , then its restriction to C_0^∞ functions extends to a continuous operator from H^s into H^t with the following bound on its norm:*

$$\|T\|_{H^s \rightarrow H^t} \leq \|T\|_{H^{s_1} \rightarrow H^{t_1}}^\theta \|T\|_{H^{s_2} \rightarrow H^{t_2}}^{1-\theta}.$$

This corollary is still true when a weight is added on the space variable:

$$\|T\|_{H_k^s \rightarrow H_{k'}^t} \leq \|T\|_{H_{k_1}^{s_1} \rightarrow H_{k'_1}^{t_1}}^\theta \|T\|_{H_{k_2}^{s_2} \rightarrow H_{k'_2}^{t_2}}^{1-\theta}.$$

In fact the abstract method of interpolation leads to the stronger result

$$\|T\|_{H_k^s \rightarrow H_{k'}^t} \leq \|T\|_{H_{k_1}^{s_1} \rightarrow H_{k'_1}^{t_1}}^\theta \|T\|_{H_{k_2}^{s_2} \rightarrow H_{k'_2}^{t_2}}^{1-\theta},$$

where the weight indexes satisfy $k = \theta k_1 + (1 - \theta)k_2$ and $k' = \theta k'_1 + (1 - \theta)k'_2$. As a consequence we could prove a strong version of the Young's inequality in the case of the weighted Sobolev spaces. We can indeed make the index of weight and regularity vary together. Namely,

$$\|f\|_{H_k^s} \leq \|f\|_{H_{k_1}^{s_1}}^\theta \|f\|_{H_{k_2}^{s_2}}^{1-\theta},$$

where $s = \theta s_1 + (1 - \theta)s_2$ and $k = \theta k_1 + (1 - \theta)k_2$. Let us emphasize the consequence of this inequality, which we use in this paper: as soon as f belongs to H^s and has finite L^1 moments of order large enough, we can deduce bounds on $H_k^{s'}$ norm for $s' < s$.

2.8.3 Regularity of a sum $H_k^s + H_k^{s+\beta}$

Theorem 2.14. *Let $h \in H_\eta^s$ ($s \geq 0$, $\eta \in \mathbb{R}$) such that for all ε small enough,*

$$h = h_1^\varepsilon + h_2^\varepsilon,$$

where the two parts h_1^ε and h_2^ε satisfy the following estimates: there exist $k_1 \geq 0$ and $k_2 > 0$ such that $\|h_1^\varepsilon\|_{H_\eta^{s+\beta}} \leq C_1 \varepsilon^{-k_1}$ and $\|h_2^\varepsilon\|_{H_\eta^s} \leq C_2 \varepsilon^{k_2}$ ($\beta > 0$). Then

$$\forall \alpha < \frac{\beta k_2}{k_1 + k_2}, \quad h \in H_\eta^{s+\alpha}.$$

Remarks:

1. Our estimate on the norm $H_\eta^{s+\alpha}$ blows up like

$$\text{cst} \left(\frac{\beta k_2}{k_1 + k_2} - \alpha \right)^{-1} \quad \text{as} \quad \alpha \rightarrow \frac{\beta k_2}{k_1 + k_2}.$$

2. In fact the proof shows that $h\langle \cdot \rangle^\eta$ belongs to the Besov space

$$B^{(\beta, \infty), 2} \subset \cap_{\alpha < \beta} H^\alpha.$$

Proof of Theorem 2.14. Let us take $\alpha < \beta k_2 / (k_1 + k_2)$. Without loss of generality we treat the case $s = \eta = 0$ (the general case can be reduced to this one). We first prove an upper bound on an annulus. Let $0 < A < B$, and

$$\begin{aligned} \int_{A \leq |\xi| \leq B} |\widehat{h}(\xi)|^2 \langle \xi \rangle^{2\alpha} d\xi &\leq 2 \int_{A \leq |\xi| \leq B} \left(|\widehat{h}_1^\varepsilon(\xi)|^2 + |\widehat{h}_2^\varepsilon(\xi)|^2 \right) \langle \xi \rangle^{2\alpha} d\xi \\ &\leq 2 \left(C_1 \varepsilon^{-k_1} \langle A \rangle^{2(\alpha-\beta)} + C_2 \langle B \rangle^{2\alpha} \varepsilon^{k_2} \right) \\ &\leq 2 \left(C_1 \varepsilon^{-k_1} A^{2(\alpha-\beta)} + 2C_2 B^{2\alpha} \varepsilon^{k_2} \right) \\ &\leq \max\{2C_1, 4C_2\} \left(\varepsilon^{-k_1} A^{2(\alpha-\beta)} + B^{2\alpha} \varepsilon^{k_2} \right). \end{aligned}$$

As this inequality holds for all ε , it can be chosen in order that the two right-members be equal in the preceding inequality. The computation leads to

$$\int_{A \leq |\xi| \leq B} |\widehat{h}(\xi)|^2 \langle \xi \rangle^\beta d\xi \leq 2 \max\{2C_1, 4C_2\} B^{\frac{2\alpha k_1}{k_1+k_2}} A^{\frac{2(\alpha-\beta)k_2}{k_1+k_2}}.$$

Let $C_3 = 2 \max\{2C_1, 4C_2\}$ and let us sum the inequalities on a family of

concentric dyadic annuli:

$$\begin{aligned}
 \|h\|_{H^\beta} &\leq \int_{0 \leq |\xi| \leq 1} |\widehat{h}(\xi)|^2 \langle \xi \rangle^\beta + C_3 \sum_{n=0}^{+\infty} 2^{\frac{2\alpha(n+1)k_1}{k_1+k_2}} 2^{\frac{2(\alpha-\beta)nk_2}{k_1+k_2}} \\
 &\leq 2 \|h\|_{L^2} + C_3 \sum_{n=0}^{+\infty} 2^{\frac{2\alpha(n+1)k_1}{k_1+k_2}} 2^{\frac{2(\alpha-\beta)nk_2}{k_1+k_2}} \\
 &\leq 2 \|h\|_{L^2} + C_3 4^{\frac{\alpha k_1}{k_1+k_2}} \sum_{n=0}^{+\infty} 4^{n(\alpha - \frac{\beta k_2}{k_1+k_2})}.
 \end{aligned}$$

Thanks to the assumption on α the right member is summable and thus $h \in H^\alpha$ with the following bound on the norm:

$$\begin{aligned}
 \|h\|_{H^\alpha} &\leq 2 \|h\|_{L^2} + C_3 4^{\frac{\alpha k_1}{k_1+k_2}} \sum_{n=0}^{+\infty} 4^{n(\alpha - \frac{\beta k_2}{k_1+k_2})} \\
 &\leq 2 \|h\|_{L^2} + C_3 \frac{4^{\frac{\alpha k_1}{k_1+k_2}}}{1 - 4^{\alpha - \frac{\beta k_2}{k_1+k_2}}}.
 \end{aligned}$$

□

2.8.4 A simple estimate on pseudo-differential operators

We conclude this section with a simple result needed for the proof of the regularity property of Q^+ . This can be linked with more general pseudo-differential estimates, but will be proved by elementary means. The space H_k^s is not an algebra in general (it is an algebra thanks to the Sobolev imbeddings as soon as $2s > N$), but we can prove a bound on the norm H_k^s of a product of functions if one of the two functions has regularity greater than s :

$$\|fg\|_{H_k^s} \leq \text{cst}(N, \varepsilon) \|f\|_{H_{k_1}^S} \|g\|_{H_{k_2}^s},$$

where $k_1 + k_2 = k$, and $S = s + N/2 + \varepsilon$ with $\varepsilon > 0$.

Now we follow the same idea but assuming that one of the two functions depends also on the Fourier variable.

Lemma 2.4. *Let $\psi(x, \xi)$ be a real-valued C^∞ function on $\mathbb{R}^N \times \mathbb{R}^N$, compactly supported in x , uniformly in ξ . Let $g : \mathbb{R}^N \rightarrow \mathbb{R}$ be a function in the Schwartz space $\mathcal{S}(\mathbb{R}^N)$, and let $s \in \mathbb{R}$. Define*

$$I = \int_{\mathbb{R}^N} \langle \xi \rangle^{2s} \left| \mathcal{F}(g(\cdot)\psi(\cdot, \xi)) \right|^2 d\xi.$$

Then for all $\varepsilon > 0$ there exists a constant $\text{cst}(N, \varepsilon)$ such that

$$I \leq \text{cst}(N, \varepsilon) \|\psi\|_{L^\infty_\xi(H_x^S)}^2 \|g\|_{H^s}^2,$$

with $S = s + N/2 + \varepsilon$.

Proof of Lemma 2.4. We have

$$g(x) = \frac{1}{(2\pi)^{N/2}} \int_{\mathbb{R}^N} e^{ix \cdot \tau} \hat{g}(\tau) d\tau$$

hence

$$\begin{aligned} I &= \frac{1}{(2\pi)^N} \int_{\mathbb{R}^N} \langle \xi \rangle^{2s} \left| \int_{\mathbb{R}^N} \int_{\mathbb{R}^N} e^{-ix \cdot (\xi - \tau)} \hat{g}(\tau) \psi(x, \xi) dx d\tau \right|^2 d\xi \\ &= \frac{1}{(2\pi)^N} \int_{\mathbb{R}^N} \langle \xi \rangle^{2s} \left| \int_{\mathbb{R}^N} \hat{g}(\tau) \left[\int_{\mathbb{R}^N} e^{-ix \cdot (\xi - \tau)} \psi(x, \xi) dx \right] d\tau \right|^2 d\xi \\ &= \frac{1}{(2\pi)^N} \int_{\mathbb{R}^N} \langle \xi \rangle^{2s} \left| \int_{\mathbb{R}^N} \hat{g}(\xi - \tau) \left[\int_{\mathbb{R}^N} e^{-ix \cdot \tau} \psi(x, \xi) dx \right] d\tau \right|^2 d\xi \\ &= \frac{1}{(2\pi)^N} \int_{\mathbb{R}^N} \langle \xi \rangle^{2s} \left| \int_{\mathbb{R}^N} \hat{g}(\xi - \tau) [\mathcal{F}_x(\psi(\cdot, \xi))](\tau) d\tau \right|^2 d\xi \end{aligned}$$

and thus

$$\begin{aligned} (2\pi)^N I &\leq \int_{\mathbb{R}^N} \langle \xi \rangle^{2s} \int_{\mathbb{R}^N} |\hat{g}|^2(\xi - \tau) \langle \tau \rangle^{-2S} d\tau \\ &\quad \times \int_{\mathbb{R}^N} |\mathcal{F}_x(\psi(\cdot, \xi))|^2(\tau') \langle \tau' \rangle^{2S} d\tau' d\xi \\ &\leq \int_{\mathbb{R}^N} \langle \xi \rangle^{2s} \int_{\mathbb{R}^N} |\hat{g}|^2(\xi - \tau) \langle \tau \rangle^{-2S} d\tau \|\psi(\cdot, \xi)\|_{H_x^S}^2 d\xi \\ &\leq \|\psi\|_{L^\infty_\xi(H_x^S)}^2 \int_{\mathbb{R}^N} \langle \tau \rangle^{-2S} \int_{\mathbb{R}^N} \langle \xi \rangle^{2s} |\hat{g}|^2(\xi - \tau) d\xi d\tau \\ &\leq \|\psi\|_{L^\infty_\xi(H_x^S)}^2 \int_{\mathbb{R}^N} \langle \tau \rangle^{-2S} \int_{\mathbb{R}^N} \langle \xi + \tau \rangle^{2s} |\hat{g}(\xi)|^2 d\xi d\tau \\ &\leq \|\psi\|_{L^\infty_\xi(H_x^S)}^2 2^s \int_{\mathbb{R}^N} \langle \xi \rangle^{2s} \hat{g}(\xi)^2 d\xi \int_{\mathbb{R}^N} \langle \tau \rangle^{-2S} \langle \tau \rangle^{2s} d\tau \\ &\leq \|\psi\|_{L^\infty_\xi(H_x^S)}^2 \|g\|_{H^s}^2 2^s \int_{\mathbb{R}^N} \langle \tau \rangle^{-N-2\varepsilon} d\tau \end{aligned}$$

which concludes the proof. \square

Acknowledgements. We thank the referee for useful comments. Support by the European network HYKE, funded by the EC as contract HPRN-CT-2002-00282, is acknowledged.

About L^p estimates for the spatially homogeneous Boltzmann equation

Article [69] en collaboration avec Laurent Desvillettes, à paraître dans
Annales de l'Institut Henri Poincaré, Analyse Non-Linéaire.

ABSTRACT: *For the homogeneous Boltzmann equation with (cutoff or non cutoff) hard potentials, we prove estimates of propagation of L^p norms with a weight $(1+|x|^2)^{q/2}$ ($1 < p < +\infty$, $q \in \mathbb{R}_+$ large enough), as well as appearance of such weights. The proof is based on some new functional inequalities for the collision operator, proven by elementary means.*

Contents

3.1	Introduction	145
3.2	Functional estimates on the collision operator . .	148
3.3	Application to the flow of the equation	159
3.4	Behavior for large times	162

3.1 Introduction

The spatially homogeneous Boltzmann equation (cf. [52]) writes

$$(3.1.1) \quad \frac{\partial f}{\partial t}(t, v) = Q(f, f)(t, v),$$

where $f(t, \cdot) : \mathbb{R}^N \rightarrow \mathbb{R}_+$ is the nonnegative density of particles which at time t move with velocity v . The bilinear operator in the right-hand side is defined by

$$(3.1.2) \quad Q(g, f)(v) = \int_{\mathbb{R}^N \times \mathbb{S}^{N-1}} \left\{ f(v') g(v'_*) - f(v) g(v_*) \right\} B \left(|v - v_*|, \frac{v - v_*}{|v - v_*|} \cdot \sigma \right) dv_* d\sigma.$$

In this formula, v', v'_* and v, v_* are the velocities of a pair of particles before and after a collision. They are defined by

$$\begin{cases} v' = \frac{v + v_*}{2} + \frac{|v - v_*|}{2} \sigma, \\ v'_* = \frac{v + v_*}{2} - \frac{|v - v_*|}{2} \sigma, \end{cases}$$

where $\sigma \in \mathbb{S}^{N-1}$.

We concentrate in this work on hard potentials or hard spheres collision kernels, with or without angular cutoff. More precisely, we suppose that the collision kernel satisfies the following:

Assumptions. The collision kernel B is of the form

$$(3.1.3) \quad B(x, y) = |x|^\gamma b(|y|),$$

where

$$(3.1.4) \quad \gamma \in [0, 1]$$

and

$$(3.1.5) \quad \begin{cases} b \in L_{loc}^\infty([-1, 1[), \\ b(y) =_{y \rightarrow 1^-} O((1 - y)^{\frac{-(N-2)+\nu}{2}}), \quad \nu > -3. \end{cases}$$

Note that assumption (3.1.5) is an alternative (and a slightly less general) formulation to the minimal condition necessary for a mathematical treatment of the Boltzmann equation identified in [186, 4], namely the requirement

$$\int_{\mathbb{S}^{N-1}} b(\cos \theta)(1 - \cos \theta) d\sigma < +\infty.$$

Then, we wish to consider initial data $f_0 \geq 0$ with finite mass and energy, such that

$$f_0(v)(1 + |v|^2)^{q/2} \in L^p(\mathbb{R}^N)$$

for some $1 < p < +\infty$ and $q \geq 0$ (notice that entropy is thus automatically finite). Existence results under the assumptions of finite mass, energy and entropy were obtained in [6] for the case of hard potentials with cutoff, in [7] for (non cutoff) soft potentials in dimension 3 under the restriction $\gamma \geq -1$, then in [107] and [186] for general kernels (our assumptions on the kernel fall in the setting of [186] for instance). Uniqueness however is proved only in the cutoff case (for an optimal result see [144]) and remains an open question in the noncutoff case (except for Maxwellian molecules $\gamma = 0$, see [180]).

Propagation of moments in L^1 was proven in [118] for Maxwellian molecules with cutoff. Then, for the case of strictly hard potentials with cutoff, it was shown in [67] that all polynomial moments were created immediately when one of them of order strictly bigger than 2 initially existed. This last restriction was later relaxed in [200].

Propagation of moments in L^p was first obtained by Gustafsson (cf. [111, 112]) thanks to interpolation techniques, under the assumption of angular cutoff. It was recovered by a simpler and more explicit method in [150], thanks to the smoothness properties of the gain part of the Boltzmann's collision operator discovered by P.-L. Lions [130, 131]. As far as appearance of moments in L^p is concerned, the first result is due to Wennberg in [198], still in the framework of angular cutoff. It is precised in [150].

In this work, we wish to improve these results by presenting an L^p theory

- first, which is elementary (that is, without abstract interpolations and without using the smoothness properties of Boltzmann's kernel),
- secondly, which includes the non cutoff case,
- finally, without assuming too many moments in L^p for the initial datum.

Our method is reminiscent of recent works by Mischler and Rodriguez Ricard [143] and Escobedo, Laurençot and Mischler [80] on the Smoluchowsky equation.

Let $1 < p < +\infty$. We define the weighted L^p space $L^p_q(\mathbb{R}^N)$ by

$$L^p_q(\mathbb{R}^N) = \left\{ f : \mathbb{R}^N \rightarrow \mathbb{R}, \quad \|f\|_{L^p_q(\mathbb{R}^N)} < +\infty \right\},$$

with its norm

$$\|f\|_{L^p_q(\mathbb{R}^N)}^p = \int_{\mathbb{R}^N} |f(v)|^p \langle v \rangle^{pq} dv,$$

and the usual notation $\langle v \rangle = \sqrt{1 + |v|^2}$.

We now state our main theorem

Theorem 3.1. *Let B be a collision kernel satisfying assumptions (3.1.3), (3.1.4), (3.1.5) and q such that*

- (i) $q \in \mathbb{R}_+$ if $\nu > -1$ (integrable angular kernel),
- (ii) $pq > 2$ if $\nu \in (-2, -1]$,
- (iii) $pq > 4$ if $\nu \in (-3, -2]$,

and f_0 be an initial datum in $L^1_{\max(p,2)q+2} \cap L^p_q$.

Then

- A. *there exists a (weak) solution to the Boltzmann equation (3.1.1) with collision kernel B and initial datum f_0 lying in $L^\infty([0, +\infty); L^p_q(\mathbb{R}^N))$ (with explicit bounds in this space),*
- B. *if $\gamma > 0$, this solution belongs moreover to $L^\infty((\tau, +\infty); L^p_r(\mathbb{R}^N))$ for all $\tau > 0$ and $r > q$ (still with explicit bounds in this space, the blow up near $\tau \sim 0^+$ being at worse polynomial).*

Remarks: Let us discuss the assumptions and the conclusion of this theorem.

1. Our result cannot hold when the hard potentials are replaced by soft potentials. In the case of Maxwellian molecules ($\gamma = 0$), we have uniform (in time) bounds but no appearance of moments (neither in L^p nor in L^1) occurs. In the case of the so-called “mollified soft potentials” with cutoff, some bounds growing polynomially in time are proved in [182], on the basis of the regularity property of the gain term of the collision operator.

2. When the collision kernel B is not a product of a function of x by a function of y (as in Assumption (3.1.3)), it is likely that Theorem 3.1 still

holds provided that the behavior of B with respect to x (when $x \rightarrow +\infty$) is that of a nonnegative power and B satisfies estimate (3.1.5) uniformly according to x .

3. The restriction on the weight q is not a technical one which is likely to be discarded (at least in our method). Indeed as suggested in [132, 188, 3] the noncutoff collision operator behaves roughly like some fractional Laplacian of order $-\nu/2$ and these derivatives will in fact be supported by the weight, as we shall see. Notice however that there is no condition on q when $\nu > -1$, i.e. in the cutoff case, which recovers existing results. Note also that the condition $f_0 \in L^1_{2q+2}$ is used only to get the uniformity when $t \rightarrow +\infty$ of the estimates. The local (in time) estimates hold as soon as $f_0 \in L^1_{pq+2}$.

4. Finally, Theorem 3.1 can certainly be improved when the collision kernel is non cutoff. In such a case (and under rather not stringent assumption (cf. [3])), it is possible to show that some smoothness is gained, and some L^p regularity will appear even if it does not initially exist. As a consequence, the assumptions of Theorem 3.1 can certainly be somehow relaxed. One can for example compare Theorem 3.1 to the results of [71] for the Landau equation. We also refer to [74] for “regularized hard potentials” without angular cutoff.

The proof of Theorem 3.1 runs as follows. In Section 3.2, we give various bounds for quantities like

$$\int_{\mathbb{R}^N} Q(f, f)(v) f^{p-1}(v) \langle v \rangle^{pq} dv.$$

These bounds are applied to the flow of the spatially homogeneous Boltzmann equation in Section 3.3, and are sufficient to prove Theorem 3.1, except that the bounds may blow up when $t \rightarrow +\infty$. Finally in Section 3.4, we explain why such a blow up cannot take place, and so we conclude the proof of Theorem 3.1. This last part is the only one which is not self-contained. It uses an estimate from [150].

3.2 Functional estimates on the collision operator

In the sequel we shall use the parametrization described in figure 3.1, where

$$k = \frac{v - v_*}{|v - v_*|}, \quad \sigma = \frac{v' - v'_*}{|v' - v'_*|},$$

and $\cos \theta = \sigma \cdot k$. The range of θ is $[0, \pi]$ and σ writes

$$\sigma = \cos \theta k + \sin \theta u,$$

where u belongs to the sphere of \mathbb{S}^{N-1} orthogonal to k (which is isomorphic to \mathbb{S}^{N-2}).

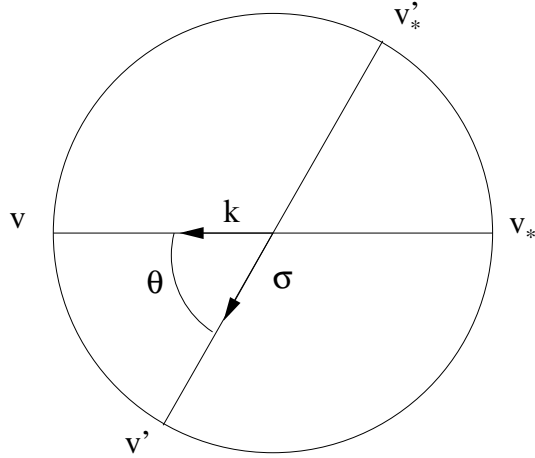

Figure 3.1: Geometry of binary collisions

Thanks to the change of variable $\theta \mapsto \pi - \theta$ which exchanges v' and v'_* , the *quadratic* collision operator can be written

$$Q(f, f)(v) = \int_{\mathbb{R}^N \times \mathbb{S}^{N-1}} \left\{ f(v') f(v'_*) - f(v) f(v_*) \right\} B_{sym}(|v - v_*|, \cos \theta) dv_* d\sigma,$$

where

$$B_{sym}(|v - v_*|, \cos \theta) = [B(|v - v_*|, \cos \theta) + B(|v - v_*|, \cos(\pi - \theta))] 1_{\cos \theta \geq 0}.$$

As a consequence, it is enough to consider the case when $B(|v - v_*|, \cos \cdot)$ has its support included in $[0, \pi/2]$. This is what we shall systematically do in the sequel (Beware that certain propositions are written for the bilinear kernel $Q(g, f)$ and not for $Q(f, f)$: they hold only in fact for the symmetrized collision kernel B_{sym} defined above).

Recalling that

$$v' = \frac{v + v_*}{2} + \frac{|v - v_*|}{2} \sigma,$$

we shall use (for all F) the formula (cf. [3, Section 3, proof of Lemma 1])

$$(3.2.6) \quad \int_{\mathbb{R}^N \times \mathbb{S}^{N-1}} B(|v - v_*|, \cos \theta) F(v') dv d\sigma \\ = \int_{\mathbb{R}^N \times \mathbb{S}^{N-1}} \frac{1}{\cos^N(\theta/2)} B\left(\frac{|v - v_*|}{\cos(\theta/2)}, \cos \theta\right) F(v) dv d\sigma.$$

Let us prove a first functional estimate independant on the integrability of the angular part of the collision kernel

Proposition 3.1. *Let B be a collision kernel satisfying Assumptions (3.1.3), (3.1.4), (3.1.5). Then, for all $p > 1$, $q \in \mathbb{R}$ and f and g nonnegative, we have*

$$(3.2.7) \quad \int_{\mathbb{R}^N} Q(g, f)(v) f^{p-1}(v) \langle v \rangle^{pq} dv \leq \\ \int_{\mathbb{R}^{2N} \times \mathbb{S}^{N-1}} |v - v_*|^\gamma b(\cos \theta) \left[(\cos(\theta/2))^{-\frac{N+\gamma}{p}} - 1 \right] \langle v \rangle^{pq} f^p(v) g(v_*) dv dv_* d\sigma \\ + \int_{\mathbb{R}^{2N} \times \mathbb{S}^{N-1}} \frac{1}{p} (\cos(\theta/2))^{-\frac{N+\gamma}{p}} |v - v_*|^\gamma b(\cos \theta) \\ \times [\langle v' \rangle^{pq} - \langle v \rangle^{pq}] f^p(v) g(v_*) dv dv_* d\sigma.$$

Proof of Proposition 3.1. We first observe that thanks to the pre-post collisional change of variables, that is, the identity

$$\int_{\mathbb{R}^{2N} \times \mathbb{S}^{N-1}} F(v, v_*, \sigma) dv dv_* d\sigma = \int_{\mathbb{R}^{2N} \times \mathbb{S}^{N-1}} F(v', v'_*, \sigma) dv dv_* d\sigma,$$

we can write

$$\int_{\mathbb{R}^N} Q(g, f)(v) f^{p-1}(v) \langle v \rangle^{pq} dv \\ = \int_{\mathbb{R}^{2N} \times \mathbb{S}^{N-1}} \left\{ g(v'_*) f(v') - g(v_*) f(v) \right\} \\ f^{p-1}(v) \langle v \rangle^{pq} |v - v_*|^\gamma b(\cos \theta) dv dv_* d\sigma \\ = \int_{\mathbb{R}^{2N} \times \mathbb{S}^{N-1}} \left[\langle v' \rangle^{pq} f^{p-1}(v') f(v) g(v_*) \right. \\ \left. - \langle v \rangle^{pq} f^p(v) g(v_*) \right] |v - v_*|^\gamma b(\cos \theta) dv dv_* d\sigma.$$

According to Young's inequality, for all $\mu \equiv \mu(\theta) > 0$,

$$f^{p-1}(v') f(v) = \left(\frac{f(v')}{\mu^{1/p}} \right)^{p-1} (\mu^{1-1/p} f(v)) \\ \leq \left(1 - \frac{1}{p} \right) \mu^{-1} f^p(v') + \frac{1}{p} \mu^{p-1} f^p(v),$$

so that

$$\begin{aligned} \int_{\mathbb{R}^N} Q(g, f)(v) f^{p-1}(v) \langle v \rangle^{pq} dv &\leq \int_{\mathbb{R}^{2N} \times \mathbb{S}^{N-1}} \left[\left(1 - \frac{1}{p}\right) \mu^{-1} \langle v' \rangle^{pq} f^p(v') \right. \\ &\quad \left. + \frac{1}{p} \mu^{p-1} \langle v' \rangle^{pq} f^p(v) - \langle v \rangle^{pq} f^p(v) \right] g(v_*) |v - v_*|^\gamma b(\cos \theta) dv dv_* d\sigma. \end{aligned}$$

We now use (for a given v_* , θ) formula (3.2.6) for the first term in this integral. We get

$$\begin{aligned} \int_{\mathbb{R}^N} Q(g, f)(v) f^{p-1}(v) \langle v \rangle^{pq} dv &\leq \\ &\int_{\mathbb{R}^{2N} \times \mathbb{S}^{N-1}} \left[\left(1 - \frac{1}{p}\right) \mu^{-1} \langle v \rangle^{pq} (\cos(\theta/2))^{-N-\gamma} f^p(v) \right. \\ &\quad \left. + \frac{1}{p} \mu^{p-1} \langle v' \rangle^{pq} f^p(v) - \langle v \rangle^{pq} f^p(v) \right] g(v_*) |v - v_*|^\gamma b(\cos \theta) dv dv_* d\sigma \\ &= \int_{\mathbb{R}^{2N} \times \mathbb{S}^{N-1}} \langle v \rangle^{pq} |v - v_*|^\gamma b(\cos \theta) f^p(v) g(v_*) \\ &\quad \times \left[\left(1 - \frac{1}{p}\right) \mu^{-1} (\cos(\theta/2))^{-N-\gamma} + \frac{1}{p} \mu^{p-1} - 1 \right] d\sigma dv_* dv \\ &\quad + \int_{\mathbb{R}^{2N} \times \mathbb{S}^{N-1}} \frac{1}{p} \mu^{p-1} |v - v_*|^\gamma b(\cos \theta) f^p(v) g(v_*) \times [\langle v' \rangle^{pq} - \langle v \rangle^{pq}] dv dv_* d\sigma. \end{aligned}$$

We now take the optimal $\mu = \mu(\theta) > 0$. This amounts to consider

$$\mu(\theta) = (\cos(\theta/2))^{-\frac{N+\gamma}{p}}.$$

In this way, we get estimate (3.2.7). \square

Remark: With the same idea, one could easily obtain

$$\begin{aligned} \int_{\mathbb{R}^N} Q(g, f)(v) f^{p-1}(v) \langle v \rangle^{pq} dv &= \int_{\mathbb{R}^{2N} \times \mathbb{S}^{N-1}} \langle v \rangle^{pq} |v - v_*|^\gamma b(\cos \theta) f^p(v) g(v_*) \\ &\quad \times \left[\left(1 - \frac{1}{p}\right) \mu^{-1} (\cos(\theta/2))^{-N-\gamma} + \frac{1}{p} \mu^{p-1} (\cos(\theta/2))^{pq} - 1 \right] dv dv_* d\sigma \\ &\quad + \int_{\mathbb{R}^{2N} \times \mathbb{S}^{N-1}} \frac{1}{p} \mu^{p-1} |v - v_*|^\gamma b(\cos \theta) f^p(v) g(v_*) [\langle v' \rangle^{pq} - (\cos(\theta/2))^{pq} \langle v \rangle^{pq}] dv dv_* d\sigma, \end{aligned}$$

so that taking the optimal μ given by

$$\mu(\theta) = (\cos(\theta/2))^{-\frac{N+\gamma}{p}-q},$$

the following inequality holds:

$$\begin{aligned} \int_{\mathbb{R}^N} Q(g, f)(v) f^{p-1}(v) \langle v \rangle^{pq} dv &\leq \\ \int_{\mathbb{R}^{2N} \times \mathbb{S}^{N-1}} \langle v \rangle^{pq} |v - v_*|^\gamma b(\cos \theta) &\left[(\cos(\theta/2))^{q-\frac{N+\gamma}{p'}} - 1 \right] f^p(v) g(v_*) dv dv_* d\sigma \\ + \int_{\mathbb{R}^{2N} \times \mathbb{S}^{N-1}} \frac{1}{p} (\cos(\theta/2))^{-q(p-1)-\frac{N+\gamma}{p'}} &|v - v_*|^\gamma b(\cos \theta) \\ &[\langle v' \rangle^{pq} - (\cos(\theta/2))^{pq} \langle v \rangle^{pq}] f^p(v) g(v_*) dv dv_* d\sigma. \end{aligned}$$

If q is big enough, i.e. such that

$$(3.2.8) \quad q - \frac{N + \gamma}{p'} > 0,$$

the first term is strictly negative, and some estimates (in the same spirit as in Lemma 3.1 below) on the term $[\langle v' \rangle^{pq} - (\cos(\theta/2))^{pq} \langle v \rangle^{pq}]$ for small and large angles θ would yield *directly*

$$\begin{aligned} \int_{\mathbb{R}^N} Q(g, f)(v) f^{p-1}(v) \langle v \rangle^{pq} dv &\leq - C \int_{\mathbb{R}^N} g(v_*) dv_* \int_{\mathbb{R}^N} f^p(v) \langle v \rangle^{pq+\gamma} dv \\ &+ D \int_{\mathbb{R}^N} g(v_*) \langle v \rangle^{pq+\gamma} dv_* \int_{\mathbb{R}^N} f^p(v) dv \\ &+ D \int_{\mathbb{R}^N} g(v_*) \langle v \rangle^2 dv_* \int_{\mathbb{R}^N} f^p(v) \langle v \rangle^{pq} dv. \end{aligned}$$

We do not follow in the sequel this line of ideas because we don't want to assume (3.2.8). We rather choose to make a global splitting between the small and large angles θ .

We now deduce from Proposition 3.1 a corollary enabling to bound

$$\int_{\mathbb{R}^N} Q(g, f)(v) f^{p-1}(v) \langle v \rangle^{pq} dv$$

in terms of weighted L^1 and L^p norms of f and g . Note that this corollary is almost obvious to prove when the collision kernel is integrable (cutoff case).

Corollary 3.1. *Let B be a collision kernel satisfying assumptions (3.1.3), (3.1.4), (3.1.5). We consider f and g nonnegative and $q \in \mathbb{R}$. We suppose moreover that $pq \geq 2$ if $\nu \in (-2, -1]$ and $pq \geq 4$ if $\nu \in (-3, -2]$. Then,*

$$(3.2.9) \quad \int_{\mathbb{R}^N} Q(g, f)(v) f^{p-1}(v) \langle v \rangle^{pq} dv \leq C_{p,N,\gamma}(b) \|g\|_{L^1_{pq+\gamma}} \|f\|_{L^p_{q+\gamma/p}}^p$$

where

$$C_{p,N,\gamma}(b) = cst(p, N, \gamma) \left(\int_{\mathbb{S}^{N-1}} b(\cos \theta) (1 - \cos \theta) d\sigma \right),$$

and $cst(p, N, \gamma)$ is a computable constant depending on p , N and γ .

Remark: Since the non cutoff collision operator behaves roughly like some fractional Laplacian of order $-\nu/2$, one could wonder how such a functional inequality which does not contain derivatives of the functions f and g can hold. The answer is that the pre-post collisional change of variable and formula (3.2.6) (which play here the role played by integration by part for differential operators) allow to transfer the derivatives on the weight function $\langle v \rangle^{pq}$. This also explains why the restriction on the weight exponent q depends on the order ν of the angular singularity.

Proof of Corollary 3.1. Estimate (3.2.7) can be written

$$\int_{\mathbb{R}^N} Q(g, f)(v) f^{p-1}(v) \langle v \rangle^{pq} dv \leq I_1 + I_2 + I_3,$$

where

$$I_1 = \int_{\mathbb{R}^{2N} \times \mathbb{S}^{N-1}} |v - v_*|^\gamma b(\cos \theta) \left[(\cos(\theta/2))^{-\frac{N+\gamma}{p'}} - 1 \right] \langle v \rangle^{pq} f^p(v) g(v_*) dv dv_* d\sigma,$$

$$I_2 = \int_{\mathbb{R}^{2N} \times \mathbb{S}^{N-1}} \frac{1}{p} \left[(\cos(\theta/2))^{-\frac{N+\gamma}{p'}} - 1 \right] |v - v_*|^\gamma b(\cos \theta) [\langle v' \rangle^{pq} - \langle v \rangle^{pq}] f^p(v) g(v_*) dv dv_* d\sigma,$$

$$I_3 = \int_{\mathbb{R}^{2N} \times \mathbb{S}^{N-1}} \frac{1}{p} |v - v_*|^\gamma b(\cos \theta) [\langle v' \rangle^{pq} - \langle v \rangle^{pq}] f^p(v) g(v_*) d\sigma dv_* dv.$$

Then the two first terms are easily estimated thanks to the formula

$$\left[(\cos(\theta/2))^{-\frac{N+\gamma}{p'}} - 1 \right] \sim_{\theta \rightarrow 0} \frac{N+\gamma}{4p'} (1 - \cos \theta).$$

For the last one, we shall need the following lemma, which takes advantage of the symmetry properties of the collision operator:

Lemma 3.1. For all $\alpha \geq 1$,

$$(3.2.10) \quad \left| \int_{u \in \mathbb{S}^{N-2}} [\langle v' \rangle^{2\alpha} - \langle v \rangle^{2\alpha}] du \right| \leq C_\alpha (\sin \theta/2) \langle v \rangle^{2\alpha} \langle v_* \rangle^{2\alpha},$$

and for all $\alpha \geq 2$,

$$(3.2.11) \quad \left| \int_{u \in \mathbb{S}^{N-2}} [\langle v' \rangle^{2\alpha} - \langle v \rangle^{2\alpha}] du \right| \leq C_\alpha (\sin \theta/2)^2 \langle v \rangle^{2\alpha} \langle v_* \rangle^{2\alpha}.$$

Remark: This lemma is reminiscent of the symmetry properties used in the “cancellation lemma” in [4] and [3] in order to give sense to the Boltzmann collision operator for strong angular singularities (i.e. $\nu \in (-3, -2]$).

Proof of Lemma 3.1. We note that since

$$|v'|^2 = |v|^2 \cos^2 \theta/2 + |v_*|^2 \sin^2 \theta/2 + 2 \cos \theta/2 \sin \theta/2 |v - v_*| u \cdot v_*,$$

if one introduces (for $x \in [0, \sqrt{2}/2]$) the function

$$R_\alpha(x) = \int_{u \in \mathbb{S}^{N-2}} \left[\left(1 + |v|^2 (1 - x^2) + |v_*|^2 x^2 + 2x \sqrt{1 - x^2} |v - v_*| u \cdot v_* \right)^\alpha - (1 + |v|^2)^\alpha \right] du,$$

we get

$$\int_{u \in \mathbb{S}^{N-2}} [(1 + |v'|^2)^\alpha - (1 + |v|^2)^\alpha] du = R_\alpha(\sin \theta/2).$$

But thanks to the change of variables $u \rightarrow -u$, we see that R_α is even. Noticing also that $R_\alpha(0) = 0$, we have the identities

$$\begin{cases} R_\alpha(x) = x \int_0^1 R'_\alpha(sx) ds, \\ R_\alpha(x) = x^2 \int_0^1 (1-s) R''_\alpha(sx) ds. \end{cases}$$

We compute

$$\begin{aligned} R'_\alpha(x) &= \alpha \int_{u \in \mathbb{S}^{N-2}} \left(-2x |v|^2 + 2x |v_*|^2 + 2(1-x^2)^{1/2} |v - v_*| u \cdot v_* \right. \\ &\quad \left. - 2x^2 (1-x^2)^{-1/2} |v - v_*| u \cdot v_* \right) \\ &\quad \times \left(1 + |v|^2 (1-x^2) + |v_*|^2 x^2 + 2x \sqrt{1-x^2} |v - v_*| u \cdot v_* \right)^{\alpha-1} du \end{aligned}$$

and

$$\begin{aligned}
 R_\alpha''(x) &= \alpha(\alpha-1) \int_{u \in \mathbb{S}^{N-2}} \left(-2x|v|^2 + 2x|v_*|^2 + 2(1-x^2)^{1/2}|v-v_*|u \cdot v_* \right. \\
 &\quad \left. - 2x^2(1-x^2)^{-1/2}|v-v_*|u \cdot v_* \right)^2 \\
 &\quad \times \left(1 + |v|^2(1-x^2) + |v_*|^2x^2 + 2x\sqrt{1-x^2}|v-v_*|u \cdot v_* \right)^{\alpha-2} du \\
 &+ \alpha \int_{u \in \mathbb{S}^{N-2}} \left(-2|v|^2 + 2|v_*|^2 - 2x(1-x^2)^{-1/2} \right. \\
 &\quad \left. |v-v_*|u \cdot v_* - 2|v-v_*|u \cdot v_* (2x(1-x^2)^{-1/2} + x^3(1-x^2)^{-3/2}) \right) \\
 &\quad \times \left(1 + |v|^2(1-x^2) + |v_*|^2x^2 + 2x\sqrt{1-x^2}|v-v_*|u \cdot v_* \right)^{\alpha-1} du.
 \end{aligned}$$

Then, for $x \in [0, \sqrt{2}/2]$, if $\alpha \geq 1$, we get

$$|R_\alpha'(x)| \leq C_\alpha \langle v \rangle^{2\alpha} \langle v_* \rangle^{2\alpha},$$

and if $\alpha \geq 2$,

$$|R_\alpha''(x)| \leq C_\alpha \langle v \rangle^{2\alpha} \langle v_* \rangle^{2\alpha}.$$

This concludes the proof of Lemma 3.1. \square

Let us come back to the proof of Corollary 3.1. We have

$$I_3 = \int_{\mathbb{R}^{2N}} \int_0^\pi \frac{1}{p} |v-v_*|^\gamma b(\cos \theta) R_\alpha(\sin \theta/2) (\sin \theta)^{N-2} f^p(v) g(v_*) dv dv_* d\theta$$

for $\alpha = (pq)/2$. Lemma 3.1 and the equality

$$(\sin \theta/2)^2 = \frac{(1 - \cos \theta)}{2}$$

conclude the proof. \square

We now turn to an estimate which holds when the (angular part of the) collision kernel has its support in $[\theta_0, \pi/2]$ for some $\theta_0 \in (0, \pi/2]$. As we shall see later on, this term is the “dominant part” of the same quantity when the (angular part of the) collision kernel has its support in $[0, \pi/2]$.

Proposition 3.2. *Let B be a collision kernel satisfying assumptions (3.1.3), (3.1.4), (3.1.5). We suppose moreover that b has its support in $[\theta_0, \pi/2]$ for*

some $\theta_0 \in (0, \pi/2]$. Then, for all $p > 1$, $q \geq 0$ and f nonnegative with bounded L^1_{pq+2} norm, we have

$$(3.2.12) \quad \int_{\mathbb{R}^N} Q(f, f)(v) f^{p-1}(v) \langle v \rangle^{pq} dv \leq C^+(b) \|f\|_{L^p_q}^p - K^-(b) \|f\|_{L^{p_{q+\gamma/p}}_q}^p$$

with

$$C^+(b) = C^+ \left(\int_{\mathbb{S}^{N-1}} b d\sigma \right), \quad K^-(b) = K^- \left(\int_{\mathbb{S}^{N-1}} b d\sigma \right),$$

where C^+ , K^- are strictly positive constants. Both depend on an upper bound on $\|f\|_{L^1_{pq+2}}$ and on a lower bound on $\|f\|_{L^1}$; C^+ also depends on θ_0 .

Remark: This estimate could be deduced from the results of [150], but we shall give here an elementary self-contained proof, in the same spirit as that of the proof of Proposition 3.1.

Proof of Proposition 3.2. Let us write the quantity to be estimated

$$\begin{aligned} \int_{\mathbb{R}^N} Q(f, f)(v) f^{p-1}(v) \langle v \rangle^{pq} dv &\leq \int_{\mathbb{R}^N} Q^+(f, f)(v) f^{p-1}(v) \langle v \rangle^{pq} dv \\ &\quad - \int_{\mathbb{R}^N} Q^-(f, f)(v) f^{p-1}(v) \langle v \rangle^{pq} dv, \end{aligned}$$

splitting as usual the operator between its gain and loss parts (remember that the small angles have been cutoff). On one hand, using $|v - v_*|^\gamma \geq [\langle v \rangle^\gamma - \text{cst} \langle v_* \rangle^\gamma]$ we get

$$\begin{aligned} - \int_{\mathbb{R}^N} Q^-(f, f)(v) f^{p-1}(v) \langle v \rangle^{pq} dv \\ \leq -K_0 \|b\|_{L^1(\mathbb{S}^{N-1})} \|f\|_{L^{p_{q+\gamma/p}}_q}^p + C_0 \|b\|_{L^1(\mathbb{S}^{N-1})} \|f\|_{L^p_q}^p \end{aligned}$$

for some constant $K_0 > 0$ depending on a lower bound on $\|f\|_{L^1}$ and $C_0 > 0$ depending on an upper bound on the $\|f\|_{L^1}$. On the other hand,

$$\int_{\mathbb{R}^N} Q^+(f, f)(v) f^{p-1}(v) \langle v \rangle^{pq} dv = \int_{\mathbb{R}^{2N} \times \mathbb{S}^{N-1}} f'_* f' f^{p-1} \langle v \rangle^{pq} B dv dv_* d\sigma$$

can be split into

$$\begin{cases} I_1 = \int_{\mathbb{R}^{2N} \times \mathbb{S}^{N-1}} f'_* (f j_r)' f^{p-1} \langle v \rangle^{pq} B dv dv_* d\sigma, \\ I_2 = \int_{\mathbb{R}^{2N} \times \mathbb{S}^{N-1}} f'_* (f j_{r^c})' f^{p-1} \langle v \rangle^{pq} B dv dv_* d\sigma, \end{cases}$$

with $j_r(v) = 1_{|v| \leq r}$ and $j_{r^c} = 1 - j_r$. This means that we treat separately large and small velocities. Then

$$\begin{aligned}
 I_1 &= \int_{\mathbb{R}^{2N} \times \mathbb{S}^{N-1}} f_* (f j_r) (f')^{p-1} \langle v' \rangle^{pq} B \, dv \, dv_* \, d\sigma \\
 &\leq \int_{\mathbb{R}^{2N} \times \mathbb{S}^{N-1}} f_* \left[\left(1 - \frac{1}{p}\right) \mu_1^{-1} f^p(v') \right. \\
 &\quad \left. + \frac{1}{p} \mu_1^{p-1} (f j_r)^p(v) \right] \langle v' \rangle^{pq} B \, dv \, dv_* \, d\sigma \\
 &\leq \|b\|_{L^1(\mathbb{S}^{N-1})} \left[\left(1 - \frac{1}{p}\right) \mu_1^{-1} (\cos \pi/4)^{-N-\gamma} \|f\|_{L^\gamma} \|f\|_{L_{q+\gamma/p}^p}^p \right. \\
 &\quad \left. + \frac{1}{p} \mu_1^{p-1} \|f\|_{L_{pq+\gamma}^1} \|f j_r\|_{L_{q+\gamma/p}^p}^p \right],
 \end{aligned}$$

and thus

$$\begin{aligned}
 (3.2.13) \quad I_1 &\leq \|b\|_{L^1(\mathbb{S}^{N-1})} \left[\left(1 - \frac{1}{p}\right) \mu_1^{-1} (\cos \pi/4)^{-N-\gamma} \|f\|_{L^\gamma} \|f\|_{L_{q+\gamma/p}^p}^p \right. \\
 &\quad \left. + \frac{1}{p} \mu_1^{p-1} r^\gamma \|f\|_{L_{pq+\gamma}^1} \|f\|_{L_q^p}^p \right].
 \end{aligned}$$

As for I_2 , we get

$$I_2 = \int_{\mathbb{R}^{2N} \times \mathbb{S}^{N-1}} f' (f j_{r^c})'_* f^{p-1} \langle v \rangle^{pq} \tilde{B} \, dv \, dv_* \, d\sigma$$

thanks to the change of variable $\sigma \rightarrow -\sigma$. Now \tilde{B} has compact support in $[\pi/2, \pi - \theta_0]$. And as

$$\begin{aligned}
 I_2 &= \int_{\mathbb{R}^{2N} \times \mathbb{S}^{N-1}} (f j_{r^c})_* f (f')^{p-1} \langle v' \rangle^{pq} \tilde{B} \, dv \, dv_* \, d\sigma \\
 &\leq \int_{\mathbb{R}^{2N} \times \mathbb{S}^{N-1}} (f j_{r^c})_* \left[\left(1 - \frac{1}{p}\right) \mu_2^{-1} f^p(v') \right. \\
 &\quad \left. + \frac{1}{p} \mu_2^{p-1} f^p(v) \right] \langle v' \rangle^{pq} \tilde{B} \, dv \, dv_* \, d\sigma
 \end{aligned}$$

we deduce

$$I_2 \leq \|b\|_{L^1(\mathbb{S}^{N-1})} \left[\left(1 - \frac{1}{p}\right) \mu_2^{-1} (\sin \theta_0/2)^{-N-\gamma} \|f j_{r^c}\|_{L^1_\gamma} \|f\|_{L^p_{q+\gamma/p}}^p + \frac{1}{p} \mu_2^{p-1} \|f j_{r^c}\|_{L^1_{pq+\gamma}} \|f\|_{L^p_{q+\gamma/p}}^p \right]$$

by using again formula (3.2.6). Hence

$$(3.2.14) \quad \begin{aligned} I_2 &\leq \|b\|_{L^1(\mathbb{S}^{N-1})} \\ &\times \left[\left(1 - \frac{1}{p}\right) \mu_2^{-1} (\sin \theta_0/2)^{-N-\gamma} (1+r^2)^{(\gamma-2)/2} \|f\|_{L^1_2} \|f\|_{L^p_{q+\gamma/p}}^p + \frac{1}{p} \mu_2^{p-1} \|f\|_{L^1_{pq+\gamma}} \|f\|_{L^p_{q+\gamma/p}}^p \right]. \end{aligned}$$

Gathering (3.2.13) and (3.2.14), we obtain for the gain part

$$\begin{aligned} &\int_{\mathbb{R}^N} Q^+(f, f)(v) f^{p-1}(v) \langle v \rangle^{pq} dv \leq \\ &\|b\|_{L^1(\mathbb{S}^{N-1})} \left[\frac{1}{p} \mu_1^{p-1} (1+r^2)^{\gamma/2} \|f\|_{L^1_{pq+\gamma}} \|f\|_{L^p_q}^p + \|b\|_{L^1(\mathbb{S}^{N-1})} \left[\left(1 - \frac{1}{p}\right) \mu_1^{-1} (\cos \pi/4)^{-N-\gamma} + \left(1 - \frac{1}{p}\right) \mu_2^{-1} (\sin \theta_0/2)^{-N-\gamma} (1+r^2)^{(\gamma-2)/2} + \frac{1}{p} \mu_2^{p-1} \right] \|f\|_{L^1_{pq+\gamma}} \|f\|_{L^p_{q+\gamma/p}}^p \right]. \end{aligned}$$

For some $\theta_0 > 0$ fixed, one can first choose μ_2 small enough, then r big enough (remember that $\gamma - 2 < 0$), then μ_1 big enough, in such a way that

$$\|f\|_{L^1_{pq+\gamma}} \left[\left(1 - \frac{1}{p}\right) \mu_1^{-1} (\cos \pi/4)^{-N-\gamma} + \left(1 - \frac{1}{p}\right) \mu_2^{-1} (\sin \theta_0/2)^{-N-\gamma} r^{\gamma-2} + \frac{1}{p} \mu_2^{p-1} \right] \leq \frac{K_0}{2}.$$

We thus get the wanted estimate by combining the estimates for the gain part and the loss part. \square

We now can gather Corollary 3.1 with Proposition 3.2 in order to get the

Proposition 3.3. *Let B be a collision kernel satisfying assumptions (3.1.3), (3.1.4), (3.1.5), p belong to $(1, +\infty)$, and $q \geq 0$. We suppose moreover that $pq \geq 2$ if $\nu \in (-2, -1]$ and $pq \geq 4$ if $\nu \in (-3, -2]$. Then, for f nonnegative with bounded L^1_{pq+2} norm, we have*

$$(3.2.15) \quad \int_{\mathbb{R}^N} Q(f, f)(v) f^{p-1}(v) \langle v \rangle^{pq} dv \leq C^+ \|f\|_{L^p_q}^p - K^- \|f\|_{L^{p_{q+\gamma/p}}}^p$$

for some positive constants C^+ and K^- , depending on an upper bound on $\|f\|_{L^1_{pq+2}}$ and on a lower bound on $\|f\|_{L^1}$.

Proof of Proposition 3.3. The proof is straightforward and based on a splitting of b of the form

$$(3.2.16) \quad b = b_c^{\theta_0} + b_r^{\theta_0},$$

where $b_c^{\theta_0} = b 1_{\theta \in [\theta_0, \pi/2]}$ stands for the ‘‘cutoff’’ part, $b_r^{\theta_0} = 1 - b_c^{\theta_0}$ for the remaining part, and $\theta_0 \in (0, \pi/2]$ is some fixed positive angle. We split the corresponding collision operator as $Q = Q_c + Q_r$. It remains then to apply Corollary 3.1 to

$$\int_{\mathbb{R}^N} Q_r(f, f)(v) f^{p-1}(v) \langle v \rangle^{pq} dv$$

and Proposition 3.2 to

$$\int_{\mathbb{R}^N} Q_c(f, f)(v) f^{p-1}(v) \langle v \rangle^{pq} dv.$$

Observing that

$$\int_{\mathbb{S}^{N-1}} b_r^{\theta_0}(\cos \theta) (1 - \cos \theta) d\sigma \rightarrow_{\theta_0 \rightarrow 0} 0,$$

we see that the term corresponding to Q_r can be absorbed by the damping (nonpositive) part of Q_c , for θ_0 small enough. \square

3.3 Application to the flow of the equation

In this section, we denote by K any strictly positive constant which can be replaced by a smaller strictly positive constant, and by C any constant which can be replaced by a larger constant. We precise the dependance with respect to time when this is useful.

We now prove Theorem 3.1 without trying to get bounds which are uniform when $t \rightarrow +\infty$. We notice that a solution $f(t, \cdot)$ at time $t \geq 0$ of the Boltzmann equation (given by the results of [6], [7] and [186]) satisfies:

$$\frac{d}{dt} \int_{\mathbb{R}^N} f^p(v) \langle v \rangle^{pq} dv = p \int_{\mathbb{R}^N} Q(f, f)(v) f^{p-1}(v) \langle v \rangle^{pq} dv.$$

We also recall that (under our assumptions on the initial datum), such a solution $f(t, \cdot)$ has a constant mass $\|f(t, \cdot)\|_{L^1}$. The L_q^p integrability of the initial datum f_0 implies that this initial datum has bounded entropy, then the H -Theorem ensures that the entropy remains uniformly bounded for all times (by the initial entropy). Also its moment of order $2 + pq$ in L^1 is propagated and remains uniformly bounded for all times with explicit constant (see for instance [200]).

Then Proposition 3.3 gives the following a priori differential inequality:

$$(3.3.17) \quad \frac{d}{dt} \|f\|_{L_q^p}^p \leq C \|f\|_{L_q^p}^p - K \|f\|_{L_{q+\gamma/p}^p}^p.$$

In particular,

$$(3.3.18) \quad \frac{d}{dt} \|f\|_{L_q^p}^p \leq C \|f\|_{L_q^p}^p.$$

According to Gronwall's lemma, the norm $\|f\|_{L_q^p}$ remains bounded (on all intervals $[0, T]$ for $T > 0$) if it is initially finite.

Let us now turn to the question of appearance of higher moments in L^p (when $\gamma > 0$). Let $r > 0$. Using Hölder's inequality, we see that

$$\|f\|_{L_r^p} \leq \|f\|_{L_{q_1}^p}^\theta \|f\|_{L_{q_2}^p}^{1-\theta}$$

with $r = \theta q_1 + (1 - \theta) q_2$. Thus with $q_2 = 0$ and $q_1 = r + \gamma/p$, we get

$$\|f\|_{L_r^p} \leq \|f\|_{L_{r+\gamma/p}^p}^{\frac{r}{r+\gamma/p}} \|f\|_{L^p}^{\frac{\gamma/p}{r+\gamma/p}}$$

Therefore,

$$\|f\|_{L_{r+\gamma/p}^p} \geq K_T \|f\|_{L_r^p}^{1+\frac{\gamma}{pr}},$$

where $K_T = (\sup_{t \in [0, T]} \|f\|_{L^p}(t))^{-\frac{\gamma}{r q}}$. But this last quantity is finite (thanks to estimate (3.3.18)). We thus obtain the following a priori differential inequality on $\|f\|_{L_r^p}^p$:

$$\frac{d}{dt} \|f\|_{L_r^p}^p \leq -K_T (\|f\|_{L_r^p}^p)^{1+\frac{\gamma}{pr}} + C \|f\|_{L_r^p}^p$$

Using a standard argument (first used by Nash for parabolic equations) of comparison with the Bernoulli differential equation

$$y' = -K_T y^{1+\frac{\gamma}{pr}} + C y,$$

whose solutions can be computed explicitly, we see that for all $0 < t \leq T$,

$$\|f\|_{L_r^p}(t) < +\infty,$$

more precisely

$$(3.3.19) \quad \|f\|_{L_r^p}(t) \leq \left[\frac{C}{K_T \left(1 - e^{-\frac{C\gamma}{pr}t}\right)} \right]^{r/\gamma}.$$

This concludes the proof of Theorem 3.1 for local in times bounds. It remains to study more accurately the behavior of these bounds when t goes to infinity.

Remarks:

1. Notice that the upper bound (3.3.19) cannot be optimal since for example if $\|f_0\|_{L_q^p} < +\infty$ then $\|f\|_{L_q^p} < +\infty$ uniformly on $[0, T]$ by the argument above, and the a priori differential inequality (3.3.17) implies that the quantity $\|f\|_{L_{q+\gamma/p}^p}^p$ is integrable at $t \sim 0^+$, which is not necessarily the case of the right-hand side term in (3.3.19).

2. Note that in the previous computation, one should use approximate solutions of the Boltzmann equation in order to give a completely rigorous proof. For example, solutions of the equation

$$\begin{cases} \frac{\partial f_\varepsilon}{\partial t} = Q(f_\varepsilon, f_\varepsilon) + \varepsilon \Delta_v f_\varepsilon, \\ f_\varepsilon(0, \cdot) = f_{in} * \phi_\varepsilon, \end{cases}$$

where ϕ_ε is a sequence of mollifiers, can be used. This point does not lead to any difficulties.

3. It is also possible to get a slightly less stringent condition on the L^1 moments of the initial data f_0 by using the appearance of the L^1 moments of f (in the case $\gamma > 0$).

3.4 Behavior for large times

The goal of this section is to conclude the proof of Theorem 3.1 by showing that the bounds on the L^p moments are uniform when $t \rightarrow +\infty$.

Our starting point is a stronger result than Proposition 3.2, which is a particular case of a result proven in [150] (where the result holds for every collision kernel which satisfies angular integrability), and is based on the regularity property of the gain term of the cutoff collision kernel¹. This result writes:

Proposition 3.4 (cf. [150], Theorem 4.1). *Let B be a collision kernel satisfying assumptions (3.1.3), (3.1.4), (3.1.5). We suppose moreover that b has its support in $[\theta_0, \pi/2]$. Then, for all $p > 1$, $q \geq 0$ and f nonnegative with bounded entropy and L^1_{2q+2} norm, we have*

$$(3.4.20) \quad \int_{\mathbb{R}^N} Q(f, f)(v) f^{p-1}(v) \langle v \rangle^{pq} dv \leq C^+(b) \|f\|_{L^p_q}^{p(1-\varepsilon)} - K^-(b) \|f\|_{L^{q+\gamma/p}}^p$$

with

$$C^+(b) = C^+ \left(\int_{\mathbb{S}^{N-1}} b d\sigma \right), \quad K^-(b) = K^- \left(\int_{\mathbb{S}^{N-1}} b d\sigma \right),$$

and C^+ , K^- are positive constants. Both depend on an upper bound on the entropy and the L^1_{2q+2} norm of f and a lower bound on $\|f\|_{L^1}$; C^+ also depends on θ_0 . Finally $\varepsilon \in (0, 1)$ is a constant depending only on the dimension N and p .

Gathering now Corollary 3.1 with Proposition 3.4, we get the

Proposition 3.5. *Let B be a collision kernel satisfying assumptions (3.1.3), (3.1.4), (3.1.5), p belong to $(1, +\infty)$ and $q \geq 0$. We suppose moreover that $pq \geq 2$ if $\nu \in (-2, -1]$ and $pq \geq 4$ if $\nu \in (-3, -2]$. Then, for f nonnegative with bounded entropy and $L^1_{\max\{pq, 2q\}+2}$ norm, we have*

$$(3.4.21) \quad \int_{\mathbb{R}^N} Q(f, f)(v) f^{p-1}(v) \langle v \rangle^{pq} dv \leq C^+ \|f\|_{L^p_q}^{p(1-\varepsilon)} - K^- \|f\|_{L^{q+\gamma/p}}^p$$

for some positive constants C^+ and K^- depending on an upper bound on $\|f\|_{L^1_{\max\{pq, 2q\}+2}}$, an upper bound on the entropy and a lower bound on $\|f\|_{L^1}$. Finally $\varepsilon \in (0, 1)$ is a constant depending only on the dimension N and p .

¹This result corresponds to Theorem 2.7 of Chapter 2 of this PhD.

Proof of Proposition 3.5. The proof is exactly the same as that of Proposition 3.3. It is based on the splitting

$$b = b_c^{\theta_0} + b_r^{\theta_0}$$

and the use of Corollary 3.1 for

$$\int_{\mathbb{R}^N} Q_r(f, f)(v) f^{p-1}(v) \langle v \rangle^{pq} dv$$

and Proposition 3.4 for

$$\int_{\mathbb{R}^N} Q_c(f, f)(v) f^{p-1}(v) \langle v \rangle^{pq} dv.$$

□

We now can prove that the bound on the L^p moments is uniform for large times. Indeed, Proposition 3.5 leads to the following a priori differential inequality on $y(t) = \|f(t, \cdot)\|_{L^p}^p$:

$$y' \leq C y^{1-\varepsilon} - K y.$$

Then, by a maximum principle, we see that $y(t)$ is bounded on $[\tau, +\infty[$ as soon as it is finite at time τ . The explicit estimate is:

$$\forall t \geq \tau, \quad y(t) \leq \max \left\{ y(\tau); \left(\frac{C}{K} \right)^{1/\varepsilon} \right\}.$$

Acknowledgment. Support by the European network HYKE, funded by the EC as contract HPRN-CT-2002-00282, is acknowledged.

Quantitative lower bounds for the full Boltzmann equation in the torus

Article [146], à paraître dans *Communications in Partial Differential Equations*.

ABSTRACT: *We prove the appearance of an explicit lower bound on the solution to the full Boltzmann equation in the torus for a broad family of collision kernels including in particular long-range interaction models, under the assumption of some uniform bounds on some hydrodynamic quantities. This lower bound is independent of time and space. When the collision kernel satisfies Grad's cutoff assumption, the lower bound is a global Maxwellian and its asymptotic behavior in velocity is optimal, whereas for non-cutoff collision kernels the lower bound we obtain decreases exponentially but faster than the Maxwellian. Our results cover solutions constructed in a spatially homogeneous setting, as well as small-time or close-to-equilibrium solutions to the full Boltzmann equation in the torus. The constants are explicit and depend on the a priori bounds on the solution.*

Contents

4.1	Introduction	167
4.1.1	Motivation	167
4.1.2	Statement of the results	171
4.1.3	Methods of proof	175
4.1.4	Notation	176
4.2	Functional toolbox	177
4.2.1	The cutoff case	177
4.2.2	The non-cutoff case	184
4.3	Proof of the lower bound in the cutoff case	187
4.4	Proof of the lower bound in the non-cutoff case	194
4.5	Application to the existing Cauchy theories	203

4.1 Introduction

This paper is devoted to the study of qualitative properties of the solutions to the full Boltzmann equation in the torus for a broad family of collision kernels. In this work we shall quantify the positivity of the solution by proving the “immediate” appearance of a stationary lower bound, uniform in space. Before we explain our results and methods in more details let us introduce the problem in a precise way.

4.1.1 Motivation

The *Boltzmann equation* describes the behavior of a dilute gas; when we assume periodic boundary conditions in space, it reads

$$\frac{\partial f}{\partial t} + v \cdot \nabla_x f = Q(f, f), \quad x \in \mathbb{T}^N, \quad v \in \mathbb{R}^N, \quad t \in [0, T],$$

where $T \in (0, +\infty]$, \mathbb{T}^N is the N -dimensional torus, the unknown $f = f(t, x, v)$ is a time-dependent probability density on $\mathbb{T}_x^N \times \mathbb{R}_v^N$ ($N \geq 2$), and Q is the quadratic *Boltzmann collision operator*. It is local in t and x and we define it by the bilinear form

$$Q(g, f) = \int_{\mathbb{R}^N \times \mathbb{S}^{N-1}} B(|v - v_*|, \cos \theta) (g'_* f' - g_* f) dv_* d\sigma.$$

Here we have used the shorthands $f' = f(v')$, $g_* = g(v_*)$ and $g'_* = g(v'_*)$, where

$$\begin{cases} v' = \frac{v + v_*}{2} + \frac{|v - v_*|}{2} \sigma, \\ v'_* = \frac{v + v_*}{2} - \frac{|v - v_*|}{2} \sigma \end{cases}$$

stand for the pre-collisional velocities of particles which after collision have velocities v and v_* . Moreover $\theta \in [0, \pi]$ is the *deviation angle* between $v' - v'_*$ and $v - v_*$, and B is the Boltzmann *collision kernel* (related to the cross-section $\Sigma(v - v_*, \sigma)$ by the formula $B = \Sigma|v - v_*|$), determined by physics. On physical grounds, it is assumed that $B \geq 0$ and that B is a function of $|v - v_*|$ and $\cos \theta = (\sigma \cdot (v - v_*))/|v - v_*|$.

In this paper we shall be concerned with the case when

- B takes the following product form

$$(4.1.1) \quad B(|v - v_*|, \cos \theta) = \Phi(|v - v_*|) b(\cos \theta),$$

- where Φ satisfies either the assumption

$$(4.1.2) \quad \forall z \in \mathbb{R}, \quad c_\Phi |z|^\gamma \leq \Phi(z) \leq C_\Phi |z|^\gamma$$

or the mollified assumption

$$(4.1.3) \quad \begin{cases} \forall |z| \geq 1, & c_\Phi |z|^\gamma \leq \Phi(z) \leq C_\Phi |z|^\gamma \\ \forall |z| \leq 1, & c_\Phi \leq \Phi(z) \leq C_\Phi \end{cases}$$

with $c_\Phi, C_\Phi > 0$ and $\gamma \in (-N, 1]$,

- and b is a continuous function on $\theta \in (0, \pi]$, strictly positive on $\theta \in (0, \pi)$, such that

$$(4.1.4) \quad b(\cos \theta) \sin^{N-2} \theta \sim_{\theta \rightarrow 0^+} b_0 \theta^{-1-\nu}$$

for some $b_0 > 0$ and $\nu \in (-\infty, 2)$.

The assumption (4.1.1) that B takes a tensorial form is made for the sake of convenience, since it is a well-accepted hypothesis which covers important physical cases. Most probably it could be relaxed to non-tensorial collision kernels with the same kind of controls, up to some technical refinements. The assumption that b is strictly positive on $\theta \in (0, \pi)$ is a technical requirement for Lemma 4.2 and Lemma 4.3 in Section 4.2 and it could be relaxed to the requirement that b is strictly positive near $\theta \sim \pi/2$.

Following the usual taxonomy we shall denote by “hard potentials” collision kernels the case when $\gamma > 0$, “Maxwellian” collision kernels the case when $\gamma = 0$, and “soft potentials” collision kernels the case when $\gamma < 0$. When Φ satisfies assumption (4.1.3) and not (4.1.2) we shall speak of “mollified soft potentials” collision kernels or “mollified hard potentials” collision kernels. In the case when $\nu < 0$, the angular collision kernel is locally integrable, an assumption which is usually referred to as *Grad’s cutoff assumption* (see [108]). Thus for $\nu < 0$ we shall speak of “cutoff” collision kernels, and for $\nu \geq 0$ we shall speak of “non-cutoff” collision kernels.

The main cases of application are “hard spheres” interaction (b constant and $\Phi(z) = |z|$ which corresponds to the case $\gamma = 1$ and $\nu = -1$), and interactions deriving from a $1/r^s$ force ($s > 2$), where r is the distance between particles, which corresponds to $\gamma = (s-5)/(s-1)$ and $\nu = 2/(s-1)$ in dimension 3.

In the case when the solution $f(t, v)$ does not depend on the space variable x , we shall speak of a *spatially homogeneous solution*.

The attempts to quantify the strict positivity of the solution to the Boltzmann equation are as old as the mathematical theory of the Boltzmann

equation, since Carleman himself established such estimates in his pioneering paper [44]. He showed, for hard potentials with cutoff in dimension 3, that the spatially homogeneous solutions radially symmetric in v he had constructed in $L_6^\infty(\mathbb{R}_v^N)^1$ (the very first result in the Cauchy theory) satisfy a lower bound of the form

$$\forall t \geq t_0 > 0, \forall v \in \mathbb{R}^3 \quad f(t, v) \geq C_1 e^{-C_2 |v|^{2+\varepsilon}},$$

for any fixed $t_0 > 0$ and $\varepsilon > 0$. The constants $C_1, C_2 > 0$ are uniform as $t \rightarrow +\infty$ and depend on t_0, ε and some estimates on the solution. The proof was based on a “spreading property” of the collision operator and the assumption that the initial datum is uniformly bounded from below by a positive quantity on a ball centered at the origin (in fact the weaker assumption of a lower bound on an annulus is sufficient, see [44]).

This result remained unchallenged until the paper from Pulvirenti and Wennberg [169]. They proved, for hard potentials with cutoff in dimension 3, that the spatially homogeneous solutions in $L_2^1(\mathbb{R}_v^N) \cap L \log L(\mathbb{R}_v^N)^2$ with bounded entropy (see [6] and [144]) satisfy a lower bound of the form

$$\forall t \geq t_0 > 0, \forall v \in \mathbb{R}^3 \quad f(t, v) \geq C_1 e^{-C_2 |v|^2},$$

for any fixed $t_0 > 0$. Again $C_1, C_2 > 0$ are uniform as $t \rightarrow +\infty$ and depend on t_0 and some estimates on the solution. Their proof was also based on the spreading property of the collision operator but the optimal decay of the lower bound was obtained by some improvements of the computations. Moreover they made a clever use of the iterated gain part of the collision kernel in order to establish the immediate appearance of a positive minoration of the solution on a ball, thus getting rid of the assumption of Carleman on the initial datum. This paper is the starting point of our study.

Two other methods should be mentioned.

On one hand, Fournier [92, 94] established by delicate probabilistic techniques that the spatially homogeneous solutions to the Kac equation without cutoff satisfy $f(t, v) \in C^\infty((0, +\infty) \times \mathbb{R}^N)$ and

$$\forall t > 0, \forall v \in \mathbb{R}^N, \quad f(t, v) > 0.$$

He proved the same kind of result in [93] for the spatially homogeneous Boltzmann equation without cutoff in dimension 2 under technical restrictions.

On the other hand there is a work in progress by Villani in order to establish lower bounds on the solution to the Boltzmann equation using suitable

¹see Subsection 4.1.4 for the notations

²id.

maximum principles. The most important feature of this new method is that it applies to the non-cutoff case. For more explanations we refer to [191, Chapter 2, Section 6]. This method has been able to recover more simply the results by Fournier, and a quantitative lower bound is in progress. We also refer to the work [99] which proves with the same tools the propagation of upper Maxwellian bounds for the spatially homogeneous solutions to the Boltzmann equation for hard spheres.

Finally we note that in the case of the spatially homogeneous Landau equation with Maxwellian or hard potentials interactions, one can prove a theorem similar to that of Pulvirenti and Wennberg by means of the standard maximum principle for parabolic equations, see [71]. Actually the result stated in this paper is not uniform as $t \rightarrow +\infty$, but it can be made uniform by the same argument as in the proof of Theorem 4.1 in Section 4.3 below.

The study of lower bounds is of interest in itself, in order to understand the qualitative behaviour of solutions to the Boltzmann equation. Moreover recently this interest has been renewed by the emergence of a new quantitative method in the study of convergence to equilibrium, the so-called “entropy-entropy production” method (see [181, 182, 72, 192]). This method requires indeed a control from below on the solution by a function decreasing at most exponentially, and uniform in time. It has been applied lately to some inhomogeneous kinetic equations: see [73] for the Fokker-Planck equation and [70] for the full Boltzmann equation. For instance the main result in [70] asserts that any solution of the Boltzmann equation satisfying uniform estimates of smoothness and fast decay at large velocities, combined with a lower bound like

$$(4.1.5) \quad \forall t \geq t_0 > 0, \forall x \in \mathbb{T}^N, \forall v \in \mathbb{R}^N, \quad f(t, x, v) \geq C_1 e^{-C_2 |v|^K}$$

for some $C_1, C_2, K \geq 0$ does converge to equilibrium at rate “almost exponential”, i.e. faster than any inverse power of t . This paper works in some *a priori* setting on the solution, since there is no general Cauchy theory whose solutions satisfies suitable estimates to apply the “entropy-entropy production” method. Nevertheless a natural question is whether the set of solution satisfying the *a priori* assumptions of [70] is not trivial, i.e. reduced to the spatially homogeneous case or to cases for which exponential convergence results are already known. Our study answers to this question, since the solutions [110] satisfy all the estimates of regularity and decay needed in [70], and a consequence of Theorem 4.1 below is that they also satisfy (4.1.5) (with $K = 2$).

4.1.2 Statement of the results

Now let us introduce the functional spaces and the macroscopic quantities on the solution. We define bounds uniform in space on the observables of the solutions. We shall study precisely in Section 4.5 in which case there is a Cauchy theory which fits these assumptions. One can say briefly that they are satisfied at least for hard spheres and inverse power laws interactions, either in the spatially homogeneous setting, or in the spatially inhomogeneous setting for solutions for small time or near the equilibrium.

Let us consider a function $f(t, x, v) \geq 0$ on $[0, T) \times \mathbb{T}^N \times \mathbb{R}^N$. We define its **local density**

$$\rho_f(t, x) := \int_{\mathbb{R}^N} f(t, x, v) dv,$$

its **local energy**

$$e_f(t, x) := \int_{\mathbb{R}^N} f(t, x, v) |v|^2 dv,$$

its **weighted local energy**

$$e'_f(t, x) := \int_{\mathbb{R}^N} f(t, x, v) |v|^{\tilde{\gamma}} dv$$

(where $\tilde{\gamma}$ is the positive part of $(2 + \gamma)$), its **local entropy**

$$h_f(t, x) := - \int_{\mathbb{R}^N} f(t, x, v) \log f(t, x, v) dv,$$

its **local L^p norm** ($p \in [1, +\infty)$)

$$l_f^p(t, x) := \|f(t, x, \cdot)\|_{L^p(\mathbb{R}^N)},$$

and its **local $W^{2,\infty}$ norm**³

$$w_f(t, x) := \|f(t, x, \cdot)\|_{W^{2,\infty}(\mathbb{R}^N)}.$$

Note that in the sequel we shall systematically speak of hydrodynamical quantities on the solution in a generalized sense, since we include in this term the quantities e'_f , h_f , l_f^p and w_f .

Then we define the following uniform bounds

³see Subsection 4.1.4 for the notations

$$\left\{ \begin{array}{ll} \varrho_f := \inf_{(t,x) \in [0,T] \times \mathbb{T}^N} \rho_f(t,x), & E_f := \sup_{(t,x) \in [0,T] \times \mathbb{T}^N} (e_f(t,x) + \rho_f(t,x)), \\ E'_f := \sup_{(t,x) \in [0,T] \times \mathbb{T}^N} e'_f(t,x), & H_f := \sup_{(t,x) \in [0,T] \times \mathbb{T}^N} |h_f(t,x)|, \\ L_f^p := \sup_{(t,x) \in [0,T] \times \mathbb{T}^N} l_f^p(t,x), & W_f := \sup_{(t,x) \in [0,T] \times \mathbb{T}^N} w_f(t,x). \end{array} \right.$$

Remark: In the spatially homogeneous setting all these quantities are independent of the space variable x and the uniformity in time is in most cases, well-known or obvious (see Section 4.5).

Our assumptions on the solution are as follows:

- When $\gamma \geq 0$ and $\nu < 0$ (hard or Maxwellian potentials with cutoff) we shall assume that

$$(4.1.6) \quad \varrho_f > 0, \quad E_f < +\infty, \quad H_f < +\infty.$$

- When $\gamma \in (-N, 0)$ (singularity of the kinetic collision kernel) we shall make the additional assumption that

$$(4.1.7) \quad L_f^{p_\gamma} < +\infty$$

with $p_\gamma > \frac{N}{N+\gamma}$ (notice that this uniform bound on $L_f^{p_\gamma}$ implies the one on the local entropy).

- When $\nu \in [0, 2)$ (singularity of the angular collision kernel) we shall make the additional assumption that

$$(4.1.8) \quad W_f < +\infty, \quad E'_f < +\infty$$

(remark that when $\gamma \leq 0$, we have $E'_f \leq E_f$ and the second part of this assumption is not necessary).

Remark: Although the regularity part of the last assumption (4.1.8) seems quite stronger compared to the other ones, the regularizing property of the non-cutoff collision operator often ensures that it holds, at least in some cases (see Section 4.5), and thus makes it rather natural.

We now state our main theorems. The first one deals with cutoff collision kernels. In this theorem a mild solution to the Boltzmann equation with initial datum f_0 is a function f which satisfies (4.3.16) pointwise (see Definition 4.1 below).

Theorem 4.1. *Let $B = \Phi b$ be a collision kernel which satisfies (4.1.1), with Φ satisfying (4.1.2) or (4.1.3), and b satisfying (4.1.4) with $\nu < 0$. Let $f(t, x, v)$ be a mild solution of the full Boltzmann equation in the torus on some time interval $[0, T)$, $T \in (0, +\infty]$ such that*

- (i) *if Φ satisfies (4.1.2) with $\gamma \geq 0$ or if Φ satisfies (4.1.3), then f satisfies (4.1.6);*
- (ii) *if Φ satisfies (4.1.2) with $\gamma < 0$, then f satisfies (4.1.6) and (4.1.7).*

Then for all $\tau \in (0, T)$ there exists some $\rho > 0$ and $\theta > 0$ depending on τ , ϱ_f , E_f , H_f (and $L_f^{p_\gamma}$ if Φ satisfies (4.1.2) with $\gamma < 0$), such that for all $t \in [\tau, T)$ the solution is bounded from below by the uniform Maxwellian distribution with density ρ and temperature θ , i.e.

$$(4.1.9) \quad \forall t \in [\tau, T), \forall x \in \mathbb{T}^N, \forall v \in \mathbb{R}^N, \quad f(t, x, v) \geq \rho \frac{e^{-\frac{|v|^2}{2\theta}}}{(2\pi\theta)^{N/2}}.$$

Remarks: Let us comment on the assumptions and conclusions of this theorem:

1. The main case of application of this theorem one should think of is $B = |v - v_*|^\gamma b(\cos \theta)$ with b bounded from above and below. It includes the hard spheres model (when $\gamma = 1$ and $b = 1$), and the so-called “variable hard spheres” model.

2. As the lower bound in (4.1.9) does not depend on the space variable x , Theorem 4.1 applies to spatially homogeneous solutions as well: take f_0 depending only on v and $f(t, v)$ the corresponding solution of the homogeneous Boltzmann equation, then $f(t, v)$ is also a solution of the inhomogeneous Boltzmann equation in the torus and Theorem 4.1 gives the appearance of a Maxwellian lower bound on the v variable. This theorem thus includes and extends the previous result of Pulvirenti and Wennberg in [169], valid for hard potentials. It gives new results for spatially homogeneous solutions in the case of soft potentials with cutoff (see Section 4.5).

3. In the inhomogeneous case, Theorem 4.1 applies to the solutions of Ukai [183] near the equilibrium for hard spheres, or to the solutions of Guo [110] near the equilibrium for soft potentials with cutoff (see Section 4.5).

4. More generally this theorem can be seen as an *a priori* result on the renormalized solutions (see [75] and [58, Chapter 5]), the only theory of solutions in the large at now. For instance for a gas of hard spheres in a torus, its converse says that if the solution f vanishes at some point in the

phase space, then either the local density ρ_f has to vanish somewhere in the torus, or the local density ρ_f , energy e_f or entropy h_f have to blow-up somewhere in the torus.

Now let us state the result we get for long-range interaction models, i.e. collision kernels with an angular singularity. In this theorem a mild solution to the Boltzmann equation with initial datum f_0 is a function f which satisfies (4.4.22) pointwise (see Definition 4.2 below).

Theorem 4.2. *Let $B = \Phi b$ be a collision kernel which satisfies (4.1.1), with Φ satisfying (4.1.2) or (4.1.3), and b satisfying (4.1.4) with $\nu \in [0, 2)$. Let $f(t, x, v)$ be a mild solution of the full Boltzmann equation in the torus on some time interval $[0, T)$, $T \in (0, +\infty]$ such that*

- (i) *if Φ satisfies (4.1.2) with $\gamma \geq 0$ or if Φ satisfies (4.1.3), then f satisfies (4.1.6) and (4.1.8);*
- (ii) *if Φ satisfies (4.1.2) with $\gamma < 0$, then f satisfies (4.1.6), (4.1.7) and (4.1.8).*

Then for all $\tau \in (0, T)$ and for any exponent K such that

$$K > 2 \frac{\log \left(2 + \frac{2\nu}{2-\nu} \right)}{\log 2},$$

there exist $C_1 > 0$ and $C_2 > 0$ depending on $\tau, K, \varrho_f, E_f, E'_f, H_f, W_f$ (and $L_f^{p_\gamma}$ if Φ satisfies (4.1.2) with $\gamma < 0$), such that

$$\forall t \in [\tau, T), \forall x \in \mathbb{T}^N, \forall v \in \mathbb{R}^N, \quad f(t, x, v) \geq C_1 e^{-C_2 |v|^K}.$$

Moreover in the case when $\nu = 0$, one can take $K = 2$ (Maxwellian lower bound).

Remarks: Let us comment on the assumptions and conclusions of this theorem:

1. One can check that this theorem is consistent with Theorem 4.1 when $\nu \rightarrow 0$. Notice that the situation when $\nu = 0$ is particular: the collision operator is non-cutoff and corresponds to some “logarithmic derivative”.

2. This theorem is, to the knowledge of the author, the first quantitative lower bound result for non-cutoff collision kernels. It applies for instance to the spatially homogeneous solutions recently obtained in [74] (see Section 4.5).

3. We mention that an extension of Theorem 4.1 and Theorem 4.2 to the case of a bounded open set Ω with specular reflection or bounce-back boundary condition on $\partial\Omega$ is in progress, and will be treated in a second part of this work.

4.1.3 Methods of proof

In the spatially homogeneous case the proof of [169] proceeds in two steps: first the construction of an “upheaval point” for the solution after a small time, i.e. a uniform minoration on a ball; second a “spreading process” of this bound from below after a small time by the collision process, iterated infinitely many times. Both these steps are based on a mixing property of the gain part of the collision operator, which is reminiscent of the regularization property of this gain part, discovered by Lions (see [130, 131] or [191, Chapter 2, Section 3.4] for a review). The second step was already present in [44] and systematically used in [169]. The main contributions of our paper are:

1. a strategy to deal with space dependent solutions (Section 4.3), based on an implementation of the “upheaval” and “spreading” steps along each characteristic, keeping track carefully of the constants in order to get uniform estimates according to the choice of the characteristic;
2. a strategy to deal with non-cutoff collision kernels (Section 4.4), based on the use of a suitable splitting of the collision operator between a cutoff part which still enjoys the spreading property, and a small non-cutoff part, for which we give L^∞ estimates of smallness thanks to the regularity assumptions on the solution. A precise balance between these two parts then allows to obtain the lower bound in the non-cutoff case, although slightly weaker;
3. the implementation of the general method for soft potentials as well (i.e. for collision kernels with a singular kinetic part), and in any dimension (Sections 4.3 and 4.4);
4. a detailed discussion of the connection between these results and the existing Cauchy theories (Section 4.5).

Here we adopt the point of view of an *a priori* setting which allows to treat separately the issue of the lower bound and the one of establishing *a priori* estimates on the solution. Therefore we do not address the question of obtaining such *a priori* estimates in the general case, which is open at now. This point of view should be understood as a unified approach for all existing Cauchy theories, as well as a way to obtain *a priori* results when no Cauchy theory exists, or when the solutions are too weak.

The paper runs as follows. Section 4.2 remains purely functional, Section 4.3 and 4.4 work on arbitrary solutions in *a priori* setting, and only Section 4.5 deals with solutions which have effectively been constructed by

previous authors. Section 4.3 is devoted to the proof of Theorem 4.1, Section 4.4 to the proof of Theorem 4.2 and Section 4.5 applies these two theorems to the existing Cauchy theories.

4.1.4 Notation

In the sequel we shall denote $\langle \cdot \rangle = \sqrt{1 + |\cdot|^2}$. We define the weighted Lebesgue space $L_q^p(\mathbb{R}^N)$ ($p \in [1, +\infty]$, $q \in \mathbb{R}$) by the norm

$$\|f\|_{L_q^p(\mathbb{R}^N)} = \left[\int_{\mathbb{R}^N} |f(v)|^p \langle v \rangle^{pq} dv \right]^{1/p}$$

if $p < +\infty$ and

$$\|f\|_{L_q^\infty(\mathbb{R}^N)} = \sup_{v \in \mathbb{R}^N} |f(v)| \langle v \rangle^q$$

when $p = +\infty$. The Sobolev space $W^{k,p}(\mathbb{R}^N)$ ($p \in [1, +\infty]$ and $k \in \mathbb{N}$) is defined by

$$\|f\|_{W^{k,p}(\mathbb{R}^N)} = \left[\sum_{|s| \leq k} \|\partial^s f(v)\|_{L^p}^p \right]^{1/p},$$

with the usual notation $H^k = W^{k,2}$. Finally, we denote $L \log L$ the Orlicz space defined by the convex function $\phi(X) = (1 + |X|) \log(1 + |X|)$. For nonnegative functions in $L_2^1(\mathbb{R}^N)$, the quantity

$$\int_{\mathbb{R}^N} f \log f dv$$

is finite if and only if f belongs to $L \log L$.

Concerning the collision kernel we define the L^1 norm of b on the unit sphere when $\nu < 0$ (integrable angular collision kernel) by

$$n_b = \int_{\mathbb{S}^{N-1}} b(\cos \theta) d\sigma = |\mathbb{S}^{N-2}| \int_0^\pi b(\cos \theta) \sin^{N-2} \theta d\theta,$$

and in the case $\nu \in [0, 2)$ we define

$$m_b = \int_{\mathbb{S}^{N-1}} b(\cos \theta) (1 - \cos \theta) d\sigma = |\mathbb{S}^{N-2}| \int_0^\pi b(\cos \theta) (1 - \cos \theta) \sin^{N-2} \theta d\theta,$$

which is always finite (since $\nu < 2$), and is related to the cross-section for momentum transfer (see [191, Chapter 1, Section 3.4]). Finally we define

$$\ell_b = \inf_{\pi/4 \leq \theta \leq 3\pi/4} b(\theta)$$

which is strictly positive by assumption.

In the following we shall keep track explicitly of the dependency of the constants according to the bounds on the collision kernel and the estimates on the solution. As a convention, “cst” shall systematically denote any constant depending only on the dimension N , γ , ν and b_0 . For a real x , we shall denote x^+ the positive part of x and we recall the shorthand $\tilde{\gamma} = (2 + \gamma)^+$.

4.2 Functional toolbox

In this section we shall gather functional tools useful for the sequel. On one hand, Lemma 4.1, Lemma 4.4 are precised versions of well-known results adapted to our study: we need L^∞ estimates whereas the usual framework of such estimates are integral spaces. On the other hand, Lemma 4.2 and Lemma 4.3 are essentially generalizations of results in [169]. We extend these results for any cutoff potentials (in the sense of (4.1.2) and (4.1.4) with $\nu < 0$), in any dimension. Moreover we intend to use these results in the context of spatially inhomogeneous solutions, using the fact that the collision operator is local in t and x , which allows to see these variables as parameters in the functional estimates. Thus we shall track precisely the dependence of these estimates on the hydrodynamical quantities: $\rho_f, e_f, e'_f, h_f, l_f^p, w_f$.

4.2.1 The cutoff case

We introduce Grad’s splitting $Q(g, f) = Q^+(g, f) - Q^-(g, f)$ with

$$\begin{cases} Q^+(g, f) := \int_{\mathbb{R}^N \times \mathbb{S}^{N-1}} B(|v - v_*|, \cos \theta) g'_* f' dv_* d\sigma \\ Q^-(g, f) := \int_{\mathbb{R}^N \times \mathbb{S}^{N-1}} B(|v - v_*|, \cos \theta) g_* f dv_* d\sigma, \end{cases}$$

where Q^+ is called the gain term and Q^- is called the loss term. We write the loss term as

$$Q^-(g, f) = L[g] f$$

with

$$(4.2.10) \quad L[g(t, x, \cdot)](v) = n_b \int_{\mathbb{R}^N} \Phi(v - v_*) g(t, x, v_*) dv_*.$$

First let us give an L^∞ bound on the action of the loss term along the characteristics.

Lemma 4.1. *Let g be a measurable function on \mathbb{R}^N . Then*

(i) *If Φ satisfy (4.1.2) with $\gamma \geq 0$ or if Φ satisfies (4.1.3), then*

$$\forall v \in \mathbb{R}^N, \quad |g * \Phi(v)| \leq \text{cst } C_\Phi \|g\|_{L^1_2} \langle v \rangle^{\gamma^+}.$$

(ii) *If Φ satisfy (4.1.2) with $\gamma < 0$, then*

$$\forall v \in \mathbb{R}^N, \quad |g * \Phi(v)| \leq \text{cst } C_\Phi \left[\|g\|_{L^1_2} + \|g\|_{L^p} \right] \langle v \rangle^{\gamma^+}.$$

with $p > N/(N + \gamma)$.

Corollary 4.1. *As a straightforward consequence we obtain the following estimates on the operators L and S defined respectively in (4.2.10) and (4.2.15)*

$$(4.2.11) \quad \forall v \in \mathbb{R}^N, \quad |L[g](v)| \leq C_L \langle v \rangle^{\gamma^+} \quad \text{and} \quad |S[g](v)| \leq C_S \langle v \rangle^{\gamma^+}$$

where the constants C_L and C_S are defined by:

(i) *If Φ satisfy (4.1.2) with $\gamma \geq 0$ or if Φ satisfies (4.1.3), then*

$$C_L = \text{cst } n_b C_\Phi e_g, \quad C_S = \text{cst } m_b C_\Phi e_g.$$

(ii) *If Φ satisfy (4.1.2) with $\gamma < 0$, then*

$$C_L = \text{cst } n_b C_\Phi [e_g + l_g^p], \quad C_S = \text{cst } m_b C_\Phi [e_g + l_g^p].$$

Proof of Lemma 4.1. In the case Φ satisfies (4.1.2) with $\gamma \geq 0$ or (4.1.3), the proof is obvious and amounts to a triangular inequality.

In the case Φ satisfies (4.1.2) with $\gamma \in (-N, 0)$, one can split $g * \Phi(v)$ into

$$\begin{aligned} g * \Phi(v) &= \int_{\{v_* ; |v-v_*| \leq 1\}} \Phi(v - v_*) g(v_*) dv_* \\ &\quad + \int_{\{v_* ; |v-v_*| \geq 1\}} \Phi(v - v_*) g(v_*) dv_* =: I_1 + I_2. \end{aligned}$$

On one hand,

$$\forall v \in \mathbb{R}^N, \quad |I_2(v)| \leq C_\Phi \|g\|_{L^1} \leq C_\Phi \|g\|_{L^1_2}$$

and on the other hand, by Cauchy-Schwarz inequality

$$\forall v \in \mathbb{R}^N, \quad |I_1(v)| \leq C_\Phi \left[\int_{\{v_* ; |v-v_*| \leq 1\}} |v - v_*|^{\gamma p'} dv_* \right]^{1/p'} \|g\|_{L^p}$$

which gives the result since

$$\text{cst} = \int_{\{v_* ; |v-v_*| \leq 1\}} |v - v_*|^{\gamma p'} dv_* = \int_{\{u ; |u| \leq 1\}} |u|^{\gamma p'} du < +\infty$$

as soon as $\gamma p' > -N$, i.e. $p > \frac{N}{N+\gamma}$. \square

The next lemma uses the mixing property of Q^+ in order to obtain a minoration of $Q^+(Q^+(\cdot, \cdot), \cdot)$ on a ball. This will be the starting point for the construction of an “upheaval point” by the iterated Duhamel formula.

Lemma 4.2. *Let $B = \Phi b$ be a collision kernel which satisfies (4.1.1), with Φ satisfying (4.1.2) or (4.1.3), and b satisfying (4.1.4) with $\nu \leq 0$. Let $g(v)$ be a nonnegative function on \mathbb{R}^N with bounded energy e_g and entropy h_g and a mass ρ_g such that $0 < \rho_g < +\infty$. Then there exist $R_0 > 0$, $\delta_0 > 0$, $\eta_0 > 0$ and $\bar{v} \in B(0, R_0)$ such that*

$$Q^+(Q^+(g \mathbf{1}_{B(0, R_0)}, g \mathbf{1}_{B(0, R_0)}), g \mathbf{1}_{B(0, R_0)}) \geq \eta_0 \mathbf{1}_{B(\bar{v}, \delta_0)}$$

and R_0, δ_0, η_0 only depend on B , on a lower bound on ρ_g , and upper bounds on e_g and h_g .

Remark: Another strategy to obtain this “upheaval point” for hard potentials could have been to iterate the regularity property of Q^+ in the form proved in [150] in Sobolev spaces enough times to get some continuous function. We did not follow this method which is less direct, and leads to harder computations to track the exact dependence of the constant. Nevertheless the remark emphasizes the fact that the mixing property used here on Q^+ is a *linear* one, which is consistent with the regularity theory for this operator (see the regularity theory of Q^+ in the cutoff case in [150]).

Proof of Lemma 4.2. This lemma is a slight variant of [169, Lemma 3.1], whose proof can be straightforwardly adapted here. Note that this proof was made assuming that b is bounded below by a positive quantity on the whole interval $[0, \pi]$ but as pointed out in [169, Proof of Lemma 3.1] the proof still works the same under the sole assumption on b that it is bounded below by a positive quantity near $\theta \sim \pi/2$, which is satisfied under our assumptions on b .

Therefore we only generalize the formula in the proof to any dimension and to any power γ of the collision kernel, and we precise the dependence of R_0, δ_0 and η_0 according to the quantities ρ_g, e_g and h_g .

First let us suppose that Φ satisfies (4.1.2) with $\gamma \geq 0$, in order to satisfy the assumptions of [169, Lemma 3.1]. As for R_0 , in the proof of [169, Lemma 3.1] R_0 is chosen such that

$$\int_{|v| \leq R_0} g(v) dv \geq \frac{\rho_g}{2}.$$

The estimate

$$\int_{|v| \geq R_0} g(v) dv \leq \frac{e_g}{R_0^2}$$

yields the possible choice

$$R_0 = \sqrt{\frac{2 e_g}{\rho_g}}.$$

Then it is straightforward to see that δ_0 depends only on upper bounds on e_g and h_g , and

$$\eta_0 = \text{cst } \ell_b c_\Phi R_0^{\gamma-(3N-1)} \delta_0^{2N}.$$

The case of a mollified kinetic collision kernel Φ (assumption (4.1.3)) with $\gamma \geq 0$ reduces to the case of a kinetic collision kernel satisfying (4.1.2) with $\gamma \geq 0$. Indeed when $\gamma \geq 0$, we have the bound from below $\Phi(z) \geq c_\Phi |z|^\gamma$ for all $z \in \mathbb{R}^N$ and the proof is unchanged.

When Φ satisfies (4.1.2) or (4.1.3) with $\gamma < 0$, we first choose R_0 as above, with $R_0 \geq 1$ (it is possible up to take a bigger R_0). Then we use that on $B(0, R_0)$, we have that $\Phi(z) \geq c_\Phi R_0^\gamma$, which means we can apply the formula above for the case $\gamma = 0$, and the final formula for η_0 is unchanged. \square

The next lemma gives a precise estimate of the “spreading property” of Q^+ (according to the velocity variable), which is pictured in Figure 4.1: for any $R' < \sqrt{r^2 + R^2}$, for any v in the ball with radius R' , it is possible to find collisions with post-collision velocity v, v_* and taking the pre-collision velocity v'_* inside the ball with radius R and the pre-collision velocity v' inside the ball with radius r .

Lemma 4.3. *Let $B = \Phi b$ be a collision kernel which satisfies (4.1.1), with Φ satisfying (4.1.2) or (4.1.3), and b satisfying (4.1.4) with $\nu \leq 0$. Then for any $\bar{v} \in \mathbb{R}^N$, $0 < r \leq R$, $\xi \in (0, 1)$, we have*

$$(4.2.12) \quad Q^+(\mathbf{1}_{B(\bar{v}, R)}, \mathbf{1}_{B(\bar{v}, r)}) \geq \text{cst } \ell_b c_\Phi r^{N-3} R^{3+\gamma} \xi^{N/2-1} \mathbf{1}_{B(\bar{v}, \sqrt{r^2+R^2}(1-\xi))}.$$

As a consequence in the particular quadratic case $\delta = r = R$, we obtain

$$(4.2.13) \quad Q^+(\mathbf{1}_{B(\bar{v}, \delta)}, \mathbf{1}_{B(\bar{v}, \delta)}) \geq \text{cst } \ell_b c_\Phi \delta^{N+\gamma} \xi^{N/2-1} \mathbf{1}_{B(\bar{v}, \delta\sqrt{2}(1-\xi))}$$

for any $\bar{v} \in \mathbb{R}^N$ and $\xi \in (0, 1)$.

Remark: In the sequel we shall use the quadratic version of Lemma 4.3 (i.e. when $r = R$) which seems compulsory when one wants to obtain the optimal Maxwellian decrease at infinity for the lower bound. Nevertheless we give a bilinear version since it highlights again the fact that the “spreading effect” of Q^+ is a linear one.

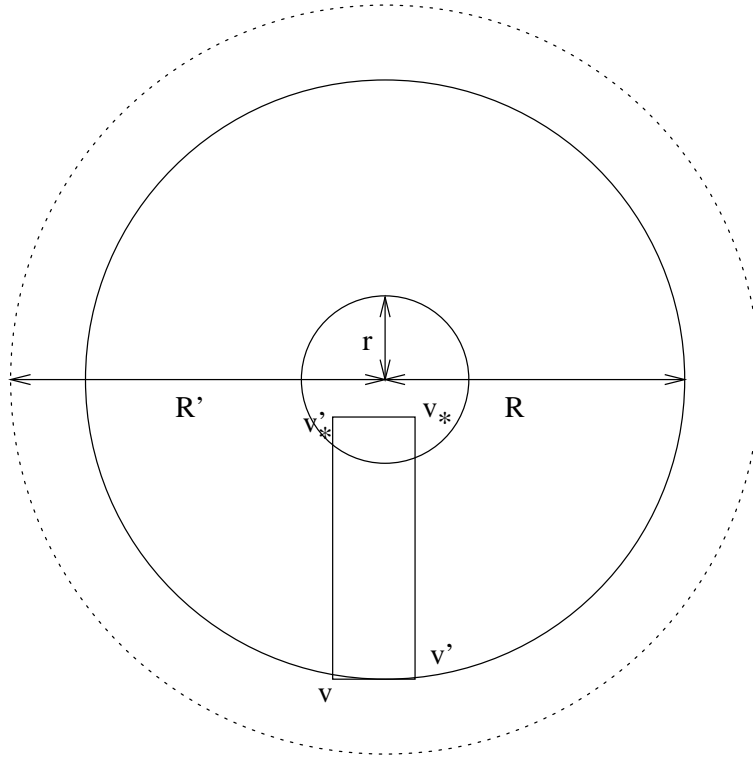
 Figure 4.1: Spreading property of Q^+

Proof of Lemma 4.3. This result is a bilinear version of [169, Lemma 3.2], written here in any dimension and for any power γ . Thus we only recall the main steps of the proof, especially those where the bilinearity, the dimension N , or γ play some role.

First we deal with collision kernel such that Φ satisfies (4.1.2) with $\gamma \geq 0$. As a general property Q^+ satisfies the homogeneity relation

$$Q^+(g, f)(\lambda v) = \lambda^{N+\gamma} Q^+(g(\lambda \cdot), f(\lambda \cdot))(v)$$

and the invariance by translation allows to reduce the proof of (4.2.12) to the proof of

$$Q^+(\mathbf{1}_{B(0,1)}, \mathbf{1}_{B(0,p)}) \geq \text{cst } \ell_b c_\Phi p^{N-3} \xi^{N/2-1} \mathbf{1}_{B(0, \sqrt{1+p^2}(1-\xi))}$$

with $p \leq 1$ stands for r/R . Now by isotropic invariance we can assume $v = z \mathbf{e}_N$ with $z < \sqrt{1+p^2}$ and $(\mathbf{e}_1, \dots, \mathbf{e}_N)$ an orthonormal basis. By

Carleman representation [45], we have

$$Q^+(\mathbf{1}_{B(0,1)}, \mathbf{1}_{B(0,\rho)})(v = z \mathbf{e}_N) \geq c_\Phi \int_{v' \in \mathbb{R}^N} \frac{\mathbf{1}_{B(0,\rho)}(v')}{|v - v'|^{N-1-\gamma}} \left[\int_{v'_* \in E_{vv'}} \mathbf{1}_{B(0,1)}(v'_*) \tilde{b}(\theta) dv'_* \right] dv'$$

where $E_{vv'}$ is the hyperplan orthogonal to $v' - v$ and containing v . We write the integral along v' in spherical coordinates centered in v and we use the bound from below $\tilde{b}(\theta) = b(\theta) (\sin \theta/2)^{-\gamma} \geq \text{cst } \ell_b$ for $\theta \in [\pi/4, 3\pi/4]$ given by the assumptions on b

$$Q^+(\mathbf{1}_{B(0,1)}, \mathbf{1}_{B(0,\rho)})(v = z \mathbf{e}_N) \geq \text{cst } \ell_b c_\Phi \int_0^{+\infty} \int_{\mathbb{S}^{N-1}} \mathbf{1}_{B(0,r)}(v + \rho\sigma) \rho^\gamma \text{Vol}(E_{vv'} \cap B(0,1) \cap \mathcal{C}_{v,\rho}) d\rho d\sigma,$$

where

$$\mathcal{C}_{v,\rho} = \left\{ u \in \mathbb{R}^N, \tan \frac{\pi}{8} \rho \leq |u - v| \leq \tan \frac{3\pi}{8} \rho \right\}.$$

Finally it is easy to see that the integrand is invariant under rotation around the axis $(0, \mathbf{e}_N)$, which allows to simplify the part of integration over the unit sphere \mathbb{S}^{N-2} of the hyperplan orthogonal to $(0, \mathbf{e}_N)$:

$$Q^+(\mathbf{1}_{B(0,1)}, \mathbf{1}_{B(0,\rho)})(v = z \mathbf{e}_N) \geq \text{cst } \ell_b c_\Phi \int_0^{+\infty} \int_0^\pi (\sin \alpha)^{N-2} \mathbf{1}_{B(0,r)}(v + \rho\sigma) \rho^\gamma \text{Vol}(E_{vv'} \cap B(0,1) \cap \mathcal{C}_{v,\rho}) d\rho d\alpha.$$

where σ in the integrand stands for any $-(\cos \alpha)\mathbf{e}_N + (\sin \alpha)\mathbf{u}$ with \mathbf{u} is any vector of the set of unit vectors orthogonal to \mathbf{e}_N . Some elementary geometrical computation lead to

$$\text{Vol}(E_{vv'} \cap B(0,1)) = \text{cst} (1 - z^2 \cos^2 \alpha)^{\frac{N-1}{2}} \mathbf{1}_{\{\cos^2 \alpha \leq 1/z^2\}}$$

and shows that

$$E_{vv'} \cap B(0,1) \subset \mathcal{C}_{v,\rho}$$

when

$$a \left(z \sin \alpha + \sqrt{1 - z^2 \cos^2 \alpha} \right) \leq \rho \leq b \left(z \sin \alpha - \sqrt{1 - z^2 \cos^2 \alpha} \right)$$

with

$$a := \tan^{-1} \frac{3\pi}{8} < 1, \quad b := \tan^{-1} \frac{\pi}{8} > 1.$$

This inequality is possible as soon as

$$1 - z^2 \cos^2 \alpha \leq \lambda^2 z^2 \sin^2 \alpha$$

with $\lambda = (b - a)/(b + a) < 1$. If one sets $y = z \cos \alpha$ as a new variable, this inequality means

$$y \geq \sqrt{\frac{1 - \lambda^2 z}{1 - \lambda^2}}$$

and one gets

$$\begin{aligned} Q^+(\mathbf{1}_{B(0,1)}, \mathbf{1}_{B(0,p)})(v = z \mathbf{e}_N) &\geq \\ \text{cst } \ell_b c_\Phi &\int_{\max\{\sqrt{z^2-1}, \sqrt{\frac{1-\lambda^2 z^2}{1-\lambda^2}}\}}^1 \int_{\max\{y-\sqrt{1-z^2+y^2}, \alpha(\sqrt{z^2-y^2}+\sqrt{1-y^2})\}}^{\min\{y+\sqrt{1-z^2+y^2}, b(\sqrt{z^2-y^2}-\sqrt{1-y^2})\}} \\ &\rho^\gamma \left(1 - \frac{y^2}{z^2}\right)^{\frac{N-3}{2}} (1-y^2)^{\frac{N-1}{2}} dy d\rho. \end{aligned}$$

Now setting $z = \sqrt{1+p^2}(1-\xi)$ and computing an expansion of this expression according to ξ in the same way as in the end of the proof of [169, Lemma 3.2], one gets the following estimates:

$$\begin{aligned} (1-y^2)^{\frac{N-1}{2}} &= (2(1+p^2)\xi)^{\frac{N-1}{2}} + O(\xi^{\frac{N+1}{2}}) \\ (z^2-y^2)^{\frac{N-3}{2}} &= p^{N-3} + O(\xi) \end{aligned}$$

$$\int_{\max\{y-\sqrt{1-z^2+y^2}, \alpha(\sqrt{z^2-y^2}+\sqrt{1-y^2})\}}^{\min\{y+\sqrt{1-z^2+y^2}, b(\sqrt{z^2-y^2}-\sqrt{1-y^2})\}} \rho^\gamma d\rho = \sqrt{2(1+p^2)\xi - 2(1-y)} + O(\xi^{3/2}).$$

Then similar computations as in the proof of [169, Lemma 3.2] conclude the proof (for the integration on y , the condition $y \geq \sqrt{(1-\lambda^2 z^2)/(1-\lambda^2)}$ plays no role at the limit since $\sqrt{(1-\lambda^2 z^2)/(1-\lambda^2)} \rightarrow_{\xi \rightarrow 0} \text{cst} < 1$).

As for the previous lemma the case of a mollified kinetic collision kernel Φ (assumption (4.1.3)) with $\gamma \geq 0$ reduces the case of a kinetic collision kernel satisfying (4.1.2) with $\gamma \geq 0$ since we have the bound from below $\Phi(z) \geq c_\Phi |z|^\gamma$ for all $z \in \mathbb{R}^N$ and the proof is unchanged.

When Φ satisfies (4.1.2) or (4.1.3) with $\gamma < 0$, we use that on $B(0, R)$, we have that $\Phi(z) \geq c_\Phi R^\gamma$ (assuming $R \geq 1$ without restriction for the sequel) which means we can apply the formula above for the case $\gamma = 0$, and the final formula (4.2.12) is unchanged. \square

4.2.2 The non-cutoff case

The two lemmas below will be useful in the treatment of non-cutoff collisions kernels. They express the fact that non-grazing collisions constitute the dominant term of the collision operator as long as “spreading effect” is concerned. They are essentially based on the by now well-known idea of using symmetry-induced cancellations effects in order to deal with the angular singularity (see [186, 3, 4]).

In the case of non-cutoff collision kernels, the usual Grad’s splitting $Q = Q^+ - Q^-$ does not make sense anymore. However, the following splitting still makes sense:

$$(4.2.14) \quad \begin{aligned} Q(g, f) &= \int_{\mathbb{R}^N \times \mathbb{S}^{N-1}} B g'_* (f' - f) dv_* d\sigma + \left(\int_{\mathbb{R}^N \times \mathbb{S}^{N-1}} B (g'_* - g_*) dv_* d\sigma \right) f \\ &=: Q^1 + Q^2 \end{aligned}$$

Thanks to the cancellation Lemma [3, Lemma 1], the operator Q^2 can be written

$$Q^2(g, f) = S[g] f$$

with

$$(4.2.15) \quad S[g](v) := |\mathbb{S}^{N-2}| \left(\int_0^{\pi/2} \sin^{N-2} \theta \left[\frac{1}{\cos^{N+\gamma}(\theta/2)} - 1 \right] b(\theta) d\theta \right) \Phi * g(v).$$

Corollary 4.1 gives L^∞ estimates (4.2.11) on S . Now let us turn to the L^∞ estimates for Q^1 .

Lemma 4.4. *Let $B = \Phi b$ be a collision kernel satisfying (4.1.1), with Φ satisfying (4.1.2) or (4.1.3), and b satisfying (4.1.4) with $\nu \in [0, 2)$. Let f, g be measurable functions on \mathbb{R}^N . Then*

(i) *If Φ satisfy (4.1.2) with $2 + \gamma \geq 0$ or if Φ satisfies (4.1.3), then*

$$\forall v \in \mathbb{R}^N, \quad |Q^1(g, f)(v)| \leq \text{cst } m_b C_\Phi \|g\|_{L^1_{\tilde{\gamma}}} \|f\|_{W^{2,\infty}} \langle v \rangle^{\tilde{\gamma}}.$$

(ii) *If Φ satisfy (4.1.2) with $2 + \gamma < 0$, then*

$$\forall v \in \mathbb{R}^N, \quad |Q^1(g, f)(v)| \leq \text{cst } m_b C_\Phi \left[\|g\|_{L^1_{\tilde{\gamma}}} + \|g\|_{L^p} \right] \|f\|_{W^{2,\infty}} \langle v \rangle^{\tilde{\gamma}}.$$

with $p > N/(N + \gamma + 2)$.

Remarks: 1. In the treatment of Q^2 , the “derivative-like” difference $(f' - f)$ can be transferred to the angular part of the collision kernel by a process of change of variable which plays the same role as integration by part for classical differential operators. One can not do the same in Lemma 4.4 because there is no “decoupling” of the two arguments f and g .

2. The proof of Lemma 4.4 is based on a similar idea as cancellation lemmas in [186, 3, 4]. We make a Taylor expansion of $(f' - f)$ for small deviation angles in order to compensate for the grazing collision singularity of the collision kernel. However for smooth functions the quantity $(f' - f)$ compensate only for a singularity of order 1. Thus one has to use the symmetry of the collision sphere in order to compensate for strong singularities: to compensate for a singularity of order 2, one has to kill the first order term of the Taylor expansion of $(f' - f)$ by integrating on the $(N - 2)$ -dimensional sphere included in the collision sphere which is orthogonal to the vector $v - v_*$ and contains v' .

3. Note that Lemma 4.4 is reminiscent of [4, Proposition 4] which implies that the complete non-cutoff operator Q satisfies the following inequality

$$\|Q(g, f)\|_{W^{-2,1}} \leq C \|g\|_{L^1_{\tilde{z}}} \|f\|_{L^1_{\tilde{z}}}$$

Essentially the difference is that Lemma 4.4 is intended to provide an L^∞ control. This is why it requires an L^p bound on the solution for soft potentials. The proof of [4, Proposition 4] uses a duality argument and the pre-post collisional change of variable to pass the “derivative-like” difference on the dual test function. The $(N - 2)$ -dimensional sphere on which cancellations occur does not appear explicitly in the representation formula as in our proof, but is rather implicit in a projection argument. Here we proceed directly, using Carleman representation.

Proof of Lemma 4.4. In order to isolate the exact sphere on which we want to use symmetry properties, we use the Carleman representation (exchanging the roles of v' and v'_*)

$$Q^1(g, f)(v) = \int_{\mathbb{R}^N} dv'_* \frac{g'_*}{|v - v'_*|^{N-1}} \int_{E_{v,v'_*}} dv' b(\cos \theta) \Phi(v - v_*) (f' - f)$$

where E_{v,v'_*} denotes the hyperplan orthogonal to the vector $v - v'_*$ and containing v . Now let us write the integration of the v' variable in spherical coordinate of center v , i.e. $v' = v + \rho\sigma$ where $\rho \in \mathbb{R}_+$ and σ describes the

$(N - 2)$ -dimensional unit sphere of E_{v, v'_*} , denoted by $\mathbb{S}_{v-v'_*}^{N-2}$.

$$Q^1(g, f)(v) = \int_{\mathbb{R}^N} dv'_* \frac{g'_*}{|v - v'_*|^{N-1}} \int_0^\infty d\rho b(\cos \theta) \Phi(v - v_*) \rho^{N-2} \left(\int_{\mathbb{S}_{v-v'_*}^{N-2}} d\sigma (f(v + \rho\sigma) - f(v)) \right).$$

Now let us study more precisely the quantity

$$I = \int_{\mathbb{S}_{v-v'_*}^{N-2}} d\sigma (f(v + \rho\sigma) - f(v)).$$

If ∇f denotes the gradient of f and $\nabla^2 f$ its Hessian matrix, one has the following Taylor expansion:

$$f(v + \rho\sigma) = f(v) + \rho(\nabla f(v) \cdot \sigma) + \frac{\rho^2}{2} \langle \nabla^2 f(v + \rho'\sigma) \cdot \sigma, \sigma \rangle$$

where $0 \leq \rho' \leq \rho$. By bounding the last term and taking the integral over σ , we get the estimate

$$\left| I - \rho \left(\int_{\mathbb{S}_{v-v'_*}^{N-2}} d\sigma (\nabla f(v) \cdot \sigma) \right) \right| \leq \frac{\rho^2}{2} |\mathbb{S}^{N-2}| \|f\|_{W^{2,\infty}}.$$

As the term involving ∇f vanishes by symmetry, we obtain

$$|I| \leq \frac{\rho^2}{2} |\mathbb{S}^{N-2}| \|f\|_{W^{2,\infty}}.$$

Thus we get for some function ϕ in $L^1_{\tilde{\gamma}}$

$$\begin{aligned} & \left| \int_{\mathbb{R}^N} Q^1(g, f)(v) \phi(v) dv \right| \\ & \leq \|f\|_{W^{2,\infty}} |\mathbb{S}^{N-2}| \int_{\mathbb{R}^N} dv \int_{\mathbb{R}^N} dv'_* \frac{g'_*}{|v - v'_*|^{N-1}} \int_0^\infty d\rho b(\cos \theta) \Phi(v - v_*) \frac{\rho^N}{2} |\phi(v)| \\ & \leq \|f\|_{W^{2,\infty}} \int_{\mathbb{R}^N} dv \int_{\mathbb{R}^N} dv'_* \frac{g'_*}{|v - v'_*|^{N-1}} \int_0^\infty d\rho \rho^{N-2} \int_{\mathbb{S}_{v-v'_*}^{N-2}} d\sigma \\ & \quad b(\cos \theta) \Phi(v - v_*) \frac{\rho^2}{2} |\phi(v)| \\ & \leq C_\Phi \|f\|_{W^{2,\infty}} \int_{\mathbb{R}^{2N} \times \mathbb{S}^{N-1}} dv dv_* d\sigma b(\cos \theta) (\sin(\theta/2))^2 |v - v_*|^{2+\gamma} |g'_*| |\phi|. \end{aligned}$$

Finally we cut the integral in two parts, for $\theta \in [0, \pi/2]$ and for $\theta \in [\pi/2, \pi]$. For the first part we use the pre-postcollisional change of variable and the change of variable $(v, v_*, \sigma) \rightarrow (v', v_*, \sigma)$ used in the cancellation lemma [3, Lemma 1] whose jacobian is $\cos^{-(N+\gamma)}(\theta/2)$ and is thus smaller than $2^{\frac{N+\gamma}{2}}$ for $\theta \in [0, \pi/2]$. For the second part we use the change of variable $(v, v_*, \sigma) \rightarrow (v, v'_*, \sigma)$ whose jacobian is $\sin^{-(N+\gamma)}(\theta/2)$, which is smaller than $2^{\frac{N+\gamma}{2}}$ for $\theta \in [\pi/2, \pi]$. Thus we get

$$\left| \int_{\mathbb{R}^N} Q^1(g, f)(v) \phi(v) dv \right| \leq C_{\Phi} 2^{\frac{N+\gamma}{2}} \|f\|_{W^{2,\infty}} \int_{\mathbb{R}^{2N} \times \mathbb{S}^{N-1}} dv dv_* d\sigma b(\cos \theta) (\sin(\theta/2))^2 |v - v_*|^{2+\gamma} |g_*| |\phi|$$

and so, if Φ satisfy (4.1.2) with $2 + \gamma \geq 0$ or if Φ satisfies (4.1.3), we get

$$\left| \int_{\mathbb{R}^N} Q^1(g, f)(v) \phi(v) dv \right| \leq C_{\Phi} \frac{\|f\|_{W^{2,\infty}}}{2^{\frac{N+\gamma}{2}+1}} \left(\int_{\mathbb{S}^{N-1}} d\sigma b(\cos \theta) (1 - \cos \theta) \right) \|g\|_{L^1_{\frac{1}{\gamma}}} \|\phi\|_{L^1_{\frac{1}{\gamma}}},$$

and if Φ satisfy (4.1.2) with $2 + \gamma < 0$, then

$$\left| \int_{\mathbb{R}^N} Q^1(g, f)(v) \phi(v) dv \right| \leq C_{\Phi} \frac{\|f\|_{W^{2,\infty}}}{2^{\frac{N+\gamma}{2}+1}} \left(\int_{\mathbb{S}^{N-1}} d\sigma b(\cos \theta) (1 - \cos \theta) \right) \left[\|g\|_{L^1_{\frac{1}{\gamma}}} + \|g\|_{L^p} \right] \|\phi\|_{L^1_{\frac{1}{\gamma}}}.$$

Since this holds for all $\phi \in L^1_{\frac{1}{\gamma}}$, this yields the result by duality, with $\text{cst} = C_{\Phi}/(2^{\frac{N+\gamma}{2}+1})$. \square

4.3 Proof of the lower bound in the cutoff case

In this section we shall prove Theorem 4.1. Since the collision operator is local in t and x , the idea of the proof is to apply first Lemma 4.2 and then Lemma 4.3 iterated on *each characteristic* of the free transport operator, in order first to obtain an upheaval point, and then to “spread” the minoration. It yields for each characteristic of the transport flow a Maxwellian lower bound with macroscopic velocity \bar{v} , temperature θ and density ρ depending on the characteristic. Then a uniform control on \bar{v} , θ and ρ yields the global

Maxwellian lower bound. This control is based on the uniform bounds on the hydrodynamic quantities. The lower bound is also made uniform as $t \rightarrow +\infty$ thanks to these uniform bounds.

The main tool is the Duhamel representation formula, written along the characteristics (which reduce to lines in the case of periodic boundary conditions):

$$(4.3.16) \quad \left\{ \begin{array}{l} \forall t \in [0, T), \forall x \in \mathbb{T}^N, \forall v \in \mathbb{R}^N, \\ f(t, x + vt, v) = f_0(x, v) \exp \left(- \int_0^t L[f(s, x + vs, \cdot)](v) ds \right) \\ \quad + \int_0^t \exp \left(- \int_s^t L[f(s', x + vs', \cdot)](v) ds' \right) \\ \quad \quad Q^+[f(s, x + vs, \cdot), f(s, x + vs, \cdot)](v) ds \end{array} \right.$$

where L was defined in (4.2.10). We define the concept of solution we shall use in the cutoff case, i.e. the concept of mild solutions (see [58, Section 5.3] for an analogous definition).

Definition 4.1. *Let f_0 be a measurable function non-negative almost everywhere on $\mathbb{T}^N \times \mathbb{R}^N$. A measurable function $f = f(t, x, v)$ on $[0, T) \times \mathbb{T}^N \times \mathbb{R}^N$ is a mild solution of the Boltzmann equation to the initial datum $f_0(x, v)$ if for almost every (x, v) in $\mathbb{T}^N \times \mathbb{R}^N$:*

$$t \mapsto L[f(t, x + vt, \cdot)](v), \quad t \mapsto Q^+[f(t, x + vt, \cdot), f(t, x + vt, \cdot)](v)$$

are in $L^1_{\text{loc}}([0; T))$, and for each $t \in [0, T)$, the equation (4.3.16) is satisfied and $f(t, x, v)$ is non-negative for almost every (x, v) .

Proposition 4.1. *Let $B = \Phi b$ be a collision kernel which satisfies (4.1.1), with Φ satisfying (4.1.2) or (4.1.3), and b satisfying (4.1.4) with $\nu < 0$. Let $f(t, x, v)$ be a mild solution of the full Boltzmann equation in the torus on some time interval $[0, T)$ ($T \in (0, +\infty]$), which satisfies*

- (i) *assumption (4.1.6) if Φ satisfies (4.1.2) with $\gamma \geq 0$ or if Φ satisfies (4.1.3),*
- (ii) *assumptions (4.1.6) and (4.1.7) if Φ satisfies (4.1.2) with $\gamma \in (-N, 0)$.*

Then for any fixed $\tau \in (0, T)$ and $x \in \mathbb{T}^N$, there exists some $R_0 > 0$ and some $\bar{v} \in B(0, R_0)$ such that

$$(4.3.17) \quad \forall n \geq 0, \forall t \in \left[\tau - \frac{\tau}{2^{n+1}}, \tau \right], \forall v \in \mathbb{R}^N, \quad f(t, x + vt, v) \geq a_n \mathbf{1}_{B(\bar{v}, \delta_n)}$$

with the induction formulae

$$a_{n+1} = \text{cst } C_e \frac{a_n^2 \delta_n^{\gamma+N} \xi_n^{N/2+1}}{2^{n+1}}$$

$$\delta_{n+1} = \sqrt{2} \delta_n (1 - \xi_n)$$

where $(\xi_n)_{n \geq 0}$ is any sequence in $(0, 1)$, $R_0 > 0$, $a_0 > 0$, $\delta_0 > 0$, C_e only depend on τ , B , ϱ_f , E_f and H_f (plus $L_f^{p_\gamma}$ if Φ satisfies (4.1.2) with $\gamma \in (-N, 0)$), and $\bar{v} \in B(0, R_0)$ depends on the same quantities plus x .

Proof of Proposition 4.1. We decompose the proof in two steps.

Step 1: Initialization. We apply Lemma 4.2 to the right-hand side member of the Duhamel representation iterated twice. More precisely, the equation (4.3.16) yields on one hand

$$f(t, x + vt, v) \geq f_0(x, v) e^{-C_L t \langle v \rangle^{\gamma^+}}$$

and on the other hand

$$f(t, x + vt, v) \geq \int_0^t e^{-C_L (t-s) \langle v \rangle^{\gamma^+}} Q^+ [f(s, x + vs, \cdot), f(s, x + vs, \cdot)](v) ds.$$

If we iterate the latter, we get

$$f(t, x + vt, v) \geq \int_0^t e^{-C_L (t-s) \langle v \rangle^{\gamma^+}} Q^+ \left[\left(\int_0^s e^{-C_L (s-s') \langle v \rangle^{\gamma^+}} Q^+ [f(s', x + vs', \cdot), f(s', x + vs', \cdot)](\cdot) ds' \right), f(s, x + vs, \cdot) \right](v) ds.$$

Whenever φ is some function on \mathbb{R}^N , we denote by φ^{R_0} the truncation $\varphi \mathbf{1}_{|v| \leq R_0}$. We can bound from below by

$$\begin{aligned} \forall v \in \mathbb{R}^N, |v| \leq R_0, \quad f(t, x + vt, v) &\geq Q^+ \left[Q^+ [f_0^{R_0}(x, \cdot), f_0^{R_0}(x, \cdot)], f_0^{R_0}(x, \cdot) \right](v) \\ &\quad \int_0^t e^{-C_L (t-s) R_0^{\gamma^+}} e^{-C_L s R_0^{\gamma^+}} \left(\int_0^s e^{-C_L (s-s') R_0^{\gamma^+}} e^{-2 C_L s' R_0^{\gamma^+}} ds' \right) ds \end{aligned}$$

and thus after some computation

$$\begin{aligned} \forall v \in \mathbb{R}^N, |v| \leq R_0, \quad f(t, x + vt, v) &\geq e^{-C_L t R_0^{\gamma^+}} \frac{(1 - e^{-C_L t R_0^{\gamma^+}})^2}{2(C_L R_0^{\gamma^+})^2} \\ &\quad Q^+ \left[Q^+ [f_0^{R_0}(x, \cdot), f_0^{R_0}(x, \cdot)], f_0^{R_0}(x, \cdot) \right](v). \end{aligned}$$

Then the use of Lemma 4.2 concludes the initialization $n = 0$ of the proof with

$$a_0 = e^{-C_L \tau R_0^{\gamma^+}} \frac{(1 - e^{-C_L (\tau/2) R_0^{\gamma^+}})^2}{2(C_L R_0^{\gamma^+})^2} \eta_0$$

where δ_0, R_0, η_0 depend on ϱ_f, E_f, H_f (as in the statement of Lemma 4.2), and \bar{v} depends on the same quantities plus x (via the function $f_0^{R_0}(x, \cdot)$).

Step 2: Proof of the induction. Now let us suppose that the induction property holds for n :

$$\forall t \in \left[\tau - \frac{\tau}{2^{n+1}}, \tau \right], \forall v \in \mathbb{R}^N, f(t, x + vt, v) \geq a_n \mathbf{1}_{B(\bar{v}, \delta_n)}.$$

The Duhamel representation yields the following lower bound

$$\begin{aligned} \forall t \in \left[\tau - \frac{\tau}{2^{n+2}}, \tau \right], \forall v \in \mathbb{R}^N, f(t, x + vt, v) \geq \\ \int_{\tau - \frac{\tau}{2^{n+1}}}^{\tau - \frac{\tau}{2^{n+2}}} e^{-C_L (t-s) \langle v \rangle^{\gamma^+}} Q^+(a_n \mathbf{1}_{B(\bar{v}, \delta_n)}, a_n \mathbf{1}_{B(\bar{v}, \delta_n)}) ds, \end{aligned}$$

which easily leads to

$$\begin{aligned} \forall t \in \left[\tau - \frac{\tau}{2^{n+2}}, \tau \right], \forall v \in \mathbb{R}^N, f(t, x + vt, v) \geq \\ e^{-C_L \frac{\tau}{2^{n+1}} \langle v \rangle^{\gamma^+}} \left(\frac{\tau}{2^{n+2}} \right) a_n^2 Q^+(\mathbf{1}_{B(\bar{v}, \delta_n)}, \mathbf{1}_{B(\bar{v}, \delta_n)}). \end{aligned}$$

Now the application of Lemma 4.3 gives

$$\begin{aligned} \forall t \in \left[\tau - \frac{\tau}{2^{n+2}}, \tau \right], \forall v \in \mathbb{R}^N, f(t, x + vt, v) \geq \\ \text{cst } e^{-C_L \frac{\tau}{2^{n+1}} \langle v \rangle^{\gamma^+}} \left(\frac{\tau}{2^{n+2}} \right) a_n^2 \delta_n^{N+\gamma} \xi_n^{N/2-1} \mathbf{1}_{B(\bar{v}, \delta_n \sqrt{2}(1-\xi_n))} \end{aligned}$$

and thus if $\delta_{n+1} = \delta_n \sqrt{2}(1 - \xi_n)$, we get

$$\begin{aligned} \forall t \in \left[\tau - \frac{\tau}{2^{n+2}}, \tau \right], \forall v \in \mathbb{R}^N, f(t, x + vt, v) \geq \\ \text{cst } e^{-C_L \langle R_0 \rangle^{\gamma^+} \frac{\tau}{2^{n+1}} \delta_{n+1}^{\gamma^+}} \left(\frac{\tau}{2^{n+2}} \right) a_n^2 \delta_n^{N+\gamma} \xi_n^{N/2-1} \mathbf{1}_{B(\bar{v}, \delta_{n+1})}. \end{aligned}$$

As an easy induction shows, we have $\delta_n \leq \delta_0 2^{n/2}$ and so

$$C_L \langle R_0 \rangle^{\gamma^+} \frac{\tau}{2^{n+1}} \delta_{n+1}^{\gamma^+} \leq C_L \langle R_0 \rangle^{\gamma^+} \frac{\tau}{2^{n+1}} (\delta_0 2^{n/2})^{\gamma^+}$$

which is uniformly bounded from above since $\gamma \leq 1$. Thus the exponential term

$$e^{-C_L \langle R_0 \rangle^{\gamma^+} \frac{\tau}{2^{n+1}} \delta_{n+1}^{\gamma^+}}$$

is bounded from below uniformly by some constant $C_e > 0$. We deduce that

$$\forall t \in \left[\tau - \frac{\tau}{2^{n+2}}, \tau \right], \forall v \in \mathbb{R}^N, \\ f(t, x + vt, v) \geq \text{cst } C_e \left(\frac{a_n^2}{2^{n+1}} \right) a_n^2 \delta_n^{N+\gamma} \xi_n^{N/2-1} \mathbf{1}_{B(\bar{v}, \delta_{n+1})}.$$

This concludes the proof. \square

Now we can apply Proposition 4.1 along the characteristics in order to prove Theorem 4.1.

Proof of Theorem 4.1. We shall divide the proof into three steps for the sake of clarity. Each step is embodied in a lemma. For these three lemmas we make the same assumptions on B and f as in Theorem 4.1.

Step 1: Choice of $(\xi_n)_{n \geq 0}$ and asymptotic behavior of $(a_n)_{n \geq 0}$.

Lemma 4.5. *For any $x \in \mathbb{T}^N$ and $\tau \in (0, T)$, there exists $\bar{v}(x) \in B(0, R_0)$ and $\rho, \theta > 0$ such that*

$$(4.3.18) \quad \forall v \in \mathbb{R}^N, \quad f(\tau, x + \tau v, v) \geq \rho \frac{e^{-\frac{|v-\bar{v}|^2}{2\theta}}}{(2\pi\theta)^{N/2}}.$$

The constants R_0, ρ, θ depend on τ, ϱ_f, E_f and H_f (and $L_f^{p_\gamma}$ if Φ satisfies (4.1.2) with $\gamma < 0$).

Proof of Lemma 4.5. Let us now chose the sequence $(\xi_n)_{n \geq 0}$. The most natural choice is a geometrical sequence $\xi_n = \xi^{n+1}$ for some $\xi \in (0, 1)$. With this choice we can estimate the asymptotic behaviour of the sequence $(\delta_n)_{n \geq 0}$. Explicitly

$$\delta_n = \delta_0 2^{n/2} (1 - \xi) (1 - \xi^2) \cdots (1 - \xi^n) = \delta_0 2^{n/2} \prod_{k=0}^n (1 - \xi^k)$$

and thus as $\xi \in (0, 1)$ one easily gets

$$\delta_n \geq c_\delta 2^{n/2}$$

where the constant c_δ depends on δ_0 and ξ . It follows that

$$\forall n \geq 0, \forall t \in [\tau - \frac{\tau}{2^{n+1}}, \tau], \forall v \in B(\bar{v}, c_\delta 2^{n/2}), f(t, x + vt, v) \geq a_n.$$

By plugging this into the expression of the Maxwellian distribution

$$\rho \frac{e^{-\frac{|v-\bar{v}|^2}{2\theta}}}{(2\pi\theta)^{N/2}}$$

we deduce that a sufficient condition to obtain (4.3.18) is the following lower bound on the coefficients a_n appearing in the minoration (4.3.17): $a_n \geq \alpha^{2^n}$ for some $\alpha \in (0, 1)$. Indeed the parameter θ can then be fixed such that

$$e^{-\frac{c_\delta^2}{2\theta}} \leq \alpha.$$

Afterwards one can fix the parameter ρ in order that

$$a_0 \geq \frac{\rho}{(2\pi\theta)^{N/2}}$$

for $|v - \bar{v}| \leq \delta_0$, which leads to (4.3.18).

Let us prove this bound from below on the sequence $(a_n)_{n \geq 0}$. If one denotes

$$\lambda_n = \frac{\delta_n^{\gamma+N} \xi_n^{N/2+1}}{2^{n+1}}$$

one gets explicitly

$$a_n = (\text{cst } C_\epsilon)^{2^n-1} [\lambda_{n-1} \lambda_{n-2}^2 \cdots \lambda_0^{2^{n-1}}] a_0^{2^n}.$$

As for the sequence $(\lambda_n)_{n \geq 0}$, we have $\lambda_n \geq \text{cst } \lambda^n$ with

$$\lambda = \frac{2^{(\gamma+N)/2} \xi^{N/2+1}}{2}$$

and so

$$a_n \geq (\text{cst } C_\epsilon)^{2^n-1} \lambda^{[(n-1)2^0 + (n-2)2^1 + \cdots + 02^{n-1}]} a_0^{2^n}.$$

If $\lambda > 1$ the proof is clearly finished. If $\lambda \in (0, 1)$ it remains to study the quantity

$$A_n = [(n-1)2^0 + (n-2)2^1 + \cdots + 02^{n-1}]$$

An easy computation shows that $A_n = 2^n - (n+1)$ and so $A_n \leq 2^n$. It yields $a_n \geq \alpha^{2^n}$ with $\alpha := \text{cst } C_\epsilon \lambda a_0$. \square

Step 2: Uniformization of the spatial dependence.

Lemma 4.6. *For any $\tau \in (0, T)$, there exists $\rho', \theta' > 0$ such that*

$$(4.3.19) \quad \forall x \in \mathbb{T}^N, \forall v \in \mathbb{R}^N, \quad f(\tau, x, v) \geq \rho' \frac{e^{-\frac{|v|^2}{2\theta'}}}{(2\pi\theta')^{N/2}}.$$

The constants ρ', θ' depend on τ, ϱ_f, E_f and H_f (and $L_f^{p_\gamma}$ if Φ satisfies (4.1.2) with $\gamma \in (-N, 0)$).

Proof of Lemma 4.6. This step is straightforward: the right-member term in the estimate (4.3.18) depends on the space variable x only through $\bar{v}(x)$. However, as a consequence of Lemma 4.2, \bar{v} is always included in the ball $B(0, R_0)$ for some radius R_0 depending only on the *a priori* bounds on the solution. Thus

$$e^{-\frac{|v-\bar{v}|^2}{2\theta}} \geq e^{-\frac{|v|^2}{\theta}} e^{-\frac{R_0^2}{\theta}}$$

and the proof is complete up to the choice of some new parameters ρ', θ' : one can take $\theta' = \theta/2$ and

$$\rho' = \rho \frac{e^{-\frac{R_0^2}{\theta}}}{2^{N/2}}.$$

□

Step 3: Uniformization of the time dependence.

Lemma 4.7. *For any $\tau > 0$, there exists $\rho', \theta' > 0$ such that*

$$\forall t \in [\tau, T), \forall x \in \mathbb{T}^N, \forall v \in \mathbb{R}^N, \quad f(t, x, v) \geq \rho' \frac{e^{-\frac{|v|^2}{2\theta'}}}{(2\pi\theta')^{N/2}}.$$

The constants ρ', θ' depend on the a priori bounds on the solution.

Proof of Lemma 4.7. Again this step is straightforward: one can check that the lower bound (4.3.19) does not depend on the precise form of the solution $f(t, x, v)$ for $t \in [0, \tau]$, $x \in \mathbb{T}^N$, $v \in \mathbb{R}^N$, but only on the uniform bounds on the solution. It means that the same argument could be started not from $t = 0$ anymore, but at any time (as long as the bounds used are uniform in time). As the lower bound appears after some time $\tau > 0$ (arbitrary small), we get the lower bound for any time $t \geq \tau$ by making the proof start at $t - \tau$. □

This concludes the proof of Theorem 4.1. □

4.4 Proof of the lower bound in the non-cutoff case

In this section we shall prove Theorem 4.2. Again we use the spreading property along each characteristic but we use the spreading property on the gain part of a truncated collision operator. The remaining part will be treated thanks to the L^∞ estimates proved in Section 4.2.

We assume that $\nu \in [0, 2)$ and we make the following splitting for any $\varepsilon \in (0, \pi/4)$:

$$Q = Q_\varepsilon^+ - Q_\varepsilon^- + Q_\varepsilon^1 + Q_\varepsilon^2$$

where Q_ε^+ and Q_ε^- are the usual Grad splitting for the collision operator with collision kernel

$$B_\varepsilon^S := \Phi [b \mathbf{1}_{|\theta| \geq \varepsilon}] =: \Phi b_\varepsilon^S,$$

and Q_ε^1 and Q_ε^2 are the splitting introduced in (4.2.14) applied to the non-cutoff collision operator with collision kernel

$$B_\varepsilon^R := \Phi [b \mathbf{1}_{|\theta| \leq \varepsilon}] =: \Phi b_\varepsilon^R.$$

For the sake of clarity the index ε shall be recalled on each quantity that depends on this splitting.

It is straightforward to check that $b_\varepsilon^S \geq \ell_b$ on $[\pi/4, 3\pi/4]$, since $b_\varepsilon^S = b$ for $\theta \in [\pi/4, 3\pi/4]$ and thus the constants given by the application of Lemma 4.2 and Lemma 4.3 on Q_ε^+ are uniform according to ε . Moreover we have

$$(4.4.20) \quad n_{b_\varepsilon^S} \sim_{\varepsilon \rightarrow 0} \frac{b_0}{\nu} \varepsilon^{-\nu}, \quad m_{b_\varepsilon^R} \sim_{\varepsilon \rightarrow 0} \frac{b_0}{2-\nu} \varepsilon^{2-\nu}$$

for $\nu \in (0, 2)$ and

$$(4.4.21) \quad n_{b_\varepsilon^S} \sim_{\varepsilon \rightarrow 0} b_0 |\log \varepsilon|, \quad m_{b_\varepsilon^R} \sim_{\varepsilon \rightarrow 0} \frac{b_0}{2-\nu} \varepsilon^2$$

when $\nu = 0$.

The basic tool is the Duhamel formula written in the following way

$$(4.4.22) \quad \left\{ \begin{array}{l} \forall t \in [0, T), \forall x \in \mathbb{T}^N, \forall v \in \mathbb{R}^N, \\ f(t, x + vt, v) = f_0(x, v) \exp \left(- \int_0^t (S_\varepsilon + L_\varepsilon)[f(s, x + vs, \cdot)](v) ds \right) \\ + \int_0^t \exp \left(- \int_s^t (S_\varepsilon + L_\varepsilon)[f(s', x + vs', \cdot)](v) ds' \right) \\ (Q_\varepsilon^+ + Q_\varepsilon^1)[f(s, x + vs, \cdot), f(s, x + vs, \cdot)](v) ds \end{array} \right.$$

where L_ε and S_ε are the operators introduced in Section 4.2 corresponding respectively to Q_ε^- and Q_ε^2 . We shall systematically use the L^∞ estimates given by (4.2.11) and Lemma 4.4, written in the following form

$$L_\varepsilon[f] \leq C_f n_{b_\varepsilon^S} \langle v \rangle^{\gamma^+}, \quad S_\varepsilon[f] \leq C_f m_{b_\varepsilon^R} \langle v \rangle^{\gamma^+}, \quad Q_\varepsilon^1(f, f) \leq C_f m_{b_\varepsilon^R} \langle v \rangle^{(2+\gamma)^+}$$

for a constant C_f depending on the uniform bounds on f .

Let us define the concept of mild solution we shall use in the non-cutoff case.

Definition 4.2. *Let f_0 be a measurable function non-negative almost everywhere on $\mathbb{T}^N \times \mathbb{R}^N$. A measurable function $f = f(t, x, v)$ on $[0, T) \times \mathbb{T}^N \times \mathbb{R}^N$ is a mild solution of the Boltzmann equation to the initial datum $f_0(x, v)$ if there exists $\varepsilon_0 > 0$ such that for all $0 < \varepsilon < \varepsilon_0$, for almost every (x, v) in $\mathbb{T}^N \times \mathbb{R}^N$:*

$$\begin{aligned} t &\mapsto Q_\varepsilon^+[f(t, x + vt, \cdot), f(t, x + vt, \cdot)](v), \\ t &\mapsto Q_\varepsilon^1[f(t, x + vt, \cdot), f(t, x + vt, \cdot)](v), \\ t &\mapsto L_\varepsilon[f(t, x + vt, \cdot)](v), \quad t \mapsto S_\varepsilon[f(t, x + vt, \cdot)](v) \end{aligned}$$

are in $L^1_{\text{loc}}([0; T))$, and for each $t \in [0, T)$, the equation (4.4.22) is satisfied and $f(t, x, v)$ is non-negative for almost every (x, v) .

Let us prove the equivalent of Proposition 4.1 in the non-cutoff case. Here we shall write the induction formula for a general sequence of time intervals Δ_n .

Indeed, on one hand at each step n of the induction the spreading effect of the gain part Q_ε^+ is now balanced by the perturbation Q_ε^1 , which imposes a careful choice of the splitting parameter ε for each n to get a lower bound on

$$Q_\varepsilon^+(f, f) + Q_\varepsilon^1(f, f) \geq Q_\varepsilon^+(f, f) - |Q_\varepsilon^1(f, f)|.$$

This yields a sequence $(\varepsilon_n)_{n \geq 0}$ going to 0 as n goes to infinity.

On the other hand at each step n of the induction we have the following action of $-Q_\varepsilon^- + Q_\varepsilon^2$ along the characteristic in the estimate from below on the solution:

$$e^{-C_f (m_{b_\varepsilon^R} + n_{b_\varepsilon^S}) (\sum_{k \geq n+1} \Delta_k) \langle v \rangle^{\gamma^+}}.$$

It makes the lower bound decrease and this exponential term goes to 0 when the splitting parameter ε goes to 0 (since $n_{b_\varepsilon^S}$ goes to infinity as ε goes to 0). That is why we shall choose time intervals Δ_n whose size decreases very fast to 0 as n goes to infinity, in order to limit the action of this part during a time interval.

Proposition 4.2. *Let $B = \Phi b$ be a collision kernel which satisfies (4.1.1), with Φ satisfying (4.1.2) or (4.1.3), and b satisfying (4.1.4) with $\nu \in [0, 2)$. Let $f(t, x, v)$ be a mild solution of the full Boltzmann equation in the torus on some time interval $[0, T)$ ($T \in (0, +\infty]$), which satisfies*

- (i) *assumptions (4.1.6) and (4.1.8) if Φ satisfies (4.1.2) with $\gamma \geq 0$ or if Φ satisfies (4.1.3);*
- (ii) *assumptions (4.1.6), (4.1.7) and (4.1.8) if Φ satisfies (4.1.2) with $\gamma \in (-N, 0)$.*

Then for any fixed $\tau \in (0, T)$ (small enough) and $x \in \mathbb{T}^N$, any sequence $(\Delta_n)_{n \geq 0}$ of positive numbers such that $\sum_{n \geq 0} \Delta_n = 1$, there exists some $R_0 > 0$ and $\bar{v} \in B(0, R_0)$ such that

$$\forall n \geq 0, \forall t \in \left[\left(\sum_{k=0}^n \Delta_k \right) \tau, \tau \right], \forall v \in \mathbb{R}^N, \quad f(t, x + vt, v) \geq a_n \mathbf{1}_{B(\bar{v}, \delta_n)}.$$

The sequence a_n satisfies the induction formula

(4.4.23)

$$a_{n+1} = cst \Delta_{n+1} \exp \left[- [C_f a_n^2 \delta_n^{N+\gamma-\tilde{\gamma}} \xi_n^{(N/2-1)}]^{-\frac{\nu}{2-\nu}} \left(\sum_{k \geq n+1} \Delta_k \right) \delta_{n+1}^{\gamma^+} \right] a_n^2 \delta_n^{\gamma+N} \xi_n^{(N/2+1)}$$

if $\nu \in (0, 2)$ and

(4.4.24)

$$a_{n+1} = cst \Delta_{n+1} \exp \left[- cst \log [C_f a_n^2 \delta_n^{N+\gamma-\tilde{\gamma}} \xi_n^{(N/2-1)}] \left(\sum_{k \geq n+1} \Delta_k \right) \delta_{n+1}^{\gamma^+} \right] a_n^2 \delta_n^{\gamma+N} \xi_n^{(N/2+1)}$$

if $\nu = 0$. The sequence δ_n satisfies the induction formula

$$\delta_{n+1} = \sqrt{2} \delta_n (1 - \xi_n).$$

Here $(\xi_n)_{n \geq 0}$ is any sequence in $(0, 1)$, the constants $R_0 > 0$, $a_0 > 0$, $\delta_0 > 0$ and C_f only depend on τ , ϱ_f , E_f , E'_f , H_f , W_f (plus $L_f^{p_\gamma}$ if Φ satisfies (4.1.2) with $\gamma \in (-N, 0)$), and $\bar{v} \in B(0, R_0)$ depends on the same quantities plus x .

Proof of Proposition 4.2. In this proof we shall use estimates of Section 4.2 as well as several equations established in the proofs of Section 4.3.

Step 1: Initialization. The initialization here is simpler than for the cutoff case since we assume some regularity on the solution, and thus we do not need the regularizing property of the iterated gain term. First we give a straightforward lemma:

Lemma 4.8. *Let g a non-negative function on \mathbb{R}^N such that e_g and w_g are bounded, and ρ_g satisfies $0 < \rho_g < +\infty$. Then there are $R_0, \delta_0, \eta > 0$ and $\bar{v} \in B(0, R_0)$ such that*

$$g(v) \geq \eta \mathbf{1}_{B(\bar{v}, \delta_0)},$$

where $R_0, \delta_0, \eta > 0$ are explicit constants depending on the upper bounds on ρ_g, e_g, w_g and the lower bound on ρ_g .

Proof of Lemma 4.8. Using the bound on the energy of g , the choice

$$R_0 = \sqrt{\frac{2e_g}{\rho_g}}$$

implies that

$$\int_{|v| \leq R_0} g(v) dv \geq \frac{\rho_g}{2}.$$

So there is $\bar{v} \in B(0, R_0)$ such that

$$g(\bar{v}) \geq \frac{\rho_g}{2\text{Vol}(B(0, R_0))}.$$

As w_g controls the Lipschitz norm, we have

$$\forall v_1, v_2 \in \mathbb{R}^N, \quad |g(v_1) - g(v_2)| \leq w_g |v_1 - v_2|$$

and thus if we take

$$\delta_0 = \frac{\rho_g}{4\text{Vol}(B(0, R_0))w_g}, \quad \eta = \frac{\rho_g}{4\text{Vol}(B(0, R_0))},$$

we get $g(v) \geq \eta \mathbf{1}_{B(\bar{v}, \delta_0)}$. □

Now we fix $x \in \mathbb{T}^N$ and we deduce from the representation (4.4.22) that

$$\begin{aligned} \forall t \in [0, \tau], \forall v \in \mathbb{R}^N, \quad f(t, x + vt, v) &\geq f_0(x, v) e^{-\int_0^t (S_\varepsilon + L_\varepsilon)[f(s, x + vs, \cdot)](v) ds} \\ &+ \int_0^t e^{-\int_s^t (S_\varepsilon + L_\varepsilon)[f(s', x + vs', \cdot)](v) ds'} Q_\varepsilon^1[f(s, x + vs, \cdot), f(s, x + vs, \cdot)](v) ds. \end{aligned}$$

We apply Lemma 4.8 to the function $f_0(x, \cdot)$ to obtain

$$\begin{aligned} \forall t \in [0, \tau], \forall v \in \mathbb{R}^N, \quad f(t, x + vt, v) &\geq \eta \mathbf{1}_{B(\bar{v}, \delta_0)} e^{-\int_0^t (S_\varepsilon + L_\varepsilon)[f(s, x + vs, \cdot)](v) ds} \\ &+ \int_0^t e^{-\int_s^t (S_\varepsilon + L_\varepsilon)[f(s', x + vs', \cdot)](v) ds'} Q_\varepsilon^1[f(s, x + vs, \cdot), f(s, x + vs, \cdot)](v) ds, \end{aligned}$$

for some $\bar{v} \in B(0, R_0)$. Then we restrict the inequality on the ball $B(\bar{v}, \delta_0) \subset B(0, R_0 + \delta_0)$ and we use the estimates on S_ε , L_ε and Q_ε^1 to get

$$\begin{aligned} \forall t \in [0, \tau], \forall v \in B(\bar{v}, \delta_0), \quad f(t, x + vt, v) &\geq \eta \mathbf{1}_{B(\bar{v}, \delta_0)} e^{-C_f (m_{b_\varepsilon^R} + n_{b_\varepsilon^S}) \langle v \rangle^{\gamma^+} \tau} \\ &- \tau C_f m_{b_\varepsilon^R} \langle v \rangle^{\tilde{\gamma}}. \end{aligned}$$

Using the bounds on the velocity in the ball we get (up to modifying the constant C_f)

$$\begin{aligned} \forall t \in [0, \tau], \forall v \in B(\bar{v}, \delta_0), \quad f(t, x + vt, v) &\geq \eta \mathbf{1}_{B(\bar{v}, \delta_0)} e^{-C_f (m_{b_\varepsilon^R} + n_{b_\varepsilon^S}) \tau} \\ &- \tau C_f m_{b_\varepsilon^R}. \end{aligned}$$

Then we assume (up to reducing τ) that $\tau \leq 1$, and we choose first ε_0 small enough such that

$$C_f m_{b_{\varepsilon_0}^R} \leq \frac{\eta}{4}$$

and then τ small enough such that

$$e^{-C_f (m_{b_{\varepsilon_0}^R} + n_{b_{\varepsilon_0}^S}) \tau} \geq \frac{1}{2}.$$

This shows that

$$\forall t \in [0, \tau], \forall v \in B(\bar{v}, \delta_0), \quad f(t, x + vt, v) \geq \frac{\eta}{4} \mathbf{1}_{B(\bar{v}, \delta_0)},$$

which concludes the initialization with \bar{v} , δ_0 and $\eta_0 = \eta/4$.

Step 2: Proof of the induction. As for the proof of the induction, we proceed quite similarly as in the proof of Proposition 4.1. We suppose that the n th step is satisfied:

$$\forall t \in \left[\left(\sum_{k=0}^n \Delta_k \right) \tau, \tau \right], \forall v \in \mathbb{R}^N, \quad f(t, x + vt, v) \geq a_n \mathbf{1}_{B(\bar{v}, \delta_n)}.$$

We use the following lower bound given by the Duhamel representation (4.4.22) and the estimate on Q_ε^1 :

$$\forall t \in \left[\left(\sum_{k=0}^{n+1} \Delta_k \right) \tau, \tau \right], \quad \forall v \in \mathbb{R}^N,$$

$$f(t, x + vt, v) \geq \int_{(\sum_{k=0}^n \Delta_n) \tau}^t e^{-C_f (m_{b_\varepsilon^R} + n_{b_\varepsilon^S}) (t-s) \langle v \rangle^{\gamma^+}} \left[Q_\varepsilon^+(a_n \mathbf{1}_{B(\bar{v}, \delta_n)}, a_n \mathbf{1}_{B(\bar{v}, \delta_n)}) - \tau C_f m_{b_\varepsilon^R} \langle v \rangle^{\tilde{\gamma}} \right] ds.$$

Thus by applying Lemma 4.3 on Q_ε^+ , we obtain

$$\forall t \in \left[\left(\sum_{k=0}^{n+1} \Delta_n \right) \tau, \tau \right], \quad \forall v \in \mathbb{R}^N,$$

$$f(t, x + vt, v) \geq \int_{(\sum_{k=0}^n \Delta_n) \tau}^t e^{-C_f (m_{b_\varepsilon^R} + n_{b_\varepsilon^S}) (t-s) \langle v \rangle^{\gamma^+}} \left[\text{cst } a_n^2 \delta_n^{N+\gamma} \xi_n^{(N/2-1)} \mathbf{1}_{B(\bar{v}, \delta_{n+1})} - \tau C_f m_{b_\varepsilon^R} \langle v \rangle^{\tilde{\gamma}} \right].$$

Then we restrict the inequality to the ball $B(\bar{v}, \delta_{n+1})$ to obtain, using the bounds on the velocity and up to modifying the constant C_f :

$$\forall t \in \left[\left(\sum_{k=0}^{n+1} \Delta_n \right) \tau, \tau \right], \quad \forall v \in B(\bar{v}, \delta_{n+1}),$$

$$f(t, x + vt, v) \geq \int_{(\sum_{k=0}^n \Delta_n) \tau}^t e^{-C_f (m_{b_\varepsilon^R} + n_{b_\varepsilon^S}) (t-s) \delta_{n+1}^{\gamma^+}} \left[\text{cst } a_n^2 \delta_n^{N+\gamma} \xi_n^{(N/2-1)} \mathbf{1}_{B(\bar{v}, \delta_{n+1})} - \tau C_f m_{b_\varepsilon^R} \delta_{n+1}^{\tilde{\gamma}} \right].$$

Then (assuming $\tau \leq 1$) we choose $\varepsilon = \varepsilon_n$ such that

$$\tau C_f m_{b_\varepsilon^R} \delta_{n+1}^{\tilde{\gamma}} \leq \frac{1}{2} \text{cst } a_n^2 \delta_n^{N+\gamma} \xi_n^{(N/2-1)}$$

which is possible since $m_{b_\varepsilon^R} \rightarrow_{\varepsilon \rightarrow 0} 0$. More precisely by using the equivalent of $m_{b_\varepsilon^R}$ for $\varepsilon \sim 0$, simple computations show that we can take

$$\varepsilon_n = \text{cst} \left[C_f a_n^2 \delta_n^{N+\gamma-\tilde{\gamma}} \xi_n^{(N/2-1)} \right]^{\frac{1}{2-\nu}}$$

where the constant C_f is independent of n and depends only on the uniform bounds on f .

Then we restrict the time integration to the interval

$$\left[\left(\sum_{k=0}^{n+1} \Delta_n \right) \tau, \left(\sum_{k=0}^{n+1} \Delta_n \right) \tau \right]$$

(since the integrand is non-negative) which yields

$$\begin{aligned} \forall t \in \left[\left(\sum_{k=0}^{n+1} \Delta_n \right) \tau, \tau \right], \forall v \in B(\bar{v}, \delta_{n+1}), \\ f(t, x + vt, v) \\ \geq \text{cst} \int_{\left(\sum_{k=0}^n \Delta_n \right) \tau}^{\left(\sum_{k=0}^{n+1} \Delta_n \right) \tau} e^{-C_f (m_{b_{\xi_n}^R} + n_{b_{\xi_n}^S}) (t-s) \delta_{n+1}^{\gamma^+}} a_n^2 \delta_n^{N+\gamma} \xi_n^{(N/2-1)} \mathbf{1}_{B(\bar{v}, \delta_{n+1})} \\ \geq \text{cst} e^{-C_f (m_{b_{\xi_n}^R} + n_{b_{\xi_n}^S}) \left(\sum_{k \geq n+1} \Delta_k \right) \delta_{n+1}^{\gamma^+}} \Delta_{n+1} a_n^2 \delta_n^{N+\gamma} \xi_n^{(N/2-1)} \mathbf{1}_{B(\bar{v}, \delta_{n+1})}. \end{aligned}$$

Finally the argument in the exponential is seen to be equivalent to

$$\left[C_f a_n^2 \delta_n^{N+\gamma-\tilde{\gamma}} \xi_n^{(N/2-1)} \right]^{-\frac{\nu}{2-\nu}} \left(\sum_{k \geq n+1} \Delta_k \right) \delta_{n+1}^{\gamma^+}$$

when $\nu \in (0, 2)$ and

$$-\text{cst} \log \left[C_f a_n^2 \delta_n^{N+\gamma-\tilde{\gamma}} \xi_n^{(N/2-1)} \right] \left(\sum_{k \geq n+1} \Delta_k \right) \delta_{n+1}^{\gamma^+}$$

when $\nu = 0$ (for some new constant C_f depending on the uniform bounds on f), which concludes the proof. \square

We are now able to conclude the proof of Theorem 4.2.

Proof of Theorem 4.2. We only study the asymptotic behavior of the coefficients a_n . The two other steps of the proof (uniformization of the spatial and time dependences) are exactly similar as those in the proof of Theorem 4.1.

We fix $\xi \in (0, 1)$ and define $\xi_n = \xi^n$. We saw above that with this choice $\delta_n \sim \text{cst} 2^{n/2}$. First we deal with the case $\nu > 0$. Let us choose any $\kappa > 2 + 2\nu/(2 - \nu)$, and take for the time intervals

$$\Delta_{n+1} = \frac{\alpha^{\beta \kappa^n}}{\sum_{k \geq 0} \alpha^{\beta \kappa^{k-1}}}$$

where $\alpha \in (0, 1)$ and $2\nu/(2-\nu) < \beta < \kappa - 2$. We shall establish by induction the lower bound

$$(4.4.25) \quad a_n \geq \alpha^{\kappa^n}.$$

One easily sees that this estimate (4.4.25) implies that

$$\forall v \in \mathbb{R}^N, \quad f(\tau, x + \tau v, v) \geq C_1 e^{-C_2 |v|^\kappa}$$

for a suitable choice of $C_1, C_2 > 0$ and

$$K = \frac{\log \kappa}{\log \sqrt{2}},$$

and thus concludes the proof.

The initialization of the induction is made by choosing α such that $\alpha \leq a_0$. Then we suppose the lower bound satisfied for a_n and we show first that the argument of the exponential in (4.4.23) is uniformly bounded. A simple computation establishes that

$$\sum_{k \geq n+1} \Delta_k \leq \text{cst } \Delta_{n+1} = \text{cst } \alpha^{\beta \kappa^n}$$

where the constant is independent of n . Thus

$$\begin{aligned} & \left[a_n^2 \delta_n^{N+\gamma-\tilde{\gamma}} \xi_n^{(N/2-1)} \right]^{-\frac{\nu}{2-\nu}} \left(\sum_{k \geq n+1} \Delta_k \right) \delta_{n+1}^{\gamma^+} \\ & \leq \left[\frac{2^{\gamma^+/2}}{(C_f 2^{(N+\gamma-\tilde{\gamma})/2} \xi_n^{(N/2-1)})^{\nu/(2-\nu)}} \right]^n \alpha^{(\beta - \frac{2\nu}{2-\nu}) \kappa^n} \end{aligned}$$

and the right-hand side member of this inequality goes to 0 as n goes to infinity. So the exponential term is uniformly bounded from below by some constant $C_e > 0$ depending on the uniform bounds on the solution f .

So the induction formula (4.4.23) defining a_n yields

$$a_{n+1} \geq \text{cst } C_e \Delta_{n+1} a_n^2 \delta_n^{\gamma+N} \xi_n^{(N/2-1)}$$

and thus

$$a_{n+1} \geq \text{cst } C_e \alpha^{(2+\beta)\kappa^n} \left[2^{(N+\gamma)/2} \xi_n^{(N/2-1)} \right]^n \geq \text{cst } \alpha^{\kappa^{n+1}}$$

if α is small enough (using $\kappa > 2 + \beta$) and the induction is proved.

Now for the case $\nu = 0$, we choose the following time intervals

$$\Delta_{n+1} = \frac{\beta^n}{\sum_{k \geq 0} \beta^{k-1}}$$

where $\beta \in (0, 1)$. We shall establish by induction the lower bound

$$a_n \geq \alpha^{2^n}$$

which implies (as in the proof of Theorem 4.1) that

$$\forall v \in \mathbb{R}^N, \quad f(\tau, x + \tau v, v) \geq C_1 e^{-C_2 |v|^2}$$

for a suitable choice of $C_1, C_2 > 0$ and thus concludes the proof.

We suppose the lower bound satisfied for a_n and we show first that the argument of the exponential in (4.4.24) is uniformly bounded. We have

$$\sum_{k \geq n+1} \Delta_k \leq \text{cst } \Delta_{n+1} = \text{cst } \beta^n$$

where the constant is independent of n , and so

$$\begin{aligned} & \left| \log \left[C_f a_n^2 \delta_n^{N+\gamma-\tilde{\gamma}} \xi_n^{\zeta(N/2-1)} \right] \left(\sum_{k \geq n+1} \Delta_k \right) \delta_{n+1}^{\gamma^+} \right| \\ & \leq |\log C_f| + \text{cst } 2^{n(\gamma^+/2+1)} \beta^n + \text{cst } n 2^{n\gamma^+/2} \beta^n \end{aligned}$$

which goes to 0 if β is taken small enough. So the exponential term is uniformly bounded from below by some constant $C_e > 0$ depending on the uniform bounds on the solution f .

The induction formula (4.4.24) defining a_n yields

$$a_{n+1} \geq \text{cst } C_e \Delta_{n+1} a_n^2 \delta_n^{\gamma+N} \xi_n^{\zeta(N/2-1)}$$

and thus

$$a_{n+1} \geq \text{cst } C_e a_n^2 \left[2^{(N+\gamma)/2} \xi^{\zeta(N/2-1)} \beta \right]^n.$$

Then if we denote

$$\lambda = 2^{(N+\gamma)/2} \xi^{\zeta(N/2-1)} \beta$$

a similar computation as in the proof of Proposition 4.1 gives

$$a_n = a_n \geq (\text{cst } C_e)^{2^n-1} \lambda^{[(n-1)2^0 + (n-2)2^1 + \dots + 02^{n-1}]} a_0^{2^n} \geq (\text{cst } C_e \lambda a_0)^{2^n}$$

and thus $a_n \geq \alpha^{2^n}$ if one takes $\alpha \leq \text{cst } C_e \lambda a_0$ and the induction is proved. This concludes the proof. \square

4.5 Application to the existing Cauchy theories

In this section we shall use Theorem 4.1 and Theorem 4.2 to study solutions which have been constructed by previous authors, by connecting these theorems to some existing results of the Cauchy theory of the Boltzmann equation.

First we give a theorem which summarizes the situation in the spatially homogeneous setting for cutoff potentials in cases where the collision kernel does not present a singularity for vanishing relative velocity (a case which is not so well understood and for which L^p estimates have not yet been derived).

Theorem 4.3. *Let $B = \Phi b$ be a collision kernel satisfying assumptions (4.1.1), with Φ satisfying assumption (4.1.2) with $\gamma \geq 0$ or (4.1.3), and b satisfying (4.1.4) with $\nu < 0$. Let f_0 be a nonnegative initial datum on \mathbb{R}_v^N with finite mass, energy. Then*

- (i) *there exists a unique solution $f(t, v)$ with constant mass and energy to the spatially homogeneous Boltzmann equation, defined for all times;*
- (ii) *if f_0 has finite entropy, then the entropy of the solution remains uniformly bounded and the solution satisfies*

$$\forall t > 0, \forall v \in \mathbb{R}^N, \quad f(t, v) \geq \rho(t) \frac{e^{-\frac{|v|^2}{2\theta(t)}}}{(2\pi\theta(t))^{N/2}}.$$

The constants $\rho(t), \theta(t) > 0$ are explicit and depend on the mass, energy and entropy of f_0 ; they are uniform for $t \rightarrow +\infty$ but not necessarily for $t \rightarrow 0$.

Remark: Let us sketch briefly how it is possible to relax the assumption of the boundedness of the entropy of the initial datum in point (ii) in the case $\gamma > 0$ in dimension 3. Indeed Mischler and Wennberg [144, Lemma 2.1] proved in this case that

$$g = Q^+(Q^+(f, f), f)$$

is uniformly integrable, with constants depending on the L_2^1 norm of f . The bound on the entropy is only used in the obtaining of the upheaval point in Lemma 4.2, whose proof requires the uniform integrability of the function. But in the initialization step of Proposition 4.1, it is possible, up some tricky computations, to obtain by iterating twice more the Duhamel representation

$$\forall v \in \mathbb{R}^N, |v| \leq R_0,$$

$$f(t, x + vt, v) \geq C_{T, R_0, B} Q^+ \left[Q^+ \left[g_0^{R_0}(x, \cdot), g_0^{R_0}(x, \cdot) \right], g_0^{R_0}(x, \cdot) \right] (v)$$

where $g_0 = Q^+(Q^+(f_0, f_0), f_0)$. As g_0 is uniformly integrable (with explicit bounds) by the result of Mischler and Wennberg above, one can apply Lemma 4.2 to

$$Q^+ \left[Q^+ [g_0^{R_0}(x, \cdot), g_0^{R_0}(x, \cdot)], g_0^{R_0}(x, \cdot) \right] (v)$$

to get the upheaval point and the rest of the proof is unchanged.

Proof of Theorem 4.3. Let us prove (i): In the case Φ satisfies assumption (4.1.2) with $\gamma > 0$, the existence and uniqueness in L^1_2 (for solutions with non-increasing energy) are proved in [144]. In the case $\gamma = 0$ or Φ satisfies assumption (4.1.3) with $\gamma \in (-N, 0)$, existence and uniqueness in L^1_2 can be deduced from Arkeryd [6]: in this case the collision operator is a bounded bilinear operator in L^1 , which implies the uniqueness, and the global existence is proved by the monotonicity argument from [6]. For (ii): In all these cases the mass and energy are conserved. By the H Theorem, if the entropy of the initial datum is bounded, then it remains bounded uniformly for all times. Thus the solution satisfies (4.1.6) and one can apply Theorem 4.1 and concludes the proof. \square

Now we give a theorem for non-cutoff mollified hard potentials collision kernels, using a recent result of Desvillettes and Wennberg [74]. Here $\mathcal{S}(\mathbb{R}_v^N)$ denotes the Schwartz space of the functions with all derivatives bounded and decreasing faster at infinity than any inverse of polynomial.

Theorem 4.4. *Let $B = \Phi b$ be a collision kernel satisfying assumptions (4.1.1), with Φ satisfying assumption (4.1.3) with $\gamma > 0$ and C^∞ , and b satisfying (4.1.4) with $\nu \in (0, 2)$. Let f_0 be a nonnegative initial datum on \mathbb{R}_v^N with finite mass, energy and entropy. Then*

- (i) *there exists a solution f to the spatially homogeneous Boltzmann equation with constant mass and energy and uniformly bounded entropy, defined for all times and belonging to $L^\infty([t_0, +\infty), \mathcal{S}(\mathbb{R}_v^N))$ for any $t_0 > 0$,*
- (ii) *this solution satisfies*

$$\forall t > 0, \forall v \in \mathbb{R}^N, \quad f(t, v) \geq C_1(t) e^{-C_2(t)|v|^K}$$

for any exponent K such that

$$K > 2 \frac{\log \left(2 + \frac{2\nu}{2-\nu} \right)}{\log 2}.$$

The constants $C_1(t), C_2(t) > 0$ are explicit and depend on the mass, energy, entropy of f_0 and K ; they are uniform for $t \rightarrow +\infty$ but not necessarily for $t \rightarrow 0$.

Proof of Theorem 4.4. First let us prove (i): Our assumptions on B imply the assumptions [74, Assumption 2] on the collision kernel B , namely $B = \Phi b$ with Φ a smooth and strictly positive function such that $\Phi(z) \sim_{|z| \rightarrow +\infty} |z|^\gamma$ with $\gamma \in (0, 1]$, and b such that $b(\cos \theta) \sim_{\theta \rightarrow 0} \text{cst } \theta^{-(N-1)-\nu}$ with $\nu > 0$. Concerning the initial datum our assumptions are exactly those of [74, Assumption 1]. So we can apply [74, Theorem 1] to prove the existence of a solution, lying in $L^\infty([t_0, +\infty), \mathcal{S}(\mathbb{R}_v^N))$ for any $t_0 > 0$. For (ii): The explicit bound $L^\infty([t_0, +\infty), \mathcal{S}(\mathbb{R}_v^N))$ for any $t_0 > 0$ immediately implies the uniform bounds (4.1.6) and (4.1.8). Thus one can apply Theorem 4.2 to obtain the lower bound for $t \geq t_0 + \tau$. As t_0 and τ are arbitrarily small this concludes the proof. \square

For spatially inhomogeneous solutions we can apply our results to the solutions near the equilibrium in a torus constructed by Ukai (see [183, 184] and [58, Section 7.6]) for hard spheres and Guo [110] for soft potentials. For the sake of clarity, we do not explicit in full detail the functional settings in which these solutions are constructed and we refer to the above-mentioned references for more precise definitions.

Theorem 4.5. *Let $B = \Phi b$ be a collision kernel satisfying assumptions (4.1.1), with*

- a- Φ satisfying assumption (4.1.2) with $\gamma = 1$ and $b = 1$ (solutions of Ukai) or
- b- Φ satisfying assumption (4.1.2) with $\gamma < 0$ and b satisfying (4.1.4) with $\nu < 0$ (solutions of Guo).

Let $f_0 = M + M^{1/2}h_0$ (M is the global Maxwellian equilibrium) be a nonnegative initial datum on $\mathbb{T}_x^N \times \mathbb{R}_v^N$ such that

$$\|h_0\|_{H^{s,q}}^2 := \sum_{|i|+|j|\leq s} \|h_0 \langle v \rangle^q\|_{L^2(\mathbb{T}^N \times \mathbb{R}^N)}^2 \leq \epsilon_0$$

with $s, q, \epsilon_0 > 0$. Then

- (i) for any $s', q' > 0$, if s, q are large enough and ϵ_0 is small enough, there exists a unique solution f to the full Boltzmann equation in $H^{s',q'}$, defined for all times, with uniform bound in $H^{s',q'}$ depending on ϵ_0 ;

(ii) this solution satisfies

$$\forall t > 0, \forall x \in \mathbb{T}^N, \forall v \in \mathbb{R}^N, \quad f(t, x, v) \geq \rho(t) \frac{e^{-\frac{|v|^2}{2\theta(t)}}}{(2\pi\theta(t))^{N/2}}.$$

The constants $\rho(t)$, $\theta(t) > 0$ depend on ϵ_0 ; they are uniform for $t \rightarrow +\infty$ but not necessarily for $t \rightarrow 0$.

Remarks: 1. Most probably the solutions of Ukai could extend to any cutoff hard potentials, even if they were constructed for hard spheres. Anyhow the method of Guo would probably recover the result for any cutoff hard potentials as well.

2. The proof of Ukai uses the spectral gap of the linearized collision operator for hard spheres, which was known to exist since Grad [108]. This spectral gap was obtained by non-constructive method (essentially Weyl's Theorem about compact perturbation of the essential spectrum). However explicit estimates on this spectral gap were recently obtained in [15], which is a step forward into a constructive theory. Nevertheless at now the proofs of Ukai (and Guo) still do not provide constructive bounds.

3. One can apply the result of convergence to equilibrium of Desvillettes and Villani [70] to the solutions of Theorem 4.5, which do satisfy every assumption of [70, Theorem 2]. Thus they converges almost exponentially to equilibrium, i.e.

$$\|f_t - M\|_{L^1_{x,v}} \leq C_\alpha t^{-1/\alpha}$$

where α can be taken as big as wanted when s and q are large enough, and the constant C_α is explicit according to the uniform regularity bounds on f and the constants in the lower bound. For the solutions of Ukai in the hard spheres case, this result is weaker than the exponential convergence to equilibrium already proved by Ukai, but the convergence to equilibrium was unknown for the solutions of Guo in the case of soft potentials.

4. Let us explain how to skip the ‘‘upheaval step’’ of the proof for solutions near the equilibrium. Indeed in the case of perturbative solutions, which are L^∞ close to a global Maxwellian distribution, Lemma 4.2 can be bypassed by a more direct argument: up to reduce the neighborhood of the Maxwellian distribution for the existence theory (i.e. reducing ϵ_0), the uniform L^∞ control of smallness on h yields

$$\forall t \in \mathbb{R}_+, \forall x \in \mathbb{T}^N, \forall v \in \mathbb{R}^N, \quad f(t, x, v) \geq \eta_0 \mathbf{1}_{B(0, \delta_0)}$$

for some $\eta_0 > 0$ and $\delta_0 > 0$.

Proof of Theorem 4.5. One can check easily that for s and q large enough and ϵ_0 small enough in the assumptions on the initial datum, f_0 satisfies the assumptions of [58, Theorem 7.6.2] in the case of Ukai’s solutions, and the assumptions of [110, Theorem 1] for Guo’s solutions. Then for s large enough, the uniform smoothness estimates on the solution imply in both cases a bound on $\|h_t\|_{L_{x,v}^\infty}$, uniform for all times, and going to 0 as $\epsilon_0 \rightarrow 0$. Thus if one take ϵ_0 small enough such that

$$\left(\sup_{t \geq 0} \|h_t\|_{L_{x,v}^\infty} \right) \int_{\mathbb{R}_v^N} \sqrt{M(v)} dv \leq \frac{1}{2} \int_{\mathbb{R}_v^N} M(v) dv$$

one immediately get

$$\varrho_f \geq \frac{1}{2} \int_{\mathbb{R}_v^N} M(v) dv > 0$$

for all times. The uniform upper bounds on the local energy and local entropy (and local L^p bound) follow from the uniform regularity bounds on the solution. Thus the solution satisfies (4.1.6) and (4.1.7) and one can apply Theorem 4.1 and conclude the proof. \square

Finally, let us say a few words about other Cauchy theories.

In the spatially inhomogeneous setting, one could apply Theorem 4.1 to solutions for small time constructed in [120] (in the cutoff case). We did not detail this application since we were more interested with global solutions.

One could also apply Theorem 4.1 to the global weakly inhomogeneous solutions (for cutoff hard potentials) constructed by Arkeryd, Esposito and Pulvirenti in [11], which would give a Maxwellian lower bound on these solutions (uniform as $t \rightarrow +\infty$). Note that the uniform bounds on the solution obtained in [11] do not seem to be constructive. As a consequence the Maxwellian lower bound given by Theorem 4.1 would not have constructive constants.

Concerning the global solutions in the whole space \mathbb{R}^N near the vacuum constructed by Kaniel, Illner and Shinbrot (cf. [119, 142, 106] or [58, Section 5.2]), a lower bound on the solution $f(t, x, v)$ cannot be uniform in space since $f(t, \cdot, \cdot)$ is integrable on $\mathbb{R}_x^N \times \mathbb{R}_v^N$, and it cannot be uniform as t goes to infinity since the solution goes to 0 as t goes to infinity for every (x, v) such that $v \neq 0$ (see [58, Theorem 5.2.2]). Our method could not apply, and is more adapted to evolution problems in bounded domains. We note that for these solutions in the whole space, in some cases a bound from below on the solutions by a “travelling Maxwellian”

$$\forall t \geq 0, \forall x \in \mathbb{R}^N, \forall v \in \mathbb{R}^N, \quad f(t, x, v) \geq C(t) e^{-\beta|x-tv|^2} e^{-\alpha|v|^2}$$

(where $\alpha > 0$ and $\beta > 0$ are absolute constants, and $C(t) > 0$ is a constant depending on time) can replace our method to provide a lower bound (see for instance [106], and also in the same spirit [136]).

Acknowledgment. Support by the European network HYKE, funded by the EC as contract HPRN-CT-2002-00282, is acknowledged.

Partie II

Théorie quantitative du retour vers l'équilibre

Explicit spectral gap estimates for the linearized Boltzmann and Landau operators with hard potentials

Article [15] en collaboration avec Céline Baranger, à paraître dans *Revista Matemática Iberoamericana*.

ABSTRACT: *This paper deals with explicit spectral gap estimates for the linearized Boltzmann operator with hard potentials (and hard spheres). We prove that it can be reduced to the Maxwellian case, for which explicit estimates are already known. Such a method is constructive, does not rely on Weyl's Theorem and thus does not require Grad's splitting. The more physical idea of the proof is to use geometrical properties of the whole collision operator. In a second part, we use the fact that the Landau operator can be expressed as the limit of the Boltzmann operator as collisions become grazing in order to deduce explicit spectral gap estimates for the linearized Landau operator with hard potentials.*

Contents

5.1	Introduction	213
5.2	The Boltzmann linearized operator	221
5.3	The Landau linearized operator	229

5.1 Introduction

This paper is devoted to the study of the spectral properties of the linearized Boltzmann and Landau collision operators with hard potentials. In this work we shall obtain new quantitative estimates on the spectral gap of these operators. Before we explain our methods and results in more details, let us introduce the problem in a precise way. The Boltzmann equation describes the behavior of a dilute gas when the only interactions taken into account are binary elastic collisions. It reads in \mathbb{R}^N ($N \geq 2$)

$$\frac{\partial f}{\partial t} + v \cdot \nabla_x f = Q^{\mathcal{B}}(f, f),$$

where $f(t, x, v)$ stands for the time-dependent distribution function of density of particles in the phase space. The N -dimensional Boltzmann collision operator $Q^{\mathcal{B}}$ is a quadratic operator, which is local in (t, x) . The time and position are only parameters and therefore shall not be written in the sequel: the estimates proven in this paper are all local in (t, x) . Thus it acts on $f(v)$ by

$$Q^{\mathcal{B}}(f, f)(v) = \int_{\mathbb{R}^N \times \mathbb{S}^{N-1}} B(|v - v_*|, \cos \theta) (f'_* f' - f_* f) dv_* d\sigma$$

where we have used the shorthands $f = f(v)$, $f_* = f(v_*)$, $f' = f(v')$, $f'_* = f(v'_*)$. The velocities are given by

$$\begin{cases} v' = \frac{v + v_*}{2} + \frac{|v - v_*|}{2} \sigma, \\ v'_* = \frac{v + v_*}{2} - \frac{|v - v_*|}{2} \sigma. \end{cases}$$

The collision kernel B is a non-negative function which only depends on $|v - v_*|$ and $\cos \theta = k \cdot \sigma$ where $k = (v - v_*)/|v - v_*|$.

Consider the collision operator obtained by the linearization process around the Maxwellian *global* equilibrium state denoted by M

$$L^{\mathcal{B}} h(v) = \int_{\mathbb{R}^N \times \mathbb{S}^{N-1}} B(|v - v_*|, \cos \theta) M(v_*) (h'_* + h' - h_* - h) dv_* d\sigma,$$

where $f = M(1 + h)$ and $M(v) = e^{-|v|^2}$ (up to a normalization). It is well-known that this operator is self-adjoint on the space $L^2(M)$, which we define

by

$$\|h\|_{L^2(M)}^2 = \int_{\mathbb{R}^N} h^2 M dv.$$

Moreover the dirichlet form satisfies

$$\begin{aligned} \langle h, L^{\mathcal{B}} h \rangle_{L^2(M)} = \\ - \frac{1}{4} \int_{\mathbb{R}^{2N} \times \mathbb{S}^{N-1}} B(|v - v_*|, \cos \theta) \left(h'_* + h' - h_* - h \right)^2 M M_* dv dv_* d\sigma. \end{aligned}$$

This quantity is non-positive, which implies that the spectrum of $L^{\mathcal{B}}$ in $L^2(M)$ is non-positive. Finally the kernel of $L^{\mathcal{B}}$ is spanned by the so-called *collision invariants*, that is

$$N(L^{\mathcal{B}}) = \text{Span} \{1, v_1, \dots, v_N, |v|^2\}.$$

At the level of the linearized equation, this two properties corresponds to Boltzmann's H theorem. Indeed for the linearized equation, the role of the entropy is played by the opposite of the $L^2(M)$ norm of h , and the "entropy production fonctionnal" is $-\langle h, L^{\mathcal{B}} h \rangle_{L^2(M)}$. Let us denote

$$D^{\mathcal{B}}(h) = -\langle h, L^{\mathcal{B}} h \rangle_{L^2(M)} \geq 0.$$

In the case of long-distance interaction, the collisions occur mostly for very small deviation angle θ . In the case of the Coulomb potential, for which the Boltzmann collision operator is meaningless (see [189, Annex I, Appendix A]), one has to replace it by the Landau collision operator

$$Q^{\mathcal{L}}(f, f)(v) = \nabla_v \cdot \left(\int_{\mathbb{R}^N} \mathbf{A}(v - v_*) [f_*(\nabla f) - f(\nabla f)_*] dv_* \right),$$

with $\mathbf{A}(z) = |z|^2 \Phi(z) \Pi_{z^\perp}$, where Π_{z^\perp} is the orthogonal projection onto z^\perp , i.e.

$$(\Pi_{z^\perp})_{i,j} = \delta_{i,j} - \frac{z_i z_j}{|z|^2}.$$

This operator is used for instance in models of plasma in the case of a Coulomb potential, i.e. a gas of (partially or totally) ionized particles (for more details see [191] and the references therein). Applying the same linearization process than for the Boltzmann operator (around the same global equilibrium M), we define the linearized Landau operator

$$L^{\mathcal{L}} h(v) = M(v)^{-1} \nabla_v \cdot \left(\int_{\mathbb{R}^N} \mathbf{A}(v - v_*) [(\nabla h) - (\nabla h)_*] M M_* dv_* \right),$$

It is well-known that this operator is self-adjoint on $L^2(M)$. Moreover the Dirichlet form (which plays the role of the (linearized) Landau “entropy production functional”) satisfies

$$\begin{aligned} D^{\mathcal{L}}(h) &:= -\langle h, L^{\mathcal{L}}h \rangle_{L^2(M)} \\ &= \frac{1}{2} \int_{\mathbb{R}^{2N}} \Phi(v - v_*) |v - v_*|^2 \left\| \Pi_{(v-v_*)^\perp} [(\nabla h) - (\nabla h)_*] \right\|^2 M M_* dv dv_* \end{aligned}$$

which is non-positive. It implies that the spectrum of $L^{\mathcal{L}}$ in $L^2(M)$ is non-positive. The null space of $L^{\mathcal{L}}$ is the same as the one of $L^{\mathcal{B}}$, that is the vector space spanned by the collision invariants.

Let us now write down our assumptions for the collision kernel B :

- B is a tensorial product

$$(5.1.1) \quad B(|v - v_*|, \cos \theta) = \Phi(|v - v_*|) b(\cos \theta),$$

where Φ and b are non-negative functions (this is the case for instance for collision kernels deriving from interaction potentials behaving like inverse-power laws).

- The kinetic part Φ is bounded from below at infinity, i.e.

$$(5.1.2) \quad \exists R \geq 0, c_\Phi > 0 \mid \forall r \geq R, \Phi(r) \geq c_\Phi.$$

This assumption holds for hard potentials (and hard spheres).

- The angular part b satisfies

$$(5.1.3) \quad c_b = \inf_{\sigma_1, \sigma_2 \in \mathbb{S}^{N-1}} \int_{\sigma_3 \in \mathbb{S}^{N-1}} \min\{b(\sigma_1 \cdot \sigma_3), b(\sigma_2 \cdot \sigma_3)\} d\sigma_3 > 0.$$

This covers all the physical cases.

Remarks:

1. Notice that there is no b left in $Q^{\mathcal{L}}$ and $L^{\mathcal{L}}$ but the function Φ is definitely the same in both Landau and Boltzmann operators. Therefore the assumptions on the Landau operator reduce to (5.1.2). Thus we deal with the so-called “hard potentials” case for the Landau operator, which excludes the Coulomb potential.

2. The assumption that B is a tensorial product is made for a sake of simplicity. Indeed, one could easily adapt the proofs in section 5.2 to relax

this assumption. The price to pay would be a more technical condition on the collision kernel B .

The spectral properties of the linearized Boltzmann and Landau operators have been extensively studied. In particular, there are of crucial interest for perturbative approach issues. For instance, the convergence to equilibrium has been studied in this context, as well as the hydrodynamical limit (see [76]).

On the one hand, for hard potentials, the existence of a spectral gap as soon as the kinetic part of the collision kernel is bounded from below at infinity is a classical result, which can be traced back unto Grad himself. The only method was up to now to work under the assumption of Grad's angular cutoff, and to apply Weyl's Theorem to L^B , written as a compact perturbation of a multiplication operator (a very clear presentation of this proof can be found in [58]). The picture of the spectrum obtained for the operator (under Grad's cutoff assumption) is described by figures 5.1 and 5.2 (see [52]).

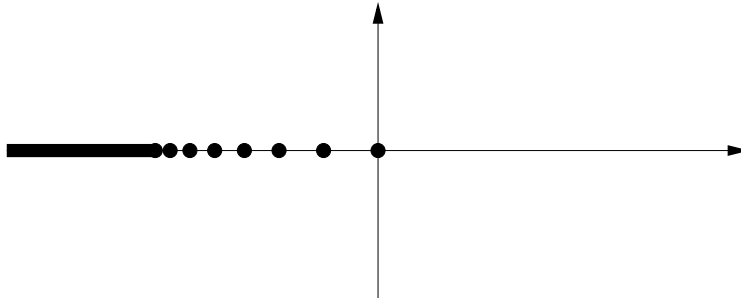

Figure 5.1: Spectrum of the collision operator for strictly hard potential with angular cutoff

A similar method has been applied to the Landau linearized operator with hard potential in [62].

On the other hand, for the particular case of Maxwellian molecules (for L^B), a complete and explicit diagonalisation has been obtained first by symmetry arguments in [194], and then by Fourier methods in [24]. The spectral gap for the “over-Maxwellian” collision kernel of the Landau linearized operator (i.e. collision kernels which are bounded from below by one for Maxwellian molecules) can be derived from results in [72], by a linearization process. Notice also that in the case of the so-called Kac's equation, an explicit entropy production estimate, based on a cancellation method, was given in [68]; this method can be linearized in order to give explicit spectral

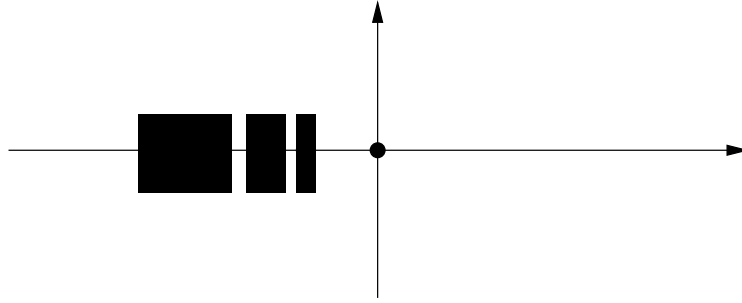

Figure 5.2: Spectrum of the collision operator for Maxwell's molecules with angular cutoff

gap estimates for “over-quadratic” linearized Kac’s operator (for which the physical meaning is not clear!). Nevertheless we did not manage to adapt this strategy to the Boltzmann operator with hard potentials. Notice however that Wennberg [195] gave an extension of the very first entropy estimates of Desvillettes [65] to allow for hard and soft potentials. His idea has some similarities with ours: to avoid the region in $\mathbb{R}^N \times \mathbb{R}^N$ where $\Phi(|v - v_*|)$ is small.

A specific study of the spectral properties of the linearized operator was made for *non-cutoff* hard potentials in [157]. Nevertheless this article was critically reviewed some years later in [122]. Also another specific study for “radial cutoff potentials” was done in [61].

Finally notice that it is proved in [41] that the Boltzmann linearized operator with soft potential has no spectral gap. The resulting spectrum is described in figure 5.3 (see [52]).

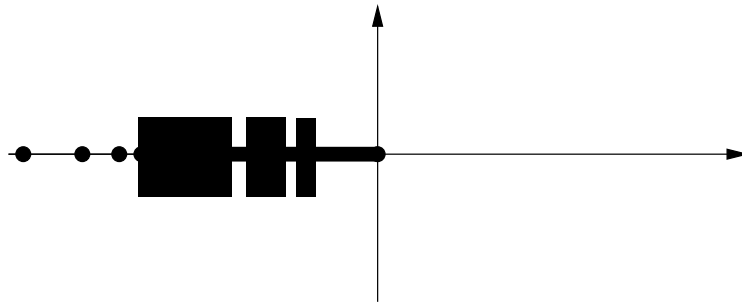

Figure 5.3: Spectrum of the collision operator for soft potentials with angular cutoff

Nevertheless if one allows a loss on the algebraic weight of the norm, it

was proved in [103] a “degenerated spectral gap” result of the form

$$\forall h \perp \{1, v_1, \dots, v_N, |v|^2\}, \quad \|L^{\mathcal{B}}h\|_{L^2(M)} \geq C \|h\|_{L^2_\gamma(M)},$$

where $\gamma < 0$ is the power such that $\Phi(|z|) = |z|^\gamma$. It is based on inequalities proven in [41] and Weyl’s Theorem.

However, the perturbative method has drawbacks, all coming from the fact that it does not rely on a physical argument. First it is not explicit, that is the width of the spectral gap is not known, which is problematic when one wants to obtain quantitative estimates of convergence to equilibrium. Secondly it gives no information about how this spectral gap is sensitive to the perturbation of the collision kernel. Finally approaches based on Weyl’s Theorem rely strongly on Grad’s cutoff assumption via “Grad’s splitting”, which means to deal separately with the gain and the loss part of the collision operator.

Our method is geometrical and based on a physical argument. It gives explicit estimates and deals with the whole operator, with or without angular cutoff. Up to our knowledge, as far as spectral gaps are considered, it covers all the results of the above-mentioned articles dealing with hard potentials, with or without angular cutoff. We also think likely that this geometrical method could be adapted to give explicit versions of “degenerated spectral gap” results in the case of soft potentials, which will be the object for forthcoming works.

We now state our main theorems:

Theorem 5.1 (The Boltzmann linearized operator). *Let $B = \Phi b$ be a collision kernel satisfying assumptions (5.1.1), (5.1.2), (5.1.3). Then the Boltzmann linearized entropy production functional $D^{\mathcal{B}}$ with collision kernel B satisfies, for all $h \in L^2(M)$*

$$(5.1.4) \quad D^{\mathcal{B}}(h) \geq C_{\Phi,b}^{\mathcal{B}} D_0^{\mathcal{B}}(h),$$

where $D_0^{\mathcal{B}}(h)$ stands for the entropy dissipation functional with $B_0 \equiv 1$ and

$$C_{\Phi,b}^{\mathcal{B}} = \left(\frac{c_\Phi c_b e^{-4R^2}}{32 |\mathbb{S}^{N-1}|} \right)$$

with R, c_Φ, c_b being defined in (5.1.2), (5.1.3).

As a consequence we deduce quantitative estimates on the spectral gap of the linearized Boltzmann operator, namely for all $h \in L^2(M)$ orthogonal in $L^2(M)$ to $1, v$ and $|v|^2$, we have

$$(5.1.5) \quad D^{\mathcal{B}}(h) \geq C_{\Phi,b}^{\mathcal{B}} |\lambda_0^{\mathcal{B}}| \|h\|_{L^2(M)}^2.$$

Here $\lambda_0^{\mathcal{B}}$ is the first non-zero eigenvalue of the linearized Boltzmann operator with $B_0 \equiv 1$ (that is, for Maxwellian molecules with no angular dependence, sometimes called pseudo-Maxwellian molecules) which equals in dimension 3 (see [24])

$$\lambda_0^{\mathcal{B}} = -\pi \int_0^\pi \sin^3 \theta \, d\theta = -\frac{4\pi}{3}.$$

Remark: As an application of this theorem, let us give explicit formulas for the spectral gap $S_\gamma^{\mathcal{B}}$ of the Boltzmann linearized operator with $b \geq 1$ and $\Phi(z) = |z|^\gamma$, $\gamma > 0$, in dimension 3. Then $c_b \geq |\mathbb{S}^2|$ and for any given R we can take $c_\Phi = R^\gamma$. Thus we get

$$S_\gamma^{\mathcal{B}} \geq \left(\frac{R^\gamma e^{-4R^2}}{32} \right) \frac{4\pi}{3}$$

for any $R > 0$. An easy computation leads to the lower bound

$$S_\gamma^{\mathcal{B}} \geq \frac{\pi (\gamma/8)^{\gamma/2} e^{-\gamma/2}}{24}$$

by optimizing the free parameter R .

Theorem 5.2 (The Landau linearized operator). *Let Φ be a collision kernel satisfying assumption (5.1.2). Then the Landau linearized entropy production functional $D^{\mathcal{L}}$ with collision kernel Φ satisfies, for all $h \in L^2(M)$*

$$(5.1.6) \quad D^{\mathcal{L}}(h) \geq C_\Phi^{\mathcal{L}} D_0^{\mathcal{L}}(h)$$

where $D_0^{\mathcal{L}}(h)$ stands for the Landau entropy dissipation functional with $\Phi_0 \equiv 1$ and

$$C_\Phi^{\mathcal{L}} = \left(\frac{c_\Phi \beta_R}{8 \alpha_N} \right)$$

with

$$\alpha_N = \int_{\mathbb{R}^{N-1}} e^{-|V|^2} \, dV, \quad \beta_R = \int_{\{V \in \mathbb{R}^{N-1} \mid |V| \geq 2R\}} e^{-|V|^2} \, dV.$$

As a consequence we deduce quantitative estimates on the spectral gap of the linearized Landau operator, namely for all $h \in L^2(M)$ orthogonal in $L^2(M)$ to 1, v and $|v|^2$, we have

$$(5.1.7) \quad D^{\mathcal{L}}(h) \geq C_\Phi^{\mathcal{L}} |\lambda_0^{\mathcal{L}}| \|h\|_{L^2(M)}^2.$$

Here $\lambda_0^{\mathcal{L}}$ is the first non-zero eigenvalue of the linearized Landau operator with $\Phi_0 \equiv 1$ (that is, for Maxwellian molecules).

Moreover in dimension 3, by grazing collisions limit, we can estimate $\lambda_0^{\mathcal{L}}$ thanks to the explicit formula on the spectral gap of the Boltzmann linearized operator for Maxwellian molecules

$$(5.1.8) \quad |\lambda_0^{\mathcal{L}}| \geq 2\pi.$$

Remarks:

1. As for the Boltzmann linearized operator, we can deduce from this theorem an explicit formula for a lower bound on the spectral gap $S_\gamma^{\mathcal{L}}$ for the Landau linearized operator with hard potentials $\Phi(z) = |z|^\gamma$, $\gamma > 0$, in dimension 3. We get

$$S_\gamma^{\mathcal{L}} \geq \left(\frac{R^\gamma e^{-4R^2}}{8} \right) 2\pi$$

for any $R > 0$. An easy computation leads to the lower bound

$$S_\gamma^{\mathcal{L}} \geq \frac{\pi (\gamma/8)^{\gamma/2} e^{-\gamma/2}}{4}$$

by optimizing the free parameter R .

2. The modulus of the first non-zero eigenvalue of the Landau linearized operator for Maxwellian molecules is estimated here by grazing collisions limit. Other methods would have been the linearization of entropy estimates in [72], or to use the decomposition (established in [187]) of the Landau operator for Maxwellian molecules into a Fokker-Planck part (for which spectral gap is already known) and a spherical diffusion process, which can only increase the spectral gap; and then to linearize the estimate thus obtained.

3. More generally, it is likely that an explicit spectral gap for the Landau linearized operator with hard potentials could be directly computed by existing methods even if up to our knowledge this is the first explicit formula. But Theorem 5.2 is stronger: it says that the property proved on the Boltzmann operator with hard potentials, namely “cancellations for small relative velocities can be neglected as far as linearized entropy production is concerned”, remains true for the Landau linearized operator with hard potentials.

The idea of the proof is to reduce the case of hard potentials (in the generalized sense (5.1.2)) to the Maxwellian case. The difficulty is to deal with the cancellations of the kinetic collision kernel Φ on the diagonal $v = v_*$.

The starting point is the following inequality which is a corollary of [50, Theorem 2.4]

$$(5.1.9) \quad \int_{\mathbb{R}^N} \int_{\mathbb{R}^N} |\xi(x) - \xi(y)|^2 |x - y|^\gamma M(x) M(y) dx dy \geq K_\gamma \int_{\mathbb{R}^N} \int_{\mathbb{R}^N} |\xi(x) - \xi(y)|^2 M(x) M(y) dx dy$$

for $\gamma \geq 0$, ξ some function, and

$$K_\gamma = \frac{1}{4 \int_{\mathbb{R}^N} M} \inf_{x, y \in \mathbb{R}^N} \int_{\mathbb{R}^N} \min \{|x - z|^\gamma, |z - y|^\gamma\} M(z) dz.$$

It was first suggested by Villani [191, Chap. 5, section 1.4], in the context of the study of entropy-entropy dissipation inequalities for the Landau equation with hard potentials, that this inequality could allow to prove that hard potentials reduce to the Maxwellian case as far as convergence to equilibrium is concerned.

The proof of (5.1.9) relies strongly on the existence of a “triangular inequality” for some function $F(x, y)$ integrated: in (5.1.9), the function F is simply $|\xi(x) - \xi(y)|^2$ which satisfies

$$F(x, y) \leq 2F(x, z) + 2F(z, y).$$

The main difficulty is hence to obtain such a “triangular inequality” adapted to our case for the Boltzmann linearized operator. It will be discussed in details in section 5.2 together with the proof of Theorem 5.1. Section 5.3 will be devoted to the Landau linearized operator: using results of section 5.2, we will prove Theorem 5.2 thanks to a grazing collision limit.

5.2 The Boltzmann linearized operator

In this section, we present the proof of inequality (5.1.4) in Theorem 5.1. In order to “avoid” the diagonal $v \sim v_*$ where Φ is not uniformly bounded from below, we use the following argument: performing a collision with small relative velocity (i.e. for a small $|v - v_*|$) is the same than performing two collisions with great relative velocity, provided that the pre- and post-collisional velocities are the same. One could summarize the situation in this way: when a collision with small relative velocity occurs, at the same time, two collisions with great relative velocity occur, which give the same pre- and post-collisional velocities, and which produce *at least the same amount of entropy*.

Before proving (5.1.4), let us begin with a preliminary lemma dealing with the angular part of the collision kernel. This lemma is based on the same geometrical idea as the one we shall use for the treatment of the cancellations of Φ : the introduction of some well-chosen intermediate collision. This first step is made for the sake of simplicity: we show that in the sequel of this section one can set $b \equiv 1$ without restriction. It makes the proof clearer, and simplifies somehow the constants.

Let us denote from now on

$$k(v, v_*, v', v'_*) = [h(v) + h(v_*) - h(v') - h(v'_*)]^2.$$

Lemma 5.1 (Homogeneization of the angular collision kernel b).

Under the assumptions (5.1.1), (5.1.2), (5.1.3), for all $h \in L^2(M)$,

$$(5.2.10) \quad D^{\mathcal{B}}(h) \geq \frac{c_b}{4 |\mathbb{S}^{N-1}|} D_1^{\mathcal{B}}(h)$$

where $D_1^{\mathcal{B}}$ denotes the entropy dissipation functional with $B = \Phi$ instead of $B = \Phi b$.

Remark: This lemma allows to bound from below the entropy dissipation functional by one with an “uniform angular collision kernel”, i.e. a constant c_b , even when b is not bounded from below by a positive number uniformly on the sphere. Notice for instance that the condition $c_b > 0$ is satisfied for b having only finite number of 0.

Proof of Lemma 5.1. First, we write down an appropriate representation of the operator. The functional $D^{\mathcal{B}}$ reads in “ σ -representation”

$$D^{\mathcal{B}}(h) = \frac{1}{4} \int_{\mathbb{R}^{2N} \times \mathbb{S}^{N-1}} \Phi(|v - v_*|) b \left(\frac{v - v_*}{|v - v_*|} \cdot \sigma_1 \right) M M_* k(v, v_*, v', v'_*) dv dv_* d\sigma_1$$

(for the classical representations of the Boltzmann operator we refer to [191]). Then keeping σ_1 fixed we do the change of variable

$$(v, v_*) \rightarrow \left(\frac{v + v_*}{2}, \frac{v - v_*}{2} \right),$$

whose jacobian is $(-1/2)^N$. Let us denote $\Omega = (v + v_*)/2$ and $\Omega' = (v - v_*)/2$. We obtain

$$D^{\mathcal{B}}(h) = \frac{2^N}{4} \int_{\Omega \in \mathbb{R}^N} \int_{\Omega' \in \mathbb{R}^N} \int_{\mathbb{S}^{N-1}} \Phi(2|\Omega'|) b \left(\frac{\Omega'}{|\Omega'|} \cdot \sigma_1 \right) k(\Omega + \Omega', \Omega - \Omega', \Omega + |\Omega'| \sigma_1, \Omega - |\Omega'| \sigma_1) e^{-2|\Omega|^2 - 2|\Omega'|^2} d\Omega d\Omega' d\sigma_1$$

(recall that $|\Omega|^2 + |\Omega'|^2 = (|v|^2 + |v_*|^2)/2$).

We now write Ω' in spherical coordinates $\Omega' = r \sigma_2$, the other variables being kept fixed, and use Fubini's Theorem

$$D^{\mathcal{B}}(h) = \frac{2^N}{4} \int_{\Omega \in \mathbb{R}^N} \int_{r \in \mathbb{R}_+} r^{N-1} \Phi(2r) e^{-2|\Omega|^2 - 2r^2} \int_{\sigma_1 \in \mathbb{S}^{N-1}} \int_{\sigma_2 \in \mathbb{S}^{N-1}} b(\sigma_1 \cdot \sigma_2) k(\Omega + r\sigma_2, \Omega - r\sigma_2, \Omega + r\sigma_1, \Omega - r\sigma_1) d\sigma_1 d\sigma_2 d\Omega dr.$$

Now we apply a geometrical idea that we shall also use below in the treatment of cancellations of Φ : namely we add a third artificial variable. Let us thus introduce two collisions points u and u_* on the sphere of center Ω and radius r (see figure 5.4) and replace the collision “ (v, v_*) gives (v', v'_*) ” by the two collisions “ (v, v_*) gives (u, u_*) ” and “ (u, u_*) gives (v', v'_*) ”.

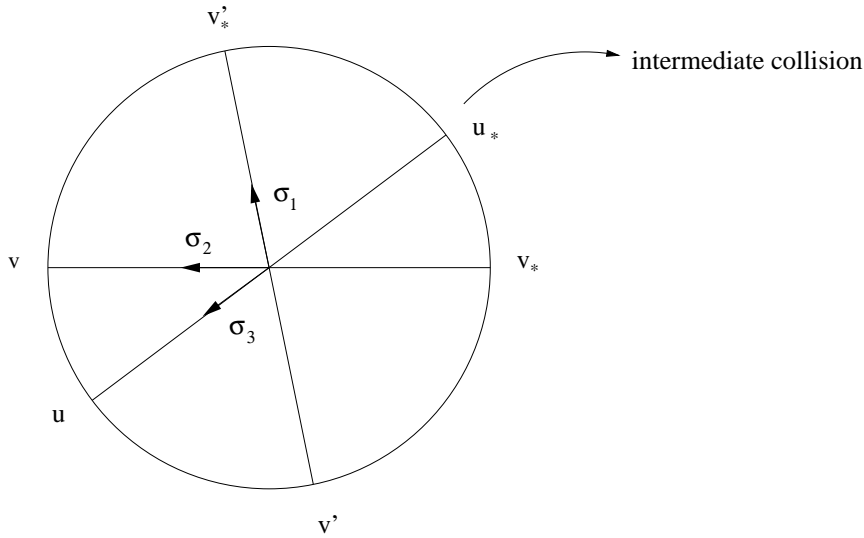

Figure 5.4: Introduction of an intermediate collision A

Then, we shall use the following “triangular” inequality on the collision points:

$$(5.2.11) \quad \begin{aligned} & \left[(h(v) + h(v_*)) - (h(v') + h(v'_*)) \right]^2 \\ & \leq 2 \left[(h(v) + h(v_*)) - (h(u) + h(u_*)) \right]^2 \\ & \quad + 2 \left[(h(u) + h(u_*)) - (h(v') + h(v'_*)) \right]^2. \end{aligned}$$

So let us add a third “blind” variable σ_3 on the sphere

$$D^{\mathcal{B}}(h) = \frac{2^N}{4 |\mathbb{S}^{N-1}|} \int_{\Omega \in \mathbb{R}^N} \int_{r \in \mathbb{R}_+} r^{N-1} \Phi(2r) e^{-2|\Omega|^2 - 2r^2} \int_{\sigma_1 \in \mathbb{S}^{N-1}} \int_{\sigma_2 \in \mathbb{S}^{N-1}} \int_{\sigma_3 \in \mathbb{S}^{N-1}} b(\sigma_1 \cdot \sigma_2) k(\Omega + r\sigma_2, \Omega - r\sigma_2, \Omega + r\sigma_1, \Omega - r\sigma_1) d\sigma_1 d\sigma_2 d\sigma_3 dr d\Omega.$$

As variables σ_1 , σ_2 and σ_3 are equivalent, one can change the “blind” variable into either σ_1 or σ_2 and compute the mean to get

$$D^{\mathcal{B}}(h) = \frac{2^N}{4 |\mathbb{S}^{N-1}|} \int_{\Omega \in \mathbb{R}^N} \int_{r \in \mathbb{R}_+} r^{N-1} \Phi(2r) e^{-2|\Omega|^2 - 2r^2} \int_{\sigma_1 \in \mathbb{S}^{N-1}} \int_{\sigma_2 \in \mathbb{S}^{N-1}} \int_{\sigma_3 \in \mathbb{S}^{N-1}} \frac{1}{2} \left[b(\sigma_1 \cdot \sigma_3) k(\Omega + r\sigma_3, \Omega - r\sigma_3, \Omega + r\sigma_1, \Omega - r\sigma_1) + b(\sigma_2 \cdot \sigma_3) k(\Omega + r\sigma_2, \Omega - r\sigma_2, \Omega + r\sigma_3, \Omega - r\sigma_3) \right] d\sigma_1 d\sigma_2 d\sigma_3 dr d\Omega,$$

which yields

$$D^{\mathcal{B}}(h) \geq \frac{2^N}{4 |\mathbb{S}^{N-1}|} \int_{\Omega \in \mathbb{R}^N} \int_{r \in \mathbb{R}_+} \int_{\sigma_1 \in \mathbb{S}^{N-1}} \int_{\sigma_2 \in \mathbb{S}^{N-1}} \int_{\sigma_3 \in \mathbb{S}^{N-1}} \Phi(2r) \frac{1}{2} \min\{b(\sigma_1 \cdot \sigma_3), b(\sigma_2 \cdot \sigma_3)\} \left[k(\Omega + r\sigma_3, \Omega - r\sigma_3, \Omega + r\sigma_1, \Omega - r\sigma_1) + k(\Omega + r\sigma_2, \Omega - r\sigma_2, \Omega + r\sigma_3, \Omega - r\sigma_3) \right] e^{-2|\Omega|^2 - 2r^2} d\sigma_1 d\sigma_2 d\sigma_3 dr d\Omega,$$

The triangular inequality needed on k is

$$\begin{aligned} k(\Omega + r\sigma_2, \Omega - r\sigma_2, \Omega + r\sigma_1, \Omega - r\sigma_1) \\ \leq 2k(\Omega + r\sigma_3, \Omega - r\sigma_3, \Omega + r\sigma_1, \Omega - r\sigma_1) \\ + 2k(\Omega + r\sigma_2, \Omega - r\sigma_2, \Omega + r\sigma_3, \Omega - r\sigma_3) \end{aligned}$$

and follows from (5.2.11). Thus if one sets

$$c_b = \inf_{\sigma_1, \sigma_2 \in \mathbb{S}^{N-1}} \int_{\sigma_3 \in \mathbb{S}^{N-1}} \min\{b(\sigma_1 \cdot \sigma_3), b(\sigma_2 \cdot \sigma_3)\} d\sigma_3,$$

one obtains (going back to the classical representation)

$$\begin{aligned} D^{\mathcal{B}}(h) &\geq \frac{c_b}{4 |\mathbb{S}^{N-1}|} \frac{1}{4} \int_{\mathbb{R}^{2N} \times \mathbb{S}^{N-1}} \Phi(|v - v_*|) M M_* k(v, v_*, v', v'_*) dv dv_* d\sigma \\ &\geq \frac{c_b}{4 |\mathbb{S}^{N-1}|} D_1^{\mathcal{B}}(h) \end{aligned}$$

which concludes the proof. \square

Lemma 5.2 (Treatment of the cancellations of Φ). *Under the assumptions (5.1.2) on Φ , for all $h \in L^2(M)$*

$$(5.2.12) \quad D_1^{\mathcal{B}}(h) \geq \left(\frac{c_{\Phi} e^{-4R^2}}{8} \right) D_0^{\mathcal{B}}(h)$$

where $D_1^{\mathcal{B}}$ is the entropy dissipation functional with $B = \Phi(|v - v_*|)$ and $D_0^{\mathcal{B}}$ is the entropy dissipation functional with $B = 1$.

Proof of Lemma 5.2. We assume here that $b \equiv 1$. Lemma 5.1 indeed shows that this is no restriction modulo a factor $c_b/(4|\mathbb{S}^{N-1}|)$. Let us consider the so-called “ ω -representation” (see [191] again): instead of the vector σ , the collision is parametrized by the unit vector $\omega = (v' - v)/|v' - v|$ on the sphere and the change of variable changes the angular kernel into

$$\tilde{b}(\theta) = 2^{N-1} \sin^{N-2} \left(\frac{\theta}{2} \right).$$

where $\cos \theta = 2(k \cdot \omega)^2 - 1$ with $k = (v - v_*)/|v - v_*|$. The operator $D_1^{\mathcal{B}}(h)$ thus becomes

$$D_1^{\mathcal{B}}(h) = \frac{1}{4} \int_{\mathbb{R}^{2N} \times \mathbb{S}^{N-1}} \Phi(|v - v_*|) \tilde{b}(\theta) M M_* k(v, v_*, v', v'_*) dv dv_* d\omega.$$

where the velocities v', v'_* are given by

$$\begin{cases} v' = v - (v - v_*, \omega)\omega, \\ v'_* = v_* + (v - v_*, \omega)\omega. \end{cases}$$

Then keeping ω fixed we do the following change of variable

$$v = r_1\omega + V_1, \quad v_* = r_2\omega + V_2$$

with $V_1, V_2 \in \omega^\perp$. The Jacobian of the change of variable is 1 since the decompositions are orthogonal. Finally we obtain the following representation

$$\begin{aligned} D_1^{\mathcal{B}}(h) &= \frac{1}{4} \int_{\mathbb{S}^{N-1}} \int_{V_1 \in \omega^\perp} \int_{V_2 \in \omega^\perp} e^{-|V_1|^2 - |V_2|^2} \\ &\quad \int_{r_1 \in \mathbb{R}} \int_{r_2 \in \mathbb{R}} e^{-r_1^2 - r_2^2} \Phi \left(\sqrt{|r_2 - r_1|^2 + |V_2 - V_1|^2} \right) \\ &\quad \tilde{b}(\theta) k(r_1\omega + V_1, r_2\omega + V_2, r_2\omega + V_1, r_1\omega + V_2) dr_1 dr_2 dV_2 dV_1 d\omega. \end{aligned}$$

Recall that $\int_{\mathbb{R}} e^{-r^2} dr = \sqrt{\pi}$. Let us add a third artificial integration variable r_3 on \mathbb{R}

$$\begin{aligned}
 D_1^{\mathcal{B}}(h) &\geq \frac{1}{4\sqrt{\pi}} \int_{\mathbb{S}^{N-1}} \int_{V_1 \in \omega^\perp} \int_{V_2 \in \omega^\perp} e^{-|V_1|^2 - |V_2|^2} \\
 &\quad \int_{r_1 \in \mathbb{R}} \int_{r_2 \in \mathbb{R}} \int_{r_3 \in \mathbb{R}} \Phi(|r_2 - r_1|) \tilde{b}(\theta_{1,2}) \\
 &\quad k(r_1\omega + V_1, r_2\omega + V_2, r_2\omega + V_1, r_1\omega + V_2) \\
 &\quad e^{-r_1^2 - r_2^2 - r_3^2} dr_1 dr_2 dr_3 dV_1 dV_2 d\omega.
 \end{aligned}$$

From now on, indexes of θ denote the points which are chosen to compute the angle. Now we rename r_1, r_2, r_3 first in r_1, r_3, r_2 , secondly in r_3, r_2, r_1 and we take the mean of these two quantities. We get

$$\begin{aligned}
 D_1^{\mathcal{B}}(h) &\geq \frac{1}{8\sqrt{\pi}} \int_{\mathbb{S}^{N-1}} \int_{V_1 \in \omega^\perp} \int_{V_2 \in \omega^\perp} e^{-|V_1|^2 - |V_2|^2} \int_{r_1 \in \mathbb{R}} \int_{r_2 \in \mathbb{R}} \int_{r_3 \in \mathbb{R}} e^{-r_1^2 - r_2^2 - r_3^2} \\
 &\quad \left[\tilde{b}(\theta_{1,3}) \Phi(|r_3 - r_1|) k(r_1\omega + V_1, r_3\omega + V_2, r_3\omega + V_1, r_1\omega + V_2) \right. \\
 &\quad \left. + \tilde{b}(\theta_{2,3}) \Phi(|r_2 - r_3|) k(r_3\omega + V_1, r_2\omega + V_2, r_2\omega + V_1, r_3\omega + V_2) \right] \\
 &\quad dr_1 dr_2 dr_3 dV_1 dV_2 d\omega.
 \end{aligned}$$

Then,

$$\begin{aligned}
 (5.2.13) \quad D_1^{\mathcal{B}}(h) &\geq \frac{1}{8\sqrt{\pi}} \int_{\mathbb{S}^{N-1}} \int_{V_1 \in \omega^\perp} \int_{V_2 \in \omega^\perp} e^{-|V_1|^2 - |V_2|^2} \int_{r_1 \in \mathbb{R}} \int_{r_2 \in \mathbb{R}} \int_{r_3 \in \mathbb{R}} \\
 &\quad \min \{ \tilde{b}(\theta_{1,3}) \Phi(|r_3 - r_1|), \tilde{b}(\theta_{2,3}) \Phi(|r_2 - r_3|) \} \\
 &\quad \left[k(r_1\omega + V_1, r_3\omega + V_2, r_3\omega + V_1, r_1\omega + V_2) + \right. \\
 &\quad \left. k(r_3\omega + V_1, r_2\omega + V_2, r_2\omega + V_1, r_3\omega + V_2) \right] \\
 &\quad e^{-r_1^2 - r_2^2 - r_3^2} dr_1 dr_2 dr_3 dV_1 dV_2 d\omega.
 \end{aligned}$$

Now we use the following triangular inequality above-mentioned which means translated on k

$$\begin{aligned}
 &k(r_1\omega + V_1, r_2\omega + V_2, r_2\omega + V_1, r_1\omega + V_2) \\
 &\leq 2k(r_1\omega + V_1, r_3\omega + V_2, r_3\omega + V_1, r_1\omega + V_2) \\
 &\quad + 2k(r_3\omega + V_1, r_2\omega + V_2, r_2\omega + V_1, r_3\omega + V_2).
 \end{aligned}$$

Plugging it in (5.2.13), we get

$$D_1^{\mathcal{B}}(h) \geq \frac{1}{16\sqrt{\pi}} \int_{\mathbb{S}^{N-1}} \int_{V_1 \in \omega^\perp} \int_{V_2 \in \omega^\perp} e^{-|V_1|^2 - |V_2|^2} \int_{r_1 \in \mathbb{R}} \int_{r_2 \in \mathbb{R}} \int_{r_3 \in \mathbb{R}} \min \{ \tilde{b}(\theta_{1,3}) \Phi(|r_3 - r_1|), \tilde{b}(\theta_{2,3}) \Phi(|r_2 - r_3|) \} k(r_1\omega + V_1, r_2\omega + V_2, r_2\omega + V_1, r_1\omega + V_2) e^{-r_1^2 - r_2^2 - r_3^2} dr_1 dr_2 dr_3 dV_1 dV_2 d\omega,$$

which yields

$$D_1^{\mathcal{B}}(h) \geq \frac{1}{16\sqrt{\pi}} \int_{\mathbb{S}^{N-1}} \int_{V_1 \in \omega^\perp} \int_{V_2 \in \omega^\perp} e^{-|V_1|^2 - |V_2|^2} \int_{r_1 \in \mathbb{R}} \int_{r_2 \in \mathbb{R}} \left(\int_{r_3 \in \mathbb{R}} \min \{ \tilde{b}(\theta_{1,3}) \Phi(|r_3 - r_1|), \tilde{b}(\theta_{2,3}) \Phi(|r_2 - r_3|) \} e^{-r_3^2} dr_3 \right) k(r_1\omega + V_1, r_2\omega + V_2, r_2\omega + V_1, r_1\omega + V_2) e^{-r_1^2 - r_2^2} dr_1 dr_2 dV_1 dV_2 d\omega.$$

We now restrict the domain of integration for r_3 to the set

$$\mathcal{D}_{r_1, r_2} = \{ r_3 \in \mathbb{R} \mid |r_3 - r_1| \geq |r_1 - r_2| \text{ and } |r_2 - r_3| \geq |r_1 - r_2| \}.$$

Since \tilde{b} is non-decreasing, and

$$\cos \theta = \frac{|V_1 - V_2|^2 - |r_1 - r_2|^2}{|V_1 - V_2|^2 + |r_1 - r_2|^2}$$

which is non-increasing with respect to $|r_1 - r_2|$ when V_1, V_2 are kept frozen, it is easy to check that on this domain we have $\theta_{1,3} \geq \theta_{1,2}$ and $\theta_{2,3} \geq \theta_{1,2}$ and thus $\tilde{b}(\theta_{1,3}) \geq \tilde{b}(\theta_{1,2})$ and $\tilde{b}(\theta_{2,3}) \geq \tilde{b}(\theta_{1,2})$. Therefore we get

$$D_1^{\mathcal{B}}(h) \geq \frac{1}{16\sqrt{\pi}} \int_{\mathbb{S}^{N-1}} \int_{V_1 \in \omega^\perp} \int_{V_2 \in \omega^\perp} e^{-|V_1|^2 - |V_2|^2} \int_{r_1 \in \mathbb{R}} \int_{r_2 \in \mathbb{R}} \left(\int_{r_3 \in \mathcal{D}_{r_1, r_2}} \min \{ \Phi(|r_3 - r_1|), \Phi(|r_2 - r_3|) \} e^{-r_3^2} dr_3 \right) \tilde{b}(\theta_{1,2}) k(r_1\omega + V_1, r_2\omega + V_2, r_2\omega + V_1, r_1\omega + V_2) e^{-r_1^2 - r_2^2} dr_1 dr_2 dV_1 dV_2 d\omega.$$

Under assumption (5.1.2), an easy computation leads to

$$\left(\int_{r_3 \in \mathcal{D}_{r_1, r_2}} \min \{ \Phi(|r_3 - r_1|), \Phi(|r_2 - r_3|) \} e^{-|r_3|^2} dr_3 \right) \geq c_\Phi \sqrt{\pi} e^{-4R^2} > 0$$

as soon as $|r_1 - r_2| \leq R$, i.e.

$$\left(\int_{r_3 \in \mathcal{D}_{r_1, r_2}} \min \{ \Phi(|r_3 - r_1|), \Phi(|r_2 - r_3|) \} e^{-|r_3|^2} dr_3 \right) \geq c_\Phi \sqrt{\pi} e^{-4R^2} 1_{|r_1 - r_2| \leq R}.$$

By taking the mean of this estimate and the one obtained by replacing Φ by its bound from below $c_\Phi 1_{r \geq R}$, we deduce that

$$\begin{aligned} D_1^{\mathcal{B}}(h) &\geq \min \left\{ \frac{c_\Phi e^{-4R^2}}{8}, \frac{c_\Phi}{2} \right\} \frac{1}{4} \int_{\mathbb{S}^{N-1}} \int_{V_1 \in \omega^\perp} \int_{V_2 \in \omega^\perp} e^{-|V_1|^2 - |V_2|^2} \int_{r_1 \in \mathbb{R}} \int_{r_2 \in \mathbb{R}} \\ &k(r_1\omega + V_1, r_2\omega + V_2, r_2\omega + V_1, r_1\omega + V_2) \tilde{b}(\theta) e^{-r_1^2 - r_2^2} dr_1 dr_2 dV_1 dV_2 d\omega. \end{aligned}$$

If we now go back to the classical representation and simplify the minimum, we obtain

$$\begin{aligned} D_1^{\mathcal{B}}(h) &\geq \left(\frac{c_\Phi e^{-4R^2}}{8} \right) \frac{1}{4} \int_{\mathbb{S}^{N-1}} \int_{\mathbb{R}^N} \int_{\mathbb{R}^N} M M_* k(v, v_*, v', v'_*) d\sigma dv dv_* \\ &= \left(\frac{c_\Phi e^{-4R^2}}{8} \right) D_0^{\mathcal{B}}(h) \end{aligned}$$

which concludes the proof of the lemma. \square

The proof of Theorem 5.1 is a straightforward consequence of inequalities (5.2.10) and (5.2.12).

5.3 The Landau linearized operator

We now prove Theorem 5.2. The idea here is to take the grazing collisions limit in some inequalities on the Boltzmann linearized operator obtained thanks to the geometrical method used in Section 5.2. In fact, the most natural idea would have been to look for a geometrical property on the Landau linearized operator similar to the triangular inequality used for the Boltzmann linearized operator. But as collision circles reduce to lines in the grazing limit, the triangular inequality becomes trivial, and thus does not seem sufficient to apply the method of section 5.2. It could be linked to the fact that in the grazing collisions limit one loses some information on the geometry of the collision.

The problem that has to be tackled is to keep track of the angular collision kernel b in the inequalities above. In fact we need it only for particular b , namely

$$(5.3.14) \quad b_\varepsilon(\theta) = \frac{j_\varepsilon(\theta)}{\varepsilon^2 \sin^{N-2} \frac{\theta}{2}}$$

where $j_\varepsilon(\theta) = j(\theta/\varepsilon)/\varepsilon$ is a sequence of mollifiers (approximating $\delta_{\theta=0}$) with compact support in $[0, \pi/2]$ and non-increasing on this interval. It is easy to see that $\tilde{b}_\varepsilon = 2^{N-1} \sin^{N-2}(\frac{\theta}{2}) b_\varepsilon$ is also non-increasing on $[0, \pi]$. Following the same strategy as in Lemma 5.2 but keeping track of the angular part of the collision kernel, one obtains

Lemma 5.3. *Under the assumptions (5.1.1), (5.1.2), (5.1.3), plus the assumption that $\tilde{b} = 2^{N-1} \sin^{N-2}(\frac{\theta}{2}) b$ is non-increasing, one gets for all $h \in L^2(M)$*

$$(5.3.15) \quad D_{b,\Phi}^{\mathcal{B}}(h) \geq \left(\frac{c_\Phi \beta_R}{8\alpha_N} \right) D_{b,1}^{\mathcal{B}}(h)$$

with

$$\alpha_N = \int_{\mathbb{R}^{N-1}} e^{-|V|^2} dV, \quad \beta_R = \int_{\{V \in \mathbb{R}^{N-1} \mid |V| \geq 2R\}} e^{-|V|^2} dV.$$

Here $D_{b,\Phi}^{\mathcal{B}}$ stands for the entropy dissipation functional with $B = \Phi b$ and $D_{b,1}^{\mathcal{B}}$ stands for the entropy dissipation functional with $B = b$.

Proof of Lemma 5.3. The geometrical idea of Lemma 5.2 can be applied to the variables V_1, V_2 . Let us thus introduce two collisions points u and u_* (see figure 5.6) and replace the collision “ (v, v_*) gives (v', v'_*) ” by the two collisions “ (v, u_*) gives (v', u) ” and “ (u, v_*) gives (u_*, v'_*) ”.

Then, we shall use the following “triangular” inequality on the collision points:

$$\begin{aligned} & [(h(v) + h(v_*)) - (h(v') + h(v'_*))]^2 \\ & \leq 2[(h(v) + h(u_*)) - (h(v') + h(u))]^2 \\ & \quad + 2[(h(u) + h(v_*)) - (h(u_*) + h(v'_*))]^2. \end{aligned}$$

Now we introduce an artificial third variable V_3 on ω^\perp . Let us denote

$$\alpha_N = \int_{\mathbb{R}^{N-1}} e^{-|V|^2} dV$$

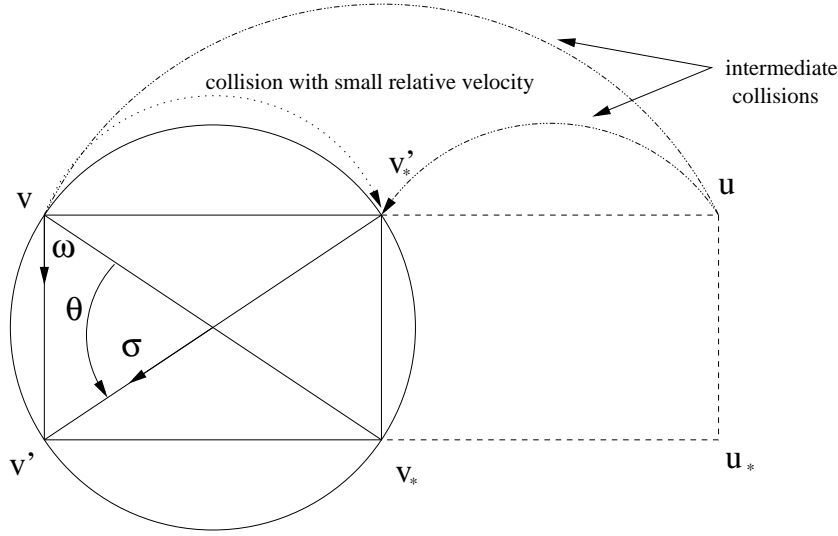

Figure 5.6: Introduction of an intermediate collision C

By inverting either V_1 and V_3 or V_2 and V_3 , taking the mean, and using the “triangular” inequality above-mentioned we get

$$D_{b,\Phi}^B(h) \geq \frac{1}{16\alpha_N} \int_{\mathbb{S}^{N-1}} \int_{r_1 \in \mathbb{R}} \int_{r_2 \in \mathbb{R}} e^{-r_1^2 - r_2^2} \int_{V_1 \in \omega^\perp} \int_{V_2 \in \omega^\perp} \left(\int_{V_3 \in \omega^\perp} \min \left\{ \tilde{b}(\theta_{1,3}) \Phi(|V_3 - V_1|), \tilde{b}(\theta_{2,3}) \Phi(|V_2 - V_3|) \right\} e^{-|V_3|^2} dV_3 \right) k(r_1\omega + V_1, r_2\omega + V_2, r_2\omega + V_1, r_1\omega + V_2) e^{-|V_1|^2 - |V_2|^2} dr_1 dr_2 dV_1 dV_2 d\omega.$$

Let us now restrict the integration along V_3 to the domain

$$\mathcal{D}_{V_1, V_2} = \{V_3 \in \omega^\perp \mid |V_3 - V_1| \geq |V_1 - V_2| \text{ and } |V_2 - V_3| \geq |V_1 - V_2|\}.$$

Then since the expression

$$\cos \theta = \frac{|V_1 - V_2|^2 - |r_1 - r_2|^2}{|V_1 - V_2|^2 + |r_1 - r_2|^2}$$

is non-decreasing according to $|V_1 - V_2|$ when r_1, r_2 are kept frozen, and \tilde{b} is non-increasing, we get $\theta_{1,3} \leq \theta_{1,2}$ and $\theta_{2,3} \leq \theta_{1,2}$ (see figure 5.6) and so

$\tilde{b}(\theta_{1,3}) \geq \tilde{b}(\theta_{1,2})$ and $\tilde{b}(\theta_{2,3}) \geq \tilde{b}(\theta_{1,2})$. Consequently

$$D_{b,\Phi}^{\mathcal{B}}(h) \geq \frac{1}{16\alpha_N} \int_{\mathbb{S}^{N-1}} \int_{r_1 \in \mathbb{R}} \int_{r_2 \in \mathbb{R}} dr_2 e^{-r_1^2 - r_2^2} \int_{V_1 \in \omega^\perp} \int_{V_2 \in \omega^\perp} \left(\int_{V_3 \in \mathcal{D}_{V_1, V_2}} \min \{ \Phi(|V_3 - V_1|), \Phi(|V_2 - V_3|) \} e^{-|V_3|^2} dV_3 \right) \tilde{b}(\theta_{1,2}) k(r_1\omega + V_1, r_2\omega + V_2, r_2\omega + V_1, r_1\omega + V_2) e^{-|V_1|^2 - |V_2|^2} dr_1 dr_2 dV_1 dV_2 d\omega.$$

Under assumption (5.1.2), an easy computation leads to

$$\left(\int_{V_3 \in \mathcal{D}_{V_1, V_2}} \min \{ \Phi(|V_3 - V_1|), \Phi(|V_2 - V_3|) \} e^{-|V_3|^2} dV_3 \right) \geq c_\Phi \int_{\{V \in \mathbb{R}^{N-1} \mid |V| \geq 2R\}} e^{-|V|^2} dV = c_\Phi \beta_R > 0$$

as soon as $|V_1 - V_2| \leq R$, i.e.

$$\left(\int_{V_3 \in \mathcal{D}_{V_1, V_2}} \min \{ \Phi(|V_3 - V_1|), \Phi(|V_2 - V_3|) \} e^{-|V_3|^2} dV_3 \right) \geq c_\Phi \beta_R 1_{|V_1 - V_2| \leq R}.$$

Taking the mean of this estimate and the one obtained by the trivial lower bound $\Phi(r) \geq c_\Phi 1_{\{r \geq R\}}$, we get in the end

$$D_{b,\Phi}^{\mathcal{B}}(h) \geq \min \left\{ \frac{c_\Phi \beta_R}{8\alpha_N}, \frac{c_\Phi}{2} \right\} \frac{1}{4} \int_{\mathbb{R}^{2N} \times \mathbb{S}^{N-1}} b(\theta) M M_* [h'_* + h' - h - h_*]^2 dv dv_* d\sigma,$$

which yields

$$D_{b,\Phi}^{\mathcal{B}}(h) \geq \left(\frac{c_\Phi \beta_R}{8\alpha_N} \right) D_{b,1}^{\mathcal{B}}(h)$$

and concludes the proof of the lemma. \square

We now have to take the grazing collisions limit in the entropy dissipation functional to prove inequality (5.1.6) of Theorem 5.2 (this limit is essentially well-known, see for instance [66]).

Lemma 5.4. *Let us consider b_ε as defined in (5.3.14) and Φ satisfying assumption (5.1.2). Then for a given $h \in L^2(M)$,*

$$D_{b_\varepsilon, \Phi}^{\mathcal{B}}(h) \xrightarrow{\varepsilon \rightarrow 0} c_{N,j} D_\Phi^{\mathcal{L}}(h)$$

where

$$c_{N,j} = \frac{2^{N-5} |\mathbb{S}^{N-2}|}{N-1} \left(\int_0^\pi j(\chi) \chi^2 d\chi \right)$$

depends only on the dimension N and the mollifier j . $D_{b_\varepsilon, \Phi}^{\mathcal{B}}$ stands for the Boltzmann entropy dissipation functional with $B = \Phi b_\varepsilon$, and $D_\Phi^{\mathcal{L}}$ stands for the Landau entropy dissipation functional with collision kernel Φ .

Proof of Lemma 5.4. The idea of the proof is to expand the expression for small ε and is very similar to what is done in [66]. Let us write the angular vector σ

$$\sigma = \frac{v - v_*}{|v - v_*|} \cos(\theta) + \mathbf{n} \sin(\theta),$$

where \mathbf{n} is a unit vector in $(v - v_*)^\perp$. Therefore, we shall write

$$\begin{aligned} D_{b_\varepsilon, \Phi}^{\mathcal{B}}(h) &= \frac{1}{4} \int_{\mathbb{R}^N} \int_{\mathbb{R}^N} \Phi(|v - v_*|) M M_* \int_{\mathbb{S}^{N-2}((v-v_*)^\perp)} \int_{\theta=0}^\pi b_\varepsilon(\theta) \\ &\quad \left[h \left(v - \frac{v - v_*}{2} (1 - \cos(\theta)) + \frac{|v - v_*|}{2} \mathbf{n} \sin(\theta) \right) \right. \\ &\quad + h \left(v_* + \frac{v - v_*}{2} (1 - \cos(\theta)) - \frac{|v - v_*|}{2} \mathbf{n} \sin(\theta) \right) \\ &\quad \left. - h(v) - h(v_*) \right]^2 \sin^{N-2} \theta d\theta d\mathbf{n} dv dv_*, \end{aligned}$$

where $\mathbb{S}^{N-2}((v - v_*)^\perp)$ denotes the unit sphere in $(v - v_*)^\perp$. Let us now focus on the integral on θ

$$\begin{aligned} \int_{\theta=0}^\pi b_\varepsilon(\theta) &\left[h \left(v - \frac{v - v_*}{2} (1 - \cos(\theta)) + \frac{|v - v_*|}{2} \mathbf{n} \sin(\theta) \right) \right. \\ &\quad + h \left(v_* + \frac{v - v_*}{2} (1 - \cos(\theta)) - \frac{|v - v_*|}{2} \mathbf{n} \sin(\theta) \right) \\ &\quad \left. - h(v) - h(v_*) \right]^2 \sin^{N-2} \theta d\theta, \end{aligned}$$

and make the change of variables $\chi = \theta/\varepsilon$. We get

$$\int_{\chi=0}^{\pi} \frac{\sin^{N-2}(\varepsilon \chi)}{\sin^{N-2}(\frac{\varepsilon \chi}{2})} \frac{j(\chi)}{\varepsilon^2} \left[h \left(v - \frac{v-v_*}{2}(1 - \cos(\varepsilon \chi)) + \frac{|v-v_*|}{2} \mathbf{n} \sin(\varepsilon \chi) \right) \right. \\ \left. + h \left(v_* + \frac{v-v_*}{2}(1 - \cos(\varepsilon \chi)) - \frac{|v-v_*|}{2} \mathbf{n} \sin(\varepsilon \chi) \right) - h(v) - h(v_*) \right]^2 d\chi$$

i.e. for small ε ,

$$\int_{\chi=0}^{\pi} (2^{N-2} + O(\varepsilon)) \frac{j(\chi)}{\varepsilon^2} \left(\frac{|v-v_*|}{2} \right)^2 \\ \left[\varepsilon \chi \mathbf{n} \cdot (\nabla_v h(v) - \nabla_{v_*} h(v_*)) + O(\varepsilon^2 \chi^2) \right]^2 d\chi,$$

which writes

$$|v-v_*|^2 \int_{\chi=0}^{\pi} 2^{N-4} j(\chi) \chi^2 \left[\mathbf{n} \cdot (\nabla_v h(v) - \nabla_{v_*} h(v_*)) \right]^2 d\chi + O(\varepsilon) \\ = 2^{N-4} \left(\int_0^{\pi} j(\chi) \chi^2 d\chi \right) |v-v_*|^2 \left[\mathbf{n} \cdot (\nabla_v h(v) - \nabla_{v_*} h(v_*)) \right]^2 + O(\varepsilon).$$

As the unit vector \mathbf{n} is orthogonal to $(v-v_*)$, we can introduce here the orthogonal projection onto $(v-v_*)^\perp$

$$D_{b_\varepsilon, \Phi}^{\mathcal{B}}(h) \\ = \frac{2^{N-4}}{4} \left(\int_0^{\pi} j(\chi) \chi^2 d\chi \right) \int_{\mathbb{R}^N} \int_{\mathbb{R}^N} \int_{\mathbb{S}^{N-2}((v-v_*)^\perp)} \Phi(|v-v_*|) |v-v_*|^2 \\ \left\{ \mathbf{n} \cdot \Pi_{(v-v_*)^\perp} [\nabla_v h(v) - \nabla_{v_*} h(v_*)] \right\}^2 M M_* d\mathbf{n} dv dv_* + O(\varepsilon).$$

It is straightforward to see that

$$\int_{\mathbb{S}^{N-2}((v-v_*)^\perp)} (\mathbf{n} \cdot u)^2 d\mathbf{n} = \zeta_N \|u\|^2$$

with, for any $\mathbf{u} \in \mathbb{S}^{N-2}$

$$\zeta_N = \int_{\mathbb{S}^{N-2}} (\mathbf{u} \cdot \mathbf{n})^2 d\mathbf{n} = \frac{|\mathbb{S}^{N-2}|}{N-1}.$$

Thus we get in the end

$$\begin{aligned} D_{b_\varepsilon, \Phi}^{\mathcal{B}}(h) &= \frac{|\mathbb{S}^{N-2}| 2^{N-4}}{4(N-1)} \left(\int_0^\pi j(\chi) \chi^2 d\chi \right) \\ &\int_{\mathbb{R}^N} \int_{\mathbb{R}^N} |v - v_*|^2 \Phi(|v - v_*|) M M_* \|\nabla_v h(v) - \nabla_{v_*} h(v_*)\|^2 dv_* dv + O(\varepsilon) \\ &= \frac{|\mathbb{S}^{N-2}| 2^{N-5}}{N-1} \left(\int_0^\pi j(\chi) \chi^2 d\chi \right) D_{\Phi}^{\mathcal{L}}(h) + O(\varepsilon). \end{aligned}$$

This concludes the proof of Lemma 5.4. □

Coming back to the proof of Theorem 5.2, we first prove (5.1.6): we write down inequality (5.3.15) on $D_{\Phi, b_\varepsilon}^{\mathcal{B}}$ since \tilde{b}_ε is non-increasing, and we apply Lemma 5.4 on each term, which gives

$$D^{\mathcal{L}}(h) \geq C_{\Phi}^{\mathcal{L}} D_0^{\mathcal{L}}(h),$$

where

$$C_{\Phi}^{\mathcal{L}} = \left(\frac{c_{\Phi} \beta_R}{8\alpha_N} \right).$$

Inequality (5.1.7) follows immediatly.

It remains to prove the lower bound (5.1.8) on the first non-zero eigenvalue of the Landau linearized operator for Maxwellian molecules in dimension 3. Let us denote by $\lambda_{0, b_\varepsilon}^{\mathcal{B}}$ the first non-zero eigenvalue for the Boltzmann linearized operator with $B = b_\varepsilon$: for all $h \in L^2(M)$ orthogonal in $L^2(M)$ to $1, v, |v|^2$,

$$D_{b_\varepsilon}^{\mathcal{B}}(h) \geq |\lambda_{0, b_\varepsilon}^{\mathcal{B}}| \|h\|_{L^2(M)}^2.$$

We apply Lemma 5.4 to this inequality which leads to

$$D_0^{\mathcal{L}}(h) \geq \frac{\lim_{\varepsilon \rightarrow 0} |\lambda_{0, b_\varepsilon}^{\mathcal{B}}|}{c_{3,j}} \|h\|_{L^2(M)}^2$$

for all $h \in L^2(M)$ orthogonal in $L^2(M)$ to $1, v, |v|^2$. An explicit formula for $|\lambda_{0, b_\varepsilon}^{\mathcal{B}}|$ is given in [24]

$$|\lambda_{0, b_\varepsilon}^{\mathcal{B}}| = \pi \int_0^\pi \sin^3(\theta) b_\varepsilon(\theta) d\theta$$

and thus

$$\lim_{\varepsilon \rightarrow 0} |\lambda_{0, b_\varepsilon}^{\mathcal{B}}| = 2\pi \left(\int_0^\pi j(\chi) \chi^2 d\chi \right)$$

which concludes the proof.

Acknowledgment. Support by the European network HYKE, funded by the EC as contract HPRN-CT-2002-00282, is acknowledged.

Explicit coercivity estimates for the linearized Boltzmann and Landau operators

Article [145], soumis pour publication.

ABSTRACT: *We prove explicit coercivity estimates for the linearized Boltzmann and Landau operators, for a general class of interactions including any inverse-power law interactions, and hard spheres. The functional spaces of these coecivity estimates depend on the collision kernel of these operators. For Maxwell molecules they coincide with the spectral gap estimates. For hard potentials they are stronger and imply these spectral estimates. For soft potentials, they play the role of explicit “degenerated spectral gap” estimates. The proofs are based on the reduction to the Maxwell case by decomposition methods. We also prove a regularity property for the linearized Boltzmann operator for non locally integrable collision kernel and for the linearized Landau operator, and we discuss the consequence on its spectrum.*

Contents

6.1	Introduction and main results	239
6.1.1	The models	239
6.1.2	Linearization	241
6.1.3	Assumptions on the collision kernel	242
6.1.4	Motivation	243
6.1.5	Main results	244
6.1.6	Method of proof	245
6.1.7	Plan of the paper	246
6.2	The linearized Boltzmann operator	246
6.2.1	Hard potentials	246
6.2.2	Soft potentials	247
6.2.3	Regularity for long-range interactions	255
6.3	The linearized Landau operator	258
6.3.1	Hard potentials and Maxwell molecules	258
6.3.2	Soft potentials	260

6.1 Introduction and main results

This paper is devoted to the study of the linearized Boltzmann and Landau collision operators. In this work we shall obtain new quantitative coercivity estimates for these operators. Before we explain our methods and results in more details, let us introduce the problem in a precise way.

6.1.1 The models

The *Boltzmann equation* describes the behavior of a dilute gas when the only interactions taken into account are binary elastic collisions. It reads in \mathbb{R}^N ($N \geq 2$)

$$\frac{\partial f}{\partial t} + v \cdot \nabla_x f = Q^{\mathcal{B}}(f, f),$$

where $f(t, x, v)$ stands for the time-dependent probability density of particles in the phase space. The N -dimensional *Boltzmann operator* $Q^{\mathcal{B}}$ is a quadratic operator, which is local in (t, x) . The time and position are only parameters and therefore shall be omitted in the sequel: the functional estimates proved in this paper are all local in (t, x) . This operator acts on $f(v)$ by

$$Q^{\mathcal{B}}(f, f)(v) = \int_{\mathbb{R}^N \times \mathbb{S}^{N-1}} B(|v - v_*|, \cos \theta) [f'_* f' - f_* f] dv_* d\sigma$$

where we have used the shorthands $f = f(v)$, $f_* = f(v_*)$, $f' = f(v')$, $f'_* = f(v'_*)$. In this formula, v' , v'_* and v , v_* are the velocities of a pair of particles before and after collision, they are related by

$$\begin{cases} v' = \frac{v + v_*}{2} + \frac{|v - v_*|}{2} \sigma, \\ v'_* = \frac{v + v_*}{2} - \frac{|v - v_*|}{2} \sigma. \end{cases}$$

The *collision kernel* B is a non-negative function which only depends on the *relative velocity* $|v - v_*|$ and the *deviation angle* θ through $\cos \theta = k \cdot \sigma$ where $k = (v - v_*)/|v - v_*|$. We also define the *collision frequency* (in $[0, +\infty]$) by

$$\nu(v) = \int_{\mathbb{R}^N \times \mathbb{S}^{N-1}} B(|v - v_*|, \cos \theta) M(v_*) dv_*.$$

In the case of long-distance interactions, collisions occur mostly for very small θ . When all collisions become concentrated on $\theta = 0$, one obtains by

the so-called *grazing collision limit* asymptotic (see for instance [13, 63, 66, 186, 5]) the *Landau operator*

$$Q^{\mathcal{L}}(f, f)(v) = \nabla_v \cdot \left(\int_{\mathbb{R}^N} \mathbf{A}(v - v_*) [f_*(\nabla f) - f(\nabla f)_*] dv_* \right),$$

with $\mathbf{A}(z) = |z|^2 \Phi(|z|) \mathbf{P}(z)$, Φ is a non-negative function, and $\mathbf{P}(z)$ is the orthogonal projection onto z^\perp , i.e

$$(\mathbf{P}(z))_{i,j} = \delta_{i,j} - \frac{z_i z_j}{|z|^2}.$$

This operator is used for instance in models of plasma in the case of a Coulomb potential where $\Phi(|z|) = |z|^{-3}$ in dimension 3 (for more details see [191, Chapter 1, Section 1.7] and the references therein). Indeed in this case the Boltzmann collision operator does not make sense anymore (see [189, Annex I, Appendix]).

Boltzmann and Landau collision operators have the fundamental properties of preserving mass, momentum and energy (Q denotes $Q^{\mathcal{B}}$ or $Q^{\mathcal{L}}$)

$$\int_{\mathbb{R}^N} Q(f, f) \phi(v) dv = 0, \quad \phi(v) = 1, v, |v|^2.$$

Moreover they satisfy well-known Boltzmann's H theorem, which writes formally

$$-\frac{d}{dt} \int_{\mathbb{R}^N} f \log f dv = - \int_{\mathbb{R}^N} Q(f, f) \log(f) dv \geq 0.$$

The functional $-\int f \log f$ is the entropy of the solution. The H theorem implies formally that any equilibrium distribution, i.e. any distribution which maximizes the entropy, has the form of a locally Maxwellian distribution

$$M(\rho, u, T)(v) = \frac{\rho}{(2\pi T)^{N/2}} \exp \left\{ -\frac{|u - v|^2}{2T} \right\},$$

where ρ , u , T are the mass, momentum and temperature of the gas

$$\rho = \int_{\mathbb{R}^N} f(v) dv, \quad u = \frac{1}{\rho} \int_{\mathbb{R}^N} v f(v) dv, \quad T = \frac{1}{N\rho} \int_{\mathbb{R}^N} |u - v|^2 f(v) dv.$$

For further details on the physical background and derivation of the Boltzmann and Landau equations we refer to [52, 58, 191].

6.1.2 Linearization

Consider the linearization process $f = M(1 + h)$ around the Maxwellian equilibrium state denoted by M . It yields the *linearized Boltzmann operator*

$$L^{\mathcal{B}}h(v) = \int_{\mathbb{R}^N \times \mathbb{S}^{N-1}} B(|v - v_*|, \cos \theta) M(v_*) \left[h'_* + h' - h_* - h \right] dv_* d\sigma,$$

with (up to a normalization) $M(v) = e^{-|v|^2}$. This operator is self-adjoint on the Hilbert space $L^2(M)$, which is defined by

$$L^2(M) = \left\{ h : \mathbb{R}^N \rightarrow \mathbb{R} \text{ measurable s. t.} \right. \\ \left. \|h\|_{L^2(M)}^2 := \int_{\mathbb{R}^N} h(v)^2 M(v) dv < +\infty \right\}.$$

The Dirichlet form in this space satisfies

$$D^{\mathcal{B}}(h) = -\langle h, L^{\mathcal{B}}h \rangle_{L^2(M)} \\ = \frac{1}{4} \int_{\mathbb{R}^N \times \mathbb{R}^N \times \mathbb{S}^{N-1}} B(|v - v_*|, \cos \theta) \left[h'_* + h' - h_* - h \right]^2 M M_* dv dv_* d\sigma.$$

It is non-negative, which implies that the spectrum of $L^{\mathcal{B}}$ in $L^2(M)$ is included in \mathbb{R}_- . The same linearization process yields the *linearized Landau operator*

$$L^{\mathcal{L}}h(v) = M(v)^{-1} \nabla_v \cdot \left(\int_{v_* \in \mathbb{R}^N} \mathbf{A}(v - v_*) [(\nabla h) - (\nabla h)_*] M M_* dv_* \right),$$

which is self-adjoint on $L^2(M)$, and whose Dirichlet form satisfies

$$D^{\mathcal{L}}(h) = -\langle h, L^{\mathcal{L}}h \rangle_{L^2(M)} \\ = \frac{1}{2} \int_{\mathbb{R}^N} \int_{\mathbb{R}^N} \Phi(v - v_*) |v - v_*|^2 \|\mathbf{P}(v - v_*) [(\nabla h) - (\nabla h)_*]\|^2 M M_* dv_* dv.$$

It is also non-negative, which implies that the spectrum of $L^{\mathcal{L}}$ in $L^2(M)$ is included in \mathbb{R}_- . The null space of the two operators $L^{\mathcal{L}}$ and $L^{\mathcal{B}}$ is

$$N(L^{\mathcal{B}}) = N(L^{\mathcal{L}}) = \text{Span}\{1, v_1, \dots, v_N, |v|^2\}$$

(note that it is independent on the collision kernel). These two properties – the fact that the time-derivative of the $L^2(M)$ norm is negative and the fact that the only functions which cancel this derivative are the collision invariants – correspond to the H theorem at the linearized level. We denote by Π the orthogonal projection on this null space in $L^2(M)$.

6.1.3 Assumptions on the collision kernel

- B takes the product form

$$(6.1.1) \quad B(|v - v_*|, \cos \theta) = \Phi(|v - v_*|) b(\cos \theta),$$

where Φ and b are non-negative functions. This is the case for instance for collision kernels deriving from interaction potentials behaving like inverse-power laws, and for hard spheres.

- The kinetic part Φ is bounded from below by a power-law:

$$(6.1.2) \quad \forall r \geq 0, \quad \Phi(r) \geq C_\Phi r^\gamma.$$

where $\gamma \in (-N, 1]$ for the linearized Boltzmann operator, or $\gamma \in [-N, 1]$ for the linearized Landau operator, and $C_\Phi > 0$ is some constant. Collision kernels deriving from interaction potentials behaving like inverse-power laws satisfy this assumption, as well as hard spheres collision kernels.

- In the case of the linearized Boltzmann operator, the angular part b satisfies

$$(6.1.3) \quad C_b = \inf_{\sigma_1, \sigma_2 \in \mathbb{S}^{N-1}} \int_{\sigma_3 \in \mathbb{S}^{N-1}} \min\{b(\sigma_1 \cdot \sigma_3), b(\sigma_2 \cdot \sigma_3)\} d\sigma_3 > 0.$$

In the particular case of the linearized Boltzmann operator with a non locally integrable collision kernel, in order to derive coercivity estimates in Sobolev spaces, we shall assume the more accurate control from below

$$(6.1.4) \quad \forall \theta \in (0, \pi], \quad b(\cos \theta) \geq \frac{c_b}{\theta^{N-1+\alpha}}$$

for some constant $c_b > 0$ and $\alpha \in [0, 2)$ (note that assumption (6.1.4) implies straightforwardly assumption (6.1.3)). The goal of this control is to measure the strength of the angular singularity, which is related to the regularity properties of the collision operator (see [3] for instance).

Remark: The assumption (6.1.1) is made for a sake of simplicity. Indeed, one could easily adapt the proofs in Section 6.2 to relax this assumption. The price to pay would be a more technical condition on the collision kernel B .

6.1.4 Motivation

We refer to [15] and the references therein for a discussion about the interest of spectral gap estimates for the linearized Boltzmann and Landau operators and some review. Let us just recall that spectral gap estimates are known to exist as soon as the collision kernel is controlled from below by a locally integrable collision kernel for which the collision frequency is finite and bounded from below by a positive number. However, apart for the case of Maxwell molecules, for which the linearized Boltzmann operator is diagonalized explicitly in [194, 24], the classical proof of the existence of a spectral gap by Grad is based on non-constructive arguments and leads to non explicit estimates. In [15], it is given a new method to obtain explicit spectral gap estimates for any hard potentials. This method relies on a geometrical argument on the whole collision operator, with no need of splitting or angular cutoff assumptions. The result was also extended in the same work to the linearized Landau operator by a grazing collision asymptotic.

As for soft potentials, it was proved in [41] that the Boltzmann linearized operator with soft potential has no spectral gap. But if one allows a loss on the algebraic weight of the norm, it was proved in [103] a “degenerated spectral gap” result of the form

$$(6.1.5) \quad D^{\mathcal{B}}(h) \geq C \|[h - \Pi(h)] \langle v \rangle^{\gamma/2}\|_{L^2(M)}^2$$

where $\gamma < 0$ is the exponent in (6.1.2) and we have denoted $\langle \cdot \rangle = \sqrt{1 + |\cdot|}$. The proof was based on inequalities proved in [41] together with Weyl’s Theorem about compact perturbation of the essential spectrum, and it lead to non explicit constants.

In this work we shall extend and complete the works [103] and [15] by

- giving a constructive proof of estimate (6.1.5) for soft potentials;
- extending it to hard potentials ($\gamma > 0$) (note that for hard potentials this estimate is stronger than the usual spectral gap estimate);
- extending this approach to the linearized Landau operator by proving coercivity estimates in H^1 with a weight corresponding to the collision kernel;
- giving a coercivity result in local Sobolev spaces for the linearized Boltzmann operator with a non locally integrable collision kernel, and discussing the consequence on its spectrum.

6.1.5 Main results

We now state our main results:

Theorem 6.1 (The linearized Boltzmann operator). *Under the assumptions (6.1.1), (6.1.2), (6.1.3), the linearized Boltzmann operator $L^{\mathcal{B}}$ with collision kernel $B = \Phi b$ satisfies*

$$(6.1.6) \quad \forall h \in L^2(M), \quad D^{\mathcal{B}}(h) \geq C_{\gamma}^{\mathcal{B}} \|[h - \Pi(h)] \langle v \rangle^{\gamma/2}\|_{L^2(M)}^2,$$

where $C_{\gamma}^{\mathcal{B}}$ is an explicit constant depending only on γ , C_{Φ} , C_b , and the dimension N .

Remarks:

1. When the collision kernel is locally integrable, the collision frequency ν is finite, and the estimate (6.1.6) can be written in the following form

$$D^{\mathcal{B}}(h) \geq \bar{C}^{\mathcal{B}} \|[h - \Pi(h)] \nu(v)\|_{L^2(M)}^2$$

for some explicit constant $\bar{C}^{\mathcal{B}} > 0$.

2. When the collision kernel is not locally integrable and b satisfies (6.1.4), a natural conjuncture would be that the estimate (6.1.6) improves into

$$D^{\mathcal{B}}(h) \geq C_{\gamma, \alpha}^{\mathcal{B}} \|[h - \Pi(h)] \langle v \rangle^{\gamma/2}\|_{H^{\alpha/2}(M)}^2,$$

where $\alpha \in [0, 2)$ is the order of angular singularity, defined in (6.1.4), and $H^{\alpha/2}(M)$ is the Sobolev space defined by

$$H^{\alpha/2}(M) = \{h \in L^2(M) \text{ s. t. } (1 - \Delta)^{-\alpha/4}h \in L^2(M)\}.$$

We were not able to obtain this coercivity estimate, however we give in the following theorem its consequence in terms of local regularity. In the following theorem, $H_{\text{loc}}^{\alpha/2}$ denotes the space of functions whose restriction to any compact set K of \mathbb{R}^N belongs to

$$H^{\alpha/2}(K) = \{h \in L^2(K) \text{ s. t. } (1 - \Delta)^{-\alpha/4}h \in L^2(K)\}$$

(here $L^2(K)$ denotes space of functions square integrable on K).

Theorem 6.2. (The linearized Boltzmann operator for long-range interactions). *Under the assumptions (6.1.1), (6.1.2), (6.1.4), the linearized Boltzmann operator $L^{\mathcal{B}}$ with collision kernel $B = \Phi b$ satisfies (6.1.6) and*

$$(6.1.7) \quad \forall h \in L^2(M), \quad D^{\mathcal{B}}(h) \geq C_{\gamma, \alpha}^{\mathcal{B}} \|h - \Pi(h)\|_{H_{\text{loc}}^{\alpha/2}}^2,$$

where $C_{\gamma, \alpha}^{\mathcal{B}}$ is an explicit constant depending only on γ , α , C_{Φ} , C_b , c_b and the dimension N .

Remark: When $\gamma > 0$ and $\alpha > 0$, it is easily seen that one can deduce from Theorem 6.2 that the operator $L^{\mathcal{B}}$ has compact resolvent, which implies that its spectrum is purely discrete in this case (see Section 6.2).

Concerning the linearized Landau operator we prove the

Theorem 6.3 (The linearized Landau operator). *Under assumptions (6.1.2), the linearized Landau operator $L^{\mathcal{L}}$ with collision kernel Φ satisfies*

$$(6.1.8) \quad \forall h \in L^2(M), \quad D^{\mathcal{L}}(h) \geq C_{\gamma}^{\mathcal{L}} \left\| [h - \Pi(h)] \langle v \rangle^{\gamma/2} \right\|_{H^1(M)}^2,$$

where $C_{\gamma}^{\mathcal{L}}$ is an explicit constant depending only on γ , C_{Φ} , and the dimension N .

Remarks:

1. Here on the contrary to the Boltzmann case we expect the coercivity estimate (6.1.8) to be optimal at the level of the functional space (although most probably not at the level of the numerical constant provided by our proof).

2. As for the linearized Boltzmann operator with a non locally integrable collision kernel, when $\gamma > 0$, we deduce from this result that the linearized Landau operator has compact resolvent and thus a purely discrete spectrum.

6.1.6 Method of proof

In the case of hard potentials, the idea is to decompose the operator between a part satisfying the desired coercivity estimate and a bounded part, and use the spectral gap estimates. This argument is reminiscent of an argument of Grad [109, Section 5] used to study the decrease of the eigenvalues of the linearized Boltzmann operator for hard potentials, and it was already noticed in [17]. Nevertheless it is the first time that it is used to obtain explicit estimates (thanks to the results in [15]). The same idea, combined with a suitable Poincaré inequality, is applied to the linearized Landau operator.

For soft potentials we decompose the Dirichlet form according to the modulus of the relative velocity. Combined with technical estimates on the non-local part of the linearized collision operators and the spectral gap estimates from the Maxwell case, it enables to reconstruct a lower bound with the appropriate weight. The proof for the linearized Landau is strongly guided by the previous study of the Boltzmann case, which helps to identify relevant estimates.

Finally the proof of the coercivity estimates in local Sobolev spaces for the linearized Boltzmann operator with a non locally integrable collision kernel

is inspired by the previous works [132, 188, 3] on the full non-linear collision operator, and by our study of the linearized Landau operator. Indeed the suitable decomposition of $L^{\mathcal{B}}$ for non locally integrable collision kernels (for which the usual Grad's splitting does not make sense anymore) is directly readable on the linearized Landau operator: the part which becomes the diffusion part in the grazing collision limit is the part which enjoys a coercivity property in Sobolev spaces, and the part which becomes the bounded part in the grazing collision limit is the part which is bounded thanks to the cancellation lemmas.

6.1.7 Plan of the paper

Section 6.2 is devoted to the linearized Boltzmann operator: it contains the proof of Theorem 6.1, divided into two parts, for hard and then soft potentials, and then the proof of Theorem 6.2. Section 6.3 is devoted to the linearized Landau operator: it contains the proof of Theorem 6.3, divided into hard and soft potentials again.

6.2 The linearized Boltzmann operator

In this section and the next one, the constants which are only internal to a proof shall be denoted C_1, C_2, \dots if they are referred to inside the proof, are simply C if not.

6.2.1 Hard potentials

Notice that the case $\gamma = 0$ of Theorem 6.1 is already proved by the explicit estimates of the Maxwell case, see [24]. Hence we assume that $\gamma > 0$ and we pick $h \in L^2(M)$ orthogonal to the null space of $L^{\mathcal{B}}$. First using the minoration of b (6.1.3) we reduce to the (cutoff case) where $b \equiv 1$ by [15, Lemma 2.1], and using the assumption (6.1.2) we reduce to the case $\Phi(z) = z^\gamma$.

Then we use Grad computations [109, Sections 2, 3, 4] to obtain the decomposition

$$L^{\mathcal{B}} = K^{\mathcal{B}} - A^{\mathcal{B}}$$

where $K^{\mathcal{B}}$ is a (compact) bounded operator (with explicit bound $C_K^{\mathcal{B}}$) and $A^{\mathcal{B}}$ is the multiplication operator by the collision frequency ν , given here by

$$\nu(v) = |\mathbb{S}^{N-1}| \int_{\mathbb{R}^N} |v - v_*|^\gamma M(v_*) dv_*.$$

On one hand we have straightforwardly

$$\int_{\mathbb{R}^N} (A^{\mathcal{B}}h) h M dv \geq C_1 \|h \langle v \rangle^{\gamma/2}\|_{L^2(M)}^2$$

with $C_1 > 0$ depending on γ . On the other hand we know by [15, Theorem 1.1] that there is an explicit constant $C_2 > 0$ such that

$$D^{\mathcal{B}}(h) = - \int_{\mathbb{R}^N} (L^{\mathcal{B}}h) h M dv \geq C_2 \|h\|_{L^2(M)}^2.$$

We deduce then that

$$\begin{aligned} \|h \langle v \rangle^{\gamma/2}\|_{L^2(M)}^2 &\leq C_1^{-1} \int_{\mathbb{R}^N} (A^{\mathcal{B}}h) h M dv \\ &\leq C_1^{-1} \left[- \int_{\mathbb{R}^N} (L^{\mathcal{B}}h) h M dv + \int_{\mathbb{R}^N} (K^{\mathcal{B}}h) h M dv \right] \\ &\leq C_1^{-1} \left[D^{\mathcal{B}}(h) + C_K^{\mathcal{B}} \|h\|_{L^2(M)}^2 \right] \\ &\leq C_1^{-1} [1 + C_K^{\mathcal{B}} C_2^{-1}] D^{\mathcal{B}}(h) \end{aligned}$$

which concludes the proof of Theorem 6.1 in the case $\gamma > 0$.

6.2.2 Soft potentials

We suppose now that $\gamma < 0$ and we pick $h \in L^2(M)$ orthogonal to the null space of $L^{\mathcal{B}}$. First using (6.1.3) we reduce to the (cutoff case) where $b \equiv 1$ by using [15, Lemma 2.1] again (this lemma is independent on the particular form of Φ), and using (6.1.2) we reduce to the case $\Phi(z) = \min\{z^\gamma, 1\}$.

Step 1. We need first a technical lemma on $K^{\mathcal{B}}$, in the case of Maxwell molecules. We define

$$K_R^{\mathcal{B}}h(v) = \int_{\mathbb{R}^N \times \mathbb{S}^{N-1}} \mathbf{1}_{\{|v-v_*| \geq R\}} M(v_*) \left[h'_* + h' - h_* \right] dv_* d\sigma.$$

Then

Lemma 6.1. *The bounded operator $K_R^{\mathcal{B}}$ satisfies*

$$\| \|K_R^{\mathcal{B}}\| \|_{L^2(M)} \xrightarrow{R \rightarrow \infty} 0$$

with explicit rate ($\| \cdot \|_{L^2(M)}$ denotes the usual operator norm on $L^2(M)$).

Proof of Lemma 6.1. First we decompose $K_R^{\mathcal{B}} = T_R - U_R$ with

$$T_R h(v) = 2 \int_{\mathbb{R}^N \times \mathbb{S}^{N-1}} \mathbf{1}_{\{|v-v_*| \geq R\}} M(v_*) h' d\sigma dv_*$$

and

$$U_R h(v) = \int_{\mathbb{R}^N \times \mathbb{S}^{N-1}} \mathbf{1}_{\{|v-v_*| \geq R\}} M(v_*) h_* d\sigma dv_*.$$

The proof for U_R is straightforward:

$$\|U_R h\|_{L^2(M)} \leq |\mathbb{S}^{N-1}|^{1/2} \|h\|_{L^2(M)} \left(\int_{\mathbb{R}^N \times \mathbb{R}^N} \mathbf{1}_{\{|v-v_*| \geq R\}} M M_* dv dv_* \right)^{1/2}$$

which gives the convergence to 0 for the operator norm with the rate.

The term T_R is more tricky to handle. First we write it as

$$T_R h(v) = 2M(v)^{-1/2} \int_{\mathbb{R}^N \times \mathbb{S}^{N-1}} \mathbf{1}_{\{|v-v_*| \geq R\}} (M')^{1/2} h' (M_*)^{1/2} (M'_*)^{1/2} d\sigma dv_*.$$

Then we use the bound

$$\mathbf{1}_{\{|v-v_*| \geq R\}} \leq \mathbf{1}_{\{|v-v'| \geq R/\sqrt{2}\}} + \mathbf{1}_{\{|v-v'_*| \geq R/\sqrt{2}\}}$$

which yields a corresponding decomposition $|T_R h| \leq T_R^1 h + T_R^2 h$ with

$$\begin{cases} T_R^1 h(v) = 2M^{-1/2} \int_{\mathbb{R}^N \times \mathbb{S}^{N-1}} \mathbf{1}_{\{|v-v'| \geq R/\sqrt{2}\}} (M')^{1/2} |h'| (M_*)^{1/2} (M'_*)^{1/2} d\sigma dv_*, \\ T_R^2 h(v) = 2M^{-1/2} \int_{\mathbb{R}^N \times \mathbb{S}^{N-1}} \mathbf{1}_{\{|v-v'_*| \geq R/\sqrt{2}\}} (M')^{1/2} |h'| (M_*)^{1/2} (M'_*)^{1/2} d\sigma dv_*. \end{cases}$$

Now we follow the computations by Grad [109, Sections 2 and 3] (recalled in [58, Chapter 7, Section 2]) to compute and bound from above the kernel of these operators: we make the changes the variables

- $\sigma \in \mathbb{S}^{N-1}$, $v_* \in \mathbb{R}^N \longrightarrow \omega = (v' - v)/|v' - v| \in \mathbb{S}^{N-1}$, $v_* \in \mathbb{R}^N$ (the jacobian is bounded by a constant);
- then $\omega \in \mathbb{S}^{N-1}$, $v_* \in \mathbb{R}^N \longrightarrow \omega \in \mathbb{S}^{N-1}$, $u = v - v_* \in \mathbb{R}^N$ (the jacobian is equal to 1);
- then keeping ω fixed, decompose orthogonally $u = u_0 \omega + W$ with $u_0 \in \mathbb{R}$ and $W \in \omega^\perp$ (the jacobian is equal to 1);

- finally keeping $W \in V^\perp$ fixed, $\omega \in \mathbb{S}^{N-1}$, $u_0 \in \mathbb{R} \rightarrow V = u_0 \omega \in \mathbb{R}^N$ (the jacobian is $(1/2)|V|^{-(N-1)}$).

We get thus

$$|T_R^1 h(v)| \leq C M(v)^{-1/2} \int_{V \in \mathbb{R}^N} \int_{W \in V^\perp} |h(v+V)| M(v+V)^{1/2} \mathbf{1}_{\{|V| \geq R/\sqrt{2}\}} |V|^{-(N-1)} M(v+W)^{1/2} M(v+V+W)^{1/2} dV dW.$$

Then using that

$$M(v+W)^{1/2} M(v+V+W)^{1/2} \leq M(V)^{1/4} = e^{-\frac{1}{4}|V|^2},$$

we obtain the bound from above

$$|T_R^1 h(v)| \leq C M(v)^{-1/2} \int_{\mathbb{R}^N} |h(v+V)| M(v+V)^{1/2} \mathbf{1}_{\{|V| \geq R/\sqrt{2}\}} |V|^{-(N-1)} e^{-\frac{1}{4}|V|^2} dV.$$

By Young's inequality one deduces immediately the convergence to 0 of T_R^1 in the operator norm with explicit rate. On the other hand for T_R^2 we use first that

$$\| \mathbf{1}_{\{|\cdot| \geq r\}} T_R^2 \|_{L^2(M)} \leq \| \mathbf{1}_{\{|\cdot| \geq r\}} T_R \|_{L^2(M)} \leq C (1+r)^{-1/2}$$

with explicit constant by Grad [109, Section 4] (or see [58, Chapter 7, Section 2] again). Thus we pick $\varepsilon > 0$ and then r such that

$$(6.2.9) \quad \| \mathbf{1}_{\{|\cdot| \geq r\}} T_R^2 \|_{L^2(M)} \leq \varepsilon/2.$$

Then using again the changes of variables detailed above we get

$$| \mathbf{1}_{\{|v| \leq r\}} T_R^2 h(v) | \leq C M(v)^{-1/2} \mathbf{1}_{\{|v| \leq r\}} \int_{\mathbb{R}^N} |h(v+V)| M(v+V)^{1/2} |V|^{-(N-1)} \left[\int_{V^\perp} M(v+W)^{1/2} M(v+V+W)^{1/2} \mathbf{1}_{\{|W| \geq R/\sqrt{2}\}} dW \right] dV.$$

We use that

$$M(v+W)^{1/4} M(v+V+W)^{1/4} \leq M(v+W)^{1/4} \leq M(v)^{-1/4} M(W)^{1/8}$$

and

$$M(v+W)^{1/4} M(v+V+W)^{1/4} \leq M(V)^{1/8}$$

to obtain

$$|\mathbf{1}_{\{|v|\leq r\}} T_R^2 h(v)| \leq C e^{3r^2/4} \int_{\mathbb{R}^N} |h(v+V)| M(v+V)^{1/2} \\ |V|^{-N-1} M(V)^{1/8} \left[\int_{V^\perp} M(W)^{1/8} \mathbf{1}_{\{|W|\geq R/\sqrt{2}\}} dW \right] dV.$$

Since the function $|V|^{-N-1} M(V)^{1/8}$ belongs to L^1 , the convolution according to this function is bounded from L^2 into L^2 , and we deduce that

$$\|\mathbf{1}_{\{|\cdot|\leq r\}} T_R^2\|_{L^2(M)} \leq C_r \left[\int_{\mathbb{R}^{N-1}} M(W)^{1/8} \mathbf{1}_{\{|W|\geq R/\sqrt{2}\}} dW \right] \|h\|_{L^2(M)}$$

and thus, for R big enough,

$$\|\|\mathbf{1}_{\{|\cdot|\leq r\}} T_R^2\|\|_{L^2(M)} \leq \varepsilon/2.$$

Together with (6.2.9) this shows that T_R^2 goes to 0 in the operator norm with explicit rate, which ends the proof. \square

Step 2. Let us do a dyadic decompositon of $D^{\mathcal{B}}(h)$. We fix a parameter $R > 1$ and we use the following decomposition of identity:

$$\mathbf{1} = \mathbf{1}_{\{|u|\leq R\}} + \sum_{n\geq 1} \mathbf{1}_{\{R^n \leq |u| \leq R^{n+1}\}}$$

to obtain

$$D^{\mathcal{B}}(h) \geq C \sum_{n\geq 0} R^{(n+1)\gamma} \tilde{D}_n^{\mathcal{B}}(h)$$

with

$$\tilde{D}_n^{\mathcal{B}}(h) = \int_{\mathbb{R}^N \times \mathbb{R}^N \times \mathbb{S}^{N-1}} \mathbf{1}_{\{R^n \leq |v-v_*| \leq R^{n+1}\}} \left[h'_* + h' - h_* - h \right]^2 M M_* dv dv_* d\sigma$$

for $n \geq 1$, and

$$\tilde{D}_0^{\mathcal{B}}(h) = \int_{\mathbb{R}^N \times \mathbb{R}^N \times \mathbb{S}^{N-1}} \mathbf{1}_{\{|v-v_*| \leq R\}} \left[h'_* + h' - h_* - h \right]^2 M M_* dv dv_* d\sigma.$$

Now if we define

$$D_k^{\mathcal{B}}(h) = \int_{\mathbb{R}^N \times \mathbb{R}^N \times \mathbb{S}^{N-1}} \mathbf{1}_{\{|v-v_*| \leq R^{k+1}\}} \left[h'_* + h' - h_* - h \right]^2 M M_* dv dv_* d\sigma$$

for any $k \geq 0$, we have

$$\begin{aligned} \sum_{k \geq 0} R^{(k+1)\gamma} D_k^{\mathcal{B}}(h) &= \sum_{k \geq 0} R^{(k+1)\gamma} \sum_{0 \leq n \leq k} \tilde{D}_n^{\mathcal{B}}(h) \\ &= \sum_{n \geq 0} \tilde{D}_n^{\mathcal{B}}(h) \left(\sum_{k \geq n} R^{(k+1)\gamma} \right) = S \sum_{n \geq 0} R^{(n+1)\gamma} \tilde{D}_n^{\mathcal{B}}(h) \end{aligned}$$

where the constant

$$S = \sum_{k \geq 0} (R^\gamma)^k$$

is finite thanks to the fact that $R > 1$. Thus we deduce that

$$D^{\mathcal{B}}(h) \geq \frac{C}{S} \sum_{n \geq 0} R^{(n+1)\gamma} D_n^{\mathcal{B}}(h).$$

Step 3. In this step we estimate each term of the dyadic decomposition. We fix $n_0 \in \mathbb{N}$ (to be latter chosen big enough) and we estimate $D_n^{\mathcal{B}}(h)$ for $n \geq n_0$. We denote χ_r the indicator function depending on the four variables v, v_*, v', v'_* such that at least one of these four points belongs to $B(0, r)$. We also define the shorthand

$$\Delta(F) = [F' + F'_* - F_* - F].$$

Then

$$\begin{aligned} D_n^{\mathcal{B}}(h) &= \int_{\mathbb{R}^N \times \mathbb{R}^N \times \mathbb{S}^{N-1}} \mathbf{1}_{\{|v-v_*| \leq R^{n+1}\}} \Delta(h)^2 M M_* dv dv_* d\sigma \\ &\geq \int_{\mathbb{R}^N \times \mathbb{R}^N \times \mathbb{S}^{N-1}} \mathbf{1}_{\{|v-v_*| \leq R^{n+1}\}} \chi_r(v, v_*, v', v'_*) \Delta(h)^2 M M_* dv dv_* d\sigma. \end{aligned}$$

We take $r = R^{n+2} - R^{n+1}$ and we denote $h_k = h \mathbf{1}_{\{|\cdot| \leq R^k\}}$. If one of the four collision points belongs to $B(0, R^{n+2} - R^{n+1})$ and the relative velocity is bounded by R^{n+1} , the collision sphere is included in $B(0, R^{n+2})$. Thus we deduce

$$D_n^{\mathcal{B}}(h) \geq \int_{\mathbb{R}^N \times \mathbb{R}^N \times \mathbb{S}^{N-1}} \mathbf{1}_{\{|v-v_*| \leq R^{n+1}\}} \chi_r(v, v_*, v', v'_*) \Delta(h_{n+2})^2 M M_* dv dv_* d\sigma.$$

Now we remove the indicator function χ_r by bounding from above the term corresponding to $1 - \chi_r$, that is when all the four collision points have a

modulus greater than $R^{n+2} - R^{n+1}$. Simple computations yield

$$D_n^B(h) \geq \int_{\mathbb{R}^N \times \mathbb{R}^N \times \mathbb{S}^{N-1}} \mathbf{1}_{\{|v-v_*| \leq R^{n+1}\}} \Delta(h_{n+2})^2 M M_* dv dv_* d\sigma \\ - C_1 e^{-(R^{n+2}-R^{n+1})} \|h_{n+2}\|_{L^2(M)}^2$$

for an explicit constant $C_1 > 0$. Then

$$\int_{\mathbb{R}^N \times \mathbb{R}^N \times \mathbb{S}^{N-1}} \mathbf{1}_{\{|v-v_*| \leq R^{n+1}\}} \Delta(h_{n+2})^2 M M_* dv dv_* d\sigma \\ = -4 \int_{\mathbb{R}^N \times \mathbb{R}^N \times \mathbb{S}^{N-1}} \mathbf{1}_{\{|v-v_*| \leq R^{n+1}\}} \\ h_{n+2} [(h_{n+2})' + (h_{n+2})'_* - (h_{n+2})_*] M M_* dv dv_* d\sigma \\ +4 \int_{\mathbb{R}^N \times \mathbb{R}^N \times \mathbb{S}^{N-1}} \mathbf{1}_{\{|v-v_*| \leq R^{n+1}\}} h_{n+2}^2 M M_* dv dv_* d\sigma \\ \geq -4 \int_{\mathbb{R}^N \times \mathbb{R}^N \times \mathbb{S}^{N-1}} h_{n+2} [(h_{n+2})' + (h_{n+2})'_* - (h_{n+2})_*] M M_* dv dv_* d\sigma \\ -4 \int_{\mathbb{R}^N} (K_{R^{n+1}}^B h_{n+2}) h_{n+2} M dv \\ +4 \int_{\mathbb{R}^N \times \mathbb{R}^N \times \mathbb{S}^{N-1}} \mathbf{1}_{\{|v-v_*| \leq R^{n+1}\}} h_n^2 M M_* dv dv_* d\sigma,$$

and thus we deduce that

$$\int_{\mathbb{R}^N \times \mathbb{R}^N \times \mathbb{S}^{N-1}} \mathbf{1}_{\{|v-v_*| \leq R^{n+1}\}} \Delta(h_{n+2})^2 M M_* dv dv_* d\sigma \\ \geq -4 \int_{\mathbb{R}^N \times \mathbb{R}^N \times \mathbb{S}^{N-1}} h_{n+2} [(h_{n+2})' + (h_{n+2})'_* - (h_{n+2})_*] M M_* dv dv_* d\sigma \\ +4 \int_{\mathbb{R}^N \times \mathbb{R}^N \times \mathbb{S}^{N-1}} h_n^2 M M_* d\sigma dv_* dv \\ -4 \int_{\mathbb{R}^N} (K_{R^{n+1}}^B h_{n+2}) h_{n+2} M dv \\ -4 \int_{\mathbb{R}^N \times \mathbb{R}^N \times \mathbb{S}^{N-1}} \mathbf{1}_{\{|v-v_*| \geq R^{n+1}\}} h_n^2 M M_* dv dv_* d\sigma.$$

From Lemma 6.1 we have

$$-4 \int_{\mathbb{R}^N} (K_{R^{n+1}}^B h_{n+2}) h_{n+2} M dv \geq -\epsilon_1(R^{n+1}) \|h_{n+2}\|_{L^2(M)}^2$$

where $\epsilon_1(r)$ is an explicit function going to 0 as r goes to infinity. Also when $v \in B(0, R^n)$ and $|v - v_*| \geq R^{n+1}$ we have by triangular inequality

$|v_*| \geq R^{n+1} - R^n$, and thus simple computations show that

$$4 \int_{\mathbb{R}^N \times \mathbb{R}^N \times \mathbb{S}^{N-1}} \mathbf{1}_{\{|v-v_*| \geq R^{n+1}\}} h_n^2 M M_* dv dv_* d\sigma \leq C_2 e^{-(R^{n+1}-R^n)} \|h_{n+2}\|_{L^2(M)}^2.$$

Collecting every term we deduce

$$\begin{aligned} \sum_{n \geq n_0} R^{(n+1)\gamma} D_n^{\mathcal{B}}(h) \geq \\ \sum_{n \geq n_0} R^{(n+1)\gamma} \left[\begin{aligned} & -4 \int_{\mathbb{R}^N \times \mathbb{R}^N \times \mathbb{S}^{N-1}} h_{n+2} [(h_{n+2})' + (h_{n+2})'_* - (h_{n+2})_*] M M_* dv dv_* d\sigma \\ & +4 R^{2\gamma} \int_{\mathbb{R}^N \times \mathbb{R}^N \times \mathbb{S}^{N-1}} h_{n+2}^2 M M_* dv dv_* d\sigma \\ & -C_1 e^{-(R^{n+2}-R^{n+1})} \|h_{n+2}\|_{L^2(M)}^2 - \epsilon_1(R^{n+1}) \|h_{n+2}\|_{L^2(M)}^2 \\ & -C_2 e^{-(R^{n+1}-R^n)} \|h_{n+2}\|_{L^2(M)}^2 \end{aligned} \right] \end{aligned}$$

which writes

$$\begin{aligned} \sum_{n \geq n_0} R^{(n+1)\gamma} D_n^{\mathcal{B}}(h) \geq \\ \sum_{n \geq n_0} R^{(n+1)\gamma} \left[\begin{aligned} & \int_{\mathbb{R}^N \times \mathbb{R}^N \times \mathbb{S}^{N-1}} \Delta(h_{n+2})^2 M M_* dv dv_* d\sigma \\ & -4(1 - R^{2\gamma}) \|h_{n+2}\|_{L^2(M)}^2 - C_1 e^{-(R^{n+2}-R^{n+1})} \|h_{n+2}\|_{L^2(M)}^2 \\ & \quad - \epsilon_1(R^{n+1}) \|h_{n+2}\|_{L^2(M)}^2 - C_2 e^{-(R^{n+1}-R^n)} \|h_{n+2}\|_{L^2(M)}^2 \end{aligned} \right]. \end{aligned}$$

Now we use the explicit spectral gap for Maxwell molecules to get

$$\int_{\mathbb{R}^N \times \mathbb{R}^N \times \mathbb{S}^{N-1}} \Delta(h_{n+2})^2 M M_* dv dv_* d\sigma \geq \lambda \|h_{n+2} - \Pi(h_{n+2})\|_{L^2(M)}^2$$

for an explicit $\lambda > 0$. Hence we deduce that

$$\begin{aligned} \sum_{n \geq n_0} R^{(n+1)\gamma} D_n^{\mathcal{B}}(h) &\geq \sum_{n \geq n_0} R^{(n+1)\gamma} \left[\lambda \|h_{n+2}\|_{L^2(M)}^2 - \lambda \|\Pi(h_{n+2})\|_{L^2(M)}^2 \right. \\ &\quad - 4(1 - R^{2\gamma}) \|h_{n+2}\|_{L^2(M)}^2 - C_1 e^{-(R^{n+2}-R^{n+1})} \|h_{n+2}\|_{L^2(M)}^2 \\ &\quad \left. - \epsilon_1(R^{n+1}) \|h_{n+2}\|_{L^2(M)}^2 - C_2 e^{R^{n+1}-R^n} \|h_{n+2}\|_{L^2(M)}^2 \right]. \end{aligned}$$

Since $\Pi(h) = 0$, we have

$$\begin{aligned} \|\Pi(h_{n+2})\|^2 &= \|\Pi(h \mathbf{1}_{\{|\cdot| \geq R^{n+2}\}})\|^2 \\ &\leq \left(\int_{\{|v| \geq R^{n+2}\}} |v|^{2+|\gamma|} M(v) dv \right) \|h\langle v \rangle^{\gamma/2}\|_{L^2(M)}^2 \\ &\leq C_3 e^{-R^{n+2}} \|h\langle v \rangle^{\gamma/2}\|_{L^2(M)}^2. \end{aligned}$$

Now if we choose $R - 1 > 0$ small enough such that

$$4(1 - R^{2\gamma}) \leq \frac{\lambda}{8},$$

then n_0 big enough so that $R^{n+2} - R^{n+1} = R^{n+1}(R - 1)$ and $R^{n+1} - R^n = R^n(R - 1)$ big enough such that

$$\forall n \geq n_0, \quad C_1 e^{-(R^{n+2}-R^{n+1})}, \quad C_2 e^{-(R^{n+1}-R^n)} \leq \frac{\lambda}{8}$$

and also n_0 big enough such that R^{n+1} big enough such that

$$\forall n \geq n_0, \quad \epsilon_1(R^{n+1}) \leq \frac{\lambda}{8},$$

we obtain for this choice of n_0 and R :

$$\begin{aligned} &\sum_{n \geq n_0} R^{(n+1)\gamma} D_n^{\mathcal{B}}(h) \\ &\geq \frac{\lambda}{2} \sum_{n \geq n_0} R^{(n+1)\gamma} \|h_{n+2}\|_{L^2(M)}^2 - C_3 \lambda \left(\sum_{n \geq n_0} e^{-R^{n+2}} \right) \|h\langle v \rangle^{\gamma/2}\|_{L^2(M)}^2 \\ &\geq [C_4 R^{n_0\gamma} - C_5 e^{-R^{n_0}}] \|h\langle v \rangle^{\gamma/2}\|_{L^2(M)}^2 \end{aligned}$$

for some explicit constants $C_4, C_5 > 0$ independent on n_0 . Thus by taking n_0 large enough we deduce that

$$\sum_{n \geq n_0} R^{(n+1)\gamma} D_n^{\mathcal{B}}(h) \geq C_6 \|h\langle v \rangle^{\gamma/2}\|^2$$

for some explicit constant $C_6 > 0$. Coming back to $D^{\mathcal{B}}(h)$, this ends the proof of Theorem 6.1 in the case $\gamma < 0$.

6.2.3 Regularity for long-range interactions

We suppose here that the collision kernel B satisfies (6.1.1), (6.1.2), (6.1.4), with $\alpha > 0$ (the case $\alpha = 0$ is deduced from Theorem 6.1). Thus we are reduced to the case where $B(|v - v_*|, \cos \theta) = |v - v_*|^\gamma \theta^{-(N-1)-\alpha}$. By symmetrizing the Dirichlet form with the change of variable $\sigma \rightarrow -\sigma$, we can finally reduce to the case where $B(|v - v_*|, \cos \theta) = |v - v_*|^\gamma \theta^{-(N-1)-\alpha} \mathbf{1}_{\theta \in [0, \pi/2]}$. We pick $h \in L^2(M)$ orthogonal to the null space of L^B .

We start by restricting the velocity variables to a bounded domain. Let us fix $R > 0$, and let us denote by \mathcal{I}_R a C^∞ mollified indicator function of the variables v, v_* which is 1 on $B_R = B(0, R)$ and 0 outside $B(0, R + 1)$.

We control from below the Dirichlet form by

$$D^B(h) \geq \frac{1}{4} \int_{\mathbb{R}^N \times \mathbb{R}^N \times \mathbb{S}^{N-1}} B \mathcal{I}_R [h' + h'_* - h - h_*]^2 M M_* dv dv_* d\sigma$$

and we develop it as

(6.2.10)

$$\begin{aligned} D^B \geq & \frac{1}{4} \int_{\mathbb{R}^N \times \mathbb{R}^N \times \mathbb{S}^{N-1}} B \mathcal{I}_R \left([h' - h]^2 + [h'_* - h_*]^2 \right) M M_* dv dv_* d\sigma \\ & + \frac{1}{2} \int_{\mathbb{R}^N \times \mathbb{R}^N \times \mathbb{S}^{N-1}} B \mathcal{I}_R (h' - h)(h'_* - h_*) M M_* dv dv_* d\sigma. \end{aligned}$$

The pre-postcollisional change of variable on the second term and the change of variable $(v, v_*, \sigma) \rightarrow (v_*, v, -\sigma)$ on the first term yield

$$\begin{aligned} D^B \geq & \frac{1}{2} \int_{\mathbb{R}^N \times \mathbb{R}^N \times \mathbb{S}^{N-1}} B \mathcal{I}_R (h' - h)^2 M M_* dv dv_* d\sigma \\ & + \int_{\mathbb{R}^N \times \mathbb{R}^N \times \mathbb{S}^{N-1}} B \mathcal{I}_R h_* (h' - h) M M_* dv dv_* d\sigma =: I_1^R + I_2^R. \end{aligned}$$

Now we estimate separately I_1^R from below and I_2^R from above. For the term I_1^R , the Carleman representation (see [45]) yields

$$I_1^R \geq C \int_{B_R \times B_R} S(v, v') \frac{(h' - h)^2}{|v - v'|^{N+\alpha}} dv dv'$$

where

$$S(v, v') = M(v) \int_{E_{v, v'} \cap B_R} \mathbf{1}_{B_R}(v_*) |v' - v'_*|^{1+\gamma+\alpha} \mathbf{1}_{\{|v' - v| \leq |v'_* - v|\}} M'_* dv'_*$$

and $E_{v,v'}$ is the hyperplan containing v and orthogonal to $v - v'$ (for the derivation of this formula, see [188, Section 4]). The second indicator function in the formula for $S(v, v')$ comes from the restriction to $\theta \in [0, \pi/2]$ by the symmetrization above. It is easily seen that $S(v, v')$ is bounded from below by some constant $C > 0$ on $B_R \times B_R$. It follows that

$$I_1^R \geq C \int_{B_R \times B_R} \frac{(h' - h)^2}{|v - v'|^{N+\alpha}} dv dv' \geq C_1 \|h\|_{H^{\alpha/2}(B_R)}^2$$

for some constant $C_1 > 0$ (for the last inequality see for instance [2]).

As for the second term I_2^R , we use the change of variable of the cancellation lemma in [3, Section 3]: keeping v_* fixed, change v, σ into v', σ (the jacobian is $\cos^{-N} \theta/2$). We obtain

$$I_2^R = \int_{\mathbb{R}^N \times \mathbb{R}^N \times \mathbb{S}^{N-1}} B h_* h |v - v_*|^\gamma M_* \\ b(\cos \theta) \left[M(\psi_\sigma(v)) \cos^{-N-\gamma} \theta/2 \mathcal{I}_R(\psi_\sigma(v), v_*) - M(v) \mathcal{I}_R(v, v_*) \right] dv dv_* d\sigma$$

where $\psi_\sigma(v)$ is the transformation introduced in [3, Lemma 1]: it is the point in the plan defined by v, v_*, σ such that

$$(\psi_\sigma(v) - v) \perp (v_* - v) \quad \text{and} \quad (\psi_\sigma(v) - v_*) \cdot (v - v_*) = \cos \theta/2.$$

Now let us fix v, v_* and θ . Then the modulus $|\psi_\sigma(v) - v| = \tan \theta/2 |v - v_*|$ is fixed, and the vector $\psi_\sigma(v) - v$ satisfies

$$\psi_\sigma(v) - v = |\psi_\sigma(v) - v| \omega$$

where ω is the opposite of the unit vector directing the projection of σ on the plan orthogonal to $v - v_*$ (see [3, Figure 1]). It motivates the study of quantities like

$$I(\varphi) = \int_{\mathbb{S}_{v-v_*}^{N-2}} (\varphi(v + \rho\omega) - \varphi(v)) d\omega$$

where φ denotes some C^2 function on \mathbb{R}^N , \mathbb{S}_{v,v_*}^{N-2} denotes the unit sphere in the plan orthogonal to $v - v_*$, and $\rho > 0$. If $\nabla\varphi$ denotes the gradient of φ and $\nabla^2\varphi$ denotes its Hessian matrix, one has the following Taylor expansion:

$$\varphi(v + \rho\omega) = \varphi(v) + \rho (\nabla\varphi(v) \cdot \omega) + \frac{\rho^2}{2} \langle \nabla^2\varphi(v + \rho'\omega) \cdot \omega, \omega \rangle$$

for some $0 \leq \rho' \leq \rho$. By bounding the last term and taking the integral over $\mathbb{S}_{v-v_*}^{N-2}$, we get the estimate

$$\left| I(\varphi) - \rho \left(\int_{\mathbb{S}_{v-v_*}^{N-2}} d\sigma (\nabla\varphi(v) \cdot \sigma) \right) \right| \leq \frac{\rho^2}{2} |\mathbb{S}^{N-2}| \|\varphi\|_{W^{2,\infty}}.$$

As the term involving $\nabla\varphi$ vanishes by symmetry, we obtain

$$|I(\varphi)| \leq \frac{\rho^2}{2} |\mathbb{S}^{N-2}| \|\varphi\|_{W^{2,\infty}}.$$

We apply this computation to $\varphi(v) = M(v) \mathcal{I}(v, v_*)$ with $\rho = |\psi_\sigma(v) - v| = \tan \theta/2 |v - v_*|$ to find

$$\begin{aligned} \forall v, v_* \in B_R, \quad & \left| \int_{\mathbb{S}^{N-1}} b(\cos \theta) [M(\psi_\sigma(v)) \mathcal{I}(\psi_\sigma(v), v_*) - M(v) \mathcal{I}(v, v_*)] d\sigma \right| \\ & \leq C \int_0^{\pi/2} \theta^{-(N-1)-\alpha} \tan^2 \theta/2 d\theta \leq C_2 \end{aligned}$$

for some finite constant $C_2 > 0$. Finally we have immediately

$$\begin{aligned} & \int_{\mathbb{S}^{N-1}} b(\cos \theta) |\cos^{-N-\gamma} \theta/2 - 1| d\sigma \\ & \leq \int_0^{\pi/2} \theta^{-(N-1)-\alpha} |\cos^{-N-\gamma} \theta/2 - 1| d\theta \leq C_3 \end{aligned}$$

for some finite constant $C_3 > 0$. We thus deduce that

$$|I_2^R| \leq C \|h\|_{L^2(B_R)}^2 \leq C_4 \|h\langle v \rangle^{\gamma/2}\|_{L^2(M)}^2.$$

Now we can conclude the proof of Theorem 6.2. For any $R > 0$, we have

$$\begin{aligned} \|h\|_{H^{\alpha/2}(B_R)}^2 & \leq C_1^{-1} I_1^R \leq C_1^{-1} [D^{\mathcal{B}}(h) + |I_2^R|] \\ & \leq C_1^{-1} [D^{\mathcal{B}}(h) + C_4 \|h\langle v \rangle^{\gamma/2}\|_{L^2(M)}^2]. \end{aligned}$$

Since $\Pi(h) = 0$ we can use the coercivity estimate of Theorem 6.1

$$\|h\langle v \rangle^{\gamma/2}\|_{L^2(M)}^2 \leq C_5 D^{\mathcal{B}}(h)$$

to deduce finally

$$\|h\|_{H^{\alpha/2}(B_R)}^2 \leq C_1^{-1} [1 + C_4 C_5] D^{\mathcal{B}}(h).$$

Since it is valid for any $R > 0$, we obtain

$$D^{\mathcal{B}}(h) \geq C \|h\|_{H_{\text{loc}}^{\alpha/2}}^2$$

for some explicit constant $C > 0$. This ends the proof of Theorem 6.2.

Let us discuss the consequence of this estimate on the spectrum of $L^{\mathcal{B}}$ when $\gamma > 0$ and $\alpha > 0$. Let us pick any $\xi \in \mathbb{C}$ such that $L^{\mathcal{B}} - \xi$ is invertible (such ξ exists since the operator is self-adjoint for instance), and let us denote $R(\xi) = (L^{\mathcal{B}} - \xi)^{-1}$ the resolvent at this point. For any sequence $(g_n)_{n \geq 0}$ bounded in $L^2(M)$, we can define the sequence $h_n = R(\xi)(g_n)$ which is also bounded in $L^2(M)$ since the operator $R(\xi)$ is bounded. We have:

$$\forall n \geq 0, \quad L^{\mathcal{B}}(h_n) = g_n + \xi h_n$$

and so the sequence $L^{\mathcal{B}}(h_n)$ is bounded in $L^2(M)$. It follows that the sequence $D^{\mathcal{B}}(h_n)$ is bounded in \mathbb{R} , and we deduce from the coercivity estimates above that the sequence $(h_n)_{n \geq 0}$ is bounded in $L^2(\langle v \rangle^\gamma M) \cap H_{\text{loc}}^{\alpha/2}$. It implies that it has a cluster point in $L^2(M)$ by Rellich-Kondrachov compactness Theorem. Thus the operator $R(\xi)$ is compact. By classical arguments (see [121] for instance), it implies that the resolvent $R(\xi)$ is compact at every $\xi \in \mathbb{C}$ for which it is defined, and that the spectrum of $L^{\mathcal{B}}$ is purely discrete.

Remark: We expect the property of having compact resolvent to hold under the more general conditions $\alpha \geq 0$ and $\gamma \geq 0$. The case $\alpha = 0$ could probably be treated by the same computations as above, using for the coercivity estimate a functional space controlling logarithmic derivatives defined by the norm $\|h \log(1 - \Delta)h\|_{L_{\text{loc}}^2}$. The restriction $\gamma > 0$ of our proof seems more serious, since in the case $\gamma = 0$, the coercivity estimate from Theorem 6.1 does not forbid the loss of mass at infinity.

6.3 The linearized Landau operator

Note that here on the contrary to [15] we are not able to take the grazing collision limit in the coercivity estimates for the linearized Boltzmann operator. Thus we do not try to deduce results on the linearized Landau operator from the Boltzmann case, instead we work directly on this operator.

6.3.1 Hard potentials and Maxwell molecules

We consider $h \in L^2(M)$ orthogonal to the null space of $L^{\mathcal{L}}$, we assume that $\gamma \geq 0$ and, thanks to the assumption (6.1.2), we reduce to the case $\Phi(z) = z^\gamma$.

Classical computations, which can be found in [62, Section 2] for instance, show that the linearized Landau operator $L^{\mathcal{L}}$ decomposes as

$$L^{\mathcal{L}} = K^{\mathcal{L}} - A^{\mathcal{L}}$$

where $K^{\mathcal{L}}$ is a (compact) bounded operator (with explicit bound $C_K^{\mathcal{L}}$) and $A^{\mathcal{L}}$ is a diffusion operator whose Dirichlet form satisfies

$$\int_{\mathbb{R}^N} (A^{\mathcal{L}}h) h M dv = \int_{\mathbb{R}^N} (\nabla_v h)^t \mathcal{M}(v) (\nabla_v h) M dv$$

where the matrix \mathcal{M} is symmetric definite positive with its smallest eigenvalue bounded from below by $C \langle v \rangle^\gamma$ for an explicit constant $C > 0$ (see [62, Section 2, Propositions 2.3 and 2.4]). Thus we deduce that

$$\int_{\mathbb{R}^N} (A^{\mathcal{L}}h) h M dv \geq C \int_{\mathbb{R}^N} |\nabla_v h|^2 \langle v \rangle^\gamma M dv.$$

First, we recall that, as noticed in [128], a simpler way to recover the coercivity result from [62, Section 3, Theorem 3.1] is to apply the Bakry-Emery criterion (see [193, Chapter 9, Section 2]), which implies that M satisfies a Poincaré inequality with constant 2, and thus (as h has zero mean)

$$\int_{\mathbb{R}^N} |\nabla_v h|^2 \langle v \rangle^\gamma M dv \geq \int_{\mathbb{R}^N} |\nabla_v h|^2 M dv \geq 2 \int_{\mathbb{R}^N} h^2 M dv.$$

Now we want to obtain a stronger coercivity estimate. Thus we apply Bakry-Emery criterion to the measure

$$m(v) = \langle v \rangle^\gamma M(v) = \exp \left[-|v|^2 + \frac{\gamma}{2} \ln(1 + |v|^2) \right] =: \exp [-\phi(v)].$$

A straightforward computation shows that

$$\nabla^2 \phi \geq (2 - \gamma) Id$$

which implies, as $(2 - \gamma) \geq 1$ thanks to the assumptions on γ , that m satisfies a Poincaré inequality with constant 1, and thus

$$\int_{\mathbb{R}^N} |\nabla_v h|^2 \langle v \rangle^\gamma M dv \geq \int_{\mathbb{R}^N} \left[h - \left(\int h \langle v \rangle^\gamma M dv \right) \right]^2 \langle v \rangle^\gamma M dv.$$

Hence by developing

$$\int_{\mathbb{R}^N} |\nabla_v h|^2 \langle v \rangle^\gamma M dv \geq \int_{\mathbb{R}^N} h^2 \langle v \rangle^\gamma M dv - \left(\int h \langle v \rangle^\gamma M dv \right)^2.$$

Now as

$$\left(\int h \langle v \rangle^\gamma M dv \right)^2 \leq C_1 \left(\int_{\mathbb{R}^N} h^2 M dv \right)$$

for some explicit constant C_1 , we deduce by collecting every term that

$$\int_{\mathbb{R}^N} (A^\mathcal{L} h) h M dv \geq C_2 \|h \langle v \rangle^{\gamma/2}\|_{H^1(M)}^2 - C_3 \|h\|_{L^2(M)}^2$$

for some explicit constants $C_2, C_3 > 0$.

Besides we have by [15, Theorem 1.2]

$$- \int_{\mathbb{R}^N} (L^\mathcal{L} h) h M dv \geq C_4 \|h\|_{L^2(M)}^2$$

for an explicit constant $C_4 > 0$. Now we can conclude the proof:

$$\begin{aligned} \|h \langle v \rangle^{\gamma/2}\|_{H^1(M)}^2 &\leq C_2^{-1} \int_{\mathbb{R}^N} (A^\mathcal{L} h) h M dv + C_2^{-1} C_3 \|h\|_{L^2(M)}^2 \\ &\leq C_2^{-1} \left[- \int_{\mathbb{R}^N} (L^\mathcal{L} h) h M dv + \int_{\mathbb{R}^N} (K^\mathcal{L} h) h M dv + C_3 \|h\|_{L^2(M)}^2 \right] \\ &\leq C_2^{-1} \left[D^\mathcal{L}(h) + (C_K^\mathcal{L} + C_3) \|h\|_{L^2(M)}^2 \right] \leq C_2^{-1} [1 + (C_K^\mathcal{L} + C_3) C_4^{-1}] D^\mathcal{L}(h) \end{aligned}$$

which concludes the proof of Theorem 6.3 when $\gamma \geq 0$.

As for the Boltzmann linearized operator with $\gamma > 0$ and $\alpha > 0$, one can deduce similarly from this estimate, when $\gamma > 0$, that the Landau linearized operator has compact resolvent (and thus a purely discrete spectrum).

6.3.2 Soft potentials

We follow exactly the same path as for the linearized Boltzmann operator. The starting point is the following coercivity estimate in the Maxwell case

$$(6.3.11) \quad \frac{1}{2} \int_{\mathbb{R}^N \times \mathbb{R}^N} |v - v_*|^2 \|\mathbf{P}(v - v_*) [(\nabla h) - (\nabla h)_*]\|^2 M M_* dv dv_* \geq \lambda \|h\|_{H^1(M)}^2$$

for some explicit constant $\lambda > 0$, which has been proved in the previous subsection.

We assume that $\gamma < 0$ and we pick $h \in L^2(M)$ orthogonal to the null space of $L^\mathcal{L}$. Using the assumption (6.1.2) we reduce to the case $\Phi(z) = \min\{z^\gamma, 1\}$.

Step 1. We first prove a technical lemma on $K^\mathcal{L}$, in the case of Maxwell molecules. We define for $R > 0$

$$K_R^\mathcal{L}h(v) = -M(v)^{-1} \nabla_v \cdot \left(\int_{\mathbb{R}^N} (1 - \Theta_R(v - v_*)) |v - v_*|^2 \mathbf{P}(v - v_*) (\nabla h)_* M M_* dv_* \right)$$

where Θ_R is a C^∞ function on \mathbb{R}^N such that $0 \leq \Theta_R \leq 1$, $\Theta_R = 1$ on $B(0, R)$ and $\Theta_R = 0$ outside $B(0, R + 1)$. Then

Lemma 6.2. *The bounded operator $K_R^\mathcal{L}$ satisfies*

$$\| \| K_R^\mathcal{L} \| \|_{L^2(M)} \xrightarrow{R \rightarrow \infty} 0$$

with explicit rate.

Proof of Lemma 6.2. It amounts to a differentiation under the integral, an integration by part, and the use of Young's inequality. \square

Step 2. Let us fix $R > 1$. We do the same dyadic decomposition of $D^\mathcal{L}(h)$ as for the Boltzmann case, to obtain

$$D^\mathcal{L}(h) \geq C \sum_{n \geq 0} R^{(n+1)\gamma} D_n^\mathcal{L}(h)$$

for some constant $C > 0$, with

$$D_n^\mathcal{L}(h) = \int_{\mathbb{R}^N \times \mathbb{R}^N} \mathbf{1}_{\{|v-v_*| \leq R^{n+1}\}} |v - v_*|^2 \| \mathbf{P}(v - v_*) [(\nabla h) - (\nabla h)_*] \|^2 M M_* dv dv_*$$

for any $n \geq 0$.

Step 3. In this step we estimate each term of the dyadic decomposition. We fix $n_0 \geq 0$ (to be latter chosen big enough) and we estimate $D_n^\mathcal{L}(h)$ for $n \geq n_0$. We denote χ_r the indicator function depending on v, v_* such that at least on of these two points belongs to $B(0, r)$. We also define the shorthand

$$\Delta(F) = \| \mathbf{P}(v - v_*) [(\nabla F) - (\nabla F)_*] \|^2.$$

Then

$$\begin{aligned} D_n^\mathcal{L}(h) &= \int_{\mathbb{R}^N \times \mathbb{R}^N} \mathbf{1}_{\{|v-v_*| \leq R^{n+1}\}} |v - v_*|^2 \Delta(h)^2 M M_* dv dv_* \\ &\geq \int_{\mathbb{R}^N \times \mathbb{R}^N} \mathbf{1}_{\{|v-v_*| \leq R^{n+1}\}} \chi_r(v, v_*) \Delta(h)^2 M M_* dv dv_*. \end{aligned}$$

We take $r = R^{n+2} - R^{n+1}$ and we denote $h_k = h \mathbf{1}_{\{|\cdot| \leq R^k\}}$. If v or v_* belongs to $B(0, R^{n+2} - R^{n+1})$ and the relative velocity is bounded by R^{n+1} , both points belong to $B(0, R^{n+2})$. Thus we deduce

$$D_n^{\mathcal{L}}(h) \geq \int_{\mathbb{R}^N \times \mathbb{R}^N} \mathbf{1}_{\{|v-v_*| \leq R^{n+1}\}} |v - v_*|^2 \chi_r(v, v_*) \Delta(h_{n+2})^2 M M_* dv dv_*.$$

Now we remove the indicator function χ_r by bounding from above the term corresponding to $1 - \chi_r$, that is when v and v_* have a modulus greater than $R^{n+2} - R^{n+1}$. Simple computations yield

$$\begin{aligned} D_n^{\mathcal{L}}(h) &\geq \int_{\mathbb{R}^N \times \mathbb{R}^N} \mathbf{1}_{\{|v-v_*| \leq R^{n+1}\}} |v - v_*|^2 \Delta(h_{n+2})^2 M M_* dv dv_* \\ &\quad - C_1 e^{-(R^{n+2} - R^{n+1})} \|h_{n+2}\|_{H^1(M)}^2 \end{aligned}$$

for an explicit constant $C_1 > 0$. Then we focus on the main term

$$\int_{\mathbb{R}^N \times \mathbb{R}^N} \mathbf{1}_{\{|v-v_*| \leq R^{n+1}\}} |v - v_*|^2 \Delta(h_{n+2})^2 M M_* dv dv_*.$$

Since $\mathbf{1}_{\{|v-v_*| \leq R^{n+1}\}} \geq \Theta_{R^{n+1}-1}(v - v_*)$, we first bound it from below by

$$\int_{\mathbb{R}^N \times \mathbb{R}^N} \Theta_{R^{n+1}-1}(v - v_*) |v - v_*|^2 \Delta(h_{n+2})^2 M M_* dv dv_*.$$

Then we proceed as in the Boltzmann case:

$$\begin{aligned} &\int_{\mathbb{R}^N \times \mathbb{R}^N} \Theta_{R^{n+1}-1}(v - v_*) |v - v_*|^2 \Delta(h_{n+2})^2 M M_* dv dv_* \\ &= -4 \int_{\mathbb{R}^N \times \mathbb{R}^N} \Theta_{R^{n+1}-1} |v - v_*|^2 \\ &\quad [\mathbf{P}(v - v_*) (\nabla h_{n+2})] \cdot [\mathbf{P}(v - v_*) (\nabla h_{n+2})_*] M M_* dv dv_* \\ &\quad + 4 \int_{\mathbb{R}^N \times \mathbb{R}^N} \Theta_{R^{n+1}-1} |v - v_*|^2 \|\mathbf{P}(v - v_*) (\nabla h_{n+2})\|^2 M M_* dv dv_* \\ &\geq -4 \int_{\mathbb{R}^N \times \mathbb{R}^N} |v - v_*|^2 \\ &\quad [\mathbf{P}(v - v_*) (\nabla h_{n+2})] \cdot [\mathbf{P}(v - v_*) (\nabla h_{n+2})_*] M M_* dv dv_* \\ &\quad - 4 \int_{\mathbb{R}^N} (K_{R^{n+1}-1}^{\mathcal{L}} h_{n+2}) h_{n+2} M dv \\ &\quad + 4 \int_{\mathbb{R}^N \times \mathbb{R}^N} \Theta_{R^{n+1}-1} |v - v_*|^2 \|\mathbf{P}(v - v_*) (\nabla h_{n+2})\|^2 M M_* dv dv_*, \end{aligned}$$

and thus we deduce that

$$\begin{aligned}
 & \int_{\mathbb{R}^N \times \mathbb{R}^N} \Theta_{R^{n+1}-1}(v - v_*) |v - v_*|^2 \Delta(h_{n+2})^2 M M_* dv dv_* \\
 & \geq -4 \int_{\mathbb{R}^N \times \mathbb{R}^N} |v - v_*|^2 \\
 & \quad [\mathbf{P}(v - v_*) (\nabla h_{n+2})] \cdot [\mathbf{P}(v - v_*) (\nabla h_{n+2})_*] M M_* dv dv_* \\
 & + 4 \int_{\mathbb{R}^N \times \mathbb{R}^N} \|\mathbf{P}(v - v_*) (\nabla h_n)\|^2 M M_* dv dv_* \\
 & - 4 \int_{\mathbb{R}^N} (K_{R^{n+1}-1}^{\mathcal{L}} h_{n+2}) h_{n+2} M dv \\
 & - 4 \int_{\mathbb{R}^N \times \mathbb{R}^N} \mathbf{1}_{\{|v-v_*| \geq R^{n+1}-1\}} \|\mathbf{P}(v - v_*) (\nabla h_n)\|^2 M M_* dv dv_*.
 \end{aligned}$$

Now we use that (from Lemma 6.2)

$$-4 \int_{\mathbb{R}^N} (K_{R^{n+1}-1}^{\mathcal{L}} h_{n+2}) h_{n+2} M dv \geq -\epsilon_2(R^{n+1} - 1) \|h_{n+2}\|_{H^1(M)}^2$$

where $\epsilon_2(r)$ is an explicit function going to 0 as r goes to infinity. Also simple computations show that

$$\begin{aligned}
 4 \int_{\mathbb{R}^N \times \mathbb{R}^N} \mathbf{1}_{\{|v-v_*| \geq R^{n+1}-1\}} \|\mathbf{P}(v - v_*) (\nabla h_n)\|^2 M M_* dv dv_* \\
 \leq C_2 e^{-(R^{n+1}-R^n)} \|h_{n+2}\|_{H^1(M)}^2.
 \end{aligned}$$

Collecting every term we deduce

$$\begin{aligned}
 & \sum_{n \geq n_0} R^{(n+1)\gamma} D_n^{\mathcal{L}}(h) \geq \sum_{n \geq n_0} R^{(n+1)\gamma} \\
 & \left[-4 \int_{\mathbb{R}^N \times \mathbb{R}^N} |v - v_*|^2 [\mathbf{P}(v - v_*) (\nabla h_{n+2})] \cdot [\mathbf{P}(v - v_*) (\nabla h_{n+2})_*] M M_* dv dv_* \right. \\
 & + 4 R^{2\gamma} \int_{\mathbb{R}^N \times \mathbb{R}^N} \|\mathbf{P}(v - v_*) (\nabla h_{n+2})\|^2 M M_* dv dv_* \\
 & - C_1 e^{-(R^{n+2}-R^{n+1})} \|h_{n+2}\|^2 - \epsilon_2(R^{n+1}) \|h_{n+2}\|_{H^1(M)}^2 \\
 & \left. - C_2 e^{-(R^{n+1}-R^n)} \|h_{n+2}\|_{H^1(M)}^2 \right]
 \end{aligned}$$

which writes

$$\begin{aligned} \sum_{n \geq n_0} R^{(n+1)\gamma} D_n^{\mathcal{L}}(h) &\geq \sum_{n \geq n_0} R^{(n+1)\gamma} \left[\int_{\mathbb{R}^N \times \mathbb{R}^N} \Delta(h_{n+2})^2 M M_* dv dv_* \right. \\ &\quad - 4(1 - R^{2\gamma}) \|h_{n+2}\|_{H^1(M)}^2 - C_1 e^{-(R^{n+2}-R^{n+1})} \|h_{n+2}\|^2 \\ &\quad \left. - \epsilon_2(R^{n+1}) \|h_{n+2}\|_{H^1(M)}^2 - C_2 e^{-(R^{n+1}-R^n)} \|h_{n+2}\|_{H^1(M)}^2 \right]. \end{aligned}$$

Now we use the explicit coercivity estimate (6.3.11) for Maxwell molecules to deduce that

$$\begin{aligned} \sum_{n \geq n_0} R^{(n+1)\gamma} D_n^{\mathcal{L}}(h) &\geq \\ \sum_{n \geq n_0} R^{(n+1)\gamma} &\left[\lambda \|h_{n+2}\|_{H^1(M)}^2 - \lambda \|\Pi(h_{n+2})\|_{H^1(M)}^2 - 4(1 - R^{2\gamma}) \|h_{n+2}\|_{H^1(M)}^2 \right. \\ &\quad - C_1 e^{-(R^{n+2}-R^{n+1})} \|h_{n+2}\|_{H^1(M)}^2 - \epsilon_2(R^{n+1}) \|h_{n+2}\|_{H^1(M)}^2 \\ &\quad \left. - C_2 e^{-(R^{n+1}-R^n)} \|h_{n+2}\|_{H^1(M)}^2 \right]. \end{aligned}$$

Since $\Pi(h) = 0$, we have

$$\|\Pi(h_{n+2})\|_{H^1(M)}^2 = \|\Pi(h \mathbf{1}_{\{|\cdot| \geq R^{n+2}\}})\|^2 \leq C_3 e^{-R^{n+2}} \|h \langle v \rangle^{\gamma/2}\|_{H^1(M)}^2.$$

Now if we choose $R - 1 > 0$ small enough such that

$$4(1 - R^{2\gamma}) \leq \frac{\lambda}{8},$$

then n_0 big enough so that $R^{n+2} - R^{n+1} = R^{n+1}(R - 1)$ and $R^{n+1} - R^n = R^n(R - 1)$ big enough such that

$$\forall n \geq n_0, \quad C_1 e^{-(R^{n+2}-R^{n+1})}, C_2 e^{-(R^{n+1}-R^n)} \leq \frac{\lambda}{8},$$

and also n_0 big enough such that R^{n+1} big enough such that

$$\forall n \geq n_0, \quad \epsilon_2(R^{n+1}) \leq \frac{\lambda}{8},$$

we obtain for this choice of n_0 and R :

$$\begin{aligned} & \sum_{n \geq n_0} R^{(n+1)\gamma} D_n^{\mathcal{L}}(h) \\ & \geq \frac{\lambda}{2} \sum_{n \geq n_0} R^{(n+1)\gamma} \|h_{n+2}\|_{H^1(M)}^2 - C_3 \lambda \left(\sum_{n \geq n_0} e^{-R^{n+2}} \right) \|h\langle v \rangle^{\gamma/2}\|_{H^1(M)}^2 \\ & \geq [C_4 R^{n_0\gamma} - C_5 e^{-R^{n_0}}] \|h\langle v \rangle^{\gamma/2}\|_{H^1(M)}^2 \end{aligned}$$

for some explicit constants $C_4, C_5 > 0$ independent on n_0 . Thus by taking n_0 large enough we deduce that

$$\sum_{n \geq n_0} R^{(n+1)\gamma} D_n^{\mathcal{L}}(h) \geq C_6 \|h\langle v \rangle^{\gamma/2}\|_{H^1(M)}^2$$

for some explicit constant $C_6 > 0$. Coming back to $D^{\mathcal{L}}(h)$, this concludes the proof of Theorem 6.3 when $\gamma < 0$.

Acknowledgment: We thank François Golse for pointing us reference [17]. Support by the European network HYKE, funded by the EC as contract HPRN-CT-2002-00282, is acknowledged.

Rate of convergence to equilibrium for the spatially homogeneous Boltzmann equation with hard potentials

Article [147], soumis pour publication.

ABSTRACT: For the spatially homogeneous Boltzmann equation with hard potentials and Grad's cutoff (e.g. hard spheres), we give quantitative estimates of exponential convergence to equilibrium, and we show that the rate of exponential decay is governed by the spectral gap for the linearized equation, on which we provide a lower bound. Our approach is based on establishing spectral gap-like estimates valid near the equilibrium, and then connecting the latter to the quantitative nonlinear theory. This leads us to an explicit study of the linearized Boltzmann collision operator in functional spaces larger than the usual linearization setting.

Contents

7.1	Introduction	269
7.1.1	The problem and its motivation	269
7.1.2	Assumptions on the collision kernel	271
7.1.3	Linearization	272
7.1.4	Spectral theory	274
7.1.5	Existing results and difficulties	276
7.1.6	Notation	277
7.1.7	Statement of the results	278
7.1.8	Method of proof	280
7.1.9	Plan of the paper	281
7.2	Properties of the linearized collision operator	281
7.2.1	Introduction of an approximate operator	281
7.2.2	Convergence of the approximation	282
7.2.3	Estimates on \mathcal{L}	289
7.2.4	Estimates on L	296
7.3	Localization of the spectrum	297
7.3.1	Spectrum of L	297
7.3.2	Essential spectrum of \mathcal{L}	299
7.3.3	Discrete spectrum of \mathcal{L}	301
7.4	Trend to equilibrium	304
7.4.1	Decay estimates on the evolution semi-group	305
7.4.2	Proof of the convergence	311
7.4.3	A remark on the asymptotic behavior of the solution	319

7.1 Introduction

This paper is devoted to the study of the asymptotic behavior of solutions to the spatially homogeneous Boltzmann equation for hard potentials with cutoff. On one hand it was proved by Arkeryd [10] by non-constructive arguments that spatially homogeneous solutions (with finite mass and energy) of the Boltzmann equation for hard spheres converge towards equilibrium with exponential rate, with no information on the rate of convergence and the constants (in fact the proof in this paper required some moment assumptions, but the latter can be relaxed with the results about appearance and propagation of moments, as can be found in [200]). On the other hand it was proved in [150] a quantitative convergence result with rate $O(t^{-\infty})$ for these solutions. The goal of this paper is to improve and fill the gap between these results by

- showing exponential convergence towards equilibrium by constructive arguments (with explicit rate and constants);
- showing that the spectrum of the linearized collision operator in the narrow space $L^2(M^{-1}(v)dv)$ (M is the equilibrium) dictates the asymptotic behavior of the solution in a much more general setting, as was conjectured in [48] on the basis of the study of the Maxwell case.

Before we explain our results and methods in more details let us introduce the problem in a precise way.

7.1.1 The problem and its motivation

The *Boltzmann equation* describes the behavior of a dilute gas when the only interactions taken into account are binary collisions, by means of an evolution equation on the time-dependent particle distribution function in the phase space. In the case where this distribution function is assumed to be independent of the position, we obtain the spatially homogeneous Boltzmann equation:

$$(7.1.1) \quad \frac{\partial f}{\partial t} = Q(f, f), \quad v \in \mathbb{R}^N, \quad t \geq 0$$

in dimension $N \geq 2$. In spite of the strong restriction that this assumption of spatial homogeneity constitutes, it has proven an interesting and inspiring case for studying qualitative properties of the Boltzmann equation. In equation (7.1.1), Q is the quadratic *Boltzmann collision operator*, defined by the

bilinear form

$$Q(g, f) = \int_{\mathbb{R}^N \times \mathbb{S}^{N-1}} B(|v - v_*|, \cos \theta)(g'_* f' - g_* f) dv_* d\sigma.$$

Here we have used the shorthands $f' = f(v')$, $g_* = g(v_*)$ and $g'_* = g(v'_*)$, where

$$v' = \frac{v + v_*}{2} + \frac{|v - v_*|}{2} \sigma, \quad v'_* = \frac{v + v_*}{2} - \frac{|v - v_*|}{2} \sigma$$

stand for the pre-collisional velocities of particles which after collision have velocities v and v_* . Moreover $\theta \in [0, \pi]$ is the *deviation angle* between $v' - v'_*$ and $v - v_*$, and B is the Boltzmann *collision kernel* determined by physics (related to the cross-section $\Sigma(v - v_*, \sigma)$ by the formula $B = |v - v_*| \Sigma$). On physical grounds, it is assumed that $B \geq 0$ and B is a function of $|v - v_*|$ and $\cos \theta$.

Boltzmann's collision operator has the fundamental properties of conserving mass, momentum and energy

$$\int_{\mathbb{R}^N} Q(f, f) \phi(v) dv = 0, \quad \phi(v) = 1, v, |v|^2$$

and satisfying Boltzmann's H theorem, which can be formally written as

$$\mathcal{D}(f) := -\frac{d}{dt} \int_{\mathbb{R}^N} f \log f dv = - \int_{\mathbb{R}^N} Q(f, f) \log(f) dv \geq 0.$$

The H functional $H(f) = \int f \log f$ is the opposite of the entropy of the solution. Boltzmann's H theorem implies that any equilibrium distribution function has the form of a Maxwellian distribution

$$M(\rho, u, T)(v) = \frac{\rho}{(2\pi T)^{N/2}} \exp\left(-\frac{|u - v|^2}{2T}\right),$$

where ρ, u, T are the density, mean velocity and temperature of the gas

$$\rho = \int_{\mathbb{R}^N} f(v) dv, \quad u = \frac{1}{\rho} \int_{\mathbb{R}^N} v f(v) dv, \quad T = \frac{1}{N\rho} \int_{\mathbb{R}^N} |u - v|^2 f(v) dv,$$

which are determined by the mass, momentum and energy of the initial datum thanks to the conservation properties. As a result of the process of entropy production pushing towards local equilibrium combined with the constraints of conservation laws, solutions are thus expected to converge to

a unique Maxwellian equilibrium. Up to a normalization we set without restriction $M(v) = e^{-|v|^2}$ as the Maxwellian equilibrium, or equivalently $\rho = \pi^{N/2}$, $u = 0$ and $T = 1/2$.

The relaxation to equilibrium is studied since the works of Boltzmann and it is at the core of the kinetic theory. The motivation is to provide an analytic basis for the second principle of thermodynamics for a statistical physics model of a gas out of equilibrium. Indeed Boltzmann's famous H theorem gives an analytic meaning to the entropy production process and identifies possible equilibrium states. In this context, proving convergence towards equilibrium is a fundamental step to justify Boltzmann model, but cannot be fully satisfactory as long as it remains based on non-constructive arguments. Indeed, as suggested implicitly by Boltzmann when answering critics of his theory based on Poincaré recurrence Theorem, the validity of the Boltzmann equation breaks for very large time (see [191, Chapter 1, Section 2.5] for a discussion). It is therefore crucial to obtain quantitative informations on the time scale of the convergence, in order to show that this time scale is much smaller than the time scale of validity of the model. Moreover constructive arguments often provide new qualitative insights into the model, for instance here they give a better understanding of the dependency of the rate of convergence according to the collision kernel and the initial datum.

7.1.2 Assumptions on the collision kernel

The main physical case of application of this paper is that of hard spheres in dimension $N = 3$, where (up to a normalization constant)

$$(7.1.2) \quad B(|v - v_*|, \cos \theta) = |v - v_*|.$$

More generally we shall make the following assumption on the collision kernel:

A. We assume that B takes the product form

$$(7.1.3) \quad B(|v - v_*|, \cos \theta) = \Phi(|v - v_*|) b(\cos \theta),$$

where Φ and b are nonnegative functions not identically equal to 0. This decoupling assumption is made for the sake of simplicity and could probably be relaxed at the price of technical complications.

B. Concerning the kinetic part, we assume Φ to be given by

$$(7.1.4) \quad \Phi(z) = C_\Phi z^\gamma$$

with $\gamma \in (0, 1]$ and $C_\Phi > 0$. It is customary in physics and in mathematics to study the case when $\Phi(v - v_*)$ behaves like a power law $|v - v_*|^\gamma$, and one traditionally separates between hard potentials ($\gamma > 0$), Maxwellian potentials ($\gamma = 0$), and soft potentials ($\gamma < 0$). We assume here that we deal with **hard potentials**.

C. Concerning the angular part, we assume the control from above

$$(7.1.5) \quad \forall \theta \in [0, \pi], \quad b(\cos \theta) \leq C_b.$$

This assumption is a strong version of Grad's angular cutoff (see [108]). It is satisfied for the hard spheres model.

Moreover, in order to prove the appearance and propagation of exponential moments (see Lemma 7.8), we shall assume additionally that

$$(7.1.6) \quad b \text{ is nondecreasing and convex on } (-1, 1).$$

This technical assumption is satisfied for the hard spheres model, since in this case b is constant.

Under these assumptions on the collision kernel B , equation (7.1.1) is well-posed in the space of nonnegative solutions with finite and non-increasing mass and energy [144]. In the sequel by "solution" of (7.1.1) we shall always denote these solutions.

Let us mention that under assumptions (7.1.3) and (7.1.5), for soft potentials ($\gamma < 0$), the linearized operator has no spectral gap and no exponential convergence is expected for (7.1.1) (see [41, 42]). For Maxwellian potentials ($\gamma = 0$), exponential convergence is known to hold for (7.1.1) if and only if the initial datum has bounded moments of order $s > 2$ (see [49]), and, under additional moments and smoothness assumptions on the initial datum, the rate is known to be governed by the spectral gap of the linearized operator (see [48]).

7.1.3 Linearization

Under assumption (7.1.5), we can define

$$\ell_b := \|b\|_{L^1(\mathbb{S}^{N-1})} := |\mathbb{S}^{N-2}| \int_0^\pi b(\cos \theta) \sin^{N-2} \theta \, d\theta < +\infty.$$

Without loss of generality we set $\ell_b = 1$ in the sequel. Then one can split the collision operator in the following way

$$\begin{aligned} Q(g, f) &= Q^+(g, f) - Q^-(g, f), \\ Q^+(g, f) &= \int_{\mathbb{R}^N \times \mathbb{S}^{N-1}} \Phi(|v - v_*|) b(\cos \theta) g'_* f' dv_* d\sigma, \\ Q^-(g, f) &= \int_{\mathbb{R}^N \times \mathbb{S}^{N-1}} \Phi(|v - v_*|) b(\cos \theta) g_* f dv_* d\sigma = (\Phi * g) f, \end{aligned}$$

and introduce the so-called *collision frequency*

$$(7.1.7) \quad \nu(v) = \int_{\mathbb{R}^N \times \mathbb{S}^{N-1}} \Phi(|v - v_*|) b(\cos \theta) M(v_*) dv_* d\sigma = (\Phi * M)(v).$$

We denote by $\nu_0 > 0$ the minimum value of ν .

Definition 7.1 (Linearized collision operator). *Let $m = m(v)$ be a positive rapidly decaying function. We define the linearized collision operator \mathcal{L}_m associated with the rescaling m , by the formula*

$$\mathcal{L}_m(g) = m^{-1} [Q(mg, M) + Q(M, mg)].$$

The particular case when $m = M$ is just called the “linearized collision operator”, defined by

$$\begin{aligned} L(h) &= M^{-1} [Q(Mh, M) + Q(M, Mh)] \\ &= \int_{\mathbb{R}^N \times \mathbb{S}^{N-1}} \Phi(|v - v_*|) b(\cos \theta) M(v_*) [h'_* + h' - h_* - h] dv_* d\sigma. \end{aligned}$$

Remark: The linearized collision operator $\mathcal{L}_m(g)$ corresponds to the linearization around M with the scaling $f = M + mg$. Among all possible choices of m , the case $m = M$ is particular since L enjoys a self-adjoint property on the space $g \in L^2(M(v)dv)$, which is why this is usually the only case considered. Note that this space corresponds to $f \in L^2(M^{-1}(v)dv)$ for the original solution. In this paper we shall need other scalings of linearization in order to connect the linearized theory to the nonlinear theory. We shall use a scaling function $m(v)$ of the form $m(v) = \exp[-a|v|^s]$ with $a > 0$ and $0 < s < 2$ to be chosen later.

The linear operators \mathcal{L}_m splits naturally between a multiplicative part \mathcal{L}_m^ν and a non-local part \mathcal{L}_m^c (the “c” exponent stands for “compact” as we shall see) in the following way:

$$(7.1.8) \quad \mathcal{L}_m(g) = \mathcal{L}_m^c(g) - \mathcal{L}_m^\nu(g) \quad \text{with} \quad \mathcal{L}_m^\nu(g) := \nu g$$

where ν is the collision frequency defined in (7.1.7), and \mathcal{L}_m^c splits between a “gain” part \mathcal{L}_m^+ (denoted so because it corresponds to the linearization of Q^+) and a convolution part \mathcal{L}_m^* as

$$(7.1.9) \quad \mathcal{L}^c(g) = \mathcal{L}_m^+(g) - \mathcal{L}_m^*(g) \quad \text{with} \quad \mathcal{L}_m^*(g) := m^{-1} M [(mg) * \Phi]$$

and

$$(7.1.10) \quad \mathcal{L}_m^+(g) := m^{-1} \int_{\mathbb{R}^N \times \mathbb{S}^{N-1}} \Phi(|v - v_*|) b(\cos \theta) [(mg)' M_*' + M'(mg)'_*] dv_* d\sigma.$$

For $L = \mathcal{L}_M$ we obtain as a particular case the decomposition

$$(7.1.11) \quad L(h) = L^c(h) - L^\nu(h) \quad \text{with} \quad L^\nu(h) := \nu h$$

and

$$(7.1.12) \quad L^c(h) = L^+(h) - L^*(h) \quad \text{with} \quad L^*(h) := (hM) * \Phi$$

and

$$(7.1.13) \quad L^+(h) := \int_{\mathbb{R}^N \times \mathbb{S}^{N-1}} \Phi(|v - v_*|) b(\cos \theta) [h' + h'_*] M_* dv_* d\sigma.$$

7.1.4 Spectral theory

Let us consider a linear unbounded operator $T : \mathcal{B} \rightarrow \mathcal{B}$ on the Banach space \mathcal{B} , defined on a dense domain $\text{Dom}(T) \subset \mathcal{B}$. Then we adopt the following notations and definitions:

- we denote by $N(T) \subset \mathcal{B}$ the *null space* of T ;
- T is said to be *closed* if its graph is closed in $\mathcal{B} \times \mathcal{B}$;

In the following definitions, T is assumed to be closed.

- the *resolvent set* of T denotes the set of complex numbers ξ such that $T - \xi$ is bijective from $\text{Dom}(T)$ to \mathcal{B} and the inverse linear operator $(T - \xi)^{-1}$, defined on \mathcal{B} , is bounded (see [121, Chapter 3, Section 5]);
- we denote by $\Sigma(T) \subset \mathbb{C}$ the *spectrum* of T , that is the complementary set of the resolvent set of T in \mathbb{C} ;
- an *eigenvalue* is a complex number $\xi \in \mathbb{C}$ such that $N(T - \xi)$ is not reduced to $\{0\}$;

- we denote $\Sigma_d(T) \subset \Sigma(T)$ the *discrete spectrum* of T , i.e. the set of *discrete eigenvalues*, that is the eigenvalues isolated in the spectrum and with finite multiplicity (i.e. such that the spectral projection associated with this eigenvalue has finite dimension, see [121, Chapter 3, Section 6]);
- for a given discrete eigenvalue ξ , we shall call the *eigenspace* of ξ the range of the spectral projection associated with ξ ;
- we denote $\Sigma_e(T) \subset \Sigma(T)$ the *essential spectrum* of T defined by $\Sigma_e(T) = \Sigma(T) \setminus \Sigma_d(T)$;
- when $\Sigma(T) \subset \mathbb{R}_-$, we say that T has a *spectral gap* when the distance between 0 and $\Sigma(T) \setminus \{0\}$ is positive, and the spectral gap denotes this distance.

It is well-known from classical theory of the linearized operator (see [109] or [58, Chapter 7, Section 1]) that

$$\begin{aligned} \langle h, Lh \rangle_{L^2(M)} &= \int_{\mathbb{R}^N} h(Lh) M dv = \\ &= -\frac{1}{4} \int_{\mathbb{R}^N \times \mathbb{R}^N \times \mathbb{S}^{N-1}} \Phi(|v-v_*|) b(\cos \theta) \left[h'_* + h' - h_* - h \right]^2 M M_* dv dv_* d\sigma \leq 0. \end{aligned}$$

This implies that the spectrum of L in $L^2(M)$ is included in \mathbb{R}_- . Its null space is

$$(7.1.14) \quad N(L) = \text{Span} \{1, v_1, \dots, v_N, |v|^2\}.$$

These two properties correspond to the linearization of Boltzmann's H theorem.

Let us denote by $D(h) = -\langle h, Lh \rangle_{L^2(M)}$ the Dirichlet form for $-L$. Since the operator is self-adjoint, the existence of a spectral gap λ is equivalent to

$$\forall h \perp N(L), \quad D(h) \geq \lambda \|h\|_{L^2(M)}^2.$$

Controls from below on the collision kernel are necessary so that there exists a spectral gap for the linearized operator. Concerning the bound from below on Φ , the non-constructive proof of Grad suggests that, when the collision kernel satisfies Grad's angular cutoff, L has a spectral gap if and only if the collision frequency is bounded from below by a positive constant ($\nu_0 > 0$). Moreover, *explicit* estimates on the spectral gap are given in [15] under the assumption that Φ is bounded from below at infinity, i.e.

$$\exists R \geq 0, c_\Phi > 0 \ ; \ \forall r \geq R, \Phi(r) \geq c_\Phi.$$

This assumption holds for Maxwellian molecules and hard potentials, with or without angular cutoff.

Thus under our assumptions on B , L has a spectral gap $\lambda \in (0, \nu_0]$ (indeed the proof of Grad shows that $\Sigma_\epsilon(L) = (-\infty, -\nu_0]$ and the remaining part of the spectrum is composed of discrete eigenvalues in $(-\nu_0, 0]$ since L is self-adjoint nonpositive). Moreover as discussed in [52, Chapter 4, Section 6], it was proved in [123] that L has an infinite number of discrete negative eigenvalues in the interval $(-\nu_0, 0)$, which implies that

$$0 < \lambda < \nu_0.$$

In fact the proof in [123] was done for hard spheres, but the argument applies to any cutoff hard potential collision kernel as well.

7.1.5 Existing results and difficulties

On the basis of the H theorem and suitable *a priori* estimates, various authors gave results of L^1 convergence to equilibrium by compactness arguments for the spatially homogeneous Boltzmann equation with hard potentials and angular cutoff (for instance Carleman [44], Arkeryd [6], etc.). These results provide no information at all on the rate of convergence.

In [109] Grad gave the first proof of the existence of a spectral gap for the linearized collision operator L with hard potentials and angular cutoff. His proof was based on Weyl's Theorem about compact perturbation and thus did not provide an explicit estimate on the spectral gap. Following Grad, a lot of works have been done by various authors to extend this spectral study to soft potentials (see [41], [103]), or to apply it to the perturbative solutions (see [183]) or to the hydrodynamical limit (see [76]).

On the basis of these compactness results and linearization tools, Arkeryd gave in [10] the first (non-constructive) proof of exponential convergence in L^1 for the spatially homogeneous Boltzmann equation with hard potentials and angular cutoff. His result was generalized to L^p spaces ($1 \leq p < +\infty$) by Wennberg [197].

At this point, several difficulties have still to be overcome in order to get a quantitative result of exponential convergence:

- (i) The spectral gap in $f \in L^2(M^{-1})$ was obtained by non-constructive methods for hard potentials.
- (ii) The spectral study was done in the space $f \in L^2(M^{-1})$ for which there is no known *a priori* estimate for the nonlinear problem. Matching results obtained in this space and the physical space $L^1((1 + |v|^2)dv)$ is

one the main difficulties, and was treated in [10] by a non-constructive argument.

- (iii) Finally, any estimate deduced from a linearization argument is valid only in a neighborhood of the equilibrium, and the use of compactness arguments to deduce that the solution enters this neighborhood (as e.g. in [10]) would prevent any hope of obtaining explicit estimate.

First it should be said that in the Maxwell case, all these difficulties have been solved. When the collision kernel is independent of the relative velocity, Wang-Chang and Uhlenbeck [194] and then Bobylev [24] were able to obtain a complete and explicit diagonalization of the linearized collision operator, with or without cutoff. Then specific metric well suited to the collision operator for Maxwell molecules allowed to achieve the goals sketched in the first paragraph of this introduction (under additional assumptions on the initial datum), see [48] and [49]. However it seems that the proofs in this case are strongly restricted to the Maxwellian case.

In order to solve the point (iii), quantitative estimates in the large have been obtained recently, directly on the nonlinear equation, by relating the entropy production functional to the relative entropy: [46, 47, 181, 192, 150]. The latter paper states, for hard potentials with angular cutoff, quantitative convergence towards equilibrium with rate $O(t^{-\infty})$ for solutions in $L^1((1 + |v|^2)dv) \cap L^2$ (or only $L^1((1 + |v|^2)dv)$ in the case of hard spheres). However it was proved in [28] that one cannot establish in this functional space a *linear* inequality relating the entropy production functional and the relative entropy, which would yields exponential convergence directly on the nonlinear equation.

Point (i) was solved in [15], which gave explicit estimates on the spectral gap for hard potentials, with or without cutoff, by relating it explicitly to the one for Maxwell molecules.

In order to solve the remaining obstacle of point (ii), the strategy of this paper is to prove explicit linearized estimates of convergence to equilibrium in the space $L^1(\exp[a|v|^s] dv)$ with $a > 0$ and $0 < s < \gamma/2$, on which we have explicit results of appearance and propagation of the norm, and thus which can be connected to the quantitative nonlinear results in [150]. It will lead us to study the linearized operator \mathcal{L}_m for $m = \exp[-a|v|^s]$ on L^1 , which has no hilbertian self-adjointness structure.

7.1.6 Notation

In the sequel we shall denote $\langle \cdot \rangle = \sqrt{1 + |\cdot|^2}$. For any Borel function $w : \mathbb{R}^N \rightarrow \mathbb{R}_+$, we define the weighted Lebesgue space $L^p(w)$ on \mathbb{R}^N ($p \in$

$[1, +\infty]$), by the norm

$$\|f\|_{L^p(w)} = \left[\int_{\mathbb{R}^N} |f(v)|^p w(v) dv \right]^{1/p}$$

if $p < +\infty$ and

$$\|f\|_{L^\infty(w)} = \sup_{v \in \mathbb{R}^N} |f(v)| w(v)$$

when $p = +\infty$. The weighted Sobolev spaces $W^{k,p}(w)$ ($p \in [1, +\infty]$ and $k \in \mathbb{N}$) are defined by the norm

$$\|f\|_{W^{k,p}(w)} = \left[\sum_{|s| \leq k} \|\partial^s f\|_{L^p(w)}^p \right]^{1/p}$$

with the notation $H^k(w) = W^{k,2}(w)$. In the sequel we shall denote by $\|\cdot\|$ indifferently the norm of an element of a Banach space or the usual operator norm on this Banach space, and we shall denote by C various positive constants independent of the collision kernel.

7.1.7 Statement of the results

Our main result of exponential convergence to equilibrium is

Theorem 7.1. *Let B be a collision kernel satisfying assumptions (7.1.3), (7.1.4), (7.1.5), (7.1.6). Let $\lambda \in (0, \nu_0)$ be the spectral gap of the linearized operator L . Let f_0 be a nonnegative initial datum in $L^1(\langle v \rangle^2) \cap L^2$. Then the solution $f(t, v)$ to the spatially homogeneous Boltzmann equation (7.1.1) with initial datum f_0 satisfies: for any $0 < \mu \leq \lambda$, there is a constant C , which depends explicitly on B , the mass, energy and L^2 norm of f_0 , on μ and on a lower bound on $\nu_0 - \mu$, such that*

$$(7.1.15) \quad \|f(t, \cdot) - M\|_{L^1} \leq C e^{-\mu t}.$$

In the important case of hard spheres (7.1.2), the assumption “ $f_0 \in L^1(\langle v \rangle^2) \cap L^2$ ” can be relaxed into just “ $f_0 \in L^1(\langle v \rangle^2)$ ”, and the same result holds with the constant C in (7.1.15) depending explicitly on B , the mass and energy of f_0 , on μ and on a lower bound on $\nu_0 - \mu$.

Remarks:

1. Note that the optimal rate $\mu = \lambda$ is allowed in the theorem, which can be related to the fact that the eigenspace of \mathcal{L}_m associated with the first

non-zero eigenvalue $-\lambda$ is not degenerate. It seems to be the first time this optimal rate is reached, since both the quantitative study in [48] for Maxwell molecules and the non-constructive results of [10] for hard spheres only prove a convergence like $O(e^{-\mu t})$ for any $\mu < \lambda$, where λ is the corresponding spectral gap.

2. From [15], one deduces the following estimate on λ : when b satisfies the control from below

$$\frac{1}{|\mathbb{S}^{N-1}|} \inf_{\sigma_1, \sigma_2 \in \mathbb{S}^{N-1}} \int_{\sigma_3 \in \mathbb{S}^{N-1}} \min\{b(\sigma_1 \cdot \sigma_3), b(\sigma_2 \cdot \sigma_3)\} d\sigma_3 \geq c_b > 0$$

(which is true for all physical cases), then

$$\lambda \geq c_b C_\Phi \frac{(\gamma/8)^{\gamma/2} e^{-\gamma/2} \pi}{24}.$$

In particular, for hard spheres collision kernels one can compute

$$\lambda \geq \pi/(48\sqrt{2e}) \approx 0.03.$$

We also state the functional analysis result on the spectrum of \mathcal{L}_m used in the proof of Theorem 7.1 and which has interest in itself. We consider the unbounded operator \mathcal{L}_m on L^1 with domain $\text{Dom}(\mathcal{L}_m) = L^1(\langle v \rangle^\gamma)$ and the unbounded operator L on $L^2(M)$ with domain $\text{Dom}(L) = L^2(\langle v \rangle^\gamma M)$. These operators are shown to be closed in Proposition 7.4 and Proposition 7.5 and we have

Theorem 7.2. *Let B be a collision kernel satisfying assumptions (7.1.3), (7.1.4) and (7.1.5). Then the spectrum $\Sigma(\mathcal{L}_m)$ of \mathcal{L}_m is equal to the spectrum $\Sigma(L)$ of L . Moreover the eigenvectors of \mathcal{L}_m associated with any discrete eigenvalue are given by those of L associated with the same eigenvalue, multiplied by $m^{-1}M$.*

Remarks:

1. This theorem essentially means that enlarging the functional space from $f \in L^2(M^{-1})$ to $f \in L^1(m^{-1})$ (for the original solution) does not yield new eigenvectors for the linearized collision operator.

2. It implies in particular that \mathcal{L}_m only has non-degenerate eigenspaces associated with its discrete eigenvalues, since this is true for the self-adjoint operator L . This is related to the fact that the optimal convergence rate is exactly $C e^{-\lambda t}$ and not $C t^k e^{-\lambda t}$ for some $k > 0$. It also yields a simple form of the first term in the asymptotic development (see Section 7.4).

3. Our study shows that, for hard potentials with cutoff, the linear part of the collision operator $f \rightarrow Q(M, f) + Q(f, M)$ “has a spectral gap” in $L^1(m^{-1})$, in the sense that it satisfies exponential decay estimates on its evolution semi-group in this space, with the rate given by the spectral gap of L . We use this linear feature of the collision process to compensate for the fact the functional inequality (*Cercignani’s conjecture*)

$$(7.1.16) \quad \mathcal{D}(f) \geq K [H(f) - H(M)], \quad K > 0,$$

is not true for $f \in L^1(\langle v \rangle^2)$. It also supports the fact that (7.1.16) could be true for solutions f of (7.1.1) satisfying some exponential decay at infinity (as was questioned in [191, Chapter 3, Section 4.2]), in the sense $f \in L^1(m^{-1})$.

7.1.8 Method of proof

The idea of the proof is to establish quantitative estimates of exponential decay on the evolution semi-group of \mathcal{L}_m . They are used to estimate the rate of convergence when the solution is close to equilibrium (where the linear part of the collision operator is dominant), whereas the existing nonlinear entropy method, combined with some *a priori* estimates in $L^1(m^{-1})$, are used to estimate the rate of convergence for solutions far from equilibrium. The proof splits into several steps.

I. The first step is to prove that \mathcal{L}_m and L have the same spectrum. We use the following strategy: first we localize the essential spectrum of \mathcal{L}_m with the perturbation arguments Grad used for L , with additional technical difficulties due to the fact that the operator \mathcal{L}_m has no hilbertian self-adjointness structure. It is shown to have the same essential spectrum as L , which is the range of the collision frequency. The main tool is the proof of the fact that the non-local part of \mathcal{L}_m is relatively compact with respect to its local part. Then, in order to localize the discrete spectrum, we show some decay estimates on the eigenvectors of \mathcal{L}_m associated to discrete eigenvalues. The operators \mathcal{L}_m and L are related by

$$\mathcal{L}_m(g) = m^{-1} M L(m M^{-1} g),$$

and our decay estimates show that any such eigenvector g of \mathcal{L}_m satisfies $m M^{-1} g \in L^2(\langle v \rangle^\gamma M) = \text{Dom}(L)$. We deduce that \mathcal{L}_m and L have the same discrete spectrum.

II. The second step is to prove explicit exponential decay estimates on the evolution semi-group of \mathcal{L}_m with optimal rate, i.e. the first non-zero eigenvalue of \mathcal{L}_m and L). To that purpose we show sectoriality estimates on \mathcal{L}_m .

This requires estimates on the norm of the resolvent of \mathcal{L}_m , which are obtained by showing that this norm can be related to the norm of the resolvent of L .

III. The third step is the application of these linear estimates to the nonlinear problem. A Gronwall argument is used to obtain the exponential convergence in an $L^1(m^{-1})$ -neighborhood of the equilibrium for the nonlinear problem. Moments estimates are used to show the appearance and propagation of this norm, and the nonlinear entropy method (in the form of [150, Theorems 6.2 and 7.2]) is used to estimate the time required to enter this neighborhood.

7.1.9 Plan of the paper

Sections 7.2 and 7.3 remain at the functional analysis level. In Section 7.2 we introduce suitable approximations of \mathcal{L}_m and L , and state and prove various technical estimates on these linearized operators useful for the sequel. In Section 7.3 we determine the spectrum of \mathcal{L}_m and show that it is equal to the one of L . Then in Section 7.4 we handle solutions of the Boltzmann equation: we prove Theorem 7.1 by translating the previous spectral study into explicit estimates on the evolution semi-group, and then connecting the latter to the nonlinear theory.

7.2 Properties of the linearized collision operator

In the sequel we fix $m(v) = \exp[-a|v|^s]$ with $a > 0$ and $0 < s < 2$. The exact values of a and s will be chosen later. With no risk of confusion we shall no more write the subscript “ m ” on the operator \mathcal{L} . We assume in this section that the collision kernel B satisfies (7.1.3), (7.1.4), (7.1.5).

7.2.1 Introduction of an approximate operator

Let $\mathbf{1}_E$ denote the usual indicator function of the set E . Roughly speaking we shall truncate smoothly v , remove grazing and frontal collisions and mollify the angular part of the collision kernel. More precisely, let $\Theta : \mathbb{R} \rightarrow \mathbb{R}_+$ be an even C^∞ function with mass 1 and support included in $[-1, 1]$ and $\tilde{\Theta} : \mathbb{R}^N \rightarrow \mathbb{R}_+$ a radial C^∞ function with mass 1 and support included in $B(0, 1)$. We define the following mollification functions ($\epsilon > 0$):

$$\begin{cases} \Theta_\epsilon(x) = \epsilon \Theta(\epsilon x), & (x \in \mathbb{R}) \\ \tilde{\Theta}_\epsilon(x) = \epsilon^N \tilde{\Theta}(\epsilon x), & (x \in \mathbb{R}^N). \end{cases}$$

Then for any $\delta \in (0, 1)$ we set

$$(7.2.17) \quad \mathcal{L}_\delta^+(g) = \mathcal{I}_\delta(v) m^{-1} \int_{\mathbb{R}^N \times \mathbb{S}^{N-1}} \Phi(|v - v_*|) b_\delta(\cos \theta) [(mg)' M'_* + M'(mg)'_*] dv_* d\sigma.$$

where

$$(7.2.18) \quad \mathcal{I}_\delta = \tilde{\Theta}_\delta * \mathbf{1}_{\{|\cdot| \leq \delta^{-1}\}},$$

and

$$(7.2.19) \quad b_\delta(z) = (\Theta_{\delta^2} * \mathbf{1}_{\{-1+2\delta^2 \leq z \leq 1-2\delta^2\}}) b(z).$$

We check that

$$\text{supp}(b_\delta) \subset \{-1 + \delta^2 \leq \cos \theta \leq 1 - \delta^2\}.$$

The approximation induces $\mathcal{L}_\delta = \mathcal{L}_\delta^+ - \mathcal{L}^* - \mathcal{L}^\nu$, following the decomposition (7.1.8, 7.1.9).

We define similarly the approximate operator

$$(7.2.20) \quad L_\delta^+(h) = \mathcal{I}_\delta(v) \int_{\mathbb{R}^N \times \mathbb{S}^{N-1}} b_\delta(\cos \theta) \Phi(|v - v_*|) [h' + h'_*] M_* dv_* d\sigma$$

which induces $L_\delta = L_\delta^+ - L^* - L^\nu$, following the decomposition (7.1.11, 7.1.12).

7.2.2 Convergence of the approximation

First for \mathcal{L} we have

Proposition 7.1. *For any $g \in L^1(\langle v \rangle^\gamma)$, we have*

$$\|(\mathcal{L}^+ - \mathcal{L}_\delta^+)(g)\|_{L^1} \leq C_1(\delta) \|g\|_{L^1(\langle v \rangle^\gamma)}$$

where $C_1(\delta) > 0$ is an explicit constant depending on the collision kernel and going to 0 as δ goes to 0.

Before going into the proof of Proposition 7.1, let us enounce as a lemma a simple estimate we shall use several times in the sequel:

Lemma 7.1. *For all $v \in \mathbb{R}^N$*

$$(7.2.21) \quad (mM_*(m')^{-1}), (mM_*(m'_*)^{-1}) \leq \exp[a|v_*|^s - |v_*|^2].$$

Proof of Lemma 7.1. Indeed

$$(mM_*(m')^{-1}) = \exp [a|v'|^s - a|v|^s - |v_*|^2]$$

and by using the conservation of energy and the fact that $s/2 < \gamma/4 \leq 1$,

$$|v'|^s = (|v'|^2)^{s/2} \leq (|v|^2 + |v_*|^2)^{s/2} \leq |v|^s + |v_*|^s.$$

This implies immediately (7.2.21) (for the other term $(mM_*(m'_*)^{-1})$, the proof is similar). \square

Proof of Proposition 7.1. Let us pick $\varepsilon > 0$. Using the pre-postcollisional change of variable [191, Chapter 1, Section 4.5] and the unitary change of variable $(v, v_*, \sigma) \rightarrow (v_*, v, -\sigma)$, we can write

$$\begin{aligned} & \|(\mathcal{L}^+ - \mathcal{L}_\delta^+)(g)\|_{L^1} \leq \\ & \int_{\mathbb{R}^N \times \mathbb{R}^N \times \mathbb{S}^{N-1}} |b - b_\delta| |g| \langle v \rangle^\gamma M_* \langle v_* \rangle^\gamma m [(m')^{-1} + (m'_*)^{-1}] dv dv_* d\sigma \\ & + \int_{\mathbb{R}^N \times \mathbb{R}^N \times \mathbb{S}^{N-1}} b |g| \langle v \rangle^\gamma M_* \langle v_* \rangle^\gamma m [(m')^{-1} \mathcal{C}_\delta(v') + (m'_*)^{-1} \mathcal{C}_\delta(v'_*)] dv dv_* d\sigma \\ & \qquad \qquad \qquad =: I_1^\delta + I_2^\delta, \end{aligned}$$

where we have denoted $\mathcal{C}_\delta(v) = v - \mathcal{I}_\delta(v)$, and \mathcal{I}_δ was introduced in (7.2.18).

The goal is to prove that

$$(7.2.22) \qquad I_1^\delta + I_2^\delta \leq \varepsilon \|g\|_{L^1(\langle v \rangle^\gamma)}$$

for δ small enough.

By Lemma 7.1,

$$\begin{aligned} I_1^\delta & \leq 2 \int_{\mathbb{R}^N \times \mathbb{R}^N \times \mathbb{S}^{N-1}} |b - b_\delta| |g| \langle v \rangle^\gamma \langle v_* \rangle^\gamma \exp [a|v_*|^s - |v_*|^2] dv dv_* d\sigma \\ & \leq 2 \|b - b_\delta\|_{L^1(\mathbb{S}^{N-1})} \|g\|_{L^1(\langle v \rangle^\gamma)} \left(\int_{\mathbb{R}^N} \langle v_* \rangle^\gamma \exp [a|v_*|^s - |v_*|^2] dv_* \right). \end{aligned}$$

Since $s < \gamma/2 < 2$, we have

$$\left(\int_{\mathbb{R}^N} \langle v_* \rangle^\gamma \exp [a|v_*|^s - |v_*|^2] dv_* \right) < +\infty$$

and thus

$$I_1^\delta \leq C \|b - b_\delta\|_{L^1(\mathbb{S}^{N-1})} \|g\|_{L^1(\langle v \rangle^\gamma)}.$$

Now as $\|b - b_\delta\|_{L^1(\mathbb{S}^{N-1})} \rightarrow 0$ as δ goes to 0 we deduce that there exists δ_0 such that for $\delta < \delta_0$

$$I_1^\delta \leq (\varepsilon/4) \|g\|_{L^1(\langle v \rangle^\gamma)}.$$

For I_2^δ , let us denote

$$\phi_1^\delta(v) := \int_{\mathbb{R}^N \times \mathbb{S}^{N-1}} b M_* \langle v_* \rangle^\gamma m(m')^{-1} \mathcal{C}_\delta(v') dv_* d\sigma$$

$$\phi_2^\delta(v) := \int_{\mathbb{R}^N \times \mathbb{S}^{N-1}} \bar{b} M_* \langle v_* \rangle^\gamma m(m'_*)^{-1} \mathcal{C}_\delta(v'_*) dv_* d\sigma.$$

We have

$$I_2^\delta = \int_{\mathbb{R}^N} |g| \langle v \rangle^\gamma [\phi_1^\delta(v) + \phi_2^\delta(v)] dv.$$

Let us show that ϕ_1^δ and ϕ_2^δ converge to 0 in L^∞ . We write the proof for ϕ_1^δ , the argument for ϕ_2^δ is symmetric. First let us pick $\eta > 0$ and introduce the truncation $\bar{b}(\cos \theta) = \mathbf{1}_{\{-1+\eta \leq \cos \theta \leq 1-\eta\}} b(\cos \theta)$. Then we have

$$\begin{aligned} & \int_{\mathbb{R}^N \times \mathbb{S}^{N-1}} |b - \bar{b}| M_* \langle v_* \rangle^\gamma m(m'_*)^{-1} \mathcal{C}_\delta(v'_*) dv_* d\sigma \\ & \leq \|b - \bar{b}\|_{L^1(\mathbb{S}^{N-1})} \left(\int_{\mathbb{R}^N} \langle v_* \rangle^\gamma \exp[a|v_*|^s - |v_*|^2] dv_* \right) \xrightarrow{\eta \rightarrow 0} 0 \end{aligned}$$

and we can choose η small enough such that for any $\delta \in (0, 1)$

$$\left| \phi_1^\delta(v) - \int_{\mathbb{R}^N \times \mathbb{S}^{N-1}} \bar{b} M_* \langle v_* \rangle^\gamma m(m')^{-1} \mathcal{C}_\delta(v') d\sigma dv_* \right| \leq \varepsilon/8.$$

Secondly let us pick $R > 0$. As

$$\begin{aligned} & \int_{\{|v_*| \geq R\} \times \mathbb{S}^{N-1}} \bar{b} M_* \langle v_* \rangle^\gamma m(m')^{-1} \mathcal{C}_\delta(v') d\sigma dv_* \\ & \leq \|b\|_{L^1(\mathbb{S}^{N-1})} \left(\int_{\{|v_*| \geq R\}} \langle v_* \rangle^\gamma \exp[a|v_*|^s - |v_*|^2] dv_* \right) \xrightarrow{R \rightarrow +\infty} 0 \end{aligned}$$

we can choose R large enough such that for any $\delta \in (0, 1)$

$$\int_{\{|v_*| \geq R\} \times \mathbb{S}^{N-1}} \bar{b} M_* \langle v_* \rangle^\gamma m(m')^{-1} \mathcal{C}_\delta(v') dv_* d\sigma \leq \varepsilon/8.$$

Thus we get for any $\delta \in (0, 1)$

$$\left| \phi_1^\delta(v) - \int_{\{|v_*| \leq R\} \times \mathbb{S}^{N-1}} \bar{b} M_* \langle v_* \rangle^\gamma m(m')^{-1} \mathcal{C}_\delta(v') dv_* d\sigma \right| \leq \varepsilon/4$$

and it remains to estimate

$$J^\delta(v) = \int_{\{|v_*| \leq R\} \times \mathbb{S}^{N-1}} \bar{b} M_* \langle v_* \rangle^\gamma m(m')^{-1} \mathcal{C}_\delta(v') dv_* d\sigma.$$

We use the following bound: on the set of angles determined by $\{-1 + \eta \leq \cos \theta \leq 1 - \eta\}$, we have

$$|v_* - v'| \leq \sin \theta/2 |v - v_*| \leq \sqrt{1 - \eta/2} |v - v_*|.$$

Thus when $|v_*| \leq R$ we obtain

(7.2.23)

$$|v'| \leq R + |v_* - v'| \leq R + \sqrt{1 - \eta/2} |v - v_*| \leq 2R + \sqrt{1 - \eta/2} |v|.$$

Moreover if we impose $\delta \leq (\sqrt{2}R)^{-1}$, up to reducing δ_0 , we get that if $|v| < \delta^{-1}/\sqrt{2}$ then

$$|v'| < \sqrt{R^2 + \delta^{-2}/2} \leq \delta^{-1},$$

and thus $J^\delta(v) = 0$. So let us assume that $|v| \geq \delta^{-1}/\sqrt{2}$. For these values of v we have (using (7.2.23))

$$J^\delta(v) \leq \exp \left[a(2R + \sqrt{1 - \eta/2} |v|)^s - a|v|^s \right] \|b\|_{L^1(\mathbb{S}^{N-1})} \left(\int_{\mathbb{R}^N} M_* \langle v_* \rangle^\gamma dv_* \right).$$

To conclude we observe that

$$\exp \left[a(2R + \sqrt{1 - \eta/2} |v|)^s - a|v|^s \right] \xrightarrow{|v| \rightarrow +\infty} 0$$

since $s > 0$. So, up to reducing δ_0 , we obtain

$$J^\delta(v) \leq \varepsilon/8$$

as it is true for $|v| \geq \delta^{-1}/\sqrt{2}$ with δ small enough and it is equal to 0 elsewhere.

This concludes the proof: we have $\|\phi_1^\delta\|_{L^\infty} \leq 3\varepsilon/8$ for $\delta \leq \delta_0$. By exactly the same proof we get $\|\phi_2^\delta\|_{L^\infty} \leq 3\varepsilon/8$, and thus $I_2^\delta \leq (3\varepsilon/4) \|g\|_{L^1(\langle v \rangle^\gamma)}$. As we had also $I_1^\delta \leq (\varepsilon/4) \|g\|_{L^1(\langle v \rangle^\gamma)}$, the proof of (7.2.22) is complete. \square

Remark: One can see from this proof that we use the fact that the weight function $m = m(v)$ satisfies

$$\frac{m(v)}{m(\eta v)} \xrightarrow{|v| \rightarrow +\infty} 0$$

for any given $\eta \in [0, 1)$. This explains why we do not use a polynomial function, but an exponential one.

For L^+ we can use classical estimates from Grad [109] to obtain a stronger result: the operator L^+ is bounded on the space $L^2(M)$, and the convergence holds in the sense of operator norm.

Proposition 7.2. *For any $h \in L^2(M)$, we have*

$$\|(L^+ - L_\delta^+)(h)\|_{L^2(M)} \leq C_2(\delta) \|h\|_{L^2(M)}$$

where $C_2(\delta) > 0$ is an explicit constant going to 0 as δ goes to 0.

Proof of Proposition 7.2. Under assumptions (7.1.4) and (7.1.5), the collision kernel \tilde{B} in ω -representation [191, Chapter 1, Section 4.6] satisfies

$$\begin{aligned} \tilde{B}(|v - v_*|, \cos \theta) &\leq 2^{N-2} C_b C_\Phi |v - v_*|^\gamma \sin^{N-2} \theta / 2 \\ &\leq 2^{N-2} C_b C_\Phi (|v - v_*| \sin \theta / 2)^\gamma \end{aligned}$$

since $N - 2 \geq 1 \geq \gamma$. Hence

$$\tilde{B}(|v - v_*|, \cos \theta) \leq 2^{N-2} C_b C_\Phi |v - v'|^\gamma.$$

Then similar computations as in [58, Chapter 7, Section 2] show that L^+ writes

$$L^+(h)(v) = M^{-1/2}(v) \int_{u \in \mathbb{R}^N} k(u, v) (h(u) M^{1/2}(u)) du$$

with a kernel k satisfying

$$k(u, v) \leq C |u - v|^{1+\gamma-N} \exp \left[-\frac{|u - v|^2}{4} - \frac{(|u|^2 - |v|^2)^2}{4|u - v|^2} \right].$$

First we see that this kernel is controlled from above by

$$k(u, v) \leq \bar{k}(u - v) := C |u - v|^{1+\gamma-N} \exp \left[-\frac{|u - v|^2}{4} \right].$$

Since \bar{k} is integrable on \mathbb{R}^N , we deduce that L^+ is bounded by Young's inequality:

$$(7.2.24) \quad \|L^+\|_{L^2(M)} \leq \|\bar{k}\|_{L^1}.$$

Moreover the computations by Grad [109, Section 4] (see also [58, Chapter 7, Theorem 7.2.3]) show that for any $r \geq 0$,

$$\int_{\mathbb{R}^N} k(u, v) \langle u \rangle^{-r} du \leq C \langle v \rangle^{-r-1}$$

for an explicit constant $C_r > 0$. Thus if we denote $\mathcal{C}_\delta(v) = v - \mathcal{I}_\delta(v)$ (\mathcal{I}_δ is defined in (7.2.18)), we have for $\|h\|_{L^2(M)} \leq 1$:

$$\begin{aligned} \|\mathcal{C}_\delta(v)L^+(h)\|_{L^2(M)}^2 &\leq C \int_{\mathbb{R}^N} \mathcal{C}_\delta(v)^2 \left[\int_{\mathbb{R}^N} k(u, v) M^{1/2}(u) h(u) du \right]^2 dv \\ &\leq C \int_{\mathbb{R}^N} \mathcal{C}_\delta(v)^2 \left[\int_{\mathbb{R}^N} k(u, v) du \right] \left[\int_{\mathbb{R}^N} k(u, v) M(u) h(u)^2 du \right] dv \\ &\leq C \int_{\mathbb{R}^N} \mathcal{C}_\delta(v)^2 \langle v \rangle^{-1} \left[\int_{\mathbb{R}^N} k(u, v) M(u) h(u)^2 du \right] dv \\ &\leq C \langle \delta^{-1} \rangle^{-1} \int_{\mathbb{R}^N} \left[\int_{\mathbb{R}^N} k(u, v) M(u) h(u)^2 du \right] dv \\ &\leq C \langle \delta^{-1} \rangle^{-1} \left[\int_{\mathbb{R}^N} \left(\int_{\mathbb{R}^N} k(u, v) dv \right) M(u) h(u)^2 du \right] \\ &\leq C \langle \delta^{-1} \rangle^{-1} \left[\int_{\mathbb{R}^N} M(u) h(u)^2 du \right] \leq C \langle \delta^{-1} \rangle^{-1} \end{aligned}$$

using finally the L^1 bound

$$\int_{\mathbb{R}^N} k(u, v) dv \leq \int_{\mathbb{R}^N} \bar{k}(u - v) dv \leq \|\bar{k}\|_{L^1} < +\infty$$

independent of u . This shows that

$$(7.2.25) \quad \|\mathcal{C}_\delta(v)L^+\|_{L^2(M)} = O(\delta)$$

and thus $\mathcal{C}_\delta(v)L^+$ goes to 0 as δ goes to 0 in the sense of operator norm, with explicit rate.

Let us again pick h with $\|h\|_{L^2(M)} \leq 1$, then

$$(7.2.26) \quad \|(L^+ - L_\delta^+)(h)\|_{L^2(M)} \leq \|\mathcal{C}_\delta(v)L^+(h)\|_{L^2(M)} + \|\mathcal{I}_\delta(v)L_{|b-b_\delta|}^+(h)\|_{L^2(M)}$$

where the notation $L_{|b-b_\delta|}^+$ stands for the linearized collision operator L^+ with the collision kernel $\Phi|b-b_\delta|$ instead of Φb . We have

$$\begin{aligned} & \|\mathcal{I}_\delta(v)L_{|b-b_\delta|}^+(h)\|_{L^2(M)}^2 \\ & \leq C \int_{\mathbb{R}^N} \mathcal{I}_\delta(v) \langle v \rangle^{2\gamma} \left[\int_{\mathbb{R}^N \times \mathbb{S}^{N-1}} M_* |b-b_\delta| \langle v_* \rangle^\gamma (h' + h'_*) dv_* d\sigma \right]^2 M(v) dv. \end{aligned}$$

We use the truncation of v to control $\langle v \rangle^\gamma$ and the Cauchy-Schwarz inequality together with the bound

$$\int_{\mathbb{R}^N} M(v_*) \langle v_* \rangle^{2\gamma} dv_* < +\infty.$$

This yields

$$\begin{aligned} \|\mathcal{I}_\delta(v)L_{|b-b_\delta|}^+(h)\|_{L^2(M)}^2 & \leq C \langle \delta^{-1} \rangle^{2\gamma} \|b-b_\delta\|_{L^1(\mathbb{S}^{N-1})} \\ & \int_{\mathbb{R}^N \times \mathbb{R}^N \times \mathbb{S}^{N-1}} |b-b_\delta| [(h')^2 + (h'_*)^2] M M_* dv dv_* d\sigma. \end{aligned}$$

Then using the pre-postcollisional change of variable we get

$$\begin{aligned} \|\mathcal{I}_\delta(v)L_{|b-b_\delta|}^+(h)\|_{L^2(M)}^2 & \leq C \langle \delta^{-1} \rangle^{2\gamma} \|b-b_\delta\|_{L^1(\mathbb{S}^{N-1})} \\ & \int_{\mathbb{R}^N \times \mathbb{R}^N \times \mathbb{S}^{N-1}} |b-b_\delta| [h^2 + (h_*)^2] M M_* dv dv_* d\sigma \\ & \leq C \langle \delta^{-1} \rangle^{2\gamma} \|b-b_\delta\|_{L^1(\mathbb{S}^{N-1})}^2. \end{aligned}$$

Finally by (7.2.19) we have

$$\|b-b_\delta\|_{L^1(\mathbb{S}^{N-1})}^2 \leq C \delta^4$$

and we deduce

$$\|\mathcal{I}_\delta(v)L_{|b-b_\delta|}^+(h)\|_{L^2(M)}^2 \leq C \langle \delta^{-1} \rangle^{2\gamma} \delta^4.$$

Since $\gamma \leq 1$, we have

$$\|\mathcal{I}_\delta(v)L_{|b-b_\delta|}^+\|_{L^2(M)} = O(\delta^{2-\gamma})$$

and thus $\mathcal{I}_\delta(v)L_{|b-b_\delta|}^+$ goes to 0 as δ goes to 0 in the sense of operator norm, with explicit rate. Together with (7.2.25) and (7.2.26), this concludes the proof. \square

7.2.3 Estimates on \mathcal{L}

Proposition 7.3. *For any $\delta \in (0,1)$, we have the following properties.*

(i) *There exists a constant $C_3 > 0$ depending only on the collision kernel such that*

$$(7.2.27) \quad \begin{cases} \|\mathcal{L}^+(g)\|_{L^1} \leq C_3 \|g\|_{L^1(\langle v \rangle^\gamma)} \\ \|\mathcal{L}_\delta^+(g)\|_{L^1} \leq C_3 \|g\|_{L^1(\langle v \rangle^\gamma)}. \end{cases}$$

(ii) *There exists a constant $C_4(\delta) > 0$ depending on δ (and going to infinity as δ goes to 0) such that*

$$(7.2.28) \quad \forall v \in \mathbb{R}^N, \quad |\mathcal{L}_\delta^+(g)(v)| \leq C_4(\delta) \mathcal{I}_\delta(v) \|g\|_{L^1}.$$

(iii) *There is a constant $C_5(\delta) > 0$ depending on δ (and possibly going to infinity as δ goes to 0) such that for all $\delta \in (0,1)$*

$$(7.2.29) \quad \|\mathcal{L}_\delta^+(g)\|_{W^{1,1}} \leq C_5(\delta) \|g\|_{L^1}.$$

(iv) *There is a constant $C_6 > 0$ such that*

$$(7.2.30) \quad \forall v \in \mathbb{R}^N, \quad |\mathcal{L}^*(g)(v)| \leq C_6 \|g\|_{L^1} m^{-1} \langle v \rangle^\gamma M(v).$$

(v) *There exists some constant $C_7 > 0$ such that*

$$(7.2.31) \quad \|\mathcal{L}^*(g)\|_{W^{1,1}} \leq C_7 \|g\|_{L^1}.$$

(vi) *There are some constants $n_0, n_1 > 0$ such that*

$$(7.2.32) \quad \forall v \in \mathbb{R}^N, \quad n_0 \langle v \rangle^\gamma \leq \nu(v) \leq n_1 \langle v \rangle^\gamma.$$

Remark: The regularity property (7.2.29) is proved here by direct analytic computations on the kernel but is reminiscent of the regularity property on Q^+ of the form

$$\|Q^+(g, f)\|_{H^s} \leq C \|g\|_{L^1_2} \|f\|_{L^2_2}$$

with $s > 0$ (see [130, 131, 199, 37, 134, 150]), proved with the help of tools from harmonic analysis to handle integral over moving hypersurfaces. Here we do not need such tools since the function integrated on the moving hyperplan is just a gaussian. Note that, using the arguments from point (iii),

one could easily prove that L_δ^+ is bounded from $L^2(M)$ into $H^1(M)$. Since L_δ^+ converges to L^+ , this would provide a proof for the compactness of L^+ , alternative to the one of Grad (which is based on the Hilbert-Schmidt theory). But in fact most of the key estimates of the proof of Grad were used in the proof of Proposition 7.2. Nevertheless it underlines the fact that the compactness property of L^+ can be linked to the same kind of regularity effect that we observe for the nonlinear operator Q^+ .

Proof of Proposition 7.3. Point (i) follows directly from convolution-like estimates in [150, Section 2] together with inequality (7.2.21). Point (ii) is a direct consequence of the estimates

$$Q^+ : L^\infty(\langle v \rangle^\gamma) \times L^1(\langle v \rangle^\gamma) \rightarrow L^\infty$$

$$Q^+ : L^1(\langle v \rangle^\gamma) \times L^\infty(\langle v \rangle^\gamma) \rightarrow L^\infty$$

valid when grazing and frontal collisions are removed (see [150, Section 2] again) and thus valid for the quantity

$$m^{-1} \int_{\mathbb{R}^N \times \mathbb{S}^{N-1}} \Phi(|v - v_*|) b_\delta(\cos \theta) [(mg)'M'_* + M'(mg)'_*] dv_* d\sigma$$

appearing in the formula of \mathcal{L}_δ^+ . Point (iv) is trivial and point (vi) is well-known. It remains to prove the regularity estimates.

For the regularity of \mathcal{L}_δ^+ (point (iii)), we first derive a representation in the spirit of the computations of Grad (it is also related to the Carleman representation, see [191, Chapter 1, Section 4.6]). Write the collision integral with the “ ω -representation” (see [191, Chapter 1, Section 4.6] again)

$$(7.2.33) \quad \mathcal{L}_\delta^+(g) = \mathcal{I}(v) m^{-1} \int_{\mathbb{R}^N \times \mathbb{S}^{N-1}} \Phi(|v - v_*|) \tilde{b}_\delta \left(\omega \cdot \frac{v - v_*}{|v - v_*|} \right) [(mg)'M'_* + M'(mg)'_*] d\omega dv_*.$$

In this new parametrization of the collision, the velocities before and after collision are related by

$$v' = v + ((v_* - v) \cdot \omega)\omega, \quad v'_* = v_* - ((v_* - v) \cdot \omega)\omega$$

and the angular collision kernel is given by

$$\tilde{b}_\delta(u) = 2^{N-1} u^{N-2} b_\delta(1 - 2u^2).$$

Up to replacing \tilde{b}_δ by a symmetrized version $\tilde{b}_\delta^s(\theta) = \tilde{b}_\delta(\theta) + \tilde{b}_\delta(\pi/2 - \theta)$, we can combine terms appearing in (7.2.33) into just one:

$$\mathcal{L}_\delta^+(g) = \mathcal{I}(v) m^{-1} \int_{\mathbb{R}^N \times \mathbb{S}^{N-1}} \tilde{b}_\delta^s \left(\omega \cdot \frac{v - v_*}{|v - v_*|} \right) \Phi(|v - v_*|) (mg)' M'_* dv_* d\omega.$$

Then, keeping ω unchanged, we make the translation change of variable $v_* \rightarrow V = v_* - v$,

$$\begin{aligned} \mathcal{L}_\delta^+(g)(v) &= \mathcal{I}(v) m^{-1} \int_{\mathbb{R}^N \times \mathbb{S}^{N-1}} \tilde{b}_\delta^s \left(\omega \cdot \frac{V}{|V|} \right) \Phi(|V|) \\ &\quad (mg)(v + (V \cdot \omega)\omega) M(v + V + (V \cdot \omega)\omega) dV d\omega. \end{aligned}$$

Then, still keeping ω unchanged, we write the orthogonal decomposition $V = V_1\omega + V_2$ with $V_1 \in \mathbb{R}$ and $V_2 \in \omega^\perp$ (the latter set can be identified with \mathbb{R}^{N-1})

$$\begin{aligned} \mathcal{L}_\delta^+(g)(v) &= \mathcal{I}(v) m^{-1} \int_{\mathbb{S}^{N-1} \times \mathbb{R} \times \omega^\perp} \tilde{b}_\delta^s \left(\frac{V_1}{\sqrt{|V_1|^2 + |V_2|^2}} \right) \\ &\quad \Phi(\sqrt{|V_1|^2 + |V_2|^2}) (mg)(v + V_1\omega) M(v + V_2) d\omega dV_1 dV_2. \end{aligned}$$

Finally we reconstruct the polar variable $W = V_1\omega$

$$\begin{aligned} \mathcal{L}_\delta^+(g)(v) &= \mathcal{I}(v) m^{-1} \int_{\mathbb{R}^N \times W^\perp} |W|^{-(N-1)} \tilde{b}_\delta^s \left(\frac{|W|}{\sqrt{|W|^2 + |V_2|^2}} \right) \\ &\quad \Phi(\sqrt{|W|^2 + |V_2|^2}) (mg)(v + W) M(v + V_2) dW dV_2. \end{aligned}$$

This finally leads to the following representation of \mathcal{L}_δ^+ :

$$(7.2.34) \quad \mathcal{L}_\delta^+(g)(v) = \mathcal{I}(v) m^{-1} \int_{\mathbb{R}^N} (mg)(v + W) \times \left(\int_{W^\perp} |W|^{-(N-1)} \tilde{b}_\delta^s \left(\frac{|W|}{\sqrt{|W|^2 + |V_2|^2}} \right) \Phi(\sqrt{|W|^2 + |V_2|^2}) M(v + V_2) dV_2 \right) dW.$$

Then we compute a derivative along some coordinate v_i . By integration

by parts,

$$\begin{aligned}
 \partial_{v_i} \mathcal{L}_\delta^\dagger(g)(v) &= -\mathcal{I}(v) m^{-1} \int_{\mathbb{R}^N} (mg)(v+W) \times \\
 \partial_{W_i} \left[\int_{W^\perp} |W|^{-(N-1)} \tilde{b}_\delta^s \left(\frac{|W|}{\sqrt{|W|^2 + |V_2|^2}} \right) \Phi(\sqrt{|W|^2 + |V_2|^2}) M(v+V_2) dV_2 \right] dW \\
 &\quad + \mathcal{I}(v) m^{-1} \int_{\mathbb{R}^N} (mg)(v+W) \times \\
 \left[\int_{W^\perp} |W|^{-(N-1)} \tilde{b}_\delta^s \left(\frac{|W|}{\sqrt{|W|^2 + |V_2|^2}} \right) \Phi(\sqrt{|W|^2 + |V_2|^2}) \partial_{v_i} M(v+V_2) dV_2 \right] dW \\
 &\quad + \partial_{v_i} (\mathcal{I}(v) m^{-1}) \int_{\mathbb{R}^N} (mg)(v+W) \times \\
 \left[\int_{W^\perp} |W|^{-(N-1)} \tilde{b}_\delta^s \left(\frac{|W|}{\sqrt{|W|^2 + |V_2|^2}} \right) \Phi(\sqrt{|W|^2 + |V_2|^2}) M(v+V_2) dV_2 \right] dW \\
 &=: I_1 + I_2 + I_3.
 \end{aligned}$$

The functions $\mathcal{I}_\delta m^{-1}$ and $\partial_{v_i} (\mathcal{I}_\delta(v) m^{-1})$ are bounded in the domain of truncation. Concerning the term I_2 we have immediately

$$|\partial_{v_i} M| \leq C M^{1/2}$$

and thus straightforwardly

$$\int_{\mathbb{R}^N} I_2 dv, \quad \int_{\mathbb{R}^N} I_3 dv \leq C(\delta) \|mg\|_{L^1((v)^\gamma)} \leq C(\delta) \|g\|_{L^1}.$$

For the term I_1 , we use the fact that, in the domain of the angular truncation b_δ , we have

$$(7.2.35) \quad \alpha_\delta |V_2| \leq |W| \leq \beta_\delta |V_2|$$

for some constants $\alpha_\delta > 0$ and $\beta_\delta > 0$ depending on δ . In order not to deal with a moving domain of integration we shall write the integral as follows. Since the integral is even with respect to W , we can restrict the study to the set of W such that the first coordinate W_1 is nonnegative. We denote e_1 the first unit vector of the corresponding orthonormal basis. Then we define the following orthogonal linear transformation of \mathbb{R}^N , for some $\omega \in \mathbb{S}^{N-1}$:

$$\forall X \in \mathbb{R}^N, \quad R(\omega, X) = 2 \frac{(e_1 + \omega) \cdot X}{|e_1 + \omega|^2} (e_1 + \omega) - X.$$

Geometrically $R(\omega, \cdot)$ is the axial symmetry with respect to the line defined by the vector $\epsilon_1 + \omega$. It is straightforward that $R(\omega, \cdot)$ is a unitary diffeomorphism from $\{X, X_1 = 0\}$ onto ω^\perp . We deduce that

$$\begin{aligned} & \int_{W^\perp} |W|^{-(N-1)} \tilde{b}_\delta^s \left(\frac{|W|}{\sqrt{|W|^2 + |V_2|^2}} \right) \Phi(\sqrt{|W|^2 + |V_2|^2}) M(v + V_2) dV_2 \\ &= \int_{\mathbb{R}^{N-1}} |W|^{-(N-1)} \tilde{b}_\delta^s \left(\frac{|W|}{\sqrt{|W|^2 + |U|^2}} \right) \\ & \quad \Phi(\sqrt{|W|^2 + |U|^2}) M \left[v + R \left(\frac{W}{|W|}, (0, U) \right) \right] dU. \end{aligned}$$

Thus we compute by differentiating each term

$$\begin{aligned} & \partial_{W_i} \left[|W|^{-(N-1)} \tilde{b}_\delta^s \left(\frac{|W|}{\sqrt{|W|^2 + |U|^2}} \right) \right. \\ & \quad \left. \Phi(\sqrt{|W|^2 + |U|^2}) M \left[v + R \left(\frac{W}{|W|}, (0, U) \right) \right] \right] \\ &= \left[-(N-1) |W|^{-N} \frac{W_i}{|W|} \tilde{b}_\delta^s \Phi M \right] \\ &+ \left[|W|^{-(N-1)} \frac{W_i |U|^2}{|W|(|W|^2 + |U|^2)^{3/2}} (\tilde{b}_\delta^s)' \Phi M \right] \\ &+ \left[|W|^{-(N-1)} \frac{W_i}{\sqrt{|W|^2 + |U|^2}} \tilde{b}_\delta^s \Phi' M \right] \\ &+ \left[-|W|^{-(N-1)} \partial_{W_i} \left| v + R \left(\frac{W}{|W|}, (0, U) \right) \right|^2 M \tilde{b}_\delta^s \Phi \right] \\ &=: I_{1,1} + I_{1,2} + I_{1,3} + I_{1,4}. \end{aligned}$$

Then we use the fact that \tilde{b}_δ^s and $(\tilde{b}_\delta^s)'$ are bounded in L^∞ by some constant depending on δ , and

$$\Phi(z) \leq C_\Phi z^\gamma, \quad |\Phi'(z)| \leq C_\Phi \gamma z^{\gamma-1}.$$

We write the previous expression according to $|W|$ only thanks to (7.2.35) (using that $|U| = |V_2|$). The three first terms are controlled as follows

$$I_{1,1}, I_{1,2} \leq C(\delta) |W|^{-N} \Phi(\sqrt{|W|^2 + |U|^2}) M \leq C(\delta) |W|^{-N+\gamma} M$$

$$I_{1,3} \leq |W|^{-N+1} |\Phi'(\sqrt{|W|^2 + |U|^2})| M \leq C(\delta) |W|^{-N+\gamma} M,$$

for some constant $C(\delta)$ depending on δ . Finally for the fourth term, easy computations give

$$\partial_{W_i} \left| v + R \left(\frac{W}{|W|}, (0, U) \right) \right|^2 \leq C \left(\frac{1 + |v|^2 + |U|^2}{|W|} \right)$$

and thus using the controls (7.2.35) we deduce that on the domain of truncation for v we have

$$I_{1,4} \leq C(\delta) (|W|^{-N+\gamma} + |W|^{-N+1+\gamma}) M.$$

Thus I_1 is controlled by

$$\begin{aligned} I_1 &\leq C(\delta) \mathcal{I}_\delta(v) m^{-1}(v) \int_{\mathbb{R}^N} (m|g|)(v+W) (|W|^{-N+\gamma} + |W|^{-N+1+\gamma}) \\ &\quad \left[\int_{\mathbb{R}^{N-1}} M \left(v + R \left(\frac{W}{|W|}, (0, U) \right) \right) dU \right] dW \\ &= C(\delta) \mathcal{I}_\delta(v) m^{-1}(v) \\ &\quad \int_{\mathbb{R}^N} (m|g|)(v+W) (|W|^{-N+\gamma} + |W|^{-N+1+\gamma}) M(v \cdot W/|W|) dW \end{aligned}$$

up to modifying the constant $C(\delta)$. Hence, using that $|\cdot|^{-N+\gamma}$ and $|\cdot|^{-N+1+\gamma}$ are integrable near 0 in \mathbb{R}^N (as $\gamma > 0$) and a translation change of variable $u = v + W$, we obtain

$$\begin{aligned} \int_{\mathbb{R}^N} I_1 dv &\leq C(\delta) \int_{\mathbb{R}^N \times \mathbb{R}^N} \mathcal{I}_\delta(v) m^{-1}(v) (m|g|)(v+W) \\ &\quad (|W|^{-N+\gamma} + |W|^{-N+1+\gamma}) M(v \cdot W/|W|) dv dW \\ &\leq C(\delta) \int_{\mathbb{R}^N} (m|g|)(u) \left[\int_{\mathbb{R}^N} \mathcal{I}_\delta(u-W) m^{-1}(u-W) \right. \\ &\quad \left. (|W|^{-N+\gamma} + |W|^{-N+1+\gamma}) dW \right] du \\ &\leq C(\delta) \|g\|_{L^1} \end{aligned}$$

up to modifying the constant $C(\delta)$ (for the last inequality we use the fact that the truncation \mathcal{I}_δ reduces the integration over W to a bounded domain). We deduce that

$$\int_{\mathbb{R}^N} I_1 dv \leq C(\delta) \|g\|_{L^1}.$$

Gathering the estimates for I_1, I_2, I_3 , we conclude that

$$\|\partial_{v_i} \mathcal{L}_\delta^+(g)\|_{L^1} \leq C(\delta) \|g\|_{L^1}.$$

The proof of inequality (7.2.29) is completed by writing this estimate on each derivative and using the bound (7.2.28) on $\|\mathcal{L}_\delta^+\|_{L^1}$.

Finally point (v) is simpler since \mathcal{L}^* has a more classical convolution structure. We compute a derivative along some coordinate v_i :

$$\begin{aligned} \partial_{v_i} \mathcal{L}^*(g)(v) &= \left(\int_{\mathbb{R}^N} \partial_{v_i} \Phi(v - v_*) (mg)(v_*) dv_* \right) m^{-1}(v) M(v) \\ &\quad + \left(\int_{\mathbb{R}^N} \Phi(v - v_*) (mg)(v_*) dv_* \right) \partial_{v_i} (m^{-1}(v) M(v)) \end{aligned}$$

and it is straightforward to control the L^1 norm of these two terms according to the L^1 norm of g . \square

Now we can deduce some convenient properties in order to handle the operator \mathcal{L} with the tools from the spectral theory. We give properties for each part of the decomposition as well as for the global operator.

Proposition 7.4.

- (i) For all $\delta \in (0, 1)$, the operator \mathcal{L}_δ^+ is bounded on L^1 (with bound $C_4(\delta)$). The operator \mathcal{L}^+ , with domain $L^1(\langle v \rangle^\gamma)$, is closable on L^1 .
- (ii) The operator \mathcal{L}^* is bounded on L^1 (with bound C_7).
- (iii) The operator \mathcal{L}^ν , with domain $L^1(\langle v \rangle^\gamma)$, is closed on L^1 .
- (iv) The operator \mathcal{L} , with domain $L^1(\langle v \rangle^\gamma)$, is closed on L^1 .

Proof of Proposition 7.4. For point (i), the boundedness of \mathcal{L}_δ^+ is already proved in (7.2.28) and \mathcal{L}^+ is well-defined on $L^1(\langle v \rangle^\gamma)$ from (7.2.27). Let us prove that \mathcal{L}^+ is closable on L^1 . It means that for any sequence $(g_n)_{n \geq 0}$ in $L^1(\langle v \rangle^\gamma)$, going to 0 in L^1 , and such that $\mathcal{L}^+(g_n)$ converges to G in L^1 , we have $G \equiv 0$. We can write

$$\mathcal{L}^+(g_n) = m^{-1} \bar{\mathcal{L}}^+(g_n)$$

where

$$\bar{\mathcal{L}}^+(g_n) = Q^+(M, mg_n) + Q^+(mg_n, M).$$

It is straightforward to see from the proof of (7.2.27) (using [150, Theorem 2.1]) that $\bar{\mathcal{L}}^+$ is bounded in L^1 . So $g_n \rightarrow 0$ in L^1 implies that $\bar{\mathcal{L}}^+(g_n) \rightarrow 0$ in L^1 , which implies that $\bar{\mathcal{L}}^+(g_n)$ goes to 0 almost everywhere, up to an extraction. After multiplication by m^{-1} , we deduce that, up to an extraction,

$\mathcal{L}^+(g_n)$ goes to 0 almost everywhere. This implies that $G \equiv 0$ and concludes the proof.

Point (ii) is already proved in (7.2.30). For point (iii), \mathcal{L}^ν is well-defined on $L^1(\langle v \rangle^\gamma)$ from (7.2.32) and the closure property is immediate: for any sequence $(g_n)_{n \geq 0}$ in $L^1(\langle v \rangle^\gamma)$ such that $g_n \rightarrow g$ in L^1 and $\mathcal{L}^\nu(g_n) \rightarrow G$ in L^1 , we have, up to an extraction, that g_n goes to g almost everywhere and νg_n goes to G almost everywhere. So $G = \nu g = \mathcal{L}^\nu(g)$ almost everywhere, and moreover as $G \in L^1$, we deduce from (7.2.32) that $g \in L^1(\langle v \rangle^\gamma) = \text{Dom}(\mathcal{L}^\nu)$.

For point (iv), first we remark that \mathcal{L}_δ is trivially closed since it is the sum of a closed operator plus a bounded operator (see [121, Chapter 3, Section 5.2]). In order to prove that \mathcal{L} is closed we shall prove on \mathcal{L}^c a quantitative relative compactness estimate with respect to ν .

By Proposition 7.1 we obtain

$$\|\mathcal{L}^+(g)\|_{L^1} \leq \|\mathcal{L}_\delta^+(g)\|_{L^1} + \frac{n_0}{2} \|g\|_{L^1(\langle v \rangle^\gamma)}$$

if we choose $\delta > 0$ such that $C_1(\delta) \leq n_0/2$ ($n_0 > 0$ is defined in (7.2.32)). Hence

$$(7.2.36) \quad \|\mathcal{L}^+(g)\|_{L^1} \leq C_4(\delta) \|g\|_{L^1} + \frac{n_0}{2} \|g\|_{L^1(\langle v \rangle^\gamma)}$$

and thus for the whole non-local part

$$\|\mathcal{L}^c(g)\|_{L^1} \leq [C_4(\delta) + C_7] \|g\|_{L^1} + \frac{n_0}{2} \|g\|_{L^1(\langle v \rangle^\gamma)} = C \|g\|_{L^1} + \frac{n_0}{2} \|g\|_{L^1(\langle v \rangle^\gamma)}.$$

Then by triangular inequality

$$\|\mathcal{L}(g)\|_{L^1} \geq \|\mathcal{L}^\nu(g)\|_{L^1} - \|\mathcal{L}^c(g)\|_{L^1} \geq \frac{n_0}{2} \|g\|_{L^1(\langle v \rangle^\gamma)} - C \|g\|_{L^1}$$

which implies that

$$(7.2.37) \quad \|g\|_{L^1(\langle v \rangle^\gamma)} \leq \frac{2}{n_0} \left(\|\mathcal{L}(g)\|_{L^1} + C \|g\|_{L^1} \right).$$

If $(g_n)_{n \geq 0}$ is a sequence in $L^1(\langle v \rangle^\gamma)$ such that $g_n \rightarrow g$ and $\mathcal{L}(g_n) \rightarrow G$ in L^1 , then $g \in L^1(\langle v \rangle^\gamma)$ and $g_n \rightarrow g$ in $L^1(\langle v \rangle^\gamma)$ by (7.2.37). Then by (7.2.27), (7.2.30), (7.2.32) we deduce that $\mathcal{L}(g_n) \rightarrow \mathcal{L}(g)$ in L^1 , which implies $G \equiv \mathcal{L}(g)$. \square

7.2.4 Estimates on L

We recall here some classical properties of L .

Proposition 7.5.

- (i) The operators L^+ and L^* are bounded on $L^2(M)$.
- (ii) The operator L^ν , with domain $L^2(\langle v \rangle^\gamma M)$, is closed on $L^2(M)$.
- (iii) The operator L , with domain $L^2(\langle v \rangle^\gamma M)$, is closed on $L^2(M)$.

Proof of proposition 7.5. Point (i) was proved in (7.2.24) (see also [109, Section 4] or [58, Chapter 7, Section 7.2]). Point (ii) is immediate since L^ν is a multiplication operator. Point (iii) is a consequence of the fact that a bounded perturbation of a closed operator is closed (see [121, Chapter 3, Section 5.2]). \square

7.3 Localization of the spectrum

In this section we determine the spectrum of \mathcal{L} . As we do not have a hilbertian structure anymore, new technical difficulties arise with respect to the study of L . Nevertheless the localization of the essential spectrum is based on a similar argument as for L , namely the use of a variant of Weyl's Theorem for relatively compact perturbation. We assume in this section that the collision kernel B satisfies (7.1.3), (7.1.4), (7.1.5).

7.3.1 Spectrum of L

Before going into the study of the spectrum of \mathcal{L} we state well-known properties on the spectrum of L . We recall that the discrete spectrum is defined as the set of eigenvalues isolated in the spectrum and with finite multiplicity, while the essential spectrum is defined as the complementary set in the spectrum of the discrete spectrum.

Proposition 7.6. *The spectrum of L is composed of an essential spectrum part, which is $-\nu(\mathbb{R}^N) = (-\infty, -\nu_0]$, plus discrete eigenvalues on $(-\nu_0, 0]$, that can only accumulate at $-\nu_0$.*

Proof of Proposition 7.6. The operator $L^c = L^+ - L^*$ is compact on the Hilbert space $L^2(M)$ (see below). Thus Weyl's Theorem for self-adjoint operators (cf. [121, Chapter 4, Section 5]) implies that

$$\Sigma_e(L) = \Sigma_e(L^\nu) = (-\infty, -\nu_0].$$

Since the operator is self-adjoint, the remaining part of the spectrum (that is the discrete spectrum) is included in $\mathbb{R} \cap (\mathbb{C} \setminus \Sigma_e(L)) = (-\nu_0, +\infty)$. Finally

since the Dirichlet form is nonpositive, the discrete spectrum is also included in \mathbb{R}_- , which concludes the proof.

Concerning the proof of the compactness of L^c , we shall briefly recall the arguments. The original proof is due to Grad [109, Section 4] (in dimension 3 for cutoff hard potentials). It was partly simplified in [58, Chapter 7, Section 2, Theorem 7.2.4] (in dimension 3 for hard spheres). It relies on the Hilbert-Schmidt theory for integral operators (see [121, Chapter 5, Section 2.4]). We give here a version valid for cutoff hard potentials (under our assumptions (7.1.3), (7.1.4), (7.1.5)), in any dimension $N \geq 2$.

Let us first consider the compactness of L^+ . First it was proved within Proposition 7.2 the convergence

$$\|\mathbf{1}_{\{|\cdot| \leq R\}} L^+ - L^+\|_{L^2(M)} \xrightarrow{R \rightarrow +\infty} 0.$$

Hence it is enough to prove the compactness of $\mathbf{1}_{\{|\cdot| \leq R\}} L^+$ for any $R > 0$. Second if one defines

$$L_\varepsilon^+(h) := \int_{\mathbb{R}^N \times \mathbb{S}^{N-1}} \mathbf{1}_{\{|v-v'| \geq \varepsilon\}} \Phi(|v - v_*|) b(\cos \theta) [h' + h'_*] M_* dv_* d\sigma,$$

the same computations of the kernel as in Proposition 7.2 show that

$$L_\varepsilon^+(h)(v) = M^{-1/2}(v) \int_{u \in \mathbb{R}^N} k_\varepsilon(u, v) (h(u) M^{1/2}(u)) du$$

where k_ε satisfies

$$k_\varepsilon(u, v) \leq C \mathbf{1}_{\{|u-v| \geq \varepsilon\}} |u - v|^{1+\gamma-N} \exp\left[-\frac{|u - v|^2}{4}\right].$$

By Young's inequality we deduce that

$$\|L_\varepsilon^+ - L^+\|_{L^2(M)} \leq C \left\| \mathbf{1}_{\{|\cdot| \leq \varepsilon\}} |\cdot|^{1+\gamma-N} \exp\left[-\frac{|\cdot|^2}{4}\right] \right\|_{L^1} \xrightarrow{\varepsilon \rightarrow 0} 0$$

since the function $|\cdot|^{1+\gamma-N} \exp\left[-\frac{|\cdot|^2}{4}\right]$ is integrable at 0. Hence it is enough to prove the compactness of $\mathbf{1}_{\{|\cdot| \leq R\}} L_\varepsilon^+$ for any $R, \varepsilon > 0$. But as

$$\int_{\mathbb{R}^N \times \mathbb{R}^N} \mathbf{1}_{\{|v| \leq R\}} \mathbf{1}_{\{|u-v| \geq \varepsilon\}} \left(|u - v|^{1+\gamma-N} \exp\left[-\frac{|u - v|^2}{4}\right] \right)^2 du dv < +\infty,$$

it is a Hilbert-Schmidt operator. This concludes the proof for L^+ . For L^* , straightforward computations show that

$$L^*(h)(v) = M^{-1/2}(v) \int_{u \in \mathbb{R}^N} k^*(u, v) (h(u) M^{1/2}(u)) du$$

with a kernel k^* satisfying

$$k^*(u, v) \leq C |u - v|^\gamma \exp \left[-\frac{|u|^2 + |v|^2}{2} \right].$$

This shows by inspection that L^* is a Hilbert-Schmidt operator. □

7.3.2 Essential spectrum of \mathcal{L}

Now let us turn to \mathcal{L} . We prove that the operator \mathcal{L}^c is relatively compact with respect to \mathcal{L}^ν . The main ingredients are the regularity estimates (7.2.29) and (7.2.31), related to the “almost convolution” structure of the non-local term. We first deal with the approximate operator.

Lemma 7.2. *For all $\delta \in (0, 1)$, the operator \mathcal{L}_δ^c is compact on L^1 .*

Proof of Lemma 7.2. We fix $\delta \in (0, 1)$. We have to prove that for any sequence $(g_n)_{n \geq 0}$ bounded in L^1 , the sequence $(\mathcal{L}_\delta^c(g_n))_{n \geq 0}$ has a cluster point in L^1 . The regularity estimates (7.2.29) and (7.2.31) on \mathcal{L}_δ^+ and \mathcal{L}_δ^- imply that the sequence $(\mathcal{L}_\delta^c(g_n))_{n \geq 0}$ is bounded in $W^{1,1}(\mathbb{R}^N)$. Then we can apply the Rellich-Kondrachov Theorem (see [39, Chapter 9, Section 3]) on any open ball $B(0, K) \subset \mathbb{R}^N$ for $K \in \mathbb{N}^*$. It implies that the restriction of the sequence $(\mathcal{L}_\delta^c(g_n))_{n \geq 0}$ to this ball is relatively compact in L^1 . By a diagonal process with respect to the parameter $K \in \mathbb{N}^*$, we can thus extract a subsequence converging in $L^1_{\text{loc}}(\mathbb{R}^N)$. The decay estimates (7.2.28) and (7.2.30) then ensure a tightness control (uniform with respect to n), which implies that the convergence holds in L^1 . This ends the proof. □

Then by closeness of the relative compactness property, we deduce for \mathcal{L}^c

Lemma 7.3. *The operator \mathcal{L}^c is relatively compact with respect to \mathcal{L}^ν .*

Proof of Lemma 7.3. Thanks to the estimate (7.2.32), it is equivalent to prove that for any sequence $(g_n)_{n \geq 0}$ bounded in $L^1(\langle v \rangle^\gamma)$, the sequence $(\mathcal{L}^c(g_n))_{n \geq 0}$ has a cluster point in L^1 . As L^1 is a Banach space it is enough to prove that a subsequence of $(\mathcal{L}^c(g_n))_{n \geq 0}$ has the Cauchy property. Let us choose a sequence $\delta_k \in (0, 1)$ decreasing to 0. Thanks to the previous lemma and a diagonal process, we can find an extraction φ such that for all $k \geq 0$ the sequence $(\mathcal{L}_{\delta_k}^c(g_{\varphi(n)}))_{n \geq 0}$ converges in L^1 . Then for a given $\varepsilon > 0$, we first choose $k \in \mathbb{N}$ such that

$$\forall n \geq 0, \quad \|\mathcal{L}_{\delta_k}^c(g_n) - \mathcal{L}^c(g_n)\|_{L^1} \leq \varepsilon/4$$

which is possible thanks to Proposition 7.1 and the uniform bound on the $L^1(\langle v \rangle^\gamma)$ norm of the sequence $(g_n)_{n \geq 0}$. Then we choose $n_{k,\varepsilon}$ such that

$$\forall m, n \geq n_{k,\varepsilon}, \quad \|\mathcal{L}_{\delta_k}^c(g_{\varphi(m)}) - \mathcal{L}_{\delta_k}^c(g_{\varphi(n)})\| \leq \varepsilon/2$$

since the sequence $(\mathcal{L}_{\delta_k}^c(g_{\varphi(n)}))_{n \geq 0}$ converges in L^1 . Then by a triangular inequality, we get

$$\forall m, n \geq n_{k,\varepsilon}, \quad \|\mathcal{L}^c(g_{\varphi(m)}) - \mathcal{L}^c(g_{\varphi(n)})\| \leq \varepsilon,$$

which concludes the proof. \square

The next step is the use of a variant of Weyl's Theorem.

Proposition 7.7. *The essential spectrum of the operator \mathcal{L} is $-\nu(\mathbb{R}^N) = (-\infty, -\nu_0]$.*

Proof of Proposition 7.7. We shall use here the classification of the spectrum by the Fredholm theory. Indeed in the case of non hilbertian operators, Weyl's Theorem does not imply directly the stability of the essential spectrum under relatively compact perturbation, but only the stability of a smaller set, namely the complementary in the spectrum of the Fredholm set (see below). We refer for the objects and results to [121, Chapter 4, Section 5.6].

Given an operator T on a Banach space \mathcal{B} and a complex number ξ , we define $\text{nul}(\xi)$ as the dimension of the null space of $T - \xi$, and $\text{def}(\xi)$ as the codimension of the range of $T - \xi$. These numbers belong to $\mathbb{N} \cup \{+\infty\}$. A complex number ξ belongs to the resolvent set if and only if $\text{nul}(\xi) = \text{def}(\xi) = 0$. Let $\Delta_F(T)$ be the set of all complex numbers such that $T - \xi$ is Fredholm (i.e. $\text{nul}(\xi) < +\infty$ and $\text{def}(\xi) < +\infty$). This set includes the resolvent set. Let $E_F(T)$ be the complementary set of $\Delta_F(T)$ in \mathbb{C} , in short the set of complex numbers ξ such that $T - \xi$ is not Fredholm. From [121, Chapter 4, Section 5.6, Theorem 5.35 and footnote], the set E_F is preserved under relatively compact perturbation.

We apply this result to the perturbation of $-\mathcal{L}^\nu$ by \mathcal{L}^c , which is relatively compact by Lemma 7.3. As $E_F(\mathcal{L}^\nu) = -\nu(\mathbb{R}^N) = (-\infty, \nu_0]$, we deduce that $E_F(\mathcal{L}) = (-\infty, -\nu_0]$ and so $\Delta_F(\mathcal{L}) = \mathbb{C} \setminus (-\infty, -\nu_0]$.

Thus it remains to prove that the Fredholm set of \mathcal{L} contains only the discrete spectrum plus the resolvent set. By [121, Chapter 4, Section 5.6], the Fredholm set Δ_F is the union of a countable number of components Δ_n (connected open sets) on which $\text{nul}(\xi)$ and $\text{def}(\xi)$ are constant, except for a (countable) set of isolated values of ξ . Moreover the boundary $\partial\Delta_F$ of the set Δ_F as well as the boundaries $\partial\Delta_n$ of the components Δ_n all belong to the set E_F . As in our case the Fredholm set $\Delta_F(\mathcal{L}) = \mathbb{C} \setminus (-\infty, -\nu_0]$ is connected,

it has only one component. It means that $\text{nul}(\xi)$ and $\text{def}(\xi)$ are constant on $\mathbb{C} \setminus (-\infty, -\nu_0]$, except for a (countable) set of isolated values of ξ .

Let us prove now that these constant values are $\text{nul}(\xi) = \text{def}(\xi) = 0$. It will imply the result, since a complex number ξ such that $\text{nul}(\xi) = \text{def}(\xi) = 0$ belongs to the resolvent set, and a complex number ξ , isolated in the spectrum, that belongs to the Fredholm set, satisfies $\text{nul}(\xi) < +\infty$ and $\text{def}(\xi) < +\infty$, and is exactly a discrete eigenvalue with finite multiplicity.

As the numbers $\text{nul}(\xi)$ and $\text{def}(\xi)$ are constant in $\Delta_F(\mathcal{L}) = \mathbb{C} \setminus ((-\infty, \nu_0] \cup \mathcal{V})$ (\mathcal{V} denotes a (countable) set of isolated complex numbers), it is enough to prove that there is an uncountable set of complex numbers in $\mathbb{C} \setminus (-\infty, \nu_0]$ such that $\text{nul}(\xi) = \text{def}(\xi) = 0$.

By using (7.2.36) and (7.2.30) we have

$$(7.3.38) \quad \forall g \in L^1(\langle v \rangle^\gamma), \quad \|\mathcal{L}^c(g)\|_{L^1} \leq C \|g\|_{L^1} + \frac{n_0}{2} \|g\|_{L^1(\langle v \rangle^\gamma)} \\ \leq C \|g\|_{L^1} + \frac{1}{2} \|\nu g\|_{L^1}$$

for some explicit constant C . Now we choose $r_0 \in \mathbb{R}_+$ big enough such that

$$\forall r \geq r_0, \quad \frac{C}{\nu_0 + r} + \frac{1}{2} < 1.$$

The multiplication operator $-(\nu + r)$ is bijective from $L^1(\langle v \rangle^\gamma)$ to L^1 (since $\nu + r > \nu_0 > 0$). The inverse linear operator is the multiplication operator $-(\nu + r)^{-1}$, it is defined on L^1 and bounded by $\|-(\nu + r)^{-1}\|_{L^\infty} = (\nu_0 + r)^{-1}$. Its range is $L^1(\langle v \rangle^\gamma)$. Hence the linear operator $\mathcal{L}^c(-(\nu + r)^{-1}\cdot)$ is well-defined, and, thanks to (7.3.38) it is bounded with a norm controlled by $a/(\nu_0 + r) + 1/2$, which is strictly less than 1 for $r \geq r_0$. Thus for $r \geq r_0$, the operator $\text{Id} + \mathcal{L}^c(-(\nu + r)^{-1}\cdot)$ is invertible with bounded inverse, and as the operator $-(\nu + r)\cdot$ is also invertible with bounded inverse for $r \geq 0$, by composition we deduce that

$$(\text{Id} + \mathcal{L}^c(-(\nu + r)^{-1}\cdot)) \circ (-(\nu + r)\cdot) = \mathcal{L}^c - (\nu + r)$$

is invertible with bounded inverse. It means that $[r_0, +\infty)$ belongs to the resolvent set, i.e. $\text{nul}(r) = \text{def}(r) = 0$ for all $r \geq r_0$, which concludes the proof. \square

7.3.3 Discrete spectrum of \mathcal{L}

In order to localize the discrete eigenvalues, we will prove that the eigenvectors associated with these eigenvalues decay fast enough at infinity to be in

fact multiple of the eigenvectors of L . This implies that these eigenvalues belong to the discrete spectrum of L and gives new geometrical informations on them: they lie in the intervalle $(-\nu_0, 0]$ with the only possible cluster point being $-\nu_0$. Moreover, explicit estimates on the spectral gap of \mathcal{L} follow by [15].

Proposition 7.8. *The operators \mathcal{L} and L have the same discrete eigenvalues with the same multiplicities. Moreover the eigenvectors of \mathcal{L} associated with these eigenvalues are given by those of L associated with the same eigenvalues, multiplied by $m^{-1}M$.*

Remarks: This result implies in particular that the (finite dimensional) algebraic eigenspaces of the discrete eigenvalues of \mathcal{L} do not contain any Jordan block (i.e. their algebraic multiplicity equals their geometric multiplicity, see the definitions in [121, Chapter 3, Section 6]) as it is the case for the self-adjoint operator L .

Proof of Proposition 7.8. Let us pick λ a discrete eigenvalue of \mathcal{L} . The associated eigenspace has finite dimension since the eigenvalue is discrete. Let us consider a Jordan block of \mathcal{L} on this eigenspace, spanned in the canonical form by the basis (g_1, g_2, \dots, g_n) . It means that

$$\mathcal{L}(g_1) = \lambda g_1$$

and for all $2 \leq i \leq n$,

$$\mathcal{L}(g_i) = \lambda g_i + g_{i-1}.$$

As λ does not belong to the essential spectrum of \mathcal{L} , we know from Proposition 7.7 that $\lambda \notin (-\infty, -\nu_0]$. Let us call $d_\lambda > 0$ the distance between λ and $(-\infty, -\nu_0]$. It is straightforward that

$$\forall v \in \mathbb{R}^N, \quad \nu(v) + \lambda \geq d_\lambda$$

and by (7.2.32) there is $d'_\lambda > 0$ such that

$$\forall v \in \mathbb{R}^N, \quad \nu(v) + \lambda \geq d'_\lambda \langle v \rangle^\gamma.$$

Let us prove by finite induction that for all $1 \leq i \leq n$ we have $mM^{-1}g_i \in L^2(\langle v \rangle^\gamma M)$. We write

$$\mathcal{L} - \lambda = (\mathcal{L}_\delta^+ - \mathcal{L}^*) - (\nu + \lambda - \mathcal{L}^+ + \mathcal{L}_\delta^+) =: A_\delta - B_\delta.$$

Both part A_δ and B_δ of this decomposition are well-defined on $L^1(\langle v \rangle^\gamma)$. Moreover we shall prove that when δ is small enough, B_δ is bijective from $L^1(\langle v \rangle^\gamma)$ to L^1 with bounded inverse, and also that its restriction $(B_\delta)_|$ to $L^2(\langle v \rangle^\gamma m^2 M^{-1}) \subset L^1$ is bijective from $L^2(\langle v \rangle^\gamma m^2 M^{-1})$ to $L^2(m^2 M^{-1})$ with bounded inverse.

We pick $\delta > 0$ such that

$$(7.3.39) \quad \forall v \in \mathbb{R}^N, \quad C_1(\delta) \leq \frac{d_\lambda''}{2} \quad \text{and} \quad C_2(\delta) \leq \frac{d_\lambda}{2}$$

where $C_1(\delta)$ and $C_2(\delta)$ are defined in Propositions 7.1 and 7.2. Then we write

$$B_\delta = (\text{Id} - (\mathcal{L}^+ - \mathcal{L}_\delta^+)((\nu + \lambda)^{-1} \cdot)) \circ ((\nu + \lambda) \cdot).$$

As $(\mathcal{L}^+ - \mathcal{L}_\delta^+)((\nu + \lambda)^{-1} \cdot)$ is bounded in L^1 with norm less than $1/2$ thanks to (7.3.39), we have that $(\text{Id} - (\mathcal{L}^+ - \mathcal{L}_\delta^+)((\nu + \lambda)^{-1} \cdot))$ is bijective from L^1 to L^1 (with bounded inverse). As $(\nu + \lambda) \cdot$ is bijective from $L^1(\langle v \rangle^\gamma)$ to L^1 (with bounded inverse), we deduce that B_δ is bijective from $L^1(\langle v \rangle^\gamma)$ to L^1 (with bounded inverse).

Then we remark that

$$\|(\mathcal{L}^+ - \mathcal{L}_\delta^+)\|_{L^2(m^2 M^{-1})} = \|L^+ - L_\delta^+\|_{L^2(M)}$$

thanks to the formula (7.1.10), (7.1.13), (7.2.17), (7.2.20) for \mathcal{L}^+ , L^+ , \mathcal{L}_δ^+ and L_δ^+ . Hence $(\mathcal{L}^+ - \mathcal{L}_\delta^+)((\nu + \lambda)^{-1} \cdot)$ is bounded in $L^2(m^2 M^{-1})$ with norm less than $1/2$ thanks to (7.3.39), and we deduce that $(\text{Id} - (\mathcal{L}^+ - \mathcal{L}_\delta^+)((\nu + \lambda)^{-1} \cdot))$ is bijective from $L^2(m^2 M^{-1})$ to $L^2(m^2 M^{-1})$ (with bounded inverse). As the multiplication operator $\nu + \lambda$ is bijective from $L^2(\langle v \rangle^\gamma m^2 M^{-1})$ to $L^2(m^2 M^{-1})$ (with bounded inverse), we deduce that $(B_\delta)_|$ is bijective from $L^2(\langle v \rangle^\gamma m^2 M^{-1})$ to $L^2(m^2 M^{-1})$ (with bounded inverse).

For the initialization, we write the eigenvalue equation on g_1 in the form

$$(7.3.40) \quad B_\delta(g_1) = A_\delta(g_1).$$

Thanks to the decay estimates (7.2.28) and (7.2.30), $A_\delta(g_1)$ belongs to $L^2(m^2 M^{-1}) \subset L^1$, and thus it implies that the unique pre-image of $A_\delta(g_1)$ by B_δ in L^1 belongs to $L^2(\langle v \rangle^\gamma m^2 M^{-1})$, thanks to the invertibilities of B_δ and $(B_\delta)_|$ proved above. Hence $g_1 \in L^2(\langle v \rangle^\gamma m^2 M^{-1})$.

Now let us consider the other vectors of the Jordan block: we pick $2 \leq i \leq n$ and we suppose the result to be true for g_{i-1} . Then g_i satisfies

$$B_\delta(g_i) = A_\delta(g_i) - g_{i-1}$$

and with the same argument as above together with the fact that $g_{i-1} \in L^2(\langle v \rangle^\gamma m^2 M^{-1})$, one concludes straightforwardly.

As a consequence, for any $1 \leq i \leq n$, g_i belongs to $L^2(\langle v \rangle^\gamma m^2 M^{-1})$ and thus $m M^{-1} g_i$ belong to the space $L^2(\langle v \rangle^\gamma M)$, i.e. the domain of L . Hence λ is necessarily an eigenvalue of L , and the eigenspace associated with λ of the operator \mathcal{L} is included in the one of L multiplied by $m^{-1} M$. As the converse inclusion is trivially true, this ends the proof. \square

To conclude this section, we give in Figure 7.1 the complete picture of the spectrum of \mathcal{L} in L^1 , which is the same as the spectrum of L in $L^2(M)$ (using Proposition 7.7 and Proposition 7.8).

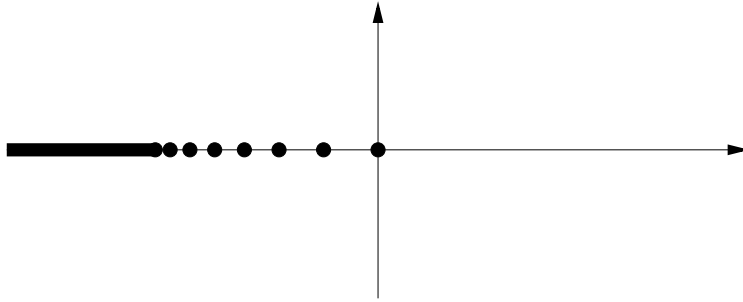

Figure 7.1: Spectrum of \mathcal{L} in L^1

7.4 Trend to equilibrium

This section is devoted to the proof of the main Theorem 7.1. We consider f a solution (in L^1_2) of the Boltzmann equation (7.1.1). The equation satisfied by the perturbation of equilibrium $g = m^{-1}(f - M)$ is

$$\frac{\partial g}{\partial t} = \mathcal{L}(g) + \Gamma(g, g)$$

with

$$\Gamma(g, g) = m^{-1} Q(mg, mg).$$

The kernel of \mathcal{L} is given by the one of L multiplied by $m^{-1} M$ (cf. Proposition 7.8), i.e. the following $(N + 2)$ -dimensional vector space:

$$N(\mathcal{L}) = \text{Span} \{m^{-1} M, m^{-1} M v_1, \dots, m^{-1} M v_N, m^{-1} M |v|^2\}.$$

Let us introduce the following complementary set of $N(\mathcal{L})$ in L^1 :

$$\mathcal{S} = \left\{ g \in L^1, \int_{\mathbb{R}^N} m g \phi dv = 0, \phi(v) = 1, v_1, \dots, v_N, |v|^2 \right\}.$$

Since

$$\int_{\mathbb{R}^N} \mathcal{L}(g) m \phi dv = \int_{\mathbb{R}^N \times \mathbb{R}^N \times \mathbb{S}^{N-1}} \Phi b m g M_* [\phi' + \phi'_* - \phi - \phi_*] dv dv_* d\sigma,$$

$$\int_{\mathbb{R}^N} \Gamma(g, g) m \phi dv = \int_{\mathbb{R}^N \times \mathbb{R}^N \times \mathbb{S}^{N-1}} \Phi b m g m_* g_* [\phi' + \phi'_* - \phi - \phi_*] dv dv_* d\sigma,$$

we see that

$$\mathcal{L}(L^1(\langle v \rangle^\gamma)) \subset \mathcal{S}, \quad \Gamma(L^1(\langle v \rangle^\gamma), L^1(\langle v \rangle^\gamma)) \subset \mathcal{S}.$$

As $g_0 \in \mathcal{S}$ since f and M have the same mass, momentum and energy, we can restrict the evolution equation to \mathcal{S} and thus we shall consider in the sequel the operator \mathcal{L} restricted on \mathcal{S} , which we denote by $\tilde{\mathcal{L}}$. The spectrum of $\tilde{\mathcal{L}}$ is given by the one of \mathcal{L} minus the 0 eigenvalue.

Similarly we define in $L^2(M)$ the following stable complementary set of the kernel $N(L)$ of L ($N(L)$ was defined in (7.1.14))

$$S = \left\{ h \in L^2(M), \int_{\mathbb{R}^N} h \phi M dv = 0, \phi(v) = 1, v_1, \dots, v_N, |v|^2 \right\}$$

which is formally related to \mathcal{S} by $S = m^{-1} M \mathcal{S}$. We define the restriction \tilde{L} of L on the stable set S , whose spectrum is given by the one of L minus the 0 eigenvalue.

7.4.1 Decay estimates on the evolution semi-group

Compared to the classical strategy to obtain decay estimates on the evolution semi-group of L , here the estimate on the Dirichlet form will be replaced by an estimate on the norm of the resolvent and the self-adjointness property will be replaced by the sectorial property.

We denote $\Sigma = \Sigma(L) = \Sigma(\mathcal{L})$ and $\Sigma_e = \Sigma_e(L) = \Sigma_e(\mathcal{L})$. For $\xi \notin \Sigma$, we denote $\mathcal{R}(\xi) = (\mathcal{L} - \xi)^{-1}$ the resolvent of \mathcal{L} at $\xi \in \mathbb{C}$, and $R(\xi) = (L - \xi)^{-1}$ the resolvent of L at $\xi \in \mathbb{C}$. $\mathcal{R}(\xi)$ is a bounded operator on L^1 , $R(\xi)$ is a bounded operator on $L^2(M)$. We have the following estimate on the norm of $\mathcal{R}(\xi)$:

Proposition 7.9. *There are explicit constants $C_8, C_9 > 0$ depending only on the collision kernel and on a lower bound on $\text{dist}(\xi, \Sigma_e)$ such that*

$$(7.4.41) \quad \forall \xi \notin \Sigma, \quad \|\mathcal{R}(\xi)\|_{L^1} \leq C_9 + C_{10} \|R(\xi)\|_{L^2(M)}.$$

Proof of Proposition 7.9. Let us introduce a right inverse of the operator $(\mathcal{L} - \xi)$: let us pick $\delta > 0$ such that

$$(7.4.42) \quad \forall v \in \mathbb{R}^N, \quad C_1(\delta) \leq \frac{\nu(v) + \xi}{2\langle v \rangle^\gamma}$$

(note that this choice only depends on the collision kernel and a lower bound on $\text{dist}(\xi, \Sigma_e)$). Then we shall use the same argument as in the proof of Proposition 7.8 to prove that the operator

$$B_\delta(\xi) = \mathcal{L}^\nu + \xi - (\mathcal{L}^+ - \mathcal{L}_\delta^+)$$

is bijective from $L^1(\langle v \rangle^\gamma)$ to L^1 and its inverse has its norm bounded by

$$\|B_\delta(\xi)^{-1}\|_{L^1} \leq \frac{2}{\text{dist}(\xi, \Sigma_e)}.$$

Indeed once the invertibility is known, the bound on the inverse is given by

$$\begin{aligned} \forall g \in L^1(\langle v \rangle^\gamma), \quad \|B_\delta(\xi)(g)\|_{L^1} &\geq \|(\nu + \xi)g\|_{L^1} - \|(\mathcal{L}^+ - \mathcal{L}_\delta^+)(g)\|_{L^1} \\ &\geq \frac{\text{dist}(\xi, \Sigma_e)}{2} \|g\|_{L^1(\langle v \rangle^\gamma)} \\ &\geq \frac{\text{dist}(\xi, \Sigma_e)}{2} \|g\|_{L^1} \end{aligned}$$

where we have used Proposition 7.1 and the bound (7.4.42) on $C_1(\delta)$. To prove the invertibility, we write

$$B_\delta(\xi) = (\text{Id} + (\mathcal{L}^+ - \mathcal{L}_\delta^+)(-\nu + \xi)^{-1}\cdot) \circ (-\nu + \xi)\cdot.$$

Since $(\mathcal{L}^+ - \mathcal{L}_\delta^+)(-\nu + \xi)^{-1}\cdot$ is well-defined and bounded on L^1 with norm less than $1/2$ thanks to (7.4.42), we have that $(\text{Id} + (\mathcal{L}^+ - \mathcal{L}_\delta^+)(-\nu + \xi)^{-1}\cdot)$ is bijective from L^1 to L^1 (with bounded inverse), and as $-\nu + \xi)\cdot$ is bijective from $L^1(\langle v \rangle^\gamma)$ to L^1 (with bounded inverse), we deduce the result.

Now we denote

$$A_\delta = \mathcal{L}_\delta^+ - \mathcal{L}^*.$$

This operator is bounded on L^1 and satisfies, thanks to the estimates (7.2.28) and (7.2.30),

$$\forall v \in \mathbb{R}^N, \quad |A_\delta(g)(v)| \leq C \|g\|_{L^1} M^\theta$$

for any $\theta \in [0, 1)$ and some explicit constant C depending on the choice of δ above, on the collision kernel, and on θ .

The operator $\mathcal{L} - \xi$ writes

$$\mathcal{L} - \xi = A_\delta - B_\delta(\xi)$$

and we define the following operator

$$I(\xi) = -B_\delta(\xi)^{-1} + (m^{-1}M) R(\xi) [(mM^{-1}) A_\delta B_\delta(\xi)^{-1}]$$

(note that here R is the resolvent of L). Let us first check that this operator is well-defined and bounded on L^1 : for $g \in L^1$, we have $B_\delta(\xi)^{-1}(g) \in L^1$ and as (choosing $\theta = 3/4$ for instance)

$$|A_\delta(B_\delta(\xi)^{-1}(g))(v)| \leq C \|B_\delta(\xi)^{-1}(g)\|_{L^1} M^{3/4},$$

we have

$$\|(mM^{-1}) A_\delta(B_\delta(\xi)^{-1}(g))\|_{L^2(M)}^2 \leq C^2 \|B_\delta(\xi)^{-1}(g)\|_{L^1}^2 \left(\int_{\mathbb{R}^N} m^2 M^{1/2} dv \right).$$

Thus

$$R(\xi) [(mM^{-1}) A_\delta B_\delta(\xi)^{-1}(g)]$$

is well-defined and belongs to $L^2(M)$. Since by Cauchy-Schwarz

$$\|m^{-1}M h\|_{L^1} \leq \|m^{-1}M^{1/2}\|_{L^2} \|h\|_{L^2(M)}$$

we deduce finally that $I(\xi)(g)$ is well-defined and belongs to L^1 . Moreover, from the computations above we deduce

$$\begin{aligned} \|I(\xi)(g)\|_{L^1} &\leq \\ &\|B_\delta(\xi)^{-1}\| \left(1 + C \|R(\xi)\|_{L^2(M)} \|m^{-1}M^{1/2}\|_{L^2} \|mM^{1/4}\|_{L^2} \right) \|g\|_{L^1}. \end{aligned}$$

Now let us check that $I(\xi)$ is a right inverse of $(\mathcal{L} - \xi)$:

$$\begin{aligned} (\mathcal{L} - \xi) \circ I(\xi)(g) &= (\mathcal{L} - \xi) \circ \left(-B_\delta(\xi)^{-1} \right. \\ &\quad \left. + (m^{-1}M) R(\xi) [(mM^{-1}) A_\delta B_\delta(\xi)^{-1}] \right)(g) \\ &= (-A_\delta + B_\delta(\xi)) \circ B_\delta(\xi)^{-1}(g) \\ &\quad + (\mathcal{L} - \xi) \circ ((m^{-1}M) R(\xi) [(mM^{-1}) A_\delta B_\delta(\xi)^{-1}])(g) \\ &= g - A_\delta B_\delta(\xi)^{-1}(g) \\ &\quad + (\mathcal{L} - \xi) \circ ((m^{-1}M) R(\xi) [(mM^{-1}) A_\delta B_\delta(\xi)^{-1}])(g). \end{aligned}$$

Now as

$$(m^{-1}M) R(\xi) [(mM^{-1}) A_\delta B_\delta(\xi)^{-1}] (g) \in L^2(m^2 M^{-1})$$

we deduce that

$$\begin{aligned} (\mathcal{L} - \xi) \circ ((m^{-1}M) R(\xi) [(mM^{-1}) A_\delta B_\delta(\xi)^{-1}]) (g) \\ = m^{-1} M (L - \xi) \circ R(\xi) [(mM^{-1}) A_\delta B_\delta(\xi)^{-1}] (g) \\ = m^{-1} M [(mM^{-1}) A_\delta B_\delta(\xi)^{-1}(g)] = A_\delta B_\delta(\xi)^{-1}(g). \end{aligned}$$

Collecting every term we deduce

$$\forall g \in L^1, \quad (\mathcal{L} - \xi) \circ I(\xi)(g) = g.$$

Let us conclude the proof: whenever $\xi \notin \Sigma$, $(\mathcal{L} - \xi)$ is bijective from $L^1(\langle v \rangle^\gamma)$ to L^1 with bounded inverse $\mathcal{R}(\xi)$, and we deduce that $\mathcal{R}(\xi) = I(\xi)$ and thus

$$\|\mathcal{R}(\xi)\|_{L^1} \leq \|B_\delta(\xi)^{-1}\| \left[1 + C \|R(\xi)\|_{L^2(M)} \|m^{-1}M^{1/2}\|_{L^2} \|mM^{1/4}\|_{L^2} \right].$$

As we have

$$\|B_\delta(\xi)^{-1}\| \leq \frac{2}{\text{dist}(\xi, \Sigma_e)}$$

and the choice of δ (determining the constant C) depends only on the collision kernel and a lower bound on $\text{dist}(\xi, \Sigma_e)$, this ends the proof. \square

Now we use this estimate in order to obtain some decay estimate on the evolution semi-group. We recall that $\lambda \in (0, \nu_0)$ denotes the spectral gap of \mathcal{L} and L .

Theorem 7.3. *The evolution semi-group of the operator $\tilde{\mathcal{L}}$ is well-defined on L^1 , and for any $0 < \mu \leq \lambda$, it satisfies the decay estimate*

$$(7.4.43) \quad \forall t \geq 0, \quad \|e^{t\tilde{\mathcal{L}}}\|_{L^1} \leq C_{10} e^{-\mu t}$$

for some explicit constant C_{10} depending only on the collision kernel, on μ , and a lower bound on $\nu_0 - \mu$.

Proof of Theorem 7.3. Let us pick $\mu \in (0, \lambda]$. We define in the complex plane the set

$$\mathcal{A}_\mu = \left\{ \xi \in \mathbb{C}, \quad \arg(\xi - \mu) \in \left[-\frac{3\pi}{4}, \frac{3\pi}{4} \right] \quad \text{and} \quad \text{Re}(\xi) \leq -\frac{\mu}{2} \right\}.$$

We shall prove the following lemma

Lemma 7.4. *There are explicit constants $a, b > 0$ depending on the collision kernel, on μ , and on a lower bound on $\nu_0 - \mu$, such that*

$$\forall \xi \in \mathcal{A}_\mu, \quad \|\mathcal{R}(\xi)\|_{L^1} \leq a + \frac{b}{|\xi - \mu|}.$$

Proof of Lemma 7.4. We shall use Proposition 7.9. In the Hilbert space $L^2(M)$, L is self-adjoint and thus we have (see [121, Chapter 5, Section 3.5])

$$\|R(\xi)\|_{L^2(M)} = \frac{1}{\text{dist}(\xi, \Sigma)}.$$

Hence Proposition 7.9 yields

$$\forall \xi \in \mathcal{A}_\mu, \quad \|\mathcal{R}(\xi)\|_{L^1} \leq C_8 + \frac{C_9}{\text{dist}(\xi, \Sigma)}$$

with C_8 and C_9 depending on a lower bound on $\text{dist}(\xi, \Sigma_e)$. Then in the set \mathcal{A}_μ , the lower bound on $\text{dist}(\xi, \Sigma_e)$ is straightforwardly controlled by a lower bound on $\nu_0 - \mu$, and we have immediately

$$\text{dist}(\xi, \Sigma \setminus \{0\}) \geq \frac{|\xi - \mu|}{\sqrt{2}}$$

and $\text{dist}(\xi, \{0\}) = |\xi|$. Since for $\xi \in \mathcal{A}_\mu$, we have $|\xi - \mu| \leq |\xi|$, we deduce that

$$\forall \xi \in \mathcal{A}_\mu, \quad \|\mathcal{R}(\xi)\|_{L^1} \leq C_8 + C_9 \max \left\{ \frac{\sqrt{2}}{|\xi - \mu|}, \frac{1}{|\xi|} \right\} \leq a + \frac{b}{|\xi - \mu|},$$

which concludes the proof. \square

Now let us conclude the proof of the theorem. Let $t > 0$ and $\eta \in (0, \pi/4)$. Let us consider Γ a curve running, within \mathcal{A}_μ , from infinity with $\arg(\xi) = \pi/2 + \eta$ to infinity with $\arg(\xi) = -\pi/2 - \eta$, and the complex integral

$$\frac{-1}{2\pi i} \int_{\Gamma} e^{t\xi} \mathcal{R}(\xi) d\xi.$$

Thanks to the bound of Lemma 7.4, the integral is absolutely convergent. As the curve encloses the spectrum of \mathcal{L} minus 0, i.e. the spectrum of $\tilde{\mathcal{L}}$, classical results from spectral analysis (see [115, Chapter 1, Section 3] and [121, Chapter 9, Section 1.6]) show that this integral defines the evolution semi-group $e^{t\tilde{\mathcal{L}}}$ of $\tilde{\mathcal{L}}$. Now we apply a classical strategy to obtain a decay estimate on the semi-group: we perform the change of variable $\xi = z/t - \mu$. Then z

describes a new path $\Gamma_t = \mu + t\Gamma$, depending on t , in the resolvent set of $\tilde{\mathcal{L}}$, and the integral becomes

$$e^{t\tilde{\mathcal{L}}} = \frac{-e^{-\mu t}}{2\pi i} \int_{\Gamma_t} e^z \mathcal{R}\left(\frac{z}{t} - \mu\right) \frac{dz}{t}.$$

By the Cauchy theorem, we deform Γ_t into some fixed Γ' , independent of t , running from infinity with $\arg(\xi) = \pi/2 + \eta$ to infinity with $\arg(\xi) = -\pi/2 - \eta$ in the set

$$\left\{ \xi \in \mathbb{C}, \quad \arg(\xi) \in \left[-\frac{3\pi}{4}, \frac{3\pi}{4}\right] \quad \text{and} \quad \operatorname{Re}(\xi) \leq \frac{\mu}{2} \right\},$$

and the formula for the semi-group becomes

$$e^{t\tilde{\mathcal{L}}} = \frac{-e^{-\mu t}}{2\pi i} \int_{\Gamma'} e^z \mathcal{R}\left(\frac{z}{t} - \mu\right) \frac{dz}{t}.$$

Then for any $t \geq 1$, $\Gamma'/t - \mu \subset \mathcal{A}_\mu$ and thus we can apply the estimate of Lemma 7.4 to get

$$\begin{aligned} \|e^{t\tilde{\mathcal{L}}}\|_{L^1} &= \left\| \frac{-e^{-\mu t}}{2\pi i} \int_{\Gamma'} e^z \mathcal{R}\left(\frac{z}{t} - \mu\right) \frac{dz}{t} \right\|_{L^1} \\ &\leq \frac{e^{-\mu t}}{2\pi} \left[a \int_{\Gamma'} |e^z| |dz| + b \int_{\Gamma'} |e^z| \frac{|dz|}{|z|} \right], \end{aligned}$$

which concludes the proof. \square

Remarks:

1. The arguments of the proof show in fact that $\tilde{\mathcal{L}}$ is a sectorial operator, which implies that its evolution semi-group is analytic in t (see [115, Chapter 1, Section 3]).

2. With the same method one can also prove that \mathcal{L} is sectorial, and define its analytic semi-group $e^{t\mathcal{L}}$ on L^1 which satisfies

$$\forall t \geq 0, \quad \|e^{t\mathcal{L}}\|_{L^1} \leq C$$

for some explicit constant C depending only the collision kernel. More precisely if Π_0 denotes the spectral projection associated with the 0 eigenvalue (for the definition of the spectral projection we refer to [121, Chapter 3, Section 6, Theorem 6.17]), then we have the following relation:

$$\forall t \geq 0, \quad e^{t\mathcal{L}} = \Pi_0 + e^{t\tilde{\mathcal{L}}}(\operatorname{Id} - \Pi_0).$$

7.4.2 Proof of the convergence

In this subsection we shall complete the proof of Theorem 7.1. We decompose the argument in several lemmas. The first technical lemma deals with the bilinear term Γ .

Lemma 7.5. *Let B be a collision kernel satisfying assumptions (7.1.3), (7.1.4), (7.1.5). Then there is an explicit constant $C_{11} > 0$ depending on the collision kernel such that the bilinear operator Γ satisfies*

$$\|\Gamma(g, g)\|_{L^1} \leq C_{11} \|g\|_{L^1}^{3/2} \|g\|_{L^1(m^{-1})}^{1/2}.$$

Proof of Lemma 7.5. Estimates in L^1 of the collision operator (for instance see [150, Section 2]), plus the obvious control

$$(m^{-1}m'm'_*), \quad (m^{-1}mm_*) \leq 1,$$

yield

$$\|\Gamma(g, g)\|_{L^1} \leq C \|g\|_{L^1} \|g\|_{L^1((v)^\gamma)}.$$

Then by Hölder's inequality

$$\|g\|_{L^1((v)^\gamma)} \leq C \|g\|_{L^1}^{1/2} \|g\|_{L^1(m^{-1})}^{1/2}.$$

□

In a second technical lemma we state a precise form of the Gronwall estimate (for which we do not search for an optimal statement).

Lemma 7.6. *Let $y = y(t)$ be a nonnegative L_{loc}^∞ function on \mathbb{R}_+ such that for some constants $a, b, \theta, \mu > 0$,*

$$(7.4.44) \quad y(t) \leq a e^{-\mu t} y(0) + b \left(\int_0^t e^{-\mu(t-s)} y(s)^{1+\theta} ds \right).$$

Then if $y(0)$ and b are small enough, we have

$$y(t) \leq C_{12} y(0) e^{-\mu t}.$$

for some explicit constant $C_{12} > 0$.

Proof of Lemma 7.6. As y is locally L^∞ on \mathbb{R}_+ , the righthand side in (7.4.44) is continuous with respect to t . If we assume that $y(0) < 1$, this remains true on a small time interval $[0, t_0]$, on which we have

$$y(t) \leq a e^{-\mu t} y(0) + b \left(\int_0^t e^{-\mu(t-s)} y(s) ds \right),$$

which implies

$$(7.4.45) \quad y(t) \leq a y(0) e^{-(\mu-b)t}.$$

So if we choose $y(0)$ small enough such that $a y(0) < 1$ and b small enough such that $\mu - b \geq 0$, we get for all time that $y(t) < 1$ with the bound (7.4.45). Now to obtain the rate of decay μ , we assume, up to reducing b , that

$$\mu - b \geq \frac{\mu + \eta}{1 + \theta}$$

for some $\eta > 0$. We deduce that

$$e^{\mu t} y(t) \leq a y(0) + b (a y(0))^{1+\theta} \left(\int_0^t e^{-\eta s} ds \right) \leq C y(0),$$

which concludes the proof. \square

Now we state the result of convergence to equilibrium assuming a uniform smallness estimate on the $L^1(m^{-1})$ norm of g (i.e. the $L^1(m^{-2})$ of $f - M$).

Lemma 7.7. *Let B be a collision kernel satisfying assumptions (7.1.3), (7.1.4), (7.1.5), and λ be the associated spectral gap. Let $0 < \mu \leq \lambda$. Then there are some explicit constants ε , $C_{13} > 0$ depending on the collision kernel, on μ and on a lower bound on $\nu_0 - \mu$, such that if f is a solution to the Boltzmann equation such that*

$$\forall t \geq 0, \quad \|f_t - M\|_{L^1(m^{-2})} \leq \varepsilon,$$

then

$$\forall t \geq 0, \quad \|f_t - M\|_{L^1(m^{-1})} \leq C_{13} \|f_0 - M\|_{L^1(m^{-1})} e^{-\mu t}.$$

Proof of Lemma 7.7. We write a Duhamel representation of g_t :

$$g_t = e^{t\tilde{\mathcal{L}}} g_0 + \int_0^t e^{(t-s)\tilde{\mathcal{L}}} \tilde{\Gamma}(g_s, g_s) ds.$$

Using Theorem 7.3 and Lemma 7.5 we get

$$\|g_t\|_{L^1} \leq C_{10} e^{-\mu t} \|g_0\|_{L^1} + C_{10} C_{11} \varepsilon^{1/2} \int_0^t e^{-\mu(t-s)} \|g_s\|_{L^1}^{3/2} ds.$$

Thus if ε is small enough, we can apply Lemma 7.6 with $y(t) = \|g_t\|_{L^1}$ and $\theta = 1/2$ to get

$$\|g_t\|_{L^1} \leq C_{13} \|g_0\|_{L^1} e^{-\mu t}.$$

This concludes the proof since

$$\|g_t\|_{L^1} = \|f_t - M\|_{L^1(m^{-1})}.$$

\square

Finally we need a result on the appearance and propagation of the $L^1(m^{-1})$ norm. This lemma is a variant of results in [25] and [32], and it is a particular case of more general results in [141].

Lemma 7.8. *Let B be a collision kernel satisfying assumptions (7.1.3), (7.1.4), (7.1.5), (7.1.6). Let f_0 be a nonnegative initial datum in $L^1_2 \cap L^2$. Then the corresponding solution $f = f(t, v)$ of the Boltzmann equation (7.1.1) in L^1_2 satisfies: for any $0 < s < \gamma/2$ and $\tau > 0$, there are explicit constants $a, C > 0$, depending on the collision kernel, s , τ , and the mass, and energy and L^2 norm of f_0 , such that*

$$(7.4.46) \quad \forall t \geq \tau, \quad \int_{\mathbb{R}^N} f(t, v) \exp[a|v|^s] dv \leq C.$$

In the important case of hard spheres (7.1.2), the assumption “ $f_0 \in L^1_2 \cap L^2$ ” can be relaxed into just “ $f_0 \in L^1_2$ ”, and the same result (7.4.46) holds with explicit constant $a, C > 0$ depending only on the collision kernel, s , τ , and the mass and energy of f_0 .

Proof of Lemma 7.8. Note that when $\gamma \in (0, 1)$, the assumption $f_0 \in L^2$ implies that f_0 has finite entropy, i.e.

$$\int_{\mathbb{R}^N} f_0(v) \log f_0(v) dv \leq H_0 < +\infty$$

which ensures by the H theorem that

$$(7.4.47) \quad \forall t \geq 0, \quad \int_{\mathbb{R}^N} f(t, v) \log f(t, v) dv \leq H_0.$$

We assume also, up to a normalization, that f satisfies

$$(7.4.48) \quad \forall t \geq 0, \quad \int_{\mathbb{R}^N} f(t, v) v dv = 0.$$

Let us fix $0 < s < \gamma/2$. We define for any $p \in \mathbb{R}_+$

$$m_p(t) := \int_{\mathbb{R}^N} f(t, v) |v|^{sp} dv.$$

The evolution equation on the distribution f yields

$$(7.4.49) \quad \frac{dm_p}{dt} = \int_{\mathbb{R}^N} Q(f, f) |v|^{sp} dv = \int_{\mathbb{R}^N \times \mathbb{R}^N} f f_* \Phi(|v - v_*|) K_p(v, v_*) dv dv_*,$$

where

$$(7.4.50) \quad K_p(v, v_*) := \frac{1}{2} \int_{S^{N-1}} (|v'|^{sp} + |v_*'|^{sp} - |v|^{sp} - |v_*|^{sp}) b(\cos \theta) d\sigma.$$

From [32, Lemma 1, Corollary 3], we have

$$(7.4.51) \quad K_p(v, v_*) \leq \alpha_p (|v|^2 + |v_*|^2)^{sp/2} - |v|^{sp} - |v_*|^{sp}$$

where $(\alpha_p)_{p \in \mathbb{N}/2}$ is a strictly decreasing sequence such that

$$(7.4.52) \quad 0 < \alpha_p < \min \left\{ 1, \frac{C}{sp/2 + 1} \right\}.$$

for some constant C depending on C_b , defined in (7.1.5). Notice that the assumptions [32, (2.11)-(2.12)-(2.13)] are satisfied under our assumptions (7.1.3), (7.1.4), (7.1.5), (7.1.6) on the collision kernel (see [32, Remark 3] for some possible ways of relaxing the assumption (7.1.6) in the elastic case).

Then we use the classical estimate

$$\int_{\mathbb{R}^N} \Phi(|v - v_*|) f(t, v_*) dv_* = C_\Phi \int_{\mathbb{R}^N} |v - v_*|^\gamma f(t, v_*) dv_* \geq K |v|^\gamma$$

for some constant K depending on C_Φ (defined in (7.1.4)) and the mass, energy and entropy H_0 of f_0 (or only the mass of f_0 in the case $\gamma = 1$). This estimate is obtained by a classical non-concentration argument when $\gamma \in (0, 1)$ (using the bound (7.4.47)), as can be found in [6] for instance, or just by convexity when $\gamma = 1$, using the assumption (7.4.48) that the distribution has zero mean (see for instance [141, Lemma 2.3]). We combine this with [32, Lemma 2 and Lemma 3] to get

$$(7.4.53) \quad \int_{\mathbb{R}^N} Q(f, f) |v|^{sp} dv \leq \alpha_p Q_p - K(1 - \alpha_p) m_{p+\gamma/s}$$

with

$$Q_p := \int_{\mathbb{R}^N \times \mathbb{R}^N} ff_* \left[(|v|^2 + |v_*|^2)^{sp/2} - |v|^{sp} - |v_*|^{sp} \right] \Phi(|v - v_*|) dv dv_*,$$

and [32, Lemma 2 and Lemma 3] shows that, for $ps/2 > 1$, we have

$$(7.4.54) \quad Q_p \leq S_p = C_\Phi \sum_{k=1}^{k_p} \binom{sp/2}{k} (m_{(2k+\gamma)/s} m_{p-2k/s} + m_{2k/s} m_{p-2k/s+\gamma/s}),$$

where $k_p := [sp/4 + 1/2]$ is the integer part of $(sp/4 + 1/2)$ and $\binom{sp/2}{k}$ denotes the generalized binomial coefficient. Gathering (7.4.49), (7.4.53) and (7.4.54), we get

$$(7.4.55) \quad \frac{dm_p}{dt} \leq \alpha_p S_p - K(1 - \alpha_p) m_{p+\gamma/s}.$$

By Hölder's inequality, we have

$$m_{p+\gamma/s} \geq \beta m_p^{1+\frac{\gamma}{sp}}$$

for some constant $\beta > 0$ depending on the mass of the distribution. By [32, Lemma 4], there exists $A > 0$ such that

$$S_p \leq A \Gamma(p + 1 + \gamma/s) Z_p$$

with

$$Z_p := \max_{k=1, \dots, k_p} \{z_{(2k+\gamma)/s} z_{p-2k/s}, z_{2k/s} z_{p-2k/s+\gamma/s}\}, \quad \text{and} \quad z_p := \frac{m_p}{\Gamma(p + 1/2)}.$$

Thus we may rewrite (7.4.55) as

$$(7.4.56) \quad \frac{dz_p}{dt} \leq A \alpha_p \frac{\Gamma(p + 1 + \gamma/s)}{\Gamma(p + 1/2)} Z_p - K'(1 - \alpha_p) \Gamma(p + 1/2)^{\frac{\gamma}{sp}} z_p^{1+\frac{\gamma}{sp}}$$

with $K' = \beta K$. On the one hand, from the definition of the sequence $(\alpha_p)_{p \geq 0}$, there exists A' such that

$$(7.4.57) \quad A \alpha_p \frac{\Gamma(p + 1 + \gamma/s)}{\Gamma(p + 1/2)} \leq A' p^{\gamma/s-1/2}.$$

On the other hand, thanks to Stirling's formula

$$n! \underset{n \rightarrow +\infty}{\sim} n^n e^{-n} \sqrt{2\pi n},$$

there is $A'' > 0$ such that

$$(7.4.58) \quad (1 - \alpha_p) \Gamma(p + 1/2)^{\frac{\gamma}{sp}} \geq A'' p^{\gamma/s}.$$

Gathering (7.4.56), (7.4.57) and (7.4.58), we deduce

$$(7.4.59) \quad \frac{dz_p}{dt} \leq A' p^{\gamma/s-1/2} Z_p - A'' K' p^{\gamma/s} z_p^{1+\frac{\gamma}{sp}}.$$

Note that in this differential inequality, for p big enough, Z_p depends only on terms z_q for $q \leq p-1$, (but not necessarily with q an integer), which allows to get bounds on the moments by induction.

At this stage, we prove by induction on $p \geq p_0$ integer ($p_0 \geq 1$) the following property

$$\forall t \geq t_p, \forall q \in [p_0, p] \quad z_q \leq x^q$$

for some $x \in (1, +\infty)$ large enough and some increasing sequence of times $(t_p)_{p \geq p_0}$ with $t_{p_0} > 0$ fixed as small as wanted. The goal is to prove this induction for a convergent sequence of times $(t_p)_{p \geq p_0}$. The initialization for $p = p_0$, with p_0 as big as wanted and t_0 as small as wanted, is straightforward by the classical theorems about the immediate appearance and uniform propagation of algebraic moments (see [200] for instance), and taking x big enough. Now as $s < \gamma/2$, if p_0 is large enough, we have for $p \geq p_0$

$$p^{\gamma/s} \geq 2 \frac{A'}{A'' K'} p^{\gamma/s-1/2}, \quad p^{\gamma/s} \geq p^{2+\varepsilon} \quad \text{and} \quad p \geq \left(\frac{A'}{A'' K'} \right)^2$$

for some $\varepsilon > 0$. So let us assume the induction property satisfied for all steps $p_0 \leq q \leq p-1$, and let us consider z_p . Assume that $z_p(t_{p-1}) \leq x^p$. Then from (7.4.59), for any t such that $z_p(t) \leq x^p$ we have

$$\begin{aligned} \frac{dz_p}{dt} &\leq A' p^{\gamma/s-1/2} Z_p - A'' K' p^{\gamma/s} z_p^{1+\frac{\gamma}{sp}} \\ &\leq A' p^{\gamma/s-1/2} \left[(x^p)^{1+\frac{\gamma}{sp}} - \frac{A'' K'}{A'} p^{1/2} z_p^{1+\frac{\gamma}{sp}} \right] \\ &\leq A' p^{\gamma/s-1/2} \left[(x^p)^{1+\frac{\gamma}{sp}} - z_p^{1+\frac{\gamma}{sp}} \right]. \end{aligned}$$

We deduce by maximum principle that this bound is propagated uniformly for all times $t \geq t_{p-1}$. If on the other hand $z_p(t_{p-1}) \in (x^p, +\infty]$, as long as $z_p(t) > x^p$ we have

$$\begin{aligned} \frac{dz_p}{dt} &\leq A' p^{\gamma/s-1/2} Z_p - A'' K' p^{\gamma/s} z_p^{1+\frac{\gamma}{sp}} \\ &\leq A' p^{\gamma/s-1/2} (x^p)^{1+\frac{\gamma}{sp}} - A'' K' p^{\gamma/s} z_p^{1+\frac{\gamma}{sp}} \\ &\leq [A' p^{\gamma/s-1/2} - A'' K' p^{\gamma/s}] z_p^{1+\frac{\gamma}{sp}} \\ &\leq -\frac{A'' K'}{2} p^{\gamma/s} z_p^{1+\frac{\gamma}{sp}} \leq -C p^{2+\varepsilon} z_p^{1+\theta}. \end{aligned}$$

with $C = (A'' K')/2$ and $\theta = \gamma/(sp)$. Then classical arguments of comparison to a differential equation show that z_p is finite for any $t > t_{p-1}$, and satisfies

the following bound independent of the initial datum:

$$z_p(t_{p-1} + t) \leq \left[\frac{1}{C \theta p^{2+\varepsilon} t} \right]^{\frac{1}{\theta}} \leq \left[\frac{s}{C \gamma p^{1+\varepsilon} t} \right]^{\frac{sp}{\gamma}}.$$

Thus if we set

$$\Delta_p := \frac{s}{C \gamma p^{1+\varepsilon} x^{\gamma/s}},$$

we have

$$\forall t \geq \Delta_p, \quad z_p(t_{p-1} + t) \leq x^p.$$

By Hölder interpolation with the bounds on z_{p-1} provided by the induction assumption, we deduce immediately

$$\forall t \geq \Delta_p, \quad \forall q \in [p, p+1], \quad z_q(t_{p-1} + t) \leq x^q,$$

which proves the step p of the induction with $t_p = t_{p-1} + \Delta_p$. So we have proved that if we set

$$\tau = \lim_{p \rightarrow +\infty} t_p = t_{p_0} + \sum_{p \geq p_0+1} \Delta_p = t_0 + \frac{s}{C \gamma x^{\gamma/s}} \left(\sum_{p=p_0+1}^{+\infty} \frac{1}{p^{1+\varepsilon}} \right) < +\infty,$$

we have

$$\forall t \geq \tau, \quad \forall p \geq p_0, \quad z_p(t) \leq x^p.$$

Moreover τ can be taken as small as wanted by taking t_0 small enough and x large enough.

So we conclude that there are explicit constants R and τ such that

$$\forall t \geq \tau, \quad \forall p \geq 0, \quad z_p(t) \leq R^{-p}.$$

We deduce explicit bounds

$$\sup_{t \geq \tau} \int_{\mathbb{R}^N} f(t, v) \exp[a|v|^s] dv \leq C < +\infty$$

for any $a < R$ since

$$\begin{aligned} \int_{\mathbb{R}^N} f(t, v) \exp[a|v|^s] dv &= \sum_{p=0}^{\infty} \int_{\mathbb{R}^N} f(t, v) a^p \frac{|v|^{sp}}{p!} dv = \sum_{p=0}^{\infty} a^p \frac{m_p}{p!} \\ &= \sum_{p=0}^{\infty} a^p \frac{z_p \Gamma(p+1/2)}{p!} \leq \sum_{p=0}^{\infty} \left(\frac{a}{R} \right)^p \frac{\Gamma(p+1/2)}{p!} \leq C \sum_{p=0}^{\infty} \left(\frac{a}{R} \right)^p p^{1/2} < \infty. \end{aligned}$$

□

Now we state a result of convergence to equilibrium for non smooth solutions deduced from [150, Theorems 6.2 and 7.2] combined with the previous lemma.

Lemma 7.9. *Let B be a collision kernel satisfying assumptions (7.1.3), (7.1.4), (7.1.5), (7.1.6). Let f_0 be a nonnegative initial datum in $L_2^1 \cap L^2$. Then the corresponding solution $f = f(t, v)$ of the Boltzmann equation (7.1.1) in L_2^1 satisfies: for any $\tau > 0$, $0 < s < \gamma/2$, there are explicit constants $C_{14} > 0$ and $a > 0$ depending on the collision kernel, τ , s and the mass, energy and L^2 norm of f_0 , such that*

$$(7.4.60) \quad \forall t \geq \tau, \quad \|f_t - M\|_{L^1(m^{-1})} \leq C_{14} t^{-1}$$

with $m(v) = \exp[-a|v|^s]$. In the important case of hard spheres (7.1.2), the assumption “ $f_0 \in L_2^1 \cap L^2$ ” can be relaxed into just “ $f_0 \in L_2^1$ ”, and the same result (7.4.60) holds with explicit constant $a, C_{14} > 0$ depending only on the collision kernel, s , τ , and the mass and energy of f_0 .

Proof of Lemma 7.9. It is straightforward that the assumptions (7.1.3), (7.1.4), (7.1.5) implies the assumptions [150, equations (1.2) to (1.7)]. Hence by [150, Theorem 6.2] we deduce that for an initial datum in $L_2^1 \cap L^2$, the solution satisfies for any $\alpha > 0$

$$(7.4.61) \quad \forall t \geq 0, \quad \|f_t - M\|_{L^1} \leq C_\alpha t^{-\alpha}$$

for some explicit constant C_α depending on α , the collision kernel and the mass, energy and L^2 norm of the initial datum. We apply this result with $\alpha = 2$ and we interpolate by Hölder’s inequality with the norm $L^1(\exp[2a|v|^s])$ for $0 < s < \gamma/2$ which is bounded uniformly for $t \geq \tau > 0$ by Lemma 7.8, to deduce that

$$\forall t \geq \tau, \quad \|f_t - M\|_{L^1(m^{-1})} \leq C_{14} t^{-1}$$

with $m(v) = \exp[-a|v|^s]$.

In the case of hard spheres we use [150, Theorem 7.2] instead of [150, Theorem 6.2], which yields the same result (7.4.61), but under the sole assumption that $f_0 \in L_2^1$. \square

Now we can conclude the proof of Theorem 7.1:

Proof of Theorem 7.1. Using Lemmas 7.8 and 7.9, we pick $t_0 > 0$ and $m(v) = \exp[-a|v|^s]$ with $0 < s < \gamma/2$ such that

$$\forall t \geq t_0, \quad \|f_t - M\|_{L^1(m^{-2})} \leq \varepsilon$$

where ε is chosen as in Lemma 7.7. Then for $0 < \mu \leq \lambda$, we apply Lemma 7.7 starting from $t = t_0$:

$$\forall t \geq t_0, \quad \|f_t - M\|_{L^1(m^{-1})} \leq C_{13} \|f_{t_0} - M\|_{L^1(m^{-1})} e^{-\mu t} \leq C e^{-\mu t}.$$

This concludes the proof. \square

7.4.3 A remark on the asymptotic behavior of the solution

Theorem 7.1 thus yields the asymptotic expansion

$$f = M + mg$$

with g going to 0 in L^1 with rate $C e^{-\lambda t}$. If we denote by Π_1 the spectral projection associated with the $-\lambda$ eigenvalue (for the definition of the spectral projection see [121, Chapter 3, Section 6, Theorem 6.17]) and $\Pi_1^\perp = \text{Id} - \Pi_1$, then the evolution equation on $\Pi_1^\perp(g)$ writes (using the fact that \mathcal{L} commutes with Π_1)

$$\partial_t \Pi_1^\perp(g) = \mathcal{L}(\Pi_1^\perp(g)) + \Pi_1^\perp(\Gamma(g, g)).$$

By exactly the same analysis as above, one could prove that the semi-group of \mathcal{L} restricted to $\Pi_1^\perp(L^1)$ decays with rate $C e^{-\lambda_2 t}$ where $\lambda_2 > \lambda$ is the modulus of the second non-zero eigenvalue. Thus by the Duhamel formula one gets

$$\|\Pi_1^\perp(g_t)\| \leq C e^{-\lambda_2 t} \|\Pi_1^\perp(g_0)\| + C \int_0^t e^{-\lambda_2(t-s)} \|\Pi_1^\perp(\Gamma(g_s, g_s))\| ds.$$

Then using that

$$\|\Pi_1^\perp(\Gamma(g_s, g_s))\| \leq C \|\Gamma(g_s, g_s)\| \leq C \|g_s\|^{3/2} \leq C e^{-(3/2)\lambda t}$$

we deduce that

$$\|\Pi_1^\perp(g_t)\| \leq C e^{-\lambda t}$$

with $\lambda < \bar{\lambda} < \min\{\lambda_2, (3/2)\lambda\}$. Hence, setting $\varphi_1 = m \Pi_1(g_t)$ and $R = m \Pi_1^\perp(g_t)$, we obtain the asymptotic expansion

$$f = M + \varphi_1 + R$$

with $\varphi_1 = \varphi_1(t, v)$ going to 0 in L^1 with rate $e^{-\lambda t}$ and $R = R(t, v)$ going to 0 in L^1 with rate $e^{-(\lambda+\varepsilon)t}$ for some $\varepsilon > 0$. Thus φ_1 is asymptotically

the dominant term of $f - M$, and as $m^{-1}\varphi_1$ belongs to the eigenspace of \mathcal{L} associated with λ , we know by the study of the decay of the eigenvectors that

$$\forall t \geq 0, \quad \varphi_1 \in L^2(\langle v \rangle^\gamma m^2 M^{-1}).$$

Moreover φ_1 is the projection of the solution on the eigenspace of the first non-zero eigenvalue. It can be seen as the first order correction to the equilibrium regime, and the asymptotic profile of this first order correction is given by the eigenvectors associated to the $-\lambda$ eigenvalue.

Acknowledgments. The idea of searching for some decay property on the eigenvectors imposed by the eigenvalue equation in order to prove that the eigenvectors belong to a smaller space of linearization originated from fruitful discussions with Thierry Gallay, under the impulsion of Cédric Villani. Both are gratefully acknowledged. Support by the European network HYKE, funded by the EC as contract HPRN-CT-2002-00282, is acknowledged.

Partie III

Étude des gaz granulaires

Cooling process for inelastic Boltzmann equations for hard spheres, Part I: The Cauchy problem

Article [150], en collaboration avec Stéphane Mischler et Mariano Rodriguez Ricard, soumis pour publication.

ABSTRACT: We develop the Cauchy theory of the spatially homogeneous inelastic Boltzmann equation for hard spheres, for a general form of collision rate which includes in particular variable restitution coefficients depending on the kinetic energy and the relative velocity. It covers physically realistic models for granular materials. We prove (local in time) non-concentration estimates in Orlicz spaces, from which we deduce weak stability and existence theorem. Strong stability together with uniqueness is proved under additional smoothness assumption on the initial datum, for a restricted class of collision rates. Concerning the long-time behaviour, we give conditions for the cooling process to occur or not in finite time.

Contents

8.1	Introduction and main results	325
8.1.1	A general framework for the collision operator . . .	326
8.1.2	Mathematical assumptions on the collision rate . .	329
8.1.3	Statement of the main results	332
8.1.4	Plan of the paper	335
8.2	Estimates in Orlicz spaces	335
8.2.1	Convolution-like estimates on the gain term	336
8.2.2	Minoration of the loss term	340
8.2.3	Estimate on the global collision operator and <i>a priori</i> estimate on the solutions	341
8.3	Proof of the Cauchy theorem for non-coupled collision rate	342
8.3.1	Propagation of moments	343
8.3.2	Stability estimate in L_2^1 and proof of the unique- ness part of Theorem 8.1	349
8.3.3	Sketch of the proof of the existence part of Theo- rem 8.1	350
8.4	Proof of the Cauchy theorem for coupled colli- sion rate	351
8.4.1	Weak stability and proof of the existence part of Theorem 8.2	351
8.4.2	Strong stability and uniqueness part of Theorem 8.2354	
8.5	Study of the cooling process	361
8.6	Appendix: Some facts about Orlicz spaces	367

8.1 Introduction and main results

In this paper we address the Cauchy problem for the spatially homogeneous Boltzmann equation modelling the dynamic of a homogeneous system of inelastic hard spheres which interact only through binary collisions. More precisely, describing the gas by the probability density $f(t, v) \geq 0$ of particles with velocity $v \in \mathbb{R}^N$ ($N \geq 2$) at time $t \geq 0$, we study the existence and the qualitative behaviour of solutions to the Boltzmann equation for inelastic collision

$$(8.1.1) \quad \frac{\partial f}{\partial t} = Q(f, f) \quad \text{in} \quad (0, +\infty) \times \mathbb{R}^N,$$

$$(8.1.2) \quad f(0, \cdot) = f_{\text{in}} \quad \text{in} \quad \mathbb{R}^N.$$

The use of Boltzmann inelastic hard spheres-like models to describe dilute, rapid flows of granular media started with the seminal physics paper [113], and a huge physics literature has developed in the last twenty years. The study of granular systems in such regime is motivated by their unexpected physical behavior (with the phenomena of *collapse* –or “*cooling effect*”– at the kinetic level and *clustering* at the hydrodynamical level), their use to derive hydrodynamical equations for granular fluids, and their industrial applications.

From the mathematical viewpoint, works on the Cauchy problem for these models have been first restricted to the so-called *inelastic Maxwell model*, which is an approximation where the collision rate is replaced by a mean value independent on the relative velocity (see [27] for instance). This simplified model is important because of its analytic simplifications allowing to use powerful Fourier transform tools. Nevertheless, although it is possible to modify the collision operator by a multiplication by a function of the kinetic energy in order to restore its dimensional homogeneity (see [27] for this *pseudo-Maxwell molecules model*), fine properties of the distribution (such as overpopulated tails or self-similar solutions) are broken or modified by the approximation. Another simplification which has lead to interesting results is the restriction to one-dimensional models (in space and velocity) (see [18, 179, 20]), where, on the contrary to the elastic case, the collision operator has a non-trivial outcome. Also the recent papers [100, 32] have studied the case of inelastic hard spheres in various regimes (for instance in a thermal bath, i.e. when a heat source term is added to the equation) in any dimension. Another common major physical simplification is to deal with *constant normal restitution coefficients*. This choice, while reasonable from the viewpoint of the mathematical complexity of the model, appears inadequate to describe the whole variety of behaviors of these materials (see the

discussion and models in [27] and [179] and the references therein). Lately the work [27] has considered some cases of normal restitution coefficients possibly depending on the kinetic energy of the solution, and the works [179, 20] have considered some cases of normal restitution coefficients depending on the relative velocity.

In this work, we shall construct solutions to the freely cooling Boltzmann equation for hard spheres in any dimension $N \geq 2$ and for a general framework of measure-valued inelasticity coefficients which covers in particular *variable normal restitution coefficients* possibly depending on the relative velocity and the kinetic energy of the solution. Our framework enables to consider interesting physical features, such as elasticity increasing when the relative velocity or the temperature decrease (“*normal*” *granular media*) or the opposite phenomenon (“*anomalous*” *granular media*). Let us emphasize that these solutions are new even in the case of a constant normal restitution coefficient. We also discuss various conditions on the collisions rate for the collapse to occur or not in finite time. A second part of this work [140] will be concerned with the existence of self-similar solutions and the tail behavior of the distribution.

Before we explain our results and methods in detail, let us introduce the problem.

8.1.1 A general framework for the collision operator

The bilinear collision operator $Q(f, f)$ models the interaction of particles by means of inelastic binary collisions (preserving mass and total momentum but dissipating kinetic energy). We denote by B the rate of occurrence of collision of two particles with pre-collisional velocities v and v_* which gives rise to post-collisional velocities v' and v'_* . The collision may be schematically written

$$(8.1.3) \quad \{v\} + \{v_*\} \xrightarrow{B} \{v'\} + \{v'_*\} \quad \text{with} \quad \begin{cases} v' + v'_* = v + v_* \\ |v'|^2 + |v'_*|^2 < |v|^2 + |v_*|^2. \end{cases}$$

More precisely, we define the collision operator by its action on test functions (which is related to the *observables* of the probability density). Taking $\varphi = \varphi(v)$ to be some well-suited regular function, we introduce the following weak formulation of the collision operator

$$(8.1.4) \quad \langle Q(f, f), \varphi \rangle := \frac{1}{2} \int_{\mathbb{R}^N} \int_{\mathbb{R}^N} f_* f \int_D (\varphi'_* + \varphi' - \varphi - \varphi_*) B(\mathcal{E}, v - v_*; dz) dv dv_*$$

where $D := \{u \in \mathbb{R}^N; |u| \leq 1\}$. Here and below we use the shorthand notations $\psi = \psi(v)$, $\psi_* = \psi(v_*)$, $\psi' = \psi(v')$ and $\psi'_* = \psi(v'_*)$ for any function ψ on \mathbb{R}^N . For any $z \in D$ and $v, v_* \in \mathbb{R}^N$ we define

$$(8.1.5) \quad \begin{cases} v' = \frac{v + v_*}{2} + z \frac{|v_* - v|}{2} \\ v'_* = \frac{v + v_*}{2} - z \frac{|v_* - v|}{2}, \end{cases}$$

which is nothing but a parametrization, for any fixed *pre-collisional particles* $\{v, v_*\}$, of all possible resulting *post-collisional particles* $\{v', v'_*\}$ in (8.1.3). Finally, \mathcal{E} is the *kinetic energy* of the distribution f , defined by

$$\mathcal{E} := \int_{\mathbb{R}^N} f |v|^2 dv.$$

The *collision rate* B is the product of the norm of the *relative velocity* by the *collisional cross section*, $B = |v - v_*|b$, reflecting the fact that we are dealing with *hard spheres* which undergo contact interactions. The *collisional cross section* b is a non-negative measure on D , depending on the kinetic energy \mathcal{E} , and on the pre-collisional velocities v, v_* . It depends on the velocity only through $v - v_*$ by Gallilean invariance. The non-negative real $|z|$ is the *restitution coefficient* which measures the loss of energy in the collision, since

$$(8.1.6) \quad |v'|^2 + |v'_*|^2 - |v|^2 - |v_*|^2 = -\frac{1}{2}(1 - |z|^2) |v_* - v|^2 \leq 0.$$

In the above formula, $|z| = 1$ corresponds to an elastic collision while $z = 0$ corresponds to a completely inelastic collision (or *sticky collision*). In the sequel we shall denote $u = v - v_*$ the *relative velocity*, and for a vector $x \in \mathbb{R}^N \setminus \{0\}$, we shall denote $\hat{x} = x/|x|$.

A first simple consequence of the definition of the operator (8.1.4) and of the parametrization (8.1.5) is that mass and momentum are conserved

$$\frac{d}{dt} \int_{\mathbb{R}^N} f \begin{pmatrix} 1 \\ v \end{pmatrix} dv = 0,$$

a fact that we easily derive (at least formally), multiplying the equation (8.1.1) by $\varphi = 1$ or $\varphi = v$ and integrating in the velocity variable (using (8.1.4)). In the same way, multiplying equation (8.1.1) by $\varphi = |v|^2$, integrating and using (8.1.6), we obtain that the kinetic energy is dissipated

$$(8.1.7) \quad \frac{d}{dt} \mathcal{E}(t) = -D(f) \leq 0,$$

where we define the energy dissipation functional D and the energy dissipation rate β , which measures the (averaged) inelasticity of collisions, by

$$D(f) := \int_{\mathbb{R}^N} \int_{\mathbb{R}^N} f f_* |u|^3 \beta(\mathcal{E}, u) dv dv_*$$

$$\beta(\mathcal{E}, u) := \frac{1}{4} \int_D (1 - |z|^2) b(\mathcal{E}, u; dz) \geq 0.$$

Finally, we introduce the *cooling time*, associated to the process of cooling (possibly in finite time) of granular gases:

$$(8.1.8) \quad T_c := \inf\{T \geq 0, \mathcal{E}(t) = 0 \forall t > T\} = \sup\{S \geq 0, \mathcal{E}(t) > 0 \forall t < S\}.$$

This cooling effect (or collapse) is one of main motivation for the physical and mathematical study of granular media.

The Boltzmann equation (8.1.1) is complemented with an initial condition (8.1.2) where the initial datum is supposed to satisfy the moment conditions

$$(8.1.9) \quad 0 \leq f_{\text{in}} \in L^1_q(\mathbb{R}^N), \quad \int_{\mathbb{R}^N} f_{\text{in}} dv = 1, \quad \int_{\mathbb{R}^N} f_{\text{in}} v dv = 0$$

for some $q \geq 2$. Notice that we can assume without loss of generality the two last moment conditions in (8.1.9), since we may always reduce to that case by a scaling and translation argument. Here we denote, for any integer $q \in \mathbb{N}$, the Banach space

$$L^1_q = \left\{ f : \mathbb{R}^N \longrightarrow \mathbb{R} \text{ measurable; } \|f\|_{L^1_q} := \int_{\mathbb{R}^N} |f(v)| (1 + |v|^q) dv < \infty \right\}.$$

We also define the weighted Sobolev spaces $W_q^{k,1}$ ($q \in \mathbb{R}$ and $k \in \mathbb{N}$) by the norm

$$\|f\|_{W_q^{k,1}} = \sum_{|s| \leq k} \|\partial^s f (1 + |v|^q)\|_{L^1}.$$

We introduce the space of normalized probability measures on \mathbb{R}^N , denoted by $M^1(\mathbb{R}^N)$, and the space $BV_q(\mathbb{R}^N)$ ($q \in \mathbb{R}$) of Bounded Variation functions, defined as the set of the weak limits in $\mathcal{D}'(\mathbb{R}^N)$ of sequences of smooth functions which are bounded in $W_q^{1,1}(\mathbb{R}^N)$. Throughout the paper we denote by “C” various constants which do not depend on the collision rate B .

8.1.2 Mathematical assumptions on the collision rate

Let us state the basic assumptions on the collision rate B :

- B takes the form

$$(8.1.10) \quad B = B(\mathcal{E}, u; dz) = |u| b(\mathcal{E}, u; dz),$$

where b is a finite measure on D for any \mathcal{E}, u . This measure b satisfies the following properties:

- It satisfies the symmetry property

$$(8.1.11) \quad b(\mathcal{E}, u; dz) = b(\mathcal{E}, -u, -dz).$$

- For any $\varphi \in C_c(\mathbb{R}^N)$ the function

$$(8.1.12) \quad (v, v_*, \mathcal{E}) \mapsto \int_D \varphi(v') b(\mathcal{E}, u; dz)$$

is continuous.

- There exists a continuous function $\alpha : (0, \infty) \rightarrow (0, \infty)$, which measures the intensity of interactions, such that

$$(8.1.13) \quad \forall u \in \mathbb{R}^N, \mathcal{E} > 0, \quad \alpha(\mathcal{E}) = \int_D b(\mathcal{E}, u; dz).$$

For the energy coupled models we will need the following additional assumption:

- The measure b satisfies the following angular spreading property: for any $\mathcal{E} > 0$, there is a function $j_{\mathcal{E}}(\varepsilon) \geq 0$, going to 0 as $\varepsilon \rightarrow 0$, such that

$$(8.1.14) \quad \forall \varepsilon > 0, u \in \mathbb{R}^N, \quad \int_{\{|u \cdot z| \in [-1, 1] \setminus [-1+\varepsilon, 1-\varepsilon]\}} b(\mathcal{E}, u; dz) \leq \alpha(\mathcal{E}) j_{\mathcal{E}}(\varepsilon).$$

Moreover we assume that this convergence is uniform according to \mathcal{E} when it is restricted to a compact set of $(0, +\infty)$.

For the uniqueness of the energy coupled models, we shall need the following assumption

H1. The cross-section b reduces to a measure on the sphere

$$(8.1.15) \quad \mathcal{C}_{u,e} = \frac{1-e}{2} \hat{u} + \frac{1+e}{2} \mathbb{S}^{N-1},$$

where $e : (0, \infty) \rightarrow [0, 1]$, $\mathcal{E} \mapsto e(\mathcal{E})$ depends only on the kinetic energy, and $\alpha = \alpha(\mathcal{E})$ and $e = e(\mathcal{E})$ are locally Lipschitz on $(0, +\infty)$. Moreover, b is assumed to be absolutely continuous according to the Hausdorff measure on $\mathcal{C}_{u,e}$, and thus writes

$$(8.1.16) \quad b(\mathcal{E}, u; dz) = \delta_{\{z=(1-e)\hat{u}/2+(1+e)\sigma/2\}} \tilde{b}(\mathcal{E}, |u|, \hat{u} \cdot \sigma) d\sigma$$

where $d\sigma$ is the uniform measure on the unit sphere, and \tilde{b} is a non-negative measurable function.

In the study of the cooling process, we always assume:

H2. The energy dissipation rate $\beta(\mathcal{E}, u)$ in (8.1.8) is continuous on $(0, +\infty) \times \mathbb{R}^N$ and satisfies

$$(8.1.17) \quad \beta(\mathcal{E}, u) > 0 \quad \forall u \in \mathbb{R}^N, \mathcal{E} > 0.$$

We will also need one of the two following additional assumptions :

H3. For any $\mathcal{E}_0, \mathcal{E}_\infty \in (0, \infty)$ (with $\mathcal{E}_0 \geq \mathcal{E}_\infty$) there exists ψ such that

$$(8.1.18) \quad \beta(\mathcal{E}, u) \geq \psi(|u|) \quad \forall \mathcal{E} \in (\mathcal{E}_\infty, \mathcal{E}_0), \forall u \in \mathbb{R}^N,$$

with $\psi \in C(\mathbb{R}_+, \mathbb{R}_+)$ and such that for any $R > 0$ there exists $\psi_R > 0$,

$$(8.1.19) \quad \psi(|u|) \geq \psi_R |u|^{-1} \quad \forall u \in \mathbb{R}^N, |u| > R/2.$$

This assumption is quite natural. In particular, it holds for a “*normal*” granular media.

H4. The cross-section b reduces to a measure on the sphere $\mathcal{C}_{u,e}$ and it is absolutely continuous according to the Hausdorff measure, where $e : (0, \infty) \times (0, \infty) \rightarrow [0, 1]$, $(\mathcal{E}, |u|) \mapsto e(\mathcal{E}, |u|)$ is a continuous function. In particular, (8.1.16) holds. Moreover we assume that for any given \mathcal{E} and $|u|$, the function $z \mapsto \tilde{b}(\mathcal{E}, |u|, z)$ is non-negative, nondecreasing and convex on $(-1, 1)$.

The fact that b is a finite measure on D allows to define the splitting $Q = Q^+ - Q^-$ where Q^+ and Q^- are defined in dual form by

$$(8.1.20) \quad \langle Q^+(g, f), \varphi \rangle := \int_{\mathbb{R}^N} \int_{\mathbb{R}^N} g_* f \int_D \varphi' |u| b(\mathcal{E}, u; dz) dv dv_*$$

and

$$(8.1.21) \quad \langle Q^-(g, f), \varphi \rangle := \int_{\mathbb{R}^N} \int_{\mathbb{R}^N} g_* f \int_D \varphi |u| b(\mathcal{E}, u; dz) dv dv_*.$$

A straightforward computation shows that it is possible to give a very simple strong form of Q^- as follows

$$(8.1.22) \quad Q^-(g, f) = L(g) f$$

where L is the convolution operator

$$(8.1.23) \quad L(g)(v) := \alpha(\mathcal{E}) \int_{\mathbb{R}^N} g(v_*) |v - v_*| dv_*.$$

Under assumption **H4**, the expression of $Q^+(f, f)$ reduces to

$$(8.1.24) \quad \langle Q^+(g, f), \varphi \rangle := \int_{\mathbb{R}^N} \int_{\mathbb{R}^N} g_* f |u| \int_{\mathbb{S}^{N-1}} \varphi' \tilde{b}(\mathcal{E}, |u|, \hat{u} \cdot \sigma) d\sigma dv dv_*.$$

We refer to [27] for physical motivations for the case when $e = e(\mathcal{E})$ and to [179] for the case when $e = e(|u|)$. Under assumption **H4** and when one assumes that \tilde{b} only depends on $\hat{u} \cdot \sigma$, the energy dissipation rate just writes

$$(8.1.25) \quad \beta(\mathcal{E}, u) = C_N (1 - e^2),$$

where C_N is a constant depending on the dimension.

We note that the classical Boltzmann collision operator for inelastic hard spheres with constant normal restitution coefficient $e \in [0, 1]$, as studied for instance in [27] and [100], is included as a particular case of our model, and satisfies all the assumptions above. But the formalism (8.1.4)–(8.1.14) is much more general than this case. In particular, we may also consider:

1. Uniformly inelastic collision processes such that

$$(8.1.26) \quad \exists z_0 \in (0, 1) \quad \text{s.t.} \quad \text{supp } B(\mathcal{E}, v, v_*, \cdot) \subset D(0, z_0) \quad \forall v, v_* \in \mathbb{R}^N, \quad \forall \mathcal{E} > 0,$$

which includes the *sticky particles model* when $z_0 = 0$.

2. The physically important case of a normal restitution coefficient e depending on the relative velocity and the kinetic energy with a cross-section \tilde{b} depending on \mathcal{E} , u and $\hat{u} \cdot \sigma$. In particular it covers the kind of models studied in [27] (where e depends on \mathcal{E} , and \tilde{b} is independent on \mathcal{E} and u).

3. This formalism also covers multidimensional versions of the kind of models proposed in [179], which corresponds to the case where b is the product of a measure depending on $|u|$, $|z|$ and a measure of $\hat{u} \cdot z$ absolutely continuous according to the Hausdorff measure. One easily checks that our assumptions are quite natural for this kind of models as well.

8.1.3 Statement of the main results

Let us now define the notion of solutions we deal with in this paper.

Definition 8.1. Consider an initial datum f_{in} satisfying (8.1.9) with $q = 2$. A nonnegative function f on $[0, T] \times \mathbb{R}^N$ is said to be a solution to the Boltzmann equation (8.1.1)-(8.1.2) if

$$(8.1.27) \quad f \in C([0, T]; L_2^1(\mathbb{R}^N)),$$

and if (8.1.1)-(8.1.2) holds in the sense of distributions, that is,

$$(8.1.28) \quad \int_0^T \left\{ \int_{\mathbb{R}^N} f \frac{\partial \phi}{\partial t} dv + \langle Q(f, f), \phi \rangle \right\} dt = \int_{\mathbb{R}^N} f_{\text{in}} \phi(0, \cdot) dv$$

for any $\phi \in C_c^1([0, T] \times \mathbb{R}^N)$.

It is worth mentioning that (8.1.27) ensures that the collision term $Q(f, f)$ is well defined as a function of $L^1(\mathbb{R}^N)$. Indeed, on the one hand, we deduce from $f \in C([0, T]; L_2^1(\mathbb{R}^N))$ that $\mathcal{E}(t) \in K_1$ on $[0, T]$ and thus $\alpha(\mathcal{E}(t)) \in K_2$ on $[0, T]$ for some compact sets $K_i \subset (0, \infty)$. On the other hand, from the dual form (8.1.20) it is immediate that Q^\pm is bounded from $L_1^1 \times L_1^1$ into L^1 , with bound $\alpha(\mathcal{E})$ (see also [100, 140] for some *strong forms* of the $Q^+(f, f)$ term). It turns out that a solution f , defined as above, is also a solution of (8.1.1)-(8.1.2) in the mild sense:

$$f(t, \cdot) = f_{\text{in}} + \int_0^t Q(f(s, \cdot)) ds \quad \text{a.e. in } \mathbb{R}^N.$$

Another consequence is that if $f \in L^\infty([0, T], L_q^1)$ then f satisfies the *chain rule*

$$(8.1.29) \quad \frac{d}{dt} \int_{\mathbb{R}^N} \beta(f) \phi dv = \langle Q(f, f), \beta'(f) \phi \rangle \quad \text{in } \mathcal{D}'([0, T]),$$

for any $\beta \in C^1(\mathbb{R}) \cap W^{1,\infty}(\mathbb{R})$, $\phi \in L_{1-q}^\infty(\mathbb{R}^N)$, see [101, 75, 126].

Let us state the main results of this paper. First, we give a Cauchy Theorem valid when the collision rate B is independent on the kinetic energy.

Theorem 8.1. *Assume that B satisfies the assumptions (8.1.10)-(8.1.13) with $b = b(u; dz)$: the cross-section does not depend on the kinetic energy. Take an initial datum f_{in} satisfying (8.1.9) with $q = 3$. Then*

- (i) *For all $T > 0$, there exists a unique solution $f \in C([0, T]; L_2^1) \cap L^\infty(0, T; L_3^1)$ to the Boltzmann equation (8.1.1)-(8.1.2). This solution conserves mass and momentum,*

$$(8.1.30) \quad \int_{\mathbb{R}^N} f(t, v) dv = 1, \quad \int_{\mathbb{R}^N} f(t, v) v dv = 0 \quad \forall t \geq 0,$$

and has a decreasing kinetic energy

$$(8.1.31) \quad \mathcal{E}(t_2) \leq \mathcal{E}(t_1) \leq \mathcal{E}_{\text{in}} = \mathcal{E}(0) \quad \forall t_2 \geq t_1 \geq 0.$$

- (ii) *Its time of life (as introduced in (8.1.8)) is $T_c = +\infty$, in particular, $\mathcal{E}(t) > 0$ for any $t > 0$. Moreover, assuming **H2-H3** or **H2-H4** (with ϵ and \tilde{b} independent on the kinetic energy), there holds*

$$(8.1.32) \quad \mathcal{E}(t) \rightarrow 0 \text{ and } f(t, \cdot) \rightharpoonup \delta_{v=0} \text{ in } M^1(\mathbb{R}^N)\text{-weak* when } t \rightarrow T_c.$$

In other words, the cooling process does not occur in finite time, but asymptotically in large time.

Remarks: Let us discuss the assumptions and conclusions of this theorem.

1. Under assumption **H4** and when the collision rate is independent on the kinetic energy, one can prove in fact that there exists a unique solution $f \in C([0, \infty); L^1)$ satisfying (8.1.30) and (8.1.31) for any initial condition f_{in} satisfying (8.1.9) with $q = 2$. The proof is quite more technical and we refer to [144] where the result is presented for the true elastic collision Boltzmann equation; nevertheless the proof may be readily adapted to the inelastic collisional framework.

2. The existence and uniqueness part of Theorem 8.1 (point (i)) extends to a cross-section $B = B(u; dz) \geq 0$ which satisfies the sole assumptions

$$\left\{ \begin{array}{l} B(-u; -dz) = B(u; dz), \\ \int_D B dz \leq C_0 (1 + |v| + |v_*|) \\ (v, v_*) \mapsto \int_D \varphi(v') B(u; dz) \in C(\mathbb{R}^N \times \mathbb{R}^N) \quad \forall \varphi \in C_c(\mathbb{R}^N) \end{array} \right.$$

for some constant $C_0 \in \mathbb{R}_+$. This corresponds to the so-called cut-off hard potentials (or variable hard spheres) in the context of inelastic gases.

3. For a uniformly dissipative collision model, i.e. such that

$$\beta(u) \geq \beta_0 \in (0, \infty),$$

a fact which holds under assumption (8.1.26) or under assumption **H4** with a normal restitution coefficient e satisfying $e(|u|) \leq e_0 \in [0, 1)$ for any $u \in \mathbb{R}^N$, we may prove the additional *a priori* bound

$$\int_0^\infty \|f(t, \cdot)\|_{L^1_3} dt \leq C(\|f_{\text{in}}\|_{L^1_2}, \beta_0).$$

As a consequence, one can easily adapt the proof of existence and uniqueness in Theorem 8.1 and then one can easily establish that the existence part of Theorem 8.1 holds for any initial datum f_{in} satisfying (8.1.9) with $q = 2$.

4. The existence and uniqueness part of Theorem 8.1 (point (i)) immediately extends to a time dependent collision rate $B = |u| \gamma(t) b(t, u; dz)$ where $b(t, u, \cdot)$ is a probability measure for any $u \in \mathbb{R}^N$, $t \in [0, T]$ such that $b(t, u; dz) = b(t, -u, -dz)$, and $\gamma(t)$ is a positive function in $L^\infty(0, T)$.

Now, let us turn to the case where the collision kernel depends on the kinetic energy of the solution.

Theorem 8.2. *Assume now that B satisfies the assumptions (8.1.10)-(8.1.14) and that the cross-section $b = b(\mathcal{E}, u; dz)$ depends also on the kinetic energy \mathcal{E} . Take an initial datum f_{in} satisfying (8.1.9) with $q = 3$.*

- (i) *There exists at least one maximal solution $f \in C([0, T_c]; L^1_2) \cap L^\infty(0, T_c; L^1_3)$ for some $T_c \in (0, +\infty]$ which satisfies the conservation laws (8.1.30) and the decrease of the kinetic energy (8.1.31).*
- (ii) *If the collision rate satisfies the assumption **H1**, and the initial datum satisfies the additional assumption $f_{\text{in}} \in BV_4 \cap L^1_3$, then this solution is unique in the class of functions $C([0, T], L^1_2) \cap L^\infty(0, T; L^1_3)$ for any $T \in (0, T_c)$.*
- (iii) *The asymptotic convergence (8.1.32) holds under the additional assumptions **H2-H3** or **H2-H4**.*
- (iv) *If α is bounded near $\mathcal{E} = 0$ and $j_\mathcal{E}$ converges to 0 as $\varepsilon \rightarrow 0$ uniformly near $\mathcal{E} = 0$, or if β is bounded by an increasing function β_0 which only depends on the energy and $f_{\text{in}} e^{a_\eta |v|^\eta} \in L^1$ with $\eta \in (1, 2]$, $a_\eta > 0$, then $T_c = +\infty$.*

(v) If $\beta(\mathcal{E}, u) \geq \beta_0 \mathcal{E}^\delta$ with $\beta_0 > 0$ and $\delta < -1/2$, then $T_c < +\infty$.

Remarks: Let us discuss the assumptions and conclusions of this theorem.

1. In point (ii), the assumption we make in order to get the uniqueness part of the theorem could most probably be relaxed to a smoothness assumption on b of the form b depends only on \mathcal{E} and z and $\mathcal{E} \rightarrow b(\mathcal{E}; dz)$ is locally Lipschitz from $(0, +\infty)$ to $W^{-1,1}(D)$.

2. Under the assumptions of point (ii) on the initial datum, by using a bootstrap *a posteriori* argument as introduced in [144], one can indeed prove that there exists a unique solution $f \in C([0, \infty); L^1)$ satisfying (8.1.30) and (8.1.31) for any initial condition f_{in} satisfying (8.1.9) with $q > 4$ and $f_{\text{in}} \in BV_4$.

8.1.4 Plan of the paper

We gather in Section 8.2 some new integrability estimates on the collision operator which can be of independent interest. Concerning the gain term we prove convolution-like estimates in Orlicz spaces. These estimates generalize similar estimates in Lebesgue spaces in the elastic and the inelastic case. Concerning the loss term we give simple bounds from below obtained by convexity. We give then estimates on the *global* operator in Orlicz space, which show essentially that even if the bilinear collision operator is not bounded, its evolution semi-group is bounded in any Orlicz space (with bound depending on time). The proof is based on Young's inequality and only requires elementary tools. In Section 8.3 we start looking at *solutions* of the Boltzmann equation and we prove Theorem 8.1, on the basis of moments estimates in L^1 . In Section 8.4, we extend the existence result to collision rates depending on the kinetic energy of the solution by proving a weak stability result on the basis of (local in time) non-concentration estimates obtained by the study of Section 8.2, to obtain the existence part of Theorem 8.2. The uniqueness part of Theorem 8.2 is obtained by proving a strong stability result valid for smooth solution. In Section 8.5 we study the cooling process and prove the remaining parts of Theorem 8.1 and Theorem 8.2. In order this paper to be as self-contained as possible, we gather some facts about Orlicz spaces in an appendix in Section 8.6.

8.2 Estimates in Orlicz spaces

In this section we gather some new functional estimates on the collision operator in Orlicz spaces, that will be used in the sequel to obtain (local in time)

non-concentration estimates. Let us introduce the following decomposition $b = b_\varepsilon^t + b_\varepsilon^r$ of the cross-section b for $\varepsilon \in (0, 1)$:

$$\begin{cases} b_\varepsilon^t(\mathcal{E}, u; dz) = b(\mathcal{E}, u; dz) \mathbf{1}_{\{-1+\varepsilon \leq \hat{u} \cdot z \leq 1-\varepsilon\}} \\ b_\varepsilon^r(\mathcal{E}, u; dz) = b(\mathcal{E}, u; dz) - b_\varepsilon^t(\mathcal{E}, u; dz) \end{cases}$$

where $\mathbf{1}_{\{-1+\varepsilon \leq \hat{u} \cdot z \leq 1-\varepsilon\}}$ denotes the usual indicator function of the set $\{-1 + \varepsilon \leq \hat{u} \cdot z \leq 1 - \varepsilon\}$. When no confusion is possible the subscript ε shall be omitted.

In the sequel, Λ denotes a function C^2 strictly increasing, convex satisfying the assumptions (8.6.91), (8.6.92) and (8.6.93). This function defines the Orlicz space $L^\Lambda(\mathbb{R}^N)$, which is a Banach space (see the definition in appendix).

8.2.1 Convolution-like estimates on the gain term

In this subsection we shall prove convolution-like estimates in Orlicz spaces. These estimates extend existing results in Lebesgue spaces: see [111, 112, 150] in the elastic case and [100] in the inelastic case for a constant normal restitution coefficient. The proof relies only on elementary tools, essentially Young's inequality, in the spirit of [69]. Another proof could be given by interpolating between the L^1 and L^∞ theories, as in [111, 112] (using tools of [21]), but this path leads to more technical difficulties. Moreover the proof given here has several advantages: its simplicity, the fact that it handles only the dual form of Q^+ and the fact that it is naturally well-suited to deal with Orlicz spaces, since it is based on Young's inequality.

As shown by the formula for the differential of the Orlicz norm in the appendix, the crucial quantity to estimate is

$$\int_{\mathbb{R}^N} Q^+(f, f) \Lambda' \left(\frac{f}{\|f\|_{L^\Lambda}} \right) dv.$$

Most of the difficulty is related to the fact that the bilinear operator Q^+ is not bounded because of the term $|v - v_*|$ in the collision rate. Nevertheless it is possible to prove a compactness-like estimate with respect to this algebraic weight. When combined with the damping effect of the loss term this estimate shall show that the evolution semi-group of the global collision operator is bounded in any Orlicz space.

Let us state the result

Theorem 8.3. For any function $f \in L^1_1 \cap L^\Lambda$, for any $\varepsilon \in (0, 1)$, there is an explicit constant $C_\varepsilon^+(\varepsilon)$ such that

$$(8.2.33) \quad \int_{\mathbb{R}^N} Q^+(f, f) \Lambda' \left(\frac{f}{\|f\|_{L^\Lambda}} \right) dv \leq \alpha(\mathcal{E}) \left[C_\varepsilon^+(\varepsilon) N^{\Lambda^*} \left(\Lambda' \left(\frac{|f|}{\|f\|_{L^\Lambda}} \right) \right) \|f\|_{L^1_1} \|f\|_{L^\Lambda} \right. \\ \left. + (2 + 2^{N+2}) j_\varepsilon(\varepsilon) \|f\|_{L^1_1} \int_{\mathbb{R}^N} f \Lambda' \left(\frac{f}{\|f\|_{L^\Lambda}} \right) |v| dv \right].$$

Remarks: Let us comment on the conclusions of this theorem.

1. We establish estimates for the quadratic Boltzmann collision operator but similar bilinear estimates could be proved under additional assumption on b , namely that either *no frontal collision occurs*, i.e. $b(\mathcal{E}, u; dz)$ should vanish for \hat{u} close to z , or *no grazing collision occurs*, i.e. $b(\mathcal{E}, ; dz)$ should vanish for \hat{u} close to $-z$. For more details on these bilinear estimates and the corresponding assumptions, we refer to [150] where they are proved in Lebesgue spaces in the elastic framework.

2. Let us emphasize that for $z \sim 0$ (close to sticky collisions), the jacobian of the change of variable $(v, v_*) \rightarrow (v', v'_*)$ (both velocities at the same time) is blowing up. However in our method, we only use the changes of variable $v \rightarrow v'$ and $v_* \rightarrow v'_*$, keeping the other velocity unchanged, and the jacobians of these changes of variable remain uniformly bounded as $z \rightarrow 0$. This explains why our bounds includes the sticky particules model, and are uniform as $z \rightarrow 0$.

Proof of Theorem 8.3. Let us denote

$$\varphi(f) = \Lambda' \left(\frac{f}{\|f\|_{L^\Lambda}} \right).$$

Using the decomposition $b = b^t + b^r$, we control separately the two terms I^t and I^r in the decomposition

$$\int_{\mathbb{R}^N} Q^+(f, f) \varphi(f) dv = \int_{\mathbb{R}^N \times \mathbb{R}^N \times D} f f_* \varphi(f') |u| b^t(\mathcal{E}, u; dz) dv dv_* \\ + \int_{\mathbb{R}^N \times \mathbb{R}^N \times D} f f_* \varphi(f') |u| b^r(\mathcal{E}, u; dz) dv dv_* \\ =: I^t + I^r.$$

Using the bound

$$|u| = |v - v_*| \leq |v| + |v_*|$$

we have

$$\begin{aligned} I^t &\leq \int_{\mathbb{R}^N \times \mathbb{R}^N \times D} (f|v|) f_* \varphi(f') b^t(\mathcal{E}, u; dz) dv dv_* \\ &\quad + \int_{\mathbb{R}^N \times \mathbb{R}^N \times D} f(f_* |v_*|) \varphi(f') |u| b^t(\mathcal{E}, u; dz) dv dv_* =: I_1^t + I_2^t. \end{aligned}$$

Now these two terms are treated similarly: the two changes of variable $\phi_1 : v \rightarrow v'$ and $\phi_2 : v_* \rightarrow v'$ (while the other integration variables are kept fixed) are allowed thanks to the truncation. Indeed it is straightforward to compute their jacobians:

$$\begin{cases} J_{\phi_1}(v, v_*, z) = 2^N (1 + z \cdot \hat{u})^{-1} \\ J_{\phi_2}(v, v_*, z) = 2^N (1 - z \cdot \hat{u})^{-1} \end{cases}$$

which yields the bound

$$(8.2.34) \quad 2^{N-1} \leq J_{\phi_1}, J_{\phi_2} \leq 2^N \varepsilon^{-1}.$$

Thus, by applying the Young's inequality (8.6.94)

$$f_* \varphi(f') = \|f\|_{L^\Lambda} \left(\frac{f_*}{\|f\|_{L^\Lambda}} \right) \varphi(f') \leq \|f\|_{L^\Lambda} \Lambda \left(\frac{f_*}{\|f\|_{L^\Lambda}} \right) + \|f\|_{L^\Lambda} \Lambda^*(\varphi(f')),$$

we get for I_1^t the following estimate

$$\begin{aligned} I_1^t &\leq \|f\|_{L^\Lambda} \int_{\mathbb{R}^N \times \mathbb{R}^N \times D} f|v| \Lambda \left(\frac{f_*}{\|f\|_{L^\Lambda}} \right) b^t(\mathcal{E}, u; dz) dv dv_* \\ &\quad + \|f\|_{L^\Lambda} \int_{\mathbb{R}^N \times \mathbb{R}^N \times D} f|v| \Lambda^*(\varphi(f')) b^t(\mathcal{E}, u; dz) dv dv_* =: I_{1,1}^t + I_{1,2}^t. \end{aligned}$$

On the one hand, using

$$\forall x \in \mathbb{R}_+, \quad \Lambda(x) \leq x \Lambda'(x),$$

which is a trivial consequence of the fact that $\Lambda(0) = 0$ and Λ' is increasing, we have

$$I_{1,1}^t \leq \alpha(\mathcal{E}) \|f\|_{L_1^1} \int_{\mathbb{R}^N} f \varphi(f) dv.$$

Hölder's inequality in Orlicz spaces (8.6.95) recalled in the appendix then yields

$$(8.2.35) \quad I_{1,1}^t \leq \alpha(\mathcal{E}) N^{\Lambda^*} \left(\Lambda' \left(\frac{|f|}{\|f\|_{L^\Lambda}} \right) \right) \|f\|_{L_1^1} \|f\|_{L^\Lambda}.$$

On the other hand, using that $\Lambda^*(y) = y(\Lambda')^{-1}(y) - \Lambda((\Lambda')^{-1}(y))$, we get

$$I_{1,2}^t \leq \int_{\mathbb{R}^N \times \mathbb{R}^N \times D} f|v|f' \varphi(f') b^t(\mathcal{E}, u; dz) dv dv_*.$$

Since the cross-section b^t is truncated, we can apply the change of variable $v_* \rightarrow v'$, with the bound (8.2.34), and we get

$$I_{1,2}^t \leq \alpha(\mathcal{E}) 2^N \varepsilon^{-1} \|f\|_{L_1^1} \int_{\mathbb{R}^N} f \varphi(f) dv.$$

Hölder's inequality (8.6.95) then yields

$$(8.2.36) \quad I_{1,2}^t \leq \alpha(\mathcal{E}) 2^N \varepsilon^{-1} \|f\|_{L_1^1} N^{\Lambda^*} \left(\Lambda' \left(\frac{|f|}{\|f\|_{L^\Lambda}} \right) \right) \|f\|_{L^\Lambda}.$$

Next, the term I_2^t is exactly similar to I_1^t , except that one has to use the change of variable $v \rightarrow v'$ instead of $v_* \rightarrow v'$ (with the bound (8.2.34) again). Therefore gathering (8.2.35), (8.2.36) and the same estimate for I_2^t , we obtain

$$(8.2.37) \quad I^t \leq 2 \alpha(\mathcal{E}) (1 + 2^N \varepsilon^{-1}) \|f\|_{L_1^1} \left[N^{\Lambda^*} \left(\Lambda' \left(\frac{|f|}{\|f\|_{L^\Lambda}} \right) \right) \right] \|f\|_{L^\Lambda}.$$

Finally, for the term I^r , we can split it as

$$\begin{aligned} I^r &\leq \int_{\mathbb{R}^N \times \mathbb{R}^N \times D} f f_* \varphi(f') \mathbf{1}_{\{\hat{u} \cdot z \geq 0\}} |u| b^r(\mathcal{E}, u; dz) dv dv_* \\ &\quad + \int_{\mathbb{R}^N \times \mathbb{R}^N \times D} f f_* \varphi(f') \mathbf{1}_{\{\hat{u} \cdot z \leq 0\}} |u| b^r(\mathcal{E}, u; dz) dv dv_* =: I_1^r + I_2^r. \end{aligned}$$

Then for I_1^r , we use Young's inequality (8.6.94) to obtain

$$\begin{aligned} I_1^r &\leq \int_{\mathbb{R}^N \times \mathbb{R}^N \times D} f f_* \varphi(f_*) \mathbf{1}_{\{\hat{u} \cdot z \geq 0\}} |u| b^r(\mathcal{E}, u; dz) dv dv_* \\ &\quad + \int_{\mathbb{R}^N \times \mathbb{R}^N \times D} f f' \varphi(f') \mathbf{1}_{\{\hat{u} \cdot z \geq 0\}} |u| b^r(\mathcal{E}, u; dz) dv dv_*. \end{aligned}$$

In the second integral we make the change of variable $v \rightarrow v'$, whose jacobian is less than 2^N thanks the truncation $\hat{u} \cdot z \geq 0$ and the formula for the jacobian, and we use that under the truncation

$$|v - v_*| \leq 2|v' - v_*| \leq 2(1 + |v'|)(1 + |v_*|).$$

Hence we obtain

$$\begin{aligned} I_1^r &\leq (1 + 2^{N+1}) \left(\sup_{u \in \mathbb{R}^N} \int_D b^r(\mathcal{E}, u; dz) \right) \|f\|_{L_1^1} \int_{\mathbb{R}^N} f \varphi(f) (1 + |v|) dv \\ &\leq (1 + 2^{N+1}) \alpha(\mathcal{E}) j_{\mathcal{E}}(\varepsilon) \|f\|_{L_1^1} \int_{\mathbb{R}^N} f \varphi(f) (1 + |v|) dv. \end{aligned}$$

The term I_2^r is treated similarly using Young's inequality and the change of variable $v_* \rightarrow v'$, whose jacobian is also less than 2^N under the truncation $\hat{u} \cdot z \leq 0$. It satisfies therefore the same estimate. Thus we obtain the estimate

$$(8.2.38) \quad I^r \leq (2 + 2^{N+2}) \alpha(\mathcal{E}) j_{\mathcal{E}}(\varepsilon) \|f\|_{L_1^1} \int_{\mathbb{R}^N} f \varphi(f) (1 + |v|) dv.$$

Defining

$$(8.2.39) \quad C_{\mathcal{E}}^+(\varepsilon) = 2(1 + 2^N \varepsilon^{-1}) + (2 + 2^{N+2}) j_{\mathcal{E}}(\varepsilon),$$

we conclude the proof gathering (8.2.37) and (8.2.38). \square

8.2.2 Minoration of the loss term

In this subsection we recall a well-known result about the minoration of the loss term Q^- . Let us recall first the following classical estimate.

Lemma 8.1. *For any non-negative measurable function f such that*

$$(8.2.40) \quad f \in L_1^1(\mathbb{R}^N), \quad \int_{\mathbb{R}^N} f dv = 1, \quad \int_{\mathbb{R}^N} f v dv = 0,$$

we have

$$\forall v \in \mathbb{R}^N, \quad \int_{\mathbb{R}^N} f_* |v - v_*| dv_* \geq |v|.$$

Proof of Lemma 8.1. Using Jensen's inequality

$$\int_{\mathbb{R}^N} \varphi(g_*) d\mu_* \geq \varphi \left(\int_{\mathbb{R}^N} g_* d\mu_* \right)$$

with the probability measure $d\mu_* = f_* dv_*$, the measurable function $v_* \mapsto g_* = v - v_*$ and the convex function $\varphi(s) = |s|$, we deduce the result. \square

Then the proof of the following proposition is straightforward:

Proposition 8.1. *For a non-negative function f satisfying (8.2.40), we have*

$$(8.2.41) \quad \int_{\mathbb{R}^N} Q^-(f, f) \Lambda' \left(\frac{f}{\|f\|_{L^\Lambda}} \right) dv \geq \alpha(\mathcal{E}) \int_{\mathbb{R}^N} f \Lambda' \left(\frac{f}{\|f\|_{L^\Lambda}} \right) |v| dv.$$

8.2.3 Estimate on the global collision operator and a priori estimate on the solutions

Combining Theorem 8.3 and Proposition 8.1 we get

Theorem 8.4. *Let us consider a non-negative function f satisfying (8.2.40). Then there is an explicit constant $C_{\mathcal{E}}$ depending on the collision rate through the functions α and $j_{\mathcal{E}}$ such that*

$$\int_{\mathbb{R}^N} Q(f, f) \Lambda' \left(\frac{f}{\|f\|_{L^\Lambda}} \right) dv \leq C_{\mathcal{E}} \left[N^{\Lambda^*} \left(\Lambda' \left(\frac{|f|}{\|f\|_{L^\Lambda}} \right) \right) \right] \|f\|_{L_1^1} \|f\|_{L^\Lambda}.$$

More precisely, $C_{\mathcal{E}} = \alpha(\mathcal{E}) C_{\mathcal{E}}^+(\varepsilon_0)$, with ε_0 such that

$$j_{\mathcal{E}}(\varepsilon_0) \leq (2 + 2^{N+2})^{-1} \|f\|_{L_1^1}^{-1}$$

and where $C_{\mathcal{E}}^+$ is defined in (8.2.39).

Proof of Theorem 8.4. One just has to combine (8.2.33) and (8.2.41) and pick a ε_0 small enough such that

$$(2 + 2^{N+2}) \|f\|_{L_1^1} j_{\mathcal{E}}(\varepsilon_0) \leq 1.$$

□

Corollary 8.1. *Assume that B satisfies (8.1.10)-(8.1.11) and (8.1.13)-(8.1.14) and let us consider a solution $f \in C([0, T]; L_2^1)$ to the Boltzmann equation (8.1.1)-(8.1.2) associated to an initial datum $f_{\text{in}} \in L_2^1$ and to the collision rate B . Assume moreover that (8.1.30) holds and there exists a compact set $K \subset (0, +\infty)$ such that*

$$\forall t \in [0, T] \quad \mathcal{E}(t) \in K.$$

Then, there exists a C^2 , strictly increasing and convex function Λ satisfying the assumptions (8.6.91), (8.6.92) and (8.6.93) (which only depends on f_{in}) and a constant C_T (which depends on K , T and B) such that

$$\sup_{[0, T]} \|f(t, \cdot)\|_{L^\Lambda} \leq C_T.$$

Remark: Let us emphasize that these non-concentration bounds are valid for the sticky particules model (in this case they provide an exponentially growing bound in L^Λ for all times). As a particular case we deduce some explicit bounds on the entropy when it is finite initially. Moreover, since our bounds are uniform as $b \rightarrow \delta_{z=0}$, we also deduce a proof of the sticky particules limit (for a cross-section being a diffuse measure converging to a Dirac mass at $z = 0$) by the Dunford-Pettis Lemma. This shows moreover that this limit is not singular.

Proof of Corollary 8.1. Since $f_{\text{in}} \in L^1(\mathbb{R}^N)$, as recalled in the appendix, a refined version of the De la Vallée-Poussin theorem [127, Proposition I.1.1] (see also [125, 126]) guarantees that there exists a function Λ satisfying the properties listed in the statement of Corollary 8.1 and such that

$$\int_{\mathbb{R}^N} \Lambda(|f_{\text{in}}|) dv < +\infty.$$

Then the L^Λ norm of f satisfies

$$\frac{d}{dt} \|f_t\|_{L^\Lambda} = \left[N^{\Lambda^*} \left(\Lambda' \left(\frac{|f|}{\|f\|_{L^\Lambda}} \right) \right) \right]^{-1} \int_{\mathbb{R}^N} Q(f, f) \Lambda' \left(\frac{|f|}{\|f\|_{L^\Lambda}} \right) dv$$

thanks to Theorem 8.6, and thus using Theorem 8.4, we get

$$\forall t \in [0, T], \quad \frac{d}{dt} \|f_t\|_{L^\Lambda} \leq C_{\mathcal{E}(t)} \|f_t\|_{L^1_1} \|f_t\|_{L^\Lambda}.$$

Thanks to the assumptions (8.1.13) and (8.1.14), the constant $C_{\mathcal{E}(t)}$ provided by Theorem 8.4 is uniform when the kinetic energy belongs to a compact set. Thus we deduce

$$(8.2.42) \quad \forall t \in [0, T], \quad \frac{d}{dt} \|f_t\|_{L^\Lambda} \leq C_K \|f_t\|_{L^1_1} \|f_t\|_{L^\Lambda}.$$

for some explicit constant $C_K > 0$ depending on K and the collision rate. We conclude thanks to the Gronwall lemma. \square

8.3 Proof of the Cauchy theorem for non-coupled collision rate

In this section we fix $T_* > 0$ and we assume that the collision rate B satisfies

$$(8.3.43) \quad B = B(t, u; dz) = |u| \gamma(t) b(t, u; dz),$$

where b is a probability measure on D for any $t \in [0, T_*]$ and $u \in \mathbb{R}^N$ satisfying

$$(8.3.44) \quad \forall t \in [0, T_*], \quad \forall u \in \mathbb{R}^N, \quad b(t, u; dz) = b(t, -u; -dz)$$

and where γ satisfies

$$(8.3.45) \quad 0 \leq \gamma(t) \leq \gamma_* \quad \text{on} \quad (0, T_*).$$

8.3.1 Propagation of moments

In this subsection we establish several moments estimates which are well known for the Boltzmann equation with elastic collision, see [144, 135, 25] and the references therein, as well as the recent works [100, 32] for the inelastic case. Let us emphasize that these moment estimates are uniform with respect to the normal restitution coefficient ϵ or more generally to the support of $b(t, u; \cdot)$ in D .

First we give a result of propagation of moments valid for general collision rates using a rough version of the Povzner inequality.

Proposition 8.2. *Assume that B satisfies (8.3.43)–(8.3.45). For any $0 \leq f_{\text{in}} \in L^1_q(\mathbb{R}^N)$ with $q > 2$ and $T > 0$, there exists C_T such that any solution f to the inelastic Boltzmann equation (8.1.1)–(8.1.2) on $[0, T]$ satisfies, at least formally,*

$$\sup_{[0, T]} \|f(t, \cdot)\|_{L^1_q} \leq C_T.$$

Proof of Proposition 8.2. We make the proof for the third moment, the general moment estimate being similar. For any function $\Psi : \mathbb{R}^N \rightarrow \mathbb{R}_+$ such that $\Psi(v) := \psi(|v|^2)$ for some function $\psi : \mathbb{R}_+ \rightarrow \mathbb{R}_+$, the evolution of the associated moment is given by

$$\frac{d}{dt} \int_{\mathbb{R}^N} f \Psi \, dv = \int_{\mathbb{R}^N \times \mathbb{R}^N} f f_* K_\Psi \, dv \, dv_*,$$

where

$$K_\Psi := \frac{1}{2} \int_D (\Psi' + \Psi'_* - \Psi - \Psi_*) B(t, u; dz).$$

For $\psi(z) = z^s$, $s > 1$, the function ψ is super-additive, that is $\psi(x) + \psi(y) \leq \psi(x + y)$, and it is an increasing function. As a consequence,

$$\begin{aligned} \Psi' + \Psi'_* - \Psi - \Psi_* &\leq \psi(|v'|^2) + \psi(|v'_*|^2) - \psi(|v'|^2 + |v'_*|^2) \\ &\quad + \psi(|v|^2 + |v_*|^2) - \psi(|v|^2) - \psi(|v_*|^2) \\ &\leq \psi(|v|^2 + |v_*|^2) - \psi(|v|^2) - \psi(|v_*|^2), \end{aligned}$$

which implies

$$K_\Psi \leq \frac{\gamma(t)}{2} |v - v_*| [\psi(|v|^2 + |v_*|^2) - \psi(|v|^2) - \psi(|v_*|^2)].$$

Making the choice $\psi(x) = x^{3/2}$ and using the inequality

$$(8.3.46) \quad \begin{aligned} (x^{1/2} + y^{1/2}) [(x + y)^{3/2} - x^{3/2} - y^{3/2}] &\leq C (x^{1/2} + y^{1/2}) \min(x^{1/2}y, xy^{1/2}) \\ &\leq C (xy + x^{1/2}y^{3/2}) \end{aligned}$$

for any $x, y > 0$, we get

$$(8.3.47) \quad \frac{d}{dt} \int_{\mathbb{R}^N} f |v|^3 dv \leq C \gamma(t) \int_{\mathbb{R}^N \times \mathbb{R}^N} f f_* (|v|^2 |v_*|^2 + |v| |v_*|^3) dv dv_*,$$

and we conclude thanks to the Gronwall Lemma. \square

Finally we give a much more precise result on the evolution moment in the case when assumption **H4** is made. On the one hand, we prove uniform in time propagation of algebraic moments (as introduced in [167, 6, 77]) and exponential moments (for which the starting reference is [25]). On the other hand we prove appearance of exponential moments (while appearance of algebraic moments was initiated in [67, 200]) using carefully tools developed in [32]. These estimates may be seen as *a priori* bounds, but in fact, by the bootstrap argument introduced in [144], they can be obtained *a posteriori* for any solution given by the existence part of Theorem 8.1 and Theorem 8.2.

Proposition 8.3. *We make assumption **H4** on B . A solution f to the inelastic Boltzman equation (8.1.1)-(8.1.2) on $[0, T_c)$ satisfies the additional moment properties:*

(i) *For any $s > 2$, there exists $C_s > 0$ such that*

$$(8.3.48) \quad \sup_{t \in [0, T_c)} \|f(t, \cdot)\|_{L^s} \leq \max \{ \|f_{\text{in}}\|_{L^s}, C_s \}.$$

(ii) *If $f_{\text{in}} e^{r|v|^\eta} \in L^1(\mathbb{R}^N)$ for $r > 0$ and $\eta \in (0, 2]$, there exists $C_1, r' > 0$, such that*

$$(8.3.49) \quad \sup_{t \in [0, T_c)} \int_{\mathbb{R}^N} f(t, v) e^{r'|v|^\eta} dv \leq C_1.$$

(iii) *For any $\eta \in (0, 1/2)$ and $\tau \in (0, T_c)$ there exists $a_\eta, C_\eta \in (0, \infty)$ such that*

$$(8.3.50) \quad \sup_{t \in [\tau, T_c)} \int_{\mathbb{R}^N} f(t, v) e^{a_\eta |v|^\eta} dv \leq C_\eta.$$

Let us emphasize that none of these constants depends on the inelasticity coefficient e (so that the estimates are uniform with respect to the inelasticity of the Boltzmann operator) and that the constant C_s, a_η, C_η may depend on f_{in} only through its kinetic energy \mathcal{E}_{in} .

Proof of Proposition 8.3. The proof of (i) is classical and we refer for instance to [144, 135, 191] and the references therein. The proofs of (ii) and (iii) are variants of [25, Theorem 3]. Let us define

$$m_p := \int_{\mathbb{R}^N} f |v|^{2p} dv.$$

Step 1: Differential inequalities on the moments. Taking $\psi(x) = x^{p/2}$ and B of the above form, there holds

$$(8.3.51) \quad \frac{d}{dt} m_p = \int_{\mathbb{R}^N} Q(f, f) |v|^{2p} dv = \alpha(\mathcal{E}) \int_{\mathbb{R}^N \times \mathbb{R}^N} f f_* |v - v_*| K_p(v, v_*) dv dv_*,$$

where

$$K_p(v, v_*) := \frac{1}{2} \int_{\mathbb{S}^{N-1}} (|v'|^{2p} + |v_*'|^{2p} - |v|^{2p} - |v_*|^{2p}) \frac{\tilde{b}(\mathcal{E}, |u|, \sigma \cdot \hat{u})}{\alpha(\mathcal{E})} d\sigma.$$

From [32, Lemma 1, Corollary 3] (see also [100, Lemma 3.1 to Lemma 3.4]), there holds

$$(8.3.52) \quad K_p(v, v_*) \leq \gamma_p (|v|^2 + |v_*|^2)^p - |v|^{2p} - |v_*|^{2p}$$

where $(\gamma_p)_{p=3/2, 2, \dots}$ is a decreasing sequence of real numbers such that

$$(8.3.53) \quad 0 < \gamma_p < \min(1, \frac{4}{p+1}).$$

(notice that the assumptions [32, (2.11)-(2.12)-(2.13)] are satisfied under our assumptions on the collision kernel). Let us emphasize that the estimate (8.3.52) does not depend on the inelasticity coefficient $e(\mathcal{E}, |u|)$. Then, from [32, Lemma 2 and Lemma 3], we have

$$(8.3.54) \quad \frac{1}{\alpha(\mathcal{E})} \int_{\mathbb{R}^N} Q(f, f) |v|^{2p} dv \leq \gamma_p S_p - (1 - \gamma_p) m_{p+1/2}$$

with

$$S_p := \sum_{k=1}^{k_p} \binom{p}{k} (m_{k+1/2} m_{p-k} + m_k m_{p-k+1/2}),$$

where $k_p := [(p+1)/2]$ is the integer part of $(p+1)/2$ and $\binom{p}{k}$ stands for the binomial coefficient. Gathering (8.3.51) and (8.3.54), we get

$$(8.3.55) \quad \frac{d}{dt} m_p \leq \alpha(\mathcal{E}) (\gamma_p S_p - (1 - \gamma_p) m_{p+1/2}) \quad \forall p = 3/2, 2, \dots$$

By Hölder's inequality and the conservation of mass,

$$m_p^{1+\frac{1}{2^p}} \leq m_{p+1/2}$$

and, by [32, Lemma 4], for any $a \geq 1$, there exists $A > 0$ such that

$$S_p \leq A \Gamma(a p + a/2 + 1) Z_p$$

with

$$Z_p := \max_{k=1, \dots, k_p} \{z_{k+1/2} z_{p-k}, z_k z_{p-k+1/2}\}, \quad z_p := \frac{m_p}{\Gamma(a p + 1/2)}.$$

We may then rewrite (8.3.55) as

$$(8.3.56) \quad \frac{dz_p}{dt} \leq \alpha(\mathcal{E}) \left(A \gamma_p \frac{\Gamma(a p + a/2 + 1)}{\Gamma(a p + 1/2)} Z_p - (1 - \gamma_p) \Gamma(a p + 1/2)^{1/2p} z_p^{1+1/2p} \right)$$

for any $p = 3/2, 2, \dots$. On the one hand, from (8.3.53), there exists A' such that

$$(8.3.57) \quad A \gamma_p \frac{\Gamma(a p + a/2 + 1)}{\Gamma(a p + 1/2)} \leq A' p^{a/2-1/2} \quad \forall p = 3/2, 2, \dots$$

On the other hand, thanks to Stirling's formula $n! \sim n^n e^{-n} \sqrt{2\pi n}$ when $n \rightarrow \infty$ and the estimate (8.3.53), there exists $A'' > 0$ such that

$$(8.3.58) \quad (1 - \gamma_p) \Gamma(a p + 1/2)^{1/2p} \geq A'' p^{a/2} \quad \forall p = 3/2, 2, \dots$$

Gathering (8.3.56), (8.3.57) and (8.3.58), we obtain the differential inequality

$$(8.3.59) \quad \frac{dz_p}{dt} \leq \alpha(\mathcal{E}) (A' p^{a/2-1/2} Z_p - A'' p^{a/2} z_p^{1+1/2p})$$

for any $p = 3/2, 2, \dots$

Step 2: Proof of (8.3.49). On the one hand, we remark, by an induction argument, that taking $p_0 := \max\{3/2, (2A'/A'')^2\}$ the sequence of functions $z_p := x^p$ is a sequence of supersolution of (8.3.59) for any $x > 0$ and for $p \geq p_0$. On the other hand, choosing x_0 large enough, which may depend on p_0 , with have from (i) that the sequence of functions $z_p := x^p$ is a sequence of supersolution of (8.3.59) for any $x \geq x_0$ and for $p \in \{3/2, \dots, p_0\}$. As a consequence, since z_p for $p = 0, 1/2, 1$ are bounded by $\|f_{\text{in}}\|_{L^1_2}$, we have proved that there exists x_0 such that the set

$$(8.3.60) \quad \mathcal{C}_x := \left\{ z = (z_p); \quad z_p \leq x^p \quad \forall p \in \frac{1}{2} \mathbb{N} \right\}$$

is invariant under the flow generated by the Boltzmann equation for any $x \geq x_0$: if $f(t_1) \in \mathcal{C}_x$ then $f(t_2) \in \mathcal{C}_x$ for any $t_2 \geq t_1$.

We put $a := 2/\eta \geq 1$. Noticing that

$$(8.3.61) \quad \int_{\mathbb{R}^N} f(v) e^{r|v|^\eta} dv = \sum_{k=0}^{\infty} \frac{r^k}{k!} m_{k\eta/2}$$

we get, from the assumption made on f_{in} , that

$$m_{k/a}(0) \leq C_0 \frac{k!}{r^k} \quad \forall k \in \mathbb{N}.$$

Since we may assume $r \in (0, 1]$, the function $y \mapsto C_0 \Gamma(y+1) r^{-y}$ is increasing, and we deduce by Hölder's inequality that for any p

$$m_p(0) \leq C_0 \frac{\ell_p!}{r^{\ell_p}} \leq C_0 \frac{\Gamma(ap+2)}{r^{ap+2}} \quad \text{with} \quad \ell_p := [ap] + 1.$$

From the definition of z_p we deduce

$$(8.3.62) \quad z_p(0) \leq C_0 \frac{ap(ap+1)}{r^{ap+2}} \leq x_1^p$$

for any p and for some constant $x_1 \in (0, \infty)$. Choosing $x := \max\{x_0, x_1\}$ we get from (8.3.60) and (8.3.62) that for any p

$$z_p(t) \leq x^p \quad \forall t \in [0, T_c).$$

Therefore, we have

$$m_p(t) \leq \Gamma(ap+1/2) x^p \quad \forall p = 3/2, 2, \dots, \quad \forall t \in [0, T_c).$$

The function $y \mapsto \Gamma(y + 1/2) x^y$ being increasing, we deduce from Hölder's inequality that for any $k \in \mathbb{N}^*$

$$m_{k/a}(t) \leq \Gamma(ap+1/2) x^p \leq \Gamma(k+a/2+1/2) x^{k/a+1/2} \quad \text{with } p := [2k/a]/2+1/2.$$

For $r' < 2x^{-1/a}(1+a)^{-1}$ we have

$$\begin{aligned} \forall t \in [0, T_c) \quad \int_{\mathbb{R}^N} f(t, v) e^{r'|v|^n} dv &\leq \sum_{k=0}^{\infty} \frac{\Gamma(k+a/2+1/2)}{k!} x^{k/a+1/2} (r')^k \\ &\leq C \sum_{k=0}^{\infty} \left(\frac{a+1}{2} x^{1/a} r' \right)^k < +\infty \end{aligned}$$

from which (8.3.49) follows.

Step 3: Proof of (8.3.50). Let us fix $\tau \in (0, T_c)$. We claim that there exists x large enough and some increasing sequence of times $(t_p)_{p \geq p_0}$ which is bounded by τ such that for any p

$$(8.3.63) \quad \forall t \in [t_p, T_c) \quad z_p(t) \leq x^p.$$

We already know by classical arguments (see [144, 191]) that for p_0 (defined at the beginning of Step 2) there exists x_1 , larger than x_0 defined in (8.3.60), such that (8.3.63) holds for any $p \leq p_0$ and $t_p = \tau/2$. We then argue by induction, assuming that for $p \geq p_0$ there holds:

$$(8.3.64) \quad z_k \leq x^k \quad \text{on } [t_{p-1/2}, T_c) \quad \forall k \leq p-1/2$$

$$(8.3.65) \quad z_p \geq x^p \quad \text{on } [t_{p-1/2}, t_p),$$

for some $x \geq x_1$ to be defined. If (8.3.65) does not hold, there is nothing to prove thanks to Step 2. Gathering (8.3.64), (8.3.65) with (8.3.59) we get from the definition of p_0 and the fact that $\mathcal{E}(t) \in [\mathcal{E}(\tau), \mathcal{E}(0)]$ so that $\alpha(\mathcal{E}) \geq \alpha_0 > 0$

$$(8.3.66) \quad \frac{dz_p}{dt} \leq -\alpha_0 \frac{A''}{2} p^{a/2} z_p^{1+1/2p} \quad \text{on } (t_{p-1/2}, t_p).$$

Integrating this differential inequality we obtain

$$-z_p^{-\frac{1}{2p}}(t_p) \leq z_p^{-\frac{1}{2p}}(t_{p-1/2}) - z_p^{-\frac{1}{2p}}(t_p) \leq -\frac{1}{2p} \frac{A'' \alpha_0}{2} p^{a/2} (t_p - t_{p-1/2}).$$

Defining (t_p) in the following way:

$$t_0 := \frac{\tau}{2}, \quad t_p := t_{p-1/2} + \frac{\tau}{2} \frac{p^{1-a/2}}{s_a}, \quad s_a := \sum_{p=0}^{\infty} p^{1-a/2}$$

and defining $x_2 := (8s_a)^2 / (A'' \alpha_0 \tau)^2$ we have then proved $z_p(t_p) \leq x_2^p$ and therefore $z_p(t) \leq x^p$ for any $t \geq (t_p, T_c)$ with $x = \max\{x_1, x_2\}$ thanks to Step 2. Setting $a := 2/\eta > 4$ ($\eta < 1/2$) we have

$$(8.3.67) \quad \sum_{k=0}^{\infty} t_{1+k/2} \leq \tau$$

and we conclude as in the end of Step 2. \square

8.3.2 Stability estimate in $L^1_{\frac{1}{2}}$ and proof of the uniqueness part of Theorem 8.1

Proposition 8.4. *Assume that B satisfies (8.3.43)–(8.3.45). For any two solutions f and g of the inelastic Boltzmann equation (8.1.1)–(8.1.2) on $[0, T]$ ($T \leq T_*$) we have*

$$(8.3.68) \quad \begin{aligned} \frac{d}{dt} \int_{\mathbb{R}^N} |f - g| (1 + |v|^2) dv \\ \leq C \gamma_* \int_{\mathbb{R}^N} (f + g) (1 + |v|^3) dv \int_{\mathbb{R}^N} |f - g| (1 + |v|^2) dv. \end{aligned}$$

We deduce that there is $C_T > 0$ depending on B and $\sup_{t \in [0, T]} \|f + g\|_{L^1_{\frac{1}{3}}}$ such that

$$\forall t \in [0, T], \quad \|f_t - g_t\|_{L^1_{\frac{1}{2}}} \leq \|f_{\text{in}} - g_{\text{in}}\|_{L^1_{\frac{1}{2}}} e^{C_T t}.$$

In particular, there exists at most one solution to the Cauchy problem for the inelastic Boltzmann equation in $C([0, T]; L^1_{\frac{1}{2}}) \cap L^1(0, T; L^1_{\frac{1}{3}})$.

Proof of Proposition 8.4. We multiply the equation satisfied by $f - g$ by $\phi(t, y) = \text{sgn}(f(t, y) - g(t, y)) k$, where $k = (1 + |v|^2)$. Using the chain rule (8.1.29), we get for all $t \geq 0$

$$\begin{aligned} \frac{d}{dt} \int_{\mathbb{R}^N} |f - g| k dv &= \frac{1}{2} \int_{\mathbb{R}^N \times \mathbb{R}^N \times D} [(f - g)g_* + f(f_* - g_*)] \\ &\quad (\phi' + \phi'_* - \phi - \phi_*) B(t, u; dz) dv_* dv \\ &= \frac{1}{2} \int_{\mathbb{R}^N \times \mathbb{R}^N \times D} (f - g)(f_* + g_*) \\ &\quad (\phi' + \phi'_* - \phi - \phi_*) B(t, u; dz) dv_* dv \\ &\leq \frac{1}{2} \int_{\mathbb{R}^N \times \mathbb{R}^N \times D} |f - g| (f_* + g_*) \\ &\quad (k' + k'_* - k + k_*) B(t, u; dz) dv_* dv, \end{aligned}$$

where we have just use the symmetry hypothesis (8.3.43), (8.3.44) on B and a change of variable $(v, v_*) \rightarrow (v_*, v)$. Then, thanks to the bounds (8.3.43), (8.3.45) we deduce

$$\begin{aligned} \frac{d}{dt} \int_{\mathbb{R}^N} |f - g| k dv &\leq \gamma_* \int_{\mathbb{R}^N \times \mathbb{R}^N} |u| |f - g| (f_* + g_*) k_* dv_* dv \\ &\leq \gamma_* \int_{\mathbb{R}^N} |f - g| k dv \int_{\mathbb{R}^N} (f_* + g_*) k_*^{3/2} dv_* \end{aligned}$$

which yields the differential inequality (8.3.68). The end of the proof is straightforward by a Gronwall Lemma. \square

The uniqueness in $C([0, T]; L^1_2) \cap L^1(0, T; L^1_3)$ as stated in Theorem 8.1 is given by Proposition 8.4.

8.3.3 Sketch of the proof of the existence part of Theorem 8.1

As for the existence part, we briefly sketch the proof. We follow a method introduced in [144] and developed in [95]. We split the proof in three steps.

Step 1. Let us first consider an initial datum f_{in} satisfying (8.1.9) with $q = 4$ and let us define the truncated collision rates $B_n = B \mathbf{1}_{|u| \leq n}$. The associated collision operators Q_n are bounded in any L^1_q , $q \geq 1$, and are Lipschitz in L^1_2 on any bounded subset of L^1_2 . Therefore following a classical argument from Arkeryd, see [6], we can use the Banach fixed point Theorem and obtain the existence of a solution $0 \leq f_n \in C([0, T]; L^1_2) \cap L^\infty(0, T; L^1_4)$ for any $T > 0$, to the associated Boltzmann equation (8.1.1)-(8.1.2), which satisfies (8.1.30)-(8.1.31).

Step 2. From Proposition 8.2, for any $T > 0$, there exists C_T such that

$$\sup_{[0, T]} \|f_n\|_{L^1_4} \leq C_T.$$

Moreover, coming back to the proof of Proposition 8.4 (see also the first step in the proof of [95, Theorem 2.6]), we may establish the differential inequality

$$\frac{d}{dt} \|f_n - f_m\|_{L^1_2} \leq C_1 \|f_n + f_m\|_{L^1_3} \|f_n - f_m\|_{L^1_2} + \frac{C_2}{n} \|f_n + f_m\|_{L^1_4}^2$$

for any integers $m \geq n$. Gathering these two informations we easily deduce that (f_n) is a Cauchy sequence in $C([0, T]; L^1_2)$ for any $T > 0$. Denoting by

$f \in C([0, T]; L_2^1) \cap L^\infty(0, T; L_4^1)$ its limit, we obtain that f is a solution to the Boltzmann equation (8.1.1)-(8.1.2) associated to the collision rate B and the initial datum f_{in} by passing to the limit in the weak formulation (8.1.28) of the Boltzmann equation written for f_n .

Step 3. When the initial datum f_{in} satisfies (8.1.9) with $q = 3$ we introduce the sequence of initial data $f_{\text{in}, \ell} := f_{\text{in}} \mathbf{1}_{\{|v| \leq \ell\}}$. Since $f_{\text{in}, \ell} \in L_4^1$, the preceding step give the existence of a sequence of solutions $f_\ell \in C([0, T]; L_2^1) \cap L^\infty(0, T; L_3^1)$ for any $T > 0$ to the Boltzmann equation (8.1.1)-(8.1.2) associated to the initial datum $f_{\text{in}, \ell}$. From Proposition 8.2, for any $T > 0$, there exists C_T such that

$$\sup_{[0, T]} \|f_\ell\|_{L_3^1} \leq C_T.$$

Thanks to (8.3.68) we establish that (f_ℓ) is a Cauchy sequence in $C([0, T]; L_2^1)$ and we conclude as before. \square

Remark: Note here that an alternative path to the proof of existence could have been the use of the result of propagation of Orlicz norm which shows here, under the assumptions on B , that the solution is uniformly bounded for $t \in [0, T]$ in a certain Orlicz space. Together with the propagation of moments and Dunford-Pettis Lemma, it would yield the existence of a solution by classical approximation arguments and weak stability results as presented below. More generally the propagation of Orlicz norm by the collision operator can be seen as a new tool (as well as a clarification) for the theory of solutions to the spatially homogeneous Boltzmann equation with no entropy bound, as in the inelastic case, or in the elastic case when the initial datum has infinite entropy, see also [6, 144] where other strategies of proof are presented.

8.4 Proof of the Cauchy theorem for coupled collision rate

8.4.1 Weak stability and proof of the existence part of Theorem 8.2

Proposition 8.5. Consider a sequence $B_n = B_n(t, u; dz)$ of collision rates satisfying the structure conditions (8.3.43)-(8.3.44) and the uniform bound

$$0 \leq \gamma_n(t) \leq \gamma_T \quad \forall t \in [0, T], \quad \forall n \in \mathbb{N}^*,$$

and let us denote by $f_n \in C([0, T]; L_2^1) \cap L^\infty(0, T; L_3^1)$ the solution associated to B_n thanks to the existence result of the preceding section (existence and uniqueness part of Theorem 8.1 and 4th point of the remarks following Theorem 8.1). Assume furthermore that (f_n) belongs to a weak compact set of $L^1((0, T) \times \mathbb{R}^N)$ and that there exists a collision rate B satisfying (8.3.43)-(8.3.45) and such that for any $\psi \in C_c(\mathbb{R}^N)$

$$\gamma_n \rightarrow \gamma \quad \text{and} \quad \int_D \psi(v') b_n(t, u; dz) \rightarrow \int_D \psi(v') b(t, u; dz) \quad \text{a.e.}$$

Then there exists a function $f \in C([0, T]; L_2^1) \cap L^\infty(0, T; L_3^1)$ and a subsequence f_{n_k} such that

$$f_{n_k} \rightharpoonup f \quad \text{weakly in} \quad L^1((0, T) \times \mathbb{R}^N),$$

and f is a solution to the Boltzmann equation (8.1.1)-(8.1.2) associated to B .

Such a stability/compactness result is classical and we refer to [75, 6] for its proof.

Proof of the existence part of Theorem 8.2. We assume without restriction that there exists a decreasing function α_0 such that $\alpha \leq \alpha_0$ on $[0, \mathcal{E}_{\text{in}}]$. We proceed in three steps.

Step 1. We start with some *a priori* bounds. We set $Y_3 := \|f\|_{L_3^1}$. From the Povner inequality (8.3.47) (with $\gamma(t) = \alpha(\mathcal{E}(t))$) and the dissipation of energy equation (8.1.7), we have

$$(8.4.69) \quad \frac{d}{dt} Y_3 \leq C_1 \alpha_0(\mathcal{E}) Y_3, \quad Y_3(0) = Y_3(f_{\text{in}})$$

and

$$(8.4.70) \quad \frac{d}{dt} \mathcal{E} \geq -C_1 \alpha_0(\mathcal{E}) Y_3, \quad \mathcal{E}(0) = \mathcal{E}_{\text{in}},$$

for some constant C_1 (which depends on \mathcal{E}_{in}). There exists T_* such that any solution (Y_3, \mathcal{E}) to the above differential inequalities system is defined on $[0, T_*]$ and satisfies

$$(8.4.71) \quad \sup_{[0, T_*]} Y_3(t) \leq 2 Y_3(f_{\text{in}}), \quad \inf_{[0, T_*]} \mathcal{E}(t) \geq \mathcal{E}_{\text{in}}/2.$$

More precisely, we choose T_* such that

$$C_1 \alpha_0(\mathcal{E}_{\text{in}}/2) T_* \leq Y_3(f_{\text{in}}) \quad \text{and} \quad C_1 \alpha_0(\mathcal{E}_{\text{in}}/2) 2 Y_3(f_{\text{in}}) T_* \leq \mathcal{E}_{\text{in}}/2,$$

in such a way that if (Y_3, \mathcal{E}) satisfies $Y_3 \leq 2Y_3(f_{\text{in}})$ and (8.4.70) on $(0, T_*)$ or if (Y_3, \mathcal{E}) satisfies $\mathcal{E} \geq \mathcal{E}_{\text{in}}/2$ and (8.4.69) on $(0, T_*)$ then (8.4.71) holds. Then we introduce

$$X := \left\{ \mathcal{E} \in C([0, T_*]), \mathcal{E}_{\text{in}}/2 \leq \mathcal{E}(t) \leq \mathcal{E}_{\text{in}} \text{ on } (0, T_*) \right\}.$$

Step 2. Let us consider a function $\mathcal{E}_1 \in X$ and define $B_2(t, u; dz) := B(\mathcal{E}_1(t), u; dz)$. From assumption (8.1.13) we may write

$$B_2(t, u; dz) = |u| \gamma_2(t) b_2(t, u; dz)$$

where b_2 is a probability measure and $\gamma_2(t)$ satisfies

$$\gamma_2(t) = \alpha(\mathcal{E}_1(t)) \leq \alpha_0(\mathcal{E}_{\text{in}}/2) < +\infty \quad \forall t \in [0, T_*].$$

Thanks to Theorem 8.1 there exists a unique solution $f_2 \in C([0, T_*]; L_2^1) \cap L^\infty(0, T_*; L_3^1)$ to the Boltzmann equation (8.1.1)-(8.1.2) associated to the collision rate B_2 and we set $\mathcal{E}_2 := \mathcal{E}(f_2)$. In such a way we have defined a map $\Phi : X \rightarrow X$, $\Phi(\mathcal{E}_1) = \mathcal{E}_2$.

In order to apply the Schauder fixed point Theorem, we aim to prove that Φ is continuous and compact from X to X . Consider (\mathcal{E}_1^n) a sequence of X which uniformly converges to \mathcal{E}_1 . Since (\mathcal{E}_1^n) belongs to the compact set $[\mathcal{E}_{\text{in}}/2, \mathcal{E}_{\text{in}}]$ for any n and any $t \in [0, T_*]$, we deduce by applying Corollary 8.1 to the the sequence (f_2^n) associated to $B_2^n(t, u; dz) = B(\mathcal{E}_1^n(t), u; dz)$ that

$$(8.4.72) \quad \forall n \geq 0, \quad \sup_{[0, T_*]} \int_{\mathbb{R}^N} \Lambda(f_2^n(t, v)) dv \leq C_2,$$

for a superlinear function Λ and a constant $C_2 > 0$. Moreover, from Proposition 8.2 we have

$$(8.4.73) \quad \forall n \geq 0, \quad \sup_{[0, T_*]} \int_{\mathbb{R}^N} f_2^n(t, v) |v|^3 dv \leq C_3$$

for some constant $C_3 > 0$.

On the one hand, gathering (8.4.72), (8.4.73) and using the Dunford-Pettis Lemma, we obtain that (f_2^n) belongs to a weak compact set of $L^1((0, T_*) \times \mathbb{R}^3)$. Proposition 8.5 then implies that there exists $f_2 \in C([0, T_*]; L_2^1) \cap L^\infty(0, T_*; L_3^1)$ such that, up to a subsequence, $f_2^n \rightharpoonup f_2$ weakly in $L^1(0, T; L_2^1)$ and f_2 is a solution to the Boltzmann equation associated to $B_2(t, u; dz) = B(\mathcal{E}_1(t), u; dz)$. Since this limit is unique by the previous study, the whole sequence (f_2^n) converges weakly to f_2 , and in particular

$$(8.4.74) \quad \mathcal{E}_2^n \rightharpoonup \mathcal{E}_2 \text{ weakly in } L^1(0, T)$$

where \mathcal{E}_2 is the kinetic energy of f_2 .

On the other hand, there holds

$$\frac{d}{dt} \mathcal{E}_2^n = - \int_{\mathbb{R}^N \times \mathbb{R}^N} f_2^n f_{2*}^n |u|^3 \beta(\mathcal{E}_1^n, u) dv dv_* =: -D_2^n.$$

Since $\beta(\mathcal{E}_1^n, u) \leq \alpha(\mathcal{E}_1^n)/4 \leq \alpha_0(\mathcal{E}_{\text{in}}/2)/4$, we deduce from (8.2) that D_2^n is bounded in $L^\infty(0, T)$ which in turn implies

$$(8.4.75) \quad \|\mathcal{E}_2^n\|_{W^{1,\infty}(0,T)} \leq C_4.$$

From Ascoli's Theorem we infer that the sequence (\mathcal{E}_2^n) belongs to a compact set of $C([0, T])$. Since the cluster points for the uniform norm are included in the set of cluster points for the L^1 norm, it then follows from (8.4.74) that $\Phi(\mathcal{E}_1^n) = \mathcal{E}(f_2^n)$ converges to $\mathcal{E}(f_2) = \Phi(\mathcal{E}_1)$ for the uniform norm on $C([0, T])$, which ends the proof of the continuity of Φ . Of course, the *a priori* bound (8.4.75) and Ascoli's Theorem also imply that Φ is a compact map on X . We may thus use the Schauder fixed point Theorem to conclude to the existence of at least one $\bar{\mathcal{E}} \in X$ such that $\Phi(\bar{\mathcal{E}}) = \bar{\mathcal{E}}$. Then, the solution $\bar{f} \in C([0, T_*]; L_2^1) \cap L^\infty(0, T_*; L_3^1)$ to the Boltzmann equation associated to $\bar{B}(t, u; dz) := B(\bar{\mathcal{E}}(t), u; dz)$ satisfies

$$\int_{\mathbb{R}^N} \bar{f}(t, v) |v|^2 dv = \Phi(\bar{\mathcal{E}})(t) = \bar{\mathcal{E}}(t)$$

and therefore \bar{f} is a solution to the Boltzmann equation associated to B in $C([0, T_*]; L_2^1) \cap L^\infty(0, T_*; L_3^1)$.

Step 3. We then consider the class of solution $f : (0, T_1) \rightarrow L_3^1$ such that $f \in C([0, T]; L_2^1) \cap L^\infty(0, T; L_3^1)$ for any $T \in (0, T_1)$, \mathcal{E} is decreasing, f is mass conserving. By Zorn's Lemma, there exists a maximal interval $[0, T_c)$ such that

$$(T_c < \infty \text{ and } \mathcal{E}(t) \rightarrow 0 \text{ when } t \rightarrow T_c) \quad \text{or} \quad T_c = \infty.$$

In order to end the proof, the only thing one has to remark is that if $T_c < \infty$ and $\lim_{t \nearrow T_c} \mathcal{E}(t) = \mathcal{E}_c > 0$, then $\lim_{t \nearrow T_c} Y_3(t) < \infty$ (by (8.4.69)) so that $f \in C([0, T_c]; L_2^1) \cap L^\infty(0, T_c; L_3^1)$ and we may extend the solution f to a larger time interval. \square

8.4.2 Strong stability and uniqueness part of Theorem 8.2

In this subsection we give a quantitative stability result in strong sense, under the additional assumption of some smoothness on the initial datum and the collision rate. Let us first prove a simple result of propagation of the total variation of the distribution.

Proposition 8.6. *Let B be a collision rate satisfying assumptions (8.3.43)-(8.3.44)-(8.3.45) and $0 \leq f_{\text{in}} \in BV_4 \cap L^1_5$ an initial datum. Then there exists C_{T_*} , depending on γ_* and $\|f_{\text{in}}\|_{L^1_5}$, such that any solution $f \in C([0, T_*], L^1_2) \cap L^\infty(0, T_*, L^1_3)$ to the Boltzmann equation constructed in the previous step satisfies*

$$\forall t \in [0, T_*], \quad \|f_t\|_{BV_4} \leq \|f_{\text{in}}\|_{BV_4} e^{C_{T_*} t}.$$

Proof of Proposition 8.6. The proof is based on the same kind of Povzner inequality as above. Let us first prove the estimate by *a priori* approach, for the sake of clearness. We have the following formula for the differential of Q :

$$\nabla_v Q(f, f) = Q(\nabla_v f, f) + Q(f, \nabla_v f).$$

This property is proved in the elastic case in [191] but as it is strictly related to the invariance property of the collision operator

$$\tau_h Q(f, f) = Q(\tau_h f, \tau_h f)$$

where the translation operator τ_h is defined by

$$\forall v \in \mathbb{R}^N, \quad \tau_h f(v) = f(v - h).$$

It is easily seen that it remains true in the inelastic case under our assumptions. The propagation of the L^1_5 norm has already been established. Then we estimate the time derivative of the L^1_4 norm of the gradient along the flow:

$$\begin{aligned} \frac{d}{dt} \|\nabla_v f_t\|_{L^1_4} &= \int_{\mathbb{R}^N \times \mathbb{R}^N \times D} f(\nabla_v f_*) \\ &\quad \left[(1 + |v'|^4) \operatorname{sgn}(\nabla_v f)' + (1 + |v_*'|^4) \operatorname{sgn}(\nabla_v f)'_* \right. \\ &\quad \left. - (1 + |v|^4) \operatorname{sgn}(\nabla_v f) - (1 + |v_*|^4) \operatorname{sgn}(\nabla_v f)_* \right] B dv dv_* \\ &\leq \int_{\mathbb{R}^N \times \mathbb{R}^N \times D} f |\nabla_v f_*| \left[(1 + |v'|^4) + (1 + |v_*'|^4) \right. \\ &\quad \left. - (1 + |v|^4) - (1 + |v_*|^4) \right] B dv dv_* \\ &\quad + 4\gamma_* \|f_t(1 + |v|^5)\|_{L^1} \|\nabla_v f(1 + |v|)\|_{L^1} \\ &\leq C \|f_t\|_{L^1_5} \|\nabla_v f\|_{L^1_4} \end{aligned}$$

using a Povzner inequality as in (8.3.46). This shows the *a priori* propagation of the BV_4 norm by a Gronwall argument.

Now let us explain how to obtain the same estimate by *a posteriori* approach. First concerning the *a posteriori* propagation of the L^1_5 norm, it is

similar to the method in [144] and does not lead to any difficulty. Concerning the propagation of BV_4 norm, we look at some “discretized derivative”. Let us denote $k = \text{sgn}(\tau_h f - f)(1 + |v|^4)$. We can compute by the chain rule the following time derivative (using the invariance property of the collision operator)

$$\begin{aligned}
 \frac{d}{dt} \|\tau_h f_t - f_t\|_{L_4^1} &= \int_{\mathbb{R}^N \times \mathbb{R}^N \times D} (\tau_h f \tau_h f_* - f f_*) [k' - k] B dv dv_* \\
 &= \int_{\mathbb{R}^N \times \mathbb{R}^N \times D} (\tau_h f - f) f_* [k' + k'_* - k - k_*] B dv dv_* \\
 &\quad + \frac{1}{2} \int_{\mathbb{R}^N \times \mathbb{R}^N \times D} (\tau_h f - f)(\tau_h f_* - f_*) \\
 &\quad \quad \quad [k' + k'_* - k - k_*] B dv dv_* \\
 &\leq \int_{\mathbb{R}^N \times \mathbb{R}^N \times D} |\tau_h f - f| f_* \\
 &\quad \quad \quad [|v'|^4 + |v'_*|^4 - |v|^4 + |v_*|^4] B dv dv_* \\
 &\quad + \frac{1}{2} \int_{\mathbb{R}^N \times \mathbb{R}^N \times D} |\tau_h f - f| |\tau_h f_* - f_*| \\
 &\quad \quad \quad [|v'|^4 + |v'_*|^4 + |v|^4 + |v_*|^4] B dv dv_*.
 \end{aligned}$$

Then using the same rough Povzner inequality as in the proof of Proposition 8.2, we have

$$[|v'|^4 + |v'_*|^4 - |v|^4 + |v_*|^4] |v - v_*| \leq C (1 + |v|^4)(1 + |v_*|^5)$$

and

$$[|v'|^4 + |v'_*|^4 + |v|^4 + |v_*|^4] \leq C [(1 + |v|^4)(1 + |v_*|^5) + (1 + |v_*|^4)(1 + |v|^5)].$$

Hence we deduce that

$$\frac{d}{dt} \|\tau_h f_t - f_t\|_{L_4^1} \leq C \gamma_* \|\tau_h f_t - f_t\|_{L_4^1} [\|f\|_{L_5^1} + \|\tau_h f_t - f_t\|_{L_5^1}]$$

and for $|h| \leq 1$, we deduce

$$\frac{d}{dt} \|\tau_h f_t - f_t\|_{L_4^1} \leq C \gamma_* \|\tau_h f_t - f_t\|_{L_4^1} \|f\|_{L_5^1}.$$

By a Gronwall argument it shows for any $|h| \leq 1$ that

$$\forall t \in [0, T_*], \quad \|\tau_h f_t - f_t\|_{L_4^1} \leq \|\tau_h f_{\text{in}} - f_{\text{in}}\|_{L_4^1} e^{C \gamma_* t}$$

for a constant C_{T^*} depending on γ_* and $\sup_{t \in [0, T^*]} \|f_t\|_{L^1_3}$. By dividing by h and letting h goes to 0, we conclude that

$$\forall t \in [0, T^*], \quad \|\nabla_v f_t\|_{M^1_4} \leq \|\nabla_v f_{\text{in}}\|_{M^1_4} e^{C_{T^*} t}$$

which ends the proof. \square

Now let us assume that the collision rate satisfies (8.1.10)–(8.1.14) plus the additional assumption **H1**: the measure b reduces to a mesure on the sphere $C_{u, \varepsilon}$ with $e(\mathcal{E}), \alpha(\mathcal{E}) : (0, +\infty) \rightarrow [0, 1]$ locally Lipschitz functions. Let us take $f_{\text{in}} \in BV_4 \cap L^1_3$ and let us consider two solutions $f, g \in C([0, T_c]; L^1_2) \cap L^\infty(0, T; L^1_3)$ constructed by the previous steps. For these two solutions the function $e(\mathcal{E})$ is locally Lipschitz, so is the function $\beta(\mathcal{E})$ and the differential equation (8.1.7) satisfied by $\mathcal{E}(f_t)$ on $[0, T^*]$ implies that it is bounded from below on this interval. Thus thanks to the continuity of α , the assumptions of Proposition 8.6 are satisfied, and thus the BV_4 norm is bounded on any time interval $[0, T^*] \subset [0, T_c]$.

Proposition 8.7. *Let B be a collision rate satisfying (8.1.10)–(8.1.14) plus the additionnal assumption **H1**. Let $f, g \in C([0, T^*]; L^1_2) \cap L^\infty(0, T^*; L^1_3)$ be two solutions with mass 1 and momentum 0, with initial data f_{in} and g_{in} , and such that $\mathcal{E}(f_t), \mathcal{E}(g_t) \in K$ on $[0, T^*]$ with K compact of $(0, +\infty)$ and*

$$\forall t \in [0, T^*], \quad \|f_t\|_{BV_4}, \|g_t\|_{BV_4} \leq C_{T^*}.$$

Then there is a constant C'_{T^} depending on B, K and C_{T^*} such that*

$$\forall t \in [0, T^*], \quad \|f_t - g_t\|_{L^1_2} \leq \|f_{\text{in}} - g_{\text{in}}\|_{L^1_2} e^{C'_{T^*} t}.$$

Proof of Proposition 8.7. Let us denote Q_f (resp. Q_g) the collision operator with collision rate associated with $\mathcal{E} = \mathcal{E}(f_t)$ (resp. $\mathcal{E} = \mathcal{E}(g_t)$). Without restriction we assume by symmetrization that b has its support included in $\hat{u} \cdot \sigma \leq 0$.

Let us denote $D = f - g$ and $S = f + g$. The evolution equation on D writes

$$\frac{\partial}{\partial t} D = \frac{1}{2} [Q_f(D, S) + Q_f(S, D)] + [Q_f(g, g) - Q_g(g, g)]$$

and thus the time derivative of the L_2^1 norm of D is

$$\begin{aligned}
 \frac{d}{dt} \|D\|_{L_2^1} &= \frac{1}{2} \int_{\mathbb{R}^N \times \mathbb{R}^N \times \mathbb{S}^{N-1}} S D_* \left[(1 + |v|^2) \operatorname{sgn}(D') + (1 + |v'_*|^2) \operatorname{sgn}(D'_*) \right. \\
 &\quad \left. - (1 + |v|^2) \operatorname{sgn}(D) - (1 + |v_*|^2) \operatorname{sgn}(D)_* \right] \\
 &\quad |u| \tilde{b}(\mathcal{E}(f_t), \hat{u} \cdot \sigma) dv dv_* d\sigma \\
 &+ \int_{\mathbb{R}^N \times \mathbb{R}^N \times \mathbb{S}^{N-1}} gg_* \left[(1 + |v'_{e(f_t)}|^2) \operatorname{sgn}(D'_{e(f_t)}) \tilde{b}(\mathcal{E}(f_t), \hat{u} \cdot \sigma) \right. \\
 &\quad \left. - (1 + |v'_{e(g_t)}|^2) \operatorname{sgn}(D'_{e(g_t)}) \tilde{b}(\mathcal{E}(g_t), \hat{u} \cdot \sigma) \right] |u| dv dv_* d\sigma \\
 &- \int_{\mathbb{R}^N \times \mathbb{R}^N \times \mathbb{S}^{N-1}} gg_* (1 + |v|^2) \operatorname{sgn}(D) |u| \\
 &\quad \left[\tilde{b}(\mathcal{E}(f_t), \hat{u} \cdot \sigma) - \tilde{b}(\mathcal{E}(g_t), \hat{u} \cdot \sigma) \right] dv dv_* d\sigma \\
 &=: I_1 + I_2 + I_3
 \end{aligned}$$

(the subscripts recall that the post-collisional velocities depend on the choice of the restitution coefficient e). The first term is easily dealt with by the same arguments as in the non-coupled case:

$$\begin{aligned}
 I_1 &\leq \int_{\mathbb{R}^N \times \mathbb{R}^N \times \mathbb{S}^{N-1}} S |D_*| (1 + |v|^2) |u| \tilde{b}(\mathcal{E}(f_t), \hat{u} \cdot \sigma) dv dv_* d\sigma \\
 &\leq \alpha(\mathcal{E}(f_t)) \|S\|_{L_3^1} \|f_t - g_t\|_{L_1^1}.
 \end{aligned}$$

The third term I_3 is controlled by

$$I_3 \leq |\alpha(\mathcal{E}(f_t)) - \alpha(\mathcal{E}(g_t))| \|g\|_{L_3^1} \|g\|_{L_1^1}$$

and using that α is locally Lipschitz on K we get

$$I_3 \leq C_K |\mathcal{E}(f_t) - \mathcal{E}(g_t)| \|g\|_{L_3^1} \|g\|_{L_1^1} \leq C_K \|f_t - g_t\|_{L_2^1} \|g\|_{L_3^1} \|g\|_{L_1^1}$$

for some constant C_K depending on α and K .

As for the second term I_2 , we use the change of variable $v_* \rightarrow v'$ with v, σ fixed and e given. This change of variable depends on e and we denote $v_* = \phi_{\sigma, e}(v, v')$. Let us denote the jacobian J_e . This jacobian is computed in [100]:

$$(8.4.76) \quad J_e(\cos \theta) = \left(\frac{1+e}{4} \right)^N (1 - \cos \theta)$$

and thus since by symmetrization we suppose here that $\theta \in [\pi/2, \pi]$, we have

$$(8.4.77) \quad \forall \epsilon \in [0, 1], \forall \theta \in [0, \pi], \quad J_\epsilon(\cos \theta) \in \left[\left(\frac{1}{4}\right)^N, 2 \left(\frac{1}{2}\right)^N \right].$$

Thus we get

$$I_2 = \int_{\mathbb{R}^N \times \mathbb{R}^N \times \mathbb{S}^{N-1}} g(1 + |v'|^2) \operatorname{sgn}(D') |u| \left[g(\phi_{\sigma, \epsilon(f_t)}(v, v')) J_{\epsilon(f_t)}(\cos \theta) - g(\phi_{\sigma, \epsilon(g_t)}(v, v')) J_{\epsilon(g_t)}(\cos \theta) \right] \tilde{b}(\mathcal{E}, \cos \theta) dv dv' d\sigma.$$

So we can split this term as

$$\begin{aligned} I_2 &= \int_{\mathbb{R}^N \times \mathbb{R}^N \times \mathbb{S}^{N-1}} g(1 + |v'|^2) \operatorname{sgn}(D') |u| \left[g(\phi_{\sigma, \epsilon(f_t)}(v, v')) - g(\phi_{\sigma, \epsilon(g_t)}(v, v')) \right] J_{\epsilon(f_t)}(\cos \theta) \tilde{b}(\mathcal{E}, \cos \theta) dv dv' d\sigma \\ &\quad + \int_{\mathbb{R}^N \times \mathbb{R}^N \times \mathbb{S}^{N-1}} g(1 + |v'|^2) \operatorname{sgn}(D') |u| \left[J_{\epsilon(f_t)}(\cos \theta) - J_{\epsilon(g_t)}(\cos \theta) \right] g(\phi_{\sigma, \epsilon(g_t)}(v, v')) \tilde{b}(\mathcal{E}, \cos \theta) dv dv' d\sigma \\ &= I_{2,1} + I_{2,2}. \end{aligned}$$

For the term $I_{2,2}$ we use that, from the formula (8.4.76) and the fact that $\mathcal{E} \mapsto \epsilon(\mathcal{E})$ is locally Lipschitz,

$$\begin{aligned} \left| J_{\epsilon(f_t)}(\cos \theta) - J_{\epsilon(g_t)}(\cos \theta) \right| &\leq C |e(f_t) - e(g_t)| \\ &\leq C_K \|\mathcal{E}(f_t) - \mathcal{E}(g_t)\|_{L^1_2} \leq C_K \|f_t - g_t\|_{L^1_2}. \end{aligned}$$

Then doing the (elastic) change of variable backward $v' \rightarrow v_*$ (whose jacobian is bounded by (8.4.77)) we get

$$I_{2,2} \leq C_K \|f_t - g_t\|_{L^1_2} \|g\|_{L^1_3} \|g\|_{L^1_1}.$$

We now aim to prove that for any functions f, g which energies \mathcal{E}_f and \mathcal{E}_g belong to a compact $K \subset (0, \infty)$ there exists a constant C_K such that the following functional inequality holds

$$(8.4.78) \quad I_{2,1} \leq C_K \|f_t - g_t\|_{L^1_2} \|g\|_{L^1_4} \|g\|_{BV_4}.$$

Let first assume that f and g are smooth functions, say $f, g \in \mathcal{D}(\mathbb{R}^N)$. We have

$$\begin{aligned} \left| g(\phi_{\sigma, e(f_t)}(v, v')) - g(\phi_{\sigma, e(g_t)}(v, v')) \right| &\leq \|\phi_{\sigma, e(f_t)}(v, v') - \phi_{\sigma, e(g_t)}(v, v')\| \\ &\quad \left(\int_0^1 \left| \nabla_v g((1-t)\phi_{\sigma, e(f_t)}(v, v') + t\phi_{\sigma, e(g_t)}(v, v')) \right| dt \right). \end{aligned}$$

As for the difference $|\phi_{\sigma, e(f_t)}(v, v') - \phi_{\sigma, e(g_t)}(v, v')|$, it is easy to see that for some fixed v, v', σ the corresponding $v_* = \phi_{\sigma, e}(v, v')$ are aligned for any e (on the line determined by the plan defined by v, v', σ and the direction defined by the angle $\theta/2$ between $v' - v$ and $v_* - v$). Thus it remains to look for the algebraic length of $[\phi_{\sigma, e(f_t)}(v, v'), \phi_{\sigma, e(g_t)}(v, v')]$ on this line, which is given explicitly in [100]:

$$|\phi_{\sigma, e(f_t)}(v, v') - \phi_{\sigma, e(g_t)}(v, v')| = \frac{|v - v'|}{\cos \theta/2} \frac{2|e(f_t) - e(g_t)|}{(1 + e(f_t))(1 + e(g_t))}.$$

Thus we get

$$|\phi_{\sigma, e(f_t)}(v, v') - \phi_{\sigma, e(g_t)}(v, v')| \leq C_K |u| \|f_t - g_t\|_{L^1_2}$$

and the term $I_{2,1,1}$ is controlled by (using the uniform bound (8.4.77) on $J_{e(f_t)}(\cos \theta)$)

$$\begin{aligned} I_{2,1,1} &\leq C_K \|f_t - g_t\|_{L^1_2} \int_0^1 \int_{\mathbb{R}^N \times \mathbb{R}^N \times \mathbb{S}^{N-1}} g(1 + |v'|^2) |u|^2 \\ &\quad \left| \nabla_v g((1-t)\phi_{\sigma, e(f_t)}(v, v') + t\phi_{\sigma, e(g_t)}(v, v')) \right| b(\cos \theta) dv dv' d\sigma dt \end{aligned}$$

Finally for any $t \in [0, 1]$ we want to perform the change of variable

$$(8.4.79) \quad v' \rightarrow (1-t)\phi_{\sigma, e(f_t)}(v, v') + t\phi_{\sigma, e(g_t)}(v, v').$$

Some tedious but elementary computations yields

$$\phi_{\sigma, e}(v, v') = v - \frac{4|v - v'|}{1 + e} \left[\frac{\sigma}{2 \cos \theta/2} + \frac{v - v'}{|v - v'|} \right].$$

We deduce that

$$(1-t)\phi_{\sigma, e_1}(v, v') + t\phi_{\sigma, e_2}(v, v') = \phi_{\sigma, e_0}(v, v')$$

with

$$e_0 = \frac{te_1 + (1-t)e_2 + e_1e_2}{1 + (1-t)e_1 + te_2} \in [\min\{e_1, e_2\}, \max\{e_1, e_2\}].$$

Thus we deduce that the jacobian of the change of variable (8.4.79) is given by

$$(J_{e(f_t, g_t)}(\cos \theta))^{-1} \quad \text{with} \quad e(f_t, g_t) = \frac{te(f_t) + (1-t)e(g_t) + e(f_t)e(g_t)}{1 + (1-t)e(f_t) + te(g_t)}$$

and thus is uniformly bounded thanks to (8.4.76). Therefore we obtain (8.4.78) for smooth functions. When $f, g \in BV_4$ we argue by density, introducing two sequences of smooth functions (f_n) and (g_n) which converge respectively to f and g in L^1 and are bounded in BV_4 , we pass to the limit $n \rightarrow \infty$ in the functional inequality (8.4.78) written for the functions f_n and g_n . We then easily conclude that (8.4.78) also holds for f and g .

Collecting all the terms we thus get

$$\frac{d}{dt} \|f_t - g_t\|_{L^1_2} \leq C'_{T_*} \|f_t - g_t\|_{L^1_2}$$

where C'_{T_*} depends on K, b and some uniform bounds on $\|f\|_{L^1_4}$ and $\|g\|_{BV_4}$. This concludes the proof by a Gronwall argument. \square

The uniqueness part of Theorem 8.2 follows straightforwardly from Proposition 8.7 and the discussion made just before its statement.

8.5 Study of the cooling process

In this section we prove the cooling asymptotic as stated in point (ii) of Theorem 8.1 and points (iii), (iv), (v) of Theorem 8.2. We first prove the collapse of the distribution function in the sense of weak * convergence to the Dirac mass in the set of measures.

Proposition 8.8. *Let $T_c \in (0, +\infty]$ be the time of life of the solution. Under the sole additional assumption **H2**, there holds*

$$(8.5.80) \quad f(t, \cdot) \xrightarrow[t \rightarrow T_c]{} \delta_{v=0} \quad \text{weakly * in } M^1(\mathbb{R}^N).$$

Proof of Proposition 8.8. We split the proof in two steps.

Step 1. Assume first that $\mathcal{E} \rightarrow 0$ when $t \rightarrow T_c$. This includes the case when $T_c < +\infty$ (since the convergence to 0 of the kinetic energy follows from the existence proof in this case) and it will be established under additional assumptions on B when $T_c = +\infty$ but probably holds true under the sole assumption **H2** in this case as well. For any $0 \leq \varphi \in \mathcal{D}(\mathbb{R}^N \setminus \{0\})$, there exists

$r > 0$ such that $\varphi = 0$ on $D(0, r)$ and then, there exists $C_\varphi = C_\varphi(r, \|\varphi\|_\infty)$ such that $|\varphi(v)| \leq C_\varphi |v|^2$. As a consequence,

$$\int_{\mathbb{R}^N} f \varphi \, dv \leq C_\varphi \mathcal{E}(t) \rightarrow 0,$$

from which we deduce that any weak * limit $\bar{\mu}$ of f in M^1 satisfies $\text{supp } \bar{\mu} \subset \{0\}$. Therefore, (8.5.80) follows using the conservations (8.1.30) and the energy bound (8.1.31).

Step 2. Assume next that $\mathcal{E} \rightarrow \mathcal{E}_\infty > 0$ (and thus also $T_c = +\infty$). Then for a fixed time $T > 0$ and for any non-negative sequence (t_n) increasing and going to $+\infty$, there exists a subsequence (t_{n_k}) and a measure $\bar{\mu} \in L^\infty(0, T; M_2^1)$ such that the function $f_k(t, v) := f(t_{n_k} + t, v)$ satisfies

$$(8.5.81) \quad f_k \rightharpoonup \bar{\mu} \text{ weakly * in } L^\infty(0, T; M^1).$$

Moreover, for any $\varphi \in C_c(\mathbb{R}^N)$, there holds

$$\frac{d}{dt} \int_{\mathbb{R}^N} f_k \varphi \, dv = \langle Q(f_k, f_k), \varphi \rangle \quad \text{on } (0, T),$$

with $\langle Q(f_k, f_k), \varphi \rangle$ bounded in $L^\infty(0, T)$. From Ascoli's Theorem, we get

$$\int_{\mathbb{R}^N} f_k \varphi \, dv \rightarrow \int_{\mathbb{R}^N} \varphi \, d\bar{\mu}(v) \quad \text{uniformly on } [0, T].$$

As a consequence, for any given function $\chi_\varepsilon \in C_c(\mathbb{R}^3 \times \mathbb{R}^3)$ such that $0 \leq \chi_\varepsilon \leq 1$ and $\chi_\varepsilon(v, v_*) = 1$ for every (v, v_*) such that $|v| \leq \varepsilon^{-1}$ and $|v_*| \leq \varepsilon^{-1}$ we may pass to the limit (using the continuity of $\beta = \beta(\mathcal{E}, u)$ which is uniform on the compact set determined by $[\mathcal{E}_\infty, \mathcal{E}_0]$ and the support of χ_ε)

$$(8.5.82) \quad \int_0^T D_\varepsilon(f_k) \, dt \xrightarrow{k \rightarrow +\infty} \int_0^T \int_{\mathbb{R}^N \times \mathbb{R}^N} |u|^3 \beta(\mathcal{E}_\infty, u) \chi_\varepsilon(v, v_*) \, d\bar{\mu} \, d\bar{\mu}_* \, dt,$$

where we have defined for any measure (or function) λ :

$$D_\varepsilon(\lambda) := \int_{\mathbb{R}^N \times \mathbb{R}^N} |u|^3 \beta(\mathcal{E}, u) \chi_\varepsilon(v, v_*) \, d\lambda(v) \, d\lambda(v_*).$$

From the dissipation of energy (8.1.7) and the estimate from below (8.1.18), there holds

$$\frac{d}{dt} \mathcal{E}(t) \leq -D(f) \quad \text{with} \quad D(f) := \int_{\mathbb{R}^N \times \mathbb{R}^N} |u|^3 \beta(\mathcal{E}, u) f f_* \, dv \, dv_*,$$

which in turn implies that $t \mapsto D(f(t, \cdot)) \in L^1(0, \infty)$, and then

$$(8.5.83) \quad \int_0^T D_\varepsilon(f_k) dt \leq \int_0^T D(f_k) dt = \int_{t_{n_k}}^{t_{n_k}+T} D(f) dt \xrightarrow[k \rightarrow \infty]{} 0.$$

Gathering (8.5.82) and (8.5.83), and letting ε goes to 0, we deduce that

$$\int_{\mathbb{R}^N \times \mathbb{R}^N} |u|^3 \beta(\mathcal{E}_\infty, u) d\bar{\mu} d\bar{\mu}_* = 0 \quad \text{on } (0, T).$$

The positivity (8.1.17) of $\beta(\mathcal{E}_\infty, u)$ then implies that $\bar{\mu} = \bar{c} \delta_{v=\bar{w}}$ for some measurable functions $\bar{w} : (0, T) \rightarrow \mathbb{R}^N$ and $\bar{c} : (0, T) \rightarrow \mathbb{R}_+$. Moreover, from the conservation of mass and momentum (8.1.30) and the bound of energy (8.1.31) we deduce that $\bar{c} = 1$ and $\bar{w} = 0$ a.e. It is then classical to deduce (by the uniqueness of the limit and the fact that it is independent on time) that (8.5.80) holds. \square

To conclude that this weak convergence of the distribution to the Dirac mass as time goes to infinity implies the convergence of the kinetic energy to 0 (i.e. the kinetic energy of the Dirac mass) we have to show that no kinetic energy is lost at infinity as $t \rightarrow T_c$. To this purpose we put stronger assumptions on the collision rate. The first additional assumption **H3** roughly speaking means that the energy dissipation functional is strong enough to forbid it, whereas the second additional assumption **H4** allows to use the uniform propagation of moments of order strictly greater than 2 to forbid it.

Proposition 8.9. *Let $T_c \in (0, +\infty]$ be the time of life of the solution. Then if either $T_c < +\infty$, or $T_c = +\infty$ and B satisfies additional assumptions **H2-H3** or **H2-H4**, we have*

$$(8.5.84) \quad \mathcal{E}(t) \rightarrow 0 \quad \text{when } t \rightarrow T_c.$$

Proof of Proposition 8.9. We split the proof in three steps.

Step 1. Assume first $T_c < +\infty$. The claim follows from the existence proof.

Step 2. Assume now $T_c = +\infty$ and that B satisfies assumption **H3**: (8.1.18)-(8.1.19). We argue by contradiction: assume that $\mathcal{E}(t) \not\rightarrow 0$, that is, there exists $\mathcal{E}_\infty > 0$ such that $\mathcal{E}(t) \in (\mathcal{E}_\infty, \mathcal{E}_{\text{in}})$. Reasoning as in Proposition 8.8, we get, for a fixed time $T > 0$ and for any sequence (t_n) increasing and going to $+\infty$, that there exists a subsequence (t_{n_k}) and a measure

$\bar{\mu} \in L^\infty(0, T; M_2^1)$ such that the function $f_k(t, v) := f(t_{n_k} + t, v)$ satisfies (8.5.81) and

$$(8.5.85) \quad \int_0^T D_\varepsilon^0(f_k) dt \rightarrow \int_0^T D_\varepsilon^0(\bar{\mu}) dt,$$

where we have defined for any measure (or function) λ :

$$D_\varepsilon^0(\lambda) := \int_{\mathbb{R}^N \times \mathbb{R}^N} |u|^3 \psi(|u|) \chi_\varepsilon(v, v_*) d\lambda(v) d\lambda(v_*).$$

From the dissipation of energy (8.1.7) and the estimate from below (8.1.18), there holds

$$(8.5.86) \quad \frac{d}{dt} \mathcal{E}(t) \leq -D^0(f) \quad \text{with} \quad D^0(f) := \int_{\mathbb{R}^N \times \mathbb{R}^N} |u|^3 \psi(|u|) f f_* dv dv_*,$$

which in turn implies that $t \mapsto D^0(f(t, \cdot)) \in L^1(0, \infty)$, and then

$$(8.5.87) \quad \int_0^T D_\varepsilon^0(f_k) dt \leq \int_0^T D_0(f_k) dt = \int_{t_{n_k}}^{t_{n_k}+T} D_0(f) dt \xrightarrow[k \rightarrow \infty]{} 0.$$

Gathering (8.5.85) and (8.5.87), and letting ε goes to 0, we deduce that $D^0(\bar{\mu}) = 0$ on $(0, T)$. The positivity of ψ implies as in Proposition 8.8 that $\text{supp } \bar{\mu} \subset \{0\}$ and $\bar{\mu} = \delta_{v=0}$. As this limit is unique and independent on time we deduce that (8.5.80) holds.

Now, on the one hand, taking $R = \sqrt{\mathcal{E}_\infty/2}$ there holds

$$(8.5.88) \quad \int_{B_R^c} f |v|^2 dv = \int_{\mathbb{R}^N} f |v|^2 dv - \int_{B_R} f |v|^2 dv \geq \mathcal{E}_\infty - R^2 \geq \mathcal{E}_\infty/2$$

for any $t \geq 0$. On the other hand, for T large enough, there holds thanks to (8.5.80)

$$(8.5.89) \quad \int_{B_{R/2}} f dv \geq \frac{1}{2} \quad \text{for any } t \geq T.$$

Remarking that on $B_{R/2} \times B_R^c$ there holds, thanks to (8.1.19),

$$(8.5.90) \quad |u|^3 \psi(|u|) \geq \frac{|v_*|^3}{8} \psi\left(\frac{|v_*|}{2}\right) \geq \psi_R \frac{|v_*|^2}{4},$$

we may put together (8.5.86)-(8.5.90) and we get thanks to (8.5.88) and (8.5.89)

$$\begin{aligned} \frac{d}{dt} \mathcal{E}(t) &\leq - \int_{B_{R/2}} \int_{B_R^c} |v - v_*|^3 \psi(|v - v_*|) f f_* dv dv_* \\ &\leq - \frac{\psi_R}{4} \int_{B_{R/2}} f dv \int_{B_R^c} f_* |v_*|^2 dv_* \leq - \frac{\psi_R}{4} \frac{1}{2} \frac{\mathcal{E}_\infty}{2} \end{aligned}$$

for any $t \geq T$. This implies that \mathcal{E} becomes negative in finite time and we get a contradiction.

Step 3. Finally, assume that $T_c = +\infty$ and B satisfies assumption **H4**. On the one hand, thanks to (8.3.48), there holds

$$\sup_{[0, \infty)} \int_{\mathbb{R}^N} f(t, v) |v|^3 dv < \infty.$$

On the other hand, arguing as in Step 2, we obtain (keeping the same notations) that (8.5.81) and then (from the uniform bound in L^1_3)

$$\mathcal{E}(f_k) \rightarrow \bar{\mathcal{E}} = \mathcal{E}(\bar{\mu}) \quad \text{and} \quad D(\bar{\mu}) = 0.$$

The dissipation of energy vanishing implies that

$$|u|^3 \mu \mu_* \equiv 0 \quad \text{or} \quad \beta(\bar{\mathcal{E}}, u) \text{ is not positive on } (0, T) \times \mathbb{R}^{2N}.$$

In the first case we deduce that $\bar{\mu} = \delta_{v=0}$ as in Step 2 and then $\bar{\mathcal{E}} = \mathcal{E}(\delta_{v=0}) = 0$. In the second case we deduce, from (8.1.17), that $\bar{\mathcal{E}}$ is not positive. In both case, there exists τ_k such that $\tau_k \rightarrow \infty$ and $\mathcal{E}(\tau_k) \rightarrow 0$ and therefore (8.9) holds since \mathcal{E} is decreasing. \square

Now we turn to some criterions for the cooling process to occur or not in finite time.

Proposition 8.10. *Assume that α is bounded near $\mathcal{E} = 0$, and $j_\mathcal{E}$ converges to 0 as $\varepsilon \rightarrow 0$ uniformly near $\mathcal{E} = 0$, then $T_c = +\infty$.*

Proof of Proposition 8.10. It is enough to remark that, thanks to the hypothesis made on α and $j_\mathcal{E}$, the *a priori* bound in Orlicz norm that one deduces from (8.2.42) as in Corollary 8.1 extends to all times:

$$\forall t \geq 0 \quad \|f_t\|_{L^\Lambda} \leq \|f_{\text{in}}\|_{L^\Lambda} \exp\left(C \|f_{\text{in}}\|_{L^1_2} t\right)$$

for some constant C depending on the collision rate. It shows that the energy cannot vanish in finite time. \square

Proposition 8.11. *Assume that for some increasing and positive function β_0 there holds $\beta(\mathcal{E}, u) \leq \beta_0(\mathcal{E})$ for any $u \in \mathbb{R}^N$, $\mathcal{E} \geq 0$ and that $f_{\text{in}} e^{r|v|^\eta} \in L^1$ for some $r > 0$ and $\eta \in (1, 2]$, then $T_c = +\infty$.*

Proof of Proposition 8.11. From the dissipation of energy (8.1.7), the bound on β and the decrease of the energy (8.1.31), we have

$$\frac{d\mathcal{E}}{dt} \geq -\beta_0(\mathcal{E}_{\text{in}}) \int_{\mathbb{R}^N} \int_{\mathbb{R}^N} f f_* |u|^3 dv dv_* =: -\beta_0(\mathcal{E}_{\text{in}}) (I_{1,R} + I_{2,R})$$

where

$$\begin{cases} I_{1,R} := \int_{\mathbb{R}^N \times \mathbb{R}^N} |u|^3 \mathbf{1}_{\{|u| \leq R\}} f f_* dv dv_* \\ I_{2,R} := \int_{\mathbb{R}^N \times \mathbb{R}^N} |u|^3 \mathbf{1}_{\{|u| \geq R\}} f f_* dv dv_* \end{cases}$$

On the one hand, for any $R > 0$, we have using (8.1.30)

$$I_{1,R} \leq R \int_{\mathbb{R}^N \times \mathbb{R}^N} |u|^2 f f_* dv dv_* = 2 R \mathcal{E}.$$

On the other hand, we infer from Proposition 8.3 that

$$\sup_{t \in [0, T_c)} \int_{\mathbb{R}^N} f(t, v) e^{2r'|v|^\eta} dv \leq C_1$$

for some $r', C_1 \in (0, \infty)$. Therefore

$$\begin{aligned} I_{2,R} &\leq \int_{\mathbb{R}^N \times \mathbb{R}^N} (4|v|^3 + 4|v_*|^3) 2 \mathbf{1}_{\{|v| > R/2\}} f f_* dv dv_* \\ &\leq 8 e^{-r' R^\eta} \int_{\mathbb{R}^N} (1 + |v|^3) e^{r'|v|^\eta} f dv \int_{\mathbb{R}^N} (1 + |v_*|^3) f_* dv_* \leq C_2 e^{-r' R^\eta}. \end{aligned}$$

Gathering these three estimates, we deduce

$$\frac{d}{dt} \mathcal{E} \geq -C_3 R \mathcal{E} - C_3 e^{-r' R^\eta},$$

which in turns implies, thanks to the Gronwall Lemma,

$$\forall R > 0, \quad \inf_{t \in [0, T]} \mathcal{E}(t) \geq \mathcal{E}_{\text{in}} e^{-C_3 R T} - \frac{e^{-r' R^\eta}}{R}.$$

We conclude that $\mathcal{E}(t) > 0$ for any $t \in [0, T]$ and any fixed $T > 0$, choosing R large enough (using that $\eta > 1$). \square

Proposition 8.12. *Assume $\beta(\mathcal{E}, u) \geq \beta_0 \mathcal{E}^\delta$ with $\beta_0 > 0$ and $\delta < -1/2$, then $T_c < +\infty$.*

Proof of Proposition 8.12. On the one hand, from the dissipation of energy (8.1.7) and the bound on β , we have

$$\frac{d\mathcal{E}}{dt} \leq -\beta_0 \mathcal{E}^\delta \int_{\mathbb{R}^N} \int_{\mathbb{R}^N} f f_* |u|^3 dv dv_*.$$

On the other hand, from Jensen's inequality and the conservation of mass and momentum, there holds

$$\int_{\mathbb{R}^N} \int_{\mathbb{R}^N} f f_* |u|^3 dv dv_* \geq \left(\int_{\mathbb{R}^N} \int_{\mathbb{R}^N} f f_* |u|^2 dv dv_* \right)^{3/2} = (2\mathcal{E})^{3/2}.$$

Gathering these two estimates, we get

$$\frac{d}{dt} \mathcal{E} \leq -\beta_0 \mathcal{E}^{\delta+3/2}$$

and \mathcal{E} vanishes in finite time. \square

8.6 Appendix: Some facts about Orlicz spaces

The goal of this appendix is to gather some results about Orlicz spaces in order to make this paper as self-contained as possible. The definition and Hölder's inequality are recalls of results which can be found in [170] for instance. We also state and prove a simple formula for the differential of Orlicz norms, which is most probably not new, but for which we were not able to find a reference.

Definition

We recall here the definition of Orlicz spaces on \mathbb{R}^N according to the Lebesgue measure. Let $\Lambda : \mathbb{R}_+ \rightarrow \mathbb{R}_+$ be a function C^2 strictly increasing, convex, such that

$$(8.6.91) \quad \Lambda(0) = \Lambda'(0) = 0,$$

$$(8.6.92) \quad \forall t \geq 0, \quad \Lambda(2t) \leq c_\Lambda \Lambda(t),$$

for some constant $c_\Lambda > 0$, and which is superlinear, in the sense that

$$(8.6.93) \quad \frac{\Lambda(t)}{t} \xrightarrow[t \rightarrow +\infty]{} +\infty.$$

We define L^Λ the set of measurable functions $f : \mathbb{R}^N \rightarrow \mathbb{R}$ such that

$$\int_{\mathbb{R}^N} \Lambda(|f(v)|) dv < +\infty.$$

Then L^Λ is a Banach space for the norm

$$\|f\|_{L^\Lambda} = \inf \left\{ \lambda > 0 / \int_{\mathbb{R}^N} \Lambda \left(\frac{|f(v)|}{\lambda} \right) dv \leq 1 \right\}$$

and it is called the *Orlicz space* associated with Λ . The proof of this last point can be found in [170, Chapter III, Theorem 3]. Note that the usual Lebesgue spaces L^p for $1 \leq p < +\infty$ are recovered as particular cases of this definition for $\Lambda(t) = t^p$.

Let us mention that for any $f \in L^1(\mathbb{R}^N)$, a refined version of the De la Vallée-Poussin theorem [127, Proposition I.1.1] (see also [125, 126]) guarantees that there exists a function Λ satisfying all the properties above and such that

$$\int_{\mathbb{R}^N} \Lambda(|f(v)|) dv < +\infty.$$

Hölder's inequality in Orlicz spaces

Let Λ be a function C^2 strictly increasing, convex satisfying the assumptions (8.6.91), (8.6.92) and (8.6.93), and Λ^* its *complementary Young function*, given (when Λ is C^1) by

$$\forall y \geq 0, \quad \Lambda^*(y) = y(\Lambda')^{-1}(y) - \Lambda((\Lambda')^{-1}(y)).$$

It is straightforward to check that Λ^* satisfies the same assumptions as Λ . Recall Young's inequality

$$(8.6.94) \quad \forall x, y \geq 0, \quad xy \leq \Lambda(x) + \Lambda^*(y).$$

Then one can define the following norm on the Orlicz space L^{Λ^*} :

$$N^{\Lambda^*}(f) = \sup \left\{ \int_{\mathbb{R}^N} |fg| dv ; \int_{\mathbb{R}^N} \Lambda(|g|) dv \leq 1 \right\}.$$

One can extract from [170, Chapter III, Section 3.4, Propositions 6 and 9] the following result

Theorem 8.5. (i) We have the following Hölder's inequality for any $f \in L^\Lambda$, $g \in L^{\Lambda^*}$:

$$(8.6.95) \quad \int_{\mathbb{R}^N} |fg| dv \leq \|f\|_{L^\Lambda} N^{\Lambda^*}(g).$$

(ii) There is equality in (8.6.95) if and only if there is a constant $0 < k^* < +\infty$ such that

$$(8.6.96) \quad \left(\frac{|f|}{\|f\|_{L^\Lambda}} \right) \left(\frac{k^*|g|}{N^{\Lambda^*}(g)} \right) = \Lambda \left(\frac{|f|}{\|f\|_{L^\Lambda}} \right) + \Lambda^* \left(\frac{k^*|g|}{N^{\Lambda^*}(g)} \right)$$

for almost every $v \in \mathbb{R}^N$.

Differential of Orlicz norms

In order to propagate bounds on Orlicz norms along the flow of the Boltzmann equation, we shall need a formula for the time derivative of the Orlicz norm.

Theorem 8.6. Let Λ be a function C^2 strictly increasing, convex satisfying (8.6.91), (8.6.92), (8.6.93), and let $0 \neq f \in C^1([0, T], L^\Lambda)$. Then we have

$$(8.6.97) \quad \frac{d}{dt} \|f_t\|_{L^\Lambda} = \left[N^{\Lambda^*} \left(\Lambda' \left(\frac{|f|}{\|f\|_{L^\Lambda}} \right) \right) \right]^{-1} \int_{\mathbb{R}^N} \partial_t f \Lambda' \left(\frac{|f|}{\|f\|_{L^\Lambda}} \right) dv.$$

Proof of Theorem 8.6. From [170, Chapter III, Proposition 6]), our assumptions on Λ imply that

$$(8.6.98) \quad \int_{\mathbb{R}^N} \Lambda \left(\frac{|f|}{\|f\|_{L^\Lambda}} \right) dv = 1$$

for all $0 \neq f \in L^\Lambda$. By differentiating this quantity along t we get:

$$0 = \int_{\mathbb{R}^N} \partial_t f \Lambda' \left(\frac{|f|}{\|f\|_{L^\Lambda}} \right) dv - \frac{1}{\|f\|_{L^\Lambda}} \frac{d}{dt} \|f\|_{L^\Lambda} \int_{\mathbb{R}^N} f \Lambda' \left(\frac{|f|}{\|f\|_{L^\Lambda}} \right) dv.$$

Now using the case of equality in Hölder's inequality (8.6.95) we have

$$\int_{\mathbb{R}^N} f \Lambda' \left(\frac{|f|}{\|f\|_{L^\Lambda}} \right) dv = \|f\|_{L^\Lambda} N^{\Lambda^*} \left(\Lambda' \left(\frac{|f|}{\|f\|_{L^\Lambda}} \right) \right)$$

since the equality (8.6.96) is trivially satisfied with

$$g = \Lambda' \left(\frac{|f|}{\|f\|_{L^\Lambda}} \right)$$

and $k^* = N^{\Lambda^*}(g)$, using that

$$xy = \Lambda(x) + \Lambda^*(y)$$

as soon as $y = \Lambda'(x)$. This concludes the proof. \square

Acknowledgment: The authors thank F. Filbet, P. Laurençot and V. Panferov for fruitful remarks and discussions. Support by the European network HYKE, funded by the EC as contract HPRN-CT-2002-00282, is acknowledged.

Cooling process for inelastic Boltzmann equations for hard spheres, Part II: Self-similar solutions and tail behavior

Article [150], en collaboration avec Stéphane Mischler, soumis pour publication.

ABSTRACT: We consider the spatially homogeneous Boltzmann equation for inelastic hard spheres, in the framework of so-called constant normal restitution coefficients. We prove the existence of self-similar solutions, and we give pointwise estimates on their tail. We also give more general estimates on the tail and the regularity of generic solutions. In particular we prove Haff's law on the rate of decay of temperature, as well as the algebraic decay of singularities. The proofs are based on the regularity study of a rescaled problem, with the help of the regularity properties of the gain part of the Boltzmann collision integral, well-known in the elastic case, and which are extended here in the context of granular gases.

Contents

9.1	Introduction and main results	373
9.1.1	The model	373
9.1.2	Introduction of rescaled variables	375
9.1.3	Motivation	376
9.1.4	Notation	377
9.1.5	Main results	378
9.1.6	Method of proof	379
9.1.7	Weak and strong forms of the collision operator . .	380
9.2	Regularity property of the collision operator . . .	383
9.2.1	Convolution-like estimates	384
9.2.2	Lions Theorem for Q^+	385
9.2.3	Bouchut-Desvillettes-Lu Theorem on Q^+	387
9.2.4	Estimates on the global collision operator in Lebesgue spaces	389
9.3	Regularity study in the rescaled variables	393
9.3.1	Uniform propagation of moments - Povzner Lemma	393
9.3.2	Stability in L^1	395
9.3.3	Uniform propagation of Lebesgue norms	396
9.3.4	Non-concentration in the rescaled variables and Haff's law	397
9.3.5	Uniform propagation of Sobolev norms	398
9.3.6	Exponential decay of singularities	400
9.4	Self-similar solutions and tail behavior	401
9.4.1	Existence of self-similar solutions	401
9.4.2	Tail of the self-similar profiles	402
9.4.3	Positivity of the rescaled solution	405
9.5	Perspectives	410

9.1 Introduction and main results

9.1.1 The model

We consider the asymptotic behavior of inelastic hard spheres described by the spatially homogeneous Boltzmann equation with a constant normal restitution coefficient (see [141]). More precisely, the gas is described by the probability density of particles $f(t, v) \geq 0$ with velocity $v \in \mathbb{R}^N$ ($N \geq 2$) at time $t \geq 0$, which undergoes the evolution equation

$$(9.1.1) \quad \frac{\partial f}{\partial t} = Q(f, f) \quad \text{in} \quad (0, +\infty) \times \mathbb{R}^N,$$

$$(9.1.2) \quad f(0) = f_{\text{in}} \quad \text{in} \quad \mathbb{R}^N.$$

The bilinear collision operator $Q(f, f)$ models the interaction of particles by means of inelastic binary collisions (preserving mass and momentum but dissipating kinetic energy). Denoting by $e \in (0, 1)$ the *normal restitution coefficient*, we define the collision operator in strong form as

$$(9.1.3) \quad Q(g, f)(v) := \int_{\mathbb{R}^N \times \mathbb{S}^{N-1}} \left[\frac{{}'f \, {}'g_*}{e^2} - fg_* \right] |u| b(\hat{u} \cdot \sigma) \, d\sigma \, dv_*,$$

where we use notations from [100]. Here $u = v - v_*$ denotes the relative velocity, \hat{u} stands for $u/|u|$, and $'v, 'v_*$ denote the possible pre-collisional velocities leading to post-collisional velocities v, v_* . They are defined by

$$'v = \frac{v + v_*}{2} + \frac{{}'u}{2}, \quad 'v_* = \frac{v + v_*}{2} - \frac{{}'u}{2},$$

with $'u = (1 - \beta)u + \beta|u|\sigma$ and $\beta = (e + 1)/(2e)$ ($\beta \in (1, \infty)$ since $e \in (0, 1)$). The function b in (9.1.3) is (up to a multiplicative factor) the differential collisional cross-section. In the sequel we assume that there exists $b_0, b_1 \in (0, \infty)$ such that

$$(9.1.4) \quad \forall x \in [-1, 1], \quad b_0 \leq b(x) \leq b_1,$$

and that

$$(9.1.5) \quad b \text{ is nondecreasing and convex on } (-1, 1).$$

Note that the “physical” cross-section for hard spheres is given by (see [100, 54])

$$b(x) = \text{cst} (1 - x)^{-\frac{N-3}{2}},$$

so that it fulfills hypothesis (9.1.4) and (9.1.5) when $N = 3$. The Boltzmann equation (9.1.1) is complemented with an initial datum (9.1.2) which satisfies (for some $k \geq 2$)

$$(9.1.6) \quad 0 \leq f_{\text{in}} \in L^1_k(\mathbb{R}^N), \quad \int_{\mathbb{R}^N} f_{\text{in}} dv = 1, \quad \int_{\mathbb{R}^N} f_{\text{in}} v dv = 0.$$

Notice that, without loss of generality, we can assume the two last moment conditions in (9.1.6), since we may always reduce to that case by a scaling and translation argument.

As explained in [141], the operator (9.1.3) preserves mass and momentum:

$$(9.1.7) \quad \frac{d}{dt} \int_{\mathbb{R}^N} f \begin{pmatrix} 1 \\ v \end{pmatrix} dv = 0,$$

while kinetic energy is dissipated

$$(9.1.8) \quad \frac{d}{dt} \mathcal{E}(f(t, \cdot)) = -D(f(t, \cdot)), \quad \text{with} \quad \mathcal{E}(f) = \int_{\mathbb{R}^N} f(v) |v|^2 dv.$$

The dissipation functional is given by

$$D(f) := \tau \int_{\mathbb{R}^N \times \mathbb{R}^N} f f_* |u|^3 dv dv_*, \quad \tau := m_b \left(\frac{1 - e^2}{4} \right),$$

where m_b is the angular momentum defined by

$$\begin{aligned} m_b &:= \int_{\mathbb{S}^{N-1}} \left(\frac{1 - (\hat{u} \cdot \sigma)}{2} \right) b(\hat{u} \cdot \sigma) d\sigma \\ &= |\mathbb{S}^{N-2}| \int_0^\pi b(\cos \theta) \sin^2 \theta / 2 \sin^{N-2} \theta d\theta \end{aligned}$$

(in the second formula, we have set $\cos \theta = \hat{u} \cdot \sigma$).

The study of the Cauchy theory and the cooling process of (9.1.1)-(9.1.2) was done in [141] (where more general models were considered). The equation is well-posed for instance in L^1_2 : for $0 \leq f_{\text{in}} \in L^1_2$, there is a unique solution in $C(\mathbb{R}_+; L^1_2) \cap L^1(\mathbb{R}_+; L^1_3)$ (see Subsection 9.1.4 for the notations of functional spaces). This solution is defined for all times. It preserves mass, momentum and has a decreasing kinetic energy. The cooling process does not occur in finite time, but asymptotically in large time, i.e. the kinetic energy is strictly positive for all times and the solution satisfies

$$\mathcal{E}(t) \rightarrow 0 \quad \text{and} \quad f(t, \cdot) \rightharpoonup \delta_{v=0} \quad \text{in} \quad M^1(\mathbb{R}^N)\text{-weak}^* \quad \text{when} \quad t \rightarrow +\infty,$$

where $M^1(\mathbb{R}^N)$ denotes the space of probability measures on \mathbb{R}^N . We refer to [141] for the proofs of these results and for the study of other physically relevant models for which the cooling process occurs in finite time.

9.1.2 Introduction of rescaled variables

Let us introduce some rescaled variables, in order to study more precisely the asymptotic behavior of the solution. This usual rescaling can be found in [32] and [78] for instance. Roughly speaking it adds an anti-drift to the equation. As we shall show in the sequel, this additional term prevents concentration and thus forces the kinetic energy to remain bounded from below.

We search for a rescaled solution g of the form

$$f(t, v) = K(t) g(T(t), V(t, v)),$$

where K, T, V are the scaling functions to be determined. Imposing the conservation of mass and the cancellations of the multiplicative term in front of g in the evolution equation, and using the following homogeneity property

$$(9.1.9) \quad Q(g(\lambda \cdot), g(\lambda \cdot))(v) = \lambda^{-(N+1)} Q(g, g)(\lambda v)$$

(which is obtained by a homothetic change of variable), we obtain by some classical computations the natural choice

$$K(t) = (c_0 + c_1 t)^N, \quad T(t) = \frac{1}{c_0} \ln \left(1 + \frac{c_1}{c_0} t \right) \quad V(t, v) = (c_0 + c_1 t)v$$

for some constants $c_0, c_1 > 0$. A solution f associated to some function g independent of T in this new variables is called a *self-similar solution*, with *profil* g . It is obvious that changing c_0 in this scaling only amounts to a translation of time of the self-similar solution, and changing c_1 only amounts to the multiplication of the self-similar solution by a constant. Hence in the following we fix without restriction $c_0 = c_1 = 1$. Then it is straightforward that g satisfies the evolution equation

$$(9.1.10) \quad \frac{\partial g}{\partial t} = Q(g, g) - \nabla_v \cdot (vg).$$

This evolution problem preserves the L^1 norm. Any steady state $G(v)$ of (9.1.10) translates into a self-similar solution

$$F(t, v) = (1 + t)^N G((1 + t)v)$$

of the original equation (9.1.1). More generally, for any solution g to the Boltzmann equation in self-similar variables (9.1.10), we associate a solution f to the evolution problem (9.1.1), defining f by the relation

$$(9.1.11) \quad f(t, v) = (1 + t)^N g(\ln(1 + t), (1 + t)v).$$

Reciprocally, for any solution f to the Boltzmann equation (9.1.1), we associate a solution g to the evolution problem (9.1.10), defining g by the relation

$$(9.1.12) \quad g(t, v) = e^{-Nt} f(e^t - 1, e^{-t}v).$$

Given an initial datum $f_{\text{in}} = g_{\text{in}} \in L^1_2$, we know from [141] that there exists a unique solution of (9.1.1) in $C(\mathbb{R}_+, L^1_2) \cap L^1(\mathbb{R}_+, L^1_3)$. Therefore, thanks to the changes of variables (9.1.11, 9.1.12), we deduce that there exists a unique solution g to (9.1.10) in $C(\mathbb{R}_+, L^1_2) \cap L^1(\mathbb{R}_+, L^1_3)$. Moreover we have the following relations between the moments of f and g :

$$(9.1.13) \quad \forall t \geq 0, \quad \begin{cases} \|g(t, \cdot) | \cdot |^k\|_{L^1} = e^{kt} \|f(e^t - 1, \cdot) | \cdot |^k\|_{L^1} \\ \|f(t, \cdot) | \cdot |^k\|_{L^1} = (1+t)^{-k} \|g(\ln(1+t), \cdot) | \cdot |^k\|_{L^1}. \end{cases}$$

9.1.3 Motivation

On the basis of the study of the non-physical simplified case of Maxwell molecules, Ernst and Brito conjectured that self-similar solutions, when they exist, should attract any solution, in the sense of convergence of the rescaled solution. Thus existence of and informations on these self-similar solutions is expected to yield informations on the asymptotic behavior of the generic solutions. And, as our study shows (as well as the study of diffusively excited inelastic hard spheres in [100]), the over-populated high energy tails for the self-similar solutions precisely indicate the tail behavior of the generic solutions.

Moreover, the kinetic energy of the self-similar solutions behaves like

$$\mathcal{E}(t) \sim_{t \rightarrow \infty} \frac{C}{t^2}$$

and it is natural to expect a similar behavior for the rate of decay of the temperature for the generic solutions. This conjecture was made twenty years ago in the pioneering paper [113], where the model of inelastic hard spheres was introduced, and this rate of decay for the temperature is therefore known as *Haff's law*. This law is a typical physical feature of inelastic hard spheres which does not hold for the simplified model of Maxwell molecules. Indeed, in this case, one can derive a closed equation for the kinetic energy, which decreases exponentially fast. More generally, the tail behavior of the solutions are different for Maxwell molecules and hard spheres.

However, until now, mathematical analysis of (spatially homogeneous) inelastic Boltzmann equations essentially dealt with Maxwell molecules because of the strong analytic simplifications it provides (see for instance [27, 29, 30]),

or with some simplified non-linear friction models (see [129] for instance). In [27], a pseudo-Maxwell approximation of hard spheres was considered, preserving Haff's law and still most of the nice simplifications of Maxwell molecules, but leading to different self-similar solutions and tail behaviors. Recently the works [100, 32] laid the first steps for a mathematical analysis of the more realistic inelastic hard spheres model: the former proved the existence of steady states and gave estimates showing the presence of overpopulated tails for diffusively excited inelastic hard spheres, and the latter proved *a priori* integral estimates on the tail of the steady state (assuming its existence) for the spatially homogeneous inelastic Boltzmann equation with various additional terms, such as a diffusion, or an anti-drift as in (9.1.10). These two papers are the starting point of our study.

In this work, we prove, for spatially homogeneous inelastic hard spheres, the existence of smooth self-similar solutions, and we improve the estimates on their tails of [32] into pointwise ones. We also give a complete regularity study of the generic solutions in the rescaled variables, as well as estimates on their tails. In particular, we give the first mathematical proof of Haff's law and we show the algebraic decay of singularities.

9.1.4 Notation

Throughout the paper we shall use the notation $\langle \cdot \rangle = \sqrt{1 + |\cdot|^2}$. We denote, for any integer $k \in \mathbb{N}$, the Banach space

$$L_k^1 = \left\{ f : \mathbb{R}^N \mapsto \mathbb{R} \text{ measurable; } \|f\|_{L_k^1} := \int_{\mathbb{R}^N} |f(v)| \langle v \rangle^k dv < +\infty \right\}.$$

More generally we define the weighted Lebesgue space $L_q^p(\mathbb{R}^N)$ ($p \in [1, +\infty]$, $q \in \mathbb{R}$) by the norm

$$\|f\|_{L_q^p(\mathbb{R}^N)} = \left[\int_{\mathbb{R}^N} |f(v)|^p \langle v \rangle^{pq} dv \right]^{1/p}$$

when $p < +\infty$ and

$$\|f\|_{L_q^\infty(\mathbb{R}^N)} = \sup_{v \in \mathbb{R}^N} |f(v)| \langle v \rangle^q$$

when $p = +\infty$. The weighted Sobolev space $W_q^{k,p}(\mathbb{R}^N)$ ($p \in [1, +\infty]$, $q \in \mathbb{R}$ and $k \in \mathbb{N}$) is defined by the norm

$$\|f\|_{W_q^{k,p}(\mathbb{R}^N)} = \left[\sum_{|s| \leq k} \int_{\mathbb{R}^N} |\partial^s f(v)|^p \langle v \rangle^{pq} dv \right]^{1/p}.$$

Finally, for $h \in \mathbb{R}^N$, we define the translation operator τ_h by

$$\forall v \in \mathbb{R}^N, \quad \tau_h f(v) = f(v - h).$$

We shall denote by “ C ” various constants which do not depend on the collision kernel B .

9.1.5 Main results

First we state a result of existence of self-similar solutions.

Theorem 9.1. *For any mass $\rho > 0$, there exists a self-similar profil G with mass ρ and momentum 0:*

$$0 \leq G \in L_2^1, \quad Q(G, G) = \nabla_v \cdot (vG), \quad \int_{\mathbb{R}^N} G \begin{pmatrix} 1 \\ v \end{pmatrix} dv = \begin{pmatrix} \rho \\ 0 \end{pmatrix},$$

which moreover can be built in such a way that G is radially symmetric, $G \in C^\infty$ and

$$\forall v \in \mathbb{R}^N, \quad a_1 e^{-a_2|v|} \leq G(v) \leq A_1 e^{-A_2|v|}$$

for some explicit constants $a_1, a_2, A_1, A_2 > 0$.

Second we give a result on the asymptotic behavior of the solution in the rescaled variables.

Theorem 9.2. *For an initial datum*

$$0 \leq g_{\text{in}} \in L_2^1 \cap L^p, p > 1, \quad \int_{\mathbb{R}^N} g_{\text{in}} \begin{pmatrix} 1 \\ v \end{pmatrix} dv = \begin{pmatrix} \rho \\ 0 \end{pmatrix},$$

the unique solution g of (9.1.10) with initial datum g_{in} in $C(\mathbb{R}_+; L_2^1) \cap L^1(\mathbb{R}_+; L_3^1)$ satisfies:

(i) *For any $s \geq 0$, $q \geq 0$ arbitrarily large, g can be written $g^S + g^R$ in such a way that*

$$\begin{cases} \sup_{t \geq 0} \|g_t^S\|_{H_q^s \cap L_2^1} < +\infty, & g^S \geq 0, \\ \exists \lambda > 0; \quad \|g_t^R\|_{L_2^1} = O(e^{-\lambda t}). \end{cases}$$

(ii) For any $\tau > 0$ and $s \in [0, 1/2)$, there are some explicit constants $a_1, a_2, A_1, A_2 > 0$ such that

$$\forall v \in \mathbb{R}^N, \quad \liminf_{t \rightarrow \infty} g(t, v) \geq a_1 e^{-a_2 |v|}$$

and

$$\forall t \geq \tau, \quad \int_{\mathbb{R}^N} g(t, v) e^{-A_1 |v|^s} dv \leq A_2.$$

(iii) As a consequence, for any $\tau > 0$, for an initial datum

$$0 \leq f_{\text{in}} \in L^1_3 \cap L^p, p > 1, \quad \int_{\mathbb{R}^N} f_{\text{in}} \begin{pmatrix} 1 \\ v \end{pmatrix} dv = \begin{pmatrix} \rho \\ 0 \end{pmatrix},$$

the associated solution of the Boltzmann equation (9.1.1, 9.1.2) satisfies Haff's law in the sense:

$$(9.1.14) \quad \forall t \geq \tau, \quad m t^{-2} \leq \mathcal{E}(t) \leq M t^{-2}$$

for some explicit constants $m, M > 0$. and τ .

All the constants in this theorem can be computed in terms of the mass, kinetic energy and L^p norm of f_{in} or g_{in} , and τ .

9.1.6 Method of proof

The main tool is the regularity theory of the collision operator. We show that the gain part satisfies similar regularity properties as in the elastic case, and we use them to study the regularity of the solution in the rescaled variables, in a similar way to the elastic case (see [150]). We show uniform propagation of Lebesgue and Sobolev norms as well as exponential decay of singularities for solutions of (9.1.10).

These uniform non-concentration estimates immediately show that the temperature is uniformly bounded from below by some positive number in the rescaled variables, which enables to prove Haff's law. The existence of self-similar solutions is proved by the use of a consequence of Tykhonov's fixed point Theorem (see Theorem 9.8), which is an infinite dimensional (rough) version of Poincaré-Bendixon Theorem on dynamical system, see for instance [14, 100, 82]. It says that a semi-group on a Banach space \mathcal{Y} with suitable weak continuity properties, and which stabilizes a nonempty convex weakly compact subset, has a steady state.

Essentially this result reduces the question of proving the existence of a steady state to the one of finding suitable *a priori* estimates on the evolution

equation. We apply it to the evolution semi-group of (9.1.10) in the Banach space $\mathcal{Y} = L_2^1 \cap L^p$, $p > 1$. The existence and continuity properties of the semi-group were proved in [141] and the nonempty convex weakly compact subset of functions with bounded moments and L^p norm (for some $1 < p < +\infty$ and a bound big enough) is stable along the flow thanks to the uniform L^p bounds obtained in the rescaled variables. Then, regularity of the profil is obtained by the previous regularity study, and pointwise estimates on the tail are obtained using results and methods of [32] on the study of moments, together with maximum principles arguments inspired from [100].

The regularity study in the rescaled variables translates in the original variables and yields the algebraic decay of singularities for the Cauchy problem (9.1.1,9.1.2). Then the tail of the solution is studied by classical techniques. For the lower bound on one hand we use the spreading effect of the evolution semi-group of (9.1.10) (in the spirit of [44, 169]). For the upper bound on the other hand we use moments estimates as in [32] and elementary o.d.e. arguments.

9.1.7 Weak and strong forms of the collision operator

Under our assumptions on b , the function $\sigma \mapsto b(\hat{u} \cdot \sigma)$ is integrable on the sphere \mathbb{S}^{N-1} , and we can set without restriction

$$\int_{\mathbb{S}^{N-1}} b(\hat{u} \cdot \sigma) d\sigma = |\mathbb{S}^{N-2}| \int_0^\pi b(\cos \theta) \sin^{N-2} \theta d\theta = 1.$$

Thus we can write the classical splitting $Q = Q^+ - Q^-$ between gain part and loss part. The loss part Q^- is

$$(9.1.15) \quad Q^-(g, f)(v) := \left(\int_{\mathbb{R}^N} g(v_*) |v - v_*| dv_* \right) f(v) = (g * \Phi) f,$$

where Φ denotes $\Phi(z) = |z|$. For any distribution g satisfying the moment conditions $\int_{\mathbb{R}^N} g dv = 1$, $\int_{\mathbb{R}^N} g v dv = 0$, we have (see for instance [141, Lemma 2.2])

$$(9.1.16) \quad (g * \Phi) \geq |v|.$$

The gain part Q^+ is defined by

$$(9.1.17) \quad Q^+(g, f)(v) := \int_{\mathbb{R}^N \times \mathbb{S}^{N-1}} \frac{f' g_*}{e^2} |u| b(\hat{u} \cdot \sigma) d\sigma dv_*.$$

In the sequel, we shall need two other representations. On the one hand from [54], there holds: for any $\psi \in L_1^\infty$,

$$(9.1.18) \quad \int_{\mathbb{R}^N} Q^+(g, f)(v) \psi(v) dv = \int_{\mathbb{R}^N \times \mathbb{R}^N \times \mathbb{S}^{N-1}} f g_* |u| b(\hat{u} \cdot \sigma) \psi(v') d\sigma dv_* dv,$$

where v' denotes the post-collisional velocity defined by

$$(9.1.19) \quad v' = \frac{v + v_*}{2} + \frac{u'}{2}, \quad u' = \frac{1 - e}{2} u + \frac{1 + e}{2} |u| \sigma.$$

On the other hand, we shall establish a Carleman representation for granular gases:

Proposition 9.1. *Let $E_{v, v'}$ be the hyperplan orthogonal to the vector $v - v'$ and passing through the point $\Omega(v, v')$, defined by*

$$\Omega(v, v') := v + (1 - \beta^{-1})(v - v') = (2 - \beta^{-1})v + (\beta^{-1} - 1)v'.$$

(recall that $\beta = (1 + e)/(2e)$). Then we have the following representation of the gain term

$$(9.1.20) \quad Q^+(g, f)(v) = \frac{2^{N-1}}{\beta^{N-1} e^2} \int_{v' \in \mathbb{R}^N} \int_{v_* \in E_{v, v'}} |v - v_*|^{2-N} B |v - v'|^{-1} g_*' f.$$

Proof of Proposition 9.1. We start from the basic identity

$$(9.1.21) \quad \frac{1}{2} \int_{\mathbb{S}^{N-1}} F(|u|\sigma - u) d\sigma = \frac{1}{|u|^{N-2}} \int_{\mathbb{R}^N} \delta(2x \cdot u + |x|^2) F(x) dx,$$

which can be verified easily by completing the square in the Dirac function, taking the spherical coordinate $x + u = r\sigma$ and performing the change of variable $r^2 = s$.

We have the following relations

$$\begin{cases} v' = v + (\beta/2) (|u|\sigma - u) \\ v_*' = v_* - (\beta/2) (|u|\sigma - u) \end{cases}$$

and thus starting from the strong form of Q^+ we get

$$Q^+(g, f) = e^{-2} \int_{\mathbb{R}^N \times \mathbb{S}^{N-1}} B f\left(v + (z/2) (|u|\sigma - u)\right) g\left(v_* - (z/2) (|u|\sigma - u)\right) dv_* d\sigma.$$

Applying (9.1.21) yields

$$Q^+(g, f) = 2e^{-2} \int_{\mathbb{R}^N \times \mathbb{R}^N} |u|^{2-N} B \delta(2x \cdot u + |x|^2) f(v + (\beta/2)x) g(v_* - (\beta/2)x) dv_* dx.$$

We do the change of variable $x \rightarrow 'v = v + (\beta/2)x$ (with jacobian $(\beta/2)^N$). Then, keeping $'v$ fixed, we do the change of variable $v_* \rightarrow 'v_*$ (with jacobian 1). This gives

$$Q^+(g, f) = \frac{2^{N+1}}{\beta^N e^2} \int_{\mathbb{R}^N \times \mathbb{R}^N} |u|^{2-N} B \delta f('v) g('v_*) d'v_* d'v.$$

Finally, keeping $'v$ fixed, we decompose orthogonally the variable $'v_*$ as $v + V_1 n + V_2$ with $V_1 = ('v_* - v) \cdot n$, $n = ('v - v)/|'v - v|$ and V_2 orthogonal to $'v - v$. This gives after computing the Dirac function in the new coordinates

$$Q^+(g, f) = \frac{2^{N+1}}{\beta^N e^2} \int_{\mathbb{R} \times \mathbb{R}^{N-1} \times \mathbb{R}^N} |u|^{2-N} B \times \delta \left(\frac{4|'v - v|}{\beta} \left[(\beta^{-1} - 1)|'v - v| - V_1 \right] \right) f('v) g(v + V_1 n + V_2) dV_1 dV_2 d'v.$$

Removing the Dirac mass leads to

$$Q^+(g, f) = \frac{2^{N-1}}{\beta^{N-1} e^2} \int_{'v \in \mathbb{R}^N} \int_{'v_* \in E_{v, 'v}^e} |u|^{2-N} |'v - v|^{-1} B f('v) g('v_*) d'v_* d'v,$$

which concludes the proof. \square

The parametrization by the Carleman representation means that for v and $'v$ fixed, the point $'v_*$ describes the hyperplan orthogonal to $('v - v)$ and passing through the point $\Omega(v, 'v)$ on the line determined by v and $'v$. Note that in the elastic case, $\Omega(v, 'v) = v$, whereas here $\Omega(v, 'v)$ is outside the segment $[v, 'v]$, which reflects the fact that for the pre-collisional velocities, the modulus of the relative velocity is bigger than $|v - v_*|$. The geometrical picture (in a plane section) is summerized in Figure 9.1.

From this proposition we immediately deduce the following representation, which is closer to the classical Carleman representation for the elastic Boltzmann collision operator:

$$Q^+(f, g)(v) = C_e \int_{\mathbb{R}^N} \frac{'f}{|v - 'v|^{N-2}} \left\{ \int_{E_{v, 'v}^e} 'g_* \tilde{b}(\hat{u} \cdot \sigma) d'v_* \right\} d'v,$$

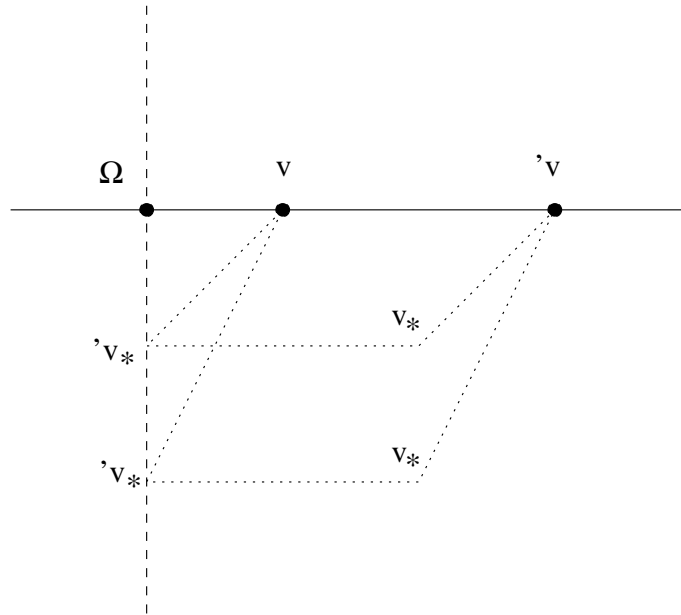

Figure 9.1: Carleman representation for granular gases

with

$$C_e = \frac{2^{\frac{3N-5}{2}}}{\beta^{2N-4} e^2}$$

and $\tilde{b}(x) = (1-x)^{-(N-3)} b(x)$.

9.2 Regularity property of the collision operator

In this section the final goal is to estimate quantities such as

$$\int_{\mathbb{R}^N} Q(f, f) f^{p-1} dv$$

for $p > 1$, i.e. the action of the collision operator on the evolution of the L^p norm (to the power p) of the solution along the flow. We shall use minoration estimates on Q^- deduced from (9.1.15)-(9.1.16), together with regularity estimates on Q^+ . The latter seem to be new in the inelastic framework but they are an extension of similar estimates in the elastic case $e = 1$, which originated in the works of Lions [130, 131], Bouchut and Desvillettes [37],

Lu [134] (and are reminiscent of the work of Grad on the linearized collision operator [109]). The main tool is the Carleman representation for granular gases of Proposition 9.1. Before turning to the regularity study of Q^+ , we recall convolution-like estimates.

9.2.1 Convolution-like estimates

In the elastic case $e = 1$, convolution-like estimates for the gain part of the collision operator were first proved in [111, 112]. This proof was simplified by a duality argument in [150], where also a more precise statement was given. These estimates were extended to the inelastic case, for a constant normal restitution coefficient $e \in (0, 1]$, in [100] (in a form slightly less precise than in [150]). Also a result weaker in one aspect (less precise for the treatment of the algebraic weight) but more general in another (valid in any Orlicz spaces, and valid for more general collision kernels) was proved in [141]. Here we only state the precise result we shall need, whose proof is straightforward from the arguments in [100, Proof of Lemma 4.1] and [150, Proof of Theorem 2.1].

We make the following assumption on the cross-section: no *frontal collision* should occur, i.e. $b(\cos \theta)$ should vanish for θ close to π :

$$(9.2.22) \quad \exists \theta_b > 0 ; \quad \text{support } b(\cos \theta) \subset \{ \theta / 0 \leq \theta \leq \pi - \theta_b \}$$

This additional assumption will not be needed, however, for the quadratic estimates, i.e. the estimates on $Q^+(f, f)$. Indeed, $Q^+(f, g) = \bar{Q}^+(g, f)$ if \bar{Q}^+ is the gain term associated to the cross-section $\bar{b}(\cos \theta) = b(\cos(\pi - \theta))$. In particular, $b(\cos \theta)$ and $[b(\cos \theta) + b(\cos(\pi - \theta))] \mathbf{1}_{\cos \theta \geq 0}$ define the same quadratic operator Q^+ , and the latter satisfies (9.2.22) automatically (with $\theta_b = \pi/2$). We note that $Q^+(g, f)$ and $Q^+(f, g)$ will not necessarily satisfy the same estimates, since assumption (9.2.22) is not symmetric. To exchange the roles of f and g , we will therefore be led to introduce the assumption that no *grazing collision* should occur, i.e.

$$(9.2.23) \quad \exists \theta_b > 0 ; \quad \text{support } b(\cos \theta) \subset \{ \theta / \theta_b \leq \theta \leq \pi \}.$$

Theorem 9.3. *Let $k, \eta \in \mathbb{R}$, $p \in [1, +\infty]$, and let $B = \Phi b$ be a collision kernel with b satisfying the assumption (9.2.22). Then, we have the estimates*

$$\|Q^+(g, f)\|_{L^p_\eta} \leq C_{k, \eta, p}(B) \|g\|_{L^1_{|k+\eta|+\eta}} \|f\|_{L^p_{k+\eta}},$$

where

$$C_{k, \eta, p}(B) = C (\sin(\theta_b/2))^{\min(\eta, 0) - 2/p'} \|b\|_{L^1(\mathbb{S}^{N-1})} \|\Phi\|_{L^\infty_{-k}}$$

If on the other hand assumption (9.2.22) is replaced by assumption (9.2.23), then the same estimates hold with $Q^+(g, f)$ replaced by $Q^+(f, g)$.

9.2.2 Lions Theorem for Q^+

In this subsection we assume that the collision kernel $B = \Phi b$ satisfies

$$(9.2.24) \quad \Phi \in C_0^\infty(\mathbb{R}^N \setminus \{0\}), \quad b \in C_0^\infty(-1, 1).$$

Then we have the

Theorem 9.4. *Let B be a collision kernel satisfying (9.2.24). Then the gain part Q^+ satisfies for all $s \in \mathbb{R}_+$ and $\eta \in \mathbb{R}_+$*

$$\|Q^+(g, f)\|_{H_\eta^{s+(N-1)/2}} \leq C(s, B) \|g\|_{H_\eta^s} \|f\|_{L_{2\eta}^1}$$

$$\|Q^+(g, f)\|_{H_\eta^{s+(N-1)/2}} \leq C(s, B) \|g\|_{H_\eta^s} \|f\|_{L_{2\eta}^1}$$

for some explicit constant $C(s, B) > 0$ depending only on s and the collision kernel.

Proof of Proposition 9.4. We follow closely the proof of [150], inspired from the works of Lions [130, 131] and Wennberg [199]. Indeed the Carleman representation proved above in Proposition 9.1 allows essentially to reduce to the study of the elastic case.

We assume first that $\eta = 0$. We denote

$$\mathcal{B}(|'v - 'v_*|, |'v - v|) = \frac{B(|v - v_*|, \cos \theta)}{|v - v_*|^{N-2} |'v - v|}$$

which belongs to $C_0^\infty((\mathbb{R}_+ \setminus \{0\})^2)$ under assumption (9.2.24). We define the following (Radon transform type) functional: for g smooth enough, Tg is defined by

$$Tg(y) = \int_{\mu y + y^\perp} \mathcal{B}(z, y) g(z) dz$$

with $\mu = 2 - \beta^{-1}$. Then a straightforward computation from the Carleman representation (9.1.20) yields

$$Q^+(g, f)(v) = 2^{N-1} \beta^{1-N} e^{-2} \int_{\mathbb{R}^N} f('v) (\tau_v \circ T \circ \tau_{-'v})(g)(v) d'v.$$

Thus if one has a bound on T of the form

$$(9.2.25) \quad \|Tg\|_{H^{s+(N-1)/2}} \leq C_T \|g\|_{H^s}, \quad C_T > 0,$$

then by using Fubini's and Jensen's theorems one gets

$$\begin{aligned} \|Q^+(g, f)\|_{H^{s+(N-1)/2}}^2 &\leq C \|f\|_{L^1} \int_{\mathbb{R}^N} f(v) \|(\tau_v \circ T \circ \tau_{-v})(g)\|_{H^{s+(N-1)/2}}^2 d'v \\ &\leq C \|f\|_{L^1} \int_{\mathbb{R}^N} f(v) \|(T \circ \tau_{-v})(g)\|_{H^{s+(N-1)/2}}^2 d'v \\ &\leq C C_T \|f\|_{L^1} \int_{\mathbb{R}^N} f(v) \|\tau_{-v}g\|_{H^s}^2 d'v \\ &\leq C C_T \|g\|_{H^s}^2 \|f\|_{L^1} \int_{\mathbb{R}^N} f(v) d'v \\ &\leq C C_T \|g\|_{H^s}^2 \|f\|_{L^1}^2, \end{aligned}$$

which concludes the proof. Thus we are reduced to prove (9.2.25). But, up to an homothetic factor, T is exactly the operator which was studied in detail in [199] and [150]. More precisely,

$$Tg(y) = \tilde{T}g(\mu y)$$

where \tilde{T} is the Radon transform

$$\tilde{T}g(y) = \int_{y+y^\perp} \tilde{\mathcal{B}}(z, y) g(z) dz$$

introduced in the elastic case in [199], with

$$\tilde{\mathcal{B}}(z, y) = \mathcal{B}(z, \mu^{-1}y).$$

It was proved in [150, Proof of Theorem 3.1] that

$$\|\tilde{T}g\|_{H^{s+(N-1)/2}} \leq C \|g\|_{H^s}$$

for an explicit bound C depending on $\tilde{\mathcal{B}}$. Coming back to T , we obtain (9.2.25). This ends the proof when $\eta = 0$. The extension to $\eta > 0$ is straightforward (and exactly similar to [150, Proof of Theorem 3.1]). \square

As a Corollary we deduce from Theorem 9.4 the following estimates in Lebesgue spaces by Sobolev embeddings (the proof is exactly similar to [150, Proof of Corollary 3.2]).

Corollary 9.1. *Let B be a collision kernel satisfying (9.2.24). Then, for all $p \in (1, +\infty)$, $\eta \in \mathbb{R}$, we have*

$$\begin{aligned} \|Q^+(g, f)\|_{L_\eta^q} &\leq C(p, \eta, B) \|g\|_{L_\eta^p} \|f\|_{L_{2|\eta|}^1} \\ \|Q^+(f, g)\|_{L_\eta^q} &\leq C(p, \eta, B) \|g\|_{L_\eta^p} \|f\|_{L_{2|\eta|}^1} \end{aligned}$$

where the constant $C(p, \eta, B) > 0$ only depends on the collision kernel, p and η , and $q > p$ is given by

$$q = \begin{cases} \frac{p}{2 - \frac{1}{N} + p(\frac{1}{N} - 1)} & \text{if } p \in (1; 2] \\ pN & \text{if } p \in [2; +\infty). \end{cases}$$

9.2.3 Bouchut-Desvillettes-Lu Theorem on Q^+

Now we turn to a slightly different regularity estimate on Q^+ , which is a straightforward extension of the works [37, 134] in the elastic case $e = 1$. This class of estimate is weaker than Lions’s Theorem 9.4 since the Sobolev norm of Q^+ is controlled by the square of the Sobolev norm of the solution with smaller order, which does not allow to take advantage of the L^1 theory. Nevertheless, it is more convenient in other aspects since it deals directly with the physical collision kernel.

Here we assume that the collision kernel writes $B(v - v_*, \cos \theta) = |v - v_*| b(\cos \theta)$ with

$$(9.2.26) \quad \|b\|_{L^2(\mathbb{S}^{N-1})}^2 = \int_0^\pi b(\cos \theta)^2 \sin^{N-1} \theta \, d\theta = c_2(b) < +\infty$$

(this assumption is obviously satisfied when b satisfies (9.1.4)). Then we have the

Theorem 9.5. *Let B be a collision kernel satisfying (9.2.26). Then the gain part Q^+ satisfies, for all $s \in \mathbb{R}_+$ and $\eta \in \mathbb{R}_+$,*

$$\|Q^+(g, f)\|_{H_\eta^{s+(N-1)/2}} \leq C(s, B) \left[\|g\|_{H_{\eta+2}^s} \|f\|_{H_{\eta+2}^s} + \|g\|_{L_{\eta+2}^1} \|f\|_{L_{\eta+2}^1} \right]$$

for some explicit constant $C(s, B) > 0$ depending only on s and B .

Proof of Theorem 9.5. We follow closely the method in [37]. We write it for $\eta = 0$ but the general case is strictly similar.

Let us denote $F(v, v_*) = f(v)g(v_*)|v - v_*|$. The same arguments as in [37] easily lead to

$$\mathcal{F}Q^+(\xi) = \int_{\mathbb{S}^{N-1}} \widehat{F}(\xi^+, \xi^-) b(\hat{\xi} \cdot \sigma) d\sigma$$

where $\mathcal{F}Q^+$ denotes the Fourier transform of Q^+ according to v , \widehat{F} denotes the Fourier transform of F according to v, v_* , and

$$\xi^+ = \frac{3-e}{4}\xi - \frac{1+e}{4}|\xi|\sigma, \quad \xi^- = \frac{1+e}{4}\xi - \frac{1+e}{4}|\xi|\sigma.$$

Thus

$$|\mathcal{F}Q^+(\xi)|^2 \leq \|b\|_{L^2(\mathbb{S}^{N-1})}^2 \left(\int_{\mathbb{S}^{N-1}} |\widehat{F}(\xi^+, \xi^-)|^2 d\sigma \right).$$

Let us consider frequencies ξ such that $|\xi| \geq 1$. As

$$\begin{aligned} & \int_{\mathbb{S}^{N-1}} |\widehat{F}(\xi^+, \xi^-)|^2 d\sigma \\ &= \int_{\mathbb{S}^{N-1}} \int_{|\xi|}^{+\infty} -\frac{\partial}{\partial r} \left| \widehat{F} \left(\frac{3-e}{4}\xi - \frac{1+e}{4}r\sigma, \frac{1+e}{4}\xi - \frac{1+e}{4}r\sigma \right) \right|^2 d\sigma dr \\ &\leq \int_{\mathbb{S}^{N-1}} \int_{|\xi|}^{+\infty} \left| \widehat{F} \left(\frac{3-e}{4}\xi - \frac{1+e}{4}r\sigma, \frac{1+e}{4}\xi - \frac{1+e}{4}r\sigma \right) \right| \times \\ & \quad \left| (\nabla_2 - \nabla_1) \widehat{F} \left(\frac{3-e}{4}\xi - \frac{1+e}{4}r\sigma, \frac{1+e}{4}\xi - \frac{1+e}{4}r\sigma \right) \right| d\sigma dr \\ &\leq \int_{|\zeta| \geq |\xi|} \left| \widehat{F} \left(\frac{3-e}{4}\xi - \frac{1+e}{4}\zeta, \frac{1+e}{4}\xi - \frac{1+e}{4}\zeta \right) \right| \times \\ & \quad \left| (\nabla_2 - \nabla_1) \widehat{F} \left(\frac{3-e}{4}\xi - \frac{1+e}{4}\zeta, \frac{1+e}{4}\xi - \frac{1+e}{4}\zeta \right) \right| \frac{d\zeta}{|\zeta|^{N-1}}, \end{aligned}$$

where we have made the spherical change of variable $\zeta = r\sigma$, we deduce

$$\begin{aligned} & \int_{|\xi| \geq 1} |\mathcal{F}Q^+(\xi)|^2 |\xi|^{2s+(N-1)} d\xi \\ &\leq \|b\|_{L^2(\mathbb{S}^{N-1})}^2 \int_{1 \leq |\xi| \leq |\zeta|} \left| \widehat{F} \left(\frac{3-e}{4}\xi - \frac{1+e}{4}\zeta, \frac{1+e}{4}\xi - \frac{1+e}{4}\zeta \right) \right| \times \\ & \quad \left| (\nabla_2 - \nabla_1) \widehat{F} \left(\frac{3-e}{4}\xi - \frac{1+e}{4}\zeta, \frac{1+e}{4}\xi - \frac{1+e}{4}\zeta \right) \right| \frac{|\xi|^{2s+(N-1)}}{|\zeta|^{N-1}} d\xi d\zeta. \end{aligned}$$

Finally we make the change of variable

$$X = \frac{3-e}{4}\xi - \frac{1+e}{4}\zeta, \quad Y = \frac{1+e}{4}\xi - \frac{1+e}{4}\zeta,$$

to obtain

$$\begin{aligned} & \int_{|\xi| \geq 1} |\mathcal{F}Q^+(\xi)|^2 |\xi|^{2s+(N-1)} d\xi \\ & \leq C \|b\|_{L^2(\mathbb{S}^{N-1})}^2 \int_{\mathbb{R}^N \times \mathbb{R}^N} \left| \widehat{F}(X, Y) \right| \left| (\nabla_2 - \nabla_1) \widehat{F}(X, Y) \right| \langle X \rangle^{2s} \langle Y \rangle^{2s} dX dY \\ & \leq C \|b\|_{L^2(\mathbb{S}^{N-1})}^2 \|F\|_{H^s} \|(v - v_*)F\|_{H^s} \leq C \|b\|_{L^2(\mathbb{S}^{N-1})}^2 \|g\|_{H_x^2}^2 \|f\|_{H_x^2}^2. \end{aligned}$$

Then small frequencies are controlled thanks to the L^1 norms of f and g , which concludes the proof. \square

9.2.4 Estimates on the global collision operator in Lebesgue spaces

We consider a collision kernel $B = \Phi b$ with $\Phi(u) = |u|$ and b integrable. We shall make a splitting of Q^+ as in [150, Section 3.1]. We denote by $\mathbf{1}_E$ the usual indicator function of the set E .

Let $\Theta : \mathbb{R} \rightarrow \mathbb{R}_+$ be an even C^∞ function such that support $\Theta \subset (-1, 1)$, and $\int_{\mathbb{R}} \Theta dx = 1$. Let $\widetilde{\Theta} : \mathbb{R}^N \rightarrow \mathbb{R}_+$ be a radial C^∞ function such that support $\widetilde{\Theta} \subset B(0, 1)$ and $\int_{\mathbb{R}^N} \widetilde{\Theta} dx = 1$. Introduce the regularizing sequences

$$\begin{cases} \Theta_m(x) = m \Theta(mx), & x \in \mathbb{R}, \\ \widetilde{\Theta}_n(x) = n^N \widetilde{\Theta}(nx), & x \in \mathbb{R}^N. \end{cases}$$

We use these mollifiers to split the collision kernel into a smooth and a non-smooth part. As a convention, we shall use subscripts S for “smooth” and R for “remainder”. First, we set

$$\Phi_{S,n} = \widetilde{\Theta}_n * (\Phi \mathbf{1}_{\mathcal{A}_n}), \quad \Phi_{R,n} = \Phi - \Phi_{S,n},$$

where \mathcal{A}_n stands for the annulus $\mathcal{A}_n = \{x \in \mathbb{R}^N ; \frac{2}{n} \leq |x| \leq n\}$. Similarly, we set

$$b_{S,m}(z) = \Theta_m * (b \mathbf{1}_{\mathcal{I}_m})(z), \quad b_{R,m} = b - b_{S,m},$$

where \mathcal{I}_m stands for the interval $\mathcal{I}_m = \{x \in \mathbb{R} ; -1 + \frac{2}{m} \leq |x| \leq 1 - \frac{2}{m}\}$ (b is understood as a function defined on \mathbb{R} with compact support in $[-1, 1]$). Finally, we set

$$Q^+ = Q_S^+ + Q_R^+,$$

where

$$Q_S^+(g, f) = e^{-2} \int_{\mathbb{R}^N \times \mathbb{S}^{N-1}} \Phi_{S,n}(|v - v_*|) b_{S,m}(\cos \theta)' g_*' f \, d\sigma \, dv_*$$

and

$$Q_R^+ = Q_{RS}^+ + Q_{SR}^+ + Q_{RR}^+$$

with the obvious notation

$$\begin{cases} Q_{RS}^+(g, f) = e^{-2} \int_{\mathbb{R}^N \times \mathbb{S}^{N-1}} \Phi_{R,n} b_{S,m}' g_*' f \, dv_* \, d\sigma \\ Q_{SR}^+(g, f) = e^{-2} \int_{\mathbb{R}^N \times \mathbb{S}^{N-1}} \Phi_{S,n} b_{R,m}' g_*' f \, dv_* \, d\sigma \\ Q_{RR}^+(g, f) = e^{-2} \int_{\mathbb{R}^N \times \mathbb{S}^{N-1}} \Phi_{R,n} b_{R,m}' g_*' f \, dv_* \, d\sigma. \end{cases}$$

Now we follow the proof as in [150, Section 4.1] since we have the same functional inequalities in Sobolev and Lebesgue spaces:

Proposition 9.2. *For any $\varepsilon > 0$ there is $C_\varepsilon > 0$ depending on ε and the collision kernel (and blowing up as $\varepsilon \rightarrow 0$) such that*

$$\int_{\mathbb{R}^N} Q^+(f, f) f^{p-1} \, dv \leq C_\varepsilon \|f\|_{L^1}^{1+p\theta} \|f\|_{L^p}^{p(1-\theta)} + \varepsilon \|f\|_{L^2} \|f\|_{L^{1/p}}^p.$$

Remark: Note that all the estimates in this section are valid only for $e > 0$ (and the constants blow up as $e \rightarrow 0$).

Proof of Proposition 9.2. Let us fix $\varepsilon > 0$. We split Q^+ as $Q_S^+ + Q_{RS}^+ + Q_{SR}^+ + Q_{RR}^+$ and we estimate each term separately. From the beginning we assume, without loss of generality, that the angular part $b(\cos \theta)$ of the collision kernel has its support included in $[0, \pi/2]$ (see the discussion on the symmetrization of b in Subsection 9.2.1). Remember that the truncation parameters n (for the kinetic part) and m (for the angular part) are implicit in the decomposition of Q^+ .

By Corollary 9.1, there exists a constant $C(m, n) > 0$, blowing up as m or n goes to infinity, such that

$$\|Q_S^+(f, f)\|_{L^p} \leq C(m, n) \|f\|_{L^q} \|f\|_{L^1},$$

for some $q < p$, namely

$$(9.2.27) \quad q = \begin{cases} \frac{(2N-1)p}{N+(N-1)p} & \text{if } p \in (1; 2N] \\ \frac{p}{N} & \text{if } p \in [2N; +\infty) \end{cases}$$

(the roles of p and q are exchanged here with respect to Corollary 9.1).

Next we fix a weight $\eta \geq -1$ and we estimate the L_η^p norm of $Q_R^+(f, f)$. We use that $\|b_{R,m}\|_{L^1(\mathbb{S}^{N-1})}$ goes to 0 as m goes to infinity (since b is integrable on the sphere), and we write, using Theorem 9.3 with $k = 1$,

$$\|Q_{RR}^+(f, f)\|_{L_\eta^p} \leq \epsilon(m) \|f\|_{L_{|1+\eta|+|\eta|}^1} \|f\|_{L_{1+\eta}^p},$$

for some $\epsilon(m)$ going to 0 as m goes to infinity. A similar estimate holds true for $\|Q_{SR}^+\|_{L_\eta^p}$. Since $1 + \eta \geq 0$, we can write $|1 + \eta| + |\eta| = 1 + 2\eta_+$, where $\eta_+ = \max(\eta, 0)$.

It remains to estimate Q_{RS}^+ . Let us consider separately large and small velocities: we write $f = f_r + f_{rc}$, where

$$\begin{cases} f_r = f \mathbf{1}_{\{|v| \leq r\}}, \\ f_{rc} = f \mathbf{1}_{\{|v| > r\}}. \end{cases}$$

On the one hand, we pick a $1 < k \leq 2$ and use Theorem 9.3. By direct computation, one can easily prove

$$\|\Phi_{R,n}\|_{L_{-k}^\infty} \leq C n^{-\min\{1, k-1\}} = C n^{-(k-1)}.$$

It follows

$$\begin{aligned} \|Q_{RS}^+(f, f_r)\|_{L_\eta^p} &\leq C \|f\|_{L_{|k+\eta|+|\eta|}^1} \|f_r\|_{L_{k+\eta}^p} \|\Phi_{R,n}\|_{L_{-k}^\infty} \\ &\leq C \|f\|_{L_{|k+\eta|+|\eta|}^1} r^{k-1} \|f\|_{L_{1+\eta}^p} n^{1-k} \\ &\leq C \left(\frac{r}{n}\right)^{k-1} \|f\|_{L_{k+2\eta_+}^1} \|f\|_{L_{1+\eta}^p}. \end{aligned}$$

(here $\theta_b = \pi/2$ thanks to the symmetrization). On the other hand, the support of $b_{S,m}$ lies a positive distance ($O(1/m)$) away from 0, so (9.2.23) holds true with $\theta_b = C m^{-1}$. Thus we can apply Theorem 9.3 with f and g exchanged, to find

$$\|Q_{RS}^+(f, f_{rc})\|_{L_\eta^p} \leq C m^\alpha \|f_{rc}\|_{L_{|1+\eta|+|\eta|}^1} \|f\|_{L_{1+\eta}^p}.$$

where $\alpha = \max(-\eta, 0) + 2/p' > 0$. Since we assume $1 + \eta \geq 0$, this can be bounded by

$$C m^\alpha r^{1-k} \|f\|_{L^1_{k+\eta+|\eta|}} \|f\|_{L^p_{1+\eta}} = C m^\alpha r^{1-k} \|f\|_{L^1_{k+2\eta_+}} \|f\|_{L^p_{1+\eta}}.$$

To sum up, we have obtained

$$\|Q_R^\pm(f, f)\|_{L^p_\eta} \leq C \left[\epsilon(m) + \left(\frac{r}{n}\right)^{k-1} + \frac{m^\alpha}{r^{k-1}} \right] \|f\|_{L^1_{k+2\eta_+}} \|f\|_{L^p_{1+\eta}}.$$

Then by choosing first m large enough, then r large enough, then n large enough, one gets

$$\|Q_R^\pm(f, f)\|_{L^p_\eta} \leq \epsilon \|f\|_{L^1_{k+2\eta_+}} \|f\|_{L^p_{1+\eta}}.$$

Now by Hölder's inequality,

$$\begin{aligned} \int_{\mathbb{R}^N} f^{p-1} Q_S^\pm(f, f) dv &\leq \left[\int_{\mathbb{R}^N} f^p dv \right]^{\frac{p-1}{p}} \left[\int_{\mathbb{R}^N} (Q_S^\pm)^p dv \right]^{\frac{1}{p}} \\ &= \|f\|_{L^p}^{p-1} \|Q_S^\pm(f, f)\|_{L^p}, \end{aligned}$$

and

$$\begin{aligned} \int_{\mathbb{R}^N} f^{p-1} Q_R^\pm(f, f) dv &= \int_{\mathbb{R}^N} (f\langle v \rangle^{1/p})^{p-1} \frac{Q_R^\pm}{\langle v \rangle^{1/p'}} dv \\ &\leq \left[\int_{\mathbb{R}^N} (f\langle v \rangle^{1/p})^p dv \right]^{\frac{p-1}{p}} \left[\int_{\mathbb{R}^N} (Q_R^\pm \langle v \rangle^{-1/p'})^p dv \right]^{\frac{1}{p}} = \|f\|_{L^{p/1/p}}^{p-1} \|Q_R^\pm(f, f)\|_{L^p_{-1/p'}}. \end{aligned}$$

By using the estimates above on Q_S^\pm and for Q_R^\pm with $\eta = -1/p'$ and $k = 2$, one can find $C_\epsilon > 0$ such that

$$\int_{\mathbb{R}^N} f^{p-1} Q^+(f, f) dv \leq C_\epsilon \|f\|_{L^q} \|f\|_{L^1} \|f\|_{L^p}^{p-1} + \epsilon \|f\|_{L^2} \|f\|_{L^{1/p}}^p$$

where q is defined by (9.2.27). Combining this with elementary interpolation and the uniform bounds on the mass and kinetic energy, we deduce that there exists $\theta \in (0, 1)$, only depending on N and p , and a constant $C_\epsilon > 0$, only depending on N, p, B and ϵ , such that

$$\begin{aligned} \int_{\mathbb{R}^N} f^{p-1} Q^+(f, f) dv &\leq C_\epsilon \|f\|_{L^1}^{1+p\theta} \|f\|_{L^p}^{1-p\theta} \|f\|_{L^p}^{p-1} + \epsilon \|f\|_{L^{1/p}}^p \\ &\leq C_\epsilon \|f\|_{L^1}^{1+p\theta} \|f\|_{L^p}^{p(1-\theta)} + \epsilon \|f\|_{L^2} \|f\|_{L^{1/p}}^p. \end{aligned}$$

This concludes the proof. \square

9.3 Regularity study in the rescaled variables

In this section we show the uniform propagation of Lebesgue and Sobolev norms and the exponential decay of singularities for the solutions of (9.1.10).

9.3.1 Uniform propagation of moments - Povzner Lemma

Let us prove that the kinetic energy of g remains uniformly bounded from above as t goes to infinity. Using (9.1.10) and (9.1.8), we get

$$\frac{d}{dt} \int_{\mathbb{R}^N} g |v|^2 dv \leq -\tau \int_{\mathbb{R}^N \times \mathbb{R}^N} g g_* |u|^3 dv_* dv + 2 \int_{\mathbb{R}^N} g |v|^2 dv.$$

On the one hand, from Jensen's inequality (see for instance [141, Lemma 2.2]), there holds

$$\int_{\mathbb{R}^N} g_* |u|^3 dv_* \geq \rho |v|^3.$$

On the other hand, Hölder's inequality yields

$$\int_{\mathbb{R}^N} g |v|^2 dv \leq \left(\int_{\mathbb{R}^N} g dv \right)^{1/3} \left(\int_{\mathbb{R}^N} g |v|^3 dv \right)^{2/3},$$

which implies that

$$\int_{\mathbb{R}^N} g |v|^3 dv \geq \rho^{1/2} \left(\int_{\mathbb{R}^N} g |v|^2 dv \right)^{3/2}.$$

Thus

$$\begin{aligned} \frac{d}{dt} \int_{\mathbb{R}^N} g |v|^2 dv &\leq -\tau \rho^{3/2} \left(\int_{\mathbb{R}^N} g |v|^2 dv \right)^{3/2} + 2 \left(\int_{\mathbb{R}^N} g |v|^2 dv \right) \\ &\leq \tau \rho^{3/2} \left(\int_{\mathbb{R}^N} g |v|^2 dv \right) \left[\frac{2}{\tau \rho^{3/2}} - \left(\int_{\mathbb{R}^N} g |v|^2 dv \right)^{1/2} \right], \end{aligned}$$

and by maximum principle we deduce

$$(9.3.28) \quad \sup_{t \geq 0} \int_{\mathbb{R}^N} g |v|^2 dv \leq C_E = \max \left\{ \left(\frac{4}{\rho^3 \tau^2} \right), \int_{\mathbb{R}^N} g_{\text{in}} |v|^2 dv \right\}.$$

The same argument, together with sharp versions of Povzner inequalities (see [141, Proof of Proposition 3.2]) shall yield uniform bounds on every moments of the solution. Indeed we prove the

Proposition 9.3. *Let g be a solution in $C(\mathbb{R}_+; L_2^1) \cap L^1(\mathbb{R}_+; L_3^1)$ to the rescaled Boltzman equation (9.1.10), with initial datum g_{in} . Then it satisfies the following additional moment properties:*

(i) *For any $s \geq 2$, there is an explicit constant $C_s > 0$, depending only on B, ϵ , and g_{in} , such that*

$$\sup_{t \in [0, \infty)} \|g(t, \cdot)\|_{L_s^1} \leq \max \{ \|g_{\text{in}}\|_{L_s^1}, C_s \}.$$

(ii) *If $g_{\text{in}} e^{r|v|^\eta} \in L^1(\mathbb{R}^N)$ for $r > 0$ and $\eta \in (0, 1]$, there exists $C_1, r' > 0$, depending only on B, ϵ , and g_{in} , such that*

$$\sup_{t \in [0, \infty)} \int_{\mathbb{R}^N} g(t, v) e^{r'|v|^\eta} dv \leq C_1.$$

(iii) *For any $\eta \in (0, 1/2)$ and $\tau > 0$, there exists $a_\eta, C_\eta \in (0, \infty)$, depending only on B, ϵ , and g_{in} , such that*

$$\sup_{t \in [\tau, \infty)} \int_{\mathbb{R}^N} g(t, v) e^{a_\eta |v|^\eta} dv \leq C_\eta.$$

Let us emphasize that the constant C_s, a_η, C_η may depend on g_{in} only through its mass ρ and its kinetic energy \mathcal{E}_{in} .

Proof of Proposition 9.3. The proof is just a copy with minor modifications of classical proofs. For the proof of (i) we refer for instance to [144, 191, 100] and the references therein. The proofs of (ii) and (iii) are variants of the proof of [141, Proposition 3.2], which itself follows closely the proof of [25, Theorem 3] and use arguments introduced in [100, 32]. The starting point is the following differential equation on the moments

$$\frac{d}{dt} m_p = \int_{\mathbb{R}^N} Q(g, g) |v|^{2p} dv + p m_p \quad \text{with} \quad m_p := \int_{\mathbb{R}^N} g |v|^{2p} dv.$$

Proceeding along the lines of [141, Proof of Proposition 3.2], we introduce the new rescaled moment function

$$z_p := \frac{m_p}{\Gamma(a p + 1/2)}, \quad Z_p := \max_{k=1, \dots, k_p} \{ z_{k+1/2} z_{p-k}, z_k z_{p-k+1/2} \},$$

for some fixed $a \geq 2$, and we obtain the differential inequality

$$(9.3.29) \quad \frac{dz_p}{dt} \leq A' p^{a/2-1/2} Z_p - A'' p^{a/2} z_p^{1+1/2p} + p z_p$$

for any $p = 3/2, 2, \dots$ and for some constants $A', A'' > 0$. Note that (9.3.29) is nothing but [141, equation (3.18)], with an additional term $p z_p$ due to the additional term $-\nabla_v \cdot (v g)$ in equation (9.1.10).

On the one hand, we remark, by an induction argument, that taking $p_0 = p_0(a, A', A'')$ and $x_0 = x_0(a, A', A'')$ large enough, the sequence of functions $z_p := x^p$ is a sequence of supersolution of (9.3.29) for any $x \geq x_0$ and $p \geq p_0$. Let us emphasize here that we have to take $a \geq 2$ (i.e. $\eta \leq 1$ in [141, Proof of Proposition 3.2]) because of the additional term $p z_p$. On the other hand, choosing x_1 large enough, which may depend on p_0 , we have from (i) that the sequence of functions $z_p := x^p$ is a sequence of supersolution of (9.3.29) for any $x \geq x_1$ and for $p \in \{0, 1/2, \dots, p_0\}$. As a consequence, we have proved that there exists $x_2 := \max(x_0, x_1)$ such that the set

$$(9.3.30) \quad \mathcal{C}_x := \left\{ z = (z_p); \quad z_p \leq x^p \quad \forall p \in \frac{1}{2} \mathbb{N} \right\}$$

is invariant under the flow generated by the Boltzmann equation for any $x \geq x_2$: if $g(t_1) \in \mathcal{C}_x$ then $g(t_2) \in \mathcal{C}_x$ for any $t_2 \geq t_1$.

The end of the proof is exactly similar to that of [141, Proof of Proposition 3.2]. \square

The integral upper bound in point (ii) of Theorem 9.2 follows from point (iii) of Proposition 9.3.

9.3.2 Stability in L^1

The stability result [141, Proposition 3.4] translates for (9.1.10) into:

$$\|g - h\|_{L^1} + e^{-2T} \|(g - h)|v|^2\|_{L^1} \leq e^{C(e^{2T} - 1)} [\|g_{\text{in}} - h_{\text{in}}\|_{L^1} + \|(g_{\text{in}} - h_{\text{in}})|v|^2\|_{L^1}]$$

for any solutions g and h in $C(\mathbb{R}_+, L^1_2) \cap L^\infty(\mathbb{R}_+, L^1_3)$ with initial datum $0 \leq g_{\text{in}}, h_{\text{in}} \in L^1_3$. This shows (together with the propagation of the L^1_3 norm) that, in the Banach space L^1_2 , the evolution semi-group S_t of (9.1.10) satisfies: for any $t \geq 0$, S_t is (strongly) continuous in any L^1_3 bounded subset of L^1_2 . However we shall prove a more precise stability result, working directly on the rescaled equation (9.1.10).

Proposition 9.4. *Let $0 \leq g_{\text{in}}, h_{\text{in}} \in L^1_3$ and let g and h be the two solutions of (9.1.10) (in $C(\mathbb{R}_+, L^1_2) \cap L^\infty(\mathbb{R}_+, L^1_3)$). Then there is $C_{\text{stab}} > 0$ depending only on B and $\sup_{t \geq 0} \|g + h\|_{L^1_3}$ such that*

$$\forall t \geq 0, \quad \|g_t - h_t\|_{L^1_2} \leq \|g_{\text{in}} - h_{\text{in}}\|_{L^1_2} e^{C_{\text{stab}} t}.$$

Proof of Proposition 9.4. We multiply the equation satisfied by $g - h$ by $\phi(t, v) = \text{sgn}(g(t, v) - h(t, v))(1 + |v|^2)$. We use on the one hand the same arguments as in [141, Proposition 3.4] to treat

$$I = \int_{\mathbb{R}^N} [Q(g, g) - Q(h, h)] \phi(t, v) dv,$$

which gives

$$I \leq C \left(\int_{\mathbb{R}^N} (g + h)(1 + |v|^3) dv \right) \left(\int_{\mathbb{R}^N} |g - h|(1 + |v|^2) dv \right).$$

On the other hand we use that

$$\begin{aligned} - \int_{\mathbb{R}^N} \nabla_v \cdot (v(g - h)) \phi(t, v) dv &= -N \int_{\mathbb{R}^N} |g - h|(1 + |v|^2) dv \\ &\quad + \int_{\mathbb{R}^N} |g - h| \nabla_v \cdot (v + v|v|^2) dv \\ &= 2 \int_{\mathbb{R}^N} |g - h| |v|^2 dv. \end{aligned}$$

This concludes the proof with

$$C_{\text{stab}} = C \sup_{t \geq 0} \|g + h\|_{L^1_3} + 2.$$

□

9.3.3 Uniform propagation of Lebesgue norms

Let us take $1 < p < +\infty$. We compute the time derivative of the L^p norm of g using equation (9.1.10):

$$\frac{1}{p} \frac{d}{dt} \int_{\mathbb{R}^N} g^p dv = \int_{\mathbb{R}^N} Q^+(g, g) g^{p-1} dv - \int_{\mathbb{R}^N} g^p L(g) dv - \int_{\mathbb{R}^N} g^{p-1} \nabla_v \cdot (vg) dv.$$

We use the control (9.1.16), and

$$\int_{\mathbb{R}^N} \nabla_v \cdot (vg) g^{p-1} dv = N \left(1 - \frac{1}{p} \right) \|g\|_{L^p}^p.$$

Gathering all these estimates, we deduce

$$\begin{aligned} \frac{1}{p} \frac{d}{dt} \int_{\mathbb{R}^N} g^p dv &\leq \int_{\mathbb{R}^N} Q^+(g, g) g^{p-1} dv \\ &\quad - \min \left\{ 1, N \left(1 - \frac{1}{p} \right) \right\} \int_{\mathbb{R}^N} g^p (1 + |v|) dv. \end{aligned}$$

Concerning the gain term, Theorem 9.4 yields, for any $\varepsilon > 0$,

$$\int_{\mathbb{R}^N} Q^+(g, g) f^{p-1} dv \leq C_\varepsilon \|g\|_{L^{\frac{1}{2}}}^{1+p\theta} \|g\|_{L^p}^{p(1-\theta)} + \varepsilon \|g\|_{L^{\frac{1}{2}}} \|g(1 + |v|)\|_{L^p}^p.$$

Hence, using the bound C_E on the kinetic energy, if we fix ε such that

$$C_E^{p(1-\theta)} \varepsilon < 1/2 \min \left\{ 1, N \left(1 - \frac{1}{p} \right) \right\},$$

we obtain

$$\frac{d}{dt} \|g\|_{L^p}^p \leq C_+ \|g\|_{L^p}^{p(1-\theta)} - K_- \|g\|_{L^{\frac{1}{p}}}^p$$

for some explicit constants $C_+, K_- > 0$. By maximum principle, it shows that the L^p norm of g is uniformly bounded by

$$\sup_{t \geq 0} \|g_t\|_{L^p} \leq \max \left\{ \left(\frac{C_+}{K_-} \right)^{\frac{1}{p\theta}}, \|g_{\text{in}}\|_{L^p} \right\}.$$

9.3.4 Non-concentration in the rescaled variables and Haff's law

In this subsection we give a short proof of Haff's law, even if a stronger pointwise result on the tail will be proved in the next section. Let $f_{\text{in}} = g_{\text{in}}$ be an initial datum in $L^{\frac{1}{3}} \cap L^p$ (with $1 < p < +\infty$). Hence according to the previous subsection, the rescaled solution g of (9.1.10) with initial datum g_{in} satisfies

$$\sup_{t \geq 0} \|g_t\|_{L^p} \leq C_p$$

for some explicit constant $C_p > 0$ depending on the collision kernel and the mass, kinetic energy and L^p norm of f_{in} . By using Cauchy-Schwarz inequality, this non-concentration estimate implies that for any $r > 0$

$$\forall t \geq 0, \int_{|v| \leq r} g(t, v) dv \leq C r^{\frac{p-1}{p} N}.$$

Thus there is $r_0 > 0$ such that

$$\forall t \geq 0, \int_{|v| \leq r_0} g(t, v) dv \leq 1/2$$

and thus

$$\begin{aligned}
 \forall t \geq 0, \quad \int_{\mathbb{R}^N} g(t, v) |v|^2 dv &\geq \int_{|v| \geq r_0} g(t, v) |v|^2 dv \\
 (9.3.31) \quad &\geq r_0^2 \int_{|v| \geq r_0} g(t, v) dv \\
 &\geq r_0^2 \left(1 - \int_{|v| \leq r_0} g(t, v) dv \right) \geq \frac{r_0^2}{2}.
 \end{aligned}$$

As a conclusion, gathering (9.3.28) and (9.3.31), we have proved that for some constants $C_0, C_1 \in (0, \infty)$ there holds

$$C_0 \leq \mathcal{E}(g(t, \cdot)) \leq C_1,$$

and Haff's law (9.1.14) (point (iii) in Theorem 9.2) follows thanks to (9.1.13). \square

Remark: The inequality $\mathcal{E}(f(t, \cdot)) \leq M t^{-2}$ (or equivalently $\mathcal{E}(g(t, \cdot)) \leq C_1$) was already known: see for instance [18, equations (2.5)-(2.6)] where it is proved for a quasi-elastic one-dimensional model with the same evolution equation (9.1.8) on the kinetic energy, by comparison to a differential equation. Indeed the harder part in Haff's law is the first inequality, which means that the solution does not cool down faster than the self-similar profil. As emphasized by the proof above, this is related to the impossibility of asymptotic concentration in the rescaled equation (9.1.10).

9.3.5 Uniform propagation of Sobolev norms

The study of propagation of regularity and exponential decay of singularities is based on a Duhamel representation of the solution we shall introduce. Let us denote

$$L(t, v) = \left(\int_{\mathbb{R}^N} g(v_*) |v - v_*| dv_* \right),$$

and

$$S_t g = g(e^{-t}v) \exp \left[-Nt - \int_0^t L(s, e^{-(t-s)}v) ds \right]$$

the evolution semi-group associated to

$$Tg = - \left(\int_{\mathbb{R}^N} g(v_*) |v - v_*| dv_* \right) g(v) - \nabla_v \cdot (v g).$$

Then the solution of (9.1.10) represents as

$$g_t = S_t g_{\text{in}} + \int_0^t S_{t-s} Q^+(g_s, g_s) ds.$$

We give a proposition similar to [150, Proposition 5.2]

Proposition 9.5. *There are some constants $\alpha > 0$, $\delta > 0$, $K > 0$ and $k > 0$ such that for any $s, \eta \geq 0$, we have*

$$\|S_t g_{\text{in}}\|_{H_\eta^{s+\alpha}} \leq C_{\text{Duh}} e^{-Kt} \|g_{\text{in}}\|_{H_{\eta+\delta}^{s+\alpha}} \sup_{0 \leq \bar{t} \leq t} \|g(\bar{t}, \cdot)\|_{H_{\eta+\delta}^{s+k}}$$

$$\left\| \int_0^t S_{t-s} Q^+(g_s, g_s) ds \right\|_{H_\eta^{s+\alpha}} \leq C_{\text{Duh}} \sup_{0 \leq \bar{t} \leq t} \|g(\bar{t}, \cdot)\|_{H_{\eta+\delta}^{s+k}}.$$

Proof of Proposition 9.5. The proof is exactly similar to [150, Proof of Proposition 5.2]. Indeed the semi-group in [150, Proof of Proposition 5.2] is

$$\bar{S}_t g = g(v) \exp \left[- \int_0^t L(s, v) ds \right]$$

and thus the estimates on the Sobolev norm in v can only improve for S_t according to \bar{S}_t . The main tool of [150, Proof of Proposition 5.2], i.e. the Bouchut-Desvillettes-Lu regularity result on Q^+ , has been proved in our case in Theorem 9.5. \square

Now results follows as in [150]:

Theorem 9.6. *Let $0 \leq g_{\text{in}} \in L_2^1$ be an initial datum and let g be the unique solution of (9.1.10) in $C(\mathbb{R}_+, L_2^1) \cap L^1(\mathbb{R}_+, L_3^1)$ associated with g_{in} . Then for all $s > 0$ and $\eta \geq 1$, there exists $w(s) > 0$ (explicitly $w(s) = \delta \lceil s/\alpha \rceil$, where α is defined in Proposition 9.5) such that*

$$g_{\text{in}} \in H_{\eta+w}^s \implies \sup_{t \geq 0} \|g(t, \cdot)\|_{H_\eta^s} < +\infty$$

with uniform bounds.

Proof of Theorem 9.6. Let $n \in \mathbb{N}$ be such that $n\alpha \geq s$ ($n = \lceil s/\alpha \rceil$). Let $w(s) = \delta \lceil s/\alpha \rceil$. The proof is made by an induction comprising n steps, proving successively that g is uniformly bounded in $H_{\eta + \frac{n-i}{n}w}^{i\alpha}$ for $i = 0, 1, \dots, n$.

Let us write the induction. The initialisation for $i = 0$, i.e. g uniformly bounded in $L_{\eta+w}^2$ is proved by the previous study of uniform propagation of

weighted L^p norms in Subsection 9.3.3. Now let $0 < i \leq n$ and suppose the induction assumption to be satisfied for all $0 \leq j < i$. Then proposition 9.5 implies

$$\|S_t g_{\text{in}}\|_{H_{\eta + \frac{n-i}{n}w}^{i\alpha}} \leq C_{\text{Duh}} e^{-Kt} \|g_{\text{in}}(\cdot)\|_{H_{\eta + \frac{n-i}{n}w + \delta}^{i\alpha}} \sup_{0 \leq t_0 \leq t} \|g(t_0, \cdot)\|_{H_{\eta + \frac{n-i}{n}w + \delta}^{i\alpha+k}},$$

and

$$\left\| \int_0^t S_{t-s} Q^+(g_s, g_s) ds \right\|_{H_{\eta + \frac{n-i}{n}w}^{i\alpha}} \leq C_{\text{Duh}} \sup_{0 \leq t_0 \leq t} \|g(t_0, \cdot)\|_{H_{\eta + \frac{n-i}{n}w + \delta}^{i\alpha+k}}.$$

Moreover as $i \geq 1$,

$$\eta + \frac{n-i}{n}w + \delta \leq \eta + \frac{n-(i-1)}{n}w.$$

Thus, using the induction assumption for $i-1$, g is uniformly bounded in $H_{\eta + \frac{n-i}{n}w}^{i\alpha}$, which concludes the proof. \square

9.3.6 Exponential decay of singularities

Theorem 9.7. *Let $0 \leq g_{\text{in}} \in L_2^1 \cap L^2$ and let g be the unique solution of (9.1.10) in $C(\mathbb{R}_+, L_2^1) \cap L^1(\mathbb{R}_+, L_3^1)$ associated with g_{in} . Let $s \geq 0$, $q \geq 0$ be arbitrarily large. Then g can be written $g^S + g^R$ in such a way that*

$$\begin{cases} \sup_{t \geq 0} \|g_t^S\|_{H_q^s \cap L_2^1} < +\infty, & g^S \geq 0 \\ \exists \lambda > 0; & \|g_t^R\|_{L_2^1} = O(e^{-\lambda t}). \end{cases}$$

All the constants in this theorem can be computed in terms of the collision kernel, the mass, kinetic energy and L^2 norm of g_{in} .

Proof of Theorem 9.7. The proof of Theorem 9.7 is exactly similar to [150, Proof of Theorem 5.4], since the only tools of the proof are the stability result, the estimate on the Duhamel representation, and the uniform propagation of Sobolev norms, which have been proved respectively in Proposition 9.4, Proposition 9.5 and Proposition 9.6. The propagation and appearance of moments in L^1 (used in this proof) were proved in Proposition 9.3. \square

Point (i) of Theorem 9.2 is deduced from this theorem.

Remark: As suggested by this study, the self-similar variables are not only useful for proving the existence of self-similar profiles, but it seems that they also provide the good framework for studying precisely the regularity of the solution. For instance, coming back to the original variables, Theorem 9.7 shows the algebraic decay of singularities for the solutions of (9.1.1).

9.4 Self-similar solutions and tail behavior

In this section we achieve the proofs of Theorem 9.1 and Theorem 9.2 by showing the existence of self-similar solutions, and obtaining estimates on their tail and the tail of generic solutions.

9.4.1 Existence of self-similar solutions

The starting point is the following result, see for instance [100, Theorem 5.2] or [14, 82].

Theorem 9.8. *Let \mathcal{Y} be a Banach space and $(S_t)_{t \geq 0}$ be a continuous semi-group on \mathcal{Y} . Assume that there exists \mathcal{K} a nonempty convex and weakly (sequentially) compact subset of \mathcal{Y} which is invariant under the action of S_t (that is $S_t y \in \mathcal{K}$ for any $y \in \mathcal{K}$ and $t \geq 0$), and such that S_t is weakly (sequentially) continuous on \mathcal{K} for any $t > 0$. Then there exists $y_0 \in \mathcal{K}$ which is stationary under the action of S_t (that is $S_t y_0 = y_0$ for any $t \geq 0$).*

Proof of Theorem 9.1 (existence part). The existence of self-similar solutions follows from the application of this result to the evolution semi-group of (9.1.10). The continuity properties of the semi-group are proved by the study of the Cauchy problem, recalled in Section 9.3. On the Banach space $\mathcal{Y} = L^1_2$, thanks to the uniform bounds on the L^1_3 and L^p norms, the nonempty convex subset of \mathcal{Y}

$$\mathcal{K} = \left\{ f \in \mathcal{Y}, \quad \|f\|_{L^1_3} + \|f\|_{L^p} \leq M \right\}$$

is stable by the semi-group provided M is big enough. This set is weakly compact in \mathcal{Y} by Dunford-Pettis Theorem, and the continuity of S_t for all $t \geq 0$ on \mathcal{K} follows from Proposition 9.4. This shows that there exists a stationary solution to (9.1.10) in $L^1_3 \cap L^p$ for any given mass, that is a self-similar solution for the original problem (9.1.1).

Then if one chooses $p = 2$, he can apply Theorem 9.7, which proves that the stationary solution of (9.1.10) obtained above belongs to C^∞ (in fact it proves that it belongs to the Schwartz space of C^∞ functions decreasing faster than any polynomial at infinity). Moreover, since the property of being radially symmetric is stable along the flow of (9.1.10), this stationary solution can be shown to exist within the set of radially symmetric functions by the same arguments. \square

9.4.2 Tail of the self-similar profiles

In this subsection we prove pointwise bounds on the tail behavior of the self-similar solutions. The starting point is the following result extracted from [32, Theorem 1]; notice that it is also a consequence of the construction of invariant sets \mathcal{C}_x for z_p with $a = 2$, as defined in (9.3.30).

Theorem 9.9 (Bobylev-Gamba-Panferov). *Let G be a steady state of (9.1.10) with finite moments of all orders. Then G has exponential tail of order 1, that is*

$$r^* = \sup \left\{ r \geq 0, \quad \int_{\mathbb{R}^N} G(v) \exp(r|v|) dv < +\infty \right\}$$

belongs to $(0, +\infty)$.

Note that if we define more generally (for $s > 0$)

$$r_s^* = \sup \left\{ r \geq 0, \quad \int_{\mathbb{R}^N} G(v) \exp(r|v|^s) dv < +\infty \right\},$$

a simple consequence of this result is that $r_s^* = +\infty$ for any $s < 1$, and $r_s^* = 0$ for any $s > 1$.

First let us prove the pointwise bound from above on the steady state. Since the evolution equation (9.1.10) makes all the moments appear (see Proposition 9.3), we assume that G has finite moments of all orders. Moreover, as discussed above, we can also assume that G is smooth and radially symmetric. We denote $r = |v|$. We thus have the

Proposition 9.6. *Let $G \in C^1$ be a radially symmetric steady state of (9.1.10) with finite moments of all order. Then there exists $A_1, A_2 > 0$ such that*

$$\forall v \in \mathbb{R}^N, \quad G(v) \leq A_1 e^{-A_2 |v|}.$$

Proof of Proposition 9.6. The differential equation satisfied by $G = G(r)$ writes

$$Q(G, G) - N G - r G' = 0.$$

Since G is smooth and integrable, it goes to 0 at infinity. By integrating this equation between $r = R$ and $r = +\infty$, we obtain

$$G(R) = N \int_R^{+\infty} \frac{G(r)}{r} dr - \int_R^{+\infty} \frac{Q(G, G)}{r} dr.$$

One deduces the following upper bound

$$G(R) \leq N \int_R^{+\infty} \frac{G(r)}{r} dr + \int_R^{+\infty} \frac{Q^-(G, G)}{r} dr.$$

Since $Q^-(G, G) = G(G * \Phi)$, we have

$$Q^-(G, G)(v) \leq C(1 + |v|)G.$$

Hence, taking $R \geq 1$ leads to

$$G(R) \leq C \int_R^{+\infty} G(r) r^{N-1} dr.$$

Finally, since we have by Theorem 9.9

$$\int_0^{+\infty} G(r) \exp(A_2 r) r^{N-1} dr \leq A_0 < +\infty$$

for some constants $A_0, A_2 > 0$, we deduce that

$$G(R) \leq C \int_R^{+\infty} G(r) r^{N-1} dr \leq C A_0 \exp(-A_2 R) = A_1 \exp(-A_2 R).$$

This concludes the proof. □

For the pointwise lower bound, we give here a proof based on a maximum principle argument, inspired from the works [100, 99]. We shall in the next subsection give a more general result for generic solutions of (9.1.10), based on the spreading effect of the gain term and the dispersion (or transport) effect of the evolution semi-group of (9.1.10) (due to the anti-drift term).

Proposition 9.7. *Let $G \in C^1$ be a steady state of (9.1.10) with finite moments of orders 0 and 2. Then there exists $a_1, a_2 > 0$ such that*

$$\forall v \in \mathbb{R}^N, \quad G(v) \geq a_1 e^{-a_2 |v|}.$$

We first start with a lemma.

Lemma 9.1. *For any $r_0, a_1, \rho_0, \rho_1 > 0$, there exists $a_2 > 0$ such that the function $h(v) := a_1 \exp(-a_2 |v|)$ satisfies*

$$(9.4.32) \quad \forall v, |v| \geq r_0, \quad Q^-(g, h) + \nabla_v(vh) \leq 0$$

for any function g such that

$$\int_{\mathbb{R}^N} g(v) dv = \rho_0, \quad \int_{\mathbb{R}^N} g(v) |v| dv = \rho_1.$$

Proof of Lemma 9.1. On the one hand, it is straightforward that

$$Q^-(g, h) := (g * \Phi) h \leq (\rho_1 + \rho_0 |v|) h.$$

On the other hand, simple computations show that

$$\nabla_v(v h) = (N - a_2 |v|) h.$$

Gathering these two inequalities there holds

$$\forall v, |v| \geq r_0, \quad Q^-(g, h) + \nabla_v(v h) \leq (\rho_1 + N + \rho_0 |v| - a_2 |v|) h \leq 0$$

for a_2 large enough. □

Proof of Proposition 9.7. Since $G \in C^1$ and radially symmetric, there holds $G'(0) = 0$. As a consequence, the equation satisfied by G reads in $v = 0$

$$Q(G, G)(0) - N G(0) = 0$$

and then

$$G(0) = \frac{Q^+(G, G)(0)}{\rho_1 + N} > 0$$

since G is not zero everywhere. By continuity, $G(v) > 2a_1$ on $B(0, r_0)$ for some $a_1, r_0 > 0$.

Let us define

$$\rho_0 := \int_{\mathbb{R}^N} G(v) dv, \quad \rho_1 := \int_{\mathbb{R}^N} G(v) |v| dv.$$

and $a_2 > 0$ by Lemma 9.1. On the one hand $h(v) := a_1 \exp(-a_2 |v|)$ satisfies (9.4.32) for $g = G$ and, on the other hand, G satisfies

$$(9.4.33) \quad \forall v \in \mathbb{R}^N, \quad Q^-(G, G) + \nabla_v(v G) = Q^+(G, G) \geq 0.$$

Introducing the auxiliary function $W := G - h$, we deduce from (9.4.32) and (9.4.33)

$$\forall v, |v| \geq r_0, \quad (G * \Phi) W + \nabla_v(v W) \geq 0$$

and $W(r_0) = G(r_0) - h(r_0) \geq G(r_0)/2 > 0$. By the Gronwall Lemma (using that all the functions involved in this inequality are radially symmetric), we get $W(v) \geq 0$ for any $v, |v| \geq r_0$, which concludes the proof. □

9.4.3 Positivity of the rescaled solution

We start with three technical lemmas.

Lemma 9.2. *Let g_0 satisfies*

$$(9.4.34) \quad \int_{\mathbb{R}^N} g_0 dv = 1, \quad \int_{\mathbb{R}^N} g_0 |v|^2 dv \leq C_1, \quad \int_{\mathbb{R}^N} g_0^2 dv \leq C_2.$$

There exist $R > r > 0$ and $\eta > 0$ depending only on C_1, C_2 , and $(v_i)_{i=1, \dots, 4}$ such that $|v_i| \leq R$, $i = 1, \dots, 4$, and $|v_i - v_j| \geq 3r$ for $1 \leq i \neq j \leq 3$, and

$$(9.4.35) \quad \int_{B(v_i, r)} g_0(v) dv \geq \eta \quad \text{for } i = 1, 2, 3,$$

$$(9.4.36)$$

$\forall w_i \in B(v_i, r), \quad E_{w_3, w_4}^e \cap S_{w_1, w_2}^e$ is a sphere of radius larger than r ,

where $E_{v', v}^e$ stands for the plane defined in Proposition 9.1 and S_{v, v_*}^e stands for the sphere of all possible post-collisional velocity v' defined by (9.1.19).

Proof of Theorem 9.2. Let C_R denotes the hypercube $[-R, R]^N$ centered at $v = 0$ with length $2R > 0$. Thanks to the mass condition and the energy bound in (9.4.34), for R large enough, there holds

$$(9.4.37) \quad \int_{C_R} g_0 dv \geq \frac{1}{2}.$$

Then we define $(K_i)_{i=1, \dots, I}$ the family of $I = (2R/r)^N$ hypercubes of length $r > 0$ (with $R/r \in \mathbb{N}$), included in C_R and such that the union of K_i is almost equal to C_R . For any given $\lambda > 0$ to be later fixed, we may find $r > 0$ such that

$$(9.4.38) \quad \int_{K_i + B(0, \lambda r)} g_0 dv \leq |K_i + B(0, \lambda r)|^{1/2} \left(\int_{K_i + B(0, \lambda r)} g_0^2 dv \right)^{1/2} \leq C [(\lambda + 1)r]^{N/2} \leq 1/4$$

for any $i = 1, \dots, I$. Hence we can choose K_{i_0} such that the mass of g_0 in K_i is maximal for $i = i_0$. Because of (9.4.37) there holds

$$(9.4.39) \quad \int_{K_{i_0}} g_0 dv \geq 1/4 (2R/r)^{-N}.$$

Gathering (9.4.37) and (9.4.38) we may find $K_{j_0} \subset C_R$ such that $\text{dist}(K_{i_0}, K_{j_0}) > \lambda r$ and (9.4.39) also holds for $i = j_0$.

Next, we fix $\lambda := 200\beta$. We define v_1 (respectively v_2) as the center of the hypercube K_{i_0} (respectively K_{j_0}), and $v_3 = (v_1 + v_2)/2$ and $v_4 = v_2$. Then we have

$$\Omega(v_3, v_4) = v_1 + \frac{\beta^{-1}}{2}(v_2 - v_1) \in [v_1, v_2],$$

which implies

$$|\Omega - v_1| = \frac{\beta^{-1}}{2}|v_2 - v_1| \geq \frac{\beta^{-1}}{2}(\lambda r) \geq 100r.$$

Thus $E_{v_3, v_4}^e \cap S^e(v_1, v_2)$ is a $(N - 2)$ -dimensional sphere of radius larger than $100r$ (because $B(\Omega, 100r)$ is included in the convex hull of $S^e(v_1, v_2)$), and (9.4.36) follows straightforwardly. \square

Lemma 9.3. *Let us fix $R > r > 0$ and $\eta > 0$. Then there exists $\delta_0 > 0$, $\eta_0 > 0$, $\xi_0 \in (0, 1)$ (depending on $R > r > 0$, $\eta > 0$ and B) such that, for any functions f, h, ℓ satisfying (9.4.35)-(9.4.36) for some velocities $(v_i)_{i=1, \dots, 4}$ such that $|v_i| \leq R$, $i = 1, \dots, 4$ and $|v_i - v_j| \geq 3r$, $1 \leq i \neq j \leq 3$, and for any $\xi \in (\xi_0, 1)$, there holds*

$$Q^+(f, Q_\xi^+(h, \ell)) \geq \eta_0 \mathbf{1}_{B(v_3, \delta_0)},$$

where we define here and below $Q_\xi^+(\cdot, \cdot)(v) = Q^+(\cdot, \cdot)(\xi v)$.

Proof of Theorem 9.3. We first establish a convenient formula to handle representations of the iterated gain term. For any f, h and ℓ and any $v \in \mathbb{R}^N$ there holds (setting $'v = w$ and $'v_* = w_*$)

$$Q^+(f, Q_\xi^+(h, \ell))(v) = C'_b \int_{\mathbb{R}^N} \frac{f(w)}{|v - w|} \left\{ \int_{E_{v, w}^e} Q_\xi^+(h, \ell)(w_*) dw_* \right\} dw.$$

From the following identity

$$Q_\xi^+(h, \ell)(w_*) = \int_{\mathbb{R}^N} \int_{\mathbb{R}^N} h(w_1) \ell(w_2) Q_\xi^+(\delta_1, \delta_2)(w_*) dw_1 dw_2$$

where δ_i stands for the Dirac measure at w_j , the term between brackets, that we denote by A , write

$$A(v, w) = \int_{\mathbb{R}^N \times \mathbb{R}^N} h(w_1) \ell(w_2) \times \left\{ \lim_{\varepsilon \rightarrow 0} \frac{1}{2\varepsilon} \int_{\mathbb{R}^N} Q^+(\delta_1, \delta_2)(\xi w_*) \Xi_\varepsilon(w_*) dw_* \right\} dw_1 dw_2$$

where Ξ_ε denotes the indicator function of the set $\{w_*; \text{dist}(w_*, E_{v,w}) < \varepsilon\}$. Denoting now by D_ε the integral just after the limit sign in the term between brackets, and using the weak formulation (9.1.18), there holds

$$\begin{aligned} D_\varepsilon &= \frac{\xi^{-1}}{2\varepsilon} \int_{\mathbb{R}^N \times \mathbb{R}^N \times \mathbb{S}^{N-1}} \delta_1(z) \delta_1(z_*) |z - z_*| b(\sigma \cdot \hat{z}) \Xi_\varepsilon(\xi^{-1} z') d\sigma dz dz_* \\ &= |w_1 - w_2| \xi^{-1} C_b \int_{\mathbb{S}^{N-1}} \frac{\Xi_\varepsilon(z' \xi^{-1})}{2\varepsilon} d\sigma, \end{aligned}$$

where in these integrales z' is defined from (z, z_*, σ) and next from (w_1, w_2, σ) thanks to formula (9.1.19). We define $\xi_0 = (1 + r/R)^{-1}$ in such a way that $|\xi^{-1} z' - z'| \leq r$ for any $z' \in B(0, R)$ and $\xi \in (\xi_0, 1)$. Taking $v \in B(v_3, r)$, $w \in B(v_4, r)$, $w_1 \in B(v_1, r)$, $w_2 \in B(v_2, r)$, we have thanks to (9.4.36) and $|w_2 - w_1| \geq r$:

$$D_0(v, w, w_1, w_2) := \lim_{\varepsilon \rightarrow 0} D_\varepsilon \geq r \xi_0^{-1} C_b C r^{N-2}.$$

As a consequence, for any $v \in B(v_3, r)$,

$$\begin{aligned} Q^+(f, Q_\xi^+(h, \ell))(v) &\geq Q^+(f \mathbf{1}_{B(v_4, r)}, Q^+(h \mathbf{1}_{B(v_1, r)}, \ell \mathbf{1}_{B(v_2, r)}))(v) \\ &\geq C'_b \int_{B(v_1, r)} \int_{B(v_2, r)} \int_{B(v_4, r)} \frac{f(w)}{|v - w|} h(w_1) \ell(w_2) D_0 dw_1 dw_2 dw \\ &\geq C'_b \eta^3 \frac{1}{2R} r \xi_0^{-1} C_b C r^{N-2} =: \eta_0. \end{aligned}$$

This concludes the proof. \square

Lemma 9.4. *For any $\bar{v} \in \mathbb{R}^N$ and $\delta > 0$, there exists $\kappa = \kappa(\delta) > 0$ such that*

$$(9.4.40) \quad \mathcal{Q}^+(v) := Q^+(\mathbf{1}_{B(\bar{v}, \delta)}, \mathbf{1}_{B(\bar{v}, \delta)}) \geq \kappa \mathbf{1}_{B(\bar{v}, \frac{\sqrt{5}}{2} \delta)}.$$

Proof of Lemma 9.4. The homogeneity property (9.1.9) of Q^+ and the invariance by translation allow to reduce the proof of (9.4.40) to the case $\bar{v} = 0$ and $\delta = 1$. The invariance by rotations implies that \mathcal{Q}^+ is radially symmetric and the homogeneity property again allows to conclude that the support of \mathcal{Q}^+ is a ball B' . More precisely, taking a C^∞ radially symmetric function ϕ such that $\phi > 0$ on $B = B(0, 1)$ and $\phi \leq \mathbf{1}_B$ on \mathbb{R}^N , we have $Q^+(\phi, \phi)$ is continuous, $\mathcal{Q}^+ \geq Q^+(\phi, \phi)$ on \mathbb{R}^N and $Q^+(\phi, \phi) > 0$ on the ball B' . As a consequence, for any ball B'' strictly included in B' , there exists $\kappa > 0$ such that $\mathcal{Q}^+ \geq \kappa \mathbf{1}_{B''}$. In order to conclude, we just need to estimate the support of \mathcal{Q}^+ .

Let us fix $R \in (0, 1)$ and choose $'v, 'v_* \in B(0, 1)$ such that $'v \perp 'v_*$, $|'v| = |'v_*| = R$. Then for any $\sigma \in \mathbb{S}^{N-1}$, $\sigma \perp 'v - 'v_*$, the function \mathcal{Q}^+ is positive at the post-collisional associated velocity v defined by

$$v = \frac{'v + 'v_*}{2} + \frac{1-e}{4} ('v - 'v_*) + \frac{1+e}{4} |'v - 'v_*| \sigma.$$

Remarking that $|'v + 'v_*|^2 = |'v - 'v_*|^2 = 2R^2$, $('v - 'v_*) \cdot ('v + 'v_*) = 0$ and $('v + 'v_*) \cdot \sigma = \sqrt{2}R$, we easily compute

$$|v|^2 = R^2 \left[1 + \left(\frac{1+e}{2} \right)^2 \right] > \frac{5}{4} R^2,$$

and the radius of B' is strictly larger than $\sqrt{5}/2$. \square

Theorem 9.10. *Let g_{in} satisfy the hypothesis of Theorem 9.2 and let g be the solution to the rescaled equation (9.1.10) associated to the initial datum g_{in} . Then for any $t_* > 0$, $g(t, \cdot) > 0$ a.e. on \mathbb{R}^N for any $t \geq t_*$, and there exists $a_1, a_2, c > 0$ such that*

$$\forall t \geq t_*, \quad g(t, v) \geq a_1 e^{-a_2|v|} \mathbf{1}_{|v| \leq c e^{t-t_*}} \quad \text{for a.e. } v \in \mathbb{R}^N.$$

Proof of Theorem 9.10. We split the proof into four steps.

Step 1. The starting point is the evolution equation satisfied by g written in the form

$$\partial_t g + v \cdot \nabla_v g + (N + |v|)g = Q^+(g, g) + (|v| - L(g))g.$$

Let us introduce the semigroup S_t associated to the operator $v \cdot \nabla_v + \lambda(v)$, where $\lambda(v) := N + |v|$. Thanks to the Duhamel formula and (9.1.16), we have

$$(9.4.41) \quad g(t, \cdot) \geq S_t g(0, \cdot) + \int_0^t S_{t-s} Q^+(g(s, \cdot), g(s, \cdot)) ds,$$

where the semigroup S_t is defined by

$$(S_t h)(v) = h(v e^{-t}) \exp \left(- \int_0^t \lambda(v e^{-s}) ds \right).$$

Notice that

$$\left(- \int_0^t \lambda(v e^{-s}) ds \right) \geq -(|v| + Nt).$$

Step 2. Let us fix $t_0 > 0$ and define $\tilde{g}_0(t, \cdot) := g(t_0 + t, \cdot)$. Using twice the Duhamel formula (9.4.41), we find

$$(9.4.42) \quad \begin{aligned} \tilde{g}_0(t, \cdot) &\geq \int_0^t S_{t-s} Q^+ \left(\tilde{g}_0(s, \cdot), \int_0^s S_{s-s'} Q^+(\tilde{g}_0(s', \cdot), \tilde{g}_0(s', \cdot)) ds' \right) ds \\ &\geq \int_0^t \int_0^s S_{t-s} Q^+ (S_s \tilde{g}_0, S_{s-s'} Q^+(S_{s'} \tilde{g}_0, S_{s'} \tilde{g}_0)) ds' ds. \end{aligned}$$

We apply now Lemma 9.2 to \tilde{g}_0 and set $R_0 := 2R$. Since S_t is continuous in L^1 , there exists $T_1 > 0$, such that for any $s \in [0, T_1]$, there holds

$$\int_{B(v_i, r)} S_s(\tilde{g}_0)(v) dv \geq \eta/2 \quad \text{for } i = 1, 2, 3,$$

and $e^{-T_1} > \xi_0$. For $v \in B(0, R_0)$ and $t \in [0, T_1]$ we may estimate $S_t h$ from below in the following way

$$(S_t h)(v) \geq \gamma h_{e^{-t}}(v)$$

for some constant $\gamma = \gamma_{R_0, T_1}$. The bound from below (9.4.42) then yields (using Lemma 9.3)

$$\begin{aligned} \tilde{g}_0(t, \cdot) &\geq \gamma^2 \int_0^t \int_0^s Q_{e^{s-t}}^+ \left(S_s \tilde{g}_0, Q_{e^{s'-s}}^+(S_{s'} \tilde{g}_0, S_{s'} \tilde{g}_0) \right) ds' ds \\ &\geq \gamma^2 \int_0^t \int_0^s \eta_0 \mathbf{1}_{v e^{s-t} \in B(v_3, r)} ds' ds. \end{aligned}$$

We have then proved that there exists $T_1 > 0$ and for any $t_1 \in (0, T_1/2]$ there exists $\eta_1 > 0$ such that (for some $\bar{v} \in B(0, R)$)

$$\forall t \in [0, T_1/2], \quad \tilde{g}_1(t, \cdot) := \tilde{g}_0(t + t_1, \cdot) \geq \eta_1 \mathbf{1}_{B(\bar{v}, \delta_1)}.$$

Step 3. Using again the Duhamel formula (9.4.41) and the preceding step we have

$$\tilde{g}_1(t, \cdot) \geq \int_0^t S_{t-s} Q^+(\tilde{g}_1(s, \cdot), \tilde{g}_1(s, \cdot)) ds.$$

Thanks to Lemma 9.3, on the ball $B(0, R_0)$, there holds

$$\begin{aligned} \tilde{g}_1(t, \cdot) &\geq \eta_1^2 \int_0^t S_{t-s} Q^+(\mathbf{1}_{B(\bar{v}, \delta_1)}, \mathbf{1}_{B(\bar{v}, \delta_1)}) ds \\ &\geq \eta_1^2 \kappa(\delta_1) e^{-(R_0 + N t)} \int_0^t \mathbf{1}_{e^{-t} v \in B(\bar{v}, \sqrt{5} \delta_1/2)} ds \\ &\geq \eta_1^2 \kappa(\delta_1) e^{-(R_0 + N T_1)} t \mathbf{1}_{B(\bar{v}, \sqrt{19} \delta_1/4)} \end{aligned}$$

on $[0, T_2]$ with $T_2 \in (0, T_1/2]$ small enough, and then

$$\tilde{g}_2(t, \cdot) := \tilde{g}_1(t + t_2, \cdot) \geq \eta_2 \mathbf{1}_{B(\bar{v}, \delta_2)} \quad \text{on} \quad [0, T_2/2]$$

with $\delta_2 := \sqrt{19} \delta_1/4$ and $t_2 \in (0, T_2/2]$ arbitrarily small, $\eta_2 > 0$. Repeating the argument we obtain

$$\tilde{g}_k(t, \cdot) := g \left(t + \sum_{i=0}^k t_i, \cdot \right) \geq \eta_k \mathbf{1}_{B(\bar{v}, \delta_k)} \quad \text{on} \quad [0, T_k/2], \quad \text{with} \quad \delta_k := (\sqrt{19}/4)^k \delta_1,$$

for $k \geq 1$ and some $t_i \in [0, T_i/2]$ arbitrarily small, $\eta_k > 0$. As a consequence, taking k large enough in such a way that $\delta_k > R_0$, we get for some explicit constant $\eta_* > 0$ and some (arbitrarily small) time $t_* > 0$

$$(9.4.43) \quad \forall t_0 \geq 0, \quad g(t_* + t_0, \cdot) \geq \eta_* \mathbf{1}_{B(0, R)}.$$

Step 4. Coming back to the Duhamel formula (9.4.41) where we only keep the first term, we have, for any $t_0 \geq 0$,

$$\forall t \geq t_*, \quad g(t_0 + t, v) \geq \eta_* \mathbf{1}_{|v| \leq R e^{t-t_*}} \exp(-|v| - N(t - t_*)).$$

As a consequence, for any $t > t_*$,

$$(9.4.44) \quad \begin{aligned} g(t, v) &\geq \mathbf{1}_{|v| \leq R e^{t-t_*}} \left(\sup_{s \in [0, t-t_*]} \mathbf{1}_{|v|=R e^s} \exp(-|v| - N s) \right) \\ &\geq \mathbf{1}_{|v| \leq R e^{t-t_*}} \left(\sup_{s \in [0, t-t_*]} \mathbf{1}_{|v|=R e^s} \right) \exp(-|v| - N \ln^+(|v|/R)), \end{aligned}$$

and we conclude gathering (9.4.43) and (9.4.44). \square

It is straightforward that Theorem 9.10 implies the lower bound in point (ii) of Theorem 9.2.

9.5 Perspectives

As a conclusion, we discuss some possible perspectives arising from our study.

Let us denote

$$\mathcal{P} = \left\{ G \in C^\infty, G \text{ radially symmetric,} \right. \\ \left. \exists a_1, a_2, A_1, A_2 > 0 \mid a_1 e^{-a_2|v|} \leq G(v) \leq A_1 e^{-A_2|v|} \right\}.$$

Conjecture 1. For any mass $\rho > 0$, the self-similar profil G_ρ with mass ρ and momentum 0 is unique.

Conjecture 2. (Strong version) For any initial datum with mass ρ and momentum 0 (maybe with some regularity or moment assumptions), the associated solution satisfies (in rescaled variables)

$$g_t \xrightarrow{t \rightarrow \infty} G_\rho,$$

for some steady state G_ρ with mass ρ and momentum 0 of (9.1.10).

Conjecture 2. (Weak version) For any initial datum with mass ρ and momentum 0 (maybe with some regularity or moment assumptions), the associated solution satisfies (in rescaled variables)

$$g_t = g_t^S + g_t^R$$

with $g_t^S \in \mathcal{P}$ and $g_t^R \xrightarrow{t \rightarrow \infty} 0$ in L^1 .

Note that conjecture 2 (in strong or weak forms) still makes sense when the self-similar profil with mass ρ and momentum 0 is not unique. Its weak version still makes sense even if there is no convergence towards some self-similar profil (which could be the case for instance if the solution in rescaled variables “oscillates” asymptotically between several self-similar profiles).

Acknowledgments. The second author wishes to thank Giuseppe Toscani for fruitful discussions. Support by the European network HYKE, funded by the EC as contract HPRN-CT-2002-00282, is acknowledged.

Partie IV

Étude numérique

Fast algorithms for computing the Boltzmann collision operator

Article [148] en collaboration avec Lorenzo Pareschi, soumis pour publication.

ABSTRACT: The development of accurate and fast numerical schemes for the five fold Boltzmann collision integral represents a challenging problem in scientific computing. For a particular class of interactions, including the so-called hard spheres model in dimension three, we are able to derive spectral methods and discrete velocity methods that can be evaluated through fast algorithms. These algorithms are based on a suitable representation and approximation of the collision operator. Explicit expressions for the errors in the schemes are given and, in particular, for the spectral method spectral accuracy is proved. Parallelization properties and adaptivity of the algorithms are also discussed.

Contents

10.1	Introduction	417
10.2	Carleman-like representation and approximation of the collision operator	421
10.2.1	The Boltzmann collision operator in bounded domains	421
10.2.2	Application to spectral methods	426
10.2.3	Application to discrete-velocity models	428
10.3	Fast spectral algorithm for a class of collision kernels	430
10.3.1	A semi-discrete collision operator	432
10.3.2	Expansion of the kernel modes	433
10.3.3	Spectral accuracy	436
10.3.4	Implementation of the algorithm	439
10.4	Fast DVM's algorithm for a class of collision kernels	440
10.4.1	Principle of the method: a pseudo-spectral viewpoint	441
10.4.2	Expansion of the discrete kernel modes	442
10.5	Conclusions	447
10.6	Appendix: Remarks on admissible collision kernels and an extension to the "non-decoupled" case	447

10.1 Introduction

The Boltzmann equation describes the behavior of a dilute gas of particles when the only interactions taken into account are binary elastic collisions. It reads for $x, v \in \mathbb{R}^d$ ($d \geq 2$)

$$\frac{\partial f}{\partial t} + v \cdot \nabla_x f = Q(f, f)$$

where $f(t, x, v)$ is the time-dependent particle distribution function in the phase space. The Boltzmann collision operator Q is a quadratic operator local in (t, x) . The time and position acts only as parameters in Q and therefore will be omitted in its description

$$(10.1.1) \quad Q(f, f)(v) = \int_{\mathbb{R}^d \times \mathbb{S}^{d-1}} B(|v - v_*|, \cos \theta) (f'_* f' - f_* f) dv_* d\sigma.$$

In (10.1.1) we used the shorthand $f = f(v)$, $f_* = f(v_*)$, $f' = f(v')$, $f'_* = f(v'_*)$. The velocities of the colliding pairs (v, v_*) and (v', v'_*) are related by

$$\begin{cases} v' = \frac{v + v_*}{2} + \frac{|v - v_*|}{2} \sigma, \\ v'_* = \frac{v + v_*}{2} - \frac{|v - v_*|}{2} \sigma. \end{cases}$$

The collision kernel B is a non-negative function which by physical arguments of invariance only depends on $|v - v_*|$ and $\cos \theta = \hat{g} \cdot \sigma$ (where $\hat{g} = (v - v_*)/|v - v_*|$).

Boltzmann's collision operator has the fundamental properties of conserving mass, momentum and energy

$$\int_{\mathbb{R}^d} Q(f, f) \phi(v) dv = 0, \quad \phi(v) = 1, v_1, \dots, v_d, |v|^2$$

and satisfies the well-known Boltzmann's H theorem

$$-\frac{d}{dt} \int_{\mathbb{R}^d} f \log f dv = - \int_{\mathbb{R}^d} Q(f, f) \log(f) dv \geq 0.$$

The functional $-\int f \log f$ is the entropy of the solution. Boltzmann H theorem implies that any equilibrium distribution function, i.e. any function which is a maximum of the entropy, has the form of a locally Maxwellian distribution

$$M(\rho, u, T)(v) = \frac{\rho}{(2\pi T)^{d/2}} \exp \left\{ -\frac{|u - v|^2}{2T} \right\},$$

where ρ , u , T are the density, mean velocity and temperature of the gas, defined by

$$\rho = \int_{\mathbb{R}^d} f(v) dv, \quad u = \frac{1}{\rho} \int_{\mathbb{R}^d} v f(v) dv, \quad T = \frac{1}{d\rho} \int_{\mathbb{R}^d} |u - v|^2 f(v) dv.$$

For further details on the physical background and derivation of the Boltzmann equation we refer to [58, 191].

The construction of numerical methods for Boltzmann equations represents a real challenge for scientific computing and it is of paramount importance in many applications, ranging from rarefied gas dynamics (RGD) [58], plasma physics [63], granular flows [18, 19], semiconductors [138] and quantum kinetic theory [81].

Most of the difficulties are due to the multidimensional structure of the collisional integral Q , as the integration runs on a 5-dimensional unflat manifold. In addition to the unpracticable computational cost of deterministic quadrature rules the integration has to be handled carefully since it is at the basis of the macroscopic properties of the equation. Additional difficulties are represented by the stiffness induced by the presence of small scales, like the case of small mean free path [96] or the case of large velocities [86].

For such reasons realistic numerical computations are based on probabilistic Monte-Carlo techniques at different levels. The most famous examples are the direct simulation Monte Carlo (DSMC) methods by Bird [22] and by Nanbu [152]. These methods preserve the conservation properties of the equation in a natural way and avoid the computational complexity of a deterministic approach. However avoiding the low accuracy and the fluctuations of the results becomes extremely expensive in presence of nonstationary flows or close to continuum regimes.

Among deterministic approximations, one of the most popular methods in RGD is represented by the discrete velocity models (DVM) of the Boltzmann equation. These methods [40, 139, 33, 60, 156, 171] are based on a regular grid in the velocity field and construct a discrete collision mechanics on the points of the grid in order to preserve the main physical properties. Unfortunately DVM have the same computational cost of a product quadrature rule and due to the particular choice of the nodes imposed by the conservation properties the accuracy of the schemes seems to be less than first order [155, 154, 156].

More recently a new class of methods based on the use of spectral techniques in the velocity space has attracted the attention of the scientific community. The method was first developed for kinetic equations in [159], inspired from spectral methods in fluid mechanics [43] and the use of Fourier

transform tools in the analysis of the Boltzmann equation [24]. It is based on a Fourier-Galerkin approximation of the equation. Generalizations of the method and spectral accuracy have been given in [160, 161]. This method, thanks to its generality, has been applied also to non homogeneous situations [89], to the Landau equation [86, 162] and to the case of granular gases [151, 87]. A related numerical strategy based on the direct use of the fast Fourier transform (FFT) has been developed in [23, 34].

The lack of discrete conservations in the spectral scheme (mass is preserved, whereas momentum and energy are approximated with spectral accuracy) is compensated by its higher accuracy and efficiency. In fact it has been shown that these spectral schemes permit to obtain spectrally accurate solutions with a reduction of the computational cost strictly related to the particular structure of the collision operator. A reduction from $O(N^2)$ to $O(N \log_2 N)$ is readily deducible for the Landau equation, whereas in the Boltzmann case such a reduction had been obtained until now only at the price of a poor accuracy (in particular the loss of the spectral accuracy), see [23, 34].

Finally we mention that spectral methods have been successfully applied also to the study of *non cut-off* Boltzmann equations, like for RGD in the grazing collision limit [164] and for granular flows in the quasi-elastic limit [151]. In particular, during these asymptotic processes it is possible to obtain intermediate approximations that can be evaluated with fast algorithms that brings the overall computational cost to $O(N \log_2 N)$. These idea has been used in [158] to obtain fast approximated algorithms for the Boltzmann equation.

For a recent introduction to numerical methods for the Boltzmann equation and related kinetic equations we refer the reader to [64].

In this paper we shall focus on the two main questions in the approximation the Boltzmann equation by deterministic schemes, that is the computational complexity and the accuracy of the numerical schemes for computing the collision operator Q .

Let us mention that a major problem associated with deterministic methods that use a fixed discretization in the velocity domain is that the velocity space is approximated by a finite region. Physically the domain for the velocity is \mathbb{R}^d . But, as soon as $d \geq 2$, the property of having compact support is not conserved by the collision operator (in fact for some Boltzmann models in dimension $d = 1$, like granular models, the support is conserved [151]). In general the collision process “spreads” the support by a factor $\sqrt{2}$ (see [169, 146]). As a consequence, for the continuous equation in time, the function f is immediately positive in the whole velocity domain

\mathbb{R}^d .

Thus at the numerical level some non physical condition has to be imposed to keep the support of the function in velocity uniformly bounded. In order to do this there are two main strategies, which we shall make more precise in the sequel.

1. One can remove the physical binary collisions that will lead outside the bounded velocity domain, which means a possible increase of the number of local invariants. If this is done properly (i.e. “without removing too many collisions”), the scheme remains conservative (and without spurious invariants). However this truncation breaks down the convolution-like structure of the collision operator, which requires the invariance in velocity. Indeed the modified collision kernel depends on v through the boundary conditions. This truncation is the starting point of most schemes based on discrete velocity models in a bounded domain.
2. One can add some non physical binary collisions by periodizing the function and the collision operator. This implies the loss of some local invariants (some non physical collisions are added). Thus the scheme is not conservative anymore, except for the mass if the periodization is done carefully (and possibly the momentum if some symmetry properties are satisfied by the function). In this way the structural properties of the collision operator are maintained and thus they can be exploited to derive fast algorithms. This periodization is the basis of the spectral method.

Note that in both cases by enlarging enough the computational domain the number of removed or added collisions can be made negligible (as it is usually done for removing the aliasing error of the FFT, for instance see [43]) as well as the error in the local invariants.

In this paper we shall focus on the second approach, which means that the schemes have to deal with some aliasing error introduced by the periodization. In this way, for a particular class of interactions using a Carleman-like representation of the collision operator we are able to derive spectral methods and discrete velocity methods that can be evaluated through fast algorithms. The class of interactions includes *Maxwellian molecules* in dimension two and *hard spheres* molecules in dimension three.

Thus the fast DVM algorithms of Section 10.4 are in fact conservative “up to the aliasing question”, whereas the fast spectral methods of Section 10.3 are not exactly conservative, since in addition to the aliasing problem, we have to

deal with the spectral projection of the nonlinear collision operator. However in this case the spectral accuracy compensates for the loss of conservations.

The rest of the paper is organized in the following way. In the next Section we introduce a Carleman-like representation of the collision operator which is used as a starting point for the development of our methods. After the derivation of the schemes the details of the fast spectral algorithm together with its accuracy properties are given in Section 10.3. In Section 10.4 the fast methods are extended to the DVM case and a detailed analysis of its computational complexity is presented. In a separate Appendix we show a possible way to extend the present fast schemes to general collision interactions.

10.2 Carleman-like representation and approximation of the collision operator

In this section we shall approximate the collision operator starting from a representation which somehow conserves more symmetries of the collision operator when one truncates it in a bounded domain. This representation was used in [23, 34, 35, 117] and it's close to the classical Carleman representation (cf. [44]). Also the kind of periodization inspired from this representation was implicitly used in [34].

10.2.1 The Boltzmann collision operator in bounded domains

The basic identity we shall need is

$$(10.2.2) \quad \frac{1}{2} \int_{\mathbb{S}^{d-1}} F(|u|\sigma - u) d\sigma = \frac{1}{|u|^{d-2}} \int_{\mathbb{R}^d} \delta(2x \cdot u + |x|^2) F(x) dx,$$

and can be verified easily by completing the square in the delta Dirac function, taking the spherical coordinate $x = r \sigma$ and performing the change of variable $r^2 = s$.

Setting $u = v - v_*$ we can write the collision operator in the form

$$Q(f, f)(v) = \int_{v_* \in \mathbb{R}^d} \left\{ \int_{\sigma \in \mathbb{S}^{d-1}} B(|u|, \cos \theta) \left[f\left(v_* - \frac{|u|\sigma - u}{2}\right) f\left(v + \frac{|u|\sigma - u}{2}\right) - f(v_*) f(v) \right] d\sigma \right\} dv_*$$

and thus equation (10.2.2) yields

$$Q(f, f)(v) = 2 \int_{v_* \in \mathbb{R}^d} \left\{ \int_{x \in \mathbb{R}^d} B \left(|u|, \frac{x \cdot u}{|x||u|} \right) \frac{1}{|u|^{d-2}} \delta(2x \cdot u + |x|^2) \right. \\ \left. [f(v_* - x/2) f(v + x/2) - f(v_*) f(v)] dx \right\} dv_*$$

Now let us make the change of variable $x \rightarrow x/2$ in x to get

$$Q(f, f)(v) = 2^{d+1} \int_{v_* \in \mathbb{R}^d} \int_{x \in \mathbb{R}^d} B \left(|u|, \frac{x \cdot u}{|x||u|} \right) \frac{1}{|u|^{d-2}} \delta(4x \cdot u + 4|x|^2) \\ [f(v_* - x) f(v + x) - f(v_*) f(v)] dx dv_*$$

and then setting $y = v_* - v - x$ in v_* we obtain

$$Q(f, f)(v) = 2^{d+1} \int_{y \in \mathbb{R}^d} \int_{x \in \mathbb{R}^d} B \left(|u|, \frac{x \cdot u}{|x||u|} \right) \frac{1}{|u|^{d-2}} \delta(-4x \cdot y) \\ [f(v + y) f(v + x) - f(v + x + y) f(v)] dx dy$$

where now $u = -(x + y)$. Thus in the end we have

$$Q(f, f)(v) = 2^{d-1} \int_{x \in \mathbb{R}^d} \int_{y \in \mathbb{R}^d} B \left(|x + y|, -\frac{x \cdot (x + y)}{|x||x + y|} \right) \frac{1}{|x + y|^{d-2}} \\ \delta(x \cdot y) [f(v + y) f(v + x) - f(v + x + y) f(v)] dx dy.$$

Figure 10.1 sums up the different geometrical quantities of the usual representation and the one we derived from Carleman's one.

Now let us consider the bounded domain $\mathcal{D}_T = [-T, T]^d$ ($0 < T < +\infty$). There are two possibilities of truncation to reduce the collision process in a box. From now on let us write

$$\tilde{B}(x, y) = 2^{d-1} B \left(|x + y|, -\frac{x \cdot (x + y)}{|x||x + y|} \right) |x + y|^{-(d-2)}.$$

One can easily see that on the manifold defined by $x \cdot y = 0$, a simpler formula is (using the parities of the collision kernel)

$$(10.2.3) \quad \tilde{B}(x, y) = \tilde{B}(|x|, |y|) \\ = 2^{d-1} B \left(\sqrt{|x|^2 + |y|^2}, \frac{|x|}{\sqrt{|x|^2 + |y|^2}} \right) (|x|^2 + |y|^2)^{-\frac{d-2}{2}}.$$

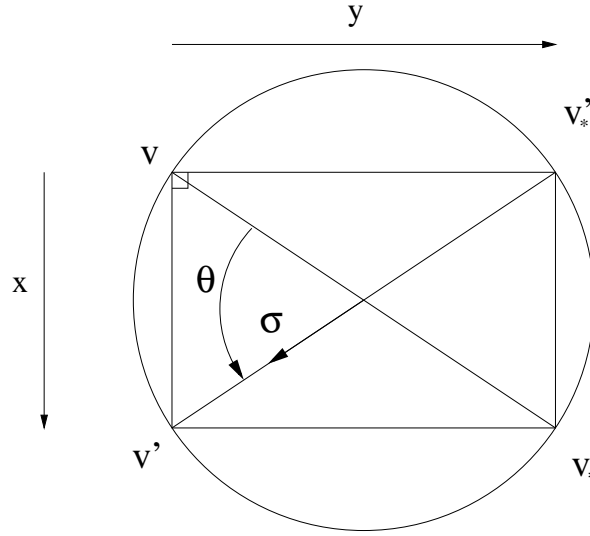
 Figure 10.1: Geometry of the collision $(v, v_*) \leftrightarrow (v', v'_*)$.

First one can remove the collisions connecting with some points out of the box. This is the natural preliminary stage for deriving conservative schemes based on the discretization of the velocity. In this case there is no need for a truncation on the modulus of x and y since we impose them to stay in the box. It yields

$$Q^{\text{tr}}(f, f)(v) = \int \int_{\{x, y \in \mathbb{R}^d \mid v+x, v+y, v+x+y \in \mathcal{D}_T\}} \tilde{B}(x, y) \delta(x \cdot y) [f(v+y) f(v+x) - f(v+x+y) f(v)] dx dy$$

defined for $v \in \mathcal{D}_T$. One can easily check that the following weak form is satisfied by this operator

$$(10.2.4) \quad \int Q^{\text{tr}}(f, f) \varphi(v) dv = \frac{1}{4} \int \int \int_{\{v, x, y \in \mathbb{R}^d \mid v, v+x, v+y, v+x+y \in \mathcal{D}_T\}} \tilde{B}(x, y) \delta(x \cdot y) f(v+x+y) f(v) [\varphi(v+y) + \varphi(v+x) - \varphi(v+x+y) - \varphi(v)] dv dx dy$$

and this implies conservation of mass, momentum and energy as well as the H theorem on the entropy. Note that at this level this formulation gives no advantage with respect to the usual one obtained from (10.1.1) by restricting $v, v_*, v', v'_* \in \mathcal{D}_T$ (except that consistency results for Discrete Velocity Models

seem easier to prove when they are derived by quadrature on this formulation, see [156]). The problem of this truncation on a bounded domain is the fact that we have changed the collision kernel itself by adding some artificial dependence on v, v_*, v', v'_* . In this way convolution-like properties are broken.

A different approach consists in periodizing the function f on the domain \mathcal{D}_T . This amounts in adding some non-physical collisions by connecting some points in the domain \mathcal{D}_T which are geometrically included in a collision circle “modulo T ” (i.e. up to a translation of T of certain points in certain directions). Here we have to truncate the integration in x and y since periodization would yield infinite result if not. Thus we set them to vary in \mathcal{B}_R , the ball of center 0 and radius R . For a compactly supported function f with support \mathcal{B}_S , we take $R = S$ in order to obtain all possible collisions. Then a geometrical argument (see [160]) shows that using the periodicity of the function it is enough to take $T \geq (3 + \sqrt{2})S/2$ to prevent intersections of the regions where f is different from zero. The operator now reads

$$(10.2.5) \quad Q^R(f, f)(v) = \int_{x \in \mathcal{B}_R} \int_{y \in \mathcal{B}_R} \tilde{B}(x, y) \delta(x \cdot y) [f(v + y)f(v + x) - f(v + x + y)f(v)] dx dy$$

for $v \in \mathcal{D}_T$ (the expression for $v \in \mathbb{R}^d$ is deduced by periodization). The interest of this representation is to preserve the real collision kernel and its properties.

By making some translation changes of variable on v (by x, y and $x + y$), using the changes $x \rightarrow -x$ and $y \rightarrow -y$ and the fact that

$$\tilde{B}(-x, y) \delta(-x \cdot y) = \tilde{B}(x, y) \delta(x \cdot y) = \tilde{B}(x, -y) \delta(x \cdot -y)$$

one can easily prove that for any function φ *periodic* on \mathcal{D}_T the following weak form is satisfied

$$(10.2.6) \quad \int_{\mathcal{D}_T} Q^R(f, f) \varphi(v) dv = \frac{1}{4} \int_{v \in \mathcal{D}_T} \int_{x \in \mathcal{B}_R} \int_{y \in \mathcal{B}_R} \tilde{B}(x, y) \delta(x \cdot y) f(v + x + y)f(v) [\varphi(v + y) + \varphi(v + x) - \varphi(v + x + y) - \varphi(v)] dv dx dy.$$

About the conservation properties one can shows that

1. The only invariant φ is 1: it is the only periodic function on \mathcal{D}_T such that

$$\varphi(v + y) + \varphi(v + x) - \varphi(v + x + y) - \varphi(v) = 0$$

for any $v \in \mathcal{D}_T$ and $x \perp y \in \mathcal{B}_R$ (see [51] for instance). It means that the mass is locally conserved but not necessarily the momentum and energy.

2. When f is even there is *global* conservation of momentum, which is 0 in this case. Indeed Q^R preserves the parity property of the solution, which can be checked using the change of variable $x \rightarrow -x, y \rightarrow -y$.
3. The collision operator satisfies formally the H theorem

$$\int_{\mathbb{R}^d} Q^R(f, f) \log(f) dv \leq 0.$$

4. If f has compact support included in \mathcal{B}_S , and we have $R = 2S$ and $T \geq (3\sqrt{2} + 1)S/2$ (no aliasing condition, see [160] for a detailed discussion¹), then no unphysical collisions occur and thus mass, momentum and energy are preserved. Obviously this compactness is not preserved with time since the collision operator spreads the support of f by a factor $\sqrt{2}$.

To sum up one could say that the lack of conservations originates from the fact that the geometry of the collision does not respect the periodization.

Finally we give the Cauchy theorems for the homogeneous Boltzmann equations in \mathcal{D}_T computed with Q^{tr} or Q^R .

Theorem 10.1. *Let $f_0 \in L^1(\mathcal{D}_T)$ be a nonnegative function. Then there exists a unique solution $f \in C^1(\mathbb{R}_+, L^1(\mathcal{D}_T))$ to the Cauchy problems*

$$(10.2.7) \quad \frac{\partial f}{\partial t} = Q^{\text{tr}}(f, f), \quad f(t = 0, \cdot) = f_0$$

$$(10.2.8) \quad \frac{\partial f}{\partial t} = Q^R(f, f), \quad f(t = 0, \cdot) = f_0$$

which is nonnegative and has constant mass (and so constant L^1 norm). If f_0 has finite entropy, the entropy is finite and non-decreasing for all time. Moreover in the case (10.2.7), if f_0 has finite momentum (respectively energy) on \mathcal{D}_T , the momentum (respectively energy) is conserved with time.

¹Note that here the dealiasing condition is slightly different, since the truncation on the modulus of x and y in the ball \mathcal{B}_R implies only a truncation in the ball $\mathcal{B}_{\sqrt{2}R}$ for the relative velocity.

Remark: When the initial data f_0 is nonnegative and has finite mass and entropy, it is possible to show by the Dunford-Pettis compactness theorem that the solution f converges weakly in $L^1(\mathcal{D}_T)$, as t goes to infinity, to the unique maximum of the entropy functional compatible with the conservation law(s) (and the periodicity in the case (10.2.8)). In the case (10.2.7) this equilibrium state is a sort of truncated Maxwellian on \mathcal{D}_T defined by the conservation laws (see [51]). In the case (10.2.8) this equilibrium state is a constant defined by the mass of the initial data, which is due to the effect of aliasing in the very long-time. We omit the proof for brevity.

Proof of Theorem 10.1. For clarity we briefly sketch the main lines of the proof. The existence and uniqueness are proved by the method of Arkeryd for bounded collision kernels, see [6, Part I, Proposition 1.1]. In our case the collision kernel is bounded because of the boundedness of the domain. The only a priori estimate required in [6, Part I, Proposition 1.1] is the mass conservation, valid for the two equations under consideration. This method is based on a monotonicity argument to prove propagation of the sign of the solution. The argument relies on a splitting of the collision operator Q into a gain part Q^+ which is monotonic (i.e. $Q^+(f, f)$ is non-negative when f is non-negative), and a loss part Q^- which writes $Q^-(f, f) = L(f)f$ with L is a linear operator such that $\|L(f)\|_\infty \leq C \|f\|_{L^1}$. One can check easily that this splitting is still valid for the two collision operators Q^{tr} and Q^R . For brevity we omit the details and refer to the article [6]. The conservation law(s) and the H theorem are deduced from the weak forms (10.2.4) and (10.2.6) (see the proof of [6, Part I, Proposition 1.2] and [6, Part I, Theorem 2.1]). \square

In the rest of the paper we will focus on the periodized truncation Q^R .

10.2.2 Application to spectral methods

Now we use the representation Q^R to derive new spectral methods. The spectral methods for kinetic equations originated in the works of [159, 160], and were further developed in [161, 89]. Before they had a long history in fluid mechanics, see [43].

The main change compared to the usual spectral method is in the way we truncate the collision operator. In fact as we shall see in the next section this yields better decoupling properties between the arguments of the operator.

To simplify notations let us take $T = \pi$. Hereafter we use just one index to denote the d -dimensional sums of integers.

The approximate function f_N is represented as the truncated Fourier series

$$\begin{cases} f_N(v) = \sum_{k=-N}^N \hat{f}_k e^{ik \cdot v}, \\ \hat{f}_k = \frac{1}{(2\pi)^d} \int_{\mathcal{D}_\pi} f(v) e^{-ik \cdot v} dv. \end{cases}$$

The spectral equation is the projection of the collision equation in \mathbb{P}^N , the $(2N + 1)^d$ -dimensional vector space of trigonometric polynomials of degree at most N in each direction, i.e.

$$\frac{\partial f_N}{\partial t} = \mathcal{P}_N Q^R(f_N, f_N)$$

where \mathcal{P}_N denotes the orthogonal projection on \mathbb{P}^N in $L^2(\mathcal{D}_\pi)$. A straightforward computation leads to the following set of ordinary differential equations on the Fourier coefficients

$$(10.2.9) \quad \hat{f}'_k(t) = \sum_{\substack{l, m = -N \\ l+m=k}}^N \hat{\beta}(l, m) \hat{f}_l \hat{f}_m, \quad k = -N, \dots, N$$

where $\hat{\beta}(l, m)$ are the so-called **kernel modes**, given by

$$\hat{\beta}(l, m) = \int_{x \in \mathcal{B}_R} \int_{y \in \mathcal{B}_R} \tilde{B}(x, y) \delta(x \cdot y) [e^{il \cdot x} e^{im \cdot y} - e^{im \cdot (x+y)}] dx dy.$$

The kernel modes can be written as

$$\hat{\beta}(l, m) = \beta(l, m) - \beta(m, m)$$

where

$$\beta(l, m) = \int_{x \in \mathcal{B}_R} \int_{y \in \mathcal{B}_R} \tilde{B}(x, y) \delta(x \cdot y) e^{il \cdot x} e^{im \cdot y} dx dy.$$

Therefore in the sequel we shall focus on β , and one easily checks that $\beta(l, m)$ depends only on $|l|$, $|m|$ and $|l \cdot m|$.

Note that the usual way to truncate the Boltzmann collision operator for periodic function starts from the following representation (see [160])

$$(10.2.10) \quad Q(f, f) = \int_{u \in \mathbb{R}^d} \int_{\sigma \in \mathbb{S}^{d-1}} B(|u|, \cos \theta) [f(v - (u - |u|\sigma)/2) f(v - (u + |u|\sigma)/2) - f(v) f(v - u)] d\sigma du$$

and then truncate the parameter $u = x + y$ in order that $u \in \mathcal{B}_R$. Thus we have

$$Q_{\text{usual}}^R(f, f)(v) = \int_{x \in \mathbb{R}^d} \int_{y \in \mathbb{R}^d} \tilde{B}(x, y) \delta(x \cdot y) \chi_{\{|x+y| \leq R\}} [f(v+y)f(v+x) - f(v+x+y)f(v)] dx dy$$

where $\chi_{\{|x+y| \leq R\}}$ denotes the characteristic function of the set $\{|x+y| \leq R\}$. One can notice that here x and y are also restricted to the ball \mathcal{B}_R but the condition $|x+y|^2 = |x|^2 + |y|^2 \leq R^2$ couples the two modulus, such that the ball is not completely covered (for instance, if x and y have both modulus R , the condition is not satisfied, since $|x+y| = \sqrt{2}R$).

Finally let us compare the new kernel modes with the usual ones. As a consequence of the representation (10.2.10), the usual kernel modes (cf. [160]) are

$$\begin{aligned} \hat{\beta}_{\text{usual}}(l, m) &= \int_{u \in \mathcal{B}_R} \int_{\sigma \in \mathbb{S}^{d-1}} B(|u|, \cos \theta) \left[e^{-i \frac{u \cdot (l+m) + |u| \sigma \cdot (m-l)}{2}} - e^{-i(u \cdot m)} \right] d\sigma du \end{aligned}$$

and hence coming back to the representation in x and y ,

$$\begin{aligned} \hat{\beta}_{\text{usual}}(l, m) &= \int_{x \in \mathcal{B}_R} \int_{y \in \mathcal{B}_R} \tilde{B}(x, y) \delta(x \cdot y) \chi_{\{|x+y| \leq R\}} [e^{il \cdot x} e^{im \cdot y} - e^{im \cdot (x+y)}] dx dy. \end{aligned}$$

Thus the usual representation contains more coupling between x and y and it is less appropriate for the construction of fast algorithms.

10.2.3 Application to discrete-velocity models

The representation Q^R of this section can also be used to derive Discrete Velocity Models (DVM). The usual representation of DVM is

$$D_i = \sum_{j, k, l \in \mathbb{Z}^d} \Gamma_{i,j}^{k,l} [f_k f_l - f_i f_j],$$

where D_i denotes the discrete Boltzmann collision operator and the integer indexes refer to the points in the computational grid. In order to keep the conservations at the discrete level the coefficients $\Gamma_{i,j}^{k,l}$ take the form

$$\Gamma_{i,j}^{k,l} = \mathbf{1}(i+j-k-l) \mathbf{1}(|i|^2 + |j|^2 - |k|^2 - |l|^2) B(|k-i|, |l-j|) w_{i,j}^{k,l}$$

where $\mathbf{1}$ denotes the function on \mathbb{Z} defined by $\mathbf{1}(z) = 1$ if $z = 0$ and 0 elsewhere, and $w_{i,j}^{k,l} > 0$ are the weights of the quadrature formula, which characterize the different DVM. $B > 0$ is the **discrete collision kernel**. One can check on this formulation that the scheme satisfies the usual conservation laws and entropy inequality (see [166] and the references therein).

We can also write at the discrete level the same representation as in the continuous case

$$D_i = \sum_{k,l \in \mathbb{Z}^d} \tilde{\Gamma}_{k,l} [f_{i+k} f_{i+l} - f_i f_{i+k+l}]$$

with

$$\tilde{\Gamma}_{k,l} = \mathbf{1}(k \cdot l) \frac{B(|k|, |l|)}{|k+l|} w_{k,l}.$$

This way of writing the DVM is discussed and justified in [26]. It is coherent with the DVM obtained by quadrature starting from the Carleman representation in [156].

Now again when one is interested to compute the DVM in a bounded domain there are two possibilities. First as in the case of Q^{tr} one can force the discrete velocities to stay in a box, which yields for $i = -N, \dots, N$ (again using the one index notation for d -dimensional sums)

$$D_i^{\text{tr}} = \sum_{\substack{k,l \\ -N \leq i+k, i+l, i+k+l \leq N}} \tilde{\Gamma}_{k,l} [f_{i+k} f_{i+l} - f_i f_{i+k+l}].$$

This new discrete operator is completely conservative but the collision kernel is not invariant anymore according to i , which breaks the convolution properties.

The other possibility is to periodize the function f over the box and truncate the sum in k and l . It yields for a given truncation parameter $\tilde{N} \in \mathbb{N}$

$$(10.2.11) \quad D_i^{\tilde{N}} = \sum_{-\tilde{N} \leq k, l \leq \tilde{N}} \tilde{\Gamma}_{k,l} [f_{i+k} f_{i+l} - f_i f_{i+k+l}],$$

for any $i = -N \dots N$.

It is easy to see that $D^{\tilde{N}}$ satisfies exactly a discrete weak form and conservation properties similar to Q^R . Moreover one can derive the following consistency result from [156, Theorem 3] in the case of hard spheres collision kernel

Theorem 10.2. *Assume that $f, g \in C^k(\mathbb{R}^3)$ ($k \geq 1$) with compact support \mathcal{B}_S . The uniform grid of step h is constructed on the box \mathcal{D}_T with the no aliasing condition $T \geq (3 + \sqrt{2})S/2$. Then for $\tilde{N} = [S/h]$ (where $[\cdot]$ denotes the integer value) and $h > 0$ sufficiently small,*

$$\|Q(g, f) - D_h^{\tilde{N}}(g, f)\|_{L^\infty(\mathbb{Z}_h)} \leq C h^r$$

where $D_h^{\tilde{N}}$ is the DVM operator defined in (10.2.11) (for the precise quadrature weights derived in [156]) on the grid above-mentioned, and $f_i = f(ih)$. Here $r = k/(k + 3)$ and the constant C is independent on h .

Remark: As can be seen from Theorem 10.2, the periodized DVM presented in this subsection is expected to have a quite poor accuracy. On the contrary the spectral method, even in the fast version of the next section, will be proven to be spectrally accurate, i.e. of infinite order for smooth solutions. Nevertheless this periodized DVM has some interesting features compared to the spectral method. Indeed, with exactly the same proof at the discrete level as in Theorem 10.1, one can prove that if the quadrature weights $w_{k,l}$ are non-negative, then the scheme is stable in the sense that if one starts from a non-negative initial datum, then the solution remains non-negative and has thus constant L^1 norm. In addition to this stability in L^1 this DVM preserves exactly the physical conservation laws, up to the aliasing issue, whereas the spectral method preserves the mass but not the momentum and energy because of the spectral projection of the operator (although the error on this conservation laws are spectrally small). Concerning the spectral method, stability is expected by the authors to hold in L^1 but only asymptotically, i.e. for N big enough related to the initial datum.

10.3 Fast spectral algorithm for a class of collision kernels

As soon as one is searching for fast deterministic algorithms for the collision operator, i.e. algorithm with a cost lower than $O(N^{2d+\varepsilon})$ (which is the cost of a usual discrete velocity model, with typically $\varepsilon = 1$), one has to find some way to compute the collision operator *without going through all the couples of collision points* during the computation. This leads naturally to search for some convolution structure (discrete or continuous) in the operator. Unfortunately, as discussed in the previous sections, this is rather contradictory with the search for a conservative scheme in a bounded domain, since the boundary condition needed to prevent for the outgoing or ingoing collisions

breaks the invariance. Thus fast algorithms seem more adapted to spectral methods, or more in general to methods where the invariance is conserved thanks to the periodization.

Here we search for a convolution structure in the equations (10.2.9). The aim is to approximate each $\hat{\beta}(l, m)$ by a sum

$$\hat{\beta}(l, m) \simeq \sum_{p=1}^A \alpha_p(l) \alpha'_p(m).$$

This gives a sum of A discrete convolutions and so the algorithm can be computed in $O(A N^d \log_2 N)$ operations by means of standard FFT techniques [43, 59]. Obviously this is equivalent to obtain such a decomposition on β . To this purpose we shall use a further approximated collision operator where the number of possible directions of collision is reduced to a finite set.

The starting point of our study is an idea of [34]: use the Carleman-like representation (10.2.5) to obtain a convolution structure for every fixed directions of the vectors x and y . In this work [34] the corresponding set of directions

$$S = \{(e, e') \in \mathbb{S}^{N-1} \times \mathbb{S}^{N-1} \mid e \perp e'\}$$

is very difficult to discretize in a way that preserves the symmetry properties of the collision operator. No systematic process was available and the discretization is done only for some particular number of grid points. Then the FFT is used in each couple of direction and finally a correction is imposed at the end to preserve the conservation laws. However no consistency result is available and the accuracy suggested by the numerical simulations is of order 1. The two main new ingredients of our method are:

- First we project the collision operator on the Fourier basis. This enables to integrate one of the two coordinates of the manifold S and to reduce to the discretization of the sphere \mathbb{S}^{N-1} . This discretization is straightforward and can be made easily to preserve the symmetries of the collision operator. Moreover it reduces the complexity of the algorithm by suppressing $N - 2$ degrees of freedom to discretize.
- Second we choose to discretize \mathbb{S}^{N-1} by the rectangular rule. Indeed the periodization shall imply that this quadrature rule is of infinite order. This point will allow to obtain a spectrally accurate scheme, and adaptativity properties.

10.3.1 A semi-discrete collision operator

We write x and y in spherical coordinates

$$(10.3.12) \quad Q^R(f, f)(v) = \frac{1}{4} \int_{e \in \mathbb{S}^{d-1}} \int_{e' \in \mathbb{S}^{d-1}} \delta(e \cdot e') \, de \, de' \left\{ \int_{-R}^R \int_{-R}^R \rho^{d-2} (\rho')^{d-2} \tilde{B}(\rho, \rho') [f(v + \rho'e')f(v + \rho e) - f(v + \rho e + \rho'e')f(v)] \, d\rho \, d\rho' \right\}.$$

Let us take \mathcal{A} a set of orthogonal couples of unit vectors (e, e') , which is even: $(e, e') \in \mathcal{A}$ implies that $(-e, e')$, $(e, -e')$ and $(-e, -e')$ belong to \mathcal{A} (this property on the set \mathcal{A} is required to preserve the conservation properties of the operator). Now we define $Q_R^{\mathcal{A}}$ to be

$$Q^{R, \mathcal{A}}(f, f)(v) = \frac{1}{4} \int_{(e, e') \in \mathcal{A}} \left\{ \int_{-R}^R \int_{-R}^R \rho^{d-2} (\rho')^{d-2} \tilde{B}(\rho, \rho') [f(v + \rho'e')f(v + \rho e) - f(v + \rho e + \rho'e')f(v)] \, d\rho \, d\rho' \right\} d\mathcal{A}$$

where $d\mathcal{A}$ denotes a measure on \mathcal{A} which is also even in the sense that $d\mathcal{A}(e, e') = d\mathcal{A}(-e, e') = d\mathcal{A}(e, -e') = d\mathcal{A}(-e, -e')$. Using translation changes of variable on v by ρe , $\rho'e'$ and $\rho e + \rho'e'$ and the symmetries of the set \mathcal{A} one can easily derive the following weak form on $Q_R^{\mathcal{A}}$. For any function φ periodic on \mathcal{D}_T ,

$$\begin{aligned} & \int_{\mathcal{D}_T} Q^{R, \mathcal{A}}(f, f) \varphi(v) \, dv \\ &= \frac{1}{16} \int_{v \in \mathcal{D}_T} \int_{(e, e') \in \mathcal{A}} \int_{-R}^R \int_{-R}^R \rho^{d-2} (\rho')^{d-2} \tilde{B}(\rho, \rho') f(v + \rho e + \rho'e') f(v) \\ & \quad [\varphi(v + \rho'e') + \varphi(v + \rho e) - \varphi(v + \rho e + \rho'e') - \varphi(v)] \, d\rho \, d\rho' \, d\mathcal{A} \, dv. \end{aligned}$$

This immediately gives the same conservations properties as Q_R . Of course one could also prove exactly the same way

Theorem 10.3. *Let $f_0 \in L^1(\mathcal{D}_T)$ be a nonnegative function. Then there exists a unique solution $f \in C^1(\mathbb{R}_+, L^1(\mathcal{D}_T))$ to the Cauchy problem*

$$\frac{\partial f}{\partial t} = Q^{R, \mathcal{A}}(f, f), \quad f(t = 0, \cdot) = f_0$$

which is nonnegative and has constant mass (and so constant L^1 norm). Moreover, if f_0 has finite entropy, the entropy is non-decreasing with time.

10.3.2 Expansion of the kernel modes

We make the *decoupling assumption* that

$$(10.3.13) \quad \tilde{B}(x, y) = a(|x|) b(|y|).$$

This assumption is obviously satisfied if \tilde{B} is constant. This is the case of Maxwellian molecules in dimension two, and hard spheres in dimension three (the most relevant kernel for applications). Extensions to more general interactions are discussed in the Appendix.

First let us deal with dimension 2 with $\tilde{B} = 1$ to explain the method. Here we write x and y in spherical coordinates $x = \rho e$ and $y = \rho' e'$ to get

$$\beta(l, m) = \frac{1}{4} \int_{e \in \mathbb{S}^1} \int_{e' \in \mathbb{S}^1} \delta(e \cdot e') \left[\int_{-R}^R e^{i\rho(l \cdot e)} d\rho \right] \left[\int_{-R}^R e^{i\rho'(m \cdot e')} d\rho' \right] de de'.$$

Let us denote by

$$\phi_R^2(s) = \int_{-R}^R e^{i\rho s} d\rho,$$

for $s \in \mathbb{R}$. It is easy to see that ϕ_R^2 is even and we can give the explicit formula

$$\phi_R^2(s) = 2 R \operatorname{Sinc}(Rs)$$

with $\operatorname{Sinc}(\theta) = (\sin \theta)/\theta$.

Thus we have

$$\beta(l, m) = \frac{1}{4} \int_{e \in \mathbb{S}^1} \int_{e' \in \mathbb{S}^1} \delta(e \cdot e') \phi_R^2(l \cdot e) \phi_R^2(m \cdot e') de de'$$

and thanks to the parity property of ϕ_R^2 we can adopt the following periodic parametrization

$$\beta(l, m) = \int_0^\pi \phi_R^2(l \cdot e_\theta) \phi_R^2(m \cdot e_{\theta+\pi/2}) d\theta.$$

The function $\theta \rightarrow \phi_R^2(l \cdot e_\theta) \phi_R^2(m \cdot e_{\theta+\pi/2})$ is periodic on $[0, \pi]$ and thus the rectangular quadrature rule is of infinite order and optimal. A regular discretization of M equally spaced points thus gives

$$\beta(l, m) = \frac{\pi}{M} \sum_{p=0}^{M-1} \alpha_p(l) \alpha'_p(m)$$

with

$$\alpha_p(l) = \phi_R^2(l \cdot e_{\theta_p}), \quad \alpha'_p(m) = \phi_R^2(m \cdot e_{\theta_p+\pi/2})$$

where $\theta_p = \pi p/M$.

More generally under the decoupling assumption (10.3.13) on \tilde{B} , we get the following decomposition formula

$$\beta(l, m) = \frac{\pi}{M} \sum_{p=0}^{M-1} \alpha_p(l) \alpha'_p(m)$$

where

$$\alpha_p(l) = \phi_{R,a}^2(l \cdot e_{\theta_p}), \quad \alpha'_p(m) = \phi_{R,b}^2(m \cdot e_{\theta_p+\pi/2})$$

and

$$\phi_{R,a}^2(s) = \int_{-R}^R a(\rho) e^{i\rho s} d\rho, \quad \phi_{R,b}^2(s) = \int_{-R}^R b(\rho') e^{i\rho' s} d\rho'$$

with $\theta_p = \pi p/M$.

Remark: In the symmetric case $a = b$ (for instance for hard spheres) it is possible to parametrize $\beta(l, m)$ as

$$\beta(l, m) = 2 \int_0^{\pi/2} \phi_{R,a}^2(l \cdot e_\theta) \phi_{R,a}^2(m \cdot e_{\theta+\pi/2}) d\theta$$

and the function $\theta \rightarrow \phi_{R,a}^2(l \cdot e_\theta) \phi_{R,a}^2(m \cdot e_{\theta+\pi/2})$ is periodic on $[0, \pi/2]$. Thus the decomposition can be obtained by applying the rectangular rule on this interval. At the numerical level it yields a reduction of the cost by a factor 2.

Now let us deal with dimension $d = 3$ with \tilde{B} satisfying the decoupling assumption (10.3.13). First we change to the spherical coordinates

$$\beta(l, m) = \frac{1}{4} \int_{e \in \mathbb{S}^2} \int_{e' \in \mathbb{S}^2} \delta(e \cdot e') \left[\int_{-R}^R |\rho| a(\rho) e^{i\rho(l \cdot e)} d\rho \right] \left[\int_{-R}^R |\rho'| b(\rho') e^{i\rho'(m \cdot e')} d\rho' \right] de de'$$

and then we integrate first e' on the intersection of the unit sphere with the plane e^\perp ,

$$\beta(l, m) = \frac{1}{4} \int_{e \in \mathbb{S}^2} \phi_{R,a}^3(l \cdot e) \left[\int_{e' \in \mathbb{S}^2 \cap e^\perp} \phi_{R,b}^3(m \cdot e') de' \right] de$$

where

$$\phi_{R,a}^3(s) = \int_{-R}^R |\rho| a(\rho) e^{i\rho s} d\rho, \quad \phi_{R,b}^3(s) = \int_{-R}^R |\rho| b(\rho) e^{i\rho s} d\rho.$$

Thus we get the following decoupling formula with two degrees of freedom

$$\beta(l, m) = \int_{e \in \mathbb{S}_+^2} \phi_{R,a}^3(l \cdot e) \psi_{R,b}^3(\Pi_{e^\perp}(m)) de$$

where \mathbb{S}_+^2 denotes the half-sphere and

$$\psi_{R,b}^3(\Pi_{e^\perp}(m)) = \int_0^\pi \phi_{R,b}(|\Pi_{e^\perp}(m)| \cos \theta) d\theta,$$

(this formula can be derived performing the change of variable $de' = \sin \theta d\theta d\varphi$ with the basis $(e, u = \Pi_{e^\perp}(m)/|\Pi_{e^\perp}(m)|, e \times u)$).

Again in the particular case where $\hat{B} = 1$ (hard spheres model), we can compute explicitly the functions ϕ_R^3 (in this case $a = b = 1$),

$$\phi_R^3(s) = R^2 [2\text{Sinc}(Rs) - \text{Sinc}^2(Rs/2)].$$

Now the function $e \rightarrow \phi_{R,a}^3(l \cdot e) \psi_{R,b}^3(\Pi_{e^\perp}(m))$ is periodic on \mathbb{S}_+^2 and so the rectangular rule is of infinite order and optimal. Taking a spherical parametrization (θ, φ) of $e \in \mathbb{S}_+^2$ and uniform grids of respective size M_1 and M_2 for θ and φ we get

$$\beta(l, m) = \frac{\pi^2}{M_1 M_2} \sum_{p,q=0}^{M_1, M_2} \alpha_{p,q}(l) \alpha'_{p,q}(m)$$

where

$$\alpha_{p,q}(l) = \phi_{R,a}^3(l \cdot e_{(\theta_p, \varphi_q)}), \quad \alpha'_{p,q}(m) = \psi_{R,b}^3(\Pi_{e_{(\theta_p, \varphi_q)}^\perp}(m))$$

and

$$(\theta_p, \varphi_q) = \left(\frac{p\pi}{M_1}, \frac{q\pi}{M_2} \right).$$

From now on we shall consider this expansion with $M = M_1 = M_2$ to avoid anisotropy in the computational grid.

Remarks:

1. It is possible to give more general exact formula in dimension 2 and 3 when $a(r) = |r|^t$, $b(r) = |r|^{t'}$ with $t, t' \in \mathbb{N}$ by computing derivatives along s of the two quantities

$$\int_0^R \sin(\rho s) d\rho, \quad \int_0^R \cos(\rho s) d\rho.$$

2. For any dimension, we can construct as above an approximated collision operator Q^{R, \mathcal{A}_M} with

$$\mathcal{A}_M = \left\{ (e, e') \in \mathbb{S}^{d-1} \times \mathbb{S}^{d-1} \mid e \in \mathbb{S}_{M,+}^{d-1}, \quad e' \in e^\perp \cap \mathbb{S}^{d-1} \right\}$$

where $\mathbb{S}_{M,+}^{d-1}$ denotes a uniform angular discretization of the half sphere with M points in each angular coordinate (the other half sphere is obtained by parity). Let us remark that this discretization contains exactly M^{d-1} points. From now on we shall denote

$$Q^{R,M} = Q^{R, \mathcal{A}_M} = \sum_{p=1}^{M^{d-1}} Q_p^{R,M}.$$

10.3.3 Spectral accuracy

In this paragraph we are interested in computing the accuracy of the scheme according to the three parameters N (the number of modes), R (the truncation parameter), and M (the number of angular directions for each angular coordinate). Instead of looking at the error on each kernel mode it is more convenient to look at the error on the global operator. Here the Lebesgue spaces L^p , $p = 1 \dots +\infty$, and the periodic Sobolev spaces H_p^k , $k = 0 \dots +\infty$ refer to \mathcal{D}_π .

In order to give a consistency result, the first step will be to prove a consistency result for the approximation of Q^R by $Q^{R,M}$.

Lemma 10.1. *The error on the approximation of the collision operator is spectrally small, i.e for all $k > d - 1$ such that $f \in H_p^k$*

$$\|Q^R(g, f) - Q^{R,M}(g, f)\|_{L^2} \leq C_1 \frac{R^k \|g\|_{H_p^k} \|f\|_{H_p^k}}{M^k}.$$

Proof of Lemma 10.1. Starting from (10.3.12), one gets

$$Q^R(g, f)(v) = \frac{1}{2} \int_{e \in \mathbb{S}_+^{d-1}} \left[\int_{e' \in \mathbb{S}^{d-1} \cap e^\perp} \int_{-R}^R \int_{-R}^R \rho^{d-2} (\rho')^{d-2} \tilde{B}(\rho, \rho') \right. \\ \left. [g(v + \rho' e') f(v + \rho e) - g(v + \rho e + \rho' e') f(v)] d\rho d\rho' de' \right] de$$

As the function in the brackets is a periodic function of e on \mathbb{S}_+^{d-1} with period π in each coordinate, one can apply the error estimate for the rectangular rule (see for instance [172, Theorem 19.10]). This error estimate is valid for $k > d - 1$ and depends on the derivative along e of this functional on the following way

$$\|Q^R(g, f) - Q^{R,M}(g, f)\|_{L^2} \\ \leq \frac{C}{2^k M^k} \sum_{i=1}^{d-1} \left\| \int_{e \in \mathbb{S}_+^{d-1}} \left| \partial_{e_i}^k \int_{e' \in \mathbb{S}^{d-1} \cap e^\perp} \int_{-R}^R \int_{-R}^R \rho^{d-2} (\rho')^{d-2} \right. \right. \\ \left. \left. \tilde{B}(\rho, \rho') [g(v + \rho' e') f(v + \rho e) - g(v + \rho e + \rho' e') f(v)] d\rho d\rho' de' \right| de \right\|_{L^2_{\frac{v}{R}}}$$

where the constant is independent on k and $\partial_{e_i}^k$ is the derivative of order k along the coordinate e_i . Then a straightforward computation gives

$$\|Q^R(g, f) - Q^{R,M}(g, f)\|_{L^2} \\ \leq \frac{C R^k}{2^k M^k} \sum_{i=1}^{d-1} \left[\sum_{k'+k''=k} \binom{k}{k'} (\|Q^{R,+}(|\partial^{k'} g|, |\partial^{k''} f|)\|_{L^2} \right. \\ \left. + \|Q^{R,-}(|\partial^{k'} g|, |\partial^{k''} f|)\|_{L^2}) \right]$$

where $\partial^{k'}$ and $\partial^{k''}$ denote some derivatives of order k' and k'' . Then using the estimates

$$\|Q^{R,+}(g, f), Q^{R,-}(g, f)\|_{L^2} \leq C \|g\|_{L^2} \|f\|_{L^2}$$

proved in [88]², we get

$$\|Q^R(g, f) - Q^{R,M}(g, f)\|_{L^2} \leq \frac{C R^k}{M^k} \|g\|_{H_p^k} \|f\|_{H_p^k}$$

which concludes the proof. \square

²Which are consequences of the L^p estimates proved in [111, 112], and revisited in [150].

For the second step we shall use the consistency result [160, Corollary 5.4] on the operator Q^R , which we quote here for the sake of clarity.

Lemma 10.2. *For all $k \in \mathbb{N}$ such that $f \in H_p^k$,*

$$\|Q^R(f, f) - \mathcal{P}_N Q^R(f_N, f_N)\|_{L^2} \leq \frac{C_2}{N^k} \left(\|f\|_{H_p^k} + \|Q^R(f_N, f_N)\|_{H_p^k} \right).$$

Combining these two results, one gets the following consistency result

Theorem 10.4. *For all $k > d - 1$ such that $f \in H_p^k(\mathcal{D}_\pi)$,*

$$\begin{aligned} & \|Q^R(f, f) - \mathcal{P}_N Q^{R,M}(f_N, f_N)\|_{L^2} \\ & \leq C_1 \frac{R^k \|f_N\|_{H_p^k}^2}{M^k} + \frac{C_2}{N^k} \left(\|f\|_{H_p^k} + \|Q^R(f_N, f_N)\|_{H_p^k} \right). \end{aligned}$$

Proof of Theorem 10.4. By triangular inequality

$$\begin{aligned} \|Q^R(f, f) - \mathcal{P}_N Q^{R,M}(f_N, f_N)\|_{L^2} & \leq \|\mathcal{P}_N(Q^R(f_N f_N) - Q^{R,M}(f_N, f_N))\|_{L^2} \\ & \quad + \|Q^R(f, f) - \mathcal{P}_N Q^R(f_N, f_N)\|_{L^2}. \end{aligned}$$

The first term on the right-hand side is controlled by Lemma 10.1

$$\begin{aligned} \|\mathcal{P}_N(Q^R(f_N, f_N) - Q^{R,M}(f_N, f_N))\|_{L^2} & \leq \\ \|Q^R(f_N, f_N) - Q^{R,M}(f_N, f_N)\|_{L^2} & \leq C_1 \frac{R^k \|f_N\|_{H_p^k(\mathcal{D}_\pi)}^2}{M^k}. \end{aligned}$$

The second term in the right-hand side is controlled by Lemma 10.2, which concludes the proof. \square

Now let us focus briefly on the macroscopic quantities. In fact here no additional error (related to M) occurs, compared with the usual spectral method, since the approximation of the collision operator that we are using is still conservative. First with Lemma 10.1 at hand one can establish the estimate

$$\|Q^{R,M}(g, f)\|_{L^2} \leq C \|g\|_{H_p^d} \|f\|_{H_p^d},$$

for a constant uniform in M . Then following the method of [160, Remark 5.4] and using this estimate we obtain the following spectral accuracy result

$$\begin{aligned} & \left| \langle Q^{R,M}(f, f), \varphi \rangle - \langle \mathcal{P}_N Q^{R,M}(f_N, f_N), \varphi \rangle \right|_{L^2} \\ & \leq \frac{C_3}{N^k} \|\varphi\|_{L^2} \left(\|f\|_{H_p^{k+d}} + \|Q^{R,M}(f_N, f_N)\|_{H_p^k} \right) \end{aligned}$$

where φ can be replaced by $v, |v|^2$. Indeed there is no need to compare the momenta of $\mathcal{P}_N Q^{R,M}(f_N, f_N)$ with those of $Q^R(f, f)$ since $Q^{R,M}$ is also conservative, and so they can be compared directly to those of $Q^{R,M}$. Thus the error on momentum and energy is independent on M and is spectrally small according to N even for very small value of the parameter M .

10.3.4 Implementation of the algorithm

The final spectral scheme depends on the three parameters N , R , and M . The only conditions on these parameters is the no-aliasing condition that relates R and the size of the box T (here π). A detailed study of the influence of the choices of N and R has been done in [160]. Here we are interested only in the influence of M over the computations, since M controls the computations speed-up.

The method of the previous subsections yields a decomposition of the collision operator, which after projection on \mathbb{P}^N gives the following decomposition

$$(10.3.14) \quad \mathcal{P}_N Q^{R,M} = \sum_{p=1}^{M^{d-1}} \mathcal{P}_N Q_p^{R,M}.$$

Each $\mathcal{P}_N Q_p^{R,M}$ can be computed with a cost $O(N^d \log_2 N)$. Thus for a general choice of M and N we obtain the cost $O(M^{d-1} N^d \log_2 N)$. The decomposition (10.3.14) is completely parallelizable and thus the cost can be strongly reduced on a parallel machine (formally up to $O(N^d \log_2 N)$). One just has to make independent computations for the M^{d-1} terms of the decomposition.

Moreover the formula of decomposition is naturally adaptive (that is the number M can be made space dependent), which can be quite useful in the inhomogeneous setting, where some regions deserve less accuracy than others. Since it relies on the rectangular formula, whose adaptivity property is well known, one can easily double the number of directions M if needed, without computing again those points already computed.

Finally the decomposition can be also interesting from the storage viewpoint, as the classical spectral method requires the storage of a $N^d \times N^d$ matrix whereas our method requires the storage of $2M^{d-1}$ vectors of size N^d . In dimension 2 the classical method requires a storage of order $O(N^4)$ and our method requires a storage of order $O(MN^2)$. In dimension 3 the classical method requires a storage of order $O(N^4)$ (thanks to the symmetries of the matrix of kernel modes, see [88]), and our method requires a storage of order $O(M^2 N^3)$.

N	$M=2$	$M=4$	$M=8$	$M=16$
32	2.129E-4	1.993E-05	2.153E-05	2.262E-5
64	2.109E-4	7.122E-10	6.830E-10	6.843E-10
128	2.112E-4	3.116E-12	3.117E-12	3.117E-12

Table 10.1: Relative L_1 norm of the error for different values of N and M for the fast spectral method.

As a numerical example we report the results obtained in the case of space homogeneous two-dimensional Maxwellian molecules using as a comparison the exact analytic solution (see [160]). The results for the relative L_1 norm of the error at time $t = 0.01$ are reported in Table 10.1.

Although further extensive testing is necessary, the results are very promising and seem to indicate a very low influence of the number of directions over the accuracy of the scheme. For $M = 2$ the angle error dominates, but as soon as $M = 4$ the error in N is dominating. Note that the number of angle directions will indirectly influence the aliasing effect through the slight change in the relaxation times. This may explain the slight error variations that we observe taking $M \geq 4$.

Finally, in view of space non homogeneous computations, we will have the additional advantage of taking a larger number of gridpoints without increasing too much the computational cost, thus allowing the computations of flows at larger Mach number compared to conventional deterministic schemes. Further numerical results are under development and will be presented elsewhere [85].

10.4 Fast DVM's algorithm for a class of collision kernels

The fast algorithms developed for the spectral method can be in fact extended to the periodized DVM method. The method that originates is in some sense related to the direct FFT approach proposed in [23, 35, 34].

10.4.1 Principle of the method: a pseudo-spectral viewpoint

We start from the periodized DVM in $[-N, N]^d$ with representation (10.2.11) and we set, for $-\tilde{N} \leq k, l \leq \tilde{N}$,

$$\tilde{B}(|k|, |l|) = \frac{B(|k|, |l|)}{|k+l|^{d-2}}$$

With this notation

$$\tilde{\Gamma}_{k,l} = \mathbf{1}(k \cdot l) \tilde{B}(|k|, |l|) w_{k,l},$$

and thus the DVM becomes

$$f'_i = \sum_{-\tilde{N} \leq k, l \leq \tilde{N}} \mathbf{1}(k \cdot l) \tilde{B}(|k|, |l|) w_{k,l} [f_{i+k} f_{i+l} - f_i f_{i+k+l}].$$

Now we transform this set of ordinary differential equations into a new one using the involution transformation of the discrete Fourier transform on the vector $(f_i)_{-N \leq i \leq N}$. This involution reads

$$\tilde{f}_I = \frac{1}{2N+1} \sum_{i=0}^{2N} f_i \mathbf{e}_{-I}(i), \quad f_i = \sum_{I=-N}^N \tilde{f}_I \mathbf{e}_I(i)$$

where $\mathbf{e}_K(k)$ denotes $e^{\frac{2i\pi K \cdot k}{2N+1}}$, and thus the set of differential equations becomes

$$\begin{aligned} \tilde{f}'_I &= \sum_{K,L=-N}^N \left(\frac{1}{2N+1} \sum_{i=0}^{2N} \mathbf{e}_{K+L-I}(i) \right) \\ &\quad \left[\sum_{-\tilde{N} \leq k, l \leq \tilde{N}} \mathbf{1}_{(k,l)} \tilde{B}(|k|, |l|) w_{k,l} (\mathbf{e}_K(k) \mathbf{e}_L(l) - \mathbf{e}_L(k+l)) \right] \tilde{f}_K \tilde{f}_L \end{aligned}$$

for $-N \leq I \leq N$. We have the following identity

$$\frac{1}{2N+1} \sum_{i=0}^{2N} \mathbf{e}_{K+L-I}(i) = \mathbf{1}(K+L-I)$$

and so the set of equations is

$$\tilde{f}'_I = \sum_{\substack{K+L=I \\ K,L=-N}}^N \tilde{\beta}(K, L) \tilde{f}_K \tilde{f}_L$$

with

$$\begin{aligned} \tilde{\beta}(K, L) &= \sum_{-\tilde{N} \leq k, l \leq \tilde{N}} \mathbf{1}(k \cdot l) \tilde{B}(|k|, |l|) w_{k,l} [\mathbf{e}_K(k) \mathbf{e}_L(l) - \mathbf{e}_L(k+l)] \\ &= \beta(K, L) - \beta(L, L) \end{aligned}$$

where

$$\beta(K, L) = \sum_{-\tilde{N} \leq k, l \leq \tilde{N}} \mathbf{1}(k \cdot l) \tilde{B}(|k|, |l|) w_{k,l} \mathbf{e}_K(k) \mathbf{e}_L(l).$$

Let us first remark that this new formulation allows to reduce the usual cost of computation of the DVM exactly to $O(N^{2d})$ (as with the usual spectral method). Note however that the $(2N+1)^d \times (2N+1)^d$ matrix of coefficients $(\beta(K, L))_{K,L}$ has to be computed and stored first, thus the storage requirements are larger with respect to usual DVM. Nevertheless symmetries in the matrix can reduce substantially this cost.

Now the aim is to give an expansion of $\beta(K, L)$ of the form

$$\beta_{K,L} \simeq \sum_{p=1}^M \alpha_p(K) \alpha'_p(L)$$

to get a lower cost by the use of discrete convolution.

10.4.2 Expansion of the discrete kernel modes

We make a decoupling assumption as in the spectral case

$$\tilde{B}(|k|, |l|) w_{k,l} = a(k) b(l).$$

Remark: Note that the DVM constructed by quadrature, in dimension 3 for hard spheres, in [156] satisfies this decoupling assumption with $a(k) = h^4/\text{gcd}(k_1, k_2, k_3)$ and $b(l) = 1$ (see [156, Formula (2.8)]), and $\text{gcd}(k_1, k_2, k_3)$ denotes the greater common divisor of the three integers.

The difference here with the spectral method, which is a continuous numerical method, is that we have to *enumerate* the set of $\{-\tilde{N} \leq k, l \leq \tilde{N} \mid k \perp l\}$. As noticed in [173], this motivates for a detailed study of the set of lines passing through 0 and another point in the grid. To this purpose let us introduce the Farey series and a new parameter $0 \leq \bar{N} \leq \tilde{N}$ for the size of the grid used to compute the number of directions. The usual Farey serie is

$$\mathcal{F}_{\bar{N}}^1 = \{(p, q) \in [0, \bar{N}]^2 \mid 0 \leq p \leq q \leq \bar{N} \text{ and } \text{gcd}(p, q) = 1\}$$

where $\gcd(p, q)$ denotes again the greater common divisor of the two integers (more details can be found in [114]). It is straightforward to see that the number of lines $A_{\bar{N}}^1$ passing through 0 in the grid $[[-\bar{N}, \bar{N}]]^2$ is $A_{\bar{N}}^1 = 4 |\mathcal{F}_{\bar{N}}^1|$. In fact symmetries often allow to reduce the number of directions needed. Similarly one can define

$$\mathcal{F}_{\bar{N}}^2 = \{ (p, q, r) \in [[0, \bar{N}]]^3 \mid 0 \leq p \leq q \leq r \leq \bar{N} \text{ and } \gcd(p, q, r) = 1 \}$$

and the number of lines $A_{\bar{N}}^2$ passing through 0 in the grid $[[-\bar{N}, \bar{N}]]^3$ is $A_{\bar{N}}^2 = 16 |\mathcal{F}_{\bar{N}}^2|$. The exponents of the Farey series refer to the dimension of the space of lines (which is $d - 1$). Now let us estimate the cardinal of $\mathcal{F}_{\bar{N}}^1$ and $\mathcal{F}_{\bar{N}}^2$.

Lemma 10.3. *The Farey series in dimension $d = 2$ and $d = 3$ satisfy the following asymptotic behavior*

$$\begin{aligned} |\mathcal{F}_{\bar{N}}^1| &= \frac{\bar{N}^2}{2\zeta(2)} + O(\bar{N} \log \bar{N}) = \frac{3\bar{N}^2}{\pi^2} + O(\bar{N} \log \bar{N}) \\ |\mathcal{F}_{\bar{N}}^2| &= \frac{\bar{N}^3}{4\zeta(3)} + O(\bar{N}^2) \end{aligned}$$

where ζ denotes the usual zeta function.

Remark: In dimension d , the formula would be

$$\mathcal{F}_{\bar{N}}^{d-1} = \left\{ (p_1, p_2, \dots, p_d) \in [[0, \bar{N}]]^d \mid \right. \\ \left. 0 \leq p_1 \leq p_2 \leq \dots \leq p_d \leq \bar{N} \text{ and } \gcd(p_1, p_2, \dots, p_d) = 1 \right\}$$

and $A_{\bar{N}}^{d-1} = 2^{2(d-1)} |\mathcal{F}_{\bar{N}}^{d-1}|$. It is likely that the cardinal of $\mathcal{F}_{\bar{N}}^{d-1}$ could be computed by induction with the same tools as in the proof below (for $d \geq 3$), with the general formula

$$|\mathcal{F}_{\bar{N}}^d| = \frac{\bar{N}^d}{2^{d-1} \zeta(d)} + O(\bar{N}^{d-1}).$$

Proof of Lemma 10.3. The proof of the first equivalent is extracted from [114], and given shortly for convenience of the reader. The proof of the second one is inspired from it.

Let us introduce $\varphi(n)$ the Euler function (as number of integers less than and prime to n) and the multiplicative Möbius function $\mu(n)$ such that $\mu(1) =$

1, $\mu(n) = 0$ if n has a squared factor and $\mu(p_1 p_2 \cdots p_k) = (-1)^k$ if all the primes p_1, p_2, \dots, p_k are different. We have the following connection between this two arithmetical functions

$$\varphi(n) = n \sum_{d|n} \frac{\mu(d)}{d} = \sum_{d|n} d' \mu(d).$$

Now let us compute the cardinal of the Farey serie in dimension 2.

$$\begin{aligned} |\mathcal{F}_{\bar{N}}^1| &= 1 + \varphi(1) + \cdots + \varphi(\bar{N}) = 1 + \sum_{m=1}^{\bar{N}} \sum_{d|d'=m} d' \mu(d) \\ &= 1 + \sum_{d|d' \leq m} d' \mu(d) = 1 + \sum_{d=1}^{\bar{N}} \mu(d) \sum_{d'=1}^{[\bar{N}/d]} d' \\ &= 1 + \frac{1}{2} \sum_{d=1}^{\bar{N}} \mu(d) ([\bar{N}/d]^2 + [\bar{N}/d]) \\ &= 1 + \frac{1}{2} \sum_{d=1}^{\bar{N}} \mu(d) ((\bar{N}/d)^2 + O(\bar{N}/d)) \end{aligned}$$

and thus

$$\begin{aligned} |\mathcal{F}_{\bar{N}}^1| &= 1 + \frac{\bar{N}^2}{2} \sum_{d=1}^{\bar{N}} \frac{\mu(d)}{d^2} + O\left(\bar{N} \sum_{d=1}^{\bar{N}} \frac{1}{d}\right) \\ &= 1 + \frac{\bar{N}^2}{2} \sum_{d=1}^{\infty} \frac{\mu(d)}{d^2} + O\left(\bar{N}^2 \sum_{\bar{N}+1}^{\infty} \frac{1}{d^2}\right) \\ &\quad + O(\bar{N} \log \bar{N}) \\ &= \frac{\bar{N}^2}{2\zeta(2)} + O(\bar{N}) + O(\bar{N} \log \bar{N}) \end{aligned}$$

where we have used the arithmetical formula $1/\zeta(s) = \sum_{n=1}^{\infty} \mu(n)/n^s$.

Now for the dimension $d = 3$, we enumerate the set $\mathcal{F}_{\bar{N}}^2$ in the following way: we fix r then $q \leq r$, then $p \leq q$ such that $\gcd(p, \gcd(q, r)) = 1$ (we use the associativity of the function \gcd). This leads us to count the number of p in $[1, q]$ such that $(p, \delta) = 1$ for a given $\delta|q$. When $\delta > 1$, writing $p = k\delta + p_0$ with $p_0 \in [1, \delta - 1]$, this number is seen to be $\varphi(\delta)(q/\delta)$. When $\delta = 1$ this number is $q + 1$ (all the value from 0 to q). Thus the formula $\varphi(\delta)(q/\delta)$ is still valid if we deal separately with the case $p = 0$, which has cardinal $|\mathcal{F}_{\bar{N}}^1|$.

Now let us compute the cardinal of $\mathcal{F}_{\bar{N}}^2$

$$\begin{aligned}
 |\mathcal{F}_{\bar{N}}^2| &= |\mathcal{F}_{\bar{N}}^1| + \sum_{r=1}^{\bar{N}} \sum_{q=1}^r q \frac{\varphi((q,r))}{(q,r)} = O(\bar{N}^2) + \sum_{r=1}^{\bar{N}} \sum_{q=1}^r q \sum_{d|q, d|r} \frac{\mu(d)}{d} \\
 &= O(\bar{N}^2) + \frac{1}{2} \sum_{d=1}^{\bar{N}} \frac{\mu(d)}{d} \left[\sum_{1 \leq q, r \leq \bar{N} \mid d|q, d|r} q \right] \\
 &= O(\bar{N}^2) + \frac{1}{2} \sum_{d=1}^{\bar{N}} \frac{\mu(d)}{d} [\bar{N}/d] d \left(\sum_{d'=1}^{[\bar{N}/d]} d' \right)
 \end{aligned}$$

and thus

$$\begin{aligned}
 |\mathcal{F}_{\bar{N}}^2| &= O(\bar{N}^2) + \frac{1}{4} \sum_{d=1}^{\bar{N}} \mu(d) \left(\bar{N}/d + O(1) \right) \left([\bar{N}/d]^2 + [\bar{N}/d] \right) \\
 &= O(\bar{N}^2) + \frac{\bar{N}^3}{4} \sum_{d=1}^{\bar{N}} \frac{\mu(d)}{d^3} + O \left(\bar{N}^2 \sum_{d=1}^{\bar{N}} \frac{\mu(d)}{d^2} \right) + O \left(\bar{N} \sum_{d=1}^{\bar{N}} \frac{\mu(d)}{d} \right) \\
 &= \frac{\bar{N}^3}{4} \sum_{d=1}^{+\infty} \frac{\mu(d)}{d^3} + O \left(\bar{N}^3 \sum_{d=\bar{N}+1}^{+\infty} \frac{1}{d^3} \right) + O(\bar{N}^2) + O(\bar{N} \log \bar{N})
 \end{aligned}$$

which yields the result

$$|\mathcal{F}_{\bar{N}}^2| = \frac{\bar{N}^3}{4 \zeta(3)} + O(\bar{N}^2).$$

□

Now one can deduce the following decomposition of the kernel modes

$$\begin{aligned}
 \beta(K, L) &= \sum_{-\tilde{N} \leq k, l \leq \tilde{N}} \mathbf{1}_{(k,l)} a(|k|) b(|l|) e_K(k) e_L(l) \\
 &\simeq \sum_{e \in \mathcal{A}_{\tilde{N}}} \left[\sum_{k \in e\mathbb{Z}, -\tilde{N} \leq k \leq \tilde{N}} a(|k|) e_K(k) \right] \left[\sum_{l \in e^\perp, -\tilde{N} \leq l \leq \tilde{N}} b(|l|) e_L(l) \right]
 \end{aligned}$$

with equality if $\bar{N} = \tilde{N}$. Here $\mathcal{A}_{\tilde{N}}$ denotes the set of primal representants of directions of lines in $[[-\tilde{N}, \tilde{N}]]$ passing through 0. After indexing this set, which has cardinal $A_{\tilde{N}}^d$, one gets

$$(10.4.15) \quad \beta_{K,L} \simeq \sum_{p=1}^{A_{\tilde{N}}^d} \alpha_p(K) \alpha'_p(L)$$

with

$$\alpha_p(K) = \sum_{k \in e_p \mathbb{Z}, -\tilde{N} \leq k \leq \tilde{N}} a(|k|) e_K(k), \quad \alpha'_p(L) = \sum_{l \in e_p^\perp, -\tilde{N} \leq l \leq \tilde{N}} b(|l|) e_L(l).$$

The method yields a decomposition of the discrete collision operator

$$D^{\tilde{N}} \simeq D^{\tilde{N}, \tilde{N}} = \sum_{p=1}^{A_{\tilde{N}}^d} D^{\tilde{N}, \tilde{N}, p}$$

with equality if $\bar{N} = \tilde{N}$. Each $D^{\tilde{N}, \tilde{N}, p}(f, f)$ is defined by the p -th term of the decomposition of the kernel modes (10.4.15). Each term $D^{\tilde{N}, \tilde{N}, p}$ of the sum is a discrete convolution operator when it is written in Fourier space.

Thus one can see that even if we take $\bar{N} = \tilde{N} = N$, i.e we take all possible directions in the grid $[[-N, N]]^d$, we get the computational cost $O(N^{2d} \log_2 N)$, which is better than the usual cost of the DVM $O(N^{2d+1})$ (but slightly worse than the cost $O(N^{2d})$ obtained by solving directly the pseudo-spectral scheme, thanks to a bigger storage requirement).

More generally for a choice of $\bar{N} < N$ we obtain the cost $O(\bar{N}^d N^d \log_2 N)$. The same remarks we did for the fast spectral algorithms about the parallelization and adaptivity (and storage interest) of the method hold true in this case: a parallel algorithm could reduce the computational cost up to $O(N^d \log_2 N)$.

Moreover we expect that for DVM one can strongly reduce the parameter \bar{N} in order to improve the cost of the scheme, without damaging the accuracy of the scheme. The justification for this is the low accuracy of the method (the reduction of the number of direction has a small effect on the already poor accuracy of the scheme).

Remarks:

1. Concerning the construction of the set of directions $\mathcal{A}_{\tilde{N}}^d$, it can be done with systematic algorithms of iterated subdivisions of a simplex, thanks to the properties of the Farey series. In dimension $d = 2$ this construction is quite simple (see [114]). In dimension 3 we refer to [153].

2. Let us remark that in order to get a *regular* scheme (i.e with no other conservation laws than the usual ones) in spite of the reduction of directions, it is enough that the scheme “contains the directions 0 and $\pi/2$ ” (see [51]). This is satisfied if we take the directions contained in \mathcal{F}_1^{d-1} , i.e. as soon as $\bar{N} \geq 1$.

3. Finally in the practical implementation of the algorithm one has to take advantage, as in the spectral case, of the symmetry of the decomposition (10.3.13) in order to reduce the number of terms in the sum: in dimension 2, if $a = b = 1$, one can write a decomposition with $A_{\tilde{N}}^d/2$ terms.

10.5 Conclusions

We have presented a deterministic way for computing the Boltzmann collision operator with fast algorithms. The method is based on a Carleman-like representation of the operator that allows to express it as a combination of convolutions (this is trivially true for the loss part but it is not trivial for the gain part). A suitable periodized truncation of the operator is then used to derive new spectral methods and new discrete velocity methods both computable with a high speed up in computation times. For the spectral method it will bring the overall cost in dimension d to $O(M^{d-1}N^d \log_2 N)$ where N is the number of velocity parameters and M the number of angular directions in each angular coordinate. For the discrete velocity method it will bring the overall cost in dimension d to $O(\bar{N}^d N^d \log_2 N)$ where N is the size of velocity grid and \bar{N} is the size of the grid used to compute directions in the approximation of the discrete operator. Consistency and accuracy of the proposed schemes are also presented. First numerical results seem to indicate the validity and the flexibility of the present approach that, to our opinion, will make deterministic schemes much more competitive with Monte Carlo methods in several situations.

10.6 Appendix: Remarks on admissible collision kernels and an extension to the “non-decoupled” case

Let us study the cases where the assumption (10.3.13) is satisfied. For hard spheres in dimension 3, or Maxwellian molecules in dimension 2, one has the equation (10.3.13) with $a = b = 1$. Formally for the Coulomb potential in dimension 3, we have

$$B(\theta, |u|) = |u|^{-3} \sin^{-4}(\theta/2),$$

and thus, thanks to formula (10.2.3)

$$\tilde{B}(x, y) = 2^{d-1} |x|^{-4}.$$

This suggests, in dimension 3, to consider the following family of “variable hard sphere” collision kernels

$$(10.6.16) \quad B_\gamma(\theta, |u|) = \sin^{\gamma-1}(\theta/2) |u|^\gamma.$$

Indeed simple computations give

$$\tilde{B}_\gamma(x, y) = 2^{d-1} |x|^{\gamma-1}$$

and thus they satisfy the decoupling assumption (10.3.13) In the case where $\gamma \in (-2, 1]$ the angular part of the collision kernel remains integrable. On the contrary, for $\theta \sim 0$, the equivalent derived from the physical non explicit formula in [52] for inverse-power laws kernels (for a potential $1/|d|^n$ with n such that $\gamma = (n - 5)/(n - 1)$) is of the form

$$B_\gamma^{\text{exact}}(\theta, |u|) \sim_{\theta \sim 0} \sin^{\frac{\gamma-5}{2}}(\theta/2) |u|^\gamma$$

with $\gamma \in [-3, 1)$. It is therefore always non-integrable for $\theta \sim 0$.

The model (10.6.16) coincides with the hard spheres model for $\gamma = 1$ and, formally, coincides with the kernel of the Coulomb potential for $\gamma = -3$. Moreover for $\gamma \in (-2, 1]$ (i.e. hard potentials and the so-called moderately soft potentials) it remains integrable for $\theta \sim 0$. Thus it seems quite reasonable to consider it as a model for cutoff hard and moderately soft potentials, as well as hard spheres.

In dimension 2 the same arguments and computations lead to the following cutoff hard and moderately soft potentials model

$$B_\gamma(\theta, |u|) = \sin^\gamma(\theta/2) |u|^\gamma$$

valid for $\gamma \in (-3, 1]$, which coincides with the case of Maxwellian molecules for $\gamma = 0$.

For the spectral method the other situation where one obtains naturally a fast algorithm is the case where collisions concentrate on the grazing part: see [163] and [164] for a fast algorithm to compute the Fokker-Planck-Landau collision operator, which is the limit of the Boltzmann collision operator in the grazing collision limit. In this case indeed one of the two variables x or y of the representation (10.2.5) disappears in the limit process, which “decouples” the kernel modes. Thus it may be possible to construct fast algorithms for non-cutoff models by splitting the collision operator into a cutoff part treated by the method presented in this paper, and a non-cutoff part restricted to very small deviation angles, which would be close to the grazing collision limit and thus could be computed by the fast algorithm of [163, 164].

Acknowledgments. The first author wishes to thank Bruno Sévenec for fruitful discussions on the Farey series. Both authors thank Francis Filbet for the numerical results of Table 1. Support by the European network HYKE, funded by the EC as contract HPRN-CT-2002-00282, is acknowledged.

Bibliographie

- [1] ABRAHAMSSON, F. Strong L^1 convergence to equilibrium without entropy conditions for the Boltzmann equation. *Comm. Partial Differential Equations* 24, 7-8 (1999), 1501–1535.
- [2] ADAMS, R. A. *Sobolev spaces*. Academic Press [A subsidiary of Harcourt Brace Jovanovich, Publishers], New York-London, 1975. Pure and Applied Mathematics, Vol. 65.
- [3] ALEXANDRE, R., DESVILLETES, L., VILLANI, C., AND WENNBORG, B. Entropy dissipation and long-range interactions. *Arch. Ration. Mech. Anal.* 152, 4 (2000), 327–355.
- [4] ALEXANDRE, R., AND VILLANI, C. On the Boltzmann equation for long-range interactions. *Comm. Pure Appl. Math.* 55, 1 (2002), 30–70.
- [5] ALEXANDRE, R., AND VILLANI, C. On the Landau approximation in plasma physics. *Ann. Inst. H. Poincaré Anal. Non Linéaire* 21, 1 (2004), 61–95.
- [6] ARKERYD, L. On the Boltzmann equation. *Arch. Rational Mech. Anal.* 45 (1972), 1–34.
- [7] ARKERYD, L. Intermolecular forces of infinite range and the Boltzmann equation. *Arch. Rational Mech. Anal.* 77 (1981), 11–21.
- [8] ARKERYD, L. L^∞ estimates for the space-homogeneous Boltzmann equation. *J. Statist. Phys.* 31, 2 (1983), 347–361.
- [9] ARKERYD, L. Existence theorems for certain kinetic equations and large data. *Arch. Rational Mech. Anal.* 103, 2 (1988), 139–149.
- [10] ARKERYD, L. Stability in L^1 for the spatially homogeneous Boltzmann equation. *Arch. Rational Mech. Anal.* 103, 2 (1988), 151–167.
- [11] ARKERYD, L., ESPOSITO, R., AND PULVIRENTI, M. The Boltzmann equation for weakly inhomogeneous data. *Comm. Math. Phys.* 111, 3 (1987), 393–407.
- [12] ARNOLD, A., CARRILLO, J. A., DESVILLETES, L., DOLBEAULT, J., JÜNGEL, A., LEDERMAN, C., MARKOWICH, P. A., TOSCANI, G., AND VILLANI, C. Entropies and equilibria of many-particle systems: an essay on recent research. *Monatsh. Math.* 142, 1-2 (2004), 35–43.
- [13] ARSEN'EV, A. A., AND BURYAK, O. E. On a connection between the solution of the Boltzmann equation and the solution of the Landau-Fokker-Planck equation. *Mat. Sb.* 181, 4 (1990), 435–446.

- [14] BALABANE, M., 1985. Cours.
- [15] BARANGER, C., AND MOUHOT, C. Explicit spectral gap estimates for the linearized Boltzmann and Landau operators with hard potentials. À paraître dans *Rev. Matem. Iberoamericana*.
- [16] BARDOS, C. What use for the mathematical theory of the Navier-Stokes equations. In *Mathematical fluid mechanics*, Adv. Math. Fluid Mech. Birkhäuser, Basel, 2001, pp. 1–25.
- [17] BARDOS, C., CAFLISCH, R. E., AND NICOLAENKO, B. The Milne and Kramers problems for the Boltzmann equation of a hard sphere gas. *Comm. Pure Appl. Math.* 39, 3 (1986), 323–352.
- [18] BENEDETTO, D., CAGLIOTI, E., AND PULVIRENTI, M. A kinetic equation for granular media. *RAIRO Modél. Math. Anal. Numér.* 31, 5 (1997), 615–641.
- [19] BENEDETTO, D., CAGLIOTI, E., AND PULVIRENTI, M. Erratum: “A kinetic equation for granular media”. *M2AN Math. Model. Numer. Anal.* 33, 2 (1999), 439–441.
- [20] BENEDETTO, D., AND PULVIRENTI, M. On the one-dimensional Boltzmann equation for granular flows. *M2AN Math. Model. Numer. Anal.* 35, 5 (2001), 899–905.
- [21] BERGH, J., AND LÖFSTRÖM, J. *Interpolation spaces. An introduction*. Springer-Verlag, Berlin, 1976. Grundlehren der Mathematischen Wissenschaften, No. 223.
- [22] BIRD, G. A. *Molecular gas dynamics and the direct simulation of gas flows*, vol. 42 of *Oxford Engineering Science Series*. The Clarendon Press Oxford University Press, New York, 1994. 1994.
- [23] BOBYLEV, A., AND RJASANOW, S. Difference scheme for the Boltzmann equation based on the fast Fourier transform. *European J. Mech. B Fluids* 16, 2 (1997), 293–306.
- [24] BOBYLËV, A. V. The theory of the nonlinear spatially uniform Boltzmann equation for Maxwell molecules. In *Mathematical physics reviews, Vol. 7*. Harwood Academic Publ., Chur, 1988, pp. 111–233.
- [25] BOBYLEV, A. V. Moment inequalities for the Boltzmann equation and applications to spatially homogeneous problems. *J. Statist. Phys.* 88, 5–6 (1997), 1183–1214.
- [26] BOBYLEV, A. V. Relationships between Discrete and Continuous Kinetic Theories. In *Rarefied Gas Dynamics*, vol. 1. Cépaduès-Éditions, 1999, pp. 1–19.
- [27] BOBYLEV, A. V., CARRILLO, J. A., AND GAMBA, I. M. On some properties of kinetic and hydrodynamic equations for inelastic interactions. *J. Statist. Phys.* 98, 3–4 (2000), 743–773.
- [28] BOBYLEV, A. V., AND CERCIGNANI, C. On the rate of entropy production for the Boltzmann equation. *J. Statist. Phys.* 94, 3–4 (1999), 603–618.
- [29] BOBYLEV, A. V., AND CERCIGNANI, C. Self-similar asymptotics for the Boltzmann equation with inelastic and elastic interactions. *J. Statist. Phys.* 110, 1–2 (2003), 333–375.
- [30] BOBYLEV, A. V., CERCIGNANI, C., AND TOSCANI, G. Proof of an asymptotic property of self-similar solutions of the Boltzmann equation for granular materials. *J. Statist. Phys.* 111, 1–2 (2003), 403–417.

-
- [31] BOBYLEV, A. V., DUKES, P., ILLNER, R., AND VICTORY, JR., H. D. On Vlasov-Manev equations. I. Foundations, properties, and nonglobal existence. *J. Statist. Phys.* 88, 3-4 (1997), 885–911.
- [32] BOBYLEV, A. V., GAMBA, I. M., AND PANFEROV, V. Moment inequalities and high-energy tails for the Boltzmann equations with inelastic interactions. Prépublication 2004, à paraître dans *J. Stat. Phys.*
- [33] BOBYLEV, A. V., PALCZEWSKI, A., AND SCHNEIDER, J. On approximation of the Boltzmann equation by discrete velocity models. *C. R. Acad. Sci. Paris Sér. I Math.* 320, 5 (1995), 639–644.
- [34] BOBYLEV, A. V., AND RJASANOW, S. Fast deterministic method of solving the Boltzmann equation for hard spheres. *Eur. J. Mech. B Fluids* 18, 5 (1999), 869–887.
- [35] BOBYLEV, A. V., AND RJASANOW, S. Numerical solution of the Boltzmann equation using a fully conservative difference scheme based on the fast Fourier transform. In *Proceedings of the Fifth International Workshop on Mathematical Aspects of Fluid and Plasma Dynamics (Maui, HI, 1998)* (2000), vol. 29, pp. 289–310.
- [36] BOLTZMANN, L. *Lectures on gas theory*. Translated by Stephen G. Brush. University of California Press, Berkeley, 1964.
- [37] BOUCHUT, F., AND DESVILLETES, L. A proof of the smoothing properties of the positive part of Boltzmann’s kernel. *Rev. Mat. Iberoamericana* 14, 1 (1998), 47–61.
- [38] BOUDIN, L., AND DESVILLETES, L. On the singularities of the global small solutions of the full Boltzmann equation. *Monatsh. Math.* 131, 2 (2000), 91–108.
- [39] BREZIS, H. *Analyse fonctionnelle*. Collection Mathématiques Appliquées pour la Maîtrise. [Collection of Applied Mathematics for the Master’s Degree]. Masson, Paris, 1983. Théorie et applications. [Theory and applications].
- [40] BUET, C. A discrete-velocity scheme for the Boltzmann operator of rarefied gas dynamics. *Transport Theory Statist. Phys.* 25, 1 (1996), 33–60.
- [41] CAFLISCH, R. E. The Boltzmann equation with a soft potential. I. Linear, spatially-homogeneous. *Comm. Math. Phys.* 74, 1 (1980), 71–95.
- [42] CAFLISCH, R. E. The Boltzmann equation with a soft potential. II. Nonlinear, spatially-periodic. *Comm. Math. Phys.* 74, 2 (1980), 97–109.
- [43] CANUTO, C., HUSSAINI, M. Y., QUARTERONI, A., AND ZANG, T. A. *Spectral methods in fluid dynamics*. Springer Series in Computational Physics. Springer-Verlag, New York, 1988.
- [44] CARLEMAN, T. Sur la théorie de l’équation intégrodifférentielle de Boltzmann. *Acta Math.* 60 (1932), 369–424.
- [45] CARLEMAN, T. *Problèmes Mathématiques dans la Théorie Cinétique des Gaz*. Almqvist & Wiksell, 1957.
- [46] CARLEN, E. A., AND CARVALHO, M. C. Strict entropy production bounds and stability of the rate of convergence to equilibrium for the Boltzmann equation. *J. Statist. Phys.* 67, 3-4 (1992), 575–608.

-
- [47] CARLEN, E. A., AND CARVALHO, M. C. Entropy production estimates for Boltzmann equations with physically realistic collision kernels. *J. Statist. Phys.* 74, 3-4 (1994), 743–782.
- [48] CARLEN, E. A., GABETTA, E., AND TOSCANI, G. Propagation of smoothness and the rate of exponential convergence to equilibrium for a spatially homogeneous Maxwellian gas. *Comm. Math. Phys.* 199, 3 (1999), 521–546.
- [49] CARLEN, E. A., AND LU, X. Fast and slow convergence to equilibrium for Maxwellian molecules via Wild sums. *J. Statist. Phys.* 112, 1-2 (2003), 59–134.
- [50] CARRILLO, J. A., MCCANN, R. J., AND VILLANI, C. Kinetic equilibration rates for granular media and related equations: entropy dissipation and mass transportation estimates. *Rev. Mat. Iberoamericana* 19, 3 (2003), 971–1018.
- [51] CERCIGNANI, C. *Theory and application of the Boltzmann equation*. Elsevier, New York, 1975.
- [52] CERCIGNANI, C. *The Boltzmann equation and its applications*, vol. 67 of *Applied Mathematical Sciences*. Springer-Verlag, New York, 1988.
- [53] CERCIGNANI, C. Errata: “Weak solutions of the Boltzmann equation and energy conservation”. *Appl. Math. Lett.* 8, 5 (1995), 95–99.
- [54] CERCIGNANI, C. Recent developments in the mechanics of granular materials. In *Fisica matematica e ingegneria delle strutture*, P. Editrice, Ed. 1995, pp. 119–132.
- [55] CERCIGNANI, C. Weak solutions of the Boltzmann equation and energy conservation. *Appl. Math. Lett.* 8, 2 (1995), 53–59.
- [56] CERCIGNANI, C. *Rarefied gas dynamics*. Cambridge Texts in Applied Mathematics. Cambridge University Press, Cambridge, 2000. From basic concepts to actual calculations.
- [57] CERCIGNANI, C. The Boltzmann equation and fluid dynamics. In *Handbook of mathematical fluid dynamics, Vol. I*. North-Holland, Amsterdam, 2002, pp. 1–69.
- [58] CERCIGNANI, C., ILLNER, R., AND PULVIRENTI, M. *The mathematical theory of dilute gases*, vol. 106 of *Applied Mathematical Sciences*. Springer-Verlag, New York, 1994.
- [59] COOLEY, J. W., AND TUKEY, J. W. An algorithm for the machine calculation of complex Fourier series. *Math. Comput.* 19 (1965), 297–301.
- [60] COQUEL, F., ROGIER, F., AND SCHNEIDER, J. A deterministic method for solving the homogeneous Boltzmann equation. *Rech. Aérospat.*, 3 (1992), 1–10.
- [61] CZECHOWSKY, Z., AND PALCZEWSKY, A. Spectrum of the Boltzmann equation collision operator for radial cut-off potentials. *Bull. Acad. Polon. Sci.* 28 (1980), 387–396.
- [62] DEGOND, P., AND LEMOU, M. Dispersion relations for the linearized Fokker-Planck equation. *Arch. Rational Mech. Anal.* 138, 2 (1997), 137–167.
- [63] DEGOND, P., AND LUCQUIN-DESREUX, B. The Fokker-Planck asymptotics of the Boltzmann collision operator in the Coulomb case. *Math. Models Methods Appl. Sci.* 2, 2 (1992), 167–182.

-
- [64] DEGOND, P., PARESCHI, L., AND RUSSO, G. *Modeling and computational methods for kinetic equations*. Modeling and Simulation in Science, Engineering and Technology. 2004.
- [65] DESVILLETES, L. Entropy dissipation rate and convergence in kinetic equations. *Comm. Math. Phys.* 123, 4 (1989), 687–702.
- [66] DESVILLETES, L. On asymptotics of the Boltzmann equation when the collisions become grazing. *Transport Theory Statist. Phys.* 21, 3 (1992), 259–276.
- [67] DESVILLETES, L. Some applications of the method of moments for the homogeneous Boltzmann and Kac equations. *Arch. Rational Mech. Anal.* 123, 4 (1993), 387–404.
- [68] DESVILLETES, L. Convergence towards the thermodynamical equilibrium. In *Trends in applications of mathematics to mechanics (Nice, 1998)*, vol. 106 of *Chapman & Hall/CRC Monogr. Surv. Pure Appl. Math.* Chapman & Hall/CRC, Boca Raton, FL, 2000, pp. 115–126.
- [69] DESVILLETES, L., AND MOUHOT, C. About L^p estimates for the spatially homogeneous Boltzmann equation. À paraître dans *Ann. Inst. H. Poincaré Anal. Non Linéaire*.
- [70] DESVILLETES, L., AND VILLANI, C. On the trend to global equilibrium in spatially inhomogeneous entropy-dissipating systems: the Boltzmann equation. Prépublication 2003, à paraître dans *Invent. Math.*
- [71] DESVILLETES, L., AND VILLANI, C. On the spatially homogeneous Landau equation for hard potentials. I. Existence, uniqueness and smoothness. *Comm. Partial Differential Equations* 25, 1-2 (2000), 179–259.
- [72] DESVILLETES, L., AND VILLANI, C. On the spatially homogeneous Landau equation for hard potentials. II. H -theorem and applications. *Comm. Partial Differential Equations* 25, 1-2 (2000), 261–298.
- [73] DESVILLETES, L., AND VILLANI, C. On the trend to global equilibrium in spatially inhomogeneous entropy-dissipating systems: the linear Fokker-Planck equation. *Comm. Pure Appl. Math.* 54, 1 (2001), 1–42.
- [74] DESVILLETES, L., AND WENNBERG, B. Smoothness of the solution of the spatially homogeneous Boltzmann equation without cutoff. *Comm. Partial Differential Equations* 29, 1-2 (2004), 133–155.
- [75] DIPERNA, R. J., AND LIONS, P.-L. On the Cauchy problem for Boltzmann equations: global existence and weak stability. *Ann. of Math. (2)* 130, 2 (1989), 321–366.
- [76] ELLIS, R. S., AND PINSKY, M. A. The first and second fluid approximations to the linearized Boltzmann equation. *J. Math. Pures Appl. (9)* 54 (1975), 125–156.
- [77] ELMROTH, T. Global boundedness of moments of solutions of the Boltzmann equation for forces of infinite range. *Arch. Rational Mech. Anal.* 82, 1 (1983), 1–12.
- [78] ERNST, M. H., AND BRITO, R. Driven inelastic Maxwell molecules with high energy tails. *Phys. Rev. E* 65 (2002), 1–4.

-
- [79] ERNST, M. H., AND BRITO, R. Scaling solutions of inelastic Boltzmann equations with over-populated high energy tails. *J. Statist. Phys.* 109, 3-4 (2002), 407-432. Special issue dedicated to J. Robert Dorfman on the occasion of his sixty-fifth birthday.
- [80] ESCOBEDO, M., LAURENÇOT, P., AND MISCHLER, S. On a kinetic equation for coalescing particles. *Comm. Math. Phys.* 246, 2 (2004), 237-267.
- [81] ESCOBEDO, M., AND MISCHLER, S. On a quantum Boltzmann equation for a gas of photons. *J. Math. Pures Appl.* (9) 80, 5 (2001), 471-515.
- [82] ESCOBEDO, M., MISCHLER, S., AND RODRIGUEZ RICARD, M. On self-similarity and stationary problem for fragmentation and coagulation models. À paraître dans *Ann. Inst. Henri Poincaré, Analyse non linéaire*.
- [83] ESCOBEDO, M., MISCHLER, S., AND VALLE, M. A. *Homogeneous Boltzmann equation in quantum relativistic kinetic theory*, vol. 4 of *Electronic Journal of Differential Equations. Monograph*. Southwest Texas State University, San Marcos, TX, 2003.
- [84] ESTEBAN, M. J., AND PERTHAME, B. On the modified Enskog equation for elastic and inelastic collisions. Models with spin. *Ann. Inst. H. Poincaré Anal. Non Linéaire* 8, 3-4 (1991), 289-308.
- [85] FILBET, F., MOUHOT, C., AND PARESCHI, L. Travail en cours.
- [86] FILBET, F., AND PARESCHI, L. A numerical method for the accurate solution of the Fokker-Planck-Landau equation in the nonhomogeneous case. *J. Comput. Phys.* 179, 1 (2002), 1-26.
- [87] FILBET, F., PARESCHI, L., AND TOSCANI, G. Accurate numerical methods for the collisional motion of (heated) granular flows. Prépublication 2003, à paraître dans *J. Comput. Physics*.
- [88] FILBET, F., AND RUSSO, G. Accurate Numerical Methods for the Boltzmann Equation. Prépublication 2003, à paraître dans "Modeling and computational methods for kinetic equations" (chapitre 4), P. Degond, L. Pareschi and G. Russo Eds.
- [89] FILBET, F., AND RUSSO, G. High order numerical methods for the space non-homogeneous Boltzmann equation. *J. Comput. Phys.* 186, 2 (2003), 457-480.
- [90] FILBET, F., AND SONNENDRÜCKER, E. Comparison of Eulerian Vlasov solvers. *Comput. Phys. Comm.* 150, 3 (2003), 247-266.
- [91] FILBET, F., SONNENDRÜCKER, E., AND BERTRAND, P. Conservative numerical schemes for the Vlasov equation. *J. Comput. Phys.* 172, 1 (2001), 166-187.
- [92] FOURNIER, N. Strict positivity of a solution to a one-dimensional Kac equation without cutoff. *J. Statist. Phys.* 99, 3-4 (2000), 725-749.
- [93] FOURNIER, N. Strict positivity of the solution to a 2-dimensional spatially homogeneous Boltzmann equation without cutoff. *Ann. Inst. H. Poincaré Probab. Statist.* 37, 4 (2001), 481-502.
- [94] FOURNIER, N. Strict positivity of the density for simple jump processes using the tools of support theorems. Application to the Kac equation without cutoff. *Ann. Probab.* 30, 1 (2002), 135-170.

- [95] FOURNIER, N., AND MISCHLER, S. On a Boltzmann equation for elastic, inelastic and coalescing collisions. Prépublication 2003.
- [96] GABETTA, E., PARESCHI, L., AND TOSCANI, G. Relaxation schemes for nonlinear kinetic equations. *SIAM J. Numer. Anal.* 34, 6 (1997), 2168–2194.
- [97] GALLAY, T., AND WAYNE, C. E. Invariant manifolds and the long-time asymptotics of the Navier-Stokes and vorticity equations on \mathbb{R}^2 . *Arch. Ration. Mech. Anal.* 163, 3 (2002), 209–258.
- [98] GALLAY, T., AND WAYNE, C. E. Long-time asymptotics of the Navier-Stokes and vorticity equations on \mathbb{R}^3 . *R. Soc. Lond. Philos. Trans. Ser. A Math. Phys. Eng. Sci.* 360, 1799 (2002), 2155–2188. Recent developments in the mathematical theory of water waves (Oberwolfach, 2001).
- [99] GAMBA, I. M., PANFEROV, V., AND VILLANI, C. Upper Maxwellian bounds for the spatially homogeneous Boltzmann equation. Travail en cours.
- [100] GAMBA, I. M., PANFEROV, V., AND VILLANI, C. On the Boltzmann equation for diffusively excited granular media. *Comm. Math. Phys.* 246, 3 (2004), 503–541.
- [101] GILBARG, D., AND TRUDINGER, N. S. *Elliptic partial differential equations of second order*, second ed., vol. 224 of *Grundlehren der Mathematischen Wissenschaften [Fundamental Principles of Mathematical Sciences]*. Springer-Verlag, Berlin, 1983.
- [102] GOLDHIRSCH, I., AND ZANETTI, G. Clustering instability in dissipative gases. *Phys. Rev. Lett.* 70, 11 (1993).
- [103] GOLSE, F., AND POUPAUD, F. Un résultat de compacité pour l'équation de Boltzmann avec potentiel mou. Application au problème de demi-espace. *C. R. Acad. Sci. Paris Sér. I Math.* 303, 12 (1986), 583–586.
- [104] GOLSE, F., AND SAINT-RAYMOND, L. The Navier-Stokes limit of the Boltzmann equation for bounded collision kernels. *Invent. Math.* 155, 1 (2004), 81–161.
- [105] GOUDON, T. Existence of solutions of transport equations with nonlinear boundary conditions. *European J. Mech. B Fluids* 16, 4 (1997), 557–574.
- [106] GOUDON, T. Generalized invariant sets for the Boltzmann equation. *Math. Models Methods Appl. Sci.* 7, 4 (1997), 457–476.
- [107] GOUDON, T. On Boltzmann equations and Fokker-Planck asymptotics: influence of grazing collisions. *J. Statist. Phys.* 89, 3-4 (1997), 751–776.
- [108] GRAD, H. Principles of the kinetic theory of gases. In *Flügge's Handbuch des Physik*, vol. XII. Springer-Verlag, 1958, pp. 205–294.
- [109] GRAD, H. Asymptotic theory of the Boltzmann equation. II. In *Rarefied Gas Dynamics (Proc. 3rd Internat. Sympos., Palais de l'UNESCO, Paris, 1962)*, Vol. I. Academic Press, New York, 1963, pp. 26–59.
- [110] GUO, Y. Classical solutions to the Boltzmann equation for molecules with an angular cutoff. *Arch. Ration. Mech. Anal.* 169, 4 (2003), 305–353.
- [111] GUSTAFSSON, T. L^p -estimates for the nonlinear spatially homogeneous Boltzmann equation. *Arch. Rational Mech. Anal.* 92, 1 (1986), 23–57.

- [112] GUSTAFSSON, T. Global L^p -properties for the spatially homogeneous Boltzmann equation. *Arch. Rational Mech. Anal.* 103, 1 (1988), 1–38.
- [113] HAFF, P. K. Grain flow as a fluid-mechanical phenomenon. *J. Fluid Mech.* 134 (1983).
- [114] HARDY, G. H., AND WRIGHT, E. M. *An introduction to the theory of numbers*, fifth ed. The Clarendon Press Oxford University Press, New York, 1979.
- [115] HENRY, D. *Geometric theory of semilinear parabolic equations*, vol. 840 of *Lecture Notes in Mathematics*. Springer-Verlag, Berlin, 1981.
- [116] HILBERT, D. Grundzüge einer Allgemeinen Theorie der Linearen Integralgleichungen. *Math. Ann.* 72 (1912). Chelsea Publ., New York, 1953.
- [117] IBRAGIMOV, I., AND RJASANOW, S. Numerical solution of the Boltzmann equation on the uniform grid. *Computing* 69, 2 (2002), 163–186.
- [118] IKENBERRY, E., AND TRUESDELL, C. On the pressures and the flux of energy in a gas according to Maxwell’s kinetic theory. I. *J. Rational Mech. Anal.* 5 (1956), 1–54.
- [119] ILLNER, R., AND SHINBROT, M. The Boltzmann equation: global existence for a rare gas in an infinite vacuum. *Comm. Math. Phys.* 95, 2 (1984), 217–226.
- [120] KANIEL, S., AND SHINBROT, M. The Boltzmann equation. I. Uniqueness and local existence. *Comm. Math. Phys.* 58, 1 (1978), 65–84.
- [121] KATO, T. *Perturbation theory for linear operators*. Die Grundlehren der mathematischen Wissenschaften, Band 132. Springer-Verlag New York, Inc., New York, 1966.
- [122] KLAUS, M. Boltzmann collision operator without cut-off. *Helv. Phys. Acta* 50, 6 (1977), 893–903.
- [123] KUŠČER, I., AND WILLIAMS, M. M. R. *Phys. Fluids* 10 (1967).
- [124] LANFORD, III, O. E. Time evolution of large classical systems. In *Dynamical systems, theory and applications (Recontres, Battelle Res. Inst., Seattle, Wash., 1974)*. Springer, Berlin, 1975, pp. 1–111. Lecture Notes in Phys., Vol. 38.
- [125] LAURENÇOT, P., AND MISCHLER, S. The continuous coagulation-fragmentation equations with diffusion. *Arch. Ration. Mech. Anal.* 162, 1 (2002), 45–99.
- [126] LAURENÇOT, P., AND MISCHLER, S. From the discrete to the continuous coagulation-fragmentation equations. *Proc. Roy. Soc. Edinburgh Sect. A* 132, 5 (2002), 1219–1248.
- [127] LÊ, C.-H. *Etude de la classe des opérateurs m -accrétifs de $L^1(\Omega)$ et accrétifs dans $L^\infty(\Omega)$* . PhD thesis, Université de Paris VI, 1997.
- [128] LEMOU, M. Linearized quantum and relativistic Fokker-Planck-Landau equations. *Math. Methods Appl. Sci.* 23, 12 (2000), 1093–1119.
- [129] LI, H., AND TOSCANI, G. Long-time asymptotics of kinetic models of granular flows. *Arch. Ration. Mech. Anal.* 172, 3 (2004), 407–428.
- [130] LIONS, P.-L. Compactness in Boltzmann’s equation via Fourier integral operators and applications. I, II. *J. Math. Kyoto Univ.* 34, 2 (1994), 391–427, 429–461.

-
- [131] LIONS, P.-L. Compactness in Boltzmann's equation via Fourier integral operators and applications. III. *J. Math. Kyoto Univ.* 34, 3 (1994), 539–584.
- [132] LIONS, P.-L. Régularité et compacité pour des noyaux de collision de Boltzmann sans troncature angulaire. *C. R. Acad. Sci. Paris Sér. I Math.* 326, 1 (1998), 37–41.
- [133] LU, X. On isotropic distributional solutions to the Boltzmann equation for Bose-Einstein particles. Prépublication 2003, à paraître dans *J. Stat. Phys.*
- [134] LU, X. A direct method for the regularity of the gain term in the Boltzmann equation. *J. Math. Anal. Appl.* 228, 2 (1998), 409–435.
- [135] LU, X. Conservation of energy, entropy identity, and local stability for the spatially homogeneous Boltzmann equation. *J. Statist. Phys.* 96, 3-4 (1999), 765–796.
- [136] LU, X. Spatial decay solutions of the Boltzmann equation: converse properties of long time limiting behavior. *SIAM J. Math. Anal.* 30, 5 (1999), 1151–1174 (electronic).
- [137] LU, X. A modified Boltzmann equation for Bose-Einstein particles: isotropic solutions and long-time behavior. *J. Statist. Phys.* 98, 5-6 (2000), 1335–1394.
- [138] MARKOWICH, P. A., RINGHOFER, C. A., AND SCHMEISER, C. *Semiconductor equations*. Springer-Verlag, Vienna, 1990.
- [139] MARTIN, Y.-L., ROGIER, F., AND SCHNEIDER, J. Une méthode déterministe pour la résolution de l'équation de Boltzmann inhomogène. *C. R. Acad. Sci. Paris Sér. I Math.* 314, 6 (1992), 483–487.
- [140] MISCHLER, S., AND MOUHOT, C. Cooling process for inelastic Boltzmann equations for hard spheres, Part II: Self-similar solutions and tail behavior. Prépublication 2004, soumis.
- [141] MISCHLER, S., MOUHOT, C., AND RODRIGUEZ RICARD, M. Cooling process for inelastic Boltzmann equations for hard spheres, Part I: The Cauchy problem. Prépublication 2004, soumis.
- [142] MISCHLER, S., AND PERTHAME, B. Boltzmann equation with infinite energy: renormalized solutions and distributional solutions for small initial data and initial data close to a Maxwellian. *SIAM J. Math. Anal.* 28, 5 (1997), 1015–1027.
- [143] MISCHLER, S., AND RODRIGUEZ RICARD, M. Existence globale pour l'équation de Smoluchowski continue non homogène et comportement asymptotique des solutions. *C. R. Math. Acad. Sci. Paris* 336, 5 (2003), 407–412.
- [144] MISCHLER, S., AND WENNBERG, B. On the spatially homogeneous Boltzmann equation. *Ann. Inst. H. Poincaré Anal. Non Linéaire* 16, 4 (1999), 467–501.
- [145] MOUHOT, C. Explicit coercivity estimates for the linearized Boltzmann and Landau operators. Prépublication 2004, soumis.
- [146] MOUHOT, C. Quantitative lower bound for the full Boltzmann equation, Part I: Periodic boundary conditions. À paraître dans *Comm. Partial Differential Equations*.
- [147] MOUHOT, C. Rate of convergence to equilibrium for the spatially homogeneous Boltzmann equation with hard potentials. Prépublication 2004, soumis.

-
- [148] MOUHOT, C., AND PARESCHI, L. Fast algorithms for computing the Boltzmann collision operator. Prépublication 2003, soumis.
- [149] MOUHOT, C., AND PARESCHI, L. Fast methods for the Boltzmann collision integral. *C. R. Acad. Sci. Paris, Ser. I* 339 (2004).
- [150] MOUHOT, C., AND VILLANI, C. Regularity theory for the spatially homogeneous Boltzmann equation with cut-off. *Arch. Rational Mech. Anal.* 173, 2 (2004), 169–212.
- [151] NALDI, G., PARESCHI, L., AND TOSCANI, G. Spectral methods for one-dimensional kinetic models of granular flows and numerical quasi elastic limit. *M2AN Math. Model. Numer. Anal.* 37, 1 (2003), 73–90.
- [152] NANBU, K. Direct simulation scheme derived from the Boltzmann equation. I. Monocomponent gases. *J. Phys. Soc. Japan* 52 (1983), 2042–2049.
- [153] NOGUEIRA, A., AND SÉVENNEC, B. Multidimensional Farey partitions. Prépublication 2003.
- [154] PALCZEWSKI, A., AND SCHNEIDER, J. Existence, stability, and convergence of solutions of discrete velocity models to the Boltzmann equation. *J. Statist. Phys.* 91, 1-2 (1998), 307–326.
- [155] PALCZEWSKI, A., SCHNEIDER, J., AND BOBYLEV, A. V. A consistency result for a discrete-velocity model of the Boltzmann equation. *SIAM J. Numer. Anal.* 34, 5 (1997), 1865–1883.
- [156] PANFEROV, V. A., AND HEINTZ, A. G. A new consistent discrete-velocity model for the Boltzmann equation. *Math. Methods Appl. Sci.* 25, 7 (2002), 571–593.
- [157] PAO, Y. P. Boltzmann collision operator with inverse-power intermolecular potentials. I, II. *Comm. Pure Appl. Math.* 27 (1974), 407–428, 559–581.
- [158] PARESCHI, L. Computational methods and fast algorithms for Boltzmann equations. In *Chapter 7 Lecture Notes on the discretization of the Boltzmann equation* (2003), pp. 527–548.
- [159] PARESCHI, L., AND PERTHAME, B. A Fourier spectral method for homogeneous Boltzmann equations. In *Proceedings of the Second International Workshop on Non-linear Kinetic Theories and Mathematical Aspects of Hyperbolic Systems (Sanremo, 1994)* (1996), vol. 25, pp. 369–382.
- [160] PARESCHI, L., AND RUSSO, G. Numerical solution of the Boltzmann equation. I. Spectrally accurate approximation of the collision operator. *SIAM J. Numer. Anal.* 37, 4 (2000), 1217–1245.
- [161] PARESCHI, L., AND RUSSO, G. On the stability of spectral methods for the homogeneous Boltzmann equation. In *Proceedings of the Fifth International Workshop on Mathematical Aspects of Fluid and Plasma Dynamics (Maui, HI, 1998)* (2000), vol. 29, pp. 431–447.
- [162] PARESCHI, L., RUSSO, G., AND TOSCANI, G. Fast spectral methods for the Fokker-Planck-Landau collision operator. *J. Comput. Phys.* 165, 1 (2000), 216–236.
- [163] PARESCHI, L., RUSSO, G., AND TOSCANI, G. Méthode spectrale rapide pour l'équation de Fokker-Planck-Landau. *C. R. Acad. Sci. Paris Sér. I Math.* 330, 6 (2000), 517–522.

- [164] PARESCHI, L., TOSCANI, G., AND VILLANI, C. Spectral methods for the non cut-off Boltzmann equation and numerical grazing collision limit. *Numer. Math.* *93*, 3 (2003), 527–548.
- [165] PERTHAME, B. Mathematical tools for kinetic equations. *Bull. Amer. Math. Soc. (N.S.)* *41*, 2 (2004), 205–244 (electronic).
- [166] PŁATKOWSKI, T., AND ILLNER, R. Discrete velocity models of the Boltzmann equation: a survey on the mathematical aspects of the theory. *SIAM Rev.* *30*, 2 (1988), 213–255.
- [167] POVZNER, A. J. On the Boltzmann equation in the kinetic theory of gases. *Mat. Sb. (N.S.)* *58 (100)* (1962), 65–86.
- [168] POVZNER, A. J. The Boltzmann equation in the kinetic theory of gases. *Amer. Math. Soc. Transl.* *47*, Ser. 2 (1965), 193–214.
- [169] PULVIRENTI, A., AND WENNBURG, B. A Maxwellian lower bound for solutions to the Boltzmann equation. *Comm. Math. Phys.* *183*, 1 (1997), 145–160.
- [170] RAO, M. M., AND REN, Z. D. *Theory of Orlicz spaces*, vol. 146 of *Monographs and Textbooks in Pure and Applied Mathematics*. Marcel Dekker Inc., New York, 1991.
- [171] ROGIER, F., AND SCHNEIDER, J. A direct method for solving the Boltzmann equation. *Transport Theory Statist. Phys.* *23*, 1-3 (1994), 313–338.
- [172] SCHATZMAN, M. *Analyse numérique*. InterEditions, Paris, 1991.
- [173] SCHNEIDER, J. *Une méthode Déterministe pour la résolution de l'équation de Boltzmann*. PhD thesis, Univ. Paris 6, 1993.
- [174] SHU, C.-W. Essentially non-oscillatory and weighted essentially non-oscillatory schemes for hyperbolic conservation laws. In *Advanced numerical approximation of nonlinear hyperbolic equations (Cetraro, 1997)*, vol. 1697 of *Lecture Notes in Math*. Springer, Berlin, 1998, pp. 325–432.
- [175] SOGGE, C. D., AND STEIN, E. M. Averages of functions over hypersurfaces in \mathbf{R}^n . *Invent. Math.* *82*, 3 (1985), 543–556.
- [176] SOGGE, C. D., AND STEIN, E. M. Averages over hypersurfaces. II. *Invent. Math.* *86*, 2 (1986), 233–242.
- [177] SOGGE, C. D., AND STEIN, E. M. Averages over hypersurfaces. Smoothness of generalized Radon transforms. *J. Analyse Math.* *54* (1990), 165–188.
- [178] STRANG, G. On the construction and comparison of difference schemes. *SIAM J. Numer. Anal.* *5* (1968), 506–517.
- [179] TOSCANI, G. One-dimensional kinetic models of granular flows. *M2AN Math. Model. Numer. Anal.* *34*, 6 (2000), 1277–1291.
- [180] TOSCANI, G., AND VILLANI, C. Probability metrics and uniqueness of the solution to the Boltzmann equation for a Maxwell gas. *J. Statist. Phys.* *94*, 3-4 (1999), 619–637.
- [181] TOSCANI, G., AND VILLANI, C. Sharp entropy dissipation bounds and explicit rate of trend to equilibrium for the spatially homogeneous Boltzmann equation. *Comm. Math. Phys.* *203*, 3 (1999), 667–706.

- [182] TOSCANI, G., AND VILLANI, C. On the trend to equilibrium for some dissipative systems with slowly increasing a priori bounds. *J. Statist. Phys.* 98, 5-6 (2000), 1279–1309.
- [183] UKAI, S. On the existence of global solutions of mixed problem for non-linear Boltzmann equation. *Proc. Japan Acad.* 50 (1974), 179–184.
- [184] UKAI, S. Les solutions globales de l'équation de Boltzmann dans l'espace tout entier et dans le demi-espace. *C. R. Acad. Sci. Paris Sér. A-B* 282, 6 (1976), A317–A320.
- [185] VILLANI, C. Entropy production and convergence to equilibrium. Notes d'une série de cours à l'Institut Henri Poincaré, Paris (hiver 2001). Prévu pour publication dans *Lecture Notes in Mathematics*.
- [186] VILLANI, C. On a new class of weak solutions to the spatially homogeneous Boltzmann and Landau equations. *Arch. Rational Mech. Anal.* 143, 3 (1998), 273–307.
- [187] VILLANI, C. On the spatially homogeneous Landau equation for Maxwellian molecules. *Math. Models Methods Appl. Sci.* 8, 6 (1998), 957–983.
- [188] VILLANI, C. Regularity estimates via the entropy dissipation for the spatially homogeneous Boltzmann equation without cut-off. *Rev. Mat. Iberoamericana* 15, 2 (1999), 335–352.
- [189] VILLANI, C. Contribution à l'étude mathématique des collisions en théorie cinétique. Master's thesis, Univ. Paris Dauphine, France, 2000.
- [190] VILLANI, C. Limites hydrodynamiques de l'équation de Boltzmann (d'après C. Bardos, F. Golse, C. D. Levermore, P.-L. Lions, N. Masmoudi, L. Saint-Raymond). *Astérisque*, 282 (2002), Exp. No. 893, ix, 365–405. Séminaire Bourbaki, Vol. 2000/2001.
- [191] VILLANI, C. A review of mathematical topics in collisional kinetic theory. In *Handbook of mathematical fluid dynamics, Vol. I*. North-Holland, Amsterdam, 2002, pp. 71–305.
- [192] VILLANI, C. Cercignani's conjecture is sometimes true and always almost true. *Comm. Math. Phys.* 234, 3 (2003), 455–490.
- [193] VILLANI, C. *Topics in optimal transportation*, vol. 58 of *Graduate Studies in Mathematics*. American Mathematical Society, Providence, RI, 2003.
- [194] WANG CHANG, C. S., UHLENBECK, G. E., AND DE BOER, J. In *Studies in Statistical Mechanics, Vol. V*. North-Holland, Amsterdam, 1970.
- [195] WENNBERG, B. On an entropy dissipation inequality for the Boltzmann equation. *C. R. Acad. Sci. Paris Sér. I Math.* 315, 13 (1992), 1441–1446.
- [196] WENNBERG, B. Stability and exponential convergence in L^p for the spatially homogeneous Boltzmann equation. In *Nonlinear kinetic theory and mathematical aspects of hyperbolic systems (Rapallo, 1992)*, vol. 9 of *Ser. Adv. Math. Appl. Sci.* World Sci. Publishing, River Edge, NJ, 1992, pp. 258–267.
- [197] WENNBERG, B. Stability and exponential convergence in L^p for the spatially homogeneous Boltzmann equation. *Nonlinear Anal.* 20, 8 (1993), 935–964.

-
- [198] WENBERG, B. On moments and uniqueness for solutions to the space homogeneous Boltzmann equation. *Transport Theory Statist. Phys.* 23, 4 (1994), 533–539.
- [199] WENBERG, B. Regularity in the Boltzmann equation and the Radon transform. *Comm. Partial Differential Equations* 19, 11-12 (1994), 2057–2074.
- [200] WENBERG, B. Entropy dissipation and moment production for the Boltzmann equation. *J. Statist. Phys.* 86, 5-6 (1997), 1053–1066.
- [201] WENBERG, B. An example of nonuniqueness for solutions to the homogeneous Boltzmann equation. *J. Statist. Phys.* 95, 1-2 (1999), 469–477.