



HAL
open science

Elements of Product Lifecycle Management: Definitions, Open Issues and Reference Models

Sergio Terzi

► **To cite this version:**

Sergio Terzi. Elements of Product Lifecycle Management: Definitions, Open Issues and Reference Models. domain_stic.inge. Université Henri Poincaré - Nancy I, 2005. English. NNT: . tel-00009559

HAL Id: tel-00009559

<https://theses.hal.science/tel-00009559>

Submitted on 21 Jun 2005

HAL is a multi-disciplinary open access archive for the deposit and dissemination of scientific research documents, whether they are published or not. The documents may come from teaching and research institutions in France or abroad, or from public or private research centers.

L'archive ouverte pluridisciplinaire **HAL**, est destinée au dépôt et à la diffusion de documents scientifiques de niveau recherche, publiés ou non, émanant des établissements d'enseignement et de recherche français ou étrangers, des laboratoires publics ou privés.



FACULTE DES SCIENCES & TECHNIQUES

U.F.R. Sciences & Techniques Mathématiques,
Informatique, Automatique
Ecole Doctorale IAEM Lorraine,
Département de Formation Doctorale Automatique

Scuola di Dottorato di Ricerca
Dottorato di Ricerca in Ingegneria Gestionale
Politecnico di Milano
XVII Ciclo

Doctoral dissertation

Thèse en co-tutelle
Tesi in cotutela

présentée pour l'obtention du titre de
presentata per l'ottenimento del titolo di

Docteur de l'Université Henri Poincaré, Nancy-I
en Automatique, Traitement du signal et Génie Informatique

*Dottore di Ricerca in Ingegneria Gestionale
Politecnico di Milano, Italia*

Sergio TERZI

Gestion du Cycle de Vie des Produits: Définitions, Problèmes Ouverts
et Modèles de Référence

*Elementi di Product Lifecycle Management: Definizioni, Problemi Aperti
e Modelli di Riferimento*

Elements of Product Lifecycle Management: Definitions, Open Issues and Reference Models

Public discussion on 27 May 2005

Members of the jury:

Reviewers: Jean-Pierre CAMPAGNE	Professor, INSA de Lyon, France President of the Jury
Stefano TONCHIA	Associate Professor, HDR, Università di Udine, Italy
Examiners: Marco GARETTI	Professor, Politecnico di Milano, Italy Research Director
Gérard MOREL	Professor, U.H.P. Nancy I, France Research Director
Hervé PANETTO	Associate Professor, U.H.P. Nancy I, France Research Co-Director
Lucio CASSIA	Professor, Università di Bergamo, Italy
Invited: Sergio CAVALIERI	Associate Professor, Università di Bergamo, Italy
Coordinator of the PhD school: Giuliano NOCI	Professor, Politecnico di Milano, Italy

To my wife

Not-forgetting my father

RESUME

Nos travaux de thèse contribuent au domaine de la Gestion du Cycle de Vie des Produits (PLM : Product Lifecycle Management) selon deux objectifs : l'un concerne plus particulièrement l'analyse et l'état de l'art des concepts liés au domaine du PLM alors que le second va chercher à tirer avantage de ces concepts pour la formalisation d'un metamodèle adapté à la Traçabilité des produits tout au long de leur cycle de vie.

La gestion intégrée de toute information relative au produit et à sa production est une des questions majeure de l'industrie. Une des réponses à cette question, actuellement d'actualité, concerne un paradigme naissant, défini par le vocable de Gestion du Cycle de Vie des Produits (PLM : Product Life Cycle Management). Dans ce contexte, l'une des problématiques concerne la traçabilité des produits tout au long de leur cycle de vie qui induit ainsi une nécessaire interopérabilité de l'information ainsi que des efforts de standardisation. Afin d'assurer ces échanges d'information, notre contribution, basés sur la situation actuelle des systèmes d'information d'entreprise (qui manipulent l'information sur les produits), doit aboutir à la définition d'une vue holonique d'un modèle conceptuel orienté produit d'un système de production, formalisant la structure du système d'information associé aux données de traçabilité des produits.

MOTS-CLES : HMS, PLM, traçabilité des produits, metamodèle, standards

ABSTRACT

The thesis contributes to the area of PLM (Product Lifecycle Management) as a two-layer topic: the first deals with a definition of the boundaries of what is considered as PLM in the market, while, in a complementary way, the second deals with the definition of a reference metamodel for product management and traceability along the product lifecycle.

Product and production management have become complicated processes where more problems are overlapping each other's. Product development might ever more take into account improved customers' tastes and requests in a shorter time-to-market. This way, the product lifecycle and its related management are becoming unavoidable key aspects, creating such a "product centric" (or product-driven) problem. The integrated management of all the information regarding the "product" and its production is one of the related questions.

One of the main issues concerning with the product management in a wider perspective (along a defined lifecycle), deals with the traceability of the product. The problem of information exchange could easily arise and further standardization efforts will be needed, so establishing a kind of barriers to the diffusion of the same holonic traceability. In order to reduce these further barriers, but ever more in order to improve the currently definition and the study of Holonic product traceability, we are looking to the current situation of enterprise information systems (where product information are resident) and trying to elaborate it in an holonic view, creating a conceptual HMS product-oriented architecture.

KEYWORDS: HMS, PLM, products traceability, metamodel, standards

SINTESI

Nell'attuale contesto competitivo, il concetto di prodotto si è intrinsecamente arricchito di servizi e sistemi accessori, mentre i relativi processi di sviluppo, produzione, distribuzione e dismissione hanno accumulato complessità. In questa visione "prodotto-centrica", la gestione efficiente ed integrata di tutte le informazioni che transitano nel ciclo di vita di un prodotto è divenuta una chiave ineluttabile di successo. Sulla scia di questa visione, ha iniziato a diffondersi nel mercato un nuovo approccio di gestione, che prevede un ri-orientamento dell'azienda al prodotto, con tutto quello che ne consegue in termini di ristrutturazione dei processi e dei correlati flussi informativi. A supporto di questa visione sono intervenute le mature tecnologie informatiche, mentre tale tendenza è stata identificata con l'acronimo di PLM, come descritto nella prima parte della tesi.

Sulla scia dell'evoluzione PLM in corso, le aziende hanno cominciato a dotarsi di sistemi informativi sempre più integrati. Quest'evoluzione non è certamente senza costo e senza rischi. In particolare, le moderne tecnologie non hanno ancora assolto una integrazione ed interoperabilità completa e non consentono di rispondere appieno alle problematiche di controllo e tracciabilità di ogni prodotto. Guardando al mondo della ricerca internazionale, in quest'area sono in corso importanti studi sulla definizione del ciclo di vita del prodotto, noto come problema della tracciabilità di prodotto. Nella tesi, questo problema è risolto tramite l'adozione di un approccio definito come paradigma "Holonico, (dalla comunità HMS - Holonic Manufacturing Systems), ove un Holone è l'unità minima inseparabile di "prodotto fisico + informazione". L'approccio Holonico promette di risolvere buona parte dei problemi di gestione delle informazioni di prodotto, ponendo le informazioni stesse sul singolo oggetto fisico. In tale contesto, nella sua seconda parte la tesi propone un modello di riferimento, corrispondente alla formalizzazione in uno schema HMS-oriented delle informazioni di prodotto, ottenuta attraverso l'analisi degli standard ICT attualmente consolidati sul mercato, ove queste informazioni sono residenti.

KEYWORDS: HMS, PLM, tracciabilità di prodotto, modello di riferimento, standard

Acknowledgements

I've to thank lot of persons for this thesis.

At first, I can't avoid to quote full professors Marco Garetti and Gerald Morel, who edified my research skills.

Then, professors Hervé Panetto and Sergio Cavalieri, who made the agreement and encouraged me along these years.

I've also to thank professors Jean-Pierre Campagne and Stefano Tonchia, who accepted to be the official reviewers of the thesis, with the other members of the bi-lateral jury, prof. Lucio Cassia, and of the Italian one, prof. Cristina Masella.

Also I've to thank prof. Giuliano Noci, the coordinator of the Italian PhD school in my department, with Mrs Gisella Di Tavi and Annalisa Riccardi, who always support Italian PhDs in the bureaucracy world.

At second, there are lots of guys who contributed to this thesis, in diverse way:

- Jacopo Cassina and Gianluca Chiari, who spend some months with me in France,
- Massimo Pilato, Alberto Codrino, Vincenzo Pagliarulo, who defined PLM elements,
- Andrea Camporini, Catia Bongiardina, Michele Lena, Michele Del Viscio, who made the interviews,
- Jeroen Gabriel, who made the simulation model on an industrial test case,
- Marco Macchi, Marco Taisch, Marco Montorio, Myrna Flores, Peter Ball, Herbert Heinzl, Alexander Smirnov, John Stark, Paolo Gaiardelli, Umberto Cugini, Matteo Pulli Umit Biticti, Mario Tucci, Fabrizio Della Corte, Paul Valckenaers, Markus Rabe, Bernardo

Ferroni, Rosanna Fornasiero, Romeo Bandinelli, Trevor Turner and the other members of IMS NoE, and in particular of Special Interest Group 1 on PLM, who shared with me their ideas,

- Roberto Pinto, Paolo Gaiardelli, Paola Benedetti, who accepted me as their colleague at University of Bergamo and supported me in the last days of the thesis,
- Luca Visconti, Pietro Mezzanotte, Andrea Vanella who are now contributing to the follow-up of this thesis.
- Donatella Corti, Luigi Uglietti, Jean Simao, David Guyon and the others, who shared with me the PhD period in Italy and in France

At last, but not at least, I've to thank who loves me, my wife, my mother, my family, and always my father, who still is not here at my third thesis.

Sergio Terzi

Milan, March 2005

SYNTHESIS

Synthesis of the research

The macro research context delegated to the PhD student has been defined in December 2001, after a preliminary period carried out in France and after that an organizational re-engineering had been carried out in Politecnico di Milano. Taking advantage from the bi-lateral tutorship of the thesis, the macro research has been identified in the area of PLM (Product Lifecycle Management) as a two-layer topic: the first deals with a definition of the boundaries of what is considered as PLM in the market, while, in a complementary way, the second deals with the definition of a reference metamodel for product management and traceability along the product lifecycle. The two layers are interconnected, as it will be demonstrated in the thesis, even if they clearly show two different point-of-views.

Research context and thesis objectives

Within the actual competitive world, enterprises are ever more stressed and subjected to high market requests. Customers are becoming more and more pretentious in terms of products quality and related services. The best product, at the lowest price, at the right time and into the right place is the only success-key for the modern enterprise.

In order to maintain (or gain) competitive advantages, modern enterprise has to manage itself along two main directions:

- Improve internal and external efficiency, reducing all the not-relevant costs.
- Improve innovation: innovation of product, process, structure, and organization.

According to these needs, enterprises have to focus on their core-competences in order to improve the efficiencies (managing innovation) and to reduce the inefficiencies.

Looking to this research, the product is re-becoming, after the soap bubble of the new-economy experiences, the real enterprise value creator and the whole production process is re-discovering its role.

By this way, within the globally scaled scenario, product and production management became complicated processes where more problems are overlapping each other's. Product development might ever more take into account customers' tastes and requests in a shorter time-to-market. The related engineering activities are consequently stressed, while inefficiencies in the production and distribution functions are not ever tolerated. This way, the product lifecycle and its related management are becoming unavoidable key aspects, creating such a "product centric" (or product-driven) problem. The integrated management of all the information regarding the "product" and its production is one of the related questions.

The first layer: definition of Product Lifecycle Management

The main answer to these questions is already on going and could be advocated as a new emerging paradigm, defined as Product Lifecycle Management (PLM). In fact, listening to the enterprise questions, several "vendors", coming from the diverse worlds interested in the product and production management, are more and more providing answers, stabling a growing "PLM market". Looking to this market, it is clear as a variety of "solution-providers" aims to be considered:

- Vendors coming from the digital engineering world (UGS, Tecnomatix, IBM-Dassault), which start from PD (Product Development) and MES (Manufacturing Engineering Systems) processes and are trying to connect Enterprise Engineering and Management processes;

- Vendors coming from the ERP world (SAP, PTC), which, at the contrary, start from Enterprise Management processes for turning to connect PD/MES tools and platforms;
- Vendors coming from the ICT world, which aim to establish collaborative environments for PLM integration (Microsoft, MatrixOne, Agile), basically using web technologies.

The needed product and production management is intrinsically related to the management of the information, so it is obvious that the related emerging market is ICT characterized. Nevertheless, PLM is not primary an ICT problem, but at first, is a strategic business orientation of the enterprise. As described in chapter 4, Product Lifecycle Management could be considered as:

“A new integrated approach to the management of all the business processes distributed along the product lifecycle (“from the cradle to the grave”), which considers:

- a strategic management point of view, where the “product” is the only enterprise value creator,
- the application of a collaborative approach for the valorization of all the enterprise core-competences distributed along different actors, and
- the adoption of a large number of ICT solutions and tools in order to practically establish a coordinated, integrated and access-safe product information management environments.”

The definition of PLM and its layers is the first result provided in the research thesis. This result has been gained using three main directions of research: (1) the analysis of the literature, (2) the analysis of the ICT market and software solutions which are already adopting the PLM acronym, (3) the analysis of more than 10 Italian industrial cases, interviewing industrial practitioners, asking how they use “PLM”.

According to the provided definition, the phenomenon PLM is multi-layered and multi-disciplinary; in fact, within the provided definition different perspectives are taken into account:

- An organizational-oriented perspective, related both to strategic and operational issues and, therefore, to a “human” dimension. Business Process Modeling is the most related discipline, even if other disciplines like Strategic Management and Human Resource Management are connected to this perspective.
- An information-oriented perspective, both in terms of needed informative dimensions (contents), and of information technologies. More disciplines are related to this dimension, from specific “sub-process” disciplines (such as Product Development or Manufacturing, but also more industrial sectors specific disciplines), to the ICT disciplines (e.g. Informatics, Automation Control).
- An infrastructure-oriented perspective, both in term of ICT solution (as the previous) and general physical solutions. PLM adopts several ICT resources (database, work-station...), but it is really connected to physical elements of the enterprise (the product itself, production resources, supplier, customers...). The relative disciplines are widely distributed.

PLM is a complex phenomenon, where more dimensions and disciplines are giving their contributions. This widely definition seems to be validated from the large use of the PLM acronym itself, both within the vendor community (as usual), but also (even if is a recently application of the PLM term) within the scientific community.

Looking up to this complex world, it is possible to highlight diverse research fields that are emerging (or re-emerging) within different communities:

- PLM-oriented business models for the enterprise management
- PLM-oriented strategies sector-(or product)-dependent
- Human resource management into collaborative environment

- Product lifecycle costing models
- PLM-oriented Operation management models
- PLM-oriented production system design and management (plant design, supply chain design)
- Traceability of the product along its lifecycle
- ICT systems integration and interoperability
- Standardization offices
- Technological innovation in product/process development
- Eco-compatibility in product/process management

From a strategic organization point of view, the adoption of a PLM approach signifies a (re-)modeling of all the relations established between the resources (people and equipments) involved into the relevant business processes oriented to a “product” lifecycle directions, with all that it concerns in terms of task allocations and measurement of the obtainable performances.

From an ICT point of view, a centric product management is no more than a “database” problem, which physically enables diverse business process models. Information about products and processes are dispersed along a variety of information systems, which - until now - have been executed such as “isolated islands” (e.g. PDM and ERP). The trends and issues currently on going deal with the integration of these “islands” into a larger integrated (even if distributed) model and data repository, in order to provide a wider and more effective use of product and production information. In the first times, these integration trends have been performed in a closed way, with the instantiation of several PLM proprietary “suites”, while recently some “standardization” efforts have been started for setting up an “open” integration (e.g. PLM XML, eb-XML, ISO 10303-239, IEC/ISO 62264).

From a structural (or infrastructure) point of view, the instantiation of a product-centric management approach signifies the product-centric design and management of diverse elements:

- An information infrastructure, which concerns with the establishment of ICT networks.
- A resource infrastructure, which concerns with the design and the management of all the physical elements involved along a product and production lifecycle (e.g. machines, plants, people, suppliers, warehouses...).
- A product itself “infrastructure” where the same product becomes a resource to be managed and traced into its own lifecycle.

The second layer: reference metamodel for Product Management and Traceability along the product lifecycle

As mentioned into the last point of view, one of the main issues concerning with the product management in a wider perspective (along a defined lifecycle), deals with the traceability of the product.

The terms “traceability” related to the product has been defined since the 90ies, when a series of industrial needs had been highlighted into the establishment of ISO 9000 procedures. Generally, product traceability is the ability of a user (manufacturer, supplier, vendor...) to trace a product through its processing procedures, in a forward and/or backward direction. Physically, the product traceability deals with maintaining records of all materials and parts along a defined lifecycle using a coding identification.

The product traceability is intrinsically a PLM question since it is related with an organizational perspective (allocation of task for tracing products), an information perspective (information identification, coding) and an infrastructure perspective (systems for product traceability), along a product centric approach. Product traceability is one of the most emerging questions within the “PLM community”. Several technological approaches exist, from bar-codes, to advanced RFID systems and micro-electromechanical systems (MEMS), which aim to transform the product

itself into an “intelligent product”, able to be tracked into systems and to cooperate automatically with other resources

In such a context, product management and its traceability is a dispersed activity yet, where lots of industrial practitioners are setting their business in a separated way. A unique vision is still avoided, also because the same technology is under development. Within this arena, and in particular taking into account the most advanced approach in the area of “intelligent product”, the current thesis formalizes a reference metamodel, which aims to be an exhaustive, even if preliminary, work in the way of a unique product centric approach.

The product traceability problem concerns with the identification of a product using a coding system. All the information related to the coded “product” is then stored into one (or more) database. Then, a merging activity between the product and its information is a mandatory step, also in the most advanced issues. This re-merging activity is still not risk-free; even if it could be already conducted in an automated manner, transactions breakdowns could occur in searching for information into the database or updating product states after its processing. A solving attitude could be identified in literature, where a simple 2D bar code attached to physical elements had been adopted to translate high-density information (whole plant drawings) from the plant designer to the contractor. Taking into account this example, each product could be provided with an advanced “product information store system” (e.g. RFID based), in order to be (i) from one side tracked into a system (e.g. a plant) and, from another side, (ii) to be able to provide itself the needed information.

This way, the product could become an “intelligent product”, able to exchange information (which is into the product itself) in real-time with different resources (e.g. machines and transporters into a plant scenario, or trucks and inventory database into a warehouse, or with refrigerators and dishwasher at home...). Looking to the literature, the paradigm of “product + information” had been already developed and it is defined as “holonic worldview”. A Holonic Manufacturing system “is an autonomous

and co-operative building block of a system for transforming, transporting, storing and/or validating information and physical objects. The holon consists of an information processing part and often a physical processing part.”

Looking at the holonic product traceability research effort and thinking to the future, in some years a “product holon” could be inserted in more systems (e.g. a plant, a supply chain, a warehouse) where it will have to exchange information with different “resource holons”. Hence, the problem of information exchange could easily arise and further standardization efforts will be needed, so establishing a kind of barriers to the diffusion of the same holonic product management and traceability. In order to reduce these further barriers, but ever more in order to improve the currently definition and the study of holonic product management and traceability, a research effort has been spent since now in this PhD thesis, looking to the current situation of enterprise information systems (where product information are resident) and trying to elaborate it in an holonic view, creating a conceptual HMS product-oriented architecture.

The proposed reference metamodel (figure 1) has already been presented in papers and conferences (ref. PhD [2], ref. PhD [7]).

In such a context, the adopted research methodology is composed by three main activities:

- The analysis of the actual situation of the enterprise information systems, provided by the analysis of the current accepted standards, which are specifically created from the integration of ICT systems. The analysis of standards (e.g. IEC/ISO 62264, ISO 10303) was a basic step for reducing the research effort, avoiding a long state of the art analysis of enterprise ICT systems.
- Definition of the main requirements of the metamodel, realized taking into account inputs coming from the literature analysis and the field analysis of product management and traceability (partly derived from the first results of the thesis).

- Definition of the reference metamodel, formalized using the UML notation.
- Validation of the metamodel. The preliminary validation of the metamodel has been realized with two virtual industrial applications in two Italian test cases. One of them has been also simulated.

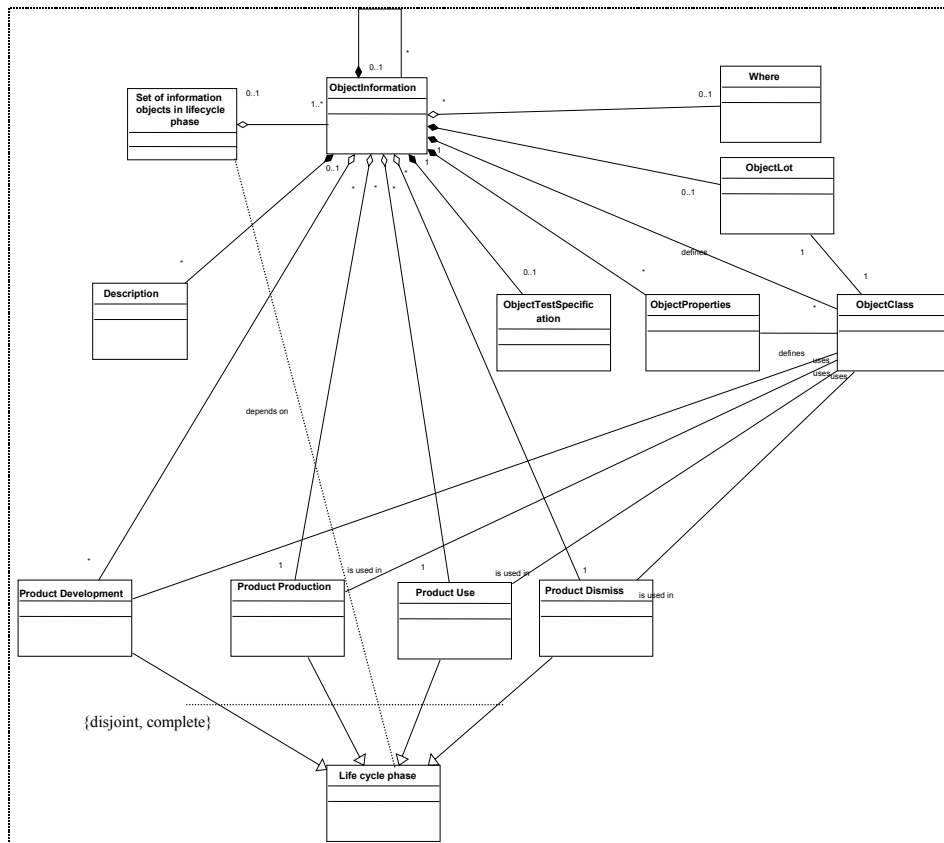

Figure 1 - Partial view of the metamodel

PhD candidate references

International journal

- [1] Terzi S., Cavalieri S., (2004), Simulation in the supply chain context: a survey, Computers in Industry, Volume 53, Issue 1, Pages 3-16

International conferences

- [2] Terzi S., Cassina J., Panetto H., (2005), Development of a metamodel to foster interoperability along the product lifecycle traceability, Proceedings at International conference on Interoperability of

- Enterprise Software and Applications IFIP-ACM/SIGAPP INTEROP-ESA, February 23rd-25th, Geneva, Switzerland
- [3] Terzi S., Cavalieri S., (2004), Proposal of a performance measurement system for the evaluation of scheduling solutions, Proceedings at: IEEE SMC 2004 International Conference on Systems, Man and Cybernetics, October 10-13 2004 The Hague, The Netherlands
 - [4] Macchi M., Terzi S., van Bokhoven G., (2004), Development of an architecture for manufacturing process improvement based on the analysis of system dynamics, Proceedings at: MITIP 2004, (Editors: Karel Mazic) Prague, Czech Republic, June 2004
 - [5] Garetti M., Terzi S., Bertacci N., Brianza M., (2004), Organizational change and knowledge management in PLM implementation, Inaugural Symposium, CIMOC, Center for Innovation Management in Organizational Change, 2-4 June 2004, City University, Hong Kong
 - [6] Garetti M., Terzi S., (2004), Product Lifecycle Management: definition, trends and open issues, in Proceedings at International Conference On Advances In Production Engineering, Warsaw, Poland, 16-18 June 2004
 - [7] Terzi S., Panetto H., Morel G., (2004), Interoperability standards along the product lifecycle: a survey, in: Proceedings at International IMS Forum 2004, May 17th – 19th 2004, Villa Erba - Cernobbio - Lake Como, Italy
 - [8] Macchi m., Garetti M., Terzi S., (2004), Using the PLM approach in the implementation of the globally scaled manufacturing, in: Proceedings at International IMS Forum 2004, May 17th – 19th 2004, Villa Erba - Cernobbio - Lake Como, Italy
 - [9] Terzi S., Cavalieri S., Bandinelli R., Tucci M., (2004), Experiences in distributed simulation for benchmarking production scheduling systems, in: Proceedings at International IMS Forum 2004, May 17th – 19th 2004, Villa Erba - Cernobbio - Lake Como, Italy
 - [10] Brambilla P., Terzi S., Cavalieri S., (2004), Towards a performance measurement system for the evaluation of scheduling solutions, in Proceedings at “International Federation of Automatic Control 11th IFAC Symposium on Information Control Problems in Manufacturing” INCOM, Salvador de Bahia, Brasil, 3-5 April 2004
 - [11] Valckenaers P., Cavalieri S., Saint Germain B., Verstraete P., Hadeli, Terzi S. and Van Brussel H., (2004), A Benchmarking Service For The Manufacturing Control Research Community, in Proceedings at “International Federation of Automatic Control 11th IFAC Symposium

- on Information Control Problems in Manufacturing” INCOM, Salvador de Bahia, Brasil, 3-5 April 2004
- [12] Bandinelli R., Rapaccini M., Terzi S., Macchi M., (2004), Proposal of a framework for production plants remote control: a preliminary test case, 15th European Simulation Symposium, October 2003, The Netherlands
- [13] Terzi S., Garetti M. Cavalieri S., (2003), Using UML for describing a reference framework for benchmarking production scheduling systems, Proceedings of Concurrent Engineering conference 2003, Madeira, Portugal
- [14] Terzi, S., Cavalieri, S., Garetti, M., Macchi, M. and Panetto, H. (2003), Development of a Reference Architecture for Benchmarking Service of Manufacturing Systems, Proceedings of the 7th IFAC Workshop on Intelligent Manufacturing Systems, Budapest, Hungary, 6-8 April, pp. 213-219.
- [15] Terzi, S., P. Brambilla, and S. Cavalieri, (2003), Evaluation and validation of scheduling systems: issues and trends, In: Proceedings of the 3rd International Workshop on Performance Measurement, Dalmine, Italy, 19-20 June, pp. 155-168.
- [16] Brun A., Cavalieri S., Macchi M., Portioli-Staudacher A., Terzi S., (2002), Distributed simulation for Supply Chain Co-ordination, Proceeding at 12° international working seminar on Production Economy, Igls
- [17] Brun A., Macchi M., Terzi S., (2002), Integrating manufacturing supply chains in a federated simulation environment: a case study, Proceeding at 12° international working seminar on Production Economy, Igls
- [18] Brun A., Poletti M., Terzi S., (2002), Achieving effectiveness in Operations through Distributed Simulation, CIRP - ICME, Ischia
- [19] Cavalieri S., Macchi M., Terzi S., (2002), Benchmarking Manufacturing Control Systems: Development issues for the performance measurement system, Proceeding at IFIP Performance Measurement Workshop, Hanover, Germany

National conferences

- [20] Terzi S., Cassina J., Chiari G., Panetto H., (2004), Traçabilité des produits : une approche holonique, 5e Conférence Francophone de Modélisation et Simulation, 1-3 Septembre 2004, IRCCyN - Ecole des Mines de Nantes, Nantes, France

- [21] Terzi S., Garetti M., Bongiardina C., Macchi M., (2003), Product Lifecycle Management: un tentativo di definizione, XXX Convegno ANIMP, Rapallo
- [22] Terzi S., Cavalieri S., Pellegri M., (2002), Impiego della simulazione come strumento integrato per la progettazione e la pianificazione di una linea di fabbricazione in un'azienda operante a commessa, XXIX Convegno ANIMP, Sorrento
- [23] Garetti M., Macchi M., Terzi S., (2002), Progettazione integrata di sistemi manifatturieri: generazione integrata di modelli di simulazione, II convegno nazionale MIMOS, Torino

Other disseminations

- [24] Garetti M., Terzi S., (2004), Processi più integrati, l'obiettivo del PLM, Computerworld Online (edizione italiana), IDG Communications Italia, Giugno 2004
- [25] Garetti M., Macchi M., Terzi S., (2004), PLM: definition, open issues and trends, working paper of IMS NoE Special Interest Group 1, May 2004
- [26] Garetti M., Terzi S., (2004), PLM: nuovo paradigma di impresa?, Automazione e strumentazione, VNU business publications Italia
- [27] Garetti M., Terzi S., (2004), PLM: definizione, caratteristiche ed elementi, white paper mPLM, Aprile
- [28] Terzi S., Garetti M., (2002) La simulazione ad eventi discreti nella logistica, white paper Laboratorio Ingegneria Gestionale

Deliverables and reports

- [29] Nunez M.J., Panetto H., Terzi S., et al., IMS SMART-fm IST-2001-52224 D2.5: Proposal for a suite of modules for PLC based on ISO 10303 STEP, including mechanisms for implantation, February 2005
- [30] Nunez M.J., Panetto H., Terzi S., Castillo A., Horna P., IMS SMART-fm IST-2001-52224 D1.1a: State of the Art in PLC models: PLM models and Frameworks, Design and Manufacturing Processes, June 2003
- [31] Terzi S., Cavalieri S., Considerazioni sull'etica della ricerca politecnica – Il ruolo dell'ingegneria gestionale, elaborato a chiusura del corso di Epistemologia della ricerca, Dicembre 2002
- [32] WILD Book I e II, Gestione Integrata di Sistemi Produttivi Interagenti: Metodi Quantitativi Avanzati per la Quick Response,

Rapporto di ricerca, Edit. Buzzone A., Mosca R., Revetria R., Stampato a Genova, Italy, Novembre 2001 (WILD I) e Novembre 2002 (WILD II)

Paper submitted

- [33] Garetti M., Terzi S., Organizational change and knowledge management in PLM implementation, forthcoming in the first issue of International Journal of PLM
- [34] Terzi S. Flores M, Analysis of PLM dimensions and applications in Europe, submitted to PLM'05 International Conference, Lyon, 1-3 July 2005

SYNTHESE

Introduction

La thèse s'inscrit dans la cadre d'une cotutelle Italo-Française, entre l'Université Henri Poincaré Nancy I (Centre de Recherche en Automatique de Nancy)) et le Politecnico di Milano, (Département de Génie industriel et d'entreprise). La complémentarité scientifique de ces deux laboratoires a orienté nos travaux de thèse dans le domaine de la Gestion du Cycle de Vie des Produits (PLM : Product Lifecycle Management) selon deux objectifs : l'un concerne plus particulièrement l'analyse et l'état de l'art des concepts liés au domaine du PLM alors que le second va chercher à tirer avantage de ces concepts pour la formalisation d'un metamodèle adapté à la Traçabilité des produits tout au long de leur cycle de vie.

Contexte de la recherche

La concurrence entre les entreprises leur impose des contraintes de plus en plus élevées en terme de qualité des produits. Elles sont soumises à des demandes de plus en plus complexes des marchés. Les clients deviennent de plus en plus exigeants en termes de qualité des produits et des services associés. Le meilleur produit, au plus bas prix, juste à temps et au bon endroit sont les clés du succès pour l'entreprise moderne.

Pour répondre à ces exigences, les entreprises doivent se concentrer sur leurs compétences propres afin d'accroître leur efficacité et réduire les points faibles. Le produit redevient ainsi, après l'éclatement de la bulle issue de la nouvelle économie, le vrai créateur de valeur d'entreprise et ainsi le processus de production redécouvre son rôle premier.

Dans ce contexte, la gestion des produits et des processus de production est devenue plus complexe ainsi que les problèmes s'y

rattachant. Le développement de produits doit dorénavant tenir compte, dans un temps très court dépendant du marché, des souhaits et des demandes des clients. Ainsi, les activités de production sont complexifiées tout en ne tolérant pas l'inefficacité dans les fonctions de production et de distribution.

Le cycle de vie des produits, leur production ainsi que leur gestion sont des aspects maintenant incontournables dans cet environnement centré sur le produit (Product-Driven). La gestion intégrée de toute information relative au produit et à sa production est une des questions majeure de l'industrie.

Une des réponses à cette question, actuellement d'actualité, concerne un paradigme naissant, défini par le vocable de Gestion du Cycle de Vie des Produits (PLM : Product Lifecycle Management). En fait, en réponse aux besoins des entreprises, de nombreux fournisseurs de solutions logicielles d'entreprise, venant de domaines divers en relation avec la conception de produits et la gestion de la production, développent des solutions adaptées à ces nouveaux besoins, participant ainsi à l'émergence et la stabilisation du paradigme PLM. Néanmoins, le PLM n'est pas un problème technologique, mais d'abord une stratégie d'entreprise (chapitre 4). Le paradigme PLM peut être défini comme : "an integrated, ICT supported, approach to the cooperative management of all product related data along the various phases of the product lifecycle".

La traçabilité induit une nécessaire interopérabilité de l'information ainsi que des efforts de standardisation. Afin d'assurer ces échanges d'information, des travaux de recherche, basés sur la situation actuelle des systèmes d'information d'entreprise (qui manipulent l'information sur les produits), doit aboutir à la définition d'une vue holonique d'un modèle conceptuel orienté produit d'un système de production.

L'analyse des standards d'entreprise, mis en œuvre dans les applications logicielles relatives à la traçabilité donne une première idée des éléments de construction d'un modèle de système d'information d'entreprise adapté à notre problématique.

De cette analyse, et plus particulièrement des éléments de base manipulés dans ces normes d'intégration impliquées le long du cycle de vie du produit, nous pouvons formaliser un meta-modèle du système d'information d'entreprise basé sur des holons. Dans ce contexte, la deuxième partie de la thèse consiste, après une analyse des meta-modèles issus de standards dédiés à la modélisation des informations liées aux produits, en un meta-modèle de la partie informationnelle permettant la traçabilité des produits le long de leur cycle de vie.

Une analyse succincte du paradigme PLM permet d'observer que :

- du point de vue de la stratégie d'organisation, une approche centrée sur le produit et sur les processus de production implique une re-ingénierie de modélisation de toutes les relations entre les ressources (personnels et équipements) impliquées dans les processus d'entreprise (Business Processes), orientés cycle de vie de produit, en tenant compte des allocations de tâches et la mesure de leur performance.
- du point de vue des technologies de l'information, la gestion de la production centrée sur le produit n'est autre qu'un problème d'intégration de base de données ou d'interopérabilité des applications. Les informations sur les produits et les processus sont dispersées dans divers systèmes d'information, qui, jusqu'ici, étaient isolés et non intéropérables (par exemple un système PDM (Product Data Management) et un ERP (Enterprise Resource Planning). Les tendances actuelles concernent l'intégration de ces « îlots » dans un unique (même s'il est distribué) entrepôt de donnée intégré, afin d'assurer une utilisation plus large et plus efficace des informations relatives aux produits. Initialement, ces processus d'intégration étaient plutôt fermés, avec une instanciation à des suites logicielles propriétaires alors que, récemment, des efforts de standardisation ont débuté pour la formalisation de processus d'intégration ouverts.

- du point de vue architecture, une approche de gestion centrée sur le produit implique la gestion et la conception centralisée de plusieurs éléments :
 - a) Une infrastructure d'information, qui concerne la mise en oeuvre de réseaux.
 - b) Une infrastructure de ressources qui concerne la conception et la gestion de tous les composants physiques impliqués le long du cycle de vie des produits et leur production (par exemple les machines, les usines, les personnels, les fournisseurs, les entrepôts, ...).
 - c) Un produit lui-même "infrastructure". En effet, un même produit peut devenir une ressource dont on pourra gérer directement la traçabilité dans son cycle de vie.

Comme mentionné précédemment dans le dernier point de vue, une des questions principales concernant le produit et sa fabrication, avec une perspective plus large (tout au long de son cycle de vie), concerne la traçabilité du produit.

Le concept de "traçabilité" lié au produit ou à la fabrication a été défini dans les années 90, quand des besoins industriels ont été mis en avant lors de l'établissement de procédures ISO 9000. Généralement, la traçabilité des produits est la capacité d'un utilisateur (fabricant, fournisseur, vendeur,...) de tracer un produit dans le temps au travers de ses procédures de traitement. Physiquement, la traçabilité des produits consiste à maintenir des enregistrements informationnels de tous les matériaux, composants, processus opérants au long d'un cycle de vie défini (par exemple de l'achat des matières premières première à la vente des produits finis), en utilisant une identification codée de chaque instance de produit. La traçabilité des produits est intrinsèquement une question relative au paradigme PLM puisqu'elle est en relation avec une perspective organisationnelle (par exemple l'attribution de tâches pour les produits tracés), une perspective informationnelle (par exemple

l'identification de l'information, son codage) et une perspective d'architecture (par exemple les systèmes physiques d'identification, de marquage) . Ces perspectives sont, bien sûr, centrées sur le produit. La traçabilité des produits est l'une des questions centrales posée par la communauté PLM. Plusieurs approches technologiques existent, depuis le simple code à barres de suivi de produit, jusqu'aux systèmes avancés RFID (Radio Frequency IDentification) et aux systèmes micro électromécaniques (MEMS : Micro Mechatronics Systems), qui visent à transformer le produit lui-même en "produit intelligent", capable d'être pisté dans des systèmes de production et de coopérer automatiquement avec des ressources.

Cependant, la traçabilité (chapitre 5) des produits ne se cantonne pas au domaine manufacturier. C'est aussi une problématique présente dans d'autres domaines, de la gestion de la qualité (par exemple dans l'agroalimentaire), à la gestion de la chaîne logistique au service après-vente et la maintenance, et à la conception des installations. Les technologies actuelles de mise en œuvre de la traçabilité concernent, particulièrement, l'identification des produits (même si l'on identifie souvent seulement le type de produit) utilisant un système physique de codage (par exemple un code à barres, un code laser, ...). Toute l'information codée liée au "produit" est alors stockée dans une (ou plusieurs) base de données. En conséquence, il est nécessaire d'assurer une synchronisation entre le produit, lui-même, et l'information qui l'identifie. Ce processus de fusion d'information n'est pas toujours sans risque. Même s'il pourrait être déjà automatisé, des pannes sur le système d'information pourraient se produire pendant une transaction de recherche d'information. Afin de mettre en œuvre la traçabilité, une solution pourrait être identifiée par le concept holonique, où chaque produit pourrait être équipé d'un système de mémorisation du système d'information, par exemple basé sur la technologie RFID, afin (i) d'une part assurer le suivi et, (ii) d'autre part permettre une mise à disposition de l'information nécessaire et des services qui y sont associés.

Le produit pourrait ainsi être considéré comme un « produit intelligent », capable d'échanger l'information (qui est mémorisée sur le produit lui-même), en temps réel, avec différentes ressources (par exemple des machines et des transports dans une usine, ou des camions et des bases de données d'inventaire dans un entrepôt).

Certains auteurs définissent le paradigme d'« Holon » comme étant l'association d'un produit avec de l'information. Les processus manipulant ces Holons sont qualifiés de processus « holoniques ». Le mot « Holon » a été présenté par Koestler en 1967, comme la combinaison du mot grec « Holos » signifiant « entier » avec le suffixe « -on », comme un proton ou un neutron qui suggère une particule ou une partie individuelle. Depuis 1993, le terme « holonique » a été adapté au monde de la fabrication, faisant ainsi émerger la communauté des systèmes de fabrication Holoniques (HMS : Holonic Manufacturing Systems). Dans cette communauté, un HMS est un système autonome et coopératif pour transformer, transporter, stocker et/ou contrôler l'information et les objets physiques.

L'analyse des standards d'entreprise (chapitre 6), mis en œuvre dans les applications logicielles relatives à la traçabilité donne une première idée des éléments de construction d'un modèle de système d'information d'entreprise adapté à notre problématique. L'une des conditions préliminaires pour le développement d'un modèle du système d'information pour la traçabilité des produits est d'étudier les standards existants modélisant les informations liées aux produits de l'entreprise. Sans être exhaustif, du fait du grand nombre de standards définissant les concepts de produit et d'information relative au produit, nous en avons étudié plusieurs, relatifs à l'intégration en entreprise, centrés sur le produit. L'analyse de ces standards, dans un contexte de traçabilité des produits, permet de formaliser les éléments de constructions dédiés à la phase de production de produits.

La structure de ce modèle, inspirée par la complexité du produit réel, est fractale; En fait un produit réel est réalisé à partir d'autres composants,

qu'ils soient des matières premières ou des produits à assembler. Chacun de ces composants est lui-même la conséquence d'un processus de production. Il est donc, lui-même traçable. Le système d'information de traçabilité d'un produit inclut donc, de manière récursive (et donc fractale), les systèmes d'information de ses composants. Dans ce modèle, un Holon est défini en adoptant sa première définition philosophique. Il est ainsi formalisé comme une représentation de la partie physique liée aux « objets d'information » qui le caractérisent, en fonction de la phase du cycle de vie concernée. La contribution de la thèse est principalement axée sur la définition d'« objets d'information » correspondant à la partie informationnelle d'un Holon, et leurs relations. La thèse propose le meta-modèle représenté sur la figure 1, qui formalise, dans le formalisme diagramme de classe UML, la structure du système d'information associé aux données de traçabilité des produits. Dans la thèse un prototypage d'une application a été réalisé dans deux cas industriels.

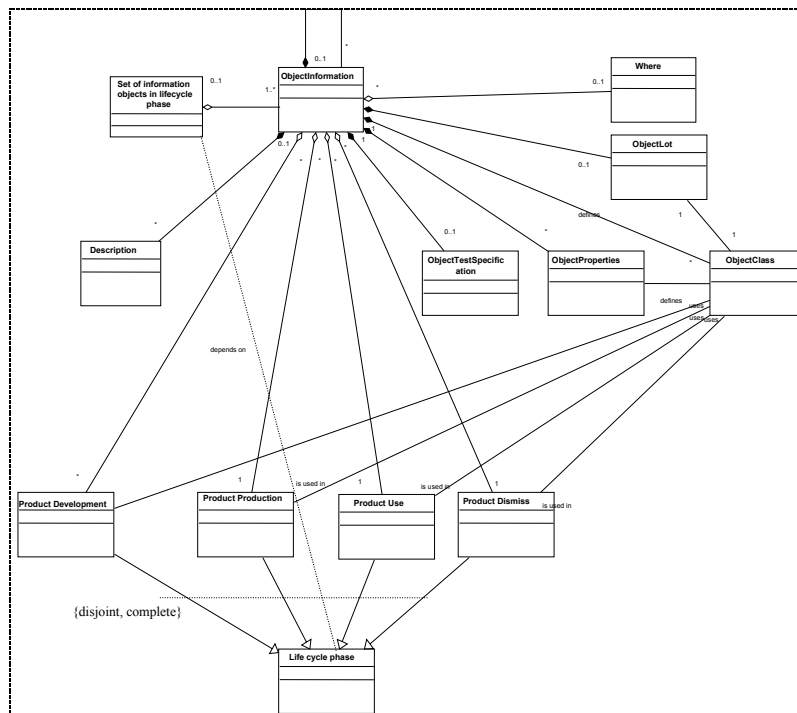

Figure 1 – Extrait du metamodel proposé

SINTESI

Premessa

La tesi di dottorato è la sintesi di una serie di attività di ricerca perseguite nei tre anni di studi, secondo un primo piano di ricerca progettato a gennaio 2003 (a conclusione del primo anno) e modificato nel corso dei seguenti due anni.

Occorre premettere come il dottorato di ricerca sia stato inquadrato all'interno di un progetto di ricerca in cotutela tra due istituti dalle radici diverse: il Dipartimento di Ingegneria Gestionale del Politecnico di Milano e i Laboratori CRAN (Centre de Recherche en Automatique de Nancy I) dell'Università francese Henri Poincaré di Nancy. I due istituti hanno provenienze ed aree di ricerche diverse, ma non mancano i punti di contatto.

Tale condizione “al contorno” si è dipanata nella medesima tesi di dottorato, generando un risultato che - innegabilmente - dimostra una connotazione a due “polmoni”: una serie di attività di ricerca in linea con gli orientamenti tipici dell'Ingegneria Gestionale (analisi di contesti di business, analisi e modellazione di sistemi produttivi e logistici) ed una serie di attività che invece mantengono una linea dagli orientamenti di Automazione (modellazione di sistemi intelligenti ed automatici). Questa doppia connotazione ha quindi portato all'elaborazione di un output originale, che ad un inquadramento gestionale unisce una proposta innovativa di applicazione attinente al mondo dell'automazione della produzione.

Definizione delle attività di ricerca

L'attività di ricerca affidata al candidato ad inizio del proprio percorso di formazione consisteva nella analisi e nella comprensione di quel fenomeno che iniziava - tre anni or sono - a farsi noto nel mercato delle

imprese – allora timidamente, oggi strenuamente – con l’acronimo di Product Lifecycle Management (PLM).

Dato questo compito sostanziale, mutuato tra intenti italiani e francesi in parte diversi, al candidato fu richiesto di iniziare a sviscerare il significato di questo acronimo, definendo contorni, componenti e caratteristiche, e quindi identificando aree potenziali di approfondimento. Nel corso dei tre anni, sono state affrontate diverse attività e sottoattività di ricerca, andando ad approfondire lo studio di aree definite preliminarmente secondo un primo quadro di riferimento (ed una prima metodologia) e nel tempo modificatesi. Seguendo un percorso a dettaglio crescente, è possibile sintetizzare le attività realizzate come segue:

- **Analisi delle componenti del Product Lifecycle Management.** Per l’elaborazione di una definizione di PLM comprensiva dei diversi significati attribuiti nel mercato a tale acronimo sono state condotte diverse attività di ricerca, affrontate con metodologie diverse, che hanno interessato (i) lo studio delle soluzioni presenti sul mercato sotto il cappello commerciale di PLM-suite, sia (ii) lo studio di casi aziendali di rilievo nazionale che rappresentano la frontiera nella comprensione del concetto di PLM. Da questa attività (riportata nella prima parte della tesi), si è quindi potuto formulare una definizione generale che considera il fenomeno PLM come è un nuovo modello contingente di business, che attraverso l’ausilio di moderne tecnologie informatiche, implementa una gestione cooperativa e collaborativa di tutte le informazioni di prodotto distribuite lungo le diverse fasi del ciclo di vita dello stesso. In tale definizione sono pertanto presenti i diversi elementi costitutivi del PLM, che comprendono sia (i) un orientamento strategico alla creazione di valore “sul” ed “attraverso” il “prodotto”, sia (ii) l’applicazione di un approccio collaborativo per la valorizzazione delle core-competence di attori diversi, sia (iii) l’uso di un consistente numero di soluzioni ICT per la pratica realizzazione della conseguente gestione coordinata,

integrata e sicura di tutte le informazioni necessarie alla creazione del valore.

- Definizione dei gap ed individuazione delle aree ove la ricerca è chiamata a contribuire in ambito PLM. Dalla prima attività di definizione, si sono individuate diverse aree di ricerca, di natura diversa, definendo una serie di research questions di varia natura, dal carattere strategico, tattico ed operativo, ma anche tecnologico, informativo ed infrastrutturale. Le diverse questioni di ricerca sono state quindi condivise all'interno dell'accordo quadro di cotutela, individuando così una area di indagine ove far confluire le intuizioni e le competenze di ricerca di entrambi gli istituti. Per i motivi che sono meglio chiariti nella tesi, si è provveduto ad individuare come area di approfondimento la tematica sinteticamente individuata con "tracciabilità di prodotto", attinente alla gestione e rintracciabilità dei dati di prodotto (e quindi del prodotto medesimo) successivamente alla sua progettazione.
- Definizione del contributo innovativo. All'interno del così definito sottocontesto, si è provveduto ad uno studio dello stato dell'arte della tracciabilità di prodotto, mantenendo la visione più ampia proveniente dalla definizione PLM elaborata. In effetti, proprio la provenienza da una visione "generale", ha permesso l'individuazione e la definizione di uno spazio di ricerca ove apportare un forte contributo innovativo, consistente nello sviluppo di un modello di riferimento per la tracciabilità intelligente di prodotto nell'intero ciclo di vita. Il modello proposto corrisponde ad un salto innovativo fondamentale nella gestione integrata dei dati di prodotto, che vede nell'applicazione di metodologie/tecnologie intelligenti (sistemi multiagente e sistemi holonici) una soluzione ad alcuni dei problemi maggiormente presenti nel contesto PLM. Il modello così realizzato, nei limiti dei suoi contenuti, è stato validato attraverso alcuni casi aziendali simulati.

Ambito della ricerca ed obiettivi

All'interno dell'ambiente competitivo odierno, le imprese sono sempre più sottoposte alle incertezze del mercato ed ad una complessità generale crescente. La sopravvivenza dell'azione imprenditoriale è legata alla soddisfazione delle richieste di clienti, divenuti sempre più esigenti in termini di qualità e servizi. Nella ricerca dei necessari vantaggi competitivi, le moderne imprese devono spingere ad un miglioramento costante dell'efficienza interna ed esterna, eliminando i costi non rilevanti, e, parallelamente, adoperandosi in una strenua tendenza all'innovazione, espressa nei suoi termini più ampi di prodotto, processo, sistema, organizzazione. In quest'ambito, con l'esaurirsi delle strategie ed azioni di taglio prevalentemente speculativo compiute dalle imprese negli anni '90, si sta riaffermando la centralità del prodotto, secondo la quale il "prodotto" è inteso come il vero elemento creatore di valore. Conseguentemente, si sta verificando una rinnovata attenzione al macroprocesso di creazione e gestione del ciclo di vita del prodotto.

In questa rifocalizzazione, il prodotto si è però intrinsecamente arricchito di servizi e sistemi accessori ormai imprescindibili, mentre i relativi processi di sviluppo, produzione, distribuzione e dismissione hanno accumulato complessità.

In questa visione "prodotto-centrica", la gestione efficiente ed integrata di tutte le informazioni che transitano "lungo" e "nel" ciclo di vita di un prodotto è divenuta una chiave ineluttabile di successo. Sulla scia di questa visione, ha iniziato a diffondersi nel mercato un nuovo approccio di gestione, che prevede un ri-orientamento dell'azienda al prodotto, con tutto quello che ne consegue in termini di ristrutturazione dei processi e dei correlati flussi informativi. A supporto di questa tendenza, sono intervenute le ormai mature tecnologie informatiche, in particolare di natura web-based. Negli ultimi anni, numerosi fornitori ICT hanno iniziato a sviluppare ambienti integrati di progettazione e gestione delle informazioni di prodotto: il mondo dell'ingegneria tecnica, caratterizzato da anni di sviluppo di tecnologie Computer-Aided, si sta man mano

connettendo al mondo dell'ingegneria gestionale ed ai relativi sistemi IT, migliorando così la gestione di tutte le informazioni concernenti al prodotto ed alla sua realizzazione. A tale tendenza, negli ultimi due anni, il mercato dell'ICT ha dato un nuovo nome: PLM (Product Lifecycle Management).

Sulla scia dell'evoluzione PLM in corso, le aziende hanno cominciato a dotarsi di sistemi informativi sempre più integrati; tale integrazione è sostanzialmente realizzata tramite sistemi di condivisione delle informazioni corrispondenti a database distribuiti o centralizzati. Quest'evoluzione non è certamente senza costo, giacché prevede una profonda ristrutturazione organizzativa ed un'infrastruttura di supporto rilevante. Peraltro, non è certamente esente da rischi né senza lacune. In particolare, le moderne tecnologie non hanno ancora assolto una integrazione ed interoperabilità completa e non consentono di rispondere appieno alle problematiche di controllo e tracciabilità di ogni prodotto, benché questa sia una delle esigenze più sentite dall'opinione pubblica, in termini di sicurezza e servizio richiesto. Nei più avanzati sistemi, ogni prodotto non è ancora visto nella sua unicità, ma al massimo è definito nella sua tipicità (cioè nella sua classe di appartenenza). Guardando al mondo della ricerca internazionale, in quest'area sono in corso importanti studi sulla definizione del ciclo di vita del prodotto, meglio noto come problema della tracciabilità di prodotto. In particolare, presso centri di ricerca internazionali come i laboratori Auto-Id del MIT (USA) e di Cambridge (UK), o i laboratori del CRAN (Francia) sono attivi interessanti studi sulla tracciabilità di prodotto, intesa come capacità di unire le informazioni alla singola istanza fisica di un prodotto. Tale unione è in grado di comportare una serie di prevedibili facilitazioni nella gestione delle informazioni di prodotto lungo le diverse fasi di vita, dalla logistica esterna, al controllo automatico di produzione, fino alla manutenzione remota. Quest'approccio è stato definito come paradigma "Holonico", secondo la definizione di Holone ereditata da Arthur Koestler (1967), fatta propria dalla comunità di ricerca mondiale HMS (Holonico Manufacturing

Systems; un Holone è l'unità minima inseparabile di "prodotto fisico + informazione".

L'approccio Holonico promette di risolvere buona parte dei problemi di gestione delle informazioni di prodotto, ponendo le informazioni stesse sul singolo oggetto fisico, usando tecnologie disparate, dalla trasmissione in radio frequenza.

Le applicazioni prototipali attualmente in corso (capitolo 5) prevedono un rilevante intervento nel mondo della logistica esterna, ma anche della logistica interna, dell'automazione della produzione e della manutenzione remota. Le frontiere più avanzate prevedono una "holonificazione" dell'intero ciclo di vita del prodotto, comprendente anche le fasi di progettazione e sviluppo del prodotto medesimo, comportando così la creazione di un prodotto "intelligente", capace di vita propria all'interno di un qualunque sistema produttivo e logistico.

All'interno di tale contesto, la tesi di ricerca assolve due obiettivi principali:

- Studiare e definire il fenomeno gestionale che si sta andando a delineare sotto l'acronimo PLM, individuando le aree effettivamente coinvolte e le ricadute in termini di futuri interventi di ricerca (capitoli 1,2,3,4).
- Sviluppare un modello di riferimento dell'approccio Holonico al problema della tracciabilità di prodotto lungo il lifecycle. In particolare, con "modello di riferimento" si intende il raggiungimento di due sotto-obiettivi e la formalizzazione degli stessi in uno schema di rappresentazione (II parte della tesi, in particolare capitolo 8):
 - a. Identificazione di una modalità di rappresentazione Holonica delle informazioni di prodotto/processo, al momento ancora non esistente in letteratura.
 - b. Definizione dei contenuti informativi del modello (quali tipi di dati possono essere riportati sull'holone prodotto) in corrispondenza delle diverse fasi del ciclo di vita di un prodotto (progettazione,

realizzazione, uso e dismissione) e delle diverse attività coinvolte (es. fabbricazione, distribuzione, manutenzione).

In questo senso, la tesi di dottorato si colloca all'interno di uno scenario strettamente innovativo, giacché intende contribuire agli sviluppi attualmente più avanzati nell'ambito della ricerca mondiale in area Operation, unendo le competenze innovative dell'università di provenienza del candidato a quelle di altri prestigiosi centri di ricerca.

Metodologie e risultati

Il conseguimento delle diverse attività e sottoattività di ricerca è stato realizzato attraverso l'adozione di metodologie di ricerca differenti. In particolare, a fianco della costante presenza di un'analisi bibliografica e delle referenze nelle diverse attività, occorre segnalare quanto segue:

- Per la comprensione del significato e dei confini del PLM, ci si è avvalsi, oltre che di un'analisi delle soluzioni marcate "PLM" (capitolo 2), anche di un'analisi empirica esplorativa (capitolo 3), condotta con interviste dirette in una decina di casi emblematici italiani.
- Il modello di gestione e tracciabilità dei dati di prodotto è stato progettato partendo dagli output delle attività precedenti, che hanno fornito una serie di requisiti minimi del modello. Il modello è stato poi realizzato ricorrendo a diversi metodi di mappatura; in particolare, la versione ultima del modello è stata redatta ricorrendo alle metodologie EPC ed UML, per descrivere le diverse viste di modellazione (capitolo 8).
- Una sufficiente validazione del modello è stata quindi ottenuta con una successiva implementazione in un modello di simulazione ad eventi discreti di una realtà aziendale ed attraverso l'istanziamento del modello stesso in XML in due realtà produttive (capitolo 9).

Concludendo, è possibile asserire quanto segue in termini di risultati e obiettivi raggiunti:

- L'acronimo PLM ha certamente senso di esistere nel momento in cui con esso si intenda quell'insieme complesso di fenomeni, che comprendono una rivisitazione completa del sistema impresa per meglio rispondere alla esigenze di mercato attraverso l'uso di tecnologie ICT abilitanti la comunicazione, la condivisione e la collaborazione. "Fare PLM" in un'azienda significa saper gestire il sistema azienda nella sua complessità, ricercando nelle offerte tecnologiche soluzioni efficienti e coerenti con gli obiettivi di business. In particolare, fare PLM significa gestire in maniera efficiente tutta quella serie di informazioni utili al soddisfacimento del core-business aziendale.
- Il modello proposto a conclusione dell'attività di ricerca suggerisce una visione innovativa della gestione e della tracciabilità dei dati di prodotto lungo l'intero ciclo di vita dello stesso (figura 1). La validazione ottenuta da una prima applicazione virtuale a casi industriali ne dimostra la rilevanza in ambito reale, ma allo stesso tempo suggerisce una serie di miglioramenti che sono possibili solo con l'erogazione di sforzi superiori, aprendo così la strada a futuri sviluppi di ricerca.



Figura 1 – Vista parziale del modello

INDEX

Index of the thesis

Synthesis (in English)

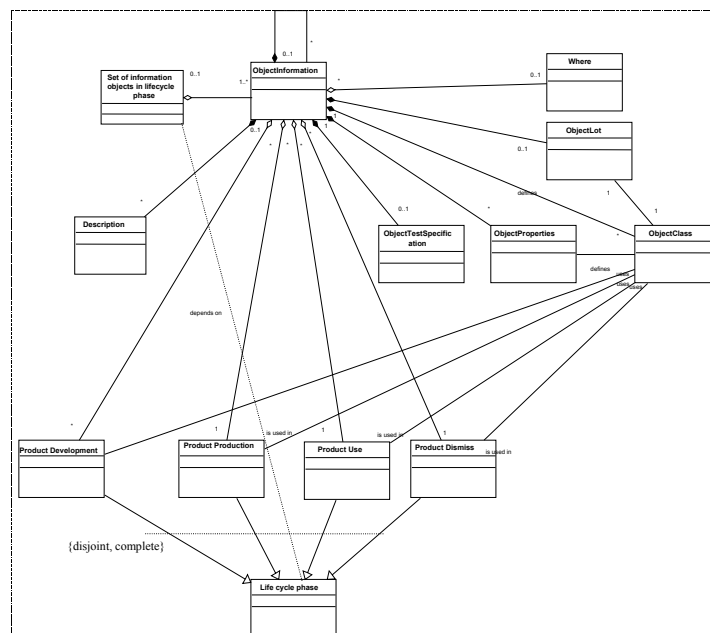
SYNTHESIS OF THE RESEARCH	i
RESEARCH CONTEXT AND THESIS OBJECTIVES	i
THE FIRST LAYER: DEFINITION OF PRODUCT LIFECYCLE MANAGEMENT	ii
THE SECOND LAYER: REFERENCE METAMODEL FOR PRODUCT MANAGEMENT AND TRACEABILITY ALONG THE PRODUCT LIFECYCLE	vi
PHD CANDIDATE REFERENCES	x

Synthèse (en français)

INTRODUCTION	xv
CONTEXTE DE LA RECHERCHE	xv

Sintesi (in italiano)

PREMESSA	xxiii
DEFINIZIONE DELLE ATTIVITÀ DI RICERCA	xxiii
AMBITO DELLA RICERCA ED OBIETTIVI	xxvi
METODOLOGIE E RISULTATI	xxix

Index

INDEX	xxxii
-------	-------

Part I – Product Lifecycle Management

Chapter 1 – Research questions and methodologies

1.1	INTRODUCTION	1
1.2	RESEARCH QUESTIONS	2
1.2.1	Definition of Product Lifecycle Management	2
1.2.2	Reference model for Product Traceability	3
1.3	RESEARCH METHODOLOGIES	4
1.4	STRUCTURE OF THE THESIS	5
1.5	REFERENCES OF THE CHAPTER	7

Chapter 2 – Elements of PLM

2.1	INTRODUCTION	9
2.2	PRODUCT LIFECYCLE PHASES	10
2.2.1	Product lifecycle reference model	15
2.3	PLM ICT ELEMENTS AND FUNCTIONALITIES	17
2.3.2	ICT evolution into the design processes	17
2.3.3	ICT evolution into the operation management processes	19
2.3.4	ICT evolution into the supporting processes	20
2.3.5	Main PLM ICT functionalities	22
2.3.6	PLM ICT foundations	25
2.4	PROCESSES IN THE PRODUCT LIFECYCLE MANAGEMENT	36
2.5	CONCLUSIONS OF THE CHAPTER	42
2.6	REFERENCES OF THE CHAPTER	44

Chapter 3 – Industrial test cases on PLM

3.1	INTRODUCTION	47
3.2	RESEARCH OBJECTIVES AND METHODOLOGY	48
3.3	ANALYSIS OF THE ITALIAN EXPERIENCES	50
3.4	CONCLUSIONS	60
3.5	REFERENCES OF THE CHAPTER	63

Chapter 4 – Definition of PLM

4.1	INTRODUCTION	65
4.2	TOWARDS A DEFINITION OF PLM	66
4.2.1	Proposal of a comprehensive definition of PLM	68
4.3	PLM MARKET AND TRENDS	70
4.4	OPEN ISSUES IN PLM	75
4.5	CONCLUSIONS	77
4.6	REFERENCES OF THE CHAPTER	80

Part II – Product Lifecycle Traceability

Chapter 5 – Product Lifecycle Traceability

5.1	INTRODUCTION	83
5.2	PRODUCT LIFECYCLE TRACEABILITY	85
5.2.1	Towards holonic product modeling and traceability	86
5.3	STATE OF THE ART OF PRODUCT LIFECYCLE TRACEABILITY	89
5.4	PRODUCT TRACEABILITY TECHNOLOGIES	92
5.4.1	Bar code technologies	95
5.4.2	Radio frequency identification	100
5.4.3	Traceability architecture	103
5.5	CONCLUSIONS	111
5.6	REFERENCES OF THE CHAPTER	112

Chapter 6 – State of the art of enterprise standards

6.1	INTRODUCTION	115
6.2	INTEGRATION REFERENCE MODELS	115
6.3	INTEROPERABILITY STANDARDS	117
6.3.1	Product Development Interoperability Standards	118
6.3.2	Product Production Interoperability Standards	121
6.3.3	Product Use Interoperability Standards	126
6.3.4	Automatic Product Identification standards	133
6.4	CONCLUSIONS	137
6.5	REFERENCES OF THE CHAPTER	138

Chapter 7 – State of the art of HMS

7.1	INTRODUCTION	141
7.2	INTRODUCTION TO HMS	141
7.3	DEFINITION OF HMS	143
7.3.1	Holon behavior	144
7.3.2	Holonic concepts in manufacturing: HMS	145
7.4	STATE OF THE ART OF HMS	146
7.4.1	System architectures	146
7.4.2	Hierarchical versus heterarchical architectures	147
7.4.3	PROSA Reference architecture	149
7.4.4	Holons in production planning and control	153
7.4.5	Virtual Holonic Enterprise	155
7.4.6	Business among Holonic Enterprises	156
7.5	CONCLUSIONS	158
7.6	REFERENCES OF THE CHAPTER	160

Chapter 8 – Proposal of a holonic product traceability model

8.1	INTRODUCTION	163
8.1.1	Product lifecycle traceability needs	163
8.2	DEFINITION OF THE REQUIREMENTS	165
8.2.1	User Requirements	166
8.2.2	Main Requirements	168
8.2.3	Model requirements	173
8.3	MODEL STRUCTURE	174
8.3.1	ObjectInformation	175
8.3.2	The Life Cycle Phase	179
8.3.3	Event, Activity and Resource	181
8.4	IMPLEMENTATION OF THE MODEL	184
8.4.1	XML Implementation	185
8.5	CONCLUSIONS	188
8.6	REFERENCES OF THE CHAPTER	188

Chapter 9 – Validation of the metamodel

9.1	INTRODUCTION	191
9.2	TEXTILE CASE	191
9.2.1	Overview of the manufacturing system	192
9.2.2	Application 1 – Producing synthetic reel	194
9.2.3	Application 2 – Producing natural reel	223
9.3	VETRORESINA PADANA CASE	229
9.3.1	Overview of the manufacturing systems	229
9.3.2	Application 1- producing California 90 PE	231
9.3.3	Application 2 – Delivering California PE	249
9.4	CONCLUSIONS	252
9.5	REFERENCES OF THE CHAPTER	252

Chapter 10 – Conclusions

10.1	INTRODUCTION	253
10.2	CONCLUSIONS ON THE FIRST PART OF THE THESIS	254
10.3	CONCLUSIONS ON THE SECOND PART OF THE THESIS	257
10.3.1	Limits and advantages of the proposed model	257
10.3.2	Further developments	261
10.4	CONCLUSIONS OF THE CONCLUSIONS	263

References

LIST OF THE REFERENCES	265
CONSULTED REFERENCES	265
PLM VENDORS WEBSITES	275
LIST OF THE ACRONYMS	276

Annexes of the thesis

Annex I

PRODUCT LIFECYCLE MANAGEMENT MODEL 279

Annex II

CLASSES OF THE METAMODEL 287

PART I

Product Lifecycle Management

CHAPTER 1

Research questions and methodologies

1.1 Introduction

Within the actual competitive world, enterprises are ever more stressed and subjected to high market requests. Customers are becoming more and more pretentious in terms of products quality and related services. The best product, at the lowest price, at the right time and into the right place is the only success-key for the modern enterprise.

In order to maintain (or gain) competitive advantages, modern enterprise has to manage itself along two main directions:

- Improve internal and external efficiency, reducing all the not-relevant costs.
- Improve innovation: innovation of product, process, structure, and organization.

According to these needs, enterprises have to focus on their core-competences in order to improve the efficiencies (managing innovation) and to reduce the inefficiencies.

Looking to this research, the product is re-becoming, after the soap-bubble new-economy experiences, the real enterprise value creator and the whole production process is re-discovering its role [1].

By this way, within the globally scaled scenario, product and production management are becoming complicated processes where more problems are overlapping each other's. Product development might ever more take into account customers' tastes and requests in a shorter time-to-market. The related engineering activities are consequently stressed, while

inefficiencies in the production and distribution functions are not ever tolerated.

This way, the product lifecycle and its related management are becoming unavoidable key aspects, creating such a “product centric” (or product-driven) problem. The integrated management of all the information regarding the “product” and its production is one of the related questions.

1.2 Research questions

Within the presented context, the candidate has been asked to formulate his research proposal, taking into account the expertise’s of the two leading research centres which have decided his co-tutorship PhD, Politecnico di Milano (Italy) and CRAN (Centre de Recherche en Automatique de Nancy - France).

The macro research context delegated to the PhD student had been defined in December 2001, after a preliminary period carried out in France and after that an organizational re-engineering had been carried out in Politecnico di Milano. Taking advantage from the bi-lateral tutorship of the thesis, the macro research has been identified in the area entitled PLM (Product Lifecycle Management) as a two-layer topic: the first deals with a definition of the boundaries of what is considered as PLM in the market, while, in a complementary way, the second deals with the definition of a reference metamodel for product management and traceability along the product lifecycle. The two layers are interconnected, as it will be demonstrated further, even if they clearly show two different point-of-views.

1.2.1 Definition of Product Lifecycle Management

The main answer to the current market questions is already on going and could be advocated as a new emerging paradigm, defined as Product Lifecycle Management. In fact, listening to the enterprise questions, several vendors, coming from the diverse worlds interested into the

product and production management, are more and more providing answers, stabling a growing “PLM market” (Chapter 2).

The needed product management is intrinsically related to the management of the information, so it is obvious that the related emerging market is ICT characterized. Nevertheless, PLM seems to be not primary an ICT problem, but at first, is a strategic business orientation of the enterprise (Chapter 4).

In such a context, the preliminary research questions delegated to the PhD candidate were the definition of the layers interested by the PLM phenomenon, in order to identify the boundaries, the means and the dimensions of such acronym. The main results of this effort are reported in Chapter 4.

1.2.2 Reference model for Product Traceability

PLM is a complex phenomenon, where more dimensions and disciplines are giving their contributions. A relevant component of PLM is the product itself and its information distributed along the whole product lifecycle, or in other words, the traceability of the product.

The terms “traceability” related to the product or manufacturing has been defined since the 90ies [2]. Physically, the product traceability deals with maintaining records of all materials and parts along a defined lifecycle using a coding technique.

Product traceability is one of the most emerging questions within the PLM community. Several technological approaches exist, since simple bar-coding product tracking, to advanced RFID (Radio Frequency Identification) systems and micro-electromechanical systems (MEMS), which aim to transform the product itself into an “Intelligent Product”, able to be tracked into systems and to automatically cooperate with some resources [3].

In such a context, product management and its traceability is a dispersed activity yet, where lots of industrial practitioners are setting their business in a separated way. A unique vision is still avoided, also because the

same technology is under development. Within this arena, and in particular taking into account the most advanced approach in the area of Intelligent Product ([3], [4]), the second research questions delegated to the PhD candidate deals with the formalization of a reference metamodel, which aims to be an exhaustive, even if preliminary, work in the way of a unique product centric approach.

1.3 Research methodologies

The definition of PLM and its layers is the first result provided in the research thesis. This result has been gained using three main directions of research: (1) the analysis of the literature, (2) the analysis of the ICT market and software solutions which is already adopting the PLM acronym, (3) the analysis of more than 10 Italian industrial cases, interviewing industrial practitioners asking how they use “PLM” (Chapter 3).

The reference metamodel for product traceability has been developed applying a multi-layered methodology, composed by four main activities:

- Analysis of the literature of the means of product traceability.
- Analysis of the current situation of the enterprise information systems, provided by the analysis of the current accepted standards, which are specifically created for the integration of ICT systems. The analysis of standards was a basic step for reducing the research effort, avoiding a long state of the art analysis of enterprise ICT systems.
- State of the art of the Holonic Manufacturing Systems (HMS), where the idea of Intelligent Product has been found.
- Definition of the main requirements of the metamodel, realized taking into account inputs coming from the literature analysis and the field analysis of product management and traceability (partly derived from the first results of the thesis), and development of the reference metamodel, physically formalized using the UML (Unified Modeling Language) notation.

- Validation of the metamodel. The preliminary validation of the metamodel has been realized with two virtual industrial applications in two Italian test cases. One of them has been also simulated.

1.4 Structure of the thesis

According to the presented research methodology, the thesis is structured as follows (figure 1.1):

- Chapter 1 (the present chapter) introduces the research questions and methodologies.
- Chapter 2 illustrates the state of the art of the PLM system, describing the diverse elements of PLM.
- Chapter 3 shows an empirical research conducted on some relevant Italian test cases, which are sensible to the PLM concept.
- Chapter 4 debates the first result of the thesis, providing a comprehensive definition of PLM and defining the current open issues in PLM research.
- Chapter 5, consequently, defines the interested research area of product lifecycle traceability, summarizing the state of the art of such a context.
- Chapter 6 illustrates the analysis of PLM interoperability standards, studied for developing the proposed reference model (Chapter 8).
- Chapter 7 shows the state of the art of Holonic Manufacturing Systems, where the concept of Intelligent Product was developed.
- Chapter 8 illustrates the requirements of the looked reference metamodel and defines it.
- Chapter 9 deals with the validation of the proposed metamodel.
- Chapter 10 concludes the thesis, summarizing the results and defining the further researches becoming from the PhD thesis.
- Two annexes are attached to the thesis in order to complete the relevant arguments.

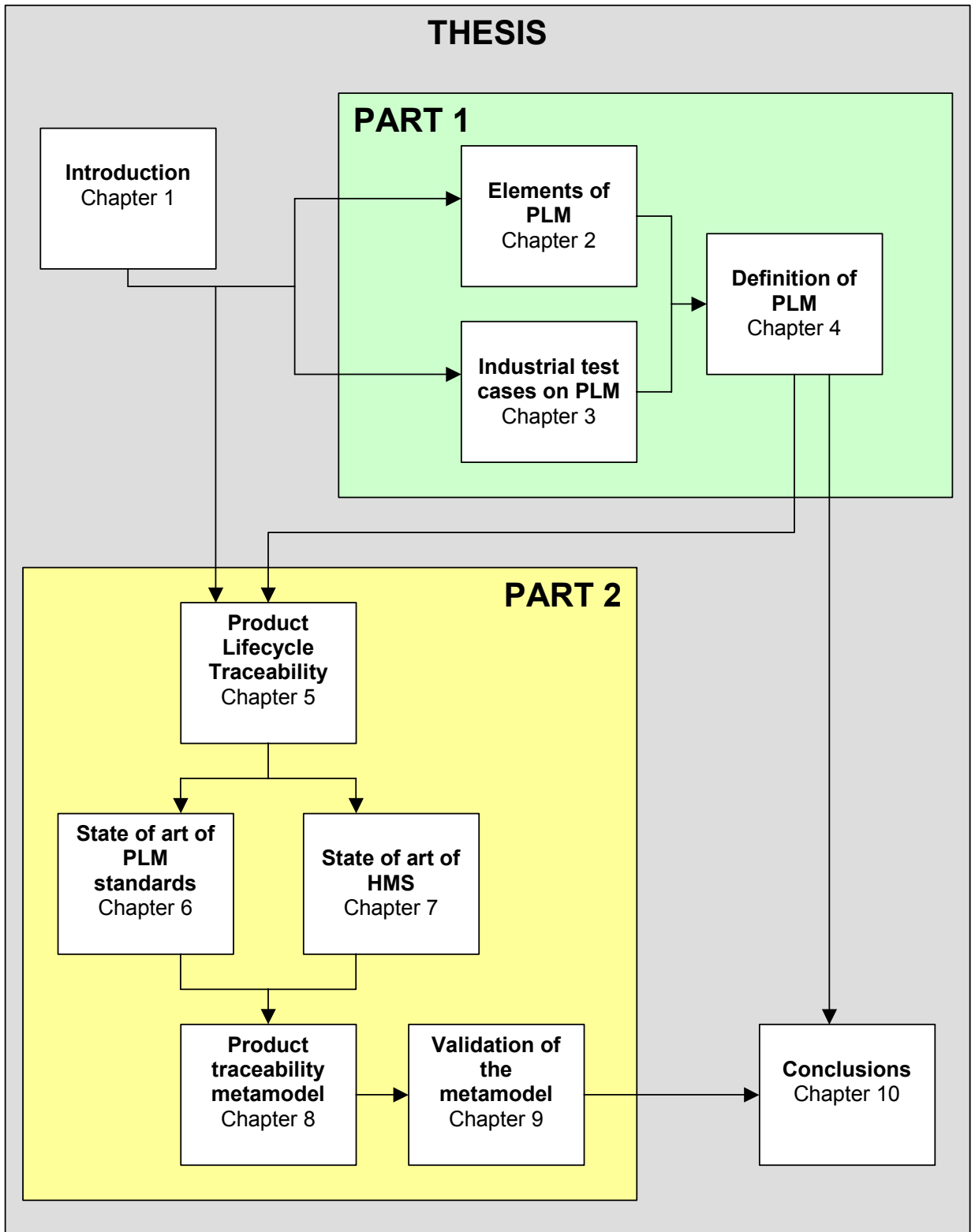

Figure 1.1 – Structure of the thesis

1.5 References of the chapter

Scientific references

- [1] Bititci U.S., (2002), Integrated Production Management in the 21st Century: A Vision and a Research Agenda, IFIP WG 5.7 Brussels Workshop
- [2] Cheng M.L., Simmons J. E. L., (1994), Traceability in manufacturing systems. International Journal of Operations and Production Management, 14, pp 4-16
- [3] McFarlane D., Sarma S., Chirn J.L., Wong C.Y., Ashton K., (2003), Auto-ID System and Intelligent Manufacturing Control, Engineering Application of Artificial Intelligence, 16, pp 365-376
- [4] Wyns J., (1999), Reference architecture for holonic manufacturing system, Ph.D. Thesis, Katholieke Universiteit Leuven

CHAPTER 2

Elements of PLM

2.1 Introduction

Within the globally scaled economy, markets are growing in a world-wide manner and customers are becoming more and more pretentious in terms of quality and delivery times, while the product itself is turning to something more complex than just physic good, but it is evermore a conjunction of such services and extra components.

All processes related to the product are growing themselves, constituting a complicated cycle, which starts from understanding markets, through product and process design, to operations and distribution management, exceeding the boundaries of the single enterprise.

All the activities performed along the “product line” must be coordinated and efficiently managed in order to gain revenues and reduce redundancies. For realizing such coordination, product engineering and manufacturing are becoming evermore-integrated processes, enabling the communication between all methods/tools/environments dispersed along themselves.

This new kind of integrating paradigm is already under deployment and a new acronym seems to be identified in Product Lifecycle Management. The tagged “PLM market” is becoming a worldwide experience and one of the few growing IT markets, while many ICT market vendors are moving into this world, proposing their PLM suites (e.g. UGS, IBM-Dassault, Tecnomatix, SAP, Baan). Looking to this market, it is clear as a variety of “solution-providers” aims to be considered:

- Vendors coming from the digital engineering world (UGS, Tecnomatix, IBM-Dassault), which start from NPD (New Product Development) and MES (Manufacturing Engineering System) processes and are trying to connect Enterprise Engineering and Management processes.
- Vendors coming from the ERP world (SAP, PTC), which, at the contrary, start from Enterprise Management processes for turning to connect NPD/MES tools and platforms.
- Vendors coming from the ICT world, which aim to establish such collaborative environments for PLM integration (Microsoft, MatrixOne, Agile), basically using web technologies.

In such a context, PLM is extrinsically an ICT related question and paradigm, even if, as demonstrated further, in a wider perspective its mean deals with a more comprehensive set of diverse elements. The present chapter aims to illustrate these main elements which compose the modern concept of PLM in the market.

In such a way, the chapter proposes a relevant dissertation on the predominant dimensions of PLM, starting at from a definition of product lifecycle, continuing with the analysis of the ICT elements and functionalities which compose PLM “suites”, and concluding with a definition of the processes involved under the PLM acronym (reported in an exhaustive way in a final reference model demanded to the annexes).

2.2 Product lifecycle phases

PLM is one of the newest acronym used in the ICT market by lot of vendors; many software developers are selling their PLM suites, even if they come from diverse backgrounds and provide diverse solutions.

Looking to the literature, PLM acronym has been used for the first time in the '70-'80ies years, in order to indicate studies of environmental compatibility designing and manufacturing: a product might be developed and produced according to its impact in the environment along each phases of its life cycle, until the dismissing and recycling (e.g. [1]).

At the end of '90ies, the PLM acronym has been extended from the environmental view to a more comprehensive mean, for indicating the management of all the activities related with the “product system” and its traceability [13] along diverse stages of its life cycle.

Generally, the “life cycle” term indicates the whole set of phases which could be recognized as independent “stages” that a product might follows, from (i) conceptualization, (ii) design, (iii) manufacturing planning, (iv) production, (v) distribution, (vi) use, (vii) dismissing and recycling (e.g. [2], [3]). It might be said that in literature, the identification of these product stages reveals at least two main domain of analysis: (i) the domain of product lifecycle phases in the market, and (ii) the domain of the product lifecycle phases which take into account the physical life of a product.

The first one is the well-know product lifecycle model which describes how a product “lives” in the market (figure 2.1) in terms of sold volumes and revenues (e.g. [3]).

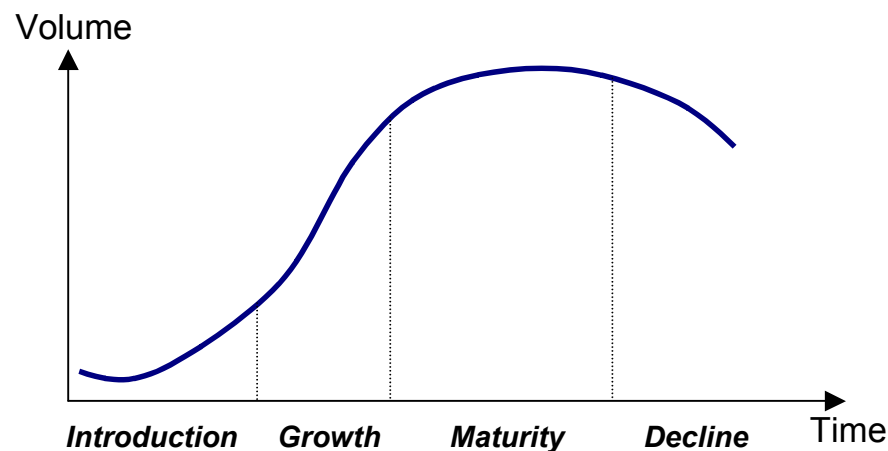

Figure 2.1 – Product lifecycle phases in the market

The same model is often used to describe how the cash flows (costs and profits) generated by a new product sold in the market are distributed (figure 2.2) [19].

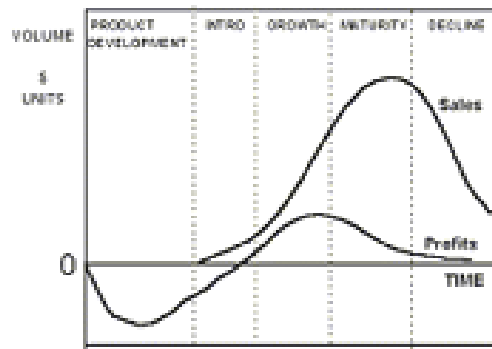

Figure 2.2 – Cost and profits along the market product lifecycle phases [19]

The relationship between the diverse business dimensions (profit, cost, marketing...) and product lifecycle phases in the market have been studied in detail by diverse authors (e.g. [3]) and they are well-know and accepted in industries. A summary of these relationship is illusrated in table 2.1.

	Lifecycle Phases			
Dimensions	Introduction	Growth	Maturity	Decline
Sales	Low	Sharply growing	Peak	Declining
Costs	Expensive for customers	Average for customers	Low for customers	Low for customers
Profits	Negative	Growing	High	Declining
Number of competitors	Small	Raising	Steady, starting to decrease	Decreasing
Customers	Innovators	First adopters	Majority	Delayers
Marketing objectives	Create product knowledge	Maximize market share	Maximize profits, defending market share	Reduce expenses

Table 2.1 – Business dimensions and product lifecycle phases in the market [3]

A second application of the terms “product lifecycle phase” which exist (and it is often used) in the day-by-day market deals with a diverse perspective. Generally, this second definition is often confused with the definition of processes distributed along the ideal product lifecycle phase (e.g. sub-processes of product concept, product design in the main process of product development – par. 2.4).

Diverse sources describe different product stages, which deal with the transformation and manipulation of the product idea and also with the physical components of a product. In such kind of models, product flow from the generation of its main idea and concept, to the production and realization, until the final customers. For example, STEP initiative [20] defines the reference model for product lifecycle phases depicted in figure 2.3, while diverse enterprises propose their reference model (e.g. [21]).

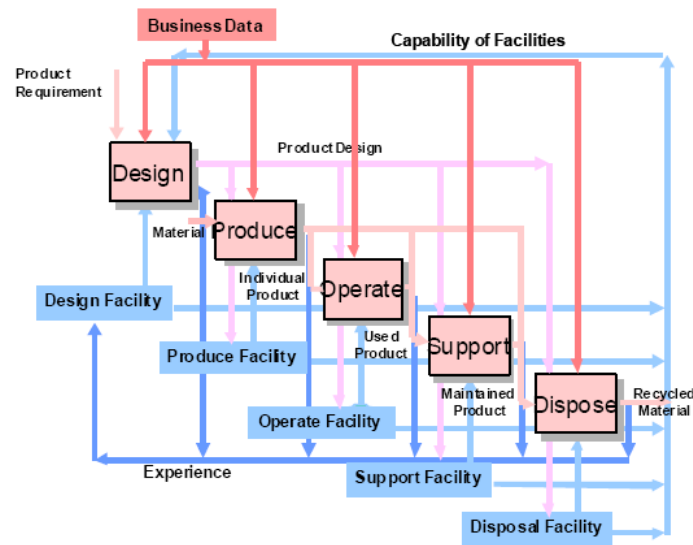

Figure 2.3 – STEP reference model for product lifecycle [20]

GERAM (Generalized Enterprise Reference Architecture and Methodology) initiative [22] and the new standard EN/ISO 19439 currently in development classify a sequence of activities in a complex system (business unit) life-cycle (figure 2.4). The different lifecycle phases define the types of activities which are pertinent during the life of the entity, lifecycle activities encompass all activities from inception to decommissioning (or end of life) of the enterprise or entity. Product lifecycle could be described with also with this model.

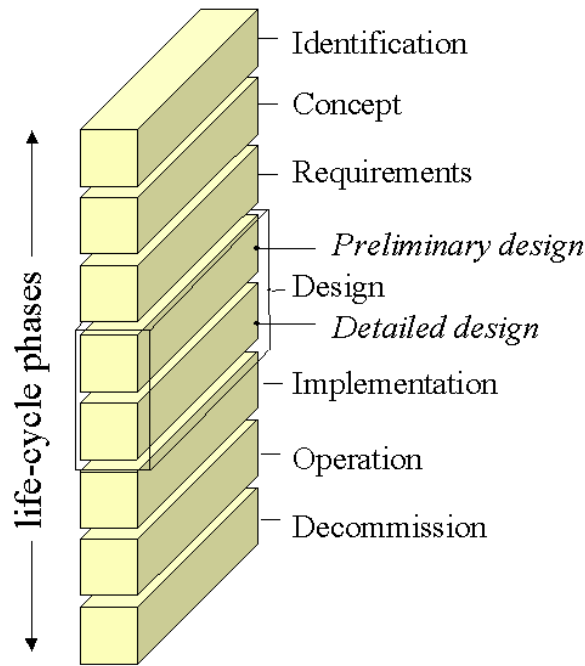

Figure 2.4 – GERAM lifecycle reference model [22]

GERAM defines the following main stages:

- *Research*: Searching, assessing and selecting technologies for use in product development.
- *Concept*: The set of activities that are needed to develop the concepts of the underlying entity. These concepts include the definition of the entity’s mission, vision, values, strategies, objectives, operational concepts, policies, business plans and so forth.
- *Requirements*: The activities needed to develop descriptions of operational requirements of the enterprise entity, its relevant processes and the collection of all their functional, behavioral, informational and capability needs. This description includes both service and manufacturing requirements and management and control requirements of the entity – no matter whether these will be satisfied by humans (individuals or organizational entities), or machinery (including manufacturing-, information-, control-, communication-, or any other technology).
- *Design*: The activities which support the specification of the entity with all of its components that satisfy the entity requirements. The

scope of design activities includes the design of all human tasks (tasks of individuals and of organizational entities), and all machine tasks concerned with the entity's customer services and products and the related management and control functions. The design of the operational processes includes the identification of the necessary information and resources (including manufacturing, information, communication, control or any other technology).

2.2.1 Product lifecycle reference model

Lots of definitions of product lifecycle exist. In order to have a unique understanding of such term, in the next chapters the thesis will refer to product lifecycle in terms of sequence of stages in the product life, not in the market. In particular, trying to merge diverse kinds of the described product lifecycle models, the following general product lifecycle model (figure 2.5) which will be considered in the thesis.

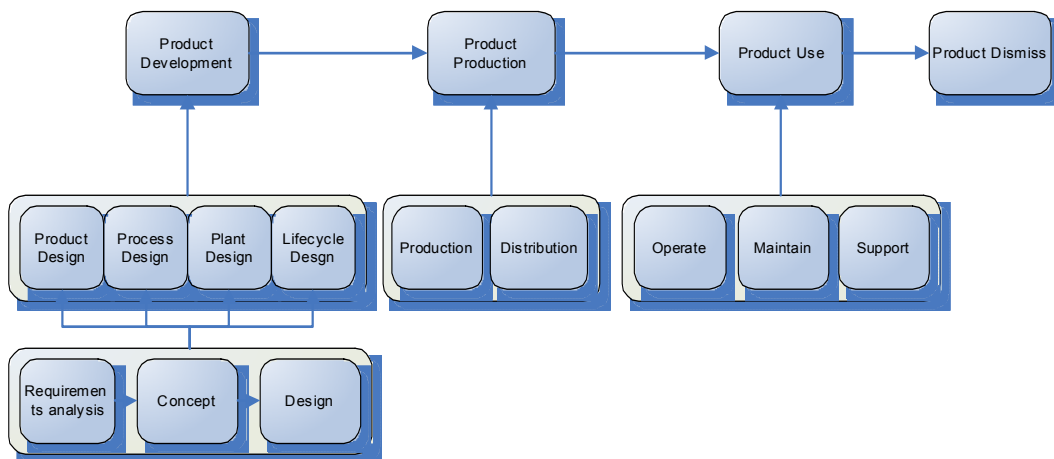

Figure 2.5 –Reference model for product lifecycle

This simple model aims to normalize a product lifecycle composed by four different phases:

- *Product Development*: it deals the developing phase of the product, starting from product design and ending, through process and plant design. Each of these four product development sub-phases usually starts from the requirements analysis (requested performances,

costs, marketing strategies and so on) and proceeds with a first draft for ending with the detailed design.

- *Product Production*: it comprises both production and distribution activities. Production phase may be very complex and often includes pre-production and prototyping, manufacturing, assembling, finishing, testing, packaging, etc. Distribution, on the other side, is related with product storage and delivery.
- *Product Use*: this is the proper product life phase and represents all activities which take place during product use: they comprise product usage and consumption, maintenance and support.
- *Product Dismiss*: in this last phase the product is destroyed, or rather disassembled and recycled.

This reference model will be used in the next paragraphs to classify diverse elements and aspects of PLM. It will be also adopted in the reference metamodel for product traceability in the second part of the thesis. The GERAM model will be also used because of its exhaustive declaration of stages; table 2.2 defines the relation between the proposed reference model and the GERAM one.

Reference model	GERAM Product Phases
Product Development	Research Concept Requirements Design
Product production	Implementation
Product Use	Operation
Product Dismiss	Decommission

Table 2.2 – Reference product lifecycle model and GERAM model

2.3 PLM ICT elements and functionalities

As mentioned, PLM is at a first approach an ICT problem. Indeed, PLM market is an ICT market, where lot of vendor are trying to survive. The present situation (and the same PLM concept) derives from an evolution of ICT which is currently on going, which is described in the present paragraph.

From the 70ies, enterprises have been disposed of several ICT systems, supporting more and more complex activities and processes. The growth of ICT adoption into enterprises has been suffered diverse accelerations: from the installation of minicomputers in the 80ies, to the revolution of Work Stations and Personal Computers in the 90ies, until the current revolution of the Internet era. All these revolutions have been supported several re-engineering of business processes; a clear example is the establishment of collaboration: organizational ideas like co-marketing, co-design, co-engineering, co-manufacturing, co-selling, which have been defined since the 80ies, would have been only theoretical exercises without the evolution provided by Internet-based ICT.

2.3.2 ICT evolution into the design processes

Looking to the main process of NPD, the design activities are supported by diverse ICT tools, which are in a continuous development and evolution. For example, in the area of product development, ICT tools supporting product engineers have been existing since more than 30 years and they are at their third generation: the first 2D Computer Aided Design (CAD) systems, introduced in the 70ies, were replaced in the 80ies by 3D CAD; the 90ies, because of the performed hardware innovation, have introduced more functional features, such as assembly supporting definition, or design path recording (e.g. [3], [4]). Nowadays, 3D technologies are assuming a relevant role: Digital Mock Up for product development provides to engineers the possibilities of a well-defined 3D simulation for stylistic, designing and also maintenance purposes. Other 3D approaches are currently under development and diffusion in the market, such as the functional approach (e.g. [23], [24]) or the most advanced Knowledge Based Engineering systems (KBE) [25], which automate sophisticated designing procedures. CAD systems can ever more communicate with other CAx tools, such as Computer Aided Styling systems (CAS) and Computer Aided Manufacturing systems (CAM), which automate NC (Numerical Control) machine programs generation. This

path to integration has been supported by the development of international standards, such as STEP [6] and IGES [8] (see also Chapter 6).

Something similar has been happened in the area of manufacturing planning: since the '70ies, several ICT tools for Computer Aided Process Planning (CAPP) have been appeared for supporting engineers in the definition of manufacturing plans. CAPP tools have evolved from simple approaches to more complicated ones [9]. In recent years, CAPP tools have being developed in distributed and collaborative environments, evolving from standalone applications in more sophisticated CAPP platforms, where engineers, coming from diverse departments and enterprises, could cooperate for developing coordinated manufacturing planning solutions (e.g. [10], [11], [12]).

Also the world of factory design and planning has been subjected to such kind of evolution; single and separated ICT tools adopted by engineers for plant layout designing, planning and simulation have been replaced by more integrated platforms and tools, connected also with other CAx systems (e.g. [24], [35]).

In the last years, many tools which enable information sharing between engineers in distributed environments appeared, under a lot of diverse names and acronyms: EDM (Engineering Data Management), PDM (Product Data Management), PIM (Product Information Management), TDM (Technical Data Management), eBOP (Electronic Bill of Processes) [26] to name a few. All these systems, generally defined as Document Management (DM) tools [27], are physically based on a central database, where there are provided central services (vault) for managing design data (product, plan, plant design), such as access rights control and design release management. These stored data are Bill of Materials (BOM), Bill of Resources (BOR), Bill of Processes (BOP), CAx files, manuals, guidelines, spread sheets files... Especially because of the evolution of these DM systems and also because of the evolution of diverse interoperability standards ([26], [27]), a large integration between IT tools of the area of design process is under development; this integration is

currently defined as Digital Manufacturing and Engineering ([28], [30]), which indicates how the whole Design Process, composed by Product Development, Manufacturing Planning and Factory Planning, could be realized using an integrated platform where engineers could cooperate, sensibly reducing the development time. Internet-oriented technologies are the key-success factors, fostering integration of software and hardware platforms, in particular because of their independent protocols (e.g. XML, eXtensible Markup Language [29], [31]).

2.3.3 ICT evolution into the operation management processes

Something similar happened in the area of ICT tools supporting production and distribution management (generally operation management) and related activities. As it is well known and accepted, the first operation activities supported by IT tools have been the production activities, where, since the end of 70ies, have been developed lot of ICT systems such as MRP (Material Requirements Planning), evolved in MRPII and CRP (Capacity Requirement Planning), and larger ERP tools (Enterprise Resource Planning), which integrate and support a lot of activities, such as financing, accounting, inventory management. Expensive costs of technological solutions available until the early '90ies (based on EDI – Electronic Data Interchange), have often decelerated these integrated ICT tools, in particular into SMEs (Small and Medium Enterprise). An inverse route, with an improvement on the diffusion of integrated ICT tools for operation management has been started with the adoption of Internet-based resources (e.g. TCP/IP protocol, or platform-independent languages such as HTML).

Moreover, with the evolution of the markets and relative outsourcing trends, new ICT tools appeared: tools of Supply Chain Management (SCM) for improving relations with suppliers, tools of Customer Relationship Management (CRM) for managing customers and their requests, tools such as Advanced Planning Systems (APS) for improving

single and multi sites production scheduling, IT tools for automating, controlling and integrating manufacturing processes with upper level systems (MES - Manufacturing Execution System).

At the present, all these kind of tools are under consolidation into larger distributed ICT platforms for the operation management processes of large international companies, constituting integrated expensive software suites. At the same time and at a cheaper cost, Internet is providing a good way for all related actions of B2B (Business-to-business) and B2C (Business-to-consumer).

2.3.4 ICT evolution into the supporting processes

The reported ICT evolutions derive intrinsically from the evolution of more basic tools. At first, with the diffusion of process orientation into enterprises, lot of instruments and tools for Business Process Automation (BPA) [27] (also defined as Work-flow Management systems - WFM) have been developed in the last ten years. These tools automate business processes improving speediness and agility in offices repetitive activities; a WFM system is physically a tool for managing information and documents (DM) based on a common repository, where access-safe rights are defined for diverse users, and where repetitive “secretarial” activities are automated using standardized electronic communications (e.g. accounting department in Ford [27]). These systems are the core elements of all the DM tools, such as PDM, EDM and TDM adopted into design processes, but also of SCM and CRM distributed systems. At second, another important evolution might be traced in the area of Project Management techniques (PM). Aboriginal developed as standalone tools, PM tools are nowadays assuming a relevant role into distributed ICT platforms and are integrated as basic techniques for managing processes and tools both of Digital Manufacturing/Engineering (e.g. [24], [35]), and Operation Management [32]. Internet offered a relevant contribution to the development of such basic tools, providing cheap services such as electronic mail and platform-independent languages, but also video and

phone streaming conference. WFM systems, at first developed into expensive EDI networks, are nowadays easily accessible at a cheaper cost on Internet (e.g. [33], [34]), also integrating mobile platforms, such as PDA (Personal Digital Assistant, e.g. Palm, Pocket-Pc), GPRS and mobile phones [36]. Also PM techniques are implemented at a low cost into Internet based tools, providing new uses and users (e.g. [37]).

ICT tools in the product lifecycle

Table 2.3 shows how ICT tools are dispersed along the product lifecycle, summarizing the current status of the above illustrated evolution.

Product phase	ICT Tools
Product Development	CAD
	CAPP
	CAM
	CAE
	DMU
	EDM
	PDM
	WFM
Product production and distribution	ERP
	MRP
	SCM
Product Use	CRM

Table 2.3 – Reference product lifecycle model and ICT tools

The evolution of enterprise ICT tools is characterized by an increasing need for integration and interoperability into and between tools and supported processes, both in design and management activities, automating critical information flows. At the present, these integration trends are overstepping the boundaries of design and operation applications [7] and new more integrated issues are coming out. In particular, there are some information flows which are ever more assuming a critical role into the modern context, where no more “manual” transactions could be supported. Data coming from the design process might be evermore connected and reported to operation management

tools, such as ERP and CRP, and also vice-versa. This way, a variegated and blooming market is coming out in the enterprise ICT market. Lot of vendors, coming from the area of Digital Manufacturing (e.g. [26], [35]) and from the area of Operation Management (e.g. ERP vendors, such as [32], [38], [39]) are providing and selling “integrated” legacy solutions for satisfying more complicated needs. This integration is supported by the establishment of WFM and DM systems, often produced by others vendors (e.g. [37]), or developed inside (e.g. [26], [35]). These systems adopt PM techniques, such as task and responsibility allocations, and physically establishing the communication and the integration between the diverse tools and processes.

2.3.5 Main PLM ICT functionalities

The diverse ICT tools implement a series of relevant functionalities, in fact, PLM encompasses numerous constituencies, including engineering, manufacturing, sales and marketing; according to [28] and [40], the main functionalities of PLM can be identified in the following: Product Portfolio Management, Customer Needs Management, Direct Materials Sourcing, Product Data Management, and Collaborative Product Design.

Product Portfolio Management (PPM) asks for capability to monitor multiple product development programs, with access to financial employee performance information, milestone status, marketing and pricing information, and project risk assessment. PPM is a coordinating capability that manages the lifecycle of products or services throughout a supply chain. Generally this component distinguishes collaboration from product lifecycle management; its key features include:

- A project management tool which is often used for managing the introduction of new products. This element is supported by a resource, financial and schedule tracking.
- A program management capability that monitors and controls several projects simultaneously.

- A portfolio management tool that allows an organization to manage the life cycle of numerous products to optimal financial effect. This feature monitors and reviews the profitability of a portfolio of products during their respective lifecycles. Furthermore, it will also indicate when products/ services should be terminated/ introduced to ensure the optimal portfolio.

Customer Needs Management focuses on the capability to capture customer requirements and assess the ability to design and manufacture a product at a profitable price. From a customer perspective there is much to be gained. The key areas of functionality are:

- A depository that allows key customer requirements to be captured. As soon as data and information are obtained, it can be immediately digested to enable an organization to be more agile and flexible in its product or service offering.
- Further to above, information can be directly stored from point of sale (POS) analytics and web based market testing tools.
- This information can be shared within the whole organization and suppliers to support effective decision making. This is particularly important for those working within new product development/ introduction that are expected to be responsive to changes in the market.

Development engineering plays a strong role in the early sourcing of direct materials, both for new product development as well as for continuous improvement to existing products through value engineering. These modules support the sourcing process with *Request for Quotation* (RFQ), bid analysis, sharing of drawings, and design collaboration. The Direct Materials Sourcing (DMS) component allows organizations to collaborate further and to reduce direct costs:

- The functionality to interrogate different systems with the aim of identifying existing components that could be used to support new designs rather than proliferating further the number of new components being introduced.

- The capability to rationalize the existing range irrespective of new component introduction.
- A capability to visualize components/items for purchase from within a supplier's internal system, which may still be under development.
- A document management system to store and manage specifications and to notify any changes, via email, to the interested stakeholders.

Product Data Management (PDM) is a foundation for the broader application of PLM and can be considered as being the core element of collaborative PLM solutions. It is concerned with integrating data, material masters and part numbers across the organization from different systems. It is the hub of an integrated collaborative solution that links different systems together. This component effectively lays the foundation for full integration across the organization. The major differentiators include the ability to control engineering data with strong Configuration Management, Engineering Change Management (ECM), and the ability to search and navigate through a product structure to associated information.

Collaborative Product Design (CPD) focuses on the interactive design process, sharing designs with trading partners, navigating to related information from the design, and importing design changes. The main elements of CPD are:

- The ability to visualize objects/drawings over the internet, particularly engineering drawings.
- The ease of integrating computer aided design (CAD) and computer aided manufacturing (CAM) solutions with a potential partner's CAD/CAM solutions.
- Workspaces where partners can deposit, exchange and share information.
- A fully auditable change control process. This would allow any design changes made to drawings or documents to be traced to the individual who made the change.

Other PLM components, such as Production Process Planning, Market Launch, and Aftermarket Service and Support, are considered at a much

lesser degree than the core five NPD-related categories. Table 2.4 summarizes the main functionalities (and sub-functionalities, defined as functions in the next par.) distributed along the product lifecycle.

Product Phases	Functionalities
Product Development	Product Definition
	Product Configuration
	Bill of X Management
	Change Management
	Project and Process Management
	Document Management
	Manufacturing Process Engineering & Management
	Authoring and Analysis Tools
Product production	Part & Classification Management
	Bill of X Management
	Change Management
	Project and Process Management
	Manufacturing Process Engineering & Management
Product Use	Bill of X Management
	Change Management
	Project and Process Management

Table 2.4 – Functionalities along the product lifecycle

2.3.6 PLM ICT foundations

To support all the presented functionalities, the PLM systems need a basic set of functions. The major components include a set of foundation technologies that support a set of core functions that in turn, support applications and focused business solutions. The following definition derives from the well-accepted reference model of PLM suites, defined by CIMData [41] (figure 2.6).



CIMdata's World-Class PLM Model

Figure 2.6 – PLM core functions [41]

Foundation technologies

According to [41], the main “technologies” of PLM suites could be identified in the following:

- Communication and notification. Users of PLM systems can automatically be notified of critical events concerning the current state of the project or product. E-mail is used to notify people about important events or required actions. PLM minimizes the delays caused by misplaced communication, with functionalities used to spawn notifications and other actions automatically. To support geographically distributed project and supplier teams, the PLM infrastructure must be able to streamline communications between all the participants, regardless of geographic location or time zone. These days, the web and web-based applications provide the data communications infrastructure and user interface for easy and secure data gathering and sharing. Subscribe functionality allows users to subscribe to a folder or hierarchy of folders on your site. Subscribers receive automatic e-mail notifications of changes, additions, or deletions.

- Data transport. Users do not need to know where the data is stored while the system keeps tracks of the data location and allows users to access it knowing only the name of data. The DBMS must be relational and object-oriented enough to capture and manage the vast variety of data types, properties, behaviors, and relationships of data that exist in an enterprise. These include not only the obvious initial documentation - BOMs and material specifications, CAD drawings, numerical control (NC) programs, work instructions/process plans - but also the data that comes from downstream processes, such as change notices, quality reports, audit files, office documents, anything that can be put into electronic format. Such a DBMS must also feature sophisticated change control, effectively management, database security, data synchronization, and database administrator-specific tools.
- Data translation. Data translators can be pre-defined to convert data between different applications and to formats for various display and output devices. Triggers can do these data translations automatically. The CAD integration issue seems to be a matter less of traditional integration architecture, since XML and a wide set of industry messaging standards are supported by most vendors, and more a problem with geometry kernels. Some users complain about the need to re-master or otherwise repair CAD files that have been transferred, but this is not something the PLM vendors can address. Industry standards for geometry and feature detail, including VRML, IGES, STEP, have long been evolving and steadily improving user access to design information, but the long-elusive common kernel remains beyond the rainbow. It is a business issue, with CAD vendors basically holding onto installed base customers with proprietary kernels. Integration to ERP systems for major points of data exchange, like BOM, material master, and parts lists, is supported with a variety of standard adapters and a list of pre-built integrations that is constantly growing.

- Visualization. Visualization tools let users anywhere in product development, manufacturing, and the supply chain display, share and communicate non-contextual information, see and modify product and process designs without having the authoring tools that created those designs. With the advances of 3D-CAD technologies, DMU replaces the need for building physical prototypes (or at least allow designers to inexpensively build many generations of digital mock-ups before building the final physical one). The ability to do so, allows designers to test problems of interference between components and modules early on and correct them at low cost. Visualization utilities include viewers that can display the vast variety of design files, from basic PDF displays to document displays to photo renderings to dynamic simulations. Along with that should be multiple user redlining options, enhanced printing and manipulation tools, including sectioning, mass properties, measurements, bird's eye, and more.
- Collaboration. Collaboration requires a higher form of information processing and exchanging. IT tools, in this regard, allow blending and brokering of collaborative contributions throughout the network of design chain partners by facilitating “rich” communication, instead of mere information exchanges. The evolution of B2B exchanges from initially brokering simple buy/sell transactions to offering value-added services by establishing “platforms” for collaboration is a case in point. This evolution represents the shift from supply chain management (i.e. information sharing), to design chain management (i.e. collaboration).
- Enterprise Application Integration (EAI). EAI allows information and processes to be shared with other enterprise applications and includes technologies that enable business processes and data to communicate to one another across applications and networks within an extended enterprise. To ensure data interoperability between the PLM system and the rest of the enterprise, EAI technologies within the PLM system must support the broad range of “open standards” defined for hardware, software, and data interoperability (see chapter 7). PLM

integration should include the semantics to synchronize structured, semi-structured, and unstructured information across applications; the mapping between high-level processes and individual applications; and the ability to present this information through some user interface or portal. However, this is currently a research topics not yet matured.

- **System administration.** The administrator sets up the operational parameters of the PLM system and monitors its performance. Administrative functions include access and change permissions, authorizations, approval procedures, data back-up and security, and data archive.

Core functions

Functionalities are realized in PLM tools adopting foundation technologies which implement core functions. Completing the concept expressed in [41], it is possible to group the core functions of PLM as follows:

- **Authoring tools.** The label in figure 2.6 “information authoring tools” stays for CAx applications ranging from mechanical and electronic CAD, to computer-aided software engineering (CASE), to technical publishing (e.g, office suites).
- **Data vault and document management.** These functions provide secure storage and retrieval of product definition information. On an integrated system the creators, approvers, and consumers of business documents work together over the entire document lifecycle, from creation down to the distribution of the final version. To work efficiently in all kinds of business processes, such as project management, R&D, production, and service, a comprehensive document management system is a necessity. On top of that, version control and the integration of document management with ECM are essential to support secure change processes under formal control. Finally, status-based workflows can speed up processes significantly. If people use documents frequently, they want to be notified as soon as changes to

the documents occur or a new version of the document is available. This requires comprehensive document distribution capabilities. Event-triggered notifications are sent electronically to all internal and external users who are registered on the distribution list, which often replaces time-consuming, paper-based distribution processes.

- **Engineering Change Management.** Changes are part of the everyday business of modern manufacturing enterprises. Changes are result of changing markets, customer requirements, technical issues or the use of new materials. For whatever reason changes take place, they usually involve various activities before and afterwards that require systematic change management. Engineering Change Management refers to the process of managing how an item is built. It is controlled by a function that assures that the process of product evolution is done smoothly and with proper authorization. The result is an efficient management of engineering changes for the extended enterprise, which provides significant value potential especially in the areas of reduced cycle times and increased customer satisfaction. The key challenge is to integrate the change across the enterprise and the value chain such that revisions to key component or ingredient materials coincide with the timing of the change, whether the change is triggered by a specified date or based on the consumption of existing inventory of materials. This requires that planning, production, purchasing, and others execute the change in a synchronized, staged process to avoid obsolescing materials. In addition to internal coordination, there is an increasing requirement to keep supply chain partners informed on a real-time basis. A key requirement for ECM is the approval and notification process. The approval process is covered under the Routing/Approval section within the Project/Process Management portion. ECM is one of the key processes in the PLM area for several reasons: (i) the history of objects, such as documents or BOMs has to be stored, (ii) changes should only be effective under defined conditions, (iii) the change process has to be documented, (iv)

the consistency of products can only be guaranteed if we use a formal and controlled change process, (v) all people affected (including data consumers) have to be involved into the change process.

- **Item/Parts Management (Classification).** Parts management is a primary building block of PDM. Parts represent discrete items, bulk materials such as liquids and gasses, packaging, and packaged items (among others). Parts or materials represent the physical materials themselves, and are associated with products that are the commercial representation of the material that is to be bought or sold. Parts include standard parts, purchased parts, proprietary parts, and versions of existing parts. Classification allows similar or standard parts, processes, and other design information to be grouped by common attributes and retrieved for use in products. Information of similar types should be capable of being grouped together in named classes. More detailed classification would be possible by using “attributes” to describe the essential characteristics of each component in a given class. Components will be entered in the database under a variety of classes that suit your business needs. Classes themselves can be grouped together under convenient broad headings. This allows all your company’s working stock of components to be organized in an easily traceable hierarchical network structure. This leads to greater product standardization, reduced redesign, savings in purchasing and fabrication, and less reinvention of the wheel. Documents relating to components and assemblies can be similarly classified; e.g. classes might be “drawings”, “3D models”, “Technical publications”, “Spread Sheet Files”. Each document can have its set of attributes - part, number, author, date entered. And, at the same time relationships between documents and the components themselves can be maintained. So, e.g. a dossier for a specific “bearing assembly” could be extracted, containing 2D drawings, solid models, and FEA files. PDM systems vary greatly in their classification capability. Some have none. Others support the ability to define a classification only at the

time when the database is implemented. More recent PDM systems have provided a capability that can be defined and modified at will as the demands of the organization change.

- **Product structure management.** The foundation of any manufacturing system is its product definition function. Product structures are defined, usually on a multi-level basis, along with the instructions for how to build the manufactured item. Bill of Material defines the products that company produces. Bill of Material Structure screen provides for a multi-level view of your product structure, along with component, inventory, and item site quantity information for each component and subassembly on the bill. Before an item can be assembled or manufactured, any good manufacturing system needs to know what items are used in the manufacturing process and what quantities are required, adjusted by designated scrap factors. Manufactured items are frequently built in a multi-level way. Single-level bills may be nested in any order to define a multi-level bill, thereby facilitating the documentation and cost rollup process. If desired, a unique Bill of Material may be maintained for each site defined in your Inventory system. The product structure management function provides customized views of product information for different users, enabled to define, compare and manage different product views e.g. As-Design; As-Manufactured; As-Build. Generally, it also support the transfer of product structure and other data between PDM and ERP.
- **Workflow management.** Workflow is the technology that gets people interacting with information. Workflow automatically routes work from one stage to the next, initiates actions, tracks project status, expedites engineering changes, moves financial decisions along, and provides relevant data to those who need it. The workflow engine is usually able of guiding users through the process of creating and modifying workflows, including defining workflow participants, business objects to be distributed, trigger events, roles, and decision trees. Workflow management systems normally have three broad functions: (i) they

manage what happens to the data when someone works on it. (“Work Management”), (ii) they manage the flow of data between people. (“Workflow Management”), they keep track of all the events and movements that happen in functions 1 and 2 during the history of a project. (“Work History Management”). PLM systems vary widely in how they perform these functions. The following is a broad overview.

- Work Management. Engineers create and change data for a living. The act of designing something is exactly that. A solid model, for example, may go through hundreds of design changes during the course of development, each involving far-reaching modifications to the underlying engineering data. Often the engineer will wish simply to explore a particular approach, later abandoning it in favor of a previous version. A PLM system offers a solution by acting as the engineer’s working environment, meticulously capturing all new and changed data as it is generated, maintaining a record of which version it is, recalling it on demand and effectively keeping track of the engineer’s every move. Of course, when an engineer is asked to carry out a design modification, he or she will normally require more than just the original design and the Engineering Change Order (ECO). Many documents, files and forms may need to be referred to and other members of the design team involved, too. PLM systems offers the ability to connect various pieces of information into a process, allowing these pieces to be accessed and utilized in context, without changing their original source, so to build virtual documents, folding many discrete pieces of content into single information composite.
- Workflow Management. During the development of a product, many thousands of parts may need to be designed. For each part, files need to be created, modified, viewed, checked and approved by many different people, perhaps several times over. Work on any of these master files will have a potential impact on

other related files. Therefore, there needs to be continuous cross checking, modification, resubmission and rechecking. Most PLM systems allow the project leader to control the progress of the project via “states” using pre-determined “triggers” and a routing list that may vary according to what type of organization or development project is involved. The most rigid systems are based on procedures. Every individual or group of individuals is made to represent a state in a procedure - “Initiated”, “Submitted”, “Checked”, “Approved”, “Released”; a file or record cannot move from one individual or group to the next without changing states. Some systems make it possible to give the task an identity of its own, separate from the people working on it. Communication within the development team is enhanced too. When packets of data and files are passed around, they can be accompanied by instructions, notes and comments. Some systems have “redlining” capability; others even have provision for informally annotating files with the electronic equivalent of “post-it” notes. A packet represents one task in a product development project that may consist of many thousands. Each packet follows its own route through the system but the relationship between packets also needs to be controlled.

- Work History Management. PLM systems should not just keep comprehensive database records of the current state of the project; they should also record the states the project has been through. This means that they are a potentially valuable source of audit trail data. The ability to perform regular process audits is a fundamental requirement for conformance to international quality management standards such as ISO 9000. However, project history management is also important to allow to “back-track” to specific points in a project’s development where a problem arose, or from which you may wish to now start a new

line of development. What specific development milestones the system records are important. Some systems provide an historic record by allowing you to record changes to any system-defined level you choose - for example, every time a modified file is saved. This level of historical tracking, as well as providing comprehensive auditing, also permits the active monitoring of individual performance - invaluable during time-critical projects.

- Program management. Program management might seem peripheral to PLM, but it has everything to do with product lifecycle and management itself: program and project management functions within PLM establish a work breakdown structure (a hierarchy of tasks and sub-tasks) to complete a program/project. This is not workflow; this functionality involves critical path analysis, costing and budget management, progress tracking, human resources, and a host of fundamental business processes. Program management coordinates the framework of the project that deliver product to market. It provides work breakdown structures (WBS) and allows resource scheduling and project tracking. Program management also provides the ability to relate WBS tasks to the PDM systems knowledge of approval and product configurations. Tasks that are required to complete the project are ordered within work breakdown structures, which can also be grouped into hierarchical structures of dependencies. This provides a convenient way to allocate resources and track the projects progress. When the project advances from task to task, actual used resources are recorded against the plan. Completion of activities for each task is tracked and reported through the approval process.
- Process Planning. Process planning translates design information into the process steps and instructions to efficiently and effectively manufacture products. As the design process is supported by many computer-aided tools, computer-aided process planning (CAPP) has evolved to simplify and improve process planning and achieve more effective use of manufacturing resources. CAPP helps optimize and

validate manufacturing operations, rooting out inefficiencies in production sequencing and production equipment. CAPP feeds into factory modeling and simulation, and ultimately into the selection of capital equipment. Incorporated within CAPP is group technology for classifying, searching, and managing the attributes of parts, processes, and tooling. Additional CAPP tools might be necessary to address industry-specific tasks. For example, automotive body-in-white assembly planning requires specific functionality, such as matching weld points to operation/station assignment. CAPP search capabilities, to pick one function, are not just the province of design or manufacturing certain product classifications for example, are relevant to purchasing, as well as the software tools to view designs (in 2D and 3D) and disclose characteristics (size, material, manufacturing process).

- Simulation. PLM-based simulations let users dynamically analyze all the part and process data contained in the PLM system. Simulation lets designers and engineers see products in action, and how they are produced and assembled. PLM users can access the appropriate data to try out different designs and production alternatives to optimize product designs (what the customer is buying) and production processes (how the enterprise is making what the customer is buying). Simulation systems can focus on piece parts, finished products, specific production operations (such as stamping operations or tool management), or full-factory modeling system (including the factory layout and the interactions of material and part movements, production equipment and assembly operations, and people).

2.4 Processes in the Product Lifecycle Management

As well defined by Porter [14], enterprise is a set of activities connected each others, which are oriented towards the same goal: creating value. This value derives from the maximization of revenues and the minimization of costs and all inefficiencies hide into the organizations. During the '80ies, looking to this research of value, enterprises spent lot of

efforts in cost reductions and productivity enlargement, in particular installing a deep automation of the factory. After the '90ies, the new worldwide scenario has been improved in complexity: customers are becoming more and more pretentious in terms of product quality and related services, while the market competitiveness is increasing in a world-wide way. Enterprises have to create their value adopting new strategies, looking for a continuous improving of innovation of products, processes, production systems and organization structures, trying to reduce time-to-market and time-to-right of their products and projects. Consequently, enterprises are dismissing the competences considered as not-core (not able to improve value), improving the collaboration with their partner outsides, suppliers and customers.

This way, enterprises have to re-engineer their structures, looking to a re-orientation of their basic business processes. Generally, a business process is a set of coordinated activities, which are distributed among different functions and departments, oriented to the creation of value of the enterprise system [42]. Physically, the enterprise value derives from the product/artefact/service that the enterprise generates and sells, obtaining revenues in the market. So, the main process that manages this creation is the most important process of the enterprise. The definition of this main process is strictly related to the enterprise ontology:

- In the area of manufacturing (e.g. automotive, textile...), this process is actually defined by two sub-processes: the New Product Development (NPD) process and the more general production and distribution process (Enterprise Operation Management). The first involves all activities that deal with the design and implementation of the productive capacity, while the second involves all needed activities for managing production, transportation, and distribution, until after sales services.
- In enterprises defined as Engineering&Contracting (e.g. construction, naval industries), the main process responsible of the value-creation starts with engineering and budgeting definition activities, thorough the

procurement of subcomponents and contractors, to the physical construction and installation on the field (EPC - Engineering Procurement Construction organizations).

- In service companies (e.g. [49]), the enterprise value is created along the activities of service design, service provision and its maintenance.

This currently on-going business process re-engineering activity is extrinsically connected, by one hand, with the identification and empowerment of the enterprise core competences (and consequent outsourcing of not-core competences) and, by the other hand, with the establishment of a collaborative attitude between functions and departments, both inside and outside the enterprise. Obviously, all these changes, currently on-going into modern enterprises, could be realized only thank to the adoption of the newest ICT., as defined in the previous paragraph

The definition of stages and problems related with PLM depends by the kind of the “product system”:

- into manufacturing enterprises, PLM deals with the single physical product (artifact), which is designed and engineered, produced into ad hoc production systems, distributed in a detailed chain and, finally, dismissed and recycled;
- into EPC enterprises, PLM deals with the design of a complex product (e.g. a chemical plant, or a navy), its installation on field (e.g. in a yard) and its maintenance and management;
- in the world of services, PLM deals with the concept of the service to be offered, the design of the infrastructure needed for providing such kind of service and with its improvement and maintenance.

What these “product systems” have in common for the PLM vision is the need of the management of a large amount of product related data that are generated in the various phases of the product lifecycle. This need is more and more emphasized by the presence of many cooperating companies.

In terms of processes, PLM encompasses a series of them, depending by the level of application/implementation. It might be said that a general definition of business process is a difficult task. In effect, in literature exist a lot contributions in such a way. One of the most important initiative is the project ENAPS (European Network for Advanced Performance Studies) [15]. The objective of this concluded project was to develop a generic set of processes and related performance measures to be used in enterprise benchmarking. This set of performance measures might allow enterprises to view performance measurement data from other enterprises all over Europe and to see their relative position on a league table of performance results. ENAPS identifies four relevant business processes (figure 2.7). Another important initiative, which is currently at an early stage, is the VCOR (Value Chain Operations Reference model, [43]). VCOR aims to enlarge the well-known and accepted SCOR (supply Chain Operations reference model) initiative, providing an international reference model for business processed which take into account also the NPD main stream (figure 2.8). The VCOR model consists of 3 process levels. Level 1 consists of Plan, Market, Research, Develop, Sell, Source, Make, Deliver, Support and Return value chain process categories (Figure 2.8). The model is defined in successive levels of detail at Levels 2 and 3. Level 4, not defined in this project, are where company specific implementation occurs. At each appropriate level, VCOR aims to provide the following information: (i) Standard Process Descriptions, (ii) Best Practices, (iii) Metrics, (iv) Inputs / Outputs.

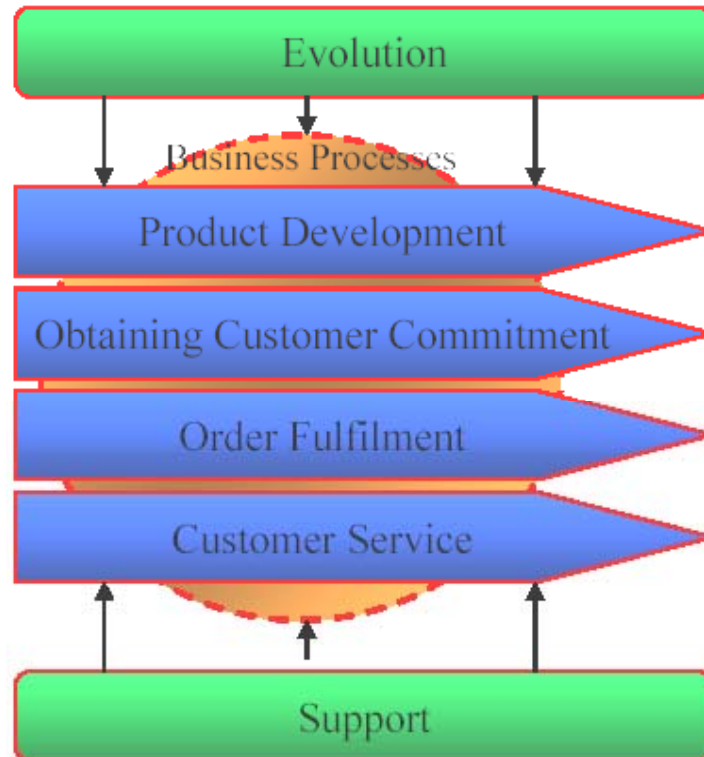

Figure 2.7 – ENAPS reference framework [15]

Plan		Enable						
Execute								
Market	Research	Develop	Source	Make	Sell	Deliver	Support	Return
K1 Analyze Market	C1 Define Opportunities	V1 Define Product Req	S1 Identify Source	M1 Finalize Eng	L1 Target Customers	D1 Process Inquiry	U1 Register User	R1 Identify Return
K2 Analyze Performance	C2 Forecast Technology	V2 Select Technology	S2 Source Negotiation	M2 Schedule Production	L2 Quality Target	D2 Negotiate Contract	U2 Manage Incidents	R2 Disposition Return
K3 Define Needs	C3 Acquire Technology	V3 Design Product	S3 Schedule Delivery	M3 Issue Material	L3 Position Solution	D3 Enter Order	U3 Resolve Problems	R3 Request RGA
K4 Solution Ideation	C4 Define Technology	V4 Optimize Processes	S4 Receive Product	M4 Produce & Test	L4 Develop Relationship	D4 Receive Depot	U4 Educate Users	R4 Schedule Return
K5 Business Case	C5 Validate Technology	V5 Validate Product	S5 Verify Receipt	M5 Package	L5 Assess Needs	D5 Pick Product	U5 Deliver Services	R5 Authorize Return
K6 Validate Opportunity	C6 Protect Technology	V6 Define Life Cycle	S6 Transfer Product	M6 Stage Product	L6 Develop Proposal	D6 Ship Product	U6 Monitor Experience	R6 Receive Return
K7 Create Roadmap	C7 Transfer Technology	V7 Launch Product	S7 Authorize Payment	M7 Release Product	L7 Present Proposal	D7 Verify Receipt		R7 Verify Condition
K8 Create Market Plan	C8 Launch Technology				L8 Finalize Contract	D8 Install & Test		R8 Transfer Return
					L9 Win / Loss Review	D9 Invoice		R9 Replace or Credit
								R10 Dispose or Recover

VCOR
VALUE CHAIN OPERATIONS REFERENCE MODEL
PLUS!
REV:0 VERSION:0

Figure 2.8 – VCOR reference framework [43]

Also the author tried to elaborate a personal reference model, a first proposal, which is not realistically important for the main contribution of the thesis, is attached in annex 1.

Table 2.5 summarizes the business processes (using the ENAPS quotations [15]) along the diverse identified product lifecycle (PLC) phases.

Product Phases	Process/es
Product Development	R & D, technologies research Idea definition Obtaining Customer commitment Market analysis and development Product development New product introduction Product research Product detailed engineering & design Process planning, engineering & design Factory planning & design
Product production	Order fulfilment Procurement & inbound logistic Production planning & control Distribution & outbound logistic Order processing Sales
Product Use	Customer service Maintenance & After sales services
Product Dismiss	Customer service Product take back Recycling

Table 2.5 – Businesses processes along the PLC

Companies collaborate with other companies (local or not local) through the various phases of the product lifecycle (making co-design, co-engineering, co-production, co-maintenance). Today competitive pressure pushes these companies to deal more efficiently with collaboration, reorganising themselves and adopting software technologies supporting it. A guideline for supporting the process modelling and re-organization of the company is absolutely necessary before adopting a PLM software tools, but at the present this guideline is still missing in the market and in the research. Also the relative performance metrics for the business processes are not well-defined and diffused in such kind of contest. Some relevant initiatives are coming up, more at a consultant level (e.g. [40], [44], [45], [46], [47]) than in term of research contributions. For example, table 2.6 proposes a series of metrics to be measured in the most relevant processes in order to evaluate PLM projects, as defined in [46] using the ENAPS reference model.

Obtaining customer commitment	Product development	Order fulfilment	Customer service
Market share for main product	Number active products	Order fulfilment lead time	Number of products received back
Marketing cost ratio	Number of new products	Material procurement lead time	Income from after sales service
Customer base growth	Average new product development lead time	Production & assembly lead time	Number of customer complaint
Lost customers	Number of products launched late	Distribution lead time	Average complaint resolution time
Tender preparation lead time	Number of co-engineered product	Inventory cost	

Table 2.6 – Performance measures in the ENAPS model

2.5 Conclusions of the chapter

Along the product lifecycle, processes and activities are realized according to diverse kind of methods/methodology. The most relevant methodology which deals with PLM is obviously the well-know concept of Concurrent Engineering (CE) [16], and the connected initiatives of Value Analysis and Engineering ([17], [18]). Concurrent Engineering is a management/operational approach which aims to improve product design, production, operation, and maintenance by developing environments in which personnel from all disciplines (design, marketing, production engineering, process planning, and support) work together and share data throughout all phases of the product life cycle. Then, PLM is partly an evolution of CE concept, supported by the ICT tools and functionalities.

Value Engineering is an organized approach to providing the necessary functions at the lowest cost. From the beginning the concept of value engineering was seen to be cost validation exercise, which did not affect the quality of the product. The straight omission of an enhancement or finish would not be considered value engineering. This led to the second definition of value engineering, which is an organized approach to the

identification and elimination of unnecessary cost. Unnecessary cost is Cost which provides neither use, nor life, nor quality, nor appearance, nor customer features. Value Analysis and Engineering methodology could nowadays be easily implemented using PLM ICT tools.

Other methods and methodologies which are interested by the PLM concept are the following:

- DFX (Design For X): Design principle according to which attention must be paid in the design to viewpoints related to following processes (ex. Design for manufacturing, design for assembly, design for supply chain etc.).
- QFD (Quality Function Deployment): Systematic process for motivating a business to focus of its customers. It is used by cross-functional teams to identify and resolve issues involved in providing products, processes, services and strategies.
- LCA (Life Cycle Assessment): Method developed to evaluate the mass balance of inputs and outputs of systems and to organize and convert those inputs and outputs into environmental themes or categories relative to resource use, human health and ecological areas.
- TRIZ (Theory of Inventing problem solving): A knowledge-based, systematic approach to innovation. TRIZ involves a systematic analysis of the system to be improved and the application of a series of guidelines for problem definition. TRIZ analysis includes an integrated system approach, function analysis and function modelling.
- FMEA & FMECA (Failure Mode, Effects and (Criticality) Analysis): Method used for the identification of potential error types in order to define its effect on the examined object.

Concluding the chapter, it might be said that PLM concept is a variegated world, or in other words PLM is holistic: it brings together products, services, structures, activities, processes, people, skills, application systems, data, information, knowledge, techniques, practices, skills and standards. The next chapters of the thesis will deal with the other aspects of PLM. In particular, in chapter 4 a comprehensive

definition will be discussed, also suggesting the missing research areas. The next chapter will illustrate an analysis conducted in some relevant Italian test cases, which will discuss the most relevant dimensions and aspects of PLM implementation in the day-by-day reality.

2.6 References of the chapter

Scientific references

- [1] Nielsen P.H., Wenzel H., (2002) Integration of environmental aspects in product development: a stepwise procedure based on quantitative life cycle assessment, *Journal of Cleaner Production*, 10, pp 247–257
- [2] Verschoor A.H., Reijnders L., (1999), The use of life cycle methods by seven major companies, *Journal of Cleaner Production*, 7, pp 375–382
- [3] Onkvisit S., Shaw J.J., (1998), *Product Life Cycles and Product Management*, Quorum Books, Greenwood Press, Westport, Connecticut
- [4] Cugini U., Wozny M., (2001), From Knowledge Intensive CAD to Knowledge Intensive Engineering, *Proceedings of IFIP WG 5.2. International Workshop on Knowledge Intensive CAD, USA*
- [5] Cugini U., Wozny M., (2001), From geometric modeling to shape modeling, *Proceedings of the IFIP WG 5.2, International Workshop on Geometric Modeling*
- [6] Mannisto T., Peltonen H., Martio A., Sulonen R., (1998), Modelling generic product structures in STEP, *Computer-Aided Design*, 30, 14, pp 1111–1118
- [7] Panetto H., Scannapieco M., Zelm M., (2004), INTEROP NoE: Interoperability Research for Networked Enterprises Applications and Software, *Proceedings of the On the Move to Meaningful Internet Systems 2004 International Workshops*, Agia Napa, Cyprus, Springer-Verlag Heidelberg
- [8] Bhandarkar M. P., Downie B., Hardwick M., Nagi R., (2000), Migrating from IGES to STEP: one to one translation of IGES drawing to STEP drafting data, *Computers in Industry*, 41, 3, pp 261-277
- [9] Zhang F., Xue D., (2001), Optimal concurrent design based upon distributed product development life-cycle modelling, *Robotics and Computer Integrated Manufacturing*, 17, pp 469-486
- [10] Wang H.F., Zhang Y.L., (2002), CAD/CAM integrated system in collaborative development environment, *Robotics and Computer Integrated Manufacturing*, 18, pp 135-145

- [11] Cutkosky T.G., Tenenbaun M. R., Glicksman J., (1993), SHARE: a methodology and environment for collaborative product development, Proceedings of the IEEE Infrastructure for Collaborative Enterprise, Morgantown
- [12] Zhang F., Xue D., Wallace D., (1998), Distribution modelling and evaluation of product design problems, Computer Aided Design, 30, pp 411-423
- [13] Soga S., Hiroshigo Y., Dobashi A., Okumura M., Kusuzaki T., (1999), PLM using radio frequency identification technology, Proceedings 7th IEEE International Conference on Emerging Technologies and Factory Automation, ETFA '99
- [14] Porter M., (1985), Competitive Advantage: creating and sustaining superior performance, NY, The Free Press
- [15] Andersen, B., Rolstadås, A., Fagerhaug, T., (1998), Practical Productivity Measurement, Proceedings 10th Working Seminar on Production Economics, Innsbruck/Igls, Austria.
- [16] Koudate A., (2003), Il management della progettazione, ISEDI Nuova ediz. (traduzione a cura di Rosario Manisera e Roberta Giovannuzzi)
- [17] Brown J., (1992), Value Engineering, Industrial Press Inc
- [18] Kaufman J.J., (1990), Value Engineering for the Practitioner, North Carolina State University

Technical references

- [19] Komninos I., (2002), Product life cycle management, Urenio press
- [20] ISO 10303 (STEP), SSID-STEP/SC4 Industrial Data Framework
- [21] Van Moll J.H., (2002), The importance of Life Cycle Modelling to the development and testing of complex products, Philips semiconductors, Presentation at TestNet Najaarsevenement 2002, Nieuwegein
- [22] GERAM, (1998), IFIP-IFAC task force, Annex A to ISO 15704, ISO TC184/SC5/WG1 N423
- [23] Impactsoft, www.impactsoft.com
- [24] IBM, www.ibm.com
- [25] Rulestream, www.rulestream.com
- [26] Tecnomatix, www.tecnomatix.com
- [27] Codrino A., (1999), I sistemi per la gestione dei processi, www.plm-systems.com
- [28] CIMData, (2002), The benefits of Digital Manufacturing, A CimData white paper, www.CIMdata.com
- [29] XML, World Batch Forum, www.w3b.org

- [30] Technology Evaluation, www.technologyevaluation.com
- [31] Verspille K., (2003), PLM Interoperability: Can XML Circuitry Be the TCP/IP of PLM?, www.coe.org
- [32] SAP, www.sap.com
- [33] Microsoft, www.microsoft.com
- [34] Lotus Notes, www.lotus.com
- [35] UGS, www.ugsplm.com
- [36] Wilson G., (2003), Product Life-Cycle Management in the Manufacturing Industry: End-User Survey Shows Solid Market Opportunities for Application Software Providers, IDC press
- [37] MatrixOne, www.matrixone.com
- [38] Baan, IBaan - Positioning white paper, www.baan.com
- [39] Oracle, www.oracle.com
- [40] AMR Research, www.amr-research.com
- [41] CIMData, (2001), Collaborative Product Definition management (cPDm): An Overview, www.CIMdata.com
- [42] Codrino A., (1999), Business Process Reengineering e Business Process Automation: moda o esigenza?, www.plm-systems.com
- [43] VCOR Group, (2004), Value Chain Operation Reference Model Overview 0.0, www.value-chain.org
- [44] Gartner Group, www.gartner.com
- [45] PRTN, www.prtm.com/plm-solutions.htm
- [46] PLM evaluation, www.plmevaluation.com
- [47] Banker R., Bardhan I., (2002), Evaluating the impact of collaborative product commerce on the product development lifecycle, White paper of the Center for Practice and Research in Software Management (PRISM), School of Management, The University of Texas at Dallas
- [48] Reedy K., (2000), Collaborative Product Commerce (CPC): How it Helps Improve a Company's Performance, Accenture press
- [49] Brown J., (2003), SLM - Service Lifecycle Management, www.technologyevaluation.com

CHAPTER 3

Industrial test cases on PLM

3.1 Introduction

In today's challenging global market, enterprises must innovate to increase their market size, to bring significant value to their stakeholders, customers, and employees, and in many cases to survive. It is important that this innovation occurs in all dimensions - product, process, and organization - to improve competitiveness and overall business performance.

Companies who demonstrate continuous innovation that consistently results in "right-to-market" products and services can clearly differentiate themselves. Innovation can occur spontaneously in almost any situation, but the ability to continuously innovate requires an environment that nurtures collaboration and enables the intellectual assets of the enterprise to be leveraged to their maximum potential. To attain this "environment for innovation," enterprises must be able to capture, manage, and leverage their intellectual assets.

Product Lifecycle Management (PLM) seems to be the approach that best allows organizations to establish such an environment. This strategic approach helps enterprises achieve their business goals of reducing costs, improving quality, and shortening time-to-market, while innovating their products, services, and business operations.

It is not simple to define the acronym PLM (chapter 4), because of every actor (vendor, consultant, researcher...) is giving his/her own interpretation and definition. The present chapter aims to contribute to the elaboration of such a kind of definition, providing the perspective of users.

In fact, an “academic” definition of PLM could be defined more or less easily (chapter 4), but how are enterprises really considering it? How (if) are they adopting it? Which kind of PLM are they looking (and applying) for?

In order to answer to these questions (or trying), an empirical research has been implemented during the PhD in diverse Italian industries.

It might be said that the obtained results are very simple and easily understandable. At the present, this research is reaching an international consensus, in particular within the established community of the Special Interest Group 1 of the IMS Network of Excellence [3], where the main members have decided to implement it at a European level. The results of the European research are attended for July 2005, and then they are out of the scope of this thesis for time reasons.

The current chapter summarizes the preliminary results of the analysis conducted in Italian leading firms, accordingly, the chapter is structured as follows: par. 3.2 details objectives and methodologies of the research; par. 3.3 illustrates the obtained results, while par. 3.4 concludes the chapter, summarising elements for the definition of PLM in chapter 4.

3.2 Research objectives and methodology

The research aims to investigate how European enterprises are really applying the defined “approach of PLM”. Lot of definitions and means are covering this new market acronym, but which are the realistic industrial dimensions of this phenomenon? How enterprises are considering it? Is there a relationship between some “product dimensions” (e.g. design complexity, high technology parts, markets, suppliers, customers...) and the application of a PLM approach?

Especially, at the present the research aims to be focused on the analysis of manufacturing industries in a cross-sector context, ranging from mass production to one-of-a-kind productions. Service companies are not considered in this stage, because of the dimensions of service are not easily comparable to the dimensions of physic goods, even if some of the PLM vendors (and consultants) are moving to this sector [4].

The methodology adopted is such of explorative research [1]. This means that the industrial cases are analysed in a medium detail with interviews, guided by a sketch of questionnaire. The questionnaire is no more than a guideline for the interviewers, where “open” and “close” questions are suggested for adopting a common model. Generally, two or three interviews to different persons in different functions in the same company were needed in order to write one industrial case. In terms of functions, the persons interviewed came from ICT department and from the technical departments.

The case studies were selected according to the main following criteria (i) PLM might be identified in enterprise business practices, even if this does not necessarily mean that the PLM vision depends upon the implementation of market “PLM suites”; (ii) PLM vision might mainly depend upon enterprise organizations and their strategic understanding for an effective requirements to better master management of products (and related information, knowledge and management activities) over product life cycle phases (whole or partially).

The sample addressed by the research is composed by Italian companies, which have already started some implementations “in PLM”. Beginner companies were not considered, where “beginners” are defined companies, which totally do not know and do not apply “PLM suites” in their design or production departments. The application of simple CAx platforms is not enough to be considered “beginners” in PLM application.

The guidelines are implemented in a questionnaire structure of five sections, which have been developed ad hoc on a context PLM model (figure 3.1):

- The first section deals with general information of the enterprise (dimensions, sectors, organizations).
- The second section focuses upon the analysis and understanding of product features. The product features are analysed to understand how they lead to requirements for different PLM strategies. The product features range over diverse aspects. (a) technical aspects (functions

and technologies), (b) aspects of marketing strategy (critical success factors), (c) aspects of operations management.

- The third section aims to investigate how the enterprise is structured in enterprise functions, processes and information flows (“intra” and “inter” enterprise).
- The fourth section deals with a closer view of the techniques and ICT tools adopted within the enterprise.
- The fifth section investigates the motivations and problems appeared during enterprise integration projects to enable the PLM approach.

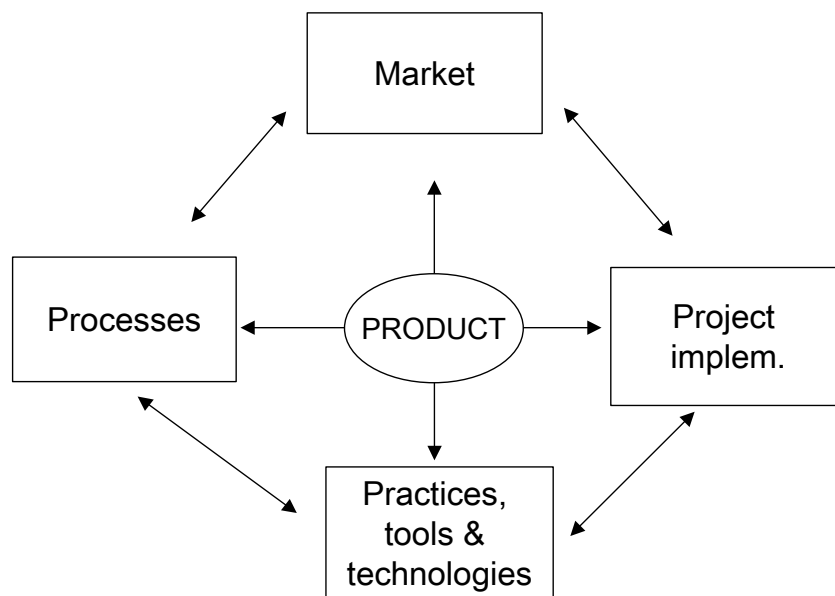

Figure 3.1 – Context PLM model adopted in the research

3.3 Analysis of the Italian experiences

In 2004, 40 Italian companies have been asked to be analysed by the candidate, and 14 accepted. Two of them have been adopted as primary test beds of the explorative research, in order to refine the first version of developed questionnaire. All the Italian cases derive from contacts provided by PLM vendors acting in Italy as market leaders. In such a way, the defined sample is not representative of the Italian industrial scenario and situation, but is obviously biased. This is acceptable for the research

strategy, which aims to investigate in an explorative manner which factors are motivating the adoption (or less) of PLM paradigm/suite.

Moreover, as recently Italian analysis demonstrates [5], PLM software sales are increasing in Italian companies, even if the great diffusion of SMEs in Italy is slowing this process, compared to USA or North-Europe. A large number of big Italian industries are testing and applying PLM suite and approaches, while SMEs are stopped by the total costs of PLM software and consultants. Effectively, almost the total Italian sample is composed by big (and leading) Italian companies (even if they are not so big compared to European average). This is a biasing effect for the research, since more than the 90% [6] of Italian companies are SMEs.

The interviewed enterprises are shown in table 3.1. Thanking these industries, it might be said that for privacy reasons all the next data will be discussed in an anonymous way. On the exception of one of them, they are all Italian groups, founded and owned by Italian entrepreneurs.

Enterprise	Sector
Alcatel	Electronics
Avio	Aerospace
B-ticino	Electromechanical
Candy	Electromechanical
CMS	Mechanical
Ferrari	Automotive
Fidia	Mechanical
Impresilo	Construction
Iveco	Automotive
Maschio	Mechanical
Riello	Electromechanical
Rossi	Textile
Snaidero	Forniture
Tecnimont	Process

Table 3.1 – Enterprises of the sample

As shown, diverse industrial sectors have been involved in the sample. In the same direction of the most important USA market [7], mechanical, automotive and aerospace are historical leading sectors in the adoption of ICT integrated suites. Interesting experiences are currently moving in related sectors, like electromechanical and electronics. Furniture and textile are new sectors interested by ICT integrated experiences. EPC

(Engineering, Procurement and Construction) leading companies are themselves adopting similar approaches.

In terms of dimensions, as declared, the most part of the interviewed companies are Italian big companies, and then the sample is not indicative of the Italian market. Figure 3.2 summarizes companies' dimensions in terms of number of employees. In term of business unit, the average of the sample is 3.4 business units per company.

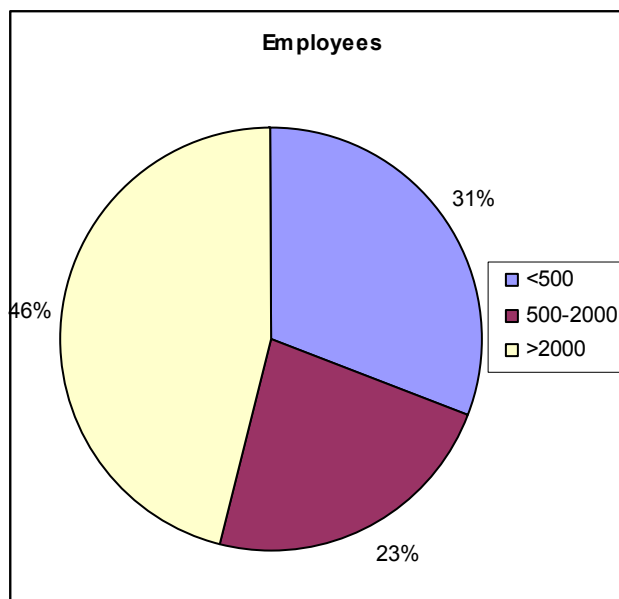

Figure 3.2 – Dimension (employees) of the sample

In terms of key-success factors, using a range 1-5 (min-max), the most important factors for the competition in the market declared by the interviewed is the “product innovation” (4.1), then “time-to-market” follows (3.8), “product low cost” (3.1) and “product quality” (2.8).

Human resources with a high level of technological competences and skills are considered the most important leverage to gain these kinds of success-factors (4.55), while ICT tools follow (3.1).

Looking to the products realized by the diverse cases, three main categorizations have been defined:

- Product complexity, described in terms of product components designed by the companies (Low, Medium, High).

- Product technological content, described in terms of high-level competences and skills needed to design and produce the final product (Low, Medium, High).
- Order point, defined using the Wortmann classification [2]. Wortmann's management strategy classification is based on comparison between delivery lead-time and manufacturing lead-time, which defines the Customer Order Decoupling Point (CODP, figure 3.3). Using this classification, it is possible to synthesise how a company react to a customer order and then how the product itself is structured. The main CODPs are:
 - MTS (Make to Stock): Products manufactured for finished-goods storage before a customer order arrives. MTS products are generally simple, with few components.
 - ATO (Assemble to Order): Standard components manufactured for storage, products assembled to specific customer order configuration. ATO products are more sophisticated, since they are an aggregation (assembly) of simpler elements.
 - MTO (Make to Order): Products manufactured to specific customer order configuration and delivery time specifications. MTO products are more complicated.
 - ETO (Engineer to Order): Products engineered to specific customer order configuration and delivery time specifications. Each product is designed, engineered and produced from scratch.

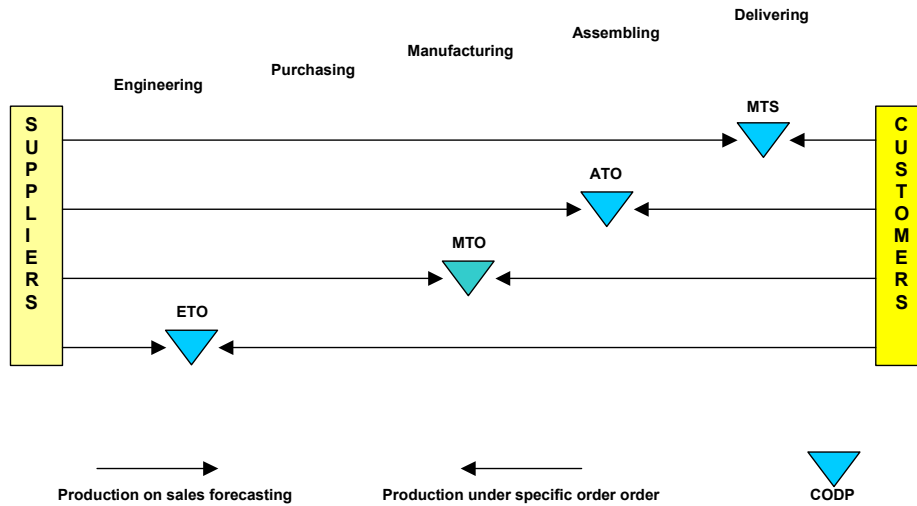

Figure 3.3. – Wortmann's classification [2]

The major parts of the designed and realized products of the sample are high complex products (figure 3.4), where complexity is defined in terms of high volume of parts and components. High complexity is more than 2000 components, while Medium complexity is in the 300-2000 range. Less than 300 components, the product is considered with a low level of complexity.

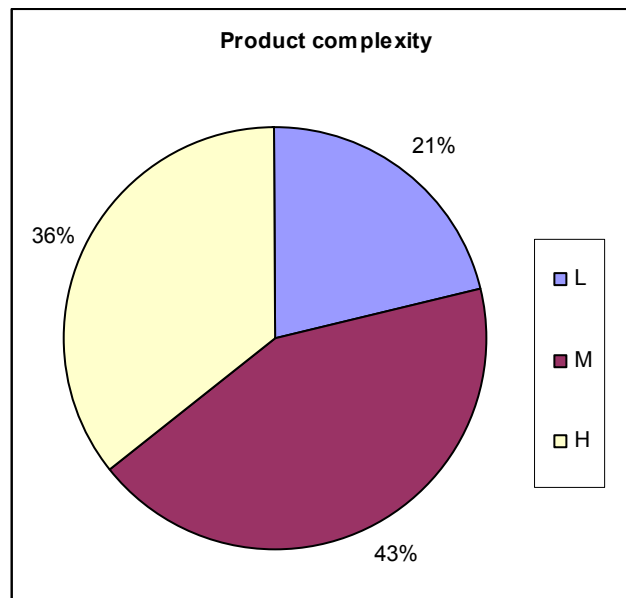

Figure 3.4 – Types of products in terms of numbers of parts

Figure 3.5 classifies the cases in terms of technological content of the products, defined by the same interviewed. The major part of the cases

deals with products, which require a medium-high range of skill and competences to be produced and designed.

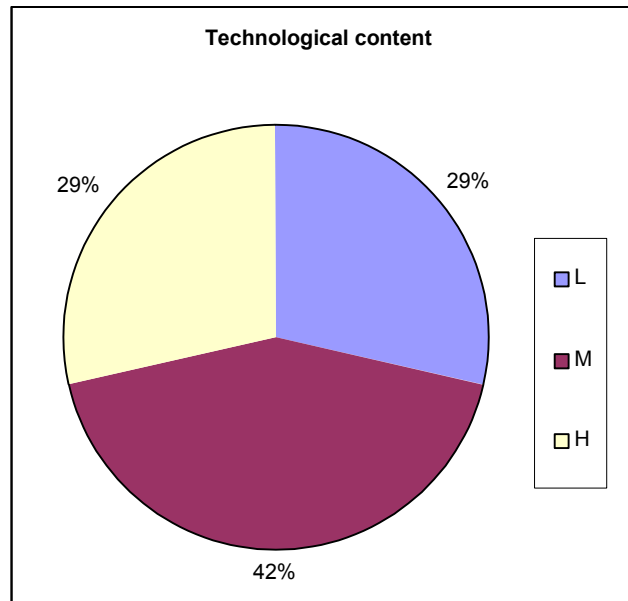

Figure 3.5 – Types of products in terms of required competences

The major parts of the companies are xTO companies (figure 3.6). Only 3 cases are structured in terms of MTS. It means that the major part of the interested products needs a complexity in terms of involved processes, from product development to manufacturing.

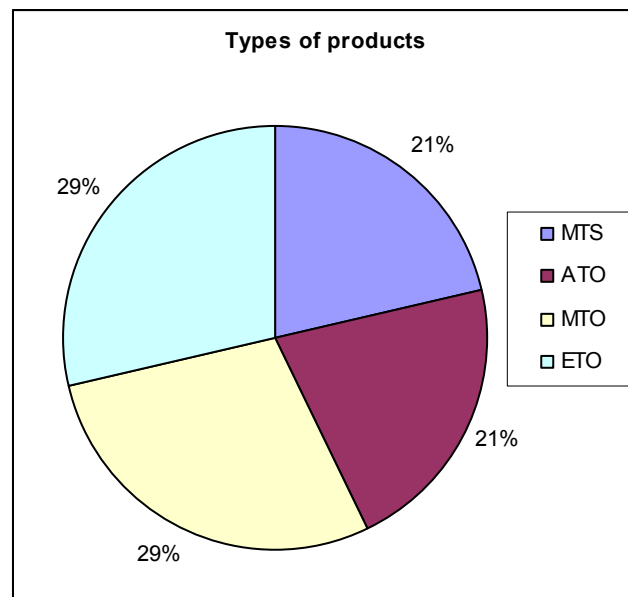

Figure 3.6 – Types of products in the Wortmann's classification

The interviewed companies have been asked about which product phase (according to the reference model of chapter 2, Product Development, Production & Distribution, Use and Dismiss-end of life) was the most relevant for the success of the company, 6 answers identified in the Product Development the most important stage, 4 on Product Production & Distribution and 4 on Product Use.

All the interviewed companies have product development departments, more or less complicated. As usual, companies from the EPC context do not have production plants, but manufacturing is delegated to suppliers; they put a strong effort in the management of the procurement of the components, tracing all the production stages from their headquarters. The other companies of the sample are generally organized with the traditional “functional” structure: product development department vs. manufacturing departments. Research & development function is generally associated/delegated to the product development department. Only few cases have an independent R&D department. By the contrary, marketing and customer relationship (where exist) functions have independent status; only in one case, marketing and product development are considered under the same functions. ICT department is generally a staffed function.

While the concept of business process is well-know and accepted by the interviewed, it might be said that a realistic “process” structure is adopted only in one case. This affects the measurement of the performances of the business processes, which is adopted and implemented only in four cases. The definition of “process owners”, who can follow for example a project/product along all the functions, exists in few cases.

In terms of functions, operation management activities are the most outsourced (distribution management 42%, after sales management 32%, manufacturing/assembling 24%). 32% declared to have relevant external collaboration in terms of product design and development with diverse kind of actors (co-engineers or co-designers), located not only in Italy, but

also in Europe, Asia and America. Only in 1 case ICT systems are totally outsourced.

In terms of ICT tools, all the interviewed companies adopted a CAD tool (figure 3.7). CAD 2D is still surviving, also in such companies where 3D systems are installed and used. CAM and CAE/CAPP systems are not often used, even if in the companies there are installed integrated suites, like [8] or [9]. Digital Mock Up (DMU) solutions are not well diffused, while Discrete Event Simulation (DES) is applied in only 1 company.

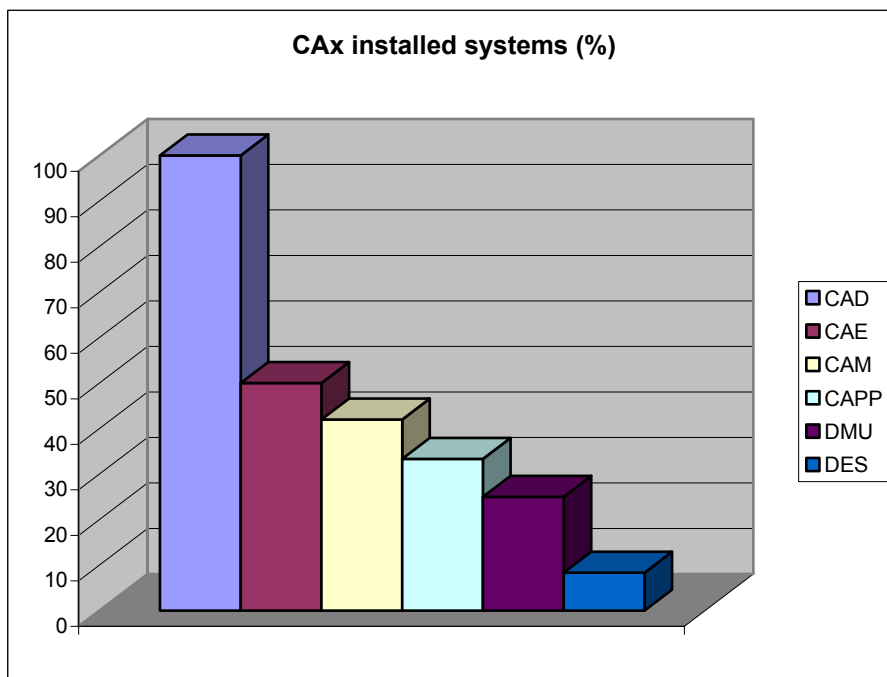

Figure 3.7 – CAx installed systems

A Product Data Management (PDM) system is installed in 86% of the interviewed cases; 1 of the missing company has a simpler and older EDM (Engineering Data Management) system. The major part of installed PDM systems are provided by the leading software vendors; in two cases proprietary PDM are used. In 5 cases, technical information and files are accessible also outside the company through diverse Data Warehouse systems, typically composed by web-based solutions. Only one company is still waiting for the installation of an ERP system.

54% of the interviewed defines its ICT systems like in figure 3.8, where information flow in a manual manner: data are transferred by operators or using simple flat file. Figure 3.8 demonstrates how Product Development and Operation management are still considered as “separated islands” by the major parts of the companies.

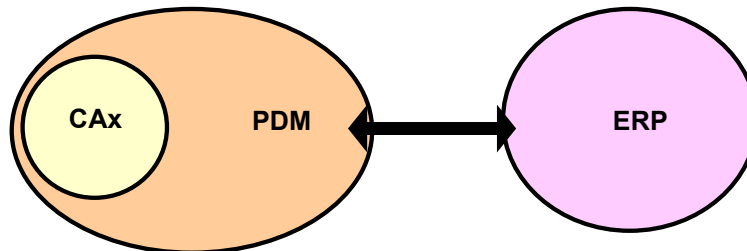

Figure 3.8 – Structure of the ICT systems

Lot of transactions of data are still made by manual computations, or using traditional media, such as telephone and paper. Email is widely used (all the companies have an email server), but structured workflows are few. Not detailed information has been collected, since all the companies did not answer in complete ways. This situation could derive from a cultural motivation: (i) Italian persons do not accept detailed interviews, and (ii) also they are worry by well-defined workflows, in particular in the area of product development.

Only companies that are working in collaboration with international partners (co-engineering and co-design) implemented workflows in product development phase, since they are obligated to collaborate each day with external and culturally different parties. In the sub-phase of product concept and basic design, (in particular in fashion contexts), designers (internal or external, like some famous Italian names) do not agree at all to adopt a standardized data transfer (e.g. a simple file format for drawings), but often they provide material prototypes, on that engineers might make reverse engineering activities to have the design specification.

Companies have been asked to define how the support of ICT systems is important for the management of the diverse product lifecycle phases. In a range 1-5 (min-max), Product Development phases received 4.68

points, Product Production and Distribution 3.3, while Product Use (e.g. for product tracking) 2 points.

In term of functionalities (chapter 2), the most adopted and searched functionalities are (in order of relevance) (i) Authoring and analysis tools (CAx), (ii) Document management, (iii) Management of the diverse points of view of Bill of Materials and (iv) Product configuration management.

The main motivations which have pressed the companies in the adoption of a structure where product data can be easily management can be defined in the followings: (i) Pressure from the R& D department/office, (ii) Necessity of a reduction of the time-to-market, (iii) Necessity of a better management of the product data for a major visibility in diverse stages.

The first two points are strictly connected. In fact, R&D departments are generally measured (even if often in a qualitative manner) on the success of a product in the market; if a product arrives to a customer after a competitor (then, the need of reduction of time-to-market...) any effort spent by R&D is not useful. Unfortunately, in the interviewed cases an analysis of the effective benefits becoming from the introduction of advanced ICT systems were not possible, since only some company had measured its performances (in particular in product development) before and after the introduction of advanced ICT solutions.

Companies have been also asked about problems encountered during the introduction of advanced ICT systems such as PDM. The main registered problems were: (i) internal resistance to the changes, problems with software vendors, lack of integration or at least interoperability between ICT systems. In particular, the internal resistance of employees (both designers, engineers) is a huge problem: in some cases, only passing from CAD 2D to 3D took more than 1 year! Diverse approaches have been used, from sophisticated change management processes, to ruder “big bang” installations. It seems (but there are no data about it) that a rude “big bang” start-up of such projects (e.g. introduction of a PDM) can cause the rapid death of the same project. Otherwise, a well-planned

change management process (in some cases more than 3 years expected for a PDM) can be the right “first step”.

3.4 Conclusions

As mentioned in chapter 2, PLM is composed of multiple elements including foundation technologies and standards, information authoring and analysis tools, core functions, functional applications. At the same time, PLM is not a definition of a piece, or pieces, of technology, but it seems an useful acronym to indicate something more complex (all the interviewed companies declared themselves “PLM-oriented” – maybe after a lesson of vendors.), where a business approach is adopted for solving diverse problems of managing sets of product information.

The interviewed companies, even if they are certainly more concentrated in the Product Development phase, are adopting diverse tools for managing product data also in production, distribution and during the use of the product by the customers. Certainly, the great integration of processes and tools which the current ICT systems are able to provide are not always used and adopted, in particular in companies which are more similar to SME dimensions.

Effectively, looking to the previous paragraphs, it is possible to define a series of conditions which can support the establishment of definable PLM approach; the main conditions seems to be (i) Presence of the product development main process, (ii) Establishment of a P/EDM system, (iii) Adoption of diverse CAx systems, (iv) Necessity of a connection with ERP systems. This configuration has been discovered in more than the 60% of the interviewed companies.

Enterprises are adopting diverse ICT solutions in order to manage complexity. Looking to the conducted research, it is possible to identify two main kinds of complexity: complexity on product design features (e.g. lots of parts, high technological content) and complexity on operational features (e.g. distribution of the customers and suppliers).

Products which are simple in terms of design and engineering, can be complex in terms of production and distribution; for example, in the textile

context, where products (like shoes, pants...) are simple (few parts, mature technology), the distribution and the analysis of the customers behaviours are two leading questions, which could afflict all the product lifecycle phase (if the colour of a pair of pants is not accepted by the market, all the actors involved in the product lifecycle are interested, from the designer, who have to modify the colour, to the production manager, who have to produce a new one).

Similarly, in the construction sector, products are complex both in terms of design features and of operational processes involved. A plant is a complex product, to be managed along its whole lifecycle, from the development (where ICT design tools are very important), to the use (where ICT tools for storing plant data are needed for normative reasons).

More the total complexity of the product increases, more ad hoc solutions are needed, while more processes are involved in the management of product data, more ICT tools might be integrated (figure 3.9).

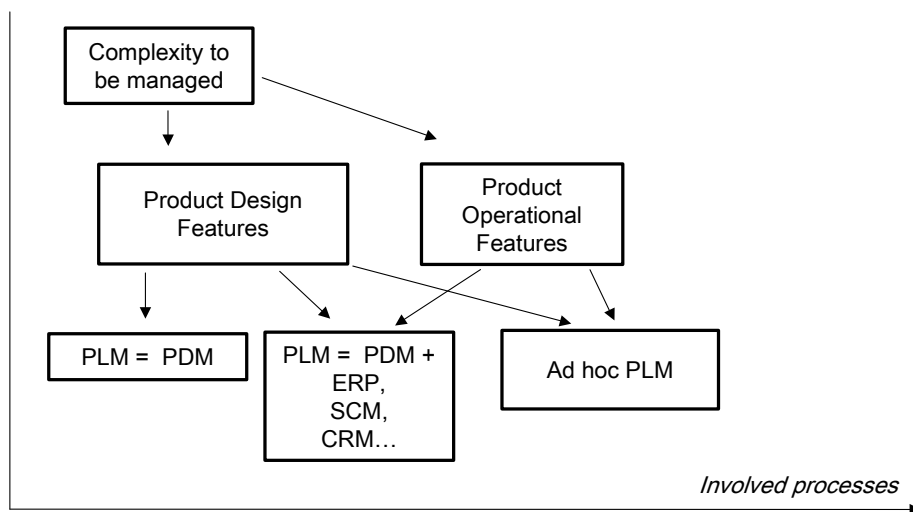

Figure 3.9 – Product complexity and PLM

All the interviewed companies revealed how their ICT systems are strictly related to their business processes, automating part of them and supporting interoperability between them. Nevertheless, only 3 cases clearly declared that in the implementation of diverse ICT solutions had re-engineered or revised their processes. The major part of the interviewed

installed diverse ICT tools, also the most pervasive like ERP, without any analysis and reengineering of their business processes. Unfortunately, without any relevant data about the performance measured before and after such a kind of projects, it is impossible to define the real success on this type of approach.

Then, from the conducted research the acronym PLM seems to have a mean that is more than just a piece of technology. In fact, companies are certainly using diverse advanced ICT tools to produce, store and manage product data, but they are doing so in order to improve their innovation, reducing time-to-market. They are applying this kind of technologies to effectively cooperate inside the company and outside, also with foreign partners in co-design and co-engineering. Data from the market and from the customers are managed by these advanced ICT systems, providing lots of useful information to designers, engineers and managers.

These adoptions signify something new, where ICT tools are used for implementing diverse kinds of strategies, where cooperation is more and more important. In such a context, the PLM acronym can be useful for indicating all these types of elements.

This phenomenon, also defined as paradigm, is investing more sectors, with diverse declinations. It also interests diverse kinds of companies, from the biggest to the medium sized. SMEs were not analysed in the research, since at the present successful SME case histories are still missing. Certainly, how it happened for other experience like ERP, it is possible to imagine a future where PLM suites could be available also in the SME offices, how the vendor market is revealing (all the vendors are promising PLM for SME packages, e.g. [8], [9]).

It might be said that in the literature is still missing a methodological guidance to assess the level of PLM implementation in companies and identify opportunity areas. Each consulting company and software vendors promise its personal way of thinking. This lack seems to have a dramatically impact, especially when considering the needs of SMEs in Europe.

As mentioned, the illustrated research is currently on going in the context of the Special Interest Group 1 of IMS NoE. Diverse European members are applying the same questionnaire designed in this PhD thesis. The preliminary results will be available from the next July, after the end of the PhD.

3.5 References of the charter

Scientific references

- [1] Yin R. K, (1994), Case study research: design and methods, Sage Publications
- [2] Wortmann J.C., (1983), A classification scheme for master production schedule, Efficiency of manufacturing Systems, Edit. Berg C., French D., Wilson B., Plenum Press

Technical references

- [3] IMS NoE, www.ims-noe.org
- [4] Brown J., (2003), SLM - Service Lifecycle Management, www.technologyevaluation.com
- [5] Codrino A., (2004), Trend del mercato PLM in Italia, Presentato a PDFForum 2004, Milano
- [6] Eurostat, (2001), Market dimensions in Europe, europa.eu.int/comm/dgs/eurostat
- [7] AMR Research, www.amr-research.com
- [8] IBM, www.ibm.com
- [9] UGS, www.ugsplm.com

CHAPTER 4

Definition of PLM

4.1 Introduction

As mentioned, the definition of stages and problems related with PLM depends by the kind of the “production system”:

- into manufacturing enterprises, PLM deals with the single physical product, which is designed and engineered, produced into ad hoc production systems, distributed in a detailed chain and, finally, dismissed and recycled;
- into EPC enterprises, PLM deals with the design of a complex product (e.g. a chemical plant, or a navy), its installation on field (e.g. in a yard) and its maintenance and management;
- in the world of services, PLM deals with the concept of the service to be offered, the design of the infrastructure needed for providing such kind of service and with its improvement and maintenance.

What these “production systems” have in common for the “new” PLM vision is the need of the management of a large amount of product related data that are generated in the various phases of the product lifecycle. This need is more and more emphasized by the presence of many cooperating companies.

The present chapter aims to provide a personal definition of the PLM phenomenon. In the next paragraph, diverse definitions existing in the market will be discussed, before providing a personal one. Then the PLM market will be briefly analyzed in its trends, before identifying the current open issues, which deal with PLM in the area of research.

4.2 Towards a definition of PLM

Looking to the market, PLM has many definitions, depending on vendors and their marketing strategies; so in this technological context, PLM is defined as (i) a piece of technology, which can interoperate with other solutions, (ii) an additional module of a larger suite. These kind of technological definitions give a reductive idea of PLM, which is a more complicated enterprise phenomenon. Effectively, the PLM acronym has become to be widely accepted when the new business needs arose in the market and enterprises needed to change their strategies and visions, giving more attention to their creating-value products. Into this scenario, information technologies are playing a fundamental role, but, even if they are enabling elements, they are not sufficient to PLM diffusion and evolution.

In literature, a comprehensive definition of the phenomenon currently named PLM is still avoided by the scientific community, even if lot of conferences and workshops has been organized in the last two years. There are lots of positioning white papers (e.g. [4], [5]) coming out from vendors, which provide vendor-oriented definitions.

Also some of the most important centres of business research have elaborated and proposed their definitions of such phenomenon, like AMR Research [6], CIMData [7], Daratech [8], ARC Advisor Group [9], Gartner [10], QAD [11]. All these definitions provide some interesting issues to be considered looking for a more comprehensive idea of PLM.

For example, Daratech [8], coherently with its backgrounds (CAx market), does not propose a detailed definition of PLM, but with PLM acronym aims to identify the last evolution of Digital Engineering and Manufacturing. On the contrary, QAD [11] considers PLM as the main instrument and media for controlling products performances, taking into account activities planning and coordination and detailed document definition and management. QAD focuses its attention not on the technological aspects of PLM, but on the collaborative needed functionalities. ARC Advisor Group [9] defines that a PLM solution is the

right solution helping enterprises to obtain the right product, at the right time, in the right place. For ARC, PLM is not a specific tool, and more than a single strategy: a PLM solution adopts collaborative software in order to create and manage a detailed documentation on product data and its life cycle. In particular, ARC defines PLM as a set of six main elements: product portfolio management, project management, collaborative design, product data management, process planning management, and support services management. CIMData [7] provides one of the more comprehensive definitions of PLM; for CIMData PLM is “A strategic business approach that applies a consistent set of business solutions in support of the collaborative creation, management, dissemination, and use of product definition information across the extended enterprise from concept to end of life—integrating people, processes, business systems, and information. For CIMData “PLM is not just a technology, but is an approach in which processes are as important, or more important than data. It is critical to note that PLM is concerned with 'how a business works' as with 'what is being created'.” CIMData defines the overall product life cycle as comprised of three major, interacting life cycles: (i) Product Definition, (ii) Production Definition, (iii) Operational Support. Product Definition is an intellectual property of a business, not just the upfront engineering design, but it also includes the entire set of information that defines how the product is designed, manufactured, operated, or used, serviced, and then retired and dismantled when it becomes obsolete. The second, Product Production, focuses on the deliverable product, including all activities associated with production and distribution of the product; ERP systems are the primary enterprise applications of this level. The third, Operations Support Life cycle, focuses on managing the enterprise’s core resources, i.e., its people, finances, and other resources required to support the enterprise.

A universal and well-accepted definition of PLM is not achieved in the market; lot of vendors and consulting companies are entering this market, providing their “marketing” PLM definitions and promoting diverse

acronyms (table 4.1). The next paragraph aims to provide a personal comprehensive definition of PLM.

Acr.	Description	Year	Source
CPD	Collaborative Product Development	2001	[12]
CPD	Collaborative Product Definition	2001	[7]
CPC	Collaborative Product Commerce	2001	[13]
UPLM	Unified Product Lifecycle Management	2001	[11]
PDS	Product Definition Server	2001	[14]
PIM	Product Information System	2001	[15]
PLM	Product Lifecycle Management	2002	[9]
ILM	Infrastructure Lifecycle Management	2002	[16]
PLM	Product Lifecycle Management	2002	[16]
PLM	Product Lifecycle Management	2002	[17]
PLM	Product Lifecycle Management	2002	[18]
PLM	Product Lifecycle Management	2002	[4]
MPM	Manufacturing Process Management	2002	[19]
PLM	Product Lifecycle Management	2002	[21]
PLM	Product Lifecycle Management	2002	[20]

Table 4.1 – PLM acronyms

4.2.1 Proposal of a comprehensive definition of PLM

Into the previous definitions it is possible to identify some common elements, such as (i) business process strategy, (ii) collaborative approach and (iii) role of ICT systems. PLM is multi-layered and multi-disciplinary, and all different perspectives might be taken into account: (a) the PLM acronym deals, at first, with a strategic vision of the enterprise, and its processes might be product oriented in order to answer to market needs and requests; (b) the PLM approach deals with an innovative solution for creating/managing/maintaining all the information shared along enterprise processes. In particular, PLM deals with the digitalization of all such kind of information, from design, to manufacturing, to after sales service activities; (c) at the same time, this comprehensive approach to digital information management, which physically enables collaboration between people, is provided by the IT evolution and interoperability.

This way, a detailed, even if simple, definition of PLM could be as follows:

- ***“PLM is an integrated, ICT supported, approach to the cooperative management of all product related data along the various phases of the product lifecycle.***
- *As such PLM involves:*
 - (1) *a strategic management point of view, where the “product” is the only enterprise value creator,*
 - (2) *the application of a collaborative approach for the empowerment of all the enterprise core-competences distributed along different actors, and*
 - (3) *the adoption of a large number of IT solutions and tools in order to practically establish a coordinated, integrated and access-safe product information management environments.”*

Definitively, PLM is not only an ICT tool more or less integrated, it is not only a organizational issue and it is not only a technique. Considering its comprehensive dimension, PLM acronym is resolutely useful in order to indicate a complex phenomenon, paradigm and approach, which is currently on going into the industrial context. It unifies organizational dimensions (processes), economics issues (costs and revenues), techniques and technologies. The same complexity of this definition could explain why it is difficult to accept, especially in a so blusterous market.

It might be said that during the last years (2004-2005), some effort have been spent for providing a unique definition of PLM, also in the research community. For example, an international PLM-Interest group was established in Europe [22]; also in the IMS NoE project, the Special Interest Group 1 was delegated to PLM [23]. Moreover, the first edition of the international journal on PLM is expected for July 2005 [1]. The PhD candidate participated to the two first initiatives, providing the proposed definition, which was considered.

4.3 PLM market and trends

The PLM market is populated by some important ICT names (e.g. [4], [25]), even if a lot of ICT SMEs are trying to enter into national markets (e.g. [26], [27] in Italy). Generally, it is possible to notice that PLM vendors, even if they come from three diverse backgrounds, are adopting the same strategies: (i) vendors coming from the digital engineering world (e.g. [17], [20]) are trying to “connect” enterprise Operation Management processes; (ii) vendors coming from the ERP world (e.g. [4], [5]) are turning to connect Digitally Manufacturing and Engineering tools and platforms; (iii) vendors coming from the ICT world aim to establish such collaborative environments for PLM integration (e.g. [28], [29]), basically using web technologies.

In the PLM market, vendors are evidently acting with the same Merger&Acquisition strategy; for example, in the area of Digitally Engineering and Manufacturing, IBM and Dassault Systèmes are developing and selling an integrated platform, where several tools such as Catia and SolidWorks Enovia and VPM are integrated with Deneb and SmarTeam, developed by other companies. UGS PLM Solutions acquired Unigraphics (CAD and PDM) and EAI (factory planning), and recently acquired Tecnomatix (CAPP and CAE – Computer Aided Engineering systems). Likewise, Autodesk acquired companies such as Linius Technologies [30] and TruEInnovations [31,] providing the market with solutions detailed in more industrial sectors (e.g. mechanical, constructions). In the area of enterprise operation management, SAP acquired Top Tier in order to develop an Internet-based platform and opening its Rx technologies.

In term of dimensions, CIMData [7] provides the most complete analysis of the 2003 Product Lifecycle Management (PLM) market available, with special emphasis on the collaborative Product Definition management (cPDm) segment of that market. The Report provides a perspective on PLM across a variety of industry and geographic sectors, identifies market

trends, reviews investments in PLM-related software and services during 2003, and forecasts PLM investments for 2004 through 2008.

CIMData defines the PLM market as comprised of two major segments: collaborative Product Definition management (cPDm) and Authoring and Analysis Tools. Authoring and Analysis Tools include the primary design authoring tools such as mechanical and electronic computer-aided design (MCAD and ECAD), computer-aided software engineering (CASE), and technical publishing. cPDm is focused on collaboration, management, and sharing of product related information.

Regarding the PLM market performance, CIMData explained that the 2003 overall PLM market grew by 4% over 2002 to approximately \$14 billion. Of that, approximately 67% or \$9.5 billion was invested in Authoring and Analysis Tools while 33% or \$4.6 billion was invested in cPDm. Both PLM segments grew in 2003, with cPDm investments increasing more rapidly with a growth of approximately 9% over 2002. Figure 4.2 shows the overall PLM market size. The forecasts are based on data available through the first quarter of 2004.

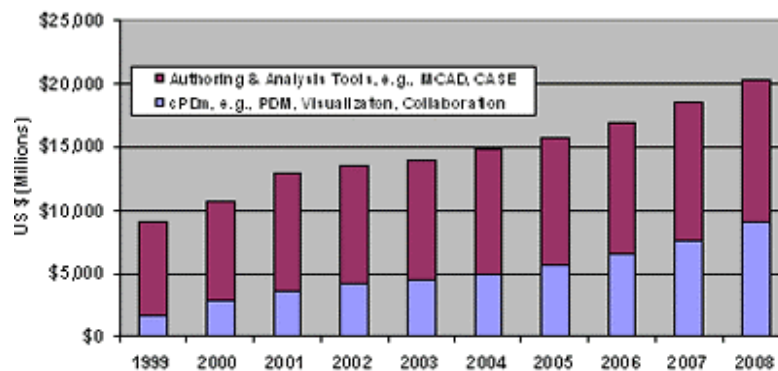

Figure 4.2 — Overall PLM Investment History and Forecast (2004- 2008) [7]

CIMData's analysis indicates that investments in cPDm software including perpetual license sales, right-to-use fees, subscriptions, recurring fees, and maintenance, increased from \$1.64 billion in 2002 to \$1.94 billion in 2003 and comprised 42% of the total cPDm market. This represented a return to license growth after two years of decline. cPDm services investments grew to \$2.6 billion, up from \$2.5 billion in 2002 and

represented 58% of the 2003 cPDm market. CIMData estimates for the 2004 cPDm market a growth at a rate of 11% to \$5 billion. With the general improvement in global economic activity and the release of new investment funds by companies may improve the forecasted growth.

Looking toward 2008, the PLM market as a whole is estimated to grow at a CAGR of 8% to exceed \$20 billion. cPDm is forecasted to be the fastest-growing segment of the PLM market with a 14% CAGR to exceed \$9 billion in 2008. The Authoring and Analysis Tools segment is forecasted to grow at a slower 3% CAGR over the next five years, reaching approximately \$11 billion during 2008.

Wide ranges of companies supply PLM-related software, applications, and services. Overall, PLM market leaders include companies from many sectors with some focused on specific technologies or industries such as MDA, EDA, CASE, or analysis, while others are focused on providing broad management systems that provide a backbone for overall PLM initiatives.

The cPDm portion of the PLM market has three primary sub-segments: comprehensive technology suppliers, system integrators-resellers-VARs, and focused application suppliers including visualization and collaboration, digital manufacturing, portfolio management, content management, and many other areas of interest. Comprehensive suppliers (e.g., Agile, IBM/Dassault, MatrixOne, PTC, SAP, UGS/EDS, etc.) comprise 50% of the cPDm segment of the PLM market, focused application suppliers hold 17%, and the independent system integrators, resellers have 33%.

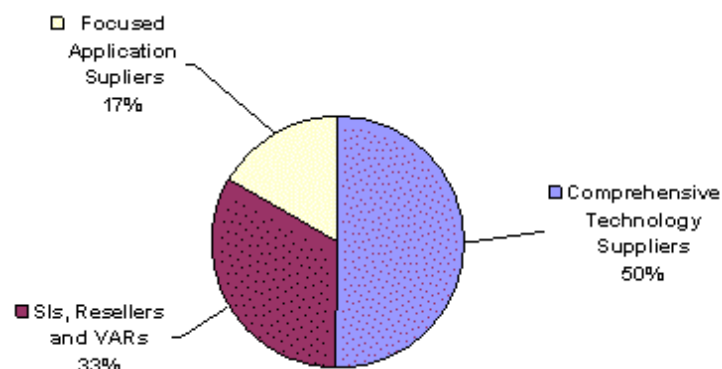

Figure 4.3 - cPDm Market Segment Distribution [7]

Many of the companies providing PLM-related technologies and services generate substantial revenues while focusing on specific niches within the broad PLM market. A few companies however, have distinguished themselves as PLM mindshare leaders, i.e., those companies who are frequently considered to be leading the market through either revenue generation or thought leadership. These PLM mindshare leaders include a few suppliers with broad-based capabilities that support a full product lifecycle-focused solution. This group includes Agile, EDS Corp (now UGS) , the combined IBM and Dassault Systèmes program, MatrixOne, PTC and SAP. In early 2004, EDS sold its PLM Solutions Group to private investors, establishing UGS as an independent entity. However, during 2003, they were still a part of EDS, therefore EDS is the entity that was present in the industry during 2003 and is reported in this analysis of the 2003 PLM market. Full PLM-based revenues from these mindshare leaders are shown in figure 4.4.

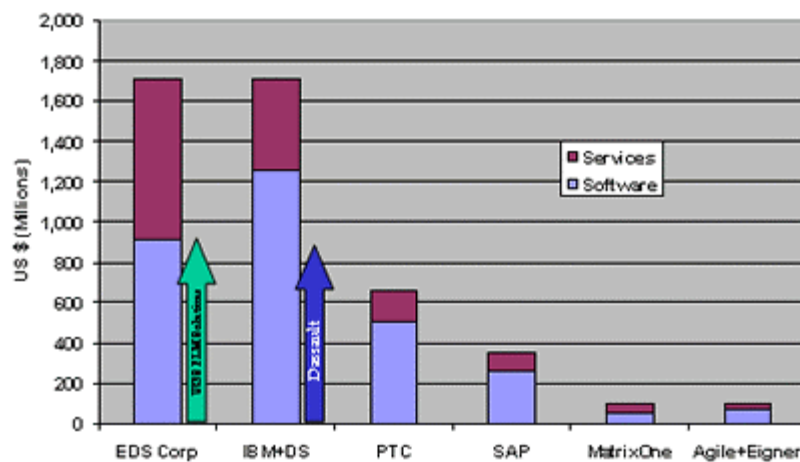

Figure 4.4 — PLM Mindshare Leaders' Revenues [7]

As can be seen, the revenues for some members of this group are represented in great part by revenues generated from the tools (services) portion of their product suites (i.e., their MDA offerings), but their cPDM (software) revenues are growing and becoming a larger portion of their overall business.

Of the PLM mindshare leaders, the two with the largest direct revenues in 2003 were EDS and IBM+DS. When considering direct PLM revenues only, EDS was the leader, followed in order by IBM+DS, PTC, SAP, MatrixOne, and Agile.

Direct revenues are only one measure of a supplier’s impact on the PLM market. Many suppliers provide technologies through their own field sales and support organizations and system integrators, resellers, and other partners. The combined core (a vendor’s direct software and services revenue) and partner revenues are the measure of the visibility and impact of these suppliers on the industry; this represents their overall “market presence.” Market presence also provides some insight as to how many other solution providers support a given supplier’s technology and products. Global PLM market presence for the PLM mindshare leaders is shown in figure 4.5.

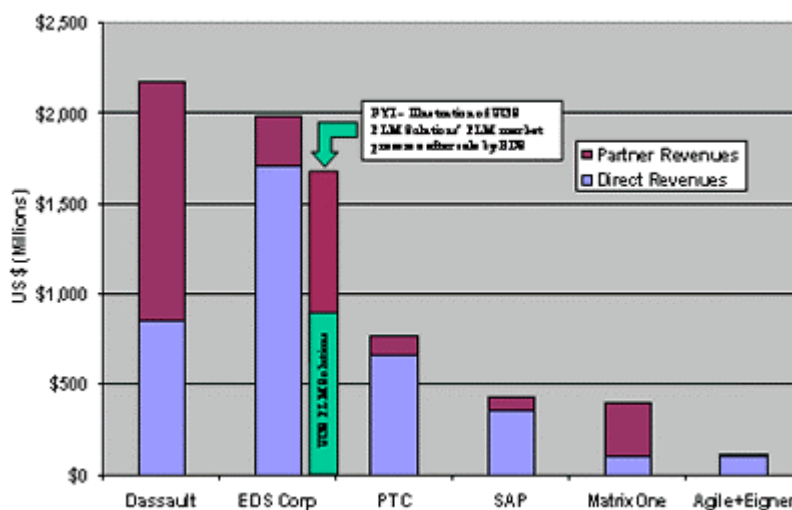

Figure 4.5 - PLM Mindshare Leaders' Presence [7]

Also as demonstrated by the empirical research in chapter 3, PLM approach is currently under development and adoption into several industrial sectors; the most part of experiences and tools exist in the world of mechanical (e.g. Automotive and aerospace), but also some interesting applications are coming out from the world of Architecture, Engineering and Construction (AEC) and Daratech [8] estimates that this will be one of

the most important sector for PLM vendors in 2005 and new acronyms are arising (e.g. PLM/AECO for Daratech [8], ILM for Cambashi [16]). Also in the world of services there is lot of interesting uses of PLM; for example, in diverse hospitals (e.g. [32]) PLM approach is adopted for collecting and managing information about patients and their “life cycles” and a new acronym has been proposed (Service Lifecycle Management - SLM [33]). Also particular industrial sectors, such as textile, fashion&apparel [34] PLM has been adopted for managing in shorter time product information: information about daily sells are reported to production managers and to designers in order to improve (i) production scheduling and (ii) change and modify seasonal catalogues (e.g. colours).

PLM phenomenon is a worldwide experience and its ICT market is considered one of the more promising for the next five years.

Business research centres, such as CIMData, Aberdeen and Gartner, even if in different ways, are really confident in the evolution of PLM and its market. Lot of managers is interested in the PLM applications into their enterprises, as reveals an Accenture analyse [12]. According to this analyse, PLM is considered as the main key success element to be implemented for (i) improving time-to-market, (ii) reducing development and management product costs, (iii) avoiding communication errors, but also (iv) fostering innovation into the enterprise.

4.4 Open issues in PLM

PLM acronym signifies something new, since it merges more complex aspects and phenomena, from a strategic “product centric” vision, to the adoption of advanced ICT distributed solutions, fostering collaboration between people and organizations. Adopting a PLM approach signifies, at first, understanding the role of information and its sharing into the enterprise along the value-creator activities and processes. According to CIMData [7], it is possible to identify a PLM approach into an enterprise when: (i) an universal, secure, managed access and use of product definition information is provided; (ii) the integrity of product definition and related information throughout the life of the product or plant is maintained;

(iii) business processes for creating, managing, disseminating, sharing and using product information are managed and maintained.

According to the definition of PLM reported above, it is possible to observe that there are several open issues and perspective in PLM evolution, such as:

- From a strategic organization point of view, the adoption of a product centric approach signifies a (re-) modelling of all the relations established between the resources (people and equipments) involved into the relevant business processes oriented to a product lifecycle directions. How to act at a strategic level in a PLM orientation is one of the main open issues to be defined.
- From the ICT point of view, a centric product management is no more than a “database” problem, which physically enables the previous business process modeling. Information about products and processes are dispersed along a variety of information systems, which - until now - has been executed no more than “isolated islands” (e.g. PDM and ERP). The trends and issues currently on going deal with the integration of these “islands” into a larger integrated (distributed) repository, in order to provide a wider and more effective use of product information. In the first times, these integration trends had been performed in a closed way, with the instantiation of several proprietary “suites”, while recently some “standardization” efforts have been started for setting up an “open” but technological integration (e.g. PLM XML, ISO/DIS 10303-239, ISO 62264, see chapter 6). From this point of view there are several open issues and further researches to be developed.
- From a structural (or infrastructure) point of view, the instantiation of a product centric management approach, signifies the product centric design and management of several elements: (i) an information infrastructure, which concerns with ICT network establishment; (ii) a resource infrastructure, which concerns with the design and the management of all physical elements involved along a product life

cycle (e.g. machines, plants, people, suppliers, warehouses...); (iii) a product itself “infrastructure”. The same product has been become a resource to be managed directly, traced into its same life cycle.

All of these points of views are open issues for the industrial and academic research and development. Within this scenario and into such a complex and under evolution context, the instantiation of the PLM acronym seems to be justified. This is not the place to discuss about the role of technology in a more detailed manner (ICT is needed, but it isn't sufficient?), but it unavoidable to observe that PLM phenomenon is intrinsically connected with the ICT evolution. How PLM success will flow and disseminate is an open question and issue.

4.5 Conclusions

This chapter has presented a comprehensive definition of PLM and has summarized the most relevant trends and open issues of such a kind of acronym. The next part of the thesis will debate a particular niche of the PLM context, which will provide an innovative point of view in the management of product data, according to the “holonic product concept and modeling”.

PLM is a complex phenomenon, where more dimensions and disciplines are giving their contributions. This widely definition seems to be validated from the large use of the PLM acronym itself, both within the vendor community (as usual), but also (even if is a recently application of the PLM term) within the scientific community. During the last year, several congresses, conferences and seminars had been conducted with a “PLM” tag into the title, from the IT, to the operation & management communities.

Moreover, before concluding this chapter a fundamental question could arise: but which kind of PLM does a company need? The answer is not really so easy. The author, during his research period, tried to answer to this question, even if a satisfactory answer is still looked. At the present, it is possible to say that the definition of a PLM approach deals with the complexity that the company might manage (see also conclusions at

chapter 3) in terms of “product” complexity and “processes” complexity. For example, AMR research defines two main complexity axes in the definition which kind of PLM (figure 4.6), while Gartner [10] classifies PLM vendors according to the complexity that they can support in a PLM context (figure 4.7).

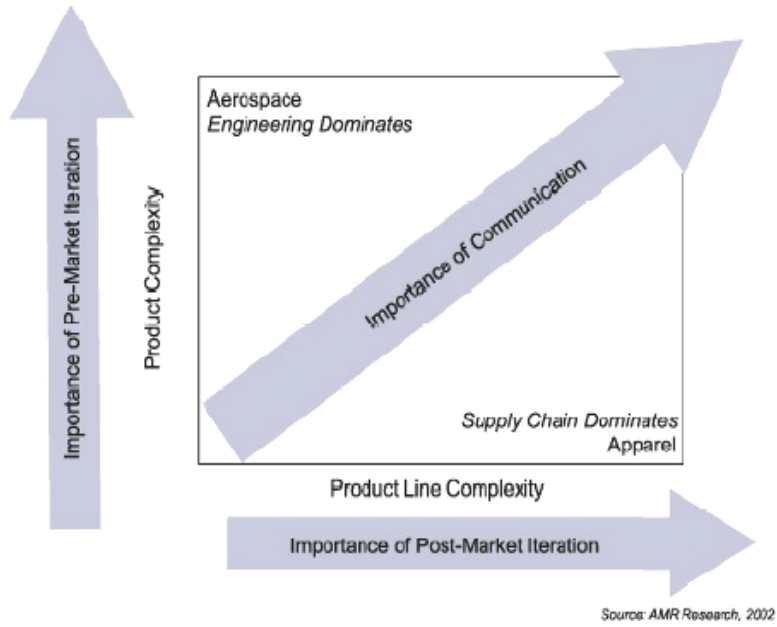

Figure 4.6 - PLM dimensions for AMR Research [6]

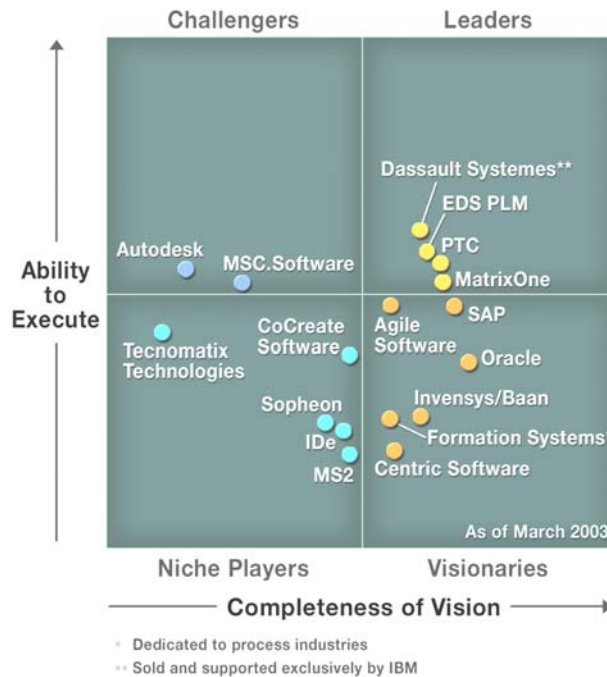

Figure 4.7. – Gartner magic quadrant [10]

This question is still open both in the research area and in the market. The present thesis doesn't have the time to answer, but the researches here conducted are suggesting the way to answer in the next years. For example, figure 4.8 summarizes a possible path of adoption of PLM: is better a PLM integrated suite or the application of modular solutions, also coming from diverse vendors? The matrix proposes two axes: complexity of the product vs. volume of generation (how many products are designed and produced?).

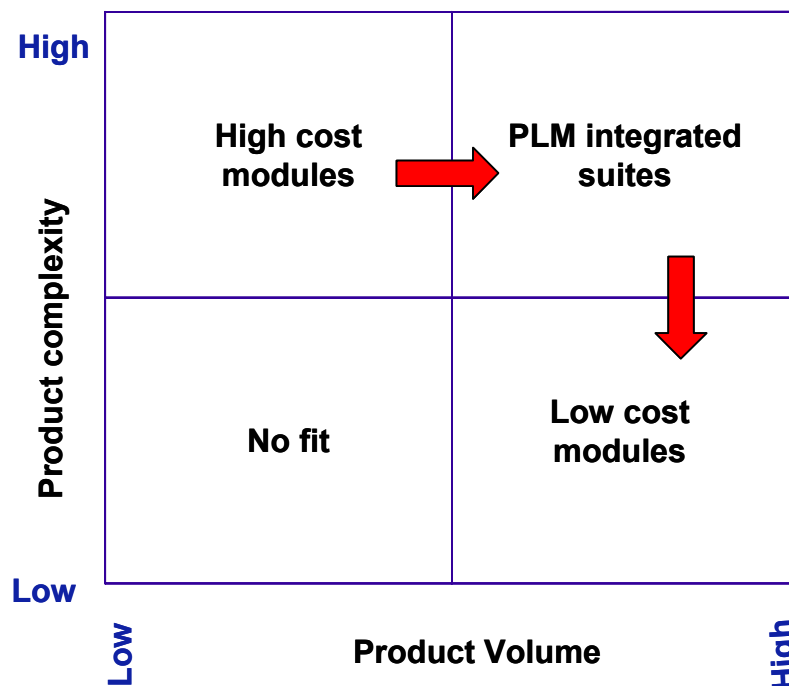

Figure 4.8. – A possible path in the adoption of PLM

The next chapter, which constitutes the second part of the thesis try to demonstrate that one of the main issues concerning with the product management in a wider perspective (along a defined lifecycle), deals with the traceability of the product. The product traceability is intrinsically a PLM question since it is related with an organizational perspective (allocation of task for tracing products), an information perspective (information identification, coding) and an infrastructure perspective (systems for product traceability), along a product centric approach.

4.6 References of the chapter

Scientific references

- [1] International Journal of PLM, InderScience Publishers, first volume expected for July 2005
- [2] Saaksvuori A., Anselmi I., (2004), Product Lifecycle Management, Springer
- [3] Stark J., (2004), Product Lifecycle Management: Paradigm for 21st century Product Realisation, Springer

Technical references

- [4] SAP, www.sap.com
- [5] Baan, (2002), IBaan - Positioning white paper, www.baan.com
- [6] AMR Research, www.amr-research.com
- [7] CIMdata, (2002), Product lifecycle Management. Empowering the Future of Business, www.cimdata.com
- [8] Daratech, www.daratech.com
- [9] ARC Advisor Group News, (2003), PLM Market to more than double. What is PLM?, www.arcweb.com
- [10] Gartner group, www.gartner.com
- [11] Qad, (2002), A Qad White Paper Unified Product Lifecycle Management, www.qad.com
- [12] Accenture, (2001), Collaborating To Compete: A New Way Forward, www.accenture.com
- [13] SUN, (2001), Collaborative Product Commerce (CPC) Solutions from Sun, Sun Whitepaper, www.sun.com
- [14] Betasphere, (2002), Collaborative Product Commerce (CPC) Solutions from Sun, www.betasphere.com
- [15] Codrino A., (2000), Le tecniche CAD, CAM, CAE e CAPP al servizio della progettazione e della produzione avanzata, www.plm-systems.com
- [16] Cambashi, (2003), Is PLM applicable to AEC?, www.cambashi.co.uk
- [17] UGS, www.ugsplm.com
- [18] Metagroup, www.metagroup.com
- [19] Tecnomatix, www.tecnomatix.com
- [20] IBM www.ibm.com
- [21] Technology Evaluation, www.technologyevaluation.com
- [22] PLM IG, www.plm-ig.com (www.johnstark.com)

- [23] IMS NoE, www.ims-noe.org
- [24] Lotus Notes, www.lotus.com
- [25] Autodesk, www.autodesk.com
- [26] Formula Group, www.gformula.com
- [27] Zucchetti, www.zucchetti.it
- [28] Microsoft, www.microsoft.com
- [29] MatrixOne, www.matrixone.com
- [30] Linius Technologies, www.linium.com
- [31] TruEInnovations, www.trueinnovations.com
- [32] Market press, (2003), Nasce Clinical Repository Service: progetto per la zona ospedaliera del padovano, www.marketpress.info
- [33] Brown J., (2003), SLM - Service Lifecycle Management, www.technologyevaluation.com
- [34] TXT E-Solution, www.txt.com

PART II

Product Lifecycle Traceability

CHAPTER 5

Product lifecycle traceability

5.1 Introduction

As analyzed, PLM is a new emerging paradigm, which aims to satisfy the more and more relevant questions of the modern enterprises. In such a context, several vendors, coming from the diverse worlds interested into the product and production management, are more and more providing answers, stabling a growing tagged PLM market. The needed product and production management is intrinsically related to the management of the information, so it is obvious that the related emerging market is ICT characterized. Nevertheless, PLM is not primary an ICT problem, but at first, is a strategic business orientation of the enterprise. As previously defined PLM aims to be a new integrated approach to the management of all the business processes distributed along the product lifecycle (“from the cradle to the grave”), which considers:

- a strategic management point of view, where the “product” is the enterprise value creator,
- the application of a collaborative approach for the valorization of all the enterprise core-competences distributed along different actors, and
- the adoption of a large number of IT solutions and tools in order to practically establish a coordinated, integrated and access-safe product information management environments.

According to the provided definition that derives from literature analysis, empirical studies and enterprise experiences (vendors and users), the phenomenon named PLM is multi-layered and multi-disciplinary; in fact, within the provided definition different perspectives are taken into account:

- An organizational-oriented perspective, related both to strategic and operational issues and, therefore, to a “human” dimension. Business Process Modeling is the most related discipline, even if other disciplines like Strategic Management and Human Resource Management are connected.
- An information-oriented perspective, both in terms of needed informative dimensions (contents), and in terms of information technologies. More disciplines are related to this dimension, from specific “sub-process” disciplines (such as Product Development or Manufacturing, but also more industrial sectors specific disciplines), to the IT related disciplines (e.g. Informatics basics, Automation Control).
- An infrastructure-oriented perspective, both in term of ICT solution (as the previous) and general physical solutions. PLM adopts several ICT resources (database, work-station...), but it is really connected to physical elements of the enterprise (the product itself, production resources, supplier, customers...). The relative disciplines are widely distributed.

PLM is a complex phenomenon, where more dimensions and disciplines are giving their contributions. This widely definition seems to be validated from the large use of the PLM acronym itself, both within the vendor community (as usual), but also (even if it is a recently application of the PLM term) within the scientific community. During the last years, several congresses, conferences and seminars had been conducted with a “PLM” tag into the title, from the ICT, to the operation & management communities. Looking up to this complex world, it is possible to highlight several research fields that are emerging (or re-emerging) into different communities:

- PLM-oriented business models for the enterprise management
- PLM-oriented strategies sector-(or product)-dependent
- Human resource management into collaborative environment
- Product lifecycle costing models

- PLM-oriented Operation management models
- PLM-oriented production system design and management (plant design, supply chain design)
- Traceability of the product along its lifecycle
- ICT systems integration and interoperability
- Standardization offices
- Technological innovation in product/process development
- Eco-compatibility in product/process management

As mentioned, from a structural point of view, the instantiation of a PLM approach signifies the product centric design and management of several elements:

- An information infrastructure, which concerns with CIT network establishment;
- A resource infrastructure, which concerns with the design and the management of all physical elements involved along a product and production lifecycle (e.g. machines, plants, people, suppliers, warehouses...);
- A product itself “infrastructure” where the same product has become a resource to be managed directly, traced into its own lifecycle.

According to the last point of view, this chapter deals, as the rest of the thesis, with the establishment of a new way of thinking for managing product data along the product lifecycle. In particular, the next paragraph will define the boundaries of such kind of contribution, while the third paragraph will introduce the state of the art of product management in the lifecycle traceability with a detailed analysis of the reference literature and the related traceability technologies (in section 5.4).

5.2 Product lifecycle traceability

As mentioned into the last point of view, one of the main issues concerning with the product management in a wider perspective (along a defined lifecycle), deals with the traceability of the product.

The term “traceability” related to the product or manufacturing has been defined since the 90ies, when a series of industrial needs had been highlighted into the establishment of ISO 9000 procedures. Generally, product traceability is the ability of a user (manufacturer, supplier, vendor...) to trace a product through its processing procedures. Physically, the product traceability deals with maintaining records of all materials and parts along a defined lifecycle (e.g. from raw material purchasing to finished goods selling and its recycling) using a coding identification.

The product traceability is intrinsically a PLM question since it is related with an organizational perspective (allocation of task for tracing products), an information perspective (information identification, coding) and an infrastructure perspective (systems for product traceability), along a product centric approach. Product traceability is one of the most emerging questions within the PLM tagged communities. Several technological approaches exist, since simple bar-coding product tracking, to advanced RFID systems (e.g. Auto-ID and EPC consortium [36]) and micro-electromechanical systems (MEMS), which aim to transform the product itself into an “intelligent product”, able to be tracked into systems and to automatically cooperate with some resources (e.g. [7]). Meanwhile, the product traceability is a question advocated into several contexts, from the quality assurance problem (e.g. food tracking [1]), to the supply chain management (e.g. [12]).

5.2.1 Towards holonic product modeling and traceability

The product traceability problem concerns with the identification of a product (even if often it is only the class of product [3]) using a coding system (e.g. bar code, laser code, EPC code). All the information related to the coded “product” is then stored into one (or more) database.

Therefore, a merging activity between the product and its information is a mandatory step, also in the most advanced issues (e.g. Auto-ID efforts in [6], or Dialog effort in [12]). This re-merging activity is still not risk-free;

even if it could be already conducted in an automated manner, transactions breakdowns could occur in searching for information into the database or updating product states after its processing. In general, two main problems could be advocated:

- Accessibility. Database could be off-line or unavailable for a short or long period.
- Timing and Costing. Database could become too large and so expensive (or many database could be needed), moreover reducing efficient reading time.

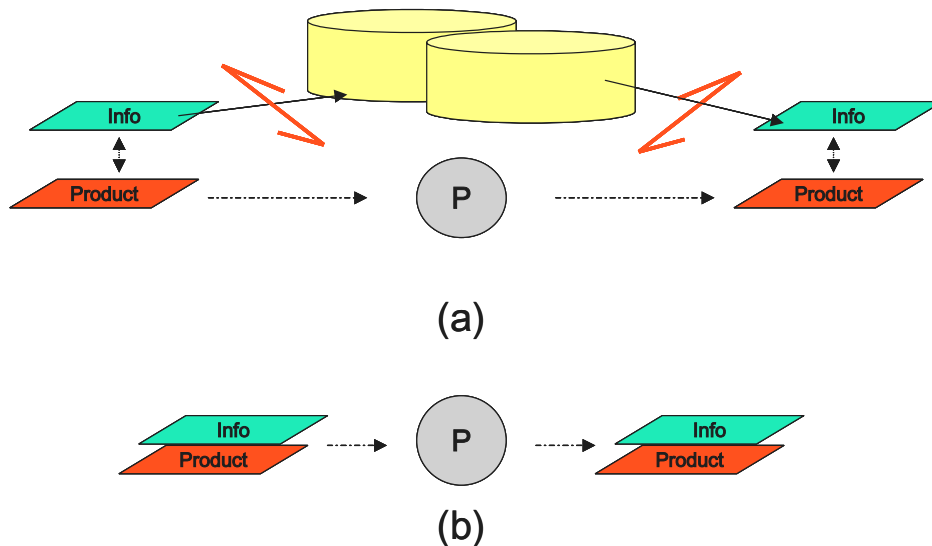

Figure 5.1 – Solving attitude for holonic traceability

A solving attitude (figure 5.1, b) could be identified in the concept partly illustrated in [13], where a simple 2D bar-code attached to physical elements had been adopted to translate high-density information (whole plant drawings) from the plant designer to the contractor. Taking into account this example, each product could be provided with an advanced “product information store system” (e.g. RFID based), in order to be (i) from one side tracked into a system (e.g. a plant) and, from another side, (ii) to be able to provide itself the needed information.

This way, the product could become an “intelligent product” [18], able to exchange information (which is into the product itself) in real-time with

different resources (e.g. machines and transporters into a plant scenario, or trucks and inventory database into a warehouse, or with refrigerators and dishwasher at home...).

Looking to the literature, the paradigm of “product + information” had been already developed and it is defined as holonic worldview. The word Holon was introduced by Koestler in 1967 [19], as a combination of the Greek Holos (whole) with the suffix –on, which as in proton and neutron suggests a particle or individual part.

In the 90ies, the holonic term was applied to the manufacturing world, creating the Holonic Manufacturing Systems (HMS) community [20]. For this community a Holonic Manufacturing “is an autonomous and co-operative building block of a system for transforming, transporting, storing and/or validating information and physical objects. The holon consists of information processing part and often a physical processing part. A holon can be part of another holon.”

Looking at the Holonic product traceability research effort and thinking to the future, in several years a “product holon” could be inserted in more systems (e.g. a plant, a supply chain, a warehouse) where it will have to exchange information with different “resource holons” [18]. Hence, the problem of information exchange could easily arise (it exists into simple bar decoding, [13]) and further standardization efforts will be needed, so establishing a kind of barriers to the diffusion of the same holonic traceability. In order to reduce these further barriers, but ever more in order to improve the currently definition and the study of holonic product traceability, a research effort has been spent since now in this PhD thesis, looking to the current situation of enterprise information systems (where product information are resident) and trying to elaborate it in an holonic view, creating a conceptual HMS product-oriented architecture. The actual situation of the enterprise information systems could be provided by the analysis of the current accepted standard, which are specifically created for the integration of ICT systems. The analysis of standards (ISO 62264,

ISO 10303, ISO 61499) seems to be a basic step that could reduce the research effort, avoiding a long state of the art analysis of enterprise IT systems. From this holonic review of integrating standards, a holonic metamodel could be formalized in order to distribute information on physical systems. This metamodel can be a preliminary reference for further holonic standard developments.

5.3 State of the art of product lifecycle traceability

According to ISO 9000:2000 [32], “traceability is defined as the ability to trace the history, application or location of which is under consideration”. In terms of products it relates to the origin of materials and parts, the processing history and the distribution after delivery. It traces and follows a product through all stages of production and distribution. Traceability has been defined by authors in many different ways; Moe [1] defines traceability as follows: “Traceability is viewed as an ability by which one may track a product batch and its history through the whole, or part, of a production chain from harvest through transport, storage, processing, distribution and sales, or internally in one of the steps in the chain, for example the production step”. A more “logistic” view on traceability is given by APICS (American Production & Inventory Control Society) [38]: “A twofold view on traceability is put forward: traceability is the attribute that allows the ongoing location of a shipment to be determined, and traceability is the registering and tracking of parts, processes and materials used in production, by lot or serial number.”

European Commission is attributing a large interest to traceability; European laws have many articles that deal with traceability. Traceability is bethought as a useful “tool” in many industrial sectors, like agriculture, breeding, healthcare, aeronautical, with the target to trace responsibility and to grant safety. In European laws, traceability means the “ability to trace products at all stages of their placing on the market through the production and distribution chains” [Regulation (EC) No 1830/2003 of the European Parliament and of the Council of 22 September 2003 Directive 2001/18/EC]. Traceability is one of the research priorities underlined in the

2002/834/EC Council Decision of 30 September 2002 as table 5.1 demonstrates; moreover, since 2005, in Europe traceability became mandatory for food logistic suppliers and vendors.

Law	Context
Commission Regulation (EC) No 2042/2003 of 20 November 2003	Aircraft and aeronautical products, parts and appliances
Regulation (EC) No 1946/2003 of 15 July 2003	Genetically modified food and feed
Commission Regulation (EC) No 1915/2003 of 30 October 2003 amending Annexes VII, VIII and IX to Regulation (EC) No 999/2001	Ovine animals
Regulation (EC) No 1829/2003 of 22 September 2003	Genetically modified food and feed
Regulation (EC) No 1830/2003 of the European Parliament and of the Council of 22 September 2003 Directive 2001/18/EC	Medical products for human use
Commission Directive 2003/94/EC of 8 October 2003	Medical products for human use
Commission Directive 2003/63/EC of 25 June 2003	Medical products for human use
Directive 2002/98/EC of the European Parliament and of the Council of 27 January 2003 and amending Directive 2001/83/EC	Human blood
Council Regulation (EC) No 2368/2002 of 20 December 2002	Rough diamonds
Commission Regulation (EC) No 753/2002 of 29 April 2002	Wine sector products
Council Resolution of 21 January 2002 on the Commission report on the implementation of Regulation (EEC) No 3911/92 on the export of cultural goods and Directive 93/7/EEC	Cultural goods
Directive 2001/95/EC of the European Parliament and of the Council of 3 December 2001	General product safety

Table 5.1 - Product traceability in European laws

Traceability is a leading question in lots of industrial context and sectors. Some of them are more relevant, constituting a series of scenarios where the traceability of products is a primary business-key, whereas in other scenarios the traceability is considered as a useful “tool” rather than a true necessity. These different fields of appliance can be gathered and summarized in few hi-level general categories like: (i) Food, (ii) Manufacturing, (iii) Construction, (iv) Projects Delivery, (v) Software, (vi) Marketing. The first three are the most relevant sectors in terms of

traceability questions, while the last three provide a series of interesting points of view, but with a minor impact (then they are grouped under the Other category).

Traceability has diverse dimensions of investigation/classification. The first one, according to Olsen [2], can be considered as Internal and External traceability (table 5.2). Internal is within one company and relates to data about raw materials and processes to the final product before it is delivered. External traceability is focused on the information about the product that are needed out of the factory; these information flows from one link in the chain to the next. It describes what data are transmitted and received, and how. External traceability is between companies, countries and depends on the presence of Internal traceability in each link.

Scenario	Internal Traceability	External Traceability
Food	[1],[3],[11]	[1],[3],[23]
Manufacturing & SCM	[6]	[5],[26]
Construction		[13],[27]
Other	[10],[25],[28]	[4],[8],[9],[28],[29]

Table 5.2 - Internal and external traceability in literature

Another dimension can also be Backward or Forward traceability (figure 5.2). Backward leads to the origin and history, and maps everything that goes to a product, linking identification (ID) of output product to ID of input product. It records all the components, the operations and the machines that work on a particular product. It writes these information after the event occurs. Forward traceability explains what will happen to a certain product, all the processes and output that the product in question went into. This information is written before the product production begins and aims to give all the information that is needed to the production. This kind of traceability is very useful in automated manufactures, to realize an IMS (Intelligent Manufacturing System, see chapter 7).

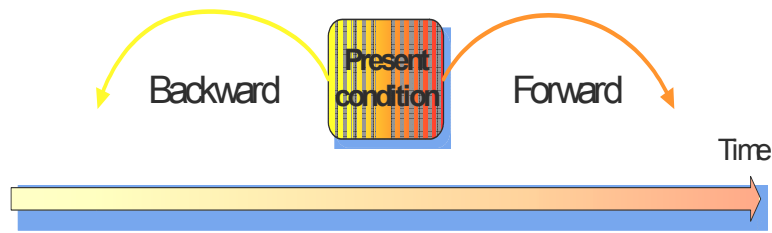

Figure 5.2. Backward and Forward traceability

Table 5.3 shows where the forward and backward traceability are discussed; in almost all scenarios is needed the backward traceability; forward traceability is under development and till now it is not really exploited at the wholeness of it's capability, however there are many studies on it.

Scenario	Forward Traceability	Backward Traceability
Food		[1],[3],[11],[23]
Manufacturing & SCM	[7],[12]	[5]
Construction	[27]	
Other		[10],[28],[29]

Table 5.3 - Backward and Forward traceability in literature

5.4 Product Traceability technologies

In terms of technologies, the leading technologies could be summarized (in order of adoption) in (i) one-dimension linear barcode, (ii) two-dimensional symbols, (iii) radio frequency identification tags (figure 5.3). While 2D barcode are widely used, the others are newer and till now have a few real applications. The newest technologies are permitting a significant increase in the amount of information that can be stored in the specific medium (e.g. while a linear bar code symbol can accommodate a dozen or so characters, two-dimensional symbols can accommodate up to 4000 alphanumeric characters, while RFIDs are arising megabytes level). While optically readable media such as linear and two-dimensional symbols are considerably less expensive than electronic, the utility of RF tags may be found in the management of manufacturing records with their reusing. Technological progress is reducing costs of RFID tags, which facilitate the reading process, and - unlike one-dimensional and two-

dimensional symbols - allow an easier writing of new information, and they can be incorporated into the product during the manufacturing, for use in downstream processes.

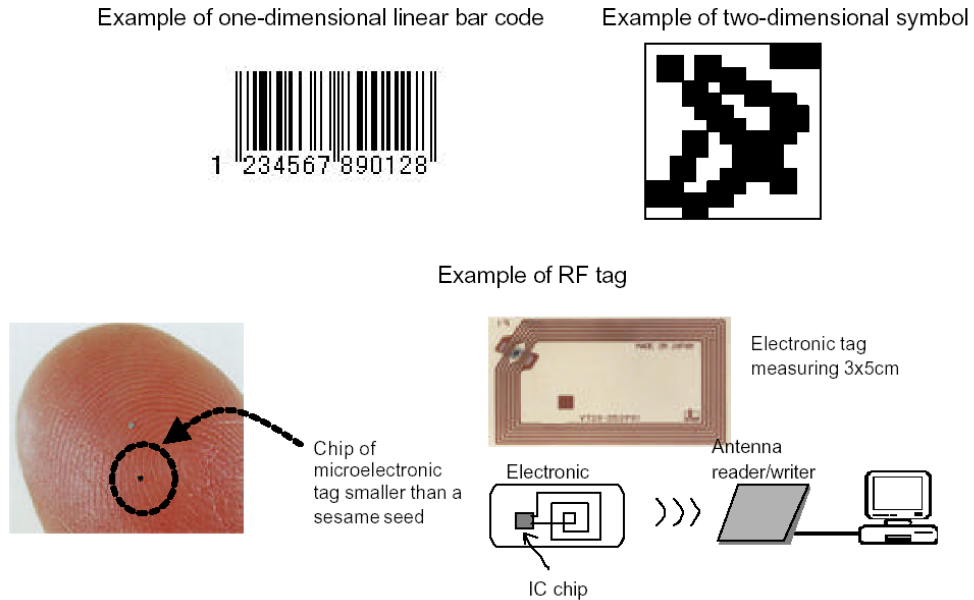

Figure 5.3 - Examples of traceability technologies [24]

At the present, due to the main differentiation of costs and performance, the diverse tracking media are fitted to different industrial sectors and scenarios; for example barcode fits very well the food industry, while RFID tags are becoming very useful in manufacturing of complex and expensive goods, where there are much more information and the cost of a tag is negligible comparing to the product itself. RFID tags also are the best technology if the information has to be updated, for example to record maintenance or to record dynamically each single process performed on the product.

The diverse technologies allows diverse innovations:

- First, these technologies are permitting a significant increase in the amount of information that can be stored in the specific medium. For instance, while a linear bar code symbol can accommodate a dozen or so characters, two-dimensional symbols can accommodate up to 4000 alphanumerical characters. Depending upon the technology employed, RF tags can store a simple license plate or can have the capacity to

store information equal to that of a two-dimensional symbol, or can have the capacity to store significantly more information than any two-dimensional symbol introduced to date.

- Secondly, optically readable media such as linear and two-dimensional symbols are considerably less expensive than electronic, RF tags. The utility of RF tags may be found in the management of manufacturing records with their reusing. RF tags may have cost from about ten euro to over a hundred euro, so use of this technology for products without considering reuse has been unthinkable. However technological progress in recent years has helped reduce their costs to some euro depending upon whether they are read-only or read-write tags and the amount of on-board memory available. Recent technological development makes tags prices in the range of half a euro per RF tag, and it has been suggested that prices in the range of several cents will not be impossible for a read-only tag.
- Thirdly, particularly RF tags, unlike one-dimensional and two-dimensional symbols, allow for the easy writing of new information onto the tag through the production process, such as required information on how a product or parts was manufactured and on which date. Further, the RF tag can be incorporated into the product during the manufacturing, for use in downstream processes. Unlike one-dimensional and two-dimensional symbols, it also permits the reading of product information remotely that is not within line-of-sight, as well as the collective reading of the information from several tags, thus sharply reducing reading costs and time.
- Finally, it is possible to enhance product traceability through the use of linear symbols, two-dimensional symbols, and read-only RF tags using today's technology. The rapid growth of networking, such as the Internet, permits remote database access to acquire information on products at higher speeds and lower costs than a few short years ago. If traceability environments can be created using linear bar code

symbols, these databases enable an easy shift to use newer technologies such as RF tags [24].

Due to this differentiation of costs and performance these methods are fitted to different industrial sectors and scenarios: For example Barcode fits very well the food industry, and the manufacturing of all these goods that are cheap and widely distributed; contrariwise RF Tag can be very useful in manufacturing of complex and expensive goods, where there are much more information and the cost of a tag is negligible comparing to the product itself. RF Tags also are the best technology if the information has to be updated, for example to record maintenance or to record dynamically each single process performed on the product.

5.4.1 Bar code technologies

Since their invention in the early '50ies bar codes [24] have accelerated the flow of products and information throughout the global business community. Bar code technology allows data to be encoded in an optical readable form. Necessary requirements for data encoding are the printing technologies that produce machine-readable symbols, the scanners and decoders that capture visual images of the these symbols and convert them to computer digital data, and the verifiers that validate symbol quality.

Many different bar code symbols and languages were developed in the past, in compliance with different targets and backgrounds, each of one is characterized by its own rules for character (e.g. letter, number, punctuation) encoding, printing and decoding requirements, error checking, and other features.

The various bar code symbols differ both in the way they represent data and in the type of data they can encode: some only encode numbers; others encode numbers, letters, and a few punctuation characters; still others offer encoding of 128-character, and even 256-character, ASCII sets.

One main difference between coding techniques is that of barcode printing system. There are two opposite solution: On-site and Off-site Printing.

On-site printing allows direct printing of barcode near the place where barcode is to be used and with up-to-date data found on local as well as remote database system. The most common on-site bar code print technologies for on-site use are: (i) Direct Thermal, (ii) Thermal Transfer, (iii) Dot Matrix Impact, (iv) Ink –Jet, (v) Laser (Xerographic).

Off-site printing offers some advantages, showing a higher degree of barcode printing quality, but printing is usually made outside the enterprise. The most common on-site bar code print technologies for on-site use are: (i) Flexography, (ii) Letterpress, (iii) Offset lithographic, (iv) Rotogravure, (v) Photocomposition, (v) Hot stamping, (vi) Laser etching.

About barcode symbology, there are many standards dealing with such matter, as shown in table 5.4

Linear Symbology	2D Symbology	Composite Symbology	Matrix Symbology
ANSI/AIM BC1-1995, USS - Code 39 ANSI/AIM BC2-1995, USS - Interleaved 2-of-5 ANSI/AIM BC3-1995, USS - Codabar ANSI/AIM BC4-1995, ISS - Code 128 ANSI/AIM BC5-1995, USS - Code 93 ANSI/AIM BC12- USS - Channel Code USS Telepen ITS - 93i ITS - Reduced Space Symbology (RSS) ITS - PosiCode	ANSI/AIM BC6-1995, USS - Code 49 ANSI/AIM BC7-1995, USS - Code 16K USS Codablock F USS - PDF417 ITS - MicroPDF417 ITS - SuperCode	ITS - EAN.UCC Composite Symbology ITS - Aztec Mesas	Dot Code A USS - Code One ANSI/AIM BC10-ISS - MaxiCode ANSI/AIM BC11-ISS - Data Matrix ANSI/AIM BC13-ISS - Aztec Code ITS - QR Code

Table 5.4 -Barcode symbol standards [24]

There are four different technologies for standard barcodes symbology: linear, 2 dimensional, composite or matrix.

Linear barcodes are well established and their use is spread all over the world, mainly because they offer a low cost, easy implementable solution for product traceability. They were introduced first 25 years ago, but this kind of symbology is still today one of the most widely used optical recognition technology. There are more than one hundred different encoding techniques for different symbology, but the most used is Code 39. Depending upon which symbology is used, bar codes may encode only numeric data (U.P.C. and ITF, for example), or all or part of the American National Standard Code for Information Interchange (ASCII) character set (e.g., Codes 39 and 128) by the width of the bars, and in most cases by the width of the spaces as well. As a scanning device is moved across the symbol, the width pattern of the bars and spaces is analyzed to extract the original encoded data. A 1D barcode is a sequence of black bars and white spaces and the width of each bar is in relation with so-called “X dimension”. Such dimension represents the width of the narrowest bar or space constituting the code and stands for a coding resolution. Barcodes can usually be scanned in any of their two reading direction because they use some special characters as terminators of the code. Most bar codes include an interpretation line, which is another way of encoding data printing them in human readable characters directly below the symbol.

The following is an overview of different standards for linear barcodes:

- (6/93) ANSI/AIM BC2-1995, Uniform Symbology Specification: it is suitable for encoding general-purpose all-numeric data. This specification is the same of the corresponding CEN (Commission for European Normalization) standard.

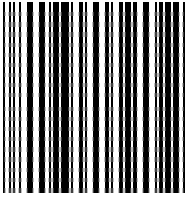
- (6/93) ANSI/AIM BC1-1995, Uniform Symbology Specification: it's known as Code 39 and is suitable for encoding general-purpose alphanumeric data. It provides reference symbology for many industry standards and is able to encode standard and optional full ASCII. This

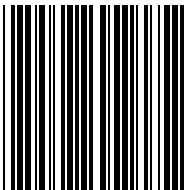

specification is the same of the corresponding CEN (Commission for European Normalization) standard.

- (6/93) ANSI/AIM BC3-1995, Uniform Symbology Specification: it can

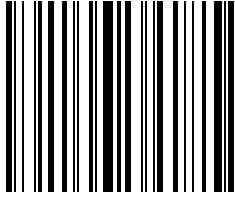

encode all numeric data and has four unique start/stop characters, which can convey additional information. This specification is the same of the corresponding CEN (Commission for European Normalization) standard.

- (6/93) ANSI/AIM BC4-1999, International Symbology Specification:

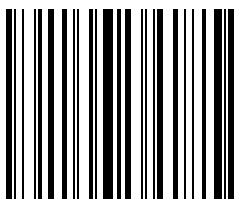

Code 128 is more condensed than Code 39 and is suitable for encoding general purpose alphanumeric, full ASCII and extended ASCII for non English characters. This specification is the same of the corresponding CEN (Commission for European Normalization) standard.

- (6/93) ANSI/AIM BC5-1995, Uniform Symbology Specification: Code

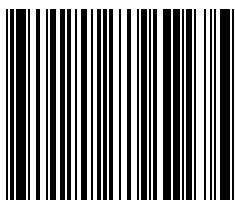

93 Code 93 offers higher information density for alphanumeric data than either Code 39 or Code 128.

Two-dimensional barcodes were developed to overcome one of the problems that sometimes restrict implementing of barcode-based systems: the limited space for encoding data. Two-dimensional barcodes considerably enhance the density of registered encoded information, allowing designing smaller barcodes or embedding a lot of useful information. There are two types of 2D bar codes in current use: Stacked codes and Matrix codes. Stacked symbology were developed starting from 1D codes (linear barcodes), such as Code 39 and Code 128, stacked in horizontal layers to create the multirow symbologies, for example Code 49 and Code 16K, respectively. Other codes, such as PDF417, encode the full ASCII character set. These kinds of barcodes share some properties in

common with linear ones: they are easily read and decoded by well-founded optical technologies, can be printed using the same methods, capabilities of error detection and correction. They can also provide a range of symbologies with capacities up to 2000 or more characters and can handle international characters sets. Matrix symbologies, on the other side, offer higher data densities than stacked codes in most cases, as well as orientation-independent scanning. A matrix code is made up of a pattern of cells that can be square, hexagonal, or circular in shape. Data is encoded via the relative positions of these light and dark areas, and encoding schemes use error detection and correction techniques to improve reading reliability and enable reading of partially damaged symbols. Matrix codes are scaleable and well suited both as small ID marks on products and as symbols on shipped packages easy to decoded by scanner on automated conveyors.

The following is an overview of different standards for 2D barcodes:

- (6/93) ANSI/AIM BC6-1995, Uniform Symbology Specification: Code 49A is a multi row symbology and offers high information density encoding of the full (128-character) ASCII set.

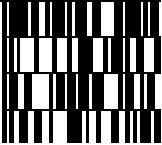
- (6/93) ANSI/AIM BC7-1995, Uniform Symbology Specification: Code 16K is a multi row symbology and offers high information density encoding of the full (128-character) ASCII set as well as of extended ASCII for non-English language characters.

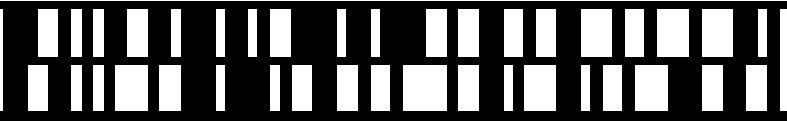
- (8/94) Uniform Symbology Specification: PDF417 is a two-dimensional, multi-row symbology designed to be scanned by laser scanners and linear CCD scanners. PDF417 is used to encode data files with hundreds or thousands of characters in a laser scannable symbol.



5.4.2 Radio frequency identification

Radio frequency identification (RFID) first appeared in tracking and access applications during the 80ies [12]. These wireless systems allow reading without a direct contact with the object and can be implemented in manufacturing environments where bar code labels performance are not enough. RFID has applications in a wide range of markets including livestock identification and automated vehicle identification (AVI) systems because of its ability to track moving objects.

Main features of RFID systems are:

- Wide area of automatic identification and data capture
- New generation, lower cost transponders offering multi-read capabilities
- Read/write electronic storage technology
- Wide range of products satisfying a range of data storage and data transfer needs
- Low to reasonably high (64Kbits) data storage capability
- Wide range of data transfer rates, depending on device and carrier frequency used.
- Robust constructions available, allowing use in reasonably harsh conditions.

A basic RFID system consist of three components:

- Tag antenna: the antenna emits radio signals to activate the tag and read and write data to it. Antennas are the conduits between the tag and the transceiver, which controls the system's data acquisition and communication
- Reader: The reader decodes the data encoded in the tag's integrated circuit (silicon chip) and the data is passed to the host computer for processing. It emits radio waves in ranges of anywhere from a few centimeters to tens of meters or more, depending upon its power output and the radio frequency used.
- A transponder (RF tag) electronically programmed with unique information

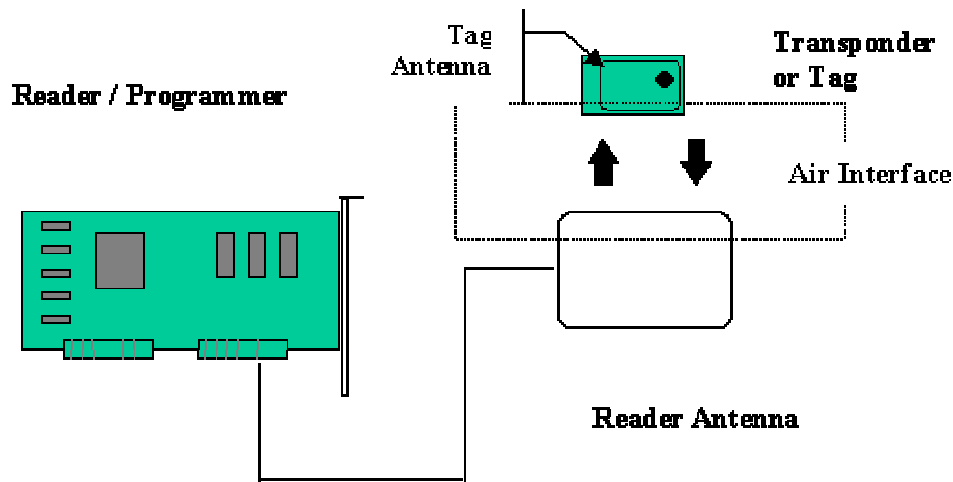

Figure 5.4 - Components of RFID Systems [33]

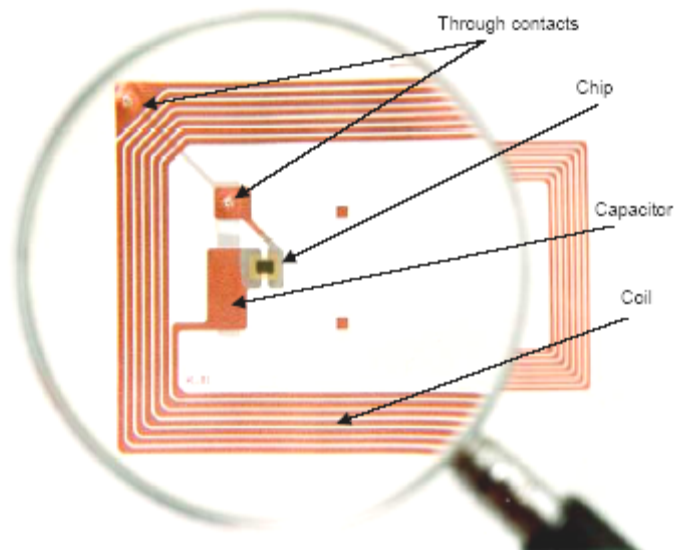

Figure 5.5 - Schematic structure for an RFID Tag [34]

There is a first relevant distinction to point out between different types of RFID tags: they are categorized as either Active or Passive. Active RFID tags are powered by an internal battery and are typically read/write, so that data can be rewritten and/or modified. An Active tag's memory size varies according to application requirements; some systems operate with up to 1MB of memory. In a typical read/write RFID manufacturing system, for example, a tag might give a machine a set of instructions, and the

machine would then report its performance to the tag. This encoded data would then become part of the tagged part's history. The power supplied by an internal battery of an active tag generally gives it a longer read range.

Passive RFID tags operate without a separate external power source and obtain operating power generated from the reader. Passive tags are consequently much lighter than Active tags, less expensive, and offer a virtually unlimited operational lifetime. They have shorter read ranges than active tags and require a higher-powered reader. Read-only tags are typically passive and are programmed with a unique set of data (usually 32 to 128 bits) that cannot be modified. Read-only tags often operate as a license plate into a database, in the same way as linear barcodes reference a database containing modifiable product-specific information.

From a technical point of view, RFID systems are also distinguished by their frequency ranges (table 5.5). Low-frequency (30 KHz to 500 KHz) systems have short reading ranges and lower system costs. They are most commonly used in security access, object tracking, and animal identification applications. High-frequency (850 MHz to 950 MHz and 2.4 GHz to 2.5 GHz) systems, offering long read ranges (greater than three or four tens of meters) and high reading speeds, are used for such applications as railroad car tracking and automated toll collection. However, the higher performance of high-frequency RFID systems implies higher system costs.

Frequency Band	Characteristics	Typical Applications
Low 100-500 kHz	Short to medium read range Inexpensive low reading speed	Access control Animal identification Inventory control Car immobiliser
Intermediate 10-15 MHz	Short to medium read range potentially inexpensive medium reading speed	Access control Smart cards
High 850-950 MHz 2.4-5.8 GHz	Long read range High reading speed Line of sight required Expensive	Railroad car monitoring Toll collection systems

Table 5.5 - Frequencies used for RFID tags [34]

Summing up, an RFID system can be useful when non-contact between the tag and the reader is required, when tags should be used within substances such as snow, fog, ice, paint, crusted grime, and other visually and environmentally challenging conditions, where barcodes or other optically read technologies would be useless. RFID tags can also be read in challenging circumstances at remarkable speeds, in most cases responding in less than 100 milliseconds. The read/write capability of an active RFID system is also a significant advantage in interactive applications such as work-in-process or maintenance tracking. Nowadays developments in RFID technology continue to yield larger

5.4.3 Traceability architecture

Traceability indeed is based on the identification of the single product; now it's common to put information in a centralized database, where the information is organized by identifying codes of the items. The information concerning a certain product can be accessed using its identity code. In practice, the products are labeled with bar codes, which can be read to access the information. The behavior of the system is shown in figure 5.6; the information is loaded in a centralized database, which records also all the unique codes that identifies the products. When information has to be retrieved, stored or modified, the user has to send an inquiry to the database, specifying the code written on the barcode of the single product.

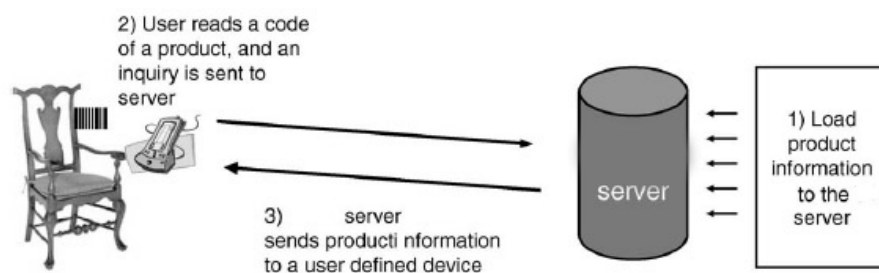

Figure 5.6 - Barcode and server system [12]

The main weaknesses of this kind of solutions are the necessity of transferring all needed information to a centralized database, and that the system is operable only after an integration period. The strength of these

systems is that they are ready-made solutions and can be taken into use quickly. Another weakness of these kinds of systems is that the codes used do not always give the possibility to manage item level information, i.e. they work only at the product type level. This is because the codes used only distinguish different types of products, not individual pieces. At last weakness is its lack of universality [12]

There are in development many other infrastructure to allow traceability; one is developed by Auto-ID (now EPC Globalinc [35], another is the Dialog system [12] developed at Helsinki University of Technology.

Auto-ID proposal

The one developed by Auto-ID is based on RF Tags; it is an intelligent infrastructure with four major components: electronic tags, Electronic Product Code (EPC), Physical Markup Language (PML) and Object Naming Service (ONS).

Electronic tags refer to a family of technologies that transfer data wirelessly between tagged objects and electronic readers. Radio Frequency Identification (RFID) tags, often used in “smart cards,” have small radio antennas, which transmit data over a short range. Electronic tags, when coupled to a reader network, allow continuous tracking and identification of physical resources. In order to access and identify tagged objects, a unique naming system was developed. The Electronic Product Code (EPC) was conceived as a means to identify physical objects [36]. The EPC code was created to enumerate all objects and to accommodate current and future naming methods. The EPC code was intended to be universally and globally accepted as a means to link physical objects to the computer network, and to serve as an efficient information reference. The Object Naming Service (ONS) is the “glue,” which links the Electronic Product Code (EPC) with its associated data file [37]. More specifically, the ONS is an automated networking service, which, when given an EPC number, returns a host addresses on which the corresponding data file are located. The ONS, currently under development, is based on the standard

Domain Naming Service (DNS). When complete, the ONS will be efficient and scalable, designed to handle the trillions of transactions that are expected.

Another infrastructure is rather different because starts from a critic to Auto-ID assumption of a unique code for each product; in fact firstly, standardization of product coding is difficult, and it is difficult to achieve a global acceptance of the coding.

For example, it took over ten years for the EAN/UPC coding to achieve a strong foothold in the consumer goods industry and grocery business [36]. The proposed solution is supposed to have an even wider appeal. Auto-ID Center [35] has been able to gather a significant base of companies to its network, but the process is not likely to be very fast.

Secondly, the approach demands central allocation of the codes. This means, that if a company wishes to start producing a new product variant, or even produce significantly more pieces of a product currently produced, it would have to request EPC codes to be allocated to those individual products. Therefore, much of the control of companies' operations is transferred to an institute responsible of the code allocation. Furthermore, the ONS network is not yet ready and the date of its possible completion is not known [37].

An EPC Network is a system for keeping track of each instance of a product in a manufacturing enterprise, based mainly on a few technologies: EPC, RF tags, ONS and PML. EPC networks are a comprehensive system for linking in a univocal way an item with some information or data related with it by means of an electronic tag. The purpose of that work is to provide necessary tools for an effective management of product production as well as for supply chain or customers relationships management. An EPC network consists of five high-levels of components: Tags and sensors, readers, Savant, an EPC Database and an ONS service. The structure of an EPC network is depicted in figure 5.7.

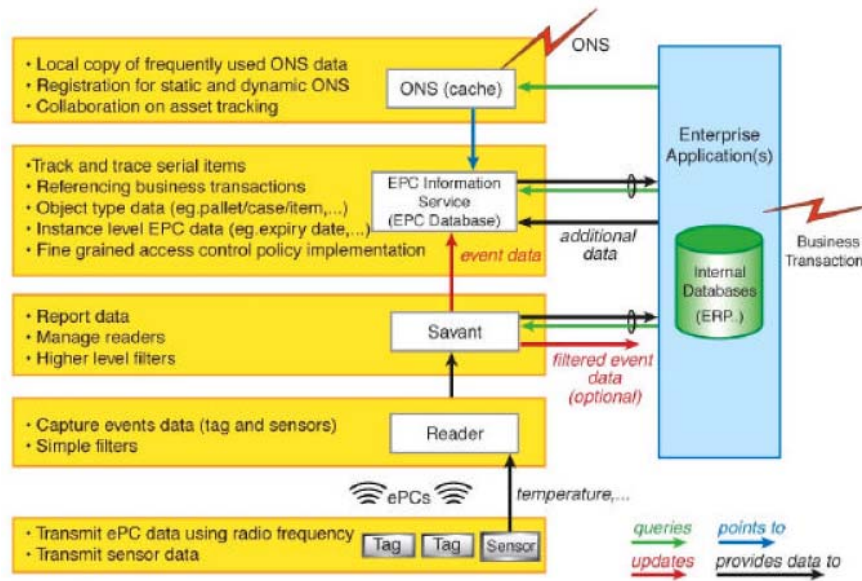

Figure 5.7 - Basic structure of components in an EPC network [35]

These components are:

- Readers: devices responsible for detecting when tags enter their read range. They may also be capable of interrogating other sensors coupled to tags or embedded within tags.
- Savant is “middleware” software designed to process the streams of tag or sensor data (event data) coming from of one or more reader devices. Savant performs filtering, aggregation, and counting of tag data, reducing the volume of data prior to sending to Enterprise Applications.
- The EPC Information Service makes EPC Network related data available in PML format to requesting services. Data available through the EPC Information Service may include tag read data collected from Savant (for example, to assist with object tracking and tracing at serial number granularity); instance-level data such as date of manufacture, expiry date, and so on; and object class-level data such as product catalogue information. In responding to requests, the EPC Information Service draws upon a variety of data sources that exist within an enterprise, translating that data into PML format. When the EPC data is distributed across the supply chain, an industry may create an EPC

Access Registry that will act as a repository for EPC Information Service interface descriptions.

- The Object Name Service provides a global lookup service to translate an EPC into one or more Internet Uniform Reference Locators (URLs) where further information on the object may be found. These URLs often identify an EPC Information Service, though ONS may also be used to associate EPCs with web sites and other Internet resources relevant to an object. ONS provides both static and dynamic services. Static ONS typically provides URLs for information maintained by an object's manufacturer. Dynamic ONS services record a sequence of custodians as an object moves through a supply chain. ONS is built using the same technology as DNS, the Domain Name Service of the Internet. The local ONS cache is used to reduce the need to query the global Object Name Service for each object which is seen, since frequently-asked / recently-asked values can be stored in the local cache, which acts as the first port of call for ONS type queries. The local cache may also manage lookup of private internal EPCs for asset tracking. Coupled with the local cache will be registration functions for registering EPCs with the global ONS system and with a dynamic ONS system for private tracking and collaboration within the supply chain seen by each unique object. The ONS root is the top-level domain name of the public EPC name space. Ultimately, all global lookups start from the ONS root, but the ONS local cache serves to limit the number of times the root is actually queried. At the time of this publication the value of the ONS root is unknown.

Such architecture can easily be extended to an inter-enterprise environment: within this context, data stored on RF tags are filtered and shared among enterprises using an Object Name Service system. Figure 5.8 shows how information are read from readers, treated by Savant systems, queried to internal enterprise ERP and distributed outside the enterprise.

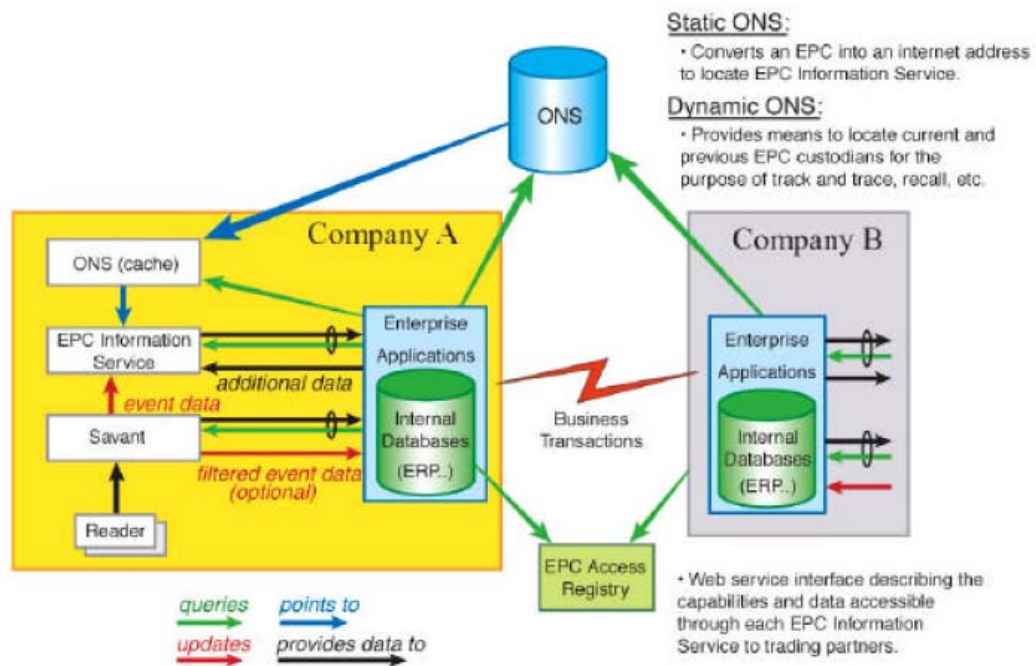

Figure5.8 - EPC inter-enterprise network [35]

Dialog System

This system [12], proposed by Helsinki University of Technology, aims at solving the challenges of item level information management without the need of developing new coding standards.

In this approach, the connection between a tangible object and the information network address that contains information regarding the object is defined by two pieces of information:

- Identification part (string containing numbers and/or text of free choice).
- Uniform Resource Identifier (URI), which is the Internet address of an agent associated with the tangible object.

These two pieces of information guarantee that the resulting combination is globally unique as long as the identification part is unique at the given URI address. The organization that owns the URI can arrange this by carefully allocating the identities inside that URI. There is, therefore, no

need to build a global base of codes for the products to be identified, nor is there any need for the codes to be centrally allocated.

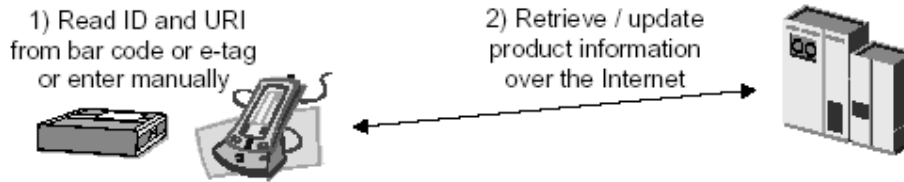

Figure 5.9 - The Dialog System [12]

The identification part may, in principle, be of any format whatsoever. However, if RFID tags are used it is most convenient to use the fixed identification number of the tag. RFID tags normally have a globally unique identification number, such as the 64-bit code defined by the ISO standard for RFID tags working at 13.56 MHz. This code can then be linked to the internal references of the company. When operating with barcodes, it is often easiest to use identity coding already in use in the company owning the URI. Examples of this kind of codes are dispatch note references, order numbers, or combined product type and serial numbers. The tag id and the programmable data area, where the URI part can be stored, are easily retrieved in one single read operation. When using bar codes, the identification and the URI can either be coded as two separate bar codes or coded into one single bar code. For coding the two parts into one field, a predefined separator between the codes has to be used. The Dialog project proposes using a coding convention similar to e-mail addresses, i.e. `identification@URI` (for instance `12345@dialog.hut.fi`).

The URI part of the Dialog item code indicates the location of the tangible object's "agent". The agent is a background service running at the computer indicated by the URI. It offers various interfaces for functionalities like location updates, item information requests, maintenance information requests, etc. The current versions of Dialog agents are programmed in Java, and they provide interfaces for receiving location updates, for linking the Dialog identification part to internal company reference numbers and for retrieving and displaying item related information. The company that has issued the tangible object is normally

the owner of the URI it is carrying, so the protocol (RMI or other), port, etc. to be used can be decided by the company without preliminary agreements with other actors. In order to connect to existing information systems, the agents use Java Database Connectivity (JDBC), which offers a standardized interface to most existing database products using the standardized query language (SQL). The Dialog system does not require modification of existing information management systems, since it creates its own data structures and links to existing company data when installed. In the event that similar data structures already exist in the company system, there is a possibility to parameterize database, table and field names so that the Dialog system can use them directly. Dialog agents exchange information in a peer-to-peer fashion, which also increases scalability, and the degree of scalability should be good enough to allow companies of any size to use them. The system also supports direct data exchange by hand-held devices. The Dialog system utilizes methods of distributed information management, where information is transmitted directly between the place where it is needed and the place where it is stored. In a peer-to-peer system, the party that has created it, so unnecessary copies of information are not made to the companies in the supply network or to intermediate databases operated by third-party companies, usually stores the information. Furthermore, Dialog always opens up a bi-directional communication between the agents exchanging information. Bi-directional information exchange is needed in a variety of situations. For example, when maintenance operations are carried out, it is important that the maintenance workers receive the necessary information to perform the work, and that their operations are recorded in the data of that specific product.

A significant limitation in implementing the Dialog system is that it encompasses only the information exchange between network participants. The content and syntax of the information must be defined separately, which may be a rather demanding task, depending on the network of companies and planned use of the system. The efforts in

standardization of information exchange syntax, e.g. the Product Markup Language of Auto-ID Centre and XML-based standardization, shown in chapter 6, may enormously ease the implementation of certain applications.

The peer-to-peer inspired principles used in Dialog partially help to improve data security since data does not need to be copied between companies and/or passed by third-party companies. Data exchange itself is secured by using existing authentication and encryption technologies. The main issue for safe data exchange is how to authenticate trusted parties. This can be done either by directly exchanging authentication keys and storing them locally for every Dialog agent as in [21]. In bigger collaboration networks, it is more appropriate to use the existing Public Key Infrastructure (PKI), where third-party certification authorities manage and certify the authenticity of public keys as described in [22]. Server or network down-time are also important issues, especially in tracking applications, where no location update should be allowed to disappear. This is why message persistence is implemented for all applications requiring it, to guarantee that no messages are lost due to network or server downtime, so they can always be retrieved and sent when the system is operational again [12].

5.5 Conclusions

This chapter described the role of holonic product modeling and traceability, as an innovative area to be studied in the PLM context.

Moreover, this chapter provided an overview on product traceability, as it's defined in literature, trying to focus on what users and enterprises mean for product traceability, and as defined by normative. Following chapter deals with a research area which is investigating and developing techniques for intelligent manufacturing automation and shares many features in common with it was called "internal traceability", both as a forward and backward one: that of Intelligent Manufacturing System and, in particular, that of Holonic Manufacturing System.

The rest of the thesis will define step-by-step the requested metamodel, starting from the analysis of the enterprise standard distributed along the product lifecycle in the next chapter.

5.6 References of the chapter

Scientific references

- [1] Moe T., (1998), Perspectives on traceability in food manufacture, Trends, Food Science & Technology, 9, pp 211-214
- [2] Olsen P., (2001), Traceability of fish products, 1st Tracefish Conference Copenhagen
- [3] Jansen-Vullers M.H., van Dorp C.A., Beulens A.J.M., (2003), Managing traceability information in manufacture, International Journal Of Information Management, 23, pp 395-413
- [4] Naka Y., Hirao M., Shimizu Y., Muraki M., Kondo Y., (2000), Technological information infrastructure for product lifecycle engineering, Computers and chemical engineering, 24, pp 665-670
- [5] Sohal A., (1997), Computerised Parts Traceability: an Implementation Case Study, Technovation, 17, 10, pp 583-591
- [6] McFarlane D., Sarma S., Chirn J.L., Wong C.Y., Ashton K., (2002), The intelligent manufacturing control and management, Engineering Applications of Artificial Intelligence: special issue on Intelligent Manufacturing, 6
- [7] McFarlane D., Sarma S., Chirn J.L., Wong C.Y., Ashton K., (2003), Auto ID System and Intelligent Manufacturing Control, Engineering Application of Artificial Intelligence, 16, pp 365-376
- [8] Choy K.L, Lee W.B., Lo V., (2003), Design of a case based intelligent supplier relationship management system the integration of supplier rating system and product coding system, Expert Systems with Applications, 25, pp 87–100
- [9] Riley D., Thomas V., Neckel W., Wagner S., (1999), Information Technology and Product Lifecycle Management, Proceeding at IEEE International Symposium on Electronics and the Environment, Danvers, USA
- [10] Ramesh B., Stubbs C., Powers T., Edwards M., (1997), Requirements traceability: Theory and practice, Annals of software engineering, 3, pp 397-415
- [11] Rutherford S., (2002), Traceability – what do consumer want?, Saskatchewan Pulse Growers

- [12] Kärkkäinen M., Ala-Risku T., Främpling K., (2003), The Product centric approach: a solution to supply network information management problems?, *Computer in Industry*, 52, pp 147-159
- [13] Finch E.F., Flanagan R., Marsh L.E., (1996), Electronic document management in construction using auto-ID, *Automation in Construction*, 5, pp 313-321
- [14] Jayaraman V., Patterson R.A., Rolland E., (2003), The design of reverse distribution network: Models and solution procedures, *European journal of operational research*
- [15] Zisman A., Spanoudakis G., Pérez-Miñana E., Krause P., (2002), Towards a Traceability Approach for Product Families Requirements, 3rd International Workshop on Software Product Lines, Economics ICSE
- [16] Barber K.S., Jernigan S.R., (1999), Changes in the model creation process to ensure traceability and reuse, *International conference on AI – software engineering track (IC-AI99)*
- [17] Terzi S., Cassina J., Panetto H., (2005), Development of a metamodel to foster interoperability along the product lifecycle traceability, *Proceedings at International conference on Interoperability of Enterprise Software and Applications IFIP-ACM/SIGAPP INTEROP-ESA, February 23rd-25th, Geneva, Switzerland*
- [18] Morel G., Panetto H, Zaremba R., Mayer F., (2003), Manufacturing enterprise control and management system engineering rationales and open issues, *Annual Reviews in Control*, 27/2, pp 199-209
- [19] Koestler A., (1967), *The Ghost in the Machine*, Arkana Books, London
- [20] Wyns J., (1999), Reference architecture for holonic manufacturing system, Ph.D. Thesis, Katholieke Universiteit Leuven
- [21] Främpling K., Holmström J., (2000), A distributed software for collaborative sales forecasting, *Proceeding at Second Conference on Management and Control of Production and Logistics*, Grenoble, France
- [22] Biennier F., (2002), Security Integration in Inter-Enterprise Business Process Engineering, *Proceedings of the International Conference on Advanced Production Management Systems (APMS)*, Eindhoven

Technical references

- [23] Sibbel R.L., (2003), Identification and traceability in swine: a business opportunities or a cost of business?, *American association of swine veterinarians*

- [24] Ministry of Economy, Trade and Industry of Japan, (2003), Study group on the improvement of product traceability, Interim Report, www.meti.go.jp
- [25] Strowbridge A., (1999), Implications of e-business for product lifecycle management, intl.ieeexplore.ieee.org
- [26] Garner Q., (2002), Product traceability mini-tutorial, www.freequality.org
- [27] Stone W., Lyte A., Furlani K., (2002), NIST White Paper On Smart Chips in Construction, www.fiatech.org
- [28] Foster E.F., (2002), Product Identification and Traceability, www.freequality.org
- [29] Smithers R., (1999), Linking the IOS/QS Quality System, www.smithersregistrar.com/
- [30] Komninos I., (2002), Product life cycle management, www.urenio.org
- [31] International Standard Organisation (ISO), (2000), International Standard ISO 9000:2000 Quality Management Systems, Fundamentals and vocabulary.
- [32] Suikka A., IFC data exchange in concrete construction, (2004), Confederation of Finnish construction industries, www.iai-international.org
- [33] AIM Global Network, (2000), Radio Frequency Identification (RFID) summary, www.aimglobal.org
- [34] Texas instrument, www.texasinstrument.com
- [35] EPC globalinc, www.epcglobalinc.org
- [36] Brock D., Cummins D., (2003), EPC Tag Data Specification, www.autoid.org
- [37] Brock, D, (2000), The Electronic Product Code – A Naming Scheme for Physical Objects, www.autoid.org
- [38] APICS, (1998), APICS dictionary, The educational society for resource management, Edit. Cox III. J. F., Blackstone Jr. J. H., USA

CHAPTER 6

State of the art of enterprise standards

6.1 Introduction

This chapter deals with standards developed for product data description, for interfacing enterprise control systems, for product identification and so on. Each standard is relevant, in some way, for providing elements, concepts and ideas to develop a product model.

The standards are described according to their position in the proposed model of product lifecycle (chapter 2).

Generally, standards are developed in order to provide means and technology to integrate business management software among business partners. According to [1], two main kinds of standards exist, Portability Standards (which allow an executable program to run in different system contexts) and Interoperability Standards (which allow a program to communicate with another program without knowing its implementation or technology). In the present chapter portability standards are not investigated, since they deal more with ICT engineering matter, than “business” matter, but two main classes are used to investigate literature: reference models for integration and interoperability, and standards for interoperability.

6.2 Integration reference models

In literature, diverse proposals of “reference framework” for the integration and the interoperability of ICT systems had been developed in different fields in the last years. The term “reference framework” addresses the idea to establish a well-defined structure that all the IT systems might adopt to “speak” the same language and to have the same

“world view” in order to communicate. In particular, two main fields might be analysed: the Product Development (PD) and Manufacturing System Engineering (MSE) field and the Enterprise Engineering (EE) field. In terms of product lifecycle phases, PD/MSE field deals with the Product Development phase (product, process and plant design), while EE field deals mainly with Product Production phase.

Looking to the PD/MSE integration efforts field, it is possible to identify lot of interesting projects, which aimed to establish collaborative environment for supporting the Product Development and Manufacturing System Engineering activities (e.g. [12], [13], [14]). Within these projects, the fundamental concepts of the new “PLM paradigm” were developed: different engineering environments and tools could be connected using a mutually understood framework and data format, creating an ICT collaborative platform, in order to improve the efficiency of the whole PD/MSE main process.

Within the MSE field, lot of works developed, for different purposes, other reference frameworks. For example, Wu [2] presented a structure for the description of manufacturing systems (HOOMA - Hierarchical and Object-Oriented Manufacturing Systems Analysis), while [3] proposed a framework for Enterprise Engineering within manufacturing contexts using four systems (plant vs. control, processing vs. logistic) and five components (Material, Location, Control system, Production subsystem, Transportation subsystem). Other efforts strive at reaching an international consensus among users concerning enterprise engineering and integration based on modelling technology (ICEIMT initiative [20]). As it is well known, an IFAC-IFIP Task Force developed a Generalized Enterprise Reference Architecture and Methodology [15] as a generalization of the CIMOSA [16], GIM [4] and PERA [5] architectures.

Within the EE area, it is possible to observe in literature how many efforts had been spent in setting up a common data format for connecting different company processes. The EE area is strongly supported by international (European and world-wide) offices for standardization. At the

international level, ISO TC184 (Industrial Automation Systems and Integration) is the leading actor in Enterprise Modeling and Integration. The main activities are carried out within two sub-committees: SC4 (Industrial data) and SC5 (Architectures, Communications, and Integration Frameworks). In Europe, CEN TC310 WG1 is the responsible organization for standardization setting in EE area. Its work is supported by the European Commission and co-coordinated with ISO TC184. Major results are: ENV 40003 Framework for enterprise modeling and its ISO counterpart ISO/CEN 19439, ENV 12204 Constructs for enterprise modeling and its ISO counterpart ISO/CEN 19440, and ENV 13550 Enterprise Model Execution and Integration Services (EMEIS). Some works are carried out by ISO in collaboration with other organizations. For example, ISO/IEC JTC1/SC7/WG7 has elaborated ISO/IEC 15288 on System Life Cycle Processes. Relevant works are also done by non-profit organizations. TOGAF (The Open Group Architectural Framework) is developed by OAG (Open Applications Group). The Object Management Group (OMG) has elaborated the Object Management Architecture (OMA) to develop integration for object-oriented applications. The efforts spent during the last decade setting standard enterprise modeling methodologies are converging within diverse research project interested in the creation of unique reference models, such as the Unified Enterprise Modeling Language project (UEML, [6]), INTEROP NoE [11] and the related Athena IP [7].

6.3 Interoperability standards

As mentioned, diverse efforts spent in the area of interoperability by diverse actors had become (or are becoming) accepted standards. The “way” of standardization is a long trip and not all the standards defined by official organizations (e.g. ISO, ISA, CEN) are always accepted and adopted in the reality of the day-by-day interoperability. On the contrary, diverse references are considered as de facto standards, even if normative offices do not already accept them. Interoperability standards [1] achieve standardization by defining elements of interoperability: (i)

Process (the message or event sequence on a business level), (ii) Payload (content of messages and events), (iii) Security (encryption standard), (iv) Packaging (packaging and transport technologies for messages representation), (v) Transaction, (vi) Adapter (connectivity to backed applications).

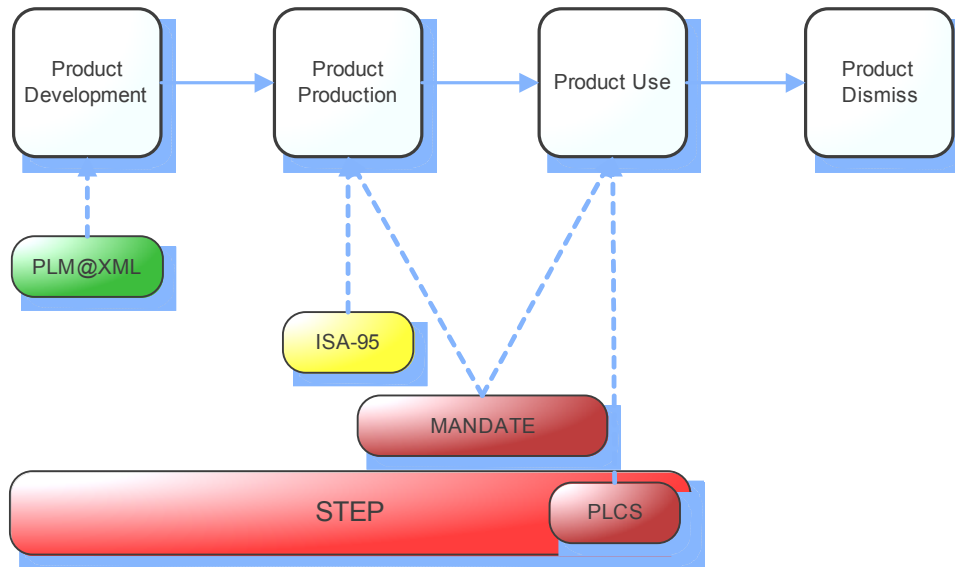

Figure.6.1 - Standards through product lifecycle

Looking to the literature of official and de facto standards distributed along the PLC, it is possible to identify three main categories of interoperability standards (figure 6.1): standard covering the Product Development phase, standards covering the Product Production phase, standards covering the Product Use phase. Obviously, this is only a subjective categorization, and it might be observed that always interoperability standards stay in an overlapping stage.

6.3.1 Product Development Interoperability Standards

In the phase of Product Development exist several standards, most of them derived from the mentioned works.

ISO 10303

The most important and well-accepted (even if not universally) standard in this phase is the mentioned STEP initiative (STandard for the Exchange

of Product model data), which is an ISO (ISO 10303) standard for the computer-interpretable representation and exchange of product definition data. It was developed with the aim to provide a mechanism capable of describing product data throughout the life cycle of a product, independently from any particular system. Its natural implementation is that of computer system and CAD, CAM, CAE software for product design. The way it was designed for describing product data makes it suitable for neutral file exchange among different software solution, also in a distributed engineering or manufacturing environment. It can also operate as a basis for implementing and sharing product databases and archiving. One of the most important aspects of STEP is its extensibility: STEP is based on a modular and reconfigurability structure, which uses Application Protocols (APs) to specify the representation of product information for one or more applications (figure 6.2).

Application Protocols are sub-sets of STEP, focused on specific issues or specific industrial sectors, which break the entire STEP standard into easily manageable views of quick implementation. STEP initiative adopts a strategy of specification into industrial context (e.g. APs for product design, for mechanical and electrical engineering, for sheet metal manufacturing, for product assembly, for automotive industry).

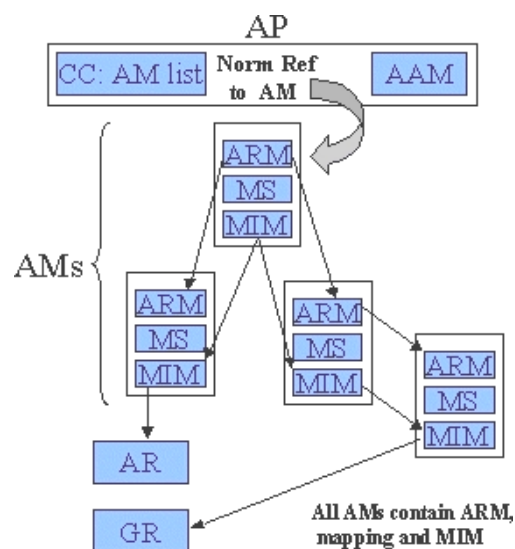

Figure 6.2 - Complex structure of an AP [17]

In the same direction of STEP, even if limited to the only drawing exchanging, it might be referenced some well known standards like IGES and its specialization VDAIS and CALS, supported and disseminated by the aeronautical sector, or like STL (Standard Triangular Language), adopted in the area of Rapid Prototyping.

PLM XML

In the same phase, recently a new de facto standard appeared, PLM XML. PLM XML is an open standard proposed by EDS (currently UGS PLM Solutions) to facilitate high-content product lifecycle data sharing. PLM XML derives partly from the STEP initiative, even if it is currently maintained by EDS/UGS R&D team in an open source way (figure 6.3). PLM XML provides a reference framework and a reference data format, based on XML, for the main sub-phases of Product Development, from Product Design to Plant Design and Process Design. In fact, PLM XML schemas define a hierarchy of product information and relationships, in particular:

- PLM XML schemas define a mechanism for exchanging evaluated product structure, suitable for product development, BOM, and assembly visualization. Part representation PLM XML includes the concept of a part and its metadata, but does not include schema definitions for the explicit geometric component representations.
- PLM XML can exchange reference or wire frame geometry via its geometry schemas. The schemas are based on Parasolid geometry definitions.
- PLM XML defines elements to enable associability back to the sending application. This associability is an optional element that may be added to virtually any PLM XML element that describes the name of the sending application and a persistent label for the object itself.

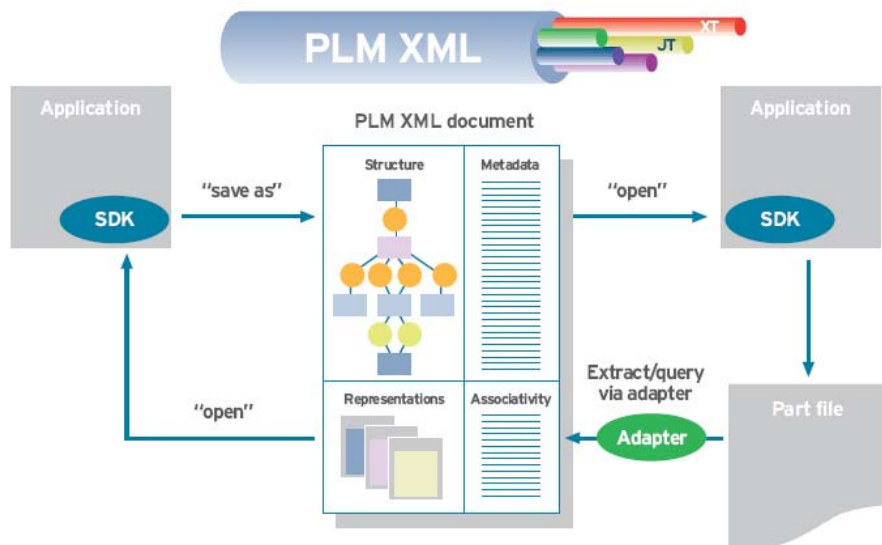

Figure 6.3 – PLM XML main functionalities [18]

6.3.2 Product Production Interoperability Standards

The Product Production phase deals with product manufacturing and distribution and all the related sub-activities. Into this phase, for a clear understanding are also considered all the activities acting at Operation Management level, like the relations with suppliers and customers, even if they are not directly related to the product itself. Since to this large definition, two main “streams” of interoperability standards might be referred: (i) standards dealing with IT system supporting the Production Management, and (ii) standards dealing with ICT tools supporting the other activities of Operation Management.

ISO 62264

Into the first classification, one of the most relevant standards, generally accepted by users and vendors, is ANSI/ISA-95 (ISO 62264) on Enterprise-Control-System Integration (figure 6.4), developed with a joint effort spent by ISO and ISA organizations. ANSI/ISA-95 (ISO 62264) is a standard composed by four different parts designed for defining the interfaces between enterprise activities and control activities.

Part1 (Enterprise/Control System Integration) describes the relevant functions within an enterprise and within the control domain of an enterprise, stating which objects are normally exchanged between these domains. In details, this first part concerns with the interface between two levels of the functional hierarchical model proposed: level 4 (Business Planning and Logistics) and level 3 (Manufacturing Operations and Control).

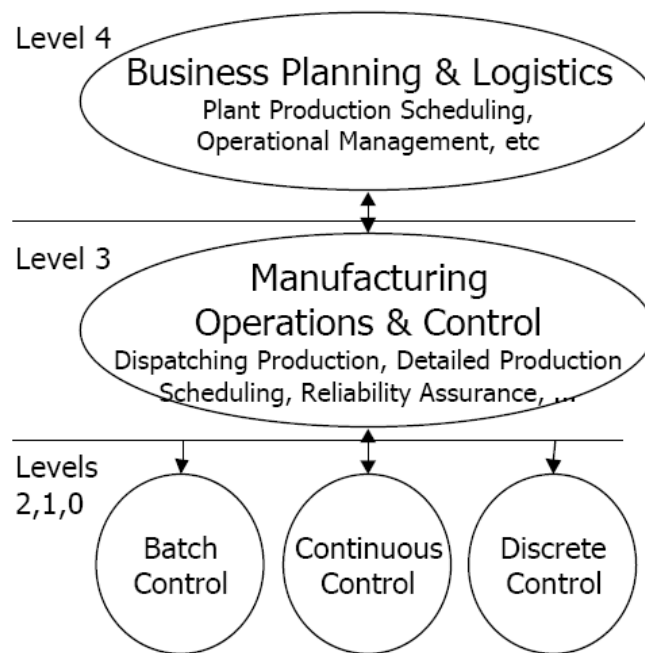

Figure 6.4 - Functional Hierarchy

ISO 62264-1 defines a functional model and a related information model, using three main areas concerning Production Capability, Product Definition Information and Production Information. Production Capability is a collection of information related to personnel, materials and equipments production capability for a specific manufacturing area or site. Product Definition describes, for each product type, its product production rules, its bill of materials and resources. This area contains all data needed for technically defining a product manufacturing operation, specifying which product subcomponents are required, which resources (as machines, personnel, tools, and so on) shall be used and how. Production Information collects information on product production history (log), on

production inventory of consumed and produced materials and information on production scheduling. Within all these areas, there are shared as well as specific types of information. ANSI/ISA-95 makes use of UML representation for displaying each “class” of information and its relations with other classes. Figure 21 depicts a UML diagram describing Production Capability class: as already seen, this information-representing modelling class involves other information, such as those of personnel, materials or equipments capability (whose abstract UML representing elements are Personnel Capability class, etc.).

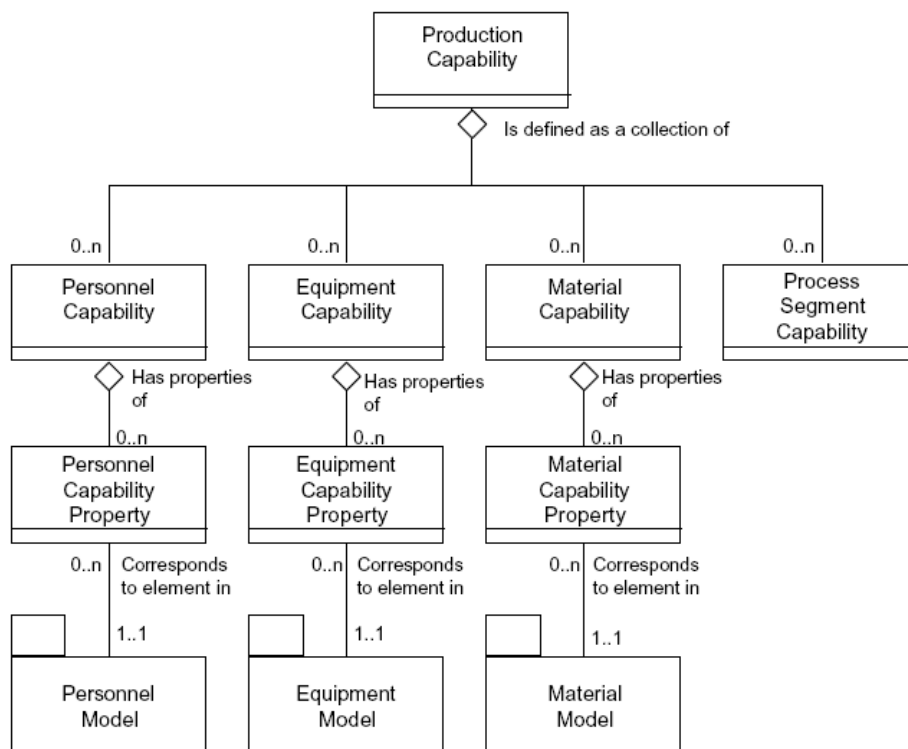

Figure 6.5 - Production capability model

Strictly related with this standard, there is the work done by the World Batch Forum (WBF), which developed the Business To Manufacturing Mark-up Language (B2MML). B2MML provides a set of XML schemas (e.g. figure 6.6) based upon the ISO 62264 family of standards. B2MML may be used to integrate business software, such as ERP and supply chain management systems with manufacturing and manufacturing execution systems such as control systems. Figure 6.7 shows the

archiving. Mandate initiative is still under development so, at the present, there is no more detailed information available. Mandate is divided in three series of parts based on a common overview and fundamental:

- Parts 15531-2's series (Production data: external exchanges): those parts include all information and functions necessary to support quality, and order management, such as planning, executing, controlling and monitoring of product quality, orders and shipments.
- Parts 15531-3's series (Manufacturing Resources Management Data): those Parts refer to the resource usage management, such as resource configuration and capabilities, operation management of manufacturing devices, installation, quality features, maintenance-features (regarding the availability) and safety-features.
- Parts 15531-4's series (Manufacturing Flow Management Data): those parts refer to the flow material control, and intend to standardize data and elements, which support the control and monitoring of the flow of material in manufacturing or industrial processes.

Mandate initiative aims to be compliant with STEP architecture, but on contrary of STEP, which takes a product-oriented view of manufacturing, Mandate is concerned with the processes of the organization which are used to produce the products. By the contrary, parts 15531-3 aim to deal with aspects of “product” lifecycle (where the “product” is a machine), which more concern with Product Use phase (e.g. maintenance, installation). This aspect demonstrates how the desire of a comprehensive standardization along the whole product lifecycle (since to the product use itself) is highly considered.

B2B standards

Looking to the more general area of Operation Management, lot of activities are currently performed into an enterprise with the support of ICT tools. Since the '80ies, in the enterprise, activities like accounting, finance, inventory management and etcetera had been integrated in complex IT (ERP) systems. Firstly, communication and integration had been

supported by the fact the main system were developed in a proprietary way, while, successively, some standards (e.g. EDI I, II) had been established, even if a realistic open integration had been neglected [8]. In the modern internet-based context, other efforts have been spent in order to foster and empower the possibility to integrate operation management IT tools dispersed between more partners and factories. At the present, two initiatives seem to play a relevant role: ebXML [19] and RosettaNet [20].

The Electronic Business XML Initiative (ebXML) was announced in 1999. UN/CEFACT (United Nations Centre for Trade Facilitation and Electronic Business) and OASIS (Organization for the Advancement of Structured Information Standards) established this non-commercial initiative with the goal to develop a comprehensive technical framework for using XML to exchange business data. This standard was developed around three main topics:

- ebXML BPSS: ebXML Business Process Specification Schema is a process definition language defined by ebXML as part of the set of ebXML standards. The goal of BPSS is to provide a language for defining collaborations between trading partners. In order to define these, it provides a set of concepts like business transactions, business collaborations, business signals, choreography and patterns. The processes defined in BPSS are represented in XML Schema.
- ebXML Registry: ebXML Registry serves as a global place for trading partners to store properties about themselves as well as to search for matching trading partners.
- ebXML MSS: ebXML Messaging Service Specification provides services to process the elements that compose an ebXML message.

RosettaNet was founded in 1998 as a non-profit consortium to develop standards for the IT supply chain management. This standard does not define a language for defining processes, but defines domain-specific processes themselves. The processes are called Partner Interface

Processes (PIPs) and are categorized as public processes between partners (trading partners). PIPs are represented as UML diagrams and specify the message exchange sequence on a business level. An underlying message transmission infrastructure supports the message transmission semantics (RosettaNet Implementation Framework - RNIF). RosettaNet defines also specific business document types for particular business data, like purchase orders or invoices. The definitions are accomplished using XML. It provides several dictionaries that define the valid content of the business data in the business documents (Business Dictionary, IT Dictionary, EC Dictionary).

6.3.3 Product Use Interoperability Standards

The phase of Product Use deals with the day-by-day life of the product itself. Into this phase, some interesting efforts spent in the area of standardization and interoperability had been identified, even if they are all at a preliminary stage.

PLCS

Mandate initiative have been already described in Product Production phase; another initiative is named PLCS- Product Life-Cycle Support (PLCS). PLCS is a standard based on ISO 10303 (STEP): furthermore, it is an Application Protocol of STEP (AP 239). It was born as an initiative supported by both industry and national governments with the aim to accelerate development of new standards for product support information. PLCS should be able to describe products needing support and the work required to sustain and maintain such product in operational conditions.

At the present, PLCS initiative is at a testing phase, with some interesting experiments in the aeronautical sector, involving important industries. For specifying or record required support activities through product lifecycle, a set of Assured Product and Support Information (ASPI) is defined. Lifecycle data for a specific product are composed by both

ASPI and their related information, such as feedback on product history, activities and resources used, etc.

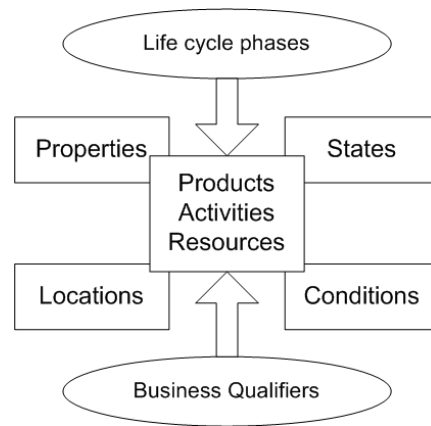

Figure 6.8 - PLCS concepts [21]

PLCS is based on three top-level concepts (figure 6.8): Product, Activity and Resource. Each of these concepts is in relation with Properties, States or Locations and Conditions can be applied to their relationship.

Products are described by means of Product Structure STEP AM (AM 1134, figure 6.9). It references other AMs to define product sub-components, their relationships, their assembly structure and many type of breakdown by which a product can be affected. Activities are defined within AM 1047 (examples of activities are works done by people or organizations, usage of products, planned maintenance, etc). Resources are required to perform a task, can be quantified, specified and are distinguished between required resources (AM 1267) and resource item (AM 1266). These resources are used by activities involving products and can represent, for example, people of support, instrumentation, software, tools for repairing products and so on.

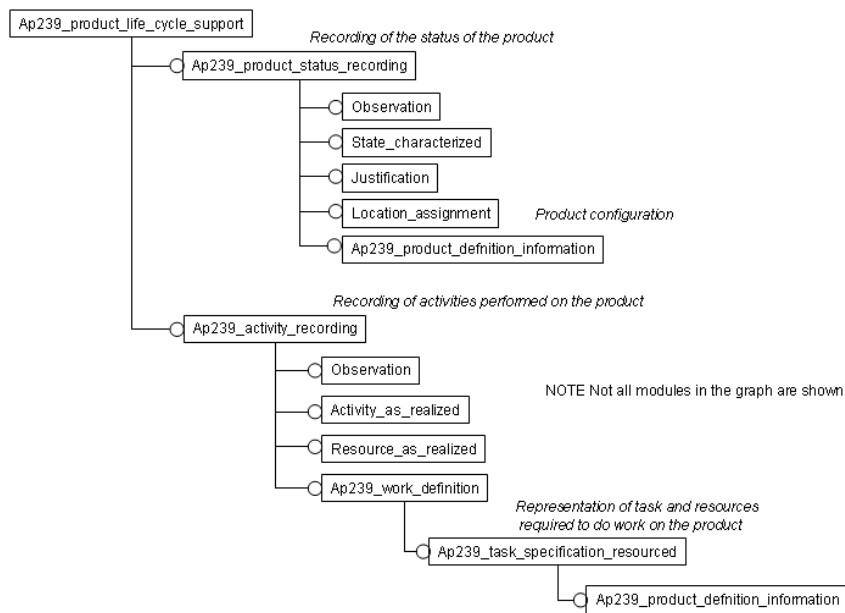
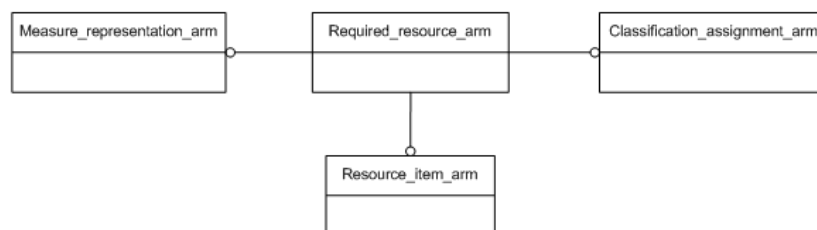

Figure 6.9 - Abstraction of module hierarchy [17]

PLCS uses the same ad-hoc developed language used for STEP (EXPRESS): its graphical representation is EXPRESS-G, allowing a synthetic representation of ARM and MIM within a module. Each AM is defined both using EXPRESS and EXPRESS-G: the result is a collection of AM schemas detailed at two different levels, both for ARM and MIM. First level is a “Schema Level” focusing on the relationships with other required AMs. Second level is “Entity Level” and focuses on entities and entities type as building blocks for AM definition. Figure 6.10 and 6.11 show an EXPRESS-G schema of ARM and MIM for a specific module at Schema Level.



**Figure 6.10 - EXPRESS-G schema of ARM for “required Resource” Application
Module (1267) [17]**

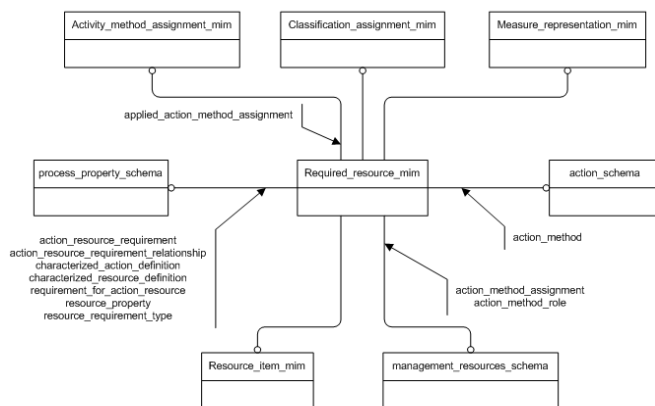

Figure 6.11 - EXPRESS-G schema of MIM for “required Resource” Application

Module (1267) [17]

PML

The last interesting initiative is the Physical Mark-up Language (PML), developed by Auto-ID laboratories [9]. PML is intended to be a general, standard means for describing the physical world. The objective of PML is a simple, general language for describing physical objects for use in remote monitoring and control of the physical environment. PLM was thought as a part of a wider structure whose purpose is that of linking physical objects to each other, people and information through the global Internet. This complex infrastructure is built around four major components: electronic tags, Electronic Product Code (EPC), Physical Mark-up Language (PML) and Object Naming Service (ONS).

Opposing to many standards and languages developed in specific application domains, PML was designed to provide broad definitions, describing those characteristics common to all physical objects. Furthermore, the need for a simple, reliable and effective framework for describing physical objects, processes and environments suggests avoiding use of complex and context-dependent standards. Many standards indeed, even if designed taking into account requirements such as generality, high descriptive power and so on, are not adopted because of their inherent complexity in learning and implementation. This is the

case, for example, of the Standard General Mark-up Language (SGML), which was born many years ago but without having seen wide spread adoption, due in part to its size and complexity. Its derivative, the Hypertext Mark-up Language (HTML), has seen a wide spread growth, in part because of its simplicity and because of the tools and viewers available for the standard. The Extensible Mark-up Language (XML), also based on the Standard General Mark-up Language, has seen increasing growth as a tool for tagging data content. PLM is, within this scope, a specialization of XML and, thus, a subset of the original SGML standard.

PLM language aims to be developed taking into account following features and properties:

- **Generality:** The objective the Physical Mark-up Language is to be a universal standard for describing physical objects, processes and environments. Clearly given the broad scope of this objective, the language cannot be overly detailed or specific.
- **Simplicity:** Thus complex standards and languages – even though powerful and effective – have slow learning curves and limited audiences than smaller, simple languages.
- **Comprehensive Data Types:** Physical Mark-up Language can be considered as a language having different ‘types’ of data – static, temporal, dynamic and algorithmic.
- **Facilitate Data Archives:** Although Web pages change frequently, PML data files will change even more rapidly. History files and efficient archiving will therefore be critical important.
- **Standard Units of Measure:** Fundamental physical properties of matter – length, mass, time, force, velocity, density, magnetic field, luminosity and temperature – must be described precisely to be communicated effectively.
- **Standard Syntax:** Rather than reinvent a new syntax for the Physical Mark-up Language, PML uses the extensible Mark-up Language (XML).

- Global Language: PML should be a global standard and thus should avoid national terms and descriptions.
- Facilitate Application Development: One of the primary purposes of the Physical Mark-up Language is to facilitate the development of software applications. Therefore, PML is to develop taking into account needs and requirements of application programmer.

The purpose of the core part of the PML is to provide a standardized format for the exchange of the data captured by the sensors in an Auto-ID infrastructure, e.g. RFID readers. PML core provides a set of schemas that define the interchange format for the transmission of the data captured. PML core focuses on observable physical properties and entities that are capable of being observed or measured by a sensor. Messages based on the PML Core schema can be exchanged between any two XML enabled systems in the EPC Network.

Information exchange based on the PML Core schema will occur between Savant (The Savant is the “middleware” of the Auto-ID technology responsible for data processing, routing and filtering) and the EPC Information Service and/or other enterprise applications. In theory, PML Core messaging can be achieved by means of any two systems capable of XML messaging.

These data might be accessed directly from a sensor, or from data routers and data stores (e.g. Savant in the Auto-ID experience). An example of PML file describing a sensor is represented below in figure 6.12.

```

<pmlcore:Sensor>
<pmluid:ID>urn:epc:1:4.16.36</pmluid:ID>
<pmlcore:Observation>
<pmluid:ID>00000001</pmluid:ID>
<pmlcore:DateTime>2002-11-06T13:04:34-06:00</pmlcore:DateTime>
<pmlcore:Tag>
<pmluid:ID>urn:epc:1:2.24.400</pmluid:ID>
<pmlcore:Sensor>
<pmluid:ID>urn:epc:1:12.8.128</pmluid:ID>
<pmlcore:Observation>
<pmlcore:DateTime>2002-11-06T11:00:00-06:00</pmlcore:DateTime>
<pmlcore:Data>
<pmlcore:XML>
<TemperatureReading xmlns="http://sensor.example.org/">

```

```

<Unit>Celsius</Unit>
<Value>5.3</Value>
</TemperatureReading>
</pmlcore:XML>
</pmlcore:Data>
</pmlcore:Observation>
<pmlcore:Observation>
<pmlcore:DateTime>2002-11-06T12:00:00-06:00</pmlcore:DateTime>
<pmlcore:Data>
<pmlcore:XML>
<TemperatureReading xmlns="http://sensor.example.org/">
<Unit>Celsius</Unit>
<Value>5.8</Value>
</TemperatureReading>
</pmlcore:XML>
</pmlcore:Data>
</pmlcore:Observation>
</pmlcore:Sensor>
</pmlcore:Tag>
</pmlcore:Observation>
</pmlcore:Sensor>

```

Figure 6.12 - Example of PLM describing a sensor object

6.3.4 Automatic Product Identification standards

Another kind of standards might be also taken into account, analyzing the product lifecycle traceability problem: the standard for product identification. Some of the most important initiatives have been analyzed in chapter 5 (e.g. standards for bar codes), while hereafter is reported an interesting initiative which aims to provide a single RF identifier for each single product.

ISO/IEC 15963 describes numbering systems that are available for the identification of RF tags. On an RF tag it is possible to perform read/write operations for storing or retrieving some kinds of data. The unique ID guarantees that the information written or read is unambiguously written to the correct data carrier (tag). A unique ID is thus requested to provide an effective and robust system for linking physical storage system (be it an electronic tag, a file or a Database) with product related information. Generally, unique ID is required in many read/write situations each time the contents of the tag are uniquely bound to a specific item and that item needs to be unambiguously identified. Even if the unique ID is mainly used to guarantee that each data is read/wrote to the correct tag, it may also be used for:

- traceability of the Integrated Circuit itself for quality control in their manufacturing process,
- traceability of the RF tag during its manufacturing process and along its life time,
- completion of the reading in a multi-antenna configuration,
- anti-collision mechanism to inventory multiple tags in the reader's field of view.
- traceability of the Item to which the RF tag is attached.

There are some situations that do not require a unique ID for reading or writing. These situations include any environment where the presence of the information is all that is required and there is no need to tightly bound each information with a specific instance of a product. Use of different types of unique ID techniques is often affected by the context of application of traceability systems based on RF tag, barcode or other. Main difference between unique ID implementations concerns the type of identifier to chose: such identifier can be permanent or time-dependent (virtual). As a matter of fact, a unique ID does not need to be a permanent unique identifier in all situations. It is sufficient at times to identify a tag unambiguously by data contents, physical position or reply timing. In these situations a virtual ID tag is sufficient to uniquely identify a tag. Figure 6.13 shows the conceptual model of unique ID, differentiating virtual or permanent identifiers.

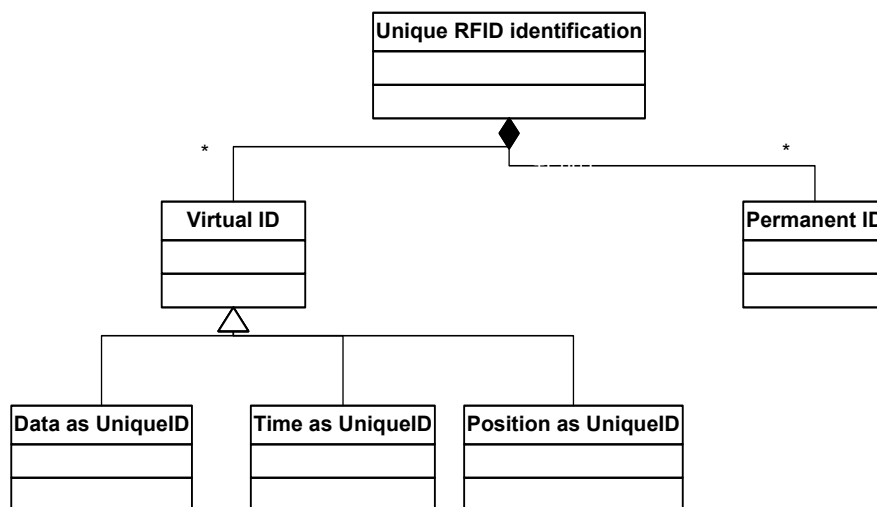

Figure6.13 - Model of possible identifiers

A permanent ID is an identifier programmed within the RF tag whose value cannot be changed or updated. This way, each tag has its own unique identifier, which is independent from time, and position. As each tag requires a unique ID, the number of required ID can be huge, depending on the number of tag used.

A virtual tag ID is a temporary ID based on tag parameters that may vary over the life of the tag. It may take several forms. A virtual ID is also known as a logical ID or a session ID. Several tags could have the same virtual ID at different times, but all tags at the same time for the same interrogator should have a different virtual ID, allowing an unambiguous identification of each tag at any time relative to any given interrogator. Virtual ID are divided into:

- Data as Unique ID: A possible way to implement a virtual ID where the tag contains data that is unique in time and location to a single tag when this data is read. An example is a tag that contains date and time information.
- Time as Unique ID: Time is a possible way to implement a virtual ID where bit patterns alone do not necessarily identify a single tag unambiguously. Tag response time slot can be part of a uniquely identifying parameter set.
- Position as Unique ID: In some applications, tag position may define a unique tag ID at a particular time. For instance, some tags have a read and write distance of only a few millimetres. In this case it is difficult to have more than one or two tags in the interrogation zone at any time. Thus any tag continually in the reading zone may be considered unique at that single time and location.

The Unique ID (UID) issuer number is assigned by either the registration authority for ISO/IEC 7816-6 (for I.C. Card manufacturers), the registration authority for ISO 14816 (for freight container and transport applications), the registration authority for EAN.UCC standardized numbering, or the

registration authority for ANSI ASC INCITS 256. The UID issuer issues the serial number and has the responsibility to ensure its uniqueness. It shall be unique in the sense that the issuer does not re-issue a number until a sufficient period of time has passed so that the first number has ceased to be of significance to any user. The serial number is a binary value. The length of the unique tag ID is dependent upon the specific Allocation Class used.

There are also standards for Supply Chain Applications of RFID, such as ISO 14816 – Numbering Systems for Supply Chain Applications of RFID. This standard identifies a structure for these kinds of application, as represented in Figure 6.14.

CSI	Length	Coding Structure Data Field			
0	Variable	Reserved for CEN/ISO			
		Not defined			
1	7 octets / 56 bits	Country Code	Issuer Identifier	Service Number	
		10	14	32	
2	6 octets / 48 bits	Manufacturer Identifier		Service Number	
		16		32	
3	22 octets / 176 bits	Start Time	Stop Time	Geographic Limit	Application Limit
		80	80	8	8
4	Variable	Country Code	Alphabet Indicator	License Plate #	
		10	8	Not defined	
5	17 octets / 136 bits	Vehicle Identification (Chassis) Number			
		126			
6	Variable	Reserved for CEN/ISO			
		Not defined			
7	93 bits	Freight Container Numbering			
		93			
8	Variable	Country Code	Tax Code		
		10	Not Defined		
9	Variable	Reserved for CEN/ISO			
		Not defined			
...	Variable	Reserved for CEN/ISO			
		Not defined			
30	Variable	Reserved for CEN/ISO			
		Not defined			
31	Variable	Reserved for CEN/ISO (Extension)			
		Not defined			

Figure 6.14 - Structure for Supply Chain Coding (ISO 14816)

6.4 Conclusions

Concluding the chapter, at first, it might be said that standardization trend is a long trip, where lot of users and developers are investing a large amount of efforts and money.

R&D teams coming from PLM vendors developed lots of the named works. For example, some vendors (e.g. IBM, SAP) are already providing their integration features according to the first OAG specifications, while within PD area, all the most important vendors are using STEP standard to guarantee the most open interoperability to their customers. PLM XML development is supported by a joint effort spent by UGS PLM Solutions and Tecnomatix R&D departments. ISO 62264 is being used as the basis for many control and MES (Manufacturing Execution System) vendors (such as Honeywell, Rockwell, Sequencia, Invensys-Baan, and Fisher-Rosemount).

Lot of projects are currently on going in the area of standardization; for example, in Europe is active a new community, structured as a network of excellence, specifically addressed to the dissemination of interoperability efforts.

At the present, the world of interoperability standards is quite a kind of Babylon tower, where lots of expressions exist. For example, in the analyzed standards there are lots of overlapping definitions and redundancies (e.g. lot of definitions for the same concept of BOM/BOR). The semantics of an ontology-based interoperability is currently the next issues for applications integration.

However about the future it might be optimistic: the road for standard setting and using, supported by the diffusion of the PLM paradigm, seems to be already started, even if it is at a preliminary stage.

Behind these standardization efforts and looking to the future, the present thesis aims to adopt an innovative approach, which passes from the most advances intelligent solutions. In particular the thesis aims to prelude the application of such kind of holonic paradigm, working on the definition of a Unified Manufacturing Modeling Language (UMML) that

should serve as a pivotal language ensuring a common understanding of the product information along its whole lifecycle. As mentioned, applying Auto-ID technology [9], information can be embedded in physical objects according to the HMS paradigm, in order to ensure the traceability and the management of product among its lifecycle. Such a holonic approach requires aggregating separated object views and constructs of the analyses standards in order to define the relevant holons and the related information. The analysis and the adoption of standards is a mandatory step to develop such a kind of language, without creating another tower in Babylon.

In the next chapter, a short state of the art of this advanced HMS solutions will be illustrated, before defining the reference metamodel.

6.5 References of the chapter

Scientific references

- [1] Bussler C., (2003), B2B Integration: Concepts and Architecture, Springer
- [2] Wu B., (1995), Object-oriented systems analysis and definition of manufacturing operations, Int. J. Production Research, 33, 4, pp 955-974
- [3] Bodner D.A., Reveliotis S.A., (1997), Virtual factories: an object-oriented simulation-based framework for real-time FMS control, Proceedings Emerging Technologies and Factory Automation, ETFA '97
- [4] Doumeingts G., Vallespir B., Chen D., (1998), Decision modelling GRAI Grid. In: Handbook on architecture for Information Systems, Edit. Bernus P., Mertins K., Schmidt G., Springer-Verlag
- [5] Williams T.J., (1992), The Purdue Enterprise Reference Architecture, A Technical Guide for CIM Planning and Implementation, ISA
- [6] Panetto H., Berio G., Benali K., Boudjlida N., Petit M., (2004), A Unified Enterprise Modelling Language For Enhanced Interoperability Of Enterprise Models, Proceedings at 11th IFAC Symposium on Information Control Problems in Manufacturing, Salvador, Brasil
- [7] Chen D., Stevens R., Schulz K., Doumeingts G., (2004), European Approach On Interoperability Of Enterprise Applications: Thematic

- Network, Integrated Project And Network Of Excellence, Proceedings at 11th IFAC Symposium on Information Control Problems in Manufacturing, Salvador, Brasil
- [8] Brandl D. (2002), Business-To-Manufacturing (B2M) collaboration between business and manufacturing using ISA95, Proceedings of the ISA/SEE conference, Nice, France
- [9] McFarlane D., Sarma S., Chirn J.L., Wong C.Y., Ashton K., (2003), Auto ID System and Intelligent Manufacturing Control, Engineering Application of Artificial Intelligence, 16, pp 365-376
- [10] Molina A., Chen D., Panetto H., Vernadat F., Whitman I., (2004). Enterprise integration and networking: issues, trends and vision, IFIP international conference on enterprise integration and modeling technology, Kluwer academics publisher, Toronto, Canada
- [11] Panetto H., Scannapieco M., Zelm M., 2004, INTEROP NoE: Interoperability Research for Networked Enterprises Applications and Software, Proceedings of the On the Move to Meaningful Internet Systems 2004 International Workshops, Agia Napa, Cyprus, Springer-Verlag Heidelberg

Technical references

- [12] Garcao A.S., (1995), SIP-STEP-based Integration Platform, BRITE/EURAM CIMTOFI project
- [13] Garetti M., (1997), Plantfaber: an integrated software workbench as a tool for the re-engineering of the Manufacturing System Engineering Process, funded by the European Commission, IV Framework
- [14] Rabe M., (1999), Mission Project: Modelling and Simulation Environments for Design, Planning and Operation of Globally Distributed Enterprises, www.ims-mission.de
- [15] GERAM, (1997), Generalized Enterprise Reference Architecture and Methodology Version 1.5, IFAC-IFIP Task Force on Enterprise Integration
- [16] AMICE, (1993), CIMOSA - Open System Architecture for CIM, 2nd edition, Springer-Verlag, Berlin
- [17] ISO 10303 (STEP) task website, stepmod.sourceforge.net
- [18] PLM XML, www.ugsplm.com
- [19] Oasis/UN/CEFACT, (2002), Creating a single electronic market: ebXML Business Process Specification Schema, Version 1.01
- [20] Rosettanet, www.rosettanet.org
- [21] PLCS, www.plcs.org

CHAPTER 7

State of the art of HMS

7.1 Introduction

This chapter analyzes and presents a new research area in production planning and control, called Holonic Manufacturing System. It focuses on historical development of the concept of Holon starting from a philosophic context and towards application in manufacturing systems; basic Holonic definitions are provided. After that, it introduces some of most relevant work done on HMS and tries to explain in what terms they can be significant for the development of a reference model in product lifecycle traceability.

7.2 Introduction to HMS

Nowadays enterprise business requirements are changing in order to fit new market, customers and suppliers evolution. Current market trends show how producing high quality goods at a low price is only one of this requirements. Manufacturing industry is facing new challenges: it operates in a customer's oriented market, where the surplus of industrial capacity increases customer chance of choice and competition between manufacturers. This brings suppliers to provide constant product innovation, flexibility in customization and effective after-sale services.

From the manufacturing point of view, these requirements imply a new product production approach, which should guarantee: (i) a product with more features and variants, (ii) reduced product life-cycle, (iii) reduced time to market, (iv) flexible volume output, (v) reduced investment.

As a consequence of these requirements, new manufacturing conditions can be summarized in “increasing complexity and continual change under decreasing costs” [1].

The top-down approach from business requirements to low-level manufacturing requirements (figure 7.1) suggests some important features that a manufacturing control system should perform, such as a decentralized architecture based on products and resources.

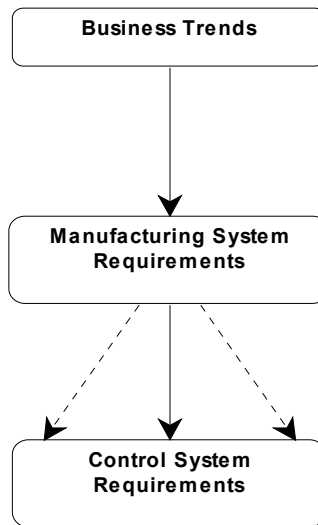

Figure 7.1 - Requirements Break Down Process [1]

A manufacturing control should be also self organizing, both reactive and proactive and flexible. These requirements are displayed in table 7.1.

	Standardization	Minimal system structure	Intuitive/transp. structure	Well-def./transp. Behavior	Flexibility	Reconfigurability	Scalability	Robustness
Decentralised architecture			X			X	X	X
Product/resource based architecture		X	X			X	X	X
Abstract/generalized interactions	X			X	X	X		
Flexible acquaintances /interactions				X	X	X	X	X
Reactive capabilities				X	X			X
Pro-active capabilities				X	X	X	X	
Self-organization		X	X			X	X	

Table 7.1 - Requirements on Manufacturing and Control [1]

Since early 90s many efforts and investments have been spent to develop and tune new strategies of manufacturing control system: they are designed to be modular, flexible, responsive and robust for a rapidly

changing manufacturing environment which integrates products, resources, machines, humans and computers. As a result, the following control techniques were developed [2]: (i) Bionic manufacturing system, (ii) Genetic manufacturing system, (iii) Virtual manufacturing system, (iv) Random manufacturing system, (v) Responsibility-based manufacturing system, (vi) Fractal factory, (vii) Holonic manufacturing system.

HMS is more than a simple control system because it involves concept like intelligent products, linking between physical object and related information and product traceability. It can be thought, indeed, as an “engineering system approach” for designing the whole manufacturing process, rather than a simple control software [3].

7.3 Definition of HMS

Holonic manufacturing systems are control systems based on the concept of Holon: this concept was introduced for the first time in 1967 by Arthur Koestler [4], a philosopher who was interested in studying the evolution of biological and social system. The word Holon, proposed by Koestler, is a merging between the Greek word “Holos” and the suffix “on”: Holos means a whole, the suffix on stands for a part or a particle. The combination of these two words is a neologism that conveys the idea of something such as an independent and stand-alone entity regarded as a compact ensemble of sub systems. These sub-systems can be themselves a whole composed by other sub-systems. Biological holons can be, for example, organelles and organs whereas individual, families and nations are examples of social holons.

According to [3], Holons are organized in holarchies: holarchies are hierarchical organizations of holons. They are hierarchical structures based on sub-systems, each of them being itself a whole of holons and, indeed, a holarchy. This explains why holarchies are considered open-ended at the top as well as at the bottom. A holon has a double nature of a whole and of a part: as a part it is a whole of sub-parts; as a whole it is a part of a wider whole. This is the so-called Janus effect: double nature of holons as whole and part at the same time. This brought Koestler to state

that a part or a whole can not be defined in an absolute sense just because a whole does not exist as a stand-alone entity but it is always a part of another upper-level whole. This applies in the same manner to holarchies because holarchies are hierarchical structures of a whole.

7.3.1 Holon behaviour

This theory tries to explain the structure and the behavior of complex system and was developed only for this purpose, of course not thinking at control systems. The observation of complex systems points out that these systems are organized in hierarchical structures composed of stable intermediate forms. They are not, therefore, simple aggregations of elementary parts but rather multilevel hierarchies of stable subsystems branching in lower order subsystems. Their behavior follows their structure so that it is not a simple chain of elementary parts behaviors.

A holon is characterized by two base behavioral properties: (i) Autonomy and (ii) Cooperation. Autonomy corresponds to the self-assertive tendency of holons that give them the opportunity to act autonomously from other holons in case of unpredictable circumstances. Cooperation is the tendency that holons show to cooperate together under stable conditions. This polarity between self-assertive and cooperative tendencies can easily be observed in biological colonies, in human beings and also in manufacturing contexts. Examples of self-assertive behaviors in human beings are competition, individualism, nationalism, etc. whereas cooperative tendencies are collaboration, flexible adaptation, etc.

A hierarchical structure, such as a holarchy, is made up of elementary entities that perform their tasks and a set of rules (or constraints). Holons in holarchies are governed by fixed sets of rules (called canons) that determine system invariant properties, its structural configuration and functional behavior. The canon defines actions and behaviors that holons can perform or show in compliance with these rules. Each holon, on the other side, has the chance to flexibly select the appropriate strategy within the canon for actual or real-time actions.

The behavior of a single holon is therefore free among strategies to take and constrained by fixed rules. The break-even point between canons and flexible strategies depends on the context.

7.3.2 Holonic concepts in manufacturing: HMS

These concepts were studied to make them suitable for manufacturing systems that are examples of complex and dynamic environments. Manufacturing systems, indeed, are made by many different types of entities such as products, machines, computers, humans and others; they have also to face with flexible production planning, rapidly changing volume of production, product configurations and so on: Holonic manufacturing systems are the result of the reinterpretation of Holonic theory in a manufacturing system view.

The idea of Holonic manufacturing was introduced for the first time in early 90ies [5] with the aim of developing a new “plug and play” approach to manufacturing system design. Since then, many researches and projects have been running and this research field is considered one of most advanced frontier in Intelligent Manufacturing System. This is why HMS became one of the six major research projects of Intelligent Manufacturing System community program. It involves Australia, Canada, the European Community (EC), European Free Trade Association (EFTA), Japan, and the US in order to provide for international research, organization and standardization.

The HMS consortium developed the following list of definitions (among others) to help understand and guide the translation of holonic concepts into a manufacturing setting:

- Holon: An autonomous and cooperative building block of a manufacturing system for transforming, transporting, storing and/or validating information and physical objects. The holon consists of information processing part and often a physical processing part. A holon can be part of another holon.

- **Autonomy:** The capability of an entity to create and control the execution of its own plans and/or strategies.
- **Cooperation:** A process whereby a set of entities develops mutually acceptable plans and executes these plans.
- **Holarchy:** A system of holons that can cooperate to achieve a goal or objective. The holarchy defines the basic rules for cooperation of the holons and thereby limits their autonomy.
- **Holonic Manufacturing System (HMS):** A holarchy that integrates the entire range of manufacturing activities from order booking through design, production, and marketing to realize the agile manufacturing enterprise.
- **Holonic Attributes:** The attributes of an entity that make it a holon. The minimum set is autonomy and cooperativeness.
- **Holonomy:** The extent to which an entity exhibits holonic attributes.

7.4 State of the Art of HMS

Having a common background on basic holonic concepts and a shared specific language, this section will focus on main works done in HMS context and brightest perspectives in this area. Among these works and researches, one of the most interesting branches is that of reference architectures development, centred around manufacturing planning and control. This is why a brief overview on different types of control architecture is given in the following paragraphs. After that we shortly explore a significant example of reference HMS architecture within a manufacturing enterprise environment and how the same holonic concepts can be extended outside the enterprise in a market centred environment.

7.4.1 System architectures

System architecture can be defined as a product of a design process; it is the solution for a specific problem and, within this solution, it comprises solution structure, solution components and their relations.

System architectures are often used in design process because they are abstract description of complex system. This means that they are useful

for understanding these systems with simplified model, determining which are vital components and which not; they can reduce the impact of changes during redesign process and they can provide for different views of the same system.

System architectures can be generalized and grouped in Reference Architectures, as a reference architecture gather basic principles and rules for system development in a specific domain. This way they can be used for designing system architecture for a particular system or environment using predefined and standardized elements.

For what concerns control system, reference architectures were developed mainly following two different theoretical approaches: hierarchical control architectures and heterarchical ones.

7.4.2 Hierarchical versus heterarchical architectures

The idea of developing hierarchical architectures derives tightly from the observation of natural complex systems: in each of them any kind of hierarchy can be found both in the structural arranging of entities and in their relationships. Within this kind of structures, commands follow a top-down route whereas feedback information produces a bottom-up control flow. There are many kinds of hierarchical structures: one of those developed at first was the ISO 10314 architecture ([10], figure 7.2). The main characterization of these structures is their deterministic behaviour, based on the fixed structuring of components. This is a key point for understanding main properties of hierarchical structures: (i) Difficulties in modifying the structure, (ii) Almost impossible incorporation of unforeseen modifications, (iii) Disturbances (such as a machine breakdown) can invalidate system behaviour or performance, (iv) A top-down development methodology implies additional constraints.

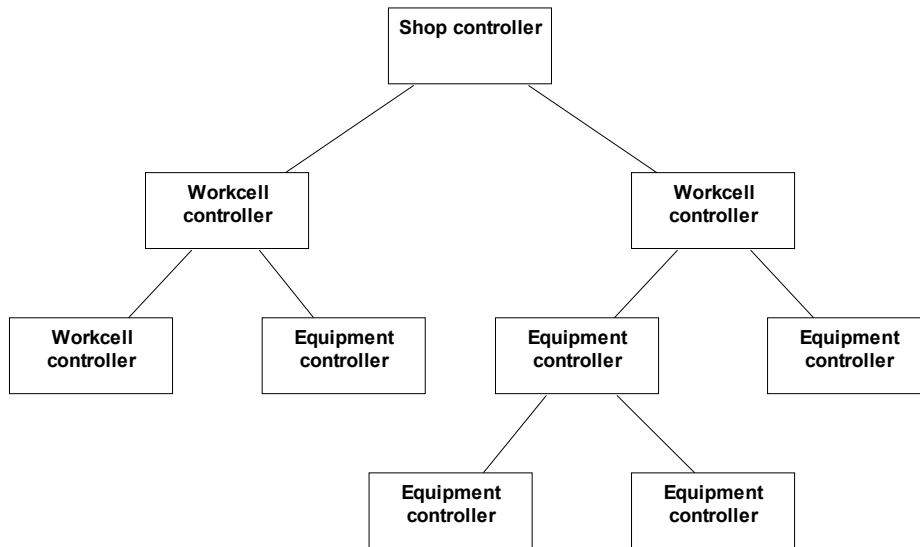

Figure 7.2: - Example of hierarchical architecture [10]

On the other side, heterarchical structures try to overcome limits and inefficiencies proper of hierarchies. For this aim they are designed as a flat structure composed of independent entities (also called agents), representing tasks or resources and operating by means of dynamic market mechanism (for example market rules). As these agents are independent and not constrained by pre-defined rules or parameters, the system became fault-tolerant: it means that it can easily adapt and survive to unforeseen disturbances. The strength of heterarchical system is also a weakness if considering that: (i) global performance (as throughput) can largely vary using different market rules, (ii) the control system can not guarantee a minimum performance level when the system works outside the scope for which the rules were tuned, (iii) the prediction of the behavior of individual orders is impossible.

Typical examples of such a kind of architectures are Multi Agents System [6]: cooperation between independent entities (agents) is achieved with control algorithms representing different marketing rules.

Holarchy is an effort for overcoming this dual view of system architectures: its approach is neither hierarchical nor heterarchical but tries to merge common qualities and benefits of both. It is heterarchical as it is composed by autonomous and cooperative elements (here called Holons).

Hierarchical when these entities are grouped forming temporary hierarchies. One of most relevant works in HMS was the development of such a kind of architecture by Jo Wins in 1999 and it is named PROSA [2].

7.4.3 PROSA Reference architecture

The name PROSA stands for Product-Resource-Order-Staff Architecture and this word briefly sums up the basic elements of this architecture: that is, four different roles a holon could play. Independently from a specific company, there are always three fundamental and relatively independent manufacturing concerns dealing with resource, product-process technology and logistic. These three aspects can be fully modeled by means of, respectively, Resource Holons, Product Holons and Order Holons.

- Resource Holons: they contain a physical part, namely a production resource of the manufacturing system, and an information processing part that control the resource. It is an abstraction of the production means such as a factory, a shop, machines, furnaces, conveyors, pipelines, pallets, components, raw materials, tools and so on.
- Product Holons: they hold the process and product knowledge to assure the correct making of the product with sufficient quality. A product holon contains consistent and up-to-date information one the product life cycle, user requirements, design, process plans, bill of materials, quality assurance procedures, etc. It contains the “product model” of the product type, not the “product state model” of one physical instance being produced.
- Order Holons: represent a task in the manufacturing system. It is responsible for performing the assigned work correctly and on time. It manages the physical product being produced, the product state model and all logistical information processing related to that job. It may represent customer orders, make-to-stock orders, and prototype-making orders, orders to maintain and repair resources.

These three kinds of holons exchange three kind of knowledge about manufacturing system: (i) process knowledge, (ii) production knowledge, (iii) process execution knowledge.

In addition to these three types of holon, PROSA defines another one, which is Staff Holon. These holons function as assistants to other holons in the system: they provide necessary information to support holons to perform their tasks and to take correct decisions and to solve problems. They are an enhancement to three basic holon types in the sense that they can help holons under disturbances effects but they are not a rigid constrain for holons' autonomy in taking decisions to do their work. Examples of such staff holons can be schedulers, on-line shop floor controls, process sequence planners, CAD systems, MRP systems and more.

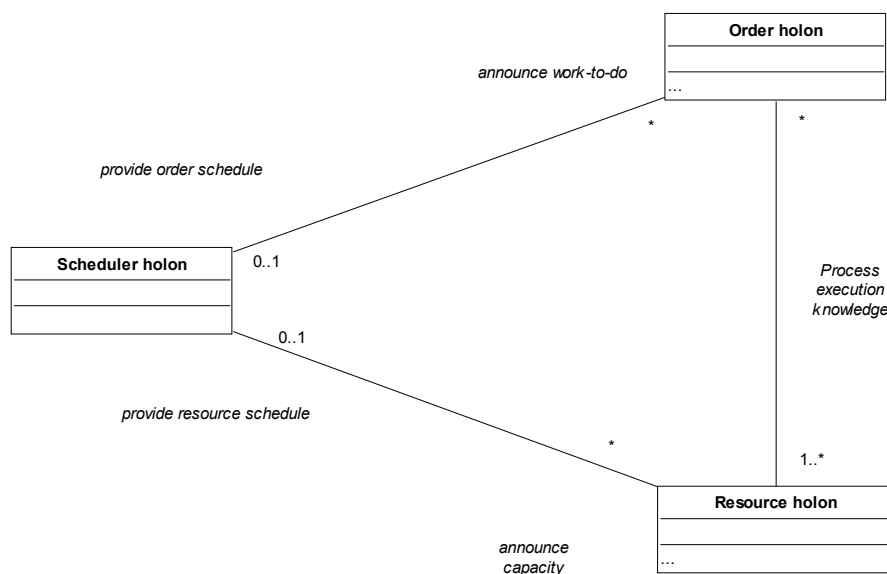

Figure 7.3 - Centralized scheduler is a staff holon to the order holons and resource holons [2]

All these holons manage data and perform specific functions: a resource holon maintains data about its capabilities, its running tasks, its sub-resources, logs of activities and performs functions such as start processing, process execution control, sub-resources management, process monitoring and maintenance planning. An order holon maintain data on the state of the physical product, on the progress of the task, on

historical data related with the task and performs functions as scheduling jobs, deadlock handling, progress monitoring, triggering the starting, suspending, resuming, stopping or aborting a process on a resource. A product holon maintains data of process plan, product description, quality requirements and perform functions of product design or re-design, process planning or re-planning and quality verification.

The following UML schema represents a mapping of three basic holons data and functions:

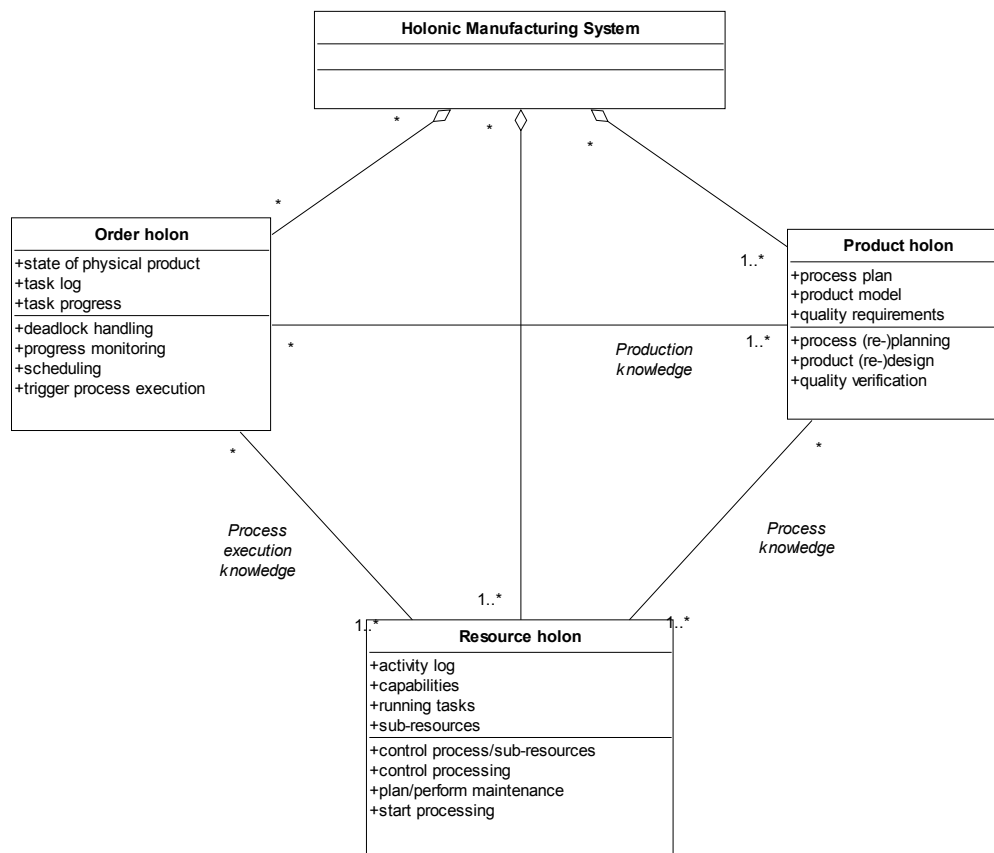

Figure 7.4 - Mapping of three basic holons data and functions [2]

Summing up, PROSA architecture seems to cover all aspects of both heterarchical and hierarchical approaches, so that it can be considered a generalization of these two opposite architectures: it behaves as a distributed system because it is composed by three different basic entities called holons and can assume a hierarchy driven structure by means of staff holons. The control system can thus switch between a distributed structure and a centralized one without discontinuity, following

disturbances, system change, and reconfiguration. This architecture, right because based on few elementary building blocks, shows a high degree of self-similarity allowing the representation of different kinds of orders, products and resources. Using concepts of aggregation and specialization of basic holons does this. The final result is a high power in representing different manufacturing system types reducing their complexity of modelling and reconfiguring: it takes only to fit this architecture to different types of orders, products and resources used.

In the same way, the general architecture proposed in [1] is in compliance with these basic properties definition. This model stands for an abstract, general and stand-alone manufacturing system entity (that is, an holon) having the chance of cooperating with other holons by means of its interfaces and comprising both information and physical part. Such general architecture is represented in figure 7.5.

This architecture can be instantiated in any of the different holon typology shown before to represent a single low-level holon as well as a complex holon made of several sub-holons. For example, a physical object transform system (in a manufacturing context) can be thought as a combination of a machine tool (as a lathe or milling machine), a Numeric Control (a control computer or a PLC) and an operator. Each of these entities is, here, a resource holon cooperating with the others through an appropriate interface: an operator can communicate with the computer control by a touch screen or a keyboard, whereas the computer control is interfaced with the machine with a proprietary interface. Aggregating this three resource holons we get an upper-level holon, for example a milling cell.

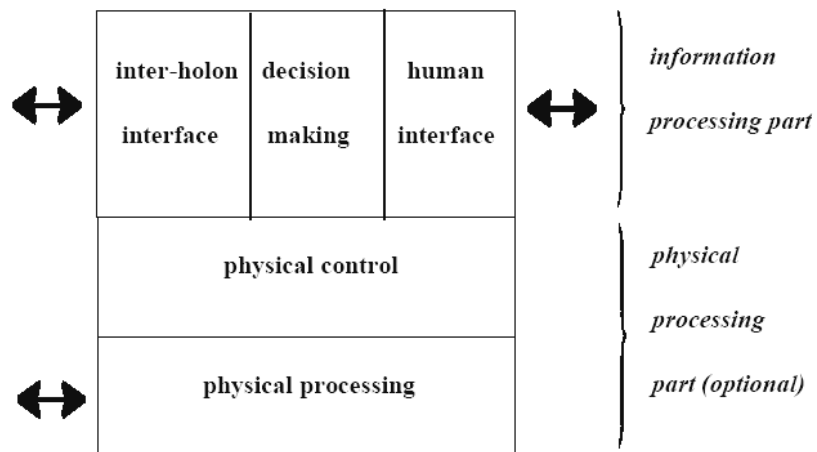

Figure 7.5 - General architecture of a holon [1]

7.4.4 Holons in production planning and control

Holonic manufacturing system is a new way of system design, as already shown, rather than a simple control issue. It means that it requires a new approach of thinking to manufacturing environments that goes beyond traditional schemas. From the production planning and control point of view, also a widely accepted and conventional architecture such as MESA (figure 7.6) could not fit new requirements of a holonic implementation. It's a matter of fact that it is often impossible to erase a well know and reliable production planning and control system replacing it with a completely new one: first of all because holonic architectures are still in an analysis and development phase, than because it requires a deep re-design of control software and of interfaces between holonic entities, giving them a suitable interface with human beings too.

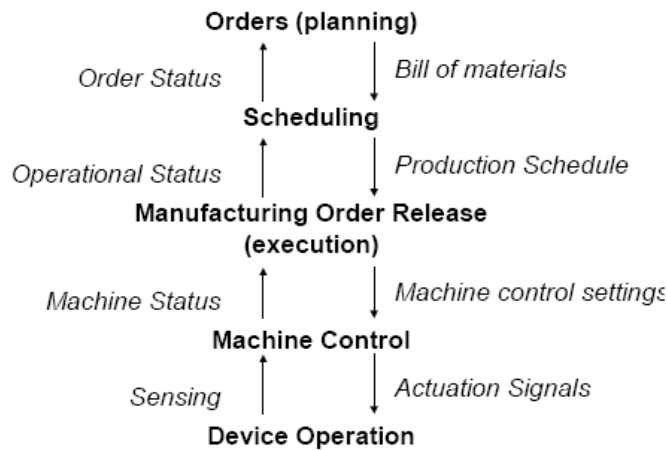

Figure 7.6 - Typical manufacturing control hierarchy [11]

Despite these difficulties, it's possible to proceed step by step, migrating from standard and classical control architecture towards a holonic one (this way of proceeding is shown in figure 7.7). This can be reached by implementation of intermediate holonic solutions in some specific areas of control system.

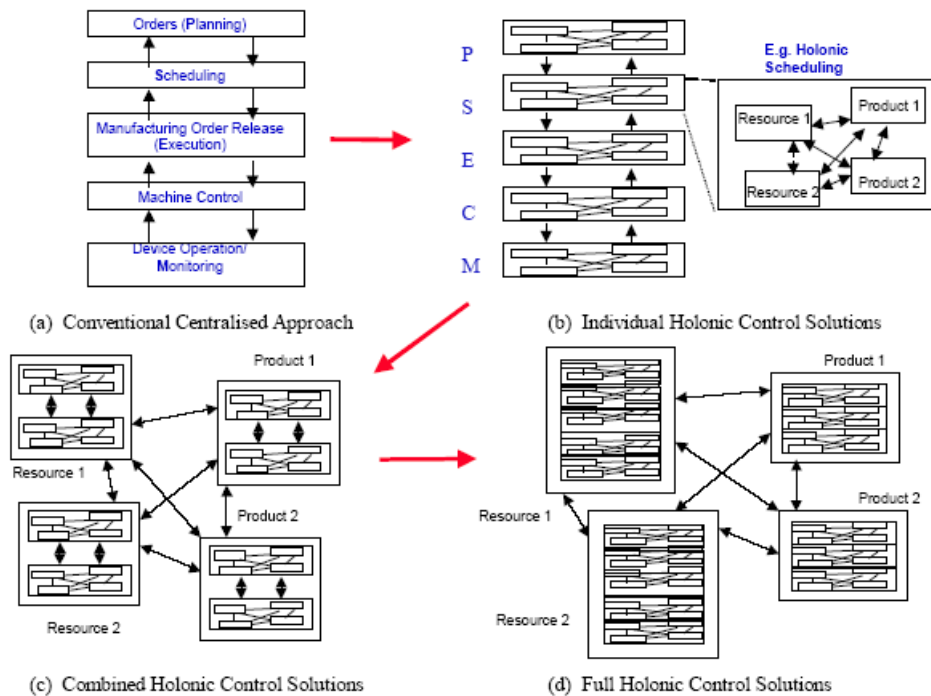

Figure 7.7 - Migration in Holonic Controls [7]

7.4.5 Virtual Holonic Enterprise

One of the problems facing with manufacturing enterprises is the geographically distributed pattern of single sub-enterprises. It means that each member of global enterprise is located in a different place, is due to autonomously perform local optimization and comply with local goals; on the other side it must also reach global optimization of wider and higher level enterprise, cooperating with other members belonging to the same parent enterprise. This parent enterprise can be thought as a “virtual enterprise holon” composed by autonomous and cooperative member enterprise holon. This way, enterprise control becomes a classical distributed control problem, which can be solved by means of a holarchical control architecture. An example of such an approach is shown in [8] and the result is a framework for virtual enterprises.

Main architecture (figure 7.8) for virtual enterprise is built around two basic holons: Virtual Enterprise Holon (the global coordinator for virtual enterprise) and Member Enterprise (ME) Holon (representing each enterprise member of parent “virtual” enterprise).

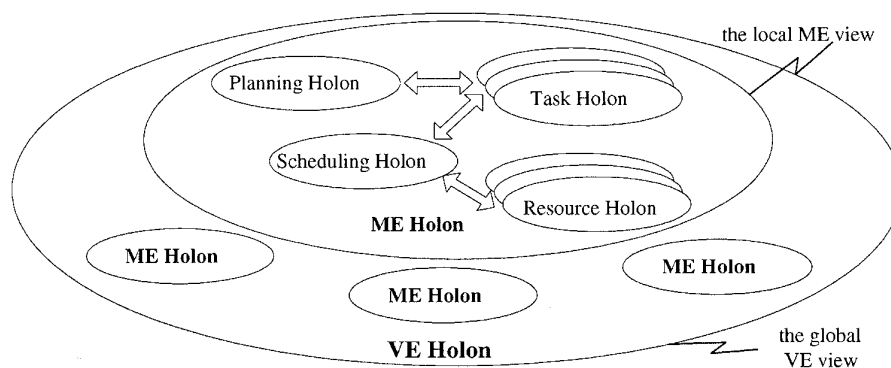

Figure 7.8 - Holonic framework for virtual enterprise [8]

At ME level, the architecture splits into three different levels, each of one composed of standard reference holons: (i) ME Holon, (ii) Planning Holon and Scheduling Holon, (iii) Task Holon and Resource Holon.

A resource holon represents and manages a corresponding real-world resource of the member enterprise, as machines, tool, computers, software, persons, etc. A task holon is in charge of a certain activity in a

certain business process (again, within the member enterprise). Both resource and task holons can aggregate themselves into higher level hierarchy of resource or task holons. The planning holon is the planner of a certain business process, which is split into multiple sub-tasks, and creates the corresponding task holons. The scheduling holon generates schemes of resource-task assignment. Both scheduling and planning holon can be software application as well as team of specialized workers,

7.4.6 Business among Holonic Enterprises

One application of holonic theory is in enterprise control system; many efforts have also been spent to bring holonic concepts in a wider scenario than control, involving both production planning and control and new business models. One of these works [9] tries to merge research results obtained by HMS community and latest standard for platform interoperability developed by FIPA (Foundation for Intelligent Physical Agents) extending holons at the enterprise.

A new concept is introduced: that of Holonic Enterprise. A Holonic Enterprise is a holarchy of collaborative enterprises each of them regarded as a single holon. As an holon, as mentioned several times, can be itself an autonomous part and at the same time composed by different holons – this property is sometimes called “granularity”, an enterprise holon can be thought a three different levels of granularity: (i) global inter-enterprise collaborative level, (ii) intra-enterprise level, (iii) machine (physical agent) level.

At inter-enterprise level, several enterprise holons aggregate themselves into temporary clusters forming a collaborative hierarchy to produce products or services. The traditional concept of supply chain is replaced by new collaborative holarchy paradigm. Each enterprise taking part in this extended holarchy is modelled as a holonic agent and the result is a dynamic system that behaves autonomously to reach best global performance. For example, it can manage auto-negotiation between customers and suppliers finding best solution for both; it can also auto-

update itself reacting to disturbances or system configuration changes, as production standby of some suppliers or introduction of new marketing customers. It can provide on-line orders handling and up-to-date bargains among partners.

At the intra-enterprise level the same dynamic clustering mechanism between enterprise holons is replicated within the manufacturing system that undertakes the responsibility for the assigned part of work to that enterprise. Holons at this level represent once again tasks and resources and through their collaboration, by means of negotiation procedures, they dynamically schedule orders, plan resources' usage by tasks and control manufacturing process (figure 7.9). Also at this level the system can filter effects of disturbances cause, for example, by new, order, machine breakdowns and so on.

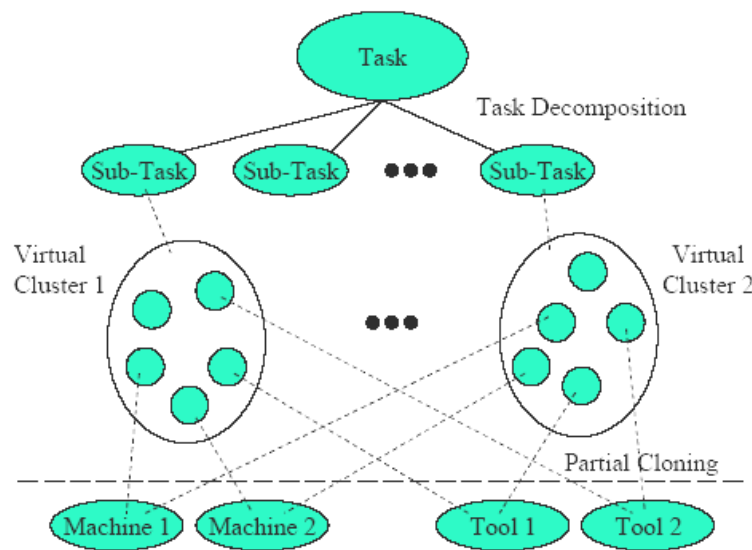

Figure 7.9 - Task distribution pattern at the Intra-Enterprise level [9]

At lowest level, the machine level, the distributed control of physical machines enable dynamic self-reconfiguring of elements to achieve a flexible real-time manufacturing. Each manufacturing entity is abstracted as a holon with necessary parameters needed for reconfiguration and interaction with other holons (figure 7.10).

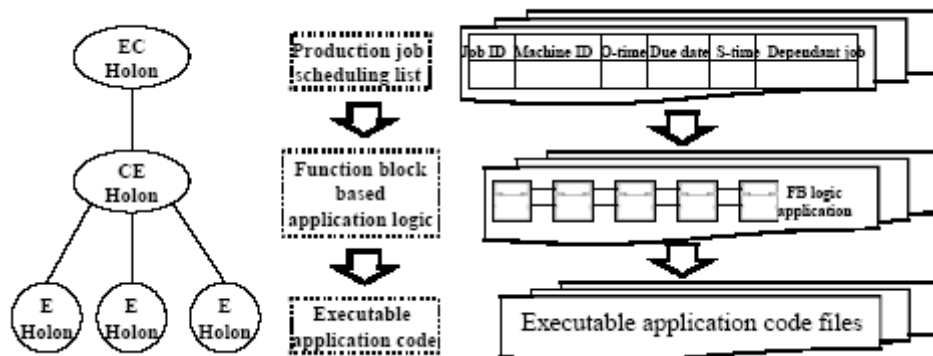

Figure 7.10 - Task deployment pattern at holonic control level [9]

7.5 Conclusions

This chapter deals with HMS, but how HMS is related with product management and traceability? The key point is the idea of Holon. The thesis has already discussed how a philosopher to explain complex system behavior introduced this concept and how it fits in a manufacturing control context. From a literary review, it is possible to state that main development of holonic concepts were reached in manufacturing production and planning researches. The same basic concepts can also be adopted in another context, such as that of product lifecycle traceability. In fact, the present thesis is not so interested, indeed, in control system development but rather in finding general concepts, ideas, meta-model that it is possible to reuse for other purposes. What we suggest to be a powerful tool for traceability is the idea of holon and some of its properties.

First of all, a holon is at the same time a whole and a part of a whole; in other words, holons can auto-aggregate themselves into other holons. The resulting structure has properties of fractal systems and is “granular”; each holonic entity can be viewed at different levels of detail.

The other key-property of holons is their double nature of physical and information part. In HMS context, physical part can be present or not whereas information processing part are mandatory. Anyway, information processing part is often viewed as a software agent, which interacts with

others summing-up main parameters and properties of its own related physical part. It is important to notice, however, the tight binding between these two parts within a single holon. Any entity inside the context is mapped by linking in a univocal way its physical part (if existing) and its proper describing information.

The main focus point is this chance for joining an object or an entity with some information that could be useful in terms of product lifecycle traceability. The thesis at the present is not so concerned about holonic behavioral aspects because they deal with the dynamic of holon, within a holarchy, in a control system context. Thus, holonic properties as autonomy and collaboration are of course significant for the development of a holonic “agent” but they are not strictly necessary for traceability, in particular at a preliminary step.

At the same time, it is possible to point out that there is an open door for the development of a manufacturing control system, which acts at the same time as ordinary control system (for example an holonic one) and as a traceability system. This means that it should perform production planning and control tasks, being for this purpose an autonomous and cooperative holon (and in this case its defined by all the properties shown in this chapter); it should also be able to keep track of all needed information about manufacturing a single product gathering them from other system holons (such as resource holons) - the so called backward traceability (see chapter 5) - and provide up-to-date information to system resource holons to let them perform their tasks – the so called forward traceability (see chapter 5). In other words, if “internal traceability” is the traceability of product lifecycle within the enterprise (from design to shipping through manufacturing and stocking), it is possible to close the existing gap between manufacturing control and manufacturing traceability. This way, an order holon can be thought as an entity which interacts with other holonic entities, aggregates in temporary holarchies, manages its related tasks and its related resources; in addition it holds in its information processing part all information necessary for its upcoming

life phases (as NC code for machining, drawings for assembly and manuals for maintenance) and records all information about its history. Information processing part of a holon is thus a joining ring between traceability and manufacturing control; physical part of a holon is a real in-becoming entity managed and described by its information processing part.

This is what it is possible to bring to light from literary review on new developments and researches in manufacturing control system and from all the related work of HMS.

Then, thanks to this chapter it is possible to be now conscious that it is necessary to link in a univocal way a physical product with its information in the same way a holon is an aggregation of a physical part and an information processing part. Next chapter will try to provide some useful tools and concepts in order to design reference architecture for this information processing part.

7.6 References of the chapter

Scientific references

- [1] McFarlane D., Bussmann S., (2002), Holonic Manufacturing Control: Rationales, Developments and Open Issues, Agent Based Manufacturing - Advances In The Holonic Approach, Springer, pp 302-326
- [2] Wyns J., (1999), Reference architecture for holonic manufacturing system, Ph.D. Thesis, Katholieke Universiteit Leuven
- [3] Morel G., Grabot B. (Eds.), (2003), Special issue on IMS, Engineering applications of artificial intelligence, 16/4
- [4] Koestler A., (1967), The Ghost in the Machine, Arkana Books, London
- [5] Bongaerts L., (1998), Concepts for Holonic Manufacturing, Integration of Scheduling and Control in HMS, Ph.D. Thesis, Katholieke Universiteit Leuven
- [6] Marik V, Pechoucek M., (2001), Special issue on industrial applications of Holonic and Multi-Agent Systems, Journal of Applied System Sciences, 2

- [7] McFarlane D., Sarma S., Chirn J.L., Wong C.Y., Ashton K., (2003), Auto ID System and Intelligent Manufacturing Control, Engineering Application of Artificial Intelligence, 16, pp 365-376
- [8] Huang B., Gou H., Liu W., Li Y., Xie M., (2002), A framework for virtual enterprise control with the holonic manufacturing paradigm, Computers in Industry, 49, pp 299-310
- [9] Ulieru M., Walker S., Brennan R., (2001), Holonic Enterprise as a Collaborative Information Ecosystem, Proceedings at Workshop: Holons, Autonomous and Cooperative Agents for the Industry, Montreal, Canada

Technical references

- [10] NIST control architecture, (1990), in ISO 10314 - Reference Model for Shop Floor Production, Geneva, Switzerland
- [11] ANSI/ISA-95.00.01, (2000), Enterprise-Control System Integration, Part 1: Models and Terminology, ISA

CHAPTER 8

Proposal of a holonic product traceability

metamodel

8.1 Introduction

This chapter deals with a holonic product traceability reference model, the needs that it has to fulfill, the characteristics that are needed, a proposal of the model and a suggestion for its implementation.

8.1.1 Product lifecycle traceability needs

As declared, product traceability is a new trend because of changes in needs and changes in technologies used. Needs related to product traceability are emerging in the form of trends to seek increasingly detailed traceability information from two directions: (i) increased social needs, and (ii) economic needs driven by efficiency in manufacturing and distribution.

Consumers need to have access to production centre, manufacturing, and distribution records of products purchased, primarily for meat, fruits, and vegetables (e.g. [20], [21]). Needs exist to reinforce risk management related to the prompt investigation into causes of food accidents [5], recovery from those accidents [1], etc. Furthermore, needs exist to systematize management of expiry dates of foods, currently done by looking at printed expiry dates. To prevent illegal dumping, needs exist in recycling efforts to promote environmental protection through the registration and management of information on component materials used in the manufacture of products [4]; this permits the identification and recovery of these materials during recycling. For automotive safety, needs exist to document and manage the record of original equipment and

subsequent service situations of repaired or replaced parts [5]; such needs exist both for product recalls of vehicles as well as service records for used ones. In healthcare, needs exist to enhance patient safety by the accurate management of medication to prevent medication errors [4]. Such errors can be introduced by misidentification of the patient, misidentification of the medication, improper identification of an expiry date. To maintain law and order needs exist for theft prevention in bookstores, jeweler shops, other retail stores, and elsewhere [6]. Needs exist for brand protection to prevent the circulation of counterfeit products such as bags, clothing, and other expensive brand name products [8].

Traceability also is needed:

- To improve efficiency and cost reduction in areas such as inspections and inventory control, and to accurately track stock quantities of products dispersed in shipping, storage, and stores [8].
- To implement customer-oriented marketing by detailed management of products owned by consumers and products sold ([9], [22]).
- To efficiently track the transportation of goods as well as improve logistic operations such as automatic sorting at shipment routing ([14], [22]).
- In manufacturing, needs exist to provide component traceability, and to track product movement and utilization between trading partners, for ensuring efficient manufacturing management [21].

Table 8.1 summarizes the needs identified in the literature analysis, classifying needs in terms of relevant scenarios. As the table highlights, there are many needs coming from diverse scenarios, each one related to at least one different industrial sectors; but it is also possible to point out that there are many similar needs shared among the different scenarios. For example, the need for tracing the single product is felt in food and in manufacturing, and in other subcategories. This work is the preliminary point to group all these different user needs into similar categories, in

order to sum them up in requirements of the requested model, as it will be described in the next paragraph.

Scenario	Declared needs	Sources
Food	Quality control Food transparency and safety Ethical and legal responsibilities Certify product (consumers pay more for products they believe are safer and higher quality) Brand protection Increase operation efficiency and profit in the food chain Lot tracing for recall procedures	[1], [20], [23], [25]
Manufacturing & supply chain management	Quality control Ethical and legal responsibilities Inventory control Real time production control Increase operation efficiency and profit in the supply chain Counterfeit protection and theft detection Remote maintenance and service provision Tracing product costs Evaluate environmental impact through the whole product life cycle Lot tracing for recall procedures	[3], [5], [6], [7], [12], [14],[16] [21],[23], [25],[26],
Construction	Manage the retrieve of instruction for installation, operation and maintenance, object monitoring and relational data from the site Manage transferring documents from designer to contractor, when electronic communication and access to remote data base are impractical	[13], [24], [29]
Other	Collect information on the product when it is own by the consumer (marketing) Make information easily readable from the consumer (marketing) Increase customer information satisfaction and loyalty (marketing) Manage the delivery chain for complex projects (project management) Manage the delivery of project deliverables (project management) Manage information to be linked to product (software development) Manage frequent modifications of the product (software development) Avoiding incorrect information and product description (software development)	[9], [10], [11], [12], [15], [22], [27]

Table 8.1 - Declared needs and scenarios

8.2 Definition of the requirements

By the analysis of the industrial needs of the previous paragraph, it is possible to identify the relevant requirements which might be satisfied along the entire product lifecycle by an innovative system, for example represented by an avatar. Using a step-by-step approach, authors defined these requirements in two main groups, named arbitrary User Requirements and Main Requirements. Each of them is closely related with what has been found in literature, even if there is a great difference: Users Requirements deal with requirements that could be explicitly

founded in literature, which represent well defined and focused needs for each singular context of application for product traceability. Complementary, Main Requirements are an elaboration of user's one and of implicitly requested needs, not clearly declared and unbind from a particular context.

Methodologically, the definition of User and Main requirements flows in the definition of the Model Requirements, which deal explicitly with the implementation level of the metamodel (figure 8.1).

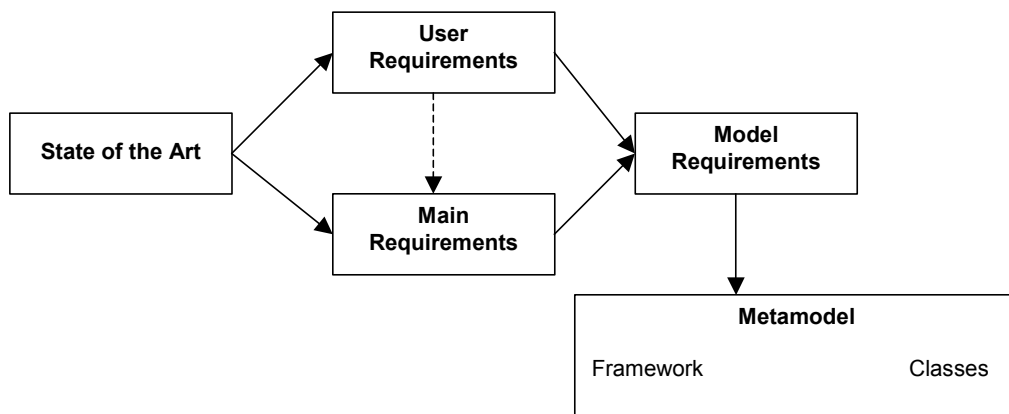

Figure 8.1 – Development of the metamodel

8.2.1 User Requirements

The first step towards an effective model is the re-organization of the declared needs, in requirements for many users, which deals with similar business problems in diverse scenarios. The result is a list of requirements that the model is due to satisfy independently from the context of implementation (table 8.2 – when the same references appears in diverse columns at the same row, it signifies the source explicitly declared this needs in diverse scenarios).

User requirements have been arranged also relating them to the different phases of product lifecycle. In fact, a model for product traceability is indeed intimately connected to a model of product life cycle: product traceability lose its meaning if unable to go along the whole life of a product, starting from the design phase to the disposal, keeping track of changes and related information.

User Requirements \ Scenario	Food	Manufacturing & supply chain management	Construction	Other
Collect information on real time product production	[25]	[3], [5],[6]		[23]
Manage warranties on product quality	[1],[20]	[3],[5],[7],[26]		[10],[11],[26]
Manage warranties on product security	[20]	[3]		[11], [20],[22],
Satisfy legal and ethical responsibilities	[1]	[3],[5],[23]		[23]
Optimize production performance	[23]	[3],[6]		
Manage recall procedures	[1]	[3]		
Achieve customer loyalty	[1]			[8]
Monitor suppliers performances		[3]		[8],[12],[22]
Manage products inventory	New legal req. from 01 Jan 2005	[6],[23]		
Manage products tracking in the supply chain		[6]		
Manage product sub-components traceability		[12],[25]		
Manage product reuse, rework and recycling		[6],[14],[16]		
Protect value-brand	[6],[20]			
Provide remote maintenance and service provision		[6]		
Verify eco-compatibility of the product		[4],[14]		
Apply product support information			[13],[24],[25]	
Collect information on product life and usage				[9], [15],[27]
Provide readability of information by the customer				[9]
Prevent mistakes during modifications				[10]
Have a unique product identification				[7],[12]

Table 8.2 - User requirements coming from the literature analysis

As shown in chapter 2, product lifecycle traceability could be ordered as a sequence of four different phases: (i) Development, (ii) Production, (iii) Use and (iv) Dismiss of products (table 8.3).

As shown in table 8.2 and 8.3, there are some requirements such as “Unique product identification”, “Quality”, “Product support information”, “Eco-compatibility” and “Security” that are shared among nearly all the phases, while other requirements seem to be specific for each different phase, as “Prevent mistakes during modifications” for Product Development.

User Requirements	Lifecycle phases			
	Product Development	Product Production	Product Use	Product Dismiss
Have a unique product identification	X	X	X	X
Satisfy legal and ethical responsibilities	X	X	X	X
Verify eco-compatibility of the product	X	X	X	X
Manage warranties on product quality	X	X	X	
Manage warranties on product security	X	X	X	
Apply product support information	X	X	X	
Prevent mistakes during modifications	X			
Manage recall procedures		X	X	
Manage product sub-components traceability		X	X	
Optimize production performance		X		
Collect information on real time product production		X		
Monitor suppliers performances		X		
Manage products inventory		X		
Manage products tracking in the supply chain		X		
Achieve customer loyalty			X	
Protect value-brand			X	
Provide remote maintenance and service provision			X	
Collect information on product life and usage			X	
Provide readability of information by the customer			X	
Manage product reuse, rework and recycling			X	X

Table 8.3 - User requirements in life cycle phases

8.2.2 Main Requirements

Main Requirements become from a critical analysis of the previous requirement, which aims to explicit and clarify needs not clearly declared in literature, where people with different specific cultural backgrounds usually deal product traceability. The defined Main Requirements are the following:

- **Product Descriptive Power:** the model should be able to describe different products. The products may be of different shape, complexity and cost. There are products requiring a lot of investments for the design or the process phase, but quite cheap because their production volume is wide (for example some electronic components). Other products are composed by a lot of sub-components and require a great amount of money for design, production and maintenance (such as ships and airplanes). For other products it is important to guarantee consumers' health, such as for foods and drugs. We do not want the

model to be focused on a particular sort of products but rather able to be instantiated for different types of products.

- **Multi-Scenario Descriptive Power:** in literature there are many scenarios and many mono-scenario models, but a multi-scenario model is missing [10]. The model has not to fit a special scenario, industrial sector, context of application or environment, but shall fit each time any different context without needs for modifications. It is intended to be useful for traceability of software as well as foods, drugs, military industry, intelligent manufacturing systems, automotive industry and so on. As Descriptive Power deals with features and properties of traced products, Multi-Scenario Descriptive Power is related with features and properties of context of application.
- **Product Lifecycle scalability:** the model should describe different phases of lifecycle, and should describe them in such a way to be useful for both single phase oriented users and whole chain lifecycle oriented user. Traceability system users feel different need of tracing all four-product lifecycle phases. For example, someone could be interested mainly in product production, another one in product use and product dismiss and so on. The model should guarantee a specific level of detail for each phase, in compliance with an effective use of traceability on products belonging to different scenarios and with different features and degrees of complexity. Figure 8.2 shows, for example, a traceability model with four lifecycle phases having similar “weight” in terms of relevance of information describing each single phase.

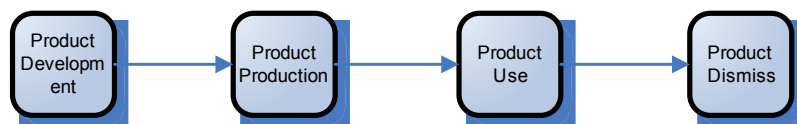

Figure 8.2 - Balanced lifecycle phases

Figure 8.3 shows an unbalanced lifecycle with a predominance of product productions based information and data (for example for an

Holonic Manufacturing System using traceability model to allow automation of tasks).

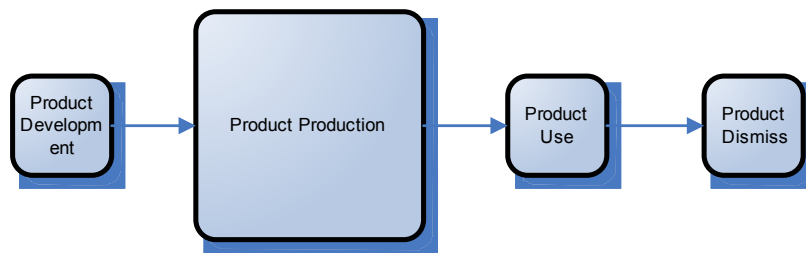

Figure 8.3 - Product Production centered model

Figure 8.4 represent the case in which Product Development and Production phases are not in use (for example when inside-enterprise traceability is not required).

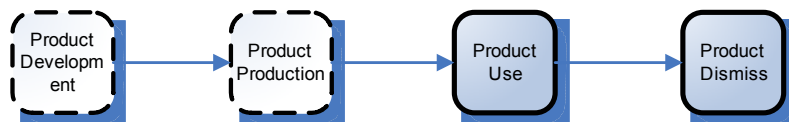

Figure 8.4 - Model describing products outside enterprise scopes.

- **Product Detail scalability:** the model should describe different detail levels, from final products, to subcomponents, since complex products needs much more information than others. At last different users should have different views of the information, following their needs. Figure 8.5 shows an example of a product (a car) requiring a high level in detailing its related information because of its complexity due to great number of sub-components. By the contrary, some product requires only a low degree in detailing information, as represented in figure 8.6.

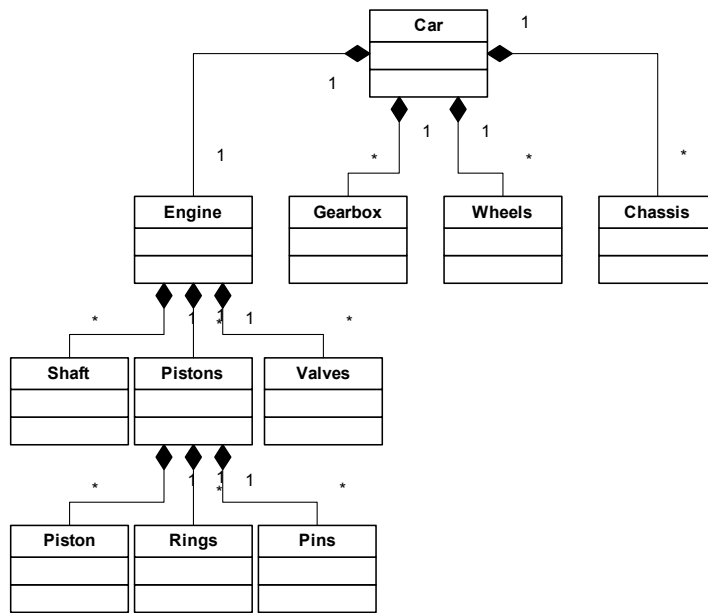

Figure 8.5 - Example of high level of detail

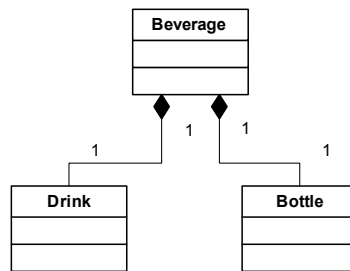

Figure 8.6 - Low level of detail for a beverage

- Updatable: the model has to follow the evolution of the product, and keep track of information describing modifications and operations made on it. It shall include information and data necessary for forward traceability and, at the same time, guarantee recording of product history (backward traceability).
- Shareable: the information should be shared between many users and industries. Information related to backward as well as forward traceability are product-bound and can be useful for a series of different actors which make use of that product, such as all customers who got in touch with the product in its operative life, product manufacturers, suppliers, retailers, maintainers, etc

- Being distributable: information could be stored in diverse supports (RFID tags, barcodes, but also databases). Due to technological reasons, for example the amount of free memory on an RFID tag for storing information, it is sometimes impossible to keep the whole description of product lifecycle together with the physical product itself. Furthermore in some cases could be useful to store only a few relevant information on the product (for example by means of a cheap barcode instead of a more expensive RFID tag), giving at the same time the chance for product traceability users to recover other information when requested. A distributable model allows splitting information into those to record on the product and those recorded in a remote database. Figure 8.7 shows how product related information could be stored partly in a local storage system (barcode, RF tag, etc.) and partly on a remote database.

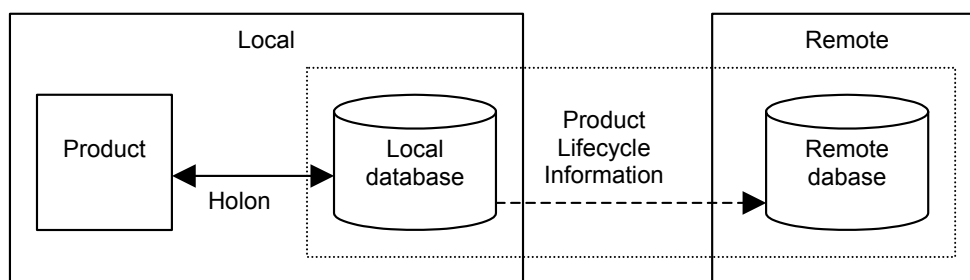

Figure 8.7 - Information are distributed between local and remote systems

- Unambiguously understandable: users of different cultures and languages could have to access information, the model should avoid misunderstandings. For this purpose, it is important to have a standardized model, developed taking into account wide spread standards already existing whenever possible.
- Trusted access: the model has to grant true information restraint to different kinds of users, guarantying safety and security access and management. . For example, manufacturers are usually concerned that some information requested for product maintenance or dismiss, result of quality analysis tests and so on can be shared only among trusted groups of users (excluding for example competitors). Implementation of

the model should take in account this matter by providing some security mechanism, such as different product lifecycle information views or masks according with registered users or users groups. In figure 8.8, the domain of product lifecycle information is split into different subsets of information whose access is restricted only to trusted users

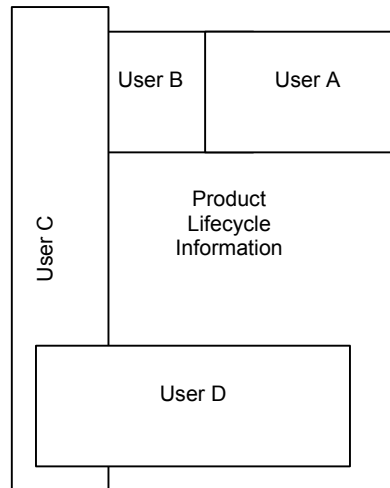

Figure 8.8 - Each users is allowed to deal with only specific subsets of information

8.2.3 Model requirements

From the conducted analysis, User and Main requirements could be grouped in a final series of requirements, named Model ones, which constitute a basic set of properties and features which might be considered for designing a traceability model able to satisfy the diverse kind of interested actors and scenarios. It is impossible to map point-to-point links between User, Main and Model, just because Model Requirements are a result of a studying phase of generalization and synthesis of the two previous types of requirements. Model requirements constitute a kind of detailed agenda of the implementation needs of the metamodel.

Shortly, model requirements are: (i) One instance for any product, (ii) Existence of different information type, (iii) Classes defined by subclasses, (iv) Product defined by subcomponents, (v) Fractal and modular structure, (vi) Open model (ANY Class), (vii) Existence of a TIME descriptor, (viii)

Existence of various instances of the same class, (ix) Existence of a LINK class, (x) Standardized definitions and information, (xi) “Access rights” class for diverse “User” and “User Group” classes to provide different information views based on access rights, (xii) Independency from the physical support.

8.3 Model structure

Taking into account the previously presented requirements and the Holon concept defined in [19] (figure 8.9), the model for Holonic Product Traceability is hereafter defined. Figure 8.9 explains that the Holon results from the linking of a Physical Object plus information. This definition is very similar to the first “philosophical” definition. If the focus is on the model, the model can be simplified in figure 8.10.

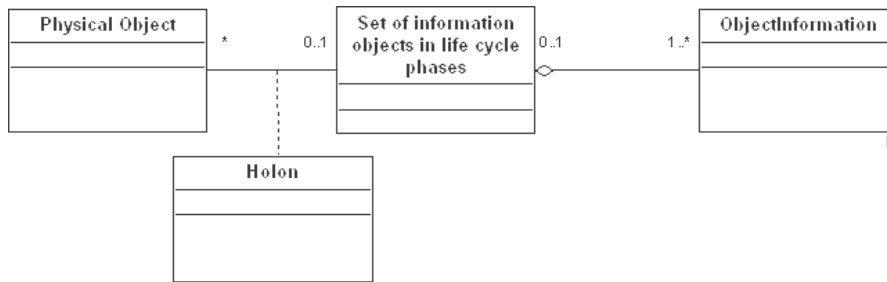

Figure 8.9 - Definition of Holon [19]

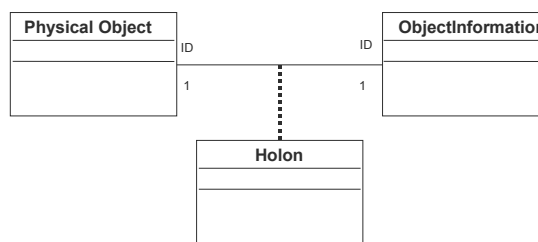

Figure 8.10 – Holon model

This model defines a Holon as the merging of a physical object and its related information; if the link between these two is missing the idea of Holon vanishes and the traceability model miss its target. The link can be established using many technologies, barcodes and databases, RF Tags, etc, but this technological implementation is out of the aim of this work; in

fact it is concentrated on the information needed to ensure traceability. To assure this linkage it has been introduced the ID class, which is an identification key for each single product and it has multiplicity mandatory 1 to 1.

8.3.1 ObjectInformation

The proposed model is mainly focused on defining the Information needed to ensure traceability. There are much information related to the product and the ObjectInformation class defines them.

ObjectInformation is a group of information that can summarize all the information needed along the life of the product; it can follow the product during its lifecycle phases, like, for example, during its production, or use. The ObjectInformation class contains general information on the product as the identification, class and batch information, a description of the product, it's characteristics and the results of possible tests made on it. The main elements of this class were derived from ISA/ANSI 95 and ISO 10303-239 (PLCS) standards.

According to the needs found in section 8.1.1, the information model has been developed as simple and flexible as possible; to achieve this target it has been used a “fractal” structure; this means that the same class and model have been used in different levels and situations; for example a machine can be seen as an Equipment in the ObjectInformation related to the product that it works, but is an Holon itself, with its own ObjectInformation class. Another example is a raw material; it is described in the model with the MaterialInformation class, but this is only a specialization of the Resource Class, that is a specialization of the ObjectInformation class. So the structure is exactly the same. This is possible because the raw material is a Holon itself, it is the final product for the supplier, and is a raw material for the user. Also documentation and personnel are Holons if it is possible to aggregate information to the physical side. So the model has to be “fractal”, “recursive”; this way it has few simple classes that describe many different object and different levels.

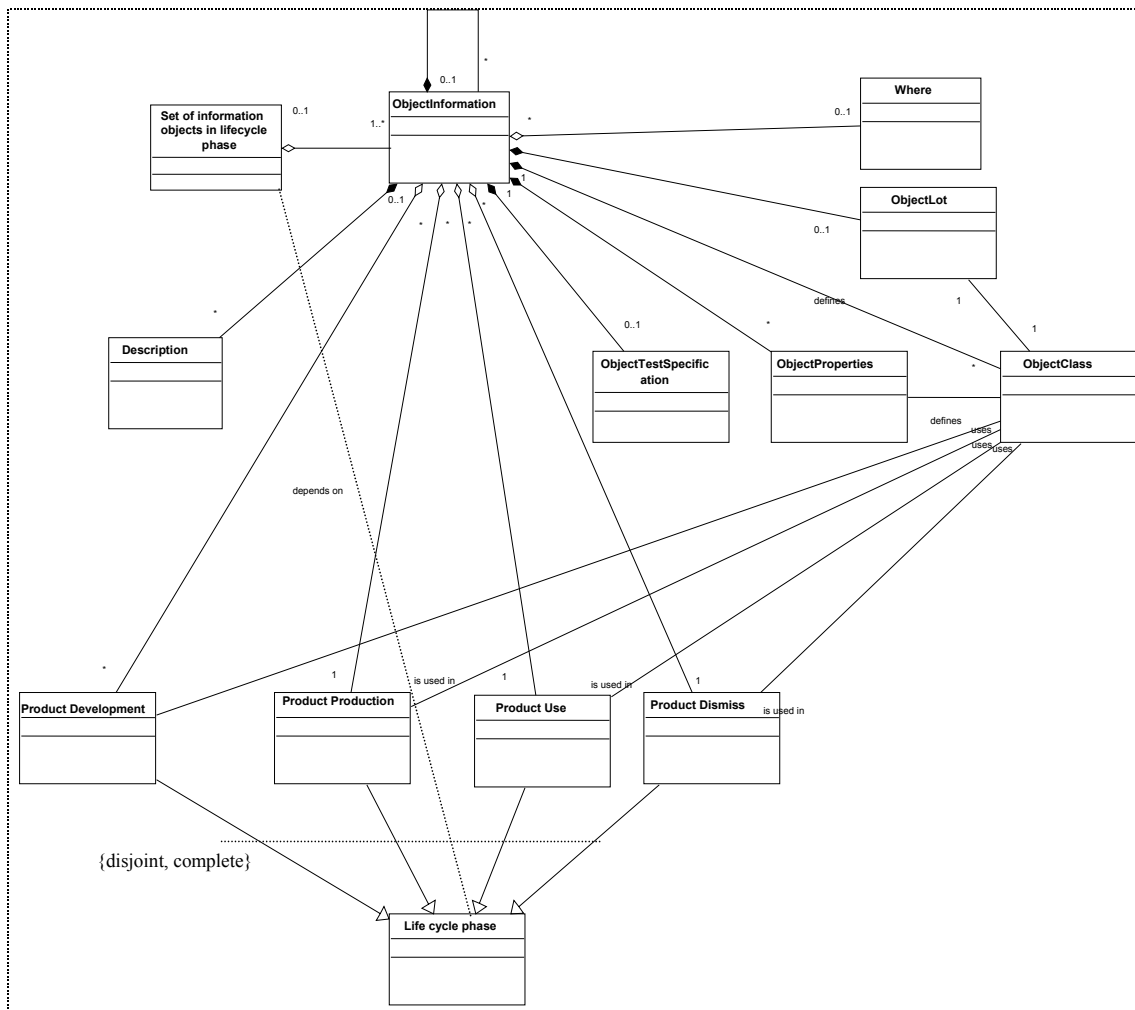

Figure 8.11 - ObjectInformation model

The ObjectInformation Class, represented in figure 8.11, is the main class of the model; it is in 1 to 1 relationship with the physical part; this tight link is needed to create the Holon. This is the core of the model, and is a class that is the “stereotype” of many others, likes for example the Resources. It is “recursive” intending that sometimes an ObjectInformation can be composed by others ObjectInformation as a product, like for example a car, can be composed by other products, in the example screws, engine etc. It is composed by many other classes, which are needed to archive information about the product during its lifecycle. First of all is needed a Where class, that is composed by a Location Class and a Time Class; this allows to trace the product movement, and to know where it has been, and where it is. Another class needed is the Description

Class, which contains a textual description of the physical object bounded to the ObjectInformation. This is useful because permits to describe in an informal and easily understandable way the object. The ObjectProperties Class instead describes the product with its more specific qualities and in a more formal way; for example it can contain the weigh of the product, the dimensions etc. It is in relation with the ObjectClass, which describes the “class”, the “type” of the product. This is also in relation with ObjectLot Class that describes in what lot is the product. The lot is useful because now is very common in manufacture, so it permits to the model to be compatible with the current traceability system. It can also be used to group product that have been ordered by the same customer. Another Class is ObjectTestSpecification, which is similar to the similar naming class in ANSI/ISA-95. This class contains the information about the tests made on the product, and the specification that it has to accomplish. To describe the Life Cycle of the product is also necessary a class for each Life Phase. These are specifications of the Life cycle phase Class.

This ObjectInformation class is created when the product begins its life; this moment can also be different to the creation of the physical object as, for example when arrives the order for a product the ObjectInformation can be created and some starting information can be filled in. In the beginning could be created a univocal Id, which will identify the product during its whole life. Then, when the life of the product advances, the information stored in the model increases, including the lot information, the properties etc. In a “backward” traceability all the information on how the life of the product evolves are stored on the file; for example where the product has been deposited, the results of the tests made on it etc.; during the Production life phase can be traced what machine and operator worked on the product, what are the subcomponent used and their origin; in the Product Use life phase, maybe the model can trace the maintenance, and the breakdown, and how and by how they are repaired, it also can trace the delivery and if used in a “forward” way it can store the information about its route and it final destination.

For example a car assembly could be seen as a good “forward” traceability case. When one orders its car in a car showroom, here the ObjectInformation is created. In fact if, as the current market survey shows, the customer wants a highly customized car, the needed accessory and characteristics have to be recorded. So it can be useful if this information is stored in the arising ObjectInformation. It can be registered the Id and the preliminary information, the due date and the name and address of the customer. Then, before arriving to the assembly line, in the file are stored all the information which are necessary to that life phase; for example, the operation that has to be done, the material and the subcomponent that has to be used, the machine that has to be employed, the tests that has to be done on the product, the shipping information etc. With all these information the product advances in the manufacturing, since it arrives to the final customer without asking other information. In the forward model could also be written the information about the maintenances that the product has to do in its life, after the selling.

The “backward” part instead records all the data on what happened to the product during its lifecycle, for example it records what machine did a work, what raw material was used, what operator was monitoring during the production, what are the results of the tests etc. The backward part has to be always present, even when there is the forward one; in fact the forward explains what to do, while the backward records how it was done.

The main information about the product is visible directly in the ObjectInformation model, while the information related to its life are in subclasses that are specialization of the Life cycle phase class. The internal structure of all these phases is the same; in fact the information to record are similar.

8.3.2 The Life Cycle Phase

The Lifecycle Phase class (figure 8.12) is specialized into: Product Development Class, Product Production Class, Product Use Class and

Product Dismiss Class; each of them describes a particular moment of the life of the product; for some kind of product it should be useful to have all these classes, for some other it could be useful to have only one.

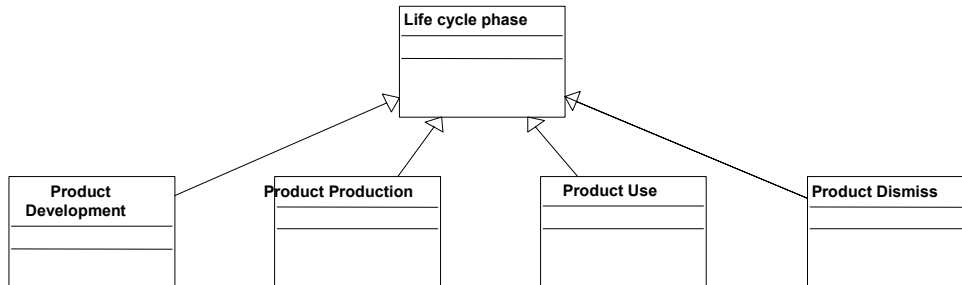

Figure 8.12 - Lifecycle Phase specializations

Product development is about the design phase of the product; it traces the decisions, the choices made, the requirements asked by the customer etc. This lifecycle phase is quite different from the others, and is also very good examined by other authors; it also has much software that already works on it (e.g. CAD like Catia, UGS NX). This phase "produces" a "product" itself that is named "Project". Project can be considered as a product made of information without a physical part. So can be used the same Holonic point of view if considering the Project and the information about it (documentation, information rights, etc) as two different entities. This way, the Project has its "information object", which could have the same structure of a physical product. This is a possible further development of the model. Note that at the present, each information could be easily retrieved from a PDM database, and, moreover, many of these aren't used in the following phases. So, we decide to skip this phase. Generally, it is assumed that from the Design Phase exit only the "Design information", the "Engineering Information" and the "Documentation", which are needed into the other lifecycle phases. Honestly, it might be said that this lifecycle phase might be more and more investigated, as it currently happening in the research community, with worldwide projects like ATHENA IP and INTEROP-NoE.

Product Production is about the production of the product, it traces who did the manufacture, what machine, what raw materials has been used. If

the model is used in a forward way it also contains the information on how the work has to be done.

Product Use traces the useful life of the product, when it is used to do what it has been created to do. In this life cycle phase the model records the “significant events” that occurs, like for example the breakdowns, the maintenances, the property transactions etc. In forward traceability it could contain when and how maintenance has to be done etc.

Product Dismiss traces how the product is disassembled and discarded. It is especially valuable if it is used in a forward way, so it can contain the information about how to disassemble it, what parts are to recycle, what are contaminating or polluting and how to store and undo them without risk. The detailed analysis of the classes, which compose the reference metamodel, is reported in annex 2.

8.3.3 Event, Activity and Resource

The Life Cycle Phase class, shown in figure 8.13, is a generalization of the four phases that a product crosses during its life; the structure is the same because the information is very similar.

This class has, as components, a Description that could be used to record some generic information about this phase, an Information Rights class that could be used to permit or deny the access to these information, a Signature Class that verify the source of the information, and an Any class (useful to customise the model for particular but not sharable information). Then there are an Event, an Activity and a Resource classes, that are in relation with a where class. These are very important because are exploited to describe everything that occurs to the product bounded to this informational model.

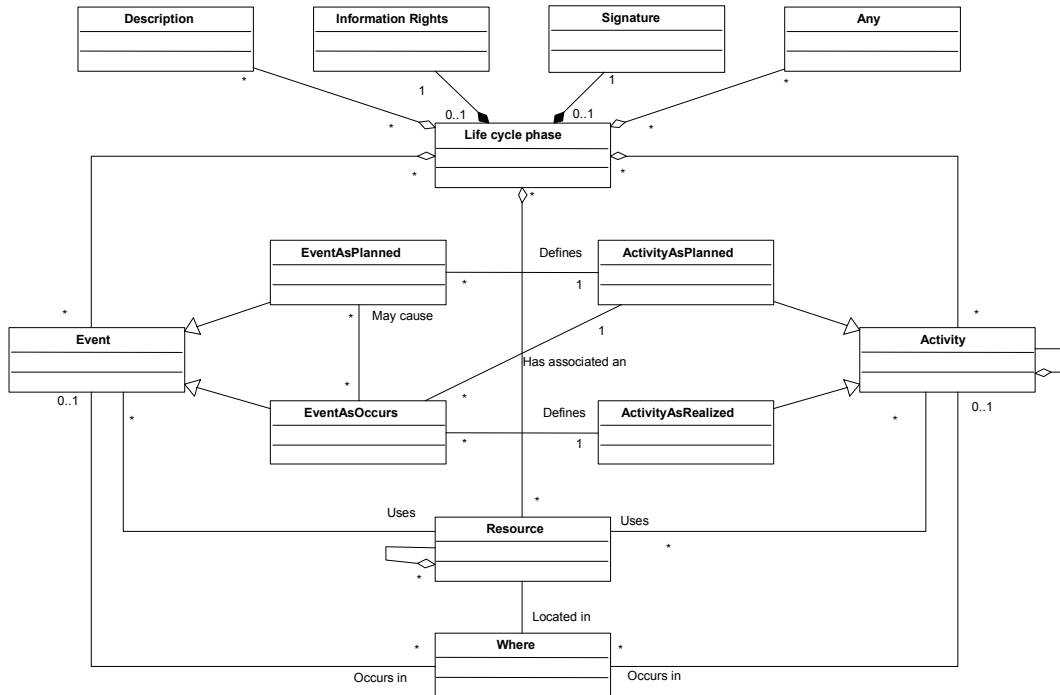

Figure 8.13 - Product Life Phase model

An “Event” is something that occurs, prevented or unexpected, that causes an activity and triggers a recording in the model; an “Activity”, caused by the “Event”, is the act of doing something, and uses the “Resources” to be done. These classes draw inspiration from discrete event simulation.

The relationship between event, activity and resources could be shown using EPC (Event Process Chain) diagrams, like the one in figure 8.14.

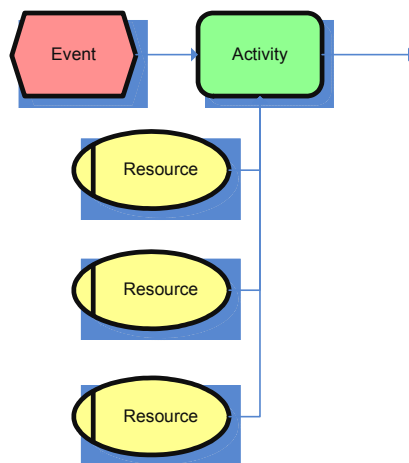

Figure 8.14 - EPC model explaining Event-Activity-Resource relation

In this diagram the hexagon is an “Event”, the rounded-rectangle an “Activity”, the ovals are “Resources”; the meaning of the diagram is that an event causes an activity that uses resources. This ideal model can be used for any kind of episode that occurs on the product.

Note that “Resources” are Holon themselves, so they have their own ObjectInformation merged in the ObjectInformation of the main product; the Resource class is only a “linkage” to this information put directly into the lifecycle phases of the main product; it is another name of this Holon made for plainness; the Resource class will be explained in details later.

For example, in the car case, an “Event” could be an engine breakdown, that causes the “Activity” of engine repairing that uses as “Resources” a mechanic, some tools, and some replacements.

These classes are also specialized in “Event As Planned” and “Activity As Planned” that are “forward” traceability classes and “Event As Occurs” and “Activity As Realized” that are the “backward” ones. The forward classes cause the happening of actions that are stored in the backward model as event and activity.

In the model of figure 8.15, the forward classes are darker, while the light ones are the backward. It explains that an “Event As Planned” and it’s related “Activity As Planned” cause the real happening that is recorded in the model as an “Event As Occurs” and its “Activity As Realized”.

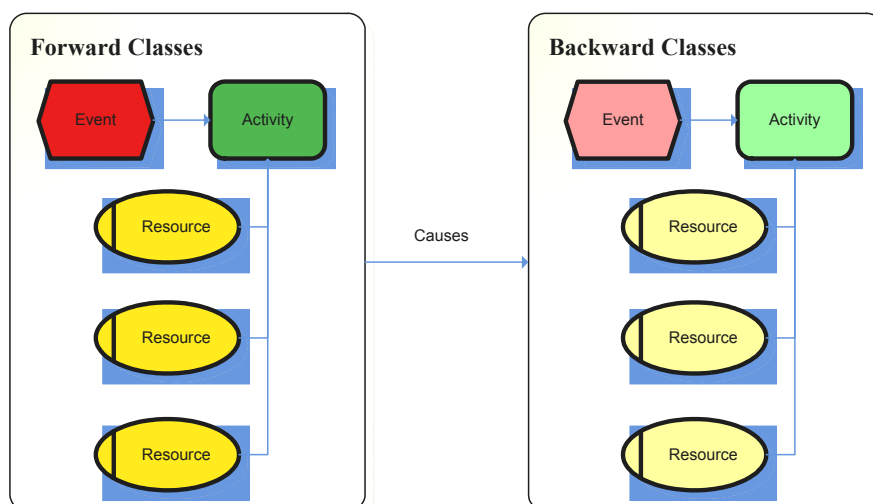

Figure 8.15 - EPC model of Forward and Backward traceability

While the forward explains what has to be done, the backward classes only records what appended and is uninterested that the “Event As Occurs” is caused by something unexpected or by something planned; it records it in the same way.

The “Event As Planned” explains when it has to happen; the “Event As Occurs” registers when it really takes place. In the same way the “Activity As Planned” explains how and with which Resources the action has to be done; the “Activity As Realized” records how it was done.

An example could be a process during the production; It is planned that it has to be done by a certain machine, supervised by a certain operator, and it has to use some raw materials; these information are in the “Activity As Planned” that is caused by a planned event like something that marks the beginning of this process or the ending of the previous. When this work is done the model will record in the “backward” traceability, the event that starts or stops it as the “Event As Occurs” and how it was done, who, what machine and what raw materials were employed in the “Activity As Realized”.

A planned maintenance can be written in the model as an “Event As Planned”; the related “Activity As Planned” records what operation has to be done during the maintenance, the “Event As Occurs” records when the maintenance really took place, and in the “Activity As Realized” are stored the data on what has done.

Another example could be about the shipping of the product; at the end of the production the information about its delivery, that are the final destination and the route, can be recorded in the model, as “Event As Planned” and “Activity As Planned”; then during the travel reading these information the shipping could be done without any other operation from the manufacturer.

8.4 Implementation of the model

To make a consistent model it is useful to ponder about a possible implementation. The implementation of the model in real cases imposes, at least, the definition of a Product ID in order to link it with its information.

This allows to a possible agent [12] to reach the information stored in a remote database. Otherwise it is possible to write more information directly on the product itself, using other more capacious supports. In both cases there is the need to write some information on a support joined with the object, and to resolve how to record them. It is possible to select within various different possibilities of describing information; after pondering about it, at least XML was chosen, according to the effort spent in the development of PML standard in [7].

XML stands for eXtensible Mark-up Language; it is a mark-up language much like HTML, which is well known and widespread. It was designed to describe data and to focus on what data is; moreover XML tags are not predefined, so it allows the author to define his own tags and its own document structure. The XML reader could interpret the XML file anyway, also if there are unknown tags. It is also very simple to read with any kind of software, in fact it is stored in plain text, so a text editor or a standard HTML browser could be enough. This makes it independent of software, hardware and application, and so it is available to anyone. XML also uses a Document Type Definition (DTD) or an XML Schema Definition to describe the data structure. As mentioned in chapter 6, it is also already used to exchange data between databases or different applications, to share and to store data and in B2B to exchange financial information. Last but not least XML is free and extensible, and it grows such a way that many thoughts that it will be very important in the future. So it matches exactly the requested needs.

8.4.1 XML Implementation

An XML object model can have only one root element; all the other classes have to be components; this fits perfectly with our model; in fact all the classes are under the ObjectInformation class. Also the ObjectInformation classes of the subcomponents are subclasses of the main ObjectInformation.

This is shown in the schema 8.16, where is compared the UML model and the XML schema; it plains that the structure is the same.

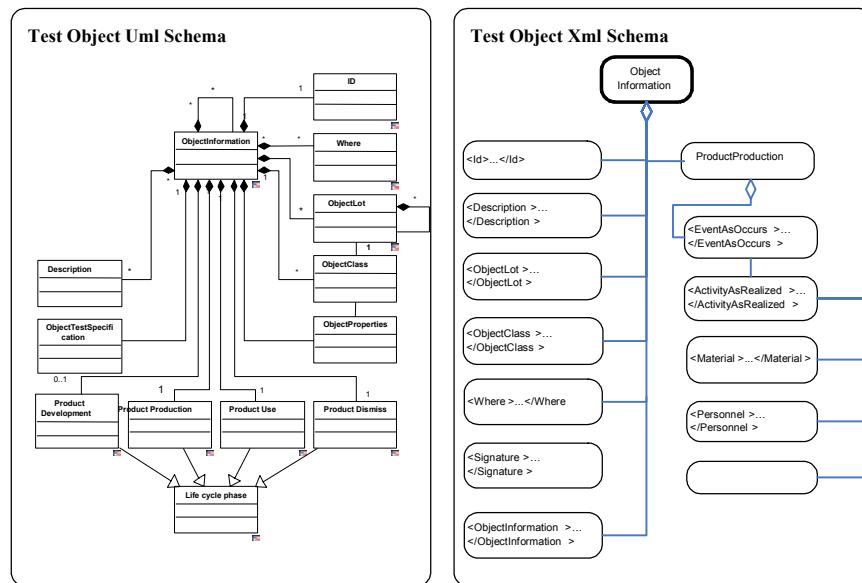

Figure 8.16 - Comparison between abstract model and XML based product representation structure

The classes are described by <ClassType> ; the information contained in the class are written between the element that marks the start of the class, <ClassType>, and that indicates the end; </ClassType>. For example: <ClassType> Informations </ClassType>. It follows a small commented example.

XML	Description
<?xml version="1.0" encoding="ISO-8859-1" ?>	The first line in the document - the XML declaration - defines the XML version and the character encoding used in the document. In this case the document conforms to the 1.0 specification of XML and uses the ISO-8859-1 (Latin-1/West European) character set.
<ObjectInformation>	Here starts the root element of this document, the ObjectInformation class.
<Id> <ObjectID>123</ObjectID> <URI>www.test.it</URI> </Id>	This is an example of how the Id class could be described in Xml; notice that ObjectId and URI are components of the Id, so are shifted to the right and are between the starter and the end of the Id Element.
<Description>Test</Description>	This is the Description class and the information it carries is only text.
<ObjectLot>89878</ObjectLot>	This is the ObjectLot Class, the information carried is a number
<Signature> Key fingerprint = 6BD9 050F D8FC 941B 4341 2DCC 68B7 AB89 5754 8DCD -----BEGIN SIGNATURE BLOCK----- mQGIBDWiHh4RBAD+I0rg5p9rW4M3sK zhs2mDxhRKDTVUnTwpMIR2kIA9pT4 3No/coPajDvhZTaDM/vSz25iZDZWJ7 Eu86RpoEdtr/eK8GuDcgsWvFs5+YpC G2dx39ME7DN+SRvEE1xUm4E9G2Nnd2	Here is described a possible example of the Signature class; it is made through a combination of the secret private key and the text of the Xml file. Using the writer public key the message can be verified.

gg82wgi/ZK4lh9CYDyo0a9awCgisn3 -----END SIGNATURE BLOCK----- </Signature>	
<ProductProduction>	This entity starts the description of the production of this specific product.
<!-- Information about the production of the product -->	Here are reordered all the information about the production; this description is made of Events, Actions and resources.
</ProductProduction>	Here ends the description of the production.
<ProductUse> <!-- Information about the production of the product --> </ProductProduction>	Here there is the description of the product use life cycle phase; here are recorded events and its corresponding actions like breakdowns, maintenances,
<ObjectInformation> <Description>Subcomponent</Description> <Id> <ObjectID>456</ObjectID> <URI>www.supplier.it</URI> </Id> </ObjectInformation>	Here there is the information about a subcomponent of the product; the supplier of the subcomponent provides this information. This is an ObjectInformation similar to the main one, but here is a subclass. This is a consequence of the "fractal" structure of our model.
</ObjectInformation>	This is the end marker of the root element, the ObjectInformation Class

Table 8.4 –XML implementation

In the previous example (table 8.4) it is explained the global structure of the XML file, in the following will be presented a short extract to make understandable how work the Event, Action and Resource Classes. For clearness it is first presented an EPC model (figure 8.17). It means that the "Test Event", that triggers the recording on the model, causes the "test Activity" that is made using as resources the "Test Machine", the "Test Object" and the "Operator".

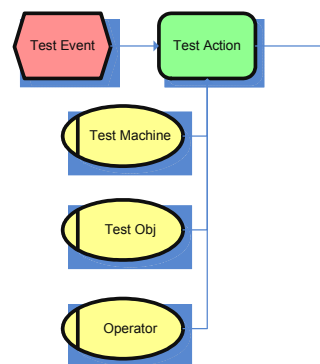

Figure 8.17 – EPC example

Follows an example of the same thing expressed in XML; this is only a section of the whole file, it is a sub part of a life cycle phase, which is a part of the whole InformationObject.

XML	Description
<pre>- <EventAsOccurs> <Description>Test Event </Description></pre>	<p>Here starts this "EventAsOccurs" element, follows the description of the Event. This event triggers the recording into the model.</p>
<pre>- <ActivityAsRealized> <Description>Test_Activity </Description></pre>	<p>Here, dependent by the event, starts the consequent ActivityAsRealized. It has also a brief description of what is this activity.</p>
<pre><EquipmentInformation> <Description> Test_machine</Description> <ObjectID>187</ObjectID> <URI>www.Test.it</URI> </EquipmentInformation></pre>	<p>Here is the description of a resource used by the activity; this is an Equipment, called test machine and with its own Id.</p>
<pre><MaterialInformation> <Description>TestObj</Description> - <MaterialID> <ObjectID>187</ObjectID> <URI>www.Supplier.it</URI> </MaterialID> </MaterialInformation></pre>	<p>Here is described an object used as raw material, its description and the information about its production are in another ObjectInformation that could be annexed to the file of the main product or could be on the supplier server.</p>
<pre><PersonnelInformation> PersonnelClass>Transporter</PersonnelClass> - <PersonnelID> <ObjectID>25</ObjectID> <URI>www.Test.it</URI> </PersonnelID> </PersonnelInformation></pre>	<p>This section of the file describes an operator who worked on the product. More specific information about him is in his objectinformation class present or in the server www.test.it or in addendum to this file.</p>
<pre></ActivityAsRealized> </EventAsOccurs></pre>	<p>These elements conclude the Activity and the Event classes.</p>

Table 8.5 – Example of XML implementation

8.5 Conclusions

In this chapter we analysed the metamodel needs defined by an analysis of the literature. From these needs, we proposed a model that fulfils them. It is also explained a proposal for its implementation in XML. In the next chapter two industrial test cases are described, analysed and schematised with the model, in order to validate the same model. It might be said since now that with this work it has been proposed an innovative vision that is the Holonic approach, for the traceability as well as the management of lifecycle data. This innovative approach aims to foster interoperability along the diverse enterprise applications, in particular at a manufacturing stage. It is proposed a meta-model supporting the informational part for the traceability of products (or Holons-products), along its lifecycle. This model was established, re-using, at best, existing work around some

standards: PLCS, Mandate, ANSI/ISA-95, PLM/XML and PML. The model is technology independent and fits to different application domains.

8.6 References of the chapter

Scientific references

- [1] Moe T., (1998), Perspectives on traceability in food manufacture, Trends in Food Science & Technology, 9, pp 211-214
- [2] Olsen P., (2001), Traceability of fish products, 1st Tracefish Conference Copenhagen
- [3] Jansen-Vullers M.H., van Dorp C.A., Beulens A.J.M., (2003), Managing traceability information in manufacture, International Journal of Information Management, 23, pp 395-413
- [4] Naka Y., Hirao M., Shimizu Y., Muraki M., Kondo Y., (2000), Technological information infrastructure for product lifecycle engineering, Computers and chemical engineering, 24, pp 665-670
- [5] Sohal A., (1997), Computerised Parts Traceability: an Implementation Case Study, Technovation, 17, 10, pp 583-591
- [6] McFarlane D., Sarma S., Chirn J.L., Wong C.Y., Ashton K., (2002), The intelligent manufacturing control and management, Engineering Applications of Artificial Intelligence: special issue on Intelligent Manufacturing, 6
- [7] McFarlane D., Sarma S., Chirn J.L., Wong C.Y., Ashton K., (2003), Auto ID System and Intelligent Manufacturing Control, Engineering Application of Artificial Intelligence, 16, pp 365-376
- [8] Choy K.L, Lee W.B., Lo V., (2003), Design of a case based intelligent supplier relationship management system the integration of supplier rating system and product coding system, Expert Systems with Applications, 25, pp 87–100
- [9] Thomas V., Neckel W., Wagner S., (1999), Information Technology and Product Lifecycle Management, Proceedings of the 1999 IEEE International Symposium of Electronics and the Environment, pp 54-57
- [10] Ramesh B., Stubbs C., Powers T., Edwards M., (1997), Requirements traceability: Theory and practice, Annals of software engineering, 3, pp 397-415
- [11] Rutherford S., (2002), Traceability – what do consumer want?, Saskatchewan Pulse Growers

- [12] Kärkkäinen M., Ala-Risku T., Främpling K., (2003), The Product centric approach: a solution to supply network information management problems?, *Computer in Industry*, 52, pp 147-159
- [13] Finch E.F., Flanagan R., Marsh L.E., (1996), Electronic document management in construction using auto-ID, *Automation in Construction*, 5, pp 313-321
- [14] Jayaraman V., Patterson R.A., Rolland E., (2003), The design of reverse distribution network: Models and solution procedures, *European journal of operational research*, 6
- [15] Zisman A., Spanoudakis G., Pérez-Miñana E., Krause P., (2002), Towards a Traceability Approach for Product Families Requirements, *Proceedings at 3rd International Workshop on Software Product Lines, Economics – ICSE*
- [16] Barber K.S., Jernigan S.R., (1999), Changes in the model creation process to ensure traceability and reuse, *International conference on AI – software engineering track IC-AI99*
- [17] APICS, (1998), APICS dictionary, The educational society for resource management, Edit. Cox III J. F., Blackstone Jr. J. H., USA
- [18] Terzi S., Cassina J., Panetto H., (2005), Development of a metamodel to foster interoperability along the product lifecycle traceability, *Proceedings at International conference on Interoperability of Enterprise Software and Applications IFIP-ACM/SIGAPP INTEROP-ESA, February 23rd-25th, Geneva, Switzerland*
- [19] Gouyon D., Simão J. M., Alkassam K., Morel G., (2004), Work in progress for product driven manufacturing automation, *Proceedings of IFAC INCOM Symposium, April 5th-7th, Salvador de Bahia, Brasil*

Technical references

- [20] Sibbel R.L., (2003), Identification and traceability in swine: a business opportunities or a cost of business?, *American association of swine veterinarians*
- [21] Ministry of Economy, Trade and Industry of Japan, (2003), Study group on the improvement of product traceability, Interim Report, www.meti.go.jp
- [22] Strowbridge A., (1999), Implications of e-business for product lifecycle management, intl.ieeexplore.ieee.org
- [23] Garner Q., (2002), Product traceability mini-tutorial, www.freequality.org

- [24] Stone W., Lyte A., Furlani K., (2002), NIST White Paper On Smart Chips in Construction, www.fiatech.org
- [25] Foster E.F., (2002), Product Identification and Traceability, www.freequality.org
- [26] Smithers R., (1999), Linking the IOS/QS Quality System, www.smithersregistrar.com
- [27] Komninos I., (2002), Product life cycle management, www.urenio.org
- [28] International Standard Organisation (ISO), (2000), International Standard ISO 9000:2000 Quality Management Systems - Fundamentals and vocabulary
- [29] Suikka A., (2004), IFC data exchange in concrete construction, Confederation of Finnish construction industries, www.iai-international.org

CHAPTER 9

Validation of the metamodel

9.1 Introduction

This chapter shows how the abstract model presented and explained in chapter 8 can be instantiated in a concrete product model representation. Two examples of how to represent product related information through product lifecycle are provided: the first, called “Textile”, involves a small manufacturer of natural as well as synthetic twists. On this test case was also developed a simulation model. The second, called “Vetroresina Padana” is related with a real manufacturer of fiberglass and polyethylene tanks for agricultural machines. Each example is based on XML language.

9.2 Textile case

Textile ltd is a small plant, specialized in the production of twists, used for the manufacture of fabrics of cloths. It is located near Varese, in Italy.

It produces twist of synthetic materials like, for example, nylon and polyester or natural materials like cotton. The natural material twist production is the main production of this enterprise, and it is also more complex than the others. They produce many different kinds of twists varying the thickness (in slang called "Title"), and the color.

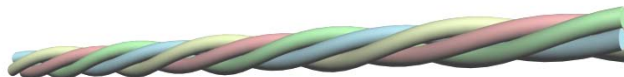

Figure 9.1 - A twist

The synthetic twist is produced on orders, and is sold in reels of 200 meters of length. The natural twist, otherwise, is produced continuously and is sold both in big reels of about 200 meters and in smaller reels of

approximately 50 meters that are to be sold directly to the haberdashery for the housekeepers.

9.2.1 Overview of the manufacturing system

The production of reel of synthetic or natural thread has to be done in separate environment to prevent pollution in the twist; in fact it is needful to void that some synthetic material could be mixed inside the natural twirl and vice versa. Due to this reason, also the machines where natural or synthetic twirl is produced are different. The process itself is also different. The synthetic twirl is simpler because it needs two operations, while the natural can require more. The raw materials for this manufacturing are reel of different "title" and material, that are merged together, twirled, and, if they are from natural fiber, cleaned, colored or discolored, and then putted again on a cardboard spool and sold. The two different processes will be described later.

The machine used in this kind of manufacture has many "slots" but only one engine, which gives energy to all the mechanisms. This is useful because the machine has to work for 5-8 hours on each reel. It's quite unusual that the main engine can suffer a breakdown, but the single working position has about 7-10% of fault during the process because of the twirl breakdown. If in a slot the thread breaks, that singular slot stops, but the rest of the machine continues its work. If the personnel repairs the breakdown in a few time, the slot restarts its working and it will finish only a few minutes after all the others, but if the machine is not supervised and no one repairs the breakdown, after the end of the working process that particular reel has to be dismantled from the slot, repaired, and remounted on another, smaller machine, that finishes the work.

The machines used are:

- The merger. This machine (figure 9.2) is used to merge till four different threads in a single spool. The different threads can have different "title" and material. It is necessary both for synthetic and for natural material.



Figure 9.2 – Picture of the merger machine

- The Twister. This machine (figure 9.3) twists the threads, so that these can be considered as only a single "twisted thread" that can be called twist. This process permits to have a thread of a different "title" starting from smaller threads. Besides, a twisted thread is stronger than a simple thread of the same thickness.



Figure 9.3 – Picture of the twister machine

- The Cleaner. This cleans the twist from the dirty and the fiber that remains attached after the process. The cleaning, which is necessary

only for some kind of natural twists, is made passing the twist through a small flame, so it burns all the impurities and the fibers.

- The Rolling Machine. This machine rolls the twirl in hanks; this is necessary to obtain a high quality of the color during the coloring process. This is also the same machine used to unroll the hank and put the thread again on the reel.

The Coloring process is done outside the manufacturing because it is cheaper to outsourcing it.

In the next paragraphs two examples adapted to Textile Ltd context are reported in order to demonstrate and validate the model in diverse scenarios.

9.2.2 Application 1 – Producing synthetic reel

The production of a synthetic reel is quite simple. The raw material are from two to four single thread reel, these threads have to be merged and twirled together, making a single "twisted thread" of different "title" and characteristics. The starting thread can be made in the same or in different materials, and can have the same or different thickness. Combining threads is possible to produce various final twirls, which can have diverse properties.

Model in figure 9.4 represents the production steps that the product goes through; these are when the model is updated and filled with new information. The under-shaded objects into the developed model are Holons; the other is only an intermediate that is made during product production; the breakdown is an unexpected event.

A breakdown has been introduced during the Twirling to exemplify how the model manages this kind of occurrences.

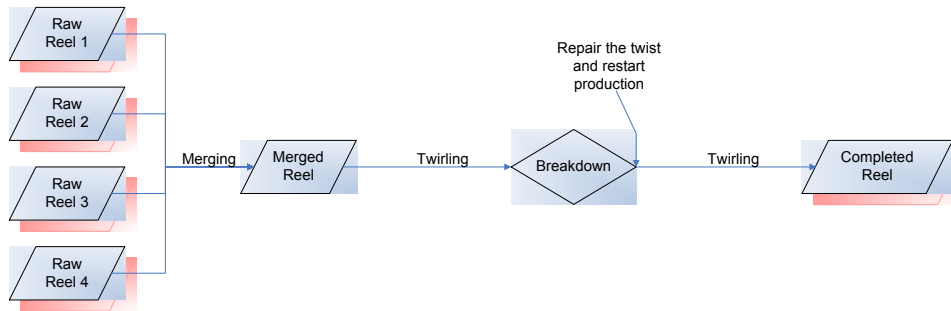

Figure 9.4 - Synthetic reel production

Backward traceability example

To clearly exemplify how the model works in a Backward traceability way, there are some schemas in EPC (Event Process Chain). EPC is a particular way of drawing diagrams that fits very well to represent how event, activity, resource works together. After, it is reported a possible example of how could be the XML file that the model should create to record all the information. The model in figure 9.5 represents what happens during the first production phase; the merging.

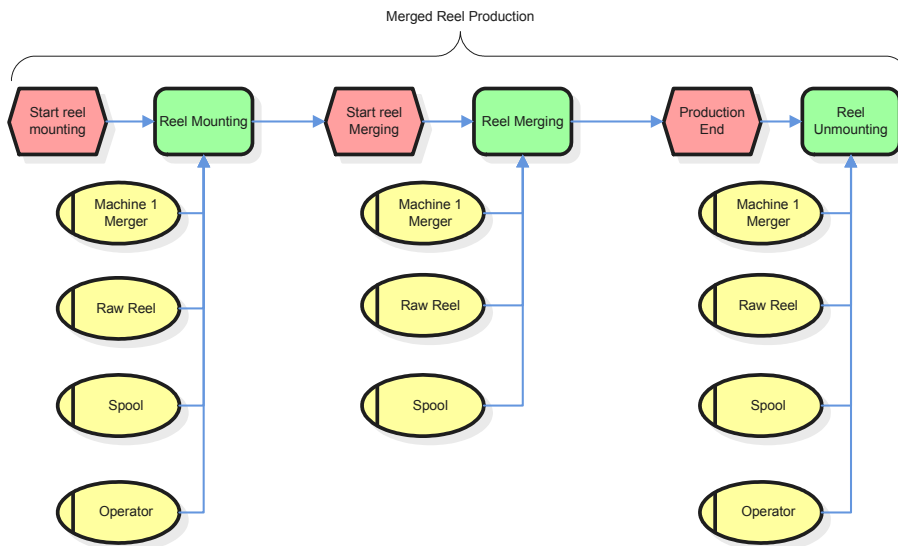

Figure 9.5 - EPC model of the Merged Reel Production

The production begins when the raw reels are put in the slots of the merger machine, then the thread is manually pulled and hooked to the Spool. The beginning of the mounting is the trigger event that causes the activity of the reel mounting and the storing of information on the model.

The model will record the information about the resource used that are operators, Raw Reels, Spool, Machine, and other useful information like for example the time of this event etc. Then, when all the reels are mounted and ready, the operator starts the machine and the production begins. The event that triggers is the starting of the machine, called in the schema “Start Reel Merging”. Next, when the production ends the reel has to be putted out the machine and the new merged reel, shaped around the spool is putted in a trolley, and carried to the twister machine.

Figure 9.6 explains the operations acted during this other production phase; to exemplify how the model manages an unexpected occurrence like a breakdown, it was introduced one during the Twisting.

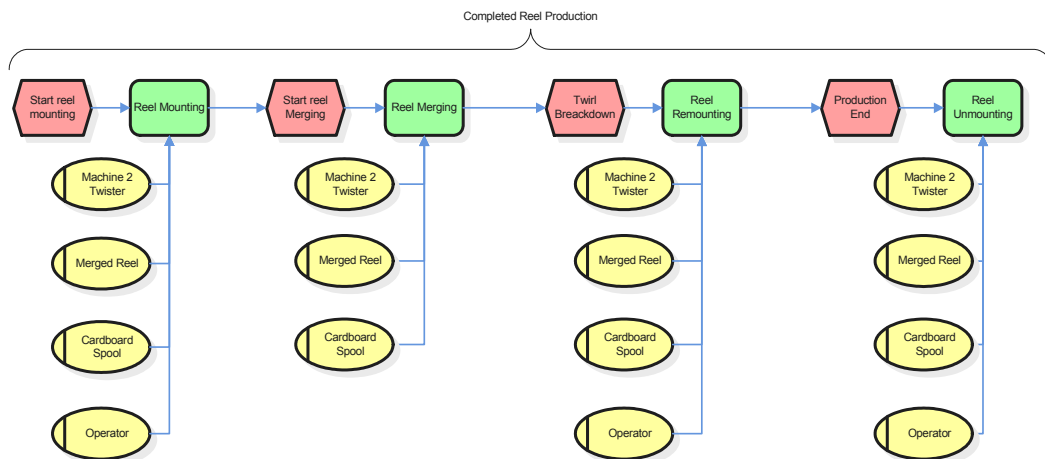

Figure 9.6 - EPC model of the Completed Reel Production

The merged reels produced by the first machine arrives in a conveyor; the reels are manually mounted in the slots of the twirler, the threads are pulled into some rings and wheels that will guide it during the twisting, and is fastened to a cardboard spool that will be the center of the final reel. The event that begins this new production phase is when the operator begins to pull the reel in the slot; this triggers a record in the model and an activity that is the reel mounting. Then, when the set up is finished and the machine is ready the production starts. Also this event is recorded in the model. After several hours a breakdown occurs; this is an unexpected event, that causes an activity that is the reel remounting; this activity requires an operator who repairs the twirl and fixes it again to the reel. If

the operator were not available, this activity would be done hours after the event that triggers it. The model will record both the time of the breakdown and of the remounting. At the end the twirling process ends and this event triggers the removal of the reel from the machine and a record on the model.

To explain how from the model derives an XML file it is first proposed the diagram in figure 9.7 to compare the abstract model with the XML schema; It shows that the classes are the same, and are identified by some tags that form the XML constructs.

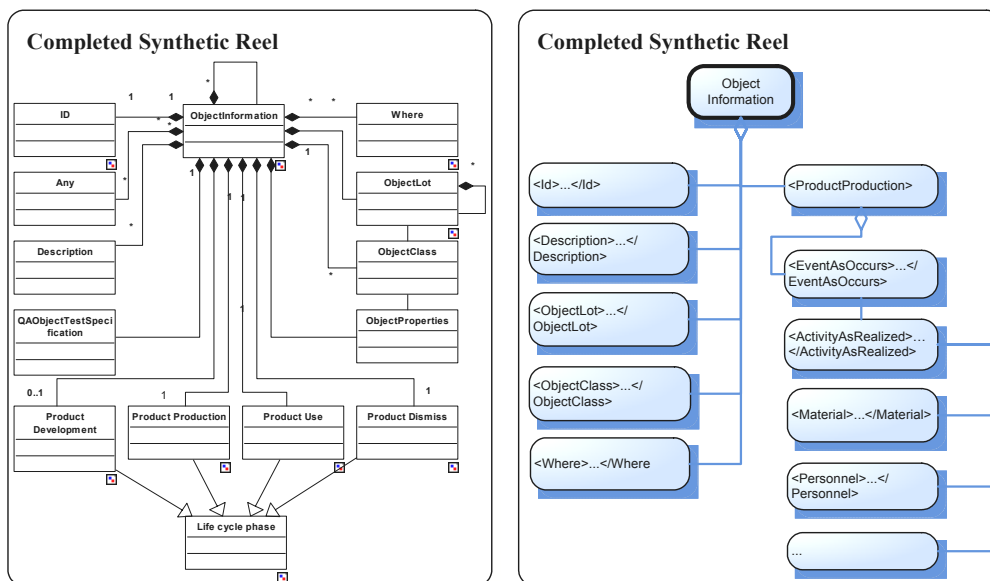

Figure 9.7 - Abstract model and XML based product representation structure

Then, it is proposed the schema of figure 9.8, which explains sketchily the structure of the XML implementation. Finally (figure 9.9), it is presented the XML “file” that the model would generate to record all this production process. In the first part of the XML file are archived the general information about the product, which are the Id, the Description, ObjectLot, ObjectClass, ObjectTestSpecification, ObjectProperties and Where; then there is the part about the product production, where are recorded all the information about this life cycle phase. Because this is a backward traceability example there are only records in the “event as occurs” class that contains the “activity as realized”.

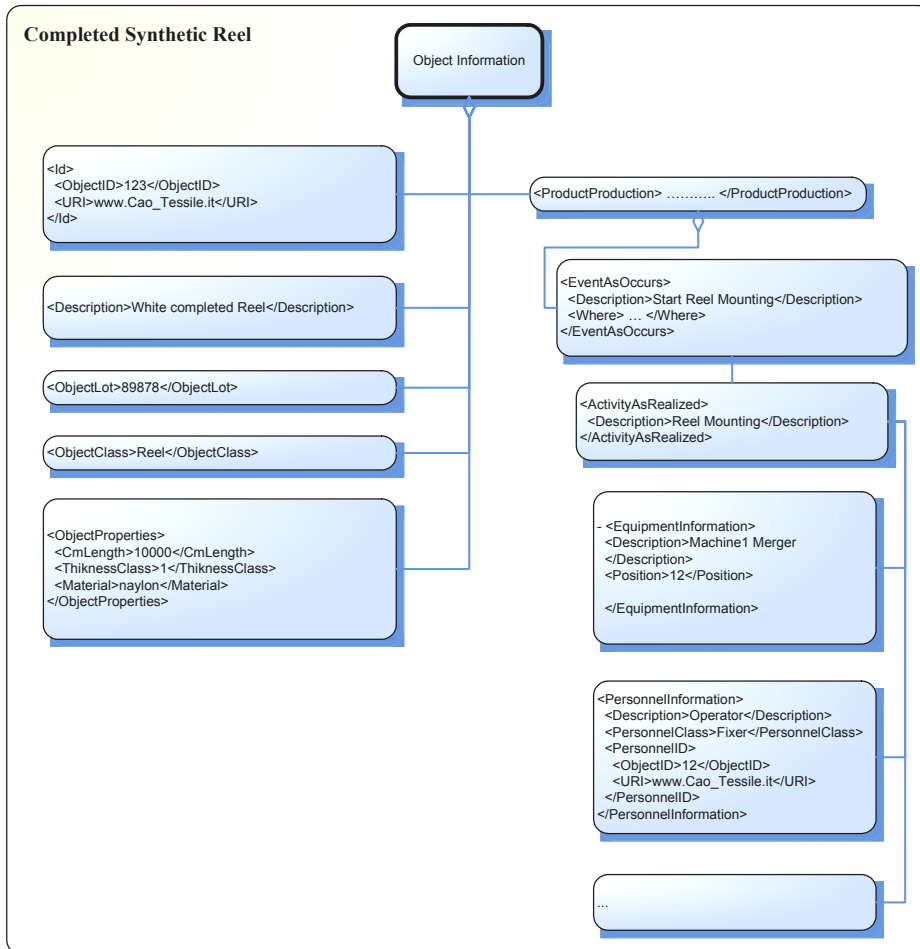

Figure 9.8 - ObjectInformation structure with XML examples

```

<?XML version="1.0" encoding="ISO88591" ?>
<ObjectInformation>
  <Id>
    <ObjectID>123</ObjectID>
    <URI>www.Textile.it</URI>
  </Id>
  <Description>White completed Reel</Description>
  <ObjectLot>89878</ObjectLot>
  <ObjectClass>Reel</ObjectClass>
  <QAObjectTestSpecification>
    <Color>OK</Color>
  </QAObjectTestSpecification>
  <ObjectProperties>
    <CmLength>10000</CmLength>
    <ThicknessClass>1</ThicknessClass>
    <Material>nylon</Material>
  <!--
  All from Any classes
  -->
  </ObjectProperties>
  <Where>
    <Time>
      <Hour>15</Hour>
      <Minutes>34</Minutes>
      <Seconds>13</Seconds>
      <Day>14</Day>
      <Month>2</Month>
      <Year>2005</Year>
    </Time>
  </Where>
</ObjectInformation>

```

```

</Time>
  <Location>Depot2</Location>
</Where>
<Where>
  <Time>
    <Hour>10</Hour>
    <Minutes>06</Minutes>
    <Seconds>09</Seconds>
    <Day>13</Day>
    <Month>2</Month>
    <Year>2005</Year>
  </Time>
  <Location>Depot1</Location>
</Where>
<ProductProduction>
  <EventAsOccurs>
    <Description>Start Reel Mounting</Description>
    <Where>
      <Time>
        <Hour>10</Hour>
        <Minutes>33</Minutes>
        <Seconds>12</Seconds>
        <Day>11</Day>
        <Month>2</Month>
        <Year>2005</Year>
      </Time>
      <Location>Room1</Location>
    </Where>
    <ActivityAsRealized>
      <Description>Reel Mounting</Description>
      <EquipmentInformation>
        <Description>Machine1 Merger</Description>
        <Position>12</Position>
        <!
          From an Any class
        >
      </EquipmentInformation>
      <MaterialInformation>
        <Description>Spool</Description>
        <MaterialID>
          <ObjectID>187</ObjectID>
          <URI>www.SpoolSupplier.it</URI>
        </MaterialID>
      </MaterialInformation>
      <MaterialInformation>
        <Description>Raw Reel</Description>
        <MaterialID>
          <ObjectID>456</ObjectID>
          <URI>www.supplier.it</URI>
        </MaterialID>
      </MaterialInformation>
      <MaterialInformation>
        <Description>Raw Reel</Description>
        <MaterialID>
          <ObjectID>457</ObjectID>
          <URI>www.supplier.it</URI>
        </MaterialID>
      </MaterialInformation>
      <MaterialInformation>
        <Description>Raw Reel</Description>
        <MaterialID>
          <ObjectID>458</ObjectID>
          <URI>www.supplier.it</URI>
        </MaterialID>
      </MaterialInformation>
      <MaterialInformation>
        <Description>Raw Reel</Description>
        <MaterialID>
          <ObjectID>480</ObjectID>
          <URI>www.supplier.it</URI>
        </MaterialID>
      </MaterialInformation>
    </ActivityAsRealized>
  </EventAsOccurs>
</ProductProduction>
</Where>
</Where>
</Time>
</Location>Depot2</Location>
</Where>
</Where>
</ProductProduction>
</EventAsOccurs>
</Description>Start Reel Mounting</Description>
</Where>
</Time>
</Hour>10</Hour>
</Minutes>33</Minutes>
</Seconds>12</Seconds>
</Day>11</Day>
</Month>2</Month>
</Year>2005</Year>
</Time>
</Location>Room1</Location>
</Where>
</ActivityAsRealized>
</Description>Reel Mounting</Description>
</EquipmentInformation>
</Description>Machine1 Merger</Description>
</Position>12</Position>
<!
  From an Any class
>
</EquipmentInformation>
</MaterialInformation>
</Description>Spool</Description>
</MaterialID>
</ObjectID>187</ObjectID>
</URI>www.SpoolSupplier.it</URI>
</MaterialID>
</MaterialInformation>
</Description>Raw Reel</Description>
</MaterialID>
</ObjectID>456</ObjectID>
</URI>www.supplier.it</URI>
</MaterialID>
</MaterialInformation>
</Description>Raw Reel</Description>
</MaterialID>
</ObjectID>457</ObjectID>
</URI>www.supplier.it</URI>
</MaterialID>
</MaterialInformation>
</Description>Raw Reel</Description>
</MaterialID>
</ObjectID>458</ObjectID>
</URI>www.supplier.it</URI>
</MaterialID>
</MaterialInformation>
</Description>Raw Reel</Description>
</MaterialID>
</ObjectID>480</ObjectID>
</URI>www.supplier.it</URI>
</MaterialID>
</MaterialInformation>
</PersonnelInformation>

```



```

<Description>Operator</Description>
<PersonnelClass>Fixer</PersonnelClass>
<PersonnelID>
  <ObjectID>12</ObjectID>
  <URI>www.Textile.it</URI>
</PersonnelID>
</PersonnelInformation>
</ActivityAsRealized>
</EventAsOccurs>
<EventAsOccurs>
  <Description>Start Reel Merging</Description>
  <Where>
    <Time>
      <Hour>10</Hour>
      <Minutes>40</Minutes>
      <Seconds>16</Seconds>
      <Day>11</Day>
      <Month>2</Month>
      <Year>2005</Year>
    </Time>
    <Location>Room1</Location>
  </Where>
  <ActivityAsRealized>
    <Description>Reel Merging</Description>
    <EquipmentInformation>
      <Description>Machine1 Merger</Description>
      <Position>12</Position>
    <!--
    From an Any class
    -->
    </EquipmentInformation>
    <MaterialInformation>
      <Description>Spool</Description>
      <MaterialID>
        <ObjectID>187</ObjectID>
        <URI>www.SpoolSupplier.it</URI>
      </MaterialID>
    </MaterialInformation>
    <MaterialInformation>
      <Description>Raw Reel</Description>
      <MaterialID>
        <ObjectID>456</ObjectID>
        <URI>www.supplier.it</URI>
      </MaterialID>
    </MaterialInformation>
    <MaterialInformation>
      <Description>Raw Reel</Description>
      <MaterialID>
        <ObjectID>457</ObjectID>
        <URI>www.supplier.it</URI>
      </MaterialID>
    </MaterialInformation>
    <MaterialInformation>
      <Description>Raw Reel</Description>
      <MaterialID>
        <ObjectID>458</ObjectID>
        <URI>www.supplier.it</URI>
      </MaterialID>
    </MaterialInformation>
    <MaterialInformation>
      <Description>Raw Reel</Description>
      <MaterialID>
        <ObjectID>480</ObjectID>
        <URI>www.supplier.it</URI>
      </MaterialID>
    </MaterialInformation>
  </ActivityAsRealized>
</EventAsOccurs>
</EventAsOccurs>
<Description>Production End</Description>
<Where>
  <Time>
    <Hour>19</Hour>

```

```

    <Minutes>20</Minutes>
    <Seconds>06</Seconds>
    <Day>11</Day>
    <Month>2</Month>
    <Year>2005</Year>
  </Time>
  <Location>Room1</Location>
</Where>
<ActivityAsRealized>
  <Description>Reel Unmounting</Description>
  <Time>
    <Hour>20</Hour>
    <Minutes>05</Minutes>
    <Seconds>06</Seconds>
    <Day>11</Day>
    <Month>2</Month>
    <Year>2005</Year>
  </Time>
  <EquipmentInformation>
    <Description>Machine1 Merger</Description>
    <Position>12</Position>
  <!--
  From an Any class
  -->
  </EquipmentInformation>
  <MaterialInformation>
    <Description>Spool</Description>
    <MaterialID>
      <ObjectID>187</ObjectID>
      <URI>www.SpoolSupplier.it</URI>
    </MaterialID>
  </MaterialInformation>
  <MaterialInformation>
    <Description>Raw Reel</Description>
    <MaterialID>
      <ObjectID>456</ObjectID>
      <URI>www.supplier.it</URI>
    </MaterialID>
  </MaterialInformation>
  <MaterialInformation>
    <Description>Raw Reel</Description>
    <MaterialID>
      <ObjectID>457</ObjectID>
      <URI>www.supplier.it</URI>
    </MaterialID>
  </MaterialInformation>
  <MaterialInformation>
    <Description>Raw Reel</Description>
    <MaterialID>
      <ObjectID>458</ObjectID>
      <URI>www.supplier.it</URI>
    </MaterialID>
  </MaterialInformation>
  <MaterialInformation>
    <Description>Raw Reel</Description>
    <MaterialID>
      <ObjectID>480</ObjectID>
      <URI>www.supplier.it</URI>
    </MaterialID>
  </MaterialInformation>
  <PersonnelInformation>
    <Description>Operator</Description>
    <PersonnelClass>carrier</PersonnelClass>
    <PersonnelID>
      <ObjectID>15</ObjectID>
      <URI>www.Textile.it</URI>
    </PersonnelID>
  </PersonnelInformation>
</ActivityAsRealized>
</EventAsOccurs>
<!--
Now Merging is finished; starts Twisting
-->

```

```

>
<EventAsOccurs>
  <Description>Start Reel Mounting</Description>
  <Where>
    <Time>
      <Hour>22</Hour>
      <Minutes>33</Minutes>
      <Seconds>12</Seconds>
      <Day>11</Day>
      <Month>2</Month>
      <Year>2005</Year>
    </Time>
    <Location>Room2</Location>
  </Where>
  <ActivityAsRealized>
    <Description>Reel Mounting</Description>
    <EquipmentInformation>
      <Description>Machine2 Twister</Description>
      <Position>15</Position>
      <!
        From an Any class
      >
    </EquipmentInformation>
    <MaterialInformation>
      <Description>Spool</Description>
      <MaterialID>
        <ObjectID>187</ObjectID>
        <URI>www.supplier.it</URI>
      </MaterialID>
    </MaterialInformation>
    <PersonnellInformation>
      <Description>Operator</Description>
      <PersonnellClass>fixer</PersonnellClass>
      <PersonnellID>
        <ObjectID>22</ObjectID>
        <URI>www.Textile.it</URI>
      </PersonnellID>
    </PersonnellInformation>
    <MaterialInformation>
      <Description>Cardboard Spool</Description>
      <MaterialID>
        <ObjectID>187</ObjectID>
        <URI>www.CardboardSupplier.it</URI>
      </MaterialID>
    </MaterialInformation>
  </ActivityAsRealized>
</EventAsOccurs>
<EventAsOccurs>
  <Description>Start Reel Twisting</Description>
  <Where>
    <Time>
      <Hour>22</Hour>
      <Minutes>50</Minutes>
      <Seconds>16</Seconds>
      <Day>11</Day>
      <Month>2</Month>
      <Year>2005</Year>
    </Time>
    <Location>Room2</Location>
  </Where>
  <ActivityAsRealized>
    <Description>Reel Twisting</Description>
    <EquipmentInformation>
      <Description>Machine2 Twister</Description>
      <Position>15</Position>
      <!
        From an Any class
      >
    </EquipmentInformation>
    <MaterialInformation>
      <Description>Spool</Description>
      <MaterialID>

```

```

    <ObjectID>187</ObjectID>
    <URI>www.SpoolSupplier.it</URI>
  </MaterialID>
</MaterialInformation>
<MaterialInformation>
  <Description>Cardboard Spool</Description>
  <MaterialID>
    <ObjectID>187</ObjectID>
    <URI>www.CardboardSupplier.it</URI>
  </MaterialID>
</MaterialInformation>
</ActivityAsRealized>
</EventAsOccurs>
<EventAsOccurs>
  <Description>Breakdown</Description>
  <Where>
    <Time>
      <Hour>5</Hour>
      <Minutes>19</Minutes>
      <Seconds>16</Seconds>
      <Day>12</Day>
      <Month>2</Month>
      <Year>2005</Year>
    </Time>
    <Location>Room2</Location>
  </Where>
  <CmLength>8500</CmLength>
<!--
From an Any class
-->
<ActivityAsRealized>
  <Description>Reel Remounting</Description>
  <Where>
    <Time>
      <Hour>7</Hour>
      <Minutes>25</Minutes>
      <Seconds>15</Seconds>
      <Day>12</Day>
      <Month>2</Month>
      <Year>2005</Year>
    </Time>
    <Location>Room2</Location>
  </Where>
  <EquipmentInformation>
    <Description>Machine2 Twister</Description>
    <Position>15</Position>
  <!--
From an Any class
-->
</EquipmentInformation>
<MaterialInformation>
  <Description>Spool</Description>
  <MaterialID>
    <ObjectID>187</ObjectID>
    <URI>www.SpoolSupplier.it</URI>
  </MaterialID>
</MaterialInformation>
<MaterialInformation>
  <Description>Cardboard Spool</Description>
  <MaterialID>
    <ObjectID>187</ObjectID>
    <URI>www.CardboardSupplier.it</URI>
  </MaterialID>
</MaterialInformation>
<PersonnelInformation>
  <Description>Operator</Description>
  <PersonnelClass>fixer</PersonnelClass>
  <PersonnelID>
    <ObjectID>25</ObjectID>
    <URI>www.Textile.it</URI>
  </PersonnelID>
</PersonnelInformation>

```

```

</ActivityAsRealized>
</EventAsOccurs>
<EventAsOccurs>
  <Description>End Reel Twisting</Description>
  <Where>
    <Time>
      <Hour>8</Hour>
      <Minutes>17</Minutes>
      <Seconds>01</Seconds>
      <Day>12</Day>
      <Month>2</Month>
      <Year>2005</Year>
    </Time>
    <Location>Room2</Location>
  </Where>
  <ActivityAsRealized>
    <Description>Reel Unmounting</Description>
    <Where>
      <Time>
        <Hour>8</Hour>
        <Minutes>25</Minutes>
        <Seconds>15</Seconds>
        <Day>12</Day>
        <Month>2</Month>
        <Year>2005</Year>
      </Time>
      <Location>Room2</Location>
    </Where>
    <EquipmentInformation>
      <Description>Machine2 Twister</Description>
      <Position>15</Position>
      <!
      From an Any class
      >
    </EquipmentInformation>
    <MaterialInformation>
      <Description>Spool</Description>
      <MaterialID>
        <ObjectID>187</ObjectID>
        <URI>www.SpoolSupplier.it</URI>
      </MaterialID>
    </MaterialInformation>
    <MaterialInformation>
      <Description>Cardboard Spool</Description>
      <MaterialID>
        <ObjectID>187</ObjectID>
        <URI>www.CardboardSupplier.it</URI>
      </MaterialID>
    </MaterialInformation>
    <PersonnelInformation>
      <Description>Operator</Description>
      <PersonnelClass>Transporter</PersonnelClass>
      <PersonnelID>
        <ObjectID>25</ObjectID>
        <URI>www.Textile.it</URI>
      </PersonnelID>
    </PersonnelInformation>
  </ActivityAsRealized>
</EventAsOccurs>
</ProductProduction>
<ObjectInformation>
  <Id>
    <ObjectID>456</ObjectID>
    <URI>www.supplier.it</URI>
  </Id>
  <Description>Raw Reel</Description>
  <ObjectLot>1569</ObjectLot>
  <ObjectClass>Reel</ObjectClass>
  <!
  Information from the supplier
  >
</ObjectInformation>

```

```

<!--
Other Object Information about the other Raw Reels
-->
<ObjectInformation>
  <Id>
    <ObjectID>187</ObjectID>
    <URI>www.SpoolSupplier.it</URI>
  </Id>
  <Description>Spool</Description>
  <ObjectLot>256</ObjectLot>
  <ObjectClass>Spool</ObjectClass>
  <!--
Information from the Spool supplier
-->
</ObjectInformation>
<ObjectInformation>
  <Id>
    <ObjectID>12</ObjectID>
    <URI>www.Textile.it</URI>
  </Id>
  <Description>
    <Name>Pinc</Name>
    <Surname>Pal</Surname>
    <!--
These classes are from the Any class
-->
  </Description>
  <ObjectClass>Personnel</ObjectClass>
  <!--
Information about the people
-->
</ObjectInformation>
</ObjectInformation>

```

Figure 9.9 – XML file of application 1, backward traceability

Forward traceability example

In this example is exploited the Forward Traceability feature of this model; all the operations that have to be performed on the product can be written in the model at the beginning of the production; then the machine, if it has an automatic control system, or the operator can know what to do from the product itself. This is not really useful in this kind of simple manufacture, but could be valuable in a more complex system like, for example a mechanical manufacture like an FMS (Flexible Manufacturing System), where are produced many different type of product.

To achieve this result have been used the “EventAsPlanned” and “ActivityAsPlanned” classes; the first describes what kind of event has to occur and when; this event then triggers the corresponding

“ActivityAsPlanned”, that describes in detail what to do and with what machines, operators, tools etc.

The figure 9.10 shows an EPC model, explaining the behavior of this process. The dark hexagon represents the EventsAsPlanned, the dark rectangle the ActivitiesAsPlanned, the dark ovals represents the resources that has to be used. The light hexagon, otherwise, represent the EventAsOccurs; the light rectangle the ActivitiesAsRealized, and finally the light oval the resource really used.

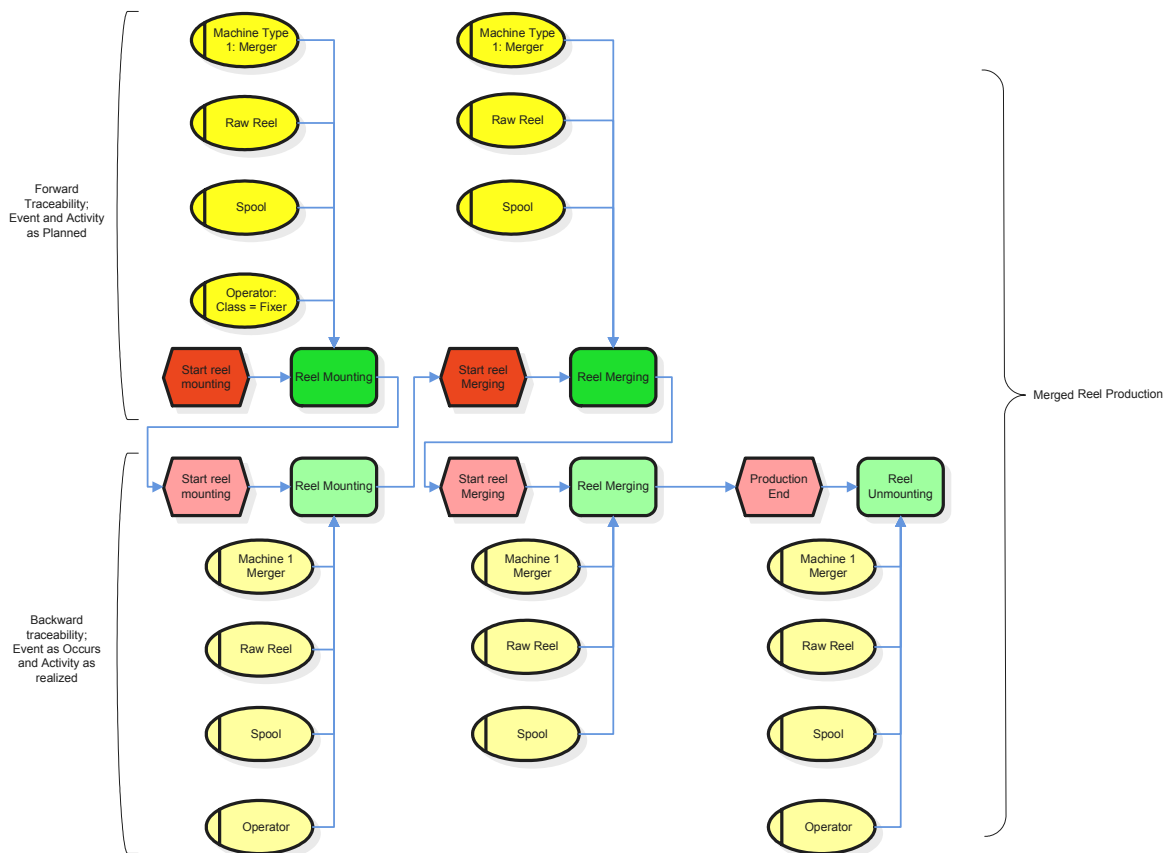

Figure 9.10 - Merged reel production EPC model

In figure 9.10, the upper part is about the “forward” traceability; it is written before the starting of the process and contains all the needed data; in fact it explains the expected operations. The lower part instead is exactly the same seen before and traces what really happens to the product, this is the “backward” part; it is written during the process, completing the information about the whole production process. In the XML file the information will be ordered as explained with the arrows.

Firstly, there is the Event as planned that makes begin the production process and its related activity, which has to use some resources. After there are the information about what really happens, how, who and with which materials the process has been done. The ending of the process is not planned because there isn't any formula that forecasts exactly when it finishes, furthermore an exact prevision is not really useful; so it is seen as a event that "occurs".

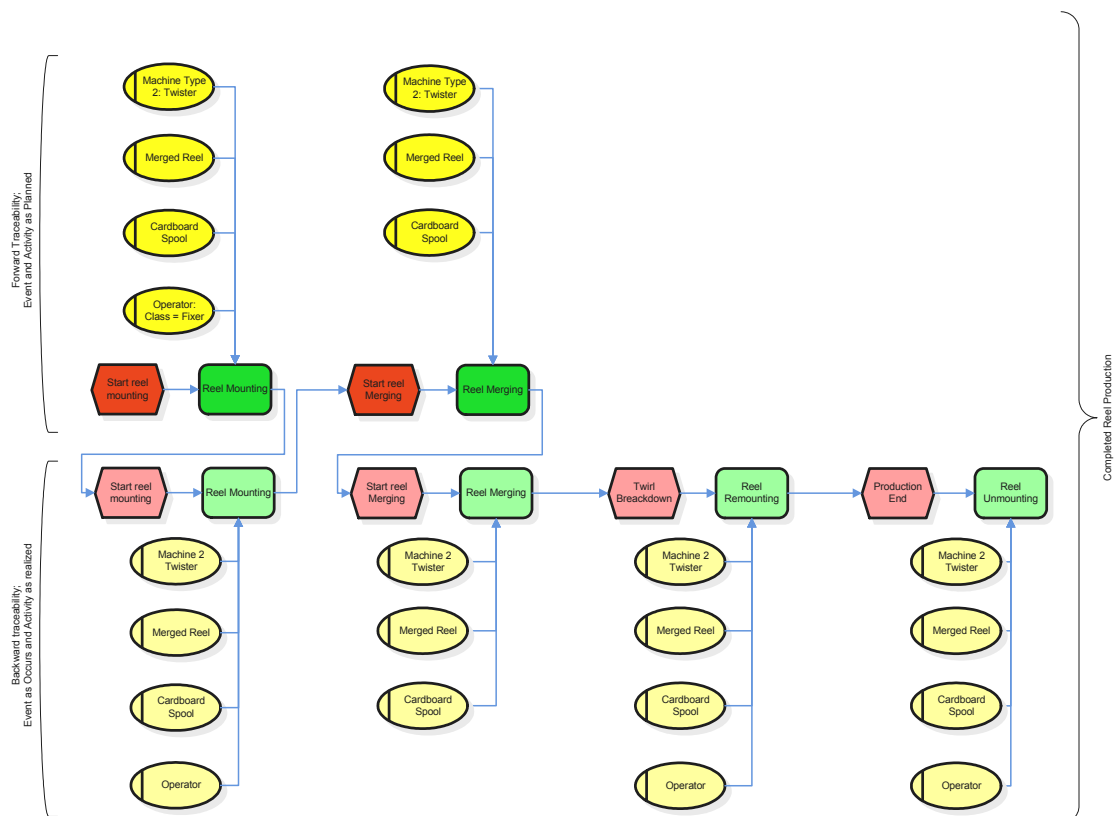

Figure 9.11 - Completed reel production EPC model

The figure 9.11 explains the process that produces the final completed reel; a breakdown has been introduced to explain how our model registers it. In the XML file part that concerns this step of the production, first of all we can notice the EventAsPlanned that triggers an ActivityAsPlanned describing when and who has to start the process; in fact it shows that a "fixer" operator has to work on the Twirler machine, and prepare it, the merged reel and the cardboard support to the process. Then there is the description of how it really happened and who really did this operation.

The model records the Id of the operator and the time when this action was done. Then the merging process has to begin, and the model explains when and how it is planned, and when and how it really took place. The breakdown isn't a planned event, the model records when it happens and when, how, and who fixes it. Finally the production ends, and the model records all the data about this event and the corresponding activity.

All these data could be archived in an XML file like the example that follows.

```
<?XML version="1.0" encoding="ISO88591" ?>
<ObjectInformation>
  <Id>
    <ObjectID>123</ObjectID>
    <URI>www.Textile.it</URI>
  </Id>
  <Description>White completed Reel</Description>
  <ObjectLot>89878</ObjectLot>
  <ObjectClass>Reel</ObjectClass>
  <QAObjectTestSpecification>
    <Color>OK</Color>
  </QAObjectTestSpecification>
  <ObjectProperties>
    <CmLength>10000</CmLength>
    <ThiknessClass>1</ThiknessClass>
    <Material>nylon</Material>
  <!--
  All from Any classes
  -->
  </ObjectProperties>
  <Where>
    <Time>
      <Hour>15</Hour>
      <Minutes>34</Minutes>
      <Seconds>13</Seconds>
      <Day>14</Day>
      <Month>2</Month>
      <Year>2005</Year>
    </Time>
    <Location>Depot2</Location>
  </Where>
  <Where>
    <Time>
      <Hour>10</Hour>
      <Minutes>06</Minutes>
      <Seconds>09</Seconds>
      <Day>13</Day>
      <Month>2</Month>
      <Year>2005</Year>
    </Time>
    <Location>Depot1</Location>
  </Where>
  <ProductProduction>
    <EventAsPlanned>
      <Description>Start Reel Mounting</Description>
      <Where>
        <Time>
          <Hour>10</Hour>
          <Minutes>33</Minutes>
          <Day>11</Day>
          <Month>2</Month>
          <Year>2005</Year>
        </Time>
        <Location>Room1</Location>
      </Where>
    </EventAsPlanned>
  </ProductProduction>
</ObjectInformation>
```

```

<ActivityAsPlanned>
  <Description>Reel Mounting</Description>
  <EquipmentInformation>
    <Description>Machine1 Merger</Description>
    <Position>12</Position>
    <!
      From an Any class
    >
  </EquipmentInformation>
  <MaterialInformation>
    <Description>Spool</Description>
    <MaterialID>
      <ObjectID>187</ObjectID>
      <URI>www.SpoolSupplier.it</URI>
    </MaterialID>
  </MaterialInformation>
  <MaterialInformation>
    <Description>Raw Reel</Description>
    <MaterialID>
      <ObjectID>456</ObjectID>
      <URI>www.supplier.it</URI>
    </MaterialID>
  </MaterialInformation>
  <MaterialInformation>
    <Description>Raw Reel</Description>
    <MaterialID>
      <ObjectID>457</ObjectID>
      <URI>www.supplier.it</URI>
    </MaterialID>
  </MaterialInformation>
  <MaterialInformation>
    <Description>Raw Reel</Description>
    <MaterialID>
      <ObjectID>458</ObjectID>
      <URI>www.supplier.it</URI>
    </MaterialID>
  </MaterialInformation>
  <MaterialInformation>
    <Description>Raw Reel</Description>
    <MaterialID>
      <ObjectID>480</ObjectID>
      <URI>www.supplier.it</URI>
    </MaterialID>
  </MaterialInformation>
  <PersonnelInformation>
    <Description>Operator</Description>
    <PersonnelClass>Fixer</PersonnelClass>
  </PersonnelInformation>
</ActivityAsPlanned>
</EventAsPlanned>
<EventAsOccurs>
  <Description>Start Reel Mounting</Description>
  <Where>
    <Time>
      <Hour>10</Hour>
      <Minutes>33</Minutes>
      <Seconds>12</Seconds>
      <Day>11</Day>
      <Month>2</Month>
      <Year>2005</Year>
    </Time>
    <Location>Room1</Location>
  </Where>
  <ActivityAsRealized>
    <Description>Reel Mounting</Description>
    <EquipmentInformation>
      <Description>Machine1 Merger</Description>
      <Position>12</Position>
      <!
        From an Any class
      >
    </EquipmentInformation>
  </ActivityAsRealized>

```

```

<MaterialInformation>
  <Description>Spool</Description>
  <MaterialID>
    <ObjectID>187</ObjectID>
    <URI>www.SpoolSupplier.it</URI>
  </MaterialID>
</MaterialInformation>
<MaterialInformation>
  <Description>Raw Reel</Description>
  <MaterialID>
    <ObjectID>456</ObjectID>
    <URI>www.supplier.it</URI>
  </MaterialID>
</MaterialInformation>
<MaterialInformation>
  <Description>Raw Reel</Description>
  <MaterialID>
    <ObjectID>457</ObjectID>
    <URI>www.supplier.it</URI>
  </MaterialID>
</MaterialInformation>
<MaterialInformation>
  <Description>Raw Reel</Description>
  <MaterialID>
    <ObjectID>458</ObjectID>
    <URI>www.supplier.it</URI>
  </MaterialID>
</MaterialInformation>
<MaterialInformation>
  <Description>Raw Reel</Description>
  <MaterialID>
    <ObjectID>480</ObjectID>
    <URI>www.supplier.it</URI>
  </MaterialID>
</MaterialInformation>
<PersonnelInformation>
  <Description>Operator</Description>
  <PersonnelClass>Fixer</PersonnelClass>
  <PersonnelID>
    <ObjectID>12</ObjectID>
    <URI>www.Textile.it</URI>
  </PersonnelID>
</PersonnelInformation>
</ActivityAsRealized>
</EventAsOccurs>
<EventAsPlanned>
  <Description>Start Reel Merging</Description>
  <Where>
    <Time>
      <Hour>10</Hour>
      <Minutes>40</Minutes>
      <Day>11</Day>
      <Month>2</Month>
      <Year>2005</Year>
    </Time>
    <Location>Room1</Location>
  </Where>
  <ActivityAsPlanned>
    <Description>Reel Merging</Description>
    <EquipmentInformation>
      <Description>Machine1 Merger</Description>
      <Position>12</Position>
      <!
        From an Any class
      >
    </EquipmentInformation>
  </MaterialInformation>
  <Description>Spool</Description>
  <MaterialID>
    <ObjectID>187</ObjectID>
    <URI>www.SpoolSupplier.it</URI>
  </MaterialID>
</MaterialInformation>

```

```

<MaterialInformation>
  <Description>Raw Reel</Description>
  <MaterialID>
    <ObjectID>456</ObjectID>
    <URI>www.supplier.it</URI>
  </MaterialID>
</MaterialInformation>
<MaterialInformation>
  <Description>Raw Reel</Description>
  <MaterialID>
    <ObjectID>457</ObjectID>
    <URI>www.supplier.it</URI>
  </MaterialID>
</MaterialInformation>
<MaterialInformation>
  <Description>Raw Reel</Description>
  <MaterialID>
    <ObjectID>458</ObjectID>
    <URI>www.supplier.it</URI>
  </MaterialID>
</MaterialInformation>
<MaterialInformation>
  <Description>Raw Reel</Description>
  <MaterialID>
    <ObjectID>480</ObjectID>
    <URI>www.supplier.it</URI>
  </MaterialID>
</MaterialInformation>
</ActivityAsPlanned>
</EventAsPlanned>
<EventAsOccurs>
  <Description>Start Reel Merging</Description>
  <Where>
    <Time>
      <Hour>10</Hour>
      <Minutes>40</Minutes>
      <Seconds>16</Seconds>
      <Day>11</Day>
      <Month>2</Month>
      <Year>2005</Year>
    </Time>
    <Location>Room1</Location>
  </Where>
  <ActivityAsRealized>
    <Description>Reel Merging</Description>
    <EquipmentInformation>
      <Description>Machine 1 Merger</Description>
      <Position>12</Position>
    <!--
    From an Any class
    -->
    <img alt="Small icon" data-bbox="285 648 310 663"/>
  </EquipmentInformation>
</MaterialInformation>
<MaterialInformation>
  <Description>Spool</Description>
  <MaterialID>
    <ObjectID>187</ObjectID>
    <URI>www.SpoolSupplier.it</URI>
  </MaterialID>
</MaterialInformation>
<MaterialInformation>
  <Description>Raw Reel</Description>
  <MaterialID>
    <ObjectID>456</ObjectID>
    <URI>www.supplier.it</URI>
  </MaterialID>
</MaterialInformation>
<MaterialInformation>
  <Description>Raw Reel</Description>
  <MaterialID>
    <ObjectID>457</ObjectID>
    <URI>www.supplier.it</URI>
  </MaterialID>

```

```

</MaterialInformation>
<MaterialInformation>
  <Description>Raw Reel</Description>
  <MaterialID>
    <ObjectID>458</ObjectID>
    <URI>www.supplier.it</URI>
  </MaterialID>
</MaterialInformation>
<MaterialInformation>
  <Description>Raw Reel</Description>
  <MaterialID>
    <ObjectID>480</ObjectID>
    <URI>www.supplier.it</URI>
  </MaterialID>
</MaterialInformation>
</ActivityAsRealized>
</EventAsOccurs>
<EventAsOccurs>
  <Description>Production End</Description>
  <Where>
    <Time>
      <Hour>19</Hour>
      <Minutes>20</Minutes>
      <Seconds>06</Seconds>
      <Day>11</Day>
      <Month>2</Month>
      <Year>2005</Year>
    </Time>
    <Location>Room1</Location>
  </Where>
  <ActivityAsRealized>
    <Description>Reel Unmounting</Description>
    <Time>
      <Hour>20</Hour>
      <Minutes>05</Minutes>
      <Seconds>06</Seconds>
      <Day>11</Day>
      <Month>2</Month>
      <Year>2005</Year>
    </Time>
    <EquipmentInformation>
      <Description>Machine1 Merger</Description>
      <Position>12</Position>
    <!--
    From an Any class

    -->
  </EquipmentInformation>
</MaterialInformation>
  <Description>Spool</Description>
  <MaterialID>
    <ObjectID>187</ObjectID>
    <URI>www.SpoolSupplier.it</URI>
  </MaterialID>
</MaterialInformation>
<MaterialInformation>
  <Description>Raw Reel</Description>
  <MaterialID>
    <ObjectID>456</ObjectID>
    <URI>www.supplier.it</URI>
  </MaterialID>
</MaterialInformation>
<MaterialInformation>
  <Description>Raw Reel</Description>
  <MaterialID>
    <ObjectID>457</ObjectID>
    <URI>www.supplier.it</URI>
  </MaterialID>
</MaterialInformation>
<MaterialInformation>
  <Description>Raw Reel</Description>
  <MaterialID>
    <ObjectID>458</ObjectID>
    <URI>www.supplier.it</URI>
  </MaterialID>

```

```

    </MaterialID>
  </MaterialInformation>
</MaterialInformation>
  <Description>Raw Reel</Description>
  <MaterialID>
    <ObjectID>480</ObjectID>
    <URI>www.supplier.it</URI>
  </MaterialID>
</MaterialInformation>
<PersonnelInformation>
  <Description>Operator</Description>
  <PersonnelClass>carrier</PersonnelClass>
  <PersonnelID>
    <ObjectID>15</ObjectID>
    <URI>www.Textile.it</URI>
  </PersonnelID>
</PersonnelInformation>
</ActivityAsRealized>
</EventAsOccurs>
<!
Now Merging is finished; starts Twisting

>
<EventAsPlanned>
  <Description>Start Reel Mounting</Description>
  <Where>
    <Time>
      <Hour>22</Hour>
      <Minutes>33</Minutes>
      <Day>11</Day>
      <Month>2</Month>
      <Year>2005</Year>
    </Time>
    <Location>Room2</Location>
  </Where>
  <ActivityAsPlanned>
    <Description>Reel Mounting</Description>
    <EquipmentInformation>
      <Description>Machine 2 Twister </Description>
      <Position>15</Position>
    </EquipmentInformation>
    <!
    From an Any class

    >
  </EquipmentInformation>
</MaterialInformation>
  <Description>Spool</Description>
  <MaterialID>
    <ObjectID>187</ObjectID>
    <URI>www.supplier.it</URI>
  </MaterialID>
</MaterialInformation>
<PersonnelInformation>
  <Description>Operator</Description>
  <PersonnelClass>fixer</PersonnelClass>
</PersonnelInformation>
<MaterialInformation>
  <Description>Cardboard Spool</Description>
  <MaterialID>
    <ObjectID>187</ObjectID>
    <URI>www.CardboardSupplier.it</URI>
  </MaterialID>
</MaterialInformation>
</ActivityAsPlanned>
</EventAsPlanned>
<EventAsOccurs>
  <Description>Start Reel Mounting</Description>
  <Where>
    <Time>
      <Hour>22</Hour>
      <Minutes>33</Minutes>
      <Seconds>12</Seconds>
      <Day>11</Day>
      <Month>2</Month>
    </Time>
  </Where>
</EventAsOccurs>

```

```

<Year>2005</Year>
</Time>
<Location>Room2</Location>
</Where>
<ActivityAsRealized>
  <Description>Reel Mounting</Description>
  <EquipmentInformation>
    <Description>Machine2 Twister</Description>
    <Position>15</Position>
    <!
      From an Any class
    >
  </EquipmentInformation>
  <MaterialInformation>
    <Description>Spool</Description>
    <MaterialID>
      <ObjectID>187</ObjectID>
      <URI>www.supplier.it</URI>
    </MaterialID>
  </MaterialInformation>
  <PersonnelInformation>
    <Description>Operator</Description>
    <PersonnelClass>fixer</PersonnelClass>
    <PersonnelID>
      <ObjectID>22</ObjectID>
      <URI>www.Textile.it</URI>
    </PersonnelID>
  </PersonnelInformation>
  <MaterialInformation>
    <Description>Cardboard Spool</Description>
    <MaterialID>
      <ObjectID>187</ObjectID>
      <URI>www.CardboardSupplier.it</URI>
    </MaterialID>
  </MaterialInformation>
</ActivityAsRealized>
</EventAsOccurs>
<EventAsPlanned>
  <Description>Start Reel Twisting</Description>
  <Where>
    <Time>
      <Hour>22</Hour>
      <Minutes>50</Minutes>
      <Day>11</Day>
      <Month>2</Month>
      <Year>2005</Year>
    </Time>
    <Location>Room2</Location>
  </Where>
  <ActivityAsPlanned>
    <Description>Reel Twisting</Description>
    <EquipmentInformation>
      <Description>Machine2 Twister</Description>
      <Position>15</Position>
      <!
        From an Any class
      >
    </EquipmentInformation>
    <MaterialInformation>
      <Description>Spool</Description>
      <MaterialID>
        <ObjectID>187</ObjectID>
        <URI>www.SpoolSupplier.it</URI>
      </MaterialID>
    </MaterialInformation>
    <MaterialInformation>
      <Description>Cardboard Spool</Description>
      <MaterialID>
        <ObjectID>187</ObjectID>
        <URI>www.CardboardSupplier.it</URI>
      </MaterialID>
    </MaterialInformation>
  </ActivityAsPlanned>

```

```

</ActivityAsPlanned>
</EventAsPlanned>
<EventAsOccurs>
  <Description>Start Reel Twisting</Description>
  <Where>
    <Time>
      <Hour>22</Hour>
      <Minutes>50</Minutes>
      <Seconds>16</Seconds>
      <Day>11</Day>
      <Month>2</Month>
      <Year>2005</Year>
    </Time>
    <Location>Room2</Location>
  </Where>
  <ActivityAsRealized>
    <Description>Reel Twisting</Description>
    <EquipmentInformation>
      <Description>Machine2 Twister</Description>
      <Position>15</Position>
    <!--
    From an Any class

    >
  </EquipmentInformation>
  <MaterialInformation>
    <Description>Spool</Description>
    <MaterialID>
      <ObjectID>187</ObjectID>
      <URI>www.SpoolSupplier.it</URI>
    </MaterialID>
  </MaterialInformation>
  <MaterialInformation>
    <Description>Cardboard Spool</Description>
    <MaterialID>
      <ObjectID>187</ObjectID>
      <URI>www.CardboardSupplier.it</URI>
    </MaterialID>
  </MaterialInformation>
</ActivityAsRealized>
</EventAsOccurs>
<EventAsOccurs>
  <Description>Breakdown</Description>
  <Where>
    <Time>
      <Hour>5</Hour>
      <Minutes>19</Minutes>
      <Seconds>16</Seconds>
      <Day>12</Day>
      <Month>2</Month>
      <Year>2005</Year>
    </Time>
    <Location>Room2</Location>
  </Where>
  <CmLength>8500</CmLength>
  <!--
  From an Any class

  >
  <ActivityAsRealized>
    <Description>Reel Remounting</Description>
    <Where>
      <Time>
        <Hour>7</Hour>
        <Minutes>25</Minutes>
        <Seconds>15</Seconds>
        <Day>12</Day>
        <Month>2</Month>
        <Year>2005</Year>
      </Time>
      <Location>Room2</Location>
    </Where>
    <EquipmentInformation>
      <Description>Machine2 Twister</Description>

```



```

<Position>15</Position>
<!
From an Any class
>
</EquipmentInformation>
<MaterialInformation>
  <Description>Spool</Description>
  <MaterialID>
    <ObjectID>187</ObjectID>
    <URI>www.SpoolSupplier.it</URI>
  </MaterialID>
</MaterialInformation>
<MaterialInformation>
  <Description>Cardboard Spool</Description>
  <MaterialID>
    <ObjectID>187</ObjectID>
    <URI>www.CardboardSupplier.it</URI>
  </MaterialID>
</MaterialInformation>
<PersonnelInformation>
  <Description>Operator</Description>
  <PersonnelClass>fixer</PersonnelClass>
  <PersonnelID>
    <ObjectID>25</ObjectID>
    <URI>www.Textile.it</URI>
  </PersonnelID>
</PersonnelInformation>
</ActivityAsRealized>
</EventAsOccurs>
<EventAsOccurs>
  <Description>End Reel Twisting</Description>
  <Where>
    <Time>
      <Hour>8</Hour>
      <Minutes>17</Minutes>
      <Seconds>01</Seconds>
      <Day>12</Day>
      <Month>2</Month>
      <Year>2005</Year>
    </Time>
    <Location>Room2</Location>
  </Where>
<ActivityAsRealized>
  <Description>Reel Unmounting</Description>
  <Where>
    <Time>
      <Hour>8</Hour>
      <Minutes>25</Minutes>
      <Seconds>15</Seconds>
      <Day>12</Day>
      <Month>2</Month>
      <Year>2005</Year>
    </Time>
    <Location>Room2</Location>
  </Where>
<EquipmentInformation>
  <Description>Machine2 Twister</Description>
  <Position>15</Position>
<!
From an Any class
>
</EquipmentInformation>
<MaterialInformation>
  <Description>Spool</Description>
  <MaterialID>
    <ObjectID>187</ObjectID>
    <URI>www.SpoolSupplier.it</URI>
  </MaterialID>
</MaterialInformation>
<MaterialInformation>
  <Description>Cardboard Spool</Description>
  <MaterialID>

```

```

        <ObjectID>187</ObjectID>
        <URI>www.CardboardSupplier.it</URI>
    </MaterialID>
</MaterialInformation>
<PersonnelInformation>
    <Description>Operator</Description>
    <PersonnelClass>Transporter</PersonnelClass>
    <PersonnelID>
        <ObjectID>25</ObjectID>
        <URI>www.Textile.it</URI>
    </PersonnelID>
</PersonnelInformation>
</ActivityAsRealized>
</EventAsOccurs>
</ProductProduction>
<ObjectInformation>
    <Id>
        <ObjectID>456</ObjectID>
        <URI>www.supplier.it</URI>
    </Id>
    <Description>Raw Reel</Description>
    <ObjectLot>1569</ObjectLot>
    <ObjectClass>Reel</ObjectClass>
    <!--
    Information from the supplier
    -->
</ObjectInformation>
<!--
Other Object Information about the other Raw Reels
-->
<ObjectInformation>
    <Id>
        <ObjectID>187</ObjectID>
        <URI>www.SpoolSupplier.it</URI>
    </Id>
    <Description>Spool</Description>
    <ObjectLot>256</ObjectLot>
    <ObjectClass>Spool</ObjectClass>
    <!--
    Information from the Spool supplier
    -->
</ObjectInformation>
<ObjectInformation>
    <Id>
        <ObjectID>12</ObjectID>
        <URI>www.Textile.it</URI>
    </Id>
    <Description>
        <Name>Alessandro</Name>
        <Surname>Rossi</Surname>
    <!--
    These classes are from the Any class
    -->
    </Description>
    <ObjectClass>Personnel</ObjectClass>
    <!--
    Information about the people
    -->
</ObjectInformation>
</ObjectInformation>

```

Figure 9.12 – XML file of application 1, forward traceability

Minimal Data Set

Two XML examples of how the information could be stored by the model in a file have been presented; these examples describe all the information that should be linked to the product; the matter is that not all these information have to be written inside the product itself; It should be possible using RF Tags, but they are too expensive for a cheap and mass produced item like this. Many of this information are also useless outside the factory. Therefore this product, as it physically exits after the manufacturing phase, could be equipped with a barcode, that is cheap and easily readable and on this tool only the useful information should be written. The ID class composes the smallest set of information that has to be written on the product to ensure the existence of the Holon. Starting from this, an agent could retrieve all the information gathering these on a remote server. This way a simple one-dimensional barcode should be enough.

```
<ObjectInformation>
  <Id>
    <ObjectID>123</ObjectID>
    <URI>www. Textile.it</URI>
  </Id>
</ObjectInformation>
```

Figure 9.13 – Minimal data set for application 1

This is an example of the XML file that should be written on the one-dimensional barcode. Thought this could be too much little; in fact there are some information that could be useful to keep on the product, in order to avoid continuous queries to remote database. So, using a 2D barcode, we can put almost all the commonly used information directly on the product itself. A 2D barcode is a little bit more expensive, but there is a reasonable benefit. This way the information is encoded in the 2D Barcode within an XML File, like the example that follows.

```
<?XML version="1.0" encoding="ISO88591" ?>
<ObjectInformation>
<Id>
  <ObjectID>123</ObjectID>
  <URI>www.Textile.it</URI>
</Id>
<Description>White completed Reel</Description>
<ObjectLot>89878</ObjectLot>
<ObjectClass>Reel</ObjectClass>
<QAObjectTestSpecification>
  <Color>OK</Color>
</QAObjectTestSpecification>
```

```

<ObjectProperties>
  <CmLength>10000</CmLength>
  <ThicknessClass>1</ThicknessClass>
  <Material>nylon</Material>
  <!--
All from Any classes
-->
</ObjectProperties>
</ObjectInformation>
    
```

Figure 9.14 – Minimal information on a 2D barcode

This example is made of 526 character; that are a few regarding the 4000 characters that a 2D barcode can contain. Figure 9.15 schematizes the merging between the tangible object and the ObjectInformation schema that forms the Holon.

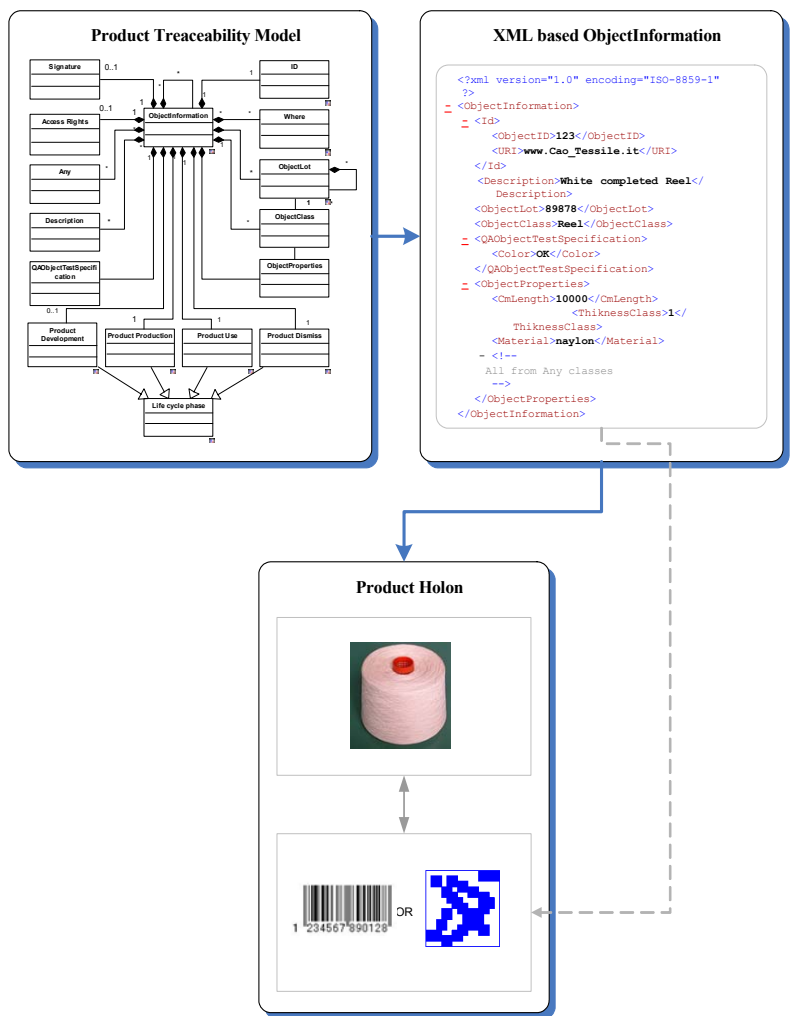

Figure 9.15 - From the abstract model to the Real life Holon

Simulation test case

After the exemplification there was to make a trial of the working of this model; it was not possible to do in the reality because it would cost too much and requires a lot of time, so it has been simulated. It has been written using Simple ++, from Tecnomatix [1]. In figure 9.16 is presented a view of the simulation; the loading and unloading stations are made of 2 parts because of some implementation needs.

This simulation exploits the information inside our model to make both “Forward Traceability” and “Backward”, making the process described before. In the process enters two Raw Synthetic Reels; these are merged together, and then are twirled producing the final product.

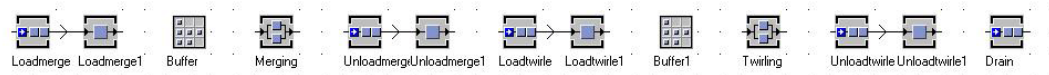

Figure 9.16 - A view of the simulation case

The Raw Reels, after their creation, are loaded into the merging machine with the first two stations. Then entering into a buffer that stores and counts them. When it counts 380 reels, meaning that all the positions in the merger machine are full, the process starts. In reality the machine slots are loaded one by one and the production starts only when this charging finishes.

From the merging exits 190 Merged Reel that are unloaded and then loaded into the twirling machine, which has 190 slots. The buffer 1 stores and counts the reels and then makes the twirling process start. When it finishes the Completed Reels are unloaded.

The Reels are considered as Holons; in fact they are supplied with an annexed table that contains some information class taken from the model. These classes are described in a table, which presents a forward part and a backward one.

The Raw Reels start their productive life at the beginning of the process, and exits the system after the merging; the Completed Reels instead are created during the merging process and the relative entity exits from the system when reaches the drain.

The information about the Raw Reel presented in table 9.1, has been recorded for implementation needs, but are not inside the ObjectInformation of the Completed Reel. These are however newsworthy because it shows the raw reel as a Holon and permits to maintain the coherence of the simulation model.

Name	Id	ProductionStep	EventAsPlanned	EventAsOccurs	Time
RawReel	2				
		1	~.Productionarea.Loadmerge	EnterLoadmerge	0
				ExitLoadmerge	1:00
		2	~.Productionarea.Buffer	Bufferenter	1:00
				Bufferexit	12:39:00
		3	~.Productionarea.Merging	Entermerging	12:39:00
				Exitmerging	1:01:39:00
		4	~.Productionarea.Unloadmerge		
		5	~.Productionarea.Loadtwirle		
		6	~.Productionarea.Buffer1		
		7	~.Productionarea.Twirling		
		8	~.Productionarea.Unloadtwirle		
		9	~.Productionarea.Drain		

Table 9.1 - Raw Reel Information

Table 9.1 shows the information bounded to a Raw Reel after it has been used in the merging process; the EventAsPlanned column explains the route the entity has to follow; this is a minimal implementation of the Forward traceability. Then in the following column are recorded the information necessary to the Backward traceability; In the EventAsOccurs are stored the performed operations while in the following one are recorded the Times when the activity took place. Note that the Raw Reels exit the merging process and then are discarded.

Table 9.2 presents the information stored in the ObjectInformation of the Completed Reel by the simulator after the end of its production. First of all we notice that the name of the Completed Reel is composed by a description of the product and by two numbers that are the id of the raw reels merged to create it. Then, there is the EventAsPlanned column that explains all the events that form the production process. This is the minimal requirement to achieve a form of Forward Traceability. Then, there are the EventAsOccurs and the related Time column; these permit a slight Backward Traceability. Though this is the minimal implementation,

reading table 9.2 is possible to know that the Completed Reel 299 has been produced starting from the Raw Reels 2 and 3; its life begins when the operator begins the loading of the merging machine; the Event EnterLoadmerge and the following ExitLoadmerge represent the beginning and the ending of its loading; next it has to wait until all the slots are filled with the reels, that is represented by the waiting into the buffer, only then the merging process begins. It takes about 12 hours and when it is finished the reel waits for the unloading. The EnterUnloadmerge exemplifies this. When the reel is really unloaded the model records the ExitUnloadmerge. Then the Reel has to be twirled; also this time it has to be loaded into the machine; EnterUnloadtwirle represents the beginning of this action while ExitUnloadtwirle the end. Later it waits into the slot till the entire machine is loaded (Represented by the Buffer), only at this time the twirling process starts. When it finishes the operator starts to unload the machine, this is the EnterUnloadtwirle Event. When the reel is really unloaded the model records the ExitUnloadtwirle, and then the product is completed and ready to be packaged, dispatched and sold.

Name	Id	Production Step	EventAsPlanned	EventAsOccurses	Time
CompletedReel 2_3	299				
		1	Productionarea.Loadmerge	EnterLoadmerge	0
				ExitLoadmerge	1:00
		2	Productionarea.Buffer	Bufferenter	1:00
				Bufferexit	12:39:00
		3	Productionarea.Merging	EnterUnloadmerge	1:01:56:00
				ExitUnloadmerge	1:01:57:00
		4	Productionarea.Loadtwirle	EnterLoadtwirle	1:01:57:00
				Exitloadtwirle	1:01:58:00
		5	Productionarea.Buffer1	Buffer1enter	1:01:58:00
				Buffer1exit	1:04:50:00
		6	Productionarea.Twirling	Entertwirling	1:04:50:00
				Exittwirling	1:17:50:00
		7	Productionarea.Unloadtwirle	EnterUnloadtwirle	1:18:07:00
				ExitUnloadtwirle	1:18:08:00
		8	Productionarea.Drain	EnterDrain	1:18:08:00

Table 9.2 - Completed Reel Information

All these information are bounded to the product; to make possible a whole seen, these can be collected also in a global table like 9.3. Here, all the data about many products are stored, such a way it is possible to

make global considerations. Note that in that table are recorded all the information about three Completed Reels and the records about the two Raw Reels (16 and 18) that have been used to create the Completed Reel 389.

Name	Entity number	Loadmerge entertime	Loadmerge exitime	Unloadmerge Exitime	Loadtwirle Entertime	Loadtwirle Exitime	Twirling Entertime	Twirling Exitime	Unloadtwirle Entertime	Unloadtwirle Exitime	Drain
Completed Reel16_17	389	28:00	29:00	1:01:47:00	1:01:47:00	1:01:48:00	1:04:50:00	1:17:50:00	1:17:57:00	1:17:58:00	1:17:58:00
Completed Reel 18_19	390	32:00	33:00	1:01:48:00	1:01:48:00	1:01:49:00	1:04:50:00	1:17:50:00	1:17:58:00	1:17:59:00	1:17:59:00
Completed Reel l20_21	391	36:00	37:00	1:01:49:00	1:01:49:00	1:01:50:00	1:04:50:00	1:17:50:00	1:17:59:00	1:18:00:00	1:18:00:00
Raw Reel	16	28:00	29:00								
Raw Reel	17	30:00	31:00								

Table 9.3 - General table

This is a minimal implementation of the information model, since it does not record information like the Operator, or other resources and neither the information about the Activity, nor as Planned nor as Realized. It records only the Events, but these could be enough for a first application of the model.

9.2.3 Application 2 – Producing natural reel

For the production of the natural reel, that is made of cotton, the process is a bit more complex; in fact, in addition to the merging and the twirling that are the same as saw before, this product also has to be cleaned and coloured. It is also sold in smaller reels, so it has to be cut. To clean the twirl it has to pass through a small flame, that burns the pollution and the waste. To colour, it is putted in suitable tanks, filled with dye. To have a high quality of the colour the twirl has to be rolled in a hank before putted in the soak.

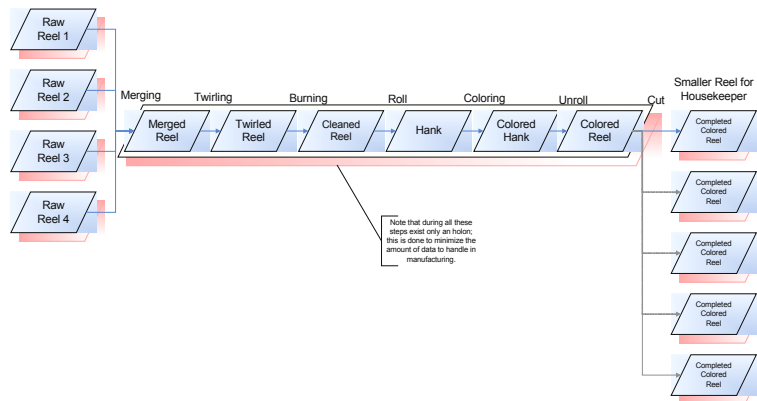

Figure 9.17 - Natural Reel production model

In figure 9.17 is exemplified the production process; notice that for convenience there is a single Holon that passes through all the phases of the production except the cutting, where “rise” five Holons; one for each housekeeper reel. These Holons have the “work in progress Holon” as a material. This stratagem has been adopted to minimize the amount of data handled in the manufacturing system. The first step of the process is the merging that from up to four reels brings to just one; here is created a “Work In Progress Reel” Holon. This reel has been twirled, and after it is rolled in a hank, that is soaked and coloured; then it is unrolled and returns to be a reel, that finally is cut in smaller reels. Here arise the final product Holon.

Backward traceability example

In this example it will be explained only the last part of the process; in fact all the production between the merging and the cutting is done on a “Wip” Holon, which is then used as a material resource in the final one. So in the following diagram and XML examples there is only the cutting process. It is interesting because it is a “disassembly” example; in fact from a Holon are produced five other holons.

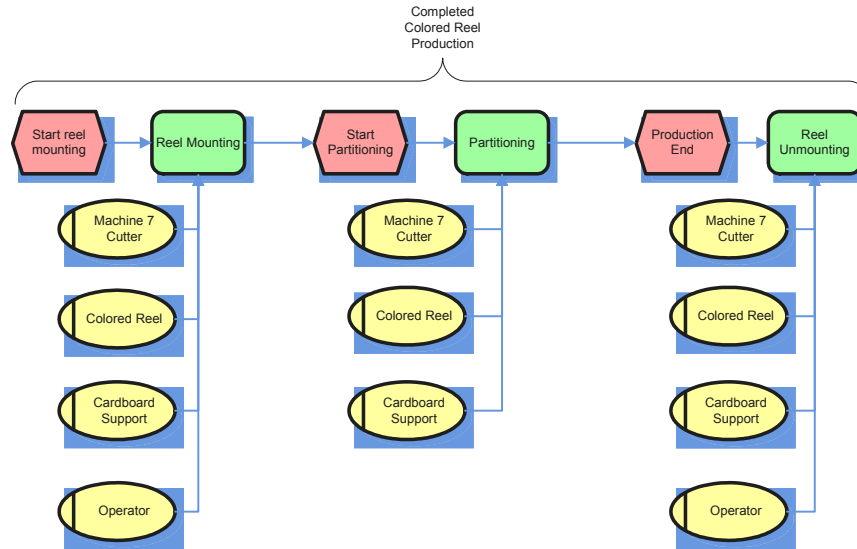

Figure 9.18 - EPC schema for the cutting process

The proposed model deals with the disassembly like all the other operations; the “wip” Holon is seen like a material resource and used in an operation. This way of considering this process is simple because it follows the real way of doing; in fact, at the beginning of this process, the operator puts the “Wip” reel and the cardboard support in their slots, then fix the twirl to the support and starts the process; when the required length is reached, the machine stops and cut the thread. Then the operator removes the completed reel, puts a new cardboard support in the slot, fixes again the twirl to it and starts the machine. This process continues till the thread on the “Wip” reel is finished. The XML file (figure 9.19) reflects this way of processing.

```

<?XML version="1.0" encoding="ISO88591" ?>
<ObjectInformation>
  <Id>
    <ObjectID>321</ObjectID>
    <ONS>www.Textile.it</ONS>
  </Id>
  <Description>Colored Small completed Reel</Description>
  <ObjectLot>456789</ObjectLot>
  <ObjectClass>Small Reel</ObjectClass>
  <QAObjectTestSpecification>
    <Color>OK</Color>
  </QAObjectTestSpecification>
  <ObjectProperties>
    <CmLength>5000</CmLength>
    <ThiknessClass>1</ThiknessClass>
    <Color>Blue</Color>
    <Material>Cotton</Material>
  <!--
  All from Any classes
  -->
</ObjectProperties>

```

```

<Where>
  <Time>
    <Hour>15</Hour>
    <Minutes>34</Minutes>
    <Seconds>13</Seconds>
    <Day>14</Day>
    <Month>2</Month>
    <Year>2005</Year>
  </Time>
  <Location>Depot2</Location>
</Where>
<ProductProduction>
  <EventAsOccurs>
    <Description>Start Reel mounting</Description>
    <Where>
      <Time>
        <Hour>10</Hour>
        <Minutes>33</Minutes>
        <Seconds>12</Seconds>
        <Day>11</Day>
        <Month>2</Month>
        <Year>2005</Year>
      </Time>
      <Location>Room7</Location>
    </Where>
    <ActivityAsRealized>
      <Description>Reel Mounting</Description>
      <EquipmentInformation>
        <Description>Machine 7 Cutter</Description>
        <Position>5</Position>
        <!
          From an Any class
        >
      </EquipmentInformation>
      <MaterialInformation>
        <Description>WipReel</Description>
        <MaterialID>
          <ObjectID>789</ObjectID>
          <ONS>www.Textile.it</ONS>
        </MaterialID>
      </MaterialInformation>
      <MaterialInformation>
        <Description>Cardboard support</Description>
        <MaterialID>
          <ObjectID>789</ObjectID>
          <ONS>www.Supplier.it</ONS>
        </MaterialID>
      </MaterialInformation>
      <PersonnelInformation>
        <Description>Operator</Description>
        <PersonnelClass>Fixer</PersonnelClass>
        <PersonnelID>
          <ObjectID>8</ObjectID>
          <ONS>www.Textile.it</ONS>
        </PersonnelID>
      </PersonnelInformation>
    </ActivityAsRealized>
  </EventAsOccurs>
</EventAsOccurs>
<EventAsOccurs>
  <Description>Start Partitioning</Description>
  <Where>
    <Time>
      <Hour>10</Hour>
      <Minutes>40</Minutes>
      <Seconds>16</Seconds>
      <Day>11</Day>
      <Month>2</Month>
      <Year>2005</Year>
    </Time>
    <Location>Room1</Location>
  </Where>
  <ActivityAsRealized>
    <Description>Reel Partitioning</Description>

```

```

<EquipmentInformation>
  <Description>Machine 7 Cutter</Description>
  <Position>5</Position>
  <!
    From an Any class
  >
</EquipmentInformation>
<MaterialInformation>
  <Description>WipReel</Description>
  <MaterialID>
    <ObjectID>789</ObjectID>
    <ONS>www.Textile.it</ONS>
  </MaterialID>
</MaterialInformation>
<MaterialInformation>
  <Description>Cardboard support</Description>
  <MaterialID>
    <ObjectID>789</ObjectID>
    <ONS>www.Supplier.it</ONS>
  </MaterialID>
</MaterialInformation>
</ActivityAsRealized>
</EventAsOccurs>
<EventAsOccurs>
  <Description>Production End</Description>
  <Where>
    <Time>
      <Hour>19</Hour>
      <Minutes>20</Minutes>
      <Seconds>06</Seconds>
      <Day>11</Day>
      <Month>2</Month>
      <Year>2005</Year>
    </Time>
    <Location>Room1</Location>
  </Where>
<ActivityAsRealized>
  <Description>Reel Unmounting</Description>
  <Time>
    <Hour>20</Hour>
    <Minutes>05</Minutes>
    <Seconds>06</Seconds>
    <Day>11</Day>
    <Month>2</Month>
    <Year>2005</Year>
  </Time>
<EquipmentInformation>
  <Description>Machine 7 Cutter</Description>
  <Position>5</Position>
  <!
    From an Any class
  >
</EquipmentInformation>
<MaterialInformation>
  <Description>WipReel</Description>
  <MaterialID>
    <ObjectID>789</ObjectID>
    <ONS>www.Textile.it</ONS>
  </MaterialID>
</MaterialInformation>
<MaterialInformation>
  <Description>Cardboard support</Description>
  <MaterialID>
    <ObjectID>789</ObjectID>
    <ONS>www.Supplier.it</ONS>
  </MaterialID>
</MaterialInformation>
<PersonnelInformation>
  <Description>Operator</Description>
  <PersonnelClass>Transporter</PersonnelClass>
  <PersonnelID>
    <ObjectID>8</ObjectID>
    <ONS>www.Textile.it</ONS>
  </PersonnelID>
</PersonnelInformation>

```

```

        </PersonnelID>
        </PersonnelInformation>
        </ActivityAsRealized>
        </EventAsOccurs>
    </ProductProduction>
    <ObjectInformation>
        <Id>
            <ObjectID>789</ObjectID>
            <ONS>www.Textile.it</ONS>
        </Id>
        <Description>Wip Reel</Description>
        <ObjectLot>15486</ObjectLot>
        <ObjectClass>Reel</ObjectClass>
        <ProductProduction>
            <!--
            Information from All the rest of the production process
            -->
        </ProductProduction>
    </ObjectInformation>
    <ObjectInformation>
        <Id>
            <ObjectID>456</ObjectID>
            <ONS>www.supplier.it</ONS>
        </Id>
        <Description>Raw Reel</Description>
        <ObjectLot>1569</ObjectLot>
        <ObjectClass>Reel</ObjectClass>
        <!--
        Information from the supplier
        -->
    </ObjectInformation>
    <!--
    Other Object Information about the other Raw Reels
    -->
    <ObjectInformation>
        <Id>
            <ObjectID>187</ObjectID>
            <ONS>www.SpoolSupplier.it</ONS>
        </Id>
        <Description>Spool</Description>
        <ObjectLot>256</ObjectLot>
        <ObjectClass>Spool</ObjectClass>
        <!--
        Information from the Spool supplier
        -->
    </ObjectInformation>
    <ObjectInformation>
        <Id>
            <ObjectID>12</ObjectID>
            <ONS>www.Textile.it</ONS>
        </Id>
        <Description>
            <Name>Alessandro</Name>
            <Surname>Rossi</Surname>
            <!--
            These classes are from the Any class
            -->
        </Description>
        <ObjectClass>Personnel</ObjectClass>
        <!--
        Information about the people
        -->
    </ObjectInformation>
</ObjectInformation>

```

Figure 9.19 – XML file for the cutting process

9.3 Vetroresina padana case

Vetroresina Padana s.r.l. is located in Poggio Rusco (MN) and produces tanks for agricultural use. These tanks are a sub-component of complete sprayer, atomizer or weed killing machines (which include the tank itself, pump unit, pump circuit, air distributor, chassis and other parts).



Figure 9.20 - A complete sprayer machine

9.3.1 Overview of the manufacturing systems

These tanks are produced using two different materials: fiberglass and polyethylene. The product of the test case is a tank called California 90 (figure 9.21) whose capacity is 2000 lt. and whose basic material is white polyethylene. For this reason, a brief overview of the manufacturing process for producing polyethylene tanks is provided.

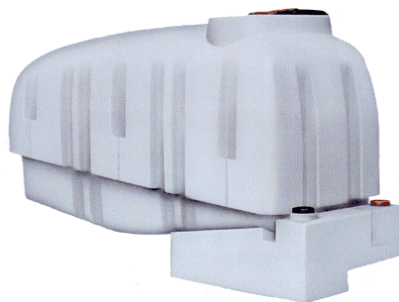

Figure 9.21 - California 90 PE 2000

The manufacturing process for these kinds of products consists of five different phases: mould setup, rotary moulding, testing, finishing, and assembly. More in detail:

- Mould setup: the correct mould (figure 9.22) is to be moved from the mould storage area to the moulding machine (figure 9.23) and attached to the correct slot. Then, it is necessary to connect some pipes

necessary to blow hot air inside the mould during the moulding phase and to place some inserts. The following steps require that the mould is filled with weighted amount of granular polyethylene and closed.

- Rotary moulding: the mould filled with raw polyethylene is then conveyed to moulding furnace where it stands at a fixed temperature of 230°C for 40 minutes in continuous rotation around three perpendicular axes of rotation. After this time mould is cooled with a decreasing temperature till its temperature is more or less 40 °C.



Figure 9.22 - Mould for California 90 PE 2000 (Main Tank)



Figure 9.23 - Moulding Machine

- Testing phase is usual an inspection for checking the correct value of the capacity and to verify that there are no holes or cracks.
- Finishing a tank is a necessary operation for removing moulding dribbles with an appropriate tool.
- A tank is than assembled with its sub-components

- Products are built to order and delivered to many customers spread all over the world.

Two applications have been studied: one on production and one on delivery the product.

9.3.2 Application 1- producing California 90 PE

California 90 PE is a family of similar product produced both with fibreglass and polyethylene with different capacities: from 1500 to 3000 lt. with steps of 500 lt. Three different sub-tanks, called “main tank”, “circuit-washing tank” and “hand-washing tank”, as shown below, compose this tank.

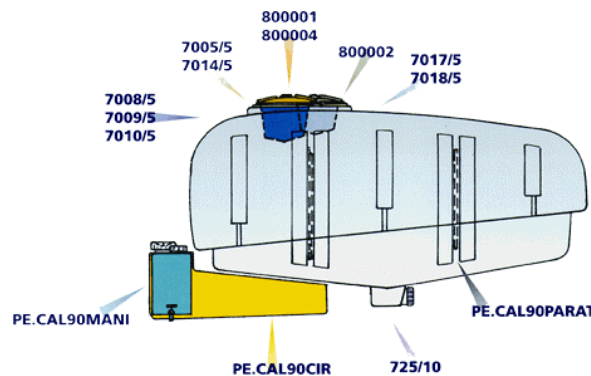

Figure 9.24 - Main tank with hand-washing tank (PE.CAL90MANI), circuit-washing tank (PE.CAL90CIR) and accessories

Figure 9.25 represents how the product production is performed, starting from raw materials and ending with the complete tank. Following the logical schema, we can notice that the complete tank is made of three different sub-tanks which share the same raw material and the same production process: Hand washing tank, Circuit washing tank and Main Tank. Main tank is the container filled, when the complete machine is in use, with water or a mixture of water and weed killing dust. Circuit and hand washing tank are exterior container, fastened to the main tank, use to be compliant with normative for these kind of products: they are necessary for containing personnel hands washing water or water used to

wash the inside of the main tank at the end of each treatment. The flow of material starts from granular polyethylene (usually white for this model); then it is moulded and the solidified polyethylene gets the same shape of the moulder; final step is finishing the tank by removing moulding slavers. After each tank is completed and tested, they are assembled together and with other components provided by specialized suppliers (outlet units, tie rods, inox breakwaters).

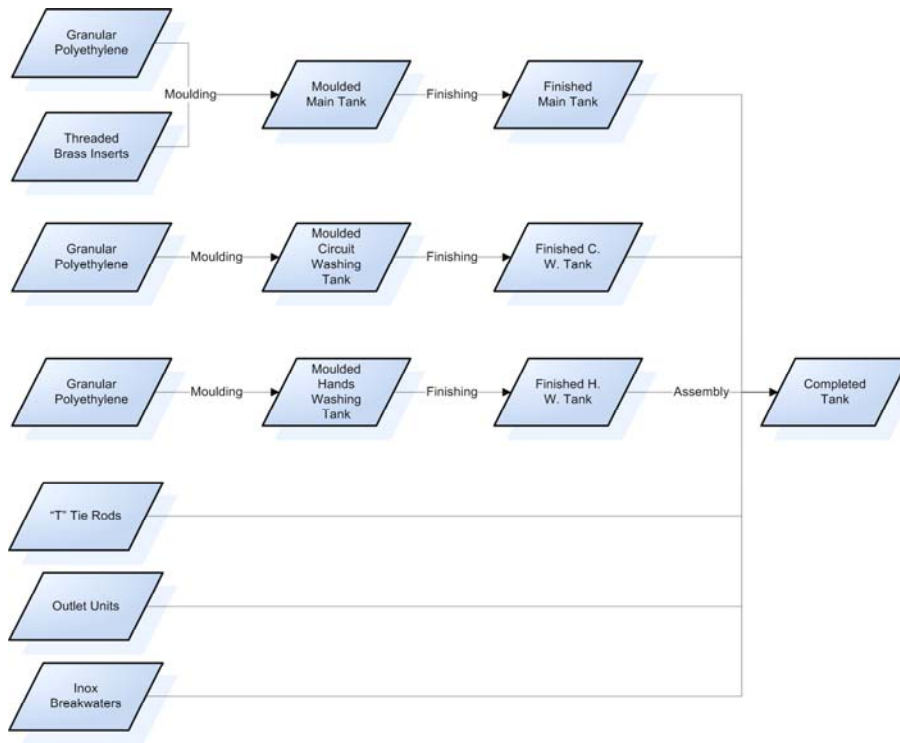

Figure 9.25 - Logical schema for complete tank production

Backward traceability example

This example shows how the model can be used to keep track of sets of information describing product production history for California 90 PE 2000. The following EPC schema (figure 9.26) represents activity, events and resources used in product production: this is, of course, only one of the four different lifecycle phases. As already described, product production proceeds through a few basic steps: mould setup, tank moulding, testing and finishing. California 90 PE 2000 Complete stands for the complete product, mad of a main tank, a circuit-washing tank, a hand

washing tank and accessories. The EPC schema is always the same for each tank, which can be considered as a sub-component of the complete product:

- Starting Mould Setup is an “event as occurs” and causes its related activity, Mould Setup: this activity is required for setting-up the correct mould on the moulding machine, filling it with the correct amount of raw polyethylene, placing a number of insert before starting moulding. This activity needs an operator (a resource of Personnel type) for connecting the mould with the machine, filling it with the PE and placing threaded inserts. Other resources involved are the moulding machine (type Equipment), the mould (type Equipment), granular PE and brass threaded inserts (type Materials).

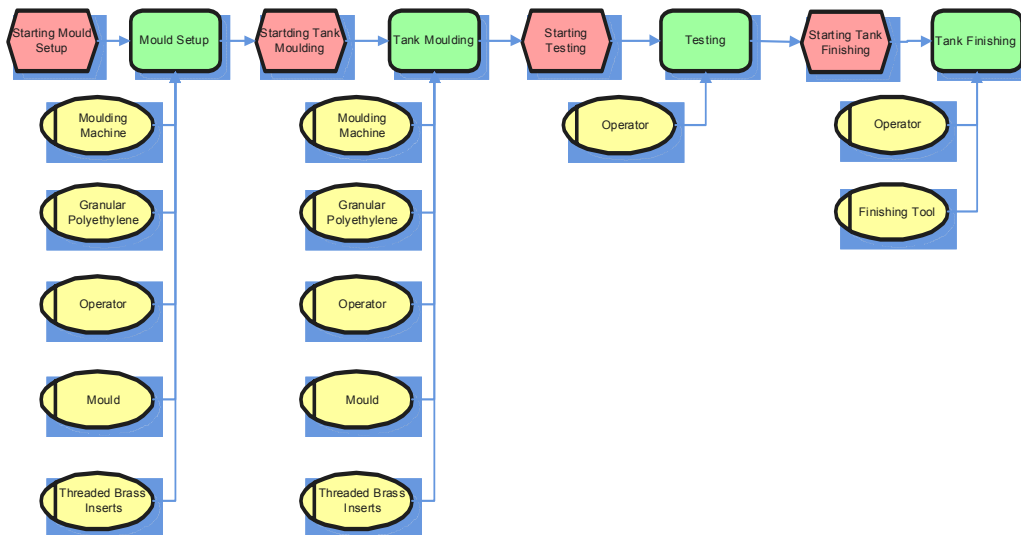

Figure 9.26 - EPC model for generic tank production

- Starting Tank Moulding: an event (as Occurs) related with Tank Moulding activity: required resources are the same used by previous activity. Here the involved operator is in charge of driving the machine. An operator is required
- Start Testing: an event (again, an Event As Occurs) defining an activity of testing the molded tank to verify its properties in compliance with production quality standards.

- Starting Tank Finishing represents the last step for generic tank manufacturing. This activity is performed by an operator using a specific tool (resource type Equipment)

All these information and data about California 90 PE 2000 can be written down in an XML file, as already done for “Textile” case. It is interesting to notice how this XML file structure should be compliant with the conceptual model suggested and explained in chapter 8. Figure 9.27 shows an intermediate step between the abstract model and XML based product representation, pointing out how the XML file straightly derives from the abstract model.

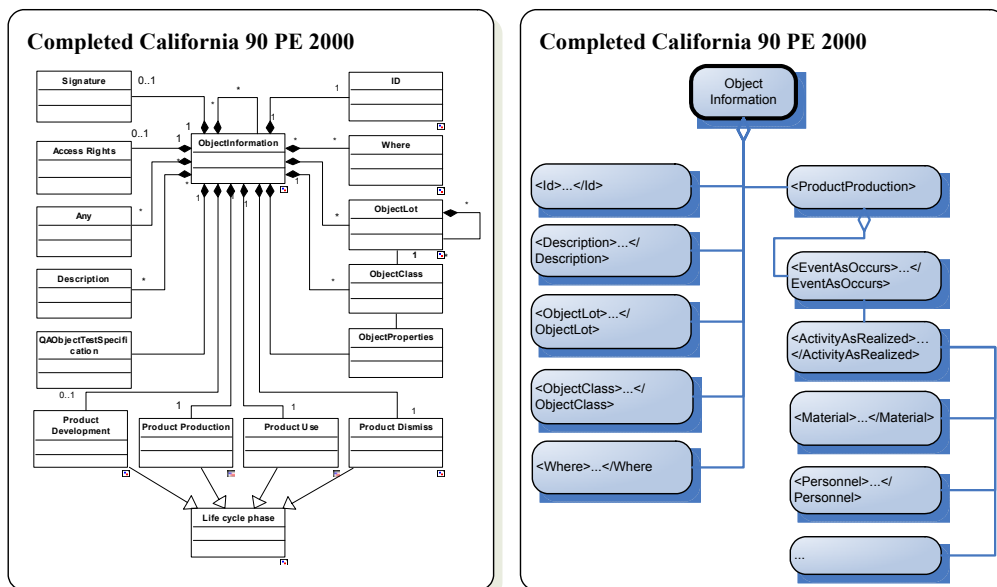

Figure 9.27 - Comparison between abstract model and XML based product representation structure

California 90 PE 2000 is a product composed of three sub-tanks: main tank, circuit washing tank and hand washing tank. Each of them, represented with this model, is an ObjectInformation. First ObjectInformation root is the completed California PE 2000 which aggregates the other three ObjectInformation representing Main tank, Circuit washing and Hand washing tanks. This structure is represented in figure 9.28.

The final step is the generation of an XML file containing all the required information to keep track of product production history (this is an example of backward traceability). This file looks like figure 9.29.

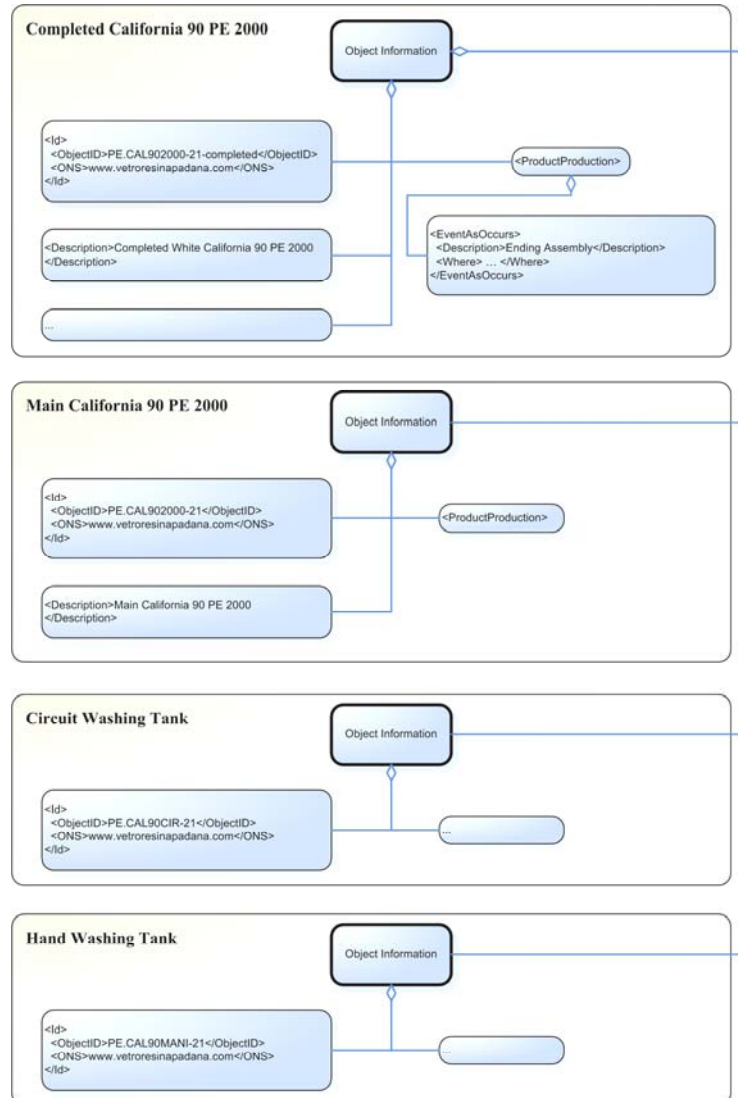

Figure 9.28 - Generating XML file from model structure: auto-aggregation of ObjectInformation

```

<?XML version="1.0" encoding="ISO88591" ?>
<ObjectInformation>
<Id>
  <ObjectID>PE.CAL90200021completed</ObjectID>
  <URI>www.vetroresinapadana.com</URI>
</Id>
<Description>Completed White California 90 PE 2000</Description>
<ObjectLot>78</ObjectLot>
<ObjectClass>California 90 PE</ObjectClass>
<Where>
<Time>
  <Hour>11</Hour>
  <Minutes>34</Minutes>
  <Seconds>33</Seconds>

```

```

<Day>09</Day>
<Month>1</Month>
<Year>2005</Year>
  </Time>
<Location>VP1</Location>
  </Where>
  <!
    ***** LIFECYCLE PHASES *****
  >
<ProductProduction>
  <!
    ***** EVENT *****
  >
<EventAsOccurs>
  <Description>Starting Assembly</Description>
  <Where>
  <Time>
  <Hour>11</Hour>
  <Minutes>49</Minutes>
  <Seconds>30</Seconds>
  <Day>09</Day>
  <Month>1</Month>
  <Year>2005</Year>
  </Time>
  <Location>VP1</Location>
  </Where>
  <ActivityAsRealized>
  <Description>Tank Assembly</Description>
  <Material>
  <Description>"T" Tie Rods Zinc Plated</Description>
  <Id>
  <ObjectID>TIR.CAL90PE1</ObjectID>
  <URI>www.TIRSupplier.it</URI>
  </Id>
  </Material>
  <Material>
  <Description>"T" Tie Rods Zinc Plated</Description>
  <Id>
  <ObjectID>TIR.CAL90PE2</ObjectID>
  <URI>www.TIRSupplier.it</URI>
  </Id>
  </Material>
  <Material>
  <Description>"T" Tie Rods Zinc Plated</Description>
  <Id>
  <ObjectID>TIR.CAL90PE3</ObjectID>
  <URI>www.TIRSupplier.it</URI>
  </Id>
  </Material>
  <Material>
  <Description>"T" Tie Rods Zinc Plated</Description>
  <Id>
  <ObjectID>TIR.CAL90PE4</ObjectID>
  <URI>www.TIRSupplier.it</URI>
  </Id>
  </Material>
  <Material>
  <Description>"T" Tie Rods Zinc Plated</Description>
  <Id>
  <ObjectID>TIR.CAL90PE5</ObjectID>
  <URI>www.TIRSupplier.it</URI>
  </Id>
  </Material>
  <Material>
  <Description>"T" Tie Rods Zinc Plated</Description>
  <Id>
  <ObjectID>TIR.CAL90PE6</ObjectID>
  <URI>www.TIRSupplier.it</URI>
  </Id>
  </Material>
</Material>

```

```

<Description>Complete Uutlet Unit 1"1/4</Description>
<Id>
<ObjectID>725/1022</ObjectID>
<URI>www.COUSupplier.it</URI>
</Id>
</Material>
<Material>
<Description>Hinged Lid Ø 455 mm</Description>
<Id>
<ObjectID>80000489</ObjectID>
<URI>www.HLSupplier.it</URI>
</Id>
</Material>
<Material>
<Description>Inox pair of Breakwater bulk heads</Description>
<Id>
<ObjectID>PE.CAL90PARAT21</ObjectID>
<URI>www.BWSupplier.it</URI>
</Id>
</Material>
<Material>
<Description>Handwashing tank</Description>
<Id>
<ObjectID>PE.CAL90MANI21</ObjectID>
<URI>www.vetroresinapadana.com</URI>
</Id>
</Material>
<Material>
<Description>Circuitwashing tank</Description>
<Id>
<ObjectID>PE.CAL90CIR47</ObjectID>
<URI>www.vetroresinapadana.com</URI>
</Id>
</Material>
<Personnel>
<Description>Operator</Description>
<Id>
<ObjectID>456</ObjectID>
<URI>www.vetroresinapadana.com/personnel</URI>
</Id>
</Personnel>
</ActivityAsRealized>
</EventAsOccurs>
</ProductProduction>
<ObjectInformation>
<Id>
<ObjectID>PE.CAL90200021</ObjectID>
<URI>www.vetroresinapadana.com</URI>
</Id>
<Description>Main White California 90 PE 2000</Description>
<ObjectLot>78</ObjectLot>
<ObjectClass>California 90 PE</ObjectClass>
<QAObjectTestSpecification>
<Weight>OK</Weight>
<leak_check>NO Leaks</leak_check>
</QAObjectTestSpecification>
<Where>
<Time>
<Hour>11</Hour>
<Minutes>34</Minutes>
<Seconds>33</Seconds>
<Day>09</Day>
<Month>1</Month>
<Year>2005</Year>
</Time>
<Location>VP1</Location>
</Where>
<!
***** LIFECYCLE PHASES *****
>
</ProductProduction>
<!

```

***** EVENT *****

```
>
<EventAsOccurs>
<Description>Starting Mould Setup</Description>
<Where>
<Time>
<Hour>08</Hour>
<Minutes>33</Minutes>
<Seconds>12</Seconds>
<Day>09</Day>
<Month>1</Month>
<Year>2005</Year>
</Time>
<Location>VP1</Location>
</Where>
<ActivityAsRealized>
<Description>Mould Setup</Description>
<Equipment>
<Description>Moulding Machine 3000</Description>
<Id>
<ObjectID>MM1</ObjectID>
<URI>www.MouldingMachineSupplier.it</URI>
</Id>
<EquipmentClass>Moulding Machines</EquipmentClass>
<EquipmentProperties>
<Spherical_Diameter_Available>3000</Spherical_Diameter_Available>
</EquipmentProperties>
</Equipment>
<Equipment>
<Description>Mould for California 90 PE 2000</Description>
<Id>
<ObjectID>MouldCalPE20004</ObjectID>
<URI>www.MouldSupplier.it</URI>
</Id>
<EquipmentClass>Aluminium Moulds</EquipmentClass>
<EquipmentProperties>
<Number_of_Moulding_Cycles>45</Number_of_Moulding_Cycles>
<Spheric_Diameter_Requested>3000 mm</Spheric_Diameter_Requested>
</EquipmentProperties>
</Equipment>
<Material>
<Description>Threaded Brass Insert</Description>
<Id>
<ObjectID>TBI4511</ObjectID>
<URI>www.InsertsSupplier.com</URI>
</Id>
<MaterialClass>Threaded Inserts</MaterialClass>
<MaterialProperties>
<Diameter>45</Diameter>
<Material>POT60</Material>
</MaterialProperties>
</Material>
<Material>
<Description>Threaded Brass Insert</Description>
<Id>
<ObjectID>TBI5012</ObjectID>
<URI>www.InsertsSupplier.com</URI>
</Id>
<MaterialClass>Threaded Inserts</MaterialClass>
<MaterialProperties>
<Diameter>50</Diameter>
<Material>POT60</Material>
</MaterialProperties>
</Material>
<Personnel>
<Description>Operator</Description>
<Id>
<ObjectID>456</ObjectID>
<URI>www.vetroresinapadana.com/personnel</URI>
</Id>
</Personnel>
<Material>
```

```

<Description>White Granular PE</Description>
<Id>
<ObjectID>PE00345</ObjectID>
<URI>www.PESupplier.com</URI>
</Id>
<MaterialClass>Granular Polyethylene</MaterialClass>
<MaterialProperties>
<Color>White</Color>
<Density>***</Density>
<Quantity>162 Kg</Quantity>
</MaterialProperties>
<MaterialLot>
<Id>
<ObjectID>PELOT114</ObjectID>
<URI>www.PESupplier.com</URI>
</Id>
<Description>White Granular Polyethylene LOT</Description>
<Quantity>250000 Kg</Quantity>
<MaterialLotProperties>
<Date_of_purchase>
<Hour>09</Hour>
<Minutes>11</Minutes>
<Seconds>33</Seconds>
<Day>19</Day>
<Month>4</Month>
<Year>2003</Year>
</Date_of_purchase>
</MaterialLotProperties>
</MaterialLot>
</Material>
</ActivityAsRealized>
</EventAsOccurs>
<!
***** EVENT *****
>
<EventAsOccurs>
<Description>Starting Moulding</Description>
<Where>
<Time>
<Hour>08</Hour>
<Minutes>55</Minutes>
<Seconds>00</Seconds>
<Day>09</Day>
<Month>1</Month>
<Year>2005</Year>
</Time>
<Location>VP1</Location>
</Where>
<ActivityAsRealized>
<Description>Main Tank Moulding</Description>
<Equipment>
<Description>Moulding Machine 3000</Description>
<Id>
<ObjectID>MM1</ObjectID>
<URI>www.MouldingMachineSupplier.it</URI>
</Id>
<EquipmentClass>Moulding Machines</EquipmentClass>
<EquipmentProperties>
<Spherical_Diameter_Available>3000</Spherical_Diameter_Available>
</EquipmentProperties>
</Equipment>
<Equipment>
<Description>Mould for California 90 PE 2000</Description>
<Id>
<ObjectID>MouldCalPE20004</ObjectID>
<URI>www.MouldSupplier.it</URI>
</Id>
<EquipmentClass>Aluminium Moulds</EquipmentClass>
<EquipmentProperties>
<Number_of_Moulding_Cycles>46</Number_of_Moulding_Cycles>
<Spheric_Diameter_Requested>3000 mm</Spheric_Diameter_Requested>
</EquipmentProperties>

```



```

</Equipment>
<Material>
<Description>White Granular PE</Description>
<Id>
<ObjectID>PE00345</ObjectID>
<URI>www.PESupplier.com</URI>
</Id>
<MaterialClass>Granular Polyethylene</MaterialClass>
<MaterialProperties>
<Color>White</Color>
<Density>***</Density>
<Quantity>162 Kg</Quantity>
</MaterialProperties>
<MaterialLot>
<Id>
<ObjectID>PELOT114</ObjectID>
<URI>www.PESupplier.com</URI>
</Id>
<Description>White Granular Polyethylene LOT</Description>
<Quantity>250000 Kg</Quantity>
<MaterialLotProperties>
<Date_of_purchase>
<Hour>09</Hour>
<Minutes>11</Minutes>
<Seconds>33</Seconds>
<Day>19</Day>
<Month>4</Month>
<Year>2003</Year>
</Date_of_purchase>
</MaterialLotProperties>
</MaterialLot>
</Material>
</ActivityAsRealized>
</EventAsOccurs>
<!
***** EVENT *****
>
<EventAsOccurs>
<Description>Starting Testing</Description>
<Where>
<Time>
<Hour>11</Hour>
<Minutes>20</Minutes>
<Seconds>00</Seconds>
<Day>09</Day>
<Month>1</Month>
<Year>2005</Year>
</Time>
<Location>VP1</Location>
</Where>
<ActivityAsRealized>
<Description>Testing</Description>
<Material>
<Description>Main White California 90 PE 2000</Description>
<Id>
<ObjectID>PE.CAL90200021</ObjectID>
<URI>www.vetroresinapadana.com</URI>
</Id>
<QAObjectTestSpecification>
<Weight>OK</Weight>
<leak_check>NO Leaks</leak_check>
</QAObjectTestSpecification>
</Material>
<Personnel>
<Description>Operator</Description>
<Id>
<ObjectID>451</ObjectID>
<URI>www.vetroresinapadana.com/personnel</URI>
</Id>
</Personnel>
</ActivityAsRealized>
</EventAsOccurs>

```

```

<!
***** EVENT *****

>
<EventAsOccurs>
<Description>Starting Finishing</Description>
<Where>
<Time>
<Hour>11</Hour>
<Minutes>25</Minutes>
<Seconds>00</Seconds>
<Day>09</Day>
<Month>1</Month>
<Year>2005</Year>
</Time>
<Location>VP1</Location>
</Where>
<ActivityAsRealized>
<Description>Finishing</Description>
<Equipment>
<Description>Finishing Cutter</Description>
<Id>
<ObjectID>FC345511</ObjectID>
<URI>www.ToolsSupplier.it</URI>
</Id>
</Equipment>
<Personnel>
<Description>Operator</Description>
<Id>
<ObjectID>456</ObjectID>
<URI>www.vetroresinapadana.com/personnel</URI>
</Id>
</Personnel>
</ActivityAsRealized>
</EventAsOccurs>
</ProductProduction>
</ObjectInformation>
<ObjectInformation>
<Id>
<ObjectID>PE.CAL90CIR21</ObjectID>
<URI>www.vetroresinapadana.com</URI>
</Id>
<Description>Circuit Washing White Tank for California 90 PE 2000</Description>
<ObjectLot>78</ObjectLot>
<ObjectClass>Circuit Washing Tank</ObjectClass>
<QAObjectTestSpecification>
<Weight>OK</Weight>
<leak_check>NO Leaks</leak_check>
</QAObjectTestSpecification>
<Where>
<Time>
<Hour>16</Hour>
<Minutes>16</Minutes>
<Seconds>53</Seconds>
<Day>09</Day>
<Month>1</Month>
<Year>2005</Year>
</Time>
<Location>VP1</Location>
</Where>
<!
***** LIFECYCLE PHASES *****

>
<ProductProduction>
<!
***** EVENT *****

>
<EventAsOccurs>
<Description>Starting Mould Setup</Description>
<Where>

```

```

<Time>
<Hour>16</Hour>
<Minutes>03</Minutes>
<Seconds>12</Seconds>
<Day>09</Day>
<Month>1</Month>
<Year>2005</Year>
</Time>
<Location>VP1</Location>
</Where>
<ActivityAsRealized>
<Description>Mould Setup</Description>
<Equipment>
<Description>Moulding Machine 3000</Description>
<Id>
<ObjectID>MM1</ObjectID>
<URI>www.MouldingMachineSupplier.it</URI>
</Id>
<EquipmentClass>Moulding Machines</EquipmentClass>
<EquipmentProperties>
<Spherical_Diameter_Available>3000</Spherical_Diameter_Available>
</EquipmentProperties>
</Equipment>
<Equipment>
<Description>Mould for California 90 PE 2000 CIR</Description>
<Id>
<ObjectID>MouldCalPE2000CIR1</ObjectID>
<URI>www.MouldSupplier.it</URI>
</Id>
<EquipmentClass>Aluminium Moulds</EquipmentClass>
<EquipmentProperties>
<Number_of_Moulding_Cycles>45</Number_of_Moulding_Cycles>
<Spheric_Diameter_Requested>3000 mm</Spheric_Diameter_Requested>
</EquipmentProperties>
</Equipment>
<Personnel>
<Description>Operator</Description>
<Id>
<ObjectID>456</ObjectID>
<URI>www.vetroresinapadana.com/personnel</URI>
</Id>
</Personnel>
<Material>
<Description>White Granular PE</Description>
<Id>
<ObjectID>PE00345</ObjectID>
<URI>www.PESupplier.com</URI>
</Id>
<MaterialClass>Granular Polyethylene</MaterialClass>
<MaterialProperties>
<Color>White</Color>
<Density>***</Density>
<Quantity>40 Kg</Quantity>
</MaterialProperties>
<MaterialLot>
<Id>
<ObjectID>PELOT074</ObjectID>
<URI>www.PESupplier.com</URI>
</Id>
<Description>White Granular Polyethylene LOT</Description>
<Quantity>250000 Kg</Quantity>
<MaterialLotProperties>
<Date_of_purchase>
<Hour>09</Hour>
<Minutes>11</Minutes>
<Seconds>33</Seconds>
<Day>19</Day>
<Month>4</Month>
<Year>2003</Year>
</Date_of_purchase>
</MaterialLotProperties>
</MaterialLot>
</Material>
</ActivityAsRealized>

```

```

</EventAsOccurs>
<!
***** EVENT *****
>
<EventAsOccurs>
<Description>Starting Moulding</Description>
<Where>
<Time>
<Hour>16</Hour>
<Minutes>43</Minutes>
<Seconds>00</Seconds>
<Day>09</Day>
<Month>1</Month>
<Year>2005</Year>
</Time>
<Location>VP1</Location>
</Where>
<ActivityAsRealized>
<Description>Circuit Washing Tank Moulding</Description>
<Equipment>
<Description>Moulding Machine 3000</Description>
<Id>
<ObjectID>MM1</ObjectID>
<URI>www.MouldingMachineSupplier.it</URI>
</Id>
<EquipmentClass>Moulding Machines</EquipmentClass>
<EquipmentProperties>
<Spherical_Diameter_Available>3000</Spherical_Diameter_Available>
</EquipmentProperties>
</Equipment>
<Equipment>
<Description>Mould for California 90 CIR</Description>
<Id>
<ObjectID>MouldCalPE2000CIR1</ObjectID>
<URI>www.MouldSupplier.it</URI>
</Id>
<EquipmentClass>Aluminium Moulds</EquipmentClass>
<EquipmentProperties>
<Number_of_Moulding_Cycles>46</Number_of_Moulding_Cycles>
<Spheric_Diameter_Requested>1500 mm</Spheric_Diameter_Requested>
</EquipmentProperties>
</Equipment>
<Material>
<Description>White Granular PE</Description>
<Id>
<ObjectID>PE00345</ObjectID>
<URI>www.PESupplier.com</URI>
</Id>
<MaterialClass>Granular Polyethylene</MaterialClass>
<MaterialProperties>
<Color>White</Color>
<Density>***</Density>
<Quantity>40 Kg</Quantity>
</MaterialProperties>
<MaterialLot>
<Id>
<ObjectID>PELOT074</ObjectID>
<URI>www.PESupplier.com</URI>
</Id>
<Description>White Granular Polyethylene LOT</Description>
<Quantity>250000 Kg</Quantity>
<MaterialLotProperties>
<Date_of_purchase>
<Hour>09</Hour>
<Minutes>11</Minutes>
<Seconds>33</Seconds>
<Day>19</Day>
<Month>4</Month>
<Year>2003</Year>
</Date_of_purchase>
</MaterialLotProperties>
</MaterialLot>

```

```

</Material>
</ActivityAsRealized>
</EventAsOccurs>
<!
***** EVENT *****
>
<EventAsOccurs>
<Description>Starting Testing</Description>
<Where>
<Time>
<Hour>17</Hour>
<Minutes>50</Minutes>
<Seconds>30</Seconds>
<Day>09</Day>
<Month>1</Month>
<Year>2005</Year>
</Time>
<Location>VP1</Location>
</Where>
<ActivityAsRealized>
<Description>Testing</Description>
<Material>
<Description>Main White California 90 PE 2000 CIR</Description>
<Id>
<ObjectID>PE.CAL90200021</ObjectID>
<URI>www.vetroresinapadana.com</URI>
</Id>
<QAObjectTestSpecification>
<Weight>OK</Weight>
<leak_check>NO Leaks</leak_check>
</QAObjectTestSpecification>
</Material>
<Personnel>
<Description>Operator</Description>
<Id>
<ObjectID>451</ObjectID>
<URI>www.vetroresinapadana.com/personnel</URI>
</Id>
</Personnel>
</ActivityAsRealized>
</EventAsOccurs>
<!
***** EVENT *****
>
<EventAsOccurs>
<Description>Starting Finishing</Description>
<Where>
<Time>
<Hour>11</Hour>
<Minutes>25</Minutes>
<Seconds>00</Seconds>
<Day>09</Day>
<Month>1</Month>
<Year>2005</Year>
</Time>
<Location>VP1</Location>
</Where>
<ActivityAsRealized>
<Description>Finishing</Description>
<Equipment>
<Description>Finishing Cutter</Description>
<Id>
<ObjectID>FC345511</ObjectID>
<URI>www.ToolsSupplier.it</URI>
</Id>
</Equipment>
<Personnel>
<Description>Operator</Description>
<Id>
<ObjectID>456</ObjectID>
<URI>www.vetroresinapadana.com/personnel</URI>

```

```

</Id>
</Personnel>
</ActivityAsRealized>
</EventAsOccurs>
</ProductProduction>
</ObjectInformation>
<ObjectInformation>
<Id>
<ObjectID>PE.CAL90MANI21</ObjectID>
<URI>www.vetroresinapadana.com</URI>
</Id>
<Description>Hand Washing White Tank for California 90 PE 2000</Description>
<ObjectLot>78</ObjectLot>
<ObjectClass>Hand Washing Tank</ObjectClass>
<QAObjectTestSpecification>
<Weight>OK</Weight>
<leak_check>NO Leaks</leak_check>
  </QAObjectTestSpecification>
<Where>
<Time>
<Hour>16</Hour>
<Minutes>16</Minutes>
<Seconds>53</Seconds>
<Day>09</Day>
<Month>1</Month>
<Year>2005</Year>
  </Time>
<Location>VP1</Location>
</Where>
<!
***** LIFECYCLE PHASES *****
>
</ProductProduction>
<!
***** EVENT *****
>
<EventAsOccurs>
<Description>Starting Mould Setup</Description>
<Where>
<Time>
<Hour>16</Hour>
<Minutes>03</Minutes>
<Seconds>12</Seconds>
<Day>09</Day>
<Month>1</Month>
<Year>2005</Year>
  </Time>
<Location>VP1</Location>
</Where>
<ActivityAsRealized>
<Description>Mould Setup</Description>
<Equipment>
<Description>Moulding Machine 3000</Description>
<Id>
<ObjectID>MM1</ObjectID>
<URI>www.MouldingMachineSupplier.it</URI>
</Id>
<EquipmentClass>Moulding Machines</EquipmentClass>
<EquipmentProperties>
<Spherical_Diameter_Available>3000</Spherical_Diameter_Available>
  </EquipmentProperties>
</Equipment>
<Equipment>
<Description>Mould for California 90 PE 2000 MANI</Description>
<Id>
<ObjectID>MouldCalPE2000MANI1</ObjectID>
<URI>www.MouldSupplier.it</URI>
</Id>
<EquipmentClass>Aluminium Moulds</EquipmentClass>
<EquipmentProperties>
<Number_of_Moulding_Cycles>45</Number_of_Moulding_Cycles>

```

```

<Spheric_Diameter_Requested>1000 mm</Spheric_Diameter_Requested>
  </EquipmentProperties>
</Equipment>
<Personnel>
<Description>Operator</Description>
<Id>
<ObjectID>456</ObjectID>
<URI>www.vetroresinapadana.com/personnel</URI>
  </Id>
</Personnel>
<Material>
<Description>White Granular PE</Description>
<Id>
<ObjectID>PE00345</ObjectID>
<URI>www.PESupplier.com</URI>
  </Id>
  <MaterialClass>Granular Polyethylene</MaterialClass>
<MaterialProperties>
<Color>White</Color>
<Density>***</Density>
<Quantity>12 Kg</Quantity>
  </MaterialProperties>
<MaterialLot>
<Id>
<ObjectID>PELOT074</ObjectID>
<URI>www.PESupplier.com</URI>
  </Id>
  <Description>White Granular Polyethylene LOT</Description>
  <Quantity>250000 Kg</Quantity>
<MaterialLotProperties>
<Date_of_purchase>
<Hour>09</Hour>
<Minutes>11</Minutes>
<Seconds>33</Seconds>
<Day>19</Day>
<Month>4</Month>
<Year>2003</Year>
  </Date_of_purchase>
  </MaterialLotProperties>
</MaterialLot>
</Material>
</ActivityAsRealized>
</EventAsOccurs>
<!
***** EVENT *****
>
<EventAsOccurs>
<Description>Starting Moulding</Description>
<Where>
<Time>
<Hour>16</Hour>
<Minutes>43</Minutes>
<Seconds>00</Seconds>
<Day>09</Day>
<Month>1</Month>
<Year>2005</Year>
  </Time>
<Location>VP1</Location>
  </Where>
<ActivityAsRealized>
<Description>Hand Washing Tank Moulding</Description>
<Equipment>
<Description>Moulding Machine 3000</Description>
<Id>
<ObjectID>MM1</ObjectID>
<URI>www.MouldingMachineSupplier.it</URI>
  </Id>
  <EquipmentClass>Moulding Machines</EquipmentClass>
<EquipmentProperties>
<Spherical_Diameter_Available>3000</Spherical_Diameter_Available>
  </EquipmentProperties>
</Equipment>

```

```

<Equipment>
  <Description>Mould for California 90 MANI</Description>
  <Id>
    <ObjectID>MouldCalPE2000CIR1</ObjectID>
    <URI>www.MouldSupplier.it</URI>
  </Id>
  <EquipmentClass>Aluminium Moulds</EquipmentClass>
  <EquipmentProperties>
    <Number_of_Moulding_Cycles>46</Number_of_Moulding_Cycles>
    <Spheric_Diameter_Requested>1500 mm</Spheric_Diameter_Requested>
  </EquipmentProperties>
</Equipment>
<Material>
  <Description>White Granular PE</Description>
  <Id>
    <ObjectID>PE00345</ObjectID>
    <URI>www.PESupplier.com</URI>
  </Id>
  <MaterialClass>Granular Polyethylene</MaterialClass>
  <MaterialProperties>
    <Color>White</Color>
    <Density>***</Density>
    <Quantity>12 Kg</Quantity>
  </MaterialProperties>
  <MaterialLot>
    <Id>
      <ObjectID>PELOT074</ObjectID>
      <URI>www.PESupplier.com</URI>
    </Id>
    <Description>White Granular Polyethylene LOT</Description>
    <Quantity>250000 Kg</Quantity>
    <MaterialLotProperties>
      <Date_of_purchase>
        <Hour>09</Hour>
        <Minutes>11</Minutes>
        <Seconds>33</Seconds>
        <Day>19</Day>
        <Month>4</Month>
        <Year>2003</Year>
      </Date_of_purchase>
    </MaterialLotProperties>
  </MaterialLot>
</Material>
</ActivityAsRealized>
</EventAsOccurs>
<!
***** EVENT *****
>
<EventAsOccurs>
  <Description>Starting Testing</Description>
  <Where>
    <Time>
      <Hour>17</Hour>
      <Minutes>50</Minutes>
      <Seconds>30</Seconds>
      <Day>09</Day>
      <Month>1</Month>
      <Year>2005</Year>
    </Time>
    <Location>VP1</Location>
  </Where>
</ActivityAsRealized>
  <Description>Testing</Description>
  <Material>
    <Description>Main White California 90 PE 2000 MANI</Description>
    <Id>
      <ObjectID>PE.CAL90200021</ObjectID>
      <URI>www.vetroresinapadana.com</URI>
    </Id>
    <QAObjectTestSpecification>
      <Weight>OK</Weight>
      <leak_check>NO Leaks</leak_check>

```



```

</QAObjectTestSpecification>
</Material>
<Personnel>
<Description>Operator</Description>
<Id>
<ObjectID>451</ObjectID>
<URI>www.vetroresinapadana.com/personnel</URI>
</Id>
</Personnel>
</ActivityAsRealized>
</EventAsOccurs>
<!
***** EVENT *****
>
<EventAsOccurs>
<Description>Starting Finishing</Description>
<Where>
<Time>
<Hour>11</Hour>
<Minutes>25</Minutes>
<Seconds>00</Seconds>
<Day>09</Day>
<Month>1</Month>
<Year>2005</Year>
</Time>
<Location>VP1</Location>
</Where>
<ActivityAsRealized>
<Description>Finishing</Description>
<Equipment>
<Description>Finishing Cutter</Description>
<Id>
<ObjectID>FC345511</ObjectID>
<URI>www.ToolsSupplier.it</URI>
</Id>
</Equipment>
<Personnel>
<Description>Operator</Description>
<Id>
<ObjectID>456</ObjectID>
<URI>www.vetroresinapadana.com/personnel</URI>
</Id>
</Personnel>
</ActivityAsRealized>
</EventAsOccurs>
</ProductProduction>
</ObjectInformation>
</ObjectInformation>

```

Figure 9.29 – XML file for application on California PE

Minimal Data Set

The XML representation of California 90 PE 2000 product production is rather complete and contains a lot of details about sub-components. Despite this fact, the XML file weights only less than 26 Kbytes, so it can easily be recorded on a chip to bind on the physical product. This is the case of a product whose retail price is more than tens of times that of the chip (for example an RFID Tag). We can suppose that, even if a chip increases the production cost of this product, its related benefits balances

this investment. Anyway, the minimum set of information, which, we remember, is represented by the product ID, can easily be encoded in a simple and low cost barcode (linear or 2D). In this latter case the XML file looks as follows:

```
<ObjectInformation>
  <Id>
    <ObjectID>PE.CAL902000-21-completed</ObjectID>
    <URI>www.vetroresinapadana.com</URI>
  </Id>
</ObjectInformation>
```

Figure 9.30 – XML minimal data set

Summing up, the abstract model provides architecture to generate a product model using standardized information and constructs. Such model can be represented by means of different languages and we choose the XML. An XML file can be recorded on a physical support using available and cost effective technologies, for example barcode or electronic memory tag.

9.3.3 Application 2 – Delivering California PE

This example shows an example related to product use lifecycle phase. The product (polyethylene tank) is delivered to the correct customers who made the order, located in Friburg (Germany).

The EPC model (9.31) represents events (as planned and as occur) and activities (as planned or as realized). Product delivery starts with product loading on a truck and goes on with transport and arrival to the final destination.

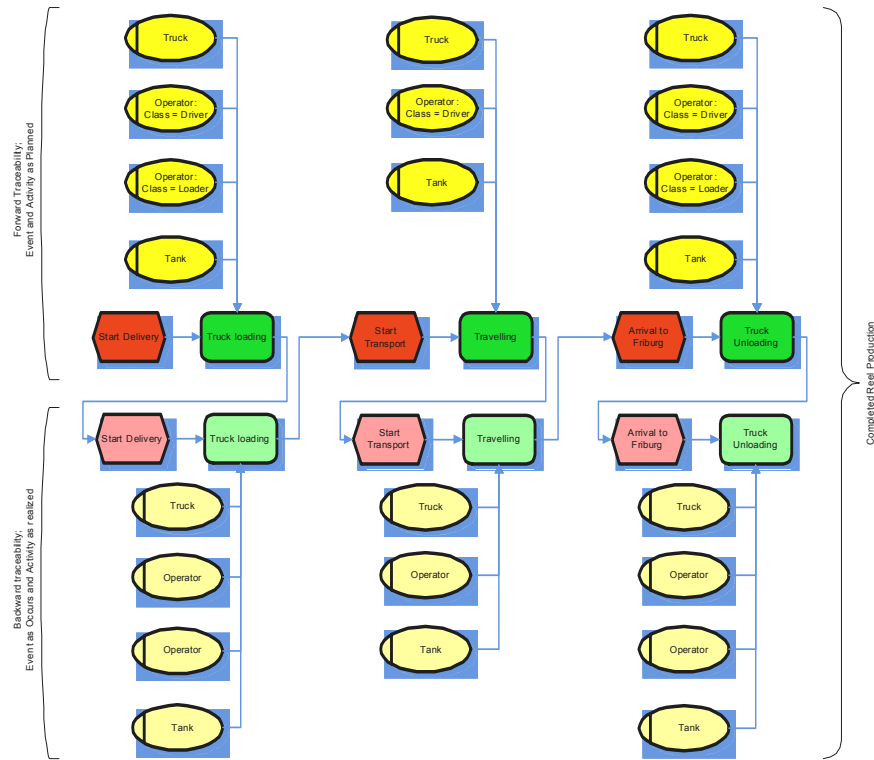

Figure 9.31 - EPC model for product delivery

The following XML code represents the product delivery, referring only to events and activities as planned (forward traceability).

```

<?xml version="1.0" encoding="iso88591" ?>
ObjectInformation>
  id>
  :ObjectID>PE.CAL90200021completed</ObjectID>
  :URI>www.vetroresinapadana.com</URI>
  </id>
  :Description>Completed White California 90 PE 2000</Description>
  :ObjectLot>78</ObjectLot>
  :ObjectClass>California 90 PE</ObjectClass>
  Where>
  Time>
  :Hour>16</Hour>
  :Minutes>14</Minutes>
  :Seconds>56</Seconds>
  :Day>15</Day>
  :Month>16</Month>
  :Year>2005</Year>
  </Time>
  :Location>VP1</Location>
  </Where>
  <!
  ***** LIFECYCLE PHASES *****
  >
  ProductUse>
  <!
  ***** EVENT *****
  >
  EventAsPlanned>
  :Description>Start Delivery</Description>
  Where>
  Time>

```

```

:Hour>16</Hour>
:Minutes>14</Minutes>
:Seconds>56</Seconds>
:Day>15</Day>
:Month>16</Month>
:Year>2005</Year>
</Time>
:Location>VP1</Location>
</Where>
ActivityAsPlanned>
:Description>Truck Loading</Description>
Personnel>
:Description>Operator</Description>
:PersonnelClass>Loader</PersonnelClass>
</Personnel>
Personnel>
:Description>Operator</Description>
:PersonnelClass>Driver</PersonnelClass>
</Personnel>
Material>
:Description>Completed White California 90 PE 2000</Description>
:Id>
:ObjectID>PE.CAL90200021completed</ObjectID>
:URI>www.vetroresinapadana.com</URI>
</Id>
</Material>
Equipment>
:Description>Truck</Description>
:EquipmentClass>Trucks 35q</EquipmentClass>
</Equipment>
</ActivityAsPlanned>
</EventAsPlanned>
<!
***** EVENT *****
>
EventAsPlanned>
:Description>Start Transport</Description>
Where>
Time>
:Hour>16</Hour>
:Minutes>00</Minutes>
:Seconds>00</Seconds>
:Day>16</Day>
:Month>1</Month>
:Year>2005</Year>
</Time>
:Location>VP1</Location>
</Where>
ActivityAsPlanned>
:Description>Transporting</Description>
Personnel>
:Description>Operator</Description>
:PersonnelClass>Driver</PersonnelClass>
</Personnel>
Material>
:Description>Completed White California 90 PE 2000</Description>
:Id>
:ObjectID>PE.CAL90200021completed</ObjectID>
:URI>www.vetroresinapadana.com</URI>
</Id>
</Material>
Equipment>
:Description>Truck</Description>
:EquipmentClass>Trucks 35q</EquipmentClass>
</Equipment>
</ActivityAsPlanned>
</EventAsPlanned>
<!
***** EVENT *****
>
EventAsPlanned>
:Description>Arrival To Friburg</Description>

```

```

Where>
Time>
Hour>10</Hour>
Minutes>00</Minutes>
Seconds>00</Seconds>
Day>17</Day>
Month>1</Month>
Year>2005</Year>
</Time>
Location>WH Friburg</Location>
</Where>
ActivityAsPlanned>
Description>Truck Unloading</Description>
Personnel>
Description>Operator</Description>
PersonnelClass>Driver</PersonnelClass>
</Personnel>
Personnel>
Description>Operator</Description>
PersonnelClass>Loader</PersonnelClass>
</Personnel>
Material>
Description>Completed White California 90 PE 2000</Description>
Id>
ObjectID>PE.CAL90200021completed</ObjectID>
URI>www.vetroresinapadana.com</URI>
</Id>
</Material>
Equipment>
Description>Truck</Description>
EquipmentClass>Trucks 35q</EquipmentClass>
</Equipment>
</ActivityAsPlanned>
</EventAsPlanned>
</ProductUse>
</ObjectInformation>

```

Figure 9.32 – XML file for product delivery

9.4 Conclusions

The chapter proposed two industrial test cases to show some examples (four applications) of how the previously explained model works. One industrial case is about a Textile manufacturing; the other concerns a fiberglass and polyethylene tanks factory.

The application to industrial test cases demonstrated how the proposed model could work, based on realistic test cases. Obviously, the present work is only interested in the implementation level, where solutions for implementing such kind of vision might be considered. Conclusions like that will be debated in the next final chapter of the thesis.

9.5 References of the chapter

Technical references

[1] Simple ++ 5.0 User guide, Tecnomatix, (1998), www.tecnomatix.com

CHAPTER 10

Conclusions

10.1 Introduction

The final chapter of thesis elaborates the main conclusions of the work realized during the PhD period, in Italy and in France.

It is impossible to avoid noting that the thesis is composed in a two-dimension way, as defined since the introduction. This difference derives directly from the co-tutorship management of the thesis, where two leading institutes were in contact and complementary. However, the main results of the thesis did not create a dichotomy arena, but, on the contrary, revealed two interesting points of view on the same problem of the management of the product data along the “product lifecycle”.

The first part of the thesis analyses and classifies the new emerging “paradigm” of PLM, while the second part, starting from the obtained definitions, proposes an innovative way-of-thinking which could become killer application for the management of the product data in the whole product lifecycle, not only in the product development phase.

The PhD candidate has the opportunity to share his knowledge in the context of two leading Network of Excellence: IMS NoE and INTEROP-NoE. Honestly, the most part of this work derives from these communities.

Within this last chapter, limits and open issues of the two research areas are described, considering that the research is always alive.

10.2 Conclusions on the first part of the thesis

As mentioned and debated in the first part of the thesis, PLM acronym is becoming more and more important in the market, assuming a lot of means for vendors and users.

Effectively, PLM is becoming something new, since it takes into account several levels and layers, from collaborative business models (such as concurrent engineering methodology defined in the 80ies), to ICT resources more and more sophisticated, to the management of each single product.

Chapter 4 has already debated in detail the diverse “PLM layers”, revealing lots of efforts spent in the diverse area. What is important in the conclusions of the chapter could be synthesized in the next points, which are the gap of the research:

- PLM might be considered not as a piece of technology, but more like a strategic approach/paradigm/model to be defined and decided at first at the top level of the enterprise,
- A relevant model to analyze PLM is the Product Lifecycle itself, at least, e.g., to put into context the different visions of PLM, but at the present a well-accepted definition of such a kind of model is still missing.
- For the next manufacturing, it seems an important need to make “and manage” products as individuals as much as possible (track and trace them, the user adoption and needs and so on) to improve the customer satisfaction, thus passing from a Customer Relationship Management to a Customer Management and Management of Products when used.

Then, it is possible to identify a kind of research agenda for the next future:

- PLM is a complex approach, where Business Process Analysis and ICT systems are strictly linked. A definition of which kinds of Processes are really part of PLM is a key success point for the diffusion of the PLM itself. Hence, according to common efforts like SCOR initiative in

the SCM field, the development of a “PLM Reference Model” is one of the most interesting research effort to be spent in the next years by the scientific community, in order to help enterprises (in particular SMEs) in the adoption of a realistic PLM approach. In particular, this PLM Reference Framework might define the map of Business Processes and IT systems related, trying to make a clear association between ICT systems provided by vendors and industrial needs.

- The adoption of the PLM paradigm depends by some relevant variables (dimensions) of the enterprise, like product design complexity, product life cycle phases, but a clear definition of these relationships is still looked in the scientific community.
- All the research efforts to be spent in the area of PLM might always consider the “cost impact”, which were not analyzed in the present thesis. Enterprises (in particular SME) are interested in a short Return-On-Investment (ROI) for their projects and in a way for measuring it. Then an interesting aspect to be analyzed in the future is the cost and performance measurement for PLM projects, which at the present is defined only by consulting companies.
- Interoperation and interoperability is a relevant topic of PLM and it might be investigated in terms of standards and reference models already existing, as chapter 6 revealed. By the way, standardization is always a long trip...

In such kind of context, the main strategic challenges for the research community will be:

- to deliver methodologies and technologies supporting the cooperative work of people/enterprises during specific product lifecycle phases, that, besides their own know-how on product, may require integration of additional knowledge and information, related to other product life cycle phases, and produced/ managed by other people/enterprises;
- to achieve integration, not only in the case of big companies (in general, they do not control the whole product life cycle by themselves,

as it will be even more in the future!), but in the networked enterprise made up of a medium-big company and many SMEs, whose collaboration along the product life cycle may gather the “best of the breed” of available competencies and flexibility for properly answering to demand complexity.

Then, in order to achieve these main strategic objectives in the context of PLM, an improved “product-oriented interoperability” both at the business process as well as at the ICT application level are the main enabling leverages to be developed in the future. In particular, the research community is asked to contribute in the following main areas of interest, sharing its knowledge:

- Development of a common reference model of PLM, which is required in order to enable the enterprise management a more engineered and structured approach for the strategic evaluation of scenarios of commitments into PLM projects.
- Development of ICT infrastructures for an integrated PLM environment, where is possible to enable a full participation of SMEs in flexible and low costing platforms. Technologies for enabling collaboration are: web services, intelligent collaboration systems (multi-national, multi-cultural, multi-organization, multi-market, multi time-zone, multi disciplinary), mobile & wireless technologies.
- Interoperability at the application level and the related standardization effort, which is already at a preliminary stage, taking into account not only the syntax but also the semantics of the exchanged models.
- Empowerment of education and training: methods and tools that would enable workers to assimilate knowledge might be defined and disseminated, also using learning technologies supported by ICT for interactive, multimedia, distance learning.

10.3 Conclusions on the second part of the thesis

Latest business trends characterizing the competitive global scaled scenario show an ever-growing importance of reducing production and logistical inefficiencies along the whole product lifecycle. It is noticeable that, for any enterprise operating within this market, concerning only on product development and production is not enough. Products and processes complexity, the need for assuring production quality standards compliance and for managing suppliers and customers relationships require any possible improvement during each phase of product life, starting from its development till the dismissing and recycling.

Product traceability is an answer for overcoming these challenges by providing an effective system for managing all aspects related with product lifecycle, keeping track of a set of information and data about product development, production, use and dismiss. Reference product traceability metamodel should provide basic concepts and guidelines for implementing effective and reliable traceability system and for their further development.

10.3.1 *Limits and advantages of the proposed model*

The need for implementing product lifecycle solutions is really spreading among enterprises operating within different business contexts. Many vendors provide software application for the PLM. But the need for product lifecycle traceability is something more: only a literature review on this topic can point out what people and organizations really require for tracing products.

As seen, product traceability (like PLM) is a business context independent matter, it is required by subjects operating in different industrial contexts (scenarios); for food as well as for healthcare and manufacturing enterprises, for software warehouse, for complex projects management, for military industry, for products delivery, etc. It's possible to find out which features and performances a product traceability model should fit to be useful for general-purpose traceability systems. The called User requirements and Main requirements represent these features as

they are requested and described in literature and they show how people or organization depict these requirements as specifically sized for a particular context of application.

The purpose for developing a reference model for traceability was that of achieving a high degree of flexibility and generality, in order to produce a useful model for any industrial context concerning with product traceability. A model focused only on a specific field of appliance could be perfectly suitable for that scenario but useless when requirements change. This is the reason for abstracting a set of requirements from those found in literature, specifying higher-level guidelines to shape the model on.

For designing a product traceability system it was necessary to take into account, keeping them together, two different aspects: from one side guidelines, required features and performances; on the other side, all useful elements which could serve to substantiate the model, as a real answer to such requirements. All these elements can be grouped into four main research areas: Product Lifecycle models, Product Traceability technologies, Holonic Manufacturing Systems (HMS) and standards for product and process data representation.

Each of previously highlighted research area provides basic concepts, structures and knowledge that have been gathered in our model. This merging permits to fulfill the requirements.

For example, the need for linking each instance of a product with its own lifecycle information can be satisfied using the Holon concept, taken from HMS. The analysis of traceability technologies, on the other side, suggests decoupling the model structure from its physical implementation, for overcoming problems related with traceability systems cost. More in detail, the model complies with the general requirements found by a literature overview and relates with today enterprise business context as follows:

- **Product Descriptive Power:** the proposed model allows a high degree of descriptive power thanks to its ObjectInformation based modular structure. This way it is possible to describe simple and low cost products as well as high value complex products, made of several

different sub-parts. Furthermore, as this product traceability model is rather independent from available traceability technologies, it can be better fitted to different products choosing the best and most effective system for each kind of product. Nowadays, for example, simple barcode-based traceability systems allow easy and quick tracing of low cost products, where more expensive system (as RFID tags) should be available in the next future. On the other side, high performances traceability systems could be used for high value products. It's a matter of fact that reasons for product traceability go side by side with the analysis of traceability cost and benefits. The challenge is to provide for a product traceability model whose implementation should be rather independent from product complexity, so that users can adopt this model for tracing ships as well as airplanes or drugs, food, beverage and so on.

- **Multi-Scenario Descriptive Power:** the model is designed for tracing product lifecycle independently from their industrial sector or business scenario. Once again, the ObjectInformation is suitable for any kind of product but, at the same time, provides a detailed description of product features by instantiating ObjectInformation related classes of information, such as ObjectClass, ObjectLot, Description and so on. This way, the model is flexibly adaptable for tracing products typical of food or agricultural industry, healthcare, projects managements, software house, etc.
- **Product Lifecycle scalability:** as already explained, Life Cycle Phase is a general class specialized into Product Development, Product Production, Product Use and Product Dismiss. It is always possible to focus only on one of these lifecycle phases as well as on all together. Each lifecycle phase, moreover, is described with a degree of detail independently from the others, because each of them keeps track of events, activities and resources related on with that particular phase and whose representation detail is proportional to the importance of the same phase. Lifecycle scalability is required because different

enterprises face the need of tracing product lifecycle focusing, for example, mainly on the development and production phases. Others are more interested in product recycling whether their business focuses on product support and maintenance.

- **Product Detail scalability:** it is achieved by using the concepts of lifecycle scalability and of aggregation. It means that a product lifecycle is scalable into more product lifecycles, each of one representing product sub-components. As a product can be made of several sub-components and each sub-component of other sub-components, an ObjectInformation can represent an aggregation of different ObjectInformation classes, one for each product sub-component.
- **Updatable:** product traceability during its lifecycle is formalized as an ever-changing set of structured information, which follows product evolution during its whole life. The model is built around the concept of Lifecycle Phase, which is a class of information specialized into the four standardized phases of product development, production, use and dismiss. A general lifecycle phase is described by listing all events, which occur to the product (both as EventAsOccurs whether EventAsPlanned). Each event is related with an activity performed onto/by the product and the model take care of representing already realized activity (for backward traceability) and planned activity (for forward traceability). Following a product lifecycle means, in these terms, keeping track of events, activities and used or required resources. For what concerns the physical and technical implementation of the model, it's obvious that an updatable database system is required. It's possible to overcome this problem by decoupling a minimal set of non-changeable information (usually the identification code ID) to store even on a non-updatable device, such as a barcode, from the dynamic product lifecycle description, to store for example on a remote database. Univocal link between these two different storage systems is provided, within the model, by the URI class.

- Unambiguously understandable: this requirement is satisfied by standardizing classes of information used within the model and to use for product traceability.
- Being distributable: product lifecycle information should be stored on different storage systems and physical supports. This is a key-feature for the proposed model, because it allows its physical implementation by means of available technologies, giving product traceability users the chance to choose best solution in relation with requested performance and implementation costs. Developments of next-generation traceability technologies and improvements of electronic tags based systems will only promote the adoption of this product traceability model.
- Shareable: product lifecycle information and data are shared among manufacturing enterprises, suppliers, customers, distributors and so on. Once again, the development of traceability related technologies and, specially, of internet-based data storage systems, distributed appliances and mobile connectivity will assure a real-time and effective availability of product lifecycle information.

10.3.2 Further developments

The development of a product traceability reference model concerns very different and usually distinct research area. A first remarkable result is that of having proposed a model, which, starting from the problem of product traceability provides reference architecture in terms of lifecycle definition, integration with Intelligent Manufacturing Systems (IMS), integration of product, and process oriented standards, all together with already available traceability technologies.

Another advantage of this lifecycle traceability is that it is really applicable in an easy, effective and reliable way, as shown by model validations provided for two generic kinds of product: one produced within the context of textile industry and the other related with agricultural machines. The result was an XML based representation of these two

product lifecycles, which can be recorded on an already existing enterprise database.

This model was developed into Business Process Analysis (BPA) and Enterprise Architecture (EA) solutions software (Mega Suite, by MEGA International software house) using UML language for its representation. So it is simple to develop and implement on-the-edge applications with an object oriented programming language (as Java, C++, etc).

A first step for the implementation of the model for tracing products used for the validation should be that of applying a low-cost barcode on the products linked, through its standardized code, to an information processing systems (a remote database, for example). A further step could be that of switching from simple barcode-based product traceability to a more effective traceability technologies such as electronic tags. Finally it could be used to its full descriptive power into IMS or HMS, exploiting its “Forward Traceability” feature.

The integration between lifecycle traceability and IMS, and in particular with HMS, emphasizes and suggests the development and adoption of next-generation holonic machines, equipments and tools, capable of sharing and exchanging data and information among them and with products and personnel. By using such machines it will be possible to assure an automated backward as well as forward traceability of all product lifecycle phases improving at the same time production performance and capabilities (as proposed by HMS community). Meanwhile the cooperation between a HMS and the Traceability model has to be improved.

It is also important that the model could fit both for expansive, complex product, exploiting its whole descriptive power and the newest technologies as RF tags, and for cheap products, using a small set of classes that describes only the most important information, stored on a cheap support as a 2D Barcode or even a simple Barcode. This kind of flexibility has been tested and shown in chapter 9, where the model has been used to track cheap reels and more expensive tank.

As a further development it could be useful to investigate the real expenses of the implementation and use of a traceability system, and the real attitude of the manufacturing.

Another aspect which deals with the physical implementation of the model is that of providing a restricted access mechanism to lifecycle information, both for writing or reading data, which should allow only predefined users and groups to have partial or complete access to data storage system. Furthermore, this protection mechanism should be implemented independently from the physical support used for data storage, such as remote database, electronic memory chips (included within RF Tags), etc. This is necessary for protecting sensible or private data which should be recorded for product traceability purpose, but at the same time should be available only to trusted users and unavailable, for example, to competitors. Technologies as digital signature and data cryptography could fit this problem but, even if the model foresees this requirement (it is defined by the AccessRights and the Signature classes), this is still an open issue.

All the technical structures required to implement the model are actually available, but are not commonly employed in the manufacturing because of their cost and complexity. But they will soon become cheaper; at the same time the new European Regulations will thrust improvements in the traceability systems, so in a few year what now is futuristic, will become reality. Meanwhile the research has to advance to show new possibilities and opportunities.

10.4 Conclusions of the conclusions

As usual, it is not so easy to conclude such kind of work. Lot of activities, experiences, meetings and persons are arising at the mind. The author hopes to be clear, even if English is not his primary language. He hopes also to have contributed to research community. Only the time will decide it.

REFERENCES

List of the references

Hereafter all the consulted references are reported. A list of the PLM vendors website is also annexed, with a list of the acronyms more used in the thesis.

Scientific references are publications like scientific books, journals, conferences. Technical references are guidebooks, standards and websites.

Consulted references

Scientific references

- [1] AMICE, CIMOSA - Open System Architecture for CIM, (1993), Springer-Verlag, ISBN 3-540-56256-7, Berlin
- [2] Andersen, B., Rolstadås, A., Fagerhaug, T., (1998), Practical Productivity Measurement, Proceedings at 10th Working Seminar on Production Economics, Innsbruck/Igls, Austria
- [3] Barber K.S., Jernigan S.R., (1999), Changes in the model creation process to ensure traceability and reuse, International conference on Artificial Intelligent, IC-AI99
- [4] Bhandarkar M. P., Downie B., Hardwick M., Nagi R., (2000), Migrating from IGES to STEP: one to one translation of IGES drawing to STEP drafting data, Computers in Industry, 41, 3, pp 261-277
- [5] Biennier F., (2002), Security Integration in Inter-Enterprise Business Process Engineering, Proceedings at the International Conference on Advanced Production Management Systems (APMS), Eindhoven
- [6] Bititci U.S., (2002), Integrated Production Management in the 21st Century: a Vision and a Research Agenda, IFIP WG 5.7 Brussels Workshop

- [7] Bodner D.A., Reveliotis S.A., (1997), Virtual factories: an object-oriented simulation-based framework for real-time FMS control, Emerging Technologies and Factory Automation Proceedings, ETFA
- [8] Bongaerts L., (1998), Concepts for Holonic Manufacturing, Integration of Scheduling and Control in HMS, Ph.D. Thesis, Katholieke Universiteit Leuven
- [9] Brandl D., (2002), Business-To-Manufacturing (B2M) collaboration between business and manufacturing using ISA95, Proceedings of the ISA/SEE conference, Nice, France
- [10] Brennan R.W., Norrie D.H., (2002), From FMS to HMS - Agent Based Manufacturing - Advances In The Holonic Approach, Springer, pp 31-49
- [11] Brezocnik M., Balic J., (2003), Emergence of intelligence in next-generation manufacturing system, Robotics and Computer Integrated Manufacturing, 19, pp 55-63
- [12] Brown J., (1992), Value Engineering, Industrial Press Inc
- [13] Bussler C., (2003), B2B Integration: Concepts and Architecture, Springer
- [14] Bussmann S., McFarlane D., (1999), Rationales for Holonic Manufacturing Control, Second International Workshop on Intelligent Manufacturing Systems
- [15] Caldwell F., (1998), A Generic Model of Hierachy for System Analysis and Simulation, Agricultural System, 57, 2, pp 197-225
- [16] Capmany C., Hooker N.H., Ozuna T., Tilburg A., (2000), ISO 9000 – A marketing tool for U.S. agribusiness, International Food and Agribusiness Management Review, 3, pp 41-53
- [17] Caporale V., Giovannini A., Di Francesco C., Calistri P., (2001), Importance of the traceability of animals and animal products in epidemiology, Rev. Sci. Tech. Off. Int. Epiz., 20, 2, pp 372-378
- [18] Chen D., Stevens R., Schulz K. and Doumeingts G., (2004), European Approach On Interoperability of Enterprise Applications: Thematic Network, Integrated Project and Network Of Excellence, Proceedings at 11th IFAC Symposium on Information Control Problems in Manufacturing, Salvador, Brasil
- [19] Cheng M.L., Simmons J. E. L., (1994), Traceability in manufacturing systems, International Journal of Operations and Production Management, 14, pp 4-16
- [20] Choy K.L, Lee W.B., Lo V., (2003), Design of a case based intelligent supplier relationship management system the integration of

- supplier rating system and product coding system, *Expert Systems with Applications*, 25, pp 87–100
- [21] Christensen F., (2003), HMS/FB Architecture and its Implementation, *Agent-Based Manufacturing: Advances in the Holonic Approach*, Springer-Verlag, pp 53-87
- [22] Cugini U., Wozny M., (2001), From Knowledge Intensive CAD to Knowledge Intensive Engineering, *Proceedings of IFIP WG 5.2. International Workshop on Knowledge Intensive CAD, USA*
- [23] Cutkosky T.G., Tenenbaum M. R., Glicksman J., (1993), SHARE: a methodology and environment for collaborative product development, *Proceedings of the IEEE Infrastructure for Collaborative Enterprise*, pp 33-41, Morgantown
- [24] Deen S. M., (2002), Introduction Agent Based Manufacturing - Advances In The Holonic Approach, Springer, pp 3-10
- [25] Doumeingts G., Vallespir B., Chen D., (1998), Decision modelling GRAI Grid, *Handbook on architecture for Information Systems*, Edit. Bernus P., Mertins K., Schmidt G. , Springer-Verlag
- [26] Finch E.F., Flanagan R., Marsh L.E., (1996), Electronic document management in construction using auto-ID, *Automation in Construction*, 5, pp 313-321
- [27] Filos E., Banahan B., (2001), Towards the smart organization: an emerging organizational paradigm and the contribution of the European RTD programs, *Journal of Intelligent Manufacturing*, 12, pp 101-119
- [28] Fletcher M., Brennan R.W., Norrie D.H., (2003), Modelling and reconfiguring intelligent holonic manufacturing system with Internet-based mobile agents, *Journal of Intelligent Manufacturing*, 14, pp 7-23
- [29] Främling K., Holmström J., (2000), A distributed software for collaborative sales forecasting, *Proceeding at Second Conference on Management and Control of Production and Logistics*, Grenoble, France
- [30] Gouyon D., Simão J. M., Alkassam K., Morel G., (2004), Work in progress for product driven manufacturing automation, *Proceedings of IFAC INCOM Symposium, April 5th-7th, Salvador de Bahia, Brasil*
- [31] Gruver A., Kotak D.B., Van Leeuwen E., Norrie D., (2001), Holonic Manufacturing System – Phase 2, *Proceedings of 18th International Meeting of the Holonic Manufacturing System Consortium*
- [32] Haumer P., Pohl K., Weidenhaupt K., Jarke M., (1999), Improving Reviews by Extended Traceability, *Hawaii International Conference on System Sciences*

- [33] Huang B., Gou H., Liu W., Li Y., Xie M., (2002), A framework for virtual enterprise control with the holonic manufacturing paradigm, *Computers in Industry*, 49, pp 299-310
- [34] *International Journal of PLM*, InderScience Publishers., first volume expected for July 2005
- [35] Jacobs R.M., (1996), Product Recall – A Vendor nightmare, *Microelectron. Reliab.*, 36, 1, pp 101-103
- [36] Jansen-Vullers M.H., van Dorp C.A., Beulens A.J.M., (2003), Managing traceability information in manufacture, *International Journal Of Information Management*, 23, pp 395-413
- [37] Jayaraman V., Patterson R.A., Rolland E., (2003), The design of reverse distribution network: Models and solution procedures, *European journal of operational research*, 6
- [38] Johnson C., (2002), Towards a formalized HMS model, *Agent Based Manufacturing - Advances In The Holonic Approach*, Springer pp 121-144
- [39] Kärkkäinen M., Ala-Risku T., Främpling K., (2003), The Product centric approach: a solution to supply network information management problems?, *Computer in Industry*, 52, pp 147-159
- [40] Kärkkäinen M., Holmström J., Främpling K., Artto K., (2003), Intelligent products – A step towards a more effective project delivery chain, *Computers in Industry*, 50, pp 141-151
- [41] Kaufman J.J., (1990), *Value Engineering for the Practitioner*, North Carolina State University
- [42] Koestler A., (1967), *The Ghost in the Machine*, Arkana Books, London
- [43] Koudate A., (2003), *Il management della progettazione*, ISEDI Nuova ediz. (traduzione a cura di Rosario Manisera e Roberta Giovannuzzi)
- [44] Mannisto T., Peltonen H., Martio A., Sulonen R., (1998), Modelling generic product structures in STEP, *Computer-Aided Design*, 30, 14, pp 1111–1118
- [45] Marik V., Pechoucek M., (2001), Special issue on industrial applications of Holonic and Multi-Agent Systems, *Journal of Applied System Sciences*, 2
- [46] McFarlane D., Bussmann S., (2000), Developments in Holonic Production Planning and Control, *Int. Journal of Production Planning and Control*, 11, 6, pp 522-536
- [47] McFarlane D., Bussmann S., (2002), *Holonic Manufacturing Control: Rationales, Developments and Open Issues*, Agent Based

- Manufacturing - Advances In The Holonic Approach , Springer, pp 302-326
- [48] McFarlane D., Sarma S., Chirn J.L., Wong C.Y., Ashton K., (2002), The intelligent manufacturing control and management, Engineering Applications of Artificial Intelligence, Special issue on Intelligent Manufacturing
- [49] McFarlane D., Sarma S., Chirn J.L., Wong C.Y., Ashton K., (2003), Auto-ID System and Intelligent Manufacturing Control, Engineering Application of Artificial Intelligence, 16, pp 365-376
- [50] Mezgár I., György K., Kovács G.L., Paganelli P., (2000), Co-operative production planning for small and medium sized enterprises, International Journal of Production Economics, 64, pp 37-48
- [51] Moe T., (1998), Perspectives on traceability in food manufacture, Trends in Food Science & Technology, 9, pp 211-214
- [52] Mohan K., Ramesh B., (2002), Managing Variability with Traceability in Product and Service Families, Hawaii International Conference on System Sciences
- [53] Molina A., Chen D., Panetto H., Vernadat F., Whitman I., (2004). Enterprise integration and networking: issues, trends and vision, IFIP international conference on enterprise integration and modeling technology, Toronto, Canada
- [54] Morel G., Panetto H, Zaremba R., Mayer F., (2003), Manufacturing enterprise control and management system engineering rationales and open issues, Annual Reviews in Control, 27/2, pp 199-209
- [55] Morel, G., Grabot, B. (Edit.), (2003), Special issue on IMS. In Engineering applications of artificial intelligence, 16
- [56] Naka Y., Hirao M., Shimizu Y., Muraki M., Kondo Y., (2000), Technological information infrastructure for product lifecycle engineering, Computers and chemical engineering, 24, pp 665-670
- [57] Nielsen P.H., Wenzel H., (2002) Integration of environmental aspects in product development: a stepwise procedure based on quantitative life cycle assessment, Journal of Cleaner Production, 10, pp 247–257
- [58] Ollero A., Morel G., Bernus P., Nof S.Y., Sasiadek J., Boverie S., Erbe H., Goodall R., (2002), Milestone report of the manufacturing and instrumentation coordinating committee: from mems to enterprise system, Annual Reviews in Control, 26, pp 151-162
- [59] Olsen P., (2001), Traceability of fish products, 1st Tracefish Conference, Copenhagen

- [60] Onkvisit S., Shaw J.J., (1998), Product Life Cycles and Product Management, Quorum Books, Greenwood Press, Westport, Connecticut
- [61] Panetto H., Scannapieco M., Zelm M., 2004, INTEROP NoE: Interoperability Research for Networked Enterprises Applications and Software, Proceedings of the International Workshops on the Move to Meaningful Internet Systems 2004, Agia Napa, Cyprus
- [62] Panetto H., Berio G., Benali K., Boudjlida N., Petit M., (2004), A Unified Enterprise Modelling Language For Enhanced Interoperability Of Enterprise Models, Proceedings at 11th IFAC Symposium on Information Control Problems in Manufacturing, Salvador, Brasil
- [63] Pohjola V., Rousu P., (2002), Using holistic product models to describe industrial production, Resources, Conservation and Recycling, 35, pp 31-43
- [64] Porter M., (1985), Competitive Advantage: creating and sustaining superior performance, NY, The Free Press
- [65] Ramesh B., Stubbs C., Powers T., Edwards M., (1997), Requirements traceability: Theory and practice, Annals of software engineering, 3, pp 397-415
- [66] Rutherford S., (2002), Traceability – what do consumer want?, Saskatchewan Pulse Growers
- [67] Saaksvuori A., Anselmi I., Product Lifecycle Management, (2004), Springer, ISBN: 3-540-40373-6
- [68] Simon M., Bee G., Moore P., Pu J., Xie C., (2001), Modelling of the life cycle of products with data acquisition features, Computers in Industry, 15, 4, pp 1-13
- [69] Smith G. C., Belk K.E., Scanga J. A., Sofos J. N., Tatum J. D., (2000), Traceback, Traceability and Source Verification in the U.S. Beef Industry, Proceedings at World Buiatrics Congress
- [70] Soga S., Hiroshigo Y., Dobashi A., Okumura M., Kusuzaki T., (1999), PLM using radio frequency identification technology, Proceedings at 7th IEEE International Conference on Emerging Technologies and Factory Automation, ETFA
- [71] Sohal A., (1997), Computerised Parts Traceability: an Implementation Case Study, Technovation, 17, 10, pp 583-591
- [72] Stark J., (2004), Product Lifecycle Management: Paradigm for 21st century Product Realisation, Springer, ISBN: 1852338105
- [73] Tharumarajah A., (2003), A self-organizing view of manufacturing enterprise, Computers in Industry, 51, pp 185-196

- [74] Terzi S., Cassina J., Panetto H., (2005), Development of a metamodel to foster interoperability along the product lifecycle traceability, Proceedings at International conference on Interoperability of Enterprise Software and Applications IFIP-ACM/SIGAPP INTEROP-ESA, February 23rd-25th, Geneva, Switzerland
- [75] Thomas V., Neckel W., Wagner S., (1999), Information Technology and Product Lifecycle Management, Proceedings of the 1999 IEEE International Symposium of Electronics and the Environment, pp 54-57
- [76] Udoka S.J., Sarin S., Massay L.L., (1995), Applications of automatic identification technologies across the I.E. curriculum, Computers in industries, 29, 4, pp 125-129
- [77] Ulieru M., Walker S., Brennan R., (2001), Holonic Enterprise as a Collaborative Information Ecosystem, Proceedings at Workshop Holons, Autonomous and Cooperative Agents for the Industry, Montreal, Canada
- [78] Van Brussel H., Wyns J., Valckenaers P, Bongaerts L, Peeters J., (1998), Reference architecture for holonic manufacturing system: PROSA, Computers in Industry, 37, pp 255-274
- [79] Verschoor A.H., Reijnders L., (1999), The use of life cycle methods by seven major companies, Journal of Cleaner Production 7, pp 375–382
- [80] Wang H.F., Zhang Y.L, (2002), CAD/CAM integrated system in collaborative development environment, Robotics and Computer Integrated Manufacturing, 18, pp 135-145
- [81] Williams T.J., (1992), The Purdue Enterprise Reference Architecture, A Technical Guide for CIM Planning and Implementation, ISA
- [82] Wortmann J.C., (1983), A classification scheme for master production schedule, Efficiency of manufacturing Systems, Edit. Berg C., French D., Wilson B., Plenum Press
- [83] Wu B., (1995), Object-oriented systems analysis and definition of manufacturing operations, Int. J. Production Research, 33, 4, pp 955-974
- [84] Wyns J., (1999) Reference architecture for holonic manufacturing system, Ph.D. Thesis, Katholieke Universiteit Leuven
- [85] Yin R. K, (1994), Case study research: design and methods, Sage Publications
- [86] Zhang F., Xue D., Wallace D., (1998), Distribution modelling and evaluation of product design problems, Computer Aided Design, 30, 411-423

- [87] Zhang F., Xue D., (2001), Optimal concurrent design based upon distributed product development life-cycle modelling, *Robotics and Computer Integrated Manufacturing*, 17, pp 469-486
- [88] Zisman A., Spanoudakis G., Pérez-Miñana E., Krause P., (2002), Towards a Traceability Approach for Product Families Requirements, 3rd International Workshop on Software Product Lines ICSE

Technical references

- [89] QAD, (2002), A Qad White Paper Unified Product Lifecycle Management, www.qad.com
- [90] Accenture, (2001), Collaborating To Compete: A New Way Forward, www.accenture.com
- [91] AIM Global Network, (2000), Radio Frequency Identification (RFID) summary, www.aimglobal.org
- [92] AMR Research, www.amr-research.com
- [93] ANSI/ISA-95.00.01, (2000), Enterprise-Control System Integration, Part 1: Models and Terminology, ISA
- [94] APICS, (1998), APICS dictionary, The educational society for resource management, Edit. Cox III J. F., Blackstone Jr J. H., USA
- [95] ARC Advisor Group News, (2003), PLM Market to more than double - What is PLM?, www.arcweb.com
- [96] Arnold F., Podehl G., (1998), Best of Both Worlds: A mapping from Express-G to UML, citeseer.nj.nec.com/arnold98best.html
- [97] Auto-ID Labs, (2000), The Object Naming Service (ONS) summary, www.autoid.org
- [98] Auto-ID, (2003), The New Network, www.autoid.org
- [99] Banker R., Bardhan I., Evaluating the impact of collaborative product commerce on the product development lifecycle, (2002), White paper of the Center for Practice and Research in Software Management (PRISM), School of Management, The University of Texas at Dallas
- [100] Betasphere, (2002), Collaborative Product Commerce (CPC) Solutions from Sun, www.betasphere.com
- [101] Bridges project, (2002), Roadmap for digital business, www.bridges-eu.org
- [102] Brock D., Cummins D., (2003), EPC Tag Data Specification, www.autoid.org
- [103] Brock D, (2000), The Electronic Product Code – A Naming Scheme for Physical Objects, www.autoid.org

-
- [104] Brock D., (2001), The Physical Markup Language, www.autoid.org
- [105] Brown J., (2003), SLM - Service Lifecycle Management, www.technologyevaluation.com
- [106] Cambashi, (2003), Is PLM applicable to AEC?, www.cambashi.co.uk
- [107] CIMData, (2001), Collaborative Product Definition management (cPDm): An Overview, www.CIMdata.com
- [108] CIMData, (2002), The benefits of Digital Manufacturing, A CimData white paper, www.CIMdata.com
- [109] CIMdata, (2002) Product lifecycle Management - Empowering the Future of Business, www.CIMdata.com
- [110] Codrino A., (1999), Business Process Reengineering e Business Process Automation: moda o esigenza?, www.plm-systems.com
- [111] Codrino A., (1999), I sistemi per la gestione dei processi, www.plm-systems.com
- [112] Codrino A., (2000), Le tecniche CAD, CAM, CAE e CAPP al servizio della progettazione e della produzione avanzata, www.plm-systems.com
- [113] Codrino A., (2004), Trend del mercato PLM in Italia, Presentato a PDFForum 2004, Milano
- [114] Daratech, www.daratech.com
- [115] Diffuse project, (2002) Product data representation and exchange standards, ww.diffuse.org
- [116] EPC globalinc, www.epcglobalinc.org
- [117] Eurostat, (2001), Market dimensions in Europe, europa.eu.int/comm/dgs/eurostat
- [118] Foster E.F., (2002), Product Identification and Traceability, www.freequality.org
- [119] Garcao A.S., (1995), SIP-STEP-based Integration Platform, BRITE/EURAM CIMTOFI project
- [120] Garetti M., (1997), Plantfaber: an integrated software workbench as a tool for the re-engineering of the Manufacturing System Engineering Process, funded by the European Commission, IV Framework, 1997
- [121] Garner Q., (2002), Product traceability mini-tutorial, www.freequality.org
- [122] Gartner Group, www.gartner.com
- [123] GERAM, (1997), Generalized Enterprise Reference Architecture and Methodology Version 1.5, IFAC-IFIP Task Force on Enterprise Integration

- [124] Gothel C.Z., Finkelstein O., (1994), An Analysis of the requirement traceability problem, www.cs.ucl.ac.uk
- [125] IMS NoE project, www.ims-noe.org
- [126] International Standard Organisation (ISO), (2000), International Standard ISO 9000:2000 Quality Management Systems - Fundamentals and vocabulary.
- [127] ISO, (1997), ISO TC184/SC4/WG8 N 138 R1.0, www.tc184-sc4.org
- [128] ISO, (1997), ISO TC184/SC4/WG8 N 147, www.tc184-sc4.org
- [129] ISO 10303 (STEP), SSID-STEP/SC4 Industrial Data Framework
- [130] ISO 10303 (STEP) task website, stepmod.sourceforge.net
- [131] ISO, (2001), STEP APPLICATION HANDBOOK V.2, www.iso.org
- [132] ISO, (2001), ISO TC 184/SC4 N1113, www.tc184-sc4.org
- [133] Komninos I., (2002), Product life cycle management, www.urenio.org
- [134] Market Press, (2003), Nasce Clinical Repository Service: progetto per la zona ospedaliera del padovano, www.marketpress.info
- [135] Metagroup, www.metagroup.com
- [136] Ministry of Economy, Trade and Industry of Japan, (2003), Study group on the improvement of product traceability, Interim Report, www.meti.go.jp
- [137] NIST control architecture, in ISO 10314, (1990), Reference Model for Shop Floor Production, Geneva, Switzerland
- [138] Oasis/UN/CEFACT, (2002), Creating a single electronic market: ebXML Business Process Specification Schema, Version 1.01
- [139] Pinto R., Rocchia M., Macchi M., Garetti M., Cavalieri S., (2002), Introduction to formal modelling methods, Vimims project, www.vimims.org
- [140] PLCS, www.plcs.org
- [141] PLM evaluation, www.plmevaluation.com
- [142] PLM IG, www.plm-ig.com (www.johnstark.com)
- [143] PLM XML, www.ugsplm.com
- [144] PRTN, www.prtm.com/plm-solutions.htm
- [145] Rabe M., (1999), Mission Project: Modelling and Simulation Environments for Design, Planning and Operation of Globally Distributed Enterprises, www.ims-mission.de
- [146] Reedy K., (2000), Collaborative Product Commerce (CPC): How it Helps Improve a Company's Performance, Accenture press
- [147] Rosettanet, www.rosettanet.org

- [148] Sibbel R.L., (2003), Identification and traceability in swine: a business opportunities or a cost of business?, American association of swine veterinarians
- [149] Simple++ 5.0 User guide, Tecnomatix, (1998), www.tecnomatix.com
- [150] Smithers R., (1999), Linking the IOS/QS Quality System, www.smithersregistrar.com
- [151] Stone W., Lyte A., Furlani K., (2002), NIST White Paper On Smart Chips in Construction, www.fiatech.org
- [152] Strowbridge A., (1999), Implications of e-business for product lifecycle management, intl.ieeexplore.ieee.org
- [153] Suikka A., (2004), IFC data exchange in concrete construction, Confederation of Finnish construction industries, www.iai-international.org
- [154] SUN, (2001), Collaborative Product Commerce (CPC) Solutions from Sun, Sun Whitepaper, www.sun.com
- [155] Technology Evaluation, www.technologyevaluation.com
- [156] Texas instrument, www.texasinstrument.com
- [157] UEML project, www.ueml.org
- [158] UML, (2004), UML Manual, www.uml.org
- [159] VCOR Group, (2004), Value Chain Operation Reference Model Overview 0.0, www.value-chain.org
- [160] Van Moll J.H., (2002), The importance of Life Cycle Modelling to the development and testing of complex products, Philips semiconductors, TestNet Najaarsevenement 2002, Nieuwegein
- [161] Verspille K., (2003), PLM Interoperability: Can XML Circuitry Be the TCP/IP of PLM?, www.coe.org
- [162] w3schools, (2004), Xml Manual, www.w3schools.com
- [163] Wilson G., (2003,) Product Life-Cycle Management in the Manufacturing Industry: End-User Survey Shows Solid Market Opportunities for Application Software Providers, IDC press
- [164] XML, World Batch Forum, www.w3b.org

PLM Vendors websites

- [1] Agile, www.agile.com
- [2] Autodesk, www.autodesk.com
- [3] Baan, IBaan - Positioning white paper, www.baan.com
- [4] Formula Group, www.gformula.com
- [5] IBM, www.ibm.com

- [6] Impactsoft, www.impactsoft.com
- [7] Linius Technologies, www.linius.com
- [8] Lotus Notes, www.lotus.com
- [9] MatrixOne, www.matrixone.com
- [10] Microsoft, www.microsoft.com
- [11] Oracle, www.oracle.com
- [12] PTC, www.ptc.com
- [13] Rulestream, www.rulestream.com
- [14] SAP, www.sap.com
- [15] SUN, www.sun.com
- [16] Softech, www.softech.com
- [17] Tecnomatix, www.tecnomatix.com
- [18] Think3, www.think3.com
- [19] TrueInnovations, www.trueinnovations.com
- [20] TXT E-Solution, www.txt.com
- [21] UGS-PLM Solutions, www.ugsplm.com
- [22] Zucchetti, www.zucchetti.it

List of the acronyms

- APS: Advanced Planning System
- BPR: Business Process Re-Engineering
- BTB: Business To Business
- BTC: Business To Consumer
- B2M: Business To Manufacturing
- CAD: Computer Aided Design
- CAM: Computer Aided Manufacturing
- CAPE: Computer Aided Product Engineering
- CAPP: Computer Aided Production Planning
- CAx: Computer Aided (x activity)
- CIM: Computer Integrated Manufacturing
- CIME: Computer Integrated Manufacturing and Engineering
- CPD: Collaborative Product Development
- CRM: Customer Relationship Management
- CRP: Capacity Requirement Planning
- DMU: Digital Mock-Up
- DES: Discrete Event Simulation
- DWS: Data Warehouse Systems
- ERP: Enterprise Resource Management
- EE: Enterprise Engineering system
- EM: Enterprise Management system

- ICT: Information and Communication Technology
- IFAC: International Federation in Automation and Control
- IFIP: International Federation of Information process
- IT: Information Technology
- IMS: Intelligent Manufacturing Systems
- MES: Manufacturing Execution System
- MRP: Material Requirement Planning
- MSE: Manufacturing System Engineering
- NPI: New Product Introduction
- NPD: New Product Development
- HMS: Holonic Manufacturing Systems
- HTML: Hyper text markup Language
- PD: Product Development
- PDM: Product Data Management
- PIM: Product Information Management
- PLM: Product Lifecycle Management
- PP&C: Production Planning and Control
- SCM: Supply Chain Management
- UML: Unified Modelling Language
- WMS: Workflow Management System
- XML: eXtensible Mark-up Language

ANNEXES

Annexes of the thesis

ANNEX I

Product Lifecycle Management model

Hereafter, it is reported a tentative definition of a product lifecycle management reference model. This model is not considered as exhaustive, since lots of levels are missing. The main contributions of this reference model derive from an Italian master thesis.

In the scientific community, lots of researchers are currently working on such topics, but a well accepted definition is still avoided.

This annex aims to contribute to these efforts, even if it is not the main innovative contribution of the thesis, which has been identified in the second part of the thesis.

The reference model is developed using the well-known IDEF 0 quotation.

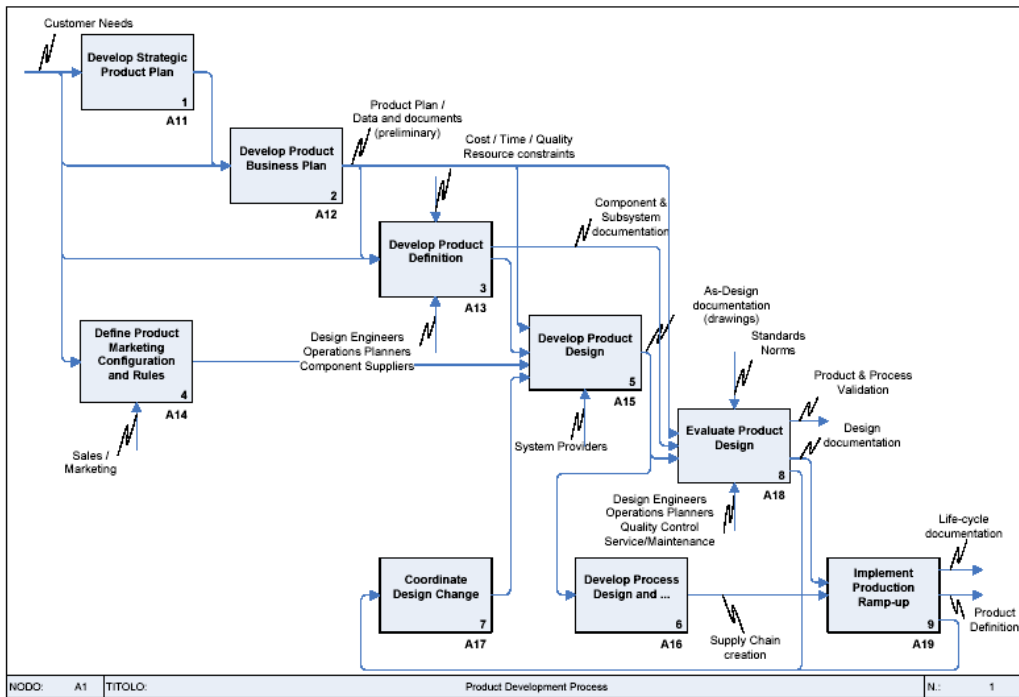
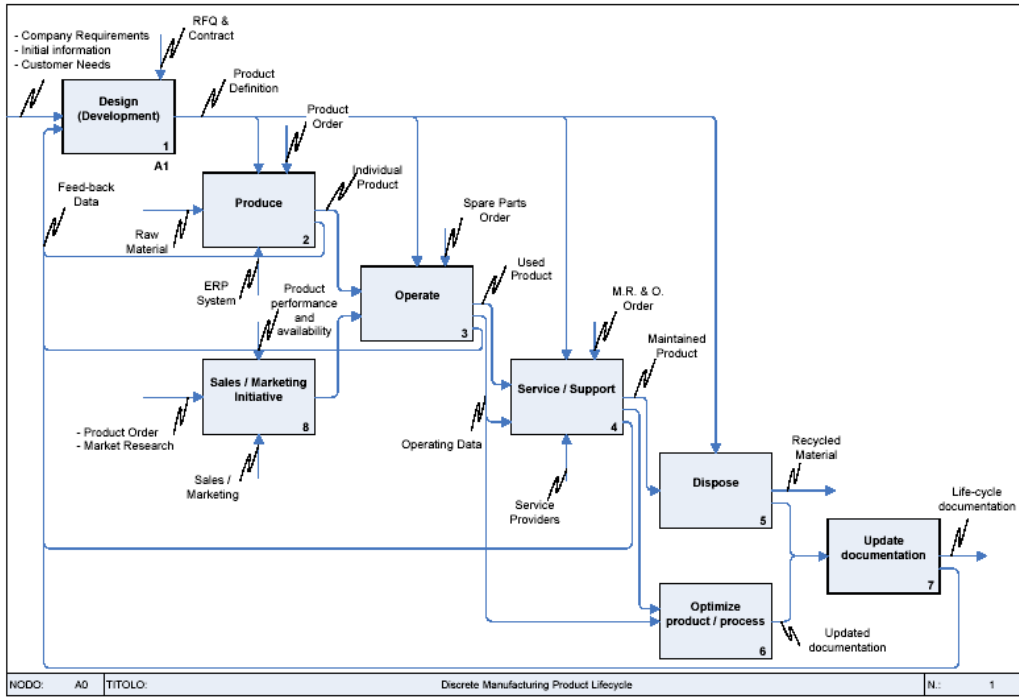

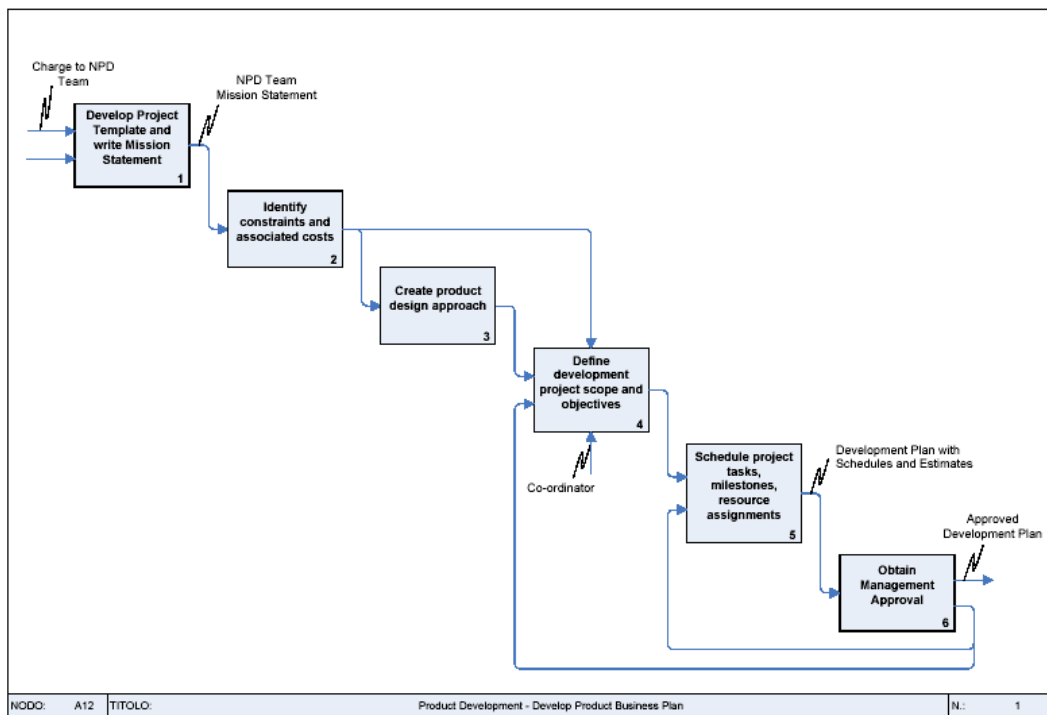
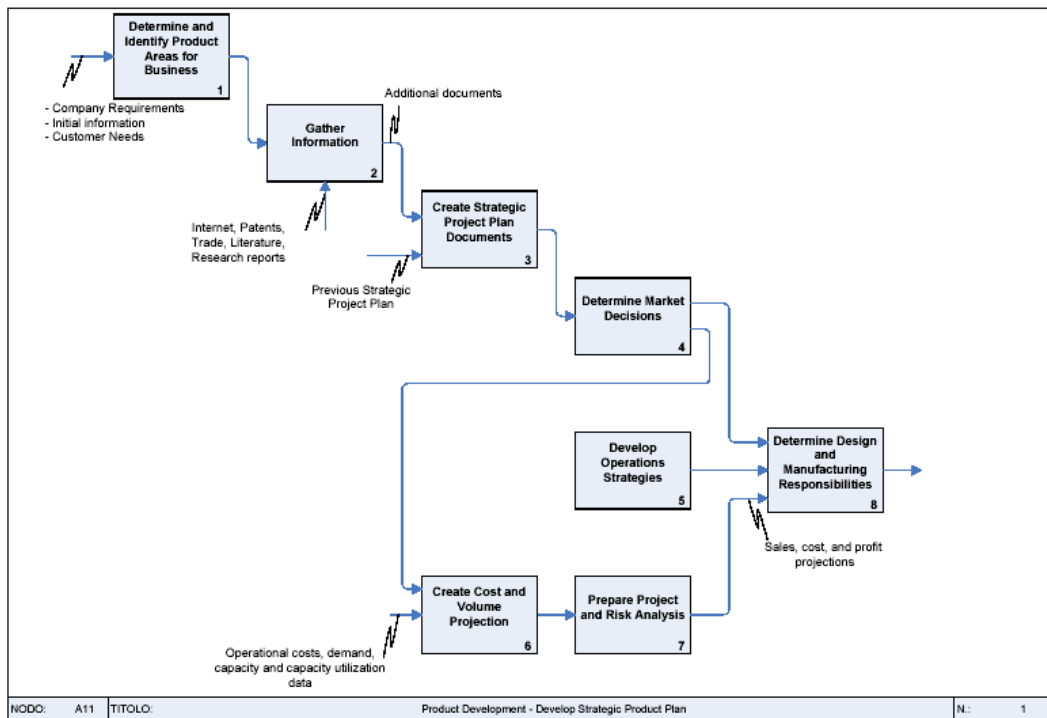

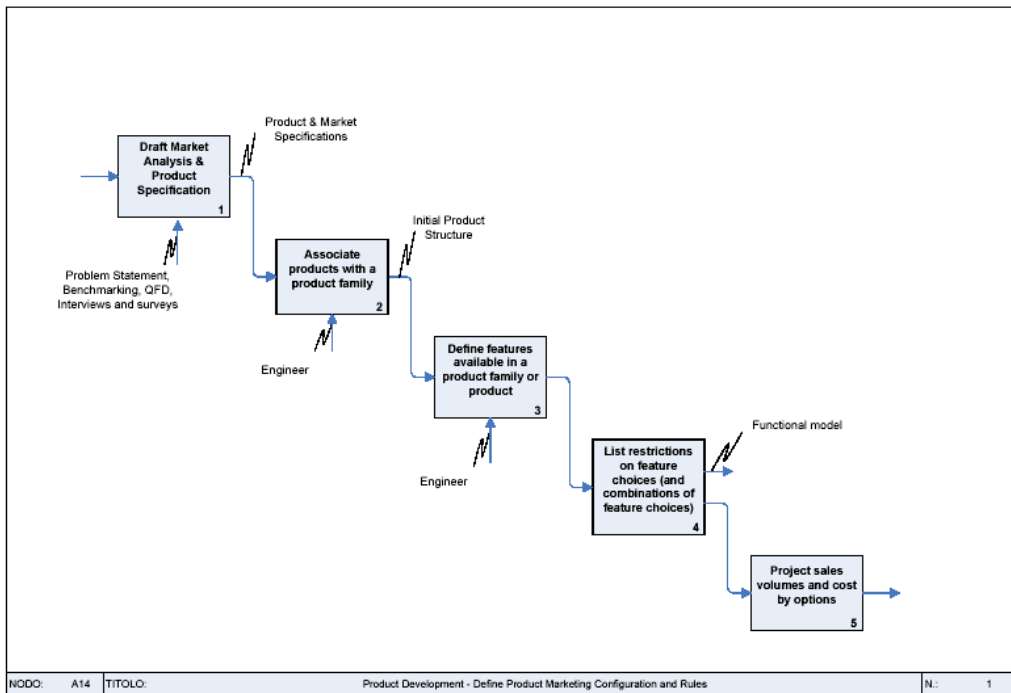
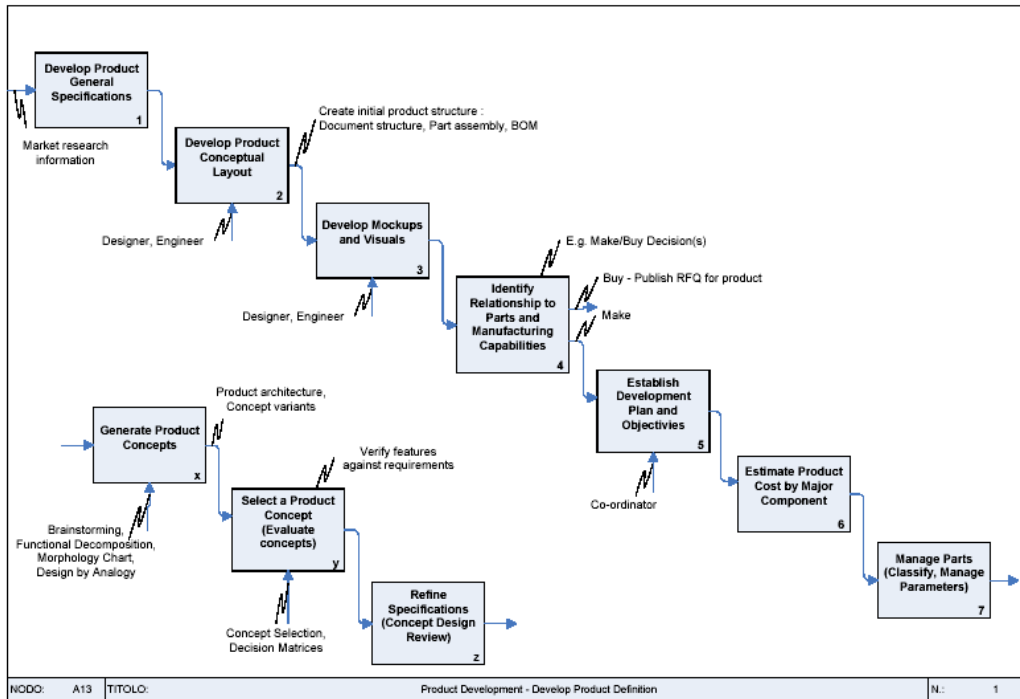

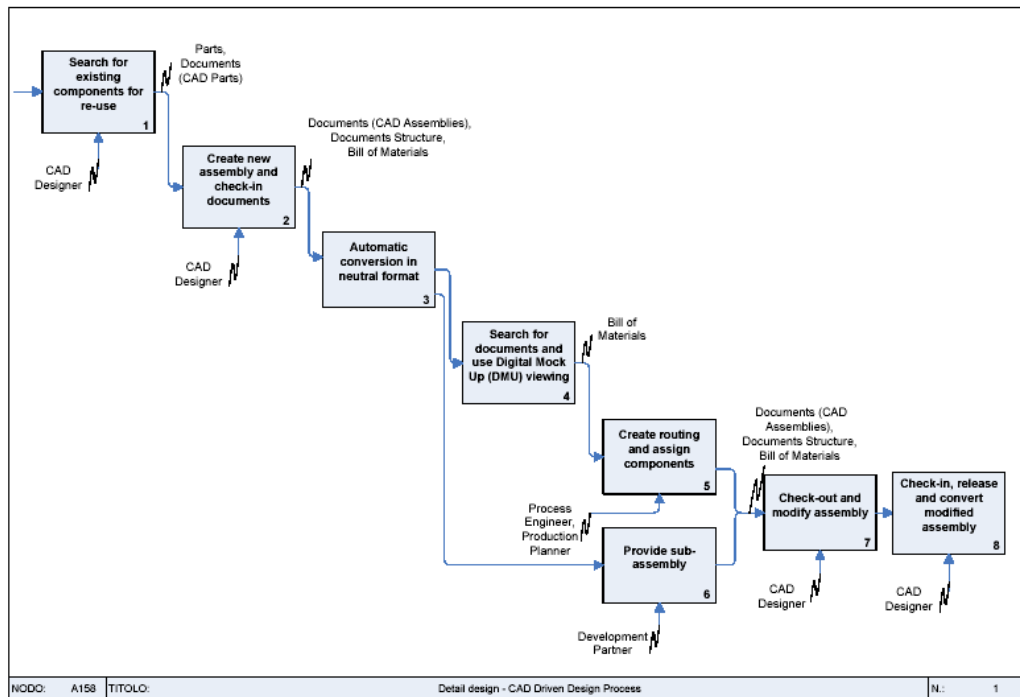
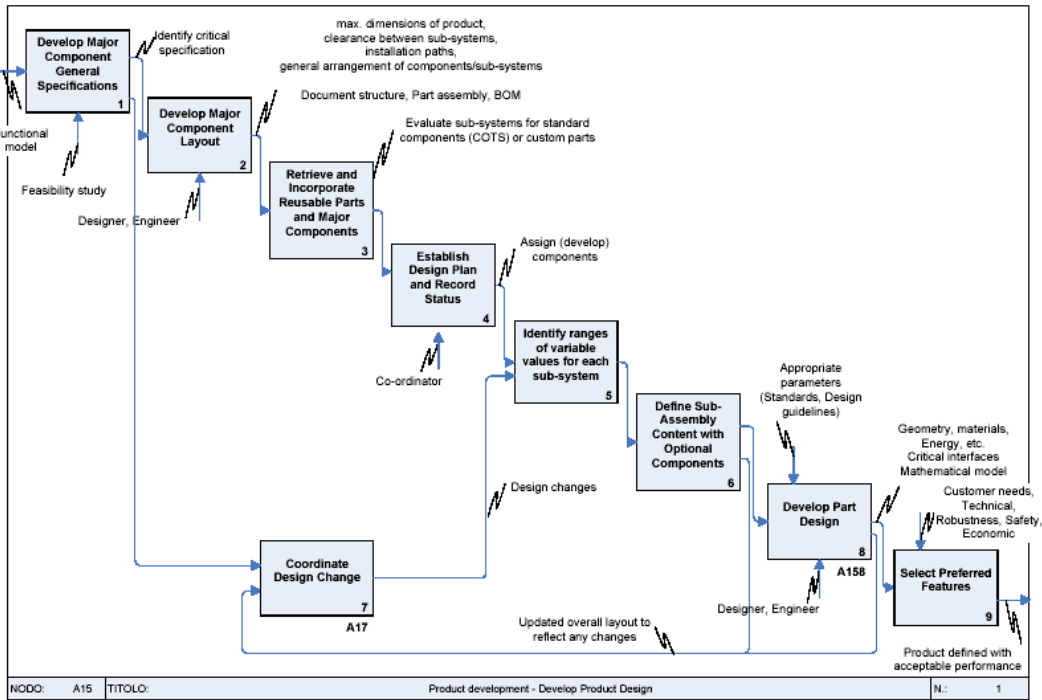

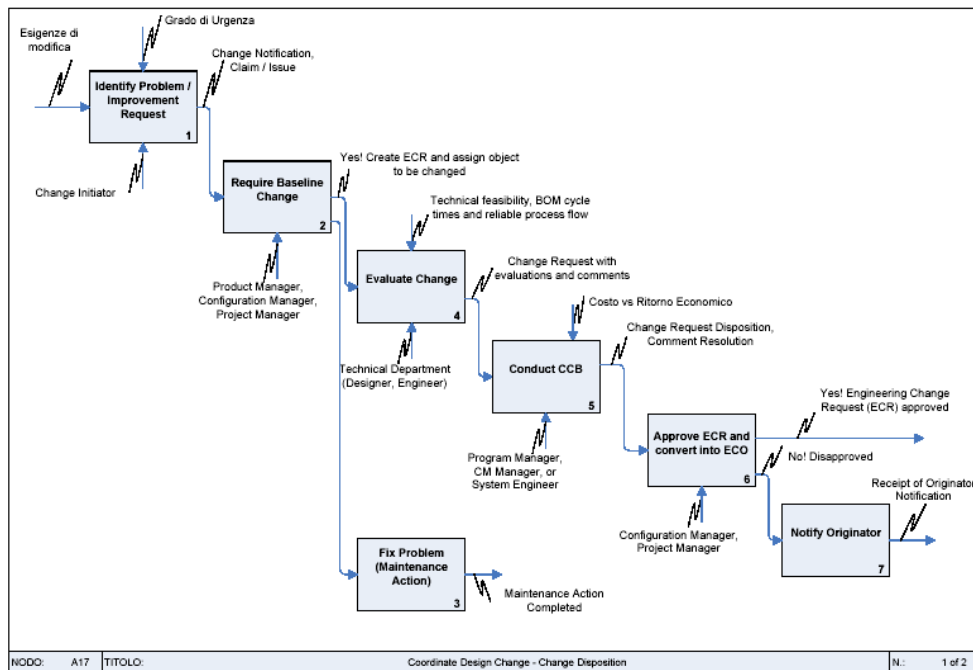
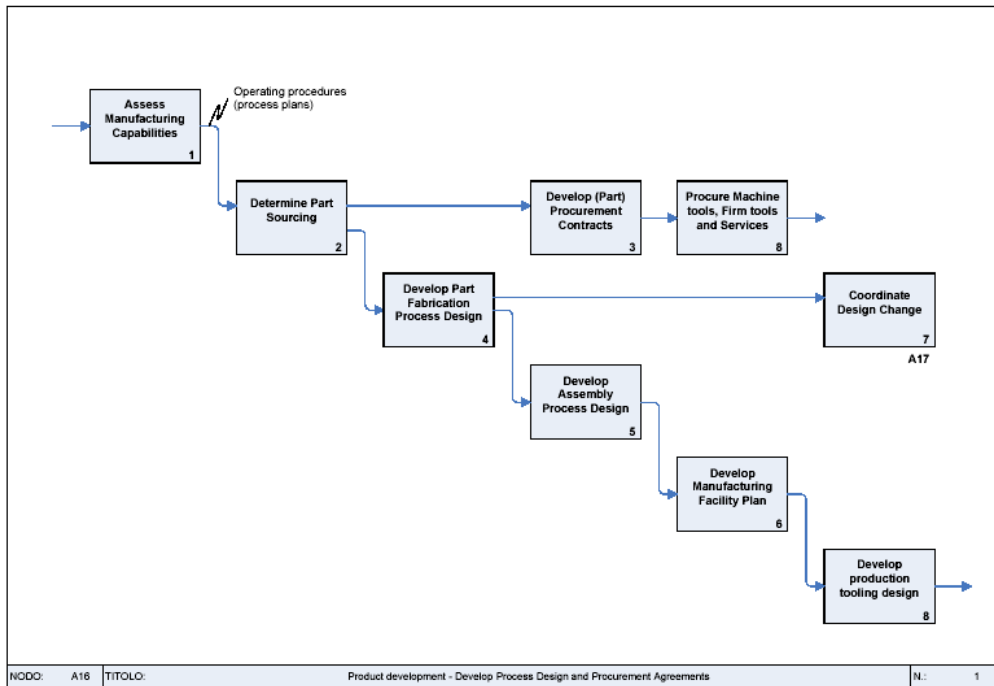

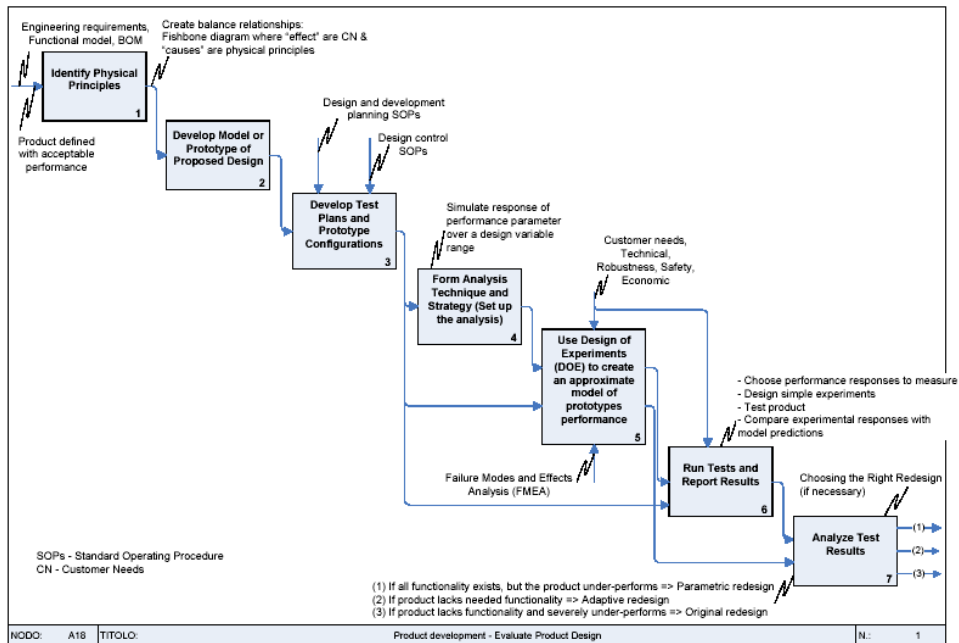
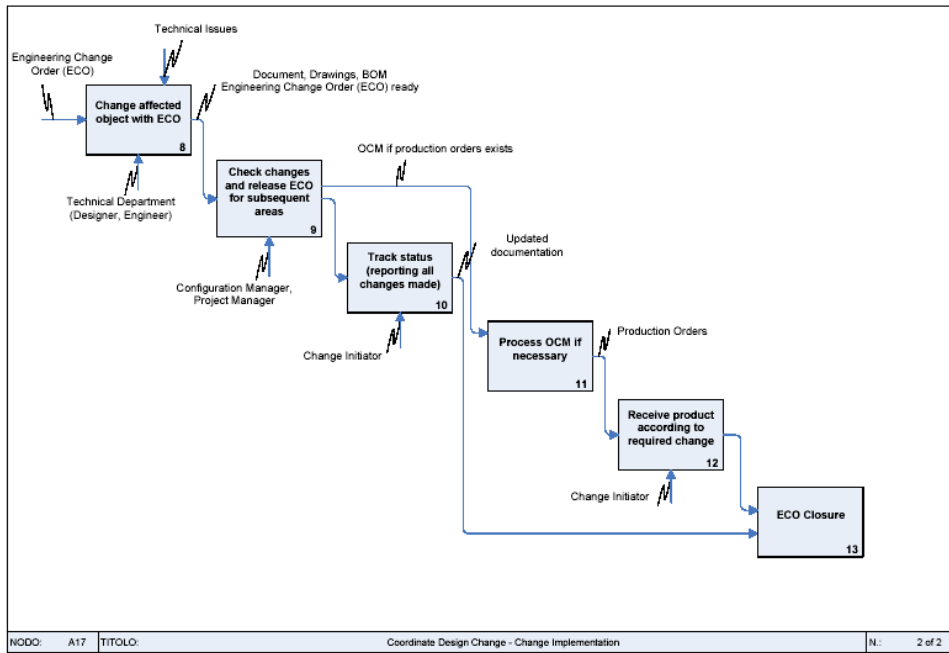

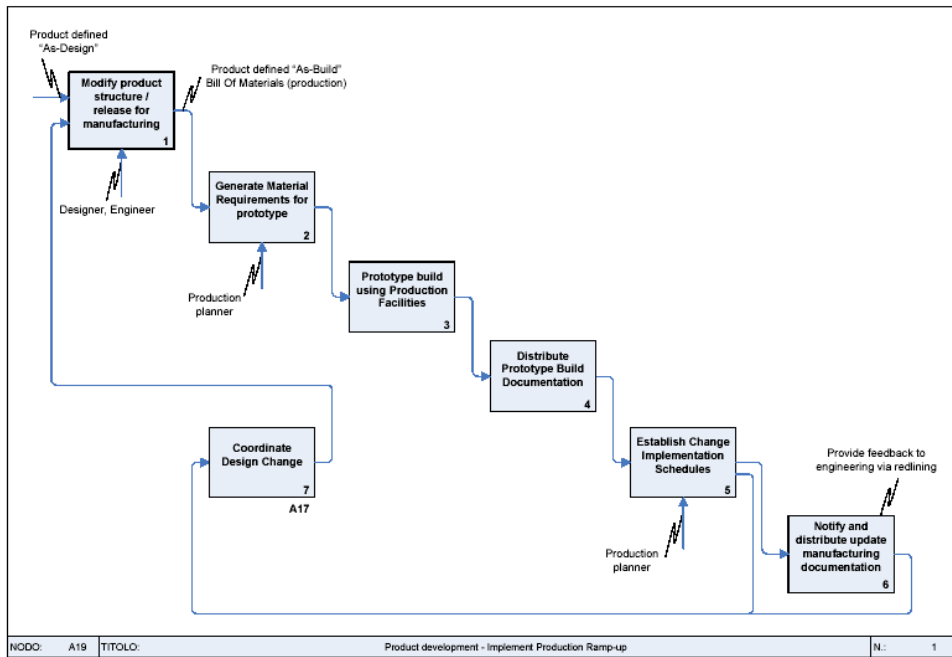

NODO: A19 | TITOLO: Product development - Implement Production Ramp-up | N.: 1

ANNEX II

Classes of the metamodel

This annex shows in details the classes which compose the reference metamodel illustrated in chapter 8. They are reported in alphabetical order.

Activity

Activity is one of most relevant concept used for dynamically describing life cycle phases, together with Event and Resources. An activity is something done towards the product by means of resources and started by an event. In terms of object model, an activity is caused by an event, uses resources and points to a time and location descriptor (Where class).

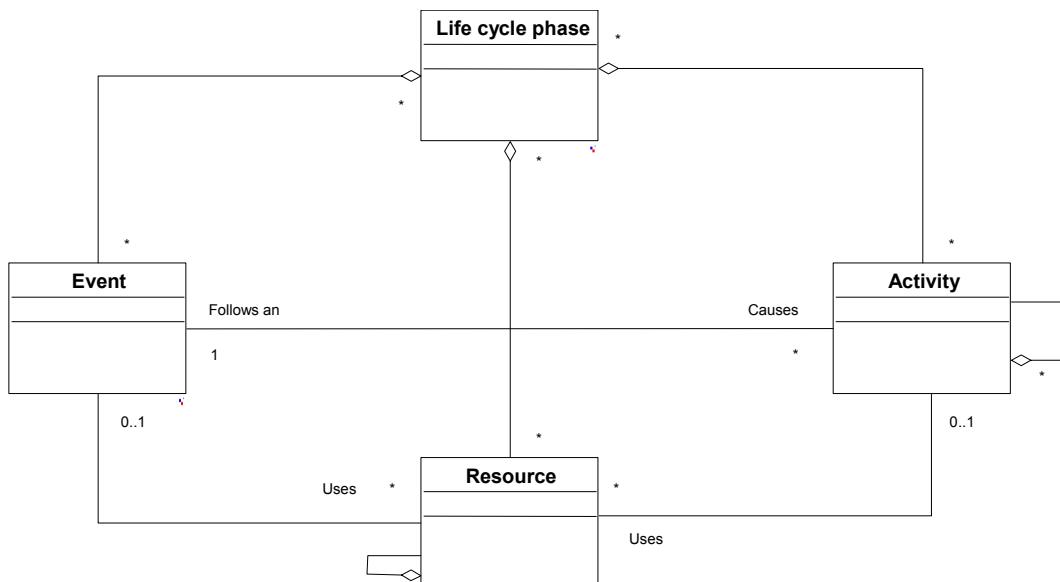

Figure A.II.1 - Activity in a Life Cycle Phase

An activity can be made, of course, by several different sub-activities. There are no limits defining upper and lower detail level for an activity because each activity can be specialized in smaller subsets in compliance

with the requested detail level. For example, when describing a manufacturing activity, it is usually distinguished between manufacturing (producing sub-components) and assembly (of sub-components). For many applications, according to product traceability purposes, this could be enough. Anyway, manufacturing activities usually cover many different phases of product production (before assembly): for example, beginning step of product production is often molding or casting; then there are other steps such as lathing, milling, drilling and so on. But might be useful describing also sub-operations of milling phase and, according with the definition of activity, it is possible to split this phase into different smaller blocks. Milling, for example, usually requires placing and fixing the piece to work and then many milling steps using different tools with different cutting speed and quality. By using UML it could be said that an activity can be an aggregation of itself, meaning that this way it is possible to obtain a hierarchical structure made of only one kind of elements (Activity class).

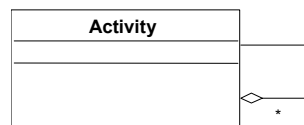

Figure A.II.2 - Activity

Examples of activities are storage, transport, manufacturing, test, use, etc. These activities are all started and ended by a specific event and change the previous state of the product: for example, a storage activity change the temporary state of the product by performing a so called time transformation. A manufacturing activity, for example lathing, drilling or a single operation of product assembly change product shape. Activities concerning usage of products can be the product use itself (each time the product is used, when, where, by whom, etc), can describe maintenance or keep track of owner changes.

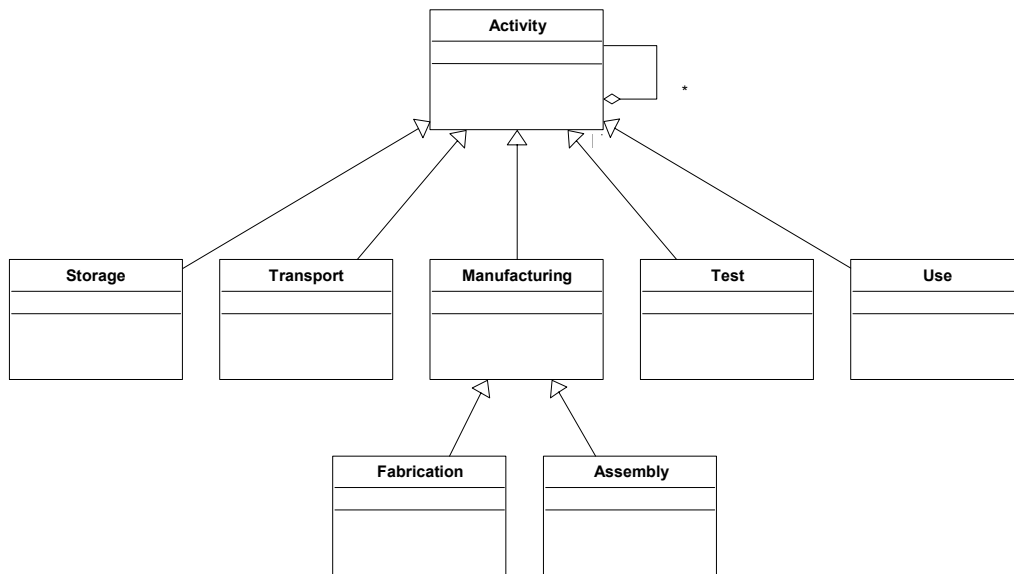

Figure A.II.3 - Activity specializations

An Activity can be Planned or Realized. An activity as realized keeps track of an activity that is already completed, it doesn't matter the amount of time between activity ending and recording. The key point is that this kind of activity is temporary bordered in the past. This way, an activity as realized describes something really happened and how it was performed. For example, an activity as realized describing casting phase of an iron bar collects data about when this bar was realized, by which casting machine, for how many minutes this operation went on, and so on. Activity as realized describing maintenance of an engine could track time and location of maintenance, which parts were refurbished, which ones were replaced, who made substitutions, etc.

An activity as planned, instead, describes an activity by specifying how it will be realized in the future. For example, it shall describe when an engine will need maintenance and how this maintenance should be performed (subcomponents to substitute, to refurbish, to update, etc.), which tools and personnel will be involved and so on.

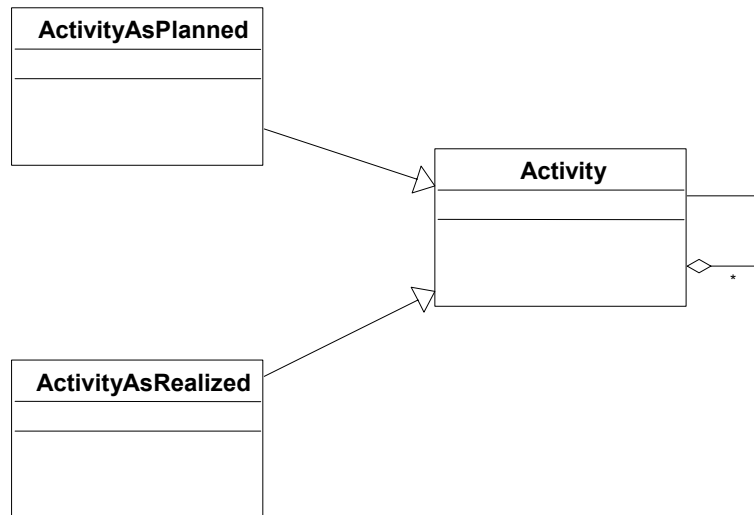

Figure A.II.4 - ActivityAsPlanned and ActivityAsRealized

ActivityAsPlanned

A specialization of Activity. It describes an activity as should be realized in the future and provide data and information for planning such activity. It represent an activity as will be. See Activity.

ActivityAsRealized

A specialization of Activity. It describes an activity as was realized in the past and keeps track of related information. See Activity.

Any

Empty class used to extend and update the model. It can be useful for specializing the model for best fitting a particular context of application.

ArrivalTime

It's a specialization of Time class and stores information about the arrival of a lot of products (for example from a supplier).

Customer

Customer class contains a description of a customer to which the lot is to be delivered. It represents a logistic information which is often useful to link with a lot of products, for example in order to satisfy product recall

procedures: when a product suffers of a failure, an unforeseen breakdown or needs an upgrade or maintenance, information about the relationship between a lot of products and its customer or customers can quickly simplify some customer relationship procedures.

Description

A generic class containing a text describing contents and meaning of an higher level class. For example, Description is associated with ObjectInformation, Life Cycle Phases, and many other classes to can provide a multi-language description explaining scopes of that specific Class.

Multiplicity involving Description class is often a Many to Many, as a single class can be described by many different description fields (se the example before) and, at the same time, a standardized text string can point to different classes.

DocumentationClass

Class grouping documents with shared properties and features.

DocumentationClassProperty

A set of properties defining a class of documents. These properties are instantiated by means of documentation properties values.

DocumentationID

Univocal identification of each single document used by an activity as a resource.

DocumentationInformation

This class provide information describing product documentation. This class doesn't contain physical documents, but might include electronic documents and, anyway, organize documentation used as resources for some kind of activities. Documentation of products consists, for example, of technical drawings, user manuals, product guides, maintenance manuals, product specification and so on.

DocumentationProperties

Properties describing documents and mapping to documentation class properties. Examples are properties defining the type of document, its realize number, its language, when it was published, its authors and so on.

DueDate

It's a specialization of Time class and displays a date for delivering the lot to the correct customer.

Event

An event deals with beginning and ending of an activity. It is something happening within the product or within the environment containing the product and causes an activity to start or to stop. An Event is always a sudden change in the state of the object and it occurs in a very short time, in a while. It can thus be considered as something taking place in a particular moment but having no duration (this is of course an approximation).

Event class represents each beginning of an activity caused by the event itself and marks also the moment the activity is brought to conclusion. It behaves as a trigger element for starting up, suspending, resuming and killing an activity.

An event shall cause recording of information related with the activity which is starting or which has just ended. An event can be planned (EventAsPlanned) or casual and accidental (EventAsOccurs) and Event Class is therefore a generalization of these two specific kinds of event. It's thus in relationship with activity (which follows an event), with resources (involved by event fulfillment) and with time and location description of the event (Where class).

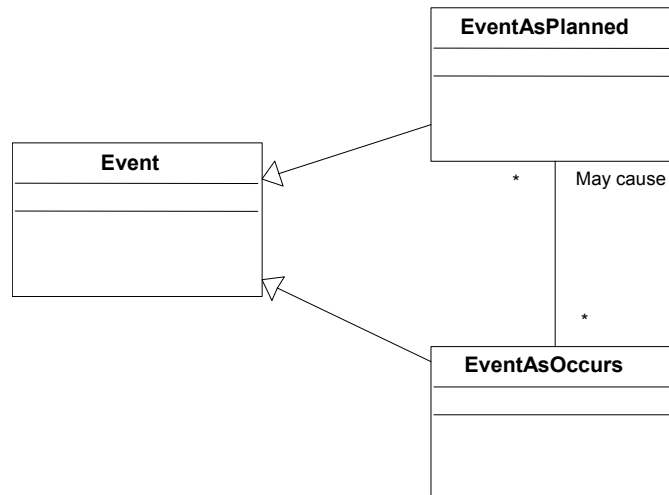

Figure A.II.5 - Event specializations

EventAsOccurs

It's a non planned event and, thus, its happening is casual both in time and in the way it happens. A bright example of what does it mean are product breakdown: a breakdown is a sudden change in working state of a product, taking place in an unforeseen moment. Such an event can happen for many reasons: sometimes it happens without any forewarning, sometimes it's representable by means of statistical laws.

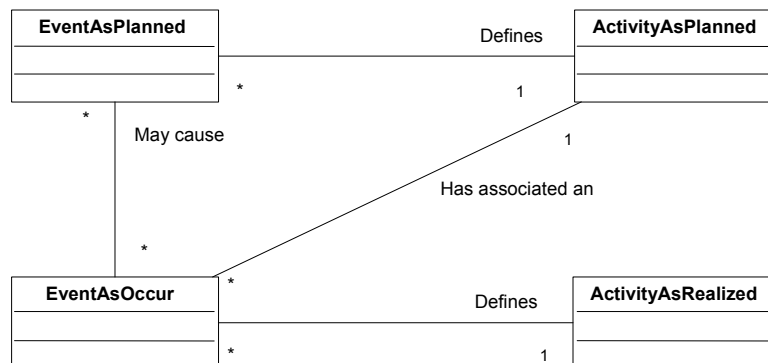

Figure A.II.6 - EventAsOccurs

This kind of event may cause an event as planned, for example when a sudden machine breakdown triggers an event as planned for starting fixing the damage. Following this example, if the relationship between failure and repairing is known, there can be an already planned activity for fixing the failure when the machine will break down (even if it's impossible to

foresee the exact moment). This way, an event as occurs may cause an event as planned, which defines an activity as planned and, thus, an event as occurs is also associated with a planned activity. Links between event as occurs and activities as planned allow forward traceability, as they state how to behave in consequence of something unforeseen. Multiplicity between EventAsOccurs and EventAsPlanned classes are many to many.

Such an event can define, of course, an activity as realized when this activity is caused by the event but was not previously planned. Recording of information describing an activity as it was realized (and, thus, already finished), in consequence of an unplanned event, realizes backward traceability.

EventAsOccurs class is specialized into Start class and End class, underlining how an event is always a trigger for starting or ending an activity.

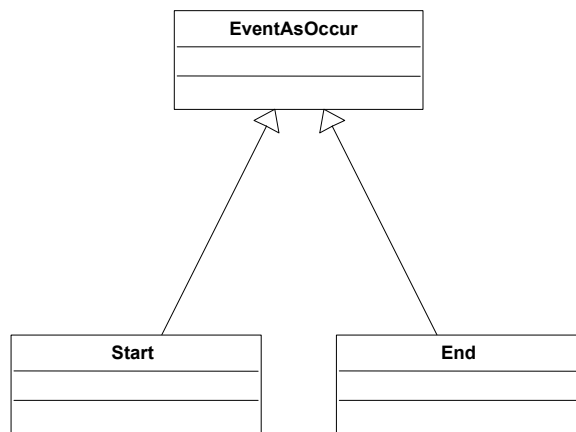

Figure A.II.7 - EventAsOccurs specializations

EventAsPlanned

It's a planned event: an event which will happen in a specific moment in the future, but whose modalities of taking place are already defined. For example, planned maintenance is an ActivityAsPlanned which will start when relative causing planned event will occur. An event as planned defines starting, ending, resuming of the related activity as planned and can also cause an event as occurs.

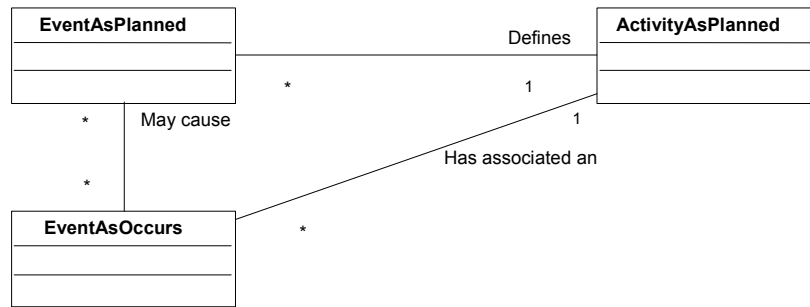

Figure A.II.8 - EventAsPlanned

EquipmentClass

Equipments, as well as other types of resources, are grouped into classes. Each class is defined by a specific set of properties. Welding robots are, for example, an example of what we mean for class of equipment: each welding robot has its own welding power, reliability, accuracy, certain degrees of freedom and so on. These properties are different, for example, from those defining Automated Guided Vehicle Class.

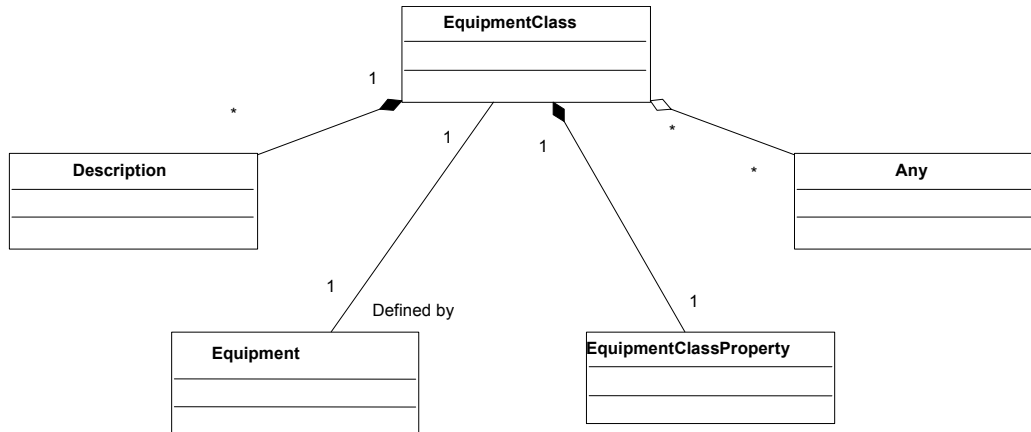

Figure A.II.9 - EquipmentClass

EquipmentClassProperties

Properties defining a class of equipments. As already seen for other resource class properties, EquipmentClassProperties are like empty boxes whose label is the name of each property and whose content is specified in EquipmentProperty classes. Relation between EquipmentClass and

EquipmentClassProperty is once again many to many: a subset of all properties define a class but, at the same time, a single EquipmentClassProperty might be involved in specifying more than one equipment class.

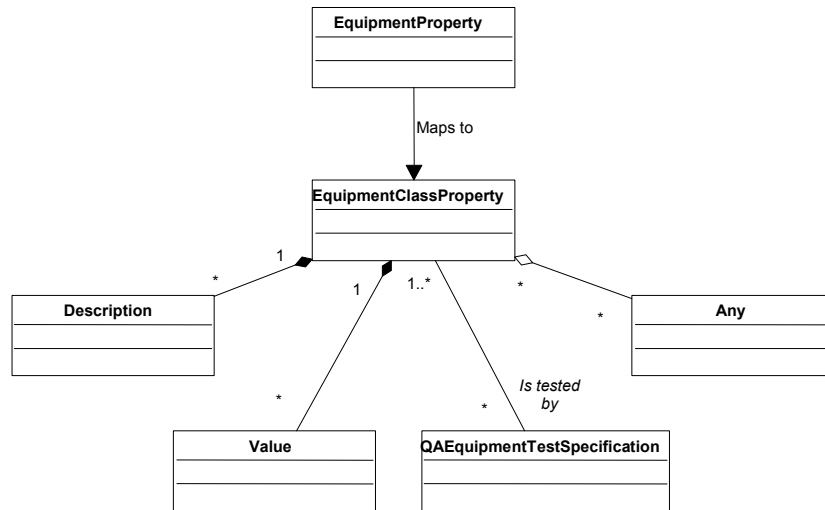

Figure A.II.10 - EquipmentClassProperty

EquipmentInformation

This class keeps track of information specifying equipments used to perform activities. Again, equipments, as well as documentation, personnel and materials are different kinds of resources. Examples of equipments are machine for product manufacturing or assembly, tools, means of transport and storage inside and outside the enterprise, computers, software, etc. EquipmentInformation and PersonnelInformation are very similar and show little differences with the other two types of resources. Materials, in product lifecycle, play a “passive” role because they are resources used or consumed when performing some activities, especially those regarding product production. Equipments and personnel, on the other side, play an “active” role because they perform transformation of time, location and shape on a product: for example an assembly machine is a resource and performs its task on the product; also personnel who works on this machine perform its task (for example checking the work while it’s in progress or managing the machine). We distinguished between equipment and personnel because personnel is

made of human beings and also because equipment are more strictly involved in Intelligent Manufacturing System techniques.

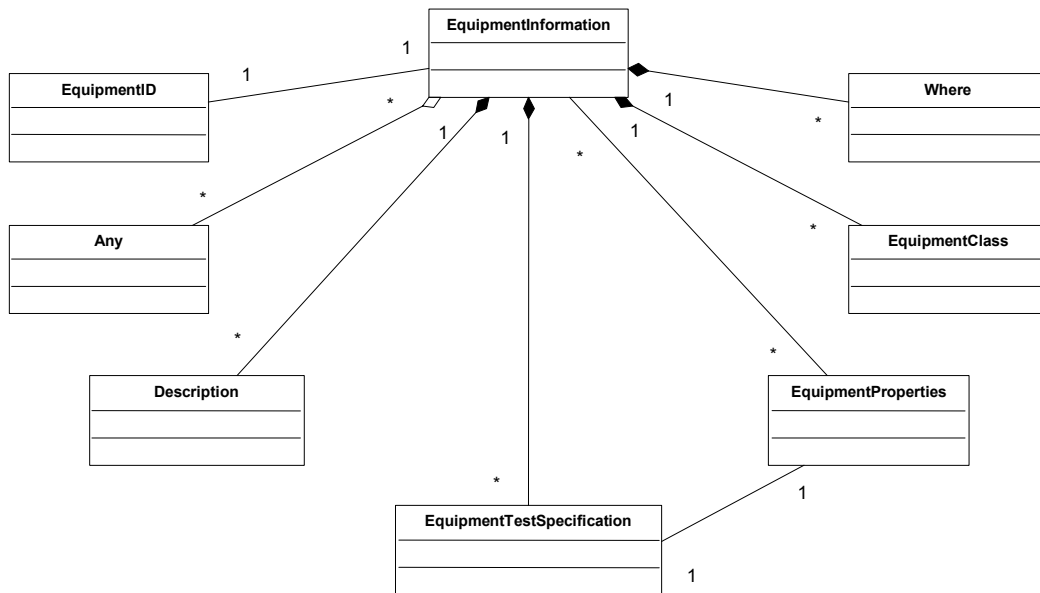

Figure A.II.11 - EquipmentInformation

EquipmentID

Univocal identification of each single equipment performing or involved in an activity and used as a resource.

EquipmentProperties

Properties characterizing each equipment. They can contain, for example, data about equipment supplier as well as data describing equipment features and capabilities. This allows forward traceability because equipments requested for performing activities are selected thanks to their properties. This class is also useful in an Intelligent Manufacturing System context for the same reason: each intelligent product can be assigned to an intelligent equipment if this equipment satisfy performances needed to fulfill tasks requested by that product. This is possible only if any activities to do is specified in terms of requested equipment performances (properties) and if these properties are declared and known.

ID

ID is an univocal identification for each object information. It is an implementation class. It is an aggregation of two classes which identify in a unique way the Physical Object and its related information, represented by means of an ObjectInformation. ID class, linking together these two entities, gives shape to the concept of Holon which is, according to its definition, an autonomous and cooperative agents made of an informative part and a physical part.

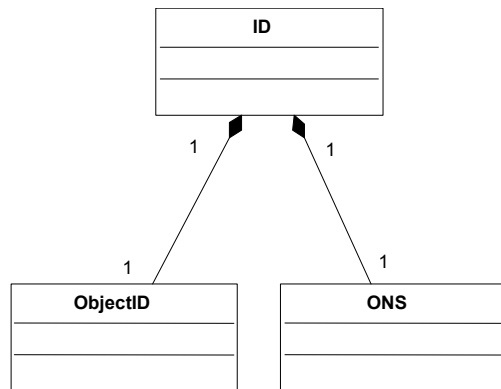

Figure A.II.12 - ID

Each ID is linked to each instance of ObjectInformation and thus, in term of UML, relationship between ID class and ObjectInformation class is a one-to-one type.

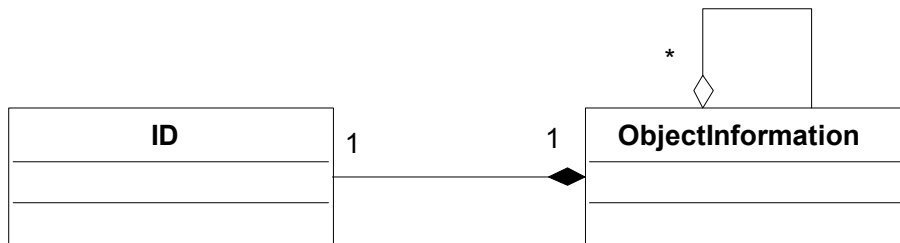

Figure A.II.13 - ID Relation with ObjectInformation

Information Rights

This is an implementation class. Its aim is to allow or deny access to information contained in any sub-part of Object Information. This is a crucial feature requested to the model because it is strictly related with “Trusted Access” general requirement. It should enable or deny access to

information to different type of users, in compliance with the role they play in product lifecycle. It's necessary, indeed, that such an object information model provides and records all requested data and information for forward as well as backward traceability; these data should be at the same time shared among users and protected against people who are not allowed to make use of them. An Object Model could include, for example, technical data about product design, product production and product maintenance and only product manufacturers or maintainers should be allowed to take advantage of these information. Customers, for example, are usually interested to know product status, next product maintenance date, product production site and date, product expire date, but should be kept apart from using, for example, technical drawings. Anyway, each single information included within the Object Model should have links to an Information Rights control performer. Together with the Segnature Class it can use cryptography techniques. Information Rights class isn't here detailed because it involves the implementations of the model, that's why we choose only to pint out the need for developing an information security system which could be similar to those used by operative systems to authenticate different users. Following this model, Information Rights class should behave as a filter, or as a mask, changing the way users or groups of users interact with the Object Model. We think it's useful to distinguish between users and groups of users to correctly manage access policies: for this purpose, the so structured Information Rights class could look like Personnel Information class, which makes a distinction between Person (like Users) and Personnel (like Groups).

Lifecycle Phase

Lifecycle Phase trace products in their life, gathering information on their previous history and providing information useful or requested for their next future. This class is a generalization of four different phases covering whole life of a product: product development, production, use and dismiss.

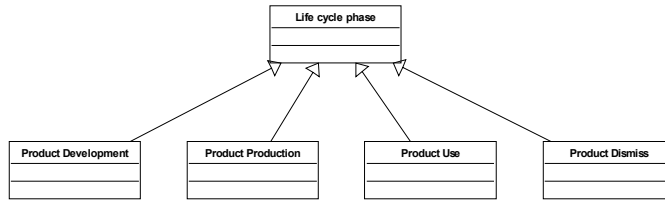

Figure A.II.14 - Lifecycle Phase specializations

Each phase records and include information describing activities as were realized, activities to realize, related events, resources used or requested and data about time and location of events, activities and resources. The structure of the four different life cycle phases is always the same, as they all are specialization of Life Cycle Phase and they differ one from another only for types of activities and resources manly involved in each phase. Manufacturing or assembly activities, for example, are usually specific for product production whereas maintenance, product fixing or product delivery are related with product use.

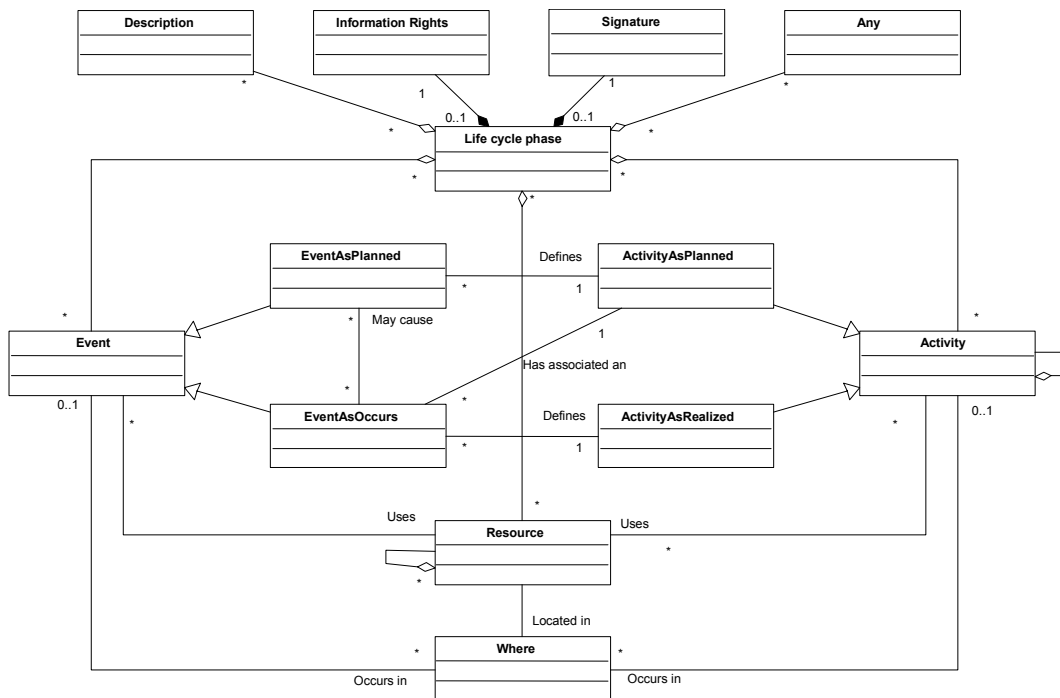

Figure A.II.15 - Lifecycle Phase

LotID

Univocal identification for a lot of products.

MaterialClass

It's a grouping of different materials under the same category. It represents an higher level of description than that of MaterialInformation, because the object in interest is no more a single material instance but a class of instances sharing common properties. Following the same example used for MaterialProperties, each iron beam is described by its own instance of the same properties describing the class named "iron beam". This is a key point. When we define a class, we implicitly think to a group of properties or features which distinguish this class of objects from another. Iron beams, as a class, could be described for example by type of iron, length and so on, whereas granular polyethylene for molding industry is characterized by color, density, melting temperature and so. MaterialClass and MaterialProperties are in close relation just because in material properties we found the specific information content, regarding a single instance of a material, of a set of properties defining a class of material.

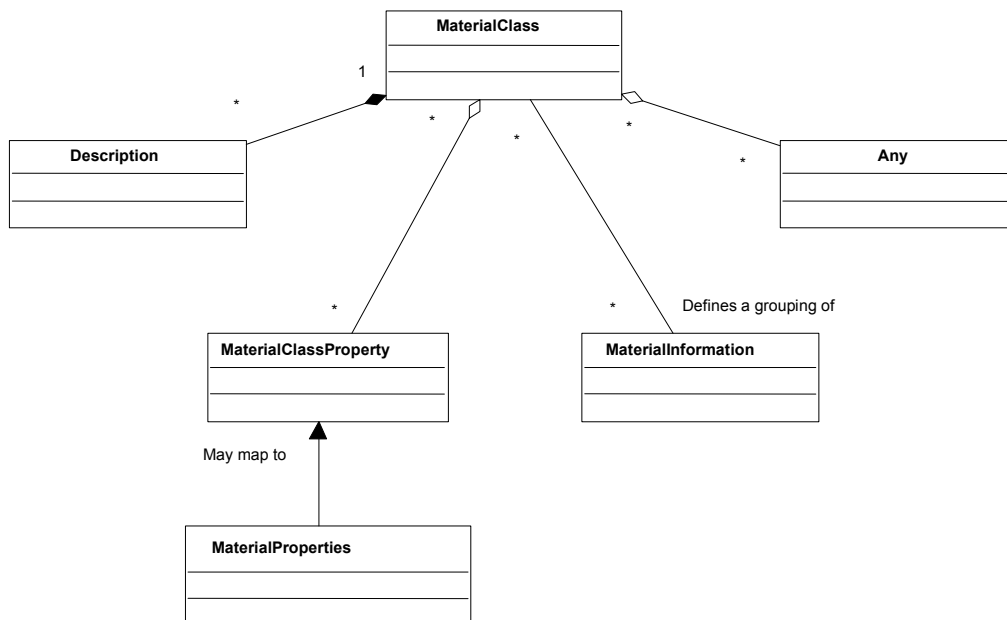

Figure A.II.16 - MaterialClass

MaterialClassProperties

A set of properties defining a class (a category, a family) of materials. They are, for example, chemical composition, color, roughness, density, weight, etc. In material class definition these properties act as empty box whose label is the name of that property (color, density,...) and whose content is instantiated into a MaterialProperty class. This way we say that MaterialProperties map to MaterialClassProperty. Material class properties are tested by quality analysis tests.

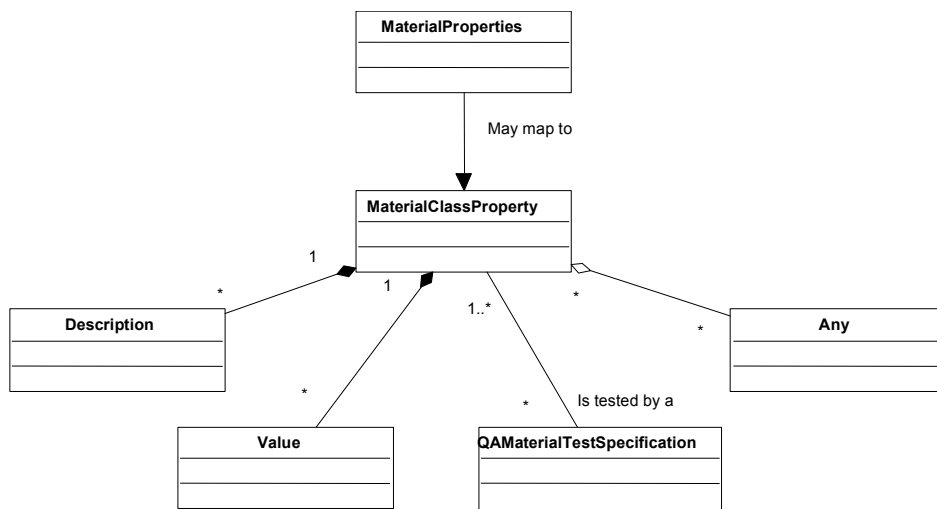

Figure A.II.17 - MaterialClassProperties

MaterialID

It is a unique and unambiguous identification for single material used as a resource.

MaterialLot

A general material instance can be a stand alone entity or can be part of a lot. It could be useful to know if a material belongs to a lot because, this way, we can group together information about materials which are supposed to be similar for all materials of the same lot. For example, if we discover some wrong performances or failures on a material, we can search for every material of the same lot, in order to verify if it was a casual problem or a problem involving the whole lot.

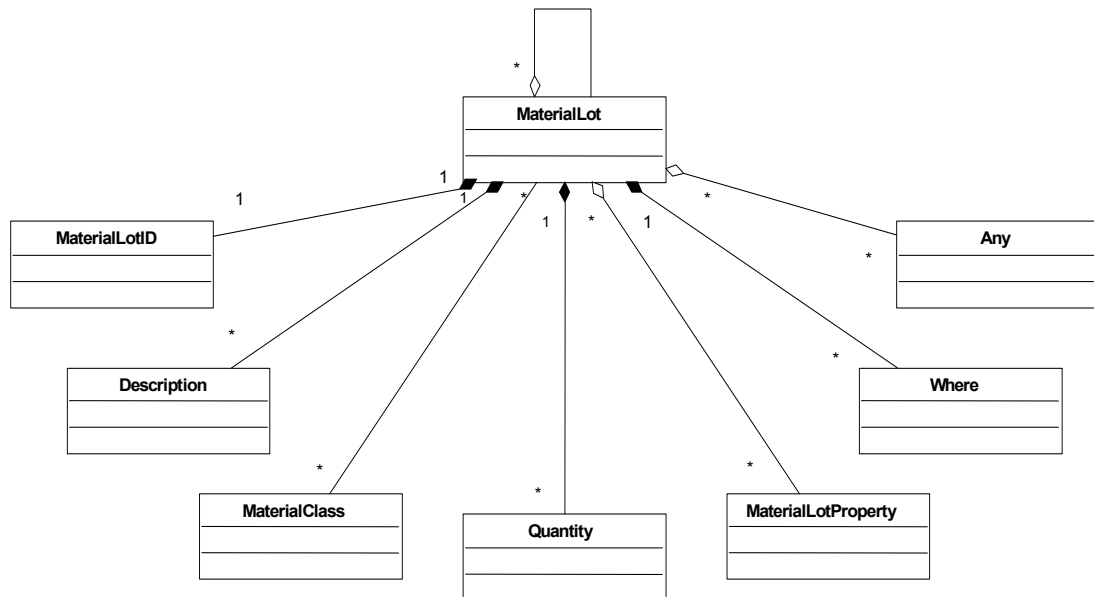

Figure A.II.18 - MaterialLot

MaterialLotID

Univocal identification for each material lot and, thus, shared among all materials belonging to the same material lot.

MaterialLotProperty

A set of properties defining useful information about a lot of material. These properties are specific for the lot and they are not the same used for material class because the target is different. MaterialLotProperties could describe a material lot, for example, in terms of arrival date, supplier, expiration date and so on.

MaterialInformation

MaterialInformation is a specialization of Resource class and represents raw materials used in product production. It's an aggregation of several different classes, which describes material features and performances in a standardized structure. Material information should represent a particular resource used in any step of lifecycle, even if it fits mainly product production phase. Examples of materials mapped with this model are materials belonging to a lot, as well as non discrete materials and energy.

MaterialProperties

This class is needed for describing specific properties of each material instance. These properties are usually of great interest for product production as well as for product use and product dismiss. Their information content is specific for each material but they also defines shared properties among materials belonging to the same class. For example, let's think to an iron beam for constructions: it's defining properties could be shape (H, T or L section), its length, its weight, chemical composition of iron used, possible thermal treatments an so on. Each instance of iron beam, described in terms of properties, shall look like: 39NiCrMo4, H section, 6 m of length... It's notable how these properties are specific for each material instance but do not represent a result of a quality analysis test. Properties could be also, for example, description of manufacturer and price per unit.

Name

Name describing qualification test.

ObjectClass

It represents a group, a class of objects which share common properties. This class stands at an higher level of abstraction than ObjectInformation, because it's non interested with properties and features specific for each object, but it's rather concerned with the definition of such properties. Here, once again, we find a structure derived form the definitions of holon and holarchy: an ObjectInformation may be composed by different instances of the same class; for example, if we think to an engine for automotive industries, this engine in our model is an holon represented by means of an ObjectInformation. As this holon is made of different hierarchically organized lower-level holon, such as pistons, shafts, valves, etc., the corresponding ObjectInformation is composed of several ObjectInformation classes, each of one related to a single instance of valve, a single shaft, a single piston and so on. Furthermore, all instances

of these components belongs to a well defined class so that we can state that also classes of objects have their hierarchical structure in which any class may be composed of other classes.

ObjectID

Class identifying each instance of a physical product. Examples of this class are Serial Number, EPC (Electronic Product Code), enterprise standard system of coding and so on.

ObjectInformation

This class represents the abstract highest level of our model. ObjectInformation stands for the informative part of an holon holds all the information requested for product traceability. First of all, here we highlight that an object information may be a composition of several different ObjectInformation classes, just as an holon may be a whole containing other smaller holons organized in an holarchy. These information and data concern both a product non-time dependent description and a description of product history in terms of product lifecycle phases. Classes like Description, ObjectTestSpecification, ObjectLot, ObjectClass and ObjectProperties provide a set of “static” information which cannot be updated through the product lifecycle. On the other side, ProductDevelopment, ProductProduction, ProductUse and ProductDismiss, keep track of changes produced by modification of time, location, shape and nature on the product. They also provide necessary information and data for the so called forward traceability.

ObjectLot

It structured around useful information describing a lot of products. First of all, an object lot is identified by an unique lot ID. Relationship between LotID and Object lot is one to and it is also mandatory. An object lot, as well as products and resources can be considered as an aggregation of different smaller sub-lots.

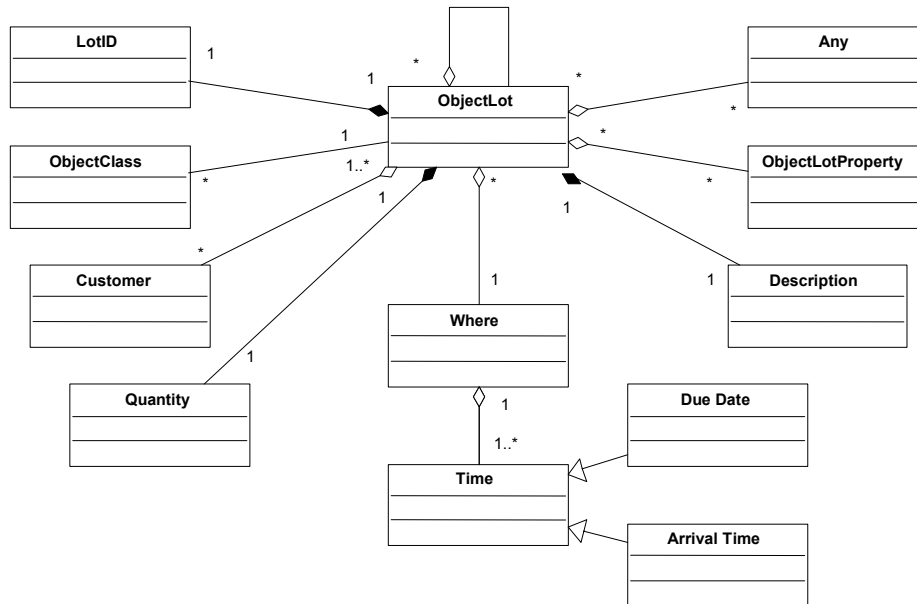

Figure A.II.19 - ObjectLot

ObjectLotProperties

Properties defining a lot of products: these properties are, in general, different from those defining objects as well as object-class properties and could involve, for example, information related to lot management or delivery.

ObjectProperties

A set of properties shared among entities which are part of a same class. They are an instance of the corresponding class defining properties and, thus, contain specific information or values regarding only the ObjectInformation in matter. ObjectProperties map to ObjectClassProperties.

ObjectTestSpecification

Quality analysis test specification conducted on the product. This class collect information about tests performed on the product to declare or certify some particular properties and feature. From literary review on user requirements for traceability of products, we found that a central role is played by systems to certify quality of products in many different industrial

sectors: typical examples are quality of food and drugs certified by testing chemical or bacteriological composition, degree of toxicity and so on.

PersonnelClass

Class grouping and abstracting several people sharing common properties. In this model each personnel class gathers personnel and each person belongs to at least one personnel class. That's why relation between personnel class and personnel is many to many.

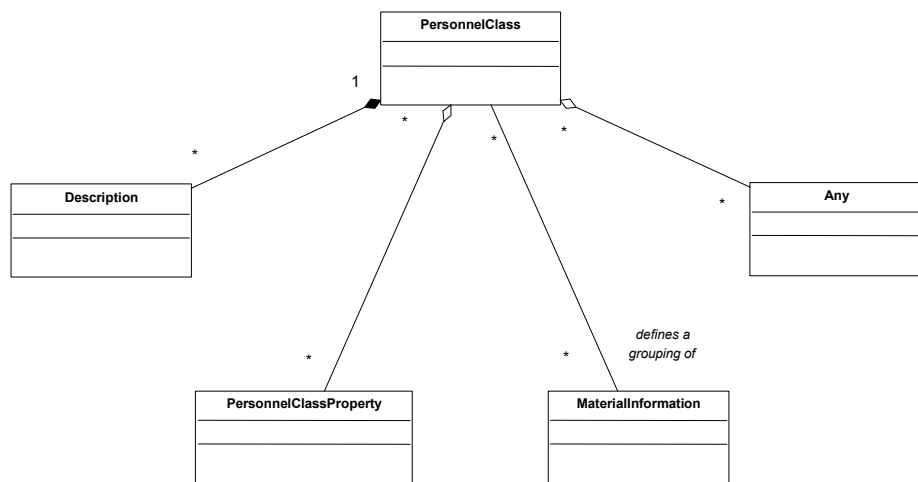

Figure A.II.20 - PersonnelClass

PersonnelClassProperty

Properties characterizing each different class of personnel. These properties are the same of those defining properties for personnel belonging to the same class and tested by qualification tests.

PersonnelID

Univocal identification of each single person performing or involved in an activity and used as a resource. This ID might be, for example, worker registration number, according to enterprise system of coding personnel.

PersonnelInformation

PersonnelInformation is very similar to those of MaterialInformation, DocumentationInformation and EquipmentInformation, as they all are specialization of Resource class. People are considered as resources for

many type of jobs such as product production, delivery, maintenance, etc. Single person, when acting as a resource are considered as personnel according with the role they play. PersonnelInformation gather and groups information about personnel involved in activities as realized as well as personnel required for planned activities. Each instance of this class describe a single personnel and arrange at the same time different personnel instances into groups sharing common properties.

Example of PersonnelInformation are information regarding the single worker who produced the product, or brought it to final destination, or performed some quality analysis tests.

PersonnelProperties

Properties characterizing each person belonging to a personnel class and corresponding to properties tested by means of qualification tests. These properties are significant for backward as well as forward traceability because they state what kind of actions (what kind of jobs) a person can or cannot do. In terms of forward traceability this means that such properties defines if a person is an appropriate resource as required for performing specific activities. On the other side, in terms of backward traceability, we might be interested in checking if a person who performed a particular activity was allowed and able to do that.

QAEquipmentTestSpecification

Quality analysis test specification is a class collecting data about test conduced on equipments to verify some parameters regarding their performances. Tests on equipments are usually used for monitoring equipment status, last maintenance received, next maintenance to provide, performances in term of speed and quality of work, and so on. Sometimes, products breakdowns, failures, or non conformity with the requested degree of quality may be an effect due to equipments used in product production. This is why we are interested in keeping trak of equipments status by means of quality analysis tests. Each

QAEquipmentTestSpecification tests at least on EquipmentClassProperty and each property may be tested by at least one test.

QAMaterialTestSpecification

This class specifies performances and features as a result of a quality analysis test executed on the single material instance. It could display, for example, the percentage of salts dissolved in a bottle of water, bacteriological quality test of meat as well as percentage of copper in a high degree copper bar for electrical applications. Multiplicity between this class and MaterialInformation is many to many, mainly because a material may request different quality analysis tests and some tests could support different material descriptions. Each QAMaterialTestSpecification tests at least one material property but it's not necessary that a particular material property is tested by a suitable test. In terms of UML diagram, the relation between these two classes shows how MaterialClassProperty is tested by zero to many QAMaterialTestSpecification each of them testing at least a property.

QualificationTestSpecification

This class contains information about qualification tests performed on personnel. This test should be specific for each personnel class, as they define skills and competencies of each person. This is useful, for example, to keep track of training provided to workers as well as what each worker can or cannot do, which activities he is allowed to perform and which not.

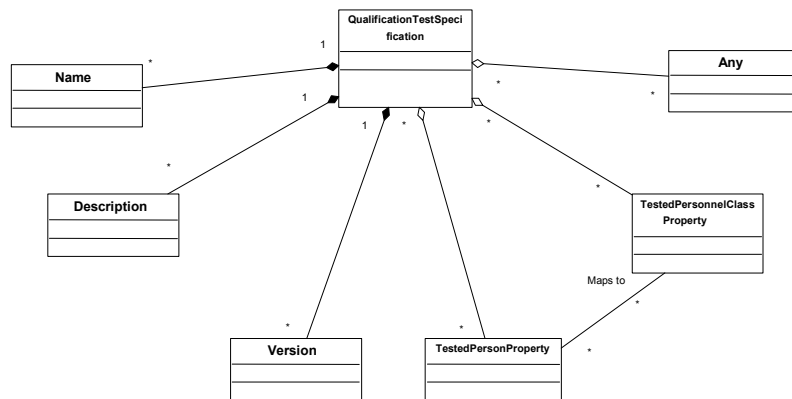

Figure A.II.21 - QualificationTestSpecification

Quantity

Numerical description, in appropriate units, of quantity of material defining the lot. It counts the number of material instances for each lot.

Resources

Resources are a key concept for understanding the Object Model. They are involved both by event and activities as an event can happen on a resource and an activity is always performed using resources. Resources are material and non material means for doing something (we say that they provide a service). Resource class is therefore associated with those of Event and Activity. Examples of resources are computers, workers, transport systems, manufacturing machines, assembly machines, storage systems, tools and so on. As any machine, sub-component or equipment can be made of different parts, here we use again the concept of auto-aggregation for Resource class. For example, a milling machine is of course a resource for product production, but it is built around many specific components (such as mandrel, numerical control, tool buffer, etc.). Object Model represent reality using an holonic view, in which any holon can always be thought as a whole containing many more detailed holons. As any resource is representable by means of a resource holon, it's useful to represent also its sub-components as sub-resource-holons.

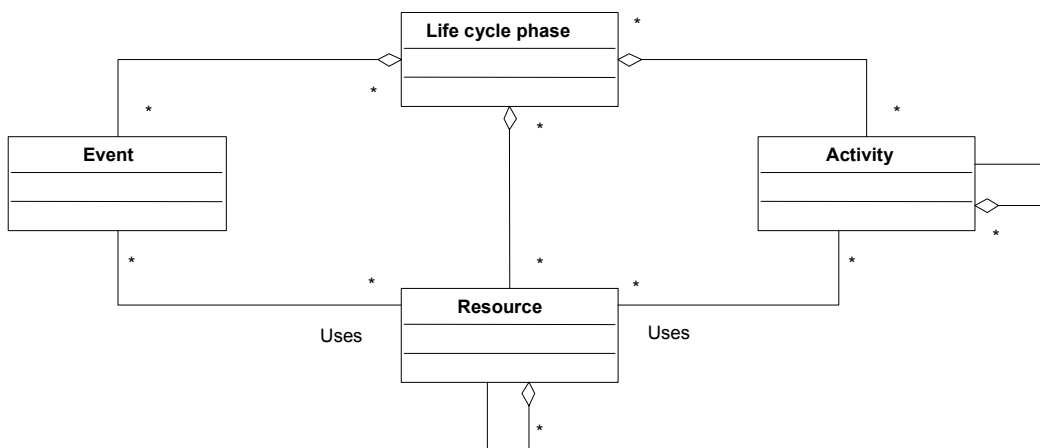

Figure A.II.22 - Resource in a Lifecycle Phase

Resource class is specialized into different type of resources, as documentation, raw materials and sub-components, personnel and equipments. These four classes symbolize different categories of resources and they share in common a similar structure of detail.

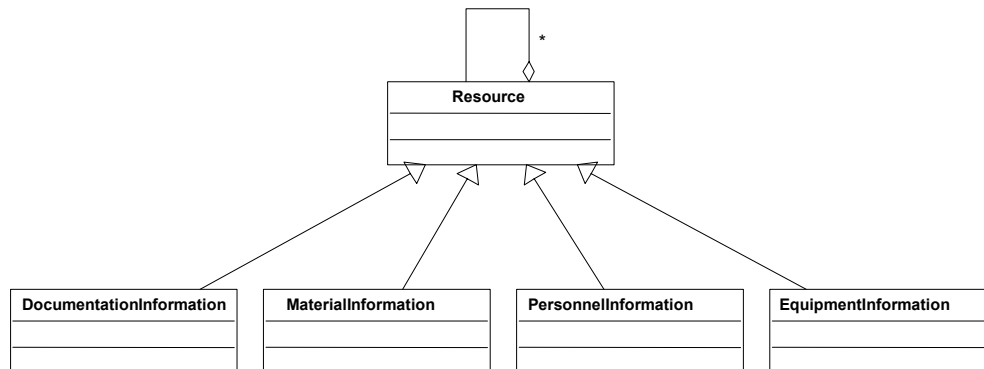

Figure A.II.23 - Resource specializations

Signature

This class an implementation class. It contains a digital signature of the document; this is required to prove who stored the information. This class is based on the concept of “public key encryption” used in many commercial or open source software, as well as in most of the B2B standards; It uses two asymmetric keys, one private for decrypting or signing that has to be secret and owned only by his legitimate owner, the other public for encrypting and check the signature which has to be spread. A digital signature is made through a combination of the secret private key and the text. Using the writer public key the message can be verified. Not only will be checked if the correct sender is involved, also the content will be checked. So it is possible to know that the message comes from the sender and has not been changed during the transportation process. This makes the information contained into the model reliable.

For example a customer can verify that the information written on his product are really written by the producer, and if some information are added it's possible to check who annexed them.

This class, together with the Information Rights class, could also be the base for cryptography of some information that hasn't to be readable to

everyone, like for example the Production or Development data. These could be stored into the model and putted directly inside the product, but encrypted, such a way that only who has the privileges and owns the right private key could read them.

This class have to be further developed; in fact here it is only hinted because it is an implementation problem that is outside the boundaries of this work.

Value

Shared class containing a value (for example a numeric one) to assign to a property.

Version

Version of the same qualification test. Each test may be conducted several times for a single person and version is a class for distinguishing, for example by numeration, each different version of the same kind of test.

