



HAL
open science

Mesure in situ et modélisation de l'hétérogénéité des écoulements dans les milieux géologiques

Tanguy Le Borgne

► **To cite this version:**

Tanguy Le Borgne. Mesure in situ et modélisation de l'hétérogénéité des écoulements dans les milieux géologiques. Hydrologie. Université Rennes 1, 2005. Français. NNT : . tel-00012050

HAL Id: tel-00012050

<https://theses.hal.science/tel-00012050>

Submitted on 28 Mar 2006

HAL is a multi-disciplinary open access archive for the deposit and dissemination of scientific research documents, whether they are published or not. The documents may come from teaching and research institutions in France or abroad, or from public or private research centers.

L'archive ouverte pluridisciplinaire **HAL**, est destinée au dépôt et à la diffusion de documents scientifiques de niveau recherche, publiés ou non, émanant des établissements d'enseignement et de recherche français ou étrangers, des laboratoires publics ou privés.

THESE

Présentée

DEVANT L'UNIVERSITE DE RENNES I

Pour obtenir

le grade de **DOCTEUR DE L'UNIVERSITE DE RENNES 1**
Mention Sciences de la Terre

PAR

Tanguy LE BORGNE

Equipe d'accueil : Géosciences Rennes UMR 6118 CNRS

Ecole doctorale : Sciences de la Matière

Composante universitaire : U.F.R. Structure et Propriétés de la Matière

**MESURE IN SITU ET MODELISATION
DE L'HETEROGENEITE DES ECOULEMENTS
DANS LES MILIEUX GEOLOGIQUES**

Soutenue le 3 Décembre 2004 devant la Commission d'Examen

COMPOSITION DU JURY

Philippe GOUZE : Université de Montpellier - Rapporteur

Frédéric DELAY : Université de Poitiers - Rapporteur

Jean-Pierre HULIN : Université Paris Sud 11 - Examineur

Jesus CARRERA : UPC Barcelona - Examineur

Olivier BOUR : Université de Rennes I - Directeur de thèse

Philippe DAVY : Université de Rennes I - co-Directeur de thèse

Résumé

Le point de départ de cette thèse est le constat suivant : les modèles prédictifs de transfert dans les milieux souterrains, souvent basés sur une représentation de type milieu poreux homogène, ne sont pas adaptés aux milieux naturels, qui sont caractérisés au contraire par une forte hétérogénéité des vitesses d'écoulement à toutes les échelles. La grande incertitude qui existe actuellement sur la prédiction des transferts et des temps de résidence dans ces systèmes ne provient pas seulement de l'incertitude sur la paramétrisation des modèles mais également de l'incertitude sur leur formulation même, liée aux hypothèses effectuées sur la représentation des distributions de vitesses d'écoulement. Pour aborder ce problème, les objectifs principaux de cette thèse étaient, d'une part de développer des méthodes de mesure *in situ* adaptées à la caractérisation de l'hétérogénéité des écoulements et de leur organisation, et d'autre part de mener une étude théorique sur la représentation de l'organisation des écoulements dans les modèles prédictifs. Cette thèse a été effectuée dans le cadre des projets européens SALTRANS (2000-2004) et ALIANCE (2001-2005) et du réseau national de sites hydrogéologiques de l'Observatoire de Recherche en Environnement H+.

Trois résultats principaux ont été obtenus. (1) Nous avons tout d'abord apporté une démonstration du caractère fractal des écoulements dans les aquifères fracturés à partir de tests hydrauliques. Cette approche permet de définir un modèle équivalent permettant de rendre compte du comportement hydraulique moyen d'un site naturel sur une large gamme d'échelles de temps et d'espace. (2) Du point de vue de la caractérisation expérimentale de la variabilité des vitesses d'écoulement, nous avons mis en oeuvre des méthodes de mesure de vitesse d'écoulement en forage, en collaboration avec Frederick Paillet (University du Maine, USA). Nous avons proposé et testé une méthode d'inversion de ces mesures permettant d'imager les chemins d'écoulement et de quantifier leurs propriétés hydrauliques à différentes échelles sur les sites naturels. (3) Enfin, à partir d'une étude numérique destinée à simuler les écoulements et le transport de soluté dans des champs de perméabilité hétérogènes, nous avons proposé une nouvelle méthode permettant de quantifier l'organisation des écoulements. Les résultats obtenus concernant l'analyse détaillée de la structure de corrélation du champ de vitesse permettent de mettre en question les hypothèses utilisées dans les modèles de transport de solutés, en vue de progresser vers une représentation plus réaliste des distributions de vitesse dans ces modèles.

Mots clés : hydrogéologie, milieux fracturés, milieux poreux, hétérogénéité, transport, contaminant

Abstract

The starting point of this work is the following observation: predictive models of flow and solute transfer in the subsurface, which are often based on homogeneous porous media type of representation, are not adapted to natural systems that are characterized by highly heterogeneous velocity fields at all scales. The current high uncertainty in the prediction of flow and solute transfer and residence times in these systems is related not only to the uncertainty in model parameter estimation but also to the uncertainty in the relevance of the models themselves, which is related to the hypothesis made concerning the representation of the distribution of fluid velocities. To tackle this problem, the principal objectives of this PhD work was (i) to develop *in situ* measurement methods adapted to the characterization of the organization and heterogeneity of the flow field, and (ii) to carry on a theoretical study on the representation of the flow field organization in predictive models. This work was done within the framework of the national network of hydrogeological sites ORE H+ and the European projects SALTRANS (2000-2004) and ALIANCE (2001-2005).

Three main results were obtained. (1) We first demonstrated the fractal nature of flow in fractured aquifer, from a scaling analysis of pumping tests. This approach allows defining an equivalent model that is consistent with the mean hydraulic behaviour of a natural site over a large range of temporal and spatial scales. (2) Concerning the experimental characterization of the flow velocity variability, we used borehole flow velocity measurement devices in collaboration with Frederick Paillet (University of Maine, USA). We proposed and tested a method of inversion of these measurements to image flow paths and quantify their hydraulic properties at different scales in field sites. (3) Finally, we developed a new method to quantify the flow field organization, based on numerical simulations of flow and solute transport in heterogeneous permeability fields. The results obtained concerning the detailed analysis of the flow field correlation structure allow re-examining the hypothesis made in solute transport models, in order to progress towards a realistic representation of the velocity field in these models.

Key words: hydrogeology, fractured media, porous media, heterogeneity, transport, contaminant

Remerciements

Je remercie tout d'abord Olivier Bour, qui, avec Philippe Davy, a encadré cette thèse avec enthousiasme. Je tiens également à remercier Jean-Raynald De Dreuzy, pour son implication dans les parties numériques et théoriques et Frederick Paillet et Jean-Pierre Caudal, pour leur contribution à la partie expérimentale. C'est grâce à toutes ces personnes aux compétences et aux approches différentes que j'ai pu avancer dans ma réflexion concernant la caractérisation et la modélisation des systèmes naturels. J'ai beaucoup apprécié de travailler dans cette équipe mais aussi de bénéficier d'une grande ouverture sur d'autres équipes et d'autres façons de travailler, notamment grâce aux projets Européens et à l'Observatoire de Recherche en Environnement H+.

Je remercie les membres du jury : Frédéric Delay, Philippe Gouze, Jesus Carrera et Jean-Pierre Hulin, pour leur remarques constructives.

Je suis reconnaissant à la mairie de Ploemeur pour son soutien précieux tout au long de la thèse. Je remercie plus particulièrement André Le Cloerec, ainsi que Gérard, Jean-Luc et Julie pour leur aide et leur accueil toujours chaleureux.

J'en profite pour saluer toutes les personnes que j'ai eu la chance de connaître au labo ou ailleurs pendant ces trois années. Je remercie en particulier Sylvie, dont j'ai partagé le bureau pendant trois ans.

Merci à toute ma famille de m'avoir supporté et aidé.

Enfin, je dédie ce travail à Caro.

Sommaire

Introduction	9
Chapitre I Hétérogénéité des écoulements et modélisation des transferts de fluide et de soluté	13
I.1. Hétérogénéité des écoulements dans les milieux géologiques	15
I.1.1 Hétérogénéités des propriétés hydrauliques	15
I.1.2 Passage de l'hétérogénéité du milieu à l'hétérogénéité des écoulements	19
I.1.3 Conséquences pour le transfert de soluté	21
I.2 Prise en compte de l'hétérogénéité dans la modélisation	26
I.2.1 Modèles moyens classiques	26
I.2.2 Implications du théorème central limite	28
I.2.3 Relation entre la dispersion et la corrélation des vitesses	31
I.2.4 Parallèle avec le transfert de pression	32
I.3. Approches développées au cours de la thèse	34
I.3.1 Définition d'un modèle d'écoulement équivalent pour les aquifères fracturés	35
I.3.2 Imagerie des structures d'écoulement à différentes échelles	35
I.3.3 Corrélation des vitesses d'écoulement	36

Chapitre II Définition d'un modèle d'écoulement équivalent pour un aquifère fracturé	37
II.1 Méthodologie pour tester les modèles moyens équivalents	39
II.2. Article: Equivalent mean flow models relevant for fractured aquifers: Insights from a pumping tests scaling interpretation (<i>Le Borgne et al., 2004</i>)	43
II.3. Conclusions	57
Chapitre III Caractérisation expérimentale de l'hétérogénéité des écoulements	59
III.1 Débitmétrie en forage	63
III.1.1 Hétérogénéité de la charge hydraulique	63
III.1.2 Hypothèses pour l'inversion des mesures	64
III.1.3 Limites et incertitudes	66
III.2. Article: Cross-borehole flowmeter tests for transient heads in heterogeneous aquifers (<i>Le Borgne et al., in press</i>)	68
III.3. Article: Integration of borehole, cross-borehole and aquifer scale hydraulic properties estimates (<i>Le Borgne et al., soumis</i>)	97
III.4. Conclusions	133
Chapitre IV Corrélation des vitesses d'écoulement dans les milieux poreux hétérogènes	135
IV.1 Article: Describing the velocity field organization in heterogeneous media by conditional correlations (<i>Le Borgne et al., en préparation</i>)	137
IV. 2 Conclusions	159
Conclusions et perspectives	161
Bibliographie	147

Chapitre I

Hétérogénéité des écoulements et modélisation des transferts de fluides et de soluté

Dans cette partie introductive, nous présentons les principales observations disponibles actuellement sur l'hétérogénéité des propriétés hydrauliques, des écoulements et sur les transferts d'éléments en solution dans les milieux géologiques. Nous introduisons également les approches utilisées pour représenter l'organisation des écoulements dans les modèles prédictifs. A partir de cet état des lieux, nous introduisons les différentes approches suivies au cours de cette thèse.

I.1. Hétérogénéité des écoulements dans les milieux géologiques

I.1.1 Hétérogénéités des propriétés hydrauliques

Les roches présentent une structure hétérogène sur une large gamme d'échelles comme le montre la Figure I. 1. Le flux d'eau traversant un volume de roche est généralement proportionnel au gradient de charge imposé. On peut définir la perméabilité comme le rapport du débit traversant le milieu sur le gradient de charge qui crée ce débit (Figure I. 2):

$$k = \frac{q}{-\nabla h} \quad (I.1)$$

q est le débit par unité de surface (m/s), h est la charge hydraulique (m) et k la perméabilité (m/s).

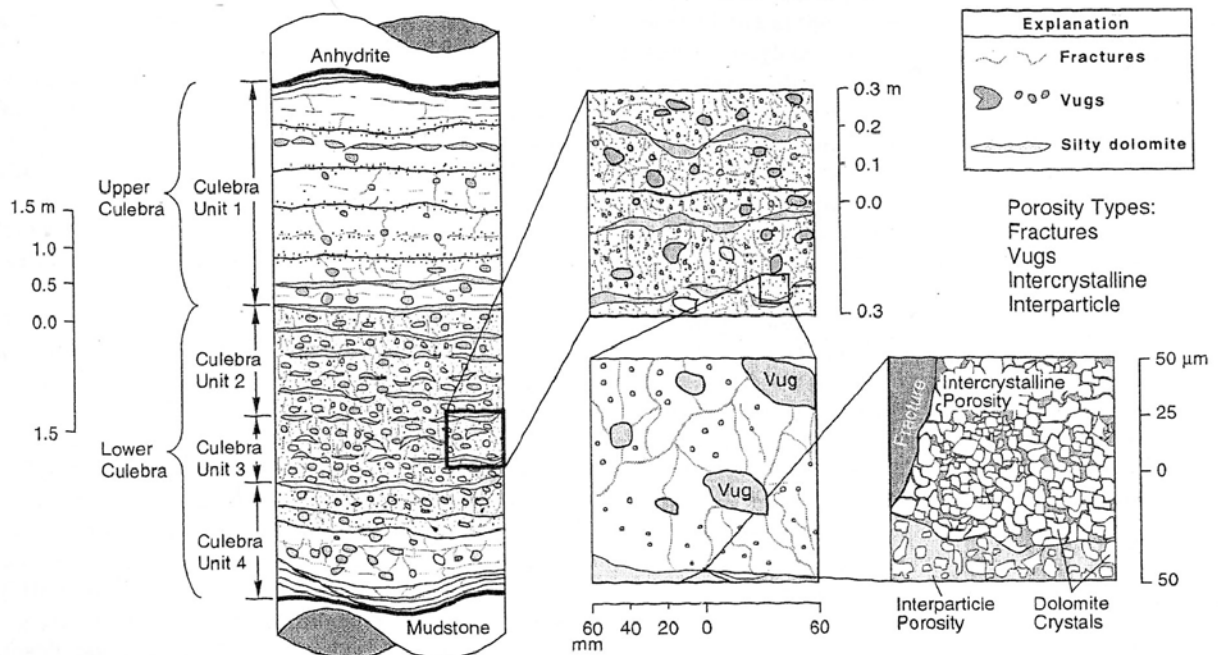

Figure I. 1: Schéma illustrant les variations de lithologies et les différents types de porosité sur le site de Culebra d'après (Meigs and Beauheim, 2001)

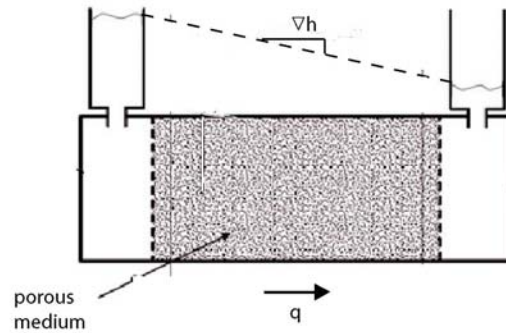
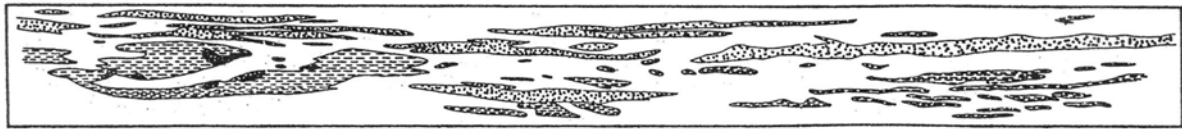

Figure I. 2: écoulement à travers un milieu poreux. L'écoulement a lieu de gauche à droite du fait de la différence de charge.

Le coefficient de perméabilité peut varier sur une dizaine d'ordres de grandeur selon les roches. La Figure I. 3 présente une coupe schématique illustrant la variabilité spatiale des faciès au sein d'une même formation impliquant une variation de la perméabilité sur cinq ordres de grandeur à l'échelle de la dizaine de mètres. En plus de la variabilité des lithologies, les fractures constituent souvent des chemins préférentiels pour les écoulements. Les fractures elles-mêmes ont des propriétés hydrauliques qui peuvent être très variables dans l'espace en fonction de leur ouverture qui varie localement, de leur éventuel remplissage et de l'endommagement de la zone autour de la fracture (Figure I. 4). La Figure I. 5 présente les distributions de perméabilités sur quatre sites hydrogéologiques de référence. Sur les sites de Borden et Cape Cod, qui sont des aquifères alluviaux de faible hétérogénéité, la perméabilité varie sur un peu plus d'un ordre de grandeur (Figure I. 5a et Figure I. 5b). Au contraire, le site de MADE (MAcroDispersion Experiment) est un aquifère alluvial beaucoup plus hétérogène (Figure I. 3), dont la perméabilité varie sur près de cinq ordres de grandeur (Figure I. 5c). Sur le site de Mirror Lake, en domaine cristallin fracturé, la perméabilité varie sur six ordres de grandeur (Figure I. 5d). Comme le montre la figure I.6, les fractures sont observées à toutes les échelles et présentent une grande distribution de tailles.



0 1 2 3 4 meters

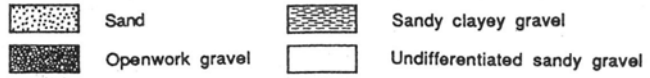

TABLE 1. Hydraulic Conductivity Assigned to Facies

	K, cm/s
Open work gravel	10^0
Sand	10^{-2}
Sandy gravel	10^{-3}
Sandy clayey gravel	10^{-5}

Figure I. 3: coupe géologique représentant les variations de faciès sédimentaires cartographiés dans un carrière sur le site de MADE d'après (Rehfeldt et al., 1992).

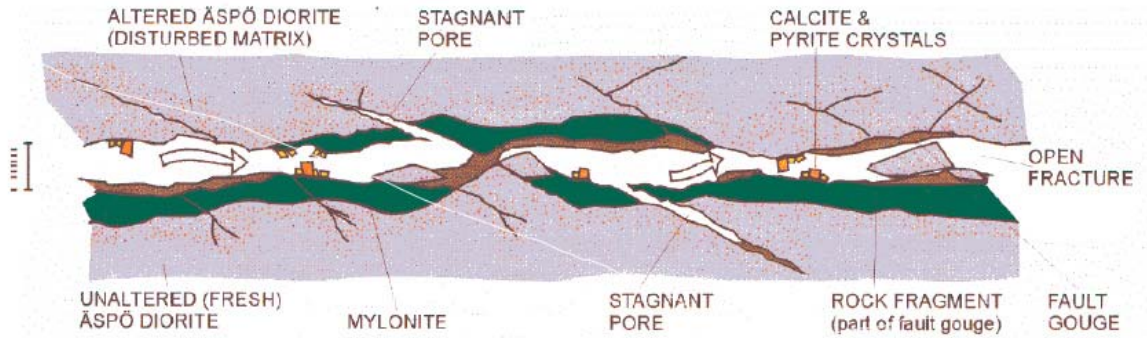

Figure I. 4 : illustration de l'hétérogénéité d'une zone fracturée d'après Winberg et al. (2000)

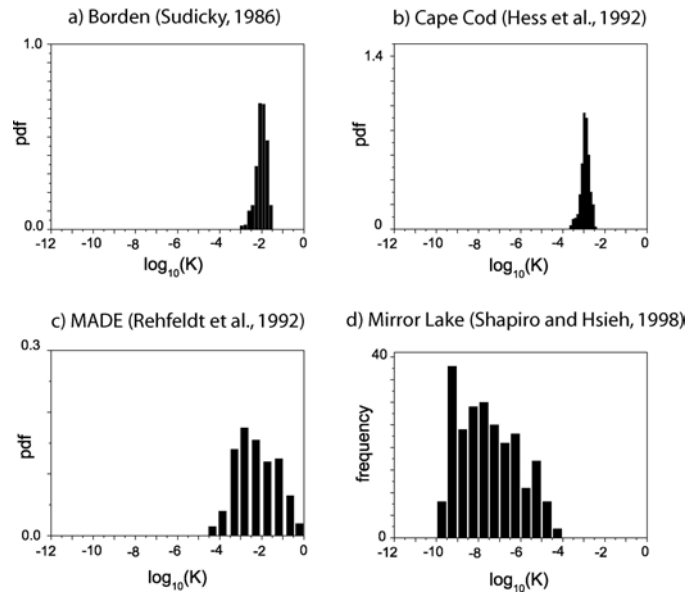

Figure I. 5: distribution des perméabilités sur les sites de a) Borden ((Sudicky, 1986)), b) Cape Cod ((Hess et al., 1992)), c) MADE ((Rehfeldt et al., 1992)), d) Mirror Lake ((Shapiro and Hsieh, 1998)).

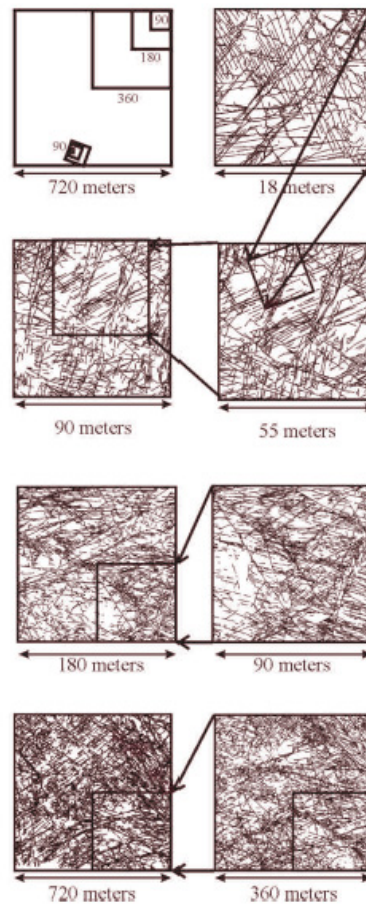

Figure I. 6: Cartographie d'un réseau de fractures à différentes échelles du site de Hornelen, d'après Odling (1997)

I.1.2 Passage de l'hétérogénéité du milieu à l'hétérogénéité des écoulements

Le passage de l'hétérogénéité du milieu à l'hétérogénéité des écoulements n'est pas trivial. L'organisation des écoulements dépend de la variabilité des propriétés hydrauliques et de leur corrélation spatiale, c'est à dire de la connectivité spatiale des zones de propriétés hydrauliques similaires. Le gradient de charge étant variable dans l'espace, la relation entre perméabilité et vitesse d'écoulement n'est pas directe (équation I.1). Des études numériques et expérimentales ont mis en évidence le fait que les écoulements dans les milieux hétérogènes ont tendance à s'organiser en chenaux plus ou moins indépendants (Moreno and Tsang, 1994, Tsang and Neretnieks, 1998, Bruderer-Weng et al., 2004, Tiedeman and Hsieh, 2004). Ce phénomène de chenalisation est souvent évoqué comme une des raisons principales de l'incapacité des modèles classiques à reproduire les observations (Tsang and Neretnieks, 1998).

La question du passage de l'hétérogénéité du milieu à celle des écoulements est généralement traitée différemment pour les milieux poreux hétérogènes ou pour des roches peu perméables fracturées. Dans ce dernier cas, la question de la connectivité est primordiale. A l'échelle des réseaux de fractures, l'organisation des écoulements dépend des propriétés géométriques des réseaux de failles. Celles-ci peuvent être caractérisées par la distribution des longueurs de failles, la densité de failles et la distribution des ouvertures de fracture. Au seuil de percolation, lorsqu'il existe un réseau de fractures connecté, l'organisation des écoulements est contrôlée par la géométrie de ce réseau connecté (Figure I. 7), ainsi que par la distribution des propriétés hydrauliques des fractures (de Dreuzy et al., 2001). Ceci implique une grande variété d'organisations possibles pour les écoulements dans ces systèmes en fonction des propriétés géométriques des réseaux (de Dreuzy, 1999) (

Figure I. 8). La caractérisation de l'organisation des écoulements dans les réseaux de fractures naturels fait l'objet du chapitre III de cette thèse.

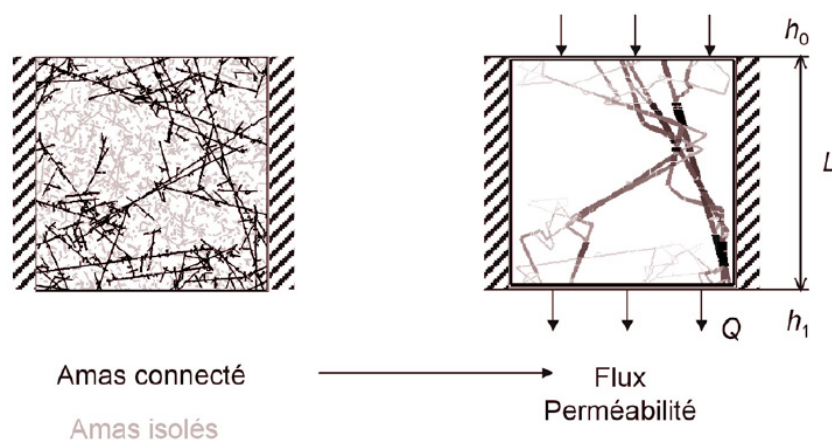

Figure I. 7: Illustration des écoulements à travers un réseau de fractures connecté d'après (Darcel, 2002)

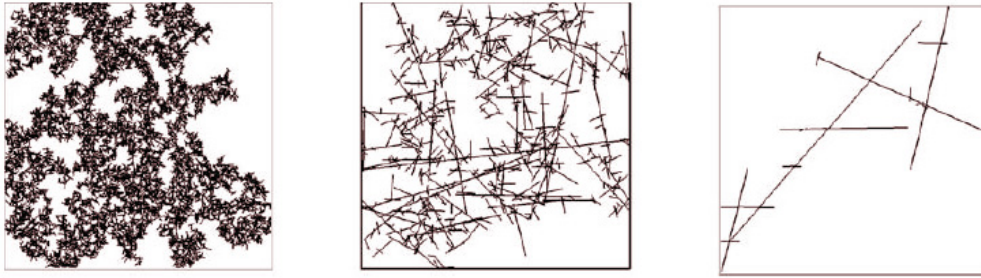

Figure I. 8: exemples de réseaux au seuil de percolation (densité de fracture pour laquelle le réseau est connecté) pour différentes distributions de longueurs de fractures: a) $a=\infty$, b) $a=2.5$, c) $a=2$. Les amas de failles non connectés ne sont pas représentés. D'après (*Darcel, 2002*). Si le réseau est représenté par des failles de tailles identiques (a), la connexion du réseau dépend de la densité de faille. Au dessus d'une densité de faille critique, le réseau est connecté quelle que soit l'échelle d'observation. Ce type de système peut être décrit dans le cadre de la théorie de la percolation (*Stauffer and Aharony, 1992*). Au contraire, si le réseau de failles est représenté par une large distribution de failles de type loi de puissance d'exposant a , la connexion dépend également de la taille du système (b,c). En effet, même pour des faibles densités de failles, il existe une échelle à partir de laquelle on rencontre des longues failles qui à elles seules garantissent la connexion du système (*Bour and Davy, 1997*).

I.1.3. Conséquences pour le transfert de soluté

L'hétérogénéité des écoulements provoque la dispersion des solutés transportés dans les milieux géologiques. Certains éléments en solution empruntent des chemins d'écoulement rapide alors que d'autres stagnent dans des zones d'écoulement faible. Pour un milieu poreux constitué de grains de taille homogène (Figure I. 9 a), on observe une distribution des temps de transfert qui se manifeste par une distribution spatiale de la concentration de soluté (Figure I. 9 b). Cette dispersion des solutés est due pour partie à la diffusion moléculaire et d'autre part à l'hétérogénéité des vitesses à l'intérieur des pores et à la variabilité de la taille des pores. Dans ce type de milieu, relativement peu hétérogène, la distribution longitudinale de la concentration attendue est une distribution gaussienne (Gelhar, 1993), ce qui est mis en évidence dans l'expérience de la Figure I. 9. La moyenne de cette distribution $\langle x \rangle$ représente la position moyenne du panache et la variance $\sigma^2(x)$ de cette distribution représente l'étalement du panache. La Figure I. 9c montre que pour cette expérience, ces deux paramètres évoluent linéairement avec le temps. On peut dans ce cas définir la vitesse et le coefficient de dispersion par:

$$V = \frac{d \langle x \rangle}{dt} \text{ et } D = \frac{1}{2} \frac{d\sigma^2(x)}{dt} \quad (\text{I.2})$$

Ces observations constituent les propriétés fondamentales du modèle d'advection dispersion utilisé classiquement pour représenter l'évolution temporelle et spatiale de la concentration C :

$$\frac{\partial C}{\partial t} = D \nabla^2 C - V \nabla C \quad (\text{I.3})$$

avec D le coefficient de dispersion. Dans le modèle d'advection-dispersion, la dispersion des solutés est donc représentée par un phénomène diffusif autour de la vitesse moyenne. Le modèle de transport est dit Fickien ou Gaussien en référence à la distribution spatiale Gaussienne des concentrations prise en compte dans ce modèle.

a) schéma de l'expérience

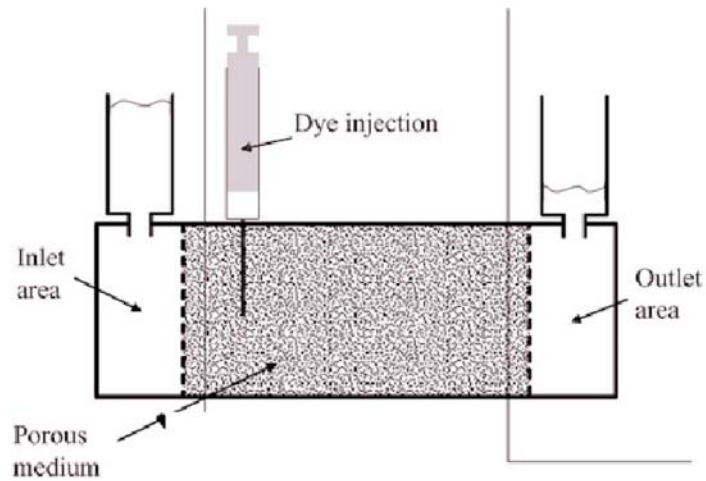

b) distribution de la concentration selon x à t=20 min, 40 min et 58 min

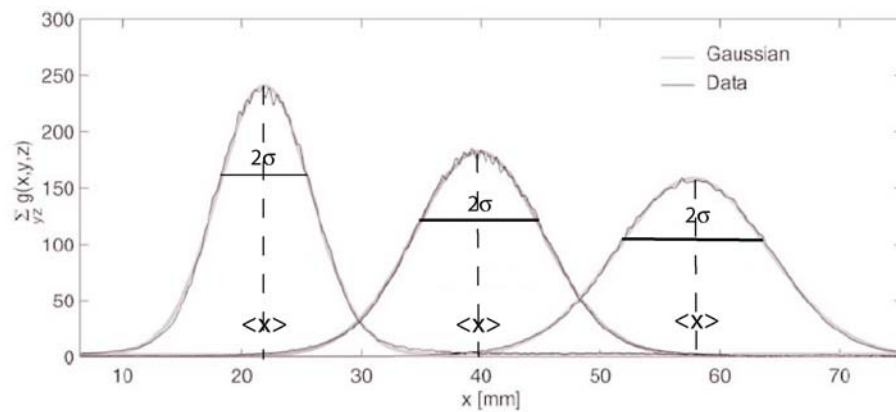

c) Evolution du déplacement moyen du panache $\langle x \rangle$ et de sa variance en fonction du temps

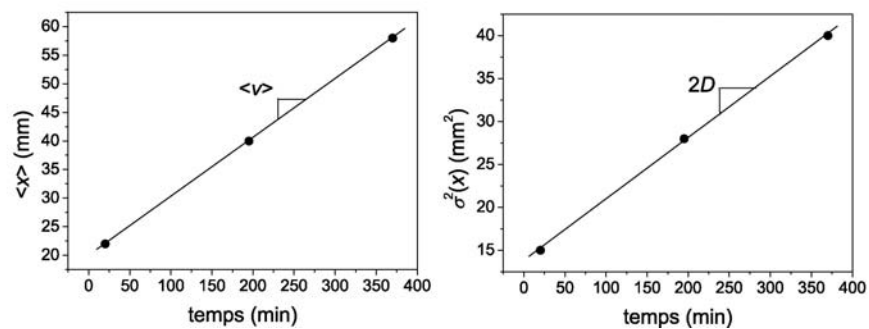

Figure I. 9: a) expérience de traçage dans un milieu poreux constitué de billes de taille identique b) distribution des concentrations en soluté selon l'abscisse à différents temps estimées par des méthodes optiques et ajustement par une distribution gaussienne c) évolution de la distance moyenne et de la variance de la distance parcourue par le panache en fonction du temps. D'après Stöhr *et al.* (2003).

Comme nous l'avons souligné dans la partie I.1.1, les milieux tels que celui de la Figure I. 9 sont en réalité rarement rencontrés dans la nature. Dans les systèmes naturels, les contrastes de vitesses existent non plus seulement à l'échelle des pores mais également entre zones de différentes perméabilités. La Figure I. 10 présente l'évolution d'un panache dans un sable homogène d'un part et dans milieu granulaire composé de deux sables différents d'autre part. Dans le cas hétérogène (Figure I. 10b), l'étalement du panache est plus important que pour le cas homogène (Figure I. 10a). Par analogie avec la dispersion en milieu poreux homogène, l'approche dite de macrodispersion propose de représenter la dispersion des solutés dans les milieux hétérogènes par une équation d'advection dispersion (équation I.3). Ceci revient à considérer l'effet de l'advection hétérogène comme un phénomène diffusif. La dispersion est alors caractérisée par un coefficient de macrodispersion. Pour des champs de perméabilité faiblement hétérogènes, il est possible de montrer par des développements analytiques au premier ordre que le transport de soluté converge effectivement rapidement vers un modèle Fickien (*Dagan, 1989, Gelhar, 1993*). Si ce modèle a pu être validé sur certains sites particulièrement peu hétérogènes (*Hess et al., 1992*), de nombreuses observations montrent que les approximations de ce modèle conduisent généralement à surestimer les temps de transfert les plus courts et à sous-estimer les temps de transfert les plus longs de plusieurs ordres de grandeurs (*Adams and Gelhar, 1992, Tsang and Neretnieks, 1998, Haggerty et al., 2000*).

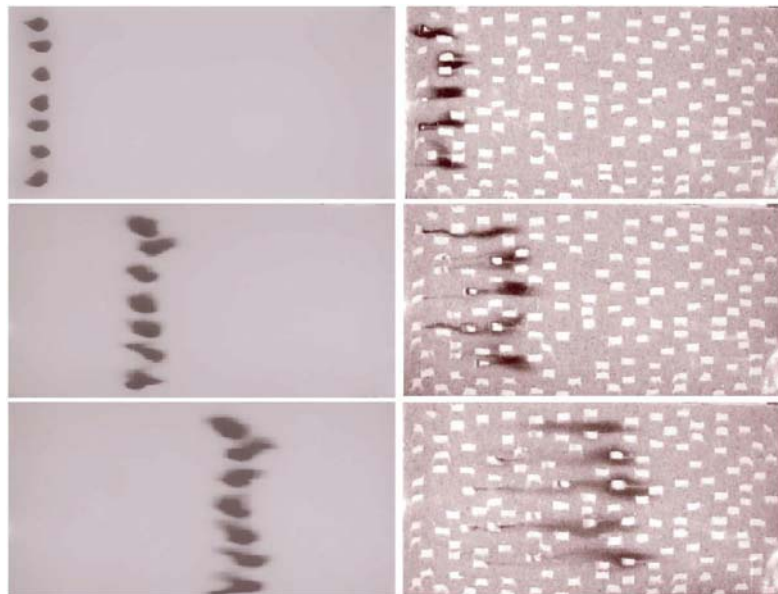

Figure I. 10: Etalement de traceur dans le cas d'un milieu constitué de billes de tailles homogènes (à gauche) et de billes de grande taille et de petite taille (à droite) d'après *Levy and Berkowitz (2003)*.

Asymétrie des profils de concentration

L'expérience MADE (Macrodispersion Experiment) a été mise en oeuvre pour tester l'applicabilité du modèle de macrodispersion pour un aquifère alluvial (*Adams and Gelhar, 1992*). La variance du

champ de perméabilité a été estimée à 4.5 à partir de tests hydrauliques. Les panaches de soluté pour les deux expériences montrent des profils de concentration avec des pics très prononcés et une dispersion très asymétrique (Figure I. 11) en comparaison avec les formes symétriques observées pour les milieux homogènes en laboratoire (Figure I. 9). Le modèle de macrodispersion ne permet pas de rendre compte de la forme extrêmement asymétrique des profils. Les processus principaux contrôlant le profil de concentration sur le site de MADE restent à ce jour un sujet de débat (*Berkowitz and Scher, 1997, Feehley et al., 2000, Harvey and Gorelick, 2000, Benson et al., 2001, Barlebo et al., 2004*). *Harvey and Gorelick (2000)* mettent en avant l'influence de processus de transfert de masse entre des chemins préférentiels et des zones de stagnation à une échelle décimétrique. Au contraire *Barlebo et al. (2004)* montrent que les observations peuvent être expliquées par les structures de différentes perméabilités à l'échelle de la dizaine de mètres. Ce cas d'étude illustre bien les questions relatives à l'influence de l'hétérogénéité des écoulements à petite échelle (Figure I. 1) et à grande échelle (Figure I. 3).

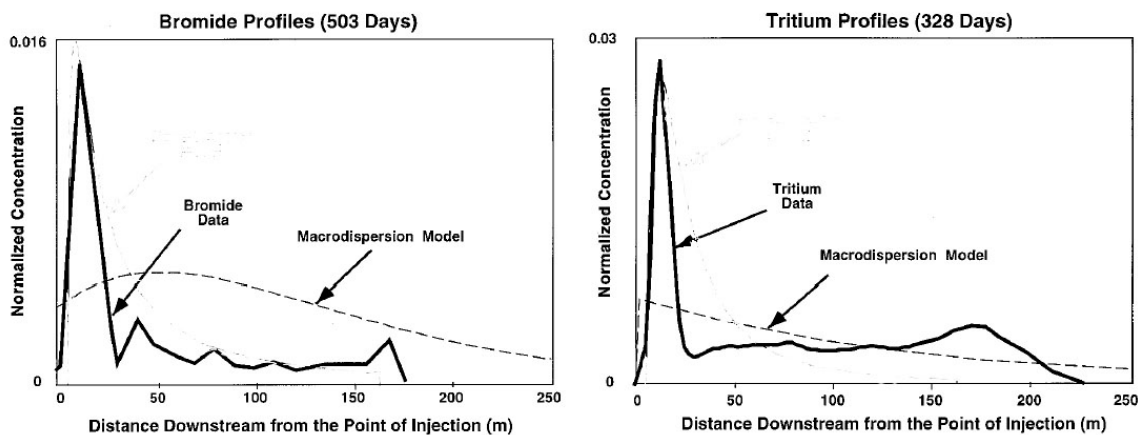

Figure I. 11: Profil de concentration mesuré et modélisé pour l'essai de traçage sur site de MADE d'après Harvey and Gorelick (2000).

Temps de rétention très longs

L'observation d'un profil spatial de concentration (Figure I. 11) nécessite une instrumentation très détaillée des sites. Les observations disponibles sont le plus souvent des courbes de restitution, représentant l'historique de concentration en un point de mesure donné. Les paramètres contrôlant le transport sont généralement déduits en ajustant un modèle de transport aux courbes de restitution. Cependant, l'interprétation d'une courbe de restitution ne permet pas en général d'identifier un modèle de transport de manière univoque (*Sanchez-Vila and Carrera, 2004*). Une façon de contraindre les modèles possibles est d'effectuer des expériences dans différentes conditions: pour différentes vitesses de transport, différentes configurations hydrauliques ou à différentes distances. Les nombreuses observations indiquant des longues queues de restitution aux temps longs (Figure I. 12) sont généralement interprétées comme la manifestation d'un transport non Fickien (*Tsang and Neretnieks,*

1998, Haggerty *et al.*, 2000, Becker and Shapiro, 2003) due à une organisation particulière des écoulements. Cependant, bien que plusieurs types de modèles puissent produire de telles courbes de restitution (Benson *et al.*, 2000, Berkowitz *et al.*, 2000, Haggerty *et al.*, 2000), la relation entre les paramètres de ces modèles et la structure d'écoulement n'est pas quantifiée. De ce fait aucun modèle de transport n'est entièrement validé pour les milieux très hétérogènes.

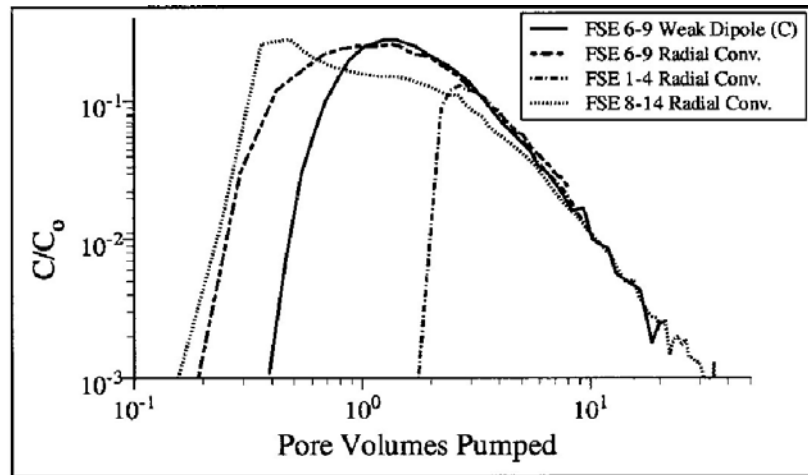

Figure I. 12: Courbes de restitution de plusieurs essais de traçage au bromide en condition "radial convergent" et "weak dipole" pour trois paires de puits différentes sur le site de Mirror Lake en domaine cristallin fracturé. D'après Becker and Shapiro (2003).

Les modèles classiques de transfert de pression et de soluté correspondent à des modèles de type diffusif. Dans la partie suivante, nous expliquons les origines possibles des phénomènes de diffusion anormale.

I.2. Prise en compte de l'hétérogénéité dans la modélisation

Les forages, qui sont quasiment les seuls moyens d'observation directe du sous-sol, ne représentent qu'une très faible portion du milieu. De ce fait, même avec l'instrumentation la plus détaillée, l'hétérogénéité des flux et du milieu ne peut pas être connue dans son intégralité. Ainsi, des modèles physiques prenant en compte l'effet de l'hétérogénéité inaccessible à la mesure doivent être employés. Ce problème est analogue aux problèmes traités par la physique statistique, qui est classiquement utilisée pour écrire des équations macroscopiques provenant d'interactions microscopiques ne pouvant être explicitement représentées (*Bouchaud & Georges, 1990*). La transmission de chaleur par l'agitation des atomes à l'échelle microscopique se traduit par exemple par une équation moyenne à l'échelle macroscopique, contenant un paramètre unique qui est la diffusivité thermique. L'efficacité de cette approche provient du fait que ce paramètre peut être mesuré simplement sans avoir besoin de connaître l'ensemble des trajectoires des atomes. La problématique des transferts à travers les aquifères peut être approchée de manière similaire. Les effets macroscopiques tels que l'étalement d'un panache de soluté proviennent de la variabilité des vitesses locales d'écoulement. Il s'agit donc de représenter l'effet moyen, à l'échelle de l'objet géologique, de processus ayant lieu à des échelles pouvant être aussi petites que le millimètre.

La question des échelles caractéristiques est fondamentale dans la définition de modèles moyens. Pour la question des transferts de chaleur, l'échelle de modélisation est toujours bien supérieure à l'échelle caractéristique de la variabilité qui est celle des atomes. La spécificité des milieux géologiques est de présenter une forte structuration provenant de la formation des roches et de l'historique des contraintes et des déformations subies. Les aquifères ont en général une structure hétérogène à des échelles allant du micromètre au kilomètre. Du fait de l'organisation multi-échelle des milieux et des réseaux de fractures (figure 2), les échelles caractéristiques de l'hétérogénéité ne sont pas a priori connues ; celles des vitesses d'écoulement le sont donc encore moins. De plus, l'existence même d'une échelle caractéristique peut être mise en doute, en particulier pour les milieux fracturés (*Bonnet et al., 2001*).

Dans cette partie, les limites des modèles classiques, qui sont des modèles de types diffusifs, sont tout d'abord mises en évidence. Nous introduisons ensuite la représentation des processus physiques en terme de marcheurs aléatoires afin de mettre en avant les facteurs contrôlant l'applicabilité des modèles diffusifs. Notamment, nous montrons la relation entre la corrélation des vitesses et la dispersion des solutés. La représentation du transfert de pression en terme de marcheurs aléatoires est également introduite.

I.2.1 Modèles moyens classiques

Les modèles classiques de transfert de pression et de soluté correspondent à des équations de type diffusif (équations I.4 et I.5 respectivement).

$$\frac{\partial h}{\partial t} = \frac{T}{S} \nabla^2 h \quad (\text{I.4})$$

avec h , la charge T la transmissivité et S le coefficient d'emmagasinement

$$\frac{\partial C}{\partial t} = D\nabla^2 C - V\nabla C \quad (I.5)$$

avec C , la concentration, D le coefficient de dispersion et V la vitesse.

La Figure I. 13 présente des exemples d'application de ces modèles pour des problèmes de transfert de pression (Figure I. 13.a) et de transfert de soluté (Figure I. 13.b) dans des sites naturels. Dans ces deux cas, un modèle peut être ajusté aux données mais il ne prend pas en compte l'évolution temporelle observée. L'utilisation des modèles classiques impose donc que les paramètres équivalents soient ajustés à différents temps ou en fonction de l'échelle. Ceci est le cas par exemple pour le paramètre de dispersivité déduit de l'application de l'équation I.5, dont les estimations dans les milieux naturels semblent dépendre de l'échelle d'observation (Figure I. 14). Ces observations montrent que les modèles moyens classiques ne prennent pas en compte les propriétés des écoulements à différentes échelles contrôlant les processus de transfert de pression et de soluté dans les milieux hétérogènes.

a) Modélisation des transferts de pression

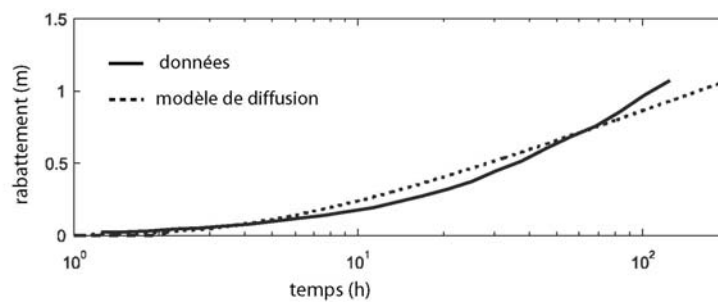

b) Modélisation des transferts de solutés

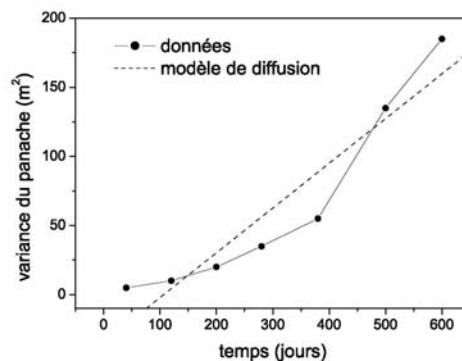

Figure I. 13: Exemples de données où les modèles moyens classiques ne sont pas applicables pour a) le transfert de pression: données de rabattement d'après *Le Borgne et al.* (2004) et modèle de Theis (équation I.4), b) le transfert de soluté: évolution temporelle de la variance du panache pour l'expérience MADE d'après *Adams and Gelhar* (1992) et modèle de transport Fickien (équation I.5).

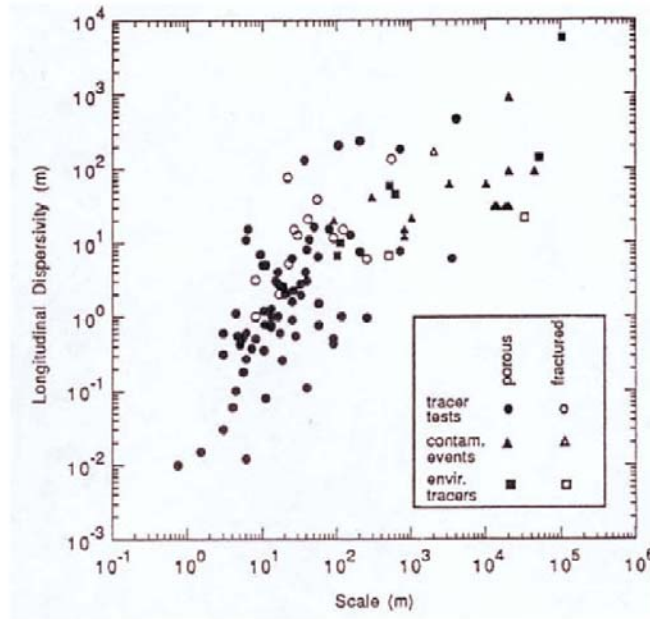

Figure I. 14: Synthèse des mesures de dispersivité effectuées sur le terrain en fonction de la longueur de transport d'après *Gelhar et al.* (1992)

I.2.2 Implications du théorème central limite

Les modèles moyens classiques pour le transfert de pression et de soluté sont basés sur l'hypothèse d'un phénomène diffusif. L'importance accordée au modèle de diffusion et la question de son application à une échelle des milieux géologiques provient en partie du théorème central limite qui implique que la somme d'événements indépendants converge vers une distribution gaussienne. Ceci peut être mieux compris en considérant la représentation des phénomènes physiques sous forme de marcheurs aléatoires. Pour le transport de soluté, la concentration de soluté peut être représentée par une densité de probabilité de la présence de marcheurs aléatoires. Les zones de forte concentration sont représentées par des zones de forte densité de probabilité. La dispersion de cette concentration dans le milieu est alors envisagée par les déplacements aléatoires des marcheurs.

Dans la théorie des marcheurs aléatoires, les marcheurs effectuent des saut dx_n choisis dans une distribution $p(dx)$, à chaque pas de temps dt choisi dans une distribution $p(t)$. La position X_t d'un marcheur après N pas, c'est à dire au temps $t = \sum dt$, est la somme de N déplacements:

$$X_t = \sum_{n=1}^N dx_n \quad (I.6)$$

Dans la limite des incréments de temps petits:

$$X_t = \int_0^t \frac{dx_t}{dt} dt \quad (I.7)$$

A la condition que les deux premiers moments $\langle dx \rangle$ et $\langle dx^2 \rangle$ soit finis et que la corrélation entre les déplacements à différents temps soit finie, le théorème central limite implique que la distribution de la position X_t est Gaussienne dans la limite des temps longs.

$$P(X, t) \rightarrow \frac{1}{\sqrt{4\pi Dt}} \exp(-(X - Vt)/4Dt) \quad (\text{I.8})$$

Dans cette limite, la moyenne et la variance de X_t dépendent linéairement du temps:

$$\overline{X_t} = Vt, \quad \overline{X_t^2} - \overline{X_t}^2 = 2Dt \quad (\text{I.9})$$

L'équation différentielle correspondante décrivant la densité de probabilité des marcheurs en fonction du temps et de l'espace est l'équation d'advection dispersion (équation I.3). Ces caractéristiques (I.8 et I.9) concordent avec les observations pour les milieux poreux peu hétérogènes (figure I.11), ce qui justifie dans ce cas l'utilisation du modèle d'advection dispersion.

Le théorème central limite s'applique en théorie dans la limite des temps longs. Pour l'application aux transferts de soluté, cela signifie que le modèle Gaussien (équation I.5) est applicable lorsque les solutés ont parcouru un trajet suffisamment long dans le milieu. Une question importante est donc de savoir quel est le temps de convergence vers un modèle Gaussien. Ce temps est tout d'abord contrôlé par la distribution des sauts possibles. Le régime diffusif est atteint lorsque l'ensemble des marcheurs a échantillonné l'ensemble de la distribution des sauts possibles. Plus la distribution des sauts est grande, plus le temps de convergence est long. L'analogie de cette distribution des sauts pour les milieux géologiques est la distribution des hétérogénéités. Toute la question est de traduire l'effet des hétérogénéités en terme de distribution de sauts. Le cas extrême pour la distribution de sauts est la distribution en loi de puissance. Dans ce cas, il y a toujours une probabilité non négligeable que les particules effectuent des sauts plus grands (Figure I. 15). Ce cas peut être étudié dans la théorie des vols de Levy qui généralise le théorème central limite à une famille de distribution stable dont la distribution Gaussienne est un cas particulier (*Metzler and Klafter, 2000*).



Figure I. 15: Exemples de trajectoires effectuées par des marcheurs aléatoires dans le cas d'un mouvement brownien (à gauche) et dans le cas où la distribution des sauts est en loi de puissance (à droite) d'après *Metzler and Klafter* (2000).

D'autre part, si la distribution de sauts est non stationnaire, par exemple si, au fur et à mesure du déplacement des marcheurs, la probabilité de faire des sauts plus grands augmente, cela signifie que la distribution totale des sauts n'est jamais échantillonnée exhaustivement par les marcheurs aléatoires. En conséquence, la distribution des marcheurs ne converge pas vers un modèle diffusif. Pour cette raison, la non stationnarité des formations géologiques, reliée à la probabilité de trouver des structures possédant des propriétés hydrauliques plus extrêmes, est proposée comme la principale explication de l'accroissement de la dispersivité avec l'échelle (Figure I. 14) (*Neuman*, 1990).

Un autre processus fondamental retardant la convergence vers un modèle diffusif est l'existence de corrélation entre les sauts. Une forte corrélation signifie par exemple qu'un petit saut aura de fortes chances d'être suivi par un autre petit saut, alors qu'il existera une forte probabilité que le marcheur effectue un long saut après avoir déjà fait un long saut. Plus la corrélation est forte, plus le temps pour que les marcheurs échantillonnent l'ensemble de la distribution des sauts est long. Un exemple illustrant l'existence de ce type de phénomène dans les milieux géologiques est le modèle d'écoulement en milieu stratifié proposé par *Matheron and de Marsily* (1980). Si l'on considère le transport de soluté dans un milieu stratifié avec un écoulement parallèle à des couches de perméabilités différentes, la vitesse d'écoulement est différente dans chaque couche. Si l'on considère de plus un échange de soluté entre les couches par diffusion, il est possible de montrer que probabilité pour une particule de soluté de rester dans une couche donnée décroît comme $t^{-1/2}$ (*Bouchaud and Georges*, 1990). Ceci implique donc une corrélation forte des déplacements. On peut montrer que, en conséquence, la variance des déplacement relatifs augmente comme $t^{3/2}$ au lieu de t (équation I.9): le

régime est dit hyper diffusif (*Matheron and de Marsily, 1980, Bouchaud and Georges, 1990*). Ce type de milieu implique donc un transport non Gaussien.

Plus généralement, le transport est dit non Gaussien lorsque la variance des déplacements n'augmente pas linéairement:

$$\overline{X_t^2} - \overline{X_t}^2 \propto t^\beta \quad (\text{I.10})$$

Si $\beta > 1$, le régime est dit hyper diffusif alors que si $\beta < 1$ le régime est dit hypo diffusif. D'autres types de champ de vitesse peuvent impliquer un transport non-Gaussien (*Bouchaud and Georges, 1990*). Nous en donnerons d'autres exemples dans le chapitre IV.

I.2.3 Relation entre la dispersion et la corrélation des vitesses

Dans le cas où la corrélation des vitesses est finie, cette grandeur est fondamentale pour la modélisation de la dispersion. Nous rappelons ici les développements permettant de mettre en évidence la relation entre la corrélation des vitesses et la dispersion des solutés. L'équation I.9 montre que la dispersion est reliée à l'accroissement temporel de la variance des déplacements. Si l'on considère les fluctuations de déplacement par rapport au déplacement moyen, le premier moment $\overline{X_t}$ est nul et l'on a:

$$\begin{aligned} \sigma^2(x, t) &= \langle X_t X_t \rangle \\ &= \int_0^t \int_0^t \left\langle \frac{dx(t')}{dt} \frac{dx(t'')}{dt} \right\rangle dt' dt'' \\ &= \int_0^t (t - t') \left\langle \frac{dx(t')}{dt} \frac{dx(0)}{dt} \right\rangle dt' \end{aligned} \quad (\text{I.11})$$

Dans l'équation I.11, la moyenne est effectuée sur l'ensemble des trajectoires des marcheurs aléatoires. on en déduit:

$$\frac{d}{dt} (\sigma^2(x, t)) = 2 \int_0^t C(t) dt \quad (\text{I.12})$$

avec $C(t)$ la covariance des vitesses: $C(t) = \left\langle \frac{dx(t')}{dt} \frac{dx(0)}{dt} \right\rangle = \langle v(t)v(0) \rangle$

où $v(t) = \frac{dx(t)}{dt}$ représente la fluctuation de vitesse autour de la vitesse moyenne.

L'équation I.12 relie l'accroissement temporel de la variance du panache de soluté à la covariance des vitesses le long des trajectoires des solutés. La covariance est une mesure de la corrélation des vitesses, qui représente le degré de similarité des vitesses d'un marcheur a deux instants différents. Au

dessus du temps caractéristique t_c de corrélation des fluctuations de vitesse, le terme $\frac{d}{dt}(\sigma^2(x,t))$ devient constant et l'on peut définir un coefficient de dispersion $D = \frac{1}{2} \frac{d}{dt}(\sigma^2(x,t)) = \int_0^{t_c} C(t) dt$. D est

d'autant plus grand que la corrélation temporelle est grande. Ainsi la corrélation des déplacements accroît la dispersion. La caractérisation de la corrélation des vitesses d'écoulement est le sujet du chapitre IV.

L'équation I.12 montre que la valeur du coefficient de dispersion dépend de la corrélation des vitesses. D'autre part, la corrélation des fluctuations de vitesses contrôle également le temps de convergence vers un modèle diffusif. Plus le champ de vitesse est corrélé en temps, plus la convergence vers un modèle de diffusion est lente. Cette conclusion a des conséquences importantes pour les applications de transfert de fluide et de soluté dans les milieux géologiques. En effet, l'application du modèle diffusif implique que le temps caractéristique de modélisation du système soit supérieur au temps de corrélation caractéristique des vitesses d'écoulement. La difficulté est de savoir prédire pour les différentes hétérogénéités présentes dans les milieux géologiques le temps pour lequel un régime diffusif est atteint et d'autre part de pouvoir modéliser les phénomènes dans le cas où le régime diffusif n'est pas atteint. Une partie du problème est de pouvoir relier la longueur de corrélation des structures géologiques et la variabilité de leurs propriétés hydrauliques au temps de corrélation équivalent des déplacements des marcheurs aléatoires. Il est généralement admis que la présence de chemins préférentiels d'écoulement rapide ou celle de zones de faibles vitesses augmentent la dispersion et impliquent un transport potentiellement anormal. Cependant, il n'existe pas de cadre théorique entièrement validé pour prendre en compte ces effets.

La question centrale est de savoir quel est le processus dominant qui entraîne la corrélation des vitesses. Une forte corrélation peut provenir d'un long temps de rétention dans des structures de petites dimensions ou au contraire des longues corrélations spatiales de certaines structures impliquant une forte corrélation temporelle. On retrouve cette problématique pour le site de MADE (partie 1.3), pour lequel la prédominance des effets des structures d'échelle décimétrique ou des corrélations à grande échelle sur le transport anormal observé est actuellement un sujet de débat (*Harvey and Gorelick, 2000, Barlebo et al., 2004*). Plus généralement, le rôle de la chenalisation et de la distribution des vitesses dans les milieux très hétérogènes (voir partie 1.2) sur le transport n'est pas clairement identifié. Cette question sera abordée dans le chapitre IV de cette thèse.

I.2.4 Parallèle avec le transfert de pression

Pour le transfert de pression, un raisonnement en terme de marcheurs aléatoires peut être également formulé. De même que pour la concentration, la charge hydraulique peut être représentée par une densité de probabilité de la présence de marcheurs. Les zones de forte charge hydraulique sont

représentées par des zones de forte densité de probabilité. La dissipation de cette charge hydraulique dans le milieu est alors envisagée par les déplacements aléatoires des marcheurs. La diffusion anormale est connue pour les milieux aux propriétés fractales (*Halvin and Ben-Avraham, 1987*). Dans de tels milieux, il existe des sous réseaux faiblement connectés dans lesquels les marcheurs sont retardés. Ces réseaux n'ont pas de taille caractéristique, ce qui implique une grande distribution des temps passés par les marcheurs dans ces sous réseaux. La diffusion anormale est en général représentée par un exposant d_w tel que la variance des déplacements de marcheurs s'écrit (équation I.10):

$$\overline{X_t^2} = t^\beta \text{ avec } d_w = 2/\beta \quad (\text{I.13})$$

Un exposant $d_w=2$ implique une diffusion normale. La valeur de d_w varie suivant les structures fractales en fonction de leur connectivité. La Figure I. 16a présente un réseau de petites fractures au seuil de percolation. L'exposant d_w peut être calculé pour ce type de réseau: $d_w=2.86$ (*Halvin and Ben-Avraham, 1987*). Les propriétés fractales observées sur les réseaux de faille naturels (*Davy, 1993, Odling, 1997*), suggèrent que la diffusion de pression dans les roches fracturées pourrait être anormale (*Chang and Yortsos, 1990*). La Figure I. 15b présente un réseau de fractures généré à partir des propriétés géométriques mesurées sur les milieux naturels (distribution de longueur en loi de puissance et densité fractale des centres de fracture). Ces aspects seront abordés plus en détail dans le chapitre II.

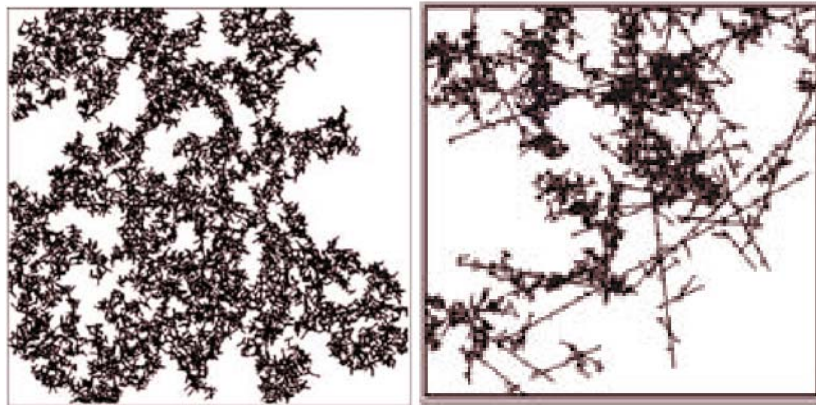

Figure I. 16: a) réseaux de failles de petites tailles au seuil de percolation, b) réseaux de failles caractérisés par une large distribution de longueurs et une distribution fractale des centres des fractures d'après (*Darcel, 2002*).

I.3. Approches développées au cours de la thèse

Les écoulements dans les milieux géologiques présentent une grande variabilité à toutes les échelles. De plus, ces écoulements sont difficiles à mesurer directement car le milieu n'est accessible à la mesure que par l'intermédiaire des forages. Une caractérisation exhaustive du milieu à toutes les échelles est impossible. De ce fait, même si l'on peut prendre en compte certaines hétérogénéités de manière explicite dans les modèles, nécessairement, à une échelle donnée, le milieu doit être représenté par un modèle moyen.

Les modèles moyens classiques utilisés en hydrogéologie – associés aux paramètres de diffusivité hydraulique et coefficient de dispersion – correspondent à des modèles de type diffusif. Dans les milieux fortement désordonnés, le modèle de diffusion est généralement un modèle limite qui est valable à une échelle de temps ou d'espace suffisamment grande (voir partie I.2). Ce modèle limite peut n'être jamais atteint, en particulier en présence de corrélation à longues portées. Comme nous l'avons montré dans la partie 1.2, la convergence vers un modèle de diffusion est contrôlée par les corrélations spatiales et temporelles des vitesses d'écoulement. L'observation du phénomène de chenalisation des écoulements aussi bien pour les milieux poreux hétérogènes que pour les réseaux de fractures suggère l'existence de corrélations spatiales des vitesses à longue portée. Cependant, ces observations restent qualitatives et l'effet de la chenalisation sur la corrélation des écoulements n'a pas été quantifié. De nombreuses observations montrent des transferts de pression et de soluté « non diffusifs ». L'un des enjeux importants en hydrogéologie est donc de déterminer les modèles moyens "équivalents" compatibles avec les propriétés des écoulements dans les formations géologiques.

La réponse à cette question passe par une meilleure caractérisation de la structuration des écoulements dans les milieux géologiques ainsi que par une meilleure compréhension des relations entre la distribution des flux et le transfert de pression et de soluté. Dans le cadre de cette thèse, nous proposons trois approches complémentaires concernant la mesure et la modélisation de l'organisation des écoulements dans les milieux géologiques. Cette démarche s'appuie sur le site expérimental de Plœmeur, en domaine cristallin fracturé (figure I.21), et les outils de mesure en forage développés dans le cadre de deux projets européens, ALIANCE (2001-2005) et SALTRANS (2000-2004) et de l'Observatoire de Recherche en Environnement H+.

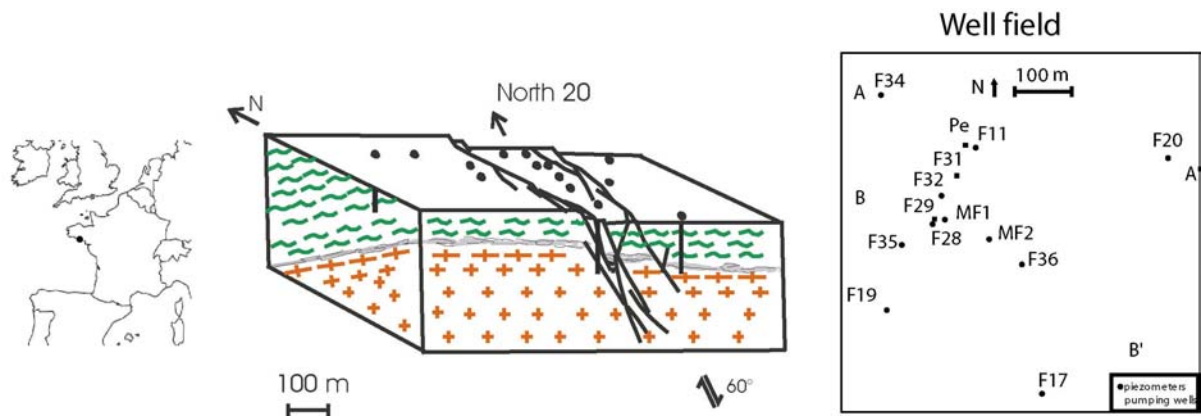

Figure I. 17: schéma conceptuel de l'aquifère en domaine cristallin fracturé de Plœmeur. Le site est situé à l'intersection de deux structures majeures: une zone de contact fracturé entre des micaschistes et du granit et une zone de faille normale.

I.3.1 Définition d'un modèle d'écoulement équivalent pour les aquifères fracturés

Comme nous l'avons souligné dans ce chapitre, la question centrale est la représentation des propriétés moyennes des écoulements dans des modèles physiques équivalents. Malgré l'existence de différents modèles issus des théories des milieux désordonnés, l'application aux systèmes naturels est rarement possible faute de méthode de validation de ces modèles. Durant cette thèse, nous avons proposé une méthode pour tester les modèles équivalents de transfert de pression dans les réseaux de fractures naturels. Comme nous l'avons expliqué dans les parties I.1.2 et I.2.4, les propriétés géométriques particulières des réseaux de fracture impliquent une grande variété d'organisations possibles pour les écoulements. L'approche proposée afin de tester différents types de représentation des écoulements est basée sur une analyse d'échelle de la réponse hydraulique du milieu, suivie sur des piézomètres à différentes distances du puits de pompage.

I.3.2 Imagerie des structures d'écoulement à différentes échelles

Comme nous l'avons mis en évidence dans ce chapitre, l'information concernant la connectivité ou la corrélation spatiale des structures d'écoulements est essentielle pour la modélisation. Cependant, il existe peu de méthodes efficaces pour acquérir ce type d'information sur les sites naturels. Dans ce but, une partie de cette thèse a été consacrée au développement de méthodes de mesure *in situ* de la variabilité spatiale des écoulements à différentes échelles. Nous avons développé une méthode permettant d'utiliser la mesure des écoulements en forage afin d'imager les chemins d'écoulements et de caractériser leur propriétés hydrauliques à différentes échelles.

I.3.3 Corrélation des vitesses d'écoulement

En parallèle aux études basées sur des données expérimentales et toujours dans le but de représenter les propriétés moyennes des écoulements dans des modèles, nous avons mené une étude numérique concernant la caractérisation de l'organisation des écoulements dans des champs de perméabilité ayant différents degrés d'hétérogénéité. Nous abordons cette question en introduisant une nouvelle méthode de caractérisation de la corrélation des vitesses, qui est une propriétés fondamentale pour la modélisation du transport (voir partie I.2.3). La méthode proposée vise à quantifier en particulier les propriétés des écoulements dans les milieux poreux hétérogènes, comme par exemple leur chenalisation (*Tsang and Neretnieks, 1998*). Bien que ce phénomène soit à la base de nombreux modèles conceptuels de transport, il n'a pas été quantitativement relié aux propriétés du champ de vitesse, telles que la corrélation des vitesses.

Chapitre II

Définition d'un modèle d'écoulement équivalent pour un aquifère fracturé

Comme nous l'avons souligné dans le chapitre I, il faut représenter les propriétés de l'hétérogénéité des écoulements inaccessible à la mesure dans des modèles moyens équivalents. Malgré l'existence de différents modèles issus en particulier des théories des milieux désordonnés (*Havlin and Ben Avraham, 1987, Bouchaud and Georges, 1990*), l'application aux systèmes naturels est rarement possible faute de méthode de validation de ces modèles. Dans ce chapitre, nous proposons une méthode pour tester les modèles équivalents de transfert de pression dans les réseaux de fractures naturels. Comme nous l'avons expliqué dans les parties I.1.2 et I.2.4, les propriétés géométriques particulières des réseaux de fracture impliquent une grande variété d'organisations possibles pour les écoulements. L'approche proposée est basée sur une analyse d'échelle de la réponse hydraulique du milieu, suivie sur des piézomètres à différentes distances du puits de pompage. La mesure des variations de niveaux piézométriques lors des essais de pompage est une mesure qui intègre l'effet de l'ensemble des hétérogénéités à l'intérieur du cône de rabattement créé par le pompage.

II.1. Méthodologie pour tester les modèles moyens équivalents

Afin de prendre en compte l'hétérogénéité des milieux géologiques, des modèles équivalents où les écoulements se font dans des structures non bidimensionnelles (*Barker, 1988*) ou plus généralement des structures fractales (*Chang and Yortsos, 1990*) ont été développés (figure II.2). Cependant, ces modèles n'ont pas été entièrement validés sur le terrain. Pour tester ces modèles moyens équivalents, nous proposons l'analyse de tests hydrauliques suivis sur des piézomètres à différentes distances du puits de pompage sur le site de l'aquifère de Plœmeur en domaine cristallin fracturé (figure I.17). Ce site présente l'avantage d'être bien instrumenté avec une trentaine de forages d'une centaine de mètres de profondeur répartis sur une zone d'environ un kilomètre carré.

Lors d'un essai de pompage, le milieu est sollicité par la mise en route d'un pompage dans un forage et l'évolution des niveaux piézométriques est enregistrée au cours du temps dans le forage pompé ou dans des forages voisins. La mise en route d'une pompe dans un forage provoque un écoulement radial transitoire autour du puit. Le pompage se traduit par un abaissement des charges hydrauliques autour du forage et les niveaux piézométriques autour du forage prennent la forme d'un cône centré sur le forage. Au fur et à mesure du pompage, le cône de rabattement s'agrandit comme illustré sur la figure II.1. Dans cette expérience, l'échelle d'investigation décrite par le rayon du cône de rabattement s'accroît au cours du temps. Pour un milieu homogène, la variation de charge dans le temps et dans l'espace est donnée par une équation de diffusion classique (équation I.4).

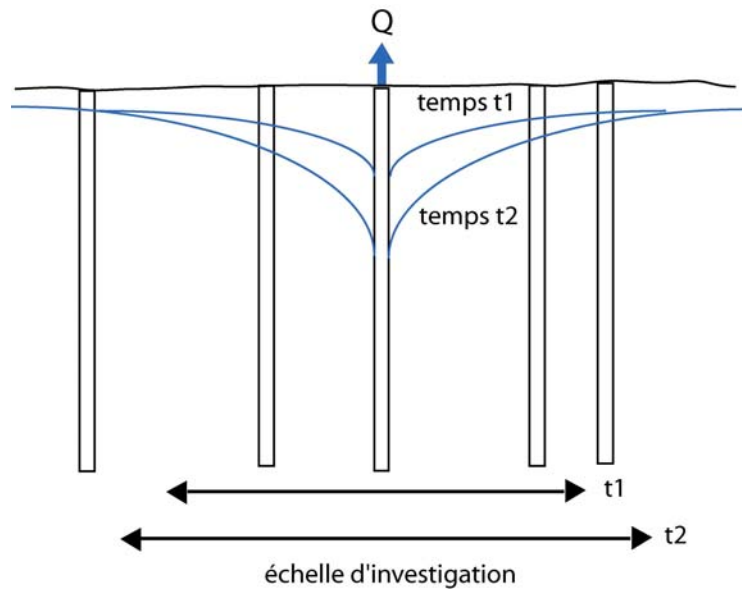

Figure II. 1: schéma illustrant le développement d'un cône de rabattement suite à un pompage à un débit Q .

Les modèles équivalents que nous avons testés, en plus du modèle de diffusion classique, sont les modèles de *Barker* (1988) et *Chang and Yortsos* (1990). Le modèle de Barker prend en compte la localisation des écoulements dans le système en introduisant un paramètre de dimension hydraulique n . Ce modèle est de plus en plus utilisé pour l'interprétation des essais de pompage car il permet généralement un meilleur ajustement du modèle aux données (*National Research Council*, 1996). Dans la plupart des cas cependant, l'interprétation de la dimension hydraulique obtenue reste qualitative et les observations dans les forages sont utilisées individuellement et ne sont pas intégrées dans un modèle équivalent global. Le modèle de *Chang and Yortsos* (1990) est issu des théories de diffusion anormale de la physique des milieux désordonnés (*O'Shaughnessy and Procaccia*, 1985, *Halvin and Ben-Avraham*, 1987). Ce modèle prend en compte une dimension fractale, qui est l'équivalent de la dimension hydraulique, et un exposant de diffusion anormal d_w . La Figure II.2 illustre ce modèle défini par une densité de sites $n(r)$ à travers lesquels se fait l'écoulement. $n(r)$ est le nombre de sites compris entre r et $r+dr$. L'évolution de la densité de sites avec r est définie par une loi de puissance:

$$n(r)=ar^{D-1} \tag{II.1}$$

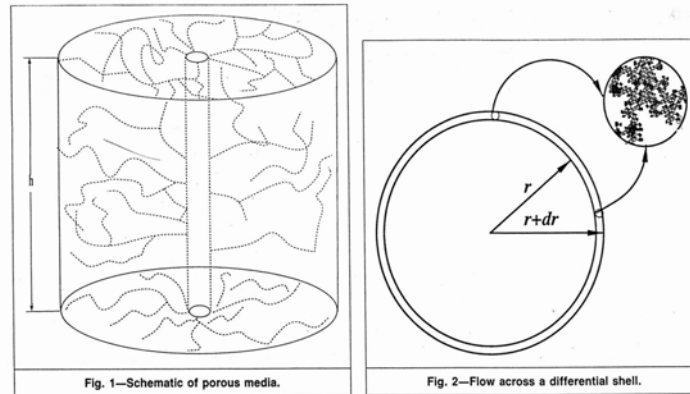

Figure II.2: représentation par un milieu fractal d'après *Chang and Yortsos (1990)*

Comme nous l'avons illustré dans la partie I.2.4, la diffusion dans les milieux fractals a tendance à être ralentie du fait de la ramification des réseaux et de nombreuses structures secondaires sans taille caractéristique. Généralement, la diffusion dans les milieux fractals est anormalement lente ($d_w > 2$). L'exposant d_w n'est pas directement relié à la dimension fractale mais à la connectivité des structures. La figure II.3 illustre la valeur des exposant D et d_w pour différentes structures. Les deux exposants D et d_w sont théoriquement indépendants. Pour les structures linéaires et bidimensionnelles, la diffusion est normale ($d_w = 2$). Pour la structure fractale de la figure II.3b, la diffusion est proche de normale car la structure est bien connectée. Ceci n'est pas le cas pour le tapis de Sierpinski ($d_w = 2.3$) et le réseau au seuil de percolation ($d_w = 2.8$). Une diffusion anormale peut aussi avoir lieu dans des milieux continus avec des corrélations à longue portée (figure II.3.f). La question est de savoir si de tels modèles équivalents peuvent être définis pour les milieux fracturés naturels (figure II.3.g).

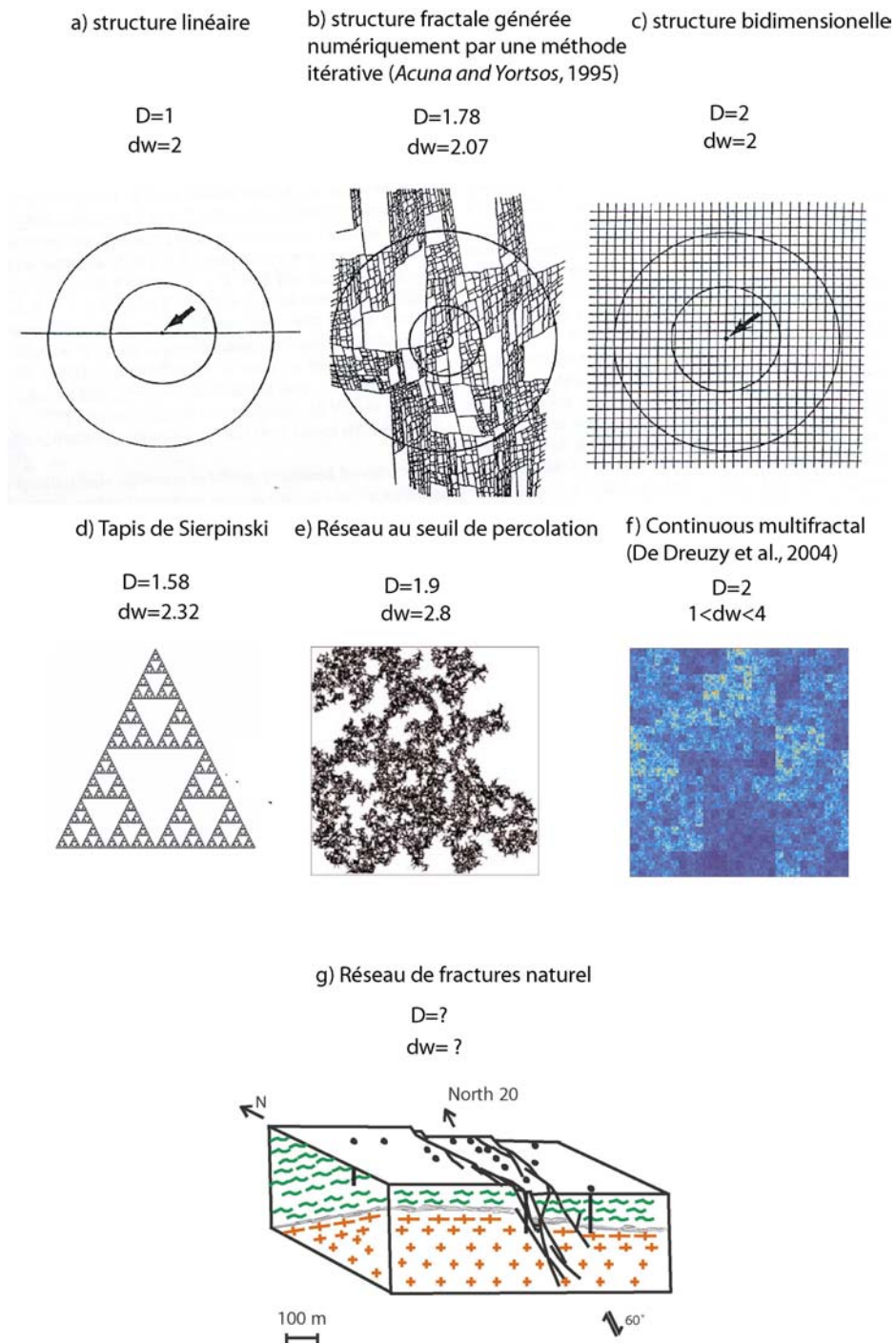

Figure II.3 : exposant fractal et exposant de diffusion anormale pour différentes structures

II.2 Article: Equivalent mean flow models relevant for fractured aquifers: Insights from a pumping tests scaling interpretation (*Le Borgne et al., 2004*)

L'objectif de l'étude est de déterminer si un modèle global équivalent peut être défini pour décrire les variations de charge pour un aquifère fracturé. Nous avons analysé la réponse hydraulique de l'aquifère de Plœmeur pour des essais de pompage à grandes échelles de temps et d'espace. Les expériences d'essai de pompage se prêtent particulièrement bien à la question de l'évolution de la structuration des écoulements avec l'échelle car la perturbation hydraulique due au pompage s'accroît avec le temps et échantillonne un volume de plus en plus grand. Nous avons testé des modèles équivalents, caractérisés par différentes propriétés d'échelle sous-jacentes. Les données interprétées sont des séries temporelles de variation de niveaux piézométriques. Les séries ont des durées allant de 5 à 90 jours et ont été enregistrées dans des forages situés à des distances allant de 2 à 400 mètres du puits de pompage. A travers cette étude, nous montrons que l'évolution temporelle des rabattements est correctement prise en compte par des modèles d'écoulements fractionnaires (*Barker, 1988, Acuna and Yortsos, 1995*). Les estimations de dimension hydraulique sont relativement constantes sur le site et comprises dans l'intervalle [1.4-1.7]. Afin de préciser l'exposant de diffusion d_w , nous proposons une méthode basée sur l'évolution avec la distance au forage pompé d'un temps et d'une amplitude caractéristiques des variations de charge hydraulique. Pour la plupart des piézomètres, ceux qui sont alignés sur une faille majeure, il est possible de définir une loi d'échelle avec un jeu de paramètres uniques (D , d_w , T et S). L'exposant d_w est égal à 2.8, ce qui implique une diffusion anormalement lente.

Equivalent mean flow models for fractured aquifers: Insights from a pumping tests scaling interpretation

T. Le Borgne, O. Bour, J. R. de Dreuzy, P. Davy, and F. Touchard¹

Géosciences Rennes, UMR 6118 CNRS, Université de Rennes 1, Campus de Beaulieu, Rennes cedex, France

Received 27 June 2003; revised 7 November 2003; accepted 9 December 2003; published 30 March 2004.

[1] We investigate if a mean equivalent flow model can be defined to describe hydraulic head variations in a crystalline aquifer characterized by multiscale heterogeneity. We analyzed in particular the hydraulic response of a crystalline aquifer to pumping tests covering a large range of spatial and temporal scales. Pumping tests appear to be well designed to test the medium hydraulic properties and to track scaling effects, since the perturbation induced by pumping grows with time and samples increasingly large volumes. We tested well-test interpretation frameworks underpinned by equivalent media models that basically contain scaling information. Interpretations of drawdown time series, recorded in piezometers located at distances ranging from 2 to 400 m from the pumping well and of durations ranging from 5 to 90 days, show that the temporal evolutions of drawdown are well modeled by fractional flow models [Barker, 1988; Acuna and Yortsos, 1995]. Estimates of flow dimensions are consistent across the whole site and lie in the range [1.4–1.7]. To investigate the nature of diffusion, we defined a methodology based on the evolution of the characteristic time or amplitude of hydraulic head variations with the distance from the pumping well. For most of the piezometers, those aligned along the main fault, it is possible to define a scaling law for all piezometers with a unique set of parameters. The derived exponents imply that hydraulic head diffusion is anomalously slow, a characteristic that is taken into account only in the model of Acuna and Yortsos [1995], based on diffusion in fractals. **INDEX TERMS:** 5104 Physical Properties of Rocks: Fracture and flow; 5114 Physical Properties of Rocks: Permeability and porosity; 1829 Hydrology: Groundwater hydrology; 3250 Mathematical Geophysics: Fractals and multifractals; **KEYWORDS:** pumping test, fracture, heterogeneity, groundwater, transient flow, fractional flow dimension

Citation: Le Borgne, T., O. Bour, J. R. de Dreuzy, P. Davy, and F. Touchard (2004), Equivalent mean flow models for fractured aquifers: Insights from a pumping tests scaling interpretation, *Water Resour. Res.*, 40, W03512, doi:10.1029/2003WR002436.

1. Introduction

[2] Field studies have shown that natural fracture networks are characterized by a wide range of scales because of the presence of fractures from the millimetric to the kilometrical scale and because of the existence of fractal correlations between fractures [Segall and Pollard, 1983; Okubo and Aki, 1987; Villemin and Sunwoo, 1987; Barton and Hsieh, 1989; Hirata, 1989; Scholz and Cowie, 1990; Olsson, 1992; Davy, 1993; Ouilton and Sornette, 1996; Odling, 1997; Bonnet *et al.*, 2001; Bour *et al.*, 2002]. The presence of heterogeneity at virtually all scales of the medium (hereinafter called multiscale heterogeneity) may lead to an extreme flow channeling and to the scale dependency of the equivalent hydraulic properties on a wide range of scales [Krali, 1975; Clauser, 1992; de Dreuzy *et al.*, 2002]. Channeling, scaling properties and the absence of any a priori characteristic scale severely calls into question the application to fractured media of the homogeneous and classical porous media models. In this paper we aim at characterizing a mean equivalent hydro-

logical model consistent with the multiscale heterogeneity of a fractured crystalline aquifer. Our objective is to replace an exhaustive description of heterogeneous media by a continuous description that can model the mean scaling flow properties of the natural medium. We especially focus on permeability scaling that is supposed to result from the spatial integration of heterogeneities. Pumping tests are particularly well designed to track these scaling effects since the perturbation induced by pumping grows with time and samples increasingly large volumes. Interpreting the drawdown curves in terms of property scaling requires a fitting model that basically contains scaling information. The simple although most commonly used Theis model [Theis, 1935] implicitly assumes scale-independent permeability and storativity. This model, as well as double-porosity models, has been found to be inconsistent with some drawdown curves from fractured sites [Bangoy *et al.*, 1992; Hamm and Bidaux, 1996; Leveinen, 2000]. New models that explicitly account for a scale dependency of hydraulic properties have been proposed [Barker, 1988; Acuna and Yortsos, 1995]. First, the generalized radial flow model of Barker [1988] assumes that flow may be characterized by any flow dimension n , with $1 \leq n \leq 3$. Barker's model is generalized in the sense that classical monodimensional, bidimensional, and tridimensional flow models are recovered for the integral dimensions $n = 1, 2, 3$. Second,

¹Now at Bureau de Recherche Géologiques et Minières, Service Géologique Régional, Poitiers, France.

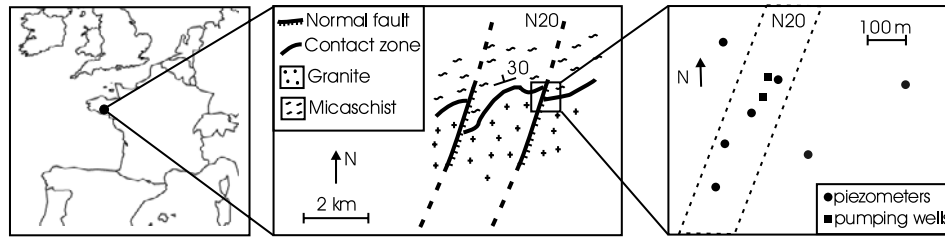

Figure 1. Geographical situation, structural map of the site [Touchard, 1999], and location of piezometers.

the equivalent model of *Acuna and Yortsos* [1995], which was originally developed by *Chang and Yortsos* [1990], is a further generalization accounting for the possible anomalously slow diffusion that has been shown to occur in fractals [Halvin and Ben-Avraham, 1987]. This latter model is exact for some deterministic fractal structures including the Sierpinski gasket [O'Shaughnessy and Procaccia, 1985].

[3] On the basis of multiscale fractured medium heterogeneity, these models, however, have never been fully verified on natural examples, mainly because of the lack of extensive data sets at different scales. In some cases, the pumping test duration was not long enough, i.e., shorter than 1 day, to establish that the dimension was nonintegral [Bangoy et al., 1992; Hamm and Bidaux, 1996; Leveinen, 2000]. In other cases, the flow dimension n has been extracted from the drawdown at a single well and has been found lower than 2 [Acuna et al., 1992; Acuna and Yortsos, 1995]. However, the full validation of these scale-dependent models requires the observation of drawdowns at different scales on a sufficiently large range of spatial and temporal scales. Using an extensive pumping test data set, we investigate if a mean equivalent flow model can be defined to describe hydraulic head variations on a large range of spatial and temporal scales. The data set consists of pumping tests performed in the crystalline aquifer of Plœmeur in Brittany (France) by monitoring drawdown time series at several observation piezometers located at distances ranging from 2 to 400 m from the pumping well. The pumping test durations varied from 5 to 80 days with sampling rates as short as 1 min, giving a scale range of 4–5 orders of magnitude in time.

[4] Note that an alternative and complementary approach to the one given here would be to assume that the site is characterized by zones of material with uniform, scale-independent properties. The zones would have geometries that correspond to geologic units or features as proposed, for instance, by *Day-Lewis et al.* [2000]. This multizone approach consists of taking into account as best as possible the medium geometric complexity while considering the classical flow equation relevant to homogeneous media. On the other hand, the purpose of the approach proposed in this paper is to investigate whether pressure diffusion in heterogeneous media can be modeled by a uniform diffusion equation, that may include additional scaling parameters, that would describe on average the flow properties arising from the multiscale heterogeneity. In the following section, we describe the site of Plœmeur and the pumping test data sets. In section 3 we describe the scale-dependent models and the methodology used to assess their relevance from pumping test data sets covering a wide range of scales. In

section 4 we explain our fitting procedure, which has been refined to precisely assess the values of the scaling exponents. In sections 5 and 6 we present the results and compare them to the geological data and models available for the site.

2. Case Study

2.1. The Plœmeur Aquifer

[5] The Plœmeur site is located on the south coast of Brittany (Figure 1). This outstandingly productive crystalline rock aquifer has been exploited at a rate of about 10^6 m³ per year since 1991 as the main water supply for a town of 20,000 inhabitants. A structural analysis reported by Touchard [1999] showed that the site is located at the contact of two main tectonic features: The regional contact between granite and schist, moderately dipping to the north (30°), and a normal fault zone with strike north 20° dipping to the east (70°) that shifts the contact zone. Geophysical investigations have confirmed the presence at the pumping site of a structure of orientation north 20° with low resistivity over a width of about 100 to 150 m. This structure is interpreted as the result of the preferential weathering of a subvertical fractured zone. The contact zone, whose full thickness may reach 100 m, is characterized by an alternation of schist enclaves and granitic dykes such as aplites and pegmatites. In most of the area, there is no significant weathering of the rocks except in the first few meters. In some boreholes, partly weathered material was encountered when drilling up to a depth of 30 m at maximum. In this case, rocks were found to be partly weathered, with a low permeability compared with fracture permeability.

[6] The drilling of wells, mostly 100 m deep, was done preferentially along the normal fault zone. Some wells intersect a series of producing zones with variable inflows (Figure 2). Others intersect mainly a highly productive level, a few meters thick, at a typical depth of about 70 m. Wells were completed with a casing that is slotted in the deep productive zones. Three of the highly productive wells were equipped for groundwater extraction. Few wells, drilled 3 km away of the groundwater extraction site along the contact between schist and granite, were found to have the same hydraulic characteristics. The productive level is thus interpreted as a regional feature located along the contact between granite and schist (Figure 1). Some wells on the site were artesian when drilled.

2.2. Data Sets

[7] The data sets used in this study correspond to three constant rate pumping tests of different durations (Table 1).

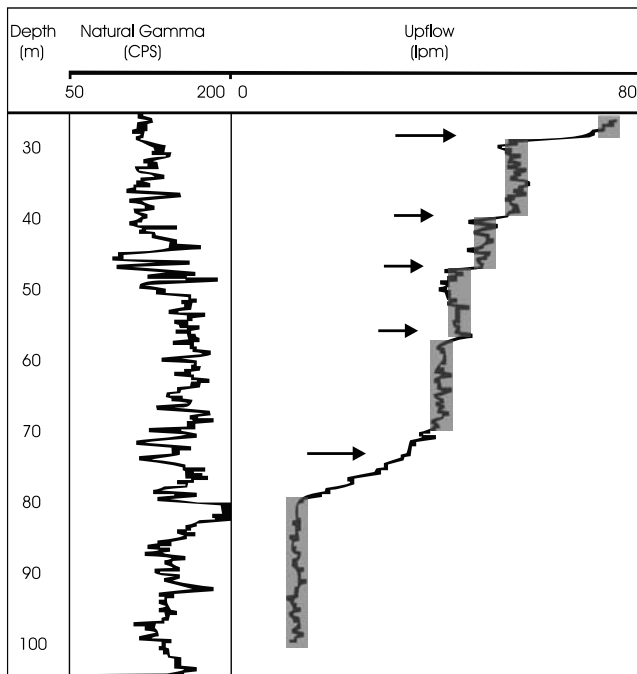

Figure 2. Example of geophysical logs performed on one of the wells at Plœmeur site: Natural gamma log in counts per seconds and flow log in liters per minute while pumping at 120 L/min.

For all pumping tests analyzed, several piezometers located at different distances from the pumping well, ranging from 2 to 400 m, were monitored (Figure 3). The use of piezometric time series recorded in wells different from the pumping well avoids the problem of well bore effects. The short-term pumping test, called ST, lasted for 5 days, the medium-term test, called MT, lasted for 13 days, and the long-term test, called LT, lasted for 88 days. In the medium- and long-term pumping tests, piezometric levels were monitored with a hand probe, while in the short-term pumping test, they were monitored with relative pressure transducers with a precision of 1 cm and a sampling rate of 5 min (Table 1).

[8] The medium-term pumping test was performed before the start of the exploitation in December 1990 by pumping in one well and monitoring piezometric levels in other wells (Figure 3b). The short-term test was performed in September 1995 during the exploitation (Figure 3a). Before starting the test, it was ensured that the two other

pumping wells on the site had been pumped at a constant rate for a time sufficient for piezometric levels to be stabilized. The pumping wells in the vicinity should therefore not have affected the short-term pumping data set. During the short- and medium-term tests, there was no net rainfall event, and the duration of tests was too short to be influenced by long-term natural variations due to seasonal effects. Note also that we do not expect any significant exchange between the aquifer and the unique stream in the area, since it has a very low discharge.

[9] The long-term pumping test data set corresponds to the evolution of piezometric levels consecutive to the start of the exploitation in June 1991, where a single well was pumped. During 88 days, the pumping rate was constant, except for approximately 1 day due to the interruption of the pump 2 days after the beginning of the exploitation (Figure 3b). To test whether long-term natural variations affected piezometric levels, we achieved a mass balance between precipitation and evapotranspiration. During the period of the long-term pumping test, there was only one period of significant net rainfall and one period of significant uptake by plants, 12 and 80 days, respectively, after the start of the pumping. The impact on piezometric levels of both events is estimated to be of about 20 cm (Figure 3b), for a total drawdown of more than 6 m. For the rest of the time, the mass balance is globally respected so that long-term variations should be small compared with piezometric level variations due to pumping. Prior to the start of the pumping test, natural variations of piezometric levels in the zone are indeed limited to a rate varying between -5 and -40 cm per month depending on the piezometers. Even by applying a linear correction of -40 cm per month to the long-term pumping test data set, which is probably an overestimation, we obtained an interpretation in terms of flow model similar to the one derived from the noncorrected data set. We should finally mention that the three data sets, ST, MT and LT, were obtained in various climatic conditions and for different durations. As we shall see in the next sections, all three data sets led to similar results in terms of flow parameters. We thus expect the influence of climatic or seasonal effects on piezometric levels to be small compared with pumping effects.

3. Pumping Test Interpretation Framework Based on Hydraulic Properties Scaling

3.1. Theoretical Models

[10] The classical interpretation framework of Theis underpinned by a homogeneous bidimensional equivalent

Table 1. Characteristics of the Different Pumping Tests

	Medium-Term (MT)	Long-Term (LT)	Short-Term (ST)
Pumping rate Q	64 m ³ /h	80 m ³ /h	34 m ³ /h
Duration	13 days	88 days	5 days
Sampling rate	30 min (first day) or 12 hours	2 hours (first day) or 12 hours	5 min
Method of measurement	hand probe	hand probe	automatic pressure recording device (absolute precision, 10^{-2} m; resolution, 0.0031 m)
Date of the test	December 1990	June 1991	September 1995

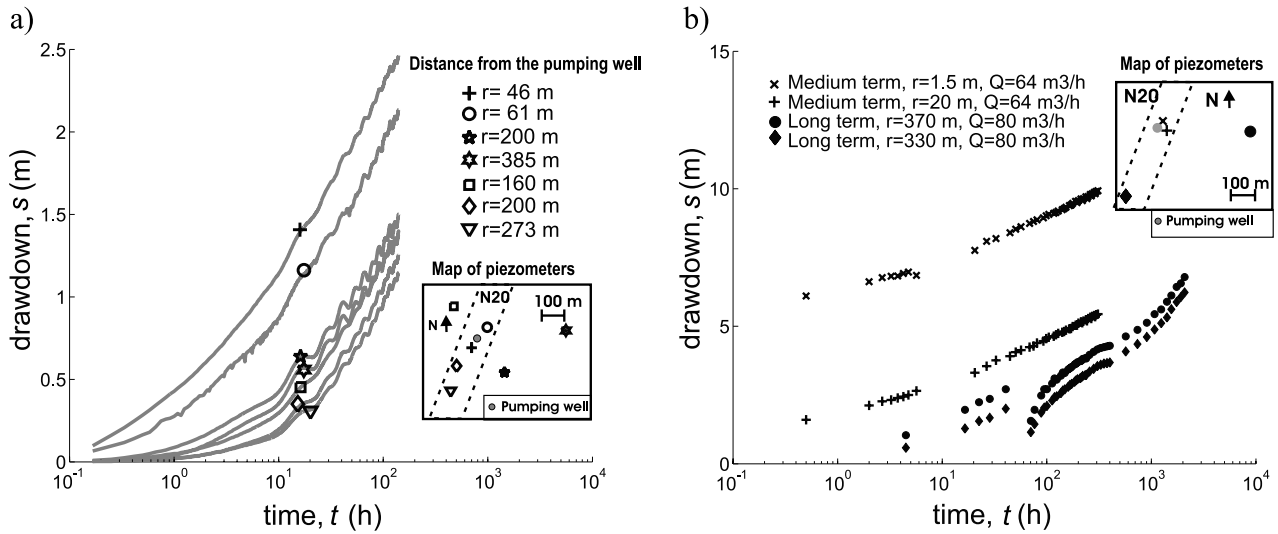

Figure 3. (a) Drawdown time series recorded in wells at different distances from the pumping well for the short-term pumping test. (b) Drawdown time series recorded in wells at different distances from the pumping for the medium- and long-term pumping tests.

medium is well known but may not be adapted to the heterogeneous fluid flow observed at Plœmeur. The dual-porosity model [Barenblatt *et al.*, 1960], although more sophisticated, also assumes an independence of permeability with scale. Two other models that assume scale-dependent storativity and permeability [Barker, 1988; Acuna and Yortsos, 1995] may account for the multiscale fracture network heterogeneity. Barker’s model is a generalization of the radial flow model for nonintegral dimensions. It is thus called the generalized radial flow model (GRF). Acuna and Yortsos’s model, which was set up on deterministic fractals like the Sierpinski Gasket, accounts for anomalously slow diffusion [O’Shaughnessy and Procaccia, 1985] and also generalizes Barker’s model. We detail in the following the assumptions and consequences of these models.

[11] Barker [1988] generalized the radial flow equation for nonintegral dimensions by assuming that flow takes place through an n -dimensional sphere, with $1 < n < 3$. He obtained a generalized diffusion equation

$$S \frac{\partial h}{\partial t} = \frac{T}{r^{n-1}} \frac{\partial}{\partial r} \left(r^{n-1} \frac{\partial h}{\partial r} \right) \quad (1)$$

where h is the hydraulic head, t is time, and r is the distance to the pumping well. S and T are generalized storage coefficient and transmissivity given by $T = b^{3-n} \times K$ and $S = b^{3-n} \times S_s$, where b is the “transversal” extent of the flow region, K and S_s are the hydraulic conductivity and the specific storage of fractures, respectively. The classical Theis type curve is recovered for $n = 2$, with the “transversal” extent of the flow region b corresponding to the aquifer thickness. When $1 < n < 2$, the hydraulic properties (transmissivity and storativity) of the nonintegral diffusion equation can be compared to the homogeneous bidimensional flow model and then appear to scale as r^{n-2} . An interesting feature of the model of Barker is that the flow dimension is related to the late time evolution of drawdown curves. In this model, the drawdown s should evolve as $s \approx t^\nu$ with $\nu = 1 - n/2$ for $n \neq 2$ (Figure 4a), in opposition to the Theis model ($n = 2$) that predicts that late time

drawdown should evolve as $s \approx \log(t)$. The study of the derivative $ds/d \log(t)$ of drawdown is particularly useful to discriminate between the two types of model since this term should asymptotically evolve as t^ν in the case of the Barker

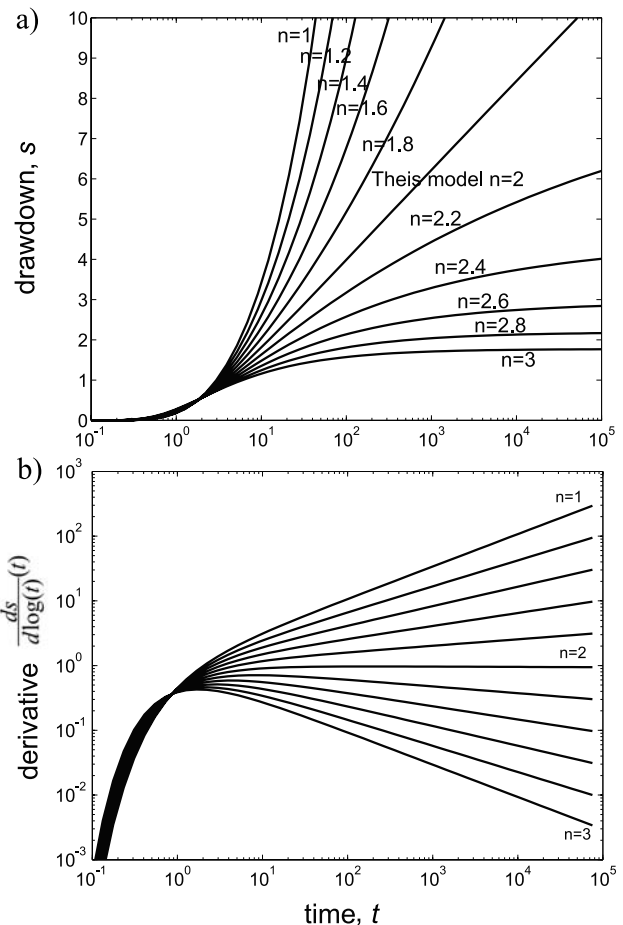

Figure 4. (a) Dimensionless drawdown versus dimensionless time for different values of fractional flow dimension n . (b) Derivative of drawdown $ds/d \log(t)$.

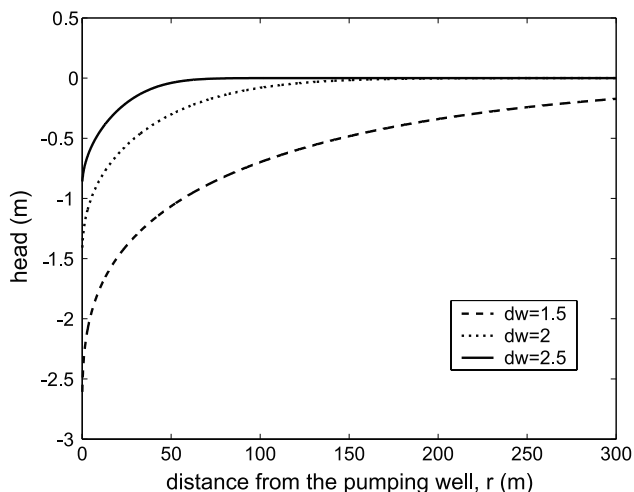

Figure 5. Head profile computed from equation (3) and Table 2 for $t = 10$ hours for different values of d_w , with $T = 3 \times 10^{-2}$, $S = 10^{-4}$, $n = 1.6$, and $Q = 50 \text{ m}^3/\text{h}$.

model [Bourdarot, 1999], whereas it should tend to a constant value for the Theis model (Figure 4b).

[12] Acuna and Yortsos's [1995] model, which was originally developed by Chang and Yortsos [1990], is based on diffusion in fractal networks. It introduces the following scalings for the macroscopic porosity and permeability $\Phi \sim r^{D-d}$ and $K \sim r^{D-d-(2-dw)}$, where D is the fractal dimension, d is the embedding dimension, and d_w is the anomalous transport dimension. The applied diffusion equation [O'Shaughnessy and Procaccia, 1985; Chang and Yortsos, 1990] can be written in a form similar to equation (1):

$$S \frac{\partial h}{\partial t} = \frac{T}{r^{D-1}} \frac{\partial}{\partial r} \left(r^{D-dw+1} \frac{\partial h}{\partial r} \right) \quad (2)$$

where S and T are generalized fracture storativity and transmissivity. Barker's model (equation (1)) is recovered for $d_w = 2$, the case for which diffusion is called "normal" as opposed to the case $d_w > 2$. For the latter case, diffusion is said to be anomalously slow. The mean square displacement of a random walker from the origin $\langle r^2 \rangle$ scales as $t^{2/dw}$ instead of t [Halvin and Ben-Avraham, 1987]. Such anomalously slow diffusion occurs in particular in percolation networks at threshold [Stauffer and Aharony, 1992], where the dead ends and bottlenecks slow down diffusion. In two-dimensional percolation networks, $d_w = 2.86$. The effect of d_w on the drawdown curve is shown on Figure 5 where head profiles at a given time are plotted for different values of d_w with all other parameters being equal. The larger d_w is, the slower is the diffusion of the drawdown cone.

3.2. Methodology for Model Assessment

[13] The methodology we used for the assessment of scale-dependent models is based on the fact that the

diffusion equations of Theis's model (equation (1) with $n = 2$), Barker's model (equation (1)), and Acuna and Yortsos's model (equation (2)) can be written in the same general formulation. We recall that Barker's solution reduces to Theis's solution when $n = 2$, as well as the Acuna and Yortsos [1995] model does when $D = 2$ and $d_w = 2$. To obtain a general analytical solution for the three models, we express the analytic solution for drawdown $s(r, t) = h(r, t = 0) - h(r, t)$, in a general formulation that depends on three independent parameters:

$$s(r, t) = h_0(r) \Gamma \left(\frac{n}{2} - 1, \frac{t_c(r)}{t} \right). \quad (3)$$

where Γ is the (complementary) incomplete gamma function given by

$$\Gamma(v, u) = \int_u^\infty e^{-t} t^{v-1} dt. \quad (4)$$

The parameter n is the hydraulic dimension, related to D and d_w (Table 2). The two other parameters, h_0 and t_c , describe the characteristic amplitude and the characteristic time of drawdown evolution. Note that t_c corresponds to the time required from the start of the pumping test to reach the inflexion point of drawdown curves, which is when the derivative of drawdown evolution is maximal. It can be interpreted as the characteristic time after the start of pumping for the drawdown cone to reach a given observation well. We derived the expressions of h_0 , t_c and n in equation (3) for the three models by reformulating the different transient flow equations [Barker, 1988; Chang and Yortsos, 1990] (Table 2).

[14] The evaluation of the relevance of these models consists of comparing the drawdown observed in the field to their solution given by equation (3). Since the three parameters h_0 , t_c and n of equation (3) are independent, they can be obtained by a single fit to the data. The hydraulic dimension n is determined by the late-time shape of the curve (Figure 4a). The parameters t_c and h_0 are time and amplitude factors. Theis's, Barker's, and Acuna and Yortsos's models can be distinguished by the value of n and by the scaling of $h_0(r)$ and $t_c(r)$ (Table 2). For the Theis model, we expect $n = 2$ and $t_c \approx r^2$. For Barker's model, we expect $n \neq 2$ and $t_c \approx r^2$. For Acuna and Yortsos's model, we expect $n \neq 2$ and $t_c \approx r^{d_w}$ with $d_w > 2$ (Table 2). The discrimination between Barker's and Acuna and Yortsos's models requires the existence in the field of piezometers located at different distances from the pumping well spanning the widest possible scale range.

4. Fitting Procedure

[15] To test the proposed mean flow models, we define a procedure that identifies the scaling properties of a mean

Table 2. Formulation of the Parameters of the Theis, Barker, and Acuna and Yortsos Models^a

	Theis [1935]	Barker [1988]	Acuna and Yortsos [1995]
n	$n = 2$	$1 < n < 3$	$1 < n < 3 \quad n = 2D/d_w$
t_c	$t_c = Sr^2/4T$	$t_c = Sr^2/4T$	$t_c = Sr^{d_w}/d_w^2 T$
h_0	$h_0 = Q/4\pi T$	$h_0 = Qr^{2-n}/4\pi^{\frac{n}{2}} T$	$h_0 = Qr^{d_w-D}/2T\pi^{\frac{D}{2}} [\Gamma(D/d_w)\Gamma(D/2)]d_w$

model from field observations. In the present case our purpose is to describe the average scaling properties of the spatial and temporal evolution of the drawdown cone consequent to pumping in heterogeneous fractured aquifers. In practice, there is access to a limited number of observation points in space (wells) and to the temporal range of drawdown evolution corresponding to the pumping test duration. The evolution of drawdown with time at one point reflects the increase of the drawdown cone in space. The definition of a mean model based on scaling arguments thus requires us to take into account the whole temporal dynamics of pressure variations from early times to late times. On the other hand, the hydraulic response measured at the observation wells is likely to show some variability around the mean response because of the local arrangement of the fracture network between the pumping well and the observation well. Drawdown data may be moreover affected by measurement errors or external perturbations such as Earth-tide-induced pressure fluctuations. The question is how to identify average scaling properties, disregarding local variability of natural fractured media or measurement error.

4.1. Definition of the Objective Function

[16] The model parameters defined in the first section, n , h_0 , and t_c , are identified from temporal series of drawdown at a given well. The optimization procedure requires the choice of an objective function to be minimized. We considered several approaches and decided to use the classical least squares objective function with a linear time sampling for the reasons that we explain in the following. The choice of the weighting of the residuals is critical to detect equivalent scaling properties from time series of drawdown values. The least squares difference, the most common approach, assigns a uniform weight to the residual. In this approach, the weight of early time data points is likely to be less than that of late time points because early times represent a smaller number of data points than late times. An alternative approach would be to use a logarithmic binning to assign an equal weight to early- and late-time data. However, in practice one should take into account some aspects that are specific to early-time drawdown data. First, at early times, drawdown curves are more likely to be influenced by local heterogeneity. Indeed, the hydraulic response at early times may be determined by the local arrangement of the fracture network locally favoring slower or quicker hydraulic head diffusion. At late times, on the other hand, the drawdown cone covers a larger volume, and therefore one expects that the temporal variation of hydraulic head at late times reflects mean properties of the medium, local heterogeneities being smoothed. Second, since the drawdown is smaller at early times, measurement errors and perturbation by external factors will introduce a greater uncertainty. Therefore forcing the model to fit early-time data leads in practice to privilege the local details of the fracture network and to a greater sensitivity to measurement error, while the trend at late times may be missed. Following this argument, we decided to use the classical least squares objective function keeping the original time sampling. We expect this choice to privilege the identification of an average temporal dynamics of hydraulic head evolution that should not be influenced by the local details of the medium and by measurement errors. Note that the

Table 3. Periods T_k , in Hours, of Five Tidal Constituents From Hsieh *et al.* [1987]

Constituent	T_k
O ₁	25,819
K ₁	23,934
N ₂	12,658
M ₂	12,421
S ₂	12,000

fitting procedure as well as the data set will be soon available on the university Web site.

4.2. Processing of the Earth-Tide-Induced Hydraulic Head Fluctuations

[17] Earth-tide-induced hydraulic head fluctuations are not perceptible on the medium-term and long-term pumping tests due to a low sampling rate of about 12 hours. On the other hand, in the short-term test, where the sampling rate is high, fluctuations of head of 1–4 cm due to Earth tides are superimposed on drawdown measurements. This phenomenon increases significantly the uncertainty in curve fitting, especially for early-time data. Note that barometric pressure variations can produce an effect similar to Earth tides by changing the effective stress in the aquifer. However, barometric pressure variations were very small during the short-term test, about 10 mbar, and were not correlated with any piezometric level variations. This suggests that for the short-term test, barometric pressure variations are too small to induce any significant change of the effective stress in the aquifer and therefore any change in piezometric levels.

[18] In order to extract the tidal signal from the data, following Hsieh *et al.* [1987], we assumed that the Earth-tide-induced hydraulic head variations comprised the five main tidal constituents with periods T_k given in Table 3. Consequently, the drawdown variations due to the Earth-tide δs are written as

$$\delta s(t) = \sum_{k=1}^5 a_k \cos\left(2\pi \frac{t}{T_k} + f_k\right) \quad (5)$$

where a_k and f_k are the amplitude and phase of each tidal constituent, respectively. The procedure used to extract the hydraulic head fluctuations due to tidal effects on the short-term pumping test data is based on three steps: A fit to the data with a smoothing spline, a fit of the difference between the data and the spline fit with the model of Earth-tide-induced fluctuations (equation (5)), and the subtraction of the fluctuation model from the data. Note that the purpose here is not to identify precisely the phases corresponding to the different tidal constituents like done by Hsieh *et al.* [1987], because the signal duration is too short, but simply to extract the tidal signal.

4.3. Sensitivity Analysis

[19] The search for the optimum set of parameters [n , t_c , h_0] that provides the best fit for drawdown evolution at piezometers is done via a three-dimensional least squares optimization. To visualize the sensitivity of the model to the parameter n , we calculate for every value of n in the interval [1, 3] the optimum value of the objective function obtained

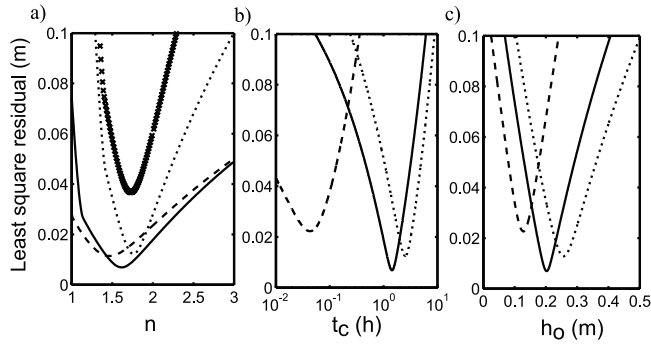

Figure 6. Example of least squares residual curves for different piezometers (solid lines, observation well at 390 m, short-term test; dotted lines, observation well at 160 m, short-term test; dashed lines, observation well at 45 m, short-term test; crosses, observation well at 370 m, long-term test). (a) Hydraulic dimension n . (b) Characteristic time t_c . (c) Characteristic amplitude h_0 . The least squares residuals are expressed as the square root of the sum of squared errors and have units of meters.

by varying the two other parameters t_c and h_0 (Figure 6a). These sensitivity curves show a unique minimum value well defined by the “sink” shape of the curve. The optimal value of n corresponds to the minimum of the sensitivity curve, and the sensitivity of the model to the parameter n is a direct function of the “flatness” of the curve around the minimum.

[20] For the short-term test ST, the optimum value of the objective function is close to 10^{-2} m, which corresponds to the absolute precision of the hydraulic head measuring device (Figure 6a). For the long-term test LT, the optimum value of objective function is higher possibly because the measurement errors are greater. This could be because the precision of the measurement of drawdown is not as good with the hand probe than with the pressure transducers (Figure 6a). However, the sink shape appears to be sharper for the long-term test than for short-term test, showing that there is less uncertainty in the determination of n for the long-term test. This is consistent with the fact that the parameter n is related to the late-time drawdown slope in a double logarithmic diagram.

[21] Since the scaling analysis of the two parameters h_0 and t_c is made for a fixed value of n (see section 5.2), the model sensitivity to h_0 and t_c is computed only for a fixed value of n . To estimate the sensitivity to h_0 , we display the evolution of the optimal value of the objective function according to the value of parameter h_0 , the parameter t_c being optimized. The sensitivity is given by the objective function curve around its minimal value. A similar procedure is used for the sensitivity of t_c . Figures 6b and 6c show that the optimum values of t_c and h_0 are well defined.

5. Results

[22] To investigate the relevance of a global flow model for the Plœmeur site, a set of parameters n , h_0 , and t_c is derived for each piezometer. We first focus on the spatial distribution of the parameter n , called the hydraulic dimension in Barker’s model. Then we study the scale evolution

of the time and amplitude parameters, t_c and h_0 , to describe the type of diffusion (normal or anomalous).

5.1. Evaluation of the Hydraulic Dimension n

[23] As mentioned in section 3.1, the hydraulic dimension n describes the late-time evolution of drawdown s with time through $s \approx t^\nu$ with $\nu = 1 - n/2$ for $n \neq 2$ and $s \approx \log(t)$ for $n = 2$. Therefore the value of the hydraulic dimension can theoretically be deduced through the calculation of the derivative:

$$\frac{d \log(s)}{d \log(t)} \xrightarrow{t \rightarrow \infty} \nu \text{ with } n = 2 \times (1 - \nu), \text{ when } n \neq 2. \quad (6)$$

For instance, applying this procedure to one of the medium-term data sets, corresponding to an observation well at 20 m from the pumping well, we observe that the term $2 \times [1 - (d \log(s)/d \log(t))]$ converges after about 30 hours after the start of the pumping test to a well-defined constant value of n of about 1.7 (Figure 7).

[24] This simple procedure for deducing n cannot be used for the short-term tests that are too short considering the distances of piezometers from the pumping well. To estimate the hydraulic dimension n , we fitted the short-term data with the general analytical solution for hydraulic variations (equation (3)). Using the same representation as Figure 4, we also plotted the derivative $ds/d \log(t)$ of the data and of the fitted model to determine whether the model derived from the fitting of hydraulic head variations also predicts the evolution of the derivative of drawdown variations [Bourdarot, 1999]. Figures 8 and 9 show drawdown curves and their derivative for piezometers, respectively, at 40 and 200 m from the pumping well. For both examples, a model with $n = 1.6$ fits well the variation of drawdown with time. Note that a curve fitting with Theis’s model ($n = 2$), although not as satisfying, does not

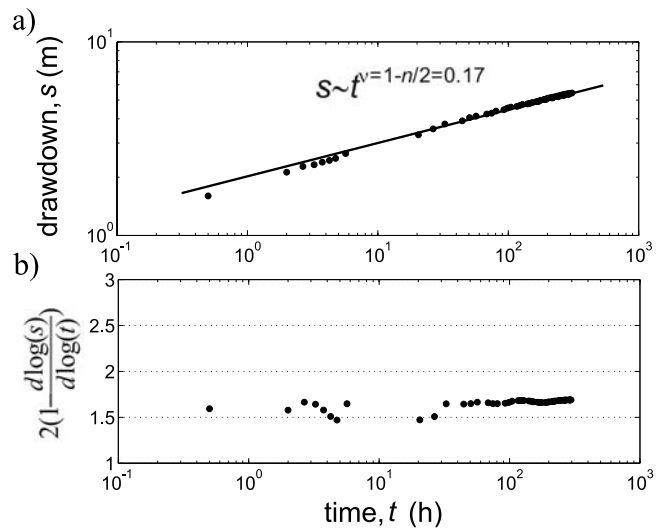

Figure 7. (a) Drawdown versus time for a piezometer located 20 m from the pumping well (medium-term pumping test). Data points are fitted by a power law such that $s \sim t^\nu$ with $\nu = 0.17$. (b) For $2[1 - (d \log(s)/d \log(t))]$ versus time. For late time, this term tends toward a hydraulic dimension n of about 1.7. To evaluate the derivative, the original data are first smoothed to reduce noise.

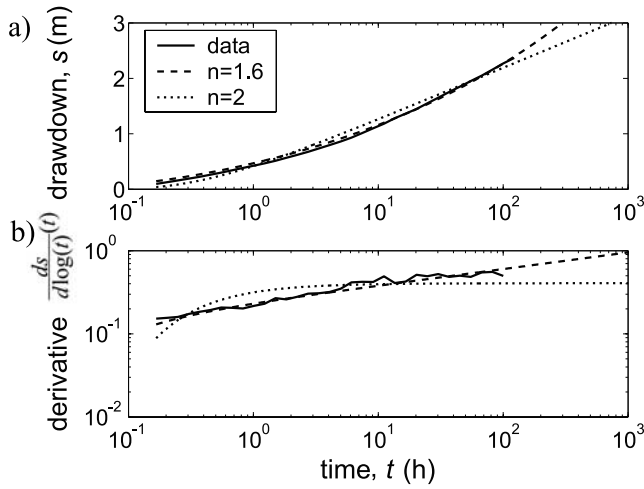

Figure 8. Comparison of best fits obtained with different hydraulic dimensions: $n = 1.6$ (dashed line) and $n = 2$ (dotted line). (a) Drawdown variation with time $s(t)$. (b) Derivative $ds/d \log(t)$. To evaluate the derivative, the original data are first smoothed to reduce noise. The well is located 40 m from the pumping well.

seem to produce a great error. However, by inspecting the variation of the derivative $ds/d \log(t)$, it appears clear that the derivative of the Theis model does not match the derivative of data contrary to the derivative of a fractional flow model with $n = 1.6$. This implies that the error between the fitted Theis model and the data will increase with time. Indeed for the long-term test, a model with $n = 2$ does not match the late-time evolution of drawdown contrary to a model with $n = 1.6$ (Figure 10). This observation appears to be valid for all piezometers, regardless of the distance from the pumping well (Figure 11).

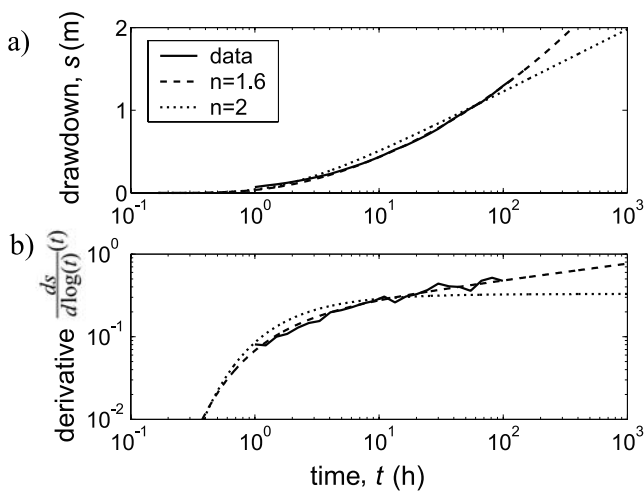

Figure 9. Comparison of best fits obtained with different hydraulic dimensions: $n = 1.6$ (dashed line) and $n = 2$ (dotted line). (a) Drawdown variation with time $s(t)$. (b) Derivative $ds/d \log(t)$. To evaluate the derivative, the original data are first smoothed to reduce noise. The well is located 200 m from the pumping well.

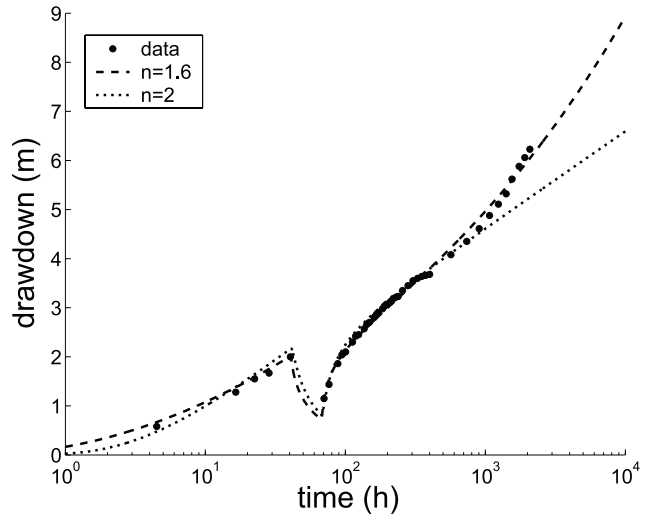

Figure 10. Comparison of best fits obtained with different hydraulic dimensions: $n = 1.6$ (dashed line) and $n = 2$ (dotted line) for a well located 300 m from the pumping well (long-term pumping test).

[25] For the different observation wells and the different pumping tests, the best estimates of the hydraulic dimension n are systematically lower than 2 and mostly comprised in the range [1.4–1.7] (Figure 11). Short-, medium-, and long-term pumping tests therefore provide consistent results. We do obtain a slightly larger value of n (about 1.85) for the piezometer located the closest to the pumping well (Figure 11). However, since this well is only at about 1.5 m from the pumping well, its response to pumping tests may be affected by skin effects or be determined by some local flow paths between the two wells.

[26] It thus appears that a mean fractional flow model with a flow dimension of about 1.6 is relatively consistent over the whole data set that covers 2 orders of magnitude in space and 4 orders of magnitude in time. This value

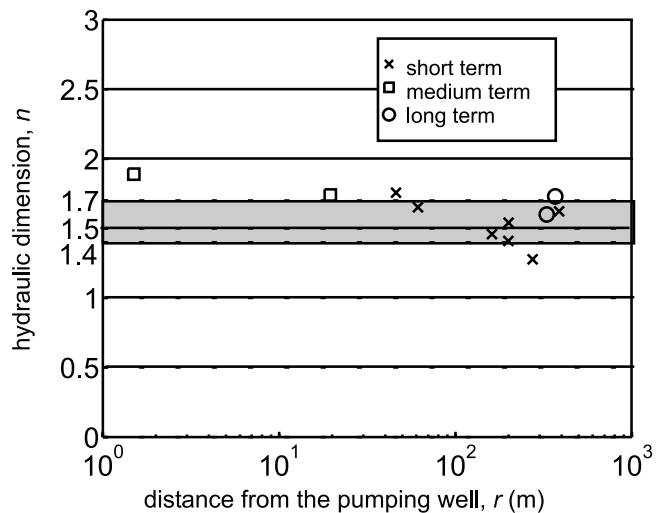

Figure 11. Synthesis of estimates of flow dimension n obtained for all piezometers and all pumping tests. The different values of n are plotted as a function of the distance between the piezometers and the pumping well.

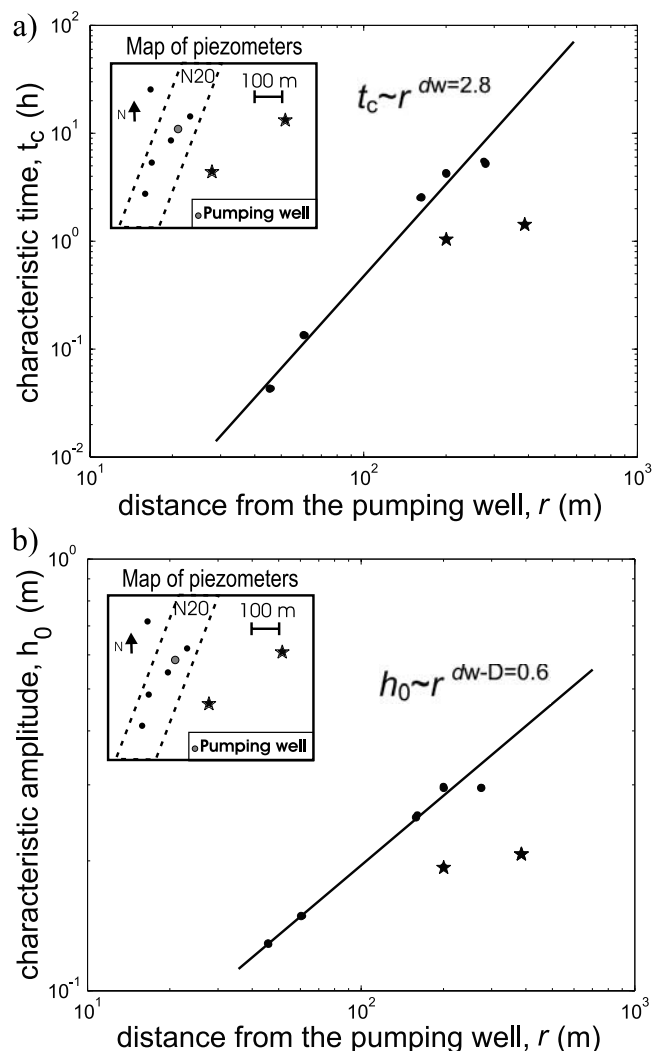

Figure 12. (a) Evolution of estimates of t_c as a function of the distance between the piezometers and the pumping well. Depending on the location of the piezometers, the derived values of t_c are plotted as solid circles or stars. The solid line in the double logarithmic diagram corresponds to a power law $t_c \approx r^{d_w}$ with $d_w = 2.8$. (b) Evolution of estimates of h_0 as a function of r . Depending on the location of the piezometers, the derived values of h_0 are plotted as solid circles or stars. The solid line in the double logarithmic diagram corresponds to a power law $h_0 \approx r^{d_w-D}$ with $d_w - D = 0.6$.

corresponds to the best fit of long-term tests and to the mean value of the estimates of short-term tests.

5.2. Evaluation of the Anomalous Diffusion Exponent d_w and of the Fractal Dimension D

[27] We recall that the anomalous diffusion exponent d_w can be estimated from the evolution of the characteristic time t_c and characteristic amplitude h_0 with scale such that $t_c \approx r^{d_w}$ and $h_0 \approx r^{d_w-D}$ [Acuna and Yortsos, 1995]. Thus, such a derivation requires monitoring the drawdown evolution at different distances from the pumping well. Only the short-term tests have been used to derive t_c and h_0 since long- and medium-term tests do not provide enough accurate values of the early-time drawdown. We also recall

that a scaling analysis of h_0 and t_c is meaningful only if the different values of t_c and h_0 are obtained for the same value of the hydraulic dimension n . Such a hypothesis is justified in the case of the Pl emeur site because the hydraulic dimensions derived from the different data sets are varying only slightly over the whole site around a mean value of 1.6. Thus, in the following, the estimates of t_c and h_0 are obtained through a fit where the hydraulic dimension is fixed to 1.6, a value chosen as a global optimal value of n . With such a value, which provides in all cases a good match to the data, we can obtain the optimum values of t_c and h_0 . These parameters are estimated as $t_c = 0.04$ hours and $h_0 = 0.13$ m in Figure 8 and to $t_c = 1.1$ hours and $h_0 = 0.2$ m in Figure 9. This procedure leads to estimates of t_c and h_0 that are well defined as shown by the least squares residual curves (Figures 6b and 6c).

[28] Except for the two piezometers located east of the zone, all derived values of t_c are following a general trend such that $t_c \approx r^{d_w}$ with $d_w = 2.8$ (Figure 12a). According to Acuna and Yortsos's model, the equivalent fractal dimension D can be deduced from the estimates of the exponents n and d_w through $D = n \times d_w/2$ that leads to a fractal dimension D of about 2.2 (Table 2). If one leaves aside the two outliers (boreholes located east of the zone), the scale evolution of h_0 also follows a power law (Figure 12b). The exponent of the power law agrees well with the expected value that should be equal to $d_w - D = 0.6$ (Table 2). Such a consistency between the scaling of the two independent parameters t_c and h_0 reinforces the relevance of the model of Acuna and Yortsos for describing the diffusion of hydraulic head at the Pl emeur site, at least for wells located west of the zone (Figures 12a and 12b).

[29] Note, however, that the value of d_w is sensitive to the estimate of n . By taking $n = 1.5$ or $n = 1.7$, we find respectively $d_w = 3.8$ and $d_w = 2.5$, leading to $D = 2.9$ and $D = 2.1$. However, whatever the choice of n in the range [1.5–1.7], the values of t_c and h_0 always follow a scaling law, except for the two wells located east of the zone. In any case, the exponent d_w remains larger than 2, showing that hydraulic head diffusion is anomalously slow, a physical process that is taken into account in the flow model of Acuna and Yortsos [1995].

5.3. Normalization of Drawdown Data Sets

[30] From the previous analysis, it seems that a mean equivalent model can be defined for all piezometers if one leaves aside the two wells located eastward of the site. To test the consistency of such a model, we present in this part a normalization of all drawdown data sets. The normalization involves a unique set of parameters for the whole data set. The optimum set of parameters is reported in Figure 13. Note, however, that we consider only the piezometers located on the normal fault zone for which we can estimate an anomalous diffusion exponent. According to Table 2, a normalized drawdown $s/(Qr^{d_w-D})$ versus normalized time t/r^{d_w} should provide a proper normalization for the three pumping tests. The normalized data sets appear indeed quite well superimposed on each other (Figure 13a) in opposite to nonnormalized data sets (Figure 3). The different data sets are also coherent with the mean equivalent model. Only the medium-term data seem to follow a slightly different trend than the model, presumably because the hydraulic dimension deduced for this test was slightly higher.

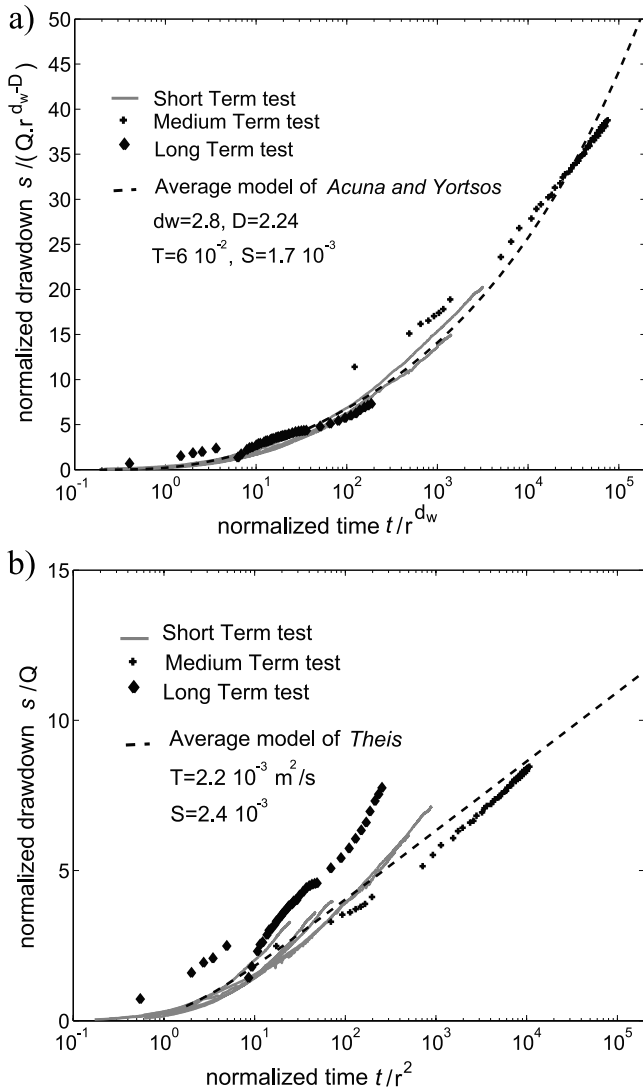

Figure 13. Normalization of the different data sets. (a) Normalized data sets according to *Acuna and Yortsos's* [1995] model with $D = 2.24$ and $d_w = 2.8$. (b) Normalized datasets according to the Theis model. In both graphs, data from the two piezometers located east of the site are not shown.

[31] For comparison, a normalization of the data sets assuming the Theis model, leads to a large scattering of data around the mean model (Figure 13b). For late time, the different data sets are offset compared with each other and are inconsistent with the mean model. Another normalization assuming Barker's model, with $n = 1.6$ and $d_w = 2$, leads to better results than a normalization of data sets assuming Theis's model, although the different data sets remain offset as in Figure 13b.

6. Discussion: Hydraulic Properties of Large-Scale Geological Structures

[32] All observations are consistent with the same global model except for the two piezometers located east of the zone. The question is whether these two distinct drawdown responses are related to the intrinsic variability of any

fractured media or to a more deterministic reason such as the geology of the site at large scale.

[33] All the piezometers following the anomalously slow diffusion trend intersect the normal fault zone except one that is slightly west of the zone (Figures 12a and 12b). On the opposite, the two outliers appear to correspond to piezometers that intersect only the zone of contact between micaschists and granite (Figure 1). It thus seems that the hydraulic response of most of the piezometers is associated with the hydraulic behavior of the normal fault zone while the two piezometers located east of the pumping zone reflect the hydraulic properties of the contact zone only.

[34] As can be inferred from Figure 12, hydraulic head variations appear to be conveyed quicker in the contact zone than in the normal fault zone (smaller t_c), while drawdowns are smaller (smaller h_0). Because of the limited number of piezometers located only in the contact zone, the parameters d_w and D cannot be derived from a scaling analysis. Nevertheless, assuming that the anomalous diffusion exponent d_w is the same in the two zones, the difference between the values of both h_0 and t_c for the contact zone boreholes and the trend of the normal fault zone can be interpreted in terms of hydraulic parameters. A simple calculation based on Table 2 shows that the generalized transmissivity of the contact zone should be about twice as high as that of the normal fault zone and the generalized storage coefficient should be about 2–7 times smaller in the contact zone compared with the normal fault zone. These differences in hydraulic properties may be due to a different nature or intensity of fracturing. For instance, if we assume that the two zones can be represented by simple models, such as well connected networks made of fractures having a constant aperture, these differences in hydraulic parameters can be interpreted in terms of variation of fracture density N or fracture aperture a , with $T \approx Na^3$ and $S \approx Na$ [Guéguen and Palciauskas, 1992]. Following the reasoning would imply that the normal fault zone would be densely fractured but with relatively small apertures. On the other hand, the contact zone should be hydraulically controlled by a less dense fracture network, thus having a lower

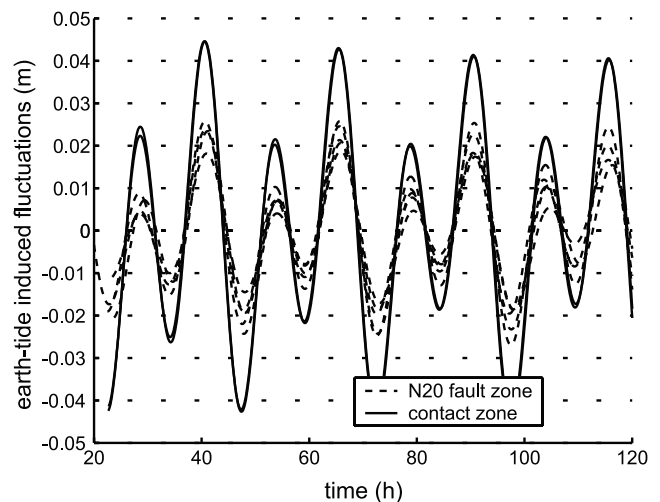

Figure 14. Model of Earth-tide-induced signal extracted from the piezometric time series of the short-term pumping test.

storage coefficient, but with larger apertures to improve transmissivity.

[35] Note finally that the amplitude of Earth-tide-induced head fluctuations provides an independent estimate of the difference in hydraulic properties between the two distinct fractured systems. The magnitude of hydraulic head fluctuations due to tidal effects observed on the wells that intersect the main contact zone is indeed about twice that observed on the other wells (Figure 14). Hsieh *et al.* [1988] showed that in a confined aquifer, the magnitude of hydraulic head fluctuation due to tidal effects is inversely proportional to specific storage. This would indicate that the specific storage of the main contact between granite and micaschist is twice as small as that of the normal fault zone, in agreement with results inferred from the pumping test analysis.

7. Conclusion

[36] Through this study, we verify the relevance of the fractional flow model [Barker, 1988; Acuna and Yortsos, 1995] over different observation wells in a fractured crystalline aquifer. The fractional flow dimensions obtained are consistent over all observation wells and for the three pumping tests of durations ranging from 5 days to 3 months. The values derived are all lying in the range 1.4–1.7, showing that the characteristics of flow are coherent over the whole aquifer. The model of Theis that is classically used to interpret pumping test data clearly fails to model the observed hydraulic head variations. In particular, the analysis of the derivative of hydraulic head shows that instead of following a logarithmic trend, hydraulic head variations at late time follow a power law trend in agreement with fractional flow models.

[37] Using the same value of hydraulic dimensions for all piezometers, we analyzed high-resolution short-term pumping tests to yield estimates of the characteristic arrival time of the hydraulic head variation, as well as its characteristic amplitude, in order to test the nature of hydraulic head diffusion. For the seven piezometers located at various distances from the pumping well, the velocity and amplitude of hydraulic head diffusion are sensitive to large-scale geologic structures, contrary to the flow dimensions that are relatively constant throughout the site. For piezometers that intersect the normal fault zone, the scale evolutions of the characteristic time and amplitude both follow power law trends. The values deduced for both exponents lead to an anomalous diffusion exponent of $d_w = 2.8$ and to a fractal dimension of $D = 2.2$, implying that hydraulic head diffusion is anomalous, a physical process that is taken into account in the model of Acuna and Yortsos [1995]. Note that despite local heterogeneities that are intrinsic to any fractured crystalline aquifers, it appears possible to define a mean equivalent flow model at the scale of the site, at least for one of the major fault zones. Thus pumping tests with observation wells located at different distances from the pumping well appear to be an interesting methodology for defining a mean equivalent model, even in highly heterogeneous media.

[38] The piezometers located in the eastern part of the zone, that intersect only the contact zone between granite and micaschist, react quicker and with less amplitude than the piezometers located within or close to the normal fault

zone. This difference may be interpreted in terms of generalized transmissivity and storage coefficient or in terms of difference in the nature or intensity of fracturing. We are currently analyzing transient flow in synthetic discrete fracture networks to understand the link between the properties of the structure supporting flow and the exponents that can be derived from pumping tests: The fractal dimension D and the anomalous diffusion exponent d_w .

[39] **Acknowledgments.** We gratefully acknowledge the Plœmeur council for their cooperation during fieldwork, especially late in the evening. This work was supported by the European project “SALTRANS” (contract EVK1-CT-2000-00062). We also wish to thank the French CNRS for their financial support, in particular through an ATIP project and through the INSUE project “ORE H+.” We are also grateful to two anonymous reviewers and to the associate editor for their constructive comments that improved the clarity of the manuscript.

References

- Acuna, J. A., and Y. C. Yortsos (1995), Application of fractal geometry to the study of networks of fractures and their pressure transient, *Water Resour. Res.*, 31(3), 527–540.
- Acuna, J. A., I. Ershaghi, and Y. C. Yortsos (1992), Practical application of fractal pressure-transient analysis in naturally fractured reservoirs, paper presented at the 1992 SPE Annual Fall Meeting, Soc. of Pet. Eng., Washington, D. C., 4–7 Oct.
- Bangoy, L. M., P. Bidaux, C. Drogue, R. Plegat, and S. Pistre (1992), A new method of characterizing fissured media by pumping tests with observation wells, *J. Hydrol.*, 138(1–2), 77–88.
- Barenblatt, G. I., I. P. Zheltov, and I. N. Kochina (1960), Basic concept in the theory of seepage of homogeneous liquids in fissured rocks, *J. Appl. Math.*, 24, 1286–1303.
- Barker, J. A. (1988), A generalized radial flow model for hydraulic tests in fractured rock, *Water Resour. Res.*, 24(10), 1796–1804.
- Barton, C. C., and P. A. Hsieh (1989), Physical and hydrological flow properties of fractures, *Field Trip Guidebook T385*, AGU, Washington, D. C.
- Bonnet, E., O. Bour, N. E. Odling, P. Davy, I. Main, P. Cowie, and B. Berkowitz (2001), Scaling of fracture systems in geological media, *Rev. Geophys.*, 39(3), 347–383.
- Bour, O., P. Davy, C. Darcel, and N. Odling (2002), A statistical scaling model for fracture network geometry, with validation on a multiscale mapping of a joint network (Hornelen Basin, Norway), *J. Geophys. Res.*, 107(B6), 2113, doi:10.1029/2001JB000176.
- Bourdarot, G. (1999), Well testing: Interpretation methods, in *Collection des Cours de l'ENSPM*, 350 pp., edited by editions TECHNIP, IFP, Paris.
- Chang, J., and Y. C. Yortsos (1990), Pressure-transient analysis of fractal reservoirs, *SPE Form. Eval.*, 5, 31–38.
- Clauser, C. (1992), Permeability of crystalline rock, *Eos Trans. AGU*, 73(21), 233, 237–238.
- Davy, P. (1993), On the frequency-length distribution of the San Andreas fault system, *J. Geophys. Res.*, 98(B7), 12,141–12,151.
- Day-Lewis, F. D., P. A. Hsieh, and S. M. Gorelick (2000), Identifying fracture-zone geometry using simulated annealing and hydraulic connection data, *Water Resour. Res.*, 36(7), 1707–1721.
- de Dreuzy, J.-R., P. Davy, and O. Bour (2002), Hydraulic properties of two-dimensional random fracture networks following power law distributions of length and aperture, *Water Resour. Res.*, 38(12), 1276, doi:10.1029/2001WR001009.
- Guéguen, Y., and V. Palciauskas (1992), *Introduction à la Physique des Roches*, 300 pp., Hermann, Paris.
- Halvin, S., and D. Ben-Avraham (1987), Diffusion in disordered media, *Adv. Phys.*, 36(6), 695–798.
- Hamm, S.-Y., and P. Bidaux (1996), Dual-porosity fractal models for transient flow analysis in fissured rocks, *Water Resour. Res.*, 32(9), 2733–2745.
- Hirata, T. (1989), Fractal dimension of fault system in Japan: Fractal structure in rock fracture geometry at various scales, *Pure Appl. Geophys.*, 121, 157–170.
- Hsieh, P. A., J. D. Bredehoeft, and J. F. Farr (1987), Determination of aquifer transmissivity from Earth tide analysis, *Water Resour. Res.*, 23(10), 1824–1832.
- Hsieh, P. A., J. D. Bredehoeft, and S. A. Rojstaczer (1988), Response of well aquifer systems to Earth tides: Problem revisited, *Water Resour. Res.*, 24(3), 468–472.

- Kirali, L. (1975), Rapport sur l'état actuel des connaissances dans le domaine des caractères physiques des roches karstiques, in *Hydrogeology of Karstic Terrains*, edited by A. Burger and L. Dubertret, pp. 53–67, Int. Assoc. of Hydrogeol., Kenilworth, UK.
- Leveinen, J. (2000), Composite model with fractional flow dimensions for well test analysis in fractured rocks, *J. Hydrol.*, 234(3–4), 116–141.
- Odling, N. (1997), Scaling and connectivity of joint systems in sandstones from western Norway, *J. Struct. Geol.*, 19(10), 1257–1271.
- Okubo, P. G., and K. Aki (1987), Fractal geometry in the San Andreas fault system, *J. Geophys. Res.*, 92(B1), 345–355.
- Olsson, O. (1992), Site characterization and validation, in *Final Report: Stripa Project 92–22*, Conterra AB, Uppsala, Sweden.
- O'Shaughnessy, B., and I. Procaccia (1985), Diffusion on fractals, *Phys. Rev. A*, 32(5), 3073–3083.
- Ouillon, G., and D. Sornette (1996), Unbiased multifractal analysis: Application to fault patterns, *Geophys. Res. Lett.*, 23(23), 3409–3412.
- Scholz, C. H., and P. Cowie (1990), Determination of total strain from faulting using slip measurements, *Nature*, 346, 837–838.
- Segall, P., and D. Pollard (1983), Joint formation in granitic rock of the Sierra Nevada, *Geol. Soc. Am. Bull.*, 94, 563–575.
- Stauffer, D., and A. Aharony (1992), *Introduction to Percolation Theory*, 2nd ed., 181 pp., Taylor and Francis, Philadelphia, Pa.
- Theis, C. V. (1935), The relation between the lowering of the piezometric surface and the rate and duration of discharge of a well using groundwater storage, *Eos Trans. AGU*, 16, 519–524.
- Touchard, F. (1999), Caractérisation hydrologique d'un aquifère en socle fracturé, Ph.D. thesis, in *Mémoires de Géosciences Rennes*, number 87, 271 pp., Geosci. Rennes, Rennes, France.
- Villemin, T., and C. Sunwoo (1987), Distribution logarithmique self-similaire des rejets et longueurs de failles: Exemple du bassin Houiller Lorrain, *C. R. Acad. Sci., Ser. II*, 305, 1309–1312.

O. Bour, P. Davy, J. R. de Dreuzy, and T. Le Borgne, Géosciences Rennes, UMR 6118 CNRS, Université de Rennes 1, Campus de Beaulieu, 35042 Rennes cedex, France. (tanguy.le-borgne@univ-rennes1.fr)

F. Touchard, Bureau de Recherche Géologiques et Minières, Service Géologique Régional, 11 allée Providence, 86000 Poitiers, France.

II.3. Conclusions

Malgré la forte hétérogénéité du site de Plœmeur, nous obtenons des dimensions hydrauliques n à peu près constantes sur le site, environ égale à 1.6. Ceci implique que les modèles classiques ($n=2$) ne sont pas applicables, et d'autre part que le paramètre de dimension hydraulique n semble adapté pour décrire l'hétérogénéité des écoulements. Par ailleurs, cette étude nous a permis de mettre en évidence un phénomène de diffusion anormale qui implique que la pression se propage anormalement lentement dans l'aquifère. Plus généralement, ce type d'observation est courant dans les systèmes désordonnés (*Bouchaud and Georges, 1990*) mais n'avait pas été mis en évidence pour les transferts de pression dans les réseaux de fractures naturels. La diffusion anormale est connue en particulier dans les systèmes aux propriétés fractales, comme les réseaux au seuil de percolation. La diffusion dans ces systèmes est ralentie du fait de la ramification du système en sous réseaux qui n'ont pas de taille caractéristique.

Pour le site de Plœmeur, il est possible de définir un modèle moyen équivalent permettant de rendre compte des observations de transfert de pression sur une large gamme d'échelles d'espace et de temps. Les paramètres caractérisant la localisation et la connectivité des zones d'écoulement sont la dimension fractale D et l'exposant de diffusion anormale d_w . Sans permettre d'identifier la structure précise des écoulements, la mesure de D et d_w apporte cependant des contraintes importantes sur les modèles d'écoulements possibles. La compréhension des relations entre les structures d'écoulement et les exposants D et d_w nécessite des recherches théoriques complémentaires. L'influence des corrélations à longue portée sur la diffusion anormale a été étudié par *de Dreuzy et al. (2004)* en simulant la diffusion de pression dans des milieux continus de distribution de conductivité multifractale. Bien que la moyenne des exposants déduits sur l'ensemble des réalisations possibles des champs de conductivité soit égale à 2, les exposants déduits sont très variables de réalisation en réalisation. L'exposant de diffusion anormale ne dépend donc pas simplement de l'exposant multifractal mais est relié à une propriété locale qui est la relation entre la conductivité au point d'injection et la conductivité moyenne du milieu.

Chapitre III

Caractérisation *in situ* de l'hétérogénéité des écoulements

Cette partie est consacrée au développement de méthodes de mesure *in situ* de la variabilité spatiale des écoulements. L'information concernant la corrélation spatiale ou la connectivité des structures d'écoulements est essentielle pour la prédiction des transferts dans les aquifères. Bien que d'importants progrès aient été réalisés dans les techniques d'imagerie des formations géologiques (*National Research Council, 1996*), celles-ci restent relativement limitées pour l'imagerie des écoulements. La figure III.1 montre un exemple d'imagerie en forage, provenant du site de Plœmeur. Les structures planes apparaissent sinusoïdales du fait de la visualisation en plan de la surface cylindrique de la paroi du forage. L'imagerie met en évidence plusieurs fractures de différents pendages dans la matrice de granit. Certaines fractures présentent un halo d'altération témoignant de la circulation de fluide. Cependant, la caractérisation des écoulements à grande échelle ne peut pas être déduite de la distribution des fractures dans les forages car seul un petit nombre de ces fractures est susceptible de former un chemin d'écoulement connecté à plus grande échelle (*Paillet, 2001*) (figure III.1b).

L'un des principaux problèmes est que les méthodes géophysiques échantillonnent des propriétés du milieu qui ne sont pas nécessairement pertinentes pour les écoulements. Ce problème est particulièrement critique pour les milieux fracturés car les écoulements sont souvent localisés dans une petite partie du volume total échantillonné par les méthodes géophysiques. La possibilité d'imager les zones d'écoulement à partir de l'imagerie géophysique de surface dépend du contraste de propriétés géophysiques qui existe entre les zones perméables et les zones imperméables. En particulier, les fractures sont difficiles à imager par ces techniques. D'autre part, l'imagerie géophysique de surface est généralement de faible résolution spatiale. Une solution consiste à effectuer des tests hydrauliques d'interférence entre forages en isolant les zones les unes des autres par des packers. Cependant cette solution est généralement trop lourde à mettre en œuvre sur les sites naturels et l'utilisation de packers n'est pas toujours possible, en particulier si les forages sont tubés.

Nous présentons ici une méthode utilisant la mesure des écoulements en forage afin d'imager les chemins d'écoulement et de caractériser leurs propriétés hydrauliques à différentes échelles. Nous avons développé une méthode d'inversion de mesures d'écoulements en forage pour mesurer l'évolution transitoire de la charge hydraulique dans chacune des zones d'écoulement. Ainsi, nous obtenons les mêmes informations que si les zones étaient isolées par des packers et nous pouvons les interpréter pour imager les zones d'écoulement entre forages. Ces développements expérimentaux résultent d'une collaboration avec Fred Paillet (Université du Maine, USA) qui a débuté en 2002. Dans un premier temps, nous introduisons les méthodes d'analyse des mesures de débit en forage et les hypothèses et incertitudes associées. Ensuite, nous présentons le modèle d'inversion utilisé pour déduire l'évolution transitoire de la charge hydraulique dans les zones d'écoulement à partir de la mesure de l'évolution transitoire du débit entre les zones d'écoulement. Enfin, nous proposons une

application sur le site de Plœmeur et nous comparons les résultats obtenus à partir des mesures d'écoulement en forage aux estimations de propriétés hydrauliques par des méthodes classiques.

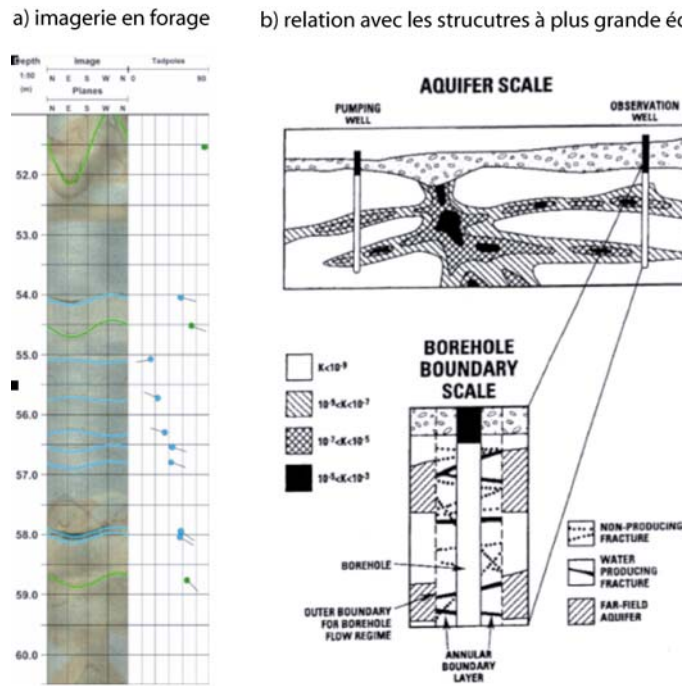

Figure III.1: A) exemple d'imagerie en forage par vidéo (données acquises dans le cadre du projet ALIANCE sur le site de Plœmeur). B) Illustration des structures d'écoulement à l'échelle du forage et à l'échelle d'aquifère d'après. Paillet (2001) et Le Borgne et al. (in press)

III.1 Débitmétrie en forage

Dans cette partie, nous introduisons brièvement le principe des mesures de débit en forage, ainsi que les méthodes d'analyse et les hypothèses et incertitudes associées.

III.1.1 Hétérogénéité de la charge hydraulique

Pour un milieu poreux homogène soumis à un écoulement horizontal (figure I.1), la charge hydraulique varie dans la direction de l'écoulement mais ne varie pas verticalement. Au contraire, dans un milieu hétérogène, les zones d'écoulements peuvent être localisées et plus ou moins isolées les unes des autres. Bien que la charge hydraulique soit constante dans un forage, les charges hydrauliques dans les zones d'écoulements ne sont en général pas identiques (figure III.2a). Ceci est le cas en particulier dans les milieux faiblement connectés tels que les milieux fracturés. La charge des zones d'écoulement est contrôlée par leurs conditions aux limites à plus grande échelle. Ces conditions peuvent être par exemple l'existence d'un pompage sur un forage rencontrant l'une des zones d'écoulement ou la recharge de l'aquifère intervenant préférentiellement dans l'une des zones d'écoulement. Si ces zones d'écoulement ne sont pas isolées les unes des autres, des écoulements verticaux se font à travers le forage entre les zones de charges différentes.

La mesure des écoulements peut se faire par différents types de débitmètres adaptés à la mesure des faibles vitesses (*Molz et al.*, 1989, *Paillet*, 1996) ou par des méthodes de dilution (*Tsang and Doughy*, 2003). Nous avons utilisé un débitmètre à pulse de chaleur (*Paillet*, 1996). Le schéma simplifié de la figure III.2 illustre les interactions entre les zones d'écoulement et le forage. Le forage intersecte deux zones d'écoulement. Celle du bas ayant une charge hydraulique plus grande que la zone du haut, un écoulement se fait à travers le forage de bas en haut. Le débit est fonction de la différence de charge et de la transmissivité de deux zones. Lorsque l'on pompe dans le forage, un débit transitoire est créé dans chaque zone, puis un régime pseudo permanent se met en place et le débit se stabilise. Il est alors fonction de la transmissivité et de la différence de charge entre les zones et le forage. La mesure des profils de débit dans deux conditions hydrauliques différentes (figure III.2) permet théoriquement d'estimer la localisation, la transmissivité et la charge hydraulique des zones intersectées par le forage. Ceci nécessite néanmoins la définition de modèles d'écoulement représentant les écoulements entre les zones transmissives par l'intermédiaire du forage.

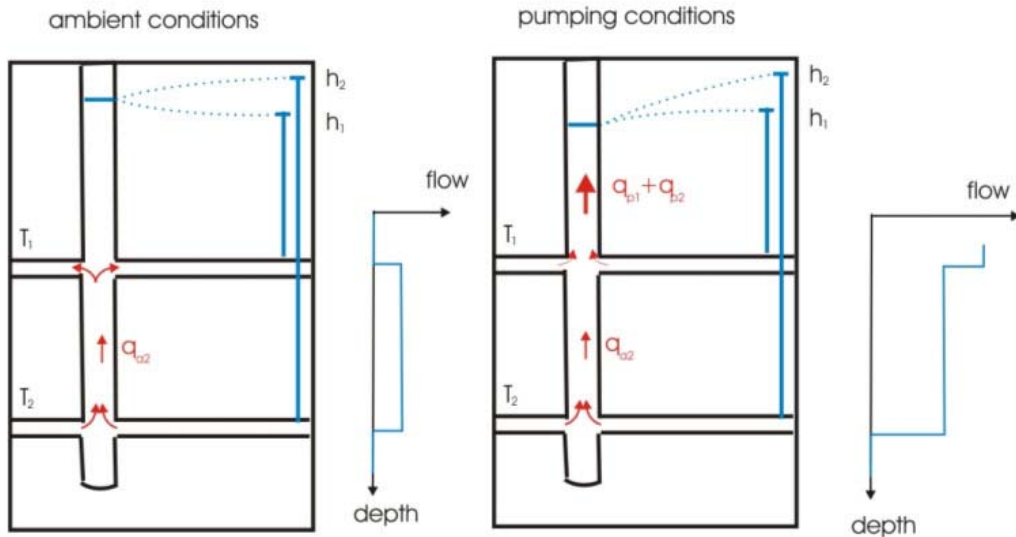

Figure III.2: schéma simplifié illustrant le principe d'interprétation des diagraphies de débit

III.1.2 Hypothèses pour l'inversion des mesures

Estimation de la transmissivité relative

Le modèle d'écoulement le plus couramment utilisé pour représenter les écoulements vers le forage est celui d'un écoulement radial en régime quasi permanent entre une charge h_i fixée à une distance radiale r_i fixée et le forage (Paillet *et al.*, 1987). La charge h_i est supposée correspondre à la charge hydraulique à plus grande échelle dans chacune des zones. La distance r_i est supposée être relativement petite dans la pratique. Le débit en régime permanent provenant de la zone d'écoulement n°i de transmissivité T_i , de charge hydraulique h_i à une distance r_i du forage s'écrit:

$$q_i = \frac{2\pi T_i (h_i - h_{wb})}{\ln(r_i/r)} \quad (\text{III.1})$$

avec r et h_{wb} respectivement le rayon et la charge hydraulique du forage

L'équation III.1 est une équation à trois inconnues pour chaque zone d'écoulement. La mesure du débit dans deux conditions différentes permet d'obtenir deux équations. C'est pourquoi, étant donné que la valeur de r_i est inconnue, les diagraphies de débit sont habituellement interprétées en terme de

transmissivité relative: $\frac{T_i}{T_{tot}} = \frac{\Delta q_i}{\Delta Q}$, avec Δq_i la différence de débit à la position i entre deux

conditions de pompage sur le forage correspondant à une différence de débit total ΔQ .

Estimation de la transmissivité absolue et des charges hydrauliques des fractures

Paillet (1998) a proposé une méthode pour lever cette indétermination et estimer directement la transmissivité absolue. La méthode impose cependant d'affecter à chaque zone d'écoulement un coefficient d'emmagasinement. Les écoulements transitoires et les variations de charge dans les zones d'écoulement et dans le forage sont modélisés par une méthode semi-analytique. Dans cette méthode, les variations de charges sont discrétisées et reliées aux écoulements à l'aide de solutions analytiques de chocs hydrauliques unitaires (figure III.3). Pour une transmissivité T_i donnée et une charge h_i donnée dans chaque zone d'écoulement, le passage par le modèle semi-analytique transitoire permet de calculer les écoulements en régime sub-permanent. Les écoulements calculés sont comparés aux écoulements mesurés et les transmissivités et charges sont itérativement réajustés pour que les débits calculés convergent vers les débits mesurés.

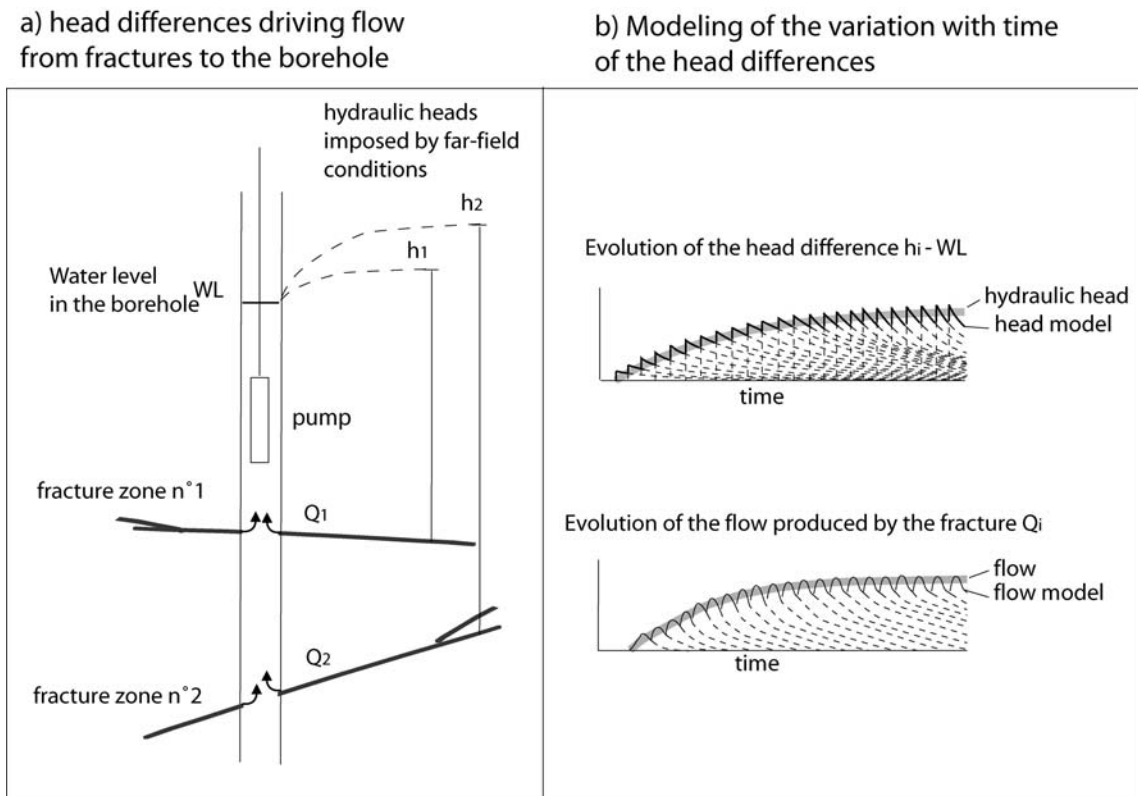

Figure III.3: a) Illustration de la différence de charge hydraulique entre les zones fractures et le forage à un temps donné en conditions de pompage; b) Modélisation de la variation temporelle de la différence de charge entre une fracture et le forage. L'évolution de la différence de charge (ligne grise) est modélisée par la superposition d'une série de chocs hydrauliques (lignes pointillées) alors que le débit provenant de chaque fracture s'ajuste en fonction de la variation de niveau dans le forage. D'après *Le Borgne et al.* (in press).

III.1.3 Limites et incertitudes relatives aux méthodes de diagraphies de débit

In fine, la méthode proposée par Paillet (1998) est équivalente à une méthode basée sur l'équation III.1. Elle présente cependant l'avantage de représenter physiquement les interactions transitoires entre les zones d'écoulement et le forage qui contrôlent le rayon effectif r_i . Le choix du coefficient d'emménagement peu être relativement bien contraint par exemple pour les zones fracturées. Dans la pratique, étant donné que le rayon r_i intervient dans l'équation sous forme de logarithme (équation III.1), une erreur sur r_i d'un facteur dix entraîne une erreur sur T_i et h_i d'un facteur deux. L'incertitude la plus grande est associée aux zones d'écoulement dont la transmissivité est faible par rapport aux autres zones intersectées.

La validation de la méthode en la comparant aux résultats de tests entre packers (figure III.4) montre qu'elle permet d'estimer les transmissivités sur deux ordres de grandeur. L'incertitude sur les estimations de la transmissivité et de la charge hydraulique dans les zones d'écoulement est liée pour partie à l'incertitude de mesure des débits dans le forage. Dans un forage, le profil latéral de vitesse suit une loi parabolique: les vitesses sont plus faibles sur les bords du forage qu'au milieu. Le positionnement de l'appareil de mesure dans le forage introduit donc une fluctuation de la vitesse mesurée. D'autre part, le diamètre du forage n'est en général pas constant. La traduction de la mesure de vitesse en débit introduit donc une incertitude supplémentaire (Paillet, 2004). De plus, de nombreux forages sont tubés. Dans ce cas, il existe en général un espace vide entre le tubage et la paroi du forage. Cet espace est souvent plus ou moins comblé par des débris ce qui introduit une variation du diamètre effectif du forage qui est très difficile à prendre en compte. L'utilisation d'un débitmètre différentiel permet d'augmenter la résolution des estimations (Rouhiainen, 2000). Cependant cette technique nécessite des forages non tubés et est sensible aux variations de diamètre du forage.

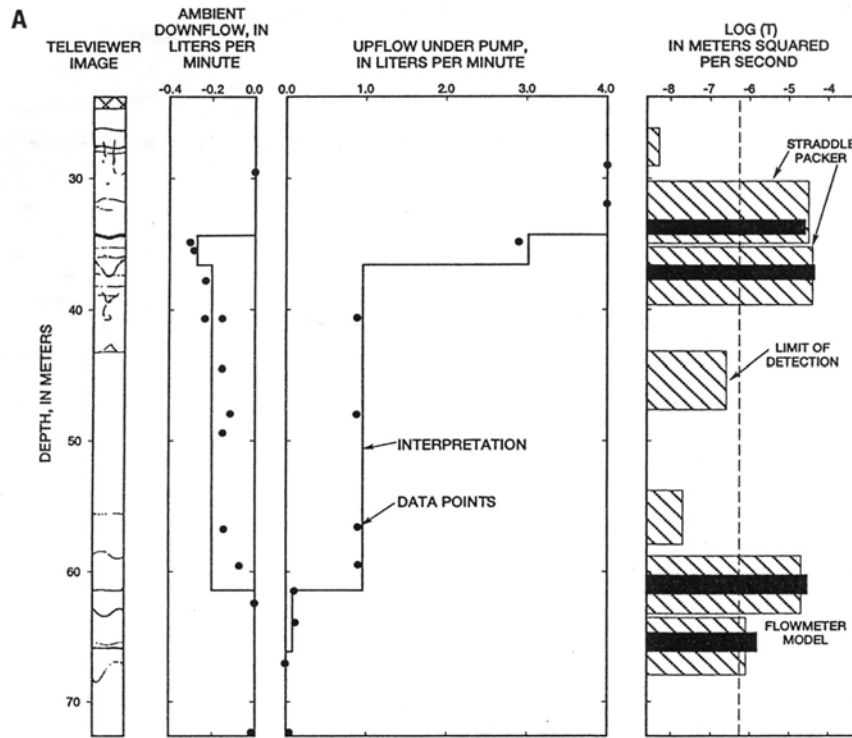

Figure III.4: Comparaison des estimations de transmissivité par les méthodes de diagraphies de débits et packer tests, Mirror Lake, USA d'après Paillet (1998)

III.2. Article: Cross-borehole flowmeter tests for transient heads in heterogeneous aquifers (*Le Borgne et al., in press*).

Les diagraphies de débit sont un moyen simple pour estimer la distribution des transmissivités le long des forages (figure III.5.a). Cependant, la caractérisation des écoulements à grande échelle ne peut pas être déduite de la distribution des fractures dans les forages car seul un petit nombre de ces fractures est susceptible de former un chemin d'écoulement connecté à plus grande échelle. Les expériences de débitmétrie en forage en mode d'interférence entre forages ont été récemment proposées pour caractériser les chemins d'écoulement préférentiel dans les aquifères hétérogènes (*Paillet, 1998*). Les expériences de débitmétrie en interférence sont basées sur l'idée qu'un changement de condition de pompage dans un aquifère entraîne une modification de la distribution spatiale des charges hydrauliques dans les chemins d'écoulement à grande échelle, ayant pour conséquence une variation des écoulements verticaux dans les forages d'observation. En théorie, la mesure de ces variations de débit doit pouvoir être interprétée pour caractériser les chemins d'écoulement entre le forage d'observation et le forage pompé. Néanmoins, l'inversion des mesures de débit en forage pour en déduire la géométrie et la connectivité des chemins d'écoulement préférentiels, ainsi que leur propriétés hydrauliques demeure un sujet de recherche. Dans l'article qui suit nous proposons une méthodologie pour effectuer ce type d'inversion.

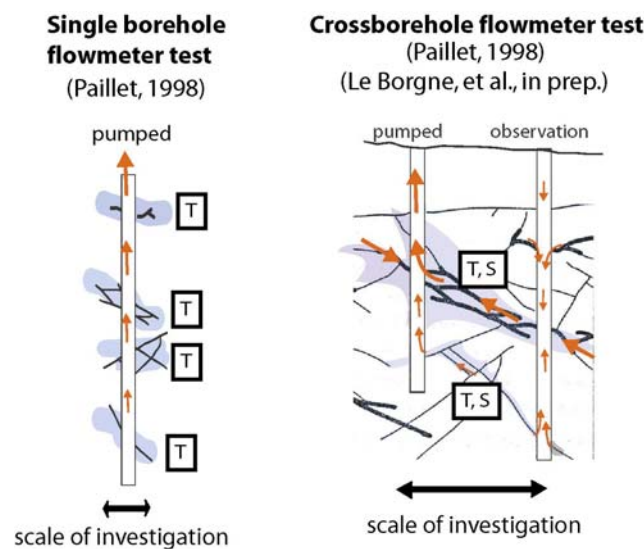

Figure III.5: illustration des méthodes de caractérisation utilisées: a) diagraphies de débit, b) débitmétrie en mode d'interférence, la propagation du rabattement suite au pompage est illustrée en gris. Le rabattement se propage différemment dans chacune des zones intersectées par les deux forages ce qui implique des différences de charges entre les zones dans le forage d'observation.

Résumé:

Les expériences de débitmétrie en forage en mode d'interférence entre forages ont été récemment proposées pour caractériser de manière efficace les chemins d'écoulement préférentiels dans les aquifères hétérogènes. Dans cette étude nous proposons un cadre d'interprétation basé sur un modèle conceptuel à deux échelles : des fractures discrètes à l'échelle du forage et des zones fracturées à l'échelle de l'aquifère. Nous proposons que les deux problèmes soient résolus de manière indépendante. Le premier problème inverse consiste à estimer les variations de charge hydraulique qui créent les écoulements verticaux transitoires mesurés dans le forage d'observation lors des tests d'interférence. Le second problème inverse consiste à caractériser la géométrie et les propriétés hydrauliques des chemins d'écoulement préférentiels entre le forage pompé et le forage d'observation, qui sont compatibles avec les variations de charge déduites du premier problème. Pour résoudre le premier problème, à l'échelle du forage, nous traitons les données de débits verticaux transitoires comme une série de débits en régime quasi permanent et nous en déduisons les variations de charge hydrauliques à chaque pas de temps dans les zones d'écoulement qui sont requises pour produire ces débits. La méthode est mise en œuvre et validée sur le site de cristallin fracturé de Plœmeur.

**CROSS-BOREHOLE FLOWMETER TESTS FOR
TRANSIENT HEADS IN HETEROGENEOUS AQUIFERS**

Paper in press in Ground Water

Tanguy Le Borgne^{a*}, Frederick Paillet^b, Olivier Bour^a and Jean-Pierre Caudal^a

^a Géosciences Rennes (UMR CNRS 6118) University of Rennes, Rennes, France

^b University of Maine, Orono, Maine, USA

* Now at Laboratoire de Tectonophysique (UMR 5568 CNRS UM2) University of
Montpellier, Montpellier, France

ABSTRACT

Cross-borehole flowmeter tests have been proposed as an efficient method to investigate preferential flow paths in heterogeneous aquifers, which is a major task in the characterization of fractured aquifers. Cross-borehole flowmeter tests are based on the idea that changing the pumping conditions in a given aquifer will modify the hydraulic head distribution in large-scale flow paths, producing measurable changes in the vertical flow profiles in observation boreholes. However, inversion of flow measurements to derive flow-path geometry and connectivity and to characterize their hydraulic properties is still a subject of research. In this study, we propose a framework for cross-borehole flowmeter test interpretation that is based on a two-scale conceptual model: discrete fractures at the borehole scale and zones of interconnected fractures at the aquifer scale. We propose that the two problems may be solved independently. The first inverse problem consists of estimating the hydraulic head variations that drive the transient borehole flow observed in the cross-borehole flowmeter experiments. The second inverse problem is related to estimating the geometry and hydraulic properties of large-scale flow paths in the region between pumping and observation wells that are compatible with the head variations deduced from the first problem. To solve the borehole-scale problem, we treat the transient flow data as a series of quasi-steady flow conditions and solve for the hydraulic head changes in individual fractures required to produce these data. The consistency of the method is verified using field experiments performed in a fractured rock aquifer.

INTRODUCTION

Conceptual models of fractured-rock aquifers are usually composed of discrete “pancake-shaped” elements of specified hydraulic conductivity and storativity. Model fractured rock aquifers are constructed from populations of such discrete fractures that intersect to form continuous flow paths, providing flow to production wells under pumping conditions, or pathways for the migration of contaminants under the influence of natural hydraulic gradients. A major task in the characterization of fractured aquifers and the prediction of wellfield performance or contaminant migration is the identification of fracture flow paths *in situ* and the specification of their hydraulic properties. The identity of the aquifer-scale flow paths is rarely obvious from the distribution of discrete fractures in a borehole (figure 1). The possibility of multiple flow paths intersecting a single borehole indicates that boreholes in fractured bedrock aquifers should be treated as observation wells intersecting multiple confined or partially-confined aquifers. Many well testing and aquifer modeling procedures are designed for such situations where multiple-piezometer completions or straddle-packer isolation systems are used to isolate the individual aquifers in each observation borehole (*Day-Lewis et al., 2000; Nakao et al., 2000*). In theory, the characterization of the hydraulic properties of fractured-bedrock aquifers is just another application of standard hydraulic testing methods in the case of complex, multi-zone aquifers.

One fundamental problem with the application of existing aquifer test techniques to fractured rock aquifers is that the characterization depends on the isolation of the individual flow paths. At best, the isolation of discrete zones with straddle packers is a labor-intensive and time-consuming process. Some observation well completions involve well construction techniques that are either difficult or impossible to change after installation. In many situations, existing open or long-screened observation boreholes are the only measurement points available. Even in circumstances where resources allow for elaborate well completions

it would be very useful to have prior information providing the identification of the primary large-scale flow paths in the regions between boreholes and a preliminary estimate of the hydraulic properties (transmissivity and storage coefficient) of those zones. Such information ensures the most effective location of measurement intervals and effective design of aquifer test procedures – such as the identification of the pumped well and the proposed pumping rate. Thus, fractured-rock aquifer characterization technology would benefit from efficient and effective hydraulic techniques to identify fracture flow paths and estimate their properties using hydraulic data obtained in open boreholes.

High-resolution borehole flowmeters such as the heat-pulse flowmeter (*Hess, 1986*) and electromagnetic flowmeter (*Molz et al., 1989*) can be used to characterize the local transmissivity of flow zones such as fractures intersecting boreholes (figure 1). In addition, ambient vertical flows between fractures are commonly observed in boreholes, due to differences in hydraulic head between large-scale flow paths that connect to fractures intersecting boreholes (figure 1). These differences in hydraulic head may be due to different boundary conditions such as connections to pumping wells. To estimate these hydraulic heads, single-borehole flowmeter tests need to be performed under two different flow conditions, usually ambient and pumping conditions (*Paillet, 1998; 2000*).

Cross-borehole flowmeter tests have been recently proposed (*Paillet, 1993*), based on the idea that changing the pumping conditions in a given aquifer will modify the head distribution in large-scale flow paths, which in turn should change the flow profiles in observation boreholes. Such cross-borehole flowmeter tests are potentially useful because they provide information on the properties of the large-scale aquifers over the extended region between and around the borehole pair, whereas single-borehole flowmeter tests provide information about the properties of the individual fracture segments surrounding the borehole. The change in flow in observation wells induced by pumping in another well may be

qualitatively interpreted in terms of flow zone connectivity since the hydraulic head should change only in the flow paths connected to the pumping well (*Paillet, 1993*). Borehole flow may also be modeled using a forward approach to quantify the hydraulic properties of the large-scale flow zones (*Paillet, 1998, 2001; Williams and Paillet, 2002*). Nevertheless, the many degrees of freedom imply that matching of the cross-borehole flowmeter data with a forward model that incorporates flow-path geometry and hydraulic properties as well as borehole flow is not a simple and obvious task.

The reason why this approach is difficult is that it tries to solve two problems simultaneously: the borehole boundary scale problem and the aquifer scale problem (figure 1). As an alternative, we propose that the two problems be treated independently. The first inverse problem consists of estimating the hydraulic-head variations at the borehole boundary scale (figure 1). This head represents the circumferentially averaged hydraulic head in the aquifer at the “outer edge” of the fracture in the vicinity of the observation well. Its variations drive the flow variations observed in the borehole during the cross-borehole flowmeter experiments. The second inverse problem is related to estimating the geometry and hydraulic properties of large-scale flow paths between the pumping and observation wells that are compatible with the hydraulic-head variations deduced from the first problem. We argue that treating the two problems separately provides a consistent framework, where local borehole-scale effects are accounted for in a first step and aquifer structure characterization is analyzed in a second step (figure 1). This article is focused on solving the first problem, which consists of converting the flow variations within the borehole to hydraulic head variations at the borehole outer edge. The aquifer-scale problem is the subject of a subsequent article (*Le Borgne et al.*, submitted).

We believe this step-by-step modeling approach has two advantages over the more direct approach of simply embedding a borehole flow predictor within a general three-

dimensional aquifer model and then attempting to match the flow log data. First, our method allows a systematic approach to what is otherwise a trial-and-error forward modeling exercise in a case with a very large number of degrees of freedom. Second, our method generates hydraulic head estimates for each active zone in the observation well, producing data similar to that given by multiple straddle packer tests (*Day-Lewis et al.*, 2000; *Nakao et al.*, 2000).

I. BOREHOLE FLOW MODELS AND INVERSION METHOD PROPOSED

I.1 Quasi-steady state borehole flow model

In single-borehole flowmeter experiments, flow logs are obtained by pumping a borehole and then measuring flow below the pump as a function of depth. The flow logging is started when the system has reached a quasi-steady state, i.e when the water level in the borehole is nearly stabilized. Different methods of interpretation have been proposed using different assumptions (*Hess*, 1989; *Moltz et al.*, 1989; *Kabala*, 1994). In the method proposed by *Paillet* (1998), the quasi-steady state flow produced by a zone is estimated for a given local transmissivity and head at the borehole outer edge by using a borehole flow model. This model reproduces the flow interactions between the different fractures within the borehole assuming that the quasi-steady state flow measured within the borehole can be modeled as the asymptotic response of a series of slug tests. The superposition of slug tests is used to produce the transient head difference between the borehole and the different flow zones, which in turn drives the transient flow that is observed within the borehole (figure 2). The solution used for each slug test is given by *Cooper et al.* (1967). In this approach, a similar storage coefficient for all flow zones is assumed. A value of 10^{-5} , corresponding to fractures in a crystalline geology, is commonly assumed. Since tests are performed under quasi-steady states conditions, such an assumption about the storage coefficient is not critical. Moreover, since

flowmeter tests are achieved under two different flow conditions, usually ambient and pumping conditions (*Paillet*, 1998), the hydraulic head imposed at the borehole outer edge boundary conditions and the local transmissivity can be derived for each fracture zone by matching the observed flow with the asymptotic flow calculated by the borehole flow model.

I.2 Fully transient borehole flow model

Instead of using the model only in its asymptotic regime as for single borehole flow experiments, the *Paillet* (1998) borehole flow model (figure 2) may also be used to model transient flow within the borehole when hydraulic heads are changing with time, such as in cross-borehole flowmeter tests.

I.3 Borehole flow model inversion

Our aim is to solve the borehole scale inverse problem that consists of estimating the borehole outer edge hydraulic head variations that drive the flow variations observed in the cross-borehole flowmeter experiments. We recall that this head represents the circumferentially averaged hydraulic head in the aquifer at the “outer edge” of the fracture in the vicinity of the observation well. Inversion of the fully transient borehole flow model is beyond the scope of this article and would require additional theoretical investigation. However, the inversion of transient flow logs is possible using a quasi-steady state assumption for the near-field fracture flow, as for single borehole flowmeter experiments. This method, greatly simplifies the inversion, by assuming that flow in the vicinity of the borehole is quasi-steady at each time step, whereas there will be some transient effects from the release of water from storage in the observation well and from the local hydraulic response of the fractures in the borehole boundary scale (figure 1). The series of hydraulic heads given by this analysis can then be used to drive flow in the borehole under fully transient conditions. Comparison of the predictions of this fully dynamic borehole model with

the preliminary quasi-steady solution will show whether these transient effects may be neglected. If necessary, the forcing hydraulic heads can be modified to match the observed flow and the observed changes in water level in the observation well. These corrected series of hydraulic head values can then be used to characterize aquifer-scale flow structures.

In the following we will detail the steps of the proposed method. Each step will be illustrated by a field example. The main steps are the following:

- Perform single-borehole flowmeter experiments to deduce local transmissivity and ambient hydraulic head at the borehole outer edge
- Perform cross-borehole flowmeter experiments
- Estimate the hydraulic-head variations within the main flow paths at the borehole outer edge
- Test the quasi-steady state assumption using a fully transient borehole flow model.
- Use the head variations at the borehole outer edge to deduce aquifer-scale flow paths geometry and hydraulic properties

II. DETAILS OF THE METHOD AND A FIELD APPLICATION

We illustrate the method using data obtained from observation and production wells in the Plœmeur, France city water-supply wellfield. The aquifer is located on the south coast of Brittany in crystalline bedrock terrain characterized by igneous and metamorphic rocks. More than forty boreholes have been drilled in and around the site since 1991. In most boreholes flow is localised within a few main fracture zones. A more detailed description of the site is given in *Le Borgne et al. (2004)* and *Le Borgne et al. (submitted)*. Cross-borehole experiments were conducted by simply turning on or off pumps in production wells.

Monitoring wells are completed with a 115-mm-inner-diameter casing that is slotted around the productive zones. The casing was inserted in the original 159-mm-diameter drilled borehole with no sand or gravel filling in the annulus except for natural debris derived from unstable zones in fracture intervals. Observation boreholes are fully slotted over the entire borehole depth below 25 meters of blank casing. The on-line pumping rate of the production well used for the experiment is about 20 m³/h (about 333 lpm).

II.1 Single borehole flowmeter experiments

Borehole flow was measured using a heat-pulse flowmeter. Ambient flow was first measured in boreholes, and was attributed to the drawdown produced by the operating wellfield. A second borehole flow profile was obtained while pumping at about 30 liters per minute and measuring the vertical distribution of flow after drawdown had stabilized. Flowmeter output was given in the field as the pulse travel time from heat grid to a thermistor located above or below the heat source within the cylindrical measurement section. Field calibration in units of borehole flow was made by fitting a second order curve (based on inverse heat-pulse travel times) to calibration values (known flow rates) for steady pumping at a point in the borehole above all inflow points where borehole flow was known to equal borehole discharge. Separate calibration curves were constructed for upwards and downwards flow to account for the hydraulic asymmetry of the probe's flow measurement section. Calibrated flow was designed to apply to total borehole flow representing the sum of flow through the probe measurement section, flow around the probe inside of the slotted borehole liner, and flow in the annulus between slotted liner and borehole wall. Thus, calibration measurements were made at least 10 borehole diameters below the blank casing in the upper part of the liner and at least 10 borehole diameters above the uppermost inflow point.

Inflow points for each observation borehole were identified by inspection of the pairs of ambient and pumping flow profiles. Complementary information is provided from fluid

temperature and conductivity profiles while pumping at the top of the borehole (figure 3). Possible debris blockages in the annulus around the outside of casing added variations in measured borehole flow, which partly complicated the interpretation of inflow points. Figure 3 shows an example of single-borehole flowmeter profiles in borehole F-28, showing four main inflow zones (table 1). In this borehole there was upflow of about 5 liters per minute under wellfield conditions at the time of logging, with flow entering at the deepest zone and exiting at the upper three zones. Borehole flow modeling (section I.1) indicated that this flow was driven by about 2 meters of hydraulic head difference between the bottom zone and the upper three zones (table 1).

II.2 Cross-borehole flowmeter experiments

After the fracture zones are identified in the observation borehole and the local transmissivity of each such zone is estimated, the influence of the nearby pumping well is investigated by turning off the pump and checking for measurable changes in flow within the observation borehole. For cross-borehole tests, the procedure consists of measuring flow at N-1 depth stations between each of the N inflow/outflow zones in the observation borehole, and at an additional station above all inflow points. At each depth, measurements are repeated according to the following regime: 1) a short period to establish a baseline ambient flow, 2) a specified period with the production well turned off, and 3) an equal period of “recovery” after the production well is brought back on line. For the experiments performed at the Plœmeur site, the measurement period is either 10 or 20 minutes, depending on borehole separation, with longer test times required for the response to propagate over larger borehole separations. The recovery period is continued for at least twice the active test period (the time with the production well off) to insure recovery to close to pre-test pumping conditions, and to allow establishment of baseline flow for the subsequent test. This procedure produces a set

of N time series of flow to be “solved” for the N hydraulic head series to be interpreted from the flow data.

The measured borehole flows at locations between and above the flow zones in borehole F-28 that resulted when the pump in well F-29 was turned off for a period of 10 minutes and then restarted are shown as the discrete data points in figure 4. Well F-29 is located 7 meters from well F-28. Except for the lowest measuring depth, the flow response is a rapid increase in upflow when the pumping stops (at $t=0$) and water level rises in borehole F-28. This response is followed by a reversal to downflow when the pump in well F-29 is started again (at $t=10$ min). In the meantime the observation well water level falls back towards the value given at the start of the experiment. The station at 26 meters is located above all water producing zones. For the 64 and 70 meters fracture zone, these flow data imply a fast connection between these zones and the pumping well. For the lower fracture zone, the fact that flow above the fracture remains constant despite the variations of the water level in the borehole imply that the hydraulic head within this fracture is also evolving with time due to change in pumping conditions. Thus, the 80 meters fracture zone should be also connected to F-29. A similar reasoning may be done for the 30 meters fracture zone. In this example all flow measurements at the four measurement stations are unambiguously greater than the scatter in the individual measurements that is less than 1 lpm. Thus, these data contain meaningful information about the evolution of hydraulic head in the four different fracture zones and may be used to construct flow profiles at different times.

II.3 Estimation of Hydraulic head variations within the aquifer flow paths

To estimate the hydraulic head variations within the aquifer flow paths that create the change in flow in the observation borehole, the N time series of flow (figure 4) are used to construct flow profiles at different times (figure 5). Each of the flow profiles at each interval is “solved” using the quasi-steady state method given by *Paillet* (2001) and described

previously (section I.1) to estimate relative hydraulic head values for the different flow zones. They account for the measured flow in the $N-1$ intervals between zones and their absolute value may be derived from the open-hole water level that was recorded during the tests using pressure transducers.

In borehole F-28, these flow profiles clearly show the flow interactions driven by changes in hydraulic head in the aquifer flow paths connected to the fractures in this borehole (figure 5). These specific “snapshots” of the flow in the observation borehole are samples from a continuous series of flow profiles obtained during the course of the pumping test and subsequent relaxation. Except for the lowermost fracture zone, the abrupt cessation of pumping in adjacent production well F-29 causes accelerated upflow between zones at 5 and 10 minutes after the pump was turned off (figure 5). The fracture zone at 70 meters, which was characterized by slight outflow from the borehole towards the fracture before the cessation of pumping, becomes a productive zone after the cessation of pumping.

The computed changes in hydraulic head in each of the four flow zones in the observation well F-28 induced by the stopping of the pump in well F-29 and the restart of the pumping 10 minutes later are illustrated in figure 6. The observed water level variation is also plotted for comparison. It appears that the head change in each of the flow zones is significantly different from the measured water level. The latter one represents in fact a transmissivity-weighted average of the hydraulic head in each flow zone. Although the three uppermost zones have approximately the same hydraulic head under ambient conditions, the recovery of water level after the cessation of pumping in well F-29 causes the water level in the two intermediate zones to increase rapidly for a few minutes and then level off. In contrast, the lower and upper zones show a simple monotonic increase in water level. When pumping restarts in well F-29, the two intermediate zones show a decrease in hydraulic head that significantly “overshoots” the original ambient value and then increases again to

approach the ambient values from below. The uppermost and lowermost zones again show simple monotonic decreases back towards the initial conditions. The details related to some of the individual data points may result for numerical scatter in the inversion, but the over-all trends in the data appear consistent, and the hydraulic head values clearly return towards the original “ambient” condition after pumping has been re-established for more than 10 minutes. Also note that the generally similar character of the hydraulic head series for the two intermediate zones in figure 6 is not likely to be an artifact of noise in the data because each series represents a separate repeat realization of the experiment and it is unlikely that random errors in flow measurement would repeat exactly during each measurement cycle.

These hydraulic head variations may be directly used to discuss aquifer flow path structure, since they should be independent from local borehole scale effects. At first sight, these head series indicate that borehole F-29 and F-28 are connected through three main aquifer flow paths. The upper flow path, which allow the 30 m fracture to be connected with F-29. Since the hydraulic head variations of the two middle zones are very similar, it is very likely that the 64 m and 70 m fractures are connected to the F-29 borehole through the same flow path. Finally, the 80 m fracture should be connected to F-29 through the lower flow path. The fastest reaction to pumping in F29 is through the middle fracture zone.

II.4 Test of the quasi-steady state assumption

The one difficulty with the flow model inversion scheme proposed here is that the method assumes quasi-steady flow at each time step, whereas it is known that water is moving into or out of casing during the course of the experiment. There may also be transient adjustments of flow within the formation in response to the evolving drawdown since the head profile in the individual fractures does not instantaneously reach a steady state. The storativity of the fractures around the borehole imply a time lag to reach steady state head profile around the borehole. In practice, this time lag is likely to be small compared to the

characteristic time of head evolution around the observation well during an aquifer test. This is true especially in the case of fractured crystalline rock where the storativity of fractures is low whereas the permeability may be very high. However, to estimate the impact of these transient effects, we use the derived hydraulic head series (the discrete points in figure 6) to drive flow in a fully dynamic borehole flow model (section I.2). The results of this fully transient model can be compared to the original flow data, and to the record of water level change in the observation borehole.

To do so, the series of hydraulic head values estimated for each time step are expanded to generate time series at much more frequent intervals by simple linear interpolation. This was required to satisfy time step requirements in the transient model to minimize numerical errors in the analysis. Smoothing of the “corners” on these interpolated series might have been a way to average out numerical noise in the model fitting results, but simple linear interpolation was judged to be the most direct and effective way to evaluate the effectiveness of the solution. The transient model predictions match the original flow transient data very closely (solid lines in figure 4). This is also true for the water level measurements given by a pressure transducer in the observation borehole during the experiment (figure 4). Note that we used a storage coefficient of 10^{-5} for the fractures intersecting the borehole in the transient borehole flow model. Error produced by the quasi-steady state assumption are likely to be more important in situations where flow zones intersected by observation boreholes have a storage coefficient much greater than 10^{-5} .

III. DISCUSSION

The preceding tests show that the hydraulic head solutions in figure 6 are perfectly consistent with the hydraulic head series required to drive the observed flow under fully transient conditions in the cross-borehole experiment of figure 4. No further adjustment is needed for any of the four flow zones. The same result was obtained for another cross-

borehole experiment on the same site, with borehole separation of 75 meters. This raises the question of how the quasi-steady inversion used to generate the hydraulic head data in figure 6 is capable of matching a fully dynamic data set where casing storage effects are far from dominant but certainly significant. We believe that casing storage effects are indirectly accounted for by the fact that the analysis does use the actual water level data in the observation borehole in converting relative to absolute water levels in each zone. By keeping track of the water level in the observation borehole, the quasi-steady solution is effectively tied to the water level fluctuations. Ignoring flow into or out of casing introduces small random errors at each inversion interval in figure 6, but these errors largely cancel each other out in the borehole inflow “accounting” during the time sequence while the transmissivity-weighted hydraulic head values in each zone effectively track measured water level. Thus, the use of the measured observation borehole water levels to provide an absolute reference level for the relative hydraulic head differences between zones indirectly accounts for a large proportion of the casing storage effects.

The results in figure 6 provide useful information about the propagation of hydraulic head changes through the fracture flow system at the Ploemeur site under the influence of changes in pumping in the active production wells. In borehole F28, the upper and lower zones respond slowly and steadily to the relaxation of drawdown when the adjacent well is turned off (figure 6). In contrast, the intermediate zones show a rapid increase. Figure 7 shows This type curve matches to the hydraulic head variation in the 30 m and 70 m zones in borehole F28. The hydraulic head variations appear to be globally consistent with a Theis curve evolution. Note, however, that for the 70-m zone the abrupt recovery cannot be matched fully by a Theis curve. Analysis of the obtained hydraulic head variations to derive the connectivity and hydraulic properties of the aquifer flow paths is the subject of a subsequent paper (Le Borgne et al., submitted).

CONCLUSIONS

In this paper, we showed how cross-borehole flowmeter tests may provide very useful information about the properties of the aquifer flow paths, which is a major task in the characterization of fractured aquifers and the prediction of wellfield performance or contaminant migration. The inversion of cross-borehole flowmeter data to derive flow path geometry and hydraulic properties requires solving two inverse problems corresponding to two different scales; the borehole boundary scale and the aquifer scale (figure 1). We argue that solving the two problems independently allows optimizing the interpretation of cross-borehole flowmeter experiments. This article is focused on the borehole boundary scale problem, which consists of converting the flow variations within the borehole to hydraulic head variations at the borehole outer edge. Such hydraulic head variations may be then used in second step to characterize at large scale the hydraulic properties of the different flow paths.

The methodology we proposed is based on a quasi-steady state model at each time-step. It is illustrated with a field example obtained in the Plœmeur fractured crystalline aquifer. Cycles of pumping and recovery in adjacent boreholes (cross-borehole tests) were successfully used to generate $N-1$ transient flow data sets with the flowmeter stationed between the N zones, yielding estimates of the relative hydraulic head of the aquifers connected to each of the N zones. Relative hydraulic head values were converted to absolute values by reference to measurements of water level in the observation borehole during the test period. The method ignores the casing storage within the borehole and assumes a low storativity of the fracture zones just around the borehole. Even so, the process of using measured water levels in the observation borehole during the test to convert the relative hydraulic-head values into absolute water-level elevations indirectly accounts for almost all of the casing storage effects. To check the quasi-steady state assumption, we modeled flow

driven by such hydraulic-head variations with a fully transient flow model. For cross-borehole tests with boreholes separation of 7 meters and 75 meters, predicted and measured flow values are in good agreement. This result indicates that for this type of geological media the local borehole-scale problem, consisting of converting the flow variation within the borehole in response to hydraulic-head variation within the main aquifer flow paths, may be solved using a quasi-steady state model, which greatly simplifies data inversion.

The hydraulic head data obtained in this way do not depend on local properties around the borehole but only on large-scale aquifer flow paths connectivity and hydraulic properties. The next step in the interpretation of cross-borehole flowmeter experiments is to use the derived head variation in the main aquifer flow paths to characterize the structure of the aquifer in the wellhead area and quantify its hydraulic properties. This is the subject of a subsequent article. Such data can also be used as an input for fluid flow modeling at the aquifer scale. This issue was addressed for example by Day-Lewis et al. (2000) or Nakao et al. (2000) who used hydraulic-head data from aquifer tests conducted by isolating fractures with straddle packers.

ACKNOWLEDGMENTS

This work was partly financed by the European project “SALTRANS” (contract EVK1-CT-2000-00062), and by the city of Plœmeur. We especially thank Gérard, Jean-Luc, Julie Manceau and André Le Cloerec from the city of Plœmeur for technical assistance during fieldwork. We also wish to thank the French CNRS for their financial support, in particular through an ATIP project and through the INSUE project “ORE H+”. We are thankful to Dave Hart, Matt Becker and Randall Hanson for their relevant comments and questions, which greatly improved the quality of the manuscript.

REFERENCES

- Day-Lewis, F. D., P. A. Hsieh, and S. M. Gorelick (2000). Identifying fracture-zone geometry using simulated annealing and hydraulic connection data. *Water Resour. Res.*, 36, 1701-1721.
- Cooper, H.H., J.D. Bredehoeft, and I.S. Papadopoulos, Response of a finite diameter well to an instantaneous charge of water, *Water Resour. Res.*, 3, 263-269, 1967.
- Hess, A. E. (1986). Identifying hydraulically conductive fractures with a slow velocity borehole flowmeter. *Can. Geotech. J.*, 23, 69-78.
- Kabala, Z.J. (1994), Measuring distributions of hydraulic conductivity and storativity by the double flowmeter test, *Water Resour. Res.*, 30(3), 685-690.
- Le Borgne, T., O. Bour, J.-R. De Dreuzy, P. Davy, and F. Touchard (2004). Equivalent mean flow models for fractured aquifers: Insights from a pumping tests scaling interpretation. *Water Resour. Res.*, 40, doi:10.1029/2003WR002436.
- Le Borgne, T., O. Bour, F.L. Paillet and J.-P. Caudal (Submitted). Small scale and large scale hydraulic properties estimates from flowmeter experiments in a fractured crystalline aquifer. Submitted to *J. of Hydrol.*
- Molz, F. J., R. H. Morin, A. E. Hess, J. G. Melville, and O. Güven (1989). The impeller meter for measuring aquifer permeability variations: evaluation and comparison with other tests. *Water Resour. Res.*, 25, 1677-1683.
- Nakao, S., J. Najita, and K. Karaski (2000). Hydraulic well testing inversion for modeling fluid flow in fractured rocks using simulated annealing: a case study at Raymond field site, California. *J. of Applied Geophys.*, 45, 203-223.
- Paillet, F. L. (1993). Using Borehole Geophysics and Cross-Borehole Flow Testing to Define Hydraulic Connections Between Fracture-Zones in Bedrock Aquifers. *J. of Applied Geophys.*, 30, 261-279.

- Paillet, F. L. (1998). Flow modeling and permeability estimation using borehole flow logs in heterogeneous fractured formations. *Water Resour. Res.*, 34, 997-1010.
- Paillet, F. L. (2000). A field technique for estimating aquifer parameters using flow log data. *Ground Water*, 38, 510-521.
- Paillet, F. L. (2001). Hydraulic head applications of flow logs in the study of heterogeneous aquifers. *Ground Water*, 39, 667-675.
- Williams, J. H., and F. L. Paillet (2002). Using flowmeter pulse tests to define hydraulic connections in the subsurface: a fractured shale example. *J. of Hydrol.*, 265, 100-117, 8/30.

TABLES

Table 1: Local transmissivity and hydraulic head estimates from single borehole flowmeter experiments in F-28

Zone (m)	Transmissivity (m ² /s)	Hydraulic head (meters above sea level)
30	$6 \cdot 10^{-4}$	3.0
64	$6 \cdot 10^{-5}$	3.0
70	$6 \cdot 10^{-5}$	3.0
80	$5 \cdot 10^{-5}$	5.0

FIGURES

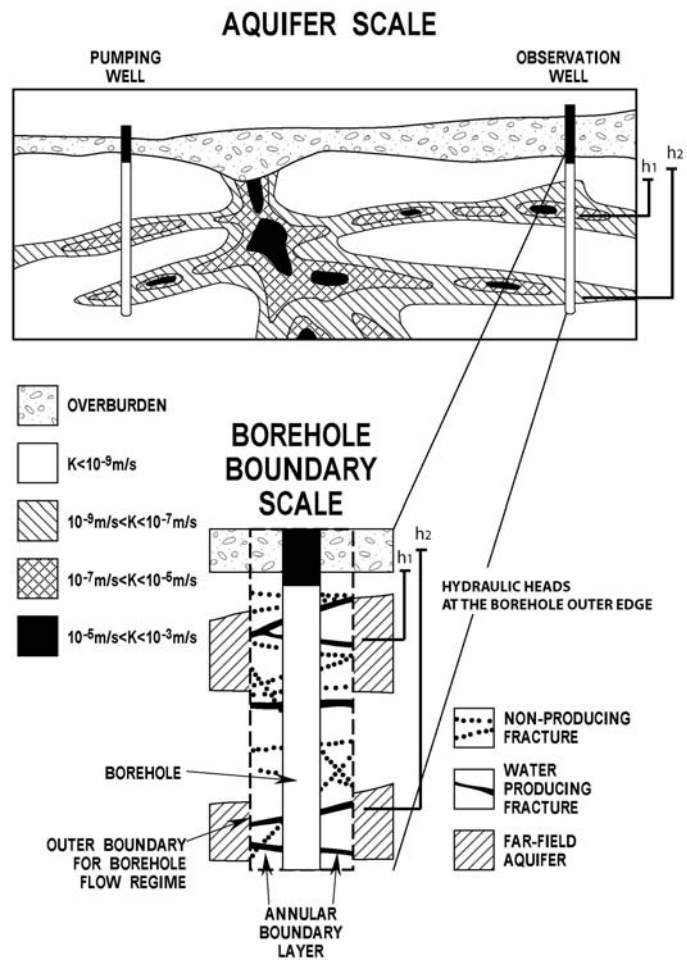

Figure 1: Schematic illustration of discrete water-conducting fractures in an annular region surrounding a borehole embedded in larger-scale aquifer flow paths.

a) head differences driving flow from fractures to the borehole

b) Modeling of the variation with time of the head differences

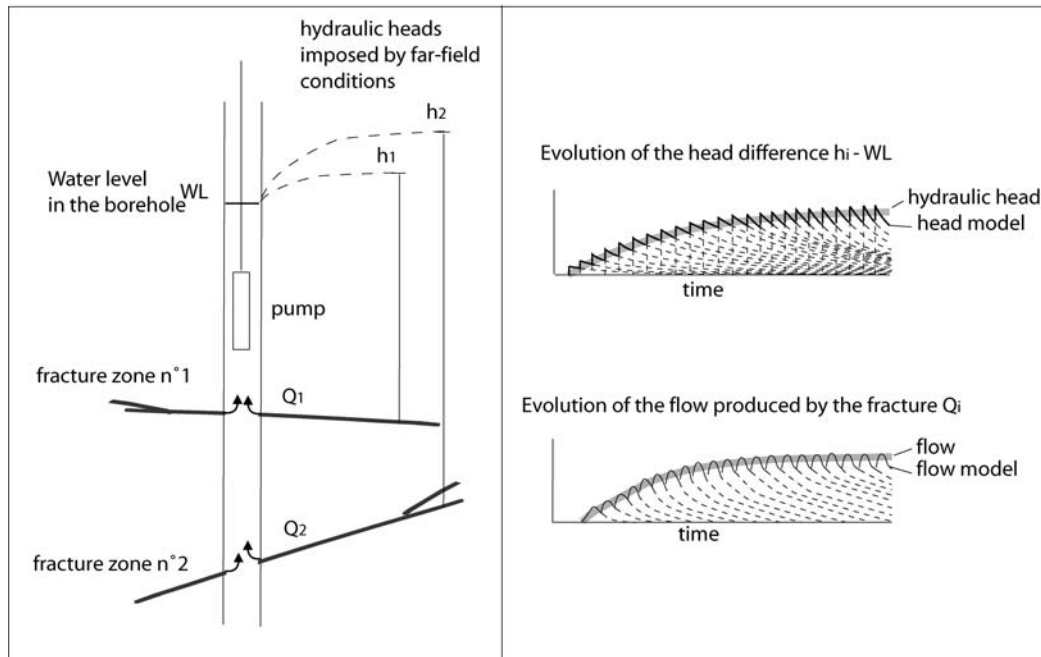

Figure 2: a) Illustration of the hydraulic head difference between fractures and a borehole at a given time in pumping conditions; h_i and Q_i are respectively the quasi-static asymptotic hydraulic heads and flows. b) Modeling of the variation with time of the head difference between the fracture and the borehole (figure 2a). The continuous evolution of the head difference (thick grey line) is modeled by the superposition of a series of incremental slug tests (dashed lines) as the flow out of each fracture adjusts to the changing water level in the borehole.

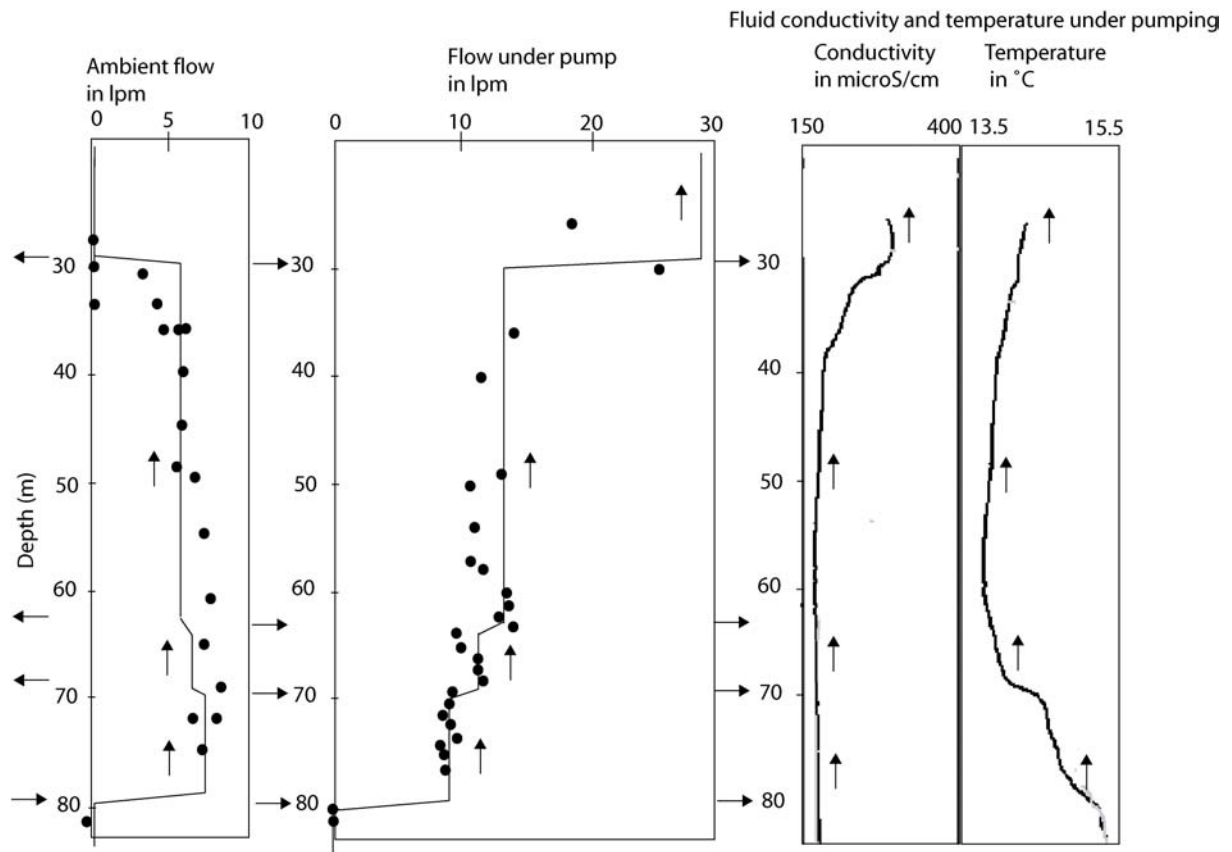

Figure 3: Ambient and steady pumping flow profiles used to identify water-producing zones and to estimate the transmissivity and hydraulic head of inflow zones in borehole F-28. The variations with depth of the fluid conductivity and fluid temperature while pumping are shown on the graph at the right of the figure.

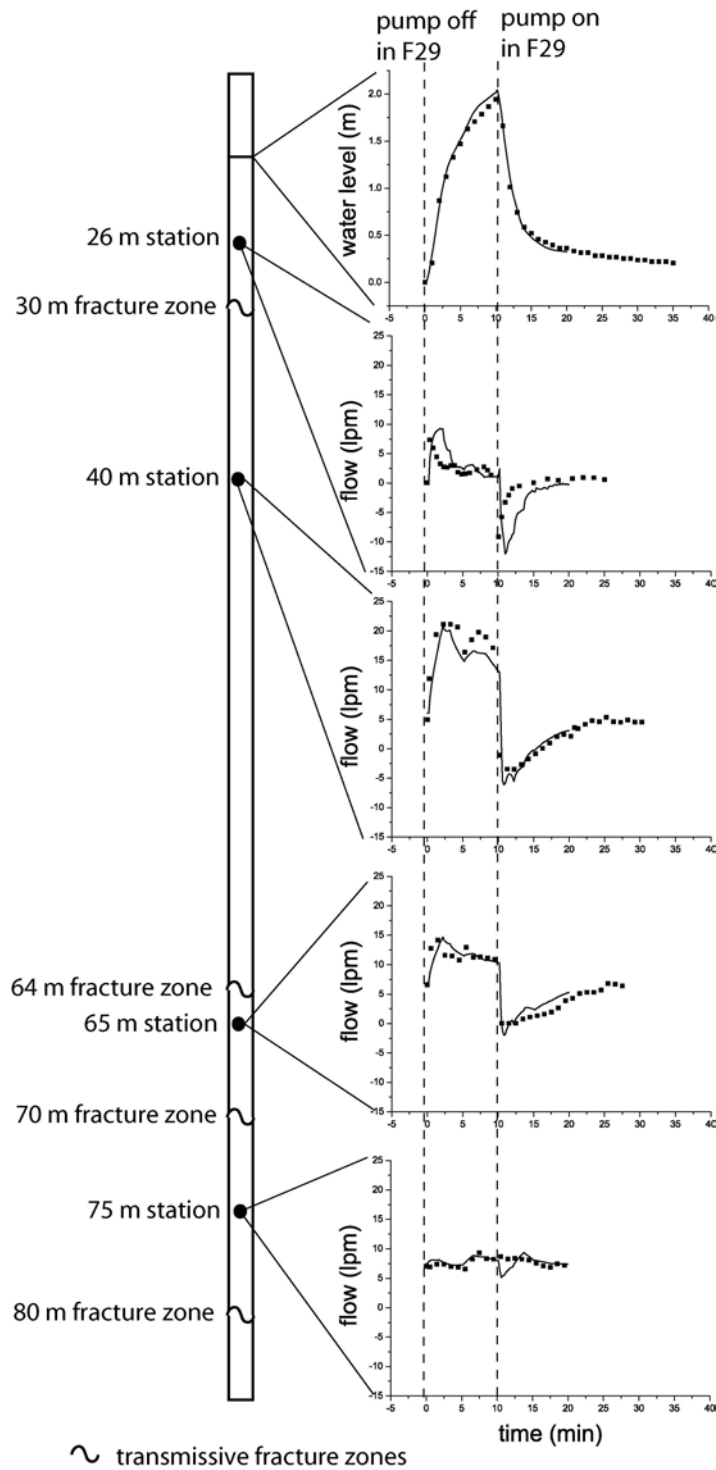

Figure 4: Observation of water level changes (top), and flow variations at four stations in borehole F-28 during cross-borehole tests with the pumping well F29. The dots represent the data points and the continuous line represents the output of the fully transient model used in section II.4.

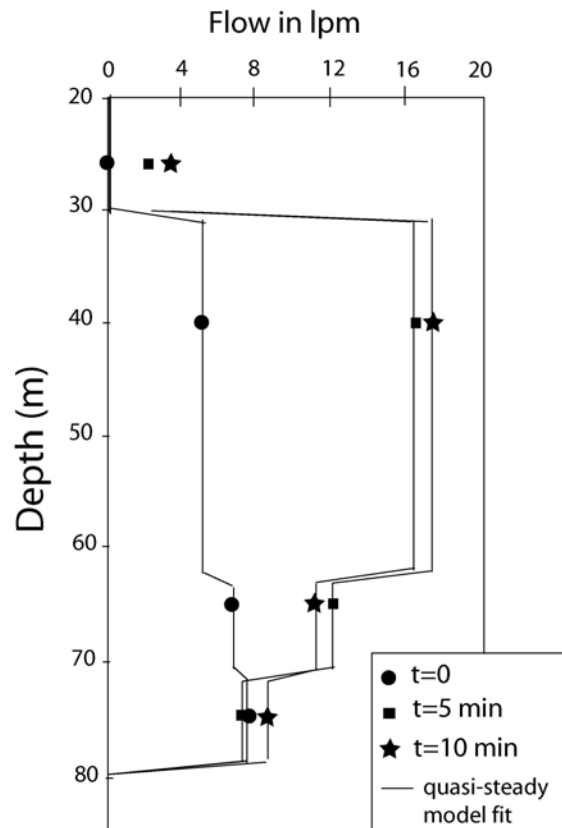

Figure 5: Example of three estimated flow profiles at different times in borehole F28 when turning off the pump in the adjacent borehole F29. These specific “snapshots” of the flow in the observation borehole are derived from the continuous time series of figure 4, by assuming quasi steady state at each time step.

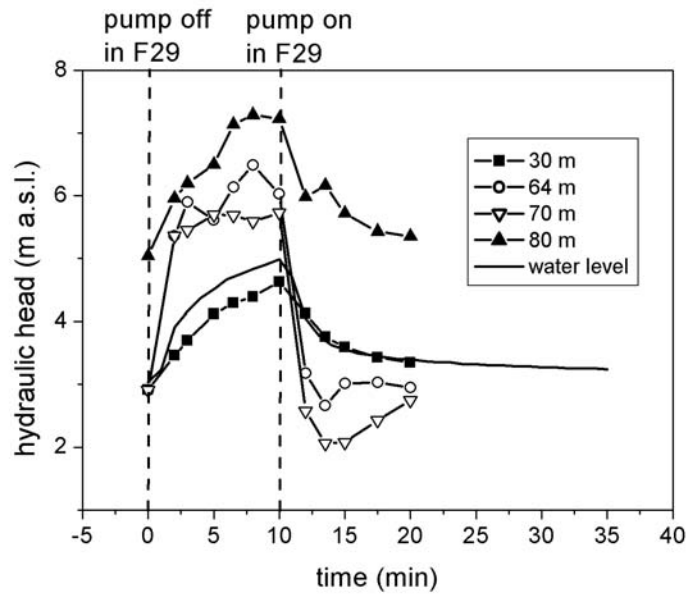

Figure 6: Hydraulic head variations in response to the off/on cycle in well F29 computed for the four fracture zones in borehole F28. The hydraulic head variations within the different inflow zones are represented with symbols while the solid thick line corresponds to water level variations in the borehole.

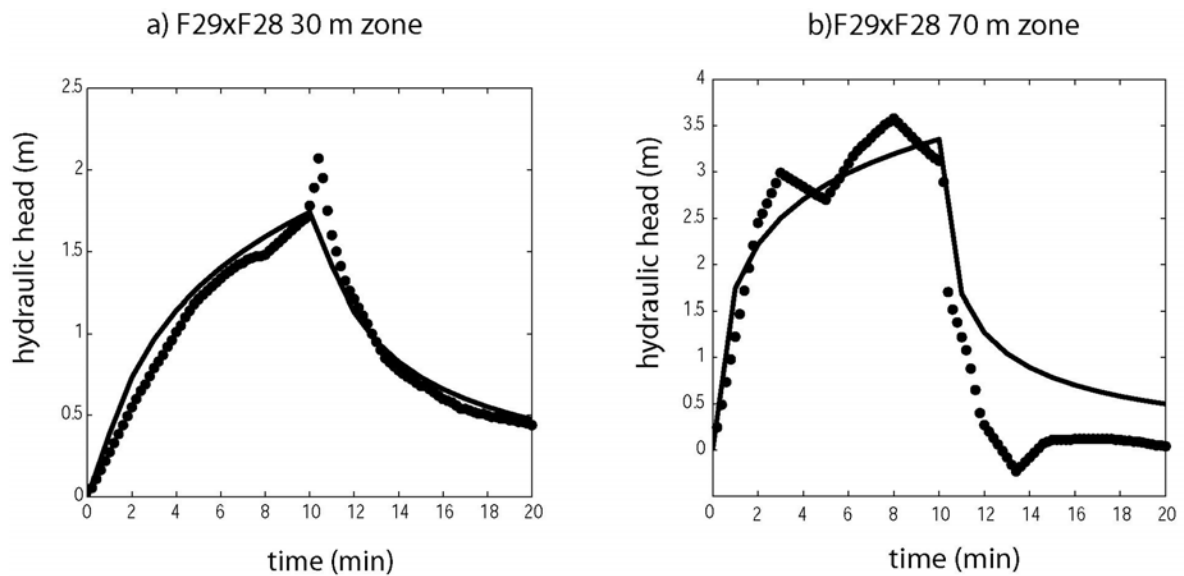

Figure 7: Example of Theis fit to hydraulic head variations deduced for some inflow zones.

III.3. Article: Small and large scale hydraulic properties estimates from flowmeter tests in a fractured crystalline aquifer (*Le Borgne et al.*, soumis)

Afin de tester jusqu'à quelles limites les expériences de débitmétrie en interférence permettent de décrire l'hétérogénéité des sites, nous avons effectué des expériences de débitmétrie en forage unique et en interférence avec des distances de séparation de forages allant de 7 mètres à 150 mètres. L'objectif est également de comparer les estimations des propriétés hydrauliques obtenues avec les tests de débitmétrie en interférence aux estimations données par les diagraphies de débit à petite échelle et par les essais de pompage à grande échelle.

Résumé:

Dans cette étude, nous comparons des estimations de propriétés hydrauliques à différentes échelles obtenues par diagraphies de débit, débitmétrie en mode d'interférence et essai de pompage à grande échelle sur l'aquifère cristallin fracturé de Plœmeur. Nous discutons ainsi de l'intérêt de la débitmétrie en interférence en comparaison à des méthodes plus classiques. De plus, nous analysons l'évolution des propriétés hydrauliques avec l'échelle sur le site de Plœmeur en relation avec l'organisation des chemins d'écoulement préférentiels déduite des expériences de débitmétrie.

Small scale and large scale hydraulic properties estimates from flowmeter experiments in a fractured crystalline aquifer

Paper submitted to Journal of Hydrology

Le Borgne T.^{1*}, Bour O.¹, Paillet F.L.² and Caudal J-P.¹

1. *Géosciences Rennes (UMR 6118 CNRS), Université de Rennes 1,
Campus de Beaulieu, 35042 Rennes cedex, France*

2. *Department of Geological Sciences, 111 Bryand Global Sciences
Center, University of Maine, Orono, ME 04469-5790*

** Now at Laboratoire de Tectonophysique (UMR 5568 CNRS),
Université de Montpellier 2, Maison des sciences de l'eau, 300 av. du
Pr. Emile Jeanbrau, F-34394 Montpellier*

Abstract

One critical concern for the prediction of flow and contaminant transfer through fractured hard rocks is the characterization of preferential flow paths that provide flow to production wells and large scale pathways for contaminant migration. Cross borehole flowmeter tests have been recently proposed as an efficient technique to characterize the connectivity of fractures between boreholes (Paillet, 1998). Furthermore, an interpretation framework has been recently proposed to derive estimates of the hydraulic properties of the connecting zones (Le Borgne et al., submitted). In this study, we synthesize hydraulic properties estimates from single borehole flowmeter experiments, which provide small scale estimates; from cross borehole flowmeter experiments and from large scale pumping tests at the Plœmeur fractured crystalline aquifer. We thus discuss the new insights that may be gained from cross-borehole flowmeter experiments in comparison with more classical techniques. We conclude by analyzing the evolution of hydraulic properties with scale at the Plœmeur site in relation to the organization of flow paths inferred from cross borehole flowmeter tests.

Keywords:

flow in fractured rock, hydraulic characterization, flowmeter, permeability

Introduction

The prediction of flow and contaminant transfer through fractured hard rocks is a major task in hydrogeology. One critical concern is the characterization of preferential flow paths that provide flow to production wells and large scale pathways for contaminant migration. While there is an established methodology for efficiently estimating fracture local transmissivity using for instance single borehole flowmeter experiments (Hess, 1986), so far the methods proposed to characterize the connectivity, geometry and hydraulic properties of larger scale flow paths are based on the use of straddle packers (Day-Lewis et al., 2000; Nakao et al., 2000), which is a labor-intensive and time-consuming process. Some observation well completions involve well construction techniques that are either difficult or impossible to change after installation. In many situations, existing open or long-screened observation boreholes are the only measurement points available. Cross borehole flowmeter tests have been recently proposed as an efficient technique to characterize the connectivity of fractures between boreholes and (Paillet, 1998, Williams and Paillet; 2002). Cross borehole flowmeter tests consist of measuring transient vertical flow in an observation borehole when the pumping rate is changed in a nearby pumping well. The rate of change in borehole flow between flow zones intersected by the borehole depends on the connectivity and hydraulic properties of the flow zones between the two boreholes. Le Borgne et al. (submitted) proposed a methodology to inverse cross borehole flowmeter data to derive the hydraulic properties of the connecting zones between boreholes.

This paper is based on a field example in the fractured crystalline aquifer of Plœmeur, where a series of single and cross-borehole flowmeter experiments as well as large scale pumping tests have been performed. The aim is to provide some insights into

what can be inferred from cross-borehole flowmeter tests in comparison with more classical techniques. Since the three techniques used have different scales of investigation, we also discuss scale effects in hydraulic properties in relation to the organization of large scale flow paths deduced from cross-borehole flowmeter tests. The paper is organized as follows. We first briefly introduce the Plœmeur site. We then present the different techniques used. In section III, we synthesize the results obtained at the Plœmeur site on the characterization of flow paths between boreholes by cross-borehole flowmeter testing. In section IV, we compare the hydraulic properties estimates obtained from the different techniques. Finally, in section V, we discuss the evolution of hydraulic properties with scale.

I The Plœmeur well field

The Plœmeur aquifer is located on the south coast of Brittany in crystalline bedrock terrain characterized by igneous and metamorphic rocks (Figure 1). This bedrock aquifer was discovered in 1991 when the city of Plœmeur wanted to complement surface water supply. Despite the crystalline nature of the rocks, it was decided to explore for an underground water supply. After a few unsuccessful test borings, one borehole drilled near the contact between micaschist and the Plœmeur granite provided a surprising estimated yield of about 80 m³/hr on the basis of air-lift flow measured by the driller. The site has subsequently been developed and exploited at a rate of about 10⁶ m³/yr to provide the main water supply for a town of 20,000 inhabitants. Compared to other bedrock aquifers in Brittany, this aquifer is outstandingly productive.

Structural analysis reported by Touchard (1999) shows that the site is located at the intersection of two regional tectonic features: a contact between Late Hercynian granite and micaschist dipping about 30° to the north, and a dextral normal fault zone striking

north 20° and dipping 70° to the east. The regional structural contact, which is characterized by enclaves of micaschist and granite dykes, may reach 100 meters in thickness. Ductile deformation within the micaschist increases towards the contact. This deformation, attributed to the granite emplacement, has been reactivated by late brittle deformation. Cores and drill cuttings show very heterogeneous lithological characteristics with an alternation of micaschist enclaves and granitic dykes such as aplites and pegmatites. The degree of fracturing is also very variable. Thus, the contact zone where most of the flow is located appears as a heterogeneous fractured zone with various lithologies. A number of geophysical experiments (seismic, electric imaging, borehole geophysics) have been performed on the site. However, because of the structural heterogeneity of the site and because the imaging of lithological properties variations are not sufficient to image flow paths, the geophysical investigations have been relatively unsuccessful in identifying deep aquifer-scale flow structures at the Plœmeur site.

Over forty boreholes have been drilled around the Plœmeur site. In the present study, we restrict our analysis to those that are the closest to the three pumping wells (Pe, F31, F29) within an area of approximately 600 meters in diameter (Figure 1). These boreholes react relatively rapidly to the pumping variations even for large separations. Most boreholes are about 100 meters deep and intersect a series of producing zones with variable inflows. In some cases the boreholes encounter a highly productive zone of a few meters in thickness, and located at a typical depth of about 70 m. Monitoring wells were completed with a 115 mm inner diameter casing that is slotted over the thickness of the productive zones. The length over which boreholes are slotted varies from 40 meters to 100 meters for the deepest borehole. The production rate of the pumps varies

between 20 m³/h to 90 m³/h. Large-scale hydraulic testing has been reported in an earlier investigation (Le Borgne et al., 2004).

II Methods and datasets

Several hydraulic characterization techniques that have very distinct scales of investigations are used in this study (figure 2). We first present the datasets and the methods of interpretation used for each method.

1) Single-borehole flowmeter tests

The first method used is the single borehole flowmeter test (Figure 2a). Borehole flow logs have been used for many years to estimate the distribution of permeability along boreholes (Hess, 1986; Molz et al., 1989; Paillet et al., 1987). At the Plœmeur site, borehole flows were first measured in ambient conditions in 6 boreholes using a heat-pulse flowmeter. For each borehole, a second borehole flow profile was obtained while pumping at about 30 liters per minute and measuring the vertical distribution of flow after drawdown had stabilized. Flowmeter output was given in the field as the pulse travel time from heat grid to a thermistor located a few cm above or below the heat source within the cylindrical measurement section. Field calibration in units of borehole flow was made by fitting a second order curve (based on inverse heat-pulse travel times) to calibration values (known flow rates) for steady pumping at a point in the borehole above all inflow points where borehole flow was known to equal borehole discharge. Separate calibration curves were constructed for upwards and downwards flow to account for the hydraulic asymmetry of the flow measurement section. Calibrated flow was designed to apply to total borehole flow representing the sum of flow through the probe measurement section, flow around the probe inside of the slotted

borehole liner, and flow in the annulus between slotted liner and borehole wall. Heat pulse flow profiles were compared with spinner flow profiles obtained while pumping at rates greater than 100 liters/minute required for effective use of that device. The flow profiles obtained with heat-pulse and spinner flowmeters were in close agreement for all the wells.

Inflow points for each observation borehole were identified by inspection of the pairs of ambient and pumping flow profiles. Possible debris blockages in the annulus around the outside of casing added variations in measured borehole flow that complicated the interpretation of inflow points. The locations of the inflow zones identified in each of the boreholes are summarized in table 1. Wells F28, F34, F11 and F35 showed three to four important inflow zones while borehole F32 displayed two main flow zones and borehole F19 showed one major inflow zone of about 10 meters in thickness (figure 3, 4). Ambient upflow varying between 1 lpm to 7 lpm was measured in boreholes F28, F11 and F34 and of 35 lpm in F32. Ambient downflow of about 2 lpm was measured in borehole F35. This ambient flow is due to the boundary conditions, and in particular to the operating well field conditions, but also to heterogeneous drawdown propagation in the different flow zones. The ambient flow gives a first indication of the presence of multiple flow paths that are isolated from each other or partially connected to each other.

Flow modeling techniques (Paillet, 2000) applied to these data sets yielded estimates for zone transmissivity ranging from less than 10^{-5} m²/s to more than 10^{-3} m²/s (table 1), and hydraulic head differences between zones ranging from a few centimeters to more than a meter. The procedure used to obtain these estimates is based on the analysis of the asymptotic behavior of a transient model of borehole flow and fracture interactions

(Paillet, 1998). Quasi-steady conditions are assumed to occur when borehole storage effects (downflow from casing) become less than 1 percent of total borehole flow.

2) Cross-borehole flowmeter tests

After the inflow points were identified and the transmissivity of each such point was estimated, the influence of various nearby pumping wells was investigated by turning off individual production pumps and checking for measurable changes in flow within each observation borehole. Such cross-borehole tests were conducted for all pairs of observation and production wells where measurable changes were identified under the influence of changes in distribution of well field production (Figure 2 b). Of the five available observation wells tested, three showed a measurable response within the experiment time under the influence of at least one of the production wells. Note that cross-borehole experiments should nevertheless be feasible for all wells since the six wells do respond to long term pumping tests. However the further the wells are located the slower are the drawdown variations and the longer is the delay for the drawdown cone of depression to reach the observation borehole. Test procedure includes measuring flow at $N-1$ depth stations between each of the N inflow/outflow zones in each observation borehole, and at an additional station above all inflow points (Paillet, 1998). At each depth, measurements were repeated according to the following regime: 1) a short period to establish a baseline ambient flow, 2) a specified period with a given production well turned off, and 3) an equal period of recovery after the production well was brought back on line. In some cases, production wells were first turned on and then off. The measurement period was either 10 or 20 minutes, depending on borehole separation, with longer test times required for the response to “propagate” over larger borehole separations. The recovery period was continued for at least twice the active test

period (the time with the production well off) to insure recovery to close to pre-test pumping conditions, and to allow establishment of baseline flow for the subsequent test.

Figure 5 shows a cross-borehole experiment where the pump in well F29 was turned on and then turned off after 20 minutes while flow was measured in borehole F35 at different depths. The measured borehole flows at locations between and above the flow zones in borehole F-35 are shown as the discrete data points in figure 5. For the 30 and 90-meter measurements, the flow response is an increase in downflow followed by a return to ambient flow when the pump is turned off in F29. On the opposite, the responses of the 20.5 and 110-meter zones are entirely within the measurement scatter and no significant variation is observed. The observed well water level decreased to a maximum of about 10 cm and increased back towards the level measured at the start of the experiment when the pump was turned off in F29.

Such data may be used to define the hydraulic connections between pumping well F29 and observation well F35. The increase in downflow measured at 30 and 90 meters is mostly due to an increase in flow to the 95 meter zone (-76 m a.s.l.) when the pump is started in F29. Thus the consequence of turning on the pump in F29 is a decrease in hydraulic head in the 95 meter zone in F35, while the head is not changing in the other zones. It can be deduced that the connection between F35 and F29 is principally made through the 95 meter zone in F35 during the time of the experiment. Note that longer time experiments may indicate other slower connections between the two wells.

To estimate the hydraulic properties of the flow zones connecting the pumped and observation well, we use the method developed by Le Borgne et al. (submitted). In this method, the transient flow measurements at different depths in the borehole (figure 5) are translated into transient head variations within the individual flow zones, using a borehole flow model. The obtained transient head variations are analogous to the data

that would be obtained by performing cross-borehole packer tests. Hence these transient head evolutions are then interpreted to yield transmissivity and storage coefficient estimates for the flow path connecting the two wells. To deduce these hydraulic parameters, the boundary conditions should be known, in particular the flow pumped in each fracture zone. It can be argued that if several flow zones intersect the pumped borehole, the flow is divided between all flow zones according to the relative transmissivity of each flow zone (Molz et al., 1989). In the absence of single borehole flowmeter profiles in the pumped boreholes, that could have been used to define the flow rate in each of the flow zones, we interpreted most cross borehole flowmeter experiments using the total pumping rate extracted from pumping wells. For borehole Pe and F31 this assumption is reasonable since they are characterized by a major flow zone as shown from air-lift measurements during drilling. For the cross-hole tests between F29 and F28, we have shown that the four zones identified in F28 are connected individually to F29 (Le Borgne et al., submitted). Since F28 and F29 are only seven meters apart, we assumed borehole F29 to have the same flow distribution as F28. The results of all of the cross-borehole experiments are discussed in section III in term of connectivity of the flow zones while the transmissivity and storage coefficient estimates (table 2) are discussed in section IV.

3) Large scale pumping tests

The large-scale pumping tests data sets are described in detail by Le Borgne et al. (2004). Water level was monitored in observation wells at distances ranging from 2 to 400 meters from a pumping well for tests duration that varies from 5 days to three months. The analysis proposed by Le Borgne et al. (2004) provides a modeling framework that is consistent with an equivalent mean flow model for the whole site. As shown in this analysis, the Theis model is not satisfying in matching the whole time

evolution of drawdown for this data set. In particular, it does not match satisfactorily the long term drawdown variations and underestimates the drawdown for late times. Thus, the Theis model does not appear as a reliable model for predicting drawdown variations at very long times. Nevertheless, at first sight, it provides rough estimates of transmissivity and storage coefficient. Moreover, for comparison purposes, one needs to use a model that is based on the same assumptions than the other techniques and that provides comparable parameters. For that reason we used the Theis model to estimate values of transmissivity and storage coefficient for the different observation wells. The transmissivity estimates based on the Theis model interpretation range from about 10^{-3} m²/s to 10^{-2} m²/s while the storage coefficient estimates range from about 10^{-4} to 10^{-2} (table 3).

III Imagery of sub-surface flow zones

The identification of preferential flow paths that provide flow to production wells and large-scale pathways for contaminant migration is a major task in hydrogeology. However, in heterogeneous medium such as the Plœmeur site, classical geophysical investigations may be relatively unsuccessful in identifying deep aquifer-scale flow structures. In such context, the methods used in general to characterize the connectivity, geometry and hydraulic properties of larger scale flow paths are based on the use of straddle packers (Day-Lewis et al., 2000; Nakao et al., 2000). However, like at Plœmeur, long-screened observation boreholes are often the only measurement points available so that packers cannot be used. Thus, in this case, cross borehole flowmeter tests present the only alternative technique to characterize aquifer-scale flow structures.

Cross-borehole flowmeter experiments have been performed on the Plœmeur site for borehole separations ranging from 7 to 150 meters. In order to define a conceptual

model of fracture network geometry and connectivity, the results of these experiments were synthesized with other available data: single borehole flowmeter tests, driller air-lift borehole logs as well as large-scale pumping tests. Air-lift borehole logs show approximately the location of the main productive zones while large scale pumping tests contain some information about larger scale connections. For the F11, F28 and F35 wells, the connectivity between boreholes was estimated by cross-borehole flowmeter tests. For instance for well F28, cross-borehole flowmeter experiments were performed with production wells F29, F31 and Pe. Whatever the pumping well used, the -47 m flow zone in F28 showed a fast connection. The flow zone located at -41 m showed also a fast connection when the pumping well Pe or F29 were used. Finally, when F29 is used as a pumping well, slow connections can also be identified for flow zones at -7 and -57 meters, due to the proximity of wells F28 and F29. Similarly, for observation well F11, cross-borehole flowmeter tests were performed using Pe and F31 as pumping wells. For the F35 well, cross-borehole flowmeter tests were performed with pumping well F29 only. All the connected fracture zones that are identified are compiled in table 2. Note that we tried to use observation wells F19 and F34 in cross-borehole experiments but the distances with the pumped well were too large (about 180 meters) to observe flow changes in less than an hour. Moreover, cross hole testing with well F32 as an observation well was not successful since the flow variation induced by changing the flow rate in nearby pumping well were too small compared to the ambient flow in F32, which is about 35 lpm. Note that it is also possible to infer connected flow zones for wells Pe, F19, F36 and F31 since these boreholes show a very important flow zone and are connected to other boreholes as deduced from large scale pumping tests.

The results on the connectivity of the major flow zones are illustrated in figure 6. Despite the vertical heterogeneity, the fastest connectivity zones are generally found

between -35 meters above sea level and -70 meters above sea level whatever the distance to the main pumping well. Sections A-A', B-B' et C-C' suggest indeed the presence of a sub-horizontal high connectivity zone located between -35 and -45 meters, which intersects wells Pe, F11, F36, F28, F19 and possibly F17. Interestingly, for wells F28 and F11, it is the same flow zone in the borehole that reacts the quickest whatever the pumping wells used. The depth of the connected zones in boreholes F31, F32 and F35 indicate that this high connectivity zone may locally be slightly shifted or that the flow system may be locally more complex, with several fast connectivity zones. Most boreholes are characterized by fast and slow connections between each other. Thus a single flow zone cannot describe flow in the subsurface that certainly involves a complex fracture network. Note that a chemical variability also exists on the site (Tarits et al., 2005), as shown by secondary permeable fractures that sometimes have clear chemical, temperature or head contrasts with the main flow zone. On a methodological point of view, it may be also noted that the fastest connectivity flow zones, the most permeable ones at large scale, do not correspond systematically to the locally highest transmissivity zones observed in the borehole. For instance, the fastest connection in borehole F28 to the pumped wells is ensured by the - 47 meters zone that is about 10 times less transmissive than the - 7 meters fracture zone.

These results are relatively consistent with the geological model presented in figure 1b. At first order, the most permeable zone that is sub-horizontal, may correspond to the contact between granite and micaschist that is slightly dipping towards the North. Secondary structures, that may have shifted locally this contact, may be linked to late faulting like the N 20° structure (figure 1). This organization of the flow field in the subsurface, and particularly the good connectivity of the permeable zones all over the

site, may have a strong impact on the variation with scale of the permeability as discussed in the next sections.

IV Comparison of hydraulic properties estimates from the different techniques

In this section, we synthesize hydraulic properties estimates given by single borehole flowmeter tests, cross borehole flowmeter tests and large scale pumping tests (figure 7a). We used a representation similar to that of Martinez-Landa and Carrera (2005), where the scale of investigation is not directly quantified but the data are qualitatively ranked according to the estimated scale of investigation of the different techniques. Indeed, estimating the scale of measurements is a difficult task as it will be extensively discussed in the next section.

Large scale pumping tests estimates present a small variability within an order of magnitude (figure 7a). Note that the transmissivity estimates in this site are very high for crystalline rocks, ranging from 10^{-3} to 10^{-2} m²/s. Cross-borehole flowmeter tests transmissivity estimates appear slightly more variable, covering two orders of magnitude. However, if one dismisses the three smallest values, all these estimates from cross-borehole flowmeter and pumping tests are very consistent. On the other hand, single borehole flowmeter tests transmissivity estimates are more variable – they cover three orders of magnitude – and the values are in general much lower – by at least an order of magnitude – than for cross-borehole estimates.

A first explanation for such a difference between cross-borehole and single flowmeter tests comes from a kind of filtering induced by cross-borehole tests. During the time of experiment, typically 10 to 20 minutes, only the most transmissive flow paths may respond for a relatively large borehole separation. On the opposite, during

single borehole flowmeter tests, it is possible to measure the response of the major flow paths intersecting the borehole, but also of relatively minor fractures. Note however, that the resolution of the tool is much less than straddle packer testing, which allows transmissivity estimates for a very broad range of values. A second explanation comes from the influence of local properties around pumping boreholes. In particular, the typical response of a pumping test or of a cross-borehole flowmeter test may depend on the local properties around the pumping borehole (de Dreuzy et al., 2004). Thus, if the pump is placed in boreholes that intersect a major flow path, one expect larger transmissivity estimates than if the pump is placed inside boreholes intersecting secondary structures, even if the observation boreholes are the same. For the present well field, the pumps were placed in the most transmissive boreholes. This may partly explain why cross-borehole flowmeter test and pumping test transmissivity estimates are systematically relatively large. Thus, the fact that pumps were installed permanently in three of the most permeable wells may induce a kind of sampling bias.

In figure 7b, storage coefficient estimates from cross-borehole flowmeter tests and large scale pumping tests are compared. Single borehole flowmeter tests do not allow deriving such a parameter. In both cases, the storage coefficient estimates vary over two orders of magnitude. The estimates from cross-borehole flowmeter tests are globally consistent with those from large scale pumping tests although the estimates from cross-borehole flowmeter tests appear to be slightly lower. This may be due to the fact that cross-borehole flowmeter experiments are short term experiments, where the fastest connection zones are preferentially characterized. Hence, low storativity features, which respond faster to hydraulic perturbations, tend to be more easily captured for relatively large borehole separations. Note that, in contrast to the consistency of the transmissivity measurements, large-scale storage coefficient estimates are much more variable. This is

in agreement with the numerical results obtained by Meier et al. (1998) who showed that transmissivity estimates are much less variable than storage coefficient in heterogeneous formations.

In summary, at first sight, hydraulic parameters estimates from cross-borehole experiments appear very consistent with those obtained from large scale pumping tests for the Plœmeur well field. The relative difference with single borehole flowmeter test estimates come partly from a sampling bias or from a filtering induced by cross-borehole and pumping tests that would sample preferably the most permeable flow paths. However, the differences in the values and variability of hydraulic properties estimates are certainly related to scale effects arising from the organization of flow paths in the Plœmeur aquifer, as discussed in the next section.

V Discussion: flow structure and evolution of hydraulic properties with scale

Scale effects, which represent the fact that hydraulic properties depend on the volume of rock through which flow is occurring, are expected to occur in crystalline rocks (Brace, 1984; Clauser, 1992; Kiraly, 1975). Accounting for such effects is essential for reliable hydrogeological modelling of natural systems. However, field evidence concerning the relationship between flow structure and scale effects is still debated in the literature. Moreover, one conceptual difficulty of such a study is to associate a measurement scale to each of the different techniques used when compiling data. In this section, we first tackle out the problem of defining a scale of measurements before discussing the results obtained at Plœmeur with other field examples.

Relevance of a scale of measurement

The volume of investigation of borehole hydraulic tests, such as single, cross-borehole flowmeter tests and pumping tests is still a subject of debate (Zlotnik and Zurbuchen, 2003). The scale of investigation could be in theory approximated by the typical radius of influence of pumping after a time t (Maréchal et al., 2004; Rovey and Cherkauer, 1995) :

$$r_0 = \sqrt{2.25 \frac{Tt}{S}} \quad (1)$$

where r_0 is the radius of influence, T and S are respectively the transmissivity and storage coefficient and t is the time since the start of experiment. A difficulty with this definition is that the radius of influence is dependent on the hydraulic properties. An example is given in figure 8 where we reported data of figure 7a as a function of r_0 . In this representation, we used in equation 1 the approximate time of experiment and the storage coefficient estimates from large scale pumping tests. In this case, such representation leads to a scaling of transmissivity with an exponent of two as a function of scale for scales less than 100 meters. However, this scaling is mostly due to the definition of the scale of investigation (equation 1). Note that one may find scaling exponents different from 2 since the duration of the experiments may also change (Maréchal et al., 2004; Rovey and Cherkauer, 1995).

Another possible way is to associate the scale of measurement to a characteristic scale of experiment. Hence, it is possible to define the scale of measurement for a pumping test as the separation distance between pumping and observation boreholes. However, depending on the duration of the experiment, the hydraulic response may depend on a much greater volume of rock than the one between the two boreholes. Moreover, when the borehole solicited is the same than the observation borehole like for single borehole flowmeter tests, one cannot define a scale of measurement from this

method. For these reasons, we used a representation similar to that of Martinez-Landa and Carrera (2005), where the scale of investigation is not directly quantified but the data are qualitatively ranked according to the scale of investigation of the different techniques (figure 7).

A consequence of the great difficulty to define a reliable scale of measurement in heterogeneous formations is that it is extremely difficult to provide a quantification of scaling effects by measuring transmissivity or storage coefficient at different scales in the field. One fundamental reason is that these parameters are based on a model that assumes medium homogeneity. Moreover, in such approach, under sampling and parameter averaging are crucial issues (Renshaw, 1998). A more consistent approach is to test physical models assuming scaling effects (Acuna and Yortsos, 1995; Barker, 1988). Pumping tests are particularly well designed to track these scaling effects since the hydraulic perturbation induced by pumping grows with time and sample increasingly large volumes. Le Borgne et al. (2004) proposed such an analysis at the Plœmeur site, based on pumping tests of different durations and with observation wells at different distances from the pumping well. Note that in this study we do not attempt to quantify scaling exponents but we wish to analyze qualitatively the variability of hydraulic properties estimates at different scales and discuss it in relation to the spatial organization of permeable flow paths inferred from cross-borehole flowmeter tests.

Comparison with previous field studies

Several field studies have been proposed where hydraulic properties estimates using techniques with different scales of investigation are compiled. Studies that compile laboratory and field estimates usually lead to an apparent increase of permeability with scale (Clauser, 1992; Zlotnik et al., 2000). However, this effect may be due to the under sampling of conductive fractures in laboratory measurements (Renshaw, 1998), since it

is technically relatively difficult to collect samples within fractured zones. The synthesis of data from different fractured crystalline rock sites by Clauser (1992), suggests that permeability increases up to a homogenization scale of about 100 meters. However, these data come from different sites, for which the fracture networks may not have comparable geometrical and hydraulic properties. These problems, that may obscure the evidence of scale effects, should be avoided in the present study since *in situ* hydraulic properties coming from a single site are compiled. Recently, few studies have presented similar datasets (Hsieh, 1998; Maréchal et al., 2004; Martinez-Landa and Carrera, 2005; Rovey and Cherkauer, 1995; Shapiro, 2003).

At the Mirror Lake site (New Hampshire, USA), which is located in similar geological setting than the Plœmeur site, it was shown that transmissivity at large scale is controlled by a network of less permeable fractures with a transmissivity three orders of magnitude less than that of the most permeable ones (Hsieh, 1998, Shapiro, 2003). Martinez-Landa and Carrera (2005) presented hydraulic properties estimates at different scales in low permeability granite. They showed a slight apparent increase in hydraulic conductivity with scale. This effect may be related mostly to the ratio of matrix and fracture permeability sampling at different scales. At small scale, a large number of tested intervals encompass mainly matrix rock, which has a very low conductivity. In the present study, only fracture zone hydraulic properties are reported.

Rovey and Cherkauer (1995) also reported an increase in hydraulic conductivity with scale up to a homogenization scale ranging from 20 to 100 meters in a carbonate geological setting. They explain this effect by the fact that small-scale tests sample preferentially primary porosity features that have a lower hydraulic conductivity than secondary porosity features. Rovey and Cherkauer (1995) also reported an increase with scale of the variability of hydraulic conductivity measurements. Finally, Maréchal et al.

(2004) give an example of a weathered fractured layer in a hard-rock aquifer, where the hydraulic conductivity does not vary with scale due to the relative homogeneity of the flow zones.

For the Plœmeur site, the geological context is different than for the sites in sedimentary rocks (Rovey and Cherkauer, 1995) and in superficial weathered rocks (Maréchal et al., 2004). At Plœmeur, we recall that flow is very heterogeneous and localized in few major flow paths in crystalline rocks. Moreover, the transmissivity is globally very high and, in contrast with the Grimsel or the Mirror Lake sites, the large-scale estimates correspond to the highest values of the transmissivity distribution. We believe that at Plœmeur, this behaviour is due to the connectivity of the main flow zones (section III). We recall that at first order, the large-scale aquifer flow paths at Plœmeur may be considered as sub-horizontal, with secondary structures that shift locally the contact. Thus the Plœmeur site may be considered as an example of a system where large-scale connectivity is ensured by few long fracture zones. Such observation is not general in all fractured hard rock sites as shown by the Mirror Lake site example. The role of the connectivity between high permeable zones has been highlighted by Sanchez-Vila et al. (1996) who showed that long range correlations of high permeability zones induces a high permeability at large scale. Note that a possible cause for such long-range correlation may be the existence of a broad length distribution of fractures that implies an increase of the connectivity with scale (Bour and Davy, 1997). Note however that the scaling of permeability still depends on the aperture distribution (de Dreuzy et al., 2001a; de Dreuzy et al., 2001b; de Dreuzy et al., 2002).

Conclusion

Through a field example on the fractured crystalline aquifer of Plœmeur we demonstrate that cross-borehole flowmeter experiments are an adapted and efficient method to image the geometry of preferential permeable flow paths in heterogeneous aquifers where packer testing is not possible. On the Plœmeur site, it was possible to characterize inter-borehole connectivity with borehole separation distances ranging from 7 to 150 meters.

Furthermore, we discuss in this article the use of cross-borehole experiments to quantify flow paths hydraulic properties between boreholes. Comparison with the hydraulic properties estimates obtained from classical tests – single borehole flowmeter and large scale pumping tests experiments – shows a good coherence with estimates from this new technique. In particular, the cross borehole transmissivity estimates are close to the large scale pumping tests estimates. On the other hand, small scale transmissivity estimates display a larger variability. Storage coefficient estimates are in the same range for cross-borehole and large scale pumping tests.

In summary, flowmeter experiments show that (i) the site is characterized by a large range of hydraulic properties, (ii) high transmissivity zones are connected over long spatial ranges. This organization of the flow field in the subsurface, and particularly the good connectivity of the permeable zones all over the site, is shown to have a strong impact on the variation with scale of the permeability. At the Plœmeur site, small scale variability of transmissivity estimates vanishes at large scale and the transmissivity converges towards the high values of the transmissivity distribution. In that respect, the Plœmeur site differs from case studies previously reported and provides an interesting example of scaling behaviour in relation to flow structures organization.

References

- Acuna, J.A. and Yortsos, Y.C., 1995. Application of fractal geometry to the study of networks of fractures and their pressure transient. *Water Resources Research*, 31(3): 527-540.
- Barker, J.A., 1988. A Generalized Radial Flow Model For Hydraulic Test in Fractured Rock. *Water Resources Research*, 24(10): 1796-1804.
- Bour, O. and Davy, P., 1997. Connectivity of random fault networks following a power law fault length distribution. *Water Resources Research*, 33(7): 1567-1583.
- Brace, W.F., 1984. Permeability of crystalline rocks: New measurements. *Journal of Geophysical Research*, 89: 4327-4330.
- Clauser, C., 1992. Permeability of crystalline rock. *Eos Trans. AGU*, 73(21): 237-238.
- Day-Lewis, F.D., Hsieh, P.A. and Gorelick, S.M., 2000. Identifying fracture-zone geometry using simulated annealing and hydraulic connection data. *Water Resources Research*, 36(7): 1707-1721.
- de Dreuzy, J.R., Davy, P. and Bour, O., 2001a. Hydraulic properties of two-dimensional random fracture networks following a power law length distribution: 1-Effective connectivity. *Water Resources Research*, 37(8).
- de Dreuzy, J.R., Davy, P. and Bour, O., 2001b. Hydraulic properties of two-dimensional random fracture networks following a power law length distribution: 2-Permeability of networks based on log-normal distribution of apertures. *Water Resources Research*, 37(8): 2079-2095.
- de Dreuzy, J.R., Davy, P. and Bour, O., 2002. Permeability of 2D fracture networks with power-law distributions of length and aperture. *Water Resources Research*, 38(12).

- de Dreuzy, J.-R., Davy, P., Erhel, J. and de Brémond d'Ars, J., 2004. Anomalous diffusion exponents in continuous 2D multifractal media. *Physical Review E*, 70.
- Hess, A.E., 1986. Identifying hydraulically conductive fractures with a slow velocity borehole flowmeter. *Canadian Geotechnical Journal*, 23: 69-78.
- Hsieh, P.A., 1998. Scale effects in fluid flow through fractured geological media, Scale dependence and scale invariance in hydrology. Cambridge University Press, pp. 335-353.
- Kiraly, L., 1975. Rapport sur l'état actuel des connaissances dans le domaine des caractères physiques des roches karstiques. In: A. Burger and L. Dubertret (Editors), Hydrogeology of karstic terrains. International association of hydrogeologists, Paris.
- Le Borgne , T., Bour, O., de Dreuzy, J.-R., Davy, P. and Touchard, F., 2004. Equivalent mean flow models for fractured aquifers: Insights from a pumping tests scaling interpretation. *Water Resources Research*: 10.1029/2003WR002436.
- Le Borgne , T., Paillet, F.L., Bour, O. and Caudal, J.-P., submitted. A methodology for using cross-borehole flowmeter tests to derive transient hydraulic head distribution in heterogeneous aquifers. *Ground Water*.
- Maréchal, J.C., Dewandel, B. and Subrahmanyam, K., 2004. Use of hydraulic tests at different scales to characterize fracture network properties in the weathered-fractured layer of a hard rock aquifer. *Water Resources Research*, 40.
- Martinez-Landa, L. and Carrera, J., 2005. An analysis of hydraulic conductivity scale effects in granite (Full-scale Engineered Barrier Experiment (FEBEX), Grimsel, Switzerland). *Water Resources Research*, 41.

- Meier, P.M., Carrera, J. and Sánchez-Villa, X., 1998. An evaluation of Jacob's method for the interpretation of pumping tests in heterogeneous formations. *Water Resources Research*, 34(5): 1011-1025.
- Molz, F.J., Morin, R.H., Hess, A.E., Melville, J.G. and Güven, O., 1989. The impeller meter for measuring aquifer permeability variations: evaluation and comparison with other tests. *Water Resources Research*, 25(7): 1677-1683.
- Nakao, S., Najita, J. and Karasaki, K., 2000. Hydraulic well testing inversion for modelling fluid flow in fractured rocks using simulated annealing: a case study at Raymond field site, California. *Journal of Applied Geophysics*, 45(3): 203-223.
- Paillet, F.L., 1998. Flow modelling and permeability estimations using borehole flow logs in heterogeneous fractured formations. *Water Resources Research*, 34(5): 997-1010.
- Paillet, F.L., 2000. A field technique for estimating aquifer parameters using flow log data. *Ground Water*, 38(4): 510-521.
- Paillet, F.L., Hess, A.E., Cheng, C.H. and Hardin, E., 1987. Characterization of fracture permeability with high-resolution vertical flow measurements during borehole pumping. *Ground Water*, 25(1): 28-40.
- Renshaw, C.E., 1998. Sample bias and the scaling of hydraulic conductivity in fractured rock. *Geophysical Research Letters*, 25(1).
- Rovey, C.W. and Cherkauer, D.S., 1995. Scale dependency of hydraulic conductivity measurements. *Ground Water*, 33(5): 769-780.
- Sanchez-Vila, X., Carrera, J. and Girardi, J.P., 1996. Scale effects in transmissivity. *Journal of Hydrology*, 183(1-2): 1-22.

Shapiro, A.M., 2003. The effect of scale on the magnitude of formation properties governing fluid movement and chemical transport in fractured rock. Groundwater in fractured rocks- proceedings of the international conference- September 15 - 19, 2003, Prague, Czech Republic.

Tarits, C. et al., 2005. Oxido-reduction sequence related to flux variations of groundwater from a fractured basement aquifer (Plomeur area, France). Applied Geochemistry, in press.

Touchard, F., 1999. Caractérisation hydrogéologique d'un aquifère en socle fracturé. Site de Plœmeur (Morbihan). Mémoire de Géosciences Rennes Thesis.

Williams, J. H., and F. L. Paillet (2002). Using flowmeter pulse tests to define hydraulic connections in the subsurface: a fractured shale example. *J. of Hydrol.*, 265, 100-117, 8/30

Zlotnik, V.A. and Zurbuchen, B.R., 2003. Field study of hydraulic conductivity in a heterogeneous aquifer: Comparison of single-borehole measurements using different instruments. *Water Resources Research*, 39(4).

Zlotnik, V.A., Zurbuchen, B.R., Ptak, T. and Teutsch, G., 2000. Support volume and scale effect in hydraulic conductivity: Experimental aspects. *Geological Society of America Special Paper*, 348: 215-231.

Figures :

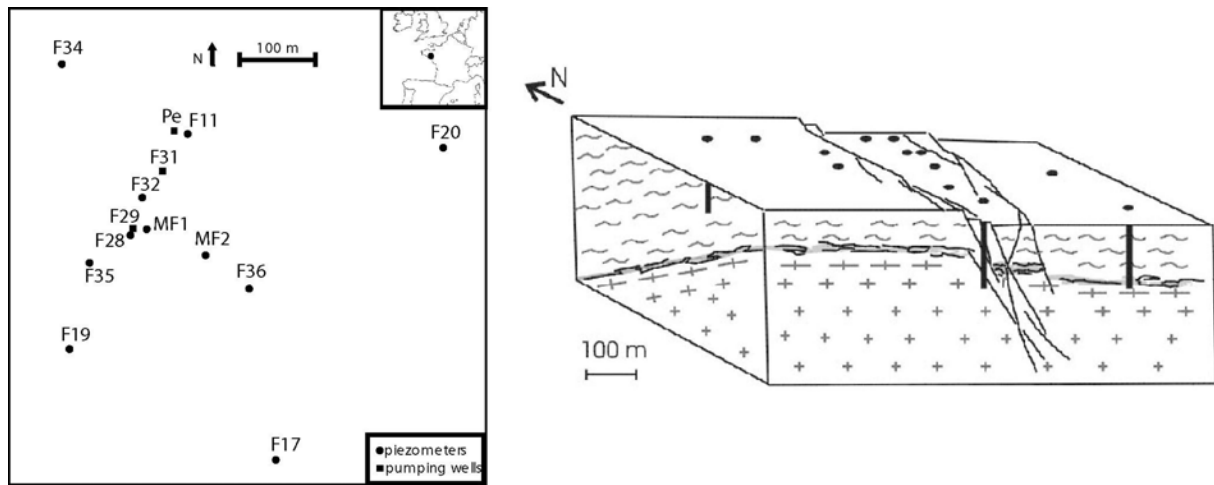

Figure 1: A. Map of the Plœmeur well field showing the location of boreholes used for this study. B. Schematic 3D diagram of the Plœmeur aquifer geology showing the regional contact dipping toward the North and the N° 20 dextral normal fault along which many boreholes are drilled.

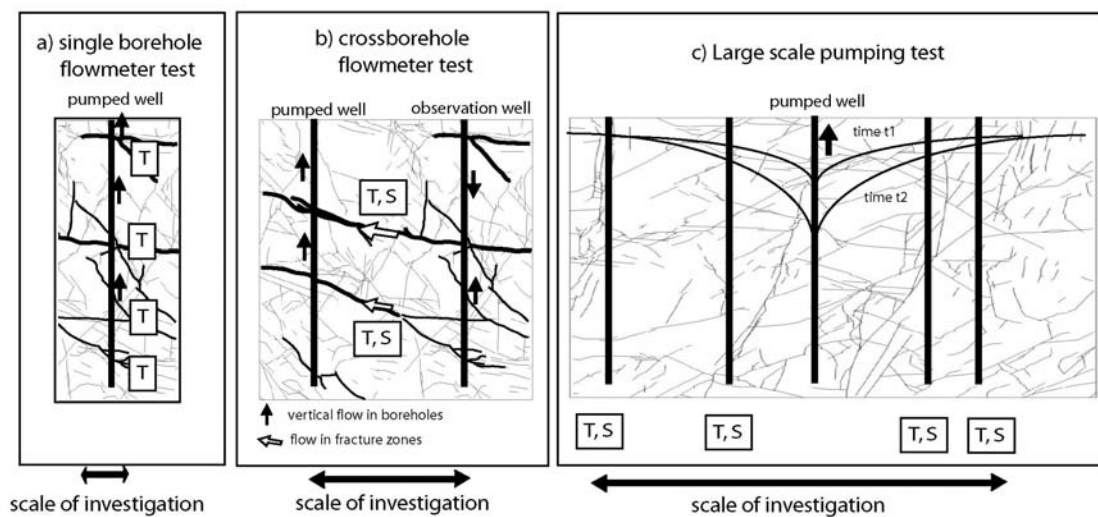

Figure 2: Illustration of the hydraulic testing techniques used to estimate transmissivity and storage coefficient (T and S): a) single borehole flowmeter test b) Cross-borehole flowmeter test, drawdown propagation is illustrated in gray c) large scale pumping test with observation wells; the piezometric level at two different times after the start of experiment is shown.

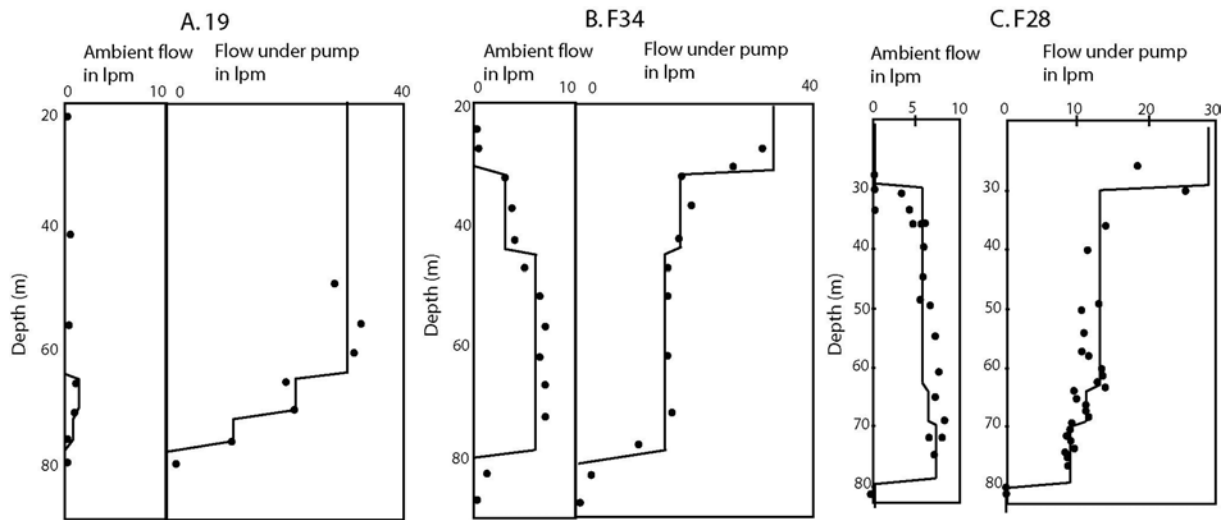

Figure 3: single flowmeter tests for wells A. F19, B. F34 and C. F28. The solid lines represent the borehole flow model fit that are used to estimate flow zone transmissivities

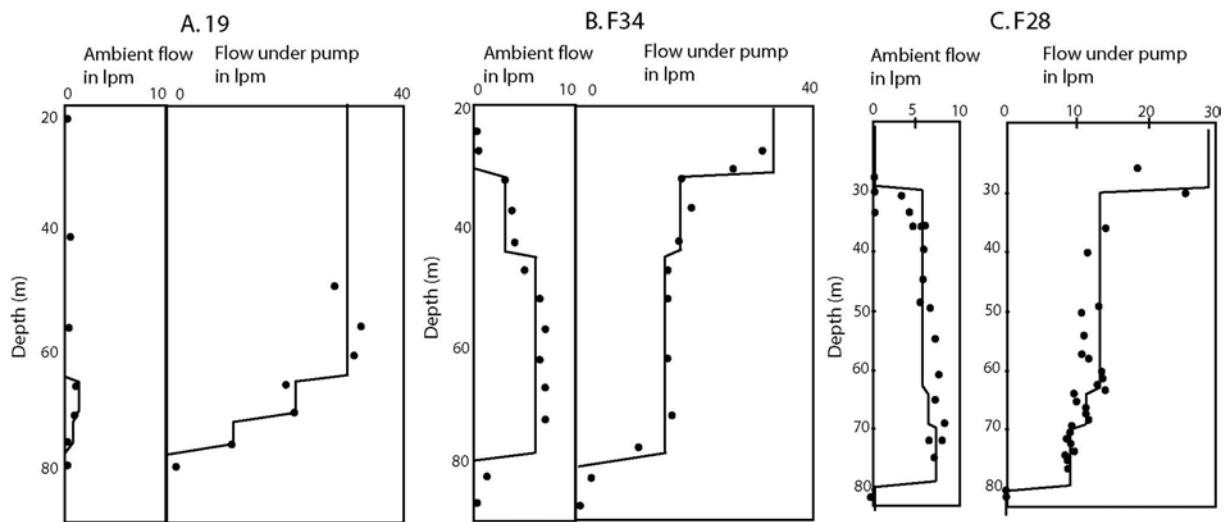

Figure 4: single flowmeter tests for wells A. F11, B. F35 and C. F32. The solid lines represent the borehole flow model fit that are used to estimate flow zone transmissivities.

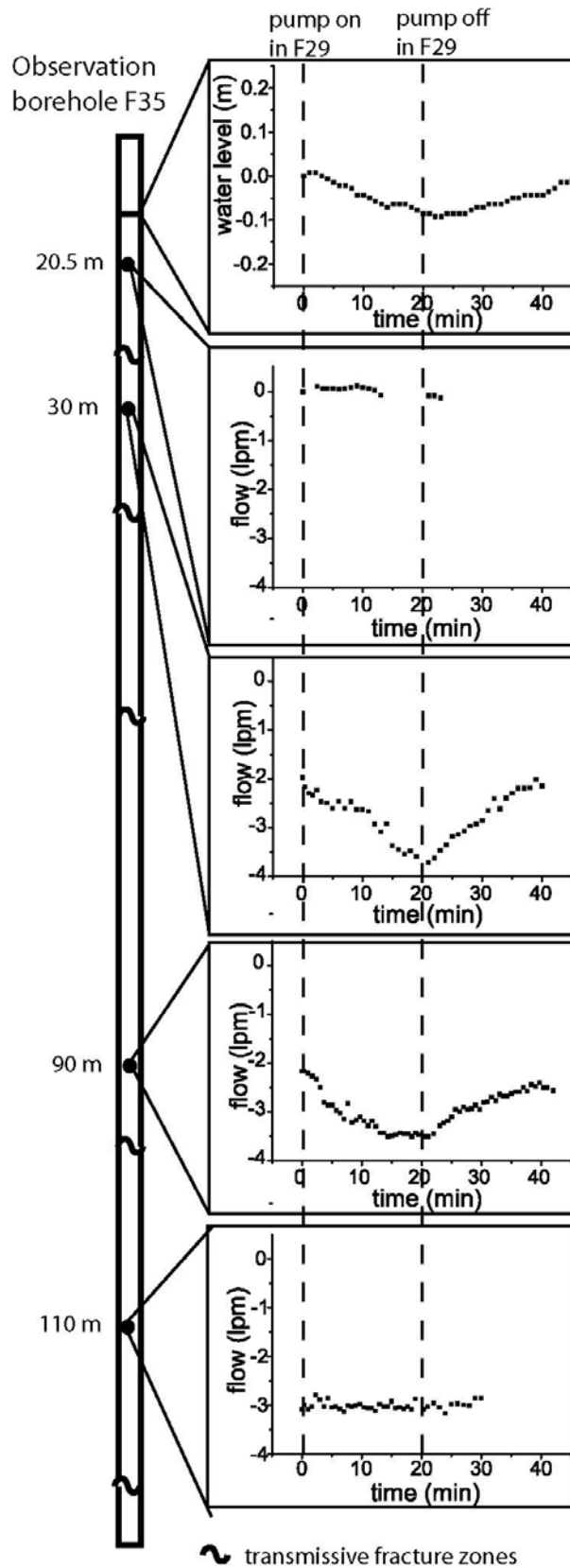

Figure 5: Transient flow data at stations 20.5 m, 30 m, 90 m and 110 m and water level variation in borehole F35 when varying the pumping rate in borehole F29.

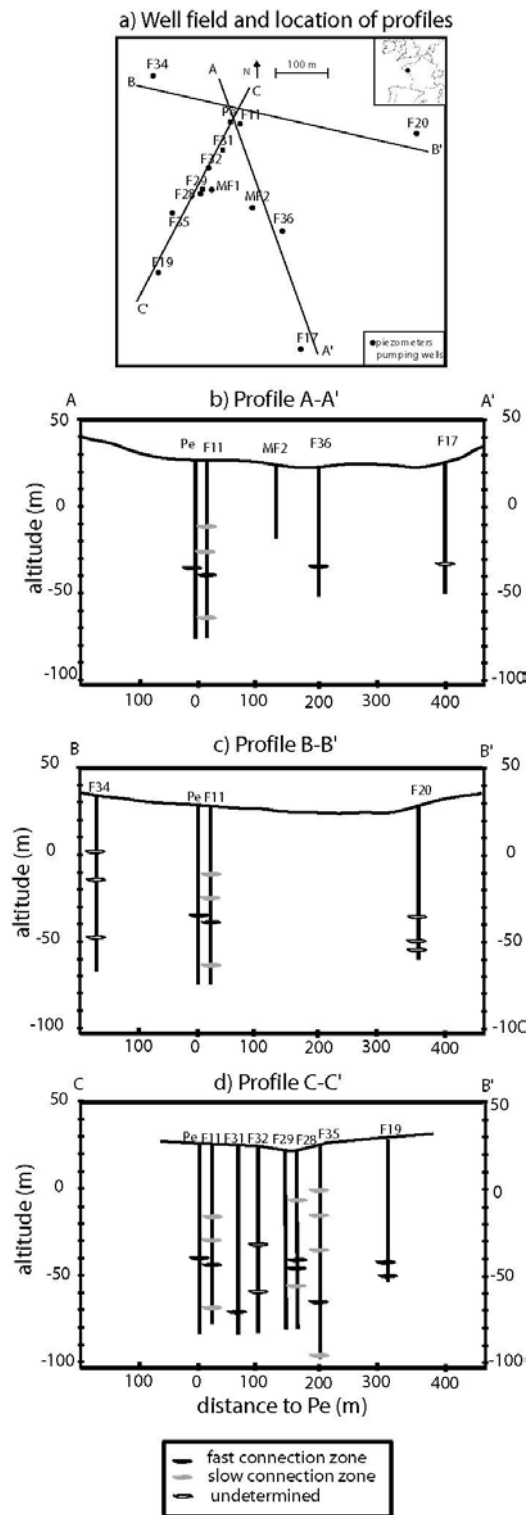

Figure 6: schematic diagram showing the different aquifer flow zones identified. a) map of the well field with approximate location of profiles, b) profile A-A', c) profile B-B', d) profile C-C'.

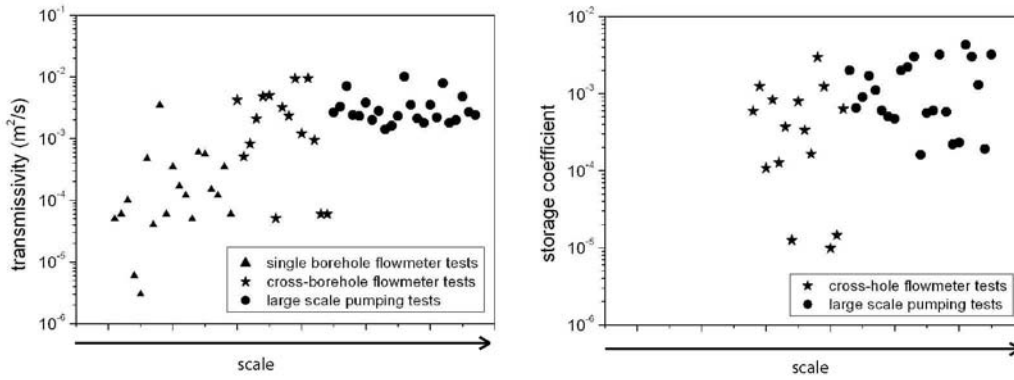

Figure 7: Transmissivity (a) and storage coefficient (b) estimates for the different techniques used.

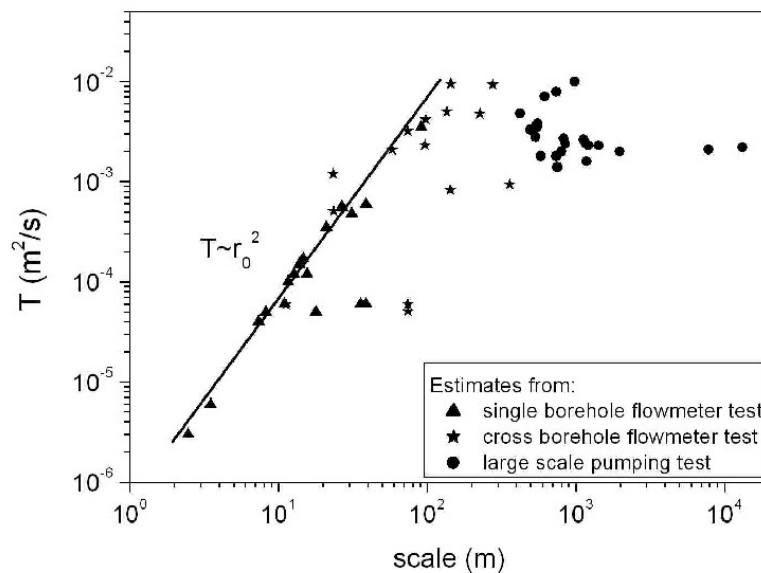

Figure 8: Representation of the transmissivity estimates from the different techniques as a function of the scale of investigation as calculated from equation 1. In this representation, we used in equation 1 the approximate time of experiment and the storage coefficient estimates from large scale pumping tests. In this case, such representation leads to a scaling of transmissivity with an exponent of two as a function of scale for scales less than 100 meters

Tables:

Table 1: Location of flow zones (meters above sea level) and single borehole transmissivity estimates

F28		F34		F35		F11		F19		F32	
z	T	z	T	z	T	z	T	z	T	z	T
m a.s.l.	m ² /s	m a.s.l.	m ² /s	m a.s.l.	m ² /s	m a.s.l.	m ² /s	m a.s.l.	m ² /s	m a.s.l.	m ² /s
-7	$6 \cdot 10^{-4}$	1	$5.6 \cdot 10^{-4}$	-1	$4.8 \cdot 10^{-4}$	-11	$1.2 \cdot 10^{-4}$	-46	$3.5 \cdot 10^{-3}$	>-32	$3.5 \cdot 10^{-4}$
-41	$6 \cdot 10^{-5}$	-14	$1.5 \cdot 10^{-4}$	-16	$6 \cdot 10^{-5}$	-26	10^{-4}			-62	$3.5 \cdot 10^{-4}$
-47	$6 \cdot 10^{-5}$	-49	$1.7 \cdot 10^{-4}$	-36	$6 \cdot 10^{-6}$	-39	$5 \cdot 10^{-5}$				
-57	$5 \cdot 10^{-5}$			-76	$1.2 \cdot 10^{-4}$	-66	$4 \cdot 10^{-5}$				
				-96	$3 \cdot 10^{-6}$						

Table 2: Cross-borehole hydraulic properties estimates of the flow paths connecting the pumped and observation boreholes.

pumping well x observation well	T (m ² /s)	S	Borehole separation (m)	Duration (min)	Depth (m asl)	Pumping rate used in the interpretation (lpm)
F29xF35	$2,3 \cdot 10^{-3}$	$3,4 \cdot 10^{-4}$	75	10	-76	350
F29xF28	$5,110^{-4}$	$1,3 \cdot 10^{-3}$	7	10	-7	300
	$6 \cdot 10^{-5}$	$1,5 \cdot 10^{-5}$	7	10	-41	30
	$5,1 \cdot 10^{-5}$	$1,3 \cdot 10^{-5}$	7	10	-47	30
	610^{-5}	$6,3 \cdot 10^{-4}$	7	10	-57	25
PexF28	$4,2 \cdot 10^{-3}$	$6 \cdot 10^{-4}$	151	10	-7	1300

	$9,3 \cdot 10^{-3}$	$1,7 \cdot 10^{-4}$	151	10	-41	1300
	$4,8 \cdot 10^{-3}$	$1,3 \cdot 10^{-4}$	151	10	-47	1300
F31xF28	$9,5 \cdot 10^{-3}$	$1,2 \cdot 10^{-3}$	96	20	-7	500
	$8,3 \cdot 10^{-4}$	$1,1 \cdot 10^{-4}$	96	20	-47	500
F31xF11	$5 \cdot 10^{-3}$	$3,7 \cdot 10^{-4}$	62	10	-11	570
	$9,4 \cdot 10^{-4}$	10^{-5}	62	10	-39	570
	$2,110^{-3}$	$8,3 \cdot 10^{-5}$	62	10	-66	570
PexF11	$1,2 \cdot 10^{-3}$	$3 \cdot 10^{-3}$	18	10	-11 and -26	1450
	$3,2 \cdot 10^{-3}$	$8 \cdot 10^{-4}$	18	10	-39 and -66	1450

Table 3: Large scale pumping tests hydraulic properties estimates

Experiment pumping well x observation well	T (m^2/s)	S	Borehole separation (m)	Duration (h)	Pumping rate (lpm)
F31xF11	$2 \cdot 10^{-3}$	$3 \cdot 10^{-3}$	60.8	120	570
F31xF19	$2.4 \cdot 10^{-3}$	$1.7 \cdot 10^{-3}$	273.7	120	570
F31xF20	$2 \cdot 10^{-3}$	$5 \cdot 10^{-4}$	386.4	120	570
F31xF32	$1.8 \cdot 10^{-3}$	$3.2 \cdot 10^{-3}$	45.7	120	570
F31xF34	$2.4 \cdot 10^{-3}$	$3.2 \cdot 10^{-3}$	199.1	120	570
F31xF35	$2.6 \cdot 10^{-3}$	$2 \cdot 10^{-3}$	159.9	120	570
F31xF36	$2.3 \cdot 10^{-3}$	$1.1 \cdot 10^{-3}$	199.45	120	570
PexF11	$2.3 \cdot 10^{-3}$	$3 \cdot 10^{-3}$	18	240	1170
PexF19	$2.1 \cdot 10^{-3}$	$6 \cdot 10^{-4}$	328	2160	1170
PexF20	$2.2 \cdot 10^{-3}$	$2.2 \cdot 10^{-4}$	372	2160	1170
F36xF20	$2.7 \cdot 10^{-3}$	$1.9 \cdot 10^{-4}$	326	6	370

F36xF28	$3.3 \cdot 10^{-3}$	$6.5 \cdot 10^{-4}$	179	6	370
F36xF29	$3.8 \cdot 10^{-3}$	$6 \cdot 10^{-4}$	179	6	370
F36xF31	$3.5 \cdot 10^{-3}$	$5.6 \cdot 10^{-4}$	200	6	370
F36xF32	$3.5 \cdot 10^{-3}$	$5.8 \cdot 10^{-4}$	194	6	370
F36xF35	$4.8 \cdot 10^{-3}$	$1.3 \cdot 10^{-3}$	222	6	370
F36xF19	$7.1 \cdot 10^{-3}$	$9 \cdot 10^{-4}$	262	6	370
F36xF11	$2.8 \cdot 10^{-3}$	$4.7 \cdot 10^{-4}$	227	6	370
F36xF17	$1.6 \cdot 10^{-3}$	$2.2 \cdot 10^{-3}$	247	238	370
PexF36	10^{-2}	$1.6 \cdot 10^{-4}$	238	120	1170
PexF17	$7.9 \cdot 10^{-3}$	$2.3 \cdot 10^{-4}$	478	120	1170
F29xF36	$1.8 \cdot 10^{-3}$	$4.3 \cdot 10^{-3}$	178	100	350
F29xF17	$1.4 \cdot 10^{-3}$	$2 \cdot 10^{-3}$	380	100	350

III.4. Conclusions

En résumé, dans cette partie nous avons montré que les expériences de débitmétrie en interférence entre forages permettent d'obtenir des informations très intéressantes sur les propriétés des chemins d'écoulement préférentiels dans les aquifères hétérogènes. L'interprétation de telles expériences passe par la résolution de deux problèmes inverses à deux échelles différentes : l'échelle du forage et l'échelle de l'aquifère. Dans le premier article de cette partie, nous proposons une méthode pour résoudre le problème inverse à l'échelle du forage qui consiste à estimer les variations de charges dans les différentes zones d'écoulement présentes dans le forage, qui sont à l'origine des variations de débits verticaux lors des tests d'interférence. Dans le deuxième article, nous utilisons les variations de charge ainsi obtenues pour déduire la géométrie et les propriétés hydrauliques des zones d'écoulement entre les forages sur le site de Plœmeur.

Sur le site de Plœmeur, il a été possible d'effectuer des expériences de débitmétrie en interférence avec des distances de séparation entre forage allant de 7 à 150 mètres. Les estimations des propriétés hydrauliques obtenues sont cohérentes avec les estimations données par les diagraphies de débit à petite échelle et par les essais de pompage à grande échelle. En particulier, les estimations des propriétés hydrauliques des chemins d'écoulement préférentiels sont proches de celles obtenues par les essais de pompage à grande échelle, tandis que les estimations obtenues par les diagraphies de débit sont plus variables.

Les expériences de débitmétrie sur le site de Plœmeur montrent que (i) le site est caractérisé par une large gamme de propriétés hydrauliques, (ii) les zones de forte transmissivité sont connectées sur de longues distances. Ce type d'organisation des écoulements dans la subsurface, et en particulier la connectivité des zones perméables a un fort impact sur la valeur et la variabilité des estimations de perméabilité à différentes échelles. Sur le site de Plœmeur, la variabilité des estimations de transmissivité décroît à grande échelle et la transmissivité converge vers les fortes valeurs de la distribution de transmissivité. De ce point de vue, le site de Plœmeur est un exemple illustrant les relations entre l'organisation des écoulements et l'évolution des propriétés hydrauliques avec l'échelle. Il est intéressant de comparer ce résultat à l'étude très détaillée du site de Mirror Lake, pour lequel le réseau de faille n'est pas connecté à grande échelle ce qui implique que la perméabilité à grande échelle est faible (figure III.6).

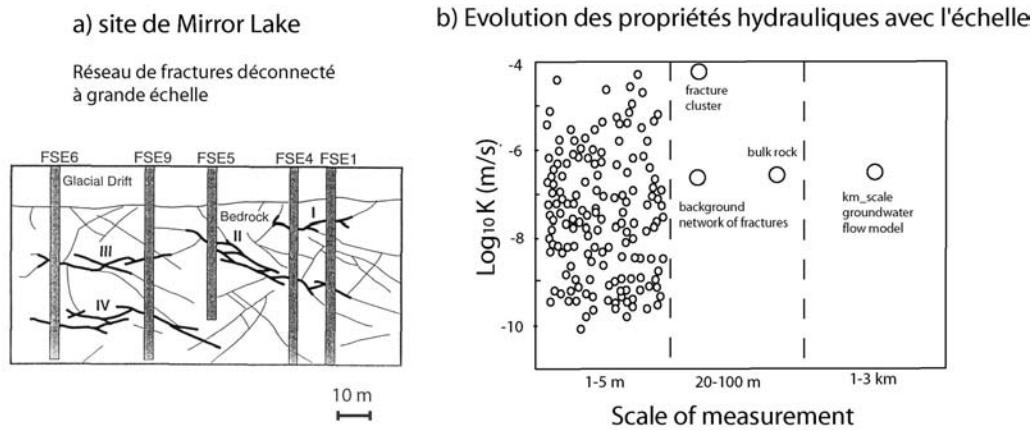

Figure III.6: schéma du site Mirror Lake (les fractures les plus transmissives sont représentées en traits plus épais) et évolution avec l'échelle des estimations de perméabilités d'après Hsieh (1998), Tiedeman et al. (1998), Day-Lewis et al. (2000).

La méthodologie que nous avons présentée pour interpréter les expériences de débitmétrie en condition d'interférence doit cependant être approfondie afin de mieux cerner les incertitudes et les possibilités d'identifier la géométrie des connexions. En particulier, certaines observations, notamment l'asymétrie de la réponse en débit lors de la mise en pompage et l'arrêt du pompage dans certains cas, suggèrent l'existence de connexions indirectes (Figure III.7). La figure 7 de la partie III.2 montre que les évolutions temporelles de charge hydraulique estimées sont parfois asymétriques et ne peuvent pas être prises en compte dans un modèle classique. La question est de savoir si ce phénomène est en partie relié aux hypothèses faites dans les modèles d'inversion ou, au contraire, si cette asymétrie est reliée à des connexions réelles dans l'aquifère.

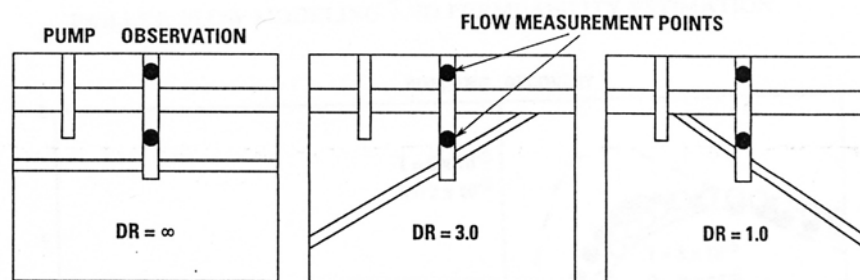

Figure III.7: exemples de géométries simples montrant des connexions indirectes d'après Paillet (1998)

Le test de l'effet de différentes géométries de connexions en trois dimensions se fera en intégrant les forages dans un modèle numérique d'écoulement dans des fractures en trois dimensions, actuellement en cours de développement dans le cadre de la thèse de Hussein Mustapha encadré par JR De Dreuzy et J. Erhel. Ceci permettra également de quantifier l'incertitude sur l'estimation de la charge hydraulique et des propriétés hydrauliques à différentes échelles, ainsi que de mieux contraindre le volume d'investigation des expériences de débitmétrie.

Chapitre IV

Corrélation des vitesses d'écoulement dans les milieux poreux hétérogènes

Les parties précédentes ont montré que, malgré l'émergence de nouvelles méthodes de caractérisation adaptées aux milieux hétérogènes, les techniques de mesure actuelles ne permettent pas d'évaluer directement la distribution des vitesses d'écoulement dans le milieu souterrain. Or la distribution des vitesses d'écoulement détermine la dispersion d'éléments en solution, tels que des polluants. Comme nous l'avons souligné dans la première partie, pour faire des prédictions sur la dispersion des solutés, il faut en conséquence représenter de la meilleure façon possible les distributions de vitesses dans des modèles physiques équivalents. La représentation des champs de vitesse concerne deux aspects : la distribution des valeurs possible de vitesse et l'organisation spatiale de ces vitesses. Cette partie est centrée sur ce deuxième aspect. Nous abordons cette question à partir de l'étude de la corrélation des vitesses d'écoulement simulées pour des champs de perméabilité générés de façon stochastique. Nous présentons une méthode permettant de quantifier l'organisation des vitesses d'écoulement. L'objectif de cette partie est de mettre en évidence l'organisation particulière des écoulements dans les milieux très hétérogènes, pour lesquels l'application des modèles de transport est la plus discutée.

IV.1 Article: describing the velocity field organization in heterogeneous media by conditional correlations (*Le Borgne et al.*, en preparation)

L'organisation du champ de vitesse en milieux poreux hétérogènes est généralement décrite par la covariance du champ de vitesse [*Salandin and Fiorotto*, 1998]. Pour un champ de vitesse stationnaire, la covariance est définie de la manière suivante (voir partie I.2.3) :

$$\text{cov}(v, d) = \langle v(x)v(x+d) \rangle \quad (\text{IV.1})$$

La covariance a les propriétés suivantes :

$$\begin{cases} \text{cov}(v,0)=\sigma^2(v) \\ \text{cov}(v,\infty)=0 \end{cases}$$

La convergence de la covariance vers zéro caractérise le degré de corrélation des vitesses, i.e. le degré de similarité de $v(x)$ et $v(x+d)$. La covariance peut être estimée pour le champ de vitesse Eulérien, la variable d représente une distance de séparation entre deux points de vitesses différentes. La moyenne est effectuée pour tous les couples de points du champ de vitesse séparés par une distance d . La covariance peut être également être estimée dans un cadre Lagrangien. La variable d représente alors le temps entre deux instants où une particule de soluté possède une vitesse $v(t)$ et $v(t+d)$. La moyenne est effectuée dans ce cas pour toutes les vitesses de particules à des instants séparés par le temps d . La figure IV.1 présente les

estimations des covariances Eulérienne et Lagrangienne du champ de vitesse simulés dans des milieux poreux hétérogènes [Salandin and Fiorotto, 1998]. L'avantage de la mesure de la covariance Lagrangienne est qu'elle se rapporte directement à la variance des fluctuations de déplacement des particules de soluté par rapport au déplacement moyen et donc au modèle de transport équivalent (voir partie I.2.3). Au contraire, le passage du champ de vitesse Eulérien au champ de vitesse Lagrangien n'est pas direct du fait de la tortuosité des chemins empruntés par les particules (Lundgren and Poitin, 1975, Dentz et al., 2003).

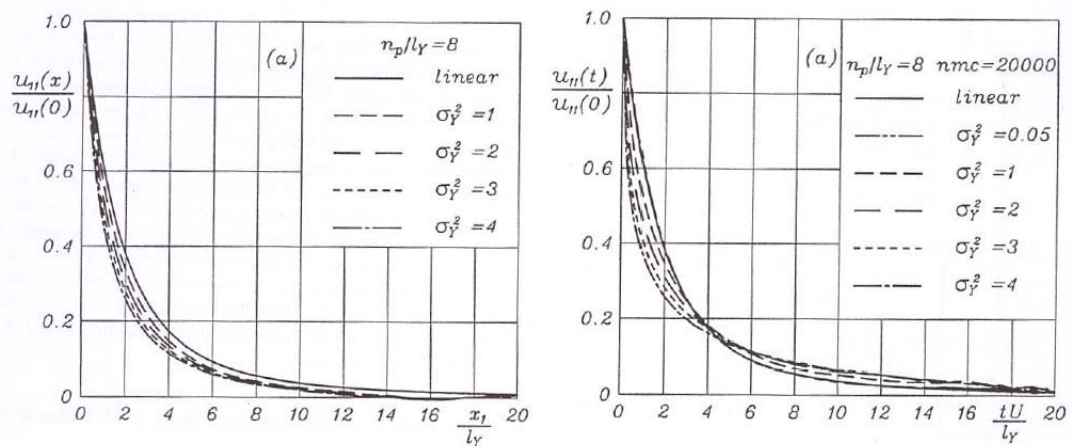

Figure IV.1 Covariance de la composante longitudinale du champ de vitesse Eulérien (à gauche) et covariance de la composante longitudinale du champ de vitesse Lagrangien (à droite) pour des champs de perméabilité ayant différentes variances. D'après Salandin et Fiorotto (1998).

L'estimation de la covariance du champ de vitesse ne permet pas cependant de caractériser totalement son organisation spatiale. La figure IV.2 montre par exemple deux champs ayant la même covariance mais une organisation spatiale totalement différente. La figure IV.2.a représente un champ multinormal Gaussien. Dans ce type de champ les valeurs extrêmes ont une faible connectivité spatiale (Gomez-Hernandez and Wen, 1998). Le champ de la figure IV.2.b a été obtenu en modifiant le premier champ de manière à connecter spatialement les fortes valeurs tout en conservant la même covariance spatiale (Zinn and Harvey, 2003). Ainsi, la covariance ne permet pas de quantifier le fait que les zones de faible ou de forte vitesse n'ont pas la même organisation spatiale. Or ce type de propriétés est sans doute une caractéristique importante à prendre en compte dans les milieux poreux et fracturés naturels, en particulier du fait de l'existence de chemins d'écoulement préférentiels de forte vitesse (voir partie I.1.2). Afin de progresser dans la représentation du champ de vitesse dans les modèles de transport, nous proposons dans l'article qui suit une méthode permettant de

caractériser ce type de propriétés du champ de vitesse. Nous effectuons pour cela des simulations numériques d'écoulement dans des champs de perméabilité hétérogènes. Nous avons pour cela travaillé à partir du code initialement développé par Katia Besnard lors de sa thèse (*Besnard, 2003*).

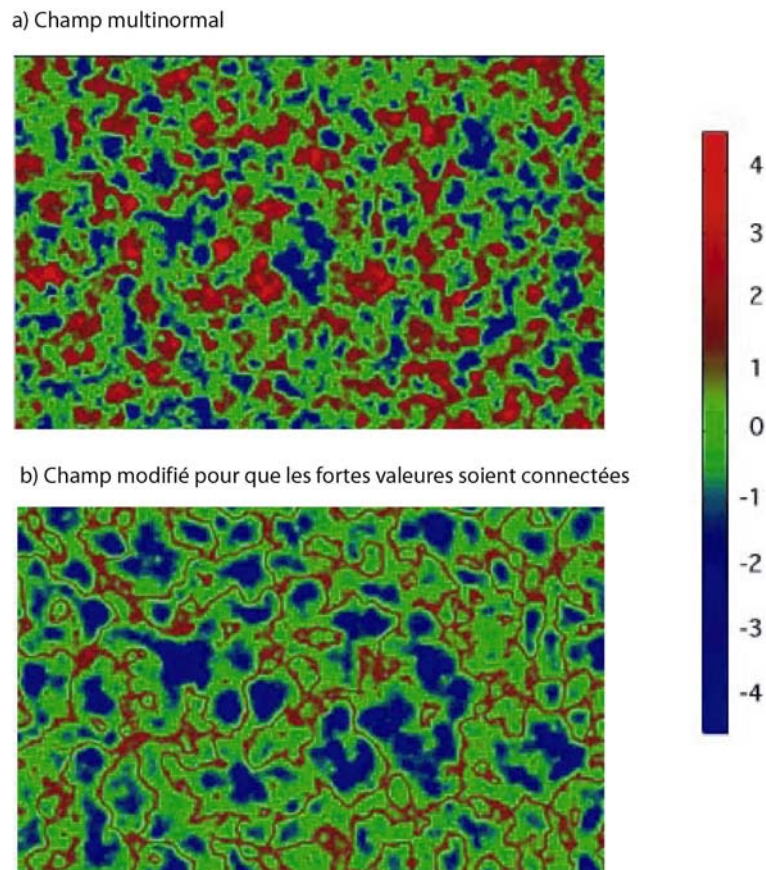

figure IV.2 a) Réalisation d'un champ multinormal Gaussien, b) Champ modifié afin que les fortes valeurs soient connectées. Ces deux champs correspondent à la même covariance. D'après *Zinn et Harvey (2003)*.

Describing the velocity field organization in heterogeneous media by conditional correlations

Paper in preparation

T. Le Borgne*, J-R. De dreuzy, P. Davy and O. Bour

*Géosciences Rennes (UMR 6118 CNRS), Université de Rennes 1,
Campus de Beaulieu, 35042 Rennes cedex, France*

** Now at Laboratoire de Tectonophysique, UMR 5568 CNRS,
Université de Montpellier 2, Montpellier, France*

Abstract

The spatial organization of the velocity field in heterogeneous porous media is generally described by the velocity field covariance [Salandin and Fiorioto, 1998]. However, such measure of spatial variability does not allow to quantify the fact that high and low velocity zones may not have the same spatial organization, which may be expected for instance if the velocity field is channelized [Tsang and Neretnieks, 1998]. In this paper, we propose to define correlation functions conditional to the initial velocity from which solute particles are departing. For this, we studied the evolution with particle travel time or distance of conditional Lagrangian velocity distributions obtained by numerical simulations of flow and transport in lognormal finite correlation length permeability fields. The velocity field organization may be quantified by (i) the increase of correlation length with initial particle velocity, (ii) the existence of long range correlations in time, which express the fact that particles leaving from high velocity zones take a long time to sample low velocity zones.

I. Introduction

Inert solute transport in underground media is controlled not only by local dispersion and diffusion but also by the heterogeneity of the velocity field producing fast and slow paths.

Predicting the influence of the geological heterogeneity on the solute localization and spreading is required in many field applications like contaminant monitoring and remediation. For the case of moderately heterogeneous media, solute dispersion may be adequately predicted by the stochastic perturbative model derived from first order developments [Sudicky, 1986; Dagan, 1989; Gelhar, 1993]. However, field observations indicate that such model is not applicable to highly heterogeneous aquifers, which represent the majority of geological settings [Adams and Gelhar, 1992, Tsang and Neretnieks, 1998, Haggerty et al., 2000; Becker and Shapiro, 2003]. Several alternative transport models, corresponding to different representation of the velocity field have been proposed [Haggerty and Gorelick, 1995, Berkowitz and Scher, 1995, Benson et al., 2000, Berkowitz et al., 2002, Becker and Shapiro, 2003]. However, the relevance of these models for natural media is still a subject of debate.

A major task is therefore to find a realistic representation of velocity fields in highly heterogeneous media. Flow channeling and the presence of preferential high velocity flow paths is often cited as the main reason for the observed anomalous transport effects [Tsang and Neretnieks, 1998]. Indeed, for large permeability variances, low and high velocity zones do not have the same spatial organization (figure 1b). High velocities zones form tortuous channels, whereas low velocity values are localized in island shaped zones. However there exist no standard method to quantify such organization of the velocity field [Gomez-Hernandez and Wen, 1998, Knudby and Carrera, 2005]. In particular, the velocity field covariance does not allow to quantify the fact that high and low velocity zones may have different spatial organizations [Zinn and Harvey, 2003].

The purpose of this paper is to investigate whether such property may be characterized by a correlation function conditioned on the initial velocity in a Lagrangian framework, i.e studying the velocity field along particle paths. Correlation should basically quantify the fact

that a particle has lost memory of its initial velocity when it has experienced the whole velocity field distribution. This may be quantified by studying velocity distributions conditioned by solute particle initial velocity, as a function of particle travel time or travel distances.

In part II, we briefly describe the numerical procedures. In part III, we analyze the evolution with particle travel time and travel distance of the Lagrangian velocity distributions conditioned with the initial particle velocities. In part IV, we define estimates of conditional correlation time and length. The consequences of the results obtained on the upscaled transport properties are discussed in part V.

II. Methodology: numerical simulation of flow and transport in heterogeneous media

Several alternative representations of the permeability field spatial variability in numerical models have been proposed. In particular, some representations include preferentially connected high permeability zones [*Gomez-Hernandez and Wen, 1998, Zinn and Harvey, 2003, Zheng and Gorelick, 2003, Knudby and Carrera, 2005*]. In this study, we analyzed the velocity field correlation lengths and time for lognormal permeability fields, for which no preferential correlation structures are introduced. Thus, we focus on the correlation properties arising from the intrinsic organization of the velocity in heterogeneous media.

The lognormal distribution is parameterized its lognormal mean $\langle \ln K \rangle$, its variance $\sigma_{\ln K}^2$ and a correlation length $\lambda_{\ln K}$. The log permeability field variances in porous aquifers range typically from 0.1 to 4 [*Gelhar, 1993*]. Spatially correlated multi-normal log conductivity fields are generated using a fast Fourier transform [*Ruan and McLaughlin, 1998*] (figure 1a). The porosity n is constant. Flow is imposed by a constant head gradient ∇h . Boundary conditions are the following: no flux across the lateral boundaries, constant head at the

upstream and downstream boundaries. The flow equation is solved numerically with a finite difference scheme [Ababou *et al.*, 1989] (figure 1b).

Once the flow field is obtained, solute transport is simulated by a particle tracking method where particle displacements are made at discrete time intervals [Kinzelbach, 1988] using a bilinear interpolation of the velocity field [Pollock, 1988]. Note that such interpolation allows mass conservation at grid scale. However, it introduces some discontinuities on the velocity norm at grid boundaries since flow is conserved only in the direction perpendicular to the grid boundary (figure 1c). In this paper, no diffusive or local dispersive effect are included. The influence of the Peclet number will be investigated in subsequent work. The time step is

chosen as $\delta t = \frac{1}{10v_{\max}}$ where v_{\max} is the maximum velocity. To present the results we

normalize particle travel distances by the permeability field correlation length $\lambda_{\ln K}$ and the

travel time by a characteristic time that we define as $\tau = \frac{n\lambda_{\ln K}}{\langle K \rangle_G \nabla h}$. In the simulations, we

take the following parameters $n=1$, $\langle K \rangle_G=1$ and $\nabla h = 1$ and we use grid sizes of 512 x 512.

To study the velocity field statistical properties conditioned by the particle initial velocities, we define velocity classes based on a regular discretization of the log velocity field. An equal number of particles departs from each class so that results are comparable for different initial velocities. Results are averaged over 800 realizations with 50000 particles departing from each velocity class in total. Note also that we did not perform the calculations for the most extreme velocity because of a lack of statistical representativity.

III. Conditional Lagrangian velocity distributions

Figure 2 shows an example of conditional velocity distributions at different particle travel times, obtained by numerical simulations for a permeability field variance $\sigma_{\ln K}^2 = 4$. At short travel times, the conditional distributions are narrow, while at late travel time, they are close

to the Lagrangian velocity distribution. Comparison of figure 2a and 2b shows that the velocity of convergence towards the final distribution is different for a low initial conditioning velocity (figure 2a) than for a high initial conditioning velocity (figure 2b). In order to quantify the evolution of Lagrangian conditional velocity distributions, we should define estimates of conditional correlation functions.

For a multinormal field, the conditional first two moments define completely the conditional distributions. So that studying the conditional first two moments is enough to define completely the correlation. For such a field Y , the analytical formulation of the conditional velocity distribution is as follows:

$$P(y/y_0, x) = \frac{1}{\sqrt{2\pi\sigma^2(1-\rho(x)^2)}} \exp\left[-1/2\left(\frac{y - \langle Y \rangle - \rho(x)(y_0 - \langle Y \rangle)}{\sigma\sqrt{1-\rho(x)^2}}\right)^2\right] \quad (2)$$

where x is the lag distance, σ is the standard deviation, $\langle Y \rangle$ is the mean, y_0 is the initial conditioning value and $\rho(x)$ is the correlation function. For example, for an exponential correlation function, $\rho(x) = \exp(x/\lambda)$ where λ is the correlation length. The first two conditional moments are:

$$E(y/y_0, x) = E(y) + \rho(x)(y_0 - E(y)) \quad (3)$$

$$\sigma^2(y/y_0) = \sigma^2(y)(1 - \rho^2(x)) \quad (4)$$

For multinormal fields, estimating the first or the second conditional moment as a function of the lag distance x allows to quantify the correlation function $\rho(x)$, which is independent of the initial value. Indeed, estimating the conditional covariance is equivalent to estimating the conditional first moment $E(v(x)/v_0)$:

$$E((v_0 - E(v))(v(x) - E(v))/v_0) = (v_0 - E(v))(E(v(x)/v_0) - E(v)) \quad (1)$$

where v_0 is the conditioning initial velocity and x is the lag distance.

Nevertheless, the velocity distributions that we obtain are highly skewed, especially at intermediate particule travel times (figure 2). This implies that the first two moments are poorly adapted to describe such distribution. Figure 3 presents the evolution of the two first moments conditioned to initial particle velocities as a function of particle travel time. Since the velocity distributions in our simulations are close to lognormal, we use the log velocity distribution in the calculations. For the conditional mean $E(\ln(\underline{v})/v_0)$, the curves start at the conditioning velocity v_0 and converges towards the total Lagrangian mean $E(\ln(\underline{v}))$. However, depending on the initial velocity, some curves “overshoot” the final value before converging back towards it. Such effect is likely related to the distribution skewness. The same type of effect is observed for the conditional second moment.

IV. Estimates of conditional correlation times and lengths

In order to define estimates of correlation time and length that may be derived for any type velocity distributions, we propose to study the whole conditional velocity distribution $P(\ln(\underline{v})/v_0, t)$. To quantify the velocity of convergence towards the Lagrangian velocity distribution, we calculate the mean absolute difference between the conditional distributions and the final Lagrangian velocity distribution. The Lagrangian distribution is computed as the late travel time or large travel distance velocity distribution of particles departing from all the possible initial velocities.

We tested such method for multinormal random fields defined by equation 2 and found that by normalizing the conditional distributions by their conditional mean at each time step or lag distance, we obtain an estimate of conditional correlation that is independent on the initial conditioning value. The integral of the obtained correlation curve is proportional to the multinormal field correlation length. We also tested the method for solute transport in stratified velocity fields with lateral mass exchange by diffusion and obtained consistent power law decay of the estimated correlation as a function of particle travel time [*Matheron*

and De Marsilly, 1980]. For such system, the correlation functions in time are independent of the initial particle velocity, while the correlation functions in distance depend strongly on the conditioning initial particle velocity. Indeed, particles traveling in high velocity stratas tend to stay in the same strata over large distances.

Figure 5 shows the obtained conditional correlation curves as a function of particle travel time and travel distance for a permeability field of variance $\sigma_{\ln K}^2=4$. They express the rate of convergence of conditional distributions towards the total Lagrangian velocity distribution. For the correlation in distance (figure 5b), the distance for convergence to the lagrangian distribution increases with velocity. This is related to the channel structure of high velocity zones (figure 1b) that implies that particles tend to stay over longer distances in high velocity zones. For the correlation in time (figure 5a), the correlation curves for initial low and high velocities have different shapes. The correlation curves conditioned by high initial velocities decrease initially rapidly but the late time convergence is slow. Hence, it takes a long time for particle departing from high velocities to sample the whole velocity distribution, in particular the low velocities. Indeed few flow lines go from high velocities to low velocities.

Figure 6 presents estimates of conditional correlation time and length obtained by integrating the curves as a function of time or distance. In order to avoid integrating the inherent variability that implies that the conditional distributions are never exactly equal to the total Lagrangian distribution, we integrate up to a threshold in correlation. This threshold was taken as 0.05, which was estimated to be slightly above the noise level. Since we departed the same number of particles in each velocity class, this level is expected to be independent of the conditioning velocity. For the correlation in distance, we obtain an increase in correlation length as a function of the initial particle velocity. For a permeability field variance $\sigma_{\ln K}^2=4$, the correlation length increase with velocity may be characterized by a power law of exponent approximately equal to 0.3. Similar evolutions are observed for less

heterogeneous permeability fields. Note that, for the same velocities, the correlation length are slightly higher for low permeability field variances.

For the correlation in time, the obtained correlation times are approximately constant over a large velocity range. As illustrated on Figure 4, this is due to the slow late time convergence of high velocity conditioned distributions that compensates for the early rapid convergence. For extremely low velocities, the long retention of particles in low velocity zones becomes a dominant effect and the correlation time becomes inversely proportional to the initial velocity. The difference in the shape of the correlation curves for low and high velocities (figure 4a) is found whatever the permeability field variance, which explains that the estimated correlation times are approximately constant, even for weakly heterogeneous permeability fields. The correlation times globally increase with the permeability field variance.

V. Discussion and relation with upscaled transport models

A detailed quantification of the velocity field correlation structure, such as proposed in this paper, should allow to reexamine the assumptions made in transport theories in order to progress towards a realistic representation of the velocity field.

For weakly heterogeneous media corresponding to $\sigma_{\ln K}^2 < 1$, perturbation methods derive the velocity field from the permeability field with a linearization of the flow equation in $\sigma_{\ln K}^2$ [Dagan, 1989, Gelhar, 1993]. For a multi-normal log permeability field, the velocity field obtained is also multi-normal [Rubin, 1990]. This implies a Gaussian distribution of velocities and constant conditional correlation length. The Lagrangian velocity field is then generally obtained through the Corrsin's conjecture [Lundgren and Pointin, 1975]. However, the assumptions made in this method, which are fundamentally related to the correlation structure of the velocity field, have been recently put into question for the application to transport in porous media [Dentz et al., 2003].

Other representations of the velocity field have been proposed. For instance, to model the channelling effects observed in the field [Tsang and Neretnieks, 1998], some models assume that solutes travel in separated velocity channels [Becker and Shapiro, 2003], which implies a constant, infinite, correlation length, whatever the particle initial velocity. Other transport models assume that the velocity field induces a range of characteristics correlation times either in the form of a CTRW formulation [Berkowitz and Scher, 1998] or in a mobile/immobile type of models [Haggerty and Gorelick, 1995], which may be shown to be equivalent under certain conditions [Dentz and Berkowitz, 2003]. In the CTRW representation, solute particles are assumed to perform random jumps in random times. The derivation of analytical solutions is generally done by assuming a decoupling between the spatial and temporal increments through a Markovian assumption in space [Montroll and Weiss, 1965], which is equivalent to assuming a constant correlation length. On the other hand, some CTRW formulations, used to model transport in porous media, are based on a Markovian hypothesis in time [Benson et al., 2000, Berkowitz et al., 2002]. Finally, some CTRW formulations have been proposed where spatial and temporal increments are coupled [Blumen, 1989]. Such framework should allow to account for a variety of possible relations between conditional correlation and velocity, including non linear relationships, such as obtained in our study. However, this type of model has not been applied yet to porous media.

Conclusions

The purpose of this paper was to investigate a new method to quantify the velocity field organization in heterogeneous porous media. The method tested is based on estimating correlation conditional to particle initial velocity in a Lagrangian framework. Correlation basically quantifies the fact that a particle has lost memory of its initial velocity when it has experienced the whole velocity field distribution. Hence, the conditional velocity distributions, that are initially narrow and centered on the initial velocity, widen as particles

experience different velocity and converge to the total Lagrangian velocity distribution. To quantify the rate of convergence as a function of initial velocity, we computed the mean absolute difference between conditional distributions and the total Lagrangian distribution at different travel times and travel distances.

We tested such method on velocity fields obtained by numerical simulations of flow and transport in lognormal, finite correlation length permeability fields. We obtain estimates of correlation length and time conditional to initial particle velocities in a Lagrangian framework. The results show that the velocity field organization and its channelling may be quantified by (i) the increase of correlation length with initial particle velocity, (ii) the existence of long range correlations in time, which express the fact that particles leaving from high velocity zones take a long time to sample the whole velocity distribution and in particular low velocity values.

We expect that the dependence of the conditional correlation on velocity may depend on the permeability field representation. The most general framework to represent such properties is CTRW with coupled temporal and spatial increments [*Blumen*, 1989]. Further research will include investigating the influence of local diffusion and dispersion, the application of the methodology to other types of permeability fields, in particular permeability fields that include preferentially connected high permeability zones and investigating the possibility to represent the obtained properties in transport models.

References

- Ababou, R., D. McLaughlin, L. W. Gelhar, and A. F. B. Tompson (1989). Numerical simulation of three-dimensional saturated flow in randomly heterogeneous porous media. *Transport in Porous Media*, 4, 549-565.
- Adams, A. E., and L. W. Gelhar (1992). Field study of dispersion in a heterogeneous aquifer, 2, spatial moments analysis. *Water Resour. Res.*, 28.
- Becker, M. W., and A. M. Shapiro (2003). Interpreting tracer breakthrough tailing from different forced-gradient tracer experiment configurations in fractured bedrock. *Water Resour. Res.*, 39, 1024, doi:10.1029/2001WR001190.
- Benson, D. A., S. W. Wheatcraft, and M. M. Meerschaert (2000). Application of a fractional advection-dispersion equation. *Water Resources Research*, 36, 1403-1412.
- Berkowitz, B., J. Klafter, R. Metzler, and H. Scher (2002). Physical pictures of transport in heterogeneous media: Advection-dispersion, random-walk, and fractional derivative formulations. *Water Resour. Res.*, 38, 1191, doi:10.1029/2001WR001030.
- Blumen, A., Zumofen, G., Klafter, J. (1989) Transport aspect in anomalous diffusion: Levy Walks. *Physical Review A*, 40 (7).
- Dagan, G. (1989). *Flow and Transport in Porous Formations*. Springer Verlag.
- Dentz, M., H. Kinzelbach, S. Attinger, and W. Kinzelbach (2003). Numerical studies of the transport behavior of a passive solute in a two-dimensional incompressible random flow field. *Phys. Rev. E*, 67.

- Dentz, M., and B. Berkowitz (2003). Transport behavior of a passive solute in continuous time random walks and multirate mass transfer. *Water Resour. Res.*, 39, 1111, doi:10.1029/2001WR001163, 2003.
- Freyberg, D. L. (1986). A natural gradient experiment on solute transport in a sand aquifer, 2, spatial moments and the advection and dispersion of nonreactive tracers. *Water Resour. Res.*, 22, 2031-2046.
- Gaisheng, L., C. Zheng, and S.M. Gorelick (2004). Limits of applicability of the advection-dispersion model in aquifers containing connected high-conductivity channels, *Water Resources Research*, Vol. 40, W08308, 2003WR002735, 1-19.
- Gelhar, L. W. 1993. *Stochastic Subsurface Hydrology*, Engelwood Cliffs, New Jersey.
- Gomez-Hernandez, J. J., and X.-H. Wen (1998). To be or not to be multi-Gaussian ? A reflection on stochastic hydrogeology. *Advances in Water Resources*, 21, 47-61.
- Haggerty, R. S., and S. M. Gorelick (1995). Multiple-rate mass transfer for modeling diffusion and surface reactions in media with pore-scale heterogeneity. *Water Resour. Res.*, 31, 2383-2400, doi:10.1029/95WR01583,.
- Haggerty, R. S., S. A. McKenna, and L. C. Meigs (2000). On the late-time behavior of tracer test breakthrough curves. *Water Resour. Res.*, 36, 3467-3479.
- Kinzelbach, W. (1988). The random walk method in pollutant transport simulation. D. Reidel, Hinghal, Mass., *Ground water Flow and Quality modelling*, edited by E. Custodio, A. Gurgui, and J. P. Lobo Ferreira, 227-246.

- Knudby, C. and Carrera, J. (2005) On the relationship between indicators of geostatistical, flow and transport connectivity. *Advances in Water Resources*, Volume 28, Issue 4, Pages 405-421
- Lundgren, T. S., and Y. B. Pointin (1975). Turbulent self-diffusion. *Phys. Fluids*, 19, 355-361.
- Matheron, G., and G. de Marsily (1980). Is transport in porous media always diffusive ? A counterexample. *Water Resources Research*, 16.
- Montroll, E. W., and G. H. Weiss (1965). *J. Math. Phys.*, 6, 167.
- Pollock, D. W. (1988). Semianalytical computation of path lines for finite-difference models. *Ground water*, 26, 743-750.
- Ruan, F., and D. McLaughlin (1998). An efficient multivariate random field generator using the Fourier transform. *Advances in Water Resources*, 21, 385-399.
- Rubin, Y. (1990). Stochastic modeling of macrodispersion in heterogeneous porous media. *Water Resources Research*, 26, 133-141.
- Salandin, P., and V. Fiorotto (1998). Solute transport in highly heterogeneous aquifers. *Water Resources Research*, 34, 949-961.
- Sudicky, E. A. (1986). A natural gradient experiment on solute transport in a sand aquifer: Spatial variability of hydraulic conductivity and its role in the dispersion process. *Water Resour. Res.*, 22, 2069-2082.
- Tsang, C.-F., and I. Neretnieks (1998). Flow Channeling in Heterogeneous Fractured Rocks. *Reviews of Geophysics*, 36, 257-298.

Zinn, B., and C. F. Harvey (2003). When good statistical models of aquifer heterogeneity go bad: A comparison of flow, dispersion, and mass transfer in connected and multivariate Gaussian hydraulic conductivity fields. *Water Resources Research*, 39, 1051, doi:10.1029/2001WR001146.

Figures

a) permeability field

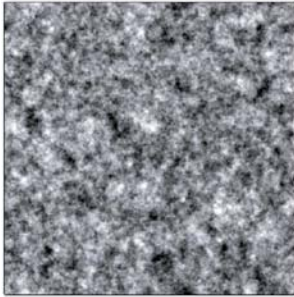

b) velocity field

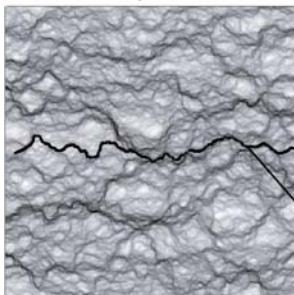

c) particle velocity as a function of travel time

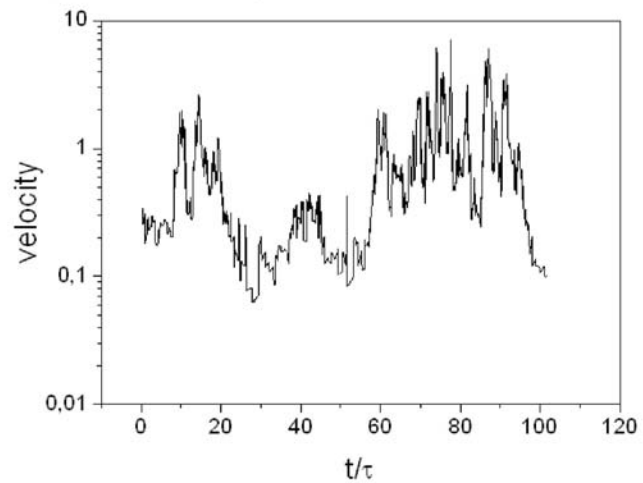
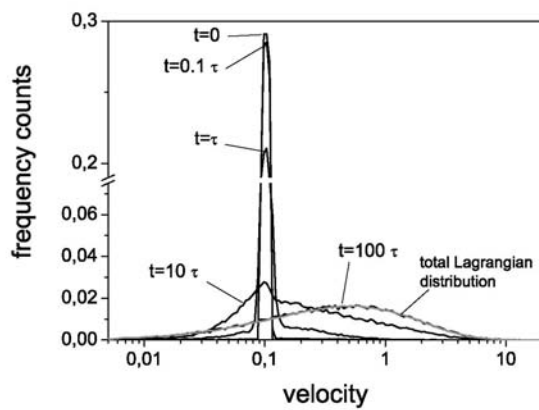

Figure 1: example of a) generated permeability field realization for a $64 \lambda \times 64 \lambda$ grid with $\sigma_{\ln K}=2$ and $\lambda_{\ln K}=8$, b) calculated velocity field and example of a particle path, c) velocity along the path of the particle.

conditional distribution for different travel times

a) for $v_0=0.1$



b) for $v_0=7.9$

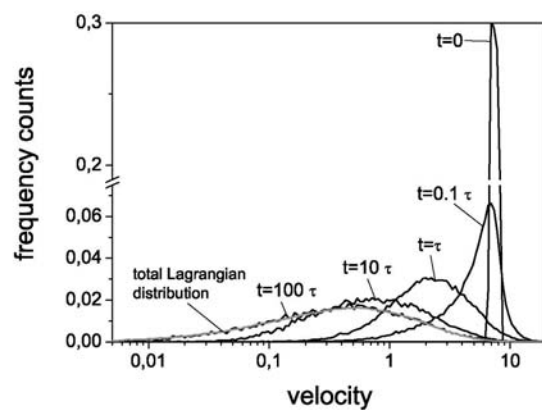

Figure 2: Conditional distributions at different travel times for a) a conditioning initial velocity $v_0=0.1$ and b) a conditioning initial velocity $v_0=7.9$. These results are obtained for a permeability field variance $\sigma_{\ln K}^2=4$ and a correlation length $\lambda_{\ln K}=2$.

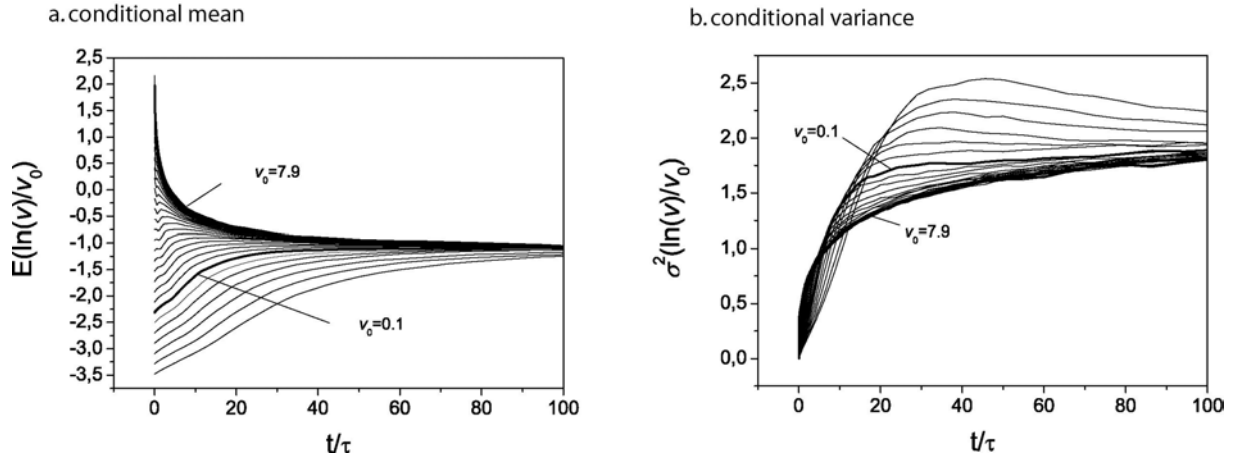

Figure 3: Evolution as a function of particle travel time of the conditional mean and variance for a velocity field obtained numerically for heterogeneous permeability fields. This example is obtained for a permeability field variance $\sigma_{\ln K}^2=4$ and a correlation length $\lambda_{\ln K}=2$.

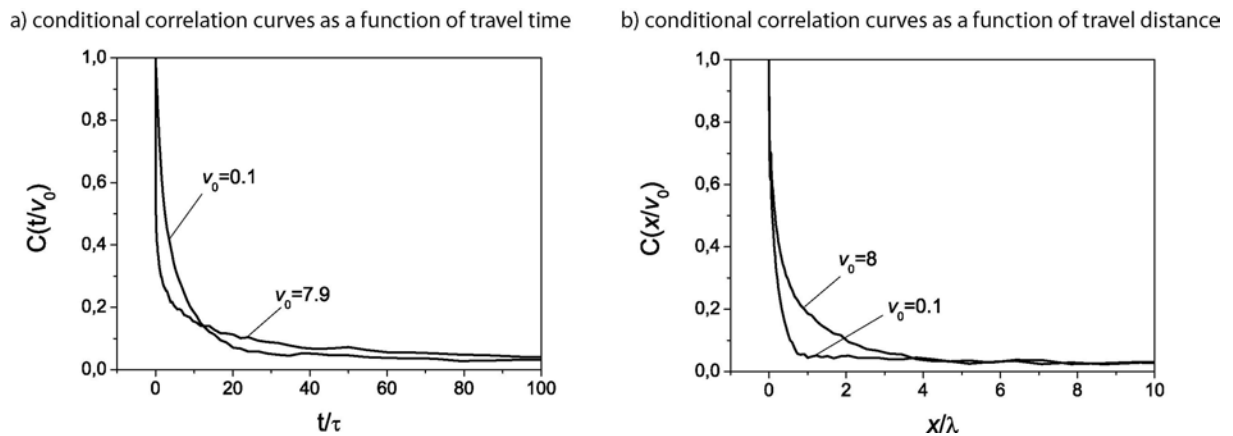

Figure 4 Conditional correlation obtained from computing the mean absolute difference between the conditional distributions and the final Lagrangian distribution a) as a function of travel time, b) as a function of travel distance. The distances are estimated in the longitudinal direction. These results are obtained for a permeability field variance $\sigma_{\ln K}^2=4$. The curve are normalized by their value for $t=0$ or $x=0$. Figure 4a is obtained for a correlation length $\lambda_{\ln K}=2$, while Figure 4b is obtained for a correlation length $\lambda_{\ln K}=20$. Such difference comes from the

fact that the correlation times are generally much larger than the correlation lengths, so that systems with many correlation lengths are needed.

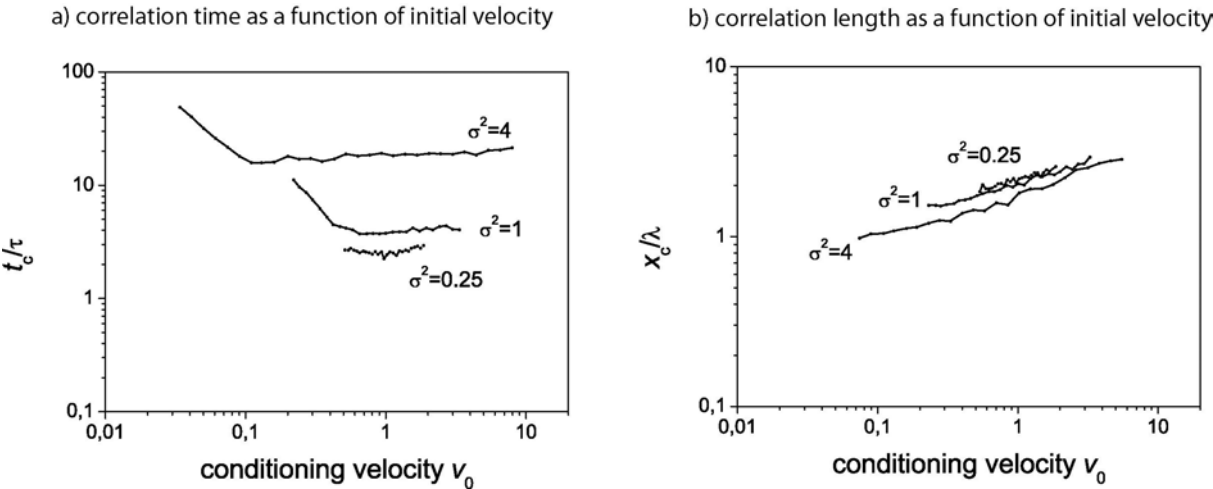

Figure 5 a) correlation time as a function of conditioning initial velocity and b) correlation length as a function of conditioning initial velocity for different permeability field variances. The estimates of correlation time and length are calculated as the integral of the correlation curves in Figure 4. In order to avoid integrating the noise at late times and large distances, the integration is done up to a threshold in correlation of 0.05. In order to compare the results with classical correlation estimates, the obtained estimates are multiplied by a factor 1/0.185. This corresponds to the factor of proportionality deduced for multinormal random fields of known correlation length.

IV.2 Conclusions

L'objectif de cette partie était de proposer des nouvelles méthodes permettant de quantifier l'organisation des écoulements en milieux poreux hétérogènes afin de la représenter de façon réaliste dans les modèles prédictifs de transfert d'éléments en solution. Il n'existe pas actuellement de méthode permettant de quantifier le fait que les vitesses d'écoulement lentes et rapides n'ont pas nécessairement la même organisation spatiale. Afin de caractériser ce type de propriété, nous avons étudié les distributions conditionnelles de vitesses d'écoulement simulées dans des milieux poreux hétérogènes. Les distributions de vitesse conditionnelles $P(v|v(t=0)=v_0)$ ont les propriétés suivantes :

$$\left\{ \begin{array}{l} P(v(0)|v(t=0)=v_0) = v_0 \delta(v_0-v) \text{ avec } \delta(0)=1 \text{ et } \delta(v)=0 \text{ pour } v \neq 0. \\ P(v(\infty)|v(t=0)=v_0)=P(v) \text{ avec } P(v) \text{ la distribution de vitesse totale.} \end{array} \right.$$

Les distributions sont étudiées dans un cadre Lagrangien, c'est-à-dire le long des trajectoires de particules de soluté. Entre ces deux distributions extrêmes pour $t=0$ et $t=\infty$, l'évolution des distributions conditionnelles dépend de la corrélation des vitesses, qui représente le degré de similarité entre les vitesses d'écoulement rencontrées par une particule à deux instants différents. Nous avons montré que, pour des champs de vitesses simulés dans des champs de perméabilités hétérogènes, l'évolution des distributions conditionnelles dépend de la vitesse initiale v_0 . Du fait que les distributions conditionnelles obtenues sont très asymétriques, leur évolution n'est pas bien décrite par leurs premiers moments ou par la covariance conditionnelle.

Afin de caractériser cette évolution, nous avons estimé la moyenne des différences entre les distributions conditionnelles et la distribution finale à différents temps. Ceci permet de définir des temps et des distances de corrélation conditionnés par les vitesses initiales, afin de caractériser séparément l'organisation spatiale des faibles et fortes vitesses d'écoulement. La structure de corrélation des vitesses d'écoulement, notamment leur chenalisation, se traduit par (i) un accroissement des longueurs de corrélation en fonction de la vitesse initiale des particules, (ii) l'existence de corrélation temporelle à longue portée, qui traduisent le fait que les particules se trouvant dans des chenaux de forte vitesse mettent un certain temps avant d'échantillonner la distribution totale des vitesses. Ce type de propriété n'est pas pris en compte dans les modèles de transport existants. Il existe cependant des cadres théoriques issus des théories de la physique statistique qui pourraient permettre de représenter ces propriétés (*Blumen et al.*, 1989).

Conclusions et perspectives

Actuellement, on constate que les modèles prédictifs de transfert dans les milieux souterrains, souvent basés sur une représentation de type milieu poreux homogène, ne sont pas adaptés aux milieux naturels. Face à ce constat et pour aborder ce problème, les objectifs principaux de cette thèse étaient, d'une part de développer des méthodes de mesure adaptées à la caractérisation de l'hétérogénéité des écoulements et de leur organisation dans les milieux géologiques, et d'autre part de mener une étude théorique sur la représentation de l'organisation des écoulements dans les modèles prédictifs.

L'objectif du chapitre II était de tester les modèles moyens équivalents capables de représenter la réponse hydraulique d'un réseau de fractures naturel à différentes échelles. Les résultats montrent que, pour le site de Plœmeur, il est possible de définir un modèle moyen équivalent permettant de rendre compte du comportement hydraulique moyen du site sur une large gamme d'échelles de temps et d'espace (*Le Borgne et al.*, 2004). Le modèle équivalent obtenu prend en compte une dimension fractale et une dimension de diffusion anormale. L'approche proposée dans ce chapitre s'attache à caractériser la réponse du réseau de fractures dans son ensemble, en intégrant l'effet des petites et des grandes fractures, ainsi que l'effet de la distribution des propriétés hydrauliques dans les zones fracturées. L'utilisation d'un tel modèle continu équivalent présente donc une alternative à l'approche de modélisation discrète pour prendre en compte l'hétérogénéité du milieu (*Day-Lewis et al.*, 2000).

Bien que cette approche permette une meilleure compréhension de l'organisation globale des écoulements, son utilisation pratique reste actuellement limitée. En particulier, la question des relations entre les deux exposants fractals, et de diffusion anormale, et les structures d'écoulement reste ouverte. Dans le cas général, l'interprétation de ces exposants est qualitative. Pour les réseaux au seuil de percolation, la diffusion anormale provient de propriétés géométriques du milieu. En revanche, pour les milieux continus multifractals qui ont une distribution de perméabilité avec des corrélations à longue portée, l'exposant de diffusion anormale est relié à l'évolution d'échelle locale de la perméabilité autour du puits (*de Dreuzy et al.*, 2004) (figure V.1). Pour les réseaux de fractures naturels ces exposants sont certainement reliés à la fois à des propriétés géométriques et hydrauliques.

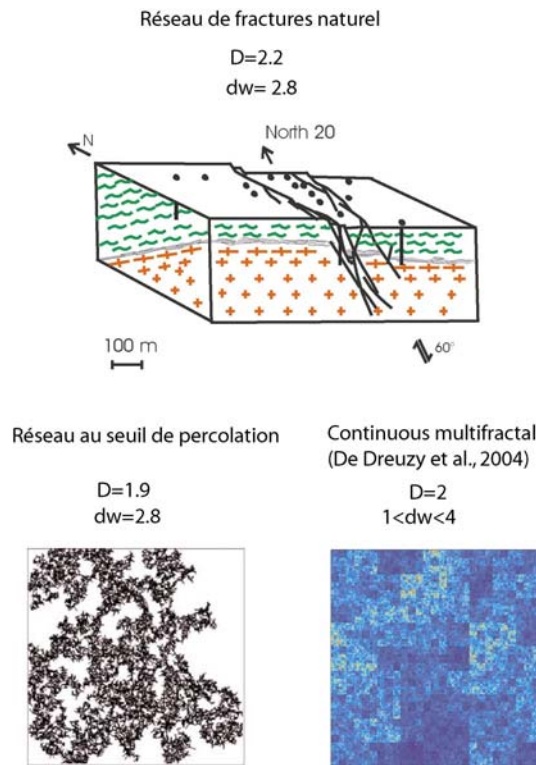

Figure V.1: milieu naturel et exposants associés et exemples de milieux types de référence et exposants associés.

Le chapitre III a été consacré au développement de la mesure *in situ* de la variabilité spatiale des écoulements à différentes échelles. Le site de Plœmeur, en milieu cristallin fracturé, instrumenté et équipé dans le cadre de l'Observatoire de Recherche en Environnement H+, a permis de tester les outils et méthodes de caractérisation. Afin d'imager les chemins d'écoulements et caractériser leur propriétés hydrauliques à différentes échelles, nous avons développé une méthode utilisant la mesure des écoulements verticaux en forage. Les expériences de débitmétrie en interférence sont basées sur l'idée qu'un changement de condition de pompage dans un aquifère entraîne une modification de la distribution spatiale des charges hydrauliques dans les chemins d'écoulement à grande échelle, ayant pour conséquence une variation des écoulements verticaux dans les forages d'observation (figure V.2.b). L'aspect original de l'approche est d'utiliser la mesure des écoulements verticaux en forage pour déduire l'évolution temporelle des charges hydrauliques dans chacune des zones d'écoulements présentes dans les forages. Cet aspect est très intéressant car cela permet d'obtenir le même type d'information que si l'on avait isolé toutes les zones d'écoulement dans les forages par des packers, ce qui représente une méthode beaucoup plus difficile à mettre en œuvre, voir impossible à utiliser lorsque les forages sont tubés. En revanche, la contrainte de cette méthode est que la conversion de la mesure de débit en charge hydraulique impose l'utilisation d'un modèle d'écoulement prenant en compte les interactions entre les zones d'écoulement à travers le forage. Nous avons proposé et testé un tel modèle (Le Borgne et al., in press).

Afin de tester jusqu'à quelles limites cette méthode permet de décrire l'hétérogénéité des sites, nous avons effectué des expériences de débitmétrie en forage unique et en interférence avec des distances de séparation de forages allant de 7 mètres à 150 mètres (*Le Borgne et al.*, soumis). Ces expériences nous ont permis d'imager sur le site de Plœmeur une structure à grande échelle qui rencontre la plupart des forages ainsi que celle de nombreuses structures secondaires moins bien connectées. Les estimations des propriétés hydrauliques obtenues sont cohérentes avec les estimations données par les diagraphies de débit à petite échelle et par les essais de pompage à grande échelle. En particulier, les estimations des propriétés hydrauliques des chemins d'écoulement préférentiels sont proches de celles obtenues par les essais de pompage à grande échelle, tandis que les estimations obtenues par les diagraphies de débit sont plus variables (figure V.2).

Les expériences de débitmétrie sur le site de Plœmeur montrent que (i) le site est caractérisé par une large gamme de propriétés hydrauliques, (ii) les zones de forte transmissivité sont connectées sur de longues distances. Ce type d'organisation des écoulements dans la subsurface, et en particulier la connectivité des zones perméables a un fort impact sur la valeur et la variabilité des estimations de perméabilité à différentes échelles. Sur le site de Plœmeur, la variabilité des estimations de transmissivité décroît avec l'échelle et la transmissivité converge vers les fortes valeurs de la distribution de transmissivité (figure V.2.c). De ce point de vue, le site de Plœmeur est un exemple illustrant les relations entre l'organisation des écoulements et l'évolution des propriétés hydrauliques avec l'échelle. La méthodologie que nous avons présentée pour interpréter les expériences de débitmétrie en condition d'interférence doit cependant être approfondie afin de mieux cerner les incertitudes et les possibilités d'identifier la géométrie des connexions.

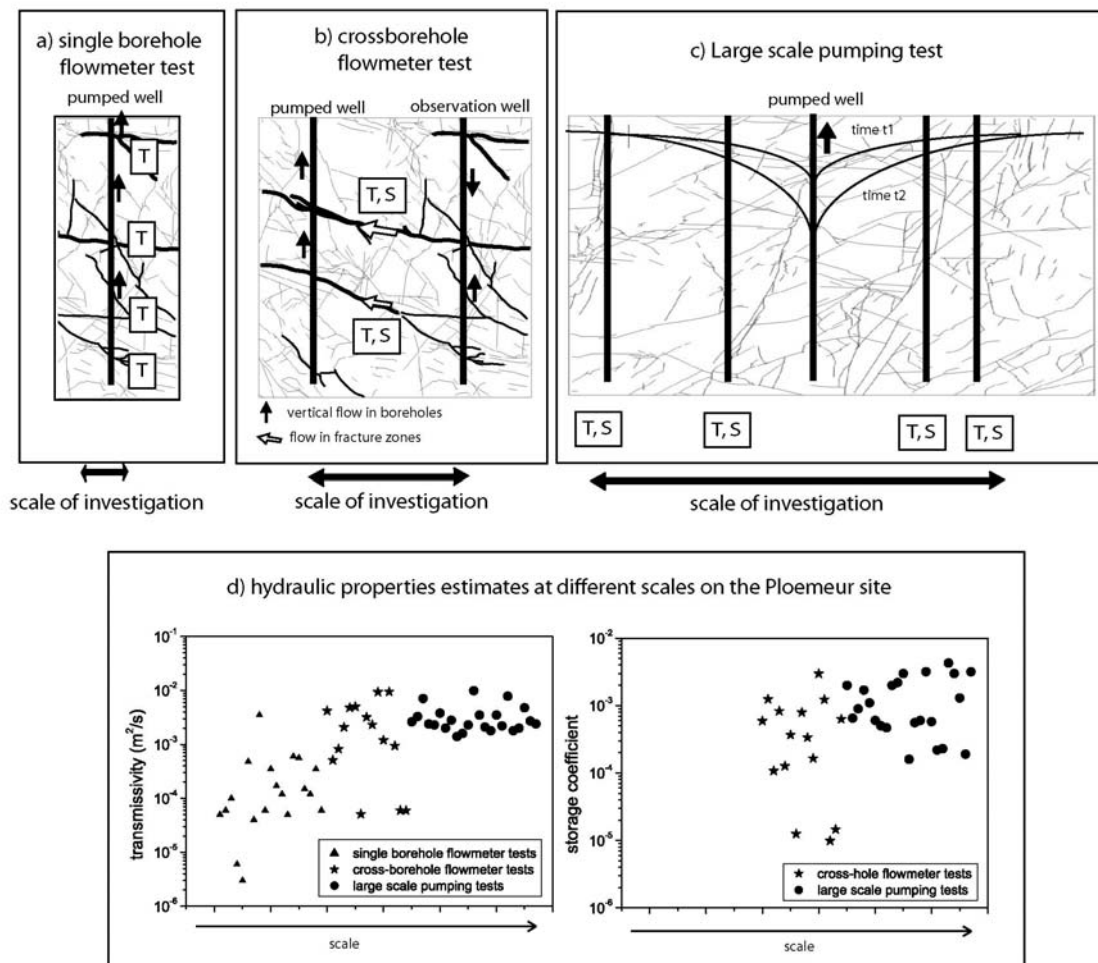

Figure V.2: Illustration schématique des méthodes de caractérisation utilisées à différentes échelles et estimations des propriétés hydrauliques sur le site de Plomeur à différentes échelles. D'après *Le Borgne et al.* (soumis).

Les expériences de débitmétrerie en mode d'interférence permettent une relativement bonne imagerie des chemins d'écoulement entre forages. Les méthodes de débitmétrerie donnent en particulier des informations essentielles pour échantillonner efficacement la chimie des zones d'écoulement ou pour préparer des expériences de traçage de forage à forage. Néanmoins, la connaissance des chemins d'écoulement en trois dimensions acquise par ces méthodes reste limitée et l'on est encore loin de pouvoir construire un modèle prédictif pour les transferts dans l'aquifère.

L'objectif de la dernière partie (chapitre IV) était de proposer des nouvelles méthodes permettant de quantifier l'organisation des écoulements en milieux poreux hétérogènes afin de la représenter de façon réaliste dans les modèles prédictifs de transfert d'éléments en solution. Il n'existe pas actuellement de méthode permettant de quantifier le fait que les vitesses d'écoulement lentes et rapides n'ont pas nécessairement la même organisation spatiale. Afin de caractériser ce type de propriété, nous avons étudié les distributions conditionnelles $P(v/v(t=0)=v_0)$ de vitesses d'écoulement simulées dans

des milieux poreux hétérogènes (figure V.3). Les distributions sont étudiées dans un cadre Lagrangien, c'est-à-dire le long des trajectoires de particules de soluté. L'évolution des distributions conditionnelles dépend de la corrélation des vitesses, qui représente le degré de similarité entre les vitesses d'écoulement rencontrées par une particule à deux instants différents.

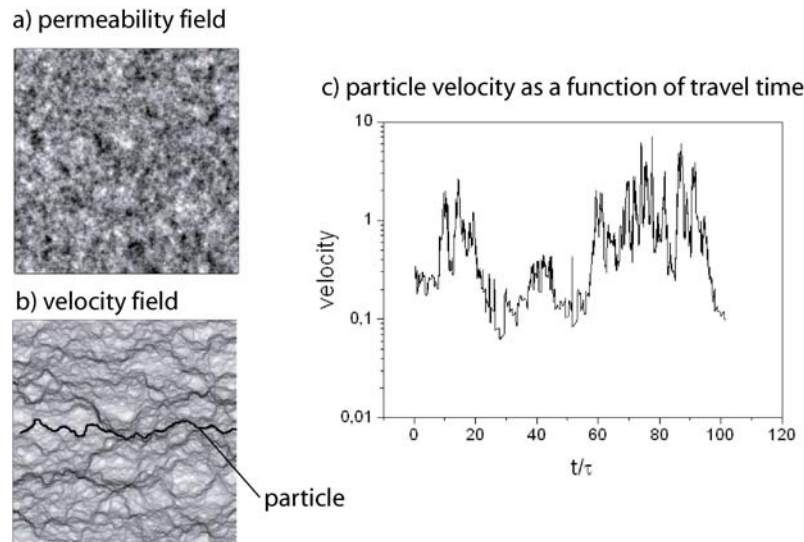

Figure V.3: a) exemple d'une réalisation de champ de perméabilité de distribution lognormale de taille $64\lambda \times 64\lambda$ b) champ de vitesse simulé et trajet d'une particule de soluté c) champ de vitesse échantillonné par la particule.

Nous avons montré que, pour des champs de vitesses simulés dans des champs de perméabilités hétérogènes, l'évolution des distributions conditionnelles dépend de la vitesse initial v_0 . Du fait que les distributions conditionnelles obtenues sont très asymétriques, leur évolution n'est pas bien décrite par leurs premiers moments ou par la covariance conditionnelle. Nous avons quantifié cette évolution par la moyenne des différences entre les distributions conditionnelles et la distribution finale à différents temps. Ceci permet de définir des temps et des distances de corrélation conditionnés par les vitesses initiales, afin de caractériser séparément l'organisation spatiale des faibles et fortes vitesses d'écoulement. La structure de corrélation des vitesses d'écoulement, notamment leur chenalisation, se traduit par (i) un accroissement des longueurs de corrélation en fonction de la vitesse initiale des particules, (ii) l'existence de corrélation temporelle à longue portée, qui traduit le fait que les particules se trouvant dans des chenaux de forte vitesse mettent un certain temps avant d'échantillonner la distribution totale des vitesses. Ces résultats permettront de remettre en question les hypothèses effectués dans les modèles théoriques de transport de soluté concernant la représentation de la structure de corrélation des vitesses.

A la suite de cette thèse, l'étude théorique du champ de vitesse se poursuivra afin de comprendre l'origine des relations obtenues entre la corrélation et la vitesse et de proposer des modèles de transport

adaptés. Dans le cadre d'une collaboration actuellement en cours avec J. Erhel (INRIA) et J-R. De Dreuzy (Géosciences Rennes), le transport de soluté sera plus précisément étudié sur des modèles numériques de taille plus afin de quantifier en fonction de l'hétérogénéité, le temps de convergence vers un modèle de transport Fickien et les paramètres de dispersion correspondants. L'objectif est de relier ces résultats aux caractéristiques du champ de vitesse mises en évidence dans ce travail.

D'autre part, le développement de nouveaux outils va permettre l'étude du champ de vitesse dans les sites naturels et en laboratoire. Un outil de mesure en forage est en cours de développement pour la mesure des écoulements horizontaux dans le cadre d'un projet impliquant Géosciences Rennes et la division technique de l'INSU. Le principe de l'outil est de filmer les particules fines présentes dans les eaux souterraines afin de caractériser directement le champ de vitesse. Des outils de ce type ont été développés mais la signification des mesures reste encore très incertaine (*Wilson et al.*, 1999). L'intérêt de ces développements est de pouvoir caractériser directement le champ de vitesse sans passer par un modèle de perméabilité. Le couplage de la mesure du champ de vitesse avec des essais de traçage paraît par exemple très intéressant. D'autre part, des méthodes de visualisation du champ de vitesse en milieu poreux sont également en cours de développement à Géosciences Rennes (DEA de Bruno Morel, 2004, encadré par J. De Brémond D'Ars). Le principe est de suivre le déplacement de particules à l'intérieur d'un milieu poreux transparent (*Moroni and Cushman*, 2001).

Bibliographie

- Ababou, R., D. McLaughlin, L. W. Gelhar, and A. F. B. Tompson (1989). Numerical simulation of three-dimensional saturated flow in randomly heterogeneous porous media. *Transport in Porous Media*, 4, 549-565.
- Acuna, J. A., and Y. C. Yortsos (1995). Application of fractal geometry to the study of networks of fractures and their pressure transient. *Water Resour. Res.*, 31, 527-540.
- Adams, A. E., and L. W. Gelhar (1992). Field study of dispersion in a heterogeneous aquifer, 2, spatial moments analysis. *Water Resour. Res.*, 28.
- Bangoy, L. M., P. Bidaux, C. Drogue, R. Plegat, and S. Pistre (1992). A new method of characterizing fissured media by pumping tests with observation wells. *J. of Hydrol.*, 138, 77-88.
- Barker, J. A. (1988). A generalized radial flow model for hydraulic tests in fractured rock. *Water Resour. Res.*, 24, 1796-1804.
- Barlebo, H. C., M. C. Hill, and D. Rosbjerg (2004). Investigating the Macrodispersion Experiment (MADE) site in Columbus, Mississippi, using a three-dimensional inverse flow and transport model. *Water Resour. Res.*, 40, doi:10.1029/2002WR001935.
- Becker, M. W., and A. M. Shapiro (2000). Tracer transport in fractured crystalline rock: evidence of non diffusive breakthrough tailing. *Water Resour. Res.*, 36, 1677-1686.
- Becker, M. W., and A. M. Shapiro (2003). Interpreting tracer breakthrough tailing from different forced-gradient tracer experiment configurations in fractured bedrock. *Water Resour. Res.*, 39, 1024, doi:10.1029/2001WR001190.
- Benson, D. A., R. Schumer, M. M. Meerschaert, and S. W. Wheatcraft (2001). Fractional dispersion, Lévy motion, and the MADE tracer tests. *Transport in Porous Media*, 42, 211-240.
- Benson, D. A., C. Tadjeran, M. M. Meerschaert, I. Farnham, and G. Pohl (submitted). Radial fractional-order dispersion through fractured rock. *Water Resour. Res.*
- Benson, D. A., S. W. Wheatcraft, and M. M. Meerschaert (2000). Application of a fractional advection-dispersion equation. *Water Resources Research*, 36, 1403-1412.
- Berkowitz, B., J. Klafter, R. Metzler, and H. Scher (2002). Physical pictures of transport in heterogeneous media: Advection-dispersion, random-walk, and fractional derivative formulations. *Water Resour. Res.*, 38, 1191, doi:10.1029/2001WR001030.
- Berkowitz, B., and H. Scher (1997). Anomalous transport in random fracture networks. *Physical Review Letters*, 79.
- Berkowitz, B., H. Scher, and S. Silliman (2000). Anomalous transport in laboratory-scale, heterogeneous porous media. *Water Resources Research*, 36.
- Besnard, K. (2003). Modélisation du transport réactif dans les milieux poreux hétérogènes. Application aux processus d'adsorption cinétique non linéaire. *Mémoires du CAREN*.
- Blumen, A., Zumofen, G., Klafter, J. (1989) Transport aspect in anomalous diffusion: Levy Walks. *Physical Review A*, 40 (7).
- Bonnet, E., O. Bour, N. Odling, I. Main, B. Berkowitz, P. Davy, and P. Cowie (2001). Scaling of Fracture Systems in Geological Media. *Rev. of Geophys.*, 39, 347-383.
- Bouchaud, J.-P., and A. Georges (1990). Anomalous diffusion in disordered media: statistical mechanism and physical applications. *Physics Report*, 195, 127-293.
- Bour, O., and P. Davy (1997). Connectivity of random fault networks following a power law fault length distribution. *Water Resources Research*, 33, 1567-1583.
- Bour, O., P. Davy, C. Darcel, and N. Odling (2002). A statistical scaling model for fracture network geometry, with validation on a multiscale mapping of a joint network (Hornelen Basin, Norway). *Journal of Geophysical Research*, 107.
- Bruderer-Weng, C., P. Cowie, Y. Bernabé, and I. Main Relating flow channelling to tracer dispersion in heterogeneous networks. *Advances in Water Resources*, In Press.
- Carrera, J. (1993). An overview of uncertainties in modelling groundwater solute transport. *Journal of Contaminant Hydrology*, 13, 23-48.
- Chang, J., and Y. C. Yortsos (1990). Pressure-transient analysis of fractal reservoirs. *SPE Form. Eval.*, 5, 631.
- Chin, D. A. (1997). An assessment of first-order stochastic dispersion theories in porous media. *Journal of hydrology*, 199, 53-73.
- Clauser, C. (1992). Permeability of crystalline rock. *Eos Trans. AGU*, 73, 237-238.

- Cortis, A., and B. Berkowitz (2004). Anomalous transport in "classical" soil and sand columns. *SOIL SCIENCE SOCIETY OF AMERICA JOURNAL*, 68, 1539-1548.
- Dagan, G. (1984). Solute transport in heterogeneous porous formations. *J. Fluid Mech.*, 145, 151-177.
- Dagan, G. (1989). *Flow and Transport in Porous Formations*. Springer Verlag.
- Darcel, C. (2002). Correlations dans les réseaux de fractures: caractérisation et conséquences sur les propriétés hydrauliques. Université de Rennes 1, Rennes.
- Darcel, C., O. Bour, and P. Davy (2003). Connectivity properties of 2D fracture networks with stochastic fractal correlation. *Water Resources Research*, submitted.
- Davy, P. (1993). On the frequency-length distribution of the San Andreas fault system. *Journal of Geophysical Research*, 98, 12,141-112,151.
- Day-Lewis, F. D., P. A. Hsieh, and S. M. Gorelick (2000). Identifying fracture-zone geometry using simulated annealing and hydraulic connection data. *Water Resour. Res.*, 36, 1701-1721.
- Day-Lewis, F. D., J. W. Lane, J. M. Harris, and S. M. Gorelick (2003). Time-lapse imaging of saline-tracer transport in fractured rock using difference-attenuation radar tomography. *Water Resour. Res.*, 39, 1290, doi:10.1029/2002WR001722.
- de Dreuzy, J. R. 1999. Analyse des propriétés hydrauliques des réseaux de fractures. Discussion des modèles compatibles avec les principales propriétés géométriques. Université de Rennes 1.
- de Dreuzy, J. R., C. Darcel, P. Davy, and O. Bour (2004a). Influence of spatial correlation of fracture centers on the permeability of two-dimensional fracture networks following a power law length distribution. *Water Resour. Res.*, 40, doi:10.1029/2003WR002260.
- de Dreuzy, J. R., P. Davy, and O. Bour (2001). Hydraulic properties of two-dimensional random fracture networks following a power law length distribution: 2-Permeability of networks based on log-normal distribution of apertures. *Water Resources Research*, 37, 2079.
- de Dreuzy, J. R., P. Davy, J. Erhel, and J. de Brémond d'Ars (2004b). Anomalous diffusion exponents in continuous two-dimensional multifractal media. *Physical Review E*, 70.
- de Marsily, G. 1986. *Quantitative Hydrogeology: Groundwater Hydrology for Engineers*. Academic Press, Orlando, FL.
- Delay, F., and J. Bodin (2001). Time domain random walk to simulate transport by advection, dispersion and matrix diffusion in fracture networks. *Geophysical Research Letters*, 28, 4051-4054.
- Dentz, M., and B. Berkowitz (2003). Transport behavior of a passive solute in continuous time random walks and multirate mass transfer. *Water Resour. Res.*, 39, 1111, doi:10.1029/2001WR001163.
- Dentz, M., H. Kinzelbach, S. Attinger, and W. Kinzelbach (2003). Numerical studies of the transport behavior of a passive solute in a two-dimensional incompressible random flow field. *Phys. Rev. E*, 67.
- Eggleston, J. R., and S. A. Rojstaczer (2000). Can we predict subsurface mass transport? *Environ. Sci. Technol.*, 34, 4010-4017.
- Feehley, C. E., C. Zheng, and F. J. Molz (2000). A dual-domain mass transfer approach for modeling solute transport in heterogeneous aquifers: application to the Macrodispersion Experiment (MADE) site. *Water Resour. Res.*, 36, 2501-2514.
- Freyberg, D. L. (1986). A natural gradient experiment on solute transport in a sand aquifer, 2, spatial moments and the advection and dispersion of nonreactive tracers. *Water Resour. Res.*, 22, 2031-2046.
- Gaisheng, L., C. Zheng, and S.M. Gorelick (2004). Limits of applicability of the advection-dispersion model in aquifers containing connected high-conductivity channels, *Water Resources Research*, Vol. 40, W08308, 2003WR002735, 1-19.
- Gelhar, L. W. 1993. *Stochastic Subsurface Hydrology*, Engelwood Cliffs, New Jersey.
- Gelhar, L. W., C. Welty, and K. R. Rehfeldt (1992). A critical review of data on field-scale dispersion in aquifers. *Water Resour. Res.*, 28, 1955-1974.
- Gomez-Hernandez, J. J., and X.-H. Wen (1998). To be or not to be multi-Gaussian? A reflection on stochastic hydrogeology. *Advances in Water Resources*, 21, 47-61.
- Gorelick, S.M., G. Liu, and C. Zheng (in press). Quantifying mass transfer in permeable media containing conductive dendritic networks, *Geophysical Research Letters*

- Haggerty, R. S., S. W. Fleming, L. C. Meigs, and S. A. McKenna (2001). Tracer tests in a fractured dolomite 2. Analysis of mass transfer in single-well injection-withdrawal tests. *Water Resour. Res.*, 37, 1129-1142.
- Haggerty, R. S., and S. M. Gorelick (1995). Multiple-rate mass transfer for modeling diffusion and surface reactions in media with pore-scale heterogeneity. *Water Resour. Res.*, 31, 2383-2400, doi:10.1029/95WR01583.
- Haggerty, R. S., C. F. Harvey, C. Freiherr von Schwerin, and L. C. Meigs (2004). What controls the apparent timescale of solute mass transfer in aquifers and soils ? A comparison of experimental results. *Water Resour. Res.*, 40, doi:10.1029/2002WR001716.
- Haggerty, R. S., S. A. McKenna, and L. C. Meigs (2000). On the late-time behavior of tracer test breakthrough curves. *Water Resour. Res.*, 36, 3467-3479.
- Halvin, S., and D. Ben-Avraham (1987). Diffusion in disordered media. *Adv. in Phys.*, 36, 695-798.
- Hamm, S.-Y., and P. Bidaux (1996). Dual-porosity fractal models for transient flow analysis in fissured rocks. *Water Resour. Res.*, 32, 2733-2745.
- Harvey, C. F., and S. M. Gorelick (2000). Rate-limited mass transfer or macrodispersion: Which dominates the plume evolution at the Macrodispersion Experiment (MADE) site ? *Water Resour. Res.*, 36, 637-650.
- Hess, A., E. and F. Paillet, L Application of the thermal-pulse flowmeter in the hydraulic characterization of fractured rocks. *geophysical applications for geotechnical investigations.*
- Hess, A. E. (1986). Identifying hydraulically conductive fractures with a slow velocity borehole flowmeter. *Can. Geotech. J.*, 23, 69-78.
- Hess, K. M., W. S. H., and M. A. Celis (1992). Large scale natural gradient tracer testing sand and gravel Cape Cod, Massachusetts. 3. Hydraulic conductivity variability and calculated macrodispersivities. *Water Resources Research*, 29, 2011-2027.
- Hsieh, P. A. 1998. Scale effects in fluid flow through fractured geological media. Pages 335-353 in *Scale dependence and scale invariance in hydrology.* Cambridge University Press.
- Hsieh, P. A., A. M. Shapiro, and C. R. Tiedeman (1999). Computer simulation of fluid flow in fractured rocks at the Mirror Lake FSE well field. Morganwalp D W, Buxton H T (eds) U.S. Geological Survey Toxic Substances Hydrology Program--Proceedings of the Technical Meeting, Charleston, South Carolina, March 8-12, 1999--Volume 3 of 3--Subsurface Contamination from Point Sources: U.S. Geological Survey Water-Resources Investigations Report 99-4018C:777-781.
- Kinzelbach, W. (1988). The random walk method in pollutant transport simulation. D. Reidel, Hinghal, Mass., *Ground water Flow and Quality modelling*, edited by E. Custodio, A. Gurgui, and J. P. Lobo Ferreira, 227-246.
- Le Borgne, T., O. Bour, J.-R. De Dreuzy, P. Davy, and F. Touchard (2004). Equivalent mean flow models for fractured aquifers: Insights from a pumping tests scaling interpretation. *Water Resources Research*, 40, doi:10.1029/2003WR002436.
- Le Borgne, T., F. Paillet, L, and O. Bour (in press). Cross borehole flowmeter tests for transient heads in heterogeneous aquifers. *Ground Water.*
- Le Borgne, T., O. Bour, and F. Paillet, L (soumis). Small scale and large scale hydraulic properties estimates from flowmeter tests in a fractured aquifer. *Journal of Hydrology.*
- Le Borgne, T., J.-R. De Dreuzy, P. Davy, and O. Bour (en préparation). Describing the velocity field organization in heterogeneous media by conditional correlations.
- Leveinen, J. (2000). Composite model with fractional flow dimensions for well test analysis in fractured rocks. *J. of Hydrol.*, 234, 116-141, 7/1.
- Levy, M., and B. Berkowitz (2003). Measurement and analysis of non-Fickian dispersion in heterogeneous porous media. *Journal of Contaminant Hydrology*, 64, 203-226.
- Lundgren, T. S., and Y. B. Pointin (1975). Turbulent self-diffusion. *Phys. Fluids*, 19, 355-361.
- Matheron, G., and G. de Marsily (1980). Is transport in porous media always diffusive ? A counterexample. *Water Resources Research*, 16.
- McKenna, S. A., L. C. Meigs, and R. S. Haggerty (2001). Tracer tests in a fractured dolomite 3. double porosity, multiple-rate mass transfer processes in convergent flow tracer tests. *Water Resour. Res.*, 37, 1143-1154.

- Meier, P. M., A. Medina, and J. Carrera (2001). Geostatistical inversion of cross-hole pumping tests for identifying preferential flow channels within a shear zone. *Ground Water*, 39, 10-17.
- Meigs, L. C., and R. L. Beauheim (2001). Tracer tests in a fractured dolomite 1. Experimental design and observed tracer recoveries. *Water Resour. Res.*, 37, 1113-1128.
- Metzler, R., and J. Klafter (2000). The random walk's guide to anomalous diffusion: a fractional dynamics approach. *Physics Reports*, 339, 1-77.
- Molz, F. J., R. H. Morin, A. E. Hess, J. G. Melville, and O. Güven (1989). The impeller meter for measuring aquifer permeability variations: evaluation and comparison with other tests. *Water Resour. Res.*, 25, 1677-1683.
- Montroll, E. W., and G. H. Weiss (1965). *J. Math. Phys.*, 6, 167.
- Moreno, L., and C.-F. Tsang (1994). Flow channeling in strongly heterogeneous porous media: A numerical study. *Water Resources Research*, 30, 1421-1430.
- Moreno, L., Y. W. Tsang, C.-F. Tsang, F. V. Hale, and I. Neretnieks (1990). Some anomalous features of flow and solute transport arising from fracture aperture variability. *Water Resour. Res.*, 26, 2377-2391.
- Moroni, M., and J. H. Cushman (2001). Three-dimensional particle tracking velocimetry studies of the transition from pore dispersion to Fickian dispersion for homogeneous porous media. *Water Resources Research*, 37, 873-884.
- Nakao, S., J. Najita, and K. Karaski (2000). Hydraulic well testing inversion for modeling fluid flow in fractured rocks using simulated annealing: a case study at Raymond field site, California. *J. of Applied Geophys.*, 45, 203-223.
- National Research Council. 1996. *Rock Fractures and Fluid Flow*. National Academy Press, Washington, D.C.
- Neuman, S. P. (1990). Universal Scaling of Hydraulic Conductivities and Dispersivities in Geologic Media. *Water Resources Research*, 26, 1749-1758.
- Odling, N. E. (1997). Scaling and connectivity of joint systems in sandstones from western Norway. *Journal of Structural Geology*, 19, 1257-1271.
- Olsson, O. (1992). Site characterization and validation. Final Report, Stripa Project 92-22, Conterra AB, Uppsala, Sweden.
- O'Shaughnessy, B., and I. Procaccia (1985). Diffusion on fractals. *Phys. rev. A*, 32.
- Paillet, F. L. (1993). Using Borehole Geophysics and Cross-Borehole Flow Testing to Define Hydraulic Connections Between Fracture-Zones in Bedrock Aquifers. *J. of Applied Geophys.*, 30, 261-279.
- Paillet, F. L. (1996). High-Resolution Flowmeter Logging Applications with the Heat-Pulse Flowmeter. *J. of Env. Eng. Geophys.*, 1, 1-11.
- Paillet, F. L. (1998). Flow modeling and permeability estimation using borehole flow logs in heterogeneous fractured formations. *Water Resour. Res.*, 34, 997-1010.
- Paillet, F. L. (2000). A field technique for estimating aquifer parameters using flow log data. *Ground Water*, 38, 510-521.
- Paillet, F. L. (2001). Hydraulic head applications of flow logs in the study of heterogeneous aquifers. *Ground Water*, 39, 667-675.
- Paillet, F. L. (2004). Borehole flowmeter applications in irregular and large-diameter boreholes. *J. Appl. Geophys.*, 55, 39-59.
- Paillet, F. L., and R. E. Crowder (1996). A generalized approach for the interpretation of geophysical well logs in ground-water studies - Theory and application. *Ground Water*, 34, 883-898.
- Paillet, F. L., A. E. Hess, C. H. Cheng, and E. Hardin (1987). Characterization of Fracture Permeability With High-Resolution Vertical Flow Measurements During Borehole Pumping. *Ground Water*, 25, 28-40.
- Pollock, D. W. (1988). Semianalytical computation of path lines for finite-difference models. *Ground water*, 26, 743-750.
- Rehfeldt, K. R., J. M. Boggs, and L. W. Gelhar (1992). Field study of dispersion in a heterogeneous aquifer, 3, geostatistical analysis of hydraulic conductivity. *Water Resour. Res.*, 28, 3309-3324, doi:10.1029/92WR01758.
- Rouhiainen, P. (2000). difference flow measurements in borehole KLX02 at Laxemar. posiva.

- Ruan, F., and D. McLaughlin (1998). An efficient multivariate random field generator using the Fourier transform. *Advances in Water Resources*, 21, 385-399.
- Rubin, Y. (1990). Stochastic modeling of macrodispersion in heterogeneous porous media. *Water Resources Research*, 26, 133-141.
- Sahimi, M. 1995. *Flow and Transport in Porous Media and Fractured Rock*. Weinheim.
- Salandin, P., and V. Fiorotto (1998). Solute transport in highly heterogeneous aquifers. *Water Resources Research*, 34, 949-961.
- Sanchez-Vila, X., and J. Carrera (2004). On the striking similarity between the moments of breakthrough curves for a heterogeneous medium and a homogeneous medium with a matrix diffusion term. *Journal of hydrology*, 294, 164-175.
- Schlesinger, M. F., J. Klafter, and Y. M. Wong (1982). Random walks with infinite spatial and temporal moments. *J. Stat. Phys.*, 27, 499-512.
- Shapiro, A. M., and P. A. Hsieh (1998). How good are estimates of transmissivity from slug tests in fractured rocks. *Ground Water*, 36.
- Stauffer, D., and A. Aharony. 1992. *Introduction to percolation theory*, second edition. Taylor and Francis, Bristol.
- Stöhr, M., K. Roth, and B. Jähne (2003). Measurement of 3D pore-scale flow in index-matched porous media. *Experiments in Fluids*, 35, 159-166, doi:10-1007/s00348-003-0641-x.
- Sudicky, E. A. (1986). A natural gradient experiment on solute transport in a sand aquifer: Spatial variability of hydraulic conductivity and its role in the dispersion process. *Water Resour. Res.*, 22, 2069-2082.
- Tiedeman, C. R., D. J. Goode, and P. A. Hsieh (1998). Characterizing a groundwater basin in a New England mountain and valley terrain. *Ground Water*, 36, 611-620.
- Tiedeman, C. R., and P. A. Hsieh (2004). Evaluation of longitudinal dispersivity estimates from simulated forced- and natural-gradient tracer tests in heterogeneous aquifers..
- Tompson, A. F. B., and L. W. Gelhar (1990). Numerical Simulation of Solute Transport in Three-Dimensional Randomly Heterogeneous Porous Media. *Water Resources Research*, 26, 2541-2562.
- Touchard, F. 1999. *Caractérisation hydrologique d'un aquifère en socle fracturé*, Ph.D. thesis, Rennes, France.
- Tsang, C.-F., and C. Doughty (2003). Multirate flowing fluid electric conductivity logging method. *Water Resour. Res.*, 39, 1354, doi:10.1029/2003WR002308.
- Tsang, C.-F., and I. Neretnieks (1998). Flow Channeling in Heterogeneous Fractured Rocks. *Reviews of Geophysics*, 36, 257-298.
- Williams, J. H., and F. L. Paillet (2002). Using flowmeter pulse tests to define hydraulic connections in the subsurface: a fractured shale example. *J. of Hydrol.*, 265, 100-117, 8/30.
- Wilson, J. T., W. A. Mandell, F. Paillet, L. E. R. Bayless, R. T. Hanson, P. M. Kearl, W. B. Kerfoot, M. W. Newhouse, and W. Pedler (1999). An evaluation of borehole flowmeters used to measure horizontal ground-water flow in limestones of Indiana, Kentucky, and Tennessee. *USGS Water-Resources Investigations Report 01-4139*.
- Winberg, A., P. Andersson, J. Hermanson, J. Byegård, V. Cvetkovic, and L. Birgersson (2000). *Äspö Hard Rock Laboratory. Final report of the first stage of the Tracer Retention Understanding Experiments*. SKB TR-00-07, Swedish Nuclear Fuel and Waste Management.
- Zheng, C. and S. M. Gorelick (2003). Analysis of solute transport in flow fields influenced by preferential flowpaths at the decimeter scale, *Ground Water*, vol. 41, No. 2, p. 142-155.
- Zinn, B., and C. F. Harvey (2003). When good statistical models of aquifer heterogeneity go bad: A comparison of flow, dispersion, and mass transfer in connected and multivariate Gaussian hydraulic conductivity fields. *Water Resources Research*, 39, 1051, doi:10.1029/2001WR001146
- Zlotnik, V. A., and B. R. Zurbuchen (2003). Field study of hydraulic conductivity in a heterogeneous aquifer: comparison of single-borehole measurements using different instruments. *Water Resour. Res.*, 39, 1101, doi:10.1029/2002WR001415.