



HAL
open science

Caractérisation expérimentale des émissions de pesticides vers l'air pendant les pulvérisations viticoles

Yvan Gil

► **To cite this version:**

Yvan Gil. Caractérisation expérimentale des émissions de pesticides vers l'air pendant les pulvérisations viticoles. Génie des procédés. Ecole nationale supérieure agronomique de Montpellier - AGRO M, 2007. Français. NNT : . tel-00129376

HAL Id: tel-00129376

<https://theses.hal.science/tel-00129376>

Submitted on 7 Feb 2007

HAL is a multi-disciplinary open access archive for the deposit and dissemination of scientific research documents, whether they are published or not. The documents may come from teaching and research institutions in France or abroad, or from public or private research centers.

L'archive ouverte pluridisciplinaire **HAL**, est destinée au dépôt et à la diffusion de documents scientifiques de niveau recherche, publiés ou non, émanant des établissements d'enseignement et de recherche français ou étrangers, des laboratoires publics ou privés.

Montpellier SupAgro
Centre International d'Études Supérieures en Sciences Agronomiques

École Doctorale
Sciences des Procédés - Sciences des Aliments

Doctorat en Génie des Procédés

Thèse présentée par

Yvan GIL

Pour obtenir le diplôme de
Docteur du Centre International d'Études Supérieures en Sciences
Agronomiques

*Caractérisation expérimentale des
émissions de pesticides vers l'air pendant
les pulvérisations viticoles*

Présentée et soutenue publiquement le 5 février 2007

Avant le jury

Henri WORTHAM	Professeur, Université de Provence, Marseille	Rapporteur
Michel CLÉMENT	Directeur de Recherche, ENSP, Rennes	Rapporteur
Véronique BELLON-MAUREL	Professeur, Montpellier SupAgro	Examineur
Yves BRUNET	Directeur de Recherche, INRA, Bordeaux	Examineur
Carole SINFORT	Maître de Conférence, Montpellier SupAgro	Examineur
Bijan MOHAMMADI	Professeur, Université de Montpellier II	Examineur
Aurélien GOUZY	Ingénieur d'Études et de Recherche, INERIS	Invité

Remerciements

De nombreuses personnes ont contribué, d'une manière ou d'une autre, à ce projet. Je voudrais tout d'abord remercier Carole Sinfort, qui a accepté de guider ce travail, elle m'a encouragé à combiner les instruments de diverses disciplines, et m'a offert de précieux conseils dans toutes les phases du travail, en plus elle a démontré une patience extraordinaire pendant mon processus d'apprentissage.

Les conseils scientifiques fournis par mon comité de thèse ont été la clé pour finir le travail avec succès. La direction de la thèse menée par Véronique Bellon-Maurel, directrice de la thèse et les apports aussi précieux de Bernard Bonicelli et Ariane Vallet ont donné beaucoup d'originalité à notre recherche.

Je mentionne avec plaisir la contribution intellectuelle de Yves Brunet, qui m'a beaucoup aidé dans les aspects de la compréhension des phénomènes atmosphériques et ainsi que dans les techniques de rédaction scientifique.

Je remercie Serge Guillaume et Bernard Palagos par leurs contributions dans les analyses de données et l'utilisation des systèmes d'inférence floue et des outils statistiques.

Je voudrais aussi rendre hommage à la contribution du Groupe Expérimentations-Prototypage de l'Unité Mixte de Recherche ITAP, de même qu'aux personnes qui ont donné si généreusement de leur temps pour les essais sur le terrain : Xavier Ribeyrolles, Gérard Diouloufet, Daniel Virgile, Hélène Fonta, Paul Oullier et Gérard Alvarez. Sans leur aide, sans eux, cette thèse n'aurait pas pu être effectuée de manière satisfaisante. Ces remerciements vont également à Bernadette Ruelle, animatrice de l'Equipe « Technologies et Equipements » et collaboratrice dans tous les aspects théoriques et bien sur pratiques de ce travail expérimental.

Je remercie Jean-Marc Brun, thésard de l'unité et compagnon de bureau pour ses apports au dernière chapitre de la thèse sur la modélisation mathématique des émissions de pesticides.

Je tiens de plus à remercier Philippe Roux et Vincent Polvêche pour leurs contributions dans plusieurs aspects sur les procédures pratiques et de mise en place de tout le dispositif pour l'expérimentation sur le terrain. Mes remerciements vont également à Albert Oliosio (INRA, Avignon) et Pierre-Yves Colin (Cemagref, Aix-en-Provence) qui ont apporté l'équipement pour la mesure des conditions météorologique dans les différentes étapes du travail.

Je remercie la Société Berthoud qui nous a prêté le pulvérisateur utilisé pendant les deux années d'expérimentations.

Ce projet a été supporté par le CDCH de la Universidad Central de Venezuela et par le programme Alban (Programme de l'Union européenne des Bourses de Haut Niveau pour Étudiants de l'Amérique Latine. Numéro d'identification E03D18224VE).

Mes pensées vont finalement à ma famille et mes amis, tout particulièrement à Carolina qui m'a accompagné et encouragé pendant ces trois années de découverte.

Table des matières

Remerciements	ii
Table des figures	iv
Préambule	vi
1 Introduction	1
1.1 Utilisation des pesticides dans l'agriculture	1
1.2 Techniques d'application de produits phytosanitaires	3
1.2.1 Types d'appareils	3
1.2.2 Formation de gouttes	4
1.2.3 Contexte de l'application des pesticides	5
1.3 Pesticides dans l'environnement	7
1.4 Objectifs de la thèse	9
2 Etat de l'art	11
2.1 Généralités	11
2.2 Description de la revue bibliographique	12
2.2.1 Influence des facteurs environnementaux sur le jet pulvérisé	12
2.2.2 Techniques pour mesurer les émissions vers l'atmosphère	12
2.2.3 Modélisation des émissions de pesticides	12
Article : Emission of pesticides to the air during sprayer application : A bibliographic review	13
2.3 Conclusions et perspectives	24
3 Méthodologie	25
3.1 Généralités	25
3.2 Efficacité des capteurs passifs	26
3.2.1 Aspects théoriques	26
3.2.2 Détermination expérimentale	28
3.2.3 Résultats	29
3.3 Détermination de pertes atmosphériques sur le terrain : Description du matériel	30
3.4 Détermination des variables micro-climatiques	31

3.4.1	Transport horizontal	32
3.4.2	Transport vertical	32
3.5	Description des essais	35
	Article : Atmospheric losses of pesticides above an artificial vineyard during air-assisted spraying	36
3.6	Conclusions et perspectives	49
4	Analyses des mesures expérimentales	51
4.1	Analyses Préliminaires	51
4.1.1	Analyses en Composantes Principales (ACP)	52
4.1.2	Méthodologie de Surface de Réponse (MSR)	52
4.2	Description des analyses	53
	Article : Influence of microclimatic factors on pesticide emission to the air during spraying : Analysis with statistical and fuzzy inference models	55
4.3	Conclusions et perspectives	79
5	Comparaison avec un modèle mathématique	81
5.1	Généralités	81
5.2	Principes du modèle DriftX	81
5.3	Paramétrisation du modèle DriftX	82
5.4	Description de l'étude	82
	Article : Comparison between experimental and modelling approaches to evaluate pesticide air pollution source during vineyard spraying	84
5.5	Conclusions et perspectives	102
6	Conclusions Générales	103
6.1	Etude Bibliographique	104
6.2	Mise en place d'une méthode expérimentale de mesure au champ	104
6.3	Valorisation de la base de données : Étude de la influence des variables micro-climatiques	105
6.4	Valorisation de la base de données : Validation du modèle DriftX	106
6.5	Perspectives	106
	Bibliographie	108
	Résumé	111
	Abstract	111

Table des figures

1.1	Consommation de pesticides en France par type de matière active, années 1996-2003. Source : UIPP (2006)	2
1.2	Formation de gouttelettes à partir du fractionnement d'une nappe de liquide produite par pression de liquide dans les processus de pulvérisation. Source : Ben et al. (2004)	5
1.3	Exemple de pulvérisateur à rampe utilisé en grandes cultures	6
1.4	Schéma des principaux types de pulvérisateurs utilisés en arbo-viticulture : A) pulvérisateur axial ; B) pulvérisateur tangentiel ; C) pulvérisateur radial avec les sorties d'air réglables. Source : Swiechowski et al. (2004)	7
1.5	Principaux facteurs affectant les pertes de pesticides dans l'activité agricole. Source Wilson (2003)	8
3.1	Fil de 2 mm de diamètre utilisé comme capteur du jet d'une solution de traceur fluorescent. Source : Roux et al. (2007)	26
3.2	Soufflerie expérimentale du Cemagref	28
3.3	Configuration des essais dans la soufflerie	29
3.4	Efficacité du collecteur estimée par différents modèles	30
3.5	Pulvérisateur à jet porté utilisé dans les essais	31
3.6	Disposition du système de simulation de la végétation pendant une application expérimentale	32
3.7	Anémomètre pour l'enregistrement de la température et des 3 composantes de vitesse du vent	33
3.8	Série de données acquises par l'anémomètre pendant 20 minutes de mesures. Composantes du vitesse du vent u, v et w et température de l'air, T	33
3.9	Variation de volume d'une goutte d'un diamètre initial de 28 μm pour plusieurs différences psychrométriques (ΔT). Distance parcourue par la goutte avant évaporation totale pour une vitesse d'éjection initiale de 12.8 $m.s^{-1}$	50
4.1	Analyses en Composantes Principales : effets des conditions micro-climatiques sur les pertes (%) pour les deux spectres de taille de gouttes	52
4.2	Surface de réponse des pertes de produit (%) pendant les applications : Effets des variations de vitesse du vent et de température de l'air pour les deux spectres de taille de gouttes. Différence psychrométrique, $\Delta T=5^\circ C$ et paramètre de stabilité, $z/L=0$	54

Préambule

Ce manuscrit présente une thèse sur travaux. Il est constitué de chapitres construits autour de quatre articles scientifiques soumis à des journaux internationaux avec comité de lecture. Dans chaque chapitre l'article est présenté et discuté dans le contexte général de la thèse. Cette thèse a été à l'origine des communications scientifiques suivantes :

Articles de revues scientifiques à comité de lecture

- Gil, Y., Sinfort, C., 2005. Emission of pesticides to the air during sprayer application : A bibliographic review. *Atmospheric Environment* 39, 5183-5193.
- Gil, Y., Sinfort, C., Brunet, Y., Polveche, V. and Bonicelli, B., 2007. Atmospheric losses of pesticides above an artificial vineyard during air-assisted spraying. *Atmospheric Environment*. In Press.
- Gil, Y., Sinfort, C., Guillaume S., Brunet, Y., Palagos, B. V. and Bellon-Maurel, V., 2007. Influence of microclimatic factors on pesticide emission to the air during spraying : Analysis with statistical and fuzzy inference models. Submitted to *Environment International*.
- Brun, J.M., Gil, Y., Sinfort, C., Mohammadi B., 2007. Comparison between experimental and modelling approaches to evaluate pesticide air pollution source during vineyard spraying. Submitted to *Computers and Electronic in the Agriculture*.

Conférences

- Gil, Y ; Sinfort, C ; Bonicelli, B. Spray drift collector efficiency : Assessment of 2 mm diameter PVC line in a wind tunnel. 8th Workshop on Spray Application Techniques In Fruit Growing. Barcelona, Espagne. 2005.
- Gil, Y ; Sinfort, C ; Bonicelli, B ; Bellon-Maurel, V ; Vallet, A. Methodology for assessment of drift from radial sprayers in vineyard applications. Frutic05 - Information and Technology for Sustainable Fruit and Vegetable Production, Montpellier, France. 2005.
- Gil, Y., Sinfort, C., Brunet, Y., Polveche, V., Bonicelli, B. Measure of Pesticide Losses to the Atmosphere During Vine Spraying. Séminaire international sur l'efficacité de la mécanisation agricole et son impact sur l'environnement, Hammamet (Tunisie) 2005.
- Gil, Y., Sinfort, C., Brunet, Y., Palagos, B., Bonicelli, B. Study on response surface methodology (RSM) of pesticide emission to the air during an air-assisted sprayer application. CIGR 2006 World Congress, Bonn Germany.

Chapitre 1

Introduction Générale

L'emploi de pesticides agricoles, essentiellement constitués de produits chimiques organiques, est une des conséquences de l'augmentation de la demande d'aliments, laquelle nécessite une lutte efficace contre les divers types de ravageurs ainsi que le maintien de rendements élevés. La relation entre les doses de pesticides appliquées et les risques potentiels, particulièrement sur la santé humaine et l'environnement, ont questionné la communauté scientifique et la société en général, au-delà de l'impact de la présence de résidus sur les aliments.

Les pesticides peuvent être rémanents, mobiles et toxiques dans le sol et l'air avec d'éventuelles conséquences négatives sur la santé humaine et le fonctionnement des écosystèmes. Ainsi, dans l'objectif d'une exploitation agricole durable en termes environnemental, économique et social, la bonne gestion des traitements phytosanitaires est devenue une exigence pour les agriculteurs et les diverses sociétés de production de produits phytosanitaires et de fabrication de machines agricoles.

1.1 Utilisation des pesticides dans l'agriculture

Toutes les tentatives de soutien pour un changement des pratiques en matière de pesticides se heurtent en premier lieu à la complexité de la collecte de données et à l'interprétation des statistiques sur l'utilisation des produits phytosanitaires ([Wilson, 2003](#)).

Les données sur l'emploi de pesticides sont généralement tirées des ventes et exprimées en tonnes d'ingrédients actifs. Toutefois, l'utilisation réelle de produits pour une année donnée peut différer des chiffres de vente du fait des stockages ou déstockages effectués par les utilisateurs ainsi que des exportations ou importations vers d'autres pays ([Aubertot et al., 2006](#)). Les données quantitatives sur l'emploi des pesticides ne sont disponibles qu'auprès des sources internationales de certains pays et limitées aux principaux types de pesticides.

Les produits phytosanitaires comprennent principalement les insecticides, les herbicides, les fongicides et les régulateurs de croissance. Dans plusieurs rapports, la consommation mondiale de pesticides pendant les dernières années a été calculée entre 2 et 3

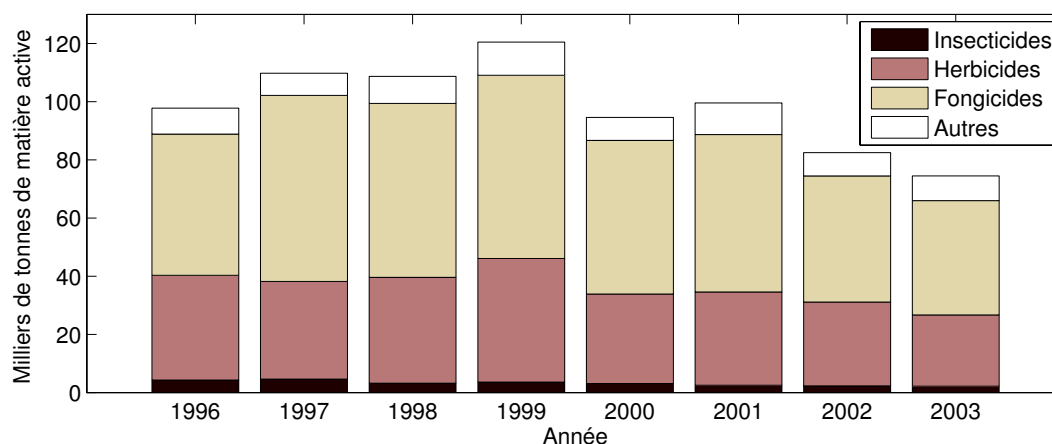

FIG. 1.1 – Consommation de pesticides en France par type de matière active, années 1996-2003. Source : UIPP (2006)

millions de tonnes dont 500 000 sont utilisées par la production agricole européenne (Candela, 2003).

D'après les données de l'UIPP¹ près de 75 000 tonnes de produits phytosanitaires ont été vendues en 2003 sur le marché français, ce qui place ce pays comme le consommateur le plus important de l'Europe.

Les produits actuellement utilisés en France sont commercialisés sous forme de 6000 préparations issues d'environ 400 matières actives, auxquelles sont associés des adjuvants. La figure 1.1 montre la répartition des pesticides consommés par type de matière active.

Dans ce schéma, la domination des fongicides est due aux grandes quantités de sulfure utilisées. Ils représentent en effet 53% du total des matières actives appliquées en France. Cette grande utilisation correspond à des traitements systématiques appliqués en cultures spécifiques, notamment les traitements du mildiou et du botrytis de la vigne. Le contrôle du fusarium et du phytophthora en pomme de terre ainsi que de la tavelure et du mildiou en fruitiers requiert également d'importantes applications de fongicides tout au long du cycle de production. Dans la consommation de fongicides, l'utilisation sur vignes représente environ 70% du volume total, suivie par celle sur céréales et sur fruitiers avec environ 8 et 9% pour chacune de ces deux cultures (Heidorn, 2002).

Les herbicides occupent 33% du marché par rapport aux quantités totales de pesticides utilisés, le glyphosate, l'isoproturon, et l'alachlor étant les substances actives les plus courantes. L'atrazine, interdite en France depuis septembre 2003, a également fait partie des herbicides les plus utilisés. Les insecticides représentent une petite partie du marché de produits phytosanitaires, à peine 3% du marché français, en volume, en 2003 (UIPP, 2006).

En France, les vignes consomment près de la moitié de la totalité de matières actives (par rapport au nombre de molécules) et 20% du volume avec seulement 4% de la Surface Agricole Utile (SAU). De telles caractéristiques font que la dose moyenne utilisée dans

¹Union des Industries de la Protection des Plantes

les vignobles s'élève à 30 kg.ha^{-1} , alors que la moyenne nationale est d'environ 5 kg.ha^{-1} (Heidorn, 2002).

Cette première évaluation des données sur l'utilisation des pesticides explique que la viticulture, ainsi que l'horticulture en général, sont soumises à une pression croissante pour réduire l'utilisation des produits chimiques de synthèse, éviter les pertes et limiter au maximum la pollution environnementale (Gaskin *et al.*, 2002).

1.2 Techniques d'application de produits phytosanitaires

L'efficacité des applications et leur impact dans l'environnement ne sont pas seulement liés au type de matière active utilisée et au moment d'application, mais aussi à la façon de transférer le produit jusqu'aux zones cibles du traitement (PISC, 2002).

Dans les procédés d'application de phytosanitaires, ceux qui utilisent un milieu liquide sont les plus importants, car ils fournissent une manipulation plus facile et un contrôle du dosage plus précis, en comparaison avec d'autres formulations (solides ou gazeuses). En conséquence, la majorité des pesticides est appliquée en phase liquide sous forme de pulvérisation, c'est-à-dire par fragmentation du liquide en un nuage de gouttes qui doivent impacter les différentes cibles. L'efficacité des traitements et l'éventuel impact dans l'environnement sont très dépendants du type de technique sélectionnée.

1.2.1 Types d'appareils

Les pulvérisateurs sont des appareils de traitement de cultures qui réalisent la fragmentation des liquides en gouttes selon l'objectif du traitement. Les méthodes de génération des gouttes et de transport jusqu'à la cible sont utilisées pour classer les différents types d'appareils (cf. Tableau 1.1).

Formation de gouttes	Transport des gouttes	Type d'appareil
Pression de liquide	Énergie cinétique (goutte)	Jet projeté
Pression de liquide	Flux d'air	Jet porté
Flux d'air et dépression	Flux d'air	Pneumatique
Forces centrifuges	Énergie cinétique (goutte)	Centrifuge

TAB. 1.1 – Principaux types de procédés d'application de pesticides

La technique de pulvérisation la plus employée et la plus simple est le jet projeté, qui est adapté à tout type de traitements. La formation des gouttelettes est obtenue par passage du liquide sous pression dans des buses. C'est l'énergie cinétique, seule, qui permettra aux gouttes d'atteindre leur cible. Les diamètres des gouttes créées oscillent entre 100 et $500 \mu\text{m}$ et le volume appliqué par hectare est généralement supérieur à 200

litres. En terme de performances, il est considéré que les appareils à jet projeté utilisés en désherbage n'occasionnent que peu de pertes dans l'environnement (Aubertot *et al.*, 2006). Le principal inconvénient de cette technique est la mauvaise pénétration dans la végétation du fait de la faible énergie de transport des gouttes. Dans la viticulture et l'arboriculture le jet projeté est utilisé dans des cultures étroites et pour une végétation peu dense.

Dans la pulvérisation par jet porté, les gouttes sont formées, comme dans le jet projeté, par le passage du liquide sous pression dans des buses. Le transport est assisté par un courant d'air. C'est un système dans lequel la pénétration et les dépôts dans la végétation sont améliorés du fait de la turbulence de l'air qui agite les plantes. La taille des gouttes oscille entre 75 et 300 μm . Ce type de procédé peut s'utiliser tant en arbo-viticulture que dans les applications pour culture basse, bien que cette dernière utilisation soit moins fréquente.

Les pulvérisateurs pneumatiques produisent des gouttes de diamètre plus faible, entre 50 et 150 μm . La fragmentation est créée au niveau d'un rétrécissement brusque de l'orifice de sortie de l'air, où la pression et la vitesse sont augmentées par effet venturi. Le transport est effectué par le courant d'air. Cette technique permet d'obtenir une bonne pénétration dans les végétations denses avec une bonne répartition grâce à la turbulence mais les pertes par dérive et évaporation des gouttes peuvent être importantes.

La pulvérisation centrifuge consiste à soumettre le flux de liquide à des efforts de traction qui entraînent le fractionnement en petites gouttes. Cet effet est généralement créé par des disques qui tournent à vitesse élevée (4000 à 20000 tours par minute) en produisant un nuage uniforme de gouttes avec un diamètre moyen inférieur à 100 μm . Son utilisation sur des machines motorisées est toutefois limitée pour des raisons de coût et d'encombrement. C'est une technique généralement employée dans les applications aériennes, sur des machines manuelles ou pour le désherbage.

1.2.2 Formation de gouttes

La pulvérisation par pression est la technique la plus utilisée pour la formation des gouttes pour l'application de produits phytosanitaires (Wilson, 2003). Le flux est forcé à travers un orifice calibré (buse) et la pression du liquide a un effet sur le débit, l'angle du jet et le spectre granulométrique des gouttelettes. La figure 1.2 illustre le processus de fragmentation de la nappe de liquide à la sortie de la buse.

Diverses méthodes de mesure et de description statistique permettent de caractériser la distribution des tailles de gouttes créées ; une revue complète est disponible dans Matthews et Hislop (1992). Pour décrire la taille des gouttes, les valeurs statistiques utilisées sont principalement le Diamètre Médian Volumétrique (VMD ou $D_{V,50}$) et le Diamètre Médian Numérique (NMD). Par définition la moitié du volume de jet contient des gouttes plus grandes que le VMD et le NMD est le diamètre de goutte tel que 50% des gouttes (en nombre) sont d'un plus petit diamètre. Ces valeurs sont usuellement données en microns.

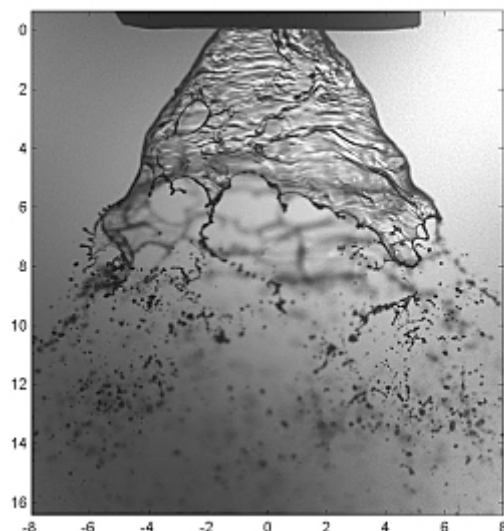

FIG. 1.2 – Formation de gouttelettes à partir du fractionnement d’une nappe de liquide produite par pression de liquide dans les processus de pulvérisation. Source : [Ben et al. \(2004\)](#)

La qualité de la pulvérisation est ensuite le plus souvent évaluée par le « span » relatif. Cette grandeur est calculée à partir des distributions volumétriques comme indiqué dans l’équation suivante 1.1 :

$$\text{span} = \frac{D_{V.90} - D_{V.10}}{D_{V.50}} \quad (1.1)$$

où $D_{V.10}$ et $D_{V.90}$ sont les percentiles à 10% et 90% respectivement.

Dans la pulvérisation hydraulique (par pression), diverses classifications ont été proposées pour décrire le spectre de gouttes produites. Ces classifications reposent sur la qualité de la pulvérisation et la susceptibilité du nuage de gouttes à être transporté sous l’effet du vent (dérive) au moment d’une application. Le premier système de classification a été proposé par le British Crop Protection Council (BCPC) au Royaume Uni, à partir des travaux de [Doble et al. \(1985\)](#) et [Southcombe et al. \(1997\)](#), en utilisant les classes « Très Fine » jusqu’à « Grosse » à partir de distributions obtenues avec des buses de référence. D’autres systèmes de classification sont aussi disponibles, par exemple celui développé par l’« American Society of Agricultural and Biological Engineers » (ASABE) aux Etats-Unis ou la « Biologischen Bundesanstalt » (BBA) en Allemagne.

1.2.3 Contexte de l’application des pesticides

L’interaction d’agents chimiques avec l’environnement varie en fonction des scénarios sur le terrain. La complexité du procédé découle de la complexité de ces scénarios. La technique et l’équipement choisis pendant une application peuvent différer énormément pour une même culture en fonction des aspects agronomiques, socio-économiques ou d’autre



FIG. 1.3 – Exemple de pulvérisateur à rampe utilisé en grandes cultures

nature comme la réglementation ou la disponibilité de main d'œuvre.

La géométrie et la caractéristique de la cible sont les premiers déterminants du choix du procédé d'application. Deux grands schémas sont fréquemment utilisés pour aborder la conception et les problématiques spécifiques des appareils : les traitements pour les grandes cultures et ceux pour l'arbo-viticulture.

De plus, des variations spatiales et temporelles sont toujours présentes dans les parcelles traitées. Tous ces éléments conditionnent de manière importante la dynamique initiale des pesticides dans le milieu naturel.

Grandes cultures

Ce type de culture est le plus important en termes de surface cultivée et d'intensité de mécanisation agricole. Pendant la pulvérisation des grandes cultures, la cible peut être considérée comme bidimensionnelle et plate, indépendamment du type de ravageur à contrôler. Toutefois la pénétration dans le végétal peut être améliorée pour certains traitements pour optimiser l'efficacité des pesticides. Des pulvérisateurs à rampe (figure 1.3) sont généralement utilisés pour ce type de cultures. L'assistance d'un flux d'air est parfois proposée pour améliorer la pénétration et éviter les pertes par dérive.

Les perspectives pour l'amélioration de l'efficacité des traitements et la minimisation de l'impact environnemental de ce type de procédé sont liées à l'optimisation de la régularité des dépôts sur le terrain (Sinfort *et al.*, 1994) et à la limitation de la dérive de produit au voisinage de la parcelle traitée, un phénomène étudié depuis des décennies (Courshee, 1959).

Arbo-viticulture

Dans l'arbo-viticulture, les cibles sont verticales et présentent une structure tridimensionnelle complexe. Les procédés d'application développés pour permettre une efficacité d'impact élevée et une bonne pénétration du jet dans la canopée se basent sur une assistance par flux d'air. Les perspectives pour optimiser ces types d'applications passent par l'amélioration du processus de dépôt du liquide dans la structure végétale (Da Silva

et al., 2001). Diverses machines sont disponibles ; on les classe généralement par rapport à la direction du flux d'air (figure 1.4) : pulvérisateur axial, tangentiel ou radial.

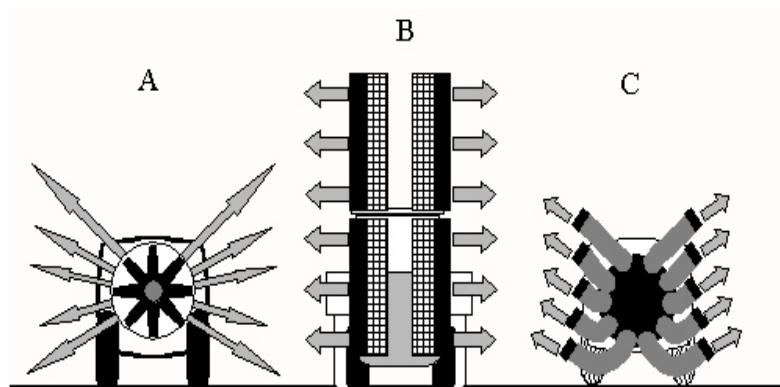

FIG. 1.4 – Schéma des principaux types de pulvérisateurs utilisés en arbo-viticulture : A) pulvérisateur axial ; B) pulvérisateur tangentiel ; C) pulvérisateur radial avec les sorties d'air réglables. Source : [Swiechowski et al. \(2004\)](#)

Une diminution du diamètre des gouttes, accompagnée d'une augmentation de la turbulence du flux d'air augmente la pénétration mais aussi les risques de pertes par évaporation et dérive. Des appareils mal réglés ou des traitements réalisés sous des conditions météorologiques inadéquates peuvent renforcer le transport de polluants et les pertes totales peuvent atteindre jusqu'à 80%, dont 20% vers l'air ([Cross et al., 2001](#)).

1.3 Pesticides dans l'environnement

Le transfert des pesticides vers l'environnement

Quelle que soit la méthode employée pour l'application des produits pour la protection des plantes, des pertes vers le milieu naturel ou d'autres espaces non visés seront présentes en plus ou moins grande importance.

La dynamique du transport et du mouvement des produits phytosanitaires, peut être décrite en deux étapes ([Wilson, 2003](#)) :

- i. Pendant la pulvérisation
- ii. Après l'application

Les principales voies de dispersion des pesticides pour chacune de ces deux étapes sont résumées dans la figure 1.5.

Pendant la pulvérisation, les produits phytosanitaires peuvent être perdus au sol ou dans l'air, à cause d'une mauvaise orientation des trajectoires ou du transport des gouttes les plus fines par le vent (dérive). La réduction du volume d'application, la diminution de la taille des gouttes et les éventuels voisinages de cultures avec diverses tolérances à certaines molécules ont fait de la dérive une des préoccupations les plus importantes pour les communautés scientifique et technique. Les procédés pour garantir une inertie

suffisante des gouttes pour qu'elles impactent les cibles, les dispositifs pour minimiser l'effet des variables climatiques et l'utilisation de zones tampon pour limiter l'impact de la dérive sont les axes de travail les plus fréquemment décrits dans la littérature.

Par ailleurs, l'impact des gouttes sur les feuilles qui détermine le pourcentage de la population qui sera piégé, ainsi que la capacité des feuilles à retenir le produit sont d'autres phénomènes déterminants pour évaluer l'efficacité des traitements.

Une fois le pesticide déposé et retenu sur la cible, d'autres processus peuvent encore affecter l'efficacité biologique et le processus de pollution. Ainsi par exemple la dureté de l'eau peut affecter l'absorption des pesticides par les végétaux (effet d'antagonisme de l'eau) et le produit est susceptible de tomber sur le sol.

La volatilisation des pesticides est peut-être la source de pertes la plus importante puisqu'elle peut atteindre jusqu'à 90% du volume total appliqué (Calvet *et al.*, 2005). Ce type de pertes peut-être minimisé, autant par l'adéquation de la taille de la goutte à la cible de l'application que par l'optimisation des propriétés physico-chimiques des produits.

Dans l'air, les pesticides sont soumis à l'effet de la photodégradation, mais ils peuvent être transportés sur de longues distances avant de retomber sous forme de pluie, neige ou brouillard.

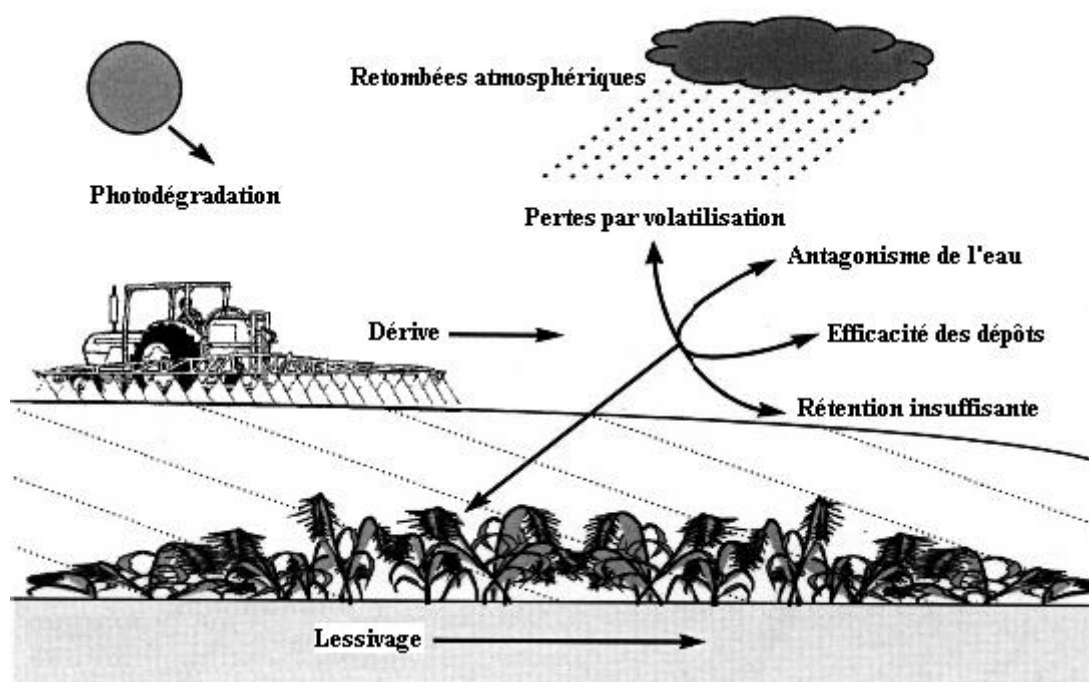

FIG. 1.5 – Principaux facteurs affectant les pertes de pesticides dans l'activité agricole. Source Wilson (2003)

Présence des pesticides dans l'environnement

La dynamique des pesticides est mise en évidence par sa présence dans diverses parties de l'écosystème. Plusieurs rapports ont documenté ce fait, en rapport avec les risques pour l'environnement et pour la santé humaine. En effet, au-delà des affections par exposition

directe, des maladies chroniques observées dans les populations rurales (voire leur voisinage), comme certains cancers ou certains troubles neurologiques, ont été associées à la présence de pesticides dans le sol, l'air et les eaux.

L'Institut français de l'environnement (Ifen, 2006) a démontré la présence de pesticides dans 96% des échantillons prélevés dans les cours d'eau et dans 61% de ceux prélevés dans les eaux souterraines, en France, avec des niveaux de contamination significatifs. 27% des sources souterraines nécessiteraient un traitement spécifique pour l'élimination des pesticides s'ils étaient utilisés pour la production d'eau potable. Sur environ 400 substances recherchées, 201 ont été mises en évidence dans les eaux de surface et 123 dans les eaux souterraines. Les herbicides sont les composés le plus souvent retrouvés dans les eaux.

Par rapport à la pollution des eaux, la pollution de l'air reste encore mal connue. Il est toutefois évident que la dérive, la volatilisation et l'érosion éolienne entraînent les pesticides vers l'air, en produisant une contamination en phases liquide, gazeuse et particulaire. Les substances sont transportées et transformées dans l'atmosphère puis peuvent se déposer sur des zones très éloignées des sources d'émissions. L'interprétation complète de la présence des pesticides dans l'air requiert aujourd'hui une bonne connaissance des émissions de la parcelle traitée, du dosage utilisé et des échelles spatiales et temporelles des zones d'application et de réception des polluants (Bedos *et al.*, 2002).

1.4 Objectifs de la thèse

La pression sociale vis-à-vis des problèmes de protection de l'environnement fait ressortir une demande d'évaluation scientifique exhaustive des mécanismes du processus de transfert des polluants vers les zones sensibles. En ce qui concerne les pesticides, le rôle de l'atmosphère dans le transport des polluants est bien décrit mais les facteurs de présence de ces substances dans l'air sont encore peu maîtrisés.

Pour expliquer ce dernier point, il est donc primordial de proposer des méthodologies expérimentales, les stratégies pour l'interprétation des interactions entre variables essentielles et la liaison avec des outils développés pour la prédiction du transport et la dispersion de polluants.

Cette thèse vise à **identifier les causes des phénomènes de pollution par les pesticides et plus particulièrement à quantifier des sources d'émission vers l'air**. Il est proposé de quantifier ces pertes par une approche expérimentale qui aura également pour objectif de mettre en évidence les variables les plus importantes ainsi que leur lien avec les quantités émises vers l'air.

Notre apport original est la conception et la validation d'une démarche expérimentale pour quantifier au champ les pertes de produit phytosanitaire vers l'air. La valorisation de ces mesures ont permis d'une part l'explication du phénomène d'émission et l'iden-

tification des variables influentes et par une autre part la paramétrisation d'un modèle mathématique pour estimer ces pertes.

La démarche générale a été la suivante :

- i. La première partie de ce document synthétise l'état de l'art en matière d'émissions des pesticides vers l'air pendant les applications. Les objectifs de cette synthèse sont **d'identifier les facteurs climatiques le plus souvent reportés et d'étudier les techniques disponibles pour la mesure des pesticides dans l'air ainsi que les méthodes de modélisation mathématiques et statistiques les plus courantes dans le cadre de la recherche agricole et environnementale.**
- ii. La deuxième partie décrit **l'élaboration et la mise en place d'un système de caractérisation des émissions au moment d'une application réelle.** Dans cette partie, on s'attachera à mettre en évidence les différentes étapes de validation de cette approche.
- iii. L'objectif est d'agrèger les résultats des expérimentations de terrain pour fournir une évaluation simple des émissions. Après une discussion sur l'efficacité de la méthode expérimentale, compte-tenu des résultats observés, **cette partie décrit deux approches qui ont été développées pour l'analyse des données et qui conduisent à des premières propositions de modèles.**
- iv. Enfin, les données expérimentales ont été utilisées pour **paramétrer un modèle à complexité réduite pour la prédiction des émissions de pesticides vers l'air** au cours d'une opération de traitement phytosanitaire sur la parcelle. Les résultats des simulations et des essais ont été comparés et permettent de discuter des hypothèses retenues pour la formulation du modèle.

Chapitre 2

État de l'art : Émission des pesticides dans l'air

Dans ce chapitre est présentée une revue bibliographique sur les techniques de mesures et modélisation des émissions de pesticides pendant les applications agricoles. L'enjeu de cette synthèse est de définir la pertinence d'une approche expérimentale pour la compréhension du processus de pulvérisation et d'identifier les variables-clés et les méthodes utilisés pour la mise en place une démarche pour la caractérisation des sources d'émission de pesticides.

Ce chapitre est basé sur l'article intitulé « *Emission of pesticides to the air during sprayer application : A bibliographic review* ».

2.1 Généralités

Dès les années soixante, la communauté scientifique a été concernée par la problématique des émissions de pesticides vers l'air et de nombreux programmes de recherche ont été lancés à travers le monde dans le but de diagnostiquer la qualité de l'air. Le rôle de l'atmosphère dans le transport des pesticides a aussi été un axe de recherche important.

Diverses stratégies ont été maîtrisées pour mener des analyses à diverses échelles géographiques, depuis les études du transport sur des distances de plusieurs milliers de kilomètres jusqu'à l'évaluation de la pollution de l'air au niveau d'un bassin versant. Le développement de l'informatique a conduit à l'adoption généralisée d'outils mathématiques pour la modélisation des phénomènes physico-chimiques complexes.

Au niveau de l'étude des sources d'émission, les scientifiques ont concentré leurs efforts sur l'étude de l'impact des applications sur le voisinage des zones traitées, et ainsi, le phénomène de dérive pendant les traitements des grandes cultures a été très discuté. Ce phénomène a été étudié de manière expérimentale mais aussi à partir d'outils de modélisation mathématique et à l'aide de diverses reproductions en conditions contrôlées, en laboratoire.

2.2 Description de la revue bibliographique

L'article « *Emission of pesticides to the air during sprayer application : A bibliographic review* » présente une complète description du transfert de pesticides vers l'air, les axes centraux développés dans cette publication sont les suivantes :

2.2.1 Influence des facteurs environnementaux sur le jet pulvérisé

Les variables qui affectent la dynamique des pesticides dans l'air pendant les applications sont analysées à partir des études mises en place pour évaluer le phénomène de dérive. Au long de cette partie est présentée l'interaction entre les pertes de produit en phase liquide et des variables : paramètres opérationnels, conditions météorologiques et caractéristiques physiques des pesticides. Les rapports essentiels entre l'évaporation des gouttes, une fois pulvérisées dans l'air, et la dérive sont aussi examinés.

2.2.2 Techniques pour mesurer les émissions vers l'atmosphère

Différentes méthodes ont été rapportées pour quantifier la présence de pesticides dans l'air au moment des applications : analyses chimiques raffinées pour détailler les molécules de pesticides en plusieurs phases, emploi de traceurs dans la bouillie de pulvérisation ainsi que de mesures à l'aide de dispositifs lasers pour évaluer le transport du jet dans divers types d'applications. Les avantages et inconvénients de chacune de ces méthodes d'évaluation sont discutés.

2.2.3 Modélisation des émissions de pesticides

De nombreux codes mathématiques sont décrits dans la littérature pour modéliser le comportement du jet et déduire les éventuelles conséquences de la pollution aérienne. Dans cette partie de l'article, les types de modèles les plus couramment utilisés pour prédire la dérive du jet lors d'un traitement agricole sont présentés. Les diverses équations qui décrivent le mouvement des gouttes, ainsi que les principales forces auxquelles elles sont soumises pendant leur déplacement, sont détaillées. Les approximations sur lesquelles s'appuie l'écriture de ces codes peuvent être classées en deux grands groupes : Celles des modèles gaussiens et celles des modèles basés sur le calcul de trajectoires de gouttes.



ELSEVIER

Available online at www.sciencedirect.com

Atmospheric Environment 39 (2005) 5183–5193

**ATMOSPHERIC
ENVIRONMENT**www.elsevier.com/locate/atmosenv

Emission of pesticides to the air during sprayer application: A bibliographic review

Y. Gil^{a,b,*}, C. Sinfort^c^aCEMAGREF, UMR ITAP, BP 5095, 34033 Montpellier Cedex 1, France^bCentral University of Venezuela, Faculty of Agronomy, Maracay 2101 AP-4579, Venezuela^cENSAM, 2, place Pierre Viala, 34060 Montpellier Cedex 1, France

Received 6 January 2005; received in revised form 18 May 2005; accepted 25 May 2005

Abstract

Air pollution due to pesticides is a persistent problem in modern agriculture, and little is known on the reversibility of its effects on the environment and health. Pesticides contaminate the atmosphere through various pathways. This paper discusses techniques for measuring and modelling pesticide emission, and the factors that affect drift processes during spray application. Chemical analyses allow the concentration of polluting agents in the air to be measured, and different methods have been developed for measuring diverse pesticide groups. Several air-sampling methods, which give different results depending on the amount of air collected, are reported. The use of various tracers, such as fluorescent dyes, is widely reported. Brilliant sulphoflavine is the best fluorescent dye due to its low degradation in sunlight. Various collector devices are used, the most common being 2 mm diameter polymer lines. Although the report indicates a good level of collection efficiency, a complete understanding of the adhesion phenomenon is necessary. The use of mathematical and computational models to determine pesticide transport simplifies test and field evaluation. However, a detailed characterization of the agricultural environment, with temporal and spatial variations, is still necessary. The most common models are limited to transport and deposition of pesticides in the liquid phase to areas adjacent to treated fields. Drifting spray is a complex problem in which equipment design and application parameters, spray physical properties and formulation, and meteorological conditions interact and influence pesticide loss.

© 2005 Elsevier Ltd. All rights reserved.

Keywords: Pesticide application; Drift; Measuring; Modelling; Environmental factors

1. Introduction

Society's preoccupation with chemical use in agricultural processes has increased significantly during the last few years. In particular, the relation between both health and environmental issues with pesticide dose is a

persistent problem in rural and urban areas. One of the main causes of this problem could be the transport of polluting agents from crop-growing areas to air, water and other natural resources, via different pathways.

Advances in research on new molecules and chemical agents, as well as in agricultural engineering, have allowed the amounts of pesticide required for crop protection to be reduced. Nevertheless, according to Candela (2003), pesticide use in Europe amounted to about 500×10^6 kg year⁻¹ towards the end of the 1990s,

*Corresponding author at: CEMAGREF, UMR ITAP, BP 5095, 34033 Montpellier Cedex 1, France.

Tel.: +33 467 04 37 89; fax: +33 467 04 37 82.

E-mail address: yvan.gilpinto@cemagref.fr (Y. Gil).

Nomenclature		Greek	
a_d	crop area density (m^{-1})	α	coefficient (dimensionless)
C_μ	empirical constant (0.09) (dimensionless)	β	coefficient (dimensionless)
d	collector characteristic diameter (m)	δ	constant (dimensionless) = 0.4
D	drop diameter (m)	Δt	time step (s)
g	gravity (m s^{-2})	ε	dissipation rate of turbulent energy kinetic (dimensionless)
h	height (m)	η	dynamic viscosity ($\text{kg m}^{-2} \text{s}^{-1}$)
k_1	constant used in $k-\varepsilon$ model (dimensionless)	v_z	entrained velocity (m s^{-1})
k_2	turbulent energy kinetic ($\text{m}^2 \text{s}^{-2}$)	ρ	density (kg m^{-3})
l_c	length of liquid spray sheet (m)	σ	standard deviation of droplet position (dimensionless)
p_c	collection probability (dimensionless)	ζ	normally distributed random number (with zero mean and unit variance)
p_t	probability transmission within the crops (dimensionless)		
R_1	particle Lagrangian correlation (dimensionless)		
t	time (s)	<i>Subscripts</i>	
u'	air velocity during lifetime in an air eddy (m s^{-1})	a	related to air
U	wind speed (m s^{-1})	i	time interval
\bar{u}	mean air velocity (m s^{-1})	L	related to sprayed liquid
\bar{u}_s	mean drop velocity (m s^{-1})	x	along wind coordinate
u^*	shear-stress velocity (m s^{-1})	y	cross-wind coordinate
		z	vertical coordinate

with an average dose of 4.3 kg ha^{-1} (4.4 in France, 2.4 in Germany, 4.9 in the UK and about 14 kg ha^{-1} in the Netherlands and Italy). In addition, the number of treatments has increased, with 66% of the cropped area using two or more herbicide types, and 80% using two or more insecticides during treatment (Bedos et al., 2002).

During application, up to 30–50% of the amount applied can be lost to the air (Van den Berg et al., 1999) and this loss may be one reason for atmospheric organic contamination (Samsonov et al., 1998). One of the main reasons is the airborne drift of effective pesticides (Yates et al., 1976). Unsworth et al. (1999) wrote that the presence of pesticides in the atmosphere was first reported towards the end of the 1950s, when there was significant use of chlorinated pesticides such as DDT, lindane and dieldrin. Pesticides are found in air in three forms: solid, gaseous and liquid (Bedos et al., 2002), and they enter the atmosphere during the application through drift (wind effect) and evaporation. After application, pesticides enter the atmosphere by volatilization (from crops, soil, etc.), degradation pathways (hydrolysis in water and soils, and photolysis and reaction with OH radicals in the atmosphere), and wind erosion (Majewski et al., 1998; Bidleman, 1999; Unsworth et al., 1999; Van Pul et al., 1999; Kumar, 2001). Once airborne pesticides are dispersed and transported by the wind (Van Pul et al., 1999), their distribution is influenced by their physical and chemical properties, as

well as environmental factors such as meteorological conditions (Hapeman et al., 2003). Thus, pesticide application to crops and soils for agricultural purposes is a major source of persistent organic pollutants in the atmosphere (Scholtz et al., 2002a).

Polluting agents are removed from the atmosphere by dry (gas and particle) and wet (precipitation by rain and snow) deposition (Majewski et al., 1998; Kumar, 2001).

Many attempts have been made to quantify pesticide losses due to spray drift and then to identify their causes (Courshee, 1959; Frost and Ware, 1970; Goering and Butler, 1975; Threadgill and Smith, 1975). But, in most tests, researchers focused on pesticide droplet transport to adjacent areas (by studying the influence of weather conditions and product types), and not on the amount of polluting agents in air (neither in vapour, nor small droplets). This article is a review of measurement techniques and simulation studies of pesticide emission to the air during crop spraying, related to sprayer technique, type of products and environmental conditions, including topography and climatic variables.

First, the techniques for flux assessment of spray application losses to air, both by direct measurement and by simulation with tracer use, including sampling devices, are described. Next, the models for emission estimations are discussed, depending on the physical representation of utilized parameters. Finally, the state-of-the-art regarding factors that are involved in pesticide emission, such as spray techniques, pesticide properties

(physical and chemical), meteorological variables and surface–air interaction, is considered.

2. Environmental factors and spray droplets emissions

The factors that influence droplets pesticide emission to air during application can be divided into technical and environmental features. Hofman and Solseng (2001) grouped them into the following categories:

- (a) Spray characteristics, such as volatility and viscosity of the pesticide formulation.
- (b) Equipment and application techniques.
- (c) Weather conditions at the time of application (wind speed and direction, temperature, relative humidity and stability of air at the application site).
- (d) Operator care, attitude and skill.

The spray drift could be defined as the quantity of pesticide that is deflected out from the treated area by the action of climatic conditions during the application process. Material applied that escapes from deposits on treated plants on the ground after application shall not be considered as spray drift. Drifting material may take the form of droplets, as dry particles or as vapour.

Indeed, spray drift is a complex problem where equipment design and application parameters, spray physical properties and formulation, and meteorological conditions interact and influence the pesticide losses (Salyani and Cromwell, 1992). The relation between liquid and vapour quantities in drifting clouds, as well as the influence of factors that have an effect on their movement and sedimentation are in constant change throughout downwind distances.

In an earlier study, Courshee (1959) recognized the importance of droplet size distribution and wind behaviour in drift processes. Threadgill and Smith (1975) suggested that the most important factors in drift deposit processes were the droplet size, atmospheric stability and wind speed (vertical and horizontal components), influencing the transport and deposition of droplets in sectors adjacent to the application area. Goering and Butler (1975) found that temperature, air turbulence and horizontal wind speed were the variables that affected the drift as well as the spraying pressure. Bode et al. (1976) and Smith et al. (1982) emphasized the influence of horizontal wind speed, nozzle height and air temperature on drift deposits.

Miller et al. (2000) found that atmospheric stability was the major determinant of the amount of deposition in areas adjacent to fields treated; additionally, Thistle (2000) asserted that the dispersion of pesticide droplets is influenced by this parameter. Stability plays an important role once the spray cloud is airborne.

2.1. Wind speed profile and stability

In drift prediction models, several authors (Holterman et al., 1997; Mokeba et al., 1997; Phillips and Miller, 1999; Asman et al., 2003) used the logarithmic law to estimate the wind profile above a plant canopy.

However, drift models do not consider atmospheric stability effects on displacement. Therefore, they underestimate the fine spray and drop cloud displacement. Thistle (2000) indicated the need of methods and of modelling to assess both stability effects and their influence on liquid drop transport.

On the other hand, the roughness height parameter (h_0) for different agricultural surfaces and crops was unsuccessfully reported in the literature. This factor has both spatial and temporal variations, depending on vegetation features. Hence, experimental determinations are necessary in real conditions, through velocity and temperature measurement.

In addition, there are spatial and temporal variations in weather conditions. In particular, important processes such as wind flow and radiation, which doubtlessly affect the spray drift, are influenced by topography (Raupach and Finnigan, 1997). This could have an important influence on the assessment of drift processes at medium scales.

2.2. Operational characteristics

Recent studies have focused on several parameters that can influence determining characteristics, mainly the droplet size spectrum. Hewitt et al. (2001) studied the effect of liquid properties and nozzle design on drift potential, and they demonstrated that adjuvant use has a direct effect on the break-up of spray through some common nozzle type, changing droplet size distribution and drift potential.

Pezzi and Rondelli (2000) studied the outlet air angle and fan speed in an air-assisted sprayer in vines. The effect of airflow on pesticide losses was more evident than for air-jet direction. The latest experiments (Cross et al., 2001a,b, 2003) demonstrated the influence of operational parameters on spray airborne drift. These parameters were airflow rate and droplet range size; the spray liquid flow rate did not have an impact on the relative spray drift. Forward speed in ground applications could not have an important effect on spray drift (Teske et al., 2001).

2.3. Drop evaporation

Spray droplet evaporation induces diameter changes along each trajectory. According to Asman et al. (2003), the evaporation and diffusion of water vapour to the surrounding air from the drop itself, as well as heat

exchange between the drop and the continuous phase, are the main processes in evaporation of sprayed drops.

Ranz and Marshall (1952) developed an evaporation drop model, on which was based the most common approaches to predict emission of spray liquid pesticides. From this model, several authors developed detailed procedures in particular conditions, and some of them incorporated statistical and experimental information about evaporation drop processes. Detailed information can be found in Duan et al. (1992) and Asman et al. (2003).

Those mathematical representations have been included in computer simulations of drop trajectories, assuming that the drops are composed merely of water (Tsay et al., 2002). Holterman et al. (1997) mentioned the “solid core phenomenon”, according to which all suspended materials gather in the drop centre and evaporation takes place on a water drop; finally, when all water is evaporated, the remaining particles are considered to stay airborne. However, the addition of non-volatile compounds to a spray mixture or adjuvant could change the behaviour of drop evaporation and, consequently, its trajectory description (Reichard et al., 1992a; Hall et al., 1994).

Indeed, Duan et al. (1992) found over-prediction in a model based on evaporation of pure water drops, compared with experimental results of evaporation of *Bacillus thuringiensis* formulations in aerial applications.

Samsonov et al. (1998) presented a model based on the evaporation of the mixtures of several pesticide compounds. However, the experimental data did not take into account surrounding air interactions with sprayed drops.

Although the physical principles of drop evaporation in pesticide application have been well described in the bibliographic resources for several decades (Goering et al., 1972; Williamson and Threadgill, 1974), the rate of evaporation in agricultural spraying technology continues to be a complex problem that involves physical and chemical properties of spray liquid and drop surrounding air conditions.

3. Techniques for measuring pesticide emissions to the atmosphere

Two methods are referenced in research conducted by the scientific community: (1) chemical analysis (by chromatographic techniques and adapted detectors) and (2) the use of tracers.

3.1. Chemical analysis

The air is drawn through an adsorbent, and the pesticide is extracted and analysed later. Results are then confirmed by mass spectrophotometry (MS).

Gas chromatography (GC) is one of the most common methods for the determination of organic concentration in the atmosphere (Sipin et al., 2003). The pesticide is extracted and analysed by GC using a GC detector. It has already been used for the quantification of agrochemicals in the air during application (Miller et al., 2000; Wittich and Siebers, 2002), and for post-application emissions (Scholtz et al., 2002b; Siebers et al., 2003), as well as for estimating pesticide concentrations in the atmosphere due to long-range transport (Majewski et al., 1998; Sanusi et al., 2000; Kumar, 2001) and its deposition (Epple et al., 2002).

Clément et al. (2000) and Briand et al. (2002b) presented a methodology for pesticide determination in air using automatic thermal desorption (ATD) and GC/MS for the determination of most common pesticides in atmospheric samples. They confirmed that the method could be adapted for studying variations of pesticide concentrations in the atmosphere after applications.

Several investigators have studied different air sampler types for GC/MS analysis. Bui et al. (1998) found diverse malathion concentrations depending on the sampler and on sampling conditions. These differences were associated with the amount of air collected. Briand et al. (2002a) evaluated several sampling techniques such as high-volume (Hi-Vol) sampling tubes with resin and impinger with cyclohexane. They explained the differences in the collection due to device ability for capturing different phases of the chemical components.

The pesticide partitioning between particle and gas phases in the atmosphere is crucial to determine the environmental fate of these agents in the air, principally the influence on deposition, chemical reaction and long-range transport of pollutant (Oh et al., 2001). Thus, the gas–particle partitioning and sampling techniques must be considered for their relation with the environmental factors and with the physico-chemical properties of pesticides, such as temperature, relative humidity, vapour pressure and total suspended particles (TSP) (Sanusi et al., 1999).

Air-sampling methods to determine gas–particle distribution were studied by several authors (Bui et al., 1998; Amin et al., 1999; Sanusi et al., 1999), as well as different partitioning models (Lohmann et al., 2000; Oh et al., 2001). These studies demonstrated the complexity of the measurement of the partition gas–particle, due to the influence of the environmental conditions. Sampling time and air volume sampled on vapour concentration of the agents in the air. Moreover, much information is still necessary on physical and chemical properties of the pesticides.

3.2. Tracers

Different tracer types have been used for pesticide spray drift assessment in order to simulate both the

transport to the air and the deposition of pesticides. The analytical method to determine the concentration varies according to which tracer is selected.

Dobson et al. (1983) evaluated a dysprosium (Dy)-like tracer in spray deposits, where neutron activation analysis was used to determine the concentration of tracer (Dy) on sampler for off-target deposition during spray application. This method is based on the detection and measurement of characteristic γ -rays emitted from radioactive isotopes. It has the advantages of sensitivity, safety in the field and speed of analysis, but it requires the use of a nuclear reactor. There are no reports about the use of radioactive isotopes to evaluate airborne transport.

Analysis with atomic absorption spectrophotometers has allowed the use of other tracers. Yates et al. (1976) developed a tracer system based on water-soluble metallic salts (manganese sulphate and strontium chloride) and air sampler collectors. Cross et al. (2001a, b) used zinc, manganese, strontium and copper chelates trapped in polythene lines to estimate both deposits and airborne spray drift.

Other analytical methods are fluorometry and colourimetry. Salyani and Whitney (1988) used copper (cupric hydroxide) as a tracer for colourimetry, and it was found to be stable and not photosensitive. However, the analysis may not be as fast or as sensitive as fluorometry. Colourants like tartrazine (E102) were used on natural targets like leaves and fruits (Pergher, 2001); the tracer is recovered by washing and its concentration is determined by spectrophotometry. There are no reports about the use of colourants in airborne spray collectors.

Several authors used fluorescent tracer dyes (Miller and Hadfield, 1989; Parkin and Wheeler, 1996; Solanelles et al., 1996; Phillips and Miller, 1999; Murphy et al., 2000), with the addition of non-ionic surfactants in water as sprayed liquid, for the quantification of airborne drift.

Some authors reported problems with the degradation of fluorescent tracers with exposure to sunlight (Yates et al., 1976), and have made tests to quantify the degradation rate under different sampling techniques (Salyani and Cromwell, 1992). According to the tracer dye and sampling technique, the degradation rate can vary and hinder a correct measurement. Nevertheless, Cai and Stark (1997) compared the performance of different fluorescent dyes and selected brilliant sulpho-flavine (BSF) as the best tracer to reproduce the atmospheric transport of pesticides, since its degradation is only 11% after 8 h exposure to sunlight.

Passive collectors have been used for spray flux measurement with tracer dyes, such as pipe cleaners and different diameter polymer lines, with diverse collection efficiency. Herbst and Molnar (2002) analysed different drift collectors in a wind tunnel. They concluded

that cylindrical collectors with a diameter of 2 mm and characterized by a smooth and well-defined surface were the most suitable collectors for airborne drift. The collection efficiency of these lines has been studied for many years, according to May and Clifford (1967), and it depends on the Stokes number, which is defined by

$$St = \frac{\rho_a U D^2}{18 \eta_a d} \quad (1)$$

Expression (1) represents particle inertia, so that when the Stokes number approaches zero the droplet follows the airflow streamlines around the obstacle, whereas when its value approaches infinity, the particles resist any change in their trajectory. Hence, the impaction efficiency can be represented by a sigmoid curve.

However, Parkin and Young (2000) found differences between experimental data, the theoretical assumptions described above and computer simulations. These discrepancies are related to the maximum values of efficiency, which could be influenced by the phenomenon of drop adhesion to the collector line.

For volatile fluids such as water, the evaporation rate can be an important disadvantage and hinder the sampling of airborne spray drift away from downwind distances (Solanelles et al., 1996). Indeed, Walklate (1992) indicated problems in the collection efficiency due to the change in diameter of drops.

Other collection devices have been evaluated. Recently, Fox et al. (2004) assessed spray collection efficiency of nylon screens, and found that screens with a porosity of about 56% were the most effective. They collected about 50–70% of spray droplets released in wind tunnel evaluations.

3.3. Laser measurement

Zalay et al. (1980) proposed the use of a laser Doppler velocimeter (LDV) to assess the transport and dispersion of the spray cloud generated from aerial applications. The LDV system allowed measurement of the relative spray concentration and particle speed along the laser beam at each sample point. From this approach, Hoff et al. (1989) developed a simple acquisition light detection and ranging (LIDAR) system, which uses the same principle as radar, to measure water with rhodamine dye sprayed from an aircraft. These systems do not allow the measurement of absolute quantity of volume sprayed.

4. Models describing pesticide emission to the atmosphere during application

Modelling spray drift has been an important point in the previous investigations, mainly to simplify field tests

5188

Y. Gil, C. Sinfort / Atmospheric Environment 39 (2005) 5183–5193

which are very difficult and expensive. The use of computer models and mathematical simulations could be an important complement to heavy tests, where many environmental variables and technical conditions are in constant change, in time as well as in space.

Nevertheless, drift models cannot be considered as a substitute for determination in the field, but rather as a very powerful complement that aids understanding of the phenomenon, as well as adapted practice implementation in order to decrease the contamination risks.

Much effort has been made to assess and model spray drift through analogy between mathematical procedures, experiments in wind tunnels, and limited field tests. Indeed, Helck and Herbst (1998) proposed a drift index (DIX) which correlated drift theory with wind tunnel and field tests. The DIX would allow one to classify the spray devices according to their drift potential, from wind tunnel tests. A good correlation between ground sediment and DIX was found.

The most commonly reported models to predict droplet movements in the air during spraying have been divided between plume and individual droplet trajectory models (Miller and Hadfield, 1989; Holterman et al., 1997). Plume models are based on the prediction of the concentration of pollutant emitted from a given source. They calculate the droplet cloud displacement and chemical agent concentration from environmental conditions. Droplet trajectory models estimate the movements and positions of individual drops set under external physical forces.

4.1. Plume model

Atmospheric dispersion models are mainly used to determine the displacement and deposition of drop clouds in medium or long-range distances (0.5–10 km) for aerial applications. This method can calculate pesticide concentrations at any geographical position from various factors, like atmospheric conditions (wind speed, direction, stability, temperature, etc.) and source characterization. Thus, De-Leeuw et al. (2000) defined it as a procedure by which predictions of an air quality indicator are made.

The most common model applied to sprayed particle dispersion is the “Gaussian plume”. Raupach et al. (2001) presented a simple model to determine contaminant transport, based on mass conservation and Gaussian-plume assumption for spray and vapour transport of agricultural chemicals in aerial application to environmental receptors.

Raupach et al. (2001) and Craig (2004) developed plume models for drift assessment in aerial applications, and the validation results showed a good correlation with measurement of downwind deposits for different droplet sizes and wind conditions. Thus, it would be possible to infer that this model would be useful to

consider zones buffer in aircraft applications. Nevertheless, additional information related to stability effects, collection efficiency, evaporation and canopy effects as well as chemical and physical properties of applied products is required.

The advantages (simplicity) and drawbacks (resolution near application zones) are discussed in Thistle (2000) and Teske et al. (2002).

4.2. Droplet trajectory models

During their trajectory into the air, the droplets are exposed to several forces that affect their movement in the flow field. Assuming that all droplets are separated and with spherical form, and neglecting other forces and physical effects (with relatively little influence), the drag or aerodynamic force and gravity are the forces that influence the droplet motion (Reichard et al., 1992b; Urip et al., 2002).

From this description, the droplet trajectory can be calculated by applying a Lagrangian approach, which is described by several authors based on Newton's second law ($F = ma$). Thus, the equation driving the droplet motion can be written as

$$\frac{d^2x}{dt^2} = \frac{1}{\tau}(\bar{u} - \bar{u}_s) + g. \quad (2)$$

The relaxation time (τ) of the drop is the characteristic time a drop needs to adapt to local airflow. It is defined by the ratio between drop mass and the air friction coefficient (Holterman et al., 1997; Teske et al., 2002), and is given by

$$\tau = \frac{4\rho_L D}{3\rho_a C_d |\bar{u} - \bar{u}_s|}, \quad (3)$$

where $|\bar{u} - \bar{u}_s|$ is the relative velocity module. It is obtained by the expression

$$|\bar{u} - \bar{u}_s| = [(u_1 - u_{s1})^2 + (u_2 - u_{s2})^2 + (u_3 - u_{s3})^2]^{1/2}, \quad (4)$$

where C_d is the drag coefficient which is related to Reynolds' number (R_e) and can be described by

$$C_d = \frac{24}{R_e} (1 + 0.197R_e^{0.63} + 0.0002R_e^{1.38}). \quad (5)$$

4.2.1. Drift from boom sprayers

When the liquid is forced through the opening in a typical hydraulic nozzle it creates a liquid sheet. The droplets are created from liquid sheet disintegration, and they move in the air-jet caused by the interaction of the spray plume and the surrounding air. Close to the nozzle, all drops move at the same speed, but as the air-jet decays, fine drops with their greater drag to mass ratio become detrained. They can then become

influenced by atmospheric air movements and cause spray drift. Lower spray volumes usually require smaller orifice nozzles that, in turn, produce finer sprays and increase the potential for spray drift (Van de Zande et al., 2003).

Several authors developed methods and mathematical procedures for predicting spray droplet trajectories as well as diameter change, combining individual motion drop equations with droplet evaporation theory (Goering et al., 1972; Williamson and Threadgill, 1974), using a multiple regression method.

Thompson and Ley (1983) developed a random-walk model, considering the droplet motion in a turbulent atmosphere with Gaussian distributions of air velocity. At any time step “ $i+1$ ” the drop velocity is related to the velocity at previous time “ i ” with the addition of a random component due to turbulence. This model fits water-based drops with an initial velocity below 2 m s^{-1} and a maximum drop diameter of $450 \mu\text{m}$ (i.e. boom sprayer).

From this approach several authors developed or evaluated numerous mathematical equations and computational programs to predict spray droplet dynamics in field conditions (Miller and Hadfield, 1989; Hobson et al., 1993; Smith and Miller, 1994; Mokeba et al., 1997; Cox et al., 2000), including successive improvements related to drop behaviour in the near nozzle region and downwind deposits. Model validation was made using a wind tunnel, and showed diverse results. Reichard et al. (1992b) verified that the modelling procedures could be used to calculate spray drift distances for a wide range of spray droplet sizes and wind velocities.

Holterman et al. (1997) proposed a detailed computational method for boom sprayers, which described the drop positions and velocities at a time step $i+1$, from the equations

$$\bar{u}_{s(i+1)} = \bar{u}_{s(i)} = \alpha_i + v_{s(i)}(1 - \alpha_i), \quad (6)$$

$$x_{i+1} = x_i + \bar{u}_{s(i)}\Delta t + \tau_i(v_{s(i)} - \bar{u}_{s(i)})(\alpha_i - 1 + \beta_i), \quad (7)$$

where

$$\alpha_i = \exp(-\beta_i), \quad (8)$$

$$\beta_i = \frac{\Delta t}{\tau_i}. \quad (9)$$

The sedimentation velocity (v_s) corresponds to the droplet velocity when all forces are in equilibrium, and is related to gravity and wind velocity during an interval of time Δt . It is given by

$$v_s = \tau g + U. \quad (10)$$

Air resistance during the droplet transit from the nozzle to crop surface causes a drag force. This reduces the droplet momentum, transferring it to the surround-

ing air and creating a flow of entrained air downward in the direction of spray droplet motion, influencing the droplet velocity from the axis of the spray cone. This phenomenon has been described by Briffa and Dombrowski (1966) through the following expression:

$$v_z(0, 0) = \bar{u}_{s(0)} \left(\frac{lc}{z} \right)^{\delta^2/2k_1}. \quad (11)$$

For the relation $(\delta^2/2k_1)$, Holterman et al. (1997) suggest a value of 0.70 for various flat fan nozzles at different pressures.

From Eq. (11), Smith and Miller (1994) and Asman et al. (2003) determine, by using two Gaussian functions, the local velocity in an x,y -plane perpendicular to the axis of the spray cone, through the function

$$v_z(x, y, z) = v_z(0, 0) \exp\left(\frac{-x^2}{2\sigma_x^2}\right) \exp\left(\frac{-y^2}{2\sigma_y^2}\right). \quad (12)$$

Drop size distribution, initial velocity and angular liquid distribution have to be measured using a phase-Doppler particle analyser or PDA.

4.2.2. Turbulent flow

Turbulent dispersion of droplets is commonly employed in spray applications in crops such as vines, apples, etc. The sprayers use the air assistance produced by a fan, mainly to help the transport of liquid sprayed while hydraulic nozzles create the drops. Many factors, such as airflow rate and spray configuration, affect drop turbulent trajectories from the nozzle to the target. Crop type setting and development are also important. Thus, many research studies focused on the physical and mathematical description of these flows through the use of computational fluid dynamic (CFD) software. In agricultural spray application, the CFD codes (FLUENT[®] or CFX[®]) more commonly used to solve the turbulent flow are the Navier–Stokes mass and momentum equations, coupled with a standard $k-\epsilon$ turbulence model.

This software has been used by several authors to simulate different air-assisted sprayers (Weiner and Parkin, 1993; Tsay et al., 2002; Sidahmed and Brown, 2002), including a spatial model to take into account the effect of interactions between the airflow and crop (Xu et al., 1998; Da Silva et al., 2001; Farooq and Salyani, 2004). Reichard et al. (1992b) and Zhu et al. (1996) verified the effectiveness of the CFD model to predict drop trajectories in turbulent flow through wind tunnel tests.

The classical $k-\epsilon$ model uses instantaneous velocity values. Then, air eddy lifetime is

$$T_e = \frac{C_\mu^{3/4}}{\sqrt{2/3}} \frac{k_2}{\epsilon} \quad (13)$$

with

$$k_2 = \frac{\bar{u}'^2}{2}. \quad (14)$$

Assuming a Gaussian probability distribution, the value of u' is obtained by

$$u' = \xi \sqrt{\bar{u}'^2}. \quad (15)$$

If the velocity fluctuations are isotropic and k_2 is the turbulence energy kinetic, then

$$\sqrt{\bar{u}'^2} = \sqrt{(2/3)k_2}. \quad (16)$$

Another random-walk model was used by Walklate (1992) and Xu et al. (1998), with temporal correlation from the following equations:

$$u'(t + \Delta t) = u'(t)R_1 + \xi \sqrt{\frac{2k_2}{3}(1 - R_1^2)}, \quad (17)$$

where R_1 is the particle Lagrangian correlation function $R_1 = \exp(-\Delta t/T_1)$.

The time scale (T_1) is related to the corresponding time scale of the air turbulence:

$$T_1 = T_c / \left[1 + A(|\bar{u} - \bar{u}_s| / \sqrt{2k_2/3})^{2/3} \right], \quad (19)$$

where A is a coefficient for the “crossing trajectory effect”.

Several authors have studied the penetration and deposition within the crops. Walklate (1992) analysed the loss of airborne spray from the plume through a single trial probability of impact and deposition p at each increment Δt along the particle trajectory:

$$p = p_c a_d [S_{(t+\Delta t)} - S_{(t)}], \quad (20)$$

where S is a scalar displacement.

The collection probability (p_c) takes into account the effects of the boundary layer around the surface of a practical drift collector and depends on drop Stokes number.

The cumulative transmission probability is given by

$$P_{t(t+\Delta t)} = P_{t(t)} - p. \quad (21)$$

Walklate et al. (1996), through an analysis of the momentum and turbulent kinetic energy conservation, presented a mathematical description for a two-dimensional air-jet penetrating a uniform crop canopy. The crop effect in airflow was simulated by a metallic mesh with artificial leaves of square form. This analysis demonstrated that the decay of both velocity and turbulent kinetic energy was exponential with respect to penetration distance, and depended on leaf area density (LAD) and on the drag coefficient. From this approach, Da Silva et al. (2001) proposed a deposition model where both drag force and deposition efficiency must be experimentally determined for different crops.

Although the equations and procedures described above are very useful tools to estimate spray drop trajectories, they could give different results from real field data because of interactions with the crop as well as the temporal and spatial variations in environmental conditions. These are very difficult and expensive to consider through mathematical and computational processes.

According to this bibliographic review, CFD codes used in turbulent flows have only allowed the study of the factors that affect drift processes, and the validation data are limited to specific and controlled conditions. Hence, an extensive field evaluation is still necessary, mainly to assess the effect of operational conditions.

5. Conclusions

This review article reflects on the importance of spray drift on emission of pesticides and air quality, and the efforts of the scientific community to understand this phenomenon with the objective of making safer applications.

Determinations of pesticide airborne flow while spraying were reported in two ways: directly (using GC and MS) through active capture of particles and with tracers trapped on obstructing passive samplers. For active samplers, the problem is the phase differentiation and how to define the adaptation of the sampling method and to quantify air volume to involve for a given type of polluting agent to evaluate. Additionally, it requires meticulous and expensive laboratory analysis. Passive samplers are demonstrated to be adapted to the assessment of spray liquid phase flow in several conditions; however, for a correct determination it is necessary to know the efficiency factor, which is not always available.

Spray emission modelling, in combination with field tests in particular conditions, could be a suitable solution to understanding the phenomenon, but, until now, more efforts are required in two ways: to characterize physical parameters that influence the emissions and to develop analytical solutions to describe the interactions.

Generally, the information and available models are limited to a small scale and particular conditions of wind velocities and droplet sizes. Thus, inclusion of physical environmental characterization on a greater scale (i.e. watersheds) is required with the aim to design plans to mitigate the impacts of pesticide application on the pollution. The use of existent models requires modification and aggregation of variables related to wind and stability performance as well as the spatial and temporal variability of environmental factors.

References

- Amin, M.K., Womac, A.R., Bui, Q.D., Mueller, T.C., Mulrooney, J.E., 1999. Air sampling of aerosol and gaseous pesticides. *Transactions of the ASAE* 42, 593–600.
- Asman, W., Jorgensen, A., Jensen, P.K., 2003. Dry deposition and spray drift of pesticides to nearby water bodies. Danish Environmental Protection Agency, Pesticide Research No. 66 (171pp).
- Bedos, C., Cellier, P., Calvet, R., Barriuso, E., 2002. Occurrence of pesticides in the atmosphere in France. *Agronomie* 22, 35–49.
- Bidleman, T., 1999. Atmospheric transport and air–surface exchange of pesticides. *Water, Air, and Soil Pollution* 115, 115–166.
- Bode, L.E., Butler, B.J., Goering, C.E., 1976. Spray drift and recovery as affected by spray thickener, nozzle type and nozzle pressure. *Transactions of the ASAE* 19, 213–218.
- Briand, O., Bertrand, F., Seux, R., Millet, M., 2002a. Comparison of different sampling techniques for the evaluation of pesticide spray drift in apple orchards. *Science of the Total Environment* 288, 199–213.
- Briand, O., Millet, M., Bertrand, F., Clément, M., Seux, R., 2002b. Assessing the transfer of pesticides to the atmosphere during and after application. Development of a multiresidue method using adsorption on Tenax and thermal desorption GC/MS. *Analytical and Bioanalytical Chemistry* 374, 848–857.
- Briffa, F.E.J., Dombrowski, N., 1966. Entrainment of air into a liquid spray. *American Institute of Chemical Engineering Journal* 12, 708–717.
- Bui, Q., Womac, A., Howard, K.D., Mulrooney, J.E., Amin, M.K., 1998. Evaluation of sampler for spray drift. *Transactions of the ASAE* 41, 37–41.
- Cai, S.S., Stark, J.D., 1997. Evaluation of five fluorescent dyes and triethyl phosphate as atmospheric tracers of agricultural sprays. *Journal of Environmental Science and Health Part B—Pesticides Contaminants and Agricultural Wastes* 32, 969–983.
- Candela, L., 2003. Pesticide contamination in the EU. In: *Proceedings of the XII Symposium Pesticide Chemistry*, Piacenza, Italy, pp. 767–780.
- Clément, M., Arzel, S., Le-Bot, B., Seux, R., Millet, M., 2000. Adsorption/thermal desorption-GC/MC for the analysis of pesticides in the atmosphere. *Chemosphere* 40, 49–56.
- Courshee, R., 1959. Investigations on spray drift. Part II: the occurrence of drift. *Journal of Agricultural Engineering Research* 4, 229–241.
- Cox, S.J., Salt, D.W., Lee, B.E., Ford, M.G., 2000. A model for the capture of aurally sprayed pesticide by barley. *Journal of Wind Engineering and Industrial Aerodynamics* 87, 217–230.
- Craig, I.P., 2004. The GDS model—a rapid computational technique for the calculation of aircraft spray drift buffer distances. *Computers and Electronics in Agriculture* 43, 235–250.
- Cross, J.V., Walklate, P.J., Murray, R.A., Richardson, G.M., 2001a. Spray deposits and losses in different sized apple trees from an axial fan orchard sprayer: 1. Effects of spray liquid flow rate. *Crop Protection* 20, 13–30.
- Cross, J.V., Walklate, P.J., Murray, R.A., Richardson, G.M., 2001b. Spray deposits and losses in different sized apple trees from an axial fan orchard sprayer: 2. Effects of spray quality. *Crop Protection* 20, 333–343.
- Cross, J.V., Walklate, P.J., Murray, R.A., Richardson, G.M., 2003. Spray deposits and losses in different sized apple trees from an axial fan orchard sprayer: 3. Effects of air volumetric flow rate. *Crop Protection* 22, 381–394.
- Da Silva, A., Sinfort, C., Vanhiesbecq, S., Polveche, V., Huberson, S., Silva, F., Bonicelli, B., 2001. Simulation of sprayed pesticide deposit within a vineyard. *Parasitica* 57, 195–204.
- De-Leeuw, F.A.A.M., Van Pul, W., Van den Berg, F., Gilbert, A.J., 2000. The use of atmospheric dispersion models in risk assessment decision support systems for pesticides. *Environmental Monitoring and Assessment* 62, 133–145.
- Dobson, C.M., Minski, M.J., Mathews, G.A., 1983. Neutron activation analysis using dysprosium as a tracer to measure spray drift. *Crop Protection* 2, 345–352.
- Duan, B., Mierzejewski, K., Yendol, W.G., 1992. A model for the prediction of the evaporation rate of pesticide droplets aurally sprayed from aircraft. *Journal of Environmental Science and Health Part B—Pesticides Contaminants and Agricultural Wastes* 27, 677–694.
- Epple, J., Maguhn, J., Spitzauer, P., Kettrup, A., 2002. Input of pesticides by atmospheric deposition. *Geoderma* 105, 327–349.
- Farooq, M., Salyani, M., 2004. Modelling of spray penetration and deposition on citrus tree canopies. *Transactions of the ASAE* 47, 619–627.
- Fox, R.D., Derksen, R.C., Zhu, H., Downer, R.A., Brazee, R.D., 2004. Airborne spray collection efficiency of nylon screen. *Applied Engineering in Agriculture* 20, 147–152.
- Frost, K., Ware, G.W., 1970. Pesticide drift from aerial and ground applications. *ASAE Paper No. 1577*.
- Goering, C.E., Butler, B., 1975. Paired field studies of herbicide drift. *Transactions of the ASAE* 18, 27–34.
- Goering, C.E., Bode, L.E., Gebhardt, M.R., 1972. Mathematical model of spray droplet deceleration and evaporation. *Transactions of the ASAE* 15, 220–225.
- Hall, F.R., Kirchner, L.M., Downer, R.A., 1994. Measurement of evaporation from adjuvant solutions using a volumetric method. *Pesticide Science* 40, 17–24.
- Hapeman, C.J., McConnell, L.L., Rice, C.P., 2003. Current United States Department of Agriculture—agricultural research service research on understanding agrochemical fate and transport to prevent and mitigate adverse environmental impacts. *Pest Management Science* 59, 681–690.
- Helck, C., Herbst, A., 1998. Drift potential index—a new parameter for the evaluation of pesticide application nozzles regarding their drift potential. *Nachrichtenblatt des Deutschen Pflanzenschutzdienstes* 50, 225–232.
- Herbst, A., Molnar, G., 2002. Comparison of spray drift collectors in a wind tunnel. *Nachrichtenblatt des Deutschen Pflanzenschutzdienstes* 54, 233–238.
- Hewitt, A.J., Miller, P.C.H., Bagley, W.E., 2001. Interaction of tank mix and nozzle design on spray performance and drift potential. *ASAE Paper 01-011081*.
- Hobson, P.A., Miller, P.C.H., Walklate, P.J., Tuck, C.R., Western, N.M., 1993. Spray drift from hydraulic spray nozzles: the use of a computer simulation model to examine

5192

Y. Gil, C. Sinfort / Atmospheric Environment 39 (2005) 5183–5193

- factors influencing drift. *Journal of Agricultural Engineering Research* 54, 293–305.
- Hoff, R.M., Mickle, R.E., Froude, F.A., 1989. A rapid acquisition Lidar system for aerial spray diagnostics. *Transactions of the ASAE* 32, 1523–1528.
- Hofman, V., Solseng, E., 2001. Reducing Spray Drift. North Dakota State University. <http://www.ext.nodak.edu/extpubs/ageng/machine/ae1210w.htm>. Consulting date: November 2004.
- Holterman, H.J., Van de Zande, J.C., Porskamp, H.A.J., Huijsmans, J.F.M., 1997. Modelling spray drift from boom sprayer. *Computers and Electronics in Agriculture* 19, 1–22.
- Kumar, Y., 2001. Pesticides in Ambient Air in Alberta. Science and Standard Division. Alberta Environment, Canada (30pp).
- Lohmann, R., Lee, R.G.M., Green, N.J.L., Jones, K.C., 2000. Gas–particle partitioning of PCDD/Fs in daily air samples. *Atmospheric Environment* 34, 2529–2537.
- Majewski, M.S., Foreman, W.T., Goolsby, D.A., Nakagak, N., 1998. Airborne pesticide residues along the Mississippi River. *Environmental Science and Technology* 32, 3689–3698.
- May, K.R., Clifford, R., 1967. The impaction of aerosol particles cylinders, spheres, ribbons and discs. *Annals of Occupational Hygiene* 10, 83–95.
- Miller, P.C.H., Hadfield, D., 1989. A simulation model of the spray drift from hydraulic nozzles. *Journal of Agricultural Engineering Research* 42, 135–147.
- Miller, D.R., Stoughton, T.E., Steinke, W.E., Huddleston, E.W., Boss, J.B., 2000. Atmospheric stability effects on pesticide drift from an irrigated orchard. *Transactions of the ASAE* 43, 1057–1066.
- Mokeba, M.L., Salt, D.W., Lee, B.E., Ford, M.G., 1997. Simulating the dynamics of spray droplets in the atmosphere using ballistic and random-walk models combined. *Journal of Wind Engineering and Industrial Aerodynamics* 67–68, 923–933.
- Murphy, S.D., Miller, P.C.H., Parkin, C.S., 2000. The effect of boom section and nozzle configuration on the risk of spray drift. *Journal of Agricultural Engineering Research* 75, 127–137.
- Oh, J.E., Choi, J.S., Chang, Y.S., 2001. Gas/particle partitioning of polychlorinated dibenzo-*p*-dioxins and dibenzofurans in atmosphere; evaluation of predicting models. *Atmospheric Environment* 35, 4125–4134.
- Parkin, C.S., Wheeler, P., 1996. Influence of spray induced vortices on the movement of drops in wind tunnels. *Journal of Agricultural Engineering Research* 63, 35–44.
- Parkin, C.S., Young, P.R., 2000. Measurements and computational fluid dynamic simulations of the capture of drops by spray drift samplers. *Aspects of Applied Biology* 57, 113–120.
- Pergher, G., 2001. Recovery rate of tracer dyes used for spray deposit assessment. *Transactions of the ASAE* 44, 787–794.
- Pezzi, F., Rondelli, V., 2000. The performance of an air-assisted sprayer operating in vines. *Journal of Agricultural Engineering Research* 76, 331–340.
- Phillips, J., Miller, P.C.H., 1999. Field and wind tunnel measurements of the airborne spray volume downwind of single flat-fan nozzle. *Journal of Agricultural Engineering Research* 72, 161–170.
- Ranz, W.E., Marshall, W.R., 1952. Evaporation from drops. Part I. *Chemical Engineering Progress* 48, 141–146.
- Raupach, M.R., Finnigan, J.J., 1997. The influence of topography on meteorological variables and surface–atmosphere interactions. *Journal of Hydrology* 190, 182–213.
- Raupach, M.R., Briggs, P.R., Ahmad, N., Edge, V.E., 2001. Endosulfan transport: II. Modelling airborne dispersal and deposition by spray and vapour. *Journal of Environmental Quality* 30, 729–740.
- Reichard, D.L., Zhu, H., Fox, R.D., Brazee, R.D., 1992a. Computer simulation of variables that influence spray drift. *Transactions of the ASAE* 35, 1401–1407.
- Reichard, D.L., Zhu, H., Fox, R.D., Brazee, R.D., 1992b. Wind tunnel evaluation of a computer program to model spray drift. *Transactions of the ASAE* 35, 755–758.
- Salyani, M., Cromwell, R., 1992. Spray drift from ground and aerial applications. *Transactions of the ASAE* 35, 1113–1120.
- Salyani, M., Whitney, J.D., 1988. Evaluation of methodologies for field studies of spray deposition. *Transactions of the ASAE* 31, 390–395.
- Samsonov, Y.N., Makarov, V.I., Koutsenogii, K.P., 1998. Physicochemical model and kinetics of pesticide constituent evaporation out of multi-ingredient polydisperse aerosols. *Pesticide Science* 52, 292–302.
- Sanusi, A., Millet, M., Mirabel, P., Wortham, H., 1999. Gas–particle partitioning of pesticides in atmospheric samples. *Atmospheric Environment* 33, 4941–4951.
- Sanusi, A., Millet, M., Mirabel, P., Wortham, H., 2000. Comparison of atmospheric pesticide concentrations measured at three sampling sites: local, regional and long-range transport. *Science of the Total Environment* 263, 263–277.
- Scholtz, M.T., Voldner, E., Van Heyst, B.J., McMillan, A.C., Pattey, E., 2002a. A pesticide emission model (PEM) Part I: model development. *Atmospheric Environment* 36, 5005–5013.
- Scholtz, M.T., Voldner, E., Van Heyst, B.J., McMillan, A.C., Pattey, E., 2002b. A pesticide emission model (PEM) Part II: model evaluation. *Atmospheric Environment* 36, 5015–5024.
- Sidahmed, M., Brown, R., 2002. Computer simulation of factors affecting drift from a forestry airblast sprayer. *Canadian Biosystems Engineering* 44, 2.27–2.35.
- Siebers, J., Binner, R., Wittich, K.P., 2003. Investigation on downwind short-range transport of pesticides after application in agricultural crops. *Chemosphere* 51, 397–407.
- Sipin, M.F., Guazzotti, S.A., Prather, K.A., 2003. Recent advances and some remaining challenges in analytical chemistry of the atmosphere. *Analytical Chemistry* 75, 2929–2940.
- Smith, R.W., Miller, P.C.H., 1994. Drift predictions in the near nozzle region of a flat fan spray. *Journal of Agricultural Engineering Research* 59, 111–120.
- Smith, D.B., Harris, F.D., Butler, B.J., 1982. Variables affecting drift from ground boom sprayer. *Transactions of the ASAE* 25, 1499–1503.
- Solanelles, F., Fillat, A., Pifarré, C., Planas, S., 1996. A method of drift measurement for spray applications in tree crops. In: *Proceeding of the AgEng 96, Madrid, Spain, Paper 96A-133*.

ARTICLE IN PRESS

Y. Gil, C. Sinfort / Atmospheric Environment 39 (2005) 5183–5193

5193

- Teske, M.E., Valcore, D.L., Hewitt, A.J., 2001. An analytical ground sprayer model. ASAE Paper 01-1051.
- Teske, M.E., Bird, S.L., Esterly, D.M., Curbishley, T.B., Ray, S.L., Perry, S.G., 2002. AgDrift[®]: a model for estimating near-field spray drift from aerial applications. *Environmental Toxicology and Chemistry* 21, 659–671.
- Thistle, H., 2000. The role of stability in fine pesticide droplet dispersion in the atmosphere: a review of physical concepts. *Transactions of the ASAE* 46, 1409–1413.
- Thompson, N., Ley, A., 1983. Estimating spray drift using a random-walk model of evaporating drops. *Journal of Agricultural Engineering Research* 28, 419–435.
- Threadgill, E., Smith, D., 1975. Effects of physical and meteorological parameters on the drift of controlled-size droplets. *Transactions of the ASAE* 18, 51–56.
- Tsay, J., Fox, R.D., Ozkan, H.E., Brazee, R.D., Derksen, R.C., 2002. Evaluation of a pneumatic-shielded spraying system by CFD simulation. *Transactions of the ASAE* 45, 47–54.
- Unsworth, J.B., Wauchope, R.D., Klein, A.W., Dorn, E., Zeeh, B., Yeh, S.M., Akerblom, M., Racke, K.D., Rubin, B., 1999. Significance of the long-range transport of pesticides in the atmosphere: technical report. *Pure and Applied Chemistry* 71, 1359–1383.
- Urip, E., Yang, S.L., Marek, C.J., 2002. An Interactive Excel Program for Tracking a Single Droplet in Cross Flow Computation. USA National Aeronautics and Space Administration, TM-2002-211710 (31pp).
- Van den Berg, F., Kubiak, R., Benjey, W.G., 1999. Emission of pesticides into the air. *Water, Air, and Soil Pollution* 115, 195–218.
- Van de Zande, J.C., Parkin, C.S., Gilbert, A.J., 2003. Application technologies. In: Wilson, M. (Ed.), *Optimising Pesticide Use*. Wiley, Chichester, UK, pp. 23–44.
- Van Pul, W.A.J., Bidleman, T.F., Brorstrom-Lunden, E., 1999. Atmospheric transport and deposition of pesticides: an assessment of current knowledge. *Water, Air, and Soil Pollution* 115, 245–256.
- Walklate, P.J., 1992. A simulation study of pesticide drift from air-assisted orchard sprayer. *Journal of Agricultural Engineering Research* 51, 263–283.
- Walklate, P.J., Weiner, K.L., Parkin, C.S., 1996. Analysis of and experimental measurements made on a moving air-assisted sprayer with two-dimensional air-jets penetrating a uniform crop canopy. *Journal of Agricultural Engineering Research* 63, 365–378.
- Weiner, K.L., Parkin, C.S., 1993. The use of computational fluid dynamic code for modelling spray from a mistblower. *Journal of Agricultural Engineering Research* 55, 313–324.
- Williamson, R.E., Threadgill, E.D., 1974. A simulation for dynamics of evaporating spray droplets in agricultural spraying. *Transactions of the ASAE* 17, 254–261.
- Wittich, K.P., Siebers, J., 2002. Aerial short-range dispersion of volatilised pesticides from an area source. *International Journal of Biometeorology* 46, 126–135.
- Xu, Z.G., Walklate, P.J., Rigby, S.G., Richardson, G.M., 1998. Stochastic modelling of turbulent spray dispersion in the near-field of orchard sprayer. *Journal of Wind Engineering and Industrial Aerodynamics* 74–76, 295–304.
- Yates, W.E., Akesson, N.B., Bayer, D., 1976. Effects of spray adjuvant on drift hazards. *Transactions of the ASAE* 19, 41–46.
- Zalay, A.D., Bouse, L.F., Carlton, J.B., Crookshank, H.R., Eberle, W.R., Howle, R.E., Shrider, K.R., 1980. Measurement of airborne spray with a laser Dropller velocimeter. *Transactions of the ASAE* 23, 548–552.
- Zhu, H., Reichard, D.L., Fox, R.D., Brazee, R.D., Ozkan, H.E., 1996. Collection efficiency of spray droplets on vertical targets. *Transactions of the ASAE* 39, 415–422.

2.3 Conclusions et perspectives

Au-delà des technologies, du réglage des appareils de pulvérisation ou d'autres éléments, comme l'aptitude de l'opérateur, qui ont une influence indiscutable sur l'efficacité des applications, la grande majorité des auteurs considère que le spectre du diamètre des gouttes est le critère opérationnel de base pour la détermination des risques de pertes atmosphériques.

En fonction de leur répartition granulométrique, les gouttes pulvérisées vont subir différemment l'influence des principaux éléments climatiques comme la vitesse du vent, la stabilité atmosphérique et la turbulence, ce qui va déterminer les conditions initiales de leur transport hors de la zone à traiter. De plus, l'hygrométrie (température et humidité relative) va affecter le processus d'évaporation et donc la composition granulométrique du spectre de gouttes et, par conséquent, la sensibilité de la pulvérisation au transport atmosphérique.

Les interactions entre ces variables vont conduire à une complexité difficile à maîtriser à la fois pour les approches expérimentales et les représentations numériques.

L'utilisation de capteurs passifs et de traceurs fluorescents semble la technique la plus adaptée aux objectifs de quantification d'une source d'émission de pesticides à échelle réelle. Il est toutefois nécessaire d'évaluer l'efficacité de ces collecteurs dans les conditions d'application, de quantifier l'ampleur des pertes par évaporation et de concevoir une stratégie adaptée sur le terrain, de manière à évaluer la quantité de bouillie qui s'échappe de la parcelle vers l'air lors d'un traitement.

Chapitre 3

Méthodologie expérimentale

L'objectif de ce chapitre est de décrire la méthodologie expérimentale de mesure du flux de produit pulvérisé émis de la parcelle.

Pour cela une démarche en deux temps a été suivie :

- i. Étude et choix d'un modèle d'évaluation de l'efficacité des collecteurs « fils PVC 2 mm de diamètre » par une étude en soufflerie
- ii. Conception et réalisation d'une expérimentation en milieu réel

Les différents essais mis en œuvre sont détaillés dans ce chapitre. Une description de la détermination expérimentale et théorique de l'efficacité est d'abord présentée. Les résultats de ces deux approches ainsi que l'influence de cette efficacité sur les expérimentations au champ sont discutés dans l'article : « *Atmospheric losses of pesticides above an artificial vineyard during air-assisted spraying* ».

Par la suite, les résultats des tests de validation de la méthode sont exposés et l'effet des principaux facteurs micro-climatiques sur les émissions de produits phytosanitaires pendant la pulvérisation sont analysés, le but étant de quantifier la source de polluants atmosphériques à partir du traitement d'une parcelle.

3.1 Généralités

L'utilisation de capteurs passifs pour évaluer la dérive est largement rapportée et pourrait être considérée comme une méthode de référence en conditions contrôlées ou en soufflerie (Costa *et al.*, 2006). Les capteurs passifs les plus couramment utilisés sont des fils de 2 mm de diamètre (figure 3.1), placés perpendiculairement à la direction du jet de manière à échantillonner le flux de gouttes. Avec la pulvérisation d'une solution de traceur fluorescent et des techniques de spectrophotométrie, la quantité de liquide déposée sur les fils est déterminée et le flux total est estimé par intégration des quantités recueillies sur les fils.

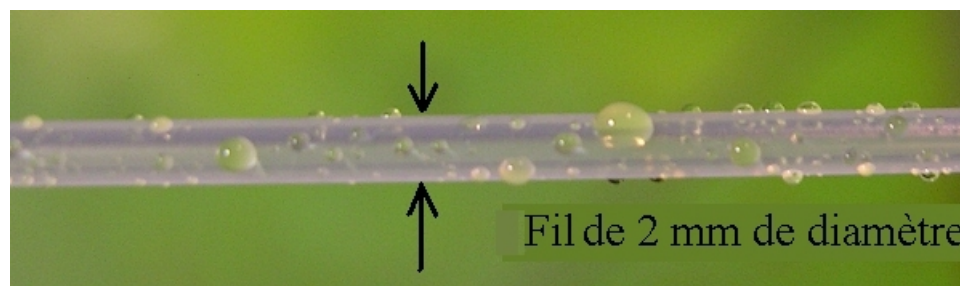

FIG. 3.1 – Fil de 2 mm de diamètre utilisé comme capteur du jet d'une solution de traceur fluorescent. Source : Roux *et al.* (2007)

Les limitations relatives à l'efficacité de ces capteurs, déjà évoquées dans le chapitre précédent, doivent être maîtrisées avant de mettre en place un dispositif expérimental basé sur ce principe. Une procédure expérimentale a donc été conçue en soufflerie pour estimer cette efficacité et la comparer à des valeurs théoriques.

Roux *et al.* (2007) ont utilisé ce type de capteur avec un système artificiel simulant des vignes pour étudier l'interaction de la végétation avec différentes vitesses du vent, pendant des tests statiques dans une soufflerie.

En se basant sur cette expérience, le choix s'est porté sur la mise en place d'essais de terrain utilisant cette même végétation artificielle, afin d'évaluer les pertes de pesticides sous conditions réelles d'application. L'objectif de ces essais était de tester la faisabilité de la méthode ainsi que sa capacité à produire des résultats comparables et répétables et, finalement, d'évaluer les variables qui affectent les émissions au moment de l'application.

3.2 Efficacité des capteurs passifs

3.2.1 Aspects théoriques

Trois modèles théoriques, proposés ou utilisés par divers auteurs, ont été analysés pour déterminer l'efficacité (Ef) des fils agissant comme capteurs de gouttes.

Modèle d'Aylor (1982) :

May et Clifford (1967) ont montré que l'efficacité d'impact des gouttes sur une cible cylindrique dépend du nombre de Stokes. Ce nombre adimensionnel permet d'estimer si l'inertie d'une goutte est suffisante pour impacter sur une cible cylindrique ou si, au contraire, la goutte va être entraînée par l'air autour de l'obstacle.

A partir de ces résultats Aylor (1982) a appliqué une relation empirique pour des cylindres (équation 3.1). Dans ce modèle, l'efficacité (Ef) augmente avec la taille de la particule, la vitesse de sédimentation (v_s) et la vitesse du vent (U), mais décroît avec le diamètre (d) de la ligne d'impact. Dans les écoulements laminaires, cette efficacité est une fonction non linéaire du nombre de Stokes.

$$Ef = \frac{0.86}{1 + 0.442 (S_t)^{-1.967}} \quad (3.1)$$

La vitesse de sédimentation est donnée par l'expression 3.3 ci-dessous. Pour calculer le nombre de Stokes, Aylor (1982) utilise la valeur du diamètre (d) exprimée en mm .

où le nombre de Stokes (S_t) est donné par :

$$S_t = \frac{v_s \cdot U}{g \cdot l} \quad (3.2)$$

où U est la vitesse de l'air en $m \cdot s^{-1}$, g , l'accélération de la force de gravité ($9.81 m \cdot s^{-2}$), l , le rayon du fil (m). Pour la vitesse de sédimentation, v_s , en $m \cdot s^{-1}$, Aylor (1982) utilise :

$$v_s = \frac{4 \cdot \rho_l \cdot g \cdot D}{3 \cdot \rho_a \cdot C_d} \quad (3.3)$$

où ρ_l et ρ_a sont les masses volumiques du liquide et de l'air respectivement, en $kg \cdot m^{-3}$, D est le diamètre de la goutte et C_d le coefficient de traînée calculé à partir de la relation 3.4 :

$$C_d = \left[\left(\frac{24}{Re} \right)^a + (b)^a \right]^{1/a} \quad (3.4)$$

où Re est le nombre de Reynolds particulière de la goutte calculé. Les coefficients a et b sont adimensionnels ; les valeurs utilisées par Aylor sont $a = 0.52$ et $b = 0.32$.

Modèle de Walklate (1992) :

Walklate (1992) a exprimé l'efficacité du collecteur à partir d'une probabilité d'impact calculée en fonction de la valeur du nombre de Stokes (eq. 3.2). La probabilité d'impact est déterminée à partir des relations suivantes :

$$Ef = \begin{cases} 1.0 & \text{pour } S_t \geq 6.76, \\ 0.5 + 0.225 \cdot \ln(S_t) & \text{pour } 0.135 < S_t < 6.76, \\ 0.135 & \text{pour } S_t \leq 0.135 \end{cases} \quad (3.5)$$

Modèle de Parkin et Young (2000) :

Finalement, par expérimentation et simulation avec un logiciel de CFD (*Computational Fluid Dynamics*), et en considérant les possibles effets d'adhésion des gouttelettes sur les fils, Parkin et Young (2000) ont obtenu l'expression suivante :

$$Ef = \alpha + \gamma \cdot \exp \{ - \exp [- \beta \cdot (P - k)] \} \quad (3.6)$$

où la valeur de l'asymptote inférieure de la courbe sigmoïde de l'efficacité par rapport au nombre de Stokes est $\alpha = 0.88 \cdot d + 5.95$ et la différence entre les asymptotes inférieure et supérieure est $\gamma = 75.9 - 2.56 \cdot d$. Les valeurs de $\beta = 1.60$ et $k = 0.49$ sont constantes. Dans

l'équation 3.6, P désigne un « paramètre d'impact » dérivé de la loi du Stokes (May et Clifford, 1967) :

$$P = \frac{\rho_l \cdot U \cdot D^2}{18 \cdot \mu_a \cdot d} \quad (3.7)$$

où μ_a est la viscosité dynamique de l'air.

3.2.2 Détermination expérimentale

Pour compléter l'approche théorique décrite ci-dessus, une détermination expérimentale de l'efficacité des fils a été réalisée dans la soufflerie expérimentale du Cemagref. Cette soufflerie est construite à partir d'un tunnel de type « Prandtl » (circuit fermé). La section du tunnel est de 1.95 x 2.95 mètres ; il est équipé de 6 ventilateurs (figure 3.2). Les essais ont été effectués à deux vitesses de ventilateur : 400 et 800 tours par minute, produisant des vitesses moyennes de vent de 3.5 et 6.8 $m \cdot s^{-1}$ respectivement.

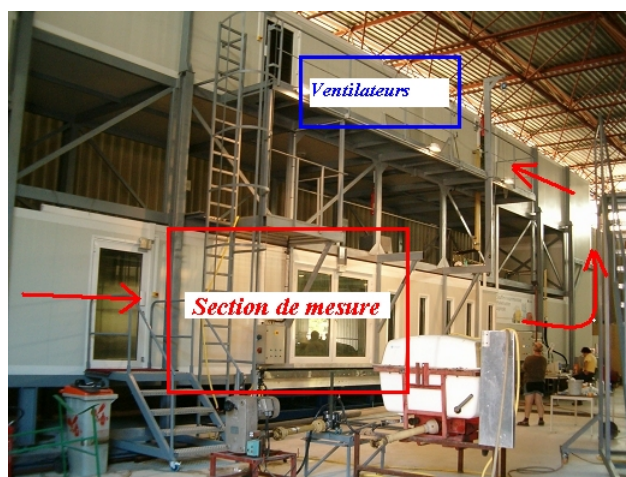

FIG. 3.2 – Soufflerie expérimentale du Cemagref

Les buses ont été placées à 2 mètres de la sortie d'air à l'intérieur du tunnel et à une hauteur de 1.5 mètres du sol, pulvérisant dans le sens du flux d'air (parallèlement au sol).

La figure 3.3 montre la disposition des fils de PVC de 2 mm de diamètre utilisés pour la capture du liquide pulvérisé, perpendiculairement au flux, à 3 mètres sous le vent de la buse.

Divers essais ont été effectués avec des distances entre fils de 30, 40 et 50 centimètres et trois spectres de pulvérisation, caractérisés par des VMD de 255, 198 et 146 μm .

Une solution à 0.1% de traceur fluorescent (Brillant Sulphoflavine) et à 0.1% d'un agent surfactant (Agral) a été pulvérisée pendant 5 secondes directement sur les collecteurs.

Après la pulvérisation, le liquide déposé sur chaque ligne à été récupéré par rinçage dans 150 ml d'eau tamponnée, après agitation mécanique. Le rapport entre la concentration de traceur de chaque échantillon et celle de la sortie de la buse, obtenue par spectrophotométrie, donne la quantité de volume du jet (V_i) piégée sur la ligne.

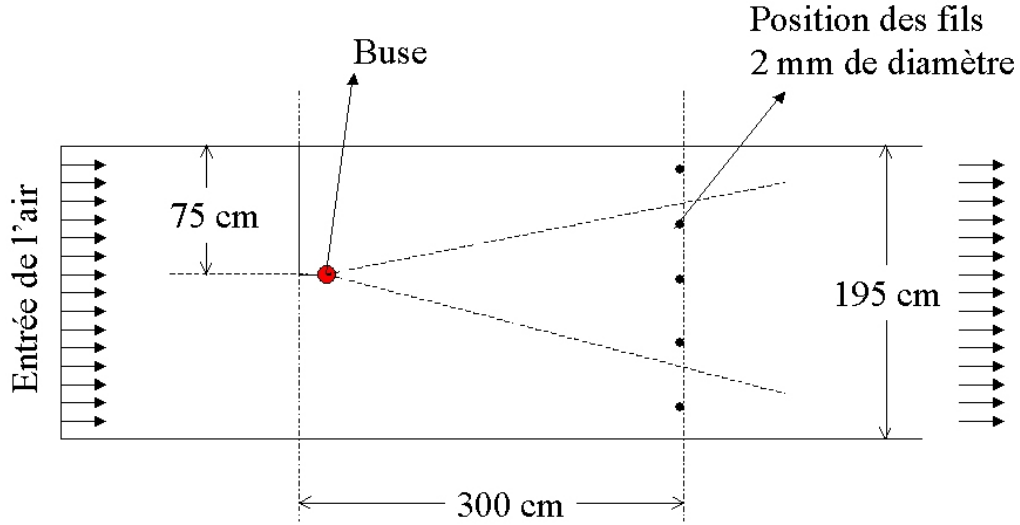

FIG. 3.3 – Configuration des essais dans la soufflerie

A partir de cette valeur le flux spécifique (S_i), en $ml.mm^{-1}.s^{-1}$, est calculé pour chaque fil par l'expression :

$$S_i = \frac{V_i}{d.t} \quad (3.8)$$

où d est le diamètre du collecteur (2 mm) et t le temps de pulvérisation (5 secondes). Le flux total en $ml.s^{-1}$ (Q) du jet qui passe par le plan créé par les fils, est alors estimé par l'interpolation :

$$Q = \sum_{i=1}^n \frac{1}{2} [S_i + S_{i+1}] [h_{i+1} - h_i] \quad (3.9)$$

où h_i désigne la position du fil, mesurée en millimètres par rapport au sol. L'efficacité est finalement donnée par le rapport entre le flux total calculé (Q) et le débit de la buse.

3.2.3 Résultats

Les valeurs d'efficacité des fils obtenues avec les trois modèles théoriques ont été calculées en fonction du diamètre des gouttes (figure 3.4). Deux vitesses d'air (1.0 et 3.5 $m.s^{-1}$) ont été évaluées de manière à permettre des comparaisons avec les essais dans le tunnel et sur le terrain. Les valeurs indiquées sur l'axe des abscisses (x) correspondent aux diamètres caractéristiques ($D_{V.10}$; $D_{V.50}$ et $D_{V.90}$) des trois pulvérisations testées dans le tunnel. Le nombre de Reynolds (R_e) a été calculé à partir d'une vitesse relative entre l'air et la goutte de 0.1 $m.s^{-1}$.

Dans le cas de la pulvérisation très fine (qui est celle pour laquelle on attend les moins bonnes efficacités) les valeurs obtenues pour le $D_{V.10}$ (28 μm), varient entre 50 et 80% avec une vitesse de 1.0 $m.s^{-1}$ et entre 77 et 100% avec une vitesse d'air de 3.5 $m.s^{-1}$, en fonction des modèles. Pour cette deuxième vitesse, l'efficacité atteint la valeur maximale estimée

par chaque modèle (valeur asymptotique). Si les vitesses d'air sont plus importantes on obtient encore ces valeurs asymptotiques.

En conséquence cette évaluation théorique préliminaire montre que la stratégie d'utilisation de fils PVC de 2 mm de diamètre est tout à fait pertinente pour répondre aux objectifs fixés de caractérisation de la source d'émission de pesticides.

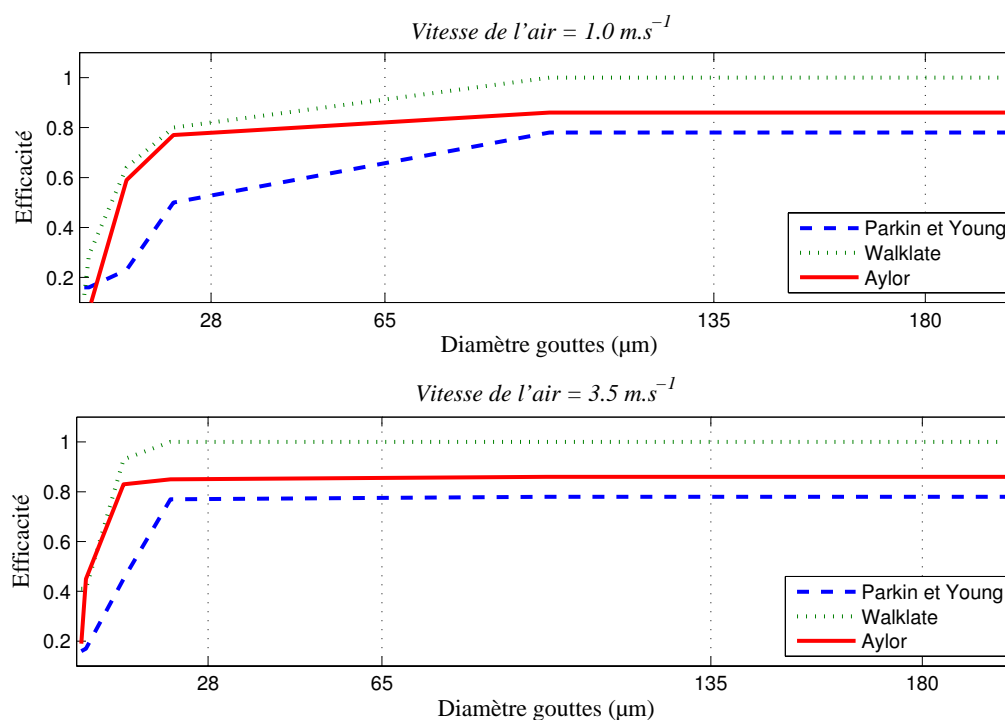

FIG. 3.4 – Efficacité du collecteur estimée par différents modèles

Dans la soufflerie expérimentale, les valeurs d'efficacité obtenues sont semblables à celles estimées par les modèles. L'efficacité moyenne varie entre 75 et 80% pour toutes les conditions étudiées pendant les essais (des résultats plus détaillés sont fournis dans l'article).

3.3 Détermination de pertes atmosphériques sur le terrain : Description du matériel

La parcelle expérimentale du Cemagref se situe dans le domaine de Lavalette à Montpellier (Département de l'Hérault). Tous les essais se sont déroulés dans la période comprise entre décembre 2004 et juillet 2005.

Afin de garantir des essais répétables et d'étudier les variables micro-climatiques et opérationnelles qui influent sur les émissions des pesticides vers les zones proches du pulvérisateur, trois conditions doivent être remplies :

- i. Conditions opérationnelles de la machine contrôlables et répétables,
- ii. Caractéristiques de la végétation invariables pendant les essais,

iii. Système de mesure des conditions climatiques robuste.

Les applications ont été réalisées avec un pulvérisateur axial à jet porté « Berthoud : Fisher Turbo 561 » (figure 3.5), dont les réglages sont faciles à référencer et à conserver. Afin d'étudier l'effet du diamètre des gouttes, deux types de buses ont été utilisés dans chaque série d'essais, les angles de déflexion étant maintenus constants. Cinq buses sont disposées de chaque côté de l'appareil. L'article « *Atmospheric losses of pesticides above an artificial vineyard during air-assisted spraying* », inclus dans ce chapitre, ainsi que celui fourni dans le chapitre suivant, détaillent toutes les caractéristiques du pulvérisateur et de ses réglages. Les spectres granulométriques sont décrits à partir des valeurs du VMD et du SPAN ainsi que par la proportion de volume du jet contenant des gouttes de diamètre supérieur à $100 \mu m$.



FIG. 3.5 – Pulvérisateur à jet porté utilisé dans les essais

Pour représenter l'effet de la végétation, un filet plastique a été tendu sur des structures rigides. Les rangs artificiels ainsi constitués présentent une porosité apparente de 34%, représentative des vignobles pendant la deuxième moitié de leur développement végétatif (Roux *et al.*, 2007). Les caractéristiques de ce système et sa capacité à reproduire le comportement aérodynamique de la vigne ont été évaluées dans une soufflerie en déterminant les coefficients de pertes d'énergie pour différents angles du vecteur du vent et l'efficacité globale (donnée par le rapport des vitesses moyennes d'air mesurées avant et après le filet). La disposition sur le terrain de la culture artificielle est illustrée par la photographie en figure 3.6.

3.4 Détermination des variables micro-climatiques

Les principales variables micro-climatiques enregistrées pendant les essais ont été obtenues à partir d'un ensemble d'anémomètres ultrasoniques 3D (figure 3.7), disposés à plusieurs hauteurs par rapport au sol.

Ces anémomètres fournissent les 3 composantes de vitesse d'air (u , v et w) ainsi que les fluctuations de température, avec une fréquence de $10 Hz$ (figure 3.8).



FIG. 3.6 – Disposition du système de simulation de la végétation pendant une application expérimentale

Les valeurs d'humidité relative ont été obtenues à partir d'une station météo placée à environ 100 mètres de la parcelle expérimentale.

Les variables qui ont été sélectionnées pour la caractérisation expérimentale des émissions des pesticides sont celles qui peuvent avoir un effet sur le transport horizontal et vertical d'un nuage de gouttes. Ainsi, les principales variables sont liées à l'effet mécanique du vent sur le nuage et aux gradients de température qui induisent des mouvements ascendants turbulents.

3.4.1 Transport horizontal

Pour le transport horizontal, les amplitudes moyennées des composantes de la vitesse du vent, parallèles (u) et perpendiculaires (v) aux rangs de vignes (disposées dans le sens nord-sud) ont été prises en compte. La moyenne a été calculée sur un temps équivalent à la durée de chaque traitement. La direction du vent a été calculée à partir des valeurs instantanées de chaque composante de la vitesse du vent par l'expression $\overline{\arctan(u/v)}$.

3.4.2 Transport vertical

Plus significative que les valeurs de la composante w de la vitesse du vent (généralement très faible), la stabilité atmosphérique représente une variable qui permet de caractériser les flux verticaux d'air. Trois états définissent cette stabilité (Sportisse, 2006) :

Atmosphère Stable :

La température du sol est inférieure à la température de l'air au-dessus, le flux de chaleur sensible est alors dirigé vers le sol et il y a destruction de la turbulence dynamique. Cet état est caractérisé par la présence de ciex clairs et calme (nuit). Le mélange est peu turbulent et il y a une accumulation des polluants dans les basses couches de l'atmosphère. Le risque que les pesticides se déposent en dehors la cible est alors important (PISC, 2002).



FIG. 3.7 – Anémomètre pour l’enregistrement de la température et des 3 composantes de vitesse du vent

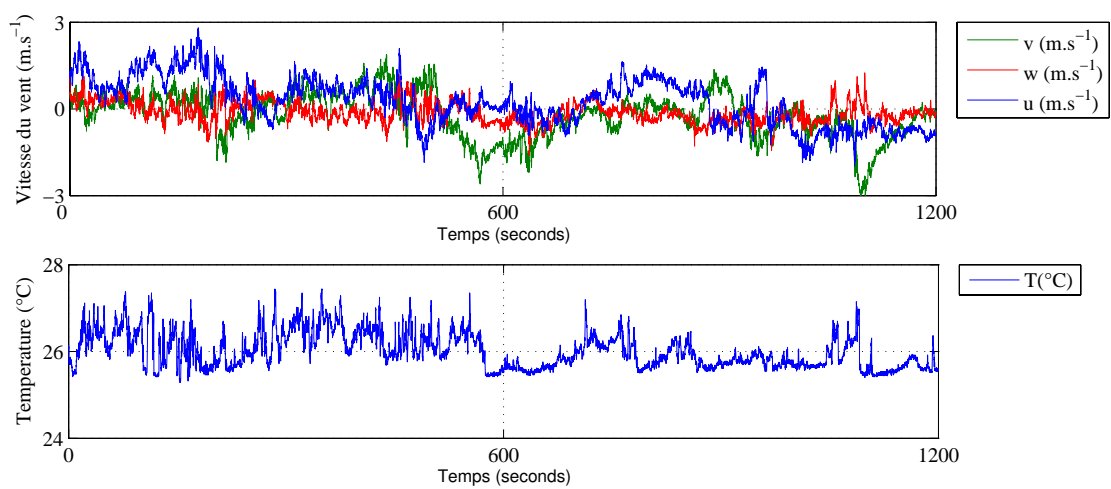

FIG. 3.8 – Série de données acquises par l’anémomètre pendant 20 minutes de mesures. Composantes du vitesse du vent u, v et w et température de l’air, T

Atmosphère Neutre :

La turbulence dans une couche limite est entièrement d'origine mécanique et dépend uniquement du frottement au niveau de la surface et de la distribution verticale de la contrainte de cisaillement du vent (Guyot, 1997). Le vent est horizontal et garde une direction constante. Ce type de condition atmosphérique est idéal pour l'application de pesticides, les pertes vers l'air sont minimales.

Atmosphère Instable :

Au voisinage du sol, la température potentielle est décroissante et il y a production thermique de turbulence (échange turbulent de chaleur du sol vers l'air). L'air chaud et léger se trouve près de la surface du sol et a tendance à s'élever sous l'effet des forces de flottabilité (Sportisse, 2006; Guyot, 1997).

Pour prendre en compte et caractériser la stabilité thermique verticale de l'atmosphère, le paramètre z/L , évalué à une hauteur z de 4 mètres (position de l'anémomètre 3D), a été utilisé. La longueur de Monin-Obukhov (L) varie entre $-\infty$ en conditions atmosphériques instables et $+\infty$ en conditions stables, en passant par 0 dans les conditions de neutralité. Ce paramètre a été calculé en utilisant l'expression 3.10. Les valeurs des fluctuations de vitesse et température de l'air ont été calculées sur des plages d'acquisition de 20 minutes.

$$L = \frac{u^{*3} \times T}{\kappa \times g \times \overline{T'w'}} \quad (3.10)$$

où u^* est la vitesse de frottement, κ est la constante de von Karman (0.41), g l'accélération de la gravité, T la température absolue de l'air et $T'w'$ le produit des fluctuations de la température de l'air et de la composante verticale de la vitesse du vent (Guyot, 1997).

La vitesse de frottement (u^* en $m s^{-1}$), est donnée par l'équation 3.11.

$$u^* = \left[\overline{u'w'^2} + \overline{v'w'^2} \right]^{1/4} \quad (3.11)$$

Les produits $\overline{u'w'}$ et $\overline{v'w'}$ sont calculés à partir des fluctuations des composantes de vitesse du vent (u' , v' and w').

Pour considérer la turbulence mécanique, l'intensité de la turbulence (I_e) a été ajoutée

à l'ensemble des variables climatiques. Elle est obtenue par l'expression 3.12, à partir des écart types ($\overline{u'^2}$, $\overline{v'^2}$ et $\overline{w'^2}$) et des valeurs moyennées (U , V et W) des différentes composantes de la vitesse du vent (Chassaing, 2000).

$$I_e = \frac{\sqrt{\overline{u'^2} + \overline{v'^2} + \overline{w'^2}}}{\sqrt{U^2 + V^2 + W^2}} \quad (3.12)$$

L'hygrométrie de l'air est un facteur important pour évaluer les caractéristiques du nuage pulvérisé et l'interaction du spectre de gouttes avec l'environnement. Ainsi, la température de l'air et la différence psychrométrique (ΔT) ont été prises en compte dans la caractérisation expérimentale. Les valeurs de ces deux variables ont été moyennées pendant la durée de chaque essai.

3.5 Description des essais

Dans l'article scientifique suivant, trois types d'expérimentations sont présentés. La première avait pour objectif d'évaluer la faisabilité de la méthode pour détecter les principaux facteurs influents. Une deuxième expérience a été menée dans le but d'évaluer le profil vertical des pertes de pesticides ainsi que l'effet des conditions micro-météorologiques. La dernière série d'essai répondait à l'objectif de construire une base de données reliant les pertes atmosphériques à un ensemble suffisamment vaste de conditions d'application.

Pour définir et évaluer ces « pertes » au niveau de la parcelle d'application deux stratégies de mesures sont présentés dans l'article « *Atmospheric losses of pesticides above an artificial vineyard during air-assisted spraying* » qui fournit une description détaillée de chaque dispositif expérimentale.

Tout d'abord les pertes ont été établies à partir des quantités de liquide en sortant d'un volume de référence au-dessus de la parcelle et construit par une « boîte » de 15 x 15 x 5.5 mètres placés à 2.5 mètres par rapport au sol. Ainsi on a calculé le volume de liquide en passant par chaque plain de la « boîte » et ce total a été normalisé par rapport au total appliqué dans la parcelle.

Dans les deux essais suivants la configuration expérimentale a été changée et les pertes ont été définies comme la quantité de produit trouvée à partir de 2.5 mètres par rapport au sol. Pour cela différents plains ont été placés de façon parallèle au sol à chaque hauteur évalué.

ARTICLE IN PRESS



ELSEVIER

Available online at www.sciencedirect.com ScienceDirect

Atmospheric Environment ■ (■■■■) ■■■-■■■

**ATMOSPHERIC
ENVIRONMENT**www.elsevier.com/locate/atmosenv

Atmospheric loss of pesticides above an artificial vineyard during air-assisted spraying

Yvan Gil^{a,b,*}, Carole Sinfort^b, Yves Brunet^c, Vincent Polveche^b, Bernard Bonicelli^b^aFaculty of Agronomy, Agricultural Engineering, Central University of Venezuela, Apartado Postal 4579, Maracay, Aragua 2101, Venezuela^bUMR ITAP, Cemagref BP 5095, 34033 Montpellier Cedex 1, France^cUR1263 EPHYSE, Inra, BP 81, F-33883 Villenave d'Ornon, France

Received 9 May 2006; received in revised form 6 December 2006; accepted 8 December 2006

Abstract

A procedure to assess pesticide emission to the air and characterise possible air pollution sources was carried out using a tracer dye and 2 mm PVC lines during air-assisted spraying of an artificial vineyard. Three experiments were performed to evaluate the method feasibility, quantify upward movements of sprayed droplets and investigate the influence of microclimatic variables on pesticide emission. During each experiment two test series were carried out with two droplet size distributions (very fine and fine spray, according to the BCPC classification). The amount of sprayed liquid collected at 2.5 m above ground varied between 9.0% and 10.7% of the total dose applied for very fine spray and between 5.6% and 7.3% for fine spray. In stable atmospheric conditions the spray drifted along the mean wind direction over the crop whereas in unstable conditions the sprayed liquid plume was larger, with a greater amount of material sent to higher levels. A statistical model based on a simple multiple regression featuring droplet characteristics and microclimatic variables (wind speed, temperature, stability parameter and relative humidity) provided a robust estimate of spray loss just above the crop, with an acceptable determination coefficient ($R^2 = 0.84$). This method is therefore suitable for quantifying spray drift and provides a way to study the influence of several variables on the amount of pesticide released into the atmosphere by air-assisted spraying, with suitable accuracy.

© 2007 Elsevier Ltd. All rights reserved.

Keywords: Air drift; Air pollution; Fluorescent tracer dye; Microclimatic conditions; Passive collectors

1. Introduction

Every year between 2 and 3 million tons of various pesticides are put up for sale in the world. In 2005 the herbicides represented 47% of the world

market, the insecticides and fungicides about 25% each and various products the remaining 4% (Aubertot et al., 2006). As a large fraction of these pesticides is aimed towards crop production, pesticide application for agricultural purposes, that may be large in places, is a major source of organic pollutants in the atmosphere. The assessment of pesticide flux to the atmosphere as a source term for transport and dispersal models is therefore impor-

*Corresponding author. Faculty of Agronomy, Agricultural Engineering, Central University of Venezuela, Apartado Postal 4579, Maracay, Aragua 2101, Venezuela. Tel./fax: +58 243 550 70 47.

E-mail address: gily@agr.ucv.ve (Y. Gil).

ARTICLE IN PRESS

2

Y. Gil et al. / Atmospheric Environment ■ (■■■■) ■■■-■■■

tant for contributing to the estimation of man-induced perturbations of the earth's atmosphere.

In Europe pesticides are mostly used for vineyards, cereals, horticulture and potatoes (CEC, 2002). Vineyards in particular, representing a total area of 4.9×10^6 ha in Europe, receive a large amount of pesticides. In France, about 20% of all marketed pesticides are applied on vines at an average rate of 30 kg ha^{-1} , to be compared with the overall rate of 4.4 kg ha^{-1} for French crops. Wine grape cropping is therefore likely to be a strong source of environmental pollution. In the same way as horticulture, it is submitted to increasing pressure for reducing pesticide use, avoiding spray drift and minimising environmental pollution (Gaskin et al., 2002). The possible exposure of humans to atmospheric pesticides due to agricultural spraying, that may become subjected to regulations, must be investigated (CEC, 2002).

Experimental data, collected over many crops with various application techniques, have demonstrated that pesticide spraying releases chemical contaminants into the atmosphere. During application the loss to the air usually stands from a few percent to 20–30%, although it can reach 50% of the total amount applied (Van-den Berg et al., 1999). This estimation is in good agreement with reported measurements of deposition on leaves and on the ground, that turn out to be of the order of 80% at least in normal conditions (Cross et al., 2001). The amount of atmospheric loss is influenced by several factors like the physico-chemical properties of the compounds, the environmental conditions and the agricultural techniques (Bedos et al., 2002).

Much effort has been devoted to quantify pesticide loss due to spray drift and identify its causes. However, most researchers have focussed on the transport of pesticide droplets to adjacent areas (studying the influence of weather conditions and product types), rather than on the amount of polluting agents released into the atmosphere, should they be under the form of vapour or small droplets. There have also been many studies on the dispersal of atmospheric pollutants, including pesticides, at various scales (local, landscape and regional scales) (Teske et al., 2002; Asman et al., 2003; Tsai et al., 2005). However, in these studies the missing information is often the source itself (i.e., the actual quantity of material entering the atmospheric compartment at its lower boundary).

Determination of the airborne flow of pesticide during spraying is usually performed in two ways: directly, through active capture of particles (Briand et al., 2002; Ravier et al., 2005), and indirectly, with tracers trapped on obstructing, passive samplers. With active samplers, liquid and gaseous phases are difficult to separate and the sampling method has to be adapted to the type of polluting agent under consideration. Additionally, they require meticulous and expensive laboratory analysis (Gil and Sinfort, 2005).

Several authors used fluorescent tracer dyes to quantify airborne drift (Miller and Hadfield, 1989; Parkin and Wheeler, 1996; Phillips and Miller, 1999; Murphy et al., 2000; Roux et al., Submitted). This methodology includes the use of cylindrical passive collectors. Herbst and Molnar (2002) concluded that cylindrical collectors with a diameter of 2 mm, characterised by a smooth and well-defined surface, were the most suitable collectors for airborne drift. Recently Roux et al. (Submitted) and Costa et al. (2006) used such devices in wind tunnels to assess spray drift interactions with various operational characteristics. However it has to be pointed out that passive collectors present some limitations related with collection efficiency, a parameter that can be estimated theoretically (Aylor, 1982; Walklate, 1992; Parkin and Young, 2000) or experimentally (Gil et al., 2005). Parkin and Young (2000) found that the phenomenon of drop adhesion to the collector line might affect the method efficiency. Additionally, for volatile fluids such as water, the evaporation rate can induce errors in the sampling of airborne spray drift. Walklate (1992) mentioned further problems in the collection efficiency due to changes in drop diameter.

The aim of this study is to quantify the input of agricultural pollutants to the atmosphere from local spraying, and provide data for air pollution and air quality research. For this purpose we designed field experiments to analyse the loss of pesticides from the plot to the atmosphere, as a source to the latter, and determine to what variables it is sensitive.

Three experimental campaigns are presented here. The first one was aimed at evaluating the ability of the method to detect the influence of the main factors, and refining the methodology. The objective of the second one was to evaluate the upward flux and the vertical profile of sprayed liquid in a range of climatic conditions. The last one was a replicate of the latter to obtain a larger range of conditions, so that the influence of the meteorological variables

AEA : 7211

ARTICLE IN PRESS

Y. Gil et al. / Atmospheric Environment (2007) (■■■■) ■■■-■■■

3

during the spraying season could be properly evaluated.

2. Methodology

2.1. Experimental site and spray application

Three different experiments were performed on a Cemagref experimental field located in Montpellier (South-East of France). Experiment A (feasibility tests) took place on December 14 and 16, 2004, Experiment B from March 24 to 29, 2005 and Experiment C from June 10 to July 20, 2005.

An artificial vineyard was built from shade nettings chosen to have similar entrapment properties to those of vines. Raupach et al. (2001) showed how such properties could be derived from the apparent porosity of the netting (34% here) and the crop row. The energy loss coefficient and the global efficiency factor of this net have been evaluated as a single-layer using tests in a wind-tunnel (Roux et al., submitted for publication).

Row spacing and crop height were 2 m each, a standard size for vineyards in this region. The artificial plot was made of four rows oriented along the North-South direction. They were 9.5 m long for Experiment A and 8 m long for Experiments B and C.

Their volume medium diameter (VMD) was $65\ \mu\text{m}$ (white nozzle) and $134\ \mu\text{m}$ (green nozzle) at the operating pressure (Table 1). The spray homogeneity was evaluated by the relative SPAN, which was derived from $D_{V,10}$, $D_{V,50}$ and $D_{V,90}$ parameters, according to Hewitt et al. (2006).

The equipment used was an axial air-assisted sprayer “Fisher Turbo 561” (Berthoud Ltd., France). Two sets of nozzles were tested at a 10 bar operating pressure: Albus ATR white hollow

cones ($0.38\ \text{l min}^{-1}$) and Conejet green hollow cones ($1\ \text{l min}^{-1}$). According to the British Crop Protection Council (BCPC) classification, spray quality is “very fine” for the white nozzle and “fine” for the green one.

Their volume medium diameter (VMD) was $65\ \mu\text{m}$ (white nozzle) and $134\ \mu\text{m}$ (green nozzle) at the operating pressure (Table 1). The spray homogeneity was evaluated by the relative SPAN, which was derived from $D_{V,10}$, $D_{V,50}$ and $D_{V,90}$ parameters, according to Hewitt et al. (2006).

All tests were carried out with the same nozzles. The nozzle orientations were designed so as to ensure the best possible vertical homogeneity of spraying over the whole canopy depth, and minimise the loss to the atmosphere. The nozzle output angles (between -10° and $+5^\circ$) and sprayer dimensions are shown in Fig. 1.

2.2. Spray solution and fluorometry

The spray liquid was an aqueous solution of $1\ \text{g l}^{-1}$ of brilliant sulphoflavine (BSF) as fluorescent tracer dye and 0.1% of non-ionic surfactant (Agral[®]). The sprayed liquid was captured on 2 mm external diameter PVC lines set up in various configurations, depending on the experiment (see next section). The fluorescent tracer dye was recovered by washing each line in 200 ml of water at neutral pH and the concentration was later determined by fluorometry. The emission and excitation values for BSF used in fluorescence determination were 518 and 412 nm, respectively.

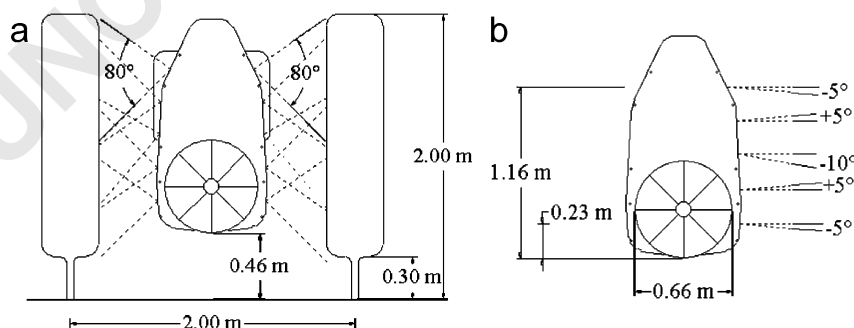

Fig. 1. (a) Sprayer and artificial crop dimensions and settings: schematic representation of spray nozzle setting and artificial crop. (b) Deflection angle and position of the nozzles.

Please cite this article as: Gil, Y., et al., Atmospheric loss of pesticides above an artificial vineyard during air-assisted spraying. Atmospheric Environment (2007), doi:10.1016/j.atmosenv.2006.12.019

ARTICLE IN PRESS

4

Y. Gil et al. / Atmospheric Environment ■ (■■■■) ■■■-■■■

2.3. Test arrangement and description

2.3.1. Experiment A

Although the use of passive collectors has been widely validated for airborne spray measurements, little is known on their performances in turbulent conditions, mainly because spray flow directions are

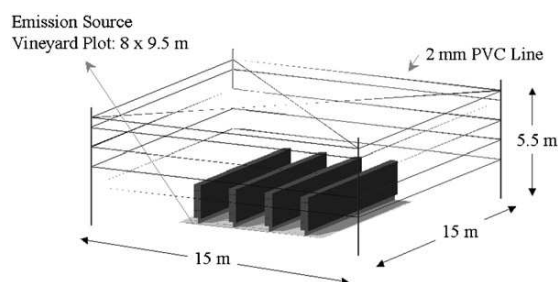

Fig. 2. Experiment A: position of the collection lines around the plot of four 9.5 m long vine rows. The frame designed to intercept the spray flow has dimensions 15 × 15 × 5.5 m.

then difficult to differentiate. Thus, the aim of this first experiment was to evaluate the feasibility of a passive collector approach to determine spray losses from the amount of sprayed liquid trapped on each line. To achieve this, a reference enclosure of 15 × 15 × 5.5 m was located around the 8 × 9.5 m artificial vine plot (Fig. 2). Five horizontal PVC lines were set up at 2, 3, 4, 5 and 5.5 m above ground on each side of this 'box' to intercept the horizontal spray flow out of the application plot. On the top plane (5.5 m), two diagonal lines were installed to capture the vertical flow of liquid spray (Table 1).

A range of experimental conditions was considered in Experiment A. The dose rates varied between 114 and 152 l ha⁻¹ for the white nozzle and between 300 and 400 l ha⁻¹ for the green nozzle, depending on the forward speed of the tractor (Table 2). Three different airflow rates were generated with three different fan rotational speeds, by selecting various power take off (PTO) rotational velocities (I: 540 rev min⁻¹; II: 405 rev min⁻¹ and III: 270 rev min⁻¹). Two configurations were chosen: in

Table 1

Droplet diameter (μm) for 10% ($D_{V,10}$), 50% ($D_{V,50}$) and 90% ($D_{V,90}$) of cumulative volume, spray volume with droplet diameter greater than 100 μm (Vol. > 100 μm) and relative SPAN

Nozzle	$D_{V,10}$	$D_{V,50}$	$D_{V,90}$	Vol. > 100 μm (%)	Spray quality	Relative SPAN
Green	72	134	180	74	Fine	0.806
White	28	65	135	24	Very fine	1.646

Spray quality is derived from the BCPC classification system. All information was obtained from manufacturer reports and the measurements were performed with a laser diffraction instrument.

Table 2

Experiment A: characteristics of the 12 samples collected during Experiment A

Test reference	Nozzle type	Nozzle number	Liquid flow (l min ⁻¹)	Air flow level	Speed (km h ⁻¹)	Vol./ha (l ha ⁻¹)	Eff. time (s)	Sprayed volume (l)
A1	White	10	3.80	I	5.00	114	13.7	0.87
A2	White	05	1.90	I	5.00	114	27.5	0.87
A3	White	10	3.80	II	3.75	152	18.3	1.16
A4	White	05	1.90	II	3.75	152	36.6	1.16
A5	White	10	3.80	III	4.00	142.5	17.1	1.08
A6	White	05	1.90	III	4.00	142.5	34.1	1.08
A7	Green	10	10.00	I	5.00	300	13.7	2.28
A8	Green	05	5.00	I	5.00	300	27.4	2.28
A9	Green	10	10.00	II	3.75	400	18.2	3.04
A10	Green	05	5.00	II	3.75	400	36.5	3.04
A11	Green	10	10.00	III	4.00	375	17.1	2.85
A12	Green	05	5.00	III	4.00	375	34.2	2.85

Eff. time: effective spraying time during each overall 2 min run duration (that includes all tractor operations).

Please cite this article as: Gil, Y., et al., Atmospheric loss of pesticides above an artificial vineyard during air-assisted spraying. Atmospheric Environment (2007), doi:10.1016/j.atmosenv.2006.12.019

ARTICLE IN PRESS

Y. Gil et al. / Atmospheric Environment (2007) 41, 38–44

5

the first one the sprayer was driven between every row (with five operating nozzles) and in the second one it was driven along every second row (with ten operating nozzles).

2.3.2. Experiment B

As will be described in the results section, Experiment A revealed that vertical movements of pesticides were fairly large, so that the PVC line arrangement was modified to better describe the upward flow. A denser network of collection lines was set up to intercept upward spray losses, consisting of five 12 m long PVC lines defining four horizontal reference planes located above the artificial vine plot at 2.5, 3.5, 4.5 and 5.5 m above the soil surface (Fig. 3). The machine was only used on the central interrow. Both the central rows were sprayed four times during each run to increase the amount of deposited spray and decrease random effects. Ten tests were carried out for each nozzle type, in various climatic conditions. In Experiment B a unique combination of experimental conditions was used. The forward speed of the tractor was set at 5.1 km h^{-1} and the airflow rate corresponded to a rotational speed of 540 rev min^{-1} PTO. The effective time of application was 27 s, with a sprayed volume of 1.44 l for the white nozzle and 3.68 l for the green one. All tests were completed in about 2 min.

2.3.3. Experiment C

The third sampling strategy was aimed at obtaining a larger data set suitable for performing a statistical analysis of the influence of microclimatic variables on spray losses. This last experiment was based on a simplified version of the configuration used in Experiment B. The 3.5 and 4.5 m reference planes were removed and the plane at 5.5 m was made of only three lines: the central one and two

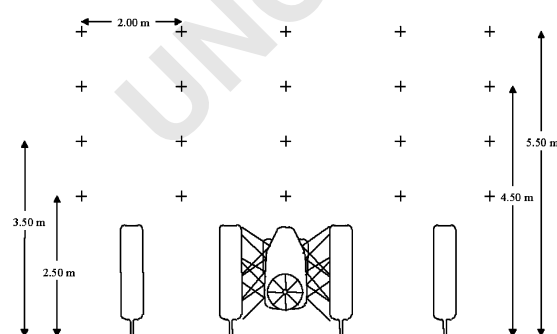

Fig. 3. Experiment B: position of the 12 m long PVC lines.

external ones. The purpose of this modification was to shorten the test duration in order to ensure that the meteorological conditions during the three replications of each run would remain fairly constant. Sets of 10 and 11 tests were completed for the white and green nozzles, respectively, with three repetitions each, providing a total of 63 runs.

2.4. Meteorological data

Relative humidity and global radiation were obtained from a standard meteorological station situated near the experimental plot. In the first experiment a meteorological mast was erected to measure wind speed at 2 and 6 m above ground with cup anemometers (A100R and A100L2, Campbell Ltd., Tonbridge Kent, UK), and at 4 m with a 3D ultrasonic anemometer (Young 81000, R.M. Young Company, Traverse City, USA). In the other two experiments only 3D ultrasonic anemometers were used. Three of them were set up at 1.9, 4 and 6.4 m above the ground in Experiment B and two of them at 4 and 6.4 m in Experiment C, on a mast that was located at about 20 m from the plot.

Wind velocity measured by the ultrasonic anemometers was sampled at 10 Hz and later averaged for each test. Friction velocity (u_*) and Monin–Obukhov length (L) were estimated from the measurements of East–West (u), North–South (v) and vertical (w) velocity components and from the temperature fluctuations, using standard expressions (e.g., Guyot, 1997). The stability parameter z/L was evaluated at $z = 4 \text{ m}$. Mean wind direction was calculated for each test from the mean values of the wind components u and v . In what follows all angles are expressed relative to the row direction.

All climatic variables used here were calculated from 20-min measurement windows centred on each spraying operation, whose effective duration was about 2 min. Stationarity was evaluated using standard methods and proved not to be a problem for most of our data set. Whenever necessary the time window was slightly shifted backward or forward, or shortened, so that the conditions encountered during the 2-min test were well representative of the 20-min window.

2.5. Spray flow estimation

Captured liquid volumes of spray are estimated from the amount of liquid captured by the 2 mm diameter lines over each horizontal and vertical

ARTICLE IN PRESS

6

Y. Gil et al. / Atmospheric Environment ■ (■■■■) ■■■–■■■

bidimensional plane. These planes are made of n lines set up at various heights h_i . Once the droplets on the lines had evaporated, each line was washed using 200 ml of tap water. This allowed the amount of tracer deposits to be estimated.

The spray volume removed from the lines in ml (V_i , in ml) was determined from the relationship between spray mixture and line wash solution concentrations, which were obtained by fluorometry reading. The specific flux (S_i , in ml mm^{-1}) was then calculated as in Eq. (1), where d is the collector diameter in mm,

$$S_i = \frac{V_i}{d}. \quad (1)$$

The airborne spray quantity (Q , in ml) crossing a collector plane during the spraying can be finally calculated as

$$Q = \sum_{i=1}^n \frac{1}{2} [S_i + S_{i+1}] [h_{i+1} - h_i]. \quad (2)$$

The amount of spray flux is then normalised by the total amount of spray applied to the crop, so that the atmospheric loss is defined as a percentage of the total amount of spray used in each test.

In Experiment A the vertical spray drift flow is determined from a two-dimensional (bi-linear) interpolation: a grid is created on the top horizontal plane and the output value (tracer deposit) for each cell is a weighted average of the values found in the nearest 2-by-2 neighbouring cells. The input values are obtained from the average amount of tracer deposit on each vertex placed at the intersection of the lines at 5.5 m above ground (there was a total of six lines: two parallel to the rows, two perpendicular and two diagonal ones).

2.6. Multiple regression analysis

A multiple regression analysis was performed on the results of Experiment C. The spray droplet concentration, expressed in percentage, was taken as the dependent variable (Y_i). The selected micro-climatic variables (independent variables) assumed to influence spray loss to the air were wind speed, stability parameter, relative humidity, air temperature, wind direction and droplet size. The variable used for atmospheric stability was the inverse of the stability parameter (z/L), which turned out to improve the prediction. The droplet size was defined as 0 for a VMD of $134 \mu\text{m}$ and 1 for a VMD of $65 \mu\text{m}$.

The experimental data set was used to test the model described in the following equation, that accounts for all variable effects on the predicted values (\hat{Y}_i):

$$\hat{Y}_i = \beta_0 + \beta_1 x_1 + \dots + \beta_n x_n. \quad (3)$$

The offset terms β_0 and $\beta_1 \dots \beta_n$ are the linear effect terms. They were found using the least square method. The independent variables are represented as x_i . The proportion of variance explained by the resulting polynomial model is given from a variance analysis (ANOVA) as the multiple coefficient of determination R^2 . The significance of each coefficient was determined using the t - and p -values of a Student test, determining the probability that the β_i are equal to zero.

3. Results and discussion

3.1. Theoretical and experimental considerations about collector performance

The largest droplets at the emission have a diameter of about $180 \mu\text{m}$, so that there should be no problem with the 2 mm sampling lines, which stand at 2 m at least above the nozzles. However, we have to consider the collector efficiency that may affect the quantities trapped by the lines during spraying.

The collector efficiency was evaluated in a wind tunnel during preliminary tests (Gil et al., 2005). In these tests, performed in standard spraying conditions with VMD values between 146 and $255 \mu\text{m}$ and a wind velocity of about 3.5 m s^{-1} , the observed efficiency was about 80%.

The impact efficiency can also be estimated theoretically, from the Stokes number, the droplet diameter and the relative velocity between the droplets and the air. Here it was estimated for the $D_{V,10}$ and $D_{V,90}$ droplet diameters (the observed range in our conditions was 28– $180 \mu\text{m}$). The particle Reynolds number was calculated with a relative velocity of 0.1 m s^{-1} . Using three different models the following efficiency values were obtained: 86% (Aylor, 1982), 100% (Walklate, 1992) and 78% (Parkin and Young, 2000), that are in fact the asymptotic values of these models. They all lie in the same range and, at least for two of them, agree well with the wind-tunnel measurements.

If we assume a smaller wind velocity (1 m s^{-1}) the efficiency slightly decreases, down to 80–86% (Aylor, 1982), 87–100% (Walklate, 1992) and

ARTICLE IN PRESS

Y. Gil et al. / Atmospheric Environment (2007) 41, 41–50

7

Table 3
Experiment A: micrometeorological variables at 4 m above ground

Test reference	Wind speed (m s^{-1})	u (m s^{-1})	v (m s^{-1})	w (m s^{-1})	Air temp. ($^{\circ}\text{C}$)	RH (%)	Wind direction	Solar time
A1	2.28	2.24	0.13	-0.01	12.8	48	87	13:39
A2	1.98	1.86	-0.61	0.06	13.2	48	108	14:35
A3	0.19	0.05	0.19	-0.01	11.9	85	15	11:31
A4	0.33	-0.31	0.1	0.01	12.3	85	341	13:41
A5	0.13	-0.12	0.02	0.04	12.3	90	352	14:23
A6	0.34	0.32	-0.09	0.05	12.2	89	164	14:57
A7	0.94	0.81	-0.47	0.02	13.6	57	150	15:45
A8	0.55	0.55	-0.08	0.01	10.9	98	172	09:23
A9	0.45	0.44	0.05	0.02	11.6	97	83	10:16
A10	0.89	0.88	0.17	-0.01	11.6	97	79	10:50
A11	0.58	-0.55	-0.18	0.03	12.4	88	252	15:32
A12	0.15	0.08	-0.13	0.03	12.6	89	121	16:07

u , v and w are the wind velocity components perpendicular to the rows, along the rows and in the vertical direction, respectively. Air temp. is the air temperature and RH the relative humidity averaged during each test.

70–78% (Parkin and Young, 2000), considering all droplet diameters. All values are still in the same range. Thus, given the distribution of droplet diameters encountered in our experiments, we can consider that the PVC lines act as a good collector even in relatively low wind conditions. It is only when we consider small droplets and very low wind velocity that the efficiency decreases substantially: e.g., with a diameter of $28 \mu\text{m}$ and an air velocity of 0.1 m s^{-1} , we obtain 12% (Aylor, 1982), 35% (Walklate, 1992) and 21% (Parkin and Young, 2000). However it has to be pointed out that wind velocity never goes below 0.5 m s^{-1} during our experiments (ejection speed is about 12 m s^{-1}).

In conclusion, there should never be any problem at the first two line planes (2.5 and 3.5 m). However the collection efficiency may become significantly smaller at the upper levels (particularly at 5.5 m, where the ejection speed cannot be felt), in low wind speed and highly evaporative conditions.

3.2. Results of Experiment A

Table 3 presents the series of 2-min averaged meteorological conditions recorded during the 12 tests of Experiment A. Air temperature shows typical diurnal values for the season (between 10.9 and 13.6). Relative humidity (RH) is larger than 85% for 75% of the tests. Mean wind speed is rather low (less than 1 m s^{-1} for 80% of the tests, with a maximum value of 2.28 m s^{-1}). Wind direction

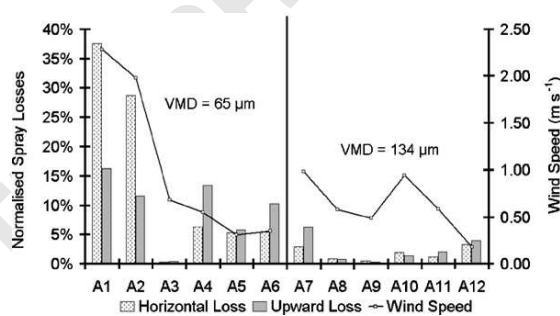

Fig. 4. Normalised spray losses and wind speed for the 12 test of A series.

strongly fluctuated during the tests, contributing to the dispersion of the sprayed cloud.

The results on normalised spray loss (Fig. 4) suggest that the outward flow is mainly influenced by droplet size and wind speed, as has been widely reported in the literature. Off-target horizontal transport of very fine spray seems to be strongly increased when wind speed is around 2 m s^{-1} : the mean loss is then about 33% of the total applied dose whereas it only represents 4.3% and 1.8% for very fine and fine sprays, respectively, when wind speed is smaller than 1 m s^{-1} .

In low wind speed conditions the vertical drift is larger than the horizontal one, both for very fine and fine VMD. However it was observed that the deposits on both the top cover lines exhibit large variability. This line configuration was, therefore,

ARTICLE IN PRESS

8

Y. Gil et al. / Atmospheric Environment ■ (■■■■) ■■■-■■■

probably not efficient enough for quantifying the amount of spray crossing the top surface above the crop. Additionally, these two top lines were difficult to collect and their implementation may have been detrimental to the quality of the results on vertical flow.

Despite this problem, it can be stated that passive collectors and tracer dye provide a reasonable possibility to assess spray concentration at various vertical levels, and we considered that our method allowed drifts to be estimated correctly during field tests and the role of influent variables on spray air losses to be evaluated.

As large amounts of spray mixture were occasionally detected at the height of 5.5 m, upward movements of spray cloud during application may certainly be an important source for air pollution. The upward movements of spray could be evaluated through an assessment of the amount crossing several horizontal planes from the ground. The line configuration was modified accordingly and a new geometrical array was built to describe properly the vertical profiles of spray drift. The results are described in Section 3.3.

3.3. Results of Experiment B

Table 4 shows the micrometeorological conditions encountered during each test in Experiment B. During the very fine spray runs, wind speed ranged from 0.18 to 2.11 m s^{-1} with an average of 1.02 m s^{-1} ; air velocity was lower than 1 m s^{-1} for half of the tests and higher than 2 m s^{-1} for one test only. The fine spray runs were performed under stronger winds, with wind velocity varying from 0.72 to 3.44 m s^{-1} around a mean value of 1.85 m s^{-1} ; it is larger than 2 m s^{-1} for 40% of the runs. Strong variations in wind direction are observed (variation coefficient of 52% and 55% for very fine and fine spray, respectively). For 45% of the runs wind direction was perpendicular to vineyard rows, within $\pm 30^\circ$.

Atmospheric stability, as defined by z/L , is fairly variable. In the first test series we found a range of conditions from unstable to stable, the latter being associated with low temperature and radiation during cloudy days. In the second series only near-neutral to unstable conditions were encountered. The temperature varied between 12.2 and 16.9 $^\circ\text{C}$

Table 4
Experiment B: micrometeorological variables at 4 m above ground

Test reference	VMD (μm)	Wind speed (m s^{-1})	u (m s^{-1})	v (m s^{-1})	w (m s^{-1})	u_* (m s^{-1})	z/L	Air temp. ($^\circ\text{C}$)	RH (%)	Wind direction	Solar time	Global radiation (W m^{-2})
B01	65	2.11	1.34	1.51	0.10	0.25	-0.09	14.5	59	53	10:01	330
B02		1.22	1.11	-0.26	0.24	0.23	-0.12	15.2	54	82	10:52	383
B03		0.83	0.54	-0.54	0.11	0.32	-0.13	15.9	48	142	11:26	478
B04		0.38	-0.26	0.20	-0.13	0.09	-0.60	14.5	84	238	09:24	96
B05		0.49	-0.45	-0.07	-0.16	0.08	-0.44	14.6	80	223	09:56	87
B06		0.71	0.05	-0.32	-0.02	0.09	-0.32	14.8	76	186	10:27	79
B07		1.76	1.63	-0.58	-0.25	0.12	0.66	15.0	77	102	10:51	76
B08		1.33	1.02	-0.66	-0.28	0.13	0.04	15.0	78	132	11:15	74
B09		0.18	0.07	0.09	-0.01	0.08	-1.79	12.2	94	74	09:29	249
B10		1.21	0.97	0.46	-0.04	0.10	-0.70	12.6	86	60	09:57	285
B11	134	2.27	1.43	1.63	0.06	0.15	-0.21	13.1	79	53	10:22	317
B12		1.33	1.26	0.07	-0.27	0.27	-0.07	13.8	75	76	10:46	396
B13		1.82	1.55	0.89	0.08	0.18	-0.17	14.1	72	62	11:07	485
B14		1.88	0.86	1.55	0.13	0.21	-0.20	14.8	69	69	11:36	568
B15		0.72	0.70	-0.02	-0.01	0.08	-1.28	13.9	46	147	09:36	323
B16		1.38	-1.21	0.56	-0.07	0.08	-1.81	14.1	48	234	10:01	325
B17		1.10	0.21	-1.03	0.04	0.1	-1.23	15.2	49	222	10:32	328
B18		2.38	-1.77	-1.47	0.03	0.15	-0.31	16.3	51	210	10:55	332
B19		2.17	-2.03	-0.49	-0.12	0.23	-0.13	16.9	53	261	11:17	336
B20		3.44	-3.12	1.26	-0.08	0.20	-0.15	16.6	55	269	11:35	326

B01–B10 tests were performed with a VMD of 65 μm and B11–B20 tests with a VMD of 134 μm . u , v and w are the wind velocity components perpendicular to the rows, along the rows and in the vertical direction, respectively; u_* is the friction velocity, z/L the atmospheric stability parameter, Air temp. is the air temperature and RH the relative humidity averaged during each test.

Please cite this article as: Gil, Y., et al., Atmospheric loss of pesticides above an artificial vineyard during air-assisted spraying. Atmospheric Environment (2007), doi:10.1016/j.atmosenv.2006.12.019

ARTICLE IN PRESS

Y. Gil et al. / Atmospheric Environment (2007) 41, 41–51

9

with a mean value of 14.6 °C. Relative humidity shows large variability, with an average of 77% for very fine spray tests and 60% for the fine ones. High evaporation rates are therefore not expected. Indeed, we used the evaporation model described in Walklate (1992) to estimate the time and travel distance in our experimental condition. In the worst case ($D_{V,10}$ from the white nozzles, with a droplet diameter of 28 μm), the droplets travel a least 4 m from the sprayer before they fully evaporate.

Fig. 5 shows the mean variation of spray loss with height for each type of spray. For fine spray, the mean lost amount is 7.3%, fluctuating between 5.8% and 9.9%. These values are smaller than those obtained for the very fine spray series for the 25th and 75th percentile at 2.5 m, although wind speed is

larger. The variability in climatic conditions during this sequence does not induce significant differences in spray concentration at 2.5 m. The amounts captured at the various levels decrease exponentially with height, which is typical of a small plot. A significant amount of spray liquid (3.3% and 1.8% for very fine and fine spray, respectively) reaches the highest level at 5.5 m above ground.

Fig. 6 shows cross-sections of spray deposits calculated from interpolated values of the amounts measured on each line, for two different stability conditions with similar wind speed (B07 and B10, i.e., stable and unstable, respectively). It reveals patterns confirming that in a stable atmosphere the spray drifts preferentially along the wind direction over the crops, whereas in unstable conditions the

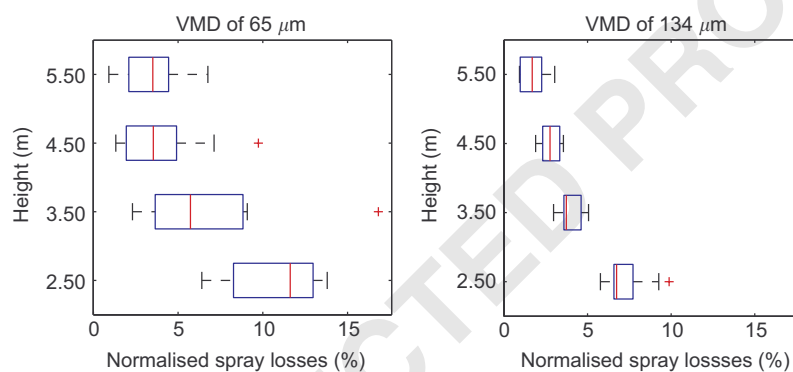

Fig. 5. Experiment B: normalised spray losses measured on horizontal planes for the 65 and 134 μm VMD tests. Box plots: median, 25th and 75th percentiles. Error bars: 10th and 90th percentiles. The plus sign is used to indicate outliers in the data.

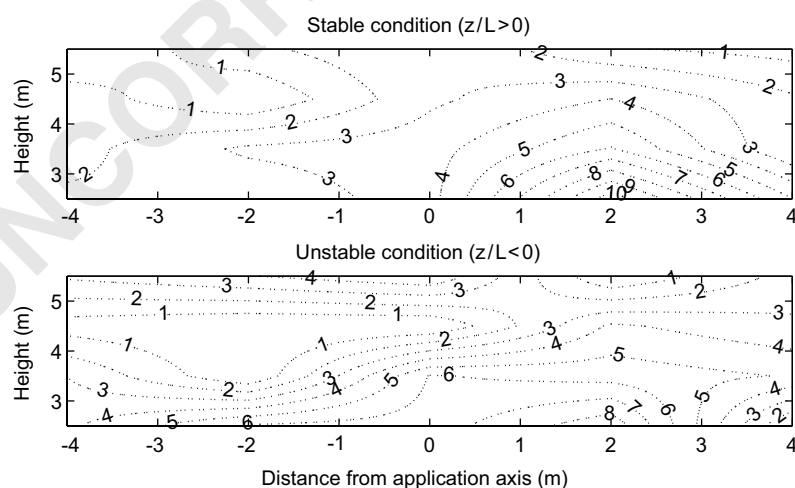

Fig. 6. Experiment B: cross-section of spray deposits on lines (μl) in stable (B07) and unstable (B10) conditions. Mean wind blows from the left to the right.

Please cite this article as: Gil, Y., et al., Atmospheric loss of pesticides above an artificial vineyard during air-assisted spraying. Atmospheric Environment (2007), doi:10.1016/j.atmosenv.2006.12.019

ARTICLE IN PRESS

10

Y. Gil et al. / Atmospheric Environment ■ (■■■■) ■■■-■■■

sprayed plume is wider. This agrees with the observations of Miller et al. (2003), who concluded that during stable conditions relatively more spray material drifts below the canopy top while in unstable conditions relatively more spray material is convected out of the canopy into the surface boundary layer.

3.4. Results of Experiment C

The objective of the last test series was to assess air pesticide emissions under a larger range of microclimatic conditions, corresponding to the entire vine-spraying season (Table 5). As most of the tests were carried out before 10:00 am, in agreement with common agricultural practices, the atmospheric conditions were near neutral or unstable for almost all runs. Horizontal wind velocity was between 0.25 and 4.15 m s⁻¹ for very fine spray tests and between 0.17 and 3.33 m s⁻¹ for fine spray tests. For more than 60% of the tests, wind direction is perpendicular to the row direction (within ±30°). A large range of temperature values was also measured, from 17.6 to 26.4. Relative

humidity was between 23% and 78% with an arithmetic mean of 44%; it was less than 50% in 71% of the cases.

Table 5 also shows the normalised spray loss at the two measurement levels. At the lowest level (2.5 m) it is 9% for very fine spray and 5.6% for fine spray runs (averaged values), whereas at the higher level (5.5 m), it becomes 1.3% and 0.7%, respectively. In comparison with the previous experiment, these results are lower for both series, for the mean values as well as for the variations.

Horizontal loss profiles are shown in Figs. 7 (with low wind velocity) and 8 ($u > 1 \text{ m s}^{-1}$). In atmospheric conditions with small wind speed, normalised losses are 29% larger for very fine spray than for fine spray, and a symmetrical plume is observed with 82% of losses concentrated within a range of four horizontal metres above the central row. This difference between the emissions of droplets with different VMD increases to 34% when wind speed becomes larger than 1 m s⁻¹; about 60% of the normalised losses occur on the downwind side (Table 6).

Table 5
Experiment C: micrometeorological variables at 4 m above ground

Test reference	VMD (µm)	Wind speed (m s ⁻¹)	u_* (m s ⁻¹)	z/L	Air temp. (°C)	RH (%)	Wind direction	Solar time	Global radiation (W m ⁻²)	Losses (%)	
										At 2.5 m	At 5.5 m
C01	65	1.87	0.35	-0.11	18.3	25	46	09:37	721	7.5	2.1
C02		3.45	0.46	-0.11	22.4	29	207	14:40	882	10.4	1.8
C03		1.42	0.13	-0.45	20.4	60	275	09:23	661	8.6	1.3
C04		1.17	0.12	-1.61	20.9	41	262	08:14	445	8.1	1.2
C05		2.05	0.35	-0.08	25.5	30	162	11:24	893	7.3	1.0
C06		0.50	0.13	-1.09	24	56	251	08:34	476	5.5	1.1
C10		3.62	0.29	-0.16	23	45	262	09:30	568	8.7	0.9
C13		1.73	0.21	-0.21	21	33	263	10:06	667	10.4	1.4
C17		0.86	0.06	0.25	17.8	61	253	06:44	162	10.1	1.1
C20		2.60	0.33	-0.10	23.7	39	284	09:22	593	12.9	1.5
C07	134	1.87	0.30	-0.16	26.3	45	70	09:37	677	5.2	0.7
C08		0.59	0.10	-1.15	25	59	44	08:26	443	5.0	0.7
C09		1.28	0.26	-0.07	22.5	44	186	08:34	509	4.8	0.5
C11		3.48	0.49	-0.04	21	31	264	09:53	752	6.4	0.7
C12		1.48	0.18	-0.12	20	42	228	08:39	300	7.1	0.8
C14		0.60	0.12	-0.90	23.8	28	239	08:44	539	4.7	0.4
C15		1.49	0.23	-0.33	26.4	23	172	10:08	775	5.5	0.8
C16		0.24	0.05	-1.23	17.6	78	129	05:40	33	5.7	0.5
C18		0.90	0.16	-0.40	24.7	64	193	08:55	348	4.0	0.7
C19		3.65	0.37	-0.04	22.7	40	269	08:34	487	7.9	0.7
C21		0.42	0.10	-0.37	21.4	34	284	08:39	515	5.3	0.9

u_* is the friction velocity, z/L the atmospheric stability parameter, Air temp. is the air temperature and RH the relative humidity averaged during each test. All spray loss values are averages over three repetitions.

Please cite this
Atmospheric En

le as: Gil, Y., et al., Atmospheric loss of pesticides above an artificial vineyard during air-assisted spraying. Atmosphere (2007), doi:10.1016/j.atmosenv.2006.12.019

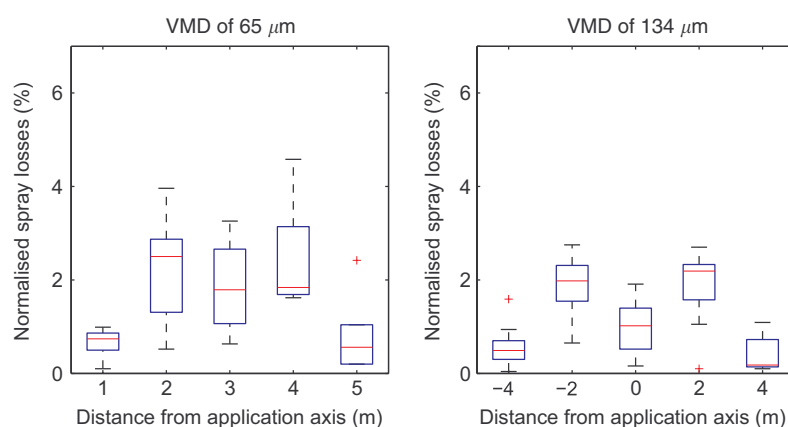

Fig. 7. Normalised spray losses at 2.5 m ($u < 0.3 \text{ m s}^{-1}$). Box plots: median, 25th and 75th percentiles. Error bars: 10th and 90th percentiles. The plus sign is an indication of an outlier in the data.

Table 6
Multiple linear regression model for the normalised loss (%) at 2.5 m

Source	Sum of squares	DF	Mean square	F	p-Value
Regression	217.44	6	36.2396	42.9963	0.0000
Residual	42.14	50	0.8429		
Total	259.58	56			

Variable	Coeff.	Std. error	t-Stat.	p-value
Intercept	14.182	1.520	9.330	0.0000
Wind speed	1.197	0.156	7.699	0.0000
Temperature	-0.364	0.052	-7.010	0.0000
VMD	1.842	0.293	6.289	0.0000
$(z/L)^{-1}$	0.059	0.018	3.310	0.0017
Relative humidity	-0.024	0.010	-2.410	0.0197
Wind direction	-0.001	0.001	-0.841	

DF: degree of freedom; p-value: probability value $> F$; F: Fisher's statistical test value; Std. error: standard error; t-stat.: student's statistical test value.

The multiple regression analysis described in Section 2.6 was performed on the results of Experiment C. After a few possible outliers were first identified by a robust linear regression model, a set of 56 runs was selected out of the initial 63 (32 runs for fine spray and 24 for very fine spray). A satisfactory determination coefficient was obtained from the multiple regression analysis ($R^2 = 0.84$). The most influential factors turn out to be the VMD, wind velocity, air temperature, stability condition and relative humidity, all determined to be significant at the 0.05 confidence level. Wind direction shows no influence (Fig. 8).

This analysis shows that it is possible to get a good prediction of sprayed liquid concentration at

2.5 m from these variables (Fig. 9). The multiple regression was carried out separately for both high and low VMD series. It appears that RH does not influence fine spray losses, suggesting that the evaporation process is more important for the very fine spray fraction and the higher distances from the sprayer, as was discussed in Section 3.1.

Spray loss at 5.5 m does not show any linear relationship with microclimatic variables ($R^2 < 0.35$). Conventional statistical tools are therefore not suitable to account for the detailed processes responsible for the upward movements of sprayed liquid. In order to go further, a physical analysis that would include meteorological and operational variables and their influence on spray

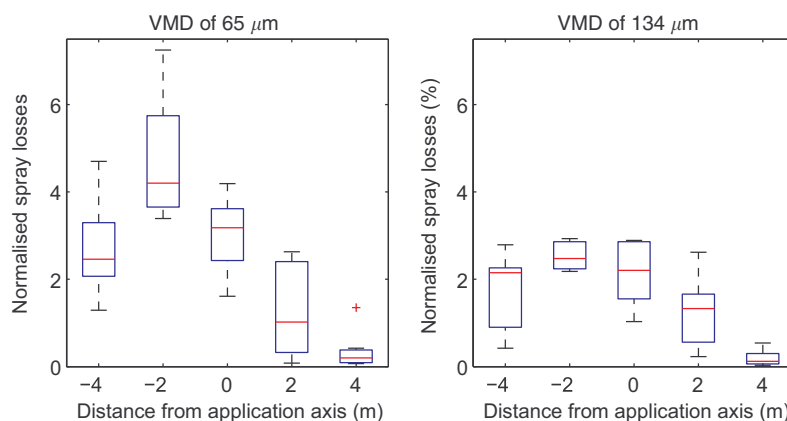

Fig. 8. Normalised spray losses at 2.5 m ($u > 1 \text{ m s}^{-1}$). Box plots: median, 25th and 75th percentiles. Error bars: 10th and 90th percentiles. The plus sign is an indication of an outlier in the data.

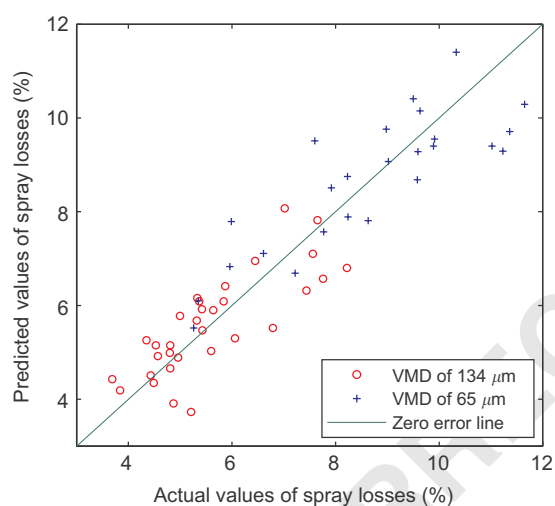

Fig. 9. Normalised losses (%) at 2.5 m from the ground: measured and estimated values obtained by the multiple regression model.

cloud dynamics is necessary to describe vertical transfer of pesticides and dispersion process during spraying.

4. Conclusions

An experimental approach based on the use of standard 2 mm diameter passive collectors has been conducted to assess near-field pesticide emissions to the air during spraying. On the basis of theoretical and experimental analyses, their collection efficiency was shown to be acceptable. Three full-scale

outdoor experimental campaigns were performed over an artificial crop simulating a vineyard. Their results suggest that the use of PVC lines and a tracer can provide a good quantification of sprayed droplet flow in field conditions, especially in the vicinity of the sprayer. However when higher levels are considered pesticide dispersion becomes a more complex process that is difficult to study with such field tests.

The variables influencing air pollution during spraying could be determined from the measurement of tracer deposits on the PVC lines. Wind speed and droplet size distribution are shown to be the most important variables influencing sprayed liquid transfer to the surface boundary layer. Air temperature plays a significant role on the amount of liquid trapped on the lines. However in this method it is not clear whether this variable acts on droplet movements or on the collection efficiency; additional information is clearly required.

Atmospheric stability is the most important factor for the characterisation of the plume type during pesticide emission to the air. Statistical models can be used to determine the relative influence of the climatic variables and predict pesticide losses just above the crop for a given set of microclimatic conditions.

Physical and mathematical models are then necessary to understand further the phenomena. The results obtained here will provide the necessary input data to run such models in a realistic way.

ARTICLE IN PRESS

Y. Gil et al. / Atmospheric Environment ■ (■■■■) ■■■-■■■

13

Acknowledgements

The authors would like to thank Berthoud Sprayers Ltd. who provided the equipment used for this research, and the Experimentation Group of UMR-ITAP (X. Ribeyrolles, G. Dioulouf, B. Ruelle, D. Virgile, H. Fonta, P. Oullier and G. Alvarez) for their contributions during field tests. This study was supported by the Alban programme, the European Union Programme of High Level Scholarships for Latin America (identification number E03D18224VE).

References

- Asman, W., Jorgensen, A., Jensen, P., 2003. Dry deposition and spray drift of pesticides to nearby water bodies. Technical Report, Danish Environmental Protection Agency.
- Aubertot, J., Barbier, J., Carpentier, A., Gril, J., Guichard, L., Lucas, P., Savary, S., Savini, I., Voltz, M. (Eds.), 2006. Pesticides, Agriculture and Environment: Expert Report. INRA, Cemagref.
- Aylor, D., 1982. Modelling spore dispersal in a barley crop. *Agricultural Meteorology* 26, 215–219.
- Bedos, C., Cellier, P., Calvet, R., Barriuso, E., 2002. Occurrence of pesticides in the atmosphere in France. *Agronomie* 22, 35–49.
- Briand, O., Millet, M., Bertrand, F., M., C., Seux, R., 2002. Assessing the transfer of pesticides to the atmosphere during and after application. Development of a multiresidue method using adsorption on Tenax and thermal desorption GC/MS. *Analytical and Bioanalytical Chemistry* 374, 848–857.
- CEC, 2002. Communication from the commission to the Council, the European Parliament and the Economic and Social Committee: towards a thematic strategy on the sustainable use of pesticides. Technical Report, Commission of the European Communities.
- Costa, A., P.C.H., M., Truck, C., 2006. The development of wind tunnel protocols for spray drift risk assessment. *Aspects of Applied Biology* 77, 289–294.
- Cross, J., Walklate, P., Murray, R., Richardson, G., 2001. Spray deposits and losses in different sized apple trees from an axial fan orchard sprayer: 1. Effects of spray liquid flow rate. *Crop Protection* 20, 13–30.
- Gaskin, R., Manktelow, D., Elliott, G., 2002. New adjuvant technology for pesticide use on wine grapes. In: 55th Conference Proceedings of the New Zealand Plant Protection Society Incorporated.
- Gil, Y., Sinfort, C., 2005. Emission of pesticides to the air during sprayer application: a bibliographic review. *Atmospheric Environment* 39, 5183–5193.
- Gil, Y., Sinfort, C., Bonicelli, B., 2005. Spray drift collector efficiency: assessment of 2 mm diameter PVC line in a wind tunnel. In: Proceedings of Eighth Workshop on Spray Application Techniques in Fruit Growing. Barcelona, Spain, pp. 135–136.
- Guyot, G., 1997. *Environmental Climatology. From Crops to Ecosystems*. Masson, Paris, France.
- Herbst, A., Molnar, G., 2002. Comparison of spray drift collectors in a wind tunnel. *Nachrichtenblatt des Deutschen Pflanzenschutzdienstes* 54, 233–238.
- Hewitt, A., O'Donnell, C., Woods, N., Dorr, G., 2006. Atomisation modelling for spray applications. *Aspects of Applied Biology* 77, 147–153.
- Miller, D., Salyani, M., Hiscox, A., 2003. Remote measurement of spray drift from orchard sprayer using LIDAR. In: ASAE Annual International Meeting, Paper N 03-1093.
- Miller, P., Hadfield, D., 1989. A simulation model of the spray drift from hydraulic nozzles. *Journal of Agricultural Engineering Research* 42, 135–147.
- Murphy, S., Miller, P., Parkin, C., 2000. The effect of boom section and nozzle configuration on the risk of spray drift. *Journal of Agricultural Engineering Research* 75, 127–137.
- Parkin, C., Wheeler, P., 1996. Influence of spray induced vortices on the movement of drops in wind tunnels. *Journal of Agricultural Engineering Research* 66, 35–44.
- Parkin, C., Young, P., 2000. Measurements and computational fluid dynamic simulations of the capture of drops by spray drift samplers. *Aspects of Applied Biology* 57, 113–120.
- Phillips, J., Miller, P., 1999. Field and wind tunnel measurements of the air-borne spray volume downwind of single flat-fan nozzle. *Journal of Agricultural Engineering Research* 72, 161–170.
- Raupach, M., Briggs, P., Ahmad, N., Edge, V., 2001. Endosulfan transport: II. modeling airborne dispersal and deposition by spray and vapor. *Journal of Environmental Quality* 30, 729–740.
- Ravier, I., Haouisee, E., Clement, M., Seux, R., Briand, O., 2005. Field experiments for the evaluation of pesticide spray-drift on arable crops. *Pesticide Management Science* 61, 728–736.
- Roux, P., Herbst, A., Richardson, G., Delpech, P., Submitted for publication. Full-scale measurement of spray-drift from a vineyard sprayer in a controlled wind-tunnel environment. *Journal of Wind Engineering and Industrial Aerodynamics*.
- Teske, M., Bird, S., Esterly, D., Curbishley, T., Ray, S., Perry, S., 2002. Ag-drift: a model for estimating near-field spray drift from aerial applications. *Environmental Toxicology and Chemistry* 21, 659–671.
- Tsai, M.-Y., Elgethun, K., Ramaprasad, J., Yost, M.G., Felsot, A.S., Hebert, V.R., Fenske, R.A., 2005. The Washington aerial spray drift study: modeling pesticide spray drift deposition from an aerial application. *Atmospheric Environment* 39, 6194–6203.
- Van-den Berg, F., Kubiak, R., Benjey, W., 1999. Emission of pesticides into the air. *Water, Air, and Soil Pollution* 115, 195–218.
- Walklate, P., 1992. A simulation study of pesticide drift from air-assisted orchard sprayer. *Journal of Agricultural Engineering Research* 51, 263–283.

3.6 Conclusions et perspectives

La méthode proposée dans ce chapitre permet de quantifier la masse de produit qui est envoyée directement vers l'air au moment de la pulvérisation. À partir de la mise en œuvre de ce type d'expérimentation, il est possible d'envisager l'élaboration d'un bilan de la dynamique des pesticides et d'en déduire les quantités perdues. ***La possibilité d'évaluer l'efficacité de divers procédés d'application dans plusieurs conditions environnementales est un des apports les plus importants de cette approche expérimentale.***

Les principaux paramètres micro-climatiques sont mesurés par de systèmes d'anémomètres ultrasoniques 3D. Une configuration adéquate de ces systèmes dans la parcelle, couplée avec une bonne définition des échelles temporelles de mesure, fournit une caractérisation des conditions atmosphériques qui influent sur le mouvement vertical de la pulvérisation.

Sur la dimension verticale, on peut vérifier que la vitesse du vent suit un profil logarithmique. Il peut donc être estimé à partir de deux valeurs seulement. Les profils de concentration peuvent, en moyenne, être représentés par une loi de transport de particules au-dessus d'une végétation :

$$\frac{C}{C_s} = \left(\frac{z}{z_s} \right)^{-\left(\frac{v_s}{\kappa u^*} \right)} \quad (3.13)$$

où $\frac{C}{C_s}$ est la concentration de polluant par rapport à une concentration connue au niveau de z_s (hauteur de référence) et v_s , la vitesse de sédimentation de la particule (eq. 3.3).

Dans le détail, quelques écarts existent entre cette relation et les valeurs mesurées, essentiellement pour des conditions de température élevées. Même si l'évaporation des gouttes n'est pas, a priori, un facteur limitant de la qualité des mesures dans les zones proches du pulvérisateur, il faudra éventuellement considérer ce phénomène pour expliquer les valeurs observées à des distances plus éloignées.

Dans ce contexte, et pour estimer la variation de la taille de goutte au moment de la pulvérisation, [Walklate \(1992\)](#) a utilisé un modèle qui est décrit dans l'équation 3.14.

$$\frac{dD^2}{dt} = C_e \cdot N_u \cdot \Delta T \quad (3.14)$$

où D est le diamètre de la goutte et C_e , le coefficient de diffusion de l'eau, constant entre 0 et 30°C avec une valeur de $4.13 \times 10^{-11} \text{ m}^2 \cdot \text{s}^{-1} \cdot \text{K}^{-1}$. Le nombre de Nusselt (N_u), permet de quantifier le rapport entre les échanges thermiques par convection et par diffusion. Il peut être estimé empiriquement à partir de l'expression de [Ranz et Marshall \(1952\)](#) (équation 3.15).

$$N_u = 2.0 + 0.6 P_r^{1/3} \cdot R_{ed}^{1/2} \quad (3.15)$$

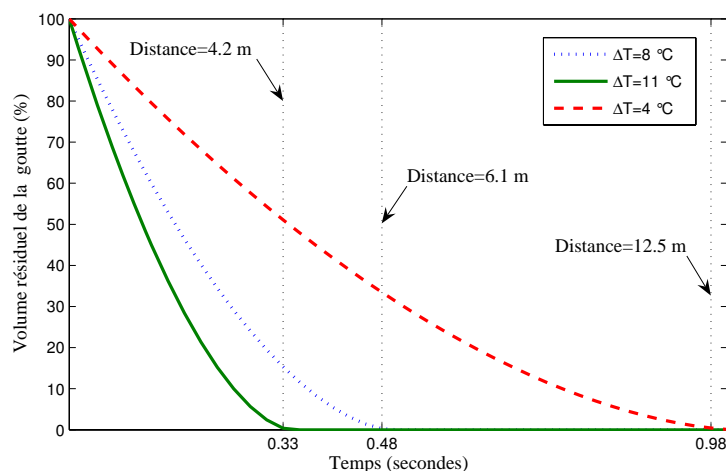

FIG. 3.9 – Variation de volume d'une goutte d'un diamètre initial de $28 \mu\text{m}$ pour plusieurs différences psychrométriques (ΔT). Distance parcourue par la goutte avant évaporation totale pour une vitesse d'éjection initiale de $12.8 \text{ m}\cdot\text{s}^{-1}$

où P_r est le nombre de Prandtl pour la vapeur d'eau et R_{ed} le nombre de Reynolds particulaire de la goutte.

Cette formule a été employée pour quantifier l'effet de l'évaporation des gouttes sur la performance de la méthode détaillée dans l'article précédent. La figure 3.9 montre les résultats obtenus pour la variation de volume d'une goutte dont le diamètre initial est le $D_{V,10}$ de la pulvérisation très fine ($28 \mu\text{m}$), et dont la vitesse initiale est la vitesse moyenne d'éjection du pulvérisateur ($12.8 \text{ m}\cdot\text{s}^{-1}$). Il apparaît ainsi, que même dans le pire des cas, les gouttes peuvent parcourir une distance d'au moins 4 mètres avant de s'évaporer totalement. Cette distance est suffisamment importante pour garantir que le premier niveau de mesure n'est pas affecté par ce phénomène.

L'occurrence de quelques contradictions par rapport à la base théorique de la physique des nuages (par exemple, l'effet de la température sur la quantité du jet mesuré) suggère que la capacité de la méthodologie à quantifier les pertes réelles puisse être remise en question pour certaines conditions d'essai.

Pour interpréter les résultats, ainsi que les limitations méthodologiques, deux stratégies d'analyse des données sont proposées, exécutées et comparées dans le prochain chapitre : un approfondissement des aspects déjà développés de façon préliminaire dans ce chapitre relatifs aux analyses par régression multiple et un système d'inférence « floue » pour modéliser les aspects les plus influents sur les quantités de liquide détectées dans le plan le plus proche du pulvérisateur.

De plus la base de données expérimentales permettra d'établir, dans le chapitre 5, les bases pour paramétrer un modèle mathématique.

Chapitre 4

Analyses des mesures expérimentales

A partir des séries de tests présentées dans le chapitre précédent, une base de données a été élaborée avec les principales variables micro-climatiques et les pertes de produits mesurées sur le plan le plus proche du pulvérisateur (2.5 mètres).

L'objectif de ce chapitre est de déterminer quelles variables influencent le phénomène et, par suite, d'élaborer des outils de prédiction suffisamment précis pour simuler de nombreuses situations.

Dans ce chapitre, les deux méthodes d'analyse évoquées ci-dessus sont décrites : d'abord, une analyse statistique par régression multiple et ensuite, une analyse basée sur des algorithmes de Systèmes d'Inférence Floue (SIF).

L'utilisation de diverses méthodes statistiques, comme l'analyse par régression multiple, est fréquemment reportée dans le cadre des diagnostics de problèmes de dérive, avec de bons résultats. Par ailleurs, des outils mathématiques relativement nouveaux, comme les SIF, ont été utilisés pour fournir des bases stables et développer des indicateurs pour des systèmes agricoles et environnementaux ; ils présentent l'avantage d'exploiter la connaissance experte pour analyser des situations complexes.

Ces deux méthodes permettent de discuter de la robustesse du procédé expérimental en fonction des variables micro-climatiques principales.

La démarche complète et les conclusions sont présentés dans l'article « *Influence of microclimatic factors on pesticide emission to the air during spraying : Analysis with statistical and fuzzy inference models* ».

4.1 Analyses Préliminaires

Avant d'appliquer les outils statistiques et SIF d'autres méthodes pour l'analyse de données expérimentales ont été teste dans le but de mettre en évidence la complexité des rapports entre les pertes de produit et les variables micro-climatiques déterminées dans le chapitre précédent.

4.1.1 Analyses en Composantes Principales (ACP)

Compte tenu de la présence d'un système complexe de corrélations entre les variables mesurées et les valeurs des pertes atmosphériques, l'ACP a été d'abord utilisée pour réduire ce système et déterminer les groupes d'essais semblables ou au contraire ceux qui s'opposent, pour chacune des deux grandes séries d'expériences (granulométrie de gouttes « fine » et « très fine »). Les variables analysées sont celles décrivant les conditions micro-climatiques et les pertes de produit vers l'air. La figure 4.1 montre, pour les deux séries d'essai, la position des variables par rapport aux axes principaux et les résultats, groupés par classes relativement aux quantités de pertes observées. Ces variables sont placées dans le plan de l'ACP par rapport à leur contribution dans l'explication de la constitution de chaque axe.

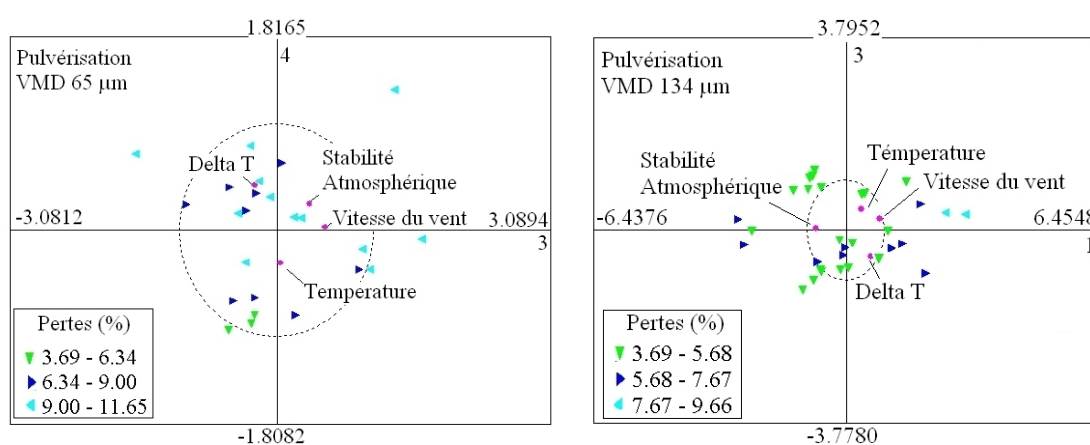

FIG. 4.1 – Analyses en Composantes Principales : effets des conditions micro-climatiques sur les pertes (%) pour les deux spectres de taille de gouttes

La dispersion des individus (essais) et la corrélation observée entre les variables et les axes suggèrent que l'essentiel de l'information ne peut pas être contenu dans une seule composante : les variables micro-climatiques sont indépendantes et ont des coefficients de corrélation quasi nuls. Par conséquent, la réduction n'apporte pas d'information supplémentaire et l'ACP de la base de données des essais n'apporte pas de nouvel élément pour l'analyse.

4.1.2 Méthodologie de Surface de Réponse (MSR)

La MSR permet de résoudre simultanément une équation multi-variables (par exemple les équations obtenues par régression multiple), en considérant la réponse comme une surface définie par les variables explicatives obtenues lors des essais de terrain. Ici la réponse est le pourcentage de pertes.

Cette méthodologie a pour objectif d'analyser l'effet de variables indépendantes quantitatives sur la réponse. Elle permet d'optimiser les valeurs des variables indépendantes pour maximiser, diminuer ou accomplir certaines restrictions dans la variable réponse (Box et Wilson, 1951). Par exemple, on peut étudier comment les valeurs de température

et de vitesse du vent affectent les pertes de produit et essayer de trouver les valeurs qui minimisent ces pertes.

La représentation mathématique des modèles de MSR peut recouvrir différentes formes : du premier ordre (linéaire) sans ou avec interactions, quadratiques ou du second ordre. Dans notre cas, une première approximation a été effectuée à partir des modèles obtenus par régression multiple, en considérant les principales variables micro-climatiques (vitesse du vent, stabilité atmosphérique, température de l'air et différence psychrométrique). Étant données les contradictions décrites dans le chapitre précédent, l'effet quadratique de la température de l'air a été rajouté. Les coefficients de chaque modèle ont été déterminés par la méthode de moindres carrés et sont présentés dans le Tableau 4.1.

Variable	VMD 65 μm	VMD 134 μm
Constante	40.77	15.51
Vitesse du vent	1.31	1.05
Paramètre de stabilité $(z/L)^{-1}$	0.09	0.02
Différence psychrométrique(ΔT)	0.31	0.10
Température de l'air	-2.87	-0.80
(Température de l'air) ²	0.05	0.01
Coefficient R^2	0.79	0.70

TAB. 4.1 – Régression multiple : Pourcentage de pertes en fonction de plusieurs variables. Coefficients obtenus par la méthode de moindres carrés pour deux granulométries (représentées par leur VMD)

La figure 4.2 montre les surfaces de réponse obtenue avec chacun des deux modèles, pour les variations de vitesse du vent et de température de l'air, dans des conditions atmosphériques stables et non évaporatives ($\Delta T=5$ °C). La figure montre la sensibilité des émissions aux facteurs atmosphériques par rapport à la taille des gouttes : pour un VMD de 65 μm la nuage pulvérisé est plus facilement transportable et plus sensible aux variations de température de l'air. D'autres surfaces de réponse peuvent être élaborées à partir des modèles de régression pour étudier les interactions entre variables.

Même si l'interaction la plus importante est celle entre vitesse et température de l'air, l'interprétation de cette interaction ne suffit pas à définir les conditions atmosphériques optimales pour les pulvérisations. C'est pourquoi un approfondissement des analyses de régression et d'autres stratégies ont été envisagées.

4.2 Description des analyses

Dans l'article fourni dans cette partie, les deux méthodes d'analyse des résultats de la mesure sont présentées et comparées pour fournir une évaluation des conditions bioclimatiques qui affectent les pertes directes de pesticides vers l'air.

Ces démarches ont été mises en place à partir des deux bases de données décrites

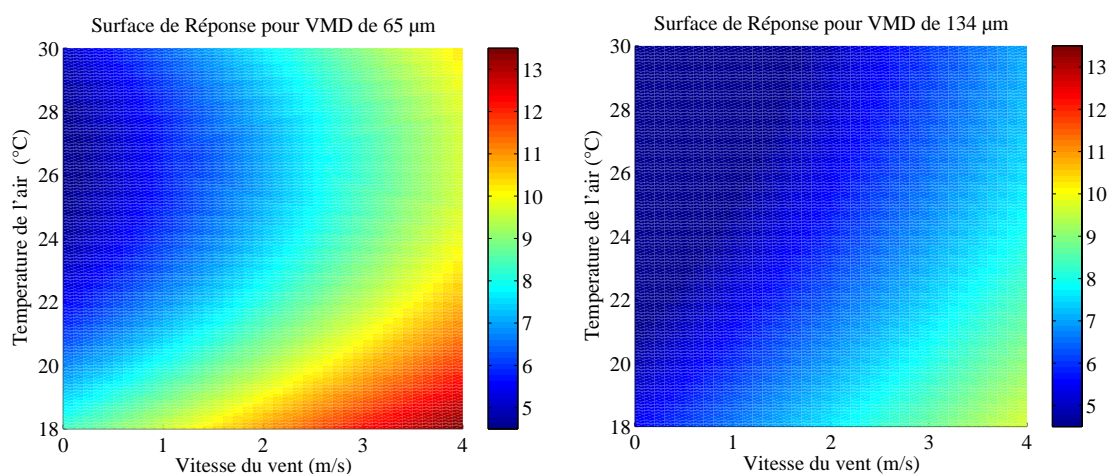

FIG. 4.2 – Surface de réponse des pertes de produit (%) pendant les applications : Effets des variations de vitesse du vent et de température de l'air pour les deux spectres de taille de gouttes. Différence psychrométrique, $\Delta T=5$ °C et paramètre de stabilité, $z/L=0$

dans le chapitre précédent, une pour chaque granulométrie. Dans ces bases de données, les principaux facteurs climatiques jouent le rôle des variables indépendantes et les pertes mesurées, celui de la réponse (ou variable dépendante).

La première stratégie développée correspond aux modèles de régression multiple. Ces modèles ont été choisis à partir d'outils d'analyse classique et, pour la sélection des variables significatives, une procédure « stepwise » a été appliquée à partir d'un modèle linéaire du premier ordre avec des interactions.

Ensuite les bases de données ont été analysées par des Systèmes d'Inférence Floue (SIF). Des règles ont été inférées en partant de l'élaboration d'arbres de décision flous, lesquelles sont une extension des arbres de décision classiques.

À partir de ces analyses une discussion sur le système expérimental est développée et l'effet des principales variables climatiques et de leurs interactions sur la performance de la méthode est discuté.

Influence of microclimatic factors on pesticide emission to the air during vine spraying: Analysis with statistical and fuzzy inference models

Yvan Gil ^{a,b,*}, Carole Sinfort ^b, Serge Guillaume ^b,
Yves Brunet ^c, Bernard Palagos ^b, Veronique Bellon-Maurel ^b

^aUCV, Faculty of Agronomy, Aptdo. Postal 4579 Maracay 2101, Venezuela

^bUMR ITAP, Cemagref BP 5095, 34033 Montpellier Cedex 1, France

^cINRA-EPHYSE, BP 81, 33883 Villenave d'Ornon, France

Abstract

Upward spray loss assessment, during a standard air-assisted application, was carried out using a fluorescent tracer dye and PVC lines as collectors. Linear multiple regression and fuzzy logic inference were used to evaluate the effects of microclimatic conditions on two droplet size distribution applications (fine and very fine). Multiple regression models were built for each test series, defined by their size droplet distribution. For the fine application the significant variables were wind speed, air temperature and wet bulb temperature depression (ΔT), obtaining a determination coefficient equal to 0.70. In the very fine treatment model the atmospheric stability parameter turned out to be also significant; the determination coefficient was equal to 0.82. Spray losses were also predicted with fuzzy inference systems and good determination coefficients were obtained ($R^2=0.72$ for fine spray and 0.66 for very fine spray). Interpretable rules were fixed for microclimatic characterization, for two different droplet distributions. Both tools could be combined with physical modelling to evaluate air pollution and spray drift from simplified field tests.

Key words: Air pollution, Drift, Fuzzy logic, Microclimatic conditions, Multiple regression, Passive collectors

* Corresponding author at: UCV, Faculty of Agronomy, Aptdo. Postal 4579 Maracay 2101, Venezuela. Tel.: +58 (243) 550 70 47; fax: +58 (243) 550 70 47
Email address: gily@agr.ucv.ve (Yvan Gil).

1 Introduction

Although many benefits were obtained from the use of pesticides, they are an incontestably pollutant source with adverse effects on the agro-ecosystems. These consequences include human health concern, lying on rural and urban populations. To mitigate these effects, it is essential to develop accurate strategies for pesticide management and reduce the environmental and economic issues.

Advances in research on new molecules and chemical agents, as well as in agricultural engineering, have allowed the amounts of pesticide required for crop protection to be reduced. Nevertheless the pesticide use in intensive agriculture still generates an increasing preoccupation in the overall population. This concern also generates a pressure to agricultural and environmental planning organisms, which must propose restrictive policies and standards for pesticide spraying practices, while assuring a framework that guarantees good crop yields.

Spray drift, the quantity of pesticide that is deflected out of the treated area by the action of climatic conditions, is one of the most critical problems pesticide applicators have to deal with, and many researchers engaged into the effort to diminish its negative effects.

Turbulent air assistance of the sprayed droplets is commonly used in crops and orchards such as vines, apples, etc. Air-assistance is produced by a fan, mainly to help the transport of the sprayed liquid while hydraulic nozzles create the drops. [Aubertot et al. \(2006\)](#) indicated that air assistance was accompanied by unquestionable losses towards the ground and the atmosphere, and that differences between air stream and droplet velocities could favour the evaporation phenomena. The losses to the air could be between 10 and 20% during a standard application.

Drift formation during radial air-assisted spraying into orchards is a complex process that was well described by [Xu et al. \(1998\)](#): the flow field coming from the air-jet outlet extends beyond the air-crop interface and affects spray penetration into the crop. Then, there is a recirculation of the droplets deposited on leaves. Streams produced by the sprayer and air deflection caused by crop-screen effect interact and generate large eddies. The mixed airflow entrains sprayed droplets and convects them out of the top of the canopy. Airborne pesticides are then dispersed and transported by the wind. Therefore, it is important to quantify the amount of pesticide lost to the atmosphere to predict downwind contamination, damage to crops and livestock risk.

Due to the costs of field tests and to the variability of microclimatic conditions, modelling the effect of the variables on environmental pollution is a suitable

alternative. Taking into account the numerous factors related to the application, equipment, meteorological and geographical conditions, tools have been developed to model drift from a few key parameters (Hewitt et al., 2002). Consequently, Computational Fluid Dynamic (CFD) codes were frequently used to solve the turbulent flow Navier-Stokes equations, with a standard $k-\epsilon$ turbulence model (Weiner and Parkin, 1993; Brown and Sidahmed, 2001; Tsay et al., 2002).

However, in these studies, the missing information is often the source itself. The quantification of the pollution source could be obtained from measurements of the emissions close to sprayer, during reduced field tests (Cross et al., 2001) and from combined spray drift models predicting the diffusion and the transport of chemical agents (Walklate, 1992). Different methods have been proposed and validated to achieve such tests (Herbst and Molnar, 2002). Among them, the use of a tracer combined with passive collectors is the most common method to assess the movement of clouds of sprayed liquid (Gil and Sinfort, 2005). Additionally its implementation is easy and cheap.

With passive collectors, some limitations are related to collection efficiency. This parameter could be theoretically (Aylor, 1982; Walklate, 1992; Parkin and Young, 2000) and experimentally (Fox et al., 2004; Gil et al., 2005) established, to interpret the result. It was shown that the method could underestimate pesticide losses to the air when very fine droplets evaporate close to the emission source (Gil et al., 2007). Suitable analysis methods could help to interpret the results and to identify the influence of the variables on spray losses.

Statistical modelling has been widely reported. Goering and Butler (1975) used regression analysis to examine spray drift deposits during ground applications, and stated that this method gave a good assessment of the effects of meteorological and application variables on drift. Smith et al. (2000) developed empirical models to determine the significant drift related variables in boom sprayer applications, finding a good agreement between predicted and measured drift deposits. The AgDRIFT[®] model, developed by the Spray Drift Task Force (Teske et al., 2002), is also partly based on a statistical model established from empirical observations during ground spraying.

In another way, Fuzzy Inference Methods were recently proposed to build environmental indicators helpful to analyse complex situations. They provide a stable basis to improve the development of generally accepted and transferable indicators for agricultural and environmental systems (Ferraro et al., 2003; Ocampo-Duque et al., 2006). Fuzzy logic is well-known for its natural language modelling ability and inference systems allow building rules of the form "If X is A then Y is C ", where A is a fuzzy set defined on the X universe and C is either a scalar or a fuzzy set defined on the Y universe. These rules can be either written by a domain expert or induced from data. For the latter, severe

constraints have to be superimposed to the algorithm inducting the rules so that the system remains linguistically interpretable to a human expert.

Consequently, statistical and fuzzy inference systems can be used to assess the complex relationship between environmental factors, spraying techniques and spray losses, from simplified and reproducible tests.

This paper aims to compare these two analysis methods to analyse test results and classify the main microclimatic conditions that affect the potential losses during a standard application. An experimental campaign was started in 2004 to evaluate pesticide emissions to the air during vine applications, while spraying a fluorescent tracer dye that was collected on classical 2 mm diameter passive collectors (Gil et al., 2007). After a brief description of these tests, both analysis methods are described. From these data analysis a discussion about passive collector assessment is presented and the relationship between the main microclimatic influential variables and the method ability are discussed.

2 Materials and Methods

2.1 Field test setting

Experiments were performed from June 10 to July 20, 2005 in Montpellier (South of France), during vine spraying period; these dates were selected to maximize the weather condition diversity.

An artificial vineyard was built from shade nettings with an apparent porosity of 34% (Roux et al., Submitted). Row spacing and crop height were 2 m each, a standard size for vineyards in this region. The artificial plot was built with four 8 m long rows oriented along the North-South direction. An axial air-assisted sprayer Fisher Turbo 561 -Berthoud Ltd.- was used.

Two sets of nozzles were tested, at a 10 bar operating pressure: Albus ATR white hollow cones (0.38 l min^{-1}) and Conejet green hollow cones (1 l min^{-1}). According to the British Crop Protection Council (BCPC) classification, spray quality is "fine" for the green nozzle, and "very fine" for the white one. Their Volume Median Diameter (VMD), are $65 \mu\text{m}$ (white nozzle) and $134 \mu\text{m}$ (green nozzle) at the operating pressure (Table 1). All tests were carried out with the same nozzles and the same air deflection angles. Mean air volumetric flow rate was of $3.3 \text{ m}^3 \text{ s}^{-1}$ and averaged air velocity was 12.8 m s^{-1} for all tests, with a PTO rotational speed of 540 rev min^{-1} . Air stream output was obtained with a 3D ultrasonic anemometer assessment. The tractor forward

Nozzle	$D_{V.10}$	$D_{V.50}$	$D_{V.90}$	Vol. $>100 \mu m$	Spray Quality
Green	72	134	180	74%	Fine
White	28	65	135	24%	Very Fine

Table 1

Droplet diameter (μm) for 10% ($D_{V.10}$), 50% ($D_{V.50}$) and 90% ($D_{V.90}$) of cumulative volume, spray volume with droplet diameter greater than 100 μm (Vol. $>100 \mu m$). Spray Quality is derived from the BCPC classification system. All information was obtained from manufacturers reports and the measurements were performed with a laser diffraction instrument.

speed was set to 5.1 $km h^{-1}$.

Sixty-three tests were run (33 runs for fine spray and 30 for very fine spray) to observe different climatic conditions for the two application spray qualities : fine and very fine. These climatic conditions are described in the section 2.3.

2.2 Spray flow estimation

The sprayed liquid was an aqueous solution of 1 $g l^{-1}$ of Brilliant Sulphoflavine (BSF) as fluorescent tracer dye and 0.1% of non-ionic surfactant.

To intercept upward spray losses, a reference plane was placed 2.5 m from the soil surface. Five 12-meter long PVC lines constituted this plane (Figure 1). Three lines were placed over the three inter-rows and two lines at 1 meter from the first and the last plot rows. During each run, the machine was driven four times on the central inter-row, to increase the amount of deposited spray and decrease random effects.

Captured liquid volumes of spray were estimated from the amount of liquid captured by the 2 mm diameter lines. Once the droplets on the lines had evaporated, each line was washed using 200 ml of tap water.

The spray volume removed from the lines (V_i , in ml) was determined from the relationship between spray mixture and line wash solution concentrations, that were obtained by fluorometry reading. The specific flux (S_i , in $ml mm^{-1}$) was then calculated as in equation 1, where d is the collector diameter in mm .

$$S_i = \frac{V_i}{d} \quad (1)$$

Then airborne spray quantity (Q , in ml) crossing the collector plane during

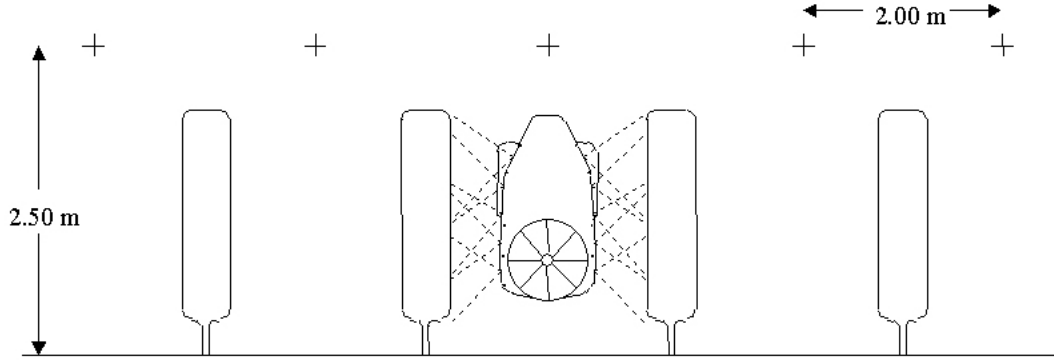

Fig. 1. Schematic plane of PVC line position above four artificial crop rows and sprayer working on central inter-row.

the spraying can be finally calculated as:

$$Q = \sum_{i=1}^n \frac{1}{2} [S_i + S_{i+1}] [h_{i+1} - h_i] \quad (2)$$

The term $[h_{i+1} - h_i]$ is the distance between each line (2000 mm). The amounts of spray flux are then normalised by the amount of spray applied to the crop so that atmospheric loss is defined as a percentage of the total amount of spray used in each test.

2.3 Determination of microclimatic variables

Hourly averaged values of relative humidity were obtained from a standard meteorological station. Wind speed components and temperature fluctuations were sampled at 10 Hz with a 3D ultrasonic anemometer (Young 81000, R.M. Young Co. USA) setup at 4 m height on a meteorological mast that was located on the border of the plot.

Friction velocity (u^* in $m s^{-1}$) was estimated, with equation 3, using the surface kinematic momentum fluxes in the East-West and North-South directions ($\overline{u'w'}$ and $\overline{v'w'}$), calculated from air velocities fluctuations (u' , v' and w').

$$u^* = [\overline{u'w'^2} + \overline{v'w'^2}]^{1/4} \quad (3)$$

Later, Monin-Obukhov length (L in m) was estimated with equation 4, where κ is the von Karman's constant (0.41), g is the acceleration due to gravity, T is the absolute temperature and T' stands for the fluctuations of air temperature

(Guyot, 1997).

$$L = \frac{u^{*3} \times T}{\kappa \times g \times \overline{T'w'}} \quad (4)$$

The stability parameter (z/L) was evaluated at $z = 4 \text{ m}$ (3D anemometer height). All values were calculated from 20-minutes measurement windows centered on each spraying operation whose effective duration was about 2 *min*.

The intensity of turbulence (I_e , dimensionless) was calculated for each test according to equation 5, from standard deviations ($\overline{u'^2}$, $\overline{v'^2}$ and $\overline{w'^2}$) and averaged values (U, V and W) of air velocity components (Chassaing, 2000).

$$I_e = \frac{\sqrt{\overline{u'^2} + \overline{v'^2} + \overline{w'^2}}}{\sqrt{U^2 + V^2 + W^2}} \quad (5)$$

The different microclimatic values, observed during the experiments, are shown in Tables 2 (White nozzle tests) and 3 (Green nozzle tests).

2.4 Multiple regression analysis

For the multiregression analysis, the spray droplet concentration, expressed in percentage, was taken as the dependent variable (Y_i). The selected microclimatic variables (independent variables) assumed to influence spray losses to the air were (Gil et al., 2007) wind speed, stability parameter (z/L), wet bulb temperature depression (ΔT), air temperature and turbulence intensity. The experimental data set was used to test the 'full interactions' (between two variables) model described in the equation 6, that accounts for all the variable interaction effects on predicted values (\widehat{Y}_i). Possible colinearity effects on regression results were evaluated through the matrix of the correlation coefficients, computed from all the possible pairings of the independent variables.

$$\widehat{Y}_i = \beta_0 + \beta_1\theta_1 + \dots + \beta_n\theta_n + \beta_{12}\theta_1\theta_2 + \dots + \beta_{(n-1)n}\theta_{(n-1)}\theta_n \quad (6)$$

The offset term is β_0 , $\beta_1 \dots \beta_n$ are the linear effect terms, and $\beta_{12} \dots \beta_{(n-1)n}$ are the interaction effects. All these terms were found using a least square method. The independent variables are represented as θ_i . The proportion of variance explained by the resulting polynomial model is given from a variance analysis (ANOVA) as the multiple coefficient of determination R^2 . The significance of each coefficient was determined using the *t-value* and *p-value* of a Student test, determining the probability that the β_i are equal to zero.

Test Reference	Wind Speed ($m s^{-1}$)	z/L	ΔT ($^{\circ}C$)	Temperature ($^{\circ}C$)	Ie	Losses (%)
W-01	0.68	-0.25	3.73	16.55	0.75	9.58
W-02	1.00	3.17	4.42	17.17	1.03	11.23
W-03	0.49	0.06	5.25	18.41	1.21	9.59
W-04	1.38	-0.08	9.60	18.51	0.94	9.63
W-05	0.89	0.34	6.85	19.65	0.76	8.23
W-06	0.26	-4.80	4.11	19.97	2.13	6.61
W-07	0.68	-0.23	4.98	20.21	1.24	7.77
W-08	2.21	-0.11	8.64	20.95	0.46	9.89
W-09	0.68	-2.58	7.74	21.02	1.03	8.24
W-10	1.61	-0.43	9.27	21.13	0.61	9.02
W-11	2.68	-0.48	5.91	21.52	0.44	11.36
W-12	4.15	-0.07	9.77	21.58	0.36	10.33
W-13	1.62	-0.22	8.49	22.02	0.59	7.92
W-14	0.61	-0.62	5.27	22.25	1.06	5.96
W-15	2.53	-0.14	10.04	22.52	0.60	9.91
W-16	3.26	-0.08	7.61	22.87	0.41	7.60
W-17	3.26	-0.19	7.61	23.34	0.46	8.98
W-18	3.66	-0.96	7.65	23.55	0.36	9.50
W-19	2.79	-0.13	10.33	23.60	0.59	11.02
W-20	3.83	-0.14	8.84	23.89	0.40	11.65
W-21	0.51	-1.44	5.98	24.08	1.55	5.35
W-22	1.00	-0.23	10.66	25.28	0.56	7.22
W-23	0.25	-2.25	6.88	25.89	2.18	5.26
W-24	1.83	-0.49	10.93	26.20	0.81	8.63
Mean	1.74	-0.51	7.52	21.76	0.86	8.77
S.D.	1.24	1.37	2.19	2.57	0.51	1.82
Min	0.25	-4.80	3.73	16.55	0.36	5.26
Max	4.15	3.17	10.93	26.20	2.18	11.65

Table 2

Very fine spray tests (VMD $65 \mu m$): microclimatic variables at 4 m above ground and measured spray losses. Mean, Standard Deviation (S.D.), minimum (Min) and maximum (Max) values for all the tests

A stepwise procedure was applied (Smith et al., 2000), starting with an empty model. Variables were added one-at-a-time as long as their *p-value* was small enough. The significance criteria for the *p-value* was set to 0.05. Finally, to validate the regression model, a leave-one-out cross validation assessment was carried out (Martinez and Martinez, 2002).

Test Reference	Wind Speed ($m s^{-1}$)	z/L	ΔT ($^{\circ}C$)	Temperature ($^{\circ}C$)	Ie	Losses (%)
G-01	0.22	-1.25	2.98	17.00	2.02	5.87
G-02	0.39	-0.34	2.37	17.33	1.25	5.37
G-03	0.30	0.77	1.89	17.80	0.85	5.84
G-04	1.67	-0.10	6.90	19.71	0.69	7.56
G-05	0.22	-0.19	8.20	19.80	2.20	5.00
G-06	0.88	-0.16	7.25	20.05	1.11	7.44
G-07	1.52	-0.13	7.76	20.26	0.82	6.45
G-08	1.75	-0.03	9.31	21.10	0.95	6.06
G-09	2.80	-0.09	9.36	21.30	0.59	7.02
G-10	0.71	-0.39	8.91	21.45	0.76	5.64
G-11	1.87	-0.05	7.51	22.03	0.77	5.42
G-12	3.33	-0.03	8.11	22.29	0.51	7.76
G-13	0.61	-2.32	9.40	22.37	1.23	5.32
G-14	0.92	-0.07	7.77	22.71	0.91	4.57
G-15	0.17	-5.51	9.93	22.88	2.55	4.81
G-16	0.80	-0.10	7.72	22.92	1.40	4.53
G-17	3.32	-0.08	8.49	22.98	0.40	7.65
G-18	3.10	-0.04	8.52	23.12	0.41	8.22
G-19	0.72	-0.69	10.59	23.82	0.93	4.35
G-20	1.07	-0.58	5.82	24.62	0.56	4.80
G-21	0.81	-0.34	4.87	24.69	0.92	3.84
G-22	0.95	-0.24	4.49	24.69	0.87	3.69
G-23	0.65	-0.59	11.27	24.95	1.17	4.96
G-24	0.20	-1.79	5.36	25.14	2.85	5.21
G-25	0.92	-2.02	5.36	25.22	1.01	4.49
G-26	1.23	-0.21	11.89	25.65	0.85	5.43
G-27	0.44	-3.15	6.23	25.93	1.36	4.87
G-28	1.40	-0.13	7.82	26.28	0.81	4.81
G-29	2.61	-0.12	8.63	26.31	0.37	5.33
G-30	1.63	-0.39	12.38	26.46	0.84	6.79
G-31	1.52	-0.35	8.38	26.58	0.92	5.60
G-32	1.01	-0.54	12.92	27.37	1.16	4.43
Mean	1.24	-0.66	7.76	22.96	1.06	5.60
S.D.	0.92	1.18	2.70	2.82	0.59	1.19
Min	0.17	-5.51	1.89	17.00	0.37	3.69
Max	3.33	0.77	12.92	27.37	2.85	8.22

Table 3

Fine spraying tests (VMD 134 μm): microclimatic variables at 4 m above ground and measured spray losses. Mean, Standard Deviation (S.D.), minimum (Min) and maximum (Max) values for all the tests

2.5 Fuzzy inference systems

Fuzzy Inference Systems (FIS) are one of the most famous applications of fuzzy logic and fuzzy set theory (Zadeh, 1965). The strength of FIS relies on their two-fold identity: on one hand they are able to handle linguistic concepts such as *High* or *Low*; on the other hand they are universal approximators able to perform non linear mappings between inputs and outputs, through automatic learning procedures.

But, applying that type of procedures with only numerical performance in mind conflicts with fuzzy logic originality: its interpretability. In this study, FIS were implemented through the use of a free software, FisPro 3.0 (Guillaume, 2001, www.inra.fr/internet/Departements/MIA/M//fispro/). Among the available methods for fuzzy rule induction, FisPro implements the ones that yield interpretable fuzzy rules.

The goal of this section is not to propose an extensive introduction to fuzzy logic (see Zadeh, 1965; Dubois and Prade, 2000; Bouchon-Meunier and Marsala, 2003), but only to provide the reader with the basic elements of fuzzy linguistic modelling.

First, we recall how fuzzy sets are used to model linguistic concepts and then the two main steps of rule generation are detailed: variable fuzzy partitioning design and rule induction.

2.5.1 Fuzzy sets and linguistic terms

A fuzzy set is defined by its membership function. A point, x , in the X universe, belongs to a fuzzy set, A , with a membership degree, $0 \leq \mu_A(x) \leq 1$. Figure 2 shows a triangle membership function.

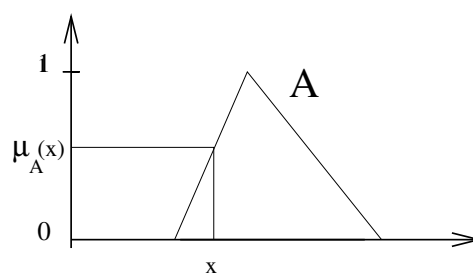

Fig. 2. A triangle membership function

Fuzzy sets can be used to model linguistic concepts. If A is the set of *High* temperatures, the membership degree of a given temperature x , $\mu_A(x)$, can be interpreted as the level to which the x temperature should be considered as *high*.

The rule “If Temperature is High then ...” is implemented as “If X is A then ...”. For the x value of temperature the matching degree of the rule is given by its membership degree, $\mu_A(x)$. Usually, several variables are involved in the rule description. In this case the membership degrees are combined using a *AND* operator, the minimum and the product being the most common ones.

Several fuzzy sets, corresponding to linguistic concepts, can be defined on the same universe, e. g. *Low, Mean, High*. The set of the fuzzy sets defined on the same universe forms a fuzzy partition of the variable.

2.5.2 Fuzzy partitioning

The readability of fuzzy partitioning is a pre-requisite condition to build an interpretable rule base.

The necessary conditions for interpretable fuzzy partitions have been studied by several authors [Ruspini \(1969\)](#); [De-Oliveira \(1999\)](#); [Glorennec \(1999\)](#). For instance, interpretable fuzzy sets must be not too numerous. They must directly correspond to linguistic concepts, and cover entirely the variable domain.

In Fispro these constraints are implemented as follows:

$$\begin{cases} \forall x, \sum_{f=1,2,\dots,m} \mu^f(x) = 1 \\ \forall f, \exists x / \mu^f(x) = 1 \end{cases} \quad (7)$$

where m is the number of fuzzy sets in the partition and $\mu^f(x)$ is the membership degree of x to the f^{th} fuzzy set.

Fuzzy sets are of triangular shape, except at the domain edges, where they are semi-trapezoidal. Conditions from equation 7 allow to define each fuzzy set with only one point, as shown in figure 3.

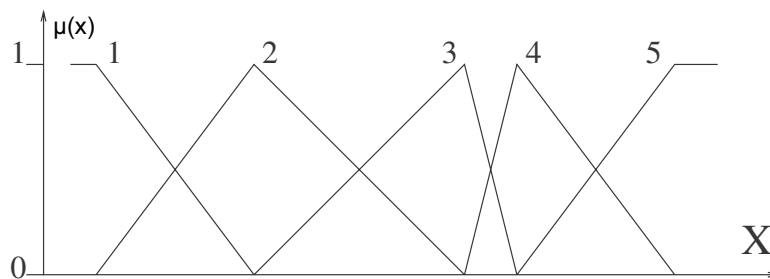

Fig. 3. A standardized fuzzy partition with five fuzzy sets and standardised membership degree (μ_x) between 0 and 1. X is the universe variable

Various methods are available within Fispro to build fuzzy partitions automatically (according to input data) or from expert knowledge.

2.5.3 Fuzzy rule generation

The next phase of FIS design consists in generating rules to be applied on the multi-variable inputs. The goal is to produce a small number of general rules. In the present case, the rule induction was proceeded with fuzzy decision tree induction.

Fuzzy decision trees (Ichihashi et al., 1996) are an extension of classical decision trees (Breiman et al., 1984; Quinlan, 1986). They can be used either for classification or regression.

The tree building is an iterative process. The root node is the starting point of the decision process. At each step a new level is added, on which each node corresponds to a split on the values of a new input variable, according to its partition. This variable is chosen while computing a selection criterion in order to reach a maximum of homogeneity amongst the examples that belong to each node, relatively to the output variable (response variable). The process is achieved when the selection criterion can not be improved. By this way, each terminal node corresponds to a particular path through the possible fuzzy sets of all variables.

The fuzzy rule associated to a given node b is written as:

IF x_{i_1} *is* $A_{i_1}^{j_1}$ *AND* x_{i_2} *is* $A_{i_2}^{j_2}$ *... THEN* y *is* C_b .

$A_{i_1}^{j_1}$ corresponds to the first node of the path starting from the root and leading to the node b , meaning that the first selected variable is i_1 , and the subtree leading to node b starts from the j_1 label of this variable. C_b , the rule conclusion, is the most represented class in node b in the classification case or the weighted average output in the regression case. An illustration is shown in figure 4.

The premise of the rule corresponding to the node b is defined by the set, Q , of the couples (i, j) , the j^{th} label of the i^{th} input variable, along the branch from the root to node b . The induction process is equivalent to minimize the entropy. When dealing with classification problems, the entropy for node b is defined as:

$$H_b = - \sum_k p_k^b * \log(p_k^b) \quad (8)$$

p_k^b is the k class density within b node, that means the proportion ratio of

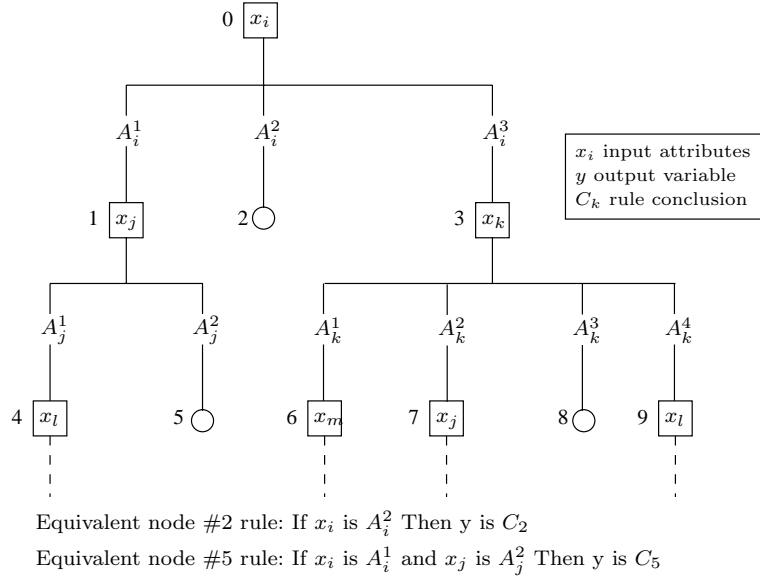

Fig. 4. An illustration of a fuzzy decision tree

elements belonging to class k . The cardinalities are fuzzy, and computed as the sum of the rule fire-strengths, w^b , for all the elements in the node.

$$p_k^b = \frac{|D_k^b|}{|D^b|} \quad \text{with} \quad |D^b| = \sum_{x \in b} w^b(x) \quad (9)$$

$$\text{and} \quad w^b(x) = \bigwedge_{(i,j) \in Q} \mu_{i,j}(x)$$

where \bigwedge is a *AND* operator, usually taken as the minimum or the product.

$|D_k^b|$ is defined in the same way but with the subset of $x \in D^b$ which belongs to class k .

To manage regression cases, the criterion of deviance is used (instead of the entropy). It is computed as the within node output variance. Each of the y values being weighted by the corresponding rule fire-strength. The deviance of node b is:

$$V_b = \frac{\sum_{i \in b} (w^b(x_i)(y_i - \bar{y})^2)}{|D^b|} \quad (10)$$

If this deviance (or the entropy) is not small enough, the node b is splitted according to a new variable. Let m the number of fuzzy sets of the considered input variable. In classification cases, a new entropy is obtained through the

weighted sum of the sub-node entropies, H_{b_f} :

$$E = \sum_{f=1}^m q^{b_f} \times H_{b_f} \quad \text{with} \quad q^{b_f} = |D^{b_f}|/|D^b| \quad (11)$$

where D^{b_f} is defined as in (9) for the part of node b elements which fall in the branch f . The information gained (G) by selecting the considered input variable is the difference between the criterion values before and after splitting. Which comes to: $G = H_b - E$, using the classification notations.

The final step consists in a rule conclusion optimisation using a least square minimization criterion. In regression cases, the output values can be then determined for any multi-variable input, as the weighted average of all terminal nodes outputs (most of the weights being null).

The main advantage of the decision trees is to generate incomplete rules, only defined by a subset of the available input variables. The generated rules are informative for experts to the condition that the partitioning is carefully defined.

3 Results

3.1 Regression model fitting

After a few possible outliers were first identified by a robust linear regression model, the multiple regression analysis described in section 2.4 was performed on a set of 56 runs selected out of the initial 63 (32 runs for fine spray and 24 for very fine spray). The correlation matrix was used to check the colinearity effects between the variables. The variable used for atmospheric stability was the inverse of the stability parameter (z/L), which turned out to improve the prediction.

3.1.1 Fine spraying

For the fine spraying data, the stepwise approach suggested two significant variables for the model. Table 4 shows the significance of each coefficient determined with the Student test as explained in section 2.4. The most influential factors turn out to be the linear term of air temperature (D), followed by the interaction effect of wind speed and wet bulb temperature depression

Variable and Interactions	β	SD of β	t -value	p -value
Off set	9.719	0.997	9.748	0.0000
Wind Speed x ΔT (AC)	0.109	0.015	7.437	0.0000
Temperature (D)	-0.229	0.044	-5.181	0.0000

Table 4

Results of the stepwise variable selection for fine spray tests. β , regression predictor; SD Standard deviation of the predictor; t -value, Student statistical test; p -value, probability that β is zero

(AC). The obtained model assesses upward spray losses during a standard air-assisted spraying through the expression given in equation 12:

$$\widehat{Y}_i = 9.719 - 0.229(D) + 0.109(AC) \tag{12}$$

The interaction effect for the product of wind speed and ΔT (AC) is positive, indicating that, as wind speed and ΔT increase, the spray losses increase too. The sign of air temperature effect (D) indicates that spray losses are smaller for high temperatures. Determination coefficient (R^2) obtained is of 0.70.

3.1.2 Very fine spraying

Results from very fine spraying data are shown in Table 5, and the equation 13 shows the selected regression model. The stepwise procedure determined the statistical significance, into the model, of two variables, and two interactions. The first variable in the model is the linear effect of wind speed (A), with a positive sign. Later comes the temperature value (D), with a negative sign, that corroborates the results obtained with the other data set. However, on this test series, the factor β is greater, demonstrating that air temperature effect is higher. Significance and positive sign of the interaction between ΔT and the temperature (CD) is also obtained. Finally interaction between wind speed and stability conditions (AB^{-1}) was entered into the model with a positive sign.

$$\widehat{Y}_i = 18.732 + 1.488(A) - 0.672(D) + 0.016(CD) + 0.058(AB^{-1}) \tag{13}$$

3.1.3 Prediction from statistical modelling

The comparison of the values obtained by the model with the measured values is shown in Figure 5. For the global approach (including both fine and very fine series) a determination coefficient $R^2=0.90$ was obtained. Using a

Variable and Interactions	β	SD of β	t value	p-value
Off set	18.732	1.965	9.534	0.000
Wind Speed (<i>A</i>)	1.488	0.257	5.788	0.000
Temperature (<i>D</i>)	-0.672	0.117	-5.744	0.000
ΔT x Temperature (<i>CD</i>)	0.016	0.005	2.911	0.009
Wind Speed x $(z/L)^{-1}$ (<i>AB</i> ⁻¹)	0.058	0.02	2.838	0.011

Table 5

Results of the stepwise variable selection for very fine spray tests. β , regression predictor; SD Standard deviation of the predictor; *t-value*, Student statistical test; *p-value*, probability that β is zero

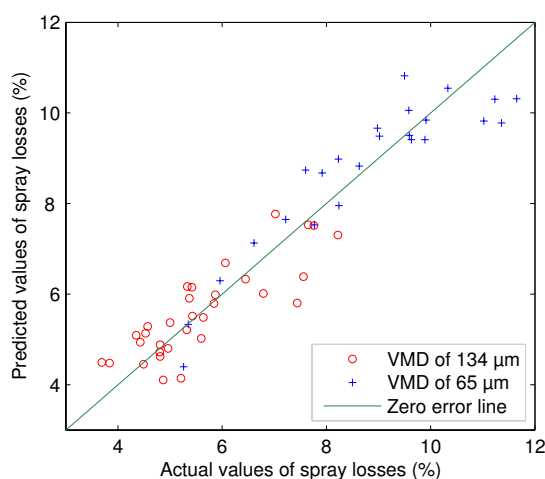

Fig. 5. Normalised losses (%) at 2.5 m from the ground: measured and estimated values obtained by the multiple regression model

cross-validation procedure, this coefficient becomes 0.83, which evidences the reliability of the statistical model for the data set assessed.

3.2 Fuzzy inference

Fuzzy sets were defined accordingly to physical influence on spray losses (Fig. 6). Three representative sets were fixed on wind speed variable. These sets were defined according to Beaufort Scale reference: *Low* when velocities are less than 0.30 m s^{-1} , *Mean*, when around 1.40 m s^{-1} and *High*, when greater than 3.00 m s^{-1} . For air temperature, wet bulb temperature depression (ΔT) and stability parameter, fuzzy sets were described by only two levels (*Low* and *High*), according to atmospheric conditions that favour spray emissions (PISC, 2002). For air temperature, the breakpoint values were set to $19 \text{ }^\circ\text{C}$ and $25 \text{ }^\circ\text{C}$

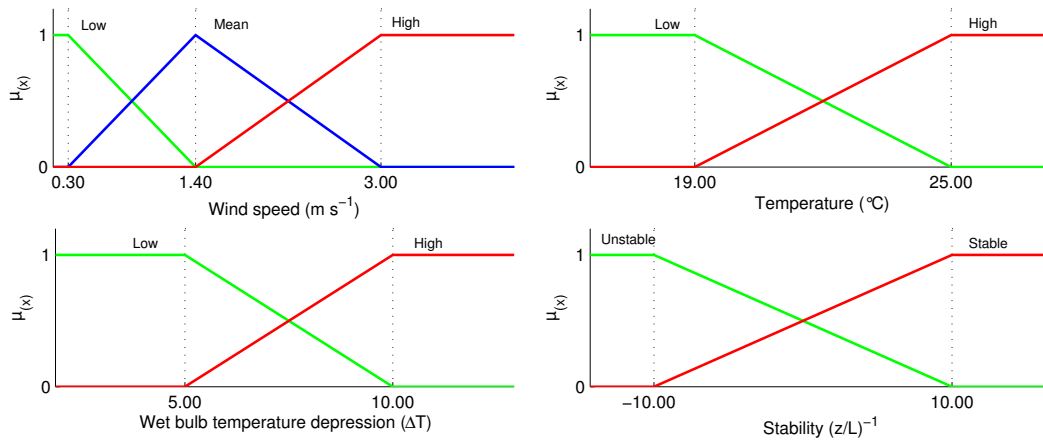

Fig. 6. Selected fuzzy partitions for wind speed, air temperature, wet bulb temperature depression and stability parameter. $\mu(x)$, normalized membership degree

whereas for ΔT they were set to 5 °C and 10 °C. Stability parameter $((z/L)^{-1})$ reference values were set to -10 and +10. The lower and higher limits of the domains optimise the classification of the registered values expressed in the Tables 2 and 3.

3.2.1 Fine spraying

The induction process for the fine spraying data set determined that three variables influence spray losses: wind speed, air temperature and ΔT (Fig. 7). The most influential variable are wind speed, then air temperature and finally ΔT . The rules are of general type and each one is activated by at least 9 examples.

From this decision tree a Rule Base was defined (Table 6). It includes five rules giving different values of spray losses. Optimised output values were computed with a least square optimisation (OLS) to improve the correlation between measured and predicted values. Spray losses increase with wind speed. *Low* and *High* wind speed labels define each one a level of losses by their own (see rules 01 and 05) and *Mean* value category is subdivided into two levels, defined by air temperature partition (rules 02 and 03 for *High* temperatures and rule 04 for *Low* temperature). There, spray losses are greater when temperatures are *Low*. Finally, when temperature is *High*, the two sets of ΔT define different spray losses: evaporative conditions (*High* ΔT) increase weakly spray losses. Spray losses inference predicted the losses with a determination coefficient $R^2 = 0.72$.

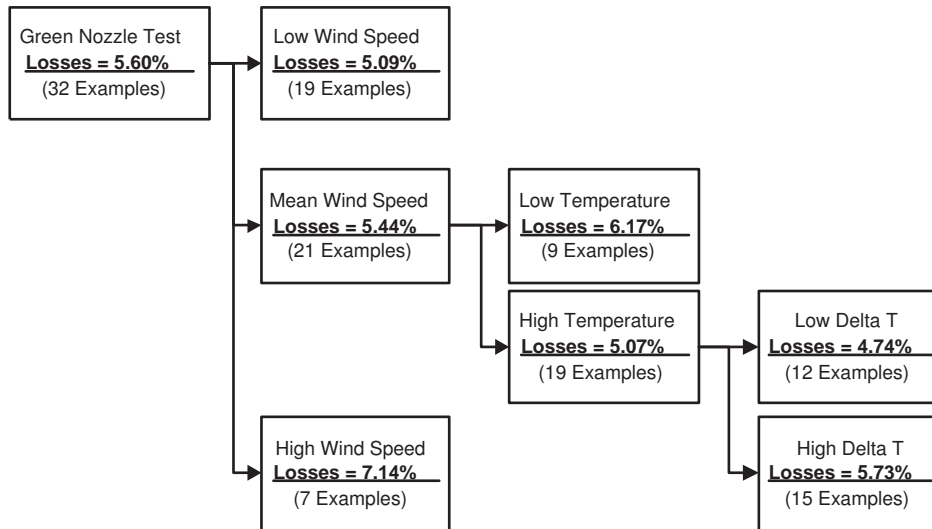

Fig. 7. Decision tree from fine spray data (VMD 134 μm). The induction process sets the variables according to their contribution for entropy minimization

Rule	Wind Speed	Temperature	ΔT	Losses (%)		
Id	($m s^{-1}$)	($^{\circ}C$)	($^{\circ}C$)	RC	OC	LM
Rule 01	Low			5.09	5.27	Mean
Rule 02	Mean	High	Low	4.75	3.13	Low
Rule 03	Mean	High	High	5.33	5.27	Mean
Rule 04	Mean	Low		6.17	7.70	Strong
Rule 05	High			7.14	7.70	Strong

Table 6

Rule base for spray loss estimation from fine spray data (VMD 134 μm). ΔT , wet bulb temperature depression. Spray losses values for Rule Conclusion (RC), Optimised Conclusion (OC), and Linguistic Mean (LM)

3.2.2 Very fine spraying

According to the decision tree from fuzzy inference (Fig. 8), the system can be modelled with only two variables: wind speed and air temperature. As in fine spraying, the more influential variable is wind speed.

Table 7 shows the obtained rule base including four rules. Averaged spray losses increase with wind speed. When wind speed is *Low*, two subdivisions are possible according to air temperature values. As for fine spraying, the spray trapped quantities on the PVC lines decrease when air temperature is greater. The resulting determination coefficient is $R^2 = 0.66$.

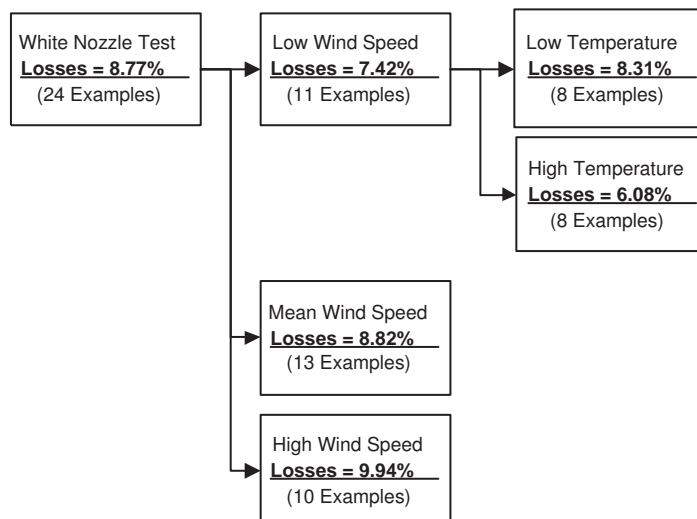

Fig. 8. Decision tree from very fine spray data (VMD 65 μm)

Rule Id	Wind Speed ($m s^{-1}$)	Temperature ($^{\circ}C$)	Losses (%)		
			RC	OC	LM
Rule 01	Low	High	6.08	4.28	Low
Rule 02	Low	Low	8.31	9.03	Mean
Rule 03	Mean		8.82	9.03	Mean
Rule 04	High		9.94	10.00	Strong

Table 7

Rule base for spray loss estimation from very fine spray data (VMD 65 μm). Spray losses values for Rule Conclusion (RC), Optimised Conclusion (OC), and Linguistic Mean (LM)

3.2.3 Prediction from Fuzzy Inference

Figure 9 shows the values predicted by fuzzy inference. From a training data set of 75% of each record set, tested on the 25% rest, cross-validation procedure showed a determination coefficient (R^2) equal to 0.80.

4 Discussion

4.1 Microclimatic effects on spray losses

Both data analysis methodologies evidence the wind speed effect on upward emissions of droplets during spraying. Predictors related to this variable in the

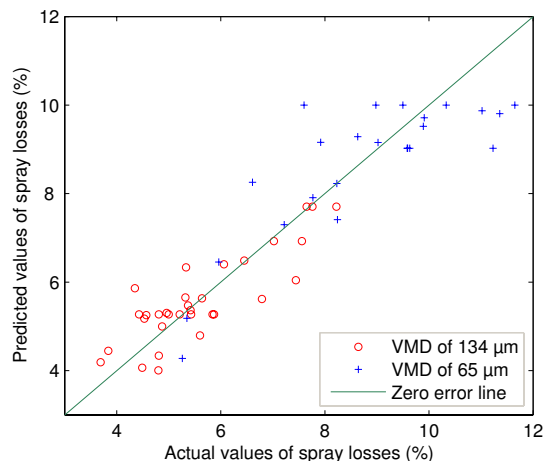

Fig. 9. Upward spray losses (%) predicted by fuzzy logic. Comparison with zero error line

multiple regression analysis have a positive sign, and the difference between the coefficients for fine and very fine spraying demonstrates that smaller droplets are more affected by this effect, which is related to eddy formation above the crops increasing upward air movement. Beaufort Scale use, during fuzzy set partitioning, allows a good classification of predicted spray losses.

Spray losses are influenced by the evaporation process, represented by the wet bulb temperature depression (ΔT). During evaporative conditions, the droplet size decreases and are more easily transported by mechanical effects. Therefore, the wind speed effects are greater. This is evidenced by the significance of the interaction between ΔT and wind speed during fine spraying with positive effects on spray emissions. For the very fine spray results, a positive sign was observed for the interaction ΔT -Air temperature, due to the greater evaporative effects at higher air temperatures. Fuzzy inference also demonstrates this effect, however it is only present during fine spraying when wind speed is *Mean*. This is probably because *Low* wind speed values are associated to less important evaporative conditions, and on the other hand because, with *High* wind speed, the droplet reach PVC lines more quickly, before being affected by evaporation.

Atmospheric stability also appears to be an influential variable for fine spraying. The significance of the interaction between this variable and wind speed indicates that, in the range of stabilities observed, the wind speed has a greater influence when the atmosphere becomes unstable. However, in Fuzzy Inference, this variable is not significant, maybe because it was integrated into wind speed effects. Nevertheless, the determination coefficient is lower if this variable is not considered.

4.2 Air temperature effect on spray quantities trapped by the lines

Multiple regression analysis show that air temperature affects the quantities trapped on the lines during both types of spraying. Indeed, a diminution of spray losses was observed as air temperature decreases, being more important during very fine application. The experimental method cannot explain this effect, and, by now, it is not possible to determine either if air temperature has a real effect on spray emissions or on the performance of drift collectors. Fuzzy inference revealed that air temperature only affects the emissions with *Low* wind speed for very fine spraying and *Mean* wind speed for fine spraying.

4.3 Collector efficiency and losses by evaporation

Particle impaction efficiency on cylinders depends on the particle Stokes number (Aylor, 1982; Walklate, 1992; Parkin and Young, 2000). Hence, the collection efficiency of the lines is expected to be a function of both droplet diameter and velocity.

The collector efficiency was evaluated in a wind tunnel (Gil et al., 2005), and was about 80% with a wind speed of 3.5 m s^{-1} and with VMD values between 146 and $255 \mu\text{m}$.

The impact efficiency was also estimated from the Stokes' number. Here, it was estimated for the $D_{V,10}$ and $D_{V,90}$ droplet diameters (the observed range in our conditions was 28 to $180 \mu\text{m}$). The particle Reynolds number was calculated with a relative velocity between the droplets and the air of 0.1 m s^{-1} . Using three different models, the following efficiency values were obtained: 86% (Aylor, 1982), 100% (Walklate, 1992) and 78% (Parkin and Young, 2000), that are in fact the asymptotic values of these models. They all lie in the same range and, at least for two of them, agree well with the wind-tunnel measurements. If we assume a smaller wind velocity (1 m s^{-1}), the efficiency slightly decreases, down to 70%-100% depending on the model used, considering all droplet diameters. Thus, given the distribution of droplet diameters encountered in our experiments, we can consider that the PVC lines act as a good collector even in relatively low wind conditions. The output air ejection speed being about 12 m s^{-1} , there should never be any problem at the height of measurement plane (2.5 m).

Due to this large ejection speed, the evaporation of the droplets is very small along their trajectory to the collection plane (that they reach after a very short travel time). This is evidenced by the effect of wet bulb temperature depression on spray losses, since higher values of ΔT were related to higher spray losses for the two data sets.

5 Conclusions

The main influential factors on the spray upwards emissions close to the crops can be assessed with the proposed test protocol. This kind of experiment could provide important information to improve the existent diffusion and pollution models. However additional information is required to better understand air temperature effects on droplet movement and collection process.

Statistical and fuzzy inference approaches characterize microclimatic factors as well as their influence on upward emissions of sprayed liquid. The dynamic of spray emissions and its relationship with the main environmental variables is different accordingly to droplet size distribution. Therefore two systems were formed, for each droplet size distribution, obtaining good determination coefficients. The most influential factors turn out to be wind speed, air temperature and wet bulb temperature depression for both different spray qualities, whereas atmospheric stability affects only the very fine spray emission.

The emission process may also be modelled using a fuzzy inference system that can include expert knowledge related to influential variables. The use of such method could improve the understanding of pesticide dynamic into the air. Additionally a classification of influential variables on spray emissions can be made, linked with pesticide emission risk levels, providing an interesting tool for environmental management.

Acknowledgements

The authors would like to thank Berthoud Sprayers Ltd. who provided the equipment used for this research, and the Experimentation Group of UMR-ITAP (X. Ribeyrolles, G. Diouloufet, B. Ruelle, D. Virgile, H. Fonta, P. Oullier and G. Alvarez) for their contributions during field tests. This study was supported by the Alban programme, the European Union Programme of High Level Scholarships for Latin America (identification number E03D18224VE).

References

- Aubertot, J., Barbier, J., Carpentier, A., Gril, J., Guichard, L., Lucas, P., Savary, S., Savini, I., Voltz, M. (Eds.), 2006. Pesticides, agriculture and environment: Expert report. INRA-Cemagref.
- Aylor, D., 1982. Modelling spore dispersal in a barley crop. *Agricultural Meteorology* 26, 215–219.

- Bouchon-Meunier, B., Marsala, C. (Eds.), 2003. Logique floue, principes, aide à la décision. [Fuzzy logic, principles, help to decision]. Lavoisier.
- Breiman, L., Friedman, J. H., Olshen, R. A., Stone, C. J., 1984. Classification and Regression Trees. Wadsworth International Group, Belmont CA.
- Brown, R., Sidahmed, M., 2001. Simulation of spray dispersal and deposition from a forestry airblast sprayer. Part II: Droplet trajectory model. Transactions of the ASAE 44, 11–17.
- Chassaing, P., 2000. Turbulence in fluids mechanics. Cepadues Editions. Toulouse, France.
- Cross, J., Walklate, P., Murray, R., Richardson, G., 2001. Spray deposits and losses in different sized apple trees from an axial fan orchard sprayer: 1. Effects of spray liquid flow rate. Crop Protection 20, 13–30.
- De-Oliveira, J. V., 1999. Semantic constraints for membership functions optimization. IEEE Transactions on Systems, Man and Cybernetics. Part A 29 (1), 128–138.
- Dubois, D., Prade, H. (Eds.), 2000. Fundamentals of fuzzy sets. Kluwer Academic Publishers.
- Ferraro, D., Ghera, C., Sznajder, G., 2003. Evaluation of environmental impact indicators using fuzzy logic to assess the mixed cropping systems of the Inland Pampa, Argentina. Agriculture, Ecosystems and Environment 96, 1–18.
- Fox, R., Derksen, R., Zhu, H., Downer, R., Brazee, R., 2004. Airborne spray collection efficiency of nylon screen. Applied Engineering in Agriculture 20, 147–152.
- Gil, Y., Sinfort, C., 2005. Emission of pesticides to the air during sprayer application: A bibliographic review. Atmospheric Environment 39, 5183–5193.
- Gil, Y., Sinfort, C., Bonicelli, B., 2005. Spray drift collector efficiency: Assessment of 2 mm diameter PVC line in a wind tunnel. In: Proceedings of 8th Workshop on Spray Application Techniques in Fruit Growing. Barcelona, Spain. pp. 135–136.
- Gil, Y., Sinfort, C., Brunet, Y., Polveche, V., Bonicelli, B., 2007. Loss of spray above an artificial vineyard during air-assisted spraying. Atmospheric Environment In Press.
- Glorennec, P.-Y., 1999. Algorithmes d'apprentissage pour systèmes d'inférence floue. [Learning algorithms for fuzzy inference systems]. Editions Hermès, Paris.
- Goering, C., Butler, B., 1975. Paired field studies of herbicide drift. Transactions of the ASAE 18, 27–34.
- Guillaume, S., 2001. Designing fuzzy inference systems from data: an interpretability-oriented review. IEEE Transactions on Fuzzy Systems 9, 426–443.
- Guyot, G., 1997. Environmental climatology. From crops to ecosystems. Masson. Paris, France.
- Herbst, A., Molnar, G., 2002. Comparison of spray drift collectors in a wind

- tunnel. Nachrichtenblatt des Deutschen Pflanzenschutzdienstes 54, 233–238.
- Hewitt, A., Maber, J., Praat, J., 2002. Drift management using modeling and GIS systems. In: Proceedings of World Congress of Computers in Agriculture and Natural Resources. pp. 290–296.
- Ichihashi, H., Shirai, T., Nagasaka, K., Miyoshi, T., 1996. Neuro-fuzzy id3: a method of inducing fuzzy decision trees with linear programming for maximizing entropy and an algebraic method for incremental learning. Fuzzy Sets and Systems 81, 157–167.
- Martinez, W., Martinez, A., 2002. Computational Statistics Handbook with Matlab. Chapman and Hall/CRC, USA.
- Ocampo-Duque, W., Ferré-Huguet, N., Domingo, J.-L., Schuhmacher, M., 2006. Assessing water quality in rivers with fuzzy inference systems: A case study. Environment International 32, 733–742.
- Parkin, C., Young, P., 2000. Measurements and computational fluid dynamic simulations of the capture of drops by spray drift samplers. Aspects of Applied Biology 57, 113–120.
- PISC, 2002. Spray drift management: Principles, strategies and supporting information. Primary Industries Standing Committee. Report 82. Tech. rep., CSIRO Publishing, Australia.
- Quinlan, J. R., 1986. Induction of decision trees. Machine Learning 1, 81–106.
- Roux, P., Herbst, A., Richardson, G., Delpech, P., Submitted. Full-scale measurement of spray-drift from a vineyard sprayer in a controlled wind-tunnel environment. Journal of Wind Engineering and Industrial Aerodynamics Submitted.
- Ruspini, E. H., 1969. A new approach to clustering. Information and Control 15, 22–32.
- Smith, D., Bode, L., Gerard, P., 2000. Predicting ground boom spray drift. Transactions of the ASAE 43, 547–553.
- Teske, M., Bird, S., Esterly, D., Curbishley, T., Ray, S., Perry, S., 2002. Ag-drift: A model for estimating near-field spray drift from aerial applications. Environmental Toxicology and Chemistry 21, 659–671.
- Tsay, J., Fox, R., Ozkan, H., Brazee, R., Derksen, R., 2002. Evaluation of a pneumatic-shielded spraying system by CFD simulation. Transactions of the ASAE 45, 47–54.
- Walklate, P., 1992. A simulation study of pesticide drift from air-assisted orchard sprayer. Journal of Agricultural Engineering Research 51, 263–283.
- Weiner, K., Parkin, C., 1993. The use of Computational Fluid Dynamic code for modelling spray from a mistblower. Journal of Agricultural Engineering Research 55, 313–324.
- Xu, Z., Walklate, P., Rigby, S., Richardson, G., 1998. Stochastic modelling of turbulent spray dispersion in the near-field of orchard sprayer. Journal of Wind Engineering and Industrial Aerodynamics 74-76, 295–304.
- Zadeh, L. A., 1965. Fuzzy sets. Information and Control 8, 338–353.

4.3 Conclusions et perspectives

Les analyses statistiques et mathématiques des résultats obtenus pour les deux séries d'essais mettent bien en évidence la complexité de l'effet des facteurs micro-climatiques sur les émissions de produits phytosanitaires vers l'air.

Malgré leurs limitations pour modéliser le système à partir de la quantité de données disponibles, l'ACP et la MSR sont des outils à considérer car ils peuvent fournir une information précieuse pour l'interprétation du mécanisme du transfert de pesticides vers l'air au moment de l'application. Dans le cadre de l'analyse globale, l'application de ces outils a permis de vérifier l'indépendance des variables et la complexité des interactions, pré-requis indispensable avant d'envisager l'emploi des méthodes de régression multiple et de SIF.

La modélisation non linéaire du phénomène à partir de multiples variables (micro-climatiques et opérationnelles) demande l'utilisation de plusieurs outils statistiques et mathématiques pour décrire les principales interactions.

L'inférence, par régression multiple ou SIF, permet de caractériser les facteurs micro-climatiques ainsi que leur influence sur les pertes verticales de produit pendant les traitements. La dynamique des émissions et sa relation avec l'état atmosphérique diffèrent en fonction de la caractéristique du spectre de gouttes. À partir des bases de données construites pour les deux granulométries étudiées, les interactions les plus influentes ont pu être mises en évidence, dans les deux cas. Il s'agit de la vitesse du vent avec le ΔT pour le spectre de gouttes « fine » et la température de l'air avec le ΔT et la vitesse du vent avec la stabilité pour le spectre « très fine ».

L'intérêt des SIF pour modéliser les émissions est mis en évidence. La représentation de la connaissance experte et l'élaboration des règles interprétables obtenues à l'aide des SIF, donnent des résultats similaires à ceux de la modélisation statistique, mais valorisent mieux la méthode expérimentale et fournissent de nouveaux éléments pour caractériser les interactions entre les variables atmosphériques et les pertes de produit en termes linguistiques.

Ce type d'inférence peut intégrer la connaissance experte et fournir des résultats avec le même ordre de précision que les outils statistiques classiques. Ainsi, en utilisant ce type de stratégie et en multipliant les essais sur le terrain, une base de connaissance peut-être bâtie et permettre, par la suite, de fixer des règles par rapport au niveau de risques de pollution en fonction du moment et des caractéristiques de l'application.

L'utilisation de la régression multiple et les SIF combinés avec une méthodologie d'essais adéquate, est ainsi une bonne alternative pour évaluer l'efficacité et les risques potentiels de pollution pour diverses techniques d'application sous différentes conditions climatiques.

Par ailleurs, la caractérisation de la source d'émission peut être complétée par des stratégies de modélisation mathématique de la dispersion atmosphérique à différentes échelles géographiques. Dans le prochain chapitre de la thèse, un couplage entre l'approche

expérimentale décrite jusqu'ici et un modèle réduit basé sur la théorie des jets est proposé. Le paramétrage du modèle a été réalisé à partir de la configuration utilisée pour les essais de terrain. Les résultats du modèle peuvent ainsi être confrontés aux valeurs mesurées, afin d'apporter les premiers éléments de validation du modèle. Cette démarche conduira à une meilleure compréhension des phénomènes de transfert des pesticides vers l'atmosphère pendant les applications.

Chapitre 5

Comparaison avec un modèle mathématique

5.1 Généralités

Au-delà de la connaissance du phénomène, l'autre intérêt d'un système de caractérisation des pertes lors de la pulvérisation est de fournir de données d'entrée de modèles de simulation de la dérive de phytosanitaires.

De tels outils de simulation sont nécessaires pour analyser les stratégies de réduction d'impacts sur l'environnement des applications de pesticides. Cependant, les procédés de simulation dans la dispersion atmosphérique conduisent à développer des systèmes complexes. Cette complexité est due à la dimension du système, aux nombreuses non-linéarités en présence et à la nature stochastique des mécanismes impliqués dans les émissions. De plus, l'information disponible est souvent incomplète du fait de la grande variabilité (spatiale et temporelle) et du nombre de paramètres impliqués. L'information absente est souvent la source elle-même. Or les études sur la source de pollution peuvent être effectuées à partir d'essais en conditions réelles se limitant aux abords immédiats du pulvérisateur (Cross *et al.*, 2001). En combinant les résultats de ces mesures avec des modèles de dérive de jet, il est alors possible de déterminer la diffusion et le transport des agents chimiques dans l'atmosphère (Walklate, 1992).

Ce chapitre est basé sur une démarche développée à partir des essais du terrain, laquelle est présentée dans l'article « *Comparison between experimental and modeling approaches to evaluate pesticide air pollution source during vineyard spraying* ».

5.2 Principes du modèle DriftX

Une modélisation à complexité réduite pour le transport et la dispersion d'un scalaire passif pour les applications de pesticides a été développée par Mohammadi et Brun (2006) pour construire le modèle « DriftX ».

DriftX est construit sur une stratégie « multi-échelle » avec une réduction de la dimension de l'espace de solution à chaque niveau. Une étape donnée fournit l'état d'admission pour le niveau supérieur. Le modèle inclut trois niveaux indépendants.

La première étape propose une description des jets issus du pulvérisateur et identifie l'effet moyen de la végétation sur ces jets. L'étape suivante concerne le calcul direct des pertes par dérive : cette étape prend en compte le déplacement du tracteur sur la parcelle et calcule les concentrations en pesticide dans l'espace au-dessus de la parcelle. Les quantités cumulées à une hauteur donnée sont considérées comme la source de pollution pour une troisième étape qui modélise le transport à partir de la parcelle traitée (jusqu'à 50 km) en utilisant la similitude des couches de mélange et une dispersion gaussienne du nuage. Cette dernière étape fournit une cartographie des concentrations dans un plan horizontal.

5.3 Paramétrisation du modèle DriftX

Le modèle a été paramétré de façon de produire des résultats comparables à ceux de la caractérisation expérimentale et interprétable par rapport à l'évaluation de la pollution par les pesticides.

Le domaine d'application des essais décrits dans les parties précédentes permet de définir le cadre d'exécution du modèle. Ce domaine est ainsi défini à partir des caractéristiques de la parcelle expérimentale. Les paramètres de comportement de la végétation ont aussi été fixés à partir du système artificiel utilisé.

Finalement les caractéristiques opérationnelles de la machine ont été prises en compte dans le modèle. Dans cette partie les variables considérées ont été les suivantes :

- Position, orientation et débit volumétrique de chaque buse de pulvérisation.
- Débit volumétrique moyenne ($m^3.s^{-1}$) et orientation du flux d'air au niveau de la sortie du jet. Ces caractéristiques ont été évaluées en utilisant le système des anémomètres 3D.

5.4 Description de l'étude

La première et la deuxième étape de DriftX visent à modéliser la source à partir de divers postulats et modèles physiques comme la théorie des jets. La première étape représente aussi la pénétration des jets dans la végétation au cours d'une application assistée par air.

Pour valider cette approche, les quantités globales de pesticide émises au-dessus de la parcelle ont été calculées et comparées avec les données expérimentales présentées dans les chapitres 3 et 4.

Le modèle ne prenant pas en compte les conditions météorologiques, les résultats des simulations ont été comparés aux pertes mesurées lorsque les variables extérieures sont peu influentes.

Dans ce chapitre, on cherche à valider les résultats obtenus avec la première partie du modèle. Dans l'article fourni, les principes du modèle sont d'abord décrits, y compris le fond théorique. Ensuite, l'approche expérimentale est présentée et en conclusion, les résultats expérimentaux et simulés sont comparés.

Coupling experimental and modelling approaches to quantify airborne pollution source during vine spraying

Jean-Marc Brun^{c,a}, Yvan Gil^{a,b}, Carole Sinfort^{a,*}
Bijan Mohammadi^c

^aUMR ITAP, Cemagref BP 5095, 34033 Montpellier Cedex 1, France

^bUCV, Faculty of Agronomy, Aptdo. Postal 4579 Maracay 2101, Venezuela

^cUniversity of Montpellier II, Department of Mathematics, CC51, 34095 Montpellier Cedex 5, France.

Abstract

This paper presents a coupled approach of experimental and numerical methods to examine spray losses to the air during vine spraying. The aim is to determine the quantity leaving the canopy layer, which is liable for transport over large distances. The model used is a module of DRIFTX, a low complexity simulation platform for drift estimation, developed at the Cemagref. This module is the part of DRIFTX dedicated to evaluate the source. Upward spray loss assessment, during a standard air-assisted application, was carried out using a fluorescent tracer dye and PVC line collectors. Two test series were performed with two different droplet size distributions ('very fine' and 'fine' spray, according to BCPC classification). With stable atmospheric conditions, low wind speed and none evaporative conditions, the amount of sprayed liquid collected at 2.5 m above ground was 10.95% of the total dose applied for very fine spray, and 6.14% for fine spray. In the simulation test, the proportion of deposits captured by the vine canopy is of the order of 30% while that lost towards the atmosphere is around 12% of the total amount sprayed. In spite of modelling assumptions, both approaches seem to be in agreement. The effects of the main characteristics of the sprayer (like forward speed, air and nozzle outlet orientations) and of the canopy (geometry and density) can be simulated to estimate the spraying performance relatively to air pollution.

Key words: Air pollution, Environmental Low Dimensional Simulation, Jet theory, Pesticide, Similitude solutions, Spray drift

* Corresponding author.

Email address: sinfort@ensam.inra.fr (Carole Sinfort).

Nomenclature		
A_{LAD}	Canopy Leaf Area Density	[dimensionless]
c	pesticide concentration in the air	$[kg.m^{-3}]$
c_0	initial concentration on the axis nozzle	$[kg.m^{-3}]$
$c_{centerline}$	concentration distribution along the axis nozzle	$[kg.m^{-3}]$
c_{canopy}	centerline concentration distribution, inside the canopy	$[kg.m^{-3}]$ $[kg.m^{-3}]$
c_{free}	centerline concentration in free air	$[kg.m^{-3}]$
c_{jet}	3D concentration scalar field	$[kg.m^{-3}]$
c_{row}	concentration on the axis nozzle at the canopy entrance	$[kg.m^{-3}]$
C_D	drag coefficient of the crop	[dimensionless]
$d(x)$	penetration distance inside the vegetation, along the jet axis	$[m]$
d_c	collector diameter	$[m]$
f	shape function	[dimensionless]
h	anemometer high	$[m]$
$K_{c_{jet}}$	centerline concentration decay coefficient	[dimensionless]
L_M	Monin-Obukhov length	$[m]$
M	global amount/quantity/mass sprayed	[kg]
Q	airborne spray quantity	$[ml]$
r	radial distance to the nozzle axis	$[m]$
Re_{jet}	Initial Reynolds number of the jet	[dimensionless]
S_i	specific flux	$[ml.mm^{-1}]$
$U = (u, v, w)$	velocity vector	$[m.s^{-1}]$
$\bar{U} = (\bar{u}, \bar{v}, \bar{w})$	mean velocity vector	$[m.s^{-1}]$
$U' = (u', v', w')$	fluctuating velocity vector	$[m.s^{-1}]$
U_0	initial injection velocity	$[m.s^{-1}]$

U_s	source displacement velocity	$[m.s^{-1}]$
V_i	recovered spray volume on the line	$[ml]$
x	distance along nozzle axis	$[m]$
x_0	virtual origin of the jet	$[m]$
x_{veg}	canopy entrance location on the nozzle axis	$[m]$
y	distance along the row axis	$[m]$
z	height above the ground	$[m]$
α_{jet}	spread rate of the jet	[dimensionless]
θ	azimuthal angle originated from the nozzle axis	$[m]$

1 Introduction

Turbulent dispersion of droplets is commonly used in spray applications in crops such as vines or orchards. The sprayers use the air-assistance produced by a fan, mainly to help the transport of liquid sprayed while hydraulic nozzles create the drops. Air assistance is accompanied by unquestionable losses towards the ground and the atmosphere; the losses to the air could be between 10 and 20% during a standard application (Aubertot et al., 2006).

Drift formation during a radial air-assisted spraying has been well explained by Xu et al. (1998). A flow field from the air-jet outlet and the fan inlet extends beyond the air-crop interface and affects spray penetration into the crop. Then there is a recirculation of spray droplets deposited on leaves. Streams produced from the sprayer and air deflection caused by crop-screen effect interact generating large eddies. The airflow generates mix, entrains sprayed droplets and then convects them out of the top of the canopy. Airborne pesticides are then dispersed and transported by the wind. Therefore it is important to quantify the amount of pesticides lost to the atmosphere to predict downwind contamination, damage to crops and livestock risk.

Due to the costs of field tests and to the variability of microclimatic conditions, modelling of complex variables which affect environmental pollution, is a suitable alternative. Taking into account the numerous factors related to the application (equipment, meteorological and geographical conditions) tools have been developed to facilitate modelling drift based on key parameters (Hewitt et al., 2002).

However, modelling and simulation processes in atmospheric dispersion lead to complex systems. This complexity is caused by the system size, the arising

nonlinearities, the wide range of scales involved and the stochastic nature of the processes. Furthermore, available data is often incomplete and with large variability. It is therefore a main challenge to reduce the complexity. This can be done by analytic or multi-scale methods.

Computational Fluid Dynamic (CFD) codes were frequently used to solve the turbulent flow Navier-Stokes equations, with a standard $k - \varepsilon$ turbulence model (Weiner and Parkin, 1993; Brown and Sidahmed, 2001; Tsay et al., 2002). Studies on pollution source could be made from reduced field trials to determine the emissions close to the sprayer (Cross et al., 2001), which could be combined with spray drift models, to determine the diffusion and the transport of chemical agents (Walklate, 1992). Gaussian dispersion models are low cost models that are very used but they are not suited for the near field ($< 100m$) domain calculation (Raupach et al., 2001).

Environmental flow modelling is an archetypal multiscale problem. Simulations have to solve a multitude of interacting scales with an emphasis on computational aspects. In a multi-level approach, a set of different models, according to the corresponding scales, is developed and combined into a net ensemble. To set-up these models, it is necessary to include information about the real processes on different scales and to link the corresponding models. To reduce the computational cost, solution space reduction and reduced order modelling appear as a natural way to proceed. In a low-complexity analysis, one replaces the calculation of the exact solution by a projection over a subspace generated, for instance, by a family of solutions ('snapshots'), of the initial full model.

These principles are used in DRIFTX, where particular attention is focused on the computational aspect, in order to obtain a manageable model of the entire system. It allows to model pesticide transport in atmospheric flows with very low calculation cost making, since merely several seconds are necessary for a simulation.

Indeed DRIFTX is built with a multi-scale strategy with a reduction in dimension of the solution space at each level. A given stage provides the inlet condition for the level above. At each step, one aims to introduce an a priori information in the search space definition for the solution and avoid partial differential equations (PDE). The soft includes three independent levels. The first step evaluates interaction between crop canopy and airflow along the centerline spray jet. It allows to identify a mean row effect. The following step concerns the module presented in this article, i.e. direct drift losses calculation. This quantity is considered as the pollution source for long distance transport using similitude for mixing layers and plumes. These solutions are well-known in cartesian metrics (Raupach et al., 2001; Agrawal et al., 2003). One original contribution of this global framework is to generalize such solutions with a

non-symmetric distance to account for non uniform winds. This is the scope of the last level which concerns similitude transport solutions in a non-Euclidean metric based on travel-time (Mohammadi and Brun, 2006).

For each level, model parameters identification is based on data assimilation. The approach does not require the solution of any (PDE) and therefore is mesh free. This method permits to access the solution in one point without computing the solution over the whole domain and the inverse problem is also very low cost. This broader context, described in another paper (Mohammadi and Brun, 2006), is an integrative assessment of these different models contributing to contaminant transport from the plots to the environment.

Globally, to model pesticide dispersion, the missing information is often the source itself. Studies on pollution source could be made from reduced field trials to determine the emissions close to the sprayer (Cross et al., 2001), which could be combined with spray drift models, to determine the diffusion and transport of chemical agents (Walklate, 1992). DriftX first step allows to model this source. This paper aims to validate the results obtained with this part of the model. A coupling of an experimental approach (Gil et al., 2006) with the model outputs is presented. The first part of this paper describes the principles of the model, including theoretical background. Then the experimental approach is presented and finally, experimental and simulated results for the source prediction are compared.

2 Modelisation of the pesticide emission

2.1 Principle of the model

A rapid computational technique for instantaneous local spray losses calculation is presented based on the jet theory. Adiabatic transport of a passive scalar is considered. Near-field solution (at the outlet of the injection device) is built in a reduced solution search space where the physical knowledge about the problem is accounted for. Wind and topography are not considered at this stage. The simulation model includes concentration distribution from the sprayer to the canopy and within the canopy.

The basic premise of this work is that two different time scales can be considered, one based on the injection velocity (U_0) and the other based on the velocity at which the injection source moves (U_s). The injection velocity being much higher ($U_0 \gg U_s$), one assumes the local concentration at the outlet of the injection device to be established instantaneously. Therefore, a steady-state behavior of the spray jet is considered. This instantaneous local flow field

is devoted to vanish immediately and not to affect the overall atmospheric circulation. This injection distribution is only designed to determine the part of the pollutant leaving near-ground area and being candidate for transport over large distances. These are strong hypothesis which seriously reduce the search space for the solution.

Using an order of magnitude analysis, the well-known governing Navier-Stokes equations of a viscous fluid flow can be simplified with the boundary layer approximation. Notably, the characteristic of the PDE becomes parabolic, rather than elliptical in the full Navier-Stokes equations. This greatly simplifies the solution of the equations.

2.2 Turbulent Jets Theory

In order to validate the experimental technique developed and to provide a benchmark against which to compare the complex flow of the spray jet nozzle, a simple, well investigated flow must be first studied. When a fluid is issued from a circular orifice, with sufficiently high Reynolds number, free turbulent round jet (also called ‘simple jet’) results. This is a well-known axisymmetric turbulent shear layer flow. This flow starts spreading outwards by engulfing ambient fluid, expands conically in the axial direction, and appears to originate from a point source. The momentum contained within the jet remains constant at any streamwise cross section, whereas its width increases at the cost of velocity. Jets are geometrically simple flows, amenable to experimental investigation and theoretical analysis. Their symmetrical nature have broad significance, for example, to reduce computational time in numerical modelling. Then, theoretical solutions for the mean flow are available ([Agrawal et al., 2003](#)) with coefficients and validation derived from experimental analysis. [Ghosh and Hunt \(1994\)](#), in their review, explained how the induced air flows in spray jets have many similarities with the air flow in turbulent jets.

The characteristics of such jets have received significant research attention both in experimental and numerical investigations, which are widely reported in the literature for a variety of flow and boundary conditions ([Stan, 2000](#); [Webb and Castro, 2006](#); [Zastavniouk, 1997](#); [Kaijen, 2004](#)).

[Shinneeb \(2006\)](#), for example, gives a comprehensive review of the characteristics of free round turbulent jets from the near-exit region to the far-field region, in a free environment and in the presence of bounding surfaces. In particular, a lot of studies focused on the similarity theory that claims that, on every position downstream, the flow variables can be described by a single analytic function, provided that they are scaled properly. This provides the basis for modeling a variety of practical and natural flows, including combustion,

waste disposal, cooling towers, and cumulus clouds (Bhat and Krothapalli, 2000; Zou, 2001).

The development of air jets from sprayers has been described by both semi-empirical assumptions and a complete solution of the fundamental conservation laws. A simple analytical mathematical model is used for its representation. In the region of the flows under consideration, the traditional approach is to first perform an order of magnitude analysis of the Navier-Stokes equations. A boundary layer approximation is usually applied, allowing a substantial reduction in the number of terms. Further, by invoking conservation of momentum, the streamwise variation of width centerline velocity and concentration can be obtained.

The free turbulent motion of a jet has an important property in common with boundary-layers: the width of the jet, b , is small relative to x (slender approximation), and the velocity gradient in the radial direction is large relative to the x direction ($\frac{\partial \bar{v}}{\partial r} \gg \frac{\partial \bar{u}}{\partial x}$). Therefore, a Prandtl's boundary layer type of approximation applies.

Applying the Reynolds decomposition, using the incompressibility condition, and neglecting the molecular terms (viscous/molecular shear stress usually can be neglected in comparison with turbulent eddy stresses throughout the entire flow field, $Re_{jet} \gg 1$), the simplified time-averaged Navier-Stokes equations for a stationary axisymmetric geometry in cylindrical coordinates become:

$$\frac{\partial \bar{u}}{\partial x} \bar{u} + \frac{1}{r} \frac{\partial \bar{u}}{\partial r} \bar{v} = -\frac{1}{\rho} \frac{\partial \bar{p}}{\partial x} - \frac{\partial \overline{u'u'}}{\partial x} - \frac{1}{r} \frac{\partial r \overline{u'v'}}{\partial r}, \text{ (x-moment)} \quad (1)$$

$$\frac{\partial \bar{u}}{\partial x} \bar{v} + \frac{1}{r} \frac{\partial \bar{v}}{\partial r} \bar{v} = -\frac{1}{\rho} \frac{\partial \bar{p}}{\partial r} - \frac{1}{r} \frac{\partial r \overline{v'v'}}{\partial r} - \frac{\partial \overline{u'v'}}{\partial x}, \text{ (r-moment)} \quad (2)$$

$$\frac{\partial \bar{u}}{\partial x} + \frac{1}{r} \frac{\partial r \bar{v}}{\partial r} = 0, \text{ (mass/continuity)} \quad (3)$$

x is the axial distance, r the radial one and θ indicates the azimuthal angle. \bar{u} is the mean velocity in the nozzle axial direction, x , and \bar{v} is the mean velocity in the radial direction, r . Equation (3) describes the conservation of mass (continuity). Overbars denote time-averaged quantities. Other symbols are defined in the nomenclature.

From the Navier-Stokes equations (1),(2),(3), the boundary layer leads to simplify the equation for conservation of momentum in the x -direction by applying scaling and thereafter by neglecting the terms with a relatively small order of

magnitude:

$$\bar{u} \frac{\partial \bar{u}}{\partial x} + \bar{v} \frac{\partial \bar{u}}{\partial r} = -\frac{1}{r} \frac{\partial r \overline{u'v'}}{\partial r} \quad (\text{cylindrical boundary-layer equations}) \quad (4)$$

The concentration distribution is closely related to the velocity distribution. To get insight in the turbulent transport processes within the jet, the Reynolds-averaged transport equation describing the mixing of a passive dispersed phase was used:

$$\frac{\partial \bar{u}\bar{c}}{\partial x} + \frac{1}{r} \frac{\partial r \bar{v}\bar{c}}{\partial r} = \frac{\partial \overline{u'c'}}{\partial x} - \frac{1}{r} \frac{\partial r \overline{v'c'}}{\partial r} \quad (5)$$

The boundary conditions applied is that the concentration tends to zero at large distances from the source.

As said above, the absence of fixed boundaries allows for self-similarity in free shear flows. Hence, at sufficient distances from the nozzle, these flows have the same characteristics and profile shapes when employing the appropriate scaling. Dimensional arguments together with experimental observations suggest forms for the mean flow variables, which are known as similarity solutions (Kaijen, 2004; Bhat and Krothapalli, 2000; Zou, 2001; Walklate et al., 1996). One looks, in a cylindrical frame (x, r, θ) , for local injection solutions of the form:

$$\frac{c(x, r, \theta)}{c_{\text{centerline}}(x, r)} = f\left(\frac{r}{x}\right) \quad (6)$$

where the search space is built using the assumption that f has a given shape.

This dispersion model is based on statistical theoretical basis that makes them successful in many outdoor applications and furnishes a simple analytical solution that needs much less computational power than CFD. This approach based on the self-similarity concept does not include discretization of the transport equation but requires a large number of simplification steps.

2.3 Application to a vineyard spray

The methodology described above was applied to derive the direct drift from the nozzle of the air assisted sprayer used in the experience. When considering the interaction between turbulent axisymmetric jets and porous walls, very few information is available. This fundamental problem in fluid mechanics is still not fully understood (Webb and Castro, 2006). (Walklate et al., 1996) presented a mathematical description for an air-jet penetrating a uniform crop canopy. This analysis demonstrated that the velocity decay is exponential with respect to penetration distance, and depends on the leaf area density (LAD) and on the drag coefficient of the canopy. This approach is used inside the canopy.

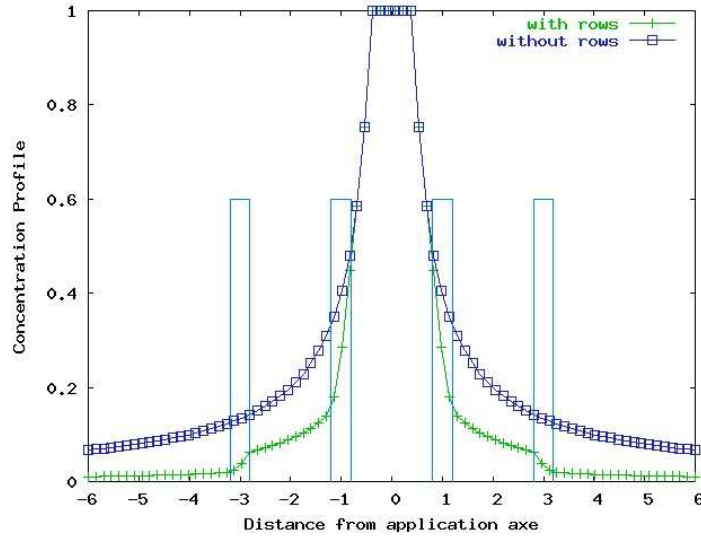

Fig. 1. Normalized centerline concentration relatively to the distance from the nozzle. The axis nozzle is perpendicular to the row. Comparison of profiles with (continuous line) and without (dashed line) the presence of vegetation canopy. Vertical straight lines indicate the location of the rows.

The concentration along the centerline axis is defined by the following continuous piecewise function:

$$c_{centerline}(x) = \begin{cases} c_{canopy}(x) = c_{row} \exp(-d(x)A_{LAD} C_D) , & \text{inside the canopy} \\ c_{free}(x) = c_0 \frac{K_{c_{jet}}}{x-x_0} , & \text{otherwise} \end{cases} \quad (7)$$

where x_0 indicates the virtual origin of the jet, c_0 the initial concentration (at the outlet nozzle), $K_{c_{jet}}$ is the centerline concentration decay coefficient, $d(x)$ the penetration distance inside the vegetation, along the jet axis, and c_{row} the concentration on the nozzle axis, at the canopy entrance. Spray concentration at the canopy boundary (c_{row}) is used to calculate spray concentration inside the canopy as a function of canopy depth and density.

It is obvious in the figure 1, that the decay rate of the mean centreline concentration becomes more important at downstream locations where the canopy is present.

Assuming an isotropic turbulence, the steady-state turbulent flow field and its concentration distribution are based on a similitude solution. The 3D concentration scalar field is then described by:

$$c_{jet}(x, r, \theta) = c_{centerline}(x) \exp\left(-\alpha_{Jet} \left(\frac{r}{x}\right)^2\right) \quad (8)$$

where α_{Jet} is the spread rate of the jet. This gaussian distribution (the shape of the function f in (6)) is an approximation in a statistical sense.

One essential assumption in this model describing the spray is that, during the development of the flow in the downstream direction, the turbulence maintains its general structure, even inside the vegetation. The lateral/radial dispersion stays Gaussian inside the vegetation.

Instantaneous spray losses are computed by:

$$\int_{z_0}^{+\infty} \int_{-\infty}^{+\infty} \int_{-\infty}^{+\infty} c(x, y, z) dx dy dz \quad (9)$$

where z_0 is the height of the canopy row.

And the conservation of mass, on the whole domain, is ensured with:

$$\int_0^T \int_0^{+\infty} \int_{-\infty}^{+\infty} \int_{-\infty}^{-\infty} c(x, y, z) dx dy dz dt = M \quad (10)$$

where T is the total time of spraying.

2.4 Numerical Implementation

The numerical implementation is based on the best possible fit of the real experimental field geometry and sprayer characteristics, in a simple way. The code was written in FORTRAN77 and can be run on any personal computer in a real-time computation (several seconds) which permits a substantial computation time-saving.

In this computation, the domain is a rectangular channel of $6m$ (longitudinal) $\times 12m$ (traverse) $\times 3m$ (vertical) size which encompassed the real domain field (see section 3). To represent the analytical similitude solution, the whole domain is discretized into a uniform mesh prescribed by the user. A rectangular pavement of size $6m \times 0.4m \times 1.m$ represents the vineyard row, supposed as a uniform medium. All these parameters are set as input variables and an automated method is employed to replicate the current characteristics of the computation domain (position, size and row characteristics) according to the parameters provided by the user.

Numerical parameters correspond to the experimental values described in section 3. In particular, the nozzle characteristics (number, locations, orientations, diameters, ejection rates) are set to the experimental data and used as input parameters to compute the turbulent jet. Each nozzle produces an independent turbulent jet described by the equation (8).

The test period is splitted into sub-intervals. The time step is estimated by dividing the row length by the sprayer ride velocity, times the trajectory discretization parameter defined by the user. In this example this parameter is set to 8, giving a local time step of roundly 1s. The sprayer ride is simulated by the nozzle movement at each time step, parallelly to the row, in the yz plane (x -coordinate = 0).

3 Field tests

3.1 Test organisation

The experimental approach was based on the use of classical 2 mm diameter passive collectors and fluorescent tracer dye to assess near-field pesticide emissions to the air during spraying process (Gil et al., 2006). The spray losses were assessed at 2.5 meter from soil. An artificial vineyard was built from shade nettings with an apparent porosity of 34%. Row spacing and crop height were 2 meters each. The artificial plot was made of four 8m long rows oriented along the North-South direction.

An axial air-assisted sprayer Fisher Turbo 561 -Berthoud Ltd.- was used. The tractor forward speed was set at 5.1 $km\ h^{-1}$. The air output stream was explored with a 3D ultrasonic sensor. Its main features are shown in Fig.2. Mean air volumetric flow was of 3.3 $m^3\ s^{-1}$ and averaged air velocity 12.8 $m\ s^{-1}$. Two sets of nozzles were tested, at a 10 bar operating pressure: Albuz ATR white hollow cones and Conejet green hollow cones. Spray characteristics of these nozzles are shown in Table 2.

Nozzle	$D_{V.10}$	$D_{V.50}$	$D_{V.90}$	Vol. >100 μm	Flow rate	Spray Quality
Green	72	134	180	74%	1.00 $l\ min^{-1}$	Fine
White	28	65	135	24%	0.38 $l\ min^{-1}$	Very Fine

Table 2

Droplet diameter (μm) for 10% ($D_{V.10}$), 50% ($D_{V.50}$) and 90% ($D_{V.90}$) of cumulative volume, spray volume with droplet diameter greater than 100 μm (Vol. >100 μm). Spray Quality is derived from the BCPC classification system. All information was obtained from manufacturers reports and the measurements were performed with a laser diffraction instrument.

Three runs were carried out for both set of nozzles. Microclimatic state was characterized by wind speed and temperature measurements from a 3D anemometer system. Wet bulb temperature depression and stability parameter were also calculated. The stability parameter is given by the relation h/L_M , where h is

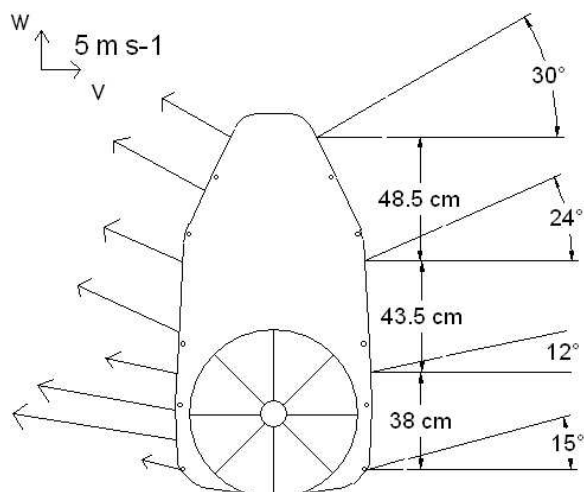

Fig. 2. Schematic view of sprayer: air output velocity vectors (left) and orientation (right)

Spray Quality	Wind Speed	Temperature	ΔT	z/L
Fine	0.30 m s^{-1}	$17.38 \text{ }^\circ\text{C}$	$2.41 \text{ }^\circ\text{C}$	-1.23
Very Fine	0.72 m s^{-1}	$17.38 \text{ }^\circ\text{C}$	$4.47 \text{ }^\circ\text{C}$	0.23

Table 3

Microclimatic conditions during each test series

the height of the 3D anemometer (four meter) and L_M is the Monin-Obukhov length.

The experiments were run between 5:00 am and 7:00 am on July 13th 2005, in an experimental plot of Cemagref at Montpellier, France. The averaged microclimatic conditions are show in Table 3. These conditions correspond to influential variables for upward spray emission (Gil et al., 2006).

Although during very fine spraying, the microclimatic conditions could be more favorable to upward spray movement, all values registered are into the recommendable range to minimize the spray drift and evaporation risks (PISC, 2002), therefore, only operational sprayer conditions and crop configuration could affect spray emissions.

3.2 Spray flow estimation

An horizontal measurement plane was setup at 2.5 m from the ground (Fig. 3) to intercept upward spray losses. This plane was made of five 12-meter long PVC lines, parallel to the rows. The separation between the lines was of two

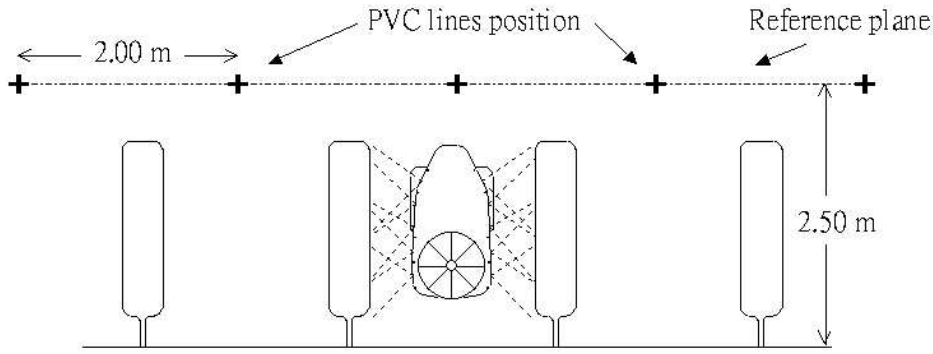

Fig. 3. PVC line and reference plane position in artificial crop plot

meter. During each run, the sprayer was driven four times on the central inter-row to increase the amount of deposited spray and decrease random effects.

The spray liquid was an aqueous solution of 1 g l^{-1} of Brilliant Sulpho-Flavine (BSF) as fluorescent tracer dye and 0.1% of non-ionic surfactant.

Captured liquid volumes of spray were estimated from the amount of liquid captured by the PVC lines. Once the droplets on the lines had evaporated, each line was washed using 200 ml of tap water.

The spray volume removed from the lines (V_i , in ml) was determined from the relationship between spray mixture and line wash solution concentrations, that were obtained by fluorometry reading. The specific flux (S_i , in ml mm^{-1}) was then calculated as in equation 11, where d is the collector diameter (2 mm).

$$S_i = \frac{V_i}{d} \quad (11)$$

Then airborne spray quantity in ml (Q) crossing the measurement plane during the spraying, can be calculated as:

$$Q = \sum_{i=1}^n \frac{1}{2} [S_i + S_{i+1}] [h_{i+1} - h_i] \quad (12)$$

The term $[h_{i+1} - h_i]$ is the distance between each line (2000 mm). The amounts of spray flux are then normalised by the amount of spray applied to the crop so that atmospheric loss is defined as a percentage of the total amount of spray used in each test.

4 Results and Discussion

4.1 Field Test

The losses, evaluated at 2.5 meter from the ground were of 6.14% for fine spray and 10.95% for very fine spraying (averaged values), the variation coefficients were 5.93% and 10.84% respectively. During the conditions observed, with small wind speed and atmospheric stability, normalised losses are 44% larger for very fine spray than for fine spray.

A relative symmetrical plume is observed with 85% of losses concentrated in a range of four meters (two meters in each direction from the central inter-row); this range is defined by two maximum peaks. A minimum peak, distinct to zero, was observed on the central line. During very fine spraying the cloud is more sensible to mechanical displacement due to wind speed than during fine spraying, even with very small wind velocity values.

Then, taking into account that the collector efficiency stands between 78 and 100% (Aylor, 1982; Walklate, 1992; Parkin and Young, 2000; Gil et al., 2006), measured spray losses directly sent to the air could be between 6.1 and 7.9% for fine spray and between 11.0 and 14.0% for very fine spray during calm atmosphere and non evaporative conditions.

The variations observed between both spray qualities is assessed to correspond to the gravity effect on droplet dynamics: small droplets follow the air stream whereas coarse droplets are deposited within the canopy and on the ground. This effect is also shown by the losses distribution profiles (fig. 4).

4.2 Simulation Test

In the simulation test, the proportion of deposits that are captured by the vine canopy is about 30% and the one lost as drift is 12% of the total amount sprayed.

Several assumptions have been made in order to find simple analytical solutions. However, it must be kept in mind that the reality is by far more complex. These simplifications neglect the importance of influential parameters and phenomena such as wind, canopy oscillations, droplet spectrum (effect of gravity and drag), density, temperature and possible effects due to the evaporation on the droplets. Moreover, (Ghosh and Hunt, 1994) also showed that there are some differences between spray jet and typical gas jet.

The conservation of the flow structure (similitude assumption inside the vegetation), is a strong approximation, but the real behavior of the flow inside a real crop is inaccessible.

Interactions between the different jets are also not taken into account, and no cross-flow effect is represented. Moreover, forward speed and wind velocity within the vine rows are considered to be constant and their values are supposed not to affect the ejection speed.

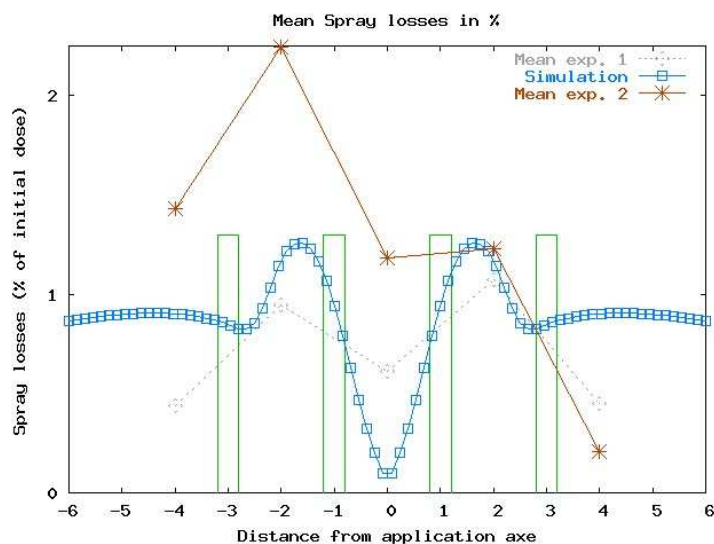

Fig. 4. Pesticide air losses relatively to the distance from the sprayer: comparison of numerical (Simulation) and experimental data (Mean exp.1, data with fine spraying and Mean exp.2, data with very fine spraying). Vertical straight lines indicate the location of the rows.

Recent studies suggested a great dependence of turbulent jet flow on the initial conditions (Shinneeb, 2006). For example, initial velocity profiles issued from a nozzle has a great importance in the flow establishment, and is seldom provided by the manufacturer. In fact, usable data is often incomplete and accurate simulations are consequently ineffective.

The effects of a vertical porous layer on a neutrally-buoyant turbulent round jet discharging from a circular nozzle into quiescent ambient air, is not still understood. In fact, free jets and wall-impinging jets are well-known classes of shear flows. But it appears to be only few studies on the intermediate cases. This porous layer could produce significant differences in growth rates of the jet because the half-widths could develop not uniformly. Moreover, a reduction in entrainment into the jet would be anticipated as a consequence of the restricted contact volume inside the porous media. In such jets, significant modifications of the usual jet motion occur, due to the porous medium and entirely new and unexplained flow phenomena may arise which require altogether different

analytical approaches. Despite of all these simplifications, the results of the model are in good agreement with the measurements, as shown in figure 4.

5 Conclusion

The model presented here can compute spray losses magnitude from experimental setting data selected by the user. The calculation time is really short and the computational are highly reduced in comparison with classical CFD approaches.

In spite of the numerous modeling assumptions, both approaches seem to be in agreement. The model does not take into account possible wind speed effect on near-to-sprayer dispersion and transport of spray, as well as gravity effect on diverse droplet sizes. However, it is possible to simulate the main characteristic of sprayer, like air and nozzle outlet orientation, forward speed and canopy geometry effects on the performance of a pesticide source. An overestimation is observed with the model compared with fine spraying experimental results, where 74% of spray volume is made of droplets greater than 100 μm .

In order to validate the model definitively, additional comparisons with experimental trials would be desirable, using several sprayers and other configurations in droplet spectra and air-flow setting.

The inclusion into the model of the micro-meteorological variables like wind speed and possible cross-flow effect within rows in the zones near to the sprayer will allow to improve the predictions, with the aim to contribute to support the further performance of DRIFTX.

Acknowledgements

The authors would like to thank Berthoud Sprayers Ltd. who provided the equipment to make this research and the Experimentation Group of UMR-ITAP (X. Ribeyrolles, G. Diouloufet, B. Ruelle, D. Virgile, H. Fonta, P. Oullier and G. Alvarez) for their contributions during field tests. This work was supported by the program $\text{Al}\beta\text{an}$, European Union Programme of High Level Scholarships for Latin America, identification number E03D18224VE.

References

- Agrawal, A., Prasad, Ajay K, M., Briggs, P., Ahmad, N., Edge, V., 2003. Integral solution for the mean flow profiles of turbulent jets, plumes, and wakes. *Journal of Fluids Engineering* 125 (5), 813–822.
- Aubertot, J., Barbier, J., Carpentier, A., Gril, J., Guichard, L., Lucas, P., Savary, S., Savini, I., Voltz, M. (Eds.), 2006. Pesticides, agriculture and environment: Expert report. INRA-Cemagref.
- Aylor, D., 1982. Modelling spore dispersal in a barley crop. *Agricultural Meteorology* 26, 215–219.
- Bhat, G., Krothapalli, A., December 2000. Simulation of a round jet and a plume in a regional atmospheric model. *Monthly Weather Review* 128 (12), 4108–4117.
- Brown, R., Sidahmed, M., 2001. Simulation of spray dispersal and deposition from a forestry airblast sprayer. Part II: Droplet trajectory model. *Transactions of the ASAE* 44, 11–17.
- Cross, J., Walklate, P., Murray, R., Richardson, G., 2001. Spray deposits and losses in different sized apple trees from an axial fan orchard sprayer: 1. Effects of spray liquid flow rate. *Crop Protection* 20, 13–30.
- Ghosh, S., Hunt, J., 1994. Induced air velocity in droplet-driven sprays. *Proc. R. Soc. Lond. A* 444, 105–127.
- Gil, Y., Sinfort, C., Brunet, Y., Polveche, V., Bonicelli, B., 2006. Loss of spray above an artificial vineyard during air-assisted spraying. *Atmospheric Environment Submitted*.
- Hewitt, A., Maber, J., Praat, J., 2002. Drift management using modeling and GIS systems. In: *Proceedings of World Congress of Computers in Agriculture and Natural Resources*. pp. 290–296.
- Kaijen, R., October 2004. Turbulent mixing of oil droplets in a round water jet. Tech. Rep. MEAH 237, Laboratory for Aero & Hydrodynamics, Delft University of Technology, Netherlands, graduation Project.
- Mohammadi, B., Brun, J.-M., 2006. General similitude solutions and low-complexity geometric models. *C. R. Mecanique* 334 (10), 634–638.
- Parkin, C., Young, P., 2000. Measurements and computational fluid dynamic simulations of the capture of drops by spray drift samplers. *Aspects of Applied Biology* 57, 113–120.
- PISC, 2002. Spray drift management: Principles, strategies and supporting information. Primary Industries Standing Committee. Report 82. Tech. rep., CSIRO Publishing, Australia.
- Raupach, M., Briggs, P., Ahmad, N., Edge, V., 2001. Endosulfan transport: Ii. modeling airborne dispersal and deposition by spray and vapor. *Journal Environ. Qual.* 30, 729740.
- Shinneeb, A.-M., August 2006. Confinement effects in shallow water jets. Ph.D. thesis, Department of Mechanical Engineering, University of Saskatchewan, Canada.
- Stan, G., 2000. Fundamental characteristics of turbulent opposed impinging

- jets. Ph.D. thesis, University of Waterloo, Ontario, Canada.
- Tsay, J., Fox, R., Ozkan, H., Brazee, R., Derksen, R., 2002. Evaluation of a pneumatic-shielded spraying system by CFD simulation. *Transactions of the ASAE* 45, 47–54.
- Walklate, P., 1992. A simulation study of pesticide drift from air-assisted orchard sprayer. *Journal of Agricultural Engineering Research* 51, 263–283.
- Walklate, P., Weiner, K.-L., Parkin, C., 1996. Analysis of and Experimental Measurements Made on a Moving Air-Assisted Sprayer with Two-Dimensional Air-Jets Penetrating a Uniform Crop Canopy. *Journal of Agricultural Engineering Research* 63, 365–378.
- Webb, S., Castro, I. P., March 2006. Axisymmetric jets impinging on porous walls. *Experiments in Fluid* (40), 951–961.
- Weiner, K., Parkin, C., 1993. The use of Computational Fluid Dynamic code for modelling spray from a mistblower. *Journal of Agricultural Engineering Research* 55, 313–324.
- Xu, Z., Walklate, P., Rigby, S., Richardson, G., 1998. Stochastic modelling of turbulent spray dispersion in the near-field of orchard sprayer. *Journal of Wind Engineering and Industrial Aerodynamics* 74-76, 295–304.
- Zastavniouk, O., Fall 1997. Study of mixing phenomena in a dual fuel diesel engine air intake manifold. Ph.D. thesis, Department of Mechanical Engineering, University of Alberta, Edmonton, Canada.
- Zou, Y., 2001. Air jets in ventilation applications. Ph.D. thesis, KTH, Department of Building Sciences.

5.5 Conclusions et perspectives

Les résultats des essais de terrain a permis de paramétrer le modèle mathématique. La réalisation de ces essais a permis la définition d'une source d'émission. A partir de ces essais le domaine d'application du modèle DriftX a également pu être défini.

La paramétrisation du modèle DriftX est une étape impérative dans l'évaluation de cet outil pour la détermination de la qualité de l'air et des risques de pollution. Ainsi, dans les deux approches on a démontré la complémentarité entre l'expérimentation et la modélisation.

La confrontation des résultats suggère aussi que le modèle mathématique peut-être raffiné par l'inclusion de variables comme la vitesse de vent et l'effet possible de croisement de flux dans la végétation et dans les zones proches du pulvérisateur, en améliorant les prévisions, et en contribuant à renforcer la fiabilité de DriftX pour les étapes ultérieures. Ainsi, les essais sont un bon moyen d'optimiser le nombre de paramètres à prendre en compte dans la modélisation.

À partir des essais de terrain, avec la configuration conçue et détaillée dans les chapitres précédents, une validation du modèle paraît possible. Différents réglages (angles de sortie d'air, buse, vitesse du tracteur, etc.) et différents types d'appareils pourraient faire l'objet d'essais afin de construire une base de données expérimentales plus importante et d'élargir de domaine de validation du modèle. Une étude de la sensibilité du modèle aux différents réglages opérationnels est aussi souhaitable.

Chapitre 6

Conclusions Générales

Pour répondre à la demande sociétale de modélisation de la pollution de l'air par les produits phytosanitaires la thèse est sous-tendue par l'hypothèse que l'étude de la pollution de l'air par les pesticides repose en un premier lieu sur la caractérisation des sources d'émission, c'est-à-dire les applications, étant entendu qu'il existe déjà de nombreux outils pour modéliser la dispersion dans l'air du nuage de pesticides émis.

L'élaboration d'une base de données pour évaluer les éventuels risques de pollution dans certaines conditions météorologiques est possible à partir des analyses statistiques et des systèmes d'inférence floue proposés dans cette thèse. Une classification des variables influentes sur les émissions de jet a déjà été établie. Elle définit des niveaux de risque d'émission de pesticide, ce qui représente un outil très important pour la planification et la gestion environnementale.

L'objectif de cette thèse a été de proposer et valider une approche expérimentale pour la quantification des sources d'émission de pesticides vers l'air pendant le processus d'application.

Cette thèse a suivi une démarche en quatre temps :

- i. Tout d'abord une étude bibliographique pour déterminer le contour de l'étude et les méthodologies à mettre en œuvre.
- ii. Ensuite mise en place d'une approche expérimentale de caractérisation de la pulvérisation ayant donné lieu à la création d'une base de données avec des conditions micro-météorologiques et les valeurs des pertes de produit.
- iii. Valorisation de cette base de données au travers d'une étude des facteurs expérimentaux les plus influents sur les pertes.
- iv. Valorisation de la base de données comme données de validation d'un modèle de transport.

Chacune de ces étapes est traduite par des apports originaux et la réalisation d'une publication scientifique. Nous allons donner par la suite les principales conclusions.

6.1 Etude Bibliographique

Elle a permis montrer que les variables qui affectent la dynamique des pesticides dans l'air pendant les applications sont analysées à partir des études mises en place pour évaluer le phénomène de dérive. Les variables influentes sur les pertes de produit en phase liquide sont : paramètres opérationnels, conditions météorologiques et caractéristiques physiques des pesticides.

De plus les méthodes pour quantifier la présence de pesticides dans l'air sont faite à partir de : analyses chimiques raffinées, emploi de traceurs dans la bouillie de pulvérisation ainsi que de mesures à l'aide de dispositifs lasers pour évaluer le transport du jet dans divers types d'applications.

L'utilisation de capteurs passifs et de traceurs fluorescents semble la technique la plus adaptée aux objectifs de quantification d'une source d'émission de pesticides à échelle réelle. L'évaluation de l'efficacité de ces collecteurs dans les conditions d'application a été une des objectifs fixés pour la mise en place du dispositif de mesure sur le terrain.

6.2 Mise en place d'une méthode expérimentale de mesure au champ

Lors de cette deuxième étape, nous avons mis au point un protocole de mesure des pertes de produit au champ.

Nous avons tout d'abord validé l'efficacité des capteurs passifs. Les valeurs d'efficacité obtenues par expérimentation dans la soufflerie sont semblables à celles estimées par des modèles. L'efficacité moyenne varie entre 75 et 80% pour toutes les conditions étudiées pendant les essais.

Nous avons ensuite étudié un protocole à la fois pertinentes et pratique pour intercepter et mesurer les gouttes émises au-delà d'un niveau de référence (2.5 mètres) au-dessus de la parcelle d'application. Sa mise en œuvre a permis de constituer une base de données exhaustive avec des conditions micro-climatiques variables (la différence étant que ces conditions ne sont pas contrôlées au champ).

Pour la construction de la base de données, le protocole a été de se placer dessus des situations très variées pendant plusieurs semaines. Les variables micro-climatiques mesurés ont été la vitesse et direction du vent, la température de l'air, l'humidité relative et la stabilité atmosphérique au moment de chaque application. Ainsi une base de données a été faite composée de 56 observations : 32 pour un spectre de gouttes « fines » et 24 pour un spectre « très fine ».

Quelques incohérences ont cependant été observées, notamment lors de l'évaluation du flux de pesticides loin du pulvérisateur et dans des conditions de température élevées. Elles affectent peu les conclusions de l'étude, essentiellement basées sur les résultats obtenus à une distance proche du pulvérisateur.

Selon le type de pulvérisation et les conditions micro-climatiques, les pertes directes

mesurées se situent dans des ordres de grandeur variant entre 8 et 14%, en prenant en considération l'efficacité des collecteurs.

Les variables influençant la pollution atmosphérique pendant la pulvérisation ont été déterminées à partir de l'utilisation d'un système d'anémomètres 3D et la caractérisation de l'hygrométrie de l'air au moment des applications.

6.3 Valorisation de la base de données : Étude de la influence des variables micro-climatiques

L'analyse de la base de données a été menée par régression linéaire multiple et par SIF. Elle a permis de montrer les variables les plus influentes.

La vitesse du vent apparaît comme étant la variable micro-climatique la plus importante par rapport au transfert de liquide pulvérisé vers l'air. La température de l'air joue un rôle significatif sur la quantité de liquide capturé sur les lignes. Cependant, l'analyse des résultats ne permet pas d'interpréter si la température de l'air agit sur le devenir des gouttelettes ou sur l'efficacité de collecte : des travaux nécessaires doivent impérativement être développés pour éclairer ce point.

L'autre variable qui affecte les pertes vers l'air jet, la différence psychrométrique (ΔT), est reliée au processus d'évaporation. En conditions évaporatives, les tailles de gouttes diminuent et sont plus facilement transportées par des effets mécaniques du vent, ce qui augmente les quantités entraînées par le mouvement ascendant de l'air.

La stabilité atmosphérique est le facteur le plus important pour la caractérisation du type de nuage et le mouvement ascendant du jet pendant les applications de pesticides.

L'interprétation de la complexité des relations entre les variables micro-climatiques et les pertes de pesticides a été menée par des méthodes de régression multiple et de Systèmes d'Inférence Floue (SIF) avec une bonne précision pour les deux méthodes ($R^2 = 0.80$). L'inclusion de la connaissance experte dans les SIF (par exemple le remplacement de l'échelle numérique de la vitesse du vent par des classes issues de l'échelle Beaufort) permet de fournir une intéressante base de règles pour évaluer les niveaux de pertes par émission de pesticides.

L'intérêt d'un modèle SIF est multiple :

- Il permet de s'exonérer de la mesure des variables environnementales (vitesse du vent, température, humidité, etc.) et de les remplacer par des classes linguistiques repérées par un opérateur (par exemple : vent fort, moyenne ou faible) ; il rend le sujet plus opérationnel et pratique pour la profession agricole.
- Il permet de générer des règles qui vont décrire les risques de pertes par émission de type :
« Si la température est *Elevé* et le vent est *Faible* alors les risques d'émissions seront *Faibles* ».

Ces règles sont facilement interprétables et peuvent contribuer à la éducation des opérateurs.

6.4 Valorisation de la base de données : Validation du modèle DriftX

La dispersion de pesticides dans l'air a déjà fait l'objet de nombreuses études et plusieurs modèles sont disponibles. Cependant, une caractérisation robuste de la source n'a jamais été incluse dans le fonctionnement de ces modèles. En effet notre objectif a été d'évaluer la correspondance entre la caractérisation expérimentale des émissions et la modélisation mathématique de cette émission (modèle DriftX) Les travaux qui ont été réalisés ici montrent que les valeurs expérimentales (entre 8 et 14% de pertes) étaient cohérentes avec les valeurs de la simulation (12%)

La relative simplicité des essais de terrain y compris des variables d'entrées ou leur expression linguistique permettra de fournir une base de données sur la source d'émission. Ces mesures permettant de valider la première étape du DriftX et d'affiner son paramétrage ; cette première étape étant indispensable à l'utilisation du modèle de dispersion à grande échelle.

Le modèle DriftX, qui ne prend pas en compte des variables environnementales, pourra être amélioré avec l'agrégation des variables liées au comportement du vent et des autres variables atmosphériques comme la stabilité et température de l'air.

6.5 Perspectives

La possibilité d'étudier les pertes vers l'air à partir de données expérimentales est présentée dans cette thèse. Il reste toutefois nécessaire de proposer des évaluations des pertes atmosphériques pour diverses technologies et différents réglages puis pour d'autres végétations.

Par ailleurs, les résultats de ces essais devront fournir une base de connaissance pour le calage et validation de modèles mathématiques tels que DriftX. Il a en effet été montré que ces essais pouvaient conduire à une évaluation des pertes au niveau d'une parcelle dans différentes configurations. Le couplage avec un modèle de dispersion atmosphérique fournit un outil pour la gestion des risques environnementaux relatifs à l'application de pesticides.

La méthode expérimentale ne prend pas en compte l'évaporation des gouttes. Or, l'analyse des résultats expérimentaux, montre que dans des conditions favorisant l'évaporation, il y a des contradictions par rapport aux quantités piégées sur les fils. Il faut donc envisager de compléter la validation du protocole expérimental pour intégrer ce phénomène.

Pour cela, des études à l'aide de la soufflerie expérimentale, permettant de réaliser des essais dans conditions contrôlées, pourront fournir des éléments relatifs au comportement

du jet dans différentes conditions qui favorisent l'évaporation. Pour observer directement l'influence de ce phénomène sur le déplacement d'un nuage pulvérisé, il sera nécessaire de mettre en place des mesures dans l'air des différentes phases (liquide, solide, gaz). Il sera alors possible de compléter les modèles physiques pour qu'ils considèrent ce phénomène.

Bibliographie

- Aubertot, J., Barbier, J., Carpentier, A., Gril, J., Guichard, L., Lucas, P., Savary, S., Savini, I., Voltz, M. (Eds.), 2006. Pesticides, agriculture and environment : Expert report. INRA-Cemagref.
- Aylor, D., 1982. Modelling spore dispersal in a barley crop. *Agricultural Meteorology* 26, 215–219.
- Bedos, C., Cellier, P., Calvet, R., Barriuso, E., 2002. Occurrence of pesticides in the atmosphere in France. *Agronomie* 22, 35–49.
- Ben, L., Vallet, A., Bonicelli, B., 2004. Atomisation of agricultural sprays : Influence of some liquid properties. In : 19th Annual Meeting of the Institute for Atomization and Spray Systems (Europe). Nottingham, UK.
- Box, G., Wilson, K., 1951. On the experimental attainment of optimum conditions. *Journal of the Royal Statistical Society B-13*, 1–45.
- Calvet, R., Barriuso, E., Benoit, P., Charnay, M.-P., Bedos, C., Coquet, Y., 2005. Les pesticides dans le sol : Conséquences agronomiques et environnementales. Editions France Agricole.
- Candela, L., 2003. Pesticide contamination in the EU. In : Proceedings of the XII Symposium Pesticide Chemistry. Italy, pp. 767–780.
- Chassaing, P., 2000. Turbulence in fluids mechanics. Cepadues Editions. Toulouse, France.
- Costa, A., Miller, P., Truck, C., 2006. The development of wind tunnel protocols for spray drift risk assessment. *Aspects of Applied Biology* 77, 289–294.
- Courshee, R., 1959. Investigations on spray drift. Part II : The occurrence of drift. *Journal of Agricultural Engineering Research* 4, 229–241.
- Cross, J., Walklate, P., Murray, R., Richardson, G., 2001. Spray deposits and losses in different sized apple trees from an axial fan orchard sprayer : 1. Effects of spray liquid flow rate. *Crop Protection* 20, 13–30.
- Da Silva, A., Sinfort, C., Vanhiesbecq, S., Polveche, V., Huberson, S., Silva, F., Bonicelli, B., 2001. Simulation of sprayed pesticide deposit within a vineyard. *Parasitica* 57, 195–204.

- Doble, S., Matthews, G., Rutherford, I., Southcombe, E., 1985. A system for classifying hydraulic nozzles and other atomisers into categories of spray quality. In : British Crop Protection Conference. pp. 1125–1133.
- Gaskin, R., Manktelow, D., Elliott, G., 2002. New adjuvant technology for pesticide use on wine grapes. In : 55th Conference Proceedings of the New Zealand Plant Protection Society Incorporated.
- Guyot, G., 1997. Environmental climatology. From crops to ecosystems. Masson. Paris, France.
- Heidorn, C. (Ed.), 2002. The use of Plant Protection Products in the European Union. Office for Official Publication of the European Communities.
- Ifen, 2006. Les pesticides dans les eaux. Données 2003 et 2004. Tech. rep., Institut Français de l'Environnement.
- Matthews, G., Hislop, E. (Eds.), 1992. Application technology for crop protection. CAB International, Wallingford, UK.
- May, K., Clifford, R., 1967. The impaction of aerosol particles on cylinders, spheres and discs. *Annals of Occupational Hygiene* 10, 83–95.
- Mohammadi, B., Brun, J.-M., 2006. Similitude généralisée et modélisation géométrique à complexité réduite. *C. R. Mécanique* 334, 634–638.
- Parkin, C., Young, P., 2000. Measurements and computational fluid dynamic simulations of the capture of drops by spray drift samplers. *Aspects of Applied Biology* 57, 113–120.
- PISC, 2002. Spray drift management : Principles, strategies and supporting information. Primary Industries Standing Committee. Report 82. Tech. rep., CSIRO Publishing, Australia.
- Ranz, W., Marshall, W., 1952. Evaporation from drops. Part I. *Chemical Engineering Progress* 48, 141–146.
- Roux, P., Herbst, A., Richardson, G., Delpéch, P., 2007. Full-scale measurement of spray-drift from a vineyard sprayer in a controlled wind-tunnel environment. *Journal of Wind Engineering and Industrial Aerodynamics* Submitted.
- Sinfort, C., Miralles, A., Sevilla, F., Maniere, G., 1994. Study and development of a test method for spray boom suspensions. *Journal of Agricultural Engineering Research* 59, 245–252.
- Southcombe, E., Miller, P., Ganzelmeier, H., de Zande, J. V., Miralles, A., Hewitt, A., 1997. The international BCPC spray classification system including a Drift Potential Factor. In : The 1997 Brighton Crop Protection Conference - Weeds. pp. 371–380.

- Sportisse, B., 2006. Modélisation de la pollution atmosphérique. http://www.enpc.fr/cerea/fich/doc_ENPC_modelling.pdf, centre d'Enseignement et de Recherche en Environnement Atmosphérique. Laboratoire Commun EDF R&D-ENPC.
- Swiechowski, W., Doruchowski, G., Holownicki, R., Godyn, A., 2004. Penetration of air within the apple tree canopy as affected by the air jet characteristics and travel velocity of the sprayer. *Electronic Journal off Polish Agricultural Universities. Series Agricultural Engineering* 7.
URL <http://www.ejpau.media.pl/series/volume7/issue2/engineering/art-03.html>
- UIPP, 2006. Repère : Les chiffres clés. <http://www.uipp.org/repere/chiffre.php>, Union des Industries de la Protection des Plantes.
- Walklate, P., 1992. A simulation study of pesticide drift from air-assisted orchard sprayer. *Journal of Agricultural Engineering Research* 51, 263–283.
- Wilson, M. (Ed.), 2003. *Optimising Pesticide Use*. Wiley Series in Agrochemicals and Plant Protection, England.

Résumé

Des évaluations de pertes verticales du jet pendant une pulvérisation agricole assistée par air ont été effectuées en utilisant un traceur fluorescent et des lignes de PVC comme collecteurs. Des analyses par régression linéaire multiple et l'inférence par logique floue ont été employées pour évaluer les effets des conditions micro-climatiques sur deux spectres de tailles de gouttes (fine et très fine). Les modèles de régression multiple ont été établis pour chaque série d'essai, selon leur distribution de la taille des gouttes pulvérisées. Pour l'application fine les variables significatives étaient vitesse de vent, température de l'air et la différence psychrométrique (ΔT), obtenant un coefficient de détermination égal à 0.70. Dans le traitement très fin la modélisation du paramètre de stabilité atmosphérique avéré pour être également significatif ; le coefficient de détermination était égal à 0.82. Les pertes ont été également modélisées avec un système d'inférence floue et des bons coefficients de détermination ont été obtenus ($R^2=0.72$ pour la pulvérisation fine et 0.66 pour la pulvérisation très fine). Des règles interprétables ont été fixées pour la caractérisation micro-climatique, pour les deux distributions de taille de gouttes. Ces deux outils peuvent être combinés avec la modélisation physique pour évaluer la pollution atmosphérique et la dérive à partir des essais simplifiés sur le terrain.

MOTS CLÉS : Pesticides ; Dérive ; Pollution de l'air ; Vignes ; Pulvérisateur ; Jet Porté

Abstract

Upward spray loss assessment, during a standard air-assisted application, was carried out using a fluorescent tracer dye and PVC lines as collectors. Linear multiple regression and fuzzy logic inference were used to evaluate the effects of microclimatic conditions on two droplet size distribution applications (fine and very fine). Multiple regression models were built for each test series, defined by their size droplet distribution. For the fine application the significant variables were wind speed, air temperature and wet bulb temperature depression (ΔT), obtaining a determination coefficient equal to 0.70. In the very fine treatment model the atmospheric stability parameter turned out to be also significant ; the determination coefficient was equal to 0.82. Spray losses were also predicted with fuzzy inference systems and good determination coefficients were obtained ($R^2=0.72$ for fine spray and 0.66 for very fine spray). Interpretable rules were fixed for microclimatic characterization, for two different droplet distributions. Both tools could be combined with physical modelling to evaluate air pollution and spray drift from simplified field tests.

KEY WORDS : Pesticide ; Spray Drift ; Air Pollution ; Vineyard ; Spraying