



**HAL**  
open science

## The Analogical Speaker or grammar put in its place

René-Joseph Lavie

► **To cite this version:**

René-Joseph Lavie. The Analogical Speaker or grammar put in its place. Linguistique. Université de Nanterre - Paris X, 2003. Français. NNT : . tel-00144458v2

**HAL Id: tel-00144458**

**<https://theses.hal.science/tel-00144458v2>**

Submitted on 5 May 2014

**HAL** is a multi-disciplinary open access archive for the deposit and dissemination of scientific research documents, whether they are published or not. The documents may come from teaching and research institutions in France or abroad, or from public or private research centers.

L'archive ouverte pluridisciplinaire **HAL**, est destinée au dépôt et à la diffusion de documents scientifiques de niveau recherche, publiés ou non, émanant des établissements d'enseignement et de recherche français ou étrangers, des laboratoires publics ou privés.

**UNIVERSITE DE PARIS 10 NANTERRE, FRANCE**

Département des Sciences du Langage

Laboratoire: MoDyCo, UMR 7114

École doctorale: Connaissance et Culture

**René Joseph Lavie**

**The Analogical Speaker  
or  
grammar put in its place**

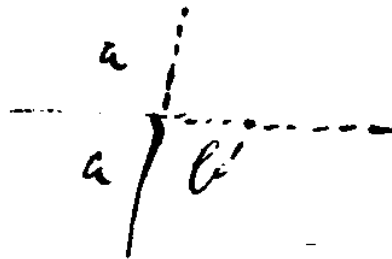

Doctoral dissertation for the grade of Doctor in Language Sciences  
defended publicly on November 18<sup>th</sup>, 2003

Translated by the author with the help of Josh Parker and Lance Miller  
Original title: *Le Locuteur Analogique ou la grammaire mise à sa place*

**Jury:**

Sylvain **Auroux** Research Director, CNRS; Ecole Normale Supérieure, Lyon

Marcel **Cori**, Professor, Université de Paris 10 Nanterre

Jean-Gabriel **Ganascia**, Professor, Université Pierre et Marie Curie (Paris 6)

Bernard **Laks**, Professor, Université de Paris 10 Nanterre

Bernard **Victorri**, Research Director, CNRS, Laboratoire LATTICE

**Director:** Bernard **Laks**

2014 01

# Content

<b>INTRODUCTION .....</b>	<b>9</b>
<b>CHAPTER 1. "SEE TO IT THAT ORDER IS NOT MADE A THING" .....</b>	<b>15</b>
1.1. OBJECT: PRODUCTIVITY, INNOVATION, EVOLUTION AND VARIATION.....	15
1.2. RENOUNCING CATEGORIES AND RULES .....	16
1.3. THE SLOT-FILLER SCHEMA .....	17
1.4. ANALOGY, THE RENEWED SEDUCTIONS OF A VENERABLE NOTION .....	19
1.5. EXPLAINING PRODUCTIVITY ASSUMES A MECHANISM .....	20
1.6. PROXIMALITY OF THE MOTIVATION DYNAMICS .....	21
1.7. CONTINGENT CAUSALITY .....	22
1.8. HYPOTHESIS .....	23
<b>CHAPTER 2. MOMENTS IN THE HISTORY OF ANALOGY, IN LINGUISTICS AND IN PSYCHOLOGY.....</b>	<b>25</b>
2.1. IN THE ANTIQUITY, A "QUARREL" ARBITRATED BY VARRO.....	25
2.2. ARNAULD AND LANCELOT, DISTURB THE LEAST POSSIBLE THE ANALOGY OF LANGUAGE.....	26
2.3. HUMBOLDT: ANALOGY PUTS SOUND AND CONCEPTS AT THE SAME PACE .....	27
2.4. BRUGMANN AND SAUSSURE, ANALOGY REPAIRS PHONETIC CHANGE DAMAGE .....	28
2.5. A REPAIRING ANALOGY WITH MORPHOLOGICAL AND SYNTACTIC EFFECT.....	32
2.6. BLOOMFIELD, THE POWER OF ANALOGY EXTENDED TO SYNTAX .....	34
2.7. HOUSEHOLDER FORMULATES THE POTENTIAL OF ANALOGY .....	35
2.8. CHOMSKY, CATEGORIES AND GENERATIVE RULES AGAINST ANALOGY.....	37
2.9. HOPPER AND TRAUOGOTT, ANALOGY PARTICIPATES IN GRAMMATICALIZATION.....	40
2.10. ANALOGY FOR PSYCHOLOGISTS AND PSYCHOANALYSTS.....	41
2.11. HOFSTADTER, EMERGENT ANALOGY.....	42
2.12. ITKONEN, REHABILITATION OF ANALOGY .....	43
2.13. ANALOGY PROFILES .....	45
2.14. STATICS, A DYNAMICS OF CHANGE, NOT YET A DYNAMICS OF ACTS .....	46
<b>CHAPTER 3. MODEL OF LINGUISTIC KNOWLEDGE, MODEL OF THE DYNAMICS OF ACTS .....</b>	<b>49</b>
3.1. TOWARDS A CONCRETE MODEL .....	50
3.2. A SPEAKER'S LINGUISTIC KNOWLEDGE AS A PLEXUS .....	55
3.3. ANATOMY OF ANALOGY .....	59
3.4. STATIC MODEL: A PLEXUS AS THE INSCRIPTION OF ANALOGIES.....	67
3.5. PHILOSOPHY OF THE STATIC MODEL.....	74
3.6. ABDUCTION, ABDUCTIVE MOVEMENTS .....	81
3.7. GENERAL FRAMEWORK OF THE DYNAMIC SIDE OF THE MODEL .....	91
3.8. CONCLUSION .....	95
<b>CHAPTER 4. STRUCTURAL PRODUCTIVITY .....</b>	<b>97</b>
4.1. ANALYSIS WITH AGENTS B2, B3 .....	97
4.2. ABOUT NON-TRANSFORMATION.....	107
4.3. JOHN IS TOO STUBBORN TO TALK / TO TALK TO / TO TALK TO BILL .....	112
4.4. AMALGAMATIONS, ARTICLE-PREPOSITION CONTRACTION IN FRENCH .....	122
4.5. QUESTIONS NOT ADDRESSED IN THIS CHAPTER .....	125
4.6. CONCLUSIONS ON STRUCTURAL PRODUCTIVITY.....	126

<b>CHAPITRE 5. SYSTEMIC PRODUCTIVITY .....</b>	<b>129</b>
5.1. SYSTEMIC PRODUCTIVITY, DEFINITION AND EXPLANATION .....	129
5.2. ADVERBIAL DERIVATION IN FRENCH, A PROCESS USING ONE PARADIGM ONLY .....	136
5.3. FRENCH VERB, TWO PARADIGMS PLAYING INTEGRATIVELY .....	139
5.4. RECRUITMENT AND EDIFICATION .....	144
5.5. AUVERGNATS AND BAVARIANS, RESETTING IN A SAME PARADIGM .....	145
5.6. FRENCH ARTICLES, REINFORCEMENT EFFECTS .....	152
5.7. GRAMMATICAL AGREEMENT WITH AN2 .....	153
5.8. CONCLUSIONS ON SYSTEMIC PRODUCTIVITY .....	157
<b>CHAPTER 6. MORE QUESTIONS OF GRAMMAR AND DESCRIPTION .....</b>	<b>159</b>
6.1. MORPHEME, WORD, SYNTAGM.....	159
6.2. SYNTAX-MORPHOLOGY SEPARATION .....	173
6.3. ZEROES.....	176
6.4. ANOMALY AND REGULARITY .....	181
6.5. SYNTACTIC HEAD.....	183
6.6. SENTENCE.....	184
6.7. CONCLUSION: DYNAMICS ARE THE CAUSE, AND THE GRAMMAR AN EFFECT.....	185
<b>CHAPTER 7. FOUNDATIONS AND CONTRASTS .....</b>	<b>186</b>
7.1. ANALOGY IN THIS MODEL AND IN OTHER PROPOSITIONS .....	186
7.2. INDIVIDUALITY OF TERMS .....	193
7.3. POSITION, POSITIONALITY, COPOSITIONING .....	202
7.4. INTEGRATIVITY.....	207
7.5. EXEMPLARS AND OCCURRENCES .....	211
7.6. PROXIMALITY, TOTALITY .....	212
7.7. EXTENSION, INTENSION.....	216
7.8. BINDING, VARIABLES, VARIABLE BINDING.....	218
7.9. PROBABILISTIC MODEL OR DYNAMIC MODEL .....	225
7.10. RELATION WITH CONNECTIONISM .....	241
<b>CHAPITRE 8. MARGINS, PROLONGATIONS, IMPROVEMENTS .....</b>	<b>247</b>
8.1. NON-CONCATENATIVE MORPHOLOGIES .....	248
8.2. ACQUISITION, LEARNING, REANALYSIS.....	249
8.3. USING A CORPUS TO SET UP A PLEXUS.....	255
8.4. SELF-ANALYSIS.....	258
8.5. TREATMENT OF MEANING, PREREQUISITES AND DIRECTIONS .....	260
8.6. IS RADICAL NON-CATEGORICITY SUSTAINABLE? .....	268
<b>9. GENERAL CONCLUSIONS .....</b>	<b>271</b>
9.1. DYNAMICS ARE PRIMARY AND GRAMMAR IS SECOND .....	271
9.2. PLAUSIBILITY .....	272
9.3. MAKING A GRAMMAR? .....	274
9.4. SUMMARY OF PROPOSITIONS.....	275
<b>10. APPENDIX: RULES AND CATEGORIES DO NOT QUALIFY AS A THEORY OF OPERATIONS.....</b>	<b>279</b>
10.1. FRAGILITY OF A LEXICAL CATEGORY: THE NOUN-VERB OPPOSITION.....	279
10.2. FUNCTIONAL APPROACH, THE GRAMMATICAL FUNCTION .....	281
10.3. A BRIEF REMINDER OF RULES REFUTATION .....	288
10.4. CONCLUSION: A DESCRIPTIVE APPROXIMATION BUT NOT A THEORETICAL BASE.....	288
<b>11. APPENDIX: THE SLOT-FILLER SCHEMA, A HISTORICAL PICTURE.....</b>	<b>291</b>
11.1. TABLE OF SOME FIGURES OF THE SLOT-FILLER SCHEMA .....	291
11.2. TABLE OF THE SLOT-FILLER SCHEMA IN NEIGHBOURING FIELDS .....	292

11.3. THE SLOT-FILLER SCHEMA IN CONSTRUCTION GRAMMARS.....	293
<b>12. APPENDIX: SPECIFICATION OF THE PLEXUS .....</b>	<b>295</b>
12.1. PLEXUS: INTRODUCTION .....	295
12.2. TERM.....	295
12.3. RECORD.....	297
12.4. A-TYPE RECORD .....	297
12.5. C-TYPE RECORD.....	297
12.6. ACCESS.....	298
12.7. PARADIGMATIC LINK, PARADIGM .....	300
12.8. FAMILIARITY ORIENTATION.....	303
12.9. OVERALL PROPERTIES OF A PLEXUS .....	310
12.10. TOPOLOGY, CONNECTIVITY, INFLUENCED PROXIMALITY .....	315
12.11. SYNTACTIC AMBIGUITY: EXAMPLE.....	316
12.12. MULTIPLE ANALYSIS: EXAMPLES .....	317
<b>13. APPENDIX: SPECIFICATION OF THE ABDUCTIVE MOVEMENTS.....</b>	<b>319</b>
13.1. ABDUCTIVE MOVEMENT BY TRANSITIVITY.....	319
13.2. ABDUCTIVE MOVEMENT BY CONSTRUCTABILITY TRANSFER .....	319
13.3. ABDUCTIVE MOVEMENT BY EXPANSIVE HOMOMOLOGY.....	320
13.4. ABDUCTIVE MOVEMENT BY TRANSPOSITION.....	321
13.5. SOLIDARITY BETWEEN THE PLEXUS AND THE DYNAMICS .....	328
<b>14. APPENDIX: SPECIFICATION OF THE DYNAMICS .....</b>	<b>331</b>
14.1. POSITION AND FUNCTION OF ABS IN THE MODEL.....	331
14.2. REQUIREMENTS FOR THE ARCHITECTURE OF THE DYNAMICS .....	332
14.3. ABS IS INDEBTED TO COPYCAT .....	332
14.4. SOLVING WITH AGENTS .....	333
14.5. AGENTS .....	334
14.6. CHANNELS: SYNTAGMATIC POSITIONS .....	335
14.7. CONVENTIONAL FORWARD-REARWARD ORIENTATION .....	336
14.8. DEVELOPMENT OF THE HEURISTIC STRUCTURE BY RECRUITMENT .....	336
14.9. AGENT REDUNDANCY CONTROL OF AND RESOURCE REUSE .....	340
14.10. DEVELOPMENT OF THE HEURISTIC STRUCTURE BY EDIFICATION .....	341
14.11. PHASE MANAGEMENT .....	345
14.12. STRENGTH MANAGEMENT.....	346
14.13. LENGTH OF COMPUTATION PATHS.....	349
14.14. ACTIVITY CONTROL .....	349
<b>15. APPENDIX: SIMPLE SIMILARITY SUGGESTION (AGENT CATZ).....</b>	<b>353</b>
15.1. DISTRIBUTIONAL SIMILARITY .....	353
15.2. CONSTITUTIONAL SIMILARITY .....	354
15.3. SIMILARITY ON REQUEST .....	354
15.4. AGENT CATZ.....	355
15.5. TECHNICAL ARCHITECTURE OF AGENT CATZ.....	355
15.6. EXAMPLES OF DISTRIBUTIONAL SIMILARITY.....	357
15.7. DECONSTRUCTING CATEGORIALITY AND PROTOTYPICITY .....	358
15.8. ADEQUATION (OR NOT) OF CATZ FOR SIMILARITY SUGGESTION.....	359
<b>16. APPENDIX: ANALYSIS (AGENTS B2 AND B3) .....</b>	<b>361</b>
16.1. PROCESS B2-B3, SPECIFICATION AND OVERALL DESIGN .....	361
16.2. HEURISTIC STRUCTURE FOR AGENTS B2 AND B3 .....	362
16.3. PARSING OF THE ARGUMENT FORM .....	365
16.4. INSTALLATION PROCESS.....	365
16.5. AGENT B2, EDIFICATION PROCEDURE .....	366
16.6. AGENT B2, EDIFICATION PROCEDURE IN PSEUDO-CODE .....	367

16.7. AGENT B3, EDIFICATION PROCEDURE .....	368
16.8. PERFORMANCE WITH THE TYPE OF SIMILARITY .....	369
16.9. PRODUCTIVITY OF AGENT B2.....	369
16.10. RESULT OF A B2-B3 ANALYSIS .....	370
<b>17. APPENDIX: BINARY BRANCHING, TERNARY BRANCHING.....</b>	<b>371</b>
17.1. THE QUESTION AND ITS HISTORY .....	371
17.2. EXEMPLARIST REASONS.....	373
17.3. COST REASONS .....	374
17.4. CHOICE OF N-ARITY .....	375
<b>18. APPENDIX: ANALOGICAL TASK (AGENT ANZ) .....</b>	<b>377</b>
18.1. AGENT ANZ, SPECIFICATION AND OVERALL DESIGN.....	377
18.2. REARWARD PROCEDURE FOR AGENT ANZ, IN PSEUDO-CODE .....	378
18.3. FORWARD PROCEDURE FOR AGENT ANZ.....	379
18.4. DISCUSSION OF AGENT ANZ: UNDER-PRODUCTIVE PRIMING.....	379
<b>19. APPENDIX: ANALOGICAL TASK WITH TWO CONSTITUENTS (AGENT S2A).....</b>	<b>381</b>
19.1. AGENT S2A, SPECIFICATION AND OVERALL DESIGN .....	381
19.2. ARCHITECTURE OF AGENT S2A.....	381
19.3. LIMITS OF AGENT S2A .....	382
<b>20. APPENDIX: LIMITED SYNTAX WITH AGREEMENT (PSEUDO-AGENT AN2) .....</b>	<b>383</b>
20.1. DEFINITION OF PSEUDO-AGENT AN2.....	383
20.2. MERITS AND LIMITS OF PSEUDO-AGENT AN2.....	383
<b>21. APPENDIX: SUMMARY OF AGENTS.....</b>	<b>385</b>
<b>REFERENCES .....</b>	<b>387</b>
<b>GLOSSARY .....</b>	<b>397</b>
<b>FRENCH-ENGLISH LEXICON .....</b>	<b>403</b>
<b>INDEX.....</b>	<b>405</b>

*Il faut dire en gros: Cela se fait par figure et par mouvement, car cela est vrai. Mais de dire quels et composer la machine, cela est ridicule. Car cela est inutile et incertain et pénible.*

Pascal (Br. 70 = Manuscrit 152), cité par Milner 1989.

Non. C'est pénible en effet mais utile.

*Is a "class of things that resemble each other" a class of things a ...n such that a chain of similarity relationships runs from a to n?*

Nelson Goodman,

*The Structure of Appearance*, Bobbs-Merrill, 1951, p. 147.

Oui. mais il faut les prendre par paires.

*Worüber man nicht sprechen kann  
darauf kann man schreiben?*

Robert A. Chametzky,

*Phrase Structure*, Blackwell 2000, p. 160.

Wovon man nicht mehr schreiben kann,  
darüber kann man noch etwas programmieren.





# Introduction

In linguistics, the question of productivity remains a central one: how can a speaker, who has been exposed to a few tens of thousands of utterances, become capable of understanding and uttering virtually an infinity of utterances.

*Productivity* may, with Auroux<sup>1</sup>, be understood in two different ways:

Chomsky himself very early distinguished two kinds of creativity: which he names 'rule-changing creativity' and 'rule-governed creativity'<sup>2</sup>. He says he is not interested in the former and protests (against ancient authors: Humboldt, Paul) who did not make the distinction [...]. Calling both of these 'creativity' is a great source of confusion, it would be better to talk respectively of creativity and productivity.

I shall understand *productivity* exactly in the sense of Auroux<sup>3</sup> above. Productivity is thus the possibility to produce or understand an infinity of utterances in a given linguistic frame, that is, given a fixed "competence". But I will show abundantly below that productivity is not accounted for by rules. However, I will also show how the successful production of an utterance, or its reception, is likely to bring up a slight, local modification to the linguistic knowledge, resulting in a manifestation of the 'creativity' following Auroux, that is, of the *rule-changing creativity*. Thus, the two notions will tend to be reconciled. Before suspecting confusion, the reader is invited to consider that such reconciliation is necessary; "competence" evolves progressively as a result of linguistic exercise, as with children, at learning time, and later we never stop learning even if not at the same pace.

Theories in cognitive linguistics, despite many interesting features, do not provide a precise, operable theory which would explain productivity; neither do functionalist linguistic theories.

Connectionist models are experimental devices and feature responses which well reproduce the productive linguistic behaviours of speakers thus bearing implications on our understanding of the linguistic phenomenon. Their current limits, in scope and in

---

<sup>1</sup> Auroux 1998, p. 95.

<sup>2</sup> Chomsky 1964, p. 59.

<sup>3</sup> Despite the potential ambiguity with a different meaning of « productivity » as in the productivity of a morphological process.

perimeter, may well be broadened in future, but these models present two shortcomings. First, they explain poorly; or to be more precise, the reductionist displacement of the explanation installs a significant distance between the evidence and the explanatory plane. Second, they fulfil with difficulty three base mechanisms<sup>4</sup>: i) to efficiently account for generalizations (for Marcus: "to make bindings between rules and variables" but this wording is not endorsed here as will be shown), ii) to represent the recursive structures which linguistic exercise requires, and iii) to individuate instances. A development will be made on these three points in Chap. 8.

In generativism, productivity is central and the question was set very early by Chomsky<sup>5</sup>, however, this current of thought delayed the goal to account for linguistic phenomena (emission, reception, learning, variation, and change); instead, it postulated a linguistic exercise, which would be that of a speaker; its elucidation would be a preliminary condition to that of the phenomena. This consequence-bearing displacement, from the linguistic phenomena to a language, defined as an abstraction, supposes to define what a language is, which turned out more difficult than anticipated. This object is constructed, artificial, and the question, thus placed on a language, adding complexities which the object itself does not contain, has hardly contributed to understand what happens by the speakers. The corresponding constructions are complex<sup>6</sup>, numerous, changing and, up to *Principles and Parameters*, present the following characters: a) they draw on categories when abundant, converging evidence shows (cf. Chap. 1) that categories cannot be taken as operative mechanisms, b) they do not explain the linguistic acts, c) they account poorly for variation between speakers and for language change, d) they offer a vision of acquisition which is difficult to match with the findings, e) they adopt a vision of meaning which is Platonic<sup>7</sup>.

The Minimalist Programme<sup>8</sup> reduces the importance of categories, but it does not seem yet to have much progressed items b, c, d, and e above.

Optimality Theories, capture convincingly many linguistic phenomena but the theoretical cost is high: the set of constraints they postulate appears not to be closed, each new publication bringing up a new one. Moreover, constraints often depend on categories. Finally acquisition, seen as the setting of ranking amongst constraints, is no more plausible than the parameter setting in *Principles and Parameters*. Recent advances in Optimality Theory, which combine it with probabilities, will be discussed in section 7.9. *Probabilistic model or dynamic model* (p. 225).

None of the frameworks cited above draw on analogy which, after the bimillenary recognition of its important role in linguistics, received renewed attention from

---

<sup>4</sup> Cf. Marcus 2001.

<sup>5</sup> Chomsky 1975 (*The Logical Structure ...*), published in 1975, based on a manuscript earlier by twenty years.

<sup>6</sup> "To achieve the goal of describing language as a property of the human mind, [Chomskys' theory] establishes an apparatus of considerable complexity". Cook 1988, p. 1.

<sup>7</sup> All these topics are detailed below.

<sup>8</sup> Chomsky 1995/1997a, *The Minimalist Programme*.

psychologists and cognitivians, then from some linguists; Itkonen, notably, rehabilitated it (cf. Chap. 2).

Thus a field is today available for an attempt which is non categorial, connectionist (but localist)<sup>9</sup> and aiming at plausibility. This is what this work proposes. It builds on analogy, thematizes its ability to operate 'cositionings', sets it at work in language dynamics and presents a model which is strictly exemplarist (later, it will have to become occurrentialist), without categories, without rules, and without abstractions. this model<sup>10</sup> is dynamic and yields effects of productivity and of regularization by mobilizing elements of linguistic knowledge which are numerous. They combine their effects in dynamics which are simple in their principle but complex in their deployment. As a counterpart of this complexity, the model is supported by a computer implementation which helps to validate it.

Chapter 1 establishes the project. Starting from the shortcomings of categorial approaches, which are briefly recalled, and from the critique of the "slot-filler schema", which is one of its figures, I suggest to give up the grammatical viewpoint, (categories, rules, slot-filler schema), which is abstract and static and I propose an occurrentialist and dynamic model. To that end, analogy appears as the major lever provided we cease to view it as Platonic (that is, static) and we reinstate it in its dynamic dimension. It will be coupled with a second important notion which is its corollary: proximality. Against the deduction as in formalized systems and in cognitivism, which does not suit cognitive systems, the abduction of Peirce is solicited as the foundation of analogical and proximal base dynamics.

Chapter 2 presents a selective history of analogy. It focuses mainly on three periods: Greek-Latin Antiquity, the 19<sup>th</sup> century, and the 20<sup>th</sup> century. It shows that analogy has initially been perceived as static; then, with the Neogrammarians and Saussure, it has been seen as a dynamics in diachrony playing an important role in language evolution, but it has not yet been considered enough as a synchronical dynamic bearing on linguistic acts.

Chapter 3 defines the model, basing it on dynamic analogy and on proximality (of inscriptions, of accesses, of abductive dynamics).

Chapter 4 puts the model at work on structural productivity: morphological and syntactical to simplify. It proposes a redefinition of 'syntactical analysis': syntactical analysis amounts to analogical structure mappings. The analysis of an utterance encompasses a number of staggered structure mappings.

Chapter 5 defines a systemic productivity which complements structural productivity. As yet, systemic productivity has been somewhat identified, little discussed, and poorly

---

<sup>9</sup> Understand 'localist' in the sense of this word in connectionism: a network is localist when the representation in it of objects of the problem is ensured by defined cells (otherwise it is 'distributed'). Cf. the glossary.

<sup>10</sup> The "Analogical Speaker" occasionally in this work. The model is thus named to denote in two words its two main characters: a) primacy of the speaker upon the language, and b) primacy of analogy to understand the inscriptions and the dynamics.

modelled. We need to understand how pluridimensional paradigmatic systems build up and operate, and how they can be learnt, and how they evolve.

Chapter 6 reformulates some classic themes of grammar and of description. For example, it shows how the model defended in this thesis can do without the notion of word; how it deals with phenomena for which other theories postulate zero elements.

Chapter 7 discusses the foundations of the model and contrasts it with other theoretical propositions.

Chapter 8 discusses the model's margins and sketches a few lines to prolong it. In particular, it contains a model of linguistic learning consistent with the production/reception dynamics, and the predictions of which are in accord with acquisitional evidence.

I conclude (section 9) that it is an error to think that a grammar – that is, a platonic, essentialist, and static elucidation of a language – is a prerequisite likely to provide a useable base to later understand linguistic dynamics. Rather, it is the preliminary elucidation of the dynamics themselves, which makes it possible i) to understand them mutually, and, as a side effect, ii) to 'explain' the grammars' stipulations and their limits.

Several appendixes provide details – some of them important – which have been expelled from the main body of the text for the sake of concentrating the argument. Further appendixes provide a technical description of the model and of its implementation. In quasi-formal natural language, or in pseudo-code, they deliver the functional and organic data which is necessary to reproduce the experiments that support my reasoning.

Acknowledgments and thanks:

Françoise Abel  
Antonio Balvet  
Josiane Bartet  
Simon Bouquet  
Erszébet Chmelik  
Antoine Challeil  
Morten Christiansen  
Marcel Cori  
Annie Delaveau  
Mariane Desmets  
Agnès Disson  
Françoise Douay  
Gilles Dowek  
Jacques Dubucs  
Roger Dupin de Saint Cyr  
Robert J. Freeman  
Jürg Gasché  
John A. Goldsmith  
Philippe Gréa  
François Guillaume  
Claude Hagège  
U. Aldridge Hansberry  
Daniel Kayser  
Marc Klein  
Françoise Kerleroux  
Bernard Laks  
Jules Lavie  
Alain Lemaréchal  
Yves Lepage  
Géraldine Mallet  
Anne-Marie Mazzega  
Lance Miller  
François Muller  
Lea Nash  
Alexis Nasr  
Joshua Parker  
Frédéric Pascal  
François Rastier  
Claude Roux  
Monique Sénémaud  
Irène Tamba  
Atanas Tchobanov  
Ali Tifrit  
Wendy Tramier  
Bernard Victorri  
Agnès Villadary  
Yves-Marie Visetti

The drawing on the title page is by Ferdinand de Saussure.



# Chapter 1.

## "See to it that order is not made a thing"

### *1.1. Object: productivity, innovation, evolution and variation*

The speaking subject is productive. Productivity is the main problem in linguistics. To provide an account of productivity is for linguists a central task.

The *referential object*<sup>11</sup>, the part of the world which we address, is language without doubt, but what is the *conceptual object*; in other words: how is the referential object profiled in the approach of it which we take? Generativism places its priority on the study of syntax and grammar. It does so for reasons of method, some aspects cannot be addressed today, and because of one of its theoretical positions: the autonomy of syntax. Its results contribute little, or artificially only to the understanding of other aspects of language. There are more reasons to this than just the choice of a particular conceptual object, among which, the endorsement of categories and of rules which are criticized below.

So the choice of a conceptual object is very important. Abney proposes one: syntax is autonomous, he says, which was noted by Tesnière before Chomsky, he recalls, but autonomy is not isolation:

Syntax in the sense of an algebraic grammar stands or falls on how well it fits into the larger picture. The larger picture, and the ultimate goal in linguistics, is to describe

---

<sup>11</sup> "I shall distinguish two types of objects : the referential object and the conceptual object I call *referential object* that part of the world which a science assigns itself to know, its initial referent. Scientific theories, different as they may be, are classified together in a same field of knowledge on the base of a common referent. The characterization of such an object bounds and identifies the discipline. In our case, all of linguistics is defined because it adopts as a referential object a universe called language. In contrast, I call *conceptual object* the particular way in which a particular theory conceives and configures the referential object. Starting from the same reference, every line of thought, every school of thought, designs a conceptual object which proposes itself as a centre of knowledge. On this point for example structuralism and generativism diverge in the measure in which they configure different conceptual objects, implying different empirical approaches so that the compatibility of their propositions is very difficult to establish." (Caravedo 1991, p.8)



language in the sense of that which is produced in language production, comprehended in language comprehension, acquired in language acquisition, and, in aggregate, that which varies in language variation and changes in language change<sup>12</sup>.

To avoid a construction that would be impossible to extend to variation and to the dynamics of production, reception, acquisition and language change, these dimensions must be incorporated to the conceptual object from the start.

Because of that, it must be shown dynamically how a new utterance is possible. It must be shown what linguistic knowledge is necessary, and how it is solicited to make the new utterances possible. In the first place, this is a matter of linguistic acts: reception, emission.

Then it must be shown how the linguistic knowledge which served this act may evolve so that a successful linguistic event (reception or emission) makes possible after it things which were not before, or makes easy after it things which used to be difficult (counter to a 'competence' determined once for all).

The need is that of a modelling approximation which be dynamic and operable. Along with the acts and acquisition, it has to encompass speaker variation. Finally, it has to account for the qualities of languages: contingency, ability to innovate, capacity of "stylistic" figures (e.g. synecdoche, metonymy).

Finally, building on results of psycholinguistics, the compatibility with a model of not necessarily linguistic knowledge and with psychology is desirable. The devices we adopt have to be concrete and flexible. Learning from the defects of categorialism and regularism, it is appropriate to stay away from abstractions of all kinds.

## ***1.2. Renouncing categories and rules***

Grammarians, when seeking to put some order in the variety of language facts, then linguists, when striving to account for them in an explanatory manner, used mostly categories<sup>13</sup> and rules<sup>14</sup>. Rules and categories are mutually necessary: stating a rule requires categories and categories have served most often to express regularities<sup>15</sup>.

Categories and rules have made several useful descriptive approximations possible without yet exhausting the question satisfactorily for two main reasons.

First, whatever the approach with categories and rules, it had to be accepted that there always remained an empirical residue that resisted explanation<sup>16</sup>.

Second, even though the descriptive system was free of empirical residue, it would still have to qualify as a plausible 'explanation' of the dynamics. In particular it would have to show how the brain might implement a rule-based operation. The debate is not new,

---

<sup>12</sup> Abney 1996, p. 12.

<sup>13</sup> Lexical, syntactical and functional categories.

<sup>14</sup> Prescriptive rules ("*de bon usage*"), diachronic evolution rules and laws, derivational rules, etc.

<sup>15</sup> With the notable exception of Optimality Theory in which categories are used to express constraints rather than rules. Cf. Smolensky 1999 for a brief introduction contrasted with Generative Grammars.

<sup>16</sup> Numerous examples will be provided below.

see Chomsky (1974/1975, p. 203) having to respond to arguments (Schwartz, Goodman) denying the brain the possibility of a rule-based operation. Thereafter, the debate has been very productive, notably upon the renewal of connectionism<sup>17</sup>. It is not closed, as evidenced by a recent book by Marcus (2001) – it will be analysed p. 243 – which poses it anew in the very field of connectionism, which once pretended to have concluded it. Although they are well known, the principal terms of the critique of categories and rules will be recalled in appendix 10 p. 279.

Partial categoriality do obtain in linguistic behaviours but this does not imply linguistic theory to be founded on categories. Regularization effects also do obtain but their explanation does not imply rules to be made the operative support. Categories make it possible – with difficulty – to build descriptive approximations, but they cannot constitute the base of a theory of linguistic dynamics.

Thence, the programme consists of putting the perspective upside down: instead of postulating categories and rules as causes, and then building the theory with them, linguistic dynamics have to be accounted for in another manner and then only, categorization – inasmuch as there is – and regularization – inasmuch as it obtains – must be reconstructed as effects and explained as consequences.

How initially are we lead into categories and rules? The initial idea is to become capable to make statements on what is possible - and what is not - in the tasks which speakers have to carry out and in which they respond to novel situations by building on older ones, already known and experimented. The generic schema which then comes to mind is to be able to say things like "Instead of this, one can put that" and the result of such substitution is judged possible. Very soon it appears that not everything may be placed everywhere; it must be stated what is possible where and this statement has to be made in terms as general as possible lest one makes only occurrential assessments and stays mute on possibility, prediction, innovation. Linguists indeed feel this need, but grammarians also well before.

One then undertakes to state what filler may occupy what slot in the most general possible terms. This is the schematization that leads immediately into categories and rules; the acceptance of this schema is the mother of the descriptive shortcomings and the theoretical difficulties which arrive then so abundantly.

### ***1.3. The slot-filler schema***

Rules and categories may be seen as conceptually dependent on a unique schema which is their antecedent in the order of necessity: the 'slot-filler schema'<sup>18</sup>, the critique of which has not been much done so far. If carried out appropriately, it may provide a track for overcoming its defects: one thing is to renounce categories and rules, another one is to devise an apparatus than can substitute them in describing and explaining.

---

<sup>17</sup> McClelland 1986.

<sup>18</sup> It is the slot-filler schema of some connectionists; one may also recognize here the *construction* of construction grammars.

The hyperonyms 'slot', 'filler' and 'slot-filler schema' are proposed because they can collectively refer to a variety of descriptions and theories. These are not all equivalent but each in its way attempted to cover a general need: to account for constitutional sameness, and for functional sameness in general terms; which is a way to approach the question of linguistic productivity.

The question of the slot-filler schema is important because it connects with the principle of structure preservation<sup>19</sup> (which will be touched again section 7.3.3. *The similarity of compositionings is mediately determinable*, p. 204), it is embryonic up to the 17<sup>th</sup> century and will be posed mainly in the 20<sup>th</sup> century (cf. p. 291). For numerous authors, it then becomes the centre of description and of theory; it is present in psycholinguistics because it is the kernel of utterance reception and production models. The descriptive adequacy and the value of the linguistic theories which were produced critically depends on the responses it receives.

Let alone the specificities of particular theories, the schema is as follows: there are slots which must be occupied by fillers, and there are fillers which may occupy slots. In order to specify which filler may occupy which slots, both have properties but in two different ways. Properties are *assigned* to fillers; they are on the contrary *prescribed* by slots for candidate fillers to qualify for occupying a slot.

Properties are category-based, and the conditions of occupation have the nature of rules. So the slot-filler schema is a corollary of rules and of categories; more exactly, it is their antecedent, a common scheme from which they derive.

Milner (1989), critical as he is on categories and rules, regretting that Chomsky did not differentiate the set of "labels" that apply to slots from the set of those which apply to the "language units" candidate to occupation (the fillers), maintains a reduced version of the slot-filler schema. It shows its limit in the coincidence / distortion question (below).

Unification grammars<sup>20</sup> present an evolution of the slot-filler schema: by deconstructing it in part, they yield an important gain in descriptive efficiency (see appendix). However, the HPSGs (Head-Driven Phrase Structure Grammars) still specify slots and fillers by their properties. As they multiply these properties, and as they contain under specification and overriding mechanisms, the HPSGs do better than many theories, but they remain residually categorial.

The rejection of rules and of categories made above leads to the rejection of the slot-filler schema since it requires stating the "occupation relation" by propositions which draw on rules and categories. Reversing the proposition, if we manage doing without the slot-filler schema, the reason to make categories and rules falls down.

In linguistics, the theory of flexible and innovative operation cannot cope with gears designed to sanction repetition and reproduction. The slot-filler schema encompasses three beats: 1) define the requirements of the slots, 2) define the properties of the

---

<sup>19</sup> Principle of structure preservation: i) a language has a fixed, limited number of slots, ii) a slot may be occupied, iii) linguistic material may not happen outside a slot, iv) in a language, the set of slots evolves extremely little, and extremely slowly. Milner 1989, p. 649.

<sup>20</sup> LFG (Lexical Functional Grammar, Bresnan 2001), HPSG (cf. *infra*), GPSG (Generalized Phrase Structure Grammar, Gazdar 1985).

potential fillers, and 3) check, based on its properties, whether a potential filler qualifies for occupying a slot. If this schema is refused, an alternative may come from an approach which syncopates the three beats; it must do the economy of a definition of needs, and of that of properties. It seems that analogy has the potential as we shall see.

An important corollary concerns variable binding. I shall defend – section 7.8. *Binding, variables, variable binding* (p. 218) – the idea that the question of variable binding, as it is currently posed, is in part (but not entirely) artifactual, because it follows from positing the slot-filler schema. If the economy of it can be done, then, a part of the binding problem ceases *ipso facto* to be posed.

#### ***1.4. Analogy, the renewed seductions of a venerable notion***

Along these lines, analogy presents itself as a possibility to grasp sameness minimally, that is, without over specifying, without determining more than necessary. As it does not require to make the analogical ratio explicit (analogy "elides the predicate", cf. chap. 3), it bears the promise to dispense with metalanguage:

*mice is to a mouse as cats is to a cat*

might well be dynamically useable without being more precise than necessary about particular mammals, without requiring a gloss on grammatical number and without a statement about whatever happened to "the indefinite article in plural".

Analogy also gives hope to let happen the useful drifts. This would be the second factor to contribute in the account of flexibility in linguistic operation.

Analogy further appears to enable the idea of contingency; it would make it possible to avoid what would be the ultimate essence of things, to eschew foundationalism. Adaptation and innovation: of behaviour, of intellection, of utterance, etc. would be possible without control over the details, without the ultimate intelligence of means and procedures.

Finally, analogy drops a hint on a theoretical construction that could be compatible with Saussurean differentialism: if things do have value by their ratios, let us take these ratios as directly constituting the linguistic knowledge and see what consequences and advantage we can take of that.

If this approach succeeds, it restores continuity with 2400 years of history in linguistic thought: Aristotle, Denys, Varro, Port-Royal, Humboldt, Paul, Brugmann, Saussure, Bloomfield, etc. which would not be its smallest interest.

It also established tracks of continuity with cognitive science (Lakoff, Gentner, Holyoak) and psychology, very specifically with the theory of second order isomorphism (representations are by similarities and are not direct representations of things, cf. Edelman *infra*. p. 41). Continuity also with neuroscience: according to Choe (2002) the thalamus and the cortex in association are producers of simple analogies: so are they functionally and their anatomy allows us to understand how.

### ***1.5. Explaining productivity assumes a mechanism***

Having recognized that the question of the possibility in principle (competence) is not antecedent to that of the possibility of acts, one is led to treat in priority these acts, linguistic processes, that is, to adopt a dynamic vision. To explain in this way linguistic productivity (and learning, and variation, and language change) supposes a mechanism. The question is central phenomenologically.

This mechanism is something else than a generative procedure. In 1965, Chomsky made the following conjecture:

A reasonable model of linguistic acts will comprise, as one of its fundamental components, the generative grammar which formulates the knowledge that the speaker has of his language<sup>21</sup>.

However, the thing did not occur and Chomsky himself later withdrew this position. Today, the more widespread vision on this topic may be borrowed from Jackendoff:

The traditional formulation of phrase structure rules and of transformational rules is conducive to viewing the rules as like a program for constructing sentences. The connotations of the term "generate" in "generative grammar" reinforce such a view. However [...] students are always cautioned to resist this interpretation. In particular, they are exhorted to view derivational movement as metaphorical: "We are after all describing competence, not performance." The upshot is that the status of such rules vis-à-vis performance models is left unspecified<sup>22</sup>.

When researching a model of linguistic acts, no one knows what to do with the transformations of transformational generativism or with the MOVE of the Minimalist Programme.

The required mechanism is not the *a priori* characterization of the set of utterances which are possible in what would be a speaker's language<sup>23</sup> by whatever procedure, generative or otherwise. On the contrary, we seek a dynamics of reception – it must be plausible as much as possible – which, when facing a variety of utterances, succeeds, or not, in building a sense, and does so with success rates that are varied and gradient depending on the utterance. So is it when uttering utterances. It is not the case that a speaker is capable of that "possible" because dwells in him a defined, static, language, which would pre specify the possible and which would have (had) to be learnt by the speaker. Otherwise said, the idea must be given up to characterize linguistic knowledge in a static manner, without reference to the dynamics that would use it.

Even though a static linguistic knowledge of the speaker is not sufficient stand-alone – without the dynamics – to linguistically define a speaker, still, an assumption concerning it is required. The orientation consists of building this model of linguistic knowledge with analogy as its base. It cannot be a lexicon governed by rules. It is something else than a corpus which does not contain the required structure and from

---

<sup>21</sup> Chomsky 1965/1971, p. 20. Quotation retranslated into English from a French translation of the original.

<sup>22</sup> Jackendoff 2002, p. 57.

<sup>23</sup> Be it called 'speaker's language', 'competence' or '*I-language*'.

which that structure cannot be extracted. It is complex, exemplarist and meshed; it will be named "plexus" in Chap. 3 where it is defined.

This assumption must be complemented by one on the principle of the dynamics. Here again, the orientation is to solicit analogy. One can make a Platonic reading of analogy (analogical ratios exist in nature) but the repairing analogy of the Neogrammarians and of Saussure<sup>24</sup> already appears as dynamic in diachrony. The intent is to extend this dynamic reading in synchrony, applying it to the accomplishment of linguistic acts and to acquisition.

We are thus led to the speaking-subject as capable of analogy and the question takes a cognitive and mental dimension. Early in Antiquity, analogy in language was narrowly associated with the – morphological and syntactical – markers which sanction the location of linguistic units in analogical systems. This directly conducted to the analogy-anomaly debate between Athens and Alexandria on one side and the Stoics of Pergamon on the other, debate which Varro arbitrated (cf. Chap. 2). The question was thereafter endorsed by the tradition.

It may be the case, however, that a step has been missed or treated inadequately. I mean questions like transitivity (total? partial?) in a series of analogical ratios, questions like the possibility of combined effects of several analogical sets sharing some of their terms or some of their analogical ratios, etc. These questions are related with deduction and, in a sense, formal theories like predicate logic or other logics have covered them. They did, but in a way which is brutal, symbolic, categorical, and this manner does not suit linguistic phenomena.

When it was finally realized that symbolic theories do not suit linguistic phenomena, analytical work might have resumed in taking account of the massiveness of analogy in language, and of the evidence that it is also dynamic, but the course taken was a different one and connectionism for example, in its first period, sought to apply to languages the associators which yielded so good results in pattern recognition. Success was in the measure in which there is pattern recognition in language, that is, limited: it does not constitute its main part.

The work proposed here may be seen as the project, building on the results of the last decades, to start anew from analogy, to apply to it a more nuanced treatment, and to view it as dynamic.

### ***1.6. Proximity of the motivation dynamics***

Analogy must however receive a complement. It corresponds to the simple idea that a thing triggers certain other things and not a great number of them or all of them, some mental transitions are preferred. It is the idea, dating back to Hume, and generally held as refuted, of associationist psychology. The enterprise here is not the restoration of associationism in its original conception but I shall show (p. 74) how proximity and analogy allied together, may discipline the associations by means of this *ratio* which precisely the analogical ratio is. This discipline will be thematized as the observance of

---

<sup>24</sup> Cf. Chap. 2.

the "copositionings" which take place between terms. Proximity also echoes a more recent formula, that of properties which Livet attributes to connectionism: "*a local compositionality and a limited systematicity*"<sup>25</sup>.

Thus, in a speaker's linguistic knowledge, starting from a given inscription, some inscriptions can be reached with ease: they are proximal. Other ones are less. The linguistic knowledge acquires as a topology: kinds of distances are set in it. The idiosyncratic detail of the inscriptions and of the proximity conditions among them is held to result from the particular history of the speaker, that is, they bear the trace of his learning history.

The processes which utilize these inscriptions to account for linguistic acts benefit from proximity and they depend on it. This makes it possible to conceive of paths and computation chains which are shorter or longer depending on the case and, in this way, to account for the fact that linguistic acts have different degrees of difficulty and impose different cognitive loads. Another important benefit will be to reconstruct and demonstrate degrees in acceptability.

### ***1.7. Contingent causality***

The cause of the successful completion of a linguistic act is primarily the precedents upon which the process which accounts for it may rest. I understand 'precedent' as a linguistic act i) which took place before with success, leaving some permanent trace, and ii) which resembles the act currently being processed.

The systematic distributional analysis of a corpus, gives this corpus the role of a body (precisely) of precedents. A generativist grammarian who picks up examples and proposes them makes the assumption that they are typical of legal (or not) productions in his target language and the elaboration which he makes on their base will license productivity.

Relating a current linguistic act to the precedents that license it brings up several questions: i) how to select the appropriate precedents, ii) on what base to recognize resemblance, and iii) how to design the process that carries all this out.

Linguistic theories, most often, adopt of this question a vision which I call 'totalistic' in the following sense: the modes of selection of the precedents are supposed to be latent in the totality that the corpus represents, or in the totality represented by the set of examples which may occur to a generativist. Then, following different procedures, a system is built: the best possible adjustment to all the cases occurring in the envisaged totality, that is, that which is descriptively most economical. This makes it abstract. As one ambitions a wide coverage of phenomena, this system becomes complex.

It must be seen, instead, that sameness-proximity retains an occurrential, exemplarist character. They remain concrete data which result from the subject's history, and of the contingent history of his learning. One must restart from similarities-proximities already given as exemplars or occurrences because the acquisitions are primary, literally and in two manners, they are primary in the course of the time of the subject's history

---

<sup>25</sup> Livet 1995, quoted by Vivicorsi 2002, p. 79.

(they occurred before the linguistic act now at stake), and they are primary by their causal position in the accomplishment of the act (they causally condition the dynamics of the act).

The conditions of productivity – of its dynamics – must be sought *a minima* only; one must build on proximality because proximality results from the subject's experience. Doing so increases confidence to rightly address the idiosyncrasy which always appears in the linguistic exercise.

Thus this approach presents itself at first sight as a theory of individual facts, as a weak theory. About it, one may fear that it might not well embrace transversal generalities which we observe and which lend themselves well to symbolic modelling (like determination by an article, SVO construction, etc). I show below that this is not the case: it is possible to design processes spanning from the smallest idiosyncrasy to the widest generality in continuity, and addressing the whole span with the same base mechanisms.

This, without yet solving the question of how sameness is approached (cf. Chap. 3), constitutes a rejection of the totalistic approach and the promotion of proximality.

### ***1.8. Hypothesis***

The hypothesis of this work can now be stated as follows.

An apparatus consisting of a) analogical inscriptions that are strictly exemplarist and endowed with proximality, and b) a dynamics of elementary abductive, analogical movements, makes it possible:

- firstly to explain in a homogeneous framework the linguistic dynamics (reception, emission, learning, the dynamics of language change), and to understand them with respect to each other,
- secondly, to reconstruct as a consequence the question of the possible / impossible in language, that is, to explain as effects of the dynamics the static stipulations which constitute the grammars.

If this track succeeds, it shows that the reverse position – which thinks it necessary to first establish a static description, a grammar, in view of explaining later the linguistic dynamics – take things in the wrong order.

Isn't a work along these lines behind time: connectionism would be fulfilling this programme in a more promising and more plausible manner? Connectionism is indeed the school of thought which presents the closest accord with these themes: a connectionist model is that of a defined speaker, it is abstraction-free and rule-free, and it is certainly dynamic. It yields gradient effects and combines viewpoints. Any single detail in it may contribute to a result but none is critically mandatory.

However: i) one thousand presentations of a training corpus do not constitute an acceptable model of learning and the training procedures of connectionist models are not incremental. French speakers have one word only: *apprentissage*, but we must not mix up *training* and *learning*, ii) the gap between observations and the implementation substrate (cells and weights borne by links) is too wide; this makes any explanation



impossible or too obscure, and c) finally neuromimetic connectionism progresses slowly and with difficulty on variable binding, on recursive structures, and on the treatment of individuals; see details in section 7.8. *Binding, variables, variable binding* (p. 218) .

Thence, another approach, based on mechanisms less opaque than those of the connectionist models, should be welcome to progress in our understanding of the linguistic dynamics.

## Chapter 2.

# Moments in the history of analogy, in linguistics and in psychology

To support what precedes, and to provide justifications which will serve in the next chapter, here are some steps in the history of analogy considered from the point of view of linguistics and, secondarily, of psychology. Thus, the analogy of the theologians (mainly Thomas Aquinas), will be considered marginally only.

This history is important mainly in three moments. In Antiquity, emerges the first figure or a debate which will keep grammarians, then linguists, busy for a long time: that between regularity (analogy) and anomaly. In the 19<sup>th</sup> century, the Neogrammarians, then Saussure, conceive with precision the role of analogy in language change. The 20<sup>th</sup> century finally is marked by the disrepute of analogy and its dismissal by Chomsky, then by its rehabilitation, first by cognitivicians then by very few linguists.

### 2.1. In the Antiquity, a "quarrel" arbitrated by Varro

After borrowing it from Thales, Aristotle defines analogy as follows:

There is an analogy when the second term is to the first what the fourth is to the third; one will then replace the second by the fourth or the fourth by the second, and sometimes, one adds the term to which that which has been replaced relates. For example in *The vase is to Dionysus what the shield is to Ares*; the vase will then be called the *shield of Dionysus*, and the shield the *vase of Ares*. Or else *Old age is to life what evening is to day*, one will then call the evening: *the old age of the day*, or as Empedocles, one will say of the old age that it is *the evening of life* or *the sunset of life*<sup>26</sup>.

Analogy, for Aristotle, is initially 'poetical' or rhetorical. It is found in *the Poetics* and not in the *de Interpretatione* where that which will serve us would rather be expected. Then the grammarians get hold of it:

Varro<sup>27</sup> recalls that it is by borrowing from the mathematicians (Euxod of Cnides, friend of Aristotle, then Euclid of Alexandria) their *proportional ratio* (*analogon* in

---

<sup>26</sup> Aristotle *Poetics* chap. 21 (Fr. ed. Seuil 1980, p.109).

<sup>27</sup> Varro, *De linguae latinae*, book 10, 45 B.C.

Greek) that the grammarians of Alexandria for the first time displayed in clear tables the complex Greek inflexional morphology: declensions and conjugations<sup>28</sup>.

A great question for grammarians in the Antiquity is known as the "quarrel" between analogists and anomalists<sup>29</sup>. For the former (Aristarchos), language is ruled by analogy, for the latter (Stoicians: Krates of Mallos, Sextus Empiricus), language is dominated by anomaly.

The arguments of both were not placed on a same theoretical plane; anomalists [...] adopt a general viewpoint: if analogy were the organizing principle of the formation of words, it would operate regularly, and would be perceivable in the entire perspective of the set of the words. Now this is not the case, [...]. For the analogists [...] despite this profound concern, all the same there exist analogous forms [*analogies de formation*] with great evidence, and they represent an organizing principle sufficient to describe the transformations of words ones with respect to the others<sup>30</sup>.

The terms of this debate will be resumed by Varro in the 1<sup>st</sup> century B.C.

Varro<sup>31</sup> criticizes both viewpoints, stressing that the matter is not to compare forms but relations between forms. Comparing *amabam* ("I loved") and *legebam* ("I read") leads to nowhere, because one could add *rosam* ("the rose" acc. sing.) on the same plane. In contrast, the proportional ratio *amabam* : *amabat* ("I loved" : "he loved") :: *legebam* : *legebat* ("I read" : "he read") makes it possible to determine the identity of a type of transformation<sup>32</sup>.

The point is well made but not very well worded: the matter is not to "transform". It is to compare, and to put at play productively terms involved in systems of relative positions, these being reflected in the overt form in some cases, and in other cases, there being no formal manifestation. In the Arab world, the analogists of Basrah and the anomalists of Kufa<sup>33</sup> will echo the Greek 'quarrel'.

As we restrict ourselves to language, we will leave Augustine, Scholasticism, and Thomas Aquinas – but his commentator Caietano will be solicited several times below – to reconnect with analogy in France in the 17<sup>th</sup> century.

## ***2.2. Arnauld and Lancelot, disturb the least possible the analogy of language***

In Arnauld and Lancelot, is to be found, after Varro and seventeen centuries, a revised position on the question anomaly-analogy but in a curious posture, 'honnête homme' and decency on one side, and a proto-scientific attitude on the other; interesting amalgamation of normativity and of an objective position with respect to language.

---

<sup>28</sup> Douay 1991, p. 8.

<sup>29</sup> On analogy-anomaly, see also the short but excellent paper of Françoise Douay (1991) which, moreover, connects this ancient quarrel with a more recent one and clarifies it : is there a cognitive linguistics and one which would not be.

<sup>30</sup> Baratin in Auroux 1989, tome 1, p. 229.

<sup>31</sup> Varron, *de Lingua Latina*, X, 37-38

<sup>32</sup> Baratin in Auroux 1989, tome 1, p. 229.

<sup>33</sup> Rey 1973, p. 178.

It is a maxim that those who work on human languages must always have present in mind, that the ways to speak which are authorized by a general and unquestioned usage must be considered good, even if they contradict the rules and the analogy of language; but they must not be invoked to put rules in doubt or to disturb analogy, neither consequently, to authorize other ways to speak that usage would not authorize<sup>34</sup>.

The *Grammaire générale et raisonnée* discusses, criticizes, or generalizes "the rules that Vaugelas had sketched without striving to make a systematic work"<sup>35</sup>. The position of Arnauld and Lancelot will amount to accommodate attested anomaly while disturbing the least possible the "analogy of language", without however authorizing non-attested usage.

[Ablative in Latin], properly speaking, is not to be found in plural, where, for this case, there is never an ending different from that of dative, but, because it would have disturbed analogy to say for example that a preposition governs the ablative in singular, and the dative in plural, it was preferred to say that this number also had an ablative, but always similar to the dative. It is for this same reason that it is useful to also give an ablative to Greek nouns, which is always similar to the dative, because this conserves a greater analogy between these two languages which, ordinarily, are to be learnt together<sup>36</sup>.

I will show how a different treatment of the question is possible in section 6.1.2. *Homography, accidental homonymy, syncretism* (p. 160),.

### ***2.3. Humboldt: analogy puts sound and concepts at the same pace***

For Humboldt<sup>37</sup>,

Concepts may be marked in three manners: [1. immediate imitation, 2. symbolic imitation, and] 3. Phonetic similarity [which] depends on the concepts to be denoted. Words with similar significations receive sounds with the same proximity [...] presupposing sets endowed with a certain magnitude. It is the most fecund function and that which realizes the clearest and most distinct adequacy between the system of intellectual productions and that of the language; such a procedure – in which the analogy of the concepts is taken to a degree such that, each remaining in its own domain, they are made to walk with the same pace – may be qualified analogical.

Analogy is then "one of the causes which gives birth to grammatical categories"<sup>38</sup>.

Trabant<sup>39</sup> sees here "the relative motivation of language" of Saussure which "is the image of the coherence of the world which thought produces with the help of language. By this very reason, that relative motivation is also an image of the coherence of the world tout court which, for sure is donated to us through language and , without language, would be a hopeless chaos".

---

<sup>34</sup> Arnauld 1660/1997, p. 60.

<sup>35</sup> Mandosio, introduction in *ibid.*, p. XV.

<sup>36</sup> Arnauld 1660/1997, p. 38.

<sup>37</sup> Humboldt 1974, p. 218.

<sup>38</sup> Destut de Tracy commenting the *Lettre à M. Abel-Rémusat* of Humboldt

<sup>39</sup> Foreword, in Humboldt 1974, p. 77.

Humboldt thus undertakes to connect the morphological analogy with that which has not yet been thematized as semantics. Does he restrict himself to morphology or is his proposition extended to longer forms, then encompassing syntax? This is possible but hard to decide given Humboldt's style which is very open and sometimes not precise.

Later in the 19<sup>th</sup> century, analogy founds an explanatory relation between what will soon after be termed 'diachrony' and 'synchrony'.

## ***2.4. Brugmann and Saussure, analogy repairs phonetic change damage***

### **2.4.1. Neogrammarians as seen by Auroux and Engler**

The following quotation is long but important to frame a critical moment in the history of analogy in the 19<sup>th</sup> century:

In 1882 Ziemer listed the new themes brought about by the Neogrammarians: [...], they make the concept of **analogy** something fundamental. Building on the (how ambiguous) concept of phonetic law, they strive to view the reality of language as an unconscious process. This makes them reject the purely subjective explanatory principles of Curtius. On the contrary, because they strive to connect language with the acts, they have to explain, calling most of the time on associationist psychology, and on the need to understand each other within a group, how, from individual acts, one passes to the regularity snatched away (sic) from individual wills. The epistemological achievement is far from obvious and definitive. If they take that, beside the phonetic laws, **analogy** is the second factor ruling the life of language, the neogrammarians use this concept rather loosely, notably to explain the exceptions which are opposed to the phonetic laws. As early as vol. IX of the *Studien*, Curtius reminded them that analogy had to be considered on series only. Progressively, the concept of analogy comes closer to what will become that of paradigm or that of paradigmatic axis of the language. For example, Brugmann notes that, to he who wants to learn German, no one says that *gastes* is the genitive singular, *gast* the dative, etc.; rather, one creates the different forms, each from the other ones. This idea is mainly an achievement of the Neogrammarians; it is because he rejects the role played by analogy, that Curtius dedicates the last part of his pamphlet to the primitive language. His effort is to show that the PIE [proto Indo-European] is an arbitrary reconstruction, and that inflections in it play no role. He thus has perfectly understood that, if one makes a link between the new conceptions of analogy with phenomena like inflections, one must also consider a series of synchronic states of the language in which forms act on each other. The concept of analogy leads to synchrony. The theme of *Ausnahmlosigkeit* [the fact of being without exceptions] historically arises from the mechanist conceptions developed in the second third of the century [...]. This prevents the Neogrammarians from understanding the role of the combinatorial formations (we would say 'syntagmatic'), as will be noted by Jespersen, and above all, to understand the effect of meaning on the change of the sound form<sup>40</sup>.

Between phonetic laws and analogy, Engler identifies in the Neogrammarians a dissymmetry in favour of the former:

... the phonetic laws, postulated without exceptions, and without counterbalance (nothing more revealing in this respect than the term "false analogy". And even if the Neogrammarians and Paul acknowledge the importance of analogy, it will only be with

---

<sup>40</sup> Auroux 2000a, p. 421.

Saussure who relates it with a fundamental principle of the mechanism of language, that analogy will play on a par with the phonetic laws.) are as many illusions that tend to make language 'inhuman'<sup>41</sup>.

This is not entirely right: Brugmann sees analogy playing on par with phonetic laws twenty years before Saussure.

#### 2.4.2. Karl-Friedrich Brugmann

This passage from Brugmann (1849-1919)<sup>42</sup> is translated from a quote in Normand 1978, p. 48-50. Brugmann exposes the derivational and inflectional combinatorics:

It is the compliance of the material element (base, root), recurring in a set of the various forms and derivations of a word, which causes the feeling of the etymological link. As to the orderly feeling of the system of inflections and of lexical formations, likewise, as to the system of the meanings of the syllables marking inflections and derivations, this feeling is rooted in groupings like *gastes-armes-spruches*, etc. *führung-leitung-bereitung*, etc., and also in the comparison of parallel series such as *gast-gastes-gäste = arm-armes-ärme = spruch-spruches-sprüche*, etc. It is therefore at the expense of a certain amount of formal analysis operating when instating some groupings that are typical of the system of lexical formation and inflection, that the speaker gains awareness of the models and rules following which he shapes most of his productions; because, including in adults, one observes the combinatorial activity play a role, in addition to memory.

The question of productivity is explicitly posed and attributed to analogy (the formation of an unknown fourth):

Whence the particular importance associated with the creative activity by combinatorial operation, which the subject operates in the domain of lexical formation and even more so in the system of inflection. As most of the forms in a system with multiple articulation were never heard before, or if they were heard, they were not inscribed in the memory, we form them with the help of groups, by establishing – in a naturally unconscious manner – ratios between already known terms and by deducting the unknown fourth term.

Productivity, thus envisaged by Brugmann, may comprehend syntactic productivity depending on the interpretation of "*system with multiple articulations*" (as with Humboldt, *supra*, it is not entirely clear). At this point, sprouts a dynamic vision of grammaticality ...

In the course of the epigenesis operating repeatedly on the model of the relevant representative groups, it is indifferent to the nature of the productive activity whether the element is already in use in the language or deprived of attested existence. In the latter case, it suffices that the speaker who creates an element which deviates from accepted usage, feels no contradiction with the inventory acquired by learning and stored in the memory.

... this makes it possible for linguistic change to explicitly integrate the explanatory frame:

---

<sup>41</sup> Engler 2000, p. 240.

<sup>42</sup> Brugmann, *Zum heutigen Stand der Sprachwissenschaft*, Strasbourg, 1885.

Group dynamics is, to a large extent, what grants each member of a linguistic community the possibility and the opportunity to go beyond accepted usage. But for a novel formation which conflicts with established usage to acquire a general validity, it will have to develop spontaneously and simultaneously in a large number of interacting individuals.

Phonetic change, the damage it makes in paradigms, and its ensuing repair by analogy, are dissociated and formulated in terms which Saussure will later endorse:

... hence a notable difference between analogical formation and phonetic change as, in the case of analogy, innovation does not necessarily incur the rejection of the older element. Now the emergence and the entrenchment of analogical formations almost always are causally related with phonetic change. Phonetic alterations cause either the displacement and uninterrupted destruction of existing groups in the course of the language history, or the emergence of new groups.

Phonetic change affects already established groupings and associations by unmotivated distinctions among congruent forms. Cf. *esti, este, eimi* ... To this loosening of the combinatorial ratio caused by phonetic variation, analogy offers a parry and a response. The entirety of language dedicates itself tirelessly to blur useless discrepancies and respond to functional constancy by constancy of the phonetic expression; with an insistent and progressive pace, it tries to reinforce the conditions of solidarity and better adjust the groupings in the domain of lexical formations and of inflection.

In a word, for Brugmann, novel formations amount to the deduction of an unknown fourth. To the loosening of the combinatorial ratio resulting from phonetic change, analogical formations offer a parry and a counterstroke.

### 2.4.3. Saussure

Saussure adopts the same analysis of the "repairing" dynamics of analogy. Phonetic change:

blurs and complicates the linguistic mechanism in the measure in which irregularities born from phonetic change contradict groupings based on general types; in other words, in the measure in which absolute arbitrariness takes over relative arbitrariness.

Fortunately, the effect of these transformations is counterpoised by analogy. Analogy is responsible for all normal modifications of the outside appearance of words which are not phonetic in nature. Analogy subsumes a model and its regular imitation. An analogical form is a form built after one or several other ones following a defined rule.

Thus in Latin the nominative *honor* is analogical. One used to say *honôs : honôsem*, then through rotacism of the *s*, one said *honôs : honôrem*. At that moment, the radical had a dual form; this duality was eliminated by the new form *honor*, created following the model of *ôrâtor : ôrâtôrem*, etc.; by a process which we assimilate to the computation of a proportional fourth :

*ôrâtôrem : ôrâtor :: honôrem : x → x = honor*

In order to counterbalance the diversifying action of phonetic change (*honôs : honôrem*), analogy re-unified the forms and restored the regularity (*honor : honôrem*)<sup>43</sup>.

Saussure takes great care to qualify the effect of analogy as an addition, not as a change.

---

<sup>43</sup> Saussure 1915/1970 (*Cours*), p. 221.

Analogy installs a competing form beside a traditional one. This competitor may eventually supersede the more traditional form<sup>44</sup>.

*Pension* : *pensionnaire*; *réaction* : *réactionnaire*. *Pensionnaire* and *réactionnaire* do not change anything to a pre existing term. They replace nothing.

Analogy is the "principle of language creations" and is grammatical:

Analogy is grammatical in nature: it supposes the awareness and the understanding of a ratio uniting the forms with each other. While the idea is nothing in the phonetic phenomenon, its intervention is necessary in analogy (intervention of a proportional fourth).

The combination:

ôrâtôrem : ôrâtor :: honôrem : x → x = honor

would have no *raison d'être* if the mind did not associate by their meanings the forms which it contains.

Therefore, everything is grammatical in analogy; but it should be added immediately that the creation which it produces, at first, can only belong to the *parole*, it is the occasional work of an isolated subject. In that sphere, and away from the *langue*, is where it is appropriate to initially catch the phenomenon. However, two things must be distinguished: i) the understanding of the ratio which relates the generating forms (*les formes génératrices*); ii) the result suggested by the comparison, the form improvised by the speaking subject to express his thought. Only this result belongs to the *parole*<sup>45</sup>.

To complete the characterization of analogy as a creation, and not as a change, the table below summarizes the contrast that Saussure<sup>46</sup> makes between analogy and what he names 'agglutination'<sup>47</sup>.

---

<sup>44</sup> Ibid. p. 234.

<sup>45</sup> Ibid. p. 226.

<sup>46</sup> Ibid. p. 243-244.

<sup>47</sup> Saussure does not use "agglutination" in the sense in which the Turkish morphology or the Japanese verb morphology are agglutinative.



<b>Analogy</b>	<b>Agglutination</b>
<i>pâg + ânus → pâgânus</i>	<i>hanc + horam → encore</i> <i>potis + sum → possum</i>
With smaller units, analogy builds a longer unit [which is analysable].	Two or more units melt by synthesis into a single one [which ceases to be analysable].
Draws on associative series [paradigms], along with the syntagms.	Does not draw on an associative series; bears on a group alone; syntagm only (no paradigm).
Supposes analyses and combinations, intelligent activity, intention. Assembly obtains at once, in an act of <i>parole</i> , by the union of elements borrowed from various associative series.	Is not voluntary, is not active. A mechanical process. Assembly obtains by itself. Slow cementing of elements. The synthesis may erase the original units.
"Construction" (vague) may apply. "Composed", "derived" must be reserved to this case.	"Construction" (vague) may also apply.

**Table 1 Analogy and agglutination according to Saussure**

About analogy substituting older formations with newer ones, cf. also a footnote in the section beginning on p. 258, where the case "*somnolent*" is analysed by Saussure.

Three points are explicit in the lines cited above: i) analogy is an act of *parole*, ii) analogy is creation or addition, not transformation, and iii) analogy is grammatical. We see therefore that it belongs directly to the dynamics of linguistic acts.

However, Saussure sees analogy as repairing or morphological without claiming any specific place for it in syntax – the *Cours* does not make much room for syntax<sup>48</sup>.

### ***2.5. A repairing analogy with morphological and syntactic effect***

Is the operation of the repairing analogy limited to morphology or lexical creation? A case will show that it may also act on a paradigm less narrowly characterized than an inflectional or derivational paradigm<sup>49</sup>.

From a corpus taken from the Internet<sup>50</sup>, Rastier picks up the following series of examples of collocations that are typical of racist pages. Detecting collocations of this sort helps in the characterization of racist contents:

<sup>48</sup> At that time, in paedagogy, *analogy* is almost a synonym of *morphology + inflection*. "*The Spanish Academy calls Analogía that part of the grammar which teaches the parts of speech with all their properties and accidents*" (Galban 1907, p. 17). This book of Spanish grammar for high schools has four major divisions: prosody (17 pages), analogy (175 p.), syntax (1 p.) and orthography (9 p.). So that grammar consists of nearly morphology and inflection alone: 87% of the total!

<sup>49</sup> This case study, which breaks the historical organization of this chapter, supports in anticipation the discussion below on Bloomfield and Chomsky.

<sup>50</sup> In a work for detecting racist pages on the Internet, sponsored by the Commission of the European Communities. Rastier 2002d (François) *Les critères linguistiques pour l'identification des textes racistes - Eléments de synthèse*, in Valette, Mathieu, éd., European project Princip.net : a platform for the research, the identification, and the neutralization of illegal and offending contents on the Internet. Deliverable 2002-1, Inalco, pp. 84-98.

<i>idéologie</i>	<i>mondialiste</i>
<i>complot</i>	<i>mondialiste</i>
<i>mafia</i>	<i>cosmopolite</i>
<i>financiers</i>	<i>étrangers</i>
<i>lobby</i>	<i>de l'immigration</i>
<i>internationale</i> ↔	<i>juive</i>

He notes, rightly, that this series, extracted from a corpus, therefore "given", presents regularity: the rightmost term concerns the axis "us-them" while the leftmost one is a determination without reference to this axis. In this, the series is regular. But it presents an anomaly; in the last item: *internationale juive*, the contrary is the case, "us-them" happens in the first term and the term without this property is the second one. The item *internationale juive* thus 'disturbs' (quoting Saussure) the series and this complicates a little, says Rastier, the detection of racist contents.

This disturbance appears to have had another effect than that of making more complex the detection; it seems it also has been perceived by the racist rhetor who, on some occasion, produced the innovation *juiverie internationale*. This creation causes a linguistic discomfort (let alone discomforts of other natures); something here succeeds despite the question always associated with a novel creation: for what benefit should the innovation cost be spent. In what then does this creation succeed? There are many factors among which the pejorative character of the suffix *-erie* in this context; there is also – it is the point here – the reintegration that this innovation operates of (*juif* + *international*) into the series. This series is present and active in the minds of the speakers even though its formal structure and working levers remain non explicit – but isn't its efficiency all the better. The form *internationale juive*, anomalous then, performed the recuperation of the rhetorical benefits – assumed available – of *idéologie mondialiste*, *complot cosmopolite*, etc. with an efficiency that was only relative, because of its anomaly; the new form *juiverie internationale*, now regular in this series, does so more efficiently.

This analogical creation is quite as repairing as that which produced *honor* in Saussure's example, yet it differs in two respects; i) the trouble it repairs is not the effect of phonetic change, it is something else, ii) the means of the reparation are not limited to a lexical creation or a morphemic regularization against the "transparency of an etymon"; beside the creation *juiverie*, they also comprise a syntactic rearrangement which in this case is the permutation of two terms.

This example is interesting for two reasons: first it bears simultaneously on morphology and syntax, another indication that the border between them is not sharp; then because it leads to envisage as a paradigm – in a broader sense – a set which is not narrowly determined by distribution but is a field onto which a same analogical pressure is exerted; despite the reasons being less easy to characterise, they are nonetheless perceived by the speakers.

## 2.6. Bloomfield, the power of analogy extended to syntax

In 1933, in *Language*, for the first time in modern linguistics as far as I am aware, Bloomfield makes a straightforward statement that analogy may be held to account for linguistic innovations in constructions:

A grammatical schema (sentence type, construction or substitution) is often called *analogy*. A regular analogy allows a speaker to utter discourse form which he has not heard; we shall say he utters them by analogy with the regular forms he has heard<sup>51</sup>,

This is followed with a development on analogical morphology and its relation with anomaly that does not innovate on what we saw with Brugmann and Saussure.

Remembering maybe Wallis, who described the phenomenon in the 17<sup>th</sup> century or, more recently Humboldt, Bloomfield anticipates the phonesthemes of Firth or the idiophones of Tournier and Philips<sup>52</sup>:

Even the morphemes that form the bases have some flexibility; when hearing a form like *squunch* in the sense of 'a step making a suction noise on a wet ground', we cannot say whether the utterer already heard it or whether he uses an analogy with [skw-] as in *squirt*, *squash*, and with [-onč] as in *crunch*<sup>53</sup>.

Adopting of analogy the full vision, that is, that of the proportional fourth, he fosters it as the explanation of learning and, therefore, of linguistic productivity:

p. 259: Regular analogies are substitution habits. Assume for example that a speaker has never head the form *Give Annie the orange* but he has heard or uttered a series of forms such as the following:

<i>Baby is hungry.</i>	<i>Poor Baby!</i>	<i>Baby's orange.</i>	<i>Give the baby the orange.</i>
<i>Dad is hungry.</i>	<i>Poor Dad!</i>	<i>Dad's orange.</i>	<i>Give Dad the orange.</i>
<i>Bill is hungry.</i>	<i>Poor Bill!</i>	<i>Bill's orange.</i>	<i>Give Bill the orange.</i>
<i>Annie is hungry.</i>	<i>Poor Annie!</i>	<i>Annie's orange.</i>	...

He now has the habit – analogy – to use *Annie* in the same positions as *Baby*, *Dad*, *Bill* and therefore, in the appropriate situation, he will utter the new form *Give Annie the orange*. The fabrication of a form by analogy with other ones is similar to solving a proportional equation with infinite ratios on the left side:

$$\begin{array}{l} \textit{Baby is hungry.} : \textit{Annie is hungry} \quad ) \\ \textit{Poor baby!} \quad : \textit{Poor Annie!} \quad ) = \textit{Give the baby the orange.} : X \\ \textit{Baby's orange.} : \textit{Annie's orange.} \quad ) \end{array}$$

The explanatory power of analogy is now explicitly claimed for syntax – so far it was claimed for morphology only. The explanation is very clearly made, one may believe and adhere, but it is not further built nor supported: we stay with "substitution habits" and the "therefore" is far from clarifying the causal chains that would show *how* the subject becomes productive or, with precision, which substitutions can be done and which ones cannot. This leaves a remainder to explain; we shall see what consequences a contradictor will draw.

---

<sup>51</sup> Bloomfield 1933/1970, p. 258.

<sup>52</sup> Didier Bottineau, personal communication

<sup>53</sup> Bloomfield 1933/1970, p. 258.

## 2.7. *Householder formulates the potential of analogy*

In 1971, Householder delivers in *Linguistic Speculations*, a chapter: *Sameness, similarity, rules and features*<sup>54</sup> which reinterprets with analogy a great number of linguistic phenomena.

At that time, the situation appears to be that each of these phenomena is, or has already been analogically analysed by some author but that these analyses are scattered in the publications and in the perception that linguists have of them. The situation is also that the current thinking at that time provides for these phenomena theories that are not analogical. The distinctive merit of this chapter by Householder is therefore to bring together such analogical analyses in one chapter and thus produce suggestion effects. This is already a value even if, as we shall see, the theory which could follow is not yet constituted.

He starts from the two-term analogy of the type *A is similar to B* – which I shall call 'A2 analogy' below – and straight away identifies that a similarity is always apprehended in some definite way, and that there are always several possible dimensions to comparison, which leads to the following:

How does one systematize, consciously or unconsciously? The only candidate so far proposed for this job is analogy. An analogy is a sameness of similarity and differences (p. 63).

Meeting with the full analogy – which I shall call below A4 because it consists of four terms – and which will be the subject matter of the twenty ensuing pages.

If I have noted that A is like B, C is like D, E is like F, ... and then go on to compare the A-B similarity to (let us say) the E-F similarity, and conclude that they are the same [both similarities are the same], I am said to have established a proportion or analogy  $A : B = E : F$ , which, just as in mathematics, can also be written as  $A : E = B : F$ , ... (p. 63).

He thus postulates analogy to be transposable; as we will see below in the 'transposition abductive moment', cf. p. 87<sup>55</sup>, this property is not always verified.

Householder then builds an analogical vision of a great many linguistic phenomena, beginning with lexical segmentation. The chapter contains few general propositions; rather, it builds a convincing effect by accumulating the setting into analogies of pairs of various natures. In this, the vision is 'exemplarist' much in the way the model promoted in this work is. The text is somewhat wearisome, which does not mean without interest, made mostly of 'boring examples (Householder) and the only thing that can be done is sampling:

A word like *bet*, let us say, is first opposed to things like *abet*, *you bet*, etc. and to those like *better*, *bet them*, etc., and *Bret*, *bent*, *best*, etc. by an analogy or analogies whose terms are *nothing : something*. Then it is successively opposed to:

*pet*, *vet*, *get*, *debt*, *jet*;

*to bait*, *to bit*, *bat*, *but*, *\*[but]*, *bot*;

---

<sup>54</sup> Householder 1971, pp. 61-80.

<sup>55</sup> But we will have to accept that this transposition does not always apply, so it is not exactly *as in mathematics*; see the quoted section and the corresponding appendix.

*to beck, \*bep, \*betch, Beth, Bess, and bed.*

*And there are no more, except ones in which one of these (or more) could be inserted as a middle term; i.e. beg is not on this list because it is the first and most closely opposed to bed, which is on the list. (p. 65).*

The discourse intimately associates segmentation and phonology. Householder does not directly link *bet* – *beg* because the chain *bet* – *bed* – *beg* is possible. He requests for individual links to be by minimal contrast where attested forms make this possible, that is, where they attest such contrasts in context. In two pages of more *boring examples* the analogical pairs are minimal contrasts, e.g. *bed* : *pet* (+ voiced : - voiced) altering voicing and articulation point, for the initial consonant, for the final consonant, etc. The phonological development is long and detailed. On the way, partial productivity in the lexicon is encountered and treated analogically (it is not the derivational productivity, which is partial itself, but the fact that not all phoneme sequences, even phonotactically good, are realized as lexemes). Also is encountered – and analogically treated – what I shall call below 'group sensitivity' (p. 169):

It is a remarkable characteristic of several Indo-European languages ... that there are sets of affixes superficially different in form from other sets, but filling exactly the same function – the so-called declensions, or declension-types (p. 69).

as well as many more phenomena: phonological, lexical, morphological, and syntactic, which we have to skip, please refer to the text. The vision of analogical change, that of Brugmann and of Saussure (it would be better said: "linguistic change by analogical creation"), is specified on the way:

The kind of linguistic change known as analogical change is not a change from non-analogy to analogy or one *caused by analogy*, as is sometimes mistakenly supposed, but a change *from one analogy to another*, a transfer of pattern or item from one proportional set (usually a short one, even unique in one dimension) to another (usually a long one with two-dimensional similarity throughout). Householder 1971, p. 78.

When Saussure insists in seeing an analogical innovation as an addition to a previous form, which will coexist with it, he does not appear to say anything else; both do indeed recognize that the older form, which may eventually be superseded by the newer one, had anterior titles to be analogical, but in different analogies.

The overall theoretical proposition, if at all, appears in the chapter's conclusion:

Enough has been said to show the great role of analogy in forming the structure in a man's brain, which is his language. We have also noted the convenience and economy, in talking about such proportions, of using conventionalized summarizing devices like rules, features, paradigms and matrices. From now on, we shall use these devices most of the time; but we should not forget that each of them rests on one or more proportions or sets of proportions. And if, in one sense, rules and features are merely arbitrary fictions (while only the utterances and proportions are real), there is another, paradoxical, manner of speaking in which only they are real while actual utterances are merely conventional abbreviations for the rules and features. Many linguists prefer this paradoxical sense of 'real' (p. 79-80).

In the rest of the book, Householder will use "rules, features, paradigms and matrices" as a matter of convenience and economy, but solely as conventional devices, refraining to forget that they rest on proportions or sets of proportions, the latter only being real. Taking the opposite route is, for him, paradoxical.

The vision I defend in this work is in very good agreement with Householder's views, but in addition, all the consequences are drawn: not only do I not forget that proportions (i.e. analogies) are the base on which rest all these "conventions" that are rules and matrices, but in addition I restore analogy as responsible for the linguistic dynamics, producing rule effects (cf. structural productivity, Chap. 4) and matrix effects: chapter 5 will substitute "matrices" and morphological paradigms with an analogical systemic productivity.

I shall still refer to rules or conventions, by "convenience" or "economy", because they may alleviate the communication, counting with the complicity and the benevolence of the reader, lest indeed we would be exposed to the long series of Householder's *boring examples*, but I fail to see why the smallest causal role should still be granted to them.

For Householder, those who take the opposite choice, that is, choose rules, features, paradigms and matrices, against analogical proportions, make a paradoxical choice.

## **2.8. Chomsky, categories and generative rules against analogy**

Chomsky, in order to respond to an observation of Descartes, undertakes explicitly to account for linguistic productivity:

the Cartesian observation that human and animal language differ in a fundamental way: *les bêtes n'ont que des connaissances directes et absolument bornées, l'homme compose son discours*<sup>56</sup>.

He finds that his predecessors did not succeed very well in that:

Thus he [Vaugelas] regards normal language use as constructed of phrases and sentences that are "*autorisées par l'usage*", although new words (e.g. *brusqueté, pleurement*) can be correctly formed by analogy. His view of language structure, in this respect, seems not very different from that of Saussure, Jespersen, Bloomfield, and many more who regard innovation as possible only "by analogy", by substitution of lexical items for items of the same category within fixed frames<sup>57</sup>.

and that neither did more contemporaneous linguists:

Modern linguistics has also failed in dealing with it in any serious way. Bloomfield, for example, observes that in natural language "the possibilities of combination are practically infinite", so that there is no hope of accounting for language use on the basis of repetition or listing, but he has nothing further to say about the problem beyond the remark that the speaker utters new forms "on the *analogy* of similar forms that he has heard". Similarly, Hockett attributes innovation to "analogy". Similar remarks can be found in Paul, Saussure, Jespersen, and many more<sup>58</sup>.

Analogy, which they called for to that end, does not suffice:

To attribute the creative aspect of language use to "analogy" or the "grammatical patterns" is to use these terms in a completely metaphorical way, with no clear sense and with no relation to the technical usage of linguistic theory. It is no less empty than Ryle's description of intelligent behaviour as an exercise of "powers" and "dispositions"

---

<sup>56</sup> Chomsky 1966b (*Cartesian linguistics*), p. 12.

<sup>57</sup> Ibid. p. 54.

<sup>58</sup> Ibid.

of some mysterious sort, or the attempt to account for the normal creative use of language in terms of "generalization" or "habit" or "conditioning"<sup>59</sup>.

Analogy is thus insufficient because it "substitutes with one another lexical units of the same category in fixed frames". Indeed, this is where Bloomfield stopped, but nothing forces one to stop here, as the demonstration will be made.

Again in 1975<sup>60</sup>:

... notions like "analogy" do not take him [a man of science free of all ideology] very far away in the study of human capacities, at least in the domain of language<sup>61</sup>.

It must be noted however that the analogy which is dismissed here is "apparent analogies":

Although *John's friends appeared to their wives to hate one another* and *John's friends appealed to their wives to hate one another* are very similar, the speakers understand them very differently, without taking their apparent analogy into account.

In short, in order to build a theory of the competence of the ideal speaker of a language, one adopts a theoretical apparatus which is complex, categorical, regularist, and abundantly "non apparent" after dismissing the unfortunate analogy: after forbidding it to use its "non apparent" talents<sup>62</sup>, it was easy to show that it would not do the job. This difference of treatment is never discussed or defended and is a qualified injustice. Indeed the authors who had seen the potential of analogy had not at that time deployed the explanatory chains, but this deficiency did not incur necessarily the dismissal of analogy. However, the logical-symbolist pressure of the time led to it and this is what was done.

Chomsky then engages into what will be the first generativism, the apparatus of which is well-known: lexical categories, phrase markers comprising nodes that represent intermediate constituents, themselves strongly categorized, derivations based on rules and transformations based on rules.

A possible schematization of the history of analogy, or of its distribution in the variety of the uses of the word 'analogy' could be the following:

- 1) Aristotle's analogy, with four terms, binding a proportional fourth to the three other terms. Let us call A4 this analogy since it holds between four terms. It is that of Varro, of the Neogrammarians and of Saussure.
- 2) A degraded analogy as for example in the utterance *A is analogous to B*. It is a commonplace usage, which corresponds to a moment of discredit of analogy and appears to have prevailed in the first half of the 20<sup>th</sup> century<sup>63</sup>. Let us call it A2

---

<sup>59</sup> Ibid. p. 12,13.

<sup>60</sup> Then again in 1985 : *The production and the interpretation of novel forms was judged at most as a question of analogy which posed no problem in principle*. (Chomsky 1985/1989, p. 21).

<sup>61</sup> Chomsky 1975/1977, *Problèmes et mystères* (Reflections on language), p. 174 et sequ.

<sup>62</sup> Yet, let us recall Saussure, quoted here again: "The combination *ôrâtôrem : ôrâtor :: honôrem : x* → *x = honor* would have no reason to be unless the mind associated by their meaning the forms which compose it " (author's highlight).

<sup>63</sup> The confusion is even much older since, at the time of the Counter-Reformation, one finds this in Caietano, commenting Thomas Aquinas : "The word analogy, as we received it from the Greek ... has

since it holds between two terms only. A2 occurrences analysed very soon also reveal four terms, they show up easily without ever digging very deeply. However, A2 users do not mention them and *A is analogous to B* is synonymous of *A is like B*; one does not specify in what A and B are alike.

- 3) In the last quarter of the 20<sup>th</sup> century, renewed attention to analogy and restoration of A4 analogy, through works in psychology and in cognitive science, then a request for its rehabilitation, made by Itkonen, which will be analysed in detail below.

When Chomsky refuses analogy, which one of these two visions does he refuse? A4, imprudently then, or is it A2, then we should have to think that the blurring of analogy was very marked in those times.

Milner (1989) makes a comparable reading of the history of analogy:

Saussure explicitly uses the notion of proportional fourth, which exactly meets the notion of analogy in the Greek sense. Moreover, the entirety of Chap. IV of the third part of the *Cours*, titled "*L'analogie*", represents a remarkable attempt, and a success, aiming at restoring the term *analogy* in its ancient and precise usage, beyond a modern and imprecise one<sup>64</sup>.

He even fosters that:

Between the Greek world and the modern universe, a difference has aroused: it is well-known that there exists today mathematical theories of irregular phenomena; in this sense, the ancient opposition between analogism and anomalism could be overcome; in fact there exists some linguistic theories which treat language as fundamentally "anomalous" in the Greek sense. In modern terms, we should better speak of complexity.

In some respects, [the opposition between analogists and anomalists] has a correspondence within linguistics. The scepticism of V. Henry with respect to the phonetic laws of the Neogrammarians, that of the school of Giliéron towards the school of Saussure and of Meillet, the conceptions of comparative grammar as a succession of "small facts", all this relates to the anomalist conception. On the other hand, formalising linguistics, be it structural, generative, etc. is rather on the side of the analogist conception<sup>65</sup>.

If we follow Householder, the first generativism would then be in the uneasy position to have refused analogy and at the same time to have accepted an analogist conception of language; a converging remark is made by Itkonen, cf. section 2.12. *Itkonen, rehabilitation of analogy* (p. 43). Perhaps. If it has accepted it, in any case, it is through the detour of the categories. That the categorical detour provides a great expressive power is not doubtful, it is very attractive to he who grants the primacy to the concision of the theory. However, the number of empirical residues that it conducts to leave unexplained disqualifies it in its application to linguistic facts. Now analogy does not imply categories; if it has to be applied, it is in its birth state, without dressing it into a

---

been so broadened and divided that we say many names analogous wrongly. ... Proportional analogy only [which is that called A4 here] constitutes analogy. As for inequality analogy [which is that called A2 here] it is absolutely foreign to analogy. Caietano 1498/1987, p. 113.

<sup>64</sup> Milner 1989, p. 631.

<sup>65</sup> Ibid. p. 631.



categorical apparatus. That is not what has been done by generativism and it is the proposition made in this work.

## 2.9. Hopper and Traugott, analogy participates in grammaticalization

Hopper and Traugott view analogy as one of the two mechanisms which account for grammaticalization, the second one being reanalysis:

[...] the mechanisms by which grammaticalization takes place: reanalysis primarily, and analogy secondarily. Reanalysis and analogy have been widely recognized as significant for change in general, most especially morphosyntactic change. Reanalysis modifies underlying representations, whether semantic, syntactic, or morphological, and brings about rule change. Analogy, strictly speaking, modifies surface manifestations and in itself does not affect rule change. Although it does affect rule spread either with the linguistic system itself or within the community. Unquestionably, reanalysis is the most important mechanism for grammaticalization, as for all change<sup>66</sup>.

This conception is summarized in the table below.

The analogy which is envisaged here is analogy following profile 3: repairing analogy (cf. p. 45). Viewing it as modifying a surface representation contradicts that on which Saussure, agreeing with Brugmann and Householder, insists much: that analogy does not modify anything but installs a new form in addition to an older one, a '*paraplasme*' says he, which may eventually cause the older one to disappear.

Hopper and Traugott make analogy (profile: repairing analogy) a secondary process behind reanalysis. Now if we adopt a less profiled and less restrictive definition of analogy, and if we put it, as I propose, at the base of linguistic inscriptions and linguistic dynamics, it is possible to show how reanalysis may on the contrary be seen as an *effect* of analogical dynamics. This will be done section 8.2.3. *Reanalysis* (p. 253).

<b>reanalysis</b>	<b>analogy</b>
primary	secondary
hidden	overt
modifies the underlying representation	modifies the surface representation
involves rule change	does not involve rule change
affects rule spread: a) in the linguistic system, b) in the community	
operates along the syntagmatic axis	operates along the paradigmatic axis

**Table 2 Reanalysis and analogy for Hopper and Traugott**

---

<sup>66</sup> Hopper 1993, p. 32.

Even supposing that we restrict analogy to repairing analogy, the opinion that it modifies only surface representations and that it operates only along the paradigmatic axis is contradicted by the case which has been studied p. 32.

The same ideas as those in the table, and a few more are to be found *ibid.* p. 56:

As we have defined it, reanalysis refers to the development of new out of old structures. It is covert. Analogy by contrast, refers to the attraction of extant forms to already existing constructions. ... It is overt. ... Reanalysis operates along the "syntagmatic" axis of linear constituent structure. Analogy by contrast, operates along the "paradigmatic" axis of options at any one constituent node. When Meillet was writing, there was a rather narrow, local interpretation of analogy, which was defined as a process whereby irregularities in grammar, particularly at the morphological level, were regularized. The mechanism was seen as one of "proportion" or equation.

cat : cats :: child : X → X = childs

The difficulty of the formula of proportion is that it gives no account of why a member of the pair is selected as the model. Kurylowicz 1947-9 pointed out to some tendencies regarding selection of the model, for example, the tendency to replace a more constrained with a more general form or vice versa. ... Neither analogy as originally conceived nor rule generalization are required to go to completion: we still have *foot-feet*, *mouse-mice*, and also *run-ran*, alongside with *love-loved*.

I exactly undertake below to show how particular members and particular pairs are selected as homologs. That these processes – analogy in particular – are not "required go to completion", that is to embrace entirely a set, whatever its definition, is certain and an illustration of this can be found, for example, in the French verb (Demarolle 1990, already quoted).

## ***2.10. Analogy for psychologists and psychoanalysts***

Wallon appears not to use the word analogy although he meets it (Wallon 1945, p. 46 *jour : nuit :: blanc : noir*).

In Piaget analogy has not been found, but the search has not been very deep.

Lacan, makes no room for analogy in his theoretical approach. He himself uses it rhetorically at places and condemns its misuse by some:

One Jaworski, in the years 1910-1920, had erected a very beautiful system in which the 'biological plane' was to be found up to the confines of culture, and which precisely gave the order of the crustaceans its historical conjunct, if I remember well, in some late Middle Age, under the heading of a common flourishing of the armour, - leaving a widower of its human respondent no animal form, without excepting molluscs and bugs. Analogy is not metaphor, and the resort which some philosophers of nature made of it, requires the genius of a Goethe whose example itself is not very encouraging. None loathes more to the spirit of our discipline, and it is by expressly rejecting it that Freud opened up the way proper to the interpretation of dreams, and with it, the notion of analytical symbolism. This notion, so we say, is counter to analogical thought of which a questionable tradition makes that some, even among us, still hold it as solid<sup>67</sup>.

---

<sup>67</sup> Lacan 1953, p. 262.

but the analogy that he fustigates is A2 analogy, this is understandable at that time, as we saw above<sup>68</sup>. There is however plenty of analogy in his work, as early as the *Séminaire sur la lettre volée* (1956) and later, for example in the  $\perp$  schema. This will have to be investigated further and one would be disappointed not to be able to make some connections, if it is true that *le sujet ... pour prendre dans la vie la couleur qu'il annonce à l'occasion ... doit recouvrir homologiquement le ternaire symbolique*<sup>69</sup>.

About the vision that it is appropriate to take of analogy, I mention the debate between schema and categorization (position embodied Holyoak) and projection and structure mapping (position embodied by Gentner):

Research on analogy are marked by two theoretical positions, which their respective tenants assess as different, the theory of projection and structure mapping elaborated by Derdre Gentner, and the schema theory, implying categorization, defended by Keith Holyoak, conception now integrated in a broader theory of induction. Without making a decision between these two approaches, work in the domain of analogy, for most of them, limited themselves to a somewhat external analysis of their hypotheses: it has been concluded that they do not stand at the same descriptive level, one addressing analogical transfer as exchange of entities between different domains that share common relationships, the other insisting more on the activities of abstraction which are necessary for the transfer itself. Gineste 1997, p. 107.

I limit myself to mentioning them because these two positions appear to share a feature: none of them places analogy itself at the root of the representations; in the works which are the subject of this debate, the representations (I shall prefer "inscriptions") follow different paradigms, types models – semantic networks and other ones (the approach is 'partonomic') – and it may well be the case that their antagonism vanishes if the vision is changed – if it is made 'isonomic', cf. section 3.6.7. *Partonomy and isonomy* (p. 89). I shall suggest how this can be done p. 186.

Finally, a text: Edelman 1998, *Representation is representation of similarities*, without directly addressing analogy, reinforces the confidence into a model that is non-essentialist and that is based on similarities/differences or on "sameness of similarities and differences", to quote Householder again. As a very brief summary of his argument, rejecting theories for which a mapping happens between perceived forms and the representations of these (which would be a *first-order isomorphism*), Edelman thinks that similarities between perceived forms map onto similarities between internal representations (which is a *second-order isomorphism*). This view is compatible with that which I defend in this work and the subject will be expanded p. 299 plus 1 page.

## 2.11. Hofstadter, emergent analogy

The question that Hofstadter addresses is analogy making.

Analogy-making is dependent on high-level perception, but the reverse holds true as well: perception is often dependent on analogy-making itself. ... It is useful to divide

---

<sup>68</sup> Another condemnation, for example, in seminar 10 *L'angoisse*, june 12, 1963, unpublished, where Theodor Reik is charged, seemingly with some reason, to make a wrong usage of analogy.

<sup>69</sup> *Du traitement possible de la psychose* in *Ecrits*, Seuil, p. 152 (*the subject ... in order to take in life the colour that he occasionally announces ... has to map homologically the symbolic ternary*).

analogical thought into situation-perception and mapping which involves taking the representations of two situations and finding appropriate correspondences between components of one representation with components of the other to produce the match-up that we call an analogy. (p. 180-181). However (p. 187) analogy-making is going on constantly in the background of the mind, helping to shape our perceptions of everyday situations. In our view, analogy is not separate from perception: analogy-making itself is a perceptual process. ... (p. 189) any modular approach to analogy-making will ultimately fail. Hofstadter 1995, pp 180-189.

How can an analogy emerge from a model which does not suppose it. Hofstadter explicitly assigns himself the reduction of analogy as one of his goals.

Hofstadter will be met again p. 261, he will help giving a feel of the want for what I shall call 'private terms'. I shall also say the debt I have towards him, his model, Copycat having been a decisive contribution in the design of the dynamic side of the model.

## 2.12. *Itkonen, rehabilitation of analogy*

In 1997 Itkonen gave a paper<sup>70</sup> which is very important for my talk and with most of which I am in good accord. He begins with refusing Chomsky's refusal of analogy, using six arguments:

1. For Chomsky, there being no discovery procedure incurs that there is no analogy. For Itkonen, this argument is false because its premise is false; there is a discovery procedure – even if we cannot formulate it today – and this is true for Chomsky himself: the language acquisition device is expected to elaborate a grammar starting from a poor stimulus.
2. For Chomsky, there is no simple, elementary induction by analogy which would account of acquisition, production or reception. For Itkonen, the method is not *simple* indeed but it does not have to be. Universal Grammar itself is not simple.
3. Initially, language creativity was equated by Chomsky with recursivity, against analogy; this opinion was later rejected by Chomsky. For Itkonen, after this, the ability to create and understand new forms is not distinct from the traditional *analogical* ability.
4. For Chomsky the speaker can produce and understand *completely new* utterances and this is why analogy does not suffice. Chomsky defines *complete novelty* as the absence of physical similarity. Therefore he restricts analogy to physical similarity and thence what Chomsky rejects is analogy-as-physical-similarity and not the classical notion analogy-as-structural-similarity<sup>71</sup>.
5. Production and reception are *processes* and analogy is at its best in processes. Now Generative Grammar, because it concentrates on *competence*, loses the dynamic vision (it never showed how the *I-language* serves the speaker in the accomplishment of the acts). It therefore has no title to disqualify analogy.

---

<sup>70</sup> Itkonen 1997.

<sup>71</sup> Itkonen's terms are quite close to those I used above when commenting Chomsky's rejection of analogy: Chomsky disqualifies analogy only because he sees it only in the overt form.

6. Chomsky speaks as follows: either you produce an explicit, analogy-based explanation, or you accept mine, which is anti-analogical. The argument may be back-lashed, says Itkonen: analogy is manifest in language and it manifests itself by processes; now Chomsky chooses to study a static idealization: *competence*; therefore Chomsky cannot account for analogical dynamics.

Itkonen then gives a definition of analogy which is very close to that of Gentner, that is, a structure mapping. He sees three classes of application to language: a) extra-linguistic reality (bird : fish :: wing : fins :: feathers : scales), b) analogy with iconic rooting (thing : action :: name : verb), and c) phonological analogy (like Trubetzkoy), morphological analogy (like Varro), and syntactic analogy (like Sapir and Bloomfield).

The remainder of the paper, which is its longest part, is dedicated to analogy in syntax. A model is built, supported by a Prolog program, which explains analogically several phenomena the analysis of which had served to found the first generativism, transformations in particular. This model of Itkonen will be analysed in detail below, p.186.

Itkonen proceeds with a claim of achievements: a) he does not pretend to rival with more fully-fledged models such as GPSG or connectionist programs, b) he requests equality of treatment: an analogical theory has the right, as generativism claims it, to take as a fact that sentence *John is too stubborn to talk to* is correct and that the sentence *John is to stubborn to* is not, c) he does not pretend to have covered language-learning and therefore also requests to take as a fact the analogical structures of utterances, d) the structure that is needed is that which explains our intuitive notion of analogy, not the structure of the 'grammatical sentence of English', so the model is a model of linguistic acts, not a model of competence, e) the model as presented covers syntax only; it is assumed that it may also be extended to morphology and to non-linguistic analogies, f) the model has been demonstrated on linguistic form alone, it is pretended that it may also apply to understanding as well, g) the model is a model of the *what*, not a model of the *how*, that is, its implementation is not plausible (it is in Prolog and it is accepted that Prolog has no relation with neural operation).

To respond to a remark made by Newmeyer on the difficulty to distinguish good analogies from bad ones, Itkonen recalls the importance of meaning and structure (counter to the view that analogy should hold in the form only). He rejects a proposition of Kiparsky to replace 'proportional' analogy with 'optimization'.

Finally, he shows that Generative Grammar uses analogy implicitly. This meets Milner's viewpoint which I already stated above.

For Itkonen, the consequences of this rehabilitation are: 1. analogy refutes the modular conception of mind because there is not a module of language that would be encapsulated with respect to extra-linguistic reality, nor versus other mental faculties; 2. analogy refutes innateness; 3. he opts for an 'analogical' representation (*à la* Kosslyn) of mental knowledge, against a digital representation (*à la* Pylyshyn, I do not support this view without however adopting Pylyshyn's thesis, cf. p.190); 4. Analogy achieves the integration of the different fields of linguistics in particular between 'core linguistics' and 'cognitive semantics' because it operates on all levels of language; 5. counter to Popper, a reassessment is needed of the distinction between *context of discovery* (where analogy has a place) and *context of justification* (where analogy would have no place): it

may be logically possible to produce something out of anything, but it is not humanly possible (this seems to me to be akin to my proximity/totality theme, cf. p 212), 6. Analogy has the potential to re-unite linguistics; it opens research avenues in continuity with the tradition. This concludes the article.

The theses developed by Itkonen are also mine for most of them Yet, Itkonen's model, as we saw it, makes an explicit use of lexical categories, functional categories, and constructional categories: name, subject, and other similar categories are explicitly and literally present in the Prolog programs. This may not be a claim; as a claim, it is never explicitly made, this may be viewed only as a licence which the author took to build a model with a limited ambition. In any case, the question of the possible dissolution of the categories is never raised. This is a lag with respect to the strict exemplarism and to the radical non-categoricity which are assumed in my work and will be analysed in detail below, (p. 186).

### **2.13. Analogy profiles**

In its various encounters, if one excepts, for aforementioned reasons, the degraded two-term "analogy" (A2), analogy always establishes a proportional ratio between four terms. However, vis-à-vis the usage which is made of them, these analogies have different profiles, and not all of them interest us equally. We shall examine successively i) a stylistic profile, ii) a systemic profile, iii) a 'repairing analogy' profile.

#### **2.13.1. Stylistic or heuristic analogy (semantic and rhetorical)**

It is a semantic profile, for philosophers, for scientists, for orators and cognitivians.

*Induction by analogy* is opposed to *deduction*.

Types: Aristotle, Plato, Wittgenstein, Quine, counter orators, linguists when, as anyone else, they use analogy to make something understood or as a heuristic means.

#### **2.13.2. Systemic analogy (form-meaning pairs constituting a system)**

This a linguist profile; the point is to identify how ratios between forms match, or not, corresponding ratios between meanings (form-meaning correspondence).

Analogy in this profile is a corollary of paradigms: paradigms are tables of analogies. Their dimensions are grammatical categories (mostly).

Types: Aristarchos (type of analogists) against the Stoics (anomalists), Varro, Arnauld and Lancelot, Humboldt, the Neogrammarians.

If we want to be precise, 'systemic analogy' may be taken in two meanings: a) either systemic analogy holds only if the overt form manifests the systemic ratios, and then *analogy* is opposed to *anomaly*, or b) a systemic analogy is considered to hold even when the overt form does not manifest the systemic ratios, in which case *analogy* is simply opposed to the absence meaning ratios and to the sheer impossibility to build a meaningful table. *Systemic analogy* will be used in the latter meaning in Chap. 3 and on.

### 2.13.3. Repairing analogy

This is a profile for linguists. Repairing analogy is the diachronic process whereby an anomaly in a system (it may be the result, for example, of phonetic change), causes the creation of a new, more regular form, a "*paraplasme*" of the contravening form, which will kill the latter, most often, thus blurring the relation to an etymon, or obscuring a previously observed analogy.

In this profile, analogy is also responsible for "popular etymology".

Types: Brugmann, Saussure (not excluding Saussure also speaking of analogy in profile 1), Meillet 1964/1922, Brunot (1961/1887, p. 70), Demarolle (1990).

This analogy holds between four terms, cf. for example Saussure 1915/1970 p. 221: *honor: honôrem*. It is opposed to the 'transparency of the etymon' (the latter at the expense of systemic anomaly).

This analogy is a diachronic dynamics; it is grammatical:

Analogy is grammatical in nature: it supposes the consciousness and the understanding of a ratio uniting the forms between one another. Whereas the idea is nothing in the phonetic phenomenon [a phonetic change which initiated an anomaly in a paradigm], its intervention is necessary in analogy (intervention of the proportional fourth)<sup>72</sup>.

It is grammar "in the making". Saussure opens up a track (but does not prolong it further); the proposition here is to pursue this track and, from there, to rebuild morphological and syntactic productivity, without rules, and without categories.

### 2.14. *Statics, a dynamics of change, not yet a dynamics of acts*

If we want to schematize, analogy, first envisaged as static and associated with morphological paradigms, comes to be considered as a dynamics in the 19<sup>th</sup> century where it is endowed with a role in diachrony: it "repairs" anomalous paradigms, be this anomaly a result of phonetic change or have it another reason. It is a dynamics of evolution.

A different dynamics is that of the linguistic acts. In this, analogy is solicited in principle, by Bloomfield for example, without however giving birth to an explanatory, precise construction. Distributionalism proposes a systematization of analogy and broadens its scope to syntax in a first substitute of the dynamics. But it turns it down onto an alleged essentiality: it is because such thing commutes in general with such other thing, that such substitutions authorize occurrential productions. Distributionalism will fail in the precise degree that should be granted to this generality.

Transformational generativism complements, improves, and further systematizes the principal components of distributionalism, to give a second substitute of the dynamics: the phrase marker and the transformation marker. This prolongs explanatory success without yet getting to grips with a dynamics of the acts. It "generates" the set of the possibles through the derivational and transformational process, which is not the dynamics of the linguistic processes – and does not pretend to be. This, which is true for generativism, is also true for Optimality Theory (OT): one generates a set, a large one

---

<sup>72</sup> Saussure 1915/1970 p. 226.

possibly, of 'candidate outputs', then is elected the output which best observes the constraints.

A static, declarative model (a static, declarative theory) is henceforth insufficient because it does not make enough room for occurrence contexts; these are combinatorial and the cases thus created are configurations in which so many elements may come into play that they cannot be summarised in propositions the number of which would remain practicable. So many such summaries have been attempted that, today, in order to get closer to experience, it becomes necessary to compute the acts one by one.

This project can be seen as a fourth profile which is another linguist's profile: that of productivity up to and including syntax. It is a dynamics of acts. This project contradicts the view that restricts analogy to morphological repairing. It was formulated by Bloomfield and Householder, for example, without being developed by them. It is illustrated by Itkonen and a few more.

The present work is now about to heavily solicit analogy to rebuild with it operationally a number of linguistic dynamics. It will always be analogy between four terms, that called "A4" above (X is to Y as A is to B) – and not its degraded variety, the one called "A2" (X is like Y).

I shall adopt a symbolic notation which is common in studies in analogy<sup>73</sup> and which I already used at places above. With this notation, analogy:

*the cup is to Dionysus as the shield is to Ares.*

becomes:

*the cup : Dionysus :: the shield : Ares.*

---

<sup>73</sup> This convention is already attested in the *Cours de Mathématiques à l'usage des gardes du Pavillon et de la Marine* by M. Bézout (Paris, chez Richard, Caille et Ravier, rue Hautefeuille, 11, au coin de la rue Serpente, an VII de la République), vol. 4, p. 63, where it denotes homologies between corresponding elements of similar triangles, and elsewhere in the book; but it may be older.





## **Chapter 3.**

# **Model of linguistic knowledge, model of the dynamics of acts**

The grammatical approach is upside-down as a theoretical approach (Chap. 1): it places the products of analogy (classes, rules) first and analogical processes second. It turns the linguistic discourse down to static categories which embody an "essential" similarity: the similarity results in properties which would be inherent to language objects themselves. Because of that, the grammatical viewpoint is not in a good position to account for the infinite variety of linguistic acts.

It is more promising to restore analogy in its duality, as static, and as dynamic, with solidarity between both. This leads to address linguistic acts first and to take consideration of the linguistic subject (the speaker) in which they take place.

Chap. 1 also showed that analogy holds under conditions of proximality and this theme is the second major one to take into account. Analogy and proximality both affect both the static side of the model (the inscriptions of the linguistic knowledge are analogical and proximal) and its dynamic side (linguistic processes are analogical and proximal).

Chap. 2 recalled in the history of the linguistic thought a few moments concerned with analogy which justify the reasoning of Chap. 1; it was shown that if the dynamics of language change has been well described with analogy, the analogical dynamics of the acts has hardly been postulated.

Analogy is thus doubly ambiguous. First it is static and dynamic: beside a Platonic analogy (between some terms, analogical ratios are to be found) we now have to envisage a dynamic one (analogy motivates new forms and facts on the base of older ones). Secondly, analogy is also ambiguous because it underdetermines the ratios between its terms (it 'elides' the predicates) and it underdetermines the motivation of new facts on the basis of old ones (novelties are linked to precedents by the relation of necessity). Contrasting with theories which put all their effort in desperately striving to make these predicates explicit and would like to view motivation as necessary, this thesis accepts this double ambiguity and takes account of it the best possible way.

This chapter, which constitutes the centre of this work:

- i) details the conditions of the enterprise by resuming, detailing and complementing the themes of Chap. 1, and by defining the conditions of a dynamic, concrete model; then it
- ii) defines the model under its static side and under its dynamic side.

The definition keeps elided several details, which are provided in the appendices, in order to show sooner the application of the model to structural productivity (Chap. 4), then to systemic productivity (Chap. 5), in order also to show the reconstruction in the model of some notions of grammar (Chap. 6).

### ***3.1. Towards a concrete model***

#### **3.1.1. Language, linguistic knowledge, conjoining statics and dynamics**

Chap. 1 provided a first definition of the object: the object is not language in general; neither is it French, Swedish, Wolof, etc. which are a matter as much for sociology and history as they are for linguistics. The object is centred on the individual speaker – which leaves open the possibility to envisage assemblies of speakers and occasions of interlocution between them, but the model of the latter does not assume a central quasi-normative object (that French, Swedish, Wolof, etc. would be).

However, having identified the speaker as a focal object, two distinct attitudes are still possible. They will be named 'disjunctive' and 'conjunctive' for clarity.

The first one, disjunctive, is that of generativism. This theory names *I-language*<sup>74</sup>, whatever is held to account for the status in which a speaker currently happens to be, linguistically speaking, at this moment of his history; and in the same movement, it assigns to this *I-language*, as a theoretical postulation, the mission of "generating the infinitely many expressions" of which the subject is assumed to be capable; that is, to define in a static way what previous states of the theory called the speaker's 'competence'. It is a 'procedure' which has exactly that purpose. This procedure is not a dynamic; it does not aim to say anything particular about the dynamics of emission or reception. Being procedural, it looks dynamic, but we must not be mistaken: it is a means to state statically the closure of the possible in the language, and this cannot be done practically by simply using propositions. I call 'disjunctive' this approach because it disjoins the characterization of the possible in a language from the language dynamics; it makes it a prerequisite and a separate enterprise.

The second attitude to approach linguistic manifestations in their phenomenology is that defended in this work; it is 'conjunctive' in the sense that, in order to linguistically characterize the speaker, one acknowledges the dynamics from the start. One does not seek a previous and separate characterization of grammaticality or acceptability. One does not try to circumscribe a constituted, static knowledge (even cast into a generative 'process') by dissociating it from its mobilization in emission, in reception, and in the

---

<sup>74</sup> Suppose Peter's FL (faculty of language) is in state *L*. We may then say that Peter has (speaks, understands, ...) the language *L*. Here, the term 'language' is used in a technical sense : call *L* an *I-language* – the letter *I* to suggest internal and individual, and also intensional [sic, intensional with *s* !?], in that *L* is a specific procedure that generates infinitely many expressions of *L*. Chomsky 2000, p. 169.

dynamics of language learning. In other words there is no trying to make a grammar, no need to separate *langue* and *parole*, competence and performance.

The conjunctive approach is desirable for the following reasons:

- a) A, approach of the effects of the dynamics which is static only is deemed an impoverishment because it encompasses a loss of adequacy and makes the task more complex.
- b) The static description of the effects of the dynamics does not help to elucidate their mechanism.
- c) Nothing proves the feasibility of the definition of the closure of an I-language.
- d) We should not ask such question as "what should a language be in order to be learnable" as long as it is not established that what the speaker learns is a language. Now a speaker does not learn a language, he/she learns how to speak which is not the same thing.
- e) It is conjectured that mental processes are dependent on conditions and phenomena of "access", they also benefit from them, and they can be fully understood with them only. Now a theory which is static only, cannot take accesses into account.
- f) Many complexities are daughters of disjunction. Conjoining statics and dynamics should yield something simpler.

It is appropriate now to prevent a possible misunderstanding. In the remainder of this chapter, I shall define the static side of the model (it will be called 'plexus'); a plexus is static and could be understood as the linguistic knowledge; however, it is not the analog of the *I-language* of the Minimalist Programme which, on its own, is supposed to characterize the speaker linguistically. A plexus does not achieve that on its own; without the dynamics it has no identifiable import at all, and cannot be validated or falsified. A plexus only acquires the value that the dynamics confer to it. It would therefore be erroneous to view a plexus alone as the linguistic knowledge of a speaker.

The conjunctive approach then ceases to attribute a focal and antecedent status to a 'language', even understood as a speaker's own or internal language. What is done is no longer a grammar. However, this route does not invalidate another scientific effort (a disjunctive approach) which takes a language as its object; it remains legitimate and may produce interesting generalizations and propositions out of reach of the conjunctive approach; but it cannot be expected to much help in establishing the operative causal chains of the linguistic phenomena. This will be addressed further in the conclusions.

### **3.1.2. Refusal of abstractions, occurrences, exemplars**

The more we study language, the more we get penetrated by the fact that everything in language is history, that is, it is an object for historical analysis, and not for abstract analysis, that it is made up of facts, and not of laws, that all which seems organic in language is actually contingent and completely accidental.

Saussure 2002, p. 149 (1st conf., Univ. of Geneva, 1891).

[...] a world of signs which underwent a mutation in the Renaissance and has been turned into a world occupied by particular, isolated facts, which may yet serve as

positive evidence of future particular facts.  
Hacking 1975/2002, p. 22.

Abstractions being refuted (Chap. 1) and analogy taking place between concrete terms, linguistic knowledge must have concrete inscriptions as its basis. Ideally (this work does not reach this ideal), one should understand "concrete" to mean occurrences that are dated and attached to the situational context in which they happen. The conjecture is that the ultimate understanding of the mechanisms of meaning requires taking things up to that point.

This ambition in principle is, within this thesis, restricted to exemplars. Exemplars are units of the linguistic form which are detached from a situational context, but which are attached to a formal context (in French, some say '*cotexte*' in this case). About exemplars vs. occurrences, please cf. p. 211. The clause above, specifying that the contexts to which exemplars are attached are restricted to be formal, is bound to be released with the introduction of private terms which is planned for future.

The exemplarity of the inscriptions prescribes that the linguistic units have a value exactly for themselves and through the exemplarist ratios which they establish with one another. The occurrences (they are contextualized though) of linguistic units in the analogies serve the linguistic dynamics without having to be relayed by any categorical abstraction, descriptive rule or operative rule. The model encompasses no class, it is entirely flat.

The exemplarity of the inscriptions goes along with the exemplarity of the processes: the assessment of similarity, that is, the calling up of terms similar to a given one, is carried out on demand, guided and commanded by the exemplarist terms involved in a defined linguistic act. Then, names and verbs not being reified, the categorical status of Fr. *rire*, as a name or as an infinitive, because it remains descriptively unsettled, does not become an obstacle to productivity.

Such radical non-categoricity is adopted as a research posture; the point is to see up to where it can be sustained. It is tempered by the conjecture that, between a model with abstractions, and one which is completely flat, without abstractions, as that of this thesis, the neurons implement something intermediate (cf. p.268).

The model being strictly concrete, this incurs a particular requirement on its design: it has to be integrative. Each of the base inscriptions being less powerful than are categories and rules, their number has to be larger than in a model comprising a lexicon with categories and containing rules. Let us see now why exemplars have to be sparse and heterogeneous.

### **3.1.3. Integrating sparse, heterogeneous data**

Speaking subjects, and the learning subjects in the first place, are not provided with data that are complete or homogeneous. They have all the time to integrate data that are sparse and heterogeneous.

The idea of **sparse** data amounts to considering that the data which are available are incomplete in the space which would be that of their totality – this theme of totality will be reviewed and criticized below (p. 212) and I will show how it comes with theories that are categorial and regularist. A 'space', in a usage of this word which is certainly

metaphorical, is supposed, and the available data populate it partially only. For example, the complete paradigm of the French verb may consist of 500 000 forms<sup>75</sup> if one builds it systematically, and the availability is restricted to five thousand of these.

In addition, these data are **heterogeneous** if they do not appear uniform along any particular criterion, if they do not appear as classified or systematized. For example, for one verb, forms are available at a given tense for all persons; for another verb, forms are available at the third person singular in several tenses. Here, the reader's complicity is requested for the usage of 'verb', 'tense', and 'person': this saves us forty lines of exemplars – remember Householder *supra* – which are rewarding neither to write nor to read, but it must remain clear that these words of metalanguage are foreign to the proposed model.

The insistence on integrating sparse, heterogeneous data is rooted in the fact that the speaking subject, when he learns, but also when he operates, does not have the option, he must do with sparse and heterogeneous data. Experience never shows up as a methodic teacher and one must always do with the availabilities, fragmentary as they may be. The subject must be efficient without a complete system, with at best some systematizations here and there, partial and contingent. A conjecture goes even further: the systematization of experience always remains marked with exemplarism, it never really substitutes exemplars and occurrences with abstractions. Abstractions may come later, at another time, that of conscious elaboration, of reflexive work, and of science, but abstractions are not a prerequisite for the subject to become linguistically productive.

Things being so, efficiency and productivity require **integrative** mechanisms that potentiate sparse and heterogeneous data despite their scarcity and their heterogeneity. Various data, each with little individual consequence must be made to play together in multiple ways yielding joined effects which acquire more interest. The model must show how potentiation happens.

### 3.1.4. From categories to similarity

Categories not being reified, the question arises of what will replace them, which leads us to the antecedent question of why we had categories. They were used for ruling the possibilities of legal, grammatical assemblies in a language. This in general, in bounding by propositions (or by derivations and transformations) the possible in a language, that is, competence. The present work modifies that aim: it is not the bounding in general of the possible in a language which is sought, rather, as will be shown in detail below, how one or a few of the available precedents can be picked up to motivate a new form. This takes place occurrence per occurrence, the base of this picking up is similarity, and its principle is an abductive heuristics.

The productive dynamics is supported by a heuristic computation which encompasses a) suggestions of similarity and b) settlements which are assessments of coincidences (among the suggested similarities some are felicitous and some other ones are not). The abductive dynamics thus repeatedly poses questions of similarity.

---

<sup>75</sup> Five thousand verbs with about one hundred conjugated forms each.

But was not the logic of categories already one of similarity; are we really making progress? We are, because while the categories are an attempt to apprehend similarity in general and *a priori*, it now suffices to apprehend it occurrentially and therefore in concrete cases. Similarity itself becomes exemplarist. The categories disappear, even refitted as categorial lattices with multiple inheritance (construction grammars, Fillmore, Goldberg, Jackendoff, etc.) since the questions to which they answered in general and *a priori*, can now be posed occurrentially.

Apprehending similarity in general and *a priori* poses the question of the closure within which similarity is to be defined. "In general" for sure but a generality of what perimeter? The question is inescapable as the perimeter cannot encompass all languages, all the states of a same language, all idiolects, all the variation. The answers are varied. For a generativist, this closure is a language (an *I-language*). How is it defined? One introspects oneself and the judgments coincide ... or vary, compromising then the agreement about the *I-language* of which an account is sought. For a corpus linguist, this closure is a corpus. What is its content? It depends on the aim that is pursued. Remember the finding of corpus linguists that the grammar extracted from a corpus degrades when the size and variation of the corpus increase (cf. p. 255); so does polysemy in it. These inconveniences, one tries to keep within bounds by associating textual productions to a notion of textual *genre*. Here, the domain within which similarity is defined is the linguistic knowledge of a single speaker, this is a first upper bound of its scope, and we shall see another one.

The item for which similar ones are wanted may be a term: a term being given, find another one or a few other ones which are similar. We shall see that this argument may also – this is better – be a pair of terms. The difference between both cases is important because it is a question of precision of the device; it will be explained in due time.

"Similarity" still remains very loose: two terms (even two pairs of terms) may have different titles of similarity. Below we shall see what dispositions apply to help separating different titles of similarity, still without reifying categories.

Similarity can be envisaged statically: how does one know that exemplars are similar or not, disregarding time and context? We shall see that this question has no true answer in the model but it is not really relevant in it: decontextualized inscriptions are impossible in it and the dynamics do not require them.

Or similarity may be envisaged dynamically: in the course of an act, with the concrete and instantaneous determinations attached to it, with the precise aim of the process or sub-process in question, what exemplars have in the past, at the same position as the current argument, contributed with most success to an already accomplished act. This will be implemented below (p. 95) by a mechanism called 'similarity suggestion'. All suggestions thus made are not good finally; suggestion is followed by a complementary mechanism: settlement.

The suggestion mechanism is based on the fact that, in linguistic knowledge, some inscriptions are proximal to one another and some other ones are less, which guides the mechanism in the suggestions it makes. Proximality, already acknowledged as a necessity in the introduction, will be defined below within the modelling apparatus which it serves.

## 3.2. *A speaker's linguistic knowledge as a plexus*

### 3.2.1. Static model and dynamic model

In linguistics, manifestations of contingency of all sorts, and showing up everywhere, suggest that 'language objects', ultimately have value only by their use in the dynamics. This idea extends to questioning their very 'existence'; it even questions the legitimacy of postulating them as monadic, static beings that would be antecedent to the dynamics which they are expected to support. This is a strong push to look for a model which would intimately integrate statics and dynamics.

However, to proceed in this direction, intellectual landmarks and generic models are lacking. In linguistics but also in other fields, let alone quantum physics, theories and models always separate a static vision and a dynamic one.

Artificial intelligence was, in the 1970s, a place for a debate to decide whether we should or not

encode the utilization of knowledge [procedural representation] rather than the knowledge itself [declarative representation]. The debate was concluded in favour of a declarative representation. This was because a procedure presents the inconvenience that it mixes up that which is general (the inferential algorithmics) with that which is specific to the represented knowledge, whence a loss of readability and increased difficulties in the tests and in the ensuing modifications<sup>76</sup>.

Moreover, in linguistics particularly, something common must be available to serve acts of emission and acts of reception: the utterable and the receivable entertain a strong coupling, even if their domains do not coincide. The model must therefore be 'bidirectional'<sup>77</sup>, something is needed which is not entirely committed with the dynamics of emission nor with that of reception. This necessary lag with each of the two dynamics leads to accept a central object which can only be static.

Finally, for learning dynamics, it is hard to adopt a model differing from a succession of states between which the transitions that constitute the linguistic events modify the previous state, giving the successor state.

So for three reasons, the proposed model makes a separation between statics and dynamics, which is considered as a second best option, as a theoretical tier with some potential for improvement in this respect. The overall model thus postulates a static model and a dynamic model; they have many relations and interdependencies but are nevertheless distinct: one could be replaced while conserving the other.

This statics-dynamics separation notwithstanding, the vision of the 'language objects' is still highly affected: the assumption of the vacuity of the terms (*infra*) represents a significant step in the direction of a possible merging because, the static knowledge being much leaned, dynamics are called in to reveal what other analyses would take as 'properties' of the terms.

---

<sup>76</sup> Kayser, in Houdé 1998, p. 349.

<sup>77</sup> Lamb 2000, p. 108.



### 3.2.2. The plexus is the static side of a speaker's knowledge

The static knowledge compensates the vacuity of the terms by rich exemplarist relations or rather copositionings<sup>78</sup> between the terms; this makes the static knowledge a network. It receives the name **plexus** to stress its meshing<sup>79</sup>.

A plexus is a model which approximates the static side of the linguistic knowledge of a speaker under the assumption of radical non categoricity. It is constituted of exemplarist inscriptions, the meshing of which makes them something very different from a lexicon. It is not more a semantic network: a semantic network encompasses essential properties attached to its nodes and the nodes have relations among them. In a plexus, as we shall see, terms are empty and what structure them are not relations but copositionings<sup>80</sup>.

A plexus is an indirect observable: it has value through its consequences only, when used by the dynamics.

### 3.2.3. Mode of constitution of a plexus

A plexus is not straightforwardly available anywhere. A structure of copositionings does not present itself as a given. Against the project – Harrissonian for example – to have a grammar emerge from a corpus without calling on subjectivity, a plexus cannot (currently and perhaps for some time) be usefully obtained from a corpus, principally because meaning is difficult to apprehend in a corpus, but there are other reasons, the complete argument is made p. 255.

A plexus may be elaborated, tested, improved, and finally validated by a human author (the 'descriptor') who introduces in it his own sensitivity as a subject of the language or the sensitivity which he thinks to be that of informants for example.

There is no other discovery procedure. The approach is similar to that of a descriptor of a language unknown to him and remote from his own: collecting 'facts' is easy, but it is not simple to decide what constitutes a fact or motivates its pertinence. The difficulty comes then, in knowing what contrasts between what facts are granted what role in the elaboration.

---

<sup>78</sup> The notion 'copositioning' is preferred to the notion 'relation', for reasons that will be explained.

<sup>79</sup> The word "plexus" denotes a meshing but it is also a tribute: "*La loi tout à fait finale du langage est qu'il n'y a jamais rien qui puisse résider dans un terme (par suite directe de ce que les symboles linguistiques sont sans relation avec ce qu'ils doivent désigner), donc que a est impuissant à rien désigner sans le secours de b (et n'est puissant de plus qu'en tant que b' lui crée de la valeur et réciproquement de sorte qu'il n'y a plus que des différences), celui-ci de même sans le secours de a; que tous deux ne valent donc que par leur réciproque différence ou qu'aucune ne vaut même par une partie quelconque de soi autrement que par ce même plexus de différences éternellement négatives*". F. de Saussure, private papers CLG/E (I), p. 265, N 10, number 1906, quoted by Fehr 2000, p. 139, also present in Saussure 2002, p. 219.

<sup>80</sup> As soon as it ceases to be ridiculously small – when too small it has no linguistic significance – a plexus is absolutely impossible to represent as a text or graphically. The principles of plexus structuration are going to be built step by step and illustrated with examples. Meaningful plexus excerpts are to be found in chapters 4 et 5.

On this question, the initial position is not different from that of the generativists: introspection (of oneself or of an informant) is what provides judgments. The difference is that the process does not produce the same final output.

Much in the same way as the description of an unknown language or as the making of a generative grammar, the elaboration of a plexus is exposed to the risk of preconceptions which a subsequent validation, if well conducted, may reveal and incite to correct.

The approach is supported by a computer implementation which is indispensable. For a generative grammar consisting of thirty categories and forty derivational rules, manual proof tests can be envisaged. Manual proof testing is still possible, but harder, in a model like HPSG. But for a large set of meshed exemplars like a plexus, this is not any more possible at all. Even less so as the 'properties' of the terms not being reified and being only revealed by the dynamics through indirect effects, the production of the smallest result involves inscriptions and elementary computation steps by the hundreds. The computer implementation is thus indispensable to the dynamic validation of the model, but it also assists in the already heavy task of just writing the plexus. It does so by facilitating the inspection of its content in such or such domain, by exerting formal correctness and coherence conditions, etc.

The burden of plexus writing leads to the idea that, from an initial state which would be built manually, the plexus might complement and improve itself by self-analysis. This would leverage its productive power. The question is mentioned here because it is important but cannot yet be developed, cf. p. 258.

#### **3.2.4. French plexus, English plexus**

The computation examples which are about to be produced in this work are based on a French plexus (this is simpler for a French author and French readers) and on an English one (for particularities of English such as the ditransitive construction or the construction with postponed preposition). The English plexus is a small sample of language and the French one is larger (about 2000 terms). Other tests were made on Basque and Japanese but, up the point where they were taken, they have not brought up anything that could not be shown with a language more familiar to most readers, so they will not be used in the text. More details of this sort are provided p. 310.

#### **3.2.5. 'Inscriptions', not 'representations'**

When defining a linguistic plexus, the matter at stake is indeed 'representation' as it is presented in the theory of knowledge and subsequently in cognitive science, the representation which is deemed *to be at the heart of cognitive science*<sup>81</sup>. The question of representation is central in cognitive science in general and in linguistics in particular.

The word 'representation' itself has the important inconvenience of sounding transitive: it suggests the representation of something. Something to be represented would impose itself by its evidence and the duty would be to represent it. In case of a problem, the representation would be imperfect, one would be led to refine and adjust it, but the thing to be represented would conserve its obviousness and stay untouched.

---

<sup>81</sup> Gardner 1987/1993, p. 436.

The debate is not the philosophical one between realism and nominalism; it opposes representationalism to non-representationalism. Between high-level observables and physiology, representationalism postulates, a 'representation level' which explains the observables. Some authors think in addition that the representations of this level should some day be explained by physiology, but the latter ambition is not deemed necessary by all. In contrast, non-representationalism negates a representation level. The representationalist position is dominant and old. Non-representationalism is a minority and more recent (it was Wittgenstein's position though), but it is embodied by scarce attempts only and representationalism turns out very difficult to overcome.

Note that in linguistics the point is even more critical: if the correspondence between 'representations' and their alleged objects is here as great a question as in any other field, the status of objects is in linguistics still much less assured; this is even truer if one accepts that metalanguage should be expelled.

When trying not to incur the connotation 'representation of something', it cannot be proposed to simply evacuate 'representations' which would amount to a caricature of behaviourism: the subject's history must leave some trace to be reused to make for novelty, some intermediary is indispensable between the stimulus and the response. The hope is that it is possible to say something about it without delving down into the physico-chemical level; a certain amount of mentalism is necessary. This hope may be vain ultimately, but approximations are possible.

'Inscription' sounds better than 'representation' because it is less transitive. With 'inscription', the push to wonder "inscription of what" is lesser. Therefore I shall write 'inscription' and not 'representation'.

Inscriptions are not countable and must not be viewed as monadic entities. It is not possible to just add one or to just delete one because of their inherently meshed character, which is a corollary of the impossibility to make decontextualized inscriptions (cf. p. 77). Rigorously then, 'inscription' should be made a mass name: 'some of inscription', 'a little of inscription', 'the quantity of inscription increases'. I shall not do it but it is important to understand well what is said.

So inscriptions are made, but without considering that they 'represent' linguistic knowledge: the inscriptions are the model of (the static side of) a speaker's linguistic knowledge; they approximate it and do not represent anything. At best, they are collectively its analogue in a model. This position shares something with that recently adopted by Jackendoff<sup>82</sup>. About the following statement by Chomsky<sup>83</sup>:

A child who has learned a language has developed an internal representation of a system of rules that determine how sentences have to be formed, used, and understood.

Jackendoff writes:

Chomsky's phrase "has developed an internal representation of a system of rules" is better expressed as "has internally developed a system of rules". The rules are not *represented* in the learner's mind. They are just there.

---

<sup>82</sup> Jackendoff 2002, p. 68.

<sup>83</sup> Chomsky 1965, p. 25.

But of course, it is not of rules that I say that "they are just there" (and not represented), but of terms, of analogies, and of the links among them. They are simply inscribed in the plexus and do not 'represent' anything else than themselves. These inscriptions are not to be judged whether they are or not adequate to represent their supposed 'objects' but whether the dynamics they support are productive in the way human speakers are.

From now on, but for quotations, the word "representation" will not appear in the text.

### 3.3. Anatomy of analogy

#### 3.3.1. Three classes of analogy

Aristotle's analogy

cup : Dionysus :: shield : Ares,

Varro's morphological analogy, and the analogy postulated by Bloomfield as the base of syntactic productivity<sup>84</sup>, all three establish similarities of differences between four terms but they do not do that exactly in the same manner. The table below proposes the definition of three classes of analogy. The three classes command the static treatment and the dynamic treatment of analogy in the model. Below (p. 67), the table will be complemented by the modes of inscription in the plexus, then (p. 88) by the abductive movements which apply to each class.

Class	Systemic non structural analogy (class A)	Structural non systemic analogy (class C)	Structural and systemic analogy (class AC)
Examples	<i>la : le :: une : un</i>  <i>soigneux : avec soin :: rapide : vite</i>  <i>happiness : happy :: beauty : beautiful</i>	<i>un : un soir :: le : le jour</i>  <i>soir : un soir :: jour : le jour</i>	<i>élu : élue :: maître : maîtresse</i>  <i>lawful : unlawful :: honest : dishonest</i>  <i>un : unlawful :: dis : dishonest</i>
Place in grammars	Paradigms without overt manifestation	Syntax	Paradigms with overt manifestation

**Table 3 Three classes of analogies**

<sup>84</sup> All three are A4 analogies (not A2 analogies), this is clear now and will not be mentioned again.

### 3.3.1.1. Class A, systemic analogy

Class A (A as analogy) is systemic non structural analogy<sup>85</sup>. Systemic analogy sanctions a similarity of differences between four terms (it being visible in the form or not).

This supposes between the pairs, a similarity of meaning ratios. The formula  $A : B :: C : D$  in which a similarity of meaning ratios does not hold is not an analogy.

'Meaning ratio' does not subsume the notion 'meaning'. 'Similarity of meaning ratios' does not even subsume the notion 'meaning ratio'. This model posits 'similarity of meaning ratios', it does not posit 'meaning' or 'meaning ratio'.

This leads to a new aspect of the notion of contextuality (cf. p. 77) which, in turn, can reassure us about the clause "a systemic analogy assumes a similarity of meaning ratios between its pairs". One might in effect object as follows: what about polysemy and ambiguity, if one of the terms A, B, C or D has several meanings (this is the general case if we comprise extensions and metaphorical meanings) a systemic analogy may hold for some of the meanings and not for all of them. We need to understand that a systemic analogy most often selects some of the meanings, extensions or acceptations. More seldom can it cope with several of them; this is rare because seldom do four terms together have compatible extensions or metaphorical uses (that is, extensions or uses which may get involved by four in an analogy). All this explanation is made in using the words "meaning", "proper meaning", "extension", etc. although they do not belong to the model and their usefulness will be firmly denied (*infra*) but I find no other way to put it, this is our shared culture, and even those of us who put these notions into doubt understand what is meant. Only when the model will be complemented in the direction of meaning, will it be possible to write more rigorously and more clearly. In the meantime, it is not possible either to say nothing, because an analogy which would be formal only has no interest in linguistics, it has only that of being available to lend itself to a game of meaning if speakers eventually start playing such a game.

Systemic analogy, as just defined, plays an important role in the explanation of "systemic productivity" and in the learnability of pluridimensional systems (Chap. 5).

### 3.3.1.2. Class C, structural analogy

Class C (C as concatenative construction) is structural analogy. Structural analogy is a structural mapping between parts of a whole and parts of another whole, such that the part-whole relations are perceived as the same in both cases. It is indeed the mapping of parts and so the formula below:

*un : un soir :: le : le jour*

has to be understood as an ellipsis of:

*un (as a part of un soir) : un soir :: le (as a part of le jour) : le jour*

---

<sup>85</sup> In this work, I use 'systemic' and 'structural' in the precise meanings specified in this section. For those two words, very overloaded, and used with much confusion – a clear distinction can be found in Paveau (2003, p. 83-84), but it is not the one adopted here – the reader will kindly accept, in this dissertation, the precise meanings proposed here. These conventions are local to this work and do not pretend to be general statements about 'structure' or 'system'.

and not as:

*un* (generally) : *un soir* :: *le* (generally) : *le jour*.

The terms play analogically as parts, and not for themselves.

Structural analogy thus subsumes a merology. For linguistic form, it supposes segmentation. This does not incur the assumption of constituency, that is, the assumption of constituents that would be univocal or essential: constituents are constituents only because they result of a segmentation on this occasion (and perhaps a few other ones) but, i) for a given form, several segmentations are concurrently possible in a same occasion, and ii) a same form may lend itself to different segmentations in different occasions (cf. p. 201) even if, most often, a form will be segmented in one way only.

To denote the ratio between *un soir* and *le jour*, the abridged formula below will also be used:

*un + soir = un soir* :: *le + jour = le jour*.

or, even briefer:

*un + soir* :: *le + jour*.

In this formula, the + sign is concatenation as far as linguistic form is concerned, but it can be interpreted differently depending on the type of merology in question:

planets + sun = solar system :: electrons + nucleus = atom.

Structural analogy is not limited to two constituents, in an appendix, can be found a statement of reasons not to limit oneself to binary assemblies.

Between its left part and its right part, a structural analogy assumes a ratio of meaning. Thus:

*John + is + easy to please* :: *John + is + eager to please*

is not an analogy. This particular case will be heavily solicited below

Likewise:

*Gaule + isme = gaullisme* :: *France + isme = franquisme*

is not an analogy (even let alone morpho-phonology). It is a mapping which is formal only, similar to one which initiates popular etymology or reanalysis, but it does not suffice. A reanalysis succeeds because it goes along with a constitutable meaning, compatible with the preceding one, or with only a small difference. In the example *gaullisme-franquisme*, the subject who would be ignorant of politics and would ignore who de Gaulle and Franco were, cannot, with the proposed analysis schema, proceed meaningfully, if he knows for example that Franquism is related with Spain.

### **3.3.1.3. Class AC, structural and systemic analogy**

Class AC is the case of analogies which are structural and systemic. A structural and systemic analogy is a structural analogy such that, between the pair consisting of the assemblies, and one of the pairs consisting of homolog parts, a systemic analogy holds.

### 3.3.2. Tenor, vehicle, analogy orientation

When he defines analogy (supra, Chap. 2, p. 25) Aristotle calls the second pair the *vehicle*. In analogy  $X : Y :: A : B$ , the second pair,  $A : B$ , is the vehicle. Later, the first pair will be called the *tenor*<sup>86</sup>. Vehicle and tenor cannot be exchanged in general: the vehicle must be more familiar. This is set by Aristotle as a condition bearing on a metaphor and it bears consequently also on the underlying analogy.

In this model, analogy orientation amounts to this: does the given of  $X : Y :: A : B$  authorize  $A : B :: X : Y$ ? If both pairs have equal familiarity, the answer is yes. Otherwise, the transposition is not cognitively founded and it should not happen.

The model recognizes analogy orientation and grants it a great cognitive significance with consequences in the statics and in the dynamics. It does so through what will be called below "familiarity orientation". Section 12.8. *Familiarity orientation* is entirely dedicated to this subject.

### 3.3.3. Analogy "elides the predicate"

Analogy maps onto each other the vehicle and the tenor, and so does it for their respective terms, regardless of the predicate which would apply between. The cup is to Dionysus as the shield is to Ares. What is the shield to Ares? attribute? substitute? symbol? sign? This remains undecided: analogy elides the predicate<sup>87</sup>. In fact, it simply omits to require it. Accepting an analogy is accepting this: the predicate which holds between the terms of the tenor and that which holds between the terms of the vehicle are the same. Nothing more is assumed; this similarity holds whatever this predicate. Its essence, its nature, its properties, etc. nothing of all this is necessary; the analogy may be good, operative, productive, without the subjects having to specify the predicate.

The elision of the predicate is the limit of analogy. Douay<sup>88</sup> reminds us an example used by Perelman and taken from Aristotle<sup>89</sup>. Iphicrates, asked to compel to the liturgies his son, who was young but tall for his age, answered this:

*If we take tall children to be men, then we should decree that small men are children.*

Iphicrates reveals the paralogism which sustained the argument of his opponents and which is an analogy, but a false one:

*tall : small :: adult : child*

by differentiating the category of age and the category of size. Age and size thenceforth categorically differentiated, it becomes possible to make propositions about one or about the other and a choice must be made. This enables the foundation of a legal point in the situation in which Iphicrates had to respond.

---

<sup>86</sup> In French, *thème* (tenor) seems to appear with the translation of the "Traité de l'argumentation" of Perelman, 1958 (Françoise Douay, pers. comm.).

<sup>87</sup> Douay 1991.

<sup>88</sup> Ibid.

<sup>89</sup> Rhetoric II 23.16.

The same movement that helps him to convince his opponents also finds a certain rationality: it is a categorization of similarity and of difference comparable to this one which structures generalizations about sense data and gives a foundation to scientific rationality. This movement however does not appear (cf. Chapter 1) to provide the foundation we need to understand linguistic dynamics.

In any case, the limit of analogy which has just been illustrated was the cause of its disrepute in the *âge classique* then till the mid twentieth century, we saw this above. However, if the omission of the predicate is the limit of analogy, it is also its power and its flexibility:

Nothing *is*, or at least, nothing *is* absolutely (in the linguistic domain). No term, assuming it is perfectly right, is applicable beyond a certain sphere. The elementary form of the judgment: "this *is* that" opens immediately the door to a thousand contestations, because one needs to say in the name of what one distinguishes and binds "this" or "that", no object being naturally bounded or given with evidence. Saussure 2002, p. 81.

They are not indeed. It is possible to eschew this inability of equativity and it is less risky to say:

This is to that is as this other one is to that other one.

Most of the time this suffices.

### 3.3.4. Determination of the analogical ratio

#### 3.3.4.1. *Quasi-bijection, three terms must roughly determine the fourth one*

Analogy is intermediary between full equivocity and univocity.  
Caetano 1498/1987, p. 122.

A proposition of type "X is to Y as A is to B" is not interesting if many  $X_i$  may be substituted to X. For example:

*red* is to *adjective* as *house* is to *noun*

is probably not false: both pairs are in the ratio instance to lexical class, so that it is not absurd to bring them together; a 'similarity of differences' does occur. However, it is not a very interesting one; *adjective*, *house* and *noun* given together do not determine *red* sufficiently, *pleasant*, *fast*, and hundreds of other ones would suit as well.

At the other end, asking a question like "what X is to Y as A is to B" is not interesting either, if one cannot conceive of a possible X. Examples:

What is to man as red is to freedom?

What is to Paris as China is to Stockholm?

What is to football as the future is to the unknown?

In none of these three cases may one answer, whichever way one tries to understand them. Thus an analogy is interesting only if the fourth term is determined by the three other ones. There must not be no answer, there must not be too many; but there may be more than one:

In French, what X is to *soigneux* as *vite* is to *rapide*?



Two answers are possible: *soigneusement* (carefully) and *avec soin* (with care). Each of them makes a very acceptable analogy.

In sum, an analogy is acceptable if it is bijective or close to bijection. The term "bijective" is used although it is improper in part. Properly, an application between two sets is bijective if it makes a one-to-one mapping between them. An application involves one term with one term, now all the effort here aims precisely at criticizing the one-to-one approach to favour alternately a several-to-several approach. In spite of this, the term "bijective" is kept rather than creating a new one.

The bijectivity of analogies incurs that the "paradigms" which are about to be defined will have to be bijective or quasi-bijective if we want them to fairly account for analogies. The question will become sensitive in the constructional paradigms (below): all constructional paradigms do not encompass quasi-bijectivity, therefore, not all of them are analogy-bearing.

The criterion of quasi-bijectivity appears to be very efficient. Please refer to section 13.4. *Abductive movement by transposition* (p. 321); there, we see an analogy which is surprising at first sight but in which binuivocity does show however. Even if a speaker may hesitate in accepting analogies of that sort externally, when they are used as a step in a computation, they operate perfectly because they are bijective.

#### 3.3.4.2. Taken alone, a pair does not determine the analogical ratio

It may happen that, starting from a same pair (*suis : serais* in the following example) it is possible to develop several different analogies, that is, several different paradigms.

	constancy and variation between pairs			
analogies / paradigms	mode	verbal base	tense	person
<i>suis : serais</i> :: <i>es : serais</i> :: <i>est : serait</i> :: <i>sommes : serions</i> :: <i>êtes : seriez</i> :: <i>sont : seraient</i>	constant (indicative : conditional)	constant ( <i>être</i> )	constant (present)	variable
<i>suis : serais</i> :: <i>ai été : aurais été</i>		constant ( <i>être</i> )	variable	constant (1S)
<i>suis : serais</i> :: <i>ai : aurais</i> :: <i>vais : irais</i> :: <i>crois : croirais</i> :: etc.		variable	constant (present)	constant (1S)

Table 4 Several analogies for a same pair

The table above, for several such paradigms, displays the elements that remain constant and those that vary when moving from one pair to another.

Beside the verbal paradigms of Indo-European languages, agglutinative morphologies produce phenomena<sup>90</sup> of that sort. In the former ones (integrative) all dimensions are marked by a single morpheme while in the latter (agglutinative) each dimension is marked by a separate morpheme. In this, both systems differ, but they are similar in the fact that they are both pluridimensional. The condition for such tables to be possible is for the system to be pluridimensional.

In other words, a pair of terms like *suis* : *serais* does not suffice to determine what will be constant and what will vary; it does not suffice to determine the analogical ratio that commands how the rest of the paradigm can develop.

On the example above, a third term suffices to complete the determination so that i) the (proportional) fourth is determined, and ii) this same logic, henceforth established, becomes the condition for more pairs to be admitted in the paradigm.

Still, a third term is not always enough to establish an analogical ratio. It is not, for example, in arithmetic analogies.

The pair 9 : 3 may be construed as multiplication by 3 or addition of 6.

Here, a third term  $X : 11 :: 9 : 3$  does not determine the fourth term because this formula still may be construed as multiplication by 3 or addition of 6 and so  $X=33$  or  $X=17$  are possible results. Three terms in this case do not suffice to determine the ratio. So is it in arithmetic, and more generally in all ring structures in the sense of set theory. However, this latter case will not be considered further: the model is not concerned with it in the linguistic field.

In summary, we should remember that the vehicle (A : B) and the analogical ratio have to be kept conceptually distinct. Most often, both are identical but in systems with more than two dimensions, the vehicle alone does not determine the analogical ratio and the addition of a third term completes the determination.

### 3.3.5. Separate analogies do not account for the continuity of the ratio

Consider now three analogies picked up from the preceding example.

- (1) *suis* : *serais* :: *est* : *serait*
- (2) *suis* : *serais* :: *sommes* : *serions*
- (3) *suis* : *serais* :: *ai été* : *aurais été*

Something specific takes place between analogies (1) and (2) which is the conservation of the analogical ratio: (indicative : conditional, constant tense, constant verbal base) whereas the grammatical person varies between pairs.

It is also the case that an analogical ratio is conserved between analogies (1) and (3) but it is not the same: (indicative : conditional, constant verbal base, constant person), the tense varying between pairs.

---

<sup>90</sup> Similar tables, still more varied, can be built for the Japanese verb

By simply giving analogies (1), (2) and (3) separate from each other, one does not reflect entirely the conservation of the analogical ratio. A first manner to be faithful to it consists of endowing the model with the notions: grammatical tense, mode, and person. This is not envisaged after the critique of the categories made in Chap. 1.

A more economical way to achieve it consists of linking (1) and (2) on the one hand, and (2) and (3) on the other, but in keeping (1)-(2) and (1)-(3) unlinked. This may be obtained by splitting each analogy into its constituting pairs and establishing links between the pairs

(1)-(2)    suis : serais    ::    est : serait    ::    sommes : serions  
(1)-(3)    suis : serais    ::    est : serait    ::    ai été : aurais été

Each pair is here called a record and each link a paradigmatic link for reasons that will soon be provided. The sets of linked pairs thus formed are called paradigms, this also will be discussed.

This way of associating together linguistic terms now faithfully reflects the conservation of the analogical ratio – and will make possible the development of a computation – while it does not overdo it; contrasting with categorial theories it does not overspecify.

### 3.3.6. Paradigms of analogies

It seems to me that all that happened for three centuries might, if one liked to, be summarized in this, that Descartes' adventure went wrong. Something is missing in the "Discours de la Méthode". When one compares the "Regulae" with the "Géométrie", one finds that a lot is missing to it indeed. For me, here is the lack I think I find. Descartes has not found a way to prevent order, once conceived, to become a thing instead of an idea. Order becomes a thing, it seems to me, as soon as one makes of it a reality distinct from the terms that compose it, by expressing it with a sign. Now this is what algebra is, and since the beginning (since Viète). Simone Weil (1966, p. 111).

Descartes is not the first one to fall into sin: Aristotle did before, with the categories.

Arranging analogies into paradigms, so it seems, allows one to respond to Weil's request: it introduces some order without making it "a reality distinct from the terms that compose it", without "expressing it with a sign".

For the pairs above, obtained from splitting analogies A1, A2, and A3, it becomes possible to say that they are paradigmatic if one accepts a slight extension<sup>91</sup> of the sense of the term *paradigm* as defined by Jakobson, who borrowed it from Donnat, and since then received in structural linguistics. In structural linguistics, *paradigmatic* is opposed to *syntagmatic*. Here, it is opposed to something else, something which has no name and is the transition from a vehicle to a tenor, from one pair to another. We shall see below that extending the meaning of *paradigm* in this way is not too offensive: in the paradigms of exemplarist constructions that will be introduced, the opposition between *paradigmatic* and *syntagmatic* is back in a quite classical meaning.

---

<sup>91</sup> Yvon (1997), whose work will be commented much further down in this dissertation, takes the same liberty in a model of pronunciation : *The model crucially relies upon the existence of numerous paradigmatic relationships in lexical databases*; for him, these paradigms are morphological analogies.

Thus "paradigm" is understood here slightly differently. In structural linguistics, terms are not required to be associated into pairs to stand in a paradigm. Here, they are. The benefits of this requirement will be made clearer below, and when "paradigm" understood in this way will be extended to morphology and syntax, it will coincide again with the classical notion.

### 3.4. Static model: a plexus as the inscription of analogies

The three classes of analogies being established and these clarifications being made, it is now possible to propose a static model showing how to inscribe analogies in a plexus, that is, how to constitute the static side of a speaker's linguistic knowledge that may support the dynamics of linguistic acts, basing them on analogy.

#### 3.4.1. Three classes of analogy with their method of inscription in a plexus

The table below, when first introduced p. 59, defined three classes of analogies. It is now complemented with the modes of inscription in a plexus which apply to each class.

Class	Systemic non structural analogy (class A)	Structural non systemic analogy (class C)	Structural and systemic analogy (class AC)
Examples	<i>la : le :: une : un</i>  <i>soigneux : avec soin :: rapide : vite</i> <i>happiness : happy :: beauty : beautiful</i>	<i>un : un soir :: le : le jour</i>  <i>soir : un soir :: jour : le jour</i>	<i>élu : élue :: maître : maîtresse</i>  <i>lawful : unlawful :: honest : dishonest</i> <i>un : unlawful :: dis : dishonest</i>
Place in grammars	Paradigms without overt manifestation	Syntax	Paradigms with overt manifestation
Inscriptions in A-type records	A <i>la le</i> A <i>une un</i>	Structural non systemic analogy cannot be expressed in A-type records	A <i>élue élu</i> A <i>maîtresse maître</i>
Inscriptions in C-type records	Systemic non structural analogy cannot be expressed in C-type records	C <i>un+soir=un soir</i> C <i>le+jour=le jour</i>	C <i>élu +e =élue</i> C <i>maître+sse=maîtresse</i> A A C <i>un+lawful =lawful</i> C <i>dis+honest =dishonest</i> A A

Table 5 Three classes of analogy with modes of inscription in a plexus

For class A analogies, the mode of inscription in a plexus is A-type records. An A-type record ("A" for "class A analogy") contains a pair of terms and the inscription of an

analogy involves two such records, one for each pair in the analogy. The two records are linked with a "paradigmatic link" (see below) in such a way that the convention:

A	<i>la</i>	<i>le</i>
A	<i>une</i>	<i>un</i>

in the table reads: "*la* is to *le* as *une* is to *un*". The dynamics that apply to a plexus, when using the records and the links, give them precisely this meaning. The convention of A-type records therefore means that their terms are just forms – they are not perceived by the model as having overt similarities (which contrasts with C-type record below) – but that a link between two such records accounts for a systemic analogy.

For class C analogies, the mode of inscription in a plexus is C-type records. A C-type record ("C" for "concatenative construction") contains in the rightmost position a linguistic assembly and, on the left, the constituents of the assembly – two only in the examples, we shall see below that there may be more. Thus, a C-type record contains an exemplarist assembly. The inscription of a structural analogy, as above for systemic analogy, consists of two such records linked together by a link.

So that the convention in the table:

C	<i>un</i>	<i>+soir</i>	<i>=un soir</i>
C	<i>le</i>	<i>+jour</i>	<i>=le jour</i>

reads as follows:

- a) *un* (as a part) is to *un soir* as *le* (as a part) is to *le jour*",
- b) *soir* (as a part) is to *un soir* as *jour* (as a part) is to *le jour*".

This is how the two exemplarist constructions are similar. "Construction" is to be understood in the sense of Fillmore (1990) or of Goldberg (1995). Here, similarity encompasses two aspects: i) the records are structurally (syntactically) similar, and ii) the semantic effect of the assembly is the same between two directly linked records. The model does not go beyond similarity thus defined: as the predicate between the shield and Ares was elided (cf. *supra*), likewise there is no attempt to make explicit the "semantism" of this syntax, no effort whatsoever to apprehend 'determination' or 'modification' with metalanguage or definitional propositions.

As for the third class of analogy, class AC, its inscription in the plexus consists of: i) modelling it as a structural-only analogy (that is, with C-type records), and then ii) writing a special mark (the A mark which is underwritten in the table) below the terms which are involved in the systemic analogy. As pointed out above, one of them is necessarily the assembly, the other one being one of the constituents (we shall see that one constituent only can bear the A mark, otherwise the quasi-bijection rule which must be satisfied by an analogy to be acceptable would be infringed).

In the following example which is picked out from the above table:

C	<i>élu</i>	<i>+e</i>	<i>=élue</i>
A			A
C	<i>maître</i>	<i>+sse</i>	<i>=maîtresse</i>
A			A

*élue* is assembled as *élu* + *-e*, *maîtresse* is assembled as *maître* + *-sse*, and in addition, *élue* is to *élu* as *maîtresse* is to *maître*.

This modelling solution is not perfect but I have not been able to devise a modelling device which would abstract cases A and C with homogeneity and economy. At least it is functionally adequate.

The table will be complemented again below (p. 88) with the abductive movements which apply to each class. Four examples are now going to be used to validate this inscription model in a variety of cases.

### 3.4.2. Systemic non structural analogy (A): anomalous verbs

The first example, in English<sup>92</sup>, illustrates A class analogies (systemic, non structural analogies). The principle is that the leftmost term is a preterit and the rightmost one a past participle.

A mention like went gone is a record. Edges between records are the paradigmatic links. The group formed by the pairs went gone and took taken, and by the edge between them reads as follows: "*took is to taken as went is to gone*".

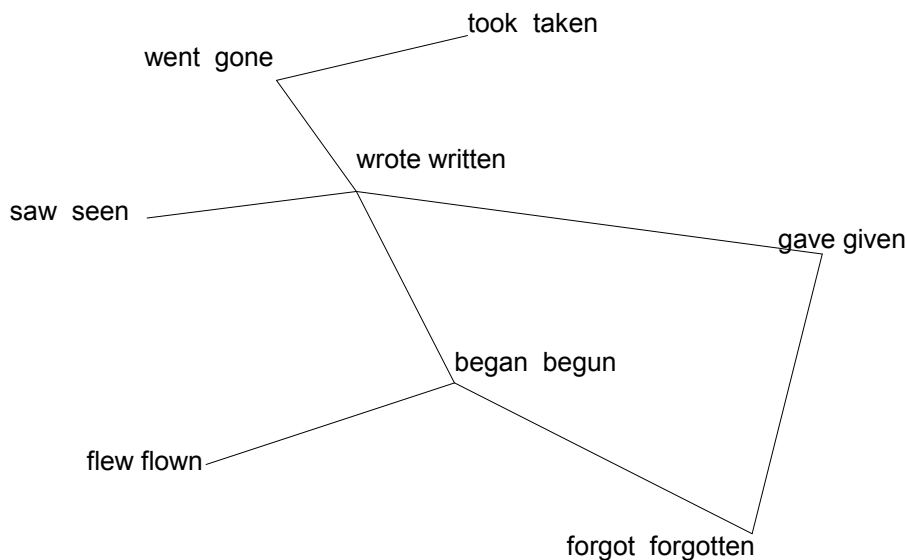

Figure 1 A paradigm which is analogical only

This paradigm tells nothing else, in particular nothing about the meaning of the terms at play. It expresses nothing about the forms of the verbs which it contains in other grammatical tenses. Some such data, bearing on some of these verbs or other verbs, may be inscribed elsewhere in the plexus, in other paradigms. When they are, they are not constrained to bear on the same verbs.

A paradigm is thus the recording of analogies exactly in the sense of Aristotle.

---

<sup>92</sup> Multiple similar examples could be taken in multiple languages, this one is chosen as a matter of commodity; it will be reused and complemented in the next chapter to discuss the question of regularity-anomaly.

The formula "*took* is to *taken* as *went* is to *gone*" incurs nothing particular about what "*took*" is to "*taken*"; in fact, the model says nothing about what "*took*" is to "*taken*": analogy *elides the predicate* (cf. *supra*). This is the central fact which allows one to build a model free of grammatical categories; "*took* is to *taken* as *went* is to *gone*" does not assume the category of the preterit or that of the past participle; neither does it posit the verbs *take* or *go* (which would be the "grammatical word" for other authors). Yet, "*took* is to *taken* as *went* is to *gone*" is a useable datum and its integrative utilization remains possible as this will be shown. So metalanguage is expelled because it ceases to be necessary.

Records (*took*, *taken*) and (*went*, *gone*) are proximal: as they are remote by one link only, one can be reached easily from the other; in this particular sample, motion terms are proximal. Likewise, terms concerning reading and memory are proximal; in the plexus of another speaker the configuration of proximalities might not be exactly the same. The precise disposition of records and their organization into paradigms, that is, what these records are, and the links between them, is subject to influences of various orders, notably cognitive and semantic. For example, it may reflect the subject's history and the sequence in which he learnt (cf. p. 249). This is discussed again generally in an appendix (p. 315). About the apparent arbitrariness attached to the detail of a plexus, see also section 3.5.2. *Determinism, idiosyncrasy, normativity* (p. 75).

### 3.4.3. Structural non systemic analogy (C): syntax

The paradigm below bears on three-constituent structures.

It expresses that, in its six records, the construction is the same: the semantic effect of the assembly is the same between two records with a direct link (a slight drift may take place when crossing several links one after another).

One might consider that *certain* and *sourire* should have to be assembled first, and then only the result of this assembly might in turn be assembled with *un*.

However, *le certain sourire*, for example, or *ton certain sourire* seemed to be less likely to be produced by this speaker (he of whom this plexus is a model) – although they are possible in French.

Similarly, *la bonne chanson* contains something that *la meilleure chanson* does not contain and this difference is something else than that between *bonne* and *meilleure*. Consequently, the constructions slightly differ; another paradigm which would contain *la meilleure chanson* and *une grosse entreprise*, is possible but it should stay disconnected from this one, or the linkages should be remote and weak. A speaking subject feels this sort of tiny difference when he structures the memory of his linguistic experience. Such slight differences are out of reach of category-based models. Here, proximality allows them to be accounted for easily.

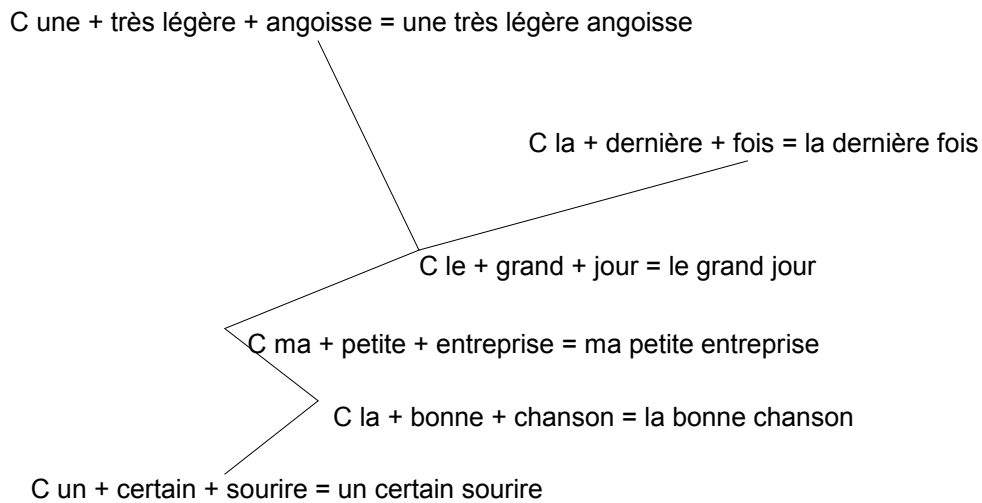

**Figure 2 Structural non systemic paradigm: syntax**

The assemblies are ternary in this example. A discussion of the reasons why ternary assemblies are needed is provided on p. 371.

About now the precise significance of analogy in this paradigm, it is possible to say:

- (a) *chanson* (in *la bonne chanson*) is to *la bonne chanson* as *sourire* (in *un certain sourire*) is to *un certain sourire*

This is a merological viewpoint, there is a structural analogy, that is, a structure mapping. But one cannot say:

- (b) *chanson* (in general) is to *la bonne chanson* as *sourire* (in general) is to *un certain sourire*.

Nor can this be said in selecting the first constituent or the second one. In other words, there is not in this example a systemic analogy. This analogy is structural and non systemic.

#### **3.4.4. Systemic and structural analogy (AC): *violoniste, violoneux***

To decide whether a structural analogy also comprises a systemic one, the criterion is that of bijection or quasi-bijection. If a paradigm behaves as a bijective or quasi-bijective function between the assemblies (rightmost part of the records) and the terms of one of the constituent positions then, these pairs constitute systemic analogies. One can convince oneself of the validity of this criterion by checking that it holds in all the examples given so far. Bijectivity may be not entirely strict:



	Site 1	Site 2	Site 3	Site 4
C	art	-iste	-	artiste
C	violon	-iste	-	violoniste
C	violon	-eux	-	violoneux
A				A

We should accept pairs (Site 1-Site 4) as systemic analogies: what an *artiste* is to *art*, a *violoneux* (En. *fiddler*) is to *violin* much in the same way as a *violoniste* is.

In a record, if a constituent takes part in a systemic analogy, the other constituents cannot. One constituent only may take part in a systemic analogy with the assembly. This is a consequence of the quasi-bijection principle.

In a systemic analogy, one of the involved participants is necessarily the assembly. The other one was the first constituent in the previous example, it is the second one in the example below:

	Site 1	Site 2	Site 3	Site 4
C	in-	correct		incorrect
C	mal-	poli		malpoli
C	a-	social		asocial
A		A		A

### 3.4.5. Structural and (everywhere) systemic analogy (AC): regular plural

The "analogical only" paradigm presented in the previous example features analogical ratios which are not apparent in the form. The one presented now, if it still encompasses that "*cows* is to *cow* as *houses* is to *house*", adds that *cow* plus *-s* assemble into *cows*.

This is what C-type records do (constructor records that assemble by concatenation).

Such a paradigm accounts for morphology. It can also account for syntax. Paradigm: *a + cow :: a + town :: an + idea ::* etc. relates noun phrases to their constituents: nouns and defined articles.

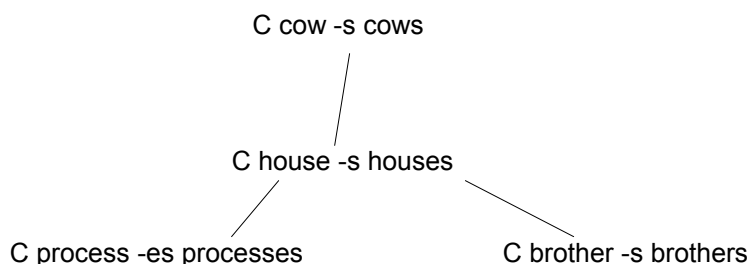

**Figure 3 Systemic and (entirely) structural paradigm: plural with regular morphology**

This model makes no criterial distinction between morphology and syntax: it treats both at once with records and paradigms of the same type and the dynamics which use these records (which will be exposed below) are not morphology-specific or syntax-specific. The cohesion which is that of the "word" arises *de facto* as an overall effect of the

abductive dynamics which apply to the plexus. For a plexus which is faithful to the linguistic knowledge of an English speaker, it just will not happen that anything may intervene between *town* and *-s*. This contributes to "define" "nouns" as cohesive with their affixes and this "definition" is pervasive and *de facto* in the plexus of this speaker – and perhaps in that of many more with whom understanding obtains. It needs to be stated that this "definition" is not propositionally made anywhere in the model. The notion "word" is at best a shortcut that we, educated humans, perhaps grammarians, find sometimes useful to use.

### 3.4.6. Systemic and partially structural paradigm (A and AC)

All plurals do not have a formal manifestation by suffixation and yet systemic analogy holds for such cases as well:

*men* is to *man* as *houses* is to *house*.

The mixed paradigm below illustrates how the model accommodates this case: C-type records and A-type records may coexist in a same paradigm, the sole condition being that, when systemic analogy applies, it applies in the entirety of the paradigm. Henceforth, in order to be rigorous, the edges of the drawings should be doubled or tripled to show the detail correspondences between the terms. The model does comprise such detail even if the drawings remain elliptic and display one line only.

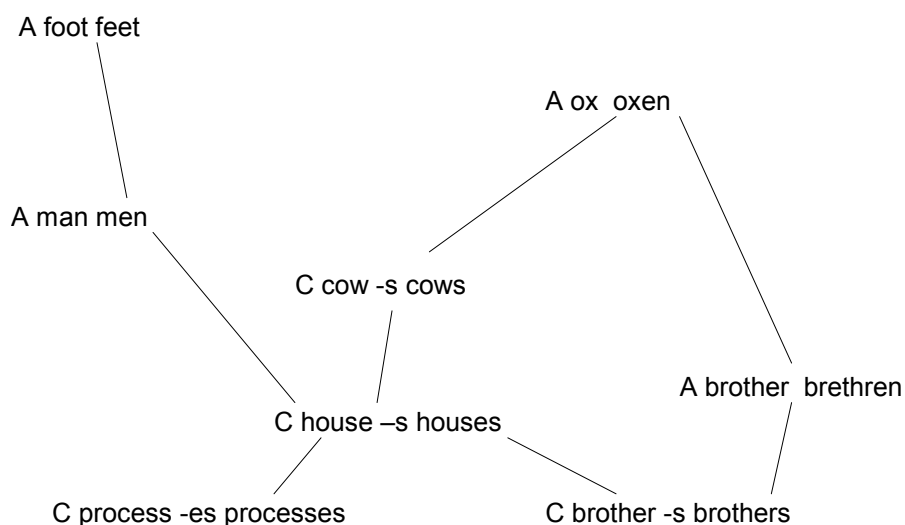

Figure 4 Systemic and partially structural paradigm: plural with anomaly

### 3.4.7. Paradigmatic link

In section 3.3.6. *Paradigms of analogies* (p. 66) we concluded that there is a need to constitute paradigms of analogies, and the examples that have just been presented showed, according to the three classes of analogies, how this could be achieved with records and paradigmatic links between them.

A paradigmatic link is the organic device which links together two records and thus manifests the analogy that holds between their terms.

In order to manifest analogies in a plexus, another possibility would consist in the direct inscription of analogies, without splitting them into records that would have to be linked thereafter. Doing so would not make it possible to manifest the continuity of the analogical ratio, the need of which has been demonstrated *supra*, p.65.

On the contrary, the splitting of an analogy into two records with a link between them leaves to each of them the possibility of being linked in turn with another record (other records) to form another analogy, the ratio of which prolongs that of the former one. This gives birth to chains of records which are the 'paradigms' of the plexus (this usage of 'paradigm' somewhat extends the classical meaning in linguistics).

A paradigmatic link may occur between two A-type records. It manifests then a systemic non-structural analogy. It may also occur between two C-type records without A marks. It manifests then a structural non-systemic analogy. It may further occur between two C-type records with A marks. It manifests then a structural and systemic analogy. It may finally occur between an A-type record and a C-type record with A marks. In this case, it manifests a systemic analogy between the terms of the A-type record and those of the C-type record that bear the A marks.

Paradigmatic links play an important role in similarity suggestion, cf. section 3.7.7. *Similarity suggestion*(p. 95).

It has been mentioned before (p. 62) that, in general, analogies bear an orientation: one of their pairs is more familiar than the other one and helps make it understood. The model recognizes this by providing for an orientation of the paradigmatic link. The need for orientation is first described in systemic analogies but it also applies to structural ones: an exemplarist construction may, vis-à-vis another one with which it has a structural mapping, be less familiar, less natural. It may have been learnt later, with the help of it upon its first encounter, etc. (cf. section 12.8. *Familiarity orientation*, p. 303).

Finally, paradigmatic links are the means whereby proximity is implemented, which is not the lesser of their roles.

### **3.5. Philosophy of the static model**

#### **3.5.1. Proximity of inscriptions**

*A un besoin est liée l'idée de la chose qui est propre à le soulager; à cette idée est liée celle du lieu où cette chose se rencontre; à celle-ci, celle des personnes qu'on y a vues; à cette dernière, les idées des plaisirs ou des chagrins qu'on y a reçus, et plusieurs autres. On peut même remarquer qu'à mesure que la chaîne s'étend, elle se sous-divise en différent chaînons; en sorte que plus on s'éloigne du premier anneau, plus les chaînons s'y multiplient. Une première idée fondamentale est liée à deux ou trois autres; chacune de celles-ci à un égal nombre ou même un plus grand et ainsi de suite.*  
Condillac 1973, p. 126.

In chapter 1, I suggested that, among the inscriptions of a plexus, some needed to be more proximal and other ones less; I suggested further that proximity would react on the dynamics by modulating their cost.

Proximalità implements the intuition that two pairs which constitute an analogy, when inscribed in a plexus, are inscribed close to one another since the analogy relates them in a way, and the paradigmatic link is the instrument of this linkage.

After the concreteness of the model (exemplars and occurrences, not abstractions) proximalità is the second corollary of the absence of rules and categories.

'Proximalità' is understood in the sense that the elements of the linguistic knowledge are proximal when one can be reached easily from another. Proximalità is that of the inscriptions in the first place: a record has links with a limited number of other records. In the static side of the model, it is the paradigmatic link which embodies proximalità.

As inscriptions acquire value only when the dynamics grant them some value, the proximalità requirement is extended to the dynamics themselves: the dynamics must be proximal, that is, short-sighted even if we expect them to yield final effects which are not. The metaphor is that of hexagonal cells in a bee-hive or of the regularity in crystals: here are no general rules which would globally determine the crystal or the form of the cells, yet regularization obtains, but as a consequence, not as the operating cause. The position of the rule in the theory changes, a causal status is denied to it, it becomes an observable, moreover a contingent one.

A philosophy of proximalità will be made p. 212, where it will be contrasted with 'totalism' which is a defect inherent in categorial theories. Proximalità allows us to overcome it. It will also be shown how it eschews 'simple associationism' – latent in the quotation of Condillac above.

Proximalità is one of the levers that support the notion of cost in the model (see below the dynamic side of the model): a unitary move from an inscription to a proximal one has a low cost; a longer sequence of such moves has a higher cost.

### **3.5.2. Determinism, idiosyncrasy, normativity**

The structure of a plexus, that is, the precise detail of inscriptions in it, poses to the reader – and to the descriptor before him – the question of its residual arbitrariness. 'Arbitrariness' here is not the arbitrariness of the sign (its conventionality), but rather questions like "Why inscribe this term and not this other one; for a given term, why in this record and not in another, why these particular paradigmatic links". Such questions may have occurred to the reader on the occasion of the paradigms provided as examples above. This arbitrariness is not as residual as that: when some obvious description needs have been satisfied (such term is a must, such record is obviously less familiar than such other one, etc.) a great deal of description micro decisions still remain, and have to be made with no particular reason. The descriptor then makes an arbitrary choice. Ensuing tests with the dynamics generally suggest corrections which are a way to move to a new, better motivated status of the plexus. However, even after validation and correction, the motivation is far to command the entire plexus detail and a great deal of arbitrariness remains. It is important not to leave it without an interpretation.

A part of the plexus arbitrariness may be put on behalf of the radical exemplarist assumption made in this research: as it is too radically poor in its apparatus, the model is too unspecified; a less radical model (cf. p. 268), but which remains to be found, would be tighter and its inscriptional detail more constrained.

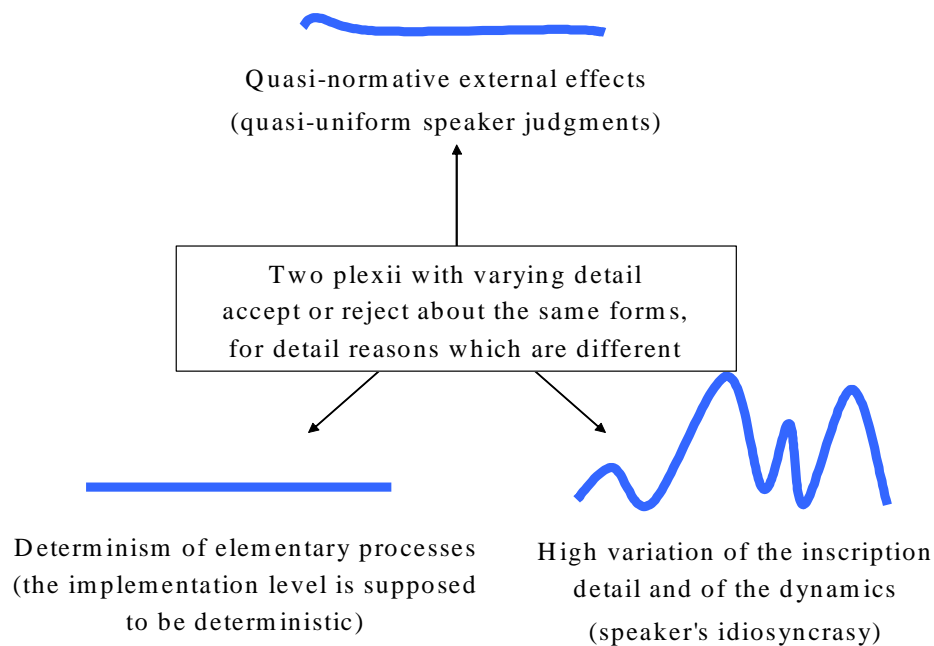

**Figure 5 Determinism, idiosyncrasy, normativity**

I propose to see the rest of plexus arbitrariness as standing for the speaker's idiosyncrasy: a plexus, being the static side of a speaker's linguistic knowledge, bears the trace of his history, of his learning history in particular. The figure above proposes a metaphorical view of the question. It suggests that an important detail variation is damped and gives quasi-uniform linguistic outputs (they are quasi-normative), that is, the linguistic knowledge of this speaker is French, for example, with the variation across speakers which one observes among French speakers. The damping would be accounted for in general by a form of stability in complex systems and in particular by the integrativity properties of the model defended in this dissertation (cf. section 7.4. *Integrativity*, p. 207 below). To put it more simply, two different plexii of French will analyse a same form about as easily (or with about equal difficulty) but each for very different detail reasons (cf. Chap. 4).

This schema reconciles three poles:

- a) the high variation of inscriptional detail across speakers (and of the detail of the dynamics) which is assumed to reflect the idiosyncrasy of speakers and the variation of individual histories,
- b) the quasi-uniformity of macroscopic effects<sup>93</sup> and

---

<sup>93</sup> About this level, Engel (1996) uses the word "normative". For example : *Frege reproaches the psychologists with confusing two meanings of the word "law" when they equate logical laws with psychological laws: the sense "normative" and the sense "descriptive". Even assuming, as he does, that logical laws are normative laws, Frege still confuses two meanings of the word "norm": a sense in which a norm describes the laws of an intelligible universe, and one in which a norm prescribes to individuals to follow a certain rule.* Engel 1996, p. 120.

- c) the determinism of the neurophysiological processes which is assumed. The neurophysiological processes which support the linguistic operation have to be deterministic if we think that they belong to chemistry and therefore do not require calling on quantum mechanics; this is a conjecture.

This model contradicts the explanation of several variation effects by means of probabilities, cf. section 7.9. *Probabilistic model or dynamic model* (p. 225).

The three-pole model also affects the theme of portability and separation. For Putnam (1960), the fact that a same process may be run on different computers (or, more abstractly, that a Turing machine is a "logical" description which leaves undetermined its concrete form) leads to envisage mental states and mental processes that can be described separately of the nervous system. This important remark is presented as likely to solve the problem of mind and body<sup>94</sup>.

It legitimates a theme which is central in cognitive science: the postulation of a representation level independent of the hardware. The three-pole model proposes a less sharp vision of this. First it does not posit an abstract object (it would be a language) which would be portable: the speaker productions are quasi-normative, they are not normative. Secondly, idiosyncrasy (bottom right pole) is both the variant result of an individual history and a dependency on the "hardware". The separation then could take place only at the expense of an abstraction (the postulation of a language) which we are trying to avoid. If one posits the possibility of a separation, one cannot provide an explanation of variation or a working explanation of learning because it cuts the model off from the concrete dynamics of the acts.

### 3.5.3. Contextuality and mutual contingency

#### Contextuality

The inscriptions in a plexus are contextual right from the start: it is not possible to make a decontextualized inscription as are those in a lexicon for example.

Inscriptions are constitutionally interdependent. After reading Saussure, consequences are drawn: if signs have value only with respect to one another, then, inscriptions that would be autonomous and self-standing (between which "relations" would then have to be made) or lexical entries (to which "properties" would then have to be attributed) must be avoided. This puts us in a better position for terms to get their value from their "eternally negative mutual differences".

Inscriptions must be contextual because i) decontextualization creates ambiguity<sup>95</sup> and ii) decontextualization prompts paronymy (cf. p. 89): the temptation to attribute properties to objects. The model therefore contains built-in contextuality: its very foundations make contextuality of inscriptions obligatory.

It does so firstly by placing terms in constructor records (C-type records), that is, in structural contexts – some say 'cotexts' – that are utterances or utterance segments. This is a vision of context which is conventional, well understood, and good by itself.

---

<sup>94</sup> The argument is recalled and summarized in Gardner 1987/1993, p. 45.

<sup>95</sup> Ricœur 1969, p. 94; Rastier 1998a, etc.

It does so secondly in the structural analogies inscribed in type C records. This is more novel and requires extending the conventional notion of context. The part of a system constituted by the four terms in a systemic analogy – that is, in a plexus, the four terms copositioned in two type A records, the latter linked with a paradigmatic link – is a 'context' inasmuch as this inscription profiles the four terms in a determined manner. Take for example the following systemic analogy:

(a) femme : homme :: vache : taureau

Remember that the definition of systemic analogy (cf. *supra*) rests on a similarity of meaning ratios. If one introspects oneself on the mode of presence of meaning in the systemic analogy above, one perceives that the meanings which are those in "*ah la vache!*", "*sang de taureau*", "*le taureau par les cornes*", "*tente mille hommes*", "*t'es pas un homme*", "*l'homme est un loup pour l'homme*", "*cherchez la femme*", "*ce type c'est une femme*"<sup>96</sup>, would make it difficult to involve such terms in analogies such as analogy (a). Consequently; analogy (a) necessarily profiles each of its terms towards biological sex, and the human or bovine character, and meaning, in that inscription, is therefore one of zoological taxonomy. This is in what the corresponding inscription is contextual; the context of *femme* in it is:

X : *homme* :: *vache* : *taureau*

Contextuality encompasses a third aspect, which is the most important one and the most difficult and is not addressed in this work: the situational context. It is ultimately regarded as the condition of a radical treatment of meaning.

Contextuality is thus constitutional in a plexus. It is so also in the dynamics, as we shall see later.

### **Dispersion**

The dispersion of terms across records – and via the records, across various paradigms – matters, because it constitutes a sort of 'potential connectivity' which is revealed upon their use in the dynamics. This connectivity is complementary to the 'static connectivity' embodied by the paradigmatic links. When dispersion is high in a zone, it increases what will be named below 'constructability transfer'. In the categorial vocabulary, one would say that high dispersion causes 'good' categories, that is, sets which share many properties and much behaviour. We shall see below (p. 108) dispersion contributing to render the systematicities that generativism treats with transformations.

When dispersion is weak on the contrary, the sharing of behaviours between terms is lessened. In the categorial vocabulary, one would describe this as sub-categorization, which may reduce to categories that communicate little or not at all. An example of this will be seen p. 112. Between this effect, and the previous one its contrary, there are of course only gradients and no sharp break, since there are no reified categories.

---

<sup>96</sup> The technique of exposition consists of enumerating those exemplars to avoid the use of "proper meaning", "meaning extension", "derived meaning", "figurative meaning" which are not postulated.

### 3.5.4. An analogy holds between terms

All segments of linguistic form making up an analogy, be they in C-type or in A-type records, are 'terms' by definition. The question of terms will be addressed in detail again p. 193.

'Term' was often used in linguistics; the definition proposed here is firstly compatible with this one: *A term is a word or a group of word constituting a syntactic unit*<sup>97</sup>. But it is secondly modified as follow: the only criterion that commands the making of terms is their belonging to an analogy, that is, terms are the consequence of (at least) one structure mapping and have no other *raison d'être*, they result only from the segmentation which contributes to structure mappings. A term thus has morphological and syntactic relevance. Saying this is just paraphrasing the clause that terms are commanded by structure mappings. Remember Saussure: "*L'analogie est d'ordre grammatical*" (*Analogy is grammatical in nature.*).

This clause, which is constitutive of the term, makes it tend to align on the constituents of classical analyses (morpheme, syntagm) without this alignment having to verify in all cases: some structure mappings may not follow classical frames. We shall see several examples of this in Chapters 4 and 5, and a typology of such cases will be made p. 193.

The only but strong request which is made for a term is that it be re identifiable in its recurrences: in each, it is re identified as "the same term".

### 3.5.5. Vacuity of terms

LINGUISTIC SUBSTANCE – We do not have to posit a fundamental substance which will then receive attributes. Saussure<sup>98</sup>

There is a dearth of analogy between language and any other human thing for two reasons: i) the nullity of the signs; ii) the faculty of our mind to consider a term which is null in itself (But this isn't what I meant initially. I deviated)<sup>99</sup>.

If one takes that any semiotics is only a network of relations (or that a natural language for example is only made up of differences), the terms can be defined only as points at the intersection of the different relations. Thus, the examination of the elementary structure of meaning well shows that any term of the semiotic square is the point where relations of contrariety, contradiction and complementarity intersect<sup>100</sup>.

After the principle above which governs them, terms have no properties which would be their attributes. Much in the way the slot-filler schema was refused in Chap. 1, it is a sort of object-property schema that is now going to be criticized.

In order to address the linguistic dynamics in an appropriate manner, one is led to envisage terms deprived of content, that is, deprived of properties. It is so because conferring a property to a term is sanctioning what has been observed in the past and in the present, without building a base open enough and flexible enough for future

---

<sup>97</sup> Pei 1969.

<sup>98</sup> Saussure 2002, p. 81.

<sup>99</sup> Ibid. 2002, p. 109.

<sup>100</sup> Greimas 1993, p. 388.



behaviours. Allocating terms properties that are susceptible to take values is in general a renouncing attitude because it renounces developing a discourse on the abductively productive dynamics to substitute them with the impoverished ratification of a collection of observed facts. Besides, these approaches invariably fail on acquisition: they fail to show in which conditions the succession of the acts makes changes in the values of these properties. Conferring on these the character of continuity or adjoining a stochastic complement to the theory does not solve the question either, as we shall see.

Terms being content-free, it is their connectivity – that is, their various occurrences in a plexus, and, in their occurrences, the copositionings of these terms with other terms – that account for their dynamic behaviours and their productive possibilities.

In this line of thought, analogy carries with it a promise (to which this model undertakes to do justice): its eliding of the predicate is an important enabler of content draining. Nothing requires that it be alone in this, but no other device has been found so far. In order to leave open the possibility for other devices with the same quality, in several places in this work, stress is moved from analogy to "copositioning", that is, to the establishment of mutual ratios between terms: any device capable of establishing any copositioning would be receivable. Analogy is the first one, the main one, and the best studied one. Others are possible, in principle only so far.

Units deprived of content are difficult to envisage and manipulate. It is hard to build solidly without a "stable foundation". It is hard to make models or theories deprived of "essences". The building of science needs solid foundations and is not deemed to be compatible with an absence of content. This is where we must strive however. Classically, three orders of properties are postulated: a) syntactical, b) semantic, and c) phonological. Let us review them and see how content draining is achieved, or not, for each in turn.

a) In the current status of this model, syntactic properties (categories, syntactic features, etc.) are refused and the model is free of them indeed. We shall see below how it is capable of syntax and in what measure.

b) Usual semantic properties (lexical meaning, linguistic meaning) are not posited either. However, in the absence currently of the semantic side of the model this non-postulation remains a *petitio principii* and the demonstration that it is possible to evacuate semantic properties is not yet made. This possibility stays as the favourite conjecture, but still to be proven.

c) Terms, as they are presented so far in the model conserve a form (orthographical in practice, it might be phonological), which seems to contradict the principle of their vacuity. This must be viewed as a lag, accepted by lack of anything better, between a desired goal and that which it was possible to realize. Besides, this region of the model poses a constitutional question, cf., p. 298, a discussion of the question of access, and, p. 296, another one as to what point it is possible to downgrade the lexicon.

Let alone this last reservation, the principle of the vacuity of terms is stated, and the demonstration of its validity will be made below in morphology and syntax. This principle will be presented p. 89 as the condition for a quality that the model must have: isonomy.

### 3.5.6. Suspending the minimality of terms

A term is not constrained to be elementary.

In establishing the categories of analysis like morpheme, seme, phoneme, etc. one strives usually towards minimality and elementarity, each time along one of the dimensions of the analysis. This aims at making available a tool set, as reduced as possible, so that various combinations of these tools give a good account of the immense variety with economy; this posture is common in science and the rationalist tradition presents it as inherent to science. This approach, when it succeeds, means that the viewpoints or dimensions in question are independent – which may be construed as tautological.

Now, in language, these independencies, without being negated, do not fully verify. This is why they should not be postulated; rather, it is appropriate to adopt weaker postulations, but these quasi-independencies will have to be reconstructed as results.

Thus, in the model, minimality itself is questioned; as a matter of principle, no minimality is posited. Consequently, description and explanation do not rest on 'elements' but rather on terms – the extension and the level of definition of which must remain contingent in principle – and on inscriptions at multiple levels. The question will be developed and discussed p. 194, after meeting several examples.

The terms and inscriptions we have been considering are static. We also saw that the rendering of the effects is expected from their use in dynamics. The major character of the latter is that they are abductive, and the device which links statics and dynamics in the model consists of four 'abductive movements'. These are now going to be exposed.

## 3.6. Abduction, abductive movements

### 3.6.1. Abduction: conjectural inference in an open frame

The model which is sought must propose mechanisms that show movements from the ancient to the new, from the already known to the never uttered, and are abductive, because this movement is each time a presumption of success without the anticipated proof of success being possible, and besides, it would not be very useful. Such presumptive movements correspond to what was studied since Aristotle, and was termed 'abduction' by Peirce.

Among the conjectural inferences which do not belong to the technical acceptance of induction, but may possibly belong to its usual one, let us single out abduction. This modality of inference was identified by Aristotle in the *Posterior Analytics* just after presenting induction. In order to catch what Aristotle understands with abduction, let us take his example:

Science may be taught	<b>Major</b>
Virtue is a science	<b>Minor</b>
Virtue may be taught	<b>Conclusion</b>

In a classical deductive reasoning, the Conclusion follows from the Major and the Minor, whereas in an abductive reasoning, a Minor is sought to act as a probable intermediary between the Major and the Conclusion; in other words, abduction starts from the Conclusion and from the Major to infer a possible Minor. We are thus in

presence of an unsure reasoning which is not, by far, an inductive reasoning, because it does not move from the general to the particular: as an illustration, in the example quoted above, the Conclusion and the Major are universal propositions in the Aristotelean sense, that is, in predicate logic, they map onto universally quantified formulae<sup>101</sup>.

Thus for Aristotle, the example abduction is:

Virtue may be taught, now virtue is a science, therefore (abductively) science may be taught

Abduction must be recognized in the *inadequate inference* of Spinoza:

The modes of perception may be grouped into four classes: I. [acquired by hearsay]; II. [by vague experience ], III. There is a perception in which the essence of a thing is inferred from something else but in a non adequate [*non adaequate*] manner; which takes place either when we infer the cause from whatever effect, or when we draw the conclusion [of the fact] that a universal is always associated with a certain property. IV. Finally, there is a perception in which the perceived thing is perceived by its essence only, or by the knowledge of its proximal cause [*cause prochaine*]<sup>102</sup>.

In the *Treaty* he will place his attention on the fourth mode of perception only. He is an atheist and Descartes a believer but for both of them the *true knowledge of things* cannot be satisfied with *inadequate inferences*, even if, he recognizes, *the things however which I could so far understand by such a knowledge [mode IV] are few* (p. 20) and the only example he gives is taken from Euclid.

We will now omit other important steps in the history of abduction (Peirce, Eco, etc.) and move on to its role in language.

Beside its role in thought and reasoning which is its origin domain, as Aristotle's example shows, *abduction plays an important role in other tasks of problem solving like utterance planning or natural language understanding*<sup>103</sup>. I suggest further that abduction is even involved in base processes like unit identification, syntactic analysis, etc.

If, as logicians remind us, abduction is dangerous in reasoning, for a speaker of a natural language, the danger is not so great: he certainly performs abductions, but he assumes that his interlocutor makes about the same ones. From experience, abductive inferencing in language works well most of the time, and it is easy to correct as language use is interactive.

We now should say how abduction happens. *For Chomsky, the autonomy of syntax constitutes the only possible response to the problem of abduction*<sup>104</sup>. The proposition made here is that this assumption is not necessary.

The accomplishment of language acts is based on abductive mechanisms. They are abductive in the sense that, from inscriptions in a plexus (attested linguistic facts), they

---

<sup>101</sup> Ganascia 2000, p. 129.

<sup>102</sup> Spinoza 1661/1984, p. 16.

<sup>103</sup> Houdé 1998, p. 24.

<sup>104</sup> Laks 1996, p. 171.

authorize new facts without this being a logical deduction, exactly as *Science may be taught* is not "demonstrated" in Aristotle's example above. There are three differences however.

Firstly, in the example of Aristotle, i) the path leading to the abductive conclusion contains only two steps, ii) there is only one result, and iii) the result is a proposition, whereas here, i) the path leading to the abducted result may (as we shall see below) consist of several steps (several 'phases'), ii) a same abductive process may produce several results in different phases each with its own strength, and iii) the results are linguistic terms (sometimes more complex results) and not propositions.

Secondly, in Aristotle's example, the mechanism is based on propositions such as *Virtue is a science*, whereas here it rests on the positional exploitation of analogical inscriptions.

Thirdly, abduction as it is presented above has a totalistic flavour: we know what sciences are (all sciences), we know that all sciences can be taught, we know with certainty that virtue is a science: *the universe of discourse* is known and closed; it is entirely framed by unambiguous categories. In the linguistic dynamics on the contrary we have to dispense with all this. Following the radical assumption which directs this work, we can rely only on occurrential and proximal inscriptions which are the result of partial cognitive experience, and therefore the processes expected to develop have to be proximal. It is an abduction reshaped in this way which must account for linguistic productivity.

Abduction is implemented by computations: the dynamic side of the model is abductive by construction, its results cannot be demonstrated by logic, and they do not come from categories and rules. The results are best compromises between the constraints associated with an occurrential linguistic act and the inscriptions accessible in the plexus. The dynamics are built up on 'abductive movements' which are elementary movements. These relate the static view of analogy to its dynamic view. Four abductive movements have been found necessary and will now be defined: by transitivity, by constructability transfer, by expansive homology, and by transposition.

### 3.6.2. Abductive movement by transitivity

From the two analogies:

(1)  $a : a' :: b : b'$  and

(2)  $b : b' :: c : c'$ ,

which share the pair  $b : b'$ , one abducts the following analogy:

(3)  $a : a' :: c : c'$ .

This is what is called 'abduction by transitivity'; rigorously, it is the paradigmatic link which is transitive, it implements the mathematical notion of transitive relation which holds between pairs. The given analogies (1) and (2) are alleged to be 'good' analogies: the speaker of whom this plexus is the static linguistic knowledge finds them acceptable.

According to the abductive movement by transitivity, the abducted analogy (3) is also alleged to be acceptable but possibly a little less. With analogy, nothing can be

demonstrated, nothing is guaranteed, this is in what the movement to (3) is an abduction and not a deduction. After several such movements, the risk thus taken may, as we shall see, be compensated (or not depending on the case) by collateral dynamics (parallel computation paths) which, integratively, add to this one other abductions, thus reinforcing the corresponding results.

Possible reinforcements let alone, along the path  $a : a'$  then  $b : b'$  then  $c : c'$ , the ratio may drift. If one chains up several steps in this way, the ratio may, after a moment, not really be conserved any more. Abduction has ended up hazardous. The assumption – this is suggested by the detail behaviours of the model, below – is that linguistic acts – utterance reception for example – in their majority, are computed with short chains and therefore under comparatively sure conditions. Some other ones, a minority but not rare, involve abductions that become hazardous because the dynamics of these acts mobilize longer chains: the terms of the linguistic act and those of the plexus are in this case not very congruent. Several such examples will be given below.

### 3.6.3. Abductive movement by constructability transfer

The second abductive movement is by constructability transfer.

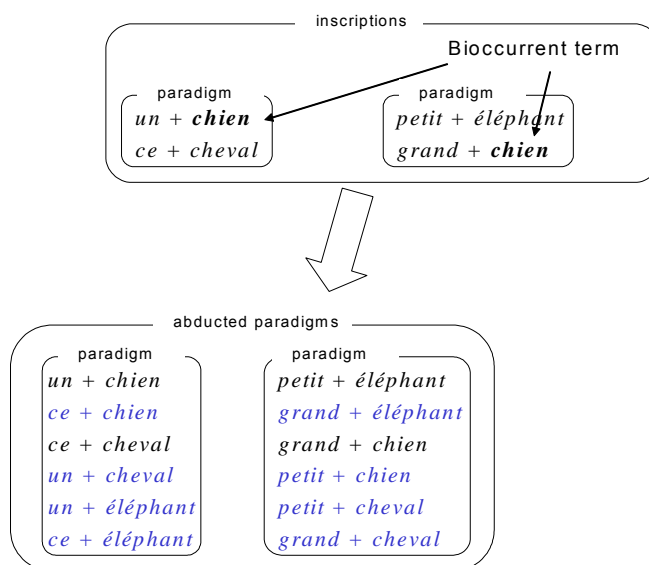

Figure 6 Constructability transfer

It is appropriate to present constructability transfer on an example – a quasi-formalization will be given in an appendix. The two paradigms at the top of the figure are inscriptions in the plexus and they share a term: *chien*. This is the "bioccurrent" term. Constructions *un + chien*, *ce + cheval* and *grand + cheval* being attested, the construction *un + cheval* becomes acceptable by abduction. This is what constructability transfer is.

The construction *grand + cheval* is not the only one to be produced by abduction: *un + éléphant*, *grand + éléphant*, *petit + chien* also can be abducted. The figure thus gives the feeling that a Cartesian product is built. This is not false but has to be complemented by noting that its elements are produced in successive phases (following the principles of the computation that will be detailed below). This phasing depends on the connexity of the initial paradigms which, in the figure is a very degraded notion since each contain only two records; usually, paradigms consist of more records. The Cartesian product of the possibilities is therefore not built entirely in general; its building is phase-wise. It begins with the elements closer to the starting ones, according to the progressive needs of the dynamic of a particular act. So the effect of the bioccurrent term, the constructability transfer, most often reaches areas not too remote from the initial records in the paradigms. In less favourable cases, it may, after a number of phases, have a broader extension but in general the products of such long paths will be superseded by other effects, following shorter paths, abductions that are more immediate and more pertinent vis-à-vis the terms of the act. This is a manifestation of the principle of proximality, there is another one.

It is not fortuitous that the data of the example all bear on animals. The starting paradigms inscribed in the plexus bring together linguistic data related to the cognitive sphere. The conjecture is of the type "birds of a feather flock together", the linguistic knowledge (and the cognitive one) would have inscriptions in observation of this principle. Of course, there are many ways to be similar, each may lead the organization of a particular zone of the plexus, or of several such zones; the zones coexist as domains in crystal structure: each is a proximal organization, and, at their borders, they join as they can, which means: with organizational breaks.

The example which illustrates constructability transfer is built with binary constructions and the definition extends straightforwardly to ternary constructions.

A formalization and a critique of constructability transfer appears in an appendix, section 13.2. *Abductive movement by constructability transfer* (p. 319).

Constructability transfer is the first movement that contributes to structural productivity; the second one is expansive homology.

### 3.6.4. Abductive movement by expansive homology

#### 3.6.4.1. Principle of expansive homology

If the constructive paradigm C1-C3 is available in a plexus:

C1	une + <b>journée</b>	→ une journée
C2	une + <b>belle journée</b>	→ une belle journée
C3	une + occasion	→ une occasion

and if in addition the constructive paradigm C4-C5 is available:

C4	belle + <b>journée</b>	→ <b>belle journée</b>
C5	belle + victoire	→ belle victoire

then constructions C6, C7 become acceptable:

C6	une + belle occasion	→ une belle occasion
C7	une + belle victoire	→ une belle victoire

Premises C1 through C5 are sufficient to abduct C6 and C7 but it is not necessary that they be exactly these ones, nor as numerous, to bear on these precise terms; it suffices that *journée* and *occasion* co-categorize<sup>105</sup> together in a way or another – we shall see how below – and it suffices that attestations like C1 - C7 apply to terms which are distributionally similar to *journée* and *occasion*.

What matters is that the expansion *belle journée* of *journée* occurs in C2 where it is homolog of *journée* in C1 (or that a similar fact holds between distributionally similar terms of these terms).

### 3.6.4.2. Expansive gate

A plexus configuration such as that of the example is an occasion for expansive homology. I call 'expansive gate' such a configuration. An expansive gate is a configuration of plexus inscriptions which allows expansive homology (the abductive movement by expansive homology) to take place. This designates in a plexus a 'resource' which is functionally defined and more or less organically bounded, that is, it is embodied by an identified subset of records. This 'resource' is not a detachable part of the plexus, it is rather a subset of the plexus which is profiled for a given finality. Its elements, the records, also link with records that are foreign to the expansive gate, thus contributing to serve other finalities.

When is an expansive gate constituted? In a restrictive view, when the criterion of expansive homology holds between the terms themselves: in the three constitutive records, the terms are themselves present with the required positions – this is the case in the example. Let us call this a 'hard' expansive gate. But an expansive gate operates also if the critical terms are not identical but are distributionally similar only. Then it is a 'soft' expansive gate. It just operates more slowly: it requires some more computation phases to assess distributional similarity (elsewhere I write "co-categorization") of terms. The softness of expansive gates is a factor of productivity and must be respected. The B2-B3 process for syntactic analysis which will be studied below operates following this soft vision.

To make things concrete, a systematic survey of expansive gates was made in the French plexus of 1800 terms that is used in chapters 4 and 5. It is restricted to hard expansive gates. The term which is homolog to its expansion is underlined and the expansion is not.

<u>hommes</u>	<u>femmes</u>		
<u>Espagnole</u>	<u>grande</u>	<u>venue</u>	
bon <u>cheval</u>	bon <u>temps</u>	bon <u>coup</u>	grande <u>sœur</u>
<u>homme</u> habile	<u>cours</u> pour adultes	<u>coup</u> tordu	<u>un livre</u> de cent pages
trop <u>grand</u>	pas <u>bon</u>		
pas assez			
<u>refaire</u>			

---

<sup>105</sup> That is, one may be suggested as similar to the other, cf. *infra*.

est arrivé  
je vais avec eux  
à chaque fois  
deux cents

est venu  
il est ici

est venue

One may call the underlined term 'head' but I do not do this: the model does not require to reify the notion 'syntactic head', cf. section 6.5. *Syntactic head* (p. 183).

In this model, causal chains are long, tenuous, multiple, and difficult to grasp between on the one hand the exemplarist detail of the plexus and the swelling of the computation, and on the other hand the overall, externally observable behaviour, the macroscopic effects. For this reason, it is difficult to perceive how mechanisms (that are elementarily variant) produce quasi-normative observable results. Neuromimetic connectionist models also present this opacity and do not solve it very well. Here, the table above contributes to alleviate it. In section 4.1. *Analysis with agents B2, B3* (p. 97) we shall see special queries that 'expose' the detail reasons of computation results; in another way they also contribute to reduce that opacity.

The notion 'expansive gate' frames for pedagogical purposes a mechanism the level of which is intermediate; this makes it possible for dynamics, otherwise obscure, to be brought closer to the knowledge that the readers have, based on previous notions like 'expansion', 'head', 'generation rule', etc. But it has to be understood that 'expansive gate' is not properly a concept of the model, it does not correspond to anything distinctly reified in it.

A complement on expansive homology is given in an appendix, section 13.3. *Abductive movement by expansive homology* (p. 320). Abductive movements by constructability transfer and by expansive homology contribute to structural productivity (cf. Chap. 4).

### 3.6.5. Transposition (or not) of analogy, abductive movement by transposition

The expansive movement which is now about to be defined does not contribute to structural productivity; it does to the systemic productivity which is the subject of Chap. 5.

The systemic analogy  $X : Y :: A : B$  being given, the following analogy:  $X : A :: Y : B$  is defined as its transposed analogy; terms  $Y$  and  $A$  are simply swapped. If an analogy is equivalent to its transposed analogy, then the question:

(a) find  $X$  which is to  $Y$  as  $A$  is to  $B$

is equivalent to:

(a') find  $X$  which is to  $A$  as  $Y$  is to  $B$ .

Moving from (a) to (a'), that is abducting (a') from (a), is performing an 'abductive movement by transposition'.

Most often, this abductive movement is acceptable, that is, a speaker that accepts (a) also accepts (a'). For example, it works very well in French articles and in the verbal paradigms of Indo-European languages. But it also occurs that transposition yields a curious analogy, one understandable at the expense of an interpretation, or even an unacceptable one. A survey of cases is made in an appendix section 13.4. *Abductive*



*movement by transposition* (p. 321). This same appendix provides a detailed description and a critique of the abductive movement by transposition.

### **3.6.6. Three classes of analogy with abductive movements**

A table of three classes of analogies was first introduced p. 59, please refer to it for class definitions. It was then complemented, p. 67, with their modes of inscription the plexus. It is now complemented again, and finally, with the abductive movements which apply to each class.

Transposition of structural analogy is impossible because the transposed pairs never define an analogical ratio. Transposition of systemic analogy is often possible with exceptions (cf. appendix), therefore it is only potential. Constructability transfer and expansive homology are proper to structural analogy.

As displayed in the table, transitivity is common to all three classes. Also shared by all three classes are notions like the individuality of terms, the elision of the predicate, the determination of the analogical ratio, and the familiarity orientation.

Class	Systemic non structural analogy (class A)	Structural non systemic analogy (class C)	Structural and systemic analogy (class AC)
Examples	<i>la</i> : <i>le</i> :: <i>une</i> : <i>un</i>  <i>soigneux</i> : <i>avec soin</i> :: <i>rapide</i> : <i>vite</i> <i>happiness</i> : <i>happy</i> :: <i>beauty</i> : <i>beautiful</i>	<i>un</i> : <i>un soir</i> :: <i>le</i> : <i>le jour</i>  <i>soir</i> : <i>un soir</i> :: <i>jour</i> : <i>le jour</i>	<i>élu</i> : <i>élue</i> :: <i>maître</i> : <i>maîtresse</i>  <i>lawful</i> : <i>unlawful</i> :: <i>honest</i> : <i>dishonest</i> <i>un</i> : <i>unlawful</i> :: <i>dis</i> : <i>dishonest</i>
Place in grammars	Paradigms without overt manifestation	Syntax	Paradigms with overt manifestation
Inscriptions in A-type records	A <i>la le</i> A <i>une un</i>	Structural non systemic analogy cannot be expressed in A-type records	A <i>élue élu</i> A <i>maîtresse maître</i>
Inscriptions in C-type records	Systemic non structural analogy cannot be expressed in C-type records	C <i>un+soir=un soir</i> C <i>le+jour=le jour</i>	C <i>élu +e =élue</i> C <i>maître+sse=maîtresse</i> A A C <i>un+lawful =lawful</i> C <i>dis+honest =dishonest</i> A A
Transitivity	+	+	+
Transposition	+ potential	- impossible	+ potential
Constructibility transfer	-	+	+
Expansive homology	-	+	+

Table 6 Three classes of analogy with abductive movements

### 3.6.7. Partonomy and isonomy

#### 3.6.7.1. Having properties or dispensing with them

For Koenig<sup>106</sup>, partonomy is the characterization of language objects by their properties. Example of partonomic proposition: "all nominals bear case". A few lines further, he opposes *partonomic* to *taxonomic*. This opposition seems to me not to be the most interesting one to be made in the Analogical Speaker.

<sup>106</sup> Koenig 1999a, p. 15.

It seems more productive to oppose partonomy to 'isonomy'. The etymology of isonomy is: same law. In mineralogy, two crystals are isonomic if they are built following the same law. In politics, the ancient French word "isonomie" means equality facing law, equality of civil rights<sup>107</sup>.

In this framework, I propose – this is a slight modification of the meanings above – to call 'isonomy' the fact of following reasons i) attached to the objects themselves, without having to draw on their properties, ii) which get defined exactly at the level at which the objects themselves are defined. The four abductive moments defined above are isonomic because they start from (pairs of) terms to reach (pairs of) terms through movements that only involve the (pairs of) terms and their copositionings.

Isonomy differs from homogeneity: a partonomic theory is homogeneous if all its objects have the same types of properties; this does not make it isonomic. Isonomy is different from merology and compatible with it: parts are not properties. So the maximum contrast of isonomy is indeed with partonomy which is the fact of positing properties.

An isonomic theory is more economical than a partonomic theory because it eschews numerous questions associated with partonomy: i) having to separately describe the structure of the properties (for example trees or lattices of syntactic features), ii) categorical effects of sharp behavioural jumps when moving between different values of a property, iii) conditions under which the value of a property should change to reflect an evolution, etc.

Isonomy facilitates the suspension of minimality (*supra*).

### **3.6.7.2. The Analogical Speaker is isonomic**

The question of analogy-making<sup>108</sup> is always presented as a partonomic process: in the survey made by French<sup>109</sup>, all models are partonomic (details can be found about two of them p. 186). Most linguistic theories are partonomic; some connectionist models only are not.

The Analogical Speaker stresses on the contrary the importance of isonomic dynamics. All four abductive movements are isonomic, this is apparent from their definition. In this model, the analysis of a received utterance will be defined below as a series of structure mappings and the dynamics that accounts for it are entirely isonomic, whereas they are usually viewed as partonomic. In the Analogical Speaker, analysis is isonomic; in it, the parsing itself of the received form is not partonomic; it has to be seen as merological which is not the same thing.

Partonomy has the unfortunate consequence of pushing one into artificial decisions, lexical category assignment for example, which has already been addressed in Chap. 1. Another example is the syncretism of the forms which is a result of positing that a form

---

<sup>107</sup> Littré dictionary.

<sup>108</sup> 'Analogy-making' (also called 'analogical mapping' by some authors) consists of discovering analogies (making them emerge) in a model in which there isn't a notion of analogy before this operation.

<sup>109</sup> French 2002

belongs to a place in a system because of the syntactic features it has as some of its properties; the question is treated in detail p. 160. Isonomy is a corollary of the vacuity of terms the utility of which was shown: terms deprived of properties can only be used by isonomic processes.

So this model concentrates on isonomic dynamics. It demonstrates an isonomic productivity of analogies but it presupposes to that end a body of analogies to start with, which have to be readily available. It does not tell how this initial body is obtained. This is 'priming' which will be met again below. Priming may well draw on different mechanisms, and these may well be partonomic. I do not pretend therefore, that the isonomic dynamics accounts for the entirety of linguistic dynamics, it surely accounts for a very great deal of it.

### ***3.7. General framework of the dynamic side of the model***

I have shown how the static side of the model is structured and can be elaborated. It is a plexus which models the static side of a speaker's linguistic knowledge.

I have just defined four abductive movements; they relate the static side and the dynamic side together by showing how static inscriptions can be conducted into the dynamics.

I have established that these dynamics are abductive and proximal. They are diverse and, as we are about to see, fragmented. Macroscopic results are produced by the synergetic cooperation of simple and numerous processes. The dynamics are controlled by a general frame in which they operate. This frame is now going to be explained. It is deterministic, and organizes the production of results by fragmenting it, ensuring the synergies and the overall operation control.

#### **3.7.1. The linguistic dynamics is a deterministic computation**

In section 3.5.2. *Determinism, idiosyncrasy, normativity* (p. 75) I stated why the dynamics must be deterministic and I indicated how determinism is compatible with high individual detail variation (speaker's idiosyncrasy) all in preserving a quasi-uniformity of external effects (linguistic quasi-normativity).

So the dynamics present themselves as deterministic computations involving details in quantities, which may be very varied. The variation is indeed individual variation because, for a given speaker, the details may differ significantly at two remote moments in the speaker's history, they may differ slightly at two close moments but, at a given moment, the computation is determined.

The computation is deterministic but not algorithmic, it is a heuristic process. Determinism and abduction are not contradictory: abduction, however unsure an inference it is, is nonetheless a procedure which may be deterministic.

#### **3.7.2. Linguistic acts and linguistic tasks**

A speaker's know-how comprises two fundamental linguistic acts: the reception of an utterance and the emission of an utterance. Attention will now move on to the dynamics

of these acts. As to dynamics of learning, it will be addressed in section 8.2. (p. 249); the dynamics of linguistic change is a consequence of that of learning and reanalysis.

The model uses a notion which is close that of linguistic act: the linguistic task. A linguistic task is an entire linguistic act or a part of it which is functionally homogeneous and can be ensured by a defined effector, in conditions that will be specified.

A linguistic act is carried out differently depending on the congruence between its terms and those of the plexus. For example, a given utterance may be received and analyzed easily vis-à-vis a given plexus and difficultly with another one. Depending on the congruence, the computation of the acts then requires uneven computational means. It is a question of cognitive load and this modulation is governed by the escalation principle.

### **3.7.3. Escalation principle**

The escalation principle is also a principle of economy depending on how you consider it. It goes as follows: the dynamics of a linguistic act (as that of any task it may comprise) launches in first rank, processes that are short, therefore economical, starting from the arguments of the act (of the task) they reach inscriptions that are proximal to them. Such a dynamics is little abductive. A short process produces in priority directly attested forms, possibly anomalous ones.

When short dynamics prove unproductive, escalation initiates longer, therefore more expensive processes, soliciting inscriptions more remote from the argument terms. Such processes are more abductive. Either they produce forms that are attested but more remote from the task's terms, or they produce forms that are not directly attested, by assembly. The latter are 'analogical', therefore 'regular'.

The escalation effect is obtained almost without particular care, a simple and sound architecture favouring more direct results. To this 'naturalness' the following model's features (cf. below) contribute: phasing, competition, possible cooperation of different paths, integration of effects.

This explanation encompasses the articulation: "when short dynamics prove unproductive, etc.". This is just a way to put it to introduce the question simply; it must not imply the idea of a particular point in the process where a precise decision would take place to trade short dynamics for longer ones. Actually there are multiple sub-processes of multiple natures, progressing in parallel. Some produce early successful intermediate results and this makes them overcome the unproductive ones, or those with weaker, later results. However, the final effect is the one that has been indicated.

The escalation principle is illustrated in section 6.4. *Anomaly and regularity* (p.181) but it must be understood that it has applications beyond anomaly-regularity; for example it has an important part in explaining the progressive generalization of a new structure during learning, cf. section 8.2. (p. 249).

The presentation of the dynamic model will now proceed in a technical mode but still remain introductory. A more complete specification appears in an appendix, p. 331.

### 3.7.4. Agents

A usual approach in modelling consists of dividing a complex dynamics into smaller fragments. In this case, fragmentation has two converging reasons:

- the complexity, the variety of overall linguistic effects and their sensitivity to multiple factors lead to consider them as a combination of multiple, simple actions,
- if the substrate of language is the neurons, it is accepted that each has a very simple function and is not the locus of an elaborate intelligence. Linguistic intelligence, rather, should obtain as an overall effect. With Minsky<sup>110</sup>, intelligence is expelled from the elementary organs; if one of them were identified as making something too complex, it should have to be replaced with an assembly of simpler organs.

In this model, the computation of a linguistic act is thus fragmented into small functional computation units. Each is assigned to a small organ, functionally specialized, and simple. Such organs are called 'agents', which may initially be perceived as a metaphor for economical agents or for agents occupying a fragmented function in a human organization. However, it is advisable to quickly give up this metaphor and stick to the clauses specifying the agent's behaviour without trying to think them after the ordinary notion of agent.

The plausibility which is claimed is not a literal one. Agents do not match neurons or anything anatomically identifiable. This work is analogy-driven and the functions of agents are defined based on the processing of analogies. This tier is somewhat higher and more linguistic than Minsky's.

Agents have different types depending on the elementary functions necessary in the computation. The main functions which motivate agent types are:

- the comprehension of an utterance,
- the production of an utterance (not developed in the current state of the model),
- similarity suggestion (function in the service of other agents),
- the productive computation in a pluridimensional system which accounts for 'systemic productivity'.

A typical linguistic act engages from a few tens to a few thousands of agents depending on the act and its congruence with the content of the plexus.

An agent<sup>111</sup> is a short-sighted entity; its scope of awareness in the computing environment comprises i) its duty, ii) a few plexus data which match the terms of its duty, and iii) the point to which it delivers its results when it happens to produce any. Upon its creation, an agent is assigned a duty which is a task to fulfil, but the agent does not fulfil it entirely. It fulfils a part of it, which may be viewed as an incremental step. In

---

<sup>110</sup> Minsky 1985, p. 23.

<sup>111</sup> In this section, underlined words have a specified meaning in the model. They are used with this meaning coherently throughout this work and are not interpretable following their meaning in ordinary usage. Please also refer to the glossary at the end.

an incremental step, an agent determines more duties depending on its own duty and on plexus data matching it; these are deemed apt to (abductively) prolong the fulfilment of the agent's duty. The agent then recruits other agents for these duties. Recruited agents are commissioners of the former which thus becomes their client. This takes place in one phase of the computation. The complete computation of an act comprises in general several phases, up to seven, ten, or fifteen; there is no definite limit to this number. Thus, phase after phase, a structure of agents is built which is called the heuristic structure. Examples of heuristic structures can be found Figure 33 p. 337 and Figure 44 p. 364. The heuristic structure has in reality two different modes of edification; in it, some global effects temper the short-sightedness of the agents, please refer to the appendix. An agent – this is not the case for all of them – may come across a favourable condition which holds between the data of its duty and the plexus data that matches it; one such condition is always a coincidence but there are several types of them; it is a settlement condition, the agent then makes a settlement. A settlement is always associated with an element which characterizes it, a term, or a term occurrence in the plexus, or an element of some other nature. This element is a finding. A settlement raises a finding. A finding will end up in a result but with an intervening merging: findings with the same content are merged into the same result. Merging is not detailed here, please refer to the appendix. An example of heuristic structure featuring settlement and merging can be found Figure 33 on p. 264.

A dynamics organized in this way is an 'agent-based solving', abbreviated into ABS. For the technique of ABS please refer to appendix 14, p. 331, which specifies it. The principal notions of ABS are also defined in the glossary.

### **3.7.5. Strengths**

ABS encompasses strengths which reflect lengths of abductive paths, that is, costs (the convention is that a weak result is one which is costly to obtain). In the implemented model, these costs are presented as computational costs and they are interpreted as the homologs of the cognitive costs associated with the linguistic acts.

The first factor influencing strengths is distance from the initial terms: the more remote a finding, the weaker the result. A second factor is reinforcement: when two parallel abductive paths yield the same result, the result is reinforced by the mechanism of merging. The dynamics of strengths is specified in detail p. 346.

### **3.7.6. Channels**

Beside agents, the second important component of ABS is the channel. Channels are points of the heuristic structure which receive results (the latter obtain from the merging of the findings). Any agent delivers necessarily to a single channel which is its delivery point. It is legitimate to see channels as ensuring the syntagmatic dimension in a computation: when a task encompasses terms in syntagmatic mutual position, it opens up exactly one channel per position. By contrast, sets of agents that are clients and commissioners to one another and between which no channel intervenes, are paradigmatic to one another: between all their findings and the terms resulting of these by merging, an exclusive choice must be made. The syntagmaticity of channels has an

application domain broader than just the received acceptance for 'syntagmatic' but it applies in particular exactly to questions of syntax in the most classical sense.

### **3.7.7. Similarity suggestion**

In a global abductive process, similarity suggestion is defined as the sub-function or the sub-process that brings up possibilities, the latter being thereafter settled – or not – that is, validated. Starting from elements of a linguistic task similarity suggestion consists of designating elements similar to them as proper to allow the development of the abductive computation.

Depending on the elements for which we want similar terms to be suggested, similarity suggestion presents two varieties:

- simple similarity suggestion which bears on one term only, cf. p.353. This is principally a matter of distributional similarity.
- copositioned similarity suggestion, which bears on a pair of terms. Copositioned similarity suggestion can be found in agent ANZ, cf. corresponding appendix p. 377.

The former (simple) is a vision of similarity that is conventional and poor. The latter (copositioned) is a richer vision, which is differential and is presented as an effort to take full advantage of analogy. The rest will show to what point this effort succeeds.

Similarity suggestion is dynamic, occurrence-based, and determined by the exemplarist terms of a linguistic task. It suppresses the need to base the productive dynamics on pre established categories. Consequently, it denies to categories the status of a theoretical foundation, to make them a phenomenon which is to be considered phenomenologically.

The general framework of the dynamics also comprises an overall control mechanism which organizes the dynamics in successive phases, chains them up, and ensures overall triggering and activity control. Please refer to the appendix.

We now have available the general frame which makes it possible to introduce particular agent types (Chap. 4 and 5). Agents have different types, each with its own nature, its own duty structure, and its own type of products. Each type also has its own procedures for recruiting commissioners and raising its findings, that is, settlement.

## **3.8. Conclusion**

This chapter promised a lot without yet delivering much – this will be done in chapters 4, 5 and 6. It was long, and yet many details, some even important to the understanding, had to be moved to appendixes in order not to further dissolve the argument.

We have established the static frame and the dynamic frame within which we are now about to build structural productivity (Chap. 4) and systemic productivity (Chap. 5). Next, Chap. 6 will show how some notions of grammar or of linguistic analysis now lose their interest or are reconstructed.





## Chapter 4.

# Structural productivity

Structural productivity is defined as a productivity of assemblies. It is contrasted with systemic productivity which is the productivity in pluridimensional language paradigms and is the subject of Chap. 5. Linguistic productivity as a whole results from the combined interplay of structural productivity and systemic productivity. This dichotomous proposition may have to be complemented upon the extension of the model to semantics but it is sufficient in the current perimeter of this work.

Structural productivity is the basis of syntax. On its own, it does not cover agreement which requires combining structural productivity with systemic productivity. This is why agreement will be addressed in the next chapter, only.

Structural productivity covers morphology and syntax in continuity in the sense that the dynamics do not differ; plexus inscriptions are the warrants of the differences between morphology and syntax.

Emission is not covered in this work because the point where to start from is not clear as long as semantics is not covered. Interpretation cannot yet be treated for the same reason. As to reception, it is treated up to (and including) analysis.

This chapter begins with redefining analysis; in this frame it is necessary to redefine what analysis is. Then a series of commented examples show the dynamics of analysis. Example after example, it progressively defines that which replaces the syntagmatic structure. I demonstrate with an experiment that the notion 'transformation' is not necessary in the theory; with another one, that the notion 'thematic role' is not necessary either; with an example, that categorial homonymy is easily solved in context and that categorial 'disambiguation' ceases to be a question. Finally I propose a solution to the problem of the amalgamation in Romance languages (ex. Fr. *de + le* → *du*) which is theoretically economical.

### ***4.1. Analysis with agents B2, B3***

In a theoretical frame which encompasses categories and rules, to analyse encompasses segmenting the received utterance and assigning to each segment thus determined one of the categories of the theory. This assignment having to follow rules and other

stipulations of the theory, its transformation rules for example<sup>112</sup>. This view cannot be conserved here since rules are not reified and neither are categories. So, in the frame of the Analogical Speaker, the definition of 'analysis' has to be clarified.

The proposed vision is as follows: in an exemplarist theory, the finality of analysis is to achieve a structure mapping – in the sense of Gentner and Holyoak – with an analogous constructor record in the available linguistic knowledge. There may be only one mapping or there may be several ones with several construction exemplars when these are compatible. A mapping should be the best possible one or at least good enough, that is, a mapping is a compromise between its adequacy and the computation cost to obtain it.

The difference with a structure mapping *a la* Gentner is that the latter is one level only; it may be quite elaborate but it encompasses one level only. Here on the contrary, it is necessary to pile up several levels of mappings, to concord with this idea, well understood since Arnauld and Lancelot at least<sup>113</sup> and taken over by Hockett, then by Generativism under the species of the syntagmatic structure – comparable levelling is present in dependency grammars and in all modern syntax theories – that, in utterances, it is necessary to make groupings. Psychology itself may need to make such levelled groupings but we see that it did it much less than linguistics<sup>114</sup>.

The difference between "the best possible one" and "at least good enough" is a question of computational cost vs. the marginal utility for the speaking subject; a sub-optimum is quite sufficient in ordinary linguistic experience and only do invite us to push the effort a little further occasionally, mathematicians, lawyers, and poets.

The view 'analysis as a mapping' will have to include meaning by the time we know how to handle meaning. For the time being, it will be showed at work restrictively in linguistic form alone, that is, in morphology and in syntax.

B2 and B3 are the agents responsible for building analyses for a received utterance. "Analyses" is a plural, this is not indifferent as we shall see. Agent B2 (for "build 2") considers binary constructions (ones with two constituents) and agent B3 ternary ones. Any particular analysis task involves B2 and B3 in solidarity: here, at this phase, it is B2 which succeeds, at another point of the same task, B3 does.

The exposition will be carried out on examples. More abstract and formal descriptions appear in appendixes.

---

<sup>112</sup> With an important reservation however: according to Janet Fodor speaking at University Paris 7, january 8, 2003, *There is no model known at present for applying transformations to parsing; nobody sees how to apply transformational rules to parsing.*

<sup>113</sup> For example this : *La deuxième chose que le relatif a de propre et que je ne sache point avoir encore été remarquée par personne, est que la proposition dans laquelle il entre (qu'on peut appeler incidente) peut faire partie du sujet ou de l'attribut d'une autre proposition, qu'on peut appeler principale.* Arnauld 1960/1997, p. 49.

<sup>114</sup> Although this idea was expressed as early as 1948 by Lashley at the Hinton symposium. Gardner 1987/1993, p. 23.

#### 4.1.1. Example *c'est beaucoup trop grand*

The example in French *c'est beaucoup trop grand* (*it is much too large*) contains several aspects interesting to present while remaining simple enough. The analysis dynamics is activated with the task to analyse the form: *c'est beaucoup trop grand*. The best is to look, phase after phase, at the states reached by the process and to comment them.

The overall principle of the B2-B3 dynamics is that, phase after phase, channels take hold of longer and longer parts of the received utterance. This begins with the smallest discernible units, that is, the smallest segments of the adopted coding, here letters. Channels are instated, each taking hold (and accounting for the analysis of) a 'span' in the utterance. A span is defined by a start and an end. The start is the rank of the first letter of the span, and the end that of the last one. For example, in form "le soleil brille" ("the sun shines"), span <1-2> is the initial "le" and span <6-7> is the "le" of "soleil".

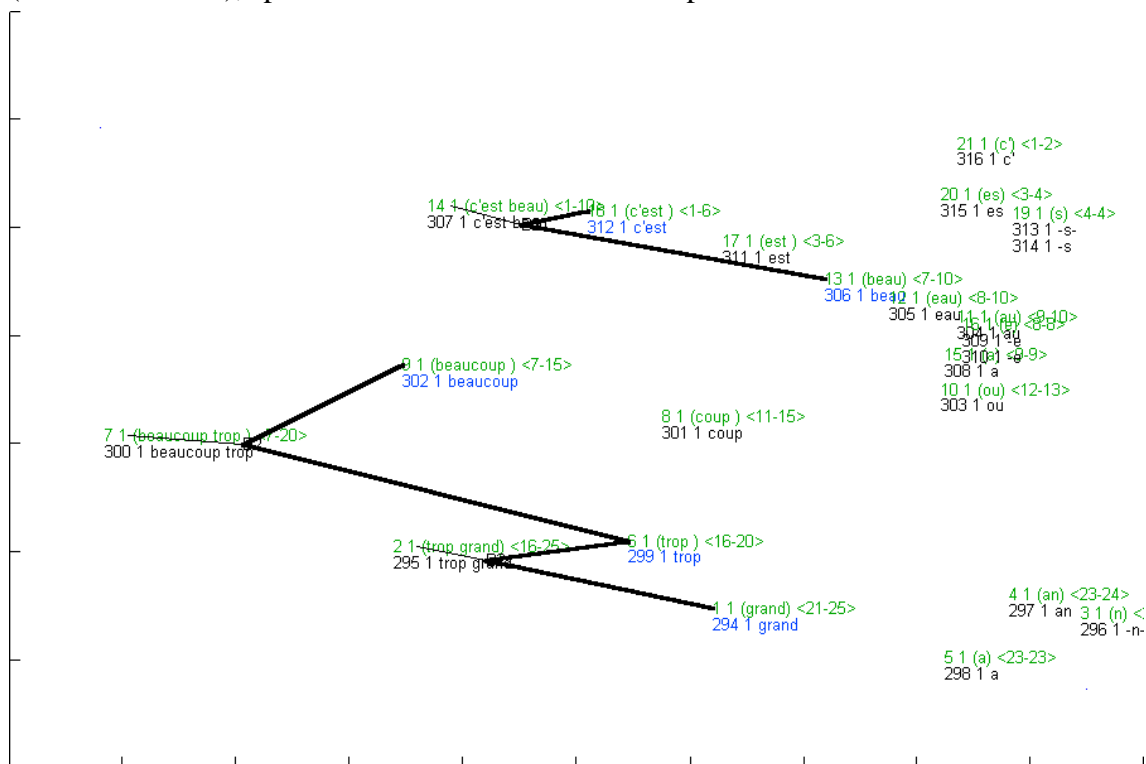

Figure 7 *c'est beaucoup trop grand* after one computation phase

The figure above is produced mechanically, and so are the following ones. They propose successive views of the heuristic structure which, phase after phase, analyse the utterance *c'est beaucoup trop grand*. They display all the channels, but agents remain elided to reduce overload and confusion. The vertical axis maps onto time which runs from top to bottom. Smaller-span channels are at the rightmost side and on the left, the channels spanning the longest parts of the utterance that could be analysed at a given phase. In other words, the maxima of structures (which are the analogs of the roots of generativist trees), which we are used to see at the top, are here presented at the left.

This disposition is adopted to let develop downwards the lists of exemplars (results at channels) which are here necessary.

In form *c'est beaucoup trop grand* the first computation phase identified all occurrences of terms existing in the plexus. For each, a channel is built, the span of which is the bounds, in the analysed form, of the occurrence in question.

On the figure, for example, group:

3 1 (beaucoup) <7-15>  
302 1 [beaucoup]

means that channel 3 was built in phase 1, spanning from letter 7 to letter 15 in the form. The content of this span is (beaucoup)<sup>115</sup>. This group also signals that span (beaucoup) is attested by result 302, produced in phase 1 and resulting from term [beaucoup] which is present as such in the plexus. So far, invention is not very great: the first phase simply picks up homographic matches between the analysed form and the plexus. This is called *installation*.

Note in the rightmost part of the figure a number of small-span channels; for example, in channel 5, segment (a), which is extracted from "grand" (En. *large, great*), is found to coincide with term [a] (En. *has*) that is present in the plexus and is a form of verb Fr. *avoir* (En. *to have*). This is an assumption which the process makes; very soon it will be found unproductive. Should we try to eliminate such hypotheses? The reason might be to grant priority to maximal terms, that is, when several segmentations are possible, to keep the one making the longest terms; this would be adopting a *longest match* principle.

This principle is efficient most often but not always. A counterexample is the following one in Japanese<sup>116</sup>:

form **kô bun shi ryô san**, must be analysed as

<b>kô bun shi</b>	<b>ryô san</b>
macromolecule, polymer	production

despite

**kô bun shi ryô**  
great quantity of polymer

which the longest match principle would favour, but this would leave **san** as an unused residue. Yet the latter analysis would be appropriate in:

<b>kô bun shi ryô</b>	<b>wa</b>
great quantity of polymer	the mark which terminates the topic

In order not discard the analysis that will turn out to be the good one and enable the correct resolution out of possible garden paths<sup>117</sup>, all analyses are kept and, in this version at least, the longest match principle is not applied.

---

<sup>115</sup> Round brackets ( ) are related to a form being analysed. They signal its segmentation by a B2 or B3 agent. Whereas square brackets [ ] are related to terms of a constructor record in the plexus. The record authorizes the particular segmentation the agent makes.

<sup>116</sup> This example is from Zoya Shalyapina of Moscow (verbal communication).

In addition to segments (beaucoup) and (trop), it turns out that segment (beaucoup trop) also finds a direct attestation in the plexus; term [beaucoup trop]. Here is an illustration of the minimality suspension principle: overlapping terms may coexist in the plexus. Channel 7 (beaucoup trop) does this as early as phase 1. To acknowledge this, a B2 agent links channel 7 (beaucoup trop) to channel 9 (beaucoup) and to channel 6 (trop). This is denoted by the three converging lines at the left of the figure; the centre of such a 'star' denotes a B2 agent. This 'assembly' is not very abductive yet: it only reflects a C-type record that exists in the plexus.

Near to the top, the process distinguished segment (c'est beau) because it finds term [c'est beau] in the plexus and matches it with a part of "c'est beaucoup" in the received utterance. This is a pun, and it will not proceed very long along this track because it will not be able to associate this rightwards with (cou), (coup), (coup trop), etc.,

So far, all channels are installation channels and all results are installation results. Phase 1 does exactly installation, its does not innovate; it has not abducted anything yet.

At phase 2, the lists of results below the channels are longer. Under channel 2 (trop grand) for example, are now 21 results, there was just one at the previous phase. For example, result 396 [trop gentil] was produced in phase 2. It was produced as a distributionally or constitutionally similar term of result 296 [trop grand].

This is because the agent in charge of similarity suggestion (agent CATZ, cf. appendix), beside a result existing at a channel, adds phase after phase the most proximal terms of the plexus which have the same distribution. In this particular case, [trop gentil] is constitutionally analog to [trop grand] and has been produced for that reason. Here, we just saw the abductive movement by constructability transfer at work.

Still to be noted under channel 2, is the creation of result 299 [grand]. This creation is remarkable because it is an occurrence of the abductive movement by expansive homology. It could work because the plexus contains the constructor records:

C	c'est + grand	→	c'est grand
C	c'est + trop grand	→	c'est trop grand

in which [grand] and its expansion [trop grand] are homologous. This is an 'expansive gate', cf. p. 86. Result [trop grand] was present at channel 2, the agent in charge of similarity suggestion, 'abductively' appends its homolog [grand] producing result 399. Result 399 will eventually have a consequence.

---

<sup>117</sup> The process of analyzing an utterance goes into a garden path when, upon a syntactic ambiguity, one of the interpretations is first adopted but is later contradicted as not compatible with some element considered later in the analysis. This contradiction pushes to restore the analysis that was initially discarded.

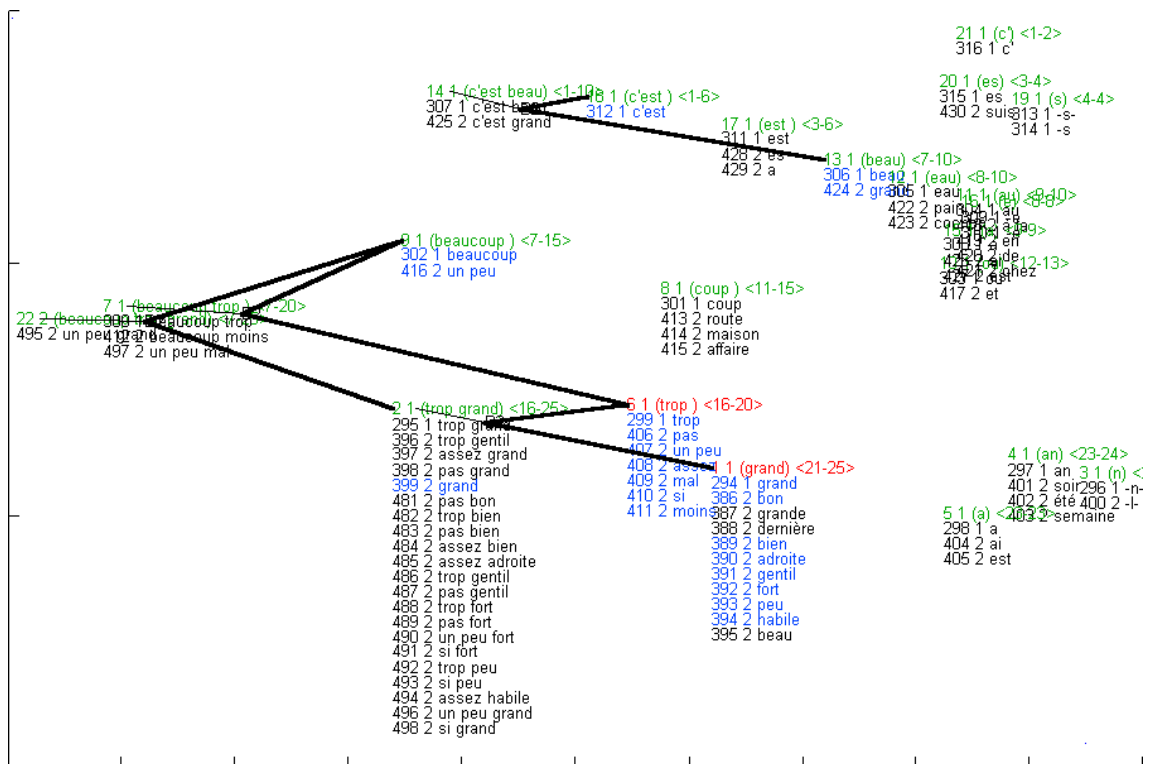

Figure 8 *c'est beaucoup trop grand* after two computation phases

The rightmost bound of the span of channel 9 is fifteen and the leftmost bound of the span of channel 2 is sixteen. Fifteen plus one = sixteen, these channels are adjacent. Because of this, the process creates a B2 agent, the mission of which is to try and see whether the spans of these channels can be assembled – this process assumes concatenative assembly, different types of assemblies are envisaged p. 248.

The spans of channels 9 and 2 are (*beaucoup*) and (*trop grand*), each separately already attested. The question now is whether (*beaucoup trop grand*) would be possible and why. A B2 agent is created to that end. Elided in the figure, it is at the intersection of the bold lines starting leftward from channel 9 (*beaucoup*) and from channel 2 (*trop grand*). The B2 agents operates as follows: taking one after another results at channel 9 and likewise at channel 2, it forms all possible pairs and looks up in the plexus whether the pair occurs as constituents in the same binary C-type record. When this is the case, the settlement condition for agent B2 is met. The record in question is the settlement record. The effect of the settlement is to raise a finding at this agent and the finding is, in the settlement record, the term which occupies the assembly position. Then this finding is merged into a result. Here, result 399 [*grand*] at channel 2 settles with result 416 [*un peu*] at channel 9 because there exists in the plexus record

$$C \quad \text{un peu} + \text{grand} \quad \rightarrow \text{un peu grand}$$

The reader reading this document in colours notes that results 399 and 416 are in blue which means exactly that they took part in a settlement; the blue colour denotes settlement results. The settlement has consequences in the leftmost part of the figure; as

it is confuse here is an enlargement:

22 2 (beaucoup trop grand) <7-25> 495 2 [un peu grand]
---

7 1 (beaucoup trop) <7-20> 300 1 [beaucoup trop] 412 2 [beaucoup moins] 497 2 [un peu mal]
---

**Figure 9 *c'est beaucoup trop grand* after 2 phases of computation (enlarged detail)**

The two effects of the settlement are: a) a channel, channel 22, is created which attests that (beaucoup trop grand) is possible and b) result 495 [un peu grand] is created at the channel. This result is the reason why 'one may say' that (beaucoup trop grand) is possible, that which authorizes this saying. The statute of this authorization is very precisely: that can be said abductively, because there happens to be a particular exemplarist reason to do it; this is exactly what makes the speaker take not too big a risk with this saying: that it will be accepted and understood in general.

There is one result only at channel 22, this is temporary; in next phase another one will be created. In general there can be from one to several results at a channel, which attest the segment corresponding to the channel's span. Below, the importance, or not, of having several results will be discussed.

Channels 1 to 6 are in red, they are extinct. These and the structures which depend on them rearwards – there aren't any yet in this figure – are extinct: they no longer recruit or produce. They are extinct because they bear enough results that settled already. This participates in an overall activity control of the heuristic structure which will be treated in detail below. Channels which stay active are displayed in green colour.

At phase three of the computation, channel 23 (*c'est beaucoup trop grand*) was created. The entirety of the form is now analysed.

After the computation's end, a query issued against the heuristic structure shows the abductions which were made. The advantage of his new figure is that it displays the agents – they were absent in the previous ones. In the jargon of this model the query requests the model to 'expose' channel 23. It is indeed an exposition of the abductive reasons to find the analysed form receivable.



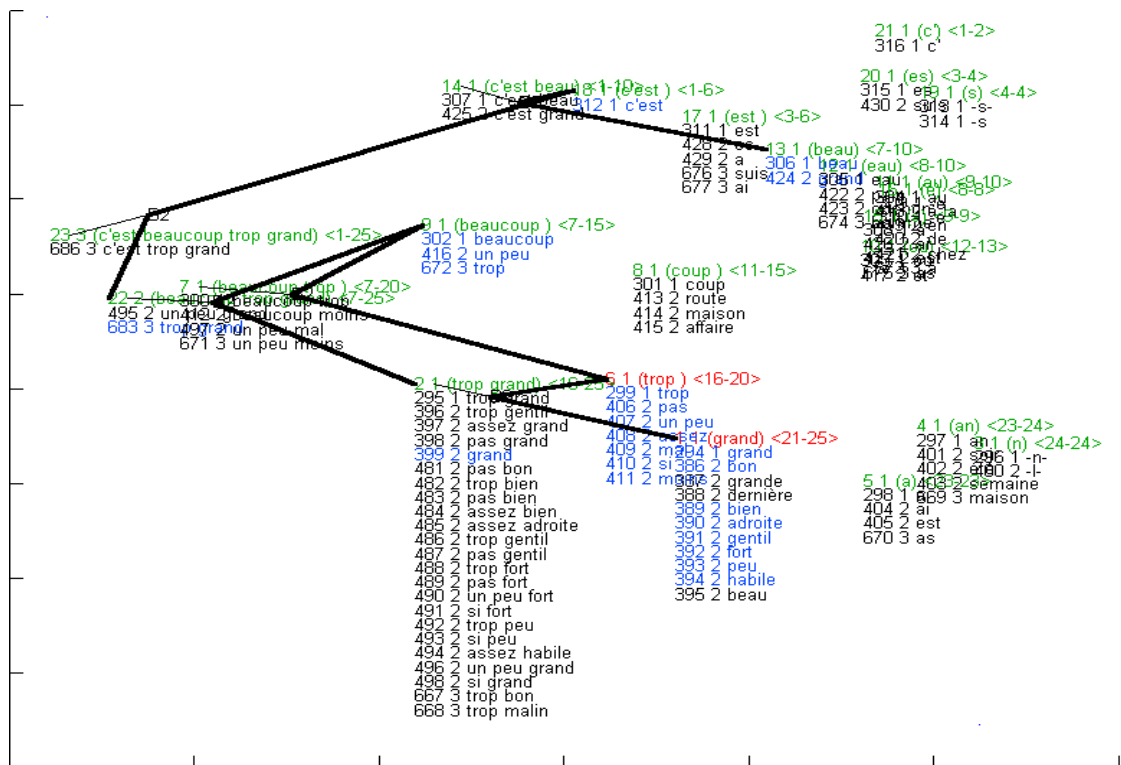

Figure 10 *c'est beaucoup trop grand* after three computation phases

Exposing channel 23	
(c'est beaucoup trop grand)	span of channel 23 (ph 3)
(c'est )(beaucoup trop grand)	how ag 531 segments the span
[c'est][trop grand]	attests the segmentation (finding 684 on record 939)
(c'est )	span of channel 18 (ph 1)
[c'est]	attests as setup term 1614 setting up channel 18
(beaucoup trop grand)	span of channel 22 (ph 2)
(beaucoup )(trop grand)	how ag 208 segments the span
[trop][grand]	attests the segmentation (finding 678 on record 427)
(beaucoup )	span of channel 9 (ph 1)
[beaucoup]	attests as setup term 138 setting up channel 9
(trop grand)	span of channel 2 (ph 1)
[trop grand]	attests as setup term 628 setting up channel 2
[trop][grand]	attests the segmentation (finding 682 on record 693) as per channel 9, already exposed as per channel 2, already exposed

Figure 11 *c'est beaucoup trop grand* after three phases, exposition of the reasons

This exposition of the reasons, which was produced mechanically, may be rearranged as follows:

1	(c'est	beaucoup trop grand)	channel
2	(c'est )	(beaucoup trop grand)	agent
3	[c'est]	[trop grand]	assembly attestation
4		(beaucoup trop grand)	channel
5		(beaucoup ) (trop grand)	agent
6		[trop] [grand]	assembly attestation
7		(trop grand)	channel
8		(trop )(grand)	agent
9		[trop grand]	assembly attestation
10	(c'est )	(beaucoup) (trop ) (grand)	installation channels
11	[c'est]	[beaucoup] [trop] [grand]	installation attestations

**Figure 12 *c'est beaucoup trop grand* after 3 phases, exposition of the reasons rearranged**

The new display reveals a tree the root of which is line 1. Caution: cases happen in which multiple, compatible analyses overlap. The unique, univocal tree is not an obliged theme here.

One observes also that some paths are longer than other ones. This is not surprising.

One notes that [trop], line 6, attests (beaucoup), line 5 while "trop" also occurs in (trop grand) line 5. These two "trop" are not in the same positions.

One is interested to note that the licensing record [trop]+[grand]→[trop grand] is used two times as a settlement record: line 11 and line 6. Syntax presents indeed this recursivity. As it happens in the example, in such two nearing occasions, in these two consecutive assembly steps, the settlement record is the same record. It might not be the case (with another plexus, for the same analyzed form). At one of these levels or at both, there might be more than one settlement record, with their sets having an intersection (as here) or not. In a plexus as scarce as the one used to compute this example<sup>118</sup>, this type of resource apt to license expansions (named 'expansive gate' above) being comparatively rare, the same gate may tend to be more reused than in a more complete plexus where several of them would be available.

Example *c'est beaucoup trop grand*, which has just been commented, features assembly steps with two constituents only, whence the "2" in "B2 agent", the agent that makes these assemblies. Agent B2 acts with plexus records which are binary themselves.

---

<sup>118</sup> 1830 terms, 1250 records only.

#### 4.1.2. B2 agent , B3 agent

The model recognizes the necessity of ternary assemblies along with binary ones. The question of n-arity, as a necessity in this model and as a property of branching, accepted or refused among the generativists, is discussed in detail p. 371. An agent, agent B3 is dedicated to ternary branching; we will see it at work in ensuing examples. Its principle of operation reproduces that of the B2 agent, let alone that adjacent channels are now taken by three to make a B3 agent. Settlement then occurs between three results, one in each of the three channels and the settlement record must now be a ternary C-type record, that is, one with three constituents.

One will have noted that an analysis as performed by a B2-B3 process is a *bottom up* one. Plausibility so demands and it cannot be otherwise since there being no explicit grammar, there being no generative rules; it is not the case that we would have a generic rule giving the *a priori* schemas of a sentence, of the type  $S \rightarrow NP VP$  whereby a *top down* process could start.

#### 4.1.3. Limits and merits of B2-B3

Analysis with B2-B3 does not respect grammatical agreement. *Une beau journée* is accepted as easily as *une belle journée*.

B2-B3 also lacks group sensitivity: it has no notion of conjugation groups in French or declension groups in Russian; it abducts inflexions too freely with respect to what speakers do (cf. p. 169).

These two defects occurring simultaneously is no surprise: both have something to do with systemic analogy. B2-B3 fails on agreement and declension classes because it takes no account of systemic analogy. Agent ANZ (below) takes account of systemic analogy, but it is not capable structural productivity (syntax). In Chap. 5, I show a first association of these two productivities, agent AN2, which is capable of some syntax and observes agreement. But the conjecture is rather that a better solution would require a revision of the very structure of the inscriptions: the current design of the exemplarist constructions (C-type record) would not be sufficient.

Coreference in a broad sense (anaphor, relative subordination, etc.) is not covered. Here again, advances on the structure of inscriptions are a prerequisite.

With these limits and in spite of them, B2-B3 has the merit to perform syntactic analysis without categories or rules. It is a concrete application of the proximity principle (cf. Chap. 3). It is an operable implementation of a situated linguistics, productive within contingency. Two attempts, as far as I know, share this character: that of Skousen and that of Freeman which will be contrasted with this work below.

#### 4.1.4. Syntactic analysis redefined

What is the purpose of syntactic analysis? Not to determine grammaticality. The success or failure of the analysis of particular utterance depends on its compatibility with the plexus, so that there is a kind of *de facto* grammaticality but we know that its precise definition is not possible, even in a language as constrained and normative as French is. Even if it were possible it should not have to be done, firstly because it is not necessary

within this model, and secondly because it would bring the risk of sterility on variation and on learning.

The final utility of analysis is meaning. As long as the model does not cover the computation of meaning, one is never sure that the attestation of an utterance is made for 'good' reasons. This is the current limit in this model's development.

When the model's scope will be broadened so as to encompass meaning, it will be possible to observe, hopefully, heuristic paths directed by meaning, concurrent and simultaneous to ones directed by the form. And also, still hopefully, heuristic paths that associate both.

If this turns out, form and meaning will cooperate in the interpretation. There will be cases in which syntax plays a minor role, thus validating the ancient idea of 'connection' of Tesnière<sup>119</sup>. It will not be the prevalence of one onto the other in general. The respective contributions of form and meaning will be a matter of observation case by case.

When I write 'heuristic path', it is not metaphorical; I understand very practically the process of edification (as illustrated above with B2-B3), assisted by recruiting processes (which will be studied below). That is, the structures comprising the agents that are created by edification and by recruitment (applying abductive movements), and comprising the associated results produced by the settlement process.

## **4.2. About non-transformation**

### **4.2.1. Analogies that motivated transformations**

Transformations appear in Chomsky's writings publicly in 1957 (*Syntactic Structures*) and non-publicly as early as 1955 (*The Logical Structure*, published in 1975 but written in 1955). The reason for transformations is that groups like<sup>120</sup>:

<i>they arrive</i>	<i>they can arrive</i>	<i>they have arrived</i>	<i>they are arriving</i>
<i>do they arrive</i>	<i>can they arrive</i>	<i>have they arrived</i>	<i>are they arriving</i>

demonstrate a systematicity for which the theory must provide an account. Now a grammar which is syntagmatic only provides for this poorly only, in any case, very far from the simplicity which is expected from a theory. Newmeyer later will remind us<sup>121</sup> how the introduction of transformations responded to a simplicity requirement.

---

<sup>119</sup> In *Alfred chante*, there are three elements, says Tesnière; *Alfred, chante* and "the link that unites *Alfred* and *chante*, and without which we would have only two independent ideas, without relation to one another, but not an organized thought." This is the link which Tesnière calls connection. ... The connection sets up automatically between some parts of speech without any mark having to be involved. Lemaréchal 1989, p. 58.

<sup>120</sup> Chomsky 1957/1969, p. 71. This example is taken among numerous other ones which would be possible.

<sup>121</sup> "Chomsky did not question in *Syntactic Structures* that phrase structure grammars are capable of weakly generating the sentences of English. He rather argued that they can do so in a cumbersome fashion and, furthermore, do not come close to assigning the correct structural descriptions to the generated sentences. ... Chomsky's arguments (auxiliation and passive in English) for transformational rules in

The examples above are analogies, the same ones as Bloomfield's (cf. *supra*, p. 34). So the facts motivating the introduction of transformations are analogies; analogies involving form and meaning even if Chomsky, as we saw it, refuses the meaning content of analogy and thence disqualifies analogy. He will adopt generative rules, and, for what matters here, transformations. Let us call "analogies which motivated transformations" analogies as those above.

How should a theory, which refuses categories and rules and intends to account for productivity with analogy, treat such systematicities? The first idea is that, since the analogies which motivated transformations are analogies, the theory must show how it solves the corresponding analogical tasks. Facing a question like:

*X : Pauline sends the letter :: a toy is offered by Alex : Alex offers a toy*

if it responds *X = the letter is sent by Pauline* (and thousands of similar answers) it will be validated. We shall see this idea followed by Itkonen (p. 190). This path is not entirely appropriate because it is not typical of the linguistic knowledge of the speaker; it is typical at best of his epilinguistic knowledge<sup>122</sup>, or even of his metalinguistic knowledge. This is not what we must account for. We must account for the fact that if a speaker can understand the utterances (a) *Pauline sends the letter*, (b) *Alex offers a toy*, and (c) *a toy is offered by Alex*, then he can also understand (d) *the letter is sent by Pauline*.

To this end, it is not necessary to operate analogical tasks<sup>123</sup> but to know how to interpret and produce utterances such as (d) by taking advantage of utterances such as (a), (b) and (c). To be more precise, it is not even necessary to have (a), (b) and (c) available, which would already too favourably share all the required terms (the lexical material) within the required constructional frames.

#### 4.2.2. Jean voit Jeanne, Jeanne est vue par Jean

An example will show the mechanism. It bears on the French plexus in which it concerns only an excerpt<sup>124</sup>, it is built on the following constructor paradigms (each line is a C-type record):

1391	j'appelle	Jean
1392	je vois	Berthe
1393	je retrouve	Victor
1394	j'attends	Berthe

---

*Syntactic Structures* were all simplicity arguments, that is, arguments appealing to weak generative capacity. They all involved showing that a grammar with phrase structure rules alone required great complexity, a complexity that could be avoided only by the positing of a transformational rule". Newmeyer 1986, p. 22-23.

<sup>122</sup> The notion ["epilinguistic"] is from A. Culioli who uses this term to designate the unconscious knowledge which any speaker has of his language and of the nature of language ("language is itself an activity which supposes a permanent epilinguistic activity defined as an unconscious metalinguistic activity"). Auroux 1989, p. 35.

<sup>123</sup> See a definition of 'analogical task' at the beginning of Chap. 5.

<sup>124</sup> Numbers heading the lines will serve as a reference in the exposition (I have adopted the record numbers which are internal in the model's implementation; this explains the large values).

1395	Victor		arrête !
1396	Berthe		viens ici !
1397	Jean		ne touche pas à ça !
1398	c'est	à	Victor
1399	c'est	à	moi
1400	c'est	à	Jeanne
1401	c'est	à	Alfred
1402	Jean	est soigné	par Jeanne
1403	Jean	est séduit	par Berthe
1404	Victor	est vu	par Berthe
1405	il	est soigné	
1406	il	est occupé	
1407	il	est vu	
1416	elle	est vue	
1408	Jeanne	voit	Berthe
1409	Victor	regarde	Jeanne
1410	Alfred	marche	
1411	Jeanne	mange	
1412	je	l'ai	vu
1413	je	l'ai	mangé
1414	par	Jeanne	
1415	par	Berthe	

This excerpt is not isolated in the plexus; the records in it are linked with the rest in multiple manners. It is extracted here only for exposition purposes. Its scope is limited, but it presents the scattering properties which it is useful to illustrate. It contains:

- proper names and the pronoun *moi* which are distributionally similar for varied and converging reasons: direct utterances like 1408, passive utterances like 1402 and other ones like 1395 1398 or 1410,
- some direct utterances like 1408,
- some passive utterances like 1402,
- the analysis of two prepositional syntagms 1414 and 1415.

The lexical material is well scattered across all records. It might be more and the reasons for distributional similarity might be even more diverse: the example would only be more tedious with no functional incidence on the result, there would only be a possible incidence on the computation load and on the number of phases necessary to obtain a result.

Tests passed on the model in the example's domain show in various ways that it is productive of direct utterances, and of passive utterances, the appropriate abductive movements operating in each case on all the resources indifferently, that is, on all the paradigms.



So the proposition is to refrain from defining 'transformation' neither in the sense of Harris or of Gross nor in the sense of Chomsky: the computations applied to the constructional exemplars of the plexus (C-type records) provides for the needs.

The treatment of analogies which motivated transformations may be summarized by the following three clauses: i) the plexus contains exemplars of constructions: affirmative, interrogative, passive, etc., ii) the lexical material is reasonably scattered among them, and iii) ordinary computations are used. This yields effects of cross licensing among the various construction types. This way of doing may be viewed as another figure of integrativity in this model.

As seen from outside, these effects may lead to think that they rest on abstract schemas of passivation applying to direct forms for example but there is nothing of this kind: just abduction based on exemplars.

At this point of the development, we must resist the temptation to consider that inscriptions, by their sole "exemplarist" presence indicate the swaps that are possible between terms and their positions. Doing so would take us to define positions and thence to stipulate the properties required from their potential occupiers; this would imply the reintroduction of categories which would be a regression as a dynamics of copositionings suffices to account for the systematicities at stake.

The solution which was indicated applies to all analogies which motivated transformations which are numerous: passivation, negation, relativation, formation of questions, fronting of various kinds, etc. Actually, their set is open and it evolves as a speaker changes his speaking habits and his language evolves.

Several recent grammatical theories do not postulate transformations. The first one to dispense with them was the *Role and Reference Grammar* (RRG) of van Vallin<sup>126</sup>. Another theory doing without transformations is the *Autolexical Syntax* of Sadock (1991). It is worth noting that both comprise several components, four components each, although they are not the same. They are thus 'pluristructural' because they have several trees which concur in describing the structure of an utterance: each tree accounts for one aspect. None of these structures suffices alone but their union succeeds, according to their authors, in accounting for all the useful properties<sup>127</sup>.

Something similar shows up in the more recent proposition of Jackendoff: his "parallel architecture"<sup>128</sup> which is also pluristructural and transformation-free.

A variety of transformations is however maintained by Chomsky up to the Minimalist Programme (Chomsky 1997a) with the operation MOVE ALPHA.

The suggestion is that the dismissal of transformations is a corollary of a pluristructural modelling. Transformations seem to be wanted when one adopts a univocal modelling

---

<sup>126</sup> van Vallin 1977.

<sup>127</sup> Robinson indicates that RRG needs indeed to have several levels of syntactic representation (S. Robinson, recension of van Vallin 1997 in *Language* vol. 75 # 3, sept 1999) while the *Autolexical Syntax* of Sadock requires trees with several levels.

<sup>128</sup> Jackendoff 2002 *Foundations of Language*, chap. 5 p. 105.



approach. The conjecture would be the following one: it is when you want to rule an utterance by a unique tree that you are most prone to introduce transformations<sup>129</sup>.

Pluristructural grammars reject transformations, like this model, but not for the same reasons: they make a linguistic of language and acknowledge the theme of theory economy. They succeed in this without transformations at the expense of a plurality of trees. This model in turn, does not make a linguistic of a language but a linguistic of acts, and does not stress theory economy. This allows it to reach its goals without transformations and without having had so far to postulate multiple structures. It is ironical to note that the non-recognition of the economy principle gives birth to a model which is remarkably economical in its way. However, it is fair to note also that the coverage is so far restricted to morphology and syntax; yet not even to the entirety of these. It may be the case that the extension within morphology and syntax, and the extension to phonology and semantics, bring pluristructural viewpoints in, without these having necessarily to be embodied in trees that would belong to categorically differentiated planes as is the case with van Vallin, Sadock or Jackendoff.

From all this it follows that deciding whether "*the main, declarative, affirmative, active clause is a more basic kernel type, or a more "neutral" pattern in reference to which all other syntactic types may be described*"<sup>130</sup>, ceases to be a question.

In a plexus, there are propositions of all these sorts. The ability of this speaking subject to constitute paradigms that are constructionally homogeneous (paradigms of interrogations, of imperatives, of passive constructions, of utterances topicalized by fronting, etc. and also of course, paradigms of "*main, declarative, affirmative, active clauses*"), added to the fact that some terms occur in propositions of various of these sorts, are the base on which abductive computations prove able to licence infinitely many other propositions. Licensing may draw on utterances of any sort in the benefit of utterances of any sort, even if some of these sorts have a heavier cognitive weight and thence license more often, but this is not explained by categories, sorts and rules, not even frequencies or probabilities: it is explained by proximal exemplars and occurrences, and by proximal abduction.

### ***4.3. John is too stubborn to talk / to talk to / to talk to Bill***

#### **4.3.1. Scope and intent**

In Chapter 1, we saw the limits of categories of various sorts, including thematic roles. About the latter, here is an example from Chomsky and the associated argument, as reported by Auroux.

One of the typical approaches of the Chomskyan school of thinking in favour of innateness amounts to invoking the lack of another available explanation. It may be

---

<sup>129</sup> The polychromous trees grammar of Cori and Marandin (cf. for example Cori 1998) does not seek to give a particular treatment to analogies which motivated transformations. It happens that it does not have transformations. This case, then, neither confirms, or infirms the conjecture "the dismissal of transformations as a corollary of pluristructural modelling".

<sup>130</sup> Givón 1979, p. 45.

circumscribed in the following argument. Argument *ab absentia* in favour of innateness: X, Y, etc., have property P; now, we have no explanation for property P, therefore, P is generated by an innate mechanism.

One may take as an example the famous argument about *John ate* which is often found in Chomsky in support of the thesis of the poverty of the stimulus, and which he uses again for example in Chomsky 1990b, p. 36-37. Classically, Chomsky gives the following examples:

- (1) John ate an apple
- (2) John ate
- (3) John is too stubborn to talk to Bill
- (4) John is too stubborn to talk to

The argument is about explaining how a subject who never heard (4) may produce or understand it. The empiricist will invoke analogy: (1) is to (2) as (3) is to (4) (suppression of a complement). But, as Chomsky points out, *John* is subject of *ate* in (1) and (2), of *talk* in (3), but not in (4); (4) is a new configuration, therefore something else than analogy is needed to explain that the child understands (4); *so, as we do not see how he might understand, it must have to be innate*<sup>131</sup>.

Here, I leave Auroux pursue his track – he will show that the *ab absentia* argument is not sufficient to conclude to innateness – to myself demonstrate that analogy allows indeed to explain with precision how a speaker who never heard (4) may relate it to inscriptions in his linguistic knowledge. I shall show how this way of making that the already known licenses novelty recognizes in each case who talks and to whom, in other words, who the agent is.

The way to succeed in this is analogical, but counter to the words of an ironical Chomsky reported by Auroux, it does not lie in trying to see a "suppression of complement" that would be licensed by the fact that (1) would be to (2) as (3) is to (4). Rather, much in the way in which passive was treated *supra*, it consist in resting on a computations, applied to a set of records in the plexus. It will yield integrative effects which are "naturally" sub-categorizing; they will be respectful of the agentive orientation.

For its processing, this case will be grouped with another classical one: *John is easy to please* - *John is eager to please*, which is similar in a way and for that reason integrated into the same experiment. The latter question is known in the literature as that of control:

With "control" one refers to regularities of the type: *J'ai promis à Pierre de venir / J'ai permis à Pierre de venir* (*I promised Peter to come / I permitted Peter to come*). The subject of the infinitive clause is not the same in both utterances. This difference may not be predicted from general syntactic phenomena because syntax, in this case, rather perceives similarities between the two verbs. The difference then has to derive from individual (lexical) properties of terms *promettre* and *permettre*. So the notion of control tells that a defined verb has the power to attribute a defined reference to the null subject of the complement infinitive proposition, by selecting to that end such or such

---

<sup>131</sup> Auroux 1998, p. 88.

controller: subject or complement in the main clause, this will depend on the particular verb. Milner 1991, p. 18.

The two cases are different but both present the following similarities: i) utterances in which the agent of the second verb is the subject of the first one, and ii) ones in which the agent of the second verb is not the subject of the first one. These critical pairs have the same syntax only if one adopts a formal and categorical vision of syntax. The proposed direction to handle these cases consists rather in recognizing that speakers do not do that because the perception that they have is informed with meaning and they make structure mappings only between utterances that deserve it, taking consideration of their meanings, in particular of the agentive orientation of the verbs.

Example *John is ...*, this was pointed out by Chomsky, has a further interest because it presents a "non-monotonicity" in the following way:

	<b>Utterance</b>	<b>Who talks</b>
(1)	<i>John is too stubborn to talk</i>	John talks
(2)	<i>John is too stubborn to talk to</i>	someone else talks
(3)	<i>John is too stubborn to talk to Bill</i>	John talks

The agent of *talk* changes twice as the utterance is prolonged. To make justice to this complication, a model with approximate commutations will not suffice; it must be very precise in the account it takes of something which underlies these utterances. In generativist propositions, this is the phrase structure. It is postulated, explicit, and its very definition supposes grammatical categories for terminal points (lexemes, morphemes) and categorial labels for syntagms. Without these, its definition could not even be stated. There is no intent here to deny the phrase structure: something of that kind is obviously at work in the dynamics of language acts. I rather undertake, abstaining from reifying it, to render its effects with simpler theoretical postulations:

- a) inscriptions which refrain from making improper analogies,
- b) the already described abductive movements (the first three ones only contribute here, transposition does not).

What I intend to show with these examples is that if, in the plexus, paradigms make no confusion as to the agentive roles, then no confusion either will be made about new utterances proposed for analysis: the analysis process will find them licensed by licensing records that are compatible with them in this respect. If this obtains, it means that, for this model, the differentiation of agentive roles, if granted once, is then productively prolonged with robustness. This property will be all the more remarkable if it obtains against the severe non-monotonicity described above.

The focus is now placed on a plexus excerpt pertinent for these examples. The example is built in the English plexus in order to be faithful to the utterances, because the construction with postponed preposition is particular to English. Below, each paragraph is a plexus paradigm; the presentation which is made does not show precisely the graph of the paradigmatic links. Graph structure, and likewise familiarity orientation (here there are none), are not very important in this case as the paradigms are small.

As in the example in the section on "non-transformation" above, the lexical material directly useful in this example is complemented with terms foreign to it and the set of

terms thus obtained is scattered among paradigms of different constructions: ones that are critical for the examples and other construction types. This helps making the experiment less *ad hoc* and enhancing its demonstrability. Records contribute in either or both the following ways: i) provide a base for distributional similarity of terms, that is, provide a base for the suggestion of similarities, and ii) provide occasions of constructability transfer and of expansive homology (that is: provide expansive gates) to enable the B2-B3 analysis process.

### 4.3.2. Excerpt of the English plexus

The major principle observed in this zone of the plexus is that, for constructions with a second verb (V2), we keep in separate paradigms:

- records in which the agent of V2 is the subject of V1 (marked + below) and
- records in which the agent of V2 is not the subject of V1 (marked - below).

This gives pairs of paradigms like (P01+, P01-). This principle also applies to constructions which assemble forms that can only be constituents of the previous ones.

Other paradigms, less proximally affected by role differentiation do not undergo this distinction. Their use by the computations will be the occasion of leakage in the "categoricity" which interests us here, but these will be second order and the first order which is guaranteed by + and - pairs will finally ensure well separated results as will be shown.

As an organization measure, the samples below are arranged into 'verbal constructions' and 'non-verbal constructions'. This does not incur that 'verb' has the slightest place in the theory, the reader now understands this well.

#### 4.3.2.1. Excerpt of the English plexus, verbal constructions

##### P01+ [the agent of V2 is the subject of V1]

63	Alice	is	willing to walk	Alice is willing to walk
----	-------	----	-----------------	--------------------------

##### P01- [the agent of V2 is not the subject of V1]

98	the job	is	too big to deal with	the job is too big to deal with
97	Al	is	too dishonest to	Al is too dishonest to
...			work for	work for
58	Fido	is	too big to take away	Fido is too big to take away
52	French	is	easy to learn	French is easy to learn
54	Spanish	is	easy to understand	Spanish is easy to understand

##### P02+ [the agent of V2 is the subject of V1 (expected on the left)]

86	too stubborn	to	talk	too stubborn to talk
87	too lazy	to	work	too lazy to work

##### P02- [the agent of V2 is not the subject of V1 (expected on the left)]

55	too big	to	take away	too big to take away
56	too difficult	to	understand	too difficult to understand
66	too difficult	to	please	too difficult to please

##### P03- [the agent of V2 is not the subject of V1 (expected on the left)]

93	too	dishonest	to work for	too dishonest to work for
----	-----	-----------	-------------	---------------------------

94	too	large	to deal with	too large to deal with
95	too	big	to deal with	too big to deal with

**P04+ [the agent of V2 is the subject of V1 (expected on the left)]**

46	willing	to	please	willing to please
45	eager	to	win	eager to win
47	willing	to	walk	willing to walk
48	trying	to	understand	trying to understand

**P04- [the agent of V2 is not the subject of V1 (expected on the left)]**

43	easy	to	understand	easy to understand
44	difficult	to	do	difficult to do
53	difficult	to	learn	difficult to learn

**P06**

30	John	is	serious	John is serious
31	Alice	is	stubborn	Alice is stubborn
57	Fido	is	big	Fido is big
32	London	is	big	London is big
96	the job	is	big	the job is big
91	French	is	easy	French is easy
33	Tokyo	is	too big	Tokyo is too big

**P08**

35	meet	with	Alice	meet with Alice
36	speak	to	her	speak to her
34	talk	to	him	talk to him
90	talk	to	Pamela	talk to Pamela

**P10**

64	I	seldom	talk	I seldom talk
65	I	often	understand	I often understand

**P12**

80	I	talk to Pamela	I talk to Pamela	
79	I	talk to him		talk to him
68	I	talk		talk
73	you	go		you go
69	I	see		I see
75	you	accept		you accept
74	you	apologize		you apologize

**P13**

81	he	is		he is
82	he	will be		he will be

**P14**

40	see	daddy		see daddy
41	understand	French		understand French
42	please	him		please him

**P16**

49	to	see		to see
----	----	-----	--	--------

50	to	go		to go
51	to	understand		to understand

**P20**

88	to	go	with	to go with
89	to	work	for	to work for
92	to	deal	with	to deal with

**P22**

61	don't	talk		don't talk
62	don't	talk to him		don't talk to him
67	don't	go		don't go

**4.3.2.2. Excerpt of the English plexus, non-verbal constructions**

**P50**

37	too	big		too big
38	too	lazy		too lazy
70	too	difficult		too difficult

**P52**

71	very	stubborn		very stubborn
72	so	difficult		so difficult

**P56**

76	happy	to	go	happy to go
77	ready	to	go	ready to go

**P58**

59	me	and	Alice	me and Alice
60	me	and	Bill	me and Bill

The plexus sample contains the following expansive gates (cf. section 3.6.4.2. *Expansive gate*, p. 86), the part which is not underlined is the expansion:

too big, (records 32 and 33)  
talk to him, (records 61 and 62)  
too big to take away, (records 33 and 58)

Several tests were made with this plexus; their results are summarized in the table below, and then discussed. For five tests, here is a summary execution report which was mechanically produced; it displays a first level detail of the abductive paths leading to the results, that is, of their 'reasons'.

In the reports, the round brackets ( ) still apply to the form submitted to analysis and denote its segmentations by a B2 agent or a B3 agent, and square brackets [ ] denote C-type records which license the forms and justify their segmentation.

Mentions at the right are mechanically produced by the model and complement the explanation of its operation. They may be skipped at first reading; they assume the understanding of the detail of B2 and B3 agents which is given in an appendix, p. 361.

#### 4.3.3. Test A: *John is easy to please*

(John is easy to please)	span of channel 9 (ph 3)
(John )(is )(easy to please)	how ag 101 segments the span
[Fido][is][too big to take away]	attests the segmentation (finding 191 on record 58)
(easy to please)	span of channel 7 (ph 2)
(easy )(to )(please)	how ag 60 segments the span
[too big][to][take away]	attests the segmentation (finding 177 on record 55)
(easy )(to please)	how ag 96 segments the span
[French][is][easy to learn]	attests the segmentation (finding 241 on record 52)
[Al][is][too dishonest to work for]	attests the segmentation (finding 263 on record 97)
[the job][is][too big to deal with]	attests the segmentation (finding 271 on record 98)

#### 4.3.4. Test B: *John is eager to please*

(John is eager to please)	span of channel 8 (ph 2)
(John )(is )(eager to please)	how ag 63 segments the span
[Alice][is][willing to walk]	attests the segmentation (finding 95 on record 63)
(eager to please)	span of channel 7 (ph 2)
(eager )(to )(please)	how ag 38 segments the span
[willing][to][walk]	attests the segmentation (finding 86 on record 47)

#### 4.3.5. Test 1: *John is too stubborn to talk*

(John is too stubborn to talk)	span of channel 11 (ph 2)
(John )(is )(too stubborn to talk)	how ag 110 segments the span
[John][is][ready to accept]	attests the segmentation (finding 234 on record 83)
(too stubborn to talk)	span of channel 2 (ph 1)
[too stubborn to talk]	attests as setup term 169 setting up channel 2
(too stubborn )(to )(talk)	how ag 108 segments the span
[too stubborn][to][talk]	attests the segmentation (finding 177 on record 86)
[Clara][will be][ready to apologize]	attests the segm. (finding 236 on record 85)
[Al][was][too stubborn to talk]	attests the segmentation (finding 246 on record 84)
[Fido][is][too big to take away]	attests the segmentation (finding 361 on record 58)

#### 4.3.6. Test 2: *John is too stubborn to talk to*

(John is too stubborn to talk to)	span of channel 17 (ph 5)
(John )(is )(too stubborn to talk to)	how ag 293 segments the span
[the job][is][too big to deal with]	attests the segmentation (finding 447 on record 98)
(too stubborn to talk to)	span of channel 16 (ph 5)
(too )(stubborn )(to talk to)	how ag 202 segments the span
[too][big][to deal with]	attests the segmentation (finding 439 on record 95)
[Al][is][too dishonest to work for]	attests the segmentation (finding 474 on record 97)
[Fido][is][too big to take away]	attests the segmentation (finding 477 on record 58)

### 4.3.7. Test 3: *John is too stubborn to talk to Bill*

(John is too stubborn to talk to Bill)	span of channel 21 (ph 6)
(John )(is )(too stubborn to talk to Bill)	how ag 374 segments the span
[AI][was][too stubborn to talk]	attests the segmentation (finding 534 on record 84)
(too stubborn to talk to Bill)	span of channel 20 (ph 6)
(too stubborn )(to )(talk to Bill)	how ag 210 segments the span
[too stubborn][to][talk]	attests the segmentation (finding 530 on record 86)
[John][is][ready to accept]	attests the segmentation (finding 619 on record 83)
[Clara][will be][ready to apologize]	attests the segmentation (finding 620 on record 85)
[Fido][is][too big to take away]	attests the segmentation (finding 651 on record 58)

### 4.3.8. Table of results

In the table below, each line is a test: the utterance in the first column is given to the model for analysis.

Column 2 indicates the expected agent of the second verb (V2). Mention "*one*" stands for the indefinite person.

Column 3 indicates the agent of V2 actually found by the model: it is the agent of V2 in the licensing record, that which settles. The mention is preceded by the number of the computation phase in which the result is obtained.

For each tested utterance, the process is continued well further the first result in order to test the model's resilience: we would not like discordant results to come up too soon behind a first concordant one. So there are several results per test.

In the last column, an = sign indicates that the obtained agent concurs with the expected agent: the model analysed well. This is to be understood in the sense that the model matches the proposed utterance with an analog (the settlement record) in which the agentive roles have homolog syntactical manifestations. An X on the contrary indicates that the model found a settlement record discordant in this regard.

Mention 'exhaustion' means that the plexus was exhausted: the heuristic process stopped by lack of more data to envisage. The English plexus used in this experiment is small. A larger plexus would not reach exhaustion that fast.



Test	Expected agent of V2	Ph Agent of V2 obtained by the model	= / X
A <i>John is easy to please</i>	one (pleases John)	3 one (takes Fido away) 4 one (learns French) 5 one (works for AI) 6 key (fits with lock) exhaustion	= = = = =
B <i>John is eager to please</i>	John (wants to please)	2 Alice (wants to succeed) exhaustion	=
1 <i>John is too stubborn to talk</i>	John (talks)	2 John (ready to accept) 2 Clara (apologizes) 2 AI (talks) one (takes Fido away)	= = = X
2 <i>John is too stubborn to talk to</i>	one (talks to John)	5 key (fits with lock) 7 one (works for AI) 8 one (takes Fido away) 9 one (learns French) exhaustion	= = = = =
3 <i>John is too stubborn to talk to Bill</i>	John (talks to Bill)	AI (talks) John (accepts) Clara (apologizes) one (takes Fido away)	= = = X

Table 21 *John is easy to please*, grammatical tests

Test	Expected agent	Ph Obtained agent
L <i>John is too stubborn to please</i> (ambiguous test)	ambiguous	3 one (takes Fido away) 5 one (learns French) 5 one (works for AI) 6 key (fits with lock)
X <i>Clara is ready to apologize to</i> (agrammatical test)	agrammatical	at phase 8, exhaustion without result
Y <i>AI is happy to accept with</i> (agrammatical test)	agrammatical	at phase 8, exhaustion without result

Table 21 *John is easy to please*, non-grammatical tests

#### 4.3.9. Results comment and conclusions

Tests A and B: the obtained agent concords with the expected one. The response is satisfying. Test B was analysed easily at phase 2 and test A was more expensive (phase 5). An optimalist interpretation of this cost difference would be that B satisfies the constraint 'it is preferable that the subject be the agent' whereas test A violates it. Then it would be the case that *de facto* the plexus embodies something of that constraint

without the thing having been sought or prepared. I write in the conditional because this point is only noticed without it being possible to make it a formal proposition; for this, more systematic tests on a larger plexus would be required.

Test 1. Three concordances in phase 2, one discordance in phase 5. The response is well separated and good.

Test 2. Four concordances between phases 5 and 8, then exhaustion. This is good.

Test 3. Three concordances (ph. 6 and 8) and a discordant result, but later (phase 10). The separation is good.

Test L. The utterance *John is too stubborn to please* is deemed difficult to interpret by four speakers (three from the United States, one from England): they find it hard to determine whether John has to be pleasant or someone else has to please him. Some opt of one conclusion, other ones for the alternate one, and the reasons they give are third order reasons. A model which would do justice to this should settle late and perhaps balance the interpretations. Here, a first result is produced at phase three which is early. The four results obtained between phases three and six all have the same orientation: the model univocally thinks that the point is to please John.

Tests X and Y: two sheer ungrammaticalities are simply refused by the model, which is good.

Let alone test L, in which results should be late and balanced to reflect speakers' judgements, all other results are good. In its current status, the model is not expected to treat appropriately test L because the difficulty it poses to the speakers is one of interpretation in which agentivity is not the original cause; we should rather see the absence of congruence between '*too stubborn*' and '*to please*'; contradictory conditions between the too hinder the easy stabilization of any interpretation. To render this, a more extended coverage of meaning should be a prerequisite.

It has just been shown, in a series of cases which are complex enough, that if we take account of speaker judgments as to the agent of verb 2, and if we respect them by not pretending to make analogous, inscriptions in which the agent is the subject of the first verb and ones in which it is not, these separations in the plexus are productively prolonged with robustness.

There are no more categories or rules than previously, here again, it suffices to rely on exemplarist inscriptions among which proximality conditions are allowed to play. What has just been shown is that the same dynamics as before, can also produce effects of agentive roles (or thematic roles depending on the authors).

Later, to treat these sentences, Chomsky will postulate the abstract pronominal element" PRO:

... a subject or an object may be an empty element that is mentally represented. More complex examples show that both simultaneously can be empty elements, as can be expected. Consider sentences (22) and (23):

(22) *John is too stubborn to talk to Bill*

(23) *John is too stubborn to talk to*

We understand these sentences respectively as:

(24) *John<sub>i</sub> is so stubborn that he<sub>i</sub> will not talk to Bill*

(25) *John<sub>i</sub> is so stubborn that one cannot talk to him*

These examples are particularly interesting because the subject of the transitive verb is interpreted differently in both cases: it is understood as designating *John* in (22) and an arbitrary person in (23). However, these sentences differ only by the explicit presence of the object which is overt in (22), but absent in (23). These strange facts also derive from the binding theory, if we suppose that the "interpreted subject" and the "interpreted object" are in fact mentally represented, as in (26) and (27), which correspond to (22) and (23), respectively:

(26) *John is too stubborn [PRO to talk to Bill]*

(27) *John<sub>i</sub> is too stubborn [PRO<sub>j</sub> to talk to X<sub>k</sub>]*

What I represented here by PRO must be understood as an abstract pronominal element, that is, a pronoun without a phonetic content. The binding theory allows PRO to be bound to *John* both in (26) and in (27) and another sub-theory, the theory of control, imposes this binding in (26). Chomsky 1981/1984 (retranslated from French).

To this "abstract element" apply the same critics as those which will be made to the zero element, cf. section 6.3. *Zero* (p. 176). The solution I propose also dispenses with calling on this artefact.

This section has shown how some complex effects, which other theories ascribe to a syntagmatic structure or to various artefacts like PRO or coreference indices, may be rendered more simply by a plexus – provided it does not flout speakers' intuitions – and by simple abductive movements.

Success in the treatment of the three cases *John is too stubborn to talk*, *John is too stubborn to talk to*, *John is too stubborn to talk to Bill*, despite the non-monotonicity (cf. above) in them, shows that the separation of effects does not require to reify structures and to base them on reified categories and rules: they can be obtained with simpler analogical dynamics.

#### **4.4. Amalgamations, article-preposition contraction in French**

Amalgamation phenomena like, in French, the contraction of an article with a preposition (*de + le* → *du*, *à + le* → *au*, etc.)<sup>132</sup> are an occasion of worry for category-based theories and they constitute a limit of morphemic analysis. Martinet, for example<sup>133</sup>, describes the problem fairly, regrets that it makes "difficult, if not impossible to distinguish the successive 'monèmes' in the utterance", but proposes no solution, be it only descriptive. In theories which, in addition, want their descriptions to be univocal, the dilemma becomes intractable: either they analyse (au)(marché) / (à la)(fête) and miss (à)(un marché) / (à)(une fête), or the contrary. In addition, they have to complexify the system of the lexical categories. Whatever the option, either generalizations are missed, or non-motivated options are imposed. This double bind can

---

<sup>132</sup> Similar phenomena are present also in Portuguese, in Gascon, in Catalan where they even have a broader extension.

<sup>133</sup> Martinet 1979, p. 6.

be broken only by accepting that analyses (structure mappings for us) can happen following the two manners: grouping preposition + article, and also ungrouping them, then allowing the article to assemble with the noun if necessary.

This is what Sadock makes. He mentions the question as, in Hockett, that of the "portmanteau" morpheme:

The term "portmanteau" was first used by Hockett 1947 to describe the behaviour of French *au*, which, he argued, had to be seen as a single morph (because it is a single phoneme) which nevertheless represented a sequence of the two morphemes *à* and *le*. Hockett correctly noted several advantages in this analysis, including the elimination of a morpheme with otherwise unattested behaviour, i.e. one that took N-bars directly into prepositional phrases, and the provision of an account for a defective distribution of *à*, which occurs before *là* but not before *le*, vis-à-vis the majority of the other prepositions in the language, which occur in both positions. Despite the disarming simplicity and intuitive appeal of Hockett's analysis, it is not one that could comfortably be maintained in theories with a strictly hierarchical relation between morphology and syntax. Several attempts have been made to deny the syntactic complexity of *au* and to attribute it to a fresh category that otherwise does not occur except in *du*, *des* and *aux*, or to posit new mechanisms of grammar to account for it. Sadock 1991, p. 188.

Hockett's solution being incompatible with a "strict hierarchy between morphology and syntax", Sadock, along the lines of his *Autolexical Syntax* which makes provisions for several trees, each more simple, models the phenomenon with two trees. The structural schema is the following:

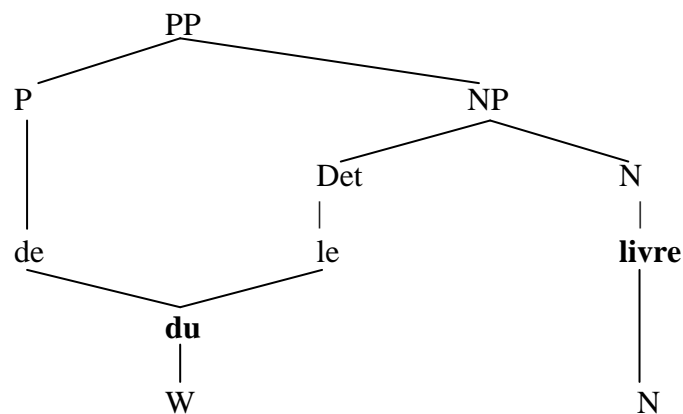

Figure 13 Sadock's treatment of the amalgamation in Fr. *de +le* → *du*

In this way, he makes room for "morpheme" W while rescuing the formulae NP → Det + N and PP → P + NP since he believes they are necessary.

Without requiring so complex and so formal an apparatus, the model proposed in this work allows either grouping to be made, or both, contingently and occurrentially, depending on the needs. Its allows this as a consequence of the principle of multiple analysis and of the minimality suspension principle which lets terms be defined at various levels without constraining them to any preset minimality. An example will show the process better.

The B2-B3 process is asked to analyse form: *à la campagne*. An analysis by [à] [la ville]<sup>134</sup> is found in phase 2 but, at phase 4, the same form *à la campagne* is segmented in another manner. Figure 14 below "exposes" the "reasons" which the model finds to license *à la campagne* (licensing records are in bold typeface).

"Exposition" of channel 12	
(à la campagne)	span of channel 12 (ph 2) = <i>form to analyse</i>
(à )(la campagne)	how ag 181 segments the span
<b>[à][la ville]</b>	attests the segmentation (finding 355 on record 1388)
(à )	span of channel 11 (ph 1)
[à]	attests as setup term 264 setting up channel 11
(la campagne)	span of channel 4 (ph 1)
[la campagne]	attests as setup term 2199 setting up channel 4
(la )(campagne)	how ag 178 segments the span
[la][ville]	attests the segmentation (finding 350 on record 1383)
(la )	span of channel 9 (ph 1)
[la]	attests as setup term 1 setting up channel 9
(campagne)	span of channel 3 (ph 1)
[campagne]	attests as setup term 2198 setting up channel 3
[la][France]	attests the segmentation (finding 704 on record 483)
<b>[à][Paris]</b>	attests the segmentation (finding 709 on record 490)
<b>[pour][la France]</b>	attests the segmentation (finding 716 on record 353)
(à la )(campagne)	how ag 179 segments the span
<b>[à la][ville]</b>	attests the segmentation (finding 351 on record 1389)
(à la )	span of channel 10 (ph 1)
[à la]	attests as setup term 300 setting up channel 10
(à )(la )	how ag 182 segments the span
[à][la]	attests the segmentation (finding 226 on record 40)
<b>[en][France]</b>	attests the segmentation (finding 707 on record 491)
<b>[en][ville]</b>	attests the segmentation (finding 711 on record 1385)

**Figure 14 Analysis of *à la campagne***

In another plexus, the order of the licensed segmentations could be different: form *à la campagne* might be licensed first and stronger by an amalgamated record, or might be simultaneously licensed by two records, one amalgamated and the other not

<sup>134</sup> Reminder of the bracketing convention : round brackets ( ) denote the segmentations made in the analysed form, and square brackets [ ] mark the terms of C-type records in the plexus whereby the form is analysed (the licensing records). Thus, [à] [la ville] means that (à la campagne) is segmented as (à)(la campagne) and that the segmentation is licensed by the constructor record *à+la ville* → *à la ville*.

amalgamated. This is contingent and depends on the congruency between a particular plexus and a particular form.

In the example as it was computed, form *à la campagne* happens to be segmented as (à)(la campagne) and concurrently as (à la)(campagne). Each segmentation allows different licensing records to play. Segmentation (à la)(campagne) is licensed by [en][France], [en][ville], it could also be licensed by [au][Canada] in comparable cases.

I now conclude that: i) the model is non-sensitive to the article-preposition amalgamation which it treats by a double analysis; licensing may be made by records with amalgamation and by records without amalgamation; ii) therefore, the phenomenon of amalgamation does not constitute an obstacle to reach faster the records which are closer to the task's terms, iii) when the model will be extended to treat meaning, the computation of meaning will thus have the best sources available, that is, those which have the greatest congruence with the argument, no matter this anomaly.

Similar behaviours obtain with other types of amalgamations<sup>135</sup>. The means utilized to obtain these results are non-specific. Multiple analyses, as shown here, also happen in cases without amalgamation.

In summary, when the question arises to relate a new utterance to its best analogs, that is, the closest ones, those which provide for interpretative bases in meaning computation, accidents like amalgamations with a diachronic phonetic reason, or numerous other anomalies whatever their reason, tend to become indifferent.

Thence, in a framework making room to processes concretely at work in a particular speaker, spending time trying to figure out with what components *du* and *au* are made up become futile. The smaller branches which would subdivide these bottoms of trees (or lattices) are useless<sup>136</sup>.

The case just exposed can also be construed as an expression of the proximity principle or of the avoidance of totalism: it ceases to be necessary to have a unique analysis frame which would exhaust the set of all phenomena and anticipate all local complexities. Local and occurrential connections which look almost *ad hoc* obtain with the combined play of mechanisms which are not *ad hoc* at all: they are non-specific.

#### ***4.5. Questions not addressed in this chapter***

The treatment of reception acts has been restricted to formal analysis because interpretation requires meaning issues to be covered, and they are not in the perimeter of this work. For the same reason, acts of production could not be treated either.

---

<sup>135</sup> It is conjectured, but not yet demonstrated, that similar treatments apply to a number of morpho-syntactic peculiarities and to phonological phenomena.

<sup>136</sup> They are useless in morphology and syntax in the service of meaning production, if one adopts an orthographical coding as the base for inscriptions, but different ones might be useful if one envisages to relate morphology and syntax with morpho-phonology and prosody in a model that would extend its ambitions in this direction.

Anaphor, relativation, and coreference more generally have not been covered. Remote dependencies are not treated. The conjecture is that the current structure of the C-type record does not suffice: it is too simply Harrissonian.

Agreement and concord were not treated because the apparatus of structural analogy alone does not have that power. A step in this direction will be done in the next chapter by involving systemic analogy.

#### **4.6. Conclusions on structural productivity**

The general frame for the dynamics which was defined in Chap. 3 has been applied to analysis: the present chapter began with the redefinition of analysis as a dynamics of staggered structure mappings; then an implementation was provided with agents B2 and B3.

The dynamics demonstrates a base productivity in about the same domain as that of first period Generativism (*Aspects, Syntactic Structures*), but this productivity is based on exemplars and uses proximity. It produces *effects* of syntagmatic structure without positing a reified syntagmatic structure, which is more flexible and has several advantages.

It is not affected by cross-categorial homonymy which is solved easily in context.

It produces systematicity effects between sentences of different types without requiring a transformational apparatus: dispersion-distribution of the lexical material across sentences of different types suffices to systematicity.

Concerning inscriptions which are formally analogous but in which agentivity is differently disposed (*easy to / eager to*), provided that they are not made directly analogous in the plexus, that is, provided that speaker judgments are respected, these separations are productively prolonged; in each case, novel utterances are licensed by inscriptions presenting compatible agentive orientations. This provides a correct base for ensuing interpretation.

In another example, the same prorogation obtains with precision and robustness: it is not compromised by the non-monotonicity of *too stubborn to talk / to talk to / to talk to Bill*. The response of the model externally seems to be categorical, but the means to obtain it are not; they make minimal postulations, in any case much weaker ones than do other theories which address linguistic productivity with precision.

The same dynamics also succeeds with amalgamations (ex.: *de + le* → *du* in Fr.) with flexibility, and with an apparatus which is non-specific.

It integrates sparse and heterogeneous inscriptions, and therefore, it is favourably oriented to explain acquisition (the demonstration was not made in this chapter, it will p. 249).

I conclude that the model is satisfying for a substantial part of syntax, and for analysis.

Without drawing on the corresponding devices of the grammars, the dynamics based on transitivity, constructability transfer, and expansive homology, produces a number of grammatical effects: category effects, regularization effects, syntagmatic structure

effects, transformation effects, effects of thematic role, effects of structure multiplicity (Sadock, van Vallin), etc.

They are obtained by productive "a-grammatical" mechanisms, although they are externally analysable as grammatical. At this point already, many points of grammar appear therefore not to be prerequisites to the explanation of the dynamics, but rather as *effects* of the latter. More will be shown in the following two chapters.





# Chapter 5.

## Systemic productivity

Systemic productivity is a dimension of linguistic productivity which has not been well identified. Current theories only grasp it as being in the margins of structural productivity – the latter very much apparent by contrast – and systemic productivity is touched only indirectly, either via morphology, or via syntactic features smuggled in to address some of its consequences: agreement or concord. Either way, systemic productivity is not studied for itself. From this unfortunate elision, there follows, in the first case, stopgap conceptions like improper derivation for example, and in the second case, an inadequate treatment of systemic anomaly, and in both cases, an approach which is categorical and this is not desirable as has been shown.

This chapter: i) defines systemic productivity, ii) approaches it with analogy, identifying for its treatment the abductive movement by transitivity, and the abductive movement by transposition, iii) defines agent ANZ as the kernel piece of its treatment, iv) applies agent ANZ to five examples, v) proposes a direction to treat the question of agreement and discusses it.

### ***5.1. Systemic productivity, definition and explanation***

#### **5.1.1. Systems as the locus of a specific productivity**

The question of linguistic productivity being posed, it is envisaged spontaneously as the ability to utter (and receive) *novel assemblies*. This vision is necessary and was the subject of chapter 4 where I accounted for it mainly with structural analogy and the abductive movements by constructability transfer and expansive homology.

But in considering linguistic productivity solely as a question of assemblies, one neglects to see that the placement of a form in a pluridimensional paradigm (that is, a system like the verbal paradigm of a Romance language), is a productive process in itself.

I understand 'placement', in reception, as the assignment of a place in a paradigmatic system to a given form, and in emission, as the attribution of the appropriate form to a given place. The notions 'paradigmatic system' and 'place in a paradigmatic system' are provisory, what follows being a critique of them; and the conclusion will be precisely

that we must produce system *effects* (without reifying the frames that would define the systems), and consequently to produce the corresponding *effects* of placement.

As a first approach, the question of the placement in a system roughly amounts to recuperating the 'semantism' that would be associated with a place in the system. We know what it turns out to be: the mapping between places in systems and their associated meaning (meanings) is contingent and complex. This is true for example, of the 'semantism' of verbal tense; as it is for definiteness, number, etc. Contingent and complex as this association may be, it nevertheless has an inescapable function in interpretation, because it helps locate terms that are similar in the sense that they are 'of the same place' and it is exactly via the similarity of their 'locality' or placement that interpretation may deploy its abductive paths.

The domain of systemic productivity encompasses all systems<sup>137</sup>, that is, all the tables which may be established in languages so that, for any pair of lines, for any pair of terms picked up from these lines in the same columns, the meaning ratio in this pair is the same as the meaning ratio in another pair picked up in the same lines and in another column; likewise after permutation of 'line' and 'column'<sup>138</sup>.

To begin with, systems are verbal systems and declension systems which are usual. Systems also encompass a vast number of tables which receive less attention because they are less usual or concern fewer forms, like the following ones in French:

S1

la	le
une	un

S2

mieux	pire	plus grand
bien	mal	grand

S3

plus	autant	moins
plus grand	aussi grand	plus petit / moindre
majeur		mineur
supérieur	égal	inférieur

S5

après	suiuant
avant	précédent

---

<sup>137</sup> The notion 'system' is a pretheoretical notion used provisorily. Below it will be abandoned for that of 'systemic productivity', which allows us to problematize the dynamics and the cognitive implications of system effects.

<sup>138</sup> This last proposition : *Likewise after permutation of 'line' and 'column'* is important. We shall see below that it justifies calling on the abductive movement by transposition.

S5						
avant	ensuite	hier	plus tôt	tôt	plus près	recule
	lors, alors	aujourd'hui	en mm temps		à égale dist.	reste sur place
après	auparavant	demain	plus tard	tard	plus loin	avance
S6						
dans	dedans	intérieur		entrer		
hors (de)	dehors	extérieur		sortir		
à côté de	à côté	proximité		passer		
S7						
vite / rapidement		soigneusement / avec soin		bien		
rapide		soigneux		bon		

The dimensions of systems are grammatical categories like gender, number, grammatical tense, and person. They may also be a set of what a categorical description would call 'lexical class', like the rows of system S7 above which are Adv. and Adj.

### 5.1.2. Explaining systemic productivity

In a small system, systemic productivity may be considered a small problem: speakers learn it by rote and there is nothing more to it. The explanation of ensuing acts of emission and reception would be covered in this way. At the lower extreme, the smallest possible system is a two-by-two system, that is, a systemic analogy. The speaker forms a systemic analogy and nothing more: once formed, he can use it.

However, this does not explain the possibility of extension of a system, be it a durable extension by conventionalization of more forms that append to the system, or an occurrential extension. One example would be the possibility of metaphors, which is always open.

Neither does this provide a base to the differential process of meaning recuperation.

In a large system, all these reasons still hold to disqualify a 'learning by rote' explanation, but moreover it is just no longer possible to learn by rote, because of the size of the system.

We know that morphology (occasionally syntax) takes over, in the very measure of the system's size, by installing in the overt form some marks (affixal marks for example) which guide the placement of forms in the system. This is an empirical fact. In what does it constitute an explanation that would nullify the need to envisage a properly systemic productivity?

### 5.1.3. An explanation by structural productivity does not suffice

Then, for instance in a verbal system, the attention focuses on a morphological schema like:

verbal base + inflection → inflected verbal form.

The question of a possible systemic productivity would then be moot because it would be replaced by structural productivity. A replacement as simple as this presents many obstacles.

This schema does not explain the alternation of bases because it does not do justice to a fact like, in Fr.:

*irai* is to *vais* as *mangerai* is to *mange*.

This schema also fails with groups (conjugation groups, declension groups, etc.). Neither does it apply to forms occupying more than one place in a system<sup>139</sup>: *fais*, in written Fr., is a first person or a second person.

This schema cannot apply to systems S1 to S7 above, which present little or no morphological regularity.

Systemic productivity takes place despite structural anomaly; therefore it cannot be explained by structural dynamics alone.

#### 5.1.4. Explaining with a dimensional frame

Theories then usually postulate a dimensional frame which underlies the system: they reify the system. For example, in the Fr. verb, a tense-mode dimension, a person dimension, and a number dimension are postulated. The frame is assumed to be given and it is spontaneously presented (this is not always made explicit) as explaining the system and its operation. This analysis is the classical one in pedagogical grammars, but these grammars are intended for speakers who already have a certain command of their language. It is also the analysis made by modern theories (generativism, HPSG, etc.) which renewed it with syntactic features. Forms are assumed to be determined by three features, one for each frame dimension, and the feature values assign a form a place in the system.

As a descriptive means, such a frame is comparatively efficient (with some defects), but is not explanatory.

#### 5.1.5. Defects of the frame

##### *The frame does not explain the anomaly of forms*

Syncretism and the alternation of bases remain as formally anomalous residues.

Now, despite formal anomaly, the forms find their place in the frame, and this set operates smoothly: speakers perform placement even when the 'base + inflection' schema cannot support the placement process.

One may object that in French the personal pronoun being obligatory, this partially compensates for anomaly and syncretism. However, in Spanish, pronouns are not used in current practice and this does not prevent anomaly:

	pres. ind. 1S	fut. ind. 1S	pret. ind. 1S
<i>ir</i> (go)	<i>voy</i> (I go)	<i>iré</i> (I shall go)	<i>fuí</i> (I went)
<i>ser</i> (be)	<i>soy</i> (I am)	<i>seré</i> (I shall be)	<i>fuí</i> (I was)
<i>hacer</i> (do, make)	<i>hago</i> (I do)	<i>haré</i> (I shall do)	<i>hice</i> (I did)
<i>andar</i> (walk)	<i>ando</i> (I walk)	<i>andaré</i> (I shall walk)	<i>anduve</i> (I walked)
<i>cantar</i> (sing)	<i>canto</i> (I sing)	<i>cantaré</i> (I shall sing)	<i>canté</i> (I sang)

---

<sup>139</sup> Phenomenon which is sometimes called 'syncretism'.

Likewise in Russian, in Basque, and in many other languages with the categories person and personal pronoun, but eliding personal pronouns, formal anomaly is not an obstacle to systemic productivity.

***The frame assumption does not explain the anomalies of the frame itself***

Such anomalies are numerous.

In systems S1-S7 above, there are many unoccupied places.

Imperative in French does not have persons 1S, 3S, 3P.

In Fr., there is no compound past subjunctive, no anterior future conditional, etc. To account for the fact that not all pairs (tense, mode) are attested in French, Gross proposes<sup>140</sup> to substitute tense and mode with a tense-mode category which would *de facto* sanction those of the pairs which are attested. This measure is prudent and wise but it fails to do justice to data like *j'aurais vu : je verrais :: j'ai vu : je vois*. That is to say: between tense and mode in French, there is a partial categorial orthogonality, certainly incomplete, but which is not nothing. Therefore, the theory underlying Gross's decision (and which he leaves non-explicit) misses a 'local generalization' if one may say so.

The French definite plural article *les* is neither masculine nor feminine.

Etc., examples of anomalies of the frame are numerous.

We see that the system of the places itself (the frame) is more a matter of empirical observation than one of postulation<sup>141</sup>, and that the systematicities which it offers are partial only; it is the case well before the forms that it hosts are found morphologically regular or not.

***The frame does not explain learning***

Postulating a multidimensional frame does not explain how children gradually build up pluridimensional ability either. The reason for this is a fact that has already been stated in Chap. 3: the learner must integrate sparse and heterogeneous data, and positing a frame is simply positing the contrary.

In a large paradigm, speakers never really acquire the same ease in all points of the domain. Even for an educated adult, at its margin (seldom used forms of seldom used irregular verbs) there are hesitations and gaps. For a speaker of French, the three-dimensional system of the verb is ideal and its margin never really gets comfortable; either it remains a zone of free variation or, to comply with a norm, the speaker uses a *Bescherelle*.

This is not compatible with an explanatory schema like innateness plus parameter setting. In the case under discussion: innateness of paradigm dimensionality plus setting the right dimensions all at once.

---

<sup>140</sup> Gross 1986-1, p. 10.

<sup>141</sup> That it has a '*contour dentelé*' as Milner (1989) would say.

***Postulating the frame does not explain language evolution***

As in any categorial theory, having postulated a frame (the dimensions of which are categories) it is impossible to show how it may undergo progressive alterations and therefore evolve.

***The frame is not appropriate because it is partonomic***

Finally, postulating a frame requires the forms in it to be attributed properties which are coordinates in the frame (for example: tense-mode, person, number). Doing this would be accepting categories (which we do not want) and would be a handicap in building an isonomic dynamics (which we want). This reason is a general reason but it is an important one in the approach we are taking.

***Finally, the frame is not explanatory, an antecedent explanatory mechanism is required***

To sum up, if we stick to a pluridimensional frame<sup>142</sup>, there is a description problem since real systems often do not even observe it, and it is difficult to explain a verbal system, i) as the contingent product of a history, ii) as learnable, iii) as useable and serviceable for the speaker when the latter does not have an available theory of this verbal system.

As we have not taken advantage of systemic analogy, this particular productivity remains unexplained. There is therefore a productive mechanism which is antecedent to its partial sanctioning by morphology, and it is not suitable to postulate a preexisting frame which would explain how the learning speaker makes the right form-meaning associations.

**5.1.6. Systemic productivity as the dynamics of systemic analogy**

The refusal of syntactic features leads us to seek an explanation by a genuine systemic dynamics, that is, a dynamics which should be exemplarist and isonomic as is that which accounts for structural productivity in the previous chapter.

This new dynamics is conceptually distinct from structural productivity, but as both operate together, complementing one another, and taking over from one another, it is not always easy to perceive what belongs to each.

The systemic dynamics is based on systemic analogy: it is based on the assumption that, at some point in his learning history, the young speaker becomes capable of making some analogies like:

va : vais	:: vient : viens
vient : viens	:: est : suis
sommes : suis	:: jouons : joue
sont allés : est allé	:: sont venus : est venu
sont : est	:: sommes : suis

---

<sup>142</sup> Which is what syntactic features do.

These elements of linguistic knowledge are exemplarist systemic analogies. Their number is modest because each has a certain cognitive cost. The young speaker makes a certain number of them, not a very great number. He does so without the availability of abstractions like 1P, 3P, indicative present, future, singular, plural, verb "aller", verb "venir".

We assume then that these elements can undergo the abductive movement by transposition. This assumption is not theoretically very costly: it is entailed by the definition of systems (cf. *supra*). These elements can also undergo the abductive movement by transitivity. The two movements then allow the unitary analogies above to enter an integrative dynamics. Starting from the initial systemic analogies, this dynamics<sup>143</sup> has the final effect – as we shall see in detail below – of producing a large number of other analogies by abduction, under conditions which are cognitively more economical.

This progressively renders effects of pluridimensional systems.

Naturally, the pluridimensional system 'pre exists' the learning speaker; it is obviously not he who establishes it. He is simultaneously the beneficiary of the mother tongue and dependent on it. Gradually, he must comply with it if he wants to understand, to be understood, and to become an esteemed member of his speaking community.

But he does not get hold of a system with three coordinates all at once. It is not a 'take it or leave it' matter. If it were, French would have a perfect infinitive, a supine, an ablative, etc. It is necessary that the conditions of this appropriation allow it to be a progressive and incremental process. It is not the case that it has to be taken to any predefined term except, in constraining pedagogies, the learning of tables that are pre established and presented as an ideal norm. In a more spontaneous exercise of language, something of the ancestral inheritance reconstitutes itself; the acquired knowledge complies with the inheritance in the very frequented parts of the paradigms and, in the less frequented parts, remains an occasion for hesitations leading to bolder abductions, and these in turn occasionally give birth to variant creations.

The perspective is reversed. A categorial theory would postulate a three-dimensional analysis frame, of which it should then have to explain the gaps (defectivity, i.e. unoccupied places, syncretism, alterations, anomaly); it would have nothing to say about the evolution of the frame. Here on the contrary, we start from the acts and from operating mechanisms which are explanatory right from the beginning. Exemplars are primary, as is the abductive computation which uses them; and the possibility of describing the system which the young speaker constructs, and in which he becomes productive, is recuperated as an effect of the base dynamics.

Adopting a dynamics as an explanatory schema of this type has many advantages, as we can see:

- A plausible discourse about learning becomes possible.
- The progressive way a verbal system is built in its dimensions is better explained.

---

<sup>143</sup> The rest of this chapter will expose in detail the systemic dynamics (agent ANZ).



- Room is made for allomorphy, syncretism and groups as a cognitively motivated residue of a regularization process.
- Inflectional morphology is better positioned: it can sanction a pluridimensional system without having to do so entirely and its role is second in time, and causally second, even if, once the language has been learnt, in the adult's knowledge, this role becomes very important.
- The 'failures' in the learning process, or its residues in the margins of the system, make room for its possible evolution.

Systemic productivity is thus based on transitivity and on transposition. It shares transitivity with structural productivity, but transposition is proper to it: structural productivity is not concerned with this movement.

Systemic productivity assumes some hypotheses concerning the inscriptions that support it. Some of this will be made clear in the course of this chapter and the topic is more technically addressed in an appendix, section 12.9.2.1. *Linguistic paradigm, system, dimension* (p. 311). In this model, systemic productivity is implemented by agent ANZ, the architecture and operation of which are now about to be explained with examples. A more formal statement is made in the corresponding appendix.

## ***5.2. Adverbial derivation in French, a process using one paradigm only***

Consider a task of the type: "find X which is to Y as A is to B", in which Y, A and B are terms<sup>144</sup>. Call this 'analogical task'.

In ABS, the agent that solves an analogical task is agent ANZ: it produces Xs which are to Y as A is to B. The Xs it produces are called 'analogisands' of Y, A and B. The set of three terms Y, A and B define the analogical task, it defines the duty of an ANZ agent. The mutual positions of these terms matter: tasks ANZ (Y, A, B) and ANZ (A, Y, B), for example are not the same tasks. Saying that terms Y, A and B are here 'copositioned' is saying nothing else. Any ANZ agent has a duty which has the form (Y, A, B).

A first agent undertakes the analogical task which is that which the problem poses. Then it recruits more agents of the same type, which in turn recruit more agents, etc<sup>145</sup>. Each such recruitment attributes to the commissioner agent a duty which is equivalent – let alone an abduction step – to that of the client agent (the recruiter).

So every recruited agent has a duty which is transitively equivalent to that of the initial one, but, with the distance, there may be a drift. It is a drifting transitive determination.

Here is now a summary definition of the operation of agent ANZ; it will look clearer with the ensuing examples and is formalized in the appendix. An ANZ agent may, in a favourable case, contain in its duty data which settle immediately: two of its terms are

---

<sup>144</sup> For Y, A and B, entities more complex than terms will be envisaged further in the text.

<sup>145</sup> Such recruitment chains dry up in case of exhaustion of the plexus, or, even when more data is still available in the plexus, when the delivery point of these agents (a channel) has enough results. Deciding when a delivery point has enough results is a question with several implications and is addressed under the title "Controlling the dynamics" in the appendix which specifies the dynamics of the model.

equal. When this is the case, it raises a finding the content of which is the third term of its duty<sup>146</sup>. In addition, an ANZ agent applies the abductive movement by transitivity by making a step in the paradigm in which it operates; this takes it to recruit more agents. Finally, an ANZ agent applies the abductive movement by transposition; for this, it transposes the roles of the arguments in its duty, this also causes the recruitment of more commissioner ANZ agents.

A first simple example will show the operation. Let us assume that, during the course of a broader linguistic act, the need arises of a term which is a little like *soigneux*, a little like *habilement*, but not really any of these two terms. Rather, it is to *soigneux* as *habilement* is to *habile*. This is an 'analogical task' such as defined above and an ANZ agent is recruited to produce the corresponding result X:

X = ANZ ('soigneux', 'habilement', 'habile')

To solve this task, the model uses one paradigm only, that of the figure below. This holds for the plexus used in this experience. With another plexus, the tracks to a solution might be different.

The paradigm that is used contains regular derivations of French adverbs by suffixation of *-ment*, but the model does not "know" it in the sense that it just records systemic analogies among the forms and ignores morphology, even if the latter is apparent of course to the human reader. The paradigm also comprises the adverb phrase *avec soin* (with care) which occupies a place in this analogical system even if it is not derived with *-ment*.

Processing regular adverbial derivation by enumerating records in this way is not very smart or very productive: the least ambitious linguistic model is expected as one of its first accomplishments, at least to apply such processes with some systematicity. The previous chapter shown how morphology and syntax were handled and this case could be approached following the same schemas, but here, the intent is to demonstrate systemic productivity and any set of forms can always be envisaged in ignoring their formal regularities. Moreover, if, with Langacker, we refuse the 'rule-list fallacy' (*supra*) it is expected in the Analogical Speaker that the plexus should contain inscriptions of that kind.

The model finds the two following results (strengths in column 1 were introduced in Chap. 3; they indicate that the first result is more economical):

---

<sup>146</sup> This amounts to solving the following trivial analogy: "What is to Y as A is to A". The result can be nothing else than Y itself.

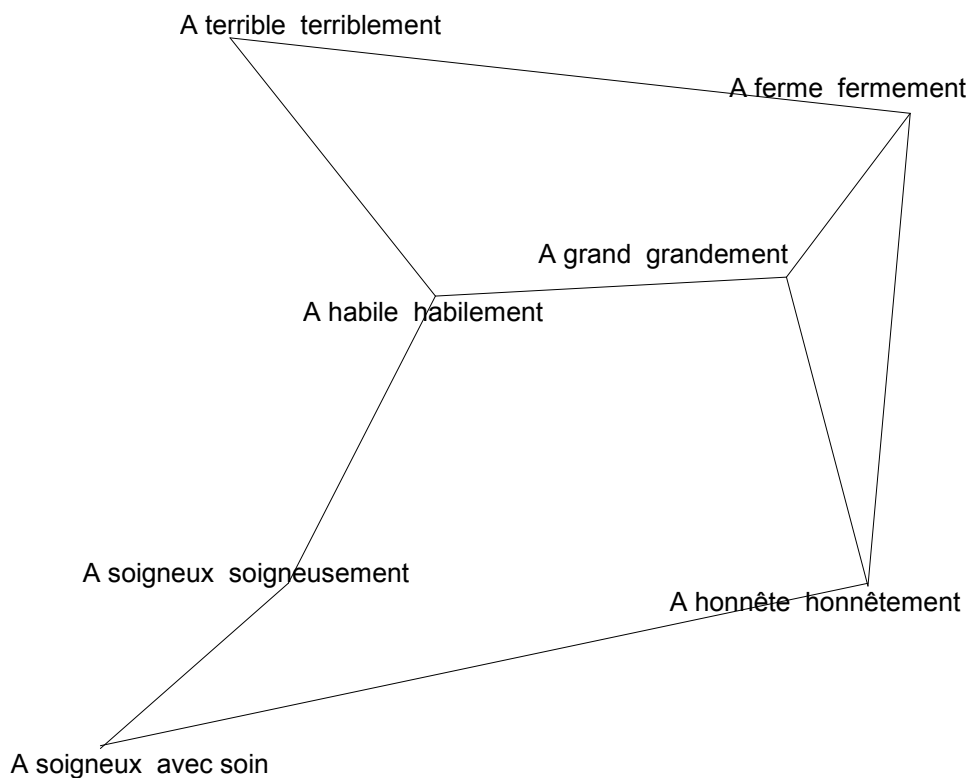

**Figure 15 Paradigm *habile-habilement***

Strength	Result
.73	<i>soigneusement</i>
.66	<i>avec soin</i>

The plexus contains potentially these two solutions; the model finds both. *Soigneusement* is found first because the connectivity of the paradigm is such, and the prepositional phrase *avec soin* is found right after. In a plexus corresponding to a different speaker the order might be different.

To reach these results, the model used the agent tree below:

Agents are displayed in straight characters and products (findings and results) in italics. Agent numbers are followed with their strengths, then with the terms that constitute the agent's duty. Product numbers are followed with the product strength, then with the term associated to the product. Note for example agent 10 which raises finding 3: *avec soin*, causing the delivery of result 4: *avec soin* at the root channel. Note also numerous agents (eg. agent 7: *soigneux mal mauvais*) which are envisaged by the computation but lead to no result.

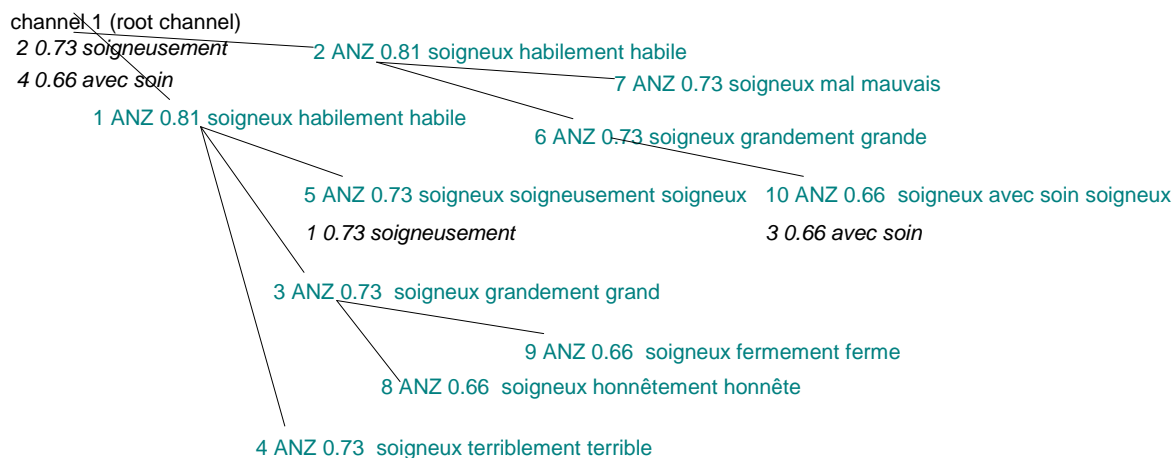

Figure 16 Agent tree

This heuristic structure is a simple one. It does not present any occasion of reinforcement: each result is merged from one finding only.

One may judge that this paradigm is a toy paradigm: it contains seven adverbs only when in French there are several thousands. What would happen with a more realistic one? What if the records useful for the task were more remote instead of being at a distance of two links as in the example? This question has several aspects, some of which only can be discussed at this point: i) nothing imposes that a single monster paradigm be built with thousands of French adverbs, the integrative cooperation of multiple, smaller, heterogeneous paradigms may do (cf. *infra* a gloss about integrativity), ii) if the records were more remote, the strengths of the results could well be lesser and this could be desirable, iii) several paths ganging up and the resulting reinforcement could increase the strength of the result, iv) familiarity orientation (cf. section 12.8. *Familiarity orientation*), much reduces the number of heuristic paths that are envisaged, v) the introduction of structural productivity (here morphological) as seen in the previous chapter, would open up different paths and the discussion would be a different one, vi) finally, there might arise dynamics so heavy as to be intolerable and impossible to amend, which would tend to refute the radical non-categoricity assumption, and to suggest that brains really have some other ways to do.

This example helped us introducing the dynamics progressively but it does not constitute by itself a very fascinating achievement. A task involving two paradigms is more interesting and more demonstrative.

### 5.3. French verb, two paradigms playing integratively

The analogical task posed to the model is now:

"find X, which is to va as venir is to vient" or X = ANZ ('va', 'venir', 'vient').

The model finds one result:

Strength	Result
.59	aller

This result is good and the only possible one in French.

To solve this task, still for a given plexus content, ABS used two paradigms. The first one associates forms of verb *aller* (to go) with their homologs for verb *venir* (to come):

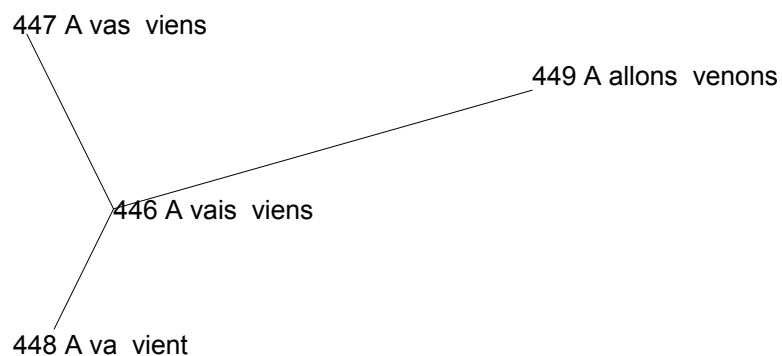

Figure 17 paradigm of *vais-viens*

The second paradigm, for a set of verbs, associates their infinitives with their third person singular of the present indicative:

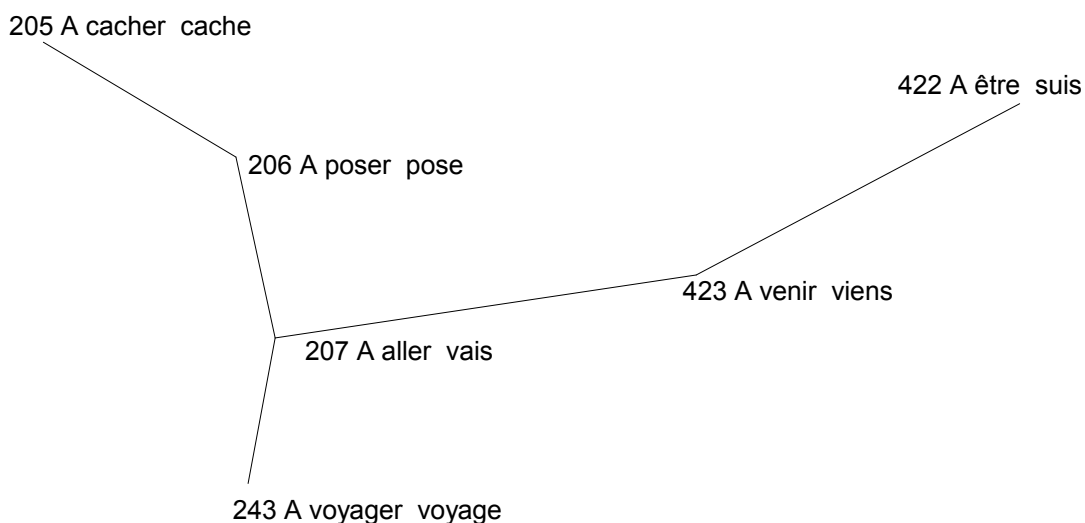

Figure 18 Paradigm of *venir-viens*

With a different plexus, the inscriptional resources serving the same task could be very different: this is an occasion to show in a concrete example the question of inter-speaker variation already alluded to in section 3.5.2. *Determinism, idiosyncrasy, normativity*, p. 75.

Please note that the two paradigms have very heterogeneous structures:

paradigm	what opposes the two terms in a record	what changes between two linked records
first paradigm	base <i>aller</i> - base <i>venir</i>	tense + person + number
second paradigm	person 1S - person 3S	base

Table 7 Contrasting the structures of the two paradigms

The diagram below is an overview of the computation and shows how it proceeds; it is limited to the branches that contribute to the result.

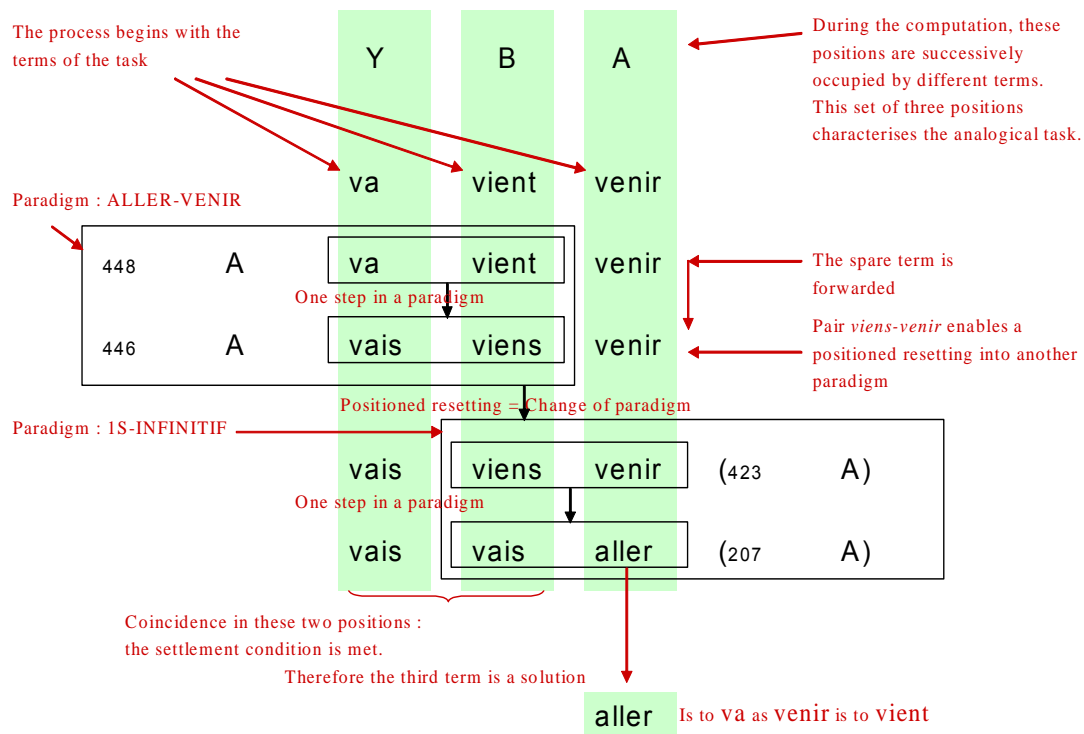

Figure 19 The mechanism of agent ANZ shown on an example

The process begins with pair *va*, *vient* (the 'current pair') which is attested in a record. This record (the 'current record') belongs to a paradigm (the 'current paradigm'). The spare term (*venir*), that is the term which does not belong to the current paradigm, is set aside. Neighbour records in the current paradigm are explored, causing the evolution of the current pair (this drawing is restricted to the paths leading to the result but numerous other paths are explored, as the agent tree below shows).

All along the process, two conditions are watched in newly created agents: the settlement condition and the positioned resetting condition. For a general introduction to positioned resetting, please cf. p. 206.

The settlement condition is met when two of the three current terms are equal. When this happens, a finding is raised.

The condition of positioned resetting is met when the agent's analogy (that which underlies that agent's duty) transposes, that is when the pair formed with the term in position B within the current pair, and the spare term, is attested in the plexus. Then the current agent recruits another one and this opens up a new branch in the heuristic tree.

Here is now the agent tree which was used in this task.

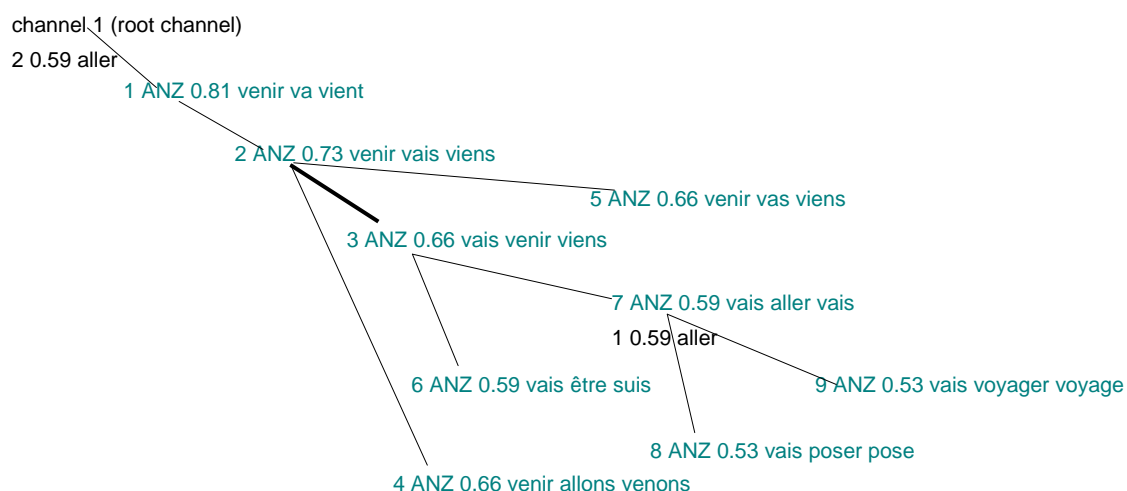

Figure 20 Agent tree

There is not yet any reinforcement effect because one agent only (agent 7) finds the settlement condition. It raises the finding 1 which will cause the delivery of result 2 at the root channel. Here again, numerous recruited branches lead to no result: they do not meet the settlement condition.

A positioned resetting occurred. The corresponding edge is drawn in bold.

Envisaged globally, the duty of the agent at the source of this edge (agent 2, the client agent) and that of the agent at the target of this edge (agent 3, the commissioner agent), both consist of the same terms. But in both agents, the terms hold different roles: they are each time in different positions; this justifies the phrase *positioned resetting*.

Positions Y and A are exchanged but position B conserves its occupier when resetting takes place. Position preservation is the key in the efficiency and flexibility of ABS computations. Linguistic positionality is conserved from end to end in the computations and this finally relates the results to the initial terms of the task in a coherent and correct manner. Channels are another means to serve the same end but they are not used by agent ANZ.

### 5.3.1. Integrativity

Leaving now the intricacies of the detail operation for a more significant topic, it is important to note in this example how two paradigms concur to produce a result. Each one is comparatively poor and not very useful if considered on its own. Used together in conjunction, they acquire a greater operational power.

Agent ANZ integrates the effects of partial paradigms. This holds not just for agent ANZ but also for the other agent types which all have an integrative effect, and it also holds for ABS generally which integrates the effects of agents of different types. The question of integrativity will be developed in section 7.4. *Integrativity* (p. 207), when more mechanisms will have been exposed.



### 5.3.2. Positioned resetting

In the preceding example two paradigms are used: the computation begins in a first one, then continues in the second one. At the point it enters the new paradigm, a **resetting** takes place. The most usual computation steps prolong a followed abduction path within a same paradigm, as above in the example about adverbial derivation. A process performs a resetting when something different happens. Upon resetting, the abductive thread makes an abduction step which is not just prolonging a track in a paradigm.

Resetting must be **positioned**: the copositioning constraints that hold between the agent's arguments must be observed. This is a little difficult to explain but it is important. The agents of this task (all ANZ type agents in this case) have three positions symbolically named Y, A and B (the green columns in the synthetic diagram above). The position names come from the statement of the analogical task: "find X which is to Y as A is to B" which is now usual. In a computation step which crosses a paradigmatic link, pairs extracted from the plexus follow one another in positions A and B. In a resetting, the movement is different, the three terms, temporary occupiers of positions Y, A and B, globally remain the same but position Y and A exchange their occupiers: this is the application of the abductive movement by transposition defined p. 87. It is a redistribution of roles which takes place in a precise and motivated choreography. This is what it means to say that copositionings are observed.

In the case under discussion, the second paradigm is different from the first: so resetting could be named "change of paradigm". This is not done because it is not always the case: the example below will contain a resetting which is a move into another record of the same paradigm, but with a reassignment of the roles. In the previous chapter, the shifts between levels during syntactic analysis, because their schema is something else than the mere crossing of a paradigmatic link, can also be called a 'resetting' and they are also 'positioned'.

The notion of 'positioned resetting' is central: it is one of the keys of productivity by integrativity. The subject will be discussed again.

### 5.4. Recruitment and edification

In syntactic analysis with the B2-B3 process (previous chapter), the heuristic structure, that is, the set of agents and channels, was built according to a process of **edification**. Edification progresses forward (towards the left of the figures and is sensitive to field data. In the case of B2-B3, field data is the beginning and the end of a substring of the string being analysed; these two numbers characterize a channel of the B2-B3 process.

In the analogical task performed by agent ANZ (this chapter), the development follows a different method: recruitment. Recruitment progresses rearward (towards the right of the figures), starting from a unique point: the root channel, and is not sensitive to field data.

Recruitment is discussed in detail p. 336 and edification p. 341, where a table contrasting both is also proposed.

## 5.5. *Auvergnats and Bavarians, resetting in a same paradigm*

### 5.5.1. The task and the resources it uses

The analogical task posed to the model is now:

Find X, which is to *Français* as *Français* is to *Européen*

X = ANZ ('Français', 'Français', 'Européen' )

This task uses one paradigm only, which is presented below. Its principle is that the leftmost term is a national membership – or an administrative or territorial membership, remind that analogy elides the predicate – which is contained while the rightmost term is one which contains the leftmost one.

A thing like 41 A Auvergnat Français is a C-type record of the plexus. It is record number 41. The edges are paradigmatic links. The two records 42 and 39 with the link between them, read as follows: "Bourguignon *is to* Français *as* Français *is to* Européen".

All records are type A records, which means that each contains two terms without their forms being necessarily related or reflecting overtly the ratio between them.

This paradigm tells nothing more. In particular, it tells nothing about the essence of territorial entities, about political units, citizenship, the containing-contained relation, etc. Some such data, related to some of the terms in this paradigm may or may not be elsewhere in the plexus, they will not serve here.

Records of the type "provinces in France" are close to "France in Europe", records "Länder in Germany" are close to "Germany in Europe", the English and the German have a close link. The Burgundians are close to the English for any good reason owing to the culture of this speaker. This is how proximality is influenced in this paradigm.

In what does this paradigm constitute a system in the sense defined at the beginning of this chapter? In other words, what are its dimensions? A first dimension is that which underlies the pair (*Auvergnat, Français*). So far, a dimension was said to be constituted of lexical categories, and the example was (Adj, Adv). This remains true but becomes more specific. The dimension here is (N, N). Both names have value, not simply as names, but as names marking an attachment to politico-territorial entities; moreover, the logic of their pairing is that the first one of these entities is geographically included in the second one. In this way, such inscriptions embody a sort of sub-categorization. A theory which would be categorial and partonomic (which would attribute properties) would find it difficult to render this because what matters here is not inherence but relative positions.

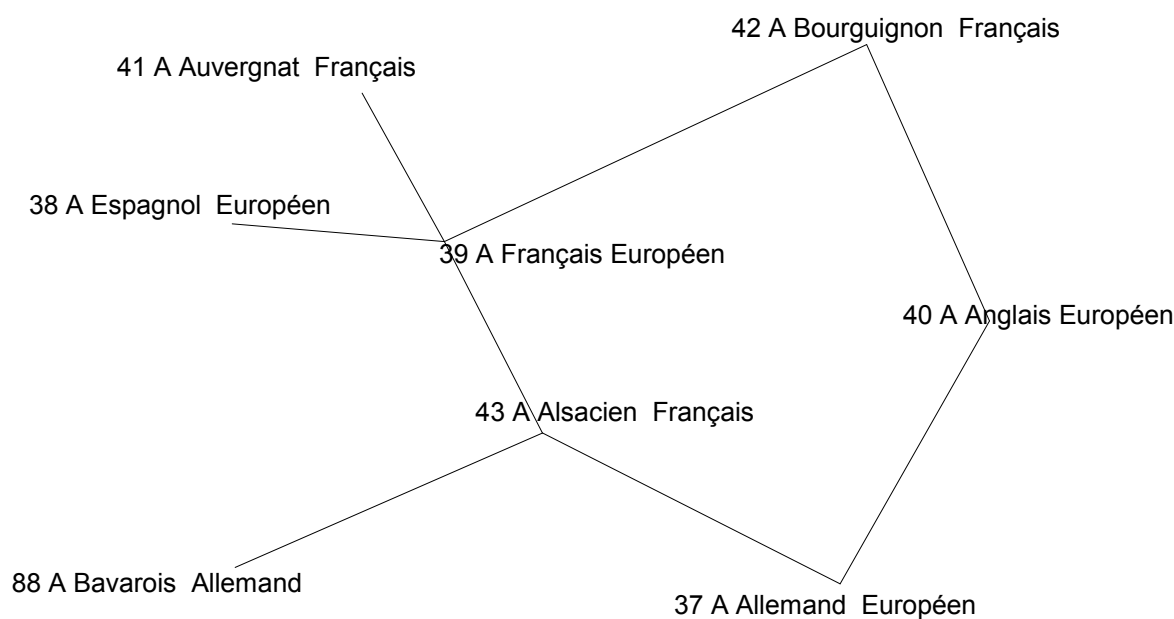

**Figure 21 Paradigm *Français-Européen***

The second dimension is the set (*Auvergnat, Français, Alsacien, Allemand, etc.*). Although this set is homogeneous in this that all its elements are inhabitant names, it ceases to be possible to contrast them two by two as this can be done with singular and plural, with indicative and subjunctive, with containing entities and contained entities, etc. It seems not to be possible any more to rescue a categorial or sub-categorial approach. Should we then have to grant that this dimension is 'false' and that the paradigm is one-dimension only. Is it still possible to say that such a table is a system? A reconciling argument can be made starting from the verbal paradigm. It was presented above as tri-dimensional: tense-mode + person + number. Actually, it comprises a fourth coordinate which is a fourth dimension: the variety of the verbs according to which it is possible to make excerpts like (*allons, venons, sommes, etc.*). The case is the same here: the series (*Auvergnat, Français, Alsacien, Allemand, etc.*) is a system dimension in the same respect. Thus a system may have, as one of its dimensions, simply that of lexical variety without ceasing to be a system for that reason. It functions quite well as any other system. In particular, the transposition movement applies (it applies under the condition of quasi-bijectivity, but this is independent from one of its dimension being lexical variety).

### **5.5.2. First results: Alsations, Burgundians and Auvergnats**

After two computation phases, the model finds the following three results:

Strength	Result
.73	Alsacien
.73	Bourguignon
.73	Auvergnat

This is expectable as they are the three French provinces inscribed in the plexus. The tree of agents (the heuristic structure) is the following:

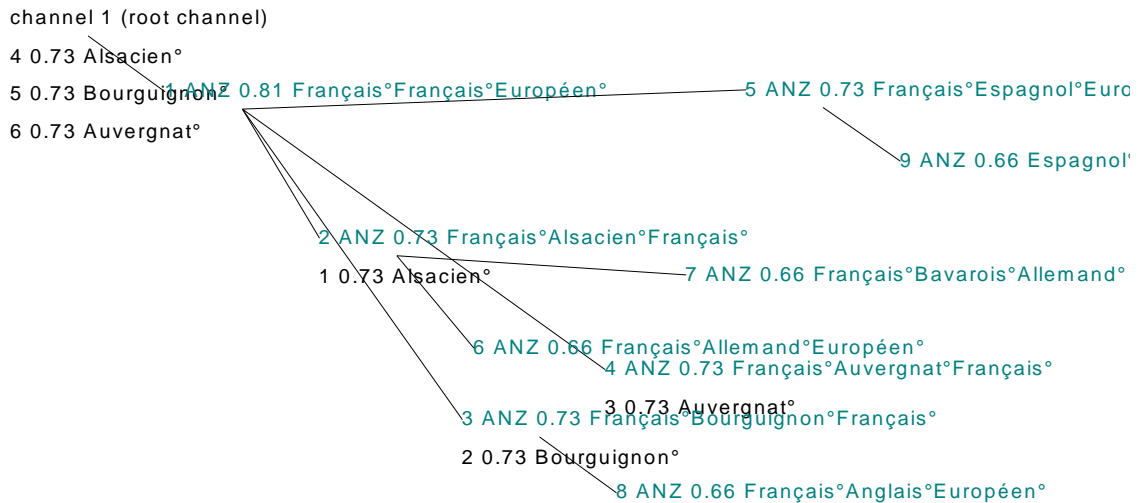

Figure 22 Tree of agents after two computation phases

The tree uses the paradigm once only.

### 5.5.3. Second line results: Bavarians

If triggered to proceed further, the model, at phase six, finds the Bavarians. The results are now:

Strength	Result
.73	Alsacien
.73	Bourguignon
.73	Auvergnat
.48	Bavarois

The *Bavarians* were found to be to the *French* as the *French* are to the *Europeans*! How is this to be understood?

The agent tree now lost readability and is provided as a document only. More readable excerpts are provided further.

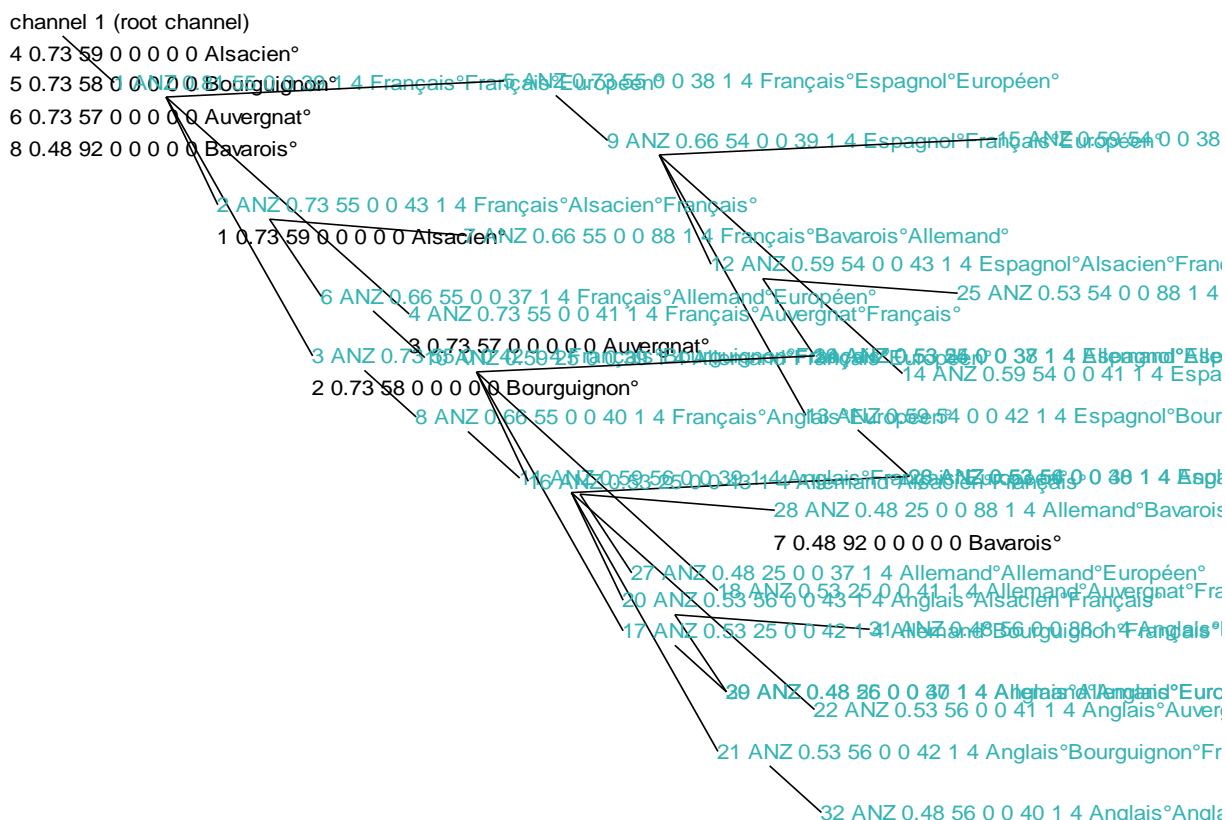

**Figure 23** Tree of agents after six computation phases

This surprising result is interpretable: the underlying reasoning has now changed and it must be reconstructed. Generally, in this task the underlying reasoning is: *find inhabitants of a contained territory*; in the first two phases it is interpreted as *contained in France which is itself contained in Europe*. The general underlying reasoning stays the same but it is now interpreted as *contained in any territory which is itself contained in Europe*. In the course of the computation, agent ANZ spontaneously broadens its search scope. In a framework accepting constraints, one would say that a constraint has been released, or violated.

Here is another presentation of the agent tree. It is restricted to the paths with which the Bavarians were found.

The positioned resetting which led to the *Bavarians* result occurred on the edge from agent 6 to agent 10. Both agents have the same set of terms in their duties, but not in the same positions. In agent 6, the spare term is *French* and the current pair is (*German, European*) whereas in agent 10, the spare term is *German* and the current pair is (*French, European*).

Metaphorically, agent 6 makes the following "reasoning". At the point where I stand, the initial task is reformulated into: *What is to French as German is to European?* This is my own duty. Let me try and transpose this analogy – some analogies transpose, other ones do not, I cannot know in advance, only the outcomes make the difference – and let

me make a try with this new duty: *What is to German as French is to European?* Let me try and recruit a commissioner with this duty. If the pair (German, European) is attested somewhere in the plexus, then, i) the recruitment takes place, opening up a new abductive path which ii) may lead to some finding. As it happens in the case in point, i) the pair *is* attested in the plexus so agent 10 is recruited and becomes a commissioner, and ii) two steps later, in agent 20, a settlement occurs because the spare term: *German*, is found to coincide with one of the terms of the current pair. The third term in the duty: *Bavarian* is then raised as a finding.

	agent type	strength	duty-----	content (interpreted duty)-----
Explanation of finding 7		.48	92 0 0 0 0 0	Bavarois
recruited by agent 28	ANZ	.48	25 0 0 88 1 4	Allemand Bavarois Allemand
recruited by agent 16	ANZ	.53	25 0 0 43 1 4	Allemand Alsacien français
recruited by agent 10	ANZ	.59	25 0 0 39 1 4	Allemand Français Européen
recruited by agent 6	ANZ	.66	55 0 0 37 1 4	Français Allemand Européen
recruited by agent 2	id	.73	55 0 0 43 1 4	Français Alsacien Français
recruited by agent 1	id	.91	55 0 0 39 1 4	Français Français Européen
recruited by channel 1		1		

**Table 8: Explanation of finding 7 'Bavarians'**

This result lends itself to several comments:

- a) The model does not particularly favour the reuse of a same paradigm but it does not prevent it; when the task allows it, the model exhausts all the possibilities of a paradigm; it re-uses the paradigm with different points of view<sup>147</sup>.
- b) There is no directly modelled logic but the model behaves logically.
- c) The most expected results, the most prototypical ones, the cheapest ones, are produced first and with higher strength. Stranger results, ones understandable, but with an effort are also produced, but later, and weaker.

---

<sup>147</sup> This may be related with a fascinating result of the early times of artificial intelligence, in the domain of theorem proving (Hofstadter 1995, p. 478 rather attributes it to Pappus of Alexandria in the 3<sup>rd</sup> century B.C.). An isocetes triangle being defined as having edges AB and AC equal, the program was asked to demonstrate that its base angles B and C were equal. Since Euclid, the demonstration consists of drawing the height AH then in showing that the right-angled triangles AHB and AHC are equal. This is achieved by applying equality theorems between right-angled triangles. With Pappus, the theorem demonstration program took a different course: it envisaged triangles ABC and ACB, which it directly demonstrated equal, whence the conclusion follows. This way is shorter and more elegant than that of Euclid but it requires a *structure mapping* which human computation is reluctant to make because it takes the **same elements in different positions**. The theorem prover dit it and so does agent ANZ in our example. In our conscious computation, we do not like to assign the same elements different positions. It may be the case that this limit does not apply in our unconscious computation but we do not know. If it were proven that our unconscious computation is subject to the same limit as our conscious computation, then a mode of operation like the one shown for agent ANZ in this section would be refuted; it might be conserved for an analogical artificial intelligence, but it would be disqualified for an analogical natural intelligence.

- d) Adaptation of model behaviour obtains with non-specific means. They apply to containing/contained territories, as here, but equally well to any systemic paradigm. They apply to copositionings between formal terms, as here, but also to ones between private terms – 'private term' will be discussed p. 262.

#### 5.5.4. The route followed by the computation in the paradigm

The thick arrow shows the succession of the records which were used as current records to obtain the Bavarians.

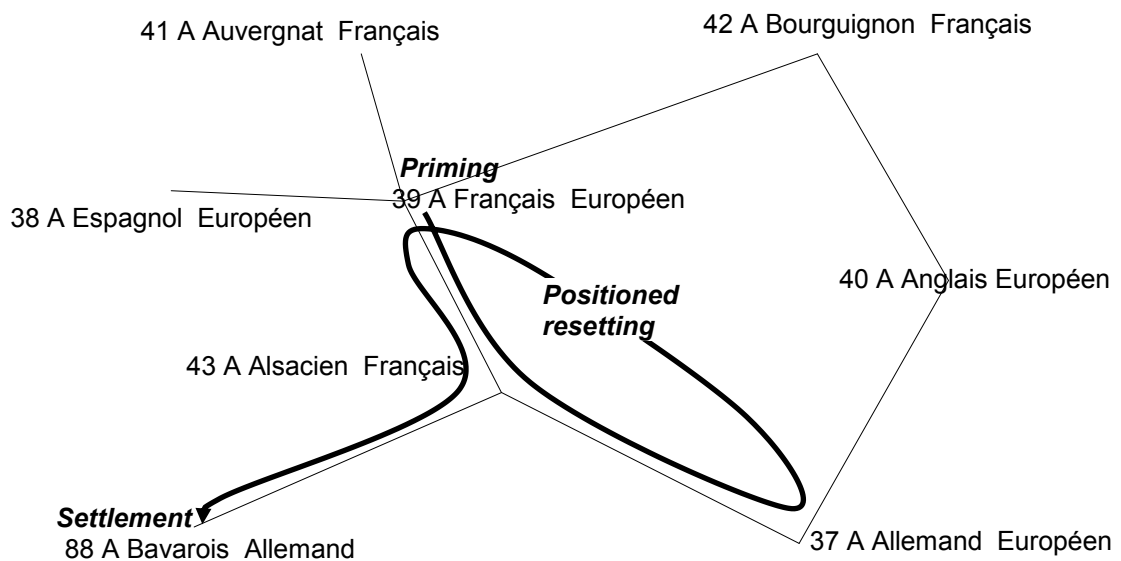

Figure 24 Route followed by the computation in the paradigm

As this example shows, a positioned resetting may target the same paradigm. This is not the general case: most often it reaches a different one.

Records 39 and 43 were used twice but not in the same respect: on the two occasions, the positions Y, A, and B did not have the same occupiers. This illustrates the possibility of the same inscriptions being used two times with distinct viewpoints; all is a question of relative positioning between the terms of the task and those of the plexus. After a positioned resetting, the process is reset. It seems it reuses the same resources of the plexus but not in the same manner.

### 5.5.5. Result 'Bavarians' interpreted as a conceptual integration

It is possible to construe the process leading to the Bavarians as a conceptual integration, the reference here is to the theory of Fauconnier and Turner<sup>148</sup>. This conceptual integration is certainly modest and moreover very peculiar.

The agent appears to have performed a conceptual integration corresponding to the following schema:

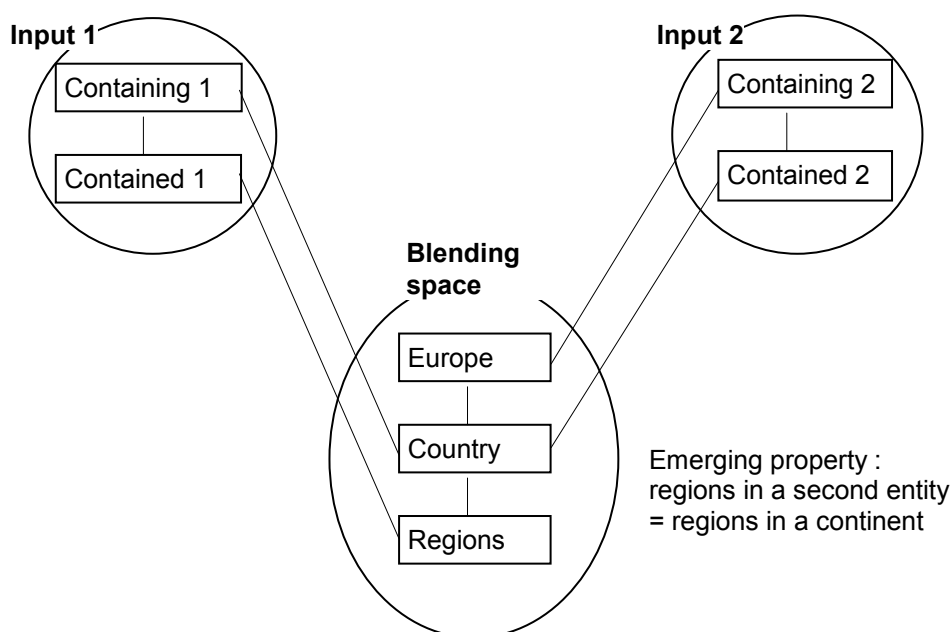

**Figure 25 Domains in the conceptual integration which produced 'Bavarians'**

The first input space ('space' and 'domain' are synonymous in this theory) is the paradigm of the question and so is the second input space: the paradigm integrates to a second instance of itself with a shift, to constitute a blending space with a two-level inclusion hierarchy.

The (unique) paradigm used here contains already in itself something of the double levelling by the fact, for example, that German occurs in the records sometimes on the left, and sometimes on the right. This is what makes the two levels communicate; this paradigm contains as virtuality the possibility to be so associated to itself. This is one of the conditions which make the integration possible and agent ANZ realizes this virtuality. In the blending space (in this theory, 'blending' and 'integration' are synonymous) emerges the property "second level inclusion". It is latent in the origin paradigm but not explicit in it. The dynamics of agent ANZ reveals it.

It must be noted that the schema is not: first build the blending space and then use it; that is, the schema is not: first prepare a framework for induction and then perform

<sup>148</sup> Cf. for example Fauconnier 1997a.



induction in it. The schema is more subtle and pervasive: the blending space is phase wise-assembled along the development of the process computing the task and, this too must be noted, integration is not the sole way to results: other results, more evident and stronger, were produced before, without conceptual integration.

In the theory of conceptual integration, setting a relation between two input spaces is deemed to be triggered by the occurrence of an 'introducer'. In the published examples, it is a formal term (for example an adverb or an adverbial phrase) occurring in a text or in a narration. If we had to look in the example above for what acts as the introducer, it should not be sought as a part of an utterance since there is no utterance here. If it has to be anywhere at all, it must be at the point of the positioned resetting. The key role in triggering the conceptual integration is the already mentioned fact that German occurs now on the left of the records and now on their right, but this fact does not play on its own, it plays with the process which uses it, that is, the dynamics of agent ANZ.

The following example will now illustrate reinforcement and flexible categorization.

### 5.6. French articles, reinforcement effects

The task submitted to the model is now: find X which is to *le* as *une* is to *un* .

X = ANZ ('le', 'une', 'un') or X : 'le' :: 'une' : 'un'

The table displays the results received with the associated strength at each phase:

		<b>phase 1</b>	<b>2</b>	<b>3</b>	<b>4</b>	<b>5</b>	<b>6</b>	<b>7</b>	<b>8</b>
la	<i>the</i> (fem.)		.73	.78	.78	.78	.78	.78	.78
cette	<i>this, that</i> (fem.)		.66	.66	.66	.66	.66	.66	.66
le	<i>the</i> (masc.)				.53	.62	.62	.62	.62
ce	<i>this, that</i> (masc)							.54	.54
cet	<i>this, that</i> (masc)							.43	.43

**Table 9 Results of task ANZ ('le', 'une', 'un')**

- *la* is normally found first and with the highest strength. In phase 3, its strength increases.
- *cette* comes second and weaker: it is another feminine determinant, definite in its own way, but less prototypically analogical to the terms defining the task.
- *le*, *ce* and *cet* come later, still weaker: they are still determinants, they are still definite, but they are masculine; whence their lesser strengths.
- this set of results illustrates category drift which is a property of this model: it makes no clear limit between categories since it does not reify them.

The figure below shows the reinforcement mechanism of result *la*:

Explanation of result 2 (0.78)	content: 1 0 0 0 0 0	la	
delivered at channel 1 1			
merged from finding 5 (0.59)	content: 1 0 0 0 0 0	la	
raised by agent 9 (0.59)	type:ANZ duty: 2 0 0 1 1 4	les la les	singular-plural
raised by agent 7 (0.66)	type:ANZ duty: 2 0 0 4 1 4	les une des	
raised by agent. 5 (0.73)	type:ANZ duty: 6 0 0 7 6 4 1	une les des	definite-indefinite
raised by agent 1 (0.81)	type:ANZ duty: 6 0 0 7 4 4 1	une le un	
recruited by channel 1			
finding 5 is directly raised by its agent			
merged from finding 1 (0.73)	content: 1 0 0 0 0 0	la	
raised by agent 4 (0.73)	type:ANZ duty: 6 0 0 7 5 4 1	une la une	definite-indefinite
recruited by agent 1 (0.81)	type:ANZ duty: 6 0 0 7 4 4 1	une le un	
recruited by channel 1			
finding 1 is directly raised by its agent			

**Table 10: Explanation of result 'la'**

Two paths using three paradigms concurred to produce result *la*.

The path in the lower third of the figure uses one paradigm only: structural analogies between definite forms and indefinite ones. This path is short and produces finding 1 with strength .73.

The path in the two thirds at the top of the figure begins within the same paradigm then (thick horizontal line) a resetting takes place which makes it enter a singular-plural paradigm. After a longer walk through the plexus, it ends up raising finding 5 with strength 0.59.

The two findings are merged, into the result *la* with strength 0.78.

Another plexus would operate differently. However, if it implements the knowledge of a not too deviant French speaker, it must produce result *la* with high strength and in first rank. This is macroscopic determinism (externally observable results may result from dynamics which vary in their detail) and quasi-normativity (all speakers of a language have *about* the same productions).

## 5.7. Grammatical agreement with AN2

### 5.7.1. Principle of agent AN2 and its effects

So far, agent ANZ addresses systemic productivity alone. In a paradigm, one dimension of which is number, it finds a plural when required. However, it is not capable of morphology or syntax (structural productivity) and therefore cannot exert an agreement constraint.

On the other hand, the B2-B3 process ensures structural productivity and performs analyses, but without exerting any systemic constraint: the notion 'system' is foreign to

it. Now grammatical agreement combines structural productivity and systemic productivity together.

The idea with agent AN2 (ANalogical task with segmentation into 2 constituents) is to combine both routes. One of its main effects will be to make the model capable of grammatical agreement, number agreement or agreement on any dimension along which an agreement constraint applies.

Formally, the task requested from agent AN2 is exactly an analogical task as defined above, that is:

find X which is to Y as A is to B.

The difference lies in the technique adopted to solve it. Here, term Y is:

- a) envisaged as a whole, as in ANZ, but also, simultaneously and concurrently,
- b) segmented into two constituents (in ANZ it was not so analysed).

In this way, tasks which did not have a solution with ANZ because Y was not directly attested in the plexus may now have one. To segment Y, AN2 uses as a commissioner agent S2A the specification of which is provided in an appendix

Here are now a few test results, still with the same French plexus. Lines 1 to 6 show that agreement performs well: gender agreement in simple noun phrases, person agreement in verb conjugation. This is happy and seems a minimum. The interesting point of course is how this is obtained: the agent responsible of these results is short-sighted and it uses only systemic analogy and structural analogy: it knows nothing about things like verb, pronoun, noun, article, gender, etc. It works without heads or syntactic features.

As in previous sections, a detail analysis would show that these results are made possible by the integration of several fragmentary paradigms.

	<b>Y</b>	<b>vehicle: A / B</b>	<b>phases</b>	<b>strength</b>	<b>result: X</b>
1	un homme	femme / homme	10	.56	une femme
2	un homme	une / un	9	.43	une femme
3	homme habile	femme / homme	10	.56	femme habile
4	homme habile	une / un	9	.43	femme habile
5	je vais	allons / vais	5	.66	nous allons
6	je vais	nous / je	5	.66	nous allons
7	très gentil	suffisamment / assez	6	.59	extrêmement gentil

**Table 11 Grammatical agreement with agent AN2**

Task's parameters

X : the question

vehicle suffisamment : assez

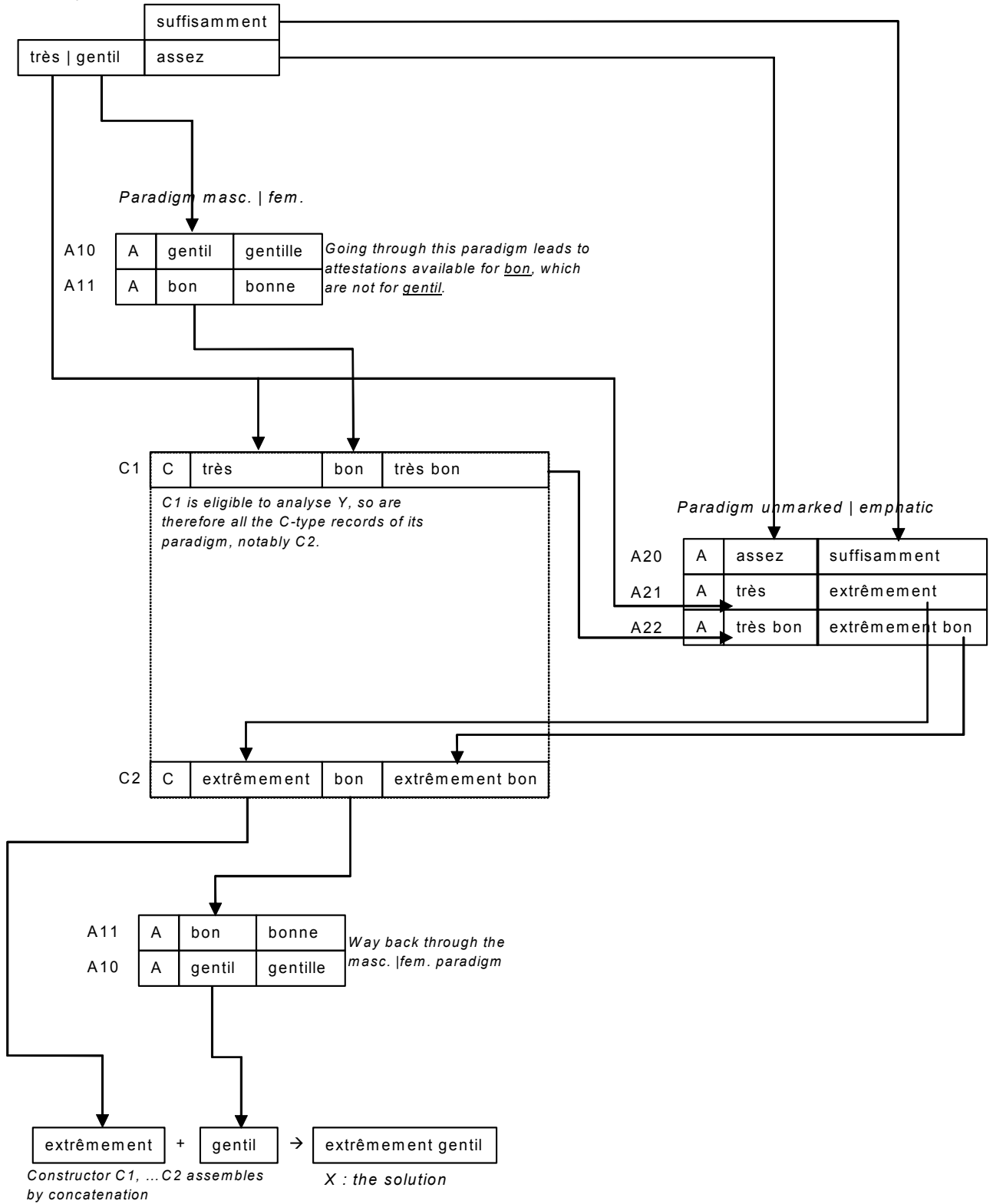

Figure 26 What is to très gentil as extrêmement is to assez

Finally, the speaker of which this plexus is a model has a good command of agreement in two-term groups, that is roughly two-morpheme groups; this ability is not rule-based, it is distributed and latent in the plexus and is revealed by a dynamics.

Line 7 shows something in addition: if one sees the pair *assez : suffisamment* (En.: *enough : sufficiently*) as defining a vehicle which is a [unmarked, emphatic] vehicle, then, the form *très gentil* (En. *very kind*) is an unmarked form and the task consists of finding for it one or several emphatic homologs. The model finds *extrêmement gentil* (En. *extremely kind*) which, in this speaker, is a possible emphatization of *très gentil*<sup>149</sup>.

The figure above is a picture of the sort of inscriptions which are mobilized, and of the paths which are taken. It may be consulted to catch an approximate idea of the mechanisms at play but, although already complex, it remains "figurative": it ignores many unproductive search paths and focuses on those that finally produce; even in the latter, it skips numerous intermediate steps, and it does not reflect rigorously the settlement mechanism.

The agent succeeds by integrating, always in a short-sighted manner, data taken out of three paradigms:

- a) a C paradigm *très+bon*→ *très bon* :: *extrêmement+bon*→ *extrêmement bon*
- b) an A paradigm *assez : suffisamment* :: *très : extrêmement*, etc.
- c) and paradigms as the A paradigm *gentil : gentille* :: *bon : bonne*, etc. which make it possible for *gentil* and *bon* to be considered similar, this in turn allows the construction in paradigm C to be applied to term *gentil*.

The heuristic deployment becomes complex but its elementary movements remain simple: they are limited to the four abductive movements defined above. This new example, illustrates once again the integrative effect of the computation.

Line 7 is also interesting because the axis of its vehicle: *assez : suffisamment*, which is termed "axis [unmarked, emphatic]" for convenience only, is now remote from what grammars described with some success. It is vaguer, and less recognized than the axis [singular, plural] for example. It is also less shared among speakers. However, it is a fact which demonstrates some systematicity and some productivity. In a speaking community there is, at work, an abundance of such oppositional axes, half-characterized, and half-shared, which constitute the dubious frontier of grammar. Oppositions, forming themselves into paradigms may appear and evolve rapidly in languages. These sorts of paradigms surge, then reinforce themselves following fashions and influences among speakers, then generalize and entrench, or droop and disappear. To this, categorial theories are helpless. With this model it suffices to add or alter a small number of records in the plexii or the relevant speakers.

---

<sup>149</sup> Some might object that this is not correct in French: *extrêmement* is not to *très* as *suffisamment* is to *assez*. It surely is not, but this model does not try to model received or standard French and what is considered is a speaker who, at a given point in his history in the language, may make that particular analogy.

### 5.7.2. Limits of agent AN2

Agent AN2 succeeds in giving way to constraints which play across paradigms and lead, for example, to render agreement effects without requiring any *ad hoc* device, that is, without the syntactic features that are usually called for this. However, this is not sufficient and agent AN2 has limits.

AN2 has a first defect which it inherits from agent ANZ which it uses (remember AN2 is client of ANZ two times: i) directly, and ii) via S2A). AN2, using ANZ, inherits its low efficiency<sup>150</sup> at priming time. More generally, AN2 also has a low efficiency in the rest of its operation: it is deemed to make an inefficient use of plexus inscriptions. To obtain results it requires more inscriptions than what would be strictly necessary following intuition. This remark was made by B. Victorri in an early stage of the project, this is recognized but I did not try to correct this defect as it is linked with the second one: the inextensibility of the agent.

The second limit of AN2, in effect, is that it cannot be extended to more than two morphemes (more precisely, two terms), from AN2's function specification itself. In a conception which would seek, for the same function, to extend its scope, one should previously have to understand to what it can apply: it makes no sense to order applying a vehicle (for example putting it into feminine) to a form of arbitrary length or with an arbitrary "categorical label" (in Fr. putting into feminine makes sense for an NP and sometimes for the group formed by NP + V in the case of the agreement of the past participle; it makes no sense for an adverb or a multipropositional utterance). Having to determine this scope, meets the second question about this extension: when do we know what vehicle has to be applied to what form, and why? In a realistic act like emission or reception, when and how are we led to assign the model a task requiring a function like that of AN2?

### 5.8. *Conclusions on systemic productivity*

In this chapter, it was shown that structural productivity does not exhaust linguistic productivity. Beside it, a systemic productivity was recognized necessary. It has a dynamics of its own, and, even if it conjoins very soon with systemic productivity, it is antecedent to it.

The dynamics of systemic productivity was constructed by means of the abductive movement by transposition (and that by transitivity). Organically, this motivated the introduction of agent ANZ which is the base organ of the model for this productivity.

Several case studies showed how this agent draws on plexus resources in different ways, and the model's integrativity received new illustrations.

---

<sup>150</sup> "Efficiency" is informally defined as the quantity of productions which a model can abduct divided by the quantity of inscriptions in the plexus. The use of the word "productivity" is dedicated to the idea that a vast number of new utterances may be produced after exposition to a much smaller number of utterances. "Efficiency" is related to a model and "productivity" to the object of investigation, so they are different. For example, one may have to say that a model accounts for linguistic productivity but that it does so with a poor efficiency.

This showed the base mechanism of the (re)construction of pluridimensional systems by the learning speaking subject.

The case *Auvergnats* and *Bavarois* illustrated the possible lexical dimension of systems.

The question of agreement was met and qualified as a mixed productivity phenomenon: both structural and systemic. A first approach solution was proposed and discussed: it is limited because it is inextensible.

The standpoint reached in this chapter is susceptible of the following extensions (which are not done in this dissertation):

- a) Massive use of the base dynamics of systemic productivity on the verbal paradigm of a language which differentiates well the forms (Romance language or Slavic language for example) to demonstrate a sigmoidal acceleration learning (avalanche effect). This poses no particular conceptual problem and is just a question of time to dedicate to an experiment which is a little bit heavy to conduct.
- b) Use of the base dynamics of systemic productivity in combination with the structural dynamics; this poses a conceptual problem and is a prerequisite to the forthcoming items.
- c) Exploration of the grey zone anomaly-analogy in this domain. For a subject not yet endowed with a pedagogical, dogmatic knowledge (a pre established multidimensional frame has not been presented to him as a norm), show how a starting configuration of inscriptions in which some are anomalous and other ones already formally analogical (or present several formally analogical subsystems with contact points between them), constitute a field where regularization (occasionally perceived from the outside as overgeneralizations) may develop in different directions.
- d) Generalization of the agreement dynamics to more than two terms.

Within these limits, this chapter showed how pluridimensional linguistic systems re implement themselves in speakers, with contingency residues, as the effect of an elementary dynamics.

The list of grammar effects rendered by dynamics that are antecedent to grammars is now complemented with the following ones: new sub-categorization effects, system effects, syntactic feature effects.

Here again, it is not an antecedent grammatical description that conditions the understanding of the dynamics. It is the previous elucidation of the dynamics which allows reconstructing the effects. The latter may, in a second tense, become the subject of grammatical discourse; but this is second.

# Chapter 6.

## More questions of grammar and description

For some notions, traditional or more recent ones, this chapter shows how the "grammatical" vision that other theories provided is affected by the analogic and exemplarist approach which is proposed here.

These notions generally lose their necessity or see it much weakened, but before dispensing with them, it is necessary to show how the needs which they were intended to meet are now covered.

### **6.1. Morpheme, word, syntagm**

#### **6.1.1. Word**

The notion 'word', as a component of grammatical description or as a theoretical component is not postulated in this model: it depends too much, cross linguistically and in time, of certain descriptive traditions. The less bad criterion to define the word has been that of cohesion: morphemes constitute a word when syntax does not make it possible to insert anything among them. Now cohesion is a *de facto* effect which results from i) terms being motivated by structure mapping, ii) the dynamics based on plexus inscriptions, and iii) the fact that C-type records (including expansive gates) license some assemblies and not other ones. Therefore, there is no need of a particular descriptive entity, the 'word', to account for it.

One of the effects of the notion 'word' would be to found the separation between morphology and syntax. Now precisely, is appears as not very useful to separate morphology and syntax with defined criteria (below).

There is therefore no 'word' in the model. This option is coherent with the suspension of minimality: for a 'language with words' (shortcut for 'a language in which a descriptive tradition finds words') it will be possible to distinguish terms shorter than words, terms longer than words, and these two things concurrently with words themselves. This option is consistent also with this conclusion drawn from the dead ends of descriptive approaches and from the suggestions of the connectionists:



The conception of the lexicon which recurrent networks suggest, contradicts the lexicographic position. Words, as entries in a list, do not exist because there is, properly speaking, no remembering from an independently stored, decontextualized knowledge. Words are always reactivated in a specific context from the memory traces constituted by the connections weighted by experience. As mental states thus reactivated, they correspond to interpretative cues geared towards the analysis of a given situation, not to building blocks that would exist independently of their usage. If they have an independent (that is: lexical) existence this must be seen only as the secondary effect of their recurrence, much the same way as a prototype is just the invariant part of all its actualizations. As an abstract lexical entry, more or less invariant, they belong to a conceptualized knowledge of language, which is derived and reflexive, not to language at work. Otherwise said, words are postulations of grammarians or of lexicographers in the double sense that they are actually produced by grammarians and that any speaker end up defining a reflexive knowledge on his own practice. Laks 1996, p. 115.

Instead of the word, the Analogical Speaker fosters the term. The term is subject to what has been called 'suspension of minimality': a term may be a word, a morpheme, or longer, or shorter; various examples have been given.

There being no word in the model does not prevent to treat written language with spaces between words, this is the case for all plexii made so far. Spaces may occur within terms but the space has no particular role ascribed: it is treated like any other written letter. In an analysis by agents B2 and B3 for example, the parsing for terms in the received form grants the space no particular role.

By contrast, an important role is played by term demarcations as they appear in C-type records. They influence immediately and directly the structure mappings of the received form onto the plexus content.

The stability (or fragility) of the notion 'word' does not hang solely on what would be its length. We must also examine the cases in which, for a same span, theories have found reasons to see one word only or several ones.

### **6.1.2. Homography, accidental homonymy, syncretism**

#### ***6.1.2.1. Statement of the question and orientations for its solution***

Classically, these cases are homography or homonymy, they encompass accidental homonymy, syncretism, "improper derivation", etc.

All these cases are characterized by a single form, but to understand it in its occurrence contexts, various theories or various analytical frameworks, which approach language by objects and properties (therefore partonomic), found the need to distinguish several words, or alternately to postulate one word only, but which may occupy several places in a pluridimensional paradigm.

Thus for example Arnauld and Lancelot (cf. p. 26), observing that Latin does not differentiate ablative and dative in the plural, maintain however the distinction ablative plural and dative plural, these two places being systematically occupied by equal forms, syncretic by this alone, because doing otherwise "would blur the analogy of the [Latin] language". And, almost worse, blur the analogy between Latin and Greek!

Now these cases are 'oblique' cases, that is more marked ones, if one accepts mark in syntax; they are also the less commonly used cases and it is of no small importance that it be here that languages make fewer differences. So is it in French for the definite article which, in plural (*les*), does not differ for gender. This happens in plural, which means, again, forms more marked and less frequent.

The fact occurs in numerous phenomena of numerous languages. Imposing differences against the evidence of the form, by submission to exceedingly coarse analysis frames, simply amounts to ignore that languages differentiate their expressive resources in proportion of the cognitive importance of the differences to make. Forcing artificial differences is certainly departing from the functioning of speakers, "optimal" in a certain sense.

This is also to be seen in the paradigm of the article in contemporaneous German. In its usual presentation, one perceives homonymous forms but with no particular organizing principle, and a great confusion as an overall impression.

	<b>masc.</b>	<b>fem.</b>	<b>neut.</b>	<b>plur.</b>
<b>nom.</b>	der	die	das	die
<b>gen.</b>	des	der	des	der
<b>dat.</b>	dem	der	dem	der
<b>acc.</b>	den	die	das	die

Now a reshuffling of columns and cases (the rows) reveals a very different picture:

	<b>masc.</b>	<b>neut.</b>	<b>fem.</b>	<b>plur.</b>
<b>nom.</b>	der	das	die	die
<b>acc.</b>	den	das	die	die
<b>gen.</b>	des	des	der	der
<b>dat.</b>	dem	dem	der	der

As in Latin, the conjunction [plural • oblique cases]<sup>151</sup> is less differentiated and, in this German example, indifferentiation also extends to feminine. The greatest difference shows up in [masculine • direct cases]. These facts are cognitively relevant. A categorial analysis of the type [gender • number • case] masks them completely, and moreover creates an artificial problem of homonymy, imposing then the artificial burden of having to "disambiguate"; designers of computer programs for syntactic analysis based on such theories will understand what is meant here. It is more faithful to facts to abstain believing in a grammatical number which would cross grammatical case with systematicity or in a gender which would differentiate for all numbers.

---

<sup>151</sup> The bold dot • denotes the Cartesian product.

A more systematic investigation in such phenomena was made by Jason Johnston<sup>152</sup>. For a variety of European and African languages in which he studies the inflexional paradigms, Johnston finds that the syncretic forms (*systematic homonymy* for him), always lend themselves to regrouping if we are allowed to reorder the rows and columns of the pluridimensional paradigms. He concludes to the inadequacy of classical analyses by features: *cross-classifying binary features are incorrect, they fail to predict linearizability* [for Johnston, *linearizability* is the rearrangement of rows and columns] *of natural classes of properties*. This meets the conclusion made above on the German article.

Certainly a theory based on categories has no other option, but we do not posit categories; we do not compel paradigms to follow frames like [gender • number • definiteness], or [case • number], for example. Moreover, terms are empty, they are not property-bearers, at no moment must we assign them a gender, a number, a declension case, etc.

What is suggested then is to adopt a faithfulness to form principle, that is, to abstain postulating two linguistic beings where one form only is produced by the structure mappings across exemplarist utterances.

In French, in effect, the definite article in singular is twofold depending on gender, but in plural there is only one. So three terms only are needed: *le*, *la* and *les*.

It is nonetheless possible to write:

*le Marocain : la Marocaine :: les Marocains : les Marocaines*

without the two *les* making a difficulty because they are comprised in longer terms in which the nouns differentiate the genders, even in plural.

By contrast, it would be inappropriate and harmful to pretend the following analogy:

*le : la :: les : les.*

This is because:

- Doing so with only one term *les*, would create confusion on the gender effect and the utilization of this inscription would introduce high noise in the results<sup>153</sup>; this analogy would be wrong.
- Choosing on the contrary to make with *les* two different terms (two distinct but homonymous "words"), one masculine and the other feminine – what would be

---

<sup>152</sup> Johnston 1997, excerpt from the introduction : *This thesis takes as its starting point proposals to model inflexional paradigms as geometrical structures, wherein systematic homonymies are constrained to occupy contiguous regions. It defines a precise criterion for assessing systematicity and shows, for a range of largely Indo-European and Afro-Asiatic data, that such models are observationally adequate in modelling systematic homonymies within a single inflexional dimension, and to a lesser extent, between different inflexional dimensions. This is taken to indicate that widely assumed characterizations of inflexional categories in terms of cross-classifying binary features are incorrect, inasmuch as such characterizations fail to predict the linearizability of natural classes of properties belonging to those categories. The same inadequacy besets attempts to account for systematic homonymies by means of rules that convert or 'refer' one morpho-syntactic representation to another.*

<sup>153</sup> Remind an analogy is all the better, the closest it is to bijection, that is, nearing a function in the mathematical sense, otherwise said, a biunivocal application. This is not verified here since the terms of the singular map onto one only in plural.

recommended by Shaumjan and Mel'cuk, against Bloomfield, cf. below – would be analogically acceptable but would infringe the faithfulness to form principle.

In a case which combines two syncretisms, it is also possible to write:

*le Suédois : la Suédoise :: les Suédois : les Suédoises*

despite the added syncretic form *Suédois* (masc. sing.) and *Suédois* (masc. plural), because the analogous forms are all different here again, be it by the noun or by the article, so that the four terms in this analogy are different even when their constituents are not.

From these examples, we can now abstract the principle adopted for the inscriptions: when making inscriptions in a plexus (A-type records and C-type records), syncretic forms must not be used directly as terms, and they must not be dissociated into as many homonyms as the places they are deemed to occupy in analysed pluridimensional frames; on the contrary, insert such forms in contexts that are broad enough for the required analogies to hold between overtly different terms. The principle of suspension of minimality finds here a precious application.

This approach suppresses the need to wonder whether a same form must be analysed as one word or as several words. It was long a worrisome question with questionable solutions. For example Bloomfield and Shaumjan disagree about it. Bloomfield takes that the word is a form<sup>154</sup> (the point here is not that it is a free form or not, what matters is that Bloomfield identifies the word with the form). Shaumjan – followed by Mel'cuk in this matter – contradicts this view in several respects notably this one: when Bloomfield sees one word only, Shaumjan wants as many (as many *grammatical words*) as there are places in the analysis system<sup>155</sup>: the word must be "defined through the notion of syntactic function". The proposition in this thesis is closer to that of Bloomfield: using his example, *shut* should not appear standalone in the plexus; rather, it must appear in contexts such as: *the Louvre shut yesterday*, or *keep your mouth shut*. In this way, one ceases to have to differentiate "homonymous words" according to their syntactic function or to fuse them into one word only.

An indication of the incidence in the model of either option can be provided.

---

<sup>154</sup> A word is a minimal free form. Bloomfield 1933, quoted by Shaumjan 1997, p. 285.

<sup>155</sup> Bloomfield definition of the word is not satisfactory for several reasons : 1. [...], 2. Bloomfield confounds the phonological representation of the word with the grammatical notion of the word. Thus the phonological word [likt] and the corresponding orthographic word *licked* represent a particular grammatical word that can be characterized as the past tense of *lick*. But the phonological word [ʃʌt] and the corresponding orthographic word *shut* represent three different grammatical words : the present tense of *shut*, the past tense of *shut*, and the past participle of *shut*. 3. [...] within applicative grammar, the main classes of words are morphological crystallizations of the basic syntaxemes : predicates crystallize into verbs, terms crystallize into nouns, modifiers of predicates crystallize into adverbs, modifiers of terms crystallize into adjectives. NAd? subclasses of words are crystallizations of their different paradigmatic functions. A definition of the word must be independent of the notion of the morpheme. The word must be defined through the notion of syntactic function. A word is a minimal linguistic unit that is capable of having various syntactic and paradigmatic functions either (1) by itself or (2) together with a word of type (1) meeting in the latter case the condition of separability. "Minimal" means that a word contains no other word. Shaumjan 1987, p. 285.

### 6.1.2.2. Plexus before elimination of homographies

form	term 1	term 2	term 3
<i>la</i>	article	clitic	
<i>des</i>	article	amalgamation <i>de les</i>	
<i>que</i>	as in <i>chaque fois que</i>	as in <i>je crois que</i>	
<i>si</i>	as in <i>si fort, si grand</i>	as in <i>si je veux</i>	
<i>-er</i>	infinitive, 1st group	as in <i>premier, dernier</i>	
<i>-es</i>	indicative present 2S	mark of fem. plural	
<i>-e</i>	indicative present 1S	mark of feminine	
<i>viens</i>	indicative present 1S	indicative present 2S	imperative 2S
<i>arrive</i>	indicative present 1S	indicative present 3S	
<i>voyage</i>	indicative present 1S	indicative present 3S	noun
<i>fait</i>	indicative present 3S	past participle	noun
<i>fatigue</i>	v. fatiguer, ind. pres 3S	v. fatiguer ind. pres. 1S	
<i>attent-</i>	as in <i>attention</i>	as in <i>attentat</i>	
<i>habite</i>	indicative present 1S	indicative present 3S	
<i>vis</i>	indicative present 1S	indicative present 2S	
<i>veux</i>	indicative present 1S	indicative present 2S	
<i>ferme</i>	indicative present 3S	En. <i>farm</i>	En. <i>firm</i>
<i>été</i>	v. <i>être</i> , past participle	the hot season	
<i>-</i>	<i>contre-jour</i>	<i>voulez-vous</i>	<i>dix-sept, cent-deux</i>

Table 12: Homographies before elimination

In the French plexus, a first development stage contains 19 forms which are occasions of homograph terms: each form corresponds to two or three terms. Some of them (*arrive*, *viens*) are syncretic, some other ones (*ferme*, *été*, *-es*) are accidental homonymies, for a few remaining ones (*la*, *des*, *fait*) it is difficult to decide.

The first step in the experiment consists in fusing such terms so as to eliminate any homography from the plexus: doing this is applying the faithfulness to form principle.

### 6.1.2.3. Effect of the elimination on tasks without apparent homography

The model is first tested with tasks that are deemed "without homography" because they do not contain, directly visible in the utterance, homograph terms – which would traditionally be analysed as such – like *ferme*, *voyage* or *été*. Yet, they do contain other ones, embedded in lower levels of the analysis. Hidden and shorter homographs like *-es* or *-e* (see the table above) occur; they may be seen as parasitic. It is interesting to see how the behaviour of the model is affected as a consequence of the elimination of homographs.

To that end, six utterances are analysed i) before the reduction of homographs, and ii) after it. For each utterance, the table displays the number of phases needed to obtain the first analysis, the number of agents, and the number of products. All three numbers are provided before and after reduction.

test utterance	phase	nb of agents		nb of products	
	before/after	before/after	loss	before/after	loss
1 <i>un très grand jour</i>	2/2	311/326	5%	287/293	2%
2 <i>une très grande maison</i>	5/5	1443/1587	10%	1576/1705	8%
3 <i>séjour de vacances</i>	4/4	547/765	40%	674/810	20%
4 <i>bon séjour en France</i>	18/25	1613/2072	28%	2083/2324	12%
5 <i>elle est arrivée avec son homme</i>	4/4	1044/1170	12%	1112/1152	3%
6 <i>elle est arrivée avec son homme et son cheval</i>	7/7	1898/2076	9%	2000/2087	4%

**Table 13 Compared tests, before elimination of homographs and after**

The volume of the heuristic structure (agents and products) increased by 15% in average and twice more for agents than for products<sup>156</sup>.

Test 3 shows an important increase. One contributing factor was the melting of *-es* as a verbal inflexion mark, and *-es* as the feminine plural mark. There may have been more.

Test 4 displays a surprising increase of seven phases which may be explained by some records disappearing as the consequence of the reduction. The computation had to take different, longer paths. The cost increase, in agent and product numbers, is significant without being explosive.

Such computation cost increase is the price to pay for getting rid of this categorialist facility which the differentiation of syncretic or homograph terms constituted in the previous state. The model in its new state supports the added cognitive load to discriminate *en passant* and to "categorize" terms which are now more ambiguous.

The utterances under test get analysed for the same reasons as before, that is, they are licensed by the same records. This is not documented in the table above but it is reassuring: the computation of the meaning, when we know how to do it, would have the same basis, whether homographs are reduced or not. This is a sort of guarantee of stability. This remark however is relative, as these tests contain no explicit, "true" homograph; which suggests another test.

---

<sup>156</sup> That the product number increase is half that of the agents draws the attention. The following interpretation may be proposed. Agents mostly reflect heuristic invention: they are opportunity-seekers spreading in several directions in search of settlement conditions, that is, of favourable conditions holding between the terms of the task and those of the plexus. Products by contrast sanction the settlements when they occur only; they are more directly dependent on the congruence between the terms of the task and those of the plexus; they depend more directly on the "possible of language", to quote Milner. Accepting this, helps understanding why homography makes the process search a lot more but makes it find a little more only. All right, but why should it not find nothing more. At the last stages of analysis, that is, when the entire utterance is analysed (assuming that there is not at this stage a final ambiguity to which homography might contribute) the process finds nothing more indeed. But before getting to there, in the intermediate steps of the analysis, some additional hypotheses surge temporarily, giving birth to some additional products. This is why the number of products also increases, less however than that of the agents.

#### 6.1.2.4. A test with a "transcategorical homography"

This new test bears on the French form *été* which, taken out of context, can be either a form (En. *been*) of verb *être* (En. *to be*), of the hot season (En. *summer*). The intent is to show how a context which determines one of these interpretations suffices to the model for utterances in which the ambiguous form is contextualized to be related to appropriate licensing analogs in the plexus.

Thus, form *cet été* for example, gets licensed in five computation phases by *une semaine* (En. *a week*) and *le soir* (En. *the evening*), without any interference of the past participle of *être*.

(cet été)	span of channel 6 (ph 5)
(cet )(été)	how ag 43 segments the span
[une][semaine]	attests the segmentation (finding 359 on record 1087)
(cet )	span of channel 3 (ph 1)
[cet]	attests as setup term 89 setting up channel 3
(été)	span of channel 1 (ph 1)
[été]	attests as setup term 2074 setting up channel 1
[le][soir]	attests the segmentation (finding 363 on record 255)
	as per channel 3, already exposed
	as per channel 1, already exposed

Form *nous avons été* (En. *we have been*), in turn, is analysed in two phases, licensed by the verbal construction *il a fait* (En. *he has done*). Here, the season *été* (En. *summer*) has no place.

(nous avons été)	span of channel 15 (ph 2)
(nous )(avons été)	how ag 279 segments the span
[il][a fait]	attests the segmentation (finding 280 on record 1256)
(nous )	span of channel 11 (ph 1)
[nous]	attests as setup term 526 setting up channel 11
(avons été)	span of channel 13 (ph 2)
(avons )(été)	how ag 116 segments the span
[a][fait]	attests the segmentation (finding 241 on record 1280)
(avons )	span of channel 4 (ph 1)
[avons]	attests as setup term 527 setting up channel 4
(été)	span of channel 1 (ph 1)
[été]	attests as setup term 2074 setting up channel 1

Thus categorization effects become insensitive to homonymy provided the context makes them non ambiguous. Here again, the day we know how to "compute meaning", we will be able to avail ourselves of the appropriate bases to do it.

The separation effect is easy to understand: the distributions of *été*-summer and *été*-been, in their possible constructions, are different enough for the plexus paradigms of their exemplars to relate them with analogs which are 'natural' to either, well before interferences, which are always possible, but remote, and necessarily weak, have an occasion to arise.

All this removes one more reason to postulate "lexical items" and takes us closer to make justice, operationally, of this precious intuition: "language is form and not substance"<sup>157</sup>.

This completes the investigation of cases in which one is tempted to postulate different words where one form only is perceived.

### 6.1.3. Allomorphy

The opposite situations are ones in which, facing several different forms, we would have reasons to postulate one linguistic being only (word, lexeme, or morpheme). There are two such situations; allomorphy – which applies to radicals and bases – and group sensitivity – which applies to conjugation affixes and to case marking affixes.

#### 6.1.3.1. Allomorphy

The examples are:

- Fr. *vais/allons/irai/fus* (En. *go* pres. 1S / *go* pres. 1P and imp. 1P / *shall go* fut. 1S / *was, were* in certain persons),
- En. *be/am/is/are/was, eat/ate* (an apophony here?),
- Jap. *ii/yoi* (*to be well, to be good*) yet this may also be analysed as a defectivity of *ii*, the homologous forms of *yoi* being called in suppletion of the non-existing ones of *ii*.

For Ducrot (1995):

Two morphs are of the same morpheme (and then are said to be allomorphs) if they carry the same semantic information, and if their substitution:

- either is never possible in the same context, this is the case with *i* and *al* (*ira, allons*) which can never be substituted since they are imposed by the person and the tense of the verb,
- or is possible in any context without meaning alteration, this is the case with *ne ... pas, ne ... point*. This is also the case with *peux* and *puis* which are always substitutable.

In the two cases envisaged by Ducrot, the first one only will count here, that of forms in complementary distribution: context imposes one of them exclusively. Allomorphy, which is an anomaly, is often associated with the anomaly of forms (*vais*) but not always: it may be concomitant with "parochial" sub-domains, which are locally regular (*allons, allez, allions, alliez; irai, iras, ira, irons, irez, iront*), but the frontiers of such sub-domains are contingent.

Phenomena of allomorphy ( /floer/ *fleur* ~ /flor/ *floral* ) or of suppletion (*jeu* ~ *ludique*), very frequent in morphology, have no clear syntactic equivalent<sup>158</sup>.

---

<sup>157</sup> Saussure, *Cours et Ecrits*.

<sup>158</sup> Houdé 1998, p. 278.



### 6.1.3.2. Theories addressing allomorphy

The most common solution is the "grammatical word" or abstract morpheme with conditional realization<sup>159</sup>. It is that of Martinet for example:

The 'monème' makes it easy to describe phenomena for which the Americans created the concept of allomorph and of portmanteau morph. Ducrot 1995, p. 434.

One describes without difficulty but one describes only and the *Distributed Morphology* (DM) does nothing better:

DM recognizes two different types of allomorphy: suppletive and morphological. Suppletive allomorphy occurs where different Vocabulary Items compete for insertion into an f-morpheme. For example, Dutch nouns have (at least) two plural number suffixes, *-en* and *-s*. The conditions for the choice are partly phonological and partly idiosyncratic. Since *-en* and *-s* are not plausibly related phonologically, they must constitute two Vocabulary items in competition.

Morphological allomorphy occurs where a single Vocabulary item has various phonologically similar underlying forms, but where the similarity is not such that Phonology can be directly responsible for the variation. For example, *destroy* and *destruct-* represent stem allomorphs of a single Vocabulary item; the latter allomorph occurs in the nominalization context. DM hypothesizes that in such cases there is a single basic allomorph, and the others are derived from it by a rule of Readjustment. The Readjustment in this case replaces the Rime of the final syllable of *destroy* with *-uct*<sup>160</sup>.

The rule of readjustment is designed to readjust, and it readjusts; but how does the notion 'readjustment' fit into a theory? What makes it something more than *ad hoc*?

### 6.1.3.3. The model addressing allomorphy

Since categories are refuted, it is not possible to postulate a lemma or abstract morpheme with conditional realization, like verb *aller* 'in abstracto', and this is not attempted. Secondly, since there are no rules, the way of readjustment cannot be taken either and this is not regretted.

The job is done by A-type paradigms in the plexus. Analogies like:

(a) irai : vais :: mangerai : mange

confer to forms *irai* and *vais* the same opportunities to enter the compositional computation as "regular" ones like *mangerai* and *mange*. But this is still true when both pairs in an analogy contain suppletive bases:

(b1) irons : allons :: irai : vais

(b2) go : eat :: went : ate

the "regularity", or not, of these forms does not prevent analogies like (b1) and (b2) to function on their own, and then to integrate their effects with other ones: simply, an analogy like (a) puts in addition the pair *irai* : *vais* in communication with a regular

---

<sup>159</sup> Which is sometimes called 'lemma' in natural language processing.

<sup>160</sup> <http://www.ling.upenn.edu/~rnoyer/dm/#impoverishment>, 2000/02/13.

zone (via the pair *mangerai* :: *mange*) and thus with the formation of a great number of forms abducted by suffixation, that is, it extends much its potential efficiency.

The analogical task, and behind it systemic productivity, is not vulnerable to allomorphy from the moment the forms which use suppletive bases are copositioned with other forms. Moreover, this is about indifferent to these presenting a locally sub-regular affixal inflexion as in *irai*, *iras*, *ira*. This means that agents ANZ and AN2 behave on allomorphs with the same felicity as on regular forms, and as on many more irregularities.

An example of this was already discussed in section 5.3. *French verb, two paradigms playing integratively* (p. 139).

In other words, allomorphy is not an obstacle to relating a form with its best analogs. So that, here again, when we can compute meaning, we will have the appropriate bases available. Then the proposal will be validated by demonstrating that similar meaning effects are recuperated from formally different allomorph terms: the terms are formally different but the model succeeds in circumventing these differences. We do not even have to fear that allomorphies create a processing/cognitive overload if direct raising of a readily inscribed form is supposed to be cheaper than assembling it (escalation principle): as allomorphy applies to more frequently used forms, it is expected that such forms are inscribed by many occurrences in a plexus and thence are directly raised, and not assembled.

#### 6.1.4. Group sensitivity

The second occasion in which one can be tempted to postulate only one "abstract morpheme" covering several different forms is that of grammatical groups: conjugation groups, and declension groups. With a French plexus containing:

- a) *je blanch-is, blanch-ir*
- b) *je chant-e, chant-er*

with from: *je finis*, the model should abduct *finir* and not a form like *finer*. Doing this rightly would be demonstrating "group sensitivity". The same need arises for declension groups in Latin or Russian for example and for other group phenomena.

Conjugation groups and declension groups share with allomorphy the fact the morphemes involved (flexion morphemes and case morphemes) present forms with non-optional complementary distribution.

It is no longer the bases which are in complementary distribution, here it is the inflexional morphemes. This let alone, they are also forms which occupy a place in a system, and in that place, several of them are possible. In the given example, the place is "indic. pres. 1S" and the corresponding form is realized as *-e* (*je rêve*) or *-is* (*je lis*).

What is the indication which selects a form among the possible ones at a given place? In allomorphy, it is a place in a system. For verb *aller*, the indication "indic. pres. 1P" selects *all-* and indication "indic. future" selects *ir-*.

The case of groups is more complex. The clause is of the type:

- (C) *finir* (and not *finer*) because *je finis, je blanchis*  
and because *blanchir* (and not *blancher*).

That is to say that, a pair like *je finis, je blanchis* must be introduced, along with other such pairs, in an analogical game which now involves more elements.

In feature-based models, the question of conjugation groups can be solved by introducing a syntactic feature for the required group. For case allomorphy (that is, for declension groups), Latin nominative is nominative whatever the declension group; it is the grammatical category 'nominative' which reduces this allomorphy. Here again, the device encompasses a syntactic feature.

This is refused in this model as features are neither applicable nor desirable. What is needed is a mechanism respecting clause (C) above. It must implement this as an effect, in a non-categorical, hopefully cognitively founded manner. It should also be implementationally plausible. The solution to this point is not yet found; an extension of agent AN2 is a possible track, but other ones should also be explored.

### 6.1.5. Sub-categorization

In theories with categories, the question of sub-categorization arises when one realizes that it is impossible to make a set of lexical categories in which each particular category provides, about its instances the lexical entries, all the information required to determine their behaviour. For example, for nouns, it must be possible to distinguish count names from mass names, animates from inanimates, humans from non-humans, referents that may be possessed from ones that may not, etc., for verbs the intransitives from the transitives and among the latter, the direct ones from the indirect ones, etc. The number of distinctions to make is not *a priori* bounded and they mix up formal viewpoints and semantic ones. Crossing all these criteria is impossible because it causes explosion in the set of sub-categories and this renders the theory intractable.

Current theories address this difficulty along two ways; either they accept a numerous set of categories, and organize them into a lattice with multiple inheritance, this is what construction grammars do (cf. Chap. 1), or with feature structures, used in unification theories such as HPSG. Both ways achieve a certain categorial flexibility, with some residual rigidity, a heavy functioning, and a null plausibility.

The example in Figure 27 illustrates one of the means proposed to treat sub-categorization. It is a plexus paradigm which bears on the ditransitive construction in English<sup>161</sup>.

---

<sup>161</sup> In previous examples, when a paradigm was drawn, a single edge between two records was sufficient. This example on the contrary requires to show term by term mappings, so edges are drawn between terms rather than between records. Yet the underlying model is the same, graphical surface presentation only has been adapted.

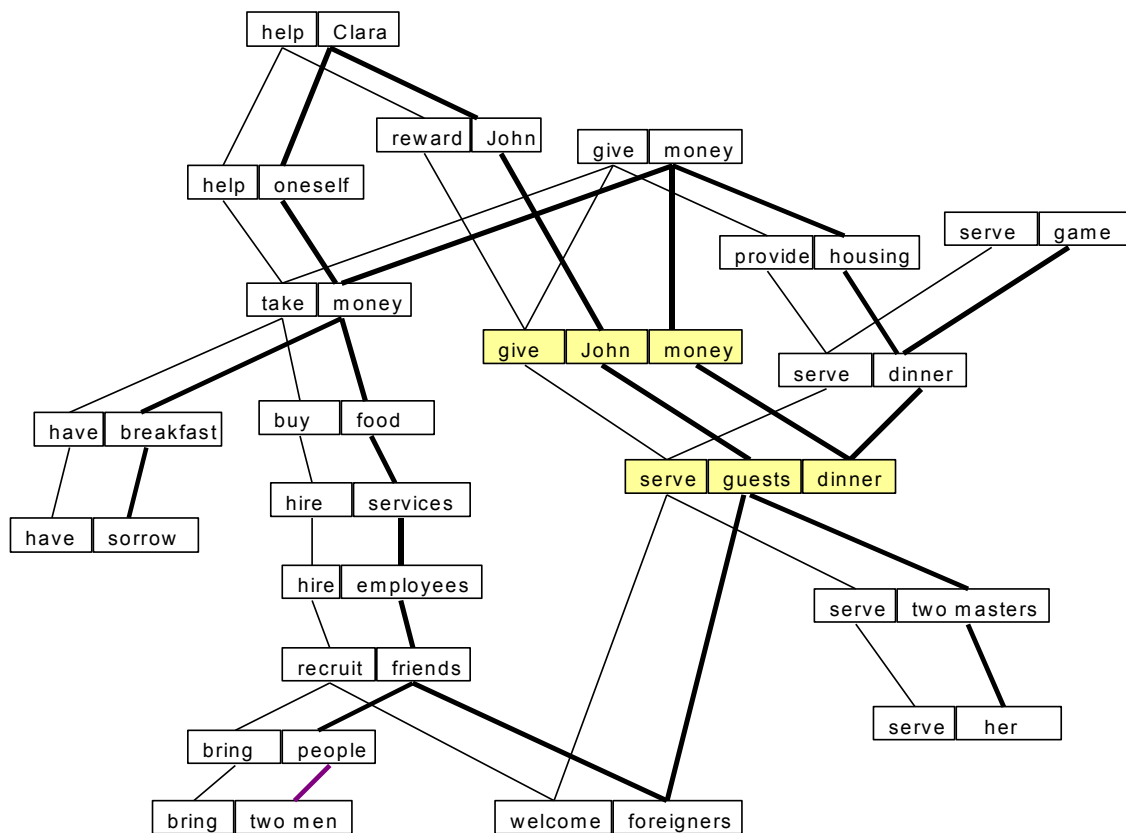

Figure 27 Ditransitive construction in English

In this paradigm, the two critical records are: *give John money* and *serve guests dinner*. The edges show how, in this region:

- a) *John* and *guests* strongly categorize with *foreigners*, *two masters*, *her*, *friends*, *Clara*, *oneself*, etc. whereas
- b) *money* and *dinner* strongly categorize with *housing*, *game*, *food*, etc.

This helps not to produce utterances like \* *offer money John*.

However, the region *buy food :: hire services :: hire employees*, which is remote from the critical records, shows how these groups finally may connect (follow the thick edges), but the connection is remote from the ditransitive region.

In short, this figure demonstrates an effect of global category ("noun phrases" if you want) flexibly coexisting with an effect of sub-categorization ("possible beneficiaries" and "possible objects"). The reader still remembers that such (sub)-categories do not have to be reified in the model and they are not.

In this example, a single paradigm contributes to the sub-categorization effect but it is not necessarily so. In the example *John is easy to please / eager to please* (p. 112), the overall sub-categorial separation effect is rendered differently by acknowledging in the plexus that "the constructions are not the same" and by the integrative play of several paradigms. What the two cases have in common is the paradigmatic distance set between records which differ constructionally even when they look alike superficially.

#### **6.1.6. About the lexicon**

What does the lexicon become in this model?

It happens that a term of the model is a "word".

It also happens that a conventional "word" never occurs directly as a term in a plexus: such finite verbal form for example or such infinitive, or such derived word, may not be found explicitly. In cases in which a form meeting its specification is called into a computation, the corresponding form is assembled on the fly by analogical abduction. The latter is authorized by C-type records containing the bases and affixes most similar to the constitutive segments of this "word".

But this may also be the case for a non-inflected word. It may happen that a "word" is present only as a part of an assembly. It is contained in one or several terms in the plexus but is not otherwise present with its exact perimeter. If the hypothesis of self-analysis is retained (cf. p. 258), such a containing term may be analysed on the fly and, in a transient manner, a form with the exact length of the "word" may be distinguished and serve, for example, to license a homograph form which appears in the received utterance. Whether this transiently distinguished form deserves to survive the occurrential act, that is, deciding whether the act is an occasion for the model to learn something, is discussed in the section just referenced.

The lexical entry is thus made precarious vs. what would be its length: it becomes fortuitous that a term is a word (but it may be frequent). This dimension of contingency, established in Chap. 2 a desirable property of the model, is thus realized in it. A more complete discussion is provided p. 194.

Even when it happens that a term is a word, the downgrading of the lexicon is increased from the fact that terms are vacuous. This is an important difference with preceding theories. A term – this point has been made already – has no other import than that of providing access to the exemplarist contexts where it is occurring, and to be recognized as "the same term" in its recurrences, see section 7.2.2. *Essentiality (or not) of a term* (p. 193).

At this point, little remains of a lexicon's conventional vision. It is not entirely nullified however. An assessment of the question is provided in an appendix (section 12.2.2. *Is a 'table of terms' needed, up to where downgrade the lexicon?* p. 296).

If the notion 'word' loses its value, an incidence has to be expected on the separation between morphology and syntax. But it cannot be a simple abolition of their separation, we need to go a little into details.

## 6.2. Syntax-morphology separation

### 6.2.1. Conversion, improper derivation

The considerations developed above, about homography and syncretism, have an extension and an application in "improper derivation". This refers to the case in which a word of a category is used with a different category, for example in Fr., an infinitive comes in the position of a noun: *le parler vrai*, *le voir baroque*<sup>162</sup>. Another example is: *le bleu du ciel*. It is non-affixal derivation.

The question which improper derivation poses to grammarians is to decide whether, after conversion, we are facing the same word as before conversion – of what category then? – or two different homonymous words – and then how is this homonymy to be handled. It is perceived by Sanctius as early as the 16<sup>th</sup> century:

One of the most characteristic leading ideas in *Minerva* is the refutation of any re-categorisation, of any non-affixal derivation which would enable a noun to play as an adjective, an adjective to "substantivise" in order to act as a noun, and the main part of the chapter dedicated to preposition, adverb and conjunction consists of reinstating in their origin category words which, *by their form*, are adjectives or pronouns, and the use of which in lieu and instead of an adverb or [text interruption]. Geneviève Clerico in Sanctius 1587/1982, p. 20.

Francoise Kerleroux writes:

We assume that this notion (improper derivation) serves to cover data which appear as residual, after application of the only available analysis model, that is: affixal morphology, which is supposed to represent all languages. Kerleroux 1996, p. 11, then the entire Chap. V on this topic.

In HPSG still, which remains categorial, members of the HPSG community consulted consider *rire*, in *envie de rire* and in *le rire*, as two distinct lexical entries. The reason for this is easy to understand: in HPSG, lexical entries are modelled as feature structures in which feature CATEGORY plays a key role.

To this, the Analogical Speaker provides again a simple solution. There is one term *rire* only, without any categorial determination since there is no room for categories. In emission, a form like *le pleurer* (strange in French) is simply not produced because of the escalation principle if terms like *ses pleurs*, *les pleurs*, *des pleurs* are found present in the plexus (it will only be possible to demonstrate this when we know how to treat meaning). In reception, *le pleurer*, if we expose the model to receive this, will be abductively licensed from *le rire* or similar terms, if the plexus contains such terms.

As for *le bleu du ciel*, *le ciel est bleu*, there is no need to decide whether *bleu* must be construed as one word or two (a noun and an adjective): the various placements of the unique term *bleu* in various structural contexts, that is, in various C-type records, provide for licensing other uses that might be done – or uses of distributionally similar terms – all in constraining each appropriately. The fact that a single term *bleu* is the sole occupier of these different placements causes a possible category leakage between what categorial frames call 'adjectives' and what they call 'nouns'. But this is exactly what we

---

<sup>162</sup> Kerleroux 1996, p. 293

need to licence *c'est très classe* (it's very classy) or *un lourd* (a heavy one, a stupid one). Naturally this also exposes us to *le rapide de sa réaction* (the fast of his reaction) which is not very accepted in contemporaneous French. In the plexus of a contemporaneous French speaker, *rapide* is at some distance of *bleu*, *réaction* is remote from *ciel*, consequently *le rapide de sa réaction* is possible but a little expensive, and so normally not produced. It may be received but with a certain cost. That phrase was much less impossible among the *précieux* in the 17<sup>th</sup> century, it could be used today with irony or distance, its unacceptability varies among speakers, and we do not know what will turn out to be in a few decades or a few centuries.

### 6.2.2. Questioning the inflection-derivation frontier

Several authors put into question that there would be too clear a distinction between inflection (which would be syntactic) and derivation (which would not be).

The opposition between inflection and derivation, appears fragile enough and the grammarians of Sanskrit could do without it. As Pinault notes: *For Panini, there are only affixes, which differentiate solely by their rank in the chain of derivation.* Auroux, 1994, p. 175.

The Stoics make no clear distinction between derivation and inflection. Swiggers 1997, p. 27.

The existence of the difference between *inflection* and *derivation* is not less obvious than the difference between *semanteme* and *morpheme*. But with the current status of knowledge the definition of this difference is not less vague than the other one. We think the difference is to be sought in the opposition between *syntagmatic relations* and *associative relations*. Hjelmslev 1933/1985, p. 56.

The difference between inflexion and derivation has a limit in *Suffixaufnahme*<sup>163</sup>. Planck 1995, p. 3.

If it is true that inflections generally incur a smaller difference of meaning than derivations, and are more general, there is a difference of degree rather than an absolute one between these categories. So it is not possible, according to Bybee, to situate inflection in syntax and derivation in the lexicon, as Generative Grammar often does. The best definition of inflection is its being obligatory so that its absence creates a lack which takes a signification. The absence of the mark of plural in French for example, indicates the presence of the singular. Vandeloise 1990, p. 230.

### 6.2.3. Reasons for merging or distinguishing morphology and syntax

Creissels, in the light of African languages questions the notion of word and consequently the morphology-syntax demarcation:

[In a language like Latin] in which the morphemes of an utterance are easily grouped into blocks with high internal cohesion and high mobility with respect to each other,

---

<sup>163</sup> Definition of *Suffixaufnahme* (paraphrase of Planck 1995, p. 7): let Nt be a nominal head with a nominal modifier N2, *Suffixaufnahme* consists of a casual mark of Nt being duplicated onto N2 without this being motivated by the function of N2. On N2, the mark is added to possible other marks, including casual marks, which N2 may bear for functional reasons. *Suffixaufnahme*, first described by Bopp, is attested in Georgian, in Caucasian languages and in ancient languages of the Middle East; it is different from group inflection even if both these phenomena are akin to each other.

there is no reason to reject the advantages of a description in words. Then we have a division into morphology and syntax. But in a language in which the cohesion of morphemes do not show such differences, it is not wise to conserve this schema. Creissels 1991, p. 31.

What is traditionally separated as morphology and syntax can be envisaged as an axis along which a variety of phenomena, functions and needs are disposed. It is not given in advance that positing a separation is the most clarifying way to structure this axis.

The position adopted in this model is not to make particular devices that would differentiate morphology and syntax. This option is motivated by three reasons: i) the notion 'word' is not postulated because of the problems it poses, ii) the clause "morphology = short assemblies, syntax = longer ones" is not criterial, iii) abductive movements by constructability transfer and by expansive homology apply in both domains.

At least in the tests made thus far, all needs of productive assemblies are covered by the interplay of the following items:

- a vision of the lexicon which is "leaned" and made contingent: demotion of the notion of lexical entry, preference for the notion of term, vacuity of terms, minimality suspension, etc.
- plexus content, notably C-type records and paradigmatic links between them: they support production of morphological assemblies and syntactic assemblies equally well,
- abductive movement by constructability transfer,
- abductive movement by expansive homology,
- the general dynamics of agent-based solving (ABS).

The refusal to distinguish between syntax and morphology by subordinating the latter to the former is a principle vision shared by several authors. Fradin (1999) points out that it is the case of Saussure, Harris, Haiman, Gruaz, Sadock, Halle and Marrantz.

In the same article, the intent of which is on the contrary to defend a distinction between morphology and syntax, Fradin surveys criteria and reasons tending to show that the distinction is necessary. Several of these criteria and reasons have no influence on the Analogical Speaker because the inscriptions in a plexus exert them *de facto*. So is it for example of the cohesion of morphemes within words. Cohesion happens simply because the plexus provides no exemplarist occasion for such or such expansion to occur, so the model cannot produce that sort of expansion. The same thing can be said about another criterion: that an assembly has a category different from its head's category (then exocentric according to Bloomfield) or has the same category (then endocentric). For Fradin (p. 27), a morphological assembly is always exocentric whereas in syntax it is more easily endocentric. This is not always true (Fr. *passé, passée, passées*) or it depends on the vision we take of categories. In any case, here again, in the Analogical Speaker, the exemplarist inscriptions place conditions on the possible outcomes of an assembly, that is, they constrain that with what it will in turn be able to assemble. These "conditions" are not reified, they are a global effect of the inscriptions and the dynamics (ABS and the agents that it hosts) do not have to know anything about it in principle or



in general. Therefore, endocentricity or exocentricity do not matter and these notions cannot be used as a base to discriminate that which is morphological and that which is syntactical.

All this does not deny that there might be in these respects some specificities or tendencies of morphology, but asserts that the abductive mechanisms do the job without having to wonder whether they are making morphology or syntax.

The inscriptions of the plexus do not mark in any special way a difference between morphology and syntax, no computation is affected by this difference in particular, the model postulates nothing concerning a possible demarcation.

It is conjectured that this indifferent dynamics would apply with the same felicity to morphological, morphosyntactical or syntactical phenomena which occur in other languages. Group inflection, for example, which is observed in Basque<sup>164</sup>, seems not to pose a particular problem but it would be more important to take a look at languages like Eskimo-Aleut languages<sup>165</sup> or some African languages in which the morphology-syntax frontier is much less clear even than in e.g. European ones. This work remains to be done. If it confirmed the findings so far, the conclusion would be that the morphology-syntax distinction is, for the most part, just for compartmental convenience and has, at best, a pre theoretical statute.

However, this order or reasons do not suffice to account for morphonology (Fradin 1999, p. 26). On this point, the model has nothing to say in its current development. It may be that solutions can be found in assembly schemes more elaborate than just concatenation, or ones inspired from the multiple structures of van Vallin, Sadock and Jackendoff; then the decompartmentalisation option would be extended and validated.

But it may be also that such phenomena impose to acknowledge something of the word. Without this having to reinstate the word in all its prerogatives, there would be one or two phenomena to treat particularly.

### **6.3. Zeroes**

Strictly speaking, the question of zeroes is not a linguistic one: by definition, zero elements are not observable phenomena; they are dispositions that some theories<sup>166</sup> adopt in the account they give of certain phenomena. The question links with that of the ellipsis without coinciding with it.

#### **6.3.1. Zero elements in grammar and in linguistics**

The temptation of zero elements in the history of linguistic thought dates back to Sanctius at least:

---

<sup>164</sup> Inflections of case, of determination, and of number are not suffixed to a noun but to an entire noun phrase.

<sup>165</sup> Cf. Tersis 2000.

<sup>166</sup> Structural linguistics and generativism principally.

Sanctius refuses to make passive impersonal [in Latin] a distinct structure from that of ordinary passive. Both may be glossed identically and integrated into equivalent constructions. Therefore it is a useless category and the mind of children should not be burdened with it. This position allows him then to "prove" with a circular argument, that any verb is necessarily transitive, including those regarded as neutral (*curere, sedere, stare*) by the tradition. Since these verbs occur in passive, (*curitur, sedetur, statur*), and since this passive is not different from the passive of transitive verbs *amatur*, this leads to positing behind them the suppletion of a transition accusative, *stationem* after *stare*, *setionem* after *sedere*, *cursum* after *curere*. This example illustrates the fact that, for an author who goes beyond formal data, phenomena in the form play a considerable role in the organization of language. Geneviève Clerico in Sanctius 1587/1982, p. 22.

Much later their usage is systematized in structural linguistics .

Giving the status of linguistic elements to zero segments can be carried out in a great many situations. It can be used in such a way as to blur the differences between two sets of morpheme-class relations. Note must therefore be taken of the descriptive effect of each zero segment that is recognized in the course of an analysis. In keeping with the present methods, it would be required that the setting up of zero segments should not destroy the one-one correspondence between morphological description and speech. Hence a zero segment in a given environment can only be a member of one class. Harris. 1951, p. 335.

In Martinet the zero element is the occasion of a curiosity. Accepting zero elements generally ("the signifier of subjunctive is occasionally the zero signifier"<sup>167</sup>, "the zero signifier of injunction"<sup>168</sup>), he states that before giving in to that temptation it must be assured that its signified is consistent:

However, there is normally [in the case of European languages], among the elements of the grammatical class, a "category" which is unmarked, that is, neither formally represented nor semantically characterized: this is the case, in French, of indicative, of present and of singular. One must not posit a "monème" for a zero signifier that would correspond to an inconsistent signified. Martinet 1985, p. 146.

This is somewhat disappointing. This author who generally recognizes opposition (in *take the book*, *take* is selected against *give*, *throw*, *put*, etc., *ibid*, p. 32), sees the absence of mark, as it does not positively characterize it, to correspond to an "inconsistent signified". Does opposition apply separately in each plane? I agree on the conclusion: zero elements are not desirable, not more in this case than in any other (cf. below), but there is a serious objection about a motivation of this kind. It is not possible to make an *ad hoc* correction at an isolated point without reconsidering the analysis frame (mode, tense, person, number) and its general relation with the formal observables. Either you recognize the ideal frame of the verb paradigm in an Indo-European language (mode, tense, person, number) and you request forms to be characterized according to it; then you cannot say that indicative present singular is an inconsistent signified and a zero element is necessary. Or you recognize the analysis frame without requesting the forms to be always differentiated in it; then a zero element is not necessary, but it remains to

---

<sup>167</sup> Martinet 1970, p. 104.

<sup>168</sup> *Ibid*.

be shown how speakers assign forms (now ambiguous) to places in the frame. Or – this is my proposition – the frame is not postulated (it would be categorial) and one shows, on exemplars, and analogically, which ratios and which oppositions a speaker can make, in what assemblies of bases and inflexions (and of contexts) in those that a speaker can license, these are not always the same for all verbs (that is for all bases); this will have to be doable without zero elements.

Even before the fundamental objections which will be made, the explanatory power of the zero postulation is not well assured in many cases. Marandin<sup>169</sup> identifies the failure of analysing with an empty category the noun phrase **Det + Adj**, ex. *les rouges sont fripés* (En. *the red (ones) are crumpled*).

Elsewhere<sup>170</sup>, zeroes are refuted in the name of checkability and non-indexability:

From an epistemological viewpoint, positing zero marks or zero constituents is questionable, since it amounts to posit a segment, constituent, or a segmental mark, the signifier of which is precisely represented by an absence of segment, therefore to posit fictitious segments under the pressure of the theory – this encompasses an important risk of non-checkability. Another difficulty quickly appears: the fundamental impossibility to categorize and to index such elements "which do not exist", and even more to coindex them.

the functions that would be theirs must be taken over by other elements<sup>171</sup>:

There is no zero mark for the person, but a pluridimensional structure of linguistic paradigms. This applies in the plane of paradigms, with paradigms of paradigms, and it applies as well from the viewpoint of the syntagmatic axis which presents a "superposition of marks" of various types, concomitant marks which enter into combination in any utterance and give distinct instructions.

In the case of relativation in languages without a relative pronoun, Japanese for example, the push to postulate zero marks is seen as a consequence of the fact that the relative proposition is perceived as a transformation of an autonomous proposition<sup>172</sup>. In a theory without transformations this reason for zero marks falls.

Lemaréchal pleads, rightly, for not positing zero marks. His intuition of the "superposition of marks" as a suppletion to what other frames analyse as a shortage of segmental marks has indeed the potential of a productive dynamics that may succeed without zero elements; this dynamics must be made explicit and this will be done below.

Sadock's Autolexical Syntax increases the model's complexity the for several reasons and succeeds in constructing the explanation without zero elements.

One of the features of the autolexical model that give rise to discrepancies between representations in different dimensions is the possibility that a lexeme that is represented in one component is simply not represented at all in another, giving the effect of deletion or insertion without the need for specific rules that actually delete or insert. The empty subject of "extraposition sentences" [*It seems that Fido barks*] for

---

<sup>169</sup> Marandin 1997, p. 144.

<sup>170</sup> Lemaréchal 1997, p. 2

<sup>171</sup> Ibid., p. 44.

<sup>172</sup> Ibid., p. 83.

example, can be treated simply as an element with a representation in syntax but none whatsoever in semantics<sup>173</sup>.

The Autolexical Syntax contains no notion of movement:

The components are modular in that the units with which they deal are distinct. The units of the morphology are stems, affixes, inflections, and so on, namely units that are appropriate to word construction; the units of the syntax are words, phrases, clauses, and so on, that is, units appropriate to sentence structure; and the units of the semantics are predicates, arguments, variables, and the like, that is, meaningful units. The components of an autonomous, modular grammar of this kind are thus "informationally encapsulated" in the terminology of Fodor 1983 (*The Modularity of Mind*), whereas the modular building blocks of a GB style grammar, such as the rule Move-Alpha, have access to all representational dimensions, and are therefore not informationally encapsulated<sup>174</sup>.

Which suggests that the Autolexical Syntax does not have transformations. Although the non-postulation of transformations and movements is never explicit in the text, these notions occur only in examples that the theory proposes to treat without them. This conjecture is reinforced by this:

... a context-free phrase structure grammar is a sufficient formalism for each of the modules, including the syntactic component<sup>175</sup>.

Now, phrase structure grammars are a supertype of X bar theory (which specializes them by adding the notion 'head') and the same X bar theory is positioned as the component which addresses syntax before transformations<sup>176</sup>. Finally, the Autolexical Syntax does not recognize transformations, which is coherent with the fact that it does not recognize zero elements.

### 6.3.2. What should be done with zero elements

In short, zero elements are introduced as a consequence either (i) of the generativist's transformations or (ii) of mono-, bi-, or three-dimensional categorial paradigms for morphology or syntax. One understands that, since there is no positing transformations and since pluridimensional paradigms are not approached with categories, the need for zero elements falls in this model and they are not introduced.

The cases which motivated their introduction in other frames are processed simply and naturally by the interplay of A-type and C-type records and of the computations that apply to them, using the escalation principle, cf. section 6.4. *Anomaly and regularity*, p. 181, for transformations, cf. section 4.2. *About non-transformation*, p. 107.

The demonstration will be better made on an example.

---

<sup>173</sup> Sadock 2000.

<sup>174</sup> Ibid., p. 11.

<sup>175</sup> Ibid., p. 21.

<sup>176</sup> X bar addresses the 'bare component' as opposed to the 'transformational component' Chametzky 2000, p. 6.

### 6.3.3. "The indefinite plural article has no realization in English".

Seemingly, speakers of English agree upon the following analogy:

(A) the cat : a cat :: the cats : cats

In a framework which posits the notion 'word', if a mass of other facts invites to posit words 'the', 'a', 'cat', 'cats', which are categorized into articles and nouns, and if the backing frame comprises the dimension defined-undefined and the dimension singular-plural, we have to face a slight obstacle: the position article + indefinite + plural is not filled with anything. The structuralist solution consists of postulating an indefinite plural article with no realization, a zero article, and the temptation is to write lines as<sup>177</sup> :

(1) the cat : a cat :: the cats :  $\emptyset$  cats

(2) cat : cat :: cats : cats

(3) the : a :: the :  $\emptyset$

The temptation is even stronger if the theoretical frame posits propositions of the type: NP  $\rightarrow$  Det + N

Line (2) is not false but trivial or tautological and has to be left out of the consideration as void.

Line (3) has two inconveniences. Firstly the double occurrence of "the" which connects with the question of syncretism (cf. p. 160), and secondly the presence of  $\emptyset$  the problems of which have just been exposed. Finally inscriptions (2) and (3) reflect nothing of a linguistic knowledge that would be useable in the linguistic computation. Now line (A) is perfect even if its terms are not minimal: it is a very good analogy, much contributing to the computation, and free of any negative side-effect. If we recognize the minimality suspension principle, it becomes possible to keep it.

As a complement we will need an operation of subtraction which may have two operative supports: a) the subtractive utilization of C-type records, in cases where the inscriptions of the plexus are abundant and sufficient, and b) formal analogy when inscriptions of the plexus do not suffice, for example in the case of unknown words. So is it for the English term *tiger*, less familiar the En. *cat*, but which some other plexus inscription<sup>178</sup> make it possible to abductively "co-categorize" with *cat*, inscription (A) will abductively license something like (B);

(B) the tiger : a tiger :: the tigers : tigers

which will contribute to align the behaviour of *tiger* on that of *cat* for matters of number and definiteness.

Although it may, line (B) does not have to be explicitly inscribed in the plexus; the computation, because it is abductive and integrative, will develop as if the inscription were explicit. When it is not, the computation will simply be slower, as the abductive

---

<sup>177</sup> This discussion does not distinguish the plural mark -s which should obviously be in a more complete coverage but is not necessary in this example.

<sup>178</sup> For example *big tiger :: big cat* or *fierce tiger :: fierce cat* or meaning-related analogies when this complement is made.

gimp which will then have to be deployed to reconstruct its effect requires a few supplementary agents.

#### **6.4. Anomaly and regularity**

Chap. 2 reminded how old the question is: analogists, anomalists in the Antiquity, and arbitration by Varro. Chap. 2 also reminded the position of Arnauld and Lancelot which boils down to accommodate attested anomaly while "*disturbing the least possible the analogy of language*", without however authorising non-attested usage.

So far, these authors make of the question anomaly-analogy – or anomaly-regularity – a treatment which is descriptive, antagonistic or ecumenical, normative in the case of Port-Royal, but the explanatory treatment, when present at all, is nascent only and no case operative.

Rather than an antagonism between analogy (rule) and anomaly, it is advantageous to see an analogy versus another one – it may be the case that the extension of the latter happening to be limited to one exemplar only. Thus, if the repairing analogy of the Neogrammarians installs a new form beside an old one that underwent phonetic change, one often sees also new forms with analogical motivation doubling old ones which did not undergo anything: they simply follow another analogy. The older form is not anomalous *per se*, it is only versus the newer analogy or a statistics. Such cases are frequent in Vaugelas, and this vision is necessary to account for the mobility of the demarcations in the "situations de partage" of verbal paradigms, along the diachrony of the French verb<sup>179</sup>.

The question of anomaly and analogy poses a problem to generativism. Following its requirement of minimality, this theory, at least in its early stages, places on rules and categories the duty of accounting for the greatest possible part of the data; this leads it to rejecting all anomaly in the lexicon and results, at the earliest stages, in some discomfort in the vision of the lexicon and morphology, and more recently, in a more lexicalized theory.

Langacker denounced this as the 'rule-list fallacy':

[in the generativist conceptions] If a grammar is a set of rules for constructing expressions, and contains the fewest statements possible, then any expression constructed by these rules must itself be omitted from the grammar. Separately listing an expression computable by general rules would be redundant (and redundancy is evil) (Langacker 1988b, p. 128). I call "rule/list fallacy" the presumption of the generative grammarians that regular expressions should not be listed in the grammar. It is fallacious because it tacitly presupposes only two options: rules vs. lists. But nothing in principle prevents positing both (ibid. p. 131).

Rules and lists are not mutually exclusive (rule/list fallacy): instantiating expressions have to be included in the grammar along with rules because rehearsed units are known despite their satisfying general patterns. Langacker (p. 2). [the approach I advocate is] non-reductive. Recognition of both rules (or patterns) and individual knowledge of specific features. Advantage: accommodates instances where a fixed expression is more

---

<sup>179</sup> Demarolle, already quoted.

detailed and elaborate than the structure that a rule or schema would allow to compute (an *eraser* is not just something that erases) (p. 132).

The question of anomaly vs. analogy was touched a first time on the occasion of a response to Jackendoff who deemed the "usage-based" principle as unable to treat it, and a direction for solution was then sketched. It encompasses A-type records exploited by the 'analogical task' (agent ANZ) on the one hand and on the other, C-type records exploited by morphological and syntactic constructive processes (agents B2 and B3), both being supervised so as to make to bear the principle of escalation (p. 92).

Thus for example, the analogical task  $X : cheval :: hommes : homme$ , which amounts – for the analysts that we are, but the model does not *know* it – to find a plural for *cheval*, initiates an abduction by systemic productivity (agent ANZ) and, if the plexus contains the anomalous term *chevaux*<sup>180</sup>, finds it by this way. Only when such a result is not found at a reasonable cost, is then launched a suppletion process which builds *chevals* licensed from the inscription  $homme + -s \rightarrow hommes$  (or similar accessible ones) and abducting its effect. The suppletion process constitutes an escalation: it is more expensive, and consequently penalized with respect to the direct process; because of this, before becoming productive itself, or even before just starting, it leaves an opportunity for *chevaux* to be produced.

The direct process is agent ANZ, the suppletion process is agent S2A and the process controlling both is agent AN2, cf. corresponding appendixes for their specifications.

Let us now revisit the modularist option concerning anomaly and regularity. It is attacked by Langacker again:

Attempts to impose a strict boundary between structural regularity and idiosyncrasy – attributing them to distinct modules or processing systems (Chomsky" 1965, Pinker" and Prince" 1991) – are, I believe, linguistically untenable and psychologically dubious. Instead, I envisage a dynamic, interactive process whereby structures at all levels of abstraction compete for activation and for the privilege of being invoked in producing and understanding utterances (Elman" & McClelland" 1984, Langacker 1988). Langacker 1998, p. 25.

If one really wants to, it is possible to see two modules in those two different processing modes: indeed both are carried out by distinct effectors, cortical areas perhaps, and distinct agents in this model. Yet it should also be noted that the effectors are minor, in their function and in their size, with respect to the overall mechanism that controls them, that obtains differentiated results according to the relevant terms in the tasks, and that globally exerts the escalation principle. Both positions can be defended: that there are modules, and that there are not; none is very interesting because in a linguistic task, as soon as it is not ridiculously small, both modes are present and what matters is their combined interplay in this entanglement. If there had to be two modules, one of regularity and one of anomaly, the interesting question would remain to know when and

---

<sup>180</sup> I indulge myself to write "the anomalous term *chevaux*" because the resources of the language are such that they incline to make this sort of metonymy. Yet, it is hopefully understood that term *chevaux* is not anomalous by itself, not more than it is anything by itself: a term having no essence and no property. Writing "anomalous" is exactly assessing that an analogical regularization is not the case; here the formation of plural by *-s*. But *chevaux*, is "regular" in the paradigm *canaux, totaux*, etc.

why either is triggered, how both interface and concur to enterprises beyond the scope of each. This cooperation/concurrence and escalation game is exactly what the dynamic side of the Analogical Speaker does.

### 6.5. Syntactic head

I remind here the example data of section 3.6.4. *Abductive movement by expansive homology* (p. 85). They consist of two constructor paradigms:

C1	une + journée	→ une journée
C2	une + belle journée	→ une belle journée
C3	une + occasion	→ une occasion

and:

C4	belle + journée	→ belle journée
C5	belle + victoire	→ belle victoire

both sharing term *belle journée* in records C2 and C4 – this last point is constitutive of expansive homology. A set of constructor records (C-type records) of that type was named 'expansive gate'. The expansive gate in the example is a "hard" one: the term is homologous to an expansion of itself. 'Soft' expansion gates are also possible in which a term is homologous to an expansion of a term which is distributionally similar to it.

If one wishes to, one may call "head" the term *journée*, that which is homologous to its expansion. However this is not required because i) the analysis of expansions takes place without having had to state generative rules or make HPSG-like lexical entries; in any case, as there are no categories, there is no base to say that a construction is endocentric or exocentric, ii) the optionality of adjuncts is a question which is solved naturally by the operation itself of the B2-B3 process using expansive homology movements, and iii) agreement and concord are handled by different ways; there is no syntactic feature to propagate, no percolation. In short, none of the reasons which motivate the introduction of the notion 'head' in theories that require it no longer hold here. The corresponding effects can be obtained without such explicit postulation.

Moreover, since the analyses are not univocal as we have seen, the head could only be ambiguous.

Finally, the notion 'head' is not necessary in the proposed frame. Dependency, the obligatoriness or optionality of a segment, are exerted in the model but they do so in a sort of *de facto* manner, they are expressed in a pervasive and distributed mode in the records of the plexus and they are manifested as effects in the utilization of the plexus that the computations do.



## 6.6. Sentence

For the sentence, as many authors, as many definitions or almost so<sup>181</sup>, and the most ironical one: "a sentence is that after which you write a full stop" is not the silliest one. And still these definitions address written language only:

Although sentences have often to be treated unquestioningly as the most basic of linguistic units, they do not always emerge from ordinary speaking with compelling clarity. ... Syntax and prosody are often at odds, and intonation units do not always combine to form structures with the properties syntacticians have traditionally assigned to the data that has been either invented or, at best, copied from some piece of writing. ... It is interesting to find that, whereas both intonation units and discourse topics remain relatively stable in content across different tellings of the same experience by the same individual, sentences do not. Chafe 1996a, p. 45.

The problems of sentence definition were well and extensively described and I shall not repeat this<sup>182</sup>.

What the model requires to operate are constructive paradigms. They may concern written language or spoken language. They may be prototypical or not, comply with an institutional norm or not. Forms terminated by a full stop may be, among others, assemblies in exemplarist constructions; that is, a sentence may be a term. To this there is no other contra-indication than the loss of usefulness of long terms cf. section 7.2.6. *Terms should be simple and commonplace* p. 200.

Things being so, sentences can be constituents in analogies bearing on sequences of replicas in dialogues, so that the model is open to "trans-sentence" processing or to sequences of verbal productions punctuated not by full stops, but by prosodic marks.

Two exemplarist constructions forming a plexus paradigm suffice to licence more if only abductive paths can be found; in the linguistic form only for the time being.

More than prosodic delimitation, phrasal delimitation, or sentential delimitation, what matters is the construction of meaning (the following concerns an extension of the model, yet to be done, in which meaning would be processed). The lag versus good formation or completeness which would be that of a well formed sentence may be as low as a synthesis point. A 'synthesis point'<sup>183</sup> is a point at which meaning may be fabricated, as little as it may be. This is not the case in all assemblies: some assemblies are steps which are necessary while awaiting a synthesis point, but which do not allow the construction of a stable meaning. In reception, as soon as a synthesis point is reached, the corresponding meaning is fabricated and becomes an asset while waiting for the rest of the utterance, the analysis of which it will contribute to orientate.

On the whole, about a form being sentential or not, as well as it being well formed or not, the idea is to abstain over specifying: it is the plexus that commands what will be

---

<sup>181</sup> One may consult Catherine Garnier *La phrase Japanese* (Garnier 1985, p. 14) for definitions of "sentence" by Arnauld and Lancelot, Saussure, Meillet, Tesnière, Bloomfield, Guillaume, Jakobson, Harris, Benveniste, Martinet, and Chomsky.

<sup>182</sup> For some questions concerning the definition of 'sentence' and the difficulty it poses to generativism, cf. Hagège 1976, p. 200.

<sup>183</sup> I owe the word '*point de synthèse*' to Irène Tamba.

possible or not, what will be easy or difficult. In a plexus of written, academic language, the notion 'sentence' will be massively present, pervasive in exemplars, and the productions based on that plexus will be univocally recognized as sentences. By contrast, such plexus of spoken language may make little or no room for sentences, or attest "sentences" which cannot be canonized against any canon. If it contains structural analogies (C-type records with paradigmatic links between them) it will constitute the foothold of an abductive productivity in the same way as the former one; it will determine the "style" of these productions.

### ***6.7. Conclusion: dynamics are the cause, and the grammar an effect***

Chapters 4 and 5 shown, in a positive manner, how a number of effects so far (badly) accounted for by stipulative discourse (grammars, static theories of a "language") were better seen as produced by a dynamic model.

We just saw in this chapter, now in a negative manner, how a number of grammatical notions, each of them problematic, loose their necessity. This was done by showing in each case how the Analogical Speaker solves differently the questions that these notions addressed.

These are ancient notions like word, homonym, lexical entry, lexical meaning, morphology-syntax boundary and sentence.

These are also more recent notions of 20<sup>th</sup> century linguistics: syntagm, zero element, syntactic head, and even morpheme to some extent.

In their stead, the dynamics and principles of the model: proximity, suspension of minimality, vacuity of terms, inscriptions of systemic analogies and structural analogies, abductive movements, and the general abductive dynamics, solve numerous description questions and theoretical questions. They do so with economy, flexibility, some plausibility, and with means which are simple and tend to be non-specific.

Thus, it has been widely proven in which way many grammatical notions become consequences of the dynamics. The relation between grammar and the dynamics was upside-down: the former was expected to explain the latter. Now it turns out that things go the other way round.

Analogy, now repositioned as a static system of ratios between terms, and a productive dynamic process, restores the reasoning in the right sense. Repositioning things in this way allows holding the phenomenon for a phenomenon and the process for a process, to make the process the cause, and the phenomenon an effect.

This enterprise of resetting things in the right order, because it reinstates analogy, restores continuity with over two thousand years of linguistic thought, and with more recent themes in the cognitive sciences. It makes the theory compatible with category leakage, with linguistic change (analogy as the mechanism of change, and the possibility of reanalysis which stays always open), and language acquisition. Language acquisition and reanalysis will be dealt with in Chap. 8 with other directions along which the model is susceptible to be prolonged.

In the meantime, a few questions touching its foundations need to be dug, which will provide opportunities to contrast the model with other approaches.

# Chapter 7.

## Foundations and contrasts

In this chapter several questions related with the foundations of the model are addressed. The vision of analogy in it is contrasted with that in other theories; the notion of term is discussed under all respects; more details are provided about copositioning and integrativity; three oppositions are discussed: exemplars vs. occurrences, proximity vs. totality, and extension vs. intension; the question of variable binding is shown to be less of a question after the refusal to reify categories and rules; the proposed model is contrasted with recent propositions tending to introduce probabilities in linguistic theories; finally the model is contrasted with connectionism.

### *7.1. Analogy in this model and in other propositions*

In the Analogical Speaker, analogy is the base of the inscriptions of linguistic knowledge and it is also the base of the linguistic dynamics; the model is isonomic (cf. p. 89). Other authors on the contrary aim at making analogies (and perhaps also metaphors and metonymies) without ambitioning to found the inscriptions and the operation themselves on analogy; they are partonomic.

#### **7.1.1. Psychologists, cognitivians, artificial intelligence**

So is it with SME (Falkenheimer 1989), ACME (Holyoak, Novick & Melz 1994), LISA (Hummel 1997), Tabletop (Hofstadter 1995), and Sapper (Veale 1988).

For the needs of the discussion, I propose to call "standard problem" vis-à-vis analogy the question as posed by psychologists (after Gentner 1983), which is also the question as posed in artificial intelligence. It is schematically recalled for example in Lepage (1996, p. 728) which I summarize. The standard problem goes as follows:

- two domains are envisaged, for example the atom and the solar system, the latter (the vehicle) being expected to help understanding the former (the tenor).
- the approach consists in achieving a structure mapping of the two domains (e.g. atom nucleus : sun).

- the structure mapping will result in property transfers (gravity : electromagnetic field). Structure mapping and property transfer are two different operations.
- the base of the structure mapping is a modelling of each domain (the solar system is made up of the sun and planets, a planet has a mass, there are eleven planets each with a different mass, planets have orbits around the sun, etc.).
- the value of an analogy is a function of the strength of the transferred properties (number, truth, etc.).
- the "standard problem" is defined as follows: the structures of the two domains being given, find a structure mapping between them.

Extension of the "standard problem": one target domain (the atom) which is poorly understood being given, and now not just another domain but a vast knowledge base (astronomy, human size mechanics, naive sociology, etc.) being available, select the best part of the knowledge base which may be taken as a source domain to make a structure mapping with the target domain.

A first manner to contrast the standard problem with the model proposed in this work, is to see that the standard problem supposes the analogous domains to be partonomically modelled (cf. p. 89): briefly, they contain entities bearing properties, and with relations among them. It is because each domain is modelled that a mapping may be searched and possibly found. The approach is partonomic.

In the Analogical Speaker on the contrary, for systemic productivity (that of Chap. 5, p. 129), a dynamics develops between terms without requiring them to have properties. It is an isonomic approach. This dimension is entirely new and is not to be found in the standard problem.

Secondly, in the syntactic computation which accounts for structural productivity (that of Chap. 4, p. 97), it is possible to see the utterance to be analysed (by the

<b>in the Analogical Speaker</b>	<b>in the "standard problem"</b>
utterance (to be analysed)	target domain (atom to be understood)
plexus	knowledge base
licensing records	source domain (solar system)

**Table 14 Mapping with the analogical "standard problem"**

model) as the target domain to be understood (the atom in the standard problem) and the plexus of the linguistic knowledge (of the model) as the knowledge base (of the standard problem); in this, the problem posed to the model would compare to the standard problem.

The mapping then would be as summarized in the table above.

There is a first difference though: in the Analogical Speaker the plexus is described on a strictly isonomic base whereas works that address the standard problem, for most of them, give of the domains to be mapped descriptions which are 'ontologies' (this is the word often used), sorts of semantic nets based on properties, on categorical types and relations. Such models are paratonic.

A second difference between the Analogical Speaker and current analogical mapping models lies in the general dynamics for producing results:

A classical solution [to produce *the good* answer] is considering all the possible representations of a situation, as in the case of modelling analogical reasoning in which it is frequent to build all possible pairings between the elements of two situations, and then to select the best adapted one according to defined constraints. But if we want a *psychological* account of this ability, the problem of encoding and the problem of representation lashes back: we do not elaborate *all* representations and it is difficult to set decision rules before the construction of representations<sup>184</sup>.

The Analogical Speaker does not build *all* possible pairings; on the contrary, it draws on proximality to reach one or a few exemplars which are *good enough* and, in this small number, it selects those with which a settlement (i.e. a solving) takes place. To this end, the dynamics envisages *certain* possibilities and never has to envisage a totality or a closure<sup>185</sup>. In the Analogical Speaker, the closure is a question at no moment: the heuristic process gradually broadens a search scope by soliciting gradually less proximal inscriptions; it is stimulated to do so only by the lack of congruence between the arguments of an act and the inscriptions in the plexus. What is heaving here is the proximality-totality antagonism which will be developed *infra* (p. 212).

### 7.1.2. Skousen: "statistical" analogy without rules or categories, but A2

A work, that of Skousen<sup>186</sup> recognizes (as I do) the inadequacy of rules as operating in language phenomena, and his argument is about that which I summarize in Chap. 1 and which is developed in an appendix. In order to "predict the linguistic behaviour", Skousen uses an analogical means.

In order to eliminate these difficulties, this book introduces a new way of accounting for language behaviour, one that can be called *analogical*. But unlike the imprecise and impressionistic appeals to "analogy" that have characterized language studies in the past, the analogical approach that this book proposes is based on an explicit definition of analogy. The main problem with traditional analogy is that there is no limit to its use: almost any form can be used to explain the behaviour of another form, providing there is some similarity, however meagre, between the two forms. Nor does this book use analogy to handle only the cases that the rules cannot account for. Instead, everything is

---

<sup>184</sup> Vivicorsi 2002, p. 83.

<sup>185</sup> Incidentally, optimalist models (the matter will be addressed again in the conclusions) meet this same question and do not appear to solve it better than current analogical mapping models. In the optimalist models, there is a worrisome step through a totality of potential solutions (among which constraints allow to select one as the best one) and the status of this totality is not sufficiently questioned, in my opinion.

<sup>186</sup> Skousen 1989 (Royal), *Analogical modelling of language*, Kluwer. This book has not been deeply analyzed. The statements made here are based on the analysis of its introduction only.

considered analogical, even the cases of complete regularity. Skousen 1989, introduction.

Analogy is responsible for accounting even of complete regularity. This theme is fully compatible with mine which is that effects of regularization must be handled along with anomalous facts in a single operating mechanism, different from the rule, and leaving to the latter no place in the *modus operandi*.

One can only follow Skousen with interest in his effort to run away from "imprecise and impressionistic appeals to analogy" which were done. In effect, the analogy which he refuses, that which satisfies itself with "some similarity, however meagre, between the two forms", resembles much the associations of associationist psychology and is probably not a sufficient lever to be applied to language. How is he going to achieve this?

Basically, an analogical description predicts behavior by means of a collection of examples called the *analogical set*. For a given context  $x$ , we construct the analogical set for  $x$  by looking through the data for (1) classes of examples that are the most similar to  $x$  and (2) more general classes of examples which behave like those examples most similar to  $x$ . The probability that a particular kind of occurrence will serve as the analogical model depends on several interrelated factors:

- (1) the similarity of the occurrence to the given context  $x$ ;
- (2) the frequency of the occurrence; and
- (3) whether or not there are intervening occurrences closer to  $x$  with the same behavior.

What appears is this: i) similarity plays always between two elements (not between four), that is, between two examples (exemplars?) or occurrences, arising for him from a corpus, that is, between such exemplar and the "given context  $x$ ", which is what determines the linguistic task, ii) the frequency of exemplars in the corpus is solicited, iii) the attention brought to "intervening occurrences" suggests the request for maximum contrast made by Householder (Chap. 2) in the lines of structural linguistics.

In the end, what is selected to "serve as the analogical model" for  $x$ , is what i) resembles it most, and ii) is most frequent in the corpus.

It is possible to see Skousen's clause "most frequent" as analogous to familiarity orientation in the Analogical Speaker.

About similarity, the examined text is not precise, but it is reasonable to infer – this was confirmed by working with Robert Freeman whose work is akin to Skousen's – that it is distributional similarity in the corpus, this means to say that  $x1$  and  $x2$  are the more similar that they have more occurrences sharing the same left context and right context.

Finally, it appears that Skousen's analogy is analogy between two terms, of the type "X is like Y" (that which was called "A2 analogy" in Chap. 2 when discussing the dismissal of analogy by Chomsky. A4 analogy of the type "X is to Y as A is to B" is not mentioned.

The cases which this book addresses convincingly are:

1. the English indefinite article *a/an*

2. the English initial /h/ in graphical realization (<h> regular case, <wh> majority exception, <j> minority exception),
3. the categorization of the labial stop by its voicing onset time (/b/ [-107,2] milliseconds, /p/ [51,94] milliseconds).
4. a diachronic phenomenon in Finnish: twelve verbs used to end with *si* in the past tense and now they end with *ti* and it is not possible to relate this change to any systematic explanation. For two verbs, Skousen explains the change by the avoidance of a homophony, then:

The effect of this minor change in an already sparse field was sufficient to break down the original gang effect of that field. Under conditions of imperfect memory, the analogical approach then predicts the subsequent historical drift, so that over time other verbs in this field have also changed their past tense forms from *si* to *ti*. The analogical approach thus accounts for the original instability of certain past tense forms in Finnish. It also predicts the overall stability of the past tense in the modern standard language.

Phonetic change of the first two verbs drove the (analogical) creation of new forms to the remaining ten verbs (gang effect) and the new forms superseded the older ones<sup>187</sup>. We recognize here the "repairing" analogy of Brugmann and Saussure already presented in Chap. 2. Repair spreads (or not yet) to the rest of the paradigm probably for reasons of the type invoked by Demarolle (1990) (repartition situations) cf. Chap. 2 again.

Now repairing analogy is an entirely A4 mechanism. How can it be invoked in a work which started out by recognizing A2 analogy only?

In the same spirit, it would be interesting to see how Skousen explains analogically questions – which he did not address – like agreement, syntagmatic expansion and, more generally, syntax matters.

In summary, in the renewed interest for analogy, it is not clear for everyone that the variety to take into account is A4 analogy. By contrast, this is very clear with Itkonen.

### **7.1.3. Itkonen: A4 analogy, but with rules and categories**

An important paper by Itkonen, tending generally to rehabilitate analogy, was analysed p. 43. This article comprises a model which suggests two remarks.

#### ***7.1.3.1. Itkonen keeps rules, categories and the slot-filler schema***

In order to explain syntax by means of analogy, Itkonen 'formalizes' syntactic analogies (p. 145).

He models linguistic knowledge as Prolog rules by typing Prolog atoms with the most usual categories of the analysis of English (N, V, NP, VP, Adv, Adj, Prep, etc.; subject, object, etc.; agent, patient, etc.). As Prolog does not have types, its use might favour a non-categorical modelling but this is not what is done: types, i.e. the above listed categories are explicitly built upon Prolog.

---

<sup>187</sup> Skousen writes that past forms "change" but if we remind Saussure (chap. 2), we understand that, in the analogical repairing of paradigms, forms do not change: newer forms are created and substitute the older ones.

The use of categories made by Itkonen in his model, this was already mentioned, may be just a convenience that this author adopted on the occasion of a limited argument; nowhere in the paper is a positive claim for categories and rules to be found, but nowhere either is the question even sketched. However, it can only be noted that Itkonen's model, as presented in the article, observes the slot-filler principle, and the potential of analogy to do better is not used or even envisaged.

### **7.1.3.2. Itkonen treats "analogies which motivated transformations" as analogical tasks**

Itkonen assigns his model to solve tasks like:

$$\begin{array}{l} X \\ \hline \text{Where did John say that Bill was?} \end{array} = \begin{array}{l} \text{John said that we have to get off the bus here} \\ \hline \text{John said that Bill was there} \end{array}$$

that is, he asks it to find:

$$X = \text{Where did John say that we have to get off the bus.}$$

This I called above 'analogical task' with syntax. The question here at stake is that of analogies which motivated transformations, cf. p. 107. He treats them by showing that it is possible to solve them as analogical tasks, that is, by showing that it is possible to compute a proportional fourth.

I addressed this above already: for me, explaining these systematicities by substituting the generation-transformation system of Generative Grammar with an analogical explanation does not necessarily require to solve analogical tasks. Such tasks in themselves are not normal speaker ability; they do not fall within the 'natural' use of language and ought to be seen rather as a metalinguistic exercise.

A first tier of explanation may be obtained as I showed in the already stated section.

However, there may be more to the analogical task than a gratuitous exercise of productive know-how. This cannot be decided as long as we do not have a model of the utterance production process. This model would start from the 'thing to be said', from the enunciative programme; it would devise an 'enunciation plan' taking account of the plexus resources that present themselves as the best ones with which to make mappings; it would then deploy an analogical computation so as to produce an utterance which represents a good compromise to 'say what has to be said'.

The enunciation process may opt for direct use of an interrogative exemplar, which will serve as a sentential template, then make substitutions<sup>188</sup> in it, without ever having to compute a 'transforming analogy'. When this is the case, analogies which motivated transformations are explained by analogy without requiring an explanation based on transforming analogical tasks. Here, I fight against this preconception which would make affirmative, active, non-thematized sentences the prototype from which every

---

<sup>188</sup> These substitutions, or sub-tasks of the overall enunciation task, may be analogical tasks, that is, computations of a proportional fourth, but the overall task would not be that. Generally, a subtask may be an analogical task without the overall task having to be. In summary, in the recursive embeddings, this discussion and this variety of possibilities may apply at any level, and independently at each level.- let alone certain dependencies and accidents of compositionality.



other type should obtain by transformations. It is important to refer this conception back to a linguistics of competence (in Chomsky's sense), that is, a linguistics of a language, which is not that made here, nor is it that which Itkonen makes.

Itkonen undertakes a micro-work-programme assigned by generativism without going to the term of a potential critique. He fulfils the programme with his weapon: analogy. He succeeds, and thence refutes the pretension which is that of generativism to impose derivations and transformations because there would be no challenging proposal. But he endorses regularism and categorialism *'en passant'*.

Here is a limit or an article which did not make this its main purpose. I wish to stress again how important this 'rehabilitational' article is, it shows the error that constitutes the dismissal of analogy by Chomsky, please refer back to the already provided summary.

#### **7.1.4. A2 analogy anyway, but differently**

Several times, great care was taken to distinguish A4 analogy (four terms) from A2 (two terms). The former is fully fledged, technical, it allows us to found a computation; the later is too poor, and for this rejected as improper to found a computation. However, in language manifestations, phenomena with two terms do occur (ex. *the vase is like the shield, Ares is like Dionysus, he is a snake, tons of worries*), likewise, phenomena with three terms occur (ex. *the vase is the shield of Dionysus*). These structures may not be those which provide its foundation to the computation, they nevertheless remain phenomena and productivity among them must be explained; but they are seen as phenomena, not as a device in the theoretical or modelling apparatus.

I am not undertaking here to cover this treatment or this explanation. The conjecture is that a computation as those presented above should yield it. It must comprise, as one of its steps, to abduct one or two supplementary terms so that there be four of them in the current conditions of the computation, after what, ensuing computations and abductive chains may become more canonical, that is, more alike to what has been presented. This is saying nothing else than what Aristotle says, and which sounds right, that underlying a metaphor, there is always an analogy.

#### **7.1.5. Three tiers**

The position of the Analogical Speaker vis-à-vis efforts which address analogical mapping directly may be proposed in distinguishing three tiers.

The upper tier is that of symbolist grammars, of categories, of rules, and of the lexicon. it is comparatively concise but leaves descriptive and explanatory residues. It does not propose a model of acts and does not account for learning.

A middle tier (this work) is isonomic. It supposes some analogies readily available, proximality, a plexus structure, abductive movements, and it proposes a dynamics which produces an infinity of analogies; it is a powerful lever of productivity. This dynamics is economical since it eschews analogical mapping which is deemed computationally (and cognitively) more expensive. It has some cognitive plausibility, but an implementational plausibility which is average only.

Finally, a lower tier encompasses analogical mapping or any other approach of reduction. It is paronomastic and descriptively voluminous. It does not suppose readily available analogies, and it supposes reduction. It is computationally (and cognitively) heavy and parallelism is quasi-imperative in it.

## **7.2. Individuality of terms**

A first introduction of the notion of term was given p. 79; this notion will now be exposed in detail.

### **7.2.1. A term is a participant in an analogy**

The four 'things' involved in an analogy are its 'terms'. I call 'term' whatever enters in the expression of an analogy. In analogy:

$$X : Y :: A : B$$

X, Y, A and B are terms.

In exemplarist constructions, constituents are terms and the assembly is also a term.

Thus, in a plexus, participants in A-type records and in C-type records are all terms. A same term may occur in many records. A same term may occur in A-type records and in C-type records. This homogeneity across record types is important because it conditions their joint mobilization into the dynamics; it is therefore a productivity factor.

A term is an excerpt of linguistic form; I will show below what non-formal terms ('private' terms) might be.

A term is a fragment of linguistic form which may constitute a syntactic unit. There are some modifications with respect to received descriptive and theoretical frames:

- a morpheme may be a term, the word not being postulated here (cf. p. 159).
- in a non-concatenative morphology, a term may be a non-cohesive part of linguistic form (for example, a tree-consonants base in a Semitic language or a vocalic pattern in the same languages) or any other excerpt of the form, according to the proper structures of the particular morphology.
- a segment of form consisting of several words or morphemes (a syntagm, e.g.: *le grand jour*) may be a term,
- we shall see that morpheme assemblies that are not usually accepted as syntagms (ex. in Fr.: *à la* or *un très*) must be able to be considered as terms (cf. p. 198).
- morphological phenomena may cause indecision as to the boundaries between terms.

### **7.2.2. Essentiality (or not) of a term**

A term is re identifiable in its recurrences, it is recognized the same term in all its occurrences.

For a term, being re identified across its recurrences, does not require that the term be reified. A term is not a thing; it has no content, no properties. Of a term, one can tell

nothing more than its occurrences in diverse positions of various systemic or structural analogies, so that what plays between terms are not relations (relations only occur between objects or individuals), what plays between terms are the copositionings instituted by the analogies of the plexus, then the copositionings which the dynamics abduct from the former.

At the expense of this poverty, we can expel essences, ontologies, and we can explain without drawing on metalanguage.

### **7.2.3. Minimality suspension for terms**

I introduced (p. 81) the need to 'suspend the minimality' of terms, that is, to refrain seeking 'atoms' the recombination of which would provide for descriptive and theoretical needs. It is so because, in linguistics, evidence invites to stay away from too "Cartesian" a vision: firstly the empirical evidence that different planes and orders interact, then the evidence that a uniform, minimal description level does not accommodate all facts. So is it for lexicalization or grammaticalization for example.

Which is why granting a minimality whatsoever to terms, or constraining them in this, is simply refused. A term is not constrained to be elementary or minimal, that is, analogies may be established between elements of different grain, this concurrently, and complementarily; an assembly of terms may also be a term. Elementarity is not foundational by itself; the decision to break a term down (to analyse it) is just a matter of opportunity, a matter of judgment which the speaker makes, unconsciously most often: it is contingent. All speakers do not make the same decisions in all points; a same speaker may not make the same decisions in all occasions.

Suspending minimality in this way is negating two things (which would constitute the antagonist viewpoint, the 'primarist' or 'elementarist', or 'foundationalist' position):

- 1) Univocity. There would be a level of breakdown into elements (the 'quarks' of linguistics) from which all phenomena would be reconstructed and explained.
- 2) Uniformity. This breakdown level ought to be the same everywhere in a language (in all languages) and apply the same way to all phenomena.

Minimality suspension asserts the contrary on both these points:

- 1) Multivocity. The same linguistic material may break down differently according to different viewpoints, giving different structures, often interdependent, but distinct<sup>189</sup>. The elements of one are not the elements of the other and there is not a system of atoms which is common to both.
- 2) Non uniformity. The same material occurring two times may have uneven breakdowns in both occurrences, even according to a same viewpoint. It is not postulated that decomposition has to result in a uniform tier; it does not have to be the same in the entirety of a language (of all languages).

No minimal uniformity of terms according to any criterion. The sub-determination of analogy allows us to make mappings among units of different grains. However, tier

---

<sup>189</sup> About this, think of the multiple structures of van Vallin, Sadock, Jackendoff, and Selkirk.

effects (e.g. morpheme) may happen and extend up to quasi-generality. As such tiers are not assigned to play in the explanatory construction; this removes the risk to produce a theory which would fail at the margins of these quasi-generalities. However, a model which suspends minimality, has to account, as an *effect* of analogy, for the (re)construction of these quasi-general tiers, but as phenomena, not as causes.

Minimality suspension relates to reanalysis. Sometimes the reanalysis process leaves a residual part with uncertain grain and un-assured statute. This part did not have a leading role in the reanalysis process, it is rather a residue. Its putative attributes get determined 'by defect', by analogy and subtraction; for the speaker, they remain a matter of subliminal conjecture. The term in question may participate concurrently in other analyses and finally, different points of view of different grain may have to coexist.

Minimality suspension is useful in three identified cases, and possibly more:

- a) for syncretism, cf. p. 160,
- b) for amalgamation (Fr. *du, des*), cf., p. 122,
- c) in the case of entrenched phrases.

Minimality suspension applies initially to formal terms: those which are constituted of linguistic form. It is expected that it would apply also to private terms<sup>190</sup>.

---

<sup>190</sup> About private terms, it is interesting to compare this proposition with the solution Nelson Goodman gave to a problem that he met.

This logician, already quoted above, having made the critical analysis of the model of "The Logical Construction of the World" by Carnap (*Der Logische Aufbau der Welt*), makes a proposal to replace it with a *realist* system (by contrast, Carnap's was *particularist*). He proposes a first solution, then finds in it the same major defect as in Carnap's system: it fails as soon as more than two *qualia* are considered. After examining several other possibilities of correction, he finds an improvement by accepting to consider as individuals "sums" of atoms, along with the atoms themselves :

*Among several different possible revisions, the best is perhaps also the most obvious. The choice of atoms need not be changed, but all sums of two or more atoms are likewise admitted as individuals, and some of these are included as basic units. In particular, primitive togetherness is construed as obtaining not only between qualia, but between any two separate sums of one or more qualia contained in a single concretum. Whereas Wh [Wh is the relation of "togetherness" defined in his first proposition] obtained between every two distinct atomic qualia in a concretum, the new primitive, W [the new relation of togetherness], obtains between every two discrete parts of a concretum (or more accurately between every two individuals that are sums of qualia, that are systematically discrete, and that are parts of one concretum). This involves no departure from the ordinary notion of togetherness, but merely interprets it systematically by a less restricted primitive. A color may quite as naturally be said to occur at a place-time, or a color-spot at a time, or a color-moment at a place, as a color at a place or at a time. Goodman 1951, p. 208-209.*

As already mentioned, the primitive relation (for Goodman the relation of *togetherness*), base of the construction of *qualia* and *qualities*, holds **between pairs**. It is possible to see this akin to analogy. However, analogy was not thematised by Carnap, and not more by Goodman. Moreover, their common project of an *Aufbau*, that is, a construction able to found "the actual process of cognition" (p. 180) on primitive elements is not mine; I already established why a primitive basis is not a good idea in linguistics and related fields. However, the finding by Goodman that it is useful to have terms with a variable grain and the minimality suspension that results is maybe more than a fortuitous coincidence.

Other authors, in the neighbouring field of 'qualitative simulation', also assess primarism as a dead-end:

The qualitative simulation algorithms developed to date are problematic as models of human reasoning. Current qualitative simulation algorithms operate via first-principles reasoning over general-purpose axiomatic knowledge. They often produce a huge number of possible behaviors (hundreds or even thousands) even for relatively simple situations. The reason for this is that qualitative simulation, because of the decreased resolution of information about a state, tends to be ambiguous. In a quantitative simulation there is a unique next state, but in qualitative simulations, there can be several next states, corresponding to different transitions that are logically consistent with the resolution of the qualitative state information. Each of these has several next states in turn so their number grows exponentially ... which makes such algorithms seem psychologically implausible, given how easily people reason about everyday physical situations.

A second problem with first-principles qualitative simulation algorithms as models of human commonsense reasoning is that their predictions tend to include a large number of spurious behaviors that logically follow from the low-resolution qualitative descriptions that they use as input but are not in fact physically possible. ... this is not a viable option for modelling the commonsense of the person on the street, who is capable of making reasonable predictions even without such detailed information. Forbus 2001, p. 35.

It is interesting to see that, in order to prevent computational explosion, these authors also call on analogy with proximal scope:

We [Forbus and Gentner 1997] suggest that the solution to this puzzle lies in our use of within-domain analogies (e.g. literal similarity) in commonsense reasoning. We claim that a psychological account of qualitative reasoning should rely heavily on analogical reasoning in addition to reasoning from first principles. Qualitative predictions of behavior can be generated via analogical inference from prior observed behaviors described qualitatively. Prediction based on experience reduces the problems of purely first-principles qualitative reasoning, because they are limited to what one has seen. Forbus 2001, p. 35,36.

*Because they are limited to what one has seen:* this is the proximality principle already discussed at length; all these things hold together jointly and severally.

#### **7.2.4. Delimitation of terms as seen from morphology**

In the current status of the model, since plexii are hand-made, the desirability to make such or such form a term is judged by the descriptor as resulting from the desirability to make defined structure mappings. We are ready to think he is serious but we also want to understand the principles which found his decisions and under what conditions a linguistic form qualifies as a term.

It appears that the response cannot be dogmatic or propositional; it will rather be contingent and dynamic.

A form is a term firstly when it meets the needs of analogical co-segmentation (for example *métal-* below). Secondly, a term may be produced by a mechanism of masking and difference as the rest (for example, *chir-* below) after subtracting another, already established term. The new term appears then as a residue.

Let us take an example in the morphology of French (italics are received words, straight typeface ones are not):

	<i>-ique</i>	<i>-urgique</i>	<i>-urgical</i>
<i>métal-</i>	<i>métallique</i>	<i>métallurgique</i>	métallurgical
<i>plast-</i>	<i>plastique</i>	<i>plasturgique</i>	plasturgical
<i>chir-</i>	chirique	<i>chirurgique</i>	<i>chirurgical</i>

**Table 15 Example in the morphology of French**

The want to account for *métallique*, *métallurgique*, *plastique*, *plasturgique* causes the creation of terms *métal-*, *plast-*, *-ique*, *-urgique*. This is analogical co segmentation. Then – let alone the gemination -ll- at this stage – the following paradigm of C-type record is set:

C	métal-	-ique	métallique
C	plast-	-ique	plastique
C	métal-	-urgique	métallurgique
C	plast-	-urgique	plasturgique

Then, the encounter of *chirurgique* establishes a mapping with *métallique*, *plasturgique* which, by masking and difference creates term *chir-*. The paradigm above is thus complemented with record:

C	chir-	-urgique	chirurgique
---	-------	----------	-------------

Form *chir-*, which is a residual form, is taken as a term; it appears in the model<sup>191</sup>. It is the residue of *chirurgique* from which *-urgique* is subtracted.

The analogical dynamics then acquires the potential to license form *chirique* by constructability transfer. That is, i) if this form is presented to it, the model can analyse it, and ii) to respond to a production need which would tend to it, the model could produce it. In the model's dialect, this form is possible at his point of the model's development and at this point of the discussion. There is a slight worry: the dialect of the model here seems to present a lag with French speakers because none would produce that form and accepting it would be a problem to all of them. The fact that the form *chirique* is possible for the model does not incur that it will produce occurrences of it. If it contains the term *manuel*, which may expected in a plexus that would approximate a French speaker, this term will occur in the plexus, for example, in a paradigm like the following:

A	métal	métallique
A	automate	automatique
A	main	manuel

<sup>191</sup> A similar development, with a suffix this time, can be done in the rightmost part of the table, with term *-urgical*.

A	œil (En. eye)	oculaire
A	œil	optique

By the principle of economy, because it costs more to assemble a new form than to retrieve one from the inscriptions which satisfies the needs of the production act, *manuel* will be produced, which will block the production of *chirique* by assembly.

This argument presupposes that there is no other obstacle to the productive reuse or term *chir-*. Now there is one in this particular case, which is that the masking-subtraction operation works well within the form, but does not find an easy prolongation in meaning. The speaker who does not know Greek (does the model know it?) has no direct reason to recognize the hand in *chir-*. Here again, the question is mentioned, but we must stop at the edge of what it is possible to do today.

In any case, it has been shown how masking-subtraction gives birth to a term. A term so obtained does not have as great a strength as one obtained by analogical co segmentation, it remains in a paradigmatic margin; *métal-* and *-ique* by contrast, are more solid because they are licensed by cross attestations. Analogical co segmentation produces stronger terms and masking-subtraction, weaker ones. Yet, term *chir-* is there for the rest of the linguistic carrier of this plexus (or of the corresponding speaker). It may find a usage upon ensuing encounters of *chiromancie*, *chiropractie* for example.

Examples in syntax could also be taken. Goldsmith<sup>192</sup> presents for example the result of a corpus analysis by the method of Minimal Description Length. Overall, the method finds the morphemes to which we are used (here these would be terms), but occasionally, it deviates; for example, it considers form *of the* without segmenting it; *the* is indeed a morpheme elsewhere, but *of* is not (here, *of the* would be a term on its own). In this corpus, the need does not arise to make *of* autonomous, all its occurrences are followed by *the*. Here is another case in which analogical co segmentation does not drive to distinguish a term<sup>193</sup>.

### 7.2.5. Delimitation of terms as seen from syntax

The model stays as underspecified as possible to let happen as freely as possible all creations and all conjunctions that are to be observed when speakers produce or accept linguistic material. Therefore, a constraint must not be placed on terms unless it is strictly motivated. In order to help understanding how terms are determined, it was stated above that "a form is a term in the first place when it results from the needs of analogical co segmentation". This is the least and still leaves possibilities very open.

A theory like Generative Grammar is by contrast very precise on this point, the notion 'syntagm' is precisely defined, and syntagmatic structure is very constrained in it. For this, this theory has ancient and precise reasons: the analysis of the shortages of markovian and probabilistic models. What is at stake is to reject monstrous formations as for example a trigram model might produce if it were taken as a productive model: *My question to you those pictures may still not in Romania and I looked up clean; you*

---

<sup>192</sup> John Goldsmith, lecture at ILPGA, Paris, May 2002.

<sup>193</sup> Incidentally, this case also illustrates minimality suspension.

were going to take their cue from Anchorage lifted off everything will work site Verdi. (cf. more complete quotation and reference p. 228).

An example in French of article-preposition amalgamation (cf. p. 122) already shown the advantage that there is to let happen terms that infringe this canonical vision and are not received syntagms: it is interesting to keep the freedom to map [*aux*] [*champs*] and [*à la*] [*ville*] together and this demands to constitute term [*à la*]. This term is not a syntagm in classical frames, but keeping this liberty offers a solution the question of amalgamation in Romance languages which is more flexible, and theoretically cheaper than ones in previous frameworks.

If we adopt this way of thinking and find some good reason<sup>194</sup> to associate article and adverb, should we then also acknowledge a paradigm – free of any amalgamation this time – like:

[ <i>un très</i> ]	[ <i>grand chien</i> ]	a very big dog
[ <i>un si</i> ]	[ <i>bon moment</i> ]	such a good moment
[ <i>un aussi</i> ]	[ <i>mauvais traitement</i> ]	such a bad treatment
[ <i>un trop</i> ]	[ <i>petit nombre</i> ]	too small a number

where the leftmost term is not a syntagm in the received acceptations. In itself, this paradigm is not bad in the sense that, among all its records, constructability transfer works well. There is no risk to make unwanted productions.

Accepting this raises a suspicion: if a plexus encompasses terms that deviate so much from strict syntagmaticity, do we not have the risk to license long assemblies, which would be aberrant because they infringe syntagmatic structure.

This is not to be feared. Longer assemblies are constructed by expansions, owing to plexus structures which involve several records and were named 'expansive gates' above, p. 86. In short, in an expansive gate, some term is homologous to its expansion. Expansive homology, because it requires expansive gates in the plexus, subordinates abductive licensing of an assembly by expansion, to a precise and constraining condition: the dynamics must find in the plexus an expansive gate adapted to the case. As long as this does not happen, long aberrant assemblies cannot be produced. Now, we are not expecting for terms like *à la* or *un très* to be anywhere homologous to an expansion of theirs. Consequently, these terms cannot cause aberrant assemblies.

So we have to distinguish two modes of syntactic productivity.

The first one is the expansive productivity schema; it is classical, uses expansive homology, and depends on expansive gates in the plexus. The terms on which it bears are constrained: they must be "well-formed" syntagms.

---

<sup>194</sup> There is indeed a reason in French to associate article and adverb together, a fuzzy and partial one, which is the commutation of this group with [*tout*] (En.: *all, any*) and [*quelque*] (En.: *some*), these two words having a tendency to better associate with group Adj+N [*tout mauvais traitement*] than with N alone [*tout traitement*], in certain cases. This is a light phenomenon, a sub-grammatical phenomenon. The locality of inscriptions allows us to account for this preference simply by means of a few paradigms.



The second one, introduced here, is the non-expansive productivity schema; it is based on constructability transfer alone. It may bear on terms which do not observe classical constituent analysis: they may be non-syntagms.

All frameworks so far, which stated something precise about syntactic productivity<sup>195</sup>, since they focused excessively on the expansive schema, only accepted as syntagms segments that undergo expansion. In doing so, they neglected to see that the non-expansive productivity schema releases a constraint on the boundaries of terms, broadens the space in which analogical mappings may take place, and adds a degree of liberty in the apprehension of analogies, that is, in the precision and in the faithfulness to linguistic data.

### **7.2.6. Terms should be simple and commonplace**

Another reason which contributes to qualify a form as a "good" term is that it will be all the more useful that it is simple and commonplace.

A commonplace term (a morpheme alone, a short assembly of ordinary morphemes) has higher possibilities to be reused.

If the content of a plexus is driven by a principle of maximum utility, one is led to favour commonplace terms. A rare morpheme must not be avoided if one thinks that the model has to contain it, but the length of the terms may be chosen. One is then led to favour short terms, even more so if they contain rare morphemes. The notion of rarity, of course, is understood vis-à-vis a specific speaker since the model is that of a speaker.

This condition would cease to hold if the model was complemented with self-analysis (cf. section 8.4. , p. 258): self-analysis reduces long terms into shorter terms with higher utility, which removes the inconvenience of the initial long term.

### **7.2.7. When do we want two different terms or a single one**

The identity of terms would not be understood completely without reminding the cases in which it is not clear whether one term is needed or several ones. These cases caused problems to previous theories and fall into two classes.

In the first one, a same form occupies different places in paradigmatic frames. This is the case of homonymy and syncretism for most of it. Section 6.1.2. *Homography, accidental homonymy, syncretism*, p. 160, showed how analogy, by allowing us not to over specify, authorizes a better adapted approach of the phenomena.

In the second one, a same place in an analysis frame is occupied by different forms depending on context. This is the case of complementary distribution, that is, of lexical allomorphy and, in phonology, of alternation. Alternation will be addressed in a forthcoming work, bearing more generally on phonology. Lexical allomorphy is treated section 6.1.3. *Allomorphy*, p. 167.

---

<sup>195</sup> Tesnière, Harris, Bar-Hillel, Lambek, Chomsky, Mel'cuk, Shaumjan, etc.

### 7.2.8. Constituency

The idea of constituency is an old one even when it is not explicitly stated; it starts from an obvious experience and from the strong intuition that parts of utterances get reassembled into other utterances. Then we will have words, phonemes, morphemes and syntagms.

Constituency crystallizes with Hockett in the 'immediate constituent' analysis. For transformational generativism, constituents map onto the nodes of the phrase structure and are also the elements affected by transformations.

Constituency is sometimes opposed to dependency: Fillmore<sup>196</sup> reconciles (with a reservation) the dependential conceptions of Tesnière (valence and the 'stemmata') with the constituential conception which is his proposition in construction grammars.

The scope of constituency exceeds linguistics and extends to cognition:

The question of constituency recently gave birth to an important debate. In their critical analysis of the propositions defended by connectionism, Fodor and Pylyshyn (1988) strongly reaffirm the foundations of what is commonly called the classical cognitivist paradigm. The debate arises from the new connectionist dynamic models which avoid compositionality as a matter of principle. The question of constituency then becomes a central argument in favour of dynamical models which do not present this property. From a demonstrative and empirical standpoint, it is indeed in the domain of the analysis of languages that the debate may be arbitrated. In effect, if there is a domain in which compositionality, constituency, and, more generally, the syntactic organization of the representations has been elaborated, it certainly is linguistics. We know the cognitive Fodorian theses to form the heart of the Chomskyan paradigm, whence the importance placed by Fodor in the syntax of linguistic expressions. In Generative Grammar, these hypotheses much exceed the scope of *stricto sensu* syntax, so that numerous generativist phonologists present their models as a theory of the syntax of phonological phrases (Kaye, Lowenstamm, Vergnaud 1990). From this viewpoint, phonology offers a particularly interesting field to test proof compositional models, because in it, the notion of constituency is expressed as a formal, high level real hypothesis<sup>197</sup>.

In syntax either, constituency, this happy mereology, does not end up exhausting the observations and:

Before promoting it, as cognitivism did, to the statute of a confirmed hypothesis, it is certainly useful to question its adequacy<sup>198</sup>.

To this question, some<sup>199</sup> already answered:

Cognitive grammar regards constituency as less essential than does generative theory, and also as more fluid and variable (Langacker, 1995a, 1997b). Phenomena for which syntactic phrase trees *per se* have been considered indispensable (e.g. the definition of subject and object) are claimed to be better analyzed in other ways.

---

<sup>196</sup> Fillmore 1992, p. 102.

<sup>197</sup> Laks 1993, p. 17-18.

<sup>198</sup> Laks 1996, p. 169.

<sup>199</sup> Langacker 1998, p. 23.

In the herein proposed model, the notion of constituency is weakened in two manners.

Firstly with the suspension of minimality: the status of possible constituents is made weaker from the fact that they may be shorter or longer depending on the occurrential needs to map the same fragment in several manners with different homologs. It is made weaker also from the fact that a same span may undergo several different segmentations, which are as many analyses, complementary and non-contradictory.

The weakening is increased by the vacuity which is requested for terms. As they are deprived of essential properties, it becomes more difficult to say about terms that they are constituents. In the schema of constitution, the "assembly shop" which grammar is supposed to be, from the properties of the constituents, elaborates those of the assembly: endo- or exocentric category, compositional meaning, etc. Here, the operation is not this one since category is not reified and meaning matters will be handled on an occurrential basis by transfers, subtractions, interpretative abductions bearing on private terms, making a place to any non-compositionality proper to each occurrence, the particular case of compositionality being after all fairly frequent.

### ***7.3. Position, positionality, copositioning***

#### **7.3.1. Positions and copositioning**

This model obtains language effects by a strict observation of positionality when establishing a plexus and then during the computations; all this with no reified category and no reified rule. Moreover, if it is difficult to figure out how neurons can be the effectors of operative rules, it is easier to see assemblies of them forwarding, transferring, and recombining copositionings.

Positions are not defined in absoluteness: they are defined for terms in relation with one another. This is why an *a priori* definition of positions – of 'positional types' – would be void. It is void also to attempt defining the essence of a position by definitional propositions. All that is expected from positions is to be able to say things like: *these two terms are with respect to one another in the same positions as are these two other ones*. And this is enough: linguistic dynamics need nothing more; whence the notion 'copositioning'. If the word 'position' happens to be found again below, it will only be by simplicity or metonymy and what is understood is always 'positionality' or 'copositioning'.

Why use 'copositioning' since 'ratio' is attested, particularly in association with analogy? Firstly because 'copositioning' suggests better a general play; then because 'copositioning' has the merit to oppose to 'position'. The importance of positions is recognized but a lag is immediately installed by setting in a differential play and simultaneously 'de-reifying' the position. This is reiterating the negation of the slot-filler schema. 'Copositioning' appears to better encompass this wealth of connotations.

#### **7.3.2. Position as place or as role**

Among linguists, the uses of 'position' span between two poles: in the first one the position is the place in the linguistic form, and in the second one something rather like a role.

The first pole is illustrated by Harris (1951):

Even when studies of particular interrelations among phonemes or morpheme classes are carried out, the frame within which these interrelations occur is usually referred ultimately to their position within an utterance., p. 11. The environment or position of an element consists of the neighbourhood, within an utterance, of elements which have been set up on the basis of the same fundamental procedures which were used in setting up the element in question. 'Neighbourhood' refers to the position of elements before, after, and simultaneous with the element in question (p. 15) ... We can thus identify any morpheme class, group of classes, or construction, in terms of the next higher construction in which it participates and the position it occupies in it (p. 332).

The second pole is illustrated by Milner. To the latter, which he names 'place', he opposes a position with a more syntactic character. The subject of the active sentence, and the agent complement of the analogous passive sentence are/occupy the same position. The stability of this notion results from the fact that:

One excludes sheer swaps between canonical positions. It never happens that a term acting as object complement becomes (by transformation or otherwise) complement of attribution or subject<sup>200</sup>.

Milner's notion of position is recognized by himself as being akin to propositions already made by other authors:

Among the absolute properties of (some of ) the positions (notably the subject), must be counted semantic properties. ... This is a research programme long formulated in terms of actors [Fr.: *actants*] (Tesnière) and more recently in terms of thematic roles (school of Cambridge). It needs to be stressed that the school of A. Culioli reframed the question by proposing to very strictly reduce the list of possible extrinsic properties; but its reasoning is not positional<sup>201</sup>.

The two poles are contrasted by Fradin<sup>202</sup>, after whom the following table may be built:

---

<sup>200</sup> Milner 1989, p. 408.

<sup>201</sup> Ibid., p. 440-441.

<sup>202</sup> Fradin 1999, p. 12

Syntactic theories which	build on relations of linear precedence and hierarchical dominance	are not combinatorial only but also recognize a notion of position, which is independent from syntagmatic realization
For these theories, the purpose of syntax is to give:	<ol style="list-style-type: none"> <li>1. rules for the construction of syntagms</li> <li>2. rules specifying their arrangement</li> <li>3. the relations between the units of these constructions</li> </ol>	<ol style="list-style-type: none"> <li>1. the geometry of the positions which a language authorizes</li> <li>2. the occupation relations which are legal for each of the positions</li> <li>3. the grammatical relations which may be associated to them</li> </ol> <p>They account for the construction of syntactic units and for their combinations</p>
Examples:	<ul style="list-style-type: none"> <li>- Categorical Grammars</li> <li>- Tree Adjoining Grammars</li> </ul>	<ul style="list-style-type: none"> <li>- Polychromous Trees Grammars (Cori &amp; Marandin)</li> <li>- Kathol &amp; Pollard 1995.</li> </ul>

**Table 16 Positions as places and positions as roles**

I write 'role', but I could have used 'function' if the term was not already so loaded in grammar. The point is to be clear about what functional scene we are talking about. The function of the grammarians can be seen as the problematic attempt to blend, hybridize or bridge the two poles. In the 'theatre' of language, the mechanisms of the play are not fundamentally different whether we consider linguistic form alone, or private terms and meaning, and the most visible part of the show happens in between.

The word 'cositioning' and many of its implications apply both to positions as places and to positions as roles. Several aspect of the computation apply equally to both. So is it for:

- the four abductive movements (already covered and addressed again in an appendix),
- the fact that the play deploys itself in the interval between the terms of a task and the inscriptions in a plexus (later in this section),
- the question of positioned resetting (later in this section),
- the similarity of cositionings which is mediately determinable (right now).

The difference between the two poles is that the position as place is supported by C-type records, the terms of which are segments of the linguistic form, whereas the position as role calls on private terms and will have to be supported by an extension of the model – yet to be done – and which might take the form of a new type of records, or some other form.

### **7.3.3. The similarity of cositionings is mediately determinable**

In the effort which he pursues, after Carnap, to build a system making a logical link between experience and categories, Goodman, borrowing from Carnap his *Elementarerlebnisse* (elements of experience, which are elementary in the sense of instantaneous) writes as follows:

The precedence of *erlebs*<sup>203</sup> near together in time will usually be determinable since such *erlebs* will usually be part similar, possessing in common some persisting quality. And because precedence is transitive, the precedence of *erlebs* that are temporally remote and wholly dissimilar will then be mediately determinable in many cases<sup>204</sup>.

Likewise, the similarity of copositionings is 'mediately determinable'. After several computation phases, the resulting configurations of terms may be very dissimilar from the initial ones and analogical ratios may have drifted. However, if upon each transition care has been taken to conserve the copositionings, the resulting configuration is positionally linked with the initial terms: the copositionings have remained 'mediately determined' throughout. This 'mediate determination' of copositionings is not separable from the very notion of abduction in linguistics.

The mediate determination of copositionings is my proposal to reconstruct the principle of structure preservation, already mentioned page 17, which is the idea, recalled by Milner, that *it is impossible for syntax to create new positions*:

This notion introduced by J. Edmonds, later taken over and modified by Chomsky, raised up high misunderstandings because it actually contains two different propositions. The first one with no direct concern here, is the distinction between main propositions and subordinate propositions (fundamentally, this constitutes structure preservation in the sense of Edmonds). The second one only concerns us: it bears on the impossibility for syntax to create positions<sup>205</sup>.

Of this principle it follows that *the number of positional configurations in a language is very limited*. This zooms back from the positions themselves, and *positional configurations* is closer to my *copositionings*. The reconstruction of the principle of structure preservation requires however a slight inflection: more than a sheer impossibility to create positions, it should better be seen as a strong, but not absolute, conservatism. Positional configurations are not immutable; they resist, but evolve slowly, we do not speak with the syntax of Latin.

Transitive conservation of copositionings is easy to conceive in the abductive movement by transitivity because paradigmatic links in plexii are exactly about that and crossing a link conserves position by definition. But it also applies in positioned resetting (cf. p. 206).

In the Analogical Speaker, the dynamics develops coherently as soon as it is initiated, that is, when initial positional settings, initial copositioning, are acquired. This model does not cover the way in which initial copositioning obtain, and deliberately so. Initial acquisition of copositioning presents itself in two complementary but distinct figures: a) acquisition of linguistic knowledge, that is, how the experiential history of a subject yields a knowledge constituted with copositionings between terms, which linguistic dynamics will later utilize, b1) upon initialization of a particular reception act, how to

---

<sup>203</sup> The basic units chosen [by Carnap] for the system are called *Elementarerlebnisse* [which I shall hereafter abbreviate as *erlebs*]. They are full momentary cross sections of the total stream of experience. They are limited to a least perceivable segment of time, but are otherwise unlimited except by the bounds of immediate experience itself; each includes all the experience at a moment. Goodman 1951, p. 154.

<sup>204</sup> Goodman 1951, p. 180.

<sup>205</sup> Milner 1989, p. 649.

pass from a perceived sound flow without status, phonetic, to more systematized units which are copositioned, phonological, or b2) upon initialization of a particular emission act, how to pass from a flow of mental events without status, to an organization of discrete and copositioned private terms to which a computation applies resulting finally in an organization of formal terms.

A resetting (cf. next page) is false or ill-defined if it does not preserve copositionings. The phrase "preserve copositionings" must be well understood. It is not a quality associated to a position alone which should have to be preserved. It bears exactly on the preservation of copositionings since terms can only be positioned with respect to one another.

This topic will be met again in a further appendix when criticizing agent CATZ: this agent is suspected because it has a single argument which leaves no room to the definition of any copositioning. An agent like CATZ has no real place ultimately in the Analogical Speaker; a next evolution of the model should render by positionally better means the function which is that of CATZ: the suggestion of similarities for the benefit of B2-B3 or other beneficiaries.

#### **7.3.4. Positionality plays between the terms of an act and terms in a plexus**

Positionality plays in the first place within a plexus, a plexus must encompass copositionings that are coherent and faithful to a speaker's linguistic and cognitive knowledge, and otherwise the plexus would be wrong.

But there is also a positional play between the plexus and the data of the act, between positions of terms of the act and positions of terms in the plexus. In the solving of a task by immersion (p. 263), immersion is an overall process which encompasses the terms of the task and the terms of the plexus.

#### **7.3.5. Positioned resetting**

The notion 'resetting' was first introduced p. 144 in the chapter on systemic productivity. A resetting takes place each time the motivation for recruiting an agent (that is, the motivation underlying a client-commissioner relation in the heuristic structure) is something else than crossing a paradigmatic link. The cases are as follows:

1. from a given term, access a record containing it by using the index of term occurrences (simple index, agent CATZ)<sup>206</sup>,
2. abductive movement by transposition: from a given pair of terms, access a record where this pair occurs by using the index of analogical pairs (double index, agent ANZ),
3. when agents B2 and B3 perform an assembly, it is possible to see a resetting since the client-commissioner link rests on something else than the crossing of a paradigmatic link, but in this case the mechanism is complex.

Resetting is important because it is one of the main factors of productivity. Without it the only possible productivity would be internal to a paradigm and this would be little.

---

<sup>206</sup> For the notion of index, cf. section *Access* in the appendix which specifies the plexus.

Upon a transition by following a paradigmatic link, that is, a movement by transitivity, copositioning is preserved in a simple and conceptually obvious manner. Upon resetting, the preservation is much less simple or obvious. Resetting is then important for this second reason that, when designing an agent that performs a resetting, care must be taken that copositioning is preserved on that occasion. When this is verified, the resetting will be said to be 'positioned'.

Very often, a resetting makes the computation enter into a new paradigm so it could be named 'change of paradigm' instead of 'resetting'. This is not done because of the meaning taken by 'change of paradigm' after Kuhn, but more importantly because it is not always the case: after a resetting, we may target a paradigm which is the same as the source one, then in another of its records, and with a reshuffling of roles.

The notion 'resetting' is essential: it is one of the keys of productivity by integrativity. Resetting contributes to productivity, and the fact that it is positioned is the condition for the computation to demonstrate coherence even in dynamics which encompass thousands of agents.

### **7.3.6. Application points of positionality**

Positionality applies in syntactic copositionings (i.e. structural analogies) but also in analogical copositionings (i.e. systemic analogies).

Both must be seen as two conjoined aspects of a common apparatus.

Positionality applies to terms which are linguistic form and also to terms which are not linguistic form: private terms.

## **7.4. Integrativity**

Integrativity was introduced as a necessary feature p. 52, then, p. 139, a first example of integrative operation was exposed. It was then met again several times, and now we shall assess in greater detail its scope and the mechanisms which support it.

### **7.4.1. Scope and necessity of integrativity**

The proposed model, because it does not assume categories and abstractions as being present during operation and effective in the dynamics, is based only on exemplarist inscriptions and exemplarist dynamics. This is a posture adopted for research and debate. The point up to which it can be sustained is discussed p.268.

From the moment an exemplarist course is adopted, a knowledge which would be both exemplarist and exhaustive is out of question; we must cope with inscriptions which are necessarily fragmentary and partial, and the duty of the theory – and of the model – is precisely to show how it makes up for the lacunae, that is, how the linguistic subject who has at his disposition a linguistic knowledge which is partial only, nevertheless demonstrates an ability which extends far beyond. The question of the integration of these fragments is therefore inherent in a model of this type; it is necessary to make fragments operate together, to potentiate them into integrative modes of operation.

Conceiving of linguistic knowledge as partial also relates with the learning experience: the subject is in contact with language facts the number of which is very small with



respect to the number of productions of which he becomes capable. This condition was long recognized as the *poverty of the stimulus* and is recalled for example in the following way:

The facts available to the child underdetermine radically the language which he finally knows with such a wonderful subtlety. Chomsky in Pollock 1997, p. XVI.

From there, a debate develops, which aims at separating what would be innate from what would be acquired, and therefore variable:

Suppose there is some aspect of language that children couldn't possibly figure out from the evidence in the speech they hear around them. Then this aspect can't be learned; it has to fall in the innate part of the language. This has been called the "poverty of the stimulus argument". Its use requires a certain amount of care, and in fact there is a running debate on what sorts of evidence children are capable of using. Jackendoff 1993, p. 34.

or, in order to justify a parametric theory of acquisition:

Very little data will suffice to allow the child to fix the ordering constraints of the language he is learning. A child learning English will only need to be exposed to a couple of transitive sentences to realize that in English verbs precede their complements. Haegeman 1991, p. 96.

If none of these courses is adopted, it is proposed to consider the occurrential inscriptions as produced, indeed, by the linguistic experience of the subject. If experience is the origin of the inscriptions, another constraint bears on them: that of heterogeneity. Experience does not happen in a particular order which would be analytically favourable, facts present themselves in a disordered manner and the subject must integrate them as he can, in the sequence in which they come.

This is the dimension which is sought when I strive to inscribe in a plexus paradigms which are not only fragmentary, but in addition heterogeneous. Remember the example of p. 142 which integrated successfully two verbal paradigms; they are very heterogeneous in their structure. The summary table is recalled here:

<b>paradigm</b>	<b>what oppose the two terms in a record</b>	<b>what changes between two linked records</b>
first paradigm	base <i>aller</i> - base <i>venir</i>	tense + person + number
second paradigm	person 1S - person 3S	base

The integrativity required from the model then has to integrate partial and heterogeneous resources.

If one succeeds in this – the claim is that his work is making a step towards it – the proposition has to be reversed: where one believed to perceive the under-

determination<sup>207</sup> of a language by the facts, is it that, because of being regularist, one has of language a vision which is maybe over-determining? And if the child ends up knowing the language with such a wonderful subtlety, is it that the understanding we have of it is so disappointingly coarse? I mentioned already that the reason is a different one: the child does not learn a language; he just learns how to speak. Repositioning the approach in this way invites us to take a very different look at the "faculty of language" and to what should have to be innate.

Another example will provide a complementary feeling of the integration of scarce and heterogeneous data.

#### **7.4.2. An extreme example: *être jolie* licensed by *homme grand***

In this example, the model is given a task the gloss of which is as follows:

Two terms *être* (*to be, being*) and *jolie* (*pretty*) are given. Is the assembly *être jolie* (*to be pretty, being pretty*) possible, to what extent, and why?

This example is a caricature by the number of paradigms and the length of abductive chains that were used to solve the task. As a consequence, the result is weak (strength .29). It was run on a French plexus in a now obsolete state of development (in the state reached today, *être jolie* would rather be licensed by *faire beau* (*[the weather] being fair*) with strength .53). In the former state, the construction infinitive + attribute was not directly attested.

---

<sup>207</sup> The linguistic knowledge of the speakers is under-determined by the facts to which children are exposed when they acquire their mother tongue. ... The under-determination of the knowledge by the facts is, in itself, a strong argument (so-called of the poverty of the stimulus) in support of the assumption that the acquisition of LI [internal language, or individual language] involves much more than just learning. Pollock 1997, p. 12.

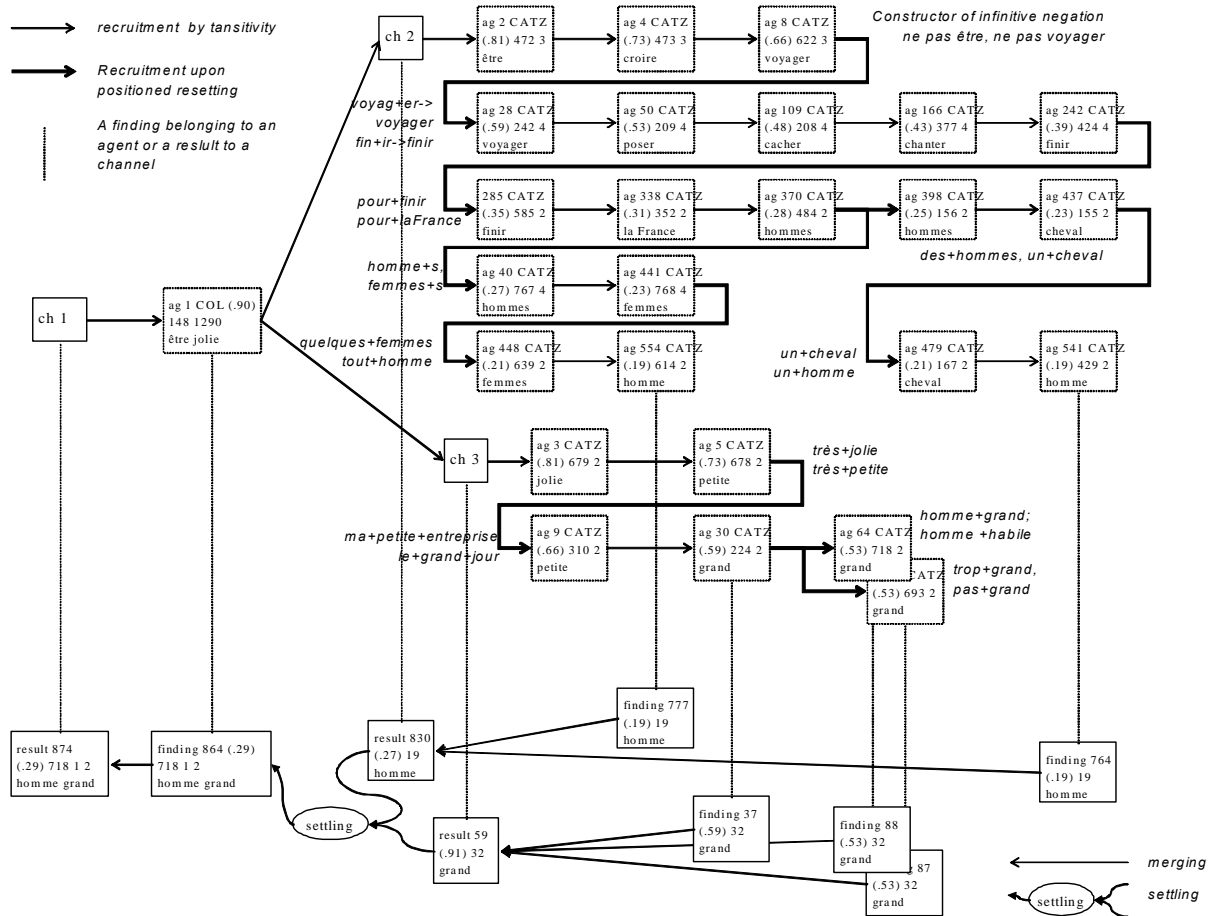

Figure 28 être jolie licensed by homme grand

The process succeeded however to find a (weak) reason to license *être jolie*, it was the C-type record *homme+ grand*. To achieve this, in the shortest abductive path, it used serially four paradigms and thirteen computation phases. The move from infinitives to nouns, their categorial assimilation<sup>208</sup>, took place thanks to a paradigm of prepositional phrases: *pour + finir*, *pour + la France* (in the end [litt. for ending], for [the sake of] France). The inspection of this path, which the reader may wish to make step by step, gives a good idea of the model's integrative power. Another aspect of integrativity is the fork at the rear of agent 30: two parallel paths are pursued and both turn out to be productive, which will cause reinforcement. This reinforcement compensates in part for the damping which is the consequence of the lengths of the abductive paths.

<sup>208</sup> This move may be considered as a critical section of the computation if one keeps in mind a culture of categories, but for a non-categorial model, this vision is quite indifferent

### 7.4.3. Mechanisms in the service of integrativity

As an overall property, integrativity is firstly a consequence of positioned resetting. Positioned resetting is essential in integrative productivity.

Secondly, integrativity results from the cooperation of various agents of different types.

Integrativity thus understood is an important conjecture in this research: that things happen in this manner in the speakers. Linguistic facts are caught and memorized as they come, in their exemplarity and in their occurrentiality, and the speaker sets up a few analogies – from one to three to give an order of magnitude – for each new fact. The analogies thus set up confer this fact a place in a few paradigms – in the actual mental processes these may be fragmentary structures which are not exactly paradigms as the model proposes them today. In themselves such structures are not much, but their conjoined utilization yields much more. The hope is that the plexus structure plus the dynamic side of the model propose an interesting approximation of the mental linguistic computation.

The stimulus may well be poor finally, it may well leave sparse traces in memory, yet the integrative use of these traces accounts for productivity.

### 7.5. Exemplars and occurrences

As we are doing away with categories and types, the apparatus contains things like *day*, *freedom*, *daffodil*, *breakfast* but it does not contain things like 'name', 'noun', or 'NP'. It contains things like:

*great + day* → *great day* or like

*she + is coming + to-morrow* → *she is coming to-morrow*

but it does not contain things like:

NP → Det + N or like

S → NP + VP + Compl.

The static inscriptions of the linguistic knowledge (the plexus) and the linguistic dynamics bear on concrete forms. Sticking to "occurrential" is not precise enough.

When writing *great + day* → *great day* one may mean that such a thing may happen in a speaker's experience, with no particular date assigned, without it being associated to a particular situation: *great day* is possible in general and is segmentable into *great + day*. If *great day* was met hundred and four times by this speaker, these hundred and four encounters are 'condensed' into one inscription only. This option cannot be said to be properly occurrential. Call it 'exemplarist': it makes no place for types, abstractions, categories and bears on exemplars which condense occurrences.

When writing *great + day* → *great day* one may mean on the contrary that a dated occurrence of *great day* was encountered by this speaker and was segmented into *great + day* for the sake of analogical mapping with other dated occurrences like *sad evening* for example, or *great day* at another date; this would be a really 'occurrentialist' option. The occurrentialist option does not separate sentences from a situation.

If *great day* was met hundred and four times, in the occurrentialist option, there are hundred and four different inscriptions. Naturally, this is not sustainable; it is not the case that we have to remember everything occurrentially. A condensation takes place but it is not a simple projection of occurrences onto exemplars: something of the situations is also condensed simultaneously. This is what should allow a proper treatment of semantic questions.

A word is needed to refer collectively to the exemplarist option and to the occurrentialist one. I propose 'concrete', although I do not ignore that categorial models also may be deemed concrete in this, that they encompass a lexicon. A 'concrete' theory, in this sense, is one with exemplars – and possibly occurrences – in which categories and abstractions are rejected.

### **7.6. Proximity, totality**

The idea of proximity is as follows: when one thinks about something, some other things come up in a privileged manner, not many other things, and even less a totality.

'Proximity' is distinct from 'locality' which applies to segments, constituents, syntagms or terms which are neighbours in the form; and is so understood in n-gram approaches in automatic language processing, or in Generative Grammars in relation with the notions of c-command, barrier and island.

'Proximal' is also distinct from 'localist', as used by connectionists. In a connectionist network<sup>209</sup>, the representation is *local* (the network is then localist) when a cell (or a group of cells) is dedicated to represent an object of the problem (a morpheme, a lexical entry, etc. as far as linguistics is concerned). When on the contrary, objects are represented by the network in a fuzzy manner as in a hologram, the representation is *distributed*.

The idea of proximity is not new; it is that of associationist psychology<sup>210</sup>. The limits are clear: why such thing rather than any other one, it says nothing about it. The mechanics of 'transition from' is not precise. Nothing can be made more necessary than anything else. The theory is non-operative and sterile; it is not even constituted as a theory. Associationism fails because it remains simple (one would associate starting from one element).

If one sets aside the critique and the overcoming of this defect (which will be done below) proximity in itself comprises a dimension of plausibility: the anatomic connectivity of neurons is very compatible with the idea of connexion "from some to some".

---

<sup>209</sup> Cf. for example Elman 1998, p. 8.

<sup>210</sup> Associationism (Plato, Aristotle, Hume, Spencer, Taine, etc.) is the attempt to reduce thought to associations; associations of (experiential) contiguity, of resemblance, of contrast. Associationism would assume a psycho-physiological parallelism and fails, according to Lalande: "how could we establish a term-to-term mapping between two sets (fibers and dendrites in the brain on the one hand, and the ideas, images and judgements of the subjective representations on the other) which do not follow the same method". Associationism is refuted by Bergson (*Matière et Mémoire*). Burloud 1948, pp. 265-267, summarized by the author.

The proximality of inscriptions is akin to the idea of the "Knowledge lines" or "K-lines" of Minsky: *We keep each thing we learn close to the agents that learn it in the first place*<sup>211</sup>, we shall see elsewhere (p. 249) the role which is attributed to proximality in learning, that is, how acquisition itself is made accountable for the proximities in a plexus.

Proximality and the concreteness of a theory (exemplarism or occurrentialism) are solidary: if a theory cannot categorize, that is, classify its terms, the only thing left to do is to link them together as exemplars or occurrences, and, as a linkage from each to each would be absurd, they can only be linked from some to some. Hence, transitivities form the bases of access and transition and this is how the notion of proximality arrives: is proximal that which can be reached easily, that is, in few computation steps. This would apply to simple associationism – which is not the adopted way – and it also applies to paradigmatic linkage and plexus structure as defined in this model.

A categorial theory makes no room for proximality: in a class, in a category, all members are equal, even if they are numerous. On the sole basis of categorial membership, evoking an element is evoking with the same ease a great number of other ones. Access has the same cost for all members of the category (this touches the difficulty of "sub-categorization"). It is true that categorial theories do not take care of access, but a linguistics which recognizes the subject, the dynamics of acts, which is heedful of the conditions of cognition and careful of plausibility has to.

Here, proximality is approached in overcoming the limits of simple associationism; it is a virtue of well-understood analogy. Analogy does a little more than simple associationism.

In a concrete theory, which therefore recognizes proximality, the solicitations (more precisely the suggestions of similarity) are stepwise and based on proximality as it is inscribed, from one point to a few other points, then from each of the latter to a few more, etc. The "point" in question here is not a single element, a single term, which would be simple associationism and is erroneous. It is at least a pair of terms, so that the preservation of positionality can be made to bear.

A concrete approach like the one adopted in the Analogical Speaker needs proximality. Proximality is implemented by the paradigmatic links between records. The abductive movements depend on it and so does the possibility to compute with a plexus. So the concreteness<sup>212</sup> of the theory implies proximality of the inscriptions of the plexus.

The effect of analogy is to establish copositionings between terms, that is, positions with proximal applicability. This may be viewed as *osculation*<sup>213</sup> in geometry: at their contact point, two osculatory curves share a lot (a point in common, same derivative, same curvature) but, gradually further of the contact point, they gradually differ in these three respects. Similarity would thus be *osculatory*: it would have a proximal validity and a proximal possible effect. This has value as a metaphor only, I am only trying to suggest

---

<sup>211</sup> Minsky 1985, p. 82.

<sup>212</sup> Once again, 'concrete' is understood generically for 'occurrential' or 'exemplarist'.

<sup>213</sup> In geometry, two curves are osculatory if they are tangent and if, at the contact point, they have the same curvature radius.

how positionality is a notion with proximal definition and effectiveness, like categorization effects, like regularization effects.

An idea of proximality is also to be found in the 'self organizing feature maps' (SOFM) of Kohonen, which are a particular technique used in neuromimetic connectionism. Its main feature is to let emerge lexical items in a 'map' which is a two dimensional space. In an SOFM, lexical items with close meanings are close on the map; the training of the network yields a meaning-based proximality. In an SOFM, proximality is defined in a two-dimension space each dimension of which is an interval of integers; this space is an (n, m) rectangle. This structure seems to me to be too precise and no problem feature calls for it particularly. The topology of a rectangle defined in a plane has no specific motivation, and in this, the SOFM of the connectionists is artifactual. In the Analogical Speaker by contrast, proximality assumes no underlying two-dimension frame; the records which have to be made neighbours are simply linked together by paradigmatic links and transitive paths across these links constitute the required proximality. The resulting topology is whatever it can be and finally its nature is not important. It cannot be mapped onto any geometrical or topological particular structure like a plane and has no reason to be. In the drawings of paradigms like those occurring in chapters 4 and 5, records are indeed displayed in a plane but it would be mistaken to understand axes underlying them, the disposition is for convenience only, readability just demands few overlaps.

In order to make 'proximal' more completely understood, it makes sense to oppose it. Let us start from a case. Commenting a work<sup>214</sup>, Lepage<sup>215</sup> writes this:

Paradigmatic relationships being relationships in which four words intervene, they are in fact morphological analogies: *reaction* is to *reactor* as *factor* is to *faction*.

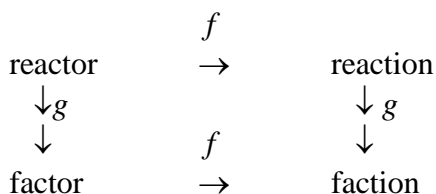

Contrasting sharply with AI approaches, morphological analogies apply in only one domain, that of words [in AI, they make mappings from the domain of the atom to the domain of the solar system and thus there are different domains]. As a consequence the number of relations between analogical terms decreases from three (*f*, *g* and *h*) to two (*f* and *g*). Moreover, because all four terms intervening in the analogy are from the same domain, the domains and ranges of *f* and *g* are identical.

This approach is very first-epoch-IA, that is, symbolist and mathematical. This framework of thought which can be said to be 'totalist' in the sense that it assumes a totality of the possibilities, a sort of universe which would have to be postulated in order for things to acquire meaning. Whatever the thing done or envisaged in particular, this thing is expressed, is defined, is understood, can be computed, only if previously

---

<sup>214</sup> About analogical conversion of analogical form into orthographical form, cf. Yvon 1994.

<sup>215</sup> Lepage 1996

referenced, related, defined as a sub-set with respect to this total, all-embracing framework. This is a 'domain and range', totalist approach.

Totalism is to be found prototypically in the logicist approaches of semantics. For Galmiche<sup>216</sup>:

the semantics of Montague is based on the 5-uple (A, W, T, <, F) where A is a set of entities, W a set of possible worlds, T a set of instants in time, < the precedence relation, which is an order in the instants in time, and F a set of functions which maps the element of A onto the logical constants.

In order to account for the meaning (for a speaker) of the smallest, contingent, personal utterance, will a theory thus based require the previous knowledge of the entire world? of eternity? of the entirety of the possible worlds? Here is another example of totalism: about the utterance *John saw everyone* we are told<sup>217</sup> that

an acceptable paraphrase of this utterance would be "For any individual whoever (if he is human), it is the case that John saw this individual". That is, in logical notation:  
( $\forall x: x$  is human) (John saw x).

Who can accept such a paraphrase? It is impossible to figure out a situation where it applies. *John saw everyone* can be paraphrased by *John already met all the family* (of his fiancée) or by *John already had meetings with all the unions* (John is a minister and the social situation is unstable) or otherwise depending on the case<sup>218</sup>. Gayral also perceives the same totalism and rejects it when she writes:

[...] in these formal approaches of semantics, the choice of the different indices is made *a priori*: the coordinates are defined in advance, regardless of any linguistic data. This supposes, and it is a very strong assumption, that a reference universe pre exists, pre-arranged, as for example in Montague, into possible worlds and into instants in time, and then one utters things about this universe. This is a great worry and it seems on the contrary that the possible worlds are triggered by enunciation and built based on discourse<sup>219</sup>.

It is indeed 'a very strong assumption' and a very unfortunate one. Logicians themselves today step away from totalism; so does Jacques Dubuc:

*The logic for the coming of which I pray should be concerned with transitions between actual thought and not with transitions between all possible thoughts*<sup>220</sup>.

The proximality advocated in the Analogical Speaker is thus opposed to totalism. Doing this is not different from rejecting types and categories. It also means computing with what is cognitively available and accessible; that is to say, making a situated linguistics,

---

<sup>216</sup> Galmiche 1991, p. 44.

<sup>217</sup> Boltanski" 2000, p. 80. Without necessarily endorsing them, B. rather seems to report the positions the Government & Binding theory.

<sup>218</sup> The above paraphrase is not acceptable also for a few more reasons but these are out of scope here, and, for this, elided.

<sup>219</sup> Gayral 1993.

<sup>220</sup> Jacques Dubuc, communication at the meeting *Philosophie Cognitive*, Ministère de la Recherche, 1, rue Descartes, Paris, 23 mars 2001.



one which is compatible with a situated cognition. This same approach also solves the extension-intension paradox.

### 7.7. *Extension, intension*

Without rules and without abstractions, it becomes difficult, but also useless, to specify a collection by its characters. Therefore the notion 'intension' falls and with it, that of extension. In this model, there is no room for extension and intension. Another manner, more technical to give a feel of this is as follows.

In the dynamics of ABS, agents (e.g. those of Figure 29), commissioners delivering at a same channel (e.g. channel C, their delivery point), produce findings which are then merged at the channel into a result. That is to say, homonymous findings are merged into a single result at channel C.

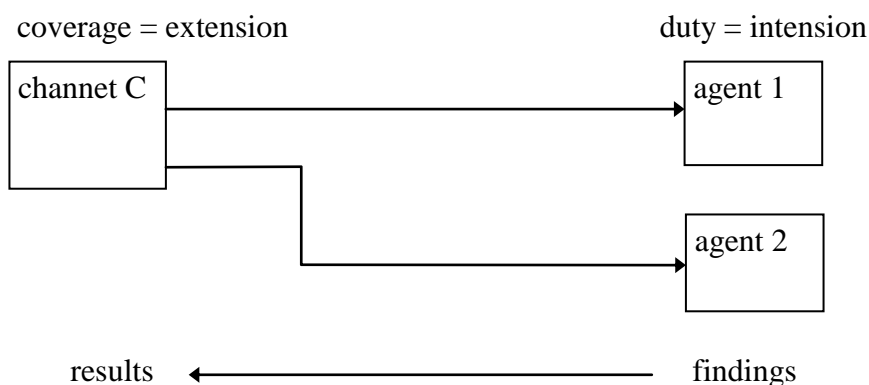

**Figure 29 Two agents delivering at a same channel**

Then, among the results delivered at a channel, it ceases to be possible to say which result comes from what agent. It is always possible to reconstruct this detail in order to analyse the behaviour of the model, but the model itself does not encompass it. Consequently, the coverage, that is, the set of results, each with a strength tag, cannot be defined by an agent but is very well defined by a channel.

We stay then with the following paradox:

- an agent defines a duty (which is an intension) when the coverage of this duty is not defined or ill-defined by the agent, because the objects that would support this definition are the findings which are minor in the model and moreover redundant, and
- a channel, having a list of results delivered to it, certainly defines a coverage *de facto* and extensionally, whereas its duty (an intension) is not defined: one cannot give an intensional definition of the results delivered at a channel.

This is counterintuitive, paradoxical, and yet operates well and renders the desired effects<sup>221</sup>. Incidentally, these considerations shed an additional light on the fact that the product of agents cannot constitute results directly and on the inanity of pretending to define agent results.

Of this paradox, the following reading may be proposed: a remodelling of the intension-extension opposition is accomplished by distinguishing between duty and its coverage, and by the ascription of these two figures of need to distinct organs. Agents are ascribed a duty (which is a specification of need), that is, intension, and channels are ascribed results (which are a coverage of need), that is, extension. The alternation channel-agent-channel-agent... in the heuristic structure amounts to building processes which microscopically amalgamate intension and extension so that macroscopically there is no longer the need to maintain this distinction.

Such distinction was found after a long and difficult analysis work, after criticizing several unfruitful trials. It was found inadvertently in a way: at no moment during the conception I had the explicit goal of overcoming the intension-extension opposition. This should have been awaited though, from the moment categories and rules were expelled. The question intension-extension made a difficulty to Hjelmlev<sup>222</sup> in 1933:

Il faut se demander quelle est la position de la question de la *définition intensionale* (sic) *de la zone sémantique de chacune des catégories morphématiques* (nous désignons cette question par l'abréviation *Int.*). Faudrait-il trancher cette question avant de pouvoir aborder la question *Ext.*? Théoriquement nous n'hésitons pas à répondre négativement: on peut en effet étudier les faits extensionaux [sic] (les faits de suppléance par exemple) sans avoir étudié d'abord le problème de la signification. D'autre part nous ne croyons pas qu'on puisse étudier les significations sans une connaissance préalable des formes et des fonctions. Une signification est toujours nécessairement une signification de quelque chose, et l'étude des significations présuppose la connaissance du porteur de ces significations. Théoriquement c'est donc la question *Int.* qui présuppose la question *Ext.*, et non inversement. Du point de vue pratique nous estimons cependant qu'il est utile d'avoir en vue les deux questions à la fois; la recherche demande dans une certaine mesure qu'on les considère ensemble, et surtout l'exposé des résultats de la recherche gagne en évidence et perspicuité [sic] et

---

<sup>221</sup> In an effort to solve this paradox, one may try to force the interpretation by viewing a channel as vested with a "virtual duty", which would be the union of the duties of the commissioners delivering to it. This is neither intension nor extension but a little of both. It is extension because it is a set of resources, instantiated at each commissioner, depending on the plexus data best matching the agent's duty, each contributing to the satisfaction of the client agent's duty. But it is also intension in the sense that this collection has a common motivation which, to simplify, if the duty of the client agent, or, to be more precise, the part of its own duty that his agent assigns to the channel. In fact, a client, even if it confers no explicit duty to its channels, nevertheless assigns them one which is a sort of 'equivalence class' of the duties of the commissioners which it recruits and appends to that channel. The 'equivalence class' in question is hard to express and remains non-explicit, elided itself in its own way: yet, it is not nothing, since the commissioner agents that are recruited in order to deliver at a channel are not anything. A client, vested with an explicit duty, distributes it to its channels, allocating each a part of it, which remains, as such, non-explicit, which has no other expression than the set of explicit duties of the commissioners, the determination of which involves the plexus, and the union of which is the best that can be proposed as its expression. This amounts to say finally that the paradox does not get well solved.

<sup>222</sup> Hjelmlev 1933. p. 60.

sera plus facilement accessible si les faits structuraux sont projetés sur une matière sémantique. Aussi ne chercherons nous pas d'éviter le problème *Int*. Mais il est nettement en marge; il ne sera qu'effleuré, et les interprétations sémantiques qui seront proposées ne seront ni discutés ni motivées. Hjelmslev, 1933/1985.

Had the question so much progressed when, still in 1989, Milner<sup>223</sup> could wonder:

Should we adopt an *extensional* or a *predicative* reading of the notion of category? In other words, must we say that *silence* and *chattering* belong to the same class of terms or must we say that they share one or several predicates?

And he made no decisive conclusion.

The alternative in question, not decidable indeed in the terms in which it was then worded, appears now just as a consequence of adopting categories and of accepting totalism. Reconciliation is achieved by a proximalist and exemplarist dynamics as the one proposed in this work. This proposition is also compatible with this evidence that linguistic behaviour and cognitive behaviour as well, take place in ignoring this dilemma which now appears a fallacy. We are exposed to it only if we accept logicism.

What has just been shown is the deconstruction, from the point of view of linguistics, of the opposition intension-extension between linguistic terms and what would be their lexical category (what is a noun in general vs. a concrete set of nouns). This is not exactly the main theme, classical since Port-Royal, of this question, which is rather the tension between the (possible) referents and a linguistic term of which they would be the reference (what is bird in general vs. a concrete set of birds). This second theme cannot be addressed in the current frame which is exemplarist only, and not yet occurrentialist. The hope is that the (yet to be done) occurrentialisation of this proposition, which is a prerequisite or a corollary of the treatment of meaning, will make it possible to address this second theme in continuity with what was done for the former.

### **7.8. *Binding, variables, variable binding***

For what is called 'binding' in English, in French we have *liaison* or *liage* depending on the case. Positioning this work versus binding will require separating its different acceptations because this word has served many purposes. Very generally the point is to understand how a generically defined place (an "expectancy of fulfilment") may be occupied by an exemplarist or occurrential occupier. On the way we will recognize something of the slot-filler schema already met in Chap. 1.

First of all will be discarded a binding which is described by the psychologists and is a concern for cognitive science but will not be a concern for us: the binding of sensory modalities together. It is presented as follows: given that colours (the red colour) and shapes (a circle) are not processed by the same neuronal areas how do we succeed in seeing a red circle and not separately something red and a circle. And if in addition there is a green square, why do we perceive the square as green and not the circle. This is a binding but not of the sort that we want to discuss.

---

<sup>223</sup> Milner 1989, p. 289

We shall address the problem of variable binding which is the most important one, then a few more, including the binding of the Government & Binding theory.

### **7.8.1. Variable binding in mathematics and in computer science**

In the idealized figure which it would have in mathematics, binding is the relation which takes place between a variable and a value that it takes. In expression  $X+2$ , among all its possible values, variable  $X$  takes the value 3,  $X$  is now bound to 3, the variable  $X$  is now bound to its value. Mathematics are such that it follows that expression  $X+2$  takes the value 5. A dimension of complexity appears in case the variable occurs again: in expression  $X^2 + 5X + 7$ , if variable  $X$  takes the value 3 in  $X^2$ , the convention requires that it be the same in  $5X$ . Variable binding is so commonplace in symbolic systems, beginning with mathematics, that it goes without special discussion.

Of this, computer science provides a similar idealization, which is different but equally rigid.

The computational architecture of the von Neuman serial computer [...] provides unlimited symbol passing, full generativity, and unlimited scalability, based on the system of data paths, memory addresses, and processing cycles that could be formalized in the logic of production systems<sup>224</sup>.

"Unlimited symbol passing", this is how the v. Neuman architecture binds variables; the central processor, for example the arithmetical processor, is in perfect functional situation versus the entirety of the memory. This touches the basic reason why these machines "do efficiently what we perform poorly and do very poorly what we perform efficiently". Their architecture cannot be a good model of brain operation. In general a symbolist theory is not the best possible one to account for phenomena happening in the brain, linguistic phenomena in particular.

The brain provides no obvious support for the symbol passing that provides the power underlying the von Neuman architecture. Instead, computations in the brain appear to rely ultimately on the formation of redundant connections between individual neurons<sup>225</sup>.

The evidence is abundant: anatomical and macroscopic. This does not prevent a current of thought to go on developing ignoring this conclusion: artificial intelligence. Artificial indeed. Incidentally, these reasons are the same that deprive rules of any plausibility as operating devices in linguistic operation, and, more generally, in cognitive operation. Rules are thus disqualified in two manners: as empirically insufficient, and as implementationally not plausible.

### **7.8.2. Connectionism faces variable binding with difficulty**

Variable binding is a subject of worry among connectionists because connectionist networks do not perform it easily; it is for them a source of difficulty:

Variable binding is a feature present in certain systems of symbolic representation which it is difficult to obtain in connectionist networks. In the application of a rule - or

---

<sup>224</sup> Mac Whinney 2000, p. 122.

<sup>225</sup> Mac Whinney 1992, p. 288.

other symbolic expression - that contains variables each variable must be bound (or linked to, or replaced with) a constant. If there are several occurrences of the same variable, each occurrence must be bound to the same constant<sup>226</sup>.

Neuromimetic connectionism long failed facing this question. That was at the time its models were mostly associators. A first progress dates back to 1985:

Touretzky and Hinton (1985) have recently developed a PDP implementation of a production system that can do rudimentary variable binding, and at present it appears that they may be able to extend it to perform recursive computations<sup>227</sup>.

The success was limited however, and, in 1991, it was still possible to write:

The connectionist bet consists of developing theories of processing that use other devices than operations on symbol strings. Generally, connectionists agree that their devices must allow them to explain the data that suggest a combinatorial structure in language. In addition, they identified in their field a closely related problem, namely *the variable binding problem*. Symbolic representations use variables so that rules may apply to various individuals in a class. ... Connectionists are challenged with building networks that perform the work which, in symbolist theories, is ensured by combinatorial structures, with symbol strings containing variables<sup>228</sup>.

Then numerous works followed, and the question progresses, with difficulty seemingly. The names are Holyoak, Thagard, Elman, Hummel, Biederman, Pollack, Shastri (the SHRUTI model, based on synchrony mechanisms), Adjjanagadde, Smolensky, and Touretzky.

As their predecessors did not differentiate enough long term memory from working memory, LISA of Hummel and Holyoak (Hummel 1997) addresses variable binding in working memory and succeeds in binding variables with a mixed network which is both connectionist and able to handle structured data. This model is analogical and performs structure mappings. Progress of neuromimeticians in variable binding is thus slow and difficult, currently obtained by somewhat violating pure connectionist 'orthodoxy'.

A recent synthesis book by Marcus (2001) is even severe for the connectionist community – but he says he still belongs to it and conserves his sympathy for the approach. Generally, he sets doubts about connectionist models having succeeded in really representing variables, and therefore operating bindings. He assigns the connectionists rules, variables and variable binding as one of the base functions they must acquire in order to progress<sup>229</sup>.

Jackendoff<sup>230</sup> sees binding as a massive phenomenon. In the sentence *The little star is beside the big star*, and about the preposition phrase *beside the big star*, he thinks that the following relations have to be encoded: a) the syntagm *beside the big star* is of type NP, b) it is a constituent of VP, c) it follows V, d) it has Prep and NP as parts, e) in the

---

<sup>226</sup> Bechtel 1991/1993, p. 329.

<sup>227</sup> McClelland 1986sp, p. 322.

<sup>228</sup> Bechtel 1991/1993, p. 231.

<sup>229</sup> The other functions which are required but yet to be accomplished by connectionist models, according to Marcus, are: the ability to represent recursive structures and the ability to represent individuals.

<sup>230</sup> Jackendoff 2002, p. 59-60.

conceptual structure, it corresponds to the Situation-constituent, f) it corresponds to the phonological constituent *beside the big star*. Binding is massive in linguistic structure says Jackendoff, and because it is so massive, it invalidates for example the synchrony of activation in the SHRUTI model as a possible explanation: the bandwidth is not wide enough.

### 7.8.3. Binding as instantiation: linking an abstraction with an exemplar

Binding, as envisaged up to this point, is binding as instantiation (other bindings will be examined later). It is the binding between an abstraction (the variable) and a concrete exemplar (the value); it concerns the application of a rule. This constitutes the central problem.

The question amounts to understanding how a rule applies, that is, for rule:

$$\text{NP} \rightarrow \text{Det} + \text{N},$$

for example, to say how Det is bound to *the*, N to *day* and NP to *the day*. This is a difficulty for connexionist networks: it is hard to make them apply rules. Marcus (2001) analyses that those who pretend dispensing with rules either fail in achieving regularized responses or implement rules without being aware of doing so, which is a mistake.

The model I present in this thesis solves this question by overcoming it or by eschewing it: it simply makes that it ceases to be posed. Take the example of *Figure 26 What is to très gentil as extrêmement is to assez* (p. 155)<sup>231</sup>. The computation, as suggested by this figure makes that there is no variable binding simply because there are no variables. The idea of variable is a non-criticized one which is inherited from cognitivism, from informatics and, before them, from logic and from mathematics.

Otherwise stated, the slot-filler schema is already too high-level a conceptualization to form the base of a plausible model. The operating dynamics work at a level below it, and do not have this problem. Much in the same way as what we saw about categorization, there are variable-value *effects* (or slot-filler *effects*, to adopt the terms of Chap. 1), and consequently binding *effects*, but effects only. The slot-filler schema is not reified in the theoretical apparatus and does not have, in itself, a direct part in the explanation of linguistic productivity. That the question of variable binding ceases to be a question is a direct consequence – and an important benefit – of the dismissal of the slot-filler schema. It is a consequence of the radical exemplariness of the model.

In order to succeed, the dynamics satisfy themselves with simpler services:

- access to term occurrences, to pairs of terms, to exemplarist constructions,
- proximity and abductive movements based on it,
- detection, within the observation of positionality, of settlement configurations that is, of matching.

The dynamics also suppose a body of already available analogies from which a very large number of other ones (virtually an infinity) can be abducted. This presupposition is different from that which is made by the connectionist models cited above.

---

<sup>231</sup> One may also use the examples pp.102 and following, or any example in Chap. 4.

If we had to force a mapping between the slot-filler schema and this model, we might take that the slot maps onto the position and the filler onto the term, with this important remark that the thing is never "functionalized" since there is no abstraction here: the binding, which then would be the occupation relation would not have itself any analog.

#### **7.8.4. Philosophical detour**

A philosopher, Bourdeau, also comes across variable binding as he writes about categories. A somewhat lengthy quotation<sup>232</sup> will provide a transition towards other figures of binding.

If there is an argument on the interpretation of variables, substitutional for some authors, objectal for others, it is because it amounts to know whether a variable takes its values within the nouns of the language or within the objects of the world. But the links which unite a variable and substitution are not limited to this normalized usage, established for the sake of computation. The vacuity of the form is an indifference towards matter, which the variable has the function of making visible. Therefore the latter is the mark of an undetermination and as the mark of an expectancy of fulfilment. As long as variation takes place within certain limits, that the constraints on categorial good formation are observed, the filling may be fulfilled by any element: this one, that one, that other one, any element may do equally well, because all are interchangeable, substitutable one to another. The empty form which a category is thus came to be equated to the (non empty!) class of expressions likely to occupy a place designated as empty. The success of the latter approach comes from its operative character, since, with it, we would have a discovery procedure for categories. However, we must question the reasons for restricting the use of these notions to the realm of language, as if substitution could not also apply to things, as if the objects could not themselves be well-formed or ill-formed as expressions are.

Wondering '*whether a variable takes its values within the nouns of the language or within the objects of the world*' does not place us in a very good position to clarify things because we should be more precise about the variable in question, but at least a problem is posed: that of the possible binding between a linguistic form and its referent and what the latter might be.

#### **7.8.5. Binding as referential resolution**

There is a binding question each time the question of the reference of a name phrase is posed. The thing which demands to be bound is now an NP; the case is no longer quite the same as the variable-value binding but the NP conserves certain characters of the variable and it is not absurd, by analogy, to see a question of binding here again.

About the nature of what the NP has to be bound to, there is however a real question: is it its reference, is it an individual of the world, is it a 'representation' of this individual? The case is not very clear and touches the root of a central and difficult question; it is the kernel of semantics and saying 'the signified' will not suffice. By lack of a firmer vision, as a provisory position, the 'private term' (cf. p. 262) is assumed to hold that role without this being positively defended as a thesis yet. Given the current definitional

---

<sup>232</sup> Bourdeau 2000, p. 146.

fuzziness of 'private term' there is no high risk but nothing quite decisive is uttered either.

The case of anaphor and generally that of coreference is similar to the case  $X^2 + 5X + 7$  in this that the anaphoric syntagm and its antecedent must 'take the same value', with the difference that in expression  $X^2 + 5X + 7$ , the two syntagms that must take the same value have the same form: "X" whereas in linguistic form (*Is Jo here? No, he just left.*), the anaphor (*he*) and its antecedent (*Jo*) generally have different forms. In summary, a mathematical variable is a systematized device for reference and coreference. The speaker's approach to the question is contingent and flexible while the mathematical approach is idealized and rigid but the targeted function is the same in both cases: how the form may raise again recurrences of identity.

#### **7.8.6. Referential binding: syntax prescribes two NPs to have the same referent**

Since the various NPs referring a same referent have different forms in natural languages, their form alone does not suffice to conclude to coreference. Languages then have devices to prescribe in which conditions coreference has to be recognized. None of these devices are categorical but some of them are very precise: they prescribe when one such NP (then anaphoric) must have the same reference as another one (then its antecedent). This is the referential binding of the Government and Binding Theory (G&B). Referential binding is then the vision, as seen from syntax, of the prescription of coreference. This prescription is in part or in whole independent from the fact that the reference is actually resolved.

In French, we have *liaison* and *liage*, English speakers only have *binding*. Thus Jackendoff<sup>233</sup>, about to start a development on binding finds it necessary to settle that it will bear on "the linguist's Binding Theory".

As we just saw, the notions 'referential binding' and 'variable binding' are different. However, they are not entirely foreign to one another because referential binding has consequences on the ensuing variable binding.

#### **7.8.7. Productivity of thought**

In the quotation above, and although somewhat elliptically, Bourdeau suggests something more: that these notions (variable, value, binding, computation) are not 'restricted to the realm of language'.

"No restriction to the realm of language. Substitution may bear on things. Objects can themselves be well-formed or ill-formed as expressions are.

The point is that the computation must be extended to objects – a prerequisite will be to sort out what these objects are. This is not very far from the language of thought, or, better said, from the productivity of thought – let alone language – of which it remains to be shown why it should have to be a language by anything else than a metaphor (Fodor, Lacan).

---

<sup>233</sup> Jackendoff 2002, p. 59.



What should the 'fillers' be in this case, those which come to satisfy an 'expectancy of fulfilment'? They can no longer be terms made up of linguistic form, I propose the private terms.

If there has to be rules, here again there would have to be a question of variable binding. But the intuition is rather, here as in the linguistic form, that exemplarist and occurrential inscriptions, a notion of proximality, and abductive dynamics analogous to those already exposed for the linguistic form, would account for the productivity of thought without rules and without categories. Things being so, the question of reference binding would be solved in the same manner: it would be eschewed, before being even posed.

#### **7.8.8. Conclusion: the model is functional, but with a plausibility residue**

As a model, the Analogical Speaker is functionally adequate on variable binding, referential binding not being covered within this work. Variable binding is solved by being eschewed: since there are no abstractions, there is just nothing to be bound. Linguistic productivity is not the result of abstractions and bindings; is the result of abductive computations working on exemplars, and observing copositionings.

This model is functionally appropriate. By creating channels, it may make multiple reference to terms (linguistic terms and private terms), and this solves the 'problem of 2' of Jackendoff (ibid. p. 61), a problem akin to that of binding. In: "the little star is beside the big star", the name "star" has two occurrences and current sentence processing models, by activation propagation in connectionist networks or in semantic networks are unable to treat it. This is exactly the question of individuals posed by Marcus as we shall see in the conclusions. The Analogical Speaker supports this well by using channels (cf. Chap. 4). Any categorial theory also does, and so do systems of automatic parsing and analysis, whatever their underlying theory, and even if they have none in particular. The novelty here is that the problem of 2 is addressed in a framework which is strictly non-categorial.

The Analogical Speaker also solves the problem posed by Jackendoff (ibid. p. 64) as that of the *encoded and instantiated typed variables* but with an important difference: Jackendoff asks for the variables to be typed, here the terms are not typed and there are no abstractions and therefore no variables, this has been explained at length above.

This model is functionally adequate but it contains an implementation-plausibility mortgage: about its support for the dynamics of the acts, that is, the heuristic structure of ABS (agents and channels), and one cannot convince oneself that neurons may implement it as such. The raw mechanism of channels in ABS cannot be proposed as a direct candidate to physiological interpretation; in itself it is not implementable.

The question will be more extensively addressed in the conclusions p. 272.

## 7.9. Probabilistic model or dynamic model

Over the last ten years, several articles<sup>234</sup> converge to complementing linguistic theories with probabilities. This line is advocated by researchers in contact with corpora and it is not clear that they aim only to improve their practice or also to promote a linguistic theory. In the conclusions of Abney<sup>235</sup>, however, the position is clear: "*The focus in computational linguistics has admittedly been on technology. But the same techniques promise progress at long last on questions about the nature of language that have been mysterious for so long*".

The general argument is that the limits of rule and category-based theories lead immediately and necessarily to a probabilistic or "probabilized" vision of language. The move is neither immediate nor necessary: all that has been exposed so far succeeds in doing away with categories and rules without calling on probabilities. At any rate, we need to see what the position of probabilities in the model could be. Therefore there is a case to clarify how the Analogical Speaker and the probability track are disposed with respect to each other.

A first argument set forward to introduce probabilities relates to learnability. We know, and Manning reminds us<sup>236</sup>, that, according to Gold's theorem, a language is not learnable without negative data. For Chomsky, this is an argument, among other ones, to postulate an innate universal grammar. Abney<sup>237</sup> and Manning<sup>238</sup> also remind us however that if context-free grammars are not learnable without negative data, it was shown by Horning (1969) that stochastic context-free grammars are. Of this, they make a case for stochastic grammars. This argument remains within the assumption that a grammar, be it stochastic, is the operating cause which accounts for linguistic acts, and that it is a grammar that has got to be learnt. This assumption is not made in my proposition which, quite on the contrary, sees a grammar as a result of operating dynamics that a) are more fundamental and simpler than a grammar, and b) operate in a given linguistic environment. A speaker does not learn a grammar; he just learns how to speak.

For the rest, in short, the advocates of probabilities – they are at various degrees – find limits in classical, algebraic models and question them seriously. They view the observable regularities as probabilistic more than rule and category-based. In their view, a mixed approach should permit progress; it should blend rules and probabilities. This can be done in several manners, the most obvious one being stochastic rules.

---

<sup>234</sup> Harris 1991, McMahon 1994, Abney 1996, Pereira 2000, Manning 2002, Habert to appear in TAL(*Traitement Automatique des Langues*, Paris, ATALA) in 2003, etc.

<sup>235</sup> Abney 1996, p. 21.

<sup>236</sup> Manning 2002, p. 16.

<sup>237</sup> Abney 1996, p. 20.

<sup>238</sup> Manning 2000, p. 17.

### 7.9.1. Reasons of legitimacy and reasons of variability

In addition to the multitude of little facts that cannot easily be solved by rules (the leakages of categorial theories), the advocates of probabilities foster them for two orders of reasons: reasons of legitimacy and reasons of variability.

Under 'legitimacy' I collect questions of gradual grammaticality, of gradual acceptability (is it different from grammaticality?), the question of the respective share of *langue* and *parole*, and the question of competence vs. performance.

For Abney, postulating a performance separate from competence does not help in coping with productions that occur in corpora and even it handicaps their apprehension. Then:

The issue of grammaticality and ambiguity judgments about sentences as opposed to structures... are no more or less computational than judgments about structures, but it is difficult to give a good account of them with grammars of the usual sort; they seem to call for stochastic, or at least weighted grammars<sup>239</sup>.

Under usual assumptions, the fact that the grammar predicts grammaticality and ambiguity where none is perceived is not a linguistic problem. The usual opinion is that perception is a matter of performance, and that grammaticality alone does not predict performance; we must also include non-linguistic factors like plausibility and parsing preferences and maybe even probabilities ... As a result, there is actually no intent that the grammar *predict* – that is, generate – individual structured sentence judgments. For a given structured sentence, the grammar only predicts whether there is some sentence with the same structure that is judged to be good<sup>240</sup>.

Preparing an argument for acknowledging probabilities, Abney notes that there is a difference between a judgment of acceptability/grammaticality on a form alone and a structure judgment. An extreme case being the English form:

(1a) the a are of I

At first sight it is judged bad. However, an interpretation, a very rare one, is possible: for geometers who are used to name plots of land with capital letters (I, J, K, etc.) and ares (the surface measure of 100 square meters) within them with small letters (a, b, c, etc.), this English utterance is grammatical and interpretable, it is a noun phrase which can be paraphrased "the are named 'a' in the plot named 'I'". Form (1a), associated with the structure which responds for this interpretation, is now judged good.

This is correct and long known: the first Chomsky, and with insistence later on, states that what constitutes the linguistic fact is not a form, but a form with an analysis, by a phrase marker for example. What is curious in Abney's argument is that the interpretation which ascribes a meaning to form (1a) is more than extremely rare in any corpus. One is curious to hear how any stochastic approach might help accounting for it. I shall come back to this. This suspicion connects, anticipating it, with a remark from Manning, below: Optimality Theory, even after a stochastic complement has nothing to say of interpretations "made possible in various contexts".

---

<sup>239</sup> Abney 1996, p. 5.

<sup>240</sup> Ibid., p. 9.

For the promoters of probabilities, the second order of reasons to introduce them collects reasons of variability: linguistic variation, linguistic change, and learning. For them, these are the stronger reasons. Abney (already quoted in Chap. 1) accepts syntax to be autonomous but notices that autonomy is not isolation, and linguistics also encompasses production, comprehension, learning, variation, and linguistic change.

Transient situations during acquisition would call for the coexistence of concurrent rules, with stochastic weighting:

Under standard assumptions about the grammar, we would expect the course of language development to be characterized by abrupt changes, each time the child learns or alters a rule or a parameter of the grammar. If, as seems to be the case, changes in child grammar are actually reflected in changes in relative frequencies of structures that extend over months or more, it is hard to avoid the conclusion that the child has a probabilistic or weighted grammar in some form. ... At any given point in this picture a child's grammar is a stochastic (i.e. probabilistic) grammar<sup>241</sup>.

If things are so, during the period in which two rules, or two variants of the same rule, coexist and compete for application, what determines which one will be applied? What determines the evolution of the relative weights of both, and later, the moment at which one of them will fade out? Adding probabilities in this manner may well have a descriptive efficiency but it makes no progress in the explanation. I will show (p. 250) how the model of the Analogical Speaker provides on the contrary a precise explanation of the way a new construction propagates gradually in a plexus, that is, in a speaker's linguistic knowledge and consequently in his usage.

Likewise, the language in a community of speakers would have to be viewed as a stochastic grammar to account for the variation among them<sup>242</sup>. It would have to be a unique grammar otherwise one could not account for intercomprehension.

The same idea of competing rules is called again for explaining linguistic change. Manning<sup>243</sup> for example makes a corpus investigation on the phenomenon constituted by the emergence of *as least as* + Adj, competing with *at least as* + Adj, during the 1990s, in the United States of North America, in South Africa, and in Australia. Here again, a stochastic rule would account for this alternation.

To summarize:

It is plausible to think of language acquisition, language change, and language variation in terms of populations of grammars of different speakers or sets of hypotheses a language learner entertains. When we examine populations of grammars varying within bounds, it is natural to expect statistical models to provide useful tools<sup>244</sup>.

So probabilities would be required, but no one ignores that they were dismissed by Chomsky in the 1950s: alone they do not suffice.

---

<sup>241</sup> Ibid., p. 2.

<sup>242</sup> Ibid., p. 3.

<sup>243</sup> Manning 2002, p. 4.

<sup>244</sup> Abney 1996, p. 4.

### 7.9.2. Original sins of probabilities in language

For Chomsky: neither *colourless green ideas sleep furiously* nor *furiously sleep ideas green colourless* was ever observed in linguistic experience but the former is grammatical and the latter is not.

Abney responds<sup>245</sup> that for this argument to hold, from the absence of occurrence of an utterance, one must have to be able to deduct that its probability is null. But, he adds, there is a whole literature about the manner to estimate the probability of an event having no occurrence in a sample, and in particular to differentiate *true zeroes from ones which only reflect a lack which just happens by chance*.

Yes but, specifically, in order to found this distinction, a theory is needed that could rule which of these non-occurrences are 'true' and which ones do not happen just as a matter of chance. In the case of linguistic phenomena this can only be a theory which rules the 'possible in a language', that is to say a grammar, and this is exactly what we are after. This is entire circularity. Chomsky's argument was weak because it depended on a grammaticality which only holds in an idealization very remote from the object, but the response of Abney is still weaker.

Two more of Chomsky's arguments were related with the length of utterances: arbitrarily long grammatical dependences can be built and therefore, a Markov model of order  $n$  fails however large  $n$  is made. These arguments are very foreign to the recent come-back of probabilities in language and so I just ignore them.

A manner to give a feeling of the "original sin" of models with probabilities only, in this case, based on transition probabilities, is to show a sample of the productions of current  $n$ -gram models. Habert reports the following:

The 'localist' models, which  $n$ -grams are, faithfully account for constraints in narrow windows, but they resist the enlargement of the span (the number of occurrences "melts") as can be shown with the pseudo-sentences generated by a tri-gram model trained on a corpus of radio and television news of 13 millions words (Rosenfeld 2000, p. 1313): *My question to you those pictures may still not in Romania and I looked up clean; you were going to take their cue from Anchorage lifted off everything will work site Verdi*<sup>246</sup>.

Transition alone is surely not a ratio. Syntax in a broad sense cannot be based on sheer sequencing. An improvement of markovism would not suffice.

At this point of the argument, the promoters of probabilities have removed a few of the classical mortgages bearing on them, without this allowing yet considering them as sufficient. With them, a structural viewpoint should be conserved somehow: dependency, the generativist phrase marker, something which reflects sentence structure: an alliance would be needed.

Two possible approaches of alliance between probabilities and structure will be examined, one following Abney (taken as a prototype because there are other representatives), and a second one according to Manning.

---

<sup>245</sup> Ibid. p. 18.

<sup>246</sup> Habert 2003a, p. 18.

### 7.9.3. Alliance number 1: stochastic grammars (Abney)

The first one approaches variation, learning, and linguistic change by making the grammars stochastic (Abney also says 'weighted').

Statistical methods – by which I mean weighted grammars and distribution induction methods – are clearly relevant to language acquisition, language change, and language comprehension. Understanding language in this broad sense is the ultimate goal of linguistics<sup>247</sup>.

For Manning, the proposal is to represent subcategorization information as the probability of occurrence of the various dependents of a verb. The English verb *retire* requires a subject with a probability 1, accepts an object with a probability 0.52, accepts a preposition phrase with a probability 0.05 (*from*) or 0.06 (*as*)<sup>248</sup>

Such models combine formal linguistic theories and quantitative data about language use in a scientifically precise way<sup>249</sup>.

Stochastic grammars of this sort do not constitute a rejection of the underlying algebraic grammars but a complementation<sup>250</sup>.

Both agree to see probabilities as combining with an algebraic grammar. Jurafsky<sup>251</sup> makes the same conclusion: probabilities are a complement, not a replacement.

### 7.9.4. Example of "disambiguation": *John walks* and its critique

For Abney (p. 13) determining which analysis is the good one – that is, the one the speakers will understand – is not a computational problem but determining the algorithm which computes this analysis is a computational problem. *John walks*, depending on the case, may be an NP or a sentence, and the probabilities are different in each case. This may be accounted for by a grammar like the following:

S	→	NP	V	0.7
S	→	NP		0.3
NP	→	N		0.8
NP	→	N	N	0.2
N	→	John		0.6
N	→	walks		0.4
V	→	walks		1.0

Applying this grammar, Abney evaluates that *John walks* is an NP with a probability 0,336 and a sentence with a probability 0.0144.

Let alone the fact that we are not told what *John walks* is in the rest of the cases (62% of the cases is not a marginal remainder!), it being a sentence or an NP is not determined by adding weights to generation rules but by the context.

---

<sup>247</sup> Abney 1996.

<sup>248</sup> Manning 2002, p. 11.

<sup>249</sup> Ibid., p. 12. Are the models scientifically precise because there are numbers in them?

<sup>250</sup> Abney 1996, p. 2.

<sup>251</sup> Jurafsky (Dan) *Probabilistic Modelling in Psycholinguistics: A Survey and Apologia*, presentation at the AMLAP 2000 Congress, Saarbrücken, June 2000

In *The weather is fair. John walks. He is happy.* the probability for *John walks* to be a sentence is 1.

In *I see that John walks.* the probability for *John walks* to be an NP is 1.

One knows what is what by the context and the punctuation in writing and, in speaking, by the situation and the prosody.

It is neither reasonable nor necessary in general to approach by a method based on probabilities that which can be known. In this particular case, it is neither reasonable nor necessary to approach by a method based on probabilities that which can be abducted at low cost and with good confidence from what immediately precedes *John walks*. In the first case: *that*, and in the second case, the full stop terminating the preceding sentence. It has been shown above how the Analogical Speaker discriminates such ambiguities without even requiring categorial labels, cf. example *été* (p. 166).

This is a new encounter of the classical argument on polysemy: it is decontextualisation which creates ambiguity (here: categorial ambiguity). It suffices to reinstate things in their context and there is no need for a stochastic apparatus.

If one seeks to make up for missing data, for example prosodic data – which may well be the case in automatic language processing – and which impede a reasonably economic and sure abduction as the one I propose, it is possible to adopt such stochastic reasoning. They may happen to be sufficient and more affordable for an engineering purpose, but they have no theoretical relevance in linguistics. Then the prediction would be that they allow us to make up for some missing data, but this will let leakage happen, as usual.

### **7.9.5. Alliance number 2: Stochastic Optimality Theory**

For some authors, complementing rules with probabilities is insufficient and old-fashioned because *the same categorial phenomena which are attributed to hard grammatical constraints in some languages continue to show up as soft constraints in other languages*<sup>252</sup>.

This section summarizes the proposition, in Manning 2002, which leads to making Optimality Theory stochastic.

After Bresnan, Dingare, Givón, etc. a model must comprise variable strength constraints, from soft ones to categorial ones, otherwise, some facts should belong to competence in some languages, and to performance in some other languages. These ideas, already established in typology and functionalism, have not been expressed in formal syntactic models. Now giving out the explanation to performance is a renouncement because it ceases to make prediction possible.

---

<sup>252</sup> Manning 2002, p. 20.

	Constraint C1 <i>Functional link</i> It is preferable for the subject to be the agent	Constraint C2 <i>Discourse</i> It is preferable for the subject to be previously mentioned	Constraint C3 <i>Person</i> It is preferable for the subject to be 1P or 2P
A <i>A policeman scolded me</i>	1	0	0
P <i>I was scolded by a policeman</i>	0	1	1

**Figure 30 Three constraints applying to two utterances**

In an example situation, a policeman scolded the utterer. In English, this may give birth to an active utterance (utterance A) in which the grammatical subject is the policeman, or a passive one (utterance P) in which the grammatical subject is the utterer. Three constraints apply:

For each of these constraints – which are cross-linguistic – each of the two forms A (active) and P (passive) satisfies it (1) or violates it (0). None satisfies them all.

For Generative Grammar, none of the constraints being categorical, none belong to the grammar: both forms A and P are grammatical, and Generative Grammar says nothing about how a speaker chooses A or P. However, in several languages, one or several of the constraints are categorical and therefore there is no option between A and P.

In a categorical grammar, in case of constraint conflict the form is non-grammatical. In case of conflict between constraint C1 and constraint C3 it is not possible to express *scold (policeman, me)*. The grammar has a gap, with no corresponding gap in the languages, but for rare exceptions. Categorical grammars then can only respond by adding manual restrictions (negative conditions) on the constraints or other devices like the elsewhere principle<sup>253</sup>.

The standard Optimality Theory (OT, also named *ordinal OT* below), which is not probabilistic, brings a progress. For it, the constraints – their set is postulated universal – are ordered, and the weaker ones may be violated to satisfy the stronger ones. OT accounts for many facts in many languages and provides the *elsewhere* principle of Kiparsky without added cost.

One of the problems of OT is that it determines a single output for a given input and so it does not account for inter individual variation nor for the variations of a single individual. Thence one has tried to make it capable of variable output. But, from the moment discursive role (constraint C1 above), and information structure (C2) are used to predict diathesis, the resulting variation suggests to call on probabilities, and a stochastic extension of OT has been proposed by Boersma.

Smolensky proposes the ranking of OT in reaction to frameworks which maximize harmony building on quantified soft constraints. Smolensky: *Order, not quantity (or counting), is the key in Harmony-based theories. In Optimality Theory, constraints are*

---

<sup>253</sup> Kiparsky 1973.



*ranked, not weighted; harmonic evaluation involves the abstract algebra of order relations rather than numerical adjudication over numerical quantities.*

Such ranking often suffices the same way as categorical constraints did for many applications, but something else is needed for variability and ganging up. Ganging up is the case of several weak constraints conspiring to overcome together a stronger one. For this, numbers are needed, ranking alone does not suffice.

Coming back to Figure 30, none of the three constraints C1, C2, C3 is categorical in English but each plays its role. Quantitative data show that a language expresses soft generalizations where other languages make categorical generalizations. A probabilistic model can model the strength of these preferences, the interactions between them, and their interactions with other principles of the grammar. By providing variable output for the same entries, it may predict the statistical patterning of the data. The model then makes it possible to relate these soft constraints to the categorical restrictions which exist in other languages; thus it shows how both are effects of common underlying principles. Typological data is thus related with quantitative data.

In Stochastic OT (Boersma, Hayes), constraints are not just ordered, they are also placed on a scale and distances between them matter for the predictions of the theory. Secondly, the theory comprises a stochastic evaluation which, for a given entry, provides a variation, that is a probabilistic distribution of the outputs of the grammar. Any ranking value of a constraint, after its evaluation, is modified by a random correction following a normal distribution law. Thus the grammar constrains the output without determining it. Does a speaker really roll dice before speaking? Whether there is randomness or not in human behaviour, the randomness introduced here reflects the incompleteness of the model: we do not wish to put into a syntactic model all the factors which influence syntax. As we cannot know them all, we simply predict that the average of their effects on the outputs will occur with certain frequencies.

An advantage of Stochastic OT over (ordinal) OT is that it is a robust learning algorithm. Another one is its ability to learn frequency distribution. This provides a unified theory of categorical phenomena and variable phenomena. Linguistic change would then be explained by the strength of a constraint moving along the ranking scale and this would predict progressive change of usage. The strength of a constraint growing slowly and linearly with time, nearing that of another constraint, then meeting it, and then crossing it would explain the shape of the usage change curve, which is a sigmoid (logistic function). For grammatical change, this model is more plausible than the coexistence of generativist rules.

Its inability to allow combinations between all the constraint values may be a limit of Stochastic OT: a few constraints among the stronger ones determine the output and the remaining ones are simply ignored. In particular, lower-rank constraint violations cannot "gang up" to win over a higher-rank constraint, and this is contrary to many observations. In generation, Stochastic OT is adequate for choosing on linguistic grounds between a limited set of candidates but seems less plausible as a parsing/interpretation model where most of the readings of an ambiguous sentence can be made plausible by varying contexts, that is, when the decisive evidence may come from many places. This explains that OT models are mainly employed for generation

whereas work in natural language processing has tended to use more general feature interaction models.

This terminates the summary of a section of Manning 2002 in which, by convention, the utterer was Manning. The utterer is now again the author of this dissertation.

#### **7.9.6. Critical commentary on Stochastic OT**

In addition to the defects and limits stated above by Manning, Stochastic OT reproduces certain limits of (ordinal) OT associated with categoricity, although all this approach is presented as an effort to escape categoricity.

The set of constraints should be unarguable, consensual, motivated, closed and stable, even more so since it is postulated universal. Here occurs the suspicion of the impossibility of a closure and of the impossibility of stability much in the same way as for lexical categories and for thematic roles and, for the time being at least, each paper on the subject or almost, brings new constraints about. However, the optimalists may respond, and this can be acknowledged, that the theory is young, and, when mature, it would stabilize the set of constraints. We must then wait kindly and see.

The three constraints C1, C2 and C3 seen above presuppose the category of subject. Do the underlying linguistic mechanisms, the detail of which Stochastic OT renounces, and which it expresses by these constraints, have a manifestation in languages without subjects? If so, how are the corresponding constraints to be expressed in these languages? Generally, the fact that constraints, from their very expression, depend so much on lexical, syntactic and functional categories, makes them the heirs of the limits of these notions. The optimalist current is a spin-off of generativism which criticizes categories little and late.

Stochastic OT also shares with stochastic grammars (alliance number 1) the "patching" character of probabilities, as they are introduced in them.

Finally, the evolution of constraint strengths, which is supposed to account for linguistic evolution and learning progress, can be related neither with the occurrential experience of speakers nor with any other notion. This constitutes a break in causal chains which demands to see this construction as a model at best but forbids it to be a theory since a link as important as this one is missing.

#### **7.9.7. In an occurrential act, reasons are occurrential**

A stochastic grammar, even an optimalist one, explains grammatical probabilities, not particular acts: it is not equipped for determining them.

In a production act, the enunciative programme of which is to express "to absorb food", "to enjoy food with friends" without this programme being specific about what is absorbed (it will for example end up producing "*we ate*" or "*we already ate*"), the uttering process, which is envisaging the 'lexical entry' *eat* to fulfil the enunciative programme, finds in linguistic knowledge that it lends itself to transitive constructions and to intransitive constructions. To select either, if we follow the promoters of probabilities, the process should be concerned with the recognition that this verb is, for example, transitive in 60% of the cases and intransitive in 40%.

First of all, if the enunciative programme encompasses no object, the intransitive construction is very much needed and it suffices that it be possible for this way to be taken. The probability distribution does not have the opportunity to get involved. The occurrential reason prevails over any statistical reason.

In a related case, suppose the required construction is not attested at all. For example the speaker plans to say "X, he takes" in a context in which X takes anything that one will care to give him, systematically, never giving anything back, etc., and there is no attestation available to this speaker of intransitive 'take' in a context that could be reported to the present one. But assume that there is one for "give": "she gives" (easily, systematically, generously). Abductive licensing is possible from there: "*he takes*" may be licensed by "*she gives*". The speaker then evaluates, by simulation, the load which he thinks his hearer can bear, upon what he decides, or not, to utter this. The 'probability' which is supposed to be null to build "take" intransitively did not impede this novel construction (novel for this verb, but not novel in general, not novel for transfer verbs). From then on, its reuse will be facilitated; a usage will have evolved a little.

If probabilities had to be considered what is the set of the possible cases (the denominator) to which the number of favourable cases (the numerator) should have to be reported? The number of occurrences of the verb *take*? The number of occurrences of transfer verbs? If we accept that linguistic operation is flexible and that the abductive chains are shorter or longer depending on the case, we lack any criterion; we do not know how to characterize the subset which should have to be counted to constitute the denominator. This is a problem of intensional characterization; what is lacking is a characteristic property.

Moreover, there is a problem of extensional characterization: we do not know from what total set this subset should be extracted: from the British National Corpus? From the set of things heard and uttered by this speaker over his life? Over the last three years?

So is it for the numerator: the number of possible cases. Should it be the number of the transitive constructions of all transfer verbs, of a narrower or broader class? We do not know.

Therefore, in production acts, i) the definition of probabilities has no firm base, and ii) the operating dynamics does not require them. What matters are the relative costs of various enunciation possibilities versus their adequacy to fulfil an enunciation programme which is occurrential. These relative costs are defined with respect to the linguistic knowledge, that is, with respect to the plexus.

The paradigm of the possible constructions of a term is a question for grammarians or for computational linguists. It is not a useful datum for the enunciative mechanics. For the latter, if "any utterance is a compromise", what matters is to settle on a reasonably good one among those which are computable; what matters is the solutions at hand in an occurrential situation and their relative costs.

Behind the fallacious vision of the 'stochastized' paradigm of the possible constructions of a term, must be identified another figure of the totalism which was already discussed p. 212. The exhaustion of a totality of possibilities, here by 'probabilising' them would be good to account for occurrential operations among them. Again, this is the idea to guide an occurrential choice in a total set, a new variant of the 'domain and range'

approach. Besides its non-plausibility, we have seen – and will see again soon – that the construction of this set is void because we just do not know what it has to be.

### **7.9.8. Probabilities do not explain the settlement points**

In occurrential acts, probabilities are not explanatory; the mechanism has to be a computation.

A next step in a process certainly is not determined by chance. When computing a next step, some terms lead the computation to consider first, and with greater strength, certain heuristic paths. Of these preferred transitions, one may give a probabilistic description, then of transitional probabilities. They are conceived of as commanding preferred expectancies and anticipating them. But they do not command the final stabilization points. They are not inventive, they are not innovative, they take the speaker into garden paths but they cannot contribute taking him out of them.

Now the Analogical Speaker, with a single device, a computation building on the proximity of inscriptions, has the power to account with homogeneity, of both i) some paths being envisaged in priority and ii) rare, non obvious stabilization points being finally elected despite them contradicting the paths initially envisaged.

*"The set of issues labelled "performance" are not essentially computational"* Abney says (1996:21). They are just computational and that only, but we need to understand correctly in which way: Abney denies them the computational character because 'performance' would be opposed to the 'grammar' that governs in general that which is possible in a language. To make things clear, as we are not making a distinction between a competence and a performance, this amounts to say that the accomplishment of language acts is principally computational.

Thus it appears that the probabilistic theme is worthless in linguistic acts. It might still have some value for the description of a 'language' and this is not contradictory since it is not a prerequisite to the explanation of the acts; in fact it does not even contribute.

### **7.9.9. "Set of possibilities" criticized**

For playing a part in an operational theory of linguistic processes, that is, of language acts, probabilities have a constitutional defect. Let us recall the simple definition of probabilities: a probability is always a ratio, the ratio of a number of favourable cases divided by a number of possible cases.

Roughly, in the data brought by the supporters of probabilities the set of possible cases is, in fact, bound by the perimeter of a corpus: a time interval in the collection of the New York Times or a defined fraction of the BNC (British National Corpus).

In order to understand how a probabilistic stance may be legitimate in a linguistic act, we need to understand the set of possibilities which would be pertinent in it.

When a speaker carries out a linguistic act, a 'possibility' is not defined within a corpus' perimeter: it is computed occurrentially. A few paradigmatic possibilities may enter the scope of the computation and stay in it as competitors for a while. They have varied strengths and one of them will be elected finally. Their consideration will have been occurrential and guided by a definite act. Each may take part in sets of possibilities from

different viewpoints. A set of possibilities is determined by the viewpoint 'diathesis type', another one by the viewpoint 'lexical choice', still another one by the viewpoint 'thematization or not', etc.

For a given linguistic act, if we envisage it from different viewpoints, there are different sets of possibilities. For two different linguistic acts envisaged from the same viewpoint – assuming it is relevant in both acts – the sets of possibilities are also different.

The 'set of possibilities' is simply not a set, at best it is a 'space' if we know what we say with 'space', but we do not, this wording is metaphorical and finally, the notion 'number of possible cases' has no firm base; we do not know how to turn this idea into a number. Therefore, in an utterance act in French which seeks to fulfil a defined enunciative project, there is no base to define a probability which might help to chose. For a given verb – assuming the lexical choice is already made – a passive construction will not be chosen because in Frantex it is constructed passively in 63.2% of the occurrences. The diathesis will rather be determined by multiple, converging or contradictory conditions, all of them related to the concrete terms of this enunciative project, then to terms close to the latter which the plexus makes it possible to reach, then possibly to terms still less proximal, until a point in which sufficient settlements obtain.

#### **7.9.10. Reception is ultimately a question of settlement**

*There must exist a rule to the exceptions of a rule; the only question is to discover it.* Leskien<sup>254</sup>.

It is important to distinguish two things:

- a) the fact that after a morpheme, or a defined segment or form, some things are more awaited than other ones
- b) from the fact that, ultimately, reception is a matter of settlement, and that this is the final criterion of success, and consequently of acceptability.

It is a matter of omen<sup>255</sup>: what precedes augurs of the continuation (formal habits, preferred sequences, routines, collocations) and certainly this can be described with probabilities. But it is also a matter of settlement (coincidence). It certainly is a matter of expectancy, but more than in the mere sequence.

It is a play between expectancy and surprise. One talks to say something new, sometimes at least. Upon a topic, a comment is expected. This point contradicts probabilities: as the interest results from the comparatively unexpected, it is necessarily insufficient to see it in frequency only. How can a probabilistic model spurt the new out of the old, the comment out of the topic? This is not very clear.

---

<sup>254</sup> Leskien 1876, quoted by Paveau 2003, p. 25.

<sup>255</sup> The original French passage is as follows: "*Question d'heurs (heur est le même mot qu'augure. Littré): ce qui précède augure de la suite (heurs d'habitudes formelles, d'enchaînements, de routines, de collocations) et ceci peut sans doute être décrit avec des probabilités. Mais il faut aussi des heurs de coïncidence (settlements). Attente oui, mais plus que dans la consécuitivité de la forme; sans cela pas de place pour les 'bonheurs d'expression'.*"

In the Analogical Speaker, the first findings, that is, the terms or records that are closer to the terms of the act, are findings that are reached by the shortest (cheapest and strongest) paths. It may happen that settlement takes place with them as will be the case in trite, usual tasks encompassing little surprise (or the parts which are such, of tasks which might not be entirely such), when the plexus is congruent with that triteness. But in tasks or parts of tasks, it may also happen that longer abductive paths are necessary; the process will then reach less probable areas and configurations, produce weaker suggestions, but ones which settle into findings. This is the case for tasks which exhibit no easy match with the inscriptions of a plexus<sup>256</sup>: they are understandable even though the ways to their understanding (I have proposed "immersion") are rare and long.

This is how the Analogical Speaker reconciles in its own manner a kind of algebraic rigour (not categorical though) with a dimension in which one might see effects of probabilities, but it does so without requiring probabilities to be assumed to take any operational role.

To quote Leskien again – he was writing in the Neogrammarian euphoria of those times – it cannot be the case that *there exists a rule to the exceptions of a rule* if the assumption of rules is not made. However, Leskien's request is not unreasonable if we reword it into: *each particular act has a motivation, even if it appears anomalous versus a series in which we place it*. Such motivation detail is certainly not always easy to know so that it often remains potential only, but at least the theoretical frame must make room for it instead of blurring everything in advance.

#### **7.9.11. Probabilistic methods are a stopgap**

It is when linguistic theory withdraws too much that it then has difficulty in facing the explanation of variety.

Homonymy: one withdraws the context, creating abstract items, "fabricating" homonymy; then one has to "disambiguate".

Categories: distributional contexts are projected over a set of classes (which one strives to keep small), that is, one withdraws the occurrential and proximal properties of contexts and the cognitive proximity; and then one has to "sub-categorize"<sup>257</sup>. Here the temptation of probabilities, the attempt to adjoin them to a categorist frame which would be conserved: derivational rules according to every argument schema, the rules being weighted by their observed frequency.

Abney<sup>258</sup> undertakes to refute an objection which he thus presents. An opponent:

Granted humans perceive only one of the many legal structures for a given sentence, but the perception is completely deterministic. We need only give a proper account of all the factors affecting the judgment. ... A probabilistic model is only a stopgap in the absence of an account of the missing factors.

---

<sup>256</sup> Far-fetched acts in other words.

<sup>257</sup> Manning 2002, p. 6, *verbal sub-categorization*.

<sup>258</sup> Abney 1996, p. 18.

Abney responds that, things being so, the queuing theory to account for the arrival of lorries at a warehouse is also a stopgap. This analogy is bad: whichever way one tries, the schema 'serially reusable exclusive-allocation resource', which is that of the entry point at a warehouse, resource on which the candidates to consume its time (the lorries) must queue up, cannot be made analogous to any linguistic operation.

Other argument<sup>259</sup>, a global, macroscopic account suffices, detail is useless:

... some properties of the system are genuinely *emergent*, and a stochastic account is not just an approximation, it provides more insight than identifying any deterministic factor. Or to use a different dirty word, it is a *reductionist* error to reject a successful stochastic account and insist that only a more complex, lower-level, deterministic model advances scientific understanding.

Let me quote Manning again, and summarize him:

Any ranking value of a constraint, after its evaluation, is altered by a correction following a normal distribution law. Thus grammar constrains the output without determining it. Does a speaker roll dice before producing an utterance? Whether or not there are probabilities in human behaviour, their introduction here reflects the incompleteness of the model: we do not wish to include in a model of syntax all the factors that influence it. As we cannot know them all, we simply predict that, in the average of their effects, some outputs will happen with certain frequencies.

It is indeed a mistake to pretend identifying all the determining factors. There is also something to understand about the lag between the determining factors and observation. But the schema which turns out useful to embrace both is not a probabilistic one, it is that of macroscopic determinism which 'smoothes' the base processes that are swarming, but for which single one, determinist causal chains are at play.

Jurafsky, speaking in Saarbrücken in June 2000 concludes: *Probability is not a replacement for structure, but an augmentation*. Structures should not be *augmented* with probabilities; symbolic rule systems, which are bad, should not be enhanced by a device which will add its own implausibility to theirs<sup>260</sup>. It is more promising to replace the structures by a device which macroscopically responds so as to produce the effects of regularity and the probabilistic distributions that are to be observed empirically; especially so if the device in question lends itself to reduction more easily.

Yes, if taken as a theoretical *complement*, probabilities are a stopgap.

### 7.9.12. The Analogical Speaker and the probabilistic speaker

The Analogical Speaker, because it is proximalist, makes that the computation considers first the closest elements, that is, ones which succeed more often in conjunction. If you wish, you may call them 'more probable'. It also makes that the consideration of these proximal elements often settles but not always. In case of failure to settle with proximal elements, settlements are sought with more remote ones. Externally, this renders a 'probability effect' which is apparent from the outside and can be described with

---

<sup>259</sup> Ibid. p. 19.

<sup>260</sup> Alleged opponent : *Surely you don't believe that people compute little symbolic Bayes equations in their heads?* Jurafsky : *No I don't.*

probabilities. But this does not imply probabilities to be *modus operandi* in the form of 'stochastic rules'.

The Analogical Speaker solves grammaticality judgments, but maybe not in the way Abney proposes:

There is a problem with grammars of the usual sort: their predictions about grammaticality and ambiguity are simply not in accord with human perceptions. The problem of how to identify the correct structure from among the in-principle possible structures provides one of the central motivations for the use of weighted grammars in computational linguistics. A weight is assigned to each aspect of structure permitted by the grammar, and the weight of a particular analysis is the combined weight of the structural features that make it up. The analysis with the greatest weight is predicted to be the perceived analysis for a given sentence<sup>261</sup>.

In the proposition above, the delicate point is the clause: *and the weight of a particular analysis is the combined weight of the structural features that make it up*. One would like to hear what the proposition is for weight combination. I do not find that a combination which would be an 'averaging' over a set, whatever it is, the perimeter of a corpus for example, might suit. This combination must itself be based on occurrential reasons and processes. In the Analogical Speaker combinations occur, at each assembly stage, in the form of several factors, which taken altogether, reflect the ease or difficulty to solve: heuristic productivity for each syntagmatic constituent, strengths of the intermediate results leading to settlement, ease or difficulty of access to the record licensing the settlement, and then, a combination ('combination' here is very precisely the quadratic function used in ABS, cf. p. 346) of the strengths of concurrent paradigmatic paths when it happens that several of them contribute to abductively license a same assembly.

It is a mechanics such as this one which makes it possible for *The a are is I*. to globally receive an interpretation with a substantial strength, in a situation context which is congruent with it, despite the weakness of *The a*, of *a are*, of *are is* and of *is I* to which no stochastic grammar ever, based on however large a corpus, can ascribe an appreciable strength.

A stochastic model (with stochastic rules for example) contradicts motivation. It cannot provide a reason, a *ratio*, that is, a relation to something else which is already known. Why understand this way and not otherwise? Why act this way and not otherwise? It cannot tell.

The Analogical Speaker on the contrary relates interpretations with precedents. Doing so, it motivates its responses occurrentially and not with probabilities. In it, the products of two syntagmatic heuristic paths, that is, two elements assumed to concur to an act, may be found either compatible and reinforcing one another, or contradictory and excluding one another, whereas a probabilistic speaker would at best have conditional probabilities. It is a poorer model.

The Analogical Speaker is based on strengths, reflecting the lengths of the abductive paths, that is, costs. At a moment, Abney, addressing on-the-fly learning of novel words

---

<sup>261</sup> Abney 1996, p. 8.



and constructions, proposes to see it by assigning costs to the learning operations. Costs indeed; but this is something else than probabilities.

Manning was regretting that Statistical OT still could not account for the ganging up of weaker constraints to prevail together over a stronger one. Because it does not reify constraints, the Analogical Speaker is not exposed to this risk; it allows reinforcements to happen between effects, even small ones. And if they are numerous, nothing prevents the elicitation of the form which they favour against another one, backed by an effect stronger, but isolated.

To respond to the deficiencies of categorical frames,	
a "stochastic alliance" solution	the model of the Analogical Speaker
pursues a linguistics of the language	centres itself on the speaker and the acts
adds probabilities to a structural component (rules, optimalist constraints)	uses: - copositioning (analogy) - proximity among inscriptions - proximity of the dynamics - abduction and settlement
is a heterogeneous construction and adds an implausibility on top of another one	is a homogeneous solution and comes close to a certain plausibility
remains embarrassed for articulating the particular and the general and remains haunted by totalism	addresses the particular first and obtains effects of generalization is at last proximalist

**Table 17 Comparison of the stochastic alliance with the Analogical Speaker**

All this discussion may be summarized in the table above.

It is by all these aspects finally that the Analogical Speaker demonstrates a junction between *langue* and *parole*, between competence and performance, actually, these oppositions are no longer mandatory.

As for them, the stochastic alliance schemas examined appear as attempts to rescue rules, categories, and constraints or to live with them by lack of anything better.

### 7.9.13. Frequential models: Skousen and Freeman

Before leaving this section, a word must be said about the statistical propositions of Freeman<sup>262</sup> and Skousen<sup>263</sup> (cf. p. 188). The word 'statistic' is used here and not 'stochastic' or 'probabilistic', for a reason which will become clear soon.

Both approaches are based on the exploitation of a corpus from which they pick up frequencies of collocations and of distribution. They collect – this is very bulky data,

<sup>262</sup> Freeman 200; see also <http://www.chaoticlanguage.com/shortSeattleCameraReady.rtf.gz> and <http://www.chaoticlanguage.com/fundamenta.ps.gz>

<sup>263</sup> Skousen 1989.

moreover not plausible – the frequencies of cooccurrence. These are 'numbers of favourable cases' and the quotient by a 'number of possible cases' is never made. In this, they may be said frequential or statistical and not probabilistic. They pay no consideration to a set of possible cases because they gave up any symbolic frame: there are no rules, no categories, no constraints. Nothing to what the counts they make could be reported. It is not an alliance, it is a replacement.

<b>Generative grammars</b> Chomsky	<b>Stochastic alliance</b> Abney, Pereira, Manning	<b>Frequential models</b> Skousen, Freeman	<b>Analogical Speaker</b> this work
'Structure' is explicit, symbolized, and precedes the acts		'Structure' is not reified, it manifests itself during he acts	
Categories + rules	Categories + rules (+ constraints) + probabilities	Frequencies/statistics making up for proximality	Proximality explicit in the inscriptions
Analogy excluded	Analogy excluded	Underlying analogy	Explicit analogy
Implausible	Twice implausible	Effects are plausible, substrate implausible	Effects are plausible, substrate more plausible

**Table 18 Four ways of acknowledging structure**

In fact there is a set of possible cases but one only: the whole corpus from which the counts are made. It is the closure of the 'language' which these models apprehend. As there is only one, it remains elided in these works. The computations of occurrential acts are then carried out by exploiting the statistical frequencies attached to terms and collocations. The computations are very heavy but remarkably insightful, they succeed on effects of tenuous grammar and they even suggest a little of semantics. A certain amount of proximality as I defined it is exerted but without having been explicitly inscribed, which is why the computations are heavy. These models – Freeman's at least – encompass what I called here 'expansive homology' and operate comparatively well, with the same limit as the Analogical Speaker currently: dependencies like agreement are not covered or poorly only.

The two frequential models are positioned as shown in the table above versus already examined frames. The case of Itkonen<sup>264</sup> does not appear in this table: he recognizes analogy, maintains categories and rules, and has neither probabilities nor statistics.

### ***7.10. Relation with connectionism***

This model is residually symbolist and it shares several characters with connectionism: no categories, no reified rules, no reified constraints, parallelism, involvement of a large

---

<sup>264</sup> Itkonen 1997, Itkonen 2003.

population of elements, competition, etc. Does this make it a connectionist model? Yes and no, in two respects.

### 7.10.1. Terms are postulated

Firstly, the model postulates entities (the *terms*) which are discrete, identifiable and can be referenced. Upon the rebirth of connectionism, a first period, typically PDP<sup>265</sup>, did not make such a postulation. Between the input layer and the output layer, there was no assignment of cells to objects of the question and there were no internal discrete entities other than the cells. The dogma was then that the weights and the links would suffice for whatever was given the model to learn, and in a connectionist model everything could interact with everything. This conception found a limit: in experiments bearing on language, the response collapsed after about 700 lexical entries and increasing the number of cells would not restore it:

Models of reading and spelling can avoid lexical representations, because orthographic-phonological correspondences typically make little reference to lexical items. However these models run into more serious problems (Cotrell and Plunkett 1991; Hoeffner 1992), when dealing with language learning and word production. Models of the Hoeffner type display this problem most clearly. They learn to associate sound to meaning and store these associations in a distributed pattern in the hidden units. This approach works well enough until the model is given more than 700 forms. At this point, the large pool of hidden units is so fully invested in distinguishing phonological and semantic subtypes and their associations that there is simply no room for new words. Adding more hidden units doesn't solve this problem, since all the interconnections must be computed and eventually the learning algorithm will bog down. It would appear that what we are seeing here is the soft underbelly of connectionism – its inability to represent Islands of Stability in the middle of a Sea of Chaos. Perhaps the problem of learning to represent lexical items is the Achilles' heel of connectionism<sup>266</sup>.

A more recent generation of connectionist models, building on Kohonen maps, the 'self-organizing feature maps' or SOFM<sup>267</sup>, accommodates lexical entries as implementable with connectionist techniques and thereby overcomes the limit met by previous models.

In this, the Analogical Speaker, by recognizing what it calls the *terms*, is compatible with the most recent connectionist routes.

### 7.10.2. This model is localist

Secondly, the Analogical Speaker is localist: it maps a linguistic entity exactly onto an entity of the model. Localism in this sense was long considered to be 'bad' in the connectionist culture: Elman took that a localist representation could be adopted because it was better explanatory since it represented better the ways of obtaining results, but he added that it was neither plausible nor necessary<sup>268</sup>; however, the same

---

<sup>265</sup> McClelland 1986

<sup>266</sup> Mac Whinney 2000, p. 133.

<sup>267</sup> Cf. for example Mac Whinney 1998, Mac Whinney 2000.

<sup>268</sup> Elman 1998.

Elman also said: *The following simulation (...) used localist representation (this makes the point that, for this issue, nothing critically hinges on localist versus distributed representation)*<sup>269</sup>. In the neighbouring field of vision, Michael Page, in *A Localist Manifesto*, advocates localism: *the localist approach is preferable whether one considers connectionist models as psychological-level models or as models of the underlying brain processes*<sup>270</sup>.

This suggests that the question with relevance is not whether the representation is distributed or localist; it is more critical to know whether the model, whatever its approach to representation, has the expressive power which, at the model's proper level, makes sufficient room for the necessary entities.

If the model is a distributed connectionist network and if it is able to let emerge lexical entries when they are needed, then it being localist or distributed is only a matter for another plane of discussion: that of plausibility, possible reduction, etc.; but at the model's level itself, Marr's intermediate level to situate the discussion, implementation considerations are second and the choice between distributed representation or localist representation has no other import than allowing, or not, the necessary entities.

### 7.10.3. What algebra for the mind

Another good manner to situate the Analogical Speaker with respect to connectionism is to remind the assessments and the discussion of Gary Marcus<sup>271</sup>. In his book (*The Algebraic Mind*), Marcus defines what he collectively calls "basic computational elements" (hereafter BCE). BCEs are functional requirements which, for Marcus, are mandatory in cognitive systems: cognition in general and language in particular. They are expressed at an intermediate level which lies between a high level vision of cognition (*high level properties of the mind*) and the neurons (*facts about cell transport*).

The three basic computational elements (BCEs) that are required are:

- (a) it must be possible to represent rules and variables and to make them interact with each other; the empiry is that the models which have them behave better,
- (b) it must be possible to represent recursive structures,
- (c) it must be possible to represent individuals and to involve them into cognitive operations.

For these three BCEs a 'symbol manipulation machinery' is needed; we do not have a proof of its existence but all the effects which we cannot obtain otherwise require that it be a product of evolution.

Still for Marcus, neuromimetic connectionism so far – he analyses dozens of propositions and architectures – is uniformly bad on these three points. For example, either the models have no rules, and their response is insufficient, or they end up

---

<sup>269</sup> Elman 1998, p. 8 (highlighted by me).

<sup>270</sup> Page 2000, p. 443.

<sup>271</sup> Marcus 2001, *Algebraic Mind*.

behaving correctly but then, they encompass rules in a hidden manner, even when they pretend not to.

All this for Markus does not invalidate connectionism but assigns to it an obligation: the three BCEs are mandatory and the models must cope with them in a way or another.

The model fostered in this work may be analysed at the same intermediate level along the three BCEs of Markus.

About point (c), individuals are required indeed. They are not the atoms or the primary elements of Russell or of the *Tractatus*, they are not the ultimate constitutive parts of reality; they are, for Marcus and in my own view, identifiable and discernible entities. "The little star is beside the big star", it must be possible not to make the confusion between the little one and the big one. For Marcus, they are bound to be instances. Here, since categories are not received, it is neither possible, nor necessary to envisage individuals as instances, they have to be viewed as (some of the) private terms. The subject of cognition and of language perceives them and recognizes them as 'the same ones' in their recurrences, which qualifies them as terms since this is the definition of 'term'. Such terms are recognized independently from the linguistic form (or forms) which may refer to them, and also of course when there is none. Being terms, they can be involved in analogies.

About point (b), recursive productivity is, for me, ensured by the abductive computation founded on the four analogic abductive movements. This was shown in the numerous examples provided, for example: "*John is too stubborn to talk / to talk to / to talk to Bill*" where productivity obtains while observing agentive roles. The provided solution is productive and recursive without having to be generative, and even less transformational.

About point (a), Marcus requires symbols but here they are not needed. We only need 'terms' which are not the same thing. As for rules, it has been shown abundantly how regularization effects obtain without reifying the least rule in the device. As for variables, it was extensively shown that there is no need for them since abstractions are rejected, and rules among these. A consequence is that (this aspect of) variable binding falls by itself. On this question, see also section 7.8. *Binding, variables, variable binding* (p. 218).

Finally, two among the three obligations<sup>272</sup> assigned by Markus to the connectionists, point (a) and point (b), correspond to capabilities which the Analogical Speaker already has. Simply, they are not fulfilled exactly as Markus formulates them. It appears, on point (a) in particular, that Markus overspecifies the requirement. He assesses – rightly – that regularity can be observed in cognitive systems, but he prescribes – wrongly – rules to be causally present in the network which approximate them. Sticking to 'rule effects' would be more faithful to observations, it would be sufficient, and no doubt easier to implement and reduce.

---

<sup>272</sup> The third one, individuals, is not anticipated to be a problem, but, as it belongs to a compartment which is not developed yet, I refrain from considering it as granted.

In other words, the effects of symbol manipulation that are to be observed maybe do not require a 'symbol manipulation machinery'. This modifies the requirements made to evolution (here understood as phylogenesis).

This is what the Analogical Speaker claims, and proves in part. This effect is obtained within an approach which is connectionist by the meshed character of the plexus but which is not, of course, neuromimetic and has its own limits of plausibility. From there, two ways are possible; a) remain a neuromimetician, that is, prolong the metaphor which is the usual one in connectionism (cells for neurons, activable connections for synapses, etc.), and try to reimplement the Analogical Speaker neuromimetically, and b) rework the Analogical Speaker in the direction of greater plausibility (simultaneously with the extension of its functional coverage, or separately).



## **Chapter 8.**

# **Margins, prolongations, improvements**

This chapter addresses some limits of the model and questions related with its architecture, like the definition of its perimeter, or which relate its limits with the architectural options taken.

Some linguistic questions are currently little addressed or poorly solved by the model. I showed a way of treating agreement without syntactic features: agent AN2. This treatment is not fully satisfactory because it is heavy, it has a low plausibility, and the procedure used seems to be difficult to extend to more than two constituents. It also seems difficult to combine it with the B2-B3 analysis process, cf. p. 157 for details.

In its current status, the model is insufficient in the treatment of groups (conjugation groups, declension groups, etc.), it mixes up morphemes across groups without any control, cf. p. 169.

The following topics will now be addressed in his chapter.

The model's extension to non-concatenative morphologies is conceptually simple and is just a question of development.

For acquisition and learning, a proposition is made which is homogeneous with the dynamics of the acts and very compatible with the findings of psycholinguistics. It should be validated by an experiment but the latter would have a certain cost.

The possibility to extract a plexus mechanically from a corpus is discussed. Overall, the conclusions are negative.

By contrast, the orientation is more positive for a concept of self-analysis which, by different means, would alleviate the description burden (plexus fabrication).

The quasi-absence of coverage of semantic questions is a limit of the model in its current development. Section 8.5. (p. 260) below draws a few lines in this direction.

Finally, the core assumption of this research: that of the radical non-categoricity is discussed.



### 8.1. Non-concatenative morphologies

Certain morphological 'recipes' are not currently treated in the model and are required: infix morphology, apophony, and, more generally, non-concatenative morphological processes. If the plausibility of the solutions deserve a discussion in themselves (at Marr's level 3, that of the material composition), such extensions pose no particular problem to the model at its own level (Marr's level 2, which Marr calls algorithmic, but this wording is not very good).

Such an extension is conceivable for apophonic morphologies in the Semitic languages; the experiment could be in Arabic as in the table below lend themselves very well to analogical computations.

triconsonantal root	accomplished	non-accomplished	imperative	noun	diminutive	place noun
KTB	kataba <i>he wrote</i>	yaktubu <i>he writes, he will write</i>	?uktub <i>write!</i>	kitaab <i>book</i>	kutayyib <i>booklet</i>	maktabun <i>office / library</i>

Table 19: Sample of Arabic morphology<sup>273</sup>

First of all, it has to be noted that n-arity of concatenative assemblies (cf. p. 371) cannot be invoked in the treatment of such phenomena. The idea would be to make *kataba* an assembly of six constituents  $k+a+t+a+b+a$ , that is, of six terms. This cannot be sustained because a pattern like K\*T\*B has to be viewed as a single unit (that is, in the model, one term only), it would be inappropriate to dissociate it and pretend making K, T, and B constituent terms. Root K\*T\*B is not itself a morphological or syntactic assembly; it is altogether a morpheme, it just has a particular structure and a particular assembly mode with the vocalic-accentual patterns which can be associated with it. Likewise for the latter, a breakdown into constituents has no reason to be.

This morphology rather calls for an adaptation of inscription structure: in addition to the C-type record (assembly by concatenation) defined above, a new record type is required and so are the corresponding dynamics for assembly and analysis. It still is a construction but the recipe is different.

Here again, the dependency is not on a language or on a group of languages but rather on a morphological process which may be found in several languages.

The morphological process: consonantal pattern + vocalic pattern apply to Arabic, Hebrew, Aramaic, and to certain apophonies in Germanic languages.

Similarly, a same morphological process of accent placement + adjustment in closed syllable applies in French (*lever* : *lève*, *crever* : *crève*, *mener* : *mène*, etc.) and in English (*insult* (noun) : *insúlt* (verb)<sup>274</sup> etc. or *sane* : *sanity*, *vain* : *vanity*, *nation* : *national*.<sup>275</sup>).

<sup>273</sup> Bohas 1993a.

<sup>274</sup> Cruttenden 1986, p.7

<sup>275</sup> Lamb 2000, p. 92.

What would be for example the impact of this measure on a process like syntactic analysis; what of the current B2-B3 process would be reused and what would be affected?

The general dynamics of the process remains stable. Overall questions like activity control, processing of syntactic ambiguity<sup>276</sup> and the way out of garden paths are not touched. About n-arity, from the examples which could be collected, it appears that binary branching suffices, no cases were found in which non-concatenative morphology would require ternary branching. However, this is contingent; if a case of non-concatenative assembly requiring ternary templates were found, the model would grant it without difficulty.

An incidence shows off on the structure of the base inscriptions: this was mentioned before, a new record type is needed which manifests the assembly recipe in question.

There is also an incidence on field data. From the point where a non-concatenative assembly is made and at which a term is obtained which, in turn, undergoes concatenative assembly, the vision of field, and of field data can be that which was provided in Chap. 5, that is, a start point and an end point of a span in a monolinear string. But before that point is reached, the terms recognized in the input flow and their assemblies, if they assemble non-concatenatively, do not follow this schema. Another topology has to be modelled – maybe with bilinearity – which is something else than edge-to-edge adjacency.

Of course, the same incidence also applies to the process which, in the input flow which it explores finds all potential constituents that are directly identifiable in the plexus and delivers them to the builder agents. Cf. section 16.3. *Parsing of the argument form* (p. 365).

## 8.2. Acquisition, learning, reanalysis

### 8.2.1. Mode of learning

This model does not tell how a plexus is initially obtained. Bootstrapping is not addressed by the Analogical Speaker which, on the contrary, focuses on the isonomic dynamics of language in a speaker, at a given point in the history of his linguistic knowledge, which means, when a minimal set of analogies is already acquired. At such a point, it is possible to propose a first-approach model of learning, by building on the definition of the plexus and of the associated dynamics.

Chomsky, writing about *rule-changing creativity* and *rule-governed creativity*<sup>277</sup>, writes this:

---

<sup>276</sup> However, the contribution of non-concatenative constructions to syntactic ambiguity ought to be investigated. There is no *a priori* reason to believe that the properties of concatenative constructions are transposed identically.

<sup>277</sup> Cf. the very beginning of the Introduction section of this dissertation.

In fact the technical means to treat the *rule-governed creativity* as distinct from the *rule-changing creativity* really became accessible recently only, in the last decades, on the occasion of work in logic and in the foundations of mathematics<sup>278</sup>.

This may be true if one keeps a symbolist approach to language, and therefore to its learning. If this is not if rules are not adopted; the point can no longer be to account for their evolution, nor for the substitution of new rules to older ones; but it may become that of showing the evolutions of the modes of regularization, that is, stressing the slight exemplarist modifications to the dynamics which produce regularity effects. The modifications will be, or will not be, followed by propagation by analogy, operating occasionally as paradigm reparation. Considering "technical means", this does not require anything mathematically or logically particularly elaborate.

### 8.2.2. Incremental learning, a simple learning model

Let us assume a speaker making a novel linguistic experience, for example he receives an utterance and analyzes it. What he makes are structure mappings: the new utterance is mapped onto an existing record which licenses it abductively<sup>279</sup>; the simple learning model consists of assuming that this linguistic experience leaves in the plexus the following remnant modifications: a) the utterance received with success is inscribed in the plexus as a new record, b) between the latter and the record which licenses it, a paradigmatic link is installed, and c) familiarity orientation between them is such that the new record is less familiar than the licensing one<sup>280</sup>.

The plexus is thus locally modified. Thereafter, in this plexus:

- a) certain utterances take advantage of the new exemplar (of the new record) and of the new link; they are analysed faster.
- b) their interpretation base is modified.

Another effect is that some utterances which used to be so difficult to analyse as to be non interpretable in practice, now acquire a better interpretability.

This schema constitutes a model of learning. It is supervised learning in the sense of the connectionists since the plexus' modification is subordinated to the speaker's presumption of the analysis which he made being successful. Modelling linguistic learning in this way has a great advantage: it is incremental because it consists of slight and successive modifications to the linguistic knowledge. They are exemplarist because they bear on the novel exemplar just inscribed and on that which licenses it. Their effect is proximal, the incidence of each is limited to a small number of other exemplars, but the repetition of such learning steps produces cascades which explain the generalization of a usage in a speaker.

---

<sup>278</sup> Chomsky 1964 .

<sup>279</sup> More precisely, an analysis consists of several such mapping which are leveled, this was shown in Chap. 4. Locally, the discussion will be carried out in this section in considering one level only, but the conclusion is the same.

<sup>280</sup> This model is compatible with a learning model proposed by Minsky, the theory of "Knowledge lines" or "K-lines": *We keep each thing we learn close to the agents that learn it in the first place.* (Minsky 1985, p. 82, already quoted *supra*)

The simple learning model may be simulated in the Analogical Speaker:

- 1) on a plexus taken in an initial state, have a given form F analysed; the result may be that the forms is analysed slowly and weakly licensed, yet it is successful.
- 2) sanction his success by modifying the plexus as indicated above.
- 3) repeat the same analysis and observe that the result is now faster to obtain.
- 4) now have the model analyse forms that share something in common with the one that caused its modification. Observe that, for some of them at least, the analysis is now carried out at a cost lower than their initial one.
- 5) check non-regression: acts akin to this one do not undergo a degradation of their results after the modification.

This experience may be done. It was not just by lack of time.

This learning model explains the progressive generalization of a usage. The constant finding in psycholinguistics is that a new syntactic acquisition does not appear in children available at once in all usages. Rather, it follows an 'epidemic' propagation schema like:

Daddy gone	Daddy gone	Daddy gone	<i>Daddy is gone</i>
Jo naughty	Jo naughty	<i>Jo is naughty</i>	<i>Jo is naughty</i>
cat dead	<i>cat is dead</i>	<i>cat is dead</i>	<i>cat is dead</i>

Let us take a result at random in the literature<sup>281</sup>; here, the phenomenon is characterized in the formalism of the Government and Binding theory but this is not the point that matters.

A syntactic acquisition by a speaker first appears as one or a few occurrences after what its extension grows progressively, slowly at first, then faster, then slowly again gaining finally the last few exemplars. The process follows a sigmoid curve and its time span lasts 20 to 40 weeks depending on the phenomenon and on the speaker. In a given speaker, several such sigmoidal acquisitions follow in time, massively between two and three years, but each lasts between 20 to 40 weeks. All reported empirical results follow this schema.

An explanation as the one of Principles and Parameters (a parameter, takes a new value and this determines the application of a new rule) is in a bad position to say why a rule does not apply everywhere at once. Incidentally, this constitutes another argument to refrain from positing rules.

Stochastic approaches explain these transition periods by the coexistence of two stochastic rules and the gradual evolution of the probabilities that weight them (cf. p. 225). But this explanation does not make a precise causal link between the evolution of stochastic weights and the occurrential experience of the speaker.

---

<sup>281</sup> Arnold Evers and Jacqueline van Kampen, 2000, *E-language, I-language and the Order of Parameter Setting*, <http://www.let.uu.nl/~Jacqueline.vanKampen/personal/downloadables/evers-kampen-Syntax.pdf>

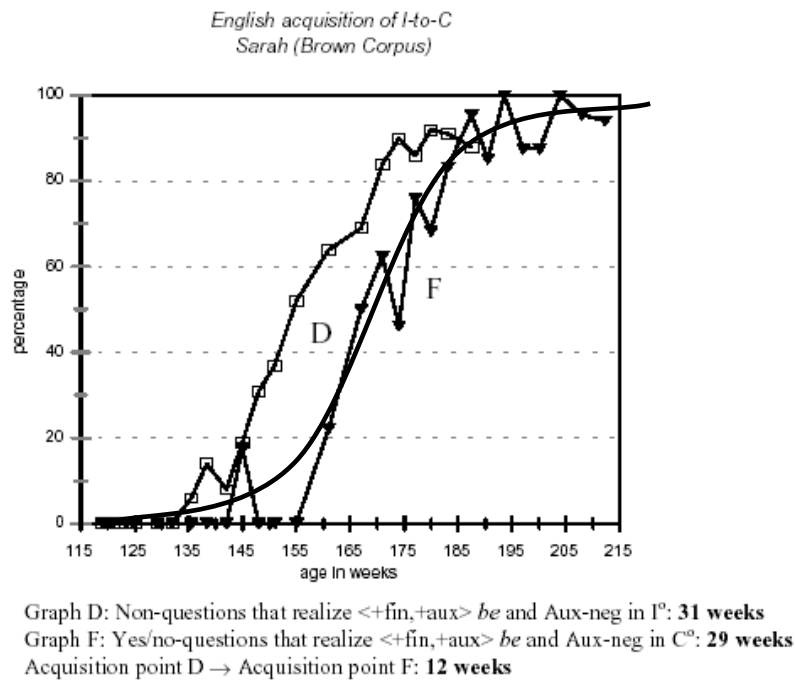

**Figure 31 The propagation of an acquisition follows a sigmoid curve**

In an exemplarist and proximalist model as the one defended here on the contrary, the explanation may be more precise if we recall what was just proposed: how a new form is licensed by analogy with one – or a few – exemplarist precedents. Chap. 4 showed how the B2-B3 process performs mappings between a new form and one or a few licensing records which are the precedents in question. For a new form F1, the licensing records (they are C-type records) are P1a, P1b, etc., they are determined proximally depending on the terms that it is possible to recognize in F1. For a form F2, the licensing records P2m, P2n, etc. may accidentally match the P1i but they are most often different, at least at the beginning of the acquisition process. This allows us to understand how, at a given point of the learning process, F1 may take advantage of a new syntactic acquisition whereas F2 cannot yet. Later, P2m for example may have been reanalysed and become aligned on the new syntactic acquisition; this modifies the outcome of the new forms that tend to be licensed by it: a step has been made in the generalization of a usage; the dynamics has progressed a little along the sigmoid.

This model lends itself to formalization. Let  $n$ , a function of time, be the fraction of the linguistic knowledge that follows a new usage. At a given point of the learning process, the variation of  $n$ , that is its derivative function, is proportional to  $n$  because, in the proposed schema, only existing exemplars of a construction can license new ones. The derivative of  $n$  is thus proportional to  $n$ :

$$dn / dt = k n$$

But the only exemplars likely to adopt the new usage are those that have not done it yet. Their number is  $(1 - n)$  so the variation of  $n$  is also proportional to  $(1 - n)$  and the derivative then has the form:

$$dn / dt = a n (1 - n)$$

where  $a$  is a factor which is constant with time. The function  $n(t)$  itself is obtained by integration of its derivative:

$$n = \int a n (1 - n) dt$$

that is, after integration:

$$n(t) = 1 / (1 + e^{-at})$$

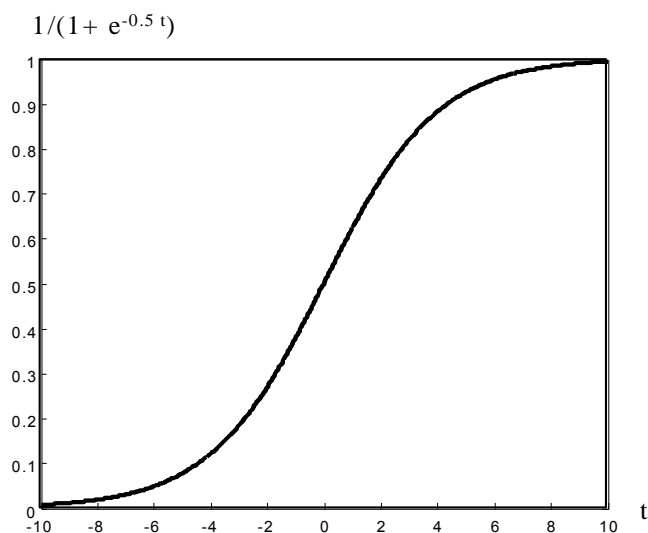

**Figure 32 The logistic function**

This function is drawn in the figure above, it is the logistic function. It governs many social and biological phenomena like the growth of a culture of bacteria, or the propagation of epidemic (when no contrary factor comes to limit its growth). The simple learning model thus predicts that the acquisitions will spread according to the logistic function.

Now the logistic function is one of the possible realizations of a sigmoid curve. The prediction of the simple learning model is then in accord with the learning curves which experience shows. Finally, proximalist inscriptions and the simple learning model make the Analogical Speaker a plausible model of linguistic learning.

### 8.2.3. Reanalysis

"P2m is then reanalysed". The simple learning model also explains reanalysis because multiple analyses is always open in it as a possibility,. Let us assume an utterance  $U$  which, before the plexus modification, is analysed with an analysis  $A1$  (that is, a segmentation of  $U$ ), by a licensing record  $C1$ ;  $C1$  operates on  $U$  a defined segmentation into constituents. Assume  $U$  is analysed also into an analysis  $A2$  by a licensing record  $C2$ , operating the same segmentation or a different one. Assume analysis  $A1$  is strong and analysis  $A2$  is weak. Macroscopically,  $U$  is analysed according to  $A1$ , the other path remaining a vitality hidden within the analysis process, probably unconscious to the speaker. Suppose now the plexus is modified as described in the preceding section, that is, a learning step is taken. It may change this balance; it may alter the difference of

strengths between A1 and A2 and make that A2 becomes the preferred analysis for U. Assume in addition that C1 and C2 impose different segmentations on U. U used to be analysed with segmentation C1, it now is analysed with segmentation C2. This is a first acceptance of reanalysis: the analysis habits of one speaker only change on a point.

There is another one, associated with the linguistic activity in a community. Of a given utterance U, Speaker S1 makes a given analysis (*somnolent* = *somn+olent* to take Saussure's example again). Of the same utterance, speaker S2 makes a different one (ex. *somnolent* = *somnol+ent*), but which is such that the meaning thus construed by S2 is not contradicted by any of the situation's data so it is accepted. Speaker S2 'reanalyses' the analysis made by S1. Speaker S2 is younger than speaker S1 and does not know the same things (he knows *lent*, *prudent*, *parlant*, *marchant*, etc. but he does not know the Latin *olentus*). As time elapses, many S2s, whose knowledges are compatible on this point, so reanalyse. The S1s grow old and die: the 'language', a shortcut for 'a static, grammatical description of their linguistic practice made by a set of speakers who think they understand each other', has operated a reanalysis.

I may stop here for the explanation of learning and change, with a worry: this all seems too simple. Yet all the steps of this reasoning are available in the model. The proposed schema may be that of an experiment; it would be heavy to carry out but all its operative steps are defined and the experiment is possible.

Actually, some explanations become much simpler if we adopt, as operational explanatory mechanisms, assumptions that are different from rules and categories, and if we dispense with the assumption of a language, conceived of as an abstraction with an explanatory role.

If this model has some value, it meets Auroux, suggesting against Chomsky that creativity and productivity (*rule-changing creativity* and *rule-governed creativity*) do not constitute two fundamentally distinct modes:

One may [...] claim that creativity is part of ordinary human behaviour, and even that there is no essential difference between the way men speak day-to-day, and the way language changes. Auroux 1998, p. 95.

If there had to be one advantage only to an exemplarist and occurrentialist theory, it would be that of explaining in continuity and with the same means, linguistic acts and learning and, after them, variation and linguistic change.

#### **8.2.4. Discussion of the simple model**

*Learning is more than a mere recording of facts.*

For the simple model, learning is the recording of a fact but not merely the recording of a fact since precise paradigmatic links are established. The novelty which is learnt is thus strictly copositioned with the already known and so is directly ready to serve, following modes already described with precision.

*Learning cannot be an in extensto recording, experience shows that it goes along with condensation.*

In the proposed schema, a first condensation is the following one: when a linguistic form, for example *this evening*, is encountered several times it is not recorded several

times as the string *t+h+i+s +e+v+e+n+i+n+g*. On the contrary, this string is inscribed once only and the various encounters of the term, its various occurrences in A-type records or C-type records are seen as as many references to its unique inscription. This is what is said when one requests that terms should be re identifiable in their recurrences. This is a first condensation; after it, A-type records and C-type records are "alleviated" of the form and the terms may be seen as punctual.

It is not the only condensation: the records, even so "alleviated", remain exemplarist ; when they accumulate, they become redundant; there is evidence that brains, without going to categorial abstractions, also condense some of this redundancy, cf. section 8.6. *Is radical non-categoricity sustainable?* (p. 268).

### ***Condensation even has to be semantic.***

But there is more to it: condensation has to become "semantic" and abandon the form. This requirement comes from the results of psycholinguistics<sup>282</sup> which show that the speaker tends to forget the form as soon as he has understood. When asked to repeat what he heard, he tends to paraphrase, instead of repeating literally.

The thing is recognized but nothing more can be said as long as the model is not further developed in the direction of meaning.

### ***8.3. Using a corpus to set up a plexus***

Currently a plexus is "hand-made", it is constituted term after term, record after record, paradigmatic link after paradigmatic link, by a human descriptor who, at each step, meets questions of opportunity and responds by judgments which involve his culture as a speaker, therefore a subjective one. This, in itself, is not an inconvenience: as the plexus is assumed to match the linguistic knowledge of an individual, it is not incoherent that it be marked by the subjectivity of a person.

Yet, when the target is the linguistic knowledge of someone else, we are not very sure of the method of 'cultural displacement' which should be adopted.

Moreover, the descriptor uses his subjectivity as a speaker but also that of the grammarian, or of the linguist, which he cannot help to be even when pretending refraining to be, in this task. This inconvenience is more serious. The risk is, beside a speaker's subjectivity, to introduce the preconceptions which the descriptor may have on the very description of his language: epilinguistic knowledge and metalinguistic knowledge. Now this is not the point which is linguistic knowledge and not metalinguistic knowledge. Therefore there is a risk to yield just that which was introduced, namely preconceptions. The risk is increased from it not being thematized in the approach; this dimension might produce effects escaping critique just because they would not be identified.

Finally, preparing a plexus by hand is expensive and hardly allows reaching a sample of a language: some thousands of terms and records when a reasonably complete coverage would rather require hundreds of thousands or millions. At worst an engineering

---

<sup>282</sup> Since Bransford 1971.



problem might one say: this would begin to matter only when trying to apply this theory. Not only that, there is a question with theoretical import associated with the plexus size which is that of the explosion, or not, of the computation costs, also that of the possible dispersion or degradation of the results with size, or of their improvement, it is hard to say before investigating. These questions are difficult to study without a range of plexii of different sizes available.

Therefore, the idea for a plexus is to make its fabrication objective and economical, maybe by mechanising it. The idea would be to exploit a corpus to that end in the most automatic possible way. I was suggested this several times.

After all, by contrast with introspection, a corpus is 'data', even with limits. Corpus investigations yield surprising results. For example, Rastier finds non-compositionalities in French which nobody would guess: for *bras*, *main*, *jambe*, *pied*, the distribution of singular and that of plural are almost entirely different. Another suggestive work is for example that of Goldsmith (2001) who finds the morphemes of a language out of a corpus by applying to it the MLD (*minimum length description*) heuristics of Rissanen<sup>283</sup>. Mostly, the method finds the morphemes with which we are familiar and when it does differently, it is for reasons that are understandable and 'good' finally on the corpus to which it was applied.

However, for the Analogical Speaker to work from corpora presents inconveniences; those that are general to corpus linguistics to begin with:

The proportion of hapax in a corpus often exceeds 60%. Turenne 1999.

Research over the last twenty years demonstrated practices exclusively based on corpora to be subject to two restrictions. 1) The construction of a grammar from a corpus by distributional or structural analysis methods fails. With a small corpus, a comparatively coherent system obtains, then, as the size increases, as the nature of the corpus changes, beyond a threshold of quality, a new rule enters in conflict or in contradiction with another and unbalances the system: it causes a previously balanced system to "diverge". 2) In "approximate" grammars built from larger and larger corpora, that which is grammatical is that which is described by the grammar. The union of two heterogeneous corpora may yield two incompatible grammars. Habert 1997.

This same fundamental property has another symptom: the multiplication of concurrent analyses:

The scope of identifying the correct parse cannot be appreciated by examining behaviour on small fragments [of English], however deeply analyzed. Large fragments are not just small fragments several times over – there is qualitative change when one begins studying large fragments. As the range of constructions that the grammar accommodates increases, the number of undesired parses for sentences increases dramatically. Abney 1996, p. 17.

Phenomenon which Hopper<sup>284</sup> summarizes as: *The larger the corpus, the smaller the grammar.*

---

<sup>283</sup> Rissanen 1989

<sup>284</sup> Paul Hopper, conference in Paris Nov. 2001.

Techniques extracting structures from a corpus generally lack incrementality, this unwanted characteristic is also present in connectionist models. Now here incrementality is essential because i) it is an experimental variable: it must be possible to assess and analyse the effects of an incremental modification of a plexus, and ii) an ambition of the model is to account for acquisition which is itself incremental. It might be possible to live with non-incremental corpus techniques and see them as providing an initial plexus which might, from that point, evolve incrementally in a manual mode. This would be compatible with the opinion ... *combine corpus-based techniques with intuition-based techniques*<sup>285</sup>.

This would be workable provided that the technique in question could yield results matching the needs. To this there are several shortages the first of which is the lack of proximality (cf. p. 212), which is a corollary of the lack of incrementality. I cannot see how proximality can be obtained from a corpus. If it were proximality of terms, this is probably possible, several models can do that; Freeman<sup>286</sup> for example, who, with enhanced distributional analyses succeeds in extracting from a massive corpus, and at a high computational cost, a kind of exemplarist grammar, which is non-categorical, very lexical, and can support syntactic analyses curiously precise and pertinent.

But an approach too exclusively centred on terms does not cover the need; it does not provide a) systemic analogies of which I do not see how to extract them from a corpus, b) constructional proximality, c) familiarity orientation, d) signification and meaning.

For systemic analogies and structural analogies the possibility to obtain them from a corpus seems conceptually and technically out of reach on any planning horizon for the time being.

As to familiarity orientation, it cannot be substituted with frequency. A proposal could be to order the corpus in chronological order: the first elements in the sequence would be assumed to be more familiar. The corpus then should have to be exploited in this order which would require developing an incremental method – corpus methods lack incrementality, this was mentioned above. The thing is possible maybe but it has not been searched. However, it should be noted that the pre-sequencing of the corpus has a cost and the economy which is usually sought in corpus approaches could not be expected then.

Finally, signification and meaning are present partially only in corpora however hard one tries to "make them talk". Meaning is present in them in a manner which is curious but very incomplete, be it as the "ontologies" which can be extracted within particular bounded domains or works about meaning in other orientations like those reported by Rastier, mentioned above.

A corpus is a snapshot, small or large, homogeneous or heterogeneous, of linguistic productions. It has to be taken as a manifestation, a symptom. The question of what it reveals of the causal chains that operated at the time of its production and how these could be reconstructed from it remains entire; so the question of the possible constitution of a plexus by mechanical techniques is an open one. A plexus must

---

<sup>285</sup> Françoise Gadet in Normand 1990, p. 342.

<sup>286</sup> Cf. a contrastive analysis above, in the conclusions section .

comprise proximality and incrementality, whereas a corpus approach is totalist. One of the signs of the totalism in corpus techniques is the aphorism of Hopper which was recalled above: "*The larger the corpus, the smaller the grammar*". I conjecture that this aphorism applies only if one thinks of a grammar based on categories and rules. It might cease to apply in a framework in which productivity is rendered without abstractions – without reified categories or rules – and if this apparatus were substituted with analogy and proximality. Now in such a case, it is precisely not a grammar which is done. Then the base assumptions of the Analogical Speaker are compatible with Hopper's position, but also, a limit is traced to what can be expected from the exploitation of a corpus.

#### ***8.4. Self-analysis***

Currently, in the model, terms must be pre-analysed. This is to be understood as terms occurring at record sites had better be segmented by the descriptor in morphemes or otherwise (and not that a syntactic analysis tree has to pre-exist). A term which would not be sufficiently analysed would constitute a limit to productivity.

One might prefer the model not to impose this. In particular, an enhancement which is obvious and comparatively at hand, would be self-analysis: the plexus would analyse itself. The idea is the following.

Assume a term which is long and in constituent position in the plexus. In the very measure in which it is long, its usefulness decreases in the abductive analysis process. It is so because it becomes less likely to coincide with an intermediate result of the computation, therefore it becomes less likely to participate in a settlement. Thus when a constructor record is reached via one of its constituents which is short – this is a frequent event – if another of its constituents is long, the heuristic path is likely to remain unproductive if the latter remains unanalysed. Things are different if the long constituent may be analysed, because it then becomes possible to assess its abductive coincidence with the converse of the problem's term which caused the arrival on the record. To analyse the terms which would demand to be, all the weapons are readily available: it is possible to trigger a B2-B3 process such as described in Chap. 4 on a term already contained in the plexus. It is so because the B2-B3 process, initially designed for an externally received term, depends on the literality of this term only, and not on its origin. The process may therefore, as it is, be applied to a term of another origin, in particular to one contained in the plexus.

This being settled, self-analysis may take two modes: either (mode A) the analysis is performed on the fly, during the computation. Any computation branch is likely to initiate one such sub-process. Naturally this has a cost which may incur an explosion of the general cost, but since the manoeuvre increases the possibilities to settle fast, and increases the possibilities to just settle, for a given description effort, it is difficult to predict the balance; an experiment should be made. This mode presents the advantage to allow the analysis of the term in question to be influenced by the concrete data of the task; globally, this would make its utilization more efficient. Or (mode B) the analysis would have been made before the execution of the particular task to which it is intended to benefit. The schema then is one of a preparation of the plexus: the plexus will have been pre-conditioned for all its part to acquire the best efficiency, without imposing this

burden to the human descriptor. Within this mode, the execution is no longer penalized, but the plexus volume increases systematically and perhaps importantly, without this increase being motivated by needs identified on the basis of exemplars.

Self-analysis presents two advantages. Firstly, it alleviates the burden of plexus description; secondly, it helps escaping the subjectivity of the descriptor and the limits of his imagination. The results of self-analysis may be innovative and creative, they may be shifted with respect to classical analysis frames, from which the descriptor might not always free himself. For example the model may perform on itself multiple self-analyses whereas a human descriptor has to make efforts to that end, forcing the Port-Royalist habits, or the Generativist habit which he learnt.

Self-analysis can be related with bootstrapping<sup>287</sup>: only a part of the effort of constructional analogy description would be required from the human descriptor. On the base of a restricted body of externally provided constructional analogies, the model would then *introspect* itself and pursue, on its own, its elaboration. It is to be expected that this might show a 'creativity' which might diverge from what a human descriptor would do; the development should be brought to that point to judge. In such case, two judgments might be possible: either to accept these surprising creations as linguistic, and qualify them, in the measure in which they do not hinder intercomprehension, this could be implemented only after a better development of meaning in the model; or refute them as non linguistic, that is, extraneous to the sort of productivity we want for the model; then a critique should be made of the sort of abduction at stake in self-analysis.

Naturally, an interesting question is the plausibility of modes A and B above. A corollary, or a prerequisite to this question, is the epistemological status and theoretical status which might be that of self-analysis.

At first sight, it seems to be artifactual only, a mere consequence of the artefact which the plexus is. It would help living with that, by reducing the plexus cost for the descriptor.

But one may see more to it. If mode A is adopted, that is, if self-analysis takes place under the pressure of a given task, and if it is constrained by the proper terms of the task, one will await with interest the appearance of analogical innovations. If the model, operating on a French plexus, already produces *j'ave, tu aves, il ave*, thus

---

<sup>287</sup> Bootstrapping here is understood as priming, for example "the bootstrapping of a computer", with no particular reference to the semantic bootstrapping of Pinker : *Pinker 1984 has been the main proponent to argue that children may use semantics as a bootstrap into syntax, particularly to acquire the major syntactic categories on which grammatical rules operate. Thus children can use the correspondence that exists between names and things to map onto the syntactic category of noun, and physical attributes or changes of state to map onto the category of verb. At the initial stages of development all sentence subjects tend to be semantic agents, and so children use this syntactic-semantic correspondence to begin figuring out the abstract relation for more complex sentences that require the category of subject.* Tager-Flusberg 1995, p. 222.

(over)regularizing verb *avoir* on the first conjugation group<sup>288</sup>, there is some hope that it might also create forms like *somnolent*<sup>289</sup> and more "popular etymologies".

A last word on self-analysis only to wonder whether a process of this nature might not contribute to explain the avalanche effect of the linguistic knowledge which takes place between two and three years, and, for non-linguistic cognitive knowledge, well before.

### ***8.5. Treatment of meaning, prerequisites and directions***

In this work, I did not seek to cover the question of meaning and I did not cover it. However, it is not possible to deal with linguistic productivity without coming across meaning, and meaning was met several times above. Moreover, the options taken to model the static knowledge and the dynamics incur consequences, some negative, some positive, on the way to address it.

The purpose of this section, a modest one then, is to present two directions of thought: 'private terms', and the conception of utterance understanding as its 'immersion' in a plexus. These directions are coherent with the general orientations of this work: rejection of abstractions, analogical copositioning, inscriptions that are necessarily contextual, proximality of the inscriptions and of the computation, etc.

Previously, some general theses about meaning will be briefly stated because they provide the background necessary to better situate private terms and immersion. They are stated without argument because, again, this stands beyond the proper perimeter of this work.

#### **8.5.1. Preliminary theses**

Rejection of representation. Language does not represent the world. Words do not represent things. Inscriptions in a plexus do not represent linguistic knowledge they are this knowledge (along with the dynamics, cf. p. 57). A dynamic model must be (and can be) non-representational. The relation between the productions of a dynamic model and their meanings are to be grasped at operation time, when the model operates; these relations are not statically reified in the model.

Rejections of 'concepts'. But for "*constructed sememes, the definition of which is stabilized by the norms of a discipline, so that each one of their occurrences is identical to their type*"<sup>290</sup> – but this is not the problem which is posed to linguistics –, in the mind,

---

<sup>288</sup> But it does not proceed with this proposition, because the escalation recuperates forms *ai*, *as*, *as*, inasmuch as they are attested in the plexus, and makes them prevail, or, as in the example, by the impossibility to pursue the assembly process with the rest of the received context, the form thus construed will only have been a local pun or a small-span garden path.

<sup>289</sup> A particularly curious example will show how analogy works, along time, on **new units**. In modern French, *somnolent* is analysed *somnol-ent*, as if it were a present participle; so much so that there exists a verb *somnoler*. But in Latin, they used to cut *somno-lentus* like *sucu-lentus*, etc. and still formerly *somn-olentus* ("smelling like sleeping", from *oleere*, as in *viin-olentus* "wine-smelling"). So, the most visible and most important effect of analogy is to substitute older, irregular, and decayed formations, with other ones more normal, composed with living elements. Saussure 1915/1970, p. 233.

<sup>290</sup> Rastier 1991, p. 126

there is no assumption of 'concepts', which would then have to be understood in their relation with words or linguistic terms.

Meaning is not a counterpart of the form. Meaning is reconstructed each time; for apprehending meaning correctly, it is appropriate to take a dynamic approach.

Meaning issues must be approached within textual context and within situational context.

Linguistic meaning is just paraphrase. 'Lexical meaning', 'linguistic meaning' are just effects. They are contingent (but certain types of effects may have a broad extension). There is no point postulating lexical meanings or linguistic meanings to build the theory.

### 8.5.2. Arguing for terms which are not formal

To prolong the model in the direction of meaning questions, the approach that comes to mind is that the treatment of linguistic form and the treatment of what is not linguistic form be made in the greatest possible continuity, by applying to what is not linguistic form the methods of analogical inscription, and the types of dynamics, which were found efficient with the form alone. This track is made credible by the importance taken by analogy among psychologists and cognitive scientists, and the evidence they bring out that the basic modes of operation are analogical. It would then be needed to perform analogies in something else than the linguistic form.

If we accept and maintain that analogy establishes between terms<sup>291</sup>, we then have to understand what sort of terms could be at play in such analogies. Do we need non-formal terms, are we able to conceive them, and with them, the processes that they support.

A first attestation of this need is to be found in Aristotle:

Sometimes, there is no existing name to designate one of the terms of the analogy but the metaphor will be made nevertheless. For example, throwing grain is *to saw*, but for the flame that comes from the sun, there isn't a name; however this action is to the sun as to saw is to grain, so that it has been possible to say; *sawing the divine flame*. There is still another manner to utilize this sort of metaphor; it is to designate by the improper noun while depriving it of some proper feature; so the shield could be named, not *Ares' cup* but *cup without wine*<sup>292</sup>.

The predicate applying to the flame which comes from the sun, and has no name for Aristotle – today we would have *radiate* in English – , can be thought before being expressed. It being thinkable has a symptomatic manifestation: a metaphor can be built concerning it. The metaphor is analogical<sup>293</sup>, and invites us to presume that, before being expressed, it is disposed in the mind of the metaphor's author in an analogy with three more things. We also have to presume that something similar is working in the hearer's mind when he hears; this is what 'understanding' would be. If one postulates this

---

<sup>291</sup> Which is the conception adopted thus far in this work for analogy in the form alone.

<sup>292</sup> Aristotle 1980 (*Poetics*) p.109.

<sup>293</sup> For Aristotle, the analogical metaphor is one of the four possible types of metaphor, it is based on an underlying analogy.

underlying analogy, we need to say between what terms it holds. Specifically, we need a term 'the flame which comes from the sun'. The term is needed not only if not lexicalized – it is in English: *radiate*, it appears it was not in Ancient Greek) – but even if it was never before expressed by any linguistic or rhetorical process. We would then need a term which should not be linguistic form.

The term called for in Aristotle's example is small and ancient. Here is another one which is big and modern: a *high-level mental chunk that lacks label* by Hofstadter:

That time I spent an hour hoping that my friend Robert, who was supposed to arrive by train some time during that day in the Danish village of F., might spot me as I lurked way out at the furthest tip of the pier, rather than merely bumping into me at random as we both walked around exploring the streets of this unknown hamlet<sup>294</sup>.

Hofstadter continues: it has to be a *mental chunk* because otherwise we cannot explain his sudden and integral remembering, fifteen year after, of this episode characterized by unrealistic hope, when, with random combinations of letters, he unrealistically tried to remember the forgotten name of a friend.

This is a rhetorical analogy:

walk up to the tip of the pier where he can't be	::	combine letters at random
find a friend		find a friend's name

The elided predicate is 'this is not a good method for', 'doing A, I'm not doing what it takes to achieve B'. It being elided does not prevent the ancient episode to make the present situation understood. The analogy is good and it operates well. But its four terms are not linguistic form. These are things to which linguistic form may be assigned, we may talk about them (what exactly was just done), but without this being a prerequisite: they are here and operate very well on their own before one talks about them and even if one never does.

### 8.5.3. Formal terms and private terms

Thus, beside formal terms, we need terms which are not formal. There are various possibilities to name them and it is interesting to look why some are rejected, it helps to better understand the notion.

*Cognitive term* does not suit because formal terms also are cognitive: the linguistic exercise is a cognitive activity as any other.

*Mental term* has the same inconvenience: formal terms also can be said to be mental.

*Experiential term* is not good because non-formal terms may be created by abduction. Then, their relation with experience is second. *Perceptual term* is not appropriate for the same reason because we need to let happen terms that are not directly perceptual, which are elaborate, remote from perception, but terms anyway.

---

<sup>294</sup> Hofstadter 2001, p. 515, condensed by RJL.

*Term without assignment* might be possible because one such term is assigned neither to the signifier, nor to the 'signifiable'. This word then has no reference inconvenience, but it is not adopted because it is a negative predication.

*Conceptual term* has the already mentioned defect to encompass "conceptual", in a field in which this word must be proscribed as a precaution of method. In the undermined land of "concepts", "thoughts" and "intellections" one discards in this way misconceptions and connotation that take us into dead-ends.

By lack of something better, 'private term' is adopted which has the best advantages and the least inconveniences. A private term is a term which participates in the linguistic computation but which is not linguistic form. It is private by opposition with linguistic form which, itself, is 'public' because it crosses the interface between speakers.

"Private" is attested in this meaning in Wittgenstein (*Philosophical Investigations*) – yet it is for negating private language – then in Mandelbrot (1954), Frei 1954 (private object vs. public object) and other authors (but they do not apply it to 'term'). With this important difference that if is not constituted with linguistic form, the private term behaves like the formal term in all other respects: identity, non-essentiality, minimality suspension, ability to coposition with other terms in analogies; this qualifies it to take part in linguistic computation.

Private terms are to be recognized in the terms *without existing name* of Aristotle or in the *high-level mental chunks that lack labels* of Hofstadter.

A term is formal or private exclusively. There is no private term with an associated linguistic form. Seeing a private term as having a form without this compelling to reconsider its quality of private term is not desirable for two reasons. First it would lead to allocate a property to a term, thus contradicting the principle of the vacuity of terms (p. 79). Then, this one-to-one coupling between the word and the object would not let the necessary room for ambiguity and paraphrase; it would be a rigid and poor treatment of reference.

A private term cannot be directly observed. Its observation is difficult even via its indirect effects because the only things ever to be observed are effects of assemblies of private terms. The best that can be done is to propose such assemblies and their plausibility will be demonstrated if, with them, effects that match what we see in nature can be reconstructed.

Private terms, along with formal terms, can belong to the common ground or to the topic, that is, elements that are well established in the interlocution, and so they may serve as targets for reference or as a base for anaphor resolution.

To private terms, (some of) the same computations apply as to formal terms. Computations may involve private terms and formal terms together.

#### **8.5.4. What is receiving an utterance, what is understanding**

In order to talk of the process of comprehension, a first metaphor<sup>295</sup> is that of the message, that is, that of information transmission. This vision is simple but inaccurate.

---

<sup>295</sup> Shannon, Jakobson, etc.



No one defends any more today the idea of a clearly defined mediate object, the 'message', which would 'mean the same' for the utterer and for the receiver. This only suits very coded situations, some of these do happen, but they are only a margin of what linguistics has to cover.

Then 'mapping' was tried: the successful reception of an utterance would operate a mapping of the linguistic material or of the intention of the utterer onto the 'conceptual structures' of the receiver. This constitutes a progress: i) there isn't any longer an intermediate, unarguable object (the message, the information), and b) between interlocutors A and C things might not be exactly the same as between A and B. If 'mapping' is understood in a vague and metaphorical meaning there is no inconvenience but nothing much has been said. In order for 'mapping' to be made more operator, more precision is needed about the units that might be mapped, and here there is nothing very firm; first of all, the candidate units: words, concepts, etc. all have more than problematic definitions, and secondly, no operational model of such mapping has been produced which would not fall down facing the smallest metonymy for example. The idea itself of mapping, that is of an application in the sense of set theory, induces a vision that is mereologic (things can be described by their parts) and partonomic (the things and their parts have properties); among them, correspondences would be established (the mapping). It is now clearer and more accepted that things do not work in this way.

The Analogical Speaker allows us to suggest another approach. With the terms, the plexus, copositioning, abduction and settlement, another track becomes conceivable. It can only be a suggestion first because this vision is far from being entirely constructed, and then because it involves many elements so that it is difficult to grasp it in linear

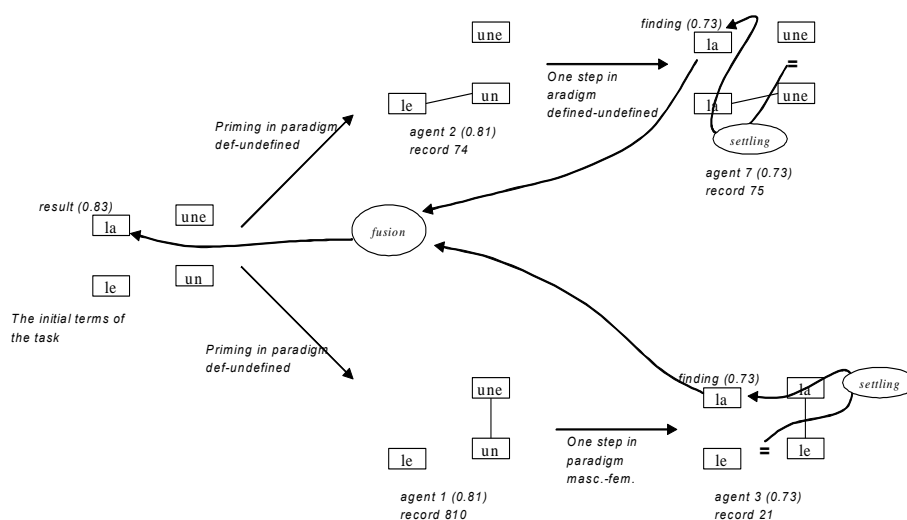

Figure 33 Elements of the computation

discourse (conventional language usage), and that any drawing that can be done of it very quickly starts out swarming; before becoming unreadable by the reader, it is expensive to produce for its author.

I propose to name this "immersion". Immersion is the process which accounts for the reception of an utterance: an utterance is received (and occasionally understood) when its immersion could take place. "Immersion" is proposed to correct the vision of mapping: it grants primacy to analogical ratios, that is, to the copositionings of terms. What is at stake between terms is the copositionings instituted by the analogies that make up the linguistic knowledge, then those that can be abducted from the latter by the computation.

Immersion can be illustrated with an example which is the computation of the following analogical task: "what is to *le* as *une* is to *un*?". Surely this task is very far from deploying all that would be expected from a decent treatment of meaning but it makes it possible to suggest how this proposition, when it would have progressed, would allow us to see the question. A first figure displays the elements involved in the task's computation.

On the second figure (below), I highlighted in thick lines (brown when reading in colour) a schema which is the abstraction that interests me. The clusters of thick lines (groups of three) stand for mappings of groups of terms onto groups of terms which conserve copositionings. This holds first between the terms of the task and their first echoes in the plexus, then between the latter and second echoes. After this, two settlements occur (equal signs on the drawing). Note that starting from the terms of the task, the immersion branches into two branches (two in this figure, an arbitrary number in general). The results of the two branches are compatible here (both find the same term: *la*) and reinforce themselves, in other cases, they may be different and concurrent. This is a small example of the general configuration: multiple branches, tree structure (or lattice structure in other cases), several possible settlements, competition or reinforcement, in short, all what was named 'heuristic structure' above. The utterance is easy to analyse and understand if the immersion is easy. If the immersion cannot take place, the task does not get solved. If the immersion is difficult, the task gets solved but badly: the utterance is difficult to analyse and understand.

The immersion is based on mappings but not of elements one-to-one: here the mappings involve terms by groups of three, with preservation of copositionings at each edge.

An effect of immersion is that the existing parts of the plexus are set into relation in a novel way which is not without link with conceptual integration. These settings into relation following novel modes occur at each linguistic act and may be connected with learning but this will not be developed here, it was already above.

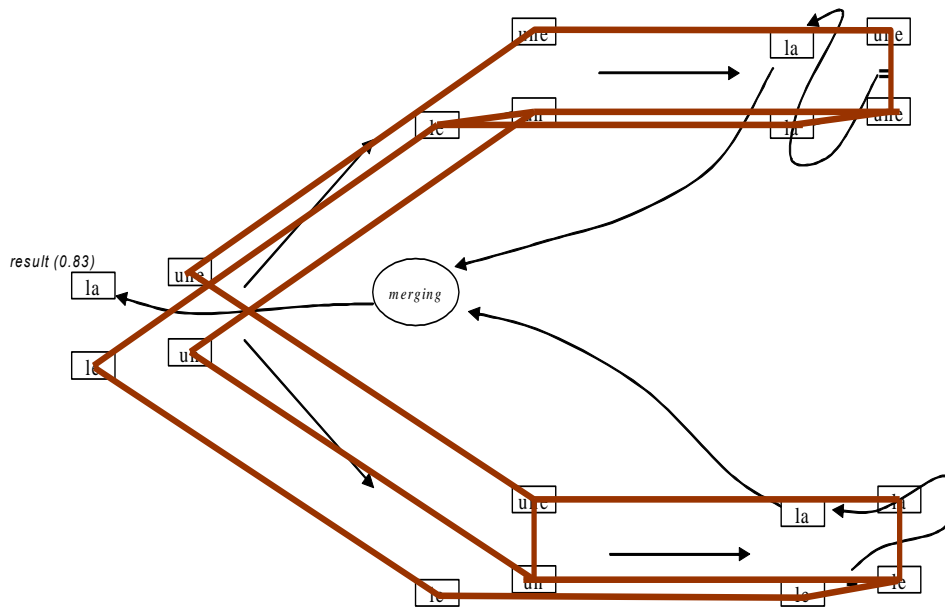

**Figure 34 Immersion schema superimposed to the elements of the computation**

If a mapping had to be found between the terms of the linguistic task and the plexus, it would have to be along these (groups of) lines.

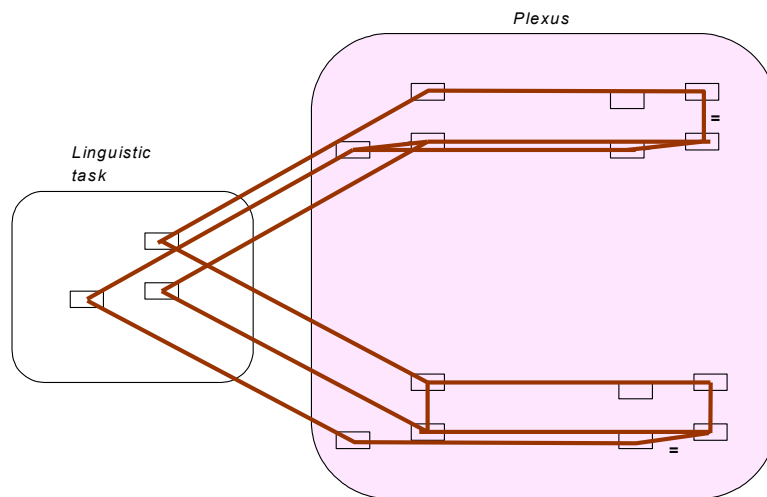

**Figure 35 Immersion schema alone**

In the above figure, the immersion schema<sup>296</sup> now appears without the concrete elements of the task, in order to be better contrasted with what would be a set-theoretic application *à la* Cantor (fig. below).

An important difference is visible: in a Cantor-like application the arrows are from one element to one element. In an immersion on the contrary the edges are grouped in bundles. That is to say, these bundles carry together the arguments and the predicates simultaneously<sup>297</sup>. It also means that the mechanism can only be contrastive and differential by construction.

There exists in English a usage of "true" in domains of professional practice like timber or carpentry which is interesting. *To true up* is to ensure that the measures are good, to adjust a window, make flat, make parallel<sup>298</sup>, put at a right angle<sup>299</sup>. *To true* = *bring (a tool, a wheel, a frame) into exact position or form required*<sup>300</sup>. So this language in a way

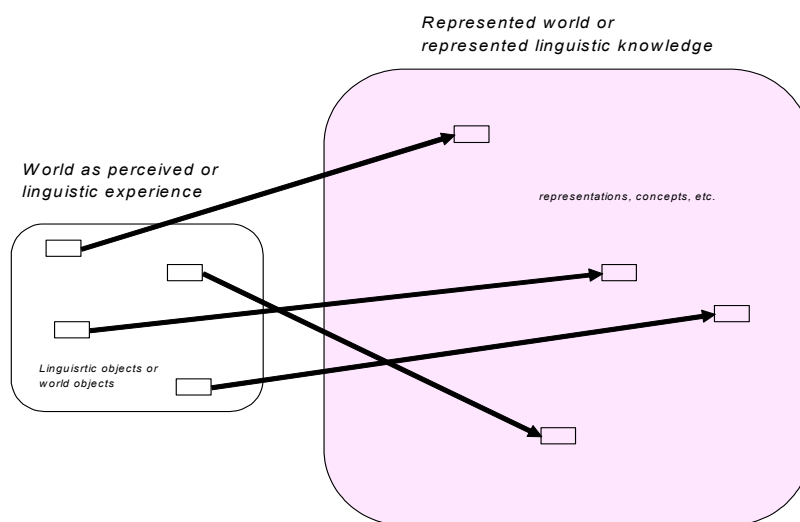

Figure 36 Cantor-like mapping

sanctions epistemological relativism. The French *vérifier* does that equally well but the Latin etymology makes this less apparent. Following this, judging the truth and adjusting would be the same thing. We just saw that understanding is an adjustment, the

<sup>296</sup> The immersion schema is exposed here according to its principal aspect only. It comprises other dispositions like persistence (the model 'learns' or not), the creation of novel structures caused by this reception occurrence, structures for which the question of their permanence arises. This is because the memory of this occurrence may consist of new paradigmatic links between existing records, the formation of new records bearing on existing terms, and the creation of new terms.

<sup>297</sup> I write 'argument' and 'predicate' using terms of previous theories, but these do not belong to the Analogical Speaker.

<sup>298</sup> Informants.

<sup>299</sup> Harrap's dictionary.

<sup>300</sup> Oxford dictionary.

least bad possible, between an utterance and the plexus. Thus *truing up* is not too bad: taking things in this way, corrects the vision of the possible worlds<sup>301</sup>, and at least assigns this 'truth' a perfectly operative status, that of comparison.

### ***8.6. Is radical non-categoricity sustainable?***

This question was touched before several times and it is now possible to discuss it in the light of all we have seen. The discussion will bear on its advantages and limits.

I call 'radical non-categoricity' the option – which is adopted in this work as a research posture – that the linguistic data, in the static side of the model (the plexus), and in the course of the computations, are and remain strictly exemplarist: they are never grouped or elaborated into abstractions. This option is initially motivated by the various inconveniences associated with categories, which were reminded in Chap. 1 – and are further exposed in an appendix – and by the wish to explore an opposed track to see up to where it can be taken. This is what was done and reported so far.

This track in turn shows inconveniences.

Firstly, on a precise example: the priming of the analogical task was found difficult.

More generally, it appears that the model, in order to provide results, requires a little more data than what should be sufficient according to intuition: the yield is sub-optimum.

Finally, the demand of computation resource seems high, even if there is no unarguable base to benchmark the model against what biological neurons do.

These observations, lessons from psycholinguistics and what neuromimetician connectionists are able to interpret from their models, all this suggests that between a categorical model and a strictly "flat" model like this one, biological neurons do something intermediate of which the figure below tries to give an image.

These small circles stand for exemplarist or occurrential linguistic facts.

On the left side is the assumption of categories: categorial structures (the K squares on the figure), even with multiple inheritance, even with under specification, ensure certain functions with efficiency but do not render the flexibility, gradation, innovation, they do not explain variation and learning.

---

<sup>301</sup> Tarski (slightly paraphrased) : I understand an utterance when I know how the world in which it can be true is.

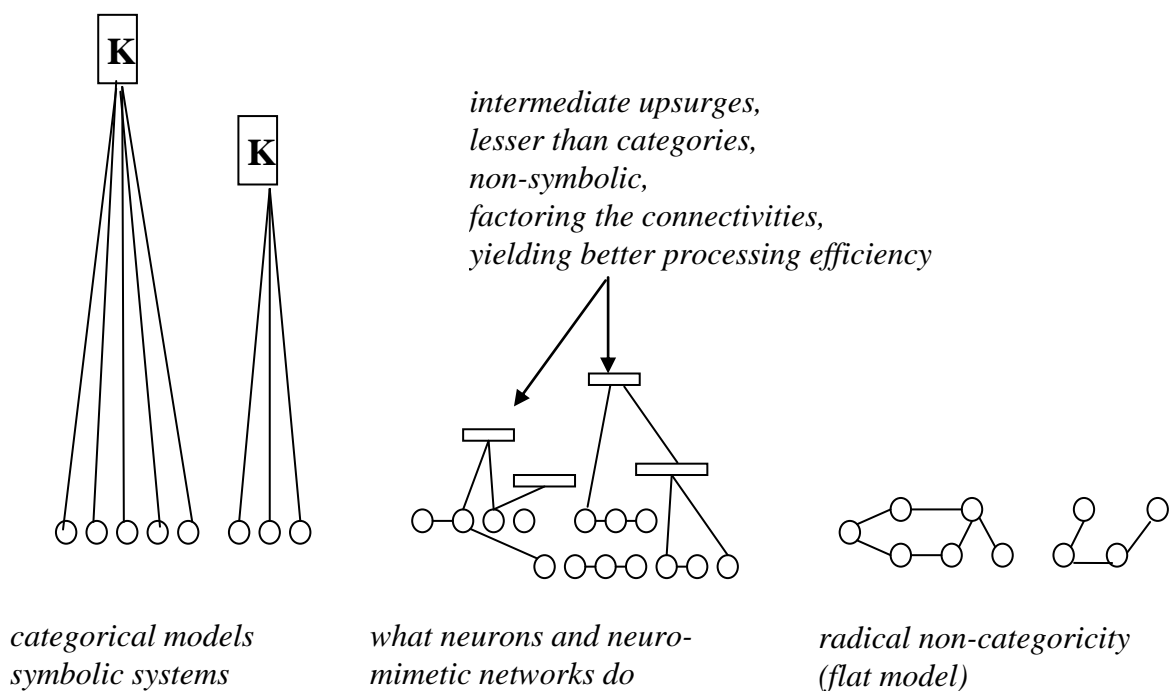

**Figure 37 Three options versus categoricity**

On the right side: radical non-categoricity (the assumption of this work) is a flat structure: the exemplars have exemplarist links and there is no other structure. No abstractions, no *a priori* groupings on the base of common properties or common behaviours.

In the middle a metaphoric drawing presenting upsurges: they reach intermediate levels, never quite as high as categories. This middle is alleged to be what the neurons do (anatomical neurons or the simulated ones): semi-categories, partial, blended viewpoints. They are not just distributional.

A track presenting this character and resting on factoring techniques will be presented in another publication.



## 9. General conclusions

### *9.1. Dynamics are primary and grammar is second*

After the critique of the intent to explain linguistic processes on the base of a static, grammatical description of a language – which is sometimes postulated to be a prerequisite to the understanding of the dynamics – I showed that directly addressing the dynamics is a more promising track. A model with this intent focuses on the speaker (not a language) and dynamical analogy (not categories or rules), whence its name: the Analogical Speaker.

Its static side was built on analogy, by modifying the notion of paradigm and by defining a notion of proximality; this led to organize the linguistic knowledge as a 'plexus'. In a plexus, analogy and anomaly coexist which makes room for a flexible interplay between them. Terms are vacuous and analogies 'co-position' them several at a time. Inscriptions are necessarily contextual.

In the proposed approach, a plexus on its own, because it is static, proves nothing without the associated dynamics. Among the inscriptions that constitute it, I defined four abductive movements which form the base of the dynamics: they articulate the static side of the model with its dynamic side. The dynamics, as a general framework, was defined to be abductive and likely to be fragmented into agents in the service of various heuristics.

For morphological and syntactic analysis, an operative model was implemented and it was shown that it explains appropriately a great deal of structural productivity.

I defined systemic productivity as that which operates in pluridimensional paradigms, I framed it in its cognitive dimension and showed how it could be constructed in the model and explained by it. The central device for this was defined, implemented, and demonstrated on various examples. It was combined with that of the structural productivity to give a first-approach reconstruction of grammatical agreement.

It was shown how this approach to modelling language dynamics, which contains no metalanguage, within the limit of its current perimeter, responds to numerous linguistic questions with a certain plausibility.

This approach joins together a static linguistic knowledge and its mobilization in the dynamics of occurrential acts.



It renders a great number of the stipulations of the grammars, or of static theories with grammatical orientation, as secondary effects, instead of expecting them to be causal or explanatory.

A simple model of acquisition was presented – without yet being implemented – it is compatible with the principles of the plexus and of the dynamics, and its predictions comply with the data provided by acquisitional investigations.

Because it is founded on analogy, the Analogical Speaker places itself in continuity with 2400 years of linguistic thought, notably with the repairing analogy of the Neogrammarians and of Saussure. It provides an implemented demonstration, still incomplete but very precise on the parts that it covers, of the intuitions that the same Neogrammarians, then Bloomfield and Householder had formulated without being able to develop them.

## ***9.2. Plausibility***

### **9.2.1. Reasons of plausibility**

The model of the Analogical Speaker is plausible for the following reasons:

1. The connections in the plexus always connect some elements to some elements, never one to many or many to many. The physiological constraints and what we know of the brain's anatomy make us think the connectivity of neurons has a property of that kind.
2. The execution of a linguistic act by the model engages elements in tens of hundreds (not hundreds of thousands) and cross a number of layers which counts in units. This is compatible with empiric results.
3. Nothing is reified. Categorization effects take place without any category being symbolically represented. An external observer may abstract categories to give an approximate description of its behaviour, but the model has no component providing categories or rules. This is compatible with the empiric and commonplace fact that speakers talk well before any explicit learning of a grammar. One may argue that the model requires preset analogical inscriptions. This must be seen as the result of learning. From there, productivity is demonstrated.
4. The model is compatible with a proximal and situated vision of linguistic operation, thus it eschews totalism.
5. Finally, the results of experience with the model present numerous properties which belong to linguistic behaviour in nature: flexibility, gradation of effects, that more categorial models find it difficult to render.

However it contains an area of arguable plausibility: the computing apparatus in ABS may seem exaggerated. This is what we now want to review.

### 9.2.2. Heuristic structure and working memory

The heuristic structure of the model appears as the homolog of the working memory set forward by psychologists because: i) as for the heuristic structure, the working memory is the main assumption to explain how psychological processes are carried out, and ii) as for the heuristic structure, its content is transient. Let us take a closer look at the conditions of his analogy.

The first thing to note is the important lag between the six to ten 'chunks' that would be the capacity of working memory<sup>302</sup>, and the volume of the heuristic structure. With the B2-B3 process, the analysis of form *elle est arrivée avec son homme* requires 1032 agents, 31 channels and 1088 products, including all intermediate objects and all non-productive paths. Assume some technical improvements divide the figures by three, assume even that the 'chunks' of the psychologists are constructs bigger than our agents or channels, the numbers in the model are still forty times larger than the capacity of working storage.

Two types of reasons help qualifying this lag. Firstly, the heuristic structure not only implements a linguistic task, but it also serializes, on a serial processor, the homolog mental process which itself has an important parallelism available; a parallelism rate of  $10^3$  to  $10^5$  is not unrealistic.

Secondly, even before questioning the inscription principles, the heuristic structure may be seen as making up for deficiencies of inscriptions in the plexus: it allows finding results despite inscriptions which could be felt to be locally deficient for the task. This is because the computation has the property to be very persevering: when short and strong abductions do not happen, it abducts a longer distance, with weaker evidence.

Finally, the very principles of structuring linguistic knowledge in the plexus may have a part in this lag. The model approximates its analog the best way it can.

The multiplicity of agents (their proliferation) may be interpreted as ensuring principally the serialization of a parallel process. Consequently, if agents are not directly plausible, there is an explanation to their exaggerated number, and a tenable, provisory response. If there were not a parallel process to serialize, there wouldn't be so many agents; with an adequately parallel processor, the proliferation of agents would disappear or be much reduced (but it remains to say what type of processor it should be, and to understand what type of parallelism is needed).

The role of channels in the serialization of a parallel process is lesser. The channel contributes in part to the serialization because it ensures for example a certain proliferation of syntactic analysis tracks, one of which only will be elected (or two concurrently prolonged, waiting for a syntactic ambiguity to be resolved). But the channel has another function: to separate different instances in the question, whether they are idioferent<sup>303</sup> or coreferent. Consequently, serialization let alone, a lag remains between the volume of the heuristic structure and the computing capacity which is presumed to be that of the humans.

---

<sup>302</sup> Atkinson 1968.

<sup>303</sup> "Idioferent" is proposed to apply to a term which would be coreferent to no other term.

Is it possible to suggest a connectionist programme in this direction: rather than staying hung up by the resisting problem of variable binding, rather accept strict exemplarism and strict occurrentialism (this must not be too difficult because these themes are congruent with connectionism) and try to implement the four abductive movements within a dynamic device which would replace the channels of ABS by a mechanism with better plausibility<sup>304</sup>. Success in this would solve together the three 'basic functional elements' assessed by Marcus to be prerequisites to progress in connectionism.

### 9.3. Making a grammar?

A grammar is an intellectual construction aiming at determining statically that which is possible in a speaker's language. This is what pedagogical grammars superficially do for the language of a community, which is supposed to be normalised. It is also what a generative grammar for a speaker's language does; despite it being named a "grammar" is sometimes regretted, a generative grammar corresponds to that aim. A grammar is envisaged, bounds the set of utterances which are possible in a language but it does not specify how acts are carried out.

The proposition defended in this thesis contrasts on the following two points:

1. It comprises no grammar, generative or otherwise: it does not define grammaticality *a priori*.
2. It proposes dynamic (abductive and analogical) models of linguistic processes based on exemplarist inscriptions. From there an explanatory vision of linguistic productivity follows.

The status of grammar is thus questioned. It still is possible to make grammars but they are not a prerequisite to the explanation of linguistic dynamics, the 'possible of language' being seen thereafter as the *de facto* result of the computation of acts. Making a grammar, as an approach, is limited by the constraints it accepts: defining a language as an ideal object, bounding this object by setting aside the subject and the cognitive interfaces (perception, proprioception, motor ability, and phonation).

Secondly, it is appropriate to remind again the rule-list fallacy of Langacker already seen p. 181. In Langacker's argument the theory does not have to choose: accepting a rule does not exclude exemplars that are regular under this rule (which ones exactly is another question). As seen from the Analogical Speaker, the argument seems strong, more especially as, no rule being reified; the model instead features regularization effects which are the result of operations bearing exactly on exemplars, those that Langacker proposes to accept beside the rule. Recognizing this is the second important factor which helps understanding the constitutional and inescapable limit of the grammatical exercise. Any grammar is bound to fail on phenomena which are marginal for it, but which are important because they are the mark of evolution or variation, that is, one of

---

<sup>304</sup> But the same Marcus, speculating on the sort of elementary apparatus which connectionist models should provide proposes a notion of "*treelet*" which looks much like the channel in ABS.

the symptoms of the mechanism itself of the object: the *factum linguae*, which is to be perceived in the linguistic dynamics and nowhere else.

Is the grammatical enterprise void then? It is not because it produces:

- general propositions of a sort which a theory like this one cannot produce, in the direction for example of linguistic universals,
- propositions which a theory like this one must consider, i) as heuristic stimulations, ii) as things to explicate and try to reduce.

For example I think of results of the binding theory, domain phenomena, subjacency, the resistance to central embedding or the prosody-syntax relation depending on the language branching left or right. The grammatical enterprise is then repositioned: it does produce interesting propositions about language, but it is no longer expected to explain the acts and the operations. For productivity, it may provide a non-explanatory, approximate vision, but for an explanatory, more accurate one we should rather rely on dynamic models.

#### ***9.4. Summary of propositions***

Here is now a summary of the defended propositions. No more justifications are provided, please refer to the text above, possibly via the index.

In the table below, a proposition may be:

- thesis: the proposition is defended, against alternate possible ones which are mentioned,
- support: the proposition, or a similar one, is necessary to at least one of the thesis, but it is not defended for itself, variants might be possible. However, it is necessary for a proposition of this nature to be conceivable and defensible (and perhaps implementable) to support the rest.
- moderate thesis: the proposition is adopted as a research posture. The two propositions with this rating are about radical non-categoricity; the conjecture would rather favour a moderate non-categoricity but for this, I do not know how to propose a model.

<b>Proposition</b>	<b>Rating</b>
1. In linguistics, the failure of grammatical frames to account for linguistic dynamics is circumvented by directly studying the dynamics. Against: improving a linguistics of the language.	thesis
2. Occurrential linguistic acts are motivated by occurrential, exemplarist, and proximal dynamics. Against: abstractions, rules alleged to be operational.	thesis
3. As far as ensuing dynamics – that is productivity – is concerned, perception is by similarity of differences – that is, by analogies. This proposition, initially a psychological one, also applies to linguistic acts. Against: <i>qualia</i> , essential properties, categories.	thesis
4. Similarity of differences is directly the principle of linguistic knowledge inscription. It holds between exemplars, that is, between terms. Against: abstractions, properties, prototype and distance to prototype.	thesis
5. Similarity of differences holds within proximality: some inscriptions are proximal to one another, other ones are less so. Against: categorization. Against: location or identification in a totality. Against: probabilistic similarity within a domain.	thesis
6. Inscriptions are directly the perceived analogies. Against: inscriptions are an abstraction or an abstractive elaboration anticipating the needs of the dynamics (prototypes, rules, lexical entries).	moderate thesis
7. In linguistics, probabilities are void as an explanatory track because they fail to define a 'set of possibilities' compatible with the explanation of acts and of learning. Against: probabilities have an explanatory value.	thesis
8. The reduction schema which reconciles a) quasi-uniform observables, with b) the idiosyncrasy of individual knowledge, and c) a deterministic implementation substrate, is macroscopic determinism based on stability in complex systems. Against: a regularist schema. Against: a stochastic schema.	thesis
9. The linguistic dynamics are abductive, by movements between an inscription and the proximal ones. They are deterministic in these movements. Against: algorithmic, based on general rules. Against: probabilistic dynamics.	thesis
10. The dynamics of acts is productive by using exactly the available analogies and by abducting more analogies from the latter. Against: break between perception and the productive dynamics.	moderate thesis
11. Terms are empty (they have no 'properties'); they have value only by being re identifiable in their recurrences, and by their analogical copositionings. Against: property-bearing lexical entries. Against: relations, the essentiality of which would then be a question.	thesis
12. A term is necessarily involved in (at least) one analogy which copositions it with other terms.	thesis

Against: monadic, decontextualized inscriptions.	
13. The success of a dynamics is sanctioned by a settlement (that is, a coincidence) which is copositioned and so involves several terms at once. Against: single-argument coincidence.	thesis
14. Single-argument, proximality-based distributional similarity is a possible model, but an imperfect one, of the similarity suggestion required by the dynamics. Missing: similarity suggestion better observing copositioning.	support
15. Agent-based solving (ABS) is a model of abductive linguistic computation which is functional but not plausible. Missing: a more plausible dynamic architecture.	support
16. The schema for reception/comprehension is the immersion in the plexus of the linguistic (then cognitive) knowledge. Against: a first order mapping schema. Against: evocation of concepts or representations.	thesis
17. The observed regularizations are secondary effects of an abductive dynamics. Against: they are the effects of rules.	thesis
18. The variation of individual histories renders exemplar-based dynamics variant in their detail. However, exemplar-based licensing licenses about the same things and this reconciles variation with quasi-normativity. Against: variation explained by stochastic rules.	thesis
19. A speaker does not learn a language; he just learns how to speak. Bootstrapping let alone, a successful act causes the inscription of the new exemplarist analogy with the lowest cognitive cost. Against: an innate universal grammar and parameter setting. Against: evolution of weights in stochastic rules or constraints.	thesis
20. The young subject of cognition and of language at a given moment succeeds in making his first analogies. Missing: analogical bootstrapping, which is not covered here.	support
21. Linguistic change is caused by many occurrential modifications in speakers' plexii. Against: evolution of weights in the stochastic rules or constraints of a language.	thesis

**Table 20 Summary of propositions**



## 10. Appendix: Rules and categories do not qualify as a theory of operations

The problems of using rules and categories have been abundantly described; this topic is among the most visible ones in the linguistic literature<sup>305</sup>. The usage of categories and rules in natural language processing also faces numerous problems<sup>306</sup> which constitutes an additional hint of their theoretical inadequacy.

The argument will be briefly reminded.

### *10.1. Fragility of a lexical category: the noun-verb opposition*

He who undertakes to question the solidity of lexical categories may chose, in French for example, to target the adverb-preposition area in which the categorial status is notoriously most precarious. He will easily recall items belonging to two categories and the variety of distributional behaviours. He will quote the French word *ne* which "categorizes with nothing else"<sup>307</sup> and he may remind the abundance of proposed classifications, none satisfactory. This is the easiest.

Compared with the categorial fragility of the adverb-preposition area, the noun-verb opposition looks better, it is the most fundamental and the one identified first in history<sup>308</sup>. However its solidity is not dogmatic.

Firstly, and formally, in French and in Romance languages, a categorial leakage is to be observed through the infinitive, participating in what was sometimes called 'improper derivation'. One may argue that the infinitive has a special position and see finite verb forms as a one category and the infinitive as another one. But the phenomenon is still more flagrant – and the case less easy to solve – in a language, as English, in which finite verb forms are less marked. If we now leave the Indo-European domain, the reasons to be confident weaken:

---

<sup>305</sup> Householder 1971 p. 15, Hagège 1976, Milner 1989 p. 86, Lemaréchal 1989 p. 63, Bechtel 1991 p. 243, Auroux 1994 p. 154, p. 175, Laks 1996 p. 153 et suiv., Marandin 1997 p. 156, Koenig 1999, p. 82, Lamb 2000, p. 117, etc.

<sup>306</sup> Fuchs 1993, p. 90 et seq. makes a good survey.

<sup>307</sup> Martinet 1985 about, p. 140.

<sup>308</sup> Aristotle: *onoma-rhema* even if this opposition does not strictly match the name-verb opposition.



... the universality of the lexical categories under which all the diversity is subsumed is far from evident. The noun-verb opposition has many degrees, from Romance languages, in which it is strong, to Salish languages, where it is weak or null, and Hungarian where it is neater in syntax than in morphology<sup>309</sup>.

Regarding the semantic determination of the noun-verb opposition it is possible to quote Mauro:

... when, not long ago, a linguist with Benveniste's authority fostered doubts on the consistency of the traditional definitions of the substantive as the part of speech indicating the 'object', and of the verb as indicating the "process", claiming on the contrary that it is the object-process distinction which is a projection and a personalization of the distinction in our languages between nouns and verbs (Benveniste 1950, p. 29-36) he caused astonishment and scandal among the 'specialists'<sup>310</sup>.

More recently, Langacker<sup>311</sup> reassesses the noun-verb opposition: ultimately, the semantic difference between nouns and verbs reside in the way they profile; nouns profile "things" and verbs profile "processes". It is difficult to disagree.

In sum, the category effect is certainly sharper between nouns and verbs than it is between adverbs and prepositions but it is not absolute here either. This gives birth to a "depackaging" approach<sup>312</sup>: since taking the constitutive properties of a category as a solid package appears not to suffice, certain authors suggest to treat the properties separately. This of course disqualifies such sets as possible universals:

The best way to argument against universals consists of "depackaging" the properties of certain categories: by showing for example that there exists in such or such language, elements which have such property of the category "noun" and such property of the category "verb". In such a case, neither the property package defining nouns nor the one defining verbs, nor the one associated with the elements in question, can be considered as universals. Auroux 1998, p. 44.

A figure of depackaging is to be found for example in the complements to HPSG<sup>313</sup> recently proposed for morphology<sup>314</sup>: accounting for lexical productivity and yielding a behaviour which produces rule effects without rules, by postulating abstract lexical categories and building on category intersection.

In the lines of the Minimalist programme<sup>315</sup>, Distributed Morphology adopts a deconstructive position on lexical categories; the following quotation is taken to Rolf Noyer from the Internet:

---

<sup>309</sup> Hagège 1976, p. 93. On this question, cf. also Hagège 1999, p. 69 et seq.

<sup>310</sup> De Mauro 1969, p. 168.

<sup>311</sup> Langacker 1998, pp. 17-19 summarized; this position was expressed as early as 1987.

<sup>312</sup> Auroux's term in French is "*décompactification*".

<sup>313</sup> *Head Driven Phrase Structure Grammars*, for a summary introduction and a bibliographical orientation, cf. Abeillé 1993.

<sup>314</sup> Koenig 1999.

<sup>315</sup> Chomsky 1995/1997a

A related hypothesis (Marantz 1997a, Embick 1997, 1998a, 1998b, Harley & Noyer 1998, to appear) contends that the traditional terms for sentence elements, such as noun, *verb*, *adjective* have no universal significance and are essentially derivative from more basic morpheme types.

In Barner *et al.* (2002) a refusal of lexical categories on linguistic, neurolinguistic and developmental grounds is to be found: postulating categories in the lexicon only increases the conversion overload with no advantage. They also envisage a solution like that of Distributed Morphology, with some qualms.

In conclusion, all this amounts to negate lexical categories: effects of categorization do obtain, but they are precarious and contingent. Thus, far from postulating lexical categories in the theory, we should rather find a different explanatory mechanism and, on the contrary, explain categorization effects in the lexicon in the exact measure in which they are to be found.

But perhaps functional categories are less questionable.

## ***10.2. Functional approach, the grammatical function***

The functional approach first constructs the grammatical function by opposing it to the lexical category.

We shall briefly review how the grammatical function develops in the history of linguistic thought, and then make a critical assessment of the most prototypical one, the subject<sup>316</sup> function, which is given as the most solid.

### **10.2.1. Categorial label and grammatical function**

The functional viewpoint seems to appear in France in the 18th century. According to Swiggers<sup>317</sup>, a functional approach can be found in the Père Buffier who, for the first time, recommends a distinction to be made between the *subject of the verb* (which commands its agreement) and the *subject of the action* (*Brutus in Caesar is murdered by Brutus*).

Again in the 18th century, the Abbé Girard, still according to Swiggers, recognizes seven functions: the subjective, the attributive, the objective, the terminative, the circumstantial, the conjunctive, and the adjunctive, plus two governments (Fr. *régimes*): the constructive and the enunciative governments, the latter breaking down into dispositive government and concord government. Dumarsais will not mention functions.

---

<sup>316</sup> The functional approach could be complemented with thematic roles (or agentive roles depending on authors) but this will not be done here to preserve focus; still another extension of the functional approach is possible: *The notions of topic (what we are talking about) and of comment (what is said about it) belong in principle to a semantic theory which would contain functional notions* (Milner 1989, p. 372). This also will not be covered here.

<sup>317</sup> Swiggers 1997 p. 192

Moving now into the 20th century, there is no room for functions in the work of Harris<sup>318</sup>, in France functions will be ignored by Bally and Tesnière, recognized by Benveniste:

In all the European structuralists, no doubt the closest to Chomsky's conceptions in his concrete investigations, was Emile Benveniste. (...) about the genitive in Latin (Benveniste 1966, p. 140), from purely syntactic considerations, he succeeds showing that all usages of the genitive boil down to a unique function: the transposition within the noun phrase of relations which were initially at sentence level. (...) Benveniste does not make the error – common to Bally and Tesnière – to make the confusion between two different levels: categories and functions. He realizes that this is a syntactic problem with impacts on morphology<sup>319</sup>.

From this brief historical browsing, let us stay with what Ruwet stresses: the interest of the function is to make a separation between properties (lexical category, categorial label, etc.) which would be inherent in a language unit, independent of its utilizations, and the role which the unit may play in specific usages. Bloomfield for example, clearly states the difference between the functional units and their *formal classes*:

Certain word and syntagms may occur in the position of actor, some other ones in the position of action. The positions in which a form may occur are its functions or its function. (...) Thus, all the English words and syntagms which may occupy the position of actor in the actor-action construction, form a large formal class which we may call noun phrases; likewise, all the English words and syntagms which may occupy the position of action in the actor-action construction, constitute a second formal class, and we shall call it conjugated verb phrases<sup>320</sup>.

The lexical form of any real utterance as a concrete linguistic form, is always associated with a grammatical form: it occurs with a certain function, and these privileges of occurrence, collectively constitute the grammatical function of the lexical form. (...) The functions of the lexical forms are created by the selection taxemes which allow constituting the grammatical forms. The lexical forms which share a function, whatever it is, belong to a common *formal class*<sup>321</sup>.

However:

The functions of the lexical forms appear as an extremely complex system... Different functions may generate overlapping formal classes<sup>322</sup>.

Here is where this theory stops. It limits itself to making statements because *the grammar of a language is made up of a very complex set of habits*<sup>323</sup>.

As for him, in order to account for the properties of linguistic terms which are not inherent to them, Martinet, considers, then quickly rejects, the assumption of a *monème de position* (a 'position morpheme'):

---

<sup>318</sup> Maurice Gross, seminar, Univ. Paris 7, 2000.

<sup>319</sup> Ruwet 1967, p. 231.

<sup>320</sup> Bloomfield 1933/1970 p. 184.

<sup>321</sup> Ibid. p. 248.

<sup>322</sup> Ibid. p. 248.

<sup>323</sup> Ibid. p. 249.

Among the meaning effects which do not match a signifier characterized by one or more distinctive features, those that manifest themselves by the respective position of certain *monèmes* [morphemes] in the chain must be pointed out [...]. In such case, one might possibly be tempted to talk of 'position *monèmes*' [...]. But, as units of this type belong to the well-characterized class of functions, and that, in this class, we will need to distinguish the signifiers composed of distinctive features from those that manifest themselves by a particular disposition of the units in the chain, it is appropriate to keep the term *monème* for the former. It will also be appropriate not to equate *monème* and function<sup>324</sup>.

Then he makes the same distinction as Bloomfield:

... the compatibility of the nominals with the verbs may undergo very different forms. Which is what is referred to when talking of the various grammatical functions. If we acknowledge this term 'function', we will say that beside the monofunctional relations that take place between the modalities and their kernels, between the attributive adjectives and the names which they determine, we find plurifunctional relations between nouns and verbs. The question which arises is by what means can a language make explicit the different functions<sup>325</sup>.

What seems to surface here without being well differentiated is the distinction between grammatical function and thematic role. It will be done later by generativism and I shall not deal further with it.

In order to assess the theoretical value of the grammatical function, let us now take a closer look at the most important one, the subject function, and at the doubts that aroused about it in the second half of the 20<sup>th</sup> century.

### 10.2.2. Contingency of a functional category: the subject

At first accepted in the European languages as a non-problematic notion with a potential to universality, the grammatical subject was attacked when phenomena were scrutinized and attention moved to other languages. A new consensus was not reached, and Langacker summarizes the general disagreement situation as follows:

One basic problem for a symbolic account of grammar is to characterize the notions of subject and object. There are few topics on which linguistic theorists exhibit such a striking lack of consensus. About the only thing virtually they all agree on is that a conceptual definition valid for all subjects or all objects is just not feasible.<sup>326</sup>

Without going into the details of the observations leading to question the notion subject – please see the references provided below – the positions fall into three classes: abolitionism, formalistic retreat, and 'depackaging'<sup>327</sup>. Some apply to a language alone (they will be illustrated here in the cases of Japanese and Basque), other ones are presented by their promoters with a cross-linguistic scope.

---

<sup>324</sup> Martinet 1985 p. 45.

<sup>325</sup> Ibid. p. 163.

<sup>326</sup> Langacker 1998, p. 26.

<sup>327</sup> This is Auroux' term, again, cf. *supra*.

In Japanese, Maes<sup>328</sup> realizes the impossibility to maintain several important properties of the subject:

... the subject in Japanese [is] a "complement as any other", that is, an optional modifier of the utterance [...]. It is easy to show sentences not only deprived of a (narrow) overt subject, but also ones which have no covert one which could be uttered, or more precisely, which could be substituted<sup>329</sup>.

This position is abolitionist: the subject ceases to be characterized, it ceases to be necessary. For this author, and for most linguists of Japanese, the less remote notion presented as stable in this language is the topic-focus opposition, but this does not 'salvage' the grammatical subject: it covers the descriptive and theoretical need differently.

In Basque, the subject is put in doubt by Martinet for the benefit of a different working:

André Martinet<sup>330</sup> proposes a new and clever interpretation of the ergative construction in Basque. For him, Basque belongs to a language type which ignores the subject-predicate syntagm and constructs regularly its utterances by the successive determinations of an existence predicate<sup>331</sup>.

More recently Rebuschi (1997) also negates the subject in Basque and proposes functions specific to that language. He sees five possible properties for the subject, and an appropriate analysis of Basque must distinguish them: i) noun-verb agreement, ii) "zero rank complement", that is, a complement mandatory to the construction of a conjugated sentence, even an "impersonal" one, iii) one-place construction with neutralization of any opposition between any semantic roles, iv) unique NP governing several transformations, and v) thematic subject of a sentence<sup>332</sup>. He identifies in Basque two 'polar roles': the agentive, and the objective; two additional roles: a dative and an instrumental, plus a few secondary roles and concludes:

Depending on the case, Basque favours either the /+animated/ feature or the /+acting/ feature. Calling on the concepts of subject and object seems insufficient to analyse the phenomena associated with transitivity, ergativity, and thematization<sup>333</sup>.

Like Martinet, Rebuschi makes for Basque theoretical propositions which are substitutive because they cover differently the descriptive and theoretical need that the grammatical subject was supposed to meet. Coyos<sup>334</sup> does the same thing by negating the notions subject and object and proposing that of *actualisateur*, generalized in the case of the Basque absolutive, non-generalized for the ergative.

---

<sup>328</sup> Maes 1980, p. 214.

<sup>329</sup> And it should be added that, in Japanese, there are also sentences with several noun phrases, for which we are without criterion to tell which one could be the subject.

<sup>330</sup> Martinet *La construction ergative et les structures élémentaires de l'énoncé* in *Journal de psychologie normale et pathologique* 1958, p. 377-392.

<sup>331</sup> Lafon 1960, p. 613.

<sup>332</sup> It is interesting to compare this list with the different acceptations of "head" according to Zwicky (1985).

<sup>333</sup> Rebuschi 1997, p. 2.

<sup>334</sup> Coyos 1999, p. 309.

This position is the same, near-consensual, as the one we identified in the linguistics of Japanese.

Facing the question of the subject, a second type of position has been announced above as 'formalist retreat'; it conserves the subject but with a definition calling on one criterion only. For an increased universality this criterion must become formal. Gross and Milner follow this track, each with a different criterion. For the subject, Gross proposes a definition based on agreement with the verb and on that alone:

It will be possible to define the subject as the term of the sentence which agrees with the verb. A definition of that sort limits itself to introducing a terminological precision which connects the formalized combinatorial description to school grammar<sup>335</sup>. This preserves the usefulness of the didactic definition. But it excludes that it be the unique concept bearing on the varied and complex set of phenomena [...]. Therefore, from a theoretical standpoint, the notion 'subject' has a very restricted place in syntactic description. So is it from a semantic standpoint, the coexistence in a language of forms like:

*John likes moving pictures.*  
*Moving pictures interest John.*

very well shows that the semantic role of the subject is almost null, since its inversion with the object play no part in the interpretation of the signifier chain in these two sentences<sup>336</sup>.

Milner, as for him, proposes to salvage the subject by adopting an indirect viewpoint, dependent on other, more structural postulations:

One may define the subject as the N which c-commands the content of S and which has S as its domain<sup>337</sup>.

However, it should be noted that the notion of c-command depends on that of VP which assumes, among the NPs surrounding the verb, one of them to be already distinguished as the subject: this condition is necessary for the VP to comprise the other NPs, and precisely to exclude the subject. So Milner's proposition appears circular.

The third type of theoretical position regarding the grammatical subject consists of separating its properties and noting that subsets of these are to be observed without they having to be the same in all cases.

Creissels (1995), in order to rescue the subject – which is a question in African languages – "depackages" its definition. In this book, the section *La notion de sujet* (p. 217) presents the various definitions which may be given for "subject": nominal argument which commands the inflection of the predicate, mutual presupposition with the predicate, etc. For Creissels, the subject in a language is that which has a set of syntactical properties globally comparable, as for their underlying principle, to those of the Latin or French subject, even if they are not identical in the details (p. 219). In view

---

<sup>335</sup> But it is operatory only in languages in which the verb undergoes agreement, which is not verified in numerous languages, notably some Asian languages (Gross' footnote).

<sup>336</sup> Gross 1996.

<sup>337</sup> Milner 1989, p. 669.

of that, a subject must not be refused in the Japanese language (p. 220). The nominal constituent recognized as subject must manifest its nature by a specific transformational behaviour which, in its details, may vary cross linguistically, but which globally must incur a hierarchy of argumental functions, the top of which being occupied by the subject (p. 221).

Along similar lines, Langacker renounces a narrow definition of the subject:

I propose that subject and object status ultimately reduces to a kind of focal prominence conferred on participants in a profiled relationship. In particular subject and object nominals are identified as respectively specifying the trajector and the landmark of a profiled relationship<sup>338</sup>.

He distinguishes properties which are "preferred" for the subject, with prevalence for semantic ones:

A subject is more likely than other nominals to be the controller for verb agreement, the antecedent for reflexivization and pronominalization, the pivot for relativization, the controller for complement-subject deletion, the source of floated quantifiers, the understood subject of adverbs and subjectless adverbial clauses etc... There are obvious problems in trying to *define* the notion subject by means of such properties. But from my standpoint, this effort misses the point in any event. The trajector / subject notion is not at root syntactic, but rather semantic, and its attendant grammatical correlates are not *critical*, but rather *symptomatic* of the special salience that trajectors (in particular clausal subjects) have by virtue of their roles as relational figures<sup>339</sup>.

What Croft thus comments:

For Langacker, there **is** a semantic basis to subjecthood, but it is not causation: a subject is a trajector, that is, a profiled figure. [...] A subject is not just a figure but also in profile. Langacker's conception of the semantic structure of linguistic units is essentially an adaptation of Fillmore's frame semantics analysis. The meaning of a linguistic unit is not only what the unit denotes (profiles), but also the frame (base in Langacker's terminology), that is, the additional concepts presupposed in the profiles part of the meaning, which are therefore present in the "background" or 'base'<sup>340</sup>.

The position of Langacker evokes, and anticipates, Optimality Theory which, by stressing constraints at the expense of essential properties, also "depackages" the subject in its own way. This theory will not be developed here, but an example of an optimalist treatment of the grammatical subject was met p. 230.

At the end of this survey of the critics made to the grammatical subject, it appears finally that this notion, when not simply negated, can be rescued only by a formalistic definition, which is very impoverishing, of by dissociating its properties; they happened to be found together as subsets only, or occasionally only. If something then might be a candidate to universality and to form a theoretical base, it might be these properties, but not the notion of subject itself which is now disqualified.

---

<sup>338</sup> Langacker 1998, p. 26.

<sup>339</sup> Langacker 1987a, p. 231.

<sup>340</sup> Croft 1993, p. 34.

### 10.2.3. Functions or organs?

A general limit of the functional viewpoint is to be seen in this passage of Newmeyer commenting Givón:

... Even if it were correct that all structure is ultimately artifactual, the conclusion that it is therefore misguided to characterize formal systems independent of the functional factors that shaped them is false. This point can be illustrated by developing further an analogy Givón himself introduces early in "On Understanding Grammar". He writes:

Imagine an anatomist describing the structure of the human body without reference to the functions of various organs. But this is precisely what happened in transformational-generative linguistics: by fiat, a priori, and with no visible empirical justification, an attempt has been made to describe the structure of human language, both syntax and phonology, without reference to natural explanatory parameters.

Givón is apparently unaware that there are anatomists – histologists for example – who do precisely what he finds so unthinkable; they describe the structure of the human body without reference to the functions of the various organs. And they have good reasons for doing so. First because they show that similar structures can perform very different functions and that many anatomical functions are performed by diverse histological structures. Some structures (the appendix, for example) serve no useful function at all, while others (the gallbladder, for example) have phylogenetically been adapted to novel functions. And second because some anatomical structures serve no known function. Clearly it would be unreasonable to postpone their study until their function is known. The point is that the organs, tissues and so forth, of the human body form structural systems that interact with the functional systems of the body (digestion, reproduction, etc.) in extremely intricate ways (p. 121). This would have no serious consequence if it turned out that there were in language a one to one match between syntactic structure and communicative function<sup>341</sup>.

Givón puts forward "natural explanatory parameters" in support of the functional viewpoint in linguistic theory: it would not be reasonable for anatomists to ignore – as the Generativists do – the functions of the organs that they describe. Newmeyer finds this argument a weak one because the functions of the organs are not always clear and, when we understand them, the organ-function mapping is seldom simple.

This analogical argument reveals indeed a limit of the functional approach in linguistics. In languages, organs (structures) are to be found for which the functional mapping is not simple: expletives, agreement phenomena implying redundant marks, etc. This imposes not to neglect the structures themselves (a grammar or linguistic theory which would be functional only would not suffice), but it does not allow us to ignore the functional view point; both are necessary. What was shown so far is that even the coupling of both is not sufficient if they are taken categorically – this comes in addition to the Newmeyer-Givón argument.

---

<sup>341</sup> Newmeyer 1983 p. 122.



### ***10.3. A brief reminder of rules refutation***

As for rules, the situation is not more satisfying than for lexical or functional categories. Their refutation is the subject of an abundant literature. Let us sample briefly, beginning with Skousen for whom they give birth to undecidable attribution conflicts, despite speakers coping very easily with the multiple cases which rules do not address well:

[...] there is empirical evidence from language behavior that the boundaries between different types of behavior are not well-defined. I consider [in my book] a number of examples from English: children's use of the indefinite article (*a/an*), misspellings, morphological extensions, pronunciation of nonce spellings, experiments with voicing onset time, and Labov's semantic experiments. In addition, there are some conceptual problems with rule approaches. One particular difficulty is the indeterminacy that occurs when either no rule or more than one rule is applicable. Yet evidence from language usage clearly demonstrates that speakers can readily deal with cases of missing information and ill-formed contexts. In addition, rule approaches have difficulty in dealing with redundancy<sup>342</sup>.

Laks on his part, writing in 1993 during the debate in the years 1989-1994 between connectionism and the symbolist approach, was setting doubts on their explanatory power as operating rules, particularly in phonology:

Writing rules is a synthetic mode of description which allows us to embrace facts in a single sight, whence their obvious heuristic value. Even if, from another viewpoint their explanatory value is a question, it may be the case that, at the end of any explanatory analysis, there remains a residue of regularities that no properly phonological constraint active in synchrony will be able to explain: the historical and social character of languages does not let itself forget so easily. Finally, we must not forget that universalizing rules as parametered principles leads necessarily to particularize the systems in which these principles bear effects. A certain amount of arbitrariness is inevitable and it is not sure that it is entirely on a single side, that of the systems. Nevertheless, the language of the rule as such is fundamentally unable to provide an explanation of properly phonological phenomena. Formal rules work on symbols which are not conceived of as objects with a substantial reality. Only after a translation can these symbols be related with properties of the substance. Thus the rule asserts regularity without providing a ratio to it, or it does so with circularity. Making a rule is assessing a regularity; the regularity is not a consequence of the rule, but the rule of the regularity. We predict, but without being able to explain<sup>343</sup>.

### ***10.4. Conclusion: a descriptive approximation but not a theoretical base***

In sum, as diverse and inventive the proposed kinds of rules and categories to account for the diversity of linguistic facts might be, limits and residues are always to be met. It is not that categorization effects do not occur, they are quite manifest on the contrary, but we have to conclude that their mass cannot be circumscribed in any categorial frame

---

<sup>342</sup> Skousen 1989, introduction.

<sup>343</sup> Laks 1993, p. 8.

applicable to all cases. Even if we found one, it would still have to be shown how it is learnable and how it copes with variation and evolution.

This lead to renounce categories and rules, which is what many linguists already do: Chomsky himself<sup>344</sup>, finally refusing rules and "categorical labels", Dryers (1997), Croft (2001), to say nothing of the connectionists since in connectionist models categories are inherently absent.

---

<sup>344</sup> *The P&P approach maintains that the basic ideas of the tradition, incorporated without great change in early generative grammar, are misguided in principle – in particular, the idea that a language consists of rules for forming grammatical constructions (relative clauses, passives, etc.). Chomsky 1995/1997a (Minimalist Program), p. 5*



# 11. Appendix: The slot-filler schema, a historical picture

In order to complement the discussion on the slot-filler schema made in Chap. 1 and to clarify it, this appendix presents a table of the aspects that this question took in the history of linguistic thought. Then the form taken by the slot-filler schema in construction grammars is discussed in greater detail: they add some flexibility into it, but they conserve the schema.

## *11.1. Table of some figures of the slot-filler schema*

The table below presents, in chronological order, figures taken by the slot-filler schema for different authors. It is not exhaustive; the intent is to suggest how a constant theme is recurrently dressed up in different fashions.

The slot-filler schema first appears rudimentarily in Aristotle who differentiates *onoma* and *rhema*, and says that a sentence is made up of both. There isn't yet a clear distinction between the slot-defining structure, the names of the slots, and the conditions under which potential occupiers qualify.

Thereafter and for long, grammarians will adopt a point of view centred on the 'parts of speech'. In Arnauld and Lancelot (1660/1997), the slot-filler question is little visible and indirectly only.

The question arises again in Tesnière, in the 1950s, with the 'valence formulae' (Fr. *formules valentielles*).

In generativism, firstly, the derivational rule both defines the slots and provides for their occupation. Secondly, the transformation rule plays a part in the modification of this economy. This theory is characterized by non-occupied slots: either empty terms in the generation process, or the traces which are left behind after a transformation has been performed.

Milner (1989) develops a post-generativist conception which differentiates between 'place' (defined in the overt form) and 'position' (with a more syntactic character). The occupation may be coincident or distorted. Something more will be said on this in another appendix, p. 308. In particular, I stress there how weak the definition of coincidence is.

Author, school of thinking, domain	Structure defining the slots	Name of a slot	Name of an occupier	Predicate of the occupation
Aristotle	[not named]	<i>onoma, rhema</i>	<i>onoma, rhema</i>	
Arnauld & Lancelot	+/- <i>rection</i> , prescriptive rules	case, <i>régime</i> [not named]		
Tesnière	<i>formule valentielle</i>	valence	actant	
Martinet (for example) Chomsky (Aspects)	(not thematized)	function (subject, object, etc.)	word, syntagm	a syntagm has a function
Generativism with transformations	derivational rule, transformation rule	e.g. NP, VP, etc.	syntagm, lexical item	
Government & Binding	in addition to the latter: thematic structure, theta grid	thematic role, morphological case vs. abstract case, structural case vs. inherent case	argument	to saturate a thematic role
Fillmore		case, semantic case		
Pottier		conceptual case / linguistic case		
Culioli 1982, p. 19. Culioli 1990, p. 49.	<i>schéma de lexis</i>	place	terms constructed from notions	a term <i>instanciates</i> a place, becomes the argument of a predicate
Shaumjan 1987	predicate frame, operator,		term acting as an operand	
Givón, McClelland	case frame	case-role		
Tanenhaus 1988		gap position	filler	
Milner		position, place	argument	
Kerleroux	syntactic skeleton			
Lemaréchal				to saturate a valence
Creissels	predication scheme	valence, argumental function	protagonist	
Langacker	valence relation	valence?		
Vergnaud, Kaye, Lowenstamm (phonology)	skeleton of positions	position		

Table 21 Figures of the slot-filler schema in linguistics

### 11.2. Table of the slot-filler schema in neighbouring fields

A similar slot-filler schema can be found in mathematic, in computer science, and in cognitive sciences, as the table below shows. This table is presented although it does not bear on linguistics, because between linguistics and neighbouring domains theories interfere and cross-fertilize; so much so that the lexicon in columns 2, 3 and 4 is common partly identical to that of the table above.

Author, school of thought, domain	Structure defining the slots	Name of a slot	Name of an occupier	Predicate of the occupation
Mathematics	operator		operand	
Mathematics	function	variable, parameter	value	a variable takes a value
Informatics: sub-program call (v. Neuman)	invocation schema, argument sechema, operator	argument	variable or value provided as a parameter	provide a parameter, give an argument a value
Informatics: naming space mapping, addressing space mapping		symbol, symbolic address, reference,	"real" address = defined in the target space	resolution/binding of a reference/of an address
Prolog (Colmerauer)	Prolog clause	goal	atom	satisfy a goal
Cognitive science	n-ary predicate	variable		bind a variable

Table 22 Figures of the slot-filler schema in neighbouring domains

### 11.3. The slot-filler schema in construction grammars

With the construction grammars, a progress towards less categoriality is made: beside the lexicon which is their first component, they define a set of constructions (cf. Goldberg 1995 infra):

C is a construction iff C is a form-meaning pair such that some aspect of meaning or some aspect of form is not strictly predictable from component parts or from other previously established constructions (p. 4).

The construction determines slots (even if the notion of slot is not explicit in Goldberg) and there does not seem to be a drift possible: in all the instantiations of the construction its semantic contribution is the same. This limit is softened by the possibility to create all the necessary constructions: there isn't a limit to their number.

A verb has systematic difference of meaning in different constructions and this is attributed to the constructions (p. 4).

Since the set of constructions may now proliferate, it matters to maintain its coherence and preserve the economy of the theory. A structure is proposed to these ends: constructions are arranged into a lattice:

The entire collection of constructions forms a lattice, with asymmetric inheritance links, which accounts for generalizations among them. It captures related form and systematically related meaning. ... Inheritance holds among constituents internal to constructions and so grasps generalization about the internal structure of constructions. Multiple inheritance applies to an instance which may be motivated by two distinct constructions. ... A highly recurrent motivation link is analogous to a rule (conclusions of chap. 3, summarized).

The verb is demoted from the central place of the element *par excellence* – if not the only one – which assigns positions to other ones.

The syntax and semantics of a clause is not projected exclusively from the main verb (p. 219).

We also note that the notion of head is absent from the theory.

A few questions left alone (for example, how are to be expressed the selectional restrictions which apply to the possible participants in a construction), this theory calls principally for two remarks.

The first and most important one is that the theory maintains a conception of semantics as form-meaning association. Even if we are now equipped to detail the constructions as necessary, there is no room made for interpretation and it is not clear how figures, metonymy for example, can be accounted for.

The second remark is that among its goals, this theory does not try to account for occurrential linguistic acts; it says nothing about it; nothing about the analysis process for example<sup>345</sup>. In this line, there is no place to say how the success of an occurrential act may modify a little the linguistic knowledge. No discourse either about inter-speaker variation. However, although this is not directly apparent in the text, one may suppose that a slightly variant configuration of the lexicon and of the construction lattice might yield inter-speaker variation; it seems this theory has such a potential.

Inheritance among constructions is fostered by Goldberg (1995, p. 2). This requires things to be inherited to be formalized, that is, to symbolize them. As with HPSG, we stay to close to abstractions.

Four types of inheritance links are provided: polysemy, metaphorical extension, sub-part, and instance. It has to be suspected that this categorical quadripartition contains a risk not to be able to respond to the need for graded and intermediate effects that facts will reveal, otherwise than with *ad hoc* responses.

A "normal mode" opposed to a "complete mode" renders inheritance less intractable but "*normal mode is designed to allow for sub-regularities and exceptions*". This theory-destructive proposition omits assigning a place in the theory to sub-regularities and exceptions and to specify how they are acknowledged; what is needed on the contrary is this to be done in a manner which is inherent, constitutive, and homogeneous with the rest.

The facts that suggest inheritance are much better treated, as we saw, by a dynamic computation, seen as a process applied to the linguistic knowledge, rather than by a structure (lattice with inheritance) described as static.

---

<sup>345</sup> A mechanism like unification for example is mentioned (p. 14) for unification grammars, but neither this one nor another one is adopted for the theory defended in the book.

## 12. Appendix: Specification of the plexus

### *12.1. Plexus: introduction*

In the Analogical Speaker, linguistic computations operate on permanent inscriptions which are the static side of the linguistic knowledge: the plexus.

A plexus is made up of records consisting of sites (four currently). Each site may be occupied by a term. Between records, paradigmatic links may be established. Terms at the same sites in linked records are said to be homolog. Thus a plexus is a graph of records for the relation 'paradigmatic link'. A connected part of the graph is a paradigm.

A plexus captures structural analogies and systemic analogies, both interfering in specified modes.

Within a paradigm, the connectivity is important, proximality matters within paradigms. With proximality are obtained proximal categorization effects, and the regularization of linguistic facts onto one another is proximal. The graph of the records linked with paradigmatic links has thus a connectivity motivated by linguistic and cognitive reasons. This let alone, a paradigm's connectivity as a graph may be diverse: linear, star-shaped, many of few cycles, long or short cycles, etc...

### *12.2. Term*

#### **12.2.1. Definition of 'term'**

The notion of term was defined and discussed p. 193. Terms are either formal or private exclusively.

Formal terms have a linguistic form, cross the interface between speakers and participate in utterances. There are no homonyms, that is, all formal terms have different forms.

Private terms have no linguistic form; they do not cross the interface and do not overtly participate in utterances. Private terms are a postulation which is felt to be necessary but they are little developed currently (cf. p. 262).

Formal terms and private terms occupy sites in records and they take part together in linguistic computations.



### 12.2.2. Is a 'table of terms' needed, up to where downgrade the lexicon?

Formally, the model contains a 'table of terms'<sup>346</sup>, a kind of impoverished lexicon in which each term has its individual place. This table is a question in itself, it is not certain that it is functional and necessary in all respects. Let us examine one after one, various possible reasons to make a table of terms; this is clarifying because it helps understanding what a term is.

In general, a table is made to methodically record data about different items. In linguistics, the intent is to have available a locus to record linguistic terms; a 'table of terms' would fulfil that need. This is what is always done in natural language processing systems; this is also what linguistic theories do: generativism has a lexicon, Mel'cuk and Shaumjan have words (even if they don't agree to distinguish homonyms or to melt them into one term), HPSG has very rich lexical descriptions. I showed why I refused the assumption that terms might have properties. Terms must be discrete, identifiable, re-identifiable in their recurrences, but they must stay 'body-less', property-free, non-essential. They take their efficacy only from their occurrences and from their mutual copositionings in these occurrences. Consequently, this reason – record properties – is not valid to justify a table of terms.

Let us assume this. "We need anyhow to distinguish what needs to be distinguished: if we have two homonyms, it is convenient to store each in a different entry of the table. Doing so, even if properties are refused for terms, we know at least what distinctions are made." Now it begins to be known that dictionary practices in this respect are variant, and that there is no way to give them a solid foundation. This problem is not one just for lexicographers; it is a theoretical question in the first place. We also know that the choice between the different entries thus created is itself intractable. In natural language processing for example – a domain in which lexical categories are usually recognized – it causes a proliferation of analysis paths which then must be reduced<sup>347</sup> using methods to which it is not possible to give a sound foundation. Finally, I showed section 6.1.2. *Homography, accidental homonymy, syncretism* (p. 160), on the example Fr. *été*, how the previous distinction between the season *été* and the past participle *été* was not necessary: it not having been done does not hamper the success of the computations because the context provides for it. Therefore, this reason – differentiate homonyms – is not either a good reason to motivate a table of terms.

There remains in the model the functional need to associate the orthographical form of a term with its occurrences in plexus records. The model comprises an organ – which is a table – that does the association. It is used by various agents (CATZ, B2, B3) for supporting the access function. It may be viewed as a very lean lexicon; the model comprises then a residual lexicon the only function of which is to support some of the access to linguistic data (cf. also section 12.6. *Access*, p. 298).

---

<sup>346</sup> The phrase 'table of terms' is deliberately chosen in spite of its culinary connotations, against the word 'lexicon', to stress that, contrasting with lexical entries in other theories, terms in the Analogical Speaker have no properties. So terms are questioned, and the access to terms in particular, we investigate the opportunity to make leaner an apparatus, still suspected to be too rich, but we stress with 'table of terms' that it is already much leaner than previous visions of lexicons.

<sup>347</sup> In that field, they say "desambiguate".

This is where the model stops in the critique of the terms. It maintains a table of terms for a reason which is not directly linguistic but which is not without implementational implications and plausibility implications: it is doubtful that brains support access in this manner. A next step in the critique of terms still remains to be done.

At this point, one cannot help to take another look at connectionism: the terms which are ours, are symbols – in a sense which will be defined shortly – and one of the main effects of the debate which, after PDP (1988) kept the profession busy, was to understand that connectionist models succeeded (when they did) because they substituted symbols with a different more flexible and more adequate apparatus; this debate reassessed preceding approaches as 'symbolist', for example, linguistic theories that were popular at the time, and are still defended today. At that time, among connectionists – I recalled this p. 241 – the word was deconstructed, the lexical entry was negated. Later, this deconstructive and negative route appeared not to suffice and novel techniques (self-organizing maps) were found to make models able to represent lexical entries; this was presented as a condition to overcome the performance barriers behind which the models were blocked before. If we believe this, it should be kept in mind, and it is maybe not the thing to do to try and get rid of the table of terms at any rate.

### ***12.3. Record***

A record is an organic (therefore implementational) unit of the model which has a type and four sites. Sites are occupied by terms. The precise meaning of site occupation depends on the record type and is specified below.

Why four sites and not three or five? For a ternary constructor, three constituents are needed plus an assembled form which makes four altogether. It did not seem urgent to consider quaternary constructors. If they had to be, the only changes would be technical.

### ***12.4. A-type record***

About A-type records, an abundant introductory material was provided in Chap. 3. This allows us to remain here brief and dogmatic.

An A-type record contains a pair of terms. That pair is likely to be involved in systemic analogies. This happens when the record has a paradigmatic link with another.

Technically, the terms occupy sites 1 and 4; in an A-type record, sites 2 and 3 are not occupied.

### ***12.5. C-type record***

About C-type record much was written in Chap. 4, which makes it possible to stay here concise and stipulative.

A C-type record defines an exemplar of concatenative construction.

Sites 1 and 2 are occupied by terms which are constituents.

Site 2 may be occupied by a term which is a third constituent. In such case, the constructor is ternary, otherwise, it is binary.

Site 4 is occupied by the assembly, which is the concatenation of the constituents.

This simple, literal vision is not sized to treat phonosyntax, which does not mean that the model is globally incapable of it. On the contrary, the exemplarist option is a favourable factor for this; but the track was not explored within this work.

The reported experiments are based on plexii with orthographical coding. It being orthographical is not obligatory, any other coding one may wish, for example a phonological one, may be adopted without consequence on the principles of the model. There is however a consequence on the description cost since a coding less familiar than the orthographical one costs more to the descriptor. There is another consequence: a different coding distributes homonymies differently. However, the model treats homonymy and ambiguity in general terms, without being affected by the coding which causes them, be it orthographical or phonological.

Whatever the selected coding, the only requirement bearing on terms is that they be identifiable in their recurrences, that is, coded identically.

## ***12.6. Access***

"Access" collectively refers to the means whereby the elements of the plexus (records, terms) are reached during the computations, either from the elements which specify a linguistic act (or a linguistic task), or from other elements of the plexus, already reached during the course of the computation.

Access in this model consists of three complementary devices, i) the index of term occurrences, ii) the index of analogical pair occurrences, and iii) the crossing of paradigmatic link.

### **12.6.1. Index of term occurrences (unary access)**

The index of term occurrences accepts a linguistic form and returns the occurrences of the corresponding term in the plexus; if the argument form is not a term known to the model, the returned list is empty.

An element in the returned list is a term occurrence. It consists of: i) a record identifier and ii) the indication of the site which the term occupies in the record. This is because a term is said to occur in the plexus when it occupies a given site in a given record.

The current implementation of the index of term occurrences is a randomization by hash coding; it might be a b-tree or any equivalent technique. The technical option is not important and might be changed. The point is that this index is a function which maps terms onto their occurrences as terms in the plexus.

There is much to say about the plausibility of this device and about its position in the theory. It is dependent on the sustainability of the radical exemplarist option, see the discussion p. 268.

In fact, in addition to the parsing process (cf. p. 365), the index of term occurrences is used only by the CATZ agent (cf. p. 95) which ensures the function of similarity

suggestion in a single-argument mode, which is questionable; it was criticized above. This index and the CATZ agent are suspected because they are invoked with one argument only; the pretension to be able to designate one thing would be a residue of essentialism.

The index of occurrences of analogical pairs is a proposition to correct this defect.

### 12.6.2. Index of analogical pair occurrences of (binary access)

The index of analogical pair occurrences accepts a pair of terms and returns the list of the occurrences in the plexus where the pair participates in a systemic analogy, that is: i) all pairs in A-type records, and ii) in C-type records, the pairs formed by terms which bear the A mark – the function of the A mark in C-type records is exactly to distinguish the terms which participate in a systemic analogy, cf. p. 67 where the inscription methods are defined.

A returned occurrence is the indication of a record plus the sites occupied in the record by the two argument terms.

The index of analogical pair occurrences is used by agent ANZ, which is the base of the dynamics of systemic productivity, and from it indirectly, by agent AN2, which is a client of agent ANZ and solves analogical tasks with two-term syntax.

Contrasting with the index of term occurrences, which is single-argument, and suspected for that reason, the index of analogical pair occurrences, which has two arguments, allows us to construct processes that observe copositionings. It is positionally more correct if one dares say.

Is it plausible? It must be if we recall the Saussurean intuition of "eternally negative differences". What is the feeling of those who their position make more familiar than us with the brain? Consider again for a while Edelman's paper already quoted in Chap. 2 (1998, *Representation is representation of similarities*). The title contains *similarity* and this invites to perceive *difference* transparently, what the rest of the reading does not fail to confirm:

Obviously, a shape, a colour, or some other quality considered in isolation can be represented in any manner whatsoever; it is the introduction of other objects that makes representation challenging. [...] It may be more productive to consider quale such as "redness versus greenness" and "pear-shape versus apple-shape" as primitive and redness or pear-shape as derived (p. 466).

It's clear: here again we must regard as primary the differential oppositions. But why should we have at all to derive the *quale* redness and the *quale* pear-shape? All which that will do will be to concentrate one more time on form [red] and on form [pear]. Back now to linguistics, we may for instance undertake to clarify the noun-verb opposition, but if we do, the most urgent is not to dig on one side what the properties and essence of the noun would be, and on the other those of the verb; the only thing that interests speakers is to successfully carry out dynamics in which nouns and verbs contrast, and what interests us is to understand these dynamics.

### 12.6.3. Crossing a paradigmatic link

The two indexes we just saw accept terms and return occurrences. They may be viewed as ensuring an access function within the model, that is, the base mechanisms of circulation, elementary support of the computation processes. As such, another elementary mechanism complements them: the move from a record R1 to one or its neighbours, by crossing a paradigmatic link between them. There is little to say about it, except that here again, we have a unary variety (from a term of R1 move to its homolog in R2) and a binary one (from a pair of term of R1 move to its homolog pair in R2).

## 12.7. Paradigmatic link, paradigm

### 12.7.1. Paradigmatic links and paradigms viewed formally

Between two records, a paradigmatic link may be established.

Between two A-type records: R1 (X, Y) and R2 (A, B), the paradigmatic link means "X is to Y as A is to B"; this is a systemic analogy.

Between two C-type records: R1 ( $a_1+a_2 \rightarrow a$ ) and R2 ( $b_1+b_2 \rightarrow b$ ), the paradigmatic link means that these two constructions by concatenative assembly are constructionally the same; this as a structural analogy.

A plexus is then a graph<sup>348</sup> with nodes the records and edges the paradigmatic links. A plexus paradigm is then a connected part of this graph.

### 12.7.2. Paradigm in the plexus and linguistic paradigm

Classically, since structural linguistics, a paradigm is a set of forms which are substitutable at the same place or at the same places.

A paradigm, as I define it in a plexus, I mentioned this already, remains a collection of elements which share something of the order of the place, but which are no longer isolated forms. They are pairs of forms, either the so-called 'analogical pairs', or assembled exemplars. As can be seen, this is a slight step aside with respect to the canonical definition of 'paradigm', and this is how the principle of obligatory contextuality is implemented in the model.

### 12.7.3. How many neighbours?

A record has a few neighbours, typically from two to six.

A record with one neighbour only is possible. For example, it is the frequent situation of a less familiar record which gets to be known via one only other record, more familiar than it. It is computable, a little awkwardly, and not very productive.

To a record, too high a number of neighbours is not reasonable: it is conjectured to contradict the anatomical constraints bearing on neuron connectivity. However, even if we limit the immediate connectivity, for example to six, it is possible to constitute a

---

<sup>348</sup> The terms used are those of Claude Berge, *La théorie des graphes et ses applications*, Paris, Dunod, 1968.

small number of records into a small diameter set, with strong internal connectivity and which may connect a high number of other records. In this way, it is easy to constitute kinds of quasi-prototypic kernels which tend to play as centres in a computationally efficient way, positively influencing a much wider area. Then, there isn't one single object acting as prototype but rather a prototype effect which the descriptor may chose to make concentrated or diffuse.

#### 12.7.4. About isolated records

In a plexus, an isolated C-type record is formally possible<sup>349</sup>. It is a syntactic hapax. An isolated record is little useful; it cannot contribute to similarity suggestion, which is based on paradigmatic links, but it may be a licensing record in an analysis (agents B2 or B3 may use it), so it may contribute to abductively license an unknown form.

In an extension of the model which would encompass learning, the analysed unknown form would cause a new record to be inscribed and a paradigmatic link to be set between the latter and the licensing record, so far an isolated one, which would put an end to its isolation, the set thus formed seeing its utility increase much more than linearly, all this was explained above.

The interesting question is: why should an isolated record arise in the model. It touches the question of *bootstrapping*, of initial learning, which is not addressed in the current perimeter, but the orientation conjecture is that an initial structure is an analogy (structural or systemic) right from the start; it involves at least two records and a paradigmatic link between them. Following this, an isolated record would be a sheer artefact, the model as it is can include one but it does not provide for it a linguistic or cognitive interpretation.

One may then wonder what the model does with the syntactic hapax which can be met in languages. There are none to be found or nearly so, by definition in a way: where nothing is comparable, there can be no syntax and therefore no syntactic hapax either: where nothing is comparable, everything is a hapax but nothing is syntax. The fact that there are no syntactic hapaxes is very congruent with this work which grants analogy the fundamental role. The question of the syntactic hapax is discussed by Kerleroux. She found one. At least she found one utterance that would take that quality if it were not so problematic: the French utterance *La ferme!*<sup>350</sup> (*Shut up!*, literally: *it shut*; the regular French construction ought to be *Ferme-la!* that is, *shut it!*).

---

<sup>349</sup> It is a matter of fact which is not changed because it has practical advantages. If it had to be prohibited, it would be easy to do.

<sup>350</sup> [...] a unique exemplar, a sort of syntactic hapax. But what can the statute of the exception be in the theoretical frame defined by generative grammar and more generally in any syntax? If we assume that sentences are the result of the interaction of a number of principles and rules, belonging to several orders or modules, since the form exists, we are led to think that the form is possible, and to try accounting for its possibility, that is, consider new analyses, since the description just proposed casts the problem into an endless contradiction: (1) [*La ferme!*] is impossible, and yet (1) it exists and it belongs to French. How can we solve the contradiction between an impossibility in the language and an occurrential possibility? Kerleroux 1996, p. 209 (...) What deserves to be noted is that everyone analyses (1) as a sentence in the imperative, at the very high expense of postulating a syntactic hapax, an assumption that might be hosted in a fantastic linguistics only. *ibid.* p. 220.

This sentence is a hapax versus other sentences, that is, if considered separately of a situation: it then has no unarguable analog. But it ceases to be a hapax if taken as an utterance, that is, if regarded in a situation, because:

*La ferme!*: [situation 1] :: *La ferme!* [situation 2] :: *Tais-toi!* [situation 2]

It is then homologous to *Tais-toi!* (*Stop talking*) or *Ta gueule!* (*Shut up!*). Then, for speakers nowadays who ignore the linguistic history of this form, it does not matter much that the grammatical analysis of *La ferme!* be difficult, discordant, however we take it, if the enunciative analysis can be done, and in this case it is comparatively easy: someone asks you to stop talking and he/she subordinates the elegance of the expression to its illocutionary force. The form is conventionalized as a whole with the associated situation, *entrenched* as Langacker would say.

The idea then would be that a syntactic hapax does not actually happen, provided that, in the 'syntax', that is, in structural analogies, we reinstate the situation – that would build on private terms. This takes us a little beyond the perimeter, within which this model may be regarded with some confidence, but if this prospect were validated, it would make it possible to extend the validity of the analogical stance; in any case, this occasion would not contradict it.

#### 12.7.5. A-type and C-type records coexisting in a paradigm: mixed paradigms

Because *geese* is to *goose* as *horses* is to *horse*, but *horses* is built regularly with the singular and *geese* is not, we would like to be able to write something like:

	S1	S2	S3	S4
C	horse	-s		horses
A	goose			geese

that is, we would like to set a paradigmatic link between an A-type record and a C-type record. The model allows that: it allows paradigms with mixed record types. This increases the productivity of inscriptions all in reducing redundancy. However, an A-type record which would intervene between two C-type records would hinder access from one to the other for syntax-oriented processes because the trace of one constituent (-s here) gets lost when paradigmatic link crossings are chained. When planning for the connectivity of a mixed paradigm, this risk of loss must be anticipated. It leads to place A-type records out of the paths linking C-type records.

#### 12.7.6. Homology, deflectors

Between two records with a paradigmatic link between them, the simplest is for sites 1 of both records to be made homologs and likewise for the other site numbers. However we may have to represent homologies between sites with differing numbers. Assume for example in an English plexus, an already numerous gender-oriented paradigm in which the feminine is in site 4. It would be difficult to complement it with the pair (bride, bride-groom), and the following inscription would be false:

	S1	S2	S3	S4
A	husband			wife
C	bride	-groom		bride-groom

The convention that sites with the same number are homologous cannot represent this analogy because *bride-groom* must be at site 4: it is a rule for assemblies. Rewriting the whole gender paradigm is expensive if it is numerous, and not doable if two conditions like this one bear in it contradictorily, which is the case as many feminine nouns in English are assemblies built on the masculine (*waitress, she-cat*). In order to describe a plexus comfortably in all cases, it must be possible to make homologous sites with different numbers, what the crossing lines suggest below:

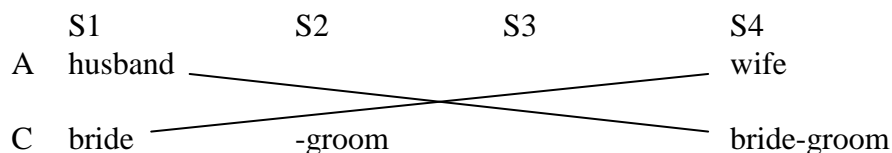

The model contains this feature; it is named "deflectors". The device has no real linguistic import; simply the intricacies of languages and the comfort of the descriptor require it.

### 12.7.7. Analogies in constructions

The subject is covered above p. 299.

## 12.8. Familiarity orientation

This section covers in detail familiarity orientation; this topic was introduced p. 62. Less familiar things are understood with the help of more familiar ones; utterances containing less familiar elements are built from more familiar precedents. This platitude, if it was stressed by some linguists, notably cognitive linguists, remained thus far unexploited by precise operable models which try to account for linguistic productivity.

### 12.8.1. The more familiar makes the less familiar understood

A first development state of the model presented the following character: the heuristics used the paradigms in all directions and tended to use them exhaustively when the number of phases granted to the computation increased. This approach has the inconvenience that it renders the computations sensitive to plexus size in average in a polynomial way. This is a practical inconvenience if we care for the duration of the computations, and it is a defect of the theory because we do not speak more slowly because we know more words or more constructions. So there was a need to reconsider this isotropic indifference and to orientate the heuristics towards what which would be more promising.

The track adopted consisted in paying consideration for Aristotle's view that, in a metaphor (and consequently in the analogy which underlies it), a less familiar tenor is understood with the help of a more familiar vehicle and not the other way round. *The cup is to Dionysus as the shield is to Ares* because the relation between Ares and its shield is assumed to be well established between the interlocutors when the relation between Dionysus and the cup would be less well established.

This venerable theme is taken over without variation on the renewal of research on metaphor:



Each metaphor has a source domain, a target domain and a source-to-target mapping. The metaphor is natural in that it is motivated by the structure of our experience. (276) The metaphor PURPOSES ARE DESTINATIONS ... from the time we can first crawl, we regularly have as an intention to getting to some particular place. In such cases we have a purpose – being at that location – that is satisfied by moving our bodies ... and at the final state, the purpose is satisfied. Schemas that structure our bodily experience preconceptually have basis logic. Preconceptual structural correlations in experience motivate metaphors to map that logic onto abstract domains. Thus, what has been called abstract reason has a bodily basis in our everyday physical functioning. It is this that allows us to base a theory of meaning and rationality on aspects of bodily functioning<sup>351</sup>.

The greater familiarity of bodily and spatial experience is explicitly made the cause of the elaboration of "superordinate concepts":

Meaning is not a thing; it involves what is meaningful to us. Nothing is meaningful in itself. Meaningfulness derives from the experience of functioning as a being of a certain sort in an environment of a certain sort. Basic-level concepts are meaningful to us because they are characterized by the way we perceive the overall shape of things in terms of PART-WHOLE structure and by the way we interact with things with our bodies. Image schemas are meaningful to us because they too structure our perception and bodily movements, though in a much less detailed way. Natural metaphorical concepts are meaningful because they are based on a) directly meaningful concepts and b) correlations in our experience. And superordinate and subordinate concepts are meaningful because they are grounded in basic-level concepts and extended on the basis of such things as function and purpose<sup>352</sup>.

Familiarity orientation is even empirically verified by the psychologists; for example:

Golson found that third and fourth grade children were able to use the farmer's dilemma as a source and transfer the solution to the missionaries' problem. However, the converse was not true; i.e. the missionaries' problem was not successfully used as a source. This has also been found to be the case for adults<sup>353</sup>.

### **12.8.2. *Amérique, ô ma Norvège!***<sup>354</sup>

Along these lines, the model is enhanced with a "familiarity orientation" which consists of two complementary measures: one in the plexus and one in the computations.

In the plexus the paradigmatic links between records (whatever their type) are oriented: one of them is supposed to be more familiar. Occasionally they may have equal familiarity.

In the computations which require them, paradigmatic link crossings take place towards a more familiar record or one with equal familiarity but not towards a less familiar record.

---

<sup>351</sup> Lakoff 1987, p. 276.

<sup>352</sup> Lakoff 1987, p. 292.

<sup>353</sup> Eliasmith 2001, p. 269.

<sup>354</sup> *America, O my Norway!* The French poet Dominique Fourcade.

The familiarity orientation holds for links between all record types. So for a C-type record, we must be able to say that its familiarity is lesser or greater than that of its neighbours. This is not self-evident because a C-type record consists of: i) terms (two or three constituents plus an assembly), and ii) the exemplarist construction itself. The terms each have their familiarity, and the exemplarist construction has also a familiarity attached to it. For example, as was already suggested, a construction in which a term presents a "categorical distortion" (following Milner) sounds less familiar than a coincident construction. There is no reason for these familiarities to be the same, so what should be the familiarity of a record the elements of which have diverse familiarities. The question should not worry too much, we can rely on an overall judgement of the descriptor – this is not the only time – or say that a record's familiarity is the lowest one of its elements.

To establish the relative familiarity of two records, a criterion among others is morphological anomaly: anomalous formations are often more familiar. This is because frequency is antagonistic to the 'analogical repair' of the forms. A frequently used form tends less to let a competitor one arise, which would follow another analogy than itself; it tends rather to perpetuate its frequency. This criterion however must be used with discrimination: in English, *brethren* cannot be said to be more familiar than *brothers* and in French *cailloux* or *genoux* certainly are familiar but not more than *trous*.

As an example, here is an analogical paradigm associating country names with names of inhabitants. The more familiar is at the bottom of the drawing and the less familiar at the top. The topmost elements are understood with the help of those below, but not in the reverse way.

This paradigm belongs to the knowledge of a defined speaker about how country names are associated with inhabitant nouns; it may well be a part only of that knowledge. He is a Frenchman; for him, England and Germany are less familiar than France, Norway and Sweden still a little less and so on. Finland is apprehended via Iceland: he is not a very good geographer but he has this particularity, maybe he travelled through Iceland. But why after all should mental inscriptions be subordinate to an academic geographical knowledge?

Dynamically, the idea is that the heuristics processes, when they exploit the paradigms, cross the links from the less familiar to the more familiar (or towards equal familiarity). Thus for example, Portugal is known through Spain, then transitively through France, but France is not known through Portugal – again for the defined speaker of whom this is the model.

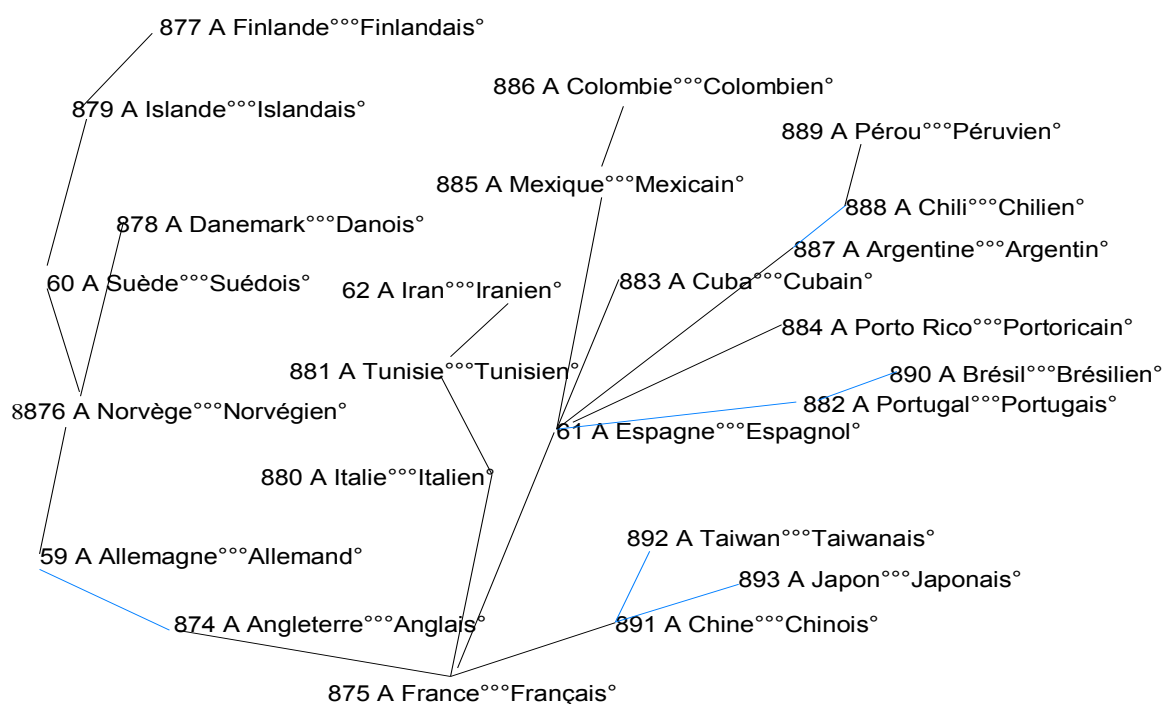

Figure 38 Country names and inhabitant names

The progression towards a greater (or equal) familiarity applies in case a paradigm is exploited by crossing a paradigmatic link. It does not apply upon resetting, even if the resetting operates within a single paradigm. For a good reason: in case of resetting, increase/decrease of familiarity cannot be defined, cf. notably section 13.4.7. *What turns out with familiarity orientation after transposition*, (p. 327). More generally, familiarity is not defined in a plexus as a measure; more weakly, it is only a partial order on the records of a paradigm. It should also be noted that the difference of familiarity is not defined for the terms themselves. Thus a same term may occur in various records each with very diverse familiarity hierarchisations.

### 12.8.3. Proximity and contingency of familiarity orientation

Familiarity orientation is proximal and has value instantaneously in a speaker's history. Its configuration varies and adapts along the linguistic and cognitive history of the subject, or of the views generally accepted at a given moment in a society of subjects. Early in the 20<sup>th</sup> century, Bohr's atom was made understood with the help of the solar system and not the contrary, but in 2002.

This [the disturbance of G7 meetings by street action] shows to what point the electrons of the public opinion may influence international affairs<sup>355</sup>.

---

<sup>355</sup> Bertrand Badie, Institut d'Etudes Politiques, Paris, speaking on the radio, 10-12-2002.

The "less familiar" Bohr's atom now became familiar enough to help explain something else. So is it for the linguistic terms and the inscriptions in which they occur. It is not granted that the relative familiarities which instantaneously apply in a young learner will remain stable in future. Their change has a part in the change of his linguistic knowledge.

#### 12.8.4. Familiarity orientation alleviates computations without sterilising them

It is interesting to appreciate the incidence of familiarity orientation on the model's behaviour. The same test set as in Chap. 6 is used, each test form is analysed twice: without and with familiarity orientation.

The table below displays i) the computation phase for which a first abductive attestation is obtained for the whole form, ii) the number of agents required, without familiarity orientation and with it, iii) the number of products, including in these figures all computation intermediates. The numbers of agents and of products may be taken as indications of the computation cost.

test form	phase without/with	nb of agents		nb of products	
		without/with	gain	without/with	gain
1 <i>un très grand jour</i>	2/2	393/311	20%	337/287	15%
2 <i>une très grande maison</i>	4/5	1693/1443	15%	1665/1576	5%
3 <i>séjour de vacances</i>	2/4	445/547	-23%	423/674	-59%
4 <i>bon séjour en France</i>	18/18	2996/1613	46%	3582/2083	42%
5 <i>elle est arrivée avec son homme</i>	6/4	1765/1044	40%	1870/1112	40%
6 <i>elle est arrivée avec son homme et son cheval</i>	10/7	3034/1898	38%	3225/2000	38%

Table 23 Compared tests, without and with familiarity orientation

From these results, two conclusions and a conjecture are drawn:

a) When a solution was found without familiarity orientation, with the orientation one is still found. As the orientation amounts to suppress certain resources from the plexus, since certain links can no longer be crossed, it was wise to check that its introduction does not impoverish the productivity. This impoverishment does not happen, which means that, before the orientation, new utterances already tended to be licensed by 'more familiar' inscriptions. The plexus' descriptor (who is the author of this work) had this good intuition, even before orientation was thematized.

b) With orientation, the computation which finds the solution is cheaper by 20 to 40% depending on the case. In one case only is the performance less good: an exemplarist inscription was missing, which required longer resolution paths. Such a phenomenon may happen in a plexus as that which was used and which may feature weak coverage of certain linguistic facts.

c) It is conjectured that this economy, significant but modest after all, becomes critically more important, first with the increase of utterance size (about ten morphemes only in these tests) and then, with the increase of plexus size.

The latter point is very important. If a paradigm is seen as a disk, the part of it that a computation uses with the orientation nears a radius. Without it, it tended to be the entire surface of the disk. The cost function, polynomial before (maybe cubic), now becomes linear (maybe logarithmic) only (the ideal would be a constant).

### 12.8.5. Familiarity orientation, coincidence and distortion

It is fortunate that familiarity orientation presents good effects, because it reduces the computation cost, but above all because it is cognitively founded and gives a sound vision of a certain asymmetry<sup>356</sup> in linguistic dynamics.

Perhaps it also provides a theoretical reception to a question raised by Milner: what he calls coincidence and distortion (distortion is non-coincidence). The question holds an important place in Milner 1989.

In the theoretical apparatus, inherited from the first generativism, with modifications, which Milner adopts for syntax, two notions play a central role: categorial label and positional label. The "individus de langue" have a categorial label; the syntactic positions have a positional label. When the position is occupied by an "individu de langue" with a categorial label that is compatible with its positional label, the occupation is coincident; otherwise it is non-coincident, it is a distortion.

In certain positions, certain categories are expected. Only with respect to this expectancy may there be distortion<sup>357</sup>.

The lag may be graded, there are degrees to distortion. Marandin renames distortion "heterocategoriality".

Heterocategoriality (distortion) constitutes a general organizational principle. Its modes of realization vary across languages (English and French differ much in this respect), across different states of a language, and in all likelihood across language levels<sup>358</sup>.

The 'positional paradox', is doubled with an 'argumental paradox':

When, in direct positional paradox, a term presents positional properties in a position which does not ascribe positional properties, in the argumental paradox (or indirect

---

<sup>356</sup> Linguists used "asymmetry" in several different meanings : 1. asymmetry of speech organs (Martinet 1955), asymmetry of auditory and articulatory organs (Laks 1993, p.15-16). 2. asymmetry in the sense that A determines B without B determining A, for example, an adverb requires a verb but a verb does not require an adverb (Bazell 1949), which is also the *autonomy-dependency asymmetry* (A-D asymmetry) of Langacker : *In a grammatical construction, the relationship between an autonomous component and a dependent component.* (Langacker 1987a, p. 485). *In [UN-DRESS], [UN] is dependent and [DRESS] is autonomous.* *ibid.* p. 313, 3. Finally, cognitive asymmetry, that of Aristotle and that of the psychologists, for example of Eliasmith already quoted. It is this third type of asymmetry which is envisaged here. We shall see that it is also that of Milner.

<sup>357</sup> Milner 1989, p. 369.

<sup>358</sup> Marandin 1997, p. 156.

positional paradox), a term presents argument properties in a position which normally receives no argument<sup>359</sup>.

How is this intuition of coincidence to be founded, what is its anchoring point, what is going to set this in relation of mutual necessity with other terms of the theory? The response is as follows:

The options taken by a theory for determining what structures are coincident depend on empirical decisions<sup>360</sup>; in a given language, one may consider that the descriptions may roughly agree on what they will consider as 'normal' structures and analyses, distinguished from 'marked' ones<sup>361</sup>.

Coincidence is not associated with any other reason or foundation. Is coincident what one agrees to find normal; the rest will be marked, that is, a distortion.

In the strictly non-categorical approach defended here, nothing of all this should cause too much worry: without the assumption of categories, positions – if positions at all – have no category, thence there is no coincidence or distortion either.

However, phenomena which the coincidence-distortion theory attempts to account for are to be observed: there is a difference between *le parler vrai* (literally: *the true speak(ing)*) and *le discours sincère* (literally: *the sincere discourse*), and simultaneously a similarity. They present a constructional similarity but speakers will agree to find the latter constructionally more familiar and the former less so.

The proposition is, soberly, to acknowledge this judgement, shared by speakers of French, with two C-type records:

- |      |                                |                              |
|------|--------------------------------|------------------------------|
| (C1) | <i>le + parler + vrai</i>      | → <i>le parler vrai</i>      |
| (C2) | <i>le + discours + sincère</i> | → <i>le discours sincère</i> |

between which a link makes C1 less familiar than C2. In order to understand the infinitive construction (C1) the computations may call on the nominal construction (C2) but not the other way round. The model of this speaker ratifies this fact, that most speakers of French probably share today, that the exemplarist infinitive construction *le parler vrai* is possible, that its meaning effect is the same as that of the exemplarist nominal construction *le discours sincère*, but that it is less common and less familiar<sup>362</sup>. One should also note the terms *discours* and *sincère* are not mandatory in C2; exactly the same effect might be obtained with:

---

<sup>359</sup> Milner 1989, p. 450.

<sup>360</sup> What is an 'empirical decision'?

<sup>361</sup> Milner 1989, p. 551.

<sup>362</sup> I indulged myself to write "nominal construction" and "infinitive construction". The alert reader has corrected of course, the difference of familiarity does not hold between abstract constructions but, here as elsewhere in this work, between exemplars. In another area of the pleus, the condition may be the opposite one. For example, for a given speaker, *le manger* may be more familiar than *la nourriture*, *le laisser-aller* than *la négligence*, the former licensing *le boire* and the latter *le laisser-faire*. Here, we touch the question of "semi-productivity" (Jackendoff 2002, p. 157-162), acknowledging the locality and the contingency of inscriptions and computations would be a way to account for this.

(C3)	<i>le + comportement + honnête</i>	→ <i>le comportement honnête</i>
(C4)	<i>le + comportement + maffieux</i>	→ <i>le comportement maffieux</i>
(C5)	<i>le + tendance + dure</i>	→ <i>la tendance dure</i>
	etc.	

provided that elsewhere in the plexus, other inscriptions provide for the necessary co-categorizations.

The orientation, the asymmetry, which is advocated here, does not hold for all viewpoints simultaneously. This can be illustrated still on the same example, (2) is more familiar than (1) and so acts as "kernel" for (1), however, *parler* is more familiar than *discours*, and *vrai* is more familiar than *sincère* and therefore, what acts as a kernel construction-wise and what acts as a kernel term-wise are not the same things, in this particular case, it is exactly the contrary, whence there is not in a plexus a centre which would be central in all respects. It is possible to select utterances which present a maximum familiarity in all respects: certain books for the pedagogy of foreign languages try and do this in the first lessons for the comfort of students, sometimes painstakingly, and the result is often not tempting. But in real language practice things are different: in a same utterance, the different elements have in general quite diverse familiarity orientations.

## ***12.9. Overall properties of a plexus***

So far, individual or local properties of records and paradigms were exposed. In a plexus there are also more global properties which concern an entire paradigm or several paradigms together.

### **12.9.1. Plexus: volume, representativity, validity**

Formally, a plexus is a set of A-type records and C-type records among which paradigmatic links are established. From the nature of paradigmatic links as defined in Chap. 3, it follows that a plexus may also be seen as a set of analogies, systemic analogies (A-type records) or structural analogies (C-type records).

To provide a base of appreciation, here are the volumes of a few plexii that were used (in bold, those which support the experiments reported in chapters 4 to 7).

A plexus is the static model of a linguistic knowledge. The linguistic knowledge inscribed in a plexus is supposed to be that of a speaker, so one expects to have several plexii of a same language: frenchSpeaker1 and frenchSpeaker2 for example. This would allow us to demonstrate variation in the realization of the same linguistic acts. This is not yet done: validating and improving the general schemas of inscription and computation was deemed a higher priority; for example in order to treat more adequately agreement and other long-distance dependencies, or group effects, as was reported above. However, I am confident that, when a sufficient level of functionality will be generally acquired, it will be quite simple to alter the detail of inscriptions to obtain variant behaviours. This, which is a hard question for category and rule-based theories, and which take a language as their object, is inherent and easy in this model.

The plexii in the table have limited sizes. In order to near the real knowledge of a speaker, if we limit ourselves to day-to-day language, excepting speciality jargon, if we start on 5,000 lexical bases, 20,000 to 30,000 terms are needed because the bases must be complemented with morphemes, semi-lexicalized forms, inflected forms, derived forms, conjugated forms (some of them only, the other ones are built following the model's productivity), longer syntagms, etc. These forms are as many terms. The records will be in the range 15,000-25,000 if we extrapolate the ratio which seems to emerge as a trend in the table. It appears then that, in the plexii that were used, the French plexus alone has a beginning of numerical representativity. Must we fear risks or methodological biases in working with too small plexii? No in a sense: a plexus, even small, is a source of experience useful for testing and improving the model. No also, because there is a compartmenting effect owing to the proximity of the inscriptions and of the dynamics. Rules by contrast are dangerous because they are too powerful and their applicability is too far-reaching. Those who use rules complain about their fragility and the instability of rule-based systems over a certain size.

	<i>number of terms</i>	<i>number of records</i>	<i>number of para- digmatic links</i>
<b>French plexus</b>	<b>1863</b>	<b>1270</b>	<b>2151</b>
Japanese plexus	401	304	410
<b>English plexus</b>	<b>188</b>	<b>96</b>	<b>158</b>
German plexus	77	31	52
Italian plexus	42	25	28
Basque plexus	18	11	8

**Table 24** Statistic of some plexii

Yet, there are reasons owing to size effect; we must verify on voluminous plexii that performance does not collapse with size increase. Moreover, occurrentialism and the making of compartments also play in the reverse sense: we may find phenomena in time adverbs which are to be found neither in other adverbs nor in other linguistic devices associated with temporality, like verbal tense. In short, we must remain cautious with excessively sampled validation.

## **12.9.2. Pluridimensional systems and single-dimensional inscriptions**

### ***12.9.2.1. Linguistic paradigm, system, dimension***

The question of linguistic systems (in the precise sense of pluridimensional tables) was introduced p. 129 in the context of the systemic productivity and of its explanation. This question is now addressed again in view of how these systems can be inscribed in a plexus with restricted means (analogy is single-dimensioned in a sense which we will see), despite their richer structure (they are pluridimensional).



The morphology of the French verb – this also holds in Romance language, in German, in Russian, etc. – is a three-dimensional system: tense-mode<sup>363</sup> • {singular, plural} • {person 1, person 2, person 3}<sup>364</sup>. In effect, an inflected form, if we limit ourselves to the dominant canonical frame and discard the syncretism of the forms (which is addressed p. 160), the infinitives and the imperatives, is determined by the conjunction of these three data. This is what *three-dimensional system* means: it is subject to three independent determinations.

The construction Det + N → NP in French, if we limit it to defined determinants (articles *le, la, les*), may be seen as an analogy between N and NP. The notion of dimension can be extended to this system and it has to be seen as one-dimensional because the determined form, the NP, is entirely identified by giving the N, that is by one data only. This extends the notion of dimension to the one-dimensional case; if we consider this construction in isolation, speaking of dimension about it is not very interesting, but accepting to do it generalizes nicely the notion of dimension and we will need this below.

An agglutinative morphology in turn can be analysed along these lines as a system with a high number of dimensions. In the Japanese verbal system, there are nine to twelve depending on the possible variations of the analysis and on the extension given to the 'verb phrase'. It seems that in the case of Turkish (cf. Hankamer for example) there are even more, but the morphology of Turkish comprises in a same system not only the verb but also other lexical classes because Turkish presents a morphology of the 'translation' (in the sense of Tesnière, that is of the change of lexical class) which is very productive and systematic: a verb can be inflected, then nominalized by affixation to this first result, and to this second result casual or derivational affixes may be appended giving a new result which may in turn undergo 'translation', etc.

This vision of the dimensionality of morphological systems is compatible with that of Demarolle (1990) already quoted. Recognizing dimensionality in this way is useful because it helps understanding the question of multiple analogical ratios. A pair of terms, candidate to enter into analogies, will be subject to as many analogical ratios as there are dimensions in the system in which the terms of the pair belong.

### ***12.9.2.2. Multiple ratios***

I introduced p. 63 the idea that a pair of terms may have several analogical ratios associated with it. This is the case in verbal paradigms, be they integrative or agglutinative, as has just been seen, and also in the articles in French, in morphological systems with double marking (gender and number for example), etc.

Now the inscription structure postulated in this model: the paradigm, which will be called "plexus paradigm" to distinguish it from the "linguistic paradigm", is not directly pluridimensional. This parsimony of the base model is intended; it is rooted in the

---

<sup>363</sup> I adopt Maurice Gross's conception : ... *our utilization of the traditional terminology for the different tenses and modes makes reference to the morphological properties only. In fact we found no base which would allow us to establish, for the different verbal forms, a distinction between tenses and modes; we call them all tense-mode, or more simply tense.* Gross 1968, p. 10.

<sup>364</sup> The • symbolises the Cartesian product operation.

presumption that neurons can implement analogies between couples of oppositional pairs, that is, similarities of differences, but they cannot directly implement pluridimensional structures. Plexus paradigms are one-dimensional chains (this is something different than the possibility for them to have ramifications or cycles) and not pluridimensional structures.

The *a priori* refusal to reify the pluridimensional analysis frame to assign the rendering of multiple dimension effects to analogy not only makes a step toward plausibility, but it also favours a better account for the accidents of the frames: defectivity, syncretism, "parochial" subsystems" with "collapsing" of entire areas in the verbal paradigms of Walmatjari<sup>365</sup>, etc.

There is another claim: the model has also the potential to render these effects in their contingency. To that end, it has to:

- i) sample diversely the linguistic paradigms by plexus paradigms which are integrative.
- ii) make the most of the plexus paradigms through computational mechanisms which are able to integrate them.

Point ii) is implemented principally by agent ANZ which was introduced in Chap. 5 and is specified formally in an appendix below.

Point i) was introduced with an example p. 139 and the rest of this section shows different sets of such integrative plexus paradigms, in the case of a linguistic paradigm with multiple dimensions. The example is taken in the Japanese verbal syntagm which is richer in this respect than an Indo-European verb.

The following sections display schemas which suggest how it is possible to set integrative plexus paradigms to account for of pluridimensional linguistic paradigm effects.

For clarity, the same pair is always used, that is, the same vehicle; it takes place within two plexus paradigms the ratios of which are different, the ratio in question being determined by the vehicle plus a third term. Practically, when describing a plexus however, it is not obligatory that the same pair be literally occurring in two such paradigms because other integrative properties may make this non necessary.

### 12.9.2.3. *Pair da-desu*

The pair opposition is non-polite-polite in both cases.

First plexus paradigm: the base varies (copula, *miru*, *yomu*), the aspect is constant (non-accomplished).

non polite	polite	
<i>da</i>	<i>desu</i>	be, copula
<i>miru</i>	<i>mimasu</i>	look
<i>yomu</i>	<i>yomimasu</i>	read

---

<sup>365</sup> Lemaréchal 1998, p. 61 et seq.

Second plexus paradigm: the aspect varies (non-accomplished, accomplished), the base is constant (copula).

non polite	polite	
<i>da</i>	<i>desu</i>	non accomplished
<i>datta</i>	<i>desita</i>	accomplished

#### 12.9.2.4. Pair *da-datta*

The pair opposition is non-accomplished-accomplished in both cases.

First plexus paradigm: the base varies (copula, *taberu*, *iru*), the politeness is constant (non-polite).

non accomplished	accomplished	
<i>da</i>	<i>datta</i>	be, copula
<i>taberu</i>	<i>tabeta</i>	eat
<i>iru</i>	<i>itta</i>	be there, stand (animate)
etc.		

Second plexus paradigm: politeness varies (non-polite, polite), the base is constant (copula).

non accomplished	accomplished	
<i>da</i>	<i>datta</i>	non polite
<i>desu</i>	<i>desita</i>	polite

#### 12.9.2.5. Pair *desu-desita*

The pair opposition is non-accomplished-accomplished in both cases:

First plexus paradigm: the base varies (copula, *kau*, *taberu*, *yasui*).

non accomplished	accomplished	
<i>desu</i>	<i>desita</i>	be, copula (polite)
<i>kaimasu</i>	<i>kaimasita</i>	buy (polite)
<i>tabemasu</i>	<i>tebemasita</i>	eat (polite)
<i>yasui desu</i>	<i>yasukatta desu</i>	be easy (polite)

Second plexus paradigm: the copula is here in both cases, what varies is that it is alone in the first three records and it receives a prefixed adjective in the fourth one. The morpheme of accomplished is borne by the adjective<sup>366</sup>. In the fourth record the copula bears the morpheme of the polite register.

non accomplished	accomplished	
<i>desu</i>	<i>desita</i>	be, copula (polite)
<i>omosiroidesu</i>	<i>omosiroidesita</i>	be interesting (polite)

Third plexus paradigm: what varies is the base but with a change in lexical category (copula in the first record, na-Adj in the second one).

---

<sup>366</sup> In Japanese adjectives are conjugated.

non accomplished	accomplished	
<i>desu</i>	<i>desita</i>	be, copula (polite)
<i>sizuka desu</i>	<i>sizuka desita</i>	be quiet (polite)

## ***12.10. Topology, connectivity, influenced proximity***

### **12.10.1. Plexus paradigm topology**

Paradigms have no centre, no privileged record. A paradigm has nothing coming close to reification: there isn't a representative of which it might be said for instance *here is where the notion of number (in English or in German) is concentrated* or *here is where the construction Subject-Verb-Object is concentrated*. On the contrary, each of its records is linked with other records by a small number of paradigmatic links: from one to six to give an order of magnitude. The mean value and the variance of these numbers is a question of tuning the model and maybe not a very important one.

Paradigms do not encompass a centre, however, the paradigmatic links being oriented by the familiarity orientation, it is possible to arrange a paradigm so that a group of records plays a central role in it: they are much accessed from other records and conversely, starting from them, the dynamics do not reach other record often. In a cognitive perspective, and particularly in an acquisitional one, these records are the analogs of the primordial acquisitions. They may form a quasi-centre, but diffuse; a quasi prototypal area.

So, the records of a plexus paradigm form a graph; in it, some pairs of records are close, other are distant. That a linguistic paradigm should have to be echoed by a single plexus paradigm (a connected graph) or on the contrary by several ones (several internally connected parts, but without link among them) is an open question, and, it seems to me, not a very important one: counter-intuitively in some measure, the ability of a plexus to serve abductive computations does not depend on the complete connectedness of the plexus paradigms; this is principally because of the integrativity of the model. Moreover, as this was explained at the beginning of Chap. 5, since a verb system, for example, is questioned as an antecedent linguistic structure, it is not even desirable that it be echoed by a plexus paradigm that would be single and systematic.

### **12.10.2. Influences determining proximity**

In a plexus paradigm, questions of closeness and remoteness matter because this is how the proximity of the model – introduced and defined in Chap. 1 then complemented in Chap. 3 – is implemented. All records having among them paradigmatic links belong to a same paradigm but some are proximal to each other and other ones are not. This notion is particular to this model and is not to be found in numerous other approaches, except in some connectionist models which may be said to encompass it in a way.

Paradigmatic proximity may be influenced by conditions that are different from those commanding the placement of the record in the paradigm. The influences may have diverse natures. In the gender paradigm in French, we expect to find pairs (le, la) and (un, une) close together and close also of the determinants (ce, cette). Elsewhere, the grouping may favour records concerning animals, motion, abstract terms, lexemes or

expressions concerning the same address level, words the plural of which is not marked, etc. The influence on the grouping is an influence only and the grouping logic may change within a same paradigm.

Preferred groupings (for example those of the articles in a gender paradigm) complement but do not replace other means, more 'structural', whereby the 'category' *article* is implemented in the plexus: i) analogies which are proper to these words and ii) their distribution such as manifested by the C-type records. These are orders of facts external to the paradigm which influence the proximity in it.

The processing of a linguistic task that encompasses *number* is accelerated when the exploited paradigm has a proximity influenced by this category. The paths to be taken are shorter; the reinforcement effects quicker, better synchronized and therefore stronger and more prevailing. These favoured paths produce winning results. In common language experience, the most common tasks benefit from this influence and so are economical for the speaker. A less common task benefits less from them, it does execute however, but its execution is more expensive.

An extreme case of influence is that which was encountered in section 4.3. *John is too stubborn to talk* (p.112); the influence in this case is rather a negative and dissociating one: two different – and unlinked – paradigms are made, with records that discord on agentive roles, even if they might seem to be connectable if we were to satisfy ourselves with a vision of their similarity that would be formal only.

Examples on how to accommodate syntactic ambiguity and multiple analysis in the plexus are now going to be provided.

### ***12.11. Syntactic ambiguity: example***

In the case of syntactic ambiguity it is appropriate to make one C-type record per interpretation and to place each in a paradigm with other records. The other records had better not be all ambiguous because if they were, the model would have no base to behave in a differentiated manner in the computations.

Example: *Pierre m'a parlé de lui*<sup>367</sup>

The ambiguity resides in the fact that *lui* may refer to *Pierre* or may be a deictic or an anaphoric referring to some other person.

*Pierre m'a parlé de lui.*

*Pierre m'a parlé de lui.*

*Pierre m'a parlé de Pierre.*

*Pierre m'a parlé de X.*

To accommodate this, make the following two paradigms:

---

<sup>367</sup> Ducrot 1972, p. 360.

C	<i>Pierre</i>	<i>m'a parlé</i>	<i>de lui</i>	<i>Pierre m'a parlé de lui</i>
C	<i>Elle</i>	<i>se parle</i>	<i>à elle-même</i>	<i>Elle se parle à elle-même</i>

Peter talked to me about himself / She speaks to herself

C	<i>Pierre</i>	<i>m'a parlé</i>	<i>de lui</i>	<i>Pierre m'a parlé de lui</i>
C	<i>On</i>	<i>m'a parlé</i>	<i>des affaires</i>	<i>On m'a parlé des affaires</i>
C	<i>Ma banquière</i>	<i>veut me parler</i>	<i>de placements</i>	<i>Ma banquière veut me parler de placements</i>
C	<i>Tout</i>	<i>me parle</i>	<i>de toi</i>	<i>Tout me parle de toi</i>

Peter talked to me about him / Someone talked to me about the affairs / My banker wants to talk to me about investments / Everything reminds me of you

In a production task, among the two paradigms, one only will be used: that which is more activated by the data which specify the utterance to be produced.

In a reception task, both might be used – along with other paradigms, foreign to this syntactic ambiguity – and one only will license the winning interpretation; it will be that which is more congruent with the complementary data, if some is available, and if it is discriminant in this. Depending on this, the ambiguity might prolong further.

### 12.12. Multiple analysis: examples

Even in the absence of syntactic ambiguity, a term may have several analyses. It is good to give a term several analyses when the first one maps it onto certain records and the second onto other ones. This amounts to recognize the term as pertaining to several constructions. In other words, the speaker processing this term is able to make several structure mappings (Gentner 1989). Examples will show this more clearly.

#### Example with factitive: Fr. *il fait marcher ses affaires*

First analysis

	S1	S2	S3	S4
C	il fait	marcher	ses affaires	il fait marcher ses affaires
C	je laisse	aller	les choses	je laisse aller les choses

He runs his business / I let things go

Second analysis

	S1	S2	S3	S4
C	il fait marcher	ses affaires	(empty)	il fait marcher ses affaires
C	il mène	sa barque	(empty)	il mène sa barque

He runs his business / He manages his affairs well

**Example: En. *unlawfully***

In the example *unlawfully*, "most analysts would bracket as follows: [[un[[law]ful]]ly]<sup>368</sup>".

The proposition is that *lawful* certainly must be assembled first, but then, for *un-* and *-ly*, each may be assembled first and then the other, or both at the same time; altogether there are three possibilities and the brother records with which the paradigmatic mapping may take place suggest why each may be interesting.

First analysis: modification of an already assembled adverb:

S1	S2	S3	S4
C very	fast	(empty)	very fast
C very	explicitly	(empty)	very explicitly
C un-	lawfully	(empty)	unlawfully
C most	decently	(empty)	most decently

Second analysis: adverbial derivation of an adjective which is negative already, or detrimental:

S1	S2	S3	S4
C unlawful	-ly	(vide)	unlawfully
C coward	-ly	(vide)	cowardly

Note that the adjective is negative either intrinsically (*coward*) or by derivation from a positive one (*unlawful*).

Third analysis: modification and adverbial derivation in a single construction:

S1	S2	S3	S4
C un-	lawful	-ly	unlawfully
C non-	explicit	-ly	non-explicitly
C very	explicit	-ly	very explicitly
C counter	clock	-wise	counter clockwise
C counter	intuitive	-ly	counter intuitively

The reasons to choose one or several of these analyses are flexible ones: a) they are not absolute, b) they may vary from lexical entry to lexical entry, and c) they may vary from plexus to plexus.

Another theory might consider it must make a uniform choice in this. A generative grammar for example, should have to decide what generation tree rules the formation of "unlawfully" and similar words; there should be one only and it should apply to all members of the same lexical category. Here, so rigid and so uniform a prescription has no reason to be.

---

<sup>368</sup> Langacker 1987 p. 307.

## 13. Appendix: Specification of the abductive movements

This appendix bears on the bases of the dynamics which the four abductive movements are. It complements the data provided in Chap. 3.

### *13.1. Abductive movement by transitivity*

For the sake of completeness only: the subject is covered in section 3.6.2. (p. 83).

### *13.2. Abductive movement by constructability transfer*

The notion was introduced, section 3.6.3. *Abductive movement by constructability transfer* (p. 84). It is now going to be formalized and criticized.

#### **13.2.1. Semi-formalization of constructability transfer**

Let C1 be a constructor plexus paradigm, P1 one of its positions, T1 the set of terms occupying P1. Idem C2, P2, T2 and let t be a term belonging both to T1 and T2 (the 'bi-occurrent' term).

Definition of the abductive movement by constructability transfer: Because t is bi-occurrent, any element of T1 **may abductively occur** in P2 of C2.

In other words: if two positions P1 and P2 of two paradigms are occupied by a same term, any homolog of the term in one of the positions **may also abductively** be its homolog in the other position.

In other words again: when a term occupies a position in a constructor paradigm and another position in another paradigm, its homologs in the former **may abductively** become its homologs in the latter.

For a given bi-occurrent term, what makes that this possibility will actually occur, that the constructability transfer will take place or not? Firstly, it is a question of need: not for all homologs in C1 of the bi-occurrent term does the need to be built into C2 arise. A constructability transfer being possible does not incur that it is necessary or useful. The push to operate the transfer is subjective, that is, it proceeds from the speaker and from no other instance: this is up to where it has to go, it is not enough to say semantic, pragmatic, cognitive. But when we say 'subjective', we comprise these three things and other ones in addition.



Secondly, it is the quality of the result: a constructability transfer being possible does not incur that its result is felicitous in all cases. The construction must in addition be free of defects of all kinds (phonological, semantic, garden paths<sup>369</sup>, interpretation difficulties). The quality of the result is computed before enunciation, the speaker anticipating by simulation the possible effect of the planned utterance on the interlocutor; alternately, the issuer realizes it afterwards, by perceiving how (un)successful the utterance was.

Constructability transfer is used by process B2-B3 which analyses a linguistic form and was exposed in Chap. 4.

### **13.2.2. Critique of constructability transfer**

The potential objection is evident: this abductive movement is too loose, it can let happen about anything and it will be easy to bring out examples among those which initiated the question of sub-categorization. But it must be reminded that this question holds in a categorial frame only.

In the adopted frame, the response cannot be a 'demonstration' of the adequacy or not of constructability transfer thus defined, because it will not be possible to 'characterize' its shortages in the first place.

First, we shall answer that speakers spend their time producing 'deviating' utterances; they spend their time soliciting the resources of their linguistic knowledge, that is, pulling them a little aside from attested uses. A very deviating utterance getting analysed by the model is not important finally if it is never produced in any situation. We are not going to begin bounding grammaticality.

We will also ask to take account of proximality, against the centralism of the rule (and the resulting efficiency loss). The rule (with the category) deprives proximal processes of the benefits of proximality, that is, of the freedom to do the best with portions of the knowledge that are most congruent with the terms of the task. When these latitudes are reinstated, many difficulties disappear which are just side effects of regularism.

We shall also observe that, within the current perimeter of the model which covers meaning very little and pragmatics not at all, some accidents happen which are due to this lack of coverage. They would be corrected upon an extension of the model.

Finally, we will grant that the current C-type record follows too simple a schema which does not yet capture enough similarity, or not always the right one.

### ***13.3. Abductive movement by expansive homology***

The abductive movement by expansive homology was introduced p. 85.

---

<sup>369</sup> A garden path is the situation in which a syntactic ambiguity leads to opt for the interpretation solution which looks the simplest one at first sight (for example following the minimal attachment clause of Janet Fodor), thus minimizing the cognitive load, but when this analysis is contradicted by the rest of the utterance, which imposes a different interpretation, the one which was less preferred initially. Example in spoken French: *Jean qui va passer son baccalauréat a la fin de l'année... gâchée par les révisions* (the example is from Ligozat 1994, p. 20).

Expansive homology is not a primitive: if an axiomatic and deductive approach was taken – this is pure counterfactual as the general character of this work is not such – we would deduce it from the movement by transitivity and from the movement by constructability transfer, in the inscription configurations which lend themselves to it, that is, those in which a term and its expansion (or some of their distributionally similar terms) are homolog. In this, expansive homology is different from the three other abductive movements: none can be made a consequence of the other ones. Whether expansive homology is made a 'theorem' or is taken as an 'axion', it has sufficient importance and dignity to be described in particular. This is why the phrase 'abductive movement by expansive homology' is used. Because of its importance, this abductive movement was described in some detail in the section quoted above and there is no further complement to add.

### ***13.4. Abductive movement by transposition***

The abductive movement by transposition was introduced p. 87. Here, we will investigate in detail the validity of analogy transposition, find it imperfect, fail in an attempt to characterize the imperfections, assess the incidence of this imperfection on the abductive movement by transposition, and conclude that the movement is dependable nevertheless.

#### **13.4.1. Principle of analogy transposition**

The abductive movement by transposition is schematized by:

$$X : Y :: A : B \rightarrow X : A :: Y : B.$$

From the former analogy the latter is abducted which is the 'transposed' analogy (terms Y and A are simply swapped).

Currently, transposition is used by agent ANZ which was described in Chap. 5 (p. 129). Therefore it is important to examine when analogy transposition is valid. The investigation of a set of examples showed that sometimes it is the case and sometimes not. Seeking a mathematical demonstration or refutation would be moot: analogy is underspecified and cannot be defined mathematically.

Thus the abductive movement by transposition works most often but not always. For example it works well in the French articles and in the verb paradigms of Indo-European languages. It also works well in the Japanese verbal syntagm. Therefore, it absorbs an integrative morphology and an agglutinative one as well.

#### **13.4.2. Transposition of "linguistic" analogies**

Informally, and for local purposes, 'linguistic analogies' are ones in which the placement of forms in language paradigms prevails on the referent or on the meaning effect; the opposite cases being called 'cognitive analogies' below. This is just a classifying measure and the demarcation between the two classes is not sharp.

### **13.4.2.1. French articles → transposable**

(a) le : la :: un : une

(a') le : un :: la : une

In (a) the vehicle and the topic are the ratio that grammarians analyse as masculine-feminine. In (a') the vehicle and the topic are the ratio that grammarians analyse as defined-undefined. This transposition operates well.

### **13.4.2.2. le : la :: homme : femme → transposable**

(a) le : la :: homme : femme

the (masc.) : the (fem.) :: man : woman

(a') le : homme :: la : femme

As previously, in (a) the vehicle and the topic are the grammatical gender. In (a') the vehicle and the topic are the move from the definite article to the name of the exponent of the human species with the same grammatical gender as the article, and conversely. Curious as this clause may sound, these ratios are precise and good, they are biunivocal (cf. p. 63); the proportional fourth is well determined in all senses and this transposition operates well.

### **13.4.2.3. l'un : l'autre :: celui-ci : celui-là → transposable**

(a) l'un : l'autre :: celui-ci : celui-là

one : the other :: this one : that one

(a') l'un : celui-ci :: l'autre : celui-là

In (a) the vehicle and the topic are a relation of rank or of proximity. In (a') the vehicle is not simple to express. One may say that "l'autre" is a quasi-synonym of "celui-là", but this is not a very good expression of the ratio because "le second" is another quasi-synonym and yet:

(a'') l'un : celui-ci :: l'autre : le second

the one : this :: the other : the second/the latter

is not an acceptable analogy, in any case not like (a') which contains something much more precise. Even if the analysis of the ratios is difficult, speakers will often feel that (a') is good, and will often accept it. Overall, it is a mixture of meaning effect and of formal variation which is almost a suppletion, it operates in these two dimensions which interact well. So the transposition is good in this case.

### **13.4.2.4. je : je souhaite :: tu : tu veux → not transposable**

(a) je : je souhaite :: tu : tu veux

I : I wish :: you : you want

(a') je : tu :: je souhaite : tu veux

In (a) the vehicle and the topic are a part-whole relation, a mereologic relation. (a) is an acceptable analogy.

In (a'), for the leftmost pair, the ratio is 1S : 2S whereas in the rightmost pair, it is not this.

Analogy (a): "What is to *je souhaite* as *tu* is to *tu veux*" is good because the answer is univocally determined, it can only be *je*. In the transposition (a') "What is to *tu* as *je souhaite* is to *tu veux*" there is no determination that would be near univocal. This analogy infringes the bijection constraint already discussed p. 63. Thus, analogy (a) does not transpose at all. So is it for all mereological analogies when the part, in the role that it plays, does not determine the whole.

### 13.4.3. Transpositions of arithmetic analogies

#### 13.4.3.1. Arithmetic, sum → transposable

(a) 12 : 9 :: 6 : 3

(a') 12 : 6 :: 9 : 3

In (a) the vehicle and the topic are the addition of 3. In (a') the vehicle and the topic are the addition de of 6. This analogy transposes.

All similar analogies, interpreted as arithmetic sum, transpose. It is so because, (a) can be "interpreted" by  $X - Y = A - B$  whence it follows that  $X - A = Y - B$ , which is the "interpretation" of (a').

I just wrote:

analogy (a) is "interpreted" by  $X - Y = A - B$

that is:

a given concrete, exemplarist analogy is "interpreted" by a given categorical (and symbolic) proposition.

Such a move is not self-evident: "What! You pretend to expel categories and make a symbol-free theory, and you indulge yourself this negligence which contradicts your approach and compromises it. This is not acceptable". The reader may note that "interpret" has quotation marks around it. The intent is momentary only: in an effort to assess the scope of transposability, one might have listed two or three pages of such examples – you would have skipped them – and suggested by abduction that numerous other examples 'worked as well'. Up to where? Up to where a subject with a moderate ability in arithmetic has nevertheless a naive arithmetic knowledge which covers his ordinary needs, and, as everybody, finds it difficult to cope with large figures, a fuzzy and variable frontier. As you are supposed to be educated in arithmetic, this shortcut was proposed but it must be seen as a shortcut only and connivance is asked for it. In particular, the vision which is proposed for interpretation – or understanding – in this theory is not to map exemplarist linguistic forms onto categorical and propositional knowledge; this vision is described elsewhere as an 'immersion' process, cf. p. 263.

#### 13.4.3.2. Arithmetic, product → transposable

(a) 18 : 9 :: 6 : 3

(a') 18 : 6 :: 9 : 3

In (a) the vehicle and the topic are multiplication by 2. In (a') the vehicle and the topic are multiplication par 3. This analogy transposes.

All similar analogies, interpreted as arithmetic product, transpose. It is so because (a) is "interpreted" by  $X / Y = A / B$  whence it follows that  $X / A = Y / B$ , and this is the interpretation of (a').

#### ***13.4.3.3. Arithmetic, exponentiation → non transposable***

(a) 25 : 5 :: 9 : 3

(a') 25 : 9 :: 5 : 3

In (a) the vehicle and the topic are exponentiation by 2, but (a') is uninterpretable. It is not and analogy. Analogy (a) does not transpose.

#### **13.4.4. Transposition of "cognitive" analogies**

Informally and locally, "cognitive", refers to analogies for which the referent of the meaning effect prevails onto the possible placement of forms in a paradigm of the language.

##### ***13.4.4.1. Motherhood → non transposable***

(a) my mother : me :: your mother : you

(a') my mother : your mother :: me : you

In (a) the vehicle and the topic both are the relation between mother and child. First attempt: in (a') my mother and your mother may be sisters, then you and I are cousins (Fr. cousins germains). If we remember that in Catalan 'brother' is 'german', (a') may be accepted if absolutely necessary, but the fact that my mother and your mother are sisters is an assumption proper to (a') and it is not at all necessary to (a). So this transposition holds poorly and only at the expense of an assumption foreign to the direct analogy. Second attempt: in (a'), it is possible to interpret the vehicle and the topic as 'being of same generation' or, more precisely, as 'being of same generation lag'. At this expense, (a') is an analogy. But this expense is somewhat expensive, or to put it in a better way, the yield of this interpretation is poor because (a') understood in this way is devaluated versus (a) which is much more precise. Third attempt: if you and I are enemies, our mothers are enemies. Maybe but numerous other ratios are equally possible; some more context should be necessary to determine this interpretation among many more, which amounts, as in the first attempt, to making an assumption which is foreign to the direct analogy. Finally, in this case, transposition is bad.

##### ***13.4.4.2. cup : Dionysus :: shield : Ares → non transposable***

(a) cup : Dionysus :: shield : Ares

(a') cup : shield :: Dionysus : Ares

In (a) the vehicle and the topic are both in the relation from representant to represented or from signifier to referent or from signifier to signified, or conventional attribute as you prefer.

In (a') the vehicle is not clear, what is the relation between Dionysos and Ares except that both belong to the Pantheon unless one is the other's father-in-law, we should look up from a reference book, but here again, doing that would be introducing data foreign to the initial analogy. The theme (cup : shield) is not clearer generally. This analogy does not transpose. This case does not seem to differ from the next one.

#### **13.4.4.3. Capital cities and countries → non transposable**

(a) Caracas : Venezuela :: Roma : Italy

(a') Caracas : Roma :: Venezuela : Italy

In (a) the vehicle and the topic both are the relation from capital city to country. In (a') the vehicle is a pair of countries between which the relation is not clear (different continents? They are not the only ones in that case. A Latin language is spoken in both? Not characterizing and somewhat poor. And so on. etc. The topic is a pair of cities between which the relation is not clearer. So an interpretation through the ratios gives nothing. In order to make meaning out of (a'), we can try to profile along possible attributes which are shared by countries and large cities: population, pleasure to live, violence, etc. Then it becomes possible to understand things like 'Caracas is 25% less rich than Rome as Venezuela is a quarter less rich than Italy', but numerous other propositions of that sort are also possible. This transposition is bad.

#### **13.4.4.4. "siblinghood" → non transposable**

Assume Alex is my brother and Bea your sister.

(a) I : Alex :: you : Bea

(a') I : you :: Alex : Bea

(a'') Alex : Bea :: I : you

In (a) the vehicle and the topic are both the siblinghood relation.

In (a') the vehicle may be the interlocution relation: you and I we are talking to each other. It might also be any relation between I and you, which would be well established between us but once again this would be calling on data foreign to the proper data of (a). The topic (Alex : Bea) is subject to the same discussion and to the same doubt. This analogy does not transpose.

#### **13.4.5. Characterizing transposability**

We have just seen that certain analogies transpose and other ones do not. Is it possible de characterize this, to find a criterion for it? A characterization effort is always interesting: if it succeeds, it point to something new, a possible structure which authorizes a local reconstruction, more interesting, descriptively and theoretically.

#### 13.4.5.1. 'Linguistic' analogies vs. 'cognitive' analogies

In the analogies which were investigated, the first candidate generalization is that 'linguistic' analogies transpose well while 'cognitive' ones, that is, those which have value from the properties of their referents (including their virtual referents<sup>370</sup>) do not.

This is true most often.

It is false for arithmetic sum and arithmetic product: these analogies are "cognitive" but transposable.

#### 13.4.5.2. Determination of the proportional fourth

The more general criterion would be possibility for three terms to determine the fourth, to determine the proportional fourth.

This phenomenological qualification is not very powerful: it is not far from tautological and cannot be connected with anything else, but it would be in the spirit of analogy.

Now this criterion is false: in the case capital cities-countries, in the direct analogy the proportional fourth is very well determined and yet this analogy does not transpose.

#### 13.4.5.3. Bijection

As in analogy there is something of the order of unique determination, one can think of bijection. But the idea is short because bijection is one application of a set onto another or of a set onto itself, whereas in analogy, whatever the set we can define, there are two applications. This left alone, each needs to be quasi-bijective only and not strictly bijective.

#### 13.4.5.4. Bidimensionality

The generalization which is then suggested is: an analogy is transposable when there is some sort of underlying bidimensionality in it. The four terms are in a bidimensional system, which sometimes is analysed in two features.

In the French articles, the two dimensions are gender and definiteness; usually, both are described by features in formalized grammars.

In the case *le : la :: homme : femme*, one of the dimensions is the gender feature. The other is not clear at all, there is something but we do not know very well how to speak about.

In the case of *l'un : l'autre :: celui-ci : celui-là*, even if they are not usually described by features, the two oppositional dimensions are present indeed but here again, they are difficult to characterize<sup>371</sup>.

---

<sup>370</sup> In the terminology of Milner (1982), **actual reference** denotes the term's referent and **virtual reference** its lexical meaning. A referential term has a virtual reference independently of its usage, but it has an actual reference only in usage context. Only when appearing in an utterance produced by a speaker can one ascribe a referent, an actual reference, to a referential term. Moeschler 1994b, p. 349-350

<sup>371</sup> The case *l'un : l'autre :: celui-ci : celui-là*, also illustrates the fact that dimensions may span few exemplars, contrasting for example with the dimensions of verbal paradigms which span thousands of forms.

In the case 'capital cities and countries', an oppositional axis is precisely the axis capital-cities-countries but for the second one, it is not possible to find anything very clear. It is the absence of a second axis which inhibits the transposition.

It must be noted that bidimensionality may be an excerpt from an underlying system with more than two dimensions. This is the case in verbal morphologies, be they integrative (Indo-European type) or agglutinative.

So, the bidimensionality criterion is not a bad idea, but it is not always possible to characterize the second dimension.

Finally, we found it hard to univocally characterize analogy transposability. This is not a surprise: analogy being underspecified, it does not lend itself to theorizing in itself. What can be approached on the contrary is a theorizing of its operation in an overall dynamics in which it operates with other elements and other mechanisms.

#### **13.4.6. Transposability and movement by transposition**

Analogy transposability which has just been surveyed needs to be considered with transposition movements that take place in agent ANZ (the base element accountable for systemic productivity).

In agent ANZ, the transposition movement is equated with (concomitant with) positioned resetting, that is, with the swapping of the roles of the three running terms, that is again, with the reassignment of their positions. The transposition movement makes a substitution between horizontal pair and vertical pair, trying all possibilities and thus causing the recruitment of a commissioner, when this proves possible. This constitutes positioned resetting.

If the current analogy – that which is associated with the recruiting agent – is such that its transposed analogy is good, this legitimates the transposition movement. What if the current analogy does not transpose? The worry is the risk to transpose wrongly and that ensuing heuristic branches might loose the relation with the initial terms of the task after such a questionable movement. The questionable movement is attempted indeed but it leads to nothing because the pair that characterizes it finds no echo in the plexus: there is no entry for it in the index of analogical pair occurrences. The vision of this index (cf. p. 299) which coindexes only the pairs that play a part in systemic analogies amounts to this: all transpositions may well be attempted; they are productive only for analogical pairs since these only are coindexed.

Consequently, the transposition movement is immune to non-transposability: all transpositions are tried, even the bad ones, but the only successful ones are those for which the new pair is coindexed. This *de facto* filtering discards bad transpositions immediately after their attempt. Agent ANZ is thus functionally very strict despite analogy under-determination, and the restrictions on its transposition.

#### **13.4.7. What turns out with familiarity orientation after transposition**

Before a transposition movement, the recruiting agent is located on a plexus record, and after it, it is located on a new plexus record. What about the mutual familiarities of these two records? The underlying question being: does it make sense that the transposition



movements should observe familiarity orientation? Or: can transposition movements take advantage of familiarity orientation?

The question is licit in principle, but the device's organization makes that it is not posed, or that it cannot be posed. It is so because familiarity orientation is defined on paradigmatic links only; now by definition the transposition movement is a resetting and, like any resetting, it consists of something else than crossing a paradigmatic link. Therefore, the familiarity of the commissioner agent is impossible to relate with that of the client agent. Of a transposition movement, it cannot be said that it moves towards higher, lower, or equal familiarity.

### ***13.5. Solidarity between the plexus and the dynamics***

In this model it is not possible to assess the value of a plexus separately of the computations which use it and, symmetrically, it is not possible to assess the computations separately of a plexus to which they apply; between both, there is an entire solidarity. This places a constraint on the elaboration of the model: it is not possible to work separately on one or the other.

Likewise, it would be void to describe the plexus and its paradigms as a static description without telling how the computations use it. In doing it, one cannot motivate why such link rather than such other one or why such record. It is more convincing to show dynamic effects. For example, agent CATZ used in the suggestion of similarities demonstrates proximal and flexible categorization.

The best that could be done to break the solidarity between the plexus and the computations was to formulate the four analogical abductive movements<sup>372</sup> and a functional notion: the expansive gate. To some extent, they make it possible to make reasoning on either the plexus or the computations while confining the impacts. For example, it is possible to question whether an area of a plexus has the necessary expansive gates. Symmetrically, when designing the computations, it is possible to take as granted in principle that the four abductive movements will be possible without defect in the plexii to which they will be applied, and this can be checked separately in a distinct operation.

But this confinement is far from complete; there remain many effects which still demonstrate interactions that are not entirely circumscribed in the four movements. The abductive movements themselves, this has been explained at length, are subject to comments, restrictions, precautions of application, long-distance effects or delayed effects which make them impure.

As already mentioned, the computation in the model has two functions: a) to model the linguistic computation that takes place in the brain with high parallelism and b) to provide of this process a serial equivalent – to serialize it – so that it can be run on an ordinary computer. The modelling function has scientific relevance whereas parallelization is technical and artifactual only. Ideally, both ought to be separated. If a

---

<sup>372</sup> The four analogic abductive movements are reminded to be: by transitivity, by constructability transfert, by expansive homology, and by transposition.

parallel processor some day became available, the modelling function, being neatly separated, would be the component to implement directly on this processor and parallelization would disappear, absorbed by the hardware.

Unfortunately, in the current state of the proposition, they could not be separated, neither conceptually nor organically. This constitutes a track for future research, but it may also be the case that the separation is not achievable.



# 14. Appendix: Specification of the dynamics

## *14.1. Position and function of ABS in the model*

Agent-based solving (ABS) is a possible implementation of the dynamic side of the model. It was not the only one: there existed a first implementation which was less architected and harder to make evolve ... but with better performance in its limited scope of application. On the other hand, ABS is not the ultimate solution: this component might eventually be replaced with a functionally equivalent one but with a better design, or broader coverage, or any other desirable quality. What matters is not the particular architecture of ABS, but what can be concluded with the experiments it supports. There is no claim that ABS is a reasonable model of brain operation when accomplishing linguistic tasks. ABS is rather a tool to explore questions like:

- the overall integrativity, which potentiates and empowers fragmentary, heterogeneous linguistic data,
- the value of the proposition of proximality (against totalism),
- can linguistic knowledge be limited to the inscription of similarities of differences, that is, does analogy suffice to structure linguistic knowledge or is something more needed,
- does a purely exemplarist and occurrential memory suffice, and if it does not what other model can be proposed for gradient and flexible abstraction and categorization, etc.

ABS may be viewed as performing two functions: a) modelling: ABS implements an inherent model which is a model of linguistic processing by the brain; abundant and converging evidence show that it is highly parallel, and b) serialization: ABS converts the inherent model into a serial equivalent which is indispensable for it to be run on a v. Neuman machine. One might like to see the two functions sharply separated but this is not the case currently; the separation did not arise on its own and was not willingly sought; I do not know whether it is possible.

An element which arose on its own in the course of the design was the distinction between recruiting process and edification process.

This appendix is followed by a few more which treat separately each agent, so it limits itself to the common architecture and the general processes. The description is formal enough to provide for the reproduction of the results; the formality may be at the

expense of pedagogy, for which introductory material and examples were provided abundantly in chapters 3, 4 and 5.

### ***14.2. Requirements for the architecture of the dynamics***

The computation must solve linguistic tasks without being limited to a predefined set of tasks: the architecture must be open because it is a research enterprise. In the general case, a task is implemented by the cooperation of agents of several types; the computing architecture must ensure the interworking of the various types of agents, here again in an open-ended approach: adding an agent must be possible at marginal cost, without incurring a completely new design.

The computation must be integrative: it must integrate the effects of several agents, and it must integrate plexus inscriptions which are sparse and heterogeneous.

The computation must be abductive because it is assumed that linguistic dynamics are abductive.

The products of the computation – intermediate products in particular – are required to be multiple, concurring or competing, thus acknowledging the conclusions of the optimalist current in linguistics<sup>373</sup> – and those of the connectionists – and providing them with an operable support. The products therefore have strengths.

It is also necessary that the computations be time-sensitive to reproduce the time-sensitiveness of real linguistic acts. For example, certain utterances, not necessarily the longer ones, are more difficult to understand than other ones; the cognitive costs differ depending on the cases, and the processing time is longer. The conjecture is that the linguistic knowledge is mobilized piecemeal and gradually.

Finally, the design must be able to evolve, even at the expense of performance, because this is a research tool and it must be possible to explore different ideas.

### ***14.3. ABS is indebted to Copycat***

The elaboration of ABS is indebted towards Douglas Hofstadter, towards the conception of the *workspace* in Copycat in particular. This text was decisive in a conception which resisted. Although ABS is very different finally, it encompasses several ideas freely reinterpreted and adapted. This is an explicit acknowledgement. The following paragraph summarizes the origin text<sup>374</sup>, the ideas of Copycat which have an echo in ABS are marked with a plus (+), and with a minus (-) those which do not.

A construction yard where several teams are at work (+). Several structures of different sizes are simultaneously under elaboration (+). Any structure can be undone to leave room for new ones (-). Initially, the process receives raw data without link between them (+). Small agents (*codelets*) patrol, seeking features of various sorts (+). Items acquire descriptions and are linked following different *perceptual structures* (-). The salience of an object in the workspace depends on its *importance* and its *unhappiness*, this

---

<sup>373</sup> Smolensky 1999 for a summary of the principles, Kager 1999 for a more systematic exposition.

<sup>374</sup> Copycat, The workspace, Hofstadter 1995, p. 216 et seq.

determines the degree of attention which it receives (+/-, the activity control mechanism could be compared). Saliency depends on the workspace (here the heuristic structure) and on the *slipnet* (? there is no recorded knowledge in Copycat, so nothing analogous to the plexus of ABS). An object is more important if its description is richer and has more active nodes (+). An object is unhappy if it has few connections to the workspace (it's the grating gear which receives the oil). Reification (of pairs of neighbouring objects) is the creation in the workspace of links between objects (links of similarity, of consecutivity, of precedence). Links have strengths which vary dynamically: conceptual depth and corresponding activation in the *slipnet* + prevalence of similar links in the neighbourhood (- because in ABS there isn't an analog of the link in Copycat, unless the channel might be seen as a possible analog but this is not very striking).

#### ***14.4. Solving with agents***

A solution which satisfies the requirements above was adopted, it is based on agents<sup>375</sup>. The computation is carried out by the cooperation of a number of agents which belong to defined types. Each agent is vested with a duty. An agent recruits more agents and assign them a duty derived from its own. Agents may be of different types. The model evolves easily by a) adding a new agent type, and b) modifying an existing one. Provided these evolutions comply with the specifications of other agents, complexity is controlled and so is the evolution cost.

This architecture is called 'agent-based solving', in short 'ABS'.

ABS integrates the effects of agents of different types: an agent may recruit commissioners of the same type or of types different from its own. Numerous examples in chapters 4 and 5 illustrate integration effects.

Beside agents are channels. An agent recruiting another agent does so via a channel when the contribution called by the recruitment is syntagmatically determined.

The set of agents and channels such as it develops at a given instant to support a computation is the 'heuristic structure'. In the simplest cases its form is a tree and a lattice in more complex ones.

Schematically, each branch of the heuristic structure is strictly exemplarist: it encompasses a limited number of terms which are exemplars. These terms are strictly copositioned with respect to one another. New terms follow one another at different positions.

The general operation of ABS ensures the preservation of positionality, that is, of the copositionings of the terms which follow one another at defined positions in the course of a computation.

The simplest schema of copositioning conservation is walking through a single paradigm using paradigmatic links. A schema beyond the latter is positioned resetting.

---

<sup>375</sup> The metaphor of economical or administrative agents is deliberate. In addition to Hofstadter, the notion of agent in ABS also owes to the agents of Minsky (1986) : as with the latter, ABS agents are numerous, autonomous, specialised, simple and short-sighted.

Positioned resetting was described in detail in section 7.3.5. *Positioned resetting* (p. 206).

## **14.5. Agents**

### **14.5.1. Agent**

An agent is a short-sighted entity: it has a limited intelligence and a limited perception of its contribution to the process that uses it. It has a duty assigned. To fulfill its duty, an agent considers in the plexus the linguistic data that matches its duty and a) the agent may identify a coincidence and perform a settlement, and b) it may recruit more agents – its commissioners – to help fulfill its duty or prolong its effect.

An agent has exactly one delivery point, which is a channel.

Redundancy control: there may not be two agents with same the type, with the same duty, and delivering at the same delivery point. This clause ensures that, when exploiting a paradigm, a single route will be taken in the paradigm, that is, in the graph which this paradigm is, a tree will be extracted, without cycles and without the same record being reused twice in the same way. However, two agents with the same type and the same duty are possible if their delivery points are different.

### **14.5.2. Agent duty**

An agent has a duty which specifies what is expected from it. An agent duty is made up of one to a few elements; six at most in the current implementation but this limit is contingent. These elements are:

- either term identifiers, that is, term numbers,
- or term occurrence identifiers, consisting of a record identifier plus the site where the term occurs in the record
- or field data: so far field data are the start and the end of spans in a linguistic form under analysis, that is, the rank in this form of the first character and of the last character of segments of this form.

All the components of an agent duty are implemented as numbers referring to the plexus or to a linguistic form under analysis. This is an implementation decision but different ones would be possible, in particular, in a different implementation, segments of linguistic form could be part of an agent duty.

The agent duty is used to watch for settlements, that is, coincidence between it and the data in the plexus that best matches the duty.

It is also used to produce duties for potential commissioner agents. Commissioners with such duties are actually recruited if the non-redundancy condition is observed: no two agents with same type, same duty and same delivery point.

These are general clauses. They are particularized for each agent type, please refer to the particular agent schemas in the appendixes below.

### **14.5.3. Life cycle of agents**

Agents are created either by recruitment, or by the edification process.

In the case of creation by recruitment, upon creation, that is, in the same phase or in the immediately following one, they take, depending on their type and the plexus data matching their duty, one or several of the following actions:

i) unconditional raising of a finding ii) production of a finding conditioned by a settlement, iii) recruitment of more agents. After this, they cease to be directly useful to the computation and they might disappear but they are conserved for the following three reasons:

- a) redundancy control. Lest having a useless and harmful redundant heuristic structure built up, two agents with same type, same duty, and same delivery point must not be allowed; this condition could not be exerted if agents disappeared.
- b) explanation: the analysis of the processes must be possible after their completion, this requires to investigate the agents detail and therefore to conserve them.
- c) measurement: the total number of agents created by a process is a measure of its cost; upon process completion, it must be possible to count the agent.

In case an agent was created within an edification process, the agent may still serve several phases after its creation. So deleting agents is even less advisable in this case.

Agents being made persistent in this way obviously raises questions of plausibility. It would also have an implementation impact if the model were extended to more than a limited linguistic task. This is not directly faced in this research.

## ***14.6. Channels: syntagmatic positions***

### **14.6.1. Notion of channel**

An agent may have channels. When an agent recruits a commissioner, it may do so directly or via a channel. Channels are an instrument to reconcile a great architectural flexibility with the rigorous observance of positionality. Channels are an important organ for positionality observance.

Channels are delivery points: they are where results are delivered by agents. That is, the merging process merges findings together giving results that belong to channels.

A channel does not have a duty, only agents have.

A channel may be created by the recruitment process, then it has no field data and it has exactly one client agent.

It may also be created by the edification process. Then it has field data and none, one, or several client agents.

### **14.6.2. Channel usage**

The first usage of channels is the case in which an agent attempts to solve with results from two or more sources which are syntagmatic with one another. For each syntagmatic position, a channel is created. Thus for example agents B2 and B3: they



accept terms at different channels and try to locate their cooccurrences in plexus C-type records. Agent B2 has two channels and agent B3 has three channels.

Coreference and anaphor seem to be able to be treated by channels. A channel would be open for the anaphoric term, and another for the antecedent, each accepting private terms which would be their interpretants. The settlement would consist in a same private term occurring at both channels. The same suggestion may also be applied to relativation. A limit of this schema is that it is referentialist and extensional only. It could work only in cases presenting this character and would not generalize. A different solution to the problem of coreference, no doubt more adequate, requires a revision of the C-type record which would enhance its expressive power.

### ***14.7. Conventional forward-rearward orientation***

In ABS, heuristic structures have a conventional orientation along a forward-rearward axis. This orientation arises from the need a) to differentiate a rearward process and a forward process (more on this below) and b) to express that recruitment develops the heuristic structure rearwards whereas edification develops it forward. In a first approach, the forward-rearward orientation is viewed merely as a convention. Later, it is granted an interpretation.

When heuristic structures are presented on figures, conventional fore is on the left and the conventional rear on the right. In the internals of the development and in certain appendixes specifying agents (*infra*), the rear is abbreviated by RW (*rearwards*) and the fore by FW (*forward*).

## ***14.8. Development of the heuristic structure by recruitment***

### **14.8.1. Recruiting process**

The heuristic structure may develop by recruitment when the linguistic task is entirely defined by few terms. It is then possible to initiate the process at a unique point, the root, which is a channel and where all results will be delivered. One agent or a few agents are appended to the root at the initialization of the process. These agents (then clients) recruit more agents (then commissioners) to which they assign a duty. The commissioners recruit in turn, then behaving as clients and so on.

The recruitment of agents develops rearwards (RW), it encompasses no field data, contrasting with the edification process. Both are contrasted below p. 341.

The recruiting process is used in simple tasks like for example the analogical task (agent ANZ) or the suggestion of similarities (agent CATZ).

### **14.8.2. Duty assignment upon recruitment**

Recruitment is commanded by the duty of the client and the corresponding data of the plexus. An agent that recruits knows how it uses these two data to assign duties to its commissioners. This belongs to its prerogative and depends on the agent type; see the ensuing appendixes per agent type.

### 14.8.3. Agent tree

After several such recruitments, agents end up forming a network which is a tree (fig. below).

This figure assumes that there are always channels between agents: all recruitments in it are opaque (cf. below) which is not always the case.

Several more trees, less readable because they are produced mechanically, but illustrating with better precision model processes, appear in chapters 4 and 5.

### 14.8.4. Transparent recruitment

Recruitment may be transparent (agent-agent) or opaque (agent-channel-agent).

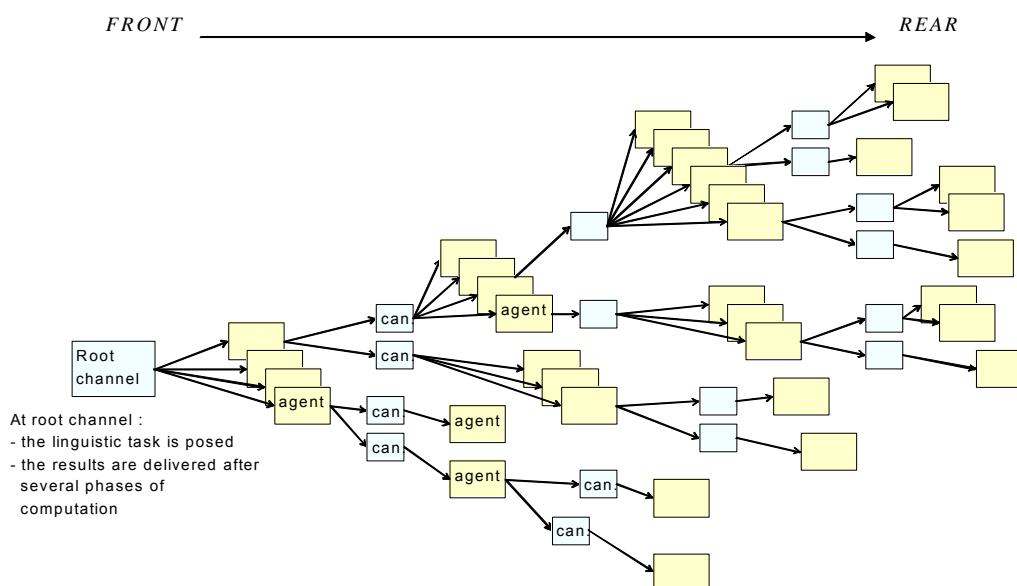

Figure 39 Agents recruit more agents and end up forming a tree

In transparent recruitment, the client agent determines the to-be-recruited commissioners, that is, it determines their duties. It then commands the recruitment of these commissioners. Recruitment is subordinated to the non-redundancy clause: if an agent of this type, with this duty, and delivering at this delivery point already exists, recruitment does not take place. Otherwise, the commissioner is created and two relations are made.

An RC relation (recruitment) is installed between client and commissioner; it supports explanation and the analysis of the model's operation which may be ordered after the computation's end; the model itself, for its own ends, does not use the RC relation.

A DL relation (delivery) is installed between delivery point and commissioner; it will be used to merge onto the delivery point the findings which may arise at this commissioner.

Note that in transparent recruitment, the forward target of the RC relation and the forward target of the DL relation are different; for details, please refer to the agent diagrams in forthcoming appendixes.

#### **14.8.5. Opaque recruitment**

Some agents have a syntagmatic vision: they need commissioners which bring results at distinct positions. In the ABS architecture, each of these positions is embodied by a distinct channel.

The agent recruits the necessary channels, according to its needs which are inherent in the agent's design. It recruits two at least because there is no syntax with one position only, by definition. An agent is the sole owner of its channels: channels are not shared, that is, a channel cannot have more than one client agent. This would have to be amended if coreference and anaphor were to be treated using channels, cf. above p. 335. For each channel, its client agent determines the appropriate commissioners. It commands their creation which is, as above, subordinated to the non-redundancy condition. If non-redundancy is verified, the commissioner agent is created and two relations are made.

An RC relation (recruitment) is installed between channel and commissioner; it supports explanation and the analysis of the model's operation which may be ordered after the computation's end; the model itself, for its own ends, does not use the RC relation.

A DL relation (delivery) is installed between channel and commissioner; here again, it will be used to merge onto the delivery point the findings which may arise at this commissioner

Note that in opaque recruitment, the forward target of the RC relation and the forward target of the DL relation are identical.

#### **14.8.6. Transparent recruitment and opaque recruitment compared**

The main contrasts between transparent recruitment and opaque recruitment are summarized in the table below:

	<b>Transparent recruitment</b>	<b>Opaque recruitment</b>
Channel	No channel creation	Creation of a channel
Delivery point	That of the client agent	The created channel
Type of the created agent	The type of the commissioner is necessarily that of its client	The type of the commissioner is not necessarily that of its client
Duties	The duty of the commissioner differs from that of the client by values only	The duty of the commissioner differs from that of the client also by its nature
Prototypical uses	Stepwise exhaustion of a paradigm Resetting without settlement (ex. CATZ) Resetting with settlement delegation (ex. ANZ)	Building of analyses (B2-B3) Non delegable settlement (ex. ANX),

**Table 25 Transparent recruitment and opaque recruitment**

#### **14.8.7. Interaction between heuristic structure and plexus**

Whatever the linguistic task and at each moment, the computation depends on the plexus content on the base of exemplars. This property is not occasional or valid for some agents; it applies to all agents and at any point in the computation.

The productions (findings, then results) depend on the plexus, but the development itself of the structure, that is, the determination of agents and channels planned for creation, whether by recruitment or by edification, is also narrowly subordinated to the plexus. It is so in association with the data of the linguistic task. At no moment is any decision based on general reasons (for one thing: the model contains no disposition to express general reasons), the mechanisms at play are always exemplarist mechanisms. The mechanism is exemplarist and only that.

In addition, it is copositioned. That is, the terms are always involved several at a time, at least as pairs, with preservation of copositionings between them all along the progress of the computation. It is so ideally, and in actuality in most cases only, because in the current development status of the model there is an exception: agent CATZ, which is single-argument and, by this alone, escapes the copositionality constraint. This is felt to be a drawback and is made responsible for certain limits. It defines a possible track for evolution and improvement, cf. p. 353.

#### **14.8.8. Rearward process, forward process**

The rearward process develops from the conventional fore to the conventional rear, that is, from left to right on the figures; it ensures:

- pending recruitments: agents which have to recruit do so,
- redundancy control: there may not be two agents with the same type, the same duty, and the same delivery point,
- finding production by direct raising,
- settlement detection and production of the corresponding finding.

The forward process develops from the conventional rear to the conventional fore, that is, from right to left on the figures; it ensures:

- merging, that is, the consolidation of findings into results,
- keeping result strengths up-to-date,

#### ***14.9. Agent redundancy control of and resource reuse***

In a heuristic structure the non-redundancy clause forbids two agents with same type, duty and delivery point.

The clause above is necessary because, without it, short-sighted mechanisms – what agents are, and this short-sightedness is explicitly wanted – are exposed to do and redo endlessly the same actions. This accident happened in a first development: the model suffocated after five or six computation steps, the computation resource was saturated with void redundancies the number of which exploded and, very quickly, nothing useful was taking place. Performance and relevance recuperation took two routes very different in scope and nature: firstly redundancy control, and much later, familiarity orientation (cf. section 12.8. *Familiarity orientation*).

The redundancy control clause for agents, as stated ahead of this section, may be implemented by different techniques. Its current implementation is a central shared service, sort of registration office able to respond to questions of the type: is an agent with such type, such duty, and such delivery point already in the heuristic structure. In computing jargon this is "posting" a condition. The condition "an agent with such type, such duty, and such delivery point is created" is "posted", which later allows the computation to avoid redundant creations. The implementation is not difficult. The problem with this solution is that it has a null plausibility. To quote Kayser again, a model may have an overall plausibility without all its details being plausible. No doubt, but detail plausibility would be an additional advantage.

One may strive for better plausibility by tagging the plexus elements that the computation already used. If the plexus is a model of the linguistic knowledge in the brain, and if proximality in the former is an analog of the anatomy of the latter, tagging plexus elements may well be the analog of activations in the brain and this would set certain parts of it in a "busy" status; therefore they would not be immediately reusable.

This track, "laying marks in the plexus", was indeed evaluated but it was not followed because it appeared that the condition which had to be posted was not "such part of the plexus is already used" but rather "such part of the plexus is already used in a defined way, with defined copositionings, for the benefit of a defined part of the task". The non-redundancy clause "not two agents with same type, duty, and delivery point" contains two parts which impede to interpret it as laying marks in the plexus: a) agent duties are not plexus elements but copositioned sets of such elements, and b) the sub-clause "same delivery point" has no possible interpretation in the plexus because channels are foreign to it, they belong to the heuristic structure which is something else than the plexus. Posting then takes place in a space which is not that in which the inscriptions constituting the linguistic knowledge are deployed, it is a much richer space.

Whether this view is right or not, it has at least two applications in the documented behaviours of the model, that is, we have already seen above two cases in which the same plexus data are used twice in a same linguistic task:

1. In the case of Bavarians, cf. Figure 24 Route followed by the computation in the paradigm (p.150) and the associated text, the same plexus records are reused but with different copositionings each time.
2. In the case *C'est beaucoup trop grand*, cf. Figure 12 c'est beaucoup trop grand (p. 105) the same expansive gate was used twice in the analysis of the utterance: the record  $[trop]+[grand] \rightarrow [trop\ grand]$  was used twice as settlement condition, that is, as licensing record; but it was each time for a different channel.

Redundancy control implemented as marks in the plexus would have prevented reuse in these two cases. The question of course is whether we want this.

Either we want the model, as it does today, to reuse on short horizon the same resources in different ways or for different parts of a task (this may be called the "remobilization") option, or something with a better implementational plausibility has to be found.

Or we think that neurons generally do not have this capability. Then, in a strict exemplarist approach as this one, we must show how the same exemplars cannot be reused twice on short term, observing a latency or recuperation delay before a second solicitation. But then we also have to show how for example the recursivity of syntax succeeds in mobilizing different expansive gates in case of reapplication of what other traditions would view as the same rule.

It is not simple to respond today to the remobilization question and I shall stop here, but it is a very interesting one because it is posed at the hinge of the symbolist option and the connectionist option: a resource which is "obliging" enough to let itself be reused very quickly with other data, or with the same data but with different argumental positions, actually acquires certain characters of rules and abstractions; the machine tends to become von Neumanian since doing this boils down to something which begins to look like an operator being put in a somewhat fluid functional relation with things which begin to look like typed data.

#### ***14.10. Development of the heuristic structure by edification***

In syntactic analysis with the B2-B3 process, the elaboration of the heuristic structure follows a mechanism now different from that of the recruitment. It develops towards the conventional fore (towards the left on the figures) and does not emanate from a single root. It was named **edification**<sup>376</sup>. Edification will now be presented, and then contrasted with recruitment.

---

<sup>376</sup> To refer to this second mechanism, the more natural term to use would have been *construction*. However, this lexeme is already loaded: it denotes syntactic constructions as defined by Fillmore in particular. As *construction* is also used with this meaning in this work, the term *edification* was preferred to refer to the second mechanism whereby the heuristic structure builds up.

### 14.10.1. Edification

This process is more open than recruitment. Counter to recruitment, at no moment it has available the entirety of the data; in the course of the reception of an utterance for example, at a given instant, a part of the analysis work is already carried out while the rest of the utterance is still being received. The process 'edifies' heuristics structures which do either or both the following: a) accept more field data (the rest of an utterance, ensuing non linguistics perceptions), and b) from the already made elaborations, carry on abductively the elaboration process. Edification works towards the conventional fore, counter to recruitment which operates towards the conventional rear.

Edification encompasses channel creation. In recruitment, channels are optional (depending on agents), and rare in average, whereas in edification, channels are between all agents and obligatory. Agent structures set up by edification may in turn initiate a local sub-process operating by recruitment; the recruiting sub-process is a sort of a subcontractor to the edification process.

Edification is used in complex tasks like for example utterance analysis (cf. below details on agents B2 and B3).

<b>Recruiting process</b>	<b>Edification process</b>
Simple tasks (e.g. analogical task) defined by few terms which hold in an agent duty	Complex task (e.g. receive an utterance, produce an utterance, analyse a scene)
No field	There is a field. Field data participate in the definition of channels and agents
Rearward development (RW)	Forward development (FW)
A client agent recruits commissioner agents rearward	Channels, the fields of which are adjacent, are paired forward into an agent. When the latter produces a finding, a channel is created forward.
Transparent and opaque depending on the case (channels are optional)	Always opaque (channels are obligatory)
Single root (= a single maximum) where the task is entirely defined	Minima installed by a third-party process Multiple maxima
Tree	Lattice
Low level, unconscious process, serializes parallelism	Low level, unconscious process, serializes parallelism, and higher level, conscious process

**Table 26 Recruitment and edification**

A heuristic structure obtained by edification does not have a single root (it is not a tree). For example, in the analysis of an utterance, in stead of a single root channel, several maxima are to be found; they are channels. At a given instant, they collect the partial analyses made that far. The heuristic structure is a lattice since the partial order

(conventional) fore-rear relation holds between its elements. Its maxima are, on the figures, the leftmost channels and they are the best abductions that could be made in the treatment of the task, that is, those which engage – in mutual conjunction, in conjunction with the plexus, and the best possible way altogether – the greatest number of the task's terms.

#### **14.10.2. What recruitment and edification share**

However different they may be, recruitment and edification coexist and cooperate in the ABS architecture where they share the following functions: agent redundancy control, the settlement-merging mechanism which forwards products to the fore, and the mechanism of strengths and reinforcement which applies to agents and products. All these constitute the general ABS framework which hosts agents of different types and rules their interworking.

In addition to this, as already stated, an edification process may, at one of its points, initiate a recruiting sub-process to fulfil a function which is limited and independent of field data. Such a "subcontracting" is very common.

#### **14.10.3. Field and field data**

Field is informally defined as that which, in the perception of the world, is within the subject's scope when he is busy performing a linguistic task. Field data are indexes on elements of situation: linguistic form exclusively so far. When extending the model's application, field would extend to perceived elements which are not linguistic form.

A recruitment process does not encompass field data. There is necessarily field data in an edification process. For example in the reception of an utterance, certain field data are the place, in the received string, of the parts (segments or constituents, possibly syntagms) addressed by sub-processes. In this case, field data stand, in the heuristic structure, for places in the organization of the string being received and processed<sup>377</sup>.

More generally, in an extension of the model to non linguistic perceptual data, field data are bound to index the spatial determinations, the temporal determinations and the perceptive channels of the elements subjected to the computation.

Defining the field in this way is not fully satisfying and might be criticized. The notion of field is an intuition arising from concrete work about the settlement architectures which are appropriate to obtain the required effects.

#### **14.10.4. Questioning the recruitment-edification duality**

The coexistence between recruitment and edification is not self-evident. Actual development work encompassed an important number of trials which cannot be reported here and it is a selection, a Darwinian one in a way, which finally selected concurrently and complementarily processes of these two natures. This was the result of the method followed in this work, which consists of having some general directions about what is desirable, some more directions about what must be rejected *a priori*, and leaves a broad

---

<sup>377</sup> This organization is currently assumed to be unilinear for simplicity but this is not a postulation inherent in the Analogical Speaker



span of possibilities in which multiple attempts are made and finally evaluated after their results.

It is this method which led to stabilize these two types of processes. It then appeared that they might constitute a useless non-minimality and that, if this work leads towards a theory, and if it is accepted that a theory must be minimal, it might be desirable to unify them into a single mode of constitution of the heuristic structure.

A unification track was followed for a while. It involved questioning the conventional forward-rearward orientation which, itself, was a result of the same method but was not supported by a very foundational argument. A suspicion also bore on the notion of root channel which seemed somewhat *ad hoc*: in a model of the speaking and knowing subject which strives for some plausibility, what could be the analog of this miraculous origin from which everything emanates. A revision which would reduce the recruitment-edification duality and, on the same occasion, could also improve the treatment of these two questions would have been welcome.

The mechanism of result processing (raising, settlement, finding merging, delivery to delivery points with possible reinforcements) was judged to obligatorily require an orientation. A partial order relation is necessary in the heuristic structure – calling it 'forward-rearward' or using any other convention is unimportant. Without this order, all the good qualities of the model including its integrativity and the gradation of its responses with the congruence or otherwise of the task's data with plexus data, all this would be lost. Whatever the architecture revision, the heuristic structure had to remain oriented.

On this axis, therefore necessary, certain agents, according to their own 'logic', continue recruiting rearwards commissioners which report results – forward – to the delivery points of their recruiters. Simultaneously, a process like syntactic analysis as envisaged with agents B2 and B3, causes the creation of agents and channels which are not the result of the 'logic' of a single existing agent but on the contrary associates several of them depending on the contiguity of their spans, that is, it involves field data. And the agents and channels to be created, far from having to report results to the already-there elements which motivate them, are on the contrary elements to which the already-there elements will have to report their own results. In recruitment, the causes of the recruitment are the beneficiaries of future results whereas in edification, the causes of edification will be result providers; they build structure pieces as sorts of assumptions to the abductive validation of which they may contribute, now or later. Some will be validated by some of these agents, not all of them by all agents. In writing, I realize how these metaphors oblige no one to nothing, in particular not the reader to adhere. On the other hand, it is not possible to say: 'this is how it's made and it works' but currently, I can do nothing better. At any rate, it is for this dissymmetry that processes with opposite orientations were let coexist, and that recruitment and edification were finally not unified.

Is it so worrying. Not that much, firstly because *en passant* the justification of the forward-rearward orientation happened to be somewhat consolidated. Secondly because the notion of root channel which used to be poorly motivated is now reinterpreted. An edification process itself does not have a root channel, it has maxima instead, several in general. It may – it often does – initiate recruiting sub-processes. The point at which it

initiates a recruiting sub-process is the point which used to be viewed as root channel. Now there may be as many 'roots' as there are starting points of such sub-processes, so they cease *ipso facto* to be tree roots, and what was felt to be the arbitrariness and lack of justification falls since the insertion of the sub-process (e.g. suggestion of similarities) in a larger process, itself better founded (e.g. syntactic analysis), confers them a better one.

#### **14.10.5. Plausibility and scope of recruitment and of edification**

Edification processes are given as models of whole linguistic tasks. To put it better, the model of a linguistic task which can be defined externally with some autonomy necessarily encompasses edification.

Contrasting with this, a process which does only recruitment is not plausible if considered in autonomy because of the doubts on the notion of root channel, and of the fact that linguistics acts cannot be defined by the few terms contained in an agent duty. So it is not pretended that any real linguistic task might be adequately modelled by a process which would recruit only. On the other hand, we just saw how an edification process, itself less implausible, may require the contribution of sub-processes that recruit only.

The work share would therefore be as follows. Edification is bound to model tasks with a certain complexity, involving field data, in particular tasks with an autonomous external definition. Whereas recruitment applies to sub-tasks of the former, therefore ones which are dependent and do not encompass field data. This does not mean that the latter are necessarily small; a recruiting-only process may occasionally involve a large number of agents and channels. There are limits to these numbers but they are of the order of plausibility, of computations remaining 'reasonable' (if really too hard, then give up) and are not inherently associated with the fact that the process only recruits.

Does the edification-recruitment opposition coincide with the conscious-unconscious opposition? On this point, for several reasons, only opinions can be stated. Recruitment processes certainly are entirely and always unconscious. Such as they were instantiated so far, they are akin to simulation of neuronal parallelism and remote from the conscious mental mechanisms. An edification process, on the other side, has unconscious parts and perhaps conscious ones and the shares between both depend on the case. In the analysis of a received utterance for example, edification processes which stay small, like lexical evocation, morphological analogy, agreement between neighbouring morphemes, etc. nearly all are unconscious. Processes affecting longer spans, more complex syntagms, anaphors close to ambiguity, etc. are conscious in the measure of their complexity and difficulty, up to the resolution of garden paths upon syntactic ambiguity which may involve elaborate conscious thinking. Finally, the conscious-unconscious opposition appears to be associated with conjunctions of factors and it does not seem that the opposition edification-recruitment might be held as a model of it.

#### ***14.11. Phase management***

The ABS computation develops in phases which are a means to ensure the overall coordination of numerous elementary process and to serialize their operation. This is a

model, it is not claimed that mental processes are phased in this way but it is certain that they have a temporal development. In ABS, phasing is a model of the temporal development of mental processes, in particular of the linguistic ones.

The model is such that each elementary action leaves elements marked as requiring the attention of the phase management process. Phase management is the general engine in ABS. It is responsible for the triggering of all required actions; it is the general controller of the computation.

A phase encompasses the execution of the rearward process then the execution of the forward process. Each agent is implemented by a rearward process and a forward process. They are particular to an agent and each is embodied in a computer program. If there are 12 agent types, there are 24 such programs: for each agent, a program for the rearward process, and in general, another one for the forward process<sup>378</sup>. When the phase management process finds an agent of a given type marked as requiring attention (for its rearward process and / or for its forward process), phase management triggers the corresponding computer program for this agent.

Phase management also ensures the forwarding of products: a finding just produced at an agent is marked as requiring attention. A finding requiring attention is merged that is, it is projected as a result at the agent's delivery point – which is a channel – and the result in question is in turn marked as requiring attention: at next phase, it will be considered as a candidate to participate in settlements.

Thus, the different elements marked as requiring the attention of phase management are finally the following ones:

- a) an agent created by this phase requires attention at next phase to activate its rearward process (and its forward process if applicable for the relevant agent type).
- b) some agents created before this phase, but on which a particular condition occurred in this phase require attention at next phase to activate their forward process.
- c) a finding new in this phase at an agent, requires attention for the merging process to be merged giving a result at the agent's delivery point.
- d) a finding the strength of which has varied in this phase, requires attention for the merging process to forward the strength change onto the corresponding result.
- e) a result which is new at a channel requires attention as a candidate to participate in a possible settlement at the client agent of this channel.

## ***14.12. Strength management***

### **14.12.1. Mechanism of strengths in ABS**

A result has a strength tag; it is a number between zero and one that marks its relative importance. At a channel of the heuristic structure, candidate results compete and the

---

<sup>378</sup> A few agents, the simpler ones, have the rearward process only and no forward process.

strongest are the winners.

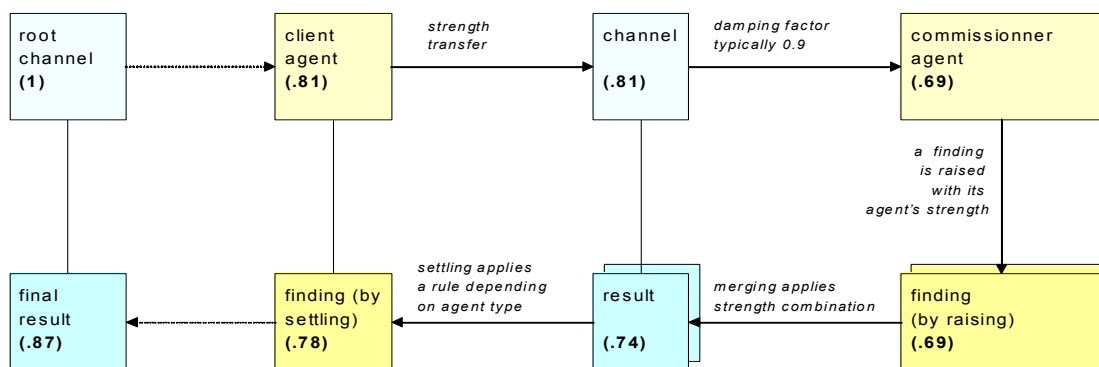

*initial strengths*

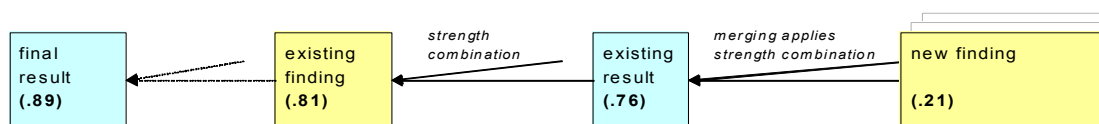

*strength revision*

**Figure 40 Mechanisms of strengths**

The mechanism of strengths is summarized in the above figure. As for many other points in ABS, the implementation is motivated in part only: the detail might differ from this one, we only need an overall mechanism which behaves about as this one.

An agent is recruited with a determined strength. A client agent recruiting a commissioner agent assigns to it its own strength reduced by a damping factor, typically 0.9. So agents have strengths which decrease exponentially with the phase in which they were recruited.

An agent raising a finding assigns to it its own strength.

A result obtained by merging one finding only takes its strength. When two findings are merged into one result, their strengths are combined following a combination function to give the result's strength.

Here are two views of the combination function. The function is  $S$ , it combines strengths  $x$  and  $y$ .

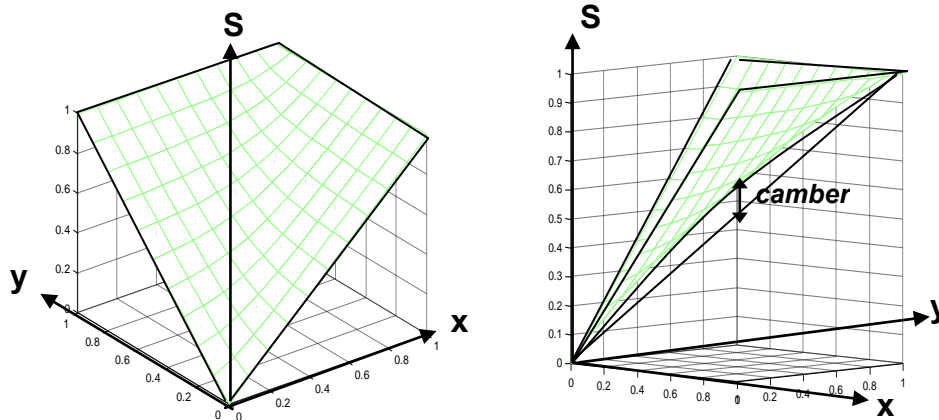

Figure 41 The strength combination function

S is a simple quadratic function of two variables, chosen to present obviously required values at the limits and to be approximately associative and to be efficiently computable. S is as follows;

$$\text{delta} = K^2 + x^2 + y^2 + 2Kx + 2Ky - 2xy - 4Kxy \quad K = 0,10 = \text{camber factor}$$

$$S = (K - x - y + \sqrt{\text{delta}}) / 2$$

Other technical options would be possible for S, the latter is just a good compromise.

#### 14.12.2. What selection schema

A general question is to understand how, among the elements in paradigmatic position in a broad sense; one will end up being distinguished. Two schemas are possible.

In the first one, of which the mechanism just described is an example, the competing elements each have a strength tag, which may evolve in time and the winner is that which ends up with the highest strength. Each competitor increases its strength in isolation of the other ones. Call this the election schema.

In a second schema, a mechanism between the competitors makes them thwart each other: one can increase its strength only at the expense of its neighbours' and competitors' ones. The point is no longer to be the best, but, in order to rule, to kill the other pretenders. Call this the Shakespearian selection schema.

The latter schema is adopted in certain connectionist models. Thus in the already quoted model by MacWhinney, which involves the emergence of lexical items in a 'self-organizing feature map' (SOFM) of Kohonen, emerging representations of a given item may concurrently arise in several points of the map but the ensuing process will make that one will survive after killing all the other ones.

The election schema has a weakness: the winner being that which ends up with the higher strength the schema does not state when this end takes place. It is so because, a computation may always be prolonged and the relative strengths may always evolve, with more remote inscriptions coming into play. The criterion "the relative order of strengths ceases to evolve" is not a good criterion because it does not specify for how

long they have to be stable before concluding. The Shakespearian schema is clearer: after a while, the competitors are dead. The weakness of the election schema can be felt in current ABS: there is not a very strong stance about the term to be set to processes and sub-processes, and this term does not set by itself. Dispositions taken for activity control (cf. next section) are an attempt to fill the gap but they have an engineering flavour and lack naturalness.

On the other hand, Shakespearian selection is associated with a metrics; this is true at least with Kohonen maps. Linguistic paradigmatics as for it does not have this property: it is not very obvious how to arrange that paradigmatic competitors may watch one another to thwart one another, and in view of that already, how they just might be conscious of one another.

Finally the option taken in ABS, which is election, counter to Shakespearian selection, is not very well motivated and might be revised, but today there isn't a firm base to have it changed while understanding well what is done.

A possible direction is to adopt a resource viewpoint. In the current election mechanism, the computational resource is not bounded: agents may be added without limit to the heuristic structure. In a real system, the computational resource is necessarily bounded. Any new resource request then should be compensated by restitution, stripping off the less useful areas of the computation, or the less promising ones, deactivating the areas with a low activity.

#### ***14.13. Length of computation paths***

The computation seems not to have to involve long paths in the plexus: this would contradict intuition and the results of psycholinguistics as well. Computation paths are typically three to ten steps long. However, the computation is parallel and branches somewhat: the categorization and regularization effects which are sought depend exactly on such branchings. Some paths get invalidated very quickly, other paths remains active longer, still more paths, weakly activated initially, later have to be awoken (syntactic ambiguity resolution, cf. below). Finally the computation may occasionally become heavy and the treatment of a linguistic task may involve one thousand agents or more.

#### ***14.14. Activity control***

As we just saw it, the election schema for paradigmatic selection does not by itself very clearly set an end to the computation: if nothing is done, longer and longer heuristics paths develop, and they may modify the acquired results, often with little significance, occasionally only with some relevance. For a complex task, and when the number of phases increase, the heuristic structure then proliferates out of proportion with the marginal benefit.

More technically said, but this amounts to the same thing, agents B2 and B3 have no settlement criterion whereby the accruing plexus data would naturally dry up. It is so because B2 and B3 use the CATZ agent which is productive without limit provided the

plexus is abundant. CATZ, lacking a drying up settlement criterion, tries everything, even very far, even involving very improbable categorial drifts<sup>379</sup>.

This is not satisfactory in practice. The presence in the model of familiarity orientation, because it much increases the efficiency of the heuristics, already makes this "waste" less critical since it reduces its incidence, but the thing remains theoretically not satisfactory because, in a long linguistic task, like the analysis of a long text, beyond a point, when the beginning of the text is analysed and understood, and when this temporary result has played its role in the interpretation of the ensuing text, the heuristic activity concerning this beginning should be stopped. 'Controlling' in this way the computational activity would direct the computation resource towards useful tracks instead of wasting it in spurious ones.

The point currently reached in this research does not make it possible to fully take advantage of this remark because we do not know how to interpret: "the beginning of the text is analysed and understood". Provisorily, it may be substituted with: "the beginning of the text is analysed syntactically", but we must watch the biases this substitution may cause. This question is not a secondary one.

In order to control activity, the first thing which comes to mind is to put off the operation of a channel deemed to have served enough. To interpret "has served enough" the simplest is that a channel has served enough if it has produced enough, that is, if the number of its results has reached a threshold. One applies the extinction clause EC0 (read EC zero):

(EC0) put off a channel with a number of results beyond a threshold

This approach is justified: a channel having enough results, the presumption is that, from it and on, the adductive analysis process may be pursued without accident towards the conventional fore. The few result exemplars obtained at the channel are expected to open enough abduction occasions for the next assembly level, and their number beyond a threshold is assumed to cover the risk that one of them be unproductive. This is most often the case in a balanced plexus, extinction, on result threshold condition, controls adequately the computation demand without hindering the yielding of final results. Extinction has to bear on the channel and on the part of the heuristic structure which depends on it (rearwards). On all these elements, the activities of recruitment, raising, settlement, and result merging are suspended.

This method was tried and showed an improvement in most cases, with a defect however. Such (commissioner) channel may have produced, for example four results – and become extinct if four is the threshold – without any of its client channels having been able to do anything with these four results – this may be a consequence of a local property of the plexus which, in itself, is not necessarily a defect – whereas a fifth result of the commissioner would allow the client to settle and therefore the analysis to progress. Extinction was too short-sighted.

---

<sup>379</sup> ANZ does not have this defect: it has a drying up settlement criterion. This must be related with the already mentioned fact that ANZ, working with several arguments, is compositionally constrained, what single-argument CATZ is not. This is a new reason to dislike agent CATZ and to place it in first line for future revision of the model.

Before putting a channel off then, one should take account of its client and of the productivity within these clients of the commissioner's results. The extinction clause then would rather be:

(EC1) put off a channel having produced beyond a threshold and if at least one of its clients was able to take advantage of its productions.

Instead of counting all results, count only those which settle at next level (in blue in the figures of Chap. 4). This modification amounts to make control decisions with one level anticipation. Computationally it costs a little more but the results thus obtained are better: the process better crosses the barren areas of the plexus without going into saturation in the fertile ones.

Concerning anticipation, why one level only (EC1) and non and not two (EC2) or n (ECn)?

The question here coming into discussion is that of garden paths, that is, the cases in which ambiguity (syntactic ambiguity so far) leads the analysis into a track which is contradicted after two or more subsequent analysis levels. The dilemma is as follows: without extinction, all tracks are concurrently pursued<sup>380</sup>, then however remote the decisive data stands, the appropriate track is still available, the alternate ones are contradicted, and the garden path is passed, but, in order to get there, the computational resource saturates so the process is often not even given a chance to reach that point. With an n-level extinction on the contrary, n-level garden paths are passed but those which resolve with more than n levels fail: when the decisive data comes under consideration, then is felt the lack of intermediate data, which would form the base of a belated abduction, a weak one maybe, but one which would make it possible to carry on the analysis.

The question does not have in principle a simple answer. Syntactic ambiguities have varied lengths. For some of them, an important effort of conscious deduction is necessary and many speakers fail at it. There is no categorical limit to the phenomenon.

A possible idea would be the general awakening of all extinct channels in the heuristic structure. It might not be a good idea because it is very expensive. Moreover, it implicitly assumes that the garden path recovery process is homogeneous to the unconscious and systematic first analysis process. Now there are reasons to think that this homogeneity is not verified: it seems on the contrary that, in certain cases, garden path recovery is a conscious and selective process. If things are so, i) it becomes legitimate to control the activity of B2-B3 by systematically extinguishing the channels which already produced beyond a threshold, for example with a EC1 or EC2 extinction clause, but ii) for difficult garden paths dispositions of another nature should have to be taken.

---

<sup>380</sup> On this occasion, a word must be said about the proliferation factors and those in this model must be compared with those arising in category-based syntactic analysers. The latter are exposed to artificial ambiguities due to the homonymies incurred by the lexical categories. This inconvenience does not occur in the Analogical Speaker. But the latter has an endemic proliferation, that which is described about agent CATZ, and which of course has no analog in categorial theories.



This closes the general discussion of the model's dynamics. The following appendixes now present separately and in detail the specification of each agent type.

## 15. Appendix: Simple similarity suggestion (agent CATZ)

In section 3.7.7. *Similarity suggestion* (p. 95) we saw, within agent-based solving, the need for a function called 'similarity suggestion'. Similarity suggestion is the substitute for lexical categories and allows us to view similarity on a dynamic and exemplarist mode. It is one of the devices which help accounting for linguistic productivity while eschewing categorical rigidities.

Following the general idea that linguistic productions regularize onto one another, when uttering or receiving a new utterance, account is taken of similar facts already met. Then, a linguistic unit being given, we need to be able to retrieve from the plexus the precedents which are similar to it in a way or another.

In the same section, we established that similarity suggestion may be simple or copositioned. Simple similarity suggestion is implemented by agent CATZ and is the subject of this appendix.

From an argument term, this agent produces those of the other terms which are most similar to it in different respects. It was mostly found useful to do so according to distribution. Another viewpoint, according to constituency, will also be presented but it is little used in the model.

### 15.1. *Distributional similarity*

In two C-type records connected by a paradigmatic link, homolog terms which are in constituent positions are distributionally similar by definition. In the following records:

C	categories	+ are rejected	categories are rejected
C	lexical classes	+ are refused	lexical classes are refused

terms *categories* and *lexical classes* are distributionally similar and terms *are rejected* and *are refused* also are. This definition is obviously issued from structural linguistics but with an adaptation: the requirement here is not that left and right distributions be the same, but that homology hold in two C-type records which are set in paradigm. Reminder: two C-type records may be set in paradigm when they are perceived as syntactically similar, that is, as constructionally similar. The perception of similarity is rooted in the plexus descriptor's intuition. Doing so protects against the accident the prototypes of which are the well-known examples: *John is easy to please / John is eager*

to please (Chomsky 1960, p. 532) or *J'ai promis à Pierre de venir / J'ai permis à Pierre de venir* (Milner 1989).

### ***15.2. Constitutional similarity***

Similarity may also be defined according to constitution. In two C-type records connected by a paradigmatic link, homolog terms which are in assembly positions are constitutionally similar by definition. In the example above, term *categories are rejected* and term *lexical classes are refused* are constitutionally similar.

In theoretical terms, constitutional similarity may be connected with the remark made by Chomsky<sup>381</sup> that a linguistic form does not count just for itself but that its 'derivational history' also counts. However, it is possible to show also that adding the derivational history is not itself sufficient if we limit ourselves to a narrowly syntactic viewpoint, that is, a formal only viewpoint. This demonstration will not be made here.

Several tests were made (one of them is reported below in section 16.8. *Performance with the type of similarity* p. 369). It adds constitutional similarity to distributional similarity. They never showed that adding constitutional similarity improved the results, the dynamics was only penalized by additional agents and the results were not better or faster. This finding has not been further elaborated.

So constitutional similarity is a possibility for similarity suggestion which remains offered in principle – and agent CATZ proposes it – but, for the moment, it stays without utilization in the model.

### ***15.3. Similarity on request***

Initially, distributional similarity is envisaged as in structural linguistics but its scope and development are different. Harris for example, even if he grants:

If we seek to form classes of morphemes such that all the morphemes in a particular class will have identical distributions, we will frequently achieve little success<sup>382</sup>.

he maintains however:

We seek to reduce the number of elements in preparation for the compact statement of the composition of utterances ... Considerable economy would be achieved if we could replace [identical or almost identical statements of distribution] by a single statement applying to the whole set of distributionally similar morphemes<sup>383</sup>.

In the Analogical Speaker, stress is placed on distribution, but the target is not statements which would apply with economy to sets of distributionally similar elements. Instructed as we are of the deficiencies of class, category and abstraction-based approaches, having adopted an exemplarist option and the notion of proximity, and having dealt the notion of *a priori* grammaticality against the dynamics, it now becomes

---

<sup>381</sup> Chomsky 1957/1969, *Structures syntaxiques*, p. 42.

<sup>382</sup> Harris 1951, p. 244.

<sup>383</sup> Ibid; p. 243.

possible to view the suggestion of similarities as operating on request. This option contrasts with the notion of lexical category in two manners.

Firstly, the suggestion of similarities is triggered for a defined term, its argument, which is the subject of an occurrential need at a defined point in a defined computation. It is exactly a term, that is, a precise exemplar. The question is to suggest terms similar to that term, not to build classes with the least generality or permanence.

Secondly, the process is expected to produce similar terms in successive phases, inasmuch as its operation is allowed to/can proceed. So there may be few or many depending on the argument term, on the plexus, and on the computation phase. It is specified that the terms most similar to the argument are produced first. Those coming later are still similar, but perhaps a little less. If the process is allowed to carry on with exaggeration, it may produce terms with weaker similarity, then suggesting more adventurous abductions. This is one of the threads whereby the escalation principle (Chap. 3) is implemented.

#### ***15.4. Agent CATZ***

Agent CATZ (this name is arbitrary) accepts a term as its argument and produces a list of terms which are most similar to it, each with a strength tag. There may be none, one, or several terms in the list; additional terms may be added to the list as the number of computation phases increases, and their strengths may evolve.

As an option, CATZ produces distributionally similar terms, constitutionally similar terms, or both. A client, depending on its needs, may in principle recruit a CATZ agent with any of these three possibilities, although the former one only was used so far (cf. above). Both options: distributional similarity and constitutional similarity, no doubt are not the last word to this variety of viewpoints.

As any other agent, agent CATZ produces its results in successive phases. In this, it simply complies with the general constraints bearing on any agent in ABS.

Successively, we will see the technical architecture of the agent, then two examples of its operation.

#### ***15.5. Technical architecture of agent CATZ***

Agent CATZ accepts a single argument – which is a term – and produces in successive phases the terms which best categorize with the argument. More precisely, the argument of CATZ is not exactly a term but rather a term occurrence, that is, in a record, a site of the record which must be occupied by a term. This option allows a better definition of the running operating conditions (the recursivity of the successive recruitments is more easily expressed), it simplifies the design but requires a slight complication when initializing a CATZ process.

As any other agent in ABS, a CATZ agent always has a delivery point (which is a channel) and one only.

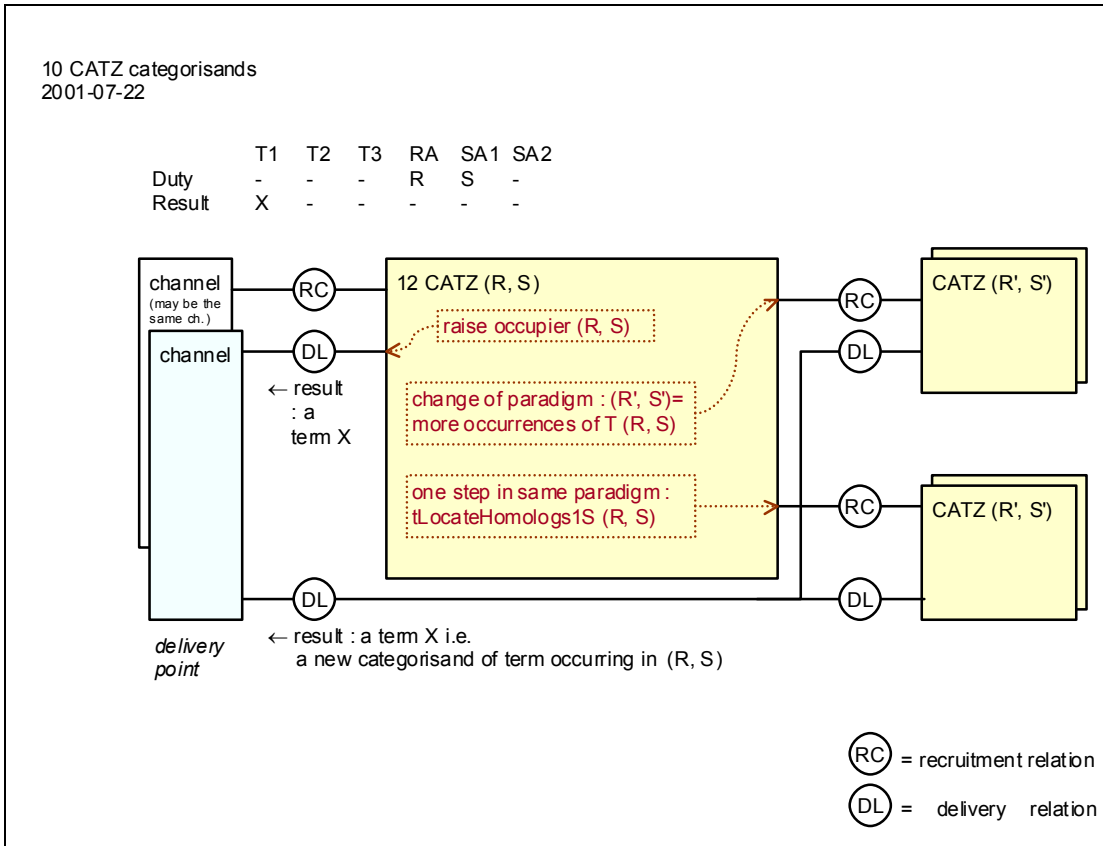

**Figure 42 Diagram of the CATZ agent**

A CATZ agent receiving its argument – which is a C-type record  $R$  at a site  $S$ , the latter being occupied by a term  $T$  – does the three things indicated on the diagram:

1. it raises a finding the content of which is  $T$ . The finding will be merged into a result at the delivery point by phase management which is a general process of ABS, and was described above (merging does not belong to the strict functional perimeter of agent CATZ).
2. it operates resetting. To that end, with term  $T$  as argument, it invokes the unary index which delivers all other occurrences of  $T$  in the plexus. Here again, any record thus reached gives birth to a new CATZ agent, commissioner of the former agent.
3. it carries on the search in the current paradigm, that which contains record  $R$ . It thus reaches  $R'$  records – which are immediate neighbours of  $R$  – at that of their sites which is homolog to  $S$ . Each new record thus reached causes the recruitment of another CATZ agent.

An ABS computation phase involves one recruitment step only. After several phases, a CATZ agent has recruited a structure of commissioners which is a tree, of which it is the root. The recruited commissioners are assigned a delivery point which is that of their client agent.

As things stand at this point, several different CATZ agents might be recruited bearing on the same plexus point. Such redundancy does not happen because of the general redundancy control mechanism which prevents it, see the appendix above which describes ABS in general. In the particular case of CATZ, this makes that there can be no two CATZ agents for the same record, the same site and the same delivery point. Thus, CATZ avoids walking in circles through the same paradigm and it also avoids using again an already used paradigm with the same position conditions.

CATZ contains a mode parameter which allows the recruiter to order the production of:

- a) distributionally similar terms only (terms occurring as constituents),
- b) constitutionally similar terms only (terms occurring as assemblies),
- c) both.

The effects of either option were exposed above.

### 15.6. Examples of distributional similarity

With a French plexus, the model is requested to produce the terms distributionally most similar to term 'le' which, in French, is the definite, masculine article. The table below shows the results of the first three computation phases. For each term, line "ph 1" displays the strength tags associated with the results at phase 1, likewise for lines "ph 2" and "ph 3". Some strengths increase with the phase number: the agent finds new reasons for similarity.

similar terms	<i>le</i>	<i>la</i>	<i>une</i>	<i>un</i>	<i>ma</i>	<i>des</i>	<i>les</i>	<i>l'</i>	<i>ce</i>	<i>son</i>	<i>mon</i>	<i>cet</i>	<i>cha- que</i>	<i>cer- tain</i>
English equiv.t	<i>the</i> msc.	<i>the</i> fem.	<i>a</i> fem.	<i>a</i> msc.	<i>my</i> fem.	ind. plur.	<i>the</i> plur.	<i>l'</i>	<i>this</i>	<i>his</i>	<i>my</i> msc.	<i>this</i>	<i>each</i>	<i>cer- tain</i>
ph 1	1.00	.91	.83	.83	.73	.73	.73	.73						
ph 2	1.00	.94	.86	.83	.73	.82	.82	.73	.59					
ph 3	1.00	.97	.93	.96	.76	.86	.84	.76	.71	.48	.48	.48	.48	.48

**Table 27 Terms distributionally similar to Fr. *le***

Articles are produced first and units with different traditional categories (for example: *ma*) follow: the model of this speaker, in its own way, recognizes the category *articles* and it also recognizes the category *determiner*. This illustrates its categorial under-determination.

Later, the term *certain* is produced. In French, it is both a determiner and an adjective. If the process were allowed to continue, many more adjectives would be found, and even nouns after them. This property is general: in this model, processes produce very expected results in the first phases and stranger ones in ensuing phases. The possibility of strange results is a corollary of the fact that the model has no reified category. This is a value because it is necessary to a flexible operation. However, excessive strangeness

would be meaningless. Strange results are produced in a decontextualized task like this one, when the number of phases is forced willingly; this condition is artificial and experimental. In a more contextually determined task, this must not happen: non-strange results occurring first, this tends to extinguish processes which would produce excessively strange results (cf. section 14.14. *Activity control*, p. 349).

The following table shows the same thing for argument term *avec* (En. *with*). More acute reinforcement effects can be observed in it.

similar terms	<i>avec</i>	<i>dans</i>	<i>à</i>	<i>en</i>	<i>sans</i>	<i>pour</i>	<i>sur</i>	<i>hors de</i>	<i>de</i>
English equivalent	<i>with</i>	<i>in</i>	<i>at</i>	-	<i>with-out</i>	<i>for</i>	<i>on</i>	<i>out of</i>	<i>of</i>
ph 1	1								
ph 2	1	0,81	0,81	0,81	0,81	0,81			
ph 3	1	0,93	1	0,99	0,97	1	0,73	0,73	0,73

**Table 28 Terms distributionally similar to Fr. *avec***

These results are not results about French in general; they are produced with a particular plexus. They are typical of the model's response facing this plexus. They cannot be used to draw the slightest conclusion on French prepositions or French determiners but solely to give a concrete indication on the similarity suggestion process.

### ***15.7. Deconstructing categoriality and prototypicity***

The similarity suggestion approach deconstructs lexical category in several respects: i) it becomes occurrential and is triggered on request, ii) it is guided by the proximity of inscriptions and iii) it depends on time via the number of phases reached by the computation. Finally, it is modulated by the congruence between the terms of the task and the plexus content.

In fact, lexical categories or the "categorial labels" of syntagms become entirely obsolete since it is no longer necessary to pre-establish them: a 'categorial computation' replaces them entirely. This may be backtracked to a pretheoretical intuition: the family resemblance of Wittgenstein.

Such a vision also replaces prototypicity. As there are no categories, the question of a category's prototype also falls, which is happy given the difficulties that it creates. The 'categorial computation' operates exactly where the computation stands in the plexus, to cover an exemplarist and occurrential need. What acts as a centre then is the term argument of the computation and nothing else is necessary.

### ***15.8. Adequacy (or not) of CATZ for similarity suggestion***

So far similarity suggestion is distributional<sup>384</sup> only. Such a vision may well be a partial and provisory one, it is likely to be complemented, in particular in the direction of meaning; it would then involve private terms. CATZ is used by several other agents, with a morphosyntactic orientation (please refer to the summary of agents below). It just happens that its clients are those yielding the most questionable results. For example B2-B3 is short on agreement.

In the vision of heuristic processes which consists of separating the suggestion of similarities from their validation by settlements, the heuristic is all the more efficient that it is monotonous, i.e., that settlement may operate closer to the suggestion because then, the heuristic structure may be pruned and focused before much proliferating; in this line of thought, strict compositionality of meaning is strict monotony – we know what it turns out to be in languages: it is partial only. CATZ, for similarity suggestion would be sub-optimal because it mixes up too many titles of similarity: even constrained to distributional only similarity for example, in order for a similar term to be produced, it suffices that it be homolog of the argument in one paradigm only; then there may be many such paradigms which constitute too many different constructions.

Seen in another way, what arises here is also the inadequacy of taking things one at a time – unfortunately, CATZ takes things one at a time, it is single-argument – and the superiority of two- or three-argument processes which may exert and propagate positional viewpoints<sup>385</sup>, positional constraints. Such n-argument processes are not easy to design and implement<sup>386</sup> but we must strive for them because this is how we can hope to make happen in an operable construction the promise of analogy, which is that terms have value only by their *différences éternellement négatives*<sup>387</sup> and that the pairs of terms have value only by similarities of differences.

---

<sup>384</sup> We have seen that a constitutional similarity is possible but currently without application

<sup>385</sup> Remind the simple idea that mutual positioning, i.e. copositioning, can only be defined between two terms at least.

<sup>386</sup> Agent ANZ is however, as we have seen, an example of a three-argument process which observes copositionings and propagates them to its commissioners.

<sup>387</sup> Saussure.





# 16. Appendix: Analysis (agents B2 and B3)

## 16.1. Process B2-B3, specification and overall design

Agent B2 alone will be discussed in detail: agent B3 derives from B2. For an overall functional presentation and an introduction to the mechanisms, please refer to the relevant sections of Chap. 4.

The figure below is an excerpt of the heuristic structure which analyses Fr. *un très grand jour pour elle* (En. *a very great day for her*). It displays a few channels, a few agents and the relations between them: recruitment relation (RC), delivery relation (DL), and agent-channel relation (AC).

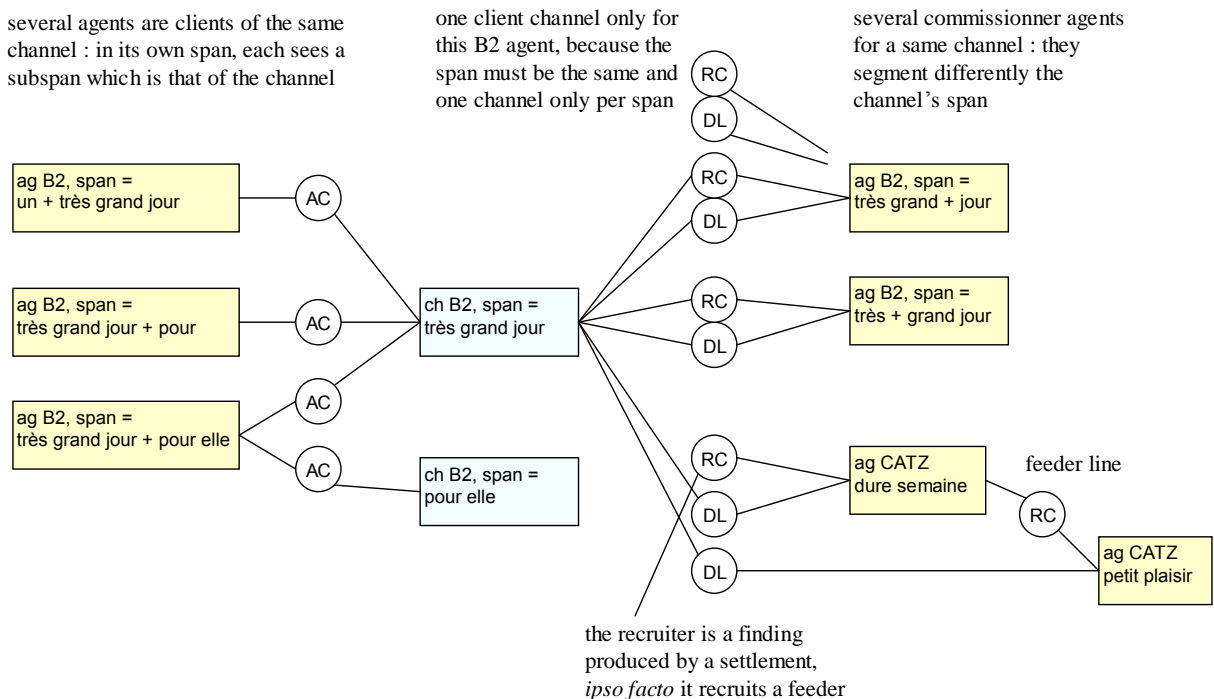

Figure 43 Connectivity of agent B2

The (DL) relation has a critical importance: it supports the consolidation of results and the update of their strengths.

The (RC) relation is less important: it is used for explanation purposes only.

## **16.2. Heuristic structure for agents B2 and B3**

### **16.2.1. B Channel**

The term 'B channel' is used although channels are not explicitly typed; agents are explicitly typed but channels are not.

Is a B channel a channel with one or several B agents as its commissioners? This definition is not sufficient because installation creates installation channels which are B channels but do not have commissioners and will never have any.

Is a B channel a channel with one or more B agents as its clients? This definition is also insufficient because an installation channel is, upon its creation, without client and may never have any.

Actually, in a B process, there are B channels only. There hasn't occurred a case which requires to mix up B channels with channels of another type.

### **16.2.2. Field data and span of a B channel**

The pair <L-R> (L for *Left*, R for *Right*) defines the span of the channel. The span is the fraction of the form being analysed (inputStr) on which the channel bears. It includes its boundaries.

### **16.2.3. Connectivity and existence of B channels**

Rearwards, a B channel has zero, one or several B agents. A commissioner agent of a B channel segments the channel's span into two parts.

Rearwards, a B channel has a feeder line of CATZ agents or not. It has a feeder line if either or both the following two conditions: 1. it is an installation channel, 2. or it is not an installation channel (then it is an assembly channel) and, one of its agents has settled and has created feeders for it.

Forward, a channel has zero, one or several client B agents.

### **16.2.4. Field data of a B agent**

A B agent uniquely segments a defined span of inputStr.

Conventions: LL is the leftmost boundary of the leftmost term of the segmentation. LR is the rightmost boundary of the leftmost term of the segmentation. Likewise RL, RR.

LL-LR + RL-RR is the segmentation (RL=LR+1).

LL-RR is the span of the B agent.

### 16.2.5. B agent as commissioner

A B agent (LL-LR + RL-RR) is a commissioner for one and only one B channel: that which has the span LL-RR. Problem: there might be several of these if installation creates as many channels with the same span as there are terms matching this span in the plexus. This problem is suppressed after homonymous terms are expelled from the plexus.

### 16.2.6. Possible ambiguity of a B agent

The segmentation which characterizes a B agent specifies two constituent spans but it does not otherwise specify their occupying terms. It may be the case that diverse findings of this agent give interpretations of this segmentation which are different in the sense that, facing the characteristic segments of the agent, they place licensing terms with "different derivational histories". In other words, puns are possible in the model. This is the case for *katta* in the figure below: the Japanese form *katta* which, in the utterance under analysis *sinakatta* (have not done, did'nt do, not having done), can only be the *katta* morpheme (negative, non polite past), is interpreted by B2 agent 142 as *katta* (bought, I bought, having bought). This is a pun.

One such ambiguity will resolve, or not, at the next assembly level (N+1). It may be the case that the assembly possibilities at level N+1 eventually disqualify some of the interpretations made at level N. On the example in the next figure, the pun *katta* is disqualified at level N+1 because this interpretation cannot assemble with *sina* on its left.

It may also be the case that several interpretations at level N still be qualified at level N+1: the ambiguity bears on a span larger than that of level N. Then level N+2 will possibly disqualify some of them.

### 16.2.7. Origins of results at a B channel

At a channel, the first result (it is the first one in time, it is the strongest in the beginning but may not remain so afterwards) is an installation result or a settlement result. The creation of the channel is motivated by that installation or settlement result. Then, terms which are distributionally similar to this first result will join at this channel. They are produced by the CATZ agents of the feeder line which is attached to this channel.

So that a channel (ex. channel 4) may have:

1. installation results. They are directly installed upon installation (ex. a result [sina], which is not on the figure, would be a direct installation result) or indirect results (ex. [oisi-], [katta] morpheme of accomplished). Installation results (direct and indirect) come through the feeder line<sup>388</sup> (CATZ agents) linked rearwards to the channel by (RC) links, or a chain of such links. They are distributionally similar to the channel's span (i.e. to the installation term) in its

---

<sup>388</sup> The phrase "feeder line" is adopted by analogy with industry. In mass production organization, for example in automotive industry, a main assembly line is feeded by secondary lines, the 'feeder lines', which bring the sub-assemblies to it. Here, the line of B agents and B channels is the main line, and the lines of CATZ agents, providing distributional similars, are the feeder lines.

entirety and therefore do not presuppose any segmentation for it. The installation results (direct and indirect) do not assume a segmentation of the channel's span and therefore are not associated with a B2 agent.

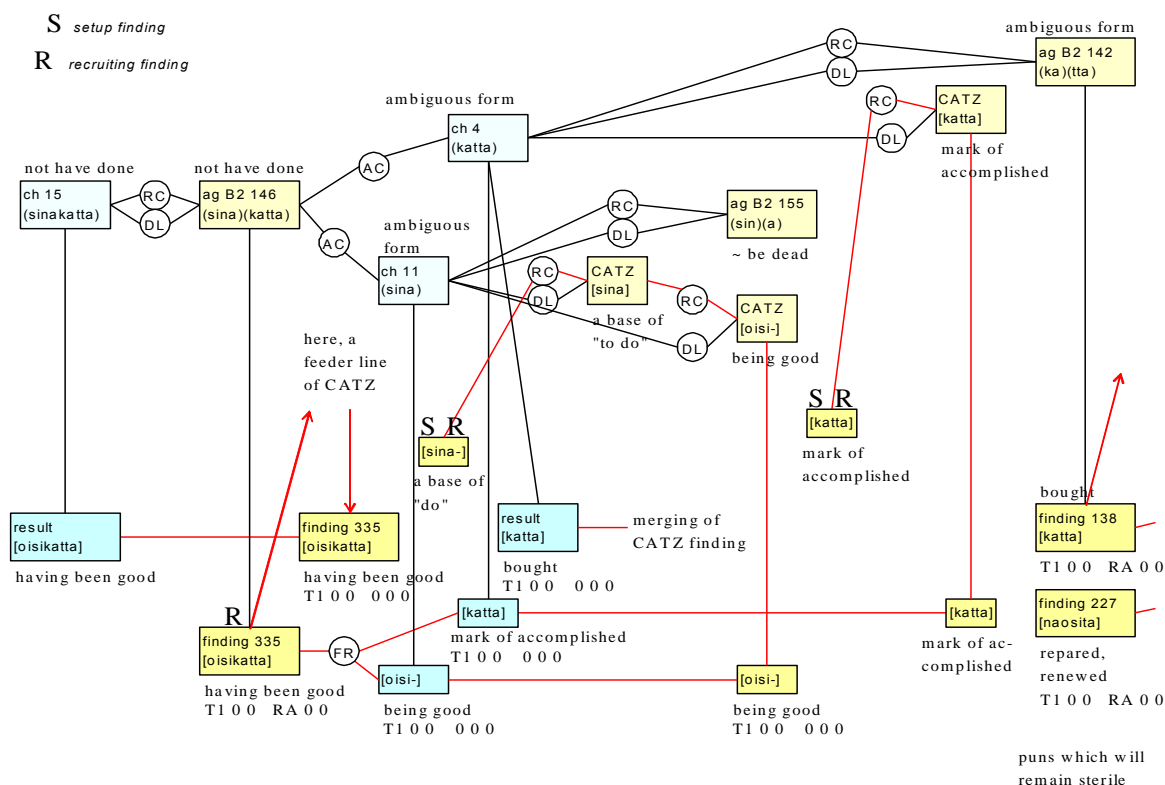

Figure 44 Installation products and merging products on the *sinakatta* example

2. direct settlement results (ex. [katta] *bought*) produced by the merging of findings (ex. finding 138), the latter being produced by settlement. Settlement results arrive by B2 agents (ex. agent B2 142). It is equivalent to say that they presuppose a segmentation of the channel's span.
3. abducted results (or indirect, or distributionally similar to the two latter types) which are produced in the feeder line, by commissioners of the line's head (the origins of the head being direct: either direct installation results or settlement results).

More precisely, those characters apply rigorously to the findings merged at this channel. Quite often a result at a channel is obtained by merging one finding only; then, by metonymy, it may be said to be direct or indirect, installation or settlement, depending on the sole finding which produces it. A result at a channel may also be the merging of several findings with different characters; then, it may not be said to be direct or indirect, installation or settlement.

### ***16.3. Parsing of the argument form***

A particular organ ensures parsing: it accepts the form to analyze and tries to find in it plexus terms.

In the form to analyze, seen as a character string, this function seeks all the possible substrings matching a plexus term, whatever their length, from one character only up to a limit set at 20 characters.

This limit, 20 characters, reflects a double condition which may ironically be paraphrased in this way: in a plexus, we may find terms which are comparatively long, but not too much. There is no fixed criterion: a long term in a plexus is always possible because of the minimality suspension principle, but it would be rare and its matching with an input string even more so (cf. section 7.2.6. *Terms should be simple and commonplace*, p. 200). Then, setting the limit too low would miss the long term at parsing time and the analysis would not take advantage of it; conversely, setting the limit too high burdens the process quadratically for a least marginal utility. This spluttering with a technical flavour is the symptom of a theoretical blindness; it is true that this particular point has not been searched. An extension – to be made – of the model in the direction of phonology should substantially improve this area, but investing here within the current perimeter (morphology and syntax) was not very promising.

Any substring found to match a plexus term produces a 'term notification'. A term notification is made up of this term and of the span, in the form under analysis, where the match was found. The span itself consists of the rank of the first character and the rank of the last character of the occurrence of this term in the form.

A term notification thus produced is delivered to the installation process.

Actually, the parser operates under control of the installation process. When invoking the parser, the latter may either order the parsing of the entire form or it may order the parsing of increments (a given number of characters). This incremental mode allows the tuning of reception time versus analysis time. The assumption is that speakers mostly analyze faster than they receive, and that this has effects. Moreover, delays in the reception process, like prosodic breaks, have effects on the analysis.

In a sense, the parser overplays its role: as the space between words is not treated as a particular sign<sup>389</sup>, for example in form *avala* (En. *swallowed*) it makes three notifications of term *a* at spans (1,1), (3,3) and (5,5) if the French plexus against which it works contains term *a*, which is expectable. For the same reason, it also notifies term *la* at span (4,5). These notifications give birth to installation structures (installation findings, channels, and feeders) which will dry up quickly because the corresponding segments cannot be assembled neither at their right nor at their left.

### ***16.4. Installation process***

The installation process receives term notifications from the parser.

---

<sup>389</sup> Reminder: this is a consequence of the minimality suspension principle, and the model does not define a notion of word.

Each term notification received creates an installation finding.

Then the installation process installs feeder line headers which are CATZ agents: one CATZ agent per occurrence of this term in the plexus. These agents are marked as recruited by the finding just created; this marking is only for later explaining the heuristic structure history and has no direct function in the ensuing analysis process. See for example the findings marked SR in *Figure 44 Installation products and merging products on the sinakatta example* above.

These CATZ agents deliver at the channel with the span of the notified term. Either this channel pre-exists, or it is created on the occasion.

Installation CATZ agents (feeder line heads) will recruit more CATZ agents, thus progressively constituting a feeder line; this structure will deliver results at the channel.

The agents of the feeder line raise in successive phases findings which will merge at the channel in question. This channel thus receives gradually distributionally similar terms of the installation term. In the simpler case, it receives these results only, but in the general case, it may, concurrently and complementarily, also receive installation results and settlement results, see the previously referenced figure.

This closes the discussion of the installation process. The rest of the analysis process is understood as the operation of agents B2 and B3, that is, the mechanism of the edification of these agents and of the associated intervening channels.

### ***16.5. Agent B2, edification procedure***

The edification mechanism consists of the recursive phasing of 'edification cycles'. An edification cycle is performed in one computation phase; its description consists of six steps:

- (1) The triggering event is a result (hereafter: argument result) arising at a channel (hereafter: argument channel). In initial conditions, the argument result is an installation result, in the subsequent course of the process it is a merging result (this clause ensures the recursivity of the whole). The rest of the edification cycle does not depend on the origin (installation or merging) of the argument result.
- (2) The process then considers any channel (L channel) left-adjacent to argument channel. It also considers any right-adjacent channel (R channel), but the rest of this description will be limited to left-adjacency.
- (3) For all left-adjacent channels, an agent is created, which is characteristic of this pair of channels. It is vested with the duty of watching the possible settlements between the channels' products. The watching starts immediately.
- (4) A settlement happens when (i) a result that is already present at L channel and (ii) argument result, both are constituents in a binary C-type record. This record is the 'licensing record' and the term in assembly position in it is called the 'licensing term'. Settlement then creates a settlement finding the content of which is the licensing term.
- (5) The merging of this finding gives a result bearing on the same licensing term.
- (6) If it does not already exist, a channel is created for this result. It is allocated a span which is the catenation of the spans of (i) argument channel, and (ii) L channel.

Delivering at this channel are recruited CATZ agents the argument of which is the licensing term. These agents are heads of feeder lines. They will report to the channel distributionally similar terms of the settlement term, hoping that these participate in settlements at next level.

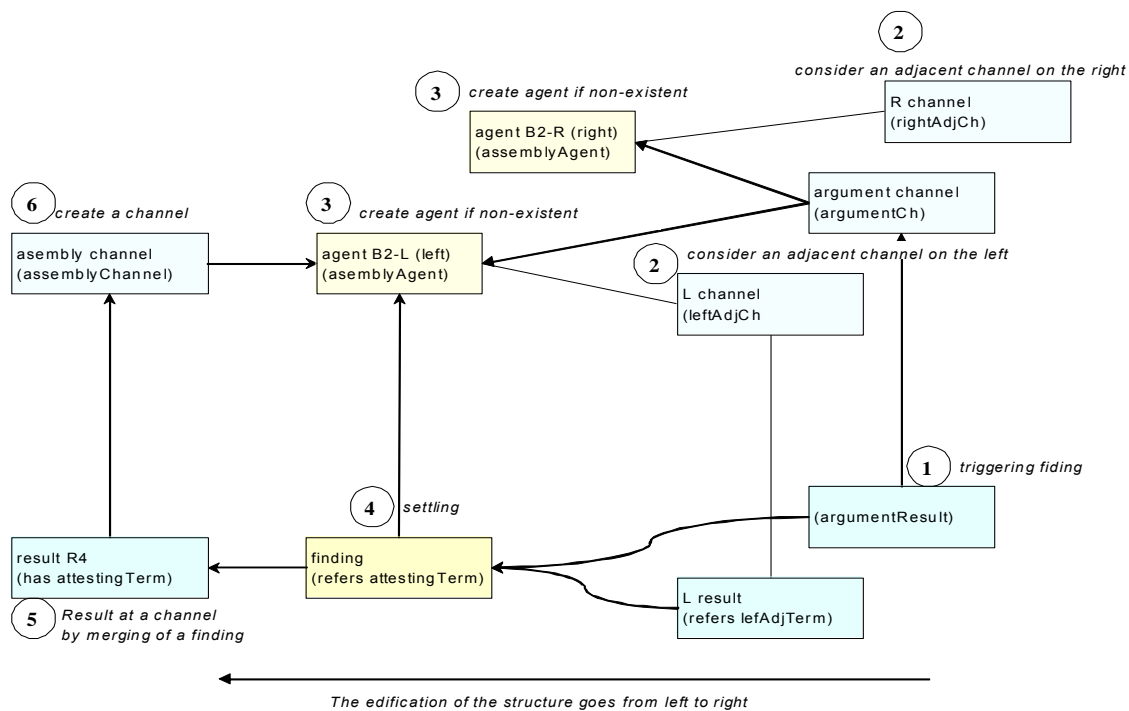

**Figure 45 Agent B2, edification mechanism**

This completes an edification cycle: the product obtained at step (5) in this instance of edification cycle acts at next computation phase as the trigger of a new instance of edification cycle, but one assembly level higher.

### ***16.6. Agent B2, edification procedure in pseudo-code***

Exactly the same cycle is described below more formally.

function ABS\_B2\_BUILD (argumentResult)  
 In ABS, the BUILD procedure for agent B2

Input arguments -----  
 argumentResult: a product number which is a result at a channel which has  
 (one at least) B2 client agent

Program logic -----  
 Let argumentCh be the channel of argumentResult.  
 For all existing channel, left-adjacent to argumentCh (leftAdjCh),



with their field data, make the putative field data of a B2 agent which is the pair (span of leftAdjCh, span of argumentCh)

If an agent with that field data does not exist, create it. In any case, call it 'assemblyAg'. Make assemblyAg a client (FW) of argumentCh (RW), and of leftAdjCh (RW).

Analysis note: assemblyAg MUST be created because without it, it is difficult to watch the solvings. Because of that, there will exist some B2 agents which will never solve and therefore will never receive any finding.

This is no big concern: the potential proliferation of the heuristic structure will stop with them: one such agent will never have a channel because channel creation is subordinated to effective solving (and is simultaneous to transparent recruitment of CATZ agents).

Try to match rightAdjTerm (the term in argumentResult) with the term (leftAdjTerm) of all results existing at the partner channel leftAdjCh.

Successful matching consists of leftAdjTerm and rightAdjTerm being adjacently attested within a C record (the solving record). This constitutes a solving (a settlement). Upon solving, in the solving record, collect the term in the assembly position (let 'attestingTerm' be that term).

Create a finding with duty = term 'attestingTerm' and owner = assemblyAg.

This is the 'recruitingFinding'.

Connect the recruitingFinding (FW) through a FR link to argumentResult and the result in which rightAdjTerm was found.

Analysis note. The mere construction of the heuristic structure might do without explicitly creating the recruitingFinding. However, the recruitingFinding is mandatory to the explanation paths so it HAS to be created explicitly.

Ensure existence/create assemblyCh (will be the delivery point of 'feeder')

Connect assemblyCh-RC-assemblyAg

Connect assemblyCh-DL-assemblyAg

Recruit/make a CATZ agent (the 'feeder'),

Connect recruitingFinding-RC-feeder

Connect assemblyCh-DL-feeder

Analysis note. The 'feeder', flagged for attention in next phase, will in turn recruit more CATZ agents thus forming a feeder line. The feeder line will produce findings which will be taken over by ensuing phases of the computation, thus generating more opportunities for solving.

This is all for left adjacency.

Do the same thing for right adjacency.

This completes a cycle of edification.

### ***16.7. Agent B3, edification procedure***

As for agent B2, just take channels by three.

## ***16.8. Performance with the type of similarity***

Agent CATZ suggests similarities in the service of the B2-B3 process; doing so, it opens up heuristic tracks which then either lead to settlements, or remain unproductive. Now CATZ may produce similar terms in different modes. (cf. 15. *Appendix: Simple similarity suggestion (agent CATZ)*). It is interesting to assess how the different modes impact the behaviour of the B2-B3 process.

Measurements were made with a set of four utterances: Fr. *elle est arrivée avec son homme*, Fr. *très très grand homme*, Fr. *reprendre la route*, and Jap. *sinakatta*.

With the distributionally similar terms alone, the production is the same as when adding the constitutionally similar terms, the number of agents is lesser and the computation time is better.

With the distributionally similar terms and the constitutionally similar terms, about 10% more agents are required and the task successful completion is never faster than with the distributionally similar terms alone.

These results may depend on properties of the plexus used.

## ***16.9. Productivity of agent B2***

### **16.9.1. Why the question is important**

A B-type channel has a commissioner agent (therefore of type B2) which attempts a segmentation of its span. It is important to report whether this segmentation is useful, that is, if something could be done with it at the client channel.

During the exposition of a B2 channel one of its commissioner agents will be exposed only if it is productive.

### **16.9.2. Productivity of an agent *with respect to its client channel***

The productivity of a B2 agent is considered *with respect to its client channel* (which is unique, cf. *Figure 43 Connectivity of agent B2*, p. 361). If the agent is considered in itself, it is not possible to assess its productions; these productions are distributionally similar to the span, but at this stage their relevance is not defined; they are just similar. The agent becomes productive with respect to its client channel when one of its findings is delivered at the channel and then merged into a result which itself settles.

Channels are fraught with results which do not settle. Settlement results only count because only them signal the agent's productivity.

It needs to be noted that the findings at stake are not the findings of the B2 agent (which are not delivered but rather recruit a feeder head). The findings at stake are those of the CATZ agents in the feeder lines, because these findings only are delivered at the client channel of the B2 agent which recruited the CATZ feeders.

### **16.9.3. Method for assessing an agent's productivity**

From the agent, via the (RC) relation, exhaust the transitive closure of the CATZ agents in the feeder line. Each CATZ agent has a term (pick it up either in its duty or in its unique finding *ad lib.*).

Consider the result at the channel which has this term. If this result settles, then the agent is productive at its channel.

It suffices that this be the case for one only of the CATZ feeders.

### **16.10. Result of a B2-B3 analysis**

The new interpretation in this model of 'analysis of a received utterance' was already explained at the beginning of Chap. 4. It is now possible to provide a more technical paraphrase building on what was presented in this appendix.

#### **16.10.1. Licensing channel, licensing finding, licensing result**

The fact that a channel has been created, the span of which entirely embraces the form submitted to analysis (inputStr), reflects the fact that a settlement took place at an agent's, (a commissioner of the channel). This means that the argument utterance is now analysed.

It may be the case that the licensing result has not yet arrived at the channel at his phase: this is normal; it will get there at next phase, after the finding will be merged. However, an exposition query issued at the channel must display the licensing finding nevertheless.

#### **16.10.2. Result of a B2 analysis**

The result of an analysis is not restricted to the sole final licensing result.

Firstly because the analysis is done before the licensing result is produced as the merging of the licensing finding, as we just saw.

Secondly because there may be several licensing findings that merge into as many different licensing results.

And finally (this is the most important) because a B2 analysis is made up not just of the sole final result but of the network of the findings, agents and results which pile up and lead to the final licensing and justify it level wise. It is so because it is at each level of this network that some meaning may be built and because the meaning of an utterance is not a monadic object but the result of a levelled construction process.

Therefore, a formal only B2 analysis is not in itself an autonomous achievement: it must be viewed as supporting a process which is subsequent to it (but interleaved with it): interpretation. This supposes the semantic side of the model which is not yet developed.

So today, a B2 analysis must be regarded cautiously:

- a) it may seem good now but prove later badly fit to support interpretation,
- b) conversely, it may seem painstaking today but in future turn out to be much facilitated by the introduction of the semantic dimension with the private terms.

## 17. Appendix: Binary branching, ternary branching

### 17.1. The question and its history

A construction may be binary: it assembles two constituents. Can it also be more than binary (assembling three constituents or more), or perhaps also, less than binary? To be rigorous, n-arity in generativism bears on derivational rules and therefore on the phrase marker<sup>390</sup>, whereas in the Analogical Speaker it bears on exemplarist C-type records since there is no abstraction here. Yet, the parallel remains possible and it is interesting. The n-arity of branching was discussed in the context of the X bar<sup>391</sup> theory and the conclusions are summarized by Chametzky<sup>392</sup>.

About whether branching may be less than binary that is, (p. 33) whether, in the analysis trees that the phrase markers are, a node may have one son only, Chametzky concludes: *no well behaved phrase structure theory ought to have such a relation* and this for a) a conceptual reason: *constituency is part-whole relation and claiming that a whole with one part is in the same relation to that part as a whole with two (or more) parts is to its parts is to make a non obvious, quite plausibly spurious claim* and b) an analytical reason *which is an examination of the actual range of cases of nonbranching domination in the literature*. In the literature four cases happen: the first one concerns level zero, just below the phrase marker<sup>393</sup>; of it, it cannot be said that it is a dominance relation; a second one is the relation of the type X"-X' or X'-X for which it is suggested to ascribe a multiple label to the same node; the two remaining cases are exocentric

---

<sup>390</sup>The generativist culture calls 'phrase marker' the tree which analyses an utterance. Its nodes are either terminal nodes, then they match the ultimate constituents picked up in the lexicon, or non-terminal nodes, then they stand for assemblies of the latter and/or of themselves. Each node has a categorial label. The edges of the phrase marker are constituency relations between the linguistic entities represented by the nodes. The phrase marker is produced by applying derivational rules.

<sup>391</sup>X bar theory was proposed by Chomsky in 1970 (*Remarks on Nominalization*) then complemented by Jackendoff in 1977 and Gazdar in 1982. It governs the constitution of noun phrases, verb phrases, and adjectival phrases. It says nothing on sentence syntax. The different expansions of the head are denoted by none, one, two, or three superscript bars, or, more conveniently, by primes, seconds and thirds (X, X', X'', X''').

<sup>392</sup>Chametzky 2000, p. 33-34.

<sup>393</sup>Chametzky here uses a metonymy for "just below the root of the phrase marker".

labelling, and the utilization of "functional" labels such as "subject" and "topic". Chametzky concludes finally: *if nonbranching domination is conceptually unsound, then there ought to be no clear and compelling instances of it – and there are not*. Less-than-binary branching not occurring in the Analogical Speaker and, as we just saw, it appearing in the X-bar theory only for reasons that are side effects of theoretical options much away from ours, we are not going to be concerned with it further.

What is now the position of the X bar theory as to more than binary branching; reasons depend on authors and, following Chametzky's survey, they are the following: 1. Restricting branching to binarity amounts to an analytical restriction (or an acquisitional one), the restriction is therefore desirable and supposed by the theory. 2. Quite often, we ignore the empirical reasons to think that branching may be more than binary. Williams 1994 however notes that these facts do not require that the effects of branching on the requirement of locality bearing on the relation "argument of" go beyond binarity, otherwise said, if a predicate has more than one argument, it cannot be the case that all arguments are brothers of this predicate. Williams seems to prefer rejecting more than binary branching to make the locality condition less strong, because he finds for the latter an autonomous justification. 3. Kayne (1994) demands that the branching should not be more than binary in order to satisfy another syntactic relation (his linear correspondence axiom) rather than stipulating binarity for itself. 4. Chomsky (1995/1997a, chap. 4) seems to think that branching must be limited to binarity by "virtual conceptual necessity". 5. Chametzky (1996) sees the restriction to binarity as an empirical generalization which moreover favours the analysis of adjuncts.

A generativist theory has to make a choice: before the application of transformations, the phrase markers result of the application of derivational rules and a derivational rule has to be binary or ternary. Such a theory must make a choice. Are the reasons for choosing good reasons? The reader will answer following his preferences in the light of the reminder above.

Since the model of the Analogical Speaker is rule-less, the reasons for opting for binarity or ternarity in it much less need to depend on general principles: they may be associated with particular cases, that is, constructional similarities attached to a few exemplars only, possibly two exemplars only.

Turning now to the organic implementation in the model, an option about n-arity consists of deciding whether C-type records are limited to two constituents or they may have three or four. The assembling agents must have a compatible design: for binary C-type records a binary assembling agent is needed (B2 currently), for ternary ones, a ternary agent (B3), etc.

In addition, a principle of homogeneity must be observed: a B2 agent cannot, in a ternary record, make an excerpt limited to two constituents and attempt to use it in this way. This is because, a) doing this is unproductive in its consequences most often, and b) when it is productive it leads to bad productions. This principle was found useful after several trials and meanderings and it is observed in the current implementation of the B2-B3 process.

## 17.2. Exemplarist reasons

What facts and needs lead to be satisfied with binarity or on the contrary to want ternarity? For clarity a case which would be an error needs to be discarded first: n-arity cannot be invoked for treating the morphology of Semitic languages. Cf. section 8.1. *Non-concatenative morphologies* (p. 248) where reasons are provided.

First, particular reasons will be reviewed.

A ternary construction allows us, as in the case of *ne ... pas* in Fr. to constrain the occurrences of non-contiguous morphemes that are (quasi-)systematically coupled. In the *ne ... pas*, construction, there is really no reason to impose ((ne parle) pas) [En.: don't talk] against ((ne (parle) pas)). The ternary formula ((ne) (parle) (pas)) seems more apt to impose the cooccurrence of *ne* and *pas*.

Concerning now the treatment of agreement with n-ary constructions, this seems to be an artefact both efficient and partial. Still it is an artefact: the scope of agreement phenomena is a whole expansion and a better adapted structure is preferable. The intuition is that the solution of agreement is elsewhere, in the direction of agent AN2 and perhaps a revision of the inscription structure which provide "feature effects" more directly.

Conjunctive constructions are a very obvious example in which ternarity is useful:

- *l'Etat + et + la société*
- *dix + - + sept, trente + - + deux*
- *est + - + ce, est + - + il*

here again, there isn't any reason to bracket right or left.

In *rouge et noir* vs. *le rouge et le noir*, allowing ternary assemblies is a very economical way not to let happen zeugma like *rouge et le noir* and *le rouge et noir*, which does not exclude to also allow, in a controlled manner, to license the latter form by other records; but this is a distinct paradigm.

Considering now the case of N-N or NP-NP juxtaposition:

- *malentendu + mère + fille* (mother-daughter misunderstanding),
- *ligne + Bordeaux + Genève* (Bordeaux-Geneva line).

"mère fille" is productive only with rare N on its left (here *malentendu*). Likewise for "Bordeaux Genève". A ternary construction eases this sort of sub-categorization.

Let us now move to general reasons.

When facing a "requirement for ternarity", as in the examples above, if a binarist limiting option were taken, making two binary levels instead of a single ternary one would always be possible. Such makeshift is an occasion of leakage. Not demonstrated but conjectured. It is also an occasion of poorer performance. Not demonstrated but conjectured.

The prototypical binarist argument in Chomsky<sup>394</sup> is about the case S=NP+SV. For Chomsky, a two-level model;

S=SubjectNP+SV and  
VP= V+ObjectNP

must be preferred to a one-level ternary rule:

NP=SubjectNP+V+ObjectNP

where the SubjectNP is distinguished from other NPs surrounding the V. These other NPs are associated with the V into a VP, while the SubjectNP is not. Why is that so? Because in the transformations the VP has to be treated as a unit: it is moved as a whole.

Firstly, this argument is not applicable to languages without subject. Secondly the model which I propose does not have transformations and so there is no need to state that the VP is moved as a whole because there is no moving a VP. Finally the conservation of the identity of the VP in analogies which motivated transformations or its move as a whole is not self-evident; and the ObjectNP has very numerous behaviours of cohesion and move that are similar to those of the SubjectNP: *Je vois la mer. Vois-je la mer? La mer je la vois. C'est la mer que je vois.* etc. It is not striking that a structure must treat them differently. That the subject be (possibly) obligatory and the object (possibly) optional, is not more a criterion. So the prototypical argument for binarism does not seem very strong in general and its strength seems even weaker within the options of this model.

In sum, there are arguments for ternarity and nothing so far which compels to reject it. Maybe an economical argument is more decisive.

### 17.3. Cost reasons

In a B2 agent, settlement consists of considering the Cartesian product<sup>395</sup> of the results appended at the two channels which this agent assembles. Such Cartesian product is bidimensional (it has two channels). For a B3 agent, it is three-dimensional, for a B4 agent, it would be four-dimensional. Is the computation cost thus moving from  $N^2$  to  $N^4$ ? This must not be feared: in an assembly with more than two constituents, almost always intervenes a position occupied by a term with few distributionally similar terms<sup>396</sup>. Example: *demande + à + voir* would be an open-closed-open B3; other example: *il + ne + ment + pas* is an open-closed-open-quasi\_closed B4 (*pas, plus, jamais, presque pas, pas toujours*).

Even in a case in which open-class terms accumulate without any 'empty word' between them (examples in En.: *Tokyo Stock Exchange*, or *summer season holiday plan forecast figures*<sup>397</sup>), rather than by B3 or B4 agents, the analysis process will take successions of

---

<sup>394</sup> As late as in Chomsky 2000, p. 58.

<sup>395</sup> It must be reminded that the Cartesian product is potential only: it is actually built in part only, as long as a settlement hasn't occurred.

<sup>396</sup> Empty words, closed lexical classes, or grammemes in other theories.

<sup>397</sup> Thanks to Robert Freeman

levelled B2 agents, applying between two successive B2s the expansive homology abductive movement.

We see finally that a cost argument is not one for favouring low n-arities. We keep the liberty to choose n so as to favour the better grasping of dependencies; we are free to choose it separately for each, or better said: for each paradigm.

#### ***17.4. Choice of n-arity***

The proposed model makes binary assemblies (B2 agent) and ternary ones (B3 agent). Quaternary assemblies make no difficulty in principle or in the implementation, simply the need has not aroused and quaternary assemblies are not currently implemented.





## 18. Appendix: Analogical task (agent ANZ)

### 18.1. Agent ANZ, specification and overall design

Given an analogy in the classical wording:

X is to Y as A is to B

or, conventionally:

$X : Y :: A : B$

Y, A and B being given, an analogical task is defined as:

find X, which is to Y as A is to B.

Depending on the case, the task may have no solution, have one, or several. Following the general principles of the dynamics established in Chap. 3, the model rewords this as follows: after a given number of computation phases, this task produces none, one, or several results, each with a strength tag. At next phase, more results may obtain, and the strengths of the existing ones may change.

The model implements this task by means of an agent which is named ANZ.

To implement the task, an agent (then client of that which interests us) recruits an ANZ agent. The latter then recruits more ANZ agents, and so on. In the successive recruitments, the agents substitute to one another analogies abductively equivalent to that of the task to solve. The abductive movements used are transitivity and transposition.

ANZ uses systemic analogy, that is, the analogical pairs of the plexus:

- a) in A-type records, the pair of terms in the record,
- b) in C-type records, the pair of the terms bearing A marks.

In short ANZ uses the coindexed pairs (it is reminded that coindexation bears exactly on pairs defined by the two clauses above).

The operation of agent ANZ is described with the four following steps (cf. Chap. 5 for examples and in particular *Figure 19 The mechanism of agent ANZ*):

1. Priming. The terms of the task being given: Y, A and B, find in the plexus a record where a pair of these terms occurs. For this, use the binary index. The pair then becomes the current pair and it is located in the plexus in defined sites of a defined record. This record belongs to a paradigm. The remaining term will be

the spare term. An ANZ agent is then recruited and assigned the duty consisting of the current pair and the spare term.

2. Step in paradigm. A move is made from the current record to directly linked records, which identifies a new current pair. A new ANZ agent is then recruited with a duty made up of the new current pair and the spare term (the recruitment is conditioned by the agent non-redundancy clause). After a sufficient number of phases, the paradigm may in this way be exhausted.
3. Positioned resetting. The ANZ agent looks whether its duty may be transposed (see above a discussion of analogy transposition): a tentative new current pair is made by involving the spare term. The attempt succeeds if the new current pair is coindexed in the plexus. Then, this ANZ agent recruits another one, assigning it this pair as its duty (again, the recruitment is conditioned by the agent non-redundancy clause).
4. Settlement. When, in its duty, the agent ANZ finds the spare term equal to a term of the current pair, then the settlement condition is detected and the third term in the duty is an X, that is, a result, as specified by the analogical task; a finding is raised. The finding is later merged by ABS at the agent's delivery point, into a result.

In short, the ANZ agent recruits a systematic tree of possibilities by exhausting its current paradigm and by performing resetting when analogy transposition allows it to do so<sup>398</sup>.

The settlement condition is the coincidence of two terms one of which is the spare term.

## ***18.2. Rearward procedure for agent ANZ, in pseudo-code***

function ABS\_RW\_ANZ (argAgNum)

Implicit arguments = components of argAgNum's duty which are relevant, that is:

a) term Y implemented in ABSagT1

b) the cooccurrence (ABSagRA(argAgNum), ABSagSA1(argAgNum),  
ABSagSA2(argAgNum))

Assumption: these sites are occupied by existing terms

Let A = term (ABSagRA(argAgNum), ABSagSA1(argAgNum))

Let B = term (ABSagRA(argAgNum), ABSagSA2(argAgNum))

Raising:

none

---

<sup>398</sup> Such a systematic and exhaustive search may be questioned: do we have reasons to think that the brain operates in this way? What is not doubtful is that numerous activations happen in parallel. The way ABS organizes the search must rather be seen as the serialization of a parallel process. Its detail may not be plausible while its overall effect may. *The general adequation and plausibility of the model do not require all its components to be adequate and plausible.* (Daniel Kayser, pers. comm.).

Solving:

if  $Y==B$  then produce A as a finding

Positioned resetting:

let newY=A

in plexus, pick up coindexed occurrences of (Y, B)  $\rightarrow$  cooccurrences (RZ, S1Z, S2)

Term (RZ, S1Z) is interpreted as newA, term (RZ, S2Z) is interpreted as newB.

For each cooccurrence found recruit ANZ (NouveauY, RZ, S1Z, S2Z),

the settlement base is transposed, the record belongs to another paradigm

One step in same paradigm = abductive movement by transitivity:

Starting from RA, take a step in paradigm  
yielding homologous cooccurrences RZ, S1Z, S2Z

For any such cooccurrence found, recruit ANZ (Y, RZ, S1Z, S2Z),

the settlement base is conserved,

the record is a homologous one in the same paradigm.

return

end ABS\_RW\_ANZ

### ***18.3. Forward procedure for agent ANZ***

None. No forward procedure is necessary for agent ANZ.

### ***18.4. Discussion of agent ANZ: under-productive priming***

For agent ANZ, priming is the initial process which accepts the terms of the task and yields current operation conditions<sup>399</sup>. Priming accepts the three terms defining an analogical task (e.g. *le, une, un*) and distributes them into: a) a spare term, and b) a current pair, the latter being located in a defined plexus record.

In the current implementation, priming requires a pair of the task's terms to be directly coindexed. However, intuition suggests that a less explicit, more diffuse attestation should suffice. Current priming may then be seen as too rough and under-productive in certain cases.

---

<sup>399</sup> "Priming" is also used in experimental psychology and in psycholinguistics, with a different meaning.

A more productive design, which would succeed in priming in less favourable cases is algorithmically possible, but it is heavy and little plausible, which is why it was not implemented. A more parallel and efficient processor, as the brain certainly is, may do things differently and one of the propositions below applies:

- it produces a more diffuse priming,
- the structuring mechanisms which the brain uses are compatible with those of the model but more flexible,
- the structuring mechanisms which the brain uses differ from those of the model,
- after all, men also find it difficult to process analogy when the conditions relating their terms are not favourable enough and the model is not overall much worse than us.

In the absence currently of a base to make a more precise statement, this point is left as it is.

## 19. Appendix: Analogical task with two constituents (agent S2A)

### 19.1. Agent S2A, specification and overall design

Agent S2A solves an analogical task of the type "find X which is to Y//Z (sign // is concatenation) as A is to B". Where there used to be a single term (Y) in agent ANZ, we now have the concatenation of two terms (Y//Z) in agent S2A. Thus S2A is productive in cases in which ANZ is not.

Agent S2A:

- finds  $Y' = \text{ANZ}(Y :: A : B)$  producing results at channel C1,
- finds  $Z' = \text{ANZ}(Z :: A : B)$  producing results at channel C2.
- adapts then its operation depending on C1 and C2 being productive. The cases are: none is productive, C1 alone is productive, C2 alone is productive, C1 and C2 both are productive.

If C1 alone is productive, let Y' be its production, then S2A produces  $X=Y//Z$  as result

If C2 alone is productive, let Z' be its production, then S2A produces  $X=Y//Z'$  as result.

If C1 and C2 are productive, S2A produces  $Y'//Z'$  as result.

This notation is a convention, actually, Y' must be understood as the set of the terms which arise in successive phases at channel C1; likewise for Z'. But this happens seldom only. The results of the agent therefore are sets in principle only; most often they contain zero or one element, less often two or three. When C1 and C2 are productive, all the Y' are concatenated with all the Z' (Cartesian product effect).

### 19.2. Architecture of agent S2A

The diagram below shows the architecture of agent S2A.

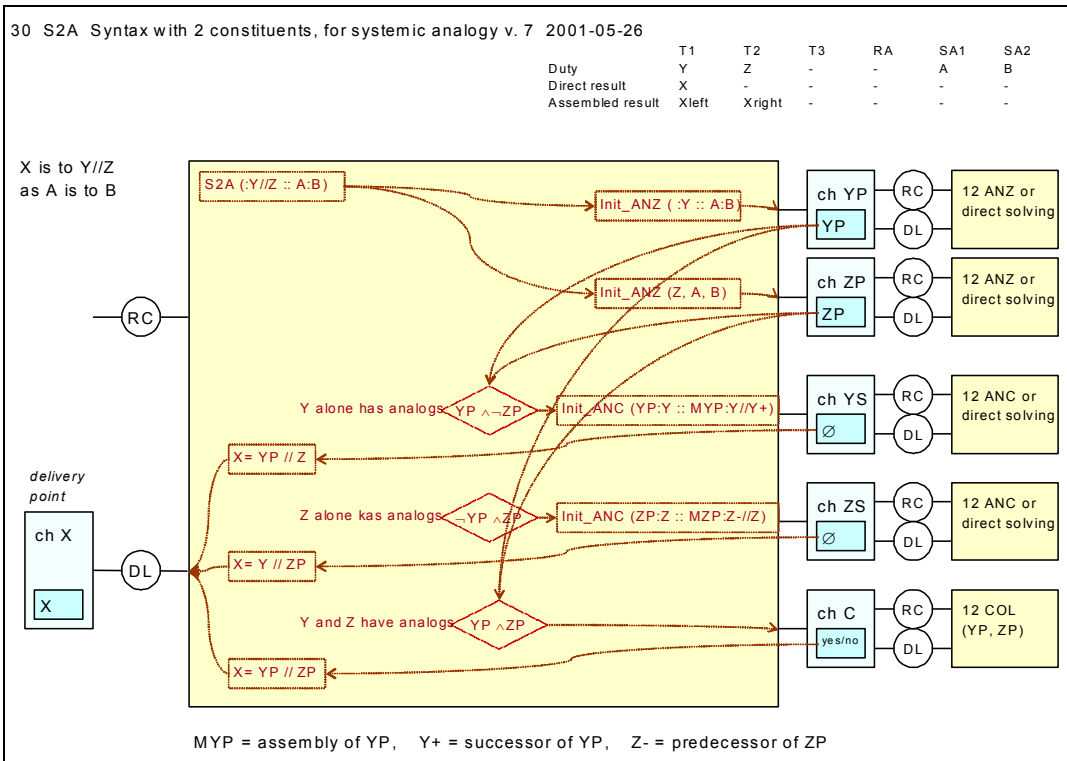

Figure 46 Diagram of agent S2A

### 19.3. Limits of agent S2A

S2A has the following limits. It:

- inherits from ANZ its own limit at priming.
- requires preanalysed constituents. This limit is minor: it is easy to wrap up S2A with a client which ensures the analysis which is done with agent AN2.
- impose the constituents to be attested terms (it does not process unknown terms). This limit is not critical in a two-term only vision. The absence of the 'unknown term' function becomes more sensitive when processing a longer form.
- is limited to two terms and the architecture is difficult to extend to more.

## 20. Appendix: Limited syntax with agreement (pseudo-agent AN2)

### 20.1. Definition of pseudo-agent AN2

AN2 treats the analogical task (find X which is to Y as A is to B) by combining two approaches:

- a) it tries to solve directly by recruiting ANZ
- b) it tries to segment Y into two attested terms and then recruits S2A.

### 20.2. Merits and limits of pseudo-agent AN2

The current implementation is a "wrap up" which modestly compensates for the absence of syntax in the analogical task (or the absence of structural analogy in B2-B3 which is the same thing). The operation is heavy and little plausible. AN2 should disappear upon 'syntactization' of the analogical task or 'analogization' of the analysis process.

AN2 is "pseudo" in this that it has no code of its own: no rearward function, no forward function (there is no ABS\_RW\_AN2 or ABS\_FW\_AN2). Its implementation is reduced to a Matlab function of triggering/initialization. With an implementation like this one, AN2 could not act as a commissioner for another agent. This is contingent, if it had to be, a cleaner packaging would be easy to make, but it was not invested upon because it is not promising.

Within its current limit, AN2 is the best that can be shown to be doing a little syntax while observing agreement, still without lexical categories, without syntactic features, and without rules.

AN2, because it is client of CATZ which neglects positionality, should not perform this well. However, the tests are good: the agent responds less than one might wish (it is deemed to be under-productive) but when it does, the results are always good. This is a happy effect which should be explained but has not yet been.





## 21. Appendix: Summary of agents

The general picture below indicates what agents use what other agents.

Agents B2 and B3 are melted to denote that they form a solidary whole. For example, B2 is its own client, B2 is client of B3, B3 is its own client and B3 is client of B2.

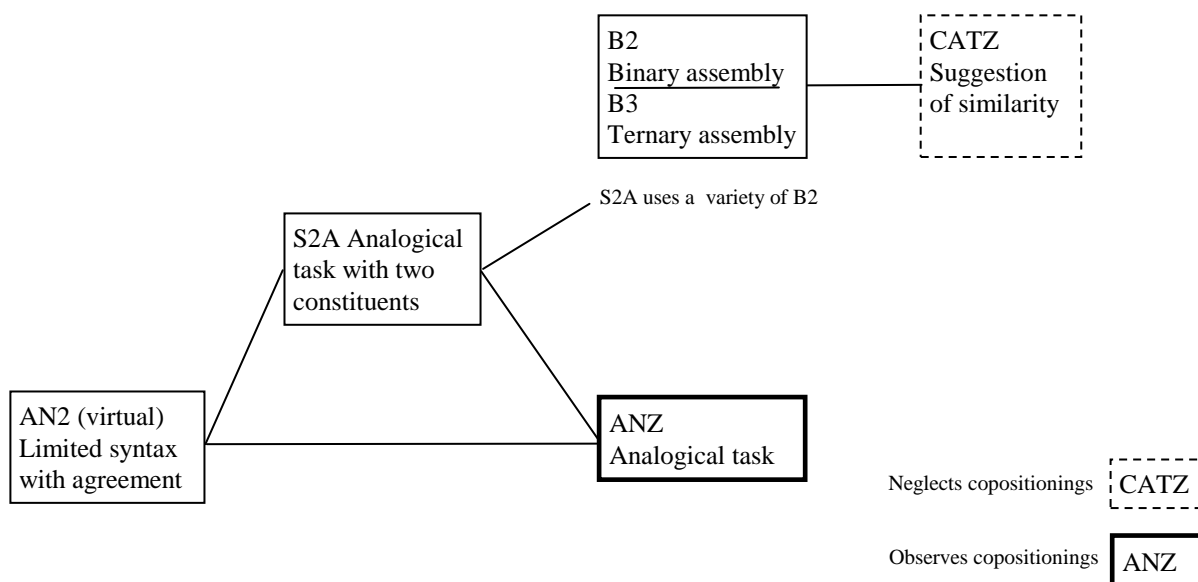

Figure 47 Client agents (on the left) and commissioner agents (on the right)

Agent CATZ neglects copositionings. The consequence must be that its clients (its left transitive closure: B2, B3, S2A, AN2) also neglect copositionings.

B2-B3 for example, which is client of CATZ, does not observe agreement.

Strictly, agent ANZ is the only one to observe copositionings. However, its client AN2 observes them too, as tests show, despite it using CATZ (cf. section 5.7. *Grammatical agreement with AN2*, page 153). This favourable effect is a surprise in the model. It is welcome but was not explained.



## References<sup>400</sup>

- Abney 1996 (Steven) *Statistical methods and linguistics*, in Judith Klavans and Philip Resnik, eds. *The balancing act*, MIT Press, 1996, <http://www.sfs.nphil.uni-tuebingen.de/~abney/>
- Altmann 1990 (Gerry T.M. ed.) *Cognitive models of speech processing* Bradford Books / MIT Press.
- Aristotle 1980, *La Poétique*, Text, transl and notes, Roselyne Dupont-Roc and Jean Lallot, Paris, Seuil.
- Arnauld 1660/1997 (Antoine, and Claude Lancelot) *Grammaire générale et raisonnée*, Editions Allia, Paris 1997, 1<sup>st</sup> publ. 1660.
- Atkinson 1968 (R. L., and R. M. Shifrin) "Human memory, a proposed system and its control processes" in K.W. Spence and J.T. Spence, eds., *The psychology of learning and motivation: advances in research and theory*, vol. 2 New York, Academic Press.
- Auroux 1989 (Sylvain, at al.) *Histoire des idées linguistiques, tome 1, la naissance des métalangages*. Mardaga, Bruxelles.
- Auroux 1991 (Sylvain) *La linguistique est une science normative* in Meschonnic 1991.
- Auroux 1994 (Sylvain) *La révolution technologique de la grammatization*, Mardaga, Liège.
- Auroux 1996 (Sylvain, and al., éditeurs) *Histoire et grammaire du sens* Armand Colin, Paris.
- Auroux 1998 (Sylvain) *La raison, le langage et les normes*, PUF, Paris.
- Barlow 2000 (Michael and Suzanne Kemmer editors) *Usage-based models of language*, CSLI Publications, Stanford.
- Barner 2002 (David, and Alan Bale) *No nouns, no verbs: psycholinguistic arguments in favor of lexical underspecification*, *Lingua* 112 (2002) 771-791.
- Bazell 1949 (C.E.) *On some asymmetries of the linguistic system*, *Acta Linguistica*, Vol 5, fasc. 3, 1945-1949.
- Bechtel 1991/1993 (William) & Adele Abrahamsen *Le Connectionnisme et l'Esprit* La Découverte Paris 1993 (Ed. orig. en ang., 1991).

---

<sup>400</sup> When two dates are provided, separated by a slash, as for example in :

Saussure 1915/1975 (Ferdinand de) *Cours de linguistique générale* (ed. Tullio de Mauro) Payot, Paris, 1975, first publ. in 1915.

the first one (e.g. 1915) is that of the original publication, it is provided for precedence reasons or to locate the publication in history; the second one (e.g. 1975) is that of a more recent publication, a more accessible one, occasionally a translation. In the quotations, the page indication is a reference to the more recent publication.

- Benveniste 1950 (Emile) *La phrase nominale*, Bull. de la Société de Linguistique, 46, 1950, p. 19-36.
- Benveniste 1966 (Emile) *Problèmes de Linguistique Générale 1*, Gallimard Collection Tel Paris 1966.
- Bloomfield 1933/1970 (Leonard) *Le Langage* Payot 1970 (1<sup>ère</sup> publ. New York 1933).
- Bohas 1993a (Georges) *Diverses conceptions de la morphologie arabe*, in Bohas Georges, (ed.) *Développements récents en linguistique arabe et sémitique*. Institut Français de Damas, Damas 1993.
- Boltanski 2002 (Jean-Elie), *La révolution chomskyenne et le langage*, L'Harmattan, Paris, 2002.
- Bourdeau 2000 (Michel) *Locus logicus* L'Harmattan Paris, coll. Commentaires philosophiques.
- Bransford 1971 (J.D. and J.J. Franks) *The abstraction of linguistic ideas*, Cognitive Psychology, 2, 331-380.
- Bresnan 2001 (Joan) *Lexical Functional Syntax*. Blackwell.
- Brunot 1887/1961 (Ferdinand Brunot and Charles Bruneau), *Précis de grammaire historique de la langue française*, Masson, 5<sup>th</sup> ed. 1961 (1<sup>st</sup> ed. 1887).
- Burloud 1948 (Albert) *Psychologie* Hachette, Paris.
- Cajétan 1498/1987, *De l'analogie des noms*, in Pinchard 1987.
- Caravedo 1991 (Rocío) *La competencia lingüística, crítica de la génesis y del desarrollo de la teoría de Chomsky*, Editorial Gredos, Madrid.
- Chafe 1996a (Wallace) *How consciousness shapes language*, Pragmatics and cognition, 4: 1, p. 35-64.
- Chametzky 1996 (Robert A.) *A theory of phrase markers and the extended base*, Sunny Press, Albany, United States of America.
- Chametzky 2000 (Robert A.) *Phrase structure*, Blackwell.
- Chauviré 1989 (Christiane) *Ludwig Wittgenstein*, Seuil, Paris.
- Chevrot 2001 (J.-P., and M. Fayol) *Acquisition of French liaison and related child errors*, in M. Almgren, A. Bareña et alii, eds, *Research on child language acquisition: Proceedings of the International Association for the Study of Child Language*, vol. 2, Cascadilla Press, 560-774.
- Chomsky 1957/1969 (Noam) *Structures syntaxiques*, Seuil, Paris, coll. Points (1<sup>ère</sup> publ. en anglais 1957).
- Chomsky 1960 (Noam) *Explanatory models in linguistics*, in E. Nagel, P. Suppes and A. Tarski, eds, *Logic, Methodology and the Philosophy of Science: proc. of the 1960 International Conference*, Stanford 1962.
- Chomsky 1964 (Noam) *Current issues in linguistic theory*, in J.A. Fodor & J.J. Katz (dir.), *The structure of language, Readings in the philosophy of language* Englewood Cliffs, Prentice Hall, 51-118.
- Chomsky 1965/1971 (Noam) *Aspects de la théorie syntaxique*, Seuil, Paris, 1965.
- Chomsky 1966b (Noam) *Cartesian linguistics*, Harper and Row, New York; (trad. *La linguistique cartésienne*, Seuil 1969).
- Chomsky 1972/1975 (Noam) *Questions de Sémantique* Paris, Seuil, trad. d'un original en anglais de 1972.

- Chomsky 1974/1975 (Noam) *Problèmes et mystères dans l'étude du langage humain* in Chomsky 1977/1975.
- Chomsky 1975 (Noam) *The logical structure of linguistic theory*, Plenum Press, New York, London.
- Chomsky 1981/1984 (Noam) *La connaissance du langage: ses composantes et ses origines*, Communications 40, Seuil 1984; déjà paru en anglais in *Philosophical transactions of the Royal Society of London* 1981.
- Chomsky 1986b (Noam) *Barriers*, MIT Press, Cambridge Mass.
- Chomsky 1990b (Noam) *On formalization and formal linguistics*, Natural Language and Linguistic Theory, 8, 143-147.
- Chomsky 1995/1997a (Noam) *The minimalist program*, MIT Press (1<sup>st</sup> publication 1995).
- Condillac 1973 *Essai sur l'origine des langues*, ed. Galilée, Paris.
- Cook 1988 (Vivian J., and Mark Newson) *Chomsky's Universal Grammar, an introduction* Blackwell.
- Cori 1998 (Marcel and Jean-Marie Marandin) *Héritage de propriétés dans les grammaires d'arbres polychromes*, Lynx vol. 39 n° 2, 1998, Université de Paris 10, Nanterre.
- Coulon 1976 (D., D. Kayser, A. Bonnet, JM. Lancel, M. Monfils), *Essai de compréhension d'un texte à l'aide d'un réseau sémantique de procédures*, Congrès AFCET-Informatique, Gif s/Yvette, Actes pp.113-122, 3-5 Novembre 1976).
- Creissels 1991 (Denis) *Description des langues négro-africaines et théorie syntaxique* Ellug, Univ. Stendhal, Grenoble.
- Creissels 1995 (Denis) *Eléments de syntaxe générale* Paris, PUF.
- Croft 1993 (William) *The semantics of subjecthood*, in Yaguello 1994.
- Croft 2001 (William) *Radical Construction Grammar*, Oxford University Press.
- Cruttenden 1986 (Alan) *Intonation*, Cambridge University Press.
- Culioli 1982 (Antoine) *Rôle des représentations métalinguistiques en syntaxe* Communication 23. congrès des Linguistes Tokyo 1982. Département de Recherches Linguistiques, lab. de Linguistic Formelle (ERA 642), Univ. Paris 7, Paris.
- Culioli 1990 (Antoine) *Pour une Linguistique de l'Énonciation, opérations et représentations, tome I* Orphys, Paris.
- De Mauro 1969 (Tullio) *Une introduction à la sémantique*, Payot, Paris (trad. par JL. Calvet d'un original italien de 1966).
- Demarolle 1990 (Pierre) *Réflexions sur l'analogie; formes et lieux dans l'étude du verbe en français moderne*, périodique *Le français moderne*, 58<sup>ème</sup> année, octobre 1990, n° 3 / 4. Edité par le CILF, 21 bis rue du Cardinal Lemoine, 75005, Paris
- Dokic 2000 (Jérôme & Joëlle Proust, eds.) *Simulation and knowledge in action*, Bibliothèque du CREA, Imprimerie de l'Ecole Polytechnique, F-92128 Palaiseau, dec. 2000.
- Douay 1991 (Françoise, and Jean-Jacques Pinto), *Analogie / Anomalie* in Vandeloise 1991.
- Ducrot 1972 (Oswald and Tzvetan Todorov), *Dictionnaire Encyclopédique des Sciences du Langage* Seuil Paris.
- Edelman 1998 (Shimon), *Representation is representation of similarities*, Behavioral and Brain Sciences (1998) 21, 449-498.

- Eliasmith 2001 (Chris, and Paul Thagard) *Integrating structure and meaning: a distributed model of analogical mapping* Cognitive Science 25.
- Elithorn 1984 (A.& Banerji P., ads.) *Artificial and human intelligence*, NATO Publications, Brussels.
- Elman 1998 (Jeff) *Generalization, simple recurrent networks, and the emergence of structure* Proceedings of the 20<sup>th</sup> annual conference of the Cognitive science Society. Mahway, NJ: Lawrence Erlbaum Associates.
- Engel 1996 (Pascal) *Philosophie et psychologie* Gallimard, coll. Folio/Essais, Paris.
- Fauconnier 1997a (Gilles) *Mappings in thought and language*, Cambridge University Press.
- Fehr 2000/1997 (Johannes) *Saussure entre linguistique et sémiologie*, Presses Universitaires de France, (traduit de l'allemand, publication originale 1997).
- Fillmore 1990 (Charles J.) *Construction Grammar. Course reader for Linguistics 120A*, Université de Californie, Berkeley.
- Fillmore 1992 (Charles J.) *Constituency v. dependency* in Madray-Lesigne 1995.
- Fodor 1983 (Jerry) *Modularity of mind*, The MIT Press.
- Fodor 1988 (Janet Dean Fodor) *Thematic roles and modularity* in Gerry T.M. Altman (ed.), *Cognitive models of speech processing* Bradford Books / MIT Press, 1990, p. 434.
- Forbus 2001 (Kenneth D.) *Exploring analogy in the large* in Gentner 2001a
- Fradin 1999 (Bernard) *Syntaxe et morphologie*, in *Histoire, épistémologie, langage*, tome 21, fascicule 2, 1999, SHESL, PUV.
- Fradin and Marandin 1997 (eds.) *Mots et grammaire*, Didier, Paris.
- Freeman 2000 (Robert J.) *Example-based Complexity--Syntax and Semantics as the Production of Ad-hoc Arrangements of Examples*, Proceedings of the ANLP/NAACL 2000 Workshop on Syntactic and Semantic Complexity in Natural Language Processing Systems, pp. 47-50.
- French 2002 (Robert M.) *The computational model of analogy-making* Trends in Cognitive Sciences Vol.6 No.5 Mai 2002.
- Frei 1954 (Henri) *Critères de délimitation* in *Word*, 1954, p. 136-145.
- Fuchs 1993 (Catherine) (and coll.) *Linguistique et Traitement Automatique des Langues*, Hachette, Paris.
- Galban 1907 (A.) *Nouvelle grammaire espagnole-française*, Garnier, Paris.
- Galmiche 1991 (Michel) *Sémantique linguistique et logique*, PUF. Paris.
- Ganascia 2000 (J.-G.) *Logique et induction, un vieux débat*, in Kodratoff 2000.
- Garnier 1985 (Catherine) *La Phrase Japonaise, Structures Complexes en Japonais Moderne* Publications Orientalistes de France (INALCO) Paris 1985.
- Gayral 1996 (Françoise , Daniel Kayser, François Lévy) *Logique et sémantique du langage naturel: models et interprétation*, in *Intellectica* 1996/2, 23, 203-325.
- Gazdar 1985 (Gerald, Ewan Klein, Geoffrey Pullum, Ivan Sag) *Generalized phrase structure grammar*, Basil Blackwell.
- Gentner 1983 (Derdre) *Structure Mapping: A Theoretical Framework for Analogy*. Cognitive Science 7:2. pp 155-170.

- Gentner 1989 (Derdre) *The mechanisms of analogical learning*, in S. Vosniadou & A. Ortony (eds.), *Similarity and analogical reasoning*, Cambridge University Press.
- Gentner 2001a (Derdre; Holyoak; Keith J., & Konokiv, Boicho N.) *The analogical mind, perspectives from cognitive science*, MIT Press, Cambridge Massachusetts, London.
- Gineste 1997 (Marie-Dominique) *Analogie et cognition, étude expérimentale et simulation informatique*, PUF.
- Givón 1979 (Talmy) *On understanding grammar*, Academic Press.
- Goldberg 1995 (Adele) *Constructions: a construction grammar approach*. The University of Chicago Press.
- Goldsmith 2001 (John A.) *Unsupervised learning of the morphology of a natural language*. Association of Computational Linguistics.
- Goodman 1951 (Nelson) *The structure of appearance*, The Bobbs-Merryl Company inc. Indianapolis, 1952.
- Gross 1986-1 (Maurice) *Grammaire transformationnelle du français, 1-Syntaxe du verbe*, Ed. Cantilène, Paris, réédition d'un ouvrage publié en 1968 par Larousse.
- Gross 1996 (Maurice) *Remarques sur le notion de sujet* in Auroux 1996.
- Habert 1997 (Benôit, Adeline Nazarenko and André Salem) *Les Linguistiques de Corpus* Armand Colin, Paris.
- Hacking 1975/2002 (Ian) *L'émergence de la probabilité* Seuil, Paris.
- Haegeman 1991 (Liliane) *Government and binding theory*, Blackwell.
- Hagège 1976 (Claude) *La grammaire générative, réflexions critiques*, PUF, Paris, 1976.
- Hagège 1999 (Claude) *La structure des langues*, PUF.
- Harris 1951 (Zellig S.) *Methods in structural linguistics* (renommé *Structural linguistics* dans des éditions ultérieures) The University of Chicago Press.
- Harris 1991 (Zellig S.) *A theory of language and information. A mathematical approach* Oxford University Press.
- Hjelmslev 1933/1985 (Louis) *Structure générale des corrélations linguistiques*, in Hjelmslev 1985 (Louis) *Nouveaux essais* gathered and presented by François Rastier, PUF, Paris, p. 25 sq.
- Hofstadter 1995 (Douglas) *Fluid concepts and creative analogies*, Basic Books (Perseus).
- Hopper 1993 (Paul J. and Elisabeth Closs Traugott) *Grammaticalization*, Cambridge textbooks in linguistics.
- Houdé 1998 (O. et al.) *Vocabulaire des Sciences Cognitives* Presses Universitaires de France, Paris, 1998.
- Householder 1971 (Frederick W.) *Linguistic speculations*, Cambridge University Press.
- Hummel 1997 (J.E. and Holyoak K. J.) *Distributed representations of structure: a theory of analogical access and mapping*, *Psychological Review* 104 (3), 427-66.
- Itkonen 1997 (Esa & Jussi Haukioja), *A rehabilitation of analogy in syntax (and elsewhere)*, in: A. Kertesz (ed.): *Metalinguistik im Wandel: die kognitive Wende in Wissenschaftstheorie und Linguistik*. Frankfurt a/M: Peter Lang, 1997, pp. 131-177).
- Itkonen 2003 (Esa), *Analogy: within reality; between reality and language; between mind and language; within language*, en cours de publication.



- Jackendoff 1975 (Ray) *Morphological and semantic regularities in the lexicon*, *Language* 51, 639-71
- Jackendoff 1993 (Ray) *Patterns in the Mind, Language and human nature*, Harvester Wheatsheaf, Hemel Hempstead, Royaume uni, 1993.
- Jackendoff 2002 (Ray) *Foundations of language*, Oxford University Press.
- Jakobson 1963 (Roman) *Essais de Linguistique Générale, Les Fondations du Langage* Ed. de Minuit, Paris.
- Johnston 1997 (Jason C.) *Systematic Homonymy and the Structure of Morphological Categories: Some Lessons from Paradigm Geometry*. PhD thesis, Université de Sydney, Australie, disponible à l'adresse: <http://www.astadhyayi.net/>
- Kager 1999 (René) *Optimality Theory*, Cambridge University Press.
- Kerleroux 1996 (Françoise) *La coupure invisible, Etudes de syntaxe et de morphologie* Septentrion, Paris 1996.
- Kirchner 2002 (R. M.) (en preparation) *Preliminary thoughts on "phonologization with an exemplar-based speech processing system (ROA-320-0699)*, Rutgers Optimality Archive, <http://ruccs.rutgers.edu/ROA>.
- Kodratoff 2000 (Y., E. Diday, P. Brito, M. Moulet, eds.) *Induction symbolique numérique à partir de données*, Cépaduès-Editions 11, rue Nicolas Vauquelin, F 31100 Toulouse France
- Koenig 1999a (Jean-Pierre) *Lexical Relations* Stanford monographs in linguistics, Centre for the Study of Language Publications, Stanford Ca.
- Lacan 1953 (Jacques) *Fonction et champ de la parole et du langage*, in *Ecrits*, Seuil, Paris, 1966.
- Lafon 1960 (René) *L'expression de l'auteur de l'action en basque* in Lafon 1999 (René) *Vasconiana Iker-11* Real Academia de la Lengua Vasca, Ezkualtzandia, Plaza Barria, 15 48005 Bilbao
- Lakoff 1987 (George) *Women, fire and dangerous things*, Chicago University Press (BNF).
- Laks 1993 (Bernard, and Marc Plénat) *De natura sonorum, essais de phonologie*, Presses Universitaires de Vincennes, Paris, 1993.
- Laks 1996 (Bernard) *Langage et Cognition*, Hermès, Paris, 1996.
- Lamb 2000 (Sydney M.) *Bidirectional processing in language and related cognitive systems*, in Barlow 2000.
- Langacker 1987 (Ronald), *Foundations of cognitive grammar I, Theoretical Prerequisites*, Stanford University Press.
- Langacker 1988b (Ronald) *A usage-based model*, in Rudzka-Ostyn 1988.
- Langacker 1998 (Ronald) *Conceptualization, symbolization and grammar* in Tomasello 1998.
- Langacker 2000 (Ronald) *A dynamic-usage based model*, in Barlow 2000.
- Lemaréchal 1989 (Alain) *Les parties du discours* PUF.
- Lemaréchal 1997 (Alain) *Zéro(s)* PUF.
- Lepage >= 1996 (Yves) *Solving analogies on words: an algorithm*. Internet, Google (lepage yves analogy).

- Ligozat 1994 (Gérard), *Représentation des Connaissances Linguistiques*, Armand Colin, Paris, 1994.
- Lima 1994 (Susan D. ed.) *The reality of linguistic rules* John Benjamins
- Livet 1995 (Pierre) Connectionnisme et fonctionnalisme, *Intellectica*, 21, 1995.
- Ludwig 1997 (Pascal) *Le langage, textes choisis*, Garnier Flammarion, Paris.
- Mac Whinney 1992 (Brian) *The dinosaurs and the ring* in Lima 1994.
- Mac Whinney 1998 (Brian) *Models of the emergence of language* in Annual review of Psychology 1998 49: 199-227.
- Mac Whinney 2000 (Brian) *Connectionism and language learning* in Barlow 2000.
- Maes 1980 (Hubert) *Thème et propos, récurrence de la structure sujet-prédicat en Japanese*. In Bernard Franck (ed.) *Mélanges offerts à M. Charles Hagenauer, Etudes Japonaises* L'Asiathèque, Paris 1980.
- Magnani 2000 (Lorenzo) *Abduction, reason and science*. Kluwer.
- Mandelbrot 1954 (Benoît) *Structure formelle des textes et communication*, Word, vol 10, 1954.
- Manning 2002 (Christopher D.) *Probabilistic syntax*, projet à paraître dans Bod, Hay and Jannedy (eds), *Probabilistic linguistics*, MIT Press.
- Manning & Sag 1995 (Christopher D. Manning and Ivan A. Sag) *Dissociations between argument structure and grammatical relations*, in Webelhuth 1999.
- Marandin 1997 (Jean-Marie) *"Pas d'entité sans identité": l'analyse des groupes nominaux DET+A*, in Fradin and Marandin 1997.
- Marcus 2001 (Gary) *The algebraic mind* Cambridge, MIT Press.
- Martinet 1955 (André) *Economie des changements phonétiques*, Berne, Francke.
- Martinet 1958 (André) *La construction ergative et les structures élémentaires de l'énoncé* in *Journal de psychologie normale et pathologique* 1958, p. 377-392.
- Martinet 1970 (André), *Éléments de linguistique générale*, Armand Colin Paris, 1965.
- Martinet 1979 (André), *Grammaire fonctionnelle du français*, Didier, Crédif, 1979.
- Martinet 1985 (André), *Syntaxe Générale*, Armand Colin, Paris 1985.
- McClelland 1986 (J.L. and Rumelhart, D.E.) *Parallel Distributed Processing, Explorations in the Microstructure of Cognition, Volume 1 et 2: Psychological and Biological Models*, Cambridge Mass.
- McClelland 1986sp (J. and Kawamoto) A. *Mechanisms of sentence processing: assigning roles to constituents* in McClelland 1986.
- Meillet 1922/1934 (A.) *Introduction à l'étude comparative des langues indo-européennes*, 1<sup>st</sup> publ. Paris 1922, reprinted in 1964 in fac-simile by the University of Alabama Press, from the 7<sup>th</sup> publication (1934).
- Melamed 2001 (Dan) *Empirical Methods for Exploiting Parallel Texts*, MIT Press.
- Meschonnic 1991 (Henri) *Le langage comme défi*, Presses Universitaires de Vincennes, Saint-Denis.
- Milner 1982 (Jean-Claude) *Ordre et raisons de langue*. Seuil, Paris.
- Milner 1989 (Jean-Claude) *Introduction à une Science du Langage* Seuil, Paris
- Milner 1991 (Jean-Claude) *Géométries* in *Le gré des Langues* No 2, L'Harmattan, Paris

- Minsky 1986 (M. L.) *The society of mind*. Simon and Schuster, New York. A society of relatively simple and autonomous agents.
- Moeschler 1994b (Jacques and A. Reboul) *Dictionnaire encyclopédique de pragmatique*, Seuil, Paris.
- Nagao 1984 (M.) *A framework of a mechanical translation between Japanese and English by analogy principle* in Elithorn 1984.
- Neelman 2001 (Ad & Fred Weerman) *Flexible syntax, or A theory of case and arguments*, Kluwer, Studies in natural language and linguistic theories, Volume: 47.
- Newmeyer 1983 (Frederick J.) *Grammatical Theory* The Chicago University Press, Chicago and London.
- Nicolas 1999 (David) *La distinction entre noms massifs et noms comptables. Aspects linguistiques et conceptuels* Thèse de doctorat, Ecole Polytechnique, 1999 Dir. Daniel Andler.
- Normand 1990 (C., sous la dir. de) *La quadrature du sens*, PUF, 1990.
- Page 2000 (Michael) *Connectionist modelling in psychology: a localist manifesto*, Behavioral and Brain Sciences (2000) vol. 23, 443-512.
- Paveau 2003 (Marie-Anne and Georges-Elia Sarfati) *Les grandes théories de la linguistique, de la grammaire comparée à la pragmatique* Armand Colin, Paris.
- Pei 1969 (Mario & Franck Gaynor), *Dictionary of linguistics*, Littlefield, Adams and Co, New Jersey.
- Pereira 2000 (Fernando) *Formal grammar and information theory: together again?* Philosophical Transactions of the Royal Society, London, A, (2000) 358, 1239-1253.
- Pierrehumbert 2002 (Janet B.) (sous presse) *Exemplar dynamics: word frequency, lenition and contrast*, in J. Bybee & P. Hopper (eds) *Frequency effects and emergent grammar*, John Benjamins, ou <http://www.ling.nwu.edu/~jpb/>
- Pinchard 1987 (Bruno) *Métaphysique et sémantique, autour de Cajétan*, étude et traduction de "Nominum Analogia", Vrin, Paris.
- Pinker 1991 (Pinker Steven and Prince Alan) *Regular and irregular morphology and the psychological status of rules of grammar*. Proceedings of the 17<sup>th</sup> annual meeting of the Berkeley linguistics society, 230-51, Berkeley, CA, BLS.
- Planck 1995 (Frans ed.) *Double case, Agreement by suffixaufnahme*, Oxford University Press.
- Pollar 1987 (C. and Sag I.) *Information-based syntax and semantics*. CSLI series, University of Chicago Press.
- Pollock 1997 (Jean-Yves) *Langage et cognition, Introduction au programme minimaliste de la grammaire générative*. PUF, Paris.
- Putnam 1960 (H.) "Minds and machines" in S. Hood ed. *Dimensions of mind*, New York, New York University Press.
- Rebuschi 1997 (Georges) *Essais de Linguistique Basque* Universidad del País Vasco Bilbao / Diputación Foral de Gipuzkoa, San Sebastián.
- Rastier 1991 (François) *Sémantique et recherches Cognitives* Paris, PUF.
- Rastier 1996 (François) Problématiques du signe et du texte, *Intellectica* 1996/2, 23, pp.11-52.
- Rastier 1998a (François) Le problème épistémologique du contexte et l'interprétation dans les sciences du langage, *Langages*, 129, pp. 97-111.

- Rastier 2002d (François) *Les critères linguistiques pour l'identification des textes racistes - Éléments de synthèse*, in Valette, Mathieu, éd., *Projet européen Princip.net, Plate-forme pour la Recherche, l'Identification et la Neutralization des Contenus Illégaux et Préjudiciables sur l'internet. Rapport 2002-1*, Inalco, pp. 84-98.
- Rey 1973 (Alain) *Théories du signe et du sens*, Klincksiek, Paris.
- Ricœur 1969 (Paul) *Le conflit des interprétations*, Paris, Seuil.
- Rissanen 1989 (Jorma) *Stochastic complexity in statistical inquiry*, Singapour, World Scientific Publishing Company.
- Rudzka-Ostyn 1988 (Brygida, ed.) *Topics in cognitive linguistics* Amsterdam, John Benjamins.
- Rumbaugh 1991/1997 (James & alli), *Modélisation et conception orientées objet*, Masson, Paris 1997, original en anglais *Object oriented Modelling*, Prentice Hall, Englewood Cliffs, 1991.
- Ruwet 1967 (Nicolas) *Introduction à la grammaire générative*, Plon, Paris.
- Sadler 1989 (V.) *Working with analogical semantics*. Dordrechts: Foris.
- Sadock 1991 (Jerrold M.) *Auto lexical syntax: a theory of parallel grammatical representations*, Chicago, Londres, University of Chicago Press.
- Sadock 2000 (Jerrold M.) *Morphologie dérivationnelle en quatre dimensions, kallaallisut, groenland occidental*, in Tersis 2000, p. 183.
- Sanctius 1587/1982 (Franciscus) *La Minerve*, Presses Universitaires de Lille.
- Saussure 1915/1975 (Ferdinand de) *Cours de linguistique générale* (éd. Tullio de Mauro) Payot, Paris, première éd. en 1915.
- Saussure 2002 (Ferdinand de) *Ecrits de linguistique générale*, Gallimard, Paris.
- Shaumjan 1966 (Sebastian), *La cybernétique et la langue*, in Benveniste 1966.
- Shaumjan 1987 (Sebastian), *Semiotic theory of language*, Indiana University Press.
- Shiver 1987 (Bruce & Peter Wegner eds.) *Research directions in object oriented programming*, MIT Press.
- Skousen 1989 (Royal), *Analogical modelling of language*, Kluwer.
- Smolensky 1999 (Paul) *Grammar-based connectionist approaches to language in Cognitive Science* Vol 23 num. 4, 1999.
- Soutet (Olivier), 2000, *Le subjonctif en français*, Orphys, Paris.
- Spinoza 1661/1984 (B. de) *Traité de la réforme de l'entendement et de la meilleure voie à suivre pour parvenir à la vraie connaissance des choses*, Text, translation and notes by par A. Koyré, Vrin, Paris.
- Swiggers 1997 (Pierre), *Histoire de la pensée Linguistique*, PUF, Paris.
- Tager-Flusberg 1996 (H.), *Language acquisition: grammar*, in Brown (Keith & Jim Miller, eds.) *Concise encyclopedia of syntactic theories* Pergamon 1996.
- Tanenhaus 1988 (Michael K. et alii), *Combinatory lexical information and language comprehension* in Altmann 1990, p. 386.
- Tersis 2000 (Nicole and Michèle Terrien eds.) *Les langues eskaléoutes, Sibérie, Alaska, Canada, Groënland*, CNRS Editions, 2000.
- Tomasello 1998 (Michael, ed.) *The new psychology of language*, Erlbaum, London.

- Turenne 1999 (Nicolas) *Apprentissage d'un ensemble pré-structuré de concepts d'un domaine* in *Math. inf. sc. humaines* num. 148 1999, p. 41.
- van Gelder 1998 (T. J.) *The dynamic hypothesis in cognitive science*. Behavioral and Brain Sciences, vol. 21, num. 5, 1-14.
- van Vallin 1997 (Robert D.) *Structure, meaning and function*, Cambridge university Press, 1997.
- Vandeloise 1990 (Claude) *Règles ou listes, l'arbitrage de la morphologie* Le français moderne, octobre 1990.
- Veale 1998 (Tony & Diarmuid O'Donoghue), *How to blend concepts and influence people: Computational models of conceptual integration*, <http://www.compapp.dcu.ie/~tonyv/metaphor.html>
- Wallon 1945 (Henri) *Les origines de la pensée chez l'enfant*, PUF, réédition PUF, col.Quadrige 1989.
- Weil 1966 (Simone) *Sur la science*, Gallimard, Paris.
- Wilks 1973 (Y.) *Understanding without proof*, Proceedings of the third international joint conference on artificial intelligence, pp. 255-261, Stanford 1973.
- Williams 1994 (Edwin), *Thematic structure in syntax*, MIT Press, Cambridge, Ma, United States of America.
- Yaguello 1994 (Maria, ed.) *Subjecthood and subjectivity, The status of the subject in linguistic theory, Proceedings of the colloquium held in London 19-29 march 1993*, Orphys, Paris, 1994.
- Yvon 1994 (François) *Paradigmatic cascades: a linguistically sound model of pronunciation by analogy*. Proc. of ACL-EACL-97, Madrid 1994, p. 428-435.
- Zwicky 1985 (A.) *Heads* In *Journal of linguistics* 21 pp 1-29.

# Glossary

**A2** 'A2 Analogy' plays between two terms. Saying "X and Y are analog", is saying that they are similar without specifying in which way. This is poorer than A4 analogy. A2 analogy, diverging from the best philosophical, semiotic, and linguistic tradition, is a popular vision. It is close to the association of associationist psychology. In most of the 20<sup>th</sup> century, many scientists perceived in analogy its A2 variety only, which contributed to the discredit of A4 analogy.

**A4** 'A4 analogy' plays between four terms as in "X is to Y as A is to B". It is the analogy of Aristotle, Varro, Saussure, Bloomfield, Gentner and many more.

**ABS** Agent-Based Solving (ABS) is a possible implementation of the dynamics in the Analogical Speaker. It is based on agents and channels.

**agent** ABS consists of agents (and channels). An agent is an organ which contributes to the computation of a linguistic act or linguistic task. It has a duty which is made up of a few terms copositioned with respect to one another. To fulfil its duty, an agent uses the plexus data matching the terms of its duty, it recruits more agents, its commissioners, and assigns them a duty in turn, derived from its own. An agent is 'short-sighted' it does not have an entire vision of the task to which it contributes. A linguistic task may involve ten to a few thousands of agents.

**Analogical Speaker** The name of the model defended in this work.

**analogies which motivated transformations.** These are linguistic facts like *John sees Jane, Jane is seen by John, or she speaks, she is the one who speaks*. To account for such systematicities, generativism postulated transformations. The model defended in this thesis does not make that postulation. Cf. section 4.2. *About non-transformation* (p. 107).

**copositioning.** The computation which is proposed to dynamically account for linguistic acts is founded mainly on analogy. Instead of simply saying 'analogy', sometimes 'copositioning' is used: a) to insist precisely on copositionality because not everyone shares this vision of analogy, and b) to make it possible for one or several mechanisms other than analogy, but presenting this same property to establish copositionings, to come later and complement the apparatus.

**channel** ABS uses channels (and agents). A (client) agent recruits other (commissioner) agents via a channel (the recruitment is then 'opaque') when it needs to see the results which will accrue to it as associated with different positions. The most common usage

of channels is the syntagmatic situation: each constituent of an assembly corresponds to a channel.

**client** In ABS, is a client an agent which recruits other agents, which then are its commissioners.

**commissioner** In ABS, an agent is commissioner for the agent which recruited it. The latter is its client.

**concrete** 'Concrete' is opposed to 'abstract' or 'categorical'. A concrete theory is one which does not call on categories or abstractions. It is based on exemplars and occurrences. Idem a model. The Analogical Speaker is a concrete model.

**delivery point** In ABS an agent has a channel to which its findings are merged into results. This is the agent's delivery point. It is obligatory and unique for any agent.

**edification** One of the two processes whereby the heuristic structure is elaborated (the other one is recruitment). Channels, when adjacent, get federated (as an assumption), giving rise to an agent which manifests this hypothetical federation. The agent is vested with a duty derived from the field data of the channels. The agent eventually settles once or several times. Settlement confirms the agent, and motivates the creation of a channel. The latter sanctions the success of the federation, thus far hypothetical. The term 'edification' is chosen to avoid confusion with 'construction', which is left for linguistic constructions in the sense of Fillmore.

**exemplar, exemplarist** 'Exemplar' is opposed to 'category'. 'Exemplarist' is opposed to 'abstract'. In this model, records are exemplarist. 'Exemplar' is also opposed in another way, to 'occurrence'.

**expansive gate** In the plexus, set of records which gives expansive homology an occasion to operate. Cf. section 3.6.4.2. *Expansive gate* (p. 86).

**familiarity orientation** A paradigmatic link bears a familiarity orientation. This is the indication that one of the records of the link is more familiar than the other, or that they have equal familiarity. The computation goes from less familiar to more familiar (or as familiar) mais but not the other way.

**field, field data** The field is defined as that which the speaking subject has at hand when he is performing a linguistic task. Field data are indexes on elements of situation: linguistic form or elements which are perceived but which are not linguistic form. For example in the reception of an utterance, certain field data are the place, in the received form, of the various parts (segments, constituents, syntagms) being processed. In this case, field data are indexes in the unilinear organization of the received form. More generally, when extending the model to encompass non linguistic perceptual data, field data are bound to index determinations of space, of time, and of perceptual channel (hearing, vision, etc.), of elements submitted to the computation. In a heuristic structure which makes recruitment only, there is no field data. There is necessarily in a process by edification.

**finding** In ABS, a finding is produced by an agent. When it settles, an agent raises a finding. Findings are merged into results at the agent' delivery point.

**form** In this work, 'form', unless mentioned otherwise, is used to refer to linguistic form, opposing it then to meaning. When something else is meant, for example a *Gestalt*, then it is explicitly said so.

**FW** (forward) In the conventional orientation of the heuristic structure, the forward direction.

**heuristic structure** The set of agents and channels that it takes to carry out a linguistic task and find results for it. The heuristic structure is elaborated by recruitment and possibly by edification.

**immersion** The process (the procedure) which is proposed to account for the reception of an utterance: an utterance is received (finally interpreted, understood) when its immersion could take place. Instead of one-to-one mappings, an immersion establishes copositionings of several terms at a time, between terms as perceived and terms in the plexus. Cf. section 8.5.4. *What is receiving an utterance, what is understanding* (p. 263).

**isonomy** The fact of following reasons associated to the objects themselves, without having to rest on their properties. Is opposed to **partonomy**. Cf. section 3.6.7. *Partonomy and isonomy* (p. 89).

**local** cf. **proximal**.

**macroscopic determinism** This term is from D. Hofstadter. Macroscopically equal observables may be the effects of mechanisms which differ in their detail. Here, macroscopic determinism is obtained by linguistic knowledge being exemplarist, by the possibility to produce a same finding by different settlements, by the multiplicity of recruitment and edification paths, by the mechanism of merging the findings into results, by any elementary resource being potentially useful without any being indispensable, by the general integrativity property which empowers fragmentary and heterogeneous resources, etc.

**merging** In ABS, different agents deliver at a same channel (their delivery point); their findings are 'merged' into results at the delivery point. The principle is that findings with the same content (but each belonging to different agents) merge at the delivery point into a same result. Merging contributes to implement macroscopic determinism.

**minimality suspension** Of a term, it is not required that it be minimal or elementary, contrary to requests made by most theories or descriptive traditions. Terms may be at different grains and terms may overlap. Cf. section 7.2.3. *Minimality suspension for terms* (p. 194). However, quasi-general plateaus are the empiry and they can be described by elementarities of various orders: morphemes, phonemes, etc.); the theory must explain why they arise, and also why they do not have to be entirely general.

**occurrence** In the experience of a subject, an occurrence is an exemplar occurring at a date and in a context. 'Occurrence' is opposed to 'exemplar'.

**opaque** In ABS, the recruitment of agents (then commissioners) by another agent (then client) is opaque when a channel is installed between them (otherwise it is transparent).

**orientation** Cf. "familiarity orientation".



**paradigmatic link** Link between two plexus records. Between two A-type records a paradigmatic link is a systemic analogy. Between two C-type records the paradigmatic link is a constructional similarity, that is, a structural analogy. A paradigmatic link bears a familiarity orientation.

**partonomy** The characterization of linguistic objects by their properties. Is opposed to **isonomy**. Cf. section 3.6.7. *Partonomy and isonomy* (p. 89).

**performance** For a process, a machine, or a program, the manner to respond, to behave, to be efficient, to use the resources, to deliver the expected results. Good performance, bad performance.

**plexus** In the Analogical Speaker, the static side of the linguistic knowledge of a speaker. A plexus consists of A-type and C-type records with paradigmatic links between them. It encodes systemic analogies and structural analogies. The word 'plexus' is chosen, after Saussure, because it is an entangled mesh.

**private term** A private term is a term which is not linguistic form. Linguistic form, is "public" because it crosses the interface between speakers. Counter to this, the private term does not cross the interface. Cf. section 8.5.3. *Formal terms and private terms* (p. 262).

**product** In ABS, 'product' collectively denotes findings and results.

**proximal/proximality/proximalist** Inscriptions (elements of linguistic knowledge) are proximal when one of them can be reached from the other with low cost. A process is proximal when it solicits inscriptions gradually, according to their proximality. Proximality is central in this model. 'Proximal' is different from 'local': a) 'local' in the sense in which segments, constituents, syntagms or terms are local when they are neighbours in the linearity of the form; it is so understood in n-gram approaches, or in generative grammar in relation with the notions c-command, barrier and island, b) 'localist' in the sense of McClelland 1986: a connectionist network is localist when the representation of a problem's object (word, morpheme, phoneme, etc.) is assigned to a defined cell (or group of cells) of the connectionist network; the representation is 'distributed' on the contrary, when there is no such assignment; then it happens much in the manner of a hologram.

**recruitment** One of the processes of the heuristic structure elaboration (the other is edification). An agent, depending on its duty, and on the matching plexus data, either finds itself sterile, or performs a settlement and/or recruits more agent (then its commissioners). It assigns them a duty which is a function of its own and of the matching plexus data. This prolongs the heuristic paths. Recruitment may be transparent (no intervening channel between client and commissioner) or opaque (the commissioner is recruited via a channel).

**resetting** Resetting takes place when a computation branch is pursued by some other means than just crossing a paradigmatic link. This may involve a) a change of paradigm, or b) staying in a same paradigm but reallocating the roles of the current computation terms. To preserve the integrity of the computation, resetting must be positioned.

**result** A result is a product at a channel (products at agents are findings). A result comes from the merging of findings. A result may come from the merging of one finding only.

**RW** (rearwards) In the conventional orientation of the heuristic structure, the rearward direction.

**settlement** The computation of a linguistic task is seen as a heuristic process involving jointly the data of the task and that of the plexus. The process encompasses a number of parallel paths. Settlement is an event in such a process: two paths (three in the case of ternary branching) are found coincident upon the discovery of a favourable datum in the plexus (settlement data). A settlement is made by an agent and its effect is the production of a finding at the agent.

**term** A term is that which is singled out to participate in an analogy (structural analogies and systemic analogies). Analogy  $A : B :: C : D$  holds between the four terms A, B, C and D. A term is reidentifiable as "the same" in its recurrences. The most received frameworks of thinking lead to reify linguistic objects, to see them as having properties and able to have relations between them. This must not be. On the contrary, a term needs only be seen as reidentifiable in its recurrences. Cf. section 7.2. *Individuality of terms* (p. 193).

**transparent** In ABS, an agent (then a client) recruits other agents (then commissioners) transparently when no channel is installed between them (otherwise the recruitment is opaque). The typical use of transparent recruitment is walking through paradigms by crossing paradigmatic link.



# French-English lexicon

This lexicon is for facilitating the relation with related publications in French.

ABS	ABS, agent-based solving
agent	agent
amorçage	priming
arrière (orientation vers l'arrière)	rearward orientation (RW)
avant (orientation vers l'avant)	forward orientation (FW)
calcul des copositionnements	computation of copositionings
canal	channel
champ	field
charge (d'agent)	duty (agent duty)
client (agent client)	client agent
commissaire	commissioner
copositionnement	copositioning
donnée(s) de champ	field data
édification	edification
enregistrement	record
escalade (principe d' -)	escalation (principle)
évoquer (une trouvaille)	raise (to - a finding)
fusion	merging
FW (orientation vers l'avant)	FW (forward orientation)
immersion	immersion
installation	setup
livraison (d'un résultat)	delivery (of a result)
Locuteur Analogique	Analogical Speaker
mouvement (abductif)	movement (abductive -)
opaque	opaque
orientation de familiarité	familiarity orientation
parsing	parsing
phore (d'une analogie)	vehicle (in an analogy)
plexus	plexus
point de livraison	delivery point
productivité (linguistique)	productivity (linguistic -)

recrutement	recruitment
rendement (d'un modèle)	efficiency (of a model)
reprise	resetting
reprise positionnée	positioned resetting
résolution par agents (ABS)	agent-based solving (ABS)
résultat	result
résultat installation	setup result
résultat de résolution	solving result
RW (orientation vers l'arrière)	RW (rearward orientation)
structure heuristique	heuristic structure
suspension de minimalité	minimality suspension
terme	term
terme privé	private term
thème (dans une analogie)	tenor
thème (opposé à rhème)	topic
transparent	transparent
trouvaille	finding

# Index

- A2 ..... 38  
  as a phenomenon, not in the theory ..... 192  
  definition ..... 397  
A2 analogy ..... 190  
A4 ..... 38, 190  
  definition ..... 397  
A4 analogy ..... 189  
abduction ..... 81  
  abductive mechanisms ..... 82  
  by expansive homology ..... 86  
  its role in the linguistic dynamics ..... 82  
abductive movement ..... 110  
  by constructability transfer ..... 84, 101, 317  
  by expansive homology ..... 85, 101, 318  
  by transitivity ..... 83  
  by transposition ..... 88, 144, 319  
  effective in linguistic form and among private  
  terms ..... 204  
abductive path ..... 209  
ablative ..... 27  
*Abney* ..... 15, 16, 224, 254  
ABS  
  definition ..... 331, 397  
  integrating two paradigms ..... 140  
  intension-extension ..... 215  
  introduction ..... 94  
  merging findings ..... 378  
abstractions refused ..... 267  
access ..... 296  
  crossing a paradigmatic link ..... 298  
ACME ..... 186  
acquisition  
  acquisitional restriction ..... 372  
  incremental ..... 255  
  initial ..... 205  
  parametric theory ..... 208  
activation propagation ..... 223  
A-D asymmetry ..... 306  
adaptation of model behaviour ..... 150  
adjunct ..... 183, 372  
adverbs and prepositions ..... 277  
affix ..... 310  
agent ..... 332  
  agent structure ..... 331  
  agents cooperating ..... 210  
  client ..... 334  
  commissionner ..... 334  
  definition ..... 397  
  life cycle ..... 333  
  number of agents ..... 305, 343  
  redundancy ..... 338  
agent AN2 ..... 154  
  as controller process ..... 182  
  definition ..... 383  
agent ANZ ..... 154  
  as direct process ..... 182  
  mechanism shown on an example ..... 142  
  specification ..... 377  
  used by AN2 ..... 157  
  uses the binary index ..... 297  
  uses transposition ..... 319  
  vs non transposable analogy ..... 325  
agent B2 ..... 101, 372  
  definition ..... 359  
  does not dry up on its own ..... 347  
  productivity ..... 367  
agent B3 ..... 374  
  definition ..... 367  
agent CATZ ..... 353  
  does not dry up on its own ..... 347  
  doubtful ..... 205  
  single-argument ..... 357  
  suspected ..... 357  
  technical architecture ..... 353  
agent redundancy control ..... 341  
agent S2A  
  as suppletion process ..... 182  
  definition ..... 381  
agent tree ..... 378  
agent-based solving definiton ..... 331  
agentive orientation ..... 113  
agglutination for Saussure ..... 31  
agglutinative ..... 325  
agglutinative morphology ..... 65  
agreement  
  addressed by Skousen? ..... 190  
  neglected by B2-B3 ..... 106  
  treated by agent AN2 ..... 154

unconscious? .....	343	positional exploitation .....	83
without syntactic head .....	183	powerful because limited .....	63
allomorphy .....	167, 200	quasi-synonym of morphology .....	32
alternation .....	200	reanalysis of <i>somnolent</i> .....	258
amalgamation in French .....	122, 195	repairing .....	190
ambiguity .....	296	repairing - with syntactic effect .....	32
syntactic - contradicts longest match		set up .....	210
principle .....	100	structural analogy 60, 61, 68, 70, 74, 88, 126,	
analogical copositioning .....	207	310	
analogical cosegmentation .....	196, 198	structural analogy analogy .....	71
analogical pair .....	297	systemic analogy ... 45, 60, 61, 68, 69, 71, 73,	
analogical set .....	189	74, 78, 88, 126	
analogical task .....	108, 334	not provided by corpus techniques .....	255
not vulnerable to allomorphy .....	169	three terms determine le 4 <sup>th</sup> .....	63
analogs .....	181	traditional - too permissive .....	188
analogy		transposable .....	35
A2 .....	192	underlying a metaphor .....	62, 301
A4 .....	189	underspecified .....	325
abductively equivalent .....	377	analogy which motivated transformations .....	191
addressing anomaly and regularity .....	189	analysis	
analogical change .....	36	self-analysis .....	256
analogy-anomaly .....	21	multiple .....	105, 123, 125, 315
arithmetic .....	65, 321	multiple self-analysis .....	257
as the base of operation .....	186	of a long text .....	348
bidimensional .....	324	synyactic -, its function .....	106
central in this work .....	11	analysis tree .....	105
class A .....	60, 67	anaphor .....	222
class AC .....	61	anomalists .....	181
class C .....	60, 68	anomalous term .....	182
cognitive .....	324	anomaly .....	189
contrasted with 'agglutination' .....	31	anomalist conception of linguistics .....	39
corrects defects of associationism .....	212	anomaly-analogy .....	26
despised by linguistic theories .....	10	morphological .....	303
dismissed .....	37	Arabic .....	246
does not establish relations .....	194	argumental paradox .....	306
does not imply categories .....	39	arithmetics	
elides the predicate .....	62	analogy in .....	321
eschews overspecification .....	200	<i>Aristarchos</i> .....	26, 45
false .....	62	<i>Aristotle</i> .....	25, 192, 277, 289, 290, 301, 306
for Bloomfield .....	33	abduction .....	81
for Chomsky .....	37	analogy .....	25, 259, 387
for Householder .....	34	metaphor .....	62
for Itkonen .....	190	arithmetic .....	65
for Popper .....	44	arithmetic product .....	322
for psychologists and cogniticians .....	11	arithmetic sum .....	321
for Saussure (old usage restored) .....	39	<i>Arnauld</i> .....	45, 184
for Skousen .....	188	<i>Arnauld and Lancelot</i> .....	26, 290
history schematized .....	38	article .....	310
iconic .....	43	indefinite .....	189
implementing contingency .....	80	artificial intelligence .....	186, 218
limited because powerful .....	63	assembly .....	193
linguistic .....	324	assembly recipe .....	247
morphological .....	43, 343	associationism .....	212
motivates transformations .....	108	associationist psychology .....	189, 211
not determined by a pair alone .....	64	associative	
phonological .....	43	series .....	31

the strength combination function is .....	346	<i>Boltanski</i> .....	214
associator .....	21	bootstrapping .....	247, 257
assumption		<i>Bopp</i> .....	174
edification makes assumptions .....	342	<i>Bottineau</i> .....	33
atom .....	195	bottom up .....	106
attention request .....	344	<i>Bourdeau</i> .....	221, 223
A-type record .....	73, 193	branching	
definition .....	295	binary .....	247
<i>Aufbau</i> .....	195	<i>Bresnan</i> .....	18, 229
<i>Augustine</i> .....	26	British National Corpus .....	234
<i>Auroux</i> .....	9, 108, 112, 113, 174, 252, 277, 278	<i>Brugmann</i> .....	29, 190
self-analysis .....	256	<i>Buffier (le Père -)</i> .....	279
an artefact .....	257	<i>Bybee</i> .....	174
restores utility of long terms .....	200	<i>Caietano</i> .....	26, 38, 63
<i>Autolexical Syntax</i> .....	111, 123, 178	<i>Cantor</i> .....	265
autonomy of syntax		<i>Caravedo</i> .....	15
explains the problem of abduction .....	82	<i>Carnap</i> .....	195, 204
awakening .....	349	cartesian product .....	85
B2 agent creation .....	102	Cartesian product .....	310, 381
B2-B3 .....	144, 247, 339, 342	case .....	290
analysing <i>à la campagne</i> .....	124	categorial label .....	306, 371
fails on agrrement .....	106	categoricity denied .....	266
B3 agent .....	106	categorization .....	220
<i>Bailly</i> ignores the function .....	279	category .....	210
bandwidth .....	220	cause of the intension-extension paradox .....	217
<i>Baratin</i> .....	26	lexical - deconstructed .....	356
<i>Barner</i> .....	279	used by generativism .....	181
barrier .....	211, 400	used by Itkonen .....	191
base (verbal base) .....	178	c-command .....	211, 400
Basque .....	176, 282	<i>Chafe</i> .....	184
<i>Bazell</i> .....	306	<i>Chametzky</i> .....	371
<i>Bechtel</i> .....	219, 277	change	
<i>Benveniste</i> .....	184, 278	explained by an exemplarist theory .....	252
recognizes the function .....	279	linguistic .....	226
bidimensionality		of paradigm .....	144, 206
bidimensional analogy .....	324	channel (in ABS) .....	344
from a syst. of more than 2 dim. ....	325	adjacent channel .....	102
bijection .....	64, 71, 324	contributing to positionality .....	143
bilinear .....	247	definition .....	397
binary .....	371	embodies a position .....	336
binary construction .....	85	installation channel .....	101
<i>binding</i> .....	217, 222	root channel .....	143
as referential resolution .....	222	checkability .....	178
instantiation .....	220	Chomsky .....	107, 184, 290
theory .....	273	attacked on rules .....	17
two translations in French .....	222	<i>John is too stubborn</i> .....	112
bioccurrent .....	84, 85, 317	modularity .....	182
biunivocal .....	320	n-arity .....	372
blending space		posing the question of productivity .....	10
progressively constructed .....	152	principle of structure preservation .....	205
<i>Bloomfield</i> .....	43, 163, 175, 184, 280	syntagm .....	200
analogy explains productivity .....	33	the autonomy of syntax explains the problem	
functions .....	280	of abduction .....	82
quoted by Chomsky .....	37	transformations .....	111
BNC .....	234	<i>Clerico (Geneviève)</i> .....	173, 177
<i>Boersma</i> .....	231	client	



definition.....	398	constructive paradigm.....	184
co-categorization .....	86	contiguity .....	342
coding		control .....	113
orthographical.....	296	control of the computation .....	344
phonological .....	296	conventional fore .....	399
cognitive .....	317	conventional rear.....	334, 401
cognitive knowledge.....	85, 206, 258	copositioning	
cognitive science studying analogy.....	38	rather than analogy.....	80
cognitivism .....	220	rather than relation .....	194
cohesion.....	159	vs. 'ratio' .....	202
coincidence.....	306	coreference.....	106, 334
coincident construction.....	303	and binding.....	222
coindexation .....	325, 377	<i>Cori</i> .....	203
<i>Colmerauer</i> .....	291	corpus.....	189, 254
combinatorial structure .....	219	corpus linguistics.....	254
commissionner		cost	
definition.....	398	computation.....	254, 305
commonplace term .....	200	computation - measurement.....	333
comparative grammar .....	39	polynomial.....	301
competence.....	43, 225, 239	count names .....	170
complementary distribution .....	167, 200	coverage .....	253
completeness.....	184	of a need .....	215
complexity .....	39	creation	
compositionality of meaning.....	357	analogical .....	190
comprehension.....	261	creativity .....	9
computation		of langage .....	37
cost.....	374	<i>Creissels</i> .....	175, 283, 290
demand.....	348	<i>Croft</i> .....	284, 286
persevering.....	271	crossing a paradigmatic link.....	298
solidary of the plexus .....	326	C-type record .....	73, 193
computer.....	218	definiton .....	295
concatenation.....	381	<i>Culioli</i> .....	108, 203, 290
concept proscribed.....	261	current pair .....	142, 377
conceptual integration.....	151, 152	installed by priming.....	379
conceptual object.....	15	damping (of strength).....	345
concord .....	183	dative.....	27
concrete		declension .....	169
definition.....	398	decontextualised knowledge .....	160
theory .....	211	decontextualization .....	77
<i>concretum</i> .....	195	deduction.....	21
condensation .....	211	delivery .....	143
semantic .....	253	delivery point .....	336, 344
connectionism.....	21, 43, 87, 241	definition .....	398
difficulties with variable binding .....	219	demarcation	
connexity or not in paradigms .....	313	between terms in C-type records .....	160
constituency .....	200, 371	<i>Demarolle</i> .....	45, 190, 310
constituent .....	193	depackaging .....	278
constitutional similarity .....	352	dependency .....	183
constraint .....	230, 239	derivation	
constructability transfer .....	84, 85, 197, 317	not separated from inflection.....	174
in example <i>John is too</i> .....	115	derivational rule .....	371
taking place or not .....	317	<i>Descartes</i> .....	66, 82
construction .....	291	Det.....	310
similar .....	351	determinant .....	152, 310
construction grammar .....	170, 291	<i>Dingare</i> .....	229
constructional analogy.....	257	direct.....	170

direct construction licensed by material from	
oblique construction.....	110
direct utterance .....	109
discursive role.....	230
distorsion .....	303, 306
<i>Distributed Morphology</i> .....	168
distribution.....	189
complementary.....	167, 200
distributional similarity.....	351, 355
disturbance of a series by an anomalous item. 32	
familiarity orientation .....	62
DL, delivery relation.....	336
domain .....	214, 273
dominance .....	371
<i>Donnat</i> .....	66
<i>Douay</i> .....	26, 62
double analysis .....	125
double index .....	206
drift	
analogical ratio drift.....	84
category drift.....	152
<i>Dryers</i> .....	286
<i>Ducrot</i> .....	167
<i>Dumarsais</i> .....	279
duty	
agent duty.....	332, 337, 343
of client agent .....	334
of commissioner agent .....	337
dynamics.....	46
short-sighted mechanisms .....	75
<i>Eco</i> .....	82
<i>Edelman</i> .....	42, 297
edification.....	144, 339, 340, 341
definition.....	398
for complex tasks .....	343
mechanism of B2-B3 .....	364
plausibility .....	343
<i>Edmonds</i> .....	205
efficiency .....	157
elementarity .....	194
<i>Eliasmith</i> .....	306
ellipsis.....	176
<i>Elman</i> .....	182, 211, 242
<i>Embick</i> .....	278
<i>Empedocles</i> .....	25
empiry of this work.....	341
endocentric .....	175, 183
English.....	189
epigenesis .....	29
epilinguistic knowledge .....	108, 253
equativity .....	63
ergative .....	282
<i>erleb</i> .....	204
escalation.....	92, 179, 182, 258
escalation principle.....	173
Eskimo-Aleut languages .....	176
essence .....	62, 145
<i>Euclid</i> .....	25
examples	
<i>à la campagne</i> .....	124
agreement in French .....	153
<i>Auvergnats and Bavarians</i> .....	145, 339
<i>c'est beaucoup trop grand</i> .....	99, 339
<i>cet été / nous avons été</i> .....	166
<i>elle est arrivée avec son homme et son</i>	
<i>cheval</i> .....	164
<i>être jolie</i> .....	209
<i>extrêmement gentil</i> .....	156
French articles .....	152
French verb .....	139
<i>give John money /serve guests dinner</i> .....	170
<i>John is eager to please</i> .....	113
<i>John is too stubborn to talk to</i> .....	113
<i>le parler vrai</i> .....	307
<i>Victor est vu par Berthe</i> .....	108
exemplar.....	348
as a term in ABS.....	331
as the base regularization .....	272
contrasted with occurrence .....	210, 211
definition .....	398
for Skousen.....	189
instead of abstract schema .....	111
learnt .....	248
undergoing systematic self-analysis .....	257
exemplarism.....	44
exemplarist.....	266
definition .....	398
detail.....	87
option .....	211, 352
reason .....	103
record .....	253
the heuristic strucure is.....	331
exemplarist analogy .....	321
exemplarist construction .....	184
exemplarist grammar.....	255
exocentric.....	175, 183
expansion (syntagmatic expansion).....	190
expansive gate.....	86, 105, 117, 199
definition .....	398
expansive homology	
and syntagm good formation .....	199
applied successively .....	375
definition .....	85, 318
in example <i>John is too</i> .....	115
is not a primitive.....	319
explanation.....	34, 333
exponential decrease of strengths.....	345
exponentiation.....	322
expose .....	103
extension .....	216
spontaneous - of search scope .....	148
vs. intension.....	215

extinction .....	103	function	
extraposition .....	111	functions and organs .....	284
faculty of language .....	208	grammatical .....	279
<i>Falkenheimer</i> .....	186	FW .....	399
familiarity orientation		<i>Galmiche</i> .....	214
a substitute to activity control .....	348	<i>Ganascia</i> .....	82
analogous of frequency .....	189	ganging up .....	239
definition .....	301, 398	garden path .....	247
does not impoverish results .....	305	definition .....	318
not provided by corpus techniques .....	255	resolution .....	343
proximal and contingent .....	304	small span .....	258
reduces the computation demand .....	305	vs activity control .....	349
vs analogy transposition .....	325	vs. longest match principle .....	100
family resemblance .....	356	<i>Gayral</i> .....	214
<i>Fauconnier</i> .....	151	<i>Gazdar</i> .....	18, 371
feature		GB .....	179
gender .....	324	gemination .....	197
syntactic .....	183	generative linguistics .....	39
syntactic - for groups .....	170	generativism .....	38, 176, 181, 306
feature structure .....	170	genitive .....	280
<i>Fehr</i> .....	56	<i>Gentner</i> .....	41, 43, 186
field .....	334, 340, 341	Georgian .....	174
data .....	247, 341, 343	German .....	28, 310
definition .....	398	article .....	161
definition .....	398	Gestalt .....	399
<i>Fillmore</i> .....	68, 201, 290	<i>Giliéron</i> .....	39
finding		<i>Gineste</i> .....	42
definition .....	398	<i>Girard (Abbé -)</i> .....	279
homonymous -s merged .....	215	<i>Givón</i> .....	112, 229, 284, 290
merged, delivered .....	336	<i>Goethe</i> .....	41
merging .....	345	<i>Gold</i> .....	224
raised .....	333, 337	<i>Goldberg</i> .....	68, 291
raised, on an example .....	102, 143, 149, 153	<i>Goldsmith</i> .....	198, 254
requiring attention .....	344	good formation .....	184
strength of finding .....	345	<i>Goodman</i> .....	17, 195, 204
Finnish .....	190	GPSG .....	18
<i>Firth</i> .....	33	gradation of responses .....	342
<i>Fodor</i> .....	179, 201	grammar	
fore (conventional -) .....	339, 340	construction grammar .....	201, 291
fore-rear (conventional -) .....	341	diverges when corpus size increases .....	254
form		its dubious frontier .....	156
definition .....	399	not a prerequisite to explanation .....	272
prevailing in Sanctius .....	177	pluristructural .....	112
formal term		stochastic .....	228
definition .....	293	this thesis does not define a grammar .....	272
forward process .....	344	grammatical change .....	231
forward-rearward orientation .....	342	grammatical gender .....	320
foundationalism .....	194	grammaticality .....	106
<i>Fradin</i> .....	175, 203	gradual .....	225
fragmentary paradigm .....	208	judgment .....	238
Freeman .....	106, 189, 239, 255, 374	grammaticalization .....	39
Frei .....	261	grammeme .....	374
frequency .....	189, 255	Greek .....	27
an obstacle to analogical repair .....	303	<i>Gross (Maurice)</i> .....	111, 279, 283, 310
<i>Freud</i> .....	41	group inflection .....	174, 176
<i>Fuchs</i> .....	277	group sensitivity .....	36, 169

<i>Gruaz</i> .....	175	immersion .....	206, 263
<i>Guillaume (Gustave)</i> .....	184	definition .....	399
<i>Habert</i> .....	224, 227, 254	imperative .....	310
<i>Hacking</i> .....	52	improper derivation.....	129, 173
<i>Haegeman</i> .....	208	improper noun.....	259
<i>Hagège</i> .....	277, 278	inconsistent signified.....	177
<i>Haiman</i> .....	175	incremental.....	255
<i>Halle</i> .....	175	incremental learning.....	248
hand-made .....	253	index	
<i>Hankamer</i> .....	310	of analogical pair occurrences .....	297
hapax .....	254, 299	of term occurrences .....	296
<i>Harley</i> .....	278	indexability (non -).....	178
<i>Harris (Zellig)</i> .....	56, 184	indicative.....	177
ignores the function .....	279	indirect .....	170
morphology not distinguished from syntax		individual .....	222, 242
.....	175	indo-european verbal paradigms .....	65
position as place.....	202	induction .....	81
transformation.....	111	inextensible .....	157
zero .....	177	infinitive .....	310
<i>Hayes</i> .....	231	inflected form.....	310
head .....	87, 292	inflection	
<i>Henry</i> .....	39	not separated fom derivation .....	174
heterogeneity .....	208	information structure .....	230
heterogeneous data .....	53	innateness.....	112, 207
heterogeneous paradigm.....	208	refuted by analogy .....	44
heuristic path .....	107	input space .....	151
heuristic structure .....	348, 349	installation	
as working memory.....	271	definition .....	364
definition.....	399	example .....	101
<i>Hinton</i> .....	219	instance .....	266
Hjelmslev.....	174, 216	integrative .....	325, 342
<i>Hockett</i> .....	37, 123, 201	integrative morphology .....	65
<i>Hofstadter</i> .....	42, 186, 260	integrativity .....	111, 143, 207
<i>Holyoak</i> .....	41, 219	mechanisms of.....	210
homography .....	164	intension.....	216
homolog.....	317	vs. extension.....	215
homology.....	300	interaction	
homonym.....	293	of planes and orders .....	194
homonymy .....	200	intercomprehension.....	73
accidental .....	164	interpretation .....	292, 348
affected by coding.....	296	interrogation.....	111
by non-affixal derivation.....	173	intonation unit .....	184
<i>Hopper</i> .....	39, 254	intransitive.....	170
<i>Horning</i> .....	224	introducer (of Fauconnier) .....	152
<i>Houdé</i> .....	82, 167	introspection	
<i>Householder</i> .....	277	self introspection of the model .....	257
HPSG.....	18	intuition of the descriptor .....	351
complements for morphology .....	278	<i>Iphicrates</i> .....	62
non-affixal derivation.....	173	island.....	211
unification.....	170	isonomy.....	80, 90, 134, 186, 187, 192, 247, 399
Hugarian .....	278	isotropy .....	301
<i>Humboldt</i> .....	9, 33, 45	<i>Itkonen</i> .....	11, 42, 108, 190, 240
<i>Hummel</i> .....	219	<i>Jackendoff</i> .....	20, 223, 307, 371
idiophone .....	33	binding is massive .....	220
<i>I-language</i> .....	43, 50, 54	generative rules do not describe performance	
immediate constituent.....	201	.....	20

innateess.....	207	incremental.....	248
parallel architecture .....	111	supervised.....	248
referential binding is not variable binding	222	with sparse, heteogeneous data.....	207
<i>Jakobson</i> .....	66, 184, 261	<i>Lemaréchal</i> .....	107, 178, 277, 290
Japanese.....	31	lemma.....	168
verbal syntagm.....	65, 310, 311, 319	<i>Lepage</i> .....	186, 213
<i>Jarovski</i> .....	41	<i>Leskien</i> .....	235
<i>Jespersen</i> .....	37	lexical class .....	310
<i>Johnston</i> .....	162	closed .....	374
judgment (speaker judgment) .....	194	open.....	374
<i>Jurafsky</i> .....	237	lexical creation .....	32
<i>Kager</i> .....	330	lexical evocation .....	343
<i>Kathol</i> .....	203	lexical material.....	108
<i>Kaye</i> .....	201, 290	lexicographic position.....	160
<i>Kayne</i> .....	372	lexicon.....	294
<i>Kayser</i> .....	338, 378	downgraded in this model .....	172
<i>Kerleroux (Françoise)</i> .....	173, 290, 299	LFG.....	18
<i>Kiparsky</i> .....	44, 230	LI, internal language .....	208
<i>Koenig</i> .....	277, 278	linear correspondence .....	372
<i>Kohonen</i> .....	241, 346	linguistic act.....	20
<i>Kosslyn</i> .....	44	linguistic knowledge .....	85
<i>Krates of Mallos</i> .....	26	linguistics	
<i>Kuhn</i> .....	206	formalizing linguistics is analogist .....	39
labial stop .....	190	generative linguistics.....	39
<i>Lacan</i> .....	41	structural linguistics .....	39
<i>Lafon</i> .....	282	treating language as anomalous .....	39
<i>Laks</i> .....	306	<i>Livet</i> .....	22
abduction .....	82	localist.....	11
categories and rules.....	277	logarithmic cost.....	306
constituency .....	201	logic .....	220
rule vs regularity .....	286	logical behaviour without hard-wired logic... 149	
<i>Lamb (Sydney)</i> .....	277	logistic function.....	231
<i>Lancelot</i> .....	184	longest match principle .....	100
<i>Langacker</i> .....	306	<i>Lowenstamm</i> .....	201, 290
against modularism .....	182	<i>Mac Whinney</i> .....	218, 241, 346
constituency .....	201	macroscopic determinism.....	153
nouns and verbs .....	278	definition .....	399
rule-list fallacy .....	272	macroscopic effects.....	87
subject and object .....	281	<i>Maes</i> .....	281
valence.....	290	<i>Mandelbrot</i> .....	261
language		<i>Mandosio</i> .....	27
acquisition device .....	43	<i>Manning</i> .....	224
of thought.....	223	mapping .....	214
under-determined .....	208	<i>Marandin</i> .....	203, 277, 306
<i>langue</i> .....	239	<i>Marantz</i> .....	278
Latin .....	27, 169, 174	<i>Marcus</i> .....	219, 220, 242
lattice		mark	
of categories.....	170	absent .....	177
of constructions.....	291	marked analysis .....	307
the heuristic structure is a .....	340	oblique cases more marked .....	161
law		unmarked.....	177
the ultimate law of language .....	56	zero.....	178
learnability.....	224	<i>Markov</i> .....	227
learning		<i>Marrantz</i> .....	175
alters familiarity orientation.....	305	<i>Martinet</i> .....	184, 277, 281, 290, 306
explained by an exemplarist theory.....	252	function .....	280

zero element.....	177
masking and difference.....	196
masking-subtraction.....	198
mass name.....	58, 170
matching.....	221
mathematics.....	218, 220
<i>Mauro</i> .....	278
maxima of the heuristic structure.....	340
maximum.....	342
<i>McClelland</i> .....	17, 182, 219, 241, 290, 400
meaning.....	184
not provided by corpus techniques.....	255
measurement of computation cost.....	333
mechanism of integrativity.....	210
mediately determinable.....	204
<i>Meillet</i> .....	39, 184
mental process.....	344
merging.....	344
as finding consolidation.....	153, 338, 378
definition.....	399
via DL relation.....	336
merology.....	262
metalanguage.....	194
metalinguistic knowledge.....	253
metaphor.....	62, 192, 301
despite the absence of a word.....	259
metonymy.....	292
<i>Milner</i> .....	18
actual reference / virtual reference.....	324
analogy.....	38, 44
asymmetry.....	306
categories.....	277
extension-intension.....	217
place vs position.....	203, 289, 290
structure preservation.....	205
subject.....	283
minimal contrast.....	35
Minimal Description Length.....	198
Minimalist Programme.....	51, 111
minimality	
of the model.....	342
of the theory.....	181
minimality suspension	
applied to amalgamation in French.....	123
definition.....	399
to dispense with 'word'.....	159
minimality suspension principle	
illustrated in analysis.....	101
minimum length description.....	254
MLD.....	254
mode.....	310
model	
parallel.....	329
serialized.....	329
stochastic.....	224
module.....	182
<i>Moeschler</i> .....	324
<i>monème</i> .....	168, 177
<i>Montague</i> .....	214
morph.....	167
morpheme.....	163, 254
abstract morpheme.....	168
as minimal.....	81
may be a term.....	193
morphemes constituting a word.....	159
portmanteau.....	123
rare.....	200
morphological analogy.....	213
morphology	
agglutinative.....	65, 310
non-concatenative.....	193
not separated from syntax.....	72
morphology-syntax demarcation.....	174
morphophonology.....	176
motivation	
contradicted by probabilities.....	238
motivation link (construction gramm.).....	291
of Kohonen maps topology.....	213
<i>Move-Alpha</i> .....	179
movement by transposition.....	325
multiple analysis.....	251
multiple inheritance.....	266
n-arity.....	106, 247, 374
n-ary.....	246, 371, 372
negation.....	111
Neogrammarians.....	38, 39, 45
network	
mixed.....	219
recurrent.....	160
semantic net.....	188
<i>Newmeyer</i> .....	108, 284
n-gram.....	400
nominalization.....	310
non-affixal derivation:.....	173
non-categorical.....	255
non-categoricity.....	44
non-cohesive.....	193
non-concatenative.....	193
<i>Normand (Claudine)</i> .....	29
noun phrase.....	178
noun, improper noun.....	259
noun-verb opposition.....	277
<i>Noyer</i> .....	278
oblique case.....	161
occurrential.....	11
occurrence.....	189, 211
definition.....	399
occurrential.....	210
occurrential need covered by suggestion of	
similarity.....	356
occurrentialist.....	211
onset.....	190

ontology.....	255	phonotactics (phonotactically well formed) ....	36
in IA.....	188	phrase marker.....	38, 371
opaque .....	335	<i>phrase structure grammar</i> .....	107, 179
definition.....	399	<i>Piaget</i> .....	41
vs transparent.....	336	<i>Pinker</i> .....	182
opposition.....	177	<i>Planck</i> .....	174
Optimality Theory .....	10, 188, 229	plausibility.....	170, 270, 378
optimization does not replace analogy.....	44	plexus.....	144, 193, 206
orientation.....	399	balanced .....	348
agentive.....	113	definition .....	56, 298, 308, 400
OT .....	188	described by analogical means .....	188
stochastic OT .....	231	description burden alleviated by self-analysis .....	257
<i>Page</i> .....	242	different sizes .....	254
pair		hand-made .....	196, 253
located.....	379	it is the - that commands.....	184
paradigm.....	66, 190	representative even when small? .....	309
connected or not.....	313	solidary of the computations .....	326
definition.....	298	two plexii operating differently .....	153
in a broader sense .....	33	plural .....	254
mixed .....	73	pluridimensional.....	65
of analogies.....	66	pluridimensional structure	
partial -s integrated .....	143	not directly implemented by neurons .....	311
same - reused .....	149	pluristructural model .....	111
topology of paradigms .....	313	point .....	184
two -s used integratively .....	140	<i>Pollard</i> .....	203
paradigmatic link .....	66, 145, 206, 212	<i>Pollock</i> .....	207, 208
definition.....	298, 400	polychromous trees grammar .....	112
oriented.....	302	<i>Popper</i> .....	44
Parallel Architecture (Jackendoff).....	111	popular etymology .....	258
parallel processor.....	327	portmanteau.....	123
parallelism .....	271, 326	Port-Royal.....	26
simulated.....	343	position .....	111, 317, 336
paralogism .....	62	as place or as role .....	202
paraphrase.....	214, 253	characteristic -s of an agent .....	144
<i>parole</i> .....	239	occupied by a term .....	143
parsing .....	363	preserved by agent ANZ.....	143
partial productivity .....	35	positional label.....	306
partonomy.. 77, 89, 90, 134, 145, 160, 186, 187, 192, 262, 400		positionality	
passive .....	109, 111, 177	observed by ABS.....	333
impersonal .....	177	positioned resetting .....	144
pattern recognition.....	21	a mechanism of integrativity .....	210
<i>Paul</i> .....	9, 37	in a task on articles .....	153
PDP .....	219, 241	in agent ANZ.....	142, 143, 378
<i>Peirce</i> .....	82	in the <i>Bavarians</i> example.....	148
perceptive channel.....	341	in the same paradigm.....	150
<i>Pereira</i> .....	224	key to integrativity.....	144
<i>Perelman</i> .....	62	positioning	
performance.....	225, 239	relative - between task and plexus.....	150
phase.....	83, 343	possible world .....	214
phase management.....	344	<i>Pottier</i> .....	290
phoneme		poverty of the stimulus.....	210
as minimal.....	81	precedent.....	351
phonestheme .....	33	present.....	177
phonetic change .....	30, 190	preservation of copositionings .....	204
phonosyntax.....	296	primarism .....	194, 195

priming	
diffuse .....	380
low efficiency .....	157
of agent ANZ .....	377, 379
primitive .....	195
<i>Prince</i> .....	182
principle of structure preservation .....	205
private term	
definition .....	260, 293
positionality .....	207
subject to minimality suspension .....	195
probability .....	224
a stopgap .....	236
constitutional defect .....	234
problem of 2 .....	223
process	
forward .....	338
long and expensive .....	92
rearward .....	337
recruiting .....	334
short and economical .....	92
product	
definition .....	400
forwarding of products .....	344
number of products .....	305
productivity .....	157
abduction accounting for it .....	83
linguistic .....	37
linguistic analogy .....	210
productivity effect .....	11
semi-productivity .....	307
projection	
of occurrences onto exemplars .....	211
Prolog .....	190
proportional fourth	
created by repairing analogy .....	30
defines A4 analogy .....	38, 39
determined .....	65
determined after transposition .....	320, 324
subordinated to the idea (Saussure) .....	31, 45
proposition	
propositions dismissed .....	83
prosody .....	184
prototype effect rendered in a plexus .....	299
proximality	
cannot be extracted from a plexus .....	255
constructional .....	255
contributes to similarity on request .....	352
definition .....	75, 211, 400
paradigmatic .....	313
similarity made proximal .....	356
used by B2-B3 .....	106
vs. probability .....	237
psycholinguistics .....	253, 266
psychology	
associationist .....	211
studying analogy .....	38
pun .....	258
<i>Pylyshyn</i> .....	44, 201
quadratic .....	346
<i>qualia</i> .....	195
quasi-normative results .....	87
quasi-synonym .....	320
radical non-categoricity .....	267
raising	
agent ANZ .....	143, 149, 153, 378
by agent B2 .....	102
one of the 3 actions of agents .....	333
strength upon raising .....	345
<i>Rastier</i> .....	32, 254
ratio	
analogical - distinct from the vehicle .....	65
multiple analogical ratios .....	310
rationalism .....	81
rational thought .....	63
RC, recruitment relation .....	335
reanalysis .....	39, 195, 251
of <i>somnolent</i> .....	258
rearward process .....	344
reasoning	
underlying .....	148
<i>Rebuschi</i> .....	282
receiving an utterance .....	261
record .....	66, 145
2 to 6 neighbours .....	298
binary .....	105
binary constructor .....	102
C-type record .....	351, 352
definiton .....	295
isolated .....	299
licensing record .....	105
settlement record .....	102, 106
used twice .....	150
recruiting sub-processes .....	342
recruitment	
an unconscious process .....	343
definition .....	400
excludes field data .....	341
for simple tasks .....	343
one of the 3 actions of agents .....	333
opaque .....	335
plausibility .....	343
transparent .....	335
vs edification .....	144, 341
within edification .....	340
recurrent network .....	160
recursivity	
of structures .....	242
of syntax .....	105
reduction .....	274
redundancy of agents .....	333
reference	



actual / virtual .....	324	A4 analogy .....	38, 39
naming spaces in informatics .....	291	morphology not diff. from syntax .....	175
referential object .....	15	quoted by Chomsky .....	37
referential term .....	324	relativism .....	63
<i>régime</i> .....	290	repairing analogy .....	30, 190
regularism .....	318	' <i>somnolent</i> ' .....	258
reinforcement .....	143, 152, 210, 341	<i>Schwartz</i> .....	17
relativization .....	111, 178	segmental mark .....	178
remobilization .....	339	selection schema .....	346
repartition situations .....	190	self-organizing map .....	241
representation		semantic net .....	188
analogical .....	44	seme .....	81
localist or distributed .....	211	semi-productivity .....	307
prefer 'inscription' .....	57	Semitic languages .....	246
resetting .....	206	sensitivity	
definition .....	400	group sensitivity .....	169
positioned - insensitive to familiarity		sentence .....	184
orientation .....	304	separation	
residue by subtraction .....	197	morphology-syntax .....	159
resource		serialization .....	271, 326, 343, 378
bounded computational .....	347	set theory .....	262
result .....	338	settlement	
definition .....	401	agent ANZ .....	149, 378
has a strength .....	344	condition for agent ANZ .....	142
installation result .....	101	definition .....	401
of a B2-B3 analysis .....	368	in rearward process .....	337
prototypical results first .....	150	long term unlikely to settle .....	256
settlement result .....	102	one of the 3 actions of agents .....	333
reuse of same resources .....	150	ternary .....	106
<i>Rissanen</i> .....	254	treated by phase management .....	344
role		settlement condition	
changing upon resetting .....	143	of agent B2 .....	102
roles redistributed .....	144	settlement configuration .....	221
root channel .....	334, 342, 343	settlement-merging .....	341
suspected .....	342	<i>Sextus Empiricus</i> .....	26
rule .....	181	<i>Shastri</i> .....	219
bad because of its 'centralism' .....	318	<i>Shaumjan</i> .....	163, 290
derivation .....	38, 289	short-sighted mechanism .....	154
derivational rule .....	20	risk of redundancy .....	338
operating - set in doubt .....	286	SHRUTI .....	219, 220
refused .....	188	sigmoid .....	231, 249
stochastic .....	225	similarity .....	189
transformational .....	20, 38, 289	binary .....	189
rule-list fallacy .....	181, 272	on request .....	352, 356
Russian .....	169, 310	successive phases .....	353
<i>Ruwet</i> .....	280	syntactic .....	351
RW (definition) .....	401	simple index .....	206
<i>Ryle</i> .....	37	simulation .....	318
<i>Sadock</i> .....	111, 175, 178	singular .....	177, 254
Salish languages .....	278	site of record .....	293, 295
<i>Sanctius</i> .....	173, 176	deflected sites .....	300
Sanskrit .....	174	in A-type record .....	295
<i>Sapir</i> .....	43	in C-type record .....	295
Sapper .....	186	situation .....	211
<i>Saussure</i> .....	51, 56, 184	<i>Skousen</i> .....	106, 188, 239
a modern analogist for Milner .....	39	slot-filler schema .....	220

structure preservation.....	18	garden path.....	247, 349
SME.....	186	syntactic copositioning.....	207
<i>Smolensky</i> .....	16, 219, 231, 330	syntactic skeleton.....	290
SOFM.....	213, 241, 346	syntagm.....	31, 198, 290
<i>somnolent</i> .....	252, 258	syntagmatic.....	66, 336
span.....	99, 102, 103, 342	syntagmatic structure.....	198
specific (non - means).....	150	syntax-morphology demarcation.....	174
<i>Spinoza</i> .....	82	synthesis point.....	184
spoken language.....	184	system.....	310
skeleton of positions.....	290	systemic	
statistic.....	240	analogy.....	72, 87, 106, 134, 297
stemma.....	201	anomaly.....	129
stochastic.....	224	productivity.....	182
stochastic grammar.....	228	table of terms?.....	294
stochastic rule.....	225	Tabletop.....	186
<i>Stoicians</i> .....	21, 26, 45, 174	<i>Tager-Flusberg</i> .....	257
stopping heuristic activity.....	348	<i>Tamba (Irène)</i> .....	184
strength.....	150, 344	<i>Tanenhaus</i> .....	290
combination.....	345	<i>Tarski</i> .....	266
combination function.....	345	task	
has varied.....	344	linguistic.....	343
of results.....	338, 345	tautology.....	324
structural analogy.....	129	tenor.....	62, 66, 186, 301
structural linguistics.....	39, 66, 176, 177, 351	tense.....	310
structural productivity.....	132	tense-mode.....	310
structure		term	
judgment.....	225	bioccurrent.....	84, 85
mapping.....	186, 219	commonplace.....	200
preservation principle.....	18	definition.....	193, 293, 401
style.....	185	formal term definition.....	293
sub-categorization.....	170, 171, 318	homolog.....	317
sub-jacency.....	273	long - little useful.....	256
subject		private - subject to minimality suspension.....	195
depackaged.....	283	private term definition.....	293, 400
in Basque.....	282	reidentifiable in its recurrences.....	193
speaking subject.....	317	several terms or a single one?.....	200
subjective.....	317	short terms favoured.....	200
subjectivity		table of terms?.....	294
of the descriptor.....	253, 257	unessential.....	79
speaker's.....	253	ternarity.....	247
subjunctive.....	177	ternary assembly.....	106
substantive.....	278	ternary construction.....	85
<i>Suffixaufnahme</i> .....	174	<i>Tesnière</i> .....	184
suggestion of similarity.....	95	actants.....	203
supervised.....	248	autonomy of syntax.....	15
suppletion.....	168, 216	connection.....	107
quasi-suppletion.....	320	dependency vs. constituency.....	201
surrection.....	267	ignores the function.....	279
suspension of minimality		syntactic productivity.....	200
applied to syncretism.....	163	translation.....	310
to avoid zero elements.....	180	valence.....	290
SVO.....	44	<i>Thales</i> .....	25
<i>Swiggers</i> .....	174, 279	theory	
symbolic system.....	218	concrete.....	212
syncretism.....	195, 200, 310	theta-role.....	290
syntactic ambiguity.....	314, 343	<i>Thomas Aquinas</i> .....	26, 38

threshold .....	348	<i>van Vallin</i> .....	111
topic		<i>Vandeloise</i> .....	174
contains private terms .....	261	variable	
totalism .....	214, 217, 234	not in this model .....	220
<i>Touretzky</i> .....	219	variation .....	226
transformation .....	178	explained by an exemplarist theory .....	252
their treatment in this model .....	111	<i>Varro</i> .....	25, 26, 43, 45, 181
transformations absent in recent theories .....	111	<i>Vaugelas</i> .....	37
transitive .....	170, 177	<i>Veale</i> .....	186
transitivity .....	377	vehicle .....	62, 66, 157, 186, 301, 311
translation .....	310	distinct of the analogical ratio .....	65
transparent .....	335	multiple .....	310
definition .....	401	on an example .....	156
vs opaque .....	336	verb	
transposability		Japanese .....	311
characterization .....	323	<i>Vergnaud</i> .....	201, 290
transposition .....	319, 377, 378	<i>Victorri</i> .....	157
in arithmetics .....	321	virtual conceptual necessity .....	372
of analogy .....	87, 148	<i>Vivicorsi</i> .....	22, 188
transposition movement		<i>von Neuman</i> .....	218, 329
vs familiarity orientation .....	325	<i>Wallon</i> .....	41
<i>Traugott</i> .....	39	<i>Walmatjari</i> .....	311
tree		weight combination .....	238
neither unique nor univocal .....	105	<i>Weil (Simone)</i> .....	66
of agents .....	147	<i>Williams</i> .....	372
polychromous trees grammar .....	112	<i>Wittgenstein</i> .....	261, 356
tridimensional .....	310	word .....	172
trigram .....	198	a word is a form .....	163
<i>Trubetzkoy</i> .....	43	as interpretative cue .....	160
Turkish .....	31, 310	empty .....	374
<i>Turner</i> .....	151	grammatical word .....	163
type		not postulated .....	159
agent .....	337	working memory .....	271
underspecification .....	266	writing .....	184
understanding with an effort .....	150	X bar .....	179, 371
unification .....	292	yield .....	266
unilinear organization .....	341	<i>Yvon</i> .....	213
universal grammar .....	43	zero .....	176
usage .....	27	a consequence of transformations .....	178
valence .....	201, 290	in Harris .....	177