



**HAL**  
open science

# Configurations de connexions de selles et échanges d'intervalles généralisés dans l'espace des modules des différentielles quadratiques

Corentin Boissy

► **To cite this version:**

Corentin Boissy. Configurations de connexions de selles et échanges d'intervalles généralisés dans l'espace des modules des différentielles quadratiques. Mathématiques [math]. Université Rennes 1, 2007. Français. NNT: . tel-00259639

**HAL Id: tel-00259639**

**<https://theses.hal.science/tel-00259639>**

Submitted on 28 Feb 2008

**HAL** is a multi-disciplinary open access archive for the deposit and dissemination of scientific research documents, whether they are published or not. The documents may come from teaching and research institutions in France or abroad, or from public or private research centers.

L'archive ouverte pluridisciplinaire **HAL**, est destinée au dépôt et à la diffusion de documents scientifiques de niveau recherche, publiés ou non, émanant des établissements d'enseignement et de recherche français ou étrangers, des laboratoires publics ou privés.

N° d'Ordre : 3634

# THÈSE

*Présentée*

**DEVANT L'UNIVERSITÉ DE RENNES I**

*pour obtenir*

**le grade de DOCTEUR DE L'UNIVERSITÉ DE RENNES I**

Mention Mathématiques et Applications

*par*

**Corentin BOISSY**

Institut de Recherche Mathématique de Rennes

École Doctorale MATISSE

U.F.R. de Mathématiques

TITRE DE LA THÈSE :

**Configurations de connexions de selles et échanges  
d'intervalles généralisés dans l'espace des modules des  
différentielles quadratiques**

Soutenue le 11 décembre 2007 devant la Commission d'Examen

COMPOSITION DU JURY :

M.	P. Arnoux	Examineur
M.	D. Cerveau	Examineur
M.	J-P. Conze	Examineur
M.	P. Hubert	Rapporteur
M.	J-C. Yoccoz	Examineur
M.	A. Zorich	Directeur



# Remerciements

Je voudrais dans un premier temps remercier Anton Zorich, pour m'avoir guidé au cours de ces trois dernières années. Ses explications et sa vision des mathématiques ont beaucoup contribué à ma formation. Merci aussi pour ses conseils, et sa gentillesse.

Je remercie Giovanni Forni et Pascal Hubert, pour avoir accepté d'être rapporteurs de ma thèse. Merci à Pierre Arnoux, Dominique Cerveau, Jean-Pierre Conze et Jean-Christophe Yoccoz pour avoir accepté de faire partie de mon jury.

Cette thèse doit beaucoup à Erwan Lanneau, pour son intérêt à mes travaux et ces deux mois de collaboration à Marseille. Merci également à Pascal Hubert et aux autres membres du groupe de travail « Teich » pour leur accueil chaleureux.

Si la « tour de math » offre des conditions de travail avantageuses, ce n'est pas grâce à la taille de des bureaux, mais surtout grâce aux gens qui s'y trouvent. Je remercie les secrétaires et beaucoup d'autres collègues pour leur gentillesse. Merci à mes voisins du septième étage, en particulier Bert et Julie. Une pensée spéciale pour mes compagnons de RU, pour leur humeur joyeuse et, le plus souvent, leur patience : Glenn, Élise, Jean-Romain, Viktoria, Mikaël, Jérôme, etc. . . Merci à Ferrán pour sa connaissance approfondie des bars rennais et ses discussions mathématiques. Merci à Steph et aux autres danseuses de lindy.

En tant qu'usager toujours mécontent des transports en commun, je ne remercie pas les bus rennais pour leur trop grande ponctualité à mes yeux, ni les bus marseillais pour la raison inverse.

Je remercie Patrick, Élisabeth, Corinne et ma famille, pour leur soutien et leurs encouragements pendant les moments difficiles. Merci en particulier à mon père qui m'a transmis son goût des mathématiques dès mon plus jeune âge.

Enfin, quelques mots à celle qui a illuminé cette fin de thèse, Мерси Славяна.



# Table des matières.

<b>Introduction</b>	<b>5</b>
0.1 Surfaces plates et différentielles quadratiques . . . . .	7
0.1.1 Surfaces de demi-translation . . . . .	7
0.1.2 Différentielles quadratiques . . . . .	8
0.1.3 Lien avec les surfaces de demi-translation . . . . .	9
0.2 Espace des modules, généralités . . . . .	10
0.2.1 Coordonnées locales naturelles . . . . .	11
0.2.2 Mesure . . . . .	12
0.2.3 Action de $SL_2(\mathbb{R})$ . . . . .	13
0.3 Connexions de selles $\hat{h}$ omologues . . . . .	14
0.3.1 Configurations . . . . .	16
0.3.2 Configurations admissibles . . . . .	17
0.3.3 Voisinage du bord d'une strate . . . . .	18
0.4 Échanges d'intervalles . . . . .	19
0.4.1 Irrationalité . . . . .	20
0.4.2 Suspensions au-dessus d'échanges d'intervalles . . . . .	20
0.4.3 Algorithme de Rauzy-Veech . . . . .	21
0.4.4 Permutations généralisées . . . . .	22
0.5 Principaux résultats exposés dans la thèse . . . . .	24
0.5.1 Configurations de connexions de selles $\hat{h}$ omologues . . . . .	24
0.5.2 Dégénérescences de différentielles quadratiques sur la sphere de Riemann . . . . .	26
0.5.3 Échanges d'intervalles généralisés . . . . .	28
<b>1 Configurations de connexions de selles <math>\hat{h}</math>omologues</b>	<b>33</b>
1.1 Configurations de connexions de selles $\hat{h}$ omologues . . . . .	33
1.2 Composantes connexes hyperelliptiques . . . . .	35
1.2.1 Configurations pour $\mathbb{CP}^1$ . . . . .	35

1.2.2	Configurations pour des composantes connexes hyper-elliptiques . . . . .	36
1.3	Composantes connexes non hyperelliptiques . . . . .	37
	Annexe du chapitre 1 . . . . .	41
<b>2</b>	<b>Dégénérescences de différentielles quadratiques sur <math>\mathbb{CP}^1</math></b>	<b>75</b>
2.1	Transport de trou . . . . .	76
2.2	Domaines de configuration simples . . . . .	77
2.3	Domaines de configuration pour une strate sur $\mathbb{CP}^1$ . . . . .	78
	Annexe du chapitre 2 . . . . .	83
<b>3</b>	<b>Échanges d'intervalles généralisés</b>	<b>119</b>
3.1	Échanges d'intervalles généralisés . . . . .	119
3.2	Géométrie d'une permutation généralisée . . . . .	122
3.3	Irrationalité . . . . .	122
3.4	Dynamique de Rauzy-Veech . . . . .	124
3.5	Classes de Rauzy . . . . .	124
	Annexe du chapitre 3 . . . . .	129
	<b>Bibliographie</b>	<b>176</b>

# Introduction

On étudie dans ce mémoire des surfaces compactes munies d'une métrique plate à singularités coniques isolées. Une classe très importante de telle surface est la classe des surfaces de *translation*, correspondant aux surfaces admettant un champ de vecteurs parallèles (à l'extérieur des singularités). Ces surfaces apparaissent naturellement dans l'étude des billards polygonaux rationnels, c'est à dire dont les angles sont des multiples rationnels de  $\pi$ . En effet, une procédure permet de « déplier » un billard rationnel en une surface de translation. Une surface de translation s'identifie à une surface de Riemann munie d'une 1-forme holomorphe.

Une surface de demi-translation se définit de façon analogue, mais possède seulement un champ de droites parallèles et correspond à une surface de Riemann munie d'une différentielle quadratique. C'est une généralisation importante car l'espace des modules associé s'identifie au fibré cotangent de l'espace des modules des surfaces de Riemann.

On appelle connexion de selles, ou lien de selles un segment (ou cycle) géodésique reliant deux singularités. Un dénominateur commun des différentes parties de cette thèse est la représentation géométrique d'une surface de demi-translation en considérant des familles de connexions de selles.

Un lien de selles peut admettre un « jumeau », c'est à dire un autre lien de selles, parallèle, et qui reste ainsi même après petite déformation de la surface. Ces deux liens sont dits *homologues*<sup>1</sup>. Deux liens de selles homologues sont de même longueur, à multiplication par deux près. Une collection maximale de liens de selles homologues découpe la surface en composantes plus simples, cette décomposition existant alors pour presque toute surface de la composante connexe de strate. Une *configuration* sert à coder cette décomposition. Une suite de différentielles quadratiques quitte tout compact de la strate si et seulement si des longueurs de liens de selles tendent vers zéro. D'après un résultat de Masur et Smillie [16], une « dégénérescence

---

<sup>1</sup>se prononce « homologue chapeau ».



typique » correspond au cas où tous les liens de selles courts sont deux à deux homologues, et définissent donc naturellement une configuration.

De façon complémentaire, une collection bien choisie de connexions de selles peut définir des coordonnées locales de la strate après calcul de l'holonomie affine correspondante. Ainsi, si une surface plate est représentée par un polygone dont les côtés sont deux à deux parallèles et de même longueur (que l'on identifie ensuite par des isométries bien choisies pour obtenir la surface plate), alors les connexions de selles correspondant à chaque paire de côtés définissent de telles coordonnées. Dans le cas des surfaces de translation, et pour une surface générique, un tel polygone peut être obtenu en considérant l'application de premier retour du flot géodésique vertical sur un segment horizontal bien choisi. Cette application est un échange d'intervalles. La représentation d'une surface plate à partir d'une telle application fournit des outils puissants pour l'étude de la dynamique du flot de Teichmüller dans l'espace des modules des différentielles abéliennes.

Ce manuscrit comporte trois parties, chacune traitant un problème relié aux notions précédentes.

Le premier problème traité est la classification des configurations par composantes connexes de strates. Masur et Zorich [19] ont donné des conditions nécessaires et suffisantes pour qu'une configuration puisse être réalisée sur une surface générique, ce qui permet de donner, pour chaque strate, la liste (finie) des configurations correspondantes. Cependant, ces critères ne distinguent pas les composantes connexes de strates. On classe dans cette partie les configurations dans chaque composante connexe, pour les strates contenant une composante connexe hyperelliptique (lorsque le genre est supérieur ou égal à cinq).

Le deuxième problème traité est une étude plus fine de certaines dégénérescences typiques. Dans les strates de différentielles quadratiques sur  $\mathbb{C}\mathbb{P}^1$ , on utilise cette étude pour établir une bijection canonique entre les configurations apparaissant dans la strate et le complémentaire d'une certaine « diagonale naturelle ». On montre également qu'une telle strate n'admet qu'un seul bout topologique.

Le dernier problème traité est une généralisation des échanges d'intervalles apparaissant dans le cadre des surfaces de demi-translation. On commence par donner une condition d'irréductibilité géométrique, correspondant au fait qu'un tel échange d'intervalles généralisé apparaît comme application de premier retour du flot géodésique vertical sur un segment horizontal bien choisi. Puis, on étudie la dynamique d'un échange d'intervalles généralisé, et on donne une condition d'irréductibilité dynamique, correspondant à un

comportement « irrationnel ». Contrairement aux cas des échanges d'intervalles habituels, il apparaît ici que ces deux conditions sont distinctes.

L'introduction reprend les définitions de base, présente le contexte mathématique et donne les résultats importants de cette thèse avec des esquisses de démonstrations. Pour les définitions d'objets plus spécifiques, comme les configurations ou les échanges d'intervalles généralisés, on se contente de donner une idée intuitive et on renvoie aux chapitres pour les détails.

## 0.1 Surfaces plates et différentielles quadratiques

### 0.1.1 Surfaces de demi-translation

**Définition 1.** Une *surface de demi-translation* est la donnée d'une surface  $M$ , compacte  $\mathcal{C}^\infty$ , d'un sous-ensemble fini  $\Sigma = \{x_1, \dots, x_r\}$ , et d'un atlas sur  $M \setminus \Sigma$  dont les fonctions de transition sont de la forme  $z \mapsto \pm z + c$ . Cet atlas munit en particulier  $M \setminus \Sigma$  d'une métrique plate. On exige en plus que chaque élément  $x_i \in \Sigma$  possède un voisinage  $V_i$  tel que  $V_i \setminus \{x_i\}$  soit isométrique à un cône pointé.

En général,  $x_i$  est une singularité pour la métrique plate et est appelée *singularité conique* de la surface  $M$ . Pour chaque singularité conique  $x_i$ , l'angle correspondant  $\theta_i$  est un multiple entier de  $\pi$ . On peut alors représenter un voisinage de  $x_i$  comme  $\frac{\theta_i}{\pi}$  demi-disques, recollés les uns et les autres par des isométries du plan (voir la figure 1).

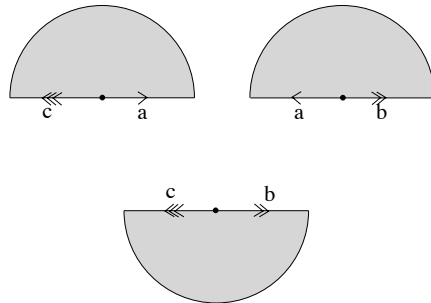

FIG. 1 – Un cône d'angle  $3\pi$

Une surface de demi-translation est donc une surface munie d'une métrique plate à singularités coniques isolées, dont le groupe d'holonomie induit par la métrique est dans  $\mathbb{Z}/2\mathbb{Z}$ . La droite verticale est préservée par les

changements de cartes, et donc chaque point de  $M \setminus \Sigma$  possède une droite privilégiée dans son espace tangent.

Lorsque le groupe d'holonomie est trivial, on peut choisir un champ de vecteurs parallèles privilégié, et on parle alors de *surface de translation* dans la mesure où l'on peut alors trouver un atlas sur  $M \setminus \Sigma$  dont les changements de cartes sont des translations.

On utilisera souvent la dénomination « surface plate » pour désigner une surface de demi-translation.

*Remarque.* La terminologie « surface de demi-translation » peut apparaître comme un abus de langage, mais indique clairement que l'on s'intéresse à une généralisation des surfaces de translation. Il se justifie également par le fait que les fonctions de transitions sont soit des translations, soit des demi-tours.

On appellera *connexion de selles* ou *lien de selles*, un segment géodésique reliant deux singularités (non nécessairement disjointes), et sans singularités dans son intérieur.

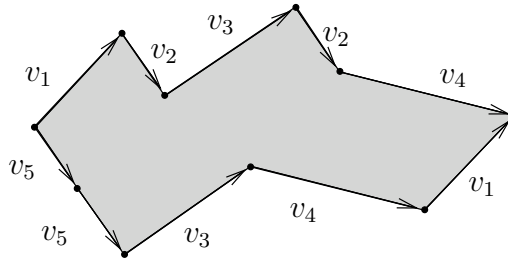

FIG. 2 – Une surface de demi-translation représentée par un polygone.

*Exemple 1.* Considérons un polygone dont les côtés vont par paires et tel que, pour chaque paire, les côtés correspondants soient parallèles et de mêmes longueurs. Alors en identifiant chaque coté avec son jumeau par des isométries appropriées préservant l'orientation, on obtient une surface de demi-translation (voir la figure 2). Les côtés du polygone, vus dans la surface de demi-translation, forment des liens de selles.

### 0.1.2 Différentielles quadratiques

**Définition 2.** Soit  $S$  une surface de Riemann de genre  $g$  supérieur ou égal à zéro, et soit  $\mathcal{A} = \{(U_i, z_i)\}_{i \in I}$  un atlas de  $S$ . Une *différentielle quadratique*

méromorphe  $q$  sur  $S$  est la donnée, pour chaque coordonnée locale  $(U_i, z_i)$ , d'une fonction méromorphe  $f_i$  en la variable  $z_i$  de sorte que, pour chaque intersection non vide  $U_i \cap U_j$ , on ait la condition de recollement suivante :

$$f_i(z_i) \left( \frac{dz_j(z_i)}{dz_i} \right)^2 = f_j(z_j).$$

On dit qu'une différentielle quadratique admet un pôle (*resp.* un zéro) au point  $z \in S$  si, pour un choix de coordonnée locale  $(U_i, z_i)$  dans un voisinage de  $z$ , la fonction  $f_i$  correspondante admet un pôle (*resp.* un zéro). Les conditions de recollement indiquées précédemment impliquent que ceci ne dépend pas du choix de la coordonnée locale. De la même manière, l'ordre d'un pôle ou d'un zéro est également bien défini. On se limitera par la suite aux différentielles quadratiques dont les éventuels pôles sont simples. Par un léger abus de langage, on appellera « zéro d'ordre  $-1$  » un pôle simple, et « zéro d'ordre  $0$  » un point marqué sur la surface.

Une *différentielle abélienne* est une 1-forme holomorphe. Notons que le carré d'une différentielle abélienne est une différentielle quadratique.

### 0.1.3 Lien avec les surfaces de demi-translation

On montre ici que les deux définitions précédentes définissent des objets équivalents. On utilisera très souvent par la suite cette équivalence.

Une surface de demi-translation  $M$  admet naturellement une structure complexe sur  $M \setminus \Sigma$ , puisque les changements de cartes  $z \mapsto \pm z + c$  sont bien évidemment holomorphes. Ces changements de cartes préservent la différentielle quadratique définie localement par  $dz^2$ , et  $M \setminus \Sigma$  possède donc une différentielle quadratique. On peut en fait étendre de manière unique cette structure complexe et cette différentielle quadratique à  $M$  tout entière, et alors une singularité conique d'angle  $\theta_i$  devient un zéro d'ordre  $\frac{\theta_i - 2\pi}{\pi}$ .

Réciproquement, soit  $(S, q)$  une surface de Riemann munie d'une différentielle quadratique. Soit  $p$  un point de  $S$  qui n'est ni un zéro ni un pôle de  $q$ , et soit  $w$  une coordonnée locale de  $S$  dans un voisinage  $U$  de  $p$ . Alors  $q$  s'écrit dans ces coordonnées  $\phi(w)dw^2$ . En choisissant une racine carrée de  $\phi$ , quitte à prendre  $U$  suffisamment petit, on définit une nouvelle coordonnée locale de  $S$  par la formule

$$z = \int_p^w \phi^{\frac{1}{2}}(x) dx,$$

et dans cette coordonnée,  $q$  s'écrit  $dz^2$ . Si  $z'$  est une autre coordonnée locale au voisinage de  $p$ , pour laquelle  $q$  s'écrit  $(dz')^2$ , alors il est facile de voir que  $z' = \pm z + c$ .

Pour avoir une surface de demi-translation, il faut décrire la structure de la métrique au voisinage d'un zéro ou d'un pôle de  $q$ . Au voisinage d'un pôle, on peut trouver des coordonnées locales pour lesquelles  $q$  s'écrit  $\frac{1}{z}dz^2$ . Remarquons que le tiré en arrière de cette différentielle quadratique par l'application  $z \mapsto z^2$  est, à une constante multiplicative près, la différentielle quadratique  $dz^2$ . Cela signifie, en terme de métrique plate induite, que l'on a un revêtement de degré 2 d'un disque euclidien dans un voisinage du pôle, ramifié au-dessus de celui-ci, et qui est une isométrie locale. Donc un voisinage du pôle est isométrique à un cône euclidien d'angle  $\pi$ . De façon analogue, un zéro  $P$  d'ordre  $k$  admet une coordonnée locale pour laquelle  $q$  s'écrit  $z^k dz^2$ , et l'application  $z \mapsto z^{k+2}$  induit un revêtement connexe d'ordre  $k+2$ , ramifié en  $P$ , d'un certain voisinage  $V$  de  $P$ , sur un cône d'angle  $\pi$ . Donc  $V$  est un cône d'angle  $(k+2)\pi$ . On a donc prouvé qu'une différentielle quadratique  $q$  définit une surface de demi-translation, et les zéros de  $q$  correspondent aux singularités coniques.

La surface plate ainsi obtenue est à holonomie triviale si et seulement si  $q$  est le carré d'une différentielle abélienne.

## 0.2 Espace des modules, généralités

On va déclarer que deux différentielles quadratiques  $q_1$  et  $q_2$  sur des surfaces de Riemann  $S_1$  et  $S_2$  sont équivalentes s'il existe un biholomorphisme  $f : S_1 \rightarrow S_2$  tel que  $f^*(q_2) = q_1$ . En terme de surfaces de demi-translation, ce biholomorphisme  $f$  apparaît comme une isométrie entre  $S_1$  et  $S_2$  pour les métriques plates correspondantes et qui préserve également la direction privilégiée.

L'espace des modules des différentielles quadratiques représente intuitivement « l'espace des différentielles quadratiques », à cette équivalence près. Il est muni d'une topologie et peut ainsi être vu comme un « espace de paramètres » pour ces structures. On notera  $\mathcal{Q}_g$  l'espace des modules des différentielles quadratiques (méromorphes à pôles au plus simples) sur des surfaces de Riemann de genre  $g$ .

Cet espace est naturellement stratifié de la manière suivante : pour chaque collection  $\{k_1, \dots, k_r\}$  d'entiers non nuls supérieurs ou égaux à  $-1$  et satisfaisant la condition  $\sum_{i=1}^r k_i = 4g - 4$  (identité de Gauss-Bonnet), la strate  $\mathcal{Q}(k_1, \dots, k_r)$  correspond aux différentielles quadratiques dont la liste des

ordres des zéros est  $\{k_1, \dots, k_r\}$  et qui ne sont pas les carrés de différentielles abéliennes. Si  $q$  est le carré d'une différentielle abélienne sur  $S$ , alors les zéros de  $q$  sont d'ordre pair et on notera  $\mathcal{H}(k_1/2, \dots, k_r/2)$  la strate correspondante. Par la suite, une strate de différentielles quadratiques désignera uniquement une strate dont les éléments correspondants ne sont pas carrés de différentielles abéliennes. Un résultat de Masur et Smillie [17] affirme que les strates sont toutes non vides, à part les quatre exceptions suivantes :

$$\mathcal{Q}(\emptyset), \mathcal{Q}(-1, 1), \mathcal{Q}(1, 3) \text{ et } \mathcal{Q}(4).$$

C'est un fait bien connu de la théorie de Teichmüller que  $\mathcal{Q}(k_1, \dots, k_r)$  et  $\mathcal{H}(n_1, \dots, n_r)$  sont des orbifolds analytiques complexes de dimensions respectives  $2g + r - 2$  et  $2g + r - 1$ . Un autre fait bien connu est que l'espace des modules des différentielles quadratiques *holomorphes* en genre  $g$  s'identifie au fibré cotangent de l'espace des modules des surfaces de Riemann, qui est un orbifold analytique complexe de dimension  $3g - 3$ . Notons que l'espace  $\mathcal{Q}_g$  défini précédemment contient des strates de dimensions arbitrairement grandes.

### 0.2.1 Coordonnées locales naturelles

Soit  $(S, \omega)$  une différentielle abélienne sur une surface de Riemann, et soit  $\Sigma \subset S$  l'ensemble des zéros de  $\omega$ . Soit  $\mathcal{H}$  la strate correspondant à  $(S, \omega)$ . Quitte à remplacer  $\mathcal{H}$  par un revêtement ramifié de  $\mathcal{H}$  dans un voisinage de  $[(S, \omega)]$ , on peut supposer que  $[(S, \omega)]$  est un point régulier de  $\mathcal{H}$ . La connexion de Gauss-Manin permet d'identifier dans un voisinage  $U$  de  $[(S, \omega)] \in \mathcal{H}$ , les classes de cohomologies relatives  $H^1(S', \Sigma'; \mathbb{C})$  avec  $H^1(S, \Sigma; \mathbb{C})$ . On définit alors une application

$$\begin{aligned} \phi : \quad U &\rightarrow H^1(S, \Sigma; \mathbb{C}) \\ [(S', \omega')] &\mapsto (c \rightarrow \int_c \omega'). \end{aligned}$$

Cette application définit des coordonnées locales de  $\mathcal{H}$  au voisinage de  $[(S, \omega)]$ .

Plus concrètement, on peut voir ces coordonnées locales de la façon suivante : considérons une collection de liens de selles  $\gamma_1, \dots, \gamma_{2g+r-1}$  formant une base de l'homologie relative  $H_1(S, \Sigma; \mathbb{Z})$ . En intégrant la différentielle abélienne  $\omega$  le long des  $(\gamma_i)_i$ , on obtient une famille de  $2g + r - 1$  nombres complexes. Les liens de selles  $(\gamma_i)_i$  étant préservés par petite déformation de  $(S, \omega)$ , on peut faire la même opération dans un voisinage de  $[(S, \omega)]$  dans  $\mathcal{H}$ . Ceci définit une application d'un ouvert de  $\mathcal{H}$  dans un ouvert de  $\mathbb{C}^{2g+r-1}$ , qui s'identifie naturellement à  $H^1(S, \Sigma; \mathbb{C})$ .

*Exemple 2.* Considérons la surface plate définie par le polygone donné dans la figure 3. Ici l'application  $[(S, \omega)] \mapsto (v_1, v_2, v_3, v_4)$  est une coordonnée locale car les côtés du polygone forment dans la surface plate une base de l'homologie, et les  $v_i$  s'obtiennent en intégrant la 1-forme  $dz$  le long de ces côtés.

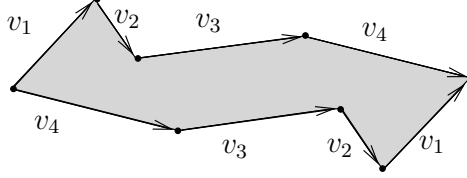

FIG. 3 – Coordonnées locales au voisinage d'une surface de translation.

Pour les strates de différentielles quadratiques, on a une construction un peu différente. Étant donné  $(S, q)$ , on peut construire un revêtement (ramifié) double canonique  $p : (\hat{S}, \omega^2) \rightarrow (S, q)$  tel que  $p^*q = \omega^2$  (appelé souvent « revêtement des orientations de  $(S, q)$  »). Si  $\Sigma$  désigne les zéros de  $q$ , on pose  $\hat{\Sigma} = p^{-1}(\Sigma)$ . La surface plate  $(\hat{S}, \omega^2)$  admet naturellement une involution  $\tau$ , ce qui induit une involution linéaire dans  $H^1(\hat{S}, \hat{\Sigma}; \mathbb{C})$ , et cet espace vectoriel se décompose alors en une partie invariante et une partie anti-invariante. Une coordonnée locale au voisinage de  $[(S, q)]$  s'obtient à partir de la construction précédente appliquée à  $[(\hat{S}, \omega)]$ , puis en projetant le résultat obtenu dans la partie anti-invariante de  $H^1(\hat{S}, \hat{\Sigma}; \mathbb{C})$ .

*Exemple 3.* Considérons la surface de demi-translation définie par le polygone donné dans la figure 2. L'application  $[(S, \omega)] \mapsto (v_1, v_2, v_3, v_4, v_5)$  n'est pas une coordonnée locale car ces vecteurs doivent satisfaire une relation non triviale (ici  $v_2 = v_4$ ). Par contre, on peut librement perturber le quadruplet  $(v_1, v_2, v_3, v_5)$  et définir ainsi une coordonnée locale de la strate au voisinage de  $[(S, q)]$ . On peut vérifier que ces vecteurs s'identifient localement à la partie anti-invariante de  $H^1(\hat{S}, \hat{\Sigma}; \mathbb{C})$ .

### 0.2.2 Mesure

Les changements de cartes pour les coordonnées définies précédemment préservent une mesure de Lebesgue sur les espaces vectoriels considérés. En particulier, ceci définit une mesure sur chaque strate.

On en déduit une mesure sur les *strates normalisées*, c'est à dire les sous-espaces de codimension réelle 1, correspondant aux surfaces d'aire euclidienne 1. On appellera *mesure de Lebesgue* cette mesure.

### 0.2.3 Action de $SL_2(\mathbb{R})$

Le groupe  $SL_2(\mathbb{R})$  agit naturellement sur chaque strate. On verra par la suite que cette action est très importante et intervient dans de nombreuses questions.

Soit  $M$  une surface de demi-translation et  $A$  une matrice dans  $SL_2(\mathbb{R})$ . Si  $\{(U_i, \phi_i)\}_{i \in I}$  est un atlas euclidien de  $M$ , alors on définit  $A.M$  par l'atlas  $\{U_i, A \circ \phi_i\}_{i \in I}$ . Cette action préserve la mesure de Lebesgue naturelle pour chaque strate.

On peut voir plus concrètement cette action de la manière suivante : supposons que la surface  $M$  soit obtenue à partir d'un polygone  $P \subset \mathbb{R}^2$  dont les côtés vont par paires, les côtés de chaque paire étant deux à deux parallèles et de même longueur, comme dans l'exemple 1. La matrice  $A$  agit linéairement sur  $\mathbb{R}^2$ . Donc si deux côtés de  $P$  sont parallèles et de même longueur, c'est aussi le cas pour les côtés correspondants dans  $A(P)$  (voir la figure 4). Ainsi, en identifiant les côtés de  $A(P)$  par les paires correspondantes, on obtient la surface plate  $A.M$ . Cette surface ne dépend pas du choix de  $P$ . La définition précédente fonctionne aussi bien pour  $A \in GL_2(\mathbb{R})$ , mais on préfère souvent se restreindre à  $SL_2(\mathbb{R})$ , puisque cette action préserve chaque strate normalisée.

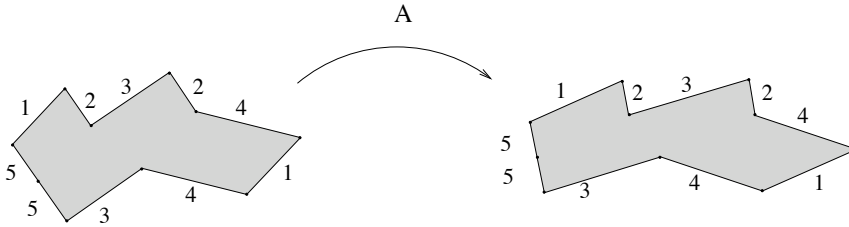

FIG. 4 – Action de  $SL_2(\mathbb{R})$  sur une surface plate.

On note  $g_t, r_\theta$  les matrices suivantes :

$$g_t = \begin{pmatrix} e^{t/2} & 0 \\ 0 & e^{-t/2} \end{pmatrix}, \quad r_\theta = \begin{pmatrix} \cos(\theta) & -\sin(\theta) \\ \sin(\theta) & \cos(\theta) \end{pmatrix}.$$

L'action par  $r_\theta$  préserve la métrique plate, mais change la direction privilégiée d'un angle  $\theta$ . L'action par  $g_t$  a pour effet de contracter la direction verticale d'un facteur  $e^{t/2}$  et de dilater la direction horizontale par le même facteur. On rappelle que l'espace des modules des différentielles quadratiques holomorphes s'identifie au fibré cotangent de l'espace des modules des surfaces de Riemann. On peut montrer que les orbites par l'action du groupe



à un paramètre  $(g_t)_{t \in \mathbb{R}}$  se projettent sur les géodésiques de l'espace des modules des surfaces de Riemann (pour la métrique de Teichmüller). L'action par ce groupe est appelée *flot géodésique de Teichmüller*.

Un résultat fondamental est le suivant (voir [15, 21] pour le cas des différentielles abéliennes ainsi que pour certaines strates de l'espace des modules des différentielles quadratiques, et [22, 23] pour le cas général).

**Théorème** (Masur ; Veech). *Soit  $\mathcal{Q}$  une strate normalisée de l'espace des modules des différentielles quadratiques ou de l'espace des modules des différentielles abéliennes. Alors :*

- $\mathcal{Q}$  est de volume fini pour la mesure de Lebesgue.
- Le flot géodésique de Teichmüller agit de façon ergodique pour la mesure de Lebesgue sur chaque composante connexe de  $\mathcal{Q}$ .

En particulier, pour presque toute surface plate  $[(S, q)] \in \mathcal{Q}$ , l'orbite de  $[(S, q)]$  par l'action de  $SL_2(\mathbb{R})$ , ou du flot de Teichmüller, est dense dans la composante connexe de  $\mathcal{Q}$  contenant  $[(S, q)]$ . Une des principales conjectures du domaine est que, pour toute surface, l'adhérence par l'action de  $SL_2(\mathbb{R})$  est une sous-variété analytique de l'espace des modules. Cette conjecture a été prouvée en genre 2 pour l'espace des modules des différentielles abéliennes, par McMullen [14].

*Remarque.* Afin d'alléger les notations, et lorsque cela ne prêtera pas à confusion, on notera par la suite une surface plate simplement  $S$  au lieu de  $(S, q)$  ou  $(S, \omega)$ , et on identifiera  $S$  avec l'élément  $[(S, q)]$  dans la strate correspondante.

### 0.3 Connexions de selles $\hat{h}$ omologues

On rappelle que la longueur d'une connexion de selles  $\gamma$  et son angle relativement à la direction horizontale sont donnés respectivement par le module et l'argument de  $\int_\gamma \omega$ . Donc si deux connexions de selles  $\gamma$  et  $\gamma'$  sur une surface de translation sont homologues, alors elles sont nécessairement parallèles et de même longueur et restent ainsi après n'importe quelle petite perturbation de la surface. La réciproque est vraie, par définition même des coordonnées naturelles vues précédemment. De plus, on dispose d'un critère géométrique très simple : les deux connexions de selles  $\gamma$  et  $\gamma'$  sont homologues si et seulement si  $S \setminus \{\gamma \cup \gamma'\}$  n'est pas connexe (notons que le complémentaire d'une connexion de selles est toujours connexe pour une surface de translation).

Dans le cas d'une surface de demi-translation, on peut définir une notion analogue en regardant l'homologie dans le revêtement double canonique de la surface. On commence par associer à  $\gamma$  le cycle  $[\hat{\gamma}]$ , défini au signe près, de la façon suivante : on considère les deux préimages  $\gamma_1$  et  $\gamma_2$  de  $\gamma$  dans le revêtement double  $\hat{S}$ . Ensuite, si  $[\gamma_1] = -[\gamma_2]$  dans  $H_1(\hat{S}, \hat{\Sigma}, \mathbb{Z})$ , on pose  $[\hat{\gamma}] = [\gamma_1]$ . Sinon, on pose  $[\hat{\gamma}] = [\gamma_1] - [\gamma_2]$ . Le cycle ainsi obtenu est anti-invariant par rapport à l'involution canonique  $\tau$ .

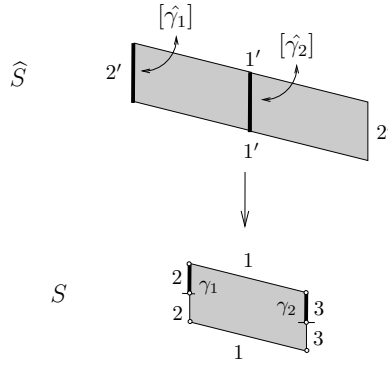

FIG. 5 – Deux connexions de selles  $\hat{\gamma}$  homologues sur une surface plate.

**Définition 3.** Soit  $(S, q)$  une surface plate. Deux connexions de selles  $\gamma$  et  $\gamma'$  dans  $S$  sont  $\hat{\gamma}$  homologues si  $[\hat{\gamma}] = \pm[\hat{\gamma}']$ .

*Exemple 4.* Considérons la surface  $S$  dans la strate  $\mathcal{Q}(-1, -1, -1, -1)$  représentée dans la figure 5. Alors les connexions de selles  $\gamma_1$  et  $\gamma_2$  sont  $\hat{\gamma}$  homologues car les cycles correspondants dans la surface  $\hat{S}$  sont homologues.

Contrairement au cas des différentielles abéliennes, deux connexions de selles  $\hat{\gamma}$  homologues ne sont pas nécessairement de la même longueur. Elles vérifient cependant une certaine « rigidité », étant donné que le rapport de longueur entre ces deux connexions est constant dans un voisinage de  $[(S, q)]$  dans la strate ambiante. On dispose également d'un critère géométrique simple pour déterminer si deux connexions de selles sont  $\hat{\gamma}$  homologues ou non [19].

**Proposition** (Masur, Zorich). Soit  $(S, q)$  une surface plate et  $\gamma, \gamma'$  deux connexions de selles. Alors les propriétés suivantes sont équivalentes :

- $\gamma$  et  $\gamma'$  sont  $\hat{\gamma}$  homologues.
- Le rapport de longueur  $\frac{|\gamma|}{|\gamma'|}$  est constant dans un voisinage de  $[(S, q)]$  dans la strate.

– Le complémentaire de  $\gamma \cup \gamma'$  dans  $S$  a une composante connexe avec holonomie triviale.

De plus, si  $\gamma$  et  $\gamma'$  sont  $\hat{h}$ omologues, alors le rapport de longueur  $\frac{|\gamma|}{|\gamma'|}$  vaut  $\frac{1}{2}$ , 1, ou 2, et les deux liens de selles  $\gamma$  et  $\gamma'$  sont parallèles.

*Exemple 5.* Considérons la surface  $S$  obtenue à partir du polygone présenté dans la figure 6. Les connexions de selles  $\gamma_1$ ,  $\gamma_2$  et  $\gamma_3$  sont deux à deux  $\hat{h}$ omologues.

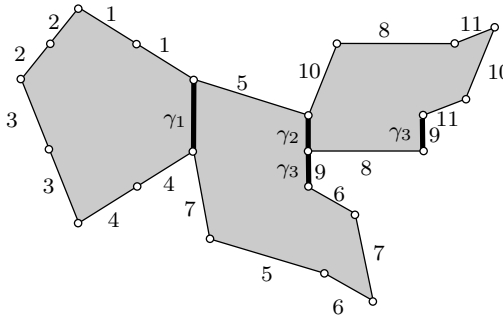

FIG. 6 – Connexions de selles deux à deux  $\hat{h}$ omologues sur une surface plate.

### 0.3.1 Configurations

Si deux connexions de selles ne sont pas  $\hat{h}$ omologues, alors les cycles correspondants dans  $H^1(\hat{S}, \hat{\Sigma}; \mathbb{C})$  sont indépendants et on peut les compléter en une base. En particulier, ceci implique que pour presque toute surface dans une strate, deux connexions de selles parallèles sont  $\hat{h}$ omologues [19]. Étant donné une connexion de selles sur une surface générique, on peut donc lui associer une collection maximale de connexions de selles deux à deux  $\hat{h}$ omologues. Cette famille est préservée par petite déformation de la surface dans la strate et reste maximale. Cette famille découpe la surface en une ou plusieurs composantes connexes. Chaque composante connexe étant une surface plate à bord géodésique. Une *configuration* est une donnée combinatoire codant ce découpage de la surface. On renvoie au chapitre 1 pour une définition plus précise.

Lorsqu'une certaine configuration est réalisée sur une surface plate  $S$ , alors elle est également réalisée dans un voisinage de  $S$  dans la strate, et sur n'importe quel élément de l'orbite de  $S$  par l'action de  $SL_2(\mathbb{R})$ . Par ergodicité de cette action, ceci implique que la configuration est réalisée sur presque toute surface de la composante connexe dans laquelle se trouve  $S$ .

Eskin et Masur ont montré que dans ce cas, le nombre de familles de connexions de selles homologues réalisant une configuration donnée, a une asymptotique quadratique  $c\pi L^2$ , quand la longueur maximale  $L$  des connexions de selles considérées tend vers l'infini [4]. La valeur  $c$  est appelée *constante de Siegel-Veech*. Dans le cas des différentielles abéliennes, les constantes de Siegel-Veech pour chaque configuration ont été calculées par Eskin, Masur et Zorich [5].

L'existence d'une certaine configuration réalisée sur une surface concrète peut être très utile pour calculer son orbite par l'action de  $SL_2(\mathbb{R})$  [14, 9]. On ne sait pas en général si une configuration peut être réalisée pour toute surface d'une strate donnée, à l'exception notable de la strate  $\mathcal{H}(1, 1)$  : toute surface dans cette strate peut se décomposer en deux tores. Cette décomposition est l'un des arguments essentiels pour la description des orbites par l'action de  $SL_2(\mathbb{R})$  dans  $\mathcal{H}(1, 1)$  par McMullen [14].

### 0.3.2 Configurations admissibles

On appelle *admissible* une configuration qui peut se réaliser sur une certaine surface. Masur et Zorich ont classifié les configurations admissibles [19]. Le nombre de configurations se réalisant sur une strate étant fini, on peut, pour chaque strate, donner la liste des configurations associées. On verra plus loin que cette liste apparaît naturellement dans l'étude du voisinage du bord d'une strate.

Cependant, lorsqu'une strate n'est pas connexe, une configuration réalisée dans une composante connexe n'est pas forcément réalisable dans une autre composante connexe. D'après Lanneau [13], les strates de différentielles quadratiques ont au plus deux composantes connexes, et il y a une infinité de strates non connexes ; une strate non connexe se place dans une des deux catégories suivantes :

- La strate est une des quatre strates exceptionnelles  $\mathcal{Q}(-1, 9)$ ,  $\mathcal{Q}(-1, 6, 3)$ ,  $\mathcal{Q}(-1, 3, 3, 3)$  ou  $\mathcal{Q}(12)$ .
- La strate contient une composante connexe hyperelliptique (voir paragraphe suivant pour une définition).

Une surface  $S$  plate est dite *hyperelliptique* si elle admet une involution isométrique  $\tau$  telle que  $S/\tau$  soit de genre 0 (en particulier, la surface de Riemann sous-jacente est hyperelliptique au sens usuel). Une composante connexe hyperelliptique est par définition entièrement constituée de surfaces plates hyperelliptiques.

Les composantes connexes hyperelliptiques ont été classifiées par Kontsevich et Zorich [11] pour le cas des différentielles abéliennes, et par Lan-

neau [12] pour le cas des différentielles quadratiques. Les strates correspondantes sont non connexes, sauf quelques exceptions en petit genre (par exemple  $\mathcal{H}(1, 1)$ ,  $\mathcal{H}(2)$ ,  $\mathcal{Q}(1, 1, 1, 1)$ ,  $\mathcal{Q}(2, 1, 1)$  etc. . .).

L'objet principal du chapitre 1 est de décrire les configurations dans chaque composante connexe des strates dans le cas hyperelliptique.

### 0.3.3 Voisinage du bord d'une strate

Une strate n'est jamais compacte, mais le sous-ensemble  $K_\varepsilon$  correspondant aux surfaces d'aire 1 dont toutes les connexions de selles sont de longueurs supérieures ou égales à  $\varepsilon$ , est compact pour tout  $\varepsilon$  strictement positif. On définit le  $\varepsilon$ -voisinage du bord comme étant le complémentaire de  $K_\varepsilon$ .

On a le résultat suivant, dû à Masur et Smillie [16].

**Proposition** (Masur, Smillie). *Soit  $\mathcal{Q}_1$  une strate normalisée de l'espace des modules des différentielles quadratiques<sup>2</sup>. Il existe une constante  $K$  telle que, pour tous  $\varepsilon, \nu > 0$  le sous-ensemble de  $\mathcal{Q}_1$  des surfaces ayant une connexion de selles de longueurs inférieure à  $\varepsilon$  est de mesure au plus  $K\varepsilon^2$ . Le sous-ensemble correspondant aux surfaces ayant une paire de connexions de selles non homologues de longueurs respectives au plus  $\varepsilon$  et  $\nu$  est de mesure au plus  $K\varepsilon^2\nu^2$ .*

On peut partitionner le  $\varepsilon$ -voisinage du bord en une partie *épaisse* et une partie *fine*. Par définition, les surfaces correspondant à la partie fine ont au moins deux connexions de selles non homologues de longueur inférieure à  $\varepsilon$ . La partie fine est de mesure négligeable par rapport à la partie épaisse. À une surface générique de la partie épaisse, on associe naturellement une configuration, en considérant la famille maximale de connexions de selles deux à deux homologues contenant une des plus petites connexions de selles de la surface. Réciproquement, considérons une configuration qui se réalise avec une famille  $\mathcal{F}$  de connexions de selles sur une surface générique  $S$ . Quitte à utiliser l'action de  $SL_2(\mathbb{R})$ , on peut toujours supposer que cette configuration apparaît dans la partie épaisse comme précédemment, pour un  $\varepsilon$  assez petit.

Ainsi, la liste des configurations d'une composante connexe de strate décrit les dégénérescences « typiques » des surfaces correspondantes.

Dans le cas des différentielles abéliennes, soit  $\mathcal{H}_1$  une strate normalisée,  $\mathcal{C}$  une configuration,  $c(\mathcal{C})$  la constante de Siegel-Veech associée, et  $\mathcal{H}_1^{ep, \varepsilon}(\mathcal{C})$  la

---

<sup>2</sup>Cet énoncé est également vrai pour une strate de l'espace des modules des différentielles abéliennes, en remplaçant « homologue » par « homologue ».

partie épaisse du voisinage du bord de  $\mathcal{H}_1$  correspondant à la configuration  $\mathcal{C}$ . Alors on peut montrer [5] que

$$c(\mathcal{C}) = \lim_{\varepsilon \rightarrow 0} \frac{1}{\pi \varepsilon^2} \frac{\text{Vol}(\mathcal{H}_1^{\text{ep}, \varepsilon}(\mathcal{C}))}{\text{Vol}(\mathcal{H}_1)}.$$

Ainsi, la structure de la strate dans un voisinage du bord est reliée aux problèmes de comptages de connexions de selles dans une surface générique de la strate.

## 0.4 Échanges d'intervalles

On s'intéresse maintenant à la dynamique de géodésiques verticales sur une surface de translation  $S$ . Soit  $I \subset S$  un segment horizontal. L'application de premier retour du flot vertical sur l'intervalle  $I$  définit une application  $T : \mathcal{D} \subset I \leftrightarrow I$  telle que  $I \setminus \mathcal{D}$  soit fini, et telle que la restriction de  $T$  sur chaque composante connexe de  $\mathcal{D}$  soit une translation. On peut voir cette application comme étant obtenue par une partition de  $I$  (privé d'un nombre fini de points) en sous-intervalles, puis par une permutation de ces intervalles. Une telle application s'appelle un échange d'intervalles (voir figure 7). On appelle *singularités* de  $T$  les éléments du complémentaire de  $\mathcal{D}$  dans  $I$  qui ne sont pas des extrémités de  $I$ .

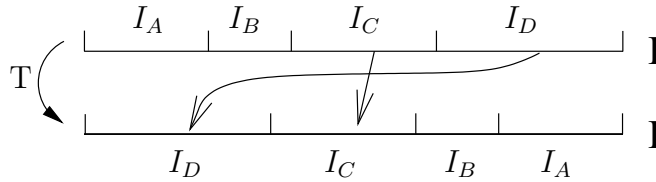

FIG. 7 – Un échange d'intervalles.

Un échange de  $d$  intervalles est entièrement déterminé par :

- Une permutation  $\pi$  de  $\{1, \dots, d\}$  codant la manière dont sont échangés les intervalles (l'intervalle initialement placé en  $i$ -ème position devient le  $\pi(i)$ -ème intervalle après l'échange).
- Un vecteur  $\lambda \in \mathbb{R}^d$  codant les longueurs des intervalles.

### 0.4.1 Irrationalité

Lorsque  $d = 2$ , un échange d'intervalles  $T$  est équivalent à l'application  $x \mapsto x + \alpha$  dans  $\mathbb{R}/\mathbb{Z}$ . Ce système dynamique est minimal (et même uniquement ergodique) si et seulement si  $\alpha$  est irrationnel. Une notion analogue d'irrationalité a été introduite par Keane [10] pour les échanges d'intervalles avec  $d \geq 3$ . Une *connexion* est une orbite finie de  $T$  qui ne peut être prolongée ni dans le futur, ni dans le passé, et un échange d'intervalles sans connexion est dit irrationnel, ou muni de la *propriété de Keane*. Un échange d'intervalles muni de la propriété de Keane est minimal [10].

Une permutation  $\pi$  de  $\{1, \dots, d\}$  est dite *réductible* s'il existe  $1 \leq k < d$  tel que  $\pi(\{1, \dots, k\}) = \{1, \dots, k\}$ . Si  $\pi$  n'est pas réductible, alors pour presque tout les paramètres de longueurs, l'échange d'intervalles associé satisfait la propriété de Keane [10]. En revanche, si  $\pi$  est réductible, il est clair que l'échange d'intervalles associé n'est jamais minimal et admet toujours une connexion.

*Remarque.* Un échange d'intervalles muni de la propriété de Keane n'est pas uniquement ergodique en général. Keane a conjecturé que l'unique ergodicité est vraie pour presque tous les paramètres [10]. Ceci fut prouvé indépendamment par Masur et Veech [15, 21].

### 0.4.2 Suspensions au-dessus d'échanges d'intervalles

Le lien entre échanges d'intervalles et surfaces de translation a été largement étudié, notamment en raison d'une construction due à Veech [21] qui permet d'écrire presque toute surface de translation comme suspension au-dessus d'un échange d'intervalles (« zippered rectangles »).

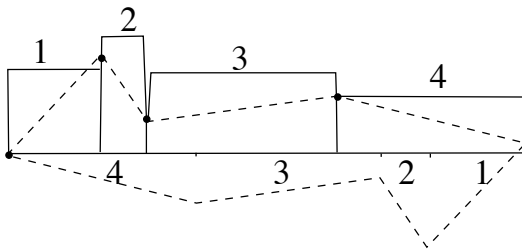

FIG. 8 – Rectangles zippés.

Le principe de la construction est le suivant : considérons les intervalles  $\{I_k\}_{k \in \{1, \dots, d\}}$  associés à l'échange d'intervalles  $T$ . Pour chaque  $k$ , on définit

un rectangle  $R_k$  de largeur  $|I_k|$  et de hauteur  $h_k > 0$ . Puis on identifie par une translation, le côté bas de  $R_k$  avec le sous-intervalle de  $I$  correspondant, puis le côté haut de  $R_k$  avec  $T(I_k)$ . On obtient une surface plate  $\tilde{S}$  à bord, telle que  $\partial\tilde{S}$  est composé de connexions de selles verticales. Puis, pour chaque composante connexe du bord de  $\tilde{S}$ , on ferme la surface comme une fermeture à glissière (voir la figure 9). Si les hauteurs des rectangles sont bien choisies, alors chaque composante connexe du bord de  $\tilde{S}$  va donner dans la surface plate résultante  $S$  une singularité. L'intervalle  $I$  est naturellement plongé dans la surface, l'application de premier retour du flot vertical de la surface sur  $I$  est donnée par  $T$ , et le temps de premier retour est donné par la hauteur des rectangles correspondants.

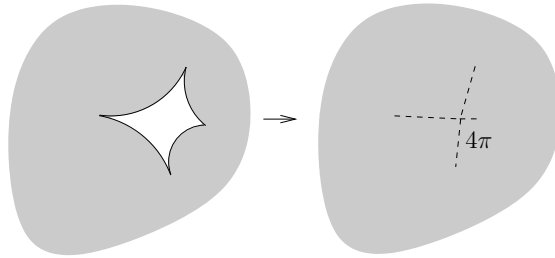

FIG. 9 – Identification des bords verticaux des rectangles

On appelle *données de suspension* pour l'échange d'intervalles  $T$  les paramètres codant cette construction. À permutation  $\pi$  fixée, la connexité de l'ensemble de ces paramètres entraîne que la composante connexe de strate dans laquelle se trouve une surface ainsi construite ne dépend que de la permutation  $\pi$ . Une permutation admet des données de suspension si et seulement si elle est irréductible [21].

Lorsque une permutation irréductible est fixée, l'ensemble des surfaces construites par la méthode des rectangles zippés forme un ouvert qui est clairement invariant par le flot géodésique de Teichmüller, et est donc de mesure pleine.

### 0.4.3 Algorithme de Rauzy-Veech

L'étude de systèmes dynamiques est souvent facilitée par des procédures de renormalisation qui consistent à regarder l'application de premier retour sur un sous-ensemble (à condition que l'application induite ne soit pas plus complexe que la première).



Lorsque l'on induit un échange d'intervalles  $T : (0, \lambda^*) \mapsto (0, \lambda^*)$  sur un intervalle  $J$  plus petit, on obtient encore un échange d'intervalles. Une procédure de renormalisation très importante est *l'induction de Rauzy-Veech* [20, 21], qui consiste à induire sur le plus grand intervalle possible de la forme  $(0, l)$  de sorte que le nouvel échange d'intervalles soit de même complexité que le premier (c'est à dire avec même nombre d'intervalles).

Une telle induction est possible si la singularité de  $T$  la plus à droite de  $T$  n'est pas une singularité de  $T^{-1}$  (c'est en particulier le cas si  $T$  vérifie la propriété de Keane). Dans ce cas,  $l$  correspond à la singularité de  $T$  ou de  $T^{-1}$  la plus à droite.

L'induction de Rauzy-Veech est très simple à décrire au niveau combinatoire. En effet la nouvelle permutation s'obtient uniquement à partir de l'ancienne et selon si  $l$  est une singularité pour  $T$  ou pour  $T^{-1}$ . Cette induction définit deux transformations  $\mathcal{R}_0$  et  $\mathcal{R}_1$  de l'ensemble des permutations irréductibles. Ces transformations définissent un graphe orienté dont les sommets sont les permutations et les arêtes sont données par  $\mathcal{R}_0$  et  $\mathcal{R}_1$ . On appelle *classe de Rauzy* une composante connexe de ce graphe.

Dans le cadre de la représentation d'une surface en rectangles zippés, l'algorithme de renormalisation de Rauzy-Veech fournit un outil puissant pour étudier la dynamique du flot de Teichmüller. Cet outil est ainsi utilisé par Veech pour montrer l'ergodicité du flot de Teichmüller sur les strates de différentielles abéliennes [21]; par Avila et Viana pour prouver la simplicité des exposants de Liapounov associés [2] (conjecturé par Kontsevich et Zorich; notons également le résultat de Forni [6]); et par Avila, Gouëzel et Yoccoz pour démontrer que ce flot est exponentiellement mélangeant [1].

Notons que tous ces résultats sont spécifiques aux différentielles abéliennes. L'objet de la troisième partie de cette thèse est d'étendre cette représentation au cas des différentielles quadratiques.

#### 0.4.4 Permutations généralisées

Dans une surface de demi-translation, l'application de premier retour du feuilletage vertical définit un échange d'intervalles « généralisé », qui est un cas particulier des *involutions linéaires* introduites par Danthony et Nogueira dans un cadre plus général de feuilletages mesurés sur des surfaces [3]. Une *permutation généralisée* est alors un analogue de la permutation codant un échange d'intervalles.

Ces objets ont ensuite été étudiés par Kontsevich et Zorich ont réalisé de nombreuses expériences numériques de calculs de classes de Rauzy en 1995-1996. Ils ont mis en évidence des phénomènes surprenants et ont été

confrontés à certaines difficultés. En particulier, ils ont trouvé des exemples de permutations généralisées pour lesquelles l'échange d'intervalles généralisé correspondant est minimal pour un ensemble de paramètres de mesure positive, et non minimal pour un autre ensemble de paramètres de mesure positive également. Ces permutations faisant partie d'une classe plus large de permutations généralisées appelées alors « permutations médiocres », qui ne pouvaient être considérées ni comme réductibles, ni comme irréductibles. Ils n'ont cependant pas trouvé de critère combinatoire raisonnable d'irréductibilité, et l'existence même d'un tel critère est resté une question ouverte.

Les permutations généralisées ont également été étudiées par Lanneau [13] comme codant une surface plate ayant une décomposition en un seul cylindre : considérons un rectangle dont les deux côtés verticaux sont identifiés par translation. Ensuite, considérons une partition des deux côtés horizontaux en intervalles, de sorte que les intervalles correspondants soient deux à deux de même longueur. Alors en identifiant les paires correspondantes par des translations (si les deux intervalles sont sur des côtés différents), ou des demi-tours (si les deux intervalles sont sur le même côté du rectangle), on obtient une surface de demi-translation (voir les figures 10 et 11 par exemple).

Lanneau [13] a étudié pour quelles permutations généralisées il pouvait y avoir une connexion de selles homologues à celle correspondant au côté vertical  $\gamma(\pi)$ , et ceci pour des paramètres génériques. Il introduit ainsi deux notions combinatoires de réductibilité :

- Réductibilité<sub>1</sub> correspond au cas où il existe une connexion de selles homologues à  $\gamma(\pi)$  et de même longueur. Dans ce cas cette connexion existe pour tous les paramètres de longueur (voir la figure 10).

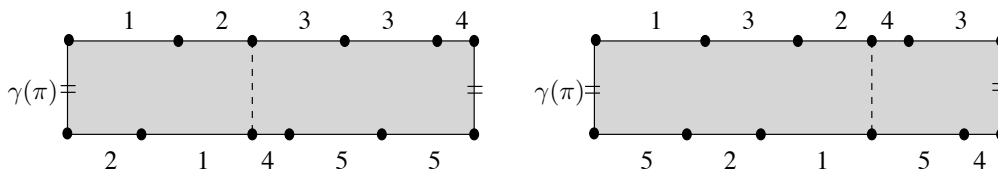
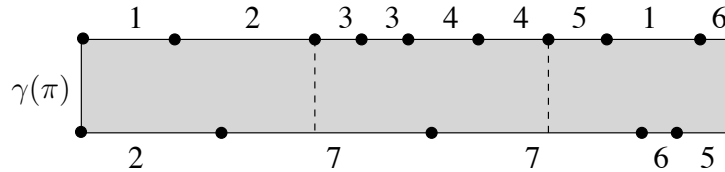

FIG. 10 – Permutations généralisées réductibles<sub>1</sub>.

- Réductibilité<sub>2</sub> correspond au cas où il existe une connexion de selles homologues à  $\gamma(\pi)$  et deux fois plus grande. Dans ce cas, cette connexion existe en général pour un ouvert de paramètres (voir la figure 11).

Ces critères seront définis précisément dans le chapitre 3, et jouent un rôle important dans l'étude des échanges d'intervalles généralisés même s'ils

FIG. 11 – Une permutation généralisée réductible<sup>2</sup>.

ne correspondent pas à la notion d'irréductibilité que nous retiendrons (voir aussi la partie 0.5.3 de cette introduction).

## 0.5 Principaux résultats exposés dans la thèse

On donne ici une description des résultats principaux de cette thèse, et on présente les idées générales des preuves. Chaque sous-partie correspond à un chapitre de la thèse.

### 0.5.1 Configurations de connexions de selles homologues

Dans le chapitre correspondant, on donne une définition plus précise d'une configuration de connexions de selles homologues, et on montre le résultat suivant :

**Théorème principal 1.** *La liste des configurations de connexions de selles homologues réalisées dans les composantes connexes hyperelliptiques est donnée par les tableaux 2, 3, 4 et 5 du chapitre 1.*

*Lorsque le genre est supérieur ou égal à 5, toute configuration réalisée dans une composante connexe hyperelliptique se réalise également dans l'autre composante connexe de la même strate.*

En particulier, en complément du théorème de Masur et Zorich, ceci donne la liste des configurations de connexions de selles homologues, dans toutes les composantes connexes de strates de différentielles quadratiques, dès que le genre est supérieur ou égal à 5.

*Esquisse de démonstration :* Dans un premier temps, on décrit toutes les configurations possibles pour une différentielle quadratique sur  $\mathbb{CP}^1$ . Ici l'hypothèse sur le genre est importante car elle donne des conditions très fortes sur les configurations possibles, les rendant aisées à calculer.

Soit  $S$  une surface plate dans une composante connexe hyperelliptique  $\mathcal{Q}^{hyp}$ , et soit  $\tau$  l'involution associée. Alors l'application  $p : S \mapsto S/\tau$  induit un revêtement de  $\mathcal{Q}^{hyp}$  sur une strate  $\mathcal{Q}$  de différentielles quadratiques sur  $\mathbb{CP}^1$ . Le critère de Masur et Zorich énoncé dans la partie 0.3 affirme que deux connexions de selles sont homologues si et seulement si leur rapport de longueur est constant par petite déformation de la surface. Ainsi, deux connexions de selles sur  $S$  sont homologues, si et seulement si les connexions de selles correspondantes dans  $S/\tau$  le sont également. On utilise la description de Lanneau [12] des composantes connexes hyperelliptiques, qui affirme que  $\mathcal{Q} = \mathcal{Q}(k_1, k_2, -1^{k_1+k_2+4})$  et qui décrit les points de ramifications de l'application  $p$ . Ceci permet de déduire les configurations sur  $\mathcal{Q}^{hyp}$  à partir des configurations sur  $\mathcal{Q}$ .

Soit  $\{\gamma_1, \dots, \gamma_s\}$  une collection maximale de connexions de selles homologues réalisant une configuration sur une surface de demi-translation hyperelliptique  $S$ . Une connexion de selles est homologue à son image par l'involution hyperelliptique  $\tau$  de  $S$ . En particulier, celle-ci préserve globalement la collection  $\{\gamma_1, \dots, \gamma_s\}$ . Ainsi, l'image d'une composante connexe  $S_0$  de  $S \setminus (\cup_i \gamma_i)$  par  $\tau$  est également une composante connexe  $S_1$  de  $S \setminus (\cup_i \gamma_i)$ . En fait, on a nécessairement  $S_0 = S_1$ , autrement on pourrait déformer continûment  $S_1$  en préservant son bord, et ainsi reconstruire une surface  $S'$ , dans la même strate que  $S$ , mais qui ne serait plus hyperelliptique. Donc  $\tau$  induit une involution isométrique sur chaque composante connexe de  $S \setminus (\cup_i \gamma_i)$ .

La dernière étape consiste à construire une surface qui n'est pas dans une composante connexe hyperelliptique en « remplaçant » au moins une composante connexe de  $S \setminus (\cup_i \gamma_i)$  par une autre surface à bord ne possédant pas d'isométrie non triviale, mais présentant les mêmes caractéristiques combinatoires, de sorte que la surface  $S'$  ainsi construite soit dans la même strate que  $S$ .

Pour cela, on remarque que trois familles de surfaces à bord apparaissent toujours dans les configurations de composantes connexes hyperelliptiques. Pour chacun de ces types, on construit explicitement une surface à bord correspondante n'ayant pas d'involutions non triviales, à partir de surfaces plates appartenant à des strates plus simples. Ces constructions peuvent échouer en petit genre à cause de l'existence de strates constituées entièrement de surfaces plates hyperelliptiques. On utilise au passage une formule explicite donnant le genre de la strate associée à la configuration correspondante (prouvée en fin de chapitre). ■

### 0.5.2 Dégénérescences de différentielles quadratiques sur la sphere de Riemann

Les résultats de ce chapitre s'inspirent de la description du voisinage du bord faite dans la partie 0.3.3 de cette introduction. On a vu qu'à une surface générique dans la partie épaisse du voisinage du bord, on peut associer une configuration. On cherche ici intuitivement à décrire les composantes connexes de la partie épaisse du voisinage du bord. Plus précisément, soit  $\mathcal{Q}$  une strate de différentielles quadratiques. Soit  $\Delta \subset \mathcal{Q}$  le sous-ensemble de codimension réelle 1 correspondant aux surfaces admettant une paire de connexions de selles non homologues de même longueur et minimales. On montre le résultat suivant :

**Théorème principal 2.** *Soit  $\mathcal{Q} = \mathcal{Q}(k_1, k_2, \dots, k_r)$  une strate de différentielles quadratiques sur  $\mathbb{CP}^1$ . Il existe une bijection naturelle entre les composantes connexes de  $\mathcal{Q} \setminus \Delta$  et les configurations de connexions de selles homologues réalisées sur  $\mathcal{Q}$ .*

Dans ce théorème, on peut remplacer  $\mathcal{Q}$  par la strate normalisée correspondante  $\mathcal{Q}_1$ , ainsi que par un  $\varepsilon$ -voisinage du bord de  $\mathcal{Q}_1$ .

Notons également que, pour démontrer le théorème, on développe des outils (« transport de trou ») qui seront nécessaires au calcul futur des constantes de Siegel-Veech pour les différentielles quadratiques.

*Esquisse de démonstration :* On montre le lemme fondamental suivant : pour toute surface  $S$  dans  $\mathcal{Q} \setminus \Delta$ , on peut associer une configuration, car la famille maximale de connexions de selles deux à deux homologues contenant les plus petits liens de selles de  $S$  reste maximale par petite déformation de  $S$  (le sous-ensemble  $\mathcal{Q} \setminus \Delta$  est ouvert).

L'application ainsi définie est localement constante, ce qui induit une application de l'ensemble des composantes connexes de  $\mathcal{Q} \setminus \Delta$  dans l'ensemble des configurations qui se réalisent dans  $\mathcal{Q}$ . Cette application est surjective comme indiqué dans la partie 0.3.3 de cette introduction. Il faut donc montrer maintenant que, pour une configuration donnée, l'ensemble des surfaces dans  $\mathcal{Q} \setminus \Delta$  correspondant à cette configuration est connexe.

On commence par le cas où cette configuration correspond à une unique connexion de selles reliant deux singularités distinctes d'ordres respectifs  $k_1$  et  $k_2$ . On se ramène à étudier la connexité du sous-domaine correspondant aux surfaces pour lesquelles cette connexion de selles est très petite par rapport à toutes les autres. L'idée est que ce domaine « ressemble » à la strate adjacente  $\mathcal{Q}(k_1 + k_2, k_3, \dots, k_r)$ ; et la connexité de  $\mathcal{Q}(k_1 + k_2, k_3, \dots, k_r)$

permet alors de conclure (notons que ce résultat n'est pas spécifique au genre zéro).

Lorsque  $k_1$  et  $k_2$  ne sont pas tous les deux impairs, il existe une procédure locale et canonique, permettant de contracter cette connexion de selles. Cela va donner à notre sous-domaine une structure de fibré topologique, de fibre le disque pointé, au-dessus de  $\mathcal{Q}(k_1 + k_2, k_3, \dots, k_r)$ . D'où sa connexité.

Lorsque  $k_1$  et  $k_2$  sont tous les deux impairs, la preuve précédente ne fonctionne plus. On développe alors un type de chirurgie apparaissant déjà dans [5, 19] : le transport de trou le long d'un chemin. On étend cette chirurgie à une classe plus large de chemins et on étudie la dépendance par rapport au choix du chemin.

Une fois l'injectivité démontrée pour ces types de configurations, on utilise la liste des configurations sur  $\mathcal{Q}(k_1, \dots, k_r)$ , calculée dans le chapitre 1, et on montre que l'on peut toujours se ramener au cas précédent. ■

*Remarque.* Un des résultats intermédiaires apparaissant dans la preuve du théorème précédent fait intervenir un analogue de la construction de Veech des rectangles zippés, et a en particulier motivé les travaux apparaissant dans la partie 3.

Un corollaire du théorème principal 2 est le suivant :

**Corollaire 1.** *Une strate normalisée de différentielles quadratiques sur  $\mathbb{CP}^1$  n'admet qu'un seul bout topologique.*

*Esquisse de démonstration :* Soit  $\mathcal{Q}_1$  une telle strate, et soit  $\varepsilon > 0$ . On montre que le sous-ensemble  $\mathcal{Q}_{1,\varepsilon}$  correspondant au  $\varepsilon$ -voisinage du bord de la strate est connexe. Pour cela, on prend  $S$  dans ce sous-ensemble, et on construit un chemin explicite dans  $\mathcal{Q}_{1,\varepsilon}$ , jusqu'à une surface  $S_1$  appartenant au sous-ensemble  $\mathcal{C}_{-1,k}$  des surfaces ayant une seule plus petite connexion de selles reliant un pôle à une singularité d'ordre  $k > 0$ . Si  $S'$  est une autre surface plate dans  $\mathcal{Q}_{1,\varepsilon}$ , on arrive de même jusqu'à une surface  $S'_1 \in \mathcal{C}_{-1,k'}$ .

Les deux sous-ensembles  $\mathcal{C}_{-1,k}$  et  $\mathcal{C}_{-1,k'}$  étant connexes d'après le théorème principal 2, il suffit de trouver un chemin reliant un élément de  $\mathcal{C}_{-1,k}$  et un élément de  $\mathcal{C}_{-1,k'}$  et on en déduira l'existence d'un chemin de  $S$  à  $S'$ . Un tel chemin s'obtient en construisant une surface admettant simultanément deux connexions de selles très petites : l'une reliant un pôle à une singularité d'ordre  $k$ , l'autre reliant un pôle à une singularité d'ordre  $k'$ . ■

On conclut ce chapitre par une preuve alternative de la caractérisation géométrique des connexions de selles homologues, plus simple que la preuve

initiale de Masur et Zorich [19]. Cette preuve est basée sur le transport de trou.

### 0.5.3 Échanges d’intervalles généralisés

Ce chapitre est issu d’un travail en collaboration avec Erwan Laneeau. On définit des *échanges d’intervalles généralisés* permettant de coder l’application de premier retour sur un segment  $I$  transverse dans une surface de demi-translation (voir [3]). L’application de premier retour est alors toujours de la forme  $z \mapsto \pm z + c$  dans chaque composante connexe de son domaine de définition. Pour décrire correctement une géodésique verticale, il faut en fait décrire deux applications de premier retour, l’une en partant « vers le haut », l’autre en partant « vers le bas ». On renvoie au chapitre 3 pour une définition précise. Un échange d’intervalles généralisé est alors entièrement défini par

- une permutation généralisée  $\pi$ ,
- un vecteur  $\lambda \in \mathbb{R}^d$  codant les longueurs des intervalles.

On propose une construction analogue à la construction de Veech à partir de données de suspension adéquates, ainsi qu’un analogue de l’induction de Rauzy-Veech. Cette construction est également indiquée dans le chapitre 2. On y montre qu’en l’absence de connexion de selles verticale, l’application de premier retour du flot géodésique sur un intervalle bien choisi définit des données de suspension correspondant précisément à la surface considérée.

On définit une notion d’irréductibilité pour une permutation généralisée, formulée en termes combinatoires très simples, et on montre le résultat suivant :

**Théorème principal 3.** *Un échange d’intervalles généralisé admet une donnée de suspension si et seulement si la permutation généralisée associée est irréductible.*

En particulier, les permutations généralisées irréductibles sont précisément celles qui apparaissent comme premier retour du flot géodésique sur une section transverse bien choisie, pour une surface plate générique.

*Remarque.* Nous avons volontairement évité de donner une définition précise de donnée de suspension et d’irréductibilité pour éviter de noyer l’idée générale dans les détails techniques. La preuve du théorème précédent est essentiellement combinatoire et assez technique dans la mesure où, contrairement au cas des échanges d’intervalles habituels, il n’y a pas de formule donnant directement une donnée de suspension, et on obtient une telle donnée par des améliorations successives de « pseudo-solutions ».

Le critère précédent peut être vu comme une « irréductibilité géométrique », qui indique quelles permutations généralisées sont à considérer pour l'étude des surfaces plates avec holonomie  $\mathbb{Z}/2\mathbb{Z}$ . Mais on peut aussi étudier un échange d'intervalles généralisé comme objet dynamique intrinsèque.

On a vu dans la partie 0.4 deux notions d'irréductibilité introduites par Laneeau [13]. On dira que  $T$  est *dynamiquement irréductible* s'il est irréductible<sup>1</sup> et irréductible<sup>2</sup>. L'ensemble des échanges d'intervalles généralisés dynamiquement irréductibles est ouvert (voir chapitre 3). Cependant, contrairement à l'irréductibilité géométrique, cette dernière notion peut dépendre des paramètres : il existe des permutations généralisées  $\pi$  telles que l'application  $T = (\pi, \lambda)$  soit dynamiquement irréductible pour un ensemble ouvert de paramètres  $\lambda$ , mais est dynamiquement réductible pour un ensemble fermé de mesure non nulle. On a le résultat suivant :

**Théorème principal 4.** *Soit  $T = (\pi, \lambda)$  un échange d'intervalles généralisé.*

- *Si  $T$  n'est pas dynamiquement irréductible, alors  $T$  n'est pas minimal.*
- *Si  $T$  est dynamiquement irréductible, et si  $\lambda$  est générique, alors  $T$  est minimal.*

Ce théorème met en lumière de grandes différences avec les échanges d'intervalles habituels. En effet, si irréductible implique dynamiquement irréductible, la réciproque est fautive : un échange d'intervalles généralisé dynamiquement irréductible peut être réductible. En particulier, les permutations correspondantes sont précisément les permutations médiocres de Kontsevich et Zorich.

*Esquisse de démonstration :* On donne ici une esquisse de preuve du second point. La minimalité est impliquée par un analogue de la propriété de Keane. Cette propriété est équivalente au fait que les itérés de  $T$  par l'induction de Rauzy-Veech sont tous bien définis, et correspondent à une induction sur un sous-intervalle dont la longueur tend vers zéro.

Dans le cas des échanges d'intervalles habituels, il suffit de prendre comme paramètre  $\lambda$  une famille de réels linéairement indépendants sur  $\mathbb{Q}$  (propriété vérifiée pour presque tout paramètre  $\lambda$ ). Ici, les paramètres de longueur vérifient forcément une équation à coefficients entiers. Il suffit alors de supposer qu'ils ne vérifient pas d'autre relation indépendante. On montre sous cette hypothèse, que si l'image par l'induction de Rauzy-Veech de  $\mathcal{R}^n(T)$  n'est pas définie, ceci implique que  $\mathcal{R}^n(T)$  est réductible<sup>1</sup>. De même, si au moins un des paramètres ne tend pas vers 0, alors cela implique que  $\mathcal{R}^n(T)$  est réductible<sup>1</sup> pour  $n$  assez grand.

Maintenant supposons que  $\mathcal{R}(T)$  est dynamiquement réductible. On montre alors que  $T$  est dynamiquement réductible (notons que l'on peut avoir  $T$  ré-



ductible2 pour  $\mathcal{R}(T)$  réductible1).

Ainsi, si  $T$  a des paramètres génériques, mais est dynamiquement irréductible, alors  $T$  vérifie nécessairement la propriété de Keane et est donc minimal. ■

**Théorème principal 5.** *Soit  $T$  un échange d'intervalles généralisé sur  $(0, 1)$  muni de la propriété de Keane, et soit  $(\mathcal{R}_r^n(T))_{n \in \mathbb{N}}$  la suite des itérés de  $T$  par l'induction de Rauzy-Veech, renormalisée de sorte que l'intervalle sous-jacent soit de longueur fixe. Alors :*

- $\mathcal{R}_r^n(T)$  est irréductible pour  $n$  assez grand.
- L'application  $\mathcal{R}_r$  est récurrente sur l'ensemble des échanges d'intervalles généralisés irréductibles.

*Esquisse de démonstration :* Il est facile de voir que si  $T$  est irréductible, alors  $\mathcal{R}(T)$  l'est aussi. On peut donc supposer que  $T$  est réductible. On montre alors que, malgré l'absence de bonnes données de suspension, on peut quand même voir  $T$  comme une application de premier retour du flot vertical sur un segment  $I_\varepsilon$  dans une surface plate  $S_\varepsilon$  (non générique). Lorsque  $\varepsilon$  tend vers zéro,  $S_\varepsilon$  tend vers une surface plate  $S$  sans connexion de selles verticale. Le problème est que dans  $S$ , l'application  $T$  est une sorte de premier retour sur une union de connexions de selles non nécessairement deux à deux disjointes, rendant cette application peu maniable. On travaille donc sur  $S_\varepsilon$ , et lorsque  $n$  est assez grand,  $\mathcal{R}^n(T)$  est une induction de  $T$  sur un petit sous-intervalle. Ce sous-intervalle, vu dans  $S$ , est alors une bonne section de Poincaré pour le flot vertical de  $S$ . On utilise alors une proposition prouvée dans le chapitre 2 utilisant l'absence de connexion de selles dans  $S$  pour montrer que  $S$  s'obtient comme suspension au-dessus de  $\mathcal{R}^n(T)$ , qui est par conséquent irréductible.

La deuxième partie du théorème est plus classique : on peut montrer en effet que  $\mathcal{R}_r$ , défini sur l'espace des échanges d'intervalles généralisés sur  $(0, 1)$ , admet une extension (toujours notée  $\mathcal{R}_r$ ) sur l'espace des suspensions correspondantes. Dans cet espace,  $\mathcal{R}_r$  apparaît alors comme une certaine application de premier retour, sur une section de Poincaré, du flot géodésique de Teichmüller sur l'espace (normalisé) des modules des suspensions (ou, de façon équivalente, l'espace des modules des rectangles zippés). Ce flot préserve une mesure de Lebesgue naturelle qui est finie car la strate (normalisée) correspondante dans l'espace des modules des différentielles quadratiques est de volume fini par un théorème de Veech [23]. On utilise alors le lemme de récurrence de Poincaré et le fait que les différentes mesures intervenant dans le problème s'obtiennent les unes des autres par décompositions en mesures produits.





# Chapitre 1

## Configurations de connexions de selles $\hat{h}$ omologues

On décrit ici les configurations dans les composantes connexes hyperelliptiques, et on montre que, lorsque le genre est supérieur ou égal à 5, toutes ces configurations apparaissent également dans l'autre composante connexe de la strate correspondante.

En annexe de ce chapitre, on propose une version plus détaillée, sous la forme d'un article en anglais. Cet article est à paraître dans la revue *Commentarii Mathematici Helvetici*.

### 1.1 Configurations de connexions de selles $\hat{h}$ omologues

On a défini dans l'introduction de cette thèse ce qu'étaient deux connexions  $\hat{h}$ omologues. Soit  $S$  une surface plate et  $\gamma = \{\gamma_1, \dots, \gamma_s\}$  une collection (nécessairement finie) de connexions de selles  $\hat{h}$ omologues. On notera par un léger abus de notations  $S \setminus \gamma$  le sous-ensemble  $S \setminus (\cup_{i=1}^s \gamma_i)$ . Ce sous-ensemble est une réunion finie de surfaces plates non compactes.

**Définition 4.** Soit  $S$  une surface plate et  $\gamma = \{\gamma_1, \dots, \gamma_s\}$  une collection de connexions de selles  $\hat{h}$ omologues. On définit le *graphe des composantes connexes*, noté  $\Gamma(S, \gamma)$ , de la façon suivante :

- Les sommets du graphe correspondent aux composantes connexes de  $S \setminus \gamma$ , et sont représentés par «  $\circ$  » si la surface correspondante est un cylindre, par «  $+$  » si elle n'est pas un cylindre mais est tout de même

d'holonomie triviale, et enfin par «  $-$  » si elle n'est pas d'holonomie triviale.

- Les arêtes correspondent aux connexions de selles dans la collection  $\gamma$ . Ainsi, chaque  $\gamma_i \in \gamma$  est dans le bord d'une ou de deux composantes connexes de  $S \setminus \gamma$ . Dans le premier cas, c'est juste une arête reliant le sommet correspondant à lui-même, tandis que dans le second cas, c'est une arête reliant les deux sommets correspondants.

Ainsi, le graphe  $\Gamma(S, \gamma)$  peut être vu comme une sorte de graphe dual de  $\gamma$  dans  $S$ . La représentation des sommets en fonction de l'holonomie des composantes connexes correspondantes est justifiée par le critère de Masur et Zorich [19], qui précise que deux connexions de selles sont homologues si et seulement si leur complémentaire dans la surface admet une composante connexe avec holonomie triviale.

Masur et Zorich ont décrit tous les graphes  $\Gamma(S, \gamma)$  possibles. La description détaillée de ces graphes étant assez technique, on renvoie à la partie 1.2 de l'annexe pour les détails (voir en particulier la figure 2).

On peut naturellement compactifier chaque composante connexe de  $S \setminus \gamma$ , en rajoutant les limites de suites de Cauchy pour la distance induite par la métrique plate. On note  $(S_j)_j$  les surfaces à bord ainsi obtenues. Cette compactification est différente de l'adhérence du sous-ensemble correspondant dans la surface  $S$  : par exemple si  $\gamma_i$  est sur le bord d'une seule composante connexe de  $S \setminus \gamma$ , alors après compactification, cette connexion de selles apparaît deux fois sur le bord de  $S_j$ , tandis qu'en prenant l'adhérence dans  $S$ , ces deux connexions de selles seraient identifiées.

Par construction, le bord de chaque  $S_j$  est homéomorphe à une réunion finie de cercles (ce qui n'aurait pas forcément été le cas si on avait pris l'adhérence dans  $S$ ), et chacun de ces cercles est une union finie de liens de selles qui sont deux à deux parallèles.

L'orientation naturelle de  $S_j$  définit donc un ordre cyclique sur les liens de selles constituant son bord, et donc, pour chaque sommet du graphe  $\Gamma(S, \gamma)$ , une permutation de l'ensemble des arêtes adjacentes. Cette permutation sera représentée par la suite avec un *graphe de ruban*.

En particulier, chaque paire de connexions de selles consécutives dans une composante de bord de  $S_j$  définit une *singularité au bord*, dont l'angle correspondant  $\theta$  est un multiple de  $\pi$ . On appelle *ordre de la singularité du bord* l'entier  $k$  tel que  $\theta = (k + 1)\pi$ .

De plus,  $S_j$  peut avoir des singularités coniques dans son intérieur, ces singularités sont appelées des *singularités intérieures*.

**Définition 5.** Soit  $S$  une surface plate et  $\gamma$  une collection de connexions de selles deux à deux homologues. La *configuration* de  $\gamma$  est la donnée combinatoire suivante :

- Le graphe  $\Gamma(S, \gamma)$ .
- Pour chaque sommet du graphe, la permutation de l'ensemble des arêtes adjacentes au sommet, définie précédemment.
- Pour chaque sommet du graphe, la liste des ordres de chaque singularité de bord.
- Pour chaque sommet du graphe, la liste des ordres de chaque singularité intérieure.

Remarquons que la donnée d'une configuration détermine entièrement la liste des ordres des singularités coniques de la surface dans laquelle elle se réalise, et donc, une configuration détermine une strate.

*Exemple 6.* La figure 1.1 est un exemple de configuration associée à la collection de connexions de selles apparaissant dans la figure 5 de l'introduction. On renvoie à la partie 1.2 de l'annexe pour les détails.

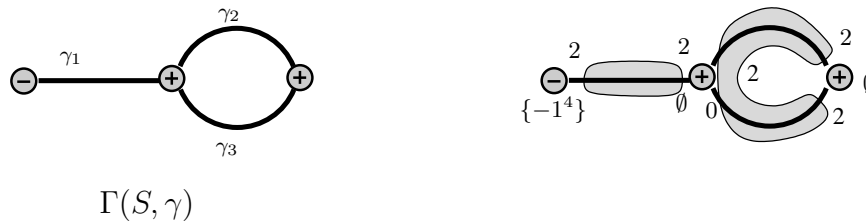

FIG. 1.1 – Un exemple de configuration

## 1.2 Composantes connexes hyperelliptiques

### 1.2.1 Configurations pour $\mathbb{CP}^1$

Les configurations dans les composantes connexes hyperelliptiques se déduisent des configurations apparaissant dans certaines strates de différentielles quadratiques sur  $\mathbb{CP}^1$ . Trouver toutes les configurations sur une strate concrète peut s'avérer une tâche fastidieuse.

L'hypothèse sur le genre facilite ici grandement le travail. En effet, soit  $\gamma$  une collection de connexions de selles sur une surface plate  $S$  de genre zéro.

Alors le graphe des composantes connexes de  $\gamma$  n'admet pas de sommets étiquetés « + ».

En particulier, ceci implique que le nombre de graphes possibles en genre zéro est très limité. On propose ici de traiter un exemple, le reste étant analogue et traité en détail dans l'annexe. On suppose qu'il n'y pas de points marqués sur la surface.

Parmi les types de graphes possibles en toute généralité, on peut avoir un graphe composé uniquement de sommets de valence 2, avec un seul sommet « - », le reste étant « o » ou « + », et sachant que deux sommets correspondant à des cylindres ne peuvent pas être adjacents (c'est le type  $b$  de la figure 2 de l'annexe).

L'absence de « + » lorsque le genre est zéro implique que seuls deux graphes sont possibles : un graphe avec un seul sommet « - » et une arête le reliant à lui-même, ou un graphe avec deux sommets « - » et « o » et deux arêtes les reliant entre eux. Ce dernier cas impliquerait l'existence d'un cylindre formant une anse dans la surface, ce qui n'est pas possible en genre zéro. Donc, si  $\gamma$  est une collection maximale de connexion de selles homologues sur une surface  $S$ , le graphe  $\Gamma(S, \gamma)$  n'a qu'un seul sommet et qu'une seule arête. Donc  $S \setminus \gamma$  a une seule composante connexe dont on note  $S_0$  la compactification. Alors  $\partial S_0$  admet soit une composante connexe, soit deux. Dans le dernier cas, on obtiendrait la surface en collant entre elles les deux composantes connexes, ce qui impliquerait que le genre de  $S$  serait strictement positif. Donc le bord de  $S_0$  est connexe, c'est à dire que la connexion de selles  $\gamma_1$  constituant la collection  $\gamma$  relie juste deux singularités distinctes. Il découle alors du théorème de Masur et Zorich sur les configurations admissibles que toutes les configurations avec ces contraintes sont possibles sauf lorsque les deux singularités sont des pôles.

### 1.2.2 Configurations pour des composantes connexes hyperelliptiques

Une surface dans une composante connexe hypelliptique s'obtient comme revêtement double d'une surface plate dans une certaine strate en genre zéro. Les strates correspondantes sont, d'après la classification de Laneeau [12], toutes celles de la forme  $\mathcal{Q}(k_1, k_2, -1^s)$ , avec  $k_1 + k_2 - s = -4$ , les revêtements à considérer étant ramifiés en  $s$  pôles et en  $k_i$  lorsque ce dernier entier est pair. Ceci aboutit à trois familles de composantes connexes hyperelliptiques selon les parités de  $k_1$  et  $k_2$ .

Comme indiqué dans l'introduction, les configurations d'une composante connexe hyperelliptique  $\mathcal{Q}^{hyp}$  se déduisent des configurations sur la strate

correspondante  $\mathcal{Q}(k_1, k_2, -1^s)$ , et du choix des points de ramifications. Notons au passage une petite difficulté : la préimage d'une connexion de selles  $\gamma$  sur  $S \in \mathcal{Q}(k_1, k_2, -1^s)$  est une réunion de deux segments géodésiques  $\tilde{\gamma}_1$  et  $\tilde{\gamma}_2$  sur le revêtement double  $\tilde{S}$  correspondant. Mais si au moins une des extrémités est un pôle ramifié, alors ce pôle devient dans  $\tilde{S}$  un point régulier et donc les  $\tilde{\gamma}_i$  ne sont plus des connexions de selles. Inversement, si  $k_i = 0$ , alors un point marqué dans  $S$  devient une singularité dans  $\tilde{S}$ . Il faut donc également considérer dans ce cas là des configurations sur  $\mathbb{CP}^1$  avec des points marqués.

Comme précédemment, on se contente ici de traiter un cas particulier, le reste étant fait dans l'annexe ou laissé au lecteur (notons cependant que d'autres cas seront moins directs que celui que nous allons traiter ici). Supposons que l'on est dans la cas de la configuration pour  $\mathbb{CP}^1$  vue précédemment. Par exemple, elle correspond à une seule connexion de selles, notée  $\gamma$  dans  $S$ , et reliant les deux singularités  $P_1$  et  $P_2$  d'ordres respectifs  $k_1$  et  $k_2$ . On suppose que le revêtement double  $\tilde{S} \rightarrow S$  est ramifié en  $P_2$ , mais pas en  $P_1$ . Alors la préimage de  $\gamma$  est une paire  $\{\tilde{\gamma}_1, \tilde{\gamma}_2\}$  de connexions de selles de même longueur, joignant respectivement chaque préimage de  $P_1$  à la préimage de  $P_2$  (elles sont toutes des vraies singularités). Ainsi  $\tilde{S} \setminus \{\tilde{\gamma}_1, \tilde{\gamma}_2\}$  n'admet qu'une seule composante connexe, sans singularité intérieure, et le bord de sa compactification contient quatre connexions de selles. Les angles des singularités de bord au-dessus de  $P_1$  sont tous les deux égaux à  $(k_1 + 2)\pi$ , tandis que les autres singularités de bord sont d'angles  $(k_2 + 2)\pi$  (car  $\tilde{\gamma}_1$  et  $\tilde{\gamma}_2$  sont échangées par l'involution hyperelliptique).

### 1.3 Composantes connexes non hyperelliptiques

Soit  $C$  une configuration, et  $(S, \gamma)$  réalisant cette configuration. On prouve en annexe une égalité donnant le genre d'une surface plate  $S$  en fonction du genre des composantes connexes de  $S \setminus \gamma$ , et du graphe de ruban associé. Il apparaît alors, au vu de la liste des configurations énoncées dans la partie précédente, qu'au moins une des propositions suivantes est nécessairement vraie dès que le genre de  $S$  est supérieur ou égal à 5.

- $S \setminus \gamma$  admet une composante connexe de genre supérieur ou égal à 3, avec une seule composante de bord, le sommet correspondant dans le graphe  $\Gamma(S, \gamma)$  étant de valence 2.
- $S \setminus \gamma$  admet une composante connexe de genre supérieur ou égal à 2, avec deux composantes de bord, le sommet correspondant dans le graphe  $\Gamma(S, \gamma)$  étant de valence 2.



- $S \setminus \gamma$  est connexe, le sommet correspondant dans le graphe  $\Gamma(S, \gamma)$  étant de valence 4.

Pour fabriquer une surface plate non-hyperelliptique dans la même strate que  $S$ , il suffit de remplacer une des composantes précédentes par une surface plate à bord n'ayant pas d'involution isométrique non triviale, mais de sorte que le nouveau couple  $(S', \gamma')$  ainsi obtenu réalise la même configuration.

On présente en détail le cas déjà traité dans ce résumé. On utilise pour cela une chirurgie introduite par Masur et Zorich qui, partant d'une surface  $S_1$  dans  $\mathcal{H}(k_1+k_2+1)$ , permet de contruire une surface dans  $\mathcal{Q}(k_1, k_1, 2k_2+2)$  avec la configuration voulue (voir [19] ou la figure 8 de l'annexe). Cette chirurgie est locale, c'est à dire ne modifie pas la métrique de la surface  $S_1$  à l'extérieur d'un voisinage de l'unique singularité de  $S_1$ . Il est alors facile de voir que la surface après chirurgie admet une involution isométrique non triviale si et seulement si  $S_1$  admet également une involution isométrique non triviale. D'après les résultats de Kontsevich et Zorich [11], puis de Lanneau [12], les seules composantes connexes de strates pour lesquelles une telle involution existe toujours sont les composantes connexes hyperelliptiques. Ces composantes connexes sont en général dans des strates non connexes, sauf exceptions en petit genre. Ainsi, si  $S$  est de genre supérieur ou égal à 3, alors  $S_1$  aussi, et on peut choisir  $S_1$  qui n'admet pas d'involution non triviale, ce qui permet de fabriquer une paire  $(S', \gamma')$  réalisant la même configuration que  $(S, \gamma)$ , mais dans une composante connexe non-hyperelliptique.

# Annexe du chapitre 1



# CONFIGURATIONS OF SADDLE CONNECTIONS OF QUADRATIC DIFFERENTIALS ON $\mathbb{CP}^1$ AND ON HYPERELLIPTIC RIEMANN SURFACES

CORENTIN BOISSY

ABSTRACT. Configurations of rigid collections of saddle connections are connected component invariants for strata of the moduli space of quadratic differentials. They have been classified for strata of Abelian differentials by Eskin, Masur and Zorich. Similar work for strata of quadratic differentials has been done by Masur and Zorich, although in that case the connected components were not distinguished.

We classify the configurations for quadratic differentials on  $\mathbb{CP}^1$  and on hyperelliptic connected components of the moduli space of quadratic differentials. We show that, in genera greater than five, any configuration that appears in the hyperelliptic connected component of a stratum also appears in the non-hyperelliptic one. For such genera, this enables to classify the configurations that appear for each connected component of each stratum.

## CONTENTS

1. Introduction	1
2. Configurations for the Riemann sphere	11
3. Configurations for hyperelliptic connected components	16
4. Configurations for non-hyperelliptic connected components	23
Appendix. Computation of the genus in terms of a configuration	30
References	33

## 1. INTRODUCTION

We study flat surfaces having isolated conical singularities of angle integer multiple of  $\pi$  and  $\mathbb{Z}/2\mathbb{Z}$  linear holonomy. The moduli space of such surfaces is isomorphic to the moduli space of quadratic differentials on Riemann surfaces and is naturally stratified. Flat surfaces corresponding to squares of Abelian differentials are often called *translation surfaces*. Flat surfaces appear in the study of billiards in rational polygons since these can be "unfolded" to give a translation surface (see [KaZe]).

---

2000 *Mathematics Subject Classification*. Primary: 32G15. Secondary: 30F30, 57R30.

*Key words and phrases*. Quadratic differentials, configuration, homologous saddle connections.

A sequence of quadratic differentials or Abelian differentials leaves any compact set of a stratum when the length of a saddle connection tends to zero. This might force some other saddle connections to shrink. In the case of an Abelian differential they correspond to homologous saddle connections. In the general case of quadratic differentials, the corresponding collections of saddle connections on a flat surface are said to be  $\hat{\text{homologous}}$ <sup>1</sup> (pronounced “hat-homologous”). According to Masur and Smillie [MS] (see also [EMZ, MZ]), a “typical degeneration” corresponds to the case when all the “short” saddle connections are pairwise  $\hat{\text{homologous}}$ . Therefore the study of configurations of  $\hat{\text{homologous}}$  saddle connections (or homologous saddle connection in the case of Abelian differential) is a first step for the study of the compactification of a given stratum. A configuration of  $\hat{\text{homologous}}$  saddle connections on a generic surface is also a natural invariant of a connected component of the ambient stratum.

In a recent article, Eskin, Masur and Zorich [EMZ] study collections of homologous saddle connections for Abelian differentials. They describe configurations for each connected component of the strata of Abelian differentials. Collections of  $\hat{\text{homologous}}$  saddle connections are studied for quadratic differentials by Masur and Zorich [MZ]: they describe all the configurations that can arise in any given stratum of quadratic differentials, but they do not distinguish connected components of such strata.

According to Lanneau [L2], the non-connected strata of quadratic differentials admit exactly two connected components. They are of one of the following two types:

- “hyperelliptic” stratum: the stratum admits a connected component that consists of hyperelliptic quadratic differentials (note that some of these strata are connected).
- exceptional stratum: there exist four non-connected strata that do not belong to the previous case.

In this article, we give the classification of the configurations that appear in the hyperelliptic connected components (Theorem 3.1). This gives therefore a necessary condition for a surface to be in a hyperelliptic connected component. Then we show that any configuration that appears in a hyperelliptic connected component also appears in the other component of the stratum when the genus is greater than five (Theorem 4.2). Hence the list of configurations corresponding to this other component is precisely the list of configuration corresponding to the ambient stratum.

For such genera, any non-connected stratum contains a hyperelliptic connected component. Hence the configurations for each connected component of each stratum, when the genus is greater than or equal to five, are given by Theorem 3.1, Theorem 4.2 and Main Theorem of [MZ]. We address the description of configurations for low dimension strata to a next article.

---

<sup>1</sup>The corresponding cycles are in fact homologous on the canonical double cover of  $S$ , usually denoted as  $\hat{S}$ , see section 1.2.

We deduce configurations for hyperelliptic components from configurations for strata of quadratic differentials on  $\mathbb{CP}^1$  (Theorem 2.2). Configurations for  $\mathbb{CP}^1$  are deduced from general results on configurations that appear in [MZ]. Note that these configurations are needed in the study of asymptotics in billiards in polygons with “right” angles [AEZ]. For such a polygon, there is a simple unfolding procedure that consists in gluing along their boundaries two copies of the polygon. This gives a flat surface of genus zero with conical singularities, whose angles are multiples of  $\pi$  (*i.e.* a quadratic differential on  $\mathbb{CP}^1$ ). Then a generalized diagonal or a periodic trajectory in the polygon gives a saddle connection on the corresponding flat surface.

We also give in appendix an explicit formula that gives a relation between the genus of a surface and the ribbon graph of connected components associated to a collection of  $\hat{\text{h}}$ omologous saddle connections.

Some particular splittings are sometimes used to compute the closure of  $\text{SL}(2, \mathbb{R})$ -orbits of surfaces (see [Mc, HLM]). These splittings of surfaces can be reformulated as configurations of homologous or  $\hat{\text{h}}$ omologous saddle connections on these surfaces. It would be interesting to find some configurations that appear in *any* surface of a connected component of a stratum, as was done in [Mc].

*Acknowledgements.* I would like to thank Anton Zorich for encouraging me to write this paper, and for many discussions. I also thank Erwan Lanneau and the Referee for their comments on the paper.

**1.1. Basic definitions.** Here we first review standart facts about moduli spaces of quadratic differentials. We refer to [HM, M, V1] for proofs and details, and to [MT, Z] for general surveys.

Let  $S$  be a compact Riemann surface of genus  $g$ . A quadratic differential  $q$  on  $S$  is locally given by  $q(z) = \phi(z)dz^2$ , for  $(U, z)$  a local chart with  $\phi$  a meromorphic function with at most simple poles. We define the poles and zeroes of  $q$  in a local chart to be the poles and zeroes of the corresponding meromorphic function  $\phi$ . It is easy to check that they do not depend on the choice of the local chart. Slightly abusing vocabulary, a pole will be referred to as a zero of order  $-1$ , and a marked point will be referred to as a zero of order 0. An Abelian differential on  $S$  is a holomorphic 1-form.

Outside its poles and zeroes,  $q$  is locally the square of an Abelian differential. Integrating this 1-form gives a natural atlas such that the transition functions are of the kind  $z \mapsto \pm z + c$ . Thus  $S$  inherits a flat metric with singularities, where a zero of order  $k \geq -1$  becomes a conical singularity of angle  $(k + 2)\pi$ . The flat metric has trivial holonomy if and only if  $q$  is globally the square of an Abelian differential. If not, then the holonomy is  $\mathbb{Z}/2\mathbb{Z}$  and  $(S, q)$  is sometimes called a *half-translation* surface since the transitions functions are either translations, or half-turns. In order to simplify the notation, we will usually denote by  $S$  a surface with such flat structure.

We associate to a quadratic differential the set  $\{k_1, \dots, k_r\}$  of orders of its poles and zeroes. The Gauss-Bonnet formula asserts that  $\sum_i k_i = 4g - 4$ . Conversely, if we fix a collection  $\{k_1, \dots, k_r\}$  of integers greater than or equal to  $-1$  satisfying the previous equality, we denote by  $\mathcal{Q}(k_1, \dots, k_r)$  the (possibly empty) moduli space of quadratic differentials which are not globally the square of any Abelian differential, and having  $\{k_1, \dots, k_r\}$  as orders of poles and zeroes. It is well known that  $\mathcal{Q}(k_1, \dots, k_r)$  is a complex analytic orbifold, which is usually called a *stratum* of the moduli space of quadratic differentials. We mostly restrict ourselves to the subspace  $\mathcal{Q}_1(k_1, \dots, k_r)$  of area one surfaces, where the area is given by the flat metric. In a similar way, we denote by  $\mathcal{H}_1(n_1, \dots, n_s)$  the moduli space of Abelian differentials of area 1 having zeroes of degree  $\{n_1, \dots, n_s\}$ , where  $n_i \geq 0$  and  $\sum_{i=1}^s n_i = 2g - 2$ .

A saddle connection is a geodesic segment (or geodesic loop) joining two singularities (or a singularity to itself) with no singularities in its interior. Even if  $q$  is not globally a square of an Abelian differential we can find a square root of it along the saddle connection. Integrating it along the saddle connection we get a complex number (defined up to multiplication by  $-1$ ). Considered as a planar vector, this complex number represents the affine holonomy vector along the saddle connection. In particular, its euclidean length is the modulus of its holonomy vector. Note that a saddle connection persists under small deformation of the surface.

Local coordinates on a stratum of Abelian differentials are obtained by integrating the holomorphic 1-form along a basis of the relative homology  $H_1(S, \text{sing}, \mathbb{Z})$ , where *sing* is the set of conical singularities. Equivalently, this means that local coordinates are defined by the relative cohomology  $H^1(S, \text{sing}, \mathbb{C})$ .

Local coordinates in a stratum of quadratic differentials are obtained by the following way (see [HM]): one can naturally associate to a quadratic differential  $(S, q) \in \mathcal{Q}(k_1, \dots, k_r)$  a double cover  $p : \widehat{S} \rightarrow S$  such that  $p^*q$  is the square of an Abelian differential  $\omega$ . The surface  $\widehat{S}$  admits a natural involution  $\tau$ , that induces on the relative cohomology  $H^1(S, \text{sing}, \mathbb{C})$  an involution  $\tau^*$ . It decomposes  $H^1(S, \text{sing}, \mathbb{C})$  into an invariant subspace  $H_+^1(S, \text{sing}, \mathbb{C})$  and an anti-invariant subspace  $H_-^1(S, \text{sing}, \mathbb{C})$ . One can show that the anti-invariant subspace  $H_-^1(S, \text{sing}, \mathbb{C})$  gives local coordinates for the stratum  $\mathcal{Q}(k_1, \dots, k_r)$ . The Lebesgue measure on these coordinates defines a measure  $\mu$  on the stratum  $\mathcal{Q}_1(k_1, \dots, k_r)$ . This measure is finite (see [V3], Theorem 0.2).

A hyperelliptic quadratic differential is a quadratic differential such that there exists an orientation preserving involution  $\tau$  with  $\tau^*q = q$  and such that  $S/\tau$  is a sphere. We can construct families of hyperelliptic quadratic differentials by the following way: to all quadratic differentials on  $\mathbb{CP}^1$ , we associate a double covering ramified over some singularities satisfying some

fixed combinatorial conditions. The resulting Riemann surfaces naturally carry hyperelliptic quadratic differentials.

Some strata admit an entire connected component that is made of hyperelliptic quadratic differentials. These components arise from the previous construction and have been classified by Kontsevich and Zorich in case of Abelian differentials [KZ] and by Lanneau in case of quadratic differentials [L1].

**Theorem** (M. Kontsevich, A. Zorich). *The strata of Abelian differentials having a hyperelliptic connected component are the following ones.*

- (1)  $\mathcal{H}(2g - 2)$ , where  $g \geq 1$ . It arises from  $\mathcal{Q}(2g - 3, -1^{2g+1})$ . The ramifications points are located over all the singularities.
- (2)  $\mathcal{H}(g - 1, g - 1)$ , where  $g \geq 1$ . It arises from  $\mathcal{Q}(2g - 2, -1^{2g+2})$ . The ramifications points are located over all the poles.

In the above presented list, the strata  $\mathcal{H}(0)$ ,  $\mathcal{H}(0, 0)$ ,  $\mathcal{H}(1, 1)$  and  $\mathcal{H}(2)$  are the ones that are connected.

**Theorem** (E. Lanneau). *The strata of quadratic differentials that have a hyperelliptic connected component are the following ones.*

- (1)  $\mathcal{Q}(2(g - k) - 3, 2(g - k) - 3, 2k + 1, 2k + 1)$  where  $k \geq -1$ ,  $g \geq 1$  and  $g - k \geq 2$ . It arises from  $\mathcal{Q}(2(g - k) - 3, 2k + 1, -1^{2g+2})$ . The ramifications points are located over  $2g + 2$  poles.
- (2)  $\mathcal{Q}(2(g - k) - 3, 2(g - k) - 3, 4k + 2)$  where  $k \geq 0$ ,  $g \geq 1$  and  $g - k \geq 1$ . It arises from  $\mathcal{Q}(2(g - k) - 3, 2k, -1^{2g+1})$ . The ramifications points are located over  $2g + 1$  poles and over the zero of order  $2k$ .
- (3)  $\mathcal{Q}(4(g - k) - 6, 4k + 2)$  where  $k \geq 0$ ,  $g \geq 2$  and  $g - k \geq 2$ . It arises from  $\mathcal{Q}(2(g - k) - 4, 2k, -1^{2g})$ . The ramifications points are located over all the singularities

In the above presented list, the strata  $\mathcal{Q}(-1, -1, 1, 1)$ ,  $\mathcal{Q}(-1, -1, 2)$ ,  $\mathcal{Q}(1, 1, 1, 1)$ ,  $\mathcal{Q}(1, 1, 2)$  and  $\mathcal{Q}(2, 2)$  are the ones that are connected.

**1.2.  $\hat{\mathbf{H}}$ omologous saddle connections.** Let  $S \in \mathcal{Q}(k_1, \dots, k_r)$  be a flat surface and let us denote by  $p : \hat{S} \rightarrow S$  its canonical double cover and by  $\tau$  the corresponding involution. Let  $\Sigma$  denote the set of singularities of  $S$  and let  $\hat{\Sigma} = p^{-1}(\Sigma)$ .

To an oriented saddle connection  $\gamma$  on  $S$ , one can associate  $\gamma_1$  and  $\gamma_2$  its preimages by  $p$ . If the relative cycle  $[\gamma_1]$  satisfies  $[\gamma_1] = -[\gamma_2] \in H_1(\hat{S}, \hat{\Sigma}, \mathbb{Z})$ , then we define  $[\hat{\gamma}] = [\gamma_1]$ . Otherwise, we define  $[\hat{\gamma}] = [\gamma_1] - [\gamma_2]$ . Note that in all cases, the cycle  $[\hat{\gamma}]$  is anti-invariant with respect to the involution  $\tau$ .

**Definition 1.1.** Two saddle connections  $\gamma$  and  $\gamma'$  are  $\hat{\mathbf{H}}$ omologous if  $[\hat{\gamma}] = \pm[\hat{\gamma}']$ .

*Example 1.2.* Consider the flat surface  $S \in \mathcal{Q}(-1, -1, -1, -1)$  given in Figure 1 (a “pillowcase”), it is easy to check from the definition that  $\gamma_1$  and  $\gamma_2$  are  $\hat{\mathbf{H}}$ omologous since the corresponding cycles for the double cover  $\hat{S}$  are homologous.



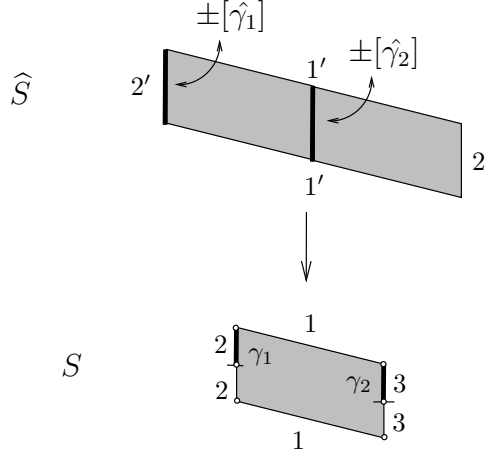

FIGURE 1. An unfolded flat surface  $S$  with two homologous saddle connections  $\gamma_1$  and  $\gamma_2$ .

*Example 1.3.* Consider the flat surface given in Figure 4 (at the end of section 1.2), the reader can check that the saddle connections  $\gamma_1$ ,  $\gamma_2$  and  $\gamma_3$  are pairwise  $\hat{\text{h}}$ omologous.

**Theorem** (H. Masur, A. Zorich). *Consider two distinct saddle connections  $\gamma, \gamma'$  on a half-translation surface. The following assertions are equivalent:*

- *The two saddle connections  $\gamma$  and  $\gamma'$  are  $\hat{\text{h}}$ omologous.*
- *The ratio of their lengths is constant under any small deformation of the surface inside the ambient stratum.*
- *They have no interior intersection and one of the connected components of  $S \setminus \{\gamma \cup \gamma'\}$  has trivial linear holonomy.*

*Furthermore, if  $\gamma$  and  $\gamma'$  are  $\hat{\text{h}}$ omologous, then the ratio of their lengths belongs to  $\{\frac{1}{2}, 1, 2\}$ .*

Consider a set of  $\hat{\text{h}}$ omologous saddle connections  $\gamma = \{\gamma_1, \dots, \gamma_s\}$  on a flat surface  $S$ . Slightly abusing notation, we will denote by  $S \setminus \gamma$  the subset  $S \setminus (\cup_{i=1}^s \gamma_i)$ . This subset is a finite union of connected half-translation surfaces with boundaries.

**Definition 1.4.** Let  $S$  be a flat surface and  $\gamma = \{\gamma_1, \dots, \gamma_s\}$  a collection of  $\hat{\text{h}}$ omologous saddle connections. The *graph of connected components*, denoted by  $\Gamma(S, \gamma)$ , is the graph defined by the following way:

- The vertices are the connected components of  $S \setminus \gamma$ , labelled by “o” if the corresponding surface is a cylinder, by “+” if it has trivial holonomy (but is not a cylinder), and otherwise by “−” if it has non-trivial holonomy.

- The edges are given by the saddle connections in  $\gamma$ . Each  $\gamma_i$  is located on the boundary of one or two connected components of  $S \setminus \gamma$ . In the first case it becomes an edge joining the corresponding vertex to itself. In the second case, it becomes an edge joining the two corresponding vertices.

In [MZ], Masur and Zorich describe the set of all possible graphs of connected components for a quadratic differential. This set is roughly given by Figure 2, where dot lines are chains of “+” and “o” vertices of valence two. The next theorem gives a more precise statement of this description. It can be skipped in a first reading.

**Theorem** (H. Masur, A. Zorich). *Let  $(S, q)$  be quadratic differential; let  $\gamma$  be a collection of homologous saddle connections  $\{\gamma_1, \dots, \gamma_n\}$ , and let  $\Gamma(S, \gamma)$  be the graph of connected components encoding the decomposition  $S \setminus (\gamma_1 \cup \dots \cup \gamma_n)$ .*

*The graph  $\Gamma(S, \gamma)$  either has one of the basic types listed below or can be obtained from one of these graphs by placing additional “o”-vertices of valence two at any subcollection of edges subject to the following restrictions. At most one “o”-vertex may be placed at the same edge; a “o”-vertex cannot be placed at an edge adjacent to a “o”-vertex of valence 3 if this is the edge separating the graph.*

*The graphs of basic types, presented in Figure 2, are given by the following list:*

- An arbitrary (possibly empty) chain of “+”-vertices of valence two bounded by a pair of “-”-vertices of valence one;*
- A single loop of vertices of valence two having exactly one “-”-vertex and arbitrary number of “+”-vertices (possibly no “+”-vertices at all);*
- A single chain and a single loop joined at a vertex of valence three. The graph has exactly one “-”-vertex of valence one; it is located at the end of the chain. The vertex of valence three is either a “+”-vertex, or a “o”-vertex (vertex of the cylinder type). Both the chain, and the cycle may have in addition an arbitrary number of “+”-vertices of valence two (possibly no “+”-vertices at all);*
- Two nonintersecting cycles joined by a chain. The graph has no “-”-vertices. Each of the two cycles has a single vertex of valence three (the one where the chain is attached to the cycle); this vertex is either a “+”-vertex or a “o”-vertex. If both vertices of valence three are “o”-vertices, the chain joining two cycles is nonempty: it has at least one “+”-vertex. Otherwise, each of the cycles and the chain may have arbitrary number of “+”-vertices of valence two (possibly no “+”-vertices of valence two at all);*
- “Figure-eight” graph: two cycles joined at a vertex of valence four, which is either a “+”-vertex or a “o”-vertex. All the other vertices (if any) are the “+”-vertices of valence two. Each of the two cycles may*

have arbitrary number of such “+”-vertices of valence two (possibly no “+”-vertices of valence two at all).

Each graph listed above corresponds to some flat surface  $S$  and to some collection of saddle connections  $\gamma$ .

*Remark 1.5.* Two homologous saddle connections are not necessary of the same length. The additional parameters 1 or 2 written along the vertices in Figure 2 represent the lengths of the saddle connections in the collection  $\gamma = \{\gamma_1, \dots, \gamma_s\}$  after suitably rescaling the surface.

Each connected component of  $S \setminus \gamma$  is a non-compact surface which can be naturally compactified (for example considering the distance induced by the flat metric on a connected component of  $S \setminus \gamma$ , and the corresponding completion). We denote this compactification by  $S_j$ . We warn the reader that  $S_j$  might differ from the closure of the component in the surface  $S$ : for example, if  $\gamma_i$  is on the boundary of just one connected component  $S_j$  of  $S \setminus \gamma$ , then the compactification of  $S_j$  carries two copies of  $\gamma_i$  in its boundary, while in the closure of the corresponding connected component of  $S \setminus \gamma$ , these two copies are identified. The boundary of each  $S_i$  is a union of saddle connections; it has one or several connected components. Each of them is homeomorphic to  $\mathbb{S}^1$  and therefore defines a cyclic order in the set of boundary saddle connections. Each consecutive pair of saddle connections for that cyclic order defines a *boundary singularity* with an associated angle which is a integer multiple of  $\pi$  (since the boundary saddle connections are parallel). The surface with boundary  $S_i$  might have singularities in its interior. We call them *interior singularities*.

**Definition 1.6.** Let  $\gamma = \{\gamma_1, \dots, \gamma_r\}$  be a maximal collection of homologous saddle connections. Then a *configuration* is the following combinatorial data:

- The graph  $\Gamma(S, \gamma)$ .
- For each vertex of this graph, a permutation of the edges adjacent to the vertex (encoding the cyclic order of the saddle connections on each connected component of the boundary of  $S_i$ ).
- For each pair of consecutive elements in that cyclic order, an integer  $k \geq 0$  such that the angle between the two corresponding saddle connections is  $(k + 1)\pi$ . This integer will be referred as the *order of the boundary singularity*.
- For each  $S_i$ , a collection of integers corresponding to the orders of the interior singularities of  $S_i$ .

Following [MZ], we will encode the permutation of the edges adjacent to each vertex by a *ribbon graph*.

*Example 1.7.* Figure 3 represents a configuration on a flat surface. The corresponding collection  $\{\gamma_1, \gamma_2, \gamma_3\}$  of homologous saddle connections decomposes the surface into three connected components. The first connected

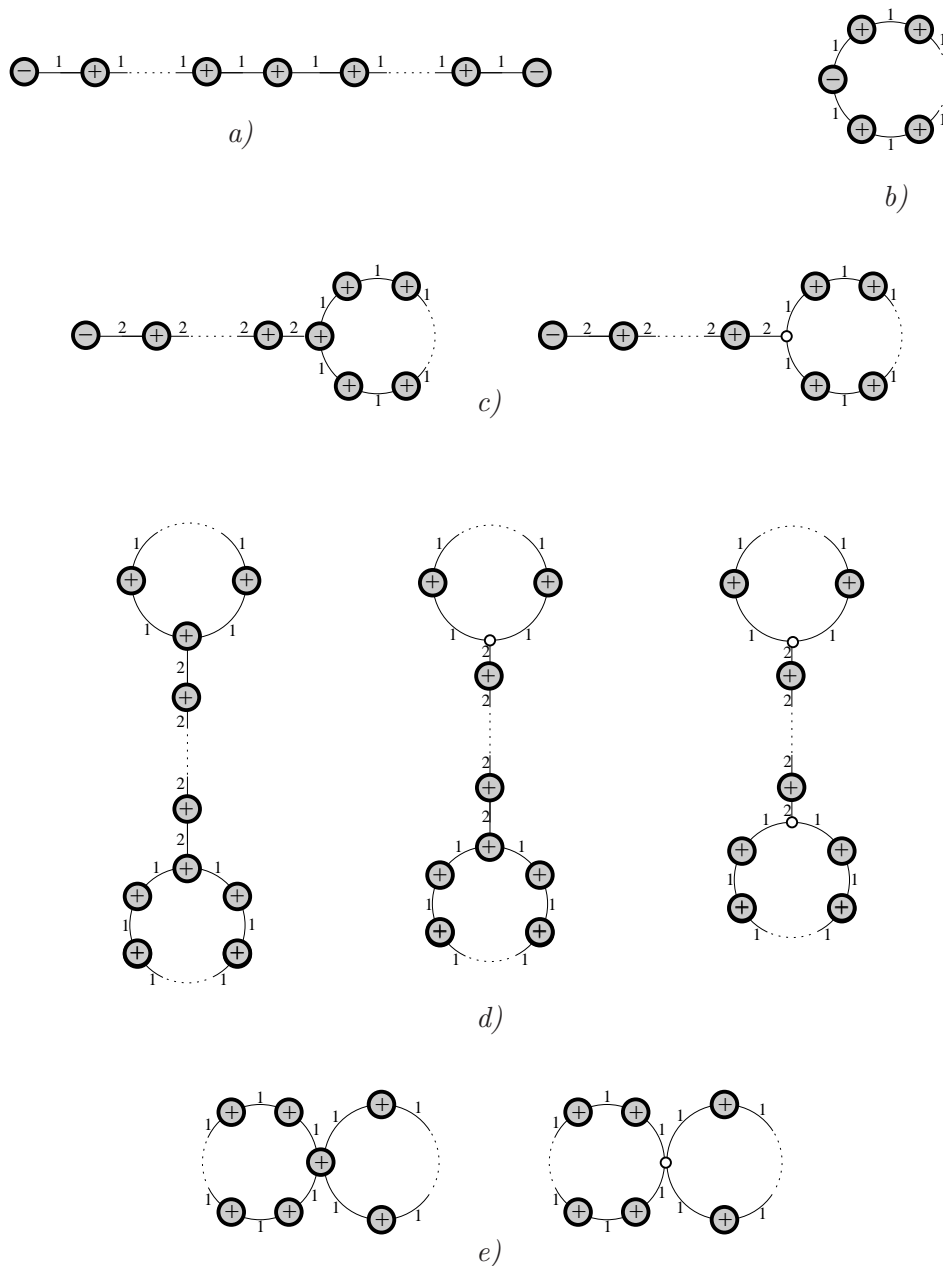

FIGURE 2. Classification of admissible graphs.

component  $\ominus\text{---}\oplus$  has four interior singularities of order  $-1$ , and its boundary consists of a single saddle connection with the corresponding boundary singularity of angle  $(2 + 1)\pi = 3\pi$ . The second connected component  $\oplus\text{---}\oplus$

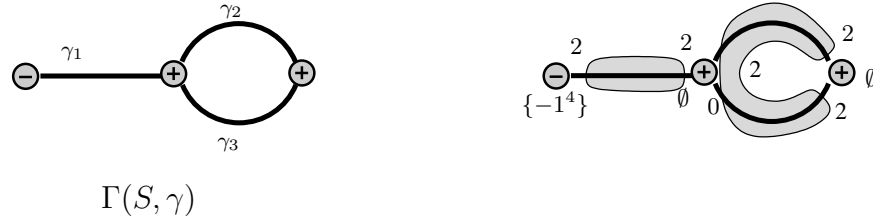

FIGURE 3. An example of configuration.

has no interior singularities. It has two boundary components, one consisting of a single saddle connection with corresponding singularity of angle  $(2 + 1)\pi$ , and the other consists of a union of two saddle connections with corresponding boundary singularities of angle  $(0 + 1)\pi$  and  $(2 + 1)\pi$ . The last connected component  $\ominus\oplus$  has no interior singularities, and admits two boundary components that consists each of a single saddle connection with corresponding boundary singularities of angles  $(2 + 1)\pi$ .

Figure 4 represents a flat surface with a collection of three homologous saddle connections realizing this configuration.

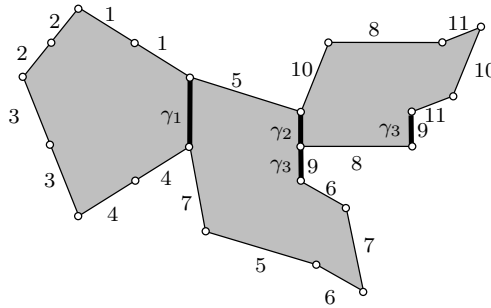

FIGURE 4. Unfolded flat surface realizing configuration of Figure 3.

*Remark 1.8.* When describing the configuration of a collection of homologous saddle connections  $\gamma = \{\gamma_1, \dots, \gamma_r\}$ , we will always assume that each saddle connection parallel to an element  $\gamma_i$  is actually homologous to  $\gamma_i$ . This condition is satisfied for a subset of full measure in the ambient stratum (see [MZ]).

*Remark 1.9.* A maximal collection of homologous saddle connections and the associated configuration persist under any small deformation of the flat surface inside the ambient stratum. They also persist under the well know  $SL(2, \mathbb{R})$  action on the stratum which is ergodic with respect to the Lebesgue measure  $\mu$  (see [M, V1, V2]). Hence, every admissible configuration that exists in a connected component is realized in almost all surfaces of that

component. Furthermore, the number of collections realizing a given configuration in a generic surface has quadratic asymptotics (see [EM]).

## 2. CONFIGURATIONS FOR THE RIEMANN SPHERE

In this section we describe all admissible configurations of  $\hat{\text{homologous}}$  saddle connections that arise on  $\mathbb{CP}^1$ . To avoid confusion of notation, we specify the following convention: we denote by  $\{k_1^{\alpha_1}, \dots, k_r^{\alpha_r}\}$  the set with multiplicities  $\{k_1, k_1, \dots, k_r\}$ , where  $\alpha_i$  is the multiplicity of  $k_i$ . We assume that  $k_i \neq k_j$  for  $i \neq j$ . For example the notation  $\mathcal{Q}(1^2, -1^6)$  means  $\mathcal{Q}(1, 1, -1, -1, -1, -1, -1)$ .

Let  $\mathcal{Q}(k_1^{\alpha_1}, \dots, k_r^{\alpha_r}, -1^s)$  be a stratum of quadratic differentials on  $\mathbb{CP}^1$  different from  $\mathcal{Q}(-1^4)$ . We give in the next example four families of admissible configurations for this stratum. In the next example,  $\gamma$  is always assumed to be a maximal collection of  $\hat{\text{homologous}}$  saddle connections. We give in Table 1 the corresponding graphs and “topological pictures”. The existence of each of these configurations is a direct consequence of Main Theorem of [MZ].

- Example 2.1.*
- a) Let  $\{k, k'\} \subset \{k_1^{\alpha_1}, \dots, k_r^{\alpha_r}, -1^s\}$  be an unordered pair of integers with  $(k, k') \neq (-1, -1)$ . The set  $\gamma$  consists of a single saddle connection joining a singularity of order  $k$  to a distinct singularity of order  $k'$ .
  - b) Let  $\{a_1, a_2\}$  be an unordered pair of positive integers such that  $a_1 + a_2 = k \in \{k_1, \dots, k_r\}$  (with  $k \neq 1$ ), and let  $A_1 \sqcup A_2$  be a partition of  $\{k_1^{\alpha_1}, \dots, k_r^{\alpha_r}\} \setminus \{k\}$ . The set  $\gamma$  consists of a simple saddle connection that decomposes the sphere into two one-holed spheres  $S_1$  and  $S_2$ , such that each  $S_i$  has interior singularities of positive order given by  $A_i$  and  $s_i = (\sum_{a \in A_i} a) + a_i + 2$  poles, and has a single boundary singularity of order  $a_i$ .
  - c) Let  $\{a_1, a_2\} \subset \{k_1^{\alpha_1}, \dots, k_r^{\alpha_r}\}$  be an unordered pair of integers. Let  $A_1 \sqcup A_2$  be a partition of  $\{k_1^{\alpha_1}, \dots, k_r^{\alpha_r}\} \setminus \{a_1, a_2\}$ . The set  $\gamma$  consists of two closed saddle connections that decompose the sphere into two one-holed spheres  $S_1$  and  $S_2$  and a cylinder, and such that each  $S_i$  has interior singularities of positive orders given by  $A_i$  and  $s_i = (\sum_{a \in A_i} a) + a_i + 2$  poles and has a boundary singularity of order  $a_i$ .
  - d) Let  $k \in \{k_1, \dots, k_r\}$ . The set  $\gamma$  is a pair of saddle connections of different lengths, and such that the largest one starts and ends from a singularity of order  $k$  and decompose the surface into a one-holed sphere and a “half-pillowcase”, while the shortest one joins a pair of poles and lies on the other end of the half-pillowcase.

**Theorem 2.2.** *Let  $\mathcal{Q}(k_1^{\alpha_1}, \dots, k_r^{\alpha_r}, -1^s)$  be a stratum of quadratic differentials on  $\mathbb{CP}^1$  different from  $\mathcal{Q}(-1^4)$  and such that  $k_i \neq 0$  for all  $i$ , and let  $\gamma$  be a maximal collection of  $\hat{\text{homologous}}$  saddle connections on a flat surface*

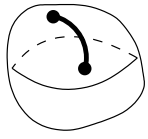
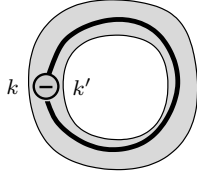
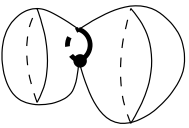
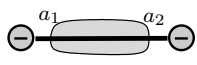
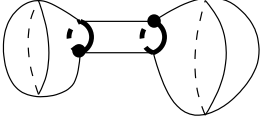
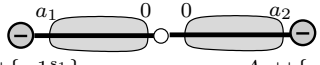
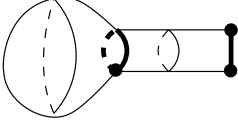
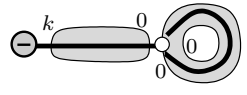
	Topological picture	Configurations
a)		
b)		 $A_1 \cup \{-1^{s_1}\}$ $A_2 \cup \{-1^{s_2}\}$
c)		 $A_1 \cup \{-1^{s_1}\}$ $A_2 \cup \{-1^{s_2}\}$
d)		

On $\mathcal{Q}(-1^4)$		
------------------------	---	--

TABLE 1. Configurations in genus zero

in this stratum. Then all possible configurations for  $\gamma$  are the ones described in Example 2.1.

*Remark 2.3.* The hypothesis  $k_i \neq 0$  appears here for simplicity. The possible configurations for a collection of saddle connections in a flat surface of genus zero that contains marked point are easily deduced from Theorem 2.2.

We first start with several preliminary lemmas which are applicable to flat surfaces of arbitrary genus. Let  $S$  be a generic flat surface of genus  $g \geq 0$  in

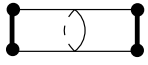
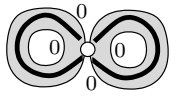
some stratum of quadratic differentials, and let  $\gamma$  be a maximal collection of  $\hat{\text{homologous}}$  saddle connections on it. Taking the natural compactification of each connected component of  $S \setminus \gamma$ , we get a collection  $\{S_i\}_{i \in I}$  of compact surfaces with boundaries. The boundary of each  $S_i$  is topologically a union of disjoint circles. We can glue a disc to each connected component of the boundary of  $S_i$  and get a closed surface  $\bar{S}_i$ ; we denote by  $g_i$  the genus of  $\bar{S}_i$ .

**Lemma 2.4.** *Let  $g$  be the genus of  $S$ , then  $g \geq \sum_{i \in I} g_i$ .*

*Proof.* For each  $S_i$ , we consider a collection of paths  $(c_{i,1}, \dots, c_{i,2g_i})$  of  $S_i$  that represent a symplectic basis of  $H_1(\bar{S}_i, \mathbb{R})$  and that avoid the boundary of  $S_i$ . When we glue the  $\{S_i\}$  together, the  $c_{i,j}$  provides a collection of cycles of  $H_1(S, \mathbb{R})$ . It forms a symplectic family because two paths arising from two different surfaces do not intersect each other. Therefore we get a free family of  $H_1(S, \mathbb{R})$ , thus:

$$2g = \dim(H_1(S, \mathbb{R})) \geq \sum_{i \in I} \dim(H_1(\bar{S}_i, \mathbb{R})) = \sum_{i \in I} 2g_i.$$

□

*Remark.* In the appendix, we will improve Lemma 2.4 and give an exact formula in terms of the graph  $\Gamma(S, \gamma)$  and the ribbon graph.

**Lemma 2.5.** *If  $S_{i_0}$  is not a cylinder and has trivial holonomy, then  $g_{i_0} > 0$ .*

*Proof.* Recall that the initial collection of  $\hat{\text{homologous}}$  saddle connections is assumed to be maximal, therefore there are no interior saddle connections  $\hat{\text{homologous}}$  to any boundary saddle connection. Let  $\{k_1, \dots, k_s\}$  be the orders of the interior conical singularities of  $S_{i_0}$  and  $\{l_1, \dots, l_{s'}\}$  be the orders of the boundary singularities. Let  $X$  be the closed flat surface obtained by gluing  $S_{i_0}$  and a copy of itself taken with opposite orientation along their boundaries. If  $m$  denotes the number of connected components of the boundary of  $S_{i_0}$  and  $g_X$  denotes the genus of  $X$ , one can see that  $g_X = 2g_{i_0} + m - 1$ . The singularities of  $X$  are of orders  $\{k_1, \dots, k_s, k_1, \dots, k_s, 2l_1, \dots, 2l_{s'}\}$ . Furthermore,  $k_i, l_j$  are nonnegative integers since  $X$  has trivial holonomy. Applying the Gauss-Bonnet formula for quadratic differentials, one gets:

$$g_X = 1 + \sum_{j=1}^s \frac{k_j}{2} + \sum_{i=1}^{s'} \frac{l_i}{2} = 2g_{i_0} + m - 1$$

which obviously gives

$$2g_{i_0} \geq 2 - m + \sum_{i=1}^{s'} \frac{l_i}{2}.$$

To conclude, we need few elementary remarks (which are already written in [MZ]) about the order of the conical singularities of the boundary:



- a) If a connected component of the boundary is just a single saddle connection, then the corresponding angle cannot be  $\pi$  otherwise the saddle connection would then be a boundary component of a cylinder. Then the other boundary component of that cylinder would be a saddle connection homologous to the previous one (see remark 1.8). So  $S_i$  would be that cylinder contradicting the hypothesis. Furthermore, the holonomy of a path homotopic to the saddle connection is trivial if and only if the conical angle of the boundary singularity is an odd multiple of  $\pi$ .

Therefore that angle is greater than or equal to  $3\pi$ , and hence, the corresponding order  $l_j$  of the boundary singularity has order at least 2.

- b) If a connected component of the boundary is given by two saddle connections, then as before, the two corresponding conical angles cannot be both equal to  $\pi$  (otherwise  $S_i$  would be a cylinder) and are of the same parity (otherwise  $S_i$  would have nontrivial holonomy).

Now we complete the proof of the lemma. We recall that the vertex corresponding to  $S_{i_0}$  in  $\Gamma(S, \gamma)$  is of valence at most four, and hence  $m \leq 4$ . The case  $m = 1$  is trivial. If  $m = 2$  then there is a connected component of the boundary of  $S_{i_0}$  with one or two saddle connections. In both cases, the remarks a) and b) imply that  $S_{i_0}$  admits a boundary singularity of order  $l_1 > 0$ , and therefore  $2g_{i_0} \geq l_1 > 0$ .

If  $m \in \{3, 4\}$ , then there are at least two boundary components that consist of a single saddle connection. From remark a), this implies that  $S_{i_0}$  admits two boundary singularities  $l_1$  and  $l_2$  of order greater than or equal to two. Applying remarks a) and b) on the other boundary components, we show that  $S_{i_0}$  admits at least an other boundary singularity of order  $l_3 > 0$ . Therefore

$$2g_{i_0} > 2 - m + l_1/2 + l_2/2 \geq 4 - m \geq 0.$$

Finally,  $g_{i_0} > 0$  and the lemma is proven.  $\square$

Now, we describe all the possible configurations when the genus  $g$  of the surface is zero.

*Proof of Theorem 2.2.* It follows from Lemmas 2.4 and 2.5 that  $\Gamma(S, \gamma)$  has no “+” components. Furthermore, a loop of the graph  $\Gamma(S, \gamma)$  cannot have any cylinder since this would add a handle to the surface. Now using the description from [MZ] of admissible graphs (see Figure 2), we can list all possible graphs. For each graphs, we now describe the corresponding admissible configurations.

- a) A single “-” vertex of valence two and an edge joining it to itself. This can represent two possible cases: either the boundary of the closure of  $S \setminus \gamma$  has two connected components, or it has only one. In the first case each connected component of the boundary is a single saddle connection. Gluing these two boundary components together adds a handle to the surface. So

this case does not appear for genus zero.

In the other case, the single boundary component consists of two saddle connections. The surface  $S$  is obtained after gluing these two saddle connections, so  $\gamma$  consists of a single saddle connection  $\gamma_1$  joining a singularity of order  $k$  to a distinct singularity of order  $k'$ . If  $k$  and  $k'$  were both equal to  $-1$ , then  $\gamma_1$  would bound a cylinder. Then the other end of that cylinder would consist of one or several saddle connections parallel to  $\gamma_1$ . Because of remark 1.8, these saddle connections would be in the collection  $\gamma$ , which is a contradiction.

b) Two “-” vertices of valence one joined by a single edge. That means that  $\gamma$  consists of a single closed saddle connection  $\gamma_1$  which separates the surface in two parts. We get an unordered pair  $\{S_1, S_2\}$  of one-holed spheres with boundary singularities of angles  $(a_1+1)\pi$  and  $(a_2+1)\pi$  correspondingly. The saddle connection of the initial surface is adjacent to a singularity of order  $a_1 + a_2 = k$ . None of the  $a_i$  is null otherwise the saddle connection would bound a cylinder, and there would exist a saddle connection homologous to  $\gamma_1$  on the other boundary component of this cylinder.

Now considering the interior singularities of positive order of  $S_1$  and  $S_2$  respectively, this defines a partition  $A_1 \sqcup A_2$  of  $\{k_1^{\alpha_1}, \dots, k_r^{\alpha_r}\} \setminus \{k\}$ . Each  $S_i$  also have  $s_i$  poles, with  $s_1 + s_2 = s$ . If we decompose the boundary saddle connection of  $S_i$  in two segments starting from the boundary singularity, and glue together these two segments, we then get a closed flat surface with  $A_i \sqcup \{a_i - 1, -1\} \sqcup \{-1^{s_i}\}$  for the order of the singularities. The Gauss-Bonnet theorem implies:

$$\left(\sum_{a \in A_i} a\right) + a_i - 2 - s_i = -4.$$

c) Two “-” vertices of valence one and a “o” vertex of valence 2. This case is analogous to the previous one.

d) A “-” vertex of valence one, joined by an edge to a valence three “o” vertex and an edge joining the “o” vertex to itself.

The “-” vertex represents a one-holed sphere. It has a single boundary component which is a closed saddle connection. The cylinder has two boundary components of equal lengths. One has two saddle connections of length 1 (after normalization) the other component has a single saddle connection of length 2. So, the only possible configuration is obtained by gluing the two saddle connections of length 1 together (creating a “half-pillowcase”) and gluing the other one with the boundary of the “-” component. The boundary singularity of the “-” component has an angle of  $(k + 2 - 1)\pi$  (equivalently, has order  $k$ ) for some  $k \in \{k_1, \dots, k_r\}$ .

e) A valence four “o” vertex with two edges joining the vertex to itself. The cylinder has two boundary components, each of them is composed of two saddle connections. All the saddle connections have the same length. If we glue a saddle connection with one of the other connected component of the boundary, we get a flat torus, which has trivial holonomy and genus

greater than zero. So, we have to glue each saddle connection with the other saddle connection of its boundary component. That means that we get a (twisted) “pillowcase” and the surface belongs to  $\mathcal{Q}(-1, -1, -1, -1)$ .

In each of these first four cases, the surface necessarily has a singularity of order at least one. So, they cannot appear in  $\mathcal{Q}(-1, -1, -1, -1)$ , which means that the fifth case is the only possibility in that stratum.  $\square$

### 3. CONFIGURATIONS FOR HYPERELLIPTIC CONNECTED COMPONENTS

In this section, we describe the configurations of  $\hat{\text{homologous}}$  saddle connections in a hyperelliptic connected component. We first reformulate Lanneau’s description of such components, see [L1].

**Theorem** (E. Lanneau). *The hyperelliptic connected components are given by the following list:*

- (1) *The subset of surfaces in  $\mathcal{Q}(k_1, k_1, k_2, k_2)$ , that are a double covering of a surface in  $\mathcal{Q}(k_1, k_2, -1^s)$  ramified over  $s$  poles. Here  $k_1$  and  $k_2$  are odd,  $k_1 \geq -1$  and  $k_2 \geq 1$ , and  $k_1 + k_2 - s = -4$ .*
- (2) *The subset of surfaces in  $\mathcal{Q}(k_1, k_1, 2k_2 + 2)$ , that are a double covering of a surface in  $\mathcal{Q}(k_1, k_2, -1^s)$  ramified over  $s$  poles and over the singularity of order  $k_2$ . Here  $k_1$  is odd and  $k_2$  is even,  $k_1 \geq -1$  and  $k_2 \geq 0$ , and  $k_1 + k_2 - s = -4$ .*
- (3) *The subset of surfaces in  $\mathcal{Q}(2k_1 + 2, 2k_2 + 2)$ , that are a double covering of a surface in  $\mathcal{Q}(k_1, k_2, -1^s)$  ramified over all the singularities. Here  $k_1$  and  $k_2$  are even,  $k_1 \geq 0$  and  $k_2 \geq 0$ , and  $k_1 + k_2 - s = -4$ .*

Taking a double covering of the configurations arising on  $\mathbb{CP}^1$ , one can deduce configurations for hyperelliptic components. This leads to the following theorem:

**Theorem 3.1.** *In the notations of the classification theorem above, the admissible configurations of  $\hat{\text{homologous}}$  saddle connections for hyperelliptic connected components are given by Tables 2, 3, 4 and 5. No other configuration can appear.*

*Remark 3.2.* Integer parameters  $k_1, k_2 \geq -1$  in Tables 2, 3, 4 are allowed to take values  $-1$  and  $0$  as soon as this does not contradict explicit restrictions. In Table 5, we list several additional configurations which appear only when at least one of  $k_1, k_2$  is equal to zero.

*Remark 3.3.* In the description of configurations for the hyperelliptic connected component  $\mathcal{Q}^{hyp}(k_1, k_1, k_2, k_2)$  with  $k_1 = k_2$ , the notation  $k_i, k_i$  (resp.  $k_j, k_j$ ) still represents the orders of a pair of singularities that are *interchanged* by the hyperelliptic involution. For example in a generic surface in the hyperelliptic component  $\mathcal{Q}^{hyp}(k, k, k, k)$ , for  $k \geq 1$ , the second line of Table 3 means that, between any pair of singularities that are interchanged by the hyperelliptic involution on  $S$ , there exists a saddle connection with

$\mathcal{Q}(k_1, k_2, -1^s)$ ( $\mathbb{CP}^1$ )	$\mathcal{Q}^{hyp}(k_1, k_1, 2k_2 + 2)$	$\begin{matrix} k_1 \text{ odd} \\ k_2 \text{ even} \end{matrix}$
$\begin{matrix} k_1 = a_1 + a_2 \\ a_1, a_2 \geq 1 \end{matrix}$ 	a) $a_1$ odd, $a_2$ even 	b) $a_1$ even, $a_2$ odd 
$\begin{matrix} k_2 = a_1 + a_2 \\ a_1, a_2 \geq 1 \end{matrix}$ 	a) $a_1, a_2$ odd 	b) $a_1, a_2$ even 
$k_1, k_2 \geq 1$ 		

TABLE 2. Configurations for  $\mathcal{Q}^{hyp}(k_1, k_1, 2k_2 + 2)$

$\mathcal{Q}(k_1, k_2, -1^s)$ ( $\mathbb{CP}^1$ )	$\mathcal{Q}^{hyp}(k_1, k_1, k_2, k_2)$ $\begin{smallmatrix} k_1, k_2 \text{ odd} \\ (k_1, k_2) \neq (-1, -1) \end{smallmatrix}$	
	$k_i \neq -1$ 	
$k_i = a_1 + a_2$ $a_1, a_2 \geq 1$ 	a) $a_1$ odd, $a_2$ even 	b) $a_1$ even, $a_2$ odd 
$k_1, k_2 \geq 1$ 		
$k_i \geq 1$ 		

TABLE 3. Configurations for  $\mathcal{Q}^{hyp}(k_1, k_1, k_2, k_2)$ 

no other saddle connections  $\hat{\text{homologous}}$  to it. But if  $\gamma$  is a saddle connection between two singularities that are not interchanged by the involution  $\tau$ , then  $\tau(\gamma)$  is a saddle connection  $\hat{\text{homologous}}$  to  $\gamma$  (see below), and which is different from  $\gamma$ .

*Proof.* Let  $\mathcal{Q}^{hyp}$  be a hyperelliptic connected component as in the list of the previous theorem and  $\mathcal{Q} = \mathcal{Q}(k_1, k_2, -1^s)$  the corresponding stratum on  $\mathbb{CP}^1$ . The projection  $p : \tilde{S} \rightarrow \tilde{S}/\tau = S$ , where  $\tilde{S} \in \mathcal{Q}^{hyp}$  and  $\tau$  is the corresponding hyperelliptic involution, induces a covering from  $\mathcal{Q}^{hyp}$  to  $\mathcal{Q}$ . This is not necessarily a one-to-one map because there might be a choice of

$Q(k_1, k_2, -1^s)$ ( $\mathbb{CP}^1$ )	$Q^{hyp}(2k_1 + 2, 2k_2 + 2)$	$k_1$ even $k_2$ even
$k_i = a_1 + a_2$ $a_1, a_2 \geq 1$	a) $a_1, a_2$ odd 	b) $a_1, a_2$ even 
$k_1, k_2 \geq 1$		
$k_i \geq 1$		

TABLE 4. Configurations for  $Q^{hyp}(2k_1 + 2, 2k_2 + 2)$

the ramification points on  $\mathbb{CP}^1$ . But if we fix the ramification points, there is a locally one-to-one correspondence.

Recall that theorem of Masur and Zorich cited after definition 1.1 says that two saddle connections are  $\hat{h}$ omologous if and only if the ratio of their length is constant under any small perturbation of the surface inside the

ambient stratum. Therefore, two saddle connections in  $\tilde{S} \in \mathcal{Q}^{hyp}$  are  $\hat{h}$ omologous if and only if the corresponding saddle connections in  $S$  are  $\hat{h}$ omologous. Hence the image under  $p$  of a maximal collection  $\tilde{\gamma}$  of  $\hat{h}$ omologous saddle connections on  $\tilde{S}$  is a collection  $\gamma$  of  $\hat{h}$ omologous saddle connections on  $S$ . Note that  $\gamma$  is not necessary maximal since the preimage of a pole by  $p$  is a marked point on  $\tilde{S}$  and we do not consider saddle connections starting from a marked point. However, we can deduce *all* configurations for  $\mathcal{Q}^{hyp}$  from the list of configurations for  $\mathcal{Q}$ .

We give details for a few configurations, the other ones are similar and the proofs are left to the reader.

-*First line of Table 2:* the configuration for  $\mathcal{Q} = \mathcal{Q}(k_1, k_2, -1^s)$  corresponds to a single saddle connection  $\gamma$  on a surface  $S$  that joins a singularity  $P_1$  of degree  $k_1$  to the distinct singularity  $P_2$  of degree  $k_2$ . The double covering is ramified over  $P_2$  but not over  $P_1$ . Therefore, the preimage of  $\gamma$  in  $\tilde{S}$  is a pair  $\{\tilde{\gamma}_1, \tilde{\gamma}_2\}$  of saddle connections of the same lengths that join each preimage of  $P_1$  to the preimage of  $P_2$ . The boundary of compactification of  $\tilde{S} \setminus \{\tilde{\gamma}_1, \tilde{\gamma}_2\}$  admits only one connected component that consists of four saddle connections. The angles of the boundary singularities corresponding to the preimages of  $P_1$  are both  $(k_1 + 2)\pi$ , and the angles of the other boundary singularities are  $(k_2 + 2)\pi$  since  $\{\tilde{\gamma}_1, \tilde{\gamma}_2\}$  are interchanged by the hyperelliptic involution.

-*Fourth line of Table 2:* the configuration for  $\mathcal{Q} = \mathcal{Q}(k_1, k_2, -1^s)$  corresponds to a single closed saddle connection  $\gamma$  on a flat surface  $S$  that separates the surface into two parts  $S_1$  and  $S_2$ . Each  $S_i$  contains some ramification points, so the preimage of  $\gamma$  separates  $\tilde{S}$  into two parts  $\tilde{S}_1$  and  $\tilde{S}_2$  that are double covers of  $S_1$  and  $S_2$ . One of the  $\tilde{S}_i$  has an interior singularity of order  $2k_2 + 2$ , while the other one does not have interior singularities. The description from Masur and Zorich of possible graphs of connected components (see Figure 2) implies that  $\tilde{S}_1$  and  $\tilde{S}_2$  cannot have the same holonomy. Let  $\tilde{S}_2$  be the component with trivial holonomy, and choose  $\omega$  a square root of the quadratic differential that defines its flat structure. If  $\tilde{S}_2$  has two boundary components, each consisting of a single saddle connection, then the corresponding boundary singularities must be of even order  $a_2$ . If  $\tilde{S}_2$  has a single boundary component, then integrating  $\omega$  along that boundary must give zero ( $\omega$  is closed), which is only possible if the order  $a_2$  of the boundary singularities are odd. Applying Lemma 3.4 below, we see that  $\tilde{S}_2$  does not have interior singularity. Hence,  $\tilde{S}_1$  has an interior singularity of order  $2k_2 + 2$ . The order of the boundary singularities of  $\tilde{S}_1$  are both  $a_1 = k_1 - a_2$ , which is of parity opposite to the one of  $a_2$ . Applying again Lemma 3.4, we get the number of boundary components of  $\tilde{S}_1$ .

-*Last line of Table 2:* the configuration for  $\mathcal{Q} = \mathcal{Q}(k_1, k_2, -1^s)$  corresponds to a pair of saddle connections on a surface  $S \in \mathcal{Q}$  that separate the surface into a cylinder  $C$  and a one-holed sphere  $S_1$ . The double cover  $\tilde{S}_1$  of  $S_1$  is connected, and applying Lemma 3.4 we see that it has two boundary

components. The double cover  $\tilde{C}$  of the cylinder  $C$  admits no ramification points. So *a priori*, there are two possibilities:  $\tilde{C}$  is either a cylinder of the same length and a width twice bigger than the width of  $C$ , or it is a pair of copies of  $C$ . Here, the first possibility is not realizable otherwise the double covering  $\tilde{S} \rightarrow S$  would be necessarily ramified over  $k_1$ . Finally we get  $\tilde{S}$  by gluing a boundary component of each cylinder to each boundary component of  $\tilde{S}_1$ , and gluing together the remaining boundary components of the cylinders.

Note that the preimage of the saddle connection joining a pair of poles on  $S$  is a *regular* closed geodesic in  $\tilde{S}$ , and hence in our convention, we do not consider such a saddle connection in the collection of  $\hat{\text{homologous}}$  saddle connections on  $\tilde{S}$ .

When at least one of  $k_1$  or  $k_2$  equals zero, there is a marked point on  $\mathbb{CP}^1$  that is a ramification point of the double covering. Hence we have to start from a configuration of saddle connections on  $\mathbb{CP}^1$  that might have marked points as end points:

- If a maximal collection of  $\hat{\text{homologous}}$  saddle connection on  $\mathbb{CP}^1$  does not intersect a marked point, then the collection has already been described in Theorem 2.2, and hence, the corresponding configuration in  $\mathcal{Q}^{hyp}$  is already presented in Tables 2 and 4.
- If a non-closed saddle connection in a collection admits a marked point as end point, then this saddle connection is simple since we can move freely that marked point. Hence the corresponding configuration in  $\mathcal{Q}^{hyp}$  is already written in Tables 2 and 4.
- If a closed saddle connection admits a marked point as end point, then it is a closed geodesic. This corresponds to a new configuration on  $\mathbb{CP}^1$  and the corresponding configuration in  $\mathcal{Q}^{hyp}$  is described in Table 5. The proof is analogous to the other cases.

This concludes the proof of Theorem 3.1. □

**Lemma 3.4.** *Let  $S_i$  be a flat surface whose boundary consists of a single closed saddle connection and let  $a > 0$  be the order of the corresponding boundary singularity. Let  $\tilde{S}_i$  be a connected ramified double cover of the interior of  $S_i$  and let  $(\tilde{k}_1, \dots, \tilde{k}_l)$  be the orders of the interior singularities. The sum  $\sum_i \tilde{k}_i$  is even and:*

- *If  $\frac{\sum_i \tilde{k}_i}{2} + a$  is even, then the compactification of  $\tilde{S}_i$  has two boundary components, each of them consists of a single saddle connection, with corresponding boundary singularity of order  $a$ .*
- *If  $\frac{\sum_i \tilde{k}_i}{2} + a$  is odd, then the compactification of  $\tilde{S}_i$  has a single boundary component which consists of a pair of saddle connections of equal lengths, with corresponding boundary singularities of order  $a$ .*



$\mathcal{Q}(k_i, 0, -1^s)$	$\mathcal{Q}^{hyp}$
$k_i \geq 1, k_i \text{ odd}$ 	$\mathcal{Q}^{hyp} = \mathcal{Q}(k_i, k_i, 2)$ 
$k_i \geq 1, k_i \text{ even}$ 	$\mathcal{Q}^{hyp} = \mathcal{Q}(2k_i + 2, 2), k_i > 0$ 
$k_1 = k_2 = 0$ 	$\mathcal{Q}^{hyp} = \mathcal{Q}(2, 2)$ 

TABLE 5. Additional configurations which appears when at least one of  $k_1$  or  $k_2$  equals 0.

*Proof.* By construction, the boundary of the compactification of  $\tilde{S}_i$  necessarily consists of two saddle connections of equal lengths. It has one or two connected components.

Now we claim that

$$\sum_i \tilde{k}_i + 2a \equiv 2r \pmod{4}$$

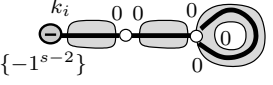
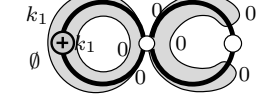
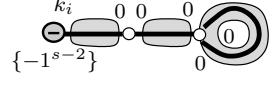
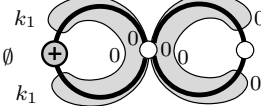
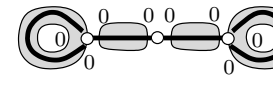
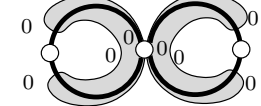
where  $r$  is the number of connected components of the boundary of  $\tilde{S}_i$ . This equality (that already appears in [MZ]) clearly implies the lemma. To prove the claim, we consider as in Lemma 2.5 the surface  $\tilde{X}$  of genus  $g_{\tilde{X}}$  obtained by gluing  $\tilde{S}_i$  and a copy of itself with opposite orientation along their boundaries. The orders of the singularities of  $\tilde{X}$  are  $\{\tilde{k}_1, \dots, \tilde{k}_l, \tilde{k}_1, \dots, \tilde{k}_l, 2a, 2a\}$ , so we get

$$4g_{\tilde{X}} - 4 = 2 \sum_i \tilde{k}_i + 4a = 4(2\tilde{g}_i + r - 1) - 4$$

and therefore

$$\sum_i \tilde{k}_i + 2a = 4g_i - 4 + 2r \equiv 2r \pmod{4}.$$

□

Given a concrete flat surface, we do not necessary see at once whether it belongs or not to a hyperelliptic connected component. Indeed, there exists hyperelliptic flat surfaces that are not in a hyperelliptic connected

component. As a direct corollary of Theorem 3.1, we have the following quick test.

**Corollary 3.5.** *Let  $S$  be a flat surface with non-trivial holonomy and let  $\gamma$  be a collection of homologous saddle connections on  $S$ . If one of the following property holds, then the surface  $S$  does not belong to a hyperelliptic connected component.*

- $S \setminus \gamma$  admits three connected components and neither of them is a cylinder.
- $S \setminus \gamma$  admits four connected components or more.

#### 4. CONFIGURATIONS FOR NON-HYPERELLIPTIC CONNECTED COMPONENTS

Following [MZ], given a fixed stratum, one can get a list of all realizable configurations of homologous saddle connections. Nevertheless it is not clear which configuration realizes in which component. In the previous section we have described configurations for hyperelliptic components.

In the section we show that *any* configuration realizable for a stratum is realizable in its non-hyperelliptic connected component, provided the genus  $g$  is sufficiently large.

We will use the following theorem which is a reformulation of the theorem of Kontsevich-Zorich and the theorem of Lanneau cited in section 1.1.

**Theorem** (M. Kontsevich, A. Zorich; E. Lanneau). *The following strata consists entirely of hyperelliptic surfaces and are connected.*

- $\mathcal{H}(0)$ ,  $\mathcal{H}(0,0)$ ,  $\mathcal{H}(1,1)$  and  $\mathcal{H}(2)$  in the moduli spaces of Abelian differentials.
- $\mathcal{Q}(-1, -1, 1, 1)$ ,  $\mathcal{Q}(-1, -1, 2)$ ,  $\mathcal{Q}(1, 1, 1, 1)$ ,  $\mathcal{Q}(1, 1, 2)$  and  $\mathcal{Q}(2, 2)$  in the moduli spaces of quadratic differentials.

*Any other stratum that contains a hyperelliptic connected component admit at least one other connected component. Each of these other components contains a subset of full measure of flat surfaces that do not admit any isometric involution.*

**Lemma 4.1.** *Let  $\mathcal{Q}$  be a non-connected stratum that contains a hyperelliptic connected component. If the set of order of singularities defining  $\mathcal{Q}$  contains  $\{k, k\}$ , for some  $k \geq 1$ , then there exists a non-hyperelliptic flat surface in  $\mathcal{Q}$  having a simple saddle connection joining two different singularities of the same order  $k$ .*

Here we call a saddle connection “simple” when there are no other saddle connections homologous to it.

*Proof.* According to Masur and Smillie [MS], any stratum is nonempty except the following four exceptions:  $\mathcal{Q}(\emptyset)$ ,  $\mathcal{Q}(1, -1)$ ,  $\mathcal{Q}(3, 1)$  and  $\mathcal{Q}(4)$ .

According to Masur and Zorich [MZ] (see also [EMZ]), if  $S \in \mathcal{Q}(k_1 + k_2, k_3, \dots, k_r)$ , then there is a continuous path  $(S_t)_{t \in [0,1]}$  in the moduli space

of quadratic differentials, such that  $S_0 = S$  and  $S_t$  is in  $\mathcal{Q}(k_1, k_2, k_3, \dots, k_r)$  for  $t > 0$ , and such that the smallest saddle connection on  $S_t$ , for  $t > 0$  is simple and joins a singularity of order  $k_1$  to a singularity of order  $k_2$ . We say that we “break up” the singularity of order  $k_1 + k_2$  into two singularities of order  $k_1$  and  $k_2$ .

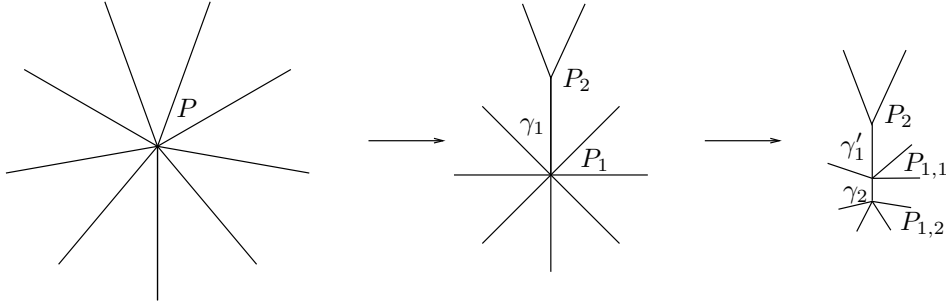

FIGURE 5. Construction of a simple saddle connection in a non-hyperelliptic surface

We first consider the stratum  $\mathcal{Q} = \mathcal{Q}(k_1, k_1, k_2, k_2)$ . By assumption,  $\mathcal{Q}$  is non-connected, so, either the genus is greater than 3, or  $k_1 = 3$  and  $k_2 = -1$ . Hence the stratum  $\mathcal{Q}(2k_1 + k_2, k_2)$  is nonempty. Now, we start from a surface  $S_0$  in that stratum, and break up the singularity  $P$  of order  $2k_1 + k_2$  into two singularities  $P_1$  and  $P_2$  of orders  $2k_1$  and  $k_2$  respectively (see Figure 5). We get a surface  $S_1$  with a short vertical saddle connection  $\gamma_1$  between  $P_1$  and  $P_2$ . Since the “singularity breaking up” procedure is continuous, there are no other short saddle connections on  $S_1$ . Then, we break up the singularity  $P_1$  of order  $2k_1$  into a pair of singularities  $P_{1,1}$  and  $P_{1,2}$  of orders  $k_1$ . We get by construction a surface  $S_2$  in the stratum  $\mathcal{Q}$  with a simple saddle connection  $\gamma_2$  between  $P_{1,1}$  and  $P_{1,2}$ , and of length very small compared to the length of  $\gamma_1$ .

The fact that the “singularity breaking up” procedure is continuous implies that there persists a saddle connection  $\gamma'_1$  between  $P_2$  and one of the  $P_{1,i}$  (see Figure 5). By construction, we can assume there are no other saddle connections of length  $\kappa l(\gamma'_1)$ , where  $l(\gamma'_1)$  denotes the length of  $\gamma'_1$  and  $\kappa \in \{\frac{1}{2}, 1, 2\}$ . Hence,  $\gamma'_1$  is simple by theorem of Masur and Zorich cited after definition 1.1. According to Theorem 3.1, this cannot exist in the hyperelliptic connected component since the corresponding configuration is not present in Table 3. Thus  $S_2$  belongs to the non-hyperelliptic connected component and we can assume, after a slight perturbation, that  $S_2$  is not hyperelliptic. Since by construction, the saddle connection  $\gamma_2$  is simple and joins two singularities of order  $k = k_1 \geq 1$ , the lemma is proven for the stratum  $\mathcal{Q}(k_1, k_1, k_2, k_2)$ .

The proofs for  $\mathcal{Q}(k_1, k_1, 2k_2 + 2)$  and for  $\mathcal{Q}(2k_1 + 2, 2k_2 + 2)$  are analogous: note that these case do not occur for the genera 1 or 2, because all

corresponding strata are connected. Therefore the genus is greater than or equal to 3 and the stratum  $\mathcal{Q}(2k_1 + 2k_2 + 2)$  is nonempty.  $\square$

**Theorem 4.2.** *Let  $\mathcal{Q}$  be a stratum of meromorphic quadratic differentials with at most simple poles on a Riemann surface of genus  $g \geq 5$ . If  $\mathcal{Q}$  admits a hyperelliptic connected component, then  $\mathcal{Q}$  is non-connected and any configuration for  $\mathcal{Q}$  is realized for a surface in the non-hyperelliptic connected component of  $\mathcal{Q}$ .*

*Proof.* The fact that  $\mathcal{Q}$  is non-connected follows directly from the Theorem of Lanneau. Let  $S$  be a flat surface in the hyperelliptic component of  $\mathcal{Q}$  and let  $\gamma = \{\gamma_1, \dots, \gamma_r\}$  be a maximal collection of  $\hat{\text{h}}$ omologous saddle connections. The hyperelliptic involution  $\tau$  maps  $\gamma$  to itself and hence, induces an involution on the set of connected components of  $S \setminus \gamma$ . Recall that the map  $S \mapsto S/\tau$  corresponds to a covering from the hyperelliptic connected component to a stratum of quadratic differentials on  $\mathbb{CP}^1$ . Let us denote by  $p$  the double cover that maps  $x \in S$  to  $(x \bmod \tau) \in S/\tau$ . The collection  $p(\gamma) = p(\gamma_1 \cup \dots \cup \gamma_r)$  is a collection of  $\hat{\text{h}}$ omologous saddle connections on  $p(S) = S/\tau$ . Let  $S_0$  be a connected component of  $S \setminus \gamma$ . By definition,  $S_0$  and  $S_1 := \tau(S_0)$  are isometric and are projected to the same component of  $p(S) \setminus p(\gamma)$ . This is still true in a neighborhood of  $S$  in the ambient stratum. Hence  $S_0$  and  $S_1$  must keep being isometric if we continuously deform  $S$ . If they were two different components of  $S \setminus \gamma$ , then one could deform  $S_0$  outside a neighborhood of its boundary and reconstruct a new flat surface  $S'$  close to  $S$ , contradicting the previous assertion. Therefore, if  $S$  is in a hyperelliptic component, then  $\tau$  must induce an isometric and orientation preserving involution on each connected component of  $S \setminus \gamma$ .

Using the formula for the genus of a compound surface proved in the appendix and the list of configurations for hyperelliptic connected components given in the previous section, we derive the following fact: if  $S$  has genus  $g \geq 5$  and if  $\gamma$  is a maximal collection of  $\hat{\text{h}}$ omologous saddle connections, then at least one of the following three propositions is true. We first specify two conventions. In the next statements, we indicate each case by the number of the table and the line. For instance, case 3.2 corresponds to the second line of Table 3. When a case appears in two different statements, we mean that there is always at least one of the two statements which is true for this case.

- a)  $S \setminus \gamma$  admits a connected component  $S_0$  of genus  $g_0 \geq 3$ , that has a single boundary component and whose corresponding vertex in the graph  $\Gamma(S, \gamma)$  is of valence 2. This corresponds to the cases 2.2, 2.4b, 2.7, 3.2, 3.3b, 3.4, 4.5, 5.1, and 2.5, 2.6, 4.3.
- b)  $S \setminus \gamma$  admits a connected component  $S_0$  of genus  $g_0 \geq 2$ , that has exactly two boundary components and whose corresponding vertex in the graph  $\Gamma(S, \gamma)$  is of valence 2. This corresponds to the cases 2.3, 2.4a, 2.8, 3.3a, 3.5, 4.2, 4.4, 5.2, and 2.5, 2.6, 4.3.

- c)  $S \setminus \gamma$  is connected and the corresponding vertex in the graph  $\Gamma(S, \gamma)$  is of valence 4. This corresponds to the cases 2.1, 3.1, and 4.1.

Remark that the only case that is not listed previously is case 5.3, but corresponds to the genus 2. The proof now follows from Lemmas 4.3, 4.4, 4.5 to situations a), b), c) correspondingly.  $\square$

**Lemma 4.3.** *Let  $S$  be a flat surface in a hyperelliptic connected component and let  $\gamma$  be a maximal collection of  $\hat{\text{homologous}}$  saddle connections. We assume that  $S \setminus \gamma$  admits a connected component  $S_0$  of genus  $g_0 \geq 3$ , whose corresponding vertex in the graph  $\Gamma(S, \gamma)$  is of valence 2, and such that  $S_0$  has a single boundary component.*

*Then there exists  $(S', \gamma')$  that has the same configuration as  $(S, \gamma)$ , with  $S'$  in the complementary component of the same stratum.*

*Proof.* The boundary components of  $S_0$  consists of two saddle connections of the same length and the corresponding boundary singularities have the same orders  $k \geq 1$ . Identifying together these two boundary saddle connections, we get a hyperelliptic surface  $\overline{S}_0$ . If we continuously deform this surface, it keeps being hyperelliptic since we can perform the reverse surgery and get a continuous deformation of  $S$ . Hence,  $\overline{S}_0$  belongs to a hyperelliptic component, and the hyperelliptic involution interchange two singularities of order  $k - 1$ .

The genus of  $\overline{S}_0$  is greater than 3, so the corresponding stratum admits an other connected component. Now we start from a closed flat surface  $X$  in this other connected component. According to Lemma 4.1, we can choose  $X$  such that it admits a simple saddle connection between the two singularities of order  $k - 1$ . Now we cut  $X$  along that saddle connection and we get a surface  $S_1$  that have, after rescaling, the same boundary as  $S_0$ . By construction,  $S_1$  admits no interior saddle connections  $\hat{\text{homologous}}$  to one of its boundary saddle connections. So, we can reconstruct a pair  $(S', \gamma')$  such that  $\gamma'$  has the same configuration as  $\gamma$  in  $S$ .

The surface  $S_1$  admits a nontrivial isometric involution if and only if  $X$  shares this property. So, we can choose  $X$  in such a way it admits no nontrivial isometric involutions, and therefore the surface  $S'$  is non-hyperelliptic.

This argument also works when  $\overline{S}_0$  is in the stratum  $\mathcal{Q}(3, 3, -1, -1)$  (here  $g_0 = 2$  and  $k = 4$ ). In any other case for  $g_0 \leq 2$ , it is not possible to replace  $S_0$  by a surface  $S_1$  with no involutions.  $\square$

**Lemma 4.4.** *Let  $S$  be a flat surface in a hyperelliptic connected component and let  $\gamma$  be a maximal collection of  $\hat{\text{homologous}}$  saddle connections. We assume that  $S \setminus \gamma$  admits a connected component  $S_0$  of genus  $g_0 \geq 2$ , that has two boundary components, and whose corresponding vertex in the graph  $\Gamma(S, \gamma)$  is of valence 2.*

*Then there exists  $(S', \gamma')$  that has the same configuration as  $(S, \gamma)$ , with  $S'$  in the complementary component of the same stratum.*

*Proof.* Each boundary component of  $S_0$  consists of one saddle connection and the corresponding boundary singularities have the same orders  $k \geq 1$ .

Now we start from a closed flat surface  $X$  with the same holonomy as  $S_0$  and whose singularities consists of the interior singularities of  $S_0$  and two singularities  $P_1$  and  $P_2$  of order  $k - 2$ . We can always choose  $X$  such that it admits a saddle connection  $\eta$  between  $P_1$  and  $P_2$ .

Now we construct a pair of holes by removing a parallelogram as in Figure 6 and gluing together the two long sides. Note that the holes can be chosen arbitrarily small, and therefore, the resulting surface with boundary does not have any interior saddle connection  $\hat{\eta}$  homologous to one of its boundary components. We denote by  $S_1$  this surface, and up to rescaling, we can assume that  $S_0$  and  $S_1$  have isometric boundaries. Hence replacing  $S_0$  by  $S_1$  in the decomposition of  $S$ , we get a new pair  $(S', \gamma')$  that have the same configuration as  $(S, \gamma)$ .

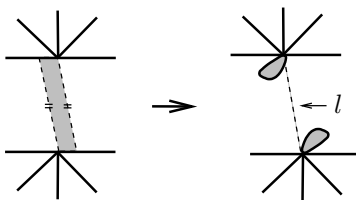

FIGURE 6. Construction of a pair of holes

We denote by  $l$  the saddle connection joining the two boundary singularities and corresponding to the two sides of the parallelogram in the previous surgery (see Figure 6). For each hole, the separatrices parallel to  $l$  are naturally ordered by turning counterclockwise around the boundary singularity (starting from the hole). For this order, the separatrix corresponding to  $l$  is the second one.

We now assume that  $S_1$  admits a nontrivial isometric (orientation preserving) involution  $\tau$ . Then this involution interchanges the two boundary components of the surface. This involution preserves the previous order, hence it fixes globally the saddle connection  $l$ . Then we can perform the reverse surgery as the one described previously and we get a closed surface that admits a nontrivial involution. Hence if  $X$  belongs to a stratum that does not consist entirely of hyperelliptic flat surfaces, then we can choose  $X$  such that  $S'$  is not in a hyperelliptic connected component.

The hypothesis on the genus, the theorem of Kontsevich-Zorich and the theorem of Lanneau imply that this argument works except when  $X$  belongs to  $\mathcal{H}(1, 1)$ ,  $\mathcal{Q}(2, 1, 1)$ ,  $\mathcal{Q}(1, 1, 1, 1)$ , or  $\mathcal{Q}(2, 2)$ .

We remark that if  $X \in \mathcal{Q}(2, 2)$ , then  $S_0$  must have nontrivial linear holonomy and no interior singularities. According to the list of configurations for hyperelliptic connected components given in section 3, this cannot happen.

We exhibit in Figure 7 three explicit surfaces with boundary that corresponds to the three cases left. We represent these three surfaces as having

a one-cylinder decomposition and by describing the identifications on the boundary of that cylinder. The length parameters can be chosen freely under the obvious condition that the sum of the lengths corresponding to the top of the cylinder must be equal to the sum of the lengths corresponding to the bottom of the cylinder. Bold lines represents the boundary of the flat surface. Now we remark that a nontrivial isometric involution must preserve the interior of the cylinder, and must exchange the boundary components. This induces some additional relations on the length parameters. Therefore, we can choose them such that there are no nontrivial isometric involutions.

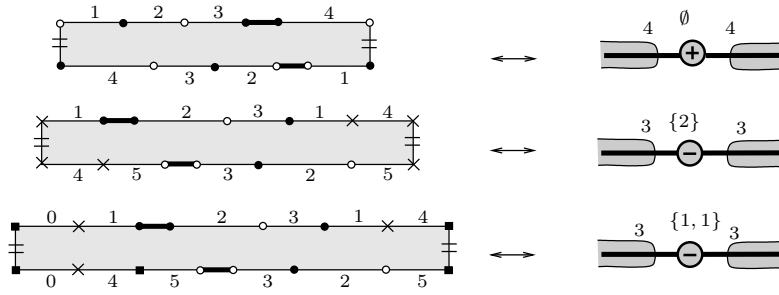

FIGURE 7. Surfaces with two boundary components and no involutions in low genus.

□

**Lemma 4.5.** *Let  $S$  be a flat surface of genus  $g \geq 3$  with nontrivial linear holonomy that belongs to a hyperelliptic connected component and let  $\gamma = \{\gamma_1, \gamma_2\}$  be a maximal collection of homologous saddle connections on  $S$ . If  $S \setminus \gamma$  is connected, then there exists  $(S', \gamma')$  that has the same configuration as  $(S, \gamma)$ , with  $S'$  in the complementary component of the same stratum.*

*Proof.* Since  $S \setminus \gamma$  is connected, the graph  $\Gamma(S, \gamma)$  contains a single vertex, and it has valence four. According to Theorem 3.1, two different cases appear:

a) The surface  $\overline{S \setminus \gamma}$  has one boundary component. In this case,  $k_1$  is odd and  $k_2$  is even, we start from a surface in  $\mathcal{H}(k_1 + k_2 + 1)$  and perform a local surgery in a neighborhood of the singularity as described in Figure 8 (see also [MZ], section 5). We get a surface and a pair of small saddle connections of length  $\delta$  that have the same configuration as  $\gamma$ . The stratum  $\mathcal{H}(k_1 + k_2 + 1)$  admits non-hyperelliptic components and the same argument as in the previous lemmas works: if we start from a generic surface in a non-hyperelliptic component, then the resulting surface after surgery does not have any nontrivial involution.

b) The surface  $\overline{S \setminus \gamma}$  has two boundary components, each of them consists of a pair of saddle connections with boundary singularities of order  $k_1 + 1$  and  $k_2 + 1$ . We construct explicit surfaces with the same configuration as  $\gamma$ ,

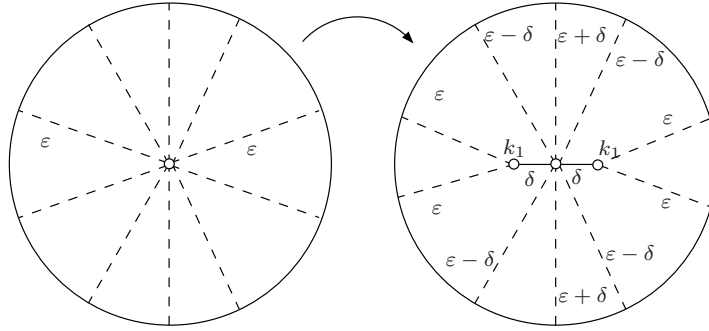

FIGURE 8. Breaking up a zero in three ones

but that have no nontrivial involutions. Let  $2n = k_1 + k_2 + 2$  and we start from a surface  $S_0$  of genus  $n$  in  $\mathcal{H}(n - 1, n - 1)$ , that have a one-cylinder decomposition and such as identification on the boundary of that cylinder is given by the permutation

$$\begin{pmatrix} 1 & 2 & \dots & 2n \\ 2n & 2n - 1 & \dots & 1 \end{pmatrix}$$

when  $n$  is even, and otherwise by the permutation

$$\begin{pmatrix} 1 & 2 & \dots & n - 1 & n & n + 1 & n + 2 & \dots & 2n - 1 & 2n \\ n - 1 & n - 2 & \dots & 1 & n & 2n - 1 & 2n - 2 & \dots & n + 1 & 2n \end{pmatrix}$$

We assume that  $k_1$  and  $k_2$  are odd and we perform a surgery on  $S_0$  to get a surface  $S_1$  with boundary as pictured on Figure 9. The surface  $S_1$  admits two boundary components that consist of two saddle connections each and which are represented by the bold segments. Each symbol  $\circ$ ,  $\bullet$ ,  $\square$ ,  $\blacksquare$  represents a different boundary singularity. It is easy to check that the boundary angles corresponding to  $\blacksquare$  and  $\square$  are both  $(k_1 + 2)\pi$  and that the angles corresponding to  $\bullet$  and  $\circ$  are  $(k_2 + 2)\pi$ . Hence after suitable identifications of the boundary of  $S_1$ , we get a surface  $S'$  and a pair of homologous saddle connections  $\gamma'$  that have the same configuration as  $(S, \gamma)$ . However,  $S'$  does not admit any nontrivial involution if the length parameters are chosen generically. Note that this construction does not work when  $n = 2$ , but according to section 3, and since  $k_1$  and  $k_2$  are odd, we have  $n = g$ , which is greater than or equal to 3 by assumption.

The case  $k_1$  and  $k_2$  even is analogous and left to the reader (note that in this case,  $g = n + 1$ , and the construction works also for  $n = 2$ ).  $\square$



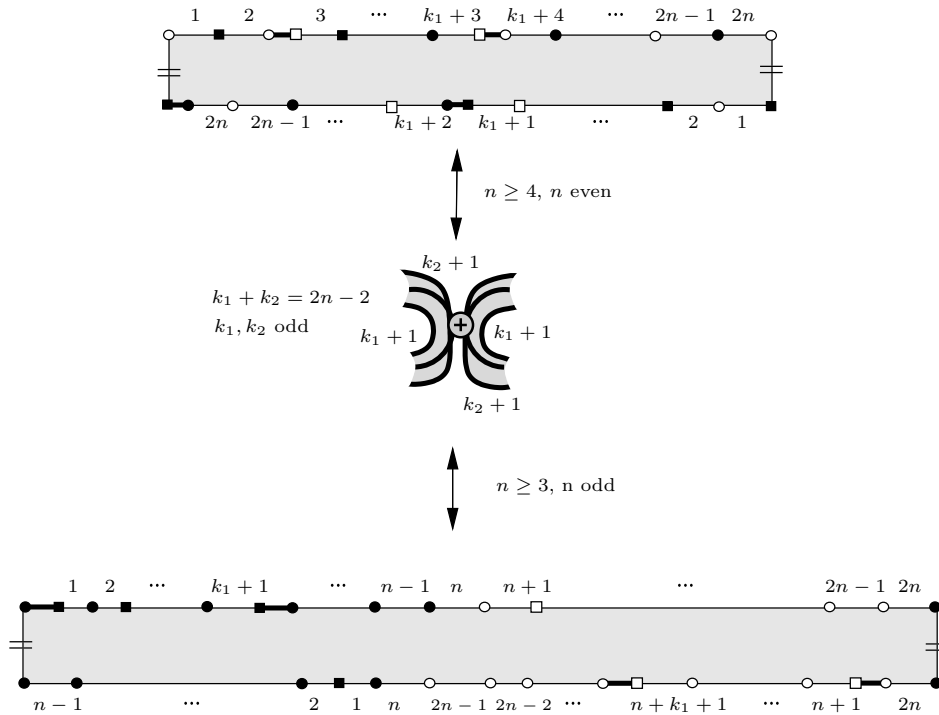

FIGURE 9. Valence four component with no involutions

#### APPENDIX. COMPUTATION OF THE GENUS IN TERMS OF A CONFIGURATION

Here we improve Lemma 2.4 and give the relation between the genus of a surface and the genera of the connected components of  $S \setminus \gamma$ , where  $\gamma$  is a collection of  $\hat{h}$ omologous saddle connections.

We first remark that this relation depends not only on the graph of connected components, but also on the permutation on each of its vertices (*i.e.* on the ribbon graph). Indeed, let us consider a pair of  $\hat{h}$ omologous saddle connections that decompose the surface into two connected components  $S_1$  and  $S_2$ . Then either both  $S_1$  and  $S_2$  have only one boundary component, or at least one of them has two boundary components. In the first case,  $S$  is the connected sum of  $\tilde{S}_1$  and  $\tilde{S}_2$ , so  $g = g_1 + g_2$ , while in the second case, one has  $g = g_1 + g_2 + 1$ .

**Definition 1.** Let  $(S, \gamma)$  be a flat surface with a collection of  $\hat{h}$ omologous saddle connections. The *pure* ribbon graph associated to  $(S, \gamma)$  is the 2-dimensional topological manifold obtained from the ribbon graph by forgetting the graph  $\Gamma(S, \gamma)$ , as in Figure 10.

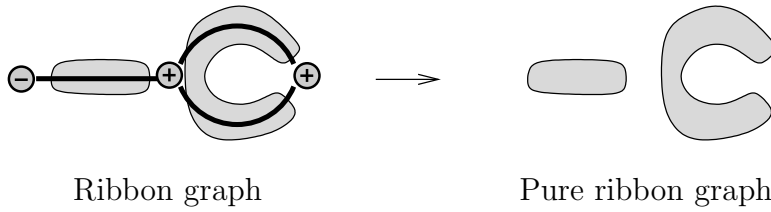

FIGURE 10. Pure ribbon graph

**Proposition 2.** *Let  $\chi_1$  be the Euler characteristic of  $\Gamma(S, \gamma)$ , let  $\chi_2$  (resp.  $n$ ) be the Euler characteristic (resp. the number of connected components) of the pure ribbon graph associated to the configuration.*

- *If the pure ribbon graph has only one connected component and does not embed into the plane (see Figure 11), then*

$$g = \left( \sum_i g_i \right) + 1$$

- *In any other case,*

$$g = \left( \sum_i g_i \right) + (\chi_2 - n) - (\chi_1 - 1)$$

*Remark 3.* Simply connected components of the pure ribbon graph do not contribute to the term  $(n - \chi_2)$ , since the Euler characteristic of a disc is 1.

Note also that in the first case, we have  $\chi_1 = -1$  and  $\chi_2 = -1$ , and therefore  $(\sum_i g_i) + 1 \neq (\sum_i g_i) + (\chi_2 - n) - (\chi_1 - 1)$ .

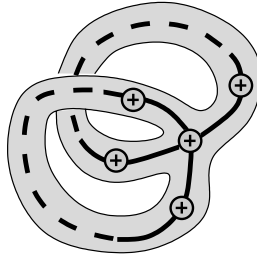

FIGURE 11. Example of a ribbon graph that does not embed into  $\mathbb{R}^2$ .

*Proof.* Here we do not assume that the collection  $\gamma$  is necessary maximal. When  $\Gamma(S, \gamma)$  has a single vertex, then we prove the proposition using direct computation and the description of the boundary components corresponding to each possible ribbon graph. We refer to [MZ] for this description. Then our goal is to reduce ourselves to that case by removing successively from the collection  $\gamma = \{\gamma_1, \dots, \gamma_k\}$  some  $\gamma_i$  whose corresponding edges joins a vertex to a distinct one.

We define a new graph  $G(S, \gamma)$ , which is a deformation retract of the pure ribbon graph: the vertices of  $G(S, \gamma)$  are the boundary components of each  $S_i$ , while the edges correspond to the saddle connections in  $\gamma$  (see Figure 12). For each vertex, there is a cyclic order on the set of edges adjacent to the vertex consistent with the orientation of the plane. If the initial pure ribbon graph does not embed into the plane, then it is also the case for  $G(S, \gamma)$ . By construction, the Euler characteristic of  $G(S, \gamma)$  is the same as the pure ribbon graph associated to  $(S, \gamma)$ , and is easier to compute.

Let us assume that  $\Gamma(S, \gamma)$  contains at least two vertices. Choose a saddle connection representing an edge joining two distinct vertices of  $\Gamma(S, \gamma)$ , and up to reenumeration, we can assume that this saddle connection is  $\gamma_1$ . Let us study the resulting configuration of  $\gamma' = \gamma \setminus \{\gamma_1\}$ . The saddle connection  $\gamma_1$  is on the boundary of two surfaces  $S_1$  and  $S_2$ . Then the connected components of  $S \setminus \gamma'$  are the same as the connected component of  $S \setminus \gamma$  except that the surfaces  $S_1$  and  $S_2$  are now glued along  $\gamma_1$ , and hence define a single surface  $S_{1,2}$ . The genus of  $S_{1,2}$  (after gluing disks on its boundary) is  $g_1 + g_2$ .

The graph  $G(S, \gamma')$  is obtained from  $G(S, \gamma)$  by shrinking an edge that joins two different vertices, so these two graphs have the same Euler characteristic  $\chi_1$ .

Furthermore, if  $\gamma_1$  was in a boundary component of  $S_1$  (resp.  $S_2$ ) defined by the ordered collection  $(\gamma_1, \gamma_{i_1}, \dots, \gamma_{i_s})$  (resp.  $(\gamma_1, \gamma_{j_1}, \dots, \gamma_{j_t})$ ). Then the cyclic order in the corresponding boundary component of  $S_{1,2}$  is defined by  $(\gamma_{i_1}, \dots, \gamma_{i_s}, \gamma_{j_1}, \dots, \gamma_{j_t})$ . Therefore  $G(S, \gamma')$  is obtained from  $G(S, \gamma)$  by shrinking the edge corresponding to  $\gamma_1$  and removing an isolated vertex that might appear (see Figure 12). It is clear that the difference  $(\chi_2 - n)$  between the Euler characteristic of  $G(S, \gamma)$  and its number of connected component is constant under this procedure. One can also remark that if  $G(S, \gamma)$  is connected and does not embed into the plane (case 1 of the proposition), then this is also true for  $G(S, \gamma')$ .

Forgetting successively these  $\gamma_i$  will lead to the case when  $\Gamma(S, \gamma)$  has a single vertex. At each steps of the removing procedure, the numbers  $\chi_1$  and  $\chi_2 - n$  do not change, and the sum of the genera associated to the vertices does not change either. This concludes the proof. □

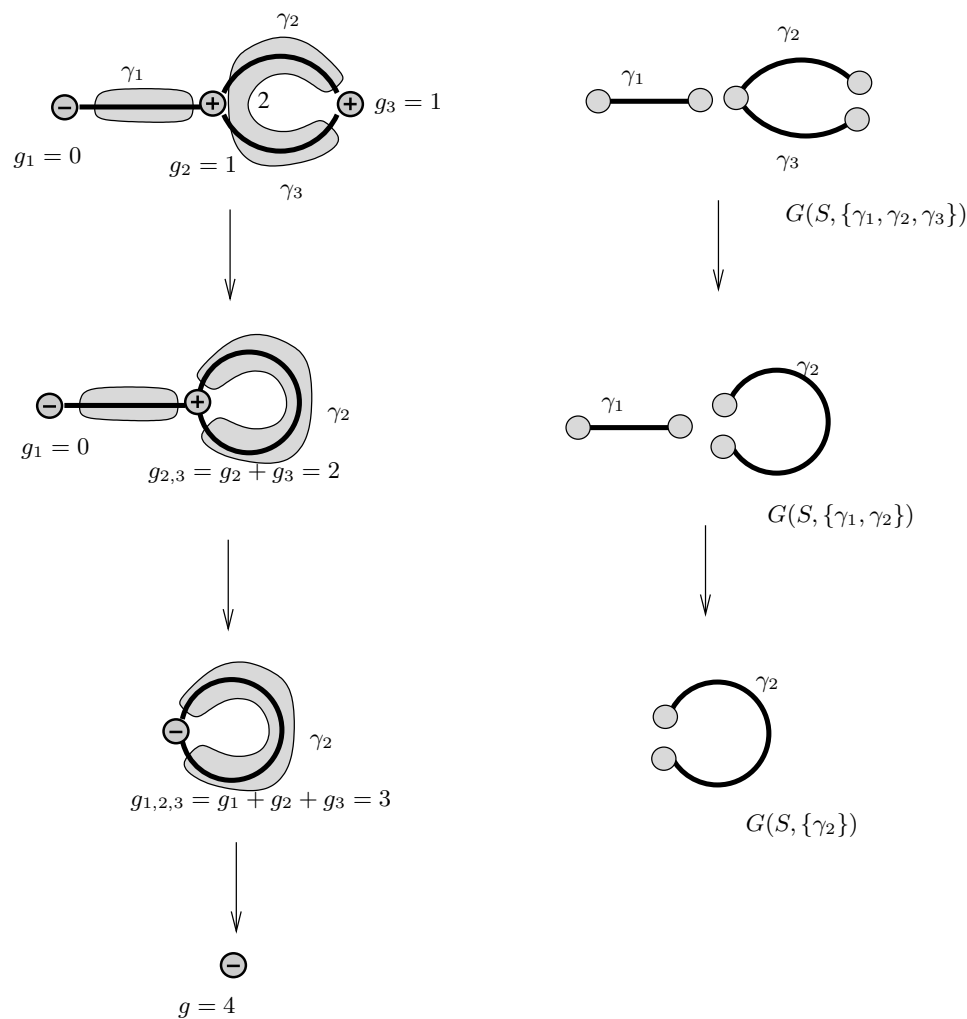

FIGURE 12. Removing successively some elements of a collection  $(\gamma_1, \gamma_2, \gamma_3)$ .

REFERENCES

[AEZ] J. Athreya, A. Eskin, A. Zorich, *Rectangular Billiards and volume of spaces of quadratic differentials*, in progress.  
 [EM] A. Eskin, H. Masur, *Asymptotic formulas on flat surfaces*, Ergodic Theory and Dynamical Systems, **21** (2) (2001), 443–478.  
 [EMZ] A. Eskin, H. Masur, A. Zorich, *Moduli spaces of Abelian differentials: the principal boundary, counting problems, and the Siegel-Veech constants*, Publ. Math. Inst. Hautes Études Sci. **97** (2003), 61–179.  
 [HLM] P. Hubert, E. Laneeau, M. Möller, *The Arnoux-Yoccoz Teichmüller disc*, preprint 2006, arXiv:math/0611655v1 [math.GT].  
 [HM] J. Hubbard, H. Masur, *Quadratic differentials and foliations*, Acta Math., **142** (1979), 221–274.

- [KaZe] A. Katok, A. Zemlyakov. *Topological transitivity of billiards in polygons*, Math. Notes, **18**, (1975), 760-764.
- [KZ] M. Kontsevich, A. Zorich *Connected components of the moduli spaces of Abelian differentials with prescribed singularities*. Invent. Math. **153** (2003), no. 3, 631–678.
- [L1] E. Lanneau, *Hyperelliptic components of the moduli spaces of quadratic differentials with prescribed singularities*, Comment. Math. Helv. **79** (2004), no. 3, 471–501.
- [L2] E. Lanneau, *Connected components of the strata of the moduli spaces of quadratic differentials* Preprint 2004, arXiv:math/0506136v2 [math.GT].
- [M] H. Masur, *Interval exchange transformations and measured foliations*. Ann. of Math., **115** (1982), 169-200.
- [MS] H. Masur, J. Smillie, *Hausdorff dimension of sets of nonergodic measured foliations*. Ann. of Math. **134** (1991), 455–543.
- [MT] H. Masur, S. Tabachnikov, *Rational billiards and flat structures*. Handbook of dynamical systems, **Vol. 1A**, North-Holland, Amsterdam, (2002), 1015-1089.
- [MZ] H. Masur, A. Zorich, *Multiple saddle connections on flat surfaces and the principal boundary of the moduli space of quadratic differentials*, arXiv:math/0402197v2 [math.GT], to appear in GAFA.
- [Mc] C. McMullen, *Dynamics of  $SL_2(\mathbb{R})$  over moduli space in genus two*. Ann. of Math., **165**, 397-456 (2007).
- [V1] W.A. Veech, *Gauss measures for transformations on the space of interval exchange maps*. Ann. of Math., **115**, 201-242 (1982).
- [V2] W.A. Veech, *The Teichmüller geodesic flow*. Ann. of Math., **124**, 441-530 (1986).
- [V3] W.A. Veech *Moduli spaces of quadratic differentials*, J. Analyse Math. **55** (1990), 117–171
- [Z] A. Zorich, *Flat Surfaces*. In collection “Frontiers in Number Theory, Physics and Geometry. Volume 1: On random matrices, zeta functions and dynamical systems”, P. Cartier; B. Julia; P. Moussa; P. Vanhove (Editors), Springer-Verlag, Berlin, (2006), 439-586.

IRMAR, UNIVERSITÉ RENNES 1, CAMPUS DE BEAULIEU, 35042 RENNES CEDEX, FRANCE

*E-mail address:* corentin.boissy@univ-rennes1.fr

## Chapitre 2

# Dégénérescences de différentielles quadratiques sur $\mathbb{CP}^1$

Le but principal de ce chapitre est d'établir une bijection naturelle entre l'ensemble des configurations de connexions de selles  $\hat{\text{homologues}}$  pour une strate sur  $\mathbb{CP}^1$  et les composantes connexes du complémentaire d'une « diagonale » naturelle de la strate. Cette diagonale  $\Delta$  est le sous-ensemble des surfaces ayant deux plus petites connexions de selles non  $\hat{\text{homologues}}$  ( $\Delta$  est fermé).

En annexe de ce chapitre se trouve une version plus détaillée, sous la forme d'un article en anglais. Cet article est soumis à une revue à comité de lecture.

**Définition 6.** Soit  $\mathcal{Q}(k_1, \dots, k_r)$  une strate de différentielles quadratiques et soit  $N \geq 1$ . On note  $\mathcal{Q}^N(k_1, \dots, k_r)$  l'ensemble des surfaces  $S$  de  $\mathcal{Q}(k_1, \dots, k_r)$  telles que, si  $\gamma$  est une plus petite connexion de selles et  $\gamma'$  un lien de selles non  $\hat{\text{homologue}}$  à  $\gamma$ , alors  $|\gamma'| > N|\gamma|$ .

En accord avec cette définition, on a  $\mathcal{Q}(k_1, \dots, k_r) \setminus \Delta = \mathcal{Q}^N(k_1, \dots, k_r)$  pour  $N = 1$ . Soit  $S$  une surface dans  $\mathcal{Q}^N(k_1, \dots, k_r)$ , on note  $\mathcal{F}_S$  l'ensemble des liens de selles  $\hat{\text{homologues}}$  à la plus petite connexion de selles de  $S$ . Cet ensemble  $\mathcal{F}_S$  est bien défini car deux plus petites connexions de selles sont nécessairement  $\hat{\text{homologues}}$ . Le lien entre configuration et composante connexe de  $\mathcal{Q}^N(k_1, \dots, k_r)$  est donné par le lemme suivant.

**Lemme.** *La configuration associée à  $\mathcal{F}_S$  est bien définie et localement constante par rapport aux variations de  $S$ .*

Tout le chapitre est ensuite articulé autour de la preuve du théorème suivant :

**Théorème 2.** *Soit  $\mathcal{Q}(k_1, k_2, \dots, k_r)$  une strate de différentielles quadratiques avec  $(k_1, k_2) \neq (-1, -1)$ , et telle que la strate  $\mathcal{Q}(k_1 + k_2, k_3, \dots, k_r)$  soit connexe. Soit  $\mathcal{C}$  l'ensemble des surfaces  $S$  dans  $\mathcal{Q}^N(k_1, \dots, k_r)$  pour lesquelles  $\mathcal{F}_S$  est constitué d'un seul lien de selles reliant une singularité d'ordre  $k_1$  à une singularité d'ordre  $k_2$ . Alors pour tout  $\delta > 0$  et tout  $N \geq 1$ , les ensembles  $\mathcal{C}$ ,  $\mathcal{C} \cap \mathcal{Q}_1(k_1, k_2, \dots, k_r)$ , et  $\mathcal{C} \cap \mathcal{Q}_{1,\delta}(k_1, k_2, \dots, k_r)$  sont connexes.*

Le théorème principal 2 découle ensuite de ce théorème (applicable ici car toute strate de différentielle quadratique sur  $\mathbb{C}\mathbb{P}^1$  est connexe) et de la liste des configurations pour les différentielles quadratiques en genre zéro.

## 2.1 Transport de trou

Soit  $(S, q)$  une surface plate à bord. On appelle *trou* une composante connexe de  $\partial S$  composé d'une seule connexion de selles. L'extrémité de cette connexion de selles est une singularité de bord. Quand l'angle est de  $3\pi$ , on dit que ce trou est *simple*.

Lorsqu'un trou simple  $\tau$  est vertical, il y a trois séparatrices horizontales partant de la singularité de bord correspondante. Il est facile de voir que  $(S, q)$  est d'holonomie triviale dans un voisinage de  $S$ . Quitte à choisir une racine carrée  $\omega$  de  $q$  dans un voisinage de  $\tau$ , on peut parler de direction « à droite » ou « à gauche ». Et on peut choisir par convention  $\omega$  de sorte qu'il y ait deux séparatrices horizontales sortant vers la droite et une seule vers la gauche.

Le transport de trou est une chirurgie consistant à déplacer un trou simple, sur sa droite ou sur sa gauche, par deux constructions (voir la figure 10 de l'annexe) : pour déplacer le trou le long d'un segment  $s$  attaché à la singularité de bord, et partant vers la droite, on considère le domaine  $\Omega$  de  $S$  obtenu comme l'union de segments parallèles à  $s$  et partant du trou. Lorsque  $\Omega$  est un parallélogramme plongé dans  $S$ , on peut l'enlever, puis recoller par translation les deux côtés parallèles à  $s$ . Pour déplacer un trou vers la gauche, cette construction échoue, il n'y a alors qu'un seul segment adjacent au trou, et parallèle à  $s$ . Dans ce cas, on effectue la procédure inverse, à savoir couper la surface le long de  $s$ , et lui inclure un parallélogramme.

Étant donné une surface sans bord, on peut toujours créer une paire de trous simples arbitrairement petits en coupant la surface le long d'un segment géodésique plongé, puis en incluant un parallélogramme comme précédemment.

De façon analogue, on peut déplacer un trou le long d'un chemin  $\mathcal{C}^1$  transverse au feuilletage vertical, comme le font Masur et Zorich [19] pour construire des surfaces réalisant certaines configurations de connexions de selles homologues (dans ce cas, ils s'appuient sur un résultat de Hubbard et Masur sur l'existence de chemins transverses utiles [8]). Ici, on étend pour des raisons techniques cette construction à des chemins non transverses.

On définit ici le transport de trou le long de chemins polygonaux simples (dans un premier temps). Puis on étudie la dépendance par rapport au choix du chemin lorsque cette construction est utilisée pour éclater une singularité conique en deux singularités coniques. Dans ce cadre, on montre que la surface résultante ne dépend pas des petites variations dans le choix du chemin (proposition 3.4 de l'annexe). On étudie également la dépendance par rapport à des choix de chemins très différents (lemme 4.4 de l'annexe).

## 2.2 Domaines de configuration simples

Le but de cette partie est de démontrer le théorème 2. Un domaine de configuration simple est une composante connexe de  $\mathcal{Q}^N(k_1, k_2, \dots, k_r)$  dont la configuration correspondante correspond à une connexion de selles simple (c'est à dire qu'aucune autre ne lui est homologue), et relie deux singularités distinctes.

On précise ici un peu la preuve du théorème 2. On introduit un sous-ensemble  $U^N$  de  $\mathcal{C}$  défini comme l'ensemble des surfaces construites à partir de  $\mathcal{Q}(k_1 + k_2, k_3, \dots, k_r)$  par la procédure d'éclatement d'une singularité d'ordre  $k_1 + k_2$  en deux singularités d'ordres respectifs  $k_1$  et  $k_2$ , et pour un paramètre continu suffisamment petit. La définition précise de  $U^N$  dépend de la procédure d'éclatement de singularité (locale ou non locale), et on renvoie à l'annexe pour les détails.

On montre les trois résultats suivants :

1. La connexité de  $\mathcal{Q}(k_1 + k_2, k_3, \dots, k_r)$  implique que  $U^N$  se trouve dans une seule composante connexe de  $\mathcal{C}$ .
2. Il existe  $L > N$  tel que  $\mathcal{Q}^L(k_1, k_2, \dots, k_r) \cap \mathcal{C} \subset U^N$ .
3. Quelque soit  $S \in \mathcal{C}$ , il existe un chemin dans  $\mathcal{C}$  reliant  $S$  à  $\mathcal{Q}^L(k_1, k_2, \dots, k_r)$ .

Ces trois propositions impliquent le théorème 2.



### 2.3 Domaines de configuration pour une strate sur $\mathbb{CP}^1$

Dans cette partie, on se limite aux différentielles quadratiques sur  $\mathbb{CP}^1$ . Pour montrer le théorème principal 2, il suffit de montrer que les sous-ensembles de  $\mathcal{Q}^N(k_1, k_2, \dots, k_r)$  associés à chaque configuration sont connexes. Le résultat de la section précédente s'applique pour les configurations correspondant à une connexion de selles simple reliant deux singularités distinctes. En effet, toute strate de différentielle quadratique sur  $\mathbb{CP}^1$  est connexe.

La liste des configurations possibles a été décrite dans le chapitre 1. On précise ici un peu la démonstration pour un autre type de configurations. Fixons une configuration réalisée par un lien de selles fermé simple  $\gamma$ . Alors l'extrémité de  $\gamma$  est une singularité de degré  $k \geq 2$ , et  $\gamma$  découpe  $S$  en deux surfaces  $S'_1$  et  $S'_2$ , ce qui induit une partition  $A_1 \sqcup A_2$  de  $\{k_1, \dots, k_r\} \setminus \{k\}$ . Chaque  $S'_i$  admet un bord composé d'un seul lien de selles et d'ordre de singularité de bord correspondante  $a_i$ .

Pour  $i$  valant 1 ou 2, on décompose  $\partial S'_i$  en deux segments de même longueur et partant de la singularité de bord. En identifiant ces deux segments par une isométrie appropriée, on obtient une surface plate  $S_i$  qui se trouve dans  $\mathcal{Q}^{2N-1}(A_i, a_i - 1, -1)$ , et dont la plus petite connexion de selles est simple et joint une singularité de degré  $a_i - 1$  à un pôle. On peut alors, par cette construction, se ramener au cas précédent. ■

Une strate de l'espace des modules n'est pas une variété en général, mais un orbifold. Le lieu des points orbifoldiques est en général compliqué. On montre ici le résultat suivant :

**Corollaire 3.** *Soit  $\mathcal{Q}(k_1, \dots, k_r)$  une strate de l'espace des modules des différentielles quadratiques sur  $\mathbb{CP}^1$ , et soit  $N \geq 1$ . Si un domaine de configuration de  $\mathcal{Q}^N(k_1, \dots, k_r)$  admet des points orbifoldiques, alors la configuration correspondante est symétrique et le lieu des points orbifoldiques correspondant est une union finie de copies (ou revêtements) de sous-ensembles ouverts de domaines de configuration dans des strates inférieures. Ces domaines de configuration sont eux-mêmes des variétés.*

On donne ici une esquisse de démonstration : un point de  $\mathcal{Q}(k_1, \dots, k_r)$  est orbifoldique si la surface plate  $S$  correspondante admet des isométries non triviales. Si on est dans  $\mathcal{Q}^N(k_1, \dots, k_r)$ , alors toute isométrie  $\tau$  doit fixer la famille  $\mathcal{F}_S$ , et on vérifie alors que  $S/\tau$  est encore une surface de demi-translation dans  $\mathcal{Q}^N(k'_1, \dots, k'_r)$ . De plus, on peut voir que  $S/\tau$  ne peut

### 2.3. DOMAINES DE CONFIGURATION POUR UNE STRATE SUR $\mathbb{C}P^1$ 79

pas admettre d'isométrie non triviale, car la configuration associée n'est pas symétrique.



## Annexe du chapitre 2



# DEGENERATIONS OF QUADRATIC DIFFERENTIALS ON $\mathbb{CP}^1$

CORENTIN BOISSY

ABSTRACT. We describe the connected components of the complement of a natural “diagonal” of real codimension 1 in a stratum of quadratic differentials on  $\mathbb{CP}^1$ . We establish a natural bijection between the set of these connected components and the set of generic configurations that appear on such “flat spheres”. We also prove that the stratum has only one topological end. Finally, we elaborate a necessary toolkit destined to evaluation of the Siegel-Veech constants.

## CONTENTS

1. Introduction	1
2. Families of quadratic differentials defined by an involution	9
3. Hole transport	15
4. Simple configuration domains	21
5. Configuration domains in strata of quadratic differentials on the Riemann sphere	28
Appendix. A geometric criterion for $\hat{\text{h}}$ omologous saddle connections	34
References	36

## 1. INTRODUCTION

The article deals with families of flat metric on surfaces of genus zero, where the flat metrics are assumed to have conical singularities,  $\mathbb{Z}/2\mathbb{Z}$  linear holonomy and a fixed vertical direction. The moduli space of such metrics is isomorphic to the moduli space of meromorphic quadratic differential on  $\mathbb{CP}^1$  with at most simple poles and is naturally stratified by the number of poles and by the orders of zeros of a quadratic differential.

Any stratum is non compact and a neighborhood of its boundary consists of flat surfaces that admit saddle connections of small length. The structure of the neighborhood of the boundary is also related to counting problems in a generic surface of the stratum (the “Siegel-Veech constants, see [EMZ] for the case of Abelian differentials).

---

2000 *Mathematics Subject Classification*. Primary: 32G15. Secondary: 30F30, 57R30.

*Key words and phrases*. Quadratic differentials, configurations,  $\hat{\text{h}}$ omologous saddle connections, Siegel-Veech constants.

When the length of a saddle connection tends to zero, some other saddle connections might also be forced to shrink. In the case of an Abelian differential this corresponds to homologous saddle connections. In the general case of quadratic differentials, the corresponding collections of saddle connections on a flat surface are said to be *homologous*<sup>1</sup> (pronounced “hat-homologous”). Configurations associated to collections of homologous saddle connections have been described for general strata in [MZ] and more specifically in genus zero and in hyperelliptic connected components in [B].

Usually, the study of the structure of the neighborhood of the boundary is restricted to a *thick part*, where all short saddle connections are pairwise homologous (see [MS], and also [EMZ, MZ]). Following this idea, we will consider the complement of the codimension 1 subset  $\Delta$  of flat surfaces that admit a pair of saddle connections that are both of minimal length, but which are not homologous.

For a flat surface in the complement of  $\Delta$ , we can define the configuration of the maximal collection of homologous saddle connections that contains the smallest saddle connection of the surface. This defines a locally constant map outside  $\Delta$  (see section 5 for more details).

We will prove the following result.

**Main Theorem.** *Let  $\mathcal{Q}_1(k_1, \dots, k_r)$  be a stratum of quadratic differentials on  $\mathbb{CP}^1$  with at most simple poles. There is a natural bijection between the configurations of homologous saddle connections existing in that stratum and the connected components of  $\mathcal{Q}_1(k_1, \dots, k_r) \setminus \Delta$ .*

We will call the connected components of  $\mathcal{Q}_1(k_1, \dots, k_r) \setminus \Delta$  the *configuration domains* of the stratum. These configuration domains might be interesting to the extent that they are “almost” manifolds in the following sense:

**Corollary 1.1.** *Let  $\mathcal{D}$  be a configuration domain of a stratum of quadratic differentials on  $\mathbb{CP}^1$ . If  $\mathcal{D}$  admits orbifoldic points, then the corresponding configuration is symmetric and the locus of such orbifoldic points are unions of copies (or coverings) of submanifolds of smaller strata.*

Restricting ourselves to the neighborhood of the boundary, we show that these domains have one topological end.

**Proposition 1.2.** *Let  $\mathcal{D}$  be a configuration domain of a stratum of quadratic differentials on  $\mathbb{CP}^1$ . Let  $\mathcal{Q}_{1,\delta}(k_1, \dots, k_r)$  be the subset of the stratum corresponding to area one surfaces with at least a saddle connection of length less than  $\delta$ . Then  $\mathcal{D} \cap \mathcal{Q}_{1,\delta}(k_1, \dots, k_r)$  is connected for all  $\delta > 0$ .*

**Corollary 1.3.** *Any stratum of quadratic differentials on  $\mathbb{CP}^1$  has only one topological end.*

---

<sup>1</sup>The corresponding cycles are in fact homologous on the canonical double cover of  $S$ , usually denoted as  $\hat{S}$ , see section 1.2.

*Acknowledgements.* I would like to thank Anton Zorich for encouraging me to write this paper, and for many discussions. I also thank Erwan Lanneau and Pascal Hubert for their useful comments.

**1.1. Basic definitions.** Here we first review standart facts about moduli spaces of quadratic differentials. We refer to [HM, M, V1] for proofs and details, and to [MT, Z] for general surveys.

Let  $S$  be a compact Riemann surface of genus  $g$ . A quadratic differential  $q$  on  $S$  is locally given by  $q(z) = \phi(z)dz^2$ , for  $(U, z)$  a local chart with  $\phi$  a meromorphic function with at most simple poles. We define the poles and zeroes of  $q$  in a local chart to be the poles and zeroes of the corresponding meromorphic function  $\phi$ . It is easy to check that they do not depend on the choice of the local chart. Slightly abusing notations, a marked point on the surface (*resp.* a pole) will be referred to as a zero of order 0 (*resp.* a zero of order  $-1$ ). An Abelian differential on  $S$  is a holomorphic 1-form.

Outside its poles and zeros,  $q$  is locally the square of an Abelian differential. Integrating this 1-form gives a natural atlas such that the transition functions are of the kind  $z \mapsto \pm z + c$ . Thus  $S$  inherits a flat metric with singularities, where a zero of order  $k \geq -1$  becomes a conical singularity of angle  $(k+2)\pi$ . The flat metric has trivial holonomy if and only if  $q$  is globally the square of any Abelian differential. If not, then the holonomy is  $\mathbb{Z}/2\mathbb{Z}$  and  $(S, q)$  is sometimes called a *half-translation* surface since transition surfaces are either half-turns, or translations. In order to simplify the notation, we will usually denote by  $S$  a surface with a flat structure.

We can associate to a quadratic differential the set with multiplicities  $\{k_1, \dots, k_r\}$  of orders of its poles and zeros. The Gauss-Bonnet formula asserts that  $\sum_i k_i = 4g - 4$ . Conversely, if we fix a collection  $\{k_1, \dots, k_r\}$  of integers, greater than or equal to  $-1$  satisfying the previous equality, we denote by  $\mathcal{Q}(k_1, \dots, k_r)$  the (possibly empty) moduli space of quadratic differential which are not globally squares of Abelian differential, and which have  $\{k_1, \dots, k_r\}$  as orders of poles and zeros. It is well known that  $\mathcal{Q}(k_1, \dots, k_r)$  is a complex analytic orbifold, which is usually called a *stratum* of the moduli space of quadratic differentials on a Riemann surface of genus  $g$ . We usually restrict ourselves to the subspace  $\mathcal{Q}_1(k_1, \dots, k_r)$  of area one surfaces, where the area is given by the flat metric. In a similar way, we denote by  $\mathcal{H}_1(n_1, \dots, n_s)$  the moduli space of Abelian differentials of area 1 having zeroes of degree  $\{n_1, \dots, n_s\}$ , where  $n_i \geq 0$  and  $\sum_{i=1}^s n_i = 2g - 2$ .

There is a natural action of  $SL_2(\mathbb{R})$  on  $\mathcal{Q}(k_1, \dots, k_r)$  that preserve its stratification: let  $(U_i, \phi_i)_{i \in I}$  is a atlas of flat coordinates of  $S$ , with  $U_i$  open subset of  $S$  and  $\phi_i(U_i) \subset \mathbb{R}^2$ . An atlas of  $A.S$  is given by  $(U_i, A \circ \phi_i)_{i \in I}$ . The action of the diagonal subgroup of  $SL_2(\mathbb{R})$  is called the Teichmüller geodesic flow. In order to specify notations, we denote by  $g_t$  and  $r_\theta$  the following



matrix of  $SL_2(\mathbb{R})$ :

$$g_t = \begin{bmatrix} e^{\frac{t}{2}} & 0 \\ 0 & e^{-\frac{t}{2}} \end{bmatrix} \quad r_\theta = \begin{bmatrix} \cos(\theta) & \sin(\theta) \\ -\sin(\theta) & \cos(\theta) \end{bmatrix}$$

A saddle connection is a geodesic segment (or geodesic loop) joining two singularities (or a singularity to itself) with no singularities in its interior. Even if  $q$  is not globally a square of an Abelian differential we can find a square root of it along the saddle connection. Integrating it along the saddle connection we get a complex number (defined up to multiplication by  $-1$ ). Considered as a planar vector, this complex number represents the affine holonomy vector along the saddle connection. In particular, its euclidean length is the modulus of its holonomy vector. Note that a saddle connection persists under any small deformation of the surface.

Local coordinates for a stratum of Abelian differential are obtained by integrating the holomorphic 1-form along a basis of the relative homology  $H_1(S, \text{sing}, \mathbb{Z})$ , where  $\text{sing}$  denote the set of conical singularities of  $S$ . Equivalently, this means that local coordinates are defined by the relative cohomology  $H^1(S, \text{sing}, \mathbb{C})$ .

Local coordinates in a stratum of quadratic differentials are obtained in the following way: one can naturally associate to a quadratic differential  $(S, q) \in \mathcal{Q}(k_1, \dots, k_r)$  a double cover  $p: \widehat{S} \rightarrow S$  such that  $p^*q$  is the square of an Abelian differential  $\omega$ . The surface  $\widehat{S}$  admits a natural involution  $\tau$ , that induces on the relative cohomology  $H^1(\widehat{S}, \text{sing}, \mathbb{C})$  an involution  $\tau^*$ . It decomposes  $H^1(\widehat{S}, \text{sing}, \mathbb{C})$  into a invariant subspace  $H_+^1(\widehat{S}, \text{sing}, \mathbb{C})$  and an anti-invariant subspace  $H_-^1(\widehat{S}, \text{sing}, \mathbb{C})$ . One can show that the anti-invariant subspace  $H_-^1(\widehat{S}, \text{sing}, \mathbb{C})$  gives local coordinates for the stratum  $\mathcal{Q}(k_1, \dots, k_r)$ .

**1.2. Homologous saddle connections.** Let  $S \in \mathcal{Q}(k_1, \dots, k_r)$  be a flat surface and denote by  $p: \widehat{S} \rightarrow S$  its canonical double cover and  $\tau$  its corresponding involution. Let  $\Sigma$  be the set of singularities of  $S$  and  $\widehat{\Sigma} = p^{-1}(\Sigma)$ .

To an oriented saddle connection  $\gamma$  on  $S$ , we can associate  $\gamma_1$  and  $\gamma_2$  its preimages by  $p$ . If the relative cycles  $[\gamma_1]$  and  $[\gamma_2]$  in  $H_1(\widehat{S}, \widehat{\Sigma}, \mathbb{Z})$  satisfy  $[\gamma_1] = -[\gamma_2]$ , then we define  $[\hat{\gamma}] = [\gamma_1]$ . Otherwise, we define  $[\hat{\gamma}] = [\gamma_1] - [\gamma_2]$ . Note that in all cases, the cycle  $[\hat{\gamma}]$  is anti-invariant with respect to the involution  $\tau$ .

**Definition 1.4.** Two saddle connections  $\gamma$  and  $\gamma'$  are homologous if  $[\hat{\gamma}] = \pm[\hat{\gamma}']$ .

*Example 1.5.* Consider the flat surface  $S \in \mathcal{Q}(-1, -1, -1, -1)$  given in Figure 1 (a ‘‘pillowcase’’), it is easy to check from the definition that  $\gamma_1$  and  $\gamma_2$  are homologous since the corresponding cycles for the double cover  $\widehat{S}$  are homologous.

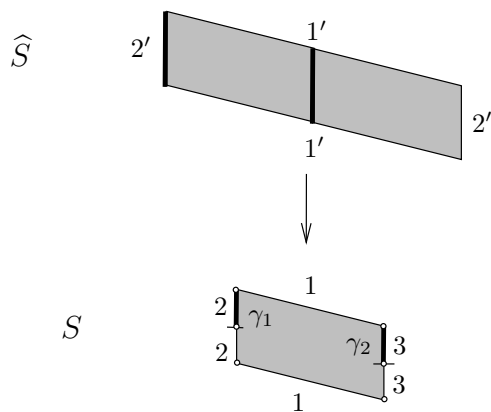

FIGURE 1. An unfolded flat surface  $S$  with two  $\hat{h}$ omologous saddle connections  $\gamma_1$  and  $\gamma_2$ .

*Example 1.6.* Consider the flat surface given in Figure 2, the reader can check that the saddle connections  $\gamma_1, \gamma_2$  and  $\gamma_3$  are pairwise  $\hat{h}$ omologous.

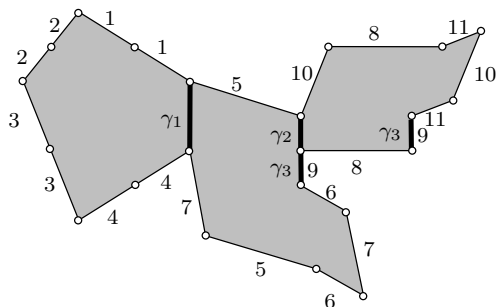

FIGURE 2. Unfolded flat surface with three  $\hat{h}$ omologous saddle connections  $\gamma_1, \gamma_2$ , and  $\gamma_3$ .

The following theorem is due to Masur and Zorich [MZ]. It gives in particular a simple geometric criterion for deciding whether two saddle connections are  $\hat{h}$ omologous. We give in the appendix an alternative proof.

**Theorem** (H. Masur, A. Zorich). *Consider two distinct saddle connections  $\gamma, \gamma'$  on a half-translation surface. The following assertions are equivalent:*

- *The two saddle connections  $\gamma$  and  $\gamma'$  are  $\hat{h}$ omologous.*
- *The ratio of their length is constant under any small deformation of the surface inside the ambient stratum.*
- *They have no interior intersection and one of the connected component of  $S \setminus \{\gamma \cup \gamma'\}$  has trivial linear holonomy.*

*Furthermore, if  $\gamma$  and  $\gamma'$  are  $\hat{h}$ omologous, then the ratio of their length belongs to  $\{1/2, 1, 2\}$  and they are parallel.*

A saddle connection  $\gamma_1$  will be called *simple* if they are no other saddle connections homologous to  $\gamma_1$ . Now we consider a set of homologous saddle connections  $\gamma = \{\gamma_1, \dots, \gamma_s\}$  on a flat surface  $S$ . Slightly abusing notation, we will denote by  $S \setminus \gamma$  the subset  $S \setminus (\cup_{i=1}^s \gamma_i)$ . This subset is a finite union of connected half-translation surfaces with boundary. We define a graph  $\Gamma(S, \gamma)$  called the graph of connected components in the following way (see [MZ]): the vertices are the connected components of  $S \setminus \gamma$ , labelled as “o” if the corresponding surface is a cylinder, as “+” if it has trivial holonomy (but is not a cylinder), and as “-” if it has non-trivial holonomy. The edges are given by the saddle connections in  $\gamma$ . Each  $\gamma_i$  is on the boundary of one or two connected components of  $S \setminus \gamma$ . In the first case it becomes an edge joining the corresponding vertex to itself. In the second case, it becomes an edge joining the two corresponding vertices.

Each connected components of  $S \setminus \gamma$  is a non-compact surface but can be naturally compactified (for example considering the distance induced by the flat metric on a connected component of  $S \setminus \gamma$ , and the corresponding completion). We denote this compactification by  $S_j$ . We warn the reader that  $S_j$  might differ from the closure of the component in the surface  $S$ : for example, if  $\gamma_i$  is on the boundary of just one connected component  $S_j$  of  $S \setminus \gamma$ , then the compactification of  $S_j$  contains two copies of  $\gamma_i$  in its boundary, while in the closure of  $S_j$  these two copies are identified. The boundary of each  $S_i$  is a union of saddle connections; it has one or several connected components. Each of them is homeomorphic to  $\mathbb{S}^1$  and therefore the orientation of  $S$  defines a cyclic order in the set of boundary saddle connections. Each consecutive pair of saddle connections for that cyclic order defines a *boundary singularity* with an associated angle which is a integer multiple of  $\pi$  (because the boundary saddle connections are parallel). The surface with boundary  $S_i$  might have singularities in its interior. We call them *interior singularities*.

**Definition 1.7.** Let  $\gamma = \{\gamma_1, \dots, \gamma_r\}$  be a maximal collection of homologous saddle connections on a flat surface. A *configuration* is the following combinatorial data:

- The graph  $\Gamma(S, \gamma)$
- For each vertex of this graph, a permutation of the edges adjacent to the vertex (encoding the cyclic order of the saddle connections on each connected component of the boundary of the  $S_i$ ).
- For each pair of consecutive elements in that cyclic order, the angle between the two corresponding saddle connections.
- For each  $S_i$ , a collection of integers that are the orders of the interior singularities of  $S_i$ .

We refer to [MZ] for a more detailed definition of a configuration (see also [B]).

**1.3. Neighborhood of the boundary, thick-thin decomposition.** For any compact subset  $K$  of a stratum, there exists a constant  $c_K$  such that the length of any saddle connection of any surface in  $K$  is greater than  $c_K$ . Therefore, we can define the  $\delta$ -neighborhood of the boundary of the stratum to be the subset of area 1 surfaces that admit a saddle connection of length less than  $\delta$ .

According to Masur and Smillie [MS], one can split the  $\delta$ -neighborhood of the boundary of a stratum into a *thin part* (of negligibly small measure) and a *thick part*. The thin part being for example the subset of surfaces with a pair of nonhomologous saddle connections of length respectively less than  $\delta$  and  $N\delta$ , for some fixed  $N \geq 1$  (the decomposition depends on the choice of  $N$ ). We also refer to [EMZ] for the case of Abelian differentials and to [MZ] for the case of quadratic differentials.

Let  $N \geq 1$ , we consider  $\mathcal{Q}^N(k_1, k_2, \dots, k_r)$  the subset of flat surfaces such that, if  $\gamma_1$  is the shortest saddle connection and  $\gamma'_1$  is another saddle connection nonhomologous to  $\gamma_1$ , then  $|\gamma'_1| > N|\gamma_1|$ . Similarly, we define  $\mathcal{Q}_1^N(k_1, k_2, \dots, k_r)$  to be the intersection of  $\mathcal{Q}^N(k_1, k_2, \dots, k_r)$  with the subset of area 1 flat surfaces.

For any surface in  $\mathcal{Q}^N(k_1, k_2, \dots, k_r)$ , we can define a maximal collection  $\mathcal{F}$  of homologous saddle connections that contains the smallest one. This is well defined because if there exists two smallest saddle connections, they are necessary homologous. We will show in section 5 the associated configuration defines a locally constant map from  $\mathcal{Q}_1^N(k_1, k_2, \dots, k_r)$  to the space of configurations. This leads to the following definition:

**Definition 1.8.** A *configuration domain* of  $\mathcal{Q}_1(k_1, \dots, k_r)$  is a connected component of  $\mathcal{Q}_1^N(k_1, \dots, k_r)$ .

*Remark 1.9.* The previous definition of a configuration domain is a little more general than the one stated in the introduction that corresponds to the case  $N = 1$ .

**Definition 1.10.** An *end* of a locally compact topological space  $W$  is a function

$$\epsilon : \{K, K \subset W \text{ is compact}\} \rightarrow \{X, X \subset W\}$$

such that:

- $\epsilon(K)$  is a (unbounded) component of  $W \setminus K$  for each  $K$
- if  $K \subset L$ , then  $\epsilon(L) \subset \epsilon(K)$ .

**Proposition.** *If  $W$  is  $\sigma$ -compact, then the number of ends of  $W$  is the maximal number of unbounded components of  $W \setminus K$ , for  $K$  compact, when the number is bounded.*

We refer to [HR] for more details on the ends of a space.

**1.4. Example on the moduli space of flat torus.** If  $T$  is a flat torus (*i.e.* a Riemann surface with an Abelian differential  $\omega$ ), then, up to rescaling  $\omega$ ,

we can assume that the holonomy vector of the shortest geodesic is 1. Then, choosing a second smallest non horizontal geodesic with a good choice of its orientation, this defines a complex number  $z = x + iy$ , with  $y > 0$ ,  $-1/2 \leq x \leq 1/2$  and  $|z| \geq 1$ . The corresponding domain  $\mathcal{D}$  in  $\mathbb{C}$  is a fundamental domain of  $\mathbb{H}/SL_2(\mathbb{Z})$ .

It is well known that this defines an map from the moduli space of flat torus with trivial holonomy (*i.e.*  $\mathcal{H}(\emptyset)$ ), to  $\mathbb{H}/SL_2(\mathbb{Z})$  which is a bundle, with  $\mathbb{C}^*$  as fiber. Orbifoldic points of  $\mathcal{H}(\emptyset)$  are over the complex number  $z_1 = i$  and  $z_2 = \frac{1+i\sqrt{3}}{2}$ . They correspond to Abelian differential on torus obtained by identifying the opposite sides of a square, or a regular hexagon.

Now with this representation,  $\mathcal{H}^N(\emptyset)$  is obtained by restricting ourselves to the subdomain  $\mathcal{D}^N = \mathcal{D} \cup \{z, |z| > N\}$  (see Figure 3). This subdomain contains neither  $z_1$  nor  $z_2$ , so  $\mathcal{H}^N(\emptyset)$  is a manifold. In the extreme case  $N = 1$ , the codimension one subset  $\Delta$  is an arc joining  $z_1$  to  $z_2$ .

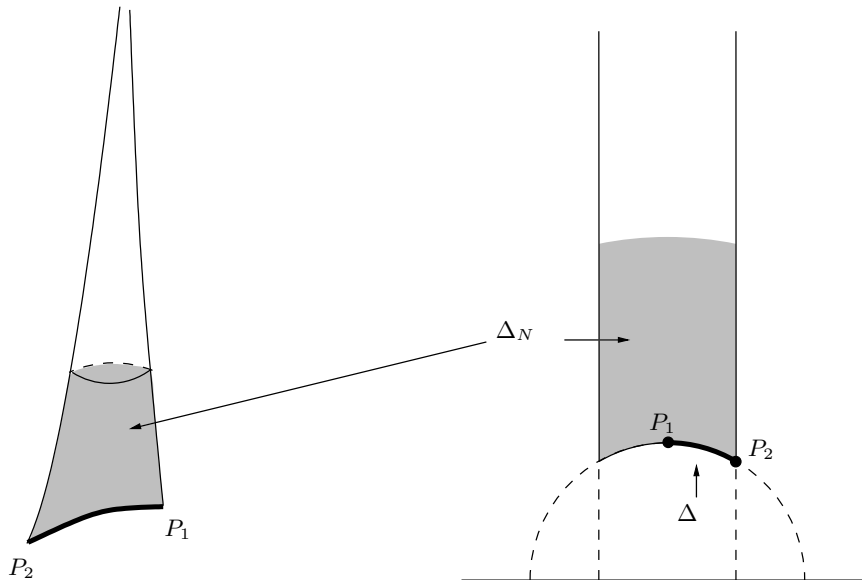

FIGURE 3. Configuration domain in  $\mathcal{H}(\emptyset)$ .

1.5. **Reader's guide.** Now we sketch the proof of the Main Theorem.

- (1) We first prove the theorem for the case of configuration domains defined by a simple saddle connection (we will refer to these configuration domains as *simple*). We will explain how we can shrink a simple saddle connection, when its length is small enough (therefore, describe the structure of the stratum in a neighborhood of an adjacent one). This is done in section 4.

There is one easy case, when the shrinking process is done by local and canonical surgeries. The other case involves some non-local surgeries (hole transport) that depend on a choice of a path. We will have to describe the dependence of the choice of the path. More details on these surgeries appear in section 3.

- (2) The list of configurations was established by the author in [B]. The second step of the proof is to consider each configuration and to show that the subset of surface associated to this configuration is connected. This will be done in section 5 and will use the “simple case”.

## 2. FAMILIES OF QUADRATIC DIFFERENTIALS DEFINED BY AN INVOLUTION

Consider a polygon whose sides come by pairs, and such that, for each pair, the corresponding sides are parallel and have the same length. Then identifying these pair of sides by appropriate isometries, this gives a flat surface. In this section we show that any flat surface can arise from such a polygon and give an explicit construction. We end by a technical lemma that will be one of the key arguments of Theorem 4.2.

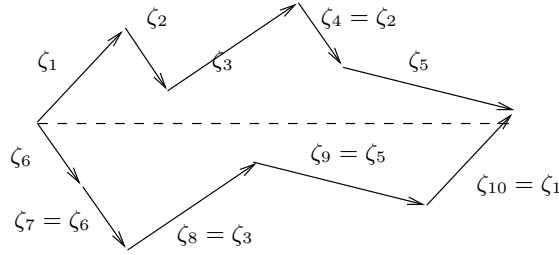

FIGURE 4. Flat surface unfolded into a polygon.

**2.1. Constructions of a flat surface.** Let  $\sigma$  be an involution of the set  $\{1, \dots, l+m\}$ , without fixed points.

We denote by  $Q_{\sigma,l}$  the set of  $\zeta = (\zeta_1, \dots, \zeta_{l+m}) \in \mathbb{C}^{l+m}$  such that:

- (1)  $\forall i \quad \zeta_i = \zeta_{\sigma(i)}$
- (2)  $\forall i \quad \operatorname{Re}(\zeta_i) > 0$ .
- (3)  $\forall 1 \leq i \leq l-1 \quad \operatorname{Im}(\sum_{k \leq i} \zeta_k) > 0$
- (4)  $\forall 1 \leq j \leq m-1 \quad \operatorname{Im}(\sum_{1 \leq k \leq j} \zeta_{l+k}) < 0$
- (5)  $\sum_{k \leq l} \zeta_k = \sum_{1 \leq k \leq m} \zeta_{l+k}$ .

Note that  $Q_{\sigma,l}$  is convex and might be empty for some  $\sigma$ . Now we will construct a map  $ZR$  from  $Q_{\sigma,l}$  to the moduli space of quadratic differentials. Slightly abusing conventional terminology, we will call a surface in  $ZR(Q_{\sigma,l})$  a *suspension* over  $(\sigma, l)$ , and a vector in  $Q_{\sigma,l}$  is then a *suspension data*.

Furthermore, since  $Q_{\sigma,l}$  is convex, the connected component of the stratum is uniquely determined by  $(\sigma, l)$ .

*Easy case.* Now we consider a broken line  $L_1$  whose edge number  $i$  ( $1 \leq i \leq l$ ) is represented by the complex number  $\zeta_i$ . Then we consider a second broken line  $L_2$  which starts from the same point, and whose edge number  $j$  ( $1 \leq j \leq m$ ) is represented by  $\zeta_{l+j}$ . The last condition implies that these two lines also end at the same point. If they have *no other intersection points*, then they form a polygon (see Figure 4). The sides of the polygon, enumerated by indices of the corresponding complex number, naturally come by pairs according to the involution  $\sigma$ . Gluing these pair of sides by isometries respecting the natural orientation of the polygon, this construction defines a flat surface which have trivial or non-trivial holonomy.

For this case, we will say that the suspension data defines a *suitable* polygon.

*First return map on a horizontal segment.* Let  $S$  be a flat surface and  $X$  be a horizontal segment with a choice of a positive vertical direction (or equivalently, a choice of left and right ends). We consider the first return map  $T_1 : X \rightarrow X$  for geodesics starting from  $X$  in the positive direction (with speed one). Any such geodesic which is infinite will intersect  $X$  again. Therefore, the map  $T_1$  is well defined outside a finite number of points that correspond to vertical geodesics that stop at a singularity before intersecting the interval  $X$  again. This set  $X \setminus \{sing\}$  is a finite union  $X_1, \dots, X_l$  of open intervals and the restriction of  $T_1$  on each  $X_i$  is of the kind  $x \mapsto \pm x + c_i$ . For each  $i$ , the first return time for the vertical geodesics starting from  $X_i$  (in the positive direction) is constant. Similarly, we define  $T_2$  to be the first return map for geodesics in the negative direction and denote by  $X_{l+1}, \dots, X_{l+m}$  the corresponding intervals. Remark that for  $i \leq l$  (resp.  $i > l$ ),  $T_1(X_i) = X_j$  (resp.  $T_2(X_i) = X_j$ ) for some  $1 \leq j \leq l + m$ . Therefore,  $(T_1, T_2)$  induce a permutation  $\sigma_X$  of  $\{1, l + m\}$ , and it is easy to check that  $\sigma_X$  is an involution without fixed points. When  $S$  is a translation surface,  $T_2 = T_1^{-1}$  and  $T_1$  is called an *interval exchange transformation*.

If  $S \in ZR(Q_{\sigma,l})$ , constructed as previously, we choose  $X$  to be the horizontal line whose left end is the starting point of the broken lines, and of length  $Re(\sum_{k \leq l} \zeta_k)$ . Then it is easy to check that  $\sigma_X = \sigma$ .

*Veech zippered rectangle construction.* The broken lines  $L_1$  and  $L_2$  might intersect at other points (see Figure 5). However, we can still define a flat surface by using an analogous construction as the well known zippered rectangles construction due to Veech. We give a description of this construction and refer to [V1, Y] for the case of Abelian differentials. This construction is very similar to the usual one, although its precise description is quite technical. Still, for completeness, we give an equivalent but rather implicit formulation.

We first consider the previous case when  $L_1$  and  $L_2$  define an suitable polygon. For each pair of interval  $X_i, X_{\sigma(i)}$  on  $X$ , the return time  $h_i = h_{\sigma(i)}$  for the corresponding geodesics starting from  $x \in X_i$  and returning in  $y \in X_{\sigma(i)}$  is constant. This value depends only on  $(\sigma, l)$  and on the imaginary

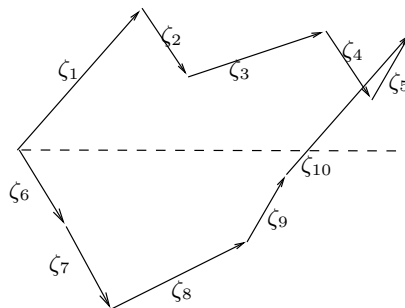

FIGURE 5. Suspension data that does not give a “suitable” polygon.

part of  $\zeta$ . For each pair  $\alpha = \{i, \sigma(i)\}$  there is a natural embedding of the open rectangle  $R_\alpha = (0, \operatorname{Re}(\zeta_i)) \times (0, h_i)$  into the flat surface  $S$  (see Figure 6). For each  $R_\alpha$ , we glue a horizontal side to  $X_i$  and the other to  $X_{\sigma(i)}$ . The surface  $S$  is then obtained after suitable identifications of the vertical sides of the the rectangles  $\{R_\alpha\}_\alpha$ . These vertical identifications only depend on  $(\sigma, l)$  and on the imaginary part of  $\zeta$ .

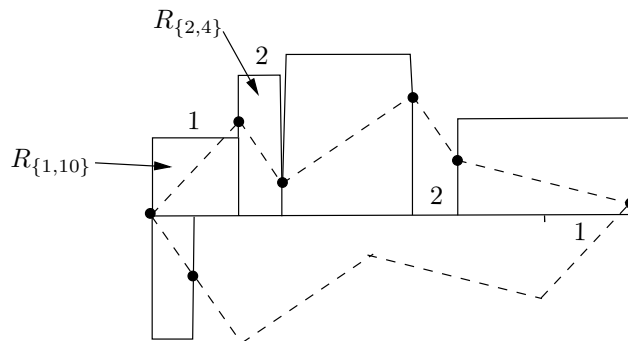

FIGURE 6. Zippered rectangle construction, for the case the flat surface of Figure 4.

For the general case, we construct the rectangles  $\{R_\alpha\}_\alpha$  by using the same formulas. Identifications for the horizontal sides are straightforward. Identifications for the vertical sides do not depends on the horizontal parameters, and will be the same as for a suspension data  $\zeta'$  that have the same imaginary part as  $\zeta$ , but which correspond to a suitable polygon. This will be well defined after the following lemma.

**Lemma 2.1.** *Let  $\zeta$  be a collection of complex numbers in  $Q_{\sigma,l}$  then there exists  $\zeta' \in Q_{\sigma,l}$  with the same imaginary part as  $\zeta$ , that defines a suitable polygon.*

*Proof.* We can assume that  $\sum_{k=1}^l \operatorname{Im}(\zeta_k) > 0$  (the negative case is analogous and there is nothing to prove when the sum is zero). If we find



a suspension data  $\zeta'$  with the same imaginary part as  $\zeta$ , and such that  $Re(\zeta'_{l+m}) < Re(\zeta'_l) + \varepsilon$ , for  $\varepsilon$  small enough. Then such suspension data defines a suitable polygon.

It is clear that  $\sigma(l+m) \neq l$  otherwise there would be no possible suspension data. If  $\sigma(l+m) < l$ , then we can shorten the real part of  $\zeta_{l+m}$  and of  $\zeta_{\sigma(l+m)}$ , keeping conditions (1)–(5) satisfied, and get a suspension data  $\zeta'$  with the same imaginary part as  $\zeta$ , and such that  $Re(\zeta'_{l+m})$  is less than  $Re(\zeta'_l)$ . This last condition implies that  $\zeta'$  defines a suitable polygon.

Similarly, if  $\sigma(l) > l$ , then one can freely increase the real part of  $\zeta_l$  and  $\zeta_{\sigma(l)}$ , keeping conditions (1)–(5) satisfied and get a suspension data  $\zeta'$  with the same imaginary part as  $\zeta$ , and such that  $\zeta'$  defines a suitable polygon.

Now we assume that  $\sigma(l+m) > l$ . If there exists  $i, \sigma(i) > l$ , such that  $\{i, \sigma(i)\} \neq \{l+m, \sigma(l+m)\}$ , then we define  $\zeta'$  by decreasing arbitrarily the real part of the corresponding  $\zeta_{l+m}, \zeta_{\sigma(l+m)}$ , and increasing the real parts of  $\zeta_i, \zeta_{\sigma(i)}$  such that the sum  $\sum_{l < k \leq l+m} \zeta_k$  is constant. More precisely:

$$\begin{aligned} Re(\zeta'_{l+m}) &= Re(\zeta'_{\sigma(l+m)}) = x \\ Re(\zeta'_i) &= Re(\zeta'_{\sigma(i)}) = Re(\zeta_i) + Re(\zeta_{l+m}) - x \\ Re(\zeta'_k) &= Re(\zeta_k) \text{ for all } k \notin \{i, \sigma(i), l+m, \sigma(l+m)\} \\ Im(\zeta'_k) &= Im(\zeta_k) \text{ for all } k. \end{aligned}$$

Then  $\zeta'$  satisfy condition (1)–(5) and defines a suitable polygon for instance for  $x < \zeta_l$ .

The last remaining case corresponds to when  $\{l+m, \sigma(l+m)\}$  is the only pair  $\{k, \sigma(k)\}$  such that  $k, \sigma(k) > l$ , and when  $\sigma(l) < l$ . There exists  $i_0, \sigma(i_0) < l$ , such that  $\{i_0, \sigma(i_0)\} \neq \{l, \sigma(l)\}$  otherwise condition (5) implies that  $\zeta_l = \zeta_{l+m}$ , and  $\zeta$  is not a suspension data. Now for each pair  $\{i, \sigma(i)\}$ , with  $i, \sigma(i) < l$  and different from  $\{l, \sigma(l)\}$  we can shorten arbitrarily the real part of the corresponding  $\zeta_i, \zeta_{\sigma(i)}$ , and increase the real parts of  $\zeta_l, \zeta_{\sigma(l)}$  such that the sum  $\sum_{k \leq l} \zeta_k$  is constant, in a similar way as previously. If we do this operation for each pair  $i, \sigma(i) < l$ , then we get a new suspension data  $\zeta'$  such that  $Re(\zeta'_{l+m}) < Re(\zeta'_l) + \varepsilon$ , for  $\varepsilon$  arbitrarily small. This gives a suitable polygon.  $\square$

**2.2. The converse: construction of suspension data from a flat surface.** Now we give a sufficient condition for a surface to be in some  $Q_{\sigma,l}$ . Note that an analogous construction for hyperelliptic flat surfaces has been done in [V2].

**Proposition 2.2.** *Let  $S$  be a flat surface with no vertical saddle connection. There exists an involution  $\sigma$  and an integer  $l$  such that  $S \in ZR(Q_{\sigma,l})$ .*

*Proof.* Let  $X$  be a horizontal segment whose left end is a singularity. Up to cutting  $X$  on the right, we can assume that the vertical geodesic starting from its right end hits a singularity before meeting  $X$  again.

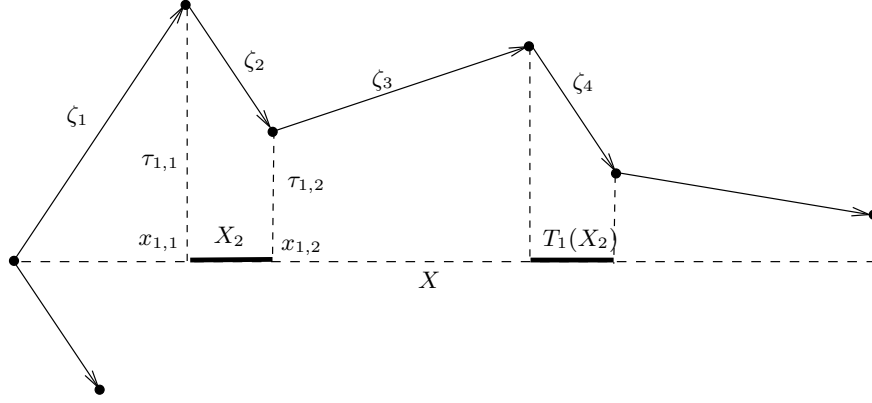

FIGURE 7. Construction of a polygon from a surface.

Let  $x_{1,1} < \dots < x_{1,l-1}$  be the points of discontinuity of  $T_1$  and  $(x_{1,0}, x_{1,l})$  be the endpoints of  $X$ . For each positive  $k$ , there exists  $\tau_{1,k} > 0$  such that the vertical geodesic starting from  $x_{1,k}$  in the positive direction stops at a singularity at time  $\tau_{1,k}$  (here  $\tau_{1,0} = 0$ , since by convention  $x_{1,0}$  is located at a singularity). Then for  $k \geq 1$  we define  $\zeta_k : (x_{1,k} - x_{1,k-1}) + i(\tau_{1,k} - \tau_{1,k-1})$ . Now we perform a similar construction for geodesics that starts in the negative direction: let  $x_{2,1} < \dots < x_{2,m-1}$  be the points of discontinuity of  $T_2$  and  $(x_{2,0}, x_{2,m})$  be the extremities of  $X$ . For each  $k \notin \{0, m\}$ , the vertical geodesic starting from  $x_{2,k}$  in the positive direction stops at a singularity at time  $\tau_{2,k} < 0$  (here again  $\tau_{2,0} = 0$  and  $\tau_{2,l} > 0$ ). For  $1 \leq k \leq m$ , we define  $\zeta_{k+l} : (x_{2,k} - x_{2,k-1}) + i(\tau_{2,k} - \tau_{2,k-1})$ . So, we have a collection of complex numbers  $\zeta_{l+1}, \dots, \zeta_{m+l}$  that defines a polygon  $\mathcal{P}$ .

We have always  $Re(\zeta_k) = Re(\zeta_{\sigma_X(k)}) = |X_k|$ . Let  $1 \leq k \leq l$ . If  $\sigma_X(k) \leq l$ , then  $\tau_{1,k-1} + \tau_{1,\sigma_X(k)} = \tau_{1,k} + \tau_{1,\sigma_X(k)-1} = h_k$  (with  $h_k$  the time of first return to  $X$  for the vertical geodesics starting from the subinterval  $X_k$ ), otherwise there would exist a vertical saddle connection (see Figure 8). So  $Im(\zeta_k) = Im(\zeta_{\sigma_X(k)})$ . The other cases are analogous. Thus  $\zeta$  is a suspension data, and  $ZR(\zeta)$  is isometric to  $S$ .  $\square$

*Remark 2.3.* In the previous construction, the suspension data constructed does not necessary give a suitable polygon. However, a sufficient condition to get a suitable polygon is to have  $\tau_{1,l} = \min(\tau_{1,k}, 0 < k \leq l)$ , were  $\tau_{1,k}$  are as in the proof of the previous proposition. Up to choosing carefully a subinterval  $X'$  of  $X$ , this condition is satisfied and the construction will give a true polygon. Since for any surface, we can find a direction with no saddle connection, we can conclude that any surface can be unfolded into a polygon as in Figure 4, up to rotating that polygon.

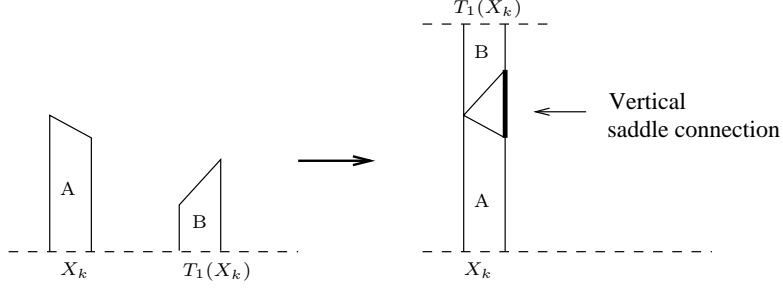

FIGURE 8. The complex numbers  $\zeta_k$  and  $\zeta_{\sigma_X(k)}$  are necessary equal.

**2.3. A technical lemma.** The following lemma is a technical lemma that will be needed in section 4.2. It can be skipped in a first reading. We previously showed that a surface with no vertical saddle connection belongs to some  $ZR(Q_{\sigma,l})$ . Furthermore, the corresponding pair  $(\sigma, l)$  is completely defined by first return maps of the vertical foliation on a well chosen horizontal segment.

We define the set  $Q'_{\sigma,l}$  defined in a similar way as  $Q_{\sigma,l}$ , but here we replace condition 2 by the following two conditions:

- (2)  $\forall i \notin \{1, \sigma(1)\} \quad \text{Re}(\zeta_i) > 0.$
- (2')  $\text{Re}(\zeta_1) = \text{Re}(\zeta_{\sigma(1)}) = 0.$

In other words, the first vector of the top broken line  $L_1$  is now vertical and no other vector is vertical except the other one of the corresponding pair. Then we define in a very similar way a map  $ZR'$  from  $Q'_{\sigma,l}$  to a stratum of the moduli space of quadratic differentials.

Note that the subset  $Q'_{\sigma,l}$  is convex.

**Lemma 2.4.** *Let  $S$  be a flat surface with a unique vertical saddle connection joining two singularities  $P_1$  and  $P_2$ . Let  $X$  be a horizontal segment whose left end is  $P_1$ , and such that the vertical geodesic starting from its left end is the unique vertical saddle connection joining  $P_1$  to  $P_2$ . There exists  $(\sigma, l)$ , that depends only on the first return maps on  $X$  of the vertical foliation and on the degree of  $P_2$ , such that  $S \in ZR'(Q'_{\sigma,l})$ .*

*Proof.* We define as in Proposition 2.2 the  $x_{i,j}, \tau_{i,j}$  and  $\zeta_j$ , with the slight difference that now,  $\tau_{1,0} > 0$ . Now, because there exists only one vertical saddle connection, the same argument as before says that there exists at most one unordered pair  $\{\zeta_{i_0}, \zeta_{\sigma(i_0)}\}$  such that  $\zeta_{i_0} \neq \zeta_{\sigma(i_0)}$ . If this pair doesn't exist, then the union of the vertical geodesics starting from  $X$  would be a strict subset of  $S$ , with boundary the unique vertical saddle connection. Therefore, we would have  $P_1 = P_2$ , contradicting the hypothesis.

Now we glue on the polygon  $\mathcal{P}$  an Euclidean triangle of sides given by  $\{\zeta_i, \zeta_{\sigma(i)}, i\tau_{1,0}\}$ , and we get a new polygon. The sides of this polygon appear in pairs that are parallel and of the same length. We can therefore glue

this pair and get a flat surface. By construction, we get a surface isometric to  $S$ , and so  $S$  belongs to some  $ZR'(Q'_{\tilde{\sigma},l})$ . The permutation  $\tilde{\sigma}$  is easily constructed from  $\sigma$  as soon as we know  $i_0$ . This value is obtained by the following way: we start from the vertical saddle connection, close to the singularity  $P_2$ . Then, we turn around  $P_2$  counterclockwise. Each half-turn is easily described in terms of the permutation  $\sigma$ . Then after performing  $k_2 + 2$  half-turns, we must arrive again on the vertical saddle connection. This gives us the value of  $i_0$ .

□

### 3. HOLE TRANSPORT

Hole transport is a surgery used in [MZ] to show the existence of some configurations and especially to break an even singularity to a pair of odd ones. It was defined along a simple path transverse to the vertical foliation. In this section, we generalize this construction to a larger class of paths and show that breaking a zero using that procedure does not depend on small perturbations of the path.

Hole transport also appears in [EMZ] in the computation of the Siegel-Veech constants for the moduli space of Abelian differentials. This improved surgery, and “dependence properties” that are Corollary 3.5 and Lemma 4.5 are a necessary toolkit for the future computation of the these Siegel-Veech constants for the case of quadratic differentials.

**Definition 3.1.** A hole is a connected component of the boundary of a flat surface given by a single saddle connection (loop). The saddle connection bounds a singularity. If this singularity has angle  $3\pi$ , this hole is said to be simple.

*Convention 1.* We will always assume that the saddle connection defining the hole is vertical

A simple hole  $\tau$  has a natural orientation given by the orientation of the underlying Riemann surface. In a neighborhood of the hole, the flat metric has trivial holonomy and therefore  $q$  is locally the square of an Abelian differential.

*Convention 2.* When defining the surgeries around a simple hole using flat coordinates, we will assume (unless explicit warning) that the flat coordinates come from a local square root  $\omega$  of  $q$ , such that  $\int_{\tau} dz \in i\mathbb{R}^+$ .

*Remark 3.2.* Under Convention 2, we may speak of the *left* or the *right* direction in a neighborhood of a simple hole. Note that there exists two horizontal geodesics starting from the singularity of and going to the right, and only one starting from the singularity and going to the left.

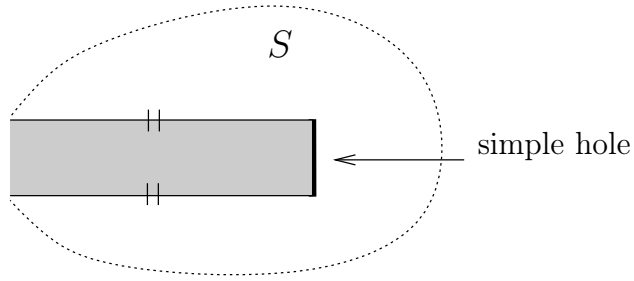

FIGURE 9. A hole in flat coordinates.

**3.1. Parallelogram constructions.** We first describe the three basic surgeries on the surface that allow us to transport a simple hole along a segment (see Figure 10). Consider a simple hole  $\tau$  and chose flat coordinates in a neighborhood of the hole that satisfy Convention 2. We consider a vector  $v$  such that  $Re(dz(v)) > 0$  (*i.e.* the vector  $v$  goes “to the right” in our flat coordinates). Consider the domain  $\Omega$  obtained as the union of geodesics of length  $|v|$ , starting at a point of  $\tau$  with direction  $v$ . When  $\Omega$  is an embedded parallelogram, we can remove it and glue together by translation the two sides parallel to  $v$ . Here we have transported the simple hole by the vector  $v$ . Note that the area changes under this construction.

When  $Re(dz(v)) < 0$ , this construction (removing a parallelogram) cannot work. The singularity is the unique point of the boundary that can be the starting point of a geodesic of direction  $v$ . Now from the corresponding geodesic, we perform the reverse construction with respect to the previous one: we cut the surface along a segment of length  $v$  and paste in a parallelogram. By means of this construction we transport the hole along the vector  $v$ .

When  $Re(dz(v)) = 0$ , we consider a geodesic segment of direction  $v$  starting from the singularity, and cut the surface along the segment, then glue it with a shift (“Earthquake construction”).

There is an easy way to create a pair of holes in a compact flat surface: we consider a geodesic segment imbedded in the surface, we cut the surface along that segment and paste in a parallelogram as in the previous construction. We get parallel holes of the same length (but with opposite orientation). Note that we can assume that the length of these holes is arbitrary small. In a similar way, we can create a pair of holes by removing a parallelogram.

**3.2. Transport along a piecewise geodesic path.** Now we consider a piecewise geodesic simple path  $\gamma = \gamma_1 \dots \gamma_n$  with edges represented by the vectors  $v_1, v_2, \dots, v_n$ . We assume for simplicity that none of the  $v_i$  is vertical. The spirit is to transport the hole by iterating the previous constructions. We make the hole to “follow the path”  $\gamma$  in the following way (under Convention 2):

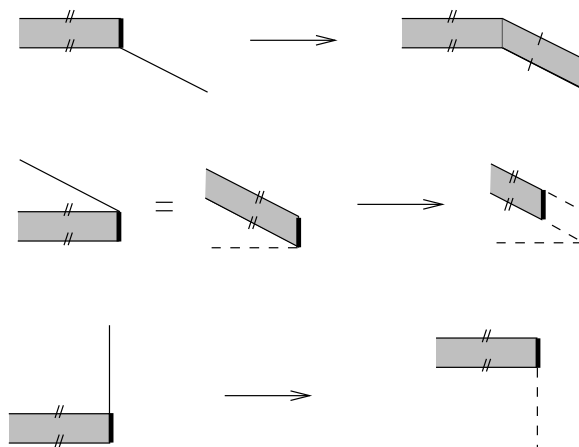

FIGURE 10. Parallelogram constructions.

- At step number  $i$ , we ask that the geodesic  $\gamma_i$  starts from the singularity of the hole.
- When  $\operatorname{Re}(dz(v_i)) > 0$ , we ask  $\gamma_i$  to be the bottom of the parallelogram  $\Omega$  defined in the previous construction.

Naive iteration does not necessary preserve these conditions. The surgery can indeed disconnect the path but then we can always reconnect  $\gamma$  by adding a geodesic segment. If the first condition is satisfied, but not the second, we can add a surgery along a vertical segment of the size of the hole to fulfill it. We just have to check that each iteration between two consecutive segments of the initial path can be done in a finite number of steps, see Figure 11.

- (1) If  $\operatorname{Re}(dz(v_i))$  and  $\operatorname{Re}(dz(v_{i+1}))$  have the same sign, then as soon as both transports are successively possible, our two conditions keep being fulfilled.
- (2) If  $\operatorname{Re}(dz(v_i)) > 0$  and  $\operatorname{Re}(dz(v_{i+1})) < 0$ , and if  $(v_i, v_{i+1})$  is positively oriented, the surgery with  $v_i$  disconnect the path, and we must add a new segment  $\tilde{v}$ , but then  $\operatorname{Re}(\tilde{v})$  and  $\operatorname{Re}(v_{i+1})$  are both negative, therefore, we can iterate the surgery keeping the two conditions fulfilled.
- (3) If  $\operatorname{Re}(dz(v_i)) < 0$  and  $\operatorname{Re}(dz(v_{i+1})) > 0$ , and if  $(v_i, v_{i+1})$  is negatively oriented, we must add a surgery along a vertical segment to fulfill the second condition.
- (4) It is an easy exercise to check that for any other configuration of  $(v_i, v_{i+1})$ , the direct iteration of the elementary surgeries works.

Of course, in the process we have just described, we implicitly assumed that at each step, the condition imposed for the basic surgeries (*i.e.* the parallelogram must be imbedded in the surface) is fulfilled. But considering any compact piecewise geodesic path, the process will be well defined as soon as the hole is small enough.

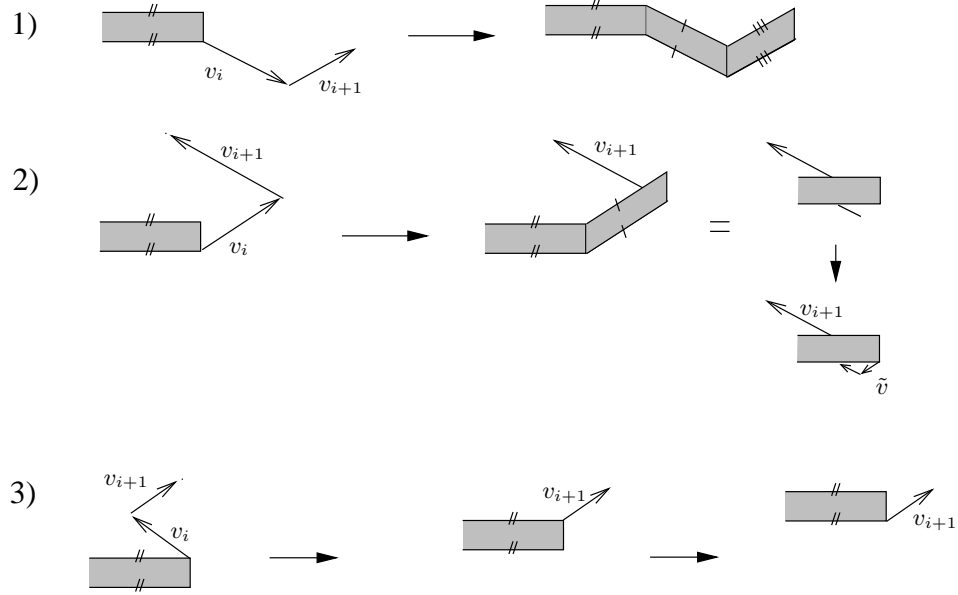

FIGURE 11. Hole transport along a piecewise geodesic curve.

*Remark 3.3.* We can also define hole transport along a piecewise geodesic path that have self intersections. Here hole transport will disconnect the path at each intersections, but we can easily reconnect it and hole transport also ends in a finite number of steps. We will not need hole transport along such paths.

**3.3. Application: breaking up an even singularity.** We consider a singularity  $P$  of order  $k = k_1 + k_2$ . When  $k_1$  and  $k_2$  are not both odd, there is a local surgery that continuously break this singularity into pair of singularities of order  $k_1$  and  $k_2$  (see section 4.1.1). When  $k_1$  and  $k_2$  are both odd, this local surgery fails. Following [MZ] we use hole transport instead.

Consider a pair  $(I, II)$  of sectors of angle  $\pi$  in a small neighborhood of  $P$ , and such that the image of the first one by a rotation of  $(k_2 + 1)\pi$  is the second sector. Now let  $\gamma$  be a simple broken line that starts and ends at  $P$ , and such that its first segment belongs to sector  $I$  and its last segment belongs to sector  $II$ . We require parallel transport along  $\gamma$  to be  $\mathbb{Z}/2\mathbb{Z}$  (this has sense because  $k$  is even, so  $P$  admits a parallel vector field in its neighborhood).

Then, we create a pair of holes by cutting the first segment and pasting in a parallelogram. Denote by  $\varepsilon$  the length of these holes. One hole is attached to the singularity. The other one is a simple hole. We can transport it along  $\gamma$ , to the sector  $II$ . Then gluing the holes together, we get a singular surface with a pair of conical singularities that are glued together. If we desingularise the surface, we get a flat surface with a pair of singularities of order  $k_1$  and  $k_2$  and a vertical saddle connection of length  $\varepsilon$ . We will denote

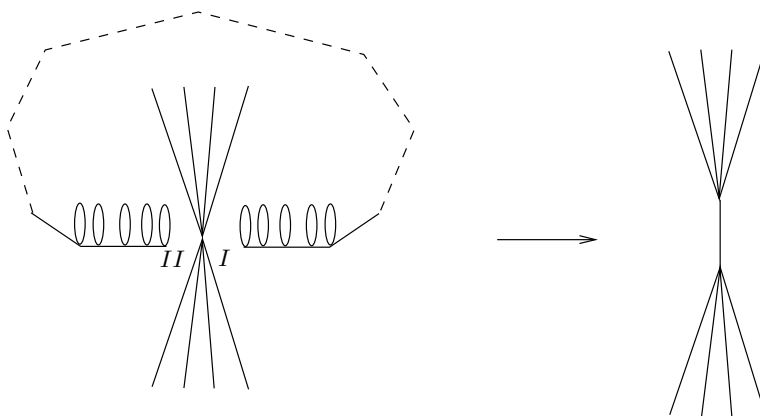

FIGURE 12. Breaking a singularity.

by  $\Psi(S, \gamma, \varepsilon)$  this surface. The construction is continuous with respect to the variations of  $\varepsilon$ .

**3.4. Dependence on small variations of the path.** The previous construction might depend on the choice of the broken line. We show the following proposition:

**Proposition 3.4.** *Let  $\gamma$  and  $\gamma'$  be two broken lines that both start from  $P$ , sector  $I$  and end to  $P$ , sector  $II$ . Let  $\varepsilon$  be a positive real number. We assume that there exists an open subset  $U$  of  $S$ , such that:*

- $U$  contains  $\gamma \setminus \{P\}$  and  $\gamma' \setminus \{P\}$ .
- $U$  is homeomorphic to a disc and have no conical singularities.
- The surgery described in section 3.3, with parameters  $(\gamma, \varepsilon)$  or  $(\gamma', \varepsilon)$  does not affect  $\partial U \setminus P$ .

Then  $\Psi(S, \gamma, \varepsilon)$  and  $\Psi(S, \gamma', \varepsilon)$  are isometric.

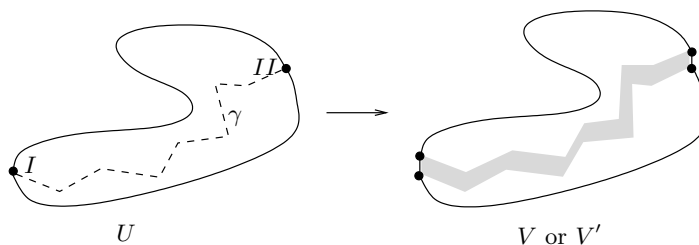
 FIGURE 13. The boundary of  $U$  and  $V$  (or  $V'$ ).

*Proof.* We denote by  $\partial U$  the boundary of the natural compactification of  $U$  (that differ from the closure of  $U$  in  $S$ , see section 1.2). We denote by  $\tilde{P}$  and  $\tilde{P}'$  the ends of  $\gamma$  in  $\partial U$  (that are also the ends of  $\gamma'$  by assumption). We



denote by  $V$  (*resp.*  $V'$ ) the flat discs obtained from  $U$  after the hole surgery along  $\gamma$  (*resp.*  $\gamma'$ ). Our goal is to prove that  $V$  and  $V'$  are isometric.

The hole surgery along  $\gamma$  (*resp.*  $\gamma'$ ) does not change the metric in a neighborhood of  $\partial U \setminus \{\tilde{P}, \tilde{P}'\}$ . Furthermore, the fact that both  $\gamma$  and  $\gamma'$  start and end at sectors  $I$  and  $II$  correspondingly implies that  $V$  and  $V'$  are isometric in a neighborhood of their boundary. We denote by  $f$  this isometry. Surprisingly, we can find two flat discs that are isometric in a neighborhood of their boundary but not globally isometric (see Figure 14).

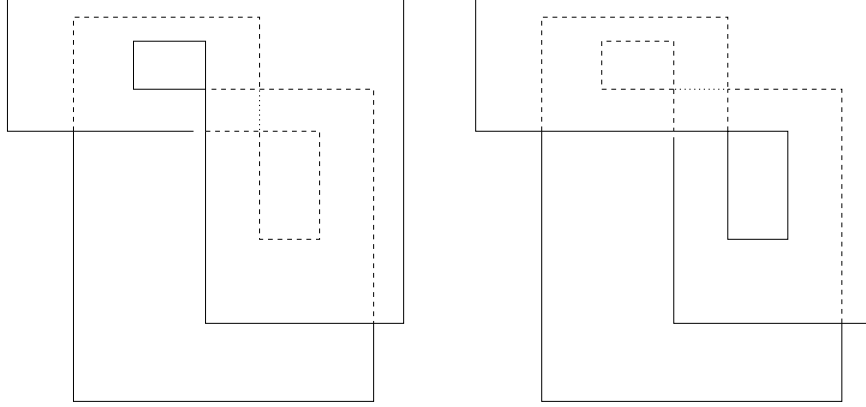

FIGURE 14. Immersion in  $\mathbb{R}^2$  of two non isometric flat discs with isometric boundaries.

In our case, we have an additional piece of information that will make the proof possible: hole transport does not change the vertical foliation (recall that the hole is always assumed to be vertical). Therefore, for each vertical geodesics in  $V$  with endpoints  $\{x, y\} \subset \partial V$ , then  $\{f(x), f(y)\}$  are the endpoints of a vertical geodesic of  $V'$ .

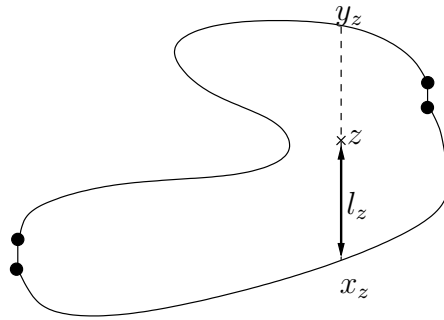

FIGURE 15. Parameters on a flat disc.

For each  $z \in V$  we define  $x_z \in \partial V$  (*resp.*  $y_z$ ) the intersection of the vertical geodesic starting from  $z$  in the negative direction (*resp.* positive direction) and the boundary of  $V$  (see Figure 15). We also call  $l_z$  the length of this geodesic. We can assume that  $\partial V$  is piecewise smooth. So we can restrict ourself to the open dense subset  $V_1 \subset V$  of  $z$  such that  $x_z$  and  $y_z$  are regular and nonvertical points.

Then we define  $\Phi : V_1 \rightarrow V'$  that send  $z$  to  $\phi_{l_z}(f(x_z))$ , where,  $\phi$  is the vertical geodesic flow. Because  $V$  and  $V'$  are translation structures, the length of the vertical segment  $[x_z, y_z]$  is obtained by integrating the corresponding 1-form along any path between  $x_z$  and  $y_z$ . Such a path can be chosen in a neighborhood of the boundary of  $V$ . Then, the isometry  $f$  implies that this length is the same as the length of the vertical segment  $[f(x_z), f(y_z)]$ . Therefore  $\Phi$  is well defined and coincide to  $f$  in a neighborhood of the boundary of  $V$ . This map is also smooth because  $z \mapsto (x_z, l_z)$  are smooth on  $V_1$ . It's easy to check that  $D\Phi(z) \equiv Id$  and that  $\Phi$  continuously extends to an isometry from  $V$  to  $V'$ .  $\square$

**Corollary 3.5.** *Let  $\gamma'$  be close enough to  $\gamma$  and such that  $\gamma$  and  $\gamma'$  intersect the same sectors of a neighborhood of  $P$ . Then  $\Psi(S, \gamma, \varepsilon)$  and  $\Psi(S, \gamma', \varepsilon)$  are isomorphic for  $\varepsilon$  small enough.*

*Proof.* If  $\gamma'$  is close enough to  $\gamma$  (and intersect the same sectors in a neighborhood of  $P$ ), then there exists a open flat disk that contains  $\gamma$  and  $\gamma'$ .  $\square$

*Remark 3.6.* Using proposition 3.4, one can also extend hole transport along a differentiable curve.

#### 4. SIMPLE CONFIGURATION DOMAINS

Recall the following notation: if  $\mathcal{Q}(k_1, k_2, \dots, k_r)$  is a stratum of meromorphic quadratic differentials with at most simple poles, then  $\mathcal{Q}_1(k_1, k_2, \dots, k_r)$  is the subset of area 1 flat surfaces in  $\mathcal{Q}(k_1, k_2, \dots, k_r)$ , and  $\mathcal{Q}_{1,\delta}(k_1, k_2, \dots, k_r)$  is the subset of flat surfaces in  $\mathcal{Q}_1(k_1, k_2, \dots, k_r)$  that have at least a saddle connection of length less than  $\delta$ .

**Definition 4.1.** A configuration domain is said to be *simple* if the corresponding configuration is realized by a simple and non closed saddle connection.

The goal of this section is to prove the following theorem, which proves the Main Theorem for the case of simple configuration domains (but for a larger class of strata).

**Theorem 4.2.** *Let  $\mathcal{Q}(k_1, k_2, \dots, k_r)$  be a stratum of quadratic differentials with  $(k_1, k_2) \neq (-1, -1)$  and such that the stratum  $\mathcal{Q}(k_1 + k_2, k_3, \dots, k_r)$  is connected. Let  $\mathcal{C}$  be the subset of flat surfaces  $S$  in  $\mathcal{Q}^N(k_1, \dots, k_r)$  such that the shortest saddle connection of  $S$  is simple and joins a singularity of order  $k_1$  to a distinct singularity of order  $k_2$ . For any pair  $N \geq 1$  and  $\delta > 0$ ,*

the sets  $\mathcal{C}$ ,  $\mathcal{C} \cap \mathcal{Q}_1(k_1, k_2, \dots, k_r)$  and  $\mathcal{C} \cap \mathcal{Q}_{1,\delta}(k_1, k_2, \dots, k_r)$  are non empty and connected.

In this section we denote by  $P_1$  and  $P_2$  the two zeros of order  $k_1$  and  $k_2$  respectively and by  $\gamma$  the simple saddle connection between them. There are two different cases.

- When  $k_1$  and  $k_2$  are not both odd, then there exists a canonical way of shrinking the saddle connection  $\gamma$  if it is small enough. Furthermore, this surgery doesn't change the metric outside a neighborhood of  $\gamma$ . This is the local case.
- When  $k_1$  and  $k_2$  are both odd, then we still can shrink  $\gamma$ , to get a surface in the stratum  $\mathcal{Q}(k_1 + k_2, k_3, \dots, k_r)$ , but this changes the metric outside a neighborhood of  $\gamma$  and this is not canonical. This is done by reversing the procedure of section 3.3.

#### 4.1. Local case.

4.1.1. *Breaking up a singularity.* Here we follow [EMZ, MZ]. Consider a singularity  $P$  of order  $k \geq 0$ , and a partition  $k = k_1 + k_2$  with  $k_1, k_2 \geq -1$ . We assume that  $k_1$  and  $k_2$  are not both odd. If  $\rho$  is small enough, then the set  $\{x \in S, d(x, P) < \rho\}$  is a metric disc embedded in  $S$ . It is obtained by gluing  $k + 2$  standard half-disks of radius  $\rho$ .

There is a well known local construction that breaks the singularity  $P$  into two singularities of order  $k_1$  and  $k_2$ , and which is obtained by changing continuously the way of gluing the half-discs together (see Figure 16, or [EMZ, MZ]). This construction is area preserving.

4.1.2. *Structure of the neighborhood of the principal boundary.* When  $\gamma$  is small enough, (for example  $|\gamma| \leq |\gamma'|/10$ , for any other saddle connection  $\gamma'$ ), then we can perform the reverse construction because a neighborhood of  $\gamma$  is precisely obtained from a collection of half-discs glued as before. This defines a canonical map  $\Phi : V \rightarrow \mathcal{Q}(k_1 + k_2, k_3, \dots, k_r)$ , where  $V$  is a subset of  $\mathcal{Q}(k_1, k_2, k_3, \dots, k_r)$ . We can choose  $U^N \subset V$  such that  $\Phi^{-1}(\{\tilde{S}\}) \cap U^N$  is the set of surfaces such that the shrinking process leads to  $\tilde{S}$ , and whose smallest saddle connection is of length smaller than  $\min(\frac{|\tilde{\gamma}|}{100}, \frac{|\tilde{\gamma}|}{2N})$  with  $\tilde{\gamma}$  the smallest saddle connection of  $\tilde{S}$ . From the proof of Lemma 8.1 of [EMZ], this map gives to  $U^N$  a structure of a topological orbifold bundle over  $\mathcal{Q}(k_1 + k_2, k_3, \dots, k_r)$ , with the punctured disc as a fiber. By assumption,  $\mathcal{Q}(k_1 + k_2, k_3, \dots, k_r)$  is connected, and therefore  $U^N$  is connected, so the proof will be completed after the following three steps:

- $U^N \subset \mathcal{C}$ .
- There exists  $L > 0$  such that  $\mathcal{Q}^L(k_1, \dots, k_r) \cap \mathcal{C} \subset U^N$ .
- For any  $S \in \mathcal{C}$ , there exists a continuous path  $(S_t)_t$  in  $\mathcal{C}$  that joins  $S$  to  $\mathcal{Q}^L(k_1, \dots, k_r)$ .

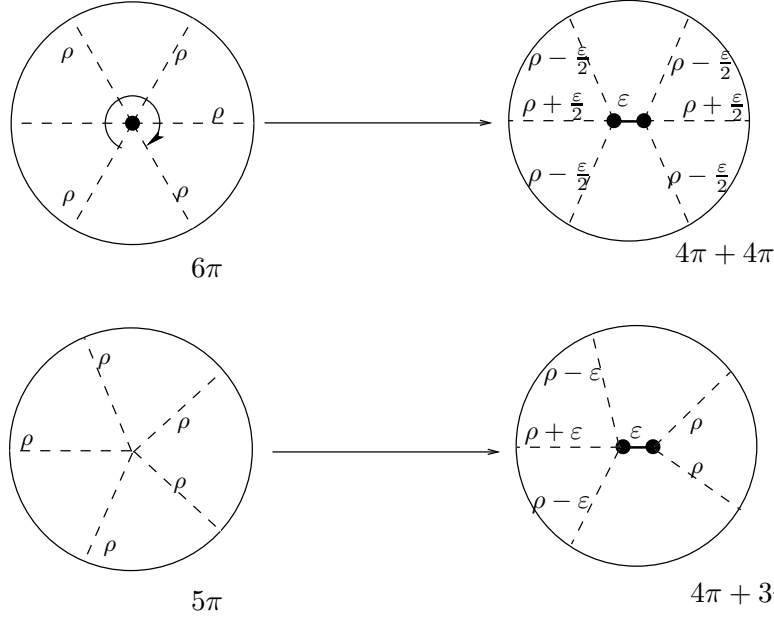

FIGURE 16. Breaking up a zero into two zeroes (after [EMZ, MZ]).

4.1.3. *Proof of Theorem 4.2: local case.* To prove the first step, it is enough to show that  $U^N$  is a subset of  $\mathcal{Q}^N(k_1, k_2, \dots, k_r)$ : let  $S$  be a flat surface in  $U^N$  and let  $\tilde{S} = \Phi(S)$ . We denote by  $\gamma$  the smallest saddle connection of  $S$ . The surgery doesn't change the surface outside a small neighborhood of the corresponding singularity of  $\tilde{S}$ . If  $|\tilde{\gamma}|$  is the length of the smallest saddle connection of  $\tilde{S}$ , then  $S$  has no saddle connection of length smaller than  $|\tilde{\gamma}| - |\gamma|$  except  $\gamma$ , which has length smaller than  $\frac{|\tilde{\gamma}|}{2N}$  by construction. We have  $\frac{|\tilde{\gamma}| - |\gamma|}{|\gamma|} = \frac{|\tilde{\gamma}|}{|\gamma|} - 1 > 2N - 1 \geq N$ , so  $S$  belongs to  $\mathcal{Q}^N(k_1, k_2, \dots, k_r)$ . Hence we have proved that  $U^N \subset \mathcal{C}$ .

To prove the second step, we remark that if  $S \in \mathcal{Q}^L(k_1, \dots, k_r) \cap \mathcal{C}$ , for  $L \geq 10$ , then the smallest saddle connection of  $\Phi(S)$  is of length at least  $L|\gamma| - |\gamma|$ , where  $\gamma$  is the smallest saddle connection of  $S$ . Hence if  $|\gamma| \leq \min(\frac{(L-1)|\gamma|}{100}, \frac{(L-1)|\gamma|}{2N})$  then  $S \in U^N$ . So we have proved that  $\mathcal{Q}^L(k_1, \dots, k_r) \cap \mathcal{C} \subset U^N$  for  $L \geq \max(101, 2N + 1)$ .

The last step is given by the following lemma:

**Lemma 4.3.** *Let  $S$  be a surface in  $\mathcal{Q}^N(k_1, \dots, k_r)$  whose smallest saddle connection  $S$  is simple and joins a singularity of order  $k_1$  to a singularity of order  $k_2$ , and let  $L$  be a positive number. Then we can find a continuous path in  $\mathcal{Q}^N(k_1, \dots, k_r)$ , that joins  $S$  to a surface whose second smallest saddle connection is at least  $L$  times greater than the smallest one.*

*Proof.* The set  $\mathcal{Q}^N(k_1, \dots, k_r)$  is open, so up to a small continuous perturbation of  $S$ , we can assume that  $S$  has no vertical saddle connection except the smallest one.

Now we use the geodesic flow  $g_t$  on  $S$ . There is a natural bijection from the saddle connections of  $S$  to the saddle connections of  $g_t.S$ . The holonomy vector  $v = (v_1, v_2)$  of a saddle connection becomes  $v_t = (e^{-t}v_1, e^t v_2)$ . This imply that the quotient of the length of a given saddle connection to the length of the smallest one increases and goes to infinity.

The set of holonomy vectors of saddle connections is discrete, and therefore, any other saddle connection of  $g_t.S$  has length greater than  $L$  times the length of the smallest one, as soon as  $t$  is large enough.  $\square$

Note that the previous proof is the same if we restrict ourselves to area 1 surfaces. The case when restricted to the  $\delta$ -neighborhood of the boundary is also analogous, since  $U^N \cap \mathcal{Q}_{1,\delta}(k_1, \dots, k_r)$  is still a bundle over  $\mathcal{Q}_1(k_1, \dots, k_r)$  with the punctured disc as a fiber.

Hence the theorem is proven when  $k_1$  and  $k_2$  are non both odd.

**4.2. Proof of theorem 4.2: non-local case.** We first show that two surfaces that are close enough to the stratum  $\mathcal{Q}(k_1 + k_2, k_3, \dots, k_r)$  (in a certain sense that will be specified below) belong to the same configuration domain. Then we show that we can always continuously reach that neighborhood.

*4.2.1. Neighborhood of the principal boundary.* Contrary to the local case, we do not have a canonical map from a subset of  $\mathcal{Q}(k_1, k_2, \dots, k_r)$  to  $\mathcal{Q}(k_1 + k_2, \dots, k_r)$  that gives to this subset a structure of a bundle.

Let  $S \in \mathcal{Q}(k_1 + k_2, \dots, k_r)$ , and let  $\nu$  be a path in  $S$ , we will say that  $\nu$  is *admissible* if it satisfies the hypothesis of the singularity breaking procedure of section 3.3. Let  $\nu$  be an admissible closed path whose endpoint is a singularity  $P$  of degree  $k_1 + k_2$  and let  $\varepsilon > 0$  be small enough for the breaking procedure. Recall that  $\Psi(S, \nu, \varepsilon)$  denotes the surface in  $\mathcal{Q}(k_1, k_2, \dots, k_r)$  obtained after breaking the singularity  $P$ , using the procedure of section 3.3 along the path  $\nu$ , with a vertical hole of length  $\varepsilon$ .

**Proposition 4.4.** *Let  $(S, S')$  be a pair of surfaces in  $\mathcal{Q}(k_1 + k_2, \dots, k_r)$  and  $\nu$  (resp.  $\nu'$ ) be an admissible broken line in  $S$  (resp.  $S'$ ). Then  $\Psi(S, \nu, \varepsilon)$  and  $\Psi(S', \nu', \varepsilon)$  belong to the same configuration domain for any sufficiently small  $\varepsilon$ .*

*Proof.* By assumption,  $\mathcal{Q}(k_1 + k_2, \dots, k_r)$  is connected, so there exists a path  $(S_t)_{t \in [0,1]}$ , that joins  $S$  and  $S'$ . We can find a family of broken lines  $\gamma_t$  of  $S_t$  such that, for  $\varepsilon$  small enough, the map  $t \mapsto \Psi(S_t, \gamma_t, \varepsilon)$  is well defined and continuous for  $t \in [0, 1]$ . The surface  $\Psi(S', \gamma_1, \varepsilon)$  might differ from  $\Psi(S', \gamma', \varepsilon)$  for two reasons:

- The paths  $\gamma_1$  and  $\gamma'$ , that both start from the same singularity  $P$ , might not start and end at the same sectors. In that case, we consider the path  $r_\theta S'$  obtained by rotating the surface  $S'$  by an angle of  $\theta$ .

We find as before a family of broken lines  $\gamma_{1,\theta} \in r_\theta S'$ . Then, for some  $\theta_k$  an integer multiple of  $\pi$ , we will have  $r_{\theta_k} S' = S'$  and  $\gamma_{1,\theta_k}$  that starts and ends on the same sectors than  $\gamma'$ .

- Even if the paths  $\gamma_1$  and  $\gamma'$  start and end in the same sectors of the singularity  $P$ , they might be very different (for example in a different homotopy class of  $S' \setminus \{sing\}$ ), so Proposition 3.4 does not apply. This case is solved by the following lemma, which says that the resulting surfaces are in the same configuration domain.

□

**Lemma 4.5.** *For any surface  $S \in \mathcal{Q}(k_1 + k_2, k_3, \dots, k_r)$ , the configuration domain that contains a surface obtained by the non-local singularity breaking construction does not depend on the choice of the admissible path, once sector  $I$  is chosen, and the hole is small enough.*

*Proof.* We consider a surface  $S$  in  $\mathcal{Q}(k_1 + k_2, \dots, k_r)$  and perform the breaking procedure. We do not change the resulting configuration domain if we perform some small perturbation of  $S$ . Therefore, we can assume that  $S$  has no vertical saddle connections (this is the case for almost all surface). Now we consider an admissible path and perform the corresponding singularity breaking procedure and get a surface  $S_1$ . Then we consider a horizontal segment in sector  $I$  adjacent to the singularity  $k_1$ . Then we perform the same construction for another admissible path (and get a surface  $S_2$ ) and consider a horizontal segment of the same length as before.

Because the hole transport preserves the vertical foliation, the first return maps of the vertical flow in the two surfaces are the same as soon as the hole is small enough.

Now from Lemma 2.4, there exists  $(\sigma, l)$  such that  $S_1$  and  $S_2$  belong to  $ZR'(Q'_{\sigma,l})$ , with parameters  $\zeta_1^1, \dots, \zeta_{l+m}^1$  and  $\zeta_1^2, \dots, \zeta_{l+m}^2$ . Note that  $Re(\zeta_i^1) = Re(\zeta_i^2)$ , because these depends only on the first returns maps of the vertical foliation (and they coincide). The family of polygons with parameters  $t\zeta_i^1 + (1-t)\zeta_i^2$  gives a path in  $MZ'(Q'_{\sigma,l})$  that joins  $S_1$  and  $S_2$ . Furthermore, the singularity breaking procedure is continuous with respect to  $\varepsilon$ . Hence, for all  $i$ ,  $\zeta_i^1$  and  $\zeta_i^2$  are arbitrary close as soon as  $\varepsilon$  is small enough. Consequently, the constructed path in  $MZ'(Q'_{\sigma,l})$  keeps being in a configuration domain.

□

Now for each  $S \in \mathcal{Q}(k_1 + k_2, \dots, k_r)$  and each admissible path  $\gamma$ , we can find  $\varepsilon_{S,\gamma}$  maximal such that  $\Psi(S, \gamma, \varepsilon) \in \mathcal{Q}^N(k_1, \dots, k_r)$  for all  $\varepsilon < \varepsilon_{S,\gamma}$ . Now we consider the set

$$U^N = \bigcup_{\theta \in [0, 2\pi]} \bigcup_{S, \gamma} \bigcup_{0 < \varepsilon < \varepsilon_{S,\gamma}} r_\theta(\Psi(S, \gamma, \varepsilon))$$

This set is in a connected subset of  $\mathcal{Q}^N(k_1, \dots, k_r)$  from Proposition 4.4.

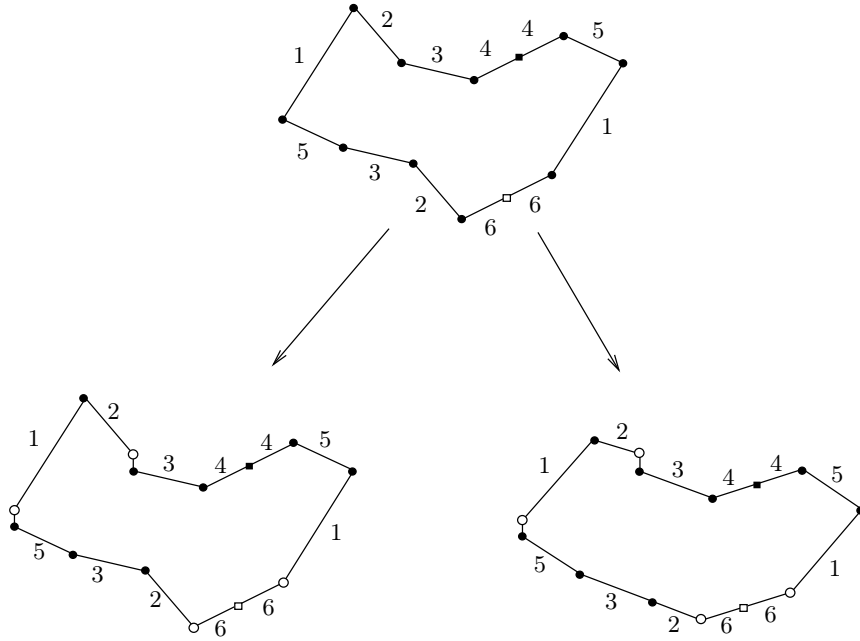

FIGURE 17. Breaking a singularity with two different paths.

4.2.2. *Reaching a neighborhood of the principal boundary.* Now we consider a surface in  $\mathcal{Q}^N(k_1, \dots, k_r)$  whose unique smallest saddle connection joins a singularity of order  $k_1$  to a singularity of order  $k_2$ . As in the local case, we can assume that its smallest saddle connection is vertical and that there are no other vertical saddle connections. Then we make use of the Teichmüller geodesic flow. This allows us to assume that the smallest saddle connection is arbitrary small compared to any other saddle connection.

We then want to contract the saddle connection using the reverse procedure of section 3.3.

**Proposition 4.6.** *Let  $N$  be greater than or equal to 1. There exists  $L > N$  such that  $\mathcal{Q}^L(k_1, \dots, k_r) \cap \mathcal{C} \subset U^N$ .*

*Proof.* We choose  $L$  large enough such that we can find  $L'$  satisfying  $2N < L'$ , and  $1 \ll L' \ll L$ . Denote by  $\gamma$  the smallest saddle connection and by  $\varepsilon$  its length. We want to find a path suitable for reversing the construction of section 3.3. When contracting  $\gamma$  in such way, we must insure that the surface stay in  $\mathcal{Q}^N(k_1, \dots, k_r)$ , by keeping a lower bound of the length of the saddle connections different from the shortest one.

Let  $B$  be the open  $L'\varepsilon$ -neighborhood of  $\gamma$ , and  $\{B_i\}_{i \in \{3, \dots, r\}}$  the open  $L'\varepsilon$ -neighborhoods of the singularities that are not endpoints of  $\gamma$ . Note that each of these neighborhoods is naturally isometric to a collection of half-disk

glued along their boundary. We denote by  $S'$  the closed subset of  $S$  obtained by removing to  $S$  the set  $\cup_i B_i \cup B$ .

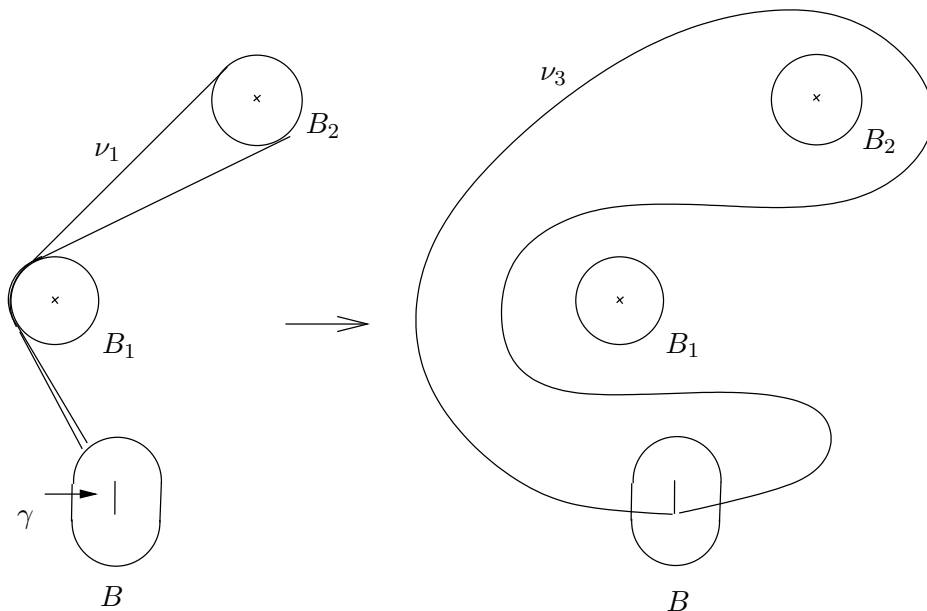

FIGURE 18. Constructing a suitable path.

Now we consider the set of paths of  $S'$  whose endpoints are on  $\partial B$  and with nontrivial holonomy (which makes sense in a neighborhood of  $\partial B$ ), and we choose a path  $\nu_1$  of minimal length with this property. Note that, we do not change the holonomy of a path by “uncrossing” generic self intersections (see Figure 19). Therefore, we can choose our path such that, after a small perturbation, it has no self intersections.

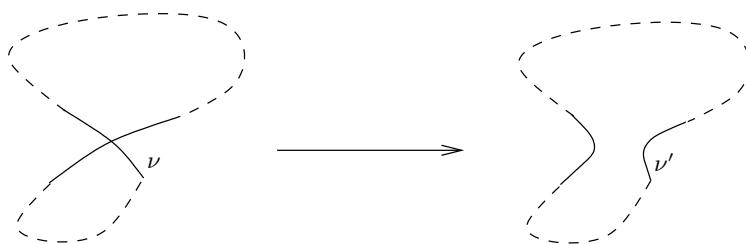

FIGURE 19. Uncrossing an intersection does not change the holonomy.

Now the condition  $L' \ll L$  implies that we can find a path  $\nu_2$  in the same homotopy class, such that the  $\varepsilon$ -neighborhood of  $\nu_2$  is homeomorphic to a disk. Now joining carefully the endpoints of  $\nu_2$  to each sides of  $\gamma$ ,



we get a path  $\nu_3$ . By construction, we can use this path to contract the saddle connection  $\gamma$ . The surgery doesn't touch the  $\varepsilon N$ -neighborhoods of the singularities, except for the endpoints of  $\gamma$ , hence any saddle connection that starts from such singularity will have a length greater than  $N\varepsilon$  during the shrinking process. A saddle connection starting from an endpoint  $a$  of  $\gamma$ , and different from  $\gamma$  will leave  $B$ . Choosing properly  $\nu_3$ , then the length of such saddle connection will have a length greater than  $(L' - 1)\varepsilon$  during the shrinking process, and  $L' - 1 \geq N + (N - 1) \geq N$ .

Therefore, when contracting  $\gamma$ , there is no saddle connection except  $\gamma$  that is of length smaller than  $N|\gamma| \leq N\varepsilon$ , where  $\varepsilon$  is the initial length of the saddle connection  $\gamma$ . Up to rescaling the surface, we can assume that the area of the surface is constant under the deformation process.  $\square$

Now let  $\mathcal{C}$  be the open subset of surfaces in  $\mathcal{Q}^N(k_1, \dots, k_r)$  whose unique smallest saddle connection joins a singularity of order  $k_1$  to a singularity of order  $k_2$ . The previous proposition shows that there exists a path from any  $S \in \mathcal{C}$  to  $U^N$ , which is pathwise connected. Therefore  $\mathcal{C}$  is pathwise connected and hence, connected. Then we have proven the theorem for the case when  $k_1$  and  $k_2$  are odd.

## 5. CONFIGURATION DOMAINS IN STRATA OF QUADRATICS DIFFERENTIALS ON THE RIEMANN SPHERE

In [B] we proved Theorem 5.1 describing all the configurations of  $\hat{\text{homologous}}$  saddle connections that exist on a given stratum of quadratic differential on  $\mathbb{CP}^1$ . We now show that they are in bijections with the configuration domains. In this section, we denote by  $\gamma$  a collection  $\{\gamma_i\}$  of saddle connections.

**Theorem 5.1.** *Let  $\mathcal{Q}(k_1, \dots, k_r)$  be a stratum of quadratic differentials on  $\mathbb{CP}^1$  different from  $\mathcal{Q}(-1, -1, -1, -1)$ , and let  $\gamma$  be a maximal collection of  $\hat{\text{homologous}}$  saddle connections on a generic surface in that stratum. Then the possible configurations for  $\gamma$  are given in the list below (see Figure 20).*

- a) Let  $\{k, k'\} \subset \{k_1, \dots, k_r\}$  be an unordered pair of integers such that  $(k, k') \neq (-1, -1)$ . The set  $\gamma$  consists of a single saddle connection joining a singularity of order  $k$  to a distinct singularity of order  $k'$ .
- b) Let  $(a_1, a_2)$  be a pair of positive integers such that  $a_1 + a_2 = k \in \{k_1, \dots, k_r\}$  (with  $k \geq 2$ ), and let  $A_1 \sqcup A_2$  be a partition of the set  $\{k_1, \dots, k_r\} \setminus \{k\}$  such that  $(\sum_{a \in A_i} a) + a_i \equiv 2 \pmod{4}$  for each  $i$ . The set  $\gamma$  consists of a simple saddle connection that decomposes the sphere into two 1-holed spheres  $S_1$  and  $S_2$ , such that each  $S_i$  has interior singularities of order given by  $A_i$ , and has a single boundary singularity of order  $a_i$ .
- c) Let  $\{a_1, a_2\} \subset \{k_1, \dots, k_r\}$  be a pair of positive integers. Let  $A_1 \sqcup A_2$  be a partition of  $\{k_1, \dots, k_r\} \setminus \{a_1, a_2\}$  such that for each  $i$ , we have  $(\sum_{a \in A_i} a) + a_i \equiv 2 \pmod{4}$ . The set  $\gamma$  consists of two closed saddle

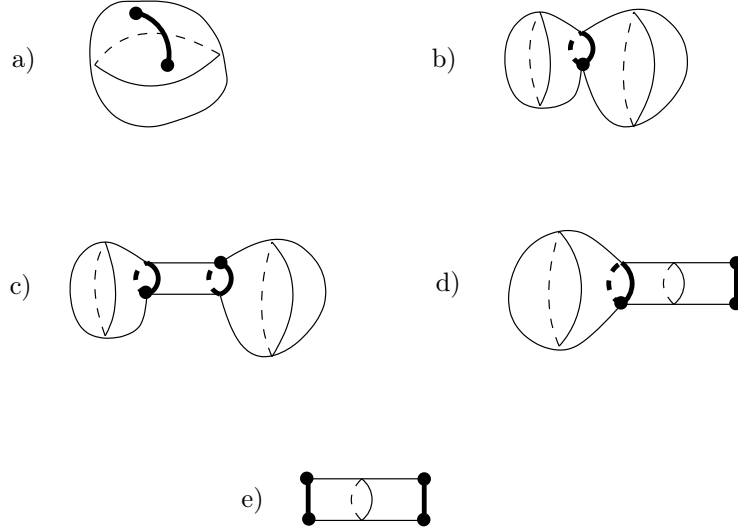
 FIGURE 20. “Topological picture” of configurations for  $\mathbb{CP}^1$ .

connections that decompose the sphere into two 1-holed spheres  $S_1$  and  $S_2$  and a cylinder, and such that each  $S_i$  has interior singularities of orders given by  $A_i$  and has a boundary singularity of order  $a_i$ .

- d) Let  $k \in \{k_1, \dots, k_r\}$  be a positive integer. The set  $\gamma$  is a pair of saddle connections of different lengths, and such that the largest one starts and ends from a singularity of order  $k$  and decompose the surface into a 1- holed sphere and a half-pillowcase, while the shortest one joins a pair of poles and lies on the other end of the half pillowcase.

When the stratum is  $\mathcal{Q}(-1, -1, -1, -1)$ , there is only one configuration, which correspond to two saddle connections are the two boundary components of a cylinder (the surface is a “pillowcase”, see Figure 1).

Now let  $S \in \mathcal{Q}^N(k_1, \dots, k_r)$ . We can define  $\mathcal{F}_S$  to be the maximal collection of homologous saddle connections that contains the smallest one. We have the following lemma.

**Lemma 5.2.** *The configuration associated to  $\mathcal{F}_S$  is locally constant with respect to  $S$ .*

*Proof.* Any saddle connection in  $\mathcal{F}_S$  persists under any small continuous deformation. This lemma is obvious as soon the number of elements of  $\mathcal{F}_S$  is locally constant.

Let  $\gamma_1$  be a saddle connection of minimal length. We assume that after a small perturbation  $S'$  of  $S$ , we get a bigger collection of saddle connections. That means that a new saddle connection  $\gamma_2$  appears. Therefore there was another saddle connection  $\gamma_3$  nonhomologous to  $\gamma_1$ , of length less than or

equal to  $|\gamma_2/2|$  (see Figure 21). But this is impossible since it would therefore be of length less than or equal to the length of  $\gamma_1$ , contradicting the hypothesis.  $\square$

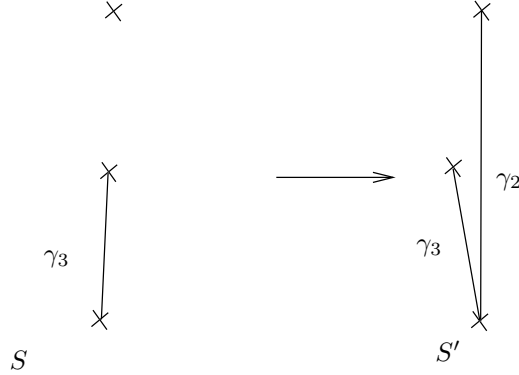

FIGURE 21. The configuration associated to  $\mathcal{F}_S$  is locally constant.

The following lemma (due to Kontsevich) implies that Theorem 4.2 can be used for any stratum of quadratic differentials on  $\mathbb{CP}^1$  (see also [KZ]).

**Lemma** (Kontsevich). *Any stratum of quadratic differentials on  $\mathbb{CP}^1$  is non empty and connected.*

*Proof.* There is only one complex structure on  $\mathbb{CP}^1$ . Therefore, we can work on the standard atlas  $\mathbb{C} \cup (\mathbb{C}^* \cup \infty)$  of the Riemann sphere.

Now we remark that if we fix  $(z_1, \dots, z_r) \in \mathbb{C}^r$  that are pairwise distincts, and  $k_1, \dots, k_r$  some integers greater than or equal to  $-1$ , then the quadratic differential on  $\mathbb{C}$ ,  $q(z) = \prod (z - z_i)^{k_i} dz^2$ , extends to a quadratic differential on  $\mathbb{CP}^1$  with possibly a singularity of order  $-4 - \sum_i k_i$  over the point  $\infty$ . Now two quadratic differentials on a compact Riemann surface with the same singularities are equal up to a multiplicative constant (because they differ by a holomorphic function).

Therefore, any stratum of quadratic differentials on  $\mathbb{CP}^1$  is a quotient of  $\mathbb{C}$  times a space of configurations of points on a sphere, which is connected.  $\square$

**Main Theorem.** *Let  $\mathcal{Q}(k_1, \dots, k_r)$  be a stratum of quadratic differentials with at most simple poles. Let  $N$  be greater than or equal to 1. There is a natural bijection between the configurations of homologous saddle connections on  $\mathcal{Q}(k_1, \dots, k_r)$  described in Theorem 5.1 and the connected components of  $\mathcal{Q}^N(k_1, \dots, k_r)$ .*

*Proof.* Lemma 5.2 implies that there is a well defined map  $\Psi$  from the set of connected components of  $\mathcal{Q}^N(k_1, \dots, k_r)$  to the set of existing configurations for the stratum. This map is surjective because if we choose a generic surface  $S$  with a maximal collection of homologous saddle connections  $\gamma$  that realizes

the given configuration  $\mathcal{C}$ , then after a small continuous perturbation of the surface, we can assume that there are no other saddle connections on  $S$  parallel to an element of  $\gamma$ . Then we use the Teichmüller geodesic flow to contract the elements of  $\gamma$ , until  $\gamma$  contains the smallest saddle connection of the surface. Then by construction, this surface belongs to  $\Psi^{-1}(\mathcal{C})$ .

Now we prove that  $\Psi$  is injective. We keep the notations of Theorem 5.1, and consider  $U = \Psi^{-1}(\{\mathcal{C}\})$ , for  $\mathcal{C}$  any existing configuration:

-If  $\mathcal{C}$  belongs to the a) case, then  $U$  is connected from Theorem 4.2 and the lemma of Kontsevich.

-If  $\mathcal{C}$  belongs to the b) case, then we consider a surface  $S$  in  $U$ . Its smallest saddle connection  $\gamma_0$  is closed and separates the surface in a pair  $(S'_1, S'_2)$  of 1-holed spheres with boundary singularities of orders  $a_1$  and  $a_2$  correspondingly. Now for each  $S'_i$  we decompose the boundary saddle connection of  $S'_i$  in two segments starting from the boundary singularity, and glue together these two segments, then we get a pair of closed flat spheres  $S_i \in \mathcal{Q}(A_i, a_i - 1, -1)$ ,  $i = 1, 2$ . For each of the sphere, the smallest saddle connection  $\gamma'_i$  is simple and joins a singularity  $Q_i$  of order  $(a_i - 1)$  to a newborn pole  $P_i$ , and is of length  $|\gamma_0|/2$ , where  $|\gamma_0|$  is the length of  $\gamma_0$ . Let  $\eta_i$  be the smallest saddle connection of  $S_i$  except  $\gamma'_i$ .

- If  $\eta_i$  intersects the interior of  $\gamma'_i$ , then it is easy to find another saddle connection on  $S_i$ , smaller than  $\eta_i$  and different from  $\gamma'_i$ .
- If  $\eta_i$  does not intersect  $\gamma'_i$ , or intersect it in  $Q_i$ , then  $\eta_i$  was a saddle connection on  $S$ , hence  $|\eta_i| > 2N|\gamma'_i|$ .
- If  $\eta_i$  intersects  $P_i$ , then we can find a saddle connection in  $S$  of length smaller than  $|\eta_i| + |\gamma_0|/2$ .

These remarks imply that  $S_i$  is in  $\mathcal{Q}^{2N-1}(A_i, a_i - 1, -1)$  which is a subset of  $\mathcal{Q}^N(A_i, a_i - 1, -1)$ . Hence we have defined a map  $f$  from  $U$  to  $U_1 \times U_2$ , with  $U_i$  a simple configuration domain of  $\mathcal{Q}^N(A_i, a_i - 1, -1)$ .

Conversely, let  $\{S_i\}_{i \in \{1,2\}}$  be two surfaces in  $\mathcal{Q}^{2N}(A_i, a_i - 1, -1)$ , such that for each  $S_i$ , the smallest saddle connection  $\gamma_i$  is simple and joins a pole to a singularity of order  $a_i - 1$ . If  $\gamma_1$  and  $\gamma_2$  are in the same direction and have the same length, then we can reconstruct a surface  $S = f^{-1}(S_1, S_2)$  in  $\mathcal{Q}(k_1, \dots, k_r)$  by cutting  $S_i$  along  $\gamma_i$ , and gluing together the two resulting surfaces by an appropriate isometry. The surface  $S$  belongs to  $\mathcal{Q}^N(k_1, \dots, k_r)$ . Note that in the reconstruction of the surface, the length of smallest saddle connection is doubled, hence we must start from  $\mathcal{Q}^{2N}(A_i, a_i - 1, -1)$ , and not  $\mathcal{Q}^N(A_i, a_i - 1, -1)$ .

Now we prove the connectedness of  $U$ : let  $X^1, X^2$  be two flat surfaces in  $U$ . After a small perturbation and after using the geodesic flow, we get a surface  $S^1$  (*resp.*  $S^2$ ) in the same connected component of  $U$  as  $X^1$  (*resp.*  $X^2$ ), with  $S^1$  and  $S^2$  in  $\mathcal{Q}^{2N}(k_1, \dots, k_r)$ .

There exists continuous paths  $(S_{i,t})_{t \in [1,2]} \in \mathcal{Q}^{2N}(A_i, a_i - 1, -1)$  such that  $(S_{1,j}, S_{2,j}) = f(S^j)$  for  $j = 1, 2$ . The pair  $(S_{1,t}, S_{2,t})$  belongs to  $f(U)$  if and only if their smallest saddle connections are parallel and have the same

length. This condition is not necessary satisfied, but rotating and rescaling  $S_{2,t}$  gives a continuous path  $A_t$  in  $GL_2(\mathbb{R})$  such that  $S_{1,t}$  and  $A_t.S_{2,t}$  satisfy that condition. Note that we necessary have  $A_2.S_{2,2} = S_{2,2}$ . Therefore  $f^{-1}(S_{1,t}, A_2.S_{2,t})$  is a continuous path in  $U$  that joins  $S^1$  to  $S^2$ . So the subset  $U$  is connected. Note that the connectedness of  $U$  clearly implies the connectedness of  $U \cap \mathcal{Q}_1(k_1, \dots, k_r)$ .

The cases c) and d) are analogous and left to the reader.  $\square$

**Corollary 5.3.** *Let  $\mathcal{Q}(k_1, \dots, k_r)$  be a stratum of quadratic differentials on  $\mathbb{CP}^1$ , and let  $N \geq 1$ . If a connected component of  $\mathcal{Q}^N(k_1, \dots, k_r)$  admits orbifoldic points, then the corresponding configuration is symmetric and the locus of orbifoldic points are a finite union of copies (or coverings) of open subset of configuration domains, which are manifolds, of smaller strata.*

*Proof.* Recall that  $S$  corresponds to an orbifoldic point if and only if  $S$  admits a nontrivial orientation preserving isometry. Now let  $U$  be a connected component of  $\mathcal{Q}^N(k_1, \dots, k_r)$ ,  $S \in U$  an orbifoldic point, and  $\tau$  an isometry.

Suppose that  $U$  corresponds to the a) case of Theorem 5.1. Then  $\tau$  must preserve the smallest saddle connection  $\gamma_0$  of  $S$ . Either  $\tau$  fixes the endpoints of  $S$ , either it interchanges them. In the first case,  $\tau = Id$ , in the other case it is uniquely determined and is an involution that fixes the middle of  $\gamma_0$ . In that case the endpoints of  $\gamma_0$  have the same order  $k \geq 0$ . Then  $S/\tau$  is a half-translation surface whose smallest saddle connection is of length  $|\gamma_0|/2$  and joins a singularity of order  $k \geq 0$  to a pole. Any other saddle connection in  $S/\tau$  is of length  $l$  or  $l/2$  for  $l$  the length of a saddle connection (different from  $\gamma_0$ ) on  $S$ . Therefore,  $S/\tau$  belongs to a configuration domain of a) type in the corresponding stratum. The flat surface  $S/\tau$  does not have a nontrivial orientation preserving isometry because  $k \neq -1$ . Therefore the configuration domain that contains  $S/\tau$  is a manifold. The involution  $\tau$  induces an involution on the set of zeros of  $S$  and the stratum and configuration domain corresponding to  $S/\tau$  depends only on that involution. This induces a covering from the locus of orbifoldic points whose corresponding involution share the same combinatorial data to an open subset of a manifold.

If  $U$  corresponds to the b) case, then similarly, a nontrivial isometric involution  $\tau$  interchanges the two 1-holed spheres of the decomposition. We have  $A_1 = A_2$  and  $a_1 = a_2 > 0$  (see notations of Theorem 5.1). The set of orbifoldic points is isomorphic to the configuration domain of a) type with data  $\{a_1, -1\}$  which is a manifold.

If  $U$  corresponds to the c) case then similarly,  $\tau$  interchanges the two 1-holed sphere of the decomposition. We must have  $A_1 = A_2$  and  $a_1 = a_2 > 0$ . The set of orbifoldic points is isomorphic to an open subset of a configuration domain of d) type, which is a manifold (see next).

In the d) case, any isometry  $\tau$  fix the saddle connection  $\gamma_1$  that separates the surface in a 1-holed sphere and a half-pillowcase, which are nonisometric. Hence they are fixed by  $\tau$ . Now since  $\tau$  is orientation preserving, it is easy to check that necessary,  $\tau$  is trivial.

□

Here we use Theorem 4.2 and the description of configurations to show that any stratum of quadratic differentials on  $\mathbb{CP}^1$  admits only one topological end.

**Proposition 5.4.** *Let  $\mathcal{Q}_1(k_1, \dots, k_r)$  be any stratum of quadratic differential on  $\mathbb{CP}^1$ . Then the subset  $\mathcal{Q}_{1,\delta}(k_1, \dots, k_r)$  is connected for any  $\delta > 0$ .*

*Proof.* Let  $S \in \mathcal{Q}_{1,\delta}(k_1, \dots, k_r)$ . We first describe a path from  $S$  to a simple configuration domain with corresponding singularities of orders  $\{-1, k\}$ . Then we show that all of these configuration domains are in the same connected component of  $\mathcal{Q}_{1,\delta}(k_1, \dots, k_r)$ .

Let  $\gamma_1$  be a saddle connection of  $S$  of length less than  $\delta$ . Up to the Teichmüller geodesic flow action, we can assume that  $\gamma_1$  is of length less than  $\delta^2$ . Now let  $P$  be a pole. There exists a saddle connection  $\gamma_2$  of length less than 1 starting from  $P$ , otherwise the 1-neighborhood of  $P$  would be an embedded half-disk of radius 1 in the surface, and would be of area  $\frac{\pi}{2} > 1$ . Then up to a slight deformation, we can assume that there are no other saddle connections parallel to  $\gamma_1$  or  $\gamma_2$  (except the ones that are homologous to  $\gamma_1$  or  $\gamma_2$ ). Now we contract  $\gamma_2$  using the Teichmüller geodesic flow. This gives a path  $(g_t.S)_{t \geq 0}$  in  $\mathcal{Q}_1(k_1, \dots, k_r)$ . For each  $t \geq 0$  the saddle connections corresponding to  $\gamma_1$  and  $\gamma_2$  in  $g_t.S$  are of length at most  $\delta^2 e^{t/2}$  and  $e^{-t/2}$  respectively. Hence the first one is smaller than or equal to  $\delta$  for  $0 \leq t \leq -2 \ln(\delta)$ , and the second one is smaller than  $\delta$  for  $t > -2 \ln(\delta)$ . Hence the path  $g_t.S$  is in the  $\delta$ -neighborhood of the boundary, and we now can assume that  $\gamma_2$  is of length smaller than  $\delta$ .

The other end of  $\gamma_2$  is a singularity of order  $k$ . If  $k \geq 0$ , then from the list of configurations given in Theorem 5.1, the saddle connection  $\gamma_2$  is simple.

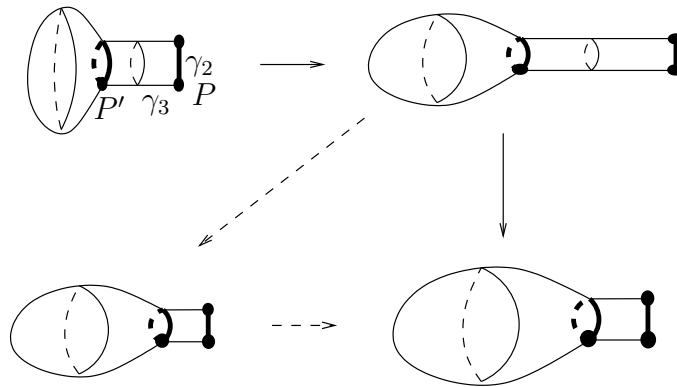

FIGURE 22. Deformation of a surface in  $\mathcal{Q}_{1,\delta}(k_1, \dots, k_r)$ .

We assume that  $k = -1$ , then the surface is a 1-holed sphere glued with a cylinder, one end of this cylinder is  $\gamma_2$  (we have a half-pillowcase), and the

other end of that cylinder is a closed saddle connection whose endpoint is a singularity  $P'$  of order  $k' > 0$ . We can assume, up to using the Teichmüller geodesic flow, that  $\gamma_2$  is of length at most  $(1 - c)\delta$ , where  $c$  is the area of the cylinder. Now we consider  $\gamma_3$  to be the shortest path from  $P$  to  $P'$ . It is clear that  $\gamma_3$  is a simple saddle connection. Now up to twisting and shrinking the cylinder, we can make this saddle connection as small as possible (see Figure 22). However, this transformation, is not area preserving and we must rescale the surfaces to keep area one surfaces. This rescaling increase the length of  $\gamma_2$  by a factor which is at most  $\frac{1}{1-c}$ , and therefore the length of  $\gamma_2$  is always smaller than  $\delta$  during this last deformation, and the resulting surface is in a simple configuration domain with corresponding singularities of orders  $\{-1, k'\}$ .

Now let  $(U_i)_{i=1,2}$  be simple configuration domains. Up to renumeration, we can assume that their corresponding configurations are represented by simple paths that joins a pole to a singularity of order  $k_i > 0$ , for  $i = 1, 2$  (here we assume that there exists two distinct singularities of positive order, the complementary case is trivial). From Theorem 4.2, for each  $i = 1, 2$ , the set  $U_i \cap \mathcal{Q}_{1,\delta}(k_1, \dots, k_r)$  is connected. So, it is enough to find a path between two specific surfaces in  $U_i$  that stays in  $\mathcal{Q}_{1,\delta}(k_1, \dots, k_r)$ . We have  $r \geq 4$ , so we can assume that  $k_{r-1} = k_r = -1$ . We start from a surface in  $\mathcal{Q}(k_1 - 1, k_2 - 1, k_3, \dots, k_{r-2})$  and for  $i = 1, 2$ , we successively break a singularity of order  $k_i - 1$  into two singularities of order  $k_i$  and  $-1$ . We get a surface in  $\mathcal{Q}_{1,\delta}(k_1, \dots, k_r)$  with two arbitrary small saddle connections. We can assume that one of these short saddle connections is vertical, and the other not. Then action on this surface by the Teichmüller geodesic flow easily give a path between  $U_1$  and  $U_2$  that keeps being in  $\mathcal{Q}_{1,\delta}(k_1, \dots, k_r)$ .  $\square$

#### APPENDIX. A GEOMETRIC CRITERION FOR HOMOLOGOUS SADDLE CONNECTIONS

Here we give a proof of the following theorem:

**Theorem** (H. Masur, A. Zorich). *Consider two distinct saddle connections  $\gamma, \gamma'$  on a half-translation surface. The following assertions are equivalent:*

- a) *The two saddle connections  $\gamma$  and  $\gamma'$  are homologous.*
- b) *The ratio of their length is constant under any small deformation of the surface inside the ambient stratum.*
- c) *They have no interior intersection and one of the connected component of  $S \setminus \{\gamma \cup \gamma'\}$  has trivial linear holonomy.*

*Proof.* The proofs of the statements  $a \Leftrightarrow b$  and  $c \Rightarrow b$  are the same as in [MZ]. We will write them for completeness. Our proof of  $b \Rightarrow c$  is new and more geometric than the initial proof.

We first show that statement a) is equivalent to statement b). We have defined  $[\hat{\gamma}]$  and  $[\hat{\gamma}']$  in  $H_1^-(\hat{S}, \hat{P}, \mathbb{Z})$ . We claim that they are primitive cycles. Let  $\gamma_1$  and  $\gamma_2$  be the two preimages of  $\gamma$  in  $\hat{S}$ . If  $[\gamma_1] = -[\gamma_2]$ , then  $[\hat{\gamma}] = [\gamma_1]$

is primitive since it is realized by a simple curve. Otherwise  $[\gamma_1]$  and  $[\gamma_2]$  are independent in  $H_1(\widehat{S}, \widehat{P}, \mathbb{Z})$ , since they cannot be equal and are primitive. We assume first that  $\gamma_1$  and  $\gamma_2$  are closed paths. If they have no intersection point, then by choosing suitably a path joining  $\gamma_1$  and  $\gamma_2$ , one can realize  $[\hat{\gamma}] = [\gamma_1] - [\gamma_2]$  by a simple curve, and hence it is a primitive cycle. If they have an intersection point  $\widehat{P}$ , then it is the preimage of the adjacent singularity  $P$  of  $\gamma$ , which is therefore a ramification point. Since the natural involution on  $\widehat{S}$  is a rotation in a neighborhood of  $\widehat{P}$ , one can always deform  $\gamma_1$  and  $\gamma_2$  to get two simple closed curves with no intersection point.

Now we assume that  $\gamma_1$  and  $\gamma_2$  are not closed, then we can find a basis of  $H_1(\widehat{S}, \widehat{P}, \mathbb{Z})$  that contains  $[\gamma_1]$  and  $[\gamma_2]$ . Hence we can find one that contains  $[\gamma_1] - [\gamma_2]$  and  $[\gamma_2]$ , hence  $[\gamma_1] - [\gamma_2]$  is primitive. So we have proved that  $[\hat{\gamma}]$  and  $[\hat{\gamma}']$  are primitive.

If  $\gamma$  and  $\gamma'$  are  $\hat{\text{homologous}}$ , then integrating  $\omega$  along the cycles  $[\hat{\gamma}]$  and  $[\hat{\gamma}']$ , we see that the ratio of their length belongs to  $\{-1/2, 1, 2\}$ , and this ratio is obviously constant under any small deformations of the surface. Conversely, if they are not  $\hat{\text{homologous}}$ , then  $(\gamma, \gamma')$  is a free family on  $H_1^-(\widehat{S}, \widehat{P}, \mathbb{C})$  (since they are primitive elements of  $H_1^-(\widehat{S}, \widehat{P}, \mathbb{Z})$ ) and so  $\int_{\hat{\gamma}} \omega$  and  $\int_{\hat{\gamma}'} \omega$  correspond to two independent coordinates in a neighborhood of  $S$ . Therefore the ratio of their length is not locally constant.

Now assume *c*). We denote by  $S^+$  a connected component of  $S \setminus \{\gamma, \gamma'\}$  that has trivial holonomy. Its boundary is a union of components homeomorphic to  $S^1$ . The saddle connections have no interior intersections, so this boundary is a union of copies of  $\gamma$  and  $\gamma'$  and it is easy to check that both  $\gamma$  and  $\gamma'$  appears in that boundary. The flat structure on  $S^+$  is defined by an Abelian differential  $\omega$ . Now we have  $\int_{\partial S^+} \omega = 0$ , which impose a relation on  $|\gamma|$  and  $|\gamma'|$ . This relation is preserved in a neighborhood of  $S$ , and therefore, the ratio is locally constant and belongs to  $\{1/2, 1, 2\}$  depending on the number of copies of each saddle connections on the boundary of  $S^+$ .

Now assume *b*). We can assume that the saddle connection  $\sigma$  is vertical. Then using the Teichmüller geodesic flow  $g_t$  on  $S$ , for some small  $t$ , induce a small deformation of  $S$ . The hypothesis implies that the saddle connection  $\gamma'$  is necessary vertical too, and so the two saddle connections are parallel and hence have no interior intersections. Let  $S_1$  and  $S_2$  the connected components of  $S \setminus \{\gamma, \gamma'\}$  that bounds  $\gamma$  (we may have  $S_1 = S_2$ ), and assume that  $S_1$  has nontrivial linear holonomy. That implies there exists a simple broken line  $\nu$  with nontrivial linear holonomy that starts and ends on the boundary of  $S_1$  that correspond to  $\gamma$ . Now, we create an small hole by adding a parallelogram on the first segment of the path  $\nu$ . This creates only one hole  $\tau$  in the interior of  $S_1$  because the other one is sent to the boundary (this procedure adds the length of the hole to the length of the boundary). If we directly move the hole  $\tau$  to the boundary, we obtain a flat surface isometric to the initial surface  $S_1$ . But if we first transport  $\tau$  along  $\nu$ ,



then this will change its orientation, and its length will be added again to the length of the boundary. So the resulting surface has a boundary component corresponding to  $\gamma$  bigger than the initial surface  $S_1$ . The surgery did not affect the boundary corresponding to  $\gamma'$ . Assume now that  $S_2$  has also nontrivial holonomy, then performing the same surgery on  $S_2$ , and gluing back  $S_1$  and  $S_2$ , this gives a slight deformation of  $S$  that change the length of  $\gamma$  and not the length of  $\gamma'$ . This contradicts the hypothesis *b*). □

## REFERENCES

- [B] C. Boissy, *Configuration of saddle connections of quadratic differential on  $\mathbb{CP}^1$  and on hyperelliptic Riemann surfaces*, preprint 2007, arXiv:0705.3142v1 [math.GT].
- [EMZ] A. Eskin, H. Masur, A. Zorich, *Moduli spaces of abelian differentials: the principal boundary, counting problems, and the Siegel-Veech constants*. Publ. Math. Inst. Hautes Études Sci. 97 (2003), 61–179.
- [KZ] M. Kontsevich, A. Zorich *Connected components of the moduli spaces of Abelian differentials with prescribed singularities*. Invent. Math. 153 (2003), no. 3, 631–678.
- [HM] J. Hubbard, H. Masur, *Quadratic differentials and foliations*, Acta Math., **142** (1979), 221–274.
- [HR] B. Hughes, A. Ranicky *Ends of complexes* Cambridge university press.
- [L] E. Lanneau, *Connected components of the moduli spaces of quadratic differentials with prescribed singularities*, Comment. Math. Helv. 79 (2004), no. 3, 471–501.
- [M] H. Masur, *Interval exchange transformations and measured foliations*. Ann. of Math., **115** (1982), 169–200.
- [MS] H. Masur, J. Smillie, *Hausdorff dimension of sets of nonergodic measured foliations*. Ann. of Math. **134** (1991), 455–543.
- [MT] H. Masur, S. Tabachnikov, *Rational billiards and flat structures*. Handbook of dynamical systems, **Vol. 1A**, North-Holland, Amsterdam, (2002), 1015–1089.
- [MZ] H. Masur, A. Zorich, *Multiple saddle connections on flat surfaces and the principal boundary of the moduli space of quadratic differentials* arXiv:math/0402197v2 [math.GT], to appear in GAFA.
- [V1] W.A. Veech, *Gauss measures for transformations on the space of interval exchange maps*. Ann. of Math., **115**, 201–242 (1982).
- [V2] W.A. Veech, *Geometric realizations of hyperelliptic curves*. Algorithms, fractals, and dynamics (Okayama/Kyoto, 1992), 217–226, Plenum, New York, (1995).
- [Y] J-C. Yoccoz, *Continued fraction algorithms for interval exchange maps: an introduction*. In collection “Frontiers in number theory, physics, and geometry. Volume 1: On random matrices, zeta functions and dynamical systems”, P. Cartier; B. Julia; P. Moussa; P. Vanhove (Editors),, 401–435, Springer, Berlin, 2006.
- [Z] A. Zorich, *Flat Surfaces*. In collection “Frontiers in Number Theory, Physics and Geometry. Volume 1: On random matrices, zeta functions and dynamical systems”, P. Cartier; B. Julia; P. Moussa; P. Vanhove (Editors), Springer-Verlag, Berlin, (2006), 439–586.

IRMAR, UNIVERSITÉ RENNES 1, CAMPUS DE BEAULIEU, 35042 RENNES CEDEX, FRANCE

*E-mail address:* corentin.boissy@univ-rennes1.fr

## Chapitre 3

# Échanges d'intervalles généralisés

Cette partie est issue d'un travail en collaboration avec Erwan Lanneau. On définit un analogue des échanges d'intervalles pour les surfaces de demi-translation, et on étudie différentes propriétés : existence de suspensions, minimalité, et induction de Rauzy-Veech.

En annexe de ce chapitre, on propose une version plus détaillée, sous la forme d'un article en anglais.

### 3.1 Échanges d'intervalles généralisés

Soit  $S$  une surface de demi-translation et  $X \subset S$  un segment horizontal, muni d'un choix d'une direction positive. Soit  $x$  un point de  $X$ , et considérons la géodésique verticale partant dans la direction positive. Si cette géodésique ne rencontre pas de singularité de  $S$ , alors elle intersectera à nouveau l'intervalle  $X$  en  $T_0(x)$ . L'application  $T_0$  est définie sur  $X$  privé d'un nombre fini de point. La restriction de cette application à une composante connexe de son domaine de définition est soit une translation, soit un demi-tour. Dans le premier cas, la géodésique correspondante intersecte  $X$  dans la direction positive, dans le second cas, c'est dans la direction négative. On définit de même l'application  $T_1$  comme premier retour des géodésiques verticales partant de  $X$  et dans la direction négative. Pour coder les intersections successives d'une géodésique verticale sur  $X$ , on définit donc un système dynamique sur  $X \times \{0, 1\}$  tel que  $T(x, \varepsilon) = (T_\varepsilon(x), \varepsilon')$ , avec  $\varepsilon = \varepsilon'$  si la dérivée de  $T_\varepsilon$  en  $x$  vaut 1, et  $\varepsilon' = 1 - \varepsilon$  si elle vaut  $-1$ . Ceci justifie la définition suivante :

**Définition 7.** Soit  $X \subset \mathbb{R}$  un intervalle ouvert. Un échange d'intervalles généralisé sur  $X$  est une application bijective et continue  $T : \mathcal{D} \rightarrow \mathcal{I}$ , avec  $\mathcal{D}, \mathcal{I}$  sous-ensembles cofinis de  $X \times \{0, 1\}$ , et telle que :

- Pour chaque intervalle  $X_{i,\varepsilon} \subset X \times \{\varepsilon\}$  de  $\mathcal{D}$ , l'image de  $X_{i,\varepsilon}$  par  $T$  est un sous-ensemble de  $X \times \{\varepsilon'\}$ . Si  $\varepsilon$  et  $\varepsilon'$  sont égaux, alors la restriction de  $T$  à  $X_{i,\varepsilon}$  est une translation. Sinon, il existe  $c_{i,\varepsilon}$  tel que cette restriction soit de la forme  $T(x, \varepsilon) = (c_{i,\varepsilon} - x, 1 - \varepsilon)$ .
- Si  $f$  est l'involution  $(x, \varepsilon) \mapsto (x, 1 - \varepsilon)$ , alors

$$T^{-1} = f \circ T \circ f.$$

- L'application  $f \circ T$  n'a pas de point fixe.

Les éléments du complémentaire de  $\mathcal{D}$  seront appelés *singularités*.

Notons qu'un échange d'intervalles généralisé est un cas particulier des involutions linéaires introduites par Danthony et Nogueira [3].

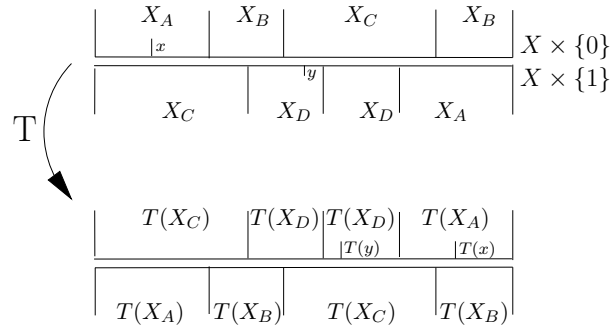

FIG. 3.1 – Un échange d'intervalles généralisé.

**Définition 8.** Soit  $\mathcal{A}$  un alphabet de  $d$  lettres. Une permutation généralisée de type  $(l, m)$ , avec  $l + m = 2d$  est une application  $\pi : \{1, \dots, l + m\} \rightarrow \mathcal{A}$ , telle que chaque élément de  $\mathcal{A}$  admette exactement deux antécédents.

Un échange d'intervalles généralisé définit une permutation généralisée, et des données de longueurs  $\lambda = (\lambda_\alpha)_{\alpha \in \mathcal{A}}$  de la façon suivante : on numérote de gauche à droite les intervalles de  $\mathcal{D} \cap X \times \{0\}$  par  $X_1, \dots, X_l$ , puis de même les intervalles de  $\mathcal{D} \cap X \times \{1\}$  par  $X_{l+1}, \dots, X_{l+m}$ . Ces intervalles vont naturellement par paires d'intervalles de même longueur. Pour chaque paire,

on choisit une lettre  $\alpha \in \mathcal{A}$  et on définit  $\lambda_\alpha$  comme étant cette longueur commune. Réciproquement, un échange d'intervalles généralisé est entièrement déterminé par le couple  $(\pi, \lambda)$ .

*Notation :* Soit  $\pi$  une permutation généralisée de type  $(l, m)$ . On notera le plus souvent  $\pi$  de la manière suivante.

$$\pi = \begin{pmatrix} \pi(1) & \dots & \pi(l) \\ \pi(l+1) & \dots & \pi(l+m) \end{pmatrix}$$

*Exemple 7.* On peut associer à l'échange d'intervalles généralisé de la figure 3.1 la permutation généralisée

$$\pi = \begin{pmatrix} A & B & C & B \\ C & D & D & A \end{pmatrix}.$$

**Définition 9.** Soit  $T = (\pi, \lambda)$  une permutation généralisée. On appelle *donnée de suspension* la famille de nombres complexes  $\zeta = (\zeta_\alpha)_{\alpha \in \mathcal{A}}$  telle que :

1.  $\forall \alpha \in \mathcal{A} \quad \operatorname{Re}(\zeta_\alpha) = \lambda_\alpha.$
2.  $\forall 1 \leq i \leq l-1 \quad \operatorname{Im}(\sum_{j \leq i} \zeta_{\pi(j)}) > 0$
3.  $\forall 1 \leq i \leq m-1 \quad \operatorname{Im}(\sum_{1 \leq j \leq i} \zeta_{\pi(l+j)}) < 0$
4.  $\sum_{1 \leq i \leq l} \zeta_{\pi(i)} = \sum_{1 \leq j \leq m} \zeta_{\pi(l+j)}.$

On définit une construction, analogue à la construction des rectangles zippés de Veech [21], qui associe à une donnée de suspension (et un segment  $X$ ), une surface plate tels que l'application de premier retour du flot vertical sur  $X$  donne précisément l'application  $T$  (voir la partie 2.3 de l'annexe).

Cette construction est très naturelle : comme prouvé dans l'annexe (proposition 2.11, voir aussi l'annexe du chapitre 2), lorsque  $S$  n'admet pas de connexion de selles verticale, l'application de premier retour sur un segment horizontal bien choisi définit une donnée de suspension ; ces données de suspension donnent par la construction des rectangles zippés une surface isométrique à  $S$ .

Tous les échanges d'intervalles généralisés n'admettent pas nécessairement de données de suspension. L'objet de la partie suivante est de donner un critère combinatoire simple d'irréductibilité équivalent au fait d'admettre une donnée de suspension.

### 3.2 Géométrie d'une permutation généralisée

**Définition 10.** Soit  $\pi$  une permutation généralisée. Supposons que  $\pi$  se décompose de la manière suivante :

$$\pi = \left( \frac{A \cup B \mid *** \mid D \cup B}{A \cup C \mid *** \mid D \cup C} \right),$$

Avec  $A, B, C, D$  sous-ensembles disjoints de  $\mathcal{A}$ . Les sous-ensembles (non ordonnés)  $A \cup B, D \cup B, A \cup C, D \cup C$  sont appelés les coins de la décomposition.

Nous dirons alors que  $\pi$  est *réductible* si les ensembles  $A, B, C, D$  ne sont pas tous vides et satisfont l'une des propriétés suivantes :

- Aucun coin n'est vide.
- Exactement un coin est vide, et il est à gauche.
- Exactement deux coins sont vides, et ils sont soit tous les deux à gauche, soit tous les deux à droite.

*Exemple 8.* Soit  $\pi$  la permutation généralisée définie par :

$$\pi = \left( \begin{array}{cccccc} 1 & 1 & 2 & 2 & 3 & 4 \\ 5 & 6 & 6 & 7 & 7 & 4 & 5 & 3 \end{array} \right).$$

Alors  $\pi$  est réductible avec  $A = B = \emptyset, C = \{5\}$  et  $D = \{3, 4\}$ .

En annexe, on montre le théorème suivant :

**Théorème.** *Un échange d'intervalles généralisé  $T = (\pi, \lambda)$  admet des données de suspension si et seulement si  $\pi$  est irréductible.*

En particulier, les permutations généralisées irréductibles sont précisément celles apparaissant comme premier retour du feuilletage vertical d'une surface générique sur un segment horizontal bien choisi.

### 3.3 Irrationalité

Dans la partie précédente, on a donné un critère combinatoire pour avoir une « irréductibilité géométrique ». On s'intéresse ici à une généralisation naturelle de la propriété de Keane (traduisant une forme d'irrationalité) pour les échanges d'intervalles.

**Définition 11.** Une *connexion* d'un échange d'intervalles généralisé est une orbite finie  $(x, \varepsilon), T(x, \varepsilon), \dots, T^r(x, \varepsilon)$  qui ne peut être prolongée ni dans le futur, ni dans le passé, c'est à dire que  $(x, \varepsilon)$  est une singularité de  $T^{-1}$  tandis

que  $T^r(x, \varepsilon)$  est une singularité de  $T$ . L'entier  $r \geq 0$  est appelé *longueur* de la connexion. On dit qu'un échange d'intervalles généralisé vérifie la propriété de Keane s'il est sans connexions.

De façon analogue aux cas des échanges d'intervalles on définit l'induction de Rauzy-Veech et on montre qu'un échange d'intervalles généralisé  $T$  vérifie la propriété de Keane si et seulement si la suite des itérés de  $T$  par cette induction est infinie, et pour laquelle la longueur des sous-intervalles correspondants tend vers 0. Cette dernière propriété traduit que l'induction de Rauzy-Veech est un bon procédé de renormalisation. De plus, si  $T$  satisfait la condition de Keane, alors  $T$  est minimal.

**Définition 12.** Un échange d'intervalles généralisé  $T = (\pi, \lambda)$  est dit *dynamiquement réductible* si l'une des deux propriétés suivantes est réalisée :

1.  $\pi$  se décompose en  $\left(\begin{array}{c|c} A & *** \\ \hline A & *** \end{array}\right)$  pour  $A$  non vide,  $\left(\begin{array}{c|c} *** & D \\ \hline *** & D \end{array}\right)$  pour  $D$  non vide, ou encore en  $\left(\begin{array}{c|c} A \cup B & D \cup B \\ \hline A \cup C & D \cup C \end{array}\right)$ .
2.  $\pi$  se décompose en  $\left(\begin{array}{c|c|c} A \cup B & *** & B \cup D \\ \hline A \cup C & \alpha_0 & C \cup D \end{array}\right)$  (quitte à échanger les deux lignes) et les paramètres de longueur  $\lambda$  satisfont l'inégalité suivante :

$$\sum_{\alpha \in C} \lambda_\alpha \leq \sum_{\alpha \in B} \lambda_\alpha \leq \lambda_{\alpha_0} + \sum_{\alpha \in C} \lambda_\alpha.$$

Si  $\pi$  satisfait une des décompositions du cas (1), alors quelque soit  $\lambda$ , l'échange d'intervalles généralisé  $T = (\pi, \lambda)$  admet une connexion de longueur 0, et  $X \times \{0, 1\}$  se décompose en deux sous-ensembles invariants et de mesures non nulle. On peut vérifier que les exemples donnés dans la figure 10 de l'introduction correspondent à ce cas.

Si  $T$  est dynamiquement réductible (cas (2)), il admet une connexion de longueur 1. En effet considérons  $x = \sum_{\alpha \in A \cup B} \lambda_\alpha$ . Alors  $(x, 0)$  est une singularité de  $T$ , donc  $(x, 1)$  est une singularité de  $T^{-1}$ . Alors  $T(x, 1) = (y, 0)$  pour un certain  $y \in X$ . Soit  $z = \sum_{\alpha \in B} \lambda_\alpha - \sum_{\alpha \in C} \lambda_\alpha$ , et  $L = \sum_{i=1}^l \lambda_{\pi(i)}$ . Alors

$$y = L - \sum_{\alpha \in D \cup C} \lambda_\alpha - z = L - \sum_{\alpha \in D} \lambda_\alpha - \sum_{\alpha \in B} \lambda_\alpha = L - \sum_{\alpha \in B \cup D} \lambda_\alpha,$$

et donc  $(y, 0)$  est une singularité pour  $T$ . Donc  $T$  admet une connexion de longueur 1. De plus, le sous-ensemble  $((0, x) \sqcup (y, L)) \times \{0, 1\}$  est invariant par  $T$ . On peut également vérifier que l'exemple donné dans la figure 11 de

l'introduction correspond à un échange d'intervalles généralisé dynamiquement réductible (cas (2)).

L'ensemble des échanges d'intervalles généralisés dynamiquement irréductible est un ouvert (non vide) dans l'espace des échanges d'intervalles généralisés. En particulier, on peut parler de « presque tous échanges d'intervalles généralisés ». Le théorème suivant (déjà énoncé dans l'introduction) affirme que les deux exemples précédents sont essentiellement les seuls.

**Théorème.** – *Un échange d'intervalles généralisé dynamiquement réductible n'est jamais minimal.*

– *Presque tous les échanges d'intervalles généralisés dynamiquement irréductibles sont munis de la propriété de Keane, et sont donc minimaux.*

L'esquisse de preuve a déjà été donnée en introduction, on renvoie à l'annexe pour plus de détails.

*Exemple 9.* Soit  $\pi = (\frac{1}{5} \frac{2}{6} \frac{2}{6} \frac{3}{7} \frac{4}{7} \frac{4}{5} \frac{3}{3})$ . Cette permutation généralisée est réductible (voir l'exemple 8). Mais il est facile de voir que, quelque soit  $\lambda$ , l'échange d'intervalles généralisé  $(\pi, \lambda)$  est dynamiquement irréductible.

### 3.4 Dynamique de Rauzy-Veech

Les deux parties précédentes suggèrent l'existence de deux notions distinctes d'irréductibilité, l'une géométrique, l'autre dynamique. L'irréductibilité géométrique étant plus forte que l'irréductibilité dynamique, et est nommée simplement « irréductibilité ».

On regarde ici la dynamique de l'induction de Rauzy-Veech renormalisée de sorte que la longueur de l'intervalle soit fixe. On rappelle le théorème suivant (qui constitue le théorème principal 5 de l'introduction).

**Théorème.** – *Soit  $T$  un échange d'intervalles généralisé muni de la propriété de Keane. Alors il existe  $n_0$  tel que pour tout  $n \geq n_0$ , la permutation généralisée associée à  $\mathcal{R}^n(T)$  est irréductible.*

– *L'application  $\mathcal{R}_r$  est récurrente sur  $\{(\pi, \lambda) \mid \pi \text{ irréductible}\}$*

On a déjà donné une esquisse de preuve de ce théorème dans l'introduction. On renvoie à l'annexe pour les détails.

### 3.5 Classes de Rauzy

Dans le cas des permutations habituelles, l'induction de Rauzy définit deux transformations  $\mathcal{R}_0$  et  $\mathcal{R}_1$  de l'espace des permutations. Ceci définit

une relation d'ordre partiel entre les permutations, et la périodicité des applications  $\mathcal{R}_i$  implique que cette relation est une relation d'équivalence. Les classes d'équivalences associées étant appelées classes de Rauzy.

Soit  $\pi$  une permutation généralisée. L'induction de Rauzy définit *au plus* deux autres permutations généralisées  $\mathcal{R}_0(\pi)$  et  $\mathcal{R}_1(\pi)$ . On peut alors définir la relation  $\pi_1 \sim \pi_2$  si  $\pi_2$  s'obtient à partir de  $\pi_1$  par une combinaison des applications  $\mathcal{R}_0$  et  $\mathcal{R}_1$ .

**Théorème 4.** *La relation définie précédemment ( $\sim$ ) est une relation d'équivalence sur l'ensemble des permutations irréductibles.*

Ce théorème permet donc de parler également de classes de Rauzy généralisées. Contrairement au cas habituel, ce théorème n'est pas élémentaire vu que l'on peut avoir  $\mathcal{R}_0(\pi)$  bien défini, mais pas  $\mathcal{R}_0^2(\pi)$ . On doit utiliser pour cela la récurrence de l'application  $\mathcal{R}_r$  : si  $\pi_1 \sim \pi_2$ , alors on trouve  $\lambda$  tel que la suite  $(\mathcal{R}_r^n(\pi_1, \lambda))_{n \in \mathbb{N}}$  passe par  $(\pi_2, \lambda')$ , et revient arbitrairement proche de  $(\pi_1, \lambda)$ . Ceci fournit une combinaison d'applications  $\mathcal{R}_0$  et  $\mathcal{R}_1$  envoyant  $\pi_2$  sur  $\pi_1$ .

Les classes de Rauzy étendues s'obtiennent en combinant les deux inductions de Rauzy avec une troisième opération consistant à « retourner » la permutation (c'est à dire que  $\begin{pmatrix} \pi(1) & \dots & \pi(l) \\ \pi(l+1) & \dots & \pi(l+m) \end{pmatrix}$  devient  $\begin{pmatrix} \pi(l+m) & \dots & \pi(l+1) \\ \pi(l) & \dots & \pi(1) \end{pmatrix}$ ).

Elles ont servi historiquement à montrer la non connexité de certaines strates de différentielles abéliennes avant la classification complète par Kontsevich et Zorich [11]. Veech [23] a ainsi montré que la strate  $\mathcal{H}(4)$  admet deux composantes connexes, et Arnoux a montré que  $\mathcal{H}(6)$  en admet trois. On montre ici le résultat suivant :

**Théorème 5.** *Les classes de Rauzy étendues de permutations généralisées sont en bijection avec les composantes connexes des strates de l'espace des modules des différentielles quadratiques.*

En particulier, ce théorème complète la preuve du théorème suivant :

**Théorème (Zorich).** *Les strates  $\mathcal{Q}(-1, 9)$ ,  $\mathcal{Q}(-1, 3, 6)$ ,  $\mathcal{Q}(-1, 3, 3, 3)$  et  $\mathcal{Q}(12)$  ne sont pas connexes.*

Ce résultat a été obtenu après le calcul<sup>1</sup> par Zorich de classes de Rauzy étendues dans les strates correspondantes. Notons que ces classes de Rauzy ont parfois plusieurs centaines de milliers d'éléments.

<sup>1</sup>Le programme *Mathematica* correspondant est disponible à l'adresse <http://perso.univ-rennes1.fr/anton.zorich>





## Annexe du chapitre 3



# ON GENERALIZED INTERVAL EXCHANGE MAPS: DYNAMICS AND GEOMETRY OF THE RAUZY-VEECH INDUCTION

CORENTIN BOISSY, ERWAN LANNEAU

ABSTRACT. Interval exchange maps are related to geodesic flows on translation surfaces; they correspond to first return maps of the vertical flow on a transverse segment. The Rauzy-Veech induction on the space of interval exchange maps provides a powerful tool to analyze the Teichmüller geodesic flow on the moduli space of Abelian differentials. Several major results have been proved using this renormalization. In this paper, we investigate analogous maps in the case of flat surfaces with  $\mathbb{Z}/2\mathbb{Z}$  linear holonomy. We relate the geometry and dynamics of such maps to combinatoric criteria on generalized permutations. We then study the Rauzy-Veech induction. This explains the Kontsevich-Zorich's observations on the generalized permutations. As an application we give a formal proof of the fact that the “exceptional” strata in the moduli space of quadratic differentials are non-connected.

## CONTENTS

Introduction	1
1. Background	5
2. Generalized interval exchange maps	13
3. Geometry of generalized permutations	21
4. Irrationality of generalized interval exchange maps	32
5. Dynamics of the renormalized Rauzy-Veech induction	36
6. Rauzy classes	40
Appendix A. Computation of Rauzy classes	44
References	46

## INTRODUCTION

The geodesic flow in a given direction on a translation surface induces on a transverse segment an interval exchange map. The dynamics of such transformations has been studied extensively during the last thirty years. These

---

2000 *Mathematics Subject Classification*. Primary: 37E05. Secondary: 37D40.

*Key words and phrases*. Interval exchange map, Rauzy-Veech induction, Quadratic differential, Moduli space, Teichmüller geodesic flow.

studies have various applications including applications to billiards in rational polygons, to measured foliations on surfaces, to Teichmüller geometry and dynamics, etc.

Interval exchange transformations are closely related to Abelian differentials on Riemann surfaces. It is well known that continued fractions encode cutting sequences of hyperbolic geodesics on the Poincaré upper half-plane. Similarly, the Rauzy-Veech induction (analogous to the Euclidean algorithm) provides a discrete model for Teichmüller geodesics (see [Rau79, Vee82]).

Using this relation Masur in [Mas82] and Veech in [Vee82] have proved unique ergodicity of almost all interval exchange transformations. Using the combinatorics of the Rauzy classes, Kontsevich and Zorich classified the connected components of the strata of the moduli spaces of Abelian differentials [KZ03]. More recently, Avila, Gouëzel and Yoccoz proved the exponential decay of correlation of the Teichmüller geodesic flow, also using a renormalization of the Rauzy-Veech induction (see [Zor96, AGY06]). Avila and Viana proved the Kontsevich-Zorich conjecture, that is the simplicity of the Lyapunov spectrum (see [AV07]).

However, all of these last results concern the moduli space of Abelian differentials. The corresponding questions for the strata of *strict* quadratic differentials (i.e. which are not the global square of any Abelian differential) remain open.

Despite numerous similarities between Abelian and quadratic differentials, combinatorics related to a natural generalization of interval exchange transformations for quadratic differentials is not trivial. Introduced by Danthony and Nogueira, cross sections of vertical foliation provides “generalized” interval exchange maps [DN90]. Kontsevich and Zorich have intensively studied these maps during the last decade [KZ97]. Through huge computer experiments they calculated the (extended) Rauzy classes for generalized permutations. They discovered some strange phenomena on the dynamics and the geometry of the Rauzy-Veech induction and were confronted to some unexpected difficulties. They observed the existence of an attractor set for the Rauzy-Veech induction, that was more or less corresponding to their definition of “irreducible” generalized permutations. They also found some examples of generalized permutations such that the corresponding generalized interval exchange maps are minimal for a domain of parameters of positive measure, and non minimal for another domain of parameters of positive measure, where the parameters are the lengths of subintervals under exchange. See for instance Figure 12 and Figure 13 in the Appendix. But at this point, there was no explanation of the phenomena, and no corresponding reasonable combinatorial criteria. In this paper we propose an interpretation of these behaviors by studying geometric and dynamical properties of such maps.

Let us first review the situation in the interval exchange maps case. These maps are encoded by combinatorial data (permutation on  $d$  elements) and

continuous data (lengths of the intervals). Recall that the Keane's property corresponds to "irrational" behavior (which implies minimality) of the dynamical system. Moreover this property is satisfied for generic parameters when the permutation  $\pi$  is irreducible (i.e.  $\pi(\{1, \dots, k\}) \neq \{1, \dots, k\}$ ,  $\forall 1 \leq k \leq d-1$ ), while when  $\pi$  is reducible, the corresponding interval exchange map is never minimal. On the other hand these irrational interval exchange maps are precisely those that arise as a cross section of a minimal vertical flow on a well chosen transverse interval.

The Rauzy-Veech operation is a well known induction process which consist in taking the Poincaré section on a smaller interval. Its behavior viewed as a dynamical system on the set of interval exchange maps gives information on the starting point. This operation is useful when all iterates are well defined and the length of the underlying subintervals tends to zero. The subset of parameters to which we can apply this induction process infinitely many times contains all irrational parameters, and so it is a full Lebesgue measure subset. The characterisation of this feature is called the Keane's property. Moreover, in the set of interval exchange maps with irreducible combinatorial data, the renormalized induction process is recurrent (with respect to the Lebesgue measure).

As above, the generalized interval exchange maps are encoded by combinatorial data ("generalized permutation") and continuous data. A generalized permutation of type  $(l, m)$  (with  $l + m = 2d$ ) is a two-to-one map  $\pi : \{1, \dots, 2d\} \rightarrow \mathcal{A}$ .

The next two results emphasize the differences between interval exchange maps and generalized interval exchange maps, and explain Kontsevich and Zorich's observations. For that we find two natural criteria that are expressed in elementary combinatorial terms:

- (1) An *irreducibility* criterion for generalized permutations.
- (2) A *dynamical irreducibility* criterion for generalized interval exchange maps that is open in the parameter space.

Note that for any parameter  $\lambda$  and irreducible permutation  $\pi$ ,  $T = (\pi, \lambda)$  is dynamically irreducible. Note also that there exists a class of generalized permutations, such that for each  $\pi$  in that class, there are two subsets of parameters of nonzero measure such that  $T = (\pi, \lambda)$  is dynamically irreducible if  $\lambda$  belongs to the first subset and  $T = (\pi, \lambda)$  is dynamically reducible if  $\lambda$  belongs to the other subset.

**Theorem A.**

- (1) *The irreducible generalized permutations are precisely those that arise as combinatorial data coming from cross sections of vertical flow on a well chosen interval in a generic surface.*
- (2) *Let  $T$  be a generalized interval exchange map.*
  - *If  $T$  is dynamically reducible then  $T$  is not minimal.*

- If  $T$  is dynamically irreducible and have generic parameters then  $T$  satisfies the Keane's property, and hence is minimal.

Since the Rauzy-Veech induction commutes with dilatations, it projectivizes to a map on length one intervals that we call the *renormalized Rauzy-Veech induction*.

**Theorem B.** *Let  $T$  be a generalized interval exchange map on  $(0, 1)$  and let  $(\mathcal{R}_r^n(T) = (\pi^{(n)}, \lambda^{(n)}))_{n \in \mathbb{N}}$  be the sequence of iterates of  $T$  by the renormalized Rauzy-Veech induction.*

- If  $T$  has the Keane's property, then there exists  $n_0$  such that  $\pi^{(n)}$  is irreducible for all  $n \geq n_0$ .
- The renormalized Rauzy-Veech induction  $\mathcal{R}_r$  is recurrent on the set  $\{(\pi, \lambda), \pi \text{ irreducible}\}$ .

From a generalized permutation  $\pi$  we can define one or two other generalized permutations  $\mathcal{R}_0(\pi)$  and  $\mathcal{R}_1(\pi)$  reflecting the possibilities for the generalized permutation associated to the Rauzy-Veech induction  $\mathcal{R}(T)$  that depend of the lengths of the two rightmost intervals in the definition of  $T$ . These combinatorial Rauzy operations define a partial order in the set of irreducible permutations, represented by a graph. A *Rauzy class* is a connected component of this graph. One will show that this relation is an equivalence relation on the set of permutations and the equivalent class of a permutation is the corresponding Rauzy class. The geometry of this graph is very different and much complicated than in the case of interval exchange maps (see for instance Figure 12).

The moduli spaces of Abelian differentials and quadratic differentials is stratified by the multiplicities of the zeroes of the corresponding form. Historically, the (extended) Rauzy classes were used to prove that some strata of Abelian differentials are non-connected. For instance, Veech proved that the stratum corresponding to genus 3 with a single zero has two connected components. Arnoux proved that the stratum corresponding to genus 4 with a single zero has three connected components. We can consider analogous classes for generalized permutations and prove the following theorem.

**Theorem C.** *The extended Rauzy classes of irreducible generalized permutations are in one-to-one correspondence with the set of connected components of the moduli spaces of quadratic differentials.*

If we denote by  $\mathcal{Q}(k_1, \dots, k_n)$  a stratum of the moduli space of strict quadratic differentials ( $k_i \geq -1$ ) then:

**Corollary** (Zorich). *The four following exceptional strata of quadratic differentials in genus 3 and in genus 4*

$$\mathcal{Q}(-1, 9), \quad \mathcal{Q}(-1, 3, 6), \quad \mathcal{Q}(-1, 3, 3, 3) \text{ and } \mathcal{Q}(12)$$

*are non connected.*

*Reader's guide.* In section 1 we recall basic properties of flat surfaces, moduli spaces and interval exchange maps. In particular we recall the Rauzy-Veech induction and its dynamical properties. We relate these properties to the irreducibility.

In section 2 we present the generalized exchange maps and give basic properties. Then in section 3 we define a combinatorial notion of irreducibility, and prove the first part of Theorem A. The main tool we use to prove this theorem is the presentation proposed by Marmi, Moussa and Yoccoz which appears in [MMY05]

In section 4 we introduce the Keane's property for generalized interval exchange maps and prove the second part of Theorem A. For that we prove that  $T$  satisfies the Keane property if and only if the Rauzy-Veech induction is always well defined and the length parameters tends to zero. Then if  $T$  does not satisfy the Keane property we show that there exists  $n_0$  such that  $\mathcal{R}^{n_0}(T)$  is dynamically reducible which then implies that  $T$  is also dynamically reducible. In section 5, we study the dynamics of the renormalized Rauzy-Veech map on the space of generalized interval exchange maps, and prove Theorem B. For that we use the Teichmüller geometry and the finiteness of the volume of the strata proved by Veech (see [Vee90]).

Section 6 is devoted to a proof of Theorem C on extended Rauzy classes and in the last section we present a result of Zorich on an explicit calculation of these classes in low genera.

In the Appendix we present some explicit Rauzy class as illustration of the problems which appear in the general case.

*Acknowledgments.* We thank Anton Zorich for useful discussions. This work was partially supported by the ANR Teichmüller "projet blanc" ANR-06-BLAN-0038.

## 1. BACKGROUND

In this section we review basic notions concerning flat surfaces, moduli spaces and interval exchange maps. For general references see say [Rau79, Vee78, Vee82, Zor96] and [MT02]. In this paper we will mostly follow notations presented in the paper [MMY05], or equivalently [Yoc03].

**1.1. Flat surfaces.** A *flat surface* is a (real, compact, connected) genus  $g$  surface equipped with a flat metric (with isolated conical singularities) such that the holonomy group belongs to  $\{\pm \text{Id}\}$ . This implies that all cone angles are integer multiples of  $\pi$ . Equivalently a flat surface is a triple  $(S, \mathcal{U}, \Sigma)$  such that  $S$  is a topological compact connected surface,  $\Sigma$  is a finite subset of  $S$  (whose elements are called *singularities*) and  $\mathcal{U} = \{(U_i, z_i)\}$  is an atlas of  $S \setminus \Sigma$  such that the transition maps  $z_j \circ z_i^{-1} : z_i(U_i \cap U_j) \rightarrow z_j(U_i \cap U_j)$  are translations or half-turns:  $z_i = \pm z_j + \text{const}$ , and for each  $s \in \Sigma$ , there is a neighborhood of  $s$  isometric to a Euclidean cone. Therefore we get a *quadratic differential* defined locally in the coordinates  $z_i$  by the formula  $q = dz_i^2$ . This form extends to the points of  $\Sigma$  to zeroes, simple poles or



marked points (see [MT02]). We will sometimes use the notation  $(S, q)$  or simply  $S$ .

Observe that the holonomy is trivial if and only if all transition functions are translations or equivalently if the quadratic differential  $q$  is the global square of an Abelian differential. We will then say that  $S$  is a translation surface.

**1.2. Moduli spaces.** For  $g \geq 1$ , we define the moduli space of Abelian differentials  $\mathcal{H}_g$  as the set of pairs  $(S, \omega)$  modulo the equivalence relation generated by:  $(S, \omega) \sim (S', \omega')$  if there exists an analytic isomorphism  $f : S \rightarrow S'$  such that  $f^*\omega' = \omega$ .

For  $g \geq 0$ , we also define the moduli space of quadratic differentials  $\mathcal{Q}_g$  as the moduli space of pairs  $(S, q)$  (where  $q$  is not the global square of any Abelian differential) modulo the equivalence relation generated by:  $(S, q) \sim (S', q')$  if there exists an analytic isomorphism  $f : S \rightarrow S'$  such that  $f^*q' = q$ .

The moduli space of Abelian differentials (respectively quadratic differentials) is stratified by the combinatorics of the zeroes. We denote by  $\mathcal{H}(k_1, \dots, k_n)$  (respectively  $\mathcal{Q}(k_1, \dots, k_n)$ ) the stratum consisting of holomorphic one-forms (respectively quadratic differentials) with  $n$  zeroes (or poles) of multiplicities  $(k_1, \dots, k_n)$ . These strata are non-connected in general (for a complete classification see [KZ03] in the Abelian differentials case and [Lan04] in the quadratic differentials case).

The linear action of the 1-parameter subgroup of diagonal matrices  $g_t := \text{diag}(e^{t/2}, e^{-t/2})$  on the flat surfaces presents a particular interest. It gives a measure-preserving flow with respect to a natural measure  $\mu^{(1)}$ , preserving each stratum of area one flat surfaces. This flow is known as the *Teichmüller geodesic flow*. Masur and Veech proved the following theorem.

**Theorem** (Masur; Veech). *The Teichmüller geodesic flow acts ergodically on each connected component of each stratum of the moduli spaces of area one Abelian and quadratic differentials (with respect to a finite measure in the Lebesgue class).*

This theorem was proved by Masur [Mas82] for the  $\mathcal{Q}(4g - 4)$  case and Veech [Vee82] for the  $\mathcal{H}(k_1, \dots, k_n)$  case.

The ergodicity of the Teichmüller geodesic flow is proved in full generality in [Vee86], Theorem 0.2. The finiteness of the measure appears in two 1984 preprints of Veech: Dynamical systems on analytic manifolds of quadratic differentials I,II (see also [Vee86] p.445). These preprints were published in 1990 [Vee90].

**1.3. Interval exchange maps.** In this section we recall briefly the theory of interval exchange maps. We will show that, under simple combinatorial conditions, such transformations arise naturally as Poincaré return maps of measured foliations and geodesic flows on translation surfaces. Moreover

we will present the Rauzy-Veech induction and its geometric and dynamical properties.

Let  $I \subset \mathbb{R}$  be an open interval and let us choose a finite subset  $\{sing\}$  of  $I$ . Its complement is a union of  $d \geq 2$  open subintervals. An interval exchange map is a one-to-one map  $T$  from  $I \setminus \{sing\}$  to a co-finite subset of  $I$  that is a translation on each subinterval of its definition domain. It is easy to see that  $T$  is precisely determined by the following data: a permutation  $\bar{\pi}$  that encodes how the intervals are exchanged (expressing that the  $k$ -th interval, when numerated from the left to the right, is sent by  $T$  to the place  $\bar{\pi}(k)$ ), and a vector with positive entries that encodes the lengths of the intervals.

Following Marmi, Moussa, Yoccoz [MMY05], we denote these intervals by  $\{I_\alpha, \alpha \in \mathcal{A}\}$ , with  $\mathcal{A}$  a finite alphabet. The length of the intervals is a vector  $\lambda = (\lambda_\alpha)_{\alpha \in \mathcal{A}}$ , and the combinatorial data is a pair  $\pi = (\pi_0, \pi_1)$  of one to one maps  $\pi_\epsilon : \mathcal{A} \rightarrow \{1, \dots, d\}$ . Then  $\bar{\pi}$  is a one-to-one map from  $\{1, \dots, d\}$  into itself given by  $\bar{\pi} = \pi_1 \circ \pi_0^{-1}$ . We will usually represent such a permutation by a table:

$$\begin{aligned} \bar{\pi} &= \begin{pmatrix} 1 & 2 & \dots & n \\ \bar{\pi}^{-1}(1) & \bar{\pi}^{-1}(2) & \dots & \bar{\pi}^{-1}(n) \end{pmatrix} = \\ &= \begin{pmatrix} \pi_0^{-1}(1) & \pi_0^{-1}(2) & \dots & \pi_0^{-1}(n) \\ \pi_1^{-1}(1) & \pi_1^{-1}(2) & \dots & \pi_1^{-1}(n) \end{pmatrix}. \end{aligned}$$

*Example 1.1.* Let us consider the following alphabet  $\mathcal{A} = \{A, B, C, D\}$  with  $d = 4$ . Then we define the permutation  $\pi$  as follows.

$$\bar{\pi} = \begin{pmatrix} A & B & C & D \\ D & C & B & A \end{pmatrix}.$$

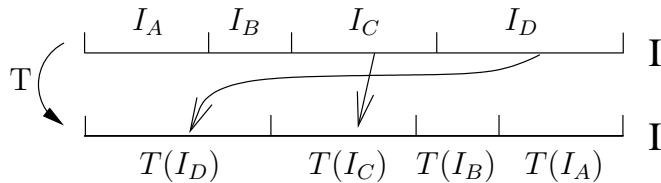

FIGURE 1. An interval exchange map.

1.3.1. *Rauzy-Veech induction.* In this section we introduce the notion of winner and loser, following the terminology of the paper of Avila, Gouezel and Yoccoz [AGY06]. For  $T = (\pi, \lambda)$  we define the *type*  $\epsilon$  by  $\lambda_{\pi_\epsilon^{-1}(d)} > \lambda_{\pi_{1-\epsilon}^{-1}(d)}$ . We will then say that  $I_{\pi_\epsilon^{-1}(d)}$  is the winner and  $I_{\pi_{1-\epsilon}^{-1}(d)}$  is the loser. Then

we define a subinterval  $J$  of  $I$  by removing the loser of  $I$  as follows.

$$\begin{cases} J = I \setminus T(I_{\pi_1^{-1}(d)}) & \text{if } T \text{ is of type 0} \\ J = I \setminus I_{\pi_0^{-1}(d)} & \text{if } T \text{ is of type 1.} \end{cases}$$

The Rauzy-Veech induction  $\mathcal{R}(T)$  of  $T$  is then defined as the first return map of  $T$  to the subinterval  $J$ . It is easy to see that this is again an interval exchange transformation, defined on  $d$  letters [Rau79]. We see now how to compute the data of the new map.

There are two cases to distinguish depending whether  $T$  is of type 0 or 1, and the combinatorial data of  $\mathcal{R}(T)$  only depends on  $\pi$  and on the type of  $T$ . This defines two maps  $\mathcal{R}_0$  and  $\mathcal{R}_1$  by  $\mathcal{R}(T) = (\mathcal{R}_\varepsilon(\pi), \lambda')$ , with  $\varepsilon$  the type of  $T$ .

- (1)  $T$  has type 0; equivalently the winner is  $I_{\pi_0^{-1}(d)}$ .

In that case, we define  $k$  by  $\pi_1^{-1}(k) = \pi_0^{-1}(d)$  where  $k \leq d-1$ . In an equivalent way  $k = \pi_1 \circ \pi_0^{-1}(d) = \bar{\pi}(d)$ . Then  $\mathcal{R}_0(\pi_0, \pi_1) = (\pi'_0, \pi'_1)$  where  $\pi_0 = \pi'_0$  and

$$\pi'_1{}^{-1}(j) = \begin{cases} \pi_1^{-1}(j) & \text{if } j \leq k \\ \pi_1^{-1}(d) & \text{if } j = k+1 \\ \pi_1^{-1}(j-1) & \text{otherwise.} \end{cases}$$

We have  $\lambda'_\alpha = \lambda_\alpha$  if  $\alpha \neq \pi_0^{-1}(d)$  and  $\lambda'_{\pi_0^{-1}(d)} = \lambda_{\pi_0^{-1}(d)} - \lambda_{\pi_1^{-1}(d)}$ .

- (2)  $T$  has type 1; equivalently the winner is  $I_{\pi_1^{-1}(d)}$ .

In that case, we define  $k$  by  $\pi_0^{-1}(k) = \pi_1^{-1}(d)$  where  $k \leq d-1$ . In an equivalent way  $k = \pi_0 \circ \pi_1^{-1}(d) = \bar{\pi}^{-1}(d)$ . Then  $\mathcal{R}_1(\pi_0, \pi_1) = (\pi'_0, \pi'_1)$  where  $\pi_1 = \pi'_1$  and

$$\pi'_0{}^{-1}(j) = \begin{cases} \pi_0^{-1}(j) & \text{if } j \leq k \\ \pi_0^{-1}(d) & \text{if } j = k+1 \\ \pi_0^{-1}(j-1) & \text{otherwise.} \end{cases}$$

We have  $\lambda'_\alpha = \lambda_\alpha$  if  $\alpha \neq \pi_1^{-1}(d)$  and  $\lambda'_{\pi_1^{-1}(d)} = \lambda_{\pi_1^{-1}(d)} - \lambda_{\pi_0^{-1}(d)}$ .

*Example 1.2.* Let  $\mathcal{A} = \{A, B, C, D\}$  be an alphabet. Let us consider the permutation  $\pi$  of Example 1.1. Then

$$\mathcal{R}_0\pi = \begin{pmatrix} A & B & C & D \\ D & A & C & B \end{pmatrix} \quad \text{and} \quad \mathcal{R}_1\pi = \begin{pmatrix} A & D & B & C \\ D & C & B & A \end{pmatrix}.$$

We stress that the Rauzy-Veech induction is well defined if and only if the two rightmost intervals do not have the same length i.e.  $\lambda_{\pi_0^{-1}(d)} \neq \lambda_{\pi_1^{-1}(d)}$ . In the next, we want to study the Rauzy-Veech induction as a dynamical system defined on the space of interval exchange transformations. Thus we want the iterates of the Rauzy-Veech induction on  $T$  to be always well defined. We also want this induction to be a good renormalization process, in the sense that the iterates correspond to inductions on subintervals that

tend to zero. This leads to the definition of reducibility and to the Keane's property.

1.3.2. *Rauzy-Veech induction and Keane's property.* We will say that  $\pi = (\pi_0, \pi_1)$  is reducible if there exists  $1 \leq k \leq d - 1$  such that  $\{1, \dots, k\}$  is invariant under  $\bar{\pi} = \pi_1 \circ \pi_0^{-1}$ . This means exactly that  $T$  splits into two interval exchange transformations.

We will say that  $T$  satisfies the *Keane's property*, or the *infinite distinct orbit condition* (i.d.o.c.), if the orbits of the singularities of  $T^{-1}$  by  $T$  are infinite. This ensures that  $\pi$  is irreducible and the iterates of the Rauzy-Veech induction are always well defined.

If the  $\lambda_\alpha$  are rationally independent vectors, that is  $\sum r_\alpha \lambda_\alpha \neq 0$  for all nonzero integer vectors  $(r_\alpha)$ , then  $T$  satisfies the Keane's property (see [Kea75]). However the converse is not true. Note that if  $T$  satisfies the Keane's property then  $T$  is minimal.

Let  $T = (\pi, \lambda)$  be an interval exchange map that satisfies the i.d.o.c property. Let us denote by  $\lambda_\alpha^{(n)}$  the length of the interval associated to the symbol  $\alpha \in \mathcal{A}$  for the  $n$ -th iterate of  $T$  by  $\mathcal{R}$ ; we denote  $\mathcal{R}^n(T) =: (\pi^{(n)}, \lambda^{(n)})$ .

**Proposition.** *The following are equivalent.*

- (1)  $T$  satisfies the Keane's condition.
- (2) The Rauzy-Veech induction  $\mathcal{R}$  is always well-defined and for any  $\alpha \in \mathcal{A}$ , the length of the intervals  $\lambda_\alpha^{(n)}$ , goes to zero as  $n$  tends to infinity.

As we will see, the situation is very similar in the case of generalized interval exchange transformations.

If we want to study the Rauzy-Veech induction as a dynamical system on the space of interval exchange maps, it is useful to consider the Rauzy-Veech renormalisation on the projective space of lengths parameters space. The natural associated object is the renormalized Rauzy-Veech induction defined on length one intervals:

$$\text{if } \mathcal{R}(\pi, \lambda) = (\pi', \lambda') \text{ then } \mathcal{R}_r(\pi, \lambda) := (\pi', \lambda' / |\lambda'|).$$

1.3.3. *Rauzy classes.* Given a permutation  $\pi$ , we can define two other permutations  $\mathcal{R}_\varepsilon(\pi)$  with  $\varepsilon = 0, 1$ . Conversely, any permutation  $\pi'$  has exactly two predecessors: there exists exactly two permutations  $\pi^0$  and  $\pi^1$  such that  $\mathcal{R}_\varepsilon(\pi^\varepsilon) = \pi'$ . Note that  $\pi$  is irreducible if and only if  $\mathcal{R}_\varepsilon(\pi)$  is irreducible. Thus the relation generated by  $\pi \sim \mathcal{R}_\varepsilon(\pi)$  is a partial order on the set of irreducible permutations; we represent it as a directed graph  $G$ . We call Rauzy classes the connected components of this graph.

**Proposition** (Rauzy). *The above relation is an equivalence relation on the set of permutations. In particular, the equivalent class of a permutation is the Rauzy class.*

*Proof.* If  $\pi' = \mathcal{R}_\varepsilon(\pi)$  then there exists  $n > 0$  such that  $\pi = \mathcal{R}_\varepsilon^n(\pi')$ . Now assume there exists an oriented path in  $G$  joining  $\pi$  and  $\pi'$ , *i.e.* there exists  $\varepsilon_1, \dots, \varepsilon_r$  such that  $\pi' = \mathcal{R}_{\varepsilon_1} \circ \dots \circ \mathcal{R}_{\varepsilon_r}(\pi)$ . Then there exists  $n_1$  such that  $\mathcal{R}_{\varepsilon_1}^{n_1}(\pi') = \mathcal{R}_{\varepsilon_2} \circ \dots \circ \mathcal{R}_{\varepsilon_r}(\pi)$ . Iterating this argument, there exist  $n_1, \dots, n_r$  such that  $\pi = \mathcal{R}_{\varepsilon_r}^{n_r} \circ \dots \circ \mathcal{R}_{\varepsilon_1}^{n_1}(\pi')$ . Thus there is an oriented path in  $G$  that joins  $\pi'$  and  $\pi$ .  $\square$

We will see that the situation in case of generalized permutations is much more complicated.

1.3.4. *Suspension data over an interval exchange transformation.* Here we describe the construction of a *suspension* of an interval exchange map  $T$ , that is a flat surface for which  $T$  is the first return map of the vertical flow on a well chosen segment.

Let  $T = (\pi, \lambda)$  be an interval exchange transformation. A *suspension data* for  $T$  is a collection of vectors  $(\zeta_\alpha)_{\alpha \in \mathcal{A}}$  such that:

- (1)  $\forall \alpha \in \mathcal{A}, \operatorname{Re}(\zeta_\alpha) = \lambda_\alpha$ .
- (2)  $\forall 1 \leq k \leq d-1, \operatorname{Im}(\sum_{\pi_0(\alpha) \leq k} \zeta_\alpha) > 0$ .
- (3)  $\forall 1 \leq k \leq d-1, \operatorname{Im}(\sum_{\pi_1(\alpha) \leq k} \zeta_\alpha) < 0$ .

Given a suspension data  $\zeta$ , we consider the broken line  $L_0$  on  $\mathbb{C} = \mathbb{R}^2$  defined by concatenation of the vectors  $\zeta_{\pi_0^{-1}(j)}$  (in this order) for  $j = 1, \dots, d$  with starting point at the origin (see figure 2). Similarly, We consider the broken line  $L_1$  defined by concatenation of the vectors  $\zeta_{\pi_1^{-1}(j)}$  (in this order) for  $j = 1, \dots, d$  with starting point at the origin. If the lines  $L_0$  and  $L_1$  have no intersections other than the endpoints, then we can construct a translation surface  $S$  as follows: we can identify each side  $\zeta_\alpha$  on  $L_0$  with the side  $\zeta_\alpha$  on  $L_1$  by a translation (in the general case, we must use the Veech zippered rectangle construction, see [Vee82], or section 1.3.5). Let  $I \subset S$  be the horizontal interval defined by  $I = (0, \sum_{\alpha \in \mathcal{A}} \lambda_\alpha) \times \{0\}$ . Then the interval exchange map  $T$  is precisely the one defined by the first return map to  $I$  of the vertical flow on  $S$ .

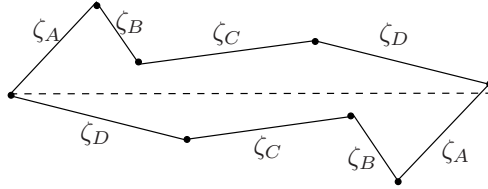

FIGURE 2. Suspension over an interval exchange transformation.

We have not yet discussed the existence of a suspension data for any interval exchange map. A necessary condition for  $T$  to have suspension data is that  $\pi$  is irreducible. Indeed, if we have  $1 \leq k \leq d-1$  such that

$\pi_1 \circ \pi_0^{-1}(\{1, \dots, k\}) = \{1, \dots, k\}$ , and let  $\zeta = (\zeta_\alpha)_\alpha$  be a collection of complex numbers, then:

$$\sum_{\pi_0(\alpha) \leq k} \zeta_\alpha = \sum_{\pi_1(\alpha) \leq k} \zeta_\alpha.$$

So the imaginary part of this number cannot be both positive and negative, so  $\zeta$  is not a suspension data for  $T$ . If  $\pi$  is irreducible, the existence of a suspension data is given by Masur and Veech independently (see [Mas82], page 174 and [Vee82], formula 3.7 page 207). We explain the construction here.

First, let us remark that  $\pi = (\pi_0, \pi_1)$  is irreducible if and only if

$$(1) \quad \sum_{i=1}^k \pi_1 \circ \pi_0^{-1}(i) - i > 0 \quad \text{for any } 1 \leq k \leq d-1.$$

Of course if  $\pi$  is irreducible, then so is  $\pi^{-1}$ , therefore

$$(2) \quad \sum_{i=1}^k \pi_0 \circ \pi_1^{-1}(i) - i > 0 \quad \text{for any } 1 \leq k \leq d-1.$$

Let us define a collection of complex number  $\zeta = (\zeta_\alpha)_\alpha$  as follows:

$$\zeta_\alpha = \lambda_\alpha + i \sum (\pi_1(\alpha) - \pi_0(\alpha)) \quad \text{for any } \alpha \in \mathcal{A}.$$

Then following (1) and (2), the collection  $(\zeta_\alpha)_{\alpha \in \mathcal{A}}$  is a suspension data over  $T$ .

1.3.5. *Zippered rectangles.* Here we describe an alternative construction of the suspension over an interval exchange transformation that works for *any* suspension data, namely the so called zippered rectangles construction due to Veech [Vee82]. Let  $T = (\pi, \lambda)$  be an interval exchange map, and let us assume that  $\pi$  is irreducible. Let  $\zeta$  be any suspension over  $T$ . Then we define  $h = (h_\alpha)_{\alpha \in \mathcal{A}}$  by

$$h_\alpha = \sum_{\pi_0(\beta) < \pi_0(\alpha)} \text{Im}(\zeta_\beta) - \sum_{\pi_1(\beta) < \pi_1(\alpha)} \text{Im}(\zeta_\beta) > 0.$$

For each  $\alpha \in \mathcal{A}$  let us consider a rectangle  $R_\alpha$  of width  $\text{Re}(\zeta_\alpha)$  and of height  $h_\alpha$  based on  $I_{\pi_0(\alpha)} \subset I$ . The zippered rectangle construction is the translation surface  $\bigcup_{\alpha \in \mathcal{A}} R_\alpha / \sim$  where  $\sim$  is the following equivalence relation: we identify the top and the bottom of these rectangles by  $(x, h_\alpha) \mapsto (T(x), 0)$  for  $x \in I_{\pi_0(\alpha)}$ . Then we “zip” the vertical boundaries of these rectangles that are adjacent (see figure 3; see also [Vee82] for a more precise description).

1.3.6. *Rauzy-Veech induction on suspensions.* We can define the Rauzy-Veech induction on the space of suspensions, as well as on the space of zippered rectangles. Let  $T = (\pi, \lambda)$  be an interval exchange map and let  $\zeta$  be a suspension over  $T$ . Then we define  $\mathcal{R}(\pi, \zeta) = (\pi', \zeta')$  as follows: we define

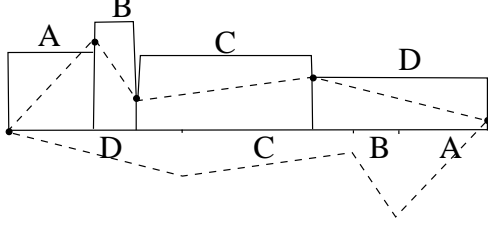

FIGURE 3. Zippered rectangles construction.

$(\pi', Re(\zeta')) = \mathcal{R}(\pi, Re(\zeta))$  (the standard Rauzy-Veech induction). If  $I_{\pi_\varepsilon^{-1}(d)}$  is the winner for  $T = (\pi, Re(\zeta))$  then

$$\begin{cases} \zeta'_{\pi_\varepsilon^{-1}(d)} = \zeta_{\pi_\varepsilon^{-1}(d)} - \zeta_{\pi_{1-\varepsilon}^{-1}(d)} \\ \zeta'_\alpha = \zeta_\alpha & \text{otherwise.} \end{cases}$$

Since  $(\pi', \zeta')$  is obtained from  $(\pi, \zeta)$  by “cutting” and “gluing”, these two surfaces differ by an element of the mapping class group, hence they define isometric surfaces.

If  $C$  is a Rauzy class, we define  $\mathcal{T}_C$  to be the set

$$\{(\pi, \zeta), \pi \in C, \zeta \text{ is a suspension data for } \pi\}.$$

We have thus defined the Rauzy-Veech map on the space  $\mathcal{T}_C$ . It is easy to check that it defines an almost everywhere invertible map: If  $\sum Im(\zeta'_\alpha) \neq 0$  then every  $(\pi', \zeta')$  has exactly one preimage for  $\mathcal{R}$ .

We define the quotient  $\mathcal{H}_C = \mathcal{T}_C / \sim$  of  $\mathcal{T}_C$  by the equivalence relation generated by  $(\pi, \zeta) \sim \mathcal{R}(\pi, \zeta)$ . The zippered rectangle construction, provides a mapping  $p$  from  $\mathcal{H}_C$  to a stratum  $\mathcal{H}(k_1, \dots, k_n)$  of the moduli space of Abelian differentials. Observe that  $(k_1, \dots, k_n)$  can be calculated in terms of  $\pi \in C$ . One can also show that  $\mathcal{H}_C$  is connected and so the image belongs to a connected component of a stratum.

We will denote by  $m$  the natural Lebesgue measure on  $\mathcal{T}_C$  i.e.  $m = d\pi d\zeta$ , where  $d\pi$  is the counting measure on  $C$  and  $d\zeta$  is the Lebesgue measure. The mapping  $\mathcal{R}$  preserves  $m$ , so it induces a measure, denoted again by  $m$  on  $\mathcal{H}_C$ .

There is natural action of the matrix

$$g_t = \begin{pmatrix} e^{\frac{t}{2}} & 0 \\ 0 & e^{-\frac{t}{2}} \end{pmatrix}$$

on  $\mathcal{T}_C$  by  $g_t(\pi, \zeta) = (\pi, (g_t(\zeta_\alpha))_\alpha)$ , where  $g_t$  acts on  $\zeta_\alpha \in \mathbb{C} = \mathbb{R}^2$  linearly. This action preserves the measure  $m$  on  $\mathcal{T}_C$  and commutes with  $\mathcal{R}$ , so it descends to a 1-parameter action on  $\mathcal{H}_C$  called the *Teichmüller flow*. Since the action of  $g_t$  on  $\mathcal{H}_C$  preserves the area of the corresponding flat surface, the Teichmüller flow also acts on the subset  $\mathcal{H}_C^1$  corresponding to area one surfaces, and preserves the measure  $m^{(1)}$  induced by the measure  $m$ .

Note that the subset

$$\left\{ (\pi, \zeta) \in \mathcal{T}_C; 1 \leq |Re(\zeta)| \leq 1 + \min(Re(\zeta_{\pi_0^{-1}(d)}), Re(\zeta_{\pi_1^{-1}(d)})) \right\}$$

is a fundamental domain of  $\mathcal{T}_C$  for the relation  $\sim$ , and the first return map of the Teichmüller flow on

$$\mathcal{S} = \{(\pi, \zeta); \pi \text{ irreducible, } |Re(\zeta)| = 1\} / \sim$$

gives the renormalized Rauzy-Veech induction on suspensions.

One can show (see [Vee82]) that the mapping  $p$  is a finite covering from  $\mathcal{H}_C^1$  onto a subset of full measure in a connected component of a stratum and the measure  $m$  projects to the measure  $\mu^{(1)}$  defined in section 1.2. Moreover the action of  $g_t$  is equivariant with respect to  $p$ , that is  $p \circ g_t(\pi, \zeta) = g_t \circ p(\pi, \zeta)$ . Hence if we restrict to area 1 surfaces, the result of Masur and Veech (finiteness of the measure) implies that the measure  $m^{(1)}$  is finite on  $\mathcal{H}_C^1$ .

**Corollary 1.3.** *The renormalized Rauzy-Veech induction is recurrent on  $\mathcal{S}$ .*

*Remark 1.4.* Veech proved a stronger result, that is the ergodicity of  $g_t$  (on the level of  $\mathcal{H}_C$  for any Rauzy class  $C$ ), which implies the ergodicity of the Teichmüller flow for Abelian differentials (see [Vee82]). He also proved that the induced measure on  $\mathcal{S}$  is always infinite.

## 2. GENERALIZED INTERVAL EXCHANGE MAPS

**2.1. Generalized interval exchange maps and generalized permutations.** Let  $S$  be a (compact, connected, oriented) flat surface with  $\mathbb{Z}/2\mathbb{Z}$  linear holonomy and  $X$  be a horizontal segment with a choice of a positive vertical direction (or equivalently, a choice of left and right endpoints). We consider the first return map  $T_0 : X \rightarrow X$  of vertical geodesics starting from  $X$  in the positive direction. Any vertical geodesic which start from  $X$  and doesn't hit a singularity will intersect  $X$  again. Therefore, the map  $T_0$  is well defined outside a finite number of points  $\{sing\}$  (called singular points) that correspond to vertical geodesics that stop at a singularity before intersecting again the interval  $X$ . The set  $X \setminus \{sing\}$  is a finite union of open intervals  $(X_i)$  and the restriction of  $T_0$  on each of these intervals is of the kind  $x \mapsto \pm x + c_i$ .

The map  $T_0$  alone does not properly correspond to the dynamics of vertical geodesics since when  $T_0(x) = -x + c_i$  on the interval  $X_i$ , then  $T_0^2(x) = x$ , and  $(x, T_0(x), T_0^2(x))$  does not correspond to the successive intersections of a vertical geodesic on  $S$  starting from  $x$ . To fix this problem, we have to consider  $T_1$  the first return map of the vertical geodesics starting from  $X$  in the negative direction. Now if  $T_0(x) = -x + c_i$  then the successive intersections with  $X$  of the vertical geodesic starting from  $x$  will be  $x, T_0(x), T_1(T_0(x)), \dots$

We get a dynamical system on  $X \times \{0, 1\}$ . This motivates the following definition which is a particular case of the *linear involutions*, that were introduced by Danthony and Nogueira [Nog89, DN90].



**Definition 2.1.** Let  $X$  be an open interval and let  $\widehat{X} = X \times \{0, 1\}$  be two disjoint copies of  $X$ . A generalized interval exchange map on  $X$  is a bijective smooth map  $T : \widehat{X} \setminus \{sing\} \rightarrow \widehat{X} \setminus \{sing'\}$  with the following properties

- $\{sing\}$  and  $\{sing'\}$  are finite subsets of  $\widehat{X}$ .
- If  $x$  and  $T(x)$  belong to the same connected component of  $\widehat{X}$  then the derivative of  $T$  at  $x$  is  $+1$  otherwise the derivative of  $T$  at  $x$  is  $-1$ .
- Let  $f$  denote the involution  $(x, \varepsilon) \mapsto (x, 1 - \varepsilon)$ . Then

$$T^{-1} = f \circ T \circ f.$$

- The map  $f \circ T$  has no fixed point (or possibly in  $\{sing\}$ ).

The previous definition is justified by the following remark.

*Remark 2.2.* The first return map of the vertical geodesic foliation on a horizontal segment in a flat surface defines a generalized interval exchange map in the following way. We denote by  $(x, \varepsilon) \in X \times \{0, 1\}$  an element of  $X$  with a choice of a vertical direction ( $\varepsilon = 0$  for the positive direction, and  $\varepsilon = 1$  for the negative direction). We denote as before by  $T_0$  and  $T_1$  the first return maps on  $X$  for these directions. Then

$$T(x, \varepsilon) = (T_\varepsilon(x), \varepsilon'),$$

where  $\varepsilon' = \varepsilon$  if  $T_\varepsilon$  is a translation in a neighborhood of  $x$ , and  $\varepsilon' = 1 - \varepsilon$  otherwise.

If  $T_0$  is an interval exchange map, then so is  $T_1$  and  $T_1 = T_0^{-1}$ .

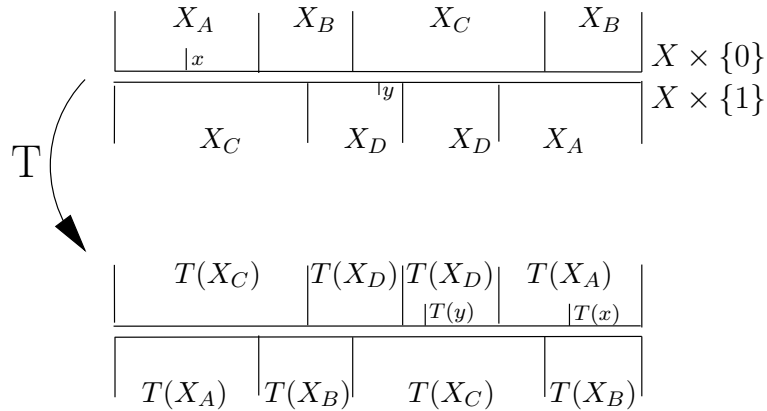

FIGURE 4. A generalized interval exchange.

Recall that interval exchange maps are encoded by combinatorial and metric data: these are a permutation and a vector with positive entries. We define an analogous object for generalized interval exchange maps.

**Definition 2.3.** Let  $\mathcal{A}$  be an alphabet of  $d$  letters. A *generalized permutation* of type  $(l, m)$ , with  $l + m = 2d$ , is a two-to-one map  $\pi : \{1, \dots, 2d\} \rightarrow \mathcal{A}$ . We will usually represent such generalized permutation by the table:

$$\begin{pmatrix} \pi(1) & \dots & \pi(l) \\ \pi(l+1) & \dots & \pi(l+m) \end{pmatrix}.$$

A generalized permutation  $\pi$  defines an involution  $\sigma$  without fixed points defined by the following way

$$\pi^{-1}(\{\pi(i)\}) = \{i, \sigma(i)\}.$$

We now describe how a generalized interval exchange map naturally defines a generalized permutation. Let  $T$  be a generalized interval exchange map and let  $T_0, T_1$  be the corresponding maps on  $X$ . The domain of definition of  $T_0$  (respectively  $T_1$ ) is a finite union of open intervals  $X_1, \dots, X_l$  (respectively  $X_{l+1}, \dots, X_{l+m}$ ). Definition 2.1 implies that, for  $i \leq l$  (resp.  $i > l$ ),  $T_0(X_i) = X_j$  (resp.  $T_1(X_i) = X_j$ ) for some  $1 \leq j \leq l+m$ . Therefore,  $T$  induces a permutation  $\sigma_T$  of  $\{1, \dots, l+m\}$ , and it is easy to check that  $\sigma_T$  is an involution without fixed points (since the map  $f \circ T$  has no fixed points). As in section 1, we choose a name  $\alpha_i \in \mathcal{A}$  to each pair  $\{i, \sigma_T(i)\}$  and we get a generalized permutation in the sense of above definition which is defined up to a one-to-one map of  $\mathcal{A}$ .

*Example 2.4.* Let us consider the following alphabet  $\mathcal{A} = \{A, B, C, D\}$  with  $d = 4$ . Then we define the generalized permutation  $\pi$  as follows.

$$\begin{aligned} l = m = 4, \quad \pi(1) = \pi(8) = A, \quad \pi(2) = \pi(4) = B, \\ \pi(3) = \pi(5) = C, \quad \pi(6) = \pi(7) = D. \end{aligned}$$

In an equivalent way, we can define an involution without fixed point in order to define  $\pi$ .

$$\sigma(1) = 8, \quad \sigma(2) = 4, \quad \sigma(3) = 5, \quad \sigma(6) = 7.$$

We represent  $\pi$  by the following table

$$\pi = \begin{pmatrix} A & B & C & B \\ C & D & D & A \end{pmatrix}.$$

One can check that the generalized interval exchange described in Figure 4 gives the generalized permutation  $\pi$ .

*Example 2.5.* Note that  $\pi$  is a “true” permutation on  $d$  letters if and only if  $l = m = d$  and for any  $i \leq l$ ,  $\sigma(i) > l$ . In this case (if  $\mathcal{A} = \{1, \dots, d\}$ ):

$$\pi = \begin{pmatrix} 1 & 2 & \dots & d \\ \sigma(1) - d & \sigma(2) - d & \dots & \sigma(d) - d \end{pmatrix}.$$

Conversely, let  $\pi$  be a generalized permutation of type  $(l, m)$  and let  $\sigma$  be the associated involution. If  $\pi$  is not equivalent to a permutation, then an obvious necessary and sufficient condition for  $\pi$  to come from a generalized interval exchange map is that there exist at least two indices  $i \leq l$  and  $j > l$  such that  $\sigma(i) \leq l$  and  $\sigma(j) > l$ .

*Convention 1.* From now we will always assume that generalized permutations will satisfy the above condition unless explicitly stated (in particular in section 3.2).

Let  $(\lambda_\alpha)_{\alpha \in \mathcal{A}}$  be a collection of positive real numbers such that

$$(3) \quad L := \sum_{i=1}^l \lambda_{\pi(i)} = \sum_{i=l+1}^{l+m} \lambda_{\pi(i)}.$$

Then it is easy to construct a generalized interval exchange map on the interval  $X = (0, L)$  with combinatorial data  $(\pi, \lambda)$ . As in section 1, we will denote by  $T = (\pi, \lambda)$  a generalized interval exchange map.

## 2.2. Rauzy-Veech induction for generalized interval exchange maps.

Let  $T = (\pi, \lambda)$  be a generalized interval exchange transformation on  $X = (0, L)$ , with  $\pi$  of type  $(l, m)$ . If  $\lambda_{\pi(l)} \neq \lambda_{\pi(l+m)}$ , then we define the *Rauzy-Veech induction* of  $T$ , denoted  $\mathcal{R}(T)$ , by the generalized interval exchange map obtained by the first return map of  $T$  to

$$(0, \max(L - \lambda_{\pi(l)}, L - \lambda_{\pi(l+m)})) \times \{0, 1\}.$$

This was first introduced by Danthony and Nogueira [DN90] for the general case of linear involutions.

As in the case of interval exchange maps, the combinatorial data of the new generalized interval exchange map depends only on the combinatorial data of  $T$  and whether  $\lambda_{\pi(l)} > \lambda_{\pi(l+m)}$  or  $\lambda_{\pi(l)} < \lambda_{\pi(l+m)}$ . As before, we say that  $T$  has type 0 or type 1. The corresponding combinatorial operations are denoted by  $\mathcal{R}_\varepsilon$  for  $\varepsilon = 0, 1$  respectively. Note that if  $\pi$  is a given generalized permutation, the subsets  $\{T = (\pi, \lambda), \lambda_{\pi(l)} > \lambda_{\pi(l+m)}\}$  and  $\{T = (\pi, \lambda), \lambda_{\pi(l)} < \lambda_{\pi(l+m)}\}$  can be empty because  $\pi(l) = \pi(l+m)$  or because of the linear relation on the  $\lambda_i$  that must be satisfied.

We first describe the combinatorial Rauzy operations  $\mathcal{R}_\varepsilon$ . Let  $\sigma$  be the involution associated to  $\pi$ .

(1) Map  $\mathcal{R}_0$ .

If  $\sigma(l) > l$  and if  $\pi(l) \neq \pi(l+m)$  then we define  $\mathcal{R}_0\pi$  to be of type  $(l, m)$  and such that:

$$\mathcal{R}_0\pi(i) = \begin{cases} \pi(i) & \text{if } i \leq \sigma(l) \\ \pi(l+m) & \text{if } i = \sigma(l) + 1 \\ \pi(i-1) & \text{otherwise.} \end{cases}$$

If  $\sigma(l) \leq l$ , and if there exists a pair  $\{x, \sigma(x)\}$  included in  $\{l+1, \dots, l+m-1\}$  then we define  $\mathcal{R}_0\pi$  to be of type  $(l+1, m-1)$  and such that:

$$\mathcal{R}_0\pi(i) = \begin{cases} \pi(i) & \text{if } i < \sigma(l) \\ \pi(l+m) & \text{if } i = \sigma(l) \\ \pi(i-1) & \text{otherwise.} \end{cases}$$

Otherwise  $\mathcal{R}_0\pi$  is not defined.

(2) Map  $\mathcal{R}_1$ .

If  $\sigma(l+m) \leq l$  and if  $\pi(l) \neq \pi(l+m)$  then we define  $\mathcal{R}_1\pi$  to be of type  $(l, m)$  such that:

$$\mathcal{R}_1\pi(i) = \begin{cases} \pi(l) & \text{if } i = \sigma(l+m) + 1 \\ \pi(i-1) & \text{If } \sigma(l+m) + 1 < i \leq l \\ \pi(i) & \text{otherwise.} \end{cases}$$

If  $\sigma(l+m) > l$  and if there exists a pair  $\{x, \sigma(x)\}$  included in  $\{1, \dots, l-1\}$  then  $\mathcal{R}_1\pi$  is of type  $(l-1, m+1)$  and:

$$\mathcal{R}_1\pi(i) = \begin{cases} \pi(i+1) & \text{if } l \leq i < \sigma(l+m) - 1 \\ \pi(l) & \text{If } i = \sigma(l+m) - 1 \\ \pi(i) & \text{otherwise.} \end{cases}$$

Otherwise  $\mathcal{R}_1\pi$  is not defined.

Now we describe the Rauzy induction  $\mathcal{R}(T)$  of  $T$ :

- If  $T = (\pi, \lambda)$  has type 0, then  $\mathcal{R}(T) = (\mathcal{R}_0\pi, \lambda')$ , with  $\lambda'_\alpha = \lambda_\alpha$  if  $\alpha \neq \pi(l)$  and  $\lambda'_{\pi(l)} = \lambda_{\pi(l)} - \lambda_{\pi(l+m)}$ .
- If  $T = (\pi, \lambda)$  has type 1, then  $\mathcal{R}(T) = (\mathcal{R}_1\pi, \lambda')$ , with  $\lambda'_\alpha = \lambda_\alpha$  if  $\alpha \neq \pi(l+m)$  and  $\lambda'_{\pi(l+m)} = \lambda_{\pi(l+m)} - \lambda_{\pi(l)}$ .

*Example 2.6.* Let us consider the permutation of example 2.4, namely  $\pi = \begin{pmatrix} A & B & C & B \\ C & D & D & A \end{pmatrix}$ . Then

$$\mathcal{R}_0(\pi) = \begin{pmatrix} A & A & B & C & B \\ C & D & D & & \end{pmatrix}, \text{ and } \mathcal{R}_1(\pi) = \begin{pmatrix} A & B & B & C \\ C & D & D & A \end{pmatrix}.$$

*Example 2.7.* Let us consider the permutation  $\pi$  defined on the alphabet  $\mathcal{A} = \{A, B, C, D\}$  by  $\pi = \begin{pmatrix} A & B & A \\ B & D & C & C & D \end{pmatrix}$ . Then

$$\mathcal{R}_0(\pi) = \begin{pmatrix} D & A & B & A \\ B & D & C & C \end{pmatrix}$$

and  $\mathcal{R}_1(\pi)$  is not defined. Indeed, consider  $T = (\pi, \lambda)$  a generalized interval exchange map with  $\pi$  as combinatorial data. Then we must have

$$2\lambda_A + \lambda_B = \lambda_B + 2\lambda_C + 2\lambda_D.$$

Therefore we necessary have  $\lambda_D < \lambda_A$ .

*Example 2.8.* Consider the permutation  $\pi$  defined on the alphabet  $\mathcal{A} = \{A, B, C\}$  by  $\pi = \begin{pmatrix} A & B & A \\ B & C & C \end{pmatrix}$ . Then  $\mathcal{R}_\varepsilon(\pi)$  is not defined for any  $\varepsilon$ . Indeed, consider  $T = (\pi, \lambda)$  a generalized interval exchange map with  $\pi$  as combinatorial data. Then we must have  $\lambda_A = \lambda_C$ , hence the Rauzy-Veech induction of  $T$  is not defined.

In the case of interval exchange maps, the Rauzy induction is usually defined only for irreducible combinatorial data. Here we have not yet defined irreducibility. However, it will appear in section 3 that some interesting phenomena with respect to Rauzy induction appear also in the reducible case.

In the next section 3, we will define a notion of irreducibility which is equivalent to have suspension data. It is easy to see that a generalized permutation  $\pi$  such that neither  $\mathcal{R}_0(\pi)$  nor  $\mathcal{R}_1(\pi)$  is defined is necessary reducible. However, the permutation  $\pi$  of Example 2.7 is irreducible (see Definition 3.1 and Theorem 3.2) while  $\mathcal{R}_1(\pi)$  is not defined. A consequence of this is that the argument of section 1.3.3 about Rauzy classes will fail for the case of generalized permutations. Still, we will prove an analogous statement in section 6.

**2.3. Suspension data and zippered rectangles.** Starting from a generalized interval exchange map  $T$ , we want to construct a flat surface and a horizontal segment whose corresponding first return maps  $(T_0, T_1)$  give  $T$ . Such surface will be called a *suspension* over  $T$ , and the parameters encoding this construction will be called *suspension data*.

**Definition 2.9.** Let  $T$  be a generalized interval exchange map and let  $(\lambda_\alpha)_{\alpha \in \mathcal{A}}$  the lengths of the corresponding intervals, and let  $\{\zeta_\alpha\}_{\alpha \in \mathcal{A}}$  by a collection of complex numbers such that:

- (1)  $\forall \alpha \in \mathcal{A} \quad \text{Re}(\zeta_\alpha) = \lambda_\alpha.$
- (2)  $\forall 1 \leq i \leq l-1 \quad \text{Im}(\sum_{j \leq i} \zeta_{\pi(j)}) > 0$
- (3)  $\forall 1 \leq i \leq m-1 \quad \text{Im}(\sum_{1 \leq j \leq i} \zeta_{\pi(l+j)}) < 0$
- (4)  $\sum_{1 \leq i \leq l} \zeta_{\pi(i)} = \sum_{1 \leq j \leq m} \zeta_{\pi(l+j)}.$

The collection  $\zeta = \{\zeta_\alpha\}_{\alpha \in \mathcal{A}}$  is said to be a *suspension data* for  $T$ .

We will also speak in an obvious manner of a suspension data for a generalized permutation.

Let  $L_0$  be a broken line on the plane such that edge number  $i$  is represented by the complex number  $\zeta_{\pi(i)}$ , for  $1 \leq i \leq l$ , and  $L_1$  be a broken line that starts on the same point as  $L_0$ , and whose edge number  $j$  is represented by the complex number  $\zeta_{\pi(l+j)}$  for  $1 \leq j \leq m$ .

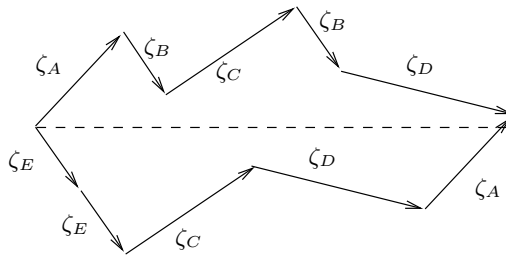

FIGURE 5. A suspension over a generalized interval exchange map.

If  $L_0$  and  $L_1$  only intersect on their endpoints, then  $L_0$  and  $L_1$  define a polygon whose sides comes by pairs and for each pairs the corresponding sides are parallel and have the same length. Then identifying these sides together, one gets a flat surface. It is easy to check that the first return

map on the segment corresponding to  $X$  in  $S$  defines the same generalized interval exchange as  $T$ , so we have constructed a suspension over  $T$ . We will say in this case that  $\zeta$  defines a *suitable polygon*.

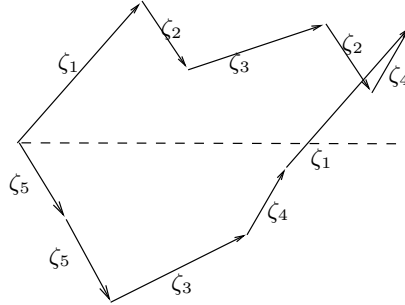

FIGURE 6. Suspension data that does not give a suitable polygon.

The broken lines  $L_0$  and  $L_1$  might intersect at other points (see Figure 6). However, we can still define a flat surface by using an analogous construction as the zippered rectangles construction. We now give a sketch of this construction (see e.g. [Vee82, Yoc03] for the case of interval exchange maps, or section 1.3.5). This construction is very similar to the usual one, although its precise description is very technical. Still, for completeness, we give an equivalent but rather implicit formulation.

We first consider the previous case when  $L_0$  and  $L_1$  define a suitable polygon. For each pair of interval  $X_i, X_{\sigma(i)}$  on  $X$ , the return time  $h_{\pi(i)}$  of the vertical flow starting from  $x \in X_i$  and returning in  $y \in X_{\sigma(i)}$  is constant. This value depends only on the generalized permutation and on the imaginary part of the suspension data  $\zeta$ . There is a natural embedding of the open rectangle  $R_{\pi(i)} = (0, \lambda_i) \times (0, h_{\pi(i)})$  into the flat surface  $S$  and this surface is obtained from  $\sqcup_{\alpha} R_{\alpha}$  by identifications on the boundaries of the  $R_{\alpha}$ . Identifications for the horizontal sides  $[0, \lambda_{\alpha}]$  are given by the generalized interval exchange map and identifications for the vertical sides only depend on the generalized permutation and on  $\{Im(\zeta_{\alpha})\}_{\alpha \in \mathcal{A}}$ .

For the general case, we construct the rectangles  $R_{\alpha}$  using the same formulas. Identifications for the horizontal sides are straightforward. Identifications for the vertical sides, that do not depends on the horizontal parameters, will be well defined after the following lemma.

**Lemma 2.10.** *Let  $\zeta$  be a suspension data for a generalized interval exchange map  $T$ , and let  $\pi$  be the corresponding generalized permutation. There exists a generalized interval exchange map  $T'$  and a suspension data  $\zeta'$  for  $T'$  such that:*

- *The generalized permutation associated to  $T'$  is  $\pi$ .*
- *For any  $\alpha$  the complex numbers  $\zeta_{\alpha}$  and  $\zeta'_{\alpha}$  have the same imaginary part.*

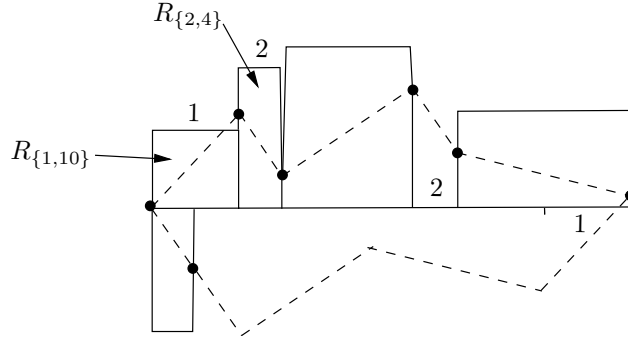

FIGURE 7. Zippered rectangle construction, for the case of the flat surface of Figure 2.3.

- The suspension data  $\zeta'$  defines a suitable polygon.

*Proof.* We can assume that  $\sum_{k=1}^l \text{Im}(\zeta_{\pi(k)}) > 0$  (the negative case is analogous and there is nothing to prove when the sum is zero). It is clear that  $\sigma(l+m) \neq l$  otherwise there would be no possible suspension data. If  $\sigma(l+m) < l$ , then we can shorten the real part of  $\zeta_{\pi(l+m)}$ , keeping conditions (1)—(4) satisfied, and get a suspension data  $\zeta'$  with the same imaginary part as  $\zeta$ , and such that  $\text{Re}(\zeta'_{\pi(l+m)}) < \text{Re}(\zeta'_{\pi(l)})$ . This last condition implies that  $\zeta'$  defines a suitable polygon.

If  $\sigma(l+m) > l$ , then condition (4) might imply that  $\text{Re}(\zeta_{\pi(l+m)})$  is necessary bigger than  $\text{Re}(\zeta_{\pi(l)})$ . However, we can still change  $\zeta$  into a suspension data  $\zeta'$ , with same imaginary part, and such that  $\text{Re}(\zeta'_{\pi(l+m)})$  is very close to  $\text{Re}(\zeta'_{\pi(l)})$ . In that case,  $\zeta'$  also defines a suitable polygon. See [Boi07], Lemma 2.1 for more details.  $\square$

Therefore, we have defined the zippered rectangle construction for any suspension data. Note that we have not yet discussed the existence of a suspension data. This will be done in the upcoming section. This notion is natural. See [Vee82] and the following Proposition.

**Proposition 2.11.** *Let  $S$  be a flat surface with no vertical saddle connections and  $X$  be a horizontal interval adjacent to a singularity on the left. Let  $\gamma$  be the vertical leaf passing through the right endpoint of  $X$ , we assume that  $\gamma$  meets a singularity before returning to  $X$ , in positive or negative direction. Let  $T = (\pi, \lambda)$  be the generalized interval exchange map given by the cross section on  $X$  of the vertical flow. There exists a suspension data  $\zeta$  for  $T$  such that  $(\pi, \zeta)$  defines a surface isometric to  $S$ .*

*Proof.* See the construction given in the proof of Proposition 2.2 in [Boi07].  $\square$

We can define the Rauzy-Veech induction on the space of suspensions, as well as on the space of zippered rectangles. Let  $T = (\pi, \lambda)$  be an interval

exchange map and let  $\zeta$  be a suspension over  $T$ . Then we define  $\mathcal{R}(\pi, \zeta) = (\pi', \zeta')$  as follows.

- If  $T = (\pi, \lambda)$  has type 0, then  $\mathcal{R}(T) = (\mathcal{R}_0\pi, \zeta')$ , with  $\zeta'_\alpha = \zeta_\alpha$  if  $\alpha \neq \pi(l)$  and  $\zeta'_{\pi(l)} = \zeta_{\pi(l)} - \zeta_{\pi(l+m)}$ .
- If  $T = (\pi, \lambda)$  has type 1, then  $\mathcal{R}(T) = (\mathcal{R}_1\pi, \zeta')$ , with  $\zeta'_\alpha = \zeta_\alpha$  if  $\alpha \neq \pi(l+m)$  and  $\zeta'_{\pi(l+m)} = \zeta_{\pi(l+m)} - \zeta_{\pi(l)}$ .

We can show that  $(\pi', \zeta')$  is a suspension over  $\mathcal{R}(T)$  and defines a surface isometric to the one corresponding to  $(\pi, \zeta)$ .

As in the case of interval exchanges, we consider the renormalized Rauzy-Veech induction defined on lengths one intervals:

$$\mathcal{R}_r(\pi, \lambda) = (\pi', \lambda'') \text{ where } \mathcal{R}(\pi, \lambda) = (\pi', \lambda') \text{ and } \lambda'' = \lambda' / |\lambda'|.$$

One can define obviously the corresponding renormalized Rauzy-Veech induction on the suspensions data by contracting the imaginary parts by a factor  $|\lambda'|$  which preserves the area of this corresponding flat surface.

### 3. GEOMETRY OF GENERALIZED PERMUTATIONS

In this section we give a necessary and sufficient condition for a generalized permutation to admit a suspension that is first part of Theorem A.

*Notation:* If  $\mathcal{A} = \{\alpha_1, \dots, \alpha_d\}$  is an alphabet under consideration, we will denote by  $\mathcal{A} \sqcup \mathcal{A}$  the set with multiplicities  $\{\alpha_1, \alpha_1, \dots, \alpha_d, \alpha_d\}$  of cardinal  $2d$ , and we will use analogous notations for subsets of  $\mathcal{A}$ .

We will also call respectively *top* and *bottom* the restriction of a generalized permutation  $\pi$  to  $\{1, \dots, l\}$  and  $\{l+1, \dots, l+m\}$ , where  $(l, m)$  is the type of  $\pi$ .

*Notation:* Let  $F_1, F_2, F_3, F_4$  be (possibly empty) unordered subsets of  $\mathcal{A}$  or  $\mathcal{A} \sqcup \mathcal{A}$ . We say that a generalized permutation  $\pi$  of type  $(l, m)$  decomposes as:

$$\pi = \left( \begin{array}{c|c|c} F_1 & *** & F_2 \\ \hline F_3 & *** & F_4 \end{array} \right),$$

if there exists  $0 \leq i_1 \leq i_2 \leq l$  and  $l \leq i_3 \leq i_4 \leq l+m = 2d$  such that

- $\{\pi(1), \dots, \pi(i_1)\} = F_1$
- $\{\pi(i_2 + 1), \dots, \pi(l)\} = F_2$
- $\{\pi(l + 1), \dots, \pi(i_3)\} = F_3$
- $\{\pi(i_4), \dots, \pi(2d)\} = F_4$ .

The sets  $F_1, F_2, F_3$ , and  $F_4$  will be referred as top-left, top-right, bottom-left and bottom-right corners respectively.

We do not assume that  $\text{card}(F_1) = \text{card}(F_3)$ , or  $\text{card}(F_2) = \text{card}(F_4)$ .

**Definition 3.1.** We will say that  $\pi$  is *reducible* if  $\pi$  admits a decomposition

$$(*) \quad \left( \begin{array}{c|c|c} A \cup B & *** & D \cup B \\ \hline A \cup C & *** & D \cup C \end{array} \right), \quad A, B, C, D \text{ disjoint subsets of } \mathcal{A},$$

where the subsets  $A, B, C, D$  are not all empty and one of the following statements holds



- i- No corner is empty
- ii- Exactly one corner is empty and it is on the left.
- iii- Exactly two corners are empty and they are either both on the left, either both on the right.

A permutation that is not reducible is *irreducible*.

The main result of this section is the next theorem which, being combined with Proposition 2.11 implies first part of Theorem A. We make clear that in this section, we only speak of suspensions given by the construction of section 2.3.

**Theorem 3.2.** *Let  $T = (\pi, \lambda)$  be a generalized interval exchange map. The map  $T$  admits a suspension  $\zeta$  if and only if the underlying generalized permutation  $\pi$  is irreducible.*

*Remark 3.3.* Note that the existence or not of a suspension is independent of the length data  $\lambda$ .

*Remark 3.4.* One can see that this reducibility notion is not symmetric with respect to the left/right, contrary to the case of interval exchange maps. And therefore, the choice of attaching a singularity on the left endpoint of the segment in the construction of section 2.3 is a real choice.

Moreover, in the usual case of interval exchange maps, one can always choose  $\zeta$  in such a way that  $Im(\sum_{i=1}^l \zeta_{\pi(i)}) = 0$  (*i.e.* there is a singularity on the left and on the right). Here it is not always possible. More precisely one can show that  $T$  admits such a suspension with this extra condition if and only if for any decomposition of  $\pi$  as in equation (\*) above, all the corners are empty.

### 3.1. Necessary condition.

**Proposition 3.5.** *A reducible generalized permutation does not admit any suspension.*

*Proof of the Proposition.* Consider  $\pi$  a reducible generalized permutation. It is convenient to introduce some notations. Let us assume that there exists a suspension  $\zeta$  over  $\pi$ . Then we define  $a$  to be the real number  $a = \sum_{j \in A} Im(\zeta_{\pi(j)})$ ; we define  $a = 0$  if the set  $A$  is empty. We also define  $b, c$  and  $d$  in an analogous manner for  $B, C$  and  $D$ . We also define  $t = \sum_{i=1}^l Im(\zeta_{\pi(i)})$ . We distinguish three cases following Definition 3.1.

*i- No corner is empty.*

Then the following inequalities hold

$$\begin{cases} a + b & > 0 \\ a + c & < 0 \\ t - d - b & > 0 \\ t - d - c & < 0 \end{cases}$$

Subtracting the second one from the first one, and the fourth one from the third one, we get:

$$\begin{cases} b - c > 0 \\ c - b > 0 \end{cases}$$

which is a contradiction.

*ii- Exactly one corner is empty, and it is on the left.*

We can assume without loss of generality that it is the top-left one. That means that  $A, B$  are empty, and  $C, D$  are nonempty. Therefore the following inequalities holds:

$$\begin{cases} c < 0 \\ t - d > 0 \\ t - d - c < 0 \end{cases}$$

Subtracting the third inequality from the second one, we get  $c > 0$ , which contradicts the first one.

*iii- Exactly two corners are empty.*

If they are both on the left side, then we have  $B$  and  $C$  empty and  $D$  non empty. This implies that  $t - d$  is both positive and negative, which is impossible.

If they are both on the right side, it is similar. If two corners forming a diagonal were empty, then it is easy to see that all the corners would be empty, hence this case doesn't occur by assumption. The proposition is proven.  $\square$

**3.2. Sufficient condition.** In this section, we will not necessarily assume that generalized permutations satisfy Convention 1, since for technical reasons, some intermediary results of this section must be stated for some generalized permutation that do not necessary satisfy this hypothesis.

We will have to work only on the imaginary part of the  $\zeta_i$  in order to build a suspension. Hence, in order to simplify the notations we will use the following ones. We will use this vocabulary only in this section.

**Definition 3.6.** A *pseudo-suspension* is a collection of real numbers  $\{\tau_i\}_{i \in \mathcal{A}}$  such that:

- For all  $k \in \{1, \dots, l\}$   $\sum_{i \leq k} \tau_{\pi(i)} \geq 0$ .
- For all  $k \in \{1, \dots, m\}$   $\sum_{l < i \leq l+k} \tau_{\pi(i)} \leq 0$ .
- $\sum_{i \leq l} \tau_{\pi(i)} = \sum_{l < i \leq l+m} \tau_{\pi(i)} = 0$

A pseudo-suspension is *strict* if all the previous inequalities are strict except the extremal ones.

A *vanishing index* on the top (respectively bottom) of a pseudo-suspension is an integer  $k_0 < l$  (respectively  $k_0 < m$ ) such that we have  $\sum_{i \leq k_0} \tau_{\pi(i)} = 0$  (respectively  $\sum_{l < i \leq l+k_0} \tau_{\pi(i)} = 0$ ).

A pseudo-suspension  $\tau'$  is *better* than  $\tau$  if the set of vanishing indices of  $\tau'$  is strictly included into the set of vanishing indices of  $\tau$ .

We will say that  $\pi$  is *strongly irreducible* if for any decomposition of  $\pi$  as in (\*) of Definition 3.1, all the corners are empty. Of course strong irreducibility implies irreducibility.

The following proposition is obvious and left to the reader.

**Proposition 3.7.** *Let  $\pi$  be generalized permutation satisfying Convention 1 that admits a strict pseudo-suspension. Then  $\pi$  admits a suspension  $\zeta$  with  $Im(\sum_{1 \leq i \leq l} \zeta_{\pi(i)}) = 0$ .*

Let us assume that  $\pi$  is any irreducible permutation. One has to find a suspension  $\zeta$  over  $\pi$ . We will first assume that  $\pi$  is strongly irreducible and we will show that  $\pi$  admits such a suspension with the extra equality  $Im(\sum_{1 \leq i \leq l} \zeta_{\pi(i)}) = 0$ . This corresponds to a special case of Proposition 3.15. We will then relax the condition on the irreducibility of  $\pi$  and prove our main result. Note that one can extend the proof of Proposition 3.5 to show that if  $\zeta$  is a suspension data such that  $Im(\sum_{1 \leq i \leq l} \zeta_{\pi(i)}) = 0$ , then  $\pi$  is strongly irreducible.

From Proposition 3.7 we reduced the problem to the construction of a strict pseudo-suspension. As we have seen in section 1, in the case of true permutations, there is an explicit formula, due to Masur and Veech, that gives a suspension when the permutation is irreducible. We will first build a pseudo-suspension  $\tau_{MV}$  by extending this formula to generalized permutations. This will not give in general a strict pseudo-suspension.

Let  $\pi : \{1, \dots, l+m\} \rightarrow \mathcal{A}$  be a generalized permutation. We can decompose  $\mathcal{A}$  into three disjoint subsets

- The subset  $\mathcal{A}_{12}$  of elements  $\alpha \in \mathcal{A}$  such that  $\pi^{-1}(\{\alpha\})$  contains exactly one element in  $\{1, \dots, l\}$  and one element in  $\{l+1, \dots, l+m\}$ . The restriction of  $\pi$  on  $\pi^{-1}(\mathcal{A}_{12})$  defines a true permutation.
- The subset  $\mathcal{A}_1$  of elements  $\alpha \in \mathcal{A}$  such that  $\pi^{-1}(\{\alpha\})$  contains exactly two elements in  $\{1, \dots, l\}$  (and hence no elements in  $\{l+1, \dots, l+m\}$ ).
- The subset  $\mathcal{A}_2$  of elements  $\alpha \in \mathcal{A}$  such that  $\pi^{-1}(\{\alpha\})$  contains exactly two elements in  $\{l+1, \dots, l+m\}$  (and hence no elements in  $\{1, \dots, l\}$ ).

The next lemma is just a reformulation of the construction of a suspension data in section 1.3.4

**Lemma 3.8** (Masur; Veech). *Let  $\pi$  be a true permutation defined on the set  $\{1, \dots, d\}$ . The integers  $\tau_i = \pi(i) - i$  for  $1 \leq i \leq d$  define a pseudo-suspension over  $\pi$ . Furthermore, we have:*

$$\sum_{i \leq i_0} \tau_i = 0 \Leftrightarrow \sum_{i \leq i_0} \tau_{\pi^{-1}(i)} = 0 \Leftrightarrow \pi(\{1, \dots, i_0\}) = \{1, \dots, i_0\}.$$

Recall that we do not assume any more that a generalized permutation satisfy convention 1.

**Lemma 3.9.** *Let  $\pi$  be a generalized permutation of type  $(l, m) = (2d, 0)$  and  $\sigma$  the associated involution. There exists a collection of real numbers  $(\tau_1, \dots, \tau_{2d})$  with  $\sum_{i \leq i_0} \tau_i \geq 0$  for all  $i_0$  and such that*

$$\sum_{i \leq i_0} \tau_i = 0 \Leftrightarrow \sigma(\{1, \dots, i_0\}) = \{2d, \dots, 2d - i_0 + 1\}.$$

*Proof.* We will construct from  $\pi_0 := \pi$  a new permutation  $\tilde{\pi}$  on  $d$  symbols. Let us consider the ‘‘mirror symmetry’’  $\pi_1$  of  $\pi_0$  as follows. In tabular representation  $\pi_0$  is  $(\tau(1), \dots, \tau(2d))$ ;  $\pi_1$  is of type  $(0, 2d)$  and its tabular representation is  $(\tau(2d), \dots, \tau(1))$ .

Then  $\tilde{\pi}$  is in tabular representation  $\begin{pmatrix} L_0 \\ L_1 \end{pmatrix}$  with  $L_i$  is obtained from  $\pi_i$  by removing the second occurrence of each letter. For instance, if  $\pi_0 = (A B C C D D A B)$  then  $\pi_1 = (B A D D C C B A)$  and  $\tilde{\pi} = \begin{pmatrix} A B C D \\ B A D C \end{pmatrix}$ . It is easy to check that  $\tilde{\pi}$  is reducible if and only if there exists  $i_0$  such that  $\sigma(\{1, \dots, i_0\}) = \{2d - i_0 + 1, \dots, 2d\}$ . Moreover the solution of Lemma 3.8 gives the desired collection of numbers  $\tau_i$ .  $\square$

**Definition/Lemma 3.10.** We define the pseudo-suspension  $\tau_{MV}$  over  $\pi$  by the collection of real numbers given by

- The solutions given by Lemma 3.8 and Lemma 3.9 for the restrictions of  $\pi$  on  $\pi^{-1}(\mathcal{A}_{12})$  and on  $\pi^{-1}(\mathcal{A}_1)$ .
- The solution of Lemma 3.9 for the restriction of  $\pi$  on  $\pi^{-1}(\mathcal{A}_2)$ , taken with opposite sign.

**Lemma 3.11.** *Let  $k \in \{1, \dots, l\}$  be any vanishing index on the top of  $\tau_{MV}$ . Setting  $A = \pi(\{1, \dots, k\}) \cap \mathcal{A}_{12}$  and  $B = \pi(\{1, \dots, k\}) \cap (\mathcal{A}_1 \sqcup \mathcal{A}_2)$ , there exists  $C \subset \mathcal{A}_2 \sqcup \mathcal{A}_1$  and  $D \subset \mathcal{A}_{12}$  such that the generalized permutation  $\pi$  decomposes as*

$$\left( \begin{array}{c|ccc|c} A \cup B & * & * & * & D \cup B' \\ \hline A \cup C & * & * & * & * \end{array} \right)$$

with  $A \cup B \neq \emptyset$  and with one of the following properties: either  $B = B' \subset \mathcal{A}$  or there exist  $i_1, i_2 \leq k$  such that  $\pi(i_1) = \pi(i_2) \in B$  and  $B' \subset B$ .

There is an analogous decomposition for vanishing indices in  $\{l+1, \dots, l+m\}$  but with different subsets  $A'$ ,  $B'$ ,  $C'$  and  $D'$  a priori.

*Proof.* It follows from Lemmas 3.8 and 3.9.  $\square$

**Remark 3.12.** If  $\tau$  is a pseudo-suspension of  $\pi = \begin{pmatrix} \alpha_1 & \alpha_2 & *** & \alpha_l \\ \alpha_{l+1} & \alpha_{l+2} & *** & \alpha_{l+m} \end{pmatrix}$  then  $\tau' = -\tau$  is a pseudo-suspension of  $\pi' = \begin{pmatrix} \alpha_{l+1} & \alpha_{l+2} & *** & \alpha_{l+m} \\ \alpha_1 & \alpha_2 & *** & \alpha_l \end{pmatrix}$ , and  $\tau$  is a pseudo-suspension of  $\pi'' = \begin{pmatrix} \alpha_l & \alpha_{l-1} & *** & \alpha_1 \\ \alpha_{l+m} & \alpha_{l+m-1} & *** & \alpha_{l+1} \end{pmatrix}$ .

Hence we can ‘‘flip’’ the generalized permutation  $\pi$  by top/bottom or left/right without loss of generality.

In the next two lemmas, we denote by  $\tau$  a pseudo-suspension that is better than  $\tau_{MV}$  and maximal (i.e. there is no better pseudo-suspensions).

**Lemma 3.13.** *Let  $i_1$  and  $i_2$  be the two first top and bottom vanishing indices for  $\tau$  (possibly  $i_1 = l, i_2 = m$ ). Let  $A = \pi(\{1, \dots, i_1\}) \cap \mathcal{A}_{12}$  and  $A' = \pi(\{l+1, \dots, l+i_2\}) \cap \mathcal{A}_{12}$ . Then either  $A = A'$  or  $A = \emptyset$  or  $A' = \emptyset$ .*

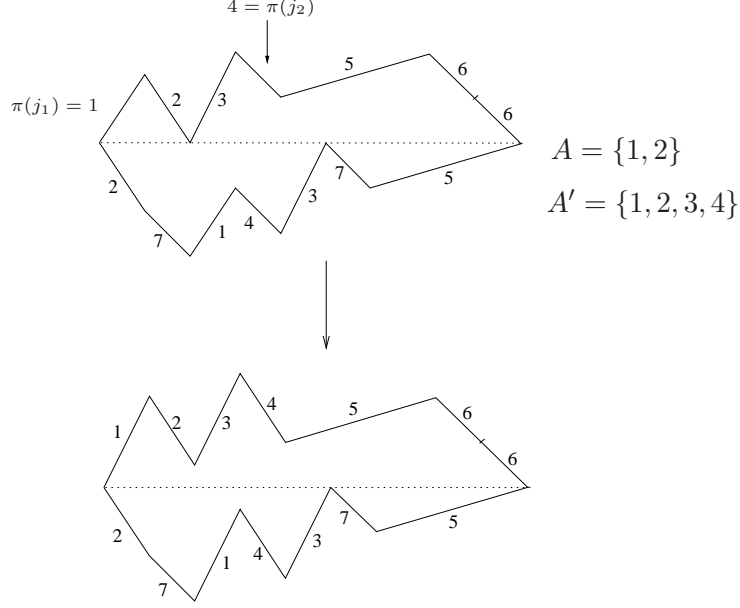

FIGURE 8. Construction of a pseudo-suspension  $\tau'$  better than  $\tau$ .

*Proof.* We assume that neither  $A$  nor  $A'$  is empty. Lemma 3.11 implies that one of this set is a subset of the other one.

Without loss of generality, we can assume that  $A \subsetneq A'$ . So there exist  $j_1, j_2$  in  $\pi^{-1}(\mathcal{A}_{12})$  such that  $1 \leq j_1 \leq i_1 < j_2 \leq l$ . But by definition of  $A$  and  $A'$ , we also have  $\sigma(j_1) < \sigma(j_2)$ .

The definition of  $i_2$  implies that there exists  $c < 0$  such that, for  $l+1 \leq k < i_2$ , the following inequality holds:

$$\sum_{1+l \leq i \leq l+k} \tau_{\pi(i)} \leq c < 0.$$

Now we replace  $\tau_{\pi(j_1)}$  (resp.  $\tau_{\pi(j_2)}$ ) by  $\tau_{\pi(j_1)} - \frac{c}{2}$  (resp.  $\tau_{\pi(j_2)} + \frac{c}{2}$ ) and get a vector  $\tau'$ , see Figure 8. We have

- $\sum_{1 \leq i \leq k} \tau'_{\pi(i)} > 0$  for  $k < j_2$ .
- $\sum_{1 \leq i \leq k} \tau'_{\pi(i)} = \sum_{1 \leq i \leq k} \tau_{\pi(i)}$  for  $k \geq j_2$ .
- $\sum_{1+l \leq i \leq k} \tau'_{\pi(i)} \leq c/2 < 0$  for  $l+1 \leq k < \sigma(j_2)$ .
- $\sum_{1+l \leq i \leq k} \tau'_{\pi(i)} = \sum_{1+l \leq i \leq k} \tau_{\pi(i)}$  for  $k \geq \sigma(j_2)$  (since  $\sigma(j_1) < \sigma(j_2)$ ).

Hence,  $\tau'$  is a pseudo-suspension better than  $\tau$ , contradicting its maximality.  $\square$

**Lemma 3.14.** *Let  $i_1$  and  $i_2$  be the first and last top vanishing indices of  $\pi$  ( $1 \leq i_1 \leq i_2 < l$ ). Let  $B = \pi(\{1, \dots, i_1\}) \cap (\mathcal{A}_1 \sqcup \mathcal{A}_1)$  and  $B' = \pi(\{i_2 + 1, \dots, l\}) \cap (\mathcal{A}_1 \sqcup \mathcal{A}_1)$ . Then either  $B' = B \subset \mathcal{A}_1$  or  $B = \emptyset$  or  $B' = \emptyset$ . Moreover if there exist  $i_{b_1} \neq i_{b_2}$  in  $\{1, \dots, i_1\}$  such that  $\pi(i_{b_1}) = \pi(i_{b_2})$  then  $B = \mathcal{A}_1 \sqcup \mathcal{A}_1$ .*

*Proof.* We assume that there exists  $i_{b_1}$  and  $i_{b_2}$  in  $\{1, \dots, i_1\}$  such that  $\pi(i_{b_1}) = \pi(i_{b_2})$ . If there exists  $i_{b_3} > i_1$  such that  $\pi(i_{b_3}) \in B$ , then we set:

$$\begin{aligned}\tau'_{\pi(i_{b_1})} &= \tau_{\pi(i_{b_1})} + \varepsilon \\ \tau'_{\pi(i_{b_3})} &= \tau_{\pi(i_{b_3})} - \varepsilon\end{aligned}$$

Then it is easy to see that, for  $\varepsilon$  small enough,  $\tau'$  is a pseudo-suspension and is better than  $\tau$ , contradicting its maximality.

Remark 3.12 implies that the same statement is true for  $B'$ . Hence, we can assume that  $B, B' \subset \mathcal{A}_1$ . Then the proof is very similar to the one of the previous lemma.  $\square$

**Proposition 3.15.** *Let  $\pi$  be a strongly irreducible generalized permutation. Let  $\tau$  be any pseudo-suspension which is better than  $\tau_{MV}$  and maximal. Then  $\tau$  is a strict pseudo-suspension.*

*Proof of Proposition 3.15.* Let us assume that  $\tau$  is not strict. From Lemmas 3.13 and 3.14 and remark 3.12 we have the following decomposition of  $\pi$ .

$$\left( \begin{array}{c|c|c} A \cup B & *** & D \cup B' \\ \hline A' \cup C & *** & D' \cup C' \end{array} \right)$$

with  $A, A', D, D' \subset \mathcal{A}_{12}$ ,  $B, B' \subset \mathcal{A}_1$  and  $C, C' \subset \mathcal{A}_2$  by assumption, and with the condition that either  $A, A'$  are equal, or at least one of them is empty (and similar statement for the pair  $(D, D')$ ); and the condition that if  $B, B' \subset \mathcal{A}_1$  then they are either equal, or at least one of them is empty, otherwise one of them is  $\mathcal{A}_1 \sqcup \mathcal{A}_1$  (and similar statements for  $C, C'$ ). By convention from now on, we will keep the notation  $B$  or  $C$  only when they are not equal to  $\mathcal{A}_1 \sqcup \mathcal{A}_1$  or  $\mathcal{A}_2 \sqcup \mathcal{A}_2$ , and therefore subsets of  $\mathcal{A}_1$  or  $\mathcal{A}_2$ .

Let us note that if there are no vanishing indices in  $\{1, \dots, l-1\}$  or in  $\{l+1, \dots, l+m-1\}$ , the corresponding right corner is just empty. But if  $\tau$  is not strict, then there exists at least a pair of nonempty corners in the top or in the bottom.

If there is a vanishing index on the top, then the two corresponding corners are non-empty. Then it is easy to see that either there is a corner with only  $A, B$  or  $D$ , or the corners are respectively  $A \cup B$  or  $D \cup B$ , with  $A, B, D$  nonempty. In this case Lemma 3.13 implies that there must be a vanishing index in  $\{l+1, \dots, l+m\}$ .

Since there must be a vanishing index in the top, or in the bottom, the previous argument implies that either  $\pi$  is not strongly irreducible, or there is

one corner that only consists of one set  $A, B, C$  or  $D$ . Thanks to Remark 3.12, we assume that this is the top-left corner; this leads to the two next cases.

The general idea of the next part of the proof is first to remove the cases that correspond to not strongly irreducible permutations, and then show that the other cases correspond to a non-maximal pseudo-solution.

*First case: The top-left corner is  $B$ .*

There is necessary a vanishing index in  $\{1, \dots, l-1\}$ , and hence the top-right corner is not empty. It also does not contains all  $\mathcal{A}_1 \sqcup \mathcal{A}_1$ , hence it is necessary  $B, D$  or  $D \cup B$ . Recall that  $\pi$  is assumed to be strongly irreducible, so the top-right corner is not  $B$ . If the bottom-right corner were  $D$ , the generalized permutation  $\pi$  would decompose as

$$\left( \begin{array}{c|ccc|c} B & * & * & * & D \cup B \\ \hline & * & * & * & D \end{array} \right),$$

or

$$\left( \begin{array}{c|ccc|c} B & * & * & * & D \\ \hline & * & * & * & D \end{array} \right)$$

which are not strongly irreducible. Hence the bottom-right corner is not  $D$ . This also implies that  $\mathcal{A}_2$  cannot be empty.

Let us assume that there are no vanishing indices in the bottom line. We choose any element  $b \in B, c \in \mathcal{A}_2$ , and  $d \in D$  and change  $\tau_b$  by  $\tau_b + \varepsilon, \tau_c$  by  $\tau_c + \varepsilon$  and  $\tau_d$  by  $\tau_d - 2\varepsilon$ . If  $\varepsilon$  is small enough, then the new vector  $\tau'$  is better than  $\tau$ , which contradicts its maximality.

So, the bottom admits vanishing indices; then the bottom-left corner can be  $C, \mathcal{A}_2 \sqcup \mathcal{A}_2, \mathcal{A}_2 \sqcup \mathcal{A}_2 \cup A, A$  or  $A \cup C$ . Let us discuss these cases in details.

- $C$ : the bottom-right corner is  $C, D$  or  $C \cup D$ . In the first and second cases,  $\pi$  is not strongly irreducible. If for instance, the top-right is  $D \cup B$ , then  $\pi$  decomposes as

$$\left( \begin{array}{c|ccc|c} B & * & * & * & D \cup B \\ \hline C & * & * & * & D \cup C \end{array} \right),$$

and therefore  $\pi$  is not strongly irreducible. The other case is similar.

- $\mathcal{A}_2 \sqcup \mathcal{A}_2$  or  $\mathcal{A}_2 \sqcup \mathcal{A}_2 \cup A$ : in that case, the bottom-right corner is necessary  $D$  and we have already proved that  $\pi$  is not strongly irreducible in this situation.
- $A$  or  $A \cup C$ : We construct a better pseudo-suspension  $\tau'$ . Let  $j_1 \leq l$  be the smallest index such that  $\sigma(j_1) > l$  and let  $j_2 \leq l$  be the largest one. Let  $i_1$  be the first vanishing index. There exists  $j_b \in \{1, \dots, i_1\}$  such that  $\sigma(j_b) < j_2$  otherwise the top-line would have a decomposition as  $B | * * * | B$ , and  $\pi$  would be not strongly irreducible. Let  $j_c$  be the first index in  $\pi^{-1}(\mathcal{A}_2)$  (see Figure 9).

Now we define  $\tau'$  in the following way:

$$\begin{aligned}\tau'_{\pi(j_1)} &= \tau_{\pi(j_1)} - \varepsilon \\ \tau'_{\pi(j_2)} &= \tau_{\pi(j_2)} - \varepsilon \\ \tau'_{\pi(j_b)} &= \tau_{\pi(j_b)} + \varepsilon \\ \tau'_{\pi(j_c)} &= \tau_{\pi(j_c)} + \varepsilon \\ \forall \alpha \notin \pi(\{j_1, j_2, j_b, j_c\}) \quad \tau'_\alpha &= \tau_\alpha\end{aligned}$$

In the extremal case  $j_1 = j_2$ , the following arguments will work similarly if we define  $\tau'_{\pi(j_1)}$  by  $\tau_{\pi(j_1)} - 2\varepsilon$ . We have

$$\begin{aligned}\forall k \in \{1, \dots, l\} \quad \sum_{i=1}^k \tau'_{\pi(i)} &= \sum_{i=1}^k \tau_{\pi(i)} + n_k \varepsilon \\ \forall k \in \{1, \dots, m\} \quad \sum_{i=l+1}^{l+k} \tau'_{\pi(i)} &= \sum_{i=l+1}^{l+k} \tau_{\pi(i)} + m_k \varepsilon\end{aligned}$$

Here  $n_k$  is the difference between the number of indices in  $\{j_b, \sigma(j_b)\}$  smaller than or equal to  $k$ , and number of indices in  $\{j_1, j_2\}$  smaller than or equal to  $k$ . This value is *always* greater than or equal to zero for  $k \in \{1, \dots, l\}$ , and is strictly greater than zero when  $k$  is the first vanishing index.

Similarly  $m_k$  is the difference between the number of indices in  $\{j_c, \sigma(j_c)\}$  that are in  $\{l+1, \dots, k\}$ , and number of indices in the set  $\{\sigma(j_1), \sigma(j_2)\}$  that are in  $\{l+1, \dots, k\}$ . This value might be positive. Let  $i_3 \leq i_4 < l+m$  be respectively the first and last bottom vanishing indices. We have the following facts:

- $\sigma(j_1) \leq i_3$  otherwise the bottom-left corner is  $C$ .
- $\sigma(j_c) > i_4$  otherwise the bottom-right corner is  $D$ .

Hence it is easy to check that  $m_k$  can be strictly positive only for  $l < k < i_3$  or  $i_4 < k < l+m$ .

Then if  $\varepsilon$  is small enough,  $\tau'$  is a pseudo-suspension, and is better than  $\tau$  (see Figure 9), which contradicts the maximality of  $\tau$ .

*Second case: The top-left corner is  $A$ .*

We assume that there are no corners  $B$  or  $C$ , since this case has already been discussed.

Let us assume that there are no vanishing indices in the bottom line. Then, according to Lemma 3.13,  $A = \mathcal{A}_{12}$ ; therefore the top-right corner is  $\mathcal{A}_1 \sqcup \mathcal{A}_1$  or  $B$ . If  $\mathcal{A}_2$  is empty, then  $\pi$  decomposes as

$$\left( \begin{array}{c|c} A & \mathcal{A}_1 \sqcup \mathcal{A}_1 \\ \hline & A \end{array} \right)$$

so  $\pi$  is not strongly irreducible. If  $\mathcal{A}_2$  is not empty, we choose any element  $a \in A$ ,  $b \in \mathcal{A}_1$ ,  $c \in \mathcal{A}_2$ , and replace  $\tau_a$  by  $\tau_a + 2\varepsilon$ ,  $\tau_b$  by  $\tau_b - \varepsilon$ , and  $\tau_c$  by

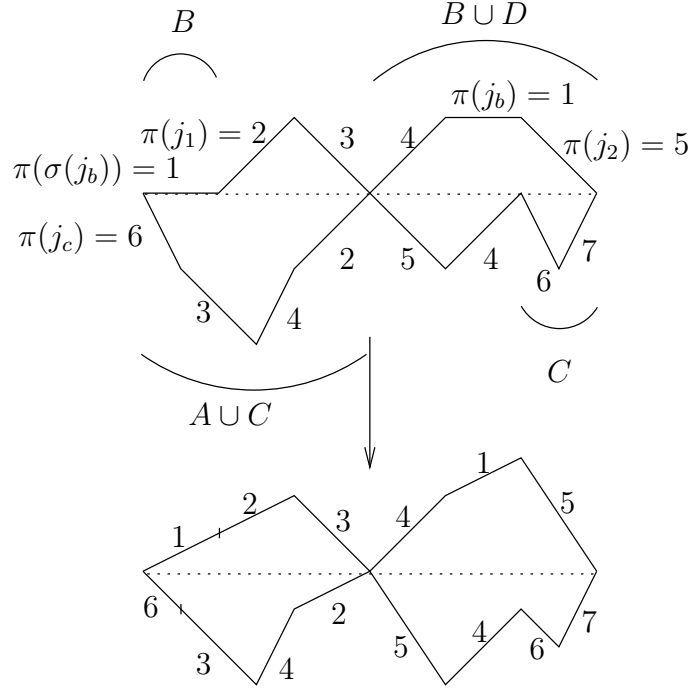

FIGURE 9. Construction a pseudo-solution  $\tau'$  better than  $\tau$ .

$\tau_c - \varepsilon$ . This new pseudo-suspension constructed is better that the old one for  $\varepsilon$  small enough.

If there are vanishing indices in the bottom, then the bottom-left corner belongs to the list:  $A$ ,  $A \cup C$ ,  $A \cup \mathcal{A}_2 \sqcup \mathcal{A}_2$  or  $\mathcal{A}_2 \sqcup \mathcal{A}_2$ .

- $A$ : the permutation  $\pi$  is then obviously not strongly irreducible.
- $A \cup C$ : the bottom-right corner is necessary  $D$  or  $D \cup C$ . If the top-right corner where  $D$ , then  $\pi$  would be not strongly irreducible. In particular, that means  $\mathcal{A}_1$  is not empty. Hence there exists  $j_d < j_1 \leq l$  such that  $d = \pi(j_d) \in D$  and  $b = \pi(j_1) \in \mathcal{A}_1$ . Then we choose any index  $a \in A$  and any index  $c \in C$ , and set:

$$\begin{aligned} \tau'_a &= \tau_a + \varepsilon \\ \tau'_d &= \tau_d + \varepsilon \\ \tau'_b &= \tau_b - \varepsilon \\ \tau'_c &= \tau_c - \varepsilon \\ \forall i \notin \{a, b, c, d\} \quad \tau'_i &= \tau_i \end{aligned}$$

Then  $\tau'$  is better than  $\tau$  for  $\varepsilon > 0$  small enough, which contradicts its maximality.

- $A \cup \mathcal{A}_2 \sqcup \mathcal{A}_2$ , or  $\mathcal{A}_2 \sqcup \mathcal{A}_2$ . The bottom-right corner is necessary  $D$ . If  $\mathcal{A}_1$  is empty, then the top-right corner is also  $D$ , and therefore  $\pi$  is not strongly irreducible. If  $\mathcal{A}_1$  is not empty, then we choose  $a \in A$ ,  $b \in \mathcal{A}_1$  and  $c \in \mathcal{A}_2$ , and set:

$$\begin{aligned}\tau'_a &= \tau_a + 2\varepsilon \\ \tau'_b &= \tau_b - \varepsilon \\ \tau'_c &= \tau_c - \varepsilon \\ \forall i \notin \{a, b, c\} \quad \tau'_i &= \tau_i\end{aligned}$$

And  $\tau'$  is better than  $\tau$ .

The proposition is proved.  $\square$

We now have all necessary tools for proving our main result.

*Proof of Theorem 3.2.* We only have to prove the sufficient condition. We consider a pseudo-suspension  $\tau$  better than  $\tau_{MV}$  and maximal for this property. We can assume that  $\pi : \{1, \dots, l + m\} \rightarrow \mathcal{A}$  is not strongly irreducible (i.e. at least one corner is non empty in the decomposition) otherwise the theorem follows from Proposition 3.7 and Proposition 3.15. Let us consider a decomposition of  $\pi$  as

$$\left( \begin{array}{c|c|c} A \cup B & U & D \cup B \\ \hline A \cup C & V & D \cup C \end{array} \right).$$

where  $A \cup B \cup C \cup D$  is maximal. Note that  $\pi' = \binom{U}{V}$  defines a generalized permutation which is not strongly irreducible by assumption. Note also that  $\pi'$  does not necessary satisfy Convention 1, even if  $\pi$  satisfies that convention

We define  $\mathcal{A}' = \mathcal{A} \setminus (A \cup B \cup C \cup D)$ ; from Proposition 3.15, the restriction of  $\tau$  to  $\mathcal{A}'$  is strict for  $\pi'$ .

Since  $\pi$  is irreducible, there is one or two empty corners in the decomposition.

- If only one corner is empty, then it is on the right. So we can assume that  $\pi$  decomposes as:

$$\left( \begin{array}{c|c|c} A \cup B & U & B \\ \hline A & V & \end{array} \right)$$

With  $\pi' = \binom{U}{V}$  strongly irreducible.

Let  $i_1$  be the first vanishing index in the top line of  $\pi$  and  $i_2$  be the first vanishing index of the second line. Consider  $i_b$  the first index such that  $b = \pi(i_b) \in B$ . Then  $i_b \leq i_1$  otherwise there would be a subdecomposition of  $\pi$  as

$$\left( \begin{array}{c|c} A' & *** \\ \hline A' & *** \end{array} \right)$$

and  $\pi$  would be reducible. Now let  $a = \pi(l+1) \in A$  and let  $c \in \mathcal{A}_2$ . We set:

$$\begin{aligned}\tau'_b &= \tau_b + 2\varepsilon \\ \tau'_c &= \tau_c + 2\varepsilon \\ \tau'_a &= \tau_a - \varepsilon \\ \forall j \notin \{a, b, c\} \quad \tau'_j &= \tau_j\end{aligned}$$

If  $\varepsilon$  is small enough, then  $\tau'$  satisfies:

- For all  $k \in \{1, \dots, l\}$   $\sum_{i \leq k} \tau'_{\pi(i)} > 0$ .
- For all  $k \in \{1, \dots, m-1\}$   $\sum_{l < i \leq l+k} \tau'_{\pi(i)} < 0$ .

And then, we can deduce from  $\tau'$  a suspension over  $\pi$ .

- If two corner are empty, then we can assume that  $\pi$  decomposes as:

$$\left( \begin{array}{c|c|c} B & U & B \\ \hline & V & \end{array} \right)$$

with  $\pi' = \left( \begin{array}{c} U \\ V \end{array} \right)$  irreducible. Now we choose  $b \in B$  and  $c \in \mathcal{A}_2$ , and then set:

$$\begin{aligned}\tau'_b &= \tau_b + 2\varepsilon \\ \tau'_c &= \tau_c + 2\varepsilon \\ \forall j \notin \{b, c\} \quad \tau'_j &= \tau_j\end{aligned}$$

Then  $\tau'$  defines a suspension over  $\pi$  for  $\varepsilon$  small enough.

The theorem is proven.  $\square$

#### 4. IRRATIONALITY OF GENERALIZED INTERVAL EXCHANGE MAPS

For an interval exchange map  $T = (\pi, \lambda)$  either the underlying permutation is reducible and then the transformation is never minimal or  $\pi$  is irreducible and  $T$  has the Keane's property, and hence is minimal, for almost every  $\lambda$  (section 1). Furthermore  $T$  admits a suspension if and only if  $\pi$  is irreducible.

Hence the combinatorial set for which the dynamics of  $T$  is good coincides with the one for which the geometry is good.

As we will see, the situation is more complicated in the general case. In this section we prove the second part of Theorem A.

##### 4.1. Keane's property.

**Definition 4.1.** A generalized interval exchange map has a connection (of length  $r$ ) if there exist  $(x, \varepsilon) \in X \times \{0, 1\}$  and  $r \geq 0$  such that

- $(x, \varepsilon)$  is a singularity for  $T^{-1}$ .
- $T^r(x, \varepsilon)$  is a singularity for  $T$ .

A generalized interval exchange map with no connections is said to have the Keane's property.

Note that, by definition of a singularity, if we have a connection of length  $r$  starting from  $(x, \varepsilon)$ , then  $\forall r' < r$ ,  $T^{r'}(x, \varepsilon)$  is not a singularity for  $T$ .

We first prove the following proposition:

**Proposition 4.2.** *Let  $T$  be a generalized permutation. Then the following statements are equivalent.*

- (1)  $T$  satisfies the Keane's property.
- (2)  $\mathcal{R}^n(T)$  is well defined for any  $n \geq 0$  and the lengths of the intervals  $\lambda^{(n)}$  tends to 0 as  $n$  tends to infinity.

Moreover in the above situation the transformation  $T$  is minimal.

**Corollary 4.3.** *Let  $T$  be a generalized interval exchange map that satisfies the Keane's property. Then all the iterates of  $T$  by the Rauzy-Veech induction are well defined.*

*Proof.* Let  $T$  be a generalized interval exchange map. Then it is easy to see that  $T$  has the Keane's property if and only if its image  $\mathcal{R}(T)$  by the Rauzy-Veech induction is well defined and has the Keane's property. Hence if  $T$  has the Keane's property, then by induction, all its iterates by  $\mathcal{R}$  are well defined and have the Keane's property.  $\square$

*Proof of Proposition 4.2.* We denote by  $\lambda^{(n)}$  the length parameters of the map  $\mathcal{R}^{(n)}(T)$ , by  $\pi^{(n)}, \sigma^{(n)}, (l^{(n)}, m^{(n)})$  the combinatorial data, and by  $X^{(n)}$  the subinterval of  $X$  corresponding to  $\mathcal{R}^{(n)}(T)$ . Let us assume  $T$  has no connections.

Thanks to Corollary 4.3 we only have to prove that  $\lambda^{(n)}$  goes to zero as  $n$  tends to infinity. Let  $\mathcal{A}'$  be the subset of elements  $\alpha \in \mathcal{A}$  such that  $(\lambda_\alpha^{(n)})_n$  decreases an infinite number of time in the sequence  $\{\mathcal{R}^n(T)\}_n$ , and let  $\mathcal{A}''$  be its complement.

Repeating the arguments for the Proposition and Corollary 1 and 2 of section 4.3 in [Yoc03], we have that:

- For  $n$  large enough, the permutation  $\pi^{(n)}$  can be written as:

$$\left( \begin{array}{ccc|ccc} \alpha_1 & \dots & \alpha_{i_0} & * & * & * \\ \beta_1 & \dots & \beta_{j_0} & * & * & * \end{array} \right),$$

with  $\{\alpha_1, \dots, \beta_{j_0}\} = \mathcal{A}'' \sqcup \mathcal{A}'$

- For all  $\alpha \in \mathcal{A}'$ ,  $\lambda_\alpha^{(n)}$  tends to zero.

If  $\mathcal{A}' = \mathcal{A}$ , then the Proposition is proven. So we can assume that  $\mathcal{A}'$  is a strict subset of  $\mathcal{A}$ . Note that  $\mathcal{A}'$  cannot be empty. Therefore, we must have

$$\sum_{i=1}^{i_0} \lambda_{\alpha_i} = \sum_{j=1}^{j_0} \lambda_{\beta_j},$$

for some  $1 \leq i_0 \leq l^{(n)} - 1$  and  $1 \leq j_0 \leq m^{(n)} - 1$ . This means that  $\mathcal{R}^n(T)$  has a connection of length zero, hence  $T$  has a connection. This contradicts the hypothesis. So we have proven that if  $T$  has no connections, then the

sequence  $\{\mathcal{R}^n(T)\}_n$  of iterates of  $T$  by the Rauzy-Veech induction is infinite and all length parameters of  $\mathcal{R}^n(T)$  tend to zero when  $n$  tends to infinity.

Now we assume that  $T$  has a connection. So, there exists  $u_0 = (x, \varepsilon)$  in  $X \times \{0, 1\}$  which is a singularity of  $T^{-1}$ , and such that its sequence  $u_1, \dots, u_m$  of iterates by  $T$  is finite, with  $u_m$  a singularity of  $T$ . We denote by  $\overline{u_1}, \dots, \overline{u_m}$  the projections of  $u_0, \dots, u_m$  on  $X$ . Let  $u_{min}$  be the element of  $\{u_0, \dots, u_m\}$  whose corresponding projection to  $X$  is minimal. We have  $u_{min} > 0$ . If for all  $n \geq 0$ , the map  $\mathcal{R}^n(T)$  is well defined and  $u_{min} \in X^{(n)}$ , then  $X^{(n)}$  does not tend to zero, and hence there exists  $\alpha \in \mathcal{A}$  such that  $\lambda_\alpha^{(n)}$  does not tend to zero. Hence we can assume that there exists a maximal  $n_0$  such that  $\mathcal{R}^{n_0}(T)$  is well defined, and  $X^{(n_0)}$  contains  $\overline{u_{min}}$ . We want to show that  $\mathcal{R}^{n_0+1}(T)$  is not defined.

Assume that  $\mathcal{R}^{n_0+1}(T)$  is defined, then  $\overline{u_{min}} \notin X^{(n_0+1)}$ . Since  $\mathcal{R}^{n_0}(T)$  is an acceleration of  $T$ , there must exist an iterate of  $u_{min}$  by  $T$ , say  $u_k$  which is a singularity for  $\mathcal{R}^{n_0}(T)$ . Either  $\overline{u_k}$  is in  $X^{(n_0+1)}$ , or it is its right endpoint. However,  $X^{(n_0+1)}$  does not contain  $\overline{u_{min}}$ , and  $\overline{u_{min}} \leq \overline{u_k}$ . Therefore, we must have  $u_{min} = u_k$ , and so  $u_{min}$  is a singularity for  $\mathcal{R}^{n_0}(T)$ .

We prove in the same way that  $u_{min}$  is also a singularity for  $\mathcal{R}^{n_0}(T)^{-1}$ . This implies that we are precisely in the case when the Rauzy-Veech induction is not defined. Hence we have proven that if  $T$  has a connection, then either the sequence  $(\mathcal{R}^n(T))_n$  is finite, either the length parameters do not all tend to zero.

This proves the first part of the proposition. We postpone the proof of the minimality to section 5.3.  $\square$

## 4.2. Dynamical irreducibility.

**Definition 4.4.** We will say that  $T = (\pi, \lambda)$  is dynamically reducible if one of the two following holds.

- (1)  $\pi$  decomposes as  $\left(\frac{A|***}{A|***}\right)$ ,  $\left(\frac{***|D}{***|D}\right)$  or  $\left(\frac{AUB|DUB}{AUC|DUC}\right)$  with  $A, D \subset \mathcal{A}_{12}$  and  $B = \mathcal{A}_1$ ,  $C = \mathcal{A}_2$  and  $A, D$  non empty in the two first cases.
- (2)  $\pi$  decomposes as  $\left(\frac{AUB|***|BUD}{AUC|\alpha_0***\alpha_0|CUD}\right)$ , with (up to switching the top and the bottom of  $\pi$ )  $A, D \subset \mathcal{A}_{12}$  and  $\emptyset \neq B \subset \mathcal{A}_1$ ,  $C \subset \mathcal{A}_2$  and the length parameters  $\lambda$  satisfies the following inequality

$$\sum_{\alpha \in C} \lambda_\alpha \leq \sum_{\alpha \in B} \lambda_\alpha \leq \lambda_{\alpha_0} + \sum_{\alpha \in C} \lambda_\alpha.$$

*Remark 4.5.* These two combinatorial notions of reducibility were introduced in [Lan04]. Observe that a dynamically reducible  $T$  have a connection of length 0 or 1 depending cases (1) or (2) of Definition 4.4, and is never minimal. More precisely there exists two invariant sets of positive measure.

One also note that if  $T = (\pi, \lambda)$  is dynamically reducible then  $\pi$  is reducible.

The length parameters for  $T$  cannot be linearly independent over  $\mathbb{Q}$  since they must satisfy a relation with integer coefficients. A generalized interval exchange map  $T = (\pi, \lambda)$  is said to have *irrational parameters* if  $\{\lambda_\alpha\}$  generates a  $\mathbb{Q}$ -vector space of dimension  $\#\mathcal{A} - 1$ . Almost all generalized interval exchange maps have irrational parameters, and this property is preserved by the Rauzy-Veech induction.

*Proof of second part of Theorem A.* Note that the dynamical reducibility involves two cases. In this proof we will distinguish the two cases. The non minimality comes from Remark 4.5. Now let us assume that  $T$  is dynamically irreducible and has irrational lengths parameters.

The proof has two steps: first we show using Proposition 4.2 that if  $T$  does not have the Keane's property, then there exists  $n_0$  such that  $\mathcal{R}^{n_0}(T)$  is dynamically reducible (case (1)). Then we show that if  $\mathcal{R}^{n_0}(T)$  is dynamically reducible (case (1)), then  $T$  is dynamically reducible. This will imply the theorem.

We still denote by  $\lambda^{(n)}$  the length parameters of  $\mathcal{R}^{(n)}$  and by  $\pi^{(n)}, \sigma^{(n)}, (l^{(n)}, m^{(n)})$  the combinatorial data.

*First step:* We assume that the sequence is finite. Then there exists  $\mathcal{R}^{n_0}(T)$  that admits no Rauzy-Veech induction. Since  $\lambda^{(n_0)}$  is irrational then either  $\sigma^{(n_0)}(l^{(n_0)}) = l^{(n_0)} + m^{(n_0)}$ , or  $l^{(n_0)}$  belongs to the only pair  $\{i, \sigma^{(n_0)}(i)\}$  on the top of the permutation and  $l^{(n_0)} + m^{(n_0)}$  belongs to the only pair  $\{j, \sigma^{(n_0)}(j)\}$  on the bottom of the permutation. In each case, the permutation  $\pi^{(n_0)}$  is dynamically reducible (case (1)).

Now we assume that the lengths parameters do not all tend to zero. As in the proof of Proposition 4.2, for  $n$  large enough, the generalized permutation  $\pi^{(n)}$  decomposes as:

$$\left( \begin{array}{ccc|ccc} a_1 & \dots & a_{i_0} & * & * & * \\ b_1 & \dots & b_{j_0} & * & * & * \end{array} \right),$$

with  $\{a_1, \dots, b_{j_0}\} = \mathcal{A}' \sqcup \mathcal{A}''$ , for some  $\emptyset \neq \mathcal{A}'' \subset \mathcal{A}$  and some  $1 \leq i_0 < l^{(n)}$  and  $1 \leq j_0 < m^{(n)}$ . And we have

$$\sum_{i=1}^{i_0} \lambda_{\pi^{(n)}(i)} = \sum_{j=1}^{j_0} \lambda_{\pi^{(n)}(j)},$$

The map  $\mathcal{R}^n(T)$  has irrational parameters, therefore  $\pi^{(n)}$  must decompose as:

$$\left( \begin{array}{c|ccc} A & * & * & * \\ \hline A & * & * & * \end{array} \right), \text{ or } \left( \begin{array}{ccc|c} * & * & * & D \\ * & * & * & D \end{array} \right).$$

And then  $\pi^{(n)}$  is dynamically reducible (case (1)).

*Second step:* It is enough to prove that if  $T' = \mathcal{R}(T)$  is dynamically reducible, then so is  $T$ . We can assume without loss of generality that the

combinatorial Rauzy-Veech transformation is  $\mathcal{R}_0$ . We denote by  $\pi, \sigma, \lambda$  the data of  $T$  and by  $\pi', \sigma', \lambda'$  the data of  $T'$ . If  $\pi'$  decomposes as:

$$\left( \frac{*** \mid D}{*** \mid D} \right).$$

Consider  $l'$  the last element of the top line. Its twin  $\sigma'(l')$  is on the bottom-right corner, but is not  $l' + m'$ . We denote by  $\beta = \pi'(\sigma'(l') + 1)$ . Then it is clear that we obtain  $\pi$  by removing  $\beta$  from that place and putting it at the right-end of the bottom line. Then  $\pi$  is dynamically reducible (case (1)).

Now we assume that  $\pi'$  decomposes as:

$$\left( \frac{A \mid ***}{A \mid ***} \right).$$

If  $\sigma'(l')$  is on the bottom line, the situation is analogous to the previous case. If not, then we denote by  $\beta = \pi'(\sigma'(l') - 1)$  and  $\alpha = \pi'(l')$ , and we get  $\pi$  by removing  $\beta$  from  $\sigma'(l') - 1$  and putting it on the right-end of the bottom line. If this place is in the top-right corner, then  $\pi$  is clearly dynamically reducible (case (1)). However, it might be the last element of the top-left corner. In that case, setting  $A = A' \cup \{\beta\}$ , the generalized permutation  $\pi$  decomposes as:

$$\left( \frac{A' \quad \alpha \mid *** \mid \alpha}{A' \cup \{\beta\} \quad \mid *** \mid \beta} \right),$$

with  $\lambda_\beta = \lambda'_\beta > 0$  and  $\lambda_\alpha = \lambda'_\alpha + \lambda'_\beta > \lambda_\beta$ , hence  $T$  is dynamically reducible (case (2)).

Now we assume that  $\pi'$  decomposes as.

$$\left( \frac{A \cup B \mid B \cup D}{A \cup C \mid C \cup D} \right).$$

Then we obtain  $\pi$  from  $\pi'$  by removing an element on the top-left corner or on the bottom-right corner, and putting it at the right-end of the bottom line. Then  $T$  is dynamically reducible (case (1)). The other cases are similar.  $\square$

## 5. DYNAMICS OF THE RENORMALIZED RAUZY-VEECH INDUCTION

As we have seen previously, there are two notions of irreducibility for a generalized interval exchange map.

- “Geometrical irreducibility” as stated in section 3, that we just called irreducibility.
- Dynamical irreducibility as stated in section 4.

In this section, we first prove that the set of irreducible generalized interval exchange maps in an attractor for the renormalized Rauzy-Veech induction. Then we show that, as in the case for interval exchange transformations, the renormalized Rauzy-Veech induction is recurrent for almost all irreducible generalized interval exchange transformations.

5.1. An attraction domain.

*Proof of the first part of Theorem B.* It is easy to show that one can find a non-zero pseudo-suspension  $(\tau_\alpha)_{\alpha \in \mathcal{A}}$  (see Definition 3.6) otherwise  $T$  is dynamically reducible (case (1)). For all  $\alpha$ , we denote by  $\zeta_\alpha$  the complex number  $\zeta_\alpha = \lambda_\alpha + i\tau_\alpha$ . Then, as in section 4.2, we consider a broken line  $L_0$  which starts at 0, and whose edge number  $i$  is represented by the complex number  $\zeta_{\pi(i)}$ , for  $1 \leq i \leq l$ . Then we consider a broken line  $L_1$ , which starts on the same point as  $L_0$ , and whose edge number  $j$  is represented by the complex number  $\zeta_{\pi(l+j)}$  for  $1 \leq j \leq m$ .

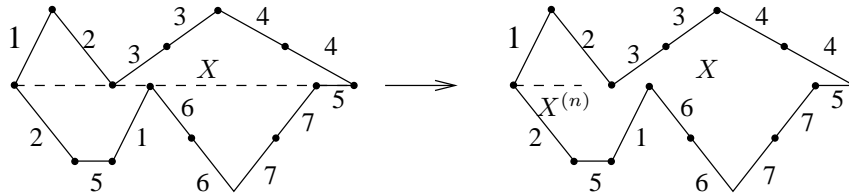

FIGURE 10. The transformation  $T$  is a first return map of the vertical flow on a union of saddle connections.

*Special case:* We assume that  $L_0$  and  $L_1$  only intersect on their endpoints. Then they define a flat surface  $S$ , and  $T$  appears as a first return map of the vertical flow on a segment  $X$  which is a union of horizontal saddle connections (see Figure 10). After  $n$  steps of the Rauzy-Veech induction, the resulting generalized interval exchange transformation  $\mathcal{R}^n(T)$  is the first return map of the vertical flow of  $S$  on a shorter segment  $X^{(n)}$ , which is adjacent to the same singularity as  $X$ . Since  $T$  has no connections, then the length of  $X^{(n)}$  tends to zero when  $n$  tends to infinity by the first part of Proposition 4.2. Hence for  $n$  large enough,  $\mathcal{R}^n(T)$  is the first return map of the vertical flow of  $S$  on a segment, adjacent to a singularity, and with no singularities in its interior. With our construction of  $S$ , it is clear that any vertical saddle connection would intersect  $X$  and would give a connexion on  $S$ . Since  $T$  has no connections, the surface  $S$  has no vertical saddle connections (note that this is not true in general for a first return map on a transverse segment). According to Proposition 2.11,  $(\pi^{(n)}, \lambda^{(n)})$  admits a suspension and hence Theorem 3.2 implies that  $\pi^{(n)}$  is irreducible. The theorem is proven for that case.

*General case:* The two broken lines  $L_0$  and  $L_1$  might have other intersection points. We first show this still defines a flat surface. We consider the line  $L_0^\varepsilon$  that starts at the complex number  $2\varepsilon$ . Then we join the first points of  $L_0^\varepsilon$  and  $L_1$  by a vertical segment, and do the same for their last points (see Figure 11). This defines a polygon and the non vertical sides come by pairs, so we can glue them as previously. Then, there are two vertical segments left. We decompose each vertical segment into a pair of vertical segments of the same length, and glue together these two segments. This creates a pole



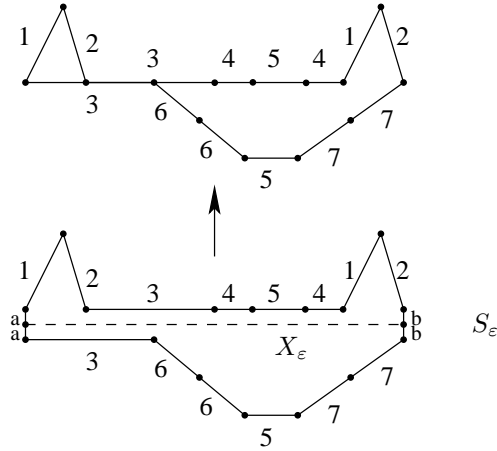

FIGURE 11. Constructing  $T$  as a first return map on a regular segment of a surface  $S_\varepsilon$ .

for each initial segment. We denote by  $S_\varepsilon$  the resulting flat surface. The first return map of the vertical flow on the horizontal segment  $X_\varepsilon$  joining the two poles is  $T$ . The surface  $S_\varepsilon$  has two vertical saddle connections of length  $\varepsilon$  starting from the poles, but there are no other vertical saddle connections on  $S_\varepsilon$  since  $T$  has no connections. When  $\varepsilon$  tends to zero, the two vertical saddle connections are the only ones that shrink to zero. Hence there is no loops that shrink to zero. Furthermore, the initial pseudo-suspension is nonzero, so the area of  $S_\varepsilon$  is bounded from below. Hence, the surface  $S_\varepsilon$  does not degenerate when  $\varepsilon$  tends to zero and so there exists a sequence  $(\varepsilon_k)_k$  that tends to zero when  $k$  tends to infinity such that  $(S_{\varepsilon_k})$  tends to a surface  $S$ .

The segment  $X \subset S$  corresponding to limit of  $X_{\varepsilon_k}$ , as  $k$  tends to infinity, might be very complicated and the first return map on  $X$  is not well defined.

The transformation  $\mathcal{R}^n(T)$  is the first return map of the vertical flow of  $S_{\varepsilon_k}$  on a short horizontal segment  $X_\varepsilon^{(n)}$ , adjacent to one of the poles. If  $n$  is large enough, then the segment  $X^{(n)} \subset S$  corresponding to the limit of  $X_{\varepsilon_k}^{(n)}$  has no singularities on its interior. Since the surgery corresponding to contracting  $\varepsilon$  does not change the vertical foliation, the first return map of the vertical foliation of  $S$  on  $X^{(n)}$  is precisely  $\mathcal{R}^n(T)$ .

As in the special case, the surface  $S$  does not have any vertical saddle connection, so the generalized permutation corresponding to  $\mathcal{R}^n(T)$  is irreducible and the proposition is proven.  $\square$

**5.2. Recurrence.** The following lemma is an analogous of Proposition 9.1 in [Vee82].

**Lemma 5.1.** *Let  $T$  be a generalized interval exchange map on  $X = (0, L)$  with no connections and let  $(x, \varepsilon) \in X \times \{0, 1\}$  be a singularity for  $T$ . Let  $X^{(n)} \subset X$  be the subinterval corresponding the generalized interval exchange map  $\mathcal{R}^n(T)$ . There exists  $n > 0$  such that  $X^{(n)} = (0, x)$ .*

*Proof.* Since  $T$  has no connections, there exists a first  $n > 0$  such that  $x \notin X^{(n)}$ . So  $x \in X^{(n-1)}$ , and  $(x, \varepsilon)$  is still a singularity for  $\mathcal{R}^{n-1}(T)$ . We obtain  $\mathcal{R}^n(T)$  from  $\mathcal{R}^{n-1}(T)$  by considering the first return map on the largest subinterval  $X^{(n)} \subset X^{(n-1)}$  whose right endpoint corresponds to a singularity of  $\mathcal{R}^{n-1}(T)$ . So  $X^{(n)} = (0, x)$ .  $\square$

Let  $\pi_0$  be an irreducible generalized permutation, and let  $C$  be the set of generalized permutations that can be obtained by iteration of the maps  $\mathcal{R}_0$  and  $\mathcal{R}_1$  (when possible).

We define  $\mathcal{T}_C = \{(\pi, \zeta), \pi \in C, \zeta \text{ is a suspension data for } \pi\}$ . We have defined the Rauzy-Veech map on the space  $\mathcal{T}_C$ . It defines an almost everywhere invertible map: If  $\sum_{i=1}^l \text{Im}(\zeta_{\pi(i)}) \neq 0$  then  $(\pi, \zeta)$  has exactly one preimage for  $\mathcal{R}$ .

We define the quotient  $\mathcal{Q}_C$  of  $\mathcal{T}_C$  by the equivalence relation generated by  $(\pi, \zeta) \sim \mathcal{R}(\pi, \zeta)$ .

One will denote by  $m$  the natural Lebesgue measure on  $\mathcal{T}_C$  i.e.  $m = d\pi d\zeta$ , where  $d\zeta$  is the natural Lebesgue measure on the hyperplane  $\sum_{i=1}^l \zeta_{\pi(i)} = \sum_{j=l+1}^{2d} \zeta_{\pi(j)}$ , and  $d\pi$  is the counting measure. The mapping  $\mathcal{R}$  preserves  $m$ , so it induces a measure, denoted again by  $m$  on  $\mathcal{Q}_C$ .

The matrix  $g_t$  acts on  $\mathcal{T}_C$  by  $g_t(\pi, \zeta) = (\pi, (g_t(\zeta_\alpha))_\alpha)$ , where  $g_t$  acts on  $\zeta_\alpha \in \mathbb{C} = \mathbb{R}^2$  linearly. This action preserves the measure  $m$  on  $\mathcal{T}_C$  and commutes with  $\mathcal{R}$ , so it descends to a measure preserving flow on  $\mathcal{Q}_C$  called the Teichmüller flow.

If  $(\pi, \zeta)$  is a suspension data, we denote by  $|Re(\zeta)|_\pi$  the length of the corresponding interval, i.e.  $\sum_{i=1}^l Re(\zeta_{\pi(i)})$ . The subset

$$\{(\pi, \zeta) \in \mathcal{T}_C; 1 \leq |Re(\zeta)|_\pi \leq 1 + \min(Re(\zeta_{\pi(l)}), Re(\zeta_{\pi(2d)}))\}$$

is a fundamental domain of  $\mathcal{T}_C$  for the relation  $\sim$  and the first return map of the Teichmüller flow on

$$\mathcal{S} = \{(\pi, \zeta); \pi \in C, |Re(\zeta)|_\pi = 1\} / \sim$$

gives the renormalized Rauzy-Veech induction on suspensions.

**Proposition 5.2.** *The zippered rectangle construction provides a finite covering  $Z$  from  $\mathcal{Q}_C$  on a subset of full measure in the connected component of the stratum  $\mathcal{Q}(k_1, \dots, k_n)$  of the moduli space of quadratic differentials.*

*Proof.* Let  $S$  be a (generic) flat surface in  $\mathcal{Q}(k_1, \dots, k_n)$  with no vertical and no horizontal saddle connection. Consider a horizontal separatrix  $l$  adjacent to a given singularity  $P$ . We call *admissible* a segment  $X$  adjacent to  $P$ , such that the vertical geodesic passing through the right endpoint of  $X$  meets a singularity before returning to  $X$ , in positive or negative direction. Then

Proposition 2.11 implies that there exists a corresponding suspension data  $\zeta$  such that  $S = Z(\zeta)$ . Conversely, any  $\zeta$  such that  $S = Z(\zeta)$  is obtained in such way by construction.

Now let  $X_0, X_1$  be two admissible segments, and let  $\zeta_0, \zeta_1$  be the corresponding suspension data. One can assume without loss of generality that  $X_0 \subset X_1$  and their left endpoint is the singularity  $P$ . Let  $T_0, T_1$  be the generalized interval exchange map corresponding to  $X_0, X_1$ . The right endpoint of  $X_0$  corresponds to a singularity of  $T_1$ . Hence there exists  $n \geq 0$  such that  $\mathcal{R}^n(T_1) = T_0$ , and therefore  $\mathcal{R}^n(\zeta_1) = \zeta_0$ .

So we have proven that for each separatix  $l$  adjacent to a singularity, there is only one preimage of  $S$  by the mapping  $Z$ . So  $Z$  is a finite covering.  $\square$

*Proof of the second part of Theorem B.* The subset  $\mathcal{Q}_C^1$  which corresponds to surfaces of area one is a finite ramified cover of a connected component of a stratum of quadratic differentials (up to a measure zero subset), and the corresponding Lebesgue measures are proportional.

By Theorem 0.2 in ZiteVe90 the volume of the moduli space of quadratic differentials is finite, and so,  $\mathcal{Q}_C^1$  has finite measure. Hence the Teichmüller geodesic flow is recurrent for the Lebesgue measure. Recall that the Rauzy-Veech renormalization for suspensions  $\mathcal{R}_r$  is the cross section of the Teichmüller geodesic flow on  $\mathcal{S}$ ; therefore the Rauzy-Veech renormalization for suspension is recurrent.

We have  $d\zeta = d\lambda d\tau$ , and the Rauzy-Veech induction commutes with the projection  $(\pi, \zeta) \mapsto (\pi, \lambda)$ . So, for almost all parameters  $\lambda$ , the sequence  $(\mathcal{R}_r^n(\pi, \lambda))_n$  is recurrent.  $\square$

**5.3. Proof of the minimality in Proposition 4.2.** Let  $T$  be a generalized interval exchange map with the Keane property. From Section 5.1, there exists  $n \geq 0$  such that  $\mathcal{R}^n(T) = (\pi, \lambda)$  is the cross section of the vertical foliation on a flat surface with no vertical saddle connections. Any infinite vertical geodesic on such surface is dense (e.g. see [MT02]). Thus  $\mathcal{R}^n(T)$  is minimal and so is  $T$ .

## 6. RAUZY CLASSES

As we have seen previously, the irreducible generalized permutations are an attractor for the Rauzy-Veech induction. In this section, we prove that there are no smaller attractors. We also prove Theorem C. We first define the Rauzy classes and then the extended Rauzy-Veech classes.

Given a permutation  $\pi$ , we can define *at most* two other permutations  $\mathcal{R}_\varepsilon(\pi)$  with  $\varepsilon = 0, 1$  when  $\mathcal{R}_\varepsilon$  is well defined. The relation  $\pi \sim \mathcal{R}_\varepsilon(\pi)$  generates a partial order on the set of generalized permutations; we represent it as a directed graph  $G$ , and as for permutations, we will call by Rauzy classes the connected components of this graph.

In the case of interval exchanges, the periodicity of the maps  $\mathcal{R}_0$  and  $\mathcal{R}_1$  gives an easy proof of the fact that the relation above is an equivalence

relation (Proposition of section 1.3.3). Here the argument fails because these maps are not always defined, and it may happen that  $\mathcal{R}_0(\pi)$  is well defined, but not  $\mathcal{R}_0^2(\pi)$ . However, the corresponding statement is still true.

**Proposition 6.1.** *The above partial order is an equivalence relation on the set of irreducible generalized permutations.*

*Proof.* Let  $\pi$  and  $\pi'$  be two generalized permutations. Assume that there is a sequence of maps  $\mathcal{R}_0$  and  $\mathcal{R}_1$  that sends  $\pi$  to  $\pi'$ . If  $\pi' = \mathcal{R}_\varepsilon(\pi'')$ , then for any parameters  $\lambda'$ , there exist parameters  $\lambda''$  such that  $\mathcal{R}(\pi'', \lambda'') = (\pi', \lambda')$ . Iterating this argument, there exists  $(\pi, \lambda^0)$  and  $n_0$  such that  $\mathcal{R}^{n_0}(\pi, \lambda^0) = (\pi', \lambda')$ . But for any  $\lambda$  in a sufficiently small neighborhood  $U$  of  $\lambda^0$ , the generalized permutation corresponding to  $\mathcal{R}^{n_0}(\pi, \lambda^0)$  is  $\pi'$ .

Recall that renormalized Rauzy-Veech induction map is recurrent (Theorem B) thus one can find  $\lambda \in U$  such that the sequence  $(\mathcal{R}_r^n(\pi, \lambda))_n$  come back in a neighborhood of  $(\pi, \lambda)$  infinitely many time. Furthermore,  $\mathcal{R}_r^{n_0}(\pi, \lambda) = (\pi', \lambda^{(n_0)})$ . Thus  $(\mathcal{R}_r^n(\pi, \lambda))_n$  gives a sequence of generalized permutations that reach  $\pi'$  and then reach  $\pi$ . So, it gives a combination of the maps  $\mathcal{R}_0$  and  $\mathcal{R}_1$  that sends  $\pi'$  to  $\pi$ . This proves the proposition.  $\square$

**Definition 6.2.** Let  $2d = l + m$ . We define the permutation  $s$  of  $\{1, \dots, 2d\}$  by  $s(i) = 2d + 1 - i \forall i$ . If  $\pi$  is a generalized permutation of type  $(l, m)$  defined over an alphabet  $\mathcal{A}$  of  $d$  letters, we define the generalized permutation  $s\pi$  to be of type  $(m, l)$  by

$$(s\pi)(k) := \pi \circ s(k).$$

We start from an irreducible generalized permutation  $\pi$  and we construct the subset of irreducible generalized permutation that can be obtained from  $\pi$  by some composition of the maps  $\mathcal{R}_0$ ,  $\mathcal{R}_1$ , and  $s$ . The quotient of this set by the equivalence relation generated by  $\pi \sim f \circ \pi$  for any bijective map  $f$  from  $\mathcal{A}$  onto  $\mathcal{A}$  is called the *extended Rauzy class* of  $\pi$ .

*Remark 6.3.* The quotient by the equivalence relation generated by  $\pi \sim f \circ \pi$  means that we look at generalized permutations defined up to renumbering. This is needed for technical reasons in the proof of Theorem C.

*Remark 6.4.* In opposite to the case of interval exchange maps, the definition of irreducibility we gave in section 3 is not invariant by the map  $s$ : for instance, the generalized permutation  $\pi = \left(\begin{smallmatrix} 1 & 2 & 1 \\ 2 & 3 & 3 & 4 & 4 \end{smallmatrix}\right)$  is irreducible while  $s\pi$  is reducible.

So an extended Rauzy class is obtained after considering the set of generalized permutations obtained from  $\pi$  by the extended Rauzy operations, and intersecting this set by irreducible generalized permutations. The results from the previous section shows that our definition of irreducibility is the good one with respect to the Rauzy-Veech induction, but we see that the convention of the “left-end singularity” is a real choice.

*Remark 6.5.* Let  $T$  be a generalized interval exchange map defined on an interval  $X = (0, L)$ . Recall that Rauzy-Veech induction applied on  $T$  consists

in considering the first return map on  $(0, L')$ , where  $L'$  is the maximal element of  $(0, L)$  that corresponds to a singularity of  $T$ . In terms of generalized permutation, this corresponds to the  $\mathcal{R}_\varepsilon$  mapping.

One can consider the first return map of  $T$  on the interval  $(L'', L)$ , where  $L''$  is the minimal element of  $(0, L)$  that corresponds to a singularity of  $T$ . In terms of generalized permutations, this corresponds to the conjugaison of  $s \circ \mathcal{R}_\varepsilon \circ s$  map. We will call this the ‘‘Rauzy-Veech induction of  $T$  by cutting on the left of  $X$ ’’, while the usual Rauzy-Veech induction will on the opposite called the ‘‘Rauzy-Veech induction of  $T$  by cutting on the right of  $X$ ’’.

*Proof of Theorem C.* Let  $\pi_1$  be an irreducible generalized permutation. The corresponding set of suspension data is connected (even convex), so the set of surfaces constructed from a suspension data, using the zippered rectangle construction, belongs to a connected component of the moduli space of quadratic differentials.

It is also open and invariant by the action of the Teichmüller geodesic flow, hence it is a subset of full measure by ergodicity.

Let  $\pi_2$  that corresponds to the same connected component of the moduli space. Then there exists a surface  $S$  and two segments  $X_1$  and  $X_2$ , each one being adjacent to a singularity  $x_1$  and  $x_2$ , such that for each  $i$ , the generalized interval exchange  $T_i$  given by the first return maps on  $X_i$  has combinatorial data  $\pi_i$ . We can assume that  $S$  has no vertical saddle connections.

We recall that each  $X_i$  have an orientation so that the corresponding singularity  $x_i$  is in its left endpoint. Consider the vertical separatrix  $l$  starting from  $x_2$ , in the positive direction and let  $y$  be its first intersection point with  $X_1 \cup \{x_1\}$ .

Applying the usual Rauzy-Veech induction for  $T_2$ , the map  $\mathcal{R}^n(T_2)$  is a first return map of the vertical flow on a subinterval  $X_2^{(n)} \subset X_2$ , adjacent to  $x_2$ . If  $n$  is large enough, then  $\mathcal{R}^n(T_2)$  is isomorphic to the first return map on the subinterval  $(y_1, y_2) \subset X_1$ , of the same length as  $X_2^{(n)}$ . We assume first that  $y_1 < y_2$ , hence this first return map is consistent with the positive direction on  $X_1$ .

Now we have to apply Rauzy-Veech inductions (on the right and on the left) on  $T_1$  until we get a first return map on  $(y_1, y_2)$  with corresponding generalized permutation  $\pi_3$ . Since  $\pi_3$  is by construction, up to renumbering the alphabet, in the same Rauzy class as  $\pi_2$ , we will therefore find some composition of the maps  $\mathcal{R}_\varepsilon, s \circ \mathcal{R}_\varepsilon \circ s$  that send  $\pi_1$  to  $\pi_2$ .

Note that  $y_2$  might not correspond a priori to some singularities of  $T_1$ , so naive Rauzy-Veech induction on  $X_1$  might miss the interval  $(y_1, y_2)$ . But  $y_1$  is corresponds to a singularity, so we can cut the interval on the left until  $y_1$  is the left endpoint, this will eventually occurs because of Lemma 5.1. Then after cutting on the right  $y_2$  will become the right endpoint of the corresponding interval.

If  $y_2 < y_1$ , then similarly, by cutting on the right and then on the left, we get two generalized interval exchange maps corresponds to first returns maps that only differ by a different choice of orientation. Hence we have found some composition of the maps  $\mathcal{R}_\varepsilon$ ,  $s \circ \mathcal{R}_\varepsilon \circ s$  that send  $\pi_1$  to some  $\pi_3$ , such that  $s.\pi_3$  is in the same Rauzy class as  $\pi_2$ .

Hence we have proved that if two irreducible generalized permutations correspond to the same connected component, then they are in the same extended Rauzy class. To prove the converse, we must consider a slightly more general kind of suspensions that do not necessarily correspond to a singularity on the left. The corresponding ‘‘extended’’ suspension data  $(t, \zeta)$  satisfy

- (1)  $\forall \alpha \in \mathcal{A} \quad \operatorname{Re}(\zeta_\alpha) > 0.$
- (2)  $\forall 1 \leq i \leq l-1 \quad t + \operatorname{Im}(\sum_{j \leq i} \zeta_{\pi(j)}) > 0$
- (3)  $\forall 1 \leq i \leq m-1 \quad t + \operatorname{Im}(\sum_{1 \leq j \leq i} \zeta_{\pi(l+j)}) < 0$
- (4)  $\sum_{1 \leq i \leq l} \zeta_{\pi(i)} = \sum_{1 \leq j \leq m} \zeta_{\pi(l+j)}.$

for some  $t \in \mathbb{R}$  (the case  $t = 0$  corresponds to suspension data as seen previously). Then we can extend the zippered rectangle construction to these extended suspension data. As in the usual case, the space of extended suspension data corresponding to a generalized permutation is convex, so the set of surfaces corresponding to a given generalized permutation belong to a connected component of stratum. Then it is easy to see that if  $\pi'$  is obtained from  $\pi$  by the map  $\mathcal{R}_0$ ,  $\mathcal{R}_1$  or  $s$ , then the corresponding connected component is the same. □

Historically, extended Rauzy classes have been used to show the non connectedness of some stratum of Abelian differentials (see for instance [Vee90]). For this case, some topological invariants were found by Kontsevich and Zorich [KZ03] (hyperellipticity and spin structure). For the case of quadratic differentials, all non-connected connected components except four are distinguished by hyperellipticity [Lan04]. For the four ‘‘exceptional ones’’, the only known proof up to now is an explicit computation of the corresponding extended Rauzy classes. Theorem C, which is now formally proven complete the proof of the following:

**Theorem (Zorich).** *The stratum  $\mathcal{Q}(-1, 9)$ ,  $\mathcal{Q}(-1, 3, 6)$ ,  $\mathcal{Q}(-1, 3, 3, 3)$  and  $\mathcal{Q}(12)$  are non connected.*

*Proof.* The generalized permutations  $(\begin{smallmatrix} 1 & 1 & 2 & 3 & 2 & 3 & 4 \\ 5 & 4 & 5 & 6 & 7 & 6 & 7 \end{smallmatrix})$  and  $(\begin{smallmatrix} 1 & 1 & 2 & 3 & 4 & 5 & 6 \\ 3 & 2 & 7 & 5 & 7 & 6 & 4 \end{smallmatrix})$  corresponds to the stratum  $\mathcal{Q}(-1, 9)$ , but according to Zorich’s computation, they are not in the same extended Rauzy classes. Hence the stratum  $\mathcal{Q}(-1, 9)$  is not connected.

Similarly,  $(\begin{smallmatrix} 1 & 1 & 2 & 3 & 2 & 3 & 4 & 5 \\ 4 & 6 & 5 & 6 & 7 & 8 & 7 & 8 \end{smallmatrix})$  and  $(\begin{smallmatrix} 1 & 1 & 2 & 3 & 4 & 3 & 4 & 5 \\ 6 & 7 & 8 & 2 & 6 & 7 & 8 & 5 \end{smallmatrix})$  corresponds to two connected components of the stratum  $\mathcal{Q}(-1, 3, 6)$ .

The generalized permutations  $(\begin{smallmatrix} 1 & 1 & 2 & 3 & 4 & 5 & 6 & 7 & 6 \\ 7 & 8 & 5 & 8 & 2 & 4 & 9 & 3 & 9 \end{smallmatrix})$  and  $(\begin{smallmatrix} 1 & 1 & 2 & 3 & 2 & 3 & 4 & 5 & 6 \\ 4 & 7 & 8 & 9 & 7 & 8 & 6 & 5 & 9 \end{smallmatrix})$  corresponds to two connected components of the stratum  $\mathcal{Q}(-1, 3, 3, 3)$ .

The generalized permutations  $(\begin{smallmatrix} 1 & 2 & 1 & 2 & 3 & 4 & 5 & 3 \\ 6 & 7 & 6 & 7 & 5 & 8 & 4 & 8 \end{smallmatrix})$  and  $(\begin{smallmatrix} 1 & 2 & 3 & 4 & 5 & 6 & 7 & 6 \\ 8 & 7 & 5 & 8 & 4 & 3 & 2 & 1 \end{smallmatrix})$  corresponds to two connected components of the stratum  $\mathcal{Q}(12)$ . □

#### APPENDIX A. COMPUTATION OF RAUZY CLASSES

Here we give explicit examples of *reduced* Rauzy classes (*i.e.* up to the equivalence  $\pi \sim f \circ \pi$ , for any permutation  $f$  of  $\mathcal{A}$ ). It is easy to see that there is only one Rauzy class with 3 letters and it is trivial (it contains four generalized permutations). Figure 12 shows a Rauzy class with 4 letters which is one of the simplest nontrivial one. It corresponds to the stratum  $\mathcal{Q}(2, -1, -1)$ . The generalized permutations  $(\begin{smallmatrix} 1 & 1 & 2 & 2 & 3 \\ 4 & 3 & 4 & 2 & 3 \end{smallmatrix})$  and  $(\begin{smallmatrix} 1 & 2 & 1 \\ 3 & 3 & 4 & 4 & 2 \end{smallmatrix})$  are not formally in the Rauzy class since they are reducible, but we can see there concretely the “attraction” phenomenon.

The (reduced) Rauzy classes for generalized permutations are in general much more complicated than the Rauzy classes for usual permutation since the vertex are either of valence one or of valence two.

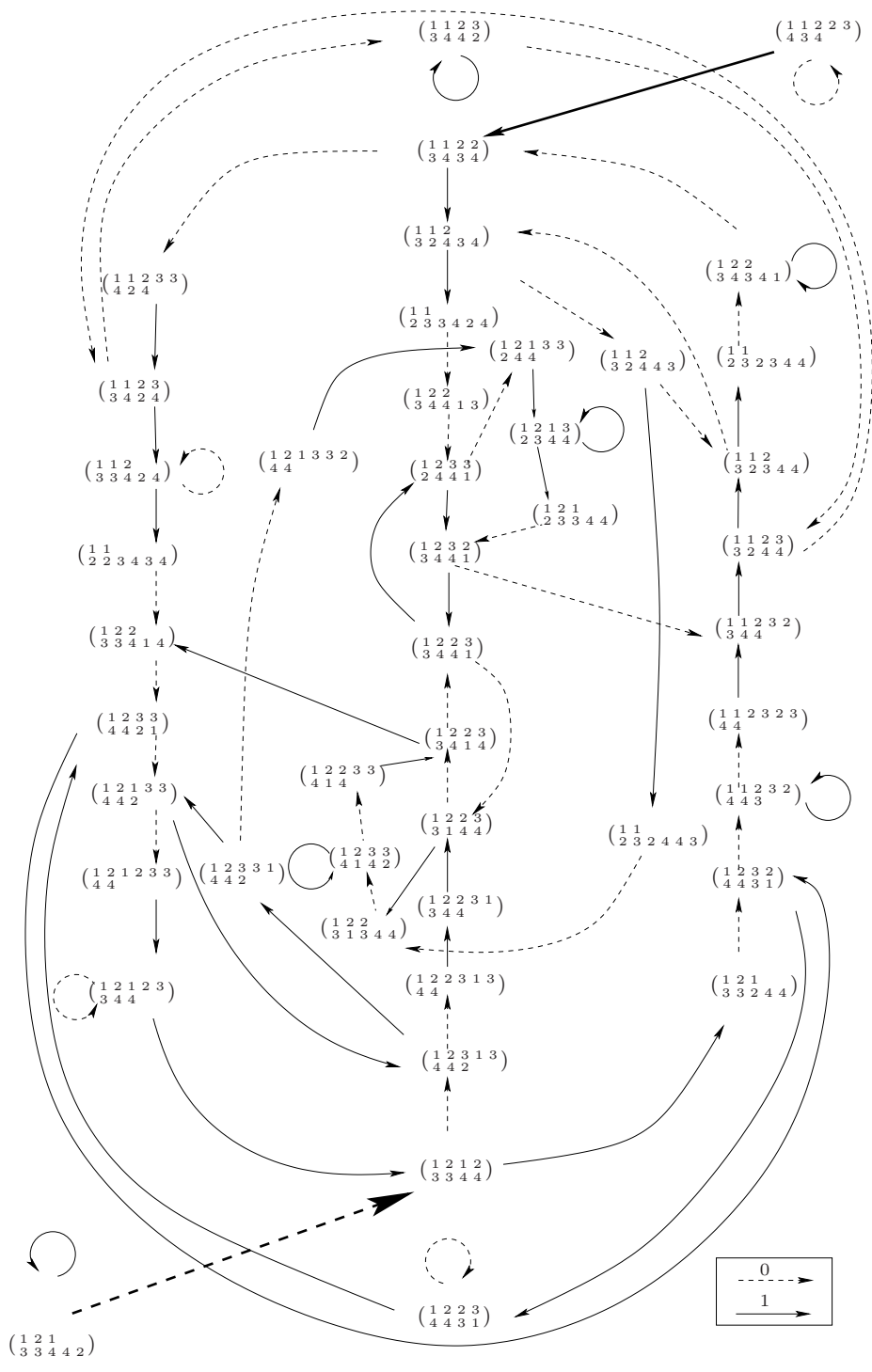

FIGURE 12. A (reduced) Rauzy class in  $\mathcal{Q}(2, -1, -1)$ .



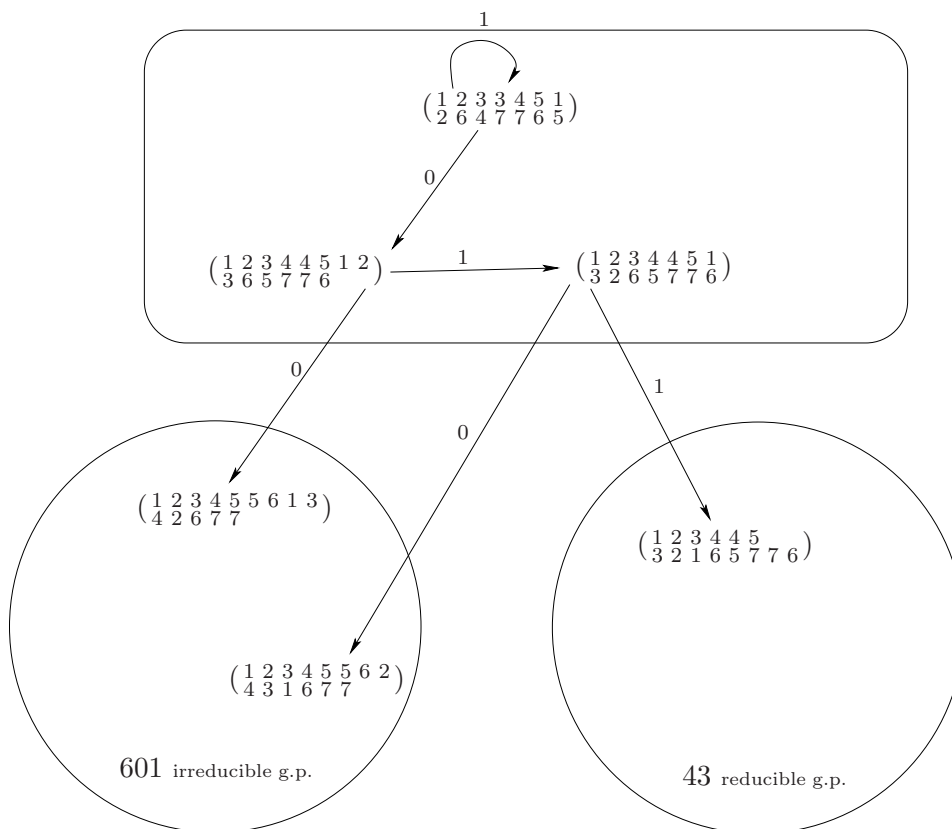

FIGURE 13. An example of a Rauzy class. The corresponding stratum is  $\mathcal{Q}(-1, -1, 6, 0)$ . There are 647 permutations in the whole “class” and 601 permutations in the “good” Rauzy class.

#### REFERENCES

- [AGY06] A. AVILA, S. GOUZEL and J.-C. YOCOZ – “Exponential mixing for the Teichmüller flow”, *Publ. Math. Inst. Hautes Études Sci.* **104** (2006), pp. 143–211.
- [AV07] A. AVILA, and M. VIANA – “Simplicity of Lyapunov spectra: proof of the Zorich-Kontsevich conjecture”, *Acta Math.* **198** (2007), no. 1, pp.1–56.
- [Boi07] C. BOISSY – “Degenerations of quadratic differentials on  $\mathbb{C}P^1$ ”, preprint 2007, arXiv:0708.3541.
- [DN90] C. DANTHONY and A. NOGUEIRA – “Measured foliations on nonorientable surfaces”, *Ann. Sci. cole Norm. Sup. (4)* **23** (1990), pp. 469–494.
- [Kea75] M. KEANE – “Interval exchange transformations”, *Math. Zeit.* **141** (1975), pp. 25–31.
- [KZ97] M. KONTSEVICH, and A. ZORICH – “Lyapunov exponents and Hodge theory”, arXiv:hep-th/9701164v1 (1997).
- [KZ03] M. KONTSEVICH, and A. ZORICH – “Connected components of the moduli spaces of Abelian differentials with prescribed singularities”, *Invent. Math.* **153** (2003), no. 3, pp.631–678.

- [Lan04] E. LANNEAU – “Connected components of the strata of the moduli spaces of quadratic differentials with prescribed singularities”, preprint 2004, to appear in *Ann. Sci. École Norm. Sup.*.
- [MMY05] S. MARMI, P. MOUSSA and J.-C. YOCOZ – “The cohomological equation for Roth type interval exchange transformations”, *Journal of the Amer. Math. Soc.* **18** (2005), pp. 823–872.
- [Mas82] H. MASUR – “Interval exchange transformations and measured foliations”, *Ann of Math.* **141** (1982) 169–200.
- [MT02] H. MASUR and S. TABACHNIKOV – “Rational billiards and flat structures”, *Handbook of dynamical systems* Vol. 1A, (2002), North-Holland, Amsterdam, p. 1015–1089.
- [Nog89] A. Nogueira – “Almost all interval exchange transformations with flips are non-ergodic”, *Ergodic Theory Dynam. Systems* **9** 1990.
- [Rau79] G. RAUZY – “Échanges d’intervalles et transformations induites”, *Acta Arith.* **34** (1979), pp. 315–328.
- [Vee78] W. VEECH – “Interval exchange transformations”, *J. Analyse Math.* **33** (1978), pp. 222–272.
- [Vee82] ———, “Gauss measures for transformations on the space of interval exchange maps”, *Ann. of Math. (2)* **115** (1982), no. 1, pp. 201–242.
- [Vee86] ———, “The Teichmüller geodesic flow”, *Ann. of Math.* **124** (1986), p. 441–530.
- [Vee90] ———, “Moduli spaces of quadratic differentials”, *J. Analyse Math.* **55** (1990), p. 117–170.
- [Yoc03] J.-C. YOCOZ – “Continued fraction algorithms for interval exchange maps: an introduction”, *Frontiers in Number Theory, Physics and Geometry* Volume 1: On random matrices, zeta fonctions and dynamical systems. Springer Verlag (2006). École de Physique des Houches, 2003.
- [Zor96] A. ZORICH – “Finite Gauss measure on the space of interval exchange transformations. Lyapunov exponents”, *Ann. Inst. Fourier* **46** (1996), pp. 325–370.

IRMAR, UMR CNRS 6625  
 UNIVERSITÉ DE RENNES I  
 35042 RENNES CEDEX, FRANCE  
*E-mail address:* `corentin.boissy@univ-rennes1.fr`

CENTRE DE PHYSIQUE THÉORIQUE (CPT), UMR CNRS 6207  
 UNIVERSITÉ DU SUD TOULON-VAR AND  
 FÉDÉRATION DE RECHERCHES DES UNITÉS DE MATHÉMATIQUES DE MARSEILLE  
 LUMINY, CASE 907, F-13288 MARSEILLE CEDEX 9, FRANCE  
*E-mail address:* `lanneau@cpt.univ-mrs.fr`



# Bibliographie

- [1] A. Avila, S. Gouëzel, J-C. Yoccoz, *Exponential mixing for the Teichmüller flow*, Publ. Math. Inst. Hautes Études Sci. **104** (2006), 143–211.
- [2] A. Avila, M. Viana, *Simplicity of Lyapunov spectra : proof of the Zorich-Kontsevich conjecture*, Acta Math. **198** (2007), no. 1, 1–56.
- [3] C. Danthony, A. Nogueira, *Measured foliations on nonorientable surfaces*, Ann. Sci. École Norm. Sup. (4) **23** (1990), 469–494.
- [4] A. Eskin, H. Masur *Asymptotic formulas on flat surfaces*, Ergodic Theory Dynam. Systems **21** (2001), no. 2, 443–478.
- [5] A. Eskin, H. Masur, A. Zorich, *Moduli spaces of Abelian differentials : the principal boundary, counting problems, and the Siegel-Veech constants*. Publ. Math. Inst. Hautes Études Sci. **97** (2003), 61–179.
- [6] G. Forni, *Deviation of ergodic averages for area-preserving flows on surfaces of higher genus*. Ann. of Math. (2) **155** (2002), no. 1, 1–103.
- [7] J. Hubbard *Teichmüller Theory and Applications to Geometry, Topology, and Dynamics. Volume I : Teichmüller Theory*. Matrix Editions (2006).
- [8] J. Hubbard, H. Masur *Quadratic differentials and foliations*. Acta Math. **142** (1979), no. 3-4, 221–274.
- [9] P. Hubert, E. Lanneau, M. Moeller *Completely periodic directions and orbit closures of many pseudo-Anosov Teichmüller discs in  $Q(1,1,1,1)$* , preprint 2007, arXiv :0707.0738v1.
- [10] M. Keane, *Interval exchange transformations*. Math. Z. **141** (1975), 25–31.
- [11] M. Kontsevich, A. Zorich *Connected components of the moduli spaces of Abelian differentials with prescribed singularities*, Invent. Math. **153** (2003), no. 3, 631–678.

- [12] E. Lanneau, *Hyperelliptic Components of the Moduli Spaces of Quadratic Differentials with Prescribed Singularities*, Com. Math. Helv. **79** no. 3, (2004) 471–501.
- [13] E. Lanneau, *Connected components of the moduli spaces of quadratic differentials with prescribed singularities*, preprint 2004, arXiv :math/0506136v2, à paraître dans les Ann. Sci. de l'ENS.
- [14] C.T. McMullen, *Dynamics of  $SL_2(\mathbb{R})$  over moduli space in genus two*, Ann. of Math. (2) **165** (2007), no. 2, 397–456.
- [15] H. Masur, *Interval exchange transformations and measured foliations*. Ann. of Math., **115** (1982), 169-200.
- [16] H. Masur J. Smillie, *Hausdorff dimension of sets of nonergodic measured foliations*, Ann. of Math. (2) **134** (1991), no. 3, 455–543.
- [17] H. Masur, J. Smillie, *Quadratic differentials with prescribed singularities and pseudo-Anosov diffeomorphisms*, Comment. Math. Helv. **68** (1993), no. 2, 289–307.
- [18] H. Masur, S. Tabachnikov, *Rational billiards and flat structures*. Handbook of dynamical systems, **Vol. 1A**, North-Holland, Amsterdam, (2002), 1015-1089.
- [19] H. Masur, A. Zorich, *Multiple saddle connexions on flat surfaces and the principal boundary of the moduli space of quadratic differentials* arxiv math.GT/0402197, à paraître dans GAFA.
- [20] G. Rauzy *Échanges d'intervalles et transformations induites*. (French) Acta Arith. **34**, (1979), no. 4, 315–328.
- [21] W.A. Veech, *Gauss measures for transformations on the space of interval exchange maps*. Ann. of Math., **115**, 201-242 (1982).
- [22] W.A. Veech *The Teichmüller geodesic flow*, Ann. of Math. (2) **124** (1986), no. 3, 441–530.
- [23] W.A. Veech *Moduli spaces of quadratic differentials*, J. Analyse Math. **55** (1990), 117–171.
- [24] A. Zorich, *Flat Surfaces*. In collection “Frontiers in Number Theory, Physics and Geometry. Volume 1 : On random matrices, zeta functions and dynamical systems”, P. Cartier ; B. Julia ; P. Moussa ; P. Vanhove (Editors), Springer-Verlag, Berlin, (2006), 439-586.
- [25] A. Zorich, *Explicit Jenkins-Strebel representative of all strata of Abelian and quadratic differentials* preprint 2007.