



HAL
open science

The dilute Ising model: phase coexistence and slow dynamics in the region of phase transition

Marc Wouts

► **To cite this version:**

Marc Wouts. The dilute Ising model: phase coexistence and slow dynamics in the region of phase transition. Mathematics [math]. Université Paris-Diderot - Paris VII, 2007. English. NNT: . tel-00272899

HAL Id: tel-00272899

<https://theses.hal.science/tel-00272899>

Submitted on 12 Apr 2008

HAL is a multi-disciplinary open access archive for the deposit and dissemination of scientific research documents, whether they are published or not. The documents may come from teaching and research institutions in France or abroad, or from public or private research centers.

L'archive ouverte pluridisciplinaire **HAL**, est destinée au dépôt et à la diffusion de documents scientifiques de niveau recherche, publiés ou non, émanant des établissements d'enseignement et de recherche français ou étrangers, des laboratoires publics ou privés.

ÉCOLE DOCTORALE DE SCIENCES MATHÉMATIQUES DE PARIS CENTRE
LABORATOIRE DE PROBABILITÉS ET MODÈLES ALÉATOIRES
UNIVERSITÉ PARIS DIDEROT – PARIS 7



THÈSE DE DOCTORAT
MATHÉMATIQUES APPLIQUÉES



LE MODÈLE D'ISING DILUÉ

COEXISTENCE DE PHASES À L'ÉQUILIBRE &
DYNAMIQUE DANS LA RÉGION DE TRANSITION DE PHASE

MARC WOUTS

Thèse dirigée par
THIERRY BODINEAU

Soutenue publiquement le
14 DÉCEMBRE 2007

JURY

THIERRY BODINEAU
ANTON BOVIER
RAPHAËL CERF
FRANCIS COMETS
FABIO TONINELLI
YVAN VELENIK

Directeur de recherche à l'E.N.S.
Professeur au Weierstrass Institute, Berlin
Professeur à l'Université Paris Sud
Professeur à l'Université Paris Diderot
Chargé de recherche à l'E.N.S. Lyon
Professeur à l'Université de Genève

Rapporteurs : ANTON BOVIER et RAPHAËL CERF

Avant-Propos

Au seuil de cette thèse, je tiens à remercier mon directeur, Thierry Bodineau. Je lui suis très reconnaissant de m'avoir accepté comme thésard et de m'avoir proposé un sujet passionnant, qui répondait au mieux à mon intérêt pour la physique. Durant ces quatre années, il a toujours été présent lorsque j'étais bloqué dans ma recherche, ou encore lorsqu'il fallait passer des journées à vérifier mes constructions. J'ai énormément appris à ses côtés, entre les nombreuses lectures qu'il me proposait et les groupes de travail auquel il m'invitait à participer. Son exigence, enfin, a été l'un des moteurs les plus efficaces de ma thèse et n'a jamais entamé le plaisir que j'avais à réaliser ce travail.

Je remercie également Francis Comets de m'avoir accordé sa confiance pour ce projet et de son soutien bienveillant au cours de ces années.

J'ai été très heureux d'apprendre que Anton Bovier et Raphaël Cerf avaient bien voulu rédiger un rapport sur ce travail. C'est un honneur que de les compter dans mon jury de thèse. Je veux aussi remercier chaleureusement Thierry Bodineau, Francis Comets, Fabio Toninelli et Yvan Velenik d'avoir accepté de former un jury des plus stimulants !

Une partie de cette thèse a été réalisée en Espagne. Ma reconnaissance va d'abord à David Nualart, pour son accueil généreux au Département de Probabilités de l'Université de Barcelone et pour la confiance qu'il m'a accordée en me chargeant d'une partie de l'enseignement du département. Ce fut un plaisir de faire la connaissance de Marta Sanz-Solé à cette occasion. D'autres collègues, Carles Rovira et David Márquez, m'ont offert une initiation aux p -spins, et je tiens également à remercier les doctorants qui m'ont manifesté leur amitié, en particulier Salvador, Lluís et Sabrina. Au Département de Physique Théorique de l'Université Complutense de Madrid, j'ai rencontré Antonio Muñoz Sudupe et Víctor Martín-Mayor, auteurs d'articles et de simulations numériques sur le modèle d'Ising dilué. Nos discussions m'ont fait prendre conscience de la difficulté de la mise en évidence expérimentale de certains résultats mathématiques¹. Je dois également beaucoup aux doctorants

¹L'exemple du Chapitre 4 est frappant de ce point de vue : la relaxation lente du modèle d'Ising dilué correspond à un événement initial de probabilité excessivement petite. Voir aussi [47].

du département, qui eurent la patience d'écouter ma construction du *coarse grainning* et l'amitié de me guider dans ma découverte de Madrid. C'est un plaisir de les remercier : Álvaro, Carlos et Rúben, ainsi que Lourdes, Javier et Héctor. Je veux aussi remercier Chon pour son enthousiasme et le Professeur Galindo pour sa bienveillance.

À Paris, j'ai trouvé au Laboratoire de Probabilités et Modèles Aléatoires un cadre de travail des plus motivants. Le Laboratoire m'a également donné l'opportunité d'approfondir ma formation au cours de plusieurs écoles d'été. Je remercie Michèle Wasse qui m'a aidé à dénouer plusieurs questions administratives. Mes collègues doctorants ont toujours été présents pour soutenir le moral des troupes, et j'ai apprécié leur gentillesse. Je regretterai notre bureau et la présence vivante de Francesco, Nicolas, Stéphane, Vincent, François, ainsi que celle de Maxime, Julien, Karim, Mohamed, Christophe, Pierre, Luca, Giulio et Arnaud – toujours disposés à une discussion mathématique improvisée. Olivier, puis Vincent et François ont tâché de me faire participer (par deux fois) au groupe de travail des thésards. Mes remerciements vont enfin à Nathalie, Maxime, Julien, François et Karim pour l'efficace cellule « agrégation » !

Je veux aussi remercier les amis qui m'ont accompagné dans cette aventure. J'ai partagé avec Aurélien l'expérience d'une thèse parfois épineuse, mais aussi et surtout de très beaux moments qui compensaient les efforts de nos journées mathématiques. Claire, Béatrice et Julien ont toujours été présents lorsque j'ai eu besoin d'eux. Radu n'a pas ménagé son temps ni ses encouragements et je lui en suis très reconnaissant. Un clin d'œil également à ceux qui faisaient régulièrement le pari de me demander l'actualité de ma thèse... au risque pourtant d'un exposé interminable sur le sujet !

Je pense aussi à ma famille et à son soutien constant. J'espère que les pages qui suivent seront à même de donner un bon aperçu des questions qui m'ont occupé ces dernières années.

Je veux enfin remercier Sophie au nom de tous les projets captivants que nous avons pu mener à bien... dont cette thèse !

Minute technique

J'ai écrit l'intégralité de cette thèse avec le logiciel $\text{T}_{\text{E}}\text{X}_{\text{MACS}}$, un éditeur scientifique libre qui renouvelle l'approche du document $\text{T}_{\text{E}}\text{X}$ et qui m'aura épargné bien des soucis de compilation $\text{L}^{\text{A}}\text{T}_{\text{E}}\text{X}$. Les figures ont été réalisées avec le logiciel X_{FIG} (lequel permet l'inclusion de formules $\text{L}^{\text{A}}\text{T}_{\text{E}}\text{X}$ en choisissant la propriété « *special* » pour les éléments de texte), et incluses dans $\text{T}_{\text{E}}\text{X}_{\text{MACS}}$ au format `.fig` directement.

Pour le rendu final, notamment pour bénéficier du paquet `hyperref` de $\text{L}^{\text{A}}\text{T}_{\text{E}}\text{X}$, j'ai utilisé la fonction de conversion de $\text{T}_{\text{E}}\text{X}_{\text{MACS}}$, pré-compilé les figures avec `fig2pdf`, revu les en-têtes ainsi que la mise en page et compilé le tout avec `pdflatex`.

Table des matières

Avant-Propos	3
Minute technique	5
Table des matières	7
Introduction	11
1. Le modèle d'Ising	11
1.1. La physique du modèle	11
1.2. Le phénomène de coexistence de phases	14
1.3. La dynamique de Glauber	18
2. Le modèle d'Ising en milieu aléatoire	18
2.1. Diagramme de phase	19
2.2. Effets de la dilution à l'équilibre	20
2.3. Un aperçu de la dynamique	21
3. Présentation des résultats	22
3.1. Les phases pures	23
3.2. La tension superficielle	27
3.3. Coexistence de phases	31
3.4. Dynamique lente	34
4. Perspectives	37
Chapter 1. Coarse graining and renormalization	39
1.1. Introduction	39
1.2. The model and our results	40
1.2.1. The random media FK model	40
1.2.2. Slab percolation	44
1.2.3. Our results	45
1.2.4. Overview of the Chapter	46
1.3. Existence of a dense cluster	47
1.3.1. The measure Ψ_Λ^L	48
1.3.2. The L -connecting family $\mathcal{E}_i^{L,H}$	50
1.3.3. Large probability for \mathcal{E}_i^L under Ψ_Λ^L	52
1.3.4. Existence of a crossing cluster	54
1.4. Uniqueness of large clusters	55
1.4.1. Typical structure in slabs of logarithmic height	56
1.4.2. First pivotal bond and local modifications	60
1.4.3. The uniform estimate (USP)	62

1.4.4.	An intermediate coarse graining	65
1.4.5.	The two dimensional case	68
1.5.	Renormalization and density estimates	69
1.5.1.	Renormalization framework	70
1.5.2.	Structure of the main cluster	73
1.5.3.	Typical density of the main cluster	75
1.5.4.	Uniqueness of the infinite volume measure	77
1.5.5.	Application to the Ising model	80
1.6.	Conclusion	85
Chapter 2. Surface tension		87
2.1.	Introduction	87
2.1.1.	Notations and definitions	88
2.1.2.	Main results	90
2.2.	Convergence and deviations	92
2.2.1.	Quenched convergence	92
2.2.2.	Volume order cost for upper deviations	95
2.2.3.	Surface order cost for lower deviations	97
2.2.4.	Annealed surface tension and fractional moments	99
2.3.	Low temperature asymptotics	101
2.3.1.	Objectives	101
2.3.2.	Maximal flow for the media	102
2.3.3.	Asymptotics of surface tension	104
2.3.4.	Applications	107
2.4.	Rate function for lower deviations	108
2.4.1.	Concentration at low temperature	108
2.4.2.	General concentration bound	113
2.4.3.	Rate function and localization	117
2.5.	Appendix	121
2.5.1.	Sub-additivity of surface tension	122
2.5.2.	Weak triangle inequality	124
2.5.3.	Surface tension under free boundary condition	127
Chapter 3. Equilibrium phase coexistence		139
3.1.	Introduction	139
3.1.1.	The dilute Ising model	140
3.1.2.	Surface energy and Wulff crystals	142
3.1.3.	Statement of the results	144
3.2.	Covering theorems for BV profiles	146
3.3.	Frozen media and phase coexistence	148
3.3.1.	Lower bound	148
3.3.2.	Upper bound	152
3.4.	Final controls on phase coexistence	156
3.4.1.	Lower bound for phase coexistence	156
3.4.2.	Upper bound for phase coexistence	158

3.4.3. Exponential tightness	159
3.4.4. Proofs of Theorems 3.1.1 and 3.1.2	161
3.5. Conclusion	163
Chapter 4. Glauber dynamics and metastability	165
4.1. Introduction and results	165
4.1.1. Phase diagram of the dilute Ising model	166
4.1.2. Glauber dynamics and convergence to equilibrium	167
4.1.3. A brief panorama	168
4.1.4. Heuristics for the phase transition region	169
4.1.5. Main results	171
4.2. A lower bound on the autocorrelation	172
4.2.1. From infinite to finite volume	173
4.2.2. Small L^1 jumps for the magnetization	174
4.2.3. The bottleneck	175
4.2.4. Specialized covering theorem	177
4.2.5. The event of dilution	180
4.2.6. Influence of the dilution on the lower bound	181
4.2.7. Influence of the dilution on the upper bound	181
4.2.8. Dilution and average magnetization	184
4.2.9. Lower semi-continuity	186
4.2.10. A probabilistic control over the magnetization	188
4.2.11. Lower bound on the autocorrelation	190
4.3. Appendix	190
4.3.1. Positivity of the additional cost	191
4.3.2. Continuous evolution and continuous separation	196
4.3.3. Additional cost on two examples	199
4.4. Conclusion	203
Bibliographie	205

Introduction

Cette thèse porte sur le modèle d'Ising dilué, dans la région de transition de phase. L'objectif de la présente introduction est de donner une présentation du modèle ainsi qu'un aperçu de nos travaux.

Dans une première partie, nous décrirons le modèle d'Ising standard et certains des phénomènes qu'il permet d'étudier. Nous justifierons ensuite l'introduction d'un aléa portant sur la force des interactions (la *dilution*) et décrirons quelques-unes des conséquences de cette dilution.

Dans la troisième partie de l'introduction, nous exposerons le sens mathématique que nous avons donné aux notions physiques de *phase* ou de *tension superficielle* et décrirons les principaux résultats de cette thèse, de l'étude de la tension superficielle à la relaxation lente sous la dynamique de Glauber, en passant par le phénomène de coexistence de phases.

1. Le modèle d'Ising

Le modèle d'Ising apparaît dans les années 1920, sous la plume de Lenz [61] et de son doctorant, Ising. Il s'agissait de répondre à la question suivante : peut-on expliquer le phénomène d'aimantation spontanée observé dans les matériaux ferromagnétiques avec un modèle de chaîne ferromagnétique ? Ising montra que la réponse était négative dans le cas unidimensionnel [52]. Heureusement, l'histoire ne s'arrêta pas là et, en 1936, Peierls prouva l'existence d'une transition de phase en dimension 2 [68]. Onsager calcula alors la fonction de partition en dimension 2 [67] dans le cas d'un champ extérieur nul, ce qui permit une description très précise de la transition de phase.

Cette transition de phase – et la généralité du modèle d'Ising, qui peut aussi bien représenter des modèles ferromagnétiques que des modèles de gaz sur réseau – ont fait du modèle d'Ising l'un des modèles les plus étudiés en physique statistique.

1.1. La physique du modèle. Dans cette première partie, nous nous intéressons au modèle d'Ising usuel. Nous allons décrire le sens physique du modèle et le phénomène de transition de phase, tout en détaillant l'aspect *probabiliste* du modèle.

1.1.1. *Le modèle.* Imaginons un métal dans lequel les atomes possèdent un moment magnétique orienté verticalement, pointant vers le haut ou vers le bas. Ce moment magnétique est une caractéristique de l'atome, on l'appellera *spin*. Pour donner une image de ce qu'est le spin, on pensera au modèle de Bohr de l'atome : le mouvement de rotation des électrons autour du noyau produit un courant électrique, qui lui-même induit ce moment magnétique.

Dans la suite, nous désignerons par ± 1 les deux valeurs possibles du spin. Nous supposons que le métal a une structure cristalline, c'est-à-dire que les atomes sont répartis suivant une structure géométrique répétée. On appelle Λ l'ensemble des positions des atomes, et $\sigma : \Lambda \rightarrow \{\pm 1\}$ la configuration des spins. Supposons que le métal est plongé dans un champ magnétique uniforme h , alors l'énergie électromagnétique du système est de la forme

$$H_{\Lambda}^h(\sigma) = - \sum_{\{x,y\}:x,y \in \Lambda, x \neq y} J_{x,y} \sigma_x \sigma_y - \sum_{x \in \Lambda} h \sigma_x$$

si nous faisons abstraction des constantes dimensionnelles. Le terme $J_{x,y}$ quantifie l'interaction entre les spins en x et y . Dans le cadre du modèle d'Ising le plus usuel, nous procédons à quelques restrictions : la structure cristalline du métal est rendue par l'hypothèse $\Lambda \subset \mathbb{Z}^d$ où $d \geq 1$ est la dimension du système, et nous choisissons le terme d'interaction $J_{x,y}$ sous la forme

$$J_{x,y} = \begin{cases} 1 & \text{si } |x - y| = 1 \\ 0 & \text{sinon} \end{cases}$$

ce qui revient à négliger les interactions entre spins non voisins. Étant donné l'Hamiltonien H_{Λ}^h , on peut modéliser le comportement du métal d'après la distribution de Boltzmann : la *probabilité* d'observer une configuration σ pour les spins vaut

$$\mu_{\Lambda}^{T,h}(\{\sigma\}) = \frac{1}{Z_{\Lambda}^{T,h}} \exp\left(-\frac{H_{\Lambda}^h(\sigma)}{T}\right)$$

où T est la température du système et $Z_{\Lambda,T}$ la fonction de partition

$$Z_{\Lambda}^{T,h} = \sum_{\sigma: \Lambda \rightarrow \{\pm 1\}} \exp\left(-\frac{H_{\Lambda}^h(\sigma)}{T}\right)$$

qui assure que $\mu_{\Lambda,T}$ est une *mesure de probabilité* sur l'ensemble des configurations, i.e.

$$\sum_{\sigma: \Lambda \rightarrow \{\pm 1\}} \mu_{\Lambda}^{T,h}(\{\sigma\}) = 1.$$

Les simplifications que nous avons faites au cours de cette modélisation ne modifient pas la nature du modèle. Nous verrons, en particulier, que la transition de phase est préservée à partir de la dimension 2.

1.1.2. *La transition de phase.* Les matériaux ferromagnétiques sont sujets à une transition de phase : ils sont aimantables tant que la température ne dépasse pas le *point de Curie* (770 °C dans le cas du fer). Nous allons voir que le modèle d'Ising possède une faculté similaire.

Étant donné une température T et un champ magnétique h , on note

$$m_{T,h} = \lim_{N \rightarrow \infty} \mu_{\hat{\Lambda}_N}^{T,h}(\sigma_0)$$

l'aimantation en volume infini. Dans cette définition, $\hat{\Lambda}_N = \{-N, \dots, N\}^d$ est un cube symétrique par rapport à l'origine et $\mu_{\hat{\Lambda}_N}^{T,h}(\sigma_0)$ correspond à la valeur moyenne du spin en 0. L'allure de $m_{T,h}$ en fonction de T et de h est représentée Figure 1 et on remarquera en particulier l'influence de la température sur les courbes : à basse température et en dimension $d \geq 2$, l'aimantation présente une *discontinuité* en $h = 0$.

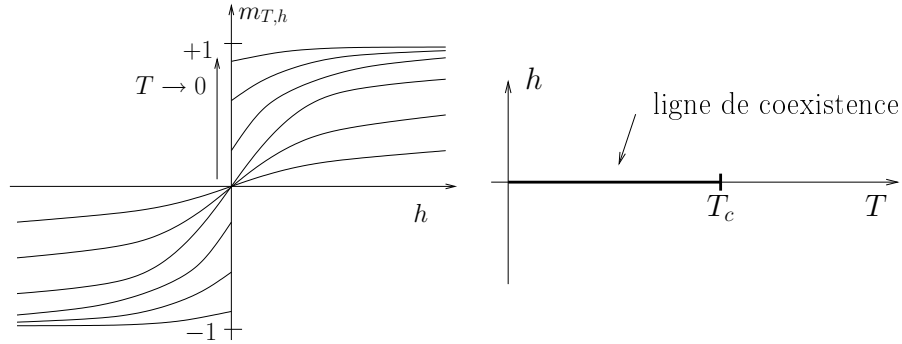

FIG. 1. Allure de $m_{T,h}$ à différentes températures; ligne de coexistence de phases

Cette discontinuité témoigne d'une transition de phase. Notons T_c la valeur de la température à laquelle apparaît cette discontinuité et étudions le comportement du modèle à température T , lorsque $h \rightarrow 0$:

- (i) Dans le cas $T > T_c$, un champ magnétique h faible a une influence très limitée sur l'aimantation $m_{T,h}$, qui est donc essentiellement nulle. En particulier, on n'observe pas d'aimantation spontanée.
- (ii) Dans le cas $T < T_c$, un champ magnétique h infinitésimal mais positif sélectionne la *phase plus* du système, c'est-à-dire une organisation des spins telle que l'aimantation moyenne vaut $m_T^+ = \lim_{h \rightarrow 0^+} m_{T,h} > 0$. Un champ magnétique $h = 0^-$ conduit à la *phase moins*, symétrique de la phase plus.

On peut alors déterminer le diagramme de phase du modèle d'Ising (Figure 1). Dans la région $T > T_c$ ou $h \neq 0$, les paramètres déterminent avec certitude la phase du modèle. Sur la ligne de coexistence $T < T_c$ et $h = 0$, la situation est plus complexe : avec probabilité 1/2 le modèle présente la phase plus, avec probabilité 1/2 il présente la phase moins... D'un point de vue plus physique,

la phase du système est déterminée, sur cette ligne, par l'*histoire* du cristal ferromagnétique : s'il a été soumis à un champ magnétique positif, il présente la phase plus, dans le cas contraire, la phase moins.

1.2. Le phénomène de coexistence de phases. À l'aide du modèle d'Ising, nous allons décrire un phénomène physique dont la généralité dépasse largement le cadre ferromagnétique : la coexistence de phases. Il s'agit de déterminer le comportement d'un système dans lequel on met en présence deux phases distinctes. L'exemple le plus parlant sera sans doute celui du mélange de liquides non miscibles, illustré Figure 2 : les gouttes du liquide minoritaire fusionnent, et on finit par obtenir une goutte principale qui contient presque tout le liquide minoritaire.

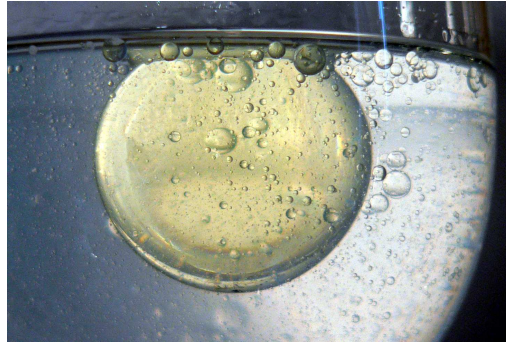

FIG. 2. Une goutte d'huile dans un mélange eau/alcool de même densité.

Dans le cas du modèle d'Ising, l'étude de la coexistence de phases donne des informations sur l'aspect *macroscopique* de la coexistence : on décrira la forme de la goutte de phase minoritaire. Notons qu'on peut, avec le même modèle, envisager une étude au niveau *microscopique* de l'interface entre les deux phases, notamment en dimension 2 [34, 7, 19, 20, 11]. Cette dernière question est toutefois délicate, aussi est-elle parfois abordée au moyen de modèles simplifiés, comme le modèle S.O.S. ou les modèles d'interfaces effectives [39, 30].

Pour décrire le phénomène de coexistence de phases dans le modèle d'Ising, nous procéderons comme suit. Tout d'abord, nous considérerons une variation du modèle précédent permettant d'obtenir, sans champ magnétique, la phase plus ou moins. Nous étudierons ensuite le coût local d'une interface, quantifié par la tension superficielle, avant de décrire la contrainte de volume qui conduit à la coexistence et de présenter les problèmes géométriques que pose le phénomène de coexistence de phases.

1.2.1. *Sélectionner la phase.* Nous avons vu à la Section 1.1.2 que nous pouvions sélectionner la phase du modèle d'Ising, lorsque $T < T_c$, en appliquant

un faible champ magnétique. Nous allons voir ici que la *condition au bord* permet également de sélectionner la phase.

Étant donné un domaine $\Lambda \subset \mathbb{Z}^d$, on considère

$$\Sigma_\Lambda^+ = \{\sigma : \mathbb{Z}^d \rightarrow \{\pm 1\} : \sigma(x) = +1, \forall x \in \mathbb{Z}^d \setminus \Lambda\}$$

l'ensemble des configurations sur \mathbb{Z}^d qui coïncident à l'extérieur de Λ avec la configuration constante, égale à $+1$. Soit

$$E^w(\Lambda) = \{\{x, y\} : x \in \Lambda, y \in \mathbb{Z}^d \text{ et } x \sim y\} \quad (1)$$

l'ensemble des *arêtes* de \mathbb{Z}^d qui touchent Λ . La notation $x \sim y$ indique que x, y sont plus proches voisins dans \mathbb{R}^d , i.e. que $|x - y| = 1$. On définit alors le modèle d'Ising $\mu_{\Lambda, T}^+$ sur Λ avec condition au bord plus en posant

$$\mu_{\Lambda, T}^+(\{\sigma\}) = \frac{1}{Z_{\Lambda, T}^+} \exp\left(\frac{1}{T} \sum_{\{x, y\} \in E^w(\Lambda)} \sigma_x \sigma_y\right), \quad \forall \sigma \in \Sigma_\Lambda^+,$$

où $Z_{\Lambda, T}^+$ est la fonction de partition

$$Z_{\Lambda, T}^+ = \sum_{\sigma \in \Sigma_\Lambda^+} \exp\left(\frac{1}{T} \sum_{\{x, y\} \in E^w(\Lambda)} \sigma_x \sigma_y\right)$$

qui fait de $\mu_{\Lambda, T}^+$ une mesure de probabilité. Un argument de limite monotone permet de considérer la limite thermodynamique

$$\mu_T^+ = \lim_{N \rightarrow \infty} \mu_{\Lambda_N, T}^+.$$

De même, on peut définir μ_T^- la mesure en volume infini associée à la condition au bord moins. Les correspondances entre μ_T^+ , μ_T^- et $\mu_{T, h=0}$ sont les suivantes : à haute température, i.e. $T > T_c$, la condition au bord n'a pas d'influence en volume infini et on a l'égalité des trois mesures

$$\mu_T^+ = \mu_T^- = \mu_{T, h=0}.$$

Par contre, dans le domaine de transition de phase $T < T_c$, on a

$$\mu_T^+ = \lim_{h \rightarrow 0^+} \mu_{T, h} \quad \text{et} \quad \mu_T^- = \lim_{h \rightarrow 0^-} \mu_{T, h}$$

et ces deux mesures ne coïncident pas, puisque μ_T^+ donne une aimantation moyenne strictement positive, alors que μ_T^- donne une aimantation moyenne opposée. De plus, la mesure $\mu_{T, h=0}$ s'écrit comme la combinaison convexe

$$\mu_{T, h=0} = \frac{1}{2} (\mu_T^+ + \mu_T^-).$$

Dans la suite de l'exposé, nous utiliserons la notion de condition au bord comme un moyen mathématique simple de *sélectionner* une phase du modèle d'Ising, dans la région de transition de phase $T < T_c$.

1.2.2. *La tension superficielle.* Nous allons maintenant donner une estimation du *coût local* de la coexistence, c'est-à-dire du coût d'une interface séparant les phases plus et moins suivant une certaine direction. L'*énergie libre* associée à la phase plus du modèle d'Ising dans le volume Λ est

$$F_{\Lambda,T} = -\log Z_{\Lambda,T}^+,$$

c'est la même que l'énergie libre associée à la phase moins. Nous allons quantifier le *surplus* d'énergie libre correspondant à la présence d'une interface. Soit \mathbf{n} un vecteur unitaire de \mathbb{R}^d , $\delta > 0$ et \mathcal{R}^N un parallélépipède rectangle centré en l'origine, de base normale à \mathbf{n} et de côté N , de hauteur δN , comme illustré Figure 3.

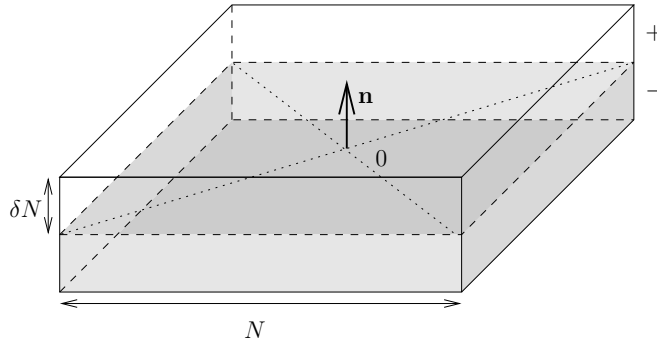

FIG. 3. Le parallélépipède \mathcal{R}^N et son bord inférieur.

On considère alors $\Sigma_{\mathcal{R}^N}^\pm$ l'ensemble des configurations de spin avec condition au bord mixte sur \mathcal{R}^N , c'est-à-dire

$$\Sigma_{\mathcal{R}^N}^\pm = \left\{ \sigma : \mathbb{Z}^d \rightarrow \{\pm 1\} : \forall x \notin \mathcal{R}^N, \sigma_x = \begin{cases} +1 & \text{si } x \cdot \mathbf{n} \geq 0 \\ -1 & \text{sinon} \end{cases} \right\}$$

et nous notons

$$Z_{\mathcal{R}^N,T}^\pm = \sum_{\sigma \in \Sigma_{\mathcal{R}^N}^\pm} \exp \left(\frac{1}{T} \sum_{\{x,y\} \in E^w(\mathcal{R}^N)} \sigma_x \sigma_y \right)$$

la fonction de partition associée à cette condition au bord mixte. La condition au bord mixte force la présence d'une interface entre les bords opposés de \mathcal{R}^N . Elle augmente également l'énergie libre du système. Nous allons donc définir l'énergie libre de l'interface comme le surplus d'énergie libre entre la condition au bord mixte et la condition au bord constante. La *tension superficielle* est alors égale au surplus d'énergie libre par unité de surface :

$$\tau_T(\mathbf{n}) = \lim_{N \rightarrow \infty} \frac{1}{N^{d-1}} \log \frac{Z_{\mathcal{R}^N(\mathbf{n}),T}^+}{Z_{\mathcal{R}^N(\mathbf{n}),T}^\pm}.$$

Cette limite existe et la tension superficielle est convexe, cf. [65]. Concluons sur le sens probabiliste de la tension superficielle : si $U \subset [0, 1]^d$ est une forme

macroscopique régulière, alors la probabilité d'observer la phase moins dans NU , dans le modèle d'Ising avec condition au bord plus sur $\Lambda_N = \{1, \dots, N\}^d$, est de l'ordre de

$$\exp\left(-N^{d-1} \int_{\partial U} \tau_T(\mathbf{n}_x) ds(x)\right) \quad (2)$$

où $x \mapsto \mathbf{n}_x$ est la normale extérieure locale à U en x , l'intégrale portant sur la surface de ∂U .

La tension superficielle est une notion essentielle pour l'étude de la coexistence de phases. Elle a permis de mettre en évidence les phénomènes de coexistence de phases dans le modèle d'Ising en dimension 2 [35, 69, 49, 50, 74, 51], puis en dimension $d \geq 3$ [12, 25, 26], et dans les modèles de percolation [6, 73, 23, 26]. Pour une introduction à l'étude L^1 de la coexistence de phases, nous renvoyons à [14, 24]. Notons que la tension superficielle permet également d'étudier les phénomènes de mouillage [70, 71, 72, 14] et certains aspects de la dynamique – nous reviendrons sur ce dernier point.

1.2.3. *Forcer la coexistence.* Dans le modèle d'Ising avec condition au bord plus, on observe uniquement la phase plus. Pour forcer la coexistence de phases, nous allons donc imposer une *contrainte de volume*. Par exemple, nous souhaitons que la phase moins occupe une fraction $v \in (0, 1)$ du domaine. L'aimantation totale du système sera alors

$$m = (1 - v)m_T^+ + vm_T^- = (1 - 2v)m_T^+,$$

et l'étude de la coexistence de phases revient à l'étude de la mesure conditionnelle

$$\mu_{T, \Lambda_N}^+(\cdot | m_{\Lambda_N} \leq m)$$

où

$$m_{\Lambda_N} = \frac{1}{N^d} \sum_{x \in \Lambda_N} \sigma_x$$

est l'aimantation totale du système.

1.2.4. *Les enjeux géométriques.* Sous la contrainte de volume, le modèle d'Ising réalise la coexistence de phases suivant la forme la moins improbable pour (2). La forme optimale sera donc celle qui *minimise* l'intégrale

$$\int_{\partial U} \tau_T(\mathbf{n}) ds$$

sous la contrainte de volume $\text{Vol}(u) = v$, et la contrainte de forme $U \subset [0, 1]^d$. Pour v petit, la solution à cette question géométrique est connue : U doit avoir la même forme que le cristal de Wulff associé à la tension superficielle. En particulier, la coexistence de phases se réalise suivant une forme *déterministe*, et à l'équilibre la phase minoritaire forme une seule goutte.

Nous détaillerons cette forme à la Section 3.3. Notons pour l’instant que le cristal de Wulff n’est pas une sphère en général, dans la mesure où le réseau qui porte le modèle n’est pas isotrope.

1.3. La dynamique de Glauber. Dans les paragraphes précédents nous avons présenté le modèle d’Ising à l’équilibre. Les questions portant sur la dynamique sont pourtant aussi nombreuses que passionnantes ! Commençons par définir une dynamique sur le modèle d’Ising : la dynamique de Glauber. Elle agit de la façon suivante :

- (i) Chaque spin est muni d’une horloge exponentielle de taux 1, ce qui signifie qu’entre les temps t et $t + dt$, dt petit, la probabilité que l’horloge en x se déclenche est d’environ dt , et que cet événement est indépendant du passé et des horloges des autres spins.
- (ii) Lorsque l’horloge sonne en x , le spin σ_x est choisi conformément à la mesure sur $\{x\}$ à température T , donnée par la condition au bord σ . Autrement dit, avec probabilité

$$\frac{\exp\left(\frac{1}{T} \sum_{y \sim x} J_{x,y} \sigma_y\right)}{\exp\left(\frac{1}{T} \sum_{y \sim x} J_{x,y} \sigma_y\right) + \exp\left(-\frac{1}{T} \sum_{y \sim x} J_{x,y} \sigma_y\right)}$$

le spin σ_x est fixé à $+1$, il est fixé à -1 avec la probabilité complémentaire.

La mesure d’équilibre est invariante sous la dynamique de Glauber. Cette propriété permet de relier certaines des questions concernant la dynamique aux propriétés du modèle d’Ising à l’équilibre. Ainsi, le temps de relaxation du modèle d’Ising partant de la phase moins, en présence d’un champ magnétique faible mais positif a été relié à l’énergie superficielle du cristal de Wulff [75]. De même, le trou spectral du modèle d’Ising avec condition au bord libre est déterminé par la tension superficielle [63]... C’est encore ce lien entre l’équilibre et la dynamique que nous exploitons dans le dernier Chapitre de cette thèse (voir la Section 3.4 pour un aperçu).

2. Le modèle d’Ising en milieu aléatoire

Dans cette thèse, nous nous sommes en fait intéressé au modèle d’Ising dilué : les interactions $J_{x,y}$ entre spins ne sont plus uniformes, mais elles-mêmes *aléatoires*. D’un point de vue physique, l’introduction de cet aléa dans le modèle permet de rendre compte des défauts ou irrégularités observés dans les matériaux ferromagnétiques. Elle permet également de rendre compte des propriétés ferromagnétiques des matériaux *non-homogènes*, comme les alliages métalliques.

2.1. Diagramme de phase. Le modèle d'Ising dilué est identique au modèle d'Ising, à ceci près que les interactions entre spins voisins ne sont plus toutes égales à 1. Dans cette partie nous considérerons le cas de la dilution proprement dite, c'est-à-dire que sous la loi \mathbb{P} , les $J_{x,y}$ (pour $\{x,y\} \in E^w(\mathbb{Z}^d)$) sont indépendants avec

$$\mathbb{P}(J_{x,y} = 1) = p, \quad \mathbb{P}(J_{x,y} = 0) = 1 - p.$$

Autrement dit, on ne conserve qu'une proportion p des interactions entre spins¹. Étant donné une réalisation J pour les interactions, on pose alors

$$\mu_{\Lambda,T}^{J,+}(\{\sigma\}) = \frac{1}{Z_{\Lambda,T}^{J,+}} \exp\left(\frac{1}{T} \sum_{\{x,y\} \in E^w(\Lambda)} J_{x,y} \sigma_x \sigma_y\right), \quad \forall \sigma \in \Sigma_{\Lambda}^+.$$

Tout comme dans le modèle d'Ising uniforme, les mesures $\mu_{\Lambda,T}^{J,+}$ décroissent stochastiquement lorsque Λ augmente et on peut par conséquent considérer la limite thermodynamique

$$\mu_T^{J,+} = \lim_{N \rightarrow \infty} \mu_{\Lambda_N,T}^{J,+}.$$

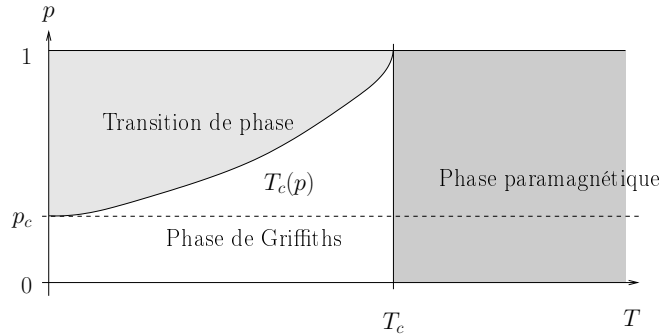

FIG. 4. Le diagramme de phase du modèle d'Ising dilué

Nous avons représenté le diagramme de phase du modèle d'Ising dilué en dimension $d \geq 2$ à la Figure 4. Il est composé de trois régions :

- (i) Lorsque $T > T_c$, les interactions dans le modèle d'Ising dilué sont plus faibles que dans le modèle non dilué à la température T , ce qui rend impossibles les phénomènes d'aimantation spontanée. On appelle cette région la *phase paramagnétique*.
- (ii) Lorsque la température est suffisamment faible $T < T_c(p)$, la condition au bord plus induit une aimantation $m_T = \mathbb{E}\mu_T^{J,+}(\sigma_0)$ positive. On dit qu'il y a *transition de phase* dans cette région.

¹Dans la thèse, nous considérons un cadre un peu plus général : voir la Section 3.1.1.

- (iii) Dans la *phase de Griffiths* $T_c(p) < T < T_c$, les interactions entre spins ne suffisent pas à établir une aimantation spontanée. Néanmoins, avec \mathbb{P} -probabilité 1 on peut trouver une région arbitrairement grande où les interactions sont égales à celles du modèle non dilué, ce qui fait qu'on retrouve *localement* un modèle d'Ising à basse température. Griffiths [41] a montré que ce phénomène conduisait à la rupture de l'analyticité de l'aimantation en $h = 0$, pour tout $T < T_c$. Nous verrons ci-après d'autres conséquences sur la dynamique du système.

Pour des bornes sur la température critique $T_c(p)$ et des asymptotiques lorsque $p \rightarrow p_c$, nous invitons le lecteur à consulter [3]. En particulier, $T_c(p)$ n'est positive que si $p > p_c$, p_c étant le paramètre critique pour la percolation par arêtes sur \mathbb{Z}^d .

2.2. Effets de la dilution à l'équilibre. Dans la région de transition de phase, on peut observer, comme pour le modèle d'Ising, deux phases distinctes : plus et moins. Le modèle d'Ising dilué permet donc d'envisager une étude théorique de la structure des interfaces en milieu aléatoire. On s'attend en particulier au phénomène suivant : les régions où les interactions sont plus faibles diminuent l'énergie de l'interface, ce qui pousse l'interface à s'attacher à ces régions, lesquelles sont réparties aléatoirement.

Dans la mesure où la description microscopique des interfaces est une question difficile, on a été amené à étudier des modèles « simplifiés », notamment le modèle des *polymères dirigés* [46] (voir [30] pour une présentation des résultats probabilistes). La localisation du polymère, à basse température, a été prouvée dans [80]. Par ailleurs, certains exposants ont pu être calculés pour la *percolation de dernier passage* [53] – la limite à température nulle du polymère dirigé. Ainsi, il a été montré que la hauteur des fluctuations transversales d'un chemin de dernier passage est de l'ordre de $l^{2/3}$ si les extrémités du chemin sont distantes de l , lorsque $l \rightarrow \infty$. Ce comportement *superdiffusif* (les fluctuations sont plus importantes que celles de la marche aléatoire, en $l^{1/2}$) indique que le chemin de dernier passage – tout comme, probablement, les polymères dirigés et les interfaces du modèle d'Ising dilué bidimensionnel – recherche effectivement les zones de faible énergie.

Dans cette thèse, nous étudierons certaines conséquences de la dilution, présentées à la Section 3.3. La tension superficielle est une quantité aléatoire dont la distribution dépend de la loi \mathbb{P} des couplages $J_{x,y}$ et dont les grandes déviations ont lieu sur des échelles non triviales. Mentionnons aussi quelques aspects de la coexistence de phases dans le modèle d'Ising dilué : cette fois encore, la phase minoritaire forme un cristal de Wulff, de forme déterministe. La dilution a bien un effet sur cette forme, et nous verrons que le cristal dépend de la mesure considérée, suivant qu'on impose la coexistence de phases pour une réalisation typique de l'interaction J (mesure *quenched*) ou bien qu'on impose la coexistence en laissant le milieu libre d'optimiser le coût de la coexistence,

en réduisant la tension superficielle sur le contour du cristal (mesure *annealed*). Nous renvoyons à la Section 3.1.6 pour la description des termes *quenched* et *annealed*.

2.3. Un aperçu de la dynamique. Nous allons donner ci-dessous un bref aperçu de la dynamique de Glauber du modèle d'Ising dilué, définie comme à la Section 1.3. Dans un premier paragraphe, nous rappellerons les résultats présentés dans [63], en l'absence de transition de phase, puis nous décrirons le mécanisme conduisant à la relaxation lente, sous la mesure *annealed*, dans la région de transition de phase.

2.3.1. *En dehors de la région de transition.* Nous allons voir que la nature de la dynamique dépend de la région du diagramme de phase (Figure 4) que l'on considère.

C'est dans la phase paramagnétique $T > T_c$ que la relaxation est la plus rapide. Elle se fait à vitesse exponentielle, dans la mesure où la relaxation est au moins aussi rapide que celle du modèle d'Ising uniforme à température T .

La relaxation est déjà nettement plus lente dans la phase de Griffiths $T_c(p) < T < T_c$. En considérant des régions exceptionnelles mais de probabilité non nulle, comme à la Section 2.1, on peut isoler certaines zones qui sont à une température effective T , et qui par conséquent, comme le modèle d'Ising uniforme à basse température $T < T_c$, relaxent lentement. Ces zones rares déterminent la dynamique dans la phase de Griffiths. Notons $(T^J(t)\pi_0)(\sigma)$ l'aimantation moyenne du spin en 0 au temps t si l'on part de l'état initial σ (cette notation sera précisée à la Section 3.4). Pour tout $p \in (0, 1)$ et $T < T_c$, on a une borne inférieure sur l'autocorrélation sous la mesure *annealed*, du type

$$\mathbb{E} \left(\int |(T_T^J(t)\pi_0)(\sigma)|^2 d\mu_T^{J,+}(\sigma) \right)^{1/2} \underset{t \rightarrow \infty}{\geq} \exp \left(-C (\log t)^{\frac{d}{d-1}} \right), \quad (3)$$

et cette borne inférieure peut-être complétée de bornes supérieures similaires dans une partie de la phase de Griffiths : voir la Section 7 de [63].

2.3.2. *Coexistence de phases et métastabilité.* L'étude de certains aspects de la dynamique du modèle d'Ising dilué, dans la région de transition de phase, est l'un des objectifs de cette thèse. On s'intéressera plus particulièrement à la décroissance de l'autocorrélation sous la mesure *annealed*, comme en (3). Un mécanisme de piégeage des interfaces, formulé dans [45], indiquait que la dynamique de Glauber du modèle d'Ising dilué serait relativement facile à contrôler... une fois surmontées les difficultés mathématiques du milieu aléatoire.

La lente relaxation de la dynamique provient, comme pour la phase de Griffiths, d'évènements atypiques. À la différence de la phase de Griffiths, ces

évènements sont liés à la coexistence de phases. Nous allons supposer que, au temps $t = 0$, une goutte de phase moins est présente, et que la tension superficielle est *réduite* sur le bord de la goutte. À l'échelle N , la probabilité de réduire la tension superficielle sur le bord de la goutte est de l'ordre de $\exp(-N^{d-1}\mathcal{I}_{\text{init}})$, et la probabilité d'obtenir la goutte initiale désirée est de l'ordre de $\exp(-N^{d-1}\mathcal{F}_{\text{init}}^r)$. Pour que le système relaxe vers l'équilibre, il faut attendre que cette goutte atypique disparaisse.

Sous certaines hypothèses sur la condition initiale, la rétraction de la goutte implique le passage par une configuration de coût $\mathcal{F}_{\text{max}}^r$ strictement supérieur à $\mathcal{F}_{\text{init}}^r$, ce qu'on peut représenter par un paysage d'énergie comme à la Figure 5.

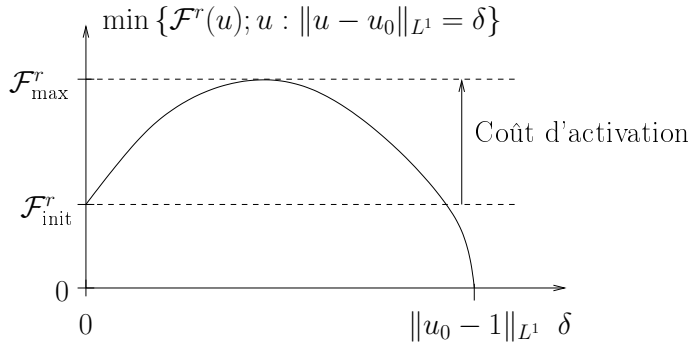

FIG. 5. Paysage d'énergie associé à une goutte u_0 métastable.

Le coût d'activation $\mathcal{F}_{\text{max}}^r - \mathcal{F}_{\text{init}}^r$ correspond à la *durée de vie* de la goutte initiale, qui est de l'ordre de

$$t = \exp(N^{d-1}(\mathcal{F}_{\text{max}}^r - \mathcal{F}_{\text{init}}^r)).$$

Inversons maintenant cette relation pour choisir N en fonction de t . L'auto-corrélation est minorée par la probabilité $\exp(-N^{d-1}\mathcal{I}_{\text{init}} - N^{d-1}\mathcal{F}_{\text{init}}^r)$ de l'état initial, qui prend donc la forme d'une *puissance* de t :

$$\mathbb{E} \int \left| (T_T^J(t)\pi_0)(\sigma) - \mu_T^{J,+}(\sigma_0) \right| d\mu_T^{J,+}(\sigma) \underset{t \rightarrow \infty}{\gtrsim} t^{-\frac{\mathcal{I}_{\text{init}} + \mathcal{F}_{\text{init}}^r}{\mathcal{F}_{\text{max}}^r - \mathcal{F}_{\text{init}}^r}}. \quad (4)$$

Cette heuristique sera confirmée au Théorème 12 (Section 3.4).

3. Présentation des résultats

Dans cette partie, nous exposons nos principaux résultats sur le modèle d'Ising dilué. L'objectif de la thèse est bien entendu de décrire la coexistence de phases dans le modèle d'Ising dilué (Section 3.3) et certains aspects de la dynamique de Glauber (Section 3.4). Néanmoins, nous devons auparavant donner un sens mathématique aux différentes phases du modèle (Section 3.1) et

décrire le comportement de la tension superficielle en milieu aléatoire (Section 3.2).

3.1. Les phases pures. Dans les parties précédentes, nous avons fait référence à maintes reprises à une notion de phase pure. Définir cette notion de manière rigoureuse est indispensable pour procéder à l'analyse mathématique du modèle d'Ising dilué... mais il ne s'agit pas là d'une tâche simple. Nous allons dans un premier temps décrire le milieu aléatoire ainsi qu'une nouvelle représentation du modèle, puis nous poserons une hypothèse technique et enfin, nous détaillerons le sens mathématique que nous donnons à la notion de phase pure.

3.1.1. *Le milieu aléatoire.* Dans notre étude, nous considérons en fait un cadre légèrement plus général que celui de la dilution : nous supposons que les interactions $(J_{x,y})$ sont *positives* et *bornées*, indépendantes et identiquement distribuées sous une loi \mathbb{P} , et nous notons \mathbb{E} l'espérance associée à \mathbb{P} . L'hypothèse d'interactions positives nous place dans le cadre des modèles ferromagnétiques, ce qui exclut d'emblée les systèmes du type *verres de spins*. Néanmoins, le cadre ferromagnétique est très appréciable d'un point de vue technique, puisque nous disposons alors de la représentation FK du modèle d'Ising (voir ci-dessous). L'hypothèse d'interactions bornées simplifie notamment l'étude de la tension superficielle.

3.1.2. *La représentation FK.* La représentation de Fortuin-Kasteleyn du modèle d'Ising est un outil formidable pour l'analyse du modèle d'Ising. Elle établit un lien entre le modèle d'Ising et un modèle de percolation dépendante. Le lecteur pourra consulter les références [43, 66, 4]. Posons

$$\Omega = \{\omega : E^w(\mathbb{Z}^d) \rightarrow \{0, 1\}\}$$

l'ensemble des configurations d'arêtes sur \mathbb{Z}^d – on rappelle que $E^w(\Lambda)$ est l'ensemble des arêtes qui touchent Λ , cf. (1). Étant donné $\omega \in \Omega$ et une arête $e \in E^w(\mathbb{Z}^d)$, on dit que l'arête e est ouverte pour ω si $\omega_e = 1$, et qu'elle est fermée dans le cas contraire. Étant donné $\omega \in \Omega$ et $x, y \in \mathbb{Z}^d$, on dit que ω connecte x et y (ce qu'on note $x \overset{\omega}{\leftrightarrow} y$) s'il existe un chemin d'arêtes ouvertes pour ω entre x et y . Enfin, étant donné $\sigma \in \Sigma$ et $\omega \in \Omega$, on dit que ω et σ sont *compatibles* si, pour tout $e = \{x, y\} \in E^w(\mathbb{Z}^d)$ on a $\omega_e = 1 \Rightarrow \sigma_x = \sigma_y$. Pour $\Lambda \subset \mathbb{Z}^d$ fini, on considère $\Omega_\Lambda = \{\omega \in \Omega : \omega_e = 0, \forall e \notin E^w(\Lambda)\}$. Étant donné une *température inverse*

$$\beta = \frac{1}{T} \geq 0$$

on pose

$$p_e^J = 1 - \exp(-2\beta J_e)$$

puis

$$\Psi_{\Lambda,\beta}^{J,+}(\{(\sigma,\omega)\}) = \frac{\mathbf{1}_{\{\omega \text{ et } \sigma \text{ sont compatibles}\}}}{Z_{\Lambda,\beta}^{J,+}} \prod_{e \in E^w(\Lambda)} (p_e^J)^{\omega_e} (1 - p_e^J)^{1-\omega_e},$$

pour tout $\sigma \in \Sigma_\Lambda^+$ et $\omega \in \Omega_\Lambda$. La fonction de partition $Z_{\Lambda,\beta}^{J,+}$ est choisie de sorte que $\Psi_{\Lambda,\beta}^{J,+}$ soit une mesure de probabilité sur $\Sigma_\Lambda^+ \times \Omega_\Lambda$. De par le choix de p_e^J , la marginale de $\Psi_{\Lambda,\beta}^{J,+}$ sur Σ_Λ^+ n'est autre que le modèle d'Ising $\mu_{\Lambda,T}^{J,+}$ à température $T = 1/\beta$. L'autre marginale – sur Ω_Λ – est appelée mesure de Fortuin-Kasteleyn (ou mesure du *cluster aléatoire*) et est notée $\Phi_{\Lambda,\beta}^{J,w}$. Il est immédiat que

$$\Phi_{\Lambda,\beta}^{J,w}(\{\omega\}) = \frac{1}{Z_{\Lambda,\beta}^{J,+}} \prod_{e \in E^w(\Lambda)} (p_e^J)^{\omega_e} (1 - p_e^J)^{1-\omega_e} 2^{C_\Lambda^w(\omega)} \quad (5)$$

où $C_\Lambda^w(\omega)$ est le nombre de composantes connexes (désormais : *clusters*) de Λ , dans le graphe ω , qui ne touchent pas le bord extérieur de Λ . Par ailleurs, la loi de σ conditionnellement à ω sous la mesure jointe $\Psi_{\Lambda,\beta}^{J,+}$ est particulièrement simple : les clusters de ω ont un spin constant, ceux qui touchent le bord $\partial\Lambda$ ont un spin $+1$ et ceux qui ne touchent pas le bord ont un spin qui vaut ± 1 avec probabilités égales, indépendamment du spin des autres clusters.

La représentation FK joue un rôle central dans l'étude de certaines questions concernant le modèle d'Ising, en particulier pour la renormalisation du modèle à des températures proches de la température critique.

3.1.3. Un résultat préliminaire. Pour décrire complètement la mesure FK, il faut étendre (5) à des conditions au bord plus générales. Dans (5) l'exposant w représente la condition au bord *wired*, i.e. la condition au bord complètement fermée. En remplaçant $C_\Lambda^w(\omega)$ par $C_\Lambda^f(\omega)$ qui représente le nombre total de clusters de Λ dans le graphe ω (la différence $C_\Lambda^f(\omega) - C_\Lambda^w(\omega)$ est donc le nombre de clusters qui touchent $\partial\Lambda$), on définit la mesure FK pour la condition au bord libre (*free*). Ces deux conditions au bord sont extrémales, c'est-à-dire que les mesures FK associées encadrent stochastiquement toute autre mesure FK. De plus, les inégalités FKG montrent que $\mathbb{E}\Phi_{\Lambda,\beta}^{J,w}$ décroît stochastiquement avec Λ , alors que $\mathbb{E}\Phi_{\Lambda,\beta}^{J,f}$ croît. Dans la suite on aura besoin de supposer que les limites en volume infini associées à ces deux mesures sont égales, ce qui est légitimé par le Théorème suivant, établi au Chapitre 1. Notons que ce même théorème a été établi, dans le cas uniforme, dans [42, 59].

THÉORÈME 1. *L'ensemble \mathcal{N} des $\beta \geq 0$ tels que*

$$\lim_{N \rightarrow \infty} \mathbb{E}\Phi_{\Lambda_N,\beta}^{J,f} \neq \lim_{N \rightarrow \infty} \mathbb{E}\Phi_{\Lambda_N,\beta}^{J,w}$$

est au plus dénombrable.

3.1.4. *L'hypothèse de percolation par tranches.* L'objectif du premier Chapitre est de décrire les phases du modèle d'Ising dilué. Nous devons donc supposer $\beta > \beta_c$ où β_c est la température inverse à laquelle a lieu la transition de phase, soit encore :

$$m_\beta = \lim_{N \rightarrow \infty} \mathbb{E} \mu_{\hat{\Lambda}_N, 1/\beta}^{J,+}(\sigma_0) > 0.$$

Suivant la représentation FK du modèle d'Ising, on a $\mu_{\hat{\Lambda}_N, 1/\beta}^{J,+} = \Phi_{\hat{\Lambda}_N, \beta}^{J,w}(0 \stackrel{\omega}{\leftrightarrow} \partial\Lambda)$ et par conséquent,

$$m_\beta = \lim_{N \rightarrow \infty} \mathbb{E} \Phi_{\hat{\Lambda}_N, \beta}^{J,w}(0 \stackrel{\omega}{\leftrightarrow} \partial\Lambda).$$

Autrement dit, l'hypothèse $m_\beta > 0$ est équivalente à l'hypothèse de *percolation* sous la mesure FK. Malheureusement pour la généralité de notre étude, nous n'avons pas été à même d'exploiter cette hypothèse de percolation. Nous avons basé la construction du coarse graining sur une hypothèse plus forte, celle de *percolation par tranches*. On dit que la mesure FK réalise la percolation par tranches à la température inverse β s'il existe $H \in \mathbb{N}^*$ et $\alpha > 0$ tels que, pour tout $L \in \mathbb{N}^*$ et pour tout $x, y \in S_{L,H} = \{1, \dots, L\}^{d-1} \times \{1, \dots, H\}$, on a

$$\mathbb{E} \Phi_{S_{L,H}, \beta}^{J,f}(x \stackrel{\omega}{\leftrightarrow} y) \geq \alpha. \quad (6)$$

Cette définition n'est adaptée qu'au cas des dimensions $d \geq 3$, aussi au Chapitre 1 nous donnons une adaptation au cas bidimensionnel.

Notons $\hat{\beta}_c$ la température inverse critique pour la percolation dans les tranches. On a clairement $\hat{\beta}_c \geq \beta_c$ et, par ailleurs, $\hat{\beta}_c$ est finie dès que β_c l'est. La comparaison avec le cas uniforme porte à croire que, comme dans le cas de la percolation [44] ou du modèle d'Ising uniforme [13], les deux valeurs critiques $\hat{\beta}_c$ et β_c sont en fait égales, et que par conséquent l'hypothèse $\beta > \hat{\beta}_c$ correspond à l'intégralité de la région de transition de phase.

3.1.5. *Le coarse graining et la phase locale.* Rappelons que l'objectif premier du Chapitre 1 est de décrire les phases du modèle d'Ising dilué, dans la région de transition de phase. Il s'agit de généraliser la procédure de renormalisation décrite par Pisztor [73] pour le cas uniforme. Vu la correspondance entre la représentation FK et le modèle d'Ising, nous commencerons par décrire l'aspect des clusters, à l'aide de techniques *spécifiques* au milieu aléatoire (voir la Section 3.1.6 ci-dessous). Par *cluster traversant* dans Λ_N , on entend un cluster pour ω qui touche toutes les faces de Λ_N .

THÉORÈME 2. *Soit $\beta > \hat{\beta}_c$. Alors il existe $c > 0$ et $\kappa < \infty$ tels que, pour tout $N \in \mathbb{N}^*$ assez grand et $l \in [\kappa \log N, N]$,*

$$\mathbb{E} \inf_{\pi} \Phi_{\Lambda_N}^{J,\pi} \left(\begin{array}{l} \text{Il existe un cluster traversant dans } \Lambda_N \\ \text{et ce cluster est le seul de diamètre } \geq l \end{array} \right) \geq 1 - \exp(-cl).$$

Ce premier contrôle permet d'ores et déjà l'application des techniques de renormalisation : si deux blocs de taille N se chevauchent, et que dans chacun

de ces blocs on a l'existence d'un cluster traversant et l'unicité des grands clusters, alors les deux grands clusters font en fait partie d'un même cluster. Le Théorème 1 permet alors d'établir un contrôle sur la densité de ce cluster principal : on montre que cette densité est, avec une très grande probabilité lorsque $\beta > \hat{\beta}_c$ et $\beta \notin \mathcal{N}$, arbitrairement proche de m_β .

Cette description de l'aspect typique de la mesure FK permet de définir localement les deux phases du modèle d'Ising dilué, ou plus exactement, les phases de la mesure jointe $\Psi_{\Lambda_N, \beta}^{J,+}$. Considérons $\varepsilon > 0$ et une échelle mésoscopique $L \in \mathbb{N}^*$. Si $\Delta = x + \{1, \dots, L\}^d$ est un bloc de taille L inclus dans Λ_N , et si $\Delta' = x' + \{-L + 1, \dots, 2L\}^d$ avec x' proche de x autant que possible sous la contrainte $\Delta' \subset \Lambda_N$, on définit

$$\phi_\Delta \in \{-1, 0, 1\}$$

en posant

- (i) $\phi_\Delta = +1$ s'il existe un cluster traversant pour ω dans Δ' et si ce cluster est le seul de diamètre au moins L , si le spin associé à ce cluster est $+1$ et enfin, si l'aimantation

$$\mathcal{M}_\Delta = \frac{1}{|\Delta|} \sum_{x \in \Delta} \sigma_x$$

dans Δ satisfait

$$|\mathcal{M}_\Delta - m_\beta| \leq \varepsilon.$$

- (ii) $\phi_\Delta = -1$ dans les mêmes conditions pour ω , si le spin associé au cluster est -1 et que $|\mathcal{M}_\Delta + m_\beta| \leq \varepsilon$.

- (iii) $\phi_\Delta = 0$ dans les autres cas.

La variable ϕ_Δ représente la phase locale. Elle donne en particulier un contrôle précis sur l'aimantation dans les régions où $\phi_\Delta \neq 0$. Notons que la condition sur ω garantit que deux blocs adjacents ne peuvent être dans des phases opposées et que, si Δ touche le bord, alors la phase ne peut être -1 , autrement dit le changement de phase nécessite le passage par une phase mal définie ($\phi = 0$). Enfin, cette définition de la phase s'assortit d'un contrôle stochastique : pour tout $\varepsilon > 0$, on montre que la probabilité que $\phi_\Delta = 0$ tend vers 0 lorsque $L \rightarrow \infty$, uniformément en Δ , puis que les suites $(|\phi_{\Delta_i}|)_i$ dominent stochastiquement un produit de mesures de Bernoulli de densité arbitrairement proche de 1, lorsque $L \rightarrow \infty$.

3.1.6. Les particularités du milieu aléatoire. La construction du coarse graining, même sous l'hypothèse technique de percolation par tranches (6), est très délicate et beaucoup plus longue que la construction de référence [73] pour le modèle d'Ising uniforme. Cette longueur n'est bien sûr pas gratuite, elle est due au milieu aléatoire qui rompt certaines des propriétés de la mesure FK. Commençons par détailler les deux types de mesures FK que nous pouvons considérer en milieu aléatoire :

(i) La mesure *annealed*, lorsque nous intégrons $\Phi_{\Lambda,\beta}^{J,\pi}$ sous \mathbb{E}

(ii) La mesure *quenched*, lorsqu'on considère $\Phi_{\Lambda,\beta}^{J,\pi}$ pour J typique sous \mathbb{P} .

Ce vocabulaire est hérité de la métallurgie : la mesure *annealed* correspond à un refroidissement progressif du métal qui permet aux impuretés (le milieu aléatoire) de se positionner et de participer à l'équilibre global du système. La mesure *quenched*, à l'opposé, correspond à un refroidissement instantané (la *trempe* en français) et *gèle* la position des impuretés suivant leur équilibre à haute température.

Au niveau mathématique, la mesure *quenched* a les mêmes propriétés que la mesure FK et satisfait en particulier aux équations DLR. Cela signifie que lorsqu'on conditionne $\Phi_{\Lambda,\beta}^{J,\pi}$ par rapport à une configuration partielle $\omega|_{\Lambda'}$, la mesure résultante dans $\Lambda \setminus \Lambda'$ est la mesure FK sur $\Lambda \setminus \Lambda'$ qui intègre ω comme condition au bord. Cette propriété est essentielle pour la construction du coarse graining [73] dans le cas uniforme.

Ce qui rend la situation délicate dans le cas du milieu aléatoire, c'est que

(i) L'hypothèse de percolation dans les tranches (6) *doit* être formulée sous la mesure *annealed*.

(ii) La mesure *annealed* n'a pas la propriété DLR.

Détaillons chacun de ces points, en commençant par (i). Prenons pour \mathbb{P} la mesure de dilution, et considérons une réalisation typique du milieu J sous la mesure \mathbb{P} . Alors, avec une grande probabilité il existe $x \in S_{L,H}$ tel que $J_e = 0$, pour toutes les arêtes qui mènent en x . Mais $J_e = 0$ implique $\Phi^J(\omega_e = 0) = 1$, et il sera donc impossible de connecter x à un autre point sous ω , d'où la nécessité de formuler (6) sous la mesure *annealed*. Le point (ii) est bien connu et nous pouvons faire l'analogie avec les chaînes de Markov en milieu aléatoire, qui perdent la propriété de Markov sous la mesure *annealed*. Les conséquences de (ii) sont très lourdes pour la construction du coarse graining, puisque cela signifie que nous ne pouvons pas utiliser directement les techniques de [73].

La solution présentée dans le Chapitre 1 suit le cheminement suivant. Dans un premier temps, on s'attaque au problème du conditionnement sous la mesure *annealed* en comparant stochastiquement celle-ci à un *produit* de mesures *annealed*, sur des domaines plus petits. Cela permet d'établir, avec une forte probabilité, l'existence d'un cluster « dense » (dans un sens que nous ne précisons pas ici) dans la boîte Λ_N . Ce cluster dense est en particulier traversant. Ensuite, une construction géométrique nous permet de rendre rigoureuse l'idée suivante : la probabilité qu'un cluster de diamètre non-négligeable côtoie le cluster dense sans s'y connecter est négligeable, ce qui prouve l'unicité et conduit au Théorème 2.

3.2. La tension superficielle. Nous avons expliqué à la Section 1.2.2 comment la tension superficielle permet de quantifier la probabilité de la

coexistence de phases locale. Ici encore, la représentation FK du modèle d'Ising dilué constitue un atout technique majeur pour l'étude de la tension superficielle, de par les inégalités FKG.

Étant donné un parallépipède rectangle \mathcal{R} de dimensions $N^{d-1} \times \delta N$, d'orientation \mathbf{n} comme à la Figure 3, centré en x , nous considérons

$$\partial^+ \mathcal{R} = \{z \in \partial \mathcal{R} : (z - x) \cdot \mathbf{n} \geq 0\} \quad \text{et} \quad \partial^- \mathcal{R} = \{z \in \partial \mathcal{R} : (z - x) \cdot \mathbf{n} < 0\},$$

les bords supérieurs et inférieurs de \mathcal{R} . L'évènement de déconnection entre les deux bords

$$\mathcal{D}_{\mathcal{R}} = \left\{ \omega \in \Omega_{\mathcal{R}} : \partial^+ \mathcal{R} \stackrel{\omega}{\not\leftrightarrow} \partial^- \mathcal{R} \right\}$$

est intimement lié à la présence d'une interface entre les deux phases dans \mathcal{R} : d'après la loi de σ conditionnellement à ω (Section 3.1.2), la déconnection entre les bords permet de choisir librement les phases de part et d'autre de l'interface. Nous définissons donc la tension superficielle dans \mathcal{R} en posant

$$\tau_{\mathcal{R}}^J = -\frac{1}{N^{d-1}} \log \Phi_{\mathcal{R}}^{J,w}(\mathcal{D}_{\mathcal{R}}).$$

Cette définition coïncide avec celle de la Section 1.2.2.

3.2.1. *Conséquences de la sous-additivité.* Une des propriétés fondamentales de la tension superficielle est, comme dans le cas uniforme, sa *sous-additivité* [65]. De cette sous-additivité nous déduisons la *convergence* de la tension superficielle. Soit (\mathcal{R}^N) une suite de rectangles centrés en 0, de bases normales à \mathbf{n} , de dimensions $N^{d-1} \times \delta N$ avec $\delta > 0$.

THÉORÈME 3. *Il existe $\tau^q(\mathbf{n}) \geq 0$, indépendant de $\delta > 0$, tel que*

$$\tau_{\mathcal{R}^N}^J \xrightarrow{N \rightarrow \infty} \tau^q(\mathbf{n}) \quad \text{en } \mathbb{P}\text{-probabilité.} \quad (7)$$

On appelle tension superficielle *quenched* cette limite.

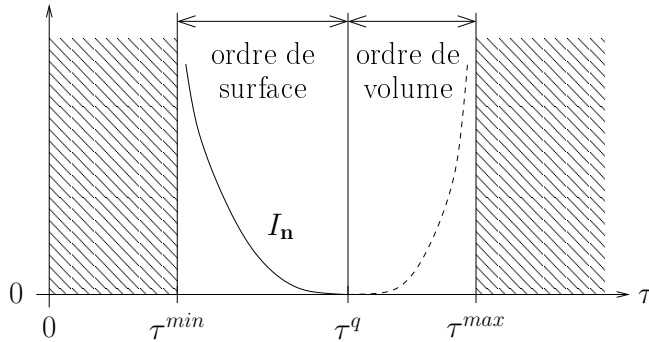

FIG. 6. Régimes de déviations pour la tension superficielle.

Nous avons également caractérisé les grandes déviations de la tension superficielle, à l'aide à nouveau de la sous-additivité. Tout d'abord, les déviations supérieures de la tension superficielle ont un coût *volumique* :

THÉORÈME 4. *Pour tous $\varepsilon, \delta > 0$, il existe $c > 0$ tel que, pour N assez grand,*

$$\mathbb{P}(\tau_{\mathcal{R}^N}^J \geq \tau^q(\mathbf{n}) + \varepsilon) \leq \exp(-cN^d).$$

Nous verrons dans la suite que ces déviations ne sont pas à même d'influencer le phénomène de coexistence de phases, à cause de leur coût trop élevé.

Les déviations inférieures de la tension superficielle ont, à l'opposé, un coût *surfaccique*. Plus précisément, notons J^{\min} la valeur minimale de J sous \mathbb{P} , et τ^{\min} la tension superficielle pour une réalisation uniforme $J \equiv J^{\min}$.

THÉORÈME 5. *Il existe $I_{\mathbf{n}} : \mathbb{R} \rightarrow [0, \infty]$ convexe décroissante, indépendante de $\delta > 0$, telle que pour tout $\tau \neq \tau^{\min}(\mathbf{n})$,*

$$I_{\mathbf{n}}(\tau) = \lim_{N \rightarrow \infty} -\frac{1}{N^{d-1}} \log \mathbb{P}(\tau_{\mathcal{R}^N}^J \leq \tau).$$

L'allure de $I_{\mathbf{n}}$ est représentée Figure 6. Il s'agit là d'une quantité importante : les déviations inférieures de la tension superficielle influencent la coexistence de phases sous la mesure annealed, et sont responsables de la dynamique lente dans la région de transition de phase.

3.2.2. *La tension superficielle annealed.* Nous allons voir pour commencer l'influence des déviations inférieures sur la valeur de la tension superficielle. On définit la tension superficielle λ -annealed en posant

$$\tau^\lambda(\mathbf{n}) = \inf_{\tau \in \mathbb{R}} \{\lambda\tau + I_{\mathbf{n}}(\tau)\} = \lim_{N \rightarrow \infty} -\frac{1}{N^{d-1}} \log \mathbb{E} \left[\left(\Phi_{\mathcal{R}^N}^{J,w}(\mathcal{D}_{\mathcal{R}^N}) \right)^\lambda \right],$$

où \mathcal{R}^N a la forme habituelle. La tension superficielle λ -annealed correspond donc à la tension superficielle sous $\mathbb{E}[\Phi_{\Lambda}^{J,w}(\cdot)]^\lambda$ ⁽¹⁾. Le cas particulier $\lambda = 1$ donne la tension superficielle annealed $\tau^a = \tau^{\lambda=1}$. De par l'inégalité de Jensen, il vient que $\tau^a(\mathbf{n}) \leq \tau^q(\mathbf{n})$ et plus généralement,

$$\tau^\lambda(\mathbf{n}) \leq \lambda\tau^q(\mathbf{n}), \quad \forall \mathbf{n}. \quad (8)$$

Une des questions majeures concernant les valeurs de la tension superficielle est de savoir si l'égalité est possible, en dehors du cas où τ^q s'annule. Dans le cas du polymère dirigé, l'inégalité $\tau^a(\mathbf{n}) < \tau^q(\mathbf{n})$ implique la *localisation* du polymère [22, 29]; elle a été démontrée à toute température [31] pour le modèle du polymère dirigé en dimension $1 + 1$.

¹Soit dit en passant, $\mathbb{E}[\Phi_{\Lambda}^{J,w}(\cdot)]^\lambda$ n'est une mesure que dans le cas $\lambda = 1$, pour $\lambda \neq 1$ il y a en effet un défaut d'additivité.

Dans la Section 3 du Chapitre 2, nous montrons, pour une large classe de lois \mathbb{P} pour l'environnement, que l'inégalité (8) est stricte à basse température. Cette question est également liée au comportement de $I_{\mathbf{n}}$ à gauche de $\tau^q(\mathbf{n})$: si la pente de $I_{\mathbf{n}}$ à gauche de $\tau^q(\mathbf{n})$ est nulle, alors l'inégalité est stricte (voir aussi le Théorème 8).

3.2.3. *À propos des déviations inférieures.* Nous avons pu généraliser à la tension superficielle du modèle d'Ising dilué un des contrôles classiques dans le cas des polymères dirigés [30, 21]. Dans la Section 4 du Chapitre 2, en utilisant des méthodes de concentration de la mesure [60], nous établissons le théorème suivant :

THÉORÈME 6. *Supposons que \mathbb{P} satisfasse une inégalité de log-Sobolev. Alors, pour tout \mathbf{n} vecteur unitaire de \mathbb{R}^d , pour Lebesgue-presque tout $\beta \geq 0$, on a*

$$\limsup_{r \rightarrow 0^+} \frac{I_{\mathbf{n}}(\tau^q(\mathbf{n}) - r)}{r^2} > 0.$$

L'hypothèse sur \mathbb{P} n'est pas véritablement contraignante. Elle est vérifiée pour les mesures usuelles (dilution, mesure uniforme sur $[0, 1]$). La condition « presque tout β » est un résidu du problème suivant : on n'a a priori pas de contrôle uniforme sur la longueur de l'interface dans le modèle d'Ising dilué, contrairement au cas du polymère. Notons que, dans le cas d'un milieu qui satisfait $J_e \geq \varepsilon > 0$, \mathbb{P} -presque sûrement, la conclusion est vraie pour tout $\beta \geq 0$ assez grand puisqu'alors, on peut contrôler la longueur de l'interface de façon uniforme.

Une des conséquences du Théorème 6 est tout simplement la *stricte positivité* de $I_{\mathbf{n}}$ à gauche de $\tau^q(\mathbf{n})$. Il s'agit là d'un fait important, puisqu'il montre que le coût de réduire la tension superficielle est toujours d'ordre surfacique. Précisément, nous avons :

COROLLAIRE 7. *Supposons que \mathbb{P} satisfasse une inégalité de log-Sobolev. Alors l'ensemble*

$$\mathcal{N}_I = \{\beta \geq 0 : \exists \mathbf{n} \in S^{d-1} \text{ et } \varepsilon > 0 : I_{\mathbf{n}}(\tau^q(\mathbf{n}) - \varepsilon) = 0\}$$

est au plus dénombrable.

Dans la Section 4 du Chapitre 2, nous donnons également une borne supérieure sur $I_{\mathbf{n}}$. En définissant $\xi_{\mathbf{n}}$, l'exposant pour les fluctuations transversales de l'interface, d'une manière appropriée, on établit :

THÉORÈME 8. *Supposons $\beta > \hat{\beta}_c$. Alors, pour tout $\gamma > \xi_{\mathbf{n}}$ et pour tout $r > 0$ assez petit, on a*

$$I_{\mathbf{n}}(\tau^q(\mathbf{n}) - r) \leq r^{2-\gamma}.$$

3.3. Coexistence de phases. Fort des outils développés dans les deux premiers Chapitres, nous abordons au Chapitre 3 l'étude de la coexistence de phases dans le modèle d'Ising dilué. Une fois n'est pas coutume, la construction se généralise sans difficulté. Cela ne veut pas dire que le milieu aléatoire n'influence pas la coexistence, et nous verrons les conséquences de l'aléa sur la forme du cristal de Wulff qui émerge.

3.3.1. *L'approche L^1 .* Le coarse graining décrit dans le premier Chapitre donne une idée précise de ce que sont les phases du modèle d'Ising dilué. Nous avons vu en particulier que l'aimantation locale, lorsque la phase est bien définie, est proche de $\pm m_\beta$. Donnons-nous $K \in \mathbb{N}^*$ et décomposons le domaine Λ_N en blocs $(\Delta_i)_{i \in I_{N,K}}$ où les Δ_i sont des cubes de la forme

$$\Delta_i = x_i + \{1, \dots, K\}^d$$

où x_i est le point le plus proche de Ki tel que $\Delta_i \subset \Lambda_N$. Étant donné une réalisation des spins $\sigma \in \Sigma_{\Lambda_N}$, l'aimantation à l'échelle *mésoscopique* K est la fonction constante par morceaux, définie par

$$\mathcal{M}_K : x \in [0, 1]^d \mapsto \frac{1}{K^d} \sum_{z \in \Delta_{i(x)}} \sigma_z$$

où $i(x)$ est le plus petit indice qui conduise à un bloc contenant Nx . Notons que ce découpage par blocs permet de passer de la structure *microscopique* du modèle (les spins, portés par Λ_N) à l'aspect *macroscopique* du système, où l'on observe dans le cube unité $[0, 1]^d$ l'aimantation locale $\mathcal{M}_K(x)$ autour du point microscopique Nx .

Le coarse graining développé au Chapitre 1 montre qu'en chaque point x , $\mathcal{M}_K(x)$ est proche de $\pm m_\beta$, avec une probabilité très élevée. L'approche L^1 de la coexistence de phases consiste à étudier la probabilité que le profil tout entier, \mathcal{M}_K/m_β , soit proche en norme L^1 d'un profil donné $u : [0, 1]^d \rightarrow \{\pm 1\}$. Nous verrons dans la suite que cette approche est tout à fait adaptée, non seulement au coarse graining, mais aussi aux nécessités géométriques du problème puisqu'elle permet de définir sans ambiguïté le coût de n'importe quel profil.

3.3.2. *Un problème d'isopérimétrie.* Étant donné $U \subset [0, 1]^d$ Borel mesurable, on note

$$\chi_U = \mathbf{1}_{U^c} - \mathbf{1}_U = \begin{cases} -1 & \text{si } x \in U \\ 1 & \text{sinon.} \end{cases}$$

On notera par ailleurs \mathcal{H}^{d-1} la mesure de Hausdorff de dimension $d-1$ dans \mathbb{R}^d (rappelons que \mathcal{H}^{d-1} est une mesure de surface). Si U a un périmètre fini (i.e. si $u = \chi_U$ a une variation finie), on peut définir une notion de bord réduit ∂^*u , telle que $\mathcal{H}^{d-1}(\partial^*u)$ est le périmètre de U , et telle qu'en tout point $x \in \partial^*u$ on

puisse considérer \mathbf{n}_x^u la normale extérieure à u en x . On pose alors

$$\mathcal{F}^q(u) = \int_{\partial^* u} \tau^q(\mathbf{n}_x^u) d\mathcal{H}^{d-1}(x) \quad \text{et} \quad \mathcal{F}^\lambda(u) = \int_{\partial^* u} \tau^\lambda(\mathbf{n}_x^u) d\mathcal{H}^{d-1}(x)$$

lorsque $u \in \text{BV}$, où BV est l'ensemble des fonctions $u : [0, 1]^d \rightarrow \{\pm 1\}$ à variation finie. On montre dans le Chapitre 3 que, pour $u \in \text{BV}$ et $\delta > 0$ assez petit, $K \in \mathbb{N}^*$ assez grand puis $N \in \mathbb{N}^*$ assez grand,

$$\frac{1}{N^{d-1}} \log \mu_{\Lambda_{N,\beta}}^{J,+} \left(\frac{\mathcal{M}_K}{m_\beta} \in \mathcal{V}(u, \delta) \right) \simeq -\mathcal{F}^q(u)$$

avec une \mathbb{P} -probabilité qui tend vers 1 lorsque $N \rightarrow \infty$, alors que

$$\frac{1}{N^{d-1}} \log \mathbb{E} \left[\mu_{\Lambda_{N,\beta}}^{J,+} \left(\frac{\mathcal{M}_K}{m_\beta} \in \mathcal{V}(u, \delta) \right) \right]^\lambda \simeq -\mathcal{F}^\lambda(u).$$

Comme dans la Section 1.2.3, cela indique que la coexistence de phases n'a pas lieu naturellement dans le modèle d'Ising dilué. On imposera donc une contrainte de volume pour forcer la coexistence. De tous les profils de volume donné, le modèle d'Ising choisira le moins improbable, c'est-à-dire celui de coût minimal. Cela nous conduit au problème isopérimétrique suivant : quel est le minimum de $\mathcal{F}^q(u)$ (ou de $\mathcal{F}^\lambda(u)$) pour $u = \chi_U \in \text{BV}$, avec $\mathcal{L}^d(U) = v$?

Au début du vingtième siècle, Wulff [81] a remarqué que, étant donné la tension superficielle τ , la forme qui minimise l'intégrale de τ sur son bord, sous la contrainte de volume 1, est

$$\mathcal{W} = \gamma \{x \in \mathbb{R}^d : x \cdot \mathbf{n} \leq \tau(\mathbf{n})\} \quad (9)$$

avec $\gamma \in (0, \infty)$ fixé de façon à avoir $\mathcal{L}^d(\mathcal{W}) = 1$. La preuve de l'optimalité de cette forme peut se faire en utilisant l'inégalité de Brunn-Minkowski, voir [76], [37] et [38]. Dans le problème que nous considérons, il y a une contrainte supplémentaire : l'interface est *confinée* au cube $[0, 1]^d$. L'optimalité du cristal de Wulff nous indique que, pour $z \in \mathbb{R}^d$ et $\alpha \in (0, \infty)$ tel que $\alpha^d = v$, le profil

$$u = \chi_{z+\alpha\mathcal{W}}$$

minimise \mathcal{F} parmi les profils satisfaisant la condition de volume. Ce profil satisfait également la contrainte du confinement au cube si $\alpha \text{diam}_\infty(\mathcal{W}) \leq 1$ et si

$$z \in \mathcal{T}_\alpha = \left[\frac{\alpha}{2} \text{diam}_\infty(\mathcal{W}), 1 - \frac{\alpha}{2} \text{diam}_\infty(\mathcal{W}) \right]^d.$$

Ces faits géométriques permettent, dans un premier temps, de déterminer le coût de la contrainte de volume sous les mesures quenched et annealed. Si \mathcal{W}^q et \mathcal{W}^λ sont les cristaux de Wulff, de volume 1, qui correspondent à τ^q et τ^λ respectivement, comme en (9), et si \mathcal{N}_I est l'ensemble des températures inverses défini au Corollaire 7, on a :

THÉORÈME 9. Soit $\beta > \hat{\beta}_c$ tel que $\beta \notin \mathcal{N}$. Alors, pour tout $0 \leq \alpha < 1/\text{diam}_\infty(\mathcal{W}^q)$,

$$\frac{1}{N^{d-1}} \log \mu_{\Lambda_N}^{J,+} \left(\frac{m_{\Lambda_N}}{m_\beta} \leq 1 - 2\alpha^d \right) \xrightarrow{N \rightarrow \infty} -\mathcal{F}^q(\alpha \mathcal{W}^q)$$

en \mathbb{P} -probabilité (et même \mathbb{P} -presque sûrement si $\beta \notin \mathcal{N}_I$). De même, pour tout $\lambda > 0$ et $0 \leq \alpha < 1/\text{diam}_\infty(\mathcal{W}^\lambda)$,

$$\frac{1}{N^{d-1}} \log \mathbb{E} \left[\left(\mu_{\Lambda_N}^{J,+} \left(\frac{m_{\Lambda_N}}{m_\beta} \leq 1 - 2\alpha^d \right) \right)^\lambda \right] \xrightarrow{N \rightarrow \infty} -\mathcal{F}^\lambda(\alpha \mathcal{W}^\lambda).$$

Formulons maintenant le Théorème qui décrit la coexistence au sens L^1 dans le modèle d'Ising dilué :

THÉORÈME 10. Soit $\beta > \hat{\beta}_c$ tel que $\beta \notin \mathcal{N}$. Pour tout $0 \leq \alpha < 1/\text{diam}_\infty(\mathcal{W}^q)$ et $\varepsilon > 0$, pour K assez grand on a

$$\lim_{N \rightarrow \infty} \mu_{\Lambda_N}^{J,+} \left(\frac{\mathcal{M}_K}{m_\beta} \in \bigcup_{z \in \mathcal{T}_\alpha^q} \mathcal{V}(\chi_{z+\alpha \mathcal{W}^q}, \varepsilon) \mid \frac{m_{\Lambda_N}}{m_\beta} \leq 1 - 2\alpha^d \right) = 1$$

en \mathbb{P} -probabilité (\mathbb{P} -presque sûrement si $\beta \notin \mathcal{N}_I$). De même, pour tout $0 \leq \alpha < 1/\text{diam}_\infty(\mathcal{W}^{\lambda=1})$ et $\varepsilon > 0$, pour K assez grand :

$$\lim_{N \rightarrow \infty} \left(\mathbb{E} \mu_{\Lambda_N}^{J,+} \right) \left(\frac{\mathcal{M}_K}{m_\beta} \in \bigcup_{z \in \mathcal{T}_\alpha^\lambda} \mathcal{V}(\chi_{z+\alpha \mathcal{W}^{\lambda=1}}, \varepsilon) \mid \frac{m_{\Lambda_N}}{m_\beta} \leq 1 - 2\alpha^d \right) = 1.$$

Autrement dit, sous les mesures conditionnelles ci-dessus, la zone de phase moins a la forme d'un cristal de Wulff de volume approprié.

3.3.3. *Influence du milieu aléatoire.* Lorsqu'on impose la coexistence de phases sous la mesure quenched, la configuration des spins doit s'adapter au milieu. Cela a pour conséquence que la tension superficielle, lorsque la température tend vers 0, est déterminée par le flux maximal associé au milieu aléatoire. Il s'ensuit (Chapitre 2, Section 3) que \mathcal{W}^q tend vers le cristal de Wulff correspondant au flux maximal de \mathbb{P} , lorsque $\beta \rightarrow +\infty$ et moyennant l'hypothèse $\mathbb{P}(J_e > 0) = 1$.

À l'opposé, sous la mesure annealed (et cela se généralise à $\lambda > 0$), le milieu aléatoire s'adapte lui aussi à la contrainte de volume pour rendre plus facile la coexistence de phases. En effet, l'inégalité $\tau^\lambda \leq \lambda \tau^q$, et le fait que \mathcal{W}^λ et \mathcal{W}^q aient tous deux un volume égal à 1, impliquent que

$$\mathcal{F}^q(\mathcal{W}^q) \geq \lambda^{-1} \mathcal{F}^\lambda(\mathcal{W}^q) \geq \lambda^{-1} \mathcal{F}^\lambda(\mathcal{W}^\lambda)$$

(l'inégalité est stricte si $\tau^\lambda < \lambda \tau^q$). Nous prouvons enfin que, lorsque $\beta \rightarrow +\infty$, et encore sous l'hypothèse $\mathbb{P}(J_e > 0) = 1$, on a la convergence de \mathcal{W}^λ vers le cube unité.

3.3.4. *Réduire le coût de la coexistence.* Dans la conclusion du Chapitre 3, nous détaillons une conséquence de la seconde partie du Théorème 9 : on peut caractériser en fonction de \mathcal{F}^λ et de \mathcal{W}^λ le coût de réduire le coût de la contrainte de volume. Précisément, posons

$$\mathcal{J}(f) = \sup_{\lambda > 0} \{ \mathcal{F}^\lambda(\mathcal{W}^\lambda) - \lambda f \} \in [0, \infty]$$

pour tout $f \in \mathbb{R}$. La fonctionnelle \mathcal{J} est la transformée de Fenchel-Legendre de $\lambda \mapsto \mathcal{F}^\lambda(\mathcal{W}^\lambda)$, tout comme I_n est la transformée de la tension superficielle. Avec des notations évidentes, on a $\mathcal{J} = +\infty$ à gauche de $\mathcal{F}^{\min}(\mathcal{W}^{\min})$, $\mathcal{J} < \infty$ à droite de $\mathcal{F}^{\min}(\mathcal{W}^{\min})$ et $\mathcal{J} = 0$ à droite de $\mathcal{F}^q(\mathcal{W}^q)$, et surtout :

THÉORÈME 11. *Soit $\beta > \hat{\beta}_c$ tel que $\beta \notin \mathcal{N}$. Pour $f \neq \mathcal{F}^{\tau^{\min}}(\mathcal{W}^{\tau^{\min}})$ et $\alpha \geq 0$ petit, on a*

$$\frac{1}{N^{d-1}} \log \mathbb{P} \left(\frac{1}{N^{d-1}} \log \mu_{\Lambda_N}^{J,+} \left(\frac{m_{\Lambda_N}}{m_\beta} \leq 1 - 2\alpha^d \right) \geq -\alpha^{d-1} f \right) \xrightarrow{N \rightarrow \infty} -\alpha^{d-1} \mathcal{J}(f).$$

Autrement dit, le coût de réduire le coût de la coexistence est d'ordre surfacique. Par contre, augmenter le coût de la coexistence au delà de $\mathcal{F}^q(\alpha \mathcal{W}^q)$ requiert l'augmentation de la tension superficielle dans tout le domaine, il s'agit donc d'un événement de coût volumique.

3.4. Dynamique lente. Dans la dernière partie de la thèse, nous nous sommes intéressé à la dynamique de Glauber du modèle d'Ising dilué, notre objectif étant le suivant : donner une preuve rigoureuse de la borne inférieure (4) en utilisant les résultats sur la coexistence de phases établis au Chapitre 3.

Nous avons décrit succinctement la dynamique de Glauber au paragraphe 1.3 et nous nous allons ici donner quelques notations supplémentaires. Étant donné un domaine $\Lambda \subseteq \mathbb{Z}^d$ quelconque, on note (σ_t) le processus de Markov associé à la dynamique de Glauber pour la réalisation J du milieu, la condition au bord plus et l'état initial $\rho \in \Sigma_\Lambda^+$. On note $P_\Lambda^{J,\rho,+}$ la loi de ce processus. À chaque instant $t \geq 0$, σ_t est donc une configuration de Σ_Λ^+ alors que $\sigma_t(x)$ est la valeur du spin en x au temps t . Enfin, on définit le semi-groupe $T_\Lambda^{J,+}$ associé à la dynamique en posant

$$\left(T_\Lambda^{J,+}(t)f \right) (\rho) = E_\Lambda^{J,\rho,+} f(\sigma_t)$$

pour tout $f : \Sigma \rightarrow \mathbb{R}$. La quantité $(T_\Lambda^{J,+}(t)f)(\rho)$ est donc la valeur moyenne de f au temps t , partant de ρ .

Le résultat principal du Chapitre 4 consiste en une borne inférieure *polynomiale* sur l'autocorrélation, définie comme suit :

$$A(t) = \mathbb{E} \int \left| (T_T^J(t)\pi_0)(\rho) - \mu_T^{J,+}(\sigma(0)) \right| d\mu_T^{J,+}(\rho).$$

L'autocorrélation mesure la vitesse de convergence de la valeur moyenne du spin en 0 au temps t vers sa valeur moyenne à l'équilibre, pour des configurations initiales distribuées sous la mesure annealed $\mathbb{P} \times \mu^{J,+}$.

3.4.1. *Borne inférieure sur l'autocorrélation.* Nous avons donné à la Section 2.3.2 un aperçu de l'heuristique conduisant à la borne inférieure sur l'autocorrélation. En utilisant la description de la coexistence de phases faite au Chapitre 3, nous pouvons rendre rigoureuse cette heuristique.

Décrivons pour commencer les conditions initiales que nous considérons. On définit IC comme l'ensemble des (u_0, τ^r) tels que :

- (i) Le profil $u_0 = \chi_{U_0} \in \text{BV}$ a un bord régulier (voir Chapitre 4), U_0 est à distance positive du bord de $[0, 1]^d$ et U_0, U_0^c sont connexes.
- (ii) La tension réduite τ^r est une fonction continue de $[0, 1]^d$ dans \mathbb{R} , et elle vérifie :

$$\tau^{\min}(\mathbf{n}_x^{u_0}) < \tau(x) \leq \tau^q(\mathbf{n}_x^{u_0}), \quad \forall x \in \partial^* u_0.$$

Étant donné une condition initiale $(u_0, \tau^r) \in \text{IC}$, on considère l'énergie superficielle réduite \mathcal{F}^r :

$$\mathcal{F}^r(u) = \int_{\partial^* u_0 \cap \partial^* u} \tau^r(x) d\mathcal{H}^{d-1}(x) + \int_{\partial^* u \setminus \partial^* u_0} \tau^q(\mathbf{n}_x^u) d\mathcal{H}^{d-1}(x)$$

qui tient compte de la réduction de la tension superficielle sur le bord de u_0 (cf. Figure 7).

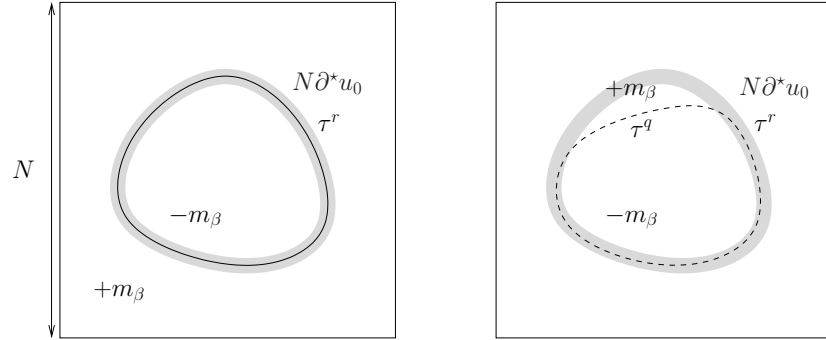

FIG. 7. Configuration initiale : dilution et coexistence de phases

Nous montrons alors que l'aimantation évolue suivant une trajectoire (presque) continue en norme L^1 , et qu'elle doit passer par une forme de coût élevé. En particulier, pour $\varepsilon > 0$ on considérera l'ensemble

$$\mathcal{C}_\varepsilon(u_0) = \left\{ (v_i)_{i=1\dots k} : \begin{array}{l} k \in \mathbb{N}; v_0 = u_0 \text{ et } v_k = \mathbf{1} \\ \forall i, v_i \in \text{BV} \text{ et } \|v_{i+1} - v_i\| \leq \varepsilon \end{array} \right\}$$

et le surcoût discret

$$\mathcal{K}_{\text{disc}}^r(u_0) = \lim_{\varepsilon \rightarrow 0^+} \inf_{v \in \mathcal{C}_\varepsilon(u_0)} \max_i \mathcal{F}^r(v_i) - \mathcal{F}^r(u_0).$$

Nous faisons alors le lien entre le coût de la coexistence à l'équilibre et la dynamique de Glauber, et confirmons la borne heuristique (4) :

THÉORÈME 12. *Soit $\beta > \hat{\beta}_c$ tel que $\beta \notin \mathcal{N} \cup \mathcal{N}_I$. Alors,*

$$\liminf_{t \rightarrow \infty} \frac{\log A(t)}{\log t} \geq - \inf_{(u_0, \tau^r) \in \text{IC}} \frac{\mathcal{I}^r(u_0) + \mathcal{F}^r(u_0)}{\mathcal{K}_{\text{disc}}^r(u_0)} \in [0, \infty]. \quad (10)$$

Rappelons que \mathcal{N} est l'ensemble des $\beta \geq 0$ où il n'y a pas unicité des mesures FK annealed en volume infini, et que \mathcal{N}_I est l'ensemble des $\beta \geq 0$ pour lesquels le coût surfacique de réduire la tension superficielle est nul. Pour des mesures \mathbb{P} usuelles, ces deux ensembles sont au plus dénombrables.

3.4.2. *Géométrie de la relaxation.* Il y a beaucoup à dire sur les questions géométriques associées à cette borne inférieure. Calculer explicitement la borne inférieure semble tout à fait hors de portée, néanmoins il est essentiel de baliser un tant soit peu le terrain.

La première question, bien que pressante, n'est pas facile. Le Théorème 12 ne mentionne aucun contrôle de finitude sur la borne inférieure, il faut donc s'assurer qu'il ne s'agit pas d'un Théorème vide! Pour cela, il faut exhiber au moins une configuration initiale qui conduise à un surcoût strictement positif. Notre réponse a été finalement assez générale :

THÉORÈME 13. *Soit $(u_0, \tau^r) \in \text{IC}$ tel que :*

(i) *Le bord de u_0 est \mathcal{C}^1*

(ii) *Il existe $\varepsilon > 0$ tel que $\tau^r(x) \leq \tau^q(\mathbf{n}_x^{u_0}) - \varepsilon$, pour tout $x \in \partial^* u_0$.*

Alors le surcoût discret $\mathcal{K}_{\text{disc}}^r(u_0)$ associé à (u_0, τ^r) est strictement positif.

Nous avons également étudié le comportement de la borne inférieure (10) à basse température :

PROPOSITION 3.1. *Supposons $0 < \mathbb{P}(J_e = 0) < 1 - p_c(d)$. Alors, il existe $c < \infty$ tel que, pour β assez grand, pour t assez grand,*

$$A(t) \geq t^{-c/\beta}.$$

Par ailleurs, afin de réduire la difficulté du problème géométrique nous avons souhaité passer des évolutions discrètes à des évolutions continues. Soit $\mathcal{E}(u_0)$ l'ensemble des évolutions continues qui se détachent de manière continue du bord de u_0 :

$$\mathcal{E}(u_0) = \left\{ (v_t)_{t \in [0,1]} : \begin{array}{l} \forall t \in [0,1], v_t \in \text{BV}, \\ t \mapsto v_t \text{ est continue pour la norme } L^1 \text{ et} \\ t \mapsto \mathbf{1}_{\partial^* v_t \cap \partial^* u_0} \text{ est continue pour la norme} \\ L^1 \text{ associée à la restriction de } \mathcal{H}^{d-1} \text{ à } \partial^* u_0 \end{array} \right\}.$$

On définit alors une notion continue du surcoût

$$\mathcal{K}^r(u_0) = \inf_{v \in \mathcal{E}(u_0)} \sup_{t \in [0,1]} \mathcal{F}^r(v_t) - \mathcal{F}^r(u_0),$$

et prouvons le théorème suivant :

THÉORÈME 14. *Pour tout $(u_0, \tau^r) \in \text{IC}$, on a*

$$\mathcal{K}_{disc}^r(u_0) = \mathcal{K}^r(u_0).$$

L'information supplémentaire du détachement continu permet de calculer le surcoût dans quelques cas simples, bidimensionnels : celui du cercle et de la tension isotrope, celui du carré et de la tension correspondant au cristal carré.

4. Perspectives

J'espère avoir convaincu le lecteur que les 80 ans du modèle d'Ising et les dizaines de milliers d'articles touchant à ce modèle [57] n'ont pas épuisé les questions essentielles ! Je n'espérais pas pour ma part rencontrer une telle effusion de problèmes physiques, probabilistes et géométriques dans un modèle pourtant si modeste de définition.

La présente thèse a pu répondre à plusieurs interrogations, mais nous avons dû laisser de côté un certain nombre de points à cause de leur difficulté technique. Le premier Chapitre repose sur la conjecture que $\beta_c = \hat{\beta}_c$ comme dans le cas uniforme [13], mais il s'agit de toute évidence d'une question épineuse. Le second Chapitre, par ses très nombreux liens avec l'étude des interfaces et les similarités avec différents modèles de la physique statistique – qu'il s'agisse des polymères dirigés ou des flux maximaux – invite à de nombreux prolongements. Nous souhaiterions notamment compléter notre résultat sur l'inégalité stricte entre la tension superficielle annealed et la tension quenched (actuellement : à basse température, moyennant une hypothèse sur \mathbb{P}) et déterminer les éventuels cas d'égalité. La question des fluctuations transversales de l'interface en milieu aléatoire est probablement aussi difficile que passionnante... tout comme la détermination des asymptotiques exactes de la fonction de taux des déviations inférieures de la tension superficielle.

L'étude de la coexistence de phases est l'un des points où nous avons le sentiment d'avoir, en quelque sorte, atteint l'objectif. Bien entendu, il est toujours possible d'aller plus loin. On pourrait, en l'occurrence, chercher à décrire plus précisément l'allure du milieu aléatoire lorsqu'on impose une réduction du coût de la coexistence et montrer, par exemple, que la tension n'est réduite que sur le bord d'un certain cristal de Wulff.

Concluons sur une direction très prometteuse : la dynamique de Glauber. Nous avons pu mettre en évidence un mécanisme de piégeage des interfaces

par le désordre, qui conduit à une relaxation très lente dans le domaine de coexistence de phases. Nous n'avons à l'évidence pas exploré toutes les conséquences de ce mécanisme. Les répercussions sur le trou spectral, par exemple, semblent prometteuses.

Une application très stimulante des techniques développées dans cette thèse est l'étude du phénomène de catalyse. La présence du milieu aléatoire peut jouer le rôle de catalyseur et favoriser la *nucléation*, i.e. l'apparition de gouttes de phase opposée. Dans la continuité de cette thèse, nous nous intéresserons à la généralisation de l'étude de la métastabilité [75] pour comprendre le rôle du désordre dans les phénomènes de nucléation.

CHAPTER 1

Coarse graining and renormalization

ABSTRACT. By the mean of a multi-scale analysis we describe the typical geometrical structure of the clusters under the FK measure in random media. Our result holds in any dimension $d \geq 2$ provided that slab percolation occurs under the annealed measure, which should be the case in the whole supercritical phase. This work extends the one of Pisztora [73] and provides an essential tool for the analysis of the supercritical regime in disordered FK models and in the corresponding disordered Ising and Potts models.

1.1. Introduction

The introduction of disorder in the Ising model leads to major changes in the behavior of the system. Several types of disorder have been studied, including random field (in that case, the phase transition disappears if and only if the dimension is less or equal to 2 [48, 5, 18]) and random couplings.

In this Chapter our interest goes to the case of random but still *ferromagnetic* and independent couplings. One such model is the *dilute* Ising model in which the interactions between adjacent spins equal β or 0 independently, with respective probabilities p and $1 - p$. The ferromagnetic media randomness is responsible for a new region in the phase diagram: the *Griffiths phase* $p < 1$ and $\beta_c < \beta < \beta_c(p)$. Indeed, on the one hand the phase transition occurs at $\beta_c(p) > \beta_c$ for any $p < 1$ that exceeds the percolation threshold p_c , and does not occur (i.e. $\beta_c(p) = \infty$) if $p \leq p_c$, $\beta_c = \beta_c(1)$ being the critical inverse temperature in absence of dilution [3, 28]. Yet, on the second hand, for any $p < 1$ and $\beta > \beta_c$, the magnetization is a *non-analytic* function of the external field at $h = 0$ [41]. See also the reviews [40, 16].

The *paramagnetic phase* $p \leq 1$ and $\beta < \beta_c$ is well understood as the spin correlations are not larger than in the corresponding undiluted model, and the Glauber dynamics have then a positive spectral gap [63]. The study of the Griffiths phase is already more challenging and other phenomena than the break in the analyticity betray the presence of the Griffiths phase, as the sub-exponential relaxation under the Glauber dynamics [8]. In the present Chapter we focus on the domain of phase transition $p > p_c$ and $\beta > \beta_c(p)$ and on the elaboration of a coarse graining.

A coarse graining consists in a renormalized description of the microscopic spin system. It permits to define precisely the notion of local phase and constitutes therefore a fundamental tool for the study of the phase coexistence phenomenon. In the case of percolation, Ising and Potts models with uniform couplings, such a coarse graining was established by Pisztorá [73] and among the applications stands the study of the L^1 -phase coexistence by Bodineau et al. [12, 14] and Cerf, Pisztorá [23, 25, 26], see also Cerf's lecture notes [24].

In the random media case there are numerous motivations for the construction of a coarse graining. Just as for the uniform case, the coarse graining is a major step towards the L^1 -description of the equilibrium phase coexistence phenomenon under both quenched and annealed measures (done in Chapter 3) – the second important step being the analysis of surface tension and its fluctuations. But our motivations do not stop there as the coarse graining also permits the study of the dynamics of the corresponding systems, which are modified in a definite way by the introduction of media randomness. We confirm in Chapter 4 the prediction of Fisher and Huse [45] that the dilution dramatically slows down the dynamics, proving the expected polynomial decay for the average spin autocorrelation under the Glauber dynamics.

Let us conclude with a few words on the technical aspects of the present work. First, the construction of the coarse graining is done under the random media FK model which constitutes a convenient mathematical framework, while the adaptation of the coarse graining to the Ising and Potts models is straightforward, cf. Section 1.5.5. Second, instead of the assumption of phase transition we require *percolation in slabs* as in [73] (under the annealed measure), yet we believe that the two notions correspond to the same threshold $\beta_c(p)$. At last, there is a major difference between the present work and [73]: on the contrary to the uniform FK measure, the annealed random media FK measure does not satisfy the DLR equation. This ruins all expectancies for a simple adaptation of the original proof, and it was indeed a challenging task to design an alternative proof.

1.2. The model and our results

1.2.1. The random media FK model.

1.2.1.1. *Geometry, configurations sets.* We define the FK model on finite subsets of the standard lattice \mathbb{Z}^d for $d \in \{1, 2, \dots\}$. Domains that often appear in this work include the box $\Lambda_N = \{1, \dots, N-1\}^d$, its symmetric version $\hat{\Lambda}_N = \{-N, \dots, N\}^d$ and the slab $S_{N,H} = \{1, \dots, N-1\}^{d-1} \times \{1, \dots, H-1\}$ for any $N, H \in \mathbb{N}^*$, $d \geq 2$.

Let us consider the norms

$$\|x\|_2 = \left(\sum_{i=1}^d x_i^2 \right)^{1/2} \quad \text{and} \quad \|x\|_\infty = \max_{i=1\dots d} |x_i|, \quad \forall x \in \mathbb{Z}^d$$

and denote $(\mathbf{e}_i)_{i=1\dots d}$ the canonical basis of \mathbb{Z}^d . We say that $x, y \in \mathbb{Z}^d$ are *nearest neighbors* if $\|x - y\|_2 = 1$ and denote this as $x \sim y$. Given any $\Lambda \subset \mathbb{Z}^d$, we define its exterior boundary

$$\partial\Lambda = \{x \in \mathbb{Z}^d \setminus \Lambda : \exists y \in \Lambda, x \sim y\} \quad (1.1)$$

and to Λ we associate the edge sets

$$E^w(\Lambda) = \{\{x, y\} : x \in \Lambda, y \in \mathbb{Z}^d \text{ and } x \sim y\} \quad (1.2)$$

$$\text{and } E^f(\Lambda) = \{\{x, y\} : x, y \in \Lambda \text{ and } x \sim y\}. \quad (1.3)$$

In other words, $E^w(\Lambda)$ is the set of edges that touch Λ while $E^f(\Lambda)$ is the set of edges between two adjacent points of Λ . Note that the set of points attained by $E^w(\Lambda)$ equals, thus, $\Lambda \cup \partial\Lambda$. We also denote $E(\mathbb{Z}^d) = E^w(\mathbb{Z}^d) = E^f(\mathbb{Z}^d)$.

The set of *cluster* configurations and that of *media* configurations are respectively

$$\Omega = \{\omega : E(\mathbb{Z}^d) \rightarrow \{0, 1\}\} \quad \text{and} \quad \mathcal{J} = \{J : E(\mathbb{Z}^d) \rightarrow [0, 1]\}.$$

Given any $E \subset E(\mathbb{Z}^d)$ we denote by $\omega|_E$ (resp. $J|_E$) the restriction of $\omega \in \Omega$ (resp. $J \in \mathcal{J}$) to E , that is the configuration that coincides with ω on E and equals 0 on E^c . We consider then

$$\Omega_E = \{\omega|_E, \omega \in \Omega\} \quad \text{and} \quad \mathcal{J}_E = \{J|_E, J \in \mathcal{J}\}$$

the set of configurations that equal 0 outside E . Given $\omega \in \Omega$, we say that an edge $e \in E(\mathbb{Z}^d)$ is *open* for ω if $\omega_e = 1$, *closed* otherwise. A *cluster* for ω is a connected component of the graph $(\mathbb{Z}^d, \mathcal{O}(\omega))$ where $\mathcal{O}(\omega) \subset E(\mathbb{Z}^d)$ is the set of open edges for ω . At last, given $x, y \in \mathbb{Z}^d$ we say that x and y are connected by ω (and denote it as $x \overset{\omega}{\leftrightarrow} y$) if they belong to the same ω -cluster.

1.2.1.2. FK measure under frozen disorder. We now define the FK measure under *frozen disorder* $J \in \mathcal{J}$ in function of two parameters p and q . The first one $p : [0, 1] \rightarrow [0, 1]$ is an increasing Borel measurable function such that $p(0) = 0$, $p(x) > 0$ if $x > 0$ and $p(1) < 1$, that quantifies the strength of interactions in function of the media. The second one $q \geq 1$ corresponds to the spin multiplicity.

Given $E \subset E(\mathbb{Z}^d)$ finite, $J \in \mathcal{J}$ a realization of the media and $\pi \in \Omega_{E^c}$ a boundary condition, we define the measure $\Phi_E^{J,p,q,\pi}$ by its weight on each $\omega \in \Omega_E$:

$$\Phi_E^{J,p,q,\pi}(\{\omega\}) = \frac{1}{Z_E^{J,p,q,\pi}} \prod_{e \in E} (p(J_e))^{\omega_e} (1 - p(J_e))^{1-\omega_e} \times q^{C_E^\pi(\omega)} \quad (1.4)$$

where $C_E^\pi(\omega)$ is the number of ω -clusters touching E under the configuration $\omega \vee \pi$ defined by

$$(\omega \vee \pi)_e = \begin{cases} \omega_e & \text{if } e \in E \\ \pi_e & \text{else} \end{cases}$$

and $Z_E^{J,p,q,\pi}$ is the partition function

$$Z_E^{J,p,q,\pi} = \sum_{\omega \in \Omega_E} \prod_{e \in E} (p(J_e))^{\omega_e} (1 - p(J_e))^{1-\omega_e} \times q^{C_E^\pi(\omega)}. \quad (1.5)$$

Note that we often use a simpler form for $\Phi_E^{J,p,q,\pi}$: if the parameters p and q are clear from the context, we omit them, and if E is of the form $E^w(\Lambda)$ for some $\Lambda \subset \mathbb{Z}^d$ we simply write $\Phi_\Lambda^{J,\pi}$ instead of $\Phi_{E^w(\Lambda)}^{J,\pi}$. For convenience we use the same notation for the probability measure $\Phi_E^{J,\pi}$ and for its expectation. Let us at last denote f, w the two extremal boundary conditions: $f \in \Omega_{E^c}$ with $f_e = 0, \forall e \in E^c$ is the *free* boundary condition while $w \in \Omega_{E^c}$ with $w_e = 1, \forall e \in E^c$ is the *wired* boundary condition.

When $q = 2$ and $p(J) = 1 - \exp(-2\beta J)$, the measure $\Phi_\Lambda^{J,p,q,w}$ is the random cluster representation of the Ising model with couplings J , and when $q \in \{2, 3, \dots\}$ and $p(J) = 1 - \exp(-\beta J)$ it is the random cluster representation of the q -Potts model with couplings J , see Section 1.5.5 and [66]. Yet, most of the results we present here are independent of this particular form for p .

Let us recall the most important properties of the FK measure $\Phi_E^{J,\pi}$. Given $\omega, \omega' \in \Omega$ we write $\omega \leq \omega'$ if and only if $\omega_e \leq \omega'_e, \forall e \in E(\mathbb{Z}^d)$. A function $f : \Omega \rightarrow \mathbb{R}$ is said increasing if for any $\omega, \omega' \in \Omega$ we have $\omega \leq \omega' \Rightarrow f(\omega) \leq f(\omega')$. For any finite $E \subset E(\mathbb{Z}^d)$, for any $J \in \mathcal{J}$, $\pi \in \Omega_{E^c}$, the following holds:

The DLR equation: For any function $h : \Omega \rightarrow \mathbb{R}$, any $E' \subset E$,

$$\Phi_E^{J,\pi}(h(\omega)) = \Phi_E^{J,\pi} \left[\Phi_{E'}^{J,(\omega \vee \pi)|_{(E')^c}} h(\omega|_{(E')^c} \vee \omega') \right] \quad (1.6)$$

where ω' denotes the variable associated to the measure $\Phi_{E'}^{J,(\omega \vee \pi)|_{(E')^c}}$.

The FKG inequality: If $f, g : \Omega \rightarrow \mathbb{R}^+$ are positive increasing functions, then

$$\Phi_E^{J,\pi}(fg) \geq \Phi_E^{J,\pi}(f)\Phi_E^{J,\pi}(g). \quad (1.7)$$

Monotonicity along π and p : If $f : \Omega \rightarrow \mathbb{R}^+$ is a positive increasing function and if $\pi, \pi' \in \Omega_{E^c}$, $p, p' : [0, 1] \rightarrow [0, 1]$ satisfy $\pi \leq \pi'$ and $p(J_e) \leq p'(J_e)$ for all $e \in E$, then

$$\Phi_E^{J,p,q,\pi}(f) \leq \Phi_E^{J,p',q,\pi'}(f). \quad (1.8)$$

Comparison with percolation: If $\tilde{p} = p/(p + q(1 - p))$, for any positive increasing function $f : \Omega \rightarrow \mathbb{R}^+$ we have

$$\Phi_E^{J,\tilde{p},1,f}(f) \leq \Phi_E^{J,p,q,\pi}(f) \leq \Phi_E^{J,p,1,f}(f). \quad (1.9)$$

The proofs of these statements can be found in [4] or in the reference book [43] (yet for uniform J). Let us mention that the assumption $q \geq 1$ is fundamental for (1.7).

1.2.1.3. *Random media.* We pass now to the description of the law on the random media. Given a Borel probability distribution ρ on $[0, 1]$, we call \mathbb{P} the product measure on $J \in \mathcal{J}$ that makes the J_e i.i.d. variables with marginal law ρ , and denote \mathbb{E} the expectation associated to \mathbb{P} . We also denote \mathcal{B}_E the σ -algebra generated by $J|_E$, for any $E \subset E(\mathbb{Z}^d)$.

We now turn towards the properties of $\Phi_E^{J,\pi}$ as a function of J . Given $E, E' \subset E(\mathbb{Z}^d)$ with E finite and a function $h : \mathcal{J} \times \Omega \rightarrow \mathbb{R}^+$ such that $h(\cdot, \omega)$ is $\mathcal{B}_{E'}$ -measurable for each $\omega \in \Omega_E$, the following holds:

Measurability: The function $J \rightarrow \Phi_E^{J,\pi}(\{\omega_0\})$ is \mathcal{B}_E -measurable while

$$J \rightarrow \Phi_E^{J,\pi}(h(J, \omega)) \quad \text{and} \quad J \rightarrow \sup_{\pi \in \Omega_{E^c}} \Phi_E^{J,\pi}(h(J, \omega)) \quad (1.10)$$

are $\mathcal{B}_{E \cup E'}$ -measurable, for all $\omega_0 \in \Omega_E$ and $\pi \in \Omega_{E^c}$.

Worst boundary condition: There exists a $\mathcal{B}_{E \cup E'}$ -measurable function $\tilde{\pi} : \mathcal{J} \mapsto \Omega_{E^c}$ such that for all $J \in \mathcal{J}$,

$$\Phi_E^{J,\tilde{\pi}(J)}(h(J, \omega)) = \sup_{\pi \in \Omega_{E^c}} \Phi_E^{J,\pi}(h(J, \omega)). \quad (1.11)$$

The first point is a consequence of the fact that $\Phi_E^{J,\pi}(\{\omega\})$ is a continuous function of the $p(J_e)$ and of the remark that

$$\Phi_E^{J,\pi}(h(J, \omega)) = \sum_{\omega \in \Omega_E} \Phi_E^{J,\pi}(\{\omega\}) h(J, \omega).$$

For proving the existence of $\tilde{\pi}$ in (1.11) we partition the set of possible boundary conditions Ω_{E^c} into finitely many classes according to the equivalence relation

$$\pi \sim \pi' \Leftrightarrow \forall \omega \in \Omega_E, C_E^\pi(\omega) = C_E^{\pi'}(\omega).$$

A geometrical interpretation for this condition is the following: π and π' are equivalent if they partition the interior boundary of the set of vertexes of E in the same way. Consider now $\pi_1, \pi_2, \dots, \pi_n \in \Omega_{E^c}$ in each of the n classes and define:

$$k(J) = \inf \left\{ k \in \{1, \dots, n\} : \Phi_E^{J,\pi_k}(h(J, \omega)) = \sup_{\pi \in \Omega_{E^c}} \Phi_E^{J,\pi}(h(J, \omega)) \right\},$$

it is a finite, $\mathcal{B}_{E \cup E'}$ -measurable function and $\tilde{\pi} = \pi_{k(J)}$ is a solution to (1.11).

1.2.1.4. *Quenched, annealed and worst-annealed measures.* A consequence of (1.10) is that one can consider the behavior of $\Phi_E^{J,\pi}$ under \mathbb{P} . The *quenched* random media FK measure corresponds to a study of the typical behavior of $\Phi_E^{J,\pi}$ under \mathbb{P} , while the *annealed* random media FK measure is $\mathbb{E}\Phi_E^{J,\pi}$. In view

of Markov's inequality the *worst annealed measure* constitutes a convenient way of controlling both the \mathbb{P} and the $\sup_{\pi} \Phi_E^{J,\pi}$ -probabilities of *rare events* (yet it is not a measure): for any $\mathcal{A} \subset \Omega_E$ and $C > 0$,

$$\begin{aligned} \mathbb{E} \sup_{\pi \in \Omega_E^c} \Phi_E^{J,\pi}(\mathcal{A}) \leq \exp(-2C) &\Rightarrow \mathbb{P} \left(\sup_{\pi \in \Omega_E^c} \Phi_E^{J,\pi}(\mathcal{A}) \geq \exp(-C) \right) \leq \exp(-C) \\ &\Rightarrow \mathbb{E} \sup_{\pi \in \Omega_E^c} \Phi_E^{J,\pi}(\mathcal{A}) \leq 2 \exp(-C). \end{aligned} \quad (1.12)$$

1.2.1.5. *Absence of DLR equation for the annealed measure.* It is well known that the annealed law of Markov chains in random media is not Markov. In our setting, the same occurs for the annealed FK measure, which does not satisfy the DLR equation. We present here a simple counterexample. Consider $\rho = \lambda \delta_1 + (1 - \lambda) \delta_0$ for $\lambda \in (0, 1)$, $q > 1$ and $p(J_e) = p J_e$ with $p \in (0, 1)$. Let $E = \{e, f\}$ where $e = \{x, y\}$ and $f = \{y, z\}$ with $z \neq x$ and π a boundary condition that connects x to z but not to y . Then,

$$\begin{aligned} \mathbb{E} \Phi_E^\pi(\omega_e = 1 \text{ and } \omega_f = 1) &= \lambda^2 p \hat{p} \\ \mathbb{E} \Phi_E^\pi(\omega_e = 0 \text{ and } \omega_f = 1) &= \lambda^2 (1 - p) \hat{p} + (1 - \lambda) \lambda \tilde{p} \end{aligned}$$

where

$$\tilde{p} = \frac{p}{1 + (1 - p)(q - 1)} \quad \text{and} \quad \hat{p} = \frac{p}{1 + (1 - p)^2(q - 1)}$$

and it follows that the conditional expectation of ω_e knowing $\omega_f = 1$ equals

$$(\mathbb{E} \Phi_E^\pi)(\omega_e | \omega_f = 1) = \frac{\lambda p}{\lambda + (1 - \lambda) \tilde{p} / \hat{p}} > \lambda p$$

since $\tilde{p} < \hat{p}$. As $\mathbb{E} \sup_{\pi'} \Phi_{\{e\}}^{\pi'}(\omega_e) = \mathbb{E} \Phi_{\{e\}}^w(\omega_e) = \lambda p$ we have proved that the conditional measure strictly dominates any random FK measure on $\{e\}$ with the same parameters, hence the DLR equation cannot hold.

1.2.2. Slab percolation. The regime of *percolation* under the annealed measure is characterized by

$$\lim_{N \rightarrow \infty} \mathbb{E} \Phi_{\hat{\Lambda}_N}^{J,f} \left(0 \stackrel{\omega}{\leftrightarrow} \partial \hat{\Lambda}_N \right) > 0 \quad (\mathbf{P})$$

yet we could not elaborate a coarse graining under the only assumption of percolation. As in [73] our work relies on the stronger requirement of *slab percolation* under the annealed measure, that is:

$$\begin{aligned} \exists H \in \mathbb{N}^*, \quad \inf_{N \in \mathbb{N}^*} \inf_{x, y \in S_{N,H} \cup \partial S_{N,H}} \mathbb{E} \Phi_{S_{N,H}}^{J,f} \left(x \stackrel{\omega}{\leftrightarrow} y \right) &> 0 \quad (\mathbf{SP}, d \geq 3) \\ \lim_{N \rightarrow \infty} \mathbb{E} \Phi_{S_{N,\kappa(N)}}^{J,f} \left(\exists \text{ an horizontal crossing for } \omega \right) &> 0 \quad (\mathbf{SP}, d = 2) \end{aligned}$$

for some function $\kappa : \mathbb{N}^* \mapsto \mathbb{N}^*$ with $\lim_{N \rightarrow \infty} \kappa(N)/N = 0$, where an *horizontal crossing* for ω means an ω -cluster that connects the two vertical faces of $\partial S_{N,\kappa(N)}$.

The choice of the annealed measure for defining $(\mathbf{SP}, d \geq 3)$ is not arbitrary and one should note that slab percolation does not occur in general under the quenched measure, even for high values of β when $p(J_e) = 1 - \exp(-\beta J_e)$: as soon as $\mathbb{P}(J_e = 0) > 0$, one has

$$\forall H \in \mathbb{N}^*, \lim_{N \rightarrow \infty} \mathbb{P} \left(\inf_{x, y \in S_{N,H} \cup \partial S_{N,H}} \Phi_{S_{N,H}}^{J,f} (x \overset{\omega}{\leftrightarrow} y) = 0 \right) = 1.$$

This fact makes the construction of the coarse graining difficult. Indeed, the annealed measure lacks some mathematical properties with respect to the quenched measure – notably the DLR equation – and this impedes the generalization of Pisztorá's construction [73], while under the quenched measure the assumption of percolation in slabs is not relevant.

Let us discuss the generality of assumption (\mathbf{SP}) . It is remarkable that (\mathbf{SP}) is *equivalent* to the *coarse graining* described by Theorem 1.2.1 (the converse of Theorem 1.2.1 is an easy exercise in view of the renormalization methods developed in Section 1.5.1). Yet, the fundamental question is whether (\mathbf{P}) and (\mathbf{SP}) are equivalent.

In the uniform case, when $d \geq 3$ it has been proved that the thresholds for percolation and slab percolation coincide in the case of percolation ($q = 1$) by Grimmett and Marstrand [44] and for the Ising model ($q = 2$) by Bodineau [13]. It is generally believed that they coincide for all $q \geq 1$. In the two dimensional case with $q = 1$ the threshold for $(\mathbf{SP}, d = 2)$ coincides again with the threshold for percolation p_c as the latter corresponds to the threshold for exponential decay of connectivities in the dual lattice [64, 1].

In the random case the equality of thresholds holds when $q = 1$ as the annealed measure boils down to a simple independent bond percolation process of intensity $\mathbb{E}(p(J_e))$. For larger q we have no clue for a rigorous proof, yet we believe that the equality of thresholds should hold. Following Aizenman et al. [3] who compare the annealed FK measure to two independent bond percolation processes of respective intensities $\mathbb{E}(p(J_e)/(p(J_e) + q(1 - p(J_e))))$ and $\mathbb{E}(p(J_e))$ (see also (1.9)) one obtains bounds on the domain for (\mathbf{SP})

$$\forall d \geq 2, \quad \mathbb{E} \left(\frac{p(J_e)}{p(J_e) + q(1 - p(J_e))} \right) > p_c(d) \Rightarrow (\mathbf{SP}) \Rightarrow \mathbb{E}(p(J_e)) \geq p_c(d)$$

according to the equality of thresholds for (\mathbf{P}) and (\mathbf{SP}) for (non-random) percolation.

1.2.3. Our results. The most striking result we obtain is a generalization of the coarse graining of Pisztorá [73]. Given $\omega \in \Omega_{E^w(\Lambda_N)}$, we say that a cluster \mathcal{C} for ω is a *crossing cluster* if it touches every face of $\partial\Lambda_N$.

THEOREM 1.2.1. *Assumption (SP) implies the existence of $c > 0$ and $\kappa < \infty$ such that, for any $N \in \mathbb{N}^*$ large enough and for all $l \in [\kappa \log N, N]$,*

$$\mathbb{E} \inf_{\pi} \Phi_{\Lambda_N}^{J,\pi} \left(\begin{array}{l} \text{There exists a crossing } \omega\text{-cluster } \mathcal{C}^* \text{ in } \Lambda_N \\ \text{and it is the unique cluster of diameter } \geq l \end{array} \right) \geq 1 - \exp(-cl)$$

where the infimum \inf_{π} is taken over all boundary conditions $\pi \in \Omega_{E(\mathbb{Z}^d) \setminus E^w(\Lambda_N)}$.

This result is completed by the following controls on the density of the main cluster: if

$$\theta^f = \lim_{N \rightarrow \infty} \mathbb{E} \Phi_{\hat{\Lambda}_N}^{J,f} \left(0 \stackrel{\omega}{\leftrightarrow} \partial \hat{\Lambda}_N \right) \quad \text{and} \quad \theta^w = \lim_{N \rightarrow \infty} \mathbb{E} \Phi_{\hat{\Lambda}_N}^{J,w} \left(0 \stackrel{\omega}{\leftrightarrow} \partial \hat{\Lambda}_N \right) \quad (1.13)$$

are the limit probabilities for percolation under the annealed measure with *free* and *wired* boundary conditions, and if we define the density of a cluster in Λ_N as the ratio of its cardinal over $|\Lambda_N|$, we have:

PROPOSITION 1.2.2. *For any $\varepsilon > 0$ and $d \geq 1$,*

$$\limsup_N \frac{1}{N^d} \log \mathbb{E} \sup_{\pi} \Phi_{\Lambda_N}^{J,\pi} \left(\begin{array}{l} \text{Some crossing cluster } \mathcal{C}^* \text{ has} \\ \text{a density larger than } \theta^w + \varepsilon \end{array} \right) < 0 \quad (1.14)$$

while assumption (SP) implies, for any $\varepsilon > 0$ and $d \geq 2$:

$$\limsup_N \frac{1}{N^{d-1}} \log \mathbb{E} \sup_{\pi} \Phi_{\Lambda_N}^{J,\pi} \left(\begin{array}{l} \text{There is no crossing cluster } \mathcal{C}^* \\ \text{of density larger than } \theta^f - \varepsilon \end{array} \right) < 0. \quad (1.15)$$

In other words, the density of the crossing cluster determined by Theorem 1.2.1 lies between θ^f and θ^w . Yet in most cases these two quantities coincide thanks to our last result, which generalizes those of Lebowitz [59] and Grimmett [42]:

THEOREM 1.2.3. *If the interaction equals $p(J_e) = 1 - \exp(-\beta J_e)$, for any Borel probability measure ρ on $[0, 1]$, any $q \geq 1$ and any dimension $d \geq 1$, the set*

$$\mathcal{D}_{\rho,q,d} = \left\{ \beta \geq 0 : \lim_{N \rightarrow \infty} \mathbb{E} \Phi_{\hat{\Lambda}_N}^{J,f} \neq \lim_{N \rightarrow \infty} \mathbb{E} \Phi_{\hat{\Lambda}_N}^{J,w} \right\}$$

is at most countable.

The coarse graining for the FK measure is then adapted to the Ising model with ferromagnetic random interactions, see Theorem 1.5.7.

1.2.4. Overview of the Chapter. A significant part of this Chapter is dedicated to the proof of the coarse graining – Theorem 1.2.1 – under the assumption of slab percolation under the annealed measure (SP, $d \geq 3$). Let us recall that no simple adaptation of the original proof for the uniform media [73] is possible as, on the one hand, the annealed measure does not satisfy the DLR equation while, on the second hand, slab percolation does not occur under the quenched measure.

In Section 1.3 we prove the existence of a crossing cluster in a large box, with large probability under the annealed measure. We provide as well a much finer result: a stochastic comparison between the annealed measure and a product of local annealed measures, that permits to describe some aspects of the structure of (J, ω) under the annealed measure.

In Section 1.4 we complete the difficult part of the coarse graining: we prove the uniqueness of large clusters with large probability. In order to achieve such a result we establish first a *quenched* and *uniform* characterization of $(\mathbf{SP}, d \geq 3)$ that we call (\mathbf{USP}) : for $\varepsilon > 0$ small enough and L large enough, with a \mathbb{P} -probability at least ε for n large enough, each x in the bottom of a slab S of length nL , height $L \log n$ is, with a ϕ_S^J -probability at least ε , either connected to the origin of S , either disconnected from the top of the slab. For proving the (nontrivial) implication $(\mathbf{SP}, d \geq 3) \Rightarrow (\mathbf{USP})$ we describe first the typical structure of (J, ω) under the annealed measure (Section 1.4.1), then we introduce the notion of *first pivotal bond* (Section 1.4.2) that enables to make *recognizable* local modifications for turning bad configurations (in terms of (\mathbf{USP})) into appropriate ones. Finally, in Section 1.4.4 we prove a first version of the coarse graining, while in Section 1.4.5 we give the same conclusion for the two dimensional case using a much simpler argument.

The objective of Section 1.5.1 is to present the adaptation of the renormalization techniques to the random media case. As a first application we state the final form of the coarse graining – Theorem 1.2.1 – and complete it with estimates on the density of the crossing cluster – Proposition 1.2.2. We generalize then the results of [59, 42] on the uniqueness of the infinite volume measure for all except at most countably many values of the parameters – see Theorem 1.2.3. We conclude the Chapter with an adaptation of the coarse graining to the Ising model with ferromagnetic disorder and discuss the structure of the local phase profile in Theorem 1.5.7.

1.3. Existence of a dense cluster

In this Section we concentrate on the proof of existence of a *dense* ω -cluster in a large box. As our proof is based on a multi-scale analysis we begin with a few notations for the decomposition of the domain into L -blocks: given $L \in \mathbb{N}^*$, we say that a domain $\Lambda \subset \mathbb{Z}^d$ is *L -admissible* if it is of the form $\Lambda = \prod_{i=1}^d \{1, \dots, a_i L - 1\}$ with $a_1, \dots, a_d \in \{2, 3, \dots\}$. Such a domain can be decomposed into blocks (and edge blocks) of side-length L as follows: we let

$$\mathring{B}_i^L = \{1, \dots, L - 1\}^d + Li \quad \text{and} \quad B_i^L = \{0, \dots, L\}^d + Li \quad (1.16)$$

and denote

$$\mathring{E}_i^L = E^w \left(\mathring{B}_i^L \right) \quad \text{and} \quad E_i^L = E^f(B_i^L) \cap E^w(\Lambda). \quad (1.17)$$

We recall that $E^f(\Lambda')$ was defined at (1.3), it is the set of *interior edges* of $\Lambda' \subset \mathbb{Z}^d$, in opposition with $E^w(\Lambda')$ defined at (1.2) that includes the edges from Λ' to the exterior. We call at last

$$I_{\Lambda,L} = \left\{ i \in \mathbb{Z}^d : \overset{\circ}{B}_i^L \subset \Lambda \right\}. \quad (1.18)$$

Remark that the $\overset{\circ}{E}_i^L$ are disjoint with $\overset{\circ}{E}_i^L \subset E_i^L$. The edge set E_i^L includes the edges on the faces of B_i^L , which makes E_i^L and E_j^L disjoint if and only if $i, j \in I_{\Lambda,L}$ satisfy $\|i - j\|_2 > 1$. See also Figure 1 for an illustration.

In order to describe the structure of configurations $\omega \in \Omega_{E^w(\Lambda)}$ we say that $(\mathcal{E}_i)_{i \in I_{\Lambda,L}}$ is a *L-connecting family* for Λ if \mathcal{E}_i is $\omega|_{E_i^L}$ -measurable, $\forall i \in I_{\Lambda,L}$ and if it has the following property: given any connected path c_1, \dots, c_n in $I_{\Lambda,L}$, for any $\omega \in \bigcap_{k=1}^n \mathcal{E}_{c_k}$ there exists an ω -cluster in $\bigcup_{k=1}^n E_{c_k}^L$ that connects all faces of all $\overset{\circ}{B}_{c_k}^L$, for $k = 1 \dots n$.

Let us present the main result of this Section:

THEOREM 1.3.1. *Given any $L \in \mathbb{N}^*$ and $\Lambda \subset \mathbb{Z}^d$ a L -admissible domain, there exist a measure Ψ_Λ^L on $\mathcal{J}_{E^w(\Lambda)} \times \Omega_{E^w(\Lambda)}$ and a L -connecting family $(\mathcal{E}_i)_{i \in I_{\Lambda,L}}$ such that*

- (i) *the measure Ψ_Λ^L is stochastically smaller than $\mathbb{E}\Phi_\Lambda^{J,f}$,*
- (ii) *under Ψ_Λ^L , each \mathcal{E}_i is independent of the collection $(\mathcal{E}_j)_{j \in I_{\Lambda,L} : \|j-i\|_2 > 1}$,*
- (iii) *there exists $\rho_L \in [0, 1]$ independent of the choice of Λ such that*

$$\inf_{i \in I_{\Lambda,L}} \Psi_\Lambda^L(\mathcal{E}_i) \geq \rho_L$$

*with furthermore $\rho_L \xrightarrow{L \rightarrow \infty} 1$ if **(SP)**, $d \geq 3$.*

An immediate consequence of this Theorem is that **(SP)**, $d \geq 3$ implies the existence of a crossing cluster in the box Λ_{LN} for $L, N \in \mathbb{N}^*$ large with large probability under the annealed measure $\mathbb{E}\Phi_{\Lambda_{LN}}^{J,f}$, cf. Corollary 1.3.5. Yet, the information provided by Theorem 1.3.1 goes much further than Corollary 1.3.5 and we will see in Section 1.4 that it is also the basis for the proof of the uniform slab percolation criterion **(USP)**.

1.3.1. The measure Ψ_Λ^L . The absence of DLR equation for the annealed random FK measure makes impossible an immediate adaptation of Pisztor's argument for the coarse graining [73]. As an alternative to the DLR equation one can however consider product measures and compare them to the annealed measure.

Assuming that $\Lambda \subset \mathbb{Z}^d$ is a L -admissible domain, we begin with the description of a partition of $E^w(\Lambda) = \bigsqcup_{k=1}^n E_k$. On the one hand, we take all the $\overset{\circ}{E}_i^L$ with $i \in I_{\Lambda,L}$ and then separately all the remaining edges, namely

the lateral edges of the B_i^L (see (1.17) for the definition of \mathring{E}_i^L and Figure 1 for an illustration of the partition). This can be written down as

$$E^w(\Lambda) = \bigsqcup_{k=1}^n E_k = \left(\bigsqcup_{i \in I_{\Lambda,L}} \mathring{E}_i^L \right) \sqcup \left(\bigsqcup_{e \in E_{\text{lat}}^L(\Lambda)} \{e\} \right) \quad (1.19)$$

where $E_{\text{lat}}^L(\Lambda) = E^w(\Lambda) \setminus \bigcup_{i \in I_{\Lambda,L}} \mathring{E}_i^L = \bigcup_{i \in I_{\Lambda,L}} (E_i^L \setminus \mathring{E}_i^L)$. We consider then for Ψ_Λ^L the measure on $\mathcal{J}_{E^w(\Lambda)} \times \Omega_{E^w(\Lambda)}$ defined by

$$\Psi_\Lambda^L(h(J, \omega)) = \left[\bigotimes_{k=1}^n \mathbb{E}_{E_k} \Phi_{E_k}^{J_k, f} \right] (h(J_1 \vee \dots \vee J_n, \omega_1 \vee \dots \vee \omega_n)) \quad (1.20)$$

for any $h : \mathcal{J} \times \Omega \rightarrow \mathbb{R}^+$ such that $h(\cdot, \omega)$ is $\mathcal{B}_{E^w(\Lambda)}$ -measurable for each $\omega \in \Omega_{E^w(\Lambda)}$, where $J_1 \vee \dots \vee J_n \in \mathcal{J}_{E^w(\Lambda)}$ (resp. $\omega_1 \vee \dots \vee \omega_n \in \Omega_{E^w(\Lambda)}$) stands for the configuration which restriction to E_k equals J_k (resp. ω_k).

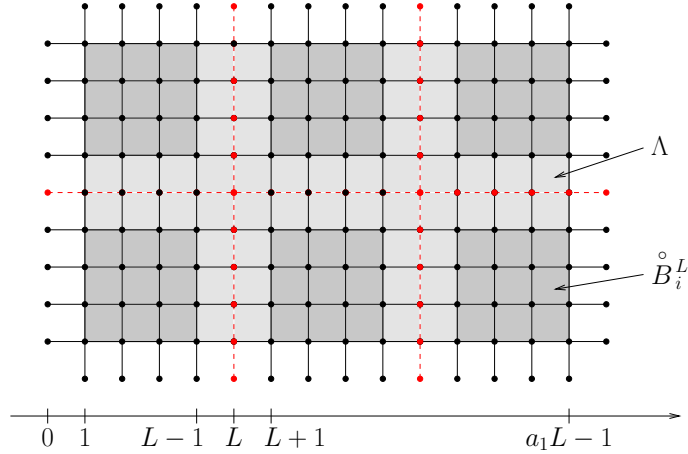

FIGURE 1. $E^w(\Lambda)$ partitioned into the \mathring{E}_i^L and the lateral (dashed) edges.

The first crucial feature of Ψ_Λ^L is its product structure: under Ψ_Λ^L the restriction of (J, ω) to any \mathring{E}_i^L with $i \in I_{\Lambda,L}$ or to $\{e\}$ with $e \in E_{\text{lat}}^L(\Lambda)$ is independent of the rest of the configuration, so that in particular the restriction of ω to E_i^L is independent of its restriction to $\bigcup_{j \in I_{\Lambda,L} : \|j-i\|_2 > 1} E_j^L$, and for any L -connecting family point (ii) of Theorem 1.3.1 is verified.

The second essential property of Ψ_Λ^L is that it is stochastically smaller than the annealed measure on Λ with free boundary condition, namely point (i) of Theorem 1.3.1 is true. This is an immediate consequence of the following Proposition:

PROPOSITION 1.3.2. *Consider a finite edge set E and a partition $(E_i)_{i=1\dots n}$ of E . Assume that $h : \mathcal{J} \times \Omega \rightarrow \mathbb{R}$ is \mathcal{B}_E -measurable in the first variable and that for every J , $h(J, \cdot)$ is an increasing function. If we denote by $(J_i, \omega_i) \in \mathcal{J}_{E_i} \times \Omega_{E_i}$ the variables associated to the measure $\mathbb{E}\Phi_{E_i}^{J_i, f}$ (resp. $\mathbb{E}\Phi_{E_i}^{J_i, w}$), we have:*

$$\mathbb{E}\Phi_E^{J, w} h \leq \left[\bigotimes_{i=1}^n \mathbb{E}_{E_i} \Phi_{E_i}^{J_i, w} \right] (h(J_1 \vee \dots \vee J_n, \omega_1 \vee \dots \vee \omega_n)) \quad (1.21)$$

$$\text{resp. } \mathbb{E}\Phi_E^{J, f} h \geq \left[\bigotimes_{i=1}^n \mathbb{E}_{E_i} \Phi_{E_i}^{J_i, f} \right] (h(J_1 \vee \dots \vee J_n, \omega_1 \vee \dots \vee \omega_n)). \quad (1.22)$$

PROOF. We focus on the proof of the second inequality since both proofs are similar. We begin with the case $n = 2$. Applying twice the DLR equation (1.6) for Φ we get, for any $J \in \mathcal{J}$:

$$\Phi_E^{J, f} (h(J, \omega)) = \Phi_E^{J, f} \left[\Phi_{E_1}^{J, \omega|_{E_2}} \left[\Phi_{E_2}^{J, \omega_1} (h(J, \omega_1 \vee \omega_2)) \right] \right]$$

where ω is the variable for $\Phi_E^{J, f}$, ω_1 that for $\Phi_{E_1}^{J, \omega|_{E_2}}$ and ω_2 that for $\Phi_{E_2}^{J, \omega_1}$. Since $h(J, \omega_1 \vee \omega_2)$ is an increasing function of ω_1 and ω_2 , it is enough to use the monotonicity (1.8) of $\Phi_E^{J, \pi}$ along π to conclude that

$$\Phi_E^{J, f} (h(J, \omega)) \geq \Phi_{E_1}^{J, f} \left[\Phi_{E_2}^{J, f} (h(J, \omega_1 \vee \omega_2)) \right].$$

The same question on the J -variable is trivial since \mathbb{P} is a product measure, namely if J, J_1, J_2 are the variables corresponding to $\mathbb{E}_E, \mathbb{E}_{E_1}$ and \mathbb{E}_{E_2} :

$$\mathbb{E}_E \Phi_E^{J, f} (h(J, \omega)) \geq \mathbb{E}_{E_1} \mathbb{E}_{E_2} \Phi_{E_1}^{J_1, f} \left[\Phi_{E_2}^{J_2, f} (h(J_1 \vee J_2, \omega_1 \vee \omega_2)) \right].$$

It is clear that \mathbb{E}_{E_2} and $\Phi_{E_1}^{J_1, f}$ commute, and that $\mathbb{E}_{E_1} \Phi_{E_1}^{J_1, f}$ and $\mathbb{E}_{E_2} \Phi_{E_2}^{J_2, f}$ also commute, hence the claim is proved for $n = 2$. We end the proof with the induction step, assuming that (1.22) holds for n and that E is partitioned into $(E_i)_{i=1\dots n+1}$. Applying the inductive hypothesis at rank 2 to E_1 and $E'_2 = \cup_{i \geq 2} E_i$ we prove that $\mathbb{E}\Phi_E^{J, f} h(J, \omega) \geq \mathbb{E}_{E_1} \Phi_{E_1}^{J_1, f} \mathbb{E}_{E'_2} \Phi_{E'_2}^{J'_2, f} h(J_1 \vee J'_2, \omega_1 \vee \omega'_2)$. Remarking that for any fixed (J_1, ω_1) the function $(J, \omega) \in \mathcal{J} \times \Omega \mapsto h(J_1 \vee J|_{E'_2}, \omega_1 \vee \omega)$ is $\mathcal{B}_{E'_2}$ -measurable in J and increases with ω we can apply the inductive hypothesis at rank n in order to expand further on J'_2 and ω'_2 and the proof is over. \square

1.3.2. The L -connecting family $\mathcal{E}_i^{L, H}$. The second step towards the proof of Theorem 1.3.1 is the construction of a L -connecting family. The faces of the blocks B_i^L play an important role hence we continue with some more notations. Remark that $(\kappa, \varepsilon) \in \{1, \dots, d\} \times \{0, 1\}$ indexes conveniently the $2d$ faces of B_i^L if to (κ, ε) we associate the face $Li + L\varepsilon\mathbf{e}_\kappa + \mathcal{F}_\kappa^L$ where

$$\mathcal{F}_\kappa^L = \{0, \dots, L\}^d \cap \{x \cdot \mathbf{e}_\kappa = 0\}. \quad (1.23)$$

We decompose then each of these faces into smaller $d - 1$ dimensional hypercubes and let

$$\mathcal{H}_\kappa^{L,H} = \left\{ j \in \mathbb{Z}^d : \begin{array}{l} j \cdot \mathbf{e}_\kappa = 0 \text{ and } \forall k \in \{1, \dots, d\} \setminus \{\kappa\}, \\ L/(3H) \leq j \cdot \mathbf{e}_k \leq 2L/(3H) - 1 \end{array} \right\} \quad (1.24)$$

and for any $j \in \mathcal{H}_\kappa^{L,H}$ we denote

$$F_{i,\kappa,\varepsilon,j}^{L,H} = Li + L\varepsilon\mathbf{e}_\kappa + Hj + \mathcal{F}_\kappa^{H-1} \quad (1.25)$$

so that $F_{i,\kappa,\varepsilon,j}^{L,H}$ is the translated of \mathcal{F}_κ^{H-1} positioned at Hj on the face (κ, ε) of B_i^L , as illustrated on Figure 2.

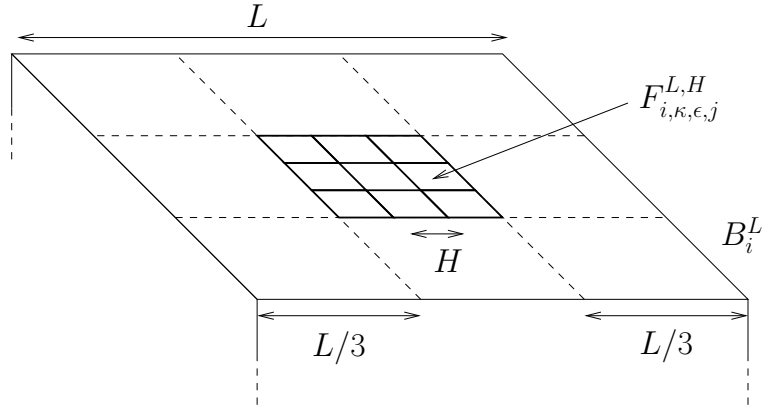

FIGURE 2. The $d - 1$ dimensional facets $F_{i,\kappa,\varepsilon,j}^{L,H}$.

The facets $F_{i,\kappa,\varepsilon,j}^{L,H}$ will play the role of seeds for the L -connecting family. Given $\omega \in \Omega_{E^w(\Lambda)}$ and $i \in I_{\Lambda,L}$, $(\kappa, \varepsilon) \in \{1, \dots, d\} \times \{0, 1\}$ and $j_0 \in \mathcal{H}_\kappa^{L,H}$, we say that $F_{i,\kappa,\varepsilon,j_0}^{L,H}$ is a *seed at scale H* for the face (κ, ε) of B_i^L if j_0 is the smallest index in the lexicographical order among the $j \in \mathcal{H}_\kappa^{L,H}$ such that either $F_{i,\kappa,\varepsilon,j}^{L,H} \cap \Lambda = \emptyset$, either all the edges $e \in E^f(F_{i,\kappa,\varepsilon,j}^{L,H})$ are open for ω (we recall that $E^f(\Lambda')$ is the set of edges between any two adjacent points of $\Lambda' \subset \mathbb{Z}^d$, cf. (1.3))

The first condition is designed to handle the case when the face (κ, ε) of B_i^L is not in Λ (this happens if $\overset{\circ}{B}_i^L$ touches the border of Λ , cf. Figure 1): with our conventions, there always exists a seed in that case and it is the $F_{i,\kappa,\varepsilon,j}^{L,H}$ of smallest index $j \in \mathcal{H}_\kappa^{L,H}$.

Then, we let

$$\mathcal{E}_i^{L,H} = \left\{ \omega \in \Omega_{E^w(\Lambda)} : \begin{array}{l} \text{Each face of } B_i^L \text{ owns a seed and} \\ \text{these are connected under } \omega|_{E_i^L} \end{array} \right\}, \forall i \in I_{\Lambda,L} \quad (1.26)$$

which is clearly a L -connecting family since, on the one hand, $\mathcal{E}_i^{L,H}$ depends on $\omega|_{E_i^L}$ only and, on the second hand, the seed on the face $(\kappa, 1)$ of B_i^L corresponds

by construction to that on the face $(\kappa, 0)$ of $B_{i+\mathbf{e}_\kappa}^L$, for any $i, i+\mathbf{e}_\kappa \in I_{\Lambda, L}$. Hence we are left with the proof of part (iii) of Theorem 1.3.1.

1.3.3. Large probability for \mathcal{E}_i^L under Ψ_Λ^L . In this Section we conclude the proof of Theorem 1.3.1 with an estimate over the Ψ_Λ^L -probability of

$$\mathcal{E}_i^L = \mathcal{E}_i^{L, [\sqrt[d]{\delta \log L}]} \quad (1.27)$$

for $\delta > 0$ small enough, and show as required that $\Psi_\Lambda^L(\mathcal{E}_i^L) \rightarrow 1$ as $L \rightarrow \infty$ assuming **(SP, $d \geq 3$)**, uniformly over Λ and $i \in I_{\Lambda, L}$. Our proof is made of the two Lemmata below: first we prove the existence of seeds with large probability and then we estimate the conditional probability for connecting them.

LEMMA 1.3.3. *Assume that $c = \mathbb{E}\Phi_{\{e\}}^{J,f}(\omega_e) > 0$ and let $\delta < -1/\log c$. Then there exists $(\rho_L)_{L \geq 3}$ with $\lim_{L \rightarrow \infty} \rho_L = 1$ such that, for every L -admissible Λ and every $i \in I_{\Lambda, L}$,*

$$\Psi_\Lambda^L \left(\left\{ \text{Each face of } B_i^L \text{ bears a seed at scale } H_L = [\sqrt[d]{\delta \log L}] \right\} \right) \geq \rho_L.$$

LEMMA 1.3.4. *Assume **(SP, $d \geq 3$)**. Then, there exists $(\rho'_H)_{H \in \mathbb{N}^*}$ with $\rho'_H \rightarrow 1$ as $H \rightarrow \infty$ such that, for any $L \in \mathbb{N}^*$ such that $\mathcal{H}_1^{L,H} \neq \emptyset$, any L -admissible domain $\Lambda \subset \mathbb{Z}^d$ and any $i \in I_{\Lambda, L}$,*

$$\Psi_\Lambda^L \left(\mathcal{E}_i^{L,H} \left| \left\{ \begin{array}{l} \text{Each face of } B_i^L \text{ bears} \\ \text{a seed at scale } H \end{array} \right\} \right. \right) \geq \rho'_H. \quad (1.28)$$

Before proving Lemmata 1.3.3 and 1.3.4 we state an important warning: the fact that $\Psi_\Lambda^L(\mathcal{E}_i^L) \rightarrow 1$ as $L \rightarrow \infty$ does not give any information on the probability of \mathcal{E}_i^L under the original annealed measure $\mathbb{E}\Phi_\Lambda^J$ as \mathcal{E}_i^L is *not* an increasing event !

PROOF. (Lemma 1.3.3). The Ψ_Λ^L -probability for any lateral edge of B_i^L to be open equals c , hence a facet $F_{i,\kappa,\varepsilon,j}^{L,H_L} \subset \Lambda$ is entirely open with a probability

$$c^{(d-1)(H_L-1)H_L^{d-2}} \geq c^{H_L^d}$$

for L large enough. Consequently, the probability that there is a seed at scale H_L on each face of B_i^L is at least

$$\begin{aligned} \rho_L &= 1 - 2d \left(1 - c^{H_L^d} \right)^{\left[\frac{L}{3H_L} - 2 \right]^{d-1}} \\ &\geq 1 - 2d \exp \left(-c^{H_L^d} \times \left[\frac{L}{3H_L} - 2 \right]^{d-1} \right) \end{aligned} \quad (1.29)$$

using the inequality $1 - u \leq \exp(-u)$. We remark at last that for L large,

$$\begin{aligned} \log \left(c^{H_L^d} \times \left[\frac{L}{3H_L} - 2 \right]^{d-1} \right) &\geq H_L^d \log c + (d-1) (\log L - \log(4H_L)) \\ &\geq (1 + \delta \log c) \log L - \log(4H_L) \end{aligned}$$

with $1 + \delta \log c > 0$ thanks to the assumption on δ , hence the term in the exponential in (1.29) goes to $-\infty$ as $L \rightarrow \infty$ and we have proved that $\lim_{L \rightarrow \infty} \rho_L = 1$. \square

PROOF. (Lemma 1.3.4). We fix a realization $\omega_{\text{ext}} \in \Omega_{E^w(\Lambda) \setminus \mathring{E}_i^L}$ such that each face of B_i^L bears a seed under ω_{ext} . Thanks to the product structure of Ψ_Λ^L , the restriction to \mathring{E}_i^L of the conditional measure $\Psi_\Lambda^L(\cdot | \omega = \omega_{\text{ext}})$ equals $\mathbb{E}\Phi_{\mathring{E}_i^L}^{J,f}$, hence the probability for connecting all seeds together is

$$\mathbb{E}\Phi_{\mathring{E}_i^L}^{J,f} \left(\omega \vee \omega_{\text{ext}} \in \mathcal{E}_i^{L,H} \right).$$

We will prove below that with large probability one can connect a seed to the seed in any adjacent face, and this will be enough for concluding the proof. Indeed, denote s_1, \dots, s_{2d} the seeds of ω_{ext} . Thanks to the requirement $a_i \geq 2$ in the definition of L -admissible sets, we can assume that s_1 and s_2 are on adjacent faces, both of them *inside* Λ so that in fact s_1 and s_2 are entirely open for ω_{ext} . If we connect s_1 to each of the seeds s_2, \dots, s_{2d-1} in the adjacent faces of B_i^L , and then in turn connect s_2 to s_{2d} we have connected all seeds together. As a consequence one can take

$$\rho'_H = 1 - (2d-1) \left(1 - \inf_{L: \mathcal{H}_1^{L,H} \neq \emptyset} \rho''_{H,L} \right) \quad (1.30)$$

as a lower bound in (1.28), where $\rho''_{H,L}$ is the least probability under $\mathbb{E}\Phi_{\mathring{E}_i^L}^{J,f}$ for connecting two facets $F_{i,\kappa,\varepsilon,j}^{L,H}$ and $F_{i,\kappa',\varepsilon',j'}^{L,H}$ in adjacent faces of B_i^L .

For the sake of simplicity we let $i = 0$, $(\kappa, \varepsilon) = (1, 0)$ and $(\kappa', \varepsilon') = (2, 0)$. Our objective is to connect any two facets $F_{0,1,0,j}^{L,H}$ and $F_{0,2,0,j'}^{L,H}$ ($j \in \mathcal{H}_1^{L,H}$ and $j' \in \mathcal{H}_2^{L,H}$) with large probability under $\mathbb{E}\Phi_{\mathring{B}_0^L}^{J,f}$, and we achieve this placing slabs in B_0^L . Thanks to assumption **(SP)**, $d \geq 3$) there exist $\alpha > 0$ and $H_s \in \mathbb{N}^*$ such that any two points in $S \cup \partial S$ are connected by ω with probability at least α under $\mathbb{E}\Phi_S^{J,f}$, provided that S is of the form $S = \{1, \dots, N-1\}^{d-1} \times \{1, H_s-1\}$ with $N \in \mathbb{N}$ large enough. We describe now two sequences of slabs of height H_s linking the seeds $F_{0,1,0,j}^{L,H}$ and $F_{0,2,0,j'}^{L,H}$ to each other. Let first, for $l \in \mathbb{N}$ and $\kappa \in \{1, 2\}$:

$$S(l, \kappa) = \{1, \dots, l-1\}^d \cap \{x : 1 \leq x \cdot \mathbf{e}_\kappa \leq H_s - 1\} \quad (1.31)$$

and then

$$U(l, h, \kappa) = S(l, \kappa) + h\mathbf{e}_\kappa + \sum_{k \geq 3} \left\lfloor \frac{L-l}{2} \right\rfloor \mathbf{e}_k \quad (1.32)$$

for $l \in \{1, \dots, L\}$, $h \in \{0, \dots, L - H_s\}$ and $\kappa \in \{1, 2\}$. The slab $U(l, h, \kappa)$ is normal to \mathbf{e}_κ and the \mathbf{e}_κ -coordinates of its points remain in $\{h+1, \dots, h+H_s-1\}$, it is in contact with the face $(\kappa', 0)$ of \mathring{B}_0^L where $\{\kappa'\} = \{1, 2\} \setminus \{\kappa\}$ and it is positioned roughly at the center of \mathring{B}_i^L in every other direction \mathbf{e}_k for $k \geq 3$. We conclude these geometrical definitions letting

$$V_n = U(j \cdot \mathbf{e}_2 H + (n-1)H_s, j' \cdot \mathbf{e}_1 H + (n-1)H_s, 1) \quad (1.33)$$

which are vertical slabs and

$$T_n = U(j' \cdot \mathbf{e}_1 H + nH_s, j \cdot \mathbf{e}_2 H + (n-1)H_s, 2) \quad (1.34)$$

which are horizontal slabs, for any $n \in \{1, \dots, \lceil H/H_s \rceil\}$. As illustrated on Figure 3, for any $n \in \{1, \dots, \lceil H/H_s \rceil\}$, $F_{0,1,0,j}^{L,H}$ is in contact with $E^w(T_n)$ since the largest dimension of the slab is at least $L/3$, while $E^w(V_n)$ touches $F_{0,2,0,j'}^{L,H}$, and by construction $E^w(V_n)$ and $E^w(T_n)$ touch each other. Furthermore the edge sets $E^w(V_n)$ and $E^w(T_n)$ are all disjoint, and all included in $E^w(\mathring{B}_0^L)$. Consider now the product measure

$$\Theta = \bigotimes_{n=1}^{\lceil H/H_s \rceil} \left(\mathbb{E}\Phi_{V_n}^{J,f} \otimes \mathbb{E}\Phi_{T_n}^{J,f} \right). \quad (1.35)$$

Under the measure Θ , the probability that there is a ω -open path in $E^w(V_n) \cup E^w(T_n)$ between the two seeds $F_{0,1,0,j}^{L,H}$ and $F_{0,2,0,j'}^{L,H}$ is at least α^2 thanks to **(SP)**, $d \geq 3$. By independence of the restrictions of ω to the unions of slabs $(E^w(V_n) \cup E^w(T_n))_{n=1 \dots \lceil H/H_s \rceil}$, it follows that the Θ -probability that ω does not connect $F_{0,1,0,j}^{L,H}$ to $F_{0,2,0,j'}^{L,H}$ in $E^w(\mathring{B}_0^L)$ is not larger than $(1 - \alpha^2)^{\lceil H/H_s \rceil}$. Thanks to the stochastic domination $\Theta \leq_{stoch.} \mathbb{E}\Phi_{\mathring{B}_0^L}^{J,f}$ seen in Proposition 1.3.2, the same control holds for the measure $\mathbb{E}\Phi_{\mathring{B}_0^L}^{J,f}$ and we have proved that

$$\rho_{H,L}'' \geq (1 - \alpha^2)^{\lceil H/H_s \rceil}$$

for any L such that $\mathcal{H}_1^{L,H} \neq \emptyset$. In view of (1.30) this yields $\lim_{H \rightarrow \infty} \rho'_H = 1$. \square

1.3.4. Existence of a crossing cluster. An easy consequence of Theorem 1.3.1 is the following:

COROLLARY 1.3.5. *If **(SP)**, $d \geq 3$, for any $L \in \mathbb{N}^*$ large enough one has*

$$\lim_N \mathbb{E}\Phi_{\Lambda_{LN}}^{J,f} (\text{There exists a crossing cluster for } \omega \text{ in } \Lambda_{LN}) = 1.$$

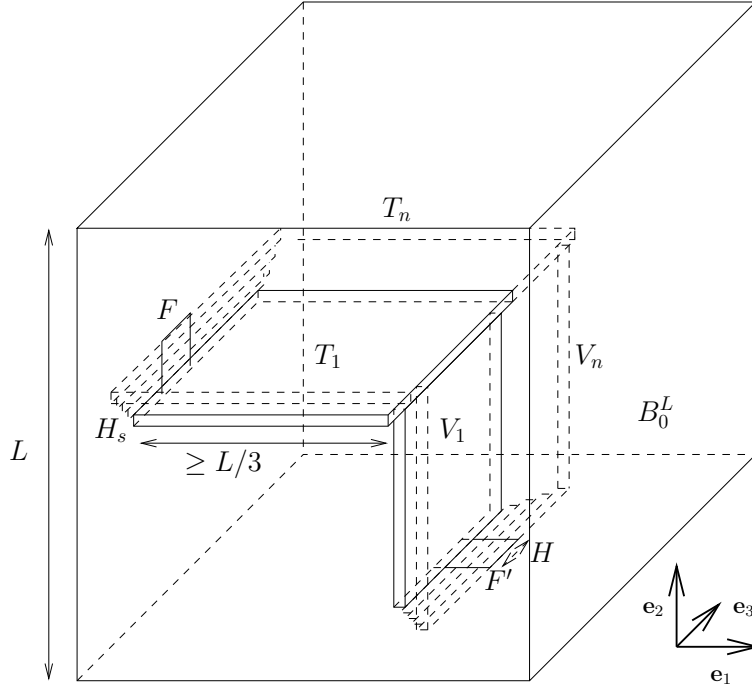
FIGURE 3. The slabs V_n and T_n in the proof of Lemma 1.3.4.

PROOF. The existence of a crossing cluster is an increasing event hence it is enough to prove the estimate under the stochastically smaller measure $\Psi_{\Lambda_{LN}}^L$. Under $\Psi_{\Lambda_{LN}}^L$ the events \mathcal{E}_i^L are only 1-dependent thus for L large enough the collection $(\mathbf{1}_{\{\mathcal{E}_i^L\}})_{i \in I_{\Lambda, L}}$ stochastically dominates a site percolation process with high density [62]. In particular, the coarse graining [73] yields the existence of a crossing cluster for $(\mathbf{1}_{\{\mathcal{E}_i^L\}})_{i \in I_{\Lambda, L}}$ in $I_{\Lambda, L}$ with large probability as $N \rightarrow \infty$, and the latter event implies the existence of a crossing cluster for ω in Λ_{LN} as $(\mathcal{E}_i^L)_{i \in I_{\Lambda, L}}$ is a L -connecting family. \square

1.4. Uniqueness of large clusters

In the previous Section we established Theorem 1.3.1, that gives a first description of the behavior of clusters in a large box. Our present objective is to use that information in order to infer from the slab percolation assumption $(\mathbf{SP}, d \geq 3)$ a uniform slab percolation criterion (\mathbf{USP}) .

Given $L, n \in \mathbb{N}^*$ with $n \geq 3$ we let

$$\Lambda_{n, L}^{\log} = \{1, Ln - 1\}^{d-1} \times \{1, L \lceil \log n \rceil - 1\}, \quad (1.36)$$

call $\text{Bottom}(\Lambda_{n, L}^{\log}) = \{1, \dots, Ln - 1\}^{d-1} \times \{0\}$ and $\text{Top}(\Lambda_{n, L}^{\log}) = \{1, \dots, Ln - 1\}^{d-1} \times \{L \lceil \log n \rceil\}$ the horizontal faces of $\partial \Lambda_{n, L}^{\log}$, consider $o = (1, \dots, 1, 1) \in \mathbb{Z}^d$

a reference point in $\Lambda_{n,L}^{\log}$ and \mathbb{H}^- the discrete half hyperplane

$$\mathbb{H}^- = \{x \in \mathbb{Z}^d : x \cdot \mathbf{e}_d \leq 0\}. \quad (1.37)$$

as well as $E^- = E^f(\mathbb{H}^-)$ the set of edges with all extremities in \mathbb{H}^- . Then, we define **(USP)** as follows:

$$\begin{aligned} & \exists L \in \mathbb{N}^*, \exists \varepsilon > 0 \text{ such that for any } n \text{ large enough,} \\ & \mathbb{P} \left(\begin{array}{l} \forall x \in \text{Bottom}(\Lambda_{n,L}^{\log}), \forall \pi \in \Omega_{E^w(\Lambda_{n,L}^{\log})^c}, \forall \xi \in \Omega_{E^-} : \\ \Phi_{\Lambda_{n,L}^{\log}}^{J,\pi} \left(x \overset{\omega \vee \xi}{\leftrightarrow} o \text{ or } x \overset{\omega \vee \xi}{\leftrightarrow} \text{Top}(\Lambda_{n,L}^{\log}) \right) \geq \varepsilon \end{array} \right) \geq \varepsilon. \end{aligned} \quad (\mathbf{USP})$$

The implication **(SP, $d \geq 3$)** \Rightarrow **(USP)** will be finally proved in Proposition 1.4.7, and its consequence – the uniqueness of large clusters – detailed in Proposition 1.4.9.

1.4.1. Typical structure in slabs of logarithmic height. As a first step towards the proof of the implication **(SP, $d \geq 3$)** \Rightarrow **(USP)** we work on the proof of Proposition 1.4.1 below. We need still a few more definitions. On the one hand, given $\omega \in \Omega$ and $x \in \mathbb{Z}^d$ we say that o and x are doubly connected under ω if there exist two ω -open paths from o to x made of disjoint edges, and consider

$$\mathcal{C}_o^2(\omega) = \{x \in \mathbb{Z}^d : x \text{ is doubly connected to } o \text{ under } \omega\}. \quad (1.38)$$

On the second hand we describe the typical J -structure in order to permit local surgery on ω later on. Given a rectangular parallelepiped $\Lambda \subset \mathbb{Z}^d$ that is L -admissible, we generalize the notation B_i^L defining

$$B_i^{L,n} = (Li + \{-nL + 1, \dots, (n+1)L - 1\}^d) \cap \Lambda \quad (1.39)$$

for $n \in \mathbb{N}$; note that $\mathring{B}_i^L = B_i^{L,0}$ if $i \in I_{\Lambda,L}$ (see (1.18)). Given $J \in \mathcal{J}$ and $e \in E(\mathbb{Z}^d)$, we say that e is J -open if $J_e > 0$. For all $i \in I_{\Lambda,L}$ we denote

$$\mathcal{G}_i^L = \left\{ \begin{array}{l} \text{There exists a unique } J\text{-open cluster in} \\ E^w(B_i^{L,1}) \text{ of diameter larger or equal to } L \\ \text{and } \forall e \in E^w(B_i^{L,3}), J_e = 0 \text{ or } J_e \geq \varepsilon_L \end{array} \right\} \quad (1.40)$$

where $\varepsilon_L > 0$ is a cutoff that satisfies $\mathbb{P}(0 < J_e < \varepsilon_L) \leq e^{-L}$. Given a finite rectangular parallelepiped $R \subset \mathbb{Z}^d$ and $I \subset \mathbb{Z}^d$ we say that I presents an horizontal interface in R if there exists no $*$ -connected path c_1, \dots, c_n (i.e. $\|c_{i+1} - c_i\|_\infty = 1, \forall i = 1 \dots n-1$) in $R \setminus I$ with $c_1 \cdot \mathbf{e}_d = \min_{x \in R} x \cdot \mathbf{e}_d$ and $c_n \cdot \mathbf{e}_d = \max_{x \in R} x \cdot \mathbf{e}_d$. We consider at last the event

$$\mathcal{L} = \left\{ (J, \omega) : \begin{array}{l} \text{There exists an horizontal interface } \mathcal{I} \text{ in} \\ \{0, \dots, n-1\}^{d-1} \times \{1, \dots, \lceil \log n \rceil - 1\} \text{ such} \\ \text{that: } \forall i \in \mathcal{I}, \mathcal{C}_o^2(\omega) \cap B_i^L \neq \emptyset \text{ and } J \in \mathcal{G}_i^L \end{array} \right\} \quad (1.41)$$

and claim:

PROPOSITION 1.4.1. **(SP, $d \geq 3$)** implies the existence of $L \in \mathbb{N}^*$ such that

$$\liminf_{n \rightarrow \infty} \mathbb{E} \inf_{\pi} \Phi_{\Lambda_{n,L}^{\log}}^{J,\pi}(\mathcal{L}) > 0.$$

The proof of this Proposition is not straightforward and we achieve first several intermediary estimates under the product measure $\Psi_{\Lambda_{n,L}^{\log}}^{L/3}$.

1.4.1.1. *Double connections.* The event \mathcal{E}_i^L introduced in the former Section efficiently describes connections between sub-blocks in the domain Λ . However, as it will appear in the proof of Proposition 1.4.7, the information provided by \mathcal{E}_i^L is not enough to be able to proceed to local modifications on ω in a *recognizable* way and this is the motivation for introducing the notion of double connections. Assuming that L is a multiple of 3, that $\Lambda \subset \mathbb{Z}^d$ is a L -admissible domain and that $i \in I_{\Lambda,L}$ we define

$$\mathcal{D}_i^L = \bigcap_{j \in 3i + \{0,1,2\}^d} \mathcal{E}_j^{L/3}. \quad (1.42)$$

Note that \mathcal{D}_i^L depends on ω in E_i^L , a box of side-length L , while the measure $\Psi_{\Lambda}^{L/3}$ associated to the $\mathcal{E}_j^{L/3}$ has a decorrelation length $L/3$.

An immediate consequence of Theorem 1.3.1 is the following fact:

LEMMA 1.4.2. *Assumption **(SP, $d \geq 3$)** implies:*

$$\lim_{L \rightarrow \infty, 3|L} \inf_{\substack{\Lambda \subset \mathbb{Z}^d \text{ } L\text{-admissible} \\ i \in I_{\Lambda,L}}} \Psi_{\Lambda}^{L/3}(\mathcal{D}_i^L) = 1.$$

Moreover, the event \mathcal{D}_i^L depends only on $\omega|_{E_i^L}$. For any $i, j \in I_{\Lambda,L}$ with $\|i - j\|_2 > 1$ the events \mathcal{D}_i^L and \mathcal{D}_j^L are independent under $\Psi_{\Lambda}^{L/3}$.

The relation between \mathcal{D}_i^L and the notion of double connections appears below:

LEMMA 1.4.3. *If (i_1, \dots, i_n) is a path in \mathbb{Z}^d such that $\overset{\circ}{B}_{i_k}^L \subset \Lambda, \forall k = 1 \dots n$ and if $\omega \in \mathcal{D}_{i_1}^L \cap \dots \cap \mathcal{D}_{i_n}^L$, then there exist $x \in B_{i_1}^L$ and $y \in B_{i_n}^L$ and two ω -open paths from x to y in $\bigcup_{k=1}^n E_{i_k}^L$ made of distinct edges.*

This fact is an immediate consequence of the properties of $\mathcal{E}_j^{L/3}$, see Figure 4. Note that the factor 3 in $\mathcal{E}_j^{L/3}$ is necessary as the ω -open clusters described by $\mathcal{E}_j^{L/3}$ can use the edges on the faces of $B_j^{L/3}$.

1.4.1.2. *Local J -structure.* We describe now the typical J -structure with the help of the event \mathcal{G}_i^L (see (1.40)).

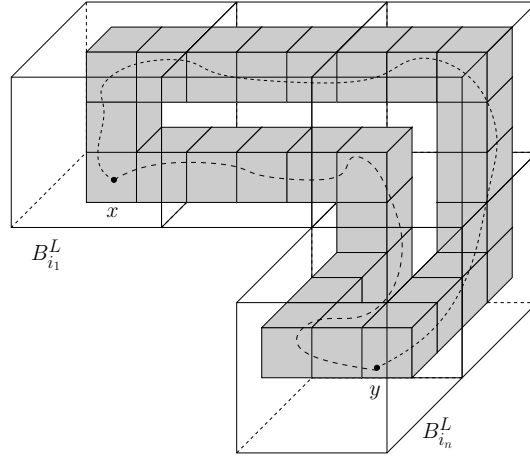

FIGURE 4. A loop made of good $\mathcal{E}^{L/3}$ -blocks in a path of good \mathcal{D}^L -blocks.

LEMMA 1.4.4. *The event \mathcal{G}_i^L depends only on $J_{|E^w(B_i^{L,3})}$, and $(\mathbf{SP}, d \geq 3)$ implies*

$$\lim_{L \rightarrow \infty} \inf_{\substack{\Lambda \subset \mathbb{Z}^d \text{ } L\text{-admissible} \\ i \in I_{\Lambda, L}}} \Psi_{\Lambda}^{L/3}(\mathcal{G}_i^L) = 1.$$

PROOF. The domain of dependence of \mathcal{G}_i^L is trivial. Concerning the estimate on its probability, we remark that the marginal on J of $\Psi_{\Lambda}^{L/3}$ equals \mathbb{P} , while $(\mathbf{SP}, d \geq 3)$ ensures that percolation in slabs holds for the variable $\mathbf{1}_{\{J_e > 0\}}$ under \mathbb{P} . Hence the condition on the structure of the J -open clusters holds with a probability larger than $1 - e^{-cL}$ for some $c > 0$ according to [73]. The condition on the value of J_e also has a very large probability thanks to the choice of ε_L : remark that $|E^w(B_i^{L,3})| \leq d(7L)^d$, hence

$$\mathbb{P}\left(\exists e \in E^w(B_i^{L,3}) : J_e \in (0, \varepsilon_L)\right) \leq d(7L)^d e^{-L}$$

which goes to 0 as $L \rightarrow \infty$. □

1.4.1.3. *Typical structure in logarithmic slabs.* We proceed now with Peierls estimates in order to infer some controls on the global structure of (J, ω) in slabs of logarithmic height. We define

$$\mathcal{T}_i^L = \mathcal{D}_i^L \cap \mathcal{G}_i^L$$

where \mathcal{D}_i^L and \mathcal{G}_i^L are the events defined at (1.42) and (1.40) (see also (1.27) for the definition of \mathcal{E}_i^L). An immediate consequence of Lemmata 1.4.2 and 1.4.4 is that

$$\lim_{L \rightarrow \infty, 3|L} \inf_{\substack{\Lambda \subset \mathbb{Z}^d \text{ } L\text{-admissible} \\ i \in I_{\Lambda, L}}} \Psi_{\Lambda}^{L/3}(\mathcal{T}_i^L) = 1$$

if **(SP, $d \geq 3$)**, together with the independence of \mathcal{T}_i^L and \mathcal{T}_j^L under $\Psi_\Lambda^{L/3}$ if $\|i - j\|_\infty \geq 7$. We recall the notation $\Lambda_{n,L}^{\log} = \{1, Ln - 1\}^{d-1} \times \{1, L\lceil \log n \rceil - 1\}$ (1.36) and claim:

LEMMA 1.4.5. *Assume **(SP, $d \geq 3$)**. For any $\varepsilon > 0$, L large enough multiple of 3,*

$$\liminf_n \Psi_{\Lambda_{n,L}^{\log}}^{L/3} \left(\begin{array}{l} \text{The cluster of } \mathcal{T}_i^L\text{-good blocks issued} \\ \text{from 0 presents an horizontal interface} \\ \text{in } \{0, n - 1\}^d \times \{1, \lceil \log n \rceil - 1\} \end{array} \right) \geq 1 - \varepsilon.$$

Remark that the cluster of \mathcal{T}_i^L -good blocks issued from 0 lives in $\{0, n - 1\}^d \times \{0, \lceil \log n \rceil - 1\}$, hence we require here (as in the definition of \mathcal{L} at (1.41)) that the interface does not use the first layer of blocks. This is done in prevision for the proof of Lemma 1.4.6.

PROOF. The proof is made of two Peierls estimates. A first estimate that we do not expand here permits to prove that some (\mathcal{T}_i^L) -cluster forms an horizontal interface with large probability in the desired region $\{0, \dots, n - 1\}^{d-1} \times \{1, \dots, \lceil \log n \rceil - 1\}$ if L is large enough. The second estimate concerns the probability that there exists a \mathcal{T} -open path from 0 to the top of the region.

If the \mathcal{T} -cluster issued from 0 does not touch the top of the region, there exists a $*$ -connected, self avoiding path of \mathcal{T} -closed sites in the vertical section $\{0, \dots, n - 1\} \times \{0\}^{d-2} \times \{0, \dots, \lceil \log n \rceil - 1\}$ separating 0 from the top of the region. We call this event \mathcal{C} and enumerate the possible paths according to their first coordinate on the left side $h \geq 0$ and their length $l \geq h + 1$: there are not more than 3^l such paths. On the other hand, in any path of length l we can select at least $\lceil l/13^2 \rceil$ positions at $\|\cdot\|_\infty$ -distance at least 7 from any other. As the corresponding \mathcal{T} -events are independent under $\Psi_{\Lambda_{n,L}^{\log}}^{L/3}$,

$$\Psi_{\Lambda_{n,L}^{\log}}^{L/3} (\mathcal{C}) \leq \sum_{h \geq 0} \sum_{l \geq h+1} 3^l (1 - \rho_L)^{\lceil l/13^2 \rceil}$$

where $\rho_L = \inf_{i \in I_{\Lambda,L}} \Psi_\Lambda^{L/3} (\mathcal{T}_i^L)$. This is not larger than $a_L / (1 - a_L)^2$ if $a_L = 3(1 - \rho_L)^{1/13^2} < 1$, and since $\lim_L a_L = 0$ the claim follows. \square

1.4.1.4. *Proof of Proposition 1.4.1.* We conclude these intermediary estimates with the proof of Proposition 1.4.1.

PROOF. (Proposition 1.4.1). As the event \mathcal{L} is increasing in ω , thanks to Proposition 1.3.2 it is enough to estimate its probability under the product

measure $\Psi_{\Lambda_{n,L}^{\log}}^{L/3}$. We consider the following events on (J, ω) :

$$A = \left\{ \begin{array}{l} (J, \omega): \text{ there exists a modification of } (J, \omega) \text{ on } E^w(\mathring{B}_0^L) \\ \text{ such that the } \mathcal{T}\text{-cluster issued from } 0 \text{ forms an} \\ \text{ horizontal interface in } \{0, \dots, n-1\}^{d-1} \times \{1, \dots, \lceil \log n \rceil - 1\} \end{array} \right\}$$

$$B = \left\{ \forall e \in E^w(\mathring{B}_0^L), J_e \geq \varepsilon_L \text{ and } \omega_e = 1 \right\}.$$

By a modification of (J, ω) on $E^w(\mathring{B}_0^L)$ we mean a configuration $(J', \omega') \in \mathcal{J} \times \Omega$ that coincides with (J, ω) outside $E^w(\mathring{B}_0^L)$. Clearly, the event A does not depend on $(J, \omega)|_{E^w(\mathring{B}_0^L)}$, whereas B depends uniquely on $(J, \omega)|_{E^w(\mathring{B}_0^L)}$. According to the product structure of $\Psi_{\Lambda_{n,L}^{\log}}^{L/3}$, we have

$$\Psi_{\Lambda_{n,L}^{\log}}^{L/3}(A \cap B) = \Psi_{\Lambda_{n,L}^{\log}}^{L/3}(A) \times \Psi_{\mathring{B}_0^L}^{L/3}(B).$$

In view of Lemma 1.4.5, $\liminf_n \Psi_{\Lambda_{n,L}^{\log}}^{L/3}(A) \geq 1/2$ for L large enough multiple of 3, whereas $\Psi_{\mathring{B}_0^L}^{L/3}(B) > 0$ for any L large enough (we just need $\mathbb{P}(J_e \geq \varepsilon_L) \geq \mathbb{P}(J_e > 0) - e^{-L} > 0$). This proves that $\liminf_n \Psi_{\Lambda_{n,L}^{\log}}^{L/3}(A \cap B) > 0$ for L large enough. We prove at last that $A \cap B$ is a subset of \mathcal{L} and consider $(J, \omega) \in A \cap B$. From the definition of A we know that there exists a modification (J', ω') of (J, ω) on $E^w(\mathring{B}_0^L)$ such that the \mathcal{T} -cluster for (J', ω') issued from 0 forms an horizontal interface in $\{0, \dots, n-1\}^{d-1} \times \{1, \dots, \lceil \log n \rceil - 1\}$. Let us call \mathcal{C} that \mathcal{T} -cluster and

$$\mathcal{I} = \mathcal{C} \cap \{0, \dots, n-1\}^{d-1} \times \{1, \dots, \lceil \log n \rceil - 1\}.$$

From its definition it is clear that \mathcal{I} contains an horizontal interface in $\{0, \dots, n-1\}^{d-1} \times \{1, \dots, \lceil \log n \rceil - 1\}$; we must check now that $\forall i \in \mathcal{I}, \mathcal{C}_o^2(\omega) \cap B_i^L \neq \emptyset$ and $J \in \mathcal{G}_i^L$. We begin with the proof that $\mathcal{C}_o^2(\omega) \cap B_i^L \neq \emptyset$, for every $i \in \mathcal{I}$: since $i \in \mathcal{C}$, Lemma 1.4.3 tells us that there exist $x \in \mathring{B}_0^L$ and $y \in \mathring{B}_i^L$ which are doubly connected under ω' . Since the corresponding paths enter at distinct positions in $E^w(\mathring{B}_0^L)$, y is also doubly connected to o under ω which has all edges open in $E^w(\mathring{B}_0^L)$. As for the J -structure, for every $i \in \mathcal{I}$ we have $(J', \omega') \in \mathcal{T}_i^L$, hence $J' \in \mathcal{G}_i^L$ and $J \in \mathcal{G}_i^L$ for every $i \in \mathcal{I}$ such that $\mathring{B}_0^L \cap B_i^{L,1} = \emptyset$. We conclude with the remark that the replacement of J' by J in $E^w(\mathring{B}_0^L)$ just enlarges an already large J' -cluster (no new large cluster is created, hence $J' \in \mathcal{G}_i^L \Rightarrow J \in \mathcal{G}_i^L$): the inclusion $(J', \omega') \in \mathcal{T}_0^L$ implies the existence of a ω' -open path of length L in $E^w(\mathring{B}_0^L)$, and this path is necessarily also J' -open, hence $J \in \mathcal{G}_i^L$ for all $i \in \mathcal{I}$ such that $\mathring{B}_0^L \cap B_i^{L,1} \neq \emptyset$, and this ends the proof that $A \cap B$ is a subset of \mathcal{L} . \square

1.4.2. First pivotal bond and local modifications. We introduce here the notion of first pivotal bond: given a configuration $\omega \in \Omega$, we call $\mathcal{C}_x^2(\omega)$

the set of points doubly connected to x under ω . Given $e \in E(\mathbb{Z}^d)$ we say that e is a *pivotal bond* between x and y under ω if $x \overset{\omega}{\leftrightarrow} y$ in ω and $x \overset{\omega_{|\{e\}^c}}{\not\leftrightarrow} y$. At last we say that e is the *first pivotal bond* from x to y under ω if it is a pivotal bond between x and y under ω and if it touches $\mathcal{C}_x^2(\omega)$.

There does not always exist a first pivotal bond between two connected points: it requires in particular the existence of a pivotal bond between these two points. When a first pivotal bond from x to y exists, it is unique. Indeed, assume by contradiction that $e \neq e'$ are pivotal bonds under ω between x and y and that both of them touch $\mathcal{C}_x^2(\omega)$. If c is an ω -open path from x to y , it must contain both e and e' . Assume that c passes through e before passing through e' , then removing e in ω we do not disconnect x from y since e' touches $\mathcal{C}_x^2(\omega) \supset \mathcal{C}_x(\omega_{|\{e\}^c})$, and this contradicts the assumption that e is a pivotal bond.

In the following geometrical Lemma we relate the event \mathcal{L} defined at (1.41) to the notion of first pivotal bond. We recall the notations $\text{Bottom}(\Lambda_{n,L}^{\log}) = \{1, \dots, Ln - 1\}^{d-1} \times \{0\}$ and $\text{Top}(\Lambda_{n,L}^{\log}) = \{1, \dots, Ln - 1\}^{d-1} \times \{L[\log n]\}$, as well as E^- for the set of edges in the discrete half hyperplane \mathbb{H}^- (see (1.37)). We say that $\omega \in \Omega_E$ is compatible with $J \in \mathcal{J}_E$ if, for every $e \in E$, $J_e = 0 \Rightarrow \omega_e = 0$.

LEMMA 1.4.6. *Consider $x \in \text{Bottom}(\Lambda_{n,L}^{\log})$, $\xi \in \Omega_{E^-}$ and $(J, \omega) \in \mathcal{L}$ with ω such that*

$$x \overset{\omega \vee \xi}{\leftrightarrow} \text{Top}(\Lambda_{n,L}^{\log}) \text{ and } x \overset{\omega \vee \xi}{\not\leftrightarrow} o.$$

Then, there exists $i \in \{0, \dots, n-1\}^{d-1} \times \{1, \dots, [\log n] - 1\}$ such that $J \in \mathcal{G}_i^L$ and there exists a modification ω' of ω on $E^w(B_i^{L,1})$ compatible with J , such that the first pivotal bond from o to x under $\omega' \vee \xi$ exists and belongs to $E^w(B_i^{L,1})$.

The variable ξ corresponds to the configuration below the slab $\Lambda_{n,L}^{\log}$. The point in introducing ξ here (and in the formulation of **(USP)**) is the need for an estimate uniform over the configuration below the slab in the proof of Lemma 1.4.8.

PROOF. Note that Figure 5 provides an illustration for the objects considered in the proof. We build by hand the modification ω' . Since $(J, \omega) \in \mathcal{L}$ there exists an horizontal interface \mathcal{I} as in (1.41). Since on the other hand $x \overset{\omega \vee \xi}{\leftrightarrow} \text{Top}(\Lambda_{n,L}^{\log})$, there exists $i \in \mathcal{I}$ such that $\mathcal{C}_x(\omega \vee \xi) \cap B_i^L \neq \emptyset$. Let us fix such an i : we clearly have $J \in \mathcal{G}_i^L$. From the definition of the event \mathcal{L} , we know that $\mathcal{C}_o^2(\omega) \cap B_i^L \neq \emptyset$. We fix $y \in \mathcal{C}_x(\omega \vee \xi) \cap B_i^L$ and $z \in \mathcal{C}_o^2(\omega) \cap B_i^L$. There exist two ω -open paths c_1, c_2 in $E^w(\Lambda_{n,L}^{\log})$ made of disjoint edges, with no loop, that link o to z , as well as an $\omega \vee \xi$ -open path d in $E^w(\Lambda_{n,L}^{\log}) \cup E^-$, with no loop, that links x to y . Of course, d does not touch $c_1 \cup c_2$ since $x \not\leftrightarrow o$ under $\omega \vee \xi$.

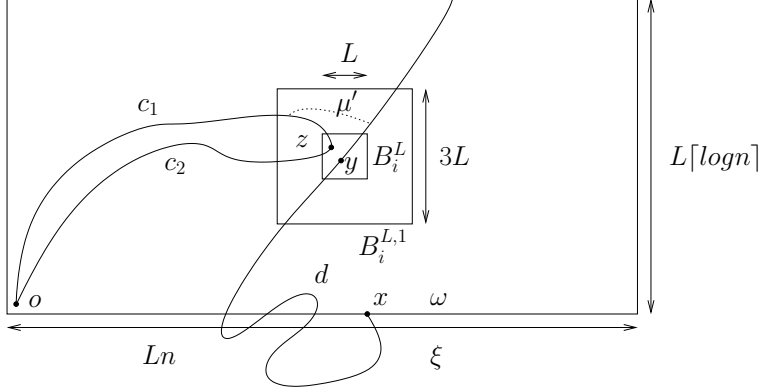

FIGURE 5. Lemma 1.4.6: c_1, c_2 are ω -open, d is $\omega \vee \xi$ -open and μ' is J -open.

Since i is not in the first block layer (see the remark after Lemma 1.4.5), $c_1 \cap E^w(B_i^{L,1})$ and $d \cap E^w(B_i^{L,1})$ have a connected component of diameter larger or equal to L . Since $\mathbf{1}_{J_e > 0}$ is larger than ω these components are also J -open, and since $J \in \mathcal{G}_i^L$, this implies that there exists a J -open path μ in $E^w(B_i^{L,1})$, self-avoiding, joining c_1 to d . Noting $(\mu_t)_t$ the vertexes of μ , we call $v = \min\{t : \mu_t \cap d \neq \emptyset\}$, then $u = \max\{t \leq v : \mu_t \cap \{c_1 \cup c_2\} \neq \emptyset\}$, and μ' the portion of μ between μ_u and μ_v . Finally, we define the modified configuration as

$$\omega'_e = \begin{cases} \omega_e & \text{if } e \notin E^w(B_i^{L,1}) \\ 1 & \text{if } e \in E^w(B_i^{L,1}) \cap \{c_1 \cup c_2 \cup d \cup \mu'\} \\ 0 & \text{else} \end{cases}$$

and claim that $\{\mu_u, \mu_{u+1}\}$ is the first pivotal bond from o to x under $\omega' \vee \xi$: first of all, there is effectively a connection between o and x under $\omega' \vee \xi$ since μ' touches both $c_1 \cup c_2$ and d . Then, it is clear that μ_u is doubly connected to o , to prove this, if $\mu_u \in c_1$ for instance we just need to consider c'_1 the portion of c_1 from o to μ_u and c''_1 the rest of c_1 ; c'_1 is a path from o to x , and a second path is made by $c''_1 \cup c_2$, which uses edges distinct from those of c'_1 . At last, $\{\mu_u, \mu_{u+1}\}$ is a pivotal bond between o and x (and more generally any edge of μ' is a pivotal bond) since μ' touches $c_1 \cup c_2$ only at its first extremity. \square

1.4.3. The uniform estimate (USP). We are now in a position to prove the uniform estimate (USP) defined at the beginning of Section 1.4.

PROPOSITION 1.4.7. (SP, $d \geq 3$) implies (USP).

PROOF. In view of Proposition 1.4.1, one can fix $L \in \mathbb{N}^*$ and $\delta > 0$ such that

$$\liminf_{n \rightarrow \infty} \mathbb{E} \inf_{\pi} \Phi_{\Lambda_{n,L}^{\log}}^{J,\pi} ((J, \omega) \in \mathcal{L}) \geq 3\delta.$$

According to Markov's inequality (1.12) we thus have

$$\mathbb{P} \left(\inf_{\pi} \Phi_{\Lambda_{n,L}^{\log}}^{J,\pi} ((J, \omega) \in \mathcal{L}) \geq \delta \right) \geq \delta$$

for any n large enough. In the sequel we fix $J \in \mathcal{J}$ such that

$$\inf_{\pi} \Phi_{\Lambda_{n,L}^{\log}}^{J,\pi} ((J, \omega) \in \mathcal{L}) \geq \delta. \quad (1.43)$$

Consider $x \in \text{Bottom}(\Lambda_{n,L}^{\log})$, $\pi \in \Omega_{E^w(\Lambda_{n,L}^{\log})^c}$ and $\xi \in \Omega_{E^-}$. One of the following cases must occur:

- (i) $\Phi_{\Lambda_{n,L}^{\log}}^{J,\pi} \left(x \overset{\omega \vee \xi}{\leftrightarrow} o \right) \geq \delta/3$
- (ii) or $\Phi_{\Lambda_{n,L}^{\log}}^{J,\pi} \left(x \overset{\omega \vee \xi}{\leftrightarrow} \text{Top}(\Lambda_{n,L}^{\log}) \right) \geq \delta/3$
- (iii) or $\Phi_{\Lambda_{n,L}^{\log}}^{J,\pi} \left(x \overset{\omega \vee \xi}{\leftrightarrow} o \text{ and } x \overset{\omega \vee \xi}{\leftrightarrow} \text{Top}(\Lambda_{n,L}^{\log}) \right) \geq 1 - 2\delta/3.$

The first two cases lead directly to the estimate

$$\Phi_{\Lambda_{n,L}^{\log}}^{J,\pi} \left(x \overset{\omega \vee \xi}{\leftrightarrow} o \text{ or } x \overset{\omega \vee \xi}{\leftrightarrow} \text{Top}(\Lambda_{n,L}^{\log}) \right) \geq \delta/3.$$

We focus hence on the third case. We let

$$\mathcal{L}_x = \left\{ \omega \in \Omega_{E^w(\Lambda_{n,L}^{\log})} : (J, \omega) \in \mathcal{L}, x \overset{\omega \vee \xi}{\leftrightarrow} o \text{ and } x \overset{\omega \vee \xi}{\leftrightarrow} \text{Top}(\Lambda_{n,L}^{\log}) \right\}, \quad (1.44)$$

it follows from (iii) and (1.43) that $\Phi_{E^w(\Lambda_{n,L}^{\log})}^{J,\pi}(\mathcal{L}_x) \geq \delta/3$. Then, for $\omega \in \mathcal{L}_x$ we define the set of could-be first pivotal bond:

$$F_x(\omega) = \left\{ \begin{array}{l} e \in \mathcal{E}(\Lambda_{n,L}^{\log}) : \exists i \in \{0, \dots, n-1\}^{d-1} \times \{1, \dots, \lceil \log n \rceil - 1\} \\ \text{with } J \in \mathcal{G}_i^L \text{ and a modification } \tilde{\omega} \text{ of } \omega \text{ on } E^w(B_i^{L,1}) \\ \text{compatible with } J \text{ such that } e \in E^w(B_i^{L,1}) \text{ is the} \\ \text{first pivotal bond from } o \text{ to } x \text{ under } \tilde{\omega} \vee \xi \end{array} \right\}$$

where $\mathcal{E}(\Lambda_{n,L}^{\log}) = \bigcup_{i \in I_{\Lambda_{n,L}^{\log}}} \mathring{E}_i^L$. Lemma 1.4.6 states that $F_x(\omega)$ is not empty whenever $\omega \in \mathcal{L}_x$. Hence, for all $\omega \in \mathcal{L}_x$ we can consider the edge $f_x(\omega) = \min F_x(\omega)$, where min refers to the lexicographical ordering of $\mathcal{E}(\Lambda_{n,L}^{\log})$. Given $e \in \mathcal{E}(\Lambda_{n,L}^{\log})$ we denote by $i(e)$ the unique index $i \in \mathbb{Z}^d$ such that $e \in \mathring{E}_i^L$. We prove now the existence of $c_L > 0$ such that

$$\forall \omega \in \mathcal{L}_x \cap \{\omega : f_x(\omega) = e\}, \Phi_{E_i}^{J,\pi \vee \omega|_{E_i^c}} \left(\begin{array}{l} e \text{ first pivotal bond from } o \\ \text{to } x \text{ under } \omega|_{E_i^c} \vee \omega' \vee \xi \end{array} \right) \geq c_L. \quad (1.45)$$

where ω' is the variable associated to $\Phi_{E_i}^{J,\pi \vee \omega|_{E_i^c}}$ and $E_i = E^w(B_{i(e)}^{L,2})$. Let $\omega \in \mathcal{L}_x \cap \{\omega : f_x(\omega) = e\}$. According to the definition of f_x , there exists i such that $J \in \mathcal{G}_i^L$, $e \in E^w(B_i^{L,1})$ and there exists a local modification $\tilde{\omega}$ of ω on $E^w(B_i^{L,1})$, compatible with J such that e is the first pivotal bond from o to x under $\tilde{\omega} \vee \xi$. From the inclusion $E^w(B_i^{L,1}) \subset E^w(B_{i(e)}^{L,2})$ we deduce that $\tilde{\omega}$ is a

modification of ω on the block $E^w(B_{i(e)}^{L,2})$ that does not depend on i . On the other hand, $E^w(B_{i(e)}^{L,2}) \subset E^w(B_{i(e)}^{L,3})$ and in view of the definition of \mathcal{G}_i^L (1.40) this implies that for all $e \in E^w(B_{i(e)}^{L,2})$, $J_e = 0$ or $J_e \geq \varepsilon_L$. From the DLR equation (1.6) it follows that

$$\Phi_{E_i}^{J, \pi \vee \omega|_{E_i^c}}(\{\tilde{\omega}\}) \geq \prod_{e \in E_i} \inf_{\pi} \Phi_{\{e\}}^{J, \pi}(\omega_e = \tilde{\omega}_e)$$

and remarking that

$$\forall J_e \in [0, 1], \quad \Phi_{\{e\}}^{J, \pi}(\omega_e = 0) \geq \Phi_{\{e\}}^{J, w}(\omega_e = 0) = 1 - p(J_e) \geq 1 - p(1) > 0$$

and

$$\forall J_e \in [\varepsilon, 1], \quad \Phi_{\{e\}}^{J, \pi}(\omega_e = 1) \geq \Phi_{\{e\}}^{J, f}(\omega_e = 1) = \tilde{p}(J_e) \geq \frac{p(\varepsilon)}{p(\varepsilon) + q(1 - p(\varepsilon))} > 0$$

thanks to the assumptions on p stated before (1.4), we conclude that (1.45) holds with

$$c_L = \left[\min \left(1 - p(1), \frac{p(\varepsilon)}{p(\varepsilon) + q(1 - p(\varepsilon))} \right) \right]^{|E_i|} > 0.$$

Combining the DLR equation for Φ^J (1.6) with (1.45), we obtain

$$\begin{aligned} & \Phi_{\Lambda_{n,L}^{\log}}^{J, \pi} \left(\begin{array}{l} e \text{ first pivotal bond from} \\ o \text{ to } x \text{ under } \omega \vee \xi \end{array} \right) \\ &= \Phi_{\Lambda_{n,L}^{\log}}^{J, \pi} \left[\Phi_{E_i}^{J, \pi \vee \omega|_{E_i^c}} \left(\begin{array}{l} e \text{ first pivotal bond from } o \\ \text{to } x \text{ under } \omega|_{E_i^c} \vee \omega' \vee \xi \end{array} \right) \right] \\ &\geq c_L \Phi_{\Lambda_{n,L}^{\log}}^{J, \pi} (\mathcal{L}_x \cap \{f_x(\omega) = e\}). \end{aligned} \quad (1.46)$$

If we now sum over $e \in \mathcal{E}(\Lambda_{n,L}^{\log})$ – the events in the left-hand term are *disjoint* for distinct edges e , and all included in $\{o \overset{\omega \vee \xi}{\longleftrightarrow} x\}$ – we obtain

$$\Phi_{\Lambda_{n,L}^{\log}}^{J, \pi} \left(o \overset{\omega \vee \xi}{\longleftrightarrow} x \right) \geq c_L \Phi_{\Lambda_{n,L}^{\log}}^{J, \pi} (\mathcal{L}_x)$$

which is larger than $c_L \delta / 3$ as seen after (1.44). To sum it up, under the assumption (1.43) which holds with a \mathbb{P} -probability not smaller than δ , we have shown that

$$\Phi_{\Lambda_{n,L}^{\log}}^{J, \pi} \left(x \overset{\omega \vee \xi}{\longleftrightarrow} o \text{ or } x \overset{\omega \vee \xi}{\leftrightarrow} \text{Top}(\Lambda_{n,L}^{\log}) \right) \geq \min(\delta/3, c_L \delta/3)$$

and the proof is over. \square

1.4.4. An intermediate coarse graining. The strength of the criterion (**USP**) lies in the fact that it provides an estimate on the $\Phi^{J,\pi}$ connection probabilities that is uniform over x , π and ξ . This is a very strong improvement compared to the original assumption of percolation in slabs (**SP**, $d \geq 3$).

In this Section, we establish an intermediate formulation of the coarse graining. We begin with an estimate on the probability of having two long vertical and disjoint ω -clusters in the domain

$$\Lambda_N^{1/4} = \{1, N-1\}^{d-1} \times \{1, [N/4]-1\}. \quad (1.47)$$

LEMMA 1.4.8. *Assume (**SP**, $d \geq 3$). There exist $L \in \mathbb{N}^*$ and $c > 0$ such that, for any $N \in \mathbb{N}^*$ large enough multiple of L and any $x, y \in \text{Bottom}(\Lambda_N^{1/4})$:*

$$\mathbb{E} \inf_{\pi} \Phi_{\Lambda_N^{1/4}}^{J,\pi} \left(x \overset{\omega}{\leftrightarrow} \text{Top}(\Lambda_N^{1/4}), y \overset{\omega}{\leftrightarrow} \text{Top}(\Lambda_N^{1/4}) \text{ and } x \overset{\omega}{\not\leftrightarrow} y \right) \leq \exp \left(-c \frac{N}{\log N} \right). \quad (1.48)$$

PROOF. We fix some $L \in \mathbb{N}^*$ and $\varepsilon > 0$ so that the uniform criterion (**USP**) holds whenever $n = N/L$ is large enough. The domain $\Lambda_N^{1/4}$ contains all slabs

$$S_h = \Lambda_{n,L}^{\log} + hL[\log n] \mathbf{e}_d, \quad h \in \{0, \dots, n/(4[\log n]) - 1\}$$

Given $J \in \mathcal{J}$, we say that S_h is J -good if for all $x \in \text{Bottom}(S_h)$, $\pi \in \Omega_{E^w(S_h)^c}$ and $\xi \in \Omega_{E_h^-}$,

$$\Phi_{S_h}^{J,\pi} \left(x \overset{\omega \vee \xi}{\leftrightarrow} o_h \text{ or } x \overset{\omega \vee \xi}{\not\leftrightarrow} \text{Top}(S_h) \right) \geq \varepsilon \quad (1.49)$$

where

$$E_h^- = E^f(\mathbb{H}^- + hL[\log n] \mathbf{e}_d)$$

(cf. (1.37)) and $o_h = o + hL[\log n] \mathbf{e}_d$. The event that S_h is J -good depends only on J_e for $e \in E^w(S_h)$, thus for distinct h these events are independent. Since they all have the same probability larger than ε , Cramér's Theorem yields the existence of $c > 0$ such that

$$\mathbb{P} \left(\begin{array}{l} \text{There are at least } [\varepsilon n / (8 \log n)] \\ J\text{-good slabs in } \Lambda_N^{1/4} \end{array} \right) \geq 1 - \exp \left(-c \frac{n}{\log n} \right) \quad (1.50)$$

for any n large enough.

Let us denote $\kappa = [\varepsilon n / (8 \log n)]$ and fix $J \in \mathcal{J}$ such that there are at least κ J -good slabs. We denote by h_1, \dots, h_κ the positions (in increasing order) of the first κ J -good slabs. Given some boundary condition π and $x, y \in \text{Bottom}(\Lambda_N^{1/4})$, we pass to an inductive proof of the fact that, for all $k \in \{1, \dots, \kappa\}$:

$$\Phi_{E^w(\Lambda_N^{1/4}) \cap E_{h_{k+1}}^-}^{J,\pi} \left(x \overset{\omega}{\leftrightarrow} \text{Top}(S_{h_k}), y \overset{\omega}{\leftrightarrow} \text{Top}(S_{h_k}) \text{ and } x \overset{\omega}{\not\leftrightarrow} y \right) \leq (1 - \varepsilon^2/4)^k. \quad (1.51)$$

We assume that either $k = 1$ or that (1.51) holds for $k - 1$ and we let

$$D_h = \begin{cases} \Omega & \text{if } h < h_1 \\ \left\{ \omega \in \Omega_{\Lambda_N^{1/4}} : \begin{array}{l} x \overset{\omega}{\leftrightarrow} \text{Top}(S_h), y \overset{\omega}{\leftrightarrow} \text{Top}(S_h) \\ \text{and } x \leftrightarrow y \text{ under } \omega|_{E_{h+1}^-} \end{array} \right\} & \text{else.} \end{cases}$$

It is obvious that $D_h \subset D_{h-1}$ for any $h \geq 1$. For any k such that $h_k \geq 1$ and $\omega \in D_{h_k-1}$, we define $x_k(\omega)$ as the first point (under the lexicographical order) of $\text{Bottom}(S_{h_k}) = \text{Top}(S_{h_k-1})$ connected to x under $\omega|_{E_{h_k}^-}$ (respectively, $y_k(\omega)$ is the corresponding point for y) – see Figure 6 for an illustration. If $h_k = 0$ we let $x_k(\omega) = x$ and $y_k(\omega) = y$.

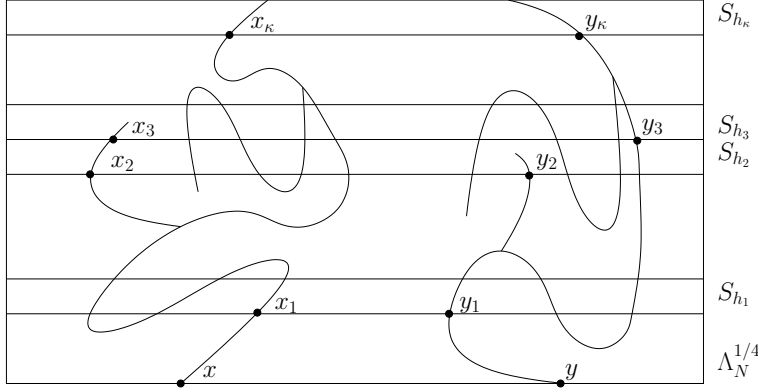

FIGURE 6. The x_k and y_k in Lemma 1.4.8.

Applying the DLR equation we get:

$$\Phi_{\Lambda_N^{1/4}}^{J,\pi}(D_{h_k}) = \Phi_{\Lambda_N^{1/4}}^{J,\pi} \left(\mathbf{1}_{D_{h_k-1}} \Phi_{S_{h_k}}^{J,\pi \vee \omega|_{E^w(S_{h_k})^c}} \left(\begin{array}{l} x_k, y_k \overset{\omega_k \vee \xi}{\leftrightarrow} \text{Top}(S_{h_k}) \\ \text{and } x_k \overset{\omega_k \vee \xi}{\leftrightarrow} y_k \end{array} \right) \right) \quad (1.52)$$

where the variable ω (resp. ω_k) corresponds to $\Phi_{\Lambda_N^{1/4}}^{J,\pi}$ (resp. to $\Phi_{S_{h_k}}^{J,\pi \vee \omega|_{E^w(S_{h_k})^c}}$), $\xi = \xi(\omega) = \omega|_{E_{h_k}^-}$ is the restriction of ω to $E_{h_k}^-$ and x_k and y_k refer to $x_k(\omega)$ and $y_k(\omega)$. Here appears the reason for the introduction of ξ in Lemma 1.4.6 and in the definition of **(USP)**: the cluster issued from x under $\omega_k \vee \xi$ is the same as that issued from x_k under $\omega_k \vee \xi$, while in general $x \overset{\omega_k \vee \xi}{\leftrightarrow} \text{Top}(S_{h_k})$ does not imply $x_k \overset{\omega_k}{\leftrightarrow} \text{Top}(S_{h_k})$.

We use now the information that S_{h_k} is a J -good slab. Given any $\pi \in \Omega_{E^w(S_{h_k})^c}$, $\xi \in \Omega_{E_{h_k}^-}$ and $z \in \text{Bottom}(S_{h_k})$ we have, according to (1.49):

$$\Phi_{S_{h_k}}^{J,\pi} \left(z \overset{\omega_k \vee \xi}{\leftrightarrow} \text{Top}(S_{h_k}) \right) \geq \frac{\varepsilon}{2} \quad \text{or} \quad \Phi_{S_{h_k}}^{J,\pi} \left(z \overset{\omega_k \vee \xi}{\leftrightarrow} o_{h_k} \right) \geq \frac{\varepsilon}{2} \quad (1.53)$$

Here we distinguish two cases. If

$$\Phi_{S_{h_k}}^{J,\pi} \left(x_k \overset{\omega_k \vee \xi}{\leftrightarrow} \text{Top}(S_{h_k}) \right) \geq \frac{\varepsilon}{2} \text{ or } \Phi_{S_{h_k}}^{J,\pi} \left(y_k \overset{\omega_k \vee \xi}{\leftrightarrow} \text{Top}(S_{h_k}) \right) \geq \frac{\varepsilon}{2}$$

it is immediate that

$$\Phi_{S_{h_k}}^{J,\pi} \left(x_k \overset{\omega_k \vee \xi}{\leftrightarrow} \text{Top}(S_{h_k}) \text{ and } y_k \overset{\omega_k \vee \xi}{\leftrightarrow} \text{Top}(T_{h_k}) \right) \leq 1 - \frac{\varepsilon}{2}. \quad (1.54)$$

In the opposite case, (1.53) implies that both

$$\Phi_{S_{h_k}}^{J,\pi} \left(x_k \overset{\omega_k \vee \xi}{\leftrightarrow} o_{h_k} \right) \geq \frac{\varepsilon}{2} \text{ and } \Phi_{S_{h_k}}^{J,\pi} \left(y_k \overset{\omega_k \vee \xi}{\leftrightarrow} o_{h_k} \right) \geq \frac{\varepsilon}{2}$$

and the FKG inequality tells us that

$$\Phi_{S_{h_k}}^{J,\pi} \left(x_k \overset{\omega_k \vee \xi}{\leftrightarrow} y_k \right) \geq \Phi_{S_{h_k}}^{J,\pi} \left(x_k \overset{\omega_k \vee \xi}{\leftrightarrow} o_{h_k} \right) \times \Phi_{S_{h_k}}^{J,\pi} \left(y_k \overset{\omega_k \vee \xi}{\leftrightarrow} o_{h_k} \right) \geq \frac{\varepsilon^2}{4}. \quad (1.55)$$

Since either (1.54) or (1.55) occurs in a good slab, we see that

$$\inf_{\pi \in \Omega_{E^w(S_{h_k})^c}} \inf_{\xi \in \Omega_{E_{h_k}^-}} \Phi_{S_{h_k}}^{J,\pi} \left(x_k, y_k \overset{\omega_k \vee \xi}{\leftrightarrow} \text{Top}(S_{h_k}) \text{ and } x_k \overset{\omega_k \vee \xi}{\leftrightarrow} y_k \right) \leq 1 - \frac{\varepsilon^2}{4}$$

and reporting in (1.52) we conclude that

$$\Phi_{\Lambda_N^{1/4}}^{J,\pi} (D_{h_k}) \leq \left(1 - \frac{\varepsilon^2}{4} \right) \Phi_{\Lambda_N^{1/4}}^{J,\pi} (\mathbf{1}_{D_{h_{k-1}}}),$$

which ends the induction step for the proof of (1.51) as $D_{h_k-1} \subset D_{h_{k-1}}$. The proof of the Lemma follows combining (1.50) and (1.51) with $k = \kappa = \lceil \varepsilon n / (8 \log n) \rceil$. \square

We are now in a position to present a first version of the coarse graining:

PROPOSITION 1.4.9. *Assume $(\mathbf{SP}, d \geq 3)$. Then for any $\varepsilon > 0$ there exists $N \in \mathbb{N}^*$ such that*

$$\mathbb{E} \inf_{\pi} \Phi_{\Lambda_N}^{J,\pi} \left(\begin{array}{l} \text{There exists a crossing cluster for } \omega \\ \text{in } \Lambda_N \text{ and it is the only cluster of} \\ \text{diameter larger or equal to } N/4 \end{array} \right) \geq 1 - \varepsilon. \quad (1.56)$$

This estimate is clearly weaker than Theorem 1.2.1, yet it provides enough information to establish Theorem 1.2.1 using renormalization techniques (Section 1.5.1). Note that at the price of little modifications in the proof below one could prove the following fact, assuming $(\mathbf{SP}, d \geq 3)$: there exist $L \subset \mathbb{N}^*$ and $c > 0$ such that, for any N large enough multiple of L and any function g such that $(\log N)^2 \ll g(N) \leq N$,

$$\mathbb{E} \inf_{\pi} \Phi_{\Lambda_N}^{J,\pi} \left(\begin{array}{l} \text{There exists a crossing cluster for } \omega \\ \text{in } \Lambda_N \text{ and it is the only cluster of} \\ \text{diameter larger or equal to } g(N) \end{array} \right) \geq 1 - \exp \left(-\frac{cg(N)}{\log N} \right)$$

Yet, this formulation suffers from arbitrary restrictions: the logarithm in the denominator and the condition that N be a multiple of L . This is the reason

for our choice of establishing a simpler control in Proposition 1.4.9, that will be reinforced later on by the use of renormalization techniques.

PROOF. In Corollary 1.3.5 we have seen the existence of $L_1 \in \mathbb{N}^*$ such that, for any N large enough multiple of L_1 ,

$$\mathbb{E} \inf_{\pi} \Phi_{\Lambda_N}^{J,\pi} (\text{There exists a crossing cluster for } \omega \text{ in } \Lambda_N) \geq 1 - \varepsilon/2. \quad (1.57)$$

It remains to prove that it is the only large cluster. We fix $L_2 \in \mathbb{N}^*$ and $c > 0$ according to Lemma 1.4.8, and assume that N is a large enough multiple of L_1 and of L_2 so that both (1.57) and (1.48) hold. We consider the event

$$A = \left\{ \begin{array}{l} \text{There exists a crossing cluster } \mathcal{C}^* \\ \text{for } \omega \text{ and another } \mathcal{C}' \text{ of diameter} \\ \text{larger or equal to } N/4 \end{array} \right\}.$$

For any $\omega \in \Omega_{E^w(\Lambda_N)} \cap A$, there exists some direction $k \in \{1, \dots, d\}$ in which the extension of \mathcal{C}' is at least $N/4$. Since all directions are equivalent we assume that $k = d$. If we denote $h = \inf\{z \cdot \mathbf{e}_d, z \in \mathcal{C}'\}$ and $\Lambda_N^{1/4,h} = \Lambda_N^{1/4} + h\mathbf{e}_d$, there exist $x, y \in \text{Bottom}(\Lambda_N^{1/4,h})$ such that

$$x, y \stackrel{\omega^r}{\leftrightarrow} \text{Top}(\Lambda_N^{1/4,h}) \text{ and } x \stackrel{\omega^r}{\leftrightarrow} y$$

where $\omega^r = \omega|_{E^w(\Lambda_N^{1/4,h})}$. As a consequence,

$$\begin{aligned} \mathbb{E} \sup_{\pi} \Phi_{\Lambda_N}^{J,\pi} (A) &\leq d \sum_{\substack{h=0 \dots \lceil 3N/4 \rceil \\ x, y \in \text{Bottom}(\Lambda_N^{1/4,h})}} \mathbb{E} \sup_{\pi} \Phi_{\Lambda_N^{1/4,h}}^{J,\pi} \left(\begin{array}{l} x, y \stackrel{\omega^r}{\leftrightarrow} \text{Top}(\Lambda_N^{1/4,h}) \\ \text{and } x \stackrel{\omega^r}{\leftrightarrow} y \end{array} \right) \\ &\leq d(3N/4 + 2)N^{2(d-1)} \exp\left(-c \frac{N}{\log N}\right) \end{aligned}$$

which goes to 0 as $N \rightarrow \infty$ and the proof is over. \square

1.4.5. The two dimensional case. In the two dimensional case the adaptation of Proposition 1.4.9 is an easy exercise: it is enough to realize a few horizontal and vertical crossings in Λ_N to ensure the existence of a crossing cluster, together with the uniqueness of large clusters.

PROPOSITION 1.4.10. *Assume $(\mathbf{SP}, d = 2)$. Then for any $\varepsilon > 0$, for any $N \in \mathbb{N}^*$ large enough:*

$$\mathbb{E} \inf_{\pi} \Phi_{\Lambda_N}^{J,\pi} \left(\begin{array}{l} \text{There exists a crossing cluster for } \omega \\ \text{in } \Lambda_N \text{ and it is the only cluster of} \\ \text{diameter larger or equal to } N/4 \end{array} \right) \geq 1 - \varepsilon. \quad (1.58)$$

PROOF. We divide Λ_N in eight horizontal parts: for $k \in \{0, \dots, 7\}$ we let

$$P_{N,k} = \{1, \dots, N-1\} \times \{[Nk/8] + 1, \dots, [N(k+1)/8] - 1\}$$

and then we decompose each $P_{N,k}$ in slabs of height $\kappa(N)$ where κ is the function appearing in the definition of $(\mathbf{SP}, d=2)$: for all

$$h \in \{0, \dots, \lceil [N/8]/\kappa(N) \rceil - 1\},$$

we define

$$S_{N,k,h} = \{1, \dots, N-1\} \times \{[Nk/8] + h\kappa(N) + 1, \dots, [Nk/8] + (h+1)\kappa(N) - 1\}.$$

Given $k \in \{0, \dots, 7\}$ we consider the measure Ψ on $(\mathcal{J}_{P_{N,k}}, \Omega_{P_{N,k}})$ induced by $(J_1 \vee \dots \vee J_{h_{\max}}, \omega_1 \vee \dots \vee \omega_{h_{\max}})$ under the product measure

$$\bigotimes_{h=0, \dots, h_{\max}} \mathbb{E}\Phi_{S_{N,k,h}}^{J,f}.$$

where $h_{\max} = \lceil [N/8]/\kappa(N) \rceil - 1$. Thanks to Proposition 1.3.2 we know that Ψ is stochastically smaller than $\mathbb{E}\Phi_{\Lambda_N}^{J,f}$, and thus than $\mathbb{E}\Phi_{\Lambda_N}^{J,\tilde{\pi}(J)}$ if $\tilde{\pi}$ is a worst boundary condition for (1.58), cf. (1.11). Consider now the event

$$\mathcal{E}_k = \left\{ \omega \in \Omega : \begin{array}{l} \text{there exists } h \in \{0, \dots, h_{\max}\} \text{ such that } \omega \\ \text{presents an horizontal crossing in } S_{N,k,h} \end{array} \right\},$$

thanks to $(\mathbf{SP}, d=2)$ and to the product structure of Ψ there exists some $c > 0$ such that

$$\Psi(\mathcal{E}_k) \geq 1 - \exp\left(-\frac{cN}{\kappa(N)}\right)$$

for any N large enough, and because of the stochastic domination (remark that \mathcal{E}_k is an increasing event) it follows that

$$\mathbb{E}\Phi_{\Lambda_N}^{J,\tilde{\pi}(J)}(\mathcal{E}_0 \cap \dots \cap \mathcal{E}_7) \geq 1 - 8 \exp\left(-\frac{cN}{\kappa(N)}\right).$$

We proceed similarly in the vertical direction and let \mathcal{E}'_k the event that ω presents a vertical link between $\text{Bottom}(\Lambda_N)$ and $\text{Top}(\Lambda_N)$ in the region

$$\{kN/8, \dots, (k+1)N/8\} \times \{1, \dots, N-1\}.$$

The event $\mathcal{E}_0 \cap \dots \cap \mathcal{E}_7 \cap \mathcal{E}'_0 \cap \dots \cap \mathcal{E}'_7$ has a large probability under $\mathbb{E}\Phi_{\Lambda_N}^{J,\tilde{\pi}(J)}$, on the other hand it implies the existence of a crossing cluster, as well as the uniqueness of clusters of diameter larger than $N/4$. \square

1.5. Renormalization and density estimates

In this Section we introduce renormalization techniques, following Pisztora [73] and Liggett, Schonmann and Stacey [62]. We then finish the proof of the coarse graining (Theorem 1.2.1 and Proposition 1.2.2). We also adapt the arguments of Lebowitz [59] and Grimmett [42] to the random-media case and prove that for all $q \geq 1$ and all ρ , for all except at most countably many values

of β , the two extremal infinite volume annealed measures with parameters $p(J_e) = 1 - \exp(-\beta J_e)$, q and ρ are equal. We conclude on an adaptation of the coarse graining to the Ising model.

1.5.1. Renormalization framework. The renormalization framework naturally breaks down in two parts. First we describe a geometrical decomposition of a large domain Λ into a double sequence of smaller cubes, then we present an adaptation of the stochastic domination Theorem of [62].

We begin with a geometrical covering of Λ with some double sequence $(\Delta_i, \Delta'_i)_{i \in I}$. Its properties are described in detail in the next Lemma, for the moment we just point out what we expect of the Δ_i and of the Δ'_i respectively:

- The Δ_i are boxes of side-length $L - 1$, they cover all of Λ and most of them are disjoint. In the applications of renormalization they will typically help to control the local density of clusters.
- The Δ'_i are boxes of side-length $L + 2L' - 1$ such that Δ'_i and Δ'_j have an intersection of thickness at least $2L'$ whenever i and j are nearest neighbors. The role of the Δ'_i is to permit the connection between the main clusters of two neighbor blocks Δ_i and Δ_j .

DEFINITION 1.5.1. Consider some domain Λ of the form

$$\Lambda = z + \prod_{k=1}^d \{1, \dots, L_k\}$$

with $z = (z_1, \dots, z_d) \in \mathbb{Z}^d$, $L_k \in \mathbb{N}^*$, and $L, L' \in \mathbb{N}^*$ with $L' \leq L$. Assume that $L + 2L' \leq \min_{k=1 \dots d} L_k$, denote

$$I_{\Lambda, L} = \prod_{k=1}^d \{0, \dots, \lceil L_k/L \rceil - 1\}$$

and for all $i \in I_{\Lambda, L}$, call x_i the point of coordinates $z_k + \min(Li \cdot \mathbf{e}_k, L_k - L)$ ($k = 1 \dots d$) and x'_i that of coordinates $z_k + \min(\max(Li \cdot \mathbf{e}_k, L'), L_k - L - L')$. Consider at last:

$$\Delta_i = x_i + \{1, \dots, L\}^d \quad \text{and} \quad \Delta'_i = x'_i + \{-L' + 1, \dots, L + L'\}^d.$$

We say that $(\Delta_i, \Delta'_i)_{i \in I_{\Lambda, L}}$ is the (L, L') -covering of Λ .

Remark that x_i and x'_i are the closest points to Li , with respect to the $\|\cdot\|_\infty$ distance, such that Δ_i and Δ'_i are subsets of Λ .

LEMMA 1.5.2. *The properties of the sequence $(\Delta_i, \Delta'_i)_{i \in I_{\Lambda, L}}$ are as follows: for any Λ, L, L' as in definition 1.5.1, we have:*

- The union $\bigcup_{i \in I_{\Lambda, L}} \Delta_i$ equals Λ .*
- For every $i \in I_{\Lambda, L}$, $\Delta_i \subset \Delta'_i$ and $d(\Delta_i, \Lambda \setminus \Delta'_i) \geq L' + 1$.*

- (iii) If $i, j \in I_{\Lambda, L}$ and $k \in \{1, \dots, d\}$ satisfy $j = i + \mathbf{e}_k$, then both Δ'_i and Δ'_j contain the slab

$$\{x \in \Delta'_j : (x - x'_j) \cdot \mathbf{e}_k \leq L'\}.$$

- (iv) For any $x \in \Lambda$ such that $x \cdot \mathbf{e}_k \leq L_k - L$ for all $k = 1 \dots d$, there exists a unique $i \in I_{\Lambda, L}$ such that $x \in \Delta_i$.
- (v) Given any $x \in \Lambda$, there exist at most 6^d indices $i \in I_{\Lambda, L}$ such that $x \in \Delta'_i$.

PROOF. We begin with the first point. If we denote $\Lambda_L = \{1, \dots, L\}^d$, it is clear that the sequence $(Li + \Lambda_L)_{i \in I_{\Lambda, L}}$ covers all Λ and that:

$$\forall i \in I_{\Lambda, L}, (Li + \Lambda_L) \cap \Lambda \subset \Delta_i \subset \Lambda$$

thanks to the definition of x_i . The equality $\bigcup_{i \in I_{\Lambda, L}} \Delta_i = \Lambda$ follows. For (ii), the inclusion $\Delta_i \subset \Delta'_i$ is a trivial consequence of the remark that $\|x_i - x'_i\|_\infty \leq L'$. As for the distance between Δ_i and $\Lambda \setminus \Delta'_i$, we compute the distance between Δ_i and the outer faces of Δ'_i included in Λ . In a given direction \mathbf{e}_k (for some $k \in \{1, \dots, d\}$), it is exactly $L' + 1$ whenever $x_i \cdot \mathbf{e}_k = x'_i \cdot \mathbf{e}_k$. If $x_i \cdot \mathbf{e}_k < x'_i \cdot \mathbf{e}_k$, then the block Δ'_i touches the face of Λ of \mathbf{e}_k -coordinate 1 and the distance between Δ_i and the unique outer face of Δ'_i normal to \mathbf{e}_k and included in Λ is larger than $L' + 1$. The same occurs if $x_i \cdot \mathbf{e}_k > x'_i \cdot \mathbf{e}_k$ with the opposite face of Λ . For (iii), remark that $x'_j - x'_i = l\mathbf{e}_k$ with $l \leq L$. For (iv), consider such an x and let $i \in I_{\Lambda, L}$ such that $x \in \Delta_i$ (it exists thanks to (i)). Since the coordinates of x_i are strictly smaller than those of x , they do not exceed $L_k - L - 1$. In view of the definition of x_i this implies that $x_i = Li$ and hence that $x \in Li + \Lambda_L$, which determines i . Consider at last $x \in \Lambda$ and $i \in I_{\Lambda, L}$ such that $x \in \Delta'_i$. For each $k = 1 \dots d$, at least one of the following inequalities must hold:

$$Li \cdot \mathbf{e}_k < L' \quad \text{or} \quad Li \cdot \mathbf{e}_k > L_k - L - L' \quad \text{or} \quad Li \cdot \mathbf{e}_k - L' + 1 \leq x \cdot \mathbf{e}_k \leq Li \cdot \mathbf{e}_k + L + L'$$

since the k -coordinate of x'_i is $Li \cdot \mathbf{e}_k$ whenever the first two inequalities are not satisfied. The first condition yields only one possible value for $i \cdot \mathbf{e}_k$: $i \cdot \mathbf{e}_k = 0$ since $L' \leq L$. For the second we consider candidates of the form $i \cdot \mathbf{e}_k = \lceil L_k/L \rceil - n$ with $n \geq 1$ (recall that $i \in I_{\Lambda, L}$), and there are at most two possibilities corresponding to $n \in \{1, 2\}$. At last, the third condition yields not more than 3 possibilities for $i \cdot \mathbf{e}_k$ and the bound in (v) follows. \square

We now present the stochastic domination Theorem and its adaptation to the annealed measure. Stochastic domination is a natural and useful concept for renormalization, that was already present in the pioneer work [73]. It goes one step beyond the Peierls estimates we use in the proof of Theorem 1.2.1 and could have used in that of Corollary 1.3.5. It is of much help for example in the proof of (1.15) in Proposition 1.2.2. Let us recall Theorem 1.3 of [62]:

THEOREM 1.5.3. *Let $G = (S, E)$ be a graph with a countable vertex set in which every vertex has degree at most $K \geq 1$, and in which every finite connected component of G contains a vertex of degree strictly less than K . Let $p \in [0, 1]$ and suppose that μ is a Borel probability measure on $X \in \{0, 1\}^S$ such that almost surely,*

$$\mu(X_s = 1 | \sigma(\{X_t : \{s, t\} \notin E\})) \geq p, \forall s \in S.$$

Then, if $p \geq 1 - (K - 1)^{K-1}/K^K$ and

$$r(K, p) = \left(1 - \frac{(1-p)^{1/K}}{(K-1)^{(K-1)/K}}\right) (1 - ((1-p)(K-1))^{1/K}),$$

the measure μ stochastically dominates the Bernoulli product measure on S of parameter $r(K, p)$. Note that as p goes to 1, $r(K, p)$ tends to 1.

We provide then an adaptation of the former Theorem to the annealed measure:

PROPOSITION 1.5.4. *Consider some finite domain $\Lambda \subset \mathbb{Z}^d$, $(E_i)_{i=1\dots n}$ a finite sequence of subsets of $E^w(\Lambda)$ and $(\mathcal{E}_i)_{i=1\dots n}$ a family of events depending respectively on $\omega|_{E_i}$ only. If the intersection of any $K + 1$ distinct E_i is empty and if*

$$p = \inf_{i=1\dots n} \mathbb{E} \inf_{\pi \in \Omega} \Phi_{E_i}^{J, \pi}(\mathcal{E}_i)$$

is close enough to 1, then for any increasing function $f : \{0, 1\}^n \rightarrow \mathbb{R}$ we have:

$$\mathbb{E} \inf_{\pi \in \Omega} \Phi_{\Lambda}^{J, \pi|_{E^w(\Lambda)}} \left(f(\mathbf{1}_{\mathcal{E}_1}, \dots, \mathbf{1}_{\mathcal{E}_n}) \Big| \omega = \pi \text{ on } E^w(\Lambda) \setminus \bigcup_{i=1}^n E_i \right) \geq \mathcal{B}_{r'(K, p)}^n(f)$$

where \mathcal{B}_r^n is the Bernoulli product measure on $\{0, 1\}^n$ of parameter r and $r'(K, p) = r^2(K, 1 - \sqrt{1-p})$ (with $r(\cdot, \cdot)$ taken from Theorem 1.5.3). In particular, $\lim_{p \rightarrow 1} r'(K, p) = 1$.

The conditional formulation for the stochastic domination is motivated by the need to control some region of the domain uniformly over constraints in the remaining region. A good example of this necessity will be seen in the formulation of the lower bound for L^1 phase coexistence in the Ising model (Proposition 3.3.4 in Chapter 3).

PROOF. The proof is based on Markov's inequality. Consider

$$\mathcal{G}_i = \left\{ J : \inf_{\pi} \Phi_{E_i}^{J, \pi}(\mathcal{E}_i) \geq 1 - \sqrt{1-p} \right\}.$$

Clearly, the \mathcal{G}_i are \mathcal{B}_{E_i} -measurable and hence any two $\mathcal{G}_i, \mathcal{G}_j$ are independent under \mathbb{P} if $E_i \cap E_j = \emptyset$. Thanks to Markov's inequality (1.12), as $\mathbb{E}(1 - \inf_{\pi} \Phi_{E_i}^{J, \pi}) \leq 1 - p$ it follows that $\mathbb{P}(\mathcal{G}_i) \geq 1 - \sqrt{1-p}$ for all $i = 1 \dots n$. Consider now the graph on $I = \{1, \dots, n\}$ induced by $L = \{\{i, j\} \in I^2 : i \neq$

j and $E_i \cap E_j \neq \emptyset$. All vertexes of the graph have degree at most $K - 1$, while almost surely

$$\inf_{i \in I} \mathbb{P}(\mathcal{G}_i | \mathcal{G}_j : \{i, j\} \notin L) = \inf_{i \in I} \mathbb{P}(\mathcal{G}_i) \geq 1 - \sqrt{1 - p}.$$

Hence the assumptions of Theorem 1.5.3 are satisfied for p large enough and it follows that the law of the \mathcal{G}_i dominates a Bernoulli product measure of parameter $r = r(K, 1 - \sqrt{1 - p})$. We keep this fact in mind for the end of the proof and now fix a realization of the media J . We call $I' = \{i \in I : J \in \mathcal{G}_i\}$. Let (I', L') be the restriction of the graph (I, L) to I' : again, the maximal degree of all vertexes is at most $K - 1$. We consider now the sequence $(\mathcal{E}_i)_{i \in I'}$ under the conditional measure

$$\mu_\pi = \Phi_\Lambda^{J, \pi|_{E^w(\Lambda)}} \left(\cdot \middle| \omega = \pi \text{ on } E^w(\Lambda) \setminus \bigcup_{i=1}^n E_i \right)$$

where $\pi \in \Omega$. Thanks to the DLR equation for $\Phi_\Lambda^{J, \pi}$ and to the definition of \mathcal{G}_i , we have again:

$$\inf_{i \in I'} \mu_\pi(\mathcal{E}_i | \mathcal{E}_j : \{i, j\} \notin L') \geq \inf_{i \in I'} \inf_{\pi} \Phi_{E_i}^{J, \pi}(\mathcal{E}_i) \geq 1 - \sqrt{1 - p}$$

almost surely. Thus, according to Theorem 1.5.3, if \mathcal{B}_r^n is a Bernoulli product measure of parameter $r = r(K, 1 - \sqrt{1 - p})$ as above, and if we denote its variable $(X_i)_{i \in I'}$, then the family $(\mathbf{1}_{\mathcal{E}_i})_{i \in I'}$ stochastically dominates $(X_i)_{i \in I'}$. In other words, for any increasing function $f : \{0, 1\}^n \rightarrow \mathbb{R}$ we can write (notice that $i \in I \setminus I' \Rightarrow \mathbf{1}_{\mathcal{G}_i} = 0$):

$$\mu_\pi(f(\mathbf{1}_{\mathcal{G}_1} \mathbf{1}_{\mathcal{E}_1}, \dots, \mathbf{1}_{\mathcal{G}_n} \mathbf{1}_{\mathcal{E}_n})) \geq \mathcal{B}_r^n(f(\mathbf{1}_{\mathcal{G}_1} X_1, \dots, \mathbf{1}_{\mathcal{G}_n} X_n))$$

and taking the infimum over π we get (since $\mathbf{1}_{\mathcal{G}_i} \mathbf{1}_{\mathcal{E}_i} \leq \mathbf{1}_{\mathcal{E}_i}$)

$$\inf_{\pi \in \Omega} \Phi_\Lambda^{J, \pi|_{E^w(\Lambda)}} \left(f(\mathbf{1}_{\mathcal{E}_1}, \dots, \mathbf{1}_{\mathcal{E}_n}) \middle| \omega = \pi \text{ on } E^w(\Lambda) \setminus \bigcup_{i=1}^n E_i \right) \geq \mathcal{B}_r^n(f(\mathbf{1}_{\mathcal{G}_1} X_1, \dots, \mathbf{1}_{\mathcal{G}_n} X_n)). \quad (1.59)$$

At this point, we just need to exploit the stochastic minoration on the sequence $(\mathcal{G}_i)_{i \in I'}$: let $\tilde{\mathcal{B}}_r^n$ another Bernoulli product measure of parameter r on I , and denote its variable $(Y_i)_{i \in I}$. Then,

$$\begin{aligned} \mathcal{B}_r^n(f(\mathbf{1}_{\mathcal{G}_1} X_1, \dots, \mathbf{1}_{\mathcal{G}_n} X_n)) &\geq \tilde{\mathcal{B}}_r^n(\mathcal{B}_r^n(f(Y_1 X_1, \dots, Y_n X_n))) \\ &= \mathcal{B}_{r^2}^n(f(X_1, \dots, X_n)) \end{aligned}$$

and reporting in (1.59) we prove the claim. \square

1.5.2. Structure of the main cluster. Using the former geometrical decomposition, the weak form of the coarse graining and the Peierls argument, we provide with Theorem 1.2.1 the final version of the control on the structure of the ω -clusters under the annealed measure. Our result is, at last, entirely similar to Theorem 3.1 of [73]. We recall that a crossing cluster in Λ_N is a

cluster that connects all outer faces of Λ_N (hence it lives on $E^w(\Lambda_N)$), and cite anew Theorem 1.2.1:

THEOREM 1.2.1. *Assumption **(SP)** implies the existence of $c > 0$ and $\kappa < \infty$ such that, for any $N \in \mathbb{N}^*$ large enough and for all $l \in [\kappa \log N, N]$,*

$$\mathbb{E} \inf_{\pi} \Phi_{\Lambda_N}^{J, \pi} \left(\begin{array}{l} \text{There exists a crossing } \omega\text{-cluster } \mathcal{C}^* \text{ in } \Lambda_N \\ \text{and it is the unique cluster of diameter } \geq l \end{array} \right) \geq 1 - \exp(-cl)$$

where the infimum \inf_{π} is taken over all boundary conditions $\pi \in \Omega_{E(\mathbb{Z}^d) \setminus E^w(\Lambda_N)}$.

PROOF. We begin with a geometrical covering of Λ_N : for $L \geq 2$ we let $(\Delta_i, \Delta'_i)_{i \in I_{\Lambda_N, L}}$ the $(L, L-1)$ -covering of Λ_N described at definition 1.5.1. For each $i \in I_{\Lambda_N, L}$ we consider

$$\mathcal{E}_i = \left\{ \omega \in \Omega : \begin{array}{l} \text{There exists a crossing cluster for } \omega \\ \text{in } \Delta'_i \text{ and it is the only cluster of} \\ \text{diameter larger or equal to } L \text{ in } \Delta'_i \end{array} \right\}$$

and denote by A_l the event

$$A_l = \left\{ \omega \in \Omega : \begin{array}{l} \text{There exists a crossing cluster } \mathcal{C}_{\mathcal{E}} \text{ for } \mathcal{E}_i \text{ in} \\ I_{\Lambda_N, L} \text{ such that the diameter of any connected} \\ \text{component of } I_{\Lambda_N, L} \setminus \mathcal{C}_{\mathcal{E}} \text{ is at most } \lceil l/L \rceil - 1 \end{array} \right\}.$$

In a first time we prove the inclusion

$$A_l \subset \left\{ \omega \in \Omega : \begin{array}{l} \text{There exists a crossing } \omega\text{-cluster } \mathcal{C}^* \text{ in } \Lambda_N \\ \text{and it is the unique cluster of diameter } \geq l \end{array} \right\}. \quad (1.60)$$

To begin with, remark that if $i, j \in I_{\Lambda_N, L}$ are nearest neighbors, and if $\omega \in \mathcal{E}_i \cap \mathcal{E}_j$, then the corresponding ω -crossing clusters in Δ'_i and Δ'_j are connected because the intersection $E^w(\Delta'_i) \cap E^w(\Delta'_j)$ has a thickness at least $2L-2$, cf. Lemma 1.5.2 (iii). Hence we see that for every $\omega \in A_l$ there exists a crossing cluster \mathcal{C} for ω in Λ_N . Consider now $\omega \in A_l$ and some ω -open path c in $E^w(\Lambda_N)$ of diameter larger or equal to l . It has an extension at least l in some direction k , thus we can find a connected path i_1, \dots, i_n in $I_{\Lambda_N, L}$ of extension at least $\lceil l/L \rceil$ in the same direction such that c enters each Δ_{i_j} . Because of the definition of A_l , at least one of the i_j pertains to $\mathcal{C}_{\mathcal{E}}$. Yet in view of Lemma 1.5.2 (ii), c has an incursion in $E^w(\Delta'_{i_j})$ of diameter at least L , hence c touches the ω -crossing cluster in $E^w(\Delta'_{i_j})$ which is a part of \mathcal{C} , thus $c = \mathcal{C}$ and (1.60) is proved.

We need now a lower bound on the probability of A_l . If $\omega \in \Omega_{E^w(\Lambda_N)}$ is such that there exists no $*$ -connected path i_1, \dots, i_n with $n = \lceil l/L \rceil$ and $\forall i \in \{1, \dots, n\}, \omega \notin \mathcal{E}_i$, then $\omega \in A_l$. This is a consequence of Lemma 2.1 in [33] or of the (simpler) remark that the set of \mathcal{E}_i -good blocks constitutes a connected interface in every slab of $I_{\Lambda_N, L}$ of height $\lceil l/L \rceil$, whatever is its orientation, hence the holes in $\mathcal{C}_{\mathcal{E}}$ have a diameter at most $\lceil l/L \rceil - 1$.

Thanks to the stochastic domination (Proposition 1.5.4), and to the fact that A_l is an increasing event, it follows that

$$\mathbb{E} \inf_{\pi} \Phi_{\Lambda_N}^{J,\pi}(A_l) \geq \mathcal{B}_{p_L}^{I_{\Lambda_N,L}} \left(\begin{array}{l} \text{There is no } * \text{-connected path } i_1, \dots, i_n \\ \text{in } I_{\Lambda_N,L} \text{ with } n = \lceil l/L \rceil \text{ and} \\ X_{i_k} = 0, \text{ for all } k \in \{1, \dots, n\} \end{array} \right)$$

where p_L can be chosen arbitrarily close to 1 for an appropriate L in view of Propositions 1.4.9 and 1.4.10. We conclude using a Peierls estimate: there are no more than $|I_{\Lambda_N,L}| \times (3^d)^n$ $*$ -connected paths of length n in $I_{\Lambda_N,L}$, hence

$$\mathbb{E} \inf_{\pi} \Phi_{\Lambda_N}^{J,\pi}(A_l) \geq 1 - N^d (3^d)^n (1 - p_L)^n.$$

If we fix L so that $p_L > 1 - 3^{-d}$, it follows that $(3^d)^n (1 - p_L)^n = \exp(-c'n)$ for some $c' > 0$, together with

$$\mathbb{E} \inf_{\pi} \Phi_{\Lambda_N}^{J,\pi}(A_l) \geq 1 - \exp(d \log N - c'l/L)$$

hence the claim holds with $c = c'/(2L)$ and $\kappa = d/c$. \square

1.5.3. Typical density of the main cluster. In this Section we prove Proposition 1.2.2 and provide estimates on the annealed probability that the density of the main cluster be larger than θ^w or smaller than θ^f , where

$$\theta^f = \lim_N \mathbb{E} \Phi_{\Lambda_N}^{J,f}(0 \overset{\omega}{\leftrightarrow} \partial \hat{\Lambda}_N) \quad \text{and} \quad \theta^w = \lim_N \mathbb{E} \Phi_{\Lambda_N}^{J,w}(0 \overset{\omega}{\leftrightarrow} \partial \hat{\Lambda}_N) \quad (1.61)$$

(see after (1.1) for the definitions of Λ_N and $\hat{\Lambda}_N$). An important question is whether these quantities are equal, and we will prove in Theorem 1.2.3 this is the case for almost all values of β . We recall the formulation of Proposition 1.2.2:

PROPOSITION 1.2.2. *For any $\varepsilon > 0$ and $d \geq 1$,*

$$\limsup_N \frac{1}{N^d} \log \mathbb{E} \sup_{\pi} \Phi_{\Lambda_N}^{J,\pi} \left(\begin{array}{l} \text{Some crossing cluster } \mathcal{C}^* \text{ has} \\ \text{a density larger than } \theta^w + \varepsilon \end{array} \right) < 0$$

while assumption (SP) implies, for any $\varepsilon > 0$ and $d \geq 2$:

$$\limsup_N \frac{1}{N^{d-1}} \log \mathbb{E} \sup_{\pi} \Phi_{\Lambda_N}^{J,\pi} \left(\begin{array}{l} \text{There is no crossing cluster } \mathcal{C}^* \\ \text{of density larger than } \theta^f - \varepsilon \end{array} \right) < 0.$$

The proofs of these two estimates differ very little from the originals in [73], yet we state them as an example of application of the renormalization methods.

PROOF. (Upper deviations). Given $L \in \mathbb{N}^*$ we consider $(\Delta_i, \Delta_i)_{i \in I_{\Lambda_N,L}}$ the $(L, 0)$ -covering of Λ_N and call $\tilde{I}_{\Lambda_N,L} = \{0, \dots, [(N-1)/L] - 1\}^d$, so that Δ_i and

Δ_j are disjoint for any $i \neq j \in \tilde{I}_{\Lambda_N, L}$, cf. Lemma 1.5.2 (iv). We let furthermore

$$Y_i = \frac{1}{L^d} \sum_{x \in \Delta_i} \mathbf{1}_{\{x \leftrightarrow \partial^i \Delta_i\}} \quad (i \in \tilde{I}_{\Lambda_N, L}),$$

they are i.i.d. variables under the product measure $\bigotimes_{i \in \tilde{I}_{\Lambda_N, L}} \mathbb{E} \Phi_{E^f(\Delta_i)}^{J, w}$ and their expectation is not larger than $\theta^w + \varepsilon/4$ for L large enough. Hence Cramér's Theorem yields:

$$\limsup_N \frac{1}{|\tilde{I}_{\Lambda_N, L}|} \log \bigotimes_{i \in \tilde{I}_{\Lambda_N, L}} \mathbb{E} \Phi_{E^f(\Delta_i)}^{J, w} \left(\frac{1}{|\tilde{I}_{\Lambda_N, L}|} \sum_{i \in \tilde{I}_{\Lambda_N, L}} Y_i \leq \theta^w + \frac{\varepsilon}{2} \right) < 0$$

for L large enough. Thanks to the stochastic domination (Proposition 1.3.2) the same control holds under $\mathbb{E} \Phi_{\Lambda_N}^{J, w}$, and thanks to the remark that

$$\sum_{x \in \Lambda_N} \mathbf{1}_{\{x \leftrightarrow \partial \Lambda_N\}} \leq L^d \sum_{i \in \tilde{I}_{\Lambda_N, L}} Y_i + dLN^{d-1}.$$

it follows that

$$\limsup_N \frac{1}{N^d} \log \mathbb{E} \sup_{\pi} \Phi_{\Lambda_N}^{J, \pi} \left(\frac{1}{|\Lambda_N|} \sum_{x \in \Lambda_N} \mathbf{1}_{\{x \leftrightarrow \partial \Lambda_N\}} \geq \theta^w + \varepsilon \right) < 0$$

which implies the claim. \square

The proof for the cost of lower deviations is more subtle as it relies on Theorem 1.2.1 and Proposition 1.5.4:

PROOF. (Lower deviations). Given $L \in \mathbb{N}^*$ we call $(\Delta_i, \Delta'_i)_{i \in I_{\Lambda_N, L}}$ the $(L, L-1)$ covering of Λ_N . We use the same notation $\tilde{I}_{\Lambda_N, L}$ as in the previous proof and let

$$Y_i = \frac{1}{L^d} \sum_{x \in \Delta_i} \mathbf{1}_{\{\text{diam}(\mathcal{C}_x) \geq \sqrt{L}\}} \quad (i \in \tilde{I}_{\Lambda_N, L})$$

where \mathcal{C}_x is the ω -cluster containing x . One has $\liminf_{L \rightarrow \infty} \mathbb{E} \Phi_{E^f(\Delta_0)}^{J, f}(Y_0) \geq \theta^f$, hence Cramér's Theorem yields

$$\limsup_N \frac{1}{|\tilde{I}_{\Lambda_N, L}|} \log \bigotimes_{i \in \tilde{I}_{\Lambda_N, L}} \mathbb{E} \Phi_{E^f(\Delta_i)}^{J, f} \left(\frac{1}{|\tilde{I}_{\Lambda_N, L}|} \sum_{i \in \tilde{I}_{\Lambda_N, L}} Y_i \leq \theta^f - \frac{\varepsilon}{2} \right) < 0$$

for any L large enough. Consider now $\tilde{\pi}_N : \mathcal{J}_{E^w(\Lambda_N)} \rightarrow \Omega_{E^w(\Lambda_N)^c}$ a measurable boundary condition as in (1.11) that satisfies

$$\Phi_{\Lambda_N}^{J, \tilde{\pi}_N(J)}(\mathcal{A}_N^\varepsilon) = \sup_{\pi} \Phi_{\Lambda_N}^{J, \pi}(\mathcal{A}_N^\varepsilon).$$

where $\mathcal{A}_N^\varepsilon$ is the event that there is no crossing cluster of density larger than $\theta^f - \varepsilon$ in Λ_N . Thanks to Proposition 1.3.2 we infer that

$$\limsup_N \frac{1}{N^d} \log \mathbb{E} \Phi_{\Lambda_N}^{J, \tilde{\pi}_N(J)} \left(\frac{1}{|\tilde{I}_{\Lambda_N, L}|} \sum_{i \in I_{\Lambda_N, L}} Y_i \leq \theta^f - \frac{\varepsilon}{2} \right) < 0 \quad (1.62)$$

for any L large enough. On the other hand, consider the collection of events

$$\mathcal{E}_i = \left\{ \begin{array}{l} \text{There exists a crossing cluster for } \omega \text{ in } \Delta'_i \\ \text{and it is the unique cluster of diameter } \geq \sqrt{L} \end{array} \right\}$$

for $i \in I_{\Lambda_N, L}$. Each \mathcal{E}_i depends only on $\omega|_{E^w(\Delta'_i)}$ while Theorem 1.2.1 implies:

$$\lim_{L \rightarrow \infty} \mathbb{E} \inf_{\pi \in \Omega_{E^w(\Delta'_i)}^c} \Phi_{\Delta'_i}^{J, \pi}(\mathcal{E}_i) = 1$$

uniformly over $i \in I_{\Lambda_N, L}$. Hence the assumptions of Proposition 1.5.4 are satisfied. Applying Theorem 1.1 of [33] thus yields: for any $\delta > 0$, any L large enough,

$$\limsup_N \frac{1}{N^{d-1}} \log \mathbb{E} \Phi_{\Lambda_N}^{J, \tilde{\pi}_N(J)} \left(\begin{array}{l} \text{There exists no crossing cluster} \\ \text{of density } \geq 1 - \delta \text{ for } (\mathcal{E}_i)_{i \in I_{\Lambda_N, L}} \end{array} \right) < 0. \quad (1.63)$$

Assume now that $\omega \in \Omega_{E^w(\Lambda_N)}$ realizes neither of the events in (1.62) and (1.63) – this is the typical behavior under $\mathbb{E} \Phi_{\Lambda_N}^{J, \tilde{\pi}_N(J)}$ up to surface order large deviations. Call $\mathcal{C} \subset I_{\Lambda_N, L}$ the crossing cluster for \mathcal{E}_i . Because of the overlapping between the Δ'_i (Lemma 1.5.2 (iii)), to \mathcal{C} corresponds a crossing cluster \mathcal{C}^* for ω in Λ_N that passes through every Δ'_i for $i \in \mathcal{C}$. Since \mathcal{C}^* is the only large cluster in each Δ'_i when $i \in \mathcal{C}$, we have

$$\begin{aligned} |\mathcal{C}^*| &\geq \sum_{i \in \mathcal{C} \cap \tilde{I}_{\Lambda_N, L}} \left(L^d Y_i - 2d\sqrt{L}L^{d-1} \right) \\ &\geq \left[\frac{N-1}{L} \right]^d L^d \left(\theta^f - \frac{\varepsilon}{2} - \frac{2d}{\sqrt{L}} \right) - \delta L^d \left(\frac{N}{L} + 1 \right)^d, \end{aligned}$$

which is not smaller than $N^d(\theta^f - \varepsilon)$ provided that $\delta = \varepsilon/6$, $L > (12d/\varepsilon)^2$ and N is large enough. \square

1.5.4. Uniqueness of the infinite volume measure. Adapting the arguments of Lebowitz [59] and Grimmett [42] to the random media case, we prove that for all except at most countably many values of the inverse temperature, the boundary condition does not influence the infinite volume limit of annealed FK measures.

To begin with, given the parameters $\rho, q, p(J) = 1 - \exp(-\beta J)$ with $\beta \geq 0$ we define two infinite volume measures on $\mathcal{J} \times \Omega$ by

$$\Theta_\infty^f = \lim_{N \rightarrow \infty} \mathbb{E} \Phi_{\Lambda_N}^{J, f} \quad \text{and} \quad \Theta_\infty^w = \lim_{N \rightarrow \infty} \mathbb{E} \Phi_{\Lambda_N}^{J, w}. \quad (1.64)$$

As for the uniform media case, these limits exist and Θ_∞^f is stochastically smaller than Θ_∞^w thanks to the stochastic inequalities

$$\mathbb{E}\Phi_{\hat{\Lambda}_N}^{J,f} \leq_{\text{stoch.}} \mathbb{E}\Phi_{\hat{\Lambda}_{N+1}}^{J,f} \leq_{\text{stoch.}} \mathbb{E}\Phi_{\hat{\Lambda}_{N+1}}^{J,w} \leq_{\text{stoch.}} \mathbb{E}\Phi_{\hat{\Lambda}_N}^{J,w}$$

regarding the law induced on $(J, \omega)_{|E^w(\hat{\Lambda}_N)}$. Let us recall Theorem 1.2.3:

THEOREM 1.2.3. *If the interaction equals $p(J_e) = 1 - \exp(-\beta J_e)$, for any Borel probability measure ρ on $[0, 1]$, any $q \geq 1$ and any dimension $d \geq 1$, the set*

$$\mathcal{D}_{\rho, q, d} = \left\{ \beta \geq 0 : \lim_{N \rightarrow \infty} \mathbb{E}\Phi_{\hat{\Lambda}_N}^{J,f} \neq \lim_{N \rightarrow \infty} \mathbb{E}\Phi_{\hat{\Lambda}_N}^{J,w} \right\}$$

is at most countable.

We will present the proof of this Theorem after we state one Lemma. Given a finite edge set E , a realization of the media $J \in \mathcal{J}_E$ and a boundary condition $\pi \in \Omega_{E^c}$ we denote

$$Y_E^{J, \pi} = \sum_{\omega \in \Omega_E} \prod_{e \in E} \left(\frac{p(J_e)}{1 - p(J_e)} \right)^{\omega_e} \times q^{C_E^\pi(\omega)} \quad (1.65)$$

the (adapted) partition function (see Section 1.2.1 for the definition of $C_E^\pi(\omega)$).

LEMMA 1.5.5. *Let $(\pi_N)_{N \in \mathbb{N}^*}$ such that $\forall N \in \mathbb{N}^*, \pi_N \in \Omega_{E^w(\hat{\Lambda}_N)^c}$. Then, the limit*

$$y(\rho, q, \beta) = \lim_{N \rightarrow \infty} \frac{1}{(2N+1)^d} \mathbb{E} \log Y_{E^w(\hat{\Lambda}_N)}^{J, \pi_N} \quad (1.66)$$

exists and is independent of (π_N) . Furthermore, y and $\mathbb{E} \log Y_E^{J, \pi}$ (for any $E \subset E(\mathbb{Z}^d)$ finite and $\pi \in \Omega_{E^c}$) are convex functions of $\log \beta$.

The parameter $\log \beta$ for the convexity appears naturally in the proof, see below after (1.69).

PROOF. As in the non-random case, the convergence in (1.66) with $\pi_N = f$ follows from the sub-additivity of the free energy. The influence of the boundary condition is negligible as $C_{E^w(\Lambda)}^\pi(\omega)$ fluctuates of at most $|\partial \Lambda|$ with π .

We address now the question of convexity. Let I be an interval and $F : I \rightarrow \mathbb{R}_+$ a twice derivable function. We parametrize the inverse temperature letting $\beta = F(\lambda)$ and denote on the other hand $\lambda_e = \log(p(J_e)/(1 - p(J_e))) \in \mathbb{R} \cup \{-\infty\}$, thus

$$Y_E^{J, \pi} = \sum_{\omega \in \Omega_E} \exp \left(\sum_{e \in E} \omega_e \lambda_e \right) \times q^{C_E^\pi(\omega)} \quad (1.67)$$

with the convention that $\omega_e \lambda_e = \omega_e \frac{d^n \lambda_e}{d\lambda^n} = 0$ when $\omega_e = 0$ and $\lambda_e = -\infty$. Using in particular the equality

$$\forall \omega \in \Omega_E, \Phi_E^{J,\pi}(\{\omega\}) = \frac{1}{Y_E^{J,\pi}} \exp\left(\sum_{e \in E} \omega_e \lambda_e\right) \times q^{C_E^\pi(\omega)} \quad (1.68)$$

we get after standard calculations that:

$$\frac{d^2}{d\lambda^2} \log Y_E^{J,\pi} = \Phi_E^{J,\pi} \left(\sum_{e \in E} \omega_e \frac{d^2 \lambda_e}{d\lambda^2} + \left(\sum_{e \in E} \omega_e \frac{d\lambda_e}{d\lambda} \right)^2 \right) - \left(\Phi_E^{J,\pi} \left(\sum_{e \in E} \omega_e \frac{d\lambda_e}{d\lambda} \right) \right)^2$$

and Jensen's inequality implies:

$$\frac{d^2}{d\lambda^2} \log Y_E^{J,\pi} \geq \Phi_E^{J,\pi} \left(\sum_{e \in E} \omega_e \frac{d^2 \lambda_e}{d\lambda^2} \right) \quad (1.69)$$

Here we recover the result of [42]¹: if $J \equiv 1$ we have $\lambda_e = \log(p(1)/(1-p(1)))$, hence $\log Y_E^{1,\pi}$ is a convex function of $\lambda = \log(p(1)/(1-p(1)))$. Let us develop the expression $\lambda_e = \log(e^{\beta J_e} - 1)$ and calculate its second derivative in terms of $\frac{d\beta}{d\lambda}$ and $\frac{d^2\beta}{d\lambda^2}$:

$$\begin{aligned} \frac{d^2 \lambda_e}{d\lambda^2} &= \frac{J_e \frac{d^2 \beta}{d\lambda^2}}{1 - e^{-\beta J_e}} - \frac{\left(J_e \frac{d\beta}{d\lambda} \right)^2 e^{-\beta J_e}}{(1 - e^{-\beta J_e})^2} \\ &= \frac{J_e}{(1 - e^{-\beta J_e})^2} \left[\frac{d^2 \beta}{d\lambda^2} - e^{-\beta J_e} \left(\frac{d^2 \beta}{d\lambda^2} + J_e \left(\frac{d\beta}{d\lambda} \right)^2 \right) \right] \end{aligned}$$

and fix at last $\beta = e^\lambda$, so that the former line simplifies to

$$\frac{d^2 \lambda_e}{d\lambda^2} = \frac{J_e \beta}{(1 - e^{-\beta J_e})^2} [1 - e^{-\beta J_e} (1 + \beta J_e)]$$

which is non-negative since $J_e \geq 0$ and $1 + \beta J_e \leq e^{\beta J_e}$. In view of (1.69) this implies the convexity of $\log Y_E^{J,\pi}$ along $\lambda = \log \beta$, and the convexity of $\mathbb{E} \log Y_E^{J,\pi}$ and y follows. \square

PROOF. (Theorem 1.2.3). We call again $\lambda = \log \beta$ and for any $N \in \mathbb{N}^*$, $\pi \in \{f, w\}$ we denote

$$y_N^\pi = \frac{1}{(2N+1)^d} \mathbb{E} \log Y_{E^w(\hat{\Lambda}_N)}^{J,\pi}$$

¹ In the same direction we could prove the following: if $\forall e \in E, J_e = 0$ or $J_e \geq \varepsilon$, then $\log Y_E^{J,\pi}$ is a convex function of $\log(p(\varepsilon)/(1-p(\varepsilon)))$ as β varies, since $f_\alpha : x \mapsto \log((1+e^x)^\alpha - 1)$ is convex for every $\alpha \geq 1$:

$$f'_\alpha(x) = \frac{\alpha e^x (1+e^x)^{\alpha-1}}{(1+e^x)^\alpha - 1} \quad \text{and} \quad (\log(f'_\alpha(x)))' = \frac{(1+e^x)^\alpha - 1 - \alpha e^x}{[1+e^x][(1+e^x)^\alpha - 1]} \geq 0.$$

Consider some $q \geq 1$ and a Borel probability measure ρ on $[0, 1]$. Since y is a convex function of λ (Lemma 1.5.5), the set

$$\mathcal{D} = \{\lambda \in \mathbb{R} : y \text{ is not derivable at } \lambda\}$$

is at most countable. Then, for any $\lambda \in \mathbb{R} \setminus \mathcal{D}$, $\pi \in \{f, w\}$ we have

$$\lim_N \frac{dy_N^\pi}{d\lambda} = \frac{dy}{d\lambda} \quad (1.70)$$

thanks to the convexity of y_N^π and to the pointwise convergence to y . Calculating the derivative we get:

$$\frac{dy_N^\pi}{d\lambda} = \frac{1}{(2N+1)^d} \mathbb{E} \Phi_{\hat{\Lambda}_N}^{J,\pi} \left(\sum_{e \in E^w(\hat{\Lambda}_N)} \frac{\beta J_e}{1 - \exp(-\beta J_e)} \omega_e \right).$$

We fix now $e_0 = \{0, \mathbf{e}_1\}$ the edge issued from 0 that heads to \mathbf{e}_1 and denote

$$r_L^f = \mathbb{E} \frac{\beta J_{e_0} \Phi_{\hat{\Lambda}_L}^{J,f}(\omega_{e_0})}{1 - \exp(-\beta J_{e_0})} \quad \text{and} \quad r_L^w = \mathbb{E} \frac{\beta J_{e_0} \Phi_{\hat{\Lambda}_L}^{J,w}(\omega_{e_0})}{1 - \exp(-\beta J_{e_0})}.$$

For any $x \in \hat{\Lambda}_N$ and $e \in E^w(\hat{\Lambda}_N)$ we have

$$\mathbb{E} \Phi_{\hat{\Lambda}_N}^{J,f}(\omega_e) \leq \mathbb{E} \Phi_{x+\hat{\Lambda}_{2N}}^{J,f}(\omega_e) \leq \mathbb{E} \Phi_{x+\hat{\Lambda}_{2N}}^{J,w}(\omega_e) \leq \mathbb{E} \Phi_{\hat{\Lambda}_N}^{J,w}(\omega_e)$$

therefore, choosing $x = x_e$ such that $e = \{x_e, x_e \pm \mathbf{e}_k\}$ and summing over $e \in E^w(\hat{\Lambda}_N)$ we obtain

$$\frac{dy_N^f}{d\lambda} \leq \frac{|E^w(\Lambda_N)|}{(2N+1)^d} r_{2N}^f \leq \frac{|E^w(\Lambda_N)|}{(2N+1)^d} r_{2N}^w \leq \frac{dy_N^w}{d\lambda}$$

as the actual direction of e_0 in the definition of r_L^w and r_L^f does not influence their value. In view of (1.70) this implies that the limits of r_{2N}^f and r_{2N}^w are equal, hence

$$\lim_{N \rightarrow \infty} \mathbb{E} \frac{\beta J_{e_0}}{1 - \exp(-\beta J_{e_0})} \left(\Phi_{\hat{\Lambda}_{2N}}^{J,w}(\omega_{e_0}) - \Phi_{\hat{\Lambda}_{2N}}^{J,f}(\omega_{e_0}) \right) = 0.$$

As $\beta J_{e_0} \geq 1 - \exp(-\beta J_{e_0})$ and $\Phi_{\hat{\Lambda}_{2N}}^{J,w}(\omega_{e_0}) \geq \Phi_{\hat{\Lambda}_{2N}}^{J,f}(\omega_{e_0})$, the equality $\Theta^f(\omega_{e_0}) = \Theta^w(\omega_{e_0})$ follows. The stochastic domination $\Theta^f \leq \Theta^w$ leads then to the conclusion: $\Theta^f = \Theta^w, \forall \lambda \in \mathbb{R} \setminus \mathcal{D}$. \square

1.5.5. Application to the Ising model. In this last Section we adapt the coarse graining to the dilute Ising model (Theorem 1.5.7). Applications include the study of equilibrium phase coexistence (Chapter 3) following [12, 14, 23, 25, 26, 24].

We start with a description of the Ising model with random ferromagnetic couplings. Given a domain $\Lambda \subset \mathbb{Z}^d$ we consider the set of spin configurations on Λ with plus boundary condition

$$\Sigma_\Lambda^+ = \{\sigma : \mathbb{Z}^d \rightarrow \{-1, +1\} \text{ with } \sigma(x) = +1 \text{ for all } x \notin \Lambda\}.$$

The Ising measure on Λ under the media $J \in \mathcal{J}_{E^w(\Lambda)}$, at inverse temperature $\beta \geq 0$ and with plus boundary condition is defined by its weight on every spin configuration: $\forall \sigma \in \Sigma_\Lambda^+$,

$$\mu_{\Lambda,\beta}^{J,+}(\{\sigma\}) = \frac{1}{Z_{\Lambda,\beta}^{J,+}} \exp \left(\beta \sum_{e=\{x,y\} \in E^w(\Lambda)} J_e \sigma_x \sigma_y \right) \quad (1.71)$$

where $Z_{\Lambda,\beta}^{J,+}$ is the partition function

$$Z_{\Lambda,\beta}^{J,+} = \sum_{\sigma \in \Sigma_\Lambda^+} \exp \left(\beta \sum_{e=\{x,y\} \in E^w(\Lambda)} J_e \sigma_x \sigma_y \right).$$

The Ising model is closely related to the random-cluster model. To begin with, we say that $\omega \in \Omega_{E^w(\Lambda)}$ and $\sigma \in \Sigma_\Lambda^+$ are compatible, and we denote this by $\sigma \prec \omega$ if:

$$\forall e = \{x, y\} \in E^w(\Lambda), \quad \omega_e = 1 \Rightarrow \sigma_x = \sigma_y.$$

We consider then the joint measure $\Psi_{\Lambda,\beta}^{J,+}$ defined again by its weight on each configuration $(\omega, \sigma) \in \Omega_{E^w(\Lambda)} \times \Sigma_\Lambda^+$:

$$\Psi_{\Lambda,\beta}^{J,+}(\{(\sigma, \omega)\}) = \frac{\mathbf{1}_{\{\sigma \prec \omega\}}}{\tilde{Z}_{\Lambda,\beta}^{J,+}} \prod_{e \in E^w(\Lambda)} p(J_e)^{\omega_e} (1 - p(J_e))^{1 - \omega_e} \quad (1.72)$$

where $p(J_e) = 1 - \exp(-2\beta J_e)$ and $\tilde{Z}_{\Lambda,\beta}^{J,+}$ is the partition function that makes $\Psi_{\Lambda,\beta}^{J,+}$ a probability measure. It is well known (see [66, Chapter 3] for a proof and for advanced remarks on the FK model, including a random cluster representation for spin systems with non-ferromagnetic interactions) that:

PROPOSITION 1.5.6. *The marginals of $\Psi_{\Lambda,\beta}^{J,+}$ on σ and ω are respectively*

$$\mu_{\Lambda,\beta}^{J,+} \quad \text{and} \quad \Phi_\Lambda^{J,p,2,w}.$$

Conditionally on ω , the spin σ is constant on each ω -cluster, equal to one on all clusters touching $\partial\Lambda$, independently and uniformly distributed on $\{-1, +1\}$ on all other clusters. Conditionally on σ , the ω_e are independent and $\omega_e = 1$ with probability $\mathbf{1}_{\{\sigma_x = \sigma_y\}} \times p(J_e)$ if $e = \{x, y\}$.

Direct applications of the previous Proposition yield the following facts: first, the annealed magnetization

$$m_\beta = \lim_{N \rightarrow \infty} \mathbb{E} \mu_{\Lambda_N, \beta}^{J,+}(\sigma_0)$$

equals the cluster density θ^w defined at (1.13). Second, assumption (**SP**, $d \geq 3$) can be reformulated as follows: there exists $H \in \mathbb{N}^*$ such that

$$\inf_{N \in \mathbb{N}^*} \inf_{x,y \in \bar{S}_{N,H}} \mathbb{E} \mu_{\bar{S}_{N,H}, \beta}^{J,f}(\sigma_x \sigma_y) > 0$$

where $\mu_{\Lambda,\beta}^{J,f}$ is the Ising measure with free boundary condition, that one obtains considering $E^f(\Lambda)$ instead of $E^w(\Lambda)$ in (1.71), and $\bar{S} = S \cup \partial S$. On the other hand, a sufficient condition for **(SP)**, $d = 2$) is: there exists a function $\kappa(N) : \mathbb{N}^* \rightarrow \mathbb{N}^*$ with $\kappa(N)/N \rightarrow 0$ as $N \rightarrow \infty$ and

$$\lim_{N \rightarrow \infty} \sup_{\substack{x \in \text{Left}(S_{N,\kappa(N)}) \\ y \in \text{Right}(S_{N,\kappa(N)})}} \mathbb{E} \mu_{\bar{S}_{N,\kappa(N)},\beta}^{J,f}(\sigma_x \sigma_y) > 0$$

where $\text{Left}(S)$ and $\text{Right}(S)$ stand for the two vertical faces of ∂S .

We now present the adaptation of the coarse graining to the Ising model with random ferromagnetic couplings (the adaptation to the Potts model would be similar). As in [73] it provides strong information on the structure of the local phase by the mean of *phase labels* ϕ . Given $N, L \in \mathbb{N}^*$ with $3L \leq N + 1$, we denote $(\Delta_i, \Delta'_i)_{i \in I_{\Lambda_N, L}}$ the (L, L) -covering of Λ_N as in Definition 1.5.1. For any $i \in I_{\Lambda_N, L}$ we let $\mathcal{M}_i^L(\sigma)$ the magnetization on Δ_i , that is

$$\mathcal{M}_i^L(\sigma) = \frac{1}{L^d} \sum_{x \in \Delta_i} \sigma_x.$$

THEOREM 1.5.7. *Assume that $\beta \geq 0$ realizes **(SP)** and $\Theta^f = \Theta^w$. Let $N, L \in \mathbb{N}^*$ with $3L \leq N + 1$ and $\delta > 0$. Then, there exists a sequence of variables $(\phi_i)_{i \in I_{\Lambda_N, L}}$ taking values in $\{-1, 0, 1\}$, with the following properties:*

(i) *For any $i \in I_{\Lambda_N, L}$, we have*

$$\phi_i \neq 0 \Rightarrow |\mathcal{M}_i^L(\sigma) - m_\beta \phi_i| \leq \delta.$$

The event $\phi_i \neq 0$ implies the existence of a ω -crossing cluster and the uniqueness of ω -clusters of diameter at least L in $E^w(\Delta'_i)$.

(ii) *If one extends ϕ letting $\phi_i = 1$ for $i \in \mathbb{Z}^d \setminus I_{\Lambda_N, L}$, then:*

$$\phi_i \phi_j \geq 0, \quad \forall i, j \in \mathbb{Z}^d \text{ with } i \sim j.$$

(iii) *For every $i \in I_{\Lambda_N, L}$, ϕ_i is determined by $\sigma|_{\Delta_i}$ and $\omega|_{E^w(\Delta'_i)}$.*

(iv) *The sequence $(|\phi_i|)_{i \in I_{\Lambda_N, L}}$ stochastically dominates a Bernoulli product measure with high density in the following sense: for every $p < 1$, if L is large enough, then for any $I \subset I_{\Lambda_N, L}$ and any increasing function $f : \{0, 1\}^I \rightarrow \mathbb{R}^+$, we have*

$$\mathbb{E} \inf_{\pi} \Psi_{\Lambda_N, \beta}^{J,+} \left(f \left((|\phi_i|)_{i \in I} \right) \middle| \omega = \pi \text{ on } E^w(\Lambda_N) \setminus \bigcup_{i \in I} E^w(\Delta'_i) \right) \geq \mathcal{B}_p^I(f) \quad (1.73)$$

where \mathcal{B}_p^I is the Bernoulli product measure on I of parameter p .

PROOF. We define the variable ϕ_i in two steps. First we let $\delta' > 0$ and consider

$$\mathcal{E}_i = \left\{ \begin{array}{l} \text{In } E^w(\Delta'_i), \text{ there exists a crossing cluster for } \omega, \\ \text{it is the unique cluster of diameter } \geq L^{1/3}. \\ \omega \in \Omega : \text{ In } E^w(\Delta_i), \text{ there exists a crossing cluster } \mathcal{C}_i \text{ for } \omega, \\ \text{its relative density belongs to } [m_\beta(1 \pm \delta/2)] \text{ and} \\ \text{there are at least } \delta' L^d \text{ isolated } \omega\text{-clusters.} \end{array} \right\}$$

and

$$\mathcal{G}_i = \left\{ (\sigma, \omega) : \begin{array}{l} \omega \in \mathcal{E}_i, \sigma \text{ and } \omega \text{ are compatible} \\ \text{and } |\mathcal{M}_i^L(\sigma) - m_\beta \varepsilon_i(\sigma, \omega)| \leq \delta \end{array} \right\}$$

where $\varepsilon_i(\sigma, \omega)$ is the value of σ on the main ω -cluster in $E^w(\Delta_i)$. Then we let

$$\phi_i = \begin{cases} \varepsilon_i(\sigma, \omega) & \text{if } (\sigma, \omega) \in \mathcal{G}_i \\ 0 & \text{else.} \end{cases}$$

Properties (i) to (iii) follow from the definition of \mathcal{E}_i and \mathcal{G}_i , together with the plus boundary condition imposed by $\Psi_{\Lambda_N, \beta}^{J, +}$ on σ .

We turn now to the proof of the stochastic domination and exploit the hypothesis **(SP)** and $\Theta^f = \Theta^w$. Combining Theorem 1.2.1, Proposition 1.2.2 and the remark that for any $\delta' > 0$ small enough,

$$\limsup_N \frac{1}{N^d} \log \mathbb{E} \sup_{\pi} \Phi_{\Lambda_N}^{J, \pi} \left(\begin{array}{l} \text{There are less than } \delta' N^d \\ \text{clusters made of 1 point in } \Lambda_N \end{array} \right) < 0$$

(remark that $\{x\}$ is a cluster for ω in Λ_N if all the ω_e with $x \in e$ are closed, which happens with probability at least $e^{-2d\beta}$ conditionally on the state of all other edges, uniformly over $J \in \mathcal{J}$), we see that there exists $p_{L, \delta, \delta'}$ with $p_{L, \delta, \delta'} \rightarrow 1$ as $L \rightarrow \infty$ (for small enough $\delta' > 0$) such that, uniformly over N and $i \in I_{\Lambda_N, L}$,

$$\mathbb{E} \inf_{\pi} \Phi_{\Delta'_i}^{J, \pi}(\mathcal{E}_i) \geq p_{L, \delta, \delta'}.$$

Given $\omega \in \mathcal{E}_i$ we examine as in [25] the conditional probability for having $(\sigma, \omega) \in \mathcal{G}_i$. The contribution of the main ω -cluster \mathcal{C}_i to $\mathcal{M}_i^L(\sigma)$ belongs to $\varepsilon m_\beta(1 \pm \delta/2)$ where ε stands for the value of σ on \mathcal{C}_i . Then, if $2dL^{-2/3} \leq \delta/4$ the contribution of the small clusters touching the boundary of Δ_i is not larger than $\delta/4$ and it remains to control the contribution of the small clusters not touching the boundary. Since the spin of these clusters are independent and uniformly distributed on $\{\pm 1\}$, Lemma 5.3 of [73] tells us that:

$$\Psi_{\Lambda_N, \beta}^{J, +} \left(\left| \frac{1}{|\text{SC}_{\Delta_i}(\omega)|} \sum_{x \in \text{SC}_{\Delta_i}(\omega)} \sigma_x \right| > \frac{\delta}{4} \middle| \omega \right) \leq 2 \exp \left(-|\text{SC}_{\Delta_i}(\omega)| \Lambda^* \left(\frac{\delta}{4L^{d/3}} \right) \right)$$

where $\text{SC}_{\Delta_i}(\omega)$ is the set of small clusters for ω in Δ_i not touching the boundary, $L^{d/3}$ an upper bound on the volume of any small cluster, and

$$\Lambda^*(x) = \frac{1+x}{2} \log(1+x) + \frac{1-x}{2} \log(1-x), \forall x \in (-1, 1)$$

is the Legendre transform of the logarithmic moment generating function of X of law $\delta_{-1/2} + \delta_{1/2}$. Because of the assumption $\omega \in \mathcal{E}_i$, we have $|\text{SC}_{\Delta_i}(\omega)| \geq \delta' L^d$. Hence,

$$\Psi_{\Lambda_N, \beta}^{J,+} \left(\left| \frac{1}{L^d} \sum_{x \in \text{SC}_{\Delta_i}(\omega)} \sigma_x \right| > \frac{\delta}{4} \middle| \omega \right) \leq 2 \exp \left(-\delta' L^d \Lambda^* \left(\frac{\delta}{4L^{d/3}} \right) \right)$$

As $\Lambda^*(x) \geq x^2/2$ and $m_\beta \leq 1$ we conclude that for L large enough, for any $\omega \in \mathcal{E}_i$,

$$\Psi_{\Lambda_N, \beta}^{J,+} (\mathcal{G}_i | \omega, \sigma_{|\Lambda \setminus \Delta_i}) \geq p'_{L, \delta, \delta'} = 1 - 2 \exp(-\delta' \delta^2 L^{d/3}/16).$$

We now conclude the proof of the stochastic domination for $|\phi_i| = \mathbf{1}_{\mathcal{G}_i}$ and consider $I \subset I_{\Lambda_N, L}$, together with an increasing function $f : \{0, 1\}^I \rightarrow \mathbb{R}^+$. We fix $\omega \in \Omega_{E^w(\Lambda_N)}$ and consider

$$I' = \{i \in I : \omega \in \mathcal{E}_i\} \quad \text{and} \quad f' : \{0, 1\}^{I'} \rightarrow \mathbb{R}^+$$

defined by

$$f'((x_i)_{i \in I'}) = f((x_i)_{i \in I}), \quad \forall (x_i) \in \{0, 1\}^I \text{ with } x_i = 0, \forall i \in I \setminus I'.$$

Since no more than 6^d distinct Δ_i can intersect, Theorem 1.5.3 tells us that

$$\begin{aligned} \Psi_{\Lambda_N, \beta}^{J,+} (f((\mathbf{1}_{\mathcal{G}_i})_{i \in I}) | \omega) &= \Psi_{\Lambda_N, \beta}^{J,+} (f'((\mathbf{1}_{\mathcal{G}_i})_{i \in I'}) | \omega) \\ &\geq \mathcal{B}_{r(6^d, p'_{L, \delta, \delta'})}^{I'} (f'((X_i)_{i \in I'})) \\ &= \mathcal{B}_{r(6^d, p'_{L, \delta, \delta'})}^I (f((X_i \mathbf{1}_{\mathcal{E}_i})_{i \in I})). \end{aligned} \quad (1.74)$$

Integrating (1.74) under the conditional measure

$$\Phi_{\Lambda_N}^{J,w} \left(\cdot \middle| \omega = \pi \text{ on } E^w(\Lambda_N) \setminus \bigcup_{i \in I} E^w(\Delta'_i) \right)$$

and taking $\mathbb{E} \inf_{\pi}$ we obtain on the left hand side, thanks to Proposition 1.5.6, the left-hand side of (1.73). For the right-hand side, we remark that

$$y = (y_i)_{i \in I} \mapsto \mathcal{B}_{X, p}^I (f((X_i y_i)_{i \in I}))$$

is an increasing function, hence Proposition 1.5.4 gives the lower bound

$$\begin{aligned} \mathbb{E} \inf_{\pi} \Phi_{\Lambda_N}^{J,w} \left(\mathcal{B}_{r(6^d, p'_{L, \delta, \delta'})}^I (f((X_i \mathbf{1}_{\mathcal{E}_i})_{i \in I})) \middle| \omega = \pi \text{ on } E^w(\Lambda_N) \setminus \bigcup_{i \in I} E^w(\Delta'_i) \right) \\ \geq \mathcal{B}_{Y, r'(6^d, p_{L, \delta, \delta'})}^I \left(\mathcal{B}_{X, r(6^d, p'_{L, \delta, \delta'})}^I (f((X_i Y_i)_{i \in I})) \right) \\ = \mathcal{B}_{X, r'(6^d, p_{L, \delta, \delta'}) \times r(6^d, p'_{L, \delta, \delta'})}^I (f((X_i)_{i \in I})) \end{aligned}$$

and the claim follows as, for any $\delta' > 0$ small enough,

$$\lim_{L \rightarrow \infty} r'(6^d, p_{L, \delta, \delta'}) \times r(6^d, p'_{L, \delta, \delta'}) = 1.$$

□

1.6. Conclusion

These estimates for the Ising model with random ferromagnetic couplings conclude our construction of a coarse graining under the assumption of slab percolation. It turns out that apart from being a strong obstacle to the shortness of the construction, the media randomness does not change the typical aspect of clusters (or the behavior of phase labels for spin models) in the regime of slab percolation.

This coarse graining is a first step towards a study of phase coexistence in the dilute Ising model that we propose in Chapter 3. Following [14, 24] we describe the phenomenon of phase coexistence in a L^1 setting, under both quenched and annealed measures. The notion of surface tension and the study of its fluctuations as a function of the media is another requirement for that study, it is thus the object of Chapter 2.

Another fundamental application of the coarse graining, together with the study of equilibrium phase coexistence, concerns the dynamics of such random media models. In opposition with the previous phenomenon which nature is hardly modified by the introduction of random media, the media randomness introduces an abrupt change in the dynamics and we confirm in Chapter 4 several predictions of [45], among which a polynomial decay for the average spin autocorrelation.

CHAPTER 2

Surface tension

ABSTRACT. This chapter is dedicated to the study of surface tension in the dilute Ising model. Media randomness is responsible for new properties of surface tension. We prove the convergence of the quenched surface tension and analyze large deviations: upper deviations occur at volume order while lower deviations occur at surface order. We provide upper and lower bounds on the rate function for lower deviations. At low temperatures we relate surface tension to maximal flows (or first passage times if $d = 2$) and prove, for a broad class of distributions of the media, that the inequality $\tau^a \leq \tau^q$ between annealed and quenched values of surface tension is strict.

2.1. Introduction

In the former chapter we designed a coarse graining in order to describe the local phases of the Ising model in random media. Here we study another notion that plays an essential role in the phenomenon of phase coexistence: surface tension. Surface tension is a physical quantity that quantifies the cost of having an interface separating the plus and minus phases in a given direction. We will see in Chapter 3 that it determines the shape of droplets when phase coexistence occurs.

The random media introduces a major modification with respect to the pure Ising model: in the dilute Ising model, surface tension depends on the realization of the media. Hence the usual question of convergence of surface tension takes a more complex form, which we answer proving the convergence in probability and studying large deviations. Lower deviations turn to be of surface order. We will expose the connection between the rate function for lower deviations and the annealed value of surface tension. The fact that lower deviations occur at surface order is also responsible for the metastability properties of the Glauber dynamics of the dilute Ising model that we describe in Chapter 4.

This Chapter is organized as follows: in the remaining of Section 2.1, we introduce a few definitions and present our main results. In Section 2.2 we prove the convergence of surface tension and introduce the rate function for lower deviations. In Section 2.3 we examine the low temperature asymptotics

of surface tension and in the last Section we provide lower and upper bounds on the rate function for lower deviations.

2.1.1. Notations and definitions. Below we describe the Fortuin-Kasteleyn representation of the Ising model and proceed to the definition of surface tension. The use of the Fortuin-Kasteleyn representation for the definition of surface tension is a great advantage on the technical level as one can use directly the FKG inequalities. A side advantage is that, at the same time, one can study surface tension corresponding to (ferromagnetic) random media percolation, Ising and Potts models.

Our analysis holds for the lattice \mathbb{Z}^d , $d \geq 2$. The canonical vectors are denoted $(\mathbf{e}_i)_{i=1\dots d}$ and for any $x = \sum_{i=1}^d x_i \mathbf{e}_i = (x_1, \dots, x_d) \in \mathbb{Z}^d$ we consider the following norms on \mathbb{Z}^d :

$$\|x\|_1 = \sum_{i=1}^d |x_i|, \quad \|x\|_2 = \left(\sum_{i=1}^d x_i^2 \right)^{1/2} \quad \text{and} \quad \|x\|_\infty = \max_{i=1}^d |x_i|.$$

Given $x, y \in \mathbb{Z}^d$ we say that x, y are nearest neighbors (which we denote $x \sim y$) if they are at Euclidean distance 1, i.e. if $\|x - y\|_2 = 1$. To any domain $\Lambda \subset \mathbb{Z}^d$ we associate the edge sets

$$\begin{aligned} E(\Lambda) &= \{\{x, y\} : x, y \in \Lambda \text{ and } x \sim y\} \\ \text{and } E^w(\Lambda) &= \{\{x, y\} : x \in \Lambda, y \in \mathbb{Z}^d \text{ and } x \sim y\}. \end{aligned}$$

The set of cluster configurations is

$$\Omega = \{\omega : E(\mathbb{Z}^d) \rightarrow \{0, 1\}\}$$

and for any $\omega \in \Omega$ and $E \subset E(\mathbb{Z}^d)$ we call $\omega|_E$ the restriction of ω to E , defined by $(\omega|_E)_e = \omega_e$ if $e \in E$, 0 else. The set of cluster configurations on E is $\Omega_E = \{\omega|_E, \omega \in \Omega\}$. Given a parameter $q \geq 1$ and an inverse temperature $\beta \geq 0$, a realization of the random couplings $J : E(\mathbb{Z}^d) \rightarrow [0, 1]$, a finite edge set $E \subset E(\mathbb{Z}^d)$ and a boundary condition $\pi \in \Omega_{E^c}$ we consider the Fortuin-Kasteleyn measure $\Phi_{E, \beta}^{J, \pi, q}$ on Ω_E defined by

$$\Phi_{E, \beta}^{J, \pi, q}(\{\omega\}) = \frac{1}{Z_{E, \beta}^{J, \pi, q}} \prod_{e \in E} p_e^{\omega_e} (1 - p_e)^{1 - \omega_e} \times q^{C_E^\pi(\omega)}, \quad \forall \omega \in \Omega_E \quad (2.1)$$

where $p_e = 1 - \exp(-\beta J_e)$, $C_E^\pi(\omega)$ is the number of clusters of the set of vertices in \mathbb{Z}^d attained by E under the wiring $\omega \vee \pi$ defined by $(\omega \vee \pi)_e = \max(\omega_e, \pi_e)$, $\forall e \in E(\mathbb{Z}^d)$, and $Z_{E, \beta}^{J, \pi, q}$ is the renormalization constant making $\Phi_{E, \beta}^{J, \pi, q}$ a probability measure.

For convenience we use the same notation for the probability measure $\Phi_{E, \beta}^{J, \pi, q}$ and for its expectation. When the parameters q and β are clear from the context we omit them in the notation. Given \mathcal{R} a compact subset of \mathbb{R}^d

(usually a rectangular parallelepiped) we denote $\Phi_{\mathcal{R}}^{J,\pi}$ the measure $\Phi_{E(\overset{\circ}{\mathcal{R}} \cap \mathbb{Z}^d)}^{J,\pi}$ on the cluster configurations on $E(\overset{\circ}{\mathcal{R}} \cap \mathbb{Z}^d)$, where $\overset{\circ}{\mathcal{R}}$ stands for the interior of \mathcal{R} .

We say that $f : \Omega_E \rightarrow \mathbb{R}^+$ is increasing if, for all $\omega, \omega' \in \Omega_E$ one has $\omega \leq_{\Omega} \omega' \Rightarrow f(\omega) \leq f(\omega')$ where \leq_{Ω} stands for the product order on Ω_E . The following fact is classical – see [4] for instance:

PROPOSITION 2.1.1. *The Fortuin-Kasteleyn measure $\Phi_{E,\beta}^{J,\pi,q}$ satisfies:*

- (i) *For any $h : \Omega_E \rightarrow \mathbb{R}^+$ increasing, $\Phi_{E,\beta}^{J,\pi,q}(h)$ is a non-decreasing function of J , β and π .*
- (ii) *FKG Inequality: for any $g, h : \Omega_E \rightarrow \mathbb{R}^+$ increasing we have*

$$\Phi_{E,\beta}^{J,\pi,q}(gh) \geq \Phi_{E,\beta}^{J,\pi,q}(g)\Phi_{E,\beta}^{J,\pi,q}(h).$$

- (iii) *DLR Equation:*

$$\Phi_{E,\beta}^{J,\pi,q}(\cdot | \omega|_{E'} = \omega') = \Phi_{E \setminus E', \beta}^{J,\pi \vee \omega', q}$$

for any $E' \subsetneq E$ and $\omega' \in \Omega_{E'}$.

The dilute interactions are represented by a sequence of random variables $J = (J_e)_{e \in E(\mathbb{Z}^d)}$ such that, under the measure \mathbb{P} , the $(J_e)_{e \in E(\mathbb{Z}^d)}$ are independent, identically distributed on $[0, 1]$ and measurable with respect to the Borel σ -field. The assumption that $J_e \geq 0$ simplifies our study as it permits the use of the FKG inequalities, while the assumption that J_e is bounded from above ensures that all bonds have finite energy (otherwise, the error terms in the subadditivity Theorem – Theorem 2.2.2 – would themselves be random, leading to some more complications). The independence makes the study easier: in particular, for any $\mathcal{R}_1, \mathcal{R}_2$ compact subsets of \mathbb{R}^d that have disjoint interiors, for any $g, h : \Omega \rightarrow \mathbb{R}$ the quantities $\Phi_{\mathcal{R}_1}^{J,\pi}(g)$ and $\Phi_{\mathcal{R}_2}^{J,\pi}(h)$ are independent under \mathbb{P} .

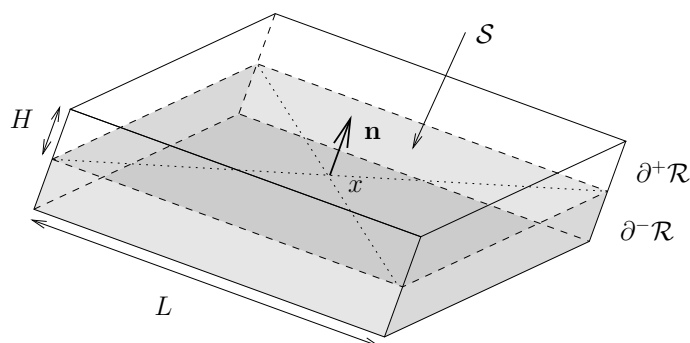

FIGURE 1. The rectangular parallelepiped $\mathcal{R}_{x,L,H}(\mathcal{S}, \mathbf{n})$.

We continue with a few geometrical notations. We call

- S^{d-1} the set of unit vectors of \mathbb{R}^d
- $\mathbb{S}_{\mathbf{n}}$ the set of $d - 1$ dimensional hypercubes of side-length 1, centered at 0, orthogonal to $\mathbf{n} \in S^{d-1}$.

Remark the set $\mathbb{S}_{\mathbf{n}}$ can be enumerated as follows:

$$\mathbb{S}_{\mathbf{n}} = \left\{ \sum_{k=1}^{d-1} [\pm 1/2] \mathbf{u}_k; (\mathbf{u}_1, \dots, \mathbf{u}_{k-1}, \mathbf{n}) \text{ is an orthonormal basis for } \mathbb{R}^d \right\}.$$

Given $\mathbf{n} \in S^{d-1}$, $\mathcal{S} \in \mathbb{S}_{\mathbf{n}}$ and $x \in \mathbb{R}^d$, two positive numbers L and H , we denote $\mathcal{R} = \mathcal{R}_{x,L,H}(\mathcal{S}, \mathbf{n})$ the rectangular parallelepiped

$$\mathcal{R}_{x,L,H}(\mathcal{S}, \mathbf{n}) = x + L\mathcal{S} + [-H, H]\mathbf{n} \quad (2.2)$$

centered at x , with basis $x + L\mathcal{S}$ and extension $2H$ in the direction \mathbf{n} (See Figure 1). The discrete version of \mathcal{R} is $\hat{\mathcal{R}} = \mathring{\mathcal{R}} \cap \mathbb{Z}^d$ and the inner discrete boundary of \mathcal{R} is

$$\partial \hat{\mathcal{R}} = \left\{ y \in \hat{\mathcal{R}} : \exists z \in \mathbb{Z}^d \setminus \hat{\mathcal{R}}, z \sim y \right\}.$$

For any \mathcal{R} as in (2.2) we decompose $\partial \hat{\mathcal{R}}$ into its *upper* and *lower* parts $\partial^+ \hat{\mathcal{R}} = \{y \in \partial \hat{\mathcal{R}} : (y - x) \cdot \mathbf{n} \geq 0\}$ and $\partial^- \hat{\mathcal{R}} = \{y \in \partial \hat{\mathcal{R}} : (y - x) \cdot \mathbf{n} < 0\}$, where x is the center of \mathcal{R} and \mathbf{n} its orientation.

DEFINITION 2.1.2. For any rectangular parallelepiped \mathcal{R} like (2.2), the surface tension in \mathcal{R} is

$$\tau_{\mathcal{R}}^J = -\frac{1}{L^{d-1}} \log \Phi_{\mathcal{R}}^{J,w}(\mathcal{D}_{\mathcal{R}}) \quad (2.3)$$

where $\mathcal{D}_{\mathcal{R}}$ is the event of disconnection between the upper and lower parts of $\partial \hat{\mathcal{R}}$:

$$\mathcal{D}_{\mathcal{R}} = \left\{ \omega \in \Omega : \partial^+ \hat{\mathcal{R}} \overset{\omega}{\not\leftrightarrow} \partial^- \hat{\mathcal{R}} \right\}. \quad (2.4)$$

We will see in the next Chapter that this quantity actually measures the cost for phase coexistence in the direction \mathbf{n} . On a physical level, it is well known that surface tension represents the excess free energy per surface unit due to the presence of an interface.

2.1.2. Main results. As in the uniform case, the surface tension is a decreasing function of H and a sub-additive function of L (apart from small error terms, see Theorem 2.2.2). In view of the applications to the study of phase coexistence, we consider from now on

$$\mathcal{R}^N = \mathcal{R}_{0,N,\delta N}(\mathcal{S}, \mathbf{n})$$

for some $\delta > 0$ small and N large. In Theorem 2.2.3 we introduce the *quenched* surface tension τ^q as the limit

$$\tau^q(\mathbf{n}) = \lim_{N \rightarrow \infty} \tau_{\mathcal{R}^N}^J \text{ in } \mathbb{P}\text{-probability}$$

which does not depend on $\mathcal{S} \in \mathbb{S}_{\mathbf{n}}$, nor on $\delta > 0$. Then we address the possibility of fluctuations of $\tau_{\mathcal{R}^N}^J$ around $\tau^q(\mathbf{n})$ for large values of N . Upper deviations occur at volume order (Proposition 2.2.4), hence they are not

relevant for the study of phase coexistence. Instead, lower deviations occur at surface order.

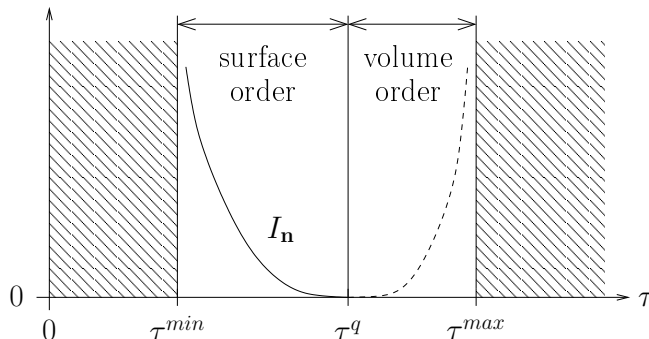

FIGURE 2. Large deviations scalings for surface tension.

We denote J^{\min} the lowest value of interactions according to the support of \mathbb{P} , namely:

$$J^{\min} = \inf\{\lambda \geq 0 : \mathbb{P}(J_e < \lambda) > 0\}.$$

The surface tension associated to the deterministic media with constant interactions J^{\min} converges, we call τ^{\min} its limit. In Theorem 2.2.5 we describe the rate function for lower deviations of surface tension: for every $\mathbf{n} \in S^{d-1}$, there is $I_{\mathbf{n}} : \mathbb{R} \rightarrow [0, +\infty]$ such that, for every $\tau \in \mathbb{R} \setminus \{\tau^{\min}(\mathbf{n})\}$,

$$I_{\mathbf{n}}(\tau) = \lim_{N \rightarrow \infty} -\frac{1}{N^{d-1}} \log \mathbb{P}(\tau_{\mathcal{R}^N}^J \leq \tau)$$

independently of $\mathcal{S} \in \mathbb{S}_{\mathbf{n}}$ and $\delta > 0$. The rate function $I_{\mathbf{n}}$ is convex, non-increasing, it is infinite on the left of $\tau^{\min}(\mathbf{n})$, finite on the right of $\tau^{\min}(\mathbf{n})$ and zero starting from $\tau^q(\mathbf{n})$.

The Fenchel-Legendre transform of $I_{\mathbf{n}}$, defined by

$$\tau^\lambda(\mathbf{n}) = \inf_{\tau \in \mathbb{R}} \{\lambda\tau + I_{\mathbf{n}}(\tau)\}$$

coincides with the λ -annealed surface tension

$$\tau^\lambda(\mathbf{n}) = \lim_{N \rightarrow \infty} -\frac{1}{N^{d-1}} \log \mathbb{E} \left(\left[\Phi_{\mathcal{R}^N}^{J,w}(\mathcal{D}_{\mathcal{R}^N}) \right]^\lambda \right) \quad \lambda > 0, \mathbf{n} \in S^{d-1},$$

see Section 2.2.4. The particular case $\lambda = 1$ corresponds to the usual notion of annealed surface tension and we denote $\tau^a(\mathbf{n}) = \tau^{\lambda=1}(\mathbf{n})$. As a consequence of this duality, the asymptotics of $I_{\mathbf{n}}$ on the left of $\tau^q(\mathbf{n})$ determines whether or not the quenched and annealed surface tension coincide, and more precisely

$$\alpha_{\mathbf{n}} = \sup \{ \lambda > 0 : \tau^\lambda(\mathbf{n}) = \lambda\tau^q(\mathbf{n}) \}$$

(with the convention $\alpha_{\mathbf{n}} = 0$ if the former set is empty) is the opposite of the slope of $I_{\mathbf{n}}$ on the left of $\tau^q(\mathbf{n})$ (Proposition 2.4.9).

For a broad class of \mathbb{P} , using low temperature expansions we prove in Section 2.3 that $\tau^\lambda(\mathbf{n})/\lambda$ and $\tau^q(\mathbf{n})$ do not have the same asymptotics as $\beta \rightarrow \infty$, showing in particular that quenched and annealed surface tension differ at low temperature.

Two more controls on the asymptotics of $I_{\mathbf{n}}$ on the left of $\tau^q(\mathbf{n})$ are provided. Using concentration methods we show that $I_{\mathbf{n}}(\tau^q(\mathbf{n}) - r)$ is at least quadratic in $r > 0$ small (Theorems 2.4.1 and 2.4.4). This implies that $I_{\mathbf{n}}(\tau)$ is positive for all $\tau < \tau^q(\mathbf{n})$. Then, making a strong assumption on the transverse fluctuations of the interface, we provide a sub-linear upper bound for $I_{\mathbf{n}}(\tau^q(\mathbf{n}) - r)$.

2.2. Convergence and deviations

Surface tension quantifies the energy per surface unit of an interface separating the two distinct phases. It is a fundamental tool for understanding the mechanism of phase coexistence and in this Section we describe its typical behavior under \mathbb{P} , as well as its large deviations.

In several aspects the surface tension for the dilute Ising model is similar to the one of the Ising model with deterministic couplings. In particular it is sub-additive and this is the reason for the convergence of the quenched surface tension. The same arguments as in the uniform case [65] prove the convexity of surface tension along \mathbf{n} . Yet an important characteristic of surface tension in random media appears here: it can *fluctuate* around its typical value. The sub-additivity helps in proving that the cost of lower deviations is of surface order (Theorem 2.2.5), and the same argument combined with a simple refinement proves that the cost for upper deviations is of volume order (Proposition 2.2.4).

2.2.1. Quenched convergence. After recalling some important but well-known estimates on surface tension, we establish the quenched convergence of surface tension. We begin with a few easy but helpful controls on surface tension:

PROPOSITION 2.2.1. *The surface tension $\tau_{\mathcal{R}}^J$ in the rectangular parallelepiped $\mathcal{R} = \mathcal{R}_{0,L,H}(\mathcal{S}, \mathbf{n})$ with $L, H \geq 2\sqrt{d}$*

- (i) *is a non-decreasing function of J and β ,*
- (ii) *is a non-increasing function of H ,*
- (iii) *satisfies the inequality*

$$0 \leq \tau_{\mathcal{R}}^J \leq c_d \beta$$

where $c_d < +\infty$ is a constant that depends on d only.

In order to concentrate on the novelties introduced by the random media, the proof of Proposition 2.2.1 is postponed to Appendix 2.5.1. The sub-additivity property of surface tension is as follows:

THEOREM 2.2.2. *Consider $\mathbf{n} \in S^{d-1}$, $\mathcal{S}, \mathcal{S}' \subset \mathbb{S}_{\mathbf{n}}$ and $H, l \geq 2\sqrt{d}$, $L \geq 4\sqrt{dl}$. Let $\mathcal{R} = \mathcal{R}_{0,L,H+\sqrt{d}/2}(\mathcal{S}, \mathbf{n})$. There is a collection $(\mathcal{R}^i)_{i \in \mathcal{C}}$ of rectangular parallelepipeds $\mathcal{R}_i = \mathcal{R}_{z_i, l, H}(\mathcal{S}', \mathbf{n})$ that are disjoint subsets of \mathcal{R} , centered at $z_i \in \mathbb{Z}^d$, with*

$$1 - c_d \left(\frac{l}{L} + \frac{1}{l} \right) \leq \left(\frac{l}{L} \right)^{d-1} |\mathcal{C}| \leq 1 \quad (2.5)$$

such that, for any $J : E(\hat{\mathcal{R}}) \rightarrow [0, 1]$:

$$\tau_{\mathcal{R}}^J \leq \frac{1}{|\mathcal{C}|} \sum_{i \in \mathcal{C}} \tau_{\mathcal{R}_i}^J + \beta c_d \left(\frac{l}{L} + \frac{1}{l} \right) \quad (2.6)$$

where $c_d < \infty$ is a constant that depends on d only.

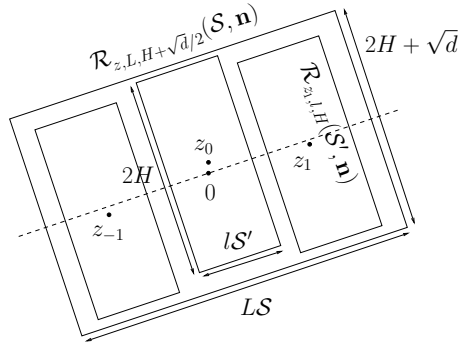

FIGURE 3. The rectangular parallelepiped \mathcal{R} and the collection $(\mathcal{R}^i)_{i \in \mathcal{C}}$ in Theorem 2.2.2.

It is well known that surface tension is sub-additive in the case of the Ising model with deterministic couplings [65]. In the random media case, sub-additivity will imply the convergence of surface tension, the surface order cost for lower deviations, as well as the volume order cost for upper deviations. The proof of Theorem 2.2.2, which is considerably shorter thanks to the use of the FK representation, is to be found in Appendix 2.5.1 as well.

A key fact in the sub-additivity as formulated in Theorem 2.2.2 is the *independence* of the $\tau_{\mathcal{R}_i}^J$ under \mathbb{P} – it is a consequence of the fact that the \mathcal{R}_i are disjoint. Furthermore, the $\tau_{\mathcal{R}_i}^J$ have the same law as the \mathcal{R}_i are all centered at lattice points. Three error terms appear in Theorem 2.2.2. Their origins are as follows (see also Figure 3):

- (i) the term $\beta c_d/l$ stands for the cost of disconnection in the middle section of \mathcal{R} between adjacent \mathcal{R}^i ,

- (ii) the term $\beta c_d l / L$ represents the cost of disconnection in the area not covered by the \mathcal{R}^i
- (iii) and the increase of H by $\sqrt{d}/2$ for \mathcal{R} with respect to the \mathcal{R}_i is a consequence of the requirement that the \mathcal{R}_i be all centered at lattice points.

This last error term could be avoided for *rational* directions $\mathbf{n} \in S^{d-1}$, yet (as the two others) it will soon disappear when we take the limit $H \rightarrow \infty$.

We establish now the convergence for surface tension:

THEOREM 2.2.3. *Let $\mathbf{n} \in S^{d-1}$, $\mathcal{S} \in \mathbb{S}_n$, $\delta > 0$ and $\mathcal{R}^N = \mathcal{R}_{0,N,\delta N}(\mathcal{S}, \mathbf{n})$ for any $N \geq 2\sqrt{d}/\delta$. Then, the limit*

$$\lim_{N \rightarrow \infty} \tau_{\mathcal{R}^N}^J = \tau^q(\mathbf{n}) \quad \text{in } \mathbb{P}\text{-probability}$$

exists and does not depend on \mathcal{S} nor on δ . $\tau^q(\mathbf{n})$ is a non-decreasing function of β and satisfies $0 \leq \tau^q(\mathbf{n}) \leq c_d \beta$ where $c_d < \infty$ depends on d only.

The quenched surface tension $\tau^q(\mathbf{n})$ is *positive* for any $\beta > \hat{\beta}_c$: the renormalization argument of Chapter 1 allows to compare the annealed surface tension $\tau^a(\mathbf{n}) \leq \tau^q(\mathbf{n})$ to the surface tension of high density site percolation, which is positive.

The proof of Theorem 2.2.3 is based on the sub-additivity of surface tension. We do not apply directly Kingman's sub-additive Theorem [56] as we want to show that τ^q does not depend on \mathcal{S} , nor on δ .

PROOF. Taking the expectation \mathbb{E} in the sub-additivity inequality (2.6) we get

$$\mathbb{E} \tau_{\mathcal{R}_{0,L,H+\sqrt{d}/2}}^J(\mathcal{S}, \mathbf{n}) \leq \mathbb{E} \tau_{\mathcal{R}_{0,L,H}}^J(\mathcal{S}', \mathbf{n}) + \beta c_d \left(\frac{l}{L} + \frac{1}{l} \right).$$

Applying $\limsup_{L \rightarrow \infty}$, then $\liminf_{l \rightarrow \infty}$ and taking the decreasing limit in H we obtain

$$\lim_{H \rightarrow \infty} \limsup_{L \rightarrow \infty} \mathbb{E} \tau_{\mathcal{R}_{0,L,H}}^J(\mathcal{S}, \mathbf{n}) \leq \lim_{H \rightarrow \infty} \liminf_{L \rightarrow \infty} \mathbb{E} \tau_{\mathcal{R}_{0,L,H}}^J(\mathcal{S}', \mathbf{n})$$

which proves that

$$\tau^q(\mathbf{n}) = \lim_{H \rightarrow \infty} \liminf_{L \rightarrow \infty} \mathbb{E} \tau_{\mathcal{R}_{0,L,H}}^J(\mathcal{S}, \mathbf{n}) = \lim_{H \rightarrow \infty} \limsup_{L \rightarrow \infty} \mathbb{E} \tau_{\mathcal{R}_{0,L,H}}^J(\mathcal{S}, \mathbf{n}) \quad (2.7)$$

exists and does not depend on $\mathcal{S} \in \mathbb{S}_n$. Immediate consequences of Proposition 2.2.1 are the inequality $0 \leq \tau^q(\mathbf{n}) \leq c_d \beta$ and the fact that $\tau^q(\mathbf{n})$ is a non-decreasing function of β .

We prove now the convergence $\tau_{\mathcal{R}^N}^J \rightarrow \tau^q(\mathbf{n})$ in \mathbb{P} -probability. The sub-additivity (2.6) yields: for any $\delta > 0$ and N large enough,

$$\tau_{\mathcal{R}^N}^J \leq \tau_{\mathcal{R}_{0,N,H+\sqrt{d}/2}}^J(\mathcal{S}, \mathbf{n}) \leq \frac{1}{|\mathcal{C}|} \sum_{i \in \mathcal{C}} \tau_{\mathcal{R}_{z_i, L, H}}^J + \beta c_d \left(\frac{L}{N} + \frac{1}{L} \right)$$

Taking $\limsup_{N \rightarrow \infty}$ and applying the strong law of large numbers give:

$$\limsup_{N \rightarrow \infty} \tau_{\mathcal{R}^N}^J \leq \mathbb{E} \tau_{\mathcal{R}_{0,L,H}}^J(\mathcal{S}, \mathbf{n}) + \frac{\beta c_d}{L} \quad \mathbb{P}\text{-a.s.}$$

and after $\liminf_{L \rightarrow \infty}$ and $\lim_{H \rightarrow \infty}$ we see that, for all $\mathcal{S} \in \mathbb{S}_{\mathbf{n}}$ and $\delta > 0$,

$$\limsup_{N \rightarrow \infty} \tau_{\mathcal{R}^N}^J \leq \tau^q(\mathbf{n}) \quad \mathbb{P}\text{-a.s.} \quad (2.8)$$

On the other hand, the sub-additivity (2.6) is also responsible for the convergence of $\mathbb{E} \tau_{\mathcal{R}^N}^J$: remark that

$$\mathbb{E} \tau_{\mathcal{R}_{0,L,\delta N+\sqrt{d}/2}}^J(\mathcal{S}, \mathbf{n}) \leq \mathbb{E} \tau_{\mathcal{R}^N}^J + \beta c_d \left(\frac{N}{L} + \frac{1}{N} \right),$$

hence $\limsup_{L \rightarrow \infty}$ followed by $\liminf_{N \rightarrow \infty}$ give:

$$\tau^q(\mathbf{n}) \leq \liminf_{N \rightarrow \infty} \mathbb{E} \tau_{\mathcal{R}^N}^J. \quad (2.9)$$

Together with (2.8) and (2.9), the boundedness of $\tau_{\mathcal{R}^N}^J$ ensures the convergence in \mathbb{P} -probability. \square

2.2.2. Volume order cost for upper deviations. The surface tension $\tau_{\mathcal{R}_{0,N,\delta N}}^J(\mathcal{S}, \mathbf{n})$, as a media-dependent variable, fluctuates around its limit value $\tau^q(\mathbf{n})$. First, we prove that upper deviations are of volume order.

PROPOSITION 2.2.4. *For any $\varepsilon > 0$ and $\delta > 0$, one has*

$$\liminf_N \frac{1}{N^d} \log \mathbb{P} \left(\tau_{\mathcal{R}_{0,N,\delta N}}^J(\mathcal{S}, \mathbf{n}) \geq \tau^q(\mathbf{n}) + \varepsilon \right) < 0.$$

The proof is based on the following argument: in order to increase $\tau_{\mathcal{R}_{0,N,\delta N}}^J(\mathcal{S}, \mathbf{n})$, one has to increase all intermediate surface tensions $\tau_{\mathcal{R}_i}^J$, where the \mathcal{R}_i are translates of $\mathcal{R}_{0,N,H}(\mathcal{S}, \mathbf{n})$ in the direction \mathbf{n} . Yet, the cost of increasing one $\tau_{\mathcal{R}_i}^J$ is already of surface order.

PROOF. As a first step towards the proof we estimate the cost of the deviations for a fixed height, exploiting the sub-additivity of τ^J . From the definition of $\tau^q(\mathbf{n})$ at (2.7) it follows that for any H large enough,

$$\limsup_L \mathbb{E} \tau_{\mathcal{R}_{0,L,H}}^J(\mathcal{S}, \mathbf{n}) \leq \tau^q(\mathbf{n}) + \frac{\varepsilon}{6}.$$

Given such an H we fix l large enough such that $\mathbb{E}\tau_{\mathcal{R}_{0,l,H}}^J(\mathcal{S}, \mathbf{n}) \leq \tau^q(\mathbf{n}) + \varepsilon/3$ and $c_d\beta/l \leq \varepsilon/4$, where c_d refers to the constant in the sub-additivity equation. With the notations of Theorem 2.2.2 we have:

$$\tau_{\mathcal{R}_{0,L,H+\sqrt{d}/2}}^J(\mathcal{S}, \mathbf{n}) \leq \frac{1}{|\mathcal{C}|} \sum_{i \in \mathcal{C}} \tau_{\mathcal{R}_{z_i,l,H}}^J(\mathcal{S}, \mathbf{n}) + \frac{\varepsilon}{4} + \beta c_d \frac{l}{L} \quad (2.10)$$

and the $\tau_{\mathcal{R}_{z_i,l,H}}^J(\mathcal{S}, \mathbf{n})$ are i.i.d. variables of mean not larger than $\tau^q(\mathbf{n}) + \varepsilon/3$. Hence, Cramér's Theorem tells that

$$\mathbb{P} \left(\frac{1}{|\mathcal{C}|} \sum_{i \in \mathcal{C}} \tau_{\mathcal{R}_{z_i,l,H}}^J(\mathcal{S}, \mathbf{n}) \geq \tau^q(\mathbf{n}) + \frac{\varepsilon}{2} \right) \leq \exp(-c|\mathcal{C}|)$$

for some $c > 0$. Reporting in (2.10) proves that for any $\varepsilon > 0$, for any H large enough:

$$\limsup_{L \rightarrow \infty} \frac{1}{L^{d-1}} \log \mathbb{P} \left(\tau_{\mathcal{R}_{0,L,H}}^J(\mathcal{S}, \mathbf{n}) \geq \tau^q(\mathbf{n}) + \varepsilon \right) < 0 \quad (2.11)$$

– that is, the cost for increasing $\tau_{\mathcal{R}_{0,L,H}}^J(\mathcal{S}, \mathbf{n})$ is of surface order. We fix such an H and decompose now the rectangular parallelepiped $\mathcal{R} = \mathcal{R}_{0,N,\delta N}(\mathcal{S}, \mathbf{n})$ in the direction \mathbf{n} . Precisely, we let

$$\tilde{x}_i = 2 \left(H + \frac{\sqrt{d}}{2} \right) i \mathbf{n}, \quad \forall i \in \mathbb{Z} \quad \text{and} \quad \tilde{\mathcal{R}}_i = \mathcal{R}_{\tilde{x}_i, N, H + \sqrt{d}/2}(\mathcal{S}, \mathbf{n}).$$

We call \mathcal{G} the set of $i \in \mathbb{Z}$ such that $\tilde{\mathcal{R}}_i \subset \mathcal{R}$ and consider, for all $i \in \mathcal{G}$, x_i the point of \mathbb{Z}^d such that $\tilde{x}_i \in x_i + [-1/2, 1/2]^d$ and let

$$\mathcal{R}_i = \mathcal{R}_{x_i, N - \sqrt{d}, H}(\mathcal{S}, \mathbf{n}).$$

The rectangular parallelepipeds \mathcal{R}_i are disjoint subsets of $\mathcal{R} = \mathcal{R}_{0,N,\delta N}(\mathcal{S}, \mathbf{n})$, all centered at lattice points. Furthermore, if we call \mathcal{E}_{lat} the set of edges in $E(\hat{\mathcal{R}})$ with one extremity at distance at most \sqrt{d} from the lateral boundary of \mathcal{R} , we have:

$$\omega \in \bigcup_{i \in \mathcal{G}} \mathcal{D}_{\mathcal{R}_i} \quad \text{and} \quad \omega_e = 0, \forall e \in \mathcal{E}_{\text{lat}} \quad \Rightarrow \quad \omega \in \mathcal{D}_{\mathcal{R}}.$$

Hence the DLR equation yields:

$$\begin{aligned} \Phi_{\mathcal{R}}^{J,w}(\mathcal{D}_{\mathcal{R}}) &\geq \max_{i \in \mathcal{G}} \Phi_{\mathcal{R}}^{J,w}(\omega_e = 0, \forall e \in \mathcal{E}_{\text{lat}} \quad \text{and} \quad \omega \in \mathcal{D}_{\mathcal{R}_i}) \\ &\geq e^{-\beta|\mathcal{E}_{\text{lat}}|} \times \max_{i \in \mathcal{G}} \Phi_{\mathcal{R}_i}^{J,w}(\omega \in \mathcal{D}_{\mathcal{R}_i}). \end{aligned}$$

As $|\mathcal{E}_{\text{lat}}| \leq c_d \delta N^{d-1}$ we conclude finally to the inequality

$$\tau_{\mathcal{R}}^J \leq c_d \delta \beta + \min_{i \in \mathcal{G}} \tau_{\mathcal{R}_i}^J. \quad (2.12)$$

Inequality (2.12) states that in order to increase significantly $\tau_{\mathcal{R}}^J$, one must increase each $\tau_{\mathcal{R}_i}^J$. Yet, the cost for increasing one of the $\tau_{\mathcal{R}_i}^J$ is of surface order

(2.11), and the $\tau_{\mathcal{R}_i}^J$ are independent variables. Hence for any $\delta > 0$ such that $c_d \delta \beta < \varepsilon$,

$$\limsup_{N \rightarrow \infty} \frac{1}{N^d} \log \mathbb{P} \left(\tau_{\mathcal{R}_{0,N,\delta N}(\mathcal{S}, \mathbf{n})}^J \geq \tau^q(\mathbf{n}) + 2\varepsilon \right) < 0.$$

As $\tau_{\mathcal{R}_{0,N,\delta N}(\mathcal{S}, \mathbf{n})}^J$ decreases with δ , the claim follows for arbitrary $\delta > 0$. \square

2.2.3. Surface order cost for lower deviations. Contrary to upper deviations, lower deviations occur at surface order. Here we establish a large deviation principle for lower deviations. The fact that deviations occur at the same order as the disconnecting event defining surface tension is responsible for the distinct behavior of surface tension under quenched and annealed measures, cf. Section 2.2.4. Explicit bounds on the rate function $I_{\mathbf{n}}$ will be derived in Section 2.4. We recall that the rate function $I_{\mathbf{n}}$ was depicted at Figure 2.

THEOREM 2.2.5. *For every $\mathbf{n} \in S^{d-1}$ and $\beta \geq 0$, $\tau \in \mathbb{R} \setminus \{\tau^{\min}(\mathbf{n})\}$, the limit*

$$I_{\mathbf{n}}(\tau) = \lim_N -\frac{1}{N^{d-1}} \log \mathbb{P} \left(\tau_{\mathcal{R}_{0,N,\delta N}(\mathcal{S}, \mathbf{n})}^J \leq \tau \right) \in [0, +\infty] \quad (2.13)$$

exists and does not depend on $\delta > 0$, nor on $\mathcal{S} \in \mathbb{S}_{\mathbf{n}}$. It is infinite for any $\tau < \tau^{\min}(\mathbf{n})$, finite for all $\tau > \tau^{\min}(\mathbf{n})$ and zero for $\tau \geq \tau^q(\mathbf{n})$. $I_{\mathbf{n}}$ is convex non-increasing, continuous on $(\tau^{\min}(\mathbf{n}), +\infty)$.

PROOF. We begin with the definition of the rate function $I_{\mathcal{R}}$ in a rectangular parallelepiped $\mathcal{R} = \mathcal{R}_{0,L,H}(\mathcal{S}, \mathbf{n})$ as the surface cost for reducing $\tau_{\mathcal{R}}^J$ to τ :

$$I_{\mathcal{R}}(\tau) = -\frac{1}{L^{d-1}} \log \mathbb{P} \left(\tau_{\mathcal{R}}^J \leq \tau \right).$$

According to Proposition 2.2.1, $I_{\mathcal{R}_{0,L,H}(\mathcal{S}, \mathbf{n})}(\tau)$ is a non-increasing function of τ and H . Hence the limit

$$I_{(\mathcal{S}, \mathbf{n})}(\tau) = \lim_{\varepsilon \rightarrow 0^+} \inf_H \limsup_L I_{\mathcal{R}_{0,L,H}(\mathcal{S}, \mathbf{n})}(\tau + \varepsilon) \in [0, \infty] \quad (2.14)$$

exists – we introduce the $\varepsilon > 0$ in order to compensate for the error terms in (2.6). It is clearly a non-increasing function of τ . We prove now that it is also convex in τ and that it does not depend on $\mathcal{S} \in \mathbb{S}_{\mathbf{n}}$: let $\mathcal{S}' \in \mathbb{S}_{\mathbf{n}}$, $\varepsilon > 0$ and $\alpha \in [0, 1]$. Using the notations $\mathcal{R} = \mathcal{R}_{0,L,H+\sqrt{l}/2}(\mathcal{S}, \mathbf{n})$, $\mathcal{R}_i = \mathcal{R}_{z_i, l, H}(\mathcal{S}', \mathbf{n})$ and \mathcal{C} of the sub-additivity Theorem (Theorem 2.2.2), we have

$$\tau_{\mathcal{R}}^J \leq \frac{|\mathcal{C}^1|}{|\mathcal{C}|} \tau^1 + \frac{|\mathcal{C}^2|}{|\mathcal{C}|} \tau^2 + \varepsilon + \beta c_d \left(\frac{l}{L} + \frac{1}{l} \right)$$

if $\mathcal{C}^1 \sqcup \mathcal{C}^2$ is a partition of \mathcal{C} such that

$$\tau_{\mathcal{R}_i}^J \leq \begin{cases} \tau^1 + \varepsilon & \text{if } i \in \mathcal{C}^1 \\ \tau^2 + \varepsilon & \text{if } i \in \mathcal{C}^2. \end{cases} \quad (2.15)$$

The probability for realizing condition (2.15) equals

$$\exp \left(-|\mathcal{C}^1| l^{d-1} I_{\mathcal{R}_{0,l,H}(\mathcal{S}', \mathbf{n})}(\tau^1 + \varepsilon) - |\mathcal{C}^2| l^{d-1} I_{\mathcal{R}_{0,l,H}(\mathcal{S}', \mathbf{n})}(\tau^2 + \varepsilon) \right)$$

and letting $|\mathcal{C}^1|/|\mathcal{C}| \rightarrow \alpha$ and $L \rightarrow \infty$ we see that

$$\begin{aligned} \limsup_L I_{\mathcal{R}_{0,L,H+\sqrt{d}/2}}(\mathcal{S}, \mathbf{n}) (\alpha\tau^1 + (1-\alpha)\tau^2 + 2\varepsilon + \beta c_d/l) &\leq \\ \alpha I_{\mathcal{R}_{0,L,H}}(\mathcal{S}', \mathbf{n}) (\tau^1 + \varepsilon) + (1-\alpha) I_{\mathcal{R}_{0,L,H}}(\mathcal{S}', \mathbf{n}) (\tau^2 + \varepsilon). \end{aligned} \quad (2.16)$$

Taking the superior limit in l , then the limit in H , when $\varepsilon \rightarrow 0^+$ we obtain

$$I_{(\mathcal{S}, \mathbf{n})} (\alpha\tau^1 + (1-\alpha)\tau^2) \leq \alpha I_{(\mathcal{S}', \mathbf{n})} (\tau^1) + (1-\alpha) I_{(\mathcal{S}', \mathbf{n})} (\tau^2)$$

which proves both the independence of $I_{(\mathcal{S}, \mathbf{n})}$ with respect to \mathcal{S} (take $\alpha = 1$) and the convexity along τ . We let now $I_{\mathbf{n}} = I_{(\mathcal{S}, \mathbf{n})}$ and postpone the proof of (2.13) for a while. The continuity of $I_{\mathbf{n}}$ on the interior of the domain of finiteness of $I_{\mathbf{n}}$ is a consequence of its convexity. Hence we examine the domain of finiteness of $I_{\mathbf{n}}$. Let first $\tau < \tau^{\min}(\mathbf{n})$. If $\varepsilon > 0$ is small enough, the event $\tau_{\mathcal{R}_{0,L,H}}^J \leq \tau + \varepsilon < \tau^{\min}(\mathbf{n})$ has a probability zero and consequently, $I_{\mathbf{n}}(\tau) = +\infty$. The second easy regime is $\tau \geq \tau^q(\mathbf{n})$: from Proposition 2.2.4 we infer that $\lim_{L \rightarrow \infty} \mathbb{P}(\tau_{\mathcal{R}_{0,L,H}}^J \leq \tau + \varepsilon) = 1$ provided that H is large enough and this implies $I_{\mathbf{n}}(\tau) = 0$. If at last $\tau > \tau^{\min}(\mathbf{n})$, there is H such that

$$\limsup_L \tau_{\mathcal{R}_{0,L,H}}^{J^{\min}} < \tau.$$

We will prove that, for $\delta > 0$ small enough we still have:

$$\limsup_L \tau_{\mathcal{R}_{0,L,H}}^{J^{\min+\delta}} < \tau. \quad (2.17)$$

If we let $\mathcal{R} = \mathcal{R}_{0,L,H}(\mathcal{S}, \mathbf{n})$ and differentiate along δ , we obtain

$$\frac{\partial \tau_{\mathcal{R}}^{J^{\min+\delta}}}{\partial \delta} = \sum_{e \in E(\hat{\mathcal{R}})} \frac{\partial \tau_{\mathcal{R}}^J}{\partial J_e} \Big|_{J=J^{\min+\delta}}$$

yet, (2.40) and Proposition 2.4.3 indicate that, for any $J \in \mathcal{J}$,

$$\frac{L^{d-1}}{\beta} \frac{\partial \tau_{\mathcal{R}}^J}{\partial J_e} \leq 1.$$

As a consequence, $\tau_{\mathcal{R}}^{J^{\min+\delta}}$ is a $c_d \beta H$ -Lipschitz function of δ . The same is true for $\limsup_L \tau_{\mathcal{R}_{0,L,H}}^{J^{\min+\delta}}$, thus (2.17) holds true for $\delta > 0$ small enough. Now we write, for any L large enough:

$$\begin{aligned} I_{\mathcal{R}_{0,L,H}}(\mathcal{S}, \mathbf{n}) (\tau) &= -\frac{1}{L^{d-1}} \log \mathbb{P} \left(\tau_{\mathcal{R}_{0,L,H}}^J \leq \tau \right) \\ &\leq -\frac{1}{L^{d-1}} \log \mathbb{P} \left(J_e \leq J^{\min} + \delta, \quad \forall e \in E \left(\hat{\mathcal{R}}_{0,L,H}(\mathcal{S}, \mathbf{n}) \right) \right) \\ &\leq c_d H \times (-\log \mathbb{P}(J_e \in [J^{\min}, J^{\min} + \delta])) \end{aligned}$$

which is finite thanks to the definition of J^{\min} . This ends the proof that $I_{\mathbf{n}}(\tau) < \infty$, for any $\tau > \tau^{\min}(\mathbf{n})$.

We address at last the convergence (2.13). The inequality $I_{\mathcal{R}_{0,N,\delta N}(\mathcal{S},\mathbf{n})}(\tau) \leq I_{\mathcal{R}_{0,N,H}(\mathcal{S},\mathbf{n})}(\tau)$ when $N\delta \geq H$ yields an upper bound on the superior limit:

$$\limsup_N I_{\mathcal{R}_{0,N,\delta N}(\mathcal{S},\mathbf{n})}(\tau) \leq \inf_H \limsup_L I_{\mathcal{R}_{0,L,H}(\mathcal{S},\mathbf{n})}(\tau) \leq I_{\mathbf{n}}(\tau^-) = I_{\mathbf{n}}(\tau)$$

for all $\tau > \tau^{\min}(\mathbf{n})$, thanks to the continuity of $I_{\mathbf{n}}$. For the lower bound we use the sub-additivity of surface tension. Applying (2.16) with $\alpha = 1$, $l = N$, $H = \delta N$ yields: for any $\varepsilon > 0$ and N large enough,

$$\limsup_L I_{\mathcal{R}_{0,L,\delta N+\sqrt{d}/2}(\mathcal{S},\mathbf{n})}(\tau + 3\varepsilon) \leq I_{\mathcal{R}_{0,N,\delta N}(\mathcal{S},\mathbf{n})}(\tau + \varepsilon)$$

and replacing $\tau + \varepsilon$ with τ , we obtain after the limits $N \rightarrow \infty$ and $\varepsilon \rightarrow 0^+$ the lower bound

$$I_{\mathbf{n}}(\tau) \leq \liminf_N I_{\mathcal{R}_{0,N,\delta N}(\mathcal{S},\mathbf{n})}(\tau), \quad \forall \tau \in \mathbb{R}.$$

□

2.2.4. Annealed surface tension and fractional moments. In order to get information on the rate function $I_{\mathbf{n}}$ we consider a dual quantity: the λ -annealed surface tension defined as the Fenchel-Legendre transform of $I_{\mathbf{n}}$. For any $\lambda > 0$ and $\mathbf{n} \in S^{d-1}$, we let

$$\tau^\lambda(\mathbf{n}) = \inf_{\tau \in \mathbb{R}} \{\lambda\tau + I_{\mathbf{n}}(\tau)\}. \quad (2.18)$$

This quantity carries as much information as $I_{\mathbf{n}}$ thanks to the duality of Fenchel-Legendre transforms for convex functions (Lemma 4.5.8 in [32]). It can be interpreted as the surface tension under a modification of the annealed measure. Indeed, if we let

$$\tau_{\mathcal{R}}^\lambda = -\frac{1}{L^{d-1}} \log \mathbb{E} \left(\left[\Phi_{\mathcal{R}}^{J,w}(\mathcal{D}_{\mathcal{R}}) \right]^\lambda \right) = -\frac{1}{L^{d-1}} \log \mathbb{E} \left(\exp(-\lambda L^{d-1} \tau_{\mathcal{R}}^J) \right), \quad (2.19)$$

for any rectangular parallelepiped \mathcal{R} of side-length L as in (2.2), then Varadhan's Lemma yields:

PROPOSITION 2.2.6. *For any $\lambda > 0$ and $\mathbf{n} \in S^{d-1}$, for any sequence of rectangular parallelepipeds $\mathcal{R}^N = \mathcal{R}_{0,N,\delta N}(\mathcal{S},\mathbf{n})$ with $\delta > 0$ and $\mathcal{S} \in \mathbb{S}_{\mathbf{n}}$, the quantity $\tau_{\mathcal{R}^N}^\lambda$ converges to $\tau^\lambda(\mathbf{n})$:*

$$\lim_N \tau_{\mathcal{R}^N}^\lambda = \tau^\lambda(\mathbf{n}). \quad (2.20)$$

Thus, the limit does not depend on $\delta > 0$ nor on $\mathcal{S} \in \mathbb{S}_{\mathbf{n}}$.

The particular case $\lambda = 1$ shows the convergence of the annealed surface tension $\tau^a = \tau^{\lambda=1}$. We describe now two of the main questions on surface tension: first, Jensen's inequality implies that

$$\tau^\lambda(\mathbf{n}) \leq \lambda \tau^q(\mathbf{n}), \quad \forall \lambda > 0$$

and we would like to discuss the cases of equality. Considering the low temperature asymptotics of τ^λ and τ^q in Section 2.3 we prove that, for a broad

class of distributions \mathbb{P} , for any $\lambda > 0$ the inequality $\tau^\lambda(\mathbf{n}) \leq \lambda\tau^q(\mathbf{n})$ is *strict* for β large enough. In fact, we believe that the inequality is strict whenever $\tau^q(\mathbf{n}) > 0$. Another clue on the strict inequality is given in Section 2.4.3, where we describe the connection between this question and the asymptotics of $I_{\mathbf{n}}$ (see Proposition 2.4.9 and Theorem 2.4.8).

The second important question concerns the positivity of $I_{\mathbf{n}}$ on the left of $\tau^q(\mathbf{n})$. Thus, we consider

$$\tilde{\tau}^q(\mathbf{n}) = \inf \{ \tau \in \mathbb{R} : I_{\mathbf{n}}(\tau) = 0 \} \quad (2.21)$$

the value of surface tension at which $I_{\mathbf{n}}$ becomes positive. Using concentration methods we prove that the equality $\tilde{\tau}^q = \tau^q$ holds for all but at most countably many β , provided that \mathbb{P} satisfies a logarithmic Sobolev inequality (see Corollary 2.4.5). This implies the positivity of $I_{\mathbf{n}}$ on the interval $(\tau^{\min}(\mathbf{n}), \tau^q(\mathbf{n}))$ and confirms that lower deviations are of surface order.

We conclude this paragraph with two propositions. First, we list some immediate consequences of the definitions (2.20) and (2.21), that permit to sketch the graph of $\lambda \mapsto \tau^\lambda(\mathbf{n})$ on Figure 4:

PROPOSITION 2.2.7. *For all $\mathbf{n} \in S^{d-1}$ the function $\lambda \mapsto \tau^\lambda(\mathbf{n})$ is concave and*

$$I_{\mathbf{n}}(\tau) = \sup_{\lambda > 0} \{ \tau^\lambda(\mathbf{n}) - \lambda\tau \}. \quad (2.22)$$

The following inequalities hold:

$$\lambda\tau^{\min}(\mathbf{n}) \leq \tau^\lambda(\mathbf{n}) \leq \lambda\tilde{\tau}^q(\mathbf{n}), \quad \forall \mathbf{n} \in S^{d-1}, \lambda > 0 \quad (2.23)$$

and we have:

$$\frac{\tau^\lambda(\mathbf{n})}{\lambda} \xrightarrow{\lambda \rightarrow 0^+} \tilde{\tau}^q(\mathbf{n}) \quad \text{and} \quad \frac{\tau^\lambda(\mathbf{n})}{\lambda} \xrightarrow{\lambda \rightarrow +\infty} \tau^{\min}(\mathbf{n}), \quad \forall \mathbf{n} \in S^{d-1}. \quad (2.24)$$

Hence, $\tau^\lambda(\mathbf{n})$ is positive if and only if $\tilde{\tau}^q(\mathbf{n}) > 0$. Furthermore:

$$\tau^\lambda(\mathbf{n}) \xrightarrow{\lambda \rightarrow +\infty} \lim_{\tau \rightarrow 0^+} I_{\mathbf{n}}(\tau) \in [0, \infty]. \quad (2.25)$$

Another important yet classical fact is the *convexity* of surface tension [65]. In Appendix 2.5.2 we prove the weak triangle inequality for $\tau_{\mathcal{R}}^J$ and derive the following Proposition:

PROPOSITION 2.2.8. *Let f^q be the homogeneous extension of τ^q to \mathbb{R}^d , namely:*

$$f^q(x) = \begin{cases} \|x\|\tau^q(x/\|x\|) & \text{if } x \in \mathbb{R}^d \setminus \{0\} \\ 0 & \text{if } x = 0, \end{cases}$$

and let f^λ (resp. \tilde{f}^q) be the homogeneous extension of τ^λ (resp. $\tilde{\tau}^q$) to \mathbb{R}^d . Then, f^q , f^λ and \tilde{f}^q are convex and τ^q , τ^λ and $\tilde{\tau}^q$ are continuous on S^{d-1} .

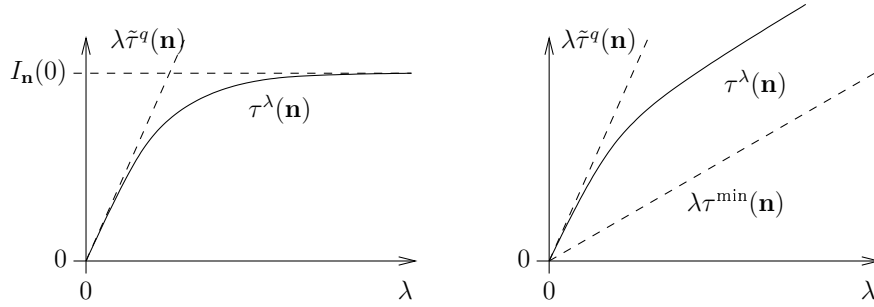

FIGURE 4. The graph of $\lambda \mapsto \tau^\lambda(\mathbf{n})$ in the case of dilution ($\tau^{\min} = 0$ and $I_{\mathbf{n}}(0) < \infty$, left) and distributions with $\tau^{\min} > 0$ (right).

2.3. Low temperature asymptotics

In this Section, we describe the low temperature asymptotics of both quenched and annealed surface tension. We will see in particular that the quenched surface tension, at low temperature, is related to the maximal flow for \mathbb{P} . This study is motivated by the two questions we answer below: Is the inequality $\tau^\lambda \leq \lambda\tau^q$ strict? What is the limit shape of the Wulff crystals when $\beta \rightarrow +\infty$?

2.3.1. Objectives. Our objective is to prove the two Theorems below. First we claim that the quenched and annealed surface tension do not coincide at low temperature, for a broad class of environments. We call $p_c(d)$ the critical threshold for bond percolation on \mathbb{Z}^d .

THEOREM 2.3.1. *Assume that $\mathbb{P}(J_e > J^{\min}) > p_c(d)$. Then, for any $\lambda > 0$ there is $\beta_c^\lambda < \infty$ such that*

$$\tau^\lambda(\mathbf{n}) < \lambda\tau^q(\mathbf{n}), \quad \forall \mathbf{n} \in S^{d-1}, \forall \beta > \beta_c^\lambda. \quad (2.26)$$

Remark that in the case $J^{\min} = 0$, the assumption of Theorem 2.3.1 corresponds to $\mathbb{P}(J_e > 0) > p_c(d)$, which is necessary for having a phase transition in the dilute Ising model (else we have $\tau^\lambda(\mathbf{n}) = \lambda\tau^q(\mathbf{n}) = 0$ for all $\beta \geq 0$). Let us mention another interesting fact about (2.26): for the directed polymer in random environment in $1+1$ dimensions (which was introduced in order to represent interfaces of the two dimensional random media Ising model at low temperatures, see [46]) it was proved recently [31] that the Lyapunov exponent is positive at all $\beta \geq 0$, which corresponds in our settings to the strict inequality $\tau_\beta^a(\mathbf{n}) = \tau_\beta^{\lambda=1} < \tau_\beta^q(\mathbf{n})$.

Then, we examine the shape of Wulff crystals associated to surface tension. Wulff crystals correspond to the deterministic shape of droplets that appear when phase coexistence occurs, they will be presented with further details in

Chapter 3 (see Section 3.1.2.4). Given a function $\tau : S^{d-1} \rightarrow (0, \infty)$ which homogeneous extension to \mathbb{R}^d is convex, we define the Wulff crystal associated to τ as

$$\mathcal{W} = \alpha \{x \in \mathbb{R}^d : x \cdot \mathbf{n} \leq \tau(\mathbf{n}), \forall \mathbf{n} \in S^{d-1}\}$$

where $\alpha \in (0, \infty)$ makes \mathcal{W} of volume 1. We claim:

THEOREM 2.3.2. *Assume that $\mathbb{P}(J_e > 0) = 1$. Then, as $\beta \rightarrow +\infty$:*

- (i) *The Wulff crystal associated to τ^q converges to the Wulff crystal associated to the maximal flow for \mathbb{P} .*
- (ii) *The Wulff crystal associated to τ^λ converges to the hypercubic Wulff crystal.*

These theorems will be finally proved in Section 2.3.4.

2.3.2. Maximal flow for the media. Before describing the low temperature asymptotics for surface tension, we have to define the maximal flow for \mathbb{P} . Here we give a brief introduction to maximal flows, the interested reader can consult [55], [54] and [15] for more details.

We will use an analogy for describing maximal flows. Imagine a liquid which has to cross a lattice made of tubes with limited capacity. Then, the maximal flow, in a given direction, is the quantity of liquid that can flow through the lattice, per unit of surface.

Maximal flow, thanks to the max-flow min-cut Theorem, correspond to surfaces of minimal weight (first-passage paths in two dimensions). We use this characterization for our definition. Given a rectangular parallelepiped $\mathcal{R} = \mathcal{R}_{0,L,H}(\mathcal{S}, \mathbf{n})$ and $I \subset E(\hat{\mathcal{R}})$, we consider the event

$$\mathcal{Z}_I = \{\omega_e = 0, \forall e \in I\}.$$

We say that I is an *interface* for \mathcal{R} if $\mathcal{Z}_I \subset \mathcal{D}_{\mathcal{R}}$ and $\forall e \in I, \mathcal{Z}_{I \setminus \{e\}} \not\subset \mathcal{D}_{\mathcal{R}}$, that is to say, if the disconnection on I is enough for disconnecting $\partial^+ \hat{\mathcal{R}}$ from $\partial^- \hat{\mathcal{R}}$ (see (2.4)) and if there is no superfluous edge in I . This corresponds to the geometrical notion of interface if, to the edges of I we associate their dual, $d - 1$ dimensional facets. Then, we call $\mathcal{I}(\mathcal{R})$ the set of interfaces for \mathcal{R} and define the maximal flow in \mathcal{R} , for a realization J of the media, as

$$\mu_{\mathcal{R}}^J = \frac{1}{L^{d-1}} \inf_{I \in \mathcal{I}(\mathcal{R})} \sum_{e \in I} J_e.$$

This quantity has the same properties as surface tension since it satisfies a sub-additivity property like Theorem 2.2.2: for $\mathcal{R}^N = \mathcal{R}_{0,N,\delta N}(\mathcal{S}, \mathbf{n})$ and $N \rightarrow \infty$, the maximal flow in \mathcal{R}^N converges in \mathbb{P} -probability, upper deviations occur at volume order and lower deviations occur at surface order (a result similar to Theorem 2.2.5 is proved in [77], for upper large deviations see [78]). In our

comparison with the low temperature asymptotics of surface tension, we will be interested in the following properties:

PROPOSITION 2.3.3. *For any $\delta > 0$, as $N \rightarrow \infty$ the quantity $\mu_{\mathcal{R}_{0,N,\delta N}}^J(\mathbf{n}, \mathcal{S})$ converges in \mathbb{P} -probability to $\mu(\mathbf{n}) \in \mathbb{R}^+$ that depends only on \mathbb{P} and \mathbf{n} . Furthermore, one has: $\forall \mathbf{n} \in S^{d-1}$,*

$$J^{\min} \|\mathbf{n}\|_1 \leq \mu(\mathbf{n})$$

and the inequality is strict (for all $\mathbf{n} \in S^{d-1}$) if $\mathbb{P}(J_e > J^{\min}) > p_c(d)$.

PROOF. We only give the proof of the strict inequality, using a renormalization argument (see [73] or Chapter 1). For $\varepsilon > 0$ small enough, we still have $\mathbb{P}(J_e \geq J^{\min} + \varepsilon) > p_c(d)$. We consider $L \in \mathbb{N}^*$ and cover $\hat{\mathcal{R}} = \hat{\mathcal{R}}_{0,N,\delta N}(\mathbf{n}, \mathcal{S})$ with blocks of side-length $2L$, positioned at $Li, i \in \mathbb{Z}^d$. We say that such a block is *good* if the set of edges with values at least $J^{\min} + \varepsilon$ presents a crossing cluster in that box, and if that cluster is the unique one of diameter at least L . For L large enough, the collection of good blocks stochastically dominates high-density site percolation. An immediate Peierls argument shows that high-density site percolation covers all interfaces with a density at least $1/2$ of open sites, with large probability. Now we consider $I \in \mathcal{I}(\mathcal{R})$. The weight of I is at least the contribution of J^{\min} on I , plus the contribution of ε of the good blocks that meet the interface I . With large \mathbb{P} -probability, there are at least $c_d N^{d-1} / (2L^{d-1})$ of these good blocks, hence

$$\mu_{\mathcal{R}}^J(\mathbf{n}) \geq J^{\min} \|\mathbf{n}\|_1 + \frac{c_d \varepsilon}{2L^{d-1}}$$

with large \mathbb{P} -probability, uniformly in the size of \mathcal{R} . The claim follows. \square

Note that the question of whether the inequality $J^{\min} \|\mathbf{n}\|_1 \leq \mu(\mathbf{n})$ is strict in general appears to be a thoughtful one. In [79] the authors give a criterion for a comparison of the first-passage time associated to two distributions (Theorem 2.13) which holds under the assumption that $\mathbb{P}(J_e = J^{\min})$ be small enough. They remark that the equality

$$J^{\min} \|\mathbf{n}\|_1 = \mu(\mathbf{n}) = 0$$

holds in the case $J^{\min} = 0$ and $\mathbb{P}(J_e > 0) \leq p_c(d)$. Yet, this case is not relevant to our analysis because phase transition does not occur for such \mathbb{P} . So, the question that remains is: does

$$J^{\min} \|\mathbf{n}\|_1 < \mu(\mathbf{n}), \forall \mathbf{n} \in S^{d-1}$$

for any \mathbb{P} with $J^{\min} > 0$? This question is of a similar nature than that of having $\tau^{\min}(\mathbf{n}) < \tau^q(\mathbf{n})$, which itself is equivalent to having $I_{\mathbf{n}}$ finite on the left of $\tau^q(\mathbf{n})$.

2.3.3. Asymptotics of surface tension. Here we study the low temperature asymptotics of surface tension and prove, under a few assumptions on the media, that the low temperature asymptotics of τ^q are determined by the maximal flow μ , while those of τ^λ are determined by J^{\min} .

We begin with easy upper bounds:

PROPOSITION 2.3.4. *For all $\beta \geq 0$, all $\mathbf{n} \in S^{d-1}$, one has*

$$\tau_\beta^q(\mathbf{n}) \leq \beta \mu(\mathbf{n}) \quad (2.27)$$

and for all $\lambda > 0$:

$$\tau_\beta^\lambda(\mathbf{n}) \leq \|\mathbf{n}\|_1 \times \log \frac{1}{\mathbb{E} \exp(-\lambda \beta J_e)} \quad (2.28)$$

which is bounded by $\|\mathbf{n}\|_1 \times \log(1/\mathbb{P}(J_e = 0))$ for all $\beta \geq 0$, if $\mathbb{P}(J_e = 0) > 0$.

Then, modulo an hypothesis on \mathbb{P} we show that the entropy is negligible at low temperature, and replace the inequalities with equivalents:

PROPOSITION 2.3.5. *Assume that $\mathbb{P}(J_e > 0) = 1$. Then, uniformly over $\mathbf{n} \in S^{d-1}$,*

$$\lim_{\beta \rightarrow +\infty} \frac{\tau_\beta^q(\mathbf{n})}{\beta} = \mu(\mathbf{n}) \quad (2.29)$$

and

$$\tau_\beta^\lambda(\mathbf{n}) \underset{\beta \rightarrow +\infty}{\sim} \|\mathbf{n}\|_1 \times \log \frac{1}{\mathbb{E} \exp(-\lambda \beta J_e)}. \quad (2.30)$$

At last, we will study one more case for the quenched surface tension:

PROPOSITION 2.3.6. *Assume that $\mathbb{P}(J_e > 0) > p_c(d)$. Then,*

$$\liminf_{\beta \rightarrow +\infty} \frac{\tau_\beta^q(\mathbf{n})}{\beta} > 0, \quad (2.31)$$

uniformly over $\mathbf{n} \in S^{d-1}$.

and conclude with the remark that

PROPOSITION 2.3.7. *For all \mathbb{P} ,*

$$\lim_{\beta \rightarrow +\infty} \frac{\tau_\beta^\lambda(\mathbf{n})}{\beta} = \lambda \|\mathbf{n}\|_1 \times J^{\min} \quad (2.32)$$

uniformly over $\mathbf{n} \in S^{d-1}$.

PROOF. (Proposition 2.3.4). We begin with the proof of (2.27) and consider a rectangular parallelepiped \mathcal{R} and $I \in \mathcal{I}(\mathcal{R})$. The DLR equation

yields

$$\Phi_{\mathcal{R}}^{J,w}(\mathcal{D}_{\mathcal{R}}) \geq \Phi_{\mathcal{R}}^{J,w}(\mathcal{Z}_I) \geq \prod_{e \in I} \Phi_{\{e\}}^{J,w}(\omega_e = 0) = \exp\left(-\beta \sum_{e \in I} J_e\right)$$

and consequently $\tau_{\beta,\mathcal{R}}^J \leq \beta \mu_{\mathcal{R}}^J$, which implies (2.27) taking the appropriate limit sequence for \mathcal{R} . Similarly, in view of the definition (2.19) we have

$$\begin{aligned} \tau_{\beta,\mathcal{R}}^\lambda &\leq -\frac{1}{L^{d-1}} \log \mathbb{E} \left(\prod_{e \in I} \Phi_{\{e\}}^{J,w}(\omega_e = 0)^\lambda \right) \\ &\leq \frac{|I|}{L^{d-1}} \log \frac{1}{\mathbb{E}(e^{-\lambda \beta J_e})} \end{aligned}$$

and choosing for I the interface of smallest cardinal in $\mathcal{I}(\mathcal{R})$ – which has a cardinal approximately $\|\mathbf{n}\|_1 L^{d-1}$ – we obtain the upper bound (2.28). The upper bound on τ_β^λ , when $\mathbb{P}(J_e = 0) > 0$, is a consequence of the inequality $\mathbb{E}(e^{-\lambda \beta J_e}) \geq \mathbb{P}(J_e = 0)$. \square

PROOF. (Proposition 2.3.5). This proof uses Peierls estimates and we use the following fact: there exists c_d depending on the dimension d only such that the number of interfaces of cardinal n in $\mathcal{I}(\mathcal{R})$ is not larger than $(c_d)^n$. We begin with the annealed case (2.30) as it is simpler. Remark that for any $I \subset \mathcal{I}(\mathcal{R})$,

$$\Phi_{\mathcal{R}}^{J,w}(\mathcal{Z}_I) \leq \prod_{e \in I} \Phi_{\mathcal{R}}^{J,f}(\omega_e = 0) \leq \prod_{e \in I} q e^{-\beta J_e}.$$

If $\lambda \leq 1$, the inequality $(\sum_{i=1}^n x_i)^\lambda \leq \sum_{i=1}^n x_i^\lambda$ yields

$$\Phi_{\mathcal{R}}^{J,w}(\mathcal{D}_{\mathcal{R}})^\lambda \leq \left(\sum_{I \in \mathcal{I}(\mathcal{R})} \Phi_{\mathcal{R}}^{J,w}(\mathcal{Z}_I) \right)^\lambda \leq \sum_{I \in \mathcal{I}(\mathcal{R})} \Phi_{\mathcal{R}}^{J,w}(\mathcal{Z}_I)^\lambda$$

hence

$$\mathbb{E} \left[\left(\Phi_{\mathcal{R}}^{J,w}(\mathcal{D}_{\mathcal{R}}) \right)^\lambda \right] \leq \sum_{I \in \mathcal{I}(\mathcal{R})} \prod_{e \in I} q^\lambda \mathbb{E} e^{-\lambda \beta J_e}.$$

As $\mathbb{E} e^{-\lambda \beta J_e} \xrightarrow{\beta \rightarrow +\infty} 0$ under the assumption $\mathbb{P}(J_e > 0) = 1$, we can apply Peierls argument and conclude that:

$$\begin{aligned} \mathbb{E} \left[\left(\Phi_{\mathcal{R}}^{J,w}(\mathcal{D}_{\mathcal{R}}) \right)^\lambda \right] &\leq \sum_{n \geq \min_{I \in \mathcal{I}(\mathcal{R})} |I|} (c_d q^\lambda \mathbb{E} e^{-\lambda \beta J_e})^n \\ &\leq \frac{1}{1 - c_d q^\lambda \mathbb{E} e^{-\lambda \beta J_e}} \times [c_d q^\lambda \mathbb{E} e^{-\lambda \beta J_e}]^{\min_{I \in \mathcal{I}(\mathcal{R})} |I|} \end{aligned}$$

for β large enough, which yields

$$\tau_\beta^\lambda \geq \|\mathbf{n}\|_1 \times \left(\log \frac{1}{\mathbb{E} e^{-\lambda \beta J_e}} - (1 + \lambda) \log c_d - \lambda \log q \right) \quad (2.33)$$

for all $\lambda \leq 1$ and β large enough. If $\lambda \geq 1$, Minkowski's inequality yields:

$$\begin{aligned} \left[\mathbb{E} \left[\left(\Phi_{\mathcal{R}}^{J,w}(\mathcal{D}_{\mathcal{R}}) \right)^\lambda \right] \right]^{1/\lambda} &\leq \sum_{I \in \mathcal{I}(\mathcal{R})} \left[\mathbb{E} \left[\left(\Phi_{\mathcal{R}}^{J,w}(\mathcal{Z}_I) \right)^\lambda \right] \right]^{1/\lambda} \\ &\leq \sum_{I \in \mathcal{I}(\mathcal{R})} \prod_{e \in I} q \left[\mathbb{E} e^{-\lambda \beta J_e} \right]^{1/\lambda} \end{aligned}$$

and we conclude similarly that (2.33) holds again for all $\lambda \geq 1$ and β large enough. (2.30) follows from the divergence $\lim_{\beta \rightarrow +\infty} \log(1/\mathbb{E} e^{-\lambda \beta J_e}) = +\infty$ under the assumption $\mathbb{P}(J_e > 0) = 1$, and the convergence is uniform in $\mathbf{n} \in S^{d-1}$ as (2.33) holds for any β large enough independent of \mathbf{n} .

For (2.29) we use Peierls estimates again. We write

$$\Phi_{\mathcal{R}}^J(\mathcal{D}_{\mathcal{R}}) \leq \sum_{I \in \mathcal{I}(\mathcal{R})} \Phi_{\mathcal{R}}^J(\mathcal{Z}_I) \leq \sum_{I \in \mathcal{I}(\mathcal{R})} \prod_{e \in I} q e^{-\beta J_e}.$$

We decompose the sum according to the length of the interface: for any $c > \|\mathbf{n}\|_1$,

$$\begin{aligned} \Phi_{\mathcal{R}}^J(\mathcal{D}_{\mathcal{R}}) &\leq \sum_{I \in \mathcal{I}(\mathcal{R}): |I| < cL^{d-1}} q^{|I|} e^{-\beta L^{d-1} \mu_{\mathcal{R}}^J} \\ &\quad + \sum_{I \in \mathcal{I}(\mathcal{R}): |I| \geq cL^{d-1}} q^{|I|} e^{-\beta \sum_{e \in I} J_e} \end{aligned} \quad (2.34)$$

The first term is not larger than

$$(c_d q)^{cL^{d-1}} \exp(-\beta L^{d-1} \mu_{\mathcal{R}}^J)$$

and the expectation of the second one is

$$\mathbb{E} \left(\sum_{I \in \mathcal{I}(\mathcal{R}): |I| \geq cL^{d-1}} q^{|I|} e^{-\beta \sum_{e \in I} J_e} \right) \leq \frac{1}{1 - c_d q \mathbb{E}(e^{-\beta J_e})} \times [c_d q \mathbb{E}(e^{-\beta J_e})]^{cL^{d-1}}$$

if $\rho_\beta = c_d q \mathbb{E}(e^{-\beta J_e}) < 1$, which is the case for β large if $\mathbb{P}(J_e > 0) = 1$. For any such β , applying Markov's inequality we obtain, for any $\varepsilon > 0$:

$$\mathbb{P} \left(\sum_{I \in \mathcal{I}(\mathcal{R}): |I| \geq cL^{d-1}} q^{|I|} e^{-\beta \sum_{e \in I} J_e} \geq (\rho_\beta)^{(1-\varepsilon)cL^{d-1}} \right) \leq \frac{1}{1 - \rho_\beta} \times (\rho_\beta)^{\varepsilon cL^{d-1}}.$$

Hence (2.34) shows that, for J typical under \mathbb{P} – up to large deviations of surface order –

$$\Phi_{\mathcal{R}}^J(\mathcal{D}_{\mathcal{R}}) \leq (c_d q)^{cL^{d-1}} \exp(-\beta L^{d-1} \mu_{\mathcal{R}}^J) + (\rho_\beta)^{(1-\varepsilon)cL^{d-1}}$$

which proves that

$$\tau_\beta^q(\mathbf{n}) \geq \min \left(\beta \mu(\mathbf{n}) - c \log(c_d q), c \log \frac{1}{\rho_\beta} \right)$$

for any $\beta \geq 0$ such that $\rho_\beta < 1$. The lower bound is optimal for

$$c = \frac{\beta\mu(\mathbf{n})}{\log(c_d q) + \log \frac{1}{\rho_\beta}}$$

which is negligible with respect to β in the limit $\beta \rightarrow +\infty$, as $\log(1/\rho_\beta) \rightarrow +\infty$. The limit (2.29) follows – the uniformity over $\mathbf{n} \in S^{d-1}$ is a consequence of the fact that μ is bounded. If $J_{\min} > 0$, then we even have, for some $C < \infty$, that for β large enough (independent of $\mathbf{n} \in S^{d-1}$),

$$\tau_\beta^q(\mathbf{n}) \geq \beta\mu(\mathbf{n}) - C.$$

□

PROOF. (Proposition 2.3.6). The proof for (2.31) exploits a renormalization argument similar to the one used in [28]. Under the assumption $\mathbb{P}(J_e > 0) > p_c(d)$, one can fix $\varepsilon > 0$ such that $\mathbb{P}(J_e \geq \varepsilon) > p_c(d)$, so that the edges with J -values larger or equal to ε percolate. We cover now the rectangular parallelepiped \mathcal{R}^N with blocks of side-length L as in definition 1.5.1 and say that a given block is *good* if there is a *crossing cluster* for the edges $J_e \geq \varepsilon$, and if that cluster is the unique one of diameter larger than $L/2$. A simple Peierls argument, together with Pisztorá's coarse graining [73] show that for L large enough, up to surface order large deviations under \mathbb{P} , there is no surface of blocks separating the upper from the lower boundaries of \mathcal{R}^N that have a density greater than ε of bad blocks. For any such J , the event of disconnection requires the choice of a block surface of cardinality at least $(N/L)^{d-1}$, and that, in each good block, at least one edge with $J_e \geq \varepsilon$ be closed. Hence: for N large and J typical up to surface order large deviations,

$$\Phi_{\mathcal{R}^N}^{J,w}(\mathcal{D}_{\mathcal{R}^N}) \leq \sum_{n \geq (N/L)^{d-1}} (c_d)^n [c_d L^d q e^{-\beta\varepsilon}]^{(1-\varepsilon)n}$$

leading to $\tau_\beta^q \geq [(1-\varepsilon)\beta\varepsilon - \log(c_d^2 L^d q)]/L^{d-1}$ for large enough β . The claim follows. □

PROOF. (Proposition 2.3.7). This is an immediate consequence of (2.28) and (2.30) in view of the limit

$$\lim_{\beta \rightarrow +\infty} \frac{1}{\beta} \log \frac{1}{\mathbb{E} e^{-\lambda\beta J_e}} = J^{\min}.$$

□

2.3.4. Applications. The low temperature asymptotics for surface tension permit to answer some important questions on surface tension, cf. Section 2.3.1. We give here the proofs of Theorems 2.3.1 and 2.3.2:

PROOF. (Theorem 2.3.1). We consider first the case $J^{\min} = 0$ and remark that the asymptotics (2.31) and (2.32) imply the claim. If $J^{\min} > 0$ and if we assume $\mathbb{P}(J_e > J^{\min}) > p_c(d)$, then again (2.29), (2.32) and Proposition 2.3.3 lead to the conclusion. \square

PROOF. (Theorem 2.3.2). This is a consequence of the fact that convergences (2.29) and (2.30) hold uniformly over $\mathbf{n} \in S^{d-1}$. \square

2.4. Rate function for lower deviations

In Theorem 2.2.5 we established a large deviation principle for the lower deviations of surface tension. We now discuss the asymptotics of the rate function $I_{\mathbf{n}}$ on the left of $\tau^q(\mathbf{n})$. Using concentration inequalities we prove, as for the directed polymer model, that $I_{\mathbf{n}}$ has at least a quadratic growth on the left of $\tau^q(\mathbf{n})$. In particular, it is non-zero for all $\tau < \tau^q(\mathbf{n})$. In the opposite direction, we show that $I_{\mathbf{n}}(\tau^q(\mathbf{n}) - r) \lesssim r^{2-\xi}$, where ξ is the exponent for transverse fluctuations of the interface defined at (2.55).

These controls are probably not optimal. In the two dimensional case, the comparison with directed polymers suggests that

$$I_{\mathbf{n}}(\tau^q(\mathbf{n}) - r) \underset{r \rightarrow 0^+}{\sim} cr^{3/2} \quad \text{and} \quad \xi = \frac{2}{3}. \quad (2.35)$$

Directed polymers were introduced in order to represent the interface in the Ising model with random couplings at low temperatures, see [46], [30]. It has been shown that their zero-temperature limit, namely *last passage percolation* satisfies (2.35) for a geometric distribution of the passage times, see Theorem 1.1 and (2.23) in [53].

The organization of this Section is as follows: first, we expose a weak version of the concentration bounds for $I_{\mathbf{n}}$ that holds for β large and environments that satisfy $J_e \geq \varepsilon > 0$ \mathbb{P} -almost surely, using the fact that the length of the interface in such a case never exceeds cN^{d-1} . In the general case the concentration estimates do not apply directly as we do not have a uniform control on the length of the interface, yet an application of the proof of the concentration inequalities itself permits to overcome the difficulty and to relate the length of the interface to a derivative of surface tension. The λ -annealed surface tension plays an important role in this proof, as well as the modified measure \mathbb{E}_{λ} defined at (2.52). Then we address the question of an upper bound on $I_{\mathbf{n}}$ and relate $I_{\mathbf{n}}$ to localization estimates.

2.4.1. Concentration at low temperature. Concentration of measure theory is a very effective tool for analyzing the fluctuations of product measures. In the case of polymers or even spin glasses it yields relevant upper bounds on the probabilities of deviations, see [60] for a review. Concerning

the Ising model with random couplings, its application to the deviations of surface tension requires a control over the surface of the interface.

If the interactions are positive and the temperature low enough, one can control uniformly the length of the interface in the Ising model (i.e. $q = 2$ for the FK measure) and establish Theorem 2.4.1 below. For a similar result in a more general setting, see Theorem 2.4.4.

THEOREM 2.4.1. *Assume that \mathbb{P} satisfies a logarithmic Sobolev inequality and that $\mathbb{P}(J_e \geq \varepsilon) = 1$ for some $\varepsilon > 0$. Then, for β large enough and $q = 2$, there exists $c > 0$ such that, for all $r > 0$,*

$$I_{\mathbf{n}}(\tau^q(\mathbf{n}) - r) \geq cr^2. \quad (2.36)$$

Before we address the proof of Theorem 2.4.1, let us recall a few facts and definitions, taken from Chapter 5 in [60]. The *entropy* of a positive measurable function f with $\mathbb{E}(f \log(1 + f)) < \infty$ is

$$\text{Ent}_{\mathbb{P}}(f) = \mathbb{E}(f \log f) - \mathbb{E}(f) \log \mathbb{E}(f). \quad (2.37)$$

Assuming that the support of J_e under \mathbb{P} is an interval, we consider $|\nabla f|$ the norm of the gradient of f derivable:

$$|\nabla f|^2 = \sum_{e \in E(\hat{\mathcal{R}})} |\nabla_e f|^2 \quad \text{where} \quad \nabla_e f = \frac{\partial f}{\partial J_e}.$$

If the support of \mathbb{P} is discrete, e.g. $\{0, 1\}$, we consider for $|\nabla f|$ the norm of the discrete gradient. We say that \mathbb{P} satisfies a *logarithmic Sobolev inequality* with constant $C_{\mathbb{P}}$ if

$$\text{Ent}(f^2) \leq 2C_{\mathbb{P}} \mathbb{E}(|\nabla f|^2) \quad (2.38)$$

for all f measurable satisfying $\mathbb{E}(f^2 \log(1 + f^2)) < \infty$. The requirement that \mathbb{P} satisfies a logarithmic Sobolev inequality is a weak assumption. It is the case for the standard measures one considers for the diluted couplings: if (i) the law of J_e under \mathbb{P} is $p\delta_1 + (1 - p)\delta_0$, or if (ii) it has a positive density on $[0, 1]$, then \mathbb{P} satisfies a logarithmic Sobolev inequality, cf. [60] or Theorems 4.2, 6.6 and Section 6.3 in [27].

Theorem 5.3 in [60] states the following: if \mathbb{P} satisfies a logarithmic Sobolev inequality with constant $C_{\mathbb{P}}$, then for every $f : \mathcal{J} \rightarrow \mathbb{R}$ measurable and 1-Lipschitz, f is integrable and for all $r \geq 0$,

$$\mathbb{P}(f \geq \mathbb{E}f + r) \leq e^{-\frac{r^2}{2C_{\mathbb{P}}}}. \quad (2.39)$$

Therefore, it is enough to get a uniform bound of the type $|\nabla \tau_{\mathcal{R}}^J| \leq c/\sqrt{L^{d-1}}$ for establishing Theorem 2.4.1. We now consider

$$a_e^J = \frac{L^{d-1}}{\beta} \frac{\partial \tau_{\mathcal{R}}^J}{\partial J_e} \quad (2.40)$$

for any $e \in E(\hat{\mathcal{R}})$ – as shown below, it is a good measure for the probability that the interface passes through the edge e .

It is a consequence of the mean value Theorem, for both the discrete and the continuous versions of the gradient, that:

LEMMA 2.4.2. *The gradient of $\tau_{\mathcal{R}}^J$ satisfies*

$$|\nabla \tau_{\mathcal{R}}^J|^2 \leq \frac{\beta^2}{(L^{d-1})^2} \sum_{e \in E(\mathcal{R})} \sup_{J_e} (a_e^J)^2. \quad (2.41)$$

The actual value of J_e does not modify consequently the value of a_e^J and we will prove, after we finish the proof of Theorem 2.4.1, the following fact:

PROPOSITION 2.4.3. *For any e , a_e^J is a C^∞ function of $J \in \mathcal{J}$. For any $J \in \mathcal{J}$, one has*

$$a_e^J = \frac{1}{p_e} \left(\Phi_{\mathcal{R}}^{J,w}(\omega_e) - \Phi_{\mathcal{R}}^{J,w}(\omega_e | \mathcal{D}_{\mathcal{R}}) \right) \quad \text{if } J_e > 0 \quad (2.42)$$

together with the following inequalities:

$$0 \leq a_e^J \leq 1 \quad \text{and} \quad \sup_{J_e} a_e^J \leq e^\beta \inf_{J_e} a_e^J. \quad (2.43)$$

PROOF. (Theorem 2.4.1). We provide a uniform upper bound on the gradient. The Ising measure is more convenient for the present proof as we condition on the position of the interface, which is uniquely defined for spins systems but not for percolation systems. In view of Proposition 2.4.3, we have

$$\sup_{J_e} (a_e^J)^2 \leq \sup_{J_e} a_e^J \leq e^\beta a_e^J$$

hence Lemma 2.4.2 yields, for $\mathcal{R} = \mathcal{R}_{0,N,\delta N}(\mathcal{S}, \mathbf{n})$:

$$|\nabla \tau_{\mathcal{R}}^J|^2 \leq \frac{\beta^2 e^\beta}{(N^{d-1})^2} \sum_{e \in E(\hat{\mathcal{R}})} a_e^J. \quad (2.44)$$

As \mathcal{R} is centered at the origin, we consider

$$\begin{aligned} \Sigma_{\mathcal{R}}^+ &= \left\{ \sigma : \mathbb{Z}^d \rightarrow \{\pm 1\} : \sigma_x = 1, \forall x \notin \hat{\mathcal{R}} \setminus \partial \hat{\mathcal{R}} \right\} \\ \Sigma_{\mathcal{R}}^\pm &= \left\{ \sigma : \mathbb{Z}^d \rightarrow \{\pm 1\} : \sigma_x = \begin{cases} 1 & \text{if } x \cdot \mathbf{n} \geq 0 \\ -1 & \text{else} \end{cases}, \forall x \notin \hat{\mathcal{R}} \setminus \partial \hat{\mathcal{R}} \right\} \end{aligned}$$

the set of spin configurations on $\hat{\mathcal{R}}$ with plus or mixed boundary conditions. The correspondence between the FK (with $q = 2$) and Ising measures gives

$$\tau_{\mathcal{R}}^J = \frac{1}{N^{d-1}} \log \frac{Z_{\mathcal{R}}^{J,+}}{Z_{\mathcal{R}}^{J,\pm}}$$

where $Z_{\mathcal{R}}^{J,+}$ and $Z_{\mathcal{R}}^{J,\pm}$ are the partition functions

$$Z_{\mathcal{R}}^{J,+} = \sum_{\sigma \in \Sigma_{\mathcal{R}}^+} \exp \left(\frac{\beta}{2} \sum_{e=\{x,y\} \in E(\hat{\mathcal{R}})} J_e \sigma_x \sigma_y \right)$$

and

$$Z_{\mathcal{R}}^{J,\pm} = \sum_{\sigma \in \Sigma_{\mathcal{R}}^\pm} \exp \left(\frac{\beta}{2} \sum_{e=\{x,y\} \in E(\hat{\mathcal{R}})} J_e \sigma_x \sigma_y \right),$$

leading thus to

$$a_e^J = \mu_{\mathcal{R}}^{J,+}(\sigma_x \sigma_y) - \mu_{\mathcal{R}}^{J,\pm}(\sigma_x \sigma_y), \quad \forall e = \{x, y\} \in E(\hat{\mathcal{R}}) \quad (2.45)$$

where $\mu_{\mathcal{R}}^{J,\pm}$ is the Ising model on $\hat{\mathcal{R}}$ with mixed boundary condition (plus on $\partial^+ \hat{\mathcal{R}}$, minus on $\partial^- \hat{\mathcal{R}}$). We consider now an interface I for \mathcal{R} as in Section 2.3.2. We recall that it is a minimal set of edges such that connections from $\partial^+ \hat{\mathcal{R}}$ to $\partial^- \hat{\mathcal{R}}$ through $E(\hat{\mathcal{R}}) \setminus I$ are impossible. We consider I^+ the upper part of the interface I :

$$I^+ = \{x : \exists y \in \mathbb{Z}^d : \{x, y\} \in I \text{ and } x \leftrightarrow \partial^- \hat{\mathcal{R}} \text{ in } E(\hat{\mathcal{R}}) \setminus I\}$$

and define symmetrically the set I^- . We call then \mathcal{S}_I the event that I is the spin interface between $\partial^+ \hat{\mathcal{R}}$ and $\partial^- \hat{\mathcal{R}}$ under the measure $\mu_{\mathcal{R}}^{J,\pm}$:

$$\mathcal{S}_I = \left\{ \sigma \in \Sigma_{\mathcal{R}}^\pm : \begin{array}{l} \sigma(x) = +1, \forall x \in I^+ \\ \sigma(x) = -1, \forall x \in I^- \end{array} \right\}.$$

Conditionally on \mathcal{S}_I , the restriction of $\mu_{\mathcal{R}}^{J,\pm}$ to the upper (resp. lower) parts of $\hat{\mathcal{R}}$ equals the Ising measure with uniform plus (resp. minus) boundary condition. Hence, for any $\{x, y\} \notin I$ we have

$$\mu_{\mathcal{R}}^{J,\pm}(\sigma_x \sigma_y | \mathcal{S}_I) \geq \mu_{\mathcal{R}}^{J,+}(\sigma_x \sigma_y), \quad (2.46)$$

and the upper bound (2.44) on the gradient becomes, thanks to (2.45) and (2.46):

$$|\nabla \tau_{\mathcal{R}}^J|^2 \leq \frac{\beta^2 e^\beta}{(Nd-1)^2} \sum_{I \text{ interface}} \mu_{\mathcal{R}}^{J,\pm}(\mathcal{S}_I) \times 2|I|.$$

Thus, it remains only to bound the average interface length under $\mu_{\mathcal{R}}^{J,\pm}$. We remark that $\mu_{\mathcal{R}}^{J,\pm}(\mathcal{S}_I)$ can also be written as

$$\mu_{\mathcal{R}}^{J,\pm}(\mathcal{S}_I) = \frac{Z_{\mathcal{R} \setminus I}^{J,+} \exp(-\beta \sum_{e \in \Gamma} J_e)}{Z_{\mathcal{R}}^{J,\pm}}$$

where $Z_{\mathcal{R} \setminus I}^{J,+}$ stands for the partition function associated to the set of configurations with plus boundary condition on I^+ , I^- and on $\partial \hat{\mathcal{R}}$. Thanks to the assumption $J_e \geq \varepsilon$ and to the remarks that

$$Z_{\mathcal{R} \setminus I}^{J,+} \leq Z_{\mathcal{R}}^{J,+}$$

and

$$Z_{\mathcal{R}}^{J,\pm} \geq Z_{\mathcal{R}}^{J,+} \exp(-\beta |\partial^- \hat{\mathcal{R}}|),$$

we have

$$\mu_{\mathcal{R}}^{J,\pm}(\mathcal{S}_I) \leq \exp(-\beta\varepsilon|I| + \beta c_d N^{d-1})$$

if $\delta < 1$. We conclude with a Peierls estimate and bound the number of interfaces of cardinal $n \geq 2c_d N^{d-1}/\varepsilon$ by $(c_d)^n$:

$$|\nabla \tau_{\mathcal{R}}^J|^2 \leq \frac{2\beta^2 e^\beta}{(N^{d-1})^2} \left(\frac{2c_d N^{d-1}}{\varepsilon} + \sum_{n \geq 2c_d N^{d-1}/\varepsilon} n (c_d)^n e^{-\beta\varepsilon n + \beta c_d N^{d-1}} \right).$$

As the second term goes to 0 with $N \rightarrow \infty$ for β large enough, we infer that

$$|\nabla \tau_{\mathcal{R}}^J|^2 \leq \frac{5c_d \beta^2 e^\beta / \varepsilon}{N^{d-1}}$$

for all N large enough, if β is large enough. This implies that

$$-\tau_{\mathcal{R}}^J \sqrt{\frac{N^{d-1}}{5c_d \beta^2 e^\beta / \varepsilon}}$$

is 1-Lipschitz and thus, according to Theorem 5.3 in [60], that

$$\mathbb{P}(\tau_{\mathcal{R}}^J \leq \mathbb{E}\tau_{\mathcal{R}}^J - r) \leq \exp(-cr^2 N^{d-1})$$

for $c > 0$. The convergence of the rate function (Theorem 2.2.5) completes the proof. \square

PROOF. (Proposition 2.4.3). The fact that a_e^J is a \mathcal{C}^∞ function of J is a consequence of the same property for τ^J , the quantity $\Phi_{\mathcal{R}}^{J,w}(\mathcal{D}_{\mathcal{R}})$ being always positive. We introduce next a few notations: we let

$$w_{\mathcal{R}}^J(\omega) = \prod_{e \in E(\hat{\mathcal{R}})} \left(\frac{p_e}{1-p_e} \right)^{\omega_e} q^{C_{E(\hat{\mathcal{R}})}^w(\omega)} \quad \text{and} \quad Z_{\mathcal{R}}^J(\mathcal{A}) = \sum_{\omega \in \mathcal{A}} w_{\mathcal{R}}^J(\omega) \quad (2.47)$$

for any $\omega \in \Omega_{E(\hat{\mathcal{R}})}$ and $\mathcal{A} \subset \Omega_{E(\hat{\mathcal{R}})}$, see (2.1) for the definition of $C_{E(\hat{\mathcal{R}})}^w(\omega)$. For all J with $J_e > 0$, we have

$$\frac{\partial \log w_{\mathcal{R}}^J(\omega)}{\partial J_e} = \beta \frac{\omega_e}{p_e}$$

and as a consequence, for all J with $J_e > 0$,

$$\begin{aligned} a_e^J &= -\frac{1}{\beta} \frac{\partial}{\partial J_e} \log \frac{Z_{\mathcal{R}}^J(\mathcal{D}_{\mathcal{R}})}{Z_{\mathcal{R}}^J(\Omega_{E(\hat{\mathcal{R}})})} \\ &= \frac{1}{p_e} \left(\Phi_{\mathcal{R}}^{J,w}(\omega_e) - \Phi_{\mathcal{R}}^{J,w}(\omega_e | \mathcal{D}_{\mathcal{R}}) \right). \end{aligned}$$

Under this formulation, the FKG inequality and the bound $\Phi_{\mathcal{R}}^{J,w}(\omega_e) \leq p_e$ imply that $0 \leq a_e^J \leq 1$ for any $J \in \mathcal{J}$ with $J_e > 0$, and the inequality extends

by continuity to the whole of \mathcal{J} . We now calculate the derivative of a_e^J along J_e for $J_e > 0$ and obtain, as

$$\frac{\partial}{\partial J_e} \left[\frac{\Phi_{\mathcal{R}}^{J,w}(\omega_e|\mathcal{A})}{p_e} \right] = \beta \left[\frac{\Phi_{\mathcal{R}}^{J,w}(\omega_e|\mathcal{A})}{p_e} - \frac{\Phi_{\mathcal{R}}^{J,w}(\omega_e|\mathcal{A})^2}{p_e^2} \right],$$

that, for any $J \in \mathcal{J}$ with $J_e > 0$,

$$\frac{\partial a_e^J}{\partial J_e} = \beta a_e^J \left(1 - \frac{\Phi_{\mathcal{R}}^{J,w}(\omega_e)}{p_e} - \frac{\Phi_{\mathcal{R}}^{J,w}(\omega_e|\mathcal{D}_{\mathcal{R}})}{p_e} \right).$$

This implies in particular that

$$\left| \frac{\partial a_e^J}{\partial J_e} \right| \leq \beta a_e^J$$

and the comparison $\sup_{J_e \in [0,1]} a_e^J \leq e^\beta \inf_{J_e \in [0,1]} a_e^J$ follows. \square

2.4.2. General concentration bound. We give here a more general formulation of the concentration lower bound. In order to bypass the requirement of a uniform upper bound on the gradient of $\tau_{\mathcal{R}}^J$ we reproduce the proof of concentration and in particular make use of Herbst's argument.

THEOREM 2.4.4. *If \mathbb{P} satisfies a logarithmic Sobolev inequality with constant $C_{\mathbb{P}} < \infty$, then for every $\mathbf{n} \in S^{d-1}$, for Lebesgue-almost all $\beta \geq 0$, one has*

$$\limsup_{r \rightarrow 0^+} \frac{I_{\beta, \mathbf{n}}(\tau_{\beta}^q(\mathbf{n}) - r)}{r^2} > 0. \quad (2.48)$$

A consequence of this Theorem is the positivity of $I_{\mathbf{n}}$. We recall that $\tilde{\tau}^q$, defined at (2.21), is the value of surface tension at which $I_{\mathbf{n}}$ becomes positive.

COROLLARY 2.4.5. *If \mathbb{P} satisfies a logarithmic Sobolev inequality, the set*

$$\mathcal{N}_I = \{ \beta \geq 0 : \exists \mathbf{n} \in S^{d-1} : \tilde{\tau}_{\beta}^q(\mathbf{n}) \neq \tau_{\beta}^q(\mathbf{n}) \} \quad (2.49)$$

is at most countable.

Before proving Theorem 2.4.4 we recall a few properties of the λ -annealed surface tension. First, the duality formula (2.22) is responsible for the following fact:

LEMMA 2.4.6. *Assume that*

$$\limsup_{\lambda \rightarrow 0^+} \frac{\tau^{\lambda}(\mathbf{n}) - \lambda \tau^q(\mathbf{n})}{\lambda^2} \geq -c \quad \text{for some } c \in [0, \infty]. \quad (2.50)$$

Then,

$$\limsup_{r \rightarrow 0^+} \frac{I_{\mathbf{n}}(\tau^q(\mathbf{n}) - r)}{r^2} \geq \frac{1}{4c} \in [0, \infty]. \quad (2.51)$$

PROOF. (Lemma 2.4.6). If $c = \infty$ the conclusion holds trivially and we thus require that $c < \infty$. We consider $c' > c$ and a sequence $(\lambda_k)_{k \in \mathbb{N}}$ of positive numbers with $\lambda_k \rightarrow 0$, such that

$$\tau^{\lambda_k}(\mathbf{n}) - \lambda_k \tau^q(\mathbf{n}) \geq -c' \lambda_k^2, \quad \forall k \in \mathbb{N}.$$

This implies that, with $r_k = 2c' \lambda_k$,

$$\begin{aligned} I_{\mathbf{n}}(\tau^q(\mathbf{n}) - r_k) &= \sup_{\lambda > 0} \{ \tau^\lambda(\mathbf{n}) - \lambda(\tau^q(\mathbf{n}) - r_k) \} \\ &\geq_{\lambda = \lambda_k} \lambda_k r_k - c' \lambda_k^2 \\ &= \frac{r_k^2}{4c'} \end{aligned}$$

which yields (2.51). \square

We begin now the core of the proof of Theorem 2.4.4 and apply Herbst's argument to obtain a lower bound on the λ -derivative of $\tau_{\mathcal{R}}^\lambda/\lambda$. For any $\lambda \geq 0$ we introduce the measure \mathbb{P}_λ (which depends also on \mathcal{R}) that to any bounded measurable $h : J \in \mathcal{J} \mapsto \mathbb{R}$ gives expectation

$$\mathbb{E}_\lambda(h(J)) = \mathbb{E} \left(h(J) \frac{\exp(-\lambda L^{d-1} \tau_{\mathcal{R}}^J)}{\mathbb{E} \exp(-\lambda L^{d-1} \tau_{\mathcal{R}}^J)} \right). \quad (2.52)$$

PROPOSITION 2.4.7. *Assume that \mathbb{P} satisfies a logarithmic Sobolev inequality with constant $C_{\mathbb{P}}$ and denote $m_{\mathbb{P}} = \mathbb{E}(J_e)$. Then, for any $\lambda \geq 0$,*

$$-\frac{\partial}{\partial \lambda} \left(\frac{\tau_{\mathcal{R}}^\lambda}{\lambda} \right) \leq \frac{C_{\mathbb{P}} \beta^2 e^{\beta(1+\lambda)}}{2m_{\mathbb{P}}} \frac{1}{\lambda} \frac{\partial \tau_{\mathcal{R}}^\lambda}{\partial \beta}. \quad (2.53)$$

PROOF. (Proposition 2.4.7). We have

$$\frac{\tau_{\mathcal{R}}^\lambda}{\lambda} = -\frac{1}{\lambda L^{d-1}} \log \mathbb{E}(\exp(-\lambda L^{d-1} \tau_{\mathcal{R}}^J))$$

so that, denoting $f_\lambda = -\lambda L^{d-1} \tau_{\mathcal{R}}^J$ and differentiating we obtain

$$\begin{aligned} -\frac{\partial}{\partial \lambda} \left(\frac{\tau_{\mathcal{R}}^\lambda}{\lambda} \right) &= \frac{1}{\lambda^2 L^{d-1}} \frac{\mathbb{E}(f_\lambda \exp(f_\lambda)) - \mathbb{E}(\exp(f_\lambda)) \log \mathbb{E}(\exp(f_\lambda))}{\mathbb{E}(\exp(f_\lambda))} \\ &= \frac{1}{\lambda^2 L^{d-1}} \frac{\text{Ent}(\exp(f_\lambda))}{\mathbb{E}(\exp(f_\lambda))} \end{aligned}$$

where Ent is the entropy defined at (2.37). Applying the logarithmic Sobolev inequality (2.38) for $\exp(f_\lambda/2)$ we conclude that

$$-\frac{\partial}{\partial \lambda} \left(\frac{\tau_{\mathcal{R}}^\lambda}{\lambda} \right) \leq \frac{2C_{\mathbb{P}}}{\lambda^2 L^{d-1}} \frac{\mathbb{E}(|\nabla \exp(f_\lambda/2)|^2)}{\mathbb{E}(\exp(f_\lambda))}.$$

Applying the Mean Value Theorem we obtain

$$-\frac{\partial}{\partial \lambda} \left(\frac{\tau_{\mathcal{R}}^\lambda}{\lambda} \right) \leq \frac{C_{\mathbb{P}}}{2\lambda^2 L^{d-1}} \sum_{e \in E(\hat{\mathcal{R}})} \frac{\mathbb{E} \left(\left(\sup_{J_e \in [0,1]} \frac{\partial f_\lambda}{\partial J_e} \right)^2 \sup_{J_e \in [0,1]} \exp(f_\lambda) \right)}{\mathbb{E}(\exp(f_\lambda))},$$

where furthermore

$$\frac{\partial f_\lambda}{\partial J_e} = -\lambda \beta a_e^J.$$

so that

$$-\frac{\partial}{\partial \lambda} \left(\frac{\tau_{\mathcal{R}}^\lambda}{\lambda} \right) \leq \frac{C_{\mathbb{P}} \beta^2}{2L^{d-1}} \sum_{e \in E(\hat{\mathcal{R}})} \frac{\mathbb{E} \left(\sup_{J_e \in [0,1]} (a_e^J)^2 \times \sup_{J_e \in [0,1]} \exp(f_\lambda) \right)}{\mathbb{E}(\exp(f_\lambda))}.$$

We relate now this expression to the β -derivative of $\tau_{\mathcal{R}}^\lambda$, exploiting the weak dependence of a_e^J and of $\tau_{\mathcal{R}}^J$ on J_e . In view of Proposition 2.4.3 we have

$$\sup_{J_e \in [0,1]} (a_e^J)^2 \leq \sup_{J_e \in [0,1]} a_e^J \leq e^\beta \inf_{J_e \in [0,1]} a_e^J$$

and, as well,

$$\sup_{J_e \in [0,1]} \exp(f_\lambda) \leq e^{\beta \lambda} \inf_{J_e \in [0,1]} \exp(f_\lambda).$$

These quantities are *independent* of J_e , hence:

$$\begin{aligned} -\frac{\partial}{\partial \lambda} \left(\frac{\tau_{\mathcal{R}}^\lambda}{\lambda} \right) &\leq \frac{C_{\mathbb{P}} \beta^2 e^{\beta(1+\lambda)}}{2L^{d-1}} \sum_{e \in E(\hat{\mathcal{R}})} \mathbb{E} \left(\frac{J_e}{m_{\mathbb{P}}} \inf_{J_e \in [0,1]} a_e^J \times \frac{\inf_{J_e \in [0,1]} \exp(f_\lambda)}{\mathbb{E}(\exp(f_\lambda))} \right) \\ &\leq \frac{C_{\mathbb{P}} \beta^2 e^{\beta(1+\lambda)}}{2m_{\mathbb{P}} L^{d-1}} \mathbb{E}_\lambda \left(\sum_{e \in E(\hat{\mathcal{R}})} J_e a_e^J \right) \\ &= \frac{C_{\mathbb{P}} \beta^2 e^{\beta(1+\lambda)}}{2m_{\mathbb{P}}} \frac{1}{\lambda} \frac{\partial \tau_{\mathcal{R}}^\lambda}{\partial \beta}. \end{aligned}$$

□

We conclude the proof of Theorem 2.4.4 introducing a technical quantity $K_{\mathbf{n}}^{\mathbb{P},\beta}$ that makes possible the control of the convergence of $\partial \tau_{\mathcal{R}}^\lambda / \partial \beta$, for Lebesgue almost all β .

PROOF. (Theorem 2.4.4). Given $\delta > 0$ and $\mathcal{S} \in \mathbb{S}_{\mathbf{n}}$, we denote \mathcal{R}^N the rectangular parallelepiped $\mathcal{R}^N = \mathcal{R}_{0,N,\delta N}(\mathbf{n}, \mathcal{S})$ and let

$$K_{\mathbf{n}}^{\mathbb{P},\beta} = \liminf_{\lambda \rightarrow 0^+} \liminf_{N \rightarrow \infty} \frac{1}{\lambda} \int_0^\lambda \frac{\partial \tau_{\mathcal{R}^N}^{\lambda'}}{\partial \beta} \frac{d\lambda'}{\lambda'} \geq 0.$$

First we assume that $K_{\mathbf{n}}^{\mathbb{P},\beta} < \infty$ and establish (2.48). In view of Theorem 2.2.3 and Proposition 2.2.6 we have

$$\begin{aligned}\tau^\lambda(\mathbf{n}) - \lambda\tau^q(\mathbf{n}) &= \lim_{N \rightarrow \infty} \tau_{\mathcal{R}_N}^\lambda - \lambda \mathbb{E} \tau_{\mathcal{R}_N}^J \\ &= \lim_{N \rightarrow \infty} \lambda \int_0^\lambda \frac{\partial}{\partial \lambda'} \left(\frac{\tau_{\mathcal{R}_N}^{\lambda'}}{\lambda'} \right) d\lambda'\end{aligned}$$

as $\lim_{\lambda \rightarrow 0} \tau_{\mathcal{R}_N}^\lambda / \lambda = \mathbb{E} \tau_{\mathcal{R}_N}^J$ for any N finite. Proposition 2.4.7 yields, for any $\varepsilon > 0$:

$$\begin{aligned}\limsup_{\lambda \rightarrow 0^+} \frac{\tau^\lambda(\mathbf{n}) - \lambda\tau^q(\mathbf{n})}{\lambda^2} &\geq -\frac{C_{\mathbb{P}}\beta^2 e^{\beta(1+\varepsilon)}}{2m_{\mathbb{P}}} \liminf_{\lambda \rightarrow 0^+} \liminf_{N \rightarrow \infty} \frac{1}{\lambda} \int_0^\lambda \frac{\partial \tau_{\mathcal{R}_N}^{\lambda'}}{\partial \beta} \frac{d\lambda'}{\lambda'} \\ &\geq -\frac{C_{\mathbb{P}}\beta^2 e^{\beta(1+\varepsilon)}}{2m_{\mathbb{P}}} K_{\mathbf{n}}^{\mathbb{P},\beta}\end{aligned}$$

and an immediate application of Lemma 2.4.6 gives, after the limit $\varepsilon \rightarrow 0$, the lower bound:

$$\limsup_{r \rightarrow 0^+} \frac{I_{\beta, \mathbf{n}}(\tau_\beta^q(\mathbf{n}) - r)}{r^2} \geq \frac{m_{\mathbb{P}}}{2C_{\mathbb{P}}\beta^2 e^\beta K_{\mathbf{n}}^{\mathbb{P},\beta}} > 0.$$

We conclude evaluating the integral of $K_{\mathbf{n}}^{\mathbb{P},\beta}$ on some interval $[\beta_1, \beta_2]$. For any $\delta > 0$ and $\mathcal{S} \in \mathbb{S}_{\mathbf{n}}$, Fatou's Lemma and Fubini Theorem imply that

$$\begin{aligned}\int_{\beta_1}^{\beta_2} K_{\mathbf{n}}^{\mathbb{P},\beta} d\beta &\leq \liminf_{\lambda \rightarrow 0^+} \liminf_{N \rightarrow \infty} \frac{1}{\lambda} \int_0^\lambda \int_{\beta_1}^{\beta_2} \frac{\partial \tau_{\mathcal{R}_N}^{\lambda'}}{\partial \beta} \frac{d\lambda'}{\lambda'} \\ &= \liminf_{\lambda \rightarrow 0^+} \liminf_{N \rightarrow \infty} \frac{1}{\lambda} \int_0^\lambda \frac{\tau_{\beta_2, \mathcal{R}_N}^{\lambda'} - \tau_{\beta_1, \mathcal{R}_N}^{\lambda'}}{\lambda'} d\lambda' .\end{aligned}$$

The convergence as $N \rightarrow \infty$ is uniformly dominated (recall that $0 \leq \tau_{\mathcal{R}_N}^\lambda \leq \lambda c_d \beta$ by Jensen's inequality and Proposition 2.2.1) hence we finally obtain

$$\begin{aligned}\int_{\beta_1}^{\beta_2} K_{\mathbf{n}}^{\mathbb{P},\beta} d\beta &\leq \liminf_{\lambda \rightarrow 0^+} \frac{1}{\lambda} \int_0^\lambda \frac{\tau_{\beta_2}^{\lambda'}(\mathbf{n}) - \tau_{\beta_1}^{\lambda'}(\mathbf{n})}{\lambda'} d\lambda' \\ &= \tilde{\tau}_{\beta_2}^q(\mathbf{n}) - \tilde{\tau}_{\beta_1}^q(\mathbf{n}).\end{aligned}$$

in view of (2.24). In particular, $K_{\mathbf{n}}^{\mathbb{P},\beta}$ is *finite* for Lebesgue almost all $\beta \geq 0$.

Note that in view of Corollary 2.4.5, for Lebesgue almost every β_1, β_2 with $\beta_1 \leq \beta_2$ the former integral is in fact dominated by $\tau_{\beta_2}^q(\mathbf{n}) - \tau_{\beta_1}^q(\mathbf{n})$. Hence, if $\tau_\beta^q(\mathbf{n})$ is derivable on some interval, we have $K_{\mathbf{n}}^{\mathbb{P},\beta} \leq \partial \tau_\beta^q(\mathbf{n}) / \partial \beta$ for Lebesgue almost every β in that interval. \square

PROOF. (Corollary 2.4.5). Let σ be the uniform measure on S^{d-1} and μ the Lebesgue measure on \mathbb{R}^+ . The set

$$\mathcal{A} = \{(\beta, \mathbf{n}) \in \mathbb{R}^+ \times S^{d-1} : \tilde{\tau}^q(\mathbf{n}) \neq \tau^q(\mathbf{n})\}$$

is measurable for the product measure. Furthermore, for every $\mathbf{n} \in S^{d-1}$ the set

$$\mathcal{A}_{\mathbf{n}} = \{\beta \in \mathbb{R}^+ : (\beta, \mathbf{n}) \in \mathcal{A}\}$$

satisfies $\mu(\mathcal{A}_{\mathbf{n}}) = 0$ thanks to Theorem 2.4.4. Applying Fubini's formula we conclude that $\mu \otimes \sigma(\mathcal{A}) = 0$ or in other words that for μ -almost every $\beta \in \mathbb{R}^+$, for σ -almost every $\mathbf{n} \in S^{d-1}$, $\tilde{\tau}(\mathbf{n}) = \tau^q(\mathbf{n})$. Let us fix some $\beta \in \mathbb{R}^+$ such that the former equality holds for σ -almost every $\mathbf{n} \in S^{d-1}$. Proposition 2.2.8 tells us that $\tilde{\tau}$ and τ^q are continuous functions of \mathbf{n} , hence the σ -almost sure equality is in fact an equality on all S^{d-1} and we proved that

$$\mu(\{\beta \in \mathbb{R}^+ : \exists \mathbf{n} \in S^{d-1} : \tilde{\tau}^q(\mathbf{n}) \neq \tau^q(\mathbf{n})\}) = 0.$$

Consider now

$$\mathcal{D} = \{\beta' \in \mathbb{R}^+, \exists \mathbf{n} \in S^{d-1} \text{ such that } \beta \mapsto \tau_{\beta}^q(\mathbf{n}) \text{ is not left continuous at } \beta'\}$$

and let us denote

$$\tau_{\beta^-}^q(\mathbf{n}) = \lim_{\varepsilon \rightarrow 0^+} \tau_{\beta-\varepsilon}^q(\mathbf{n})$$

the value of $\tau^q(\mathbf{n})$ on the left of β , which exists since $\tau_{\mathcal{R}}^J$, and thus $\tau^q(\mathbf{n})$, are non-decreasing functions of β . Similarly, $I_{\mathbf{n}}$ and $\tilde{\tau}(\mathbf{n})$ are also non-decreasing functions of β . In view of the equality $\tilde{\tau}(\mathbf{n}) = \tau^q(\mathbf{n})$ for almost all β , as well as the trivial domination $\tilde{\tau}^q(\mathbf{n}) \leq \tau^q(\mathbf{n})$ we write:

$$\forall \mathbf{n} \in S^{d-1}, \forall \beta > 0, \tau_{\beta^-}^q(\mathbf{n}) \leq \tilde{\tau}_{\beta}^q(\mathbf{n}) \leq \tau_{\beta}^q(\mathbf{n})$$

and this proves that $\tilde{\tau}_{\beta}(\mathbf{n}) = \tau_{\beta}^q(\mathbf{n})$, $\forall \mathbf{n} \in S^{d-1}$ and for every $\beta \notin \mathcal{D}$. We prove at last that \mathcal{D} is at most countable. The homogeneous extension of $\tau_{\beta^-}^q(\mathbf{n})$ to \mathbb{R}^d is convex since it is the pointwise limit of the $f_{\beta-\varepsilon}^q$, hence $\tau_{\beta^-}^q(\mathbf{n})$ is again a continuous function of $\mathbf{n} \in S^{d-1}$. Let $(\mathbf{n}_n)_{n \in \mathbb{N}}$ be a dense sequence in S^{d-1} . We have:

$$\mathcal{D} \subset \bigcup_{n \in \mathbb{N}} \left\{ \beta \in \mathbb{R}^+ : \tau_{\beta}^q(\mathbf{n}_n) \neq \tau_{\beta^-}^q(\mathbf{n}_n) \right\}$$

which is at most countable. □

2.4.3. Rate function and localization. We now relate the asymptotics of $I_{\mathbf{n}}$ to the transverse fluctuations of the interface. We begin with the definition of surface tension in rectangular parallelepipeds of fixed height, unbounded width: for any $H \geq \sqrt{d}$, we let

$$\tau_H^q(\mathbf{n}) = \limsup_{L \rightarrow \infty} \mathbb{E} \tau_{\mathcal{R}_{0,L,H}^J}(\mathbf{s}, \mathbf{n}). \quad (2.54)$$

It follows from the proof of Theorem 2.2.3 that $\tau_H^q(\mathbf{n})$ converges to $\tau^q(\mathbf{n})$ as $H \rightarrow \infty$. We define the exponent $\xi_{\mathbf{n}}$ in function of the speed of convergence:

$$\xi_{\mathbf{n}} = \inf \left\{ \gamma > 0 : \limsup_{H \rightarrow +\infty} H^{1/\gamma} (\tau_H^q(\mathbf{n}) - \tau^q(\mathbf{n})) < \infty \right\}. \quad (2.55)$$

One can interpret $\xi_{\mathbf{n}}$ as an exponent for the transverse fluctuations of the interface, in the uniform case at least. For example: in the two dimensional case, assume that the transverse fluctuations of the interface scale like L^χ when the two extremities of the interface are at distance L . We require now that the interface be pinned periodically to the straight line, at a period $L = H^{1/\chi}$. This increases surface tension by $(-\log p_L)/L$, where p_L is the probability that, without the constraint, the interface initiated at a periodic point reaches the straight line at the next point. This constraint also ensures that the interface does not escape the rectangle of height H and thus indicates that

$$\tau_H^q(\mathbf{n}) - \tau^q(\mathbf{n}) \lesssim \frac{-\log p_{H^{1/\chi}}}{H^{1/\chi}}.$$

In the case of uniform media we expect that, for any $\varepsilon > 0$, $-\log p_L \leq L^\varepsilon$ for large L , and this leads to the inequality $\xi \leq \chi$.

We want to emphasize that the convergence of τ_H has been studied in the literature. In the case of deterministic interactions and effective models [17] (continuum Gaussian, discrete Gaussian and S.O.S. models), it has been shown that

$$\tau_H - \tau_\infty \leq \begin{cases} cH^{-2} & \text{if } d = 2 \\ e^{-cH} & \text{if } d \geq 3 \end{cases}$$

for some $c > 0$, where $d - 1$ stands for the dimension of the effective model and d for its physical dimension. One should compare these bounds with the values for the transverse fluctuations exponent: $1/2$ in two dimensions, 0 in higher dimensions.

The main result of the present section is an upper bound on the rate function $I_{\mathbf{n}}$ on the left of $\tau^q(\mathbf{n})$:

THEOREM 2.4.8. *Assume $\beta > \hat{\beta}_c$. Then, for any $\mathbf{n} \in S^{d-1}$, any $\gamma > \xi_{\mathbf{n}}$ and $r > 0$ small enough (depending on β and \mathbb{P}),*

$$I_{\mathbf{n}}(\tau^q(\mathbf{n}) - r) \leq r^{2-\gamma}.$$

We thus expect that $I_{\mathbf{n}}$ is sub-linear on the left of $\tau^q(\mathbf{n})$. We recall that the slope of $I_{\mathbf{n}}$ on the left of $\tau^q(\mathbf{n})$ – which we expect to be 0 – has the following meaning:

PROPOSITION 2.4.9. *The slope of $I_{\mathbf{n}}$ on the left of $\tau^q(\mathbf{n})$ coincides with the last $\lambda \geq 0$ for which the equality between λ -annealed and quenched surface tension holds:*

$$\lim_{r \rightarrow 0^+} \frac{I_{\mathbf{n}}(\tau^q(\mathbf{n}) - r)}{r} = \max \{ \lambda \geq 0 : \tau^\lambda(\mathbf{n}) = \lambda \tau^q(\mathbf{n}) \}.$$

If $\mathbb{P}(J_e > J^{\min}) > p_c(d)$, this quantity goes to 0 as $\beta \rightarrow \infty$, uniformly over \mathbf{n} .

PROOF. (Proposition 2.4.9). The existence of a slope for $I_{\mathbf{n}}$ on the left of $\tau^q(\mathbf{n})$ is a consequence of its convexity. The equality is then an immediate consequence of the duality formula (2.22). The fact that the limit of the right-hand term is 0 as $\beta \rightarrow \infty$ under the assumption $\mathbb{P}(J_e > J^{\min}) > p_c(d)$ is an immediate consequence of Theorem 2.3.1. \square

The main step for proving Theorem 2.4.8 is the next proposition, where we show that the cost for reducing the surface tension in a finite rectangular parallelepiped is at most quadratic in the *volume* of the rectangular parallelepiped:

PROPOSITION 2.4.10. *Assume $\beta > \hat{\beta}_c$. Then, there exists $c < \infty$ such that, for all $\mathbf{n} \in S^{d-1}$, $\mathcal{S} \in \mathbb{S}_{\mathbf{n}}$ and $H > \sqrt{d}$, if $r > 0$ is small enough and $\mathcal{R} = \mathcal{R}_{0,L,H}(\mathcal{S}, \mathbf{n})$, then*

$$\mathbb{P}(\tau_{\mathcal{R}}^J \leq \mathbb{E}\tau_{\mathcal{R}}^J - r) \geq \exp(-cr^2HL^{d-1}) \quad (2.56)$$

for any L large enough.

Then, the proof of Theorem 2.4.8 goes as follows:

PROOF. (Theorem 2.4.8). For any $\gamma > \xi_{\mathbf{n}}$, there is $c < \infty$ such that, for any H large enough,

$$\tau_H^q(\mathbf{n}) - \tau^q(\mathbf{n}) \leq cH^{-1/\gamma}.$$

Define then $H_r = (r/c)^{-\gamma}$ so that, for any $r > 0$ small enough, $\tau_{H_r}^q(\mathbf{n}) - \tau^q(\mathbf{n}) \leq r$. Then, we consider $\delta > 0$ and $\mathcal{S} \in \mathbb{S}_{\mathbf{n}}$, let $\mathcal{R}^N = \mathcal{R}_{0,N,\delta N}(\mathcal{S}, \mathbf{n})$ and write: for N large enough,

$$\begin{aligned} \mathbb{P}(\tau_{\mathcal{R}^N}^J \leq \tau^q(\mathbf{n}) - r) &\geq \mathbb{P}\left(\tau_{\mathcal{R}_{0,N,H_r}^J}(\mathcal{S}, \mathbf{n}) \leq \tau^q(\mathbf{n}) - r\right) \\ &\geq \mathbb{P}\left(\tau_{\mathcal{R}_{0,N,H_r}^J}(\mathcal{S}, \mathbf{n}) \leq \tau_{H_r}^q(\mathbf{n}) - 2r\right) \\ &\geq \mathbb{P}\left(\tau_{\mathcal{R}_{0,N,H_r}^J}(\mathcal{S}, \mathbf{n}) \leq \mathbb{E}\tau_{\mathcal{R}_{0,N,H_r}^J}(\mathcal{S}, \mathbf{n})(\mathbf{n}) - 3r\right) \\ &\geq \exp(-9c'r^2H_rN^{d-1}) \end{aligned}$$

in view of Proposition 2.4.10, for some $c' < \infty$. Then, we take some $\gamma' > \gamma$ and remark that, as $r \rightarrow 0^+$, the term $9c'r^2H_r = 9c'c^\gamma r^{2-\gamma}$ is negligible with respect to $r^{2-\gamma'}$. \square

PROOF. (Proposition 2.4.10). The idea of the proof is as follows: we prove first that a deviation of the empirical mean of the couplings J_e leads to a deviation of the same order for surface tension. Then, we remark that the cost for reducing the empirical mean of the couplings is quadratic at volume order.

To begin with, we introduce the measure $\tilde{\mathbb{P}}_\mu$ for $\mu \geq 0$, defined by

$$\tilde{\mathbb{E}}_\mu(h) = \mathbb{E}\left(h(J)e^{-\mu \sum_{e \in E(\tilde{\mathcal{R}})} J_e}\right) / \mathbb{E}\left(e^{-\mu \sum_{e \in E(\tilde{\mathcal{R}})} J_e}\right)$$

for h bounded measurable. A major difference with \mathbb{P}_λ considered at (2.52) is that $\tilde{\mathbb{P}}_\mu$ is a *product measure*.

We examine first the expectation of $\tau_{\mathcal{R}}^J$ under $\tilde{\mathbb{E}}_\mu$ and remark that

$$\begin{aligned} \frac{\partial}{\partial \mu} \tilde{\mathbb{E}}_\mu (\tau_{\mathcal{R}}^J) &= - \sum_{e \in E(\mathcal{R})} \text{Cov}_{\tilde{\mathbb{E}}_\mu} (J_e, \tau_{\mathcal{R}}^J) \\ &\leq - \sum_{e \in E(\mathcal{R})} V_{\tilde{\mathbb{E}}_\mu} (J_e) \times \tilde{\mathbb{E}}_\mu \left(\inf_{J_e \in [0,1]} \frac{\partial \tau_{\mathcal{R}}^J}{\partial J_e} \right) \end{aligned}$$

where $V_{\tilde{\mathbb{E}}_\mu} (J_e)$ is the variance of J_e under $\tilde{\mathbb{E}}_\mu$. $V_{\tilde{\mathbb{E}}_\mu} (J_e)$ is a continuous function of μ and hence satisfies $V_{\tilde{\mathbb{E}}_\mu} (J_e) \geq V_{\mathbb{E}} (J_e)/2$ for all $\mu \geq 0$ small enough. As for the second factor, it follows from Proposition 2.4.3 that

$$\inf_{J_e \in [0,1]} \frac{\partial \tau_{\mathcal{R}}^J}{\partial J_e} \geq \frac{\beta e^{-\beta}}{L^{d-1}} \left(\Phi_{\mathcal{R}}^{J,w} (\omega_e) - \Phi_{\mathcal{R}}^{J,w} (\omega_e | \mathcal{D}_{\mathcal{R}}) \right)$$

which implies:

$$\begin{aligned} \frac{\partial}{\partial \mu} \tilde{\mathbb{E}}_\mu (\tau_{\mathcal{R}}^J) &\leq - \frac{V_{\mathbb{E}} (J_e) \beta e^{-\beta}}{2 L^{d-1}} \\ &\quad \times \left(\tilde{\mathbb{E}}_\mu \Phi_{\mathcal{R}}^{J,w} \left(\sum_{e \in E(\hat{\mathcal{R}})} \omega_e \right) - \tilde{\mathbb{E}}_\mu \left[\Phi_{\mathcal{R}}^{J,w} \left(\sum_{e \in E(\hat{\mathcal{R}})} \omega_e \middle| \mathcal{D}_{\mathcal{R}} \right) \right] \right) \end{aligned}$$

for small enough $\mu \geq 0$. The FKG inequality implies, as $\mathcal{D}_{\mathcal{R}}$ is a decreasing event, that the marginal on ω of the measure $\tilde{\mathbb{E}}_\mu \Phi_{\mathcal{R}}^{J,w}$ stochastically dominates that of $\tilde{\mathbb{E}}_\mu [\Phi_{\mathcal{R}}^{J,w} (\cdot | \mathcal{D}_{\mathcal{R}})]$. Hence one can consider a joint measure on (ω, ω') that satisfies $\omega \geq \omega'$ a.s., which marginals coincide with those of $\tilde{\mathbb{E}}_\mu \Phi_{\mathcal{R}}^{J,w}$ and $\tilde{\mathbb{E}}_\mu [\Phi_{\mathcal{R}}^{J,w} (\cdot | \mathcal{D}_{\mathcal{R}})]$, respectively. Since $\omega' \in \mathcal{D}_{\mathcal{R}}$ almost surely, the difference $\sum_{e \in E(\hat{\mathcal{R}})} \omega_e - \omega'_e$ is at least equal to the number of edges one needs to close in ω to ensure the disconnection and we conclude that

$$\frac{\partial}{\partial \mu} \tilde{\mathbb{E}}_\mu (\tau_{\mathcal{R}}^J) \leq - \frac{V_{\mathbb{E}} (J_e)}{2} \times \frac{\beta e^{-\beta}}{L^{d-1}} \tilde{\mathbb{E}}_\mu \Phi_{\mathcal{R}}^{J,w} (d^{\mathcal{D}_{\mathcal{R}}}(\omega))$$

where $d^{\mathcal{D}_{\mathcal{R}}}(\omega)$ is the distance between ω and the set $\mathcal{D}_{\mathcal{R}}$, i.e.

$$d^{\mathcal{D}_{\mathcal{R}}}(\omega) = \inf \left\{ n \in \mathbb{N} : \begin{array}{l} \exists e_1, \dots, e_n \in E(\hat{\mathcal{R}}) \text{ such that } \tilde{\omega} \in \mathcal{D}_{\mathcal{R}}, \text{ where} \\ \tilde{\omega} : \begin{cases} \tilde{\omega}_{e_i} = 0 & \forall i \in \{1 \dots n\} \text{ and} \\ \tilde{\omega}_e = \omega_e & \forall e \notin \{e_1, \dots, e_n\} \end{cases} \end{array} \right\}.$$

We now use the assumption $\beta > \hat{\beta}_c$ which implies that a coarse graining holds for $\mathbb{E} \Phi_{\mathcal{R}}^{J,w}$, that is to say that for any $\varepsilon > 0$, there exists $l \in \mathbb{N}$ large enough so that

$$\tilde{\mathbb{E}}_\mu \inf_{\pi} \Phi_{\Lambda_l}^{J,\pi} \left(\begin{array}{l} \text{There exists a crossing cluster for } \omega \text{ in } \Lambda_l \\ \text{and it is the unique one of diameter } \geq l/2 \end{array} \right) > 1 - \varepsilon \quad (2.57)$$

for $\mu = 0$, where $\Lambda_l = \{0, \dots, l-1\}^d$. In view of the renormalization techniques of Chapter 1, this assumption is enough, if $\varepsilon > 0$ is small enough, to conclude that $\mathbb{E}\Phi_{\mathcal{R}}^{J,w}(d^{\mathcal{D}\mathcal{R}}(\omega)) \geq c_d(L/l)^{d-1}$. Now, remark that the left-hand side in (2.57) is a *continuous* function of μ for fixed l , so that (2.57) holds in fact for any $\mu \geq 0$ small enough. We conclude therefore to the existence of $\mu_0 > 0$ and $c > 0$ not depending on \mathcal{R} such that, for all $\mu \in [0, \mu_0)$, the inequality $\tilde{\mathbb{E}}_{\mu}(\tau_{\mathcal{R}}^J) \leq \mathbb{E}\tau_{\mathcal{R}}^J - c\mu$ holds and implies, by Markov's inequality:

$$\tilde{\mathbb{P}}_{\mu}\left(\tau_{\mathcal{R}}^J \leq \mathbb{E}\tau_{\mathcal{R}}^J - \frac{c\mu}{2}\right) \geq \frac{c\mu}{2\mathbb{E}\tau_{\mathcal{R}}^J}. \quad (2.58)$$

We conclude now the proof of Proposition 2.4.10 and turn (2.58) into a lower bound for the \mathbb{P} -probability that $\tau_{\mathcal{R}}^J \leq \mathbb{E}\tau_{\mathcal{R}}^J - c\mu/2$. We let

$$m^J = \frac{1}{|E(\hat{\mathcal{R}})|} \sum_{e \in E(\hat{\mathcal{R}})} J_e$$

and denote $m_{\mu} = \tilde{\mathbb{E}}_{\mu}(J_e)$. As a consequence of the law of large numbers, for any $\mu \in (0, \mu_0)$ and $\varepsilon > 0$ we have

$$\tilde{\mathbb{P}}_{\mu}\left(\tau_{\mathcal{R}}^J \leq \mathbb{E}\tau_{\mathcal{R}}^J - \frac{c\mu}{2} \text{ and } m^J \geq m_{\mu} - \varepsilon\mu\right) \geq \frac{c\mu}{3\mathbb{E}\tau_{\mathcal{R}}^J}$$

for L large enough. In view of the definition of $\tilde{\mathbb{P}}_{\mu}$, we infer that

$$\mathbb{E}\left(\mathbf{1}_{\{\tau_{\mathcal{R}}^J \leq \mathbb{E}\tau_{\mathcal{R}}^J - \frac{c\mu}{2}\}} e^{-\mu|E(\hat{\mathcal{R}})|(m_{\mu} - \varepsilon\mu)}\right) \geq \frac{c\mu}{3\mathbb{E}\tau_{\mathcal{R}}^J} \mathbb{E}e^{-\mu \sum_{e \in E(\hat{\mathcal{R}})} J_e}$$

that is to say:

$$\mathbb{P}\left(\tau_{\mathcal{R}}^J \leq \mathbb{E}\tau_{\mathcal{R}}^J - \frac{c\mu}{2}\right) \geq \frac{c\mu}{3\mathbb{E}\tau_{\mathcal{R}}^J} \left(e^{\Lambda(\mu) + \mu m_{\mu} - \varepsilon\mu^2}\right)^{|E(\hat{\mathcal{R}})|}$$

where $\Lambda(\mu) = \log \mathbb{E}e^{-\mu J_e}$ is the cumulant generating function of J_e . An immediate expansion yields

$$\begin{aligned} \Lambda(\mu) &= -\mu m_{\mathbb{P}} + \frac{\mu^2}{2} V_{\mathbb{E}}(J_e) + o_{\mu \rightarrow 0}(\mu^2) \\ m_{\mu} &= -\Lambda'(\mu) = m_{\mathbb{P}} - \mu V_{\mathbb{E}}(J_e) + o_{\mu \rightarrow 0}(\mu) \end{aligned}$$

where $m_{\mathbb{P}} = \mathbb{E}(J_e)$, so that

$$\Lambda(\mu) + \mu m_{\mu} - \varepsilon\mu^2 = -\frac{\mu^2}{2} V_{\mathbb{E}}(J_e) - \varepsilon\mu^2 + o_{\mu \rightarrow 0}(\mu^2)$$

and the claim follows. \square

2.5. Appendix

We conclude this Chapter on surface tension with the proofs which are not influenced in their structure by the media randomness. We will prove first the sub-additivity of surface tension, then its convexity. In a third Section (Appendix 2.5.3) we will prove that surface tension does not depend much on

the boundary condition. This will help in the study of the phase coexistence phenomenon (Chapter 3).

2.5.1. Sub-additivity of surface tension. We give here the proofs of Proposition 2.2.1 and Theorem 2.2.2.

PROOF. (Proposition 2.2.1). The fact that $\tau_{\mathcal{R}_{0,L,H}(\mathcal{S},\mathbf{n})}^J$ is a non-decreasing function of J and β is an immediate consequence of the monotonicity of Φ^J along the same parameters, noting that $\mathcal{D}_{\mathcal{R}}$ is a decreasing event. We consider then $H' \geq H$ and call $\mathcal{R} = \mathcal{R}_{0,L,H}(\mathcal{S},\mathbf{n})$ and $\mathcal{R}' = \mathcal{R}_{0,L,H'}(\mathcal{S},\mathbf{n})$. The inclusion $\mathcal{D}_{\mathcal{R}} \subset \mathcal{D}_{\mathcal{R}'}$ is clear and, on the second hand $\Phi_{\mathcal{R}'}^{J,w}$ is stochastically smaller than $\Phi_{\mathcal{R}}^{J,w}$ in view of the DLR equation and of the monotonicity of $\Phi_{\mathcal{R}}^{J,\pi}$ along π . As $\mathcal{D}_{\mathcal{R}}$ is a decreasing event we conclude that

$$\Phi_{\mathcal{R}}^{J,w}(\mathcal{D}_{\mathcal{R}}) \leq \Phi_{\mathcal{R}'}^{J,w}(\mathcal{D}_{\mathcal{R}}) \leq \Phi_{\mathcal{R}'}^{J,w}(\mathcal{D}_{\mathcal{R}'}),$$

i.e. $\tau_{\mathcal{R}_{0,L,H}(\mathcal{S},\mathbf{n})}^J$ is a non-increasing function of H . The non-negativity of $\tau_{\mathcal{R}}^J$ is a trivial consequence of its definition, and we conclude with the upper bound

$$\tau_{\mathcal{R}_{0,L,H}(\mathcal{S},\mathbf{n})}^J \leq \tau_{\mathcal{R}_{0,L,2\sqrt{d}}(\mathcal{S},\mathbf{n})}^J.$$

It is enough to close all the edges of $\hat{\mathcal{R}}_L = \hat{\mathcal{R}}_{0,L,2\sqrt{d}}(\mathcal{S},\mathbf{n})$ to realize the disconnection in $\hat{\mathcal{R}}_L$. The DLR equation, combined with the monotonicity of $\Phi_{\{e\}}^{J,\pi}$ yields:

$$\begin{aligned} \tau_{\mathcal{R}_L}^J &\leq -\frac{1}{L^{d-1}} \log \prod_{e \in E(\hat{\mathcal{R}}_L)} \Phi_{\{e\}}^{J,w}(\{\omega_e = 0\}) \\ &\leq \beta \frac{|E(\hat{\mathcal{R}}_L)|}{L^{d-1}} \end{aligned}$$

as $\Phi_{\{e\}}^{J,w}(\{\omega_e = 0\}) = 1 - p_e = \exp(-\beta J_e) \geq \exp(-\beta)$. We bound the cardinal of $E(\hat{\mathcal{R}}_L)$ using the following technique: $|E(\hat{\mathcal{R}}_L)|$ is not larger than $2d$ times the cardinal of $\hat{\mathcal{R}}_L$, which is itself not larger than the volume of $V = \bigcup_{x \in \hat{\mathcal{R}}_L} (x + [0, 1]^d) \subset \mathcal{R}_{0,L+2\sqrt{d},3\sqrt{d}}(\mathcal{S},\mathbf{n})$. Consequently

$$\tau_{\mathcal{R}_L}^J \leq \beta \times 2d \times \frac{(L + 2\sqrt{d})^{d-1} \times 6\sqrt{d}}{L^{d-1}} \leq \beta \times 6 \times 2^d d^{3/2}$$

and the claim follows. \square

PROOF. (Theorem 2.2.2). We begin with the definition of z_i and \mathcal{C} . We call $(e'_k)_{k=1\dots d-1}$ the edges of \mathcal{S}' and $e'_d = \mathbf{n}$, so that $(e'_k)_{k=1\dots d}$ is an orthonormal

basis for \mathbb{R}^d . For all $i = (i_k)_{k=1\dots d-1} \in \mathbb{Z}^{d-1}$ we define z_i as the unique point of \mathbb{Z}^d such that

$$(l + \sqrt{d}) \sum_{k=1}^{d-1} i_k \mathbf{e}'_k \in z_i + \left[-\frac{1}{2}, \frac{1}{2}\right)^d$$

and call

$$\mathcal{C} = \{i \in \mathbb{Z}^{d-1} : \mathcal{R}^i \subset \mathcal{R}\}$$

letting

$$\mathcal{R} = \mathcal{R}_{0,L,H+\sqrt{d}/2}(\mathcal{S}, \mathbf{n}) \quad \text{and} \quad \mathcal{R}^i = \mathcal{R}_{z_i,l,H}(\mathcal{S}', \mathbf{n}).$$

We proceed with the proof of (2.5) first. We call $\mathcal{H}_{\mathbf{n}}$ the hyperplane of \mathbb{R}^d orthogonal to \mathbf{n} that contains 0 and remark that the orthogonal projections of $z_i + l\mathcal{S}'$ (for all $i \in \mathcal{C}$) on $\mathcal{H}_{\mathbf{n}}$ are disjoint and all included in $L\mathcal{S}$. Hence their total surface $|\mathcal{C}|l^{d-1}$ does not exceed the surface of $L\mathcal{S}$, namely L^{d-1} , and the upper bound in (2.5) follows. Reusing the previous notations we call

$$z'_i = (l + \sqrt{d}) \sum_{k=1}^{d-1} i_k \mathbf{e}'_k, \quad \forall i \in \mathbb{Z}^{d-1}$$

so that $z'_i \in \mathcal{H}_{\mathbf{n}}$. We consider then

$$\mathcal{C}' = \left\{i \in \mathbb{Z}^{d-1} : z'_i + (l + \sqrt{d})\mathcal{S}' \subset L\mathcal{S}\right\}.$$

In view of the inequality $d(z_i, z'_i) \leq \sqrt{d}/2$ it follows that $z_i + l\mathcal{S}' \subset \mathcal{R}$, for all $i \in \mathcal{C}'$, hence $\mathcal{C}' \subset \mathcal{C}$. On the other hand, for any $i \in \mathbb{Z}^{d-1}$ such that $z'_i + (l + \sqrt{d})\mathcal{S}' \cap (L - 2\sqrt{d}(l + \sqrt{d}))\mathcal{S} \neq \emptyset$ we have $i \in \mathcal{C}'$, hence

$$\left(\frac{L - 2\sqrt{d}(l + \sqrt{d})}{l + \sqrt{d}}\right)^{d-1} \leq |\mathcal{C}'| \leq |\mathcal{C}|$$

and

$$\begin{aligned} \left(\frac{l}{L}\right)^{d-1} |\mathcal{C}| &\geq \left(\frac{l}{l + \sqrt{d}} - 2\sqrt{d}\frac{l}{L}\right)^{d-1} \\ &\geq \left(1 - \frac{\sqrt{d}}{l} - 2\sqrt{d}\frac{l}{L}\right)^{d-1} \\ &\geq 1 - (d-1) \left(\frac{\sqrt{d}}{l} + 2\sqrt{d}\frac{l}{L}\right) \end{aligned}$$

which yields the lower bound for (2.5). We pass now to the proof of (2.6) and call

$$\mathcal{E} = \left\{e \in E(\hat{\mathcal{R}}) \setminus \bigcup_{i \in \mathcal{C}} E(\hat{\mathcal{R}}_i) : d(e, \mathcal{H}_{\mathbf{n}}) \leq \frac{\sqrt{d}}{2}\right\}$$

where $d(e, \mathcal{H}_n)$ stands for the shortest distance between one extremity of e and \mathcal{H}_n . The inclusion

$$\left(\bigcap_{i \in \mathcal{C}} \mathcal{D}_{\mathcal{R}_i} \right) \cap \{\omega_e = 0, \forall e \in \mathcal{E}\} \subset \mathcal{D}_{\mathcal{R}}$$

holds: consider ω that belongs to the left-hand side and let c an ω -open path issued from $\partial^+ \hat{\mathcal{R}}$. Every times c enters some $\hat{\mathcal{R}}_i$ by the upper boundary $\partial^+ \hat{\mathcal{R}}$, it also exits by the same upper boundary since $\omega \in \mathcal{D}_{\hat{\mathcal{R}}_i}$. As c cannot use the edges of \mathcal{E} it is not able to cross the middle hyperplane \mathcal{H}_n elsewhere than in the $\hat{\mathcal{R}}_i$, and in particular it cannot reach $\partial^- \hat{\mathcal{R}}$. Since the $\mathcal{D}_{\hat{\mathcal{R}}_i}$ as well as the $\{\omega_e = 0\}$ are decreasing events, the DLR equations and the monotonicity along the boundary condition for Φ^J imply that

$$\begin{aligned} \Phi_{\hat{\mathcal{R}}}^{J,w}(\mathcal{D}_{\mathcal{R}}) &\geq \prod_{i \in \mathcal{C}} \Phi_{\mathcal{R}_i}^{J,w}(\mathcal{D}_{\mathcal{R}_i}) \times \prod_{e \in \mathcal{E}} \Phi_{\{e\}}^{J,w}(\{\omega_e = 0\}) \\ &\geq \prod_{i \in \mathcal{C}} \Phi_{\mathcal{R}_i}^{J,w}(\mathcal{D}_{\mathcal{R}_i}) \times \exp(-\beta|\mathcal{E}|) \end{aligned} \quad (2.59)$$

as $\Phi_{\{e\}}^{J,w}(\{\omega_e = 0\}) = 1 - p_e = \exp(-\beta J_e) \geq \exp(-\beta)$. We proceed then with an estimate over the cardinality of \mathcal{E} : we call $F = \{x \in \mathbb{Z}^d : \exists y, \{x, y\} \in \mathcal{E}\}$ the set of extremities of some $e \in \mathcal{E}$ and remark that $|\mathcal{E}| \leq d \text{Vol}(V)$ where $V = \bigcup_{x \in F} x + [0, 1]^d$. We have

$$V \subset \mathcal{R}_{0, L+2\sqrt{d}, 3\sqrt{d}/2}(\mathcal{S}, \mathbf{n}) \quad \text{while} \quad V \cap \mathcal{R}_{z_i, l-2\sqrt{d}, \infty}(\mathcal{S}', \mathbf{n}) = \emptyset, \quad \forall i \in \mathcal{C},$$

hence

$$|\mathcal{E}| \leq d \times \frac{3\sqrt{d}}{2} \times \left((L + 2\sqrt{d})^{d-1} - |\mathcal{C}| (l - 2\sqrt{d})^{d-1} \right) \leq c_d L^{d-1} \left(\frac{l}{L} + \frac{1}{l} \right)$$

in view of the lower bound in (2.5). Taking logarithms in (2.59) and dividing by $-L^{d-1}$ we obtain the inequality

$$\tau_{\mathcal{R}}^J \leq \left(\frac{l}{L} \right)^{d-1} \sum_{i \in \mathcal{C}} \tau_{\mathcal{R}_i}^J + c_d \beta \left(\frac{l}{L} + \frac{1}{l} \right)$$

and (2.6) follows from the upper bound in (2.5).

We conclude with a word on the structure of the sequence $(\tau_{\mathcal{R}_i}^J)_{i \in \mathcal{C}}$. The \mathcal{R}^i are disjoint by construction, hence so are the edge sets $E(\hat{\mathcal{R}}_i)$, hence the $\tau_{\mathcal{R}_i}^J$ are independent. They are identically distributed as the \mathcal{R}_i are all centered at lattice points, \mathbb{P} being translation invariant as a product measure. \square

2.5.2. Weak triangle inequality. In order to prove Proposition 2.2.8 we establish the weak triangle inequality for surface tension (see [65] or Proposition 11.6 in [24]). We consider three unit vectors \mathbf{u}, \mathbf{v} and \mathbf{n} such that \mathbf{n} is a linear combination of \mathbf{u} and \mathbf{v} with positive coefficients, and an orthonormal basis $\mathbf{e}_1, \mathbf{e}_2, \dots, \mathbf{e}_{d-1}, \mathbf{e}_d$ such that $\mathbf{e}_d = \mathbf{n}$ and $\mathbf{e}_1 \in \text{Vect}(\mathbf{u}, \mathbf{v})$

with $\mathbf{e}_1 \cdot \mathbf{v} \geq 0$. In the oriented plane $(\mathbf{e}_1, \mathbf{e}_d)$ we denote by θ the angle between \mathbf{u} and \mathbf{n} and by φ that between \mathbf{n} and \mathbf{v} . Note that $\cos \theta = \mathbf{u} \cdot \mathbf{n}$ and $\cos \varphi = \mathbf{v} \cdot \mathbf{n}$. As seen on Figure 5 the triangle with faces orthogonal to $-\mathbf{n}, \mathbf{u}, \mathbf{v}$ has side-lengths proportional to $1/\tan \theta + 1/\tan \varphi$, $1/\sin \theta$ and $1/\sin \varphi$.

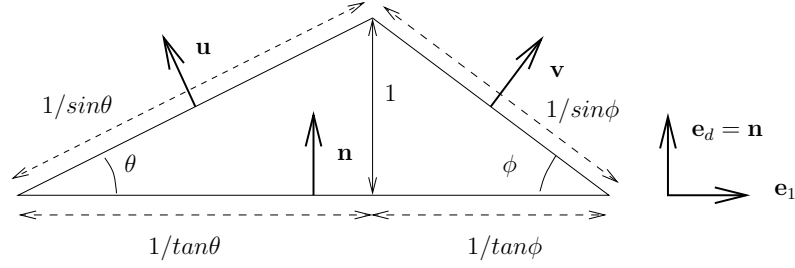

FIGURE 5. The triangle associated to the vectors \mathbf{u}, \mathbf{v} and \mathbf{n} in the plane $(\mathbf{e}_1, \mathbf{e}_d)$.

Let us describe how, into a rectangular parallelepiped oriented in the direction \mathbf{n} , we construct an interface made of rectangular parallelepipeds oriented in the directions \mathbf{u} and \mathbf{v} . Let

$$h = n(1/\tan \theta + 1/\tan \varphi), \quad h_{\mathbf{u}} = 1/\sin \theta \quad \text{and} \quad h_{\mathbf{v}} = 1/\sin \varphi$$

where $n \in \mathbb{N}^*$. We consider then the hypercubes

$$\begin{aligned} \mathcal{S} &= [\pm 1/2]\mathbf{e}_1 + \dots + [\pm 1/2]\mathbf{e}_{d-1} \\ \mathcal{S}_{\mathbf{u}} &= [\pm 1/2]\mathbf{u}' + [\pm 1/2]\mathbf{e}_2 + \dots + [\pm 1/2]\mathbf{e}_{d-1} \\ \mathcal{S}_{\mathbf{v}} &= [\pm 1/2]\mathbf{v}' + [\pm 1/2]\mathbf{e}_2 + \dots + [\pm 1/2]\mathbf{e}_{d-1}, \end{aligned}$$

where \mathbf{u}' is the direct normal to \mathbf{u} in the plane $(\mathbf{e}_1, \mathbf{e}_d)$, and \mathbf{v}' that to \mathbf{v} . Note that $\mathcal{S}, \mathcal{S}_{\mathbf{u}}$ and $\mathcal{S}_{\mathbf{v}}$ are respectively orthogonal to \mathbf{n}, \mathbf{u} and \mathbf{v} . Then, as on Figure 6 we consider the rectangular parallelepiped $\mathcal{R} = \lambda \mathcal{S} + [\pm 1]\mathbf{n}$ and, for any $i \in \mathbb{Z}^{d-1}$ the rectangular parallelepipeds

$$\begin{aligned} \mathcal{R}_{\mathbf{u}}^i &= \left(i_1 \left(\frac{1}{\tan \theta} + \frac{1}{\tan \varphi} \right) - \frac{1}{2 \tan \theta} \right) \mathbf{e}_1 \\ &\quad + \frac{1}{\sin \theta} \left(\sum_{k=2}^{d-1} i_k \mathbf{e}_k + (1 - \varepsilon_{\delta}) (\mathcal{S}_{\mathbf{u}} + [\pm \delta] \mathbf{u}) \right) \\ \mathcal{R}_{\mathbf{v}}^i &= \left(i_1 \left(\frac{1}{\tan \theta} + \frac{1}{\tan \varphi} \right) + \frac{1}{2 \tan \varphi} \right) \mathbf{e}_1 \\ &\quad + \frac{1}{\sin \varphi} \left(\sum_{k=2}^{d-1} i_k \mathbf{e}_k + (1 - \varepsilon_{\delta}) (\mathcal{S}_{\mathbf{v}} + [\pm \delta] \mathbf{v}) \right) \end{aligned}$$

where $\delta > 0$ and $\varepsilon_{\delta} = \delta \max(\tan \theta, \tan \varphi)$ ensures that the \mathbf{e}_1 -extension of $\mathcal{R}_{\mathbf{u}}^i$ (resp. of $\mathcal{R}_{\mathbf{v}}^j$) does not exceed $1/\tan \theta$ (resp. $1/\tan \varphi$), thus no $\mathcal{R}_{\mathbf{u}}^i$ and $\mathcal{R}_{\mathbf{v}}^j$ intersect each over.

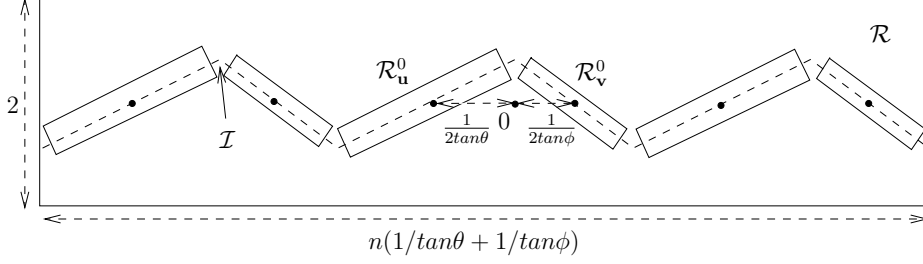

FIGURE 6. Intersection of the rectangular parallelepipeds \mathcal{R} , $\mathcal{R}_{\mathbf{u}}^i$ and $\mathcal{R}_{\mathbf{v}}^j$ with the plane $(\mathbf{e}_1, \mathbf{e}_d)$.

We now state an intermediate Lemma:

LEMMA 2.5.1. *There is a finite constant $c = c(d, \theta, \varphi)$ such that for any $N \in \mathbb{N}$, any n large enough:*

$$\Phi_{\mathcal{R}^N}^{J,w}(\mathcal{D}_{\mathcal{R}^N}) \geq \prod_{i \in \mathcal{K}_{\mathbf{u}}} \Phi_{(\mathcal{R}_{\mathbf{u}}^i)^N}^{J,w}(\mathcal{D}_{(\mathcal{R}_{\mathbf{u}}^i)^N}) \prod_{i \in \mathcal{K}_{\mathbf{v}}} \Phi_{(\mathcal{R}_{\mathbf{v}}^i)^N}^{J,w}(\mathcal{D}_{(\mathcal{R}_{\mathbf{v}}^i)^N}) \times e^{-c\beta(nN)^{d-1}(\frac{1}{n} + \delta)} \quad (2.60)$$

where $\mathcal{K}_{\mathbf{u}} = \{i \in \mathbb{Z}^{d-1} : \mathcal{R}_{\mathbf{u}}^i \subset \mathcal{R}\}$ and $\mathcal{K}_{\mathbf{v}} = \{i \in \mathbb{Z}^{d-1} : \mathcal{R}_{\mathbf{v}}^i \subset \mathcal{R}\}$ satisfy

$$1 - \frac{c}{n} \leq \frac{1}{n} \left(\frac{h_{\mathbf{u}}}{h} \right)^{d-2} |\mathcal{K}_{\mathbf{u}}| \leq 1 \quad \text{and} \quad 1 - \frac{c}{n} \leq \frac{1}{n} \left(\frac{h_{\mathbf{v}}}{h} \right)^{d-2} |\mathcal{K}_{\mathbf{v}}| \leq 1. \quad (2.61)$$

PROOF. We begin with (2.61). One can pile exactly n rectangular parallelepipeds $\mathcal{R}_{\mathbf{u}}^i$ in the direction \mathbf{e}_1 , and at least $h/h_{\mathbf{u}} - 2$, not more than $h/h_{\mathbf{u}}$ in each other direction $\mathbf{e}_2, \dots, \mathbf{e}_{d-1}$. Since h is proportional to n , (2.61) follows. We proceed now with the probabilistic estimates and consider the set of edges

$$\mathcal{E} \subset E(\widehat{\mathcal{R}^N}) \setminus \left\{ \bigcup_{i \in \mathcal{K}_{\mathbf{u}}} E((\widehat{\mathcal{R}_{\mathbf{u}}^i})^N) \cup \bigcup_{i \in \mathcal{K}_{\mathbf{v}}} E((\widehat{\mathcal{R}_{\mathbf{v}}^i})^N) \right\}$$

made of the edges that touch laterally some $(\mathcal{R}_{\mathbf{u}}^i)^N$ or $(\mathcal{R}_{\mathbf{v}}^i)^N$, and of the edges that touch the interface $N\mathcal{I}$ where \mathcal{I} is the interface invariant by translation in the directions \mathbf{e}_k , $k \in \{2, \dots, d-1\}$, which projection on the plane $(\mathbf{e}_1, \mathbf{e}_d)$ equals the union over $i \in \mathbb{Z}$ of

$$i \left(\frac{1}{\tan \theta} + \frac{1}{\tan \varphi} \right) \mathbf{e}_1 + \left(\left[\pm \frac{1}{2 \sin \theta} \right] \mathbf{u}' - \frac{1}{2 \tan \theta} \right) \cup \left(\left[\pm \frac{1}{2 \sin \varphi} \right] \mathbf{v}' + \frac{1}{2 \tan \varphi} \right)$$

(cf. Figure 6). It is clear that if disconnection happens under ω in every rectangular parallelepiped $(\mathcal{R}_{\mathbf{u}}^i)^N$, $i \in \mathcal{K}_{\mathbf{u}}$, in every $(\mathcal{R}_{\mathbf{v}}^i)^N$, $i \in \mathcal{K}_{\mathbf{v}}$ and if every edge in \mathcal{E} is closed for ω , then disconnection happens in the large rectangular parallelepiped \mathcal{R}^N . The cardinal of \mathcal{E} is not larger than

$$c_d N^{d-1} (1 + \delta/\varepsilon_\delta) \left[\mathcal{H}^{d-1}(\mathcal{I} \cap \mathcal{R}) - |\mathcal{K}_{\mathbf{u}}| \left(\frac{(1 - \varepsilon_\delta)}{\sin \theta} \right)^{d-1} - |\mathcal{K}_{\mathbf{v}}| \left(\frac{(1 - \varepsilon_\delta)}{\sin \varphi} \right)^{d-1} \right]$$

and since $\mathcal{H}^{d-1}(\mathcal{I} \cap \mathcal{R}) \leq (n+2)(h/h_{\mathbf{u}}+2)^{d-2}(1/\sin\theta)^{d-1} + (n+2)(h/h_{\mathbf{v}}+2)^{d-2}(1/\sin\varphi)^{d-1}$ and $\varepsilon_\delta \propto \delta$, one concludes that

$$|\mathcal{E}| \leq cn^{d-1}N^{d-1}(1/n + \delta)$$

for some $c = c(d, \theta, \varphi)$. Then, (2.60) follows just as in Theorem 2.2.2 from the DLR equation, together with the remark that the conditional probability that any edge be closed is at least $e^{-\beta}$. \square

We state now the proof of Proposition 2.2.8:

PROOF. (Proposition 2.2.8). Consider $x, y \in \mathbb{R}^d$ and $\alpha \in (0, 1)$. If x and y are on the same line issued from 0, the convexity inequality $f^q((1-\alpha)x + \alpha y) \leq (1-\alpha)f^q(x) + \alpha f^q(y)$ is trivial. Else, we call

$$\mathbf{u} = \frac{x}{\|x\|}, \quad \mathbf{v} = \frac{y}{\|y\|} \quad \text{and} \quad \mathbf{n} = \frac{(1-\alpha)x + \alpha y}{\|(1-\alpha)x + \alpha y\|}$$

and define by $\theta, \varphi \in (0, \pi/2)$ the numbers such that $\mathbf{u} \cdot \mathbf{n} = \cos\theta$ and $\mathbf{v} \cdot \mathbf{n} = \cos\varphi$. Remark that $\mathbf{n}, \mathbf{u}, \mathbf{v}$ comply the assumptions stated before Lemma 2.5.1. Taking $-1/(hN)^{d-1}\mathbb{E} \log$ in equation (2.60) and the inferior limit in N , then $n \rightarrow \infty$ and $\delta \rightarrow 0$ we obtain in view of Theorem 2.2.3 the weak triangle inequality for τ^q , namely:

$$\left(\frac{1}{\tan\theta} + \frac{1}{\tan\varphi} \right) \tau^q(\mathbf{n}) \leq \frac{1}{\sin\theta} \tau^q(\mathbf{u}) + \frac{1}{\sin\varphi} \tau^q(\mathbf{v}).$$

This implies the convexity of f^q and also, since $\sup_{\mathbf{n} \in S^{d-1}} \tau^q(\mathbf{n}) < \infty$, the continuity of τ^q – cf. Proposition 11.9 in [24] and references therein. The same is true for τ^λ : elevating equation (2.60) to the power λ , taking $-1/(hN)^{d-1} \log \mathbb{E}$ and the superior limit in N we obtain, in view of (2.20):

$$\begin{aligned} \tau^\lambda(\mathbf{n}) - \frac{\lambda c_d \beta}{h} &\leq |\mathcal{K}_{\mathbf{u}}| \left(\frac{h_{\mathbf{u}}(1-\varepsilon_\delta)}{h} \right)^{d-1} \tau^\lambda(\mathbf{u}) + |\mathcal{K}_{\mathbf{v}}| \left(\frac{h_{\mathbf{v}}(1-\varepsilon_\delta)}{h} \right)^{d-1} \tau^\lambda(\mathbf{v}) \\ &\quad + c\beta \left(\frac{n}{h} \right)^{d-1} \left(\frac{1}{n} + \delta \right) \end{aligned}$$

hence, letting $\delta \rightarrow 0$ and $n \rightarrow \infty$ we get the weak triangle inequality for τ^λ , hence f^λ is convex and τ^λ continuous on S^{d-1} . At last, remark that \tilde{f} is the pointwise limit of f^λ/λ as $\lambda \rightarrow 0^+$ (cf. (2.24)), hence it is again convex, and $\tilde{\tau}$ is continuous on S^{d-1} . \square

2.5.3. Surface tension under free boundary condition. The subject of this last appendix is the proof of the Proposition 2.5.2 below. Given a rectangular parallelepiped $\mathcal{R} = \mathcal{R}_{x,L,H}(\mathcal{S}, \mathbf{n})$, the surface tension in \mathcal{R} , with free boundary condition is

$$\tilde{\tau}_{\mathcal{R}}^J = -\frac{1}{L^{d-1}} \log \Phi_{\mathcal{R}}^{J,f}(\mathcal{D}_{\mathcal{R}}) \quad (2.62)$$

where $\tilde{\mathcal{R}} = \mathcal{R}_{x,L,H/2}(\mathcal{S}, \mathbf{n})$ is the twice finer rectangular parallelepiped. We will compare the value of $\tilde{\tau}_{\tilde{\mathcal{R}}}^J$ to that of

$$\tau_{\mathcal{R}}^J = -\frac{1}{L^{d-1}} \log \Phi_{\mathcal{R}}^{J,w}(\mathcal{D}_{\mathcal{R}}),$$

the surface tension in \mathcal{R} with wired boundary condition as in (2.3), and to

$$\tau_{\tilde{\mathcal{R}}}^J = -\frac{1}{L^{d-1}} \log \Phi_{\tilde{\mathcal{R}}}^{J,w}(\mathcal{D}_{\tilde{\mathcal{R}}}),$$

the surface tension in the finer rectangular parallelepiped $\tilde{\mathcal{R}}$, with wired boundary condition. We use the notations $\hat{\beta}_c$ for the slab percolation threshold and \mathcal{N} for the set of inverse temperatures at which infinite volume FK measures are not unique, see (3.4) and (3.5) for instance.

PROPOSITION 2.5.2. *For any rectangular parallelepiped \mathcal{R} , $\tilde{\tau}_{\mathcal{R}}^J \leq \tau_{\tilde{\mathcal{R}}}^J$. On the other hand, if $\beta > \hat{\beta}_c$ and $\beta \notin \mathcal{N}$ there exists $c_d < \infty$ such that, if $\mathcal{R}^N = \mathcal{R}_{0,N,\delta N}(\mathcal{S}, \mathbf{n})$ with $\delta \in (0, 1)$,*

$$\limsup_N \frac{1}{N^d} \log \mathbb{P}(\tilde{\tau}_{\mathcal{R}^N}^J \leq \tau_{\mathcal{R}^N}^J - c_d \delta \log q) < 0. \quad (2.63)$$

As a consequence, for $\beta > \hat{\beta}_c$ with $\beta \notin \mathcal{N}$, the cost for reducing $\tilde{\tau}_{\mathcal{R}}^J$ does not differ much from that of reducing $\tau_{\mathcal{R}}^J$: for all $\tau \geq 0$,

$$\begin{aligned} -I_{\mathbf{n}}(\tau^-) &\leq \liminf_{N \rightarrow \infty} \frac{1}{N^{d-1}} \log \mathbb{P}(\tilde{\tau}_{\mathcal{R}^N}^J \leq \tau) \\ &\leq \limsup_{N \rightarrow \infty} \frac{1}{N^{d-1}} \log \mathbb{P}(\tau_{\mathcal{R}^N}^J \leq \tau) \leq -I_{\mathbf{n}}(\tau + c_d \delta \log q). \end{aligned}$$

In order to prove that the boundary condition has little influence on the actual value of surface tension, we will adapt the argument of Cerf and Pisztora [25]. First, we will evaluate the density of the ‘‘induced boundary condition’’ under free and wired boundary conditions, as well as the cost for deviations. Then, we will use an appropriate geometrical decomposition together with a coupling argument and conclude that typically – up to volume order – the boundary condition in (2.62) does not influence the value of surface tension.

We begin with the definition of the density of the induced boundary condition. We call $\mathbb{H} = \mathbb{Z}^{d-1} \times \{0\}$ the discrete horizontal hyperplane and $E^+ = E(\mathbb{Z}^{d-1} \times \mathbb{N}) \setminus E(\mathbb{H})$ the set of edges with at least one extremity above \mathbb{H} . For any box $\hat{\Lambda} \subset \mathbb{Z}^d$ symmetric with respect to \mathbb{H} and any $\omega \in \Omega$, the boundary condition induced by ω on \mathbb{H} is $\omega|_{E^+}$. Then, we consider

$$K_{\hat{\Lambda}}(\omega) = \text{number of clusters of } \hat{\Lambda} \cap \mathbb{H} \text{ under the wiring } \omega|_{E^+}$$

as well as the density of clusters

$$\kappa_{\hat{\Lambda}}(\omega) = \frac{K_{\hat{\Lambda}}(\omega)}{|\hat{\Lambda} \cap \mathbb{H}|}.$$

In order to define localized versions of $K_{\hat{\Lambda}}(\omega)$ and $\kappa_{\hat{\Lambda}}(\omega)$, we consider the edge sets

$$\mathcal{B}_{\hat{\Lambda}} = E^+ \cap E(\partial\hat{\Lambda}) \quad \text{and} \quad \mathcal{E}_{\hat{\Lambda}} = E^+ \cap (E(\hat{\Lambda}) \setminus E(\partial\hat{\Lambda}))$$

where $\partial\Lambda = \{x \in \Lambda : \exists y \in \mathbb{Z}^d \setminus \Lambda : x \sim y\}$ is the (inner) boundary of $\Lambda \subset \mathbb{Z}^d$, and let

$$K_{\hat{\Lambda}}^f(\omega) = K_{\hat{\Lambda}}(\omega|_{\mathcal{E}_{\hat{\Lambda}}}) \quad \text{and} \quad K_{\hat{\Lambda}}^w(\omega) = K_{\hat{\Lambda}}(\omega|_{\mathcal{E}_{\hat{\Lambda}}} \vee w|_{\mathcal{B}_{\hat{\Lambda}}}) \quad (2.64)$$

where $w \in \Omega$ is the configuration with all edges open. We consider as well the associated densities:

$$\kappa_{\hat{\Lambda}}^f(\omega) = \frac{K_{\hat{\Lambda}}^f(\omega)}{|\hat{\Lambda} \cap \mathbb{H}|} \quad \text{and} \quad \kappa_{\hat{\Lambda}}^w(\omega) = \frac{K_{\hat{\Lambda}}^w(\omega)}{|\hat{\Lambda} \cap \mathbb{H}|}.$$

If $\hat{\Lambda}_N$ is the symmetric box $\hat{\Lambda}_N = \{-N, \dots, N\}^d$, we have:

PROPOSITION 2.5.3. *The limits*

$$\kappa^f = \lim_{N \rightarrow \infty} \mathbb{E} \Phi_{\hat{\Lambda}_N}^{J,f} \left(\kappa_{\hat{\Lambda}_N}^f(\omega) \right) \quad \text{and} \quad \kappa^w = \lim_{N \rightarrow \infty} \mathbb{E} \Phi_{\hat{\Lambda}_N}^{J,w} \left(\kappa_{\hat{\Lambda}_N}^w(\omega) \right)$$

exist and satisfy $0 \leq \kappa^w \leq \kappa^f \leq 1$. They are equal for any $\beta > \hat{\beta}_c$ such that $\beta \notin \mathcal{N}$. Furthermore, for any $\varepsilon > 0$:

$$\limsup_N \frac{1}{N^{d-1}} \log \mathbb{E} \Phi_{\hat{\Lambda}_N}^{J,f} \left(\kappa_{\hat{\Lambda}_N}^f \geq \kappa^f + \varepsilon \right) < 0 \quad (2.65)$$

and

$$\limsup_N \frac{1}{N^{d-1}} \log \mathbb{E} \Phi_{\hat{\Lambda}_N}^{J,w} \left(\kappa_{\hat{\Lambda}_N}^w \leq \kappa^w - \varepsilon \right) < 0. \quad (2.66)$$

PROOF. We prove that $\kappa_{\hat{\Lambda}_N}^f$ and $\kappa_{\hat{\Lambda}_N}^w$ are respectively sub and super-additive. Given $L, N \in \mathbb{N}^*$ with $L \leq N$ and $i \in \mathbb{H}$, we denote

$$\Delta_i^L = (2L+1)i + \hat{\Lambda}_L \quad \text{and} \quad I_{N,L} = \left\{ i \in \mathbb{H} : \Delta_i^L \subset \hat{\Lambda}_N \right\}. \quad (2.67)$$

Explicit calculations show that

$$|I_{N,L}| = \left(\frac{N}{L} \right)^{d-1} \left(1 + O\left(\frac{1}{L} \right) \right)$$

and

$$\left| \mathbb{H} \cap \left(\hat{\Lambda}_N \setminus \bigcup_{i \in I_{N,L}} \Delta_i^L \right) \right| \leq N^{d-1} O\left(\frac{1}{L} \right).$$

Since $K_{\hat{\Lambda}_N}$ is decreasing, we have

$$K_{\hat{\Lambda}_N}^f(\omega) \leq K_{\hat{\Lambda}_N}^f \left(\bigvee_{i \in I_{N,L}} \omega|_{\mathcal{E}_{\Delta_i^L}} \right) = \sum_{i \in I_{N,L}} K_{\Delta_i^L}^f(\omega) + \left| \mathbb{H} \cap \left(\hat{\Lambda}_N \setminus \bigcup_{i \in I_{N,L}} \Delta_i^L \right) \right|$$

and as a consequence,

$$\kappa_{\hat{\Lambda}_N}^f(\omega) \leq \frac{1 + O(1/L)}{|I_{N,L}|} \sum_{i \in I_{N,L}} \kappa_{\Delta_i^L}^f(\omega) + O\left(\frac{1}{L}\right). \quad (2.68)$$

In other words, $\kappa_{\hat{\Lambda}_N}^f$ is a sub-additive quantity. Taking on the left hand side the expectation $\mathbb{E}\Phi_{\hat{\Lambda}_N}^{J,f}$ and on the right-hand side the product $\bigotimes_{i \in I_{N,L}} \mathbb{E}\Phi_{\Delta_i^L}^{J,f}$ – which is stochastically smaller than $\mathbb{E}\Phi_{\hat{\Lambda}_N}^{J,f}$, cf. Proposition 1.3.2 in Chapter 1 – we conclude, on the one hand, to the convergence:

$$\mathbb{E}\Phi_{\hat{\Lambda}_N}^{J,f} \left(\kappa_{\hat{\Lambda}_N}^f(\omega) \right) \xrightarrow{N \rightarrow \infty} \kappa^f$$

and on the other hand that, for L and N/L large enough:

$$\begin{aligned} \mathbb{E}\Phi_{\hat{\Lambda}_N}^{J,f} \left(\kappa_{\hat{\Lambda}_N}^f(\omega) \geq \kappa^f + \varepsilon \right) &\leq \mathbb{E}\Phi_{\hat{\Lambda}_N}^{J,f} \left(\frac{1}{|I_{N,L}|} \sum_{i \in I_{N,L}} \kappa_{\Delta_i^L}^f(\omega) \geq \kappa^f + \frac{\varepsilon}{2} \right) \\ &\leq \bigotimes_{i \in I_{N,L}} \mathbb{E}\Phi_{\Delta_i^L}^{J,f} \left(\frac{1}{|I_{N,L}|} \sum_{i \in I_{N,L}} \kappa_{\Delta_i^L}^f(\omega) \geq \kappa^f + \frac{\varepsilon}{2} \right). \end{aligned}$$

Provided that L is large enough, the former probability decays as $\exp(-c(N/L)^{d-1})$ in the limit $N \rightarrow \infty$ thanks to Cramér's Theorem, and we proved (2.65). Symmetrically, $\kappa_{\hat{\Lambda}_N}^w$ is a super-additive quantity since, if we open all edges that do not belong to any $\mathcal{E}_{\Delta_i^L}$, we obtain the inequality

$$K_{\hat{\Lambda}_N}^w(\omega) \geq K_{\hat{\Lambda}_N} \left(\omega \bigvee w|_{\cap_{i \in I_{N,L}} \mathcal{E}_{\Delta_i^L}^c} \right) = \sum_{i \in I_{N,L}} \left[K_{\Delta_i^L}^w(\omega) - 1 \right] + 1$$

that is to say

$$\kappa_{\hat{\Lambda}_N}^w(\omega) \geq \frac{1 - O(1/L)}{|I_{N,L}|} \sum_{i \in I_{N,L}} \kappa_{\Delta_i^L}^w(\omega) - O\left(\frac{1}{L}\right) \quad (2.69)$$

and the convergence $\mathbb{E}\Phi_{\hat{\Lambda}_N}^{J,w} \left(\kappa_{\hat{\Lambda}_N}^w(\omega) \right) \xrightarrow{N \rightarrow \infty} \kappa^w$ as well as the surface cost for lower deviations (2.66) follow in the same way. The inequality $0 \leq \kappa^w \leq \kappa^f \leq 1$ is a trivial consequence of the fact that $K_{\hat{\Lambda}_N}$ is a decreasing function of ω , and of the estimates $1 \leq K_{\hat{\Lambda}_N}(\omega) \leq (2N + 1)^d$. In order to prove the equality, we take $\mathbb{E}\Phi_{\hat{\Lambda}_N}^{J,f}$ in (2.68) and $\mathbb{E}\Phi_{\hat{\Lambda}_N}^{J,w}$ in (2.69) and letting N , then $L \rightarrow \infty$ we obtain respectively

$$\kappa^f \leq \liminf_L \Theta \left(\kappa_{\hat{\Lambda}_L}^f(\omega) \right) \quad \text{and} \quad \kappa^w \geq \limsup_L \Theta \left(\kappa_{\hat{\Lambda}_L}^w(\omega) \right) \quad (2.70)$$

where Θ is the weak limit of both $\mathbb{E}\Phi_{\hat{\Lambda}_N}^{J,f}$ and $\mathbb{E}\Phi_{\hat{\Lambda}_N}^{J,w}$ as $N \rightarrow \infty$, thanks to the assumption $\beta \notin \mathcal{N}$. On the other hand, the assumption $\beta > \hat{\beta}_c$ and the coarse

graining (Theorem 1.2.1 in Chapter 1) imply the existence of $c > 0$ such that, for all $L \in \mathbb{N}$ large enough:

$$\Theta(\mathcal{U}_{\hat{\Lambda}_L}) \geq 1 - \exp(-c\sqrt{L})$$

where

$$\mathcal{U}_{\hat{\Lambda}_L} = \left\{ \begin{array}{l} \text{In } \hat{\Lambda}_L, \text{ there exists a unique} \\ \text{cluster for } \omega \text{ of diameter } \geq \sqrt{L} \end{array} \right\}.$$

For any $\omega \in \mathcal{U}_{\hat{\Lambda}_L}$ it is immediate that

$$0 \leq \kappa_{\hat{\Lambda}_L}^f(\omega) - \kappa_{\hat{\Lambda}_L}^w(\omega) \leq \frac{d-1}{\sqrt{L}}$$

and as a consequence:

$$\kappa^w \geq \limsup_L \Theta(\kappa_{\hat{\Lambda}_L}^w(\omega)) = \limsup_L \Theta(\kappa_{\hat{\Lambda}_L}^f(\omega)) \geq \liminf_L \Theta(\kappa_{\hat{\Lambda}_L}^f(\omega)) \geq \kappa^f.$$

□

The second step towards the proof of Proposition 2.5.2 is a control on the density of the boundary condition induced by ω on an increasing sequence of sets $(V_n)_{n \in \{0, n_{\max}\}}$ defined as follows: given $\mathcal{R}^N = \mathcal{R}_{0,N,\delta N}(\mathcal{S}, \mathbf{n})$ as in (2.2) and $\tilde{\mathcal{R}} = \mathcal{R}_{0,N,\delta N/2}(\mathcal{S}, \mathbf{n})$, $N, L \in \mathbb{N}^*$ we call

$$U_n = \mathcal{R}_{0,N,\delta N/2+4n\sqrt{d}L}(\mathcal{S}, \mathbf{n})$$

for any $n \in \{0, \dots, n_{\max}\}$ where

$$n_{\max} = \lceil \delta N / (8\sqrt{d}L) \rceil - 1.$$

Then, for all $i \in \mathbb{Z}^d$ we let

$$\tilde{\Delta}_i^L = 2Li + \{-L, \dots, L\}^d \quad \text{and} \quad V_n = \mathcal{R}^N \cap \left(\bigcup_{i \in \mathbb{Z}^d: \tilde{\Delta}_i^L \cap U_n \neq \emptyset} \tilde{\Delta}_i^L \right).$$

These sets are illustrated on Figure 7. Note that the rectangular parallelepipeds \mathcal{R}^N , $\tilde{\mathcal{R}}^N$ and U_n , $n \in \{0, \dots, n_{\max}\}$ are all centered at the origin. The essential feature of V_n is that its boundary is mostly constituted by $d-1$ dimensional facets of side-length $2L+1$, which makes possible to control the density of the boundary condition induced by ω on V_n . Precisely, if $\pi \in \Omega_{E(\widehat{\mathcal{R}^N})^c}$ and $\omega \in \Omega_{E(\widehat{\mathcal{R}^N})}$ we let

$$\mathcal{N}_n(\omega, \pi) = \text{Number of connected components of } \partial V_n \text{ under } \omega|_{E(\widehat{\mathcal{R}^N}) \setminus E(V_n)} \vee \pi, \quad (2.71)$$

and the following holds:

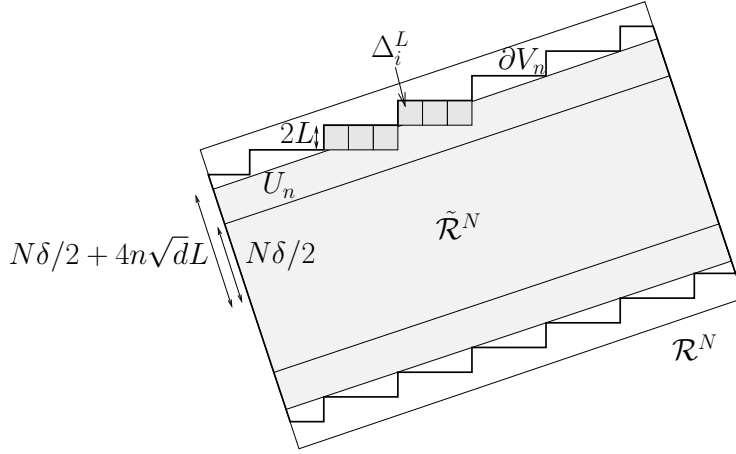
FIGURE 7. An illustration for the definition of V_n .

PROPOSITION 2.5.4. *Assume that $\beta > \hat{\beta}_c$ and $\beta \notin \mathcal{N}$ and let $\mathcal{R}^N = \mathcal{R}_{0,N,\delta N}(\mathcal{S}, \mathbf{n})$. Then, there exists $c_d < \infty$ depending on d only and $L \in \mathbb{N}^*$ such that:*

$$\limsup_{N \rightarrow \infty} \frac{1}{N^d} \log \mathbb{E} \Phi_{\mathcal{R}^N}^{J,f} \left(\left| \left\{ n : \frac{\mathcal{N}_n(\omega, f)}{|\partial V_n|} \geq \kappa + c_d \delta \right\} \right| \geq \frac{n_{\max}}{2} \right) < 0 \quad (2.72)$$

and

$$\limsup_{N \rightarrow \infty} \frac{1}{N^d} \log \mathbb{E} \Phi_{\mathcal{R}^N}^{J,w} \left(\left| \left\{ n : \frac{\mathcal{N}_n(\omega, w)}{|\partial V_n|} \leq \kappa - c_d \delta \right\} \right| \geq \frac{n_{\max}}{2} \right) < 0 \quad (2.73)$$

as well as

$$\forall n \in \{0, \dots, n_{\max}\}, \quad |\partial V_n| \leq c_d(1 + \delta)N^{d-1}. \quad (2.74)$$

We decompose the proof of Proposition 2.5.4 in three steps. First, in Lemma 2.5.5 we estimate the number of facets in each V_n as well as the cardinal of ∂V_n not covered by these facets. Then, in Lemma 2.5.6 we compare \mathcal{N}_n to a sum of local variables that are similar to the $K^{f/w}$ defined at (2.64), and at last we conclude using the stochastic domination Theorem (Proposition 1.3.2 in Chapter 1).

We begin with a notation for the facets of the $\tilde{\Delta}_i^L$: given $(i, k, \varepsilon) \in \mathbb{Z}^d \times \{1, \dots, d\} \times \{\pm 1\}$, we denote by

$$F_{i,k,\varepsilon}^L = \left\{ x \in \tilde{\Delta}_i^L : x \cdot \mathbf{e}_k = 2Li \cdot \mathbf{e}_k + \varepsilon L \right\}$$

the facet of $\tilde{\Delta}_i^L$ in the direction $\varepsilon \mathbf{e}_d$. Then, we let

$$\mathcal{F}_n = \left\{ (i, k, \varepsilon) : F_{i,k,\varepsilon}^L \subset \partial V_n, \tilde{\Delta}_i^L \subset V_n \text{ and } \tilde{\Delta}_{i+\varepsilon \mathbf{e}_k}^L \subset \mathcal{R}^N \right\},$$

and we prove the following fact:

LEMMA 2.5.5. *There exists a constant $c_d < \infty$ depending on d only such that, for any consistent N, L, δ and n with N/L large enough, one has*

$$\frac{1}{c_d} \left(\frac{N}{2L+1} \right)^{d-1} \leq |\mathcal{F}_n| \leq c_d \left(\frac{N}{2L+1} \right)^{d-1} \quad (2.75)$$

as well as

$$\left| \partial V_n \setminus \bigcup_{(i,k,\varepsilon) \in \mathcal{F}_n} F_{i,k,\varepsilon}^L \right| \leq c_d (\delta N + L) N^{d-2}. \quad (2.76)$$

PROOF. We begin with the right-hand side inequality in (2.75). The cubes contributing to \mathcal{F}_n remain at distance not larger than $2L\sqrt{d}$ from the top and bottom faces of U_n , that is, they pertain to a region of volume not larger than $8L\sqrt{d}N^{d-1}$. Since each cube has a volume $(2L)^d$ and bears $2d$ faces, we conclude that

$$|\mathcal{F}_n| \leq 8d^{3/2} \left(\frac{N}{2L} \right)^{d-1}.$$

In order to prove the left-hand side inequality in (2.75), we consider the orthogonal projection of the hyper-rectangular parallelepiped $\text{Top}(U_n)$ onto the hyperplane $\{x \in \mathbb{R}^d : x \cdot \mathbf{e}_k = 0\}$, it has an area equal to $N^{d-1} \times |\mathbf{e}_k \cdot \mathbf{n}|$, and this area is a lower bound for the area of the facets of \mathcal{F}_n with outer normal $\pm \mathbf{e}_k$. Hence the area of the facets of \mathcal{F}_n is at least of the order of

$$N^{d-1} \|\mathbf{n}\|_1$$

for N/L large, and (2.75) follows since $\|\mathbf{n}\|_1 \geq 1$. We address now the proof of (2.76), and remark that $\partial V_n \setminus \bigcup_{(i,k,\varepsilon) \in \mathcal{F}_n} F_{i,k,\varepsilon}^L$ can be covered by the union of the $\partial \tilde{\Delta}_i^L$ for all $i \in \mathbb{Z}^d$ such that

$$\tilde{\Delta}_i^L \cap (\partial V_n \setminus \partial_{\text{lat}}(\mathcal{R}^N)) \neq \emptyset \quad \text{and} \quad \exists(k, \varepsilon) : \tilde{\Delta}_{i+\varepsilon \mathbf{e}_k}^L \cap \mathcal{R}^N,$$

and by the lateral boundary of \mathcal{R}^N , namely

$$\partial_{\text{lat}}(\mathcal{R}^N) = \{x \in \mathcal{R}^N \cap \mathbb{Z}^d : \exists y \in \mathbb{Z}^d \setminus \mathcal{R}_\infty^N, \|y - x\|_2 = 1\}$$

where \mathcal{R}_∞^N is the rectangular parallelepiped with the same basis and center as \mathcal{R}^N , with infinite extension in the directions $\pm \mathbf{n}$. On the one hand, there are not more than $c'_d (N/L)^{d-2}$ cubes $\tilde{\Delta}_i^L$ that intersect $\partial V_n \setminus \partial_{\text{lat}}(N\mathcal{R})$, being at a distance not larger than $2\sqrt{d}L$ from $\partial_{\text{lat}}(N\mathcal{R})$, hence the contribution of the corresponding $\partial \tilde{\Delta}_i^L$ is not larger than $c''_d L N^{d-2}$. On the other hand, it is clear that $|\partial_{\text{lat}}(N\mathcal{R})| \leq c'''_d \delta N^{d-1}$ and (2.76) follows. \square

We turn now to the second step of the proof of Proposition 2.5.4, and make the link between $\mathcal{N}_n(\omega, \pi)$ defined at (2.71) and the quantities $K^{f/w}$ defined at (2.64). Precisely, given any $(i, k, \varepsilon) \in \mathcal{F}_n$ we call

$$B_{i,k,\varepsilon}^L = \tilde{\Delta}_i^L + L\varepsilon \mathbf{e}_k$$

the box placed symmetrically around the face $F_{i,k,\varepsilon}^L$, then

$$B_{i,k,\varepsilon}^{L,+} = \{x \in B_{i,k,\varepsilon}^L : (x - 2Li) \cdot \varepsilon \mathbf{e}_k \geq L\}$$

its middle half which intersection with V_n is reduced to $F_{i,k,\varepsilon}^L$. Then, we call $\mathcal{B}_{i,k,\varepsilon}^L$ the set constituted of the lateral edges of $B_{i,k,\varepsilon}^{L,+}$ not in $E(F_{i,k,\varepsilon}^L)$, namely $\mathcal{B}_{i,k,\varepsilon}^L = E(\partial B_{i,k,\varepsilon}^{L,+}) \setminus E(F_{i,k,\varepsilon}^L)$, and $\mathcal{E}_{i,k,\varepsilon}^L$ the set with one extremity in the interior of $B_{i,k,\varepsilon}^{L,+}$, namely $\mathcal{E}_{i,k,\varepsilon}^L = E(B_{i,k,\varepsilon}^{L,+}) \setminus E(\partial B_{i,k,\varepsilon}^{L,+})$. These edge sets are illustrated on Figure 8. Then, we call

- (i) $K_{i,k,\varepsilon}^{L,f}(\omega)$ the number of clusters of $F_{i,k,\varepsilon}^L$ under the wiring $\omega|_{\mathcal{E}_{i,k,\varepsilon}^L}$ and
- (ii) $K_{i,k,\varepsilon}^{L,w}(\omega)$ the number of clusters of $F_{i,k,\varepsilon}^L$ under the wiring $\omega|_{\mathcal{E}_{i,k,\varepsilon}^L \cup w|_{\mathcal{B}_{i,k,\varepsilon}^L}}$,

that is to say: in the computation of $K_{i,k,\varepsilon}^{L,f}(\omega)$, we take into account only the edges of ω in $\mathcal{E}_{i,k,\varepsilon}^L$, while for $K_{i,k,\varepsilon}^{L,w}(\omega)$ we close first the all the border edges $e \in \mathcal{B}_{i,k,\varepsilon}^L$.

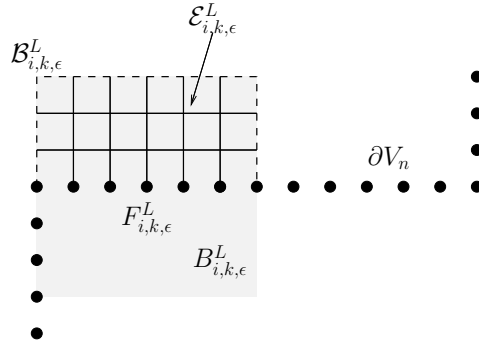

FIGURE 8. The two edge sets $\mathcal{B}_{i,k,\varepsilon}^L$ and $\mathcal{E}_{i,k,\varepsilon}^L$.

These new quantities $K^{f/w}$ correspond to those defined at (2.64), except for their orientation $\varepsilon \mathbf{e}_k$ in place of \mathbf{e}_d . We prove now:

LEMMA 2.5.6. *There exists $c_d < \infty$ that depends on d only such that, given any $\pi \in \Omega_{E(\widehat{\mathcal{R}^N})^c}$ and $\omega \in \Omega_{E(\widehat{\mathcal{R}^N})}$, $n \in \{0, \dots, n_{\max}\}$:*

$$\sum_{(i,k,\varepsilon) \in F_n} \left[K_{i,k,\varepsilon}^{L,w}(\omega) - 1 \right] \leq \mathcal{N}_n(\omega, \pi) \leq c_d (\delta N + L) N^{d-2} + \sum_{(i,k,\varepsilon) \in F_n} K_{i,k,\varepsilon}^{L,f}(\omega). \quad (2.77)$$

PROOF. We begin with the left-hand side inequality. Let $x \in F_{i,k,\varepsilon}^L$ and call \mathcal{C}_x the cluster of $\omega|_{\mathcal{E}_{i,k,\varepsilon}^L} \cup w|_{\mathcal{B}_{i,k,\varepsilon}^L}$ that contains x . If $\mathcal{C}_x \cap \mathcal{B}_{i,k,\varepsilon}^L \neq \emptyset$ (and this is the case of all but one cluster), \mathcal{C}_x is also a cluster for $\omega|_{E(\mathcal{R}^N) \setminus E(V_n)}$. Furthermore, it touches exactly one facet of ∂V_n since it does not touch $\mathcal{B}_{i,k,\varepsilon}^L$.

Hence, summing on all such clusters we obtain the left-hand side inequality in (2.77).

We examine then the right hand side inequality and consider \mathcal{C} a cluster of $\omega|_{E(\mathcal{R}^N) \setminus E(V_n)} \vee \pi$ touching V_n on some facet $(i, k, \varepsilon) \in \mathcal{F}_n$. There exists at least one cluster $\mathcal{C}' \subset \mathcal{C}$ for $\omega|_{\mathcal{E}_{i,k,\varepsilon}^L}$ that touches $F_{i,k,\varepsilon}^L$, thus it follows that the number of clusters under $\omega|_{E(\mathcal{R}^N) \setminus E(V_n)} \vee \pi$ touching $\bigcup_{(i,k,\varepsilon) \in \mathcal{F}_n} F_{i,k,\varepsilon}^L$ is not larger than $\sum_{(i,k,\varepsilon) \in \mathcal{F}_n} K_{i,k,\varepsilon}^{L,f}(\omega)$. The right-hand side inequality in (2.77) is then a direct consequence of (2.76) in the previous Lemma. \square

We address at last the proof of Proposition 2.5.4.

PROOF. (Proposition 2.5.4). We denote by $\mathcal{F} = \bigcup_{n=0}^{n_{\max}} \mathcal{F}_n$ the set of all facets of some V_n and consider the collection of events

$$\mathcal{D}_{i,k,\varepsilon}^L = \left\{ \omega : K_{i,k,\varepsilon}^{L,f}(\omega) \geq (2L+1)^{d-1}(\kappa + \delta) \right\}$$

for $(i, k, \varepsilon) \in \mathcal{F}$, as well as

$$\mathcal{G} = \left\{ \omega : \frac{|\{(i, k, \varepsilon) \in \mathcal{F} : \omega \in \mathcal{D}_{i,k,\varepsilon}^L\}|}{|\mathcal{F}|} \geq \delta \right\}$$

the event that a proportion at least δ of the facets satisfy $\mathcal{D}_{i,k,\varepsilon}^L$. First, we prove that if $C_d = 2 + 3c_d^2$ where $c_d < \infty$ is the maximum of the constants appearing in Lemmas 2.5.5 and 2.5.6, for L and N/L large enough we have the implication:

$$\omega \in \mathcal{G}^c \Rightarrow \left| \left\{ n : \frac{\mathcal{N}_n(\omega, f)}{|\partial V_n|} \geq \kappa + C_d \delta \right\} \right| < \frac{n_{\max}}{2}. \quad (2.78)$$

The proof is as follow: we consider $\omega \in \mathcal{G}^c$ and a sequence $(n_t)_{t=1 \dots \lceil n_{\max}/2 \rceil}$ such that, for all $t \in \{1, \dots, \lceil n_{\max}/2 \rceil\}$:

$$\mathcal{N}_{n_t}(\omega, f) \geq (\kappa + C_d \delta) |\partial V_{n_t}| \quad (2.79)$$

and exhibit a contradiction. To begin with, we sum (2.79) over t , consider the lower bound $|\partial V_{n_t}| \geq (2L-1)^{d-1} |\mathcal{F}_{n_t}|$, divide by $(2L+1)^{d-1} \sum_{t=1}^{\lceil n_{\max}/2 \rceil} |\mathcal{F}_{n_t}|$ and obtain

$$\frac{\sum_{t=1}^{\lceil n_{\max}/2 \rceil} \mathcal{N}_{n_t}(\omega, f)}{(2L+1)^{d-1} \sum_{t=1}^{\lceil n_{\max}/2 \rceil} |\mathcal{F}_{n_t}|} \geq (\kappa + C_d \delta) \frac{(2L-1)^{d-1}}{(2L+1)^{d-1}}. \quad (2.80)$$

Then, we remark thanks to (2.77) that

$$\sum_{t=1}^{\lceil n_{\max}/2 \rceil} \mathcal{N}_{n_t}(\omega, f) \leq \sum_{(i,k,\varepsilon) \in \bigcup_{t=1}^{\lceil n_{\max}/2 \rceil} \mathcal{F}_{n_t}} K_{i,k,\varepsilon}^{L,f}(\omega) + \left\lceil \frac{n_{\max}}{2} \right\rceil c_d (\delta N + L) N^{d-2}$$

while the assumption $\omega \in \mathcal{G}^c$ implies that

$$\sum_{(i,k,\varepsilon) \in \bigcup_{t=1}^{\lceil n_{\max}/2 \rceil} \mathcal{F}_{n_t}} K_{i,k,\varepsilon}^{L,f}(\omega) \leq (2L+1)^{d-1}(\kappa + \delta) \sum_{t=1}^{\lceil n_{\max}/2 \rceil} |\mathcal{F}_{n_t}| + \delta(2L+1)^{d-1}|\mathcal{F}|.$$

Reporting in (2.80) and noting that $|\mathcal{F}|/\sum_{t=1}^{\lceil n_{\max}/2 \rceil} |\mathcal{F}_{n_t}| \leq 2c_d^2$, as well as $(2L+1)^{d-1} \sum_{t=1}^{\lceil n_{\max}/2 \rceil} |\mathcal{F}_{n_t}| \geq c_d^{-1} \lceil n_{\max}/2 \rceil N^{d-1}$ thanks to (2.75), we conclude that

$$\kappa + \delta(1 + 3c_d^2) + c_d^2 \frac{L}{N} \geq (\kappa + C_d \delta) \frac{(2L-1)^{d-1}}{(2L+1)^{d-1}}.$$

which is false for L and N/L large enough. Hence (2.78) holds for L and N/L large enough. Now we estimate the $\mathbb{E}\Phi_{\mathcal{R}^N}^{J,f}$ -probability for \mathcal{G} . Remark that for $i = 0$, $k = d$ and $\varepsilon = 1$ we have $K_{0,d,1}^{L,f}(\omega) = K_{\hat{\Lambda}_L}^f(\omega)$ where $K_{\hat{\Lambda}_L}^f(\omega)$ is the quantity defined at (2.64). Hence, from the assumption $\beta > \hat{\beta}_c$ and $\beta \notin \mathcal{N}$, we deduce from Proposition 2.5.3 and in particular (2.65) the existence of $c > 0$ such that

$$\mathbb{E} \sup_{\pi} \left(\Phi_{E^f(B_{i,k,\varepsilon}^{L,+})}^{J,\pi}(\mathcal{D}_{i,k,\varepsilon}^L) \right) \leq \exp(-cL^{d-1}) \xrightarrow{L \rightarrow \infty} 0$$

for any L large enough. Now remark that the events $\mathcal{D}_{i,k,\varepsilon}^L$ and $\mathcal{D}_{j,k,\varepsilon}^L$ have disjoint domains of dependence $E(B_{i,k,\varepsilon}^{L,+})$ and $E(B_{j,k,\varepsilon}^{L,+})$ as soon as $\|i-j\|_{\infty} > 2$, hence the assumptions of Proposition 1.5.4 in Chapter 1 are satisfied. This means that we can fix L (large enough so that (2.78) holds for N large enough) such that the $\mathbb{E}\Phi_{\mathcal{R}^N}^{J,f}$ -probability for \mathcal{G} is not larger than

$$\mathcal{B}_{\delta/2}^{\mathcal{F}} \left(\frac{1}{|\mathcal{F}|} \sum_{f \in \mathcal{F}} X_f \geq \delta \right)$$

where $\mathcal{B}_{\delta/2}^{\mathcal{F}}$ is the Bernoulli product measure on \mathcal{F} of density $\delta/2$, and X_f its variable. By Cramér's Theorem, we know that the later probability decays as $\exp(-c|\mathcal{F}|)$ for some $c > 0$. Thanks to Lemma 2.5.5 it appears that $|\mathcal{F}|$ is larger than $c_{d,L} \delta h^d N^d$, hence we proved the existence of $c > 0$ such that

$$\mathbb{E}\Phi_{\mathcal{R}^N}^{J,f}(\mathcal{G}) \leq \exp(-cN^d)$$

and in view of the implication (2.78), the proof of (2.72) is over. The proof of (2.73) would be identical. At last, from (2.76) and (2.75) we check that

$$|\partial V_n| \leq c_d N^{d-1} (1 + \delta + L/N),$$

hence for any N large enough

$$|\partial V_n| \leq C_d N^{d-1} (1 + \delta)$$

and (2.74) is proved. \square

We are now in a position for proving Proposition 2.5.2. In order to quantify the influence of the boundary condition on surface tension we describe a coupling between the two measures $\mathbb{E}\Phi_{\mathcal{R}^N}^{J,f}$ and $\mathbb{E}\Phi_{\mathcal{R}^N}^{J,w}$. Following Cerf and Pisztor in [25], we consider an enumeration e_1, \dots, e_m of the edges in $E(\widehat{\mathcal{R}^N})$, where $m = |E(\widehat{\mathcal{R}^N})|$ and assume that this enumeration describes first $E(\widehat{\mathcal{R}^N}) \setminus E(V_{n_{\max}})$, then $E(V_{n_{\max}}) \setminus E(V_{n_{\max}-1})$ and so on until $E(V_0)$. On the other hand, we let U_1, U_2, U_m be i.i.d. random variables uniformly distributed on $[0, 1]$. Given a realization of the media $J \in \mathcal{J}$, we construct then two configurations $\bar{\omega}, \bar{\omega}' \in \Omega_{E(\widehat{\mathcal{R}^N})}$ by induction, letting

$$\begin{aligned}\bar{\omega}_{e_{k+1}} &= \mathbf{1}_{\{U_{k+1} \leq \Phi_{E(NR)}^{J,f}(\omega_{e_{k+1}} | \omega_{e_1} = \bar{\omega}_{e_1}, \dots, \omega_{e_k} = \bar{\omega}_{e_k})\}} \\ \bar{\omega}'_{e_{k+1}} &= \mathbf{1}_{\{U_{k+1} \leq \Phi_{E(NR)}^{J,w}(\omega_{e_{k+1}} | \omega_{e_1} = \bar{\omega}'_{e_1}, \dots, \omega_{e_k} = \bar{\omega}'_{e_k})\}}\end{aligned}\quad (2.81)$$

and we call $\tilde{\Phi}_{\mathcal{R}^N}^{J,f,w}$ the resulting law for $(\bar{\omega}, \bar{\omega}')$. This joint measure $\tilde{\Phi}_{\mathcal{R}^N}^{J,f,w}$ has the following properties: first, $\bar{\omega} \leq \bar{\omega}'$ almost surely – this is an inductive consequence of the FKG inequality. Second, the marginal laws of $\tilde{\Phi}_{\mathcal{R}^N}^{J,f,w}$ on $\bar{\omega}$ and $\bar{\omega}'$ are $\Phi_{\mathcal{R}^N}^{J,f}$ and $\Phi_{\mathcal{R}^N}^{J,w}$ respectively, and even, given any $n \in \{1, \dots, n_{\max}\}$, the marginal laws of $\bar{\omega}, \bar{\omega}'$ under the conditional measure

$$\tilde{\Phi}_{\mathcal{R}^N}^{J,f,w} \left(\cdot | \bar{\omega} = \omega \text{ and } \bar{\omega}' = \omega' \text{ on } E(\widehat{\mathcal{R}^N}) \setminus E(V_n) \right)$$

are respectively

$$\Phi_{E(V_n)}^{J,\omega | E(\widehat{\mathcal{R}^N}) \setminus E(V_n)} \quad \text{and} \quad \Phi_{E(V_n)}^{J,w | E(\widehat{\mathcal{R}^N})^c \vee \omega' | E(\widehat{\mathcal{R}^N}) \setminus E(V_n)}.\quad (2.82)$$

PROOF. (Proposition 2.5.2). The inequality $\tilde{\tau}_{\mathcal{R}}^J \leq \tau_{\mathcal{R}}^J$ is immediate: notice that

$$\Phi_{\mathcal{R}}^{J,f}(\mathcal{D}_{\tilde{\mathcal{R}}}) \geq \Phi_{\tilde{\mathcal{R}}}^{J,w}(\mathcal{D}_{\tilde{\mathcal{R}}}).$$

We address now the proof of (2.63) in the case $q > 1$ (if $q = 1$, the result is clear) and consider, for every $n \in \{1, \dots, n_{\max}\}$, the events

$$\mathcal{A}_n = \left\{ (\bar{\omega}, \bar{\omega}') \in \Omega_{E(\widehat{\mathcal{R}^N})}^2 : \bar{\omega} \leq \bar{\omega}' \text{ and } 0 \leq \mathcal{N}(\bar{\omega}, f) - \mathcal{N}(\bar{\omega}', w) \leq 4c_d^2 \delta h^{d-1} N^{d-1} \right\},$$

$$\mathcal{A} = \bigcup_{n=1}^{n_{\max}} \mathcal{A}_n \quad \text{and} \quad \mathcal{B}_n = \mathcal{A}_n \setminus \bigcup_{k=n+1}^{n_{\max}} \mathcal{A}_k$$

where $c_d < \infty$ is the constant appearing in Proposition 2.5.4. The latter Proposition yields:

$$\begin{aligned}\mathbb{E}\tilde{\Phi}_{\mathcal{R}^N}^{J,f,w}(\mathcal{A}^c) &\leq \mathbb{E}\tilde{\Phi}_{\mathcal{R}^N}^{J,f,w} \left(\forall n \leq n_{\max}, \frac{\mathcal{N}_n(\bar{\omega}, f)}{|\partial V_n|} \geq \kappa + c_d \delta \text{ or } \frac{\mathcal{N}_n(\bar{\omega}', w)}{|\partial V_n|} \leq \kappa - c_d \delta \right) \\ &\leq 2 \exp(-cN^d)\end{aligned}\quad (2.83)$$

for some $c > 0$ and $L \in \mathbb{N}^*$, for any N large enough. Now, we write

$$\begin{aligned} \Phi_{\mathcal{R}^N}^{J,f}(\mathcal{D}_{\tilde{\mathcal{R}}^N}) &= \tilde{\Phi}_{\mathcal{R}^N}^{J,f,w}(\bar{\omega} \in \mathcal{D}_{\tilde{\mathcal{R}}^N}) \\ &\leq \tilde{\Phi}_{\mathcal{R}^N}^{J,f,w}(\bar{\omega} \in \mathcal{D}_{\tilde{\mathcal{R}}^N} \cap \mathcal{A}) + \tilde{\Phi}_{\mathcal{R}^N}^{J,f,w}(\mathcal{A}^c) \\ &= \sum_{n=1}^{n_{\max}} \tilde{\Phi}_{\mathcal{R}^N}^{J,f,w}(\bar{\omega} \in \mathcal{D}_{\tilde{\mathcal{R}}^N} \cap \mathcal{B}_n) + \tilde{\Phi}_{\mathcal{R}^N}^{J,f,w}(\mathcal{A}^c) \end{aligned} \quad (2.84)$$

and thanks to (2.82) we know that for every $(\omega, \omega') \in \mathcal{B}_n$,

$$\begin{aligned} \tilde{\Phi}_{\mathcal{R}^N}^{J,f,w}(\bar{\omega} \in \mathcal{D}_{\tilde{\mathcal{R}}^N} \mid \bar{\omega} = \omega \text{ and } \bar{\omega}' = \omega' \text{ on } E(\widehat{\mathcal{R}^N}) \setminus E(V_n)) \\ = \Phi_{E(V_n)}^{J,\omega|_{E(\widehat{\mathcal{R}^N}) \setminus E(V_n)}}(\mathcal{D}_{\tilde{\mathcal{R}}^N}). \end{aligned}$$

Remark now that the boundary condition $\omega|_{E(\widehat{\mathcal{R}^N}) \setminus E(V_n)}$ induces $\mathcal{N}_n(\omega, f)$ clusters on ∂V_n , while $\omega'|_{E(\widehat{\mathcal{R}^N}) \setminus E(V_n)} \vee w|_{E(\widehat{\mathcal{R}^N})^c}$ induces $\mathcal{N}'(\omega', w) \geq \mathcal{N}_n(\omega, f) - 4c_d^2 \delta h^{d-1} N^{d-1}$ clusters. Hence (Lemma 3.3 in [25]) we have

$$\Phi_{E(V_n)}^{J,\omega|_{E(\widehat{\mathcal{R}^N}) \setminus E(V_n)}}(\mathcal{D}_{\tilde{\mathcal{R}}^N}) \leq q^{4c_d^2 \delta N^{d-1}} \times \Phi_{E(V_n)}^{J,w|_{E(\widehat{\mathcal{R}^N})^c} \vee \omega'|_{E(\widehat{\mathcal{R}^N}) \setminus E(V_n)}}(\mathcal{D}_{\tilde{\mathcal{R}}^N})$$

and using (2.82) again and reporting in (2.84), noting also $\mathcal{D}_{\tilde{\mathcal{R}}^N} \subset \mathcal{D}_{\mathcal{R}^N}$ we conclude that

$$\Phi_{\mathcal{R}^N}^{J,f}(\mathcal{D}_{\tilde{\mathcal{R}}^N}) \leq q^{4c_d^2 \delta N^{d-1}} \Phi_{\mathcal{R}^N}^{J,w}(\mathcal{D}_{\mathcal{R}^N}) + \tilde{\Phi}_{\mathcal{R}^N}^{J,f,w}(\mathcal{A}^c).$$

Yet, Markov's inequality indicates that $\tilde{\Phi}_{\mathcal{R}^N}^{J,f,w}(\mathcal{A}^c) \leq \exp(-c/2N^d)$ up to volume order large deviations on J . On the event that $\tau_{\mathcal{R}^N}^J \geq 5c_d^2 \delta \log q > 0$, $\tilde{\Phi}_{\mathcal{R}^N}^{J,f,w}(\mathcal{A}^c)$ is hence smaller than the first term for N large, up to volume order large deviations on J and we proved that

$$\limsup \frac{1}{N^d} \log \mathbb{P}(\tilde{\tau}_{\mathcal{R}^N}^J \leq \tau_{\mathcal{R}^N}^J - 5c_d^2 \delta \log q \text{ and } \tau_{\mathcal{R}^N}^J \geq 5c_d^2 \delta \log q) < 0.$$

We conclude with the remark that, as $\tilde{\tau}_{\mathcal{R}^N}^J \geq 0$,

$$\mathbb{P}(\tilde{\tau}_{\mathcal{R}^N}^J \leq \tau_{\mathcal{R}^N}^J - 5c_d^2 \delta \log q \text{ and } \tau_{\mathcal{R}^N}^J < 5c_d^2 \delta \log q) = 0.$$

□

CHAPTER 3

Equilibrium phase coexistence

ABSTRACT. In this Chapter we address the problem of phase coexistence in the dilute Ising model at equilibrium. Using the coarse graining developed in Chapter 1 and the analysis of surface tension realized in Chapter 2, we extend the L^1 -analysis of phase coexistence developed for the pure Ising model to the dilute Ising model, in all dimensions $d \geq 2$.

3.1. Introduction

The Ising model below the critical temperature, without external field, is a very convenient framework for the rigorous study of phase coexistence. Indeed, a constraint on the overall magnetization leads to the occurrence of two immiscible phases, the plus and minus phase (characterized by their local magnetization $\pm m_\beta$). These phases organize in space, and surface tension is responsible for the resulting shape, which has minimal surface energy under the given volume constraint.

A first impressive mathematical achievement was a detailed description of this phenomenon in the two dimensional Ising model [35] at low temperature. The construction was then simplified [69] and extended up to the critical temperature [49, 50, 51]. It appeared that not only, a mathematical implementation of surface tension was needed, but also that a *coarse graining* describing in a precise way the structure of both plus and minus phases was incontrovertible. See also [14] and Chapter 5.5 in [24] for a survey.

One specificity of the two dimensional case is that one is able to control the position of the microscopic interface between the plus and minus phase. In higher dimensions, it is predicted that clusters of plus and minus spins both percolate at temperatures close to the critical temperature [2]. This is the reason for which phase coexistence in dimensions $d \geq 3$ was studied in a L^1 -setting [12, 23, 25], see also the reviews [14] and [24].

The objective of the present Chapter is to extend the L^1 -description of phase coexistence to the dilute Ising model. In that model, the couplings between spins are random, independent and identically distributed, yet they remain ferromagnetic and bounded.

The structure of the Chapter is as follows: we continue the current section recalling a few facts on the dilute Ising model and on the associated geometrical optimization problems. We state the main results in Section 3.1.3. Section 3.2 is dedicated to the elaboration of a covering theorem for the boundary of phase profiles. In Section 3.3 we prove the lower and upper bound for phase coexistence, for specific realizations of the media. In Section 3.4 the reader will find the classical formulation of the lower and the upper bounds, together with the exponential tightness and, finally, the proofs of Theorems 3.1.1 and 3.1.2.

3.1.1. The dilute Ising model.

3.1.1.1. *Definition.* Given a realization of the couplings $J : E(\mathbb{Z}^d) \rightarrow [0, 1]$ we define the dilute Ising model with couplings J and plus boundary condition as follows: given $\beta \geq 0$ and Λ a finite subset of \mathbb{Z}^d , we define the Gibbs measure $\mu_{\beta, \Lambda}^{J, +}$ on Λ letting

$$\mu_{\beta, \Lambda}^{J, +}(\{\sigma\}) = \frac{1}{Z_{\Lambda, \beta}^{J, +}} \exp\left(\frac{\beta}{2} \sum_{e=\{x, y\} \in E^w(\Lambda)} J_e \sigma_x \sigma_y\right) \quad (3.1)$$

for any

$$\sigma \in \Sigma_{\Lambda}^+ = \{\sigma : \mathbb{Z}^d \rightarrow \{\pm 1\} : \sigma_z = 1, \forall z \notin \Lambda\},$$

where $Z_{\Lambda, \beta}^{J, +}$ is the partition function

$$Z_{\Lambda, \beta}^{J, +} = \sum_{\sigma \in \Sigma_{\Lambda}^+} \exp\left(\frac{\beta}{2} \sum_{e=\{x, y\} \in E^w(\Lambda)} J_e \sigma_x \sigma_y\right).$$

We already remarked in the first Chapter that the Ising model and the Fortuin-Kasteleyn measure are strongly connected, and that the Fortuin-Kasteleyn model $\Phi_{E, \beta}^{J, w, q}$ with parameters $p_e = 1 - e^{-\beta J_e}$ and $q \in \{2, 3, \dots\}$ corresponds to the q -Potts model with random couplings J_e , fixed boundary condition, at inverse temperature β . The 2-Potts model itself is the Ising model at inverse temperature $\beta/2$ and this is the reason for which we take $\beta/2$ instead of the usual β in (3.1).

Recall that we denote by \mathbb{P} the law of the media J . We require that the J_e are independent, identically distributed on $[0, 1]$. The magnetization in the thermodynamic limit is

$$m_{\beta} = \lim_{N \rightarrow \infty} \mathbb{E} \mu_{\hat{\Lambda}_N, \beta}^{J, +}(\sigma_0),$$

where $\hat{\Lambda}_N$ is the symmetric box $\hat{\Lambda}_N = \{-N, \dots, N\}^d$. It is a non-decreasing function of β . The critical inverse temperature

$$\beta_c = \inf \{\beta \geq 0 : m_{\beta} > 0\}$$

satisfies $\beta_c \geq \beta_c^{\text{pure}}$, where β_c^{pure} is the critical inverse temperature for the pure Ising model (with $J \equiv 1$). The argument of [3], described in Chapter 1, shows that the condition $\mathbb{P}(J_e > 0) > p_c(d)$ where $p_c(d)$ is the threshold for bond percolation on \mathbb{Z}^d is necessary and sufficient for having a phase transition at a finite β_c .

3.1.1.2. *The magnetization profile.* The objective of this Chapter is to describe the behavior of the magnetization profile in the dilute Ising model. The magnetization profile \mathcal{M}_K , at mesoscopic scale $K \in \mathbb{N}^*$, is a piecewise constant function from $[0, 1]^d$ to $[-1, 1]$ that we define as follows: given $N \in \mathbb{N}^*$ with $N \geq 3K + 1$, we consider $(\Delta_i, \Delta'_i)_{i \in I_{\Lambda_N, K}}$ the (K, K) -covering of Λ_N as in Definition 1.5.1. For $x \in [0, 1]^d$, we let

$$i(x) = \left(\left\lfloor \frac{Nx_1}{K} \right\rfloor, \dots, \left\lfloor \frac{Nx_d}{K} \right\rfloor \right) \in I_{\Lambda_N, K} \quad (3.2)$$

if $x = (x_1, \dots, x_d)$, and

$$\mathcal{M}_K(x) = \frac{1}{K^d} \sum_{z \in \Delta_{i(x)}} \sigma_z, \quad \forall x \in [0, 1]^d \quad (3.3)$$

so that $\mathcal{M}_K(x)$ is the average magnetization on a block of side-length K that contains Nx .

Theorem 1.5.7 in Chapter 1 provides a strong stochastic control on \mathcal{M}_K , under the assumption that slab percolation occurs under the annealed measure, and that uniqueness holds for infinite volume annealed FK measures. Let us denote

$$\hat{\beta}_c = \inf \{ \beta \geq 0 : (\mathbf{SP}) \text{ occurs} \} \quad (3.4)$$

the critical inverse temperature for slab percolation (see Section 1.2.2 for the definition of (\mathbf{SP})) and

$$\mathcal{N} = \left\{ \beta \geq 0 : \lim_{N \rightarrow \infty} \mathbb{E} \Phi_{\Lambda_N}^{J, f} \neq \lim_{N \rightarrow \infty} \mathbb{E} \Phi_{\Lambda_N}^{J, w} \right\} \quad (3.5)$$

the set of β such that infinite volume annealed FK measures are not unique, where $\Phi_{\Lambda_N}^{J, \pi}$ denotes the Fortuin-Kasteleyn representation of the dilute Ising model.

The study of phase coexistence that we propose in this Chapter holds for any $\beta > \hat{\beta}_c$ such that $\beta \notin \mathcal{N}$. This assumption is possibly stronger than that of phase coexistence $\beta > \beta_c$. Yet, we proved that \mathcal{N} is at most countable (Theorem 1.2.3), and we believe that, as in the uniform case [13], $\hat{\beta}_c = \beta_c$. At least we have $\hat{\beta}_c \geq \beta_c$, and $\hat{\beta}_c$ is finite under the same assumption as β_c , namely: $\mathbb{P}(J_e > 0) > p_c(d)$ (Section 1.2.2).

3.1.1.3. *Surface tension.* We will also make an extensive use, in the present Chapter, of the notion of surface tension. We refer the reader to Section 2.1.2 for an overview on surface tension in the dilute Ising model.

3.1.2. Surface energy and Wulff crystals. The coarse graining for the dilute Ising model (Theorem 1.5.7) implies that, at every $x \in [0, 1]^d$, $\mathcal{M}_K(x)/m_\beta$ is close to ± 1 with large probability. In order to describe the geometrical structure of the phases, we will estimate the probability that \mathcal{M}_K/m_β be close, in L^1 -distance, to a given Borel measurable function $u : [0, 1]^d \rightarrow \{\pm 1\}$. This probability is determined by the *surface energy* of u , namely: the integral of surface tension over the boundary of u .

Below, we define the notions of boundary and of surface energy for such a profile u and describe the associated isoperimetric problem.

3.1.2.1. *A few notations.* In the following, \mathcal{L}^d stands for the Lebesgue measure on \mathbb{R}^d and \mathcal{H}^{d-1} for the $d - 1$ dimensional Hausdorff measure, which gives to any Borel set $X \subset \mathbb{R}^d$ the weight

$$\mathcal{H}^{d-1}(X) = \lim_{\delta \rightarrow 0^+} \frac{\alpha_{d-1}}{2^{d-1}} \inf \left\{ \sum_{i \in I} [\text{diam}(E_i)]^{d-1} : \sup_{i \in I} \text{diam}(E_i) < \delta, X \subset \bigcup_{i \in I} E_i \right\}$$

where the infimum takes into account finite or countable coverings $(E_i)_{i \in I}$, and α_{d-1} is the volume of the unit ball of \mathbb{R}^{d-1} . The L^1 -distance between two Borel measurable functions $u, v : [0, 1]^d \rightarrow \mathbb{R}$ is

$$\|u - v\|_{L^1} = \int_{[0, 1]^d} |u - v| d\mathcal{L}^d,$$

and the set L^1 is

$$\{u : [0, 1]^d \rightarrow \mathbb{R} \text{ Borel measurable, } \|u\|_{L^1} < \infty\}.$$

In order that L^1 be a Banach space for the L^1 -norm, we identify $u : [0, 1]^d \rightarrow \mathbb{R}$ with the class of functions $v : \|u - v\|_{L^1} = 0$ that coincide with u on a set of full measure. At last, we denote by $\mathcal{V}(u, \delta)$ the neighborhood of radius $\delta > 0$ in L^1 around $u \in L^1$.

3.1.2.2. *Profiles of bounded variation.* For the study of phase coexistence, we have to consider virtually any $u \in L^1$ taking values in $\{\pm 1\}$. We need to define a notion of boundary for such profiles, which is done conveniently in the framework of bounded variation profiles (Chapter 3 in [10]). Given a Borel subset $U \subset \mathbb{R}^d$, the variation (or perimeter) of U is

$$\mathcal{P}(U) = \sup \left\{ \int_U \text{div } f d\mathcal{L}^d, f \in \mathcal{C}_c^\infty(\mathbb{R}^d, [-1, 1]) \right\} \in [0, \infty]$$

where $\mathcal{C}_c^\infty(\mathbb{R}^d, [-1, 1])$ is the set of \mathcal{C}^∞ functions from \mathbb{R}^d to $[-1, 1]$ with compact support, and div the divergence operator:

$$\text{div } f = \frac{\partial f}{\partial x_1} + \dots + \frac{\partial f}{\partial x_n}.$$

To $U \subset \mathbb{R}^d$ Borel measurable, we associate

$$u = \chi_U = x \in \mathbb{R}^d \mapsto \begin{cases} 1 & \text{if } x \notin U \\ -1 & \text{else} \end{cases}$$

and define the set of bounded variation profiles BV as follows:

$$\text{BV} = \{u = \chi_U : U \subset (0, 1)^d \text{ is a Borel set and } \mathcal{P}(U) < \infty\}.$$

Bounded variations profiles $u = \chi_U \in \text{BV}$ have a *reduced boundary* ∂^*u and an outer normal $\mathbf{n}^u : \partial^*u \rightarrow S^{d-1}$ with, in particular, $\mathcal{H}^{d-1}(\partial^*u) = \mathcal{P}(U)$.

3.1.2.3. *Surface energy.* As the outer normal \mathbf{n}^u defined on ∂^*u is Borel measurable, one can consider the functionals

$$\mathcal{F}^q(u) = \int_{\partial^*u} \tau^q(\mathbf{n}_x^u) d\mathcal{H}^{d-1}(x), \quad \forall u \in \text{BV} \quad (3.6)$$

and

$$\mathcal{F}^\lambda(u) = \int_{\partial^*u} \tau^\lambda(\mathbf{n}_x^u) d\mathcal{H}^{d-1}(x), \quad \forall u \in \text{BV}, \forall \lambda > 0. \quad (3.7)$$

where τ^q (resp. τ^λ) stands for the quenched (resp. λ -annealed) surface tension of the dilute Ising model, see Theorem 2.2.3 and (2.18) in Chapter 2. Because the homogeneous extension of the surface tensions τ^q and τ^λ are convex (Proposition 2.2.8 in Chapter 2), \mathcal{F}^q and \mathcal{F}^λ are lower semi-continuous with respect to the L^1 -norm. See Chapter 14 in [24] or Theorem 2.1 in [9].

When surface tension is positive, the level sets of \mathcal{F}^q and \mathcal{F}^λ are compact in view of the following fact: for all $a \geq 0$, the set

$$\text{BV}_a = \{u = \chi_U \in \text{BV} : \mathcal{P}(U) \leq a\} \quad (3.8)$$

is compact for the L^1 -norm, cf. Theorem 3.23 in [10]. Consequently, \mathcal{F}^q and \mathcal{F}^λ are good rate functions.

3.1.2.4. *Isoperimetric problems and Wulff crystals.* We will show in this Chapter that the quenched probability of observing a given profile $u \in \text{BV}$ for the magnetization \mathcal{M}_K/m_β in the domain Λ_N is of order $\exp(-N^{d-1}\mathcal{F}^q(u))$ under the quenched measure. Hence, in the absence of constraint the system selects the plus phase uniformly in the whole domain (i.e. $\mathcal{M}_K/m_\beta \simeq \mathbf{1}$ in L^1). As we are interested in the phenomenon of phase coexistence, we impose a *volume constraint* and condition on the event that $m_{\Lambda_N} \leq m$, where m_{Λ_N} is the mean magnetization in Λ_N and m is some value $m < m_\beta$.

This volume constraint leads to the following *isoperimetric problem*: what are the $u \in \text{BV}$ such that

$$\int_{[0,1]^d} u d\mathcal{L}^d \leq \frac{m}{m_\beta} \quad \text{and} \quad \mathcal{F}^q(u) \text{ is minimal?} \quad (3.9)$$

We describe first the Wulff crystal, which is the solution to the same problem *without* the constraint that $U \subset (0, 1)^d$. The Wulff crystal associated to τ^q , for

$\beta > \hat{\beta}_c$, is

$$\mathcal{W}^q = \alpha \bigcap_{\mathbf{n} \in S^{d-1}} \{x \in \mathbb{R}^d : x \cdot \mathbf{n} \leq \tau^q(\mathbf{n})\}$$

where $\alpha \in (0, \infty)$ normalizes the volume such that $\mathcal{L}^d(\mathcal{W}^q) = 1$. As the homogeneous extension of τ^q is convex (Proposition 2.2.8), the solution to $U \subset \mathbb{R}^d$ Borel set with

$$\mathcal{L}^d(U) = 1 \quad \text{and} \quad \mathcal{F}^q(\chi_U) \text{ minimal}$$

are the translates of the Wulff crystal \mathcal{W}^q , see [76], [37] and [38].

For $m < m_\beta$ not too small, \mathcal{W}^q determines as well the optimal profiles in the cube (3.9). Let $\alpha > 0$ such that

$$\alpha^d = \frac{1}{2} \left(1 - \frac{m}{m_\beta} \right),$$

α^d is the least volume of U corresponding to $u = \chi_U \in \text{BV}$ with $\int_{[0,1]^d} u d\mathcal{L}^d \leq m/m_\beta$. If some translate of $\alpha\mathcal{W}^q$ fits into the unit cube $[0, 1]^d$, that is if

$$\alpha \times \text{diam}_\infty(\mathcal{W}^q) \leq 1, \quad (3.10)$$

then for $z_0 = (1/2, \dots, 1/2)$ the phase profile $\chi_{z_0 + \alpha\mathcal{W}^q}$ belongs to BV and therefore the infimum of $\mathcal{F}^q(u)$ for $u \in \text{BV}$ with $\int_{[0,1]^d} u d\mathcal{L}^d \leq m/m_\beta$ is

$$\mathcal{F}^q(\chi_{\alpha\mathcal{W}^q}).$$

As a consequence, for all α satisfying (3.10) the optimal phase profiles correspond to the translates of $\alpha\mathcal{W}^q$ that belong to $[0, 1]^d$, which are the

$$\chi_{z + \alpha\mathcal{W}^q}, \quad z \in \mathcal{T}_\alpha^q = \left[\frac{\alpha}{2} \text{diam}_\infty(\mathcal{W}^q), 1 - \frac{\alpha}{2} \text{diam}_\infty(\mathcal{W}^q) \right]^d.$$

The same remains true if we replace \mathcal{F}^q and \mathcal{W}^q with \mathcal{F}^λ and \mathcal{W}^λ , for any $\lambda > 0$.

3.1.3. Statement of the results. We denote m_{Λ_N} the mean magnetization in Λ_N :

$$m_{\Lambda_N} = \frac{1}{N^d} \sum_{z \in \Lambda_N} \sigma_z$$

and

$$\mathcal{N}_I = \{ \beta \geq 0 : \exists \mathbf{n} \in S^{d-1} : \exists \varepsilon > 0 : I_{\mathbf{n}}(\tau^q(\mathbf{n}) - \varepsilon) = 0 \}$$

which is at most countable if \mathbb{P} satisfies a logarithmic Sobolev inequality, see Corollary 2.4.5 in Chapter 2. We use as well the notations $\hat{\beta}_c$ for the slab percolation threshold and \mathcal{N} for the set of β such that there is no uniqueness of infinite volume FK measures, see (3.4) and (3.5).

Our main results are the following: first, the cost of reducing the magnetization (and obtaining phase coexistence) is determined by the surface energy of the Wulff crystal:

THEOREM 3.1.1. *Assume $\beta > \hat{\beta}_c$ with $\beta \notin \mathcal{N}$. Then, for all $0 \leq \alpha < 1/\text{diam}_\infty(\mathcal{W}^q)$,*

$$\frac{1}{N^{d-1}} \log \mu_{\Lambda_N}^{J,+} \left(\frac{m_{\Lambda_N}}{m_\beta} \leq 1 - 2\alpha^d \right) \xrightarrow{N \rightarrow \infty} -\mathcal{F}^q(\chi_{\alpha\mathcal{W}^q}) \quad \text{in } \mathbb{P}\text{-probability,} \quad (3.11)$$

and \mathbb{P} -almost surely if $\beta \notin \mathcal{N}_I$. Similarly, for all $\lambda > 0$ and $0 \leq \alpha < 1/\text{diam}_\infty(\mathcal{W}^\lambda)$,

$$\frac{1}{N^{d-1}} \log \mathbb{E} \left[\left(\mu_{\Lambda_N}^{J,+} \left(\frac{m_{\Lambda_N}}{m_\beta} \leq 1 - 2\alpha^d \right) \right)^\lambda \right] \xrightarrow{N \rightarrow \infty} -\mathcal{F}^\lambda(\chi_{\alpha\mathcal{W}^\lambda}). \quad (3.12)$$

The second control describes the geometrical structure of the two phases when they coexist. We show that the minus phase has the shape of the Wulff crystal:

THEOREM 3.1.2. *For all $\beta > \hat{\beta}_c$ with $\beta \notin \mathcal{N}$, for all $0 \leq \alpha < 1/\text{diam}_\infty(\mathcal{W}^q)$ and $\varepsilon > 0$, for any K large enough one has*

$$\lim_{N \rightarrow \infty} \mu_{\Lambda_N}^{J,+} \left(\frac{\mathcal{M}_K}{m_\beta} \in \bigcup_{z \in \mathcal{T}_\alpha^q} \mathcal{V}(\chi_{z+\alpha\mathcal{W}^q}, \varepsilon) \left| \frac{m_{\Lambda_N}}{m_\beta} \leq 1 - 2\alpha^d \right. \right) = 1 \quad \text{in } \mathbb{P}\text{-probability,} \quad (3.13)$$

and \mathbb{P} -almost surely if $\beta \notin \mathcal{N}_I$. For any $0 \leq \alpha < 1/\text{diam}_\infty(\mathcal{W}^{\lambda=1})$ and $\varepsilon > 0$, for any K large enough one has

$$\lim_{N \rightarrow \infty} \left(\mathbb{E} \mu_{\Lambda_N}^{J,+} \right) \left(\frac{\mathcal{M}_K}{m_\beta} \in \bigcup_{z \in \mathcal{T}_\alpha^{\lambda=1}} \mathcal{V}(\chi_{z+\alpha\mathcal{W}^{\lambda=1}}, \varepsilon) \left| \frac{m_{\Lambda_N}}{m_\beta} \leq 1 - 2\alpha^d \right. \right) = 1. \quad (3.14)$$

Note that (3.14) can be generalized to any $\lambda > 0$, at the price of heavier notations ($\mathbb{E}[(\mu_{\Lambda_N}^{J,+}(\cdot))^\lambda]$ is not a measure for $\lambda \neq 1$ since it is not additive): under the same conditions as in Theorem 3.1.2, for any $\lambda > 0$ and any $0 \leq \alpha < 1/\text{diam}_\infty(\mathcal{W}^\lambda)$, $\varepsilon > 0$, for large enough K one has

$$\lim_{N \rightarrow \infty} \frac{\mathbb{E} \left[\left(\mu_{\Lambda_N}^{J,+} \left(\frac{\mathcal{M}_K}{m_\beta} \in \bigcup_{z \in \mathcal{T}_\alpha^\lambda} \mathcal{V}(\chi_{z+\alpha\mathcal{W}^\lambda}, \varepsilon) \text{ and } \frac{m_{\Lambda_N}}{m_\beta} \leq 1 - 2\alpha^d \right) \right)^\lambda \right]}{\mathbb{E} \left[\left(\mu_{\Lambda_N}^{J,+} \left(\frac{m_{\Lambda_N}}{m_\beta} \leq 1 - 2\alpha^d \right) \right)^\lambda \right]} = 1.$$

A slight improvement in the formulation of Theorem 3.1.2 with respect to former works is the fact that we prove (3.13) and (3.14) for some large but fixed K . This implies a similar result for any sensible mesoscopic scale: if K_N satisfies $1 \ll K_N \ll N$, then \mathcal{M}_{K_N} is close to the local mean of \mathcal{M}_K as $K_N \gg 1$, and this local mean is close to $\chi_{z+\alpha\mathcal{W}}$ because the K_N -blocks intersecting $N\partial(z + \alpha\mathcal{W})$ contribute to a negligible volume ($K_N \ll N$).

Concerning the shape of crystals at low temperature, let us recall Theorem 2.3.2 of Chapter 2:

THEOREM. *Assume that $\mathbb{P}(J_e > 0) = 1$. Then, as $\beta \rightarrow +\infty$:*

- (i) *The Wulff crystal associated to τ^q converges to the Wulff crystal associated to the maximal flow for \mathbb{P} .*
- (ii) *The Wulff crystal associated to τ^λ converges to the hypercubic Wulff crystal.*

3.2. Covering theorems for BV profiles

Covering theorems play an essential role in the study of phase coexistence, as they allow to pass from the macroscopic scale (the phase profile u) to the microscopic scale (the dilute Ising model). We give first two definitions:

DEFINITION 3.2.1. Let $u \in \text{BV}$, $\delta > 0$ and \mathcal{R} a rectangular parallelepiped as in (2.2), included in $[0, 1]^d$. We say that \mathcal{R} is δ -adapted to u at $x \in \partial^*u$ if the following holds:

- (i) If $\mathbf{n} = \mathbf{n}_x^u$ is the outer normal to u at x , there are $\mathcal{S} \in \mathbb{S}_{\mathbf{n}}$ and $h \in (0, \delta]$ such that, if $\mathcal{R} \subset (0, 1)^d$ (we say that \mathcal{R} is interior), then

$$\mathcal{R} = x + h\mathcal{S} + [\pm\delta h]\mathbf{n},$$

and if $\mathcal{R} \cap \partial[0, 1]^d \neq \emptyset$ (we say that \mathcal{R} is on the border), then $x \in \partial[0, 1]^d$, \mathbf{n} is also the outer normal to $[0, 1]^d$ at x and

$$\mathcal{R} = x + h\mathcal{S} + [-\delta h, 0]\mathbf{n}.$$

- (ii) We have

$$\mathcal{H}^{d-1}(\partial^*u \cap \partial\mathcal{R}) = 0,$$

$$\left| 1 - \frac{1}{h^{d-1}} \mathcal{H}^{d-1}(\partial^*u \cap \mathcal{R}) \right| \leq \delta,$$

and

$$\left| \tau^q(\mathbf{n}) - \frac{1}{h^{d-1}} \int_{\partial^*u \cap \mathcal{R}} \tau^q(\mathbf{n}^u) d\mathcal{H}^{d-1} \right| \leq \delta.$$

- (iii) If $\chi : \mathbb{R}^d \rightarrow \{\pm 1\}$ is the characteristic function of \mathcal{R} defined by

$$\chi(z) = \begin{cases} +1 & \text{if } (z - x) \cdot \mathbf{n} \geq 0 \\ -1 & \text{else} \end{cases}, \forall z \in \mathbb{R}^d,$$

then

$$\frac{1}{2\delta h^d} \int_{\mathcal{R}} |\chi - u| d\mathcal{H}^d \leq \delta.$$

DEFINITION 3.2.2. Let $u \in \text{BV}$ and $\delta > 0$. A finite sequence $(\mathcal{R}_i)_{i=1\dots n}$ of disjoint rectangular parallelepipeds included in $[0, 1]^d$ is said to be a δ -covering for ∂^*u if each \mathcal{R}_i is δ -adapted to u and if

$$\mathcal{H}^{d-1} \left(\partial^*u \setminus \bigcup_{i=1}^n \mathcal{R}_i \right) \leq \delta. \quad (3.15)$$

With the help of the Vitali covering theorem (see below), one can establish:

THEOREM 3.2.3. *For any $u \in \text{BV}$ and $\delta > 0$, there is a δ -covering for ∂^*u .*

Before we give the proof, let us remark that the δ -covering is adapted to the quenched surface tension τ^q (Definition 3.2.1 (ii)), yet the Theorem remains true if we replace τ^q with the λ -annealed surface tension τ^λ .

The Vitali covering theorem (Theorem 13.3 in [24]) is especially well adapted to our purpose. Given a Borel set $E \subset \mathbb{R}^d$, we say that a collection of sets \mathcal{U} is a Vitali class for E if, for each $x \in E$ and $\delta > 0$, there is $U \in \mathcal{U}$ with $0 < \text{diam } U < \delta$ containing x .

THEOREM 3.2.4. [Vitali] *Let $E \subset \mathbb{R}^d$ be \mathcal{H}^{d-1} -measurable and consider \mathcal{U} a Vitali class of closed sets for E . Then, there is a countable disjoint sequence $(U_i)_{i \in I}$ in \mathcal{U} such that*

$$\text{either } \sum_{i \in I} (\text{diam } U_i)^{d-1} = \infty \quad \text{or} \quad \mathcal{H}^{d-1} \left(E \setminus \bigcup_{i \in I} U_i \right) = 0.$$

Before we give the proof of Theorem 3.2.3 we recall a property of the reduced boundary (see Theorem 3.59 in [10]):

LEMMA 3.2.5. *Let $u \in \text{BV}$. For all $x \in \partial^*u$, for all $\delta \in (0, 1)$, all $\mathcal{S} \in \mathbb{S}_{\mathbf{n}_x^u}$ one has*

$$\lim_{h \rightarrow 0^+} \frac{1}{h^{d-1}} \mathcal{H}^{d-1} \left(\partial^*u \cap \mathring{\mathcal{R}}_{x,h,\delta h}(\mathcal{S}, \mathbf{n}_x^u) \right) = 1.$$

PROOF. (Theorem 3.2.3). We design a set E that has zero \mathcal{H}^{d-1} -measure and such that the collection of closed rectangular parallelepipeds

$$\mathcal{U}_\delta = \{ \mathcal{R} \text{ } \delta\text{-adapted to } u \text{ at } x \in \partial^*u \setminus E \}$$

is a Vitali class for $\partial^*u \setminus (E)$. This is enough to prove the claim: thanks to the Vitali covering Theorem, this implies the existence of a countable disjoint sequence $(\mathcal{R}_i)_{i \in I}$ of δ -adapted rectangular parallelepipeds with either

$$\sum_{i \in I} (\text{diam } \mathcal{R}_i)^{d-1} = \infty \quad \text{or} \quad \mathcal{H}^{d-1} \left(\partial^*u \setminus \bigcup_{i \in I} \mathcal{R}_i \right) = 0.$$

The first case is in contradiction with the inequalities $1/h_i^{d-1} \mathcal{H}^{d-1}(\partial^* u \cap \mathcal{R}_i) \geq 1 - \delta$ and $\mathcal{H}^{d-1}(\partial^* u) < \infty$, hence the second is realized and the Theorem is proved.

We define the set E by its complement in $\partial^* u$: $\partial^* u \setminus E$ is the set of all $x \in \partial^* u$ such that, for all $\mathcal{S} \in \mathbb{S}_{\mathbf{n}_x^u}$, the following holds:

- (i) If $x \in \partial[0, 1]^d$, then \mathbf{n}_x^u is the outer normal to $[0, 1]^d$ at x .
- (ii) The set $\{h > 0 : \mathcal{H}^{d-1}(\partial^* u \cap \partial \mathcal{R}_{x,h,\delta h}(\mathcal{S}, \mathbf{n}_x^u)) > 0\}$ is at most countable.
- (iii) $\lim_{h \rightarrow 0^+} \frac{1}{h^{d-1}} \mathcal{H}^{d-1}(\partial^* u \cap \mathring{\mathcal{R}}_{x,h,\delta h}(\mathcal{S}, \mathbf{n}_x^u)) = 1$.
- (iv) $\lim_{h \rightarrow 0^+} \frac{1}{h^{d-1}} \int_{\partial^* u \cap \mathring{\mathcal{R}}_{x,h,\delta h}(\mathcal{S}, \mathbf{n}_x^u)} \tau^q(\mathbf{n}^u) d\mathcal{H}^{d-1} = \tau^q(\mathbf{n}_x^u)$.
- (v) $\lim_{h \rightarrow 0^+} \frac{1}{h^d} \int_{\mathcal{R}_{x,h,\delta h}(\mathcal{S}, \mathbf{n}_x^u)} |\chi_{x, \mathbf{n}_x^u} - u| d\mathcal{L}^d = 0$.

This definition for E implies that \mathcal{U}_δ is a Vitali class of closed sets for $\partial^* u \setminus E$. We conclude the proof of Theorem 3.2.3 showing that E has zero \mathcal{H}^{d-1} -measure, and more precisely that each of conditions (i)-(v) is true for (at least) \mathcal{H}^{d-1} -almost all $x \in \partial^* u$:

- (i) This condition holds for all $x \in \partial^* u$ because of the inclusion $U \subset (0, 1)^d$ if $u = \chi_U$, cf. Theorem 3.5.9 in [10].
- (ii) Since the volume of $\partial^* u$ is zero, (ii) holds for all x .
- (iii) Condition (iii) holds for all $x \in \partial^* u$ in view of Lemma 3.2.5.
- (iv) It is a consequence of the strong form of the Besicovitch derivation theorem (Theorem 5.5.2 in [10]) together with Lemma 3.2.5, that condition (iv) holds for \mathcal{H}^{d-1} -almost all $x \in \partial^* u$.
- (v) Condition (v) holds for all $x \in \partial^* u$, cf. Theorem 3.5.9 in [10].

□

3.3. Frozen media and phase coexistence

This section is dedicated to the proofs of the lower and upper bound for the probability of phase coexistence, for any realization of the media. In particular, we relate the cost for phase coexistence to the value of surface tension $\tau_{\mathcal{R}}^J$. The usual form of the lower and upper bounds (under quenched and annealed measures) will be given in Section 3.4.

3.3.1. Lower bound. Here we establish a first version of the lower bound for phase coexistence. In view of the applications, we establish it for a large class of profiles, that include Wulff crystals and shapes with C^1 boundary (see also Theorem 4.1.2).

Proposition 3.3.3 below gives a lower bound on the probability of phase coexistence, and relates the cost of phase coexistence to the surface tension, for a given realization of the media.

Given some region $U \subset (0, 1)^d$, $N \in \mathbb{N}^*$ and $\delta > 0$, we consider $\mathcal{E}_U^{N,\delta}$ the set of edges at distance at most $N\sqrt{d}\delta$ from $N\partial U$:

$$\mathcal{E}_U^{N,\delta} = \left\{ e \in E^w(\Lambda_N), d(e, N\partial U) \leq N\sqrt{d}\delta \right\}$$

(see Figure 1) and call

$$\mathcal{D}_U^{N,\delta} = \left\{ \omega \in \Omega_{E^w(\Lambda_N)} : x \overset{\omega}{\leftrightarrow} y, \forall x \in \Lambda_N \setminus NU, y \in \Lambda_N \cap NU \text{ with } d(x/N, \partial U) > \sqrt{d}\delta \text{ and } d(y/N, \partial U) > \sqrt{d}\delta \right\}$$

the event that disconnection occurs around ∂U . In order to be able to control the probability of $\mathcal{D}_U^{N,\delta}$, we introduce the following definition:

DEFINITION 3.3.1. We say that a profile $u = \chi_U$ is regular if

- (i) U is open and at positive distance from the boundary $\partial[0, 1]^d$ of the unit cube,
- (ii) ∂U is $d - 1$ rectifiable and
- (iii) for small enough $r > 0$, $[0, 1]^d \setminus (\partial U + B(0, r))$ has exactly two connected components.

We recall that $E \subset \mathbb{R}^d$ is a $d - 1$ rectifiable set if there exists a Lipschitzian function mapping some bounded subset of \mathbb{R}^{d-1} onto E (Definition 3.2.14 in [36]). It is the case in particular of the boundary of non-empty Wulff crystals (Theorem 3.2.35 in [36]) and of bounded polyhedral sets. It follows from Proposition 3.62 in [10] that any $u = \chi_U$ regular belongs to BV and that $\partial U = \partial^* u$ up to a \mathcal{H}^{d-1} -negligible set, so that the covering Theorem applies as well to ∂U . Assumption (ii) in Definition 3.3.1 has the following consequence:

LEMMA 3.3.2. *Let $u = \chi_U \in \text{BV}$ be a regular profile. Then, for any $\delta > 0$, for any δ -covering $(\mathcal{R}_i)_{i=1\dots n}$ of u , one has*

$$\limsup_{r \rightarrow 0} \frac{\mathcal{L}^d((\partial U \setminus \bigcup_{i=1}^n \mathcal{R}_i) + B(0, r))}{r} \leq 2\delta.$$

PROOF. Clearly, the set

$$E = \partial U \setminus \bigcup_{i=1}^n \overset{\circ}{\mathcal{R}}_i$$

is a closed, $d - 1$ rectifiable set. Thus, the $d - 1$ Minkowski content of E equals the $d - 1$ dimensional Hausdorff measure of E (Theorem 3.2.39 in [36]). In other words:

$$\lim_{r \rightarrow 0} \frac{\mathcal{L}^d(E + B(0, r))}{2r} = \mathcal{H}^{d-1}(E) \leq \delta$$

and the claim follows. \square

Before we state Propositions 3.3.3 and 3.3.4 we give one more notation. The analysis of surface tension (Chapter 2) has been done for rectangular parallelepiped centered *at lattice points*. Changing the center of the parallelepipeds does not modify the behavior of surface tension, but this would have led to heavier notations in Chapter 2. We prefer to proceed to a small adjustment here: given a macroscopic rectangular parallelepiped $\mathcal{R} \subset (0, 1)^d$ and $N \in \mathbb{N}^*$, we let

$$\mathcal{R}^N = N\mathcal{R} + z_N(\mathcal{R}) \quad (3.16)$$

where $z_N(\mathcal{R}) \in (-1/2, 1/2]^d$ ensures that the center of \mathcal{R}^N belongs to \mathbb{Z}^d . Still, for any finite collection $(\mathcal{R}_i)_{i=1\dots n}$ of disjoint rectangular parallelepipeds in $(0, 1)^d$ and large enough N , the collection $(\mathcal{R}_i^N)_{i=1\dots n}$ is disjoint and included in $(0, N)^d$.

We split the lower bound for phase coexistence in two parts. In Proposition 3.3.3 we relate the cost of disconnection to surface tension, whereas in Proposition 3.3.4 we examine the conditional probability for having phase coexistence. For an application to the case of the quenched and annealed Wulff crystals, see Proposition 3.4.1.

PROPOSITION 3.3.3. *Consider a regular $u = \chi_U$. For any $\delta > 0$ and any δ -covering $(\mathcal{R}_i)_{i=1\dots n}$ for u , we have*

$$\frac{1}{N^{d-1}} \log \Phi_{\Lambda_N}^{J,w} \left(\mathcal{D}_U^{N,\delta} \right) \geq - \sum_{i=1}^n h_i^{d-1} \tau_{\mathcal{R}_i^N}^J - c\beta\delta \quad (3.17)$$

for any N large enough, where $c < \infty$ depends on d and u .

PROPOSITION 3.3.4. *Assume $\beta > \hat{\beta}_c$ and $\beta \notin \mathcal{N}$, and let $u = \chi_U$ regular. For any $\varepsilon > 0$, for small enough $\delta > 0$ there are $K \in \mathbb{N}^*$ and $c > 0$ such that, for large enough N :*

$$\mathbb{P} \left(\inf_{\pi \in \mathcal{D}_U^{N,\delta}} \Psi_{\Lambda_N}^{J,w,+} \left(\frac{\mathcal{M}_K}{m_\beta} \in \mathcal{V}(u, \varepsilon) \mid \omega = \pi \text{ on } \mathcal{E}_U^{N,\delta} \right) \leq \frac{1}{2} - e^{-c\sqrt{N}} \right) \leq e^{-c\sqrt{N}}. \quad (3.18)$$

PROOF. (Proposition 3.3.3). To realize the event of disconnection $\mathcal{D}_U^{N,\delta}$, it is enough to realize all the $\mathcal{D}_{\mathcal{R}_i^N}$ and to close all the edges that are at distance less than $1 + \sqrt{d}$ from

$$N \left[\left(\partial U \setminus \bigcup_{i=1}^n \mathring{\mathcal{R}}_i \right) \cup \bigcup_{i=1}^n \partial_{\text{lat}} \mathcal{R}_i \right]$$

where $\partial_{\text{lat}} \mathcal{R}$ stands for the lateral boundary of \mathcal{R} , that is the faces of $\partial \mathcal{R}$ that are parallel to the orientation \mathbf{n} of \mathcal{R} . Thanks to Lemma 3.3.2 and Definition 3.2.1, there are at most $\delta c_d N^{d-1} (1 + \mathcal{H}^{d-1}(\partial U))$ such edges for large enough N . An immediate application of the DLR equation yields (3.17). \square

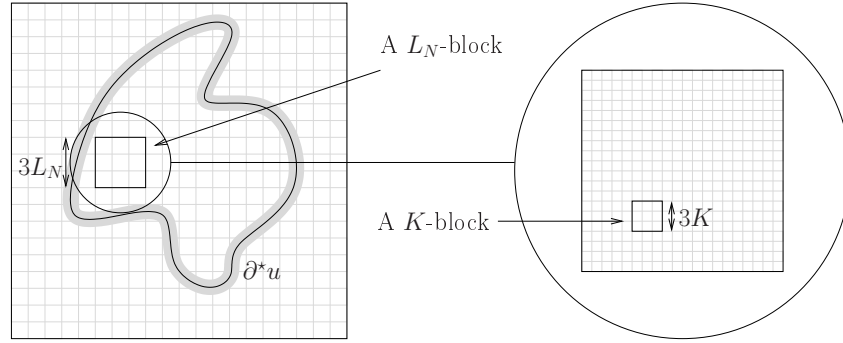
FIGURE 1. The scales K and L_N .

PROOF. (Proposition 3.3.4). In order to obtain the claim for a mesoscopic scale K that does not depend on N , we proceed to a coarse grained analysis at two characteristic scales K and $L_N = \lceil \sqrt{N} \rceil$. Given $K \in \mathbb{N}^*$, we consider $(\Delta_i, \Delta'_i)_{i \in I_{\Lambda_N, K}}$ the (K, K) -covering of Λ_N as well as the phase indicator

$$(\phi_i)_{i \in I_{\Lambda_N, K}}$$

given by Theorem 1.5.7, for the tolerance δ . We call $F = \{0, 1\}^{I_{\Lambda_N, K}}$ the set of site configurations on $I_{\Lambda_N, K}$. In order to apply the stochastic domination Theorem 1.5.7 (iv), we will define an increasing function $f : F \rightarrow \{0, 1\}$ with the appropriate properties. First, we need to describe the L_N -blocks: we call $(\tilde{\Delta}_j, \tilde{\Delta}'_j)_{j \in J_{N, K}}$ the (L_N, L_N) -covering for $I_{\Lambda_N, K}$ as in Definition 1.5.1. Then we let

$$J = \left\{ j \in J_{N, K} : \forall i \in \tilde{\Delta}'_j, E^w(\Delta'_i) \cap \mathcal{E}_U^{N, \delta} = \emptyset \right\}$$

and

$$I = \bigcup_{j \in J} \tilde{\Delta}'_j.$$

Given $\rho \in F$ a site configuration on $I_{\Lambda_N, K}$ and $j \in J$, we say that the L_N -block $\tilde{\Delta}'_j$ is good if there is a crossing cluster of open sites for ρ in $\tilde{\Delta}'_j$, of density at least $1 - \delta$. Then we define $f : F \rightarrow \{0, 1\}$ letting

$$f(\rho) = \mathbf{1}_{\{\text{For all } j \in J, \tilde{\Delta}'_j \text{ is good}\}}.$$

Clearly, f is an increasing function. We prove now that its expectation is close to 1 under high-parameter site percolation. Consider \mathcal{B}_p^I the site percolation process on I of density $p \in (0, 1)$. According to Theorem 1.1 in [33], for large enough $p < 1$ there is $c > 0$ such that, for large enough N , for all $j \in J$:

$$\mathcal{B}_p^I \left(\left\{ \tilde{\Delta}'_j \text{ is good} \right\} \right) \geq 1 - \exp(-2cL_N^{d-1})$$

and consequently (the cardinal of J is bounded by N^d), for $p < 1$ close enough to 1, for large enough N ,

$$\mathcal{B}_p^I(f) \geq 1 - \exp(-c\sqrt{N}).$$

Consequently, the stochastic domination for $(|\phi_i|)_{i \in I_{\Lambda_N, K}}$ (see Theorem 1.5.7 (iv)) yields the same lower bound on the expectation of $f((|\phi_i|)_{i \in I})$: for large enough K (depending on δ), there is $c > 0$ such that, for any N large enough:

$$\mathbb{E} \inf_{\pi} \Psi_{\Lambda_N, \beta}^{J, +} \left(f((|\phi_i|)_{i \in I}) \mid \omega = \pi \text{ on } E^w(\Lambda_N) \setminus \bigcup_{i \in I} E^w(\Delta'_i) \right) \geq 1 - e^{-c\sqrt{N}}. \quad (3.19)$$

The event that $f((|\phi_i|)_{i \in I}) = 1$ gives a control on the magnetization. For large enough N , the blocks $(\Delta_i)_{i \in I}$ cover a fraction of Λ_N that is close to $1 - \mathcal{L}^d(\partial U + B(0, c_d \delta)) \xrightarrow{\delta \rightarrow 0^+} 1$. This and the properties of $(\phi_i)_{i \in I_{\Lambda_N, K}}$ (Theorem 1.5.7 (i) and (ii)) imply that, for small enough $\delta > 0$, for large enough N :

$$f((|\phi_i|)_{i \in I}) = 1 \Rightarrow \frac{\mathcal{M}_K}{m_\beta} \in \mathcal{V}(u, \varepsilon) \text{ or } \frac{\mathcal{M}_K}{m_\beta} \in \mathcal{V}(\mathbf{1}, \varepsilon).$$

We now consider a boundary condition $\pi \in \mathcal{D}_U^{N, \delta}$. Because of the ω -disconnection, the spin of the clusters touching some $\Delta_i \subset NU$ with $i \in I$ has a symmetric distribution under the conditional measure

$$\Psi_{\Lambda_N, \beta}^{J, +} \left(\cdot \mid f((|\phi_i|)_{i \in I}) = 1 \text{ and } \omega = \pi \text{ on } \mathcal{E}_U^{N, \delta} \right).$$

Hence, one has

$$\begin{aligned} \inf_{\pi \in \mathcal{D}_U^{N, \delta}} \Psi_{\Lambda_N, \beta}^{J, +} \left(\frac{\mathcal{M}_K}{m_\beta} \in \mathcal{V}(u, \varepsilon) \mid \omega = \pi \text{ on } \mathcal{E}_U^{N, \delta} \right) \\ \geq \frac{1}{2} \inf_{\pi \in \mathcal{D}_U^{N, \delta}} \Psi_{\Lambda_N, \beta}^{J, +} \left(f((|\phi_i|)_{i \in I}) \mid \omega = \pi \text{ on } \mathcal{E}_U^{N, \delta} \right) \end{aligned}$$

The claim follows as (3.19) implies, as $\mathcal{E}_U^{N, \delta} \subset E^w(\Lambda_N) \setminus \bigcup_{i \in I} E^w(\Delta'_i)$, that

$$\mathbb{P} \left(\inf_{\pi \in \mathcal{D}_U^{N, \delta}} \Psi_{\Lambda_N, \beta}^{J, +} \left(f((|\phi_i|)_{i \in I}) \mid \omega = \pi \text{ on } \mathcal{E}_U^{N, \delta} \right) \leq 1 - e^{-c/2\sqrt{N}} \right) \leq e^{-c/2\sqrt{N}}.$$

□

3.3.2. Upper bound. Here we address the opposite problem of providing an upper bound on the probability of phase coexistence along a given phase profile. Our analysis follows the same line as [12, 14] and we exploit as well the minimal section argument (see Proposition 3.3.7).

We first introduce a L^1 -notion of surface tension. Given $\delta > 0$, a rectangular parallelepiped $\mathcal{R} \subset [0, 1]^d$ as in Definition 3.2.1 (i) and $K, N \in \mathbb{N}^*$ we define

$$\tilde{\tau}_{N\mathcal{R}}^{J, \delta, K} = -\frac{1}{(hN)^{d-1}} \log \sup_{\bar{\sigma} \in \Sigma_{\Lambda_N}^+} \mu_{N\mathcal{R}}^{J, \bar{\sigma}} \left(\left\| \frac{\mathcal{M}_K}{m_\beta} - \chi \right\|_{L^1(\mathcal{R})} \leq 2\delta \mathcal{L}^d(\mathcal{R}) \right) \quad (3.20)$$

where χ is the characteristic function of \mathcal{R} as in Definition 3.2.1 (iii), and $\mu_{\widehat{N\mathcal{R}}}^{J,\bar{\sigma}}$ the Gibbs measure on $\widehat{N\mathcal{R}}$ with boundary condition $\bar{\sigma}$. This definition implies the following:

PROPOSITION 3.3.5. *Let $u \in \text{BV}$, $\delta > 0$ and assume that $(\mathcal{R}_i)_{i=1\dots n}$ is a δ -covering for u . Then, for any $\varepsilon > 0$ small enough, any $K, N \in \mathbb{N}^*$ one has:*

$$\frac{1}{N^{d-1}} \log \mu_{\Lambda_N}^{J,+} \left(\frac{\mathcal{M}_K}{m_\beta} \in \mathcal{V}(u, \varepsilon) \right) \leq - \sum_{i=1}^n h_i^{d-1} \tilde{\tau}_{N\mathcal{R}_i}^{J,\delta,K}. \quad (3.21)$$

PROOF. For $\varepsilon > 0$ small enough, the implication

$$\frac{\mathcal{M}_K}{m_\beta} \in \mathcal{V}(u, \varepsilon) \Rightarrow \left\| \frac{\mathcal{M}_K}{m_\beta} - u \right\|_{L^1(\mathcal{R}_i)} \leq \delta \mathcal{L}^d(\mathcal{R}_i), \quad \forall i \in \{1, \dots, n\}$$

holds. Thanks to (iii) in Definition 3.2.1, for such ε we have

$$\frac{\mathcal{M}_K}{m_\beta} \in \mathcal{V}(u, \varepsilon) \Rightarrow \left\| \frac{\mathcal{M}_K}{m_\beta} - \chi_i \right\|_{L^1(\mathcal{R}_i)} \leq 2\delta \mathcal{L}^d(\mathcal{R}_i), \quad \forall i \in \{1, \dots, n\}.$$

Now, the Gibbs property for $\mu_{\Lambda_N}^{J,+}$ implies that

$$\begin{aligned} & \mu_{\Lambda_N}^{J,+} \left(\frac{\mathcal{M}_K}{m_\beta} \in \mathcal{V}(u, \varepsilon) \right) \\ & \leq \mu_{\Lambda_N}^{J,+} \left(\left\| \frac{\mathcal{M}_K}{m_\beta} - \chi_i \right\|_{L^1(\mathcal{R}_i)} \leq 2\delta \mathcal{L}^d(\mathcal{R}_i), \forall i \in \{1, \dots, n\} \right) \\ & = \mu_{\Lambda_N}^{J,+} \left(\prod_{i=1}^n \mu_{\widehat{N\mathcal{R}_i}}^{J,\sigma} \left(\left\| \frac{\mathcal{M}_K}{m_\beta} - \chi_i \right\|_{L^1(\mathcal{R}_i)} \leq 2\delta \mathcal{L}^d(\mathcal{R}_i) \right) \right) \\ & \leq \exp \left(-h_i^{d-1} N^{d-1} \tilde{\tau}_{N\mathcal{R}_i}^{J,\delta,K} \right) \end{aligned}$$

thanks to (3.20), and the claim is proved. \square

On the other hand, using the minimal section argument as in [12] we prove that the L^1 -surface tension does not differ much from the surface tension under free boundary condition. We recall that the surface tension with free boundary condition in $\mathcal{R} = \mathcal{R}_{x,L,H}(\mathcal{S}, \mathbf{n})$ is

$$\tilde{\tau}_{\mathcal{R}}^J = -\frac{1}{L^{d-1}} \log \Phi_{\mathcal{R}}^{J,f}(\mathcal{D}_{\tilde{\mathcal{R}}}) \quad (3.22)$$

where $\tilde{\mathcal{R}} = \mathcal{R}_{x,L,H/2}(\mathcal{S}, \mathbf{n})$ is a rectangular parallelepiped twice finer than \mathcal{R} . In Appendix 2.5.3 we proved, following the argument of [25], that the boundary condition has little influence on the value of surface tension, and we compared the value of $\tilde{\tau}_{\mathcal{R}}^J$ to that of

$$\tau_{\mathcal{R}}^J = -\frac{1}{L^{d-1}} \log \Phi_{\mathcal{R}}^{J,w}(\mathcal{D}_{\mathcal{R}}),$$

the surface tension in \mathcal{R} with wired boundary condition as in (2.3):

PROPOSITION 3.3.6. *Assume $\beta > \hat{\beta}_c$ and $\beta \notin \mathcal{N}$. Let \mathcal{R} be a rectangular parallelepiped \mathcal{R} as in Definition 3.2.1 (i), with $\delta \in (0, 1)$. Then,*

$$\limsup_N \frac{1}{N^d} \log \mathbb{P} \left(\tilde{\tau}_{\mathcal{R}^N}^J \leq \tau_{\mathcal{R}^N}^J - c_d \delta \right) < 0 \quad (3.23)$$

where $c_d < \infty$ depends on d only.

Here we claim the following:

PROPOSITION 3.3.7. *Assume $\beta > \hat{\beta}_c$ with $\beta \notin \mathcal{N}$. Then, there exists a quantity $c_{d,\delta} \in (0, \infty)$ with $\lim_{\delta \rightarrow 0} c_{d,\delta} = 0$ such that, for any \mathcal{R} as in Definition 3.2.1 (i), for any $\delta > 0$, if K is large enough then:*

$$\limsup_N \frac{1}{N^d} \log \mathbb{P} \left(\tilde{\tau}_{N\mathcal{R}}^{J,\delta,K} \leq \tilde{\tau}_{\mathcal{R}^N}^J - c_{d,\delta} \right) < 0. \quad (3.24)$$

PROOF. This is another application of Theorem 1.5.7. Let $\delta > 0$ and K large enough so that the phase indicator $(\phi_i)_{i \in I_{\Lambda_N, K}}$ with tolerance δ stochastically dominates site percolation of density $1 - \delta$ (Theorem 1.5.7 (iv)). In view of Cramér's Theorem, this implies that

$$\mathbb{E} \Psi_{\mathcal{R}^N}^{J,+} \left(\begin{array}{l} \text{A proportion greater than } 2\delta \text{ of the} \\ \Delta_i \text{ that intersect } \mathcal{R}^N \text{ have } \phi_i = 0 \end{array} \right) \leq \exp \left(-c_\delta \left(\frac{hN}{K} \right)^d \right)$$

for N large enough, with $c_\delta > 0$. Hence the \mathbb{P} -probability that

$$\Psi_{\mathcal{R}^N}^{J,+} \left(\left\| \frac{\mathcal{M}_K}{m_\beta} - \phi_K \right\|_{L^1(\mathcal{R})} \geq \frac{10\delta}{m_\beta} \mathcal{L}^d(\mathcal{R}) \right) \leq \exp \left(-\frac{c_\delta}{2} \left(\frac{hN}{K} \right)^d \right) \quad (3.25)$$

is at least $1 - \exp(-c_\delta/2(hN/K)^d)$, where $\phi_K : [0, 1]^d \rightarrow \{-1, 0, 1\}$ is the macroscopic version of the phase profile:

$$\phi_K(x) = \varphi_{i(x)} \quad (3.26)$$

as in (3.3). In the rest of the proof we assume that J satisfies (3.25). To realize an arbitrary boundary condition $\bar{\sigma}$ we just need to condition $\Psi_{\mathcal{R}^N}^{J,w,+}$ on the event that $\sigma = \bar{\sigma}$ on the exterior boundary of $\widehat{\mathcal{R}^N}$. Such an event has a probability at least $\exp(-c'\beta N^{d-1})$ with $c' < \infty$, hence the volume order in (3.25) dominates and

$$\sup_{\bar{\sigma} \in \Sigma_{\Lambda_N}^+} \Psi_{\mathcal{R}^N}^{J,\bar{\sigma}} \left(\left\| \frac{\mathcal{M}_K}{m_\beta} - \phi_K \right\|_{L^1(\mathcal{R})} \geq \frac{10\delta}{m_\beta} \mathcal{L}^d(\mathcal{R}) \right) \leq \exp \left(-\frac{c_\delta}{4} \left(\frac{hN}{K} \right)^d \right)$$

if N is large enough. In view of the definition of the L^1 -surface tension $\tilde{\tau}_{N\mathcal{R}}^{J,\delta,K}$, we see that, for arbitrary small $\gamma > 0$,

$$\tilde{\tau}_{N\mathcal{R}}^{J,\delta,K} \geq -\frac{1}{(hN)^{d-1}} \log \sup_{\bar{\sigma} \in \Sigma_{\Lambda_N}^+} \Psi_{\mathcal{R}^N}^{J,\bar{\sigma}} \left(\|\phi_K - \chi\|_{L^1(\mathcal{R})} \leq \frac{12\delta}{m_\beta} \mathcal{L}^d(\mathcal{R}) \right) - \gamma$$

for N large enough – note that passing from $N\mathcal{R}$ to \mathcal{R}^N yields a negligible volume.

We are now in a position of applying the minimal section argument. We say that a block Δ_i is a *bad block* if the corresponding phase ϕ_i disagrees with χ on Δ_i/N . On the event $\|\phi_K - \chi\|_{L^1(\mathcal{R})} \leq 12\delta/m_\beta \mathcal{L}^d(\mathcal{R})$, the density of bad blocks does not exceed $14\delta/m_\beta$. We decompose now the set of blocks $\{i \in I_{\Lambda_N, K} : \Delta_i \subset \widehat{\mathcal{R}^N}\}$ into slabs

$$S_k = \{i \in I_{\Lambda_N, K} : \Delta_i \subset \mathcal{R}_{Nx+2\sqrt{d}Kkn, Nh, \sqrt{d}K}(\mathcal{S}, \mathbf{n})\}$$

for $|k| \leq N\delta h/4 - 1$. If \mathcal{R} is on the border, we will consider only negative k . The event $\|\phi_K - \chi\|_{L^1(\mathcal{R})} \leq 12\delta/m_\beta \mathcal{L}^d(\mathcal{R})$ implies the existence of $k^+, k^- \in \{1, \dots, [N\delta h/4] - 1\}$ with

$$\begin{aligned} \# \{i \in S_{k^+} : \Delta_i \text{ is a bad block}\} &\leq c_d \delta (hN/K)^{d-1} \quad (\text{if } \mathcal{R} \text{ is interior}) \\ \text{and } \# \{i \in S_{k^-} : \Delta_i \text{ is a bad block}\} &\leq c_d \delta (hN/K)^{d-1} \end{aligned} \quad (3.27)$$

where $c_d < \infty$ depends on d only. We prove at last that this event is not essentially different from $\mathcal{D}_{\tilde{\mathcal{R}}^N}$ and consider, for example, the case of interior \mathcal{R} . Consider (σ, ω) such that (3.27) holds and $\omega \notin \mathcal{D}_{\tilde{\mathcal{R}}^N}$. There exists a ω -open path linking the top to the bottom of $\tilde{\mathcal{R}}^N$. Because of the properties of ϕ_i (Theorem 1.5.7 (i)) this path cannot cross good blocks in both S_{k^+} and S_{k^-} . This means that, if (σ, ω) realizes (3.27) and if one sets

$$\tilde{\omega}_e = \begin{cases} 0 & \text{on all } E^w(\Delta'_i), \Delta_i \text{ bad block of } S_{k^+} \cup S_{k^-} \\ \omega_e & \text{else,} \end{cases}$$

then $\tilde{\omega} \in \mathcal{D}_{\tilde{\mathcal{R}}^N}$. Hence $\|\phi_K - \chi\|_{L^1(\mathcal{R})} \leq 12\delta/m_\beta \mathcal{L}^d(\mathcal{R})$ implies an ‘‘almost disconnection’’ event, in the sense that one can find two slabs (among $\delta hN/\sqrt{d}K$) and $c_d \delta (N/K)^{d-1}$ blocks in both of them (among $c'_d (N/K)^{d-1}$) such that the disconnection of ω on the contour of these blocks leads to $\mathcal{D}_{\tilde{\mathcal{R}}^N}$. We conclude with a counting argument:

$$\sup_{\bar{\sigma} \in \Sigma_{\Lambda_N}^+} \Psi_{\mathcal{R}^N}^{J, \bar{\sigma}} \left(\|\phi_K - \chi_{\mathcal{R}^-}\|_{L^1(\mathcal{R})} \leq \frac{12\delta}{m_\beta} \mathcal{L}^d(\mathcal{R}) \right) \leq \sum_{A \in \mathcal{A}} \Phi_{\mathcal{R}^N}^{J, f}(\tilde{\omega}^A \in \mathcal{D}_{\tilde{\mathcal{R}}^N})$$

where \mathcal{A} is the collection

$$\mathcal{A} = \left\{ A = \bigcup_{i \in I} E^w(\partial \Delta'_i) : I \subset I_{\Lambda_N, K} : \begin{array}{l} \exists k^-, k^+ \text{ such that } I \subset S_{k^+} \cup S_{k^-} \\ \text{and } |I| \leq 2c_d \delta (hN/K)^{d-1} \end{array} \right\}$$

of possible contours of the locations of the bad blocks in $S_{k^+} \cup S_{k^-}$, and for any $A \in \mathcal{A}$ and $\omega \in \Omega$, $\tilde{\omega}^A$ is the configuration equal to ω outside A , zero on A . Since

$$\Phi_A^{J, \omega}(\omega \equiv 0) \geq e^{-\beta|A|} \geq \exp(-c'_d \delta (hN)^{d-1})$$

for all $A \in \mathcal{A}$, we have, thanks to the DLR equation:

$$\begin{aligned} \Phi_{\mathcal{R}^N}^{J,f}(\tilde{\omega}^A \in \mathcal{D}_{\mathcal{R}^N}) &\leq \Phi_{\mathcal{R}^N}^{J,f} \left(\mathbf{1}_{\tilde{\omega}^A \in \mathcal{D}_{\mathcal{R}^N}} \frac{\Phi_A^{J,\omega}(\mathcal{D}_{\mathcal{R}^N})}{e^{-\beta|A|}} \right) \\ &\leq \exp(c_d'' \delta (hN)^{d-1}) \Phi_{\mathcal{R}^N}^{J,f}(\mathcal{D}_{\mathcal{R}^N}). \end{aligned}$$

On the other hand, the cardinality of \mathcal{A} does not exceed

$$|\mathcal{A}| \leq \left(\frac{\delta h N}{\sqrt{dK}} \right)^2 \times \left(\frac{c_d'(hN/K)^{d-1}}{2c_d \delta (hN/K)^{d-1}} \right)$$

where $\binom{n}{k}$ is the binomial coefficient. An immediate application of Stirling's formula gives

$$\frac{1}{n} \log \binom{n}{[\delta n]} \xrightarrow{n \rightarrow \infty} \delta \log \frac{1}{\delta} + (1 - \delta) \log \frac{1}{1 - \delta}$$

which converges to 0 as $\delta \rightarrow 0$, hence the cardinality of $|\mathcal{A}|$ does not exceed $\exp(c_{d,\delta} (hN/K)^{d-1})$ for N large, where the quantity $c_{d,\delta}$ goes to 0 as $\delta \rightarrow 0$. As a conclusion, we proved that

$$\mathbb{P} \left(\tilde{\tau}_{\mathcal{R}^N}^{J,\delta,K} \geq \tilde{\tau}_{\mathcal{R}^N}^J - c_d'' \delta - \frac{c_{d,\delta}}{K^{d-1}} - \gamma \right) \geq 1 - \exp \left(-\frac{c_\delta}{2} \left(\frac{hN}{K} \right)^d \right)$$

for N large, if K is large enough. The claim follows. \square

3.4. Final controls on phase coexistence

In this section we combine the former results to establish the usual lower and upper bounds on phase coexistence, for both quenched and annealed measures. Then we prove the exponential tightness for the magnetization and conclude the proofs of Theorems 3.1.1 and 3.1.2.

3.4.1. Lower bound for phase coexistence. The final formulation of the lower bound for phase coexistence is the following:

PROPOSITION 3.4.1. *Assume $\beta > \hat{\beta}_c$ and $\beta \notin \mathcal{N}$. For any $0 \leq \alpha < 1/\text{diam}_\infty(\mathcal{W}^q)$ and $\varepsilon > 0$ there exists $K \in \mathbb{N}^*$ such that,*

$$\liminf_{N \rightarrow \infty} \frac{1}{N^{d-1}} \log \mu_{\Lambda_N}^{J,+} \left(\frac{\mathcal{M}_K}{m_\beta} \in \mathcal{V}(\chi_{z_0 + \alpha \mathcal{W}^q}, \varepsilon) \right) \geq -\mathcal{F}^q(\chi_{\alpha \mathcal{W}^q}) \quad \mathbb{P}\text{-a.s.} \quad (3.28)$$

where $z_0 = (1/2, \dots, 1/2)$. Similarly, for any $\lambda > 0$ and $0 \leq \alpha < 1/\text{diam}_\infty(\mathcal{W}^\lambda)$,

$$\liminf_{N \rightarrow \infty} \frac{1}{N^{d-1}} \log \mathbb{E} \left[\left(\mu_{\Lambda_N}^{J,+} \left(\frac{\mathcal{M}_K}{m_\beta} \in \mathcal{V}(\chi_{z_0 + \alpha \mathcal{W}^\lambda}, \varepsilon) \right) \right)^\lambda \right] \geq -\mathcal{F}^\lambda(\chi_{\alpha \mathcal{W}^\lambda}). \quad (3.29)$$

PROOF. Let $U = z_0 + \alpha \mathcal{W}^q$. According to Theorem 3.2.35 in [36], ∂U is rectifiable, hence the profile $u = \chi_U$ is regular. Let $\varepsilon, \delta > 0$. Thanks to Theorem 3.2.3 there exists a δ -covering $(\mathcal{R}_i)_{i=1}^n$ adapted to the profile χ_U . Proposition 3.3.3 applies and gives, for $\delta > 0$ small enough:

$$\begin{aligned} \mu_{\Lambda_N}^{J,+} \left(\frac{\mathcal{M}_K}{m_\beta} \in \mathcal{V}(\chi_U, \varepsilon) \right) &\geq \inf_{\pi \in \mathcal{D}_U^{N,\delta}} \Psi_{\Lambda_N}^{J,w,+} \left(\frac{\mathcal{M}_K}{m_\beta} \in \mathcal{V}(\chi_U, \varepsilon) | \omega = \pi \text{ on } \mathcal{E}_U^{N,\delta} \right) \\ &\quad \times \exp \left(-N^{d-1} \left(\sum_{i=1}^n h_i^{d-1} \tau_{\mathcal{R}_i}^J + c\beta\delta \right) \right) \end{aligned} \quad (3.30)$$

where $c < \infty$ depends on d and u . An important remark is that the two factors are *independent* under the product measure \mathbb{P} . Proposition 3.3.4 yields:

$$\mathbb{P} \left(\inf_{\pi \in \mathcal{D}_U^{N,\delta}} \Psi_{\Lambda_N}^{J,w,+} \left(\frac{\mathcal{M}_K}{m_\beta} \in \mathcal{V}(\chi_U, \varepsilon) | \omega = \pi \text{ on } \mathcal{E}_U^{N,\delta} \right) \leq \frac{1}{3} \right) \leq e^{-c\sqrt{N}}. \quad (3.31)$$

We prove first (3.28) and consider $\gamma, \xi > 0$. If $\delta > 0$ is small enough, Proposition 2.2.4 in Chapter 2 tells that the \mathbb{P} -probability that $\tau_{\mathcal{R}_i}^J > \tau^q(\mathbf{n}_i) + \gamma$ for some $i \in \{1, \dots, n\}$ decays like $\exp(-cN^d)$ where $c > 0$. Hence, with \mathbb{P} -probability at least $1 - e^{-c\sqrt{N}/3}$ we have

$$\begin{aligned} \frac{1}{N^{d-1}} \log \mu_{\Lambda_N}^{J,+} \left(\frac{\mathcal{M}_K}{m_\beta} \in \mathcal{V}(\chi_{z_0 + \alpha \mathcal{W}^\tau}, \varepsilon) \right) &\geq - \sum_{i=1}^n h_i^{d-1} (\tau^q(\mathbf{n}_i) + \gamma) - c\beta\delta \\ &\geq -\mathcal{F}^q(\chi_{\alpha \mathcal{W}^q}) - \xi \end{aligned}$$

for small enough $\delta > 0$ and $\gamma > 0$. Borel-Cantelli Lemma ensures that \mathbb{P} -almost surely,

$$\liminf_{N \rightarrow \infty} \frac{1}{N^{d-1}} \log \mu_{\Lambda_N}^{J,+} \left(\frac{\mathcal{M}_K}{m_\beta} \in \mathcal{V}(\chi_{z_0 + \alpha \mathcal{W}^\tau}, \varepsilon) \right) \geq -\mathcal{F}^q(\chi_{\alpha \mathcal{W}^q}) - \xi$$

and (3.28) follows letting $\xi \rightarrow 0^+$. We conclude with the proof of (3.29), take $\lambda > 0$ and denote here $U = z_0 + \alpha \mathcal{W}^\lambda$. For N large enough, the \mathcal{R}_i^N are disjoint and hence the $\tau_{\mathcal{R}_i^N}^J$ are independent under \mathbb{P} . Consequently, for N large enough and $\lambda > 0$, (3.30) and (3.31) give

$$\begin{aligned} \mathbb{E} \left[\left(\mu_{\Lambda_N}^{J,+} \left(\frac{\mathcal{M}_K}{m_\beta} \in \mathcal{V}(\chi_U, \varepsilon) \right) \right)^\lambda \right] &\geq \frac{1}{2 \times 3^\lambda} \times \prod_{i=1}^l \mathbb{E} \exp \left(-\lambda N^{d-1} h_i^{d-1} \tau_{\mathcal{R}_i^N}^J \right) \\ &\quad \times \exp \left(-\lambda N^{d-1} c\beta\delta \right). \end{aligned}$$

In view of Proposition 2.2.6 in Chapter 2, this means

$$\liminf_{N \rightarrow \infty} \frac{1}{N^{d-1}} \log \mathbb{E} \left[\left(\mu_{\Lambda_N}^{J,+} \left(\frac{\mathcal{M}_K}{m_\beta} \in \mathcal{V}(\chi_U, \varepsilon) \right) \right)^\lambda \right] \geq - \sum_{i=1}^n h_i^{d-1} \tau^\lambda(\mathbf{n}_i) - \lambda c \beta \delta$$

and the claim follows as $\delta \rightarrow 0$. \square

3.4.2. Upper bound for phase coexistence.

PROPOSITION 3.4.2. *For all $\beta > \hat{\beta}_c$ with $\beta \notin \mathcal{N}$, for every $u \in \text{BV}$ and $\xi, \lambda > 0$, there exists $\varepsilon > 0$ such that, for $K \in \mathbb{N}^*$ large enough,*

$$\limsup_N \frac{1}{N^{d-1}} \log \mu_{\Lambda_N}^{J,+} \left(\frac{\mathcal{M}_K}{m_\beta} \in \mathcal{V}(u, \varepsilon) \right) \leq -\mathcal{F}^q(u) + \xi \quad (3.32)$$

in \mathbb{P} -probability (and \mathbb{P} -almost surely if $\beta \notin \mathcal{N}_I$) and

$$\limsup_N \frac{1}{N^{d-1}} \log \mathbb{E} \left[\mu_{\Lambda_N}^{J,+} \left(\frac{\mathcal{M}_K}{m_\beta} \in \mathcal{V}(u, \varepsilon) \right) \right]^\lambda \leq -\mathcal{F}^\lambda(u) + \xi. \quad (3.33)$$

PROOF. We fix $\delta \in (0, 1)$ and a δ -covering $(\mathcal{R}_i)_{i=1 \dots n}$ for u as in Definition 3.2.2. We examine first the quenched convergence: according to Propositions 3.3.7 and 3.3.6 there is $c > 0$ such that

$$\mathbb{P} \left(\tilde{\tau}_{\mathcal{R}_i}^{J,\delta,K} \geq \tau_{\mathcal{R}_i}^J - c_{d,\delta} - c_d \delta \right) \geq 1 - \exp(-cN^d), \quad \forall i = 1 \dots n \quad (3.34)$$

for K and N large enough. On the other hand, for any $\varepsilon > 0$ small enough Propositions 3.3.5 yields

$$\frac{1}{N^{d-1}} \log \mu_{\Lambda_N}^{J,+} \left(\frac{\mathcal{M}_K}{m_\beta} \in \mathcal{V}(u, \varepsilon) \right) \leq - \sum_{i=1}^n h_i^{d-1} \tilde{\tau}_{\mathcal{R}_i}^{J,\delta,K}$$

and hence, for K and N large enough,

$$\frac{1}{N^{d-1}} \log \mu_{\Lambda_N}^{J,+} \left(\frac{\mathcal{M}_K}{m_\beta} \in \mathcal{V}(u, \varepsilon) \right) \leq - \sum_{i=1}^n h_i^{d-1} [\tau_{\mathcal{R}_i}^J - c_{d,\delta} - c_d \delta]$$

with \mathbb{P} -probability greater than $1 - n \exp(-cN^d)$. This implies (3.32) for $\delta > 0$ small enough in view of the convergence $\tau_{\mathcal{R}_i}^J \rightarrow \tau^q(\mathbf{n}_i)$ in \mathbb{P} -probability (Theorem 2.2.3 in Chapter 2) or of the almost-sure convergence if $\beta \notin \mathcal{N}_I$ (Corollary 2.4.5 in Chapter 2). We examine now the annealed convergence: consider $\lambda > 0$ and again, a δ -covering $(\mathcal{R}_i)_{i=1 \dots n}$ for u . For K, N large enough and $\varepsilon > 0$ small enough we have

$$\mathbb{E} \left(\left[\mu_{\Lambda_N}^{J,+} \left(\frac{\mathcal{M}_K}{m_\beta} \in \mathcal{V}(u, \varepsilon) \right) \right]^\lambda \right)$$

$$\begin{aligned}
&\leq \mathbb{E} \exp \left(- \sum_{i=1}^n \lambda (h_i N)^{d-1} \tilde{\tau}_{\mathcal{R}_i^N}^{J, \delta, K} \right) \\
&\leq n \exp(-cN^d) + \mathbb{E} \exp \left(- \sum_{i=1}^n \lambda (h_i N)^{d-1} \tau_{\mathcal{R}^N}^J \right) \\
&\quad \times \exp \left(\lambda \sum_{i=1}^n h_i^{d-1} N^{d-1} (c_{d, \delta} + c_d \delta) \right)
\end{aligned}$$

in view of (3.34). Varadhan's Lemma (Proposition 2.2.6 in Chapter 2) yields: for any $\varepsilon > 0$ small enough, any K large enough,

$$\begin{aligned}
&\limsup_N \frac{1}{N^{d-1}} \log \mathbb{E} \left(\left[\mu_{\Lambda_N}^{J, +} \left(\frac{\mathcal{M}_K}{m_\beta} \in \mathcal{V}(u, \varepsilon) \right) \right]^\lambda \right) \\
&\leq - \sum_{i=1}^l h_i^{d-1} [\tau^\lambda(\mathbf{n}_i) - c_{d, \delta} - c_d \delta]
\end{aligned}$$

and the conclusion follows for $\delta > 0$ small enough. \square

3.4.3. Exponential tightness. The last step towards the proofs of Theorems 3.1.1 and 3.1.2 is the proof of the exponential tightness property. Note that the compact set BV_a was defined at (3.8).

PROPOSITION 3.4.3. *For any $\beta > \hat{\beta}_c$ with $\beta \notin \mathcal{N}$, there exists $C > 0$ and for every $\delta > 0$, for any $K \in \mathbb{N}^*$ large enough one has*

$$\limsup_N \frac{1}{N^{d-1}} \log \mathbb{E} \mu_{\Lambda_N}^{J, +} \left(\frac{\mathcal{M}_K}{m_\beta} \notin \mathcal{V}(\text{BV}_a, \delta)^c \right) \leq -Ca. \quad (3.35)$$

PROOF. We follow the argument of Bodineau, Ioffe and Velenik in [14] and estimate the phase of small contours. The proof consists in three estimates: first, thanks to the stochastic domination (Theorem 1.5.7 (iv)) and to Cramér's Theorem, it is immediate that for any K large enough:

$$\limsup_N \frac{1}{N^d} \log \mathbb{E} \Psi_{\Lambda_N}^{J, w, +} \left(\left\| \frac{\mathcal{M}_K}{m_\beta} - \phi_K \right\|_{L^1} > \frac{3\delta}{m_\beta} \right) < 0 \quad (3.36)$$

if ϕ_K is the phase profile: $[0, 1]^d \rightarrow \{-1, 0, 1\}$ at mesoscopic scale K , tolerance δ , defined in the same way as \mathcal{M}_K , cf. (3.26). Hence it is sufficient to estimate the probability that ϕ_K be far from BV_a . The second step consists in removing the small clusters from ϕ . Given $\kappa > 0$ that will be adjusted latter on, we say that $V \subset I_{\Lambda_N, K}$ is a small cluster for $(\phi_i)_{i \in I_{\Lambda_N, K}}$ if it is connected in $I_{\Lambda_N, K}$, if $\text{diam}(V) \leq \kappa \log N$, if

$$\phi_i = 0, \forall i \in V$$

and if V is maximal in the sense that, for every $i \in I_{\Lambda_N, K} \setminus V$ adjacent to V , $\phi_i \neq 0$. We consider then

$$\phi_i^\kappa = \begin{cases} \phi_i & \text{if there is no small cluster for } \phi \text{ that surrounds } i \\ s & \text{else, } s \text{ being the constant sign of } \phi_j \text{ around the} \\ & \text{largest small cluster that surrounds } i. \end{cases} \quad (3.37)$$

Consider then $k \in \{0, \dots, \lceil 2\kappa \log N \rceil - 1\}^d$ and denote

$$I_k = I_{\Lambda_N, K} \cap (k + \lceil 2\kappa \log N \rceil \mathbb{Z})^d.$$

It is clear that the $(I_k)_{k \in \{0, \dots, \lceil 2\kappa \log N \rceil - 1\}^d}$ form a partition of $I_{\Lambda_N, K}$; moreover any two points in I_k are at distance at least $\lceil 2\kappa \log N \rceil$. Consider at last $I = I_{\Lambda_N, K}$ and apply Theorem 1.5.7 (iv) to the increasing function

$$f_k : X \in \{0, 1\}^I \mapsto \begin{cases} 0 & \text{if there exists more than } \delta |I_k| \text{ positions in } I_k \\ & \text{that are surrounded by a contour } \Gamma \subset \mathcal{P} \text{ with} \\ & \text{diam}(\Gamma) \leq \kappa \log N \text{ and such that } X_i = 0, \forall i \in \Gamma, \\ 1 & \text{else.} \end{cases}$$

Since the contours are confined to non-intersecting regions, the occurrence of contours around distinct points of I_k are independent under the Bernoulli product measure \mathcal{B}_ρ^I . The probability that any point be surrounded by a contour with $X_i = 0$ goes to 0 as $\rho \rightarrow 1$, hence applying Cramér's Theorem we conclude that for any K large enough there exists $c > 0$ such that, for any N large enough:

$$\mathbb{E} \Psi_{\Lambda_N}^{J, w, +} \left(f_k \left((|\phi_i|)_{i \in I_{\Lambda_N, K}} \right) \right) \geq 1 - \exp \left(-c \left(\frac{N}{2K \kappa \log N} \right)^d \right).$$

As a consequence, the expectation of $\sum_{k \in \{0, \dots, \lceil 2\kappa \log N \rceil - 1\}^d} (1 - f_k)$ is negligible at surface order, or in other words: for any $\kappa > 0$, for any K large enough:

$$\limsup_N \frac{1}{N^{d-1}} \log \mathbb{E} \Psi_{\Lambda_N}^{J, w, +} (\|\phi_K^\kappa - \phi_K\|_{L^1} \geq \delta) = -\infty. \quad (3.38)$$

We pass to the third control on the proximity between ϕ_K^κ and BV_a . Call $\Gamma_1, \dots, \Gamma_n \subset I_{N, K}$ the contours of zero blocks surrounding clusters of minus phase in ϕ^κ . Remark that if $\sum_i |\Gamma_i| \leq a(N/K)^{d-1}$ and if the density of zero blocks does not exceed δ (cf. (3.36)), then replacing zero blocks with one blocks we get a phase profile in BV_a , and hence $\phi_K^\kappa \in \mathcal{V}(\text{BV}_a, \delta)$. Remains thus to control the total length of the contours of ϕ^κ . We use once more Theorem 1.5.7 (iv), combined with a Peierls estimate: the number of contours in $I_{\Lambda_N, K}$ of size s is not larger than $\lceil N/K \rceil^d \times (c_d)^n$. Hence, for any $\varepsilon > 0$ and K large

enough:

$$\begin{aligned} & \mathbb{E}\Psi_{\Lambda_N}^{J,w,+} \left(\sum_i |\Gamma_i| > a(N/K)^{d-1} \right) \\ & \leq \sum_{n \geq 1} \sum_{\substack{s_1, \dots, s_n \geq \kappa \log N \\ \text{and } \sum s_i \geq a(N/K)^{d-1}}} \prod_{i=1}^n N^d \times (c_d)^{s_i} \times \varepsilon^{s_i}. \end{aligned}$$

We fix then $\varepsilon = \exp(-3)/c_d$ and $\kappa = d$, so that

$$\begin{aligned} & \mathbb{E}\Psi_{\Lambda_N}^{J,w,+} \left(\sum_i |\Gamma_i| > a(N/K)^{d-1} \right) \\ & \leq \sum_{n \geq 1} \sum_{\substack{s_1, \dots, s_n \geq d \log N \\ \text{and } \sum s_i \geq a(N/K)^{d-1}}} \exp \left(-2 \sum_{i=1}^n s_i \right) \\ & \leq \exp \left(-a(N/K)^{d-1} \right) \sum_{n \geq 1} \left(\sum_{s \geq d \log N} e^{-s} \right)^n \end{aligned}$$

We remark at last that $\sum_{s \geq d \log N} \exp(-s) \leq 1/2$ for N large enough, yielding: for any K large enough, any N large enough:

$$\mathbb{E}\Psi_{\Lambda_N}^{J,w,+} \left(\sum_i |\Gamma_i| > a(N/K)^{d-1} \right) \leq \exp \left(-a(N/K)^{d-1} \right). \quad (3.39)$$

The claim follows then from the combination of (3.36), (3.38) and (3.39). \square

3.4.4. Proofs of Theorems 3.1.1 and 3.1.2. Theorems 3.1.1 and 3.1.2 are consequences of the large deviations estimates (Propositions 3.4.1 and 3.4.2) together with the exponential tightness (Proposition 3.4.3) in view of the compactness of BV_a . The annealed case presents complete similarity with the non-random case, hence we focus here on the quenched case. Furthermore, the proof of Theorem 3.1.1 is similar to that of Theorem 3.1.2, which is the reason for which we give the proof of (3.13) only.

PROOF. (First half of Theorem 3.1.2). First we establish the lower bound

$$\liminf_N \frac{1}{N^{d-1}} \log \mu_{\Lambda_N}^{J,+} \left(\frac{m_{\Lambda_N}}{m_\beta} \leq 1 - 2\alpha^d \right) \geq -\mathcal{F}^q(\chi_{\alpha\mathcal{W}^q}), \quad \mathbb{P}\text{-almost surely.} \quad (3.40)$$

The proof goes as follows: for any $\alpha' > \alpha$, for small enough $\varepsilon > 0$ one has

$$\frac{\mathcal{M}_K}{m_\beta} \in \mathcal{V}(\chi_{z_0 + \alpha'\mathcal{W}^q}, \varepsilon) \Rightarrow \frac{m_{\Lambda_N}}{m_\beta} \leq 1 - 2\alpha^d$$

hence, Proposition 3.4.2 gives: for any $\alpha' > \alpha$,

$$\liminf_N \frac{1}{N^{d-1}} \log \mu_{\Lambda_N}^{J,+} \left(\frac{m_{\Lambda_N}}{m_\beta} \leq 1 - 2\alpha^d \right) \geq -\mathcal{F}^q(\chi_{\alpha' \mathcal{W}^q}), \quad \mathbb{P}\text{-almost surely.}$$

The lower bound (3.40) follows if we let $\alpha' \rightarrow \alpha$.

Now we establish the following upper bound: for any $\varepsilon > 0$, there is $\delta > 0$ such that

$$\limsup_N \frac{1}{N^{d-1}} \log \mu_{\Lambda_N}^{J,+} \left(\frac{\mathcal{M}_K}{m_\beta} \notin \bigcup_{x \in \mathcal{T}_\alpha^q} \mathcal{V}(\chi_{x+\alpha \mathcal{W}^q}, \varepsilon) \text{ and } \frac{m_{\Lambda_N}}{m_\beta} \leq 1 - 2\alpha^d \right) \leq -\mathcal{F}^q(\chi_{\alpha \mathcal{W}^q}) - \delta \quad (3.41)$$

in \mathbb{P} -probability (\mathbb{P} -almost surely if $\beta \notin \mathcal{N}_I$). To begin with, we choose $a > 0$ so large that Ca in Proposition 3.4.3 is larger than $2\mathcal{F}^q(\chi_{\alpha \mathcal{W}^q}) + 2$. Thanks to Markov's inequality, this implies that, for any $\gamma > 0$, for large enough K ,

$$\limsup_N \frac{1}{N^{d-1}} \log \mu_{\Lambda_N}^{J,+} \left(\frac{\mathcal{M}_K}{m_\beta} \notin \mathcal{V}(\text{BV}_a, \gamma) \right) \leq -\mathcal{F}^q(\chi_{\alpha \mathcal{W}^q}) - 1, \quad (3.42)$$

\mathbb{P} -almost surely (see (3.8) for the definition of BV_a). Consider $\eta > 0$ and let

$$F = \left\{ u \in \text{BV}_a : \int_{[0,1]^d} u \leq 1 - 2\alpha^d + \eta \text{ and } u \notin \bigcup_{x \in \mathcal{T}_\alpha^q} \mathcal{V} \left(\chi_{x+\alpha \mathcal{W}^q}, \frac{\varepsilon}{2} \right) \right\}.$$

For $\gamma > 0$ small enough, for large enough N the event

$$\frac{\mathcal{M}_K}{m_\beta} \notin \bigcup_{x \in \mathcal{T}_\alpha^q} \mathcal{V}(\chi_{x+\alpha \mathcal{W}^q}, \varepsilon) \text{ and } \frac{m_{\Lambda_N}}{m_\beta} \leq 1 - 2\alpha^d$$

implies that

$$\frac{\mathcal{M}_K}{m_\beta} \notin \mathcal{V}(\text{BV}_a, \gamma) \text{ or } \frac{\mathcal{M}_K}{m_\beta} \in \mathcal{V}(F, \gamma).$$

The probability of the first event is under control (3.42) for any $\gamma > 0$ (and large enough K), hence we focus on the probability of the second one. Given $\xi > 0$, applying Proposition 3.4.2 we obtain $\varepsilon : u \in \text{BV} \mapsto \varepsilon(u) \in (0, \xi)$ such that, for any $u \in \text{BV}$ and any K large enough:

$$\limsup_{N \rightarrow \infty} \frac{1}{N^{d-1}} \log \mu_{\Lambda_N}^{J,+} \left(\frac{\mathcal{M}_K}{m_\beta} \in \mathcal{V}(u, \varepsilon(u)) \right) \leq -\mathcal{F}^q(u) + \xi \quad (3.43)$$

in \mathbb{P} -probability (\mathbb{P} -almost surely if $\beta \notin \mathcal{N}_I$). The set BV_a is compact for the L^1 -norm, thus it can be covered by a finite union $\text{BV}_a \subset \bigcup_{i=1}^n \mathcal{V}(u_i, \varepsilon(u_i))$ with $u_i \in \text{BV}_a$, $i = 1 \dots n$. Since the right-hand side term is open, for $\gamma > 0$ small enough we still have

$$\mathcal{V}(\text{BV}_a, \gamma) \subset \bigcup_{i=1}^n \mathcal{V}(u_i, \varepsilon(u_i)).$$

We consider $(u'_i)_{i=1\dots l}$ the subsequence of the u_i such that $\mathcal{V}(u_i, \varepsilon(u_i))$ intersects $\mathcal{V}(F, \gamma)$. Thanks to the inclusion

$$\mathcal{V}(F, \gamma) \subset \bigcup_{i=1}^l \mathcal{V}(u'_i, \varepsilon(u'_i))$$

and to (3.43), we have: for small enough γ , for large enough K :

$$\limsup_{N \rightarrow \infty} \frac{1}{N^{d-1}} \log \mu_{\Lambda_N}^{J,+} \left(\frac{\mathcal{M}_K}{m_\beta} \in \mathcal{V}(F, \gamma) \right) \leq - \inf_{u \in \text{BV}: u \in \mathcal{V}(F, 2\xi)} \mathcal{F}^q(u) + \xi$$

in \mathbb{P} -probability (\mathbb{P} -almost surely if $\beta \notin \mathcal{N}_I$). Yet, the limit as $\xi \rightarrow 0$ of the right-hand side is bounded from above by $-\inf_{u \in F'} \mathcal{F}^q(u)$ where

$$F' = \left\{ u \in \text{BV}_a : \int_{[0,1]^d} u \leq 1 - 2\alpha^d + 2\eta \text{ and } u \notin \bigcup_{x \in \mathcal{T}_\alpha^q} \mathcal{V} \left(\chi_{x+\alpha\mathcal{W}^q}, \frac{\varepsilon}{4} \right) \right\},$$

for any $\eta > 0$. Yet, $-\inf_{u \in F'} \mathcal{F}^q(u)$ is strictly smaller, in the limit $\eta \rightarrow 0$, than $-\mathcal{F}^q(\chi_{\alpha\mathcal{W}^q})$ since the solutions to the isoperimetric problem (3.9) are excluded. Together with (3.42), this implies (3.41) and the conclusion (3.13) follows from (3.40) and (3.41). \square

3.5. Conclusion

We saw that the presence of random media does not alter the essence of the phase coexistence phenomenon: in particular, phase separation occurs and there appears a droplet of the minority phase, which shape is deterministic. However, it modifies the shape of crystals, and we have shown in particular that the low temperature limit of the quenched Wulff crystal is the Wulff crystal for the maximal flow of \mathbb{P} (Theorem 2.3.2).

The lower and upper bound that we established in Section 3.3 will help to control the dynamics of the dilute Ising system: reducing surface tension along the boundary of the initial profile makes the latter metastable.

As a matter of conclusion, let us mention a consequence of (3.12) in Theorem 3.1.1: for any $f \in \mathbb{R}$, let

$$\mathcal{J}(f) = \sup_{\lambda > 0} \{ \mathcal{F}^\lambda(\chi_{\mathcal{W}^\lambda}) - \lambda f \} \in [0, \infty].$$

The functional \mathcal{J} plays the same role for the cost of phase coexistence as I_n for the lower deviations of surface tension. In particular, if \mathcal{F}^{\min} stands for the surface energy associated to τ^{\min} and \mathcal{W}^{\min} for its Wulff crystal, then \mathcal{J} is infinite on the left of $\mathcal{F}^{\min}(\chi_{\mathcal{W}^{\min}})$, finite on the right of $\mathcal{F}^{\min}(\chi_{\mathcal{W}^{\min}})$ and zero on the right of $\mathcal{F}^q(\chi_{\mathcal{W}^q})$, and above all:

THEOREM 3.5.1. *For any $f \neq \mathcal{F}^{\min}(\chi_{\mathcal{W}^{\min}})$ and $\alpha \geq 0$ small enough,*

$$\lim_N \frac{1}{N^{d-1}} \log \mathbb{P} \left(\frac{1}{N^{d-1}} \log \mu_{\Lambda_N}^{J,+} \left(\frac{m_{\Lambda_N}}{m_\beta} \leq 1 - 2\alpha^d \right) \geq -\alpha^{d-1} f \right) = -\alpha^{d-1} \mathcal{J}(f).$$

On the other hand, upper deviations for the cost of phase coexistence happen at volume order (cf. the proof of Proposition 3.4.2).

CHAPTER 4

Glauber dynamics and metastability

ABSTRACT. In this Chapter we report new results on the slow dynamics of the dilute Ising model in the phase transition region. Using the analysis of phase coexistence developed in the former Chapter, we show that appropriate initial profiles are *metastable*. As an application, we give a lower bound on the average autocorrelation at time t , of the form $t^{-\alpha}$.

4.1. Introduction and results

Equilibrium aspects of statistical mechanics models are far better understood in general than dynamical aspects. The Ising model is no exception: while many aspects of the equilibrium are under mathematical control, only a few questions concerning the dynamics are solved. For instance, the question of whether droplet relaxation follows a mean curvature evolution under the Glauber dynamics remains out of reach in the current state of the mathematical theory.

For the dilute Ising model, it was remarked in [45] that appropriate initial configuration for both the media and the spin configuration could lead to metastable states, forcing the dynamics to pass through a bottleneck before equilibrium is reached. If one is able to estimate the probability for these initial configurations and the duration of the associated droplets, then one can control some aspects of the dynamics.

The analysis of phase coexistence under the equilibrium measure (Chapter 3) plays a fundamental role in this study. We highlight as well a feature of the dynamics that was formerly unnoticed: not only the volume of droplets evolves continuously, but the phase profile itself evolves (almost) continuously in time. In some cases, this leads to better bounds.

The organization of this Chapter is as follows: in the remaining part of the current Section, we recall the definitions of the dilute Ising model and those of the Glauber dynamics. We review earlier results on the Glauber dynamics of the Ising model in the three regions of the phase diagram. Then we present the heuristic for our construction and state our main results. Section 4.2 is dedicated to the proof of Theorem 4.1.1. In Appendix 4.3.1 we give upper bounds on the constant that appears in Theorem 4.1.1. In Appendix 4.3.2 we

show that the additional cost can be calculated on *continuous evolutions*, and in Appendix 4.3.3 we compute the additional cost in two simple cases.

4.1.1. Phase diagram of the dilute Ising model. Let us recall the definition of the dilute Ising model. Given a ferromagnetic realization of the media $J : E(\mathbb{Z}^d) \rightarrow [0, 1]$ (the couplings of the Ising model) and Λ a finite domain, we let

$$\mu_{\beta, \Lambda}^{J, \bar{\sigma}}(\{\sigma\}) = \frac{\mathbf{1}_{\{\sigma = \bar{\sigma} \text{ on } \Lambda^c\}}}{Z_{\beta, \Lambda}^{J, \bar{\sigma}}} \exp\left(\frac{\beta}{2} \sum_{e=\{x, y\} \in E^w(\Lambda)} J_e \sigma(x) \sigma(y)\right)$$

where $\sigma, \bar{\sigma} \in \Sigma = \{\pm 1\}^{\mathbb{Z}^d}$ are spin configurations, $\beta \geq 0$ is the inverse temperature and $Z_{\beta, \Lambda}^{J, \bar{\sigma}}$ the partition function which ensures that $\mu_{\beta, \Lambda}^{J, \bar{\sigma}}$ is a probability measure. Remark that, contrary to the former Chapters, we denote by $\sigma(x)$ the spin at x . Then, we consider \mathbb{P} a product measure on J , such that the $J_e \in [0, 1]$ are independent, identically distributed.

The phase diagram of the dilute Ising model is made of three regions. The region $\beta < \beta_c^{\text{pure}}$ where β_c^{pure} is the critical inverse temperature for the pure Ising model (with $J \equiv 1$) is called the *paramagnetic phase*. No phase transition occurs and the physical quantities are analytic functions of the parameters. Then is the *Griffiths phase* $\beta_c^{\text{pure}} < \beta < \beta_c$, where β_c is the critical inverse temperature for phase transition in the dilute Ising model. Griffiths showed [41] that the magnetization, as a function of the external field, is not analytic at $h = 0$, for any $\beta > \beta_c^{\text{pure}}$. The third region $\beta > \beta_c$ is the *phase transition region*, where the boundary condition is able to select the phase of the system:

$$m_\beta = \lim_{N \rightarrow \infty} \mathbb{E} \mu_{\beta, \Lambda_N}^{J, +}(\sigma(0)) > 0. \quad (4.1)$$

This last phase is present only if the couplings are large enough, namely $\mathbb{P}(J_e > 0) > p_c(d)$.

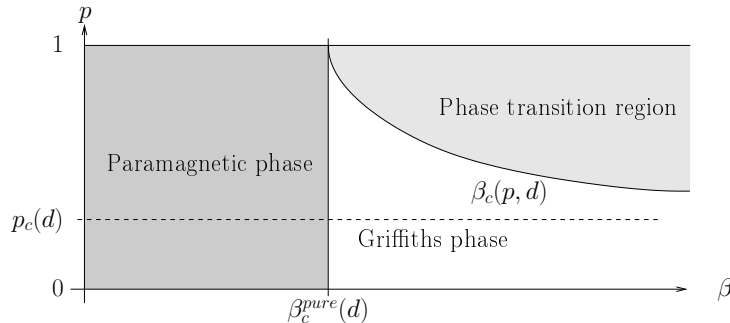

FIGURE 1. The phase diagram of the dilute Ising model

4.1.2. Glauber dynamics and convergence to equilibrium. The Glauber dynamics associated to the dilute Ising model have different behaviors in the three regions of the phase diagram. Before presenting these facts, we recall the definition of Glauber dynamics.

We consider a family of *transition rates* $c^J(x, \sigma)$ that satisfies the following conditions:

- (i) There exists $r < \infty$, the *range of interaction*, such that $c^J(x, \sigma)$ is independent of $\sigma(y)$ when $d(x, y) > r$, and of J_e when $d(e, x) > r$.
- (ii) The rates are uniformly bounded from below and above: there are $c_m, c_M \in (0, \infty)$ such that

$$c_m \leq c^J(x, \sigma) \leq c_M, \quad \forall x \in \mathbb{Z}^d \text{ and } \sigma \in \Sigma.$$

- (iii) They satisfy the *detailed balance condition*: for all $\sigma \in \Sigma$ and $x \in \mathbb{Z}^d$, for all $J \in \mathcal{J}$,

$$c^J(x, \sigma) \times \exp \left(\beta \sum_{y \sim x} J_{\{x, y\}} \sigma(x) \sigma(y) \right)$$

is independent of $\sigma(x)$.

- (iv) They are *translation invariant*: if, for some $z \in \mathbb{Z}^d$ one has

$$J'_e = J_{z+e}, \forall e \in E(\mathbb{Z}^d) \quad \text{and} \quad \sigma'(x) = \sigma(x+z), \forall x \in \mathbb{Z}^d,$$

then $c^{J'}(x, \sigma') = c^J(x+z, \sigma)$.

- (v) They are *attractive*: given any $\sigma, \sigma' \in \Sigma$ with $\sigma \leq \sigma'$, the equality $\sigma(x) = \sigma'(x)$ implies

$$\sigma'(x) c^J(x, \sigma') \leq \sigma(x) c^J(x, \sigma).$$

Then, we consider the *Markov generator* defined by

$$(L^J f)(\sigma) = \sum_{x \in \mathbb{Z}^d} c^J(x, \sigma) (f(\sigma^x) - f(\sigma))$$

where σ^x is the configuration with the spin at x flipped, i.e.

$$\sigma^x(y) = \begin{cases} \sigma(y) & \text{if } y \neq x \\ -\sigma(y) & \text{if } y = x. \end{cases}$$

To this generator corresponds a Markov process $t \mapsto \sigma_t$ and we denote by T^J the associated semi-group:

$$[T^J(t)f](\sigma) = E^{J, \sigma}(f(\sigma_t))$$

where $P^{J, \sigma}$ is the law of the process σ_t with initial state σ , and $E^{J, \sigma}$ its expectation.

Condition (iii) ensures that Gibbs measures are *reversible* with respect to the dynamics. This implies that L^J is selfadjoint on $L^2(\mu^{J,+})$. To characterize

the relaxation under the Glauber dynamics, we study the convergence of

$$\mathbb{E} \left\| T^J(t)\pi_0 - \mu^{J,+}\pi_0 \right\|_{L^2(\mu^{J,+})}$$

as $t \rightarrow \infty$, where π_0 is the function $\pi_0 : \Sigma \rightarrow \mathbb{R}$ defined by $\pi_0(\sigma) = \sigma(0)$, for any $\sigma \in \Sigma$. This quantity is called the average autocorrelation, and can be written as well

$$\mathbb{E} \left(\int_{\Sigma} |(T^J(t)\pi_0)(\rho) - \mu^{J,+}(\sigma(0))|^2 d\mu^{J,+}(\rho) \right)^{1/2}. \quad (4.2)$$

Note that $\mu^{J,+}\pi_0 = \mu^{J,+}(\sigma(0))$ is the mean value of the magnetization at the origin for a realization J of the media. It is non-negative and its average under \mathbb{P} equals m_β (see (4.1)). The term $(T^J(t)\pi_0)(\rho)$ corresponds to the average (over the dynamics) of the magnetization at the origin, at time t , starting from the spin configuration ρ . For almost any ρ under $\mu^{J,+}$ we have

$$(T^J(t)\pi_0)(\rho) \xrightarrow[t \rightarrow \infty]{} \mu^{J,+}(\sigma(0))$$

and the question is: how fast ?

4.1.3. A brief panorama. The dynamics of the dilute Ising model have been studied already in several parts of the phase diagram and we follow here the review [63]. In the paramagnetic phase $\beta < \beta_c^{\text{pure}}$, the weak mixing property holds uniformly over realizations J of the media and this implies exponential ergodicity of the Glauber dynamics in the $\|\cdot\|_\infty$ norm uniformly over J , that is to say: there is $m > 0$ and for any local function $f : \Sigma \rightarrow \mathbb{R}$ there is $C_f < \infty$ such that

$$\sup_J \|T^J(t)f - \mu^J f\|_\infty \leq C_f e^{-mt}.$$

The situation in the Griffiths phase $\beta_c^{\text{pure}} < \beta < \beta_c$ is more complex, even if the Gibbs measure remains unique in that region. We focus on the case of dilution, i.e. we assume that there is p such that $\mathbb{P}(J_e = 1) = p$ and $\mathbb{P}(J_e = 0) = 1 - p$, and give the main steps for the proof of a lower bound on the average autocorrelation if $0 < p < 1$ and $\beta > \beta_c^{\text{pure}}$. We consider again π_0 the function that to a configuration $\sigma \in \Sigma$ associates the spin at the origin, and call m_Λ the function that associates, to $\sigma \in \Sigma$, the average magnetization in the finite domain Λ , i.e. $m_\Lambda(\sigma) = \sum_{x \in \Lambda} \sigma(x)/|\Lambda|$. Minkowski's inequality yields the lower bound

$$\mathbb{E} \|T^J(t)\pi_0\|_{L^2(\mu^J)} \geq \mathbb{E} \|T^J(t)m_\Lambda\|_{L^2(\mu^J)}.$$

Now, we choose for Λ the box of side-length L and restrict the integration \mathbb{E} to the couplings J with $J = 1$ in $E^f(\Lambda_L)$ and $J = 0$ between Λ_L and Λ_L^c . Those realizations of the media yield on Λ_L a pure Ising model at inverse temperature $\beta > \beta_c^{\text{pure}}$. In particular, the initial configuration under μ^J is very close to either the plus or the minus phase in Λ_L . In order to approach equilibrium, the system has to relax to the opposite phase and this will take a time $\exp(\tau L)$ in two dimensions, where τ is the surface tension in the direction of the axis,

and a duration $\exp(\kappa_\beta L^{d-1})$ if $d \geq 3$, with $\kappa_\beta > 0$ for β large enough. Taking $L = (\kappa_\beta^{-1} \log t)^{1/(d-1)}$ we conclude that, for t large enough,

$$\mathbb{E} \|T^J(t)\pi_0\|_{L^2(\mu^J)} \geq p^{c_d L^d} (1-p)^{c_d L^{d-1}} \geq \exp\left(-C(\log t)^{\frac{d}{d-1}}\right)$$

for any $p \in (0, 1)$ and $\beta > \beta_c^{\text{pure}}$ if $d = 2$, β large enough if $d \geq 3$. Similar upper bounds have been proved as well in a fraction of the Griffiths phase and we refer to Sections 7.2 and 7.3 in [63] for further details.

Already in the Griffiths phase, the slow relaxation is caused by atypical realizations of the media. The almost-sure behavior of the dynamics is different: Theorem 7.2 in the same reference states the existence of $c < \infty$ such that, in a region of the phase diagram included in the Griffiths phase, \mathbb{P} -almost surely, for any local function f and for t large enough depending on J and f , one has

$$\|T^J(t)f - \mu^J f\|_\infty \leq \exp\left(-t \exp\left(-c(\log t)^{\frac{d-1}{d}} (\log \log t)^{d-1}\right)\right)$$

which is smaller than any stretched exponential $\exp(-t^{1-\delta})$ with $\delta > 0$, for large t .

4.1.4. Heuristics for the phase transition region. In the region of phase transition the dynamics are even slower than in the Griffiths phase. Below, we describe a mechanism that leads to slow relaxation under the annealed measure, see also [45].

In order to give a lower bound to the autocorrelation (4.2), we will focus on the metastability of special initial conditions. Consider $u_0 = \chi_{U_0} : [0, 1]^d \rightarrow \{\pm 1\}$ and some microscopic scale N , and define

$$\begin{aligned} \mathcal{G} &= \left\{ \begin{array}{l} \text{Surface tension is reduced to } \tau^r < \tau^q \\ \text{on the contour of } N\partial^* u_0 \end{array} \right\} \\ \mathcal{C} &= \left\{ \begin{array}{l} \text{Phase coexistence occurs at } t = 0, \\ \text{with a minus droplet of shape } NU_0 \end{array} \right\}. \end{aligned}$$

The event of *dilution* \mathcal{G} concerns the media J , while \mathcal{C} is an event on spin configurations. Both are rare events: we have

$$\begin{aligned} \mathbb{P}(\mathcal{G}) &\simeq \exp(-N^{d-1} \mathcal{I}^r(u_0)) \\ \mu^{J,+}(\mathcal{C}) &\simeq \exp(-N^{d-1} \mathcal{F}^r(u_0)), \forall J \in \mathcal{G} \end{aligned}$$

where $\mathcal{I}^r(u_0)$ is the surface cost for reducing surface tension around $\partial^* u_0$:

$$\mathcal{I}^r(u_0) = \int_{\partial^* u_0} I_{\mathbf{n}_x}(\tau^r(x)) d\mathcal{H}^{d-1}(x) \quad (4.3)$$

and $\mathcal{F}^r(u)$ is the reduced surface energy after dilution:

$$\mathcal{F}^r(u) = \int_{\partial^* u_0 \cap \partial^* u} \tau^r(x) d\mathcal{H}^{d-1}(x) + \int_{\partial^* u \setminus \partial^* u_0} \tau^q(\mathbf{n}_x) d\mathcal{H}^{d-1}(x). \quad (4.4)$$

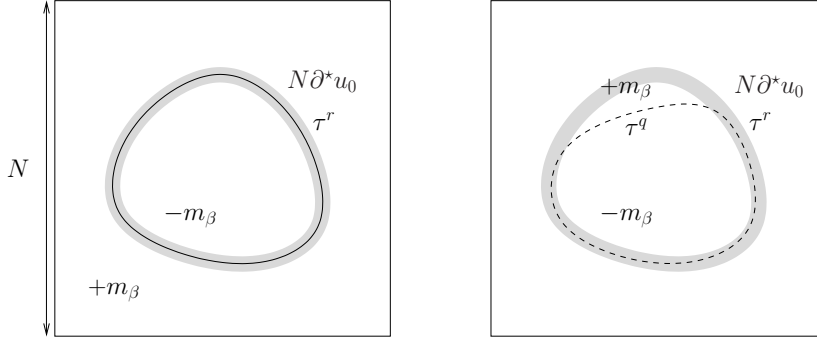

FIGURE 2. Initial dilution and phase coexistence; additional cost for relaxation.

Under the Glauber dynamics, the phase profile evolves continuously. Yet, if the initial condition is regular enough, removing the initial droplet has a positive cost (see Theorem 4.1.2 or Figure 2): for any continuous evolution $(u_s)_{s \in [0,1]}$ starting from u_0 , ending at $u_1 \equiv \mathbf{1}$,

$$\sup_{s \in [0,1]} \mathcal{F}^r(u_s) \geq \mathcal{K}^r(u_0) + \mathcal{F}^r(u_0)$$

where $\mathcal{K}^r(u_0)$, the additional cost for the optimal evolution, is strictly positive. This creates a bottleneck for the dynamics and impedes the removal of the initial droplet up to time

$$t = \exp(N^{d-1} \mathcal{K}^r(u_0)).$$

In that sense, the initial configuration is *metastable*. This implies that, for any N and any $t \leq \exp(N^{d-1} \mathcal{K}^r(u_0))$, the average autocorrelation

$$\mathbb{E} \int_{\Sigma} |(T^J(t)\pi_0)(\rho) - \mu^{J,+}(\sigma(0))| d\mu^{J,+}(\rho) \gtrsim \exp(-N^{d-1} [\mathcal{I}^r(u_0) + \mathcal{F}^r(u_0)])$$

is comparable to the probability of the initial condition (u_0, τ^r) . Inverting $N^{d-1} = \log t / \mathcal{K}^r(u_0)$ and optimizing over the initial condition (u_0, τ^r) , we obtain

$$\mathbb{E} \int_{\Sigma} |(T^J(t)\pi_0)(\rho) - \mu^{J,+}(\sigma(0))| d\mu^{J,+}(\rho) \geq t^{-\inf_{(u_0, \tau^r)} \frac{\mathcal{I}^r(u_0) + \mathcal{F}^r(u_0)}{\mathcal{K}^r(u_0)}}$$

which is the claim of Theorem 4.1.1 below, and we see that the average spin autocorrelation decays like a *negative power of time*. This is by far larger than the exponential decay ($d \geq 3$) or stretched exponential decay ($\exp(-c\sqrt{t})$, for $d = 2$) that are predicted for the pure Ising model [45].

4.1.5. Main results. Our main result is an inverse polynomial lower bound on the average autocorrelation. For any $\lambda, \nu > 0$ we define the average autocorrelation as follows:

$$\begin{aligned} A^{\lambda, \nu}(t) &= \mathbb{E} \|T^J(t)\pi_0 - \mu^{J,+}\pi_0\|_{L^\nu(\mu^{J,+})}^{\nu\lambda} \\ &= \mathbb{E} \left(\left[\int_{\Sigma} |(T^J(t)\pi_0)(\rho) - \mu^{J,+}(\sigma(0))|^\nu d\mu^{J,+}(\rho) \right]^\lambda \right) \end{aligned}$$

where $\pi_0 : \Sigma \rightarrow \mathbb{R}$ is the function that, to the spin configuration σ , associates $\pi_0(\sigma) = \sigma(0)$.

Then, we define the set of relevant initial conditions as

$$\text{IC} = \left\{ (u = \chi_U, \tau) \in \text{BV} \times \mathcal{C}([0, 1]^d, \mathbb{R}) : u \text{ is regular and there is } \varepsilon > 0 \text{ such that, for all } x \in \partial^* u, \tau^{\min}(\mathbf{n}_x^u) + \varepsilon < \tau(x) \leq \tau^q(\mathbf{n}_x^u). \right\} \quad (4.5)$$

The notion of *regular profile* is given in Definition 3.3.1: it requires that U is open and at positive distance from the border of the unit cube, that ∂U is $d - 1$ rectifiable and that $[0, 1]^d \setminus (\partial U + B(0, r))$ has exactly two connected components for small enough $r > 0$.

Given an initial condition $(u_0, \tau^r) \in \text{IC}$ and $u \in \text{BV}$ we consider the reduced surface energy $\mathcal{F}^r(u)$ as in (4.4) and the cost for initial phase coexistence $\mathcal{I}^r(u_0)$ as in (4.3). For any $\varepsilon > 0$, we let

$$\mathcal{C}_\varepsilon(u_0) = \left\{ (v_i)_{i=1\dots k} : k \in \mathbb{N}; v_0 = u_0 \text{ and } v_k = \mathbf{1} \right. \\ \left. \forall i \in \{0, \dots, k-1\}, v_i \in \text{BV} \text{ and } \|v_{i+1} - v_i\|_{L^1} \leq \varepsilon \right\}$$

the set of evolutions by small jumps in L^1 and define

$$\mathcal{K}_{\text{disc}}^r(u_0) = \lim_{\varepsilon \rightarrow 0^+} \inf_{v \in \mathcal{C}_\varepsilon(u_0)} \max_i \mathcal{F}^r(v_i) - \mathcal{F}^r(u_0) \quad (4.6)$$

the discrete additional cost for relaxation, starting from $(u_0, \tau^r) \in \text{IC}$. Finally, we call

$$\alpha_\lambda = \inf_{(u_0, \tau^r) \in \text{IC}} \frac{\mathcal{I}^r(u_0) + \lambda \mathcal{F}^r(u_0)}{\mathcal{K}_{\text{disc}}^r(u_0)} \in [0, \infty], \forall \lambda > 0.$$

This quantity is a lower bound on the exponent for the polynomial decay of the autocorrelation:

THEOREM 4.1.1. *For any $\beta > \hat{\beta}_c$ such that $\beta \notin \mathcal{N} \cup \mathcal{N}_I$, any $\lambda, \nu > 0$ one has:*

$$\liminf_{t \rightarrow \infty} \frac{\log A^{\lambda, \nu}(t)}{\log t} \geq -\alpha_\lambda. \quad (4.7)$$

Obviously, this result is interesting only if $\alpha_\lambda < \infty$. The calculation of α_λ seems to be out of reach, yet we could prove the following:

THEOREM 4.1.2. *Let $(u_0, \tau^r) \in \text{IC}$ and assume that the boundary of u_0 is \mathcal{C}^1 , and that*

$$\tau^r(x) \leq \tau^q(\mathbf{n}_x^{u_0}) - \varepsilon, \quad \forall x \in \partial^* u_0$$

for some $\varepsilon > 0$. Then, the additional cost $\mathcal{K}_{\text{disc}}^r(u_0)$ is strictly positive.

Considering the case of the ball for u_0 , this shows that $\alpha_\lambda < \infty$ as soon as $\tau^{\min} < \tau^q$, which is the case in particular if $J^{\min} = 0$ and $\beta > \hat{\beta}_c$. We conclude with a low temperature estimate on α_λ :

PROPOSITION 4.1.3. *Assume that $0 < \mathbb{P}(J_e = 0) < 1 - p_c(d)$. Then, for any $\lambda > 0$ there is $C < \infty$ such that, for β large enough,*

$$\alpha_\lambda \leq \frac{C}{\beta}.$$

We could also give an alternative characterization of the additional cost $\mathcal{K}_{\text{disc}}^r(u_0)$. Let $\mathcal{E}(u_0)$ be the set of continuous evolutions initiated from u_0 :

$$\mathcal{E}(u_0) = \left\{ \begin{array}{l} v : t \in [0, 1] \mapsto v_t \in \text{BV}: v_0 = u_0, v_1 \equiv 1, \\ t \mapsto v_t \text{ is continuous for the } L^1\text{-norm} \\ \text{and } t \mapsto \mathbf{1}_{\partial^* v_t \cap \partial^* u_0} \text{ is continuous for the} \\ L^1\text{-norm associated to the measure } \mathcal{H}^{d-1} \end{array} \right\} \quad (4.8)$$

and

$$\mathcal{K}^r(u_0) = \inf_{v \in \mathcal{E}(u_0)} \sup_{t \in [0, 1]} \mathcal{F}^r(v_t) - \mathcal{F}^r(u_0) \geq 0. \quad (4.9)$$

In Appendix 4.3.2, we prove:

THEOREM 4.1.4. *For all $(u_0, \tau^r) \in \text{IC}$,*

$$\mathcal{K}_{\text{disc}}^r(u_0) = \mathcal{K}^r(u_0).$$

In Appendix 4.3.3, we use that Theorem in order to calculate the additional cost $\mathcal{K}^r(u_0)$ on two simple examples.

4.2. A lower bound on the autocorrelation

The subject of the present section is the proof of Theorem 4.1.1. In order to construct a rigorous proof from the argument sketched in Section 4.1.4, we have to detail a certain number of steps. We will reduce the problem to finite volume, show the continuity of the evolution of the phase profile, then describe the dilution event and its influence on the phenomenon of phase coexistence.

4.2.1. From infinite to finite volume. We begin the proof of Theorem 4.1.1 with a Lemma that relates the autocorrelation $A^{\lambda,\nu}(t)$ to the dynamics in a finite domain. We denote $T_{\Lambda_N}^{J,+}(t)$ the semigroup associated to the Glauber dynamics on Λ_N , which update only the spins in Λ_N , according to the plus boundary condition on Λ_N .

LEMMA 4.2.1. *For any $\nu \geq 1$, any $\varepsilon > 0$ and $N \in \mathbb{N}^*$ one has*

$$A^{\lambda,\nu}(t) \geq \varepsilon^{\nu\lambda} \mathbb{E} \left[\mathbf{1}_{\{\mu^{J,+}(m_{\Lambda_N}) \geq m_\beta - \varepsilon\}} \times \left(\mu_{\Lambda_N}^{J,+} \left(T_{\Lambda_N}^{J,+}(t) m_{\Lambda_N} \leq m_\beta - 2\varepsilon \right) \right)^\lambda \right] \quad (4.10)$$

where

$$m_{\Lambda_N} : \sigma \mapsto \frac{1}{N^d} \sum_{x \in \Lambda_N} \sigma(x).$$

We will see that the event $\{J : \mu^{J,+}(m_{\Lambda_N}) \geq m_\beta - \varepsilon\}$ in (4.10) has a large probability under \mathbb{P} (Proposition 4.2.13), yet most of our work will concentrate on the proof of a lower bound for

$$\mathbb{E} \left[\left(\mu_{\Lambda_N}^{J,+} \left(T_{\Lambda_N}^{J,+}(t) m_{\Lambda_N} \leq m_\beta - 2\varepsilon \right) \right)^\lambda \right].$$

PROOF. Minkowski's inequality implies, as $\nu \geq 1$, that

$$\begin{aligned} & \frac{1}{N^d} \sum_{x \in \Lambda_N} \left[\int_{\Sigma} |T^J(t) \pi_x - \mu^{J,+} \pi_x|^\nu d\mu^{J,+} \right]^{1/\nu} \\ & \geq \left[\int_{\Sigma} |T^J(t) m_{\Lambda_N} - \mu^{J,+}(m_{\Lambda_N})|^\nu d\mu^{J,+} \right]^{1/\nu} \end{aligned}$$

where $\pi_x : \Sigma \rightarrow \mathbb{R}$ is the function which associates, to the spin configuration $\sigma \in \Sigma$, the spin at x , $\sigma(x)$. The translation invariance of \mathbb{E} and of the Glauber dynamics implies that

$$A^{\lambda,\nu}(t) \geq \mathbb{E} \left[\left(\int_{\Sigma} |T^J(t) m_{\Lambda_N} - \mu^{J,+}(m_{\Lambda_N})|^\nu d\mu^{J,+} \right)^\lambda \right].$$

Hence, for any $\varepsilon > 0$ we have

$$A^{\lambda,\nu}(t) \geq \varepsilon^{\nu\lambda} \mathbb{E} \left[\mathbf{1}_{\{\mu^{J,+}(m_{\Lambda_N}) \geq m_\beta - \varepsilon\}} \times \left(\mu^{J,+} \left(T^J(t) m_{\Lambda_N} \leq m_\beta - 2\varepsilon \right) \right)^\lambda \right]$$

and we conclude using the attractivity of the Glauber dynamics for the dilute Ising model:

$$\begin{aligned} \mu^{J,+} \left(T^J(t) m_{\Lambda_N} \leq m_\beta - 2\varepsilon \right) & \geq \mu^{J,+} \left(T_{\Lambda_N}^{J,+}(t) m_{\Lambda_N} \leq m_\beta - 2\varepsilon \right) \\ & \geq \mu_{\Lambda_N}^{J,+} \left(T_{\Lambda_N}^{J,+}(t) m_{\Lambda_N} \leq m_\beta - 2\varepsilon \right) \quad (4.11) \end{aligned}$$

□

4.2.2. Small L^1 jumps for the magnetization. A crucial property of the dynamics is the fact that the magnetization profile evolves smoothly in L^1 . The following Proposition shows that, with overwhelming probability, the magnetization profile follows a continuous evolution in L^1 . Define

$$\mathcal{C}_{a,\varepsilon}^k = \left\{ (v_i)_{i \in \{0, \dots, k\}} \in (\text{BV}_a)^{k+1} : \|v_{i+1} - v_i\|_{L^1} \leq \varepsilon, \forall i \in \{0, \dots, k-1\} \right\} \quad (4.12)$$

the set of sequences of phase profiles in BV_a of length $k+1$ that satisfy a small jump property. Recall that BV_a was defined at (3.8). Given $\varepsilon > 0$, $T \in (0, \infty)$ and a sequence $(t_N)_{N \in \mathbb{N}^*}$ with

$$1 \leq t_N \leq \exp(N^{d-1}T), \quad \forall N \in \mathbb{N}^*, \quad (4.13)$$

we denote

$$\zeta_N(\varepsilon, T) = \sup \left\{ \zeta \leq \frac{\varepsilon m_\beta}{12c_M} : \frac{t_N}{\zeta} \in \mathbb{N} \right\}$$

and

$$k_N(\varepsilon, T) = \frac{t_N}{\zeta_N(\varepsilon, T)} \in \mathbb{N},$$

where c_M is an upper bound on the value of the transition rates (see Section 4.1.2). We say that the magnetization profile $(\mathcal{M}_K(\sigma_{i\zeta_N})/m_\beta)_{0 \leq i \leq k_N}$ at times $i\zeta_N$, for $i \in \{0, \dots, k_N\}$, is ε -close to $\mathcal{C}_{a,\varepsilon}^{k_N}$ if there is $v \in \mathcal{C}_{a,\varepsilon}^{k_N}$ such that

$$\sup_{i \in \{0, \dots, k_N\}} \left\| \frac{\mathcal{M}_K(\sigma_{i\zeta_N})}{m_\beta} - v_i \right\|_{L^1} \leq \varepsilon.$$

In the following, $P_{\Lambda_N}^{J,+, \mu}$ stands for the law of the Markov process $(\sigma_t)_{t \geq 0}$ with initial distribution μ , that evolves according to the Glauber dynamics in Λ_N with plus boundary condition. We have:

PROPOSITION 4.2.2. *Assume that $\beta > \hat{\beta}_c$ and $\beta \notin \mathcal{N}$. There is $C > 0$ such that, for any $a, T \in (0, \infty)$, any $(t_N)_{N \in \mathbb{N}^*}$ as in (4.13), for any $\varepsilon > 0$ and for large enough $K \in \mathbb{N}$, for large enough N ,*

$$\mathbb{E} P_{\Lambda_N}^{J,+, \mu_{\Lambda_N}^{J,+}} \left(\left(\frac{\mathcal{M}_K(\sigma_{i\zeta_N})}{m_\beta} \right)_{0 \leq i \leq k_N} \text{ is not } \varepsilon\text{-close to } \mathcal{C}_{a,\varepsilon}^{k_N} \right) \leq \exp(N^{d-1}(T - Ca))$$

where $\zeta_N = \zeta(\varepsilon, t_N)$ and $k_N = k(\varepsilon, t_N)$.

PROOF. The measure $\mu_{\Lambda_N}^{J,+}$ is invariant for the Glauber dynamics with plus boundary condition on Λ_N . It follows that

$$\begin{aligned} \mathbb{E} P_{\Lambda_N}^{J,+, \mu_{\Lambda_N}^{J,+}} \left(\#v \in (\text{BV}_a)^{k_N+1} : \forall i \in \{0, \dots, k_N\}, \frac{\mathcal{M}_K(\sigma_{i\zeta_N})}{m_\beta} \in \mathcal{V}(v_i, \frac{\varepsilon}{3}) \right) \\ \leq (k_N + 1) \mathbb{E} \mu_{\Lambda_N}^{J,+} \left(\frac{\mathcal{M}_K(\sigma)}{m_\beta} \notin \mathcal{V}(\text{BV}_a, \frac{\varepsilon}{3}) \right) \end{aligned} \quad (4.14)$$

and in view of the exponential tightness (Proposition 3.4.3 in Chapter 3) there is $C > 0$ such that, for large enough a , for large enough K , for large enough N the former probability does not exceed

$$(k_N + 1) \exp(-2CaN^{d-1}) \leq \exp(N^{d-1}(T - Ca))/2.$$

Then we write

$$\begin{aligned} P_{\Lambda_N}^{J,+, \mu_{\Lambda_N}^{J,+}} \left(\exists v \in (\text{BV}_a)^{k_N+1} \setminus \mathcal{C}_{a,\varepsilon}^{k_N} : \sup_{i \in \{0, \dots, k_N\}} \left\| \frac{\mathcal{M}_K(\sigma_{i\zeta_N})}{m_\beta} - v_i \right\|_{L^1} \leq \frac{\varepsilon}{3} \right) \\ \leq (k_N + 1) \sup_{\sigma_0} P_{\Lambda_N}^{J,+, \sigma_0} \left(\left\| \frac{\mathcal{M}_K(\sigma_{\zeta_N})}{m_\beta} - \frac{\mathcal{M}_K(\sigma_0)}{m_\beta} \right\|_{L^1} > \frac{\varepsilon}{3} \right). \end{aligned} \quad (4.15)$$

Now, remark that the probability that there are more than $2c_M t N^d$ spin updates before time t is exponentially small at volume order, uniformly over the initial condition σ_0 and the interaction J . Each step modifies the L^1 -distance between the magnetization profiles by $2/N^d$, hence for any $t > 0$,

$$\lim_N \frac{1}{N^{d-1}} \log \sup_{J \in \mathcal{J}, \sigma_0 \in \Sigma} P_{\Lambda_N}^{J,+, \sigma_0} \left(\sup_{s \leq t} \|\mathcal{M}_K(\sigma_s) - \mathcal{M}_K(\sigma_0)\|_{L^1} \geq 4c_M t \right) = -\infty.$$

Applying this to $t = \varepsilon m_\beta / (12c_M) \geq \zeta_N$ proves that (4.15) is also bounded by $\exp(N^{d-1}(T - Ca))/2$ for large N (uniformly over J) and the claim follows. \square

4.2.3. The bottleneck. We saw that the evolution of the magnetization profile is almost continuous in L^1 -norm. Given $(u_0, \tau^r) \in \text{IC}$, $a > 0$ and $\varepsilon > 0$ we define the set of profiles of maximal cost for such evolutions as follows:

$$\mathcal{L}_{a,\varepsilon}(u_0) = \left\{ u \in \text{BV}_a : \begin{array}{l} \text{There are } k \in \mathbb{N}^* \text{ and } v \in \mathcal{C}_{a,\varepsilon}^k \text{ such that } v_0 = u_0, \\ v_k \equiv \mathbf{1}, u \in \{v_0, \dots, v_k\} \text{ and } u \in \mathcal{V}(v_l, \varepsilon) \text{ where } l \\ \text{satisfies } \inf_{w \in \mathcal{V}(v_l, \varepsilon)} \mathcal{F}^r(w) \geq \max_{i=0}^k \inf_{w \in \mathcal{V}(v_i, \varepsilon)} \mathcal{F}^r(w). \end{array} \right\} \quad (4.16)$$

In that definition, we consider $\inf_{w \in \mathcal{V}(v_i, \varepsilon)} \mathcal{F}^r(w)$ instead of $\mathcal{F}^r(v_i)$ in order to ensure that we recover the additional cost $\mathcal{K}_{\text{disc}}^r(u_0)$, see Proposition 4.2.15.

If the trajectory of the magnetization profile \mathcal{M}_K/m_β is ε -continuous, and does not approach $\mathcal{L}_{a,\varepsilon}(u_0)$ at some time, then the initial droplet cannot disappear. We formulate this as follows:

PROPOSITION 4.2.3. *There is $c < \infty$ such that, for any $(u_0, \tau^r) \in \text{IC}$ and $\varepsilon > 0$, $a, T < \infty$, for any $(t_N)_{N \in \mathbb{N}^*}$ as in (4.13),*

$$\begin{aligned} \mu_{\Lambda_N}^{J,+} \left(\begin{array}{l} \mathcal{M}_K/m_\beta \in \mathcal{V}(u_0, \varepsilon) \text{ and} \\ T_{\Lambda_N}^{J,+}(t_N) m_{\Lambda_N} \geq m_\beta - 2\varepsilon \end{array} \right) \leq \frac{1}{\varepsilon} P_{\Lambda_N}^{J,+, \mu_{\Lambda_N}^{J,+}} \left(\begin{array}{l} (\mathcal{M}_K(\sigma_{i\zeta_N})/m_\beta)_{0 \leq i \leq k_N} \\ \text{is not } \varepsilon\text{-close to } \mathcal{C}_{a,\varepsilon}^{k_N} \end{array} \right) \\ + \frac{k_N + 1}{\varepsilon} \mu_{\Lambda_N}^{J,+} \left(\frac{\mathcal{M}_K}{m_\beta} \in \mathcal{L}_{a,c\varepsilon}(u_0) \right) \end{aligned}$$

where $\zeta_N = \zeta(\varepsilon, t_N)$ and $k_N = k(\varepsilon, t_N)$.

PROOF. To begin with, we reformulate the probability

$$p_N^J = \mu_{\Lambda_N}^{J,+} \left(\frac{\mathcal{M}_K/m_\beta \in \mathcal{V}(u_0, \varepsilon) \text{ and } T_{\Lambda_N}^{J,+}(t_N)m_{\Lambda_N} \geq m_\beta - 2\varepsilon \right)$$

in terms of the Markov process (σ_t) associated to the Glauber dynamics on Λ_N , with plus boundary condition. By definition of the semi-group $T_{\Lambda_N}^{J,+}(t_N)$, we have

$$p_N^J = \int_{\left\{ \frac{\mathcal{M}_K(\rho)}{m_\beta} \in \mathcal{V}(u_0, \varepsilon) \right\}} \mathbf{1}_{\left\{ E_{\Lambda_N}^{J,+,\rho} m_{\Lambda_N}(\sigma_{t_N}) \geq m_\beta - 2\varepsilon \right\}} d\mu_{\Lambda_N}^{J,+}(\rho).$$

An immediate calculation shows that

$$E_{\Lambda_N}^{J,+,\rho} m_{\Lambda_N}(\sigma_t) \geq m_\beta - 2\varepsilon \Rightarrow P_{\Lambda_N}^{J,+,\rho} [m_{\Lambda_N}(\sigma_t) \geq m_\beta - 3\varepsilon] \geq \varepsilon,$$

hence

$$\begin{aligned} p_N^J &\leq \frac{1}{\varepsilon} \int_{\left\{ \frac{\mathcal{M}_K(\rho)}{m_\beta} \in \mathcal{V}(u_0, \varepsilon) \right\}} P_{\Lambda_N}^{J,+,\rho} [m_{\Lambda_N}(\sigma_{t_N}) \geq m_\beta - 3\varepsilon] d\mu_{\Lambda_N}^{J,+}(\rho) \\ &= \frac{1}{\varepsilon} P_{\Lambda_N}^{J,+,\mu_{\Lambda_N}^{J,+}} \left(\frac{\mathcal{M}_K}{m_\beta}(\sigma_0) \in \mathcal{V}(u_0, \varepsilon) \text{ and } m_{\Lambda_N}(\sigma_{t_N}) \geq m_\beta - 3\varepsilon \right). \end{aligned} \quad (4.17)$$

This form is easier to handle since the Gibbs measure $\mu_{\Lambda_N}^{J,+}$ is reversible for the Markov process (σ_t) . Now we consider the event

$$\mathcal{A}_{v,\varepsilon} = \left\{ \begin{array}{l} (\mathcal{M}_K(\sigma_{i\zeta_N})/m_\beta)_{0 \leq i \leq k_N} \text{ is } \varepsilon\text{-close to } v, \\ \mathcal{M}_K(\sigma_0)/m_\beta \in \mathcal{V}(u_0, \varepsilon) \text{ and } m_{\Lambda_N}(\sigma_t) \geq m_\beta - 3\varepsilon \end{array} \right\}, \quad \forall v \in \mathcal{C}_{a,\varepsilon}^{k_N}.$$

Let $c = 6/m_\beta$, $v \in \mathcal{C}_{a,\varepsilon}^{k_N}$ and call v' the evolution starting at u_0 , ending at $\mathbf{1}$ (the constant profile) defined by

$$v'_i = \begin{cases} u_0 & \text{if } i = 0 \\ v_i & \text{if } 1 \leq i \leq k_N - 1 \\ \mathbf{1} & \text{if } i = k_N. \end{cases}$$

If $\mathcal{A}_{v,\varepsilon}$ is not empty, we have $\|u_0 - v_0\|_{L^1} \leq 2\varepsilon$, hence $\|v'_0 - v'_1\|_{L^1} \leq 3\varepsilon$. Similarly, if $\mathcal{A}_{v,\varepsilon}$ is not empty, we have

$$\begin{aligned} \|\mathbf{1} - v_{k_N}\|_{L^1} &= \int_{[0,1]^d} (1 - v_{k_N}(x)) d\mathcal{L}^d(x) \\ &\leq \int_{[0,1]^d} \left(1 - \frac{\mathcal{M}_K(\sigma_t)}{m_\beta}(x) \right) d\mathcal{L}^d(x) + \varepsilon \\ &\leq 1 - \frac{m_{\Lambda_N}(\sigma_t)}{m_\beta} + 2\varepsilon \\ &\leq 5\varepsilon/m_\beta. \end{aligned} \quad (4.18)$$

and this implies that $v' \in \mathcal{C}_{a,c\varepsilon}^{k_N}$, i.e. that v' is a $c\varepsilon$ -continuous evolution. Now we prove the inclusion

$$\mathcal{A}_{v,\varepsilon} \subset \mathcal{A}_{v',c\varepsilon} \quad (4.19)$$

which means that, when the evolution is ε -continuous, starts close to u_0 and ends with an overall magnetization close to m_β , then it is close to some $c\varepsilon$ -evolution that starts at u_0 and ends at $\mathbf{1}$. In order to prove (4.19) we have to show that, if $\mathcal{A}_{v,\varepsilon}$ occurs, then

$$\left\| \frac{\mathcal{M}_K(\sigma_{i\zeta_N})}{m_\beta} - v'_i \right\|_{L^1} \leq c\varepsilon, \quad \forall i \in \{0, \dots, k_N\}.$$

This is obvious for $1 \leq i < k_N$. For $i = 0$, this is clear as well and for $i = k_N$, it is a consequence of (4.18).

We now end the proof of the Proposition and consider the upper bound (4.17). Excluding the possibility that the magnetization does not follow an ε -continuous evolution, we see that

$$p_N^J \leq \frac{1}{\varepsilon} P_{\Lambda_N}^{J,+, \mu_{\Lambda_N}^{J,+}} \left(\begin{array}{l} (\mathcal{M}_K(\sigma_{i\zeta})/m_\beta)_{0 \leq i \leq k_N} \\ \text{is not } \varepsilon\text{-close to } \mathcal{C}_{a,\varepsilon}^{k_N} \end{array} \right) + \frac{1}{\varepsilon} P_{\Lambda_N}^{J,+, \mu_{\Lambda_N}^{J,+}} \left(\bigcup_{v \in \mathcal{C}_{a,\varepsilon}^{k_N}} \mathcal{A}_{v,\varepsilon} \right).$$

But in view of (4.19), we have

$$\begin{aligned} P_{\Lambda_N}^{J,+, \mu_{\Lambda_N}^{J,+}} \left(\bigcup_{v \in \mathcal{C}_{a,\varepsilon}^{k_N}} \mathcal{A}_{v,\varepsilon} \right) &\leq P_{\Lambda_N}^{J,+, \mu_{\Lambda_N}^{J,+}} \left(\bigcup_{v \in \mathcal{C}_{a,\varepsilon}^{k_N} : v_0 = u_0 \text{ and } v_{k_N} = \mathbf{1}} \mathcal{A}_{v,c\varepsilon} \right) \\ &\leq P_{\Lambda_N}^{J,+, \mu_{\Lambda_N}^{J,+}} \left(\exists i \leq k_N : \frac{\mathcal{M}_K(\sigma_{i\zeta})}{m_\beta} \in \mathcal{L}_{a,c\varepsilon}(u_0) \right) \\ &\leq (k_N + 1) \mu_{\Lambda_N}^{J,+} \left(\frac{\mathcal{M}_K}{m_\beta} \in \mathcal{L}_{a,c\varepsilon}(u_0) \right) \end{aligned}$$

as $\mu_{\Lambda_N}^{J,+}$ is invariant for the dynamics. The claim follows. \square

4.2.4. Specialized covering theorem. The rest of the proof of Theorem 4.1.1 is based on the upper and lower bounds on phase coexistence developed in the former Chapter. Yet, we have to define first the event of *dilution*, namely the event that surface tension is reduced to τ^r on the boundary of u_0 (see Definition 4.2.8 below). In order to ensure that this event has all expected properties, we need first to define carefully the rectangular parallelepipeds we consider. The main difficulty is that we have to prepare the way to the proof of the conditional upper bound for phase coexistence – see Proposition 4.2.11 and Figure 3. This accounts for the fourth line in (iii) and for (iv) in the following definition.

DEFINITION 4.2.4. Let $(u_0 = \chi_{U_0}, \tau^r) \in \text{IC}$ and $u \in \text{BV}$, together with $\gamma, \delta > 0$. We say that a rectangular parallelepiped $\mathcal{R} \subset [0, 1]^d$ is δ -adapted to u at $x \in \partial^* u$ if:

- (i) It is δ -adapted to $\partial^* u$ at $x \in \partial^* u$ in the sense of Definition 3.2.1.
- (ii) If \mathcal{R} is on the border it does not intersect ∂U_0 .

(iii) If \mathcal{R} intersects ∂U_0 , then $x \in \partial U_0$ and

$$\left| \frac{1}{h^{d-1}} \mathcal{H}^{d-1} ((\partial^* u \Delta \partial^* u_0) \cap \mathcal{R}) \right| \leq \delta,$$

$$\left| \tau^r(x) - \frac{1}{h^{d-1}} \int_{\partial^* u_0 \cap \mathcal{R}} \tau^r d\mathcal{H}^{d-1} \right| \leq \delta,$$

$$\left| I_{\mathbf{n}}(\tau^r(x)) - \frac{1}{h^{d-1}} \int_{\partial^* u_0 \cap \mathcal{R}} I_{\mathbf{n}_z^{u_0}}(\tau^r(z)) d\mathcal{H}^{d-1}(z) \right| \leq \delta,$$

and

$$\left| I_{\mathbf{n}}(\tau^r(x) - \gamma) - \frac{1}{h^{d-1}} \int_{\partial^* u_0 \cap \mathcal{R}} I_{\mathbf{n}_z^{u_0}}(\tau^r(z) - \gamma) d\mathcal{H}^{d-1}(z) \right| \leq \delta.$$

(iv) If \mathcal{R} intersects ∂U_0 , then the enlarged volume

$$\mathcal{R}' = \mathcal{R} + B(0, 2\sqrt{dh^2}) = \left\{ z \in \mathbb{R}^d : d(z, \mathcal{R}) \leq 2\sqrt{dh^2} \right\}$$

satisfies

$$\frac{1}{h^{d-1}} \mathcal{H}^{d-1} (\partial^* u_0 \cap \mathcal{R}' \setminus \mathcal{R}) \leq \delta.$$

We adapt as well the notion of covering:

DEFINITION 4.2.5. Let $(u_0, \tau^r) \in \text{IC}$ and $u \in \text{BV}$, $\delta, \gamma > 0$. A finite sequence $(\mathcal{R}_i)_{i=1 \dots n}$ of disjoint rectangular parallelepipeds included in $[0, 1]^d$ is said to be a δ -covering for $\partial^* u$ if each \mathcal{R}_i is δ -adapted to u in the sense of Definition 4.2.4 and if

$$\mathcal{H}^{d-1} \left(\partial^* u \setminus \bigcup_{i=1}^n \mathcal{R}_i \right) \leq \delta. \quad (4.20)$$

In the remaining of the Chapter, the notions of δ -adapted rectangular parallelepiped and that of δ -covering refer to those of Definitions 4.2.4 and 4.2.5, unless explicitly stated. The parameter $\gamma > 0$ in Definition 4.2.4 (iii) concerns uniquely the proof of Proposition 4.2.11.

THEOREM 4.2.6. *Let $(u_0, \tau^r) \in \text{IC}$ and $u \in \text{BV}$, together with $\gamma, \delta > 0$. There is a δ -covering for $\partial^* u$.*

Before we prove Theorem 4.2.6 (with the help of the Vitali covering Theorem), let us show the next Lemma, where Δ stands for the symmetric difference:

LEMMA 4.2.7. *Assume $u, u_0 \in \text{BV}$. Then, for \mathcal{H}^{d-1} almost all $x \in \partial^* u \cap \partial^* u_0$,*

$$\lim_{r \rightarrow 0^+} \frac{1}{r^{d-1}} \mathcal{H}^{d-1} (\partial^* u \Delta \partial^* u_0) = 0.$$

PROOF. (Lemma 4.2.7) Consider the Borel measurable function

$$f : x \in \mathbb{R}^d \mapsto \begin{cases} 1 & \text{if } x \in \partial^* u_0 \\ 2 & \text{else.} \end{cases}$$

Besicovitch derivation Theorem (Theorem 2.22 in [10]) implies that for \mathcal{H}^{d-1} -almost all $x \in \partial^* u \cap \partial^* u_0$,

$$\lim_{r \rightarrow 0^+} \frac{1}{\alpha_{d-1} r^{d-1}} \int_{\partial^* u \cap B(x, r)} f d\mathcal{H}^{d-1} = f(x)$$

where $\alpha_{d-1} = \mathcal{H}^{d-1}(\{x \in B(0, 1) : x \cdot \mathbf{e}_d = 0\})$. Therefore,

$$\lim_{r \rightarrow 0^+} \left[\frac{\mathcal{H}^{d-1}(\partial^* u \cap B(x, r))}{\alpha_{d-1} r^{d-1}} + \frac{\mathcal{H}^{d-1}(\partial^* u \setminus \partial^* u_0 \cap B(x, r))}{\alpha_{d-1} r^{d-1}} \right] = 1.$$

As the first term goes to 1 already as $r \rightarrow 0$, we conclude that

$$\lim_{r \rightarrow 0^+} \frac{1}{\alpha_{d-1} r^{d-1}} \mathcal{H}^{d-1}(\partial^* u \setminus \partial^* u_0 \cap B(x, r)) = 0$$

for \mathcal{H}^{d-1} -almost all $x \in \partial^* u \cap \partial^* u_0$. The claim follows as u and u_0 play a symmetric role. \square

PROOF. (Theorem 4.2.6). As in the proof of Theorem 3.2.3, we design a set E that has zero \mathcal{H}^{d-1} -measure and such that the collection of closed rectangular parallelepipeds

$$\mathcal{U}_\delta = \{\mathcal{R} \text{ } \delta\text{-adapted to } \partial^* u \text{ at } x \in \partial^* u \setminus E\}$$

is a Vitali class for $\partial^* u \setminus E$. Again, we define E by its complement in $\partial^* u$: $\partial^* u \setminus E$ is the set of all $x \in \partial^* u$ such that, for all $\mathcal{S} \in \mathbb{S}_{\mathbf{n}_x^u}$, the following holds:

- (i) Conditions (i) to (v) in the proof of Theorem 3.2.3 hold.
- (ii) If $x \notin \partial U_0 \cup \partial[0, 1]^d$, then for $h > 0$ small enough, $\mathcal{R}_{x, h, \delta h}(\mathcal{S}, \mathbf{n}_x^u)$ does not intersect $\partial U_0 \cup \partial[0, 1]^d$.
- (iii) If $x \in \partial U_0$, then $\lim_{h \rightarrow 0^+} \frac{1}{h^{d-1}} \mathcal{H}^{d-1} \left((\partial^* u \Delta \partial^* u_0) \cap \mathring{\mathcal{R}}_{x, h, \delta h}(\mathcal{S}, \mathbf{n}_x^u) \right) = 0$.
- (iv) If $x \in \partial U_0$, then

$$\lim_{h \rightarrow 0^+} \frac{1}{h^{d-1}} \int_{\partial^* u_0 \cap \mathring{\mathcal{R}}_{x, h, \delta h}(\mathcal{S}, \mathbf{n}_x^u)} \tau^r(\mathbf{n}_z^u) d\mathcal{H}^{d-1}(z) = \tau^r(x),$$

$$\lim_{h \rightarrow 0^+} \frac{1}{h^{d-1}} \int_{\partial^* u_0 \cap \mathring{\mathcal{R}}_{x, h, \delta h}(\mathcal{S}, \mathbf{n}_x^u)} I_{\mathbf{n}_z^{u_0}}(\tau^r(z)) d\mathcal{H}^{d-1}(z) = I_{\mathbf{n}_x^{u_0}}(\tau^r(x))$$

and

$$\lim_{h \rightarrow 0^+} \frac{1}{h^{d-1}} \int_{\partial^* u_0 \cap \mathring{\mathcal{R}}_{x, h, \delta h}(\mathcal{S}, \mathbf{n}_x^u)} I_{\mathbf{n}_z^{u_0}}(\tau^r(z) - \gamma) d\mathcal{H}^{d-1}(z) = I_{\mathbf{n}_x^{u_0}}(\tau^r(x) - \gamma).$$

- (v) If $x \in \partial U_0$, then $\lim_{h \rightarrow 0^+} \frac{1}{h^{d-1}} \mathcal{H}^{d-1}(\partial^* u \cap \mathcal{R}'_{x, h, \delta h}(\mathcal{S}, \mathbf{n}_x^u)) = 1$ where \mathcal{R}' is defined as in Definition 4.2.4 (iv).

As in the proof of Theorem 3.2.3, we have to prove that E has zero \mathcal{H}^{d-1} -measure.

- (i) See the proof of Theorem 3.2.3.
- (ii) Condition (ii) is true for all x since $\partial U_0 \cup \partial[0, 1]^d$ is compact.
- (iii) Lemma 4.2.7 shows that condition (iii) is verified for \mathcal{H}^{d-1} -almost all $x \in \partial^* u$.
- (iv) It is a consequence of the strong form of the Besicovitch derivation theorem (Theorem 5.52 in [10]) together with Lemma 3.2.5, that conditions (iv) and (v) hold for \mathcal{H}^{d-1} -almost all $x \in \partial^* u$.

□

4.2.5. The event of dilution. Here we define the event of dilution of the media, that is, we reduce the surface tension τ^J around $N\partial^* u_0$ in order to realize the part of the initial condition $(u_0, \tau^r) \in \text{IC}$ that concerns the random media. Our definition considers $\delta_0 > 0$ which ensures that we modify the media in the region at distance at most $N\delta_0$ from the boundary $N\partial^* u_0$. See also (3.16) for the definition of \mathcal{R}^N .

DEFINITION 4.2.8. Given $(u_0, \tau^r) \in \text{IC}$ and $\delta_0, \gamma > 0$, we call

$$\mathcal{G}_N = \left\{ J \in \mathcal{J} : \tau_{\mathcal{R}_i^N}^J \leq \tau^r(x_i), \forall i = 1 \dots n \right\} \quad (4.21)$$

the event of δ_0 -dilution, if $(\mathcal{R}_i)_{i=1 \dots n}$ is a δ_0 -covering for $\partial^* u_0$ with parameter γ .

No matter how small $\delta_0 > 0$ is, the event of dilution gives the appropriate $\mu_{\Lambda_N}^{J,+}$ -probability to the cost of initial phase coexistence, at the expected cost on \mathbb{P} . We recall that $\mathcal{I}^r(u_0)$ was defined at (4.3).

PROPOSITION 4.2.9. Assume that $\beta > \hat{\beta}_c$ and $\beta \notin \mathcal{N}$. Let $(u_0, \tau^r) \in \text{IC}$ and $\varepsilon, \xi > 0$. Then, for any $\delta_0 > 0$ small enough, if we denote \mathcal{G}_N the event of δ_0 -dilution, we have: for any N large enough,

$$\mathbb{P}(\mathcal{G}_N) \geq \exp(-N^{d-1}(\mathcal{I}^r(u_0) + \xi)).$$

PROOF. According to the definition of the dilution, there is a δ_0 -covering $(\mathcal{R}_i)_{i=1 \dots n}$ for $\partial^* u_0$ such that (4.21) holds. Because the \mathcal{R}_i^N are disjoint for large enough N , we have

$$\begin{aligned} \liminf_{N \rightarrow \infty} \frac{1}{N^{d-1}} \log \mathbb{P}(\mathcal{G}_N) &= \liminf_{N \rightarrow \infty} \sum_{i=1}^n \frac{1}{N^{d-1}} \log \mathbb{P}(\tau_{\mathcal{R}_i^N}^J \leq \tau^r(x_i)) \\ &= - \sum_{i=1}^n h_i^{d-1} I_{\mathbf{n}_i}(\tau^r(x_i)) \end{aligned}$$

in view of Theorem 2.2.5, thanks to the assumption $\tau^r(x) > \tau^{\min}(\mathbf{n}_x^{u_0})$ for all $x \in \partial^* u_0$ (see (4.5)). In view of the definition of the δ -covering (Definition 4.2.5

and point (iii) in Definition 4.2.4), it is immediate that for $\delta > 0$ small enough, the former limit is larger than $-\mathcal{I}^r(u_0) - \xi/2$ and the claim follows. \square

4.2.6. Influence of the dilution on the lower bound.

PROPOSITION 4.2.10. *Assume that $\beta > \hat{\beta}_c$ and $\beta \notin \mathcal{N}$. Let $(u_0, \tau^r) \in \text{IC}$ and $\varepsilon, \xi > 0$. Then, for any $\delta_0 > 0$ small enough, if we denote by \mathcal{G}_N the event of δ_0 -dilution, we have: for large enough K ,*

$$\lim_{N \rightarrow \infty} \mathbb{P} \left(\mu_{\Lambda_N}^{J,+} \left(\frac{\mathcal{M}_K}{m_\beta} \in \mathcal{V}(u_0, \varepsilon) \right) \geq \exp(-N^{d-1}(\mathcal{F}^r(u_0) + \xi)) \middle| J \in \mathcal{G}_N \right) = 1.$$

PROOF. We use the notations of Proposition 3.3.4 in Chapter 3 and denote $\delta = \delta_0$. We recall that $\mathcal{D}_{U_0}^{N,\delta}$ is the event of ω -disconnection around $N\partial^*u_0$ and that $\mathcal{E}_{U_0}^{N,\delta}$ is the set of edges close to $N\partial^*u_0$. We let then

$$F_N^J = \inf_{\pi \in \mathcal{D}_{U_0}^{N,\delta}} \Psi_{\Lambda_N}^{J,w,+} \left(\frac{\mathcal{M}_K}{m_\beta} \in \mathcal{V}(u_0, \varepsilon) \middle| \omega = \pi \text{ on } \mathcal{E}_{U_0}^{N,\delta} \right).$$

In view of Proposition 3.3.4 and of the definition of the δ -covering, we have:

(i) For any $\delta > 0$ small enough,

$$\liminf_{N \rightarrow \infty} \inf_{J \in \mathcal{G}_N} \frac{1}{N^{d-1}} \log \Phi_{\Lambda_N}^{J,w} \left(\mathcal{D}_{U_0}^{N,\delta} \right) \geq -\mathcal{F}^r(u_0) - \xi/2. \quad (4.22)$$

(ii) For any $\delta > 0$ small enough, for K large enough,

$$\lim_{N \rightarrow \infty} \mathbb{P} \left(F_N^J < \frac{1}{3} \right) = 0. \quad (4.23)$$

The definition of F_N^J yields

$$\mu_{\Lambda_N}^{J,+} \left(\frac{\mathcal{M}_K}{m_\beta} \in \mathcal{V}(u_0, \varepsilon) \right) \geq F_N^J \Phi_{\Lambda_N}^{J,w} \left(\mathcal{D}_{U_0}^{N,\delta} \right)$$

hence, using (4.22) we obtain: for large enough N ,

$$\begin{aligned} \mathbb{P} \left(\mu_{\Lambda_N}^{J,+} \left(\frac{\mathcal{M}_K}{m_\beta} \in \mathcal{V}(u_0, \varepsilon) \right) \geq \exp(-N^{d-1}(\mathcal{F}^r(u_0) + \xi)) \middle| J \in \mathcal{G}_N \right) \\ \geq \mathbb{P} \left(F_N^J \geq \frac{1}{3} \middle| J \in \mathcal{G}_N \right) \end{aligned}$$

Yet, the variable F_N^J is *independent* of the J_e with $e \in \mathcal{E}_{U_0}^{N,\delta}$. Thus it is as well independent of \mathcal{G}_N , and (4.23) yields the conclusion. \square

4.2.7. Influence of the dilution on the upper bound. Here we show that the event of dilution has the expected impact on the upper bound for phase coexistence, that is: conditionally on the dilution, we recover $\mathcal{F}^r(u)$ as the upper bound for the cost of phase coexistence.

PROPOSITION 4.2.11. Assume $\beta > \hat{\beta}_c$ and $\beta \notin \mathcal{N} \cup \mathcal{N}_I$. Let $(u_0, \tau^r) \in \text{IC}$, $u \in \text{BV}$ and $\xi > 0$. There are $\varepsilon > 0$ and $\gamma > 0$ such that, for small enough $\delta_0 > 0$ and large enough K , if we denote by \mathcal{G}_N the event of δ_0 -dilution with parameter γ ,

$$\lim_{N \rightarrow \infty} \mathbb{P} \left(\mu_{\Lambda_N}^{J,+} \left(\frac{\mathcal{M}_K}{m_\beta} \in \mathcal{V}(u, \varepsilon) \right) \leq \exp(-N^{d-1} (\mathcal{F}^r(u) - \xi)) \mid J \in \mathcal{G}_N \right) = 1.$$

Proposition 4.2.11 is a consequence of the following lemma, which is itself a consequence of conditions (iv) and (v) in Definition 4.2.4.

LEMMA 4.2.12. Assume $\beta > \hat{\beta}_c$ and $\beta \notin \mathcal{N} \cup \mathcal{N}_I$. Let $(u_0, \tau^r) \in \text{IC}$ and $\gamma > 0$. For $\delta > 0$ small enough, the following holds: for any $u \in \text{BV}$ and any \mathcal{R} that is δ -adapted to $\partial^* u$ at $x \in \partial^* u \cap \partial^* u_0$ with parameter γ , for any K large enough and any $\delta_0 \in (0, h^2)$,

$$\lim_{N \rightarrow \infty} \mathbb{P} \left(\tilde{\tau}_{N\mathcal{R}}^{J,\delta,K} < \tau^r(x) - c'_{d,\delta} - \gamma \mid J \in \mathcal{G}_N \right) = 0$$

if \mathcal{G}_N is the event of δ_0 -dilution and $c'_{d,\delta} = c_d \delta + c_{d,\delta}$ is the sum of the constants that appear in Propositions 3.3.6 and 3.3.7.

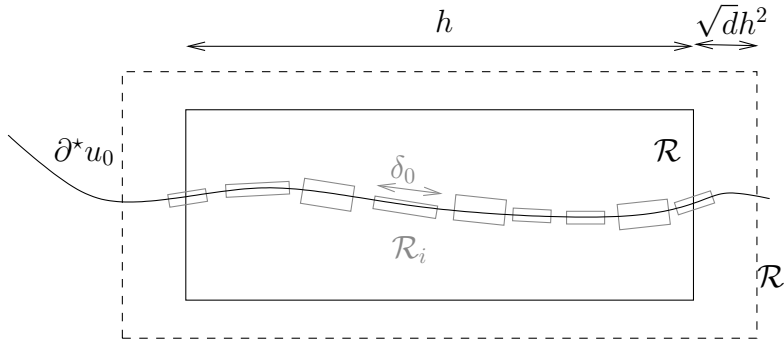

FIGURE 3. The scale of dilution δ_0 .

PROOF. (Lemma 4.2.12). We consider $(\mathcal{R}_i)_{i=1\dots n}$ a δ_0 -covering for $\partial^* u_0$ such that (4.21) holds. Thanks to the product structure of \mathbb{P} , for large enough N the surface tension $\tilde{\tau}_{\mathcal{R}_i^N}^{J,\delta,K}$ is independent of the $\tau_{\mathcal{R}_i^N}^J$ such that $\mathcal{R}_i \cap \mathcal{R} = \emptyset$. Hence, for large enough N , the conditional probability

$$\mathbb{P} \left(\tilde{\tau}_{N\mathcal{R}}^{J,\delta,K} < \tau^r(x) - c'_{d,\delta} - \gamma \mid J \in \mathcal{G}_N \right)$$

equals

$$\mathbb{P} \left(\tilde{\tau}_{N\mathcal{R}}^{J,\delta,K} < \tau^r(x) - c'_{d,\delta} - \gamma \mid \tau_{\mathcal{R}_i^N}^J \leq \tau^r(x_i), \forall i : \mathcal{R}_i \cap \mathcal{R} \neq \emptyset \right),$$

which is bounded from above by

$$p_N = \frac{\mathbb{P}\left(\tilde{\tau}_{N\mathcal{R}}^{J,\delta,K} \leq \tau^r(x) - c'_{d,\delta} - \gamma\right)}{\mathbb{P}\left(\tau_{\mathcal{R}_i}^J \leq \tau^r(x_i), \forall i : \mathcal{R}_i \cap \mathcal{R} \neq \emptyset\right)}.$$

We prove now that this quantity goes to 0 as $N \rightarrow \infty$, under the appropriate conditions. We show in fact that $1/N^{d-1} \log p_N$ has a negative superior limit: because of the definition of $c'_{d,\delta}$, Propositions 3.3.6 and 3.3.7 in Chapter 3, together with Theorem 2.2.5, indicate that for large enough K ,

$$\limsup_N \frac{1}{N^{d-1}} \log p_N \leq -h^{d-1} I_{\mathbf{n}}(\tau^r(x) - \gamma) + \sum_{i: \mathcal{R}_i \cap \mathcal{R} \neq \emptyset} h_i^{d-1} I_{\mathbf{n}_i}(\tau^r(x_i)). \quad (4.24)$$

We show at last that the right-hand side of (4.24) is negative, for small enough $\delta > 0$ and $\delta_0 \leq h^2$. Thanks to the definition of δ -adapted rectangular parallelepipeds, and in particular (iv) in Definition 4.2.4, one sees (Figure 3) that the right-hand side of (4.24) is not larger, for $\delta \leq 1/2$ and $\delta_0 \leq h^2$, than

$$\int_{\partial^* u_0 \cap \mathcal{R}} [I_{\mathbf{n}_z}(\tau^r(z)) - I_{\mathbf{n}_z}(\tau^r(z) - \gamma)] d\mathcal{H}^{d-1}(z) + M\delta h^{d-1}$$

where

$$M = 3 + 2 \sup_{x \in \partial^* u_0} I_{\mathbf{n}_x^{u_0}}(\tau^r(x))$$

is finite thanks to the definition of IC at (4.5) (see also Theorem 2.2.5). Now we give an upper bound on the integral. Using the convexity of $I_{\mathbf{n}}$ (the slope of $I_{\mathbf{n}}$ is non-increasing), we write

$$\begin{aligned} & \int_{\partial^* u_0 \cap \mathcal{R}} [I_{\mathbf{n}_z}(\tau^r(z)) - I_{\mathbf{n}_z}(\tau^r(z) - \gamma)] d\mathcal{H}^{d-1}(z) \\ & \leq - \int_{\partial^* u_0 \cap \mathcal{R}} I_{\mathbf{n}_z}(\tau^q(\mathbf{n}_z) - \gamma) d\mathcal{H}^{d-1}(z) \\ & \leq -(1/2)h^{d-1} \inf_{\mathbf{n} \in S^{d-1}} I_{\mathbf{n}}(\tau^q(\mathbf{n}) - \gamma). \end{aligned}$$

It remains to show that

$$\inf_{\mathbf{n} \in S^{d-1}} I_{\mathbf{n}}(\tau^q(\mathbf{n}) - \gamma) > 0, \quad (4.25)$$

which permits to take any

$$\delta < \min\left(\frac{1}{2}, \frac{1}{2M} \inf_{\mathbf{n} \in S^{d-1}} I_{\mathbf{n}}(\tau^q(\mathbf{n}) - \gamma)\right).$$

We conclude with the proof of (4.25) and assume by contradiction that there is a sequence (\mathbf{n}_k) in S^{d-1} such that $I_{\mathbf{n}_k}(\tau^q(\mathbf{n}_k) - \gamma) \rightarrow 0$ as $k \rightarrow \infty$. By compactness we can extract a converging subsequence; in the sequel we assume

that (\mathbf{n}_k) converges to $\mathbf{n} \in S^{d-1}$. The characterization of $I_{\mathbf{n}}$ in terms of τ^λ (Equation (2.22) in Chapter 2) yields

$$\tau^\lambda(\mathbf{n}_k) \leq \lambda \tau^q(\mathbf{n}_k) - \lambda \gamma + \underset{k \rightarrow \infty}{o}(1), \quad \forall \lambda > 0$$

and passing to the limit $k \rightarrow \infty$ we obtain $\tau^\lambda(\mathbf{n}) \leq \lambda \tau^q(\mathbf{n}) - \lambda \gamma$, i.e. $I_{\mathbf{n}}(\tau^q(\mathbf{n}) - \gamma) = 0$, which contradicts the assumption $\beta \notin \mathcal{N}_I$. \square

PROOF. (Proposition 4.2.11). Consider $\gamma > 0$ and $(\mathcal{R}_i)_{i=1 \dots n}$ a δ -covering for $\partial^* u$. Taking $\gamma > 0$ small enough, for any $\delta > 0$ small enough we have

$$\sum_{i=1}^n h_i^{d-1} (\tau^r(x_i) - c_{d,\delta} - \gamma) \geq \mathcal{F}^r(u) - \xi/2.$$

We can take furthermore $\delta > 0$ small enough so that the conclusion of Lemma 4.2.12 holds. Then, in view of Proposition 3.3.5 in Chapter 3 we have: there is $\varepsilon > 0$ such that, for any K , if \mathcal{G}_N is the event of δ_0 -dilution

$$\begin{aligned} \mathbb{P} \left(\mu_{\Lambda_N}^{J,+} \left(\frac{\mathcal{M}_K}{m_\beta} \in \mathcal{V}(u, \varepsilon) \right) > \exp(-N^{d-1}(\mathcal{F}^r(u) - \xi)) \mid J \in \mathcal{G}_N \right) \\ \leq \sum_{i=1}^n \mathbb{P} \left(\tilde{\tau}_{N\mathcal{R}_i}^{J,\delta,K} < \tau^r(x_i) - c_{d,\delta} - \gamma \mid J \in \mathcal{G}_N \right). \end{aligned}$$

Yet, we saw at Lemma 4.2.12 that this quantity goes to 0 as $N \rightarrow \infty$, provided that $\delta_0 \leq \min_{i=1}^n h_i^2$ and K be large enough. \square

4.2.8. Dilution and average magnetization. Here we show that the dilution does not influence much the value of the magnetization on Λ_N , under the infinite volume measure $\mu^{J,+}$:

PROPOSITION 4.2.13. *Assume $\beta > \hat{\beta}_c$ and $\beta \notin \mathcal{N}$. Let $(u_0, \tau^r) \in \text{IC}$ and $\varepsilon > 0$. For any $\delta_0 > 0$ small enough, one has*

$$\lim_{N \rightarrow \infty} \mathbb{P} \left(\mu_{\Lambda_N}^{J,+}(m_{\Lambda_N}) \geq m_\beta - \varepsilon \mid J \in \mathcal{G}_N \right) = 1$$

where \mathcal{G}_N is the event of δ_0 -dilution.

PROOF. It is equivalent to show that

$$\lim_{N \rightarrow \infty} \inf_{M \geq N} \mathbb{P} \left(\mu_{\hat{\Lambda}_M}^{J,+}(m_{\Lambda_N}) \geq m_\beta - \varepsilon \mid J \in \mathcal{G}_N \right) = 1$$

for small enough δ_0 . The proof is similar to that of Proposition 3.3.4: again, we consider two mesoscopic scales K and $L_N = \lceil \sqrt{N} \rceil$. We call $(\Delta_i, \Delta'_i)_{i \in I_{\hat{\Lambda}_M, K}}$ the (K, K) -covering of $\hat{\Lambda}_M$ and $(\tilde{\Delta}_j, \tilde{\Delta}'_j)_{j \in J_{M, K}}$ the (L_N, L_N) -covering for $I_{\hat{\Lambda}_M, K}$. Then, given $\delta > 0$ we let

$$(\phi_i)_{i \in I_{\hat{\Lambda}_M, K}}$$

the phase indicator given by Theorem 1.5.7, for the tolerance δ . Then, we consider the set of L_N -blocks that correspond to positions not intersecting the rectangular parallelepipeds $(\mathcal{R}_k)_{k=1\dots n}$ corresponding to \mathcal{G}_N as in (4.21):

$$J = \left\{ j \in J_{M,K} : \forall i \in \tilde{\Delta}'_j, \Delta'_i \cap \bigcup_{k=1}^n \mathcal{R}_k^N = \emptyset \right\}$$

and denote

$$I = \bigcup_{j \in J} \tilde{\Delta}'_j.$$

Given a realization of $\rho = (|\phi_i|)_{i \in I_{\tilde{\Delta}'_j}}$, we say that the L_N -block $\tilde{\Delta}'_j$ is good if there is a crossing cluster of ρ -open sites in $\tilde{\Delta}'_j$, of density at least $1 - \delta$. As we need a control on m_{Λ_N} that is uniform in $M \geq N$, we consider

$$J^{\text{int}} = \left\{ j \in J : \exists i \in \tilde{\Delta}'_j, \Delta'_i \cap \Lambda_N \neq \emptyset \right\}$$

and let

$$f \left((|\phi_i|)_{i \in I_{\tilde{\Delta}'_j}} \right) = \mathbf{1} \left\{ \begin{array}{l} \tilde{\Delta}'_j \text{ is good, for all } j \in J^{\text{int}} \text{ and there is a path of} \\ \text{good } L_N\text{-blocks from } J^{\text{int}} \text{ to the border of } J_{M,K} \end{array} \right\},$$

which defines an increasing function. As in Proposition 3.3.4, we remark that, if we take ρ under the site percolation measure \mathcal{B}_p^I with $p < 1$ close enough to 1, there is $c > 0$ such that, for large enough N , for all $j \in J$:

$$\mathcal{B}_p^I \left(\left\{ \tilde{\Delta}'_j \text{ is good} \right\} \right) \geq 1 - \exp(-3cL_N^{d-1})$$

– this is a consequence of Theorem 1.1 in [33]. We bound from below the expectation of f under the measure \mathcal{B}_p^I : in order that $f(\rho) = 0$, one must have either

- (i) one bad L_N -block $\tilde{\Delta}'_j$ with $j \in J^{\text{int}}$ – this event has a probability smaller than $\exp(-2c\sqrt{N})$ for large N
- (ii) or a path of bad blocks of length $n \geq \sqrt{N}$ around J^{int} , that remains in a plane and starts at a distance less than n from J^{int} . This event has a probability at most

$$\sum_{n \geq \sqrt{N}} n (c_d \exp(-2cL_N))^n \leq \exp(-cN)$$

for large enough N .

Hence we have: for large enough N ,

$$\mathcal{B}_p^I(f) \geq 1 - \exp(-c\sqrt{N}).$$

Consequently, the stochastic domination for $(|\phi_i|)_{i \in I_{\Lambda_N, K}}$ (Theorem 1.5.7 (iv)) yields the same lower bound on the expectation of $f((|\phi_i|)_{i \in I})$: for large enough

K (depending on δ), there is $c > 0$ such that, for any N large enough:

$$\mathbb{E} \inf_{\pi} \Psi_{\Lambda_N, \beta}^{J, +} \left(f \left((|\phi_i|)_{i \in I} \right) \middle| \omega = \pi \text{ on } \bigcup_{k=1}^n E^f \left(\widehat{\mathcal{R}}_k^N \right) \right) \geq 1 - e^{-c\sqrt{N}}.$$

Now, we remark that the volume of $\bigcup_{k=1}^n \mathcal{R}_k$ is not larger than $2\delta_0 \mathcal{H}^{d-1}(\partial^* u_0)$, hence it is small with respect to $\varepsilon > 0$, for small enough δ_0 . For large enough N , the L_N -blocks are much finer than the rectangular parallelepipeds \mathcal{R}_k^N and hence, not only the L_N -blocks with $j \in J^{\text{int}}$ cover almost all the volume of Λ_N , but also J has exactly one connected component. Hence: for small enough $\delta_0, \delta > 0$, for large enough N ,

$$f \left((|\phi_i|)_{i \in I} \right) = 1 \Rightarrow m_{\Lambda_N} \geq m_{\beta} - \frac{\varepsilon}{2}.$$

Theorem 1.5.7 (iv) thus yields: the \mathbb{P} -probability that

$$\inf_{\pi} \Psi_{\Lambda_N, \beta}^{J, +} \left(m_{\Lambda_N} \geq m_{\beta} - \frac{\varepsilon}{2} \middle| \omega = \pi \text{ on } \bigcup_{k=1}^n E^f \left(\widehat{\mathcal{R}}_k^N \right) \right) \leq 1 - e^{-c\sqrt{N}}$$

is at most $e^{-c\sqrt{N}}$. As the conditional probability

$$\inf_{\pi} \Psi_{\Lambda_N, \beta}^{J, +} \left(m_{\Lambda_N} \geq m_{\beta} - \frac{\varepsilon}{2} \middle| \omega = \pi \text{ on } \bigcup_{k=1}^n E^f \left(\widehat{\mathcal{R}}_k^N \right) \right)$$

is *independent* of the J_e for $e \in \bigcup_{k=1}^n E^f \left(\widehat{\mathcal{R}}_k^N \right)$, hence of \mathcal{G}_N as well, we infer that

$$\mathbb{P} \left(\Psi_{\Lambda_N, \beta}^{J, +} \left(m_{\Lambda_N} \geq m_{\beta} - \frac{\varepsilon}{2} \right) \leq 1 - e^{-c\sqrt{N}} \middle| \mathcal{G}_N \right) \leq e^{-c\sqrt{N}}$$

and the claim follows. \square

4.2.9. Lower semi-continuity. Here we show that \mathcal{F}^r is lower semi-continuous, which is a consequence of the assumption $\tau^r(x) \leq \tau^q(\mathbf{n}_x)$, and relate the additional cost $\mathcal{K}_{\text{disc}}^r$ defined at (4.6) to the set $\mathcal{L}_{\infty, \varepsilon}(u_0)$ (see (4.16)).

PROPOSITION 4.2.14. *For any $(u_0, \tau^r) \in \text{IC}$, the functional \mathcal{F}^r defined at (4.4) is lower semi-continuous.*

As an application, we show that:

PROPOSITION 4.2.15. *For any $(u_0, \tau^r) \in \text{IC}$, we have*

$$\mathcal{K}_{\text{disc}}^r(u_0) = \lim_{\varepsilon \rightarrow 0^+} \inf_{u \in \mathcal{L}_{\infty, \varepsilon}(u_0)} \mathcal{F}^r(u) - \mathcal{F}^r(u_0). \quad (4.26)$$

PROOF. (Proposition 4.2.14). We show the lower semi-continuity as an application of the covering Theorem (Theorem 4.2.6). Let $u \in \text{BV}$ and $\delta > 0$,

and consider a δ -covering $(\mathcal{R}_i)_{i=1\dots n}$ for ∂^*u . Since the \mathcal{R}_i are disjoint, for any $v \in \text{BV}$ we have

$$\begin{aligned} \mathcal{F}^r(v) &\geq \sum_{i=1}^n \int_{\mathring{\mathcal{R}}_i \cap \partial^*u_0 \cap \partial^*v} \tau^r(x) d\mathcal{H}^{d-1}(x) + \int_{(\mathring{\mathcal{R}}_i \setminus \partial^*u_0) \cap \partial^*v} \tau^q(\mathbf{n}_x^v) d\mathcal{H}^{d-1}(x) \\ &\geq \sum_{i: \mathcal{R}_i \cap \partial U_0 \neq \emptyset} \mathcal{H}^{d-1}(\mathring{\mathcal{R}}_i \cap \partial^*v) \inf_{x \in \mathcal{R}_i} \tau^r + \sum_{i: \mathcal{R}_i \cap \partial U_0 = \emptyset} \int_{\mathring{\mathcal{R}}_i \cap \partial^*v} \tau^q(\mathbf{n}_x^v) d\mathcal{H}^{d-1}(x) \end{aligned}$$

since $\tau^r(x) \leq \tau^q(\mathbf{n}_x)$. Thanks to the lower semi-continuity of the surface energy in open sets (Chapter 14 in [24]), the quantities $\mathcal{H}^{d-1}(\mathring{\mathcal{R}}_i \cap \partial^*v)$ and $\int_{\mathring{\mathcal{R}}_i \cap \partial^*v} \tau^q(\mathbf{n}_x^v) d\mathcal{H}^{d-1}(x)$ become not smaller than their value at u when v converges to u in L^1 norm. Hence:

$$\begin{aligned} \liminf_{\varepsilon \rightarrow 0} \inf_{v \in \mathcal{V}(u, \varepsilon)} \mathcal{F}^r(v) &\geq \sum_{i: \mathcal{R}_i \cap \partial U_0 \neq \emptyset} (1 - \delta) h_i^{d-1} \inf_{x \in \mathcal{R}_i} \tau^r + \sum_{i: \mathcal{R}_i \cap \partial U_0 = \emptyset} (1 - \delta) h_i^{d-1} \tau^q(\mathbf{n}_i^u) \end{aligned}$$

which is arbitrary close to $\mathcal{F}^r(u)$ for small δ , thanks to the uniform continuity of τ^r . \square

PROOF. (Proposition 4.2.15). The fact that $\mathcal{K}_{\text{disc}}^r(u_0)$ is larger or equal to the right-hand side follows from the definitions. Consider now $\varepsilon > 0$ and $u \in \mathcal{L}_{\infty, \varepsilon}(u_0)$ such that

$$\mathcal{F}^r(u) \leq \inf_{w \in \mathcal{L}_{\infty, \varepsilon}(u_0)} \mathcal{F}^r(w) + \varepsilon. \quad (4.27)$$

Since $u \in \mathcal{L}_{\infty, \varepsilon}(u_0)$, there are $k \in \mathbb{N}^*$ and $v \in \mathcal{C}_{\infty, \varepsilon}^k$ (see (4.12)) such that $v_0 = u_0$, $v_k = \mathbf{1}$ and

$$\mathcal{F}^r(u) \geq \max_{i=0}^k \inf_{w \in \mathcal{V}(v_i, \varepsilon)} \mathcal{F}^r(w). \quad (4.28)$$

For each $i = 0 \dots k$, one can select $v'_{i+1} \in \mathcal{V}(v_i, \varepsilon)$ such that

$$\inf_{w \in \mathcal{V}(v_i, \varepsilon)} \mathcal{F}^r(w) \geq \mathcal{F}^r(v'_{i+1}) - \varepsilon$$

We let then $v'_0 = u_0$ and $v'_{k+2} = \mathbf{1}$. Clearly, the evolution $v' = (v'_i)_{i=0\dots k+2}$ is 3ε -continuous. Its maximal cost does not occur at $k+2$ since $\mathcal{F}^r(\mathbf{1}) = 0$, hence

$$\max_{i=0}^k \mathcal{F}^r(v'_{i+1}) \geq \max_{i=0}^{k+2} \mathcal{F}^r(v'_i) - \sup_{w \in \mathcal{V}(u_0, \varepsilon)} (\mathcal{F}^r(u_0) - \mathcal{F}^r(w)).$$

Reporting in (4.27) and (4.28), we obtain

$$\inf_{i=0} \mathcal{F}^r(w) \geq \max_{i=0}^{k+2} \mathcal{F}^r(v'_i) - 2\varepsilon - \sup_{w \in \mathcal{V}(u_0, \varepsilon)} (\mathcal{F}^r(u_0) - \mathcal{F}^r(w))$$

for some $v' \in \mathcal{C}_{\infty, \varepsilon}^{k+2}$ with $v'_0 = u_0$ and $v'_{k+2} = \mathbf{1}$. Taking the limit $\varepsilon \rightarrow 0^+$ we obtain, thanks to the lower semi-continuity of \mathcal{F}^r (Proposition 4.2.14), the desired inequality

$$\lim_{\varepsilon \rightarrow 0^+} \inf_{u \in \mathcal{L}_{\infty, \varepsilon}(u_0)} \mathcal{F}^r(u) - \mathcal{F}^r(u_0) \geq \mathcal{K}_{\text{disc}}^r(u_0).$$

□

4.2.10. A probabilistic control over the magnetization. The end of the proof of Theorem 4.1.1 is now at hand. The next proposition is the before to last step:

PROPOSITION 4.2.16. *Assume $\beta > \hat{\beta}_c$ with $\beta \notin \mathcal{N} \cup \mathcal{N}_I$. Then, for all $(u_0, \tau^r) \in \text{IC}$ and $\xi > 0$, for $\varepsilon > 0$ small enough, for any sequence $(t_N)_{N \in \mathbb{N}^*}$ with*

$$1 \leq t_N \leq \exp(N^{d-1}(\mathcal{K}_{\text{disc}}^r(u_0) - 5\xi)), \quad \forall N \in \mathbb{N}^*,$$

for any N large enough the \mathbb{P} -probability that $\{\mu^{J,+}(m_{\Lambda_N}) \geq m_\beta - \varepsilon\}$ and

$$\mu_{\Lambda_N}^{J,+} \left(T_{\Lambda_N}^{J,+}(t_N) m_{\Lambda_N} \leq m_\beta - 2\varepsilon \right) \geq \exp(-N^{d-1}(\mathcal{F}^r(u_0) + \xi))$$

is at least $\exp(-N^{d-1}(\mathcal{I}^r(u_0) + \xi))$.

PROOF. Let $(u_0, \tau^r) \in \text{IC}$. Let $\xi > 0$ and $T = \mathcal{K}_{\text{disc}}^r(u_0) - 5\xi$. In view of Proposition 4.2.15, there is $\varepsilon > 0$ such that

$$T \leq \inf_{u \in \mathcal{L}_{\infty, \varepsilon}(u_0)} \mathcal{F}^r(u) - \mathcal{F}^r(u_0) - 4\xi. \quad (4.29)$$

We fix $a < \infty$ with

$$Ca \geq T + \mathcal{I}^r(u_0) + 1$$

where C is the constant appearing in Proposition 4.2.2. For all $u \in \text{BV}_a$ we let

$$\varepsilon(u) = \min(\varepsilon_\xi(u)/2, \varepsilon/3)$$

where $\varepsilon_\xi(u)$ is the ε that appears in Proposition 4.2.11. Since the set BV_a (defined at (3.8)) is compact and included in the union of the open neighborhoods $\mathcal{V}(u, \varepsilon(u))$ for $u \in \text{BV}_a$, there is a finite collection $(u_i)_{i=1 \dots n}$ of elements of BV_a such that

$$\text{BV}_a \subset \bigcup_{i=1}^n \mathcal{V}(u_i, \varepsilon(u_i)).$$

Since the right-hand set is open and BV_a is compact, there is $\varepsilon' \in (0, \varepsilon/3)$ such that

$$\mathcal{V}(\text{BV}_a, \varepsilon') \subset \bigcup_{i=1}^n \mathcal{V}(u_i, \varepsilon(u_i)).$$

We let then $\delta_0 > 0$ small enough so that we can apply Proposition 4.2.11 to u_1, \dots, u_n . We require as well that δ_0 be small enough in regard to Propositions

4.2.10 and 4.2.13. Then, we let $\eta \leq \varepsilon'/c$ where c is the constant appearing in Proposition 4.2.3 and call

$$\tilde{\mathcal{G}}_N = \mathcal{G}_N \cap \left\{ \begin{array}{l} \text{(i) } \mu_{\Lambda_N}^{J,+} \left(\frac{\mathcal{M}_K}{m_\beta} \in \mathcal{V}(u_0, \eta) \right) \geq \exp(-N^{d-1}(\mathcal{F}^r(u_0) + \xi)), \\ \text{(ii) for all } i \in \{1, \dots, n\}, \\ \mu_{\Lambda_N}^{J,+} \left(\frac{\mathcal{M}_K}{m_\beta} \in \mathcal{V}(u_i, \varepsilon(u_i)) \right) \leq \exp(-N^{d-1}(\mathcal{F}^r(u_i) - \xi)), \\ \text{(iii) } \mu_{\Lambda_N}^{J,+}(m_{\Lambda_N}) \geq m_\beta - \eta \text{ and} \\ \text{(iv) } P_{\Lambda_N}^{J,+, \mu_{\Lambda_N}^{J,+}} \left(\begin{array}{l} (\mathcal{M}_K(\sigma_{i\zeta})/m_\beta)_{0 \leq i \leq k_N} \\ \text{is not } \eta\text{-close to } \mathcal{C}_{a, \varepsilon'}^{k_N} \end{array} \right) \\ \leq \exp(-N^{d-1}(\mathcal{F}^r(u_0) + 1)) \end{array} \right\}$$

where \mathcal{G}_N is the event of δ_0 -dilution, see (4.21). Thanks to the choice of δ_0 and to Propositions 4.2.9, 4.2.10, 4.2.11, 4.2.13 and 4.2.2, the \mathbb{P} -probability of $\tilde{\mathcal{G}}_N$ is at least

$$\mathbb{P}(\tilde{\mathcal{G}}_N) \geq \exp(-N^{d-1}(\mathcal{I}^r(u_0) + \xi)) \quad (4.30)$$

for large enough N , if K is large enough. On the other hand, for any $J \in \tilde{\mathcal{G}}_N$ we have, in view of Proposition 4.2.3, the inequality

$$\begin{aligned} & \mu_{\Lambda_N}^{J,+} \left(\frac{\mathcal{M}_K}{m_\beta} \in \mathcal{V}(u_0, \eta) \text{ and } T_{\Lambda_N}^{J,+}(t_N)m_{\Lambda_N} \geq m_\beta - 2\eta \right) \\ & \leq \frac{1}{\eta} \exp(-N^{d-1}(\mathcal{F}^r(u_0) + 1)) + \frac{2}{\eta\zeta_N} \exp(N^{d-1}T) \mu_{\Lambda_N}^{J,+} \left(\frac{\mathcal{M}_K}{m_\beta} \in \mathcal{L}_{a, \varepsilon'}(u_0) \right) \end{aligned}$$

with $\zeta_N \geq c' > 0$ since $t_N \geq 1$. Now, remark that

$$\begin{aligned} \mathcal{L}_{a, \varepsilon'}(u_0) & \subset \text{BV}_a \cap \bigcup_{i: d(u_i, \mathcal{L}_{a, \varepsilon'}(u_0)) \leq \varepsilon' + \varepsilon(u_i)} \mathcal{V}(u_i, \varepsilon(u_i)) \\ & \subset \bigcup_{i \in \{1, \dots, n\}: u_i \in \mathcal{L}_{a, \varepsilon}(u_0)} \mathcal{V}(u_i, \varepsilon(u_i)) \end{aligned}$$

since $\varepsilon', \varepsilon(u_i) \leq \varepsilon/3$. This implies that, for any $J \in \tilde{\mathcal{G}}_N$:

$$\begin{aligned} \mu_{\Lambda_N}^{J,+} \left(\frac{\mathcal{M}_K}{m_\beta} \in \mathcal{L}_{a, \varepsilon'}(u_0) \right) & \leq n \exp \left(-N^{d-1} \left(\inf_{u \in \mathcal{L}_{a, \varepsilon}(u_0)} \mathcal{F}^r(u) - \xi \right) \right) \\ & \leq \exp \left(-N^{d-1} \left(\inf_{u \in \mathcal{L}_{a, \varepsilon}(u_0)} \mathcal{F}^r(u) - 2\xi \right) \right). \end{aligned}$$

From the choice of T at (4.29) we conclude that, uniformly over $J \in \tilde{\mathcal{G}}_N$, for N large enough,

$$\mu_{\Lambda_N}^{J,+} \left(\frac{\mathcal{M}_K}{m_\beta} \in \mathcal{V}(u_0, \eta), T_{\Lambda_N}^{J,+}(t_N)m_{\Lambda_N} \geq m_\beta - 2\eta \right) \leq \exp(-N^{d-1}(\mathcal{F}^r(u_0) + 2\xi))$$

in other words:

$$\mu_{\Lambda_N}^{J,+} \left(T_{\Lambda_N}^{J,+}(t_N)m_{\Lambda_N} \leq m_\beta - 2\eta \mid \frac{\mathcal{M}_K}{m_\beta} \in \mathcal{V}(u_0, \eta) \right) \geq 1 - \exp(-N^{d-1}\xi)$$

thus

$$\mu_{\Lambda_N}^{J,+} \left(T_{\Lambda_N}^{J,+}(t_N) m_{\Lambda_N} \leq m_\beta - 2\eta \right) \geq \exp(-N^{d-1} (\mathcal{F}^r(u_0) - \xi))$$

and the claim follows from (4.30). \square

4.2.11. Lower bound on the autocorrelation. We finalize now the proof of Theorem 4.1.1.

PROOF. (Theorem 4.1.1). Let $(s_n)_{n \in \mathbb{N}^*}$ an increasing sequence with $s_n \rightarrow \infty$, such that

$$\lim_{n \rightarrow \infty} \frac{\log A^{\lambda,\nu}(s_n)}{\log s_n} = \liminf_{t \rightarrow \infty} \frac{\log A^{\lambda,\nu}(t)}{\log t}.$$

We fix $(u_0, \tau^r) \in \text{IC}$ and $\xi > 0$ such that

$$T = \mathcal{K}_{\text{disc}}^r(u_0) - 5\xi$$

is strictly larger than ξ and denote

$$N_n = \left\lceil \sqrt[d-1]{\frac{\log s_n}{T}} \right\rceil, \quad \forall n \in \mathbb{N}^*.$$

It is clear that $N_n \rightarrow \infty$ and that, for n large enough $s_n \leq \exp(N_n^{d-1} T)$. Now we define

$$n_N = \max \{n : N_n \leq N\} \quad \text{and} \quad t_N = s_{n_N}$$

so that $t_N \rightarrow \infty$ with $t_N \leq \exp(N^{d-1} (\mathcal{K}_{\text{disc}}^r(u_0) - 5\xi))$ for large enough N . Proposition 4.2.16 applies and there is $\varepsilon > 0$ such that, for N large enough,

$$A^{\lambda,\nu}(t_N) \geq \varepsilon^{\nu\lambda} \exp(-N^{d-1} (\mathcal{I}^r(u_0) + \lambda \mathcal{F}^r(u_0) + (1 + \lambda)\xi)) \quad (4.31)$$

according to Lemma 4.2.1. For $N = N_n$ and large enough n such that $N_{n+1} > N_n$ (thus $s_n = t_N$), (4.31) together with the inequality $N_n^{d-1} \leq \log s_n / (T - \xi)$ yield

$$\lim_{n \rightarrow \infty} \frac{\log A^{\lambda,\nu}(s_n)}{\log s_n} \geq -\frac{\mathcal{I}^r(u_0) + \lambda \mathcal{F}^r(u_0) + (1 + \lambda)\xi}{\mathcal{K}_{\text{disc}}^r(u_0) - 6\xi}.$$

The claim follows letting $\xi \rightarrow 0$ and optimizing over $(u_0, \tau^r) \in \text{IC}$. \square

4.3. Appendix

In this Appendix we study a few issues on the additional cost: we prove that it is positive for regular initial profiles (Theorem 4.1.2) and give an upper bound at low temperatures. Then we show that the additional cost does not change if we consider *continuous evolutions* that present as well a *continuous separation* from the substrate of dilution (Theorem 4.1.4). We also compute the additional cost on two simple examples.

4.3.1. Positivity of the additional cost. Here we show that natural constraints on the initial configuration $(u_0, \tau^r) \in \text{IC}$ imply the positivity of the additional cost, proving the effective presence of a bottleneck for the dynamics.

4.3.1.1. *Positive additional cost.* The proof of Theorem 4.1.2 is not immediate and we proceed as follows: first, given a profile $u \in \text{BV}$ at L^1 -distance $\varepsilon > 0$ from u_0 , we decompose the difference between u and u_0 into small droplets, creating new portions of interfaces that have a cost of order $C\varepsilon$, where $C < \infty$ depends on the diameter we require for the droplets. Then, using a local Winterbottom construction we show that the overall cost of these droplets is at least $C'\varepsilon^{1-1/d}$. The conclusion follows as

$$\mathcal{F}^r(u) - \mathcal{F}^r(u_0) \geq C'\varepsilon^{1-1/d} - C\varepsilon$$

is positive for small enough $\varepsilon > 0$.

In a first lemma we separate the difference between u and u_0 into interior and exterior profiles v, w , and compare the additional cost $\mathcal{F}^r(u) - \mathcal{F}^r(u_0)$ to surface energy $\mathcal{F}^{r,-}$ of v and w , where

$$\mathcal{F}^{r,-}(u) = \int_{\partial^*u \setminus \partial^*u_0} \tau^q(\mathbf{n}^u) d\mathcal{H}^{d-1} - \int_{\partial^*u \cap \partial^*u_0} \tau^r d\mathcal{H}^{d-1}, \quad \forall u \in \text{BV}. \quad (4.32)$$

LEMMA 4.3.1. *Let $(u_0, \tau^r) \in \text{IC}$ and $u \in \text{BV}$. Consider*

$$v = \chi_{U_0 \setminus U} \quad \text{and} \quad w = \chi_{U \setminus U_0}$$

if $u = \chi_U$ and $u_0 = \chi_{U_0}$. Then,

$$\mathcal{F}^r(u) - \mathcal{F}^r(u_0) \geq \mathcal{F}^{r,-}(v) + \mathcal{F}^{r,-}(w) \quad (4.33)$$

PROOF. First, we remark that

$$\mathcal{F}^r(u) - \mathcal{F}^r(u_0) = \int_{\partial^*u \setminus \partial^*u_0} \tau^q(\mathbf{n}^u) d\mathcal{H}^{d-1} - \int_{\partial^*u_0 \setminus \partial^*u} \tau^r d\mathcal{H}^{d-1}.$$

The inclusion

$$\partial^*u \setminus \partial U_0 \supset (\partial^*v \setminus \partial U_0) \sqcup (\partial^*w \setminus \partial U_0)$$

(where \sqcup stands for the disjoint union) is clear and accounts for the $\int \tau^q d\mathcal{H}^{d-1}$ part of inequality (4.33) as $\partial U_0 = \partial^*u_0$. Next we show that, up to \mathcal{H}^{d-1} -negligible sets,

$$\partial^*u_0 \setminus \partial^*u \subset (\partial^*w \cap \partial^*u_0) \cup (\partial^*v \cap \partial^*u_0)$$

which accounts for the $\int \tau^r d\mathcal{H}^{d-1}$ part of inequality (4.33). Theorem 3.61 in [10] shows that, given any $u = \chi_U \in \text{BV}$ the local density of U at x is either 0, 1/2 or 1, for \mathcal{H}^{d-1} -almost all $x \in \mathbb{R}^d$. Furthermore, the set of points at which the local density is 1/2 coincides, up to a \mathcal{H}^{d-1} -negligible set, to the reduced boundary ∂^*u (denoted $\mathcal{F}U$ in [10]). Consequently, up to \mathcal{H}^{d-1} -negligible sets $\partial^*u_0 \setminus \partial^*u$ coincides with the set of x at which the density of U_0 is 1/2 and that of U is either 0 or 1. Yet, a density 1/2 for U_0 and 0 for U at x gives a

density $1/2$ for $V = U_0 \setminus U$, hence $x \in \partial^* v$ (for \mathcal{H}^{d-1} almost all x), while a density 1 for U yields similarly $x \in \partial^* w$. The claim follows. \square

In a second step we decompose V and W into small droplets:

LEMMA 4.3.2. *Let $(u_0, \tau^r) \in \text{IC}$, $u \in \text{BV}$ and $\varepsilon, \delta > 0$ and assume that*

$$\|u - u_0\|_{L^1} = 2\delta.$$

Then, there is a finite collection $(V_i)_{i=1\dots n}$ of disjoint Borel sets with diameter at most ε , such that, if we denote $v_i = \chi_{V_i}$,

(i) *The droplets have an overall volume*

$$\sum_{i=1}^n \mathcal{L}^d(V_i) = \delta.$$

(ii) *There is $c_\varepsilon < \infty$ that does not depend on δ such that*

$$\mathcal{F}^r(u) - \mathcal{F}^r(u_0) \geq \sum_{i=1}^n \mathcal{F}^{r,-}(v_i) - c_\varepsilon \delta.$$

(iii) *Each V_i is included in either $\overline{U_0}$ or $\overline{U_0^c}$.*

PROOF. We simply decompose V and W according to a grid of mesh ε , in order to obtain droplets of diameter not larger than $\varepsilon\sqrt{d}$. We fix m integer such that

$$m\varepsilon \geq 1 + \varepsilon$$

and, for $h \in (0, \varepsilon)^d$ we consider the collection of cubes (C_i) :

$$C_i = i\varepsilon - h + (0, \varepsilon)^d, \text{ for all } i \in \{0, \dots, m-1\}^d.$$

Then, we define

$$\begin{aligned} \{V_i, i \in \{1, \dots, n\}\} &= \{V \cap C_i, i \in \{0, \dots, m-1\}^d\} \\ &\cup \{W \cap C_i, i \in \{0, \dots, m-1\}^d\} \end{aligned}$$

where V and W correspond to u as in Lemma 4.3.1. By construction, the V_i satisfy $\text{diam}(V_i) \leq \varepsilon\sqrt{d}$, as well as points (i) and (iii) above. In order that point (ii) be satisfied as well, we choose h carefully. For any $k \in \{1, \dots, d\}$, the mean value Theorem indicates the existence of $h_k \in (0, \varepsilon)$ such that

$$\sum_{i=0}^{m+1} \mathcal{L}^{d-1}(\{x \in V \cup W : x \cdot e_k = \varepsilon i - h_k\}) \leq \frac{\delta}{\varepsilon},$$

as the integral of the left-hand side over $h_k \in (0, \varepsilon)$ amounts to δ , the volume of $V \cup W$. Letting $h = (h_1, \dots, h_d)$, we get

$$\sum_{i=1}^n \mathcal{F}^{r,-}(v_i) - 2d \frac{\delta}{\varepsilon} \sup_{\mathbf{n} \in S^{d-1}} \tau^q(\mathbf{n}) \leq \mathcal{F}^{r,-}(v) + \mathcal{F}^{r,-}(w)$$

and the claim follows thanks to Lemma 4.3.1. \square

In the next lemma, we show that local Winterbottom crystals (Wulff crystals for $\mathcal{F}^{r,-}$) have a positive volume. An essential implication of this fact is the isoperimetric inequality

$$\mathcal{F}(u) \geq d\mathcal{L}^d(\mathcal{W})^{1/d}\mathcal{L}^d(U)^{1-1/d}, \quad \text{for all } u = \chi_U \in \text{BV}, \quad (4.34)$$

see [58].

LEMMA 4.3.3. *Assume that $\beta > \hat{\beta}_c$. For all $0 < \varepsilon \leq d(0, (\mathcal{W}^q)^c)^d$, there is $\delta > 0$ such that, for all $\mathbf{n}_0 \in S^{d-1}$ and $\tau : S^{d-1} \rightarrow \mathbb{R}$ with*

$$\begin{aligned} \tau(\mathbf{n}) &= \tau^q(\mathbf{n}) && \text{if } \mathbf{n} \cdot \mathbf{n}_0 < 1 - \delta \\ \tau(\mathbf{n}) &\geq -\tau^q(\mathbf{n}_0) + \varepsilon && \text{else,} \end{aligned}$$

the Wulff crystal \mathcal{W} corresponding to τ has a volume at least

$$\mathcal{L}^d(\mathcal{W}) \geq c_d \varepsilon^d.$$

PROOF. We recall that the Wulff crystal corresponding to τ is

$$\mathcal{W} = \{x \in \mathbb{R}^d : x \cdot \mathbf{n} \leq \tau(\mathbf{n}), \forall \mathbf{n} \in S^{d-1}\}$$

and that \mathcal{W}^q , the Wulff crystal for τ^q , characterizes τ^q in the sense that

$$\tau^q(\mathbf{n}) = \sup_{x \in \mathcal{W}^q} x \cdot \mathbf{n}, \quad \forall \mathbf{n} \in S^{d-1}.$$

Since \mathcal{W}^q is a compact set, for any $\mathbf{n}_0 \in S^{d-1}$ there is $x_0 \in \mathcal{W}^q$ that satisfies $x_0 \cdot (-\mathbf{n}_0) = \tau^q(-\mathbf{n}_0) = \tau^q(\mathbf{n}_0)$. Because τ^q (and thus \mathcal{W}^q) has the same symmetries as the lattice \mathbb{Z}^d , all the transformations of x_0 by symmetries around a canonical hyperplane containing the origin also belong to \mathcal{W}^q . Hence, there is a d -dimensional cube C_0 centered at the origin, of which x_0 is a vertex, that is contained in \mathcal{W}^q .

Then, we consider

$$\delta_{\beta, \varepsilon} = \sup \left\{ \delta \in (0, 1) : \begin{array}{l} \forall \mathbf{n}, \mathbf{n}_0 \in S^{d-1} \text{ with } \mathbf{n} \cdot \mathbf{n}_0 \geq 1 - \delta : \\ \tau^q(\mathbf{n}) \leq \tau^q(\mathbf{n}_0) + \varepsilon/3 \text{ and} \\ x \cdot \mathbf{n} \leq x \cdot \mathbf{n}_0 + \varepsilon/3, \forall x \in \mathcal{W}^q \end{array} \right\}. \quad (4.35)$$

For any $\varepsilon > 0$, $\delta = \delta_{\beta, \varepsilon}$ is positive because, on the one hand, $\mathbf{n} \mapsto \tau^q(\mathbf{n})$ is uniformly continuous on the compact S^{d-1} , and on the second hand, \mathcal{W}^q is bounded. We now consider τ that satisfies the required conditions and prove the inclusion

$$C_0 \cap B(x_0, \varepsilon/3) \subset \mathcal{W}. \quad (4.36)$$

To do so, we fix $x \in C_0 \cap B(x_0, \varepsilon/3)$ and $\mathbf{n} \in S^{d-1}$ and check the inequality $x \cdot \mathbf{n} \leq \tau(\mathbf{n})$. If $\mathbf{n} \cdot \mathbf{n}_0 < 1 - \delta$, this follows immediately from the equality $\tau(\mathbf{n}) = \tau^q(\mathbf{n})$ and the inclusion $C_0 \subset \mathcal{W}$. In the opposite case $\mathbf{n} \cdot \mathbf{n}_0 \geq 1 - \delta$,

we write

$$\begin{aligned}
x \cdot \mathbf{n} &\leq x_0 \cdot \mathbf{n} + \varepsilon/3 \\
&\leq x_0 \cdot \mathbf{n}_0 + 2\varepsilon/3 \\
&= -\tau^q(\mathbf{n}_0) + 2\varepsilon/3 \\
&\leq -\tau^q(\mathbf{n}) + \varepsilon \\
&\leq \tau(\mathbf{n})
\end{aligned}$$

and the proof of (4.36) is over. If $\varepsilon > 0$ is smaller than the distance $d(0, (\mathcal{W}^q)^c)$, (4.36) implies immediately

$$\mathcal{L}^d(\mathcal{W}) \geq c_d \varepsilon^d.$$

□

Now we conclude the proof of Theorem 4.1.2:

PROOF. (Theorem 4.1.2). We call

$$\varepsilon = \min \left(d(0, (\mathcal{W}^q)^c), \inf_{x \in \partial^* u_0} (\tau^q(\mathbf{n}_x^{u_0}) - \tau^r(x)) \right)$$

which is positive thanks to the assumptions in Theorem 4.1.2. We consider $\delta > 0$ corresponding to ε in Lemma 4.3.3. Since we assumed that $\partial^* u_0$ is \mathcal{C}^1 , there is $\xi > 0$ such that, for all $x, y \in \partial^* u_0$ one has

$$d(x, y) \leq \xi \Rightarrow \mathbf{n}_x^{u_0} \cdot \mathbf{n}_y^{u_0} > 1 - \delta.$$

Consider now $u \in \text{BV}$ at L^1 -distance $2\eta > 0$ from u_0 . According to Lemma 4.3.2 there is a finite collection $(V_i)_{i=1 \dots n}$ of Borel subsets of \mathbb{R}^d with $\text{diam}(V_i) \leq \xi$, such that

$$\sum_{i=1}^n \mathcal{L}^d(V_i) = \eta$$

and

$$\mathcal{F}^r(u) - \mathcal{F}^r(u_0) \geq \sum_{i=1}^n \mathcal{F}^{r,-}(\chi_{V_i}) - c_\xi \eta. \quad (4.37)$$

The isoperimetric inequality (4.34) together with Lemma 4.3.3 imply in turn that

$$\mathcal{F}^{r,-}(\chi_{V_i}) \geq d (c_d \varepsilon^d)^{1/d} \mathcal{L}^d(V_i)^{1-1/d} \quad (4.38)$$

because the surface tension

$$\tau(\mathbf{n}) = \begin{cases} \inf_{x \in \partial^* u_0 \cap V_i: \mathbf{n}_x^{u_0} = \mathbf{n}} \tau^r(x) & \text{if } \mathbf{n}_x^{u_0} = \mathbf{n}, \text{ for some } x \in \partial^* u_0 \cap V_i \\ \tau^q(\mathbf{n}) & \text{else} \end{cases}$$

satisfies the assumptions of Lemma 4.3.3 and gives a surface energy $\mathcal{F}(\chi_{V_i}) \leq \mathcal{F}^{r,-}(\chi_{V_i})$. Now, if we combine (4.37) and (4.38) it appears that

$$\begin{aligned} \mathcal{F}^r(u) - \mathcal{F}^r(u_0) &\geq d(c_d \varepsilon^d)^{1/d} \sum_{i=1}^n \eta_i^{1-1/d} - c_\xi \eta \\ &\geq d(c_d \varepsilon^d)^{1/d} \eta^{1-1/d} - c_\xi \eta \end{aligned}$$

which is strictly positive for $\eta > 0$ small enough, and we have proved that $\mathcal{K}_{\text{disc}}^r(u_0) > 0$ under the given conditions. \square

4.3.1.2. *Additional cost at low temperatures.* Here we give the proof of Proposition 4.1.3. It is based on the following remarks:

- (i) For any $\tau > 0$, any $\beta \geq 0$ the cost for reducing the surface tension to τ is not larger than the cost for the J -disconnection (leading to $\tau^J = 0$), which is finite as $\mathbb{P}(J_e = 0) > 0$. In other words, for any u_0 we have

$$\sup_{\beta \geq 0} \sup_{\tau^r: (u_0, \tau^r) \in \text{IC}} \mathcal{I}^r(u_0) < \infty.$$

- (ii) On the other hand, as $\mathbb{P}(J_e > 0) > p_c(d)$ the surface tension τ^q is greater than $C\beta$ for $C > 0$, for large β and this leads to a additional cost $\mathcal{K}_{\text{disc}}^r(u_0)$ proportional to β .

PROOF. (Proposition 4.1.3). Consider the initial configuration (u_0, τ^r) determined by

$$u_0 = \chi_{B(z_0, 1/4)} \quad \text{and} \quad \tau^r(x) = 1, \forall x \in \partial^* u_0$$

where $z_0 = (1/2, \dots, 1/2)$. It is immediate that

$$\mathcal{I}^r(u_0) \leq c_d \sup_{\mathbf{n} \in S^{d-1}} \tau^{\text{perc}}(\mathbf{n}), \quad \forall \beta \geq 0$$

where $\tau^{\text{perc}}(\mathbf{n})$ is the (finite) value of surface tension for bond percolation on \mathbb{Z}^d with parameter $\mathbb{P}(J_e > 0) < 1$. As well, the initial cost $\mathcal{F}^r(u_0)$ of u_0 is bounded and does not depend on β .

Now we show that $\mathcal{K}^r(u_0) \geq c\beta$ for some $c > 0$, for large β . According to Proposition 2.3.6 there is $C > 0$ such that $\tau^q(\mathbf{n}) \geq C\beta$ for large β , uniformly over $\mathbf{n} \in S^{d-1}$. This implies that $(u_0, \tau^r) \in \text{IC}$ for large enough β . We take then $\varepsilon = C\beta/2$ and apply Lemma 4.3.3 in order to choose $\delta > 0$ that does not depend on β (remark that $\delta_{\beta, \varepsilon}$ defined at (4.35) satisfies $\liminf_{\beta \rightarrow \infty} \delta_{\beta, \varepsilon} > 0$ in view of Proposition 2.3.6). Then we fix $\xi > 0$ depending on δ as in the proof of Theorem 4.1.2, and obtain

$$\mathcal{K}^r(u_0) \geq dc_d^{1/d} C\beta/2\eta^{1-1/d} - c\eta$$

for all $\eta \leq \|u_0 - \mathbf{1}\|_{L^1}/2$. The claim follows if we let $\beta \rightarrow \infty$. \square

4.3.2. Continuous evolution and continuous separation. Here we prove Theorem 4.1.4, that is: the additional cost can be computed on continuous evolution, that detach their boundary in a continuous way from the initial position.

The inequality $\mathcal{K}^r(u_0) \geq \mathcal{K}_{\text{disc}}^r(u_0)$ is clear since the set $\mathcal{E}(u_0)$ is more restrictive. We prove the reverse inequality with the help of an *interpolation*: given an evolution $v \in \mathcal{C}_{\infty, \varepsilon}^k$ (see (4.12)) we interpolate from v a continuous evolution v' with continuous separation from $\partial^* u_0$, at the price of a small increase in the maximal cost, negligible as $\varepsilon \rightarrow 0$ (and uniform over v):

$$v' \in \mathcal{E}(u_0): v'_{i/k} = v_i \quad \text{and} \quad \sup_{t \in [0,1]} \mathcal{F}^r(v'_t) \leq \max_{i=0 \dots k} \mathcal{F}^r(v_i) + o_{\varepsilon \rightarrow 0}(1).$$

The next lemma is one of the keys to the proof of Theorem 4.1.4.

LEMMA 4.3.4. *Let $(u_0, \tau^r) \in \text{IC}$ and $\delta > 0$. For any Borel set $\Delta \subset [0, 1]^d$ with volume $\mathcal{L}^d(\Delta) \leq \delta$, there exists a collection of measurable sets $U = (U_t)_{t \in \mathbb{R}}$ such that:*

(i) U_t is a non-decreasing function of t with

$$\lim_{t \rightarrow -\infty} U_t = \emptyset \quad \text{and} \quad \lim_{t \rightarrow +\infty} U_t = \mathcal{T}$$

where \mathcal{T} is the tube $\mathcal{T} = [0, 1]^d \times \mathbb{R}$.

- (ii) The function $t \mapsto U_t - t\mathbf{e}_d$ is 1-periodic.
- (iii) The volume $t \mapsto \mathcal{L}^d(U_t \cap [0, 1]^d)$ is a continuous function of t
- (iv) The area $t \mapsto \mathcal{H}^{d-1}(U_t \cap \partial^* u_0)$ is a continuous function of t
- (v) The portion of the boundary of U_t that intersects $\Delta + \mathbb{Z}\mathbf{e}_d$ in $\overset{\circ}{\mathcal{T}}$ has a small area:

$$\sup_{t \in [0,1]} \mathcal{H}^{d-1} \left(\partial U_t \cap (\Delta + \mathbb{Z}\mathbf{e}_d) \cap \overset{\circ}{\mathcal{T}} \right) \leq 7\sqrt{\delta}$$

for $\delta > 0$ small enough.

PROOF. The reader is invited to consult Figure 4 for an illustration of the proof. To begin with, we partition $[0, 1]^d$ in horizontal slabs: let $n = \lfloor 1/\sqrt{\delta} \rfloor$ and call

$$A_i = \left\{ x \in [0, 1]^d : \frac{i-1}{n} \leq x \cdot \mathbf{e}_d \leq \frac{i}{n} \right\}$$

for $i \in \{1, \dots, n\}$. Because each slab has a volume at least $\sqrt{\delta}$, for each $i \in \{0, \dots, n-1\}$ there exists $z_i \in (i/n, (i+1)/n)$ such that the density $\mathcal{L}^{d-1}(\Delta \cap \{z : z \cdot \mathbf{e}_d = z_i\})$ of Δ at height z_i is not larger than $\sqrt{\delta}$. We extend then the definition of z_i by periodicity, letting

$$z_{i+n} = 1 + z_i, \forall i \in \mathbb{Z}.$$

Then, we let $\mathbf{n} = \cos \alpha \mathbf{e}_1 + \sin \alpha \mathbf{e}_d$ for some $\alpha \in [0, \pi/3]$ such that $\partial^* u_0$ has no face orthogonal to \mathbf{n} and define

$$U_t = \left\{ x \in \mathcal{T} : \begin{array}{l} x \cdot \mathbf{e}_d \leq z_{[nt]} \text{ or} \\ x \cdot \mathbf{e}_d \leq z_{[nt]} \text{ and } x \cdot \mathbf{n} \leq l_t \end{array} \right\}, \quad \forall t \in \mathbb{R}$$

where l is the piecewise linear function defined by: $\forall i \in \mathbb{Z}$,

$$\begin{aligned} l_{(i/n)^+} &= z_i \mathbf{e}_d \cdot \mathbf{n} \\ l_{(i+1)/n} &= (z_{i+1} \mathbf{e}_d + \mathbf{e}_1) \cdot \mathbf{n} \end{aligned}$$

and l linear on each interval $(i/n, (i+1)/n]$. The set U_t evolves as follows: between times i/n and $(i+1)/n$, U_t invades the region $\{x \in [0, 1]^d : z_i \leq x \cdot \mathbf{e}_d \leq z_{i+1}\}$ by the mean of a frontline normal to \mathbf{n} , that moves at a constant speed.

It is immediate from the definition that $U_t - t\mathbf{e}_d$ is 1-periodic and that U_t increases continuously in volume. The \mathcal{H}^{d-1} measure of $U_t \cap \partial^* u_0$ is non-decreasing and the assumption on \mathbf{n} ensures that it increases continuously. We consider at last the portion of the surface of U_t in \mathcal{T} that might intersect $\Delta + \mathbb{Z}\mathbf{e}_d$. We just have to take into account the upper portion of ∂U_t , made of the two planes at height z_i, z_{i+1} , and of a portion of plane normal to \mathbf{n} . Recall that the z_i have been chosen so that the density of $\Delta + \mathbb{Z}\mathbf{e}_d$ at height z_i does not exceed $\sqrt{\delta}$. Similarly, because $\alpha \leq \pi/3$, the piece of plane orthogonal to \mathbf{n} has a surface at most $4/n \leq 5/\sqrt{\delta}$ for $\delta > 0$ small enough. The claim follows. \square

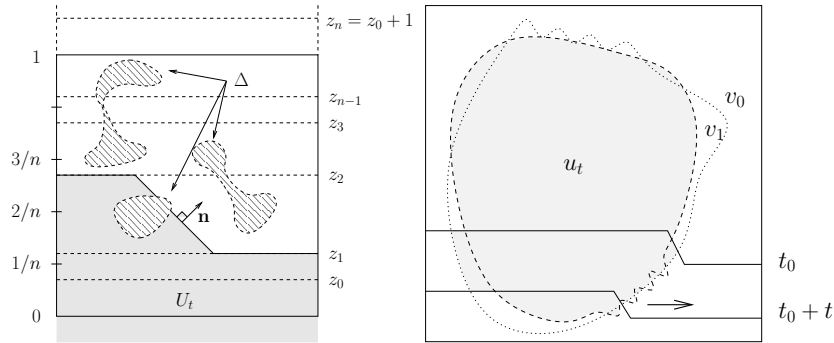

FIGURE 4. The construction of U_t , and the interpolation u_t between v_0 and v_1 .

The second key argument is periodicity: as seen on Figure 4, the interpolation between v_0 and v_1 has to choose first the region where the cost of v_1 is smaller than that of v_0 – which means that we have to fix t_0 carefully.

PROOF. (Theorem 4.1.4). Let $\delta > 0$. There exists $\varepsilon \in (0, 2\delta]$ and $k \in \mathbb{N}$, together with $v \in \mathcal{C}_{\infty, \varepsilon}^k$, such that

$$\max_{i=0 \dots k} \mathcal{F}^r(v) \leq \mathcal{K}_{\text{disc}}^r(u_0) + \delta.$$

Starting from v , we construct a continuous evolution $u \in \mathcal{E}(u_0)$ that has a maximal cost not much larger than that of v . It is enough to do the interpolation between two successive v_i , as one can paste together the successive interpolations to deduce the continuous evolution u .

Hence we consider $v_0, v_1 \in \text{BV}$ and assume that $\|v_0 - v_1\|_{L^1} \leq 2\delta$. We let

$$\Delta = \{x : v_0(x) \neq v_1(x)\}$$

which has a volume at most δ . Lemma 4.3.4 applies and there is U_t with properties (i)-(v). Given $t_0 \in \mathbb{R}$ and $t \in [0, 1]$ we let

$$G_{t_0, t} = \{x \in [0, 1]^d : \exists k \in \mathbb{Z} : x + k\mathbf{e}_d \in U_{t_0+t} \setminus U_{t_0}\},$$

for any t_0 the set $G_{t_0, t}$ increases continuously from the empty to the full set in $[0, 1]^d$, makes the surface $\mathcal{H}^{d-1}(\partial^* u_0 \cap G_{t_0, t})$ a continuous function of t , and the area

$$\mathcal{H}^{d-1}(\partial G_{t_0, t} \cap \Delta \cap \overset{\circ}{T}) \leq 14\sqrt{\delta}$$

small, for $\delta > 0$ small enough. Now we define

$$u_t(x) = \begin{cases} v_0(x) & \text{if } x \notin G_{t_0, t} \\ v_1(x) & \text{if } x \in G_{t_0, t}. \end{cases}$$

The cost of u_t decomposes in the following way: it is the sum of the cost of v_0 in $G_{t_0, t}^c$, of the cost of v_1 in $G_{t_0, t}$, and of the cost of $\partial G_{t_0, t}$ in Δ . In other words,

$$\mathcal{F}^r(u_t) \leq \mathcal{F}^r(v_0) - \mathcal{F}_{G_{t_0, t}}^r(v_0) + \mathcal{F}_{G_{t_0, t}}^r(v_1) + 14\sqrt{\delta} \quad (4.39)$$

where $\mathcal{F}_E^r(u)$ stands for

$$\mathcal{F}_E^r(u) = \int_{\partial^* u \cap \partial^* u_0 \cap E} \tau^r d\mathcal{H}^{d-1} + \int_{(\partial^* u \setminus \partial^* u_0) \cap E} \tau^q(\mathbf{n}^u) d\mathcal{H}^{d-1}.$$

It is clear that the initial cost of u_t is $\mathcal{F}^r(v_0)$ and that its final cost is $\mathcal{F}^r(v_1)$. Yet in the interval $(0, 1)$ it could be that $G_{t_0, t}$ selects first the region where v_1 has a larger cost than v_0 , leading to a maximal cost larger than expected. We rule out this possibility with an appropriate choice for t_0 – see Figure 4 for an illustration of the discussion below.

For $t_0 \in \mathbb{R}$ and $t \in [0, 1)$ we consider

$$f(t_0, t) = \mathcal{F}_{G_{t_0, t}}^r(v_1) - \mathcal{F}_{G_{t_0, t}}^r(v_0).$$

Our aim is to extend f to arbitrary values of $t \in \mathbb{R}^+$. For $k \in \mathbb{Z}$, we denote by v_i^k the translated of v_i by $k\mathbf{e}_d$, then for any $t_0 \in \mathbb{R}$ and $t \in [0, 1)$ we have

$$f(t_0, t) = \sum_{k \in \mathbb{Z}} \left(\mathcal{F}_{U_{t_0+t} \setminus U_{t_0}}^r(v_1^k) - \mathcal{F}_{U_{t_0+t} \setminus U_{t_0}}^r(v_0^k) \right)$$

from the definition of $G_{t_0,t}$. The latter formula permits to extend f to $\mathbb{R} \times \mathbb{R}^+$ and puts in evidence the existence of a function $g : \mathbb{R} \rightarrow \mathbb{R}$ such that

$$f(t_0, t) = g(t_0 + t) - g(t_0), \quad \forall (t_0, t) \in \mathbb{R} \times \mathbb{R}^+.$$

This function is, apart from a linear correction, 1-periodic: for all $t \in \mathbb{R}$,

$$g(t + 1) = g(t) + \mathcal{F}^r(v_1) - \mathcal{F}^r(v_0),$$

in other words,

$$g(t) = h(t) + t(\mathcal{F}^r(v_1) - \mathcal{F}^r(v_0))$$

where h is a 1-periodic function. Now we fix t_0 such that

$$h(t_0) \geq \sup_t h(t) - \sqrt{\delta},$$

it is immediate that

$$\begin{aligned} f(t_0, t) &= g(t_0 + t) - g(t_0) \\ &= h(t_0 + t) - h(t_0) + t(\mathcal{F}^r(v_1) - \mathcal{F}^r(v_0)) \\ &\leq t(\mathcal{F}^r(v_1) - \mathcal{F}^r(v_0)) + \sqrt{\delta}. \end{aligned}$$

Reporting into (4.39) we conclude that u_t is a satisfactory interpolation between v_0 and v_1 : provided that $\delta > 0$ is small enough,

$$\mathcal{F}^r(u_t) \leq (1 - t)\mathcal{F}^r(v_0) + t\mathcal{F}^r(v_1) + 15\sqrt{\delta}, \quad \forall t \in [0, 1].$$

□

4.3.3. Additional cost on two examples. Here we give the value of the additional cost on two simple (bidimensional) examples: the circle in the case of isotropic surface tension, the square in the case of square Wulff crystal.

4.3.3.1. *Additional cost in the isotropic case.* Below we consider the case of the circle, for an isotropic surface tension.

LEMMA 4.3.5. *Assume $d = 2$, $\tau^q(\mathbf{n}) = 1$ for all $\mathbf{n} \in S^{d-1}$ and consider*

$$u_0 = \chi_B \quad \text{and} \quad \tau^r(x) = \lambda, \forall x \in \partial^* u_0$$

where B is the disk of radius $r < 1/2$ centered at $(1/2, 1/2)$, and $\lambda \in (0, 1)$. Then

$$\mathcal{K}^r(u_0) = 2r \left[\sqrt{1 - \lambda^2} - \lambda \cos \lambda \right].$$

An optimal continuous evolution in this setting is illustrated on Figure 5.

PROOF. In order to simplify the notation we will consider $r = 1/2$. The upper bound

$$\mathcal{K}^r(u_0) \leq \sup_{\theta \in [0, \pi]} (\sin \theta - \lambda \theta)$$

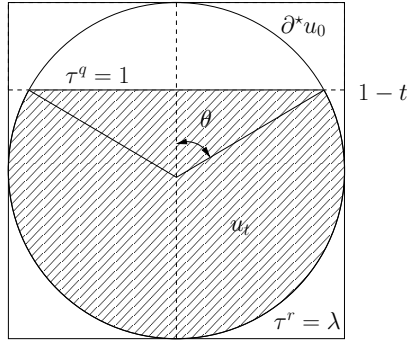

FIGURE 5. A continuous evolution of minimal cost.

is immediate if one considers the continuous evolution $(u_t)_{t \in [0,1]}$ defined by

$$u_t(x) = \begin{cases} -1 & \text{if } x \in B \text{ and } x \cdot e_2 \leq 1-t \\ 1 & \text{else} \end{cases}$$

and θ satisfying $1-t = 1/2 + \sin \theta$, as illustrated on Figure 5. The lower bound is scarcely more difficult to establish: given $(u_t)_{t \in [0,1]} \in \mathcal{E}(u_0)$ a continuous evolution with continuous detachment, there is $t \in (0,1)$ such that

$$\mathcal{H}^1(\partial^* u_0 \setminus \partial^* u_t) = \text{acos } \lambda.$$

Optimizing the droplets of u_t as in Figure 6 – we replace each portion of the interface not in $\partial^* u_0$ with a segment – we obtain a profile u'_t with a lower cost, yet it still has the same contact length $\text{acos } \lambda$ with $\partial^* u_0$. By isotropy of surface tension it is possible to aggregate the droplets together and obtain u''_t with a unique droplet and a lower cost, preserving again the length of contact. At last, inverting the order of the segments and arcs and optimizing again we see that the profile of lower cost that satisfies $\mathcal{H}^1(\partial^* u_0 \setminus \partial^* u) = \text{acos } \lambda$ coincides, apart from a rotation, with the profiles considered in the upper bound. The claim follows. \square

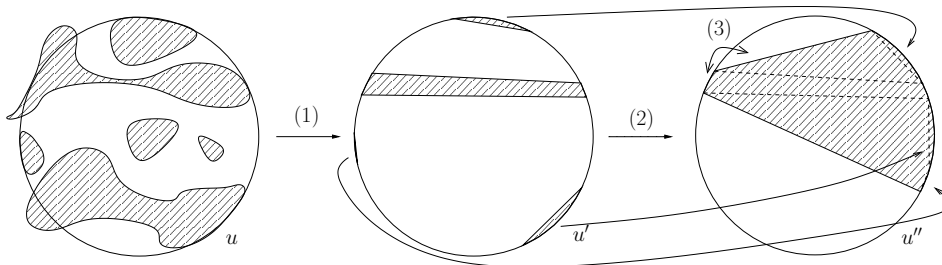

FIGURE 6. Reduction of u to a portion of disk in three steps. The surface energy decreases, the length of contact is preserved.

4.3.3.2. *Additional cost for the cubic Wulff crystal.* In this paragraph we state two results: first, we calculate the additional cost for \mathcal{W}^q square and u_0 corresponding to a square. Then, we remark that in that case at least our bound on the relaxation is better than the one obtained by an optimization over the volume of the relaxing droplet.

LEMMA 4.3.6. *Assume $d = 2$, $\tau^q(\mathbf{n}) = \|\mathbf{n}\|_1$ for all $\mathbf{n} \in S^{d-1}$ and*

$$u_0 = \chi_C \quad \text{and} \quad \tau^r(x) = \lambda, \forall x \in \partial^* u_0$$

where $C = [1/2 - r, 1/2 + r]^2$, $r < 1/2$ and $\lambda \in [0, 1]$. Then, we have

$$\mathcal{K}^r(u_0) = 2r[1 - \lambda].$$

PROOF. Again we consider $r = 1/2$ in order to simplify the notations. The upper bound on the additional cost is immediate considering $u_t = \chi_{\{x \cdot \mathbf{e}_2 \leq 1-t\}}$. For the lower bound we need a finer analysis. First, it is a consequence of the assumption on τ^q that for any open, connected $U \subset \mathbb{R}^2$ with extension h^1, h^2 in the canonical directions, that is:

$$h(k) = \sup_{x \in U} x \cdot \mathbf{e}_k - \inf_{x \in U} x \cdot \mathbf{e}_k,$$

we have

$$\mathcal{F}^q(\chi_U) \geq 2h^1 + 2h^2.$$

Then, we decompose a profile configuration u into its droplets $(U_i)_{i \geq 0}$. We call h_i^1, h_i^2 the extension of U_i in the canonical directions and let l_i the length of contact between $\partial^* \chi_{U_i}$ and $\partial^* u_0$, so that, for all i :

$$\mathcal{F}^r(\chi_{U_i}) \geq 2h^1 + 2h^2 - (1 - \lambda)l_i$$

If a droplet U_i touches two opposite faces of $\partial^* u_0$, say $h^1 = 1$, then its extension in the orthogonal direction is at least $h^2 \geq (l_i - 1)/2$ and the inequality

$$\mathcal{F}^r(\chi_{U_i}) \geq 1 + \lambda l_i$$

follows. If on the opposite the droplet is in contact with at most two adjacent sides of $\partial^* u_0$, we have $h^1 + h^2 \geq l_i$ and hence

$$\mathcal{F}^r(\chi_{U_i}) \geq (1 + \lambda)l_i.$$

Assume now that the total length of contact is 3, i.e. that $\sum_i l_i = 3$. A consequence of the former lower bounds is that, whether or not some droplet touches two opposite faces, the cost of u is at least $\mathcal{F}^r(u) \geq 1 + 3\lambda$. The claim follows. \square

We conclude the present section with a comparison between the bottleneck due to the positivity of $\mathcal{K}^r(u_0)$ and the one due to the continuous evolution of the magnetization:

LEMMA 4.3.7. *In the settings of the former lemma, with furthermore $\lambda \in (0, 1)$, we have*

$$\mathcal{K}^r(u_0) > \sup_{m \in [-1, 1]} \inf_{u \in \text{BV}: \int_{[0, 1]^d} u = m} \mathcal{F}^r(u) - \mathcal{F}^r(u_0).$$

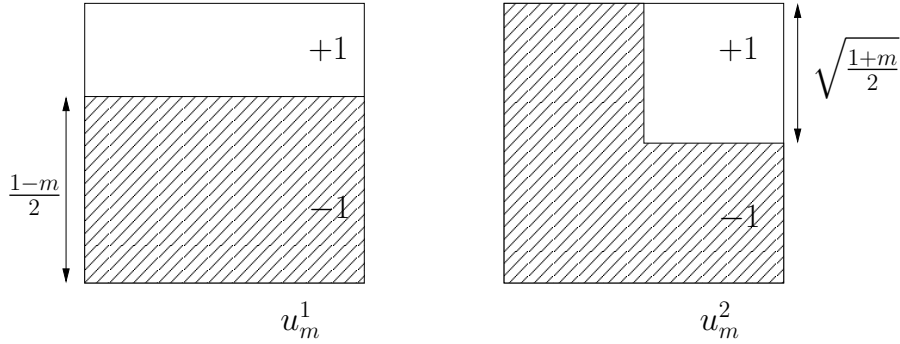

FIGURE 7. The two profiles u_m^1 and u_m^2 : for $m \simeq 1$ the first one is better, for $m \simeq -1$ the second one has a smaller cost.

PROOF. We provide an upper bound for the right hand term, considering for a given m the two profiles (see Figure 7)

$$u_m^1 = \begin{cases} -1 & \text{if } x \in [0, 1]^d \text{ and } x \cdot e_2 \leq \frac{1-m}{2} \\ 1 & \text{else} \end{cases}$$

and

$$u_m^2 = \begin{cases} -1 & \text{if } x \in [0, 1]^d \text{ and } \min(x \cdot e_1, x \cdot e_2) \leq 1 - \sqrt{\frac{1+m}{2}} \\ 1 & \text{else} \end{cases}$$

that both satisfy the volume constraint $\int_{[0, 1]^d} u = m$. It is immediate that

$$\mathcal{F}^r(u_m^1) = 1 + (2 - m)\lambda \quad \text{and} \quad \mathcal{F}^r(u_m^2) = 4\lambda + 2(1 - \lambda)\sqrt{\frac{1+m}{2}},$$

hence

$$\sup_{m \in [-1, 1]} \inf_{u \in \text{BV}: \int_{[0, 1]^d} u = m} \mathcal{F}^r(u) \leq \sup_{m \in [-1, 1]} \min(\mathcal{F}^r(u_m^1), \mathcal{F}^r(u_m^2)).$$

Note that $\mathcal{F}^r(u_m^1)$ decreases with m while $\mathcal{F}^r(u_m^2)$ increases with m . Because of their extremal values there exists some $m_0 \in (0, 1)$ at which $\mathcal{F}^r(u_{m_0}^1) = \mathcal{F}^r(u_{m_0}^2) = \sup_{m \in [-1, 1]} \min(\mathcal{F}^r(u_m^1), \mathcal{F}^r(u_m^2))$, and since $m_0 < 1$ we have in particular $\mathcal{F}^r(u_{m_0}^1) < \mathcal{F}^r(u_{-1}^1) = 1 + 3\lambda$ which is the maximal cost of an optimal continuous detachment evolution. \square

4.4. Conclusion

Theorem 4.1.1 confirms the prediction of [45] that the average over the media of the autocorrelation decays at most like $t^{-\alpha}$. Hence, the annealed relaxation is much slower than the relaxation in the Griffiths phase [63], and incomparably slower than the conjectured relaxation in the pure Ising model, where the autocorrelation should decay like $e^{-c\sqrt{t}}$ in $d = 2$, e^{-ct} in $d \geq 3$, see [45].

Yet, numerous questions on the dynamics remain open. First of all, the proof of Theorem 4.1.1 is based on unlikely events for the random environment and we would like to study the relaxation under the quenched measure, which is probably quite different from the relaxation described in Theorem 4.1.1. Then, there is the issue of optimality: is the inequality (4.7) an equality? In other words, does the mechanism described in Section 4.2 capture all the factors of metastability?

Much remains to be said as well on the spectral gap associated to the Glauber dynamics. The mechanism presented in this last Chapter can be used to prove upper bound on the spectral gap. Following [63], it is likely that one can also give lower bounds on the spectral gap, and again stands the question of whether these bounds will coincide.

Finally, we believe that the framework developed in this Thesis makes possible the study of some more aspects of the dynamics. In particular, we would like to determine whereas the random media can play the role of a catalyst in the nucleation phenomenon [75].

Bibliographie

- [1] M. Aizenman and D. J. Barsky. Sharpness of the phase transition in percolation models. *Comm. Math. Phys.*, 108(3) :489–526, 1987.
- [2] M. Aizenman, J. Brémont, and J. L. Lebowitz. Percolation of the minority spins in high-dimensional Ising models. *J. Statist. Phys.*, 49(3-4) :859–865, 1987.
- [3] M. Aizenman, J. T. Chayes, L. Chayes, and C. M. Newman. The phase boundary in dilute and random Ising and Potts ferromagnets. *J. Phys. A*, 20(5) :L313–L318, 1987.
- [4] M. Aizenman, J. T. Chayes, L. Chayes, and C. M. Newman. Discontinuity of the magnetization in one-dimensional $1/|x - y|^2$ Ising and Potts models. *J. Statist. Phys.*, 50(1-2) :1–40, 1988.
- [5] M. Aizenman and J. Wehr. Rounding of first-order phase transitions in systems with quenched disorder. *Phys. Rev. Lett.*, 62(21) :2503–2506, 1989.
- [6] K. Alexander, J. T. Chayes, and L. Chayes. The Wulff construction and asymptotics of the finite cluster distribution for two-dimensional Bernoulli percolation. *Comm. Math. Phys.*, 131(1) :1–50, 1990.
- [7] K. S. Alexander. Cube-root boundary fluctuations for droplets in random cluster models. *Comm. Math. Phys.*, 224(3) :733–781, 2001.
- [8] K. S. Alexander, F. Cesi, L. Chayes, C. Maes, and F. Martinelli. Convergence to equilibrium of random Ising models in the Griffiths phase. *J. Statist. Phys.*, 92(3-4) :337–351, 1998.
- [9] L. Ambrosio and A. Braides. Functionals defined on partitions in sets of finite perimeter. II. Semicontinuity, relaxation and homogenization. *J. Math. Pures Appl. (9)*, 69(3) :307–333, 1990.
- [10] L. Ambrosio, N. Fusco, and D. Pallara. *Functions of bounded variation and free discontinuity problems*. Oxford Mathematical Monographs. The Clarendon Press Oxford University Press, New York, 2000.
- [11] M. Biskup, L. Chayes, and R. Kotecký. Critical region for droplet formation in the two-dimensional Ising model. *Comm. Math. Phys.*, 242(1-2) :137–183, 2003.
- [12] T. Bodineau. The Wulff construction in three and more dimensions. *Comm. Math. Phys.*, 207(1) :197–229, 1999.
- [13] T. Bodineau. Slab percolation for the Ising model. *Probab. Theory Related Fields*, 132(1) :83–118, 2005.
- [14] T. Bodineau, D. Ioffe, and Y. Velenik. Rigorous probabilistic analysis of equilibrium crystal shapes. *J. Math. Phys.*, 41(3) :1033–1098, 2000. Probabilistic techniques in equilibrium and nonequilibrium statistical physics.
- [15] D. Boivin. Ergodic theorems for surfaces with minimal random weights. *Ann. Inst. H. Poincaré Probab. Statist.*, 34(5) :567–599, 1998.
- [16] A. Bovier. *Statistical mechanics of disordered systems*. Cambridge Series in Statistical and Probabilistic Mathematics. Cambridge University Press, Cambridge, 2006. A mathematical perspective.

- [17] J. Bricmont, A. El Mellouki, and J. Fröhlich. Random surfaces in statistical mechanics : roughening, rounding, wetting, . . . *J. Statist. Phys.*, 42(5-6) :743–798, 1986.
- [18] J. Bricmont and A. Kupiainen. Phase transition in the 3d random field Ising model. *Comm. Math. Phys.*, 116(4) :539–572, 1988.
- [19] M. Campanino and D. Ioffe. Ornstein-Zernike theory for the Bernoulli bond percolation on \mathbb{Z}^d . *Ann. Probab.*, 30(2) :652–682, 2002.
- [20] M. Campanino, D. Ioffe, and Y. Velenik. Ornstein-Zernike theory for finite range Ising models above T_c . *Probab. Theory Related Fields*, 125(3) :305–349, 2003.
- [21] P. Carmona, F. Guerra, Y. Hu, and O. Menjane. Strong disorder for a certain class of directed polymers in a random environment. *J. Theoret. Probab.*, 19(1) :134–151, 2006.
- [22] P. Carmona and Y. Hu. On the partition function of a directed polymer in a Gaussian random environment. *Probab. Theory Related Fields*, 124(3) :431–457, 2002.
- [23] R. Cerf. Large deviations for three dimensional supercritical percolation. *Astérisque*, (267) :vi+177, 2000.
- [24] R. Cerf. *The Wulff crystal in Ising and percolation models*, volume 1878 of *Lecture Notes in Mathematics*. Springer-Verlag, Berlin, 2006. Lectures from the 34th Summer School on Probability Theory held in Saint-Flour, July 6–24, 2004, With a foreword by Jean Picard.
- [25] R. Cerf and A. Pisztor. On the Wulff crystal in the Ising model. *Ann. Probab.*, 28(3) :947–1017, 2000.
- [26] R. Cerf and A. Pisztor. Phase coexistence in Ising, Potts and percolation models. *Ann. Inst. H. Poincaré Probab. Statist.*, 37(6) :643–724, 2001.
- [27] D. Chafaï. Inégalités de Poincaré et de Gross pour les mesures de Bernoulli, de Poisson, et de Gauss. *preprint*, 2005.
- [28] J. T. Chayes, L. Chayes, and J. Fröhlich. The low-temperature behavior of disordered magnets. *Comm. Math. Phys.*, 100(3) :399–437, 1985.
- [29] F. Comets, T. Shiga, and N. Yoshida. Directed polymers in a random environment : path localization and strong disorder. *Bernoulli*, 9(4) :705–723, 2003.
- [30] F. Comets, T. Shiga, and N. Yoshida. Probabilistic analysis of directed polymers in a random environment : a review. In *Stochastic analysis on large scale interacting systems*, volume 39 of *Adv. Stud. Pure Math.*, pages 115–142. Math. Soc. Japan, Tokyo, 2004.
- [31] F. Comets and V. Vargas. Majorizing multiplicative cascades for directed polymers in random media. *ALEA Lat. Am. J. Probab. Math. Stat.*, 2 :267–277 (electronic), 2006.
- [32] A. Dembo and O. Zeitouni. *Large deviations techniques and applications*, volume 38 of *Applications of Mathematics (New York)*. Springer-Verlag, New York, second edition, 1998.
- [33] J.-D. Deuschel and A. Pisztor. Surface order large deviations for high-density percolation. *Probab. Theory Related Fields*, 104(4) :467–482, 1996.
- [34] R. Dobrushin and O. Hryniv. Fluctuations of the phase boundary in the 2D Ising ferromagnet. *Comm. Math. Phys.*, 189(2) :395–445, 1997.
- [35] R. Dobrushin, R. Kotecký, and S. Shlosman. *Wulff construction : A global shape from local interaction*, volume 104 of *Translations of Mathematical Monographs*. American Mathematical Society, Providence, RI, 1992.
- [36] H. Federer. *Geometric measure theory*. Die Grundlehren der mathematischen Wissenschaften, Band 153. Springer-Verlag, New York, 1969.
- [37] I. Fonseca. The Wulff theorem revisited. *Proc. Roy. Soc. London Ser. A*, 432(1884) :125–145, 1991.

- [38] I. Fonseca and S. Müller. A uniqueness proof for the Wulff theorem. *Proc. Roy. Soc. Edinburgh Sect. A*, 119(1-2) :125–136, 1991.
- [39] T. Funaki. Stochastic interface models. In *Lectures on probability theory and statistics*, volume 1869 of *Lecture Notes in Math.*, pages 103–274. Springer, Berlin, 2005.
- [40] H.-O. Georgii, O. Häggström, and C. Maes. The random geometry of equilibrium phases. In *Phase transitions and critical phenomena*, volume 18, pages 1–142. Academic Press, San Diego, CA, 2001.
- [41] R. Griffiths. Non-analytic behaviour above the critical point in a random Ising ferromagnet. *Phys. Rev. Lett.*, 23(1) :17–19, 1969.
- [42] G. Grimmett. The stochastic random-cluster process and the uniqueness of random-cluster measures. *Ann. Probab.*, 23(4) :1461–1510, 1995.
- [43] G. Grimmett. *The random-cluster model*, volume 333 of *Grundlehren der Mathematischen Wissenschaften [Fundamental Principles of Mathematical Sciences]*. Springer-Verlag, Berlin, 2006.
- [44] G. Grimmett and J. M. Marstrand. The supercritical phase of percolation is well behaved. *Proc. Roy. Soc. London Ser. A*, 430(1879) :439–457, 1990.
- [45] D. A. Huse and D. S. Fisher. Dynamics of droplet fluctuations in pure and random Ising systems. *Phys. Rev. B*, 35(13) :6841–6846, 1987.
- [46] D. A. Huse and C. L. H. Henley. Pinning and roughening of domain walls in Ising systems due to random impurities. *Phys. Rev. Lett.*, 54(25) :2708–2711, 1985.
- [47] J. Imry. Griffiths singularity in finite macroscopically large dilute Ising models. *Phys. Rev. B*, 15(9) :4448–4450, 1977.
- [48] Y. Imry and S.-K. Ma. Random-field instability of the ordered state of continuous symmetry. *Phys. Rev. Lett.*, 35(21) :1399–1401, Nov 1975.
- [49] D. Ioffe. Large deviations for the 2D Ising model : a lower bound without cluster expansions. *J. Statist. Phys.*, 74(1-2) :411–432, 1994.
- [50] D. Ioffe. Exact large deviation bounds up to T_c for the Ising model in two dimensions. *Probab. Theory Related Fields*, 102(3) :313–330, 1995.
- [51] D. Ioffe and R. H. Schonmann. Dobrushin-Kotecký-Shlosman theorem up to the critical temperature. *Comm. Math. Phys.*, 199(1) :117–167, 1998.
- [52] E. Ising. Beitrag zur theorie des ferromagnetismus. *Z. Phys.*, 31, 1925.
- [53] K. Johansson. Shape fluctuations and random matrices. *Comm. Math. Phys.*, 209(2) :437–476, 2000.
- [54] H. Kesten. Aspects of first passage percolation. In *École d'été de probabilités de Saint-Flour, XIV—1984*, volume 1180 of *Lecture Notes in Math.*, pages 125–264. Springer, Berlin, 1986.
- [55] H. Kesten. Surfaces with minimal random weights and maximal flows : a higher-dimensional version of first-passage percolation. *Illinois J. Math.*, 31(1) :99–166, 1987.
- [56] J. F. C. Kingman. The ergodic theory of subadditive stochastic processes. *J. Roy. Statist. Soc. Ser. B*, 30 :499–510, 1968.
- [57] S. Kobe. Ernst Ising – physicist and teacher. *J. Statist. Phys.*, 88(3-4) :991–995, 1997.
- [58] R. Kotecký and C.-E. Pfister. Equilibrium shapes of crystals attached to walls. *J. Statist. Phys.*, 76(1-2) :419–445, 1994.
- [59] J. L. Lebowitz. Coexistence of phases in Ising ferromagnets. *J. Statist. Phys.*, 16(6) :463–476, 1977.
- [60] M. Ledoux. *The concentration of measure phenomenon*, volume 89 of *Mathematical Surveys and Monographs*. American Mathematical Society, Providence, RI, 2001.

- [61] W. Lenz. Beitrag zum verständnis der magnetischen eigenschaften in festen körpern. *Phys. Zeitschrift*, 21 :613–615, 1920.
- [62] T. M. Liggett, R. H. Schonmann, and A. M. Stacey. Domination by product measures. *Ann. Probab.*, 25(1) :71–95, 1997.
- [63] F. Martinelli. Lectures on Glauber dynamics for discrete spin models. In *Lectures on probability theory and statistics (Saint-Flour, 1997)*, volume 1717 of *Lecture Notes in Math.*, pages 93–191. Springer, Berlin, 1999.
- [64] M. V. Menshikov. Coincidence of critical points in percolation problems. *Dokl. Akad. Nauk SSSR*, 288(6) :1308–1311, 1986.
- [65] A. Messenger, S. Miracle-Solé, and J. Ruiz. Convexity properties of the surface tension and equilibrium crystals. *J. Statist. Phys.*, 67(3-4) :449–470, 1992.
- [66] C. M. Newman. *Topics in disordered systems*. Lectures in Mathematics ETH Zürich. Birkhäuser Verlag, Basel, 1997.
- [67] L. Onsager. Crystal statistics. I. A two-dimensional model with an order-disorder transition. *Physical Review*, 65 :117–149, Feb. 1944.
- [68] R. Peierls. On Ising’s model of ferromagnetism. *Proc. Camb. Phil. Soc.*, 32, 1936.
- [69] C.-E. Pfister. Large deviations and phase separation in the two-dimensional Ising model. *Helv. Phys. Acta*, 64(7) :953–1054, 1991.
- [70] C.-E. Pfister and Y. Velenik. Mathematical theory of the wetting phenomenon in the 2D Ising model. *Helv. Phys. Acta*, 69(5-6) :949–973, 1996. Papers honouring the 60th birthday of Klaus Hepp and of Walter Hunziker, Part I (Zürich, 1995).
- [71] C.-E. Pfister and Y. Velenik. Large deviations and continuum limit in the 2D Ising model. *Probab. Theory Related Fields*, 109(4) :435–506, 1997.
- [72] C.-E. Pfister and Y. Velenik. Interface, surface tension and reentrant pinning transition in the 2D Ising model. *Comm. Math. Phys.*, 204(2) :269–312, 1999.
- [73] A. Pisztora. Surface order large deviations for Ising, Potts and percolation models. *Probab. Theory Related Fields*, 104(4) :427–466, 1996.
- [74] R. H. Schonmann and S. B. Shlosman. Constrained variational problem with applications to the Ising model. *J. Statist. Phys.*, 83(5-6) :867–905, 1996.
- [75] R. H. Schonmann and S. B. Shlosman. Wulff droplets and the metastable relaxation of kinetic Ising models. *Comm. Math. Phys.*, 194(2) :389–462, 1998.
- [76] J. E. Taylor. Crystalline variational problems. *Bull. Amer. Math. Soc.*, 84(4) :568–588, 1978.
- [77] M. Theret. On the small maximal flows in first passage percolation. *To appear in Annales de la faculté des sciences de Toulouse*, 2007.
- [78] M. Theret. Upper large deviations for the maximal flow in first passage percolation. *Stochastic Process. Appl.*, 117(9) :1208–1233, 2007.
- [79] J. van den Berg and H. Kesten. Inequalities for the time constant in first-passage percolation. *Ann. Appl. Probab.*, 3(1) :56–80, 1993.
- [80] V. Vargas. Strong localization and macroscopic atoms for directed polymers. *Probab. Theory Related Fields*, 138(3-4) :391–410, 2007.
- [81] G. Wulff. Zur frage der geschwindigkeit des wachstums und der auflösung der kristallflächen. *Z. Krystallogr.*, 34 :449–530, 1901.

Résumé

Cette thèse porte sur le modèle d'Ising dilué, dans la région de transition de phase. Le modèle d'Ising est un modèle classique de la mécanique statistique ; il a la particularité de présenter deux phases distinctes à basse température, ce qui a motivé, entre autres, son utilisation pour l'étude rigoureuse de la coexistence de phases. Notre objectif était d'étendre la description du phénomène de coexistence de phases au cas du milieu aléatoire, c'est-à-dire au modèle d'Ising dilué, lorsque la température et la dilution sont suffisamment faibles pour que deux phases d'aimantation opposées apparaissent.

La thèse comporte quatre chapitres. Dans un premier chapitre, nous adaptons les travaux de Pisztor au cas du milieu aléatoire et établissons une procédure de renormalisation compatible avec la dilution. Dans un second chapitre, nous étudions en détail la tension superficielle de ce modèle, pour la mesure de Gibbs correspondant à un milieu fixé, et pour la mesure moyennée. Nous caractérisons la limite à basse température de chacune de ces quantités et décrivons les formes des cristaux correspondants. Nous montrons que les déviations inférieures de la tension superficielle ont un coût surfacique et donnons une borne inférieure sur la fonction de taux à l'aide de méthodes de concentration de la mesure. Dans un troisième chapitre, nous décrivons le phénomène de coexistence de phases, sous la mesure Gibbs et sous la mesure moyennée. Dans un quatrième et dernier chapitre, nous concluons la thèse avec une application à la dynamique de Glauber, et montrons que l'autocorrélation décroît au plus vite comme une puissance inverse du temps.

Mots-clés

Modèle d'Ising, représentation de Fortuin-Kasteleyn, milieu aléatoire, renormalisation, tension superficielle, flux maximal, cristal de Wulff, coexistence de phases, concentration de la mesure, dynamique de Glauber, métastabilité.

Abstract

This PhD thesis is concerned with the dilute Ising model, in the region of phase transition. The Ising model is a classical model of statistical mechanics; it has the peculiarity of having two distinct phases at low temperature, which motivated its use for the rigorous study of the phase coexistence phenomenon. Our objective was to extend the description of the phase coexistence phenomenon to the case of random media, that is to say, to the dilute Ising model, when the temperature and the dilution are weak enough for having two phases of opposite magnetization.

The thesis is made of four chapters. In a first chapter, we adapt the work of Pisztor to the random media and establish a coarse graining which is compatible with the dilution. In a second chapter, we study in detail the surface tension for that model, for both the Gibbs measure corresponding to a given realization of the media, and the averaged Gibbs measure. We characterize the low temperature limit of both quantities and describe the shape of the corresponding crystals. We show that lower deviations of surface tension happen at surface order and give a lower bound on the rate function with the help of concentration of measure theory. In a third chapter, we describe the phase coexistence phenomenon for both the Gibbs and averaged Gibbs measures. In a fourth and last chapter, we conclude the thesis with an application to the Glauber dynamics, and show that the autocorrelation decays not quicker than an inverse power of time.

Keywords

Ising model, Fortuin-Kasteleyn representation, random media, coarse graining, surface tension, maximal flow, Wulff crystal, phase coexistence, concentration of measure, Glauber dynamics, metastability.