



HAL
open science

Polyèdres et structures combinatoires

Denis Naddef

► **To cite this version:**

Denis Naddef. Polyèdres et structures combinatoires. Modélisation et simulation. Université Joseph-Fourier - Grenoble I, 1983. tel-00307745

HAL Id: tel-00307745

<https://theses.hal.science/tel-00307745>

Submitted on 29 Jul 2008

HAL is a multi-disciplinary open access archive for the deposit and dissemination of scientific research documents, whether they are published or not. The documents may come from teaching and research institutions in France or abroad, or from public or private research centers.

L'archive ouverte pluridisciplinaire **HAL**, est destinée au dépôt et à la diffusion de documents scientifiques de niveau recherche, publiés ou non, émanant des établissements d'enseignement et de recherche français ou étrangers, des laboratoires publics ou privés.

THESE

présentée à

l'Université Scientifique et Médicale de Grenoble

pour obtenir le grade de
DOCTEUR ES SCIENCES
«mathématiques appliquées»

par

NADDEF Denis



POLYEDRES ET STRUCTURES COMBINATOIRES



Thèse soutenue le 2 décembre 1983 devant la commission d'examen.

C. BERGE	}	Président
C. BENZAKEN		
J. FONLUPT	}	Examineurs
A. JOLLIBERT		
M. LAS VERGNAS		
M. SAKAROVITCH		

UNIVERSITE SCIENTIFIQUE ET MEDICALE DE GRENOBLE

Année universitaire 1982-1983

Président de l'Université : M. TANCHE

MEMBRES DU CORPS ENSEIGNANT DE L'U.S.M.G.

(RANG A)

SAUF ENSEIGNANTS EN MEDECINE ET PHARMACIE

PROFESSEURS DE 1ère CLASSE

ARNAUD Paul	Chimie organique
ARVIEU Robert	Physique nucléaire I.S.N.
AUBERT Guy	Physique C.N.R.S.
AYANT Yves	Physique approfondie
BARBIER Marie-Jeanne	Electrochimie
BARBIER Jean-Claude	Physique expérimentale C.N.R.S. (labo de magnétisme)
BARJON Robert	Physique nucléaire I.S.N.
BARNOUD Fernand	Biosynthèse de la cellulose-Biologie
BARRA Jean-René	Statistiques - Mathématiques appliquées
BELORISKY Elie	Physique
BENZAKEN Claude (M.)	Mathématiques pures
BERNARD Alain	Mathématiques pures
BERTRANDIAS Françoise	Mathématiques pures
BERTRANDIAS Jean-Paul	Mathématiques pures
BILLET Jean	Géographie
BONNIER Jean-Marie	Chimie générale
BOUCHEZ Robert	Physique nucléaire I.S.N.
BRAVARD Yves	Géographie
CARLIER Georges	Biologie végétale
CAUQUIS Georges	Chimie organique
CHIBON Pierre	Biologie animale
COLIN DE VERDIERE Yves	Mathématiques pures
CRABBE Pierre (détaché)	C.E.R.M.O.
CYROT Michel	Physique du solide
DAUMAS Max	Géographie
DEBELMAS Jacques	Géologie générale
DEGRANGE Charles	Zoologie
DELOBEL Claude (M.)	M.I.A.G. Mathématiques appliquées
DEPORTES Charles	Chimie minérale
DESRE Pierre	Electrochimie
DOLIQUE Jean-Michel	Physique des plasmas
DUCROS Pierre	Cristallographie
FONTAINE Jean-Marc	Mathématiques pures
GAGNAIRE Didier	Chimie physique

GASTINEL Noël	Analyse numérique - Mathématiques appliquées
GERBER Robert	Mathématiques pures
GERMAIN Jean-Pierre	Mécanique
GIRAUD Pierre	Géologie
IDELMAN Simon	Physiologie animale
JANIN Bernard	Géographie
JOLY Jean-René	Mathématiques pures
JULLIEN Pierre .	Mathématiques appliquées
KAHANE André (détaché DAFCO)	Physique
KAHANE Josette	Physique
KOSZUL Jean-Louis	Mathématiques pures
KRAKOWIAK Sacha	Mathématiques appliquées
KUPTA Yvon	Mathématiques pures
LACAZE Albert	Thermodynamique
LAJZEROWICZ Jeannine	Physique
LAJZEROWICZ Joseph	Physique
LAURENT Pierre	Mathématiques appliquées
DE LEIRIS Joël	Biologie
LLIBOUTRY Louis	Géophysique
LOISEAUX Jean-Marie	Sciences nucléaires I.S.N.
LOUP Jean	Géographie
MACHE Régis	Physiologie végétale
MAYNARD Roger	Physique du solide
MICHEL Robert	Minéralogie et pétrographie (géologie)
MOZIERES Philippe	Spectrométrie - Physique
OMONT Alain	Astrophysique
OZENDA Paul	Botanique (biologie végétale)
PAYAN Jean-Jacques (détaché)	Mathématiques pures
PEBAY PEYROULA Jean-Claude	Physique
PERRIAUX Jacques	Géologie
PERRIER Guy	Géophysique
PIERRARD Jean-Marie	Mécanique
RASSAT André	Chimie systématique
RENARD Michel	Thermodynamique
RICHARD Lucien	Biologie végétale
RINAUDO Marguerite	Chimie CERMAV
SENGEL Philippe	Biologie animale
SERGERAERT Francis	Mathématiques pures
SOUTIF Michel	Physique
VAILLANT François	Zoologie
VALENTIN Jacques	Physique nucléaire I.S.N.
VAN CUTSEN Bernard	Mathématiques appliquées
VAUQUOIS Bernard	Mathématiques appliquées
VIALON Pierre	Géologie
PROFESSEURS DE 2ème CLASSE	
ADIBA Michel	Mathématiques pures
ARMAND Gilbert	Géographie

AURIAULT Jean-Louis	Mécanique
BEGUIN Claude (M.)	Chimie organique
BOEHLER Jean-Paul	Mécanique
BOITET Christian	Mathématiques appliquées
BORNAREL Jean	Physique
BRUN Gilbert	Biologie
CASTAING Bernard	Physique
CHARDON Michel	Géographie
COHENADDAD Jean-Pierre	Physique
DENEUVILLE Alain	Physique
DEPASSEL Roger	Mécanique des fluides
DOUCE Roland	Physiologie végétale
DUFRESNOY Alain	Mathématiques pures
GASPARD François	Physique
GAUTRON René	Chimie
GIDON Maurice	Géologie
GIGNOUX Claude (M.)	Sciences nucléaires I.S.N.
GUITTON Jacques	Chimie
HACQUES Gérard	Mathématiques appliquées
HERBIN Jacky	Géographie
HICTER Pierre	Chimie
JOSELEAU Jean-Paul	Biochimie
KERCKOVE Claude (M.)	Géologie
LE BRETON Alain	Mathématiques appliquées
LONGEQUEUE Nicole	Sciences nucléaires I.S.N.
LUCAS Robert	Physiques
LUNA Domingo	Mathématiques pures
MASCLE Georges	Géologie
NEMOZ Alain	Thermodynamique (CNRS - CRTBT)
OUDET Bruno	Mathématiques appliquées
PELMONT Jean	Biochimie
PERRIN Claude (M.)	Sciences nucléaires I.S.N.
PFISTER Jean-Claude (détaché)	Physique du solide
PIBOULE Michel	Géologie
PIERRE Jean-Louis	Chimie organique
RAYNAUD Hervé	Mathématiques appliquées
ROBERT Gilles	Mathématiques pures
ROBERT Jean-Bernard	Chimie physique
ROSSI André	Physiologie végétale
SAKAROVITCH Michel	Mathématiques appliquées
SARROT REYNAUD Jean	Géologie
SAXOD Raymond	Biologie animale
SOUTIF Jeanne	Physique
SCHOOL Pierre-Claude	Mathématiques appliquées
STUTZ Pierre	Mécanique
SUBRA Robert	Chimie
VIDAL Michel	Chimie organique
VIVIAN Robert	Géographie



REMERCIEMENTS

Je tiens à remercier toute l'équipe de Recherche Operationnelle de l'Université de Grenoble de m'avoir accueilli et fourni une ambiance de travail très agréable. Je tiens plus particulièrement à remercier Jean-Pierre Uhry qui a très patiemment guidé mes premiers pas dans la recherche. Je n'oublie pas Michel Sakarovitch qui a su me faire découvrir ce domaine des mathématiques qu'est l'Optimisation Combinatoire ni Jean Fonlupt avec qui j'ai eu des discussions très profitables. J'exprime ma plus vive sympathie à mes amis Gérard Cornuejols et Bill Pulleyblank avec lesquels j'ai effectué une grande partie des recherches exposées dans cette thèse.

Je remercie l'Institut d'Etudes Commerciales de Grenoble, où j'enseigne, pour les facilités qu'il m'a données pour effectuer des visites de longue durée dans divers laboratoires étrangers.

Je suis très sensible à l'honneur que me fait Monsieur Claude Berge en présidant le jury de cette thèse. Que Messieurs Claude Benzaken, Jean Fonlupt, Alain Jolibert, Michel Las Vergnas et Michel Sakarovitch soient remerciés d'avoir accepté de participer à mon jury.

Je remercie enfin le service de Monsieur Daniel Iglésias pour le soin apporté au tirage de cette thèse.

INTRODUCTION

L'Optimisation combinatoire est une branche des mathématiques qui a eu un essor important ces vingt dernières années, bien que l'apport français dans ce domaine soit resté assez limité.

Tout problème d'Optimisation Combinatoire peut se décrire brièvement comme étant celui de trouver un meilleur élément, pour une fonction d'évaluation donnée, parmi un nombre fini mais élevé d'éléments possibles. En d'autres termes, parmi un ensemble discret de solutions possibles, trouver la "meilleure". Le problème réside dans le nombre élevé de solutions. Ce nombre interdisant l'utilisation de la méthode de résolution naïve qui consiste à regarder toutes les solutions et à prendre la meilleure. Pour tous les exemples qui vont être cités ci-après, un nombre d'opérations supérieur à 2^{64} est atteint pour des problèmes de taille moyenne, or, pour faire 2^{64} opérations à raison de 10^9 opérations à la seconde, il faut à un ordinateur 585 années. Voici maintenant quelques problèmes d'Optimisation Combinatoire liés aux graphes auxquels on s'est beaucoup intéressés ces dernières années. Etant donné un graphe $G = (V, E)$ et une fonction $c : E \rightarrow R$, le problème de trouver un couplage de poids maximum dans G est connu sous le nom de Problème du Couplage de Poids Maximum, celui de trouver un cycle hamiltonien de poids minimum est connu sous le nom de Problème du Voyageur de Commerce, celui de trouver un arbre maximal de poids minimum l'est sous le nom de Problème de l'arbre de poids minimum. Si on se donne non plus une fonction de $E \rightarrow R$ mais de $V \rightarrow R$ on peut chercher le stable de poids maximum, la clique de poids maximum etc. Le nombre de ces problèmes est considérable et l'on ne peut en faire une liste exhaustive ici.

Il peut paraître surprenant, à première vue, que les

techniques les plus récentes en Optimisation Combinatoire fassent un usage très important de la Programmation Linéaire, en effet dans un cas le domaine des solutions est discret tandis qu'il est continu dans l'autre. Cependant le lecteur averti sait bien qu'en Programmation Linéaire l'ensemble dans lequel l'optimum est recherché est en fait discret puisqu'il s'agit de l'ensemble des sommets du polyèdre défini par les contraintes. Ces polyèdres qui permettent le passage de l'optimisation sur un ensemble discret à celui, en général plus facile, de l'optimisation sur un domaine convexe, vont jouer un rôle central dans cette thèse.

La recherche en Optimisation Combinatoire consiste essentiellement à développer, pour un problème donné, des algorithmes performants, ceci allant en général de pair avec la description par des inéquations linéaires de l'enveloppe convexe des solutions. Seul le dernier chapitre de cette thèse entre vraiment dans ce cadre là. Le premier s'intéresse essentiellement à des propriétés combinatoires des couplages, principalement parfaits, dans les graphes. Cependant les outils essentiels utilisés viennent de l'Optimisation Combinatoire, en particulier la description par des inéquations linéaires de l'enveloppe convexe des couplages donnée par J. Edmonds est le point de départ de ces recherches. Le deuxième chapitre est consacré à l'étude purement combinatoire des polyèdres à sommets en 0 et 1. Aucune technique d'Optimisation Combinatoire n'est utilisée, cependant il est indéniable que c'est leur formation dans ce domaine qui a amené les auteurs à s'intéresser à ces polyèdres très importants en Optimisation Combinatoire.

Cette thèse est le résultat de plusieurs travaux, pour la plupart publiés ou en cours de parution. Comme on vient de le voir ceux-ci peuvent être classés en 3 catégories:

1) Les travaux relatifs aux couplages qui ont donnés lieu aux publications suivantes:

(1.1) "Rang des couplages maximums d'un graphe"

Thèse de 3ème cycle, Université Scientifique et Médicale de Grenoble, février 78.

- (1.1) "Rank of maximum matchings in a graph"
Mathematical Programming 22 (1982) 52-70.
- (1.2) "Matchings in regular graphs" avec
W.R.Pulleyblank, Discrete mathematics 34 (1981) 283-291.
- (1.3) "Ear Decomposition of elementary graphs and GF_2
rank of perfect matchings" avec W.R. Pulleyblank, Annals of
Discrete Mathematics 16 (1982) 241-260
- (1.4) "Pavage d'une surface par des calissons et
ses applications à des problèmes de dénombrement liés aux
suites de Young" RR.153 U.S.M.G. et un résumé est paru dans
les Actes du Colloque Algèbre Appliquée et Combinatoire.
Grenoble. (1978).
- (1.5) "L'organisation d'une coupe de ski: un
problème d'affectation mini-max" Manuscrit.
- 2) Les travaux relatifs aux propriétés du squelette des
polyèdres bornés à sommets en 0 et 1, qui ont donné lieu aux
publications suivantes:
- (2.1) "Hamiltonicity and Combinatorial polyhedra"
avec W.R.Pulleyblank. Journal of Combinatorial Theory, B, 3
(31) (1981) 297-312.
- (2.2) "Hamiltonicity and (0-1) polyhedra" avec W.R.
Pulleyblank, Research Report CORR 82-46, University of
Waterloo, soumis à Journal of Combinatorial Theory.
- (2.3) "Pancyclic properties of some (0,1)
polyhedra", à paraître dans Journal of Combinatorial Theory.
- 3) Les travaux relatifs au Problème du Voyageur de Commerce
dont les résultats se trouvent dans :
- (3.1) "Halin Graphs and the Travelling Salesman
Problem" avec G.Cornuejols et W.R.Pulleyblank, à paraître
dans Mathematical Programming
- (3.2) "The Travelling Salesman Problem in graphs
with 3-edge cutsets" avec G.Cornuejols et W.R.Pulleyblank
CORE discussion paper n°8212 et soumis à ACM
- (3.3) "The Travelling Salesman Problem on a graph and
some related integer polyhedra" avec G.Cornuejols. et
J.F.Fonlupt. Rapport de recherche IMAG (1983)

La thèse comprendra trois chapitres, un pour chacun des thèmes précédents et dans l'ordre dans lequel ils ont été énoncés. Chaque chapitre contiendra un résumé des notions nécessaires, replacera les travaux dans leur contexte et enfin essaiera de référencier les suites données à ces travaux par d'autres chercheurs.

Si un article ou un auteur est cité sans références, celles-ci se trouvent sans ambiguïté dans le travail décrit. Sinon une référence [.] renvoie à la fin du chapitre. Les articles non encore publiés seront mis en annexe. Les autres pour des raisons de droits de reproduction réservés ne le seront pas.

Le reste de ce chapitre est consacré à des notations communes aux 3 chapitres suivants.

Un graphe dont l'ensemble des sommets est V et l'ensemble des arêtes est E sera noté $G = (V, E)$. Pour un ensemble de sommets $S \subset V$ on note $\gamma(S)$ l'ensemble des arêtes dont les deux extrémités sont dans S et $\delta(S)$ l'ensemble des arêtes dont une seule extrémité est dans S , ce dernier ensemble s'appellera le cocycle défini par S . On notera $G(S)$ le sous-graphe induit par S , i.e. $G(S) = (S, \gamma(S))$. Pour un ensemble A on note $|A|$ le nombre de ses éléments. Si l'on a une fonction $c : E \rightarrow \mathbb{R}$ qui à $e \in E$ associe son coût $c(e)$ ou c_e , étant donné $\tilde{E} \subset E$ on appelle coût de \tilde{E} , que l'on note $c(\tilde{E})$, la somme des coûts des éléments de \tilde{E} , i.e. $c(\tilde{E}) = \sum \{c_e : e \in \tilde{E}\}$.

Etant donné une famille \mathcal{F} de parties de E , on peut lui associer un ensemble X d'éléments de $\{0,1\}^{|E|}$ de la façon suivante:

A tout élément $F \in \mathcal{F}$ on associe $x^F \in X \subset \{0,1\}^E$ tel que $x_e^F = 1$ si et seulement si $e \in F$. En d'autres termes X est l'ensemble des vecteurs caractéristiques des éléments de \mathcal{F} . On utilisera parfois le terme de vecteurs d'incidence ou de vecteur représentatif de F au lieu de vecteur caractéristique.

Etant donné un ensemble $X \subset \{0,1\}^{|E|}$ on appelle enveloppe convexe de X , que l'on note $\text{conv}(X)$, l'ensemble des combinaisons convexes des éléments de X . Quand X est donné par

une famille \mathcal{F} on dira aussi, par abus de langage, l'enveloppe convexe de \mathcal{F} , ou, quand celle-ci est bornée, le polytope associé à \mathcal{F} . C'est ainsi qu'on parlera du polytope des couplages ou du polytope des cycles hamiltoniens.

La dimension d'un polyèdre de \mathbb{R}^n est celle de la variété affine de plus petite dimension qui le contient. Un polyèdre de \mathbb{R}^n est de pleine dimension si sa dimension est n .

Pour $E \subset E$ on note $x(E) = \{ x_e : e \in E \}$.

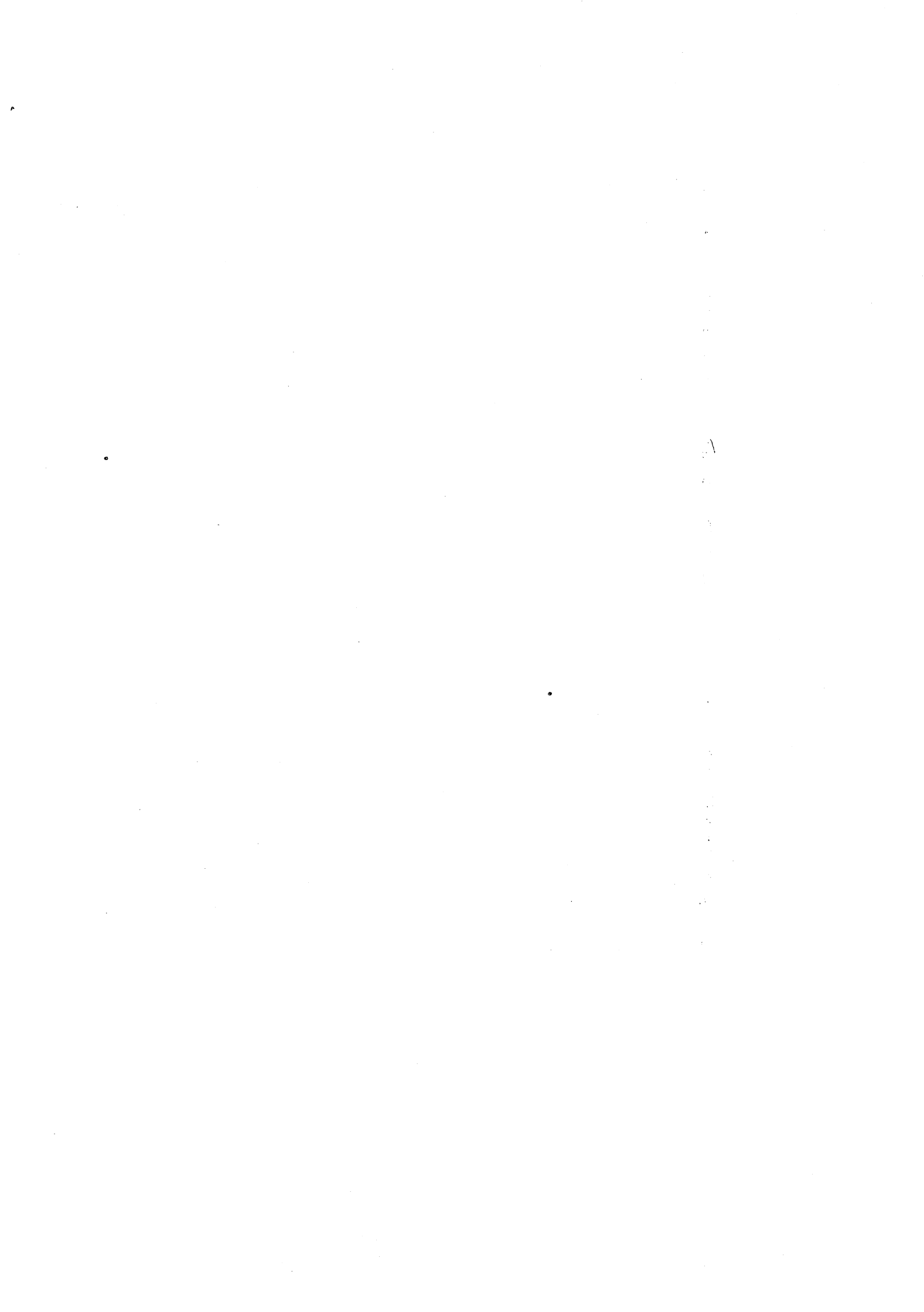

CHAPITRE 1

TRAVAUX SUR LES COUPLAGES D'UN GRAPHE

1. INTRODUCTION

Etant donné un graphe $G = (V, E)$, un sous-ensemble d'arêtes $M \subset E$ est un couplage, si deux arêtes quelconques de M n'ont aucun sommet en commun. Un sommet adjacent à une arête du couplage M est dit saturé par M . Un couplage est dit parfait si tous les sommets sont saturés par ce couplage. Etant donnée une fonction $c: E \rightarrow \mathbb{R}$ qui à toute arête associe son coût ou poids c_e (ou $c(e)$), le problème du couplage de poids maximum est celui de l'obtention d'un couplage M^* tel que: $c(M^*) = \max \{c(M) : M \text{ est un couplage}\}$.

Ce problème est, à plus d'un titre intéressant en Optimisation Combinatoire. C'est le premier dont la résolution a nécessité l'application d'algorithmes dont la justification ne peut se faire qu'à l'aide d'outils issus de la Programmation Linéaire. Cette technique s'est ensuite considérablement développée pour s'appliquer à de nombreux autres problèmes.

Le cas particulier où tous les coûts valent 1 (i.e. $c_e = 1$ pour tout $e \in E$) est connu sous le nom de Problème de Recherche d'un Couplage de Cardinalité maximum. Ce problème a intéressé de nombreux mathématiciens. Dans un premier temps une étude purement combinatoire a été entreprise. C'est ainsi que sont nés, avant même de savoir résoudre le problème, de nombreux théorèmes parmi lesquels on peut citer le théorème de Galai [5] sur la classification des sommets d'un graphe relativement à leur rôle dans les couplages maximums du

graphe, le théorème de Tutte [8] sur une condition nécessaire et suffisante d'existence d'un couplage parfait dans un graphe. Enfin Berge [1] a donné une condition nécessaire et suffisante que devait satisfaire un couplage pour être de cardinalité maximum.

Ce n'est qu'en 1965 que J. Edmonds a donné le premier algorithme efficace pour résoudre d'abord le problème du couplage de cardinalité maximum, puis celui du couplage de poids maximum. Ce fut une nouveauté car, pour la première fois, l'Optimisation Combinatoire utilisait la programmation linéaire comme outil, ainsi s'amorçait donc le rapprochement de ces deux branches des mathématiques appliquées qui s'est avéré des plus fructueux, car depuis cette date, les liens n'ont fait que se renforcer. Un autre fait très marquant est que, sauf le théorème de Berge qui est à la base de l'algorithme, quasiment tous les théorèmes trouvés auparavant peuvent se déduire très facilement des résultats d'Edmonds. L'article (1,2), qui sera décrit dans le chapitre 3, en donne un exemple.

Il semble qu'aujourd'hui tout soit à peu près dit sur le problème de la résolution du problème de couplage de poids maximum, seuls quelques informaticiens essaient d'améliorer l'implémentation des algorithmes existants. Cependant beaucoup de problèmes liés aux couplages demeurent. Certains purement combinatoires, d'autres liés aux applications de cette théorie. C'est dans cette optique qu'ont été entrepris les travaux résumés dans les paragraphes suivants.

2. RANG DES COUPLAGES MAXIMUMS D'UN GRAPHE [(1.1) et (1.1)']

La combinatoire étant avant tout la science du dénombrement, il est tout à fait naturel que l'on se soit posé la question de connaître le nombre de couplages maximums d'un graphe. Le cas qui a suscité le plus d'intérêt est celui du dénombrement des couplages parfaits. Des méthodes algébriques ont été développées, celles-ci seront utilisées dans (1.4)

décrit plus loin. D'un autre côté des bornes inférieures ont été données en fonction de la connectivité par Zaks [9] et Lovasz [6] (voir aussi Mader[7]). Dans les deux cas les résultats ne concernent que les couplages parfaits. Une question toute naturelle est de trouver d'autres bornes qui permettraient de voir ce qui se passe, par exemple, si le nombre de sommets tend vers l'infini, ceci est à l'origine des travaux qui vont être décrits.

L'idée de départ est qu'un polyèdre borné de dimension k possède au moins $k + 1$ points extrêmes. Ainsi, si on arrive à déterminer la dimension de l'enveloppe convexe des couplages maximums d'un graphe, ceci nous donne une borne inférieure sur le nombre de couplages maximums. Il est remarquable que ceci nous donne dans de nombreux cas la meilleure borne connue à ce jour.

A la connaissance de l'auteur, c'est la première fois que cette méthode est utilisée pour donner une borne en combinatoire. Celle-ci a été utilisée par la suite par J.Fonlupt et A.Zemirline [4] pour donner une borne inférieure aux nombre de bases communes à deux matroïdes.

C'est le cas des couplages parfaits qui a donné les développements les plus intéressants. Dans ce cas particulier les résultats ont été repris et redémontrés de façon plus élégante par J.Edmonds et L.Lovasz [2], cependant la technique est restée la même. Ce dernier article a été repris et généralisé dans [3] par les mêmes auteurs auxquels s'était joint W.R.Pulleyblank. Dans cet article les auteurs donnent une description de la structure des graphes qui possèdent un couplage parfait, description qui semble être la plus fine possible.

La suite est consacrée à la description des résultats contenus dans (1.1) et (1.1)' ainsi que ceux de [2] et [3]. Donnons d'abord quelques définitions nécessaires à la compréhension des résultats qui vont suivre.

Soit $G = (V,E)$, un graphe admettant des couplages parfaits. Si toute arête appartient à un couplage parfait sans appartenir à tous, G est appelé U-graphe ; si l'ensemble des

arêtes ayant cette propriété forme un graphe partiel maximal et connexe de G , alors G est appelé élémentaire par Lovasz.

Soit $S \subset V$ un ensemble impair de sommets, S est dit serré si quel que soit le couplage parfait M de G on a $M \cap \delta(S) = 1$, en d'autres termes, quel que soit le couplage parfait M de G tous les sommets de S , à l'exception d'un seul, sont saturés par des arêtes de $M \cap \gamma(S)$.

Une famille \mathcal{S} de parties de V est dite emboîtée si deux éléments quelconques de \mathcal{S} sont soit disjoints, soit l'un contenu dans l'autre. On dit que $\mathcal{S}_1 \subset \mathcal{S}_2$ si tout élément de \mathcal{S}_1 est un élément de \mathcal{S}_2 . On note $G \times S$ le graphe obtenu en contractant S , c'est à dire le graphe obtenu en remplaçant S par un seul sommet σ , ce sommet étant relié par une arête à tous les sommets qui étaient reliés à un sommet de S , les adjacences en dehors de S n'étant pas modifiées. On dit que \mathcal{S} a la propriété de cycle impair si, étant donné $S \in \mathcal{S}$, quand on contracte dans le sous-graphe $G(S)$ les éléments maximaux de \mathcal{S} strictement contenus dans S , le graphe obtenu est non-biparti, ceci quel que soit l'élément S choisi.

Le théorème principal de (1.1) et (1.1)' s'énonce alors:

Théorème 1.2.1: Soit $G = (V, E)$ un U -graphe, la dimension du polytope des couplages parfaits de G est:

$$v(G) - |\mathcal{S}|$$

où $v(G)$ est le nombre cyclomatique de G et \mathcal{S} une famille emboîtée maximale d'ensembles serrés avec la propriété de cycle impair.

Remarquons que si G est biparti $\mathcal{S} = \emptyset$ et le résultat est relativement simple. Le cas des couplages non parfaits a été aussi résolu, ce résultat est moins intéressant et l'on pourra le trouver dans (1.1) ou (1.1)'.

La méthode utilisée va être résumée et l'on pourra alors donner la variante utilisée par J. Edmonds et L. Lovasz [2] pour redémontrer ce résultat.

Le point de départ est le théorème suivant dû à J. Edmonds

Théorème 1.2.2: (J.Edmonds). Le polytope des couplages parfaits est décrit par le système d'équations et d'inéquations linéaires suivant:

- (i) $x_e \geq 0$ pour tout $e \in E$
- (ii) $x(\delta(v)) = 1$ pour tout $v \in V$
- (iii) $x(\gamma(S)) < \frac{|S|-1}{2}$ pour tout $S \subset V, |S|$ impair

Si S est un ensemble serré alors l'inéquation (iii) correspondante est alors une équation. Trouver la dimension du polytope des couplages parfaits revient à chercher combien d'équations (ii) et (iii) sont linéairement indépendantes, car ce nombre, disons k , et la dimension sont liés par:

$$\text{dimension du polytope} + k = |E|.$$

On démontre dans un premier temps que les $|V|$ équations de type (i) et les $|\mathcal{Y}|$ équations de type (ii), où \mathcal{Y} satisfait aux conditions du théorème, sauf éventuellement à la condition de cycle impair, engendrent par combinaison linéaire toute autre équation. Ceci est la partie difficile de la démonstration. On démontre alors que $|V| + |\mathcal{Y}| - (\text{nombre de composantes connexes})$ de ces équations sont linéairement indépendantes, c'est là qu'intervient la propriété de cycles impairs de \mathcal{Y} .

L'approche utilisée par J.Edmonds et L.Lovasz [2] est exactement la même à l'exception du fait que ces auteurs sont partis d'une autre forme du théorème qui est la suivante:

Théorème 1.2.3: (J.Edmonds). Le polytope des couplages parfaits est décrit par le système d'équations et d'inéquations linéaires suivant:

- (i) $x_e > 0$ pour tout $e \in E$
- (ii) $x(\delta(v)) = 1$ pour tout $v \in V$
- (iii)' $x(\delta(S)) > 1$ pour tout $S \subset V, |S|$ impair

Notons que S et $V-S$ donnent la même inéquation (iii)', S et $V-S$ s'appellent les plages du cocycle $\delta(S) = \delta(V-S)$. Un cocycle $\delta(S)$ est dit impair si S (et donc $(V-S)$) est de cardinalité impaire.

Soit \mathcal{C} une famille de cocycles, on dit que \mathcal{C} est laminaire si, pour tout i et j , en notant S_i et S_j une des

plages des i^e et j^e cocycles, on a soit $S_i \cap S_j = \emptyset$, soit $S_i \cup S_j = V$, soit $S_i \subset S_j$, soit $S_j \supset S_i$. Un cocycle (impair) est dit serré si pour tout couplage parfait M l'inégalité correspondante (iii) est une égalité, i.e. $|M \cap \delta(S)| = 1$ où S est une des plages du cocycle. Notons que (ii) implique que

$\delta(\{v\})$ est serré pour tout $v \in V$. Soit un cocycle $\delta(S)$ de \mathcal{C} , tout autre cocycle de \mathcal{C} a une de ses plages T définies de façon unique par $T \subset S$ ou $T \subset V-S$ une fois que S a été choisie. Quand on contracte les différents T ainsi définis ainsi que S on obtient un graphe que l'on appelle une \mathcal{C} -contraction de G . Il est facile de voir par la définition que G admet $|\mathcal{C}| + 1$ contractions et que tous ces graphes ont un nombre pair de sommets. On dit que \mathcal{C} a la propriété de cycle impair si chaque \mathcal{C} -contraction contient un cycle impair (i.e est non biparti). On a alors:

Théorème 1.2.4: Soit G un U-graphe connexe avec n sommets et m arêtes, la dimension du polytope des couplages parfaits est

- (i) $m - n + 1 = v(G)$ si G est biparti
- (ii) $m - |\mathcal{C}|$ sinon

où \mathcal{C} est une famille laminaire maximale de cocycles impairs serrés avec la propriété de cycle impairs.

Dans ce même article les auteurs développent un algorithme polynomial pour déterminer cette dimension. Une version légèrement modifiée de cet algorithme est donnée dans (1.1)'.

Ce théorème 1.2.4. a été repris dans l'article [3] de J.Edmonds, L.Lovasz et W.Pulleyblank dont on va donner maintenant un aperçu.

Un graphe $H = (W, T)$ est dit bicritique si la suppression de deux sommets quelconques ainsi que de toutes les arêtes qui leur sont adjacentes laisse un graphe possédant un couplage parfait. Le résultat principal de [3] est obtenu à partir d'une procédure qui casse $G = (V, E)$ en morceaux bicritiques et 3-connexes appelés briques. Si β est le nombre de briques obtenues ce résultats s'énonce:

Théorème 1.2.5: Si G est un U-graphe alors la dimension

du polytope des couplages parfaits de G est :

$$v(G) - \beta$$

Un des outils nécessaires à la démonstration de ce théorème est le théorème suivant

Théorème 1.2.6: Soit $G = (V,E)$ un graphe bicritique, 3-connexe, alors G n'admet pas d'ensemble serré non trivial, i.e qui ne soit pas un sommet ou son complémentaire.

Ce théorème ayant comme corollaire:

Corollaire 1.2.7: Un graphe $G = (V,E)$ bicritique et 3-arête connexe possède au moins $\lfloor \frac{|V|}{2} \rfloor$ couplages parfaits.

Ceci était une conjecture de L.Lovasz et M.Plummer de 1975 et généralise un résultat obtenu pour les graphes cubiques bicritiques dans l'article décrit au prochain paragraphe.

3. Matchings in regular graphs [(1.2)] (en collaboration avec W.R.Pulleyblank).

Cet article illustre le fait que de nombreux théorèmes sur les couplages, connus en général avant les travaux de J.Edmonds, peuvent se redémontrer à l'aide de la description, par des inéquations linéaires, de l'enveloppe convexe des couplages, donnée ci-après, ou de l'enveloppe convexe des couplages parfaits donnée dans 1.2.2, ces deux descriptions étant dues à J.Edmonds. Les théorèmes concernés sont ici ceux relatifs à l'existence de couplages parfaits dans les graphes réguliers, à la propriété d'être critiques ou bicritiques de ces graphes. Tous ces théorèmes sont bien connus sauf le théorème 1.3.2 cité ci-après et qui se trouvait dans un manuscrit de l'auteur comme une conséquence du théorème 1.2.1.

Voici d'abord la description de l'enveloppe convexe des couplages

Théorème 1.3.1: (J.Edmonds). Soit $G = (V,E)$ un graphe, le polytope des couplages de G est défini par les inéquations linéaires suivantes

- (i) $x_e \geq 0$ $e \in E$
(ii)' $x(\delta(v)) \leq 1$ $v \in V$
(iii) $x(\gamma(S)) \leq (S-1)/2$ $S \subset V$ et $|S|$ impaire

Théorème 1.3.2: Soit G un graphe k -régulier dont la suppression de $i < k$ arêtes ne déconnecte celui-ci que si ces arêtes sont adjacentes à un même sommet. Alors si G a un nombre pair de sommets, G est bicritique.

Par la suite un graphe k -régulier satisfaisant aux conditions du théorème 1.3.2 sera dit faiblement $k + 1$ arêtes connexe.

La deuxième partie de l'article utilise le théorème 1.2.1 pour trouver une borne inférieure au nombre de couplages parfaits de certains graphes cubiques. Dans le cas des graphes bicritiques il a été noté au paragraphe précédent que les résultats sont désormais caduques à la suite des travaux de J.Edmonds et al. Cependant la question suivante y était posée:

"Y a-t-il d'autres graphes cubiques faiblement 4-arêtes connexes, que le graphe de Petersen, qui ont exactement $\frac{|V|}{2} + 1$ couplages parfaits ?"

P.D.Seymour donna quelques temps plus tard une réponse négative à cette question.

Théorème 1.3.3: (P.D.Seymour) Parmi les graphes cubiques faiblement 4-arêtes connexes, seul le graphe de Peterson n'a que $\frac{|V|}{2} + 1$ couplages parfaits.

4. "EAR DECOMPOSITION OF ELEMENTARY GRAPHS AND G F_2 RANK OF PERFECT MATCHINGS" (en collaboration avec W.R.Pulleyblank)

Le théorème 1.2.1 qui nous donne la dimension du polytope des couplages parfaits d'un graphe nous donne aussi le nombre maximum de couplages parfaits dont les vecteurs d'incidences sont linéairement indépendants, puisque ces deux nombres ne

différent que d'une unité. L.Lovasz avait posé la question de savoir si le travail fait quand l'indépendance linéaire est considérée dans \mathbb{R}^n pouvait se faire sur $(\text{GF}_2)^n$ où GF_2 est le corps à 2 éléments 0 et 1. Plus précisément Lovasz se posait la question de savoir s'il y avait une relation entre ce nombre maximum de couplages parfaits GF_2 -indépendants, qu'on appellera désormais le GF_2 -rang des couplages parfaits, et le nombre de pas dans une décomposition du graphe qu'il a développée avec M.D.Plummer et appelée décomposition en oreilles.

Un graphe $\tilde{G} = (\tilde{V}, \tilde{E})$ est dit obtenu à partir de $G = (V, E)$ par adjonction d'une oreille si $V \subset \tilde{V}$, $E \subset \tilde{E}$ et $\tilde{E} - E$ est l'ensemble des arêtes d'une chaîne dont seulement les 2 extrémités sont dans G et tous les sommets $\tilde{V} - V$ sont sur cette chaîne (cf figure 1.a).

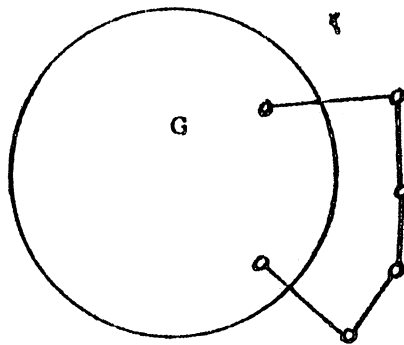
 \tilde{G}

(a)

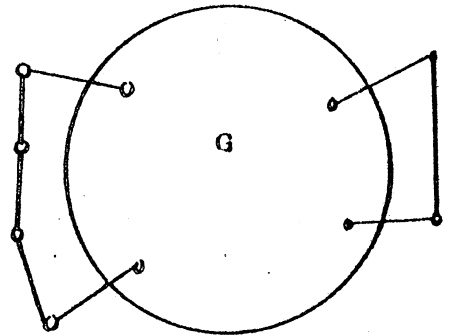

G

(b)

Figure 1.

On dit que $G = (V, E)$ est obtenu par l'adjonction de deux oreilles si $E \subset \tilde{E}$ et $\tilde{E} - E$ est l'ensemble des arêtes de deux chaînes disjointes dont seules les extrémités sont dans \tilde{V} , de plus $V \subset \tilde{V}$ et les sommets de $\tilde{V} - V$ sont sur ces chaînes (voir figure 1.b).

Une décomposition en oreilles d'un U-graphe G est une séquence $G_0, \dots, G_t = G$ de graphes tels que:

(i) G_0 est constitué de deux sommets joints par une arête

(ii) G_1, G_2, \dots, G_t sont des U-graphes

(iii) pour $i = 1, \dots, t$, G_i est obtenu à partir de G_{i-1} par l'adjonction d'une ou deux oreilles. Dans ce dernier cas, l'adjonction d'une seule de ces oreilles ne donnerait pas un U-graphe.

Plummer et Lovasz ont démontré qu'une telle décomposition existait toujours ce qui, bien sûr, n'est pas évident à priori. La principale question est de savoir si t ainsi défini est indépendant ou non de l'ordre d'introduction des oreilles et de leur choix et s'il y a une relation avec le $G \mathbb{F}_2$ - rang des couplages parfaits.

La réponse est, qu'en général t n'est pas indépendant du choix des oreilles et de l'ordre de leur introduction. Ceci entraîne que t ne donne pas en général le $G \mathbb{F}_2$ - rang des couplages parfaits. Cependant l'on conjecture qu'il y a une relation quand la décomposition est choisie la plus courte.

Pour certains cas particulier de décompositions relativement simples, on démontre que cette relation est vraie. En particulier l'on étudie les graphes dits de Halin que l'on retrouvera dans le chapitre suivant.

L'article se termine par sept questions restées jusqu'à ce jour sans réponses.

5. "PAVAGE D'UNE SURFACE PAR DES CALISSONS ET SES APPLICATIONS A DES PROBLEMES DE DENOMBREMENT LIES AUX SUITES DE YOUNG"

Dans ce travail on montre comment le dénombrement du nombre de recouvrements d'un hexagone par des losanges identiques se ramène aux dénombrement de couplages parfaits d'un graphe. En appliquant des méthodes développées par Kasteleyn, Temperley et Fisher, ce dénombrement de couplages

parfaits est effectué. Les résultats obtenus l'avaient été très longtemps auparavant par Mac Mahon pour les suites de Young. La relation entre ces résultats est montrée.

6. UN PROBLEME PLAISANT: "L'ORGANISATION D'UNE COUPE DE SKI. PROBLEME D'AFFECTATION MINI-MAX"

Une coupe de ski se compose en général de deux manches. Les plus favorisés des concurrents sont ceux qui partent avec les premiers numéros, aussi l'ordre est-il inversé pour la deuxième manche. S'il y a n coureurs, la somme des ordres de départs est de $n+1$ pour chaque coureur. Une compétition devant avoir lieu l'été sur glacier, il était impossible pour des raisons d'horaires de faire courir les deux manches à la suite l'une de l'autre, il fallait qu'elles se déroulent simultanément. Compte tenu du temps nécessaire à la récupération et à la remontée au sommet des pistes comment organiser l'ordre des départs de façon à léser le moins de monde possible et surtout est-ce possible de façon "simple" ? Il est montré que dans la mesure où il existe une solution réalisable, i.e le temps de remontée n'est pas trop important, alors on peut diviser les coureurs en 4 groupes seulement, avec dans chaque groupe des numéros de dossard consécutifs, les départs se faisant dans l'ordre ou l'ordre inverse de ceux-ci. Ces groupes ne sont pas en général de taille égale. Voir annexe 2

Références:

- [1] C.BERGE "Sur le Couplage Maximum d'un Graphe" C.R.A.S. 247 (1958) 258-259.
- [2] J. EDMONDS et L.LOVASZ "On The Dimension of Perfect Matchings of a Graph" Manuscrit
- [3] J.EDMONDS, L.LOVASZ et W.PULLEYBLANK "Brick Decomposition and the Matching Rank of a Graph" à paraître dans Combinatorica.
- [4] J.FONLUPT et A.ZEMERLINE "On the Number of Common Bases of two matroids" à paraître dans Discrete Mathematics.

- [5] T.GALAI "Maximale Systeme unabhängiger Kanten"
Mat.Kut.Int.Kozl.9 (1964) 373-395
- [6] L.LOVASZ " On the Structure of Factorizable Graphs" Acta
Math. Acad.Sci.Hungaricae 23 (1-2) (1972) 179-195
- [7] W.MADER "1-Faktoren von Graphen" Math.Annals,201(1973)
269-282.
- [8] W.TUTTE "The Factorization of Linear Graphs" J. of London
Math. Soc. 22 (1947) 107-111.
- [9] J.ZAKS "On the 1-Factors of n-connected Graphs"
Combinatorial Structures and their Applications, (New-
York,London,Paris,1970) 481-488.

CHAPITRE II

ETUDE DU SQUELETTE DES POLYEDRES BORNES A SOMMETS EN 0 ET 1

1. INTRODUCTION

Etant donné un polyèdre borné P , son squelette, $G(P)$ est le graphe dont l'ensemble des sommets est en bijection avec l'ensemble des sommets (ou points extrêmes) de P , deux sommets de $G(P)$ sont adjacents si et seulement s'ils sont adjacents sur P .

Ces squelettes ont intéressé depuis longtemps les mathématiciens puisque c'est sur un tel graphe, celui du dodécaèdre, que Sir William Hamilton a posé en 1858 son fameux problème de trouver un cycle qui désormais portera son nom. Ensuite Tait avait en 1880 conjecturé que tout graphe cubique planaire et 3-connexe était hamiltonien, ceci s'est avéré faux comme l'a démontré Tutte en 1947. Cependant puisque les graphes planaires 3-connexes sont justement les graphes qui sont les squelettes des polyèdres de R^3 (voir Steinitz[2] et Grunbaum[1]), il avait ouvert la voie aux recherches des propriétés hamiltoniennes des squelettes de polyèdres. Tutte en 1956 apporta un élément de plus en démontrant que tout graphe planaire 4-connexe est hamiltonien. Cependant on sait que pour toute dimension il existe des polyèdres dont le squelette n'est pas hamiltonien. Enfin notons qu'un des problèmes fascinants de la combinatoire demeure la caractérisation des graphes qui sont le squelette d'un polyèdre.

En Optimisation combinatoire, on est très souvent amené à étudier l'enveloppe convexe de l'ensemble des vecteurs d'incidences d'une famille d'objets : couplages d'un graphe, bases ou indépendants d'un matroïde, stables d'un graphe... Ces polyèdres ont la propriété, par définition, que chacun de leurs sommets est représenté par un vecteur à composantes en 0 ou 1. L'objet de ce chapitre est l'étude de ces polyèdres dits à sommets en 0 et 1.

2.HAMILTONICITE DANS LES POLYEDRES EN 0 ET 1 : (articles (2.1) et (2.2))

Comme va le montrer l'historique qui suit, de nombreux combinatoriciens se sont penchés sur des cas particuliers de polyèdres en 0 et 1 et ont pu démontrer pour ceux-ci des résultats liés aux cycles hamiltoniens.

Le premier résultat remonte à 1966 et est dû à R.L.Cummings. Il concerne le graphe des arbres maximaux d'un graphe connexe $H = (U, E)$. Ce graphe est obtenu en prenant comme ensemble de sommets l'ensemble des arbres maximaux de H , deux sommets étant adjacents si et seulement si les deux arbres qu'ils représentent s'obtiennent l'un de l'autre par l'échange d'une arête de chacun, en d'autres termes, si et seulement s'ils ne diffèrent que de deux arêtes. En fait ce graphe n'est autre que le squelette de l'enveloppe convexe des arbres de H , car la condition nécessaire et suffisante d'adjacence ainsi définie est celle de l'adjacence sur l'enveloppe convexe.

Le résultat de Cummings s'énonce:

Théorème 2.2.1: (Cummings 1966). Soient $H = (V, E)$ un graphe, $\mathcal{F} = \{\text{arbres maximaux de } H\}$, X l'ensemble des vecteurs d'incidences d'éléments de \mathcal{F} , $P = \text{conv}(X)$. Alors $G(P)$ est hamiltonien.

Une démonstration plus élégante de ce théorème a été donnée en 1969 par H.Shank. Ce théorème a été généralisé en 1972 par Holzmann et Harary de la façon suivante:

Théorème 2.2.2: (C.Holzmann, F.Harary 1972). Soit $M = (\mathcal{B}, E)$ un matroïde dont l'ensemble des bases est \mathcal{B} . Soit X l'ensemble des vecteurs d'incidence des éléments de \mathcal{B} , $P = \text{conv}(X)$, alors $G(P)$ communément appelé graphe des bases d'un matroïde est fortement hamiltonien, c'est à dire que toute arête appartient à un cycle hamiltonien mais pas à tous.

En 1974 Balinski et Russakoff publiaient un résultat sur le squelette du polytope d'affectation. Soit E l'ensemble des n^2 entrées d'une matrice $n \times n$. Soit \mathcal{F} l'ensemble des parties de E ayant un élément par ligne et par colonne, et soit X l'ensemble des vecteurs d'incidence des éléments de

\mathcal{F} , alors $P = \text{conv}(X)$ s'appelle le polytope d'affectation et on a :

Théorème 2.2.3 (M. Balinski et A. Russakoff 1974) : Le squelette du polytope d'affectation est hamiltonien.

Quelques années plus tard, en 1977, paraissait un article de Brualdi et Gipson sur le graphe des couplages parfaits d'un graphe biparti, le théorème principal s'énonçait

Théorème 2.2.4 : (Brualdi et Gibson 1977). Soit $H = (V, E)$ un graphe biparti, soit \mathcal{M} l'ensemble des parties de E qui forment un couplage parfait de H , X l'ensemble des vecteurs d'incidences d'éléments de \mathcal{M} . Alors le squelette de $\text{conv}(X)$ est soit un hypercube, soit hamilton connexe, c'est à dire qu'il existe entre deux sommets quelconques une chaîne hamiltonienne.

Enfin en 1978, H.P. Young s'intéressait au polytope des permutations. Ce polytope est obtenu de la façon suivante : E est l'ensemble des n^2 entrées d'une matrice $n \times n$. Etant donnée une permutation $\sigma = (\sigma_1 \dots \sigma_n)$ soit F_σ la matrice $n \times n$ telle qu'il y a un 1 dans la position (i, j) si i précède j dans la permutation σ , et 0 autrement. Soit X l'ensemble des vecteurs d'incidences des matrices F_σ , $\text{conv}(X)$ s'appelle indifféremment le polytope des permutations ou polytope des "linear orderings". Il ne faut pas confondre ce polytope des permutations ni avec celui d'affectation, ni avec le permutoèdre, ce dernier n'étant pas en 0 et 1.

Théorème 2.2.5 : (H.P. Young 1978). Le squelette du polytope des permutations est hamiltonien.

En 1980 l'auteur et W.R. Pulleyblank ont entrepris d'englober tous ces résultats dans un unique théorème. Ils ont alors remarqué que tous les polytopes précédents ont la propriété que deux sommets u et v sont adjacents si et seulement s'il n'existe pas deux autres sommets t et z tels que $u + v = t + z$. En écrivant $1/2u + 1/2v = 1/2t + 1/2z$ on voit que la relation ne fait que traduire le fait que deux sommets sont adjacents si et seulement si le milieu du segment qui les joint n'est pas le milieu d'un autre segment joignant deux autres sommets. Un polyèdre en 0 et 1 avec cette propriété avait alors été appelé combinatoire. Cette

terminologie provient du fait que de nombreux polyèdres rencontrés en combinatoire ont cette propriété comme le montre la liste suivante:

Exemples de polyèdres combinatoires:

- polytope des stables d'un graphe
- polytope des couplages d'un graphe
- polytope des couplages parfaits d'un graphe
- polytope des b-couplages d'un graphe
- polytope des indépendants d'un matroïde
- polytope des bases d'un matroïde
- le "set partitionning polytope" associé à une matrice (0-1)
- l'enveloppe convexe des sous-ensembles définis par une équation:

$$X = \{ x \in \{0,1\}^n : Ax = b \}$$

- l'enveloppe convexe des arborescences d'un graphe orienté
- le polytope des permutations.

Par contre tous les polytopes en 0 et 1 ne sont pas combinatoires comme le montrent les exemples suivants:

Exemples de polytopes non combinatoires:

- le polytope des circuits hamiltoniens d'un graphe orienté
- le polytope des ordres partiels d'un ensemble

On ignore la réponse pour les polytopes suivants:

- l'enveloppe convexe des indépendants communs à deux matroïdes
- l'enveloppe convexe des cycles hamiltoniens dans un graphe non orienté.

Rappelons qu'un hypercube de dimension n ou n-hypercube est défini récursivement par:

pour n = 0 le graphe a un seul sommet et pas d'arêtes

pour n = k on prend 2 copies du (k-1) hypercube et l'on joint les sommets correspondants par une arête. Ainsi le 1-hypercube est le graphe formé de deux sommets joints par une arête, le 2-hypercube est le carré, le 3-hypercube le squelette du cube à 3 dimensions...

Rappelons aussi qu'un graphe est dit hamilton connexe si deux sommets quelconques sont joints par une chaîne hamiltonienne.

Le principal théorème de "Hamiltonicity and combinatorial polyhedra" qui unifie tous les théorèmes cités auparavant est:

Théorème 2.2.6: Soit P un polyèdre combinatoire. Son squelette $G(P)$ est soit un hypercube soit hamilton connexe.

Cependant ce théorème, comme tous les précédents, utilise une structure "combinatoire" des polytopes étudiés. La grande question qui restait posée était celle de savoir si le fait d'être en 0 et 1 n'était pas suffisant pour impliquer les mêmes conclusions. Cette idée nous a semblé à priori peu réaliste et c'est pourquoi il a fallu deux ans avant que nous n'attaquions ce problème pour finalement démontrer le théorème suivant qui met un terme aux recherches sur l'hamiltonicité dans les polyèdres en 0 et 1 . Ce théorème est le principal résultat de (2.2).

Théorème 2.2.7: Soit un polyèdre en 0 et 1 . Le squelette $G(P)$ de P est soit un hypercube soit hamilton-connexe.

Un corollaire de ce théorème est que les seuls graphes bipartis qui sont le squelette d'un polyèdre en 0 et 1 sont les hypercubes. Ceci est en fait un point crucial de la démonstration du théorème 2.2.7.

Enfin dans (2.2) on trouvera le théorème suivant, évident pour les squelettes de polyèdres quelconques, mais qui ne l'est pas du tout si l'on se restreint aux polyèdres en 0 et 1 .

Théorème 2.2.8: Soit P un polyèdre en 0 et 1 de \mathbb{R}^n tel que $\dim(P)=k < n$. Alors il existe un polyèdre Q en 0 et 1 de \mathbb{R}^k tel que $G(P)=G(Q)$.

3. Propriété arête-pancyclique de certains polytopes en 0 et 1 (article 2.3)

Un graphe $G = (V, E)$ est dit pancyclique s'il admet des cycles de toutes les longueurs de 3 à $|V|$. Une arête est dite pancyclique si elle appartient à des cycles de toutes les longueurs de 3 à $|V|$. Dans le cas où la propriété précédente est vraie sauf pour des cycles de longueurs 3, on dit que l'arête est presque pancyclique.

Contrairement à l'hamiltonicité très peu de choses ont été faites sur la pancyclicité. Cependant A. Bondy s'est intéressé à cette propriété et a montré que dans le graphe des bases d'un matroïde, i.e. le squelette de l'enveloppe convexe des bases d'un matroïde, si celui-ci n'était pas un hypercube, toute arête est soit pancyclique soit presque pancyclique. Ce théorème sera donné plus explicitement en temps voulu.

Ceci a donné le départ d'une étude plus systématique de cette propriété dans les squelettes de polyèdres en 0 et 1. Dans un premier temps, dans un manuscrit non publié, cette même propriété a été démontrée pour le graphe des couplages parfaits d'un graphe.

Le départ étant prometteur on peut se demander dans quelle mesure ces deux théorèmes se généralisent. Avant de pouvoir exposer les résultats, il convient de définir la notion de séparabilité qui est d'ailleurs centrale dans les travaux décrits au paragraphe précédent.

Soit $X \subset \{0,1\}^E$ et soit $S \subset E$. Pour tout $x \in X$ on note

$$x[S] \equiv (x_j : j \in S) \quad \text{et} \quad X[S] = \{x[S] : x \in X\}$$

i.e. $x[S]$ est la restriction de x aux composantes indexées par S , $X[S]$ est l'ensemble de toutes ces restrictions.

$S \subset E$ est un séparateur de X si et seulement si pour tout $x' \in X[S]$ et tout $x'' \in X[E-S]$ la concatenation x de x' et x'' définie par

$$x_j = \begin{cases} x'_j & \text{si } j \in S \\ x''_j & \text{si } j \in E - S \end{cases}$$

appartient aussi à X . Si $\emptyset \neq S \neq E$, le séparateur S est dit non trivial. On dit que X est non séparable s'il n'existe pas

de séparateurs non triviaux. Une composante de X est un séparateur minimal non trivial.

Soit $r = |X[S]|$ où S est une composante de X , on dit alors que S est à r -valeurs. Seules vont nous intéresser dans ce paragraphe les composantes 1 et 2 valeurs. Si S est à 1-valeurs alors $S = \{e\}$ et pour tout $x \in X$ $x[e] = \epsilon$ où $\epsilon \in \{0,1\}$. Si S est à 2-valeurs alors $X[S]$ est composée de 2 vecteurs complémentaires. Cette notion de composante correspond à celle de composante connexe quand il s'agit de matroïde, les composantes 1-valeur étant les isthmes ou les boucles suivant que la valeur est 1 ou 0 respectivement.

Le théorème de Bondy s'énonce;

Théorème 2.3.1: Soit M un matroïde dont toutes les composantes ne sont pas à 1 ou 2 valeurs. Soit $B_1 B_2$ une arête du graphe des bases de M et $X = \{\text{vecteurs d'incidences de bases}\}$.

(i) Si $B_1 \Delta B_2$ est une composante 1-valeurs de X alors $B_1 B_2$ est presque pancyclique et pas pancyclique

(ii) Sinon $B_1 B_2$ est pancyclique.

et le théorème annoncé sur les couplages parfaits s'énonce

Théorème 2.3.2: Soit $H = (V,E)$ un graphe tel que le graphe partiel formé par les arêtes qui appartiennent à au moins un couplage parfait a au moins une composante qui n'est pas un cycle ou une arête isolée.

Soit $X = \{\text{vecteurs d'incidence de couplages parfaits de } H\}$. Soit $M_1 M_2$ une arête joignant le couplage parfait M_1 à son voisin M_2 alors

(i) si $M_1 \Delta M_2$ est une composante connexe du graphe partiel formé par les arêtes qui appartiennent à au moins un couplage parfait, alors $M_1 M_2$ est presque pancyclique mais pas pancyclique.

(ii) sinon $M_1 M_2$ est pancyclique.

Disons tout de suite que tous les polyèdres en 0 et 1 dont le squelette n'est pas un hypercube n'ont pas cette propriété. Un contre-exemple est donné dans (2.3) qui montre que cette propriété est fausse même si on se restreint aux polyèdres monotones, c'est à dire ceux qui sont l'enveloppe convexe des indépendants d'un système d'indépendance.

Il convenait donc de trouver un cadre général à ces deux théorèmes.

Soient u et $v \in X \subset \{0,1\}^E$, on note $D(u,v) \subset E$ l'ensemble des positions dans lesquelles u et v diffèrent. Il est facile de voir qu'une condition suffisante (mais non nécessaire) d'adjacence de u et v est que $D(u,v)$ soit minimal par inclusion dans l'ensemble $\{D(t,z) \neq \emptyset : t \in X, z \in X\}$.

Considérons le sous-ensemble \mathcal{P} des polytopes en n et 1 qui ont la propriété que leurs sommets peuvent être représentés par des vecteurs en 0 et 1 de telle manière que la condition précédente soit aussi une condition nécessaire d'adjacence.

Par exemple, étant donné un matroïde $M = (\mathcal{B}, E)$, le polytope des bases de ce matroïde appartient à \mathcal{P} , car deux bases sont adjacentes si et seulement si leur différence symétrique est de cardinalité 2 . Or étant donnés deux ensembles équicardinaux ceci est le minimum possible pour la cardinalité de leur différence symétrique. De même soit $H = (V, E)$ un graphe, le polytope des couplages parfaits de H appartient à \mathcal{P} , car deux couplages parfaits de H sont adjacents si et seulement si leur différence symétrique est un cycle élémentaire (pair). Or le retrait de n'importe quelle arête ne laisse plus un cycle et encore moins une collection de cycles disjoints, donc cette différence symétrique est minimale parmi toutes différences symétriques. Le résultat principal de l'article référencié est le :

Théorème 2.3.3: Soit $X \subset \{0,1\}^E$ tel que $\text{conv}(X)$.
Si toutes les composantes de X ne sont pas à 1 ou 2 -valeurs, alors une arête (u,v) de $G = (\text{conv}(X))$ est:

- (i) presque pancyclique et pas pancyclique si $D(u,v)$ est une composante 2 -valeurs de X
- (ii) pancyclique sinon

Ce théorème généralise bien, comme annoncé, les théorèmes 2.3.1. et 2.3.2.

Le contre-exemple cité plus haut est "combinatoire" selon la définition donnée au paragraphe précédent. Les polyèdres combinatoires n'ont donc pas en général la propriété d'arête-

pancyclicité . Notons qu'il est spécifié dans (2.3) qu'il n'y a pas de relation d'inclusion liant l'ensemble \mathcal{P} de polyèdres en 0 et 1 que l'on a considéré dans ce paragraphe et les polyèdres combinatoires du paragraphe précédent.

4. CONCLUSIONS :

Une question importante, comme on l'a déjà noté, est celle de la caractérisation des graphes qui sont le squelette d'un polyèdre. Seul le cas des polyèdres de R^3 a été résolu et pour le reste il semble que l'on soit encore très loin de la solution. Peut-on espérer une réponse si l'on se restreint aux polyèdres en 0 et 1 ? Le contenu de ce chapitre a déjà permis de caractériser les graphes bipartis qui sont de tels squelettes. Notons enfin que S.B.Maurer a donné une réponse dans le cas particulier du graphe des bases d'un matroïdes.

BIBLIOGRAPHIE

- [1] B.GRÜNBAUM: "Convex polytopes" chapitre 13, Interscience 1967.
- [2] E.STEINITZ: "Polyeder und Raumeinteilungen" Enzykl.Math.Wiss. 3A12 pp1-139 (1922).



CHAPITRE III

TRAVAUX EN RELATION AVEC LE PROBLEME DU VOYAGEUR DE COMMERCE

I. INTRODUCTION:

Les problèmes d'Optimisation Combinatoire ont été classés en 2 catégories, ceux dit faciles ou Polynomiaux et ceux dits difficiles ou NP-difficiles (cf [4] pour plus de détails). Parmi les problèmes de la deuxième classe celui du Voyageur de Commerce est certainement celui qui a suscité le plus de travaux. Cela peut s'expliquer par ses applications aux problèmes de tournées, mais surtout parce qu'il est de ceux qui se visualisent le mieux. Telle la théorie du couplage qui a servi de moteur au développement d'algorithmes pour les problèmes de la première classe, le Problème du Voyageur de Commerce est au centre du développement de méthodes pour ceux de la deuxième.

Rappelons en quelques mots le problème. Etant donné un graphe $G = (V, E)$ orienté (resp. non-orienté) et une fonction $c : E \rightarrow R$ qui à tout arc (resp. arête) e associe son coût

C_e , le problème du Voyageur de Commerce consiste à trouver un circuit (resp. cycle) hamiltonien de coût minimum (le coût d'un circuit (resp. cycle) étant la somme des coûts des arcs (resp. arêtes) qui le composent). C'est le cas des graphes non orientés qui a reçu le plus d'attention et dans ce qui suit, sauf si le contraire est précisé les graphes considérés sont non orientés.

Une des voies de recherche qui a attirée de nombreux chercheurs est le développement d'heuristiques (i.e. de méthodes empiriques) avec, soit l'étude du cas le plus défavorable pour ces méthodes, soit l'étude de leur comportement probabiliste. Aucun des travaux de cette thèse n'est dans cette perspective

Les pionniers de la Programmation Linéaire que furent G.B. Dantzig D.R. Fulkerson et S.M. Johnson [2] et [3] avaient

entrepris en 1954 de résoudre un problème de voyageur de Commerce sur 48 villes. Pour cela ils ont employé la méthode suivante.

En reprenant les idées déjà exposées au chapitre précédent, on peut associer à chaque cycle hamiltonien un $(0-1)$ vecteur de R^m ($m = |E|$ et l'enveloppe convexe de tous ces vecteurs a pour sommets exactement l'ensemble de ces vecteurs. Puisque tout polyèdre peut-être décrit par un ensemble fini d'inéquations linéaires et puisque tout programme linéaire admet un sommet du polyèdre des solutions comme optimum, le procédé suivant conduit nécessairement à l'optimum:

(1) Prendre un sous-ensemble des inéquations qui définissent l'enveloppe convexe. Résoudre le programme linéaire obtenu en prenant ces inéquations comme ensemble de contraintes, la fonction objective étant évidemment de minimiser $\sum_{e \in E} c_e x_e$

(2) Si la solution est entière et vérifie toutes les autres inéquations on s'arrête car cette solution est optimale (il suffit que les arcs tels que $x_e = 1$ forment un cycle hamiltonien)

(3) Sinon on choisit un ensemble de contraintes violées, on les incorpore au programme linéaire et on recommence.

Les auteurs précités étaient partis du programme linéaire (P) suivant

$$(P) \quad \begin{cases} \text{minimiser } \sum_{e \in E} c_e x_e & \text{sous les contraintes} \\ x_e > 0 & \text{pour tout } e \in E \\ x(\delta(v)) = 2 & \text{pour tout sommet } v \in V \end{cases}$$

Les contraintes ajoutées au cours de la résolution étaient uniquement du type $x(\gamma(S)) < |S| - 1$ pour $S \subset V$, dites contraintes d'élimination de sous-tours, en effet si la solution est entière elles empêchent la formation de cycles non hamiltoniens. Dans le problème à 48 villes étudié les auteurs avaient eu la chance de pouvoir conclure en ayant uniquement à leur disposition ces contraintes. Cependant puisque à ce jour un système complet d'inégalités décrivant l'enveloppe convexe des cycles hamiltoniens n'est pas connu, la méthode décrite n'est pas applicable à toutes les instances

du problème. C'est ainsi qu'une variante de cette méthode a été développée par M.Held et R.Karp [5] d'une part, H.Crowder et M.W.Padberg d'autre part. Celle-ci peut se résumer de la façon suivante:

Soit J un ensemble connu d'inéquations linéaires nécessaire à la description de l'enveloppe convexe des cycles hamiltoniens et soit J^* un sous-ensemble de ces inéquations.

(1) Résoudre le problème de minimiser $\sum_{e \in E} c_e x_e$ sous les contraintes J^*

(2) Si la solution est entière et correspond à un cycle hamiltonien on s'arrête car on a trouvé la solution optimale

(3) S'il y a des contraintes de $J - J^*$ violées on les rajoute à J^* et on retourne en (1)

(4) Sinon on utilise une méthode de Séparation et Evaluation Progressive (S.E.P.) (Branch and Bound en Anglais). On essaie alors de résoudre par (1), (2) et (3) chacun des sous problèmes créés.

Le succès de cette méthode ainsi que de la précédente réside donc non seulement dans la connaissance d'une famille importante d'inéquations linéaires nécessaires à la description de l'enveloppe convexe des cycles hamiltoniens, mais aussi dans la facilité avec laquelle une inéquation violée est reconnue. De nombreuses recherches ont été effectuées en vue de découvrir de nouvelles inéquations nécessaires pour définir l'enveloppe convexe des cycles hamiltoniens. Les travaux les plus intéressants dans cette voie sont dus à M.Grötschel et M.Padberg qui ont définis les contraintes dites de peigne. C'est dans cette voie que se situe l'article (3.3) qui sera décrit au chapitre 3.

La quasi totalité des travaux effectués à ce jour considère que $G = (V,E)$ est un graphe complet. Il est surprenant que peu de chercheurs se soient souciés de rechercher des classes non triviales de graphes pour lesquels on peut développer un algorithme efficace pour résoudre le Problème du Voyageur de Commerce. Dans le cas des graphes orientés quelques exemples de tels graphes avaient été trouvés, mais dans le cas des graphes non-orientés aucun cas n'était connu avant l'article (3.1). Dans cet article le premier tel cas est donné. Ceci est repris et développé dans

(3.2) où l'on montre en particulier le rôle joué par les ensembles déconnectant de 3 arêtes. Cette méthode de réduction du problème est dans l'esprit des travaux de M.Boulala et J.P.Uhry sur le problème du stable dans les graphes séries-parallèles. Cette approche a été utilisée par la suite par F.Barahona [1] pour le problème de la coupe de poids maximum dans une certaine classe de graphes, ce problème, comme celui du Voyageur de Commerce, étant difficile en général.

2. Le problème du Voyageur de Commerce dans les graphes ayant un ensemble déconnectant de 3 arêtes (articles (3.1) et (3.2))

En collaboration avec G.Cornuejols et W.R.Pulleyblank

Supposons que l'on ait un ensemble déconnectant de 3 arêtes, soit S une de ses plages, i.e. $\delta(S) = \{e, f, g\} \subseteq E$. Or suppose de plus que e, f et g sont incidents à des sommets distincts u, v et w de S cf figure 2).

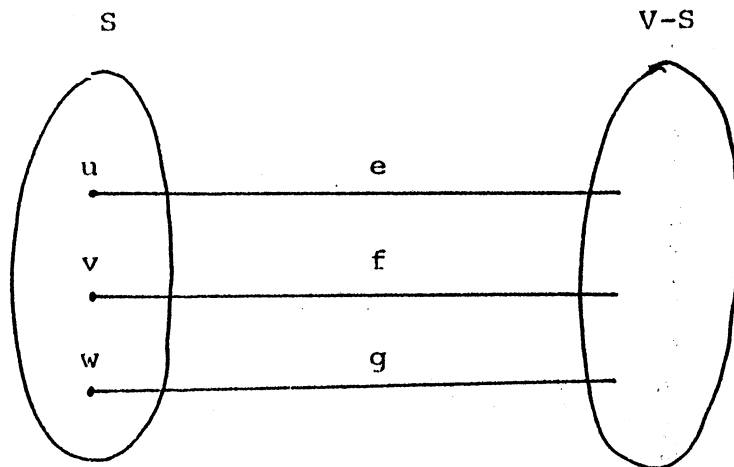

Figure 2

Si l'on sait calculer efficacement les longueurs L_{uv} , L_{uw} , L_{vw} des plus courtes chaînes hamiltoniennes dans $G(S)$ entre u et v , u et w , v et w respectivement, alors on peut contracter S pour se ramener à un problème du Voyageur de

Commerce sur un graphe plus petit, tous les coûts étant inchangés sauf ceux de e , f et g auxquels il convient d'ajouter des nombres α , β et γ respectivement, ceux-ci étant facilement calculés en fonction des L_{ij} $i, j \in \{u, v, w\}$ comme étant l'unique solution du système de 3 équations à 3 inconnues suivant:

$$\begin{cases} \alpha + \beta & = L_{uv} \\ \beta + \gamma & = L_{vw} \\ \alpha & + \gamma = L_{uw} \end{cases}$$

Un graphe de Halin est un graphe obtenu à partir d'un arbre sans sommets de degré 2 dessiné de façon planaire, dont les sommets pendants sont alors joints par des arêtes formant un cycle, le tout demeurant planaire. Ces graphes sont 3-connexes, hamiltoniens etc... Pour cette classe de graphes la contraction précédente permet de développer un algorithme efficace pour la résolution du Problème du Voyageur de Commerce. C'est ce qui est explicité dans (3.1).

L'existence d'un algorithme polynomial va souvent de pair, en Optimisation Combinatoire, avec la possibilité de donner une description complète par des inéquations linéaires de l'enveloppe convexe des solutions. L'exception la plus notoire à cette remarque est le problème du stable de poids maximum dans les graphes sans étoiles ($K_{1,3}$) pour lequel on connaît un algorithme efficace (Minty) mais seule une description partielle du polytope des solutions est connue. Il est donc tout à fait normal que l'on se soit intéressé à l'implication polyédrale de l'existence de déconnectants à 3 arêtes. Pour cela définissons une opération, inverse de la réduction précédemment définie. Soient $v_1 \in V_1$ et $v_2 \in V_2$ deux sommets de degré 3, posons:

$$\delta(v_1) = \{e_1, f_1, g_1\}, \quad \delta(v_2) = \{e_2, f_2, g_2\}. \quad \text{on dit que}$$

$G = G_1 * G_2$ si G est le graphe dont l'ensemble des sommets est $(V_1 - \{v_1\}) \cup (V_2 - \{v_2\})$ et l'ensemble des arêtes est $E_1 \cup E_2$ dans lequel les arêtes e_1 et e_2 , f_1 et f_2 , g_1 et g_2 ont été identifiées à e , f et g respectivement (cf figure 3).

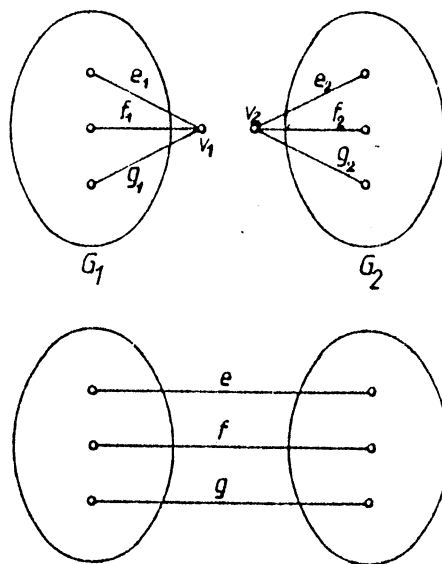

$$G = G_1 * G_2$$

Figure 3

Bien entendu G dépend du choix de v_1 et v_2 , mais dépend aussi des paires d'arêtes identifiées, nous maintiendrons néanmoins la notation $G = G_1 * G_2$.

Le théorème central de (3.2) est le

Théorème 3.2.1: Soit $G = G_1 * G_2$, un système d'inéquations qui décrit complètement l'enveloppe convexe des cycles hamiltoniens de G est obtenu en prenant un tel système définissant l'enveloppe convexe des cycles hamiltoniens dans G_1 et en lui juxtaposant le système correspondant à G_2 le tout en identifiant les variables associées à e_1 et e_2 , f_1 et f_2 , g_1 et g_2 respectivement

$$(i.e. \quad x_{e_1} \equiv x_{e_2}, \quad x_{f_1} \equiv x_{f_2}, \quad x_{g_1} \equiv x_{g_2}) .$$

Ce théorème permet de déterminer l'enveloppe convexe des cycles hamiltoniens d'un graphe de Halin sachant que

Proposition 3.2.2: Soit $G = (V, E)$ une roue, i.e. un graphe de Halin dont l'arbre de départ est une étoile $K_{1,n}$ alors l'enveloppe convexe des cycles hamiltoniens est donnée par

$$0 < x_e < 1 \quad \text{pour tout } e \in E$$

$$x(\delta(v)) = 2 \quad \text{pour tout } v \in V$$

Donc pour les graphes de Halin on obtient

Proposition 3.2.3: Soit $G = (V, E)$ un graphe de Halin, l'enveloppe convexe des cycles hamiltoniens est donnée par

$$0 < x_e < 1 \quad \text{pour tout } e \in E$$

$$x(\delta(v)) = 2 \quad \text{pour tout } v \in V$$

$$x(\delta(S)) = 2 \quad \text{pour tout } S \subset V \text{ tel que } |\delta(S)| = 3$$

Si l'on connaît une classe graphes pour lesquels l'enveloppe est donnée par les systèmes d'inéquations de la proposition 3.2.3, alors dans la mesure où il y a des sommets de degré 3 on sait construire une classe infinie de graphes pour lesquels l'enveloppe convexe est donnée par le système de la proposition 3.2.3. Certaines classes de graphes ont été trouvées mais la caractérisation de ces graphes n'a pas été obtenue.

3. Le Problème du Voyageur de Commerce sur un graphe

En collaboration avec G.Cornuejols et J.Fonlupt.

Etant donné un graphe $G = (V, E)$ et une fonction $c : E \rightarrow \mathbb{R}$ on a vu que le Problème du Voyageur de Commerce classique est celui de trouver un cycle hamiltonien de poids minimum dans G . Cependant il se peut que G ne possède pas de tels cycles et même s'il en possède, il se peut que le parcours d'un tel cycle ne soit pas le moyen le plus court de visiter chaque ville au moins une fois. La méthode classique pour contourner ces deux difficultés est de travailler sur le graphe complet K_n où $n = |V|$, le coût d'une arête de K_n étant égale à la longueur, dans G , d'un plus court chemin entre les extrémités de cette arête. Cette méthode a deux inconvénients majeurs. La première est que si l'on part avec un graphe ayant relativement peu d'arêtes, et que l'on veut utiliser une méthode dans laquelle à chaque arête est associée une variable, on augmente considérablement le nombre de ces variables. La deuxième est que l'on risque de transformer un problème facile en un problème difficile. Notre but a été d'étudier directement le problème sous sa forme généralisée (ou graphique).

Il est facile de voir que si une arête a un coût négatif alors cette arête est absorbante, i.e. on va la parcourir une infinité de fois. On supposera donc désormais que tous les coûts sont non négatifs.

Une tournée T est une famille d'arêtes, une même arête pouvant être prise plusieurs fois, telle que a) le nombre d'arêtes qui touche chaque sommet est pair et non nul et b) le graphe partiel construit sur ces arêtes est connexe. La longueur d'une tournée est la somme des longueurs des arêtes qui la constituent (avec leur ordre de multiplicité). Notre problème est donc de trouver une tournée de longueur ou poids minimum.

A une tournée T on peut associer un vecteur x de \mathbb{R}^E tel que $x_e =$ nombre de fois que l'arête apparaît dans T . On note $GTSP(G)$ l'enveloppe convexe de tous ces vecteurs. Notons que $GTSP(G)$ n'est pas bornée.

Afin de pouvoir approcher ce problème par la méthode de Dantzig, Fulkerson et Johnson décrite au paragraphe précédent, il convient de déterminer des inéquations valides pour ce problème, c'est à dire des hyperplans d'appui de $GTSP(G)$. Les inéquations les plus fortes, et les seules utiles, sont celles qui correspondent aux faces maximales de $GTSP(G)$. Ces faces sont alors appelées facettes et les inéquations sont alors dites génératrices de facettes.

En Optimisation Combinatoire les polyèdres sympatiques sont ceux de pleine dimension car le système minimal d'inéquations qui le décrit est unique (à une multiplication près des inéquations par des constantes positives) et dans un tel système chaque inéquation définit une facette. L'enveloppe convexe des cycles hamiltoniens est loin d'être de pleine dimension, par contre pour les tournées on a :

Théorème 3.3.1: Si G est connexe alors $GTSP(G)$ est de pleine dimension. De plus si G est 2-connexe l'enveloppe convexe des points extrêmes de $GTSP(G)$ est aussi de pleine dimension.

Les deux théorèmes suivants donnent deux classes de facettes dites triviales

Théorème 3.3.2: L'inéquation $x_e > 0$ définit une facette

si et seulement si e n'est pas un isthme

Théorème 3.3.3: Soit U un cocycle, $U = (S, \bar{S})$. Alors $x(U) > 2$ est une facette si et seulement si les sous graphes $G(S)$ et $G(\bar{S})$ sont tous les deux connexes.

Ces inéquations bien entendu ne suffisent pas pour définir GTSP(G). Dans le cas des graphes séries-parallèles ces inéquations définissent un polyèdre entier, cependant toute solution entière ne correspond pas à une tournée car il faut en plus que $x(\delta(v)) \equiv 0 \pmod{2}$ pour tout $v \in V$.

Une classe plus complexe de facettes a alors été trouvée. Considérons la configuration de la figure 4 où $A, \{B_i^j\}_{i,j}, Z$ forment une partition de V et sont tels que les sous graphes induits sur ces ensembles sont connexes. De plus k est impair et $n_j > 2$ pour tout j .

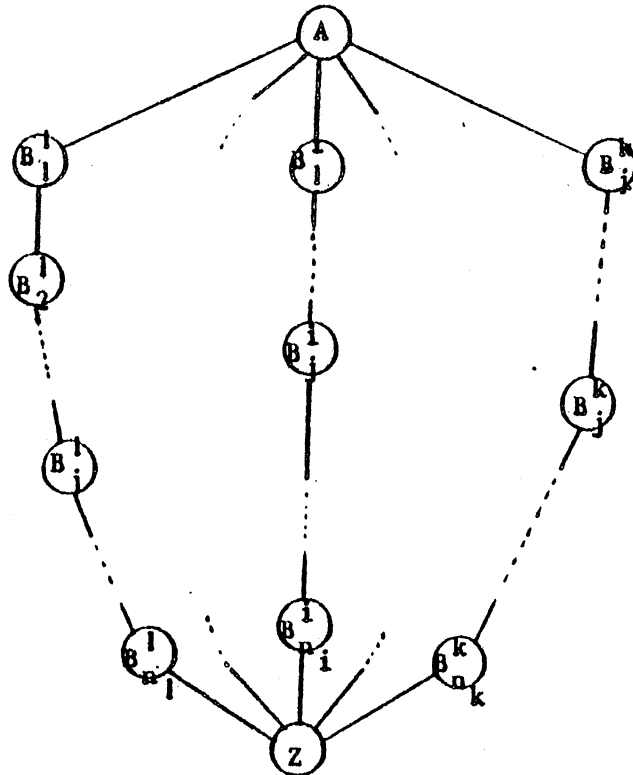

Figure 4

Considérons l'inéquation suivante dite de k-chaînes

$$\sum_{e \in E} f_e x_e > a$$

où $a = 1 + \sum_{j=1}^k \frac{n_j + 1}{n_j - 1}$

et

$$f_e = \begin{cases} 0 & \text{pour } e \in \gamma(B_i^j) & \text{pour tout } i \text{ et tout } j \\ 1 & \text{pour } e \in (A, Z) \\ \frac{i-r}{n_j-1} & \text{pour } e \in (B_i^j, B_r^j) \\ \max \left(\frac{p}{n_r-1} - \frac{i-2}{n_j-1}, \frac{i}{n_j-1} - \frac{p-2}{n_r-1} \right) & \text{pour tout } j \text{ et } i-r < n_j, r \neq i \\ & \text{pour } e \in (B_i^j, B_p^j), \\ & i \neq 0 \text{ et } n_j - 1, p \neq 0 \text{ et } n_r - 1, r \neq j \end{cases}$$

On obtient alors

Théorème 3.3.4: Soit $G = (V, E)$ un graphe, l'inéquation (*) décrite ci-dessus définit une facette de GTSP(G).

Si $n_j = 2$ pour tout j et si l'on impose $x(\gamma(v)) = 2$ pour tout v , on retrouve pour le problème du Voyageur de Commerce les fameuses inéquations dites de peigne (cf (3.3)).

Soit k un nombre impair, considérons la configuration de la figure 5 où $\{ \{A_i^j\}, \{B_i^j\}, \{C_i^j\} : i = 1 \dots k, j = i \dots n \}$ forment une partition de V , chacun des sous-graphes induits étant connexe et le graphe obtenu en identifiant tous les sommets de chacun de ces ensembles possède un graphe partiel maximal formé de deux cycles de longueur k dont les sommets sont deux à deux joints par des chaînes disjointes de longueur n (si $n = 0$ on n'a pas de C_i^j).

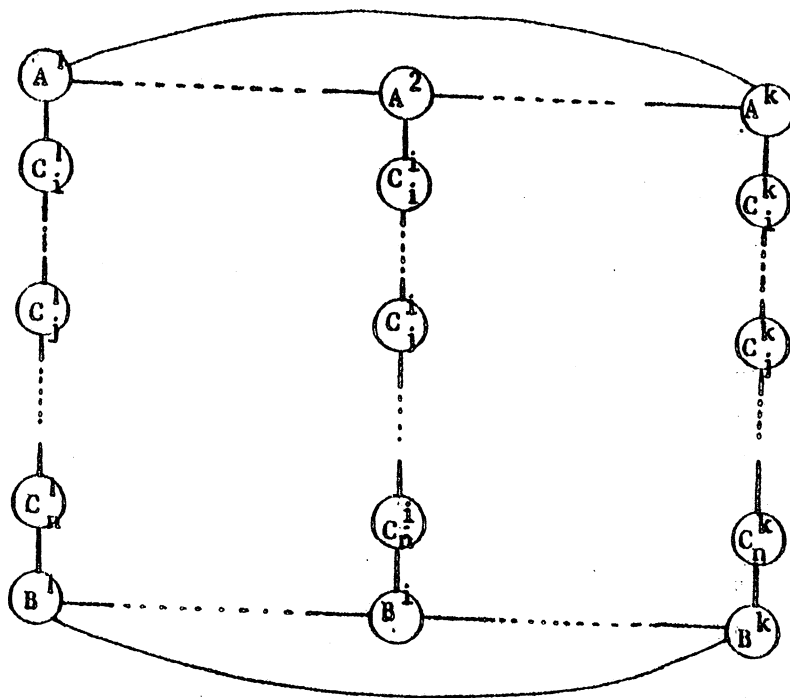

Figure 5

Considérons l'inéquation suivante dite de bicyclette

$$\sum_{e \in E} f_e x_e > a$$

où $a = (k + 1)(n + 1) + 2k$

et

$$f_e = \begin{cases} 1 & \text{si } e \in (C_j^i, C_{j+1}^i) \quad , j = 0, \dots, n \text{ et tout } i \\ 2 & \text{si } e \in (A^i, A^j) \text{ ou } (B^i, B^j) \quad i \neq j \\ 2 + j - r & \text{si } e \in (C_j^1, C_p^r) \quad i \neq r \\ j - p & \text{si } e \in (C_j^1, C_p^1) \quad i = 1 \dots k \\ 0 & \text{sinon} \end{cases}$$

Théorème 3.3.5: Une inéquation de bicyclette est toujours valide. Si de plus $(A^1, A^{i+2}) \neq \emptyset \neq (B^1, B^{i+2})$ pour tout i elle définit une facette.

Dans le même genre d'idée considérons la configuration suivante dérivée de la précédente dans laquelle tous les B^i ont été remplacés par un seul ensemble Z tel que le sous-graphe induit sur Z est connexe. De plus on suppose $n > 1$. (figure 6)

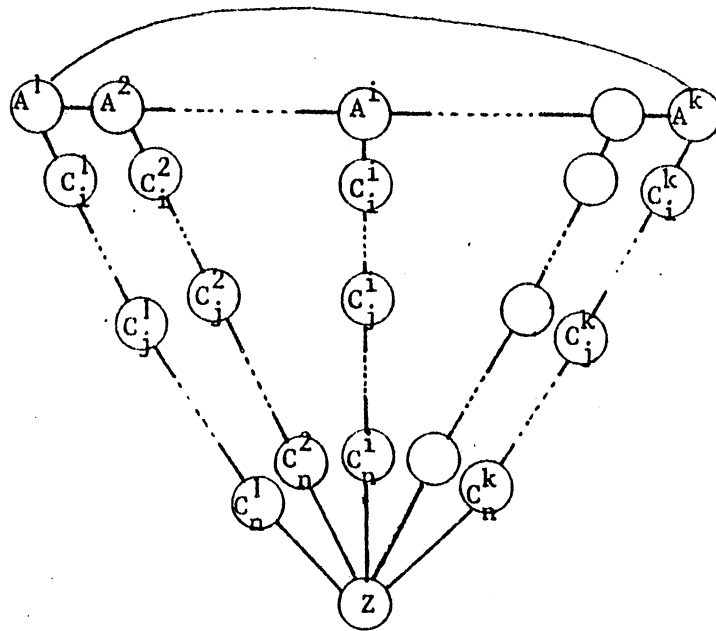

Figure 6

Considérons l'inéquation obtenue à partir d'une configuration de bicyclette en remplaçant a par $(k + 1)(n + 1) + 2\lfloor k/2 \rfloor$ et chaque B_i par Z (où $\lfloor t \rfloor =$ partie entière de t) Une telle inéquation est dite de brouette.

Théorème 3.3.6: Une inéquation de brouette définit une facette de $GTSP(G)$.

Un graphe est hypo-hamiltonien s'il n'est pas hamiltonien mais le retrait de n'importe quel sommet et des arêtes adjacentes à ce sommet laisse un graphe hamiltonien. Soit la classe des graphes hypohamiltoniens qui ont la propriété de devenir hamiltoniens dès qu'on leur rajoute une arête entre deux sommets non-adjacents quelconques. Le graphe de Petersen est dans .

Soit $A_1 \dots A_k$ une partition des sommets de $G = (V, E)$ telle que quand on contracte chaque A_i en un sommet a_i on obtienne un graphe contenant comme graphe partiel en élément de . Soit $H = (W, F)$ ce graphe avec $W = \{a_1 \dots a_k\}$ et F maximal, c'est à dire contenant tous les arcs où aucun entre a_i et a_j (pour tout i et tout j).

On a alors:

Théorème 3.3.7: L'inéquation

$$\sum_{e \in E} f_e x_e > V + 1 \text{ avec}$$

$$f_e = \begin{cases} 1 & \text{si } e \in (A_i, A_j) \text{ et } (a_i, a_j) \notin F \\ 2 & \text{si } e \in (A_i, A_j) \text{ et } (a_i, a_j) \in F \\ 0 & \text{sinon} \end{cases}$$

définit une facette de GTSP(G).

Enfin dans un dernier paragraphe le problème est étudié dans le cas particulier des graphes série-parallèles. Un algorithme efficace est donné dans ce cas ainsi que pour une version dite de Steiner où seuls certains sommets doivent être visités. En adaptant cet algorithme on peut aussi résoudre efficacement le problème de l'arbre de Steiner qui est dans le cas général NP difficile.

Références:

- [1] F.BARAHONA "The Max-Cut Problem on Graphs not Contractible to K_5 " Rapport de Recherche 822390R Université de Bonn.
- [2] G.DANTZIG, D.FULKERSON et S.JONHSON "Solution to a Large Scale Travelling Salesman Problem" JORSA Vol.2,4 (1954) 393-410
- [3] -----"On a Linear Programming Combinatorial Approach to the Travelling Salesman Problem" Operations Research Vol.7,1 (1959) 58-66
- [4] M.GAREY et D.JOHNSON "Computers and Intractability: A Guide to the Theory of NP-Completeness" H.Freeman and sons, San-Francisco.
- [5] M.HELD et R.KARP "The Travelling Salesman Problem and Minimum Spanning Trees" Part I dans Operations Research 18 (1970) 1138-1162 et Part II dans Mathematical Programming 1 (1970) 6-25.

ANNEXE 1

PAVAGE D'UNE SURFACE PAR DES CALISSONS
 ET SES APPLICATIONS A DES PROBLEMES DE DENOMBREMENT LIES AUX SUITES DE YOUNG

Denis NADDEF
 Université Scientifique et Médicale de Grenoble - France

I - INTRODUCTION

Nous allons retrouver certains résultats contenus dans [2], grâce à l'étude du recouvrement de certaines surfaces par des calissons, et par une méthode qui semble originale, possédant, en outre, l'avantage d'expliquer de façon naturelle la forme matricielle de ces résultats.

Nous rappellerons, au §II, certaines définitions de la théorie des graphes. Celles sur les suites de Young sont données au début du §IV. Le paragraphe suivant sera consacré à l'étude des recouvrements d'un hexagone particulier par des calissons. Le §IV montrera comment appliquer cette étude des recouvrements au dénombrement de ce qui est appelé dans [2], les solides normaux contenus dans un parallélépipède rectangle. Enfin, le dernier paragraphe utilisera la même méthode pour déterminer le nombre de suites de Young "comprises" entre deux suites du même type, comparables dans le treillis que forme l'ensemble des suites de Young, relativement à la relation d'ordre habituelle sur les suites.

II - RAPPELS SUR LA THEORIE DES GRAPHES

$G = (X,U)$ représentera un graphe simple non orienté (respectivement orienté) dont l'ensemble des sommets est X et l'ensemble des arêtes (resp. arcs) U . Un sommet $x \in X$ sera dit incident à une arête (resp. arc) $u \in U$ si x est une des extrémités de u . Deux arêtes (resp. arcs) seront dites adjacentes si elles ont une extrémité commune. Dans le cas où le graphe est orienté, pour $u = (x,y)$, on appellera x extrémité initiale et y extrémité terminale de u .

Soit $A \subset X$. On appelle cocycle de A , que l'on note $\Omega(A)$, l'ensemble des arêtes ayant une seule extrémité dans A . Si G est orienté, on appelle cocycle extérieur de A , que l'on note $\Omega^+(A)$, l'ensemble des arcs ayant leur extrémité initiale dans A et leur extrémité terminale hors de A . On note $\gamma(A)$ l'ensemble des arêtes (ou arcs) ayant leurs deux extrémités dans A . Enfin, $G(A)$ représente le sous-graphe induit par G sur A , c'est-à-dire le graphe $G(A) = (A, \gamma(A))$.

Soit $\tilde{U} \subset U$. On dit que \tilde{U} est un couplage de G si les éléments de \tilde{U} sont deux à deux non adjacents. Un sommet $x \in X$ est dit saturé par le couplage \tilde{U} s'il est incident à une arête de \tilde{U} . Un couplage \tilde{U} tel que tous les sommets $x \in X$ sont saturés est dit parfait.

Un graphe est dit planaire s'il en existe une représentation graphique telle qu'aucune de ses arêtes n'en coupe une autre en dehors de ses extrémités. La représentation graphique plane d'un graphe de ce type découpe le plan en portions, toutes bornées sauf une, que l'on appelle faces du graphe plane. Les faces bornées sont délimitées par des polygones dont les côtés sont formés par des arêtes du graphe. A un graphe plane G (représenté graphiquement sous une forme plane), on associe le graphe dual $G^* = (X^*, U^*)$ dont l'ensemble des sommets X^* représente les faces bornées de G , $(x^*, y^*) \in U^*$, si et seulement si les faces que désignent x^* et y^* ont des frontières ayant au moins une arête en commun. Par la suite, on représentera souvent G et G^* sur une même figure ; les arêtes de G seront alors en trait plein et celles de G^* en pointillé.

Pour un ensemble Y , on note $|Y|$ le nombre de ses éléments. Pour plus de détails sur les notions que l'on vient de citer on pourra lire Berge [1].

III - PAVAGE D'UN HEXAGONE PAR DES CALISSONS

On appelle calisson un losange dont les angles sont de 120 et 60 degrés. Soit H un hexagone ABCDEF dont les angles sont égaux, dont les côtés parallèles sont égaux et de longueurs respectives p , q et r . Un pavage de H est un recouvrement de H par des sous-ensembles disjoints. On se propose d'étudier les propriétés d'un pavage de H par des calissons de côtés égaux à l'unité. La figure 1 donne un exemple de pavage. (p , q et r sont entiers).

Un tel pavage utilise des calissons que l'on peut partitionner en 3 classes selon leurs positions dans l'hexagone. Nous donnerons cette classification un peu plus loin après avoir défini un problème équivalent au précédent.

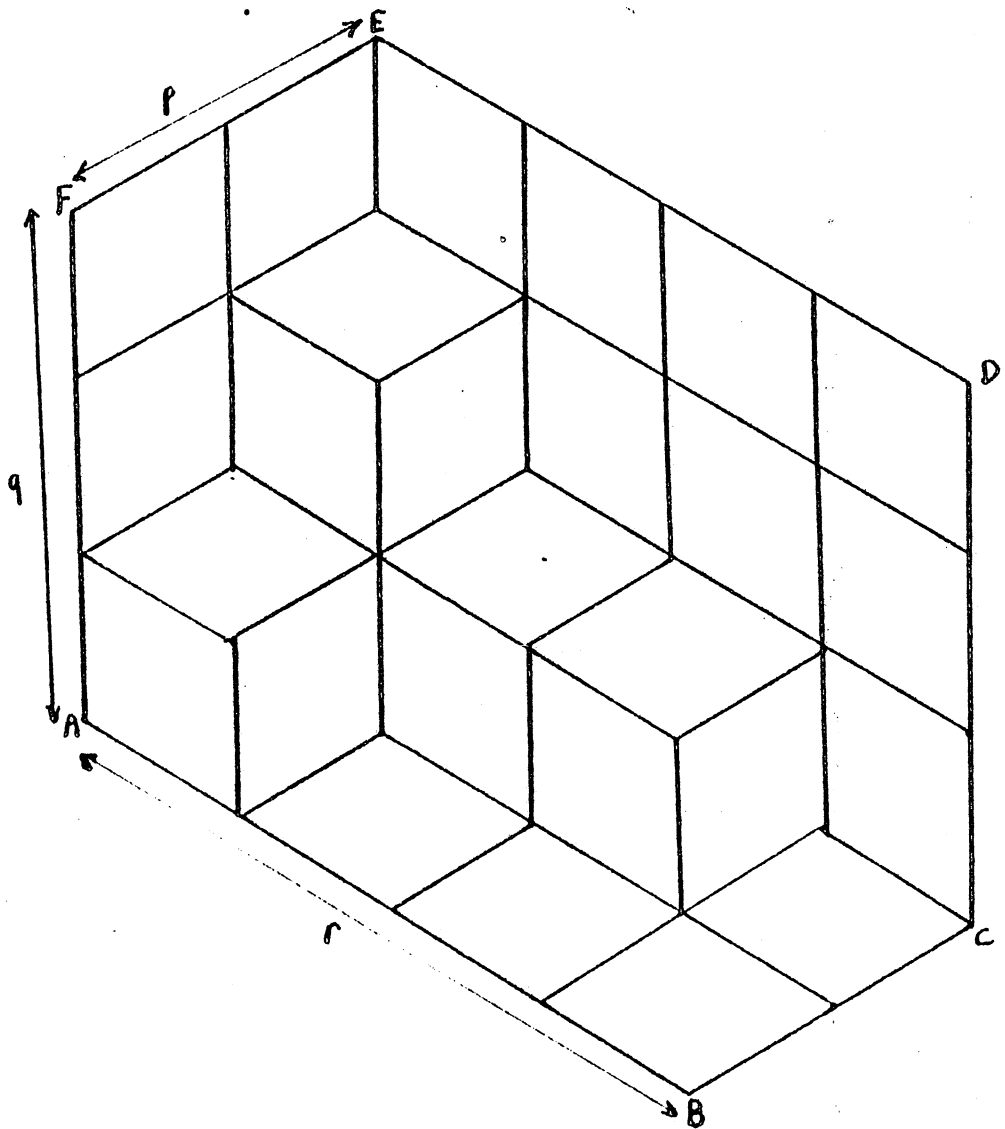

Figure 1

Par les points qui partagent AB, BC et CD respectivement en r , p et q segments égaux, menons les parallèles aux côtés de l'hexagone (2 droites sont à tracer par point). Cette opération découpe l'hexagone H en triangles équilatéraux (cf. figure 2).

Le pavage par des calissons est alors équivalent au problème d'effacer un et un seul côté de chaque triangle équilatéral.

L'ensemble des côtés des triangles équilatéraux se partitionne en trois sous-ensembles représentant chacun un ensemble de côtés de même direction. Appelons u , v et w ces trois directions (cf. figure 2). Cette partition des côtés nous induit à la partition suivante des calissons : un calisson sera dit un u -calisson (resp. v , w -calisson) s'il est obtenu en effaçant un côté de direction u (resp. v , w).

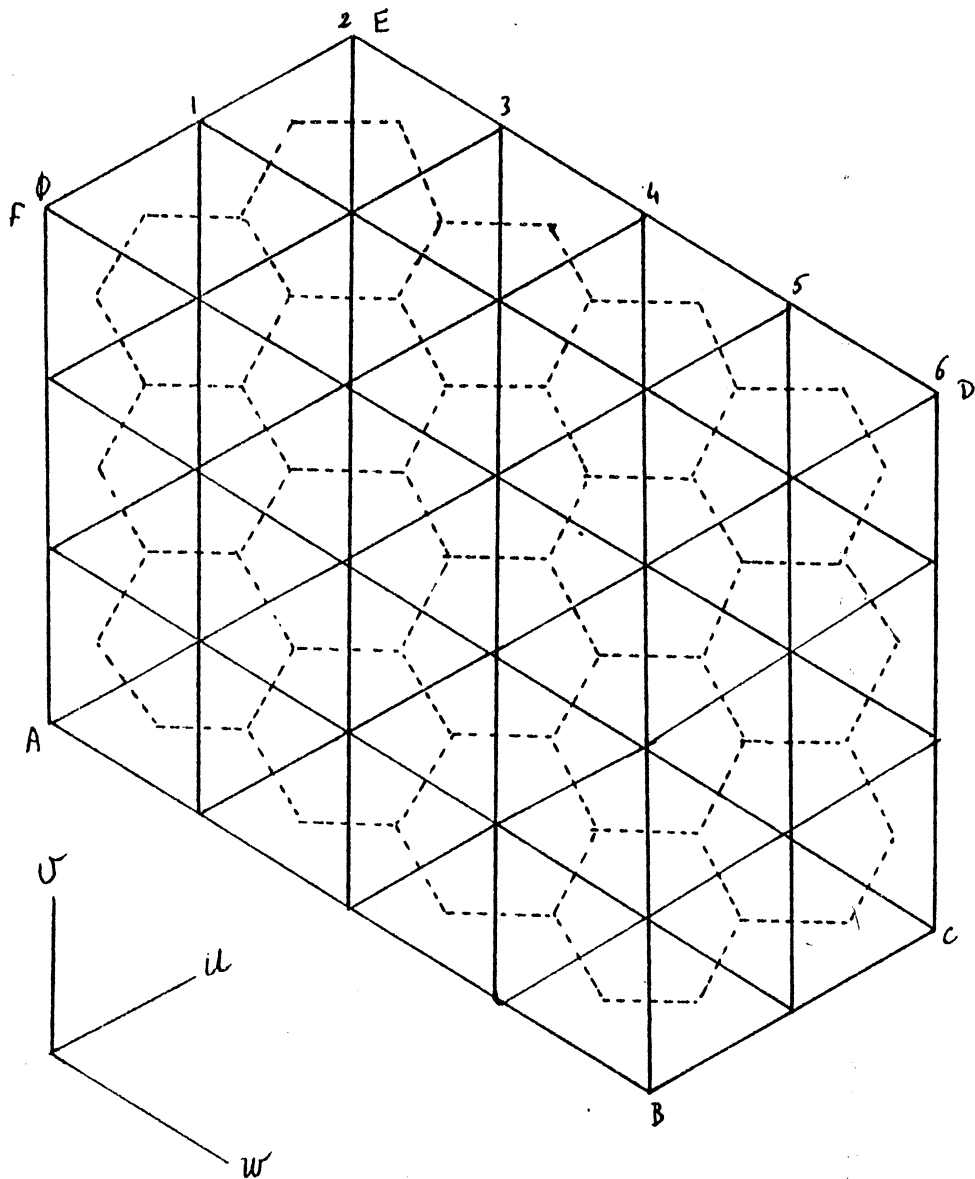

Figure 2

Nous allons donner maintenant une troisième forme équivalente du problème de recouvrement de H par des calissons. Considérons la figure obtenue par le quadrillage précédent comme un graphe planaire G . Soit G^* le dual de ce graphe planaire (en pointillé sur la figure 3). Associons à chaque côté du triangle effacé l'arête de G^* qui le traverse. A un ensemble de côtés effacés de façon à donner un recouvrement par des losanges correspond un couplage parfait de G^* , et réciproquement. Il s'agit d'un couplage parce que l'on efface au plus un côté de chaque triangle, et d'un couplage parfait car on en efface exactement un. La réciproque aussi est évidente.

Désormais G et G^* seront dessinés sur une même figure. On numérote d'autre part, de gauche à droite, les droites parallèles à la direction v , la droite AF prenant le numéro 0.

On dira qu'un calisson est à cheval sur la ligne i si cette ligne supporte le petit axe de ce calisson et qu'il appuie sur cette ligne i si un de ses côtés est contenu dans celle-ci (un calisson à cheval sur une ligne est nécessairement un v -calisson).

On supposera sans perte de généralité que $p \leq r$. On a alors :

Théorème 1 : Dans un recouvrement de l'hexagone par des calissons, le nombre de calissons qui s'appuient sur la ligne i ($0 \leq i \leq p+r$) est $2q$ pour tout $i \neq 0, p+r$, et q pour $i = 0$ et $p+r$.

Démonstration : Il y a exactement q calissons qui s'appuient sur la ligne 0. Les côtés opposés de ces q calissons sont contenus dans la ligne 1. Chaque fois qu'un calisson s'appuie sur une ligne i , ($i \neq 0, p+r$) il en existe un autre s'appuyant sur cette ligne i , suivant le même segment dans l'autre demi-plan délimité par cette ligne (mais pas forcément symétrique du précédent). Il existe donc au moins $2q$ calissons s'appuyant sur la première ligne. Supposons qu'il y en ait $2q'$ avec $q' > q$: un raisonnement analogue, fait de la ligne 1 vers la ligne 0, nous amène à une impossibilité.

Le raisonnement se poursuit alors trivialement par récurrence.

Corollaire 1 : Dans un recouvrement de l'hexagone (avec $p \leq r$) par des calissons, le nombre v -calissons qui sont à cheval sur la ligne i est :

$$\begin{cases} i & \text{si } i \leq p \\ p & \text{si } p \leq i \leq r \\ p+r-1 & \text{si } i \geq r \end{cases}$$

Démonstration : Il suffit de faire le calcul du nombre de segments découpés sur la ligne i .

Corollaire 2 : Dans tout recouvrement de l'hexagone H par des calissons, il y a pr v -calissons; pq w -calissons et qr u -calissons.

Démonstration : Le nombre de v -calissons est une conséquence directe du corollaire 1 ; les autres nombres s'obtiennent par permutation des paramètres.

Corollaire 3 : Dès que l'on se fixe, de façon compatible, la position des calissons de l'une des trois classes, la position des autres calissons est fixée sans ambiguïté.

Démonstration : Faisons la démonstration pour les y -calissons : la démonstration est la même par rotation de la figure (i.e. permutation des paramètres) dans les autres cas.

Si on se fixe, de façon compatible les v -calissons, il nous reste sur chaque ligne i exactement q segments. Si l'on numérote de 1 à q ces segments (de haut en bas par exemple) sur chaque ligne, les segments de même numéro sur deux lignes consécutives doivent appartenir au même calisson.

IV - APPLICATION AU DENOMBREMENT DES SOLIDES NORMAUX

On appelle suite de Young une suite décroissante (au sens large) d'entiers naturels, nuls à partir d'un certain rang. Soit y une telle suite. On écrira $y = (y_1, y_2, \dots, y_n)$ avec $y_i \geq y_{i+1}$, et n tel que pour tout $k > n$ $y_k = 0$. Soient y et z deux suites. On dira que z recouvre y si $y \leq z$ (i.e. $y_i \leq z_i$ pour tout $i \in \mathbb{N}$). Avec cette relation d'ordre, l'ensemble des suites de Young est un treillis. Posons $T(y, z) = \{t/t \text{ est une suite de Young et } y \leq t \leq z\}$. Suivant en cela la terminologie de Kreweras [2], on appelle riches de z par rapport à y , et on note $\rho(y, z)$, le nombre $|T(y, z)|$.

Considérons le parallélépipède OABCDEFG de côtés p, q, r de base OABC (figure 3).

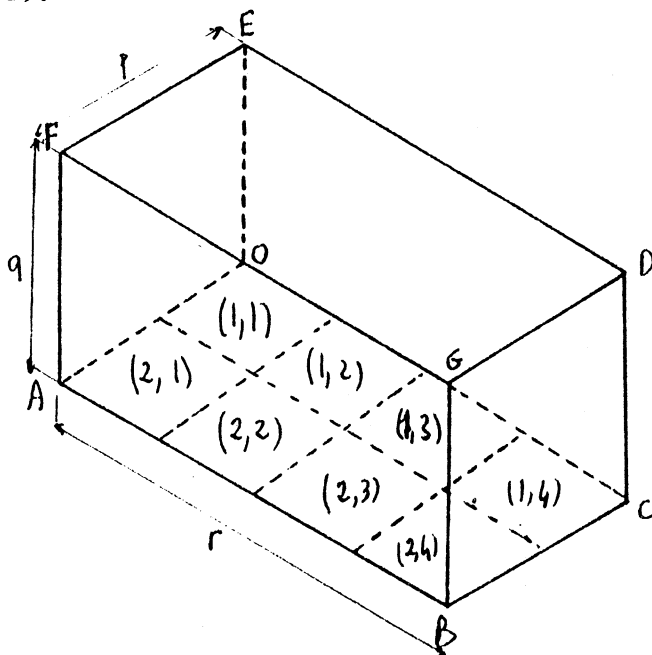

Figure 3

On suppose la base OABC découpée en $p \cdot r$ carrés de côtés de longueur 1 et parallèles aux segments OA et OC. Ces carrés sont repérés par un doublet (i, j) déterminé de façon cartésienne à partir de O, le long des axes OA et OC (figure 3).

On dit qu'un empilement de cubes, d'arêtes l'unité, dans cette pièce forme un solide normal, si les cubes sont disposés en piles au-dessus des cases (i, j) , de telle sorte que les hauteurs h_{ij} des piles vérifient les deux conditions suivantes :

(i) $y^{(i)} = (h_{i1}, h_{i2}, \dots, h_{ir})$ est une suite de Young pour tout $i = 1, \dots, p$.

(ii) $y^{(i)} \leq y^{(j)}$ pour $i \geq j$.

Remarque : Les conditions (i) et (ii) précédentes impliquent les suivantes :

(i') $z^{(i)} = (h_{i1}, h_{i2}, \dots, h_{ip})$ est une suite de Young pour tout $i = 1, \dots, r$

(ii') $z^{(i)} \leq z^{(j)}$ pour $i \geq j$.

Soit E un empilement de cubes dans le parallélépipède OABCDEFG formant un solide normal (dans le coin O). Dessinons cet empilement, ainsi que les parois OABC, OAFE et OCDE du parallélépipède, vu sous un angle convenable.

Si les trois parois dessinées sont atriées de façon à être recouvertes par des carrés de côtés 1, le dessin plan obtenu est un hexagone recouvert par des calissons (cf. figure 4). Donc, à condition de strier les parois, à tout solide normal correspond un pavage par des calissons de l'hexagone ABCDEF, qui est en quelque sorte le profil du parallélépipède. Réciproquement :

Théorème 2 : A tout pavage de l'hexagone ABCDEF par des calissons correspond un solide normal contenu dans le parallélépipède rectangle OABCDEFG.

Démonstration : Soit R un pavage de l'hexagone par des calissons ; il suffit, d'après le corollaire 3 du théorème 1 de montrer qu'il existe un solide normal tel que le recouvrement de l'hexagone qu'il induit possède les mêmes v -calissons que R .

Soit \tilde{U} le couplage de G^* associé au recouvrement R . Soient m_1^1, \dots, m_i^t où $t(i) = i$ si $i \leq p$, $t(i) = p$ si $p \leq i \leq r$ et $t(i) = r+p-i$ si $i \geq r$ (cf. théorème 1), les numéros des arêtes de \tilde{U} , qui traversent la i ème ligne quand on a numéroté les arêtes de G^* qui traversent cette ligne de bas en haut à partir de O.

Considérons l'empilement E suivant, donné par la hauteur de ses piles

$$h_{ij} = \binom{t(p_1 - (i-j) - j + 1)}{p_1 - (i-j)}$$

L'empilement E donne un pavage possédant les mêmes v -calissons que le pavage R . En raison du corollaire 3 du théorème 1, ce pavage est donc identique à R . \square

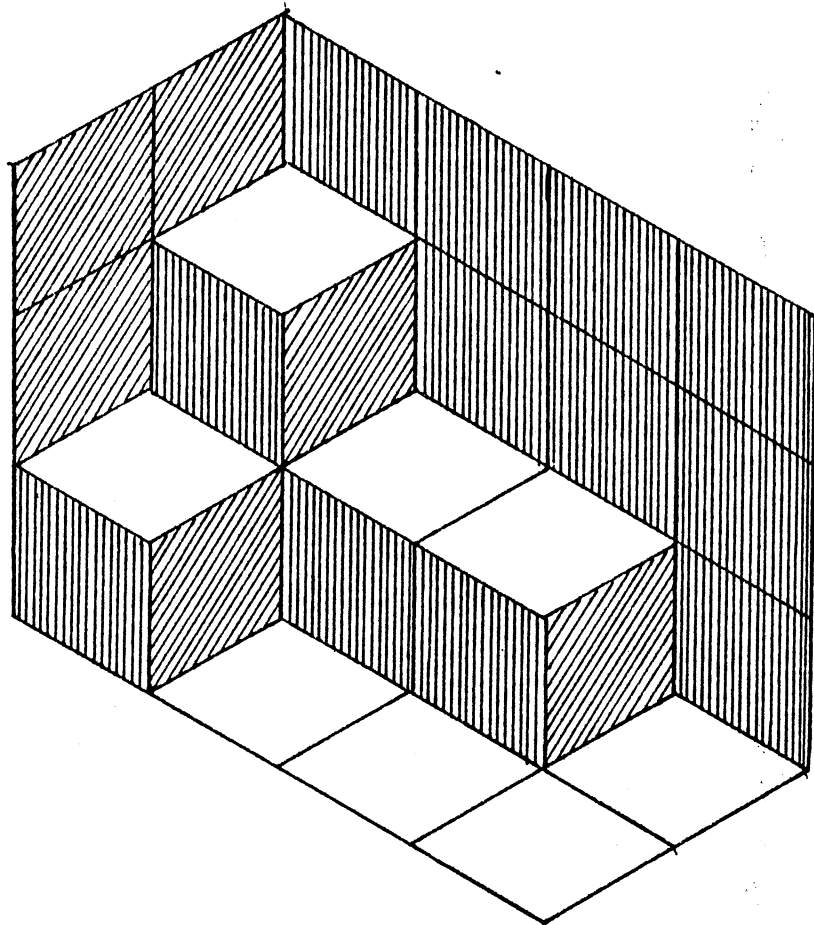

Figure 4

Corollaire 1 : Il y a bijection entre les solides normaux contenus dans un parallélépipède rectangle de dimension $p \times q \times r$ et les pavages par des calissons d'un hexagone ABCDEF, isogone tel que

$$AB = ED = r, \quad AF = CD = q \quad \text{et} \quad EF = BC = p.$$

Corollaire 2 : Il y a bijection entre les solides normaux contenus dans un parallélépipède rectangle de dimension $p \times q \times r$ et les couplages parfaits du graphe G^* correspondant à l'hexagone décrit dans le corollaire 1.

Le corollaire 2 va nous permettre de dénombrer les solides normaux contenus dans un parallélépipède rectangle. En effet, dans certains cas, on sait dénombrer les couplages parfaits d'un graphe. C'est le cas en particulier pour les graphes planaires. Nous donnons ci-dessous les rappels nécessaires ; pour plus de détails, on pourra consulter Berge [1], chapitre 7 d'où sont empruntés ces rappels.

Soit $\tilde{G} = (\tilde{X}, \tilde{U})$ un graphe simple orienté antisymétrique (c'est-à-dire que si $(x_i, x_j) \in \tilde{U}$, alors $(x_j, x_i) \notin \tilde{U}$). On suppose $\tilde{X} = \{x_1, x_2, \dots, x_{|\tilde{X}|}\}$. Au graphe \tilde{G} , on peut associer une matrice antisymétrique $B(\tilde{G}) = (b_{ij})$ en posant :

$$b_{ij} = \begin{cases} +1 & \text{si } (x_i, x_j) \in \tilde{U} \\ -1 & \text{si } (x_j, x_i) \in \tilde{U} \\ 0 & \text{sinon} \end{cases}$$

Cette matrice $B(\tilde{G})$ sera appelée la matrice adjointe de \tilde{G} .

Si $B = (b_{ij})$ est une matrice d'ordre $n = 2k$ pair, antisymétrique, on appelle pfaffien de B l'expression :

$$\text{Pfb} = \sum_{\pi} \epsilon(\sigma_{\pi}) b_{i_1 i_2} b_{i_3 i_4} \dots b_{i_{2k-1} i_{2k}}$$

où $\pi = [i_1, i_2 - i_3, i_4] \dots [i_{2k-1}, i_{2k}]$ est une permutation qui se décompose en k -cycles de longueur 2 avec

$$i_1 < i_3 < \dots < i_{2k-1}$$

$$i_1 < i_2, i_3 < i_4, \dots, i_{2k-1} < i_{2k}$$

et où $\sigma_{\pi} = \begin{pmatrix} 1 & 2 & \dots & n \\ i_1 & i_2 & \dots & i_n \end{pmatrix}$ et $\epsilon(\sigma_{\pi})$ est la signature de σ_{π} .

Lemme 1 : Si $\tilde{G} = (\tilde{X}, \tilde{U})$ est un graphe simple orienté anti-symétrique tel que $|\tilde{X}| = 2k$ et si $B(\tilde{G}) = (b_{ij})$ est sa matrice adjointe, alors $|\text{Pfb}(\tilde{G})|$ est égal au nombre de couplages parfaits de G , si et seulement si, tous les termes du développement de $\text{Pfb}(\tilde{G})$ ont le même signe.

Lemme 2 : Si B est une matrice carrée d'ordre n , anti-symétrique, alors on a :

$$\begin{aligned} \text{Det } B &= (\text{Pfb})^2 \text{ si } n \text{ est pair} \\ &= 0 \text{ si } n \text{ est impair} \end{aligned}$$

Lemme 3 : Soit G un graphe simple planaire non orienté. Si on oriente les arêtes de G de sorte que chaque contour pair d'une face bornée ait un nombre impair d'arcs dans le sens d'un parcours éventuel de celui-ci, on obtient un graphe G tel que le nombre de couplages parfaits de G est égal à Pf(B(G)).

Ces trois lemmes nous permettent d'augurer que le dénombrement des solides normaux contenus dans un parallélépipède rectangle pourra se mettre sous forme de déterminant de matrice.

On supposera désormais $p \leq q \leq r$.

Si on numérote de façon quelconque les sommets de G^* et si on donne aux arêtes une orientation telle que la condition sur les frontières des faces bornées soit réalisée, on obtient un graphe \tilde{G}^* tel que $(\det B(\tilde{G}^*))^{1/2}$ représente le nombre cherché de solides normaux. Cependant, cette matrice $B(\tilde{G}^*)$ est de dimension $2(pq+qr+pr)$ qui, dans le cas régulier $p = q = r = n$ croît comme n^2 . Nous allons donner une numérotation des sommets et une orientation des arêtes de G^* de sorte que l'on puisse réduire la matrice $B(\tilde{G}^*)$ en une matrice $BR(\tilde{G}^*)$ telle que :

$$BR(\tilde{G}^*) = \left(\begin{array}{c|c} \mathbf{0} & A(\tilde{G}^*) \\ \hline {}^t A(\tilde{G}^*) & \mathbf{0} \end{array} \right)$$

avec $A(\tilde{G}^*)$ une matrice carrée de dimension q ($p \leq q \leq r$) ce qui démontrera le

Théorème 3 : Le nombre de solides normaux contenus dans un parallélépipède rectangle de dimensions $p \times q \times r$ avec $p \leq q \leq r$ est égal au déterminant de la matrice $A(G) = (a_{ij})$ suivante :

$$\forall i, j \in [1, q] \quad a_{ij} = \begin{cases} C^{r+i-j} & \text{si } j - i \leq r \\ p+r & \\ 0 & \text{sinon} \end{cases}$$

Remarque 1 : On pourrait ramener aussi à une matrice $A'(\tilde{G}^*)$ carrée de dimension mais notre but est de trouver le résultat sous la forme d'un déterminant de matrice carrée aussi petite que possible.

Remarque 2 : q n'apparaît pas dans les coefficients de la matrice, mais dans sa dimension. Cependant, par combinaison de lignes, on peut rendre l'expression des coefficients symétriques en p , q et r (voir Kreweras [2]).

Remarque 3 : La matrice $A(\tilde{G}^*)$ n'est en général pas symétrique. Elle l'est dans le cas régulier $p = q = r$.

Remarque 4 : Tous les termes d'une même diagonale parallèle à la diagonale principale sont égaux.

Dans le cas régulier, la matrice $A(\tilde{G}^*)$ a donc la forme de celle de la figure 5.

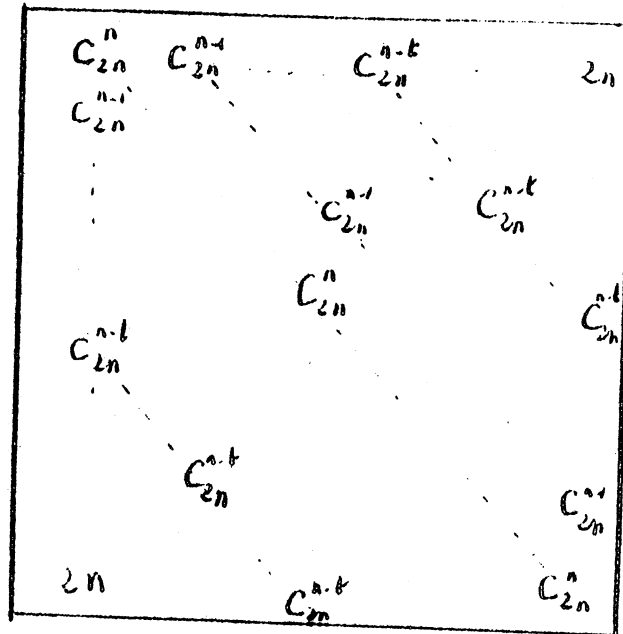

Figure 5

Remarque 5 : Si on note $p!! = (p-1)!(p-2)!\dots 2!! 1!!$ on a (cf. Kreweras [2])

$$\det A(\tilde{G}^*) = \frac{(p+q)!! p!! q!! r!!}{(p+q)!! (q/r)!! (p+r)!!}$$

Démonstration du théorème 3 :

1) Numérotation des sommets de G^* (fig. 6)

Considérons les $p+q$ bandes de l'hexagone que découpent les droites parallèles aux côtés de longueur r . On notera $X_1^*, \dots, X_j^*, \dots, X_{p+q}^*$ les sommets de G^* qui se trouvent dans ces bandes (numérotées par exemple de haut en bas dans une situation de figure où ces bandes sont parallèles à la direction w).

$$\begin{aligned}
 & |X_1^*| = 2r+1 \\
 \text{pour } i \leq p & \quad |X_i^*| = 2(r+i)-1 \\
 \text{pour } p \leq i \leq q & \quad |X_i^*| = 2(r+p) \\
 \text{pour } i \geq q & \quad |X_i^*| = |X_{p+q-i}^*| = 2(p+q+r-i)-1.
 \end{aligned}$$

On supposera désormais que l'hexagone est placé de telle sorte que les bandes contenant les X_i^* soient parallèles à la direction w afin de pouvoir distinguer facilement les deux extrêmes de celles-ci.

La numérotation choisie des sommets de G^* est alors la suivante :

- . Numéroter de gauche à droite le long de $G^*(X_1^*)$ les sommets de 1 à $2r+1$.
- . Une fois les sommets de X_i^* numérotés, continuer la numérotation le long de $G^*(X_{i+1}^*)$, en commençant par le sommet le plus à gauche.

2) Orientation des arêtes de G^* pour obtenir le graphe \tilde{G}^* (fig. 6)

Orienter chaque arête de son sommet du plus petit numéro vers l'autre. On laisse au lecteur le soin de montrer qu'avec cette orientation toutes les faces bornées ont 3 arcs dans chaque sens de parcours (très facile).

Avec cette orientation, on a $\Omega^+(X_i^*) = \Omega \left(\bigcup_{k=1}^i X_k^* \right)$.

D'autre part :

$$\begin{aligned}
 & |\Omega^+(X_1^*)| = r+1 \\
 \text{pour } i \leq p & \quad |\Omega^+(X_i^*)| = |\Omega^+(X_{i-1}^*)| + 1 = r+i \\
 \text{pour } p \leq i \leq q & \quad |\Omega^+(X_i^*)| = r+p \\
 \text{pour } i \geq q & \quad |\Omega^+(X_i^*)| = p+q+r-i
 \end{aligned}$$

3) Forme de la matrice adjointe $B(G)$ (figure 7)

La figure 7 est faite dans le cas $p = 2$, $q = 3$ et $r = 4$ qui est l'exemple déjà pris pour la figure 6.

Pour une matrice carrée $n \times n$ on appellera diagonale principale la diagonale du tableau carré qui la représente qui traverse toutes les cases (j, j) pour $j = 1, \dots, n$.

On appellera k^e s-diagonale une parallèle à la première diagonale et traversant les cases $(j, j+k)$ pour tout $j = 1, \dots, n-k$ (on suppose $k < n$) et k^e i-diagonale celle traversant les cases $(j+k, j)$.

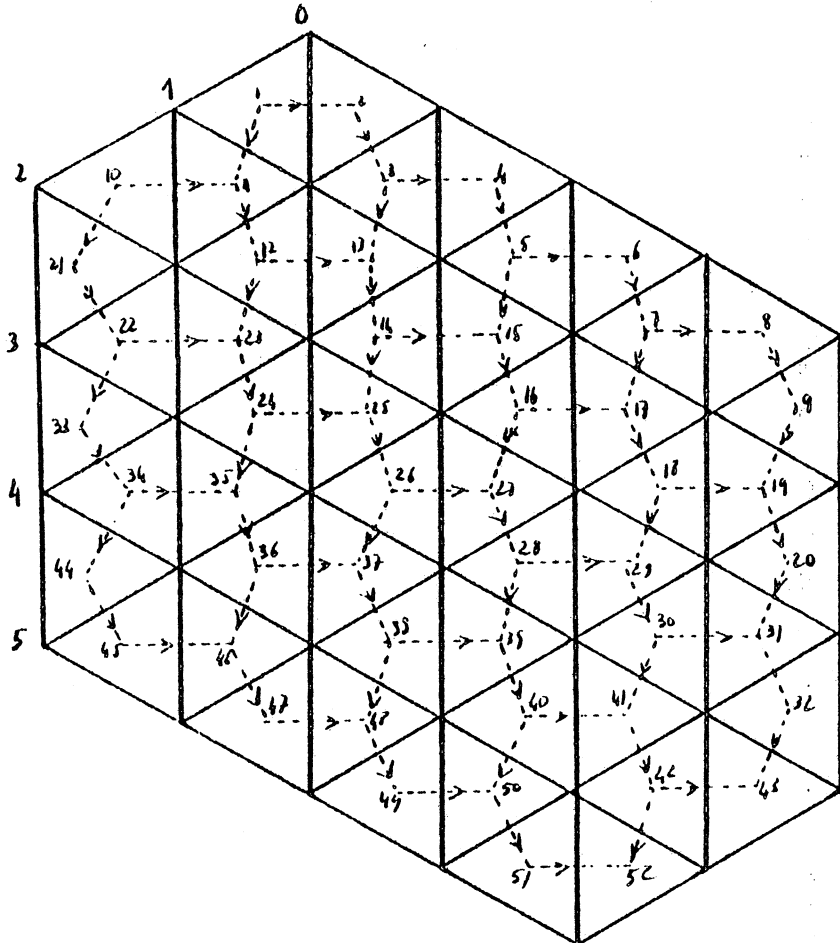

Figure 6

- (α) La matrice $B(\tilde{G}^*)$ est anti-symétrique par définition d'une matrice adjointe.
- (β) Tous les éléments au-dessus de la diagonale principale sont positifs ou nuls, ceux en dessous sont tous négatifs ou nuls (provient de l'orientation).
- (γ) Les arcs du chemin $G^*(X_k^*)$ donnent une suite ininterrompue de $|X_k^*| - 1$ éléments égaux à 1 sur la 1ère s-diagonale et une même suite de nombres égaux à -1 sur la 1ère i-diagonale. Deux suites sont espacées sur ces diagonales par un unique élément nul.

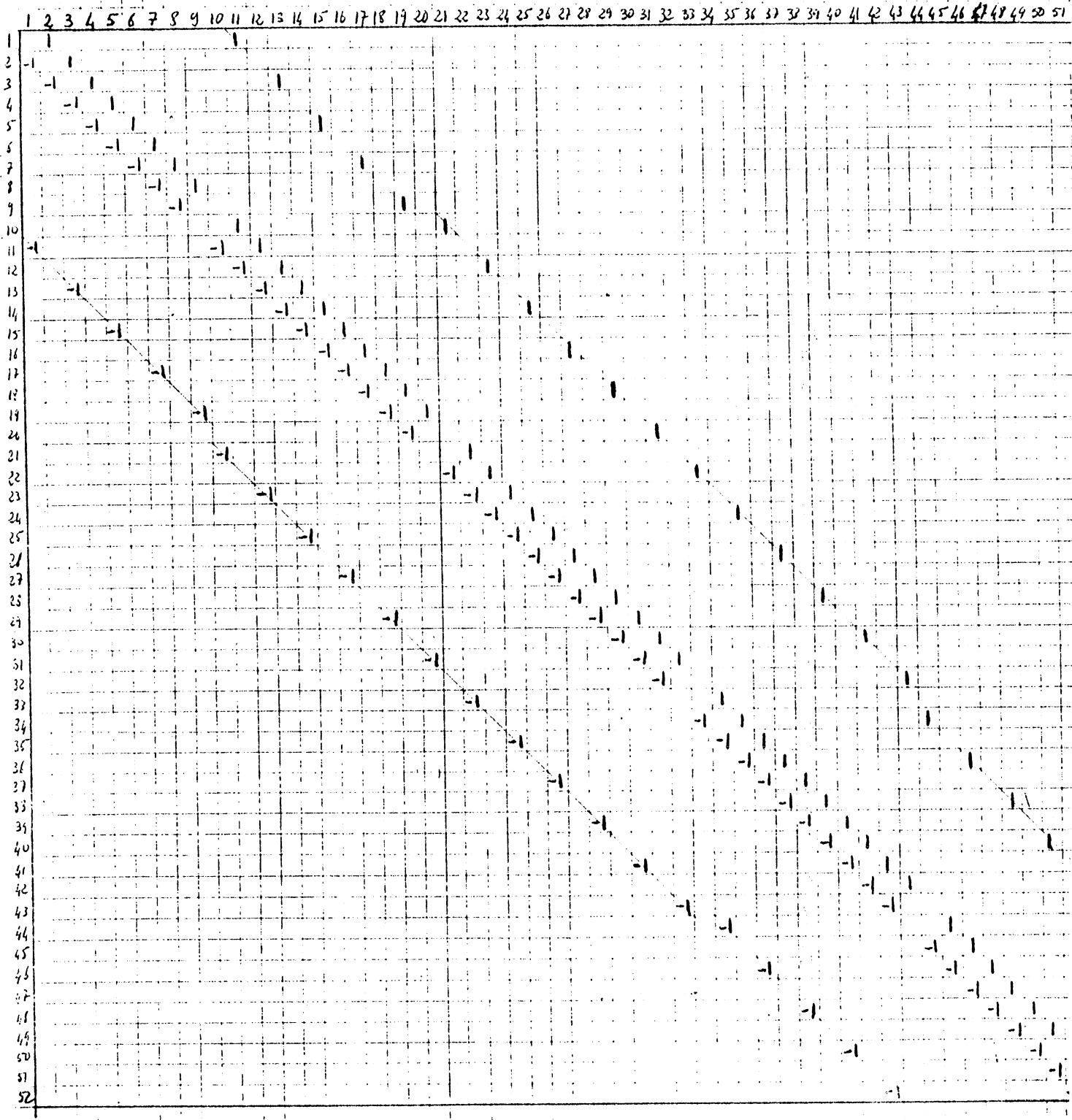

Figure 7

(δ) Pour toute arête du même cocycle $\omega^+(X_k^*)$ la différence en valeur absolue des numéros de ses extrémités est constante d_k avec :

$$d_k = \begin{cases} 2(r+k) & \text{si } 1 \leq k < p \\ 2(p+r)-1 & \text{si } p \leq k \leq q \\ d_{p+q-k} = 2(p+q+r-k) & \text{si } k \geq q \end{cases}$$

Pour cette raison les arcs de $\Omega^+(X_k^*)$ donnent une série de 1 (resp. de -1) sur la même d_k s-diagonale (resp. d_k i-diagonale). Ces 1 (resp. -1) sont espacés sur cette s-diagonale (resp. i-diagonale) par exactement un élément nul

Notons L_k et C_k (resp. \tilde{L}_k et \tilde{C}_k) l'ensemble des indices de lignes et colonnes, respectivement, dans lesquelles les arcs de $\Omega^+(X_k^*)$ donnent un élément +1 (resp. -1) sur la d_k s-diagonale (resp. i-diagonale).

Soit $L_k = \{\ell_k^1, \ell_k^2, \dots, \ell_k^{|L_k|}\}$ dans l'ordre croissant, on note $\lambda_k = \ell_k^{|L_k|}$

$C_k = \{c_k^1, c_k^2, \dots, c_k^{|C_k|}\}$ dans l'ordre croissant, on note $\gamma_k = c_k^1$

Les mêmes notations tiennent pour \tilde{L}_k et \tilde{C}_k .

On a $\ell_k^j = \ell_k^{j-1} + 2$

$c_k^j = c_k^{j-1} + 2$

D'autre part :

et $\ell_k^1 = \tilde{c}_k^1 = \begin{cases} \text{numéro du premier sommet de } X_k^* & \text{si } k \leq p \\ \text{numéro du deuxième sommet de } X_k^* & \text{si } k > p \end{cases}$

$\ell_k^{|L_k|} = \tilde{c}_k^{|C_k|} = \begin{cases} \text{numéro du dernier sommet de } X_k^* & \text{si } k \leq q \\ \text{numéro de l'avant dernier sommet de } X_k^* & \text{si } k > q \end{cases}$

Par anti-symétrie, on obtient des considérations analogues pour $\tilde{\ell}_i^1$ et c_i^1 d'une part, et, $\tilde{\ell}_i^{|L_i|}$ et $c_i^{|L_i|}$ d'autre part.

(ε) Pour un élément non nul b_{ij} situé au dessus de la diagonale principale, on appellera colonne associée (resp. ligne associée) la colonne (resp. la ligne), quand elle existe, qui possède un 1 à l'intersection de la ième ligne et de la 1ère s-diagonale (resp. un 1 à l'intersection de la jème colonne et de la 1ère i-diagonale), c'est-à-dire la $(i+1)$ ème colonne quand $b_{i,i+1} = 1$ (resp. la $(j-1)$ ème ligne quand $b_{j-1,j} = 1$).

Par anti-symétrie, on donne des définitions analogues pour les éléments non nuls situés sous la diagonale principale.

Avec ces définitions, on a les propriétés suivantes :

(ε*) Seuls les éléments $b_{\ell_i | L_i | C_i}$ pour $i \leq n$ et $b_{\ell_i | C_i}$ pour $i \geq n$ n'ont pas de colonne associée. De même, seuls les $b_{\ell_i | C_i}$ et $b_{\ell_i | L_i | C_i}$ n'ont pas de ligne principale.

(ε**) Soit $b_{ij} = 1$ avec $j > i+1$ et soit k tel que l'arc $(i,j) \in \Omega^+(X_k^+)$. Sauf pour $k = 1$ (resp. $k = p+q-1$), la colonne associée (resp. la ligne associée) à laquelle elle existe, possède un élément non nul unique en dehors des premières s -diagonales et i -diagonales, de plus cet élément non nul correspond à un arc de $\Omega^+(X_{k-1}^*)$ (resp. de $\Omega^+(X_{k+1}^*)$). Plus précisément, si $b_{ij} = 1$ est le p^e élément du bloc alors cet élément non nul de la colonne associée à b_{ij} correspond au p^e arc du groupe $k-1$ si $k \leq p$ et au $(p+1)^e$ arc du groupe $k-1$ si $k > p$.

Par anti-symétrie, on a des propriétés analogues pour $b_{ij} = -1$ avec $i < j-1$. (Cette propriété sera justifiée au §5).

4) Algorithme de réduction de la matrice $B(\tilde{G}^*)$

On ne donnera ici que l'algorithme réservant sa justification pour le paragraphe suivant.

Afin de faciliter l'exposé qui suit notons : $T_K^P = \sum_{\ell_1=1}^p \sum_{\ell_2=1}^{\ell_1} \dots \sum_{\ell_{k-1}=1}^{\ell_{k-2}}$

l'indice du bas donne le nombre de sommations, celui du haut donne une des bornes de la première sommation, l'autre étant 1.

$$\text{On posera } T_0^P = \underbrace{1+1+\dots+1}_p = p$$

$$T_{-1}^P = 1 \text{ et } T_{+k}^P = 0 \text{ si } p \leq 0.$$

On a d'autre part pour $k \geq -1$

$$T_k^P = C_{p+k}^{p-1} = \binom{p+k}{p-1} \quad (\text{coefficients du binôme})$$

et par définition

$$\left\{ \sum_{p=1}^q T_K^P = T_{K+1}^q \right.$$

Définissons maintenant certaines opérations sur $B(\tilde{G}^*)$ qui ne modifient pas $\det B(\tilde{G}^*)$.

- On appellera descente d'un élément b_{ij} situé au-dessus de la diagonale principale (ou montée d'un élément situé au-dessous de cette diagonale), l'opération qui consiste à retrancher à la i ème colonne b_{ij} fois la colonne associée à b_{ij} quand elle existe. Cette opération, quand elle est possible, "descend" de deux lignes l'élément b_{ij} dans la même colonne si $b_{i+2,j+1} = -1$ l'annule sinon. Cependant si la colonne associée possède un élément non nul c dans la k ème ligne ($k \neq i, k \neq i+2$), alors $(-c b_{ij})$ vient s'ajouter dans la j ème colonne à l'élément qui se trouvait dans cette k ème ligne.

On appellera descente répétitive (resp. montée répétitive) le fait de recommencer l'opération avec l'élément $b'_{i+2,j}$ (resp. $b'_{i-2,j}$) et ainsi de suite tant que possible, c'est à dire jusqu'à ce que l'élément $b'_{i+2\ell,j}$ (resp. $b'_{i-2\ell,j}$) ne possède pas de colonne associée.

- On appellera poussée à droite et poussée à gauche les opérations similaires réalisées sur les lignes. On définit de même les poussées répétitives.

Remarque 1 : On note $b'_{ij}, b''_{ij}, \dots, b^{(k)}_{ij}$ les termes de la matrice $B(\tilde{G}^*)$ après un premier ensemble de transformation, un deuxième, etc...

Remarque 2 : Aucune des opérations n'affecte les éléments non nuls sur les 1ère s-diagonale et i-diagonales.

Algorithme de réduction de $B(\tilde{G}^*)$

Phase 1 :

- . Descente répétitivement tous les 1 au dessus de la 1ère s-diagonale.
- . Pousser répétitivement à droite tous les -1 en dessous de la 1ère i-diagonale.

Remarque : L'existence ou non d'une colonne ou ligne associée est considérée avant toute transformation : les descentes ou poussées répétitives s'arrêtent même si une transformation précédente a amené un 1 ou un -1 sur la 1ère s-diagonale ou i-diagonale alors qu'il n'y en avait pas avant. Par exemple, la descente de l'élément $b_{12,23}$ (figure 8) s'arrête en (20,23) alors qu'une descente précédente a mis un 1 en (20,21) et qu'on pourrait donc continuer la descente.

Etat de la matrice à la fin de la phase 1 (figure 8)

a) Elle est toujours anti-symétrique.

b) Dans $B(\tilde{G}^*)$ on dira que les éléments b_{ij} de même signe correspondant à une même $\Omega^+(\chi_k^+)$ appartiennent à un même groupe k. (Ils sont sur une même s-diagonale ou i-diagonale, mais ne sont pas, en général, les seuls sur celle-ci). Avec cette définition, tous les éléments $b_{ij} = 1$ situés au-dessus de la 1ère s-diagonale sont descendus au niveau du 1 le plus bas de leur groupe k si $k \leq q$, ont disparu si $k > q$. Par anti-symétrie, tous les $b_{ij} = -1$ situés sous la 1ère i-diagonale se trouvent au niveau du -1 le plus à droite de leur groupe k si $k \leq q$ et ont disparu sinon.

c) Les seuls éléments non nuls au-dessus de la 1ère s-diagonale se trouvent dans les lignes λ_i pour $i = 1, \dots, q$ et valent :

$$b'_{\lambda_i c_j} = (-1)^{i+j} T_{j-(i+1)}^{r+i-j-k+3} \quad (\text{pour } j \geq i)$$

On obtient la valeur des éléments non nuls au-dessous de la 1ère i-diagonale par anti-symétrie.

Phase 2 :

. Pousser répétitivement, avec la même restriction que dans la remarque de la phase 1, les éléments non nuls situés au-dessus de la 1ère s-diagonale. De même monter répétitivement les éléments non nuls situés sous la 1ère i-diagonale.

Remarque : On peut se dispenser de cette opération pour les éléments au-dessus de la 1ère s-diagonale dans les colonnes c_i^k avec $i \leq q-1$ et ceux en dessous de la 1ère i-diagonale dans les lignes λ_i^k avec $i \leq p$. (Ceci est appliqué dans l'exemple de la figure

Etat de la matrice à la fin de la phase 2 (figure 9)

Les seuls termes non nuls au-dessus de la 1ère s-diagonale sont les

$$b''_{\lambda_i \gamma_j} = \sum_{t=1}^{|\Omega^+(\chi_j)|} b'_{\lambda_i L_i} |_{c_j}^t = (-1)^{i+j} T_{j-i}^{r+i-j+2}$$

On obtient par anti-symétrie les termes non nuls en dessous de la 1ère i-diagonale

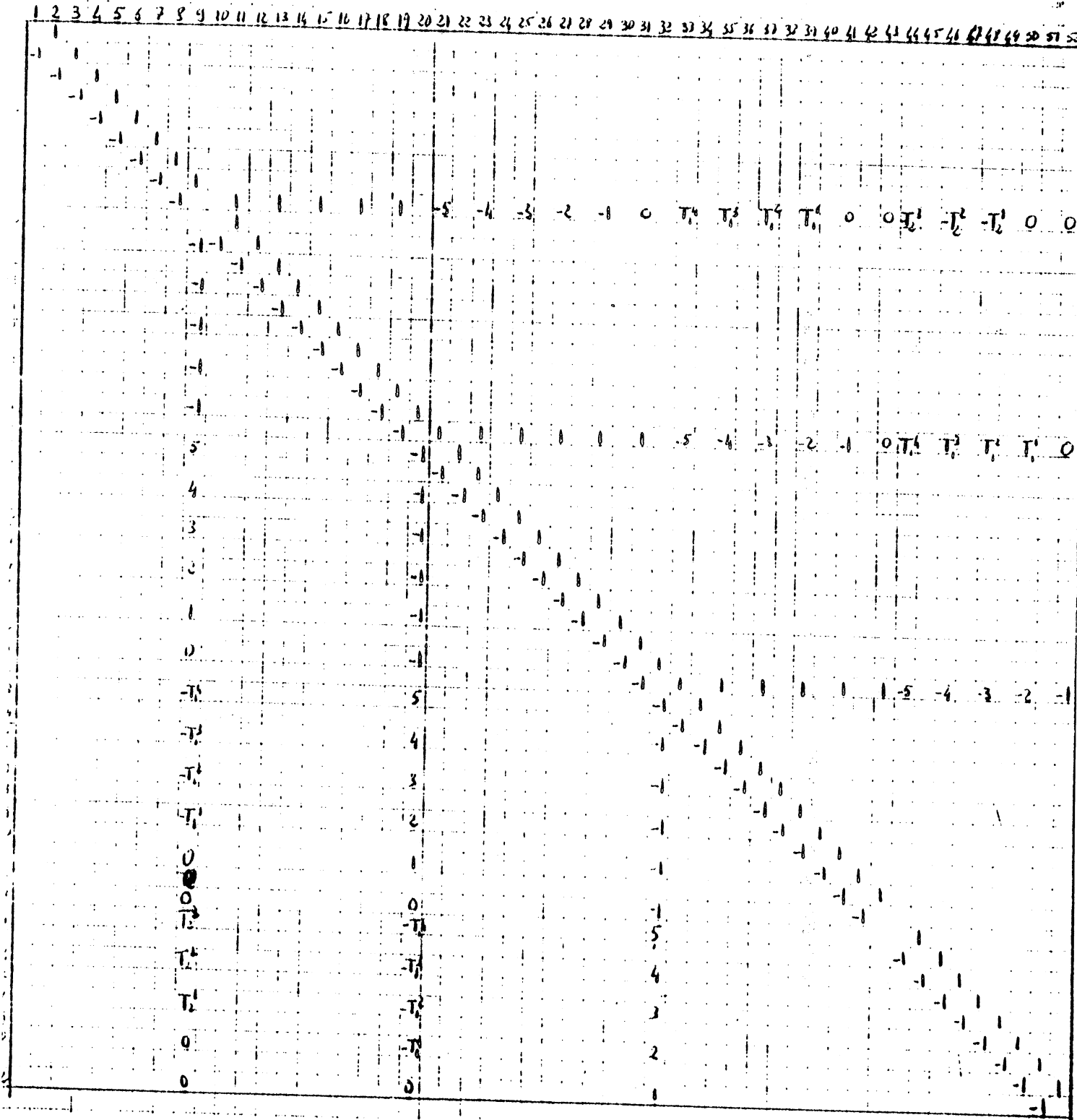

Figure 8

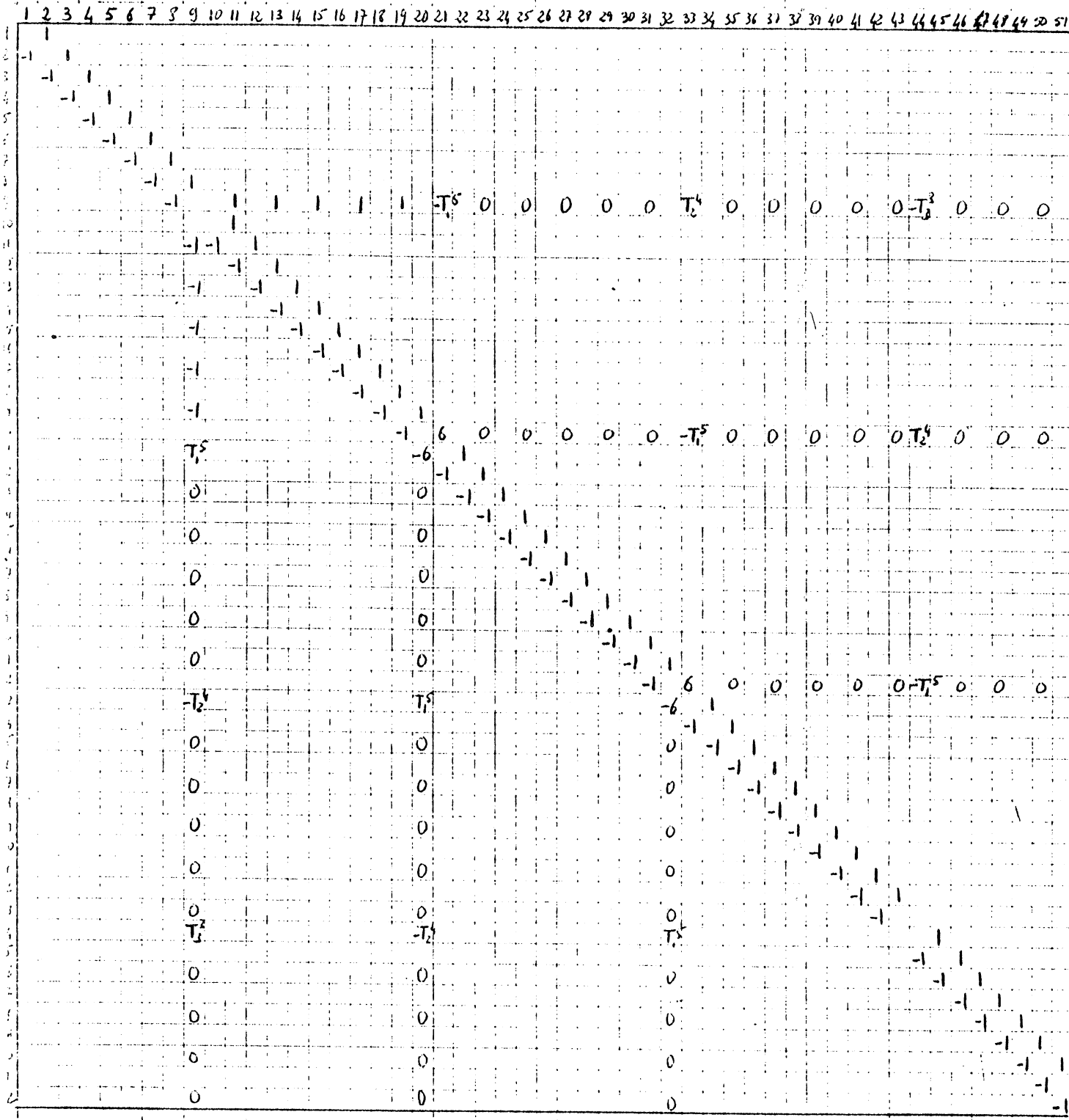

Figure 9

Phase 3 :

Par extension des définitions déjà données, on dira qu'on pousse répétitivement vers la droite un élément $b_{1,i+1} = 1$ de la 1ère s-diagonale en ajoutant à la ième ligne la (i+2)ème puis la (i+4)ème et ainsi de suite (i+2k)ème à condition que cette ligne possède un -1 sur la 1ère i-diagonale et un +1 sur la 1ère s-diagonale, on s'arrête quand cette (i+2)ème ligne ne possède pas cette propriété. Par anti-symétrie la descente d'un $b_{i-1,i} = 1$ de la 1ère i-diagonale.

. Pousser répétitivement vers la droite l'élément $b_{1,i+1} = 1$ correspondant au premier arc de $\tilde{G}(X_k^*)$ pour $p+1 \leq k \leq q$ et Descendre répétitivement l'élément $b_{i-1,i} = -1$ correspondant aux arcs précédents.

Remarque : si $p = q$ et, plus particulièrement, si on se trouve dans le cas régulier, il n'y a pas de phase 3.

Etat de la matrice après la phase 3 (figure 10)

La matrice a très peu évoluée, seuls les 1 (resp. -1) correspondant aux arcs mentionnés ont été poussés vers la droite (resp. ont été descendus), ces opérations n'ont créés aucun terme nouveau en dehors des case de départ et d'arrivée de ces éléments.

Phase 4 :

. Développer en ligne puis en colonne tant que possible la matrice $B(\tilde{G}^*)$.

Etat de la matrice après la phase 4 (cf. figure 10 sur laquelle les lignes et colonnes, suivant lesquelles on a développé, sont coiffées d'un astérisque).

Seules demeurent les lignes λ_i pour $i = 1, \dots, q$ et $\tilde{\lambda}_i^1$ pour $i = p, \dots, p+q-1$ et les colonnes γ_i pour $i = p, \dots, p+q-1$ et \tilde{c}_i^1 pour $i = 1, \dots,$

Phase 5 :

Soit B la matrice obtenue après la phase 4 (cf. figure 11).

Ordonner les lignes dans l'ordre suivant :

- . Celles correspondant aux λ_i prises dans l'ordre croissant des $i = 1, \dots,$
- . Puis celles correspondant aux $\tilde{\lambda}_i^1$ prises dans l'ordre croissant des $i = p, \dots, p+q-1$.

On classe dans le même ordre les colonnes, c'est à dire d'abord celle correspondant aux $|c_i|$ dans l'ordre croissant des i puis celles correspondant aux c_i^1 dans un même ordre (cf. figure 12).

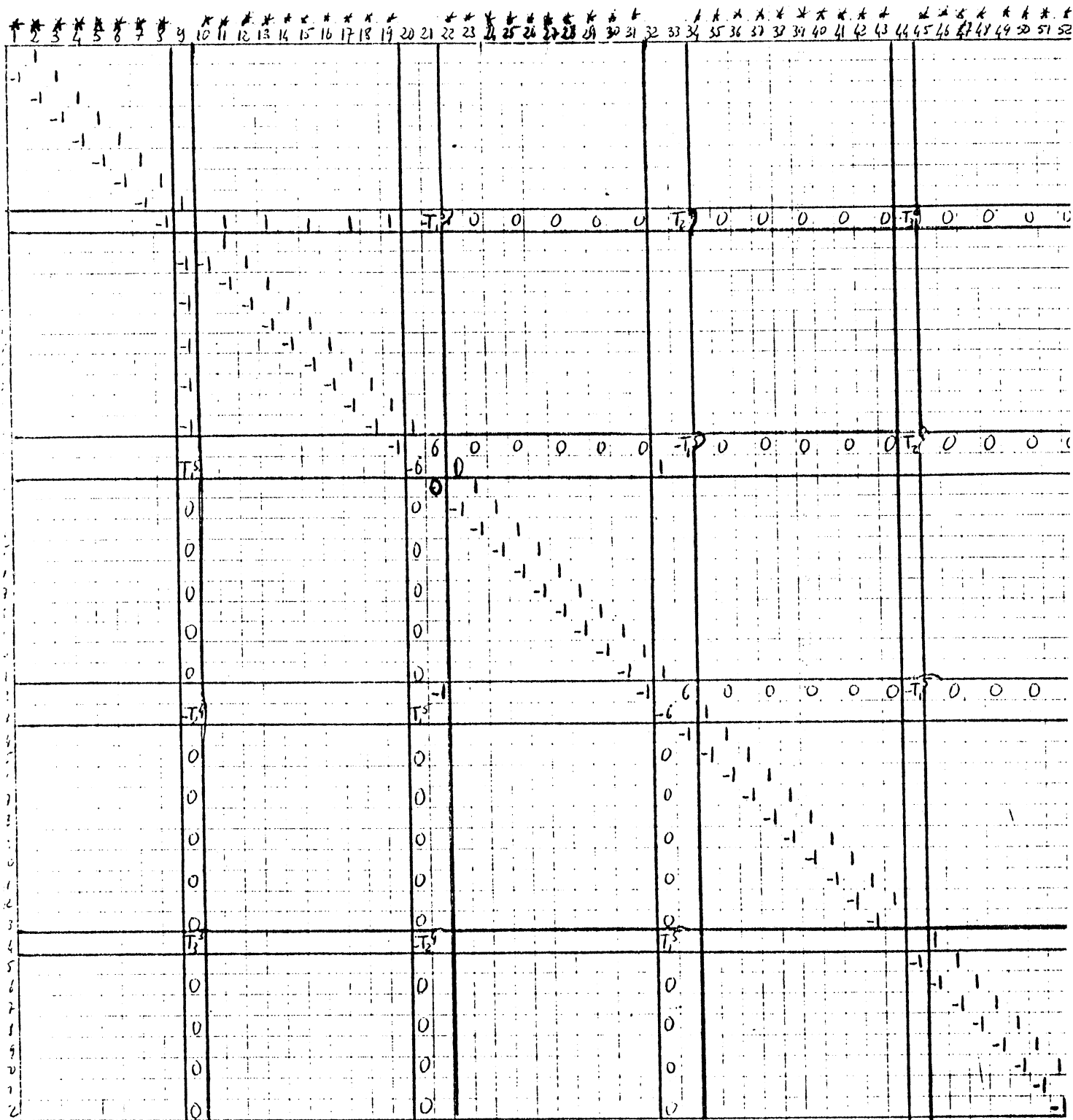

Figure 10

	9	20	21	32	33	44
9			$-T_1^5$		T_2^4	$-T_2^1$
20			6		$-T_1^5$	T_2^4
21	T_1^5	-6		1		
32			-1		6	$-T_1^5$
33	$-T_2^4$	T_1^5		-6		
44	T_3^3	$-T_2^4$		T_1^5		

Figure 11

	9	20	32	21	33	44
9	0	0	0	$-T_1^5$	T_2^4	$-T_2^1$
20	0	0	0	6	$-T_1^5$	T_2^4
32	0	0	0	-1	6	$-T_1^5$
21	T_1^5	-6	1	0	0	0
33	$-T_2^4$	T_1^5	-6	0	0	0
44	T_3^3	$-T_2^4$	T_1^5	0	0	0

Figure 12

Etat de la matrice B après la phase 5

Elle est par blocs de la forme suivante (figure 13) : où A est la matrice donnée dans l'énoncé du théorème, compte tenu de la valeur des T_k^p données au début de ce paragraphe au signe près de certains termes. Si $\tilde{A} = (\tilde{a}_{ij})$ on $\tilde{a}_{ij} = (-1)^{i+j} a_{ij}$ est donc $\det \tilde{A} = \det A$.

0	\tilde{A}
$-\tilde{A}^t$	0

Figure 13

Par conséquent, $\det \tilde{B} = \epsilon \det B(\tilde{G}^*) = \epsilon \det A^2$ d'où $(\det \tilde{B})^{1/2} = |\det$

: Dans le cas $p = q$ et donc dans le cas régulier, cette phase est inutile puisque le classement opéré ne change rien à \tilde{B} .

5) Justification de l'algorithme

Dans cette partie, nous ne détaillerons pas complètement la justification de l'algorithme, mais nous nous contenterons, en général, de donner la

la propriété du graphe \tilde{G}^* ou de sa matrice adjointe $B(\tilde{G}^*)$ qui permet la justification. La raison de ce choix est que l'accumulation de détails rendrait très pénible la lecture de cette partie qui serait en plus fort longue.

Phase 1 :

a) Puisque toutes les opérations sont faites symétriquement la matrice $B'(\tilde{G}^*)$ obtenue à la fin de la phase 1 est encore anti-symétrique.

b) La descente des éléments de chaque bloc k au niveau du 1 le plus bas (resp. la poussée à droite vers le -1 le plus à droite) de ce bloc pour $k \leq q$ et leur disparition dans la descente s'explique de la façon suivante :

Si $k \leq q$ le dernier sommet de X_k^* est incident à un arc de $\Omega^+(X_k^*)$ alors que $k > q$, c'est l'avant dernier sommet de X_k^* qui est incident à un tel arc, alors que le dernier ne l'est pas. Ceci se traduit sur la matrice $B(\tilde{G}^*)$ par le fait que si $k \leq q$ le $b_{ij} = 1$ le plus bas du bloc k n'a pas de colonne associée (et c'est le seul dans ce cas dans ce bloc) alors que si $k > q$ cet élément possède une telle colonne qui de plus n'a pas de terme -1 sur la 1ère i -diagonale.

Pour la poussée à droite, même raisonnement par anti-symétrie.

c) En raison de b) ci-dessus, seule est à justifier la valeur des coefficients b'_{ij} . Cette valeur est une conséquence directe de la propriété (ϵ^{**}) du paragraphe précédent. Justifions ici cette propriété.

Soit e l'arête associée à $b_{ij} = 1$ du groupe k , $e \in \Omega^+(X_k^*)$, soit e' l'arête associée au 1 du groupe $k-1$ appartenant à la colonne associée à b_{ij} , $e' \in \Omega^+(X_{k-1}^*)$. Soient $v(T(e'))$ et $v(I(e))$ les numéros de l'extrémité terminale de e' et de l'extrémité initiale de e respectivement.

On a :

$$v(T(e')) = v(I(e)) + 1$$

Or pour $k \leq p$ le premier arc de $\Omega^+(X_{k-1}^*)$ est adjacent au deuxième sommet de X_{k-1}^* alors que pour $k > p$, cet arc est adjacent au premier de ces sommets (cf. figure 4 bis). La justification est alors immédiate.

Phase 2 :

. Pour justifier cette phase, il suffit de constater qu'après la phase 1 les lignes associées à des éléments non nuls au-dessus de la 1ère s-diagonale, ainsi que les colonnes associées à ces mêmes éléments sous la 1ère i-diagonale n'ont comme éléments non nuls que les éléments sur les 1ères s-diagonales et i-diagonales.

. L'objet de la remarque est d'éviter de s'occuper de termes qui de toute façon seront éliminés dans le développement en lignes et en colonnes de la phase

. La valeur des coefficients s'obtient facilement à l'aide de la définition des T_k^P .

Phase 3 :

La justification est la même que pour le premier point de la phase précédente. Le but de cette phase est évidemment de permettre le développement en lignes et en colonnes de la phase suivante.

Phase 4 :

Pour $k \leq p$, on développe selon les lignes $\lambda_{k-1} + 1, \dots, \lambda_{k-1} + 2i + 1$, puis selon ces mêmes colonnes. Ceci est possible puisqu'en raison des transformations effectuées à la phase 1 la première de ces lignes (resp. colonnes) ne possède qu'un élément non nul. Après développement selon cette ligne (resp. colonne) la suivante possède la même propriété et ainsi de suite. (On suppose que $\lambda_0 = 0$).

Pour $p < k \leq q$ remarquons d'abord que $\lambda_{k-1} = \tilde{\lambda}_{k-1}^1 - 1$. D'autre part, l'objet de la phase 3 a été de faire en sorte que les $(\tilde{\lambda}_{k-1}^1 + 1)$ ème ligne et colonne ne possèdent qu'un seul élément non nul, ce qui permet de développer en ligne de deux en deux à partir de celle-ci, puis en colonne de la même manière. Dans cette phase les lignes et colonnes de numéros compris entre $\tilde{\lambda}_{k-1}^1$ et $\lambda_k^{L_{k-1}} - 1$ disparaissent.

Pour $k > q$ tout ce passe comme pour le cas $k \leq p$ mais on démarre de la dernière ligne du "bloc" (resp. dernière colonne).

Phase 5 :

Rappelons que $c_i^1 = \tilde{c}_i^1 = \gamma_i$ et $\tilde{c}_i^1 = \tilde{c}_i^1 = \lambda_i$. De plus, il est évident par la structure de \tilde{G}^* , et de la numérotation de ses sommets, qu'on a

$$\gamma_i \neq \lambda_k$$

quels que soient i et k .

(Ceci voudrait dire qu'un même sommet recevrait le premier arc d'un cocycle et serait l'extrémité initiale du dernier d'un autre, les arcs d'un cocycle étant supposés ordonnés en fonction des numéros de leurs sommets initiaux par exemple).

Soit $B^{(3)}(\tilde{G}^*)$ la matrice obtenue à la fin de la phase 3, calculons $b_{\lambda_i}^{(3)}$, avec $\alpha \in \{\lambda_i / i=1, \dots, q\} \cup \{\gamma_i / i=r, \dots, p+q-1\}$

Or $b_{\lambda_i \lambda_k}^{(3)} = 0$ car $\lambda_k \neq \gamma_j \quad \forall j$ et k .

De plus, d'après la phase 3 on a :

$$k > i \quad b_{\lambda_i \gamma_k}^{(3)} = (-1)^{i+k} T_{k-i}^{r+i-k+2}$$

$$k = i \quad b_{\lambda_i \gamma_c}^{(3)} = p+r$$

$$k = i-1 \quad b_{\lambda_i \gamma_{i-1}}^{(3)} = -1$$

$$k < i-1 \quad b_{\lambda_i \gamma_k}^{(3)} = 0$$

Par anti-symétrie on obtient les $b_{\gamma_k \lambda_i}^{(3)}$.

Ceci termine la justification de cette phase et de l'algorithme.

Calcul de la dimension de la matrice B et de celle de A

Il y a :

- 1 ligne (resp. 1 colonne) par $\Omega^+(X_i^*)$ pour $i \leq p-1$
- 2 lignes (resp. 2 colonnes) par $\Omega^+(X_i^*)$ pour $p \leq i \leq q$
- 1 ligne (resp. 1 colonne) par $\Omega^+(X_i^*)$ pour $i > q$.

Puisqu'il y a $p+q-1$ ensembles X_i^* ceci donne :

$$(p-1) + 2(q-p+1) + p-1 = 2q$$

La dimension de A étant moitié de celle de \tilde{B} on obtient bien $q \cdot y$

Remarque : Les justifications précédentes peuvent aussi s'appuyer sur des considérations de forme des bandes de l'hexagone comprises entre les ième et (i+1)ème lignes verticales. Ces bandes sont de 3 types, les unes trapézoïdales de petite base à gauche de la grande ($i < p$), les deuxièmes forment des parallélogrammes ($p \leq i < q$) enfin les dernières trapézoïdales avec la grande base plus à gauche que la petite ($i \geq q$).

V - APPLICATION A LA DETERMINATION DE LA RICHESSE RELATIVE DE DEUX SUITES DE YOUNG

Soient deux suites de Young y et z avec $y \leq z$. Rappelons que l'on se propose de calculer la cardinalité de l'ensemble $T(y, z) = \{t / t \text{ est une suite de Young et } y \leq t \leq z\}$.

$$\text{Posons } q = \max_i z_i$$

$$p = \max\{i / z_i \neq 0\}$$

On supposera de plus que $y_p = 0$, sinon il suffit de retrancher y_p à tous les termes z_i et y_i pour $i = 1, \dots, p$.

Les suites de Young y , z et $t \in T(y, z)$ peuvent être considérées comme représentant la hauteur des piles de cubes de côtés 1 des solides normaux contenus dans un parallélépipède π de côtés $1 \times q \times p$.

Soient H , G et G^* respectivement l'hexagone, les graphes G et G^* associés à ce parallélépipède π (cf. (III)). Soit S un solide normal contenu dans π et \tilde{U} le couplage parfait de G^* associé. D'après le théorème 1, on sait qu'une et une seule arête de \tilde{U} traverse chaque ligne verticale (sauf celles de numéro 0 et $p+1$). Une conséquence de la démonstration du théorème 1 est,

qu'une fois choisie le niveau de l'arête de $\Omega(\bigcup_{i=1}^k X_i^*)$, le couplage du sous graphe sur les chaînes de $G(X_k^*)$ joignant le sommet incident à l'arête de $\Omega(\bigcup_{i=1}^k X_i^*) \cap \tilde{U}_z$ au sommet le plus haut de X_k^* et celle joignant le sommet incident à l'arête de $\Omega(\bigcup_{i=1}^k X_i^*) \cap \tilde{U}_y$ au sommet le plus bas de X_k^* , est toujours le même, quelque soit le couplage \tilde{U}_t associé à un $t \in T(y, z)$.

D'après les considérations précédentes, il y a bijection entre l'ensemble des couplages parfaits de G_{yz}^* et les éléments de $T(y, z)$.

Si G_{yz}^* n'est pas connexe, on peut traiter indépendamment chaque composante connexe, on suppose donc G_{yz}^* connexe. Ceci suppose en particulier que $y_i < z_i$ et $z_{i+1} > y_i$.

Notons \hat{X}_i^* les sommets de \tilde{G}_{yz}^* compris entre les lignes $i-1$ et i . Numérotons les par exemple de haut en bas (pour changer) en commençant par \hat{X}_1^* (cf. figure 14) et orientons les arêtes du sommet du numéro le plus petit vers l'autre. Soit \tilde{G}_{yz}^* le graphe orienté obtenu.

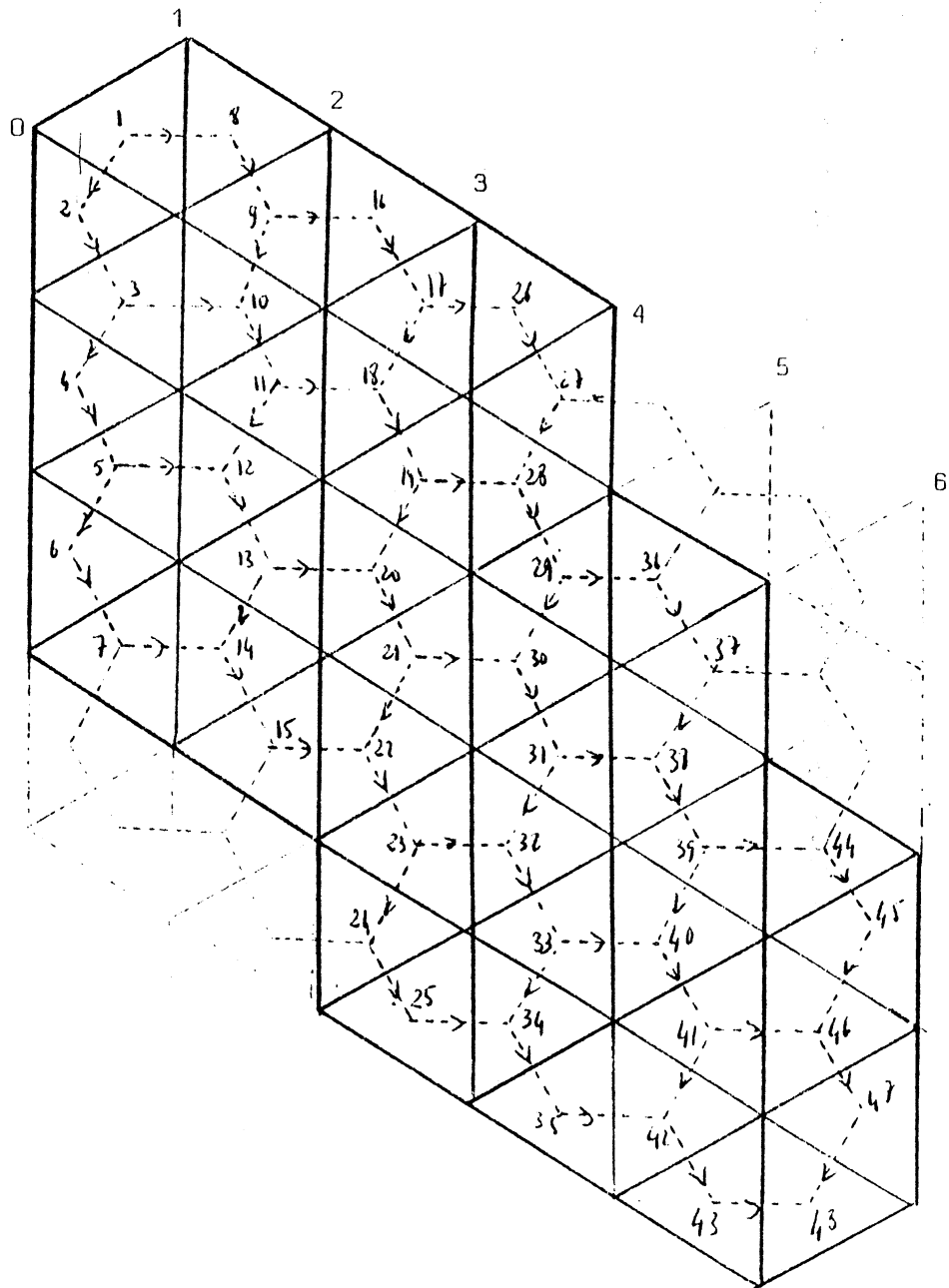

Figure 14

Quelques paramètres de \tilde{G}_{yz}^*

- a) Il y a $z_1 - y_1 + 1$ arcs horizontaux qui coupent la i ème ligne.
 b) La 1ère arête de $\Omega^+(\tilde{X}_1^*)$, comptée à partir de haut, est incidente au $s_i = 2(z_{i-1} - z_{i+1})$ ième sommet de \tilde{X}_1^* ; or le $(s_i + 1)$ ième sommet de \tilde{X}_1^* est sommet terminal du $(z_{i-1} - z_{i+2})$ ième arc de $\Omega^+(\tilde{X}_{i-1}^*)$ (toujours compté à partir du haut)

c) On a :

$$|\tilde{X}_1^*| = 2(z_1 - y_1) + 1$$

$$|\tilde{X}_i^*| = 2(z_i - y_i + 1) \quad 1 < i \leq p$$

$$|\tilde{X}_{p+1}^*| = 2(z_p - y_p) + 1 = 2z_p + 1 \quad (\text{car } y_p = 0)$$

$$d) \omega_i = |\Omega^+(\tilde{X}_i^*)| = z_i - y_i + 1$$

Calcul de $|T(y, z)|$

Soit $B(\tilde{G}_{yz}^*)$ la matrice adjointe de \tilde{G}_{yz}^* . Cette matrice est du même type que celle, $B(\tilde{G}^*)$, rencontrée dans le paragraphe précédent. Pour en calculer le déterminant, appliquons lui les phases 1, 2, 3, 4 et 5 décrites au §IV. Nous obtenons alors le :

Théorème 4 : $|T(y, z)| = \det A$

où $A = (a_{ij})$ avec

$$a_{ij} = \begin{cases} 0 & \text{si } j < i-1 \\ -1 & \text{si } j = i-1 \\ C^{j-i+1} & \text{si } j-i < z_j - y_i + 1 \\ z_j - y_i + 1 & \\ 0 & \text{sinon} \end{cases}$$

Démonstration :

. Calculons les coefficients situés au-dessus de la diagonale principale à l'issue de la phase 1.
 Comme dans le cas de $\tilde{B}(\tilde{G}^*)$ au paragraphe précédent, les seuls éléments non nuls, hors de la 1ère s-diagonale, se trouvent dans les lignes λ_i où λ_i est le numéro du sommet initiale du dernier arc (compté de haut en bas) de $\Omega^+(\tilde{X}_i^*)$ (pour $i = 1, \dots, p$). De plus, ces coefficients se trouvent tous dans des colonnes paires.

Le fait suivant va nous permettre de calculer de façon récursive les coefficients désirés :

"La valeur du coefficient $b'_{(\lambda_i, \lambda_j + 2k+1)}$ pour $j > i$ est la somme des coefficients

$b'_{(\lambda_i, \lambda_{j-1} + 2(z_{ij-1} - z_j + 2\ell + 1))}$ pour $\ell = k \dots \tilde{k}$ où \tilde{k} est tel que

$\lambda_{j-1} + 2(z_{j-1} - z_j + 2\tilde{k} + 1) < \lambda_j$ ".

Ce qui nous donne :

$$(\alpha) \quad b'_{(\lambda_i, \lambda_{i+1})} = b'_{(\lambda_i, \lambda_{i+3})} = \dots = b'_{(\lambda_i, \lambda_{i+2\omega_i+1})} = 1 = T_{-1}^{z_i - y_i}$$

$$(\beta) \quad b'_{(\lambda_i, \lambda_{i+1} + 1)} = -[\omega_i - (z_i - z_{i+1} + 1)] = -[z_{i+1} - y_i] = -T_0^{z_{i+1} - y_i}$$

$$b'_{(\lambda_i, \lambda_{i+1} + 2k+1)} = \max\{0, z_{i+1} - y_i - k\} = -T_0^{z_{i+1} - y_i - k}$$

(\gamma) Pour voir apparaître l'hypothèse de récurrence regardons le terme

$$b'_{(\lambda_i, \lambda_{i+2} + 1)} = \sum_{k=z_{i+1} - z_{i+2} + 1}^{z_{i+1} - y_i} (z_{i+1} - y_i - k) = \sum_{k'=1}^{z_{i+2} - y_i} (z_{i+2} - y_i - k') = \sum_{t=0}^{z_{i+2} - y_i - 1} t = T_1^{(z_{i+2} - y_i - 1)}$$

$$\text{et } b'_{(\lambda_i, \lambda_{i+2} + 2k+1)} = T_1^{z_{i+2} - y_i - 2k - 1}$$

$$(\delta) \text{ Supposons que } b'_{(\lambda_i, \lambda_{i+p-1} + 1)} = (-1)^{p-1} T_{p-2}^{z_{i+p-1} - y_i - p + 2}$$

$$\text{et } b'_{(\lambda_i, \lambda_{i+p-1} + 2k+1)} = (-1)^{p-1} T_{p-2}^{z_{i+p-1} - y_i - p - k + 2}$$

alors

$$\begin{aligned} b'_{(\lambda_i, \lambda_{i+p} + 1)} &= (-1)^p \sum_{k=z_{i+p-1} - z_{i+p} + 1}^{z_{i+p-1} - y_i - p + 2} T_{p-2}^{z_{i+p-1} - y_i - p - k + 2} \\ &= (-1)^p \sum_{k'=1}^{z_{i+p} - y_i - p + 2} T_{p-2}^{z_{i+p} - y_i - p + 2 - k} \\ &= (-1)^p \sum_{t=0}^{z_{i+p} - y_i - p + 1} T_{p-2}^t = (-1)^p T_{p-1}^{z_{i+p} - y_i - p + 1} \end{aligned}$$

et de la même façon :

$$b'_{(\lambda_1, \lambda_{i+p} + 2k+1)} = (-1)^p T_{p-1}^{z_{i+p} - y_{i-p} - k+1}$$

. Calculons les coefficients au dessus de la diagonale principale à la fin de la phase 2. Ce calcul est simple puisque :

$$\begin{aligned} b''_{(\lambda_1, \lambda_{i+p} + 1)} &= (-1)^p \sum_{k=0}^{\tilde{k}} b'_{(\lambda_1, \lambda_{i+p} + 2k+1)} = (-1)^p \sum_{k=0}^{\tilde{k}} T_{p-1}^{z_{i+p} - y_{i-p} - k+1} \\ &= (-1)^p T_p^{z_{i+p} - y_{i-p} + 1} \end{aligned}$$

et ce sont les seuls coefficients non nuls situés au dessus de la 1ère s-diagonale.

. La phase 3 est nécessaire pour tous les X_i sauf pour $i = 1$ et $i = q+1$. Elle crée un -1 en $(\lambda_1, \lambda_{i-1} + 1)$ et crée un zéro à la place du premier -1 de la première i-diagonale du bloc correspondant à X_i . Les autres termes restent inchangés.

(Remarque : le -1 créé est sous la diagonale principale).

Il convient maintenant de compléter tout ce que l'on vient de dire par antisymétrie.

. A l'issue de la phase 4, il ne reste plus que les lignes et colonnes λ_i et $\lambda_i + 1$ pour $i = 1, \dots, p$.

. La phase 5 nous met la matrice sous la forme :

$$B^{(5)}_{(\tilde{G}_{yz}^*)} = \left(\begin{array}{c|c} 1 & A \\ \hline t-A & 1 \end{array} \right)$$

où $A = (a_{ij})$ avec $a_{ij} = b^{(3)}_{(\lambda_i, \lambda_j + 1)}$

donc

$$\begin{cases} 0 & \text{si } j < i-1 \\ -1 & \text{si } j = i-1 \\ (-1) T_{j-1}^{z_j - y_{i-j+1}} & \text{sinon (avec les conventions de la page 16)} \end{cases}$$

Ceci est une conséquence immédiate des considérations précédentes.

Or comme au §IV les $(-1)^{j-i}$ sont inutiles et d'autre part on a :

$$T_{j-i}^{z_j - y_i^{-j+i+1}} = \begin{cases} C_{z_j - y_i^{-j+i+1}}^{z_j - y_i^{-j+i}} = C_{z_j - y_i^{+1}}^{j-i+1} & \text{si } z_j - y_i^{-j+i+1} = 0 \\ 0 & \text{sinon} \end{cases}$$

Ce qui donne le résultat recherché.

Remarque 1 : Nous n'avons pas, contrairement à ce qui a été fait au §IV, essayé d'optimiser l'ordre de la matrice $B^{(5)}(\tilde{G}_{yz}^*)$. Il est bien évident que le résultat peut être donné par un déterminant de matrice carrée d'ordre $\min(p,q)$.

Remarque 2 : Le théorème 3 s'obtient très facilement à partir du théorème 4, c'est d'ailleurs l'approche utilisée par Kreweras [2].

Remerciements : Je remercie Monsieur Pierre JULLIEN qui m'a suggéré ce problème et qui se trouve être à l'origine de la principale idée de cet article.

BIBLIOGRAPHIE

- [1] C. BERGE, "Graphes et Hypergraphes". Dunod, Paris.
- [2] G. KREWERAS, "Sur une classe de problèmes de dénombrements liés aux treillis des partitions des entiers". Thèse, Paris 1965.
- [3] G. KREWERAS, "Sur une extension du problème de Simon Newcomb". C.R.A.S., t. 263, Série A-43.

ANNEXE 2

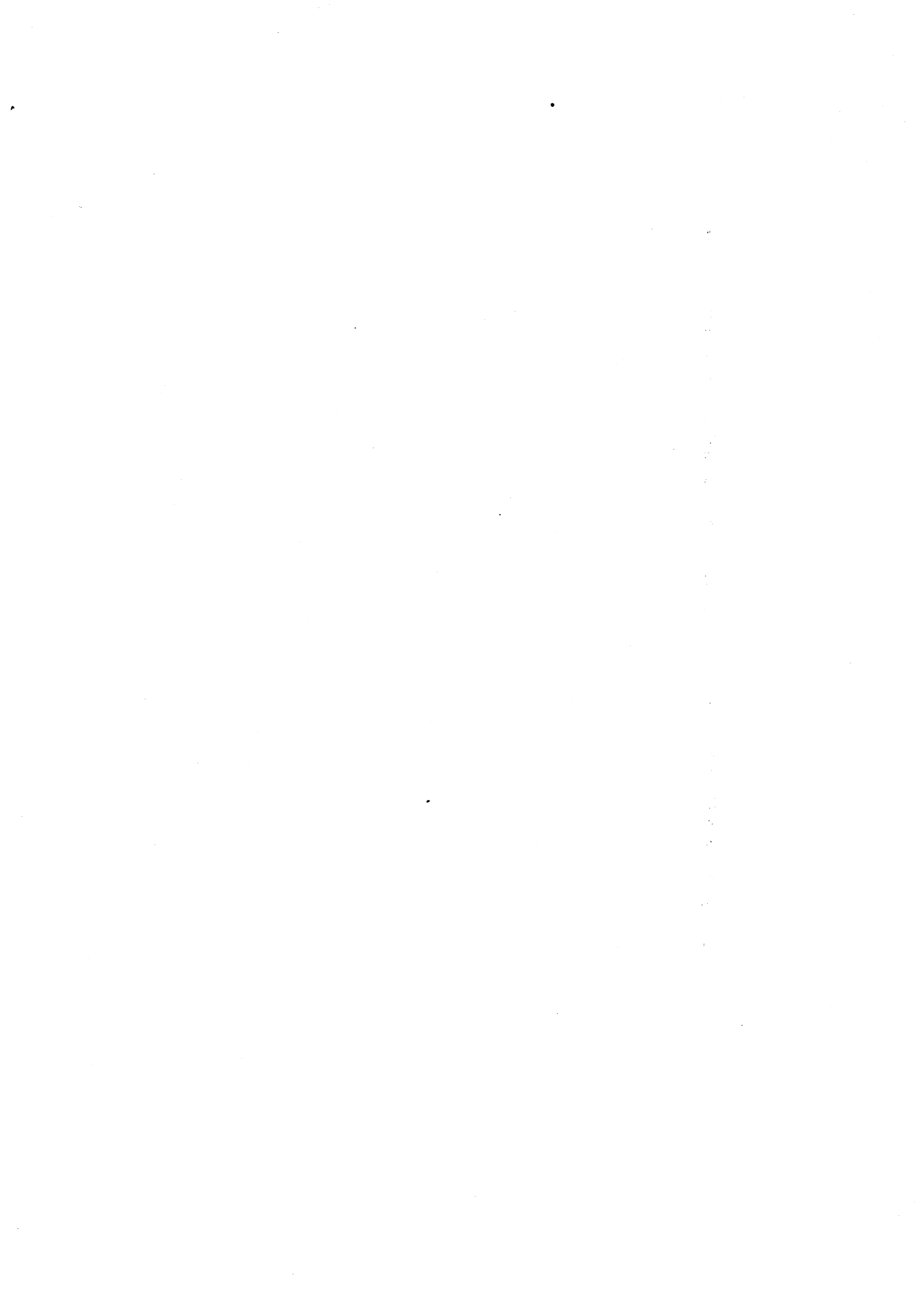

L'ORGANISATION D'UNE COUPE DE SKI

Une compétition de ski se comporte en général de deux manches de slalom courues l'une après l'autre en inversant, d'une manche sur l'autre, les ordres de départ puisqu'il est reconnu que les premiers concurrents à partir le font avec un avantage certain. Ainsi s'il y a n coureurs la somme des ordres de départ dans chacune des manches est de $n+1$ pour chacun des coureurs.

Pour des raisons de contraintes horaires (ski d'été) on peut être amené à faire courir les deux manches simultanément. Le problème est de déterminer les ordres de départ dans chaque manche de façon à minimiser les injustices, un coureur étant bien entendu avantagé si la somme des ordres de ses départs est inférieure à $n+1$, désavantagé si cette somme est supérieure à $n+1$. L'inversion des ordres de départ ne marche plus car les coureurs du milieu de tableau devraient être présents presque simultanément sur les deux parcours.

On supposera que les départs se font à intervalle réguliers et c'est cet intervalle qui servira d'unité de temps. Il faut d'autre part un temps k à un coureur pour se présenter au départ d'une manche après un premier parcours. Ce temps k tient compte du temps de récupération ainsi que du temps nécessaire pour remonter au sommet des pistes. Ainsi un coureur parti dans une manche au temps t ne pourra s'aligner dans l'autre manche qu'à $t+k+1$.

Remarque 1: On peut supposer sans perte de généralité que les coureurs partent dans le premier slalom dans l'ordre des dossards (ceci étant fait en général par tirage au sort). Le problème se ramène donc à trouver une permutation σ de l'ensemble des permutations de $\{1, 2, \dots, n\}$.

Problème mini-max: On se propose de trouver un ordre de départ dans le deuxième slalom tel que la plus grande injustice, en valeur absolue de la différence à $n+1$, soit la plus petite possible. On cherche donc la permutation σ^* telle que:

$$\max_i (n+1 - (i + \sigma^*(i))) = \min_{\sigma} \max_i (n+1 - (i + \sigma(i)))$$

Théorème 1:

$$\max_{\sigma} (n+1-(i+\sigma(i))) = \begin{cases} k & \text{si } n \text{ est pair et } k \leq n/2 \\ k+1 & \text{si } n \text{ est impair et } k \leq (n-1)/2 \end{cases}$$

Démonstration: Le problème se ramène à un problème d'affectation min-max en posant $x_{ij} = 1$ si et seulement si le coureur j part en i ème position dans le deuxième slalom. On a alors trivialement $\sum_i x_{ij} = 1$ pour tout j et $\sum_j x_{ij} = 1$ pour

tout i et la matrice des coûts suivante $C = (c_{ij})$ avec

$$c_{ij} = \begin{cases} +\infty & \text{si } i-k < j \leq i+k \\ n+1-(i+j) & \text{sinon} \end{cases}$$

Donc si $k > n/2$ pour n pair (resp. $k > (n-1)/2$ pour n impair) alors la $(n/2)$ ème ligne (resp. la $(n-1)/2$ ème) de la matrice des coûts ne comporte que des $+\infty$ et par conséquent le problème min-max n'a pas de solution finie. Supposons donc que $k < n/2$ (resp. $(n-1)/2$). Dans Gross [1] on trouve le théorème de dualité suivant:

$$\min_{\sigma} \max_i c_{i, \sigma(i)} = \max_{\substack{A, B \subset \{1, \dots, n\} \\ |A| + |B| = n+1}} \min_{\substack{i \in A \\ j \in B}} c_{ij}$$

Prenons $A_0 = \{ 1, 2, \dots, [n/2]+1 \}$

$$B_0 = \{ 1, 2, \dots, [n/2] \}$$

alors $\min_{\substack{i \in A_0 \\ j \in B_0}} c_{ij} = c_{[n/2]+1, [n/2]-k} = k$ ou $k+1$ suivant la

parité de n

D'autre part si $(A, B) \neq (A_0, B_0)$ alors A ou B contient une ligne de $\{ 1, 2, \dots, n \} - A_0$, respectivement une colonne de $\{ 1, 2, \dots, n \} - B_0$ et n'importe laquelle de ces lignes ou colonnes contient un élément inférieur ou égal à k (ou $k+1$), ce qui prouve le théorème.

Maintenant que l'on sait qu'il existe un ordre de départ tel que l'injustice maximum est de k ou $k+1$ (selon la parité de n) l' on peut se demander laquelle parmi ceux-ci minimise la somme de toutes les injustices. Ceci est un problème d'affectation avec la matrice des coûts $C^* = (c_{ij}^*)$ où:

$$c_{ij}^* = \begin{cases} c_{ij} & \text{si } c_{ij} \leq k \text{ (ou } k+1) \\ c_{ij} & \text{sinon} \end{cases}$$

Nous allons donner ci-après la valeur minimum de la somme de toutes les injustices et montrer qu'il existe toujours un ordre de départ dans le second parcours tel que les concurrents sont partagés en 4 groupes, chaque groupe étant composé de coureurs ayant des numéros de dossard consécutifs, les départs ayant lieu dans chaque groupe soit dans l'ordre soit dans l'ordre inverse des dossards.

Théorème 2: Soit \hat{z} la valeur minimum de la somme des injustices parmi les ordres de départ qui sont solution optimales du problème min-max du théorème précédent. On a alors:

$$\hat{z} = \begin{cases} \frac{[k/2]}{4} \sum_{i=0}^{[k/2]} (k-2i) & \text{si } n \text{ est pair} \\ [k/2] + \sum_{i=1}^{[k/2]} (k-2i) & \text{si } n \text{ est impair} \end{cases}$$

Démonstration: Considérons la permutation σ (n pair)

$$\sigma(i) = \begin{cases} n+1-i & \text{si } 1 \leq i \leq n/2 - (k+1) \\ i+k+1 & \text{si } n/2 - k < i < n/2 \\ \sigma^{-1}(n+1-i) & \text{si } i > n/2 + 1 \end{cases}$$

La figure 1 donne un exemple avec $n=20$ et $k=6$, les nombres entourés correspondent aux cases choisies dans la solution. Le cas impair se construit de la même façon la symétrie étant légèrement rompue

	1	2	3	4	5	6	7	8	9	10	11	12	13	14	15	16	17	18	18	20		
1	∞	∞	∞	∞	∞	∞	∞	∞	∞	∞	∞	∞	∞	6	5	4	3	2	1	0		
2	∞	∞	∞	∞	∞	∞	∞	∞	∞	∞	∞	∞	∞	6	5	4	3	2	1	0	1	
3	∞	∞	∞	∞	∞	∞	∞	∞	∞	∞	∞	∞	6	5	4	3	2	1	0	1	2	
4	∞	∞	∞	∞	∞	∞	∞	∞	∞	∞	∞	∞	6	5	4	3	2	1	0	1	2	3
5	∞	∞	∞	∞	∞	∞	∞	∞	∞	∞	∞	∞	4	3	2	1	0	1	2	3	4	
6	∞	∞	∞	∞	∞	∞	∞	∞	∞	∞	∞	∞	∞	2	1	0	1	2	3	4	5	
7	∞	∞	∞	∞	∞	∞	∞	∞	∞	∞	∞	∞	∞	0	1	2	3	4	5	6		
8	∞	∞	∞	∞	∞	∞	∞	∞	∞	∞	∞	∞	∞	∞	2	3	4	5	6	∞		
9	∞	∞	∞	∞	∞	∞	∞	∞	∞	∞	∞	∞	∞	∞	∞	4	5	6	∞	∞		
10	∞	∞	∞	∞	∞	∞	∞	∞	∞	∞	∞	∞	∞	∞	∞	∞	∞	6	∞	∞	∞	
11	∞	∞	∞	6	∞	∞	∞	∞	∞	∞	∞	∞	∞	∞	∞	∞	∞	∞	∞	∞	∞	
12	∞	∞	6	5	4	∞	∞	∞	∞	∞	∞	∞	∞	∞	∞	∞	∞	∞	∞	∞	∞	
13	∞	6	5	4	3	2	∞	∞	∞	∞	∞	∞	∞	∞	∞	∞	∞	∞	∞	∞	∞	
14	6	5	4	3	2	1	0	∞	∞	∞	∞	∞	∞	∞	∞	∞	∞	∞	∞	∞	∞	
15	5	4	3	2	1	0	1	2	∞	∞	∞	∞	∞	∞	∞	∞	∞	∞	∞	∞	∞	
16	4	3	2	1	0	1	2	3	4	∞	∞	∞	∞	∞	∞	∞	∞	∞	∞	∞	∞	
17	3	2	1	0	1	2	3	4	5	6	∞	∞	∞	∞	∞	∞	∞	∞	∞	∞	∞	
18	2	1	0	1	2	3	4	5	6	∞	∞	∞	∞	∞	∞	∞	∞	∞	∞	∞	∞	
19	1	0	1	2	3	4	5	6	∞	∞	∞	∞	∞	∞	∞	∞	∞	∞	∞	∞	∞	
20	0	1	2	3	4	5	6	∞	∞	∞	∞	∞	∞	∞	∞	∞	∞	∞	∞	∞	∞	

Figure 1

Montrons que cette permutation σ nous donne un ordre de départ optimum. Il est aisé de remarquer que les cases choisies possèdent le plus petit élément soit de leur ligne soit de leur colonne (ces deux alternatives étant exclusives).

Soient $u_i, i=1, \dots, n$ et $v_j, j=1, \dots, n$ des nombres associés aux lignes et colonnes respectivement. Posons:

u_i (resp. v_j) = c_{ij} si $\sigma(i) = j$ et si c_{ij} est le plus petit élément de sa ligne (resp. colonne). On a alors trivialement

que pour tout i et tout j $c_{ij} - u_i - v_j > 0$ et

$$\sum_i u_i + \sum_j v_j = \sum_{i=1}^n c_{i\sigma(i)}$$

ce qui prouve par dualité que la solution est optimale.

La valeur de \hat{z} découle facilement du calcul des coefficients c_{ij}

BIBLIOGRAPHIE

[1] O.GROSS: "The Bottleneck Assignment Problem:an algorithm" Proceedings of a RAND Symposium on Mathematical Programming. RAND Publication 351(1960),87-88.

ANNEXE 3

Hamiltonicity in (0-1)-polyhedra

D.J. Naddef

Laboratoire d'Informatique et de
Mathématiques Appliquées,
Université Scientifique et Médicale
de Grenoble and Université des
Sciences Sociales de Grenoble, France

W.R. Pulleyblank

Department of Combinatorics and Optimization
University of Waterloo

Research supported, in part, by the Natural Sciences and
Engineering Research Council of Canada. This research was
carried out while the first author was a visiting
professor in the Department of Combinatorics and Optimization,
University of Waterloo.

Abstract.

The graph $G(P)$ of a polyhedron P has a node corresponding to each vertex of P and two nodes are adjacent in $G(P)$ if and only if the corresponding vertices of P are adjacent on P . We show that if $P \subseteq \mathbb{R}^n$ is a polyhedron, all of whose vertices have (0-1)-valued coordinates, then

- i) if $G(P)$ is bipartite, then $G(P)$ is a hypercube;
- ii) if $G(P)$ is nonbipartite, then $G(P)$ is hamilton connected.

We show that if $P \subseteq \mathbb{R}^n$ has (0-1)-valued vertices and is of dimension d ($\leq n$) then there exists a polyhedron $P' \subseteq \mathbb{R}^d$ having (0-1)-valued vertices such that $G(P) \simeq G(P')$. We also discuss some combinatorial consequences of these results.

1. Introduction

The graph $G(P)$ (or skeleton) of a polyhedron P is the graph whose nodes are the vertices of P , and which has an edge joining two nodes if and only if the corresponding vertices of P are adjacent on P . That is, the edges of $G(P)$ correspond to the bounded 1-dimensional faces of P , provided that P has vertices. A (0-1)-polyhedron is a polyhedron $P \subseteq \mathbb{R}^E$, for some finite set E , such that every vertex of P has 0-1 valued coordinates. In [6] we defined a combinatorial polyhedron to be a 0-1 polyhedron P which satisfied the following additional property:

(1.1) . If vertices u, v of P are nonadjacent, then there exist vertices w, x distinct from u and v such that $.5u + .5v = .5w + .5x$.

In other words, a 0-1 polyhedron is combinatorial if vertices u and v of P are nonadjacent if and only if there exists different vertices w and x such that the midpoint of the line joining u and v is the midpoint of the line joining w and x . (Hausmann [4] calls (1.1) the "intersection-union" property.) We showed in [6] that if the graph of a combinatorial polyhedron is bipartite then it is a hypercube and that if it is nonbipartite it is hamilton connected. (A graph is hamilton connected if every pair of distinct vertices is joined by a hamilton path.)

In this note we show that condition (1.1) can be dropped and the same results will hold. We prove

Theorem 3.2. If the graph $G(P)$ of a (0-1)-polyhedron P is bipartite, then it is a hypercube.

Theorem 3.6. If the graph $G(P)$ of a (0-1)-polyhedron P is nonbipartite, then $G(P)$ is hamilton connected.

We also prove a "minimality of representation" theorem for the graphs of (0-1)-polyhedra:

Theorem 3.4. If $P \subseteq \mathbb{R}^J$ is a non full-dimensional (0-1)-polyhedron then there exists a (0-1)-polyhedron $P' \subseteq \mathbb{R}^K$ for $K \subset J$ such that $G(P)$ and $G(P')$ are isomorphic and P' is of full dimension.

The importance of Theorem 3 is that when considering questions of adjacency of vertices of (0-1)-polyhedra, we can restrict our attention to polyhedra of full dimension. The main use we make of it is the corollary that a (0-1)-polyhedron of dimension d can have at most 2^d vertices.

A main reason for interest in adjacency properties of polyhedra is that they often have attractive combinatorial interpretations. For example, the matroid basis polytope consists of the convex hull of the incidence vectors of the bases of a matroid M . Two vertices are adjacent if and only if the symmetric difference of the corresponding bases has cardinality two. The perfect matching polytope consists of the convex hull of the incidence vectors of the perfect matchings of a graph G . Two vertices are adjacent if and only if the symmetric difference of the corresponding matchings consists of a single alternating cycle. Thus Theorems 1 and 2 have the following consequences for these cases. For any matroid M containing a circuit of cardinality at least three, for any pair B, \hat{B} of bases, it is possible to sequence the bases of $M : B = B_1, B_2, \dots, B_n = \hat{B}$ such that each basis differs from the previous basis by a single "basis exchange". (See Welsh [7] for matroid definitions and properties.) For any graph G in which the edges appearing in perfect matchings do not partition into node-disjoint even cycles, for any perfect matchings M and \hat{M} , it is possible to sequence the perfect matchings $M = M_1, M_2, \dots, M_n = \hat{M}$ in such a way that each perfect matching appears exactly once, and further, the symmetric difference of each successive pair of matchings is a single alternating cycle. See [6] or Hausmann [4] for further combinatorial interpretations of polyhedral adjacency criteria.

In Section 2 we summarize the basic definitions and results from [6] which we require. In Section 3 we prove the main theorems and in Section 4 we discuss some of the consequences.

2. Basic results and definitions.

Let E be a finite set and let $\{0,1\}^E$ denote the set of all (0-1)-vectors indexed by E . Let $X \subseteq \{0,1\}^E$ and let $\text{conv}(X)$ denote the convex hull of X in \mathbb{R}^E . Then it is well known that the vertices of $\text{conv}(X)$ are precisely the members of X .

We let $G(X)$ denote the graph, or skeleton, of $\text{conv}(X)$. Thus the node set of $G(X)$ is X , and

(2.1) $u, v \in X$ are adjacent in $G(X)$ if and only if, for every λ satisfying $0 < \lambda < 1$, the point $\lambda u + (1-\lambda)v$ cannot be expressed as a convex combination of members of $X \setminus \{u, v\}$.

For any $u, v \in X$, we let

$$A(u, v) := \{e \in E : u_e = v_e\}$$

$$D(u, v) := \{e \in E : u_e \neq v_e\} = E \setminus A(u, v).$$

Thus $A(u, v)$ and $D(u, v)$ are the sets of coordinates where u and v agree and disagree respectively. We let $\bar{X}(u, v) := \{x \in X : x_e = u_e (= v_e) \text{ for all } e \in A(u, v)\}$. It is trivial to see that we can replace " $X \setminus \{u, v\}$ " with " $\bar{X}(u, v) \setminus \{u, v\}$ " in (2.1). Therefore

(2.2) for any $u, v \in X$ such that $\bar{X}(u, v) = \{u, v\}$ we have u and v adjacent in $G(X)$.

A hypercube of dimension $d \geq 0$ is defined as follows. A hypercube of dimension 0 is a graph consisting of a single node and no edges. For $d \geq 1$, a hypercube of dimension d is obtained by taking two copies of a hypercube of dimension $d - 1$, and joining the corresponding nodes

in the two copies. It is easily seen that G is a hypercube of dimension $d \geq 1$ if and only if G is isomorphic to $G(\{0,1\}^E)$, where $|E| = d$. Hypercubes are bipartite, and a hypercube having dimension at least one contains the same number of nodes in each part. Moreover

(2.3) for any pair $\{u,v\}$ of nodes of a hypercube G , they are joined by a hamilton path of G if and only if they belong to opposite parts of G .

A graph G is said to be hamilton connected if, for any pair $\{u,v\}$ of distinct nodes, there exists a hamilton path of G joining u and v . Every hamilton connected graph on three or more nodes has a hamilton cycle. Hypercubes of dimension zero or one are hamilton connected.

For any $S \subseteq E$, for any $x \in X$ we let $x[S] := (x_j : j \in S)$ and we let $X[S] := \{x[S] : x \in X\}$. Thus $X[S]$ is the set of all subvectors indexed by S in X . We say that $S \subseteq E$ is a separator of X if and only if for every $x' \in X[S]$, for every $x'' \in X[E \setminus S]$, the concatenation x of x' and x'' , defined by

$$x_j := \begin{cases} x'_j & \text{for } j \in S \\ x''_j & \text{for } j \in E \setminus S \end{cases}$$

belongs to X . If a separator S satisfies $\emptyset \neq S \neq E$ then we call S a proper separator. If there exists no proper separator of X , then we say that X is nonseparable. Otherwise we say that X is separable.

A component of X is a minimal nonempty separator of X which is E if X is nonseparable. Clearly the components of $X \subseteq \{0,1\}^E$ partition E .

Let S be a component of $X \subseteq \{0,1\}^E$ and let $r := |X[S]|$. Then we call S an r -valued component of X . If S is a 1-valued component, then $|S| = 1$ and $x_e = x'_e$ for all $x, x' \in X$, where $S = \{e\}$. If S is a 2-valued component then $X[S]$ consists of two complementary vectors. We say that S is a $\geq k$ -valued component if $|X[S]| \geq k$.

Berge [2] defines the graph $G = (V, E)$ to be the cartesian sum of graphs $G_1 = (V_1, E_1)$ and $G_2 = (V_2, E_2)$ if $V = V_1 \times V_2$ and nodes (v_1, v_2) and $(w_1, w_2) \in V$ are adjacent in G if and only if either $v_1 = w_1$ and v_2 and w_2 are adjacent in G_2 or $v_2 = w_2$ and v_1 and w_1 are adjacent in G_1 . We write $G = G_1 \times G_2$, and note that this product is both associative and commutative, under isomorphism. For graphs G_1, G_2, \dots, G_k we write $\prod_{i=1}^k G_i$ to denote $G_1 \times G_2 \times \dots \times G_k$.

Lemma 2.1 ([6], Lemma 2.1). If S_1, S_2, \dots, S_k are the ≥ 2 -valued components of X , then $G(X)$ is isomorphic to $\prod_{i=1}^k G(X[S_i])$.

Lemma 2.2 (Brualdi and Gibson [3]). Let G_1, G_2, \dots, G_k be hamilton connected graphs and let $G = \prod_{i=1}^k G_i$. If $|V(G_i)| \geq 3$ for any $i \in \{1, 2, \dots, k\}$ then G is hamilton connected. If $|V(G_i)| \leq 2$ for all $i = 1, 2, \dots, k$ then G is a hypercube.

Let $X \subseteq \{0, 1\}^E$ and let $e \in E$. We let

$$X_e^0 := \{x \in X : x_e = 0\}$$

$$X_e^1 := \{x \in X : x_e = 1\}.$$

This defines a partition of X which is proper unless $\{e\}$ is a 1-valued component of X . An important fact we use is that adjacencies on $G(X_e^0)$ and $G(X_e^1)$ are the same as on the corresponding subgraphs of $G(X)$.

Lemma 2.3 ([6] Lemma 2.5). Elements $v, w \in X_e^0$ (X_e^1) are adjacent in $G(X_e^0)$ ($G(X_e^1)$) if and only if they are adjacent in $G(X)$.

Moreover, we have the following result concerning adjacencies between nodes of X_e^0 and X_e^1 .

Lemma 2.4 ([6] Lemma 2.4). Every $v \in X_e^0$ is adjacent to at least one $w \in X_e^1$, provided that this set is nonempty. Moreover, if v is adjacent to exactly one $w \in X_e^1$ then $v[E \setminus S] = w[E \setminus S]$, where S is the set of 1-valued components of X_e^1 .

A universal node of a graph G is a node adjacent to every other node. Lemma 2.4 implies that if either $|X_e^0| = 1$ or $|X_e^1| = 1$ then G has a universal node. It is straightforward to verify the following:

(2.4) If v is a universal node of G and if $G \setminus v$ is hamilton connected or a hypercube then G is hamilton connected.

Finally, we note that it is easy to verify that if $|X| \leq 3$ then $G(X)$ is a complete graph on $|X|$ nodes.

3. The Theorems

First we prove a useful lemma.

Lemma 3.1. If $X \subseteq \{0,1\}^E$ is nonseparable and $|X| \geq 3$ then $G(X)$ is nonbipartite.

Proof. We prove by induction on $|X|$. If $|X| = 3$ then $G(X)$ is a triangle and the result is immediate. Suppose it is true whenever $|X| < k$ (for $k \geq 4$) and we have $|X| = k$. Choose $e \in E$. Since X is nonseparable, $X_e^0 \neq \emptyset \neq X_e^1$. If either X_e^0 or X_e^1 has a ≥ 3 -valued component, then by induction the graph of this component is nonbipartite so by Lemma 2.1, $G(X_e^0)$ or $G(X_e^1)$ is nonbipartite and by Lemma 2.3, so too is $G(X)$. So suppose that all components of X_e^0 and of X_e^1 are 1-valued or 2-valued. If $|X_e^0| = 1$ or $|X_e^1| = 1$, then by Lemma 2.4, $G(X)$ has a universal node and so cannot be bipartite. So we assume that each of X_e^0 and X_e^1 contains at least one 2-valued component.

Let S^0 and S^1 be the set of 1-valued components of X_e^0 and X_e^1 respectively. Suppose that whenever $w \in X_e^0$ and $x \in X_e^1$ are adjacent, we have $D(w,x) \subseteq S^1 \cap S^0$. If there existed $j \in (S^1 \cap S^0) \setminus D(w,x)$ then $\{j\}$ would be a 1-valued component of X , contradicting our nonseparability assumption, so we must have $D(w,x) = S^1 \cap S^0$ for all adjacent $w \in X_e^0$ and $x \in X_e^1$. Since, by Lemma 2.4, every $w \in X_e^0$ is adjacent to some $v \in X_e^1$, it follows that for every $w \in X_e^0$ there exists $v \in X_e^1$ such that

$w(\text{EX}(S^1 \cap S^0)) = v[\text{EX}(S^1 \cap S^0)]$, and conversely for every $v \in X_e^1$. Thus $S^1 \cap S^0$ is a 2-valued component of X which contradicts the non-separability of X .

Therefore we assume there exist adjacent $w \in X_e^0$ and $x \in X_e^1$ such that there is some $k \in D(w,x) - S^1$ (say). Let C be the 2-valued component of X_e^1 that contains k and let \bar{x} be obtained from x by switching the values indexed by C . Then x and \bar{x} are adjacent in $G(X_e^1)$, and so, by Lemma 2.3, in $G(X)$. If w and \bar{x} are adjacent we are finished: w, x, \bar{x} are the nodes of a triangle in $G(X)$. So suppose w and \bar{x} are not adjacent. Then there exist $\{u^i \in X_e^0 : i = 1, 2, \dots, p\}$, $\{v^j \in X_e^1 : j = 1, 2, \dots, q\}$ and $\alpha > 0, \beta > 0, (\alpha_i > 0 : i = 1, 2, \dots, p), (\beta_j > 0 : j = 1, 2, \dots, q)$ satisfying $\alpha + \beta = 1$ and $\sum_{i=1}^p \alpha_i + \sum_{j=1}^q \beta_j = 1$ and $\alpha w + \beta \bar{x} = \sum_{i=1}^p \alpha_i u^i + \sum_{j=1}^q \beta_j v^j$. By considering the component indexed by e , we see that $\beta = \sum_{j=1}^q \beta_j$ and hence $\alpha = \sum_{i=1}^p \alpha_i$. By our choice of k , we have $w_k \neq x_k$ so $w_k = \bar{x}_k$. Therefore $u_k^i = v_k^j = \bar{x}_k$ for $i = 1, 2, \dots, p$ and $j = 1, 2, \dots, q$. Since C is a 2-valued component, we can, for $j = 1, 2, \dots, q$, obtain \bar{v}^j from v^j by switching on the coordinates indexed by C , and have $\bar{v}^j \in X_e^1$. But then $\alpha w + \beta x = \sum_{i=1}^p \alpha_i u^i + \sum_{j=1}^q \beta_j \bar{v}^j$, contradicting the adjacency of w and x . \square

Now we can immediately obtain our first theorem.

Theorem 3.2. If $G(X)$ is bipartite for $X \subset \{0,1\}^E$ then $G(X)$ is a hypercube.

Proof. If X has a ≥ 3 -valued component S then $G(X[S])$ is non-bipartite by Lemma 3.1 so by Lemma 2.1, so too is $G(X)$. If X has only 1-valued and 2-valued components, then by Lemma 2.2 $G(X)$ is a hypercube. \square

Now we will prove the theorem mentioned in the introduction which asserts that, from the point of view of the graph or skeleton, we need

only consider full dimensional polyhedra. Let $P \subseteq \mathbb{R}^J$ be a polyhedron and let $j \in J$. The projection of P onto the j -coordinate hyperplane is the polyhedron $\bar{P} := \{\bar{x} \in \mathbb{R}^{J \setminus \{j\}} : \text{there exists } x \in P \text{ satisfying } x_e = \bar{x}_e \text{ for all } e \in J \setminus \{j\}\}$. That is, we simply drop the j^{th} coordinate from all members of P . The following theorem applies to all polyhedra.

Theorem 3.3. Let $P \subseteq \mathbb{R}^J$ be a nonempty polyhedron not of full dimension. Then there exists $j \in J$ such that, if \bar{P} is the projection of P onto the j -coordinate hyperplane, then $G(P) \cong G(\bar{P})$.

Proof. If P is not of full dimension, then there exist $a \in \mathbb{R}^J$ and $a_0 \in \mathbb{R}$ such that all $x \in P$ satisfy $ax = a_0$. Let $j \in J$ be such that $a_j \neq 0$, and let \bar{P} be the projection of P onto the j -coordinate hyperplane. We show that $G(P)$ and $G(\bar{P})$ are isomorphic.

For any $x \in P$, let \bar{x} denote the member of P obtained by dropping the j^{th} coordinate. Then the mapping $x \rightarrow \bar{x}$ is a bijection. For if we choose any $y \in \bar{P}$ then the unique member x of P satisfying $\bar{x} = y$ has $x_j = (a_0 - \bar{a}y)/a_j$ (where \bar{a} is obtained by dropping the j^{th} coordinate of a). Trivially, if $x \in P$ can be expressed as a convex combination of other members of P , then \bar{x} is a convex combination of the corresponding members of \bar{P} . Conversely, if $\bar{x} \in \bar{P}$ can be expressed as $\sum_{i=1}^p \alpha_i \bar{x}^i$ for $\bar{x}^i \in \bar{P}$, where $\sum_{i=1}^p \alpha_i = 1$, then $x_j = (a_0 - \bar{a}\bar{x})/a_j$ and $x_j^i = (a_0 - \bar{a}\bar{x}^i)/a_j$ for all $i = 1, 2, \dots, p$. Therefore $x_j = \sum_{i=1}^p \alpha_i x_j^i$ and so x is a convex combination of the corresponding members of P . Therefore x is a vertex of P if and only if \bar{x} is a vertex of \bar{P} .

Now suppose vertices u, v of P are nonadjacent. Then there exist $\lambda \in \mathbb{R}$ satisfying $0 < \lambda < 1$ and $(\alpha_i > 0 : i = 1, 2, \dots, p)$ satisfying $\sum_{i=1}^p \alpha_i = 1$ and $\{x^i \in P : i = 1, 2, \dots, p\}$ such that $\lambda u + (1-\lambda)v = \sum_{i=1}^p \alpha_i x^i$. Then, trivially, $\lambda \bar{u} + (1-\lambda)\bar{v} = \sum_{i=1}^p \alpha_i \bar{x}^i$. There-

fore \bar{u} and \bar{v} are nonadjacent on \bar{P} .

Conversely, if $\bar{u}, \bar{v} \in \bar{P}$ are nonadjacent, then there exist $\lambda \in \mathbb{R}$ satisfying $0 < \lambda < 1$, $(\alpha_i \geq 0 : i = 1, 2, \dots, p)$ satisfying $\sum_{i=1}^p \alpha_i = 1$ and $\{\bar{x}^i \in \bar{P} : i = 1, 2, \dots, s\}$ such that $\lambda \bar{u} + (1-\lambda)\bar{v} = \sum_{i=1}^p \alpha_i \bar{x}^i$. But then we have $u_j = (a_0 - \bar{a}\bar{u})/a_j$, $v_j = (a_0 - \bar{a}\bar{v})/a_j$, $x_j^i = (a_0 - \bar{a}\bar{x}^i)/a_j$, for $i = 1, 2, \dots, p$ so $\lambda u_j + (1-\lambda)v_j = \sum_{i=1}^p \alpha_i x_j^i$. Therefore $\lambda u + (1-\lambda)v = \sum_{i=1}^p \alpha_i x^i$, i.e., u and v are not adjacent on P .

Therefore vertices u, v of P are adjacent if and only if vertices \bar{u}, \bar{v} of \bar{P} are adjacent and so $G(P)$ and $G(\bar{P})$ are isomorphic. \square

If P is a (0-1)-polyhedron, then trivially every projection of P onto a coordinate hyperplane is a (0-1)-polyhedron, so by repeatedly applying Theorem 3.3 we obtain the following:

Theorem 3.4. Let $P \subset \mathbb{R}^J$ be a (0-1)-polyhedron. Then there exists a full dimensional (0-1)-polyhedron $P' \subset \mathbb{R}^K$, for $K \subset J$, such that $G(P)$ and $G(P')$ are isomorphic.

Corollary 3.5. If $P \subset \mathbb{R}^J$ is a (0-1)-polyhedron of dimension d then P has at most 2^d vertices.

We can apply the procedure of Theorems 3.2 and 3.3 to obtain a minimal representation of the graph of a (0-1)-polyhedron P provided that we know a linearly independent set of equations whose solution set is the affine hull of P . Simply consider the equations one after the other and, for each, find a coordinate not yet deleted having nonzero coefficient and delete that coordinate. For example, let \tilde{M} be the convex hull of the incidence vectors of the perfect matchings of the Petersen graph. (See Fig. 3.1.) Then the affine hull is the solution set to the independent equations

$$\sum (x_j : j \text{ incident with } v) = 1 \text{ for all nodes } v.$$

We sequentially delete the components indexed by the edges 1-5 and 11-15 and we have that $G(\tilde{M})$ is isomorphic to $G(\lambda)$, where X is as given in Fig. 3.1(b).

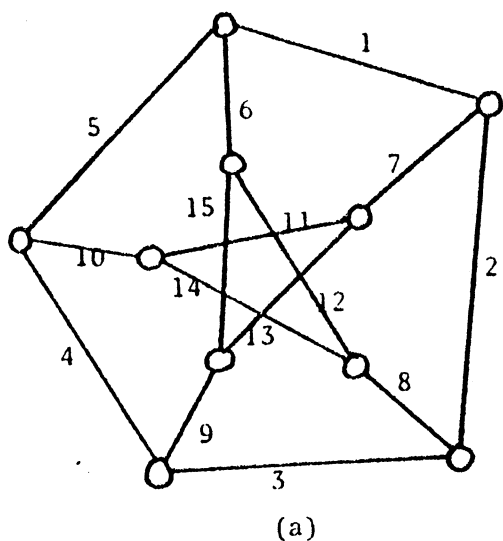

Col:	6	7	8	9	10
	1	1	1	1	1
	1	0	0	0	0
X	0	1	0	0	0
	0	0	1	0	0
	0	0	0	1	0
	0	0	0	0	1

(b)

Fig. 3.1.

Therefore, by (2.2), $G(\tilde{M})$ is isomorphic to K_6 , the complete graph on six nodes.

Finally, we prove the last theorem.

Theorem 3.6. If $G(X)$ is nonbipartite for $X \subseteq \{0,1\}^E$ then $G(X)$ is hamilton connected.

Proof. Let $G := G(X)$. We prove by induction on $|X|$. If $|X| = 3$ then G is a triangle so suppose $|X| = k \geq 4$ and the result holds for all smaller values of $|X|$. We can assume that X has no 1-valued component (i.e. there is no $j \in E$ such that x_j is constant for all $x \in X$) for such a component could be dropped without changing G .

Suppose X is separable. If every component is 2-valued then by Lemmas 2.1 and 2.2, G is a hypercube, contradicting G being nonbipartite. If any component S is ≥ 3 -valued, then by Lemma 3.1 $G(X[S])$ is nonbipartite so, by induction, $G(X[S])$ is hamilton connected. Therefore, by Lemmas 2.1 and 2.2, G is hamilton connected. So we assume that X is

nonseparable. Let x and y be distinct members of X . We will show that x and y are the ends of a hamilton path of G .

Let $e \in E$ be such that $x_e \neq y_e$. Then $X_e^0 \neq \emptyset \neq X_e^1$. If $|X_e^0| = 1$ or $|X_e^1| = 1$ then, by Lemma 2.4, G has a universal node. Whichever of X_e^0 or X_e^1 contains three or more elements must be either bipartite, and hence by Theorem 3.2 a hypercube, or else nonbipartite, and hence by induction hamilton connected. In either case, by (2.4), G will be hamilton connected. So we assume $|X_e^0| \geq 2$, $|X_e^1| \geq 2$ and, without loss of generality, assume $x \in X_e^0$ and $y \in X_e^1$. Each of $G(X_e^0)$ and $G(X_e^1)$ must be either a hypercube or hamilton connected; we distinguish three cases:

Case 1. Both $G(X_e^0)$ and $G(X_e^1)$ are hamilton connected. If there exist $u \in X_e^0 \setminus \{x\}$ and $v \in X_e^1 \setminus \{y\}$ which are adjacent in G then we are done. For concatenating a hamilton path in $G(X_e^0)$ from x to u , the edge $[u,v]$, and a hamilton path in $G(X_e^1)$ from v to y gives the desired hamilton path from x to y . So suppose, to obtain a contradiction, that y is the only node of X_e^1 adjacent to a node of $X_e^0 \setminus \{x\}$, and hence, x is the only node of X_e^0 adjacent to a node of $X_e^1 \setminus \{y\}$. Then $\{x,y\}$ is a two node cutset of G , so by a theorem of Balinski [1], $\text{conv}(X)$ has dimension two. Therefore, by Corollary 3.5, $|X| = 4$, and $|X_e^0| = |X_e^1| = 2$. Let $\{u\} := X_e^0 \setminus \{x\}$ and let $\{v\} := X_e^1 \setminus \{y\}$. We have assumed u,v are nonadjacent, so there exist λ satisfying $0 < \lambda < 1$ and μ satisfying $0 < \mu < 1$ such that $\lambda u + (1-\lambda)v = \mu \cdot x + (1-\mu)y$. Therefore x and y are nonadjacent, so G is a 4-cycle, which is bipartite, a contradiction.

Case 2. One of $G(X_e^0)$ and $G(X_e^1)$, say $G(X_e^0)$ is hamilton connected and the other, $G(X_e^1)$, is a hypercube of dimension at least two. Then $|X_e^1| \geq 4$. Let W be the part of $G(X_e^1)$ that does not contain y . If any $v \in W$

is adjacent to any $u \in X_e^0 \setminus \{x\}$, then using (2.3) we can proceed as in the previous case. So suppose, to get a contradiction, that x is the only node of X_e^0 adjacent to any $v \in W$. Then, by Lemma 2.4, $v[E \setminus S] = x[E \setminus S]$ for all $v \in W$, where S is the set of coordinates of 1-valued components of X_e^0 .

Suppose there existed $v' \in X_e^1 \setminus W$ such that $v'[E \setminus S] \neq x[E \setminus S]$. Since v' is adjacent to some member of W , some 2-valued component of X_e^1 contains an element of $E \setminus S$. Since $|X_e^1| \geq 4$ there is another 2-valued component and let \bar{v}' be obtained from v' by changing the value on this component. Then \bar{v}' and v' are adjacent so $\bar{v}' \in W$. But $\bar{v}'[E \setminus S] \neq x[E \setminus S]$, a contradiction. Therefore

$$(3.1) \quad v[E \setminus S] = x[E \setminus S] \quad \text{for all } v \in X_e^1.$$

Now choose $u \in X_e^0 \setminus \{x\}$ and $v \in W$. By hypothesis they are non-adjacent so there exist $p, q \geq 1$, $\alpha > 0$, $\beta > 0$, $(\alpha_i > 0 : i = 1, 2, \dots, p)$, $(\beta_j > 0 : j = 1, 2, \dots, q)$, $\{u^i \in X_e^0 \setminus \{u\} : i = 1, 2, \dots, p\}$ and $\{v^j \in X_e^0 \setminus \{v\} : j = 1, 2, \dots, q\}$ such that

$$\alpha + \beta = 1, \quad \sum_{i=1}^p \alpha_i + \sum_{j=1}^q \beta_j = 1$$

$$\alpha u + \beta v = \sum_{i=1}^p \alpha_i u^i + \sum_{j=1}^q \beta_j v^j.$$

By considering the coordinate indexed by e , we see $\beta = \sum_{j=1}^q \beta_j$. Since S is the set of 1-valued components of X_e^0 , $u[S] = u^i[S]$ for $i = 1, 2, \dots, p$. Since $\beta = \sum_{j=1}^q \beta_j$, we have, therefore $v[S] = v_j[S]$ for $j = 1, 2, \dots, q$. But this, together with (3.1), gives that $v = v_j$ for $j = 1, 2, \dots, q$, a contradiction, which finishes this case.

Case 3. Both $G(X_e^0)$ and $G(X_e^1)$ are hypercubes of dimension at least two.
Then $|X_e^0| \geq 4$, $|X_e^1| \geq 4$. Let Y^0 and Z^0 be the parts of $G(X_e^0)$ and

let Y^1 and Z^1 be the parts of $G(X_e^1)$, where $x \in Y^0$ and $y \in Z^1$.

Our objective is to establish

(3.2) there exists a node $u \in Z^0$ adjacent in G to a node $v \in Y^1$.

For then, once again, the result is obtained, using (2.3), by concatenating a hamilton path in $G(X_e^0)$ from x to u , the edge $[uv]$, and a hamilton path in $G(X_e^1)$ from v to y .

Let S^0 and S^1 respectively be the sets of coordinates of 1-valued components of X_e^0 and X_e^1 . First we observe that if $S^0 \cup S^1 = E$ then every $u \in X_e^0$ is adjacent to every $v \in X_e^1$. For if such u, v were non-adjacent, there would exist $p, q \geq 1$, $\alpha > 0$, $\beta > 0$, $(\alpha_i > 0 : i = 1, 2, \dots, p)$, $(\beta_j > 0 : j = 1, 2, \dots, q)$, $(u^i \in X_e^0 \setminus \{u\} : i = 1, 2, \dots, p)$ and $(v^j \in X_e^1 \setminus \{v\} : j = 1, 2, \dots, q)$ such that

$$\alpha + \beta = 1, \quad \sum_{i=1}^p \alpha_i + \sum_{j=1}^q \beta_j = 1,$$

$$\alpha u + \beta v = \sum_{i=1}^p \alpha_i u^i + \sum_{j=1}^q \beta_j v^j.$$

Once again, considering e we see that $\beta = \sum_{j=1}^q \beta_j$. Since $u[S^0] = u^i[S^0]$ for $i = 1, 2, \dots, p$, and $\beta = \sum_{j=1}^q \beta_j$ it follows that $v[S^0] = v^j[S^0]$ for all $j = 1, 2, \dots, q$. Since we also have $v[S^1] = v^j[S^1]$ for all $j = 1, 2, \dots, q$ and $E = S^0 \cup S^1$ it follows that $v = v^j$ for $j = 1, 2, \dots, q$ a contradiction. Therefore, if $S^0 \cup S^1 = E$, (3.2) holds.

So suppose that $S^0 \cup S^1 \neq E$ and that (3.2) does not hold. By Lemma 2.4, every $u \in X_e^0$ is adjacent to some $v \in X_e^1$ and conversely, so since G is nonbipartite, there must exist adjacent $s \in Y^0$ and $t \in Z^1$.

Suppose there exists $k \in E \setminus (S^0 \cup S^1 \cup D(s, t))$. (That is k is a coordinate not in $S^0 \cup S^1$ where s and t agree in value.) Let C^0 and C^1 respectively be the 2-valued components of X_e^0 and X_e^1 that contain k . Let \bar{s} and \bar{t} be obtained from s and t by switching the

values indexed by coordinates in C^0 and C^1 , respectively. Then $\bar{s} \in Z^0$ and $\bar{t} \in Y^1$, since s and \bar{s} are adjacent, as are t and \bar{t} . Therefore \bar{s} and \bar{t} are nonadjacent (since we assume (3.2) does not hold) so there exist $p, q \geq 1$, $\alpha > 0$, $\beta > 0$, $(\alpha_i > 0 : i = 1, 2, \dots, p)$, $(\beta_j > 0 : j = 1, 2, \dots, q)$ $\{u^i \in X_e^0 \setminus \{\bar{s}\} : i = 1, 2, \dots, p\}$ and $\{v^j \in X_e^1 \setminus \{\bar{t}\} : j = 1, 2, \dots, q\}$ such that

$$\alpha + \beta = 1, \quad \sum_{i=1}^p \alpha_i + \sum_{j=1}^q \beta_j = 1$$

and

$$\alpha \bar{s} + \beta \bar{t} = \sum_{i=1}^p \alpha_i u^i + \sum_{j=1}^q \beta_j v^j.$$

Since $\bar{s}_k = \bar{t}_k$, we must have $u_k^i = v_k^j = \bar{s}_k = \bar{t}_k$ for all $i = 1, 2, \dots, p$ and $j = 1, 2, \dots, q$. Therefore $\bar{s}[C^0] = u^i[C^0]$ for $i = 1, 2, \dots, p$ and $\bar{t}[C^1] = v^j[C^1]$ for $j = 1, 2, \dots, q$. Let \bar{u}^i be obtained from u^i by switching on C^0 for $i = 1, 2, \dots, p$ and let \bar{v}^j be obtained from v^j by switching on C^1 for $j = 1, 2, \dots, q$. Then $\alpha s + \beta t = \sum_{i=1}^p \alpha_i \bar{u}^i + \sum_{j=1}^q \beta_j \bar{v}^j$, contradicting the adjacency of s and t .

Suppose, on the other hand, $E = S^0 \cup S^1 \cup D(s, t)$. Choose any $k \in E \setminus (S^0 \cup S^1)$. Then $k \in D(s, t)$. Let C^0, C^1, \bar{s} and \bar{t} be defined as above. Then, again, \bar{s} and \bar{t} are nonadjacent, so there exist p, q, α, β , $(\alpha_i : i = 1, \dots, p)$, $(\beta_j : j = 1, 2, \dots, q)$, $\{u^i : i = 1, \dots, p\}$, $\{v^j : j = 1, 2, \dots, q\}$ as above. Now suppose that $C^0 \neq C^1$. Then there exists $\ell \in C^0 - C^1$ (say). If $\ell \notin D(s, t)$ then $\ell \in D(\bar{s}, \bar{t})$. Moreover, we must have $\ell \in S^1$ so $u^i[C^0] = \bar{s}[C^0]$ for all $i = 1, 2, \dots, p$. Similarly, since $k \in C^0 \cap C^1$, we have $v^j[C^1] = \bar{t}[C^1]$ for all $j = 1, 2, \dots, q$. But then we can obtain, as before, \bar{u}^i from u^i , $i = 1, 2, \dots, p$ by switching on C^0 and \bar{v}^j from v^j , $j = 1, 2, \dots, q$ by switching on C^1 and contradict the adjacency of s and t . So we must have $\ell \in D(s, t)$. But then $\ell \in A(\bar{s}, \bar{t})$ so once again $u^i[C^0] = \bar{s}[C^0]$ for all $i = 1, 2, \dots, p$. Since $k \in D(\bar{s}, \bar{t})$ we must also have $v^j[C^1] = \bar{t}[C^1]$

for $j = 1, 2, \dots, q$ so, as above, we obtain \bar{u}^i for $i = 1, 2, \dots, p$ and \bar{v}^j for $j = 1, 2, \dots, q$ and contradict the adjacency of s and t .

Therefore, we have $C^0 = C^1 \subseteq D(s, t)$. We conclude the proof by showing that C^0 is a 2-valued component of X , contradicting non-separability. For choose any $w' \in X[C^0]$ and any $w'' \in X[E \setminus C^0]$, and suppose $w'' = \bar{w}[E \setminus C^0]$ for $\bar{w} \in X$. Then we can, if necessary, switch the values of \bar{w} on $C^0 = C^1$ and obtain the concatenation w of w' and w'' in X . Therefore we contradict nonseparability.

This final contradiction exhausts all possibilities, and so (3.2) is established and the theorem follows. \square

4. Concluding Remarks

There are several consequences of the results presented here.

First, they show that results appearing in literature (see [6]) concerning hamiltonicity of special classes of (0-1)-polyhedra do not, in fact, depend on the combinatorial structure of the members of the classes. Rather they depend upon finding a 0-1 formulation of the problem for which the "combinatorial" adjacency criterion of interest is equivalent to polyhedral adjacency.

Secondly, they show that there are some natural notions of adjacency which cannot be represented in the polyhedral fashion discussed in this paper. For example, consider the set of all permutations of an n element set, $n \geq 3$. It is not possible to construct a 0-1 polyhedron having one vertex for each permutation and such that two vertices are adjacent if and only if the corresponding permutations differ only by the interchange of an adjacent pair of elements. For the skeleton of such a polyhedron would necessarily be bipartite, since even permutations are only adjacent to odd permutations and conversely. But that would require (Theorem 3.2) that it be a hypercube and hence have 2^d nodes for $d \geq 2$.

But the number of permutations of an n element set, $n!$, is not a power of 2 for $n \geq 3$.

Moreover, they show what a strong restriction it is to impose on a polyhedron, from the point of view of its graph or skeleton, to require it to have 0-1 valued vertices. Perhaps the outstanding question at this point is whether or not it is possible to give a good (in some sense) characterization of the graphs of 0-1 polyhedra.

Finally, Naddef [5] has considered pancyclicity questions for some special classes of (0-1)-polyhedra. This property, which is much stronger than hamiltonicity, is not necessarily satisfied by the graphs of all (0-1)-polyhedra, even if attention is restricted to monotone (or lower comprehensive) polytopes.

References

1. M. Balinski, "On the graph structure of convex polyhedra in n-space", Pacific J. Math. 11 (1961) 431-434.
2. C. Berge, Graphes et Hypergraphes, Dunod, Paris (1973).
3. R.A. Brualdi and P.M. Gibson, "Convex polyhedra of doubly stochastic matrices II. Graph of Ω_n ", J. Combin. Theory Ser. B 22 (1977), 175-198.
4. D. Hausmann, Adjacency on Polytopes in Combinatorial Optimization, Anton Hain, Meisenheim (1980).
5. D. Naddef, "Pancyclic property of the graph of some 0-1 polyhedra", preprint. S.V. 1978
6. D. Naddef and W.R. Pulleyblank, "Hamiltonicity and combinatorial polyhedra", J. Combin. Theory Ser. B 31 (1981) 297-312.
7. D.J.A. Welsh, Matroid Theory, Academic Press, London (1976).

ANNEXE 4

PANCYCLIC PROPERTIES OF THE GRAPH OF SOME 0-1 POLYHEDRA

Denis Naddef

I.N.A.G.

Université Scientifique et Médicale de Grenoble
et Université des Sciences Sociales de Grenoble

Abstract.

In this paper it is shown that a certain class of (0-1) polyhedra, which includes the matroid basis polytopes and the perfect matching polytopes, have graphs with the property that the edges, under a certain condition, belong to cycles of every length $l \geq 3$, and the others to cycles of every length $l \geq 4$. This generalizes a result of J.A. Bondy for matroids basis polytopes. It is also shown that not all (0-1) polytopes have this property even if we restrict ourselves to monotone (or lower comprehensive) polytopes.

I. INTRODUCTION

The graph $G(P)$ of a bounded polyhedron (i.e. a polytope) is the graph whose nodes are the vertices of the polyhedron and which has an edge joining each pair of nodes for which the corresponding vertices of the polyhedron are adjacent, that is, joined by an edge of the polyhedron.

We consider here polytopes whose vertices can be represented by 0-1 vectors of \mathbb{R}^n . These polyhedra were shown ([9]) to have a graph which is hamilton connected when not a hypercube (a hamilton connected graph being a graph such that there exists a hamilton path linking any two vertices u and v).

J.A. Bondy [5] proved that if one considers the convex hull of bases of a non separable matroid, then every edge of the graph of that polyhedron belongs to cycles of every length $l \geq 3$. The author proved the same result for the convex hull of perfect matchings of an elementary graph (a graph is elementary if the set of edges which belong to some perfect matching forms a spanning subgraph).

This paper gives a similar result for a class of polyhedra which includes the two preceding ones. This class will be defined in the next section where the basic concepts on polyhedra with 0-1 valued vertices are recalled.

The third section contains the proof of the main theorem, together with an example of a (0-1) polytope not satisfying the conclusions of that theorem. The proof of some lemmas on properties of the product of graphs will be postponed until the last section.

We end this section with a few definitions. A graph $G = (V, E)$ is said to be pancyclic if it has a cycle of every length l , $3 < l < |V|$. It is said to be edge-pancyclic if every edge belongs to cycles of every length l , $3 < l \leq V$. An edge is pancyclic (resp. almost pancyclic) if it belongs to cycles of every length $l > 3$ (resp. $l > 4$). For more details on pancyclic graphs see A. Bondy [3] and [4], also B. Bollobas [2] (chap. III.5).

Throughout the paper $A+B$, for sets A and B will denote the union of sets A and B when $A \cap B = \emptyset$.

II. POLYHEDRA WITH 0-1 VALUED VERTICES.

Our notation is similar to that used in [8] and [9] from which part of this section is taken.

Let E be a finite set and let $\{0,1\}^E$ denote the set of all 0-1 vectors indexed by E . Let $X \subseteq \{0,1\}^E$ and let $\text{conv}(X)$ denote the convex hull of X , where these vectors are considered as elements of \mathbb{R}^E . It is well known that:

(2.1) for any $X \subseteq \{0,1\}^E$ the vertices of $\text{conv}(X)$ are precisely the members of X . We let $G(X)$ denote the graph whose nodes are the members of X and which has an edge joining two nodes if and only if the corresponding vertices are adjacent on $\text{conv}(X)$. Since two vertices of a polyhedron are adjacent if and only if they are the vertices of a one dimensional face, we see that:

(2.2) $u, v \in X$ are adjacent nodes of $G(X)$ if and only if, for every λ satisfying $0 < \lambda < 1$, the point $\lambda u + (1-\lambda)v$ cannot be expressed as a convex combination of members of $X - \{u, v\}$.

For any $u, v \in X$, we let $A(u, v) \subseteq E$ denote the set of coordinates wherein u and v agree in value and we let $D(u, v) \subseteq E$ denote the set of coordinates wherein they disagree. We let $X(u, v)$ be the set of members of X which agree with u and v in all coordinates of $A(u, v)$. Trivially, $u, v \in X(u, v)$ and (2.2) can be strengthened to

(2.3) $u, v \in X$ are adjacent nodes of $G(X)$ if and only if there does not exist λ satisfying $0 < \lambda < 1$ such that the point $\lambda u + (1-\lambda)v$ is a convex combination of members of $X(u, v) - \{u, v\}$.

In other words, when checking adjacency it is sufficient to consider only members of X which agree with u and v for all those coordinates where they themselves have the same value. Therefore, if $D(u, v)$ is a minimal member of $\{D(u, x) : x \in X - \{u\}\}$, we have $X(u, v) - \{u, v\} = \emptyset$ and so

(2.4) If $D(u, v)$ is a minimal member of $\{D(x, y) / x \in X, y \in X, D(x, y) \neq \emptyset\}$

then u and v are adjacent.

It is not difficult to construct examples that show that the converse of (2.4) is false. For example, consider the matching polyhedron of a graph, two vertices of that polyhedron are adjacent if and only if the symmetric difference of the matchings they represent is connected (see [6]). Consider the graph which is a three edge path : $\{e,f,g\}$. The matchings $\{f\}$ and $\{e,g\}$ are adjacent but their symmetric differences $\{e,f,g\}$ is not minimal since $\{f,g\}$ is the symmetric difference of matching $\{f\}$ and matching $\{g\}$. So the $(0-1)$ polyhedra which have the following property :

(Π) vertices u and v are adjacent iff $D(u,v)$ is a minimal member of $\{D(x,y) \neq \emptyset / x \in X, y \in X\}$

form a proper subset of the set of all $(0-1)$ polyhedra. Since the adjacency criterion for two vertices of the convex hull of perfect matchings in a graph is that the symmetric difference of the two matchings they represent is an even cycle, this polytope has property(Π).

So does the convex hull of bases of a matroid since two bases correspond to adjacent vertices iff their symmetric difference is of cardinality 2.

From now on minimal set will stand for minimal among non empty sets.

This property (Π) seems quite restrictive but some combinatorial polyhedra do not have property (Π) when imbedded in a space of a certain dimension and satisfy (Π) when imbedded properly in higher dimensional spaces. This is the case of the d -simplex as a polyhedron in the d -dimensional space, which can be imbedded in the $(d+1)$ -dimensional space, setting the $(d+1)^{th}$ coordinate to be 1 for the point $(0, \dots, 0)$ of the d -simplex, and 0 elsewhere. This is also the case for the polyhedron obtained by cutting off two opposed vertices of the cube, considered in the 3-dimensional space. The graph of this polyhedron is given in Figure 1.

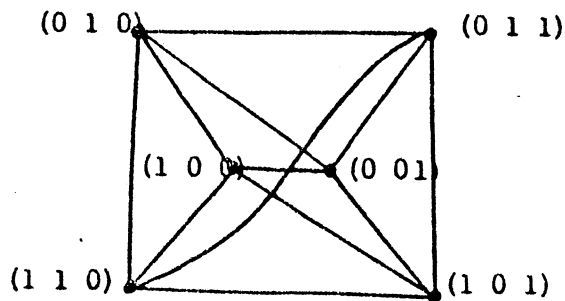

Figure 1

By a result of S. Maurer [7] this graph is the graph of the matroid basis polytope for some matroid, and so has property (II) in a higher dimensional space. Conversely, the polytope obtained by deleting from the cube two distance-two vertices (i.e. non adjacent but not opposed) seems impossible to imbed in a higher dimensional space such as to have property (II). The graph of that polyhedron is given in figure 2

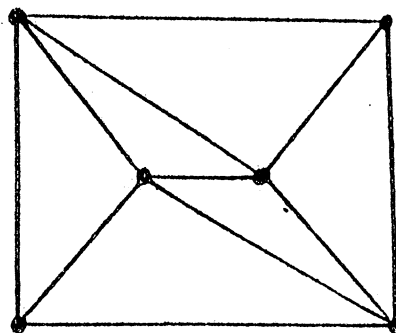

Figure 2

A quite useful relation in the sequel, where Δ denotes symmetric difference, is :

$$(2.5) \quad \forall u, v, w \in X, D(u, w) = D(u, v) \Delta D(v, w)$$

By definition of adjacency, if u and $v \in X$ are nonadjacent, one has:

$$(2.6) \quad \text{There exist } \alpha > 0, \beta > 0, t_i \in X - \{u, v\} \text{ and } \gamma_i > 0 \quad i = 1, \dots, p \text{ such}$$

$$\text{that } \alpha + \beta = 1, \sum_{i=1}^p \gamma_i = 1 \text{ and } \alpha u + \beta v = \sum_{i=1}^p \gamma_i t_i.$$

And for any t_i in relation (2.6) one has

$$(2.7) \quad D(u, v) = D(t_i, u) + D(t_i, v).$$

For any $S \subset E$ and for any $x \in X$ we let $x[S] = (x_j; j \in S)$.

A hypercube is a graph isomorphic to the graph of the convex hull of $\{0, 1\}^E$ for some set E . If $|E| = d$, then we say that the hypercube is of dimension d , see Figure 3.

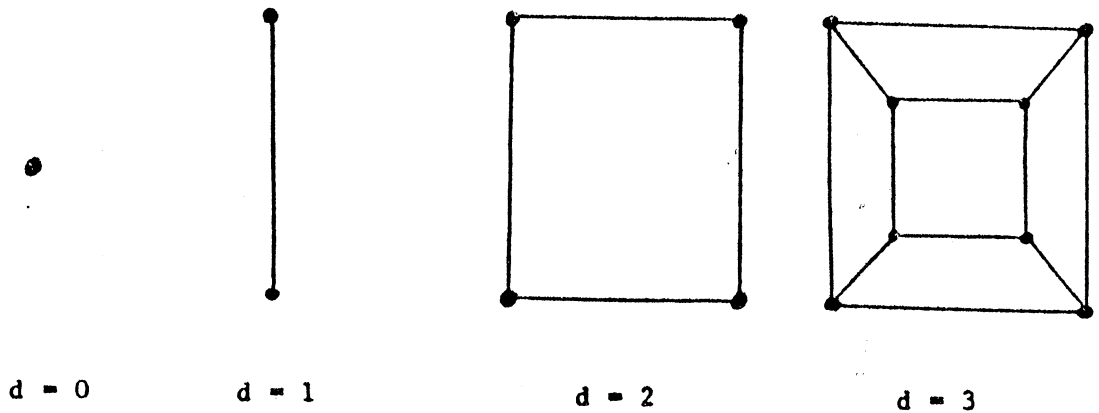

Figure 3 : Hypercubes of dimension d

It is easily verified that a d -dimensional hypercube is constructed by taking two copies of a $(d-1)$ -dimension hypercube and then joining the two corresponding copies of each node. It follows that hypercubes are bipartite with the same number of nodes in each part, when the dimension is at least 1.

Recall that for any $S \subseteq E$ and for any $x \in X$ we let $x[S] \equiv (x_j / j \in S)$ and we let $X[S] \equiv \{x[S] / x \in X\}$. An important notion when studying 0-1 polyhedra is that of separability. We say that $S \subseteq E$ is a separator of X if and only if for every $x' \in X[S]$ and for every $x'' \in X[E-S]$, the concatenation x of x' and x'' , defined by

$$x_j \equiv \begin{cases} x'_j & : j \in S \\ x''_j & : j \in E-S \end{cases}$$

belongs to X . In other words, the values of the coordinate positions corresponding to S and $E-S$ are independent of each other. If a separator S satisfies $\emptyset \neq S \neq E$ then we say that S is a proper separator of X . We say that X is nonseparable if there exists no proper separator. Otherwise, X is said to be separable. A component of X is a minimal nonempty separator of X (which is E if X is nonseparable). Clearly, the components of X provide a partition of E .

Let S be a component of X and let $r \equiv |X[S]|$. We say that S is an r -valued component. If S is a 1-valued component, then $|S| = 1$. If S is a 2-valued component then $X[S]$ consists of two complementary vectors. That is, $X[S] = \{u, v\}$ where $u_i = 0$ if and only if $v_i = 1$, for $i \in S$. For any positive integer k , we say that S is $>k$ -valued provided $r > k$.

Let $G_1 = (V_1, E_1)$ and $G_2 = (V_2, E_2)$ be graphs. Following the terminology

of Berge [1], we say that $G = (V, E)$ is the cartesian sum of G_1 and G_2 if $V = V_1 \times V_2$ and nodes (v_1, v_2) and $(w_1, w_2) \in V$ are adjacent in G if and only if either $v_1 = w_1$ and v_2 is adjacent to w_2 in G_2 , or $v_2 = w_2$ and v_1 is adjacent to w_1 in G_1 . Since this is the only form of graph product that we use, we write in this case, $G = G_1 \times G_2$. It is easily verified that this product is associative under isomorphism so if

G_1, G_2, \dots, G_k are graphs we can write $G = \prod_{i=1}^k G_i$, to denote their cartesian sum without ambiguity.

Moreover, we note that $G_1 \times G_2$ and $G_2 \times G_1$ are isomorphic graphs, so this product is commutative under isomorphism.

If G is an hypercube of dimension n and G' another one of dimension $(n-1)$ then $G = G' \times K_2$.

Lemma 2.1 : If S_1, S_2, \dots, S_k are the >2 -valued components of X ,

then $G(X)$ is isomorphic to $\prod_{i=1}^k G(X[S_i])$.

Proof : Easy. See [8] ■

Let $X \subseteq \{0, 1\}^E$ and let $e \in E$. We let

$$X_e^0 \equiv \{x \in X / x_e = 0\}$$

$$X_e^1 \equiv \{x \in X / x_e = 1\}.$$

This defines a partition of X and unless $\{e\}$ is a 1-valued component of X , this is a proper partition. Moreover, we observe that when we "split" X by means of an element e , the adjacencies within $G(X_e^0)$ and $G(X_e^1)$ are the same as within $G(X)$.

Lemma 2.2 : Elements $v, w \in X_e^0$ are adjacent in $G(X_e^0)$ if and only if they are adjacent in $G(X)$.

Proof : This is an immediate consequence of relation (2.3). □

A universal node of a graph is a node that is adjacent to every other

node. We say that G is a pyramid if it contains a universal node.

Lemma 2.3 : Every $v \in X_e^0$ is adjacent to at least one $w \in X_e^1$ provided that this set is nonempty. Moreover if v is adjacent to exactly one $w \in X_e^1$, then $v[E-S] = w[E-S]$ where S is the set of coordinate of 1-valued components of X_e^1 . As a consequence, if either $|X_e^0| = 1$ or $|X_e^1| = 1$ then $G(X)$ is a pyramid.

Proof : See [8].

The following Lemma 2.4 and Theorem 2.5 can be found in [9], for sake of completeness their proof will be repeated here.

Lemma 2.4 : If $X \subseteq \{0,1\}^E$ is nonseparable and $|X| \geq 3$ then $G(X)$ is nonbipartite

Proof : We prove by induction on X . If $|X| = 3$ then $G(X)$ is a triangle and the result is immediate. Suppose it is true whenever $|X| < k$ (for $k \geq 4$) and we have $|X| = k$. Choose $e \in E$. Since X is nonseparable, $X_e^0 \neq \emptyset \neq X_e^1$. If either X_e^0 or X_e^1 has a ≥ 3 -valued component, then by induction the graph of this component is nonbipartite so by Lemma 2.1, $G(X_e^0)$ or $G(X_e^1)$ is nonbipartite and by Lemma 2.2, so too is $G(X)$. So suppose that all components of X_e^0 and of X_e^1 are 1-valued or 2-valued. If $|X_e^0| = 1$ or $|X_e^1| = 1$, then by Lemma 2.3, $G(X)$ has a universal node and so cannot be bipartite. So we assume that each of X_e^0 and X_e^1 contains at least one 2-valued component.

Let S^0 and S^1 be the set of 1-valued components of X_e^0 and X_e^1 respectively. Suppose that whenever $w \in X_e^0$ and $x \in X_e^1$ are adjacent, we have $D(w,x) \subseteq S^1 \cap S^0$. If there existed $j \in (S^1 \cap S^0) \setminus D(w,x)$ then $\{j\}$ would be a 1-valued component of X , contradicting our nonseparability assumption, so we must have $D(w,x) = S^1 \cap S^0$ for all adjacent $w \in X_e^0$ and $x \in X_e^1$. Since, by Lemma 2.3, every $w \in X_e^0$ is adjacent to some $v \in X_e^1$, it follows that for every $w \in X_e^0$ there exists $v \in X_e^1$ such that $w(E \setminus (S^1 \cap S^0)) = v[E \setminus (S^1 \cap S^0)]$, and conversely for every $v \in X_e^1$. Thus $S^1 \cap S^0$ is a 2-valued component of X which contradicts the nonseparability of X .

Therefore we assume there exist adjacent $w \in X_e^0$ and $x \in X_e^1$ such that there is some $\ell \in D(w,x) - S^1$ (say). Let C be the 2-valued component of X_e^1 that contains ℓ and let \bar{x} be obtained from x by switching the values indexed by C . Then x and \bar{x} are adjacent in $G(X_e^1)$, and so, by Lemma 2.2 in $G(X)$. If w and \bar{x} are adjacent we are finished : w, x, \bar{x} are the nodes

of a triangle in $G(X)$. So suppose w and \bar{x} are not adjacent. Then there exist $\{u^i \in X_e^0 : i = 1, 2, \dots, p\}$, $\{v^j \in X_e^1 : j = 1, 2, \dots, q\}$ and $\alpha > 0$, $\beta > 0$, $(\alpha_i > 0 : i = 1, 2, \dots, p)$, $(\beta_j > 0 : j = 1, 2, \dots, q)$ satisfying $\alpha + \beta = 1$ and

$$\sum_{i=1}^p \alpha_i + \sum_{j=1}^q \beta_j = 1 \quad \text{and} \quad \alpha w + \beta \bar{x} = \sum_{i=1}^p \alpha_i u^i + \sum_{j=1}^q \beta_j v^j.$$

By considering the component indexed by e , we see that $\beta = \sum_{j=1}^q \beta_j$ and hence $\alpha = \sum_{i=1}^p \alpha_i$. By our

choice of ℓ , we have $w_\ell \neq x_\ell$ so $w_\ell = \bar{x}_\ell$. Therefore $u_\ell^i = v_\ell^j = \bar{x}_\ell$ for $i = 1, 2, \dots, p$ and $j = 1, 2, \dots, q$. Since C is a 2-valued component, we can, for $j = 1, 2, \dots, q$, obtain \bar{v}^j from v^j by switching on the coordinates indexed by C , and have $\bar{v}^j \in X_e^1$. But then $\alpha w + \beta x = \sum_{i=1}^p \alpha_i u^i + \sum_{j=1}^q \beta_j \bar{v}^j$, contradicting the adjacency of w and x . \square

Proposition 2.5. If $G(X)$ is bipartite for a set $X \subseteq \{0, 1\}^E$ then $G(X)$ is a hypercube.

Proof : If X has a ≥ 3 -valued component S then $G(X[S])$ is nonbipartite by Lemma 2.4 so by Lemma 2.1, so too is $G(X)$. If X has only 1-valued and 2-valued components, then $G(X)$ is a hypercube. \square

Lemma 2.6 : Let X be nonseparable and have property (Π) . If both $G(X_e^0)$ and $G(X_e^1)$ are bipartite, then every vertex of X_e^0 is adjacent to every vertex of X_e^1 .

Proof : If either $|X_e^0| = 1$ or $|X_e^1| = 1$ it is a direct consequence of lemma 2.3. So assume $|X_e^0| \neq 1$ and $|X_e^1| \neq 1$. Let $u_0 \in X_e^0$ and $v_0 \in X_e^1$ be adjacent to u_0 (v_0 exists by lemma 2.3). Let $v_1 \in X_e^1$ be node adjacent to v_0 , and $C = D(v_0, v_1)$. Since $G(X_e^1)$ is an hypercube, C is a 2-valued component of X_e^1 .

If u_0 and v_1 are non adjacent, there exist $\alpha > 0$, $\beta > 0$, $\gamma_i > 0$, and $t_i \in X_e - \{u_0, v_1\}$ $i = 1, \dots, p$ such that :

$$(2.8) \quad \alpha u_0 + \beta v_1 = \sum_{i=1}^p \gamma_i t_i, \quad \alpha + \beta = 1, \quad \sum_{i=1}^p \gamma_i = 1.$$

At least one t_i , say t_1 , belongs to X_e^1 . By definition of a 2-valued component, either $D(t_1, v_1) \supseteq C$ or $D(t_1, v_1) \cap C = \emptyset$. This latter case is impossible since $e \in D(u_0, v_0) - D(t_1, v_1)$ implies that $D(t_1, v_1)$ is a

proper subset of $D(u_0, v_0)$. So $D(t_1, v_1) \supseteq C$. If

$D(t_1, v_1) \neq C$ then $D(t_1, u_0) \subsetneq D(u_0, v_0)$ which is again impossible by (I).

So $D(t_1, v_1) = D(v_0, v_1) = C$ and $t_1 = v_0$. Thus, there is only one t_i which belongs to X_e^1 , hence $\gamma_1 = \beta$ and (2.8) becomes:

$$(2.9) \quad \alpha u_0 + \beta v_1 = \beta v_0 + \sum_{i=2}^p \gamma_i t_i \quad \text{with} \quad \sum_{i=2}^p \gamma_i = \alpha$$

which implies that for all $i = 2 \dots p$ one has :

$$t_i(e) = \begin{cases} 1 & \text{if } u_0(e) = v_1(e) = 1 \\ 0 & \text{if } u_0(e) = v_1(e) = 0 \\ u(e) & \text{if } e \notin D(v_0, v_1) \\ ? & \text{if } e \in D(v_0, v_1) \end{cases}$$

so $D(t_1, u_0) \subsetneq D(v_0, v_1) = C$ and by (II), $D(t_1, u_0) = C$ for all $i = 2 \dots p$. So C is the union of 2-valued components of X_e^0 . By (II), C is a 2-valued component of X_e^0 and the two values are the same as in X_e^1 (by (II) again), which contradicts the non-separability of X .

Since $G(X_e^1)$ is connected, one can prove that u_0 is adjacent to every vertex of X_e^1 (no matter which $u_0 \in X_e^0$ is chosen).

III - THE MAIN THEOREM

The proof of the four following propositions or lemmas is postponed to the last section. The product of graphs is as defined in section 2.

Proposition 3.1 : If G is a hypercube of dimension n , any edge belongs to cycles of every even length $l > 4$. The same is true for any two adjacent edges, i.e. they belong together to cycles of every even length $l > 4$. If one excludes hamilton cycles (cycles of length 2^n), every $e = (u, v)$ belongs to cycles of every even length $l > 4$ such that a prescribed neighbour of u is on none of those cycles.

Lemma 3.2 : If G_1, G_2, \dots, G_p are edge-pancyclic graphs, then

$\prod_{i=1}^p G_i$ is also edge-pancyclic.

Lemma 3.3 : Let G_1 be a hamiltonian graph and G_2 be an edge-pancyclic graph, then every edge of the type $((v_1, u), (v_2, u))$ is almost pancyclic and not pancyclic and every edge of the type $((v, u_1), (v, u_2))$ is pancyclic.

Lemma 3.4 : Let $G = \prod_{i=1}^p G_i$ where G_i is either edge-pancyclic or a hypercube. If at least one G_i is not a hypercube, then every edge of G is at least almost pancyclic.

Proposition 3.5. Let $X \subseteq \{0,1\}^E$ and let $\epsilon = (u,v)$ be an edge of $G(X)$.

If X has property (Π) and if $D(u,v)$ is not a 2-valued component of X , then ϵ belongs to a triangle.

Proof. If $D(u,v) = E$ then by property (Π) , $X = \{u,v\}$. So we can assume $D(u,v) \neq E$. The proof will be by induction on $|X|$.

For $|X| = 3$ the proposition is true, since $G(X)$ is a triangle. Assume it is true for all X such that $|X| \leq k$. Let X be such that $|X| = k+1$. If for some $e \in A(u,v)$, $D(u,v)$ is not a 2-valued component of which ever X_e^i contains u and v , then by the induction hypothesis we are done. So assume that for all $e \in A(u,v)$, $D(u,v)$ is a 2-valued component of whichever of X_e^0 or X_e^1 that contains u and v and that $\epsilon = (u,v)$ does not belong to any triangle. We are going to show that $D(u,v)$ is then a 2-valued component of X . First we show that if $z \notin \{u,v\}$ then either $D(u,z) \supset D(u,v)$ or $D(u,z) \cap D(u,v) = \emptyset$. Assume the contrary and let $e \in D(u,z) \cap D(u,v)$ and t be such that

$D(u,t) = \min\{D(u,w) \cup D(u,z) : e \in D(u,w)\}$. Since $D(u,v) \cap D(u,z) \neq \emptyset$, $t \neq v$

and by property (II), u and t are adjacent. If v and t are not adjacent, then by relation (2.6)

$$(3.1) \quad \alpha v + \beta t = \sum_{i=1}^p \gamma_i t_i.$$

$D(u,t) \not\subset D(u,v)$ by property (II) but also because it would contradict the fact that $D(u,v)$ is a 2-valued component of $X_f^\delta \supset \{u,v,t\}$ with $f \in A(u,v)$ and $\delta \in \{0,1\}$

(Note that property (II) is hence not necessary at this point). Let

$f \in D(u,t) - D(u,v)$ and assume that for $i \in \{1, \dots, j < p\} = I_1$, $t_i[f] = v[f]$

in relation (3.1) (we know at least one t_i has this property). One

trivially has $\sum_{i=1}^j \gamma_i = \alpha$ and $t_i \in X_f^\delta \supset \{u,v\}$, for $i \leq j$, so, since $D(u,v)$ is a

2-valued component of X_f^δ , let $\bar{t}_i \in X$ be the element obtained from t_i

by taking the other value on each position of $D(u,v)$. One gets

$$\alpha u + \beta t = \sum_{i=1}^j \gamma_i \bar{t}_i + \sum_{i=j+1}^p \gamma_i t_i,$$

contradicting the adjacency of u and t , which proves the assertion that

either $D(u,z) \supset D(u,v)$ or $D(u,z) \cap D(u,v) = \emptyset$ for all $z \notin \{u,v\}$.

Assume that z agrees with u and v on some position. Let j be that position. Then for $\delta = 0$ or 1 $\{u,v,z\} \subset X_j^\delta$ and since by hypothesis $D(u,v)$ is a 2-valued component of X_j^δ , \bar{z} defined as above is also in X .

So the case of at most two elements of X has to be solved, z^* and z^{**} , if they exist such that

$$D(u,z^*) + D(u,v) = E \quad \text{and} \quad D(v,z^{**}) + D(u,v) = E.$$

If both exist or none, we are done, since if they both exist $D(z^*,z^{**}) = D(u,v)$ and $D(u,v)$ is hence a 2-valued component of X . So assume only one exists, say z^* . Let t be any element of $X - \{u,v,z^*\}$ which

agrees with u on any position of $D(u,v)$ (we know that they agree or disagree on all positions of $D(u,v)$), so $D(u,t) \cap D(u,v) = \emptyset$ and $A(z^*,t) - D(u,v) = D(u,t) \neq \emptyset$. If no such t exist then $X_e^\delta = \{v\}$, for $\delta = 0$ or 1 and $X_e^{1-\delta} = \{u, z^*\}$. Then by Lemma 2.3 u, v, z^* is a triangle. Let $j \in D(u,t)$ and so, t being defined as earlier, $\{t, \bar{t}, z^*\} \subset X_j^\delta$ for $\delta = 0$ or 1 . If $D(t, \bar{t}) = D(u,v)$ was a 2-valued component of X_j^δ then z^{**} would exist, so by induction hypothesis the edge (t, \bar{t}) belongs to a triangle, and the only possible way is that it contains z^* . Now $D(z^*, \bar{t})$ contains $D(u,v)$ properly which gives a contradiction to property (Π) . This ends the proof but note that we just proved that z^* is adjacent to every vertex other than u and v . The following justifies this remark.

Remark 3.6. Considering the main result of [9] which states that all (0-1) polytopes have a graph which is either a hypercube or hamilton connected, it was not unreasonable to raise the question whether Proposition 3.5 and the following main theorem remain true if property (Π) is deleted. Property (Π) has been used as little as possible in the previous proof to give us insight to a possible counterexample. The following example shows that Proposition 3.5 is not true for all (0-1) polytopes (figure 4).

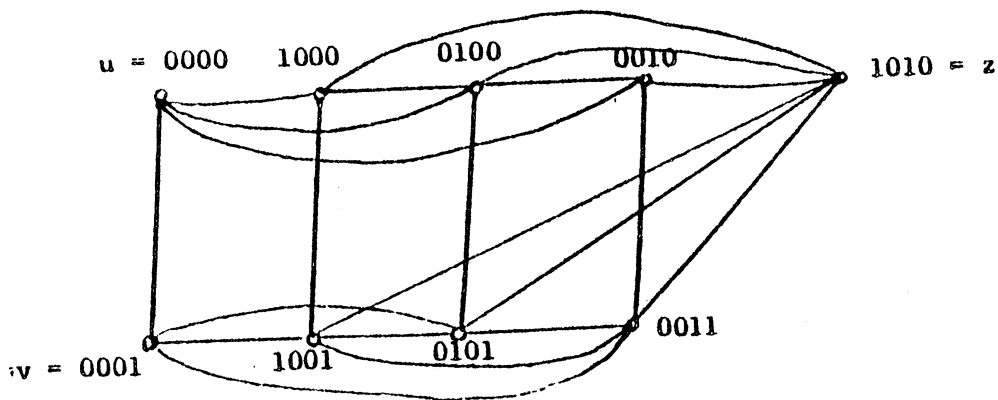

Figure 4.

One has $\frac{1}{2}u + \frac{1}{2}z = \frac{1}{2}(1000) + \frac{1}{2}(0010)$ and obviously v is not adjacent to any vertex of the top level other than u . Also, since $\bar{z} = 1011 \notin X$, $D(u,v)$ is not a 2-valued component, but (u,v) does not belong to a triangle.

A monotone or lower comprehensive (0-1) polytope is one such that if $u \in X$ then $v \leq u$ implies $v \in X$. The preceding example is that of a monotone polytope, so proposition 3.5 need not be valid without property (II) for all monotone polytopes.

Remark 3.7. The converse of proposition 3.5 is obviously true, that is, if $D(u,v)$ is a 2-valued component of X , then $\varepsilon = (u,v)$ does not belong to a triangle. This is a consequence of lemma 2.1.

Lemma 3.8. Let u and v be two adjacent vertices of a set $X \subset \{0,1\}^E$ which satisfies property (II). Let $e \in D(u,v)$ and assume $u \in X_e^0$ and $v \in X_e^1$. If neither $|X_e^0| = 1$ nor $|X_e^1| = 1$ then there exists u' adjacent to u in $G(X_e^0)$ and v' adjacent to v in $G(X_e^1)$ such that u' and v' are adjacent (see figure 5).

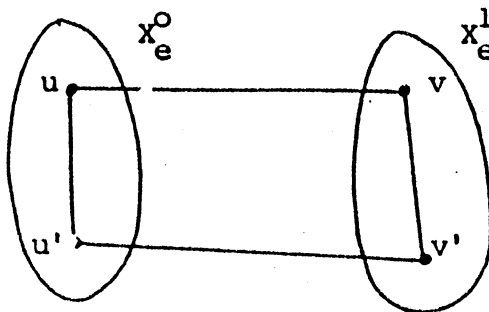

Figure 5

Proof : Let $u' \in X_e^0$ and $v' \in X_e^1$ be such that :

$$(3.2) \quad D(u,u') \cup D(v,v') - D(u,v) = \min\{D(u,s) \cup D(v,t) - D(u,v) / s \text{ adjacent to } u \text{ in } X_e^0 \text{ and } t, \text{ adjacent to } v \text{ in } X_e^1\}.$$

To help the reader in the sequel, figure 6 sketches the different $D(x,y)$ that are going to be used.

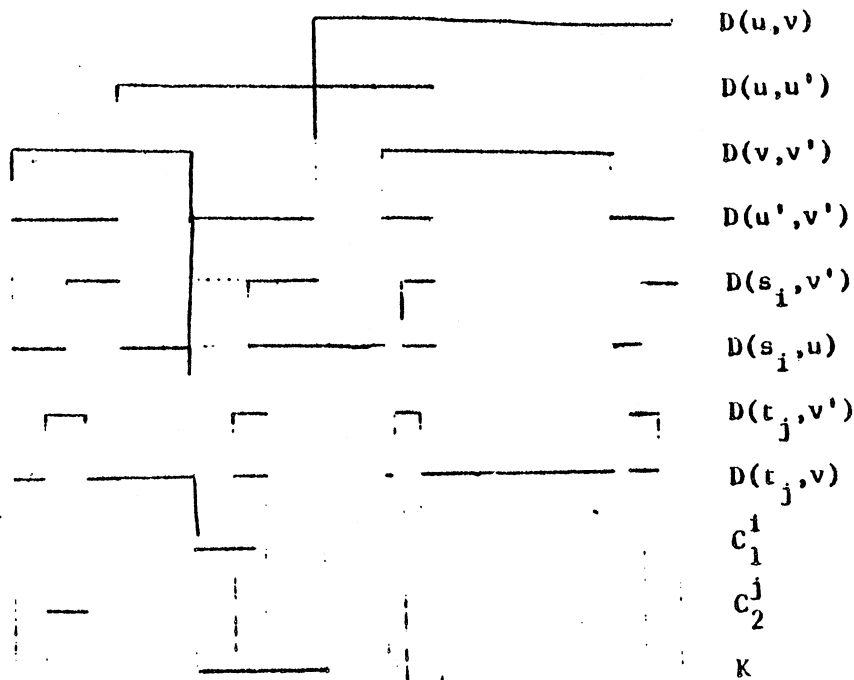

Figure 6.

If u' and v' are not adjacent, then there exist $\alpha > 0, \beta > 0, \alpha_i > 0$, $s_i \in X_e^0 \quad i = 1 \dots p, \beta_j > 0, t_j \in X_e^1 \quad j = 1 \dots k$ such that $\alpha + \beta = \sum_{i=1}^p \alpha_i + \sum_{j=1}^k \beta_j = 1$ and

$$(3.3) \quad \alpha u' + \beta v' = \sum_{i=1}^p \alpha_i s_i + \sum_{j=1}^k \beta_j t_j.$$

We first prove that for all $j = 1 \dots k \quad D(t_j, v') - (D(u, v)UD(u, u')) = \emptyset$, i.e. $C_2^j = \emptyset$ in figure 6. If not, $D(t_j, v) - (D(u, v)UD(u, u')) \not\subseteq D(v, v') - (D(u, v)UD(u, u'))$, so if \tilde{t} is such that $D(\tilde{t}, v) = \min\{D(z, v) : z \in X_e^1 \text{ and } D(z, v) \subseteq D(t_j, v)\}$, it is adjacent to v and using \tilde{t} instead of v' contradicts relation (3.2).

For all $i, D(s_i, v') - (D(u, v)UD(v, v')) = D(u', v') - (D(u, v)UD(v, v')) = K$, i.e. $C_1^1 = \emptyset$ in figure 6. If not, since $D(s_i, v') - (D(u, v)UD(v, v')) = D(s_i, u) - (D(u, v)UD(v, v'))$ if \tilde{s} is such that $D(\tilde{s}, u) = \min\{D(z, u) : z \in X_e^0 \text{ and } D(z, u) \subseteq D(s_i, u)\}$ it is adjacent to u and contradicts relation (3.2).

Let us prove that for all j , $D(t_j, v') \cap K = \emptyset$. Since $K \subseteq D(s_i, v')$ for all i and since if $f \in K$ and $v'[f] = 1$ then $s_i[f] = u'[f] = 0$ for all i , we have that $t_j[f] = 1$ for all j , in order to attain the value β in that component in the right hand side of relation (3.3). If $f \in K$ and $v'[f] = 0$, $s_i[f] = u'[f] = 1$ for all i , so $t_j[f] = 0$ for all j in order to attain value α in that component in the right hand side of relation (3.3).

But then $D(t_j, v') \subseteq D(u, v)$, which contradicts the adjacency of u and v since $e \in D(u, v) - D(t_j, v')$. Hence u' and v' are adjacent.

Remark 3.9. Lemma 3.8 does not require nonseparability of X .

We now state the main theorem:

Theorem 3.10. Let $X \subseteq \{0,1\}^E$ have property (Π) . If $G(X)$ is non bipartite then an edge $e = (u,v)$ is pancyclic if $D(u,v)$ is not a 2-valued component of X and almost pancyclic in the contrary.

Proof : The proof will be by induction on $|X|$. If $|X| < 3$ then the result is immediate, so suppose $|X| = k > 4$ and that the result is true for all values of $|X|$ smaller than k . We assume that X has no 1-valued component, for these can be eliminated without changing G .

If X is separable then it is easily verified that for each component S , $X[S]$ is a combinatorial set with property (Π) . Therefore using the induction hypothesis, lemmas 2.1, and, 3.3, together with proposition 2.5 one gets the desired result for $G(X)$. So assume X is non-separable. Let $e \in D(u,v)$. If either $|X_e^0| = 1$ or $|X_e^1| = 1$, then by Lemma $G(X)$ is a pyramid and the result is trivial, so from now on we suppose that $|X_e^0| > 2$ and $|X_e^1| > 2$. If $G(X_e^i)$ is bipartite for $i = 0$ and $i = 1$, then the result is an easy consequence of Lemma 2.6 since X_e^i has property (Π) , assume that at least one $G(X_e^i)$, $i = 0,1$, is non bipartite, say $G(X_e^1)$. Set $l = l_0 + l_1$ with $l_0 > 2$ even, $l_1 > 2$.

Let u' and v' be as in lemma 3.8.

If $\lambda_0 \neq 2$ (resp. $\lambda_1 \neq 2$ and 3) let $C_{\lambda_0}^0$ (resp. $C_{\lambda_1}^1$) be a cycle of length λ_0 in $G(X_e^0)$ (resp. λ_1 in $G(X_e^1)$) containing (u, u') (resp. (v, v')). Note that $C_{\lambda_0}^0$ exists by Proposition 3.1 and $C_{\lambda_1}^1$ by the induction hypothesis.

If $\lambda > 6$ we can assume that $\lambda_1 > 4$, then

$$\Gamma = \begin{cases} C_{\lambda_0}^0 - \{(u, u')\} + C_{\lambda_1}^1 - \{(v, v')\} + \{(u, v), (u', v')\} & \text{if } \lambda_0 \neq 2 \\ \{(u, u'), (u, v), (u', v')\} + C_{\lambda_1}^1 - \{(v, v')\} & \text{if } \lambda_0 = 2 \end{cases}$$

is a cycle of length λ containing $\varepsilon = (u, v)$.

If $\lambda = 4$ the result is trivial, so we now consider the last case :

$\lambda = 5$. The problem is that (v, v') may not belong to a triangle in

$G(X_e^1)$. By proposition 3.5, ε belongs to a triangle T . One edge of that triangle, say η , lies in a $G(X_e^i)$ for $i = 0$ or 1. If $|X_e^i| > 4$, by induction or because $G(X_e^i)$ is a hypercube, η belongs to a 4-cycle C (in $G(X_e^i)$). The cycle $\Gamma = C + T - \{\eta\}$ is a 5-cycle containing ε . The case $|X_e^i| = 2$ is the only case left since if $|X_e^i| = 3$ this $G(X_e^i)$ is a triangle. By the hypothesis that $G(X_e^1)$ is nonbipartite, one has $|X_e^0| = 2$, also u and v' can be assumed to be nonadjacent, else the triangle $T = (u, v, v')$ would give us the result.

If (v, v') does not belong to a triangle in X_e^1 , $D(v, v')$ is a 2-valued component of X_e^1 . Since u and v' are nonadjacent there exist $\alpha > 0$, $\beta > 0$, $\beta_1 > 0$ and $t_i \in X_e^1$ $i = 1 \dots \ell$ such that $\alpha + \beta = 1$, $\beta = \sum \beta_1$ and

$$\alpha u + \beta v' = \alpha u' + \sum_{i=1}^{\ell} \beta_1 t_i$$

and by relation (2.7), $D(t_i, u) + D(t_i, v') = D(u, v')$. Since $D(v, v')$ is a 2-valued component of X_e^1 , either $D(t_i, v') \supseteq D(v, v')$ or

$D(t_i, v') \cap D(v, v') = \emptyset$. In the latter case $D(t_i, v') \subset D(u, v)$ which, by

(II) contradicts the adjacency of u and v . In the former case

$D(t_i, u) \subset D(u, v)$, which implies that $t_i = v$ for all i and one gets

$$\alpha u + \beta v' = \alpha u' + \beta v,$$

which implies that u' and v are not adjacent. But u' and v must be adjacent since (u, v) belongs to a triangle. So this case is impossible. \square

Let X be the set of incidence vectors of the bases of a matroid M . Since two bases B_1 and B_2 are adjacent if and only if $|B_1 \Delta B_2| = 2$, property (II) is satisfied. So we have:

Corollary 3.11 (Bondy [5]). Let M be a matroid in which not all components are 1 or 2-valued and let $B_1 B_2$ be an edge of $G(X)$ then

(i) If $B_1 \Delta B_2$ is a component of M , $B_1 B_2$ is almost pancyclic but not pancyclic.

(ii) If $B_1 \Delta B_2$ is not a component of M , $B_1 B_2$ is pancyclic.

Let X be the set of incidence vectors of the perfect matchings of a graph G . A 1-valued component consists of an edge which belongs to every perfect matching or to none. Let \tilde{E} be the set of those edges. A 2-valued component is given by the set of edges of a component of $G - \tilde{E}$ which is a cycle. Two perfect matchings M_1 and M_2 are adjacent if and only if $M_1 \Delta M_2$ is a cycle, so X satisfies (II). Thus:

Corollary 3.12. Let H be a graph, let X be the set of representative vectors of perfect matchings of H , and let $M_1 M_2$ be an edge of $G(X)$. If every component of X is not 1- or 2-valued, then:

(i) if $M_1 \Delta M_2$ is the edge set of a cycle, which is a component of $G - \tilde{E}$, $M_1 M_2$ is almost pancyclic but not pancyclic.

(ii) otherwise $M_1 M_2$ is pancyclic.

IV - PROOF OF PROPOSITION 3.1 AND LEMMAS 3.2 - 3.4

Lemma 4.1 : Let $G_1 = (V_1, E_1)$ be an edge-pancyclic graph, $G_2 = C_p$ a cycle of length p , then $G = G_1 \times G_2$ is such that every edge of type $((u_1, v_1), (u_2, v_1))$ is pancyclic and those of type $((u_1, v_1), (u_1, v_2))$ are almost pancyclic and not pancyclic (except if $p = 3$ in which case they are pancyclic).

Proof : Let e_1 and e_2 be two edges of G as shown in Figure 7.

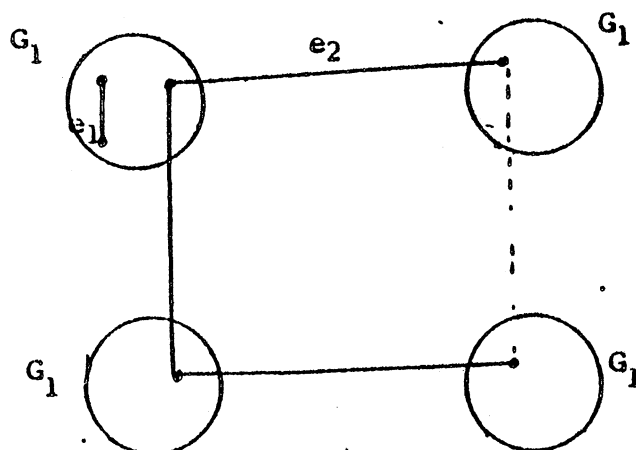

$G_1 \times G_2$
Figure 7

Consider the subgraph of G induced by $G_1 \times \{e_2\} = G_1 \times K_2$. As pointed out in Lemma 2 of [5], every edge like e_1 is pancyclic in $G_1 \times K_2$ and every edge like e_2 is almost pancyclic but not pancyclic. So e_1 belongs to cycles of every length l , $3 < l < 2n_1$, and e_2 to cycles of every length l , $4 < l < 2n_1$.

Let $\{\Gamma_t\}_{t=2, \dots, p}$ be a family of paths of G_2 of length t (number of vertices on Γ_t), each containing e_2 and such that $\Gamma_t \supset \Gamma_{t-1}$ for every $t > 3$. These Γ_t will be identified with the subgraphs of G_2 which they induce. We now consider the family of subgraphs of G consisting of the different $G_1 \times \Gamma_t$, $t > 2$. For $t = 2$ it was shown that every edge like e_1 is pancyclic and every edge like e_2 is almost pancyclic but

not pancyclic. Assume that this is true up to $t = k$. Let C_k^1 (resp. C_k^2) be a hamilton cycle of $G_1 \times \Gamma_k$ containing e_1 (resp. e_2). These exist by the induction hypophthesis. The vertices of $G_1 \times \Gamma_{k+1}$ which are not vertices of $G_1 \times \Gamma_k$ induce a subgraph G_1^{k+1} isomorphic to G_1 . The neighbours of those vertices in $G_1 \times \Gamma_k$ induce another subgraph G_1^k isomorphic to G_1 (see Figure 8).

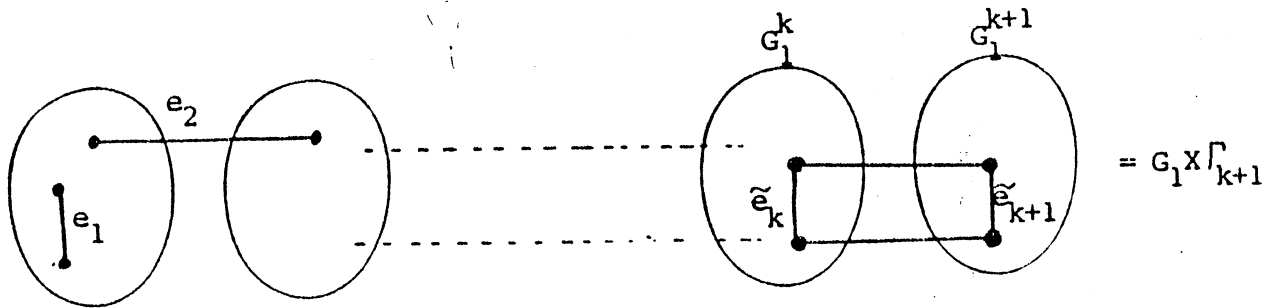

Figure 8

The vertices of G_1^k and G_1^{k+1} induce a subgraph of $G_1 \times \Gamma_{k+1}$ isomorphic to $G_1 \times K_2$. Let \tilde{e}^k be an edge of C_k^1 (resp. C_k^2) contained in G_1^k and e^{k+1} the corresponding edge of G_1^{k+1} . Since G is edge pancyclic we can assume

$|V_1| > 2$, so \tilde{e}^k can always be chosen different from e_1 . Since by hypothesis G_1 is edge-pancyclic it is now trivial to build a cycle of length ℓ , $kn_1 + 2 < \ell < (k+1)n_1$. To obtain a cycle of length $kn_1 + 1$ one must use a cycle of length $kn_1 - 1$ of $G \times \Gamma_k$ instead of a hamilton cycle. The proof of Lemma 4.1 is hence obtained by induction.

Lemma 3.2 : If G_1, G_2, \dots, G_p are edge pancyclic, then $\sum_{i=1}^p G_i$ is also edge pancyclic.

Proof : Since the cartesian sum is associative one may restrict the proof to the case $p = 2$. Assume $e = ((u_1, v_1), (u_2, v_1))$ and let C_2 be a hamilton cycle of G_2 .

The graph $G_1 \times C_2$ is a subgraph of $G_1 \times G_2$ in which e is pancyclic by Lemma 4.1. \square

Lemma 3.3 : Let G_1 be a hamiltonian graph and G_2 be an edge pancyclic graph, then every edge of the type $((v_1, u), (v_2, u))$ is almost pancyclic and not pancyclic, and every edge of the type $((v, u_1), (v, u_2))$ is pancyclic.

Proof : This is a direct consequence of Lemma 4.1.

Lemma 3.4 : Let $G = \sum_{i=1}^p G_i$ where G_i is either edge pancyclic or a hypercube.

If at least one G_i is not a hypercube, then every edge of G is at least almost pancyclic.

Proof : Since $G_1 \times G_2 = G_2 \times G_1$ and since the cartesian sum is associative let G_1 be the sum of the pancyclic graphs, G_2 be the sum of the hypercubes. Since G_1 is pancyclic by Corollary 4.2 and G_2 is hamiltonian the result follows directly from Lemma 4.1. ■

We now end with:

Proof of Proposition 3.1 :

Let E be such that $|E| = n$, then G is the graph of $X_n = \{0,1\}^E$. Two elements x and y of X_n are adjacent if and only if $|D(x,y)| = 1$. The subscript on X will be omitted from now on.

For $n = 2$ Proposition 3.1 is trivially true since $G = 4$ -cycle. Assume it is true for $n = k-1$ and let G be a k -dimensional hypercube. Let $\epsilon = (u,v)$ and $\tilde{\epsilon} = (u,w)$ be two adjacent edges of G . By the adjacency criterion on X_k , the set $A(u,v,w)$ of components on which u, v and w agree, is non-empty. Let $e \in A(u,v,w)$, then $G(X_e^0) = G(X_e^1) = (k-1)$ -dimensional hypercube. Suppose $u,v,w \in X_e^0$. Since $G(X_e^0) \simeq G(X_e^1)$, for each vertex t of $G(X_e^0)$ we will denote by t' the vertex of $G(X_e^1)$ adjacent to t .

First we prove that ϵ and $\tilde{\epsilon}$ belong together to a hamilton cycle of G . By induction hypothesis there exists a hamilton cycle C^0 in $G(X_e^0)$ containing ϵ and $\tilde{\epsilon}$. Let t_1 and t_2 be two consecutive vertices of C^0 such that t_1 or t_2 is different from u, v and w . Let C^1 be any hamilton cycle of $G(X_e^1)$ containing the edge (t_1', t_2') , then $C = C^0 + C^1 - (t_1, t_2) - (t_1', t_2') + (t_1, t_1') + (t_2, t_2')$ is a hamilton cycle containing ϵ and $\tilde{\epsilon}$.

We now prove that there exist cycles of every length i , $4 \leq i \leq 2^k - 2$ containing ϵ and $\tilde{\epsilon}$ and not containing u' , and this will end the proof of Proposition 3.1 (see Figure 9)

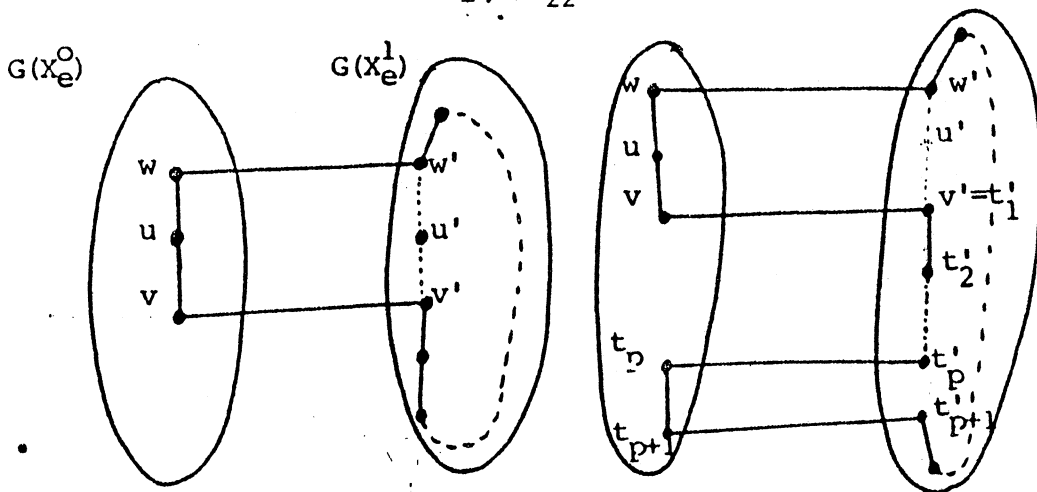

Figure 9

For $l < 2^{k-1}$ it is a consequence of the induction hypothesis because the cycles may be taken in $G(X_e^0)$. For $l > 2^{k-1}$, let C^1 be a hamilton cycle of $G(X_e^1)$ containing $\epsilon' = (u', v')$ and $\tilde{\epsilon}' = (u', w')$. Suppose $C^1 = (u', t'_1 = v', t'_2, \dots, t'_p, t'_{p+1}, \dots, t'_{2^{k-1}-1} = w', u')$. The following set of cycles defined recursively by :

$$\Gamma_2 = C^1 - \epsilon' - \tilde{\epsilon}' + \epsilon + \tilde{\epsilon} + (w, w') + (v, v')$$

$$\Gamma_{2p} = \Gamma_{2p-2} - (t'_{2p}, t'_{2p+1}) + (t_{2p}, t_{2p+1}) + (t'_{2p}, t'_{2p}) + (t_{2p+1}, t'_{2p+1})$$

$$\text{for } 2 < p < 2^{k-2} - 1$$

is such that Γ_{2p} is of length $2^{k-1} + 2p$ and does not contain u' .

Acknowledgement : The author wishes to acknowledge Pr. W.R. Pulleyblank for bringing to his attention the result of A. Bondy on matroid basis graphs which initialized this study.

REFERENCES

- [1] C. Berge, "Graphes et hypergraphes", 2ème édition, Dunod, Paris, 1973.
- [2] B. Bollobas, "Extremal Graph Theory", Academic Press, NY 1978.
- [3] A. Bondy, "Large cycles in graphs", Discrete Mathematics 1(1971), 121-138.
- [4] A. Bondy, "Pancyclic Graphs I", Journal of Combinatorial Theory, B 11 (1971), 80-84.

- [5] A. Bondy, "Pancyclic Graphs II", Journal of Combinatorial Theory, Vol.B20, n°1 (1976), 41-46.
- [6] V. Chvatal, "On certain polytopes associated with graphs", Journal of Combinatorial Theory, B 18 (1975), 138-154.
- [7] S.B. Maurer, "Matroid basis Graphs I", Journal of Combinatorial Theory 14(B) (19783) 216-240.
- [8] D. Naddef and W.R. Pulleyblank, "Hamiltonicity and Combinatorial Polyhedra", Journal of Combinatorial Theory, B 31, n°3(1981), 297-312.
- [9] D. Naddef and W.R. Pulleyblank, "Hamiltonicity in (0-1)-polyhedra" submitted to Journal of Combinatorial Theory B.

ANNEXE 5



Halin Graphs and the Travelling Salesman Problem

G. Cornuéjols[†]

D. Naddef*

W. R. Pulleyblank**

November 1981

revised July, 1982

[†] Graduate School of Industrial Administration, Carnegie-Mellon University, Pittsburgh, PA. On leave at Centre for Operations Research and Econometrics, B-1348 Louvain-la-neuve, Belgium. Research supported in part by NSF grant ENG 79-02526 to Carnegie-Mellon University.

* I.R.M.A., Université Scientifique et Médicale de Grenoble, Grenoble, France.

** Department of Combinatorics & Optimization, University of Waterloo, Waterloo, Ontario, Canada and Inst. für Operations Research, Universität Bonn. Research supported by the National Science and Engineering Research Council of Canada and by the University of Bonn (Sonderforschungsbereich 21 (DFG), Institut für Operations Research).

Abstract: A Halin graph $H = T \cup C$ is obtained by imbedding a tree T having no nodes of degree two in the plane, and then adding a cycle C to join the leaves of T in such a way that the resulting graph is planar. These graphs are edge minimal 3-connected, hamiltonian, and in general have large numbers of hamilton cycles. We show that for arbitrary real edge costs the travelling salesman problem can be polynomially solved for such a graph, and we give an explicit linear description of the travelling salesman polytope (the convex hull of the incidence vectors of the hamilton cycles) for such a graph.

A *Halín graph* is constructed as follows: Start with a tree T in which each nonleaf has degree at least three, i.e., which has no nodes of degree two. Imbed the tree in the plane in a planar fashion and then add new edges to form a cycle C containing all the leaves of T in such a way that the resulting graph H is planar. (See Fig. 1.) We write $H = T \cup C$.

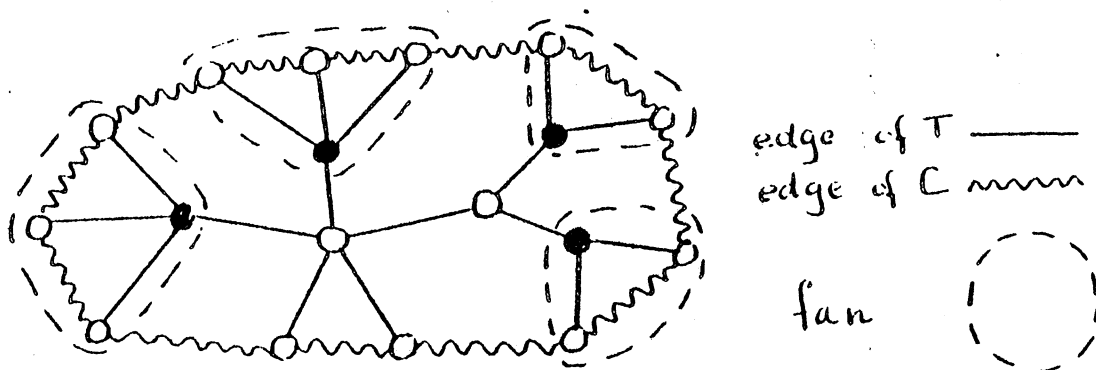

Figure 1. A *Halín Graph*.

These graphs are sometimes called *roofless polyhedra* and were introduced by Halín [4] as an example of a class of edge minimal planar 3-connected graphs.

Since planar 3-connected graphs are uniquely (up to the choice of the infinite face) imbeddable in the plane, it is easy to verify whether or not an arbitrary graph is a Halín graph. First verify that it is 3-connected then imbed it in the plane. Now see if there is any face such that the deletion of the edges on its boundary leaves a tree having no nodes of degree two.

Lovász and Plummer [5] and Pulleyblank [7] obtained various lower bounds on the number of distinct perfect matchings in such graphs.

Naddef and Pulleyblank [6] showed that these graphs have a particularly simple "ear decomposition" and, consequently, the linear rank over GF_2 of the incidence vectors of the perfect matchings is always equal to the cyclomatic number. Other properties of Halin graphs are investigated by Syslo and Proskurowski [8].

Bondy and Lovasz, see [5], showed that Halin graphs are 1-hamiltonian -- they have hamilton cycles and if any node is deleted, the resulting graph still has a hamilton cycle. It is also true that every edge of a Halin graph belongs to a hamilton cycle, and the number of hamilton cycles can grow exponentially with the size of the graph. For example, consider the class of Halin graphs illustrated in Fig. 2. Start with a tree T^k obtained by taking $k \geq 3$ nodes u_1, u_2, \dots, u_k , make each be adjacent to three distinct new nodes plus a common centre node v , and then join the leaves of T^k to obtain a cycle C^k in such a way that $H^k = T^k \cup C^k$ is a Halin graph. Then

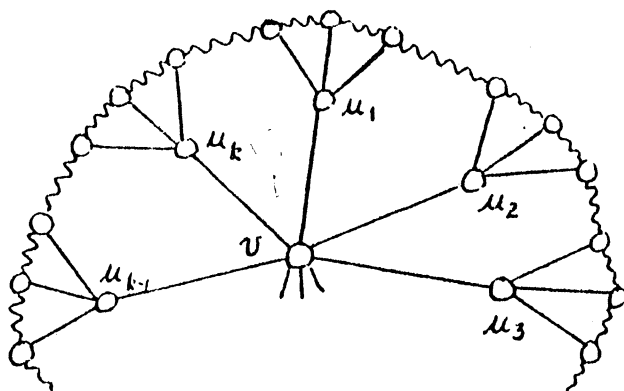

Figure 2. The Halin graph H^k .

H^k has $k \cdot 2^{k-2}$ hamilton cycles and $4k + 1$ nodes, so the number of hamiltonian cycles grows exponentially with the number of nodes.

Hence the travelling salesman problem will not become trivial, by virtue of a small number of feasible solutions, for this class of graphs.

Let $H = T \cup C$ be a Halin graph. If T is a star, i.e., a single node v joined to n other nodes then H is called a *wheel* and is the simplest type of Halin graph. We call v the *centre* of the wheel. Now suppose T has at least two nonleaves. Let w be a nonleaf of T which is adjacent to only one other nonleaf of T . Then the set of leaves of T adjacent to w , which we denote by $C(w)$, comprises a consecutive subsequence of the cycle C . We call the subgraph of H induced by $\{w\} \cup C(w)$ a *fan* and call w the *centre* of the fan. In Figure 1 the black nodes are the centres of the fans which are indicated by dotted lines.

Lemma 1. *A Halin graph $H = T \cup C$ which is not a wheel has at least two fans.*

Proof. Suppose H is not a wheel and let T^* be the subtree of T obtained by deleting all leaves. Then T^* has more than one node and so has at least two leaves. Each of these is the centre of a fan of H . \square

Let $G = (V, E)$ be a graph and let $S \subseteq V$. We let $G \times S$ denote the graph obtained from G by shrinking S to form a new "pseudonode". That is, the nodes of $G \times S$ are all nodes of G not in S , together with the new pseudonode which we call \tilde{S} ; the edges are all edges of G which do not have both ends in S ; the nodes incident with a given edge are the same as in G , unless one was a node of S in which case that end of the edge is now taken to be the pseudonode \tilde{S} . If G' is a subgraph of G , we

abbreviate $G \times V(G')$ by $G \times G'$.

Lemma 2. *If F is a fan in a Halin graph H then $H \times F$ is a Halin graph.*

Proof. Immediate. \square

Now suppose we are given an arbitrary graph $G = (V, E)$ and a real cost c_j for each $j \in E$. The travelling salesman problem, henceforth denoted by *TSP*, is to find a hamilton cycle of G , the sum of whose edge costs is minimum. We define a *tour* to be the incidence vector of the edges belonging to a hamilton cycle of G and then define the *travelling salesman polytope*, denoted by $P(G)$, to be the convex hull of the tours of G . Then solving the *TSP* for G is equivalent to minimizing $(c_j x_j : j \in E)$ over all $x = (x_j : j \in E) \in P(G)$. We can assume, without loss of generality, that G does not have multiple edges so if edge j joins nodes u and v we will sometimes denote c_j by $c(u, v)$.

An *edge cutset* of a connected graph $G = (V, E)$ is a minimal set of edges whose removal leaves a disconnected graph. If it consists of exactly k edges, then we call it a *k-edge cutset*. The *shores* of an edge cutset J are the nodesets of the (two) components of $G \setminus J$. A simple but useful property is the following:

- (1) Every hamilton cycle contains exactly two edges of every 3-edge cutset of G .

Now we describe how to solve the *TSP* for a Halin graph

$$H = (V, E) = T \cup C.$$

Case 1. H is a wheel. For each edge $j \in E(C)$ let $\Delta(j)$ equal the sum of the costs of the two edges that join the nodes incident with j to the centre of the wheel, minus the cost of j . Let $k \in E(C)$

be an edge for which $\Delta(j)$ is minimized. Then the optimum solution to the TSP is obtained by taking all edges of C except for k , together with the two edges joining the nodes incident with k to the centre of the wheel.

Case 2. H is not a wheel. By Lemma 1, H has at least two fans; let F be any fan of H . Let v be the centre of F and let u_1, u_2, \dots, u_r for $r \geq 2$ be the nodes of F that belong to C (in that order). There are exactly three edges of H which join nodes of F to nodes of $V \setminus V(F)$. Let j be the edge incident with u_1 , let k be the edge incident with v and let l be the edge incident with u_r . See Fig. 3.

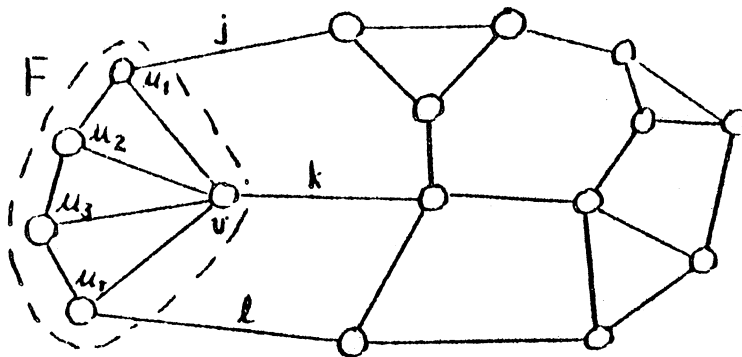

Figure 3.

By (1) any hamilton cycle of H uses exactly two of $\{j, k, l\}$. If it uses j and k then it must traverse the nodes of F in the order u_1, u_2, \dots, u_r, v . If it uses k and l then it must traverse the nodes of F in the order v, u_1, u_2, \dots, u_r . If it uses j and l then it must traverse the nodes of F in the order $u_1, u_2, \dots, u_i, v, u_{i+1}, \dots, u_r$ for some $i \in \{1, 2, \dots, r-1\}$. (That is, it must follow C except for one "jog" to go through v .) Let K be the sum of the costs of the edges of C in F . Then

- (2) if the tour uses j and k , the edges in F contribute $\tilde{C}_{jk} \equiv K + c(v, u_p)$ to the cost;
- (3) if the tour uses k and l , the edges in F contribute $\tilde{C}_{kl} \equiv K + c(v, u_1)$ to the cost;
- (4) if the tour uses edges j and l , then the edges in F contribute at least $\tilde{C}_{jl} \equiv K + \min\{c(u_i, v) + c(v, u_{i+1}) - c(u_i, u_{i+1}) : 1 \leq i \leq r - 1\}$ to the cost, and this minimum is realizable.

Now let $H' \equiv H \times F$ and let c' be defined by

$$c'_h \equiv \begin{cases} c_h & \text{for } h \in E(G') \setminus \{j, k, l\}, \\ c_j + (\tilde{C}_{jl} + \tilde{C}_{jk} - \tilde{C}_{kl})/2 & \text{if } h = j, \\ c_k + (\tilde{C}_{kl} + \tilde{C}_{jk} - \tilde{C}_{jl})/2 & \text{if } h = k, \\ c_l + (\tilde{C}_{jl} + \tilde{C}_{kl} - \tilde{C}_{jk})/2 & \text{if } h = l. \end{cases}$$

By Lemma 2, H' is a Halin graph and we now recursively solve the TSP for H' and c' . Since any hamilton cycle of H' uses exactly two of $\{h, k, l\}$, the optimum tour can be extended, by (2)-(4), to a hamilton cycle of H having the same cost. Conversely, any hamilton cycle of H induces a hamilton cycle of H' whose cost, relative to C' , is no greater than the cost of the original with respect to C . Therefore we can extend the optimum solution for G' using the appropriate path through F as indicated above, and obtain the optimum solution to the TSP for G and c .

This algorithm consists of recursively applying the Case 2 procedure until the graph is reduced to a wheel, then applying the

Case 1 procedure to solve the *TSP* for the wheel, and then expanding each of the shrunk fans (in the reverse order of shrinking) and correctly extending the hamilton cycle through each fan.

Note that each time a fan is shrunk in a Halin graph, the number of nonleaf nodes of the tree is reduced by one. Therefore the total number of times Case 2 will be applied is one less than the number of nonleaves of T . If a fan F contains $r + 1$ nodes, then it is easily verified that the time for Case 2 is $O(r)$. Moreover, shrinking F reduces the number of nodes of the graph by r . Since the time for Case 1 is $O(|V|)$, it therefore follows that the total time for this algorithm is $O(|V|)$, provided that H is represented in such a way that the total time spent finding fans is $O(|V|)$. One such method is to store T as a tree rooted at some nonleaf node r and then perform a postorder scan of T . (In other words, a node is scanned only after all its children have been scanned). Then when a node is scanned there are three possibilities: if it is a leaf of T it is simply bypassed; if it is a nonleaf of T different from r then it is the centre of a fan to which Case 2 applies; if it is r then H has been reduced to a wheel and Case 1 applies. The optimal tour is then constructed by rescanning the nodes in the reverse order. Provided that standard data structures for representing rooted trees are used, the total time for this scanning and rescanning is $O(|V|)$.

Now we describe a linear system sufficient to define the travelling salesman polytope $P(H)$ for a Halin graph H . It is based upon two lemmas. First we characterize $P(W)$ for a wheel W . For any graph $G = (V, E)$, for any $v \in V$, we let $\delta(v)$ denote the set of edges incident with v . Since loops are of no interest for travelling salesman problems, we assume that all graphs are loop free and so every $j \in \delta(v)$ has exactly one end incident with v .

Lemma 3. Let $W = (V, E)$ be a wheel. Then $P(H) = \{x \in \mathbb{R}^E :$

$$(5) \quad x_j \leq 1 \text{ for all } j \in E$$

$$(6) \quad \sum_{j \in \delta(v)} x_j = 2 \text{ for every } v \in V.$$

Proof. First note that every edge j is incident with a degree three node and so the constraints (5) for the other two edges meeting the node, plus the constraint (6) for the node imply $x_j \geq 0$. Therefore we have that (5) and (6) imply the constraints

$$(7) \quad 0 \leq x_j \quad \text{for all } j \in E.$$

It is well known (see Grötschel [3] §13) and easily verified that if \tilde{x} is a vertex of the polyhedron defined by (5)-(7) then the set of edges j for which $0 < \tilde{x}_j < 1$ make up an even number of node disjoint odd cycles. Since a wheel does not have two node disjoint cycles, it follows that in this case, every vertex of the solution set to (5)-(7) is integer valued and moreover is the incidence vector of a hamilton cycle of W , i.e., a tour. Clearly every tour satisfies (5), (6) so the lemma is proved. \square

Now we prove a lemma which enables us to combine linear descriptions of travelling salesman polytopes for certain subgraphs of a graph and thereby obtain a linear description of the travelling salesman of the graph.

Lemma 4. *Let K be a 3-edge cutset in a hamiltonian graph $G = (V, E)$ and let S be a shore of the cut. Then a linear system for $P(G)$ can be obtained by taking the union of linear systems for $P(G \times S)$ and $P(G \times (V \setminus S))$.*

Proof. By (1) every hamilton cycle of G induces hamilton cycles in $G \times S$ and $G \times (V \setminus S)$ so the union of the linear systems for $P(G \times S)$

and $P(G \times (V \setminus S))$ will be satisfied by every tour of G . Therefore all we need show is that every solution \tilde{x} to the union of these systems can be expressed as a convex combination of tours of G .

Let x^1 be the restriction of \tilde{x} to $G \times S$. Then x^1 satisfies the linear systems for $P(G \times S)$ and so can be expressed as a convex combination of tours of $G \times S$. That is, if T^1 is the set of tours of $G \times S$ then $x^1 = \sum (\lambda_t t : t \in T^1)$ where $0 \leq \lambda_t$ for all $t \in T^1$ and $\sum (\lambda_t : t \in T^1) = 1$. Let j, k, l be the three edges of K and let

$$\mu(j,k) \equiv \sum (\lambda_t : t \in T^1 \text{ and } t_j = t_k = 1),$$

$$\mu(k,l) \equiv \sum (\lambda_t : t \in T^1 \text{ and } t_k = t_l = 1),$$

$$\mu(j,l) \equiv \sum (\lambda_t : t \in T^1 \text{ and } t_j = t_l = 1).$$

Then

$$\mu(j,k) + \mu(k,l) = x_k^1 = \tilde{x}_k$$

$$(8) \quad \mu(j,k) + \mu(j,l) = x_j^1 = \tilde{x}_j$$

$$\mu(k,l) + \mu(j,l) = x_l^1 = \tilde{x}_l$$

Note that the linear system (8) together with the values \tilde{x}_k , \tilde{x}_j and \tilde{x}_l uniquely determine the values $\mu(j,k)$, $\mu(k,l)$ and $\mu(j,l)$.

Now we can let x^2 be the restriction of \tilde{x} to $G \times (V \setminus S)$, let T^2 be the set of tours of $G \times (V \setminus S)$ and analogously we obtain $x^2 = \sum (\sigma_t t : t \in T^2)$ where $0 \leq \sigma_t$ for all $t \in T^2$ and $\sum (\sigma_t : t \in T^2) = 1$. We define

$$v(j,k) \equiv \sum (\sigma_t : t \in T^2 \text{ and } t_j = t_k = 1),$$

$$v(k,l) \equiv \sum (\sigma_t : t \in T^2 \text{ and } t_k = t_l = 1),$$

$$v(j,l) \equiv \sum (\sigma_t : t \in T^2 \text{ and } t_j = t_l = 1).$$

Then $v(j,k)$, $v(k,l)$ and $v(j,l)$ satisfy the system (8), replacing μ with v , so we must have $v(j,k) = \mu(j,k)$, $v(k,l) = \mu(k,l)$ and $v(j,l) = \mu(j,l)$. Therefore we can combine the tours t in T^1 and the tours t' in T^2 to obtain a set T of tours of F , and we can obtain $n_t \geq 0$ for all $t \in T$ satisfying $\sum (n_t : t \in T) = 1$ and $\tilde{x} = \sum (n_t t : t \in T)$. That is, \tilde{x} is a convex combination of tours of G and the proof is complete. \square

It is now straightforward to combine Lemmas 3 and 4 and obtain the following linear description of $P(H)$ for a Halin graph H .

Theorem 5. *Let $H = (V,E)$ be a Halin graph. Then $P(H) = \{x \in \mathbb{R}^E :$
 $x_j \leq 1$ for all $j \in E,$*

$$(9) \quad \sum (x_j : j \in \delta(v)) = 2 \text{ for all } v \in V,$$

$$\sum (x_j : j \in K) = 2 \text{ for every 3-edge cutset } K \text{ of } G\}.$$

Proof. Let $H = T \cup C$ and we prove by induction on the number k of nonleaves of T . If $k = 1$ then H is a wheel and the result follows from Lemma 3. Suppose that it is true for all values of $k < k^* \geq 2$ and suppose $k = k^*$. Then H has a fan F and by induction $P(H \times F)$ is of the form (9). Moreover $H \times (V \setminus V(F))$ is a wheel, so by Lemma 3 $P(H \times (V \setminus V(F)))$ is of the form (9). Note that $\delta(V(F))$ is a 3-edge cutset of H so, by Lemma 4, $P(H)$ is of the form (9) and the proof is complete. \square

We close with a few remarks. First, we note that the linear system (9) is very small. If K is a 3-edge cutset of $H = T \cup C$ then K contains one edge k of T and two edges j, l of C . Moreover, the choice of k uniquely determines K . If k is incident with a leaf v of T then the constraints $\sum(x_h : h \in K) = 2$ and $\sum(x_h : h \in \delta(v))$ are identical. Therefore the number of 3-edge cutsets K of G for which we require an equality $\sum(x_h : h \in K) = 2$ is equal to the number of edges of T which are not incident with a leaf, which is one less than the numbers of nonleaf nodes of T . Therefore the TSP for a Halin graph reduces to the "small" linear program: maximize cx subject to (9).

Second, it is possible to prove Theorem 5 by means of an algorithm which obtains a tour t^* of H and constructs a solution y^* to the dual linear program to the linear program: maximize cx subject to (9) such that the value of y^* in the dual objective function is equal to $\sum(c_j \cdot t_j^* : j \in E)$. Also it is possible to extend the applicability of Lemma 4 to a broader class of graphs than Halin graphs. These topics are discussed in a subsequent, expanded paper [1].

A 2-factor of a general graph $G = (V, E)$ is a set of node disjoint cycles containing every node of G and the 2-factor polytope, denoted by $P^2(G)$, is the convex hull of the incidence vectors of the edge sets of the 2-factors of G . Edmonds and Johnson [2] gave a linear system sufficient to define $P^2(G)$ for a general graph G . For a Halin graph H we can show that $P(H)$ is a face of $P^2(H)$, so the Edmonds Johnson linear system can be used to obtain a defining linear system for $P(H)$. This also is elaborated on in [1].

This work also leads to a new approach for the heuristic solution of the general travelling salesman problem: find heuristically a low cost Halin subgraph of the original graph and solve optimally the *TSP* in this subgraph. This will be developed in a subsequent paper.

References

1. G. Cornuéjols, D. Naddef, W. R. Pulleyblank, "The travelling salesman problem in graphs with 3-edge cutsets", Discussion paper no. 8212, Centre for Operations Research and Econometrics, Louvain-la-Neuve (1982).
2. J. Edmonds and E. L. Johnson, "Matching: a well-solved class of integer programs", in R. K. Guy et al eds., Combinatorial Structures and their Applications, Gordon and Breach (1970) 89-92.
3. M. Grötschel, Polyedrische Charakterisierungen kombinatorischer Optimierungsprobleme, Verlag Anton Hain, Meisenheim am Glan (1977).
4. R. Halin, "Studies on minimally n-connected graphs", in D. J. A. Welsh ed., Combinatorial Mathematics and its Applications, Academic Press (1971), 129-136.
5. L. Lovász and M. Plummer, "On a family of planar bicritical graphs", Proc. London Math. Soc. 30 (1975) 160-176.
6. D. Naddef and W. R. Pulleyblank, "Ear decompositions of elementary graphs and GF_2 -rank of perfect matchings", Report 80171-OR Institut für Okonometric und Operations Research, Universität Bonn (1980), to appear in Annals of Discrete Mathematics.
7. W. R. Pulleyblank, "The matching rank of Halin graphs", RR210 IMAG, Université Scientifique et Médicale de Grenoble, France (1980).

8. M. Syslo and A. Proskurowski, "On Halin Graphs", to appear in Proceedings of the Tagow Conference dedicated to the memory of R. Kuratowski (1981).

ANNEXE 6

VI.1

**The Travelling Salesman Problem in Graphs
with 3-Edge Cutsets**

*G. Cornuéjols**

G.S.I.A.
Carnegie Mellon University

D. Naddef

I.M.A.G., Université
Scientifique et Médicale de Grenoble;
Université des Sciences
Sociales de Grenoble

*W. Pulleyblank***

Combinatorics and Optimization
University of Waterloo

Revised August 1983.

In this paper we analyse decomposition properties of a graph which, when they occur, permit a polynomial solution of the travelling salesman problem and a description of the travelling salesman polytope by a system of linear equalities and inequalities. The central notion is that of a 3-edge cutset, namely a set of 3 edges which, when removed, disconnects

the graph. Conversely, our approach can be used to construct classes of graphs for which there exists a polynomial algorithm for the travelling salesman problem. We illustrate the approach on two examples: Halin graphs and prismatic graphs.

1. Introduction

Many NP-hard graph problems become polynomially solvable for special classes of graphs. For example, the problem of finding a maximum weight stable set in a general graph is NP-hard, but is polynomially solvable for series-parallel graphs (Boulala, Uhry [2]), for claw-free graphs (Minty [23], see also Sbihi [27]) and for perfect graphs (Grötschel, Lovász and Schrijver [15]). Many optimization problems on graphs can be formulated as integer programs. There is a polyhedron naturally associated with any integer program, namely the convex hull of the feasible integer solutions. Following the pioneering work of Edmonds on matchings [8] and matroids [9], the development of a polynomial algorithm for such a problem has often been very closely related to the obtaining of a system of linear equalities and inequalities whose solution set is the corresponding polyhedron. Knowledge of such a linear system is useful for two reasons: First, if the size of the system is small, then general linear programming methods can be used to solve the integer program. Second, even when this linear system is large, linear programming duality provides a good optimality criterion.

Recently Grötschel, Lovász and Schrijver [15] have shown that there is indeed a close connection between the problem of finding a polynomial optimization algorithm and the problem of finding a linear description of the underlying polyhedron. They showed, by making use of the

*Research supported in part by NSF grants ENG 79-02506 and ECS 8205425

**Research supported in part by the Natural Sciences and Engineering Research Council of Canada

polynomially bounded Schor-Kachian ellipsoidal algorithm for linear programming, that there exists a polynomially bounded algorithm for an optimization problem if and only if there is a polynomially bounded algorithm for the associated separation problem: given a point x , either verify that it belongs in the polyhedron or else find a hyperplane that separates it from the polyhedron. (See [15] for a precise description of this result.)

In fact, their algorithm for finding a maximum weighted stable set in a perfect graph makes use of an earlier theorem of Chvátal which gives a complete linear system sufficient to define the convex hull of the incidence vectors (or characteristic vectors) of the stable sets. The Boulala-Uhry algorithm for series-parallel graphs is developed in connection with a defining linear system for the stable set polyhedra for these graphs. Curiously, the Minty algorithm for maximum weight stable sets in claw-free graphs does not provide an explicit linear description of the associated polyhedra, and it would be fair to say that the obtaining of such a linear system is one of the outstanding open problems of polyhedral combinatorics. Giles and Trotter [11] have shown that such a system will be less "simple" than for the other classes for which such a system is known.

At present, perhaps surprisingly, only very few classes of travelling salesman problems (TSP's) are known to be polynomially solvable (see Gilmore and Gomory [12], Syslo [28], Lawler [20], Garfinkel [10], Cutler [7] and Ratliff and Rosenthal [26]). They are generally cases of the asymmetric TSP and assume a special cost structure. To our knowledge there is no nontrivial class of graphs for which the TSP polytope has been explicitly described by a system of linear inequalities.

In this paper we show that the TSP can be solved polynomially for a class of graphs which includes, as special cases, Halin graphs and prismatic

graphs. This algorithm is based on some more general decomposition properties which are presented in Section 2. (It is interesting to relate these decomposition ideas to those of Boulala and Uhry [2].) Section 3 gives the examples of Halin and prismatic graphs whereas Section 4 deals with polyhedral theorems. The last two sections contain additional results and extensions. The remainder of this section will be devoted to some basic definitions and notation.

We let $G=(V,E)$ denote a graph with vertex set V and edge set E . If an edge $e \in E$ is incident with vertices $u, v \in V$, then we write $e=(u,v)$. For any $S \subseteq V$ we let $\delta(S)$ denote the set of edges with one end-vertex in S and the other in $V-S$, i.e., $\delta(S) \equiv \{(u,v) \in E : u \in S, v \notin S\}$. For $v \in V$ we abbreviate $\delta(\{v\})$ by $\delta(v)$. When S and $V-S$ each contain at least two vertices, we call $\delta(S)$ a *nontrivial edge cutset*, or simply an *edge cutset*, and call S and $V-S$ its *shores*. (For $v \in V$, we call $\delta(v)$ a *trivial edge cutset*.) For $S \subseteq V$, we let $G \times S$ denote the graph obtained by *shrinking* (or *contracting*) S . That is, the vertices of $G \times S$ are all vertices of $V-S$, plus a new pseudovertex \bar{S} obtained by identifying all vertices of S . The edges of $G \times S$ are defined as follows (Figure 1):

- (i) An edge with both ends in S disappears;
- (ii) An edge with both ends in $V-S$ remains unchanged;
- (iii) An edge of $\delta(S)$ now joins the incident vertex of $V-S$ and the pseudo-vertex \bar{S} .

For any $S \subseteq V$ we let $\gamma(S)$ denote the set of edges of G having both ends in S and we let $G[S]$ denote the subgraph of G induced by the vertex set S , i.e., $G[S] \equiv (S, \gamma(S))$. If $x=(x(e):e \in E)$ is any function from E into R then for any $\tilde{E} \subseteq E$ we define $x(\tilde{E}) \equiv \sum\{x(e):e \in \tilde{E}\}$.

A *Hamilton cycle* of G is a cycle passing through each vertex exactly once. A *Hamilton path* between vertices u and v is a path joining u and v

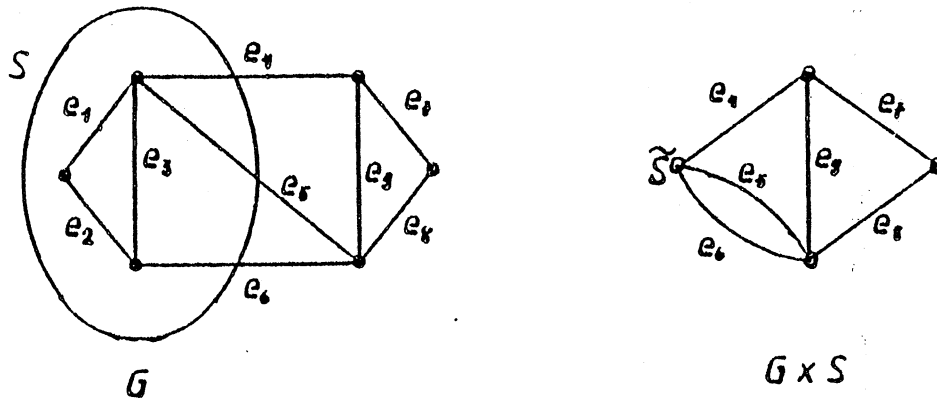

Figure 1

which passes exactly once through each vertex of G . A graph is called *Hamiltonian* if it contains at least one Hamilton cycle. A *tour* is the incidence vector of the edges belonging to a Hamilton cycle. Thus a tour is a 0-1 vector $x = (x(e) : e \in E)$ having $|E|$ components, such that the set of edges having $x(e) = 1$ is the edge set of a Hamilton cycle.

The *travelling salesman polytope*, $TSP(G)$, is the convex hull of the tours of G . That is, $TSP(G)$ consists of all those $y \in \mathbb{R}^E$ which can be expressed as a convex combination of tours of G . Therefore, $TSP(G)$ is the smallest convex polytope in \mathbb{R}^E which contains all tours of G . Every extreme point of $TSP(G)$ will be a tour, and conversely, every tour is an extreme point of $TSP(G)$.

Now suppose that we are given a vector $l = (l(e) : e \in E)$ of real edge costs. The cost of a set $\tilde{E} \subseteq E$ is simply $l(\tilde{E}) = \sum_{e \in \tilde{E}} l(e)$. The *travelling salesman problem* (abbreviated by TSP) is the following: Given a graph $G = (V, E)$ and a vector $l = (l(e) : e \in E)$ of edge costs, find a Hamilton cycle for which the cost of the edge set is minimized. This problem is well known to be NP-hard for general graphs. It has attracted a great deal of attention in the last two decades and references on the subject are too

numerous to be listed here completely. One can consult for example Little et al [21], Held and Karp [19] and more recently, Grötschel [14], Crowder and Padberg [6].

Solving a *TSP* is equivalent to minimizing $\sum(l(e)x(e):e \in E)$ over all $x \in TSP(G)$, for the minimum of a linear objective function over a polytope is always attained at an extreme point, in our case a tour. Because of the fact that the number of Hamilton cycles in a graph can grow exponentially with the number of vertices, the above definition of *TSP*(*G*) does not provide a reasonable means for solving the travelling salesman problem. However a classical result of polyhedral theory is that every polytope is the solution set to a finite system of linear inequalities. For several classes of graphs described in this paper, the size of such a system for *TSP*(*G*) grows linearly with the number of vertices, even though the number of tours grows exponentially. Thus the polyhedral results presented here enable us to solve *TSP*'s in these classes of graphs using standard linear programming algorithms as an alternative to the direct algorithms presented in the paper.

However a complete description of *TSP*(*G*) by a system of linear inequalities is not known for general graphs. It is known that the number of essential inequalities in such a system can grow at least exponentially with the number of vertices. A partial description can be found in Grötschel and Padberg [16], Grötschel [13], Cornuejols and Pulleyblank [5] and Grötschel and Pulleyblank [17].

2. Some Basic Results

The basic reductions

Let $\{e, f, g\}$ be a 3-edge cutset and let S and $V-S$ be its two shores. Assume (see Figure 2) that there are distinct vertices u, v, w , of S incident with e, f, g respectively. Let L_{uv}, L_{vw}, L_{uw} be the costs of the optimal Hamilton paths between u and v , u and w and v and w respectively in $G[S]$, where we set this cost to some large value L if no such Hamilton path exists. (For example, we can let L be twice the sum of the absolute values of the edge costs plus one.)

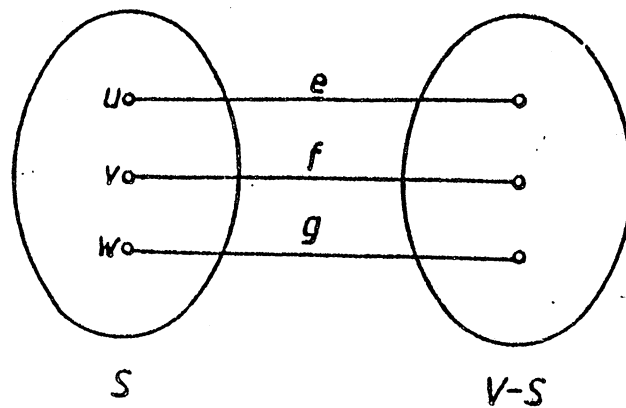

Figure 2

Let α, β, ϵ be defined by the following system of equations:

$$\alpha + \beta = L_{uv}$$

$$\beta + \epsilon = L_{vw}$$

$$\alpha + \epsilon = L_{uw}$$

This system has the unique solution

$$\alpha = \frac{1}{2}(L_{uv} - L_{vw} + L_{uw})$$

$$\beta = \frac{1}{2}(L_{vw} - L_{uv} + L_{uu})$$

$$\epsilon = \frac{1}{2}(L_{uv} - L_{uu} + L_{vw}).$$

Now define the vector l' of edge costs for $G \times S$ by letting $l' \equiv l$ for all edges except e, f and g and by letting $l'(e) \equiv l(e) + \alpha$, $l'(f) \equiv l(f) + \beta$, $l'(g) \equiv l(g) + \epsilon$. If $G \times S$ has no Hamilton cycle or if the cost of an optimum Hamilton cycle of $G \times S$ with respect to l' is at least $L/2$ then G has no Hamilton cycle. Otherwise the cost of an optimum Hamilton cycle of $G \times S$, with respect to l' , is the cost of an optimum Hamilton cycle of G with respect to l . Furthermore the optimum cycle for $G \times S$ can be extended to an optimum Hamilton cycle of G , with respect to l , by taking an appropriate optimum Hamilton path of $G[S]$.

Thus, effectively, the basic reduction reduces the TSP for G to four TSP's, three for $G \times (V-S)$ to compute L_{uv}, L_{uw} and L_{vw} , and one for $G \times S$. This rather simple observation does, however, have some useful algorithmic consequences as observed below.

A *3-connected graph* is a graph such that at least 3 vertices must be removed in order to disconnect it. Given a vertex set $S \subseteq V$, let $\bar{S} = V - S$.

LEMMA 2.1. Given a 3-connected graph G and vertex sets S_1 and S_2 such that $|\delta(S_1)| = |\delta(S_2)| = 3$, then at least one of S_1 and \bar{S}_1 is contained in one of S_2 and \bar{S}_2 .

PROOF: Suppose the conclusion is false. Then the sets $S_1 \cap S_2$, $S_1 \cap \bar{S}_2$, $\bar{S}_1 \cap S_2$ and $\bar{S}_1 \cap \bar{S}_2$ are all nonempty and so, since G is 3-connected, each has at least three edges in the coboundary. Let J_1 be the set of edges joining nodes of $S_1 \cap S_2$ and $\bar{S}_1 \cap \bar{S}_2$ and let J_2 be the set of edges joining nodes of $\bar{S}_1 \cap S_2$ and $S_1 \cap \bar{S}_2$. Then $|\delta(S_1)| + |\delta(S_2)| - |J_1| - |J_2| = \frac{1}{2}(|\delta(S_1 \cap S_2)| + |\delta(\bar{S}_1 \cap S_2)| + |\delta(S_1 \cap \bar{S}_2)| + |\delta(\bar{S}_1 \cap \bar{S}_2)|) \geq 6$. Since

$|\delta(S_1)| + |\delta(S_2)| = 6$ we must have therefore that $J_1 = J_2 = \emptyset$ and $|\delta(S_1 \cap S_2)| = |\delta(S_1 \cap \bar{S}_2)| = |\delta(\bar{S}_1 \cap S_2)| = |\delta(\bar{S}_1 \cap \bar{S}_2)| = 3$. But this means that $\delta(S_1 \cap S_2)$ can contain at most one edge of one of $\delta(S_1)$ or $\delta(S_2)$, say $\delta(S_1)$. Therefore $\delta(\bar{S}_1 \cap S_2)$ contains at most one edge of $\delta(S_1)$. Then since $\delta(S_1 \cap S_2)$ must contain at least two edges of $\delta(S_2)$, $\delta(\bar{S}_1 \cap S_2)$ contains at most one edge of $\delta(S_2)$. Since $J_2 = \emptyset$ we have, therefore, that $|\delta(\bar{S}_1 \cap S_2)| \leq 2$, contradictory to G being 3-connected. \square

We say that a class \mathbf{C} of 3-connected graphs is *fully reducible* if it satisfies the following:

- (i) if $G \in \mathbf{C}$ has a 3-edge cutset with shores S and \bar{S} , then both $G \times S$ and $G \times \bar{S}$ are in \mathbf{C} ; and
- (ii) the *TSP* can be solved in polynomial time for the graphs in \mathbf{C} which do not have a 3-edge cutset. We call such graphs *irreducible*.

The basic reduction introduced in this section enables us to polynomially solve the *TSP* for the graphs in any fully reducible class.

The basic algorithm:

Input: A 3-connected graph $G = (V, E)$ belonging to a fully reducible class \mathbf{C} and a vector of edge costs.

Output: A minimum cost Hamilton cycle.

Step 1. If G contains no 3-edge cutset, then the *TSP* is polynomially solvable in G , since $G \in \mathbf{C}$. Solve the *TSP* and stop.

Otherwise find a 3-edge cutset with a shore S which is minimal with respect to set inclusion. Go to Step 2.

Step 2. Solve three *TSP*'s in $G \times \bar{S}$ imposing in turn that each pair of edges of $\delta(S)$ be in the solution. We can force a pair of edges in $\delta(S)$ to be in the solution by giving a large cost to the third edge of $\delta(S)$. (Note

that the minimality of S insures that $G \times \bar{S}$ will contain no 3-edge cutset, so solving TSP 's in $G \times \bar{S}$ is polynomial.)

Step 3. Modify the edge costs of the members of $\delta(S)$ as described in the basic reduction and recursively apply the algorithm to $G \times S$. Extend the optimum tour in $G \times S$ found by the algorithm to an optimum tour of G by combining it with the appropriate tour of $G \times \bar{S}$ found in Step 2. Stop.

Note that Step 1 can be performed in polynomial time by simply trying all sets of edges of cardinality three.

This algorithm provides a framework which can be specialized for specific fully reducible classes. The actual time for such a class will depend on how efficiently we can find the 3-edge cutset required in Step 1 and how efficiently we can solve TSP 's in irreducible graphs. In the next section we show that for the case of Halin graphs, the basic algorithm specializes to a linear time algorithm.

As mentioned in the introduction, the existence of a polynomial algorithm for a combinatorial optimization problem is often related to finding a system of linear inequalities which define the convex hull of its feasible solutions. When the graph G has a 3-edge cutset we have a remarkable polyhedral result relating $TSP(G)$, $TSP(G \times S)$ and $TSP(G \times \bar{S})$, where S and \bar{S} are the shores of the 3-edge cutset.

The basic polyhedral theorem:

THEOREM 2.2. Suppose that G has a 3-edge cutset with shores S and \bar{S} . A linear system sufficient to define $TSP(G)$ is obtained by taking the union of linear systems sufficient to define $TSP(G \times S)$ and $TSP(G \times \bar{S})$.

PROOF. Every tour of G induces a tour in $G \times S$ and one in $G \times \bar{S}$, and therefore it satisfies linear systems defining $TSP(G \times S)$ and $TSP(G \times \bar{S})$.

Conversely, we need to prove that every solution \hat{z} to the union of these systems can be expressed as a convex combination of tours of G .

Let z^1 be the restriction of \hat{z} to $G \times S$. The vector z^1 satisfies the linear system defining $P(G \times S)$ and so can be expressed as a convex combination of tours of $G \times S$. That is, if T^1 is the set of tours of $G \times S$, then $z^1 = \sum(\lambda_i: i \in T^1)$ where $\lambda_i \geq 0$ for all $i \in T^1$ and $\sum(\lambda_i: i \in T^1) = 1$.

Let e, f, g be the three edges of the 3-edge cutset joining S to \bar{S} , and let

$$\mu(e, f) = \sum(\lambda_i: i \in T^1 \text{ and } t_e = t_f = 1)$$

$$\mu(f, g) = \sum(\lambda_i: i \in T^1 \text{ and } t_f = t_g = 1)$$

$$\mu(e, g) = \sum(\lambda_i: i \in T^1 \text{ and } t_e = t_g = 1)$$

Then

$$\hat{z}_e = z_e^1 = \mu(e, f) + \mu(e, g)$$

$$\hat{z}_f = z_f^1 = \mu(e, f) + \mu(f, g) \quad (2.1)$$

$$\hat{z}_g = z_g^1 = \mu(e, g) + \mu(f, g).$$

Note that the linear system (2.1) together with the values \hat{z}_e , \hat{z}_f and \hat{z}_g uniquely determines the values $\mu(e, f)$, $\mu(f, g)$ and $\mu(e, g)$.

Now let z^2 be the restriction of \hat{z} to $G \times \bar{S}$, and let T^2 be the set of tours of $G \times \bar{S}$. Analogously we obtain $z^2 = \sum(\sigma_i: i \in T^2)$ where $\sigma_i \geq 0$ for all $i \in T^2$ and $\sum(\sigma_i: i \in T^2) = 1$. We define

$$\nu(e, f) = \sum(\sigma_i: i \in T^2 \text{ and } t_e = t_f = 1)$$

$$\nu(f, g) = \sum(\sigma_i: i \in T^2 \text{ and } t_f = t_g = 1)$$

$$\nu(e, g) = \sum(\sigma_i: i \in T^2 \text{ and } t_e = t_g = 1).$$

Then $\nu(e,f)$, $\nu(f,g)$ and $\nu(e,g)$ satisfy the system (2.1), replacing μ with ν . So we must have $\nu(e,f)=\mu(e,f)$, $\nu(f,g)=\mu(f,g)$ and $\nu(e,g)=\mu(e,g)$. Therefore we can combine the tours t in T^1 and t' in T^2 to obtain a set T of tours of G and a set of coefficients $\eta_t \geq 0$ for all $t \in T$ satisfying $\sum(\eta_t : t \in T) = 1$ and $\hat{x} = \sum(\eta_t t : t \in T)$. That is, \hat{x} is a convex combination of tours of G and the proof is complete. \square

This theorem enables us to obtain a complete linear description of $TSP(G)$ for any graph G in a fully reducible class provided that we know a linear description of the travelling salesman polytopes of the irreducible graphs in the class. Some examples of this are given in the next section.

3. Some Examples

One method of constructing a fully reducible class is to start with a specific set of irreducible graphs and then close the class under a composition which is the inverse of the basic reduction. First we introduce some useful irreducible graphs.

For certain graphs $G=(V,E)$, the polytope $TSP(G)$ is given by the following linear system:

$$0 \leq x_e \leq 1 \text{ for all } e \in E \quad (3.1)$$

$$x(\delta(v)) = 2 \text{ for all } v \in V. \quad (3.2)$$

We call such graphs *elementary*. For these graphs, not only can we solve the TSP as a small linear program, but we can solve this linear program polynomially by reducing it to a weighted bipartite matching problem. (In fact the linear program minimize $(x : x \text{ satisfies (3.1), (3.2)})$ can be solved in this way for any graph.) However all elementary graphs we know have a sufficiently simple structure that the TSP is more easily solved by direct methods.

The following is a useful tool in showing that a graph is elementary:

LEMMA 3.1. (cf Grötschel [14]). Let x be an extreme point of the polytope defined by (3.1), (3.2). Then $x_e \in \{0, \frac{1}{2}, 1\}$ for all $e \in E$ and, moreover, the set of edges e with $x_e = \frac{1}{2}$ partitions into the edge sets of an even number of vertex disjoint odd cycles.

COROLLARY 3.2. If G does not have two vertex disjoint cycles, then G is elementary.

This implies that the complete graphs K_3, K_4 and K_5 and the complete bipartite graphs $K_{2,2}$ and $K_{3,3}$ (or, in fact, $K_{3,n}$ for $n \geq 2$) are all elementary. Moreover, we have the following:

LEMMA 3.3. If $G=(V,E)$ is elementary then for any $E' \subseteq E$, the graph $G'=(V,E')$ is elementary.

PROOF. A linear system sufficient to define $TSP(G')$ is obtained by deleting the variables corresponding to $e \in E-E'$ from the system (3.1), (3.2) for G . This is equivalent to adjoining the equations $x_e=0$ for all $e \in E-E'$ to (3.1),(3.2) for G . (Polyhedrally, $TSP(G')$ is a face of $TSP(G)$.) \square

In particular, any graph on five or fewer nodes is elementary.

A useful infinite class of elementary graphs is the class of wheels. For $k \geq 3$, the *wheel* W_k consists of a cycle containing k vertices, called *rim* vertices, plus a *centre* vertex adjacent to each rim vertex. (See Figure 3) The fact that wheels are elementary follows from Corollary 3.2. In Section 5 we give other examples of elementary graphs.

Let $G_1=(V_1,E_1)$ and $G_2=(V_2,E_2)$ be two graphs. Let $v_1 \in V_1$ and $v_2 \in V_2$ be two vertices of degree three, say $\delta(v_1)=\{e_1, f_1, g_1\}$ and

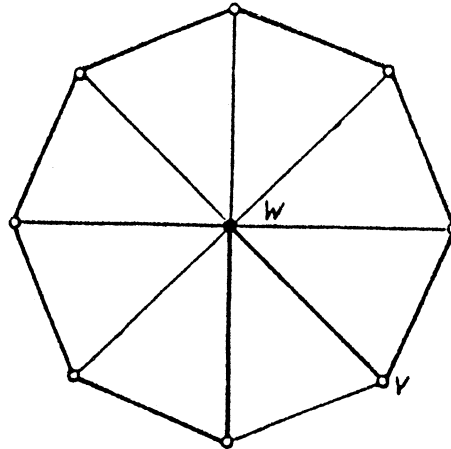

Figure 3. A wheel

$\delta(v_2) = \{e_2, f_2, g_2\}$. We say that the graph G is obtained from G_1 and G_2 by 3-splicing if it is constructed as follows: The vertex set of G is $(V_1 - \{v_1\}) \cup (V_2 - \{v_2\})$. The edge set of G is $E_1 \cup E_2$ where the edges e_1 and e_2 are identified, as well as the edges f_1 and f_2 , and g_1 and g_2 . Therefore in G each of these three edges has one end in V_1 and the other in V_2 . (See Figure 4.)

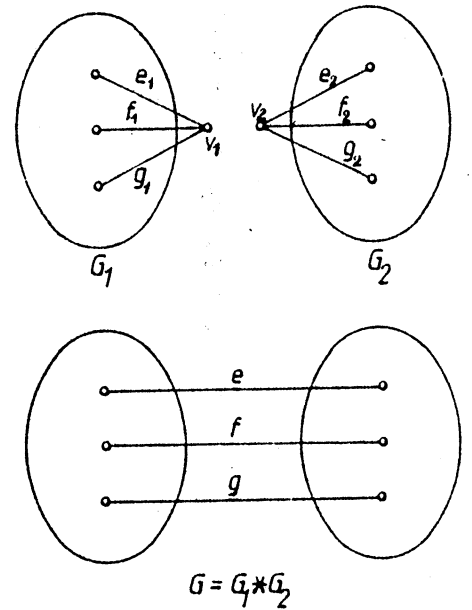

Figure 4. 3-splicing

$$G = G_1 * G_2$$

We will write $G = G_1^{v_1, v_2} + G_2^{v_1, v_2}$ or sometimes simply $G = G_1 + G_2$ or $G = G_1^{v_1} + G_2^{v_2}$ or $G = G_1^{v_1} + G_2$. Notice that if $G = G_1^{v_1} + G_2^{v_2}$, then G_1 is isomorphic to $G \times (V_2 - \{v_2\})$ and G_2 is isomorphic to $G \times (V_1 - \{v_1\})$.

We define the *closure* $cl(\mathcal{C})$ of a class \mathcal{C} of graphs with respect to 3-splicing as follows: $G \in cl(\mathcal{C})$ if either $G \in \mathcal{C}$ or there exist $G_1, G_2 \in \mathcal{C}$ such that $G = G_1 + G_2$. The graphs in $cl(\mathcal{C})$ which are irreducible with respect to our basic reduction will all belong to \mathcal{C} . If \mathcal{C} is a class of graphs for which we can polynomial solve *TSP*'s, then $cl(\mathcal{C})$ will be a fully reducible class of graphs.

If a graph G has no degree three vertex, then it cannot be used in a 3-splice. If a graph G is not Hamiltonian, and it is used in a 3-splice, then the result will not be Hamiltonian. Hence the graphs which are useful to us as "building blocks" are those which are Hamiltonian and have at least one degree three vertex, for example wheels, K_4 , $K_{3,3}$ and some subgraphs of K_6 .

For all these examples, the *TSP* is easily solved. Note that for the wheel W_k there are precisely k different Hamilton cycles, depending on between which consecutive pair of rim vertices we visit the centre. A minimum cost Hamilton cycle can be found in linear time by computing the minimum, over all pairs r, r' of consecutive rim vertices, of $l(c, r) + l(c, r') - l(r, r')$ where c is the centre of the wheel.

THEOREM 3.4. Let \mathcal{C} be ^{the} class of elementary graphs. Then for any $G = (V, E) \in cl(\mathcal{C})$, *TSP*(G) is defined by

$$0 \leq x_e \leq 1 \text{ for all } e \in E, \quad (3.4)$$

$$x(\delta(v)) = 2 \text{ for all } v \in V, \quad (3.5)$$

$$x(C) = 2 \text{ for all 3-edge cutsets } C \text{ of } G. \quad (3.6)$$

PROOF. All the constraints are valid. It follows from repeated application of Theorem 2.2 (the basic polyhedral theorem) that (3.4) - (3.6) is sufficient. Note that when we perform a 3-splice $G = G_1^{v_1} * G_2^{v_2}$, the constraints (3.5) for v_1 in G_1 and for v_2 in G_2 become the constraint (3.6) for the 3-edge cutset created by 3-splicing. \square

Let \mathbf{W} be the class of wheels. Then 3.4 applies to $cl(\mathbf{W})$. A subclass of $cl(\mathbf{W})$ has received some study on the literature. These are the so called Halin graphs, or roofless polyhedra which are described as follows:

A Halin graph $H = T \cup C$ is obtained by taking a tree T having no vertices of degree two, embedding it in the plane in a planar fashion then adding new edges to form a cycle C containing all the leaves (degree one vertices) of the tree in such a way that the resulting graph is planar. (See Figure 5). These graphs were introduced by Halin [18] as an example of a class of planar edge minimal 3-connected graphs. They are exactly those 3-connected planar graphs for which one face shares one edge with every other face. Bondy and Lovász (see [22]) showed that these graphs are Hamiltonian and moreover, the deletion of any vertex leaves a Hamiltonian graph. It can also be verified that for each edge e , there exists a Hamilton cycle containing e and another that does not contain e . They were studied from a point of view of matching theory by Lovász and Plumer [22], Pulleyblank [25] and Naddef and Pulleyblank [24]. Recently Syslo and Proskurowski [29] have shown that several NP-complete problems are polynomially solvable for these graphs.

Since Halin graphs are 3-connected and planar, there is a planar embedding of such a graph which is unique, up to the choice of the infinite face. Thus determining whether or not an arbitrary graph is a Halin graph requires simply finding a planar embedding, verifying 3-connectivity, and then seeing if there exists a face such that the deletion of the edges in its boundary leaves a tree. Therefore Halin graphs can be recognized in

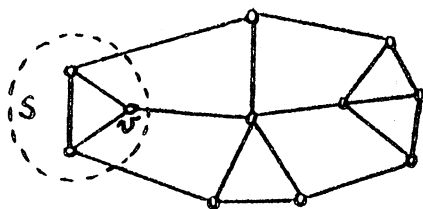

Figure 5. A Halin graph.

polynomial time.

We can see that the class \mathcal{H} of Halin graphs is contained in $cl(\mathcal{W})$ as follows. Let $G = T \cup C$ be a Halin graph. If T is a star then G is a wheel. If T is not a star, then there exists a nonleaf vertex v of T adjacent only to leaves of T plus one other nonleaf vertex. Let S consist of v plus all adjacent leaves of T . Then $|N(S)| = 3$ and $G \times S$ is a Halin graph and $G \times \bar{S}$ is a wheel. Thus G can be obtained by 3-splicing a wheel to a smaller Halin graph. Therefore, by induction, $G \in cl(\mathcal{W})$. For a more detailed description of these ideas for Halin graphs, see [4].

It is easy to see that we can construct precisely the class of Halin graphs from wheels if we restrict 3-splicing as follows: For any Halin graph $G = T \cup C$ we call a vertex v a *rim vertex* if v is in C . (This is consistent with our definition for wheels.) Similarly edge e is a *rim edge* if e is in C .

We only permit splicing between rim vertices, with the additional condition that rim edges must be identified with rim edges.

Now we describe how the basic algorithm specializes for Halin graphs. As we already noted, the *TSP* in a wheel can be solved in linear time. In order to find 3-edge cutsets with minimal shores we do the following. Represent T as a tree rooted at some nonleaf vertex r , order the children of each vertex on the basis of the planar embedding of T , and then perform a postorder scan of T . (In other words, each node is processed after all its children have been processed.) When a node is processed there are three possibilities: if it is a leaf of T it is bypassed; if it is a nonleaf vertex v different from r then v together with the adjacent leaves form a suitable set S ; if v is equal to r then G is a wheel. Note that when we recursively apply the basic algorithm to $G \times S$, we can start our postorder scan with the vertex obtained by shrinking S .

Finally, note that $G \times \bar{S}$ will be a wheel W_l . Therefore finding a minimum cost Hamilton cycle which uses a prescribed pair of edges incident with a rim vertex u is easy. If either edge joins u to the centre vertex, there is a unique possibility. If neither edge joins u to the centre, there are $l-2$ possibilities.

Therefore the basic algorithm, specialized to the case of Halin graphs can be implemented in time linear in the number of vertices. See [4] for more details.

A *2-factor* of a graph is a set of vertex-disjoint cycles which span the vertices (i.e. every vertex of the graph belongs to exactly one cycle of the 2-factor). Edmonds [8] has described the convex hull of the incidence vectors of the 2-factors of a graph (the *2-factor polytope*) by a system of linear inequalities. In order to describe this system, we require a definition. A *blossom* $B=(S, J)$ is a subgraph of G consisting of $S \subseteq V$ having $|S| \geq 3$ and an odd cardinality set $J \subseteq \delta(S)$ of edges such that each $e \in J$ is incident

with a different vertex of S . We let $P^2(G)$ denote the 2-factor polytope of G .

THEOREM 3.5. (Edmonds [8]) For an arbitrary graph $G=(V,E)$, $P^2(G)$ is defined by

$$0 \leq x_e \leq 1 \text{ for all } e \in E \quad (3.7)$$

$$x(\delta(v))=2 \text{ for all } v \in V \quad (3.8)$$

$$x(\gamma(S)) + x(J) \leq |S| + (|J|-1)/2 \text{ for every blossom } (S,J) \text{ of } G. \quad (3.9)$$

In addition to this theorem Edmonds gave a polynomial algorithm to find a minimum cost 2-factor in a graph. Therefore graphs for which every 2-factor is a Hamilton cycle constitute interesting building blocks for 3-splicing. Note that the fully reducible class obtained as the closure of these graphs contains that generated as the closure of elementary graphs. In particular it contains Halin graphs.

Recently Cornuejols, Hartvigsen and Pulleyblank [3] have described the convex hull of the *triangle-free 2-factors* of a graph (i.e. Those 2-factors in which every cycle has length at least 4) and have given a polynomial algorithm to find a minimum cost such 2-factor. Thus, the class of graphs where every triangle-free 2-factor is a Hamilton cycle can be closed under 3-splicing to form a fully reducible class. This class contains those introduced earlier in this section.

Now we turn to another fully reducible class of graphs, called *prismatic graphs*. A graph G_p is a *prism* if it consists of two vertex disjoint cycles of length p , say with vertices (u_1, \dots, u_p) and (v_1, \dots, v_p) , where in addition each pair u_i, v_i is joined by an edge. (See Figure 6.) Note that prisms are Hamiltonian and regular of degree 3 and so they generate Hamiltonian graphs by 3-splicing. A graph is called *prismatic* if it belongs

to the closure of prisms under 3-splicing. (See Figure 6.)

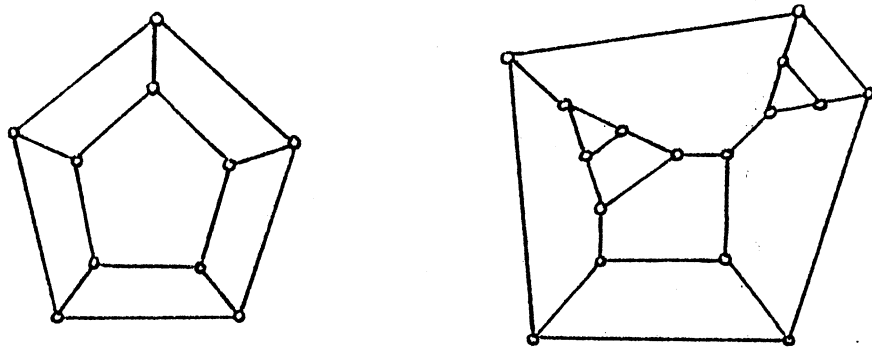

Figure 6. The prism G_5 and a prismatic graph $G_4 * G_3 * G_3$.

When p is odd the prism G_p has exactly p Hamilton cycles, all using a pair of edges $(u_i v_i)(u_{i+1} v_{i+1})$ and no other edge $(u_k v_k)$, $k \neq i, i+1$. (Here and in the remainder of this section, the indices of the vertices are assumed to be defined modulo p , e.g. $u_{p+1} \equiv u_1$.) On the other hand, when p is even, the prism G_p has $p+2$ Hamilton cycles, namely the p Hamilton cycles described above for odd p plus two new cycles H_1 and H_2 containing all the edges $(u_i v_i)$ and every other edge of the cycles $\{u_1, \dots, u_p\}$ and $\{v_1, \dots, v_p\}$. Whether p is odd or even, a minimum cost Hamilton cycle can be found in linear time.

Next we will show that $TSP(G)$ is particularly simple for a prism. A *simplex* is a polytope such that, for any extreme point, there is a hyperplane that does not contain it but contains all the other extreme points. For example triangles and tetrahedra are simplices whereas squares and cubes are not. As a consequence, in a defining linear system for a simplex, the number of inequalities required is equal to the number of extreme points of the simplex. This number is always relatively small. In fact, as will become clear in Section 4, the total number of relations needed

in a linear system defining a simplex (number of equalities and inequalities) is equal to the number of variables plus one (except for isolated points, which are simplices and can be defined with just as many equalities as variables.) Every polytope which is not a simplex requires more relations.

Suppose we are given a polytope $S \subseteq \mathbb{R}^n$ having a set W of extreme points and satisfying a linear system $Ax \leq b, Cz = d$. Then S is a simplex and our defining linear system is a minimal defining linear system if and only if the following conditions hold:

(3.10) C consists of $n - |W| + 1$ linearly independent rows;

(3.11) A contains $|W|$ rows and for each $\hat{w} \in W$ there is an inequality $ax \leq \beta$ from $Ax \leq b$ such that $aw = \beta$ for all $w \in W \setminus \hat{w}$ and $a\hat{w} < \beta$.

For (3.11) ensures that W is affinely independent and hence S is a simplex of dimension $|W| - 1$. By (3.10), $Cx = d$ is a minimal set of equations. An inequality $ax \leq \beta$ valid for S is essential if and only if there are $\dim(S)$ affinely independent members x of S satisfying $ax = \beta$. By (3.11) we have all such essential inequalities, and conversely, all our inequalities are essential. (See also Section 4.)

THEOREM 3.6. If G_p is a prism, then $TSP(G_p)$ is a simplex. When $p \geq 3$ is odd, a minimal defining linear system is:

$$x(\delta(w)) = 2 \text{ for every vertex } w \text{ of } G_p,$$

$$\sum_{i=1}^k x(u_i, v_i) = 2$$

$$x(u_k, u_{k+1}) \leq 1 \text{ for } k = 1, 2, \dots, p.$$

When $p \geq 4$ is even, a minimal defining linear system is:

$$x(\delta(w)) = 2 \text{ for all vertices } w \text{ of } G_p, \text{ except one;}$$

$$\sum_{i=1}^k x(u_i, v_i) + (p-2)[x(u_k, u_{k+1}) + x(v_k, v_{k+1})] \leq 2p-2 \text{ for } k = 1, 2, \dots, p;$$

$$\sum_{i=1}^p x(u_i v_i) + (p-2)x(H_j) \geq p(p-1) \text{ for } j=1,2,$$

where H_1 and H_2 are as described above.

PROOF. First suppose that p is odd. Then G_p is nonbipartite and it is well known (and easy to verify) that the equations $x(\delta(w))=2$ for all vertices w of G_p are linearly independent. If we let \hat{x} be the incidence vector of the two disjoint cycles of length p , then \hat{x} satisfies all of these equations but $\sum_{i=1}^p \hat{x}(u_i v_i)=0$. Therefore the equation $\sum_{i=1}^p x(u_i v_i)=2$ is linearly independent of these other equations so (3.10) holds. (Note that G_p has $3p$ edges and p distinct Hamilton cycles.) Moreover, (3.11) follows immediately, since for each edge $(u_k u_{k+1})$ there is a unique Hamilton cycle which does not use this edge.

Now suppose that p is even. Then G_p is bipartite and so if we take all the degree constraints $x(\delta(w))=2$ except one, we have (3.10) satisfied. Consider a Hamilton cycle which uses only two edges of the form $(u_i v_i)$, say $(u_j v_j)$, $(u_{j+1} v_{j+1})$. Then it satisfies all of the first p inequalities with equality except the one corresponding to $k=j$. It also satisfies the last two inequalities as equations. The Hamilton cycles H_j both satisfy the first p inequalities as equalities and each also satisfies as an equation the one of the last two inequalities corresponding to the other. Therefore (3.11) is satisfied. \square

4. Polyhedral Theorems.

Theorem 2.2 (the basic polyhedral theorem) showed that we could obtain a linear system sufficient to define $TSP(G)$ from linear systems sufficient to define $TSP(G \times S)$ and $TSP(G \times \bar{S})$ where $\delta(S) = \delta(\bar{S})$ is a 3-edge cutset of G . In this section we show that stronger results are true. First we review certain facts concerning linear systems and their solution sets. (See Bachem and Grötschel [1]) for a good introduction to polyhedral theory.)

Let $P = \{x \in \mathbb{R}^n : Ax \leq b, Cx = d\}$. If we are interested in using linear programming techniques to solve an optimization problem

$$\text{Minimize } (lx : x \in P)$$

it is often desirable to have our defining linear system as small as possible. In particular, we want to eliminate any redundant equations or inequalities. First we assume

(4.1) no inequality from the set $Ax \leq b$ is satisfied with equality by all $x \in D$. In other words, if any of the inequalities can be made into equations without changing the solution set we do so.

A consequence of assumption (4.1) is that any equation which is satisfied by all $x \in P$ is a linear combination of the equalities $Cx = d$. Subject to (4.1) a fundamental result of polyhedral theory is that the defining linear system is minimal if and only if

(4.2) the rows of C are linearly independent,

(4.3) for any inequality $ax \leq \beta$ from the system $Ax \leq b$, there exists $\hat{x} \in P$ satisfying $a\hat{x} = \beta$

(4.4) for any two inequalities $a^1x \leq \beta^1$ and $a^2x \leq \beta^2$ from the system $Ax \leq b$, there exists $\hat{x} \in P$ satisfying $a^1\hat{x} = \beta^1$ and $a^2\hat{x} < \beta^2$.

A *face* of a polyhedron P is defined to be the set of all $x \in P$ satisfying $cx = \gamma$ for some inequality $cx \leq \gamma$ satisfied by all members of P . A *facet* is a maximal (with respect to set inclusion) nonempty face of P which is different from P . Conditions (4.3) and (4.4) require that, for each inequality $ax \leq \beta$ from $Ax \leq b$, $\{x \in P : ax = \beta\}$ must be a facet of P .

The *dimension* of P , denoted by $\dim(P)$ is defined (subject to (4.1) and (4.2)) as the difference between the number of columns and rows of C , with the convention that the dimension of the empty set is taken to be -1. A set X of vectors is *affinely independent* if for any $\hat{x} \in X$, the set $\{x - \hat{x} : x \in X - \{\hat{x}\}\}$ is linearly independent and the *affine rank* of a set is the size of a largest affinely independent subset. We say that \hat{x} is an *affine combination* of X if there exists $\alpha \in R^X$ satisfying $\sum(\alpha_x : x \in X) = 1$ and $\hat{x} = \sum(\alpha_x x : x \in X)$. (Recall that for any set S , R^S denotes the set of all real vectors indexed by S .) It can be seen that $\dim(P)$ is one less than the affine rank of P and that a nonempty face F of P is a facet if and only if $\dim(F) = \dim(P) - 1$.

Let J be a 3-edge cutset in a graph $G = (V, E)$. Let \hat{J} denote the set of those $j \in J$ such that G has a Hamilton cycle which does not use j . In other words, for each pair of edges of J which belongs to a Hamilton cycle of G , the other edge is in \hat{J} . If G has no Hamilton cycles, then $\hat{J} = \emptyset$. If, as is the case for Halin graphs and prismatic graphs, every edge is missed by some Hamilton cycle, then $\hat{J} = J$.

When we wish to obtain minimality results for a linear representation of $TSP(G)$, this set \hat{J} plays an important role. We define a restricted travelling salesman polytope as follows: for any $E' \subseteq E$ we let $TSP(G, E')$ denote the convex hull of those tours of G which use all the edges of E' , (Thus $TSP(G, \emptyset) = TSP(G)$.)

We now show that if $J = \delta(S)$ is a 3-edge cutset in $G = (V, E)$ then

we can combine minimal defining linear systems for $TSP(G \times S, J-\bar{J})$ and $TSP(G \times \bar{S}, J-\bar{J})$ and obtain an essentially minimal defining system for $TSP(G)$. There are two technical problems. First, the equations $x(J)=2$ and $x_j=1$ for $j \in J-\bar{J}$ need not occur explicitly in either linear system and yet will be obtainable as linear combinations of equations defining both $TSP(G \times S, J-\bar{J})$ and $TSP(G \times \bar{S}, J-\bar{J})$. Therefore combining the equations in these systems results in some redundancies which must be eliminated. Second, there is one situation in which an inequality is facet inducing for one of two smaller systems and yet not facet inducing for $TSP(G)$. This is when it induces the same facet as $x_j \leq 1$ for some $j \in \bar{J}$ in one of the subsystems, but this inequality is not facet inducing in the other.

In the applications we make of this Theorem, these problems will be minimized. Every edge will appear in some Hamilton cycle and not appear in another. Consequently we will always have $\bar{J}=J$. Moreover, $x_j \leq 1$ will be facet inducing for all j and the equation $x(J)=2$ will occur explicitly in both subsystems.

THEOREM 4.1. Let $J=\delta(S)$ be a 3-edge cutset in a graph G for which $TSP(G) \neq \emptyset$. Let $P_1 = TSP(G \times S, J-\bar{J})$ and let $P_2 = TSP(G \times \bar{S}, J-\bar{J})$. For $i=1,2$, let

$$A^i x \leq b^i$$

$$x(J)=2$$

$$x_j=1 \text{ for } j \in J-\bar{J}$$

$$C^i x = d^i$$

be a minimal defining linear system for P_i , which satisfies (4.1). Then

- (4.5) the union of these linear systems gives a linear system satisfying (4.1) whose solution set is $TSP(G)$;
- (4.6) the equations $x(J)=2, x_j=1$ for all $j \in J-\hat{J}, C^1x=d^1, C^2x=d^2$ are a linearly independent basis of the equations satisfied by all $x \in TSP(G)$;
- (4.7) an inequality from $A^1x \leq b^1$ or $A^2x \leq b^2$ is facet inducing, and hence essential, for $TSP(G)$ unless it induces the same facet as $x_j \leq 1$ for some $j \in \hat{J}$, for one of the two subsystems, and this inequality $x_j \leq 1$ does not induce a facet of the polyhedron defined by the other system.

PROOF. We first establish (4.5). Let P_1 and P_2 be the set of all vectors in R^E which satisfy $\{x(S)=2, C^1x=d^1, A^1x \leq b^1\}$ and $\{x(S)=2, C^2x=d^2, A^2x \leq b^2\}$ respectively. Then $TSP(G) \subseteq P_1 \cap P_2$. Let \tilde{P}_1 and \tilde{P}_2 be the sets of all vectors in R^E which satisfy linear systems sufficient to define $TSP(G \times S)$ and $TSP(G \times \bar{S})$ respectively. Then $\tilde{P}_1 \supseteq P_1$ and $\tilde{P}_2 \supseteq P_2$ and, by Theorem 2.1, $TSP(G) = \tilde{P}_1 \cap \tilde{P}_2$. Therefore $TSP(G) = P_1 \cap P_2$ and so the union of those two linear systems defines $TSP(G)$.

Now we prove (4.6) and (4.7). Let $X^1 \subseteq R^{E-\gamma(S)}$ be a maximal affinely independent set of tours of P_1 and let $X^2 \subseteq R^{E-\gamma(\bar{S})}$ be analogously defined for P_2 . For each $j \in \hat{J}$ we choose a tour $\bar{x}^j \in X^1$ such that $\bar{x}_j^j = 0$ and a tour $\tilde{x}^j \in X^2$ such that $\tilde{x}_j^j = 0$.

For any tours x of $G \times S$ and \bar{x} of $G \times \bar{S}$ such that $x_j = \bar{x}_j$ for all $j \in J$, we define the *splice* of x and \bar{x} to be the tour x' of G defined by

$$x'_j = \begin{cases} \bar{x}_j & \text{for } j \in \gamma(S) \\ x_j & \text{for } j \in \gamma(\bar{S}) \\ x_j = \bar{x}_j & \text{for } j \in J - \delta(S) \end{cases}$$

We now define the following sets of tours:

\tilde{X}^1 is the set of all splices of tours of $X^1 - \{\bar{x}^j: j \in J\}$ with the appropriate tour of $\{\bar{x}^j: j \in J\}$;

\tilde{X}^2 is the set of all splices of tours of $X^2 - \{\bar{x}^j: j \in J\}$ with the appropriate tour of $\{\bar{x}^j: j \in J\}$

\tilde{X}^3 is the set of splices of \bar{x}^j and \bar{x}^j for all $j \in J$.

Note that

$$|\tilde{X}^1 \cup \tilde{X}^2 \cup \tilde{X}^3| = |X^1| + |X^2| - |J|. \quad (4.8)$$

CLAIM 1: $\tilde{X}^1 \cup \tilde{X}^2 \cup \tilde{X}^3$ forms an affinely independent basis of the tours of G .

First, we show that they are affinely independent. Suppose there exists $\alpha \in R^{\tilde{X}^1 \cup \tilde{X}^2 \cup \tilde{X}^3}$ such that

$$\sum(\alpha_z: z \in \tilde{X}^1 \cup \tilde{X}^2 \cup \tilde{X}^3) = 0.$$

Since X^1 is affinely independent, we must have $\alpha_z = 0$ for all $z \in \tilde{X}^1$ and $\sum(\alpha_z: z \in \tilde{X}^2 \cup \tilde{X}^3) = 0$. Similarly, since X^2 is affinely independent, we must have $\alpha_z = 0$ for all $z \in \tilde{X}^2$. Thus we must have $(\sum \alpha_z: z \in \tilde{X}^3) = 0$, which implies $\alpha_z = 0$ for $z \in \tilde{X}^3$, since the members of \tilde{X}^3 are affinely independent. Therefore $\alpha = 0$ so $\tilde{X}^1 \cup \tilde{X}^2 \cup \tilde{X}^3$ is linearly independent.

Now let \hat{z} be a tour in G and let \hat{j} be the edge j of J for which $\hat{z}_j = 0$. Let \hat{z}^1 and \hat{z}^2 be the tours of $G \times S$ and $G \times \bar{S}$ respectively induced by \hat{z} . By the maximality of X^1 and X^2 there exist $\alpha^1 \in R^{X^1}$ and $\alpha^2 \in R^{X^2}$ such that

$$\sum(\alpha_z^1: z \in X^1) = 1 \text{ and } \hat{z}^1 = \sum(\alpha_z^1: z \in X^1)$$

and

$$\sum(\alpha_i^2: x \in X^2) = 1 \text{ and } \hat{x}^2 = \sum(\alpha_i^2 x: x \in X^2).$$

Note that this implies that for any $x \in X^1$ such that $\alpha_i^1 \neq 0$, $x_j = 0$, and similarly for X^2 . In other words, the only tours having α_i^1 or α_i^2 nonzero are those agreeing with \hat{x} on J . Now for any $x \in X^1$, if $x \neq \bar{x}^j$ for any $j \in \hat{J}$, we define x' to be corresponding tour of \bar{X}^1 . If $x = \bar{x}^j$ for some $j \in \hat{J}$ we define x' to be the corresponding tour of \bar{X}^3 . The vector $\sum(\alpha_i^1 x': x \in X^1)$ is identical with \hat{x} on $E - \gamma(S)$ and equals \bar{x}^j on $\gamma(S)$. We define x' analogously for $x \in X^2$ and have $\sum(\alpha_i^2 x': x \in X^2)$ is identical with \hat{x} on $E - \gamma(\bar{S})$ and equals \bar{x}^j on $\gamma(\bar{S})$. Therefore

$$\hat{x} = \sum(\alpha_i^1 x': x \in X^1) + \sum(\alpha_i^2 x': x \in X^2) - x^j$$

where x^j is the splice of \bar{x}^j and \bar{x}^j . Since $\sum(\alpha_i^1: x \in X^1) + \sum(\alpha_i^2: x \in X^2) - 1 = 1$, we have expressed \hat{x} as an affine combination of members of $\bar{X}^1 \cup \bar{X}^2 \cup \bar{X}^3$ as required. Thus Claim 1 is established.

Note that (4.1) is clearly satisfied for our combined linear system, for consider an inequality $ax \leq \beta$, which belongs to $A^1 x \leq b^1$, say. Some tour $\hat{x} \in P_1$ satisfies $a\hat{x} < \beta$ so there will be a tour x' of G obtained by splicing some tour of P_2 with \hat{x} which also satisfies $ax' < \beta$.

It follows from Claim 1 and (4.8) that

$$\dim(TSP(G)) = \dim(P_1) + \dim(P_2) - |J| + 1.$$

Since we have assumed minimal defining systems for P_i , the equations $x(J) = 2$, $x_j = 1$ for $j \in J - \hat{J}$, $C^i x = d^i$ are linearly independent. Let r_i be the number of these equations for P_i . By the definition of dimension, we have $\dim(P_1) + r_1 = |E - \gamma(S)|$ and $\dim(P_2) + r_2 = |E - \gamma(\bar{S})|$. The linear rank of the combined system is $|E| - \dim(TSP(G)) = r_1 + r_2 - 1 - |J - \hat{J}|$ since $|E| = |E - \gamma(S)| + |E - \gamma(\bar{S})| - |J|$. But this is exactly the number of equations

so they are linearly independent and hence all essential which establishes (4.6), since our combined system satisfies (4.1).

Now let $ax \leq \beta$ be an inequality from the system $A^1 x \leq b^1$. Then there exists a set Y^1 of $\dim(P_1)$ affinely independent tours in P_1 all satisfying $ax = \beta$. Moreover, if the facet of P_1 induced by $ax \leq \beta$ is different from the facets induced by $x_j \leq 1$ for all $j \in J$ then for each $j \in J$ there exists a tour $x^j \in Y^1$ satisfying $x_j^j = 0$. We now splice the tours of Y^1 and X^2 in the same manner as we did previously with X^1 and X^2 to obtain $\dim(P_1) + \dim(P_2) + 1 - |J|$ affinely independent tours of G , all satisfying $ax = \beta$. Therefore $\dim(TSP(G))$ affinely independent members of $TSP(G)$ all satisfy $ax = \beta$ so the inequality is facet inducing and essential.

Suppose $ax \leq \beta$ induces the same facet as $x_j \leq 1$ for some $j \in J$. If $x_j \leq 1$ is also facet inducing for P_2 , then we can find sets Y_1 and Y_2 of $\dim(P_1)$ and $\dim(P_2)$ tours respectively of P_1 and P_2 , all satisfying $x_j = 1$. Let $k \in J - \{j\}$. Suppose every $x \in Y_1 \cup Y_2$ also satisfies $x_k = 1$. If there existed a tour \bar{x} in either P_1 or P_2 which satisfied $\bar{x}_k = 1$ but $\bar{x}_j = 0$, then we would have contradicted $\{x \in P_1 \text{ or } P_2 : x_j = 1\}$ being a maximal proper face, i.e. a facet. Therefore every tour x in P_1 or P_2 which has $x_k = 1$ must also have $x_j = 1$. But every tour x in P_1 or P_2 must have $x_j = 1$ or $x_k = 1$, hence must have $x_k = x_j = 1$. This means that the inequality $x_j \leq 1$ is not facet inducing for P_1 or P_2 , a contradiction. Therefore, for each $k \in J - \{j\}$ there exists $x^k \in Y_1$ such that $x_k^k = 0$, and similarly for Y_2 . So as before we can splice Y_1 and Y_2 and obtain $\dim(P_1) + \dim(P_2) - (|J| - 1) = \dim(TSP(G))$ affinely independent tours of G all satisfying $x_j = 1$. Therefore the inequality is facet inducing.

Finally, suppose $ax \leq \beta$ induces the same facet as $x_j \leq 1$ for $j \in J$, but $x_j \leq 1$ is not facet inducing for P_2 . Then there is some other inequality $a'x \leq \beta'$ from $A^2 x \leq b^2$ such that $\{x \in P_2 : a'x = \beta'\} \supset \{x \in P_2 : x_j = 1\}$. If we extend the tours in these two sets to tours of G in all possible ways, we see

that $\alpha x \leq \beta$ does not induce a maximal nonempty face of $TSP(G)$, i.e., the inequality is not facet inducing and so is inessential.

This completes the proof of (4.7) and the theorem. \square

COROLLARY 4.2. Let $J = \delta(S)$ be a 3-edge cutset in a graph G for which $TSP(G) \neq \emptyset$. Then

$$\dim(TSP(G)) = \dim(TSP(G \times S, J - \hat{J})) + \dim(TSP(G \times \bar{S}, J - \hat{J})) - |\hat{J}| + 1.$$

(We actually proved this explicitly in the course of proving Theorem 4.1.)

Now we apply these results to Halin graphs. Recall that for a wheel W_k we defined a *rim edge* to be an edge not incident with the centre vertex.

PROPOSITION 4.3. The following is a minimal defining linear system for $TSP(W_k)$ for a wheel W_k :

$$x_j \leq 1 \text{ for every rim edge } j$$

$$x(\delta(v)) = 2 \text{ for every vertex } v.$$

PROOF. The wheel W_k has exactly k different Hamilton cycles, each one omitting a different rim edge. It is easy to verify that (3.10) and (3.11) are satisfied so $TSP(W_k)$ is a simplex and the given linear system is both minimal and sufficient. \square

We remark that there are two notable omissions in our list of inequalities in Proposition 4.3. First we do not require $x_j \leq 1$ for a non rim edge j . However this inequality can be deduced as follows. Suppose j joins vertices u and w . Then the inequality $x_j \leq 1$ can be obtained by adding $1/2$ times the equations $x(\delta(v))$ for $v \in \{u, w\}$; $-1/2$ times the equations $x(\delta(v))$ for $v \in V(W_k) - \{u, w\}$; and the inequalities $x_k \leq 1$ for all $k \in E(W_k) - (\delta(u) \cup \delta(w))$. Moreover, all of the above are part of our linear

system. Second we do not have inequalities $x_j \geq 0$ for any of our edges. These can be derived from the fact that every edge is incident with a degree three vertex and each edge k incident with the vertex has the inequality $x_k \leq 1$ either explicitly in or derivable from our linear system.

THEOREM 4.4. Let $H = T \cup C$ be a Halin graph. The following is a minimal linear system sufficient to define $TSP(H)$:

$$x_j \leq 1 \text{ for all } j \in E(C);$$

$$x(\delta(v)) = 2 \text{ for all } v \in V(H);$$

$$x(J) = 2 \text{ for every (nontrivial) 3-edge cutset } J \text{ of } H.$$

PROOF. We prove by induction on the number p of nonleaf vertices of T . If $p = 1$ then H is a wheel and the result follows from Prop. 4.3. If $p > 1$ then the result follows by induction and Theorem 4.1 applied to any (nontrivial) 3-edge cutset J of H . \square

COROLLARY 4.5. If $H = T \cup C$ is a Halin graph such that T has p leaf vertices and q nonleaf vertices then $\dim(TSP(H)) = p - q$.

PROOF. There is a bijection between the (nontrivial) 3-edge cutsets of H and the edges of T which are not incident with a leaf. Therefore the number of equations in a minimal defining system for H is $(p + q) + (q - 1) = p + 2q - 1$. The number of edges in H is $(p + q - 1) + p = 2p + q - 1$. Therefore $\dim(TSP(H)) = p - q$. \square

In the previous section we discussed those graphs obtainable by 3-splicing from elementary graphs, and observed how Theorem 2.2 provided an easy means of obtaining a sufficient linear system to define their TSP 's. We now show how Theorem 4.2 can be used to give converse results.

Let \mathbf{E} be the class of those graphs $G = (V, E)$ satisfying

(4.9) for each edge j of G there is a Hamilton cycle of G which does not use j ;

(4.10) $TSP(G)$ is defined by the following linear system:

$$0 \leq x_j \leq 1 \text{ for all } j \in E, \quad (4.11)$$

$$x(\delta(v)) = 2 \text{ for all } v \in V \quad (4.12)$$

$$x(J) = 2 \text{ for every 3-edge cutset } J. \quad (4.13)$$

First we show that $\mathbf{E} \subseteq \mathbf{cl}$ (Elementary graphs).

THEOREM 4.6. Let G be a graph having a 3-edge cutset $J = \delta(S)$. Then $G \in \mathbf{E}$ if and only if both $G \times S$ and $G \times \bar{S}$ are in \mathbf{E} .

PROOF. If both $G \times S$ and $G \times \bar{S}$ are in \mathbf{E} , then (4.10) follows from Theorem 2.2, and it is easy to see that (4.9) is satisfied. Conversely, suppose $G \times S \notin \mathbf{E}$. Then there must be a facet not induced by an inequality of the form (4.11) or else a valid equation linearly independent of (4.12) and (4.13). Thus an inequality or equation not of the form (4.11) - (4.13) is essential for $TSP(G \times S)$. Therefore, by Theorem 4.2, it is also essential for $TSP(G)$. Hence $G \notin \mathbf{E}$, a contradiction. \square

Therefore characterizing the graphs in \mathbf{E} reduces to the problem of characterizing graphs $G = (V, E)$ such that $|\delta(S)| \geq 4$ for every $S \subset V$ satisfying $2 \leq |S| \leq |V| - 2$ and for which $TSP(G)$ is defined by (4.11) and (4.12). Some results in this direction are presented in Section 5.

Finally we show that not only do we have algorithmic and polyhedral reductions over 3-edge cutsets, but we can also construct optimum solutions to the dual linear program of minimizing lx for $x \in TSP(G)$ from optimum dual solutions for $G \times S$ and $G \times \bar{S}$ where $\delta(S)$ is a 3-edge cutset.

For convenience, we assume that $J = \hat{J}$, i.e., each pair of edges of J belongs to a Hamilton cycle. (This assumption could be removed using the

same ideas as in Theorem 4.1) Suppose that $TSP(G \times S)$ and $TSP(G \times \bar{S})$ are defined by the linear systems $(A^1 x \leq b^1, C^1 x = d^1)$ and $(A^2 x \leq b^2, C^2 x = d^2)$ respectively. The dual linear program to minimizing lx subject to this linear system (i.e. to solving the TSP for edge costs l) is the following:

$$\text{Maximize } -\eta^1 b^1 - \eta^2 b^2 + \rho^1 d^1 + \rho^2 d^2$$

subject to

$$-\eta^1 A^1 - \eta^2 A^2 + \rho^1 C^1 + \rho^2 C^2 = l$$

$$\eta^1, \eta^2 \geq 0.$$

We proceed as in the basic reduction. Let u, v and w be the vertices of S incident with edges of J and let u', v' and w' be the adjacent vertices in \bar{S} . (Note that our $J = \bar{J}$ assumption ensures that these vertices are distinct.) We compute $L_{uv}, L_{uv'}$ and L_{vw} to be the minimum costs of Hamilton paths between u and v , u and w , and v and w respectively in $G[S]$. (Again, by virtue of our $J = \bar{J}$ assumption, these values are well defined). Again, we compute

$$\alpha = (L_{uv} + L_{vw} - L_{uv'})/2$$

$$\beta = (L_{uv} + L_{vw} - L_{v'w})/2$$

$$\epsilon = (L_{uv} + L_{vw} - L_{uv'})/2.$$

We now define vectors l^1 and l^2 of edge costs as follows, where $e = (u, u')$, $f = (v, v')$, $g = (w, w')$. We define l_j^1 for $j \in E - \gamma(\bar{S})$ by

$$l^1(j) = \begin{cases} l(j) & \text{if } j \in E - \gamma(\bar{S}) - \{e, f, g\} \\ l(e) - \alpha & \text{if } j = e \\ l(f) - \beta & \text{if } j = f \\ l(g) - \epsilon & \text{if } j = g \end{cases}$$

We define l_j^2 for $j \in E - \gamma(\bar{S})$ by

$$l^2(j) = \begin{cases} l(j) & \text{if } j \in E - \gamma(S) - \{c, f, g\} \\ l(c) + \alpha & \text{if } j = c \\ l(f) + \beta & \text{if } j = f \\ l(g) + \epsilon & \text{if } j = g \end{cases}$$

Note that l^2 is just the normal cost vector we use for $G \times S$ in the basic reduction. However by subtracting α, β, ϵ to construct l^1 , we have ensured that the minimum cost (with respect to l^1) tours in $G \times \bar{S}$ using each pair of edges of G will have the same objective value, namely zero.

Let $(\bar{\eta}^1, \bar{\rho}^1)$ and $(\bar{\eta}^2, \bar{\rho}^2)$ be optimum dual solutions to minimizing $l^1 x$ subject to $(A^1 x \leq b^1, C^1 x = d^1)$ and to minimizing $l^2 x$ subject to $(A^2 x \leq b^2, C^2 x = d^2)$ respectively. Then, since the optimum value of the first linear program is zero, we have

$$-\bar{\eta}^1 b^1 + \bar{\rho}^1 d^1 = 0.$$

The optimum value of the second linear program is $\min\{lx : x \in TSP(G)\}$ so

$$-\bar{\eta}^2 b^2 + \bar{\rho}^2 d^2 = \min\{lx : x \in TSP(G)\}.$$

If we extend l^1 and l^2 to be vectors defined on E by letting any undefined components take on the value zero, then $l = l^1 + l^2$. Therefore

$$-\bar{\eta}^1 A^1 - \bar{\eta}^2 A^2 + \bar{\rho}^1 C^1 + \bar{\rho}^2 C^2 = l,$$

$$\bar{\eta}^1, \bar{\eta}^2 \geq 0,$$

$$\bar{\eta}^1 b^1 + \bar{\eta}^2 b^2 - \bar{\rho}^1 d^1 - \bar{\rho}^2 d^2 = \min\{lx : x \in TSP(G)\}.$$

Therefore $\bar{\eta}^1, \bar{\eta}^2, \bar{\rho}^1, \bar{\rho}^2$ comprise an optimum feasible solution to the dual linear program as required.

We illustrate this process for Halin graphs. The only problem is to compute an optimum solution to the dual problem for a wheel $W_k = (V, E)$ having centre \hat{v} and arc costs l . Let \hat{u} and \hat{w} be adjacent rim vertices such that $l(\hat{v}, \hat{u}) + l(\hat{v}, \hat{w}) - l(\hat{u}, \hat{w})$ is minimized, over all adjacent pairs of rim vertices. Our primal linear program is

minimize lx

subject to

$$x(\delta(v)) = 2 \text{ for all } v \in V,$$

$$x_j \leq 1 \text{ for every edge } j \text{ joining two rim vertices.}$$

The dual problem is

$$\text{maximize } \sum_{v \in V} 2p(v) - \sum (\eta(j); j \in E \text{ joins two rim vertices}).$$

We define an optimum dual solution $\bar{\eta}, \bar{p}$ as follows:

$$\bar{p}(\hat{v}) := (l(\hat{v}, \hat{u}) + l(\hat{v}, \hat{w}) - l(\hat{u}, \hat{w})) / 2$$

$$\bar{p}(v) := l(v, \hat{u}) - \bar{p}(\hat{v}) \text{ for } v \in V - \{\hat{v}\},$$

$$\bar{\eta}(u, w) := \bar{p}(u) + \bar{p}(w) - l(u, w) \text{ for each pair } (u, w)$$

of adjacent rim vertices.

It is routinely checked that $(\bar{\eta}, \bar{p})$ is feasible and that it gives the same objective value as the Hamilton cycle of W_k which uses the edges (\hat{u}, \hat{v}) and (\hat{v}, \hat{w}) .

For any arbitrary Halin graph, we can use the general method described above, together with this specific optimum for a wheel, to construct an optimum dual solution. Note that this provides a second

proof of the validity of our basic reduction - a solution to a primal linear program is optimal if and only if there exists a feasible solution to the dual linear program giving the same objective value.

5. Additional results on elementary graphs

As stated in Section 3, the travelling salesman problem can be solved in polynomial time for an elementary graph $G=(V,E)$. Remember that, for these graphs, the polytope $TSP(G)$ is defined by the linear system

$$0 \leq x_j \leq 1 \text{ for all } j \in E, \quad (5.1)$$

$$x(\delta(v)) = 2 \text{ for all } v \in V. \quad (5.2)$$

If this system satisfies assumption (4.1), the graph G is called *basic elementary*. An equivalent way of stating assumption (4.1) is

(5.3) for every edge $j \in E$, there is at least one Hamilton cycle which contains j and at least one which misses j .

Examples introduced earlier such as wheels, $K_{3,3}, K_4, K_5$, K_5 minus one edge and K_5 minus two nonadjacent edges are basic elementary graphs.

PROPOSITION 5.1. A basic elementary graph with n vertices contains at least $n/2 + 1$ affinely independent Hamilton cycles.

PROOF. By assumption (4.1), the dimension of $TSP(G)$ is $|E|$ minus the number of linearly independent equations (5.2). Note that $|E| \geq \frac{3n}{2}$ since every vertex of G has degree at least 3. [Edges incident with a vertex of degree 1 or 2 would violate (5.3).] The number of equations (5.2) is at most n . So the dimension of the polytope $TSP(G)$ is at least $\frac{n}{2}$ and so the affine rank is at least $n/2 + 1$. \square

The next theorem shows the importance of bipartite basic elementary graphs.

THEOREM 5.2. If G_1 and G_2 are two basic elementary graphs and G_1 is bipartite, then $G_1 * G_2$ is also a basic elementary graph. Conversely, if a basic elementary graph G has a 3-edge cutset with shores S_1 and S_2 , then either $G \times S_1$ or $G \times S_2$ is bipartite. Furthermore both $G \times S_1$ and $G \times S_2$ are basic elementary graphs.

PROOF. Suppose $G_1 = (V_1, E_1)$ is bipartite. Then the constraint $x(\delta(v_1)) = 2$ for a vertex $v_1 \in V_1$ is a linear combination of $x(\delta(v)) = 2$ for the vertices $v \in S_1 \equiv V_1 - \{v_1\}$. As a consequence, in $G_1 * G_2$, the 3-edge cutset constraint $x(\delta(S_1)) = 2$ is implied by the degree constraints for $v \in S_1$ and thus can be omitted. Now it follows from Theorem 2.2 that, if G_1 and G_2 are elementary, then $G_1 * G_2$ also elementary. If G_1 and G_2 both satisfy (5.3), then consider any edge j of $G_1 * G_2$. Without loss of generality assume that edge j belongs to G_1 . By (5.3), there is a Hamilton cycle of G_1 that contains j and another one that misses j . Any such Hamilton cycle contains two edges of $\delta(S_1)$ and misses the third edge, say j_1 . By (5.3), there is a Hamilton cycle of G_2 that misses j_1 and therefore any Hamilton cycle of G_1 can be completed into a Hamilton cycle of $G_1 * G_2$. That proves that $G_1 * G_2$ satisfies property (5.3).

Conversely, if G is a basic elementary graph, then the assumption (4.1) implies that the valid equality $x(\delta(S_1)) = 2$ must be a linear combination of the degree constraints $x(\delta(v)) = 2$ for $v \in V$, i.e. $x(\delta(S_1)) - 2 \equiv \sum_{v \in V} \alpha_v [x(\delta(v)) - 2]$. Let $\tilde{V} = \{v \in V : \alpha_v \neq 0\}$. If $\tilde{V} = S_1$ or S_2 , then $G \times \tilde{V}$ is bipartite as required. Otherwise $\tilde{V} = V$, since $\delta(\tilde{V}) \subseteq \delta(S_1) = \delta(S_2)$ and $G[S_1]$ and $G[S_2]$ are connected. Then note that all the coefficients α_v for $v \in S_1$ (respectively $v \in S_2$), must be equal in absolute value. (This follows from the fact that the linear combination of degree

constraints must add to 0 for every edge of $G[S_1]$.) Furthermore $G[S_1]$ is bipartite, the bipartition being given by the sign of α_e . Let $\delta(S_1) = \{e, f, g\}$ and denote by u_e, u_f, u_g (respectively v_e, v_f, v_g) the vertices of S_1 (resp. S_2) incident with e, f and g . If $\alpha_e = \alpha_f = \alpha_g$, then $G \times S_2$ is bipartite since u_e, u_f and u_g belong to the same side of the bipartition of $G[S_1]$. Otherwise, assume without loss of generality that $\alpha_e = -\alpha_f$. Then $\alpha_e + \alpha_{v_e} = 1$ and $\alpha_f + \alpha_{v_f} = 1$ imply $\alpha_{v_e} + \alpha_{v_f} = 2$. Since these two coefficients are equal in absolute value, we must have $\alpha_{v_e} = \alpha_{v_f} = 1$. This implies $\alpha_e = 0$ and $\alpha_f = 0$ which contradicts $\bar{V} = V$. \square

Theorem 5.2 gives a way of generating infinite families of basic elementary graphs, by recursively 3-splicing a basic elementary bipartite graph onto a basic elementary graph. Unfortunately we only know two irreducible basic elementary bipartite graphs, namely $K_{3,3}$ and the 3-6 cage (see Figure 7.)

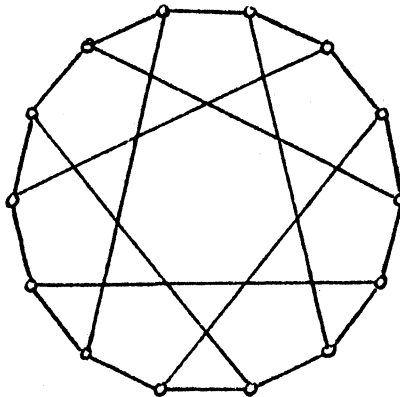

Figure 7. The 3-6 cage

By specializing Lemma 3.1 to bipartite graphs, we have that all the extreme points of the polytope defined by the linear system (5.1) - (5.2) are 2-factors. Thus, to show that the 3-6 cage is elementary, we have to check

that all its 2-factors are Hamilton cycles. Since every cycle contains at least 6 vertices, it suffices to check that the vertices of the 3-6 cage cannot be partitioned into a cycle of length 6 and a cycle of length 8. This verification is left to the reader. It is also easy to verify that condition (5.3) is satisfied.

In the remainder of this section we describe an infinite class of basic elementary graphs which contains the wheels.

LEMMA 5.3. Let B be a bipartite basic elementary graph and u a degree-3 vertex of B . Let B' be constructed from B by inserting new vertices v and w on two edges of B incident with u , and joining v and w by an edge. Then B' is a basic elementary graph.

PROOF. It is clear from the construction of B' and the fact that B is bipartite that B' cannot have two disjoint odd cycles. Thus by Lemma 3.1 every extreme point of (5.1) - (5.2) is a 2-factor. Now consider a 2-factor x of B' . If the edge (v, w) is not in the 2-factor, then x induces a 2-factor in B , and therefore it must be Hamiltonian since B is elementary. So assume that the edge (v, w) is in the 2-factor x . Note that the triangle (u, v, w) cannot be a cycle of x because the removal of these 3 vertices would leave a bipartite graph with one more vertex on one side of the bipartition. Therefore exactly one of the edges (u, v) or (u, w) must be in the 2-factor (a consequence of the fact that u has degree 3). So x is a Hamiltonian cycle. \square

By Theorem 5.2, every graph obtained as $\{(W_i \ast B_1) \ast \dots \ast B_p\}$ is basic elementary if $B_i, 1 \leq i \leq p$, stands for $K_{3,3}$, the 3-6 cage or some other bipartite basic elementary graph. A larger class W can be obtained as follows.

- (i) $W_3 = K_4 \in \mathbf{W}$. Let w be the center of W_3 .
- (ii) If $G \in \mathbf{W}$ and B is a bipartite basic elementary graph, then $G \ast B \in \mathbf{W}$ for any $v \neq w$.
- (iii) If $G \in \mathbf{W}$, then the graph obtained from G by joining w to a new vertex x' placed on some edge (x, u) where x is adjacent to w and $u \neq w$, also belongs to \mathbf{W} .

Note that, through operations (ii) and (iii), the center w of any graph in \mathbf{W} remains well defined. Of course the wheels belong to \mathbf{W} , from (i) and repeated application of (iii). Then, by repeated application of (ii) the graphs $[(W_3 \ast B_1) \ast \dots] \ast B_r$ can be obtained. It is interesting that some or all of their 3-edge cutsets can then be removed by application of (iii). (See Figure 8).

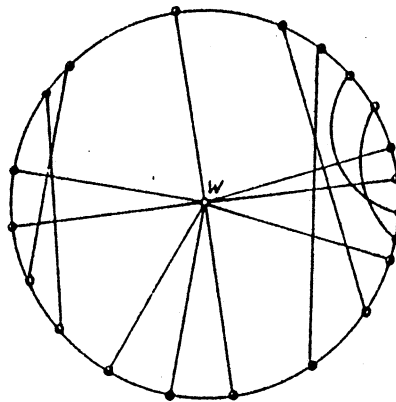

Figure 8. An irreducible graph in \mathbf{W}

PROPOSITION 5.4. Every graph in the class \mathbf{W} is a basic elementary graph.

PROOF. Assume not and let G be the smallest graph in \mathbf{W} which is not basic elementary. Consider an extreme point x of $(5,1) - (5,2)$ which is not the incidence vector of a Hamilton cycle.

Assume $G = G_1 * B$ with $G_1 \in \mathcal{W}$ and B a bipartite basic elementary graph. Let e, f, g be the edges in the 3-edge cutset joining G_1 and B . The constraint $x_e + x_f + x_g = 2$ is implied by the fact that B is bipartite. If $x_e = x_f = 1$ and $x_g = 0$, then the facts that every 2-factor of B is Hamiltonian and that x is a non-Hamiltonian 2-factor of G imply that the 2-factor induced by x on G_1 is non-Hamiltonian. This contradicts the minimality of G . If $x_e = x_f = \frac{1}{2}$ and $x_g = 1$, then the facts that B contains no odd cycle and that the 2-factor x of G has at least two odd cycles assigned the value $\frac{1}{2}$ imply that the 2-factor induced by x on G_1 has at least two odd cycles with $\frac{1}{2}$'s. Again this contradicts the minimality of G .

Note that $x(\delta(w)) = 2$ and the fact that $x_e = 0, \frac{1}{2}$ or 1 on every edge, with the $\frac{1}{2}$'s occurring on vertex disjoint odd cycles implies that at most 3 edges incident with w have $x_e > 0$. Assume that some duplicated edge e (step (iii)) has the value $x_e = 0$. Then the graph without the duplicated edge also has an extreme point which is not Hamilton cycle. This contradicts the minimality of G . Thus in G , step (iii) has been applied at most twice.

Therefore G must be obtained as $[(W_3^{v_1} * B_1) * \dots]^{v_p} * B$, followed by one or two duplications of the vertex v_i , where $v_i, 2 \leq i \leq p$, is the vertex of B_{i-1} which is adjacent to w . This is equivalent to $W_3^{v_i} * B$ followed by one or two duplications of v_i .

Consider the case of one duplication, say edge (w, v) is duplicated into (w, u) . Since x must be positive on these two edges, it has to be zero on at least one of the original edges in W_3 . Remove it as well as its end vertex other than w . Then we have a graph B' obtained from B as

described in Lemma 5.3. So G is basic elementary.

In the case of two duplications, two of the original edges of W_3 must have $x_e=0$. Removing them leaves a graph with a 2-edge cutset. In this graph every 2-factor is a Hamilton cycle as a consequence of the fact that B is elementary. \square

6. Extensions

This paper deals only with one graph reduction. Specifically 3-edge cutsets are used to break up travelling salesman problem into four smaller problems. But other reductions could also be studied. One obvious direction is to reduce a graph using its k -edge cutsets, for any given k . When $k=2$, this works nicely. Let S and \bar{S} be the shores of a 2-edge cutset. Then minimum cost Hamilton cycles for $G \times S$ and $G \times \bar{S}$ can simply be patched to produce an optimal solution for G . The basic polyhedral theorem (Theorem 2.2) also holds. When $k \geq 4$, a reduction into $G \times S$ and $G \times \bar{S}$ does not seem to work since a Hamilton cycle of G may use 4 or more edges of the k -edge cutset. Even if every Hamilton cycle were to use only two edges of the k -edge cutset, one could not in general use cost reductions $\alpha, \beta, \gamma, \dots$, (recall the basic reduction in Section 2) because they would have to satisfy $\binom{k}{2}$ equations with only k unknowns.

A more promising direction for investigation is to consider vertex cutsets instead of edge cutsets. Suppose $\{u, v\}$ is a 2-vertex cutset of G . Let $G[S_1]$ and $G[S_2]$ be the two connected components of $G[V - \{u, v\}]$. (Note that three connected components cannot occur if G is a Hamiltonian graph.) Then solutions of the travelling salesman problem in $G \times S_1$ and $G \times S_2$ can be patched into a solution for G . A simple polyhedral theorem also exists.

The most appealing generalization of our basic reduction occurs by allowing both edges and vertices in a cutset. (See Figure 9.)

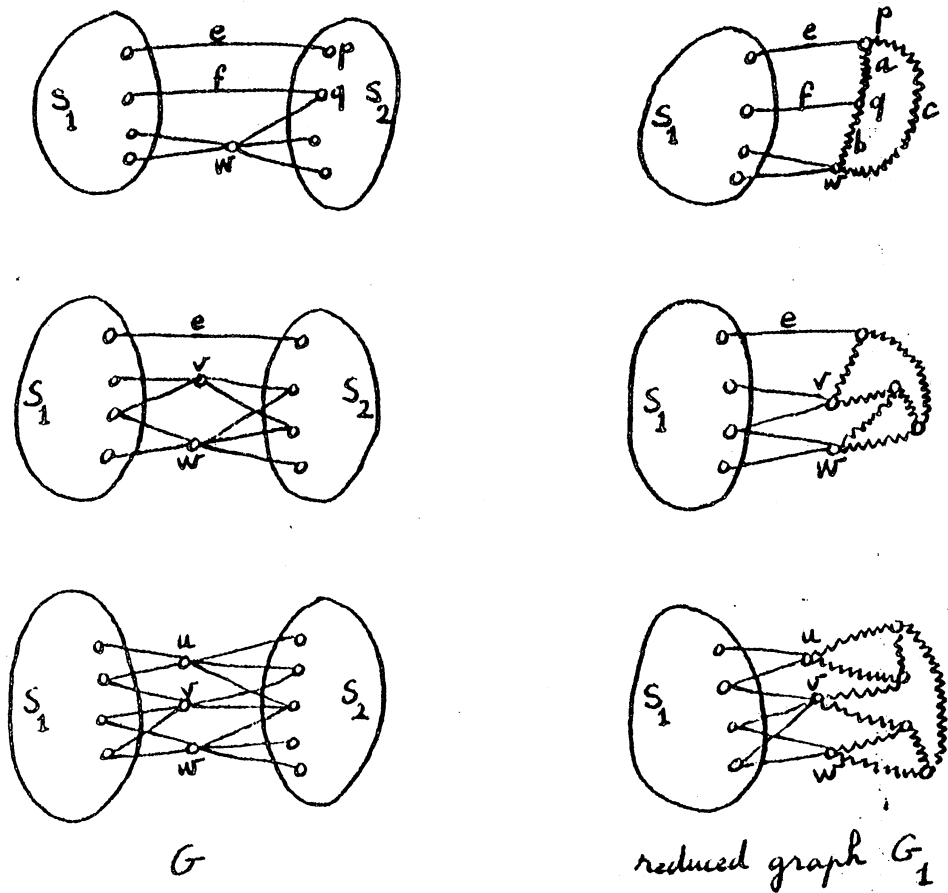

Figure 9. Reductions

First consider the case where G has a cutset consisting of two edges and one vertex, say edges e and f and vertex w . We will show that the travelling salesman problem on G can be reduced to five smaller problems (assuming both S_1 and S_2 contain at least 3 vertices.) Let $p \in S_2$ and $q \in S_2$ be the endpoints of edges e and f respectively. Compute the values

H_{pq} = minimum cost of a Hamilton path from p to q in $G[S_2]$

L_{pq} = minimum cost of a Hamilton path from p to q in $G[S_2 \cup \{w\}]$

L_{pw} = minimum cost of a Hamilton path from p to w in $G[S_2 \cup \{w\}]$

L_{qw} = minimum cost of a Hamilton path from q to w in $G[S_2 \cup \{w\}]$.

Now consider the reduced graph G_1 given in Figure 9. In order to reflect in G_1 the cost of the four Hamilton paths computed above, we introduce costs α, β, γ for the edges a, b, c respectively and we modify the costs $l(e)$ and $l(f)$ to $l'(e) = l(e) + \epsilon$ and $l'(f) = l(f) + \eta$. A proper set of values $\{\alpha, \beta, \gamma, \epsilon, \eta\}$ is given by the system

$$\begin{cases} H_{pq} = \alpha + \epsilon + \eta \\ L_{pq} = \beta + \gamma + \epsilon + \eta \\ L_{pw} = \alpha + \beta + \epsilon \\ L_{qw} = \alpha + \gamma + \eta. \end{cases}$$

A solution to this system is

$$\alpha = \frac{1}{2}(-L_{pq} + L_{pw} + L_{qw})$$

$$\beta = \frac{1}{4}(-2H_{pq} + L_{pq} + 3L_{pw} - L_{qw})$$

$$\gamma = \frac{1}{4}(-2H_{pq} + L_{pq} - L_{pw} + 3L_{qw})$$

$$\epsilon = \eta = \frac{1}{4}(2H_{pq} + L_{pq} - L_{pw} - L_{qw}).$$

With these costs, a minimum cost Hamilton cycle in G_1 is also a minimum cost solution of the travelling salesman problem in G .

The graph G_1 was obtained from G by replacing the graph $G[S_2 \cup \{w\}]$ by three edges a, b, c . Similarly we can define a reduced graph G_2 from G by replacing the graph $G[S_1 \cup \{w\}]$ by three edges, say a', b'

and c' . Assume that we know linear systems defining $TSP(G_1)$ and $TSP(G_2)$. Following the proof of Theorem 2.2 it can be shown that a linear system defining $TSP(G)$ is simply the union of linear systems for $TSP(G_1)$ and $TSP(G_2)$. Note however that the linear system just given for $TSP(G)$ contains variables $x_a, x_b, x_c, x_{a'}, x_{b'}$ and $x_{c'}$ which do not correspond to edges of G . To get a linear system only in terms of the edge variables of G we need to eliminate those 6 variables. It turns out that this can be done since the following equations are valid (they are degree constraints)

$$\begin{cases} x_a + x_b = 2 - x_j \\ x_a + x_c = 2 - x_a \\ x_b + x_c = 2 - x(W_1) \end{cases} \quad \text{and} \quad \begin{cases} x_{a'} + x_{b'} = 2 - x_j \\ x_{a'} + x_{c'} = 2 - x_a \\ x_{b'} + x_{c'} = 2 - x(W_2) \end{cases}$$

where W_i is the set of edges of G joining S_i to the vertex w , for $i=1,2$.

Now we will mention briefly the cases where the cutset consists of one edge and two vertices or where it consists of 3 vertices. The travelling salesman problem in G can then be reduced to six or seven problems on smaller graphs, respectively. A valid reduced graph G_1 which accomplishes this is given in Figure 9. The reader can easily figure out the costs that must be associated with its wiggly edges. Again, if G_2 is defined as G_1 except that S_2 is replaced by S_1 , it is still true that a linear system defining $TSP(G)$ is obtained as the union of linear systems for $TSP(G_1)$ and $TSP(G_2)$. However now there are not enough valid equations to eliminate the variables which are associated with edges of G . If we insist on eliminating these variables we must perform a Fourier - Motzkin elimination (see e.g. [1]). Then the size of the system defining $TSP(G)$ can increase exponentially in the number of eliminated variables.

References

- [1] Bachem, A. and M. Grötschel, "New aspects of polyhedral theory", in B. Korte (ed.) *Modern Applied Mathematics - Optimization and Operations Research*, North Holland (1982), 51-106.
- [2] Boulala, M. and J.P. Uhry, "Polytope des independants d'un graph serie-parallele", *Discrete Mathematics* 27(1979), 225-243.
- [3] Cornuejols, G., D. Hartvigsen and W. Pulleyblank, "2-Factors and Triangle-Free 2-Factors", to appear.
- [4] Cornuejols, G., Naddef, D. and W. Pulleyblank, "Halin Graphs and the Travelling Salesman Problem", *Mathematical Programming* 16 (1983), 287-294.
- [5] Cornuejols, G. and W. Pulleyblank, "The Travelling Salesman Polytope and $\{0,2\}$ -Matchings", *Annals of Discrete Mathematics* 16 (1982), 27-55.
- [6] Crowder, H. and M.W. Padberg, "Solving Large-Scale Symmetric Travelling Salesman Problems to Optimality", *Management Science* 26 (1980), 495-509.
- [7] Cutler, "Efficient Special Case Algorithm for the N Line Planar Travelling Salesman Problem", *Networks* 10 (1980), 183-195.
- [8] Edmonds, J., "Maximum Matching and a Polyhedron with 0,1 Vertices", *Journal of Research of the National Bureau of Standards* 69 B (1965), 125-139.
- [9] Edmonds, J., "Matroid Intersection", *Annals of Discrete Mathematics* 4 (1979), 39-49.
- [10] Garfinkel, R.S., "Minimising Wallpaper Waste, Part I: A Class of Travelling Salesman Problems", *Operations Research* 25 (1977), 741-751.
- [11] Giles, F.R. and L.E. Trotter, "On Stable Set Polyhedra for $K_{1,3}$ - Free Graphs", *Journal of Combinatorial Theory B* 31(1981), 313-328.
- [12] Gilmore, P.C. and R.E. Gomory, "Sequencing a one State-Variable Machine: A Solvable Case of the Travelling Salesman Problem", *Operations Research* 12 (1964), 655-679.
- [13] Grötschel, M., "On the Monotone Symmetric Travelling Salesman Problem: Hypohamiltonian/Hypotractable Graphs and Facets", *Mathematics of Operations Research* 5 (1980), 285-292.

- [14] Grötschel, M., *Polyedrische Charakterisierungen kombinatorischen Optimierungsprobleme*, Verlag Anton Hain, Meisenheim am Glan (1977).
- [15] Grötschel, M., Lovász, L. and A. Schrijver, "The Ellipsoid Method and its Consequences in Combinatorial Optimisation", *Combinatorica* 1 (1981), 169-197.
- [16] Grötschel, M. and M.W. Padberg, "On the Symmetric Travelling Salesman Problem I and II", *Mathematical Programming* 10 (1979), 295-302.
- [17] Grötschel, M. and W. Pulleyblank, "Clique Tree Inequalities and the Symmetric Travelling Salesman Problem", Report 81108-OR Institut für Ökonometrie und Operations Research, Bonn (1981). (to appear in *Mathematics of Operations Research*.)
- [18] Halin, R., "Studies on Minimally n -Connected Graphs", *Combinatorial Mathematics and its Applications*, D.J.A. Welsh ed., Academic Press (1971), 129-136.
- [19] Held, M. and R. Karp, "The Travelling Salesman Problem and Minimum Spanning Trees", Part I in *Operations Research* 18 (1970), 1139-1162, Part II in *Mathematical Programming* 1 (1971), 6-25.
- [20] Lawler, E., "A Solvable Case of the Travelling Salesman Problems", *Mathematical Programming* 1 (1971), 267-289.
- [21] Little, G., Murty, K., Sweney, D. and C. Karel, "An Algorithm for the Travelling Salesman Problem", *Operations Research* 11 (1963), 972-980.
- [22] Lovász, L. and M. Plummer, "On a Family of Planar Bicritical Graphs", *Proceedings of the London Mathematical Society* 30 (1975), 160-176.
- [23] Minty, G., "On Maximal Independent Sets of Vertices in Claw-Free Graphs", *Journal of Combinatorial Theory B* 28 (1980), 286-304.
- [24] Naddef, D. and W. Pulleyblank, "Ear Decomposition of Elementary Graphs and G F_2 -Rank of Perfect Matchings", *Annals of Discrete Mathematics* 16 (1982), 261-269.
- [25] Pulleyblank, W., "The Matching Rank of Halin Graphs", Rapport de Recherche 210 IMAG, Université Scientifique et Médicale de Grenoble, France (1980).

- [26] Ratliff, H.D. and A.S. Rosenthal, "Order-Picking in a Rectangular Warehouse. A Solvable Case of the Travelling Salesman Problem", *Operations Research* 31 (1983), 507-521.
- [27] Sbihi, N., "Algorithme de recherche d'un stable de cardinalité maximum dans un graphe sans étoile", *Discrete Mathematics* 29 (1980), 53-70.
- [28] Syslo, M., "A New Solvable Case of the Travelling Salesman Problem", *Mathematical Programming* 4 (1973), 347-348.
- [29] Syslo, M. and A. Proskurowski, "On Halin Graphs", to appear in *Proceedings of The Tagow conference dedicated to the memory of P. Kuratowski (1981)*.

ANNEXE 7

1

The Travelling Salesman Problem on a Graph and Some Related Integer Polyhedra

Gerard CORNUEJOLS

Denis NADFF

Jean FONLUPT

1. INTRODUCTION :

Given a graph $G = (N, E)$ and a function $l: E \rightarrow R$ which associates to each arc $e \in E$ its length or cost $l(e)$, the classical Travelling Salesman Problem, denoted TSP, is that of finding a hamilton cycle of G , say $C = (N, H)$, whose length $\sum(l(e) : e \in H)$ is minimum. (A Hamilton cycle of G is a cycle going exactly once through each node). The problem derives its name from the following interpretation: the nodes of the graph are cities that must be visited by a salesman and the edges represent roads. One of the cities is the travelling salesman's home town from which he starts his tour and to which he must return.

Two difficulties arise in stating the travelling salesman problem as above. First the graph G may not have a hamilton cycle; second even when the graph has a hamilton cycle, the shortest way to visit all nodes may not be to follow a hamilton cycle. Instead the travelling salesman may find it shorter to go through some nodes more than once and use some edges more than once. The traditional way to overcome these difficulties is to transform G into a complete graph $K = (N, E)$ on the same nodeset. The length function $l : E \rightarrow R$ is defined as follows:

for every $e \in F$, $l(e)$ is the length of the shortest path of G joining the endpoints of e . Solving the TSP on K instead of G clearly resolves the two difficulties just mentioned. In fact, with only a few exceptions, an underlying complete graph is usually assumed in the literature when the TSP is defined.

However, the transformation of G into K has two drawbacks of its own. In most solution technics a variable is associated with each edge of the graph. Therefore the TSP on K requires $(N-1)N/2$ variables even when the original graph is sparse which is often the case in applications where the graphs encountered are more or less planar. The second drawback is that the original problem may be easier to solve on G than the TSP on a complete graph. Such is the case for a class of graphs introduced by Ratcliff and Rosenthal [7] in connection with the picking up of orders in a rectangular warehouse. They present a linear time algorithm for this problem. This latter class is extended in section 4. Another class of graphs for which the TSP can be solved in linear time is given in Cornuejols, Naddef and Pulleyblank [1]. For these reasons we prefer to avoid using the complete graph K . We propose an alternative way to overcome the deficiencies of the classical definition of the TSP when it is applied to a general graph G . Our approach is to introduce a new version of the TSP which we call the graphical travelling salesman problem.

A tour of a connected graph G is a cycle going at least once through each node of G . (Here a cycle may use the same node or the same edge more than once). The length of a tour $T=(v_1, e_1, \dots, v_k, e_k, v_1)$ is $l(T) = \sum_{i=1}^k l(e_i)$. The graphical travelling salesman problem, denoted by GTSP, consists in finding a tour of G whose length is minimum. The importance of this problem was pointed out by Fleischman

[3]. Of course TSP is NP-hard since, setting $l(e)=1$ for all $e \in E$, its solution would show whether or not G has a Hamilton cycle, a known NP-complete problem..

If an edge has a negative length it is an absorbing one since, using this edge an indefinite number of times, one can obtain tours of length as small as wanted. In other words, there is no finite optimum solution. In the remainder we assume that all edge lengths are nonnegative. With this assumption it can easily be shown that an edge is used at most twice in an optimum solution.

To each tour of G we associate an integral vector $x=(x_e : e \in E)$ where x_e is the number of times that edge e occurs in the tour. In terms of x the length of a tour is simply $\sum (l(e)x_e : e \in E)$. The vector x will also be called a tour.

In this paper, for $U \subseteq E$, $x(U)$ denotes $\sum (x_e : e \in U)$. For $S \subseteq N$, $\gamma(S)$ denotes the set of edges with both ends in S and $\delta(S)$ those with exactly one end in S . Also $\delta(\{v\})$ is abbreviated by $\delta(v)$. With this notation, the tours are those vectors $x \in \mathbb{R}^{|E|}$ which satisfy

- (1.1) $x_e \geq 0$ and integer, for all $e \in E$.
- (1.2) $x(\delta(v))$ is a positive even integer, for all $v \in N$.
- (1.3) the graph induced by the edges such that $x_e > 0$ is connected.

Equivalently $x \in \mathbb{R}^{|E|}$ is a tour if and only if it satisfies relations (1.1), (1.2) and

- (1.4) $x(U) \geq 2$, for every cutset $U \subseteq E$.

(an edge cutset $U \subseteq E$ is a set of edges such that $U = \delta(S) = \delta(N-S)$ for

some nonempty $S \subset N$. These two sets, S and $\bar{S} = N - S$ are then called the shores of the edge cutset U).

The convex hull of the tours of G will be denoted by GTSP(G). Note that this polyhedron is not bounded and that the classical travelling salesman polytope $TSP(G)$ is a face of $GTSP(G)$. In fact $TSP(G) = GTSP(G) \cap \{x \in R^{|E|} : x(E) = |N|\}$.

In section 2 we show that, when G is connected, the polyhedron $GTSP(G)$ is full-dimensional i.e. of dimension $|E|$. The inequalities (1.4) define facets (i.e. faces of dimension $|E|-1$) of this polyhedron if and only if the graphs induced by the shores of the edge cutset are both connected. These facets are in fact the subtour elimination inequalities which have become usual in the definition of $TSP(G)$. The facets (1.4) and the essential nonnegativity conditions are called the trivial facets of $GTSP(G)$. The main result of section 2 is a class of valid inequalities (which we call "path inequalities") for $GTSP(G)$ which are shown to generalize the comb inequalities for $TSP(G)$, (see Grötschel and Padberg [5]). Some other classes of facets are also presented in that section.

In section 3 we introduce four polyhedra which are related to $GTSP(G)$. In particular we give a full description of $P_1 = \text{conv}\{x \in R^{|E|} : (1.1) \text{ and } (1.2) \text{ hold}\}$ and $P_2 = \text{conv}\{x \in R^{|E|} : (1.1) \text{ and } (1.3) \text{ hold}\}$. The polyhedron $P_3 = \text{conv}\{x \in R^{|E|} : (1.1) \text{ and } (1.4) \text{ hold}\}$ may also be of some interest since it contains $TSP(G)$ as a face.

In section 4 we introduce a generalization of the graphical travelling salesman problem. In addition to the graph G and the length function l , we are given a subset $V \subset N$ of the nodes. A Steiner tour is a cycle going at least once through each nodes of V . However the cycle

is not required to pass through the nodes of $N-V$. The Steiner travelling salesman problem, denoted by STSP, consists in finding a Steiner tour of G whose length is minimum. Of course the CTSP is the special case of STSP where $V=N$. In this section we give an efficient algorithm to solve STSP on a series-parallel graph.

2. Some Facets of the Graphical Travelling Salesman Polyhedron.

Desirable polyhedra are those which are full dimensional. Reasons for this is that the minimal set of inequalities defining those polyhedra is unique (up to scaling any inequality by a positive constant). Moreover in such a set each inequality induces a facet. In other words each facet has a unique description by a linear inequality, up to scaling by a constant. This is of course no longer true if the polyhedron is not full dimensional. First we show that the graphical travelling salesman polyhedron, $GTSP(G)$, is either empty or full-dimensional. We then show that if G is 2-connected the convex hull of extreme points of $GTSP(G)$ is also full dimensional.

Theorem 2.1: If G is not connected then $GTSP(G) = \emptyset$. If G is connected, then $GTSP(G)$ is full-dimensional.

Proof : If G is not connected no tour exist. If G is connected , then consider any tour x and the $|E|$ tours $x + Mv^i$ where M is a large even integer and v^i is the unit vector such that $v_j^i = 1$ and $v_j^i = 0$ for $i \neq j$. These $|E|+1$ tours are affinely independant.

The proof of Theorem 2.2 will need the following lemma which is a particular instance of a theorem on the convex hull of independent sets of a matroid (see [2]).

Lemma 2.2: Let $G = (N, E)$ be a graph then:

1) The convex hull of the representative vectors of the acyclic subgraphs of G is described by the following set of inequalities :

$$\begin{cases} x_e > 0 & \text{for all } e \in E \\ x(\gamma(S)) \leq |S|-1 & \text{for all } S \subset N \end{cases}$$

2) The convex hull $ST(G)$ of the representative vectors of the spanning trees of G is obtained by setting to equality those constraints which correspond to maximal subsets S of N such that the induced subgraph $G(S)$ is connected and without cutnode.

3) $\dim(ST(G)) = |E| - \text{number of blocs of } G$ (a bloc is a maximal subset of N without cutnode)

Proof : see [2].

Theorem 2.3: Let $G = (V, E)$ be a 2-connected graph , then the convex hull of extreme points of $GTSP(G)$ is a full dimensional polytope .

Proof : As a consequence of Lemma 2.2 $\dim(ST(G)) = |E| - 1$ since G is 2-connected. So there exist $|E|$ linearly independent trees $A_1, \dots, A_{|E|}$. Consider the $|E|$ tours $T_1, \dots, T_{|E|}$ where T_1 is obtained by

taking twice each arc of A_1 . Now add to A_1 an arc not in that tree. This yields a unique cycle, let $T_{|E|+1}$ be the tour obtained by taking once each edge of that cycle and twice the other edges of A_1 . These $|E|+1$ tours are linearly independent since the $|E|$ first ones are so and the last one is the only one not to have the sum of the values of its variables equal to $2(|N|-1)$.

A bridge of a graph is an edge whose removal disconnects the graph. In the next two theorems we derive the so-called trivial facets of $\text{GTSP}(G)$.

Theorem 2.4: $x_e \geq 0$ is a facet of $\text{TSP}(G)$ if and only if e is not a bridge of G .

Proof : If e is a bridge then $x_e > 0$ in every tour of G . Conversely if e is not a bridge, then let x be a tour such that $x_e = 0$. (Such a tour exists since G is 2-connected.) The tour x and the $|E|-1$ tours $x + Mv^j$, $j \neq e$, are affinely independent, M and v^j being defined as in proof of Theorem 2.1.

For any $S \subset N$, we denote by $G(S)$ the subgraph of G induced by the nodeset S .

Theorem 2.5: Let U be an edge cutset with shores S and \bar{S} . The valid inequality $x(U) \geq 2$ is a facet of $\text{GTSP}(G)$ if and only if the graphs $G(S)$ and $G(\bar{S})$ are both connected.

Proof : If, say, $G(S)$ is not connected then let $S_1 \subset S$ be a node set which induces a connected component of $G(S)$. Then the cutset $\delta(S_1)$ is

strictly contained in U . Therefore the valid inequality $x(\delta(S_1)) \geq 2$ is stronger than $x(U) \geq 2$, showing that the latter inequality cannot induce a facet.

Conversely assume that $G(S)$ and $G(\bar{S})$ are both connected. For each $u \in U$, let x^u be a tour such that $x_e^u = 2$ and $x_e^u = 0$ for every $e \in U - \{u\}$. In addition, consider the tours $x^u + Mv^i$ for some $u \in U$ and for every $i \in U$ where M and v^i are as defined in the proof of Theorem 2.1. These $|E|$ tours are affinely independent and they all satisfy $x(U) = 2$.

An interesting question is to characterize the graphs for which the facets of Theorems 2.4 and 2.5 completely define $GTSP(G)$. A small graph for which these facets are not sufficient is given in figure 1 where $x(E) \geq 10$ defines a facet. Note that the graph of Figure 1 comprises three node disjoint paths joining a common origin and destination. This provided our motivation for introducing what we are going to call "path inequalities". These inequalities generalize the 3-star constraint defined by B. Fleischman [3].

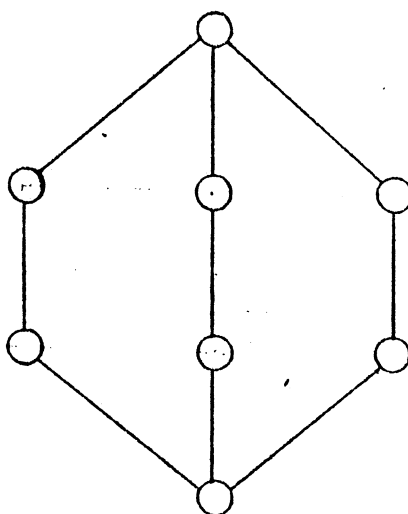

Figure 1

For V_1 and V_2 two disjoint sets of nodes we denote by (V_1, V_2) the set of edges with one end in V_1 and the other in V_2 . In the following when we will talk of two edges of (V_1, V_2) these are not necessarily distinct.

Consider the following k-path configuration (Figure 2) defined by:

* $k \geq 3$ an odd integer, $n_i \geq 2$ and integral for all $i=1, \dots, k$.

* $\{A, Z, \{B_j^i : i=1, \dots, k \text{ and } j=1, \dots, n_i\}\}$ form a partition of N

For convenience let $B_0^i = A$ and $B_{n_i+1}^i = Z$ for all i .

* The subgraphs $G(P_j^i)$ are connected for all i and all j .

* $|E_j^i, B_{j+1}^i| \geq 1$ for all i and all j .

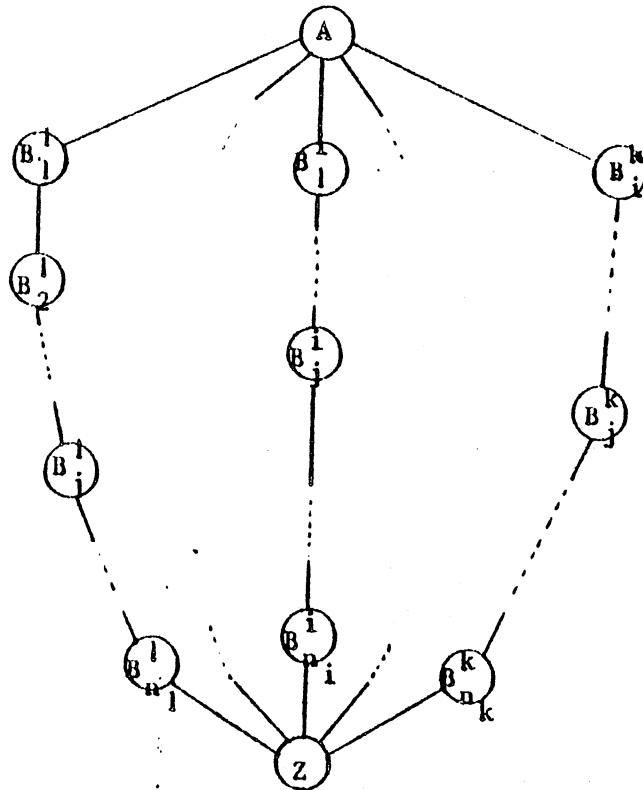

Figure 2

The path inequality corresponding to this configuration is:

$$\sum_{e \in E} f_e x_e \geq a=1+ (n_1+1)/(n_1-1)$$

where

$$f_e = \begin{cases} 1 & \text{for any } e \in (A, Z) \\ |j-p|/(n_i-1) & \text{for any } e \in (E_j^i, E_p^i) \text{ for some } i, |j-p| \leq n_i, p \neq j \\ \max(p/(n_r-1) - (j-2)/n_i - 1, j/(n_i-1) - (p-2)/(n_r-1)) & \text{for } e \in (E_j^i, E_p^r), \\ & j \neq 0 \text{ and } n_i - 1, p \neq 0 \text{ and } n_r - 1, r \neq i \\ 0 & \text{else} \end{cases}$$

An interesting particular case is obtained when $n_i = n \geq 2$ for all $i=1, \dots, k$. Such a configuration will be called n-regular. We can then multiply each inequality by $n-1$ to obtain easily integer coefficients and one has:

$$\sum_{e \in E} f_e x_e \geq (k+1)(n+1)+2n$$

where

$$f_e = \begin{cases} n-1 & \text{for } e \in (A, Z) \\ |j-p| & \text{for } e \in (E_j^i, E_p^i) \text{ for all } i \text{ and } j \neq p \\ |p-j|+2 & \text{for } e \in (E_p^i, E_j^r) \text{ } p, j \neq 0 \text{ and } n-1, r \neq i \\ 0 & \text{else} \end{cases}$$

When $k=3$ and $n=2$ this is exactly the 3-star constraint given by B. Fleischman

The case $n=1$ is not a particular case of k -path inequalities since it was assumed that $n_i \geq 2$ for all i . Nevertheless one can use $n=1$ in the preceding regular configuration to obtain a valid inequality which is

not a facet since this inequality can be obtained summing up all $x(P_j^1) \geq 2$ $j=1, \dots, k$. This fact will be needed in the proofs of Theorems 2.12 and 2.14.

Theorem 2.6: Path inequalities are valid for GTSP(G).

Proof : To show the validity of an inequality $\sum_{e \in E} f_e x_e \geq a$ one must show that the minimum cost of a tour is "a" when the cost function is defined by the f_e 's. Also note that the more edges in the graph less an inequality $\sum_{e \in E} f_e x_e \geq a$, $f_e \geq 0$ for all e , is likely to be valid so we will never have to worry about the existence of the edges we need in the proof of validity of such an inequality. First assume the tour x only uses edges from $\{(P_j^1, B_{j+1}^1) : j=0, \dots, n, i=1, \dots, k\}$, (these edges will be called edges of the skeleton of the k -path configuration). Any minimum cost such a tour uses a single edge of each (P_j^1, B_{j+1}^1) for $i \neq r$, for $i=r$ 2 such edges are used except for some $j=j^*$ for which none is used. In other words $k-1$ paths are used once the other is broken in two parts each used twice. The choice of the values of the f_e 's is such that for any $1 < r < k$ and any $0 < j^* \leq n$ the cost of such a tour is "a". Note that for e not an edge of the skeleton f_e is defined in such a way that a minimum cost tour using only edges from the skeleton except e has cost "a".

Now assume the inequality is not valid. Let x be a tour with cost less than "a" such that the number of edges not in the skeleton is minimum among all tours not satisfying the inequality. It is easy to see that x does not contain any edge from any (B_j^1, B_t^1) , $|j-r| > 1$, for any j , since one can replace any such edge taking instead one edge of each (B_t^1, B_{t+1}^1) $t=j, \dots, r-1$ obtaining a tour of same cost but with less

edges outside the skeleton.

Note that for any $e \in (E_j^i, E_p^r)$, $r \neq i$, one has $f_e \geq 1/(n_j-1) + 1/(n_r-1)$ since: assume w.l.o.g. that:

$$f_e = p/(n_r-1) - (j-2)/(n_i-1) \geq j/(n_i-1) - (p-2)/(n_r-1)$$

this leads to: $2(p-1)/(n_r-1) > 2(j-1)/(n_i-1)$. Since:

$$f_e - (1/(n_r-1) + 1/(n_i-1)) = (p-1)/(n_r-1) - (j-1)/(n_i-1) \geq 0$$

one has that:

$$f_e \geq 1/(n_r-1) + 1/(n_i-1) \text{ for all } e \in (E_j^i, E_p^r), r \neq i.$$

If x contains an edge e of (A, Z) then obviously it cannot violate the inequality since by the previous remark e is completed the cheapest way to a tour using a single edge of each (E_j^i, E_{j+1}^i) . So, since k is odd, there must exist some r such that either no edge or two of (A, B_1^r) are in x . Assume that x contains no edge of any (E_j^r, E_p^i) , $i \neq r$, then x contains two edges of each (E_j^r, B_{j+1}^r) except perhaps for one value of j . But then the tour obtained from x by taking the same edges outside the r th path, taking one edge from each (E_j^r, B_{j+1}^r) and one from (A, Z) yields a tour of cost at most that of x which we just saw is impossible. So let j^* be the smallest j such that x uses an edge e^* of (E_j^r, B_p^i) for some $i \neq r$ and some p . By the choice of j^* and r , for every $t \leq j^*$ except maybe for one, say t^* , the tour x has two edges in (B_t^r, B_{t+1}^r) . Since $f_{e^*} \geq (p/n_i-1) - ((j^*-2)/n_r-1)$ the tour obtained from x by deleting e^* , adding, if necessary, an edge of $(E_{t^*}^r, B_{t^*+1}^r)$, deleting one from each (E_t^r, B_{t+1}^r) , $t \neq t^*$, $t \leq j^*$, and finally adding one from each (B_t^i, B_{t+1}^i) , $0 \leq t \leq p-1$, yields a tour of cost at most that of x which again contradicts the minimality of x and ends the proof.

Theorem 2.7: Path inequalities define facets of TSP(C).

Proof: Let $\sum_{e \in E} f_e x_e \geq a$ be a path inequality (which we will refer to as inequality 1 in this proof). Assume it does not define a facet. Then there exists an inequality, say $\sum_{e \in E} c_e x_e \geq a$, (inequality 2), such that the face defined by the first inequality is contained in the facet defined by the latter. Our aim is to show that $c_e = f_e$ for all $e \in E$. We first show that c_e has the same value for each edge of the same path, i.e. $c_e = c^r$ for $e \in (B_j^r, B_{j+1}^r)$ for all j . Let x be a tour using one edge of each (B_j^1, B_{j+1}^1) for $1 \neq r$ and two edges of every (B_j^r, B_{j+1}^r) except for $j=j^*$. This tour x satisfies inequality 1 with equality and hence it is also the case for inequality 2. Any tour obtained from x by just changing the value of j^* also satisfies both inequalities with equality which proves the previous statement. Changing in x the value of r also yield tours satisfying with equality both inequalities. The different c^r , $r=1, \dots, k$, must hence satisfy a system of k equalities whose unique solution is $c^r = 1/(n_r - 1)$ for $r = 1, \dots, k$. Now let e^* be an edge not in the skeleton and x be a tour using e^* and only edges of the skeleton, which satisfies inequality 1, and hence inequality 2, with equality (such a tour we know exists). Since $c_e = f_e$ for all edges in the skeleton one trivially obtains $c_{e^*} = f_{e^*}$ which ends this proof.

A comb C is defined by a set $W_0 \subset N$ called the handle and k disjoint subsets, k odd, W_1, \dots, W_k called the teeth, these having a nonempty intersection with W_0 . Let TSP(G) be the convex hull of the incidence vectors of Hamilton cycles of a complete graph G , the comb inequality associated to the comb C is (see for example [5]):

$$\sum_i x(\gamma(W_i)) \leq |W_0| + \sum_{i=1}^k (|W_i| - 1) - [k/2].$$

where $[t]$ denotes the greatest integer smaller or equal to t .

Remark 2.8: The path inequalities for GTSP(G) generalize those comb
 inequalities for TSP(G) for which $W_0 = \cup_{i=1}^k W_i \neq \emptyset$. To see this consider a
 path inequality $\sum_{e \in E} f_e x_e \geq a$ for which $n_i = 2$ for all i and let $W_0 = \cup_{i=1}^k F_i$
 and $W_i = B_1^i \cup B_2^i$. Since for TSP, $x(\delta(v)) = 2$ for all $v \in N$, one has for all $W \subset$

N : $x(\gamma(W)) = |W| - 1/2 x(W, \bar{W})$ so:

$$\sum_{i=0}^k x(\gamma(W_i)) = \sum_{i=0}^k |W_i| - 1/2 x(W_i, \bar{W}_i) = \sum_{i=0}^k |W_i| - 1/2 \sum_{e \in E} f_e x_e$$

$$\leq \sum_{i=0}^k |W_i| - 1/2(3k+1) = |W_0| + \sum_{i=1}^k (|W_i| - 1) - 1/2(k+1)$$

and since this quantity must be an integer, one may replace $1/2(k+1)$ by $[k/2]$.

When studying the extreme points of the polyhedron defined by the inequalities (1.1) and (1.4) one may find the following extreme points. Let $H = (W, F)$ consist of two odd cycles of same length k joined by a matching (see Figure 3) and let $x_e = 1/2$ for all e on each one of the two cycles and $x_e = 1$ for e belonging to the matching.

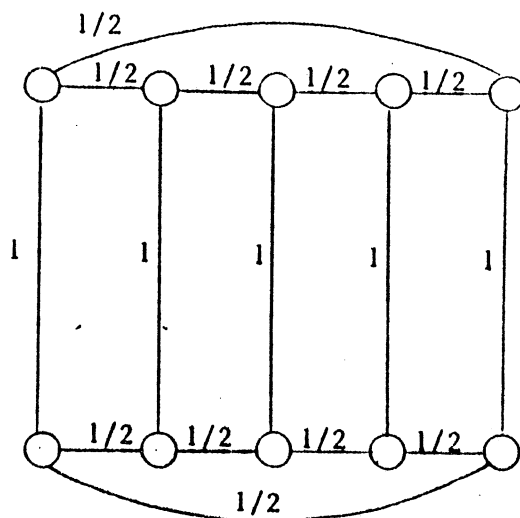

Figure 3

this is an extreme point since there are $|F|$ linearly independent equalities $x(U) = 2$, namely those where $U = \delta(v)$ for every v in N and $U = \delta(\{u, v\})$ where u and v are the two ends of an edge of the matching.

This is the motivation of the following bicycle inequalities.

A bicycle consists of a partition of N into $2k$ subsets A^i and B^i , $i=1, \dots, k$, k odd, such that the induced subgraphs $G(A^i)$ and $G(B^i)$, $i=1, \dots, k$ are connected and finally such that $(A^i, A^{i+1}) \neq \emptyset$ so as (B^i, B^{j+1}) and (A^i, B^j) for all i . (see Figure 4).

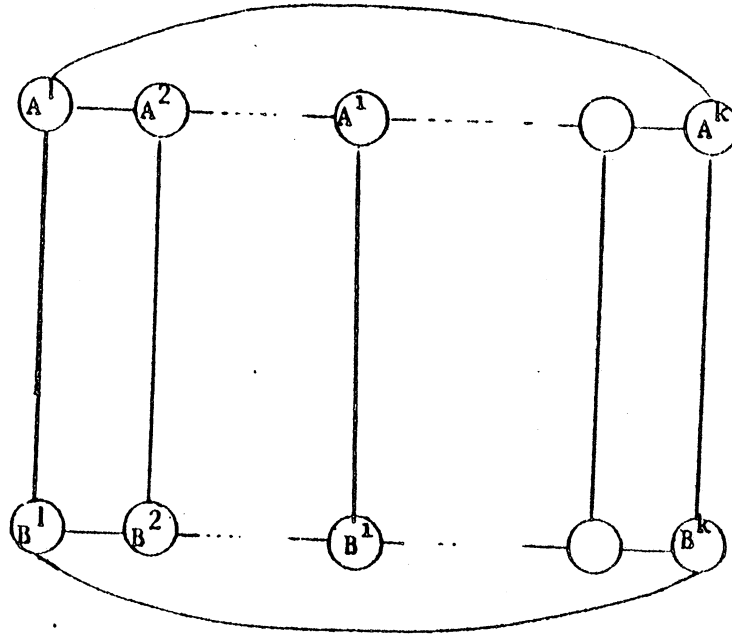

Figure 4

The bicycle inequality is the following $\sum_{e \in E} f_e x_e \geq 3k+1$ where

$$f_e = \begin{cases} 1 & \text{if } e \in (A^i, B^i) \text{ for some } i \\ 2 & \text{if } e \in (A^i, A^j) \text{ or } (B^i, B^j) \text{ for some } i \neq j \\ 3 & \text{if } e \in (A^i, B^j) \text{ for some } i \neq j \\ 0 & \text{else} \end{cases}$$

Theorem 2.9: Bicycle inequalities are valid inequalities for CTSP(G).

Proof: Let $Qx \geq b$ be a system of valid inequalities, $x \geq 0$ and integer

implies that for $r=(r_1, r_2, \dots)$ the following inequality is also valid:

$(\langle rQ \rangle - [r]Q)x \geq \langle rb \rangle - [r]b$, where $\langle a \rangle$ (resp. $[a]$) denotes the smallest (resp. the largest) integer greater (resp. smaller) or equal to a (see for example Fleischman [3]).

Consider the following system of inequalities where $t=[k]$:

$$\left\{ \begin{array}{ll} x(A^i, A^i) \geq 2 & \text{for all } i \text{ with } r=t/k \\ x(B^i, B^i) \geq 2 & \text{for all } i \text{ with } r=t/k \\ x(A^i \cup B^i, A^i \cup B^i) \geq 2 & \text{for all } i \text{ with } r=(t+1)/k \\ x(\cup_i A^i, \cup_i B^i) \geq 2 & \text{with } r=1/k \end{array} \right.$$

then one gets that $\sum_{e \in E} f_e x_e \geq 3k$ where the f_e 's are defined as in the statement of the Theorem. Now, since all f_e 's are integers and the set of edges with odd f_e is exactly the set of edges $(\cup_i A^i, \cup_i B^i)$ an even number of which must be taken in any tour, $\sum_{e \in E} f_e x_e$ must be even. Since $3k$ is odd one has the desired inequality.

The following theorem gives a sufficient condition for such an inequality to define a facet.

Theorem 2.10: For $k=3$ the bicycle inequality defines a facet. For $k \geq 5$ if for all i , $(A^i, A^{i+2}) \neq \emptyset \neq (B^i, B^{i+2})$, then the bicycle inequality defines a facet.

Proof: Assume it defines a face which is not a facet. Then there exists an inequality which induces a facet that contains that face. Let it be $\sum_{e \in E} c_e x_e \geq 3k+1$. For convenience the bicycle inequality will be referred to as inequality 1 and the other as inequality 2. Our aim is

to show that $c_e = f_e$ for all $e \in E$. Consider the following tours described by Figure 5.

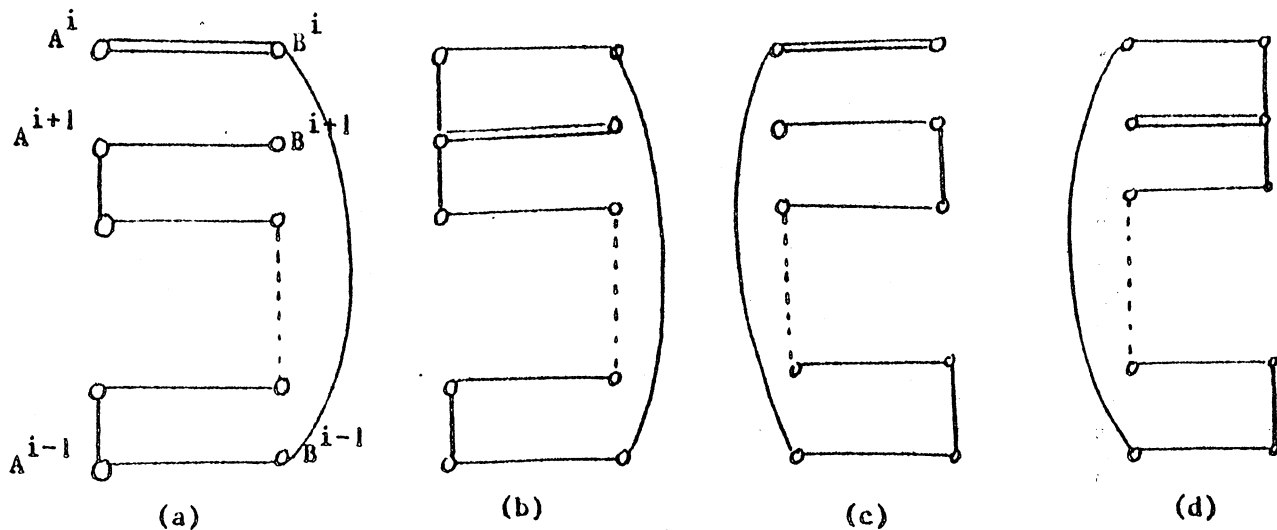

Figure 5

All satisfy inequality 1 with equality so such must be the case for equality 2. Let $r_1 = c_e$ for e in (A^i, A^{i+1}) , $t_1 = c_e$ for e in (B^i, B^{i+1}) and $z_1 = c_e$ for e in (A^i, B^i) . Tours given by Figures 5 (a) and (b) imply that $r_1 + z_{1+1} = t_1 + z_1$ and those of Figure 5 (c) and (d) imply that $t_1 + z_{1+1} = r_1 + z_1$ which yield that $z_1 = z_{1+1}$ for all i and hence $r_1 = t_1$. A first consequence is that $z_1 = z$ for all i . First assume $k \neq 3$ and consider the three following tours given in Figure 6

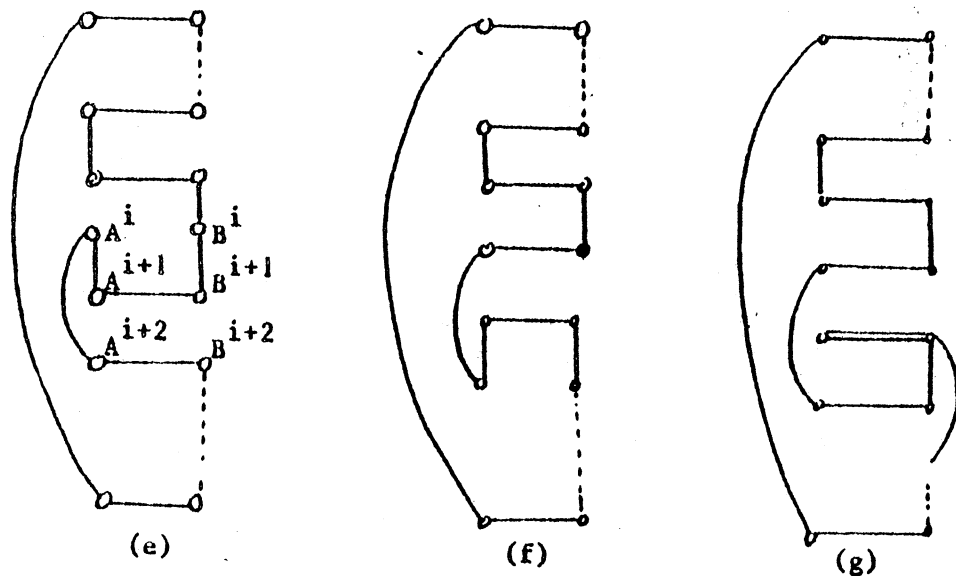

Figure 6

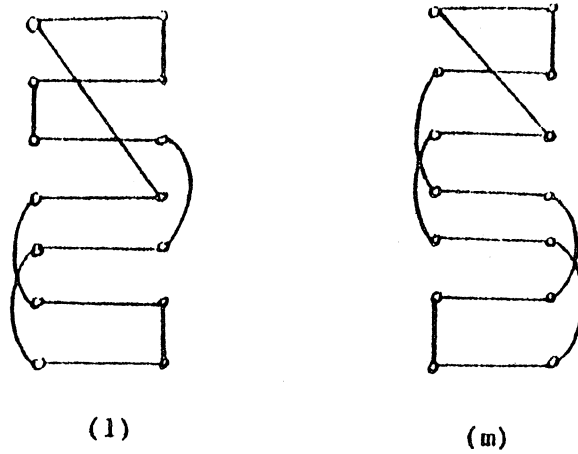

Figure 8

These show that $c_e = 3$ since both tours satisfy inequality 1 with equality. This ends the case $k > 5$.

If $k=3$, the following tour given in Figure 9 shows that $r_i = r$ for all $i=1, 2$ or 3 and since $4z+3r=2z+4r=10$ one has $r=2z$ and hence $r=2$ and $z=1$.

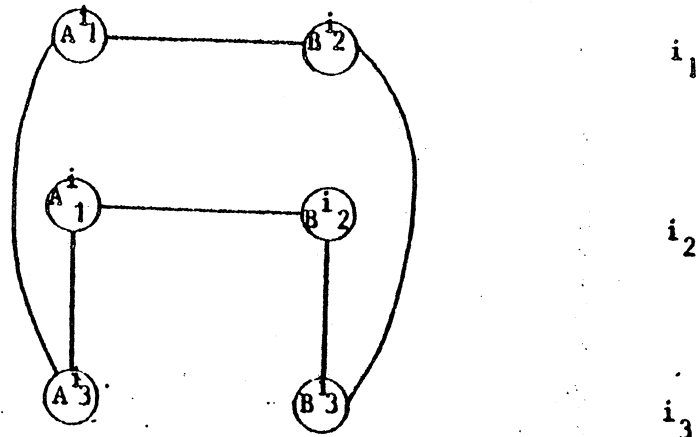

Figure 9

Remark 2.11: These inequalities also generalize comb inequalities for $TSP(G)$. To see this let the handle be $W_0 = \bigcup_{i=1}^k A^i$ and the teeth $W_i = A^i \cup B^i$. Note that each vertex of the handle is contained in a teeth.

Replacing in the previous configuration each edge of the matching by a path of length n (see figure 10) yields another facet inducing

configuration. Let C_j^i $i=1, \dots, k$; $j=1, \dots, n$ be j th vertex set on the i th path. In addition to the hypotheses of Theorem 2.10 one assumes that each subgraph $G(C_j^i)$ is connected and that $(C_j^i, C_{j+1}^i) \neq \emptyset$ for all i and j .

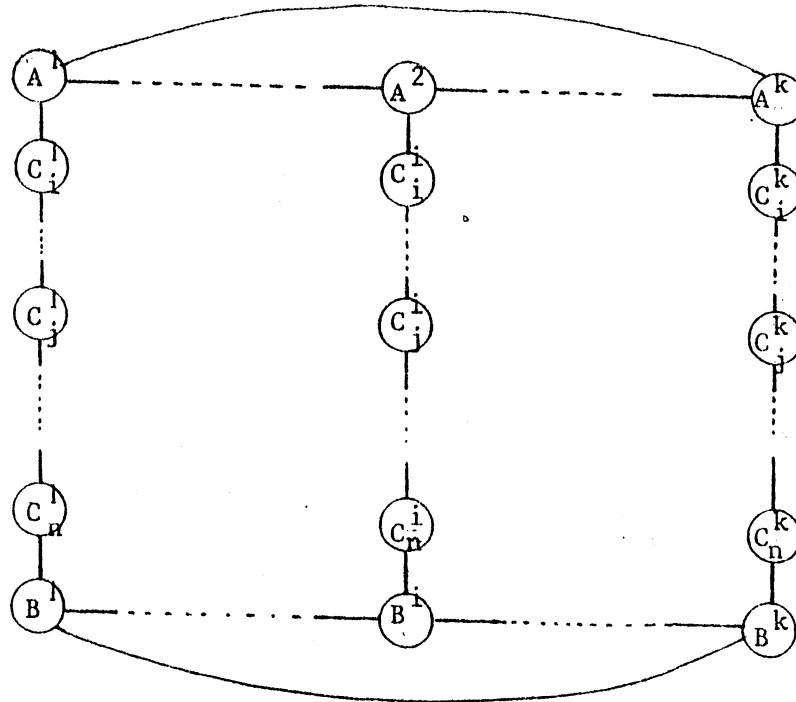

Figure 10

The generalized bicycle inequality is the following: $\sum_{e \in E} f_e x_e \geq a$ where:

$$a = (k+1)(n+1) + 2k$$

and

$$f_e = \begin{cases} 1 & \text{if } e \in (C_j^i, C_{j+1}^i) \text{ for } j=0, \dots, n \text{ and all } i. \\ 2 & \text{if } e \in (A^i, A^r) \text{ or } (B^i, B^r) \text{ for some } i \neq r \\ 2+|j-p| & \text{if } e \in (C_j^i, C_p^r) \text{ for } i \neq r \\ |j-p| & \text{if } e \in (C_j^i, C_p^i) \text{ for some } i. \\ 0 & \text{else} \end{cases}$$

where $C_0^i = A^i$ and $C_{n+1}^i = B^i$ for all i .

The sets A^1, \dots, A^k (resp. B^1, \dots, B^k) will be called sets of one of the wheels (resp. the other wheel) of the bicycle. An edge between two

sets of the same wheel will be said in a wheel.

Theorem 2.12: The generalized bicycle inequalities are valid for $GFSP(G)$.

Proof: We assume $n > 1$ since Theorem 2.10 gives the proof for $n=0$. Assume the tour uses only edges of the k paths and of the wheels, i.e. no edge of any (C_j^1, C_q^r) for $i \neq r$, $j \neq 0 \neq q$ and $j \neq n+1 \neq q$. It is easy to see that each such tour uses at least k edges in the wheels. No such tour of cost less or equal to $a = (k+1)(n+1) + 2k$ can use more than $k+1$ such edges because each path has at least $n+1$ edges in any such tour and one path has $2n$ edges in it since k is odd and the number of edges leaving a wheel is even and since $(k+1)(n+1) + 2k - ((k-1)(n+1) + 2n + 2(k+1)) = 0$. This also proves that no such tour containing $k+1$ edges in the wheels can violate the inequality. Any such tour using k edges in the wheels is of the type shown in Figure 11 i.e. every path is used once except one which is used twice. No such tour can violate the inequality.

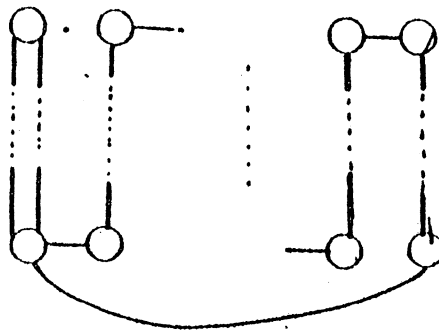

Figure 11

Now let T be a tour with the minimum number of edges outside the wheels and the k paths among all tours which violate the inequality.

For the same reason as in the proof of Theorem 2.6 no such tour can contain an edge of some (C_j^i, C_r^i) for some $j \neq r$. One may assume it contains no edge $e \in (C_j^i, C_r^p)$ for $i \neq p$ and $j < r$ since if it did one could replace e by an edge of (C_j^i, C_j^p) and one of each (C_q^p, C_{q+1}^p) for $q=1, \dots, r-1$, getting a tour of same cost. At most one edge of any (C_j^i, C_j^p) , $i \neq p$, is used in T since if two were in T one could delete them and replace them by two edges in a wheel, if necessary, to reconstruct a tour which has a cost at most that of T which contradicts the minimality of T . If there exist i, p , and $j \geq 1$ such that T contains an edge e^* of (C_j^i, C_j^p) , $i \neq p$ and two of each (C_r^i, C_{r+1}^i) for either $r=0, \dots, j-1$ or $r=j, \dots, n$, the tour obtained from T by deleting e^* and one edge of each (C_r^i, C_{r+1}^i) for $r=0, \dots, j-1$ (or resp. $r=j, \dots, n$), adding one edge of each (C_r^p, C_{r+1}^p) , $r=0, \dots, j-1$ (or resp. $r=j, \dots, n$) and one of (A^i, A^p) (or resp. of (B^i, B^p)) contradicts the minimality of T . (see Figure 12 for the first case)

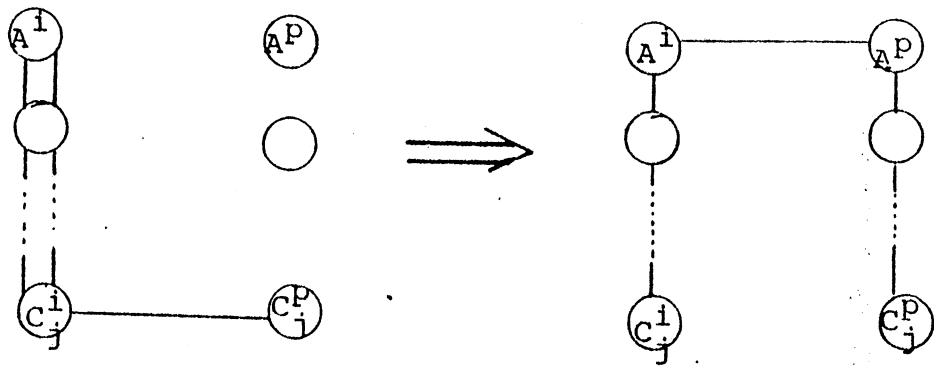

Figure 12.

So assume no such i, p and j exist. If one shrinks the two wheels one finds a n -regular k -path configuration. The coefficients are exactly those defined for that configuration except for those edges which join the two shrunk vertices for which the coefficient is one larger, so one has:

$$(2.1) \quad \sum \{ f_e x_e : e \text{ is not in a wheel} \} \geq (k-1)(n+1)+2n.$$

Each path is in one of the following configurations (Figure 13)

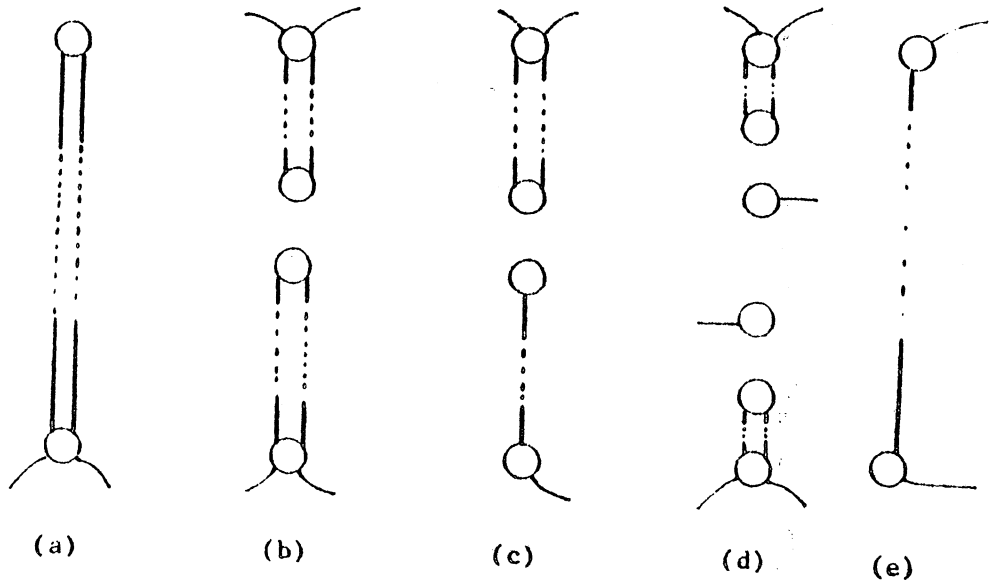

Figure 13

So to each path there corresponds at least 2 edges in the wheels. Since k is odd one of the paths must be of type (a), (b), (c) or (d). If there is one of type (b), (c) or (d) then there are at least $k+1$ edges of T in the wheels. If not there is at least one of type (a). If after shrinking the two wheels one can delete two edges between two sets of that path and maintain a tour of the k -path configuration then the right hand side of the inequality (2.1) can be increased by 2. If one cannot do so, this path is useful in maintaining connectivity so there are at least 2 edges of each wheel incident to it and again one has at least $k+1$ (in fact at least $k+2$) edges of T in the wheels.

Anyhow one gets:

$$\sum_{e \in E} f_e x_e \geq (k-1)(n+1)+2n+2+2k = (k-1)(n+1)+2n+2(k+1) = (k+1)(n+1)+2k \text{ so } T \text{ cannot violate the inequality and this ends the proof.}$$

Theorem 2.13: Under the same hypotheses as Theorem 2.10 the generalized bicycle inequalities define facets of $CTSP(G)$.

Proof: Easy since one may follow step by step the proof of Theorem 2.10

A wheelbarrow configuration is defined like a generalized bicycle configuration where all $B^i, i=1, \dots, k$ are replaced by a single set Z . one assumes that $G(Z)$ is connected and $n \geq 1$. The corresponding wheelbarrow inequality is defined as the generalized bicycle one except that $a = (k+1)(n+1) + 2\lfloor k/2 \rfloor$ and every B^i is replaced by Z (see Figure 14).

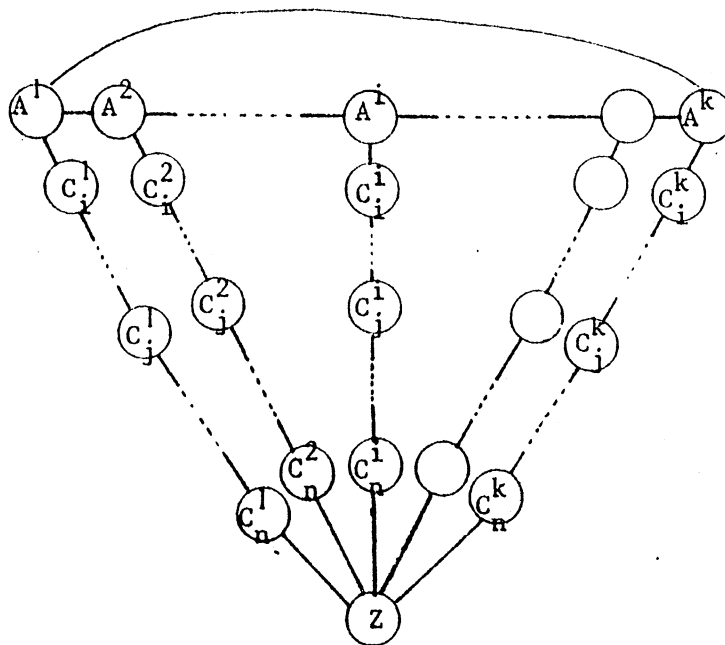

Figure 14

Theorem 2.14: Wheelbarrow inequalities define facets.

Proof: The proof the validity of such an inequality is similar to that of the validity of the bicycle inequalities up to the shrinking of the

wheels. If one shrinks the wheel of our configuration one obtains a n -regular configuration. Since the coefficients induced by the wheelbarrow inequality are those of the n -regular k -path inequality except again for those edges between the shrunken wheel and Z for which this coefficient is one larger one has:

$$\sum \{ f_e x_e : e \notin \text{wheel} \} \geq (k-1)(n+1) + 2n.$$

Moreover in the wheelbarrow each path is of one of the following type: (Figure 15) (assuming that, no i, p, j exist as in Theorem 2.12)

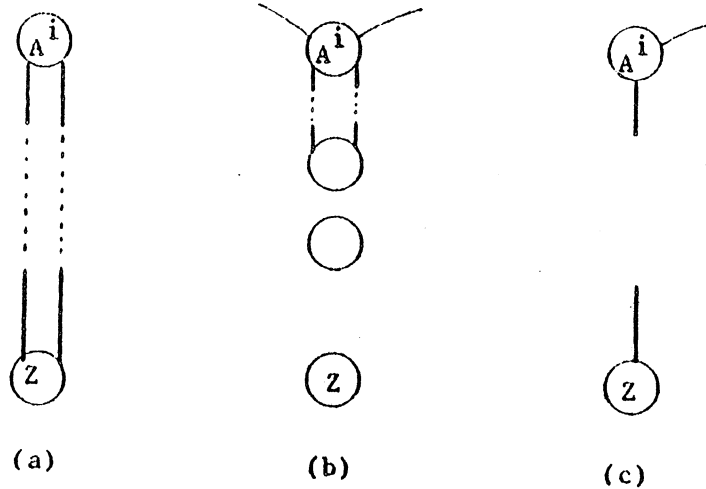

Figure 15

Since k is odd one path at least must be of type (a) or (b). As in the proof of Theorem 2.12, if none of type (b) exist then either one can augment by 2 the right hand side of the preceding inequality or there are 2 edges of the wheel incident to the paths of type (a) and so T contains at least $\lfloor k/2 \rfloor$ edges in the wheel. Since $(k-1)(n+1) + 2n + 2\lfloor k/2 \rfloor + 2 = (k+1)(n+1) + 2\lfloor k/2 \rfloor$, T cannot violate the inequality. This ends the proof of validity. Assume it does not define a facet. Let $\sum_{e \in E} c_e x_e \geq (n+1)(k+1) + \lfloor k/2 \rfloor$ be an inequality defining a facet which contains the face defined by our inequality. Consider the tours described in Figure 16 which use every edge of each path exactly once

except for a given path i for which every edge except one is used twice.

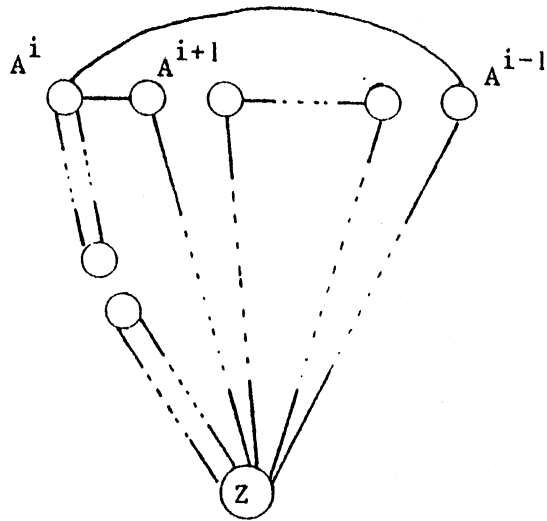

Figure 16

Since these tours only use $(k+1)/2$ edges in the wheel they all satisfy our inequality with equality so must do so with the facet inducing one. This shows that $c_e = c^i$ for all $e \in (C_j^i, C_{j+1}^i)$ for all $j \geq 0$.

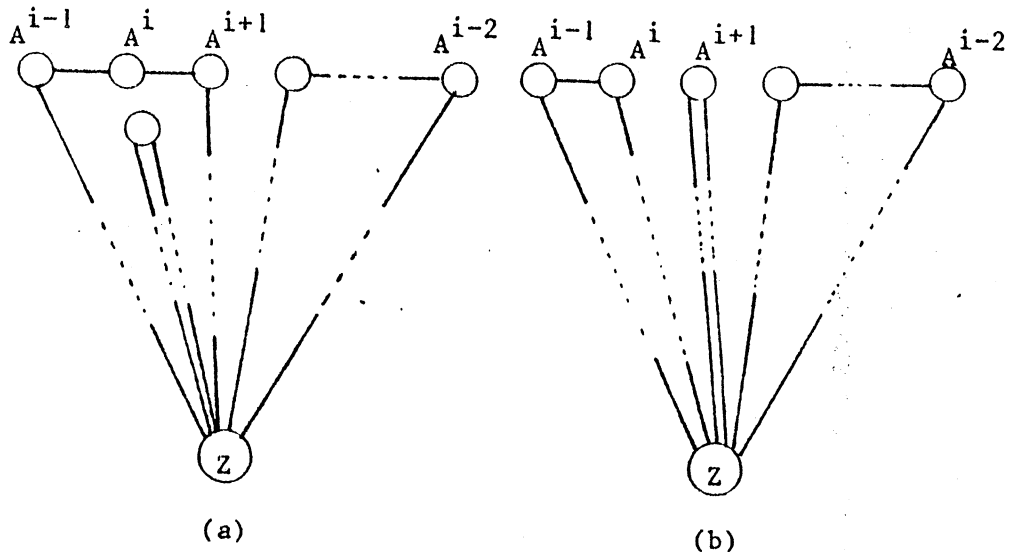

Figure 17

The two tours of Figure 17 (a) and (b) give us the following relation between c^i , c^{i+1} and r^i , the value of c_e for $e \in (A^i, A^{i+1})$:

$$r^i = (n+1)c^{i+1} - (n-1)c^i.$$

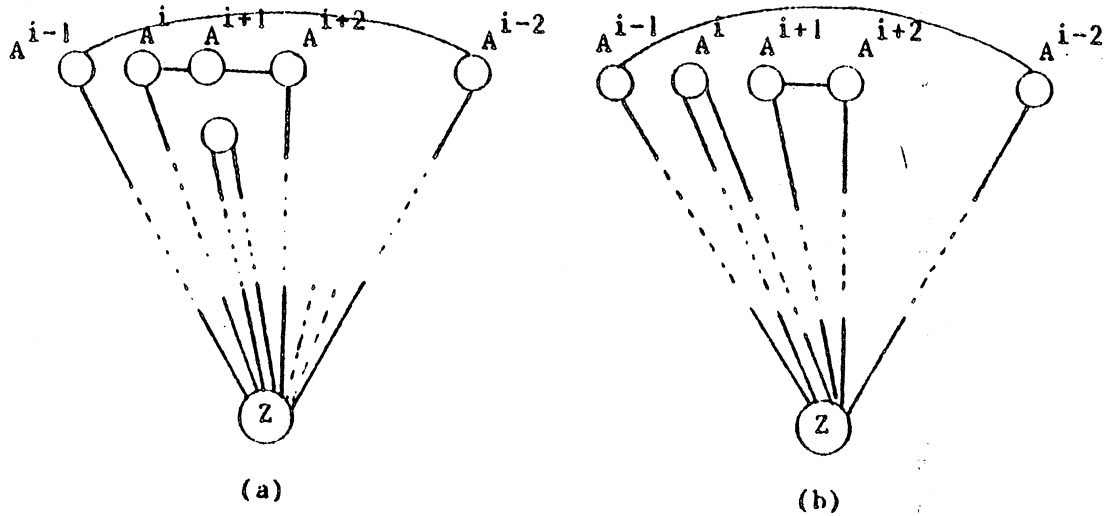

Figure 18.

The two tours of Figure 18 (a) and (b) give us the following relation between the same entities: $r^i = (n+1)c^i - (n-1)c^{i+1}$. Since $n \neq 0$ one gets $c^i = c^{i+1}$ so $c^i = c$ and $r^i = 2c$ for all i and finally $c=1$ can be determined using any of the tours of Figure 17 or 18. The proof that $f_e = c_e$ for all other e is quite obvious and left to the reader.

Remark 2.15: If $n=0$ the wheelbarrow inequality is not a facet since it can be obtained by adding up the k inequalities $x(A^i) \geq 2, i=1, \dots, k$.

Question 2.16: What happens when, in the 2 last configurations, one replaces the paths by paths of different lengths as in the general k -path configuration?

Remark 2.17: The path inequalities, the bicycle inequalities, for $n \geq 0$, and the wheelbarrow inequalities generalize all the comb inequalities for TSP(G).

A hypohamiltonian graph is a graph which is not hamiltonian and such that the deletion of any one of its vertices yields a hamiltonian graph. Let \mathcal{H} be the family of hypohamiltonian graphs such that any adjonction of an edge between two nonadjacent vertices turns it into a hamiltonian graph G . This family is nonempty since the Petersen graph belongs to it. Let A_1, \dots, A_k be a partition of N such that the subgraphs $G(A_i)$ are connected for all i . Identify each A_i to a single vertex a_i and set $W = \{a_i : i=1, \dots, k\}$. Let F be a maximal subset of the edges such that $H = (W, F) \in \mathcal{H}$ (maximality just implies that all edges, or none, between two vertices a_i and a_j are in F). If such a set F exists the corresponding partition of N is called a \mathcal{H} -partition.

Theorem 2.18 : Let A_1, \dots, A_k be a \mathcal{H} -partition, the following inequality then defines a facet of $CTSP(G)$.

$$\sum_{e \in E} f_e x_e \geq |N| + 1 \quad \text{where}$$

$$f_e = \begin{cases} 1 & \text{if } e \in (A_i, A_j) \text{ and } (a_i, a_j) \in F \\ 2 & \text{if } e \in (A_i, A_j) \text{ and } (a_i, a_j) \notin F \\ 0 & \text{else} \end{cases}$$

Proof: That this inequality is valid is obvious. Assume it defines a face which is not a facet and let $\sum_{e \in E} c_e x_e \geq |N| + 1$ be an inequality defining a facet of $CTSP(G)$ containing that face. We first prove that $c_e = 1$ for all $e \in F$. Let $a \in W$ and S be a hamiltonian cycle of $H - \{a\}$. Let T be a tour of H obtained by adding to S twice an edge incident to a (see Figure 19). This tour induces on G a tour which satisfies with equality the first inequality and hence must do so with the second. Changing the edge incident to a yields a tour with the same property

and this implies that every edge incident to a has the same c_e and since the graph is connected one has $c_e = c = 1$ for all $e \in F$. Let $e \in (A_1, A_j)$ and $e \notin F$. There exists a hamilton cycle S such that every edge of S except e is in T and since S is on the face defined by the first inequality one gets $c_e = 2$.

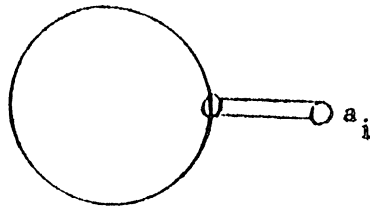

Figure 19

3. Some well described related integer polyhedra.

In this section we mainly study the polyhedra P_1 and P_2 defined in the introduction. Recall P_1 is the convex hull of integer vectors satisfying (1.2) and P_2 that of integer vectors satisfying (1.3) with

(1.2) the sum of the values at each node is even and at least 2

(1.3) the graph induced by the edges such that $x_e > 0$ is connected

Theorem 3.1: The convex hull of the integer vectors satisfying (1.2) is

$$P_1 = \{x : x_e \geq 0 \text{ for all } e \in E \text{ and } x(\delta(v)) \geq 2 \text{ for all } v \in N\}$$

The convex hull of the integer vectors satisfying (1.3) is

$$P_2 = \{x : x(F) \geq p-1 \text{ for all } F \subseteq E, \text{ where } p \text{ is the number of connected components of } G[F] = (V, E-F)\}.$$

Proof: To impose condition (1.2) it suffices to add a triangle to each node $v \in N$. See Figure 20.

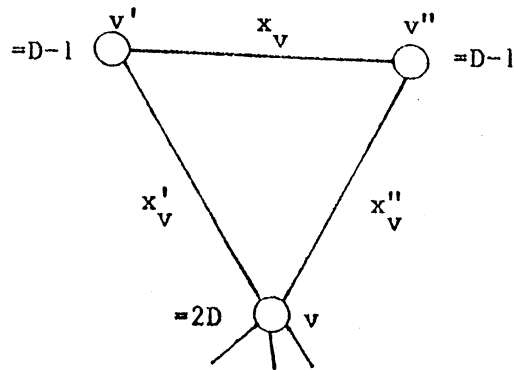

Figure 20

Consider the b-matching problem with equality requirements at each node ($=2D$ at node v and $D-1$ at each of the additional node v' and v''). Then the integer solutions of the b-matching problem are exactly the solutions satisfying (1.2), assuming that D is large.

Take D to be odd and very large. Then the requirement at each node of the expanded graph is an even b , so there is no blossom constraint in the b-matching problem. In other words the b-matching polyhedron is given by:

$$\left\{ \begin{array}{ll} x_e \geq 0 & \text{for all } e \in E \\ x'_v + x''_v + x(\delta(v)) = 2D & \text{for all } v \in N \\ x'_v + x_v = D-1 & \text{for all } v \in N \\ x''_v + x_v = D-1 & \text{for all } v \in N \\ x_v, x'_v, x''_v > 0 & \text{for all } v \in N \end{array} \right.$$

x'_v and x''_v are easily eliminated from the system. The remaining system in terms of x_e , $e \in E$, and x_v , $v \in N$ is:

$$\left\{ \begin{array}{ll} x_e \geq 0 & \text{for all } e \in E \\ x_v = x(\delta(v)) - 2 & \text{for all } v \in N \\ x_v \geq 0 & \text{for all } v \in N \end{array} \right.$$

Again it is easy to eliminate x_v . So we get:

$$P_1 = \{ x : x_e \geq 0 \text{ for all } e \in E \text{ and } x(\delta(v)) \geq 2 \text{ for all } v \in N \}$$

The condition (1.3) may be easier to state using matroid terminology. It says that $x \geq y$ where y is the $(0,1)$ -incidence vector of the spanning set of the graphic matroid M associated with G . Equivalently $y^* = 1 - y$ is an independent set of the dual matroid M^* .

The system of inequalities describing the convex hull of the y^* 's is:

$$\left\{ \begin{array}{l} y^* \geq 0 \\ y^*(F) \leq r^*(F) \quad \text{for all } F \subseteq E, \text{ where} \end{array} \right.$$

$r^*(F) = |F| + r(E-F) - r(E)$ is the rank function of M^* and r the rank function of M .

So the convex hull of the vectors y is:

$$\left\{ \begin{array}{l} y \leq 1 \\ y(F) \geq r(E) - r(E-F) \text{ for all } F \subseteq E. \end{array} \right.$$

Therefore the polyhedron P_2 is

$$P_2 = \{ x : x(F) \geq r(E) - r(E-F) \text{ for all } F \subseteq E \}.$$

For a graphic matroid $r(E) - r(E-F)$ is one less than the number of connected components of $G[F] = (N, E-F)$.

Condition (1.3) can be strengthened to

(1.4) The sum of the values on any edge cutset is at least 2.

Remark 3.2: The set of integer solution to (1.2) and (1.3) is identical to the set of integer solutions to (1.2) and (1.4).

Remark 3.3 : Deciding whether there is a feasible solution to (1.4) with total value $|N|$ is NP-complete since this would decide whether the graph is hamiltonian.

Remark 3.4: Let P_3 be the convex hull of the integer feasible solution to (1.4). Then $P_3 \subset P_2$. In fact none of the inequalities defining P_2 is tight for P_3 . It is easy to show that the system:

$$x(F) \geq p \text{ for all } F \subseteq E$$

where p is the number of connected components of $G[F] = (N, E-F)$ is valid. This follows by taking linear combinations of the valid inequalities $x_e > 0$ and $x(F) \geq 2$ for any edge cutset F .

Remark 3.5 : $P_3 \subset P_1$ since all the degree constraints $x(\delta(v)) \geq 2$ for P_1 are also valid for P_3 .

Remark 3.6: Let Q be the convex hull of the integer solutions satisfying both (1.2) and (1.3). Then $Q \subset P_3$ and in general the

inclusion is strict as already noted by the example of Figure 1 in section 2 where one has an extreme point of P_3 which does not belong to Q .

Remark 3.7 : The extreme points of Q are those extreme points of P_3 which are also extreme in P_1 .

Remark 3.8: The travelling salesman polytope (i.e. the convex hull of the $(0,1)$ -incidence vectors of the hamiltonian cycles) is the face of P_3 defined by $x(E)=|N|$. Therefore every facet inducing inequality for the travelling salesman polytope can be rotated into one or several facet defining inequalities for P_3 .

The same relation holds for Q instead of P_3 . The nice feature of P_3 and Q is that they are full dimensional polyhedra.

An interesting question is to characterize those graphs for which

$$P_3 = \{ x : x_e \geq 0 \text{ for all } e \in E \text{ and } x(F) \geq 2 \text{ for all edge cutset } F \subseteq E \}.$$

Series-parallel graphs are the concern of the next section, the reader is sent to that section for the definition of such graphs.

Theorem 3.9 : If G is a series-parallel graph, then :

$$P_3 = \{ x : x_e \geq 0 \text{ for all } e \in E \text{ and } x(F) \geq 2 \text{ for all edge cutset } F \subseteq E \}.$$

Proof: The Theorem is true for the graph with two vertices and an edge joining them. Assume it is true for all series-parallel graphs with n vertices and m edges. We will prove the Theorem for series-parallel graphs with either one more vertex or one more edge. As will be pointed out in the next section all series-parallel graphs are

obtained from smaller ones by either duplicating an edge or by inserting a vertex on an existing edge.

If an edge is duplicated, then the theorem is true by induction since every edge cutset contains either both the edge and its duplicate or neither of them.

If a vertex is inserted on an edge, then let x_1 and x_2 be the two new edge variables. The new system of inequalities is made of two copies of the former system one with x_1 , the other with x_2 instead of the variable associated to the divided edge, to which is added the constraint $x_1 + x_2 \geq 2$. We want to show that every extreme point of this new system is integral.

If $x_1 = x_2$ for some extreme point, then this extreme point must be integral by the induction hypothesis. So assume $x_1 > x_2$ for some extreme point. Note that no constraint involving x_1 can be tight except possibly $x_1 + x_2 \geq 2$. If even this constraint is not tight, then x_1 could be decreased and therefore x is not an extreme point. Now assume $x_1 + x_2 = 2$. This equation determines the value of x_2 , whereas the rest of the system defining x_1 has an integral solution by induction. So x_2 is integral too. Again the extreme point is integral.

Finally consider the polyhedron R defined by (1.4) and the nonnegativity constraints, i.e.

$$\begin{cases} x(T) \geq 2 \text{ for every edge cutset } T \subseteq E \\ x_e \geq 0 \text{ for all } e \in E \end{cases}$$

A family of subsets $\{S_i : i=1, \dots, k\}$ is said to be nested if for any $i \neq j$ either one of S_i and S_j contains the other or they are disjoint.

It is said to be a crossing family if it does not contain the empty set, contains the complement of each of its members and finally if given any S_1 and S_2 in the family such that $S_1 \not\subseteq S_2, S_2 \not\subseteq S_1, S_1 \cap S_2 \neq \emptyset$ and $S_1 \cup S_2 \neq N$ then both $S_1 \cup S_2$ and $S_1 \cap S_2$ belong to that family.

A family of edge-cutsets $\{T_i = (S_i, \bar{S}_i) : i=1, \dots, k\}$ is said to be laminar if the family $\{S_i : i=1, \dots, k\}$ is nested.

Let x^* be a vertex of R and let $\mathcal{A}(x) = \{S \in \mathcal{N} : x(S, \bar{S}) = 2\}$.

Theorem 3.10: $\mathcal{A}(x)$ is a crossing family.

Proof: Let S_1 and $S_2 \in \mathcal{A}(x)$ such that $S_1 \not\subseteq S_2, S_2 \not\subseteq S_1, S_1 \cap S_2 \neq \emptyset$ and $S_1 \cup S_2 \neq N$, set $S_3 = S_1 \cup S_2$ and $S_4 = S_1 \cap S_2$.

$$x(S_3, \bar{S}_3) = x(S_3, S_1 - S_2) + x(S_3, S_2 - S_1) + x(S_3, S_4)$$

$$x(S_4, \bar{S}_4) = x(S_1 - S_2, S_4) + x(S_2 - S_1, S_4) + x(S_3, S_4)$$

$$x(S_1, \bar{S}_1) = x(S_3, S_2 - S_1) + x(S_3, S_4) + x(S_1 - S_2, S_2 - S_1) + x(S_1 - S_2, S_4)$$

$$x(S_2, \bar{S}_2) = x(S_3, S_1 - S_2) + x(S_3, S_4) + x(S_1 - S_2, S_2 - S_1) + x(S_1 - S_2, S_4)$$

Therefore:

$$x(S_1, \bar{S}_1) + x(S_2, \bar{S}_2) = x(S_3, \bar{S}_3) + x(S_4, \bar{S}_4) + 2x(S_1 - S_2, \overline{S_2 - S_1})$$

Since $x(S_1, \bar{S}_1) = x(S_2, \bar{S}_2) = 2$, $x(S_3, \bar{S}_3) \geq 2$ and $x(S_4, \bar{S}_4) \geq 2$ we deduce that:

$$x(S_3, \bar{S}_3) = x(S_4, \bar{S}_4) = 2.$$

This leads us to the following

Theorem 3.11: Let x be an extreme point of R . The set of equalities defining x can be chosen in such a way that the corresponding edge-cutsets form a laminar family.

Proof: By definition of an extreme point x can be defined as the only solution of a system of k (= dimension of R) linear equations

$x(S, S) = 2$, $(S, S) \in \mathcal{B}$, (so $|\mathcal{B}| = k$). For any cutset $T = (S, \bar{S})$ let $a(T) = \min\{|S|, |\bar{S}|\}$ and $a(\mathcal{B}) = \sum \{a(T) : T \in \mathcal{B}\}$. Assume that among all the families defining x as the unique solution to the corresponding system of equalities \mathcal{B} is the one such that $a(\mathcal{B})$ is minimum. If \mathcal{B} is not laminar then there exist (S_1, \bar{S}_1) and (S_2, \bar{S}_2) in \mathcal{B} such that $S_1 \not\subseteq S_2$ and $S_2 \not\subseteq S_1$. From Theorem 3.10 one has then that $x(S_1 \cup S_2, \overline{S_1 \cup S_2}) = 2 = x(S_1 \cup S_2, \overline{S_1} \cup \overline{S_2})$ and that $x(S_2, \bar{S}_2) = 2$ can be deduced from these two last equations together with $x(S_1, \bar{S}_1) = 2$. Hence one can replace it in the system by these 2. But now we have $k+1$ equations so one is redundant. Assume it is $x(S_1 \cup S_2, \overline{S_1 \cup S_2}) = 2$. The new family \mathcal{B}^* obtained contradicts the minimality of \mathcal{B} , a contradiction.

Remark 3.11: This result seems to have been proven independently by W. Cunningham in unpublished work on the polyhedron R .

4. The Graphical Travelling Salesman Problem, a "Steiner" version of it and the Steiner Tree Problem in series-parallel graphs.

Let $G = (V, E)$ be a graph, $c: E \rightarrow \mathbb{R}$ a cost function on the edges of G and $\tilde{V} \subset V$ which we call a set of Steiner points. The Steiner tree problem is that of finding a minimum cost tree that spans every element of \tilde{V} . This problem is known to be in general NP-hard. Similarly one can define the Steiner GTSP as the problem of finding a minimum cost cycle which passes at least once through every vertex of \tilde{V} , every edge used by the cycle being an edge of G . Recall that we define a cycle as being a connected graph with an even number of edges incident to each vertex. In both Steiner problems vertices of $V - \tilde{V}$ may or not be on the tree or the cycle.

A series-parallel graph , noted SP-graph , is one that can be obtained, starting with the graph consisting of two vertices joined by an edge, applying recursively the following operations:

(a) replace an edge between u and v by several between the two same vertices.

(b) replace an edge between u and v by a path between the two same vertices, all the vertices of that path, except u and v do not belong to the former graph.

Many NP-complete or NP-hard problem have been solved efficiently in series-parallel graphs, a nonexhaustive list can be found in K.Takamizawa, T.Nishizeki and N.Saito [8], list which contains the Steiner tree problem. We are going to give an efficient algorithm for both the Steiner tree and CTSP problems in SP-graphs. It is quite surprising that the same type of algorithm solves both problems since if G is an arbitrary graph and $\tilde{V}=V$ one problem is easy while the other is NP-hard.

D.Ratcliff and A.Rosenthal [7] have solved the Steiner CTSP for a special case of SP-graphs and where \tilde{V} is a very particular subset of vertices. It is their technic which is generalized to solve the two Steiner problems in SP-graphs. We now denote by STG and SCTSP, respectively, these two problems. We first solve the SCTSP in SP-graphs.

A S-tour is a set of edges which is a solution to the SCTSP.

Let (u,v) be a two node cutset, let V_1 be as in Figure 21 and $V_1 \neq \emptyset \neq V - V_1^*$ where $V_1^* = V_1 \cup \{u,v\}$. The subgraph defined by the edges of a S-tour which are in $\gamma(V_1)$ can be described by (a,b,c) where "a" is the parity of the

degree of u , "b" the parity of the degree of v and "c" is the number of components. One has $a, b \in \{E, U, 0\}$ where E stands for even, U for odd (uneven) and 0 for zero. The edges of such a subgraph will be called a partial S-tour.

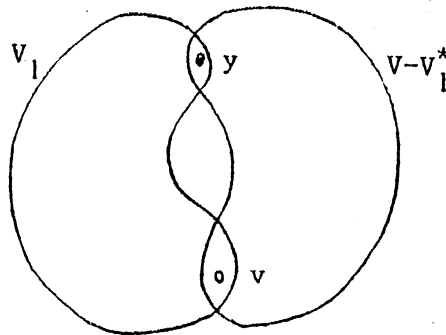

Figure 21

Proposition 4.1: There are only seven possible values for (a, b, c) , namely:

$(E, E, 1), (E, F, 2), (0, E, 1), (E, 0, 1), (U, U, 1), (0, 0, 1), (0, 0, 0)$

Proof: easy, see [7].

Corollary 4.2: Partial S-tours can be partitioned in 7 classes.

Note that $(0, 0, 1)$ means that $\tilde{V} \subset V_1 - \{u, v\}$, i.e. there are no Steiner points outside $V_1 - \{u, v\}$. The same is true for $(0, 0, 0)$ replacing V_1 by $V - V_1^*$.

We will now use $(a, b, c)(V_1)$ to represent the class of partial S-tours on V_1 described by the triplet (a, b, c) . Every partial S-tour of $(a, b, c)(V_1)$ can be completed to a tour of G by the same set of edges, hence if one of these is going to appear in an optimal S-tour, it is the one of minimum cost (this is nothing else than the optimality principle of dynamic programming). Assume one can find the

optimal element in each of the 7 classes relatively to V_1 (some may be empty), and do the same for $V - V_1^*$, then putting together suitably these optimal partial tours, the optimal solution is among the few solutions obtained that way. The following table (4.1) precises what we mean by suitably:

(4.1) the best of	with the best of
$(U, U, 1)(V_1)$	$(U, U, 1)(V - V_1^*)$
$(E, E, 1)(V_1)$	$(E, E, 1)(V - V_1^*)$
$(E, F, 1)(V_1)$	$(E, F, 2)(V - V_1^*)$
$(E, F, 1)(V_1)$	$(E, 0, 1)(V - V_1^*)$ only if $v \in \tilde{V}$
$(E, F, 1)(V_1)$	$(0, E, 1)(V - V_1^*)$ only if $u \in \tilde{V}$
$(E, F, 2)(V_1)$	$(E, F, 1)(V - V_1^*)$
$(E, 0, 1)(V_1)$	$(E, E, 1)(V - V_1^*)$ only if $v \in \tilde{V}$
$(0, E, 1)(V_1)$	$(E, E, 1)(V - V_1^*)$ only if $u \in \tilde{V}$
$(0, E, 1)(V_1)$	$(0, E, 1)(V - V_1^*)$ if $u \notin \tilde{V}$
$(E, 0, 1)(V_1)$	$(E, 0, 1)(V - V_1^*)$ if $v \notin \tilde{V}$
$(0, 0, 0)(V_1)$	$(E, E, 1)(V - V_1^*)$ if $(\tilde{V} - \{u, v\}) \cap V_1 \neq \emptyset$
$(0, 0, 1)(V_1)$	$(0, 0, 0)(V - V_1^*)$ if $\tilde{V} \subset V_1 - \{u, v\}$

Let us see now how the best of $(a, b, c)(V_1)$ and $(a, b, c)(V - V_1^*)$ can be computed recursively. Let us consider the construction of the SP-graph G using (a) and (b), formerly defined, starting with an edge (u_0, v_0) . Each time (a) is performed one may assume, w.l.o.g., that further on no edge between the two same vertices will be n-uplicated since this could have been done right away. So the i^{th} time (a) is performed call $\{u_i, v_i\}$ the two vertices between which it is performed. Note that a same vertex may appear in more than one $\{u_i, v_i\}$. Let V_i be the set of vertices of G which is the vertex set of the SP-graph that has replaced $\{u_i, v_i\}$ once G has been completely built. One has $V_0 = V$ and $\{V_i : i \in I\}$ is a nested family (see end of preceding section for the

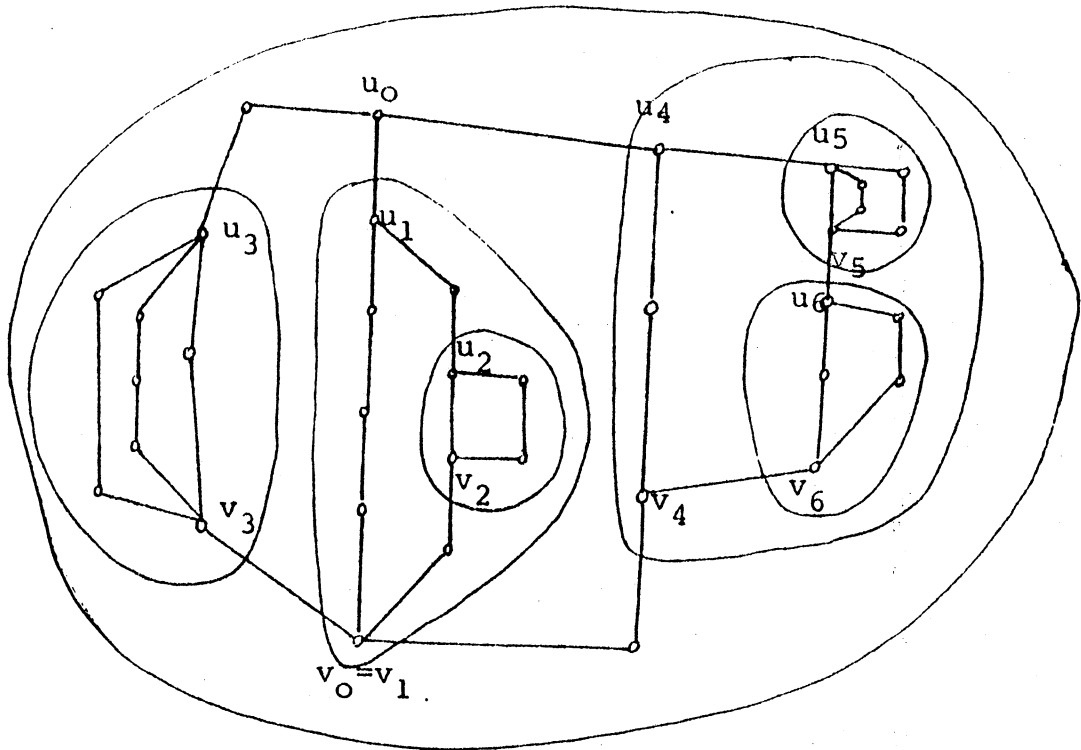

Figure 22

Let V_i^* be a minimal element of $\{V_i : i \in I\}$, i.e. one that contains no other V_i . Then $G(V_i^*)$ is made of $k \geq 2$ disjoint paths P_1, P_2, \dots, P_k between u_i^* and v_i^* . For each $P_j, j=1, \dots, k$, the best of each $(a, b, c)(P_j)$ is easily computed (see Figure 23).

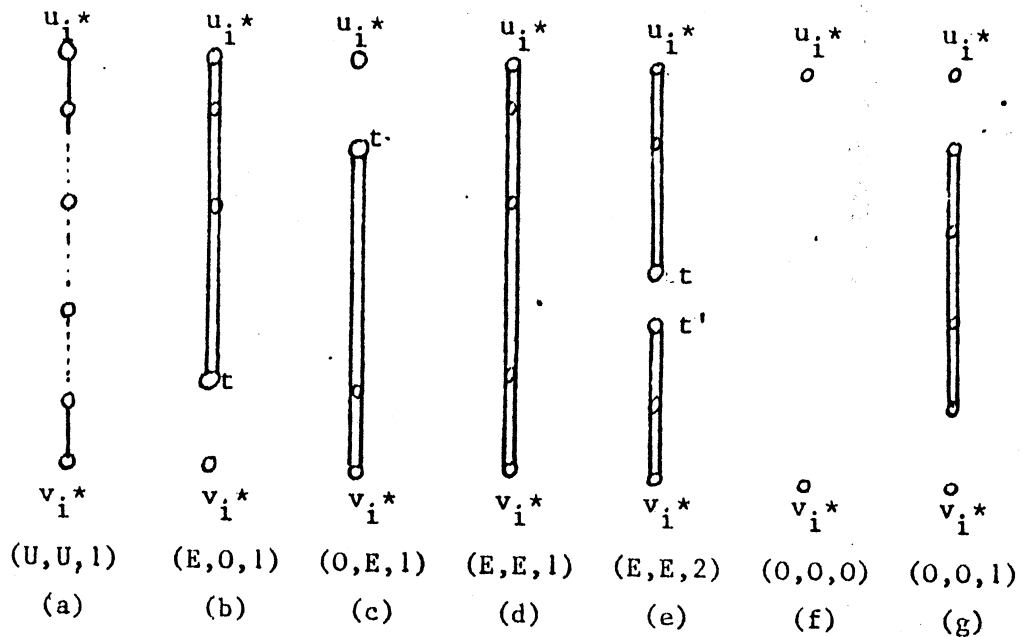

Figure 23

In case (b) (resp.(c)) there are no Steiner points between t and v_j^* (resp. u_j^*). In case (e) are two consecutive Steiner points such that the distance between them is the largest among all consecutive Steiner points on P_j . Hence it is easy, using table (4.1), to compute recursively the best of each $(a,b,c)(V_j^*)$. Assume the best of each $(a,b,c)(V_j^*)$ has been computed for each $i \in J$. Let \bar{i} be such that any $V_j \subset V_{\bar{i}}$ is such that $i \in J$, i.e. minimal among those V_j for which the best of each $(a,b,c)(V_j)$ has not been computed. Let C_r $r=1, \dots, k$ be the different components of $C(V_{\bar{i}}) - (u_{\bar{i}}, v_{\bar{i}})$ and set $C_r = C_r \cup \{u, v\}$. Each subgraph $C(C_r)$ is such that once $V_j \subset C_r$ is shrunk one obtains a path; more precisely $C(C_r)$ is as in Figure 24:

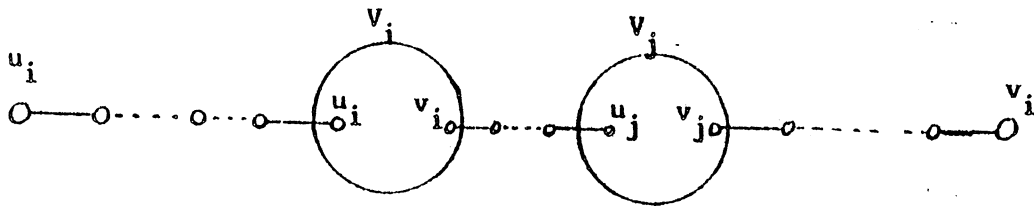

Figure 24

Knowing the best of each $(a,b,c)(V_j)$ for every $V_j \subset C_r$ it is easy to compute the best of each $(a,b,c)(C_r)$, note that one must watch for those u_j and v_j which are Steiner points. Now, using recursively table (4.1), it is easy to compute the best of each $(a,b,c)(V_{\bar{i}})$. And so on until $V_{\bar{i}}=V$.

Let us turn now to the Steiner tree problem. Since there are no longer any parity requirements an edge is never taken more than once and there are only 6 classes to consider namely:

$$(\neq 0, \neq 0, 2), (\neq 0, \neq 0, 1), (\neq 0, 0, 1), (0, \neq 0, 1), (0, 0, 1), (0, 0, 0)$$

These are the only differences so the details are left to the reader.

Very few problems are such that an efficient algorithm to solve it is known and a complete set of linear inequalities defining the convex hull of its solutions has not been defined. The most famous such problem is the maximum stable set problem in claw-free graphs [6]. In fact that problem is transformed into a matching problem so the algorithm does not give us any insight to the structure of the convex hull. In the Steiner CTSP on SP-graphs a similar thing occurs. It seems quite hard to find the convex hull of all S-tours. Our algorithm gives us no information since in fact we have transformed CTSP into several shortest path problems. This is not obvious to see for general SP-graphs but is for the special case of the graphs studied by D.Ratcliff and A.Rosenthal where the problem is solved by turning it into a single shortest path problem on a sparse graph on at most $14 * (\text{number of ailes of the warehouse}) + 2$ vertices.

REFERENCES

- [1] G.CORNUEJOLS, D.NADDEF, W.PULLEYBLANK: "Halin Graphs and the Travelling Salesman Problem", to appear in Mathematical Programming.
- [2] J.EIMONDS: "Matroids and the Greedy Algorithm" Mathematical Programming 1 (1971) 127-136
- [3] B.FLEISCHMAN: "Linear Programming Approaches Travelling Salesman and Vehicle Scheduling Problems", Universitat Hamburg, paper presented at the XI International Symposium on Mathematical Programming, Bonn August 1982.
- [4] G.N.FREIERIKSON and J.JAGER: "On the relationship between biconnectivity and Travelling Salesman Problems", Theoretical Computer

Science 19(1982), 189-201.

[5] M. CRÖTSCHHEL and M. PADBERG: "On the Symetric Travelling Salesman Problem I: Inequalities" Mathematical Programming 16(1979), 265-280.

[6] G. MINTY: "On Maximal Independant Set of Vertices in Claw-Free Graphs", Journal of Combinatorial Theory B 28 (1980), 284-304

[7] D. RATCLIFF and A. ROSENTHAL: "Order-Picking in a Rectangular Warehouse: a Solvable Case of Travelling Salesman Problem", PDRC Report Series 81-10, september 1981.

[8] K. TAKAMIZAWA, T. NISHIZEKI and N. SAITO: "Linear Time Computability of Combinatorial Problems on Series-Parallel Graphs" Journal of the ACM vol. 29, 3(1982) 632-641.

AUTORISATION DE SOUTENANCE

DOCTORAT D'ETAT

Vu les dispositions de l'article 5 de l'arrêté du 16 avril 1974,

Vu les rapports de M. ... *Sakarovich Michel*

M. ... *Beze Claude*

M. ... *Las Vergnes Michel*

M. ... *Denis NADDEF* est autorisé à
présenter une thèse en vue de l'obtention du grade de DOCTEUR D'ETAT ES SCIENCES.

Fait à Grenoble, le 21 NOV 1983

Le Président de l'U.S.M.G.

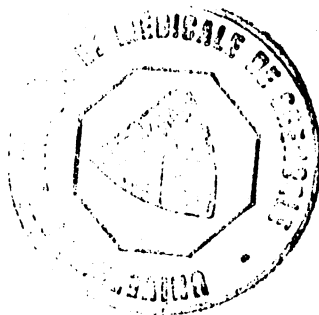

S. Fauche

