



HAL
open science

**The palaeozoic palynostratigraphy of the Karoo
supergroup and palynofacies insight into
palaeoenvironmental interpretations, Kalahari Karoo
Basin, Botswana**

Benson Modie

► **To cite this version:**

Benson Modie. The palaeozoic palynostratigraphy of the Karoo supergroup and palynofacies insight into palaeoenvironmental interpretations, Kalahari Karoo Basin, Botswana. Minéralogie. Université de Bretagne occidentale - Brest, 2007. Français. NNT : . tel-00312752

HAL Id: tel-00312752

<https://theses.hal.science/tel-00312752>

Submitted on 26 Aug 2008

HAL is a multi-disciplinary open access archive for the deposit and dissemination of scientific research documents, whether they are published or not. The documents may come from teaching and research institutions in France or abroad, or from public or private research centers.

L'archive ouverte pluridisciplinaire **HAL**, est destinée au dépôt et à la diffusion de documents scientifiques de niveau recherche, publiés ou non, émanant des établissements d'enseignement et de recherche français ou étrangers, des laboratoires publics ou privés.

**THE PALAEOZOIC PALYNOSTRATIGRAPHY OF THE KAROO
SUPERGROUP
AND
PALYNOFACIES INSIGHT INTO PALAEOENVIRONMENTAL
INTERPRETATIONS, KALAHARI KAROO BASIN, BOTSWANA**

Benson N. Modie

2007



Thesis submitted for the degree of Doctor of Science: Palynostratigraphy



UNIVERSITE DE BRETAGNE OCCIDENTALE
Ecole Doctorale des Sciences de la Mer

THESE

Présentée

DEVANT L'UNIVERSITE DE BRETAGNE OCCIDENTALE

Pour obtenir

Le grade de DOCTEUR DE L'UNIVERSITE DE BRETAGNE OCCIDENTALE
Mention Sciences de la Terre

Par

Benson Ndadzila MODIE

Equipe d'accueil : UMR 6538 Domaines Océaniques
Ecole Doctorale des Sciences de la Mer (EDSM)
Composante universitaire : U.F.R. « Sciences et Techniques

**THE PALAEOZOIC PALYNOSTRATIGRAPHY OF THE KAROO SUPERGROUP
AND PALYNOFACIES INSIGHT INTO PALAEOENVIRONMENTAL
INTERPRETATIONS, KALAHARI KAROO BASIN, BOTSWANA**

Soutenue le 27 Avril 2007 devant la commission d'examen

Composition du Jury:

Dr. Jean BROUTIN
Dr. Jean-Jacques CHATEAUNEUF
Dr. Alain LE HERISSE
Dr. Patrick René RACHEBOEUF
Dr. Mike STEPHENSON
Dr. Jean-Jacques TIERCELIN

Rapporteur
Examineur invité
Directeur de Thèse
Examineur
Rapporteur
Co-Directeur de Thèse

**To Mum (*may her soul rest in peace*) and Dad for giving me the opportunity to
experience the process of life on Planet Earth.**

DECLARATION

This is to certify that the work submitted for a doctorate degree under the title “The Palaeozoic Palynostratigraphy of the Karoo Supergroup and palynofacies insight into palaeoenvironmental interpretations, Kalahari Karoo Basin, Botswana” is the result of original work. All authors and works consulted are fully acknowledged. No part of this work has been accepted, or is currently being submitted, in consideration for any other degree.

.....
Benson N. Modie

ACKNOWLEDGEMENTS

I would like to express my gratitude to Dr. Alain Le Hérissé of the Université de Bretagne Occidentale (Brest, France) for introducing me to the subject of palynology and then providing kind supervision with guidance throughout the term of study, and who together with his wife Ms. M. Le Hérissé helped with sample preparations, for which I am also greatly thankful. I extend my gratitude to Dr. Bernard Le Gall and Dr. Jean-Jacques Tiercelin, also of the Université de Bretagne Occidentale, who acted as co-supervisors and provided valuable discussions, and most importantly initiated dialogue with the Botswana Department of Geological Survey that led to the present study cooperation.

This study has greatly benefited from valuable comments, suggestions, and assistance obtained from Dr. Michael H. Stephenson of the British Geological Survey (Keyworth, U.K.), Professor Jean Broutin of the University of Paris (Jussieu), and Dr. Barry D. Millstead then of the University of Durban-Westville (Durban, South Africa), all of whom I am indebted to.

Special thanks go to the Department of Geological Survey (DGS), currently my employer, for providing me with all the support and data I used in this study, and to the director, for allowing the results of an official project to be used for dissertation purposes. To the staff of DGS who assisted with the procedures for sample collection and transportation to the laboratory in France as well as my external visit to the laboratory to perform analytical work on the samples, I am very thankful. A great many thanks to the staff at the Accounts Section of the Ministry of Minerals, Energy and Water Resources who provided great support to effect my international financial transactions for the study.

Finally, I wish to thank the few friends I had in France who helped me cope in a new environment, and equally, my family for their constant support throughout the duration of the study.

INTRODUCTION GÉNÉRALE

Cadre de l'étude

Au Botswana, les séries sédimentaires et volcaniques d'âge Paléozoïque supérieur et Mésozoïque appartenant au super-groupe du Karoo, sont connues dans la partie centrale du pays, dans une vaste zone appelée Bassin du Kalahari-Karoo (Fig.1). Les roches du super-groupe Karoo incluent d'importantes ressources naturelles, dominées par le charbon et le gaz naturel, mais comprenant aussi des argiles et des eaux souterraines. A l'échelle du pays, bien connu déjà pour ces ressources minières, il est incontestable que le Bassin du Kalahari-Karoo a également un très grand potentiel économique. Le Service Géologique du Botswana (DGS), mis en place en 1948, dont la mission est de faire progresser les connaissances sur les ressources naturelles et de conseiller le gouvernement et le public sur leur utilisation, est à l'origine de ces prospections de ressources dans le bassin du Kalahari-Karoo (e.g. Green, 1966; Baldock et. al., 1977; Farr, 1981; Clark et. al., 1986; Gwosdz and Sekwale, 1982; Williamson, 1996; ECL, 1998; ARI, 2003).

Les réserves en charbon découvertes jusqu'à présent au Botswana sont estimées à 17 billions de tonnes (SADC, 2001), et garantissent le pays d'une source majeure d'énergie. C'est la seule énergie fossile mise en évidence. Mais bien que le charbon ait un grand potentiel comme source première d'énergie pour les maisons, pour l'industrie et la production d'électricité, son utilisation reste encore limitée. Stephenson et Penn (2005) ont mis l'accent sur les améliorations importantes que ces ressources naturelles comme le charbon pourraient générer : création d'emploi direct, fourniture de services et richesse pour les populations pauvres, à condition qu'il y ait une augmentation des investissements,

Dans cette optique, et afin de compléter la connaissance géologique sur le bassin du Kalahari Karoo, le DGS a lancé un projet scientifique dans le cadre du Plan National de Développement 8 (NDP8), avec deux objectifs principaux :

1. Estimer la disponibilité et le potentiel pour développer les ressources en gaz naturel (c'est à dire le gaz contenu dans les charbons), associées aux séries riches en charbon dans le bassin du Kalahari-Karoo au Botswana.
2. Etablir une base de données sur la stratigraphie et développer un système de corrélation qui caractériserait les séries sédimentaires à charbon du bassin de Kalahari-Karoo.

Les travaux concernant le 1er objectif de ce projet, ont été confiés à une entreprise privée de consultance, "Advanced Resources International Inc." (USA), en association avec "Scales Associates" (Botswana). Ils ont été achevés en 2003. Les résultats de cette étude indiquaient que les niveaux de charbons contenaient une ressource en gaz en place estimée à 60 trillions de pieds cubes (Tcf). On estime que les schistes carbonés associés contiennent en supplément 136 Tcf. L'ensemble correspond à un total de 196 Tcf de gaz en place (ARI, 2003).

Le second objectif du projet, concernait le sujet de cette thèse, et s'intégrait dans un programme de recherches en collaboration avec les géologues de l'UMR 6538 du CNRS et l'Université de Bretagne Occidentale

Portée de l'étude

Bien que plusieurs projets, à l'initiative du DGS, ont confirmé le grand potentiel en ressources économiques des séquences du Karoo, il manque encore une connaissance géologique précise pour permettre des corrélations efficaces sur l'ensemble du bassin du Kalahari-Karoo. La situation est compliquée par le manque d'affleurements. Il n'existe qu'une zone très limitée du Karoo (Fig.2) affleurant sous la couverture Crétacée et les sédiments récents appartenant à l'environnement du désert du Kalahari. Durant ces dernières années, pour l'exploration du charbon en particulier, on a utilisé à l'échelle régionale une méthode traditionnelle de corrélations stratigraphiques, basée sur des similitudes lithologiques dans des séries très peu exposées, pour corréler des sections en sondage souvent très éloignées (Farr, 1981; Smith, 1984; ECL, 1998). On sait cependant que les corrélations lithostratigraphiques, n'ont pas de signification chronostratigraphique, et peuvent conduire à des erreurs importantes; On peut avoir en effet des unités semblables d'âge différent, dans des régions différentes, sans connection physique entre elles (Reading, 1986; Mial, 1990). On ne peut effectuer de corrélations lithostratigraphiques que dans des régions où les couches de terrain peuvent être suivies sur le sol et où il y a des niveaux repères aisément reconnaissables, ce qui est rare dans le bassin du Kalahari-Karoo.

L'objectif de cette étude est de promouvoir le concept de biostratigraphie dans le Bassin du Kalahari-Karoo au Botswana et d'établir un schéma de corrélation biostratigraphique préliminaire, afin d'améliorer le système de corrélations lithostratigraphique utilisé actuellement.

La biostratigraphie, que l'on peut définir comme l'étude de l'arrangement relatif des strates en fonction de leur contenu fossilifère (Miall, 1990; Murphy and Salvador, 1994) est devenue une discipline indispensable pour les corrélations. La méthode de corrélation biostratigraphique s'appuie sur des zonations établies à l'échelle locale et régionale, et forme la base d'un système global de subdivisions chronostratigraphiques (Miall, 1990; Agterberg and Gradstein, 1999). Dans le cas présent, la zonation biostratigraphique aidera à valider les corrélations de sections du super-groupe du Karoo dans l'ensemble du bassin, et permettra de s'affranchir de l'utilisation de noms locaux différents pour des unités équivalentes dans différentes parties du bassin, comme c'est le cas actuellement (e.g. Smith, 1984). Ces méthodes entraînaient d'importantes difficultés dans les corrélations lors des prospections géologiques et minières. L'approche biostratigraphique apporte aussi des données complémentaires pour placer le bassin du Kalahari-Karoo, dans l'histoire géologique locale et régionale.

Dans cette étude, les horizons biostratigraphiques, que l'on peut définir comme des limites stratigraphiques, des surfaces ou interfaces en travers desquelles d'importants changements biostratigraphiques sont notés (Murphy and Salvador, 1994), sont utilisés à la base pour proposer des biozones. La section en sondage la mieux préservée et la mieux échantillonnée a été désignée comme section standard de référence. La section standard composite de référence, qui peut être mise à jour régulièrement, en fonction de la disponibilité de nouvelles données, forme la base pour un système de corrélation dans le bassin du Kalahari-Karoo.

Bases de l'étude

La Paleopalynologie, qui concerne l'étude des palynomorphes, c'est à dire de l'ensemble des microfossiles à paroi organique et microrestes de plantes conservés dans les sédiments puis extraits par attaques acides (Traverse, 1988; Jansonius and McGregor, 1996), est parfaitement adaptée pour les études biostratigraphiques dans ce travail sur sondages, à défaut de sections exposées disponibles pour une étude de fossiles et macrorestes végétaux. En conséquence la méthode utilisée ici sera une approche palynostratigraphique, basée pour ces séries essentiellement continentales sur l'étude des spores et pollens. Ceux ci sont conservés en abondance dans les sédiments analysés, et montrent une évolution morphologique au niveau spécifique et générique qui traduit l'évolution de la paléoflore au cours des temps géologiques. Les variations dans la composition des assemblages de spores et pollens sont utilisés à la fois pour différencier les séquences et établir la biozonation, mais aussi discuter les variations des conditions d'environnement.

Les études de corrélations stratigraphiques dans le bassin du Kalahari-Karoo sont basées largement sur des études de sondages, lesquels présentent un meilleur potentiel pour la conservation des microfossiles en raison de leur petite taille (maximum 200µm), par rapport aux macrofossiles. Un autre avantage des palynomorphes est lié à la nature de leurs parois composées de sporopollenine ou de chitine (Traverse, 1988), qui comprennent des chaînes carbonées extrêmement résistantes, à la diagenèse, à l'enfouissement ainsi qu'aux processus de macération chimique en laboratoire. Le bon état de préservation des palynomorphes dans les échantillons de sondage du bassin de Kalahari-Karoo a été déjà noté dans des études précédentes (e.g. Cadman, 1995).

En plus de ces considérations biostratigraphiques basées sur l'étude de la répartition des palynomorphes, un autre aspect de ce travail s'est intéressé à l'évolution générale de la matière organique sédimentaire (MOS) dans les échantillons, pour une discussion des corrélations et des interprétations paléoenvironnementales. La MOS est constituée des différents composants organiques des roches sédimentaires, incluant les palynomorphes, mais souvent dominée par les restes de plantes continentales comme les morceaux de troncs d'arbres, de branches et de feuilles (Batten, 1996). La MOS peut être séparée en différentes catégories, que l'on peut identifier, et que l'on peut compter, malgré les modifications physiques et chimiques subies par ces microrestes avant et après le dépôt. Les différents éléments organiques dans la roche composent ce que l'on appelle aussi le palynofaciès (Combaz, 1967). Dans la mesure où la matière organique sédimentaire est partie intégrante de la roche sédimentaire, les différentes catégories qui la constitue, sont utiles pour l'interprétation des environnements de dépôt (Batten, 1996). Différents types de palynomorphes peuvent donner des indications sur les anciens environnements naturels où vivaient les plantes, aussi bien que les conditions paléoclimatiques à l'origine des sédiments (Traverse, 1988).

RÉSUMÉ (Extended, in French)

Late Carboniferous to Permian strata of the Lower Karoo sequence in the Kalahari Karoo Basin, Botswana, contains suitably preserved palynomorphs for biostratigraphic classifications. All taxa described from eight out of the nine coreholes sampled for the study comprise sixty-eight genera made of one hundred and sixty-five miospore species, eleven arcritarchs species, seven prasinophytes species, and 1 chlorophyte. Two well-sampled coreholes, namely STRAT 1 and CKP6, have been subdivided on the basis of species ranges to produce three Range Zones (2 concurrent range zones and 1 taxon range zone) and three Assemblage Zones, for each section. Comparison of taxa in the zones indicates a preliminary direct correlation between the sequences at STRAT1 and CKP6 boreholes only on the basis of the Assemblage Zones as well as the Taxon Range Zones. STRAT 1 section has been designated the standard reference section on the basis of relatively good palynomorph yields and preservation, for comparative analysis both in the present and future studies.

The range zones established for STRAT1 comprises, in ascending order of stratigraphy, the *Potoniesporites congoensis* – *Converrucosisporites irregularis* Concurrent Range Zone (Biozone S1-1), the *Retusotriletes diversiformis* – *Divaricrassus minor* Concurrent Range Zone (Biozone S1-2), the *Lophotriletes rectus* – *Concavisporites mortonii* Concurrent Range Zone (Biozone S1-3), and the *Platysaccus papilionis* Taxon Range Zone (Biozone S1-4). Biozone S1-1 is defined on the basis of short to medium range taxa of which the most significant are: *Raistrickia crenata*, *Converrucosisporites pseudoreticulatus*, *Converrucosisporites irregularis*, *Potoniesporites congoensis*, *Limitisporites rectus*, and *Hamiapollenites bullaeformis*. Biozone S1-2 is also defined on the basis of short to medium range taxa, the most significant of which include: *Retusotriletes diversiformis*, *Apiculatisporis unicus*, *Divaricrassus minor*, *Lophotriletes rarus*, *Horriditriletes curvibaculosus*, *Cristatisporites inconstans*, *Cristatisporites menendezii*, *Lundbladispota gracilis*, *Striomonosaccites crucistriatus*, *Caheniasaccites flavatus*, *Illinites spectabilis*, *Protohaploxylinus haigii*, *Protohaploxylinus rugatus*, *Vittatina foveolata*, and *Arabispheera bellula*. Biozone S1-3 is the least productive palynologically, and has the following significant taxa: *Concavisporites mortonii*, *Lophotriletes rectus*, *Horriditriletes brevis*, *Laevigatosporites vulgaris*, *Laevigatosporites plicatus*, *Alisporites australis*, *Alisporites potonieii*, *Lueckisporites virkkiae*, *Protohaploxylinus perexiguus*, *Marsupipollenites triradiatus*, and *Cymatiosphaera gondwanensis*. Biozone S1-4 correspond to a narrow topmost section of the borehole and has a limited range. The zone is characterized based on short-range taxa of which the most significant are: *Florinites eremus*, *Platysaccus papilionis*, *Hamiapollenites saccatus*, *Striatopodocarpites fusus*, and *Striatopodocarpites pantii*.

The assemblage zones erected are common to both STRAT1 and CKP6, and are comprised of, in ascending order of stratigraphy, the *Hamiapollenites bullaeformis* Assemblage Zone (Biozone KK1), the *Cyclogranisporites gondwanensis* Assemblage Zone (Biozone KK2), and the *Platysaccus papilionis* Assemblage Zone (Biozone KK3). Biozone KK1 is characterized by an assemblage of fourteen taxa most of which are either restricted or nearly restricted to the zone. The lower limit of the zone is placed at the lowermost occurrences of taxa *Apiculatisporis parmatus* and *Potoniesporites brasiliensis*. The upper limit of the zone is placed at the last occurrences of taxa *Punctatisporites gracilis*, *Densosporites rotundus*, and *Cristatisporites microvacuolatus*. The zone has been named after the species *Hamiapollenites bullaeformis*, which forms one of the diagnostic taxa, and is restricted to the zone in both STRAT 1 and CKP6. Biozone KK2 is palynologically less productive and has been defined on the basis of long-range and some medium-range taxa. The lower limit of this zone is

determined by the upper limit of the preceding zone i.e. *Hamiapollenites bullaeformis* *Assemblage Zone*. The upper limit of the zone is placed at the last occurrence of taxon *Cyclogranisporites gondwanensis*. Biozone KK3 correspond to a narrow topmost section of the borehole. The upper limit of the zone is not defined and the lower limit is placed at the first occurrence of taxa *Platysaccus papilionis* and *Striatopodocarpites fusus*. STRAT 1 section has also been subdivided on the basis of palynofacies data generating stratigraphic marker horizons that are comparable to biohorizons and can be utilized for correlating local basin sequences.

Lithological comparisons with the palynozones reveal a younging of the Dwyka glacial facies to the southwest, from CKP6 to STRAT 1, representing the palaeo-trend in glacial migration. The qualitative data indicates notable differences in taxa diversity that include the predominance of trilete spores with monosaccates pollen in the Dwyka glacial facies, in comparison to a significant emergence of bisaccates and the disappearance of several spores in the lower Ecca sequence, attributed to palaeoclimatic influences associated with the transition from glacial to deglaciation and post-glacial era. Age determinations deduced from a comparison of the palynozones of STRAT 1 section, designated the standard reference section, with other regional and Gondwana-wide zonation schemes indicates Late Carboniferous (Kasimovian – Gzhelian) to earliest Late Permian (Roadian) ages for the Lower Karoo sequence in the Kalahari Karoo Basin. Broad palaeoclimatic inferences from the qualitative analysis support a transition from cold and humid conditions, during deposition of the Dwyka glacial facies, to warm and drier conditions during deposition of the lower Ecca sequences. Palaeoclimatic conditions ultimately turned wet during middle Ecca times generating coal-forming settings. Palaeoenvironmental interpretations based on palynofacies data indicate a predominantly proximal palaeo-depositional setting for the entire Lower Karoo sequence at STRAT 1 borehole. The broader depositional environment transformed from glacial sub-environments, during deposition of the Dwyka Group, into a relatively wider basin punctuated by some rare marine incursions, in the early Ecca Group, and ultimately developing into a deltaic system.

ABSTRACT

Late Carboniferous to Permian strata of the Lower Karoo sequence in the Kalahari Karoo Basin, Botswana, contains suitably preserved palynomorphs for biostratigraphic classifications. All taxa described from eight out of the nine coreholes sampled for the study comprise sixty-eight genera made of one hundred and sixty-five miospore species, eleven arccritarchs species, seven prasinophytes species, and 1 chlorophyte species. Two well-sampled coreholes, namely STRAT 1 and CKP6, have been subdivided on the basis of species ranges to produce three Range Zones (2 concurrent range zones and 1 taxon range zone) and three Assemblage Zones, for each section. Comparison of taxa in the zones indicates a preliminary direct correlation between the sequences at STRAT1 and CKP6 boreholes only on the basis of the Assemblage Zones as well as the Taxon Range Zones. STRAT 1 section has also been subdivided on the basis of palynofacies data generating stratigraphic marker horizons. Lithological comparisons with the palynozones reveal a younging of the Dwyka glacial facies to the southwest, from CKP6 to STRAT 1, representing the palaeo-trend in glacial migration. The qualitative data indicates notable differences in taxa diversity that include the predominance of trilete spores with monosaccates pollen in the Dwyka glacial facies, in comparison to a significant emergence of bisaccates and the disappearance of several spores in the lower Eccla sequence, attributed to palaeoclimatic influences associated with the transition from glacial to deglaciation and post-glacial era. Age determinations deduced from a comparison of the palynozones of STRAT 1 section, designated the standard reference section, with other regional and Gondwana-wide zonation schemes indicates Late Carboniferous (Kasimovian – Gzhelian) to earliest Late Permian (Roadian) ages for the Lower Karoo sequence in the Kalahari Karoo Basin. Broad palaeoclimatic inferences from the qualitative analysis support a transition from cold and humid conditions, during deposition of the Dwyka glacial facies, to warm and drier conditions during deposition of the lower Eccla sequences. Palaeoclimatic conditions ultimately turned wet during middle Eccla times generating coal-forming settings. Palaeoenvironmental interpretations based on palynofacies data indicate a predominantly proximal palaeo-depositional setting for the entire Lower Karoo sequence at STRAT 1 borehole. The broader depositional environment transformed from glacial sub-environments, during deposition of the Dwyka Group, into a relatively wider basin punctuated by some rare marine incursions, in the early Eccla Group, and ultimately developing into a deltaic system.

LIST OF CONTENTS

Declaration	i	5.1.1.1.1.1 Range Zones	162
Acknowledgements	ii	5.1.1.1.1.2 Assemblage Zones	166
<i>Introduction générale</i>	iii	5.1.1.2 CKP6 Borehole	170
<i>Résumé</i>	vi	5.1.1.2.1 Biozones	170
Abstract	viii	5.1.1.2.1.1 Range Zones	173
Contents	ix	5.1.1.2.1.2 Assemblage Zones	175
1. INTRODUCTION	1	5.1.2 Quantitative Analysis	177
1.1 Background to the Study	1	5.1.2.1 Palynofacies Horizons	177
1.2 Scope of Study	2	5.1.2.1.1 Total sedimentary organic matter (TSOM)	178
1.3 Bases of Study	4	5.1.2.1.2 Palynomorphs	180
1.4 Previous Work	5	5.1.2.1.3 Phytoclasts	183
2. BACKGROUND GEOLOGY	8	5.1.2.1.4 Log ₁₀ ratios	185
2.1 Regional Setting	8	5.1.2.2 Statistical Analysis	187
2.2 Structural Development	11	6. DISCUSSIONS	196
2.3 Stratigraphy	13	6.1 Correlation	196
2.4 Sedimentary Evolution	18	6.1.1 STRAT 1 correlation with CKP 6 and CKP 9	196
3. MATERIALS AND METHODS	23	6.1.2 Local Correlations	201
3.1 Core Description and Sampling	23	6.1.3 Regional Correlations	206
3.2 Sample Preparations	33	6.1.4 Gondwana-wide Correlations	210
3.3 Microscopy	35	6.2 Age	215
3.3.1 Qualitative analysis	35	7. PALAEOENVIRONMENTAL INTERPRETATIONS	218
3.3.2 Quantitative analysis	35	7.1 Qualitative Analysis	218
4. PALAEOPALYNOLOGY SYSTEMATICS	37	7.2 Quantitative Analysis	222
4.1 Terminology	37	7.2.1 Relative Abundance Distributions	222
4.2 Systematic Descriptions	43	7.2.2 Statistical Analysis	226
5. RESULTS	159	7.2.2.1 Ternary Plots	226
5.1 Palynostratigraphy	159	7.2.2.2 Stratigraphic Trends	232
5.1.1 Qualitative Analysis	160	8. CONCLUSIONS	242
5.1.1.1 STRAT1 Borehole	160		
5.1.1.1.1 Biozones	162		

PLATES

Exposures

Plate A: Rare exposure depicting the Dwyka – Ecca contact, South East Central Kalahari Sub-basin 19

Plate B: Thinly bedded medium- to coarse-grained sandstone of the Ecca Group, Southern belt Central Kalahari Sub-basin 19

Plate C: Erosional remnants of the Ntane Sandstone, Tuli Basin 22

Plate D: Sandstone bed inter-layered with basaltic lava, Tuli Basin 22

Palynomorphs 248

Palynofacies 271

REFERENCES 278

TABLES

Table 1: Total number of samples submitted for the study and their status of palynomorph yields 33

Table 2: Categories of sedimentary organic matter and supra-generic taxa 36

Table 3: Summary explanation of palynofacies fields and environments (after Tyson, 1995) 228

FIGURES

Introduction

Figure 1: Regional disposition of the Kalahari Karoo Basin in Botswana 1

Figure 2: Area of exposed Karoo Supergroup rocks in the Kalahari Karoo Basin 3

Figure 3: Summary of previous palynology studies in Botswana 7

Background Geology

Figure 4: Regional outline of the Karoo basins in Southern Africa 8

Figure 5a: Late Palaeozoic Gondwana framework and the location of accretionary foreland basins (Turner, 1999) 9

Figure 5b: Geodynamic setting of the Main Karoo Basin as foreland basin to the Cape Fold-belt (Turner, 1999) 10

Figure 6: Geodynamic model explaining the origin of the northern Karoo basins 10

Figure 7: Major aeromagnetic interpretation lineaments associated with the Kalahari Karoo Basin structure 11

Figure 8: Boundaries to sub-basins of the Kalahari Karoo Basin relative to major pre-Karoo aeromagnetic interpretation structural elements 12

Figure 9: Lithostratigraphy and palaeoenvironments of the Karoo Supergroup 15

Figure 10: Sub-basins of the Kalahari Karoo Basin 16

Figure 11: Nomenclature and correlation of the Karoo Supergroup in Botswana 17

Materials and Methods

Figure 12: Locality map showing boreholes sampled for the study 23

Figure 13: STRAT 1 borehole section indicating sampled levels; sample numbers ending in -01 represent the initial 20 samples used for the trial run (*A3 size*) 24

Figure 14: CKP9 borehole section indicating sampled levels 25

Figure 15: CKP6 borehole section indicating sampled levels (*A3 size*) 26

Figure 16: KGO3 borehole section indicating sampled levels 27

Figure 17: ML1 borehole section indicating sampled levels 28

Figure 18: ML2 borehole section indicating sampled levels 29

Figure 19: TLMB1 borehole section indicating sampled levels 30

Figure 20: NATA borehole section indicating sampled levels 31

Figure 21: ME58 borehole section indicating sampled levels 32

Systematic Palaeopalynology

Figure 22: Principal morphological features and measurement terminology of trilete spores 38

Figure 23: Principal morphological features and measurement terminology of monolete spores 39

Figure 24: Principal morphological features and measurement terminology of monocolpate pollen 40

Figure 25: Principal morphological features and measurement terminology of monosaccate pollen 41.

Figure 26: Principal morphological features and measurement terminology of bisaccate pollen grains 42.

Results

Figure 27: Stratigraphic range chart of determined taxa and biostratigraphic subdivision of STRAT 1 borehole section; broken lines reflect a zone of non-occurrence between the preceding relatively consistent occurrence and the last occurrence for the respective taxon (*A3 size*) 161

Figure 28: Stratigraphic range chart of significant taxa and biostratigraphic subdivision of STRAT 1 borehole section 163

Figure 29: Summary of significant qualitative and quantitative analyses with subdivision of STRAT 1 borehole section (*A3 size*) 165

Figure 30: Significant assemblage zone taxa with subdivision of STRAT 1 borehole section 167

Figure 31: Summary of assemblage zones highlighting notable characteristics 169

Figure 32: Stratigraphic range chart of determined taxa and biostratigraphic subdivision of CKP 6 borehole section; broken lines reflect a zone of non-occurrence between the preceding or succeeding relatively consistent occurrence and the last or first occurrence, respectively (*A3 size*) 171

Figure 33: Stratigraphic range chart of significant taxa and biostratigraphic subdivision of CKP 6 borehole section 172

Figure 34: Summary of significant qualitative analyses with subdivision of CKP 6 borehole section (*A3 size*) 174

Figure 35: Significant assemblage zone taxa with subdivision of CKP 6 borehole section 176

Figure 36: Relative abundance and stratigraphic distribution of 3 major groups of sediment organic matter, and significant horizons (plotted as % of TSOM) 179

Figure 37: Relative abundance of 11 selected palynomorph groups depicting their stratigraphic distribution and significant horizons (plotted as % of TPa counted, including degraded palynomorphs not shown in figure) 181

Figure 38: Relative abundance and stratigraphic distribution of 4 selected phytoclasts categories, and significant horizons (plotted as % of TPh) 184

Figure 39: Stratigraphic distribution of selected \log_{10} ratios, and significant horizons 186

Figure 40: Cluster analysis dendrogram for total sediment organic matter counts i.e. AOM (Amorphous organic matter), TPH (Total phytoclasts), and TPA (Total palynomorphs) 189

Figure 41: Cluster analysis dendrogram for spores, pollen, and microplanktons depicting several associations of samples 190

Figure 42: Cluster analysis dendrogram for selected categories of phytoclasts e.g. Black equidimensional (BLKE), Brown equidimensional (BRNE), and Cuticle and membranous tissues (CAMT) 191

Figure 43: Cluster analysis dendrogram for total sediment organic matter using only samples from the Malogong and Khuis formations, Dwyka Group 192

Figure 44: Cluster analysis dendrogram for total sediment organic matter using only samples from the Middlepits formation, Dwyka Group 193

Figure 45: Cluster analysis dendrogram for total sediment organic matter using only samples from the Kobe formation, Ecca Group 194

Figure 46: Cluster analysis dendrogram for total sediment organic matter using only samples from the Otshe formation, Ecca Group 195

Discussions

Figure 47: Biostratigraphic correlation of STRAT 1 and CKP 6 boreholes 198

Figure 48: Tentative biostratigraphic correlation of STRAT 1 with CKP 9 200

Figure 49: Biostratigraphic correlation chart of STRAT 1 borehole with other local previous studies 205

Figure 50: Biostratigraphic correlation chart of STRAT 1 borehole with selected regional and Gondwana-wide zonation schemes. Chronostratigraphic units are sourced from the International Stratigraphic Chart based on Gradstein et. al. (2004) (*A3 size*) 216

Palaeoenvironmental Interpretations

Figure 51: Ternary AOM-total phytoclasts-total palynomorphs plot: (a) ternary plot based on dendrogram of Figure 40, (b) palynofacies fields and environments (see Table 2 for explanations) 227

Figure 52: Ternary microplankton-spore-pollen palynomorph plot: (a) ternary plot based on dendrogram of Figure 41, (b) ternary diagram for palynomorphs indicating the characteristic depositional environments 230

Figure 53: Ternary black equidimensional (BLKE)-brown equidimensional (BRNE)-cuticular and membranous tissues (CAMT) phytoclasts plot, based on dendrogram of Figure 42 231

Figure 54: Small-scale palaeoenvironmental stratigraphic cycles in the Malogong and Khuis formations: (a) ternary AOM-TPH-TPA plot based on dendrogram of Figure 43, (b) proximal-distal trends, and notable relative abundances for the AOM 234

Figure 55: Small-scale palaeoenvironmental stratigraphic cycles in the Middlepits Formation: (a) ternary AOM-TPH-TPA plot based on dendrogram of Figure 44, (b) proximal-distal trends, and notable relative abundances for total phytoclasts (TPH) and total palynomorphs (TPa) 236

Figure 56: Small-scale palaeoenvironmental stratigraphic cycles in the Kobe Formation: (a) ternary AOM-TPH-TPA plot based on dendrogram of Figure 45, (b) proximal-distal trends, and notable relative abundances for total sediment organic matter 238

Figure 57: Small-scale palaeoenvironmental stratigraphic cycles in the Otshe Formation: (a) ternary AOM-TPH-TPA plot based on dendrogram of Figure 46, (b) proximal-distal trends, and notable relative abundances for total sediment organic matter 240

APPENDICES 288

Appendix I 288

1. All taxa index list

Appendix II 293

1. STRAT1 all taxa occurrence chart (*A3 size*) 293
2. STRAT 1 all taxa ranges with biohorizons (*A3 size*) 294

3. CKP6 all taxa occurrence chart (*A3 size*) 295
4. CKP6 all taxa range with biohorizons (*A3 size*) 296
5. CKP9 borehole all taxa occurrence chart 297
6. CKP9 borehole all taxa range with biohorizons 298
7. KGO3 borehole all taxa occurrence chart 299
8. ML1 borehole all taxa occurrence chart 299
9. NATA borehole all taxa occurrence chart 300
10. ME58 borehole all taxa occurrence chart 300

Appendix III 301

1. Summary of palynofacies horizons and their correlation with biohorizons, and notable characteristics of the qualitative and quantitative analyses (*A3 size*) 301

CHAPTER 1: INTRODUCTION

1.1 Background to the Study

In Botswana, late Palaeozoic to early Mesozoic sedimentary rocks and volcanic sequence belonging to the Karoo Supergroup occur in an extensive, centrally located area collectively termed the Kalahari Karoo Basin (Fig. 1).

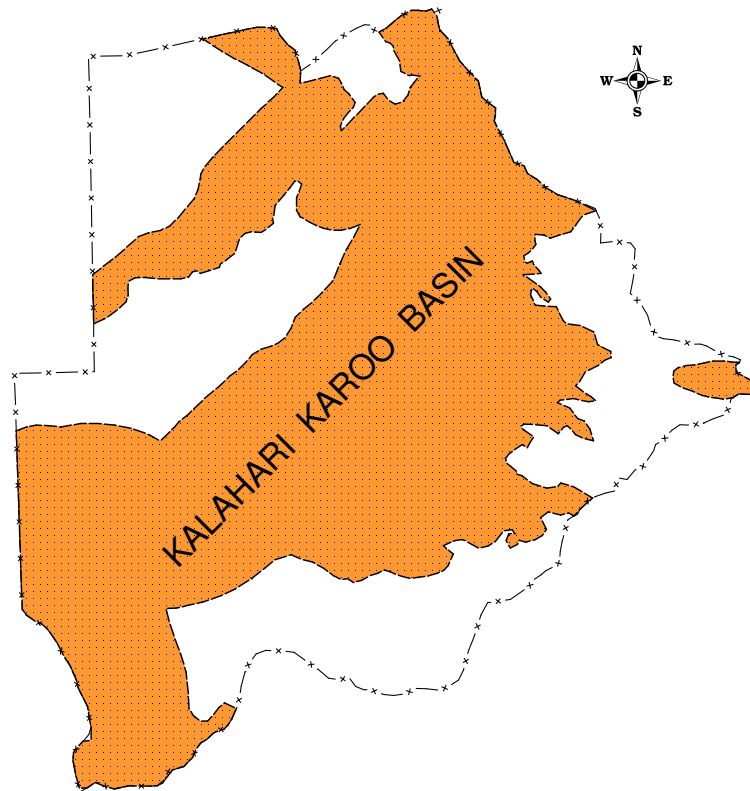

Figure 1 Regional disposition of the Kalahari Karoo Basin in Botswana (Farr, 1981; Smith, 1984).

The Karoo Supergroup rocks host important natural resources dominated by coal, including coalbed methane natural gas, in addition to clay and groundwater resources. It is without doubt then that the Kalahari Karoo Basin holds great potential as a major contributor to build an economy of scale in Botswana, a country whose economic backbone is already anchored on mineral resources. Since its inception in 1948, the Botswana Department of Geological Survey (DGS), whose mission is to advance knowledge on earth resources, and to advise government and the public on their sustainable utilization, has pioneered several earth resources investigations in the Kalahari Karoo Basin (e.g. Green, 1966; Baldock et. al., 1977; Farr, 1981; Clark et. al., 1986; Gwosdz and Sekwale, 1982; Williamson, 1996; ECL, 1998; ARI, 2003). To date, huge amounts of coal resources, estimated at about 17 billion tons (SADC, 2001), have been discovered in Botswana. The discovery of coal in the Kalahari Karoo Basin provided Botswana with one of the major primary sources of energy

known in the world, which has over decades been the only known fossil fuel resource to exist in the country. Despite the great potential that coal has as a primary source of energy for homes and industry, and more significantly for the generation of electricity, its usage in Botswana still remains minimal. Stephenson and Penn (2005) also highlighted important benefits such natural resources, as is coal, could generate by creating wealth for poor communities through increased investment, direct employment and service provision.

On this realization, and in an attempt to further upgrade geological knowledge on the Kalahari Karoo Basin, the DGS initiated an applied science project, under the auspices of the National Development Plan 8 (NDP8) policy, with two main objectives:

1. To assess the availability and the potential to develop natural gas resources (i.e. coalbed methane) associated with the coal-bearing sequences of the Kalahari Karoo Basin in Botswana.
2. To establish a database on stratigraphy and develop a correlation system that characterizes the coal-bearing sedimentary sequence of the Kalahari Karoo Basin in Botswana.

The works for the first objective of the project, successfully completed in 2003, were awarded to a private consultancy, namely, Advanced Resources International Inc. (USA), in association with Scales Associates (Botswana). The results of this study indicated that the coal beds within the study area contain an estimated gas-in-place resource of 60 trillion cubic feet (Tcf). The associated carbonaceous shales are estimated to contain an additional 136 Tcf, resulting in a combined total of 196 Tcf of gas-in-place (ARI, 2003).

The works for the second objective of the project, which forms the subject of this thesis, were incorporated into a collaborative research study with the school of doctorate of the University of Brest, in France.

1.2 Scope of Study

Although several projects initiated by the DGS have to date proven great potential in terms of economic resources associated with the Karoo sequence there is still a lack of adequate geological knowledge to effectively correlate across the entire Kalahari Karoo Basin. The situation is compounded by the lack of exposure owing to widespread cover by Cretaceous to recent sediments belonging to the Kalahari Desert environment, which has resulted in only an insignificant area of Karoo exposure (Figure 2). Nevertheless, several years of exploration, particularly coal exploration, has seen the continued use of the traditional method of stratigraphic correlation, based on lithological similarities, in the poorly exposed Kalahari Karoo Basin, to correlate widely spaced borehole sections (Farr, 1981; Smith, 1984; ECL, 1998). However,

correlations based solely on lithostratigraphic evidence have, through geological time, been found lacking in their chronostratigraphic significance and can lead to erroneous lithostratigraphic mis-correlations. This is because studies of sedimentary environments and facies distributions have shown that similar units can be deposited at different times, in different areas, and with no physical connection to each other (Reading, 1986; Mial, 1990). Lithostratigraphic correlations are reliable only in areas where beds can be physically traced out on the ground, and where there are distinctive and readily recognizable marker beds, a phenomenon that is rare in the Kalahari Karoo Basin.

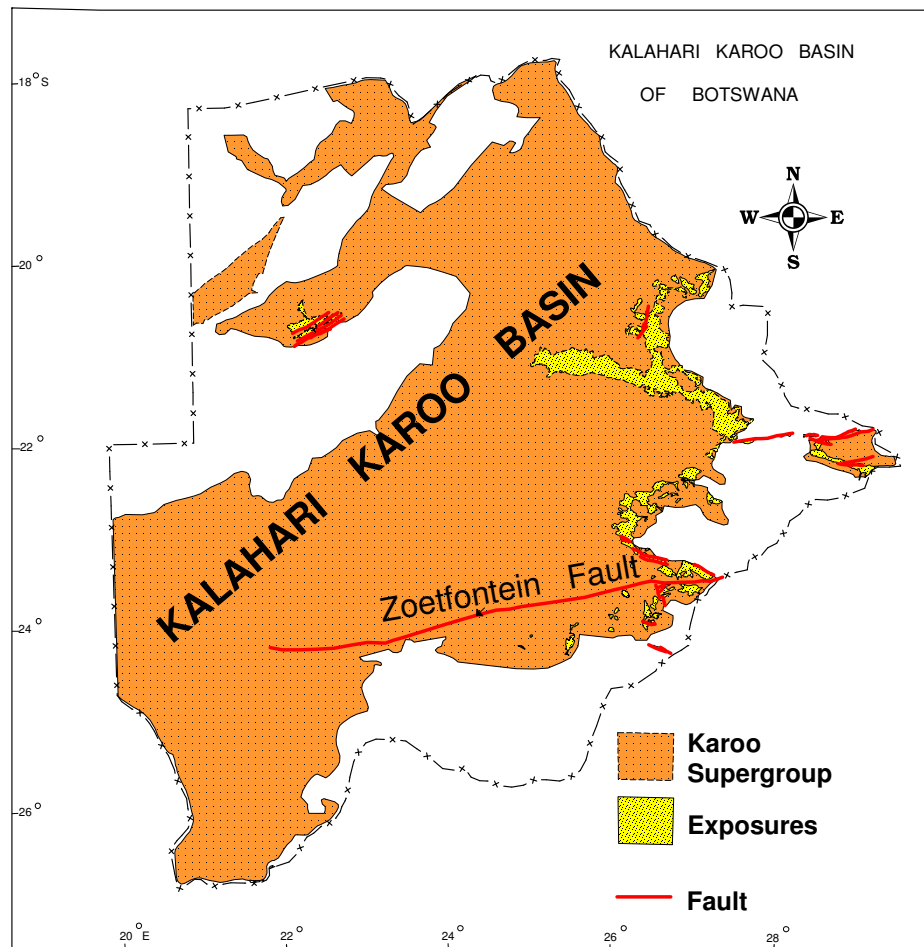

Figure 2 Area of exposed Karoo Supergroup rocks in the Kalahari Karoo Basin (Farr, 1981; Smith, 1984; Modie, 2000).

The purpose of this study is to advance the concept of biostratigraphy in the Kalahari Karoo Basin of Botswana, and establish a preliminary biostratigraphic correlation scheme to augment the current lithostratigraphic correlation scheme that is being used. Biostratigraphy, which can be defined as the study of the relative arrangement of strata with regard to their fossil content (Miall, 1990; Murphy and Salvador, 1994) has become an indispensable aspect in lithostratigraphic correlations. The method of biostratigraphic correlation is used to erect zones of local or regional stratigraphic

correlations, and forms the basis for a global system of chronostratigraphic subdivision (Miall, 1990; Agterberg and Gradstein, 1999). Biostratigraphic zonation will help improve correlation of sections of the Karoo Supergroup from across the basin and minimize the use of local names for the same units in different parts of the basin, as is the case at present (e.g. Smith, 1984), which often give rise to difficulties in correlation during geological and mineral investigations. Additionally, a biostratigraphic approach shall generate data that can be used to place the Kalahari Karoo Basin in both a regional and global setting.

In this study biostratigraphic horizons, which can be defined as stratigraphic boundaries, surfaces or interfaces across which significant biostratigraphic changes are noticed (Murphy and Salvador, 1994), are used as the basis for creating biozones. One better-preserved and closely sampled borehole section is designated a standard reference section. The standard reference section is then compared and correlated with other sections to produce a composite standard reference section. The composite standard reference section, which can be updated from time to time, as and when new data is availed, form the bases for a biostratigraphic correlation scheme in the Kalahari Karoo Basin.

1.3 Bases of Study

Palaeopalynology, which entails the study of palynomorphs i.e. plant microfossils and other remains of living organisms (Traverse, 1988; Jansonius and McGregor, 1996), is the main line of evidence used for biostratigraphic considerations in this study, owing to the unavailability of exposed sections for the study of larger scale fossils or macrofossils. Consequently, this study is specifically based on a palynostratigraphic approach, dominated by pollen and spore palynomorphs. The fundamental base upon which pollen and spore palynomorphs are utilized in correlation emanate from the fact that plants have evolved through geological time, during which various forms of palynomorphs were deposited with sediments. As a result, palynomorph assemblages retrieved from different levels of the sedimentary strata are likely to be different in compositions, and hence, allow sequences to be differentiated.

Stratigraphic correlation studies in the Kalahari Karoo Basin are largely based on boreholes section, which has great potential for the retrieval of palynomorphs in contrast to that of macrofossils. Because of their small sizes (e.g. 200 μ m), palynomorphs are not affected by the smaller area coverage controlled by the drill-core diameters, which adversely affects the macrofossils, often resulting in only fragmentary evidence that is less reliable for biostratigraphic correlations. The fundamental advantage of palynomorphs lies in their highly protective and resistive external wall made of durable substances i.e. sporopollenin and chitin (Traverse, 1988). Sporopollenin on the outside wall allows pollen and spores to withstand and survive various depositional and burial processes of the rock sequence, as well as the rigorous laboratory maceration processes for their liberation for study. Relatively

good palynomorph preservations from borehole samples of the Kalahari Karoo Basin have been reported from some previous studies (e.g. Cadman, 1995).

In addition to palynomorph based evidence for biostratigraphic considerations, a major component of this study entails a general assessment of the sedimentary organic matter (SOM) present in the samples and their potential for correlation as well as palaeoenvironmental interpretations. SOM comprises the organic components of sedimentary rocks, inclusive of palynomorphs, and often largely dominated by the remains of land plants such as tree trunks, branches, and leaves (Batten, 1996). The SOM found in sedimentary rocks has undergone various pre- and post-depositional physical and chemical changes but the remains consist of various recognizable categories. Because sedimentary organic matter forms an integral part of the sedimentary rock the constituent categories are considered useful in the interpretation of depositional environments (Batten, 1996). Different palynomorph types can give insight into ancient environments in which parent organisms lived, as well as palaeoclimatic environments at source of sediments (Traverse, 1988). Studies in which acid-resistant organic matter have been categorized to define what are termed palynofacies (Combaz, 1964) are very common in palynological investigations, an approach which is generally similar to the interpretation of sedimentary facies in sedimentology (e.g. Courtinat, B., Piriou, S. and Rio, M, 2003; Roncalgia, L, 2004; Martin-Closas, C., Permanyer, A. and Vila, M, 2005; Masselter, T. and Hofmann, C, 2005).

1.4 Previous Work

There is a limited amount of previous palynological investigations undertaken from the Kalahari Karoo Basin of Botswana. The level and density of palynological information occurrence is still very low and of a sporadic nature across the basin. No palynofacies studies have ever been undertaken.

MacRae (1978) created the first preliminary biozonation system for the Karoo Supergroup in Botswana, which was based on samples from one borehole (N1/3) along the northeastern fringe of the basin. This work established the occurrence of three concurrent range zones (I, II, III) based on the species ranges and quantitative distribution of the major miospore taxa in the palynomorph assemblages. The positions of the lower and upper limits of the concurrent range zones I and III, respectively, were not conclusive from this study.

In a combined palaeontological and radiometric studies to determine the onset of Karoo vulcanicity Aldiss et. al (1984) established the occurrence of Early Jurassic palynomorphs i.e. *Classopollis intrareticulatus*. The palynomorphs were found in fluvio-lacustrine sedimentary rocks of the Tuli Sub-basin, intercalated with lava at the base of Karoo basalt, marking the end of Karoo sedimentation and the upper limit of the Lebung Group.

Dolby (1990) established the occurrence of two zones based on micropalaeontological and palynological assemblages obtained from a lower Karoo Supergroup section (i.e. lower Ecca to Dwyka) intersected in a petroleum investigation borehole (Masetlheng Pan-1) drilled in southwest Botswana. The two zones, from young to old, were assigned to an Early Permian (Sakmarian-Asselian) and Late Carboniferous (Gzhelian-Kasimovian) age, respectively.

ECL (1990) developed a regional palynozone scheme (MZI – MZV) in an attempt to underline the importance of chronostratigraphic control within the Lower Karoo sequence of southern Africa as opposed to the commonly used stratigraphic subdivision based solely on lithostratigraphic features across the region. The scheme was based on palynological analyses of borehole and field samples from Namibia, Botswana, Zimbabwe and Zambia, in addition to published literature on Karoo palynology. Much of the samples analysed from the Kalahari Karoo Basin were from the Dwyka and Ecca section of the lithostratigraphy, and the recovered palynomorphs indicate Permian age.

Drilling for water in a Tribal Grazing Land Policy programme in southwest Botswana (northern Gemsbok Sub-basin) provided several lower Karoo Supergroup samples for Cadman (1995) to establish six palynological biozones (A – F), based on fossil pollen-spore assemblages. The six biozones range from Late Permian (Tatarian – Kazanian) to Late Carboniferous (Gzhelian – Kasimovian) ages.

Key et. al. (1995) presents biozone and age divisions of a lower Karoo Supergroup section from southwest Botswana, in the southern Gemsbok Sub-basin of the Kalahari Karoo Basin. This work however does not include the data (palynomorph assemblages) from which the biozones and ages were derived from.

The latest palynological publication from the Kalahari Karoo Basin is the work of Stephenson and McLean (1999) that gives details of palynological assemblages from the Morupule Main Seam, the main coal seam currently mined at Morupule Colliery, along the eastern fringe of the Kalahari Karoo Basin. Extensive regional and Gondwana-wide correlations based on palynological assemblages are detailed in this work. Strata of the Karoo Supergroup that host the Morupule Main Seam is assigned to an Early Permian age.

Figure 3 is a summary of the previous palynological studies undertaken on rocks of the Karoo Supergroup in Botswana.

AGE		STAGE	STRATIGRAPHY	LOCATION	AUTHOR
JURASSIC	LOWER	Toarcian - Sinemurian	STORMBERG LAVA GROUP	TULI BASIN Intercalated fluvio-lacustrine sediments at base of volcanics	Aldiss, Benson & Rundle, 1984
PERMIAN	UPPER	Artinskian - Kazanian	ECCA GROUP	North East Botswana	ECL, 1990
				Northern Belt & South East Central Kalahari Sub-basin.	MacRae, 1978 ECL, 1990 Stephenson & McLean, 1999
	West Central Kalahari Sub-basin	ECL, 1990			
	LOWER	Sakmarian - Asselian		South West Botswana	Dolby, 1990 ECL, 1990 Cadman, 1995 Key, McGeorge, Aitken, Cadman, Tidi & Anscombe, 1995
CARBONIFEROUS	UPPER		Gzhelian - Kasimovian	DWYKA GROUP	Northern Belt Central Kalahari Sub-basin
		West Central Kalahari Sub-basin			ECL, 1990
		South West Botswana			Dolby, 1990 ECL, 1990 Key, McGeorge, Aitken, Cadman, Tidi & Anscombe, 1995

Figure 3 Summary of previous palynology studies in Botswana.

CHAPTER 2: BACKGROUND GEOLOGY

2.1 Regional Setting

The Kalahari Karoo Basin of Botswana is one among several contemporaneous Karoo basins (Smith et. al., 1993; Johnson et. al., 1996; ECL, 1998) of southwestern Gondwana that became active in the Permo-Carboniferous times (Fig. 4).

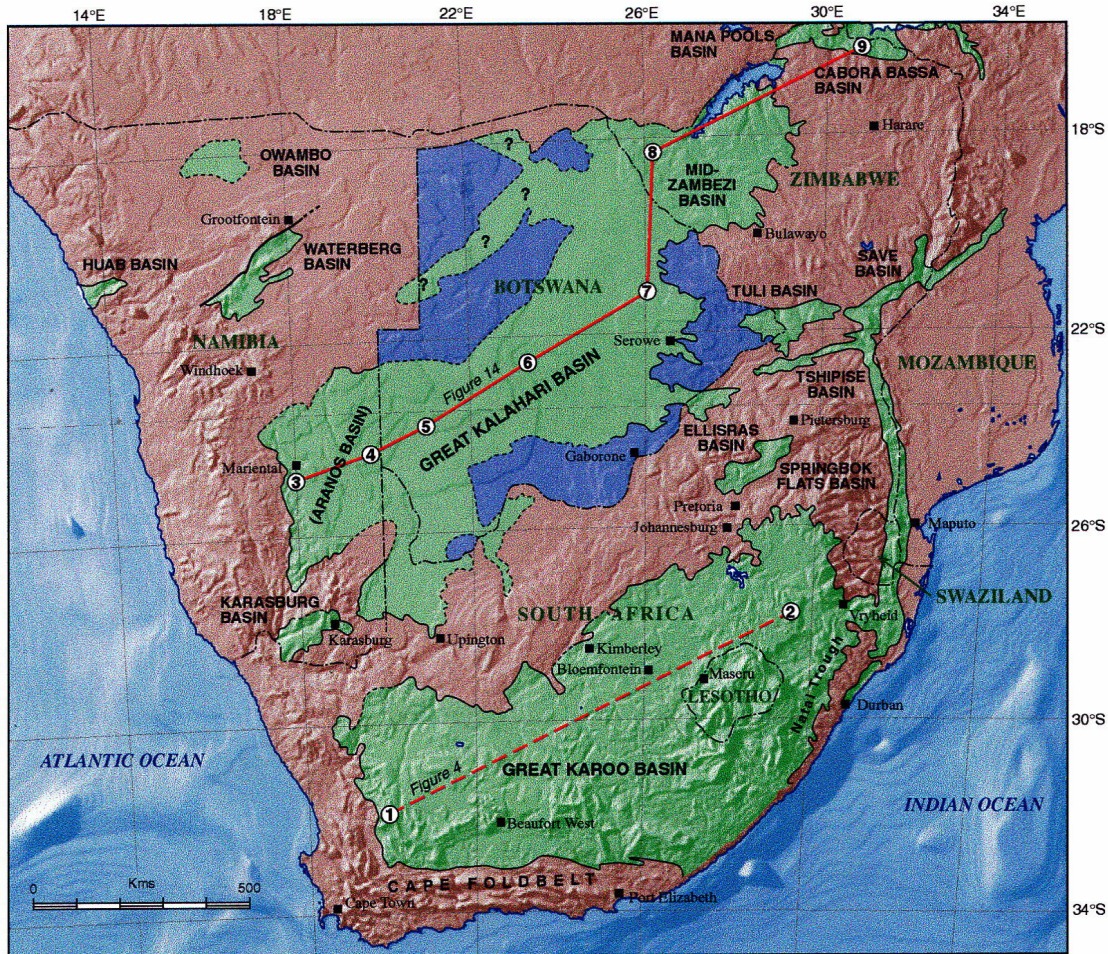

Figure 4: Regional outline of the Karoo basins in Southern Africa (ECL, 1998).

Sedimentation in these basins continued to accumulate until it was interrupted and eventually brought to a close by widespread flood basaltic volcanism, initiated by extensional tectonics in the early Jurassic, which marked the onset of Gondwana break-up (Cox, 1992; ECL, 1998; Jourdan et. al., 2005). The maximum pre-erosion areal extent of the Karoo basins of southern Africa, in early Permian times, is considered to have covered about 4.5 million km², with a thickness range of 10 000m to 1000m, recorded in the Main Karoo and Cabora Bassa basins, and the other subsidiary basins, respectively (Smith et. al., 1993; Johnson et. al., 1996). Several dolerite dikes, that are considered to represent conduits for Karoo basalts, are

abundant across the region. The sedimentary fill of the Karoo basins throughout southern Africa have a remarkably uniform lithologic characteristics and fossil assemblages, which has been a great aid in regional stratigraphic correlation. In addition, the Karoo basins of southern Africa host all the coal deposits in the region.

The largest of the Karoo basins, which is also the type basin for Karoo stratigraphy, is the Main Karoo Basin of South Africa that is considered to have developed as a foreland basin to the Cape Foldbelt (Johnson, 1991; Smith et al., 1993; Johnson et al., 1996; Turner, 1999). The Kalahari Karoo Basin of Botswana and several other subsidiary basins in South Africa, Namibia, Botswana, Zimbabwe and Mozambique are classified as intracratonic sag basins or rift basins (Orpen et al., 1989; Verniers et al., 1989; Johnson et al., 1996; ECL, 1998; Holzforster et al., 1999).

The exact geodynamic setting for the Kalahari Karoo basin, together with the other Karoo basins remains little understood. However, several workers e.g. Daly *et al.* (1991), Cox (1992), ECL (1998), and Turner (1999) have attributed origin of these basins to collision induced extensional tectonics related to the Late Palaeozoic to Early Mesozoic Gondwanide Cape orogeny that resulted from the subduction of a palaeo-Pacific plate under southern Gondwana. The latter gave rise to the development of the main Karoo Basin in the south as a retro-arc foreland basin to the Cape Foldbelt (Fig. 5a, b), while the Kalahari Karoo Basin, and other subsidiary basins, developed in the north as intracratonic basins.

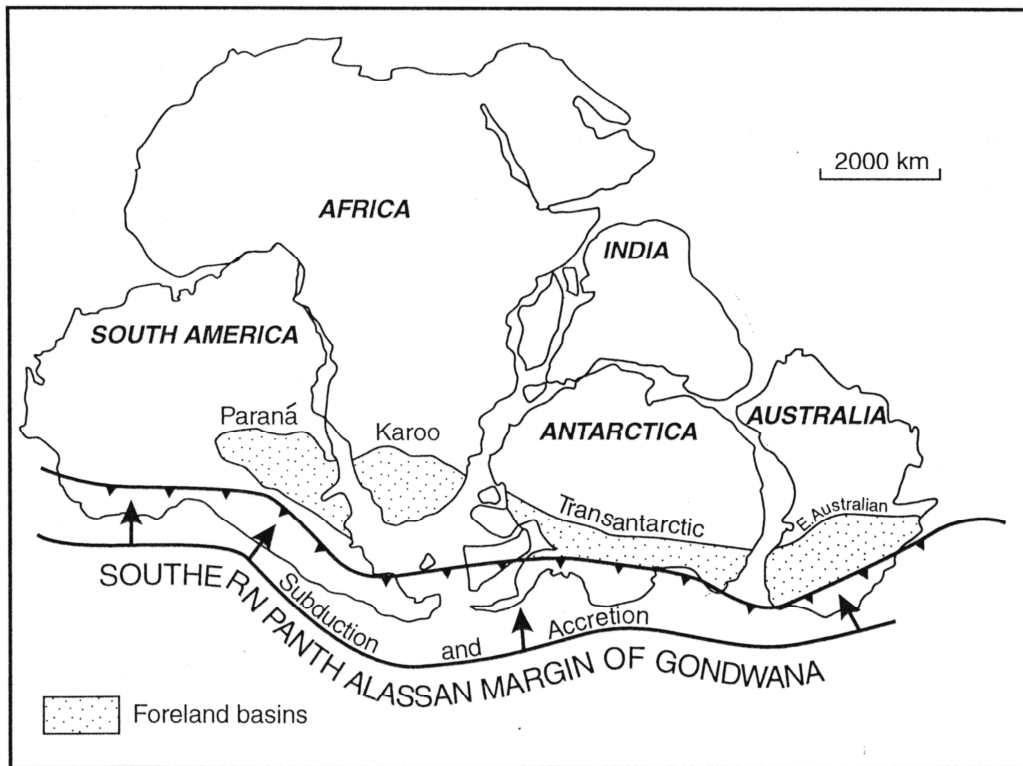

Figure 5a: Late Palaeozoic Gondwana framework and the location of accretionary foreland basins (Turner, 1999).

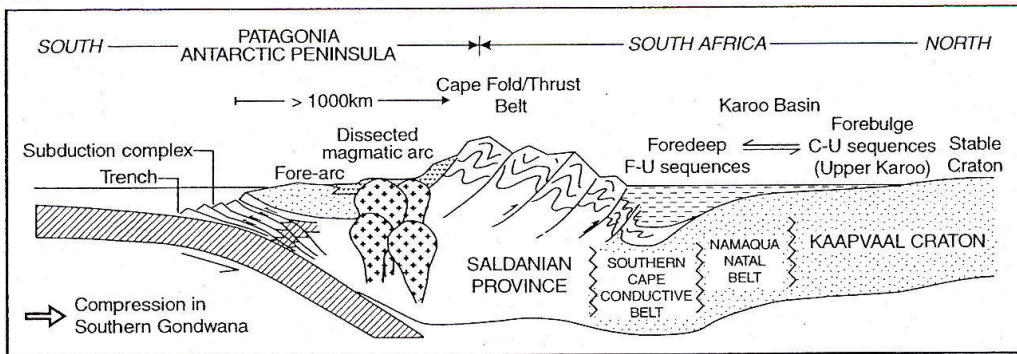
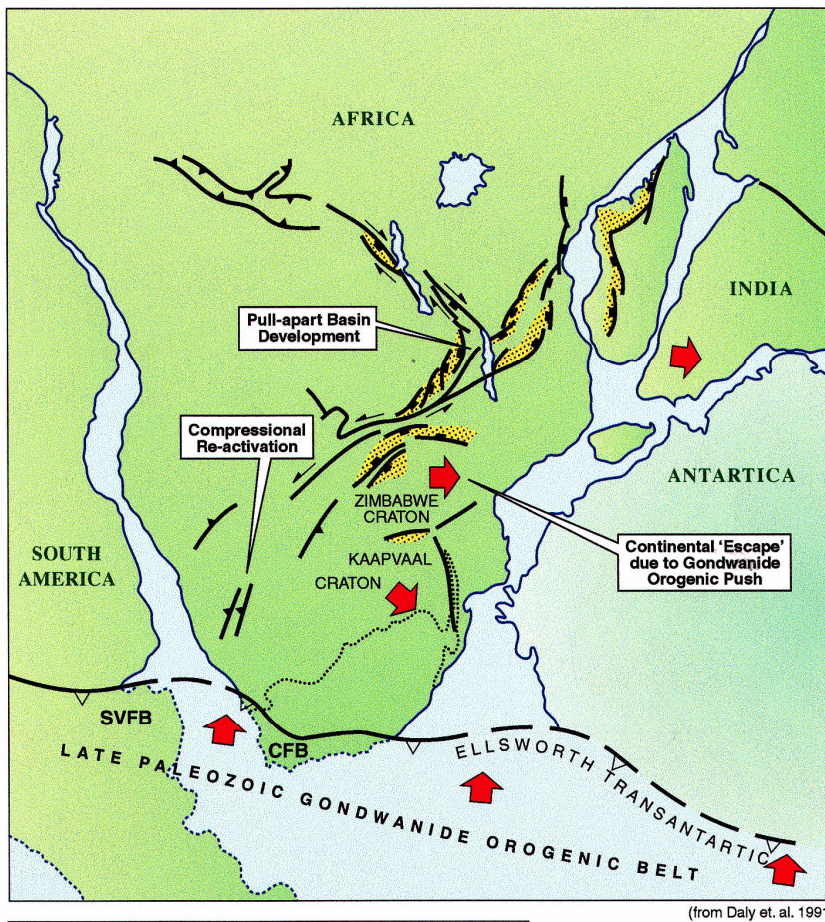

Figure 5b: Geodynamic setting of the Main Karoo Basin as foreland basin to the Cape Fold-belt (Turner, 1999).



Through the mechanism of collision-induced tectonics ECL (1998) invoked an interpretive model that depicts compressional re-activation and pull-apart basin development, with a continental “escape” vector, as the main setting for the northern basins (Fig. 6).

Figure 6: Geodynamic model explaining the origin of the northern Karoo basins (ECL, 1998).

2.2 Structural Development

The sub-surface structural framework of the Kalahari Karoo basin is little understood due to widespread cover by sediments of the Kalahari Desert environment. Consequently much of the covered centrally located Kalahari Karoo basin has hitherto been considered to define an intracratonic sag basin. Only along the eastern fringe of the basin, where there is limited exposure and near-surface bedrock, has it been possible to demonstrate the occurrence of fault-bounded graben structures (Green et. al., 1980; Williamson, 1996). In recent times though, the use of potential field data (e.g. seismic, aeromagnetics) to delineate major structural elements, such as faults and lineaments, indicates a rift basin setting for parts of the covered interior of the Kalahari Karoo basin (Davison and Steenkamp, 1995).

The structural evolution of the Kalahari Karoo basin appears to have been influenced by pre-Karoo (Archaean, Proterozoic) structural elements as evidenced by the close association of major interpreted geophysical lineaments (Fig. 7) and the basin

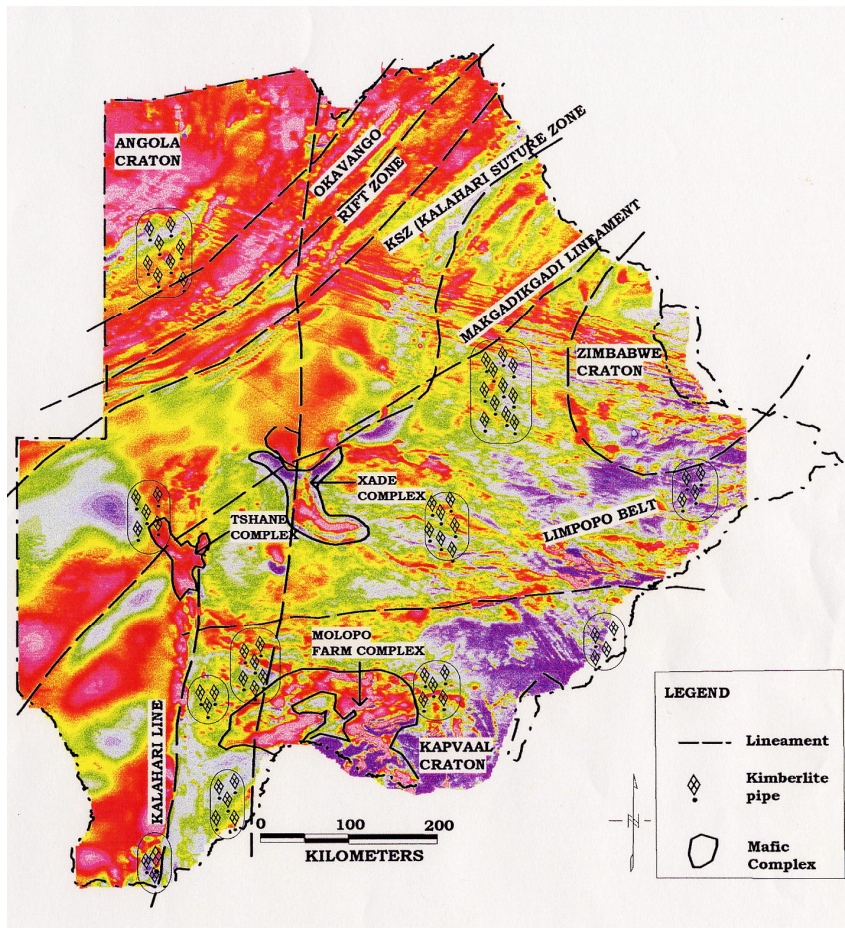

Figure 7: Major aeromagnetic interpretation lineaments associated with the Kalahari Karoo Basin structural setting (*source: DGS*).

disposition (ECL, 1998).

Such lineaments (Carney et. al., 1994), which includes the Kalahari Line, the

Makgadikgadi Line, the Zoetfontein Fault, and fault lines associated with the Pan African

Ghanzi-Chobe belt, generally parallels major boundaries that defines segments of the Kalahari Karoo Basin (Fig. 8).

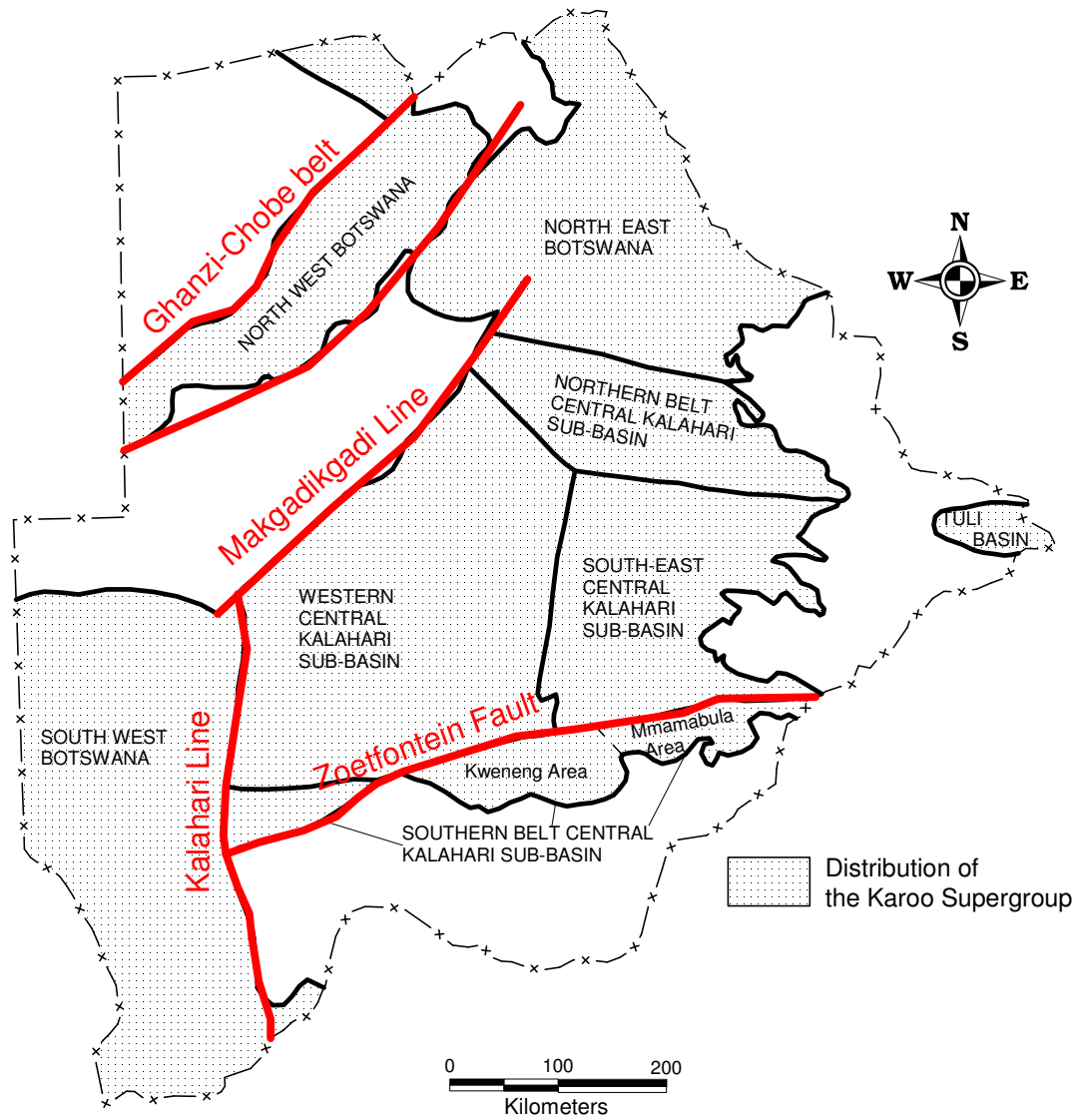

Figure 8: Boundaries to sub-basins of the Kalahari Karoo Basin relative to major pre-Karoo aeromagnetic interpretation structural elements.

The exact nature of the relationship between the Kalahari and Makgadikgadi lines with the Karoo basin configuration is not unequivocal. ECL (1998) considers the Kalahari and Makgadikgadi lineaments to represent the edge of more stable cratonic blocks. In the Ghanzi-Chobe belt Karoo rocks are preserved in fault-bounded graben structures that are clearly superimposed on older lineaments of the Pan African Damara Orogeny (Modie, 1996). On the other hand, the Zoetfontein Fault, which appears to be a reactivation of older tectonic features between the Archaean Kaapvaal Craton and the Limpopo Belt, can be geophysically traced westward into the interior of the Kalahari Karoo basin (Williamson, 1996; ECL, 1998). A seismic survey interpretation of the Karoo Supergroup reflects reactivation of the Zoetfontein Fault during Karoo sedimentation and its development as a growth fault (Davison and Steenkamp, 1995). The present structural elements (i.e. open folds, normal faulting, inversion etc.) of the Kalahari Karoo basin, as interpreted from seismic data, represent several phases of Mid-Late Karoo and post-Karoo compressional or extensional tectonics (ECL, 1998).

2.3 Stratigraphy

Sub-division of Karoo stratigraphy in the Kalahari Karoo basin is largely based on lithological distinctions than it is on palaeontological aspects because of the unavailability of exposure to study fossils. The earlier “Karoo System” for Bechuanaland by Green (1966) although implying a chronostratigraphic sequence was essentially based on lithological factors and relied heavily on regional correlation with the “Karoo System” of South Africa (e.g. Du Toit, 1954). Subsequently, the Karoo of Botswana has been described under the lithostratigraphic term “Supergroup” by Stansfield (1973) working in the north of the country i.e. in the Dukwi (2026C) and Tlamabele (2126A) areas. Several other workers in the country have since adopted this usage e.g. Aldiss (1983a/b), Meixner and Peart (1984), Smith (1984), Williamson (1996) etc. The Karoo Supergroup is divided into group and formation ranks most of which have lithological equivalents in the Main Karoo Basin of South Africa, as well as in Namibia and Zimbabwe.

The group nomenclature is largely adopted from the South African stratigraphy, owing to correlation with the better-exposed Main Karoo basin, and comprises such terminology as the Dwyka, Ecca, and Beaufort groups (SACS, 1980; Carney et. al., 1994; Johnson et. al., 1996). Figure 9 shows a generalized lithostratigraphy of the Karoo Supergroup from across the Kalahari Karoo Basin in Botswana. Overall, the broad lithostratigraphy of the Kalahari Karoo basin can be generally sub-divided into Lower and Upper Karoo about a major regional mid-Karoo unconformity (ECL, 1998). Sequences assigned to the Lower Karoo include the Dwyka, Ecca, and Beaufort groups whilst those assigned to the Upper Karoo include the Lebung and Stormberg Lava groups (Fig. 9).

Younger Cretaceous to Recent sediments masks much of the area underlain by the Karoo rocks, except for pockets of exposures (Fig. 2) confined to the basin fringe (Modie, 2000), as a result knowledge on the Karoo stratigraphy in Botswana has relied extensively on borehole information obtained from coal exploration. However, several of

the coal exploration companies have tended to use different local formation names for the same units, which pose difficulties during correlation. There is yet no formalised stratigraphy of the Karoo Supergroup in Botswana. Smith (1984) divided the Kalahari Karoo basin into seven depositional sectors or sub-basins (Fig. 10) on the basis of geological setting and facies changes, with some however delineated on the basis of convenience for description. Sequences established in the seven sub-basins were given local formation names and correlated across the country (Fig. 11). This lithostratigraphy (i.e. Smith, 1984) now forms the basis for geological correlation of the Karoo Supergroup in the Kalahari Karoo basin of Botswana.

AGE	STRATIGRAPHY		LITHOLOGY	DEPOSITIONAL ENVIRONMENT	
> 181 Ma < Late Carboniferous - Early Jurassic	KAROO SUPERGROUP	STORMBERG LAVA GROUP	Basalt > amygdaloidal	Continental flood basalts > <i>extensional tectonics related to on-set of Gondwana break-up.</i>	
		BEAUFORT	LEBUNG GROUP	Red beds > sandstone	Arid continental palaeo-climate > <i>Aeolian</i> > <i>Fluvial</i> > <i>Lacustrine</i>
				> siltstone, mudstone	
				> sandstone, rare c/glomerate	
				Siltstone, mudstone, limestone	Transitional > <i>Lacustrine</i>
ECCA GROUP		Sandstone, siltstone, carbonaceous mudstone, and coal	De-glaciation, and amelioration of the palaeo-climate. > <i>Fluvio-deltaic</i> > <i>Swamps</i> > <i>Lacustrine/marginal marine</i>		
		Mudstone			
DWYKA GROUP		Mudstone, varvites, siltstone, sandstone, and tillites	Glacial palaeo-climate > <i>Subglacial</i> > <i>Glacio-fluvial</i> > <i>Glacio-lacustrine</i>		

Figure 9: Lithostratigraphy and palaeoenvironments of the Karoo Supergroup, Kalahari Karoo Basin, Botswana.

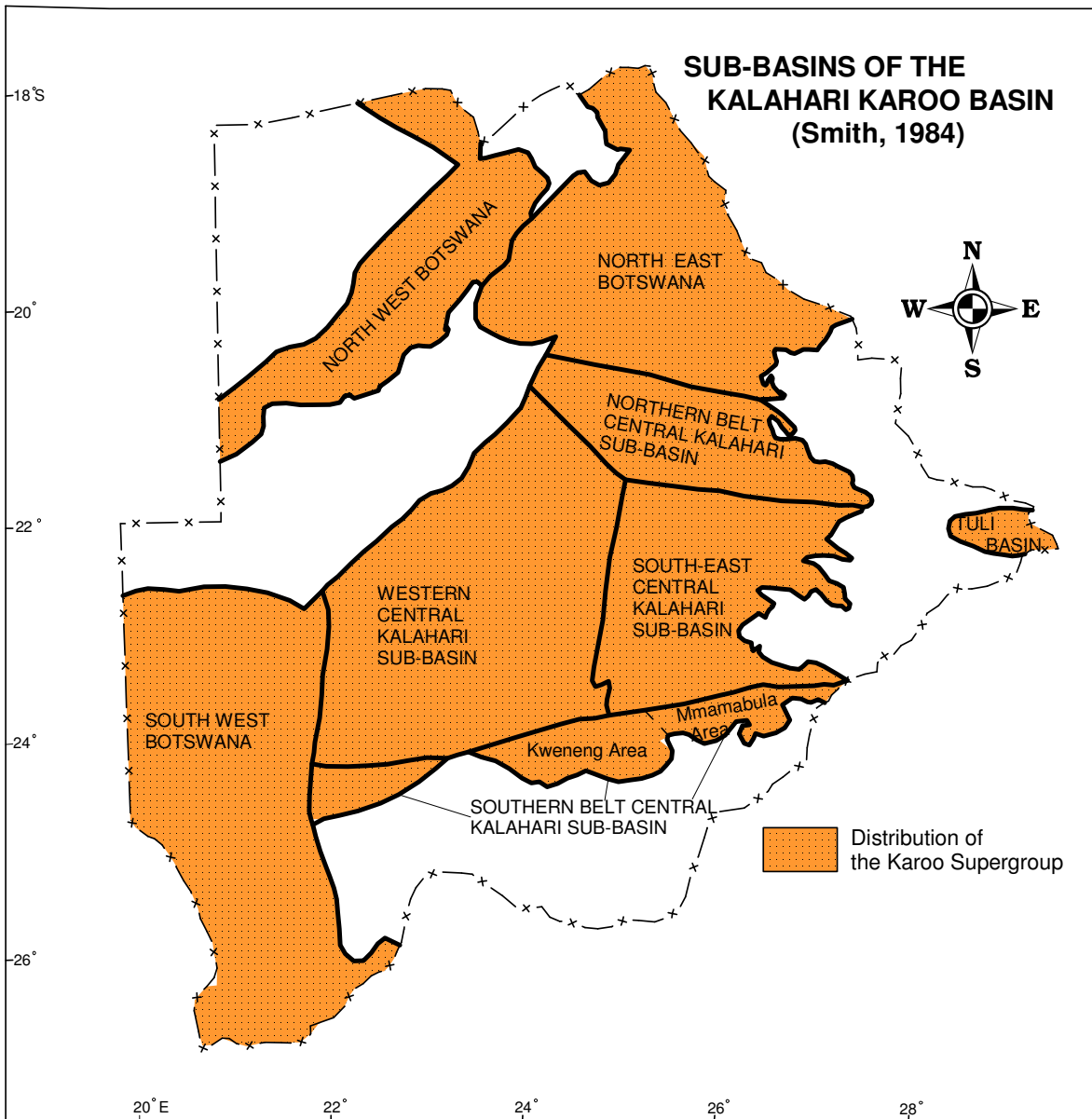

Figure 10: Sub-basins of the Kalahari Karoo Basin (Smith, 1984)

GROUPS	SOUTH WEST	KWENENG/WESTERN CENTRAL KALAHARI	MMAMABULA	S.E. CENTRAL KALAHARI	NORTH EAST AND NORTHERN BELT	NORTH WEST	TULI BASIN
STOMBERG LAVA (U. Stomberg Series)							Bobonong Lava Fm.
LEBUNG (L. Stormberg Series)	Nakalatlou Sst.	Ntane Sandstone Formation				Bodibeng Sst.	Tsheung Sst.
	Dongdong Fm.	Mosolotsane Formation			Ngwasha (n/east) Pandamatenga	Savuti Fm.	Thune Fm. Korebo Fm.
(Beaufort Series)	Kule Fm.	Kwetla Fm.	Tlhabala Formation			?	Seswe Formation
ECCA (Ecca Series)	Otshe Fm.	Boritse Fm.	Korotlo Fm.	Serowe Fm.	Tlapanana Fm.	Marakwena Fm.	
			Mmamabula Fm.	Morupule Fm.		Tale Fm.	
	Kweneng Fm.	Mosomane Fm.	Kamotaka Fm.	Mea Arkose	?		
	Kobe Fm.	Bori Fm.	Bori Fm.	Makoro Fm.	Tswane Fm.	?	Mofdiahogolo Fm.
DWYKA (Dwyka Series)	Middlepits Fm.	Dukwi Formation				?	?
	Khuis Fm.						
	Malogong Fm.						

Figure 11: Nomenclature and correlation of the Karoo Supergroup in Botswana (Smith, 1984).

2.4 Sedimentary Evolution

The stratigraphy of the Karoo Supergroup (Fig. 9) in the Kalahari Karoo Basin, as in many of the other Karoo basins of Southern Africa, records a transition from a glacial period through fluvio-deltaic and swampy periods and ultimately turning arid before the extrusion of continental flood basalts (Smith, 1984; Smith et. al., 1993; Johnson et. al., 1996; Williamson, 1996; Modie, 1999; ARI, 2003). The transition is represented by a dominantly siliciclastic sedimentary sequence ranging from glacial diamictites of the Dwyka Group to a succession of fluvio-deltaic sandstone and mudstone units with intercalated coal beds, belonging to the Ecca Group, and siltstone and mudstone lacustrine facies of the Beaufort Group that gives way to fluvial and aeolian red beds of the Lebung Group, and eventually the succeeding basalt lava flows of the Stormberg Lava Group (Green, 1966; Smith, 1984; Mapeo, 1987; Key et. al., 1995; Williamson, 1996; Modie, 1999, 2000).

The Dwyka Group was deposited during the late Palaeozoic glacial event that accumulated widespread glacial facies across southern Gondwana (Crowell, 1983; Eyles, 1983; Von Brunn and Gravenor, 1983; Visser and Look, 1982). This occurred during the migration of the southern part of Gondwana over the South Pole giving rise to a major ice sheet (Smith et. al., 1993). The Dwyka Group of the Kalahari Karoo Basin consists of diamictite and fine laminated mudstones that lie on pre-Karoo topography and have been interpreted as tillites and varvites, respectively (Du Toit, 1916; Smith, 1984). Outcrop analysis of Dwyka Group deposits from southwestern Botswana support the interpretation of a pro-glacial environment of either marine or lacustrine setting as evidenced by the occurrence of proximal debris-flow conglomerate in association with finely laminated argillites with dropstones (Modie, 2000). Rare exposures (Plate A) of the Dwyka Group occur along the eastern fringe of the Kalahari Karoo basin and comprise massive diamictite, locally interbedded with thin lenses of sandstone and laminated siltstone, reflecting possibly the deposits of glacially-influenced environments e.g. subglacial, glaciofluvial etc. (Modie, 1999, 2000).

The Ecca Group, which succeeds the Dwyka Group, belong to the postglacial period which is indicated to have been characterized by a complexity of fluvial and delta plain systems with lacustrine and swampy conditions, in which sandstone, siltstone, mudstone, carbonaceous mudstone and coal beds were accumulated (Smith, 1984; Williamson, 1996).

Plate A: Rare exposure depicting the Dwyka – Eccca contact (*note geological hammer or arrows*), South East Central Kalahari Sub-basin.



Plate B: Thinly bedded medium- to coarse-grained sandstone of the Eccca Group, Southern belt Central Kalahari Sub-basin.



It was during this period that plants colonised inland basin shores and inter-distributory bay areas and eventually provided ample organic debris that led to the formation of coal beds. Evidence on the depositional environment is recorded from the isolated exposures of Ecca Group deposits that occur along the eastern margin of the Kalahari Karoo basin (Modie, 2000). Exposures (Plate B) are dominated by medium to coarse-grained sandstone facies with a preponderance of graded lamination and planar cross- and trough-crossbedding. Palaeocurrent trends deduced from limited outcrops reflect the occurrence of fluvial-dominated depositional sectors within the basin. Complimentary evidence from boreholes indicates a large proportion of the non-exposed Ecca Group deposits to be dominated by fine argillitic and carbonaceous facies with coal seams. Overall facies interpretation reflects the occurrence of a very wet or swampy condition with a thriving vegetation colony, developed within the floodplains of a major fluvio-deltaic system. A marine incursion during the early stages of the Ecca Group deposition is indicated in the southwest of the Kalahari Karoo basin, from the recognition of a shallow marine bivalve i.e. *Eurydesma* (Ellis, 1979).

Further movement of Gondwana away from the polar region resulted in climatic warming and increased aridity. This gave rise to deposition of the lacustrine-estuarine Tlhabala Formation of the Beaufort Group (Smith, 1984; Williamson, 1996). The Tlhabala Formation is dominated by monotonous, non-carbonaceous, often silty and calcareous mudstones with minor occurrences of fine- to coarse-grained sandstones, siltstones, calcareous nodules and silty limestones (Williamson, 1996; ECL, 1998). Rare exposures of Tlhabala Formation deposits occur in the northeast part of the Kalahari Karoo basin i.e. Northern Belt Central Kalahari Sub-basin of Smith (1984). Limited sedimentary structures such as cross-bedding and ripple-marks, as well as carbonate content, indicates deposition in relatively shallow water and mildly arid environment (ECL, 1998, Modie, 2000).

Succeeding the Beaufort Group is the Lebung Group, which represents the end-phase of Karoo sedimentation and indicates progressive aridity from lacustrine to fluvial and aeolian systems (Williamson, 1996). The Lebung Group comprises the Ntane and Mosolotsane formations (also described elsewhere under local formation names), which comprises clastic red-bed facies. Locally, a lowermost deltaic Lekotsana formation has been identified in the eastern margin of the basin (Williamson, 1996). The Mosolotsane Formation forms the basal unit of the Lebung Group over much of the Kalahari Karoo basin. However, exposure of the Mosolotsane Formation is considerably poor with much information sourced from borehole intersections, and indicates a dominance of siltstone and fine- to medium-grained sandstone, and minor mudstones as well as the occurrence of haematitic beds (Williamson, 1996). Elsewhere, the occurrence of calcareous nodules is notable e.g. in the Tuli sub-basin (Modie, 2000). Overall, the internal facies and rare sedimentary structures of the Mosolotsane Formation are considered to reflect a predominantly shallow-water, terrestrial semi-arid environment of deposition, inclusive of a distal alluvial system (Williamson, 1996).

The Mosolotsane Formation commonly conformably gives way to the Ntane Sandstone Formation that forms the uppermost lithostratigraphic unit of the Lebung Group. The Ntane Sandstone Formation is primarily comprised of thick sequences of massive and bedded fine- to medium-grained sandstones of variable colours that includes yellow, red, white, orange or brown (Williamson, 1998; Modie, 2000). Locally, the Ntane Sandstone Formation may consist of minor mudstone, siltstone and pebble conglomerate. The Ntane Sandstone Formation is exposed in several isolated localities along the eastern fringe of the Kalahari Karoo basin. Much of these exposures, which consist of low-lying whale-backs as well as hilly and escarpment sections, show variable weathering and diagenetic effects (Plate C). Environmental interpretations based on limited sedimentary structures, which include low-angle planar and trough cross-bedding as well as rare high-angle cross-bedding, and textural analysis that show high mineralogical maturity and sorting, reflects a broad depositional environment acted upon by both sub-aqueous and aeolian processes (Modie, 2000).

Sedimentation in the Kalahari Karoo basin ended in the early Jurassic (Aldiss et. al., 1984) when interrupted (Plate D) by widespread continental flood basalt volcanism, initiated by extensional tectonics that marked the beginning of Gondwana break-up, and resulted in the accumulation of the Stormberg Lava Group. The Karoo continental flood basalt represents a major regional magmatic event that occurred between 185 – 177 Ma ago giving rise to lava flows, sills, and culminating in an array of dykes (Jourdan et. al., 2005).

Plate C: Erosional remnants of the Ntane Sandstone, Tuli Basin.



Plate D: Sandstone bed (white) inter-layered with basaltic lava, Tuli Basin.



CHAPTER 3: MATERIALS AND METHODS

3.1 Core Descriptions and Sampling

A total of 9 cored borehole sections were selected from across the Kalahari Karoo Basin to provide samples for the purpose of this study (Fig. 12). These boreholes consisted of 6 previously drilled stratigraphic as well as coal exploration borehole sections, and an additional 3 borehole sections from the Coalbed Methane Project, of which this particular study is a component of. Each borehole core section was logged and described with the final logs constructed in MapInfo Professional (Figs. 13 - 21).

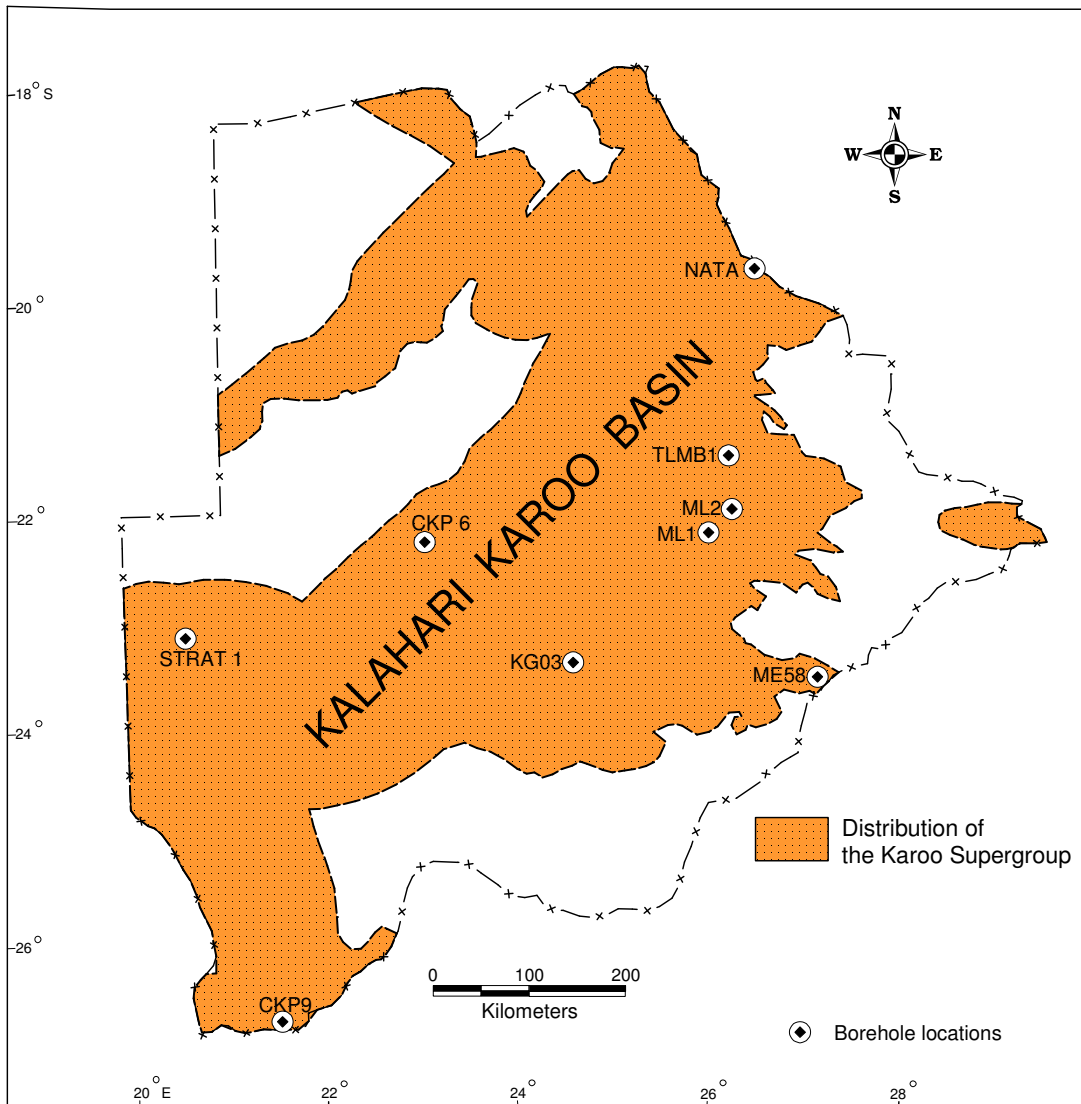

Figure 12: Locality map showing boreholes sampled for the study.

LITHOSTRATIGRAPHY		DEPTH (M)	LITHOLOGY	SAMPLE NUMBER	LITHOLOGICAL DESCRIPTION
KALAHARI GROUP					Sand and Calcrete.
LEBUNG GROUP	Nakalatlou Formation	50			Sandstone; medium-grained, cream white, occasionally reddish. Interbedded red mudstone.
	Dongdong				Sandstone; medium-coarse, red, basal pebbly conglomerate.
BEAUFORT GROUP	Kule Formation	100			Mudstone; reddish.
					Sandstone; fine-grained.
ECCA GROUP	Otshe Formation	150			Mudstone; black, iron oxide lenses (after pyrite), coal laminae.
					Sandstone; interbeds of fine-coarse, light brown, micaceous, pyrite nodules, low-angle cross-bedding. Interbedded dark, fissile/thinly laminated shales.
		200		STR1BNM1P-02 STR1BNM2P-02 STR1BNM3P-02 STR1BNM4P-02 STR1BNM5P-02 STR1BNM6P-02 STR1BNM7P-02 STR1BNM8P-02 STR1BNM9P-02 STR1BNM10P-02 STR1BNM11P-02 STR1BNM12P-02 STR1BNM13P-02 STR1BNM14P-02 STR1BNM15P-02	Carbonaceous mudstone: fining-up rhythmic lamination, contorted/disturbed lamination, mudstone clasts, thin sandstone beds with cross-lamination.
					Carbonaceous mudstone and thin coal seams; interbedded siltstone and sandstone, disrupted laminae.
					Sandstone; medium-coarse, pale grey-pink.
					Mudstone; dark.
					Sandstone; medium-coarse, white, thin carbonaceous shale beds, faint cross-laminae.
					Siltstone; white, sandy, thin carbonaceous mudstone beds.
					Sandstone; fine-medium, granule-rich at base, rare dark laminae.
					Sandstone; very fine, silty, white, no lamination visible.
ECCA GROUP	Kobe Formation	300		STR1BNM23P-02 STR1BNM24P-02 STR1BNM25P-02 STR1BNM26P-02 STR1BNM27P-02	Sandstone; fine-medium, pale white, coal stringers and dark carbonaceous horizons, sporadic laminae near base, fines-down into mudstone.
					Mudstone; dark, fine parallel lamination.
		350		STR1BNM28P-02 STR1BNM29P-02 STR1BNM30P-02 STR1BNM31P-02 STR1BNM32P-02 STR1BNM33P-02 STR1BNM34P-02 STR1BNM35P-02 STR1BNM36P-02 STR1BNM37P-02	Sandstone; fine-grained, white, thin mudstone beds and flasers.
					Mudstone; pale grey-green, fine laminae, thin siltstone beds.
					Conglomerate; matrix-supported (fine-medium sandstone).
					Siltstone; pale grey, fine irregular bedding units.
					Mudstone; pale grey, split easily into thin slabs.
					Mudstone and siltstone interbeds; also thin interbedded sandstone units. Dominated by isolated pebbles.
					Sandstone; with siltstone and mudstone interbeds, convolute/slumped laminae, thin intraclastic units, ripple drift lamination, intraclastic sharp bases.
					Mudstone; pale grey-green, rhythmic lamination, convolute lamination.
DWAYKA GROUP	Khuis Formation	500		STR1BNM38P-02 STR1BNM39P-02 STR1BNM40P-02 STR1BNM41P-02 STR1BNM42P-02 STR1BNM43P-02 STR1BNM44P-02 STR1BNM45P-02 STR1BNM46P-02 STR1BNM47P-02 STR1BNM48P-02 STR1BNM49P-02 STR1BNM50P-02 STR1BNM51P-02 STR1BNM52P-02 STR1BNM53P-02 STR1BNM54P-02 STR1BNM55P-02 STR1BNM56P-02 STR1BNM57P-02 STR1BNM58P-02 STR1BNM59P-02 STR1BNM60P-02 STR1BNM61P-02 STR1BNM62P-02 STR1BNM63P-02 STR1BNM64P-02 STR1BNM65P-02 STR1BNM66P-02 STR1BNM67P-02 STR1BNM68P-02 STR1BNM69P-02 STR1BNM70P-02 STR1BNM71P-02 STR1BNM72P-02 STR1BNM73P-02 STR1BNM74P-02 STR1BNM75P-02 STR1BNM76P-02 STR1BNM77P-02 STR1BNM78P-02 STR1BNM79P-02 STR1BNM80P-02 STR1BNM81P-02 STR1BNM82P-02 STR1BNM83P-02 STR1BNM84P-02 STR1BNM85P-02 STR1BNM86P-02 STR1BNM87P-02 STR1BNM88P-02 STR1BNM89P-02 STR1BNM90P-02 STR1BNM91P-02 STR1BNM92P-02 STR1BNM93P-02 STR1BNM94P-02 STR1BNM95P-02 STR1BNM96P-02 STR1BNM97P-02 STR1BNM98P-02 STR1BNM99P-02 STR1BNM100P-02	Siltstone; pale green, massive, isolated pebbles.
					Sandstone; very fine-grained, conspicuous dark irregular and wavy lamination. Dark laminae consist of fine mud at top of sandstone beds.
DWAYKA GROUP	Malogong Formation	550			Lamination slightly regular and rhythmic downhole e.g. sandstone-mudstone fining-up pulses. Locally disrupted bedding/convolute bedding.
					Mudstone; grey, structureless/massive.
DWAYKA GROUP	Malogong Formation	600			Diamictite; matrix-supported, sandstone matrix (fine-coarse), clasts dominated by quartz. Four interbedded mudstone horizons.

Figure 13: STRAT 1 borehole section indicating sampled levels; sample numbers ending in 01 represent the initial 20 samples used for the trial run.

LITHOSTRATIGRAPHY	DEPTH (M)	LITHOLOGY	SAMPLE NUMBER	LITHOLOGICAL DESCRIPTION		
KALAHARI GROUP	50			Sand and calcrete.		
DWYKA GROUP	100		CKP9BNM1P-02	Mudstone		
			CKP9BNM2P-02	Sandstone; fine to medium-grained.		
	Middlepits Formation	150		CKP9BNM3P-02	Siltstone; dark grey, massive, extraclasts, slumped bands, rare varves.	
				CKP9BNM4P-02	Siltstone; mid to dark grey, slumped sandy laminae, micrite bands, mottled and bioturbated sandstone lenses, limestone and fissile mudstone, ripple-cross laminae, rare graded bedding near top, micro-faulting and slumping,	
					CKP9BNM5P-02	Mudstone; delicate laminae, pebbly.
						CKP9BNM6P-02
	Khuis Formation	250		CKP9BNM7P-02	Mudstone; black, shaly (fissile), sporadic siltstone laminae, rare coarse grained sandstone lenses, thin limestone bands, rare extraclasts near base.	
				CKP9BNM8P-02	Mudstone; grey-black, massive, pebbly, interbedded finely laminated siltstone and fine-grained sandstone (disturbed or slumped), limestone and calcareous siltstone at the top.	
					CKP9BNM9P-02	Mudstone; black, finely laminated, becomes dark grey with clots of diamicrite near base.
				Malogong Formation		550
CKP9BNM10P-02	Diamictite; stratified, shale interbeds, high extraclasts of mainly quartzite.					

Figure 14: CKP9 borehole section indicating sampled levels.

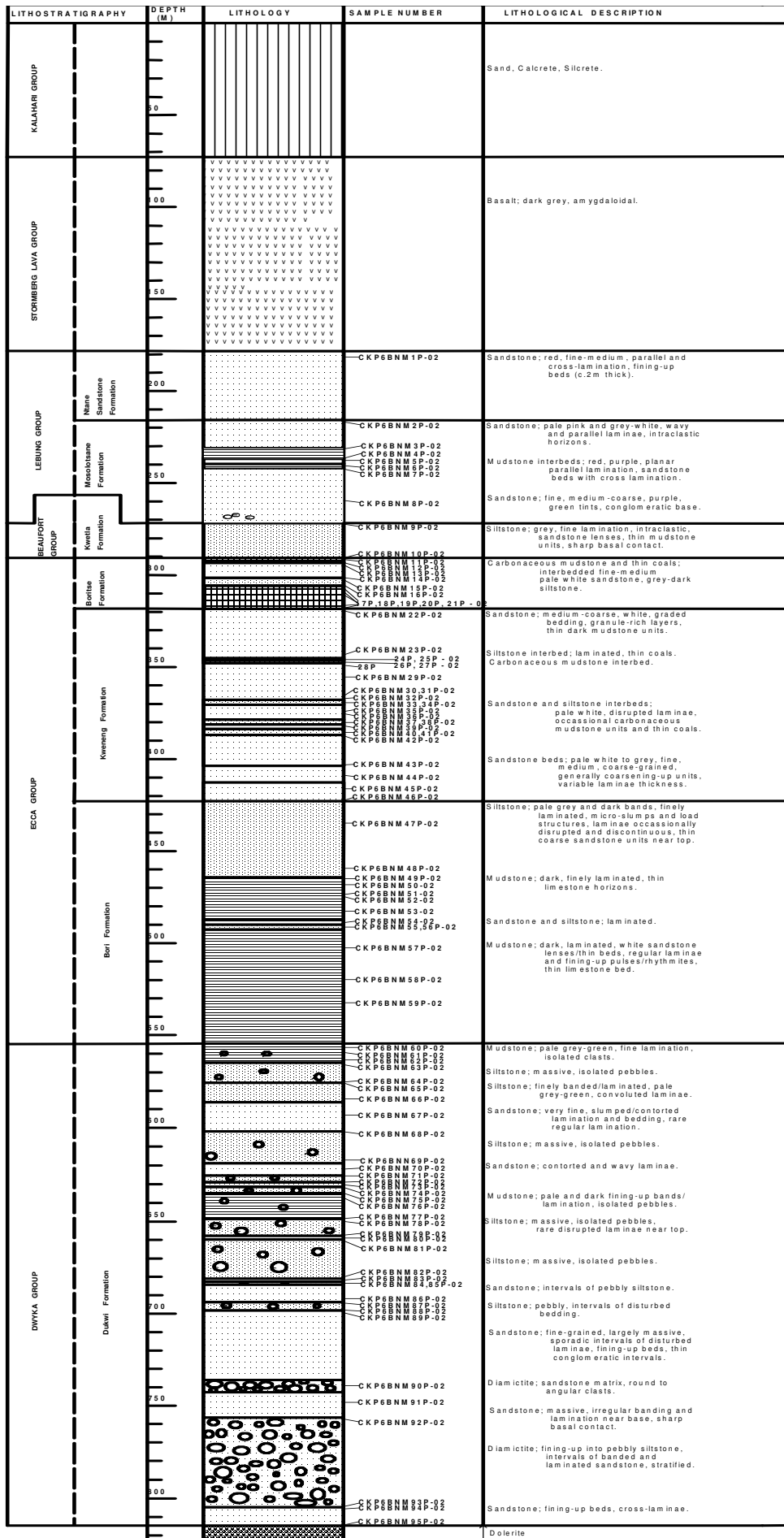

Figure 15: CKP6 borehole section indicating sampled levels.

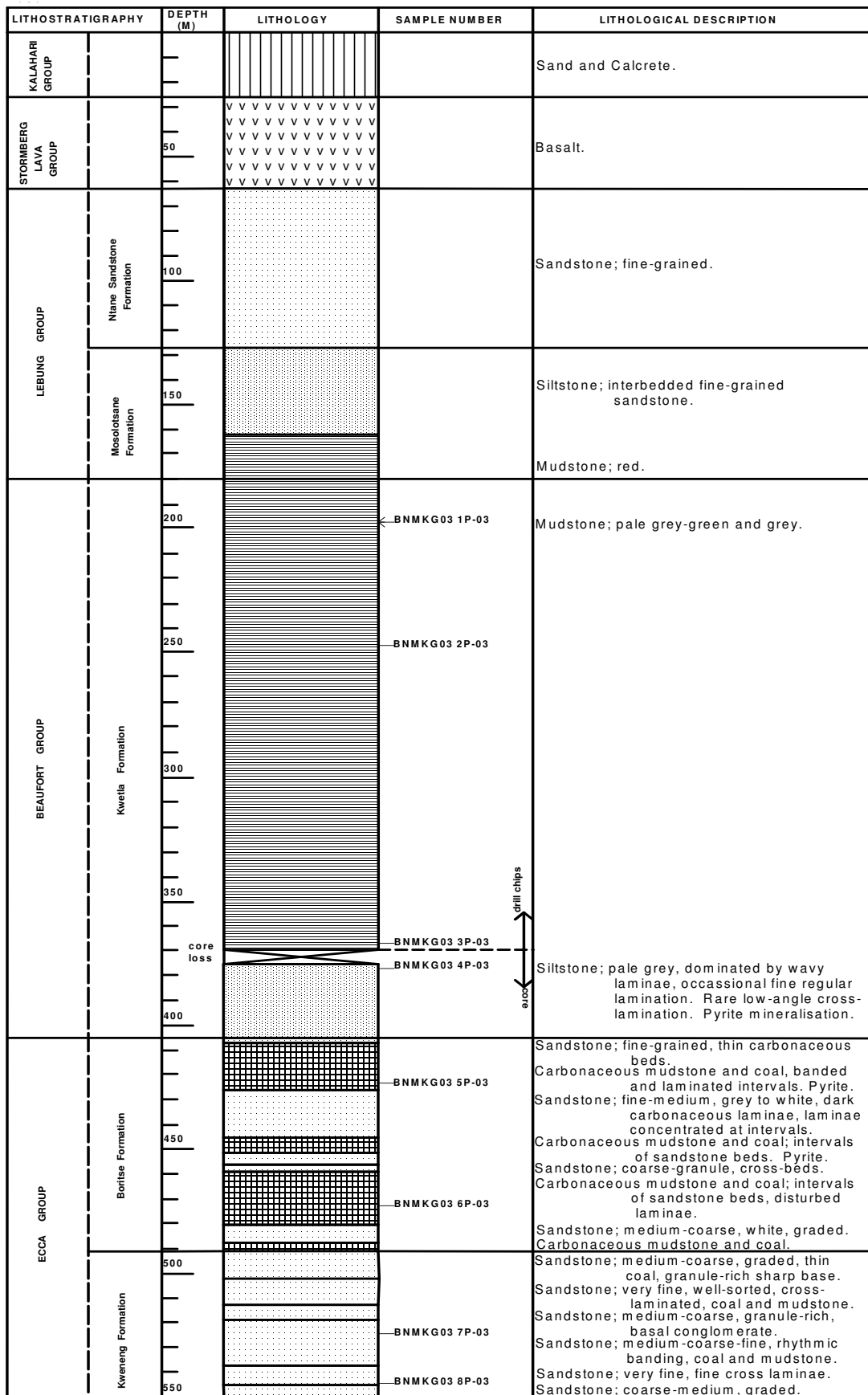

Figure 16: KGO3 borehole section indicating sampled levels.

LITHOSTRATIGRAPHY		DEPTH (M)	LITHOLOGY	SAMPLE NUMBER	LITHOLOGICAL DESCRIPTION
KALAHARI GROUP					Sand, Silcrete and Calcrete
		50			
STORMBERG LAVA GROUP			V V		Basalt; dark grey, intervals of pink weathered horizons, locally amygdaloidal.
		100			
LEBUNG GROUP	Niane Sandstone Formation				Sandstone; very fine to medium-grained, pink to white, intervals of purple shale and siltstone.
		150			
		200			
		250			
	Mosolotsane Formation			ML1BNM1P-03	Mudstone; red, grey-green intervals, broad lamination, rare clasts. grey, red intervals, massive.
BEAUFORT GROUP	Thabala Formation	300		ML1BNM2P-03	Mudstone; pale grey-green, massive, silty, rare extraclasts and nodules, micro-fractured, uniform lithology.
				ML1BNM3P-03	
		350			Siltstone; massive, grey, grey-green intervals, calcareous (or silty limestone) bed at top. Sandstone interval with ripple cross-lamination. Mudstone interbeds.
		400			
ECCA GROUP	Serowe Formation			ML1BNM4P-03	Carbonaceous mudstone and coal; interbedded non-carbonaceous siltstone, with rare fine parallel lamination and cross-lamination, locally deformed lamination. Non-carbonaceous mudstone intervals.
	Morupule Formation	450			Carbonaceous mudstone and coal
				ML1BNM5P-03	
	Kamotaka Formation	500			

Figure 17: ML1 borehole section indicating sampled levels.

LITHOSTRATIGRAPHY		DEPTH (M)	LITHOLOGY	SAMPLE NUMBER	LITHOLOGICAL DESCRIPTION
KALAHARI GROUP					Sand, Calcrete, and Silcrete.
STORMBERG LAVA GROUP		50			Basalt; pink, weathered.
					Basalt; dark, amygdaloidal.
LEBUNG GROUP	Niame Sandstone Formation	100			Sandstone; very fine-grained, pale white to pink
		150			
	Lekotsana Formation	200			Mudstone; pink and green, interbedded pale white sandstone.
BEAUFORT GROUP	Thabala Formation				Sandstone; medium- to coarse-grained, white, granule-rich.
		250			Mudstone; pink-grey to grey.
				ML2BNM1P-03	Mudstone; pale grey-green, massive, stratified near base i.e. interbedded thin sandstone layers.
		300		ML2BNM2P-03	Sandstone; pale grey-green, medium- coarse, laminated, graded, fining-up, pebbly layer and basal conglomeratic bed.
				ML2BNM3P-03	
350					
ECCA GROUP	Serowe Formation			ML2BNM4P-03	Carbonaceous mudstone and coal; interbedded dark grey mudstone near top.
	Morupule Formation				interbedded sandstone, very fine-grained, cream-white, dark irregular fine lamination and coal stringers.
		400			Carbonaceous mudstone and coal; sandstone lenses near base.
Kamoloka Formation	450		ML2BNM5P-03	Sandstone; conglomeratic, cream-white.	
					Dolerite.

Figure 18: ML2 borehole section indicating sampled levels.

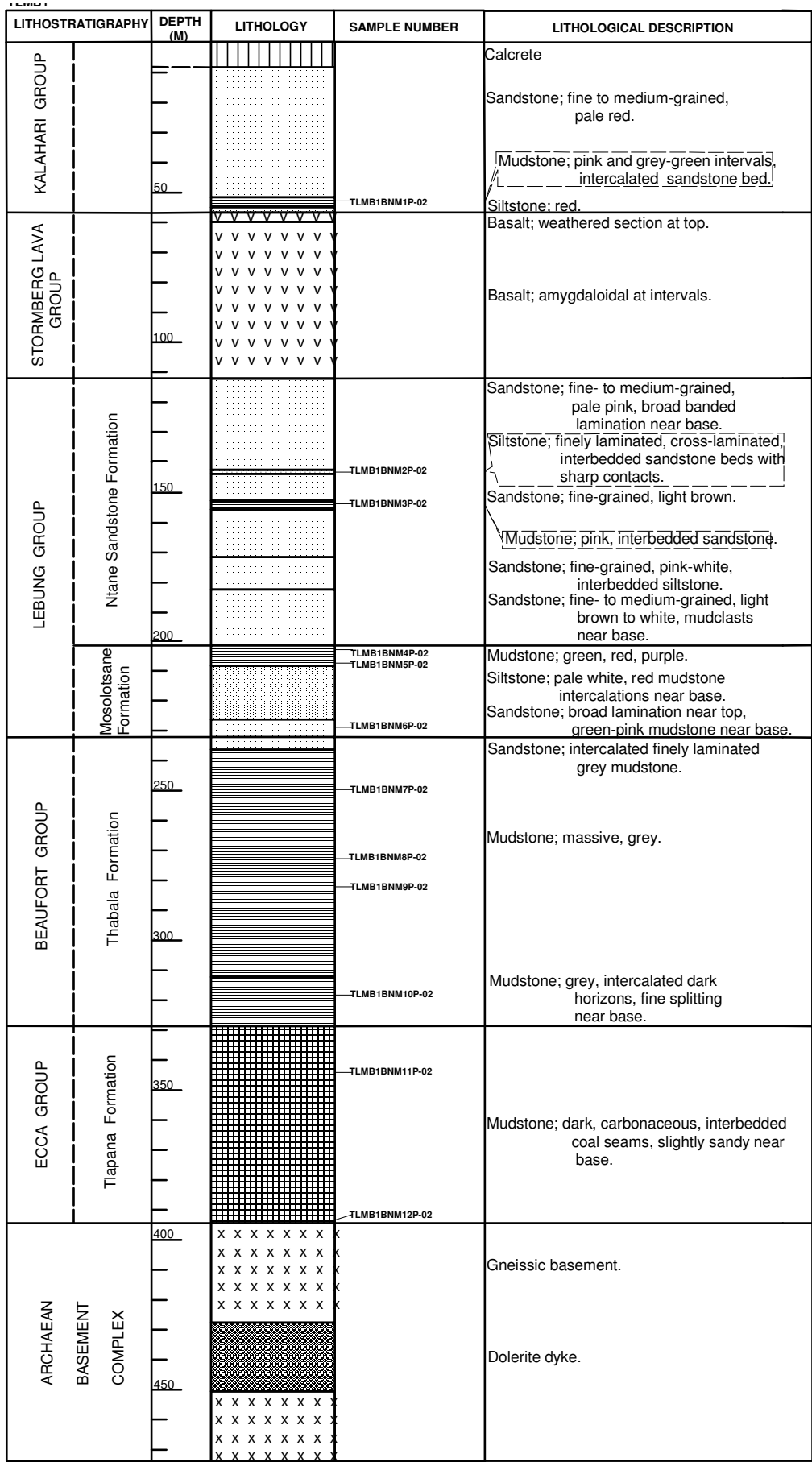

Figure 19: TLMB1 borehole section indicating sampled levels.

NATA

LITHOSTRATIGRAPHY		DEPTH (M)	LITHOLOGY	SAMPLE NUMBER	LITHOLOGICAL DESCRIPTION
LEBUNG GROUP	Niame Sandstone Formation	350			Sandstone; fine-grained, vari-coloured i.e. pale white, pink, purple, grey-green. Massive, fine to broad lamination. Rare intraclasts. interbedded mudstone, pink, red, purple, banded, conglomeratic layers.
		400			
	Ngwasha Formation			NATBNM1P-03	Siltstone; sandstone lenses/lenticular bedding.
				NATBNM2P-03	Sandstone; fine-medium, silty layers, pebbly, pebbly layers, rare mudstone layers. medium-coarse, pebbly, conglomeratic layers. conglomerate.
		450			Mudstone; silty, red, disturbed laminae. wavy laminae, sandy lenses, disrupted laminae, micro-faulted, conglomerate layers.
				NATBNM3P-03	pale grey-green interval, banded, sandstone bed. interbedded sandy bed with disturbed laminae.
	Pandamatenga Formation	500		NATBNM4P-03	Sandstone; medium-coarse, graded, cross-bedding, dark lamination, rare mudclasts, thin mudstones.
BEAUFORT GROUP	Thabala Formation	550		NATBNM5P-03	Mudstone; grey to pale grey-green, red interbeds near top. massive, silty limestone horizons. Sandy and micaceous near base. interbedded sandstone, fine-medium, graded laminae, mudstone drapes, conglomeratic base. grey to pale grey-green, darker near base.
				NATBNM6P-03	
		600			
				NATBNM7P-03	
ECCA GROUP	Tlapana Formation	650		NATBNM8P-03	Mudstone; dark, carbonaceous.
					Dolerite with top chilled margin.

Figure 20: NATA borehole section indicating sampled levels.

ME58

LITHOSTRATIGRAPHY		DEPTH (M)	LITHOLOGY	SAMPLE NUMBER	LITHOLOGICAL DESCRIPTION
ECCA GROUP	Mosomane Formation	10		ME58BNM1P-03 ME58BNM2P-03 ME58BNM3P-03 ME58BNM4P-03 ME58BNM5P-03	Sandstone; coarse-grained, cream-white, graded beds, broad laminae. thin carbonaceous mudstone and coal intervals. Carbonaceous mudstone; silty. Sandstone; pebbly and conglomeratic layers, carbonaceous and coal layers.
		20			
		30			
		40			
		50			
DWYKA GROUP	Manyelanong Formation Dukwi Formation	60		ME58BNM6P-03 ME58BNM7P-03	Diamictite; matrix-supported, medium-coarse sandstone matrix, angular to rounded clasts, banded siltstone with fine delicate laminae (rare).
70					
80					
WATERBERG GROUP (Prec. Basement)					Sandstone; red with white patches/spots.

Figure 21: ME58 borehole section indicating sampled levels.

An initial 20 samples were collected from STRAT 1 borehole, sampled at a wide spacing to cover the extent of the borehole section, and used as a trial run to determine the level of preservation of palynomorphs in the Karoo Supergroup of the Kalahari Karoo Basin. Preliminary analyses on the 20 samples indicated that the Karoo strata had a significant occurrence of palynomorphs (pollen and spores), and also that the palynomorphs were relatively well preserved, and hence the sequence was considered suitable to undertake a biostratigraphic study for correlation purposes. A more closely spaced sampling exercise was undertaken in STRAT 1 core section at a later stage, which resulted in an additional 100 samples collected. Sampling interval varied according to variations in the lithofacies throughout the borehole section. In general the intervals were closely spaced in the argillaceous facies ranging between about 20cm apart to 3m apart whereas for the arenaceous facies the sample range was between about 0.5m to 10m apart.

The remaining 8 borehole core sections were then also sampled and all the samples submitted to the Palaeontology Laboratory of the Universite de Bretagne Occidentale, Brest, France, for sample preparation. Preliminary examination of slides from all the borehole samples indicated that palynomorph yields were variable per sample, as well as between boreholes, from very poor i.e. 1 to 5 recognisable specimens, to good i.e. hundred's of better-preserved specimens. STRAT 1 borehole samples had the best preserved palynomorphs, and consequently, it was selected to form a standard reference section in this study. Although with less well-preserved specimens, borehole CKP6 forms an important control point in this study, more especially since it provides a complete section across the Karoo Supergroup. Data on the number of samples and their yields per borehole is presented in Table 1.

Borehole	Number of samples submitted	Samples yielding palynomorphs	Barren samples
<i>STRAT 1</i>	120	113	7
<i>CKP6</i>	95	78	17
<i>CKP9</i>	10	9	1
<i>TLMB1</i>	12	2	10
<i>ML1</i>	5	2	3
<i>ML2</i>	5	0	5
<i>KG03</i>	8	6	2
<i>ME58</i>	7	7	0
<i>NATA</i>	8	2	6
Totals	270	219	51

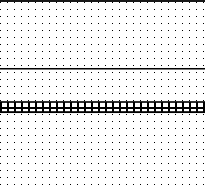
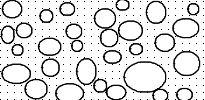
Table 1: Number of samples submitted for the study and their status of palynomorph yields.

3.2 Sample Preparations

Miospores, e.g. spores and pollen less than 200 μ , are usually produced in large numbers, and because of their smaller sizes are widely dispersed by natural agencies dominated by wind and water currents. These miospores are ultimately incorporated into sedimentary deposits as evenly dispersed particles, and will form a part of the consolidated sedimentary rock formations. In order to undertake palynological research a procedure commonly referred to as the “Maceration Process” is required for the purpose of liberating the miospores from the surrounding rock matrix as well as to separate and concentrate the miospore fraction. There are several techniques employed during the maceration process and most of them are described in many publications including the detailed review of Wood et. al. (1996). The techniques usually vary in accordance with the nature and composition of the rock samples to be macerated. In this study the procedure followed is that developed at the Lab de Palaeontologie, Universite de Bretagne Occidentale, Brest, France. A summary of the method is described below:

Preparation of sample

- i) The sample is cleaned and washed with brush and water to remove possible contaminants.

- ii) Then the sample is dried and crushed in a ceramic mortar to about 1mm – 2mm size fragments.

Acid dissolution

- i) The sample is dissolved in HCL to remove carbonates; no HCL was used in this case as no carbonates were found.
- ii) The sample is then dissolved in 48% HF to remove silicates.
- iii) The dissolution process usually takes 12 – 24 hours and is conducted in a fume chamber with an extractor to expel gaseous fumes released; all samples were dissolved in 24 hours.
- iv) The residue is washed twice in 1000ml water allowing it to settle to the bottom in 1 hour.
- v) Treatment of residue with HCL to dissolve fluoro-silicates formed during preceding reactions.
- vi) Treatment of residue with HNO₃ to remove fine particles.
- vii) Treatment with KOH to clean the residue.

Sieving

- i) After acid dissolution, the residue is sieved through a 200µm sieve to retain large organic particles, which may contain mega spores and large pollen that could easily break.
- ii) The more than 200µm fraction is examined separately, with individual specimens of megaspores picked by capillary action using a glass pipette and prepared for a SEM analysis.

Heavy liquid separation and concentration

- i) The less than 200µm residue is subjected to centrifugation and heavy-liquid separation to obtain a final residue. LST heavy liquid (a low toxicity concentrate of *lithium heteropolytungstates* in water, with optimal working density of 2.85, but in this case adjusted to 2.2 for the separation of palynomorphs) is used for density separations. The LST heavy liquid is preferred because it can be dissolved in water and does not produce toxic fumes like other liquids such as bromoform that uses alcohol. LST heavy liquid also has a relatively low viscosity and hence allows faster grain separations.
- ii) A concentrated organic residue, which forms the “light minerals” fraction in the separation process is obtained as the final residue.

Slide preparation

- i) A drop of residue is placed on slide followed by a drop of dispersal agent; the two are then mixed and allowed to dry.

- ii) A drop of glue is then placed on the slide and a cover-slip fixed.
- iii) Finally, the covered slide is warmed and dried, and is ready for use.

3.3 Microscopy

A transmitted-light microscope (*Leitz DIAPLAN*) was used in routine slides analyses for the examination and counting of palynomorphs and sediment organic matter. The microscopic examinations were conducted in magnification powers of x 250, x 625 and x 1250, the latter with oil immersion in order to facilitate the study of fine morphological features of palynomorphs. A magnification of x 500 was used during the counting exercise. Photomicrographs were taken with an attached digital camera, which stored images in JPEG file format; these were later transferred to a computer for further analyses and presentation. The coordinates for specific palynomorphs and the different categories of sediment organic matter, on the slide surface, were recorded using the *England Finder* for future retrieval. In order to increase the chance of identifying genera and species occurrence in the samples considered, the entire surface of slides per sample was traversed; this was made sure by allowing a slight overlap of the field of views at consecutive positions of the microscope stage. However, the quantitative count involved traverses that were non-overlapping in field of views; the traverses were spread-out in order to cover the entire limit of the slide surface and their separation depended on the distribution of material per slide.

3.3.1 Qualitative analysis

This comprises the study of palynomorphs at generic and specific levels within each sample, in order to establish the stratigraphic range of each species. Details of the study involve the examination of the morphology and fine structures of the palynomorphs, as well as measurements of important dimensional attributes (Figs. 22 - 26). The resultant generic and species content of the palynomorphs examined in each productive sample is presented in Figures 27 – 35.

3.3.2 Quantitative analysis

This constitutes the determination of the distribution of major supra-generic palynomorph taxa and categories of sediment organic matter or palynofacies, in percentage relative abundance, throughout the borehole core. Details of the analysis involve visual counts of individual specimens of the supra-generic palynomorph taxa and pre-defined categories of the sediment organic matter. Categories of palynomorph taxa and sediment organic matter for counting were defined following completion of the qualitative analysis, which provided a good assessment of the types of material present on the slides. The classification of the sediment organic matter or palynofacies elements generally follows that discussed by several authors (e.g. Mussard et. al., 1994; Tyson, 1995; Batten, 1996; Courtinat et. al., 2003). A summary of the categories counted is presented on Table 2,

with some examples illustrated in plates PF1 – PF3. The counting procedures adopted in this study are similar to those discussed in Traverse (1988) and Tyson (1995). In both the major groups i.e. palynomorphs and sediment organic matter, counts not less than 300 were undertaken per slide. Fields of view were arbitrarily selected far enough apart, based on microscope stage coordinates, in order to increase areal coverage as most slides were very rich in material. The relative abundance of the major groups of palynomorph taxa and sediment organic matter considered in this study are illustrated in Figures 36 - 39.

	CLASS	DESCRIPTION	CATEGORY
SEDIMENT ORGANIC MATTER (SOM)	PHYTOCLASTS	Brown, dark to semi-opaque, woody; with or without biostructure.	1. Brown equidimensional (BRNE) 2. Brown lath-shaped (BRNL)
		Black or opaque, woody; with or without biostructure.	3. Black equidimensional (BLKE) 4. Black lath-shaped (BLKL)
		Pale, thin, irregularly shaped cuticle and membranous tissues.	5. Cuticle and membranous tissues (CMT)
		Grey, yellowish brown, or black degraded phytoclasts; most resembles AOM but with recognizable traces of original outline.	6. Degraded phytoclasts (DGPH)
	AMORPHOUS ORGANIC MATTER	Pale to grey, unstructured, irregular micro-granular masses - AOM.	7. AOM
	PALYNOMORPHS	Pollen and spores	8. Saccate pollen (SAPO) 9. Plicates (PLIC) 10. Spores (SPOR)
		Phytoplankton	11. Acritarchs (ACRT) 12. Prasinophytes (PRSN) 13. Chlorophytes (CHLR)
Undetermined palynomorphs		14. Undetermined (UNDT)	
SUPRA-GENERIC TAXA	PALYNOMORPHS	Spores	Azonotriletes - laevigate (AZLA) Azonotriletes - apiculate (AZAP) Zonolaminatritriletes (ZOLA) Muromate (MURO) Other spores (OTSP)
		Pollen	Monosaccates (MOPO) Bisaccate striate (BIST) Bisaccate non-striate (BINS) Plicates (PLIC)
		Other palynomorphs	Acritarchs (ACRT) Prasinophytes (PRSN) Chlorophytes (CHLR) Undetermined (UNDT) Degraded palynomorphs (DGPA)

Table 2: Categories of sediment organic matter and supra-generic taxa.

CHAPTER 4: PALAEOPALYNOLOGY SYSTEMATICS

Palaeopalynological studies are now considered of great potential as sources of biological information that can be used to acquire better knowledge on the phylogeny of a number of fossil groups. However, the complexity of relating dispersed Palaeozoic and Mesozoic spores and pollen to their parent plants remains a major task, which only the palaeobotanists seem to have greater interest. Palaeopalynologists on the other hand, commonly of geological background, are more inclined toward studies involving geochronology, biostratigraphy and palaeoecology for the purpose of rock dating, correlation and environmental interpretations. Consequently, the choice of a taxonomic system used is usually dependent on the nature and purpose of the study. For this study therefore, of largely biostratigraphic nature, a neutral scheme generally based on revised versions (e.g. Smith and Butterworth, 1967; Foster, 1979; MacRae, 1988; Traverse, 1988; Marques-Toigo and Klepzig, 1995) of the Potonié's (Potonié 1956 *et seq.*) suprageneric tural system is followed. This classificatory scheme organizes spores and pollen according to morphological features, without any phylogenetic connotations, but allows for the recognition and identification of palynological assemblages.

A minor but significance occurrence of acritarchs and other similar phytoplanktons were noted in the study material. However, due to the complexity of these forms and the lack of any definitive and universally accepted classificatory scheme their descriptions only followed broad general groups.

4.1 Terminology

Definitions for most of the terms used in the systematic descriptions are commonly acceptable and widely used throughout much of palynology literature (e.g. Kremp, 1965). Figures 22 to 26, which depicts the principal morphological features and measurement terminology used, were sourced from the following works: Smith and Butterworth(1967), MacRae(1978), Traverse(1988), Playford and Dettmann(1996), and Millsted(1999). Extensive use has also been made of the *Glossary of Pollen and Spore Terminology* (Hoen, 1999). The terminology of acritarchs was sourced from various literature that includes Segroves (1967), Cramer and Diez (1979), Tappan (1980), Martin (1993), with an extensive use of Fensome et. al's (1990) *Acritarchs and Fossil Prasinophytes: An Index to Genera, Species and Intraspecific Taxa, AASP Contributions Series Number 25*.

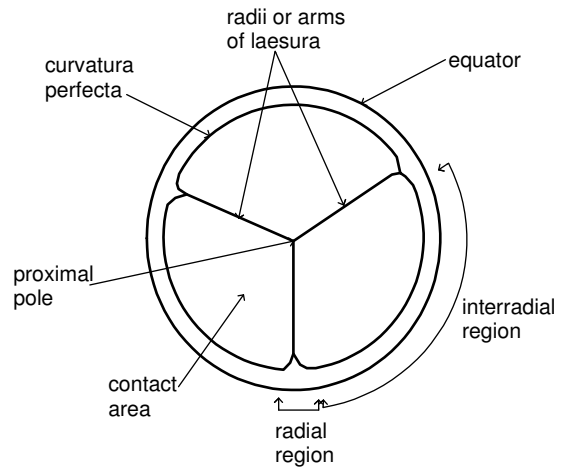

I. Polar view of trilete spore from tetrahedral tetrad.

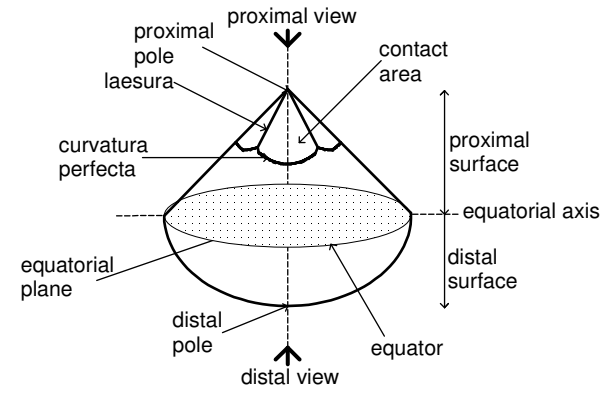

II. Lateral view of trilete spore.

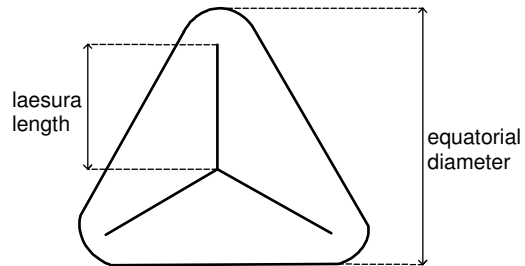

III. Measurement terminology and features of acavate spores.

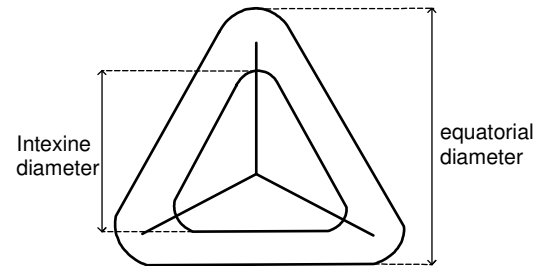

IV. Measurement terminology and features of cavate zonate spores.

Figure 22: Principal morphological features and measurement terminology of trilete spores.

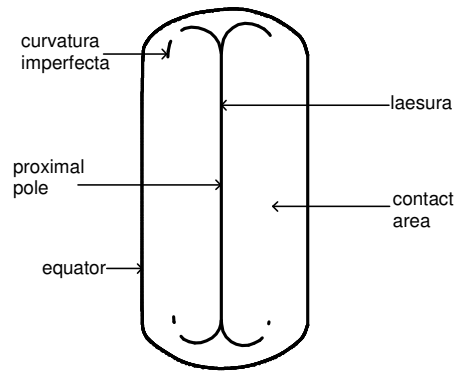

I. Polar view of monolete spore from tetragonal tetrad.

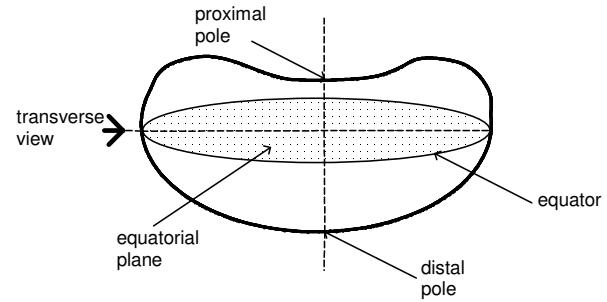

II. Equatorial longitudinal view of monolete spore

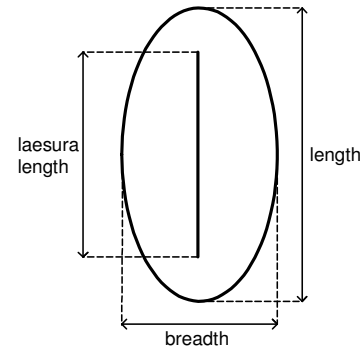
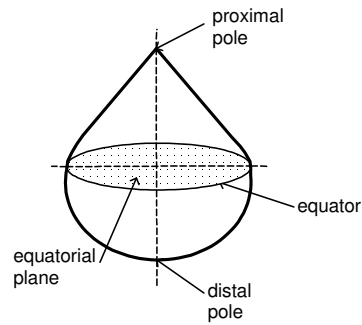
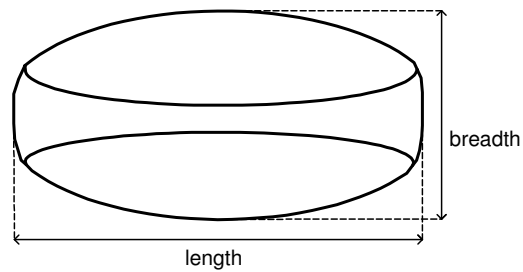
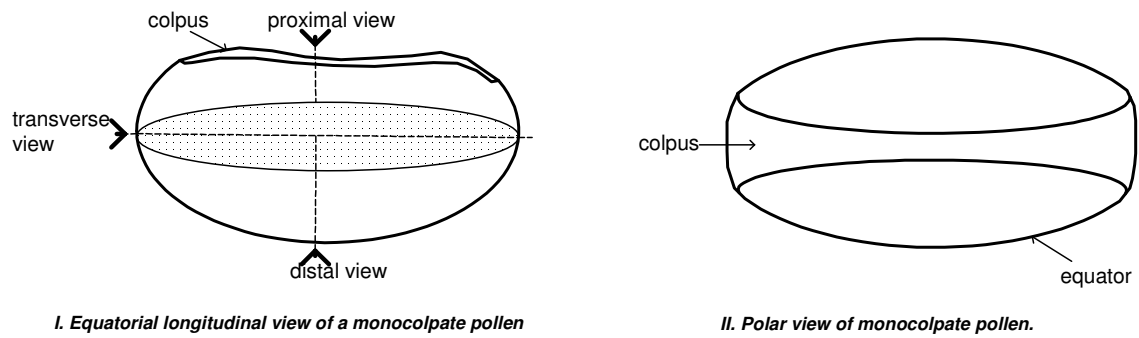
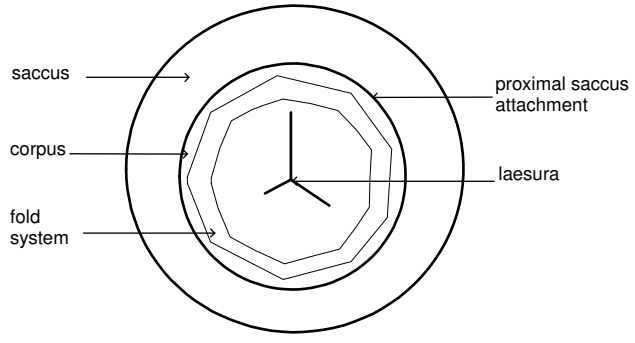

Figure 23: Principal morphological features and measurement terminology of monolete spores.



III. Measurement terminology for monocolpate pollen

Figure 24: Principal morphological features and measurement terminology of monocolpate pollen.



I. Polar view of a trilete monosaccate pollen.

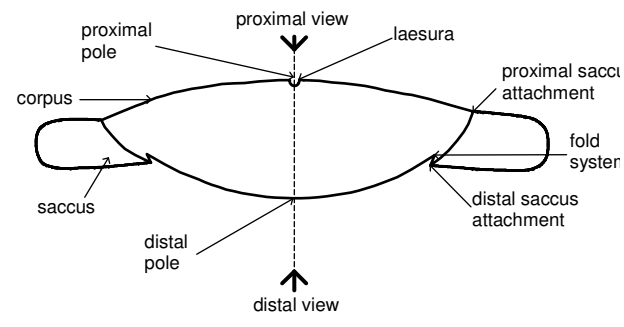

II. Lateral section of a monosaccate pollen.

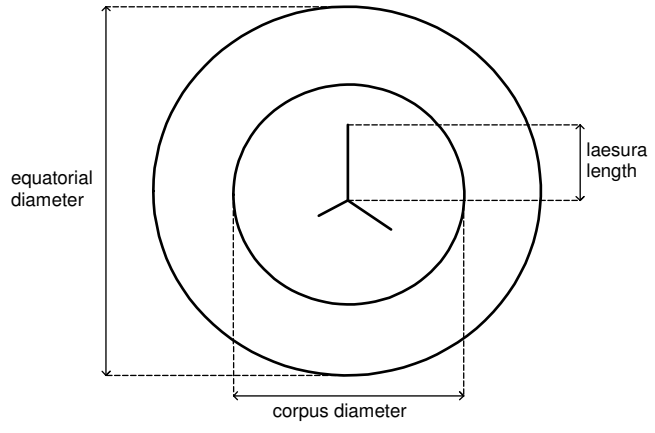

III. Measurement terminology for monosaccate pollen.

Figure 25: Principal morphological features and measurement terminology of monosaccate pollen.

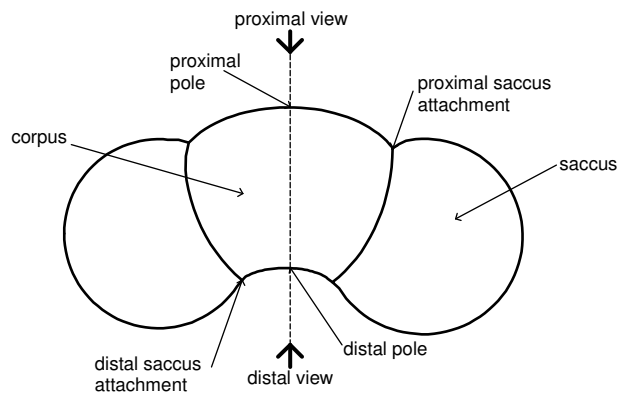

I. Lateral view of bisaccate pollen.

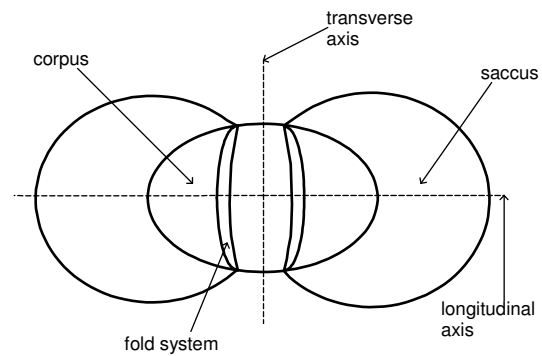

II. Polar view of bisaccate pollen.

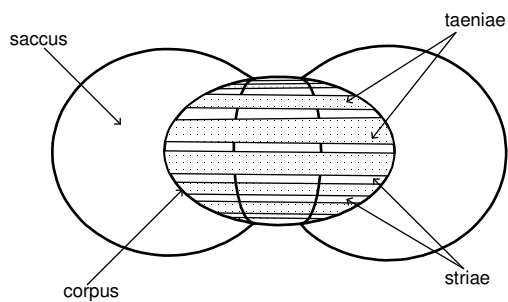

III. Polar view of striate bisaccate pollen.

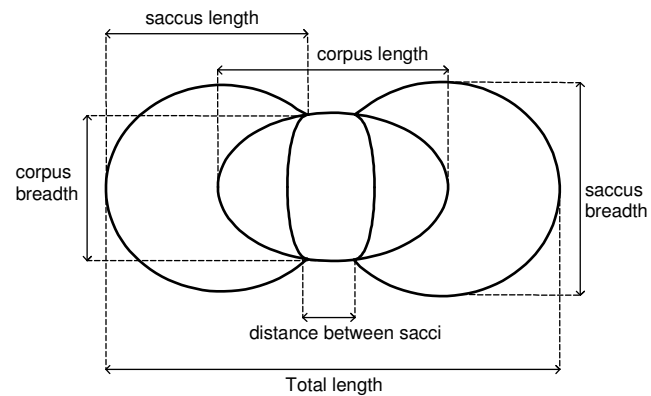

IV. Measurement terminology for bisaccate pollen.

Figure 26: Principal morphological features and measurement terminology of bisaccate pollen grains.

4. 2 Systematic Descriptions

Anteturma **PROXIGERMINANTES** Potonié 1970

Turma **TRILETES** Reinsch *emend.* Dettmann 1963

Suprasubturma **ACAVATITRILETES** Dettmann 1963

Subturma **AZONOTRILETES** Luber *emend.* Dettmann 1963

Infraturma **LAEVIGATI** Bennie & Kidston *emend.* Potonié 1956

Genus **CALAMOSPORA** Schopf, Wilson & Bentall 1944

Type species: *Calamospora hartungiana* Schopf in Schopf, Wilson & Bentall 1944 (by original designation); Late Carboniferous, Illinois, U.S.A.

Calamospora aplata Bharadwaj and Salujha 1964

Plate 1, figure 1

1964 *Calamospora aplata* Bharadwaj and Salujha, p. 191; pl. 1, figs. 13 – 15.

1965 *Calamospora plicata* (Luber and Waltz) Hart, p. 135; text fig. 350.

For synonymy see MacRae (1988).

Description: Spores trilete, with mark placed off-center of grain. Amb generally sub-circular but exhibits polygonal edges due to folding. Laesurae distinct, with darkened margins or labra, extends $\frac{1}{4}$ to $\frac{1}{2}$ spore radius. Exine 0.5-1 μ m thick, laevigate, scabrate, conspicuously folded. Few specimens with micro-granulate texture.

Dimensions: Equatorial diameter; 35(44)60 μ m (19 specimens, STRAT 1), 36(44)54 μ m (14 specimens, CKP6). Specimens with pronounced longer axis in one dimension were not included.

Remarks: The genus is known to have so few distinguishing characters for typical forms despite quite a number of species having been erected in the past (Smith & Butterworth, 1967). The specimens (p.136; pl.3, figs.7-8) assigned by Smith and Butterworth (1967) to *Calamospora parva* Guenel 1958 appear very similar to the present species and is probably conspecific. *Calamospora microrugosus* (Ibrahim) Schopf, Wilson & Bentall 1944 has an extremely larger size compared to the present species. *Calamospora brunneola* Virbitskas 1983 described (p. 32 – 33; pl. 1, figs. 1-3) by Utting (1994) is considered conspecific with the present species.

Occurrence: STRAT 1, CKP6, CKP9, ME58.

Previous records: India; Permian (Bharadwaj and Salujha, 1964). South Africa; Late Carboniferous to Permian (Anderson, 1977; MacRae, 1988). South America; Permian (Marques-Toigo and Klepzig, 1995). Canada; Permian (Utting, 1994).

Genus CONCAVISPORITES Pflug 1953

Type species: *Concavisporites rugulatus* Pflug in Thompson & Pflug 1953

Concavisporites mortonii (de Jersey) de Jersey 1962

Plate 1, figure 2.

1959 *Leotriletes mortoni* de Jersey, p. 354; pl. 1, fig. 15

1962 *Concavisporites mortoni* de Jersey, p. 4; pl. 1, figs 14, 15.

1967 *Leiotriletes lukugaensis* Kar & Bose, p. 9-10; pl. 1, figs 3, 4.

Description: Spores radial, trilete. Amb triangular, inter-apices concave, apices rounded to sharply curved and tending to slightly laterally expanded. Laesurae distinct, commonly flanked by tori, often terminates into curvatura imperfecta. Exine 0.5-1µm, laevigate or commonly distally sculptured with faint grana.

Dimensions: Equatorial diameter; 21(26)29µm (10 specimens, STRAT 1)

Remarks: With the exception of faint granulate texture, the present specimens are indistinguishable from the from the specimens with concave sides (p.33; pl. 1, figs. 6-8) described and assigned by Utting (1994) to *Leiotriletes ulutus*.

Occurrence: STRAT 1, ML1.

Previous records: South Africa; Late Permian (MacRae, 1988). Canada; Permian (Utting, 1994).

Concavisporites sp.

Plate 1, figure 3.

Description: Spores radial, trilete. Amb triangular, inter-apices slightly concave, apices broadly rounded. Laesurae distinct, extends to about $\frac{3}{4}$ spore radius, wide and tapering towards apex. Tori poorly developed but distinct. Exine 0.5-1µm, laevigate. Rarely scabrate and distally faintly micro-granulate.

Dimensions: Equatorial diameter; 31(36)39µm (7 specimens, STRAT 1), 30(35)43µm (6 specimens, CKP6).

Remarks: The specimens (p. 33; pl.1, figs. 4-5) with straight to slightly convex sides described and assigned by Utting (1994) to *Leiotriletes ulutus* are considered conspecific with the present specimens.

Occurrence: STRAT 1, CKP6, KGO3.

Previous records: Canada; Permian (Utting, 1994).

Genus DELTOIDOSPORA Miner *emend.* Potonié 1956

Type species: *Deltoidospora hallii* Miner *emend.* Potonié 1956

Deltoidospora directa (Balme & Hennelly) Norris 1965

Plate 1, figure 4.

1956 *Leiotriletes directus* Balme & Hennelly, p. 244; pl. 1, figs 1 – 4.

1965 *Deltoidospora directa* (Balme & Hennelly) Norris, p. 240; figs 1b, 7, 8.

1965 *Deltoidospora directa* (Balme & Hennelly) Hart, p.133, text fig. 343.

Description: Spores radial, trilete. Amb triangular, interapices slightly convex, apices broad to slightly sharply rounded. Laesurae distinct, straight to sinuous, extend to equator; occasionally develop *Curvatura Imperfecta*. Exine 0.5 - 1µm thick, proximally laevigate; distal face commonly micro-granulate or scabrate, micro-punctate to rarely foveolate.

Dimensions: Equatorial diameter; 28(42)63µm (28 specimens, STRAT 1), 28(45)56 (23 specimens, CKP6).

Remarks: The relationship between *Deltoidospora* and *Leiotriletes* is briefly discussed in MacRae(1988) and Millsted (1999) following Norris (1965) and Staplin (1960). The views expressed by MacRae(1988) considering *Deltoidospora* as a senior synonym to *Leiotriletes* are accepted.

Occurrence: STRAT 1, CKP6, CKP9, NATA.

Previous records: South Africa: Late Carboniferous to Permian (MacRae, 1988; Millsted, 1999). Australia: Late Carboniferous to Permian (Balme & Hennelly, 1956; Foster, 1975, 1979).

Genus PACHYTRILETES Bose & Kar 1966

Type species: *Pachytriletes densus* Bose & Kar 1966 (by original designation)

Pachytriletes splendens (Saksena) Millsted 1999

Plate 1, figure 5.

1971 *Densosporites splendens* Saksena, p. 245; pl. 2, fig. 24.

1977 *Pachytriletes densus* (Bose & Kar) Anderson, p. 65; pl. 63, figs 1-31.

Description: Spores radial, trilete. Amb sub-triangular, interapices slightly convex, apices round to angular. Laesurae distinct, straight to rarely sinuous, extend full extent of intexine diameter; appear to terminate at exoxine, which seems separated. Exine 2 - 5µm thick, occasionally appears double-layered; proximally laevigate to distally micro-punctate.

Dimensions: Equatorial diameter; 28(37)48µm (18 specimens, STRAT 1), 31(41)54 (30 specimens, CKP6)

Remarks:

Occurrence: STRAT 1, CKP6, CKP9.

Previous records: South Africa: Early Permian (Anderson, 1977; Millstead, 1999).

Genus PUNCTATISPORITES Ibrahim *emend.* Potonié & Kremp 1954

Type species: *Punctatisporites punctatus* (Ibrahim) Ibrahim 1933 (by original designation)

Punctatisporites gretensis Balme & Hennelly 1956
Plate 1, figure 6.

1956 *Punctatisporites gretensis* Balme & Hennelly, p. 245 – 245; pl. 2, figs 11 -13.

1977 *Punctatisporites medius* Anderson, p. 68; pl. 65, figs 8 – 9.

Description: Spores radial, trilete. Amb circular to sub-circular and tending to roundly triangular. Laesurae distinct, straight to curvi-linear, extends about $\frac{3}{4}$ of spore radius. Exine 2 - 4µm thick, laevigate; occasional micro-puncta commonly displayed in polar regions. Rare specimens appear double layered.

Dimensions: Equatorial diameter; 45(60)106µm (24 specimens, STRAT 1)

Remarks: The genus generally has few distinguishing characters. Several spores with morphological characters identical to those of *P. gretensis* Balme & Hennelly 1956 have been assigned to different species based on size differences. However the size ranges show much overlap in most cases. *P. gracilis* Anderson 1977 seems to be different because of its commonly lighter colour hue and tendency to folding compared to the much darker and seemingly robust *P. gretensis* Balme & Hennelly 1956. *P. parvus* Anderson 1977 has the smallest size range.

Occurrence: STRAT1, CKP6, CKP9, KGO3, ME58, NATA.

Previous records: Gondwana; Late Carboniferous to Permian (Foster, 1975; Anderson, 1977; MacRae, 1988; Backhouse, 1991; Marques-Toigo and Klepzig, 1995).

Punctatisporites gracilis Anderson 1977
Plate 1, figure 7.

1977 *Punctatisporites gracilis* Anderson, p. 66; pl. 64, figs 1-24.

Description: Spores radial, trilete. Amb circular to sub-circular and slightly triangular. Laesurae distinct, straight to curvi-linear, occasionally obscured by folds, extends 2/3 to 3/4 spore radius. Exine 1 - 2µm thick, laevigate; infrapunctate.

Dimensions: Equatorial diameter; 38(53)79µm (18 specimens, STRAT 1).

Remarks: The specimen (p. 175; fig.9.3f) figured in Traverse (1988) as *Punctatisporites glaber* (Naumova) Playford appear identical to the present specimens.

Occurrence: STRAT 1, CKP6, CKP9.

Previous records: South Africa; Early Permian (Anderson, 1977; Millsted, 1999).

Punctatisporites parvus Anderson 1977
Plate 1, figure 8.

1977 *Punctatisporites parvus* Anderson, p. 67; pl. 65, figs 1-7.

Description: Spores radial, trilete. Amb circular to sub-circular, occasionally roundly triangular. Laesurae distinct, extends more than 3/4 spore radius. Exine 1µm thick, laevigate; infragranulate.

Dimensions: Equatorial diameter; 17(28)39µm (9 specimens, STRAT 1)

Remarks: The present specimens have a close description and are probably conspecific to the specimens (p. 126; pl. 1, figs. 15 – 16) assigned by Smith and Butterworth (1967) to *Punctatisporites minutus* Kosanke 1950.

Occurrence: STRAT1, CKP6

Previous records: South Africa; Early Permian (Anderson, 1977)

Punctatisporites ubischii Foster 1979 *comb. nov.*

Plate 1, figure 9.

1979 *Calamospora ubischii* Foster, p.28; pl. 40, figs. 15 – 18.

Description: Spores radial, trilete. Amb circular to sub-circular. Laesurae distinct, extends $\frac{1}{4}$ - $\frac{3}{4}$ spore radius; a third ray typically shorter. Exine 1-2 μ m thick, smooth at equator, internally appears finely stratified or lamellate. Distal view with sporadic or clusters of flat-topped granulate to verrucate elements.

Dimensions: Equatorial diameter; 39(45)56 μ m (11 specimens, STRAT 1)

Remarks: The present species has been assigned to the genus *Punctatisporites* because of close similarities in form (except for the “ubischii” elements) to other specimens of this genus as opposed to those of the genus *Calamospora* under which it was described by Foster (1979) and Lindström (1995).

Occurrence: STRAT 1, CKP6, CKP9.

Previous records: Australia; Permian (Foster, 1979), Antarctica; Permian (Lindström, 1995).

Punctatisporites sp.

Plate 1, figure 10.

Description: Spores radial, trilete. Amb circular to sub-circular. Trilete mark slightly off-center, two rays reach equator. Exine 1 - 2 μ m thick; equator with sporadic gemmate to verrucate elements, about 2 μ m in height and base diameter. Plan view display isolated sub-circular to polygonal verrucae, 1 - 2 μ m across.

Dimensions: Equatorial diameter (excluding ornamentation); 55 μ m (1 specimen, STRAT 1), 46 μ m, 52 μ m, 55 μ m, 57 μ m (4 specimens, CKP6).

Remarks: The present specimens differ from *Punctatisporites ubischii* in displaying isolated coarse verrucae and gemmate elements, some of which are developed at the equator. Rigby and Hekel (1977) described a similar specimen (Plate 1, fig. 12), which they recorded as *?Punctatisporites gretensis*.

Occurrence: STRAT 1, CKP6.

Genus *RETUSOTRILETES* Naumova *emend.* Streele 1964

Type species: *Retusotriletes simplex* Naumova 1953 (by subsequent designation of Potonié, 1958).

Retusotriletes diversiformis (Balme & Hennelly) Balme & Playford 1967
Plate 1, figure 11.

1956 *Calamospora diversiformis* Balme & Hennelly, p. 246; pl. 2, figs 14 – 18.

1967 *Retusotriletes diversiformis* (Balme & Hennelly) Balme & Playford, p. 181; pl. 1, fig. 3.

1977 *Apiculatisporites diversiformis* (Balme & Hennelly) Anderson, p. 81; pl. 77, figs 1 – 18.

1979 *Retusotriletes nigrifellus* (Luber) Foster, p. 30; pl. 1, fig. 7.

Description: Spores radial, trilete. Amb sub-circular, tending to roundly triangular. Laesurae distinct, tapering away from central point, extends $\frac{1}{2}$ to $\frac{3}{4}$ spore radius; appears to be confined within a characteristic darkened triangular area centered at the proximal pole. Exine 0.5 - 2 μ m thick, laevigate; some specimens distally punctate or micro-granulate, commonly on polar regions.

Dimensions: Equatorial diameter; 27(33)42 μ m (6 specimens, STRAT 1)

Occurrence: STRAT 1

Previous records: Gondwana; Late Carboniferous to Late Permian (Foster 1975, 1979; Anderson, 1977; Backhouse, 1991; Marques-Toigo and Klepzig, 1995; Millstead, 1999)

Retusotriletes golatensis Staplin 1960
Plate 1, figure 12.

1960 *Retusotriletes golatensis* *in* Marques-Toigo (1995, p. 110).

Description: Spores radial, trilete. Amb circular to sub-circular or slightly roundly triangular. Laesurae distinct, extends full spore radius to equator, often culminates into curvaturae perfectae or imperfectae. Exine 1-2 μ m thick, laevigate; commonly inframicrogranulate and punctate.

Dimensions: Equatorial diameter; 25(31)42 μ m (18 specimens, STRAT 1)

Remarks: The specimens (pl. 1, fig. 5; pl. 2, fig. 12) described as *Retusotriletes?* *sp.* A by Foster (1979) closely resembles the present species except for its strongly triangular amb. However, few specimens described in this study do exhibit a slight triangular appearance similar to the figured specimen (pl. 1, fig. 5) of Foster (1979); the latter is probably the same as the present species.

Occurrence: STRAT 1, CKP6, CKP9.

Previous records: Australia; Middle Permian (Foster, 1979). South America; Early Permian (Marques-Toigo, 1995).

Infraturma **APICULATI** Bennie & Kidston *emend.* Potonié 1956
Subinfraturma **GRANULATI** Dybová & Jachowicz 1957

Genus **CYCLOGRANISPORITES** Potonié & Kremp 1954

Type species: *Cyclogranisporites leopoldii* (Kremp) Potonié & Kremp 1954 (by original designation).

Cyclogranisporites gondwanensis Bharadwaj & Salujha 1964
Plate 1, figure 13.

1962 *Cyclogranisporites sp.* Bharadwaj, p. 79; pl. 1, figs 11 – 14.

1964 *Cyclogranisporites gondwanensis* Bharadwaj & Salujha, p. 192; pl. 1, figs 19 – 22.

1970 *Cyclogranisporites barakarensis* Srivastava, p. 156; pl. 1, figs 2 – 4.

Description: Spores radial, trilete. Amb circular to sub-circular. Laesurae commonly distinct but occasionally uncertain; extends more than ½ spore radius to equatorial margin. Exine 0.5 - 1µm thick; sculptured with discreet and closely spaced (less than 1µm apart) fine grana.

Dimensions: Equatorial diameter; 21(30)36µm (15 specimens, STRAT 1)

Remarks: The present specimens differ from similarly sculptured forms by its more distinct laesurae display and its discreet granulate sculptural elements.

Occurrence: STRAT 1, CKP6, CKP9, ML1.

Previous records: South Africa; Late Carboniferous to Permian (MacRae, 1988)

Cyclogranisporites sp.
Plate 1, figure 14.

Description: Spore radial, trilete. Amb subcircular; most specimens compressed into irregular shapes. Laesurae rarely distinct, bordered by pronounced labra; often obscured by strong, irregular exinal folds. Exine 0.5µm thick, finely granulate; elements often appear fused to give an impression of a coarse, uneven granulate texture.

Dimensions: Equatorial diameter; 20(23)28µm (9 specimens, STRAT 1)

Remarks: The present specimens differ from *C. gondwanensis* Bharadwaj & Salujha 1964 by its smaller size range and the strong exinal folding. *Cyclogranisporites minutus* Bharadwaj 1957 described in Marques-Toigo and Klepzig (1995) closely resembles the present specimens but falls within a larger size range. The specimens (pl. 1, figs *m, o*) assigned by Stephenson (2004) to *Cyclogranisporites pox* Stephenson and Osterloff 2002, seems to be identical to the present species but also differs by its larger size.

Occurrence: STRAT 1, CKP9, TLMB.

Genus GRANULATISPORITES Ibrahim *emend.* Potonié & Kremp 1954

Type species: *Granulatisporites granulatus* Ibrahim 1933 (following Schopf, Wilson & Bentall, 1944).

Granulatisporites papillosus Hart 1965
Plate 1, figure 15.

1965 *Granulatisporites papillosus* Hart, p. 14; pl. 1, fig. 9.

Description: Spores radial, trilete. Amb triangular, apices rounded, interapices straight to just slightly convex. Laesurae clearly distinct, extends $\frac{3}{4}$ to full extent of spore radius; bordered by firm labra, and occasionally narrowly tapering towards apices. Exine 0.5 - 1µm thick; comprehensively sculptured with uniformly distributed grana, less than 1µm apart, 1-2µm basal diameter, and about 0.5µm high. Grana largely discreet but occasionally appears fused to resemble verrucate elements. Sculpture dominantly on the distal surface, diminishes on the proximal surface.

Dimensions: Equatorial diameter (including sculpture); 24(32)42µm (25 specimens, STRAT 1), 22(32)42µm (16 specimens, CKP6)

Remarks: The present specimens differ from similarly sculptured forms by its more distinct, straight and firmly labrate laesurae.

Occurrence: STRAT 1, CKP6, CKP9, KGO3, ME58.

Previous records: South Africa, Late Carboniferous to Late Permian (MacRae, 1988).

Granulatisporites angularis (Staplin) Ybert 1975

Plate 1, figure 16.

1975 *Granulatisporites angularis* (Staplin) Ybert, p.186; pl. 1, figs 24-25.

1979 *Granulatisporites austroamericanus* Archangelsky & Gammero, p. 421; pl. 1, fig. 4.

Description: Spores radial, trilete. Amb triangular, apices rounded, interapices straight to just slightly convex; one side usually conspicuously more convex than the other two sides. Laesurae distinct, simple, extends to equator; commonly paralleled by marginal folds. Exine 0.5 - 1µm thick; comprehensively sculptured with grana, largely developed on the distal surface, only poorly developed in the proximal surface. Grana discreet, less than 1µm base diameter, and less than 1µm apart.

Dimensions: Equatorial diameter (including sculpture); 31(35)40µm (22 specimens, STRAT 1), 29(34)40µm (5 specimens, CKP6).

Remarks: The present specimens closely resemble *Granulatisporites trisinus* Balme & Hennelly 1956, except the latter displays a much larger size i.e. 45(76)110, described by Balme & Hennelly (1956).

Occurrence: STRAT 1, CKP6, CKP9, KGO3, ME58, ML1, NATA.

Previous records: South America; Late Carboniferous to Early Permian (Archangelsky and Gammero, 1979; Marques-Toigo and Klepzig, 1995).

Granulatisporites trisinus Balme & Hennelly 1956

Plate 1, figure 17.

1956 *Granulatisporites trisinus* Balme & Hennelly, p. 244-245; pl. 1, figs 5-8.

1977 *Microbaculispora trisina* (Balme & Hennelly) Anderson, p. 46; pl. 51, figs 1-18; pl. 53, figs 1-12.

Description: Spores radial, trilete. Amb triangular, apices rounded, interapices slightly convex. Laesurae distinct, straight to sinuous, extend to equator; weakly labrate. Exine 0.5µm thick; comprehensively sculptured with grana, well-developed on the distal surface, and poorly developed on the proximal surface. Grana 0.5µm high, 1µm or less in basal diameter, and less than 1µm apart.

Dimensions: Equatorial diameter (including sculpture); 45(46)47µm (4 specimens, STRAT 1), 44(45)47µm (3 specimens, CKP6).

Remarks: The present specimens differ from *Granulatisporites angularis* (Staplin) Ybert 1975 by virtue of a larger size.

Occurrence: STRAT 1, CKP6, CKP9.

Previous records: Australia; Permian (Foster, 1979). South Africa; Early to Late Permian (Anderson, 1977; MacRae, 1988).

Granulatisporites sp.

Plate 1, figure 18a, b.

Description: Spores radial, trilete. Amb triangular, apices rounded to broadly rounded, interapices straight to convex. Laesurae distinct, extend to equator, bounded by thin sinuous labra; occasionally bifurcates near apices. Exine 0.5 - 1µm thick; distally sculptured with fine dense grana, proximally laevigate.

Dimensions: Equatorial diameter (including sculpture); 26(31)35µm (7 specimens, STRAT 1).

Remarks: The present specimens differ from similarly sculptured forms by a clear distinction between laevigate proximal surfaces and granulate distal surfaces. The latter feature closely compare the present specimens with the species *Lacinitriletes badamensis* described by Venkatachala and Kar (1965, p.339; pl. 1, figs. 8-15), which however has a much larger size range. However, the present specimens are considered to form end-members of the forms assigned to the genus *Lacinitriletes* by Venkatachala and Kar (1965).

Occurrence: STRAT 1, CKP6

Previous records: India; Permian (Venkatachala and Kar, 1965).

Granulatisporites sp. A

Plate 1, figure 19a, b.

Description: Spores radial, trilete. Amb triangular, interapices commonly concave but may be straight, apices round to slightly nearly flat. Laesurae distinct, extend to equator, simple to labrate; often opens wide at apices. Exine 0.5 - 1µm thick; proximally laevigate, distally commonly sculptured with fine discreet grana but may exhibit coarse or fused grana that depicts verrucae to reticulate patterns.

Dimensions: Equatorial diameter (including sculpture); 18(24)30µm (9 specimens, STRAT 1), 28(32)35µm (4 specimens, CKP6).

Remarks: *Granulatisporites sp. B* is distinguished by its dominant concavely triangular amb as well as its small size range. A clear distinction between proximally laevigate and distally granulate surfaces is also helpful to distinguish this species.

The specimen (pl. 4, fig. 22), assigned by MacRae (1988) to *Granulatisporites microgranifer* Ibrahim 1933, seem closest to the present specimens but exhibit broadly round apices.

Occurrence: STRAT 1

Subinfraturma **NODATI** Dybová & Jachowicz 1957

Genus **ANACANTHOTRILETES** Ravn 1986

Type species: *Anacanthotriletes spinosus* (Kosanke) Ravn 1986 (by original designation)

***Anacanthotriletes* sp.**

Plate 2, figure 1

Description: Spores radial, trilete. Amb triangular, apices rounded, inter-apices straight to slightly convex. Laesurae distinct, extends to equator; simple to slightly labrate. Exine 0.5µm thick; distally sculptured with regularly tapered spinae up to 2µm high, proximally aligned in sub-equatorial inter-radial regions but absent on the contact areas.

Dimensions: Equatorial diameter (excluding sculpture); 35µm (1 specimen, STRAT 1).

Remarks: Specimen rare, however bares great similarity to the specimens (pl. 60, figs 29 – 40) assigned by Anderson (1977) to *Microbaculispora spinosa*. The figured specimens (pl. vii, figs 1 – 5) of Backhouse (1991), assigned to *Procoronaspora spinosa* Anderson, are also very similar to the present specimen and are considered to be conspecific.

Occurrence: STRAT 1

***Anacanthotriletes* sp. A**

Plate 2, figure 2

Description: Spores radial, trilete. Amb subtriangular, apices rounded, inter-apices straight to slightly convex. Laesurae discernible, extend to equator. Exine 0.5µm; distally sculptured with fine baculae and coni, less than 1µm apart and high. Sculpture reduced on proximal surface; may be concentrated in sub-equatorial parts of the inter-radial areas.

Dimensions: Equatorial diameter (excluding sculpture); 26, 38, 38µm (3 specimens, STRAT 1).

Remarks: The present specimens appear very similar to specimens (pl. 3, figs 5-9) assigned by Millstead (1999) to *Anacanthotriletes macrei*, however the latter has a much larger size range. *Microbaculispora micronodosa* (Balme & Hennelly) Anderson 1977 has great similarities with the present specimens but also differs by its large size range.

Occurrence: STRAT 1, ME58.

Genus APICULATISPORIS Potonié & Kremp 1956

Type species: *Apiculatisporis aculeatus* (Ibrahim) Potonié 1956 (by original designation of Potonié & Kremp, 1956).

Remarks: The history regarding validation of this genus is clearly stated in Foster (1979) and MacRae (1988) who both consider the date of publication as 1956. This study follows the arguments of MacRae (1988) that *Brevitriletes* Bharadwaj & Srivastava 1969 form a synonym of the present genus. Therefore, species described elsewhere under *Brevitriletes* Bharadwaj & Srivastava 1969 are herein placed under the genus *Apiculatisporis* Potonié & Kremp 1956.

Apiculatisporis cornutus (Balme & Hennelly) Høeg & Bose 1960
Plate 2, figure 3

1956 *Apiculatisporites cornutus* Balme & Hennelly, p. 274; pl. 2, figs 24 – 26.

1960 *Apiculatisporis cornutus* (Balme & Hennelly) Høeg & Bose, p. 77; pl. 31, figs 4, 5.

1970 *Apiculatisporis cornutus* (Balme & Hennelly) Segroves, p. 58; pl. 4, figs G – L.

Description: Spores radial, trilete. Amb circular or sub-circular, commonly tending to sub-triangular; some specimens occasionally compressed into ovoidal forms with long axis. Laesurae discernible to distinct, straight with labra, extend to equator. Exine 0.5 – 1.5µm thick; distally and equatorially sculptured with typically broad-based coni. Elements 1 - 3µm base diameter, 1 - 3µm high, 2 - 5µm apart.

Dimensions: Equatorial diameter (excluding sculpture); 18(25)30µm (21 specimens, STRAT 1), 20(24)28µm (11 specimens, CKP6).

Remarks: The present specimens have a smaller size range than for *Apiculatisporis unicus* (Tiwari) Bharadwaj & Srivastava *comb. nov.*

Occurrence: STRAT 1, CKP6, KG03, ME58, TLMB.

Previous records: Australia; Permian (Segroves 1970; Fosters, 1979). South Africa; Early Permian (Anderson, 1977; MacRae, 1988). South America; Early Permian (Marques-Toigo & Klepzig, 1995).

Apiculatisporis unicus (Tiwari) Bharadwaj & Srivastava *comb. nov.*
Plate 2, figure 4

- 1968 *Apiculatisporis irregularis* Nahuys, Alpern & Ybert,
1969 *Brevitriletes unicus* (Tiwari) Bharadwaj & Srivastava,
1995 *Apiculatisporis paranaensis* Marques-Toigo & Klepzig, p. 26.

Description: Spores radial, trilete. Amb sub-circular to sub-triangular. Laesurae discernible to distinct in rare specimens; may form *curvatura perfecta*. Exine 1 – 1.5µm thick; distally and equatorially ornamented with coarse coni and rare baculae. Elements 2 - 3µm base diameter, 3 - 5µm high, 2 – 5µm apart.

Dimensions: Equatorial diameter (excluding sculpture); 29(40)45µm (3 specimens, STRAT 1), 34(38)39µm (8 specimens, CKP6).

Remarks: The present specimens are typically coarsely sculptured with commonly blunt coni, with occasional baculae and rare verrucae-like elements.

Occurrence: STRAT 1, CKP6, CKP9

Previous records: South America; Permian (Marques-Toigo & Klepzig, 1995). Oman and Saudi Arabia (Stephenson & Osterloff, 2002; Stephenson, 2004).

Apiculatisporis levis (Balme & Hennelly) Segroves 1970
Plate 2, figure 5

- 1956 *Apiculatisporites levis* Balme & Hennelly, p. 246; pl. 2, figs 19 – 21.
1969 *Brevitriletes levis* (Balme & Hennelly) Bharadwaj & Srivastava, p. 226 – 227; pl. 1, figs 17 – 20.
1970 *Apiculatisporis levis* (Balme & Hennelly) Segroves, p. 59; pl. 5, fig. 1.
1977 *Apiculatisporis bulliensis* (Hennelly) Anderson, p. 85; pl. 78, figs 1 – 17.

Description: Spores radial, trilete. Amb circular or sub-circular. Laesurae discernible to distinct, straight, thin labra; occasionally with *Curvatura Imperfecta*. Exine 1 - 2µm thick; sculptured with small coni, well-developed at the equator and the distal surface. Elements 1 - 2µm high, 1 - 2µm base diameter, less than 1µm to 2µm apart.

Dimensions: Equatorial diameter (excluding sculpture); 21(28)39µm (8 specimens, STRAT 1), 19(28)34µm (6 specimens, CKP6).

Remarks: The specimens (pl. iii, figs 1 – 3) described as *Apiculatisporis* sp. A by Backhouse (1991) appears very similar to the present species and is probably the same.

Occurrence: STRAT 1, CKP6, KG03.

Previous records: South Africa; Early Permian (Anderson, 1977; MacRae, 1988; Millsted, 1999). Australia; Permian (Balme & Hennelly, 1956; Segroves, 1970; Foster, 1979). India; Early Permian (Bharadwaj & Srivastava, 1969).

Apiculatisporis leptocaina (Jones & Truswell) *comb. nov.*
Plate 2, figure 6

1992 *Brevitriletes leptocaina* Jones & Truswell

Description: Spores radial, trilete. Amb circular or sub-circular; may display a broadly roundly triangular form. Laesurae distinct, straight with labra, extend to margin often terminating into *Curvatura Imperfecta*; few specimens indicate *Curvatura Perfecta*. Exine 1 – 2µm thick; distally and equatorially sculptured with spinae, baculae or pilate elements. Elements 1 - 2µm high, 1µm base diameter, 1 - 3µm apart.

Dimensions: Equatorial diameter (excluding sculpture); 20(26)36µm (17 specimens, STRAT 1).

Remarks: These specimens differ from the other specimens of this genus by the relatively narrow-based elements, and the occurrence of baculae and pilate elements. The specimen (pl. iii, fig. 7) assigned by Backhouse (1991) to *Brevitriletes levis* (Balme & Hennelly) Bharadwaj & Srivastava 1969 appears identical to the present species.

Occurrence: STRAT 1, KG03.

Previous records: Australia; Late Carboniferous to Early Permian (Jones and Truswell, 1992). Oman and Saudi Arabia; Early Permian (Stephenson, 2004).

Apiculatisporis parmatus (Balme & Hennelly) *comb. nov.*
Plate 2, figure 7

1956 *Verrucosisporites parmatus* Balme & Hennelly, p. 251; pl. 5, figs 51 – 52.

1977 *Apiculatisporis major* Anderson, p. 83; pl. 77, figs 29 – 35.

1991 *Brevitriletes parmatus* (Balme & Hennelly) Backhouse, p. 263 – 264; pl. iii, figs 11 – 13.

Description: Spores radial, trilete. Amb sub-circular; some specimens indicate a broadly roundly triangular form. Laesurae discernible to distinct, straight, extend to equator; may show *Curvatura Imperfecta*. Exine 1 - 2µm thick; distally sculpture with low, flat circular to sub-circular verrucate elements, about 1µm apart and in base diameter. Equator exhibits rare usually sub-dued coni or spinae.

Dimensions: Equatorial diameter; 22(25)28µm (5 specimens, STRAT 1), 21, 24µm (2 specimens, CKP6).

Remarks: There is close similarity between the present species and the descriptions given for the genus *Divaricrassus* (Kar & Bose) *emend.* Millsted 1999. It may well be that the present species belong to the latter genus, however, it is retained here due to its recognizable apiculate character and its documented history of association with the apiculate forms (e.g. Anderson, 1977; Backhouse, 1991; Stephenson, 2004).

Occurrence: STRAT 1, CKP6

Previous records: Australia; Early Permian (Balme & Hennelly, 1956; Backhouse, 1991). South Africa; Early Permian (Anderson, 1977).

Genus DIDECITRILETES Venkatachala & Kar 1965

Type species: *Didecitriletes horridus* Venkatachala & Kar 1965 (by original designation)

Didecitriletes eoericiana (Anderson) Millsted 1999
Plate 2, figure 8

1977 *Microbaculispora eoericiana* Anderson, p. 50; pl.55, figs 7 – 20.

1999 *Didecitriletes eoericiana* (Anderson) Millsted, p. 13 – 14; pl. 5, figs 9 – 10, 12.

Description: Spores radial, trilete. Amb sub-triangular, apices rounded, inter-apices straight to slightly convex. Laesurae discernible, extend to equator. Exine 1µm thick; distally and equatorially sculptured with fine coni and spinose, intermixed with fine grana and rare small verrucae. Elements are less than 1µm to 1.5µm base diameter. Spinae characteristically sharply tapered, 2 - 3µm high.

Dimensions: Equatorial diameter (excluding sculpture); 53µm, 60µm (2 specimens, STRAT 1).

Remarks: The description given by Foster (1979) for the species *Didecitriletes ericianus* (Balme & Hennelly) Venkatachala & Kar 1965 agrees closely with the present specimens. However, Foster's (1979) figured specimens (pl. 9, figs 10 – 14) and his list of synonymy do not reflect the aspect described as “comprehensively

sculptured with discrete spinae, coni, and grana". For that reason the present specimens are classified following Millsted (1999).

Occurrence: STRAT 1

Previous records: South Africa; Early Permian (Anderson, 1977; Millsted, 1999).

Didicitriletes ericianus (Venkatachala & Kar 1965)

Plate 2, figure 9

1956 *Acanthotriletes ericianus* Balme & Hennelly, p. 248; pl. 3, figs 30 – 33.

1965 *Didicitriletes ericianus* (Balme & Hennelly) Venkatachala & Kar, p. 338 – 339.

1977 *Microbaculispora ericana* (Balme & Hennelly) Anderson, p. 49; pl. 55, figs 1 – 6.

Description: Spores radial, trilete. Amb triangular, apices rounded, inter-apices straight to slightly convex. Exine 1µm thick; sculptured with closely spaced spinae, less than 1µm apart, 3 - 4µm high, and 2µm base diameter. Sculpture proximally reduced. Spinae displaying rare polygonal bases.

Dimensions: Equatorial diameter (excluding sculpture); 49µm, 52µm (2 specimens, STRAT 1), 38, 40, 42, 50µm (4 specimens, CKP6).

Remarks: The present specimens appear to be very similar to the specimens (pl. vii, figs 13 – 15) in Backhouse (1991). Although other authors (e.g. Rigby and Hekel, 1977; Foster, 1979) have differentiated forms previously included under this species, depending on separation of the sculptural elements, it has not been possible to do the same in this study owing to the rarity of this species. The present specimens have been classified following the original broad account of Balme & Hennelly (1956) that considered this species to include forms with variable spine density.

Occurrence: STRAT 1, CKP6, CKP9

Previous records: Australia; Permian (Balme & Hennelly, 1956; Rigby and Hekel, 1977; Foster, 1979). South Africa; Early Permian (Anderson, 1977). India; Permian (Venkatachala and Kar, 1965).

Genus *DIVARICRASSUS* Kar & Bose *emend.* Millsted 1999

Type species: *Divaricrassus opimus* Kar & Bose 1976 (by original designation).

Divaricrassus minor (Anderson) Millsted 1999

Plate 2, figure 10

- 1977 *Apiculatisporis minor* Anderson, p. 82; pl. 77, figs 19 – 28.
 1991 *Rattiganispora? Minor* (Anderson) Backhouse, p. 264; pl. iii, figs 9, 10.
 1999 *Divaricrassus minor* (Anderson) Millstead, p. 10 – 11; pl. 4, figs 6 – 8.

Description: Spores radial, trilete. Amb sub-circular; also appear slightly weakly sub-triangular. Laesurae distinct, straight, extends $\frac{3}{4}$ to margin of intexine; terminates into Curvaturae Imperfectae. Sculptured with low verrucae concentrated in the distal polar regions, absent at the equator; elements 1 - 2 μ m basal diameter and 1 μ m apart. Narrow grooves between verrucae elements may join to form negative reticulum.

Dimensions: Equatorial diameter; 19, 22 μ m (2 specimens, STRAT 1), 20 μ m (1 specimen, CKP6).

Remarks: The present specimens lack apiculate features i.e. coni, as described from the emended diagnosis of Millstead (1999). The specimens (pl. iii, figs 9 – 10) described by Backhouse (1991) also do not appear to exhibit any apiculate elements. It is likely that the specimens described in the diagnosis as bearing coni belongs to the forms herein assigned to *Apiculatisporis parmatus* (Balme & Hennelly), which show a very close similarity to the present species.

Occurrence: STRAT 1, CKP6

Previous records: Australia; Late Carboniferous to Early Permian (Backhouse, 1991). South Africa; Early Permian (Anderson, 1977).

Genus LOPHOTRILETES Naumova *ex* Potonié & Kremp 1954

Type species: *Lophotriletes gibbosus* (Ibrahim) Potonié & Kremp 1954 (by subsequent designation of Potonié & Kremp, 1954, p. 129).

Lophotriletes rectus Bharadwaj & Salujha 1964

Plate 2, figure 11

1964 *Lophotriletes rectus* Bharadwaj & Salujha, p.192; pl.2, figs.26-28.

1977 *Acanthotriletes spp.* of Anderson, pl. 39, figs 1 – 11.

Description: Spores radial, trilete. Amb sub-triangular, apices rounded, inter-apices straight to concave. Laesurae discernible, extend $\frac{3}{4}$ to full extent of spore radius. Exine 0.5 μ m thick; sculptured with widely spaced coni and rare baculae. Elements 1 - 3 μ m apart, 1 - 2 μ m base diameter and height.

Dimensions: Equatorial diameter (excluding sculpture); 20(27)29 μ m (9 specimens, STRAT 1), 20(25)35 μ m (3 specimens, CKP6).

Remarks: The present specimens are distinguished from *Lophotriletes novicus* Singh 1964 based on their smaller size range. The specimen (pl. 1, fig. 10) assigned to *Lophotriletes rarus* Bharadwaj & Salujha 1964 by Foster (1975) is very similar to the present specimens; however, although the figured specimen exhibit a concavely sub-triangular amb the description given refers to convex sides.

Occurrence: STRAT 1, CKP6, CKP9, ME58.

Previous records: South America; Permian (Marques-Toigo & Klepzig, 1995). Australia; Permian (Foster, 1975, 1979). India; Permian (Bharadwaj and Salujha, 1964).

Lophotriletes novicus Singh 1964

Plate 2, figure 12

1964 *Lophotriletes novicus* Singh, p. 247; pl. 44, figs 24 – 25.

1977 *Acanthotriletes* spp. of Anderson, pl. 41, figs 46 – 52.

1978 *Lophotriletes pseudolukugaensis* Falcon, p. 10 – 11; pl. I, figs 22 – 23.

Description: Spores radial, trilete. Amb sub-triangular, apices broadly rounded, inter-apices straight to slightly concave. Laesurae discernible to distinctive, sharply tapers towards apices, extend about $\frac{3}{4}$ spore radius. Exine 0.5 - 1 μ m thick; sculptured with low coni, associated with baculae and grana. Elements generally unevenly spaced, less than 1 μ m to 2 μ m base diameter, and 1 - 2 μ m high.

Dimensions: Equatorial diameter (excluding sculpture); 29(42)48 μ m (7 specimens, STRAT 1), 41 μ m (3 specimens, CKP6).

Remarks: The present specimens are distinguished from *Lophotriletes rectus* Bharadwaj & Salujha 1964 based on their larger size range.

Occurrence: STRAT 1, CKP6

Previous records: Australia; Permian (Foster, 1979). Pakistan; Permian (Balme, 1970). South Africa; Permian (Anderson, 1977; MacRae, 1988; Millsted, 1999).

Lophotriletes rarus Bharadwaj and Salujha 1964

Plate 2, figure 13

1964 *Lophotriletes rarus* Bharadwaj and Salujah, p. 193; pl.2, figs. 30-33.

Description: Spores radial, trilete. Amb triangular, apices broad to narrowly rounded, inter-apices straight. Laesurae distinct, straight, extend to equator; occasional

curvaturae imperfectae. Distinct tori outline. Exine 0.5 - 1 μ m thick; appear separated. Equator bearing very low sharp or pointed conii, with occasional baculae or grana; 1 - 1.5 μ m high, 1 - 2 μ m base diameter. Elements in polar view appear sub-circular to elongate in shape.

Dimensions: Equatorial diameter (excluding sculpture); 35 μ m, 37 μ m, 39 μ m, 45 μ m (4 specimens, STRAT 1).

Remarks: The specimens (pl. i, fig. 21) assigned to *Lophotriletes dwykanensis* by Falcon (1978) appear identical to the present specimens.

Occurrence: STRAT 1, CKP9.

Previous records: India; Permian (Bharadwaj and Salujah, 1964).

Lophotriletes sp.

Plate 2, figure 14

Description: Spores radial, trilete. Amb sub-triangular, apices rounded to nearly straight, tending to slightly laterally expanded apices, inter-apices distinctively concave. Laesurae discernible to distinct, straight, labrate, extend to margin of intexine; terminates into poorly distinct but discernible curvaturae imperfectae. Exine 1 μ m thick; distally and proximally sculptured with broad-based sharp to blunt conii, with circular to sub-circular bases, and rare baculae or grana. Elements generally evenly-spaced, about 1 - 3 μ m apart, 1 - 2 μ m base diameter and height.

Dimensions: Equatorial diameter (excluding sculpture); 28(32)38 (5 specimens, STRAT 1).

Remarks: The present specimens appear very similar to the figured specimen (pl. I, fig. 20) described and assigned to *Lophotriletes labratum* by Falcon (1978); however, the present specimens have a much smaller size range comparatively.

Occurrence: STRAT 1

Lophotriletes sp. A

Plate 2, figure 15

Description: Spores radial, trilete. Amb sub-triangular, apices slightly broadly rounded, inter-apices slightly concave. Laesurae occasionally distinct, straight to slightly sinuous, extend to equator, terminates into curvaturae imperfectae. Exine 1 μ m thick; distally and equatorially sculptured with conii and grana, with rare baculae. The proximal surface is distinctively laevigate.

Dimensions: Equatorial diameter (excluding sculpture); 36 μ m, 37 μ m, 38 μ m (3 specimens, STRAT 1).

Remarks: The present specimens are distinguished from similar forms of this genus by the display of clearly laevigate or psilate proximal surface.

Occurrence: STRAT 1.

Subinfraturma **BACULATI** Dybová & Jachowicz 1957

Genus **CIRRABACULISPORITES** Maheshwari and Bose 1969

1964 *Cirrabaculisporites* Maheshwari and Bose, p. 21-22.

1999 *Eccaspora* Millstead, p. 11.

Type species: *Cirrabaculisporites praeclarus* Maheshwari and Bose 1969 (by original designation)

Remarks: There are no major variations noted between the diagnosis of the genus *Cirrabaculisporites* Maheshwari and Bose 1969 and *Eccaspora* Millstead 1999, and hence the latter is considered a junior synonym. Specimens assigned under this genus are very rare in this study. As pointed out by Millstead (1999) there is a wide range of variation in the sculptural elements displayed by the various specimens, and this has been used in this study to identify different forms and assign them to different species.

Cirrabaculisporites lageniformis (Anderson) *comb. nov.*

Plate 2, figure 16

1977 *Microbaculispora lageniformis* Anderson, p.56; pl.59, figs. 26-42.

1999 *Eccaspora plumsteadii* Millstead, p.11; pl.4, figs. 13-16.

Description: Spore radial, trilete. Amb triangular, apices sharply rounded, inter-apices straight. Laesurae discernible, appear to reach equator; bordered by wide labra that seemingly tapers toward apices. Exine 0.5 μ m thick; distally sculptured with weakly distinct grana and verrucae. Interradial areas bear single arcuate rows of narrow, irregularly-shaped bacula; rows extend between margins of the apices.

Dimensions: Equatorial diameter (excluding sculpture); 28 μ m (1 specimen, STRAT 1).

Remarks: The present species differs from other forms of the genus in having narrower and elongate irregularly-shaped baculate elements, described by Anderson (1977)

as bottle-shaped spines, forming rows inside the equatorial contour of the proximal surface.

Occurrence: STRAT 1

Previous records: South Africa; Early Permian (Anderson, 1977; Millsted, 1999).

Cirrabaculisporites plumsteadiae (Hart) Anderson *comb. nov.*

Plate 2, figure 17

1977 *Microbaculispora plumsteadii* (Hart) Anderson, p. 55; pl.59, figs.1-25.

Description: Spore radial, trilete. Amb sub-triangular, apices rounded, inter-apices slightly concave to straight. Laesurae discernible, extend to equator; bordered by a sinuous weakly developed labra. Exine 1 μ m thick. Ornamentation of small verrucae or grana, unevenly distributed, and concentrated on the distal surface. Proximally with rows of verrucae on sub-equatorial inter-radial areas. Elements with variable diameter, up to 1 μ m maximum.

Dimensions: Equatorial diameter (excluding sculpture); 28 μ m (1 specimen, STRAT 1).

Remarks: The present specimen differs from other forms of the genus in the absence of baculate or elongate sculpture, but has been assigned to this genus based on the similarity in arrangement of the proximal inter-radial sculpture with the other forms i.e. displaying rows.

Occurrence: STRAT 1

Previous records: South Africa; Early Permian (Anderson, 1977).

Cirrabaculisporites ramosus Maheshwari and Bose 1969

Plate 2, figure 18

1968 *Anapiculatisporites subbaculiferus* Nahuys, Alpern and Ybert in Marques-Toigo and Klepzig (1995).

1969 *Cirrabaculisporites ramosus* Maheshwari and Bose, p.23; pl.3, figs.4-7, text-fig. 9.

1977 *Microbaculispora digitiformis* Anderson, p. 61; pl.60, fig. 45.

Description: Spores radial, trilete. Amb sub-triangular, apices rounded, inter-apices straight to slightly convex. Laesurae extend to equator. Exine comprehensively sculptured with coni, bacula, and verrucae elements. Characteristically displays an arcuate row of bacula or verrucae extending from one apex to the other, shown on one side of specimen; seem to define abrupt margin of contact area to laevigate

sub-equatorial inter-radial area. Elements also clearly aligned at equator on other sides of specimen; up to 3µm high.

Dimensions: Equatorial diameter (excluding sculpture); 39µm, 45µm (2 specimens, STRAT 1), 39µm (1 specimen, CKP6).

Remarks: *Cirrabaculisporites ramosus* is distinguished from *Cirrabaculisporites sp.* in displaying a much more pronounced and dense ornamentation that obscures the tetrad mark, and also has a larger size range.

Occurrence: STRAT 1, CKP6

Previous records: Congo(DRC); Late Permian (Maheshwari and Bose, 1969). South Africa; Early Permian (Anderson, 1977). South America; Early Permian (Marques-Toigo and Klepzig, 1995).

Cirrabaculisporites sp.

Plate 2, figure 19

Description: Spore radial, trilete. Amb sub-triangular, apices obscured but seem sharply rounded, inter-apices slightly convex. Laesurae poorly displayed, appear to extend to equator. Exine largely laevigate but bearing rows of bacula extending between the apices through the sub-equatorial interradial areas; specimen also show a single row of verrucae above the row of bacula on one side.

Dimensions: Equatorial diameter; 31µm (1 specimen, STRAT 1).

Remarks: The present specimen indicate an identical arrangement of proximal sculptural elements, consisting of two rows inside the equatorial contour, as is that displayed in the species *Microbaculispora plumsteadi* (Hart) Anderson 1977. However, the latter is characterized by two rows of expanded grana or verrucae, whereas the present specimen has one inside row of expanded grana or verrucae and an outside row comprised of baculae.

Occurrence: STRAT 1, ME58.

Genus HORRIDITRILETES Bharadwaj & Salujha 1964

Type species: *Horriditriletes curvibaculosus* Bharadwaj & Salujha 1964 (by original designation).

Horriditriletes brevis Bharadwaj and Salujah 1964

Plate 3, figure 1

1964 *Horriditriletes brevis* Bharadwaj and Salujah, p. 194; pl.2, fig. 41.

Description: Spores radial, trilete. Amb sub-triangular, apices broadly rounded, interapices straight to slightly convex. Laesurae discernible, weakly labrate, extend 2/3 to full extent of spore radius. Exine 0.5 - 1µm thick; sparsely sculptured with narrow bacula and coni. Elements 1 - 3µm high.

Dimensions: Equatorial diameter (excluding sculpture); 20µm, 22µm, 28µm, 28µm (4 specimens, STRAT 1).

Remarks: The present specimens differ from *Horriditriletes ramosus* (Balme & Hennelly) Bharadwaj & Salujha 1964 in having relatively sparse, narrow and slender sculptural elements.

Occurrence: STRAT 1

Previous records: India; Permian (Bharadwaj and Salujah, 1964).

Horriditriletes ramosus (Balme & Hennelly) Bharadwaj & Salujha 1964
Plate 3, figure 2

1956 *Acanthotriletes ramosus* Balme & Hennelly, p. 249; pl. 3, figs 39 – 41. Lectotype pl. 3, fig. 39 (Hart, 1960).

1964 *Horriditriletes ramosus* (Balme & Hennelly) Bharadwaj & Salujha, p. 193.

1977 *Raistrickia ramosa* (Balme & Hennelly) Rigby & Hekel, p. 14; pl. 3, figs 2 – 3, 5, 8 – 9.

1977 *Acanthotriletes spp.* of Anderson, pp. 33 - 35; pl. 38, figs 28 – 49; pl. 40, figs 39 – 40, 48, 50, 61.

Description: Spores radial, trilete. Amb triangular, apices commonly broadly rounded but may be narrowly rounded, interapices convex to occasionally slightly concave. Laesurae discernible to distinct, extend 2/3 radius to equator; often tapering toward apices. Exine 0.5 - 1µm thick; dominantly sculptured with baculate elements, with rare coni and spinae. Baculae characteristically flat-tipped, and often with slightly expanded terminations e.g. 1.5µm base, 2.5µm head. Elements 2 - 5µm high, 1 - 2µm base diameter, and 1 - 4µm apart. Ornamentation reduced on proximal surface.

Dimensions: Equatorial diameter (excluding sculpture); 22(33)49µm (28 specimens, STRAT 1), 25(34)45µm (12 specimens, CKP6).

Remarks: Several species of this genus exhibits remarkable similarities in form, which probably is an indication of the transition between end members. The present specimens are differentiated based on their showing of flat-tipped to blade-like elements and the commonly roundly triangular amb.

Occurrence: STRAT 1, CKP6

Previous records: Australia; Permian (Balme & Hennelly, 1956; Foster, 1975, 1979; Rigby & Hekel, 1977; Backhouse, 1991). Oman and Saudi Arabia; Early Permian (Stephenson & Osterloff, 2002; Stephenson, 2004). South Africa; Permian (Anderson, 1977; MacRae, 1988; Millstead, 1999). South America; Permian (Marques-Toigo & Klepzig, 1995).

Horriditriletes tereteangulatus (Balme & Hennelly) Backhouse 1991

Plate 3, figure 3

1956 *Acanthotriletes tereteangulatus* Balme & Hennelly, pp. 247 – 248; pl. 2, figs 27 – 29.

1991 *Horriditriletes tereteangulatus* (Balme & Hennelly) Backhouse, pp. 259 – 261; pl. II, figs 6 – 9.

1977 *Acanthotriletes* spp. of Anderson, pp. 33 – 35; pl. 42, figs 1 – 25.

Description: Spores radial, trilete. Amb triangular, apices rounded, inter-apices commonly slightly concave to rarely straight or slightly convex. Laesurae discernible, extend $\frac{3}{4}$ to full length of spore radius. Exine 0.5 - 1 μ m thick; sculptured with an admixture of coni and baculae, and rare spinae. Elements 1 - 4 μ m high, 0.5 - 2 μ m base diameter, 1 - 3 μ m apart.

Dimensions: Equatorial diameter (excluding sculpture); 24(31)41 μ m (21 specimens, STRAT 1), 20(25)29 μ m (7 specimens, CKP6).

Remarks: The present species differs from morphologically related forms of the genus by the presence of more pronounced conate and spinose elements.

Occurrence: STRAT 1, CKP6, CKP9, KGO3.

Previous records: Australia; Permian (Rigby and Hekel, 1977; Backhouse, 1991). Pakistan; Permian (Balme, 1970). Oman and Saudi Arabia; Early Permian (Stephenson, 2004). South Africa; Late Carboniferous to Permian (Anderson, 1977; Millstead, 1999).

Horriditriletes uruguayensis (Marques-Toigo) Archangelsky & Gamero 1979

Plate 3, figure 4

1974 *Neoraistrickia uruguayensis* Marque-Toigo, p. 604; pl. I, figs 4 – 5.

1979 *Horriditriletes uruguayensis* (Marque-Toigo) Archangelsky & Gamero, pp. 424 – 426; pl. II, figs 2 - 4.

1977 *Acanthotriletes* spp. of Anderson, pp. 33 – 35; pl. 40, fig. 47.

Description: Spores radial, trilete. Amb triangular, apices rounded, inter-apices straight to slightly convex. Laesurae discernible, extend to equator; occasionally develops *curvaturae imperfectae*. Exine 0.5 - 1µm thick; generally scarcely sculptured with characteristic pilate elements admixed with baculate and rare conic. Elements 2 - 5µm high, 1 - 2µm base diameter. Pilate elements 1.5 - 2µm at base, 2 - 3µm at head. Sculpture generally proximally reduced.

Dimensions: Equatorial diameter (excluding sculpture); 32(35)40µm (11 specimens, STRAT 1), 31µm, 44µm, 45µm (3 specimens, CKP6).

Remarks: The present specimens are distinguished from forms of the closely related *H. ramosus* by having few to rare but distinct pilate elements; there however seems to be a transition between the two end members.

Occurrence: STRAT 1, CKP6, CKP9.

Previous records: Oman and Saudi Arabia; Early Permian (Stephenson, 2004). South Africa; Late Carboniferous to Permian (Anderson, 1977). South America; Late Carboniferous to Early Permian (Archangelsky and Gamero, 1979).

Horriditriletes curvibaculosus Bharadwaj & Salujha 1964

Plate 3, figure 5

1964 *Horriditriletes curvibaculosus* Bharadwaj & Salujha, pp. 193 – 194; pl. 2, figs 34 – 39.

1977 *Raistrickia curvibaculosus* (Bharadwaj & Salujha) Rigby & Hekel, pp. 13 – 14; pl. 2, fig. 11.

Description: Spores radial, trilete. Amb sub-triangular, apices rounded, inter-apices slightly convex or concave. Laesurae rarely discernible; seem to extend to equator. Exine 0.5 - 1µm thick; usually ornamented with delicate curved bacula, commonly longer than broad, with subordinate spinose. Elements 2 - 3µm high, 0.5 - 2µm base diameter, 1 - 3µm apart.

Dimensions: Equatorial diameter (excluding sculpture); 20(26)32µm (7 specimens, STRAT 1), 25(36)41µm (12 specimens, CKP6).

Remarks: The present specimens are distinguished from closely related forms of the genus in having relatively longer than broad, delicate, and curved baculae.

Occurrence: STRAT 1, CKP6, CKP9, ML1.

Previous records: Australia; Permian (Rigby & Hekel, 1977; Foster, 1979). South America; Permian (Macques-Toigo and Klepzig, 1995). India; Permian (Bharadwaj and Salujha, 1964).

Horriditriletes gondwanensis (Tiwari & Moiz) Foster 1975

Plate 3, figure 6

- 1971 *Lobatisporites gondwanensis* Tiwari & Moiz, pp. 98 – 99; pl. 1, figs 9 – 4, text-fig. 2.
1975 *Horriditriletes gondwanensis* (Tiwari & Moiz) Foster, p. 132; pl. 2, figs 5 – 7.
1977 *Lobatisporites* sp. cf. *L. gondwanensis* (Tiwari & Moiz) Rigby & Hekel, p. 12; pl. 4, figs 2 – 3.
1977 *Acanthotriletes* spp. of Anderson, pp. 33 – 35; pl. 37, figs 40 – 47; pl. 39, fig. 30.

Description: Spores radial, trilete. Amb sub-triangular, apices rounded, inter-apices markedly concave. Laesurae discernible to slightly distinct, straight, extend to equator. Sculptured with spinae, baculae, and rare conii. Elements 3 - 5 μ m high, 2 μ m base diameter, and 1 - 2 μ m apart.

Dimensions: Equatorial diameter (excluding sculpture); 21(24)30 μ m (5 specimens, STRAT 1).

Occurrence: STRAT 1

Previous records: Australia; Permian (Rigby & Hekel, 1977; Foster, 1979). South Africa; Early Permian (Anderson, 1977).

***Horriditriletes* sp.**

Plate 3, figure 7a, b

Description: Spore radial, trilete. Amb sub-triangular, apices rounded, inter-apices markedly concave. Laesurae distinct, straight, labrate, extend to margin of intexine. Exine 0.5 - 1 μ m thick; distally and equatorially sculptured with baculae and subordinate conii. Elements 3 μ m high, 1.5 μ m at base. Proximally laevigate.

Dimensions: Equatorial diameter (excluding sculpture); 20 μ m, 28 μ m (2 specimens, STRAT 1).

Remarks: The present specimens differ from *Horriditriletes gondwanensis* in having shorter and relatively broader elements, as well as being proximally laevigate.

Occurrence: STRAT 1

Horriditriletes sp. A

Plate 3, figure 8

Description: Spore radial, trilete. Amb sub-triangular, apices rounded, inter-apices markedly concave. Laesurae discernible, appear to extend to equator. Exine 1µm thick; sculptured with characteristically pilate elements, with subordinate baculae. Elements 2µm high, 1 - 2µm at base.

Dimensions: Equatorial diameter (excluding sculpture); 28µm (1 specimen, STRAT 1).

Remarks: The present specimen is very similar to *Lophotriletes sp.* but differs in bearing pilate elements.

Occurrence: STRAT 1

Genus RAISTRICKIA Schopf, Wilson & Bentall *emend.* Potonié & Kremp 1954

Type species: *Raistrickia grovensis* Schopf *in* Schopf, Wilson & Bentall 1944

Raistrickia crenata Foster 1979

Plate 3, figure 9

Description: Spores with circular to sub-circular amb. Tetrad mark indistinct; only one specimen indicate vague outline of possible trilete mark. Exine 1µm thick; sculptured with bacula, coni, and verrucae. Bacula commonly constricted at base with expanded terminations tending to pilate form. Elements 2 - 3µm high, 0.5 - 2.5µm base diameter, up to 3µm head diameter for pilate forms, spaced 1 - 3µm apart.

Dimensions: Equatorial diameter (excluding sculpture); 27(38)48 (5 specimens, STRAT 1).

Remarks: *Raistrickia crinita* Kosanke 1950 is distinguished from the present specimens in having a much larger size range and elements height of 54µm-67µm and 7.7µm-9.5µm, respectively.

Occurrence: STRAT 1

Previous records: Australia; Middle Permian (Foster, 1979).

Subinfraturma VERRUCATI Dybová & Jachowicz 1957

Genus CONVERRUCOSISPORITES Potonié & Kremp 1954

Type species: *Convruccosisporites triquetrus* (Ibrahim) Potonié & Kremp 1954 (by original designation).

Remarks: This genus is included here following Backhouse (1991) to accommodate triangular spores of dominantly verrucate sculptural elements as opposed to those that have sub-circular to circular amb. The latter are themselves placed under the genus *Verrucosisporites* Ibrahim *emend.* Smith and Butterworth 1967, in this study.

Convruccosisporites naumoviae (Hart) Backhouse 1991
Plate 3, figure 10

1977 *Microbaculispora naumoviae* (Hart) Anderson, p. 52; pl. 57, figs. 1 – 24.

1991 *Convruccosisporites naumoviae* (Hart) Backhouse, p. 265; pl. V, figs 1 – 3.

Description: Spores radial, trilete. Amb sub-triangular, apices narrow to slightly broadly rounded, inter-apices convex. Laesurae discernible to distinct, extend to equator; straight or sinuous with weakly developed labra. Exine 0.5 - 1µm thick; sculptured with verrucae and subordinate grana to occasional gemmae-like sculpture at equator. Verrucae circular to sub-circular or polygonal to elongate in form. Elements closely packed but discreet; 0.5 - 1µm high, less than 1µm to 1µm apart. Verrucae 1 - 2µm in diameter or up to 2 x 3µm in dimension. Sculpturing often reduced proximally.

Dimensions: Equatorial diameter; 26(40)57µm (31 specimens, STRAT 1), 26(41)54 (7 specimens, CKP6).

Remarks: The present specimens have a smaller size range than those described in Anderson (1977), MacRae (1988), and Millsted (1999); no size ranges are given in Backhouse (1991) for comparison.

Occurrence: STRAT 1, CKP6, CKP9, NATA, TLMB.

Previous records: Australia; Permian (Backhouse, 1991). South Africa; Permian (Anderson, 1977; MacRae, 1988).

Convruccosisporites pseudoreticulatus (Balme & Hennelly) *comb. nov.*
Plate 3, figure 11

1956 *Verrucosisporites pseudoreticulatus* Balme & Hennelly, p. 250; pl. 4, figs 42 – 44.

1977 *Microbaculispora pseudoreticulata* (Balme & Hennelly) Anderson, p. 51; pl. 56, figs 1 – 16.

1999 *Pseudoreticulatispora pseudoreticulata* (Balme and Hennelly) Millsted, p. 14; pl.6, figs. 6-9.

2002 *Converrucosisporites confluens* (Archangelsky and Gamarro) Playford and Dino, p. 246 – 248; pl. 2, figs. 3-8.

Description: Spores radial, trilete. Amb sub-triangular, apices slightly sharp to rounded, inter-apices straight to convex. Laesurae weakly distinct; extend up to equator. Exine 1µm thick; sculptured with dense verrucae on the distal surface, scarcely so on the proximal surface.

Dimensions: Equatorial diameter; 41µm, 50µm, 50µm (3 specimens, CKP6).

Remarks: The present specimen is distinguished from similarly sculptured forms of the genus in having very tight or closely packed, often fused, verrucae separated by fine interconnected grooves resembling a reticulate pattern.

Occurrence: CKP6, CKP9, KGO3.

Previous records: Australia; Permian (Balme & Hennelly, 1956; Foster 1975, 1979; Rigby & Hekel, 1977; Backhouse, 1991). Oman and Saudi Arabia; Early Permian (Stephenson and Filatoff, 2000; Stephenson, 2004). South Africa; Permian (Anderson, 1977; MacRae, 1988).

Converrucosisporites irregularis (Anderson) *comb. nov.*

Plate 3, figure 12

1977 *Microbaculispora irregularis* Anderson, p. 54; pl. 58, figs. 17, 21.

Description: Spore radial, trilete. Amb triangular, apices narrowly rounded, inter-apices straight to just slightly convex. Laesurae discernible, seem slightly sinuous and extend to margin. Exine 0.5µm thick; distally sculptured with irregular rugulate elements and subordinate verrucae; inter-connected narrow grooves between the muri tending to negative reticulate pattern.

Dimensions: Equatorial diameter; 34µm (1 specimen, STRAT 1).

Remarks: Backhouse (1991) described similar specimens (e.g. pl. 6, fig. 8) with a wide morphological variation, which he assigned to *Pseudoreticulatispora pseudoreticulata*.

Occurrence: STRAT 1

Previous records: South Africa; Early Permian (Anderson, 1977). Australia; Permian (Backhouse, 1991).

Converrucosisporites sp.

Plate 3, figure 13a, b

Description: Spore radial, trilete. Amb triangular, apices rounded to almost straight, inter-apices straight to slightly convex. Laesurae distinct, straight to slightly sinuous, extend $\frac{3}{4}$ to full extent of radius; labrate. Distally comprehensively sculptured with circular verrucae and subordinate grana. Proximally laevigate.

Dimensions: Equatorial diameter; 37 μ m (1 specimen, STRAT 1).

Remarks: The present species closely resembles *Granulatisporites sp.* but has a larger size and bears clearly discreet verrucae elements. However, it appears highly likely that the present specimen and those of *Granulatisporites sp.* are transitional end-members of the same form. The latter are considered to form end-members of the genus *Lacinitriletes* Venkatachala and Kar 1965 but have in this study been assigned to different genera based on similarities in ornamentation.

Occurrence: STRAT 1.

Previous records: India; Permian (Venkatachala and Kar, 1965).

Converrucosisporites sp. A

Plate 3, figure 14

Description: Spores radial, trilete. Amb triangular, apices almost sharp, inter-apices straight. Laesurae less distinct, obscured by ornamentation, but clearly defined by darkened margins; extend to equator. Exine 0.5 μ m thick; comprehensively sculptured with sub-circular to circular verrucae. Elements less or equal 1 μ m high, 1 - 2 μ m in diameter, and less or equal 1 μ m apart.

Dimensions: Equatorial diameter; 30 μ m, 31 μ m, 39 μ m (3 specimens, STRAT 1).

Remarks: The present specimens differ from similarly sculptured specimens of the genus in having nearly sharp apices and straight inter-apices. Elements at the equator indicate a slightly constricted base.

Occurrence: STRAT 1

Genus VERRUCOSISPORITES Ibrahim *emend.* Smith & Butterworth 1967

Type species: *Verrucosisporites verrucosus* (Ibrahim) Ibrahim 1933 (by original designation).

Verrucosisporites morulatus (Knox) *emend.* Smith & Butterworth 1967
Plate 3, figure 15

1967 *Verrucosisporites morulatus* (Knox) *emend.* Smith & Butterworth in Marques-Toigo & Klepzig (1995), p. 133.

Description: Spores radial, trilete. Amb sub-circular to slightly oval elongate. Laesurae commonly indistinct; only rarely discernible. Exine 0.5 - 2 μ m thick (excluding sculpture); sculptured with variously sized and spaced largely rounded verrucae, commonly displayed at equator and in plan view. Verrucae sub-circular to polygonal and elongate in form; 1 - 1.5 μ m high, 1 - 2 μ m diameter or 1 x 2 μ m to 2 x 3 μ m in dimensions.

Dimensions: Equatorial diameter; 30(42)66 μ m (9 specimens, STRAT 1), 40 μ m (1 specimen, CKP6).

Remarks: The present specimens differ from similar forms of the genus in having a slightly oval elongate amb as well as commonly rounded than flat verrucae.

Occurrence: STRAT 1, CKP6.

Previous records: South America; Permian (Marques-Toigo & Klepzig, 1995).

Verrucosisporites andersonii (Anderson) Backhouse 1988
Plate 3, figure 16

1977 *Cyclogranisporites verrucosus* Anderson, p. 73; pl. 72, figs 23 - 56.

1988 *Verrucosisporites andersonii* (Anderson) Backhouse, p. 55 - 56; fig. 5a - g.

Description: Spores radial, trilete. Amb sub-circular. Laesurae poorly displayed to slightly distinct, extend 2/3 spore radius; with curvaturae imperfectae. Exine 1 μ m thick; comprehensively sculptured with closely spaced grana to verrucae.

Dimensions: Equatorial diameter; 32, 42, 57 μ m (3 specimens, STRAT 1).

Remarks: The present specimens differ from *Verrucosisporites morulatus* in having a more circular amb and finer, relatively flat verrucae.

Occurrence: STRAT 1, CKP9.

Previous records: Australia; Permian (Backhouse, 1988, 1991). South Africa; Early Permian (Anderson, 1977; Millsted, 1999).

Verrucosisporites trisecatus Balme & Hennelly 1956

Plate 3, figure 17

1956 *Verrucosisporites trisecatus* Balme & Hennelly, p. 250; pl. 4, figs 48 – 49; pl. 5, fig. 50.

Description: Spore radial, trilete. Amb sub-circular tending to roundly triangular. Laesurae distinct, wide open and extend to equator; gradually tapers toward the equator. Exine 1µm thick; sculptured with grana to verrucae elements.

Dimensions: Equatorial diameter; 41µm (1 specimen, STRAT 1).

Remarks: Specimen rare for detailed comparisons. The original specimens (pl. 4, figs 48-49; pl. 5, fig. 50) described in Balme & Hennelly (1956) are much larger in size than the present specimen.

Occurrence: STRAT 1

Previous records: Australia; Permian (Balme & Hennelly, 1956; Foster, 1979).

Verrucosisporites sp.

Plate 3, figure 18

Description: Spores sub-circular with indistinct aperture; one specimen appear to exhibit a concealed trilete mark. Exine 1.5 - 2µm thick; equator bearing rounded verrucae, with subordinate low broad-based conical. Plan view with commonly flat verrucae, polygonal to elongate, defining a reticulate to near regulate pattern; brochi 1 - 3µm wide.

Dimensions: Equatorial diameter; 32µm, 45µm (2 specimens, STRAT 1).

Remarks: The present specimens are rare but are considered to belong to the same form as some of the specimens (fig.16A-D, F, K-L) assigned by Backhouse (1988) to *Secarisporites lacunatus* Tiwari 1965. *Verrucosisporites verrucosus* (Ibrahim) Ibrahim 1933 also bears identical sculptural features to the present specimens but has a larger size range e.g. Marques-Toigo and Klepzig (p. 134, 1995).

Occurrence: STRAT 1

Previous records: Australia; Permian (Backhouse, 1988).

Verrucosisporites sp. A

Plate 4, figure 1

Description: Spore sub-circular, indistinct aperture; some irregular opening possibly reflect trilete mark. Exine 1.5µm thick; equator bearing spaced out coni. Plan view finely granulate to verrucate. Verrucae angular or polygonal.

Dimensions: Equatorial diameter; 39µm (1 specimen, STRAT 1).

Remarks: Specimen rare. The present specimen show a slight resemblance to the specimen described by Marques-Toigo and Klepzig (p. 132, 1995) and assigned to *Verrucosisporites microtuberosus* (Loose) Smith & Butterworth 1967.

Occurrence: STRAT 1

Subinfraturma **MURORNATI** Potonié & Kremp 1954

Genus **CONVOLUTISPORIA** Hoffmeister, Staplin & Malloy 1955

Type species: *Convolutispora florida* Hoffmeister, Staplin and Malloy 1955 (by original designation).

Remarks: In this study, the present genus is considered to include only sub-circular to circular spores of dominantly fossulate to rugulate and tending to reticulate or verrucate ornamentation. The aperture for most of the specimens consists of commonly asymmetric trilete marks, often with a reduced third ray. Some of the specimens considered under this genus have been variously classified by several authors under the genera **POLYPODIISPORITES** Potonié and Gelletich ex Potonié 1956 and **THYMOSPORIA** Wilson and Venkatachala 1963. This is primarily due to the variable nature of the laesurae that indicate transition from an almost monolete to a complete trilete form.

Convolutispora intrareticulata (Anderson) *comb. nov.*

Plate 4, figures 2 - 3

1977 *Cyclogranisporites intrareticulatus* Anderson, p. 72; pl. 70, figs 1 – 11 and 13 – 20.

1999 *Convolutispora intrareticulatus* (Anderson) Millstead, p. 14-15; pl. 7, figs 1 – 3.

Description: Spores trilete, commonly asymmetric; some specimen with greatly reduced third ray tending to an almost monolete form. Amb circular or sub-circular. Laesurae discernible to distinct with mark placed either at center or off-center of grain. Main rays extend 2/3 to full radius of spore total diameter while short ray extend 1/3 radius and may reach margin if mark placed sub-equatorially. Exine (non-pitted) 1 - 3µm thick; equatorially strongly corrugated with roundly

depressions and flat to round projections (i.e. verrucae), and subordinate low broad-based nearly connate elements. Depressions and projections about 0.5 – 1.5µm in depth or height. Plan view depicts winding to curvilinear and bifurcating depressions (i.e. fossulate or vermiculate) about 0.5 - 2µm wide surrounding irregularly shaped ridges indicating a rugulate pattern, with subordinate puncta or micro-foveola.

Dimensions: Equatorial diameter; 28(36)42µm (17 specimens, STRAT 1), 31µm (1 specimen, CKP6).

Remarks: The present species is distinguished from similar forms of the genus in having a much dense fossulate or rugulate pattern giving rise to a conspicuously corrugated equator outline with roundly depressions. The specimens described in Millsted (1999) and those figured in Anderson (1977) generally indicate a larger size range than the present forms.

Occurrence: STRAT 1, CKP6, KGO3.

Previous records: South Africa; Early Permian (Anderson, 1977; Millsted, 1999).

Convolutispora sp.

Plate 4, figure 4

Description: Spores trilete; symmetric to asymmetric, with reduced third ray. Amb circular to sub-circular. Laesurae discernible to distinct; main rays extend 2/3 to full spore radius, reduced ray extend ½ radius. Exine 1 - 3µm thick; equator relatively rarely corrugated, but with flat to round, smoothly undulating projections. Plan view displaying widely spaced, discontinuous winding and curvilinear narrow depressions (i.e. fossulate or vermiculate); seem better developed on the distal surface. Specimens generally conspicuously punctate or micro-foveolate.

Dimensions: Equatorial diameter; 31(36)45µm (19 specimens, STRAT 1).

Remarks: The present specimens differ from similar forms of the genus in displaying a more punctate or micro-foveolate pattern, with short discontinuous narrow grooves or depressions. The exoexine appears more robust with minimal corrugations or pits. The specimen (pl. 2, fig. 1) assigned by Souza (2006) to *Foveosporites hortonensis* appear identical to the present specimens and is probably the same.

Occurrence: STRAT 1, CKP9, KGO3.

Convolutispora sp. A

Plate 4, figure 5

Description: Spores trilete; rays fully developed but asymmetric. Amb circular to sub-circular. Laesurae discernible, seem to extend almost to equator. Exine 1 - 2 μ m thick; with distal ornamentation of narrow, closely interconnected, depressions leading to discreet verrucae and rugulate elements, depicting a negative reticulate pattern. Equator irregularly corrugated.

Dimensions: Equatorial diameter; 30(33)37 (6 specimens, STRAT 1).

Remarks: The present specimens are distinguished from similar forms of the genus in having distinctively interconnecting depressions that depicts an almost negative reticulum pattern. *Convolutispora ordonezii* Archangelsky and Gamarro 1979 (Playford and Dino, 2002) seem very close to the present specimens, but has a much larger size range.

Occurrence: STRAT 1

Convolutispora sp. B

Plate 4, figure 6a, b

Description: Spore radial, trilete. Amb sub-circular or roundly triangular. Laesurae distinct, straight, labrate, tapers towards margin; extend to within margin of intexine. Exine 3 μ m thick; equator corrugated or notched, with depressions and projections about 1 μ m in height. Proximally laevigate. Distal surface with winding to inter-connected narrow depressions depicting reticulate to rugulate ornamentation, and rare verrucae.

Dimensions: Equatorial diameter; 31 μ m (1 specimen, STRAT 1).

Remarks: The present specimen appear similar to the specimens (p.254; pl.4, figs.12-16) assigned by Playford and Dino (2002) to *Convolutispora archangelskyi*, however, the latter has a much larger size range. *Convolutispora sp. B* differs from other species described under this genus in having a much more pronounced cinguliform outer wall, as well as tending to a sub-triangular amb.

Occurrence: STRAT 1

Genus FOVEOSPORITES Balme 1957

Type species: *Foveosporites canalis* Balme 1957 (by original designation)

Foveosporites karroensis Anderson *comb. nov.*

Plate 4, figure 7

1977 *Paucipunctatosporites karroensis* Anderson, p. 70; pl.67, figs. 1-11.

Description: Spores radial, trilete. Amb sub-circular tending to roundly triangular. Laesurae distinct, extend $\frac{2}{3}$ radius; partly display curvaturae imperfectae. Exine 1-2 μ m thick; equator sporadically pitted, plan view with elongate and circular foveolae.

Dimensions: Equatorial diameter; 27 μ m, 37 μ m, 45 μ m, 64 μ m (4 specimens, STRAT 1)

Occurrence: STRAT 1

Previous records: South Africa; Early Permian (Anderson, 1977).

Foveosporites sp.

Plate 4, figure 8

Description: Spore radial, trilete. Amb triangular, apices narrowly rounded, inter-apices straight. Laesurae discernible, slightly sinuous, extend to equator. Equator strongly corrugated or pitted. Plan view display sub-circular to elongate fossulae.

Dimensions: Equatorial diameter; 25 μ m (1 specimen, STRAT 1).

Remarks: Species rare. The present specimens closely resembles the specimens (pl. 10, figures 5-7) assigned by Foster (1979) to *Microfoveolatispora explicita*.

Occurrence: STRAT 1

Foveosporites sp. A

Plate 4, figure 9

Description: Spores radial, trilete. Amb sub-circular or roundly triangular; one side straight, perhaps due to compaction. Laesurae distinct, extend to equator. Exine 3 μ m thick; equator smooth, plan view with short fossulae and circular foveolae.

Dimensions: Equatorial diameter; 34 μ m (1 specimen, STRAT 1)

Remarks: Specimen rare.

Occurrence: STRAT 1

Foveosporites sp. B

Plate 4, figure 10

Description: Spores radial, trilete. Amb sub-circular. Laesurae discernible, straight, extend to equator. Exine 0.5µm thick; distally sculptured with circular foveolae. Equator seems smooth and non-pitted.

Dimensions: Equatorial diameter; 28µm (1 specimen, STRAT 1).

Remarks: Specimen rare.

Occurrence: STRAT 1

Genus MICRORETICULATISPORITES Knox *emend.* Potonié & Kremp 1954

Type species: *Microreticulatisporites lacunosus* (Ibrahim) Knox 1950 (by original designation).

Remarks: The history of the genus is briefly stated in Smith and Butterworth (1967), including the fact that the original proposition for the genus by Knox was based on circular species as opposed to the triangular form designated type species by Potonié and Kremp (1954). No triangular forms have been identified in this study.

Microreticulatisporites sp.

Plate 4, figure 11

Descriptions: Spores radial, trilete. Amb circular to sub-circular. Laesurae distinct, straight, extend 1/3 spore radius. Exine 1 - 2µm thick; equator strongly finely notched or corrugated i.e. narrow depressions about 1µm deep in-between flat-topped muri projections giving rise to a negative micro-reticulate pattern. Plan view also depicts a micro-reticulate ornamentation.

Dimensions: Equatorial diameter; 31µm, 34µm, 34µm (3 specimens, STRAT 1).

Remarks: The present specimens are very rare and there has not been any identical form recognized from the Permian literature. Only the Carboniferous specimens (p.191-192; pl.11, figs.5-6) assigned by Smith and Butterworth (1967) to *Microreticulatisporites microreticulatus* Knox 1950 appear closely related to the present specimens.

Occurrence: STRAT 1

Microreticulatisporites sp. A

Plate 4, figure 12

Description: Spores radial, trilete. Amb circular or sub-circular. Laesurae discernible to distinct, straight, simple; extend $\frac{1}{2}$ radius or less. Exine 1.5 - 2 μ m thick; equator finely uneven or scabrate, plan view very faintly micro-reticulate to nearly granulate.

Dimensions: Equatorial diameter; 41 μ m, 42 μ m, 45 μ m (3 specimens, STRAT 1).

Remarks: The present specimens bears poorly defined ornamentation which pose a problem for their classification, they are however placed under the present genus due to their similarity to *Microreticulatisporites sp.* They both have identical small, simple laesurae and exhibit faint reticulate patterns. However, the present specimens have a larger size range compared to *Microreticulatisporites sp.*

Occurrence: STRAT 1

Subinfraturma **UNKNOWN**

Genus CLAVATISPORITES Kedves & Simoncsics 1964

Type species: *Clavatisporites clavus* Kedves & Simoncsics 1964

Clavatisporites sp.

Plate 4, figure 13

Description: Spores radial, trilete. Amb sub-circular. Laesurae discernible, extend to equator. Exine 2 - 4 μ m thick; comprehensively sculptured with pilate or clavate and occasionally globular or gemmate elements. Most elements strongly constricted at base, with thickened tops; 1 μ m base diameter, 2 μ m top diameter, and 2 μ m high.

Dimensions: Equatorial diameter (excluding sculpture); 41 μ m, 42 μ m (2 specimens, STRAT 1).

Remarks: The present specimens are rare in the study material and equally in the literature. Rigby and Hekel (1977) discussed similarly sculptured forms (pl. 5, figs 5, 7, 8, 10) from the Permian of Australia, which however display sub-triangular ambes in contrast to the present specimens. The Cretaceous specimen figured in Traverse (1988, p.267; fig. 13.8d) and assigned to *Gemmatriletes clavatus* appear identical to the present specimens.

Occurrence: STRAT 1

Suprasubturma **LAMINATITRILETES** Smith & Butterworth 1967

Subturma **ZONOLAMINATITRILETES** Smith & Butterworth 1967

Infraturma **CINGULICAVATI** Smith & Butterworth 1967

Genus **INDOTRIRADITES** Tiwari *emend.* Foster 1979

Type species: *Indotriradites korbaensis* Tiwari 1964 (by original designation)

Indotriradites australensis (Hart) Millsted 1999
Plate 4, figure 14

For synonymy see Millsted (1999)

Description: Spores radial, trilete, cavate, zonate. Amb roundly sub-triangular. Laesurae discernible to distinct, labrate, extend to margin of zona. Exoexine with an outer paler thin layer 4 - 9 μ m wide, and an inner often darker, occasionally lamellate, thicker layer about 2 - 3 μ m wide. Exoexine bearing coni and spinae of variable size and separation, commonly developed at margin of the inner layer. Intexine dominantly proximally laevigate, and distally variously ornamented with coni, spinae, grana, verrucae and rare puncta.

Dimensions: Equatorial diameter; 34(50)72 μ m (23 specimens, STRAT1), 40 μ m, 42 μ m, 50 μ m, 55 μ m (4 specimens, CKP6). Intexine diameter; 25(30)37 (7 specimens, STRAT 1).

Remarks: The present specimens mainly include forms previously assigned by Hart (1963) to *C. africanensis* and *C. australensis*, separated based on the size and separation of sculptural elements. It has not been possible to follow the example of Hart (1963) due to the lack of clearly distinct forms in this study. As Backhouse (1991) and Millsted (1999) observed earlier, there is a complete range of variation in terms of sculptural character, which is also evident in the present specimens. The classification of Millsted (1999) is followed in handling the present specimens.

Occurrence: STRAT 1, CKP6.

Previous records: Australia; Late Carboniferous to Permian (Balme & Hennelly, 1956; Foster, 1979; Backhouse, 1991). South Africa; Permian (Anderson, 1977; MacRae, 1988; Anderson, 1999). India; Early Permian (Tiwari, 1964).

Genus CRISTATISPORITES Potonié & Kremp *emend.* Butterworth, Jansonius, Smith & Staplin 1964

Type species: *Cristatisporites indignabundus* (Loose) Potonié & Kremp 1954 (by original designation).

Remarks: A review of the literature indicate that similar specimens as the ones described under the present genus have also been assigned by other workers to different genera. Almost all of the specimens described by MacRae (1988) and assigned to the genus *Kraeuselisporites* Leschik *emend.* Scheuring 1974 are also assigned to the genus *Cristatisporites* Potonié and Kremp *emend.* Butterworth, Jansonius, Smith & Staplin 1964 in Marques-Toigo (1995). *Cristatisporites* has been favoured in this work owing to the comments by Balme (1970) that the circumscription of *Kraeuselisporites* is still not firmly established. Stephenson (1994) fully discusses the uncertainty surrounding the relationship between the present genus and two other closely related genera i.e. *Jayantisporites* Lele and Makada 1972 and *Zinjisporites* Hart 1965.

Cristatisporites crassilabratus Archangelsky and Gamero 1979.
Plate 4, figure 15

1979 *Cristatisporites crassilabratus* Archangelsky and Gamero, pp. 435 – 437; pl. V, figs. 6 – 8.

Description: Spores radial, trilete; weakly cavate. Amb roundly triangular but often obscured due to strong irregular sculptural elements at the margin. Intexine roundly triangular. Laesurae poorly discernible; extend to equator. Equator bearing long irregular elements dominated by bifurcating and cristate-form apices, and rare biform types, including some bacula. Elements 7 - 8µm high.

Dimensions: Equatorial diameter (excluding ornamentation); 25, 29, 31, 32µm (4 specimens, STRAT 1).

Remarks: The present specimens differ from *Cristatisporites lestai* Archangelsky and Gamero 1979 in having much longer elements that bears relatively sharp apices i.e. spinose or connate.

Occurrence: STRAT 1.

Previous records: Oman and Saudi Arabia; Late Carboniferous – Early Permian (Stephenson, 2004). South America; Late Carboniferous – Early Permian (Archangelsky and Gamero, 1979; Marques-Toigo and Klepzig, 1995).

Cristatisporites inconstans Archangelsky and Gamero 1979

Plate 4, figure 16

1979 *Cristatisporites inconstans* Archangelsky and Gamero, p. 435; pl. V, figs 1 – 5.

Descriptions: Spores trilete, radial, cavate. Amb generally roundly triangular but outline comprised of spinose and connate elements. Intexinal body roundly triangular, often surrounded by a lamellate and punctuate wall 2µm thick. Laesurae weakly discernible, extend to equator. Distal face with broad, sub-circular warts or verrucae tending to reticulate. Proximal face commonly punctate. Zona about 7µm wide, incomplete; some sections comprised of coalesced or completely merged elements at base while some indicate distinct closely packed broad-based coni or spinae. Elements 4 - 5µm high, ± biform and bifurcating.

Dimensions: Equatorial diameter; 24(32)46µm (7 specimens, STRAT 1). Intexine diameter; 20, 22, 24, 27µm (4 specimens, STRAT 1). Equatorial diameter; 30, 37, 44µm (3 specimens, CKP6). Intexine diameter; 30µm (2 specimens, CKP6).

Remarks: The present specimens are significantly smaller than those described in Archangelsky and Gamero (1979).

Occurrence: STRAT 1, CKP6, CKP9.

Previous records: South America; Late Carboniferous – Early Permian (Archangelsky and Gamero, 1979; Marques-Toigo and Klepzig, 1995).

Cristatisporites lestai Archangelsky and Gamero 1979

Plate 4, figure 17

1979 *Cristatisporites lestai* Archangelsky and Gamero, pp. 437 – 438; pl. VI, figs 1 – 3.

Descriptions: Spores radial, trilete; cavate. Amb generally roundly sub-triangular but outline irregular due to ornamentation. Intexinal body roundly triangular. Laesurae discernible, extend to equator. Proximally pitted or punctate and granulate. Distally verrucate to micro-rugulate, with bacula. Equator bearing bacula or coni of rounded apices, bifurcating, with cristate, blunt bacula and spinose elements. Elements up to 5µm high.

Dimensions: Equatorial diameter; 26(38)49µm (6 specimens, STRAT 1). Intexine diameter; 34µm (1 specimen, STRAT 1). Equatorial diameter; 39(46)51µm (12 specimens, CKP6). Intexine diameter; 31µm (1 specimen, CKP6).

Remarks: The present specimens differ from similarly sculptured forms of this genus in having bacula and coni with nearly rounded tips.

Occurrence: STRAT 1, CKP6.

Previous records: South America; Early Permian (Archangelsky and Gamarro, 1979; Marques-Toigo and Klepzig, 1995).

Cristatisporites microvacuolatus (Dias-Fabrício) *emend.* Picarelli & Dias-Fabrício 1990
Plate 5, figure 1

1990 *Cristatisporites microvacuolatus* (Dias-Fabrício) *emend.* Picarelli & Dias-Fabrício *in* Marques-Toigo and Klepzig, p. 43, 1995.

Descriptions: Spores radial, trilete. Amb roundly triangular but margin strongly spinose. Intextinal body distinct, roundly triangular and flanked by external lamellate zone that bears aligned puncta or vacuoles at contact with the cingulizone. Laesurae discernible, appear to extend to inner margin of cingulizone. Proximal intexine comprehensively punctuate, distally verrucate. Sculptural elements on exoexine vary from broad-based coalesced or bi-furcating, \pm biform spinae to discreet, fine, curly spinae on uniformly smooth non-punctate cingulizone. Elements 3 - 5 μ m in height.

Dimensions: Equatorial diameter; 22(31)38 μ m (13 specimens, STRAT 1). Intexine diameter; 22, 26, 30, 34 μ m (4 specimens, STRAT 1). Equatorial diameter; 30(41)50 μ m (10 specimens, CKP6). Intexine diameter; 26, 29 μ m (2 specimens, CKP6).

Remarks: The present specimens appear similar to *Cristatisporites inconstans* Archangelsky and Gamarro 1979 but differ in having a relatively narrower and seemingly more regular cingulizone. The specimens (pl. vi, figs 4 – 6) assigned by Archangelsky and Gamarro (1979) to *Cristatisporites sp. B* indicate close similarity to the present specimens.

Occurrence: STRAT 1, CKP6, CKP9.

Previous records: South America; Early Permian (Marques-Toigo and Klepzig, 1995).

Cristatisporites morungavensis (Dias-Fabrício) *emend.* Picarelli & Dias-Fabrício 1990
Plate 5, figure 2

1990 *Cristatisporites morungavensis* (Dias-Fabrício) *emend.* Picarelli & Dias-Fabrício *in* Marques-Toigo and Klepzig, p. 44, 1995.

Descriptions: Spores radial, trilete, cavate. Amb roundly sub-triangular. Intexinal body discernible to distinct, roundly triangular; outer margin often marked by alignment of puncta or vacuoles. Laesurae discernible up to outer margin of intexine. Intexine proximally laevigate with rare puncta, distally granulate to verrucate. Cingulizone 3 - 6 μ m wide, sculptured with discreet fine elements i.e. short coni, spinae, rare bacula.

Dimensions: Equatorial diameter; 24(37)52 μ m (13 specimens, STRAT 1). Intexine diameter; 17(26)37 μ m (6 specimens, STRAT 1). Equatorial diameter; 41, 44 μ m (2 specimens, CKP6).

Remarks: The present specimens differ from similar forms of the present genus in having an irregular outline on the cingulizone dominated by variable discreet short elements that include coni, spinae, and bacula.

Occurrence: STRAT 1, CKP6, CKP9.

Previous records: South America; Early Permian (Marques-Toigo and Klepzig, 1995).

Cristatisporites spinosus (Menendez & Azcuy) Playford 1978
Plate 5, figure 3

For synonymy see Marques-Toigo and Klepzig (1995).

Descriptions: Spores radial, trilete, cavate. Overall amb roundly triangular; rough outline due to irregular ornamentation. Intexinal body distinct, roundly triangular. Laesurae poorly distinct; appear to extend to within zona. Proximally punctate and microgranulate, distally verrucate and spinose. Zona 6 - 8 μ m wide; irregular with a corroded to spongy appearance depicting cristate-like outline and spinose elements.

Dimensions: Equatorial diameter; 38 μ m, 38 μ m, 45 μ m, 75 μ m (4 specimens, STRAT 1). Intexine diameter; 26 μ m, 28 μ m, 36 μ m, 57 μ m (4 specimens, STRAT 1). Equatorial diameter; 38, 48 μ m (2 specimens, CKP6).

Remarks: The present specimen has a generally spongy appearance in comparison to other forms of the genus.

Occurrence: STRAT 1, CKP6, CKP9.

Previous records: South America; Carboniferous (Marques-Toigo & Klepzig, 1995).

Cristatisporites menendezii Playford 1978

Plate 5, figure 4

1972 *Ancistrospora verrucosa* Menéndez & Azcuy in Marques-Toigo & Klepzig, p42, 1995.

Descriptions: Spores radial, trilete, cingulate. Amb roundly sub-triangular. Laesurae discernible, straight to sinuous; extend to margin of intexine. Prominent slender spinae developed on cingulum that display undulating surface; in rare compacted and broken specimens the spinae is indicated to form part of biform elements that seem now coalesced to form cingulum. Distal face with sub-circular to slightly irregular warts 1 - 3 μ m across i.e. verrucae, with superimposed puncta. Cingulum 3 - 6 μ m wide. Spinae 2 μ m high.

Dimensions: Equatorial diameter; 32(35)42 μ m (9 specimens, STRAT 1), 34(37)48 μ m (5 specimens, CKP6). Intexine diameter; 22(26)28 μ m (7 specimens, STRAT 1), 28, 38 μ m (2 specimens, CKP6).

Remarks: The present specimens are distinguished in having prominent biform elements dominated by roundly bases with very narrow or delicate spinose tops.

Occurrence: STRAT 1, CKP6, CKP9.

Previous records: South America; Carboniferous (Marques-Toigo & Klepzig, 1995).

Cristatisporites sp.

Plate 5, figure 5

Descriptions: Spores radial, trilete, cavate. Overall amb triangular to roundly triangular but with irregular outline caused by spinose elements. Intexinal body distinct, convexly sub-triangular. Laesurae discernible up to margin of intexine. Proximally laevigate, distally and equatorially spinose. Elements coalesced to form cingulizone; broad to bulbous base spinae, \pm biform and bifurcating, up to 5 μ m in height.

Dimensions: Equatorial diameter (excluding ornamentation); 20 μ m, 21 μ m, 25 μ m (2 specimens, STRAT 1), 25 μ m, 38 μ m (2 specimens, CKP6).

Remarks: The present specimens differ from *Cristatisporites sp. A* in having much pronounced broad-based biform conical elements.

Occurrence: STRAT 1, CKP6.

Cristatisporites sp. A

Plate 5, figure 6

Descriptions: Spores radial, trilete, cavate. Amb roundly sub-triangular. Laesurae poorly discernible; appear to extend to margin of intexine. Cingulizone narrow; formed by coalesced or fused coni and spinae that continues on distal surface. Elements sharply tapers to apices; \pm bifurcating and biform, up to 5 μ m in height. Promixally laevigate to punctate.

Dimensions: Equatorial diameter (excluding sculpture); 22 μ m (1 specimen, STRAT 1), 24, 26, 27, 45 μ m (4 specimens, CKP6).

Remarks: The present specimens appear similar to *Cristatisporites sp.* but differ in having a less pronounced biform character of the elements.

Occurrence: STRAT 1, CKP6.

Genus DENSOISPORITES Weyland & Krieger 1953

Type species: *Densoisporites velatus* Weyland & Krieger 1953 (by original designation)

Densoisporites sp.

Plate 5, figure 7

Description: Spores radial, trilete, cavate. Amb sub-triangular, apices rounded, inter apices convex; intexine regularly roundly triangular. Laesurae indistinct to discernible, sinuous to straight, labrate; appear to extend to equator. Exoexine punctate or spongy in appearance; 5 μ m - 10 μ m wide.

Dimensions: Equatorial diameter; 35(45)67 (11 specimens, STRAT 1), 39(49)67 (12 specimens, CKP6). Intexine diameter; 20(25)30 (5 specimens, STRAT 1), 27(31)42 (5 specimens, CKP6).

Remarks: The specimens (p.16; pl.7, figs.4, 7-8) figured in Millsted(1999) and referred to *Densoisporites cf. Cirratiradites gondwanensis* Tiwari 1965 appear identical to the present specimens; the former however indicate a larger size range. The specimens (p.25; pl. 24, figs.7-9, 12) assigned by Anderson (1977) to *Gondisporites braziliensis* Pant and Srivastava 1965 are considered conspecific with the present specimens.

Occurrence: STRAT 1, CKP9.

Previous records: South Africa; Permian (Anderson, 1977)

Genus DENSOSPORITES (Berry) Potonié & Kremp 1954

Type species: *Densosporites covensis* Berry 1937 (by original designation)

Densosporites rotundus Falcon 1978

Plate 5, figure 8

1977 *Gondisporites congoensis* (Maheshwari & Bose) Anderson, p. 26; pl. 25, figs 24 – 25.

1978 *Densosporites rotundus* Falcon, pp. 13, 15 – 16; pl. 2, figs 1 – 5.

Description: Spores radial, trilete; one specimen appears cingulate and cavate. Amb sub-circular or roundly triangular. Laesurae discernible, extend to equator. Cingulum 2µm wide; slightly undulating, smooth or scabrate to sub-dued coni at equator. Intexine sculptured with grana to verrucae tending to reticulate.

Dimensions: Equatorial diameter; 27µm, 38µm (2 specimens, STRAT 1).

Remarks: The specimen (pl.12, fig.11) figured in MacRae (1988) and assigned to *Cirratiradites splendens* Balme and Hennelly emend. Hart 1963 is considered conspecific with the present specimens.

Occurrence: STRAT 1, CKP6, KGO3.

Previous records: South Africa; Permian (Anderson, 1977; MacRae, 1988). Zimbabwe; Permian (Falcon, 1978).

Densosporites sp.

Plate 5, figure 9

Description: Spores radial, trilete, cavate, cingulate. Amb roundly triangular. Laesurae discernible, extend to margin of intexine. Cingulum smooth to slightly scabrate; 4µm wide. Intexine finely granulate.

Dimensions: Equatorial diameter; 36µm, 39µm (2 specimens, CKP6). Intexine diameter; 28µm (1 specimen, CKP6).

Remarks: The specimens (p. 27; pl. 3, figs.17-20) described by Maheshwari and Bose (1969) and assigned to *Densosporites congoensis* appear very identical to the present specimens, except the latter has a smaller size range.

Occurrence: CKP6

Genus LUNDBLADISPORA Balme *emend.* Playford 1965

Type species: *Lundbladispora willmottii* (Balme) Playford 1965 (by subsequent designation of Playford, 1965, p. 189).

Lundbladispora braziliensa (Pant & Srivastava) *emend.* Marques-Toigo & Picarelli 1984.

Plate 5, figure 10

1965 *Densosporites braziliensis* Pant & Srivastava, p. 469-470.

1974 *Lundbladispora braziliensis* (Pant & Srivastava) Marques-Toigo & Pons, p. 279.

1977 *Gondisporites braziliensis* (Pant & Srivastava) Anderson, p. 23; pl. 23, figs 1 – 27.

1984 *Lundbladispora braziliensis* (Pant & Srivastava) Marques-Toigo & Picarelli, p.48.

Descriptions: Spores radial, trilete, cavate, cingulate. Amb sub-circular to roundly sub-triangular. Laesurae poorly defined, locally discernible in some specimens; appear to extend full distance to equator. Exoexine generally smooth and unstructured but commonly rough or finely irregular at equator. Intexine proximally laevigate, punctate to finely granulate, distally verrucate to connate or spinose. Verrucae 1 - 2µm diameter and distance apart. Cingulum 5 - 10µm wide; margin bearing rare to relatively dense sculptural elements comprising conical and bifiform spines, up to 2µm in height.

Dimensions: Equatorial diameter; 47(55)66µm (16 specimens, STRAT 1), 43(68)134µm (6 specimens, CKP6). Intexine diameter; 29(37)44 (8 specimens, STRAT 1).

Remarks: Although the specimens from STRAT 1 indicate a smaller size range compared to the specimens described (p. 433) in Archangelsky and Gamero (1979) as well as in Marques-Toigo and Klepzig (p. 84, 1995), those in CKP6 do indicate a compatible size overlap.

Occurrence: STRAT 1, CKP6, CKP9, NATA, TLMB.

Previous records: Oman and Saudi Arabia; Late Carboniferous – Early Permian (Stephenson, 2004). South Africa; Permian (Anderson, 1977). South America; Late Carboniferous to Permian (Archangelsky and Gamero, 1979; Pant and Srivastava, 1965; Marques-Toigo and Picarelli, 1984).

Lundbladispora gracila Stephenson and Osterloff 2002

Plate 5, figure 11

2002 *Lundbladispora gracilis* Stephenson and Osterloff, p. 16.

1977 *Gondisporites punctatus* (Hart) Anderson, p.21; pl.13-16.

Descriptions: Spores radial, trilete. Amb sub-circular to sub-triangular. Laesurae poor to well defined, straight to sinuous; extend to equator. Exine two-layered; intexinal body commonly hard to discern in most specimens. Overall exine comprehensively punctate to give spongy texture; commonly folded. Exine also finely textured with micro-granulate and micro-vermiculate or micro-reticulate ornamentations. Distal face and equator may bear conii, spinae and grana. Exoexinal zona 7µm wide.

Dimensions: Equatorial diameter; 37(51)62µm (10 specimens, STRAT 1), 58, 65, 72, 90µm (4 specimens, CKP6). Intexine diameter; 31µm (1 specimen, STRAT 1).

Remarks: The present species appear very much identical to *Lundbladispora riobonitensis* Marques-Toigo & Picarelli 1984; the latter though is described as devoid of ornamentation on the distal face. However, the present species displays a rather delicate form indicated by its largely spongy character which may reflect susceptibility to poor preservation. As a result much of the ornamentation could be expected to be equally poorly preserved to none at all. A possibility exist that further investigation on the relationships of *Lundbladispora riobonitensis* Marques-Toigo & Picarelli 1984 and the present species could find them to be equivalent.

Occurrence: STRAT 1, CKP6, ME58.

Previous records: Oman and Saudi Arabia; Early Permian (Stephenson and Osterloff, 2002; Stephenson, 2004). South Africa; Permian (Anderson, 1977).

Genus VALLATISPORITES Hacquebard 1957

Type species: *Vallatisporites vallatus* Hacquebard 1957 (by original designation)

***Vallatisporites* sp.**

Plate 5, figure 12

Description: Spores radial, trilete, cavate. Amb roundly triangular. Intexinal body distinct, roundly triangular. Laesurae poorly distinct. Intexine punctate, rare spinae at margin. Exoexine characterized by linear or rod-like features radiating from outer margin of intexine and laterally joining near outer margin of exoexine; defines pattern of elongate polygonal to ovoidal segments, either hollow or comprised of membranous exoexine. Overall exoexine 5µm wide.

Dimensions: Equatorial diameter; 45µm (1 specimen, STRAT 1), 47µm, 50µm (2 specimens, CKP6). Intexine diameter; 32µm (1 specimen, STRAT 1).

Remarks: The present specimens closely resemble specimens described by Stephenson (2004) and Marques-Toigo & Klepzig (1995) and assigned to *Vallatisporites arcuatus* (Marques-Toigo) Archangelsky and Gamarro 1979. A detailed assessment of some of the characteristic elements in *V. arcuatus* are outlined by Stephenson (2004); those identified in the present specimens include the “submarginal ring” formed by the lateral joining of radial features as well as the “oval and rectangular” hollows that characterize much of the exoexine. Specimens described in the present study are however smaller in size range.

Occurrence: STRAT 1, CKP6.

Vallatisporites sp. A

Plate 5, figure 13

Description: Spores radial, trilete, cavate. Amb roundly triangular; outline uneven. Intexinal body distinct, roundly triangular. Laesurae weakly discernible; appear to extend to equator. Intexine proximally finely granulate and punctate, distally verrucate with spinose at margin. Zona 5 - 8µm wide, laevigate to finely granulate and bearing radiating linear features; equator with blunt coni or short bacula and spinose.

Dimensions: Equatorial diameter; 53µm (1 specimen, STRAT 1), 45µm (1 specimen, CKP6). Intexine diameter; 36µm (1 specimen, STRAT 1), 29µm (1 specimen, CKP6).

Remarks: The present specimens appear similar to the specimen assigned by Marques-Toigo and Klepzig (p. 130, 1995) to *Vallatisporites banffensis* Staplin & Janssonius 1964.

Occurrence: STRAT 1, CKP6, ME58.

Turma **MONOLETES** Ibrahim 1933

Suprasubturma **ACAVATOMONOLETES** Dettmann 1963

Subturma **AZONOMONOLETES** Lubert 1935

Infraturma **LAEVIGATOMONOLETI** Dybová & Jachowicz 1957

Genus **LAEVIGATOSPORITES** Ibrahim 1933

Type species: *Laevigatosporites vulgaris* (Ibrahim) Ibrahim 1933 (by original designation).

Laevigatosporites vulgaris (Ibrahim) Ibrahim 1933

Plate 5, figure 14

- 1933 *Laevigatosporites vulgaris* (Ibrahim) Ibrahim, pp. 39 – 40; pl. 2, fig. 16.
1956 *Laevigatosporites vulgaris* forma *colliensis* Balme & Hennelly, pp. 55 – 56; pl. 1, figs 1 – 5.

Description: Spores bilateral, monolete. Amb longitudinally oval. Laesurae simple to weakly labrate, tapered at both ends; extend about ½ of longitudinal axis. Exine 1µm thick, laevigate, and commonly folded; occasional fine grana, puncta, and rare micro-reticulum.

Dimensions: Length; 39(53)67µm, Breadth; 28(39)47µm (6 specimens, STRAT 1). Length; 36µm, 40µm, 63µm, 66µm, Breadth 28µm, 29µm, 46µm, 62µm (4 specimens, CKP6).

Remarks: The relatively few specimens identified in this study did not allow recognition of distinctively curvaturate specimens noted in MacRae (1988) and Foster (1979); however the variations described by MacRae (1988) that include oval to longitudinally oval amb and laevigate to finely granulate exine are evident in the present specimens.

Occurrence: STRAT 1, CKP6.

Previous records: Has a wide geographic distribution in Late Carboniferous and Permian palynofloras (e.g. Balme & Hennelly, 1956; Bharadway, 1962; Balme, 1970; Anderson, 1977; Foster, 1979; MacRae, 1988; Marques-Toigo and Klepzig, 1995; Millsted, 1999 etc.)

Laevigatosporites plicatus Kar 1968
Plate 5, figure 15

1968 *Laevigatosporites plicatus* Kar, p.120-121; pl. 1, figs.28-29, text-fig. 3.

Description: Spores monolete; tetrad scar distinct in rare specimens. Amb oval to elongate. Laesurae simple; extend about ¾ of total length of grain. Exine 0.5µm thick; laevigate or finely infrapunctate, with narrow longitudinal folds (about 2) or plicae.

Dimensions: Length; 45(62)86µm, Breadth; 34(43)62µm (6 specimens, STRAT 1).

Remarks: The present specimens differ from *Laevigatisporites vulgaris* in having plicae-like features as well as a much larger size range. The present specimens are generally poorly preserved and depict numerous longitudinal exinal folds that obscure the laesura. The specimen (p.76; pl. 19, figs. 19-20) assigned by Bose and Kar (1966) to *Latosporites sp.* are considered to belong to the present species.

Occurrence: STRAT 1.

Previous records: Australia; Permian (Foster, 1979). DR-Congo; Permian (Bose and Kar, 1966). India; Permian (Kar, 1968).

Infraturma **SCULPTATOMONOLETI** Dybová & Jachowicz 1957

Genus **POLYPODIISPORITES** Potonié in Potonié & Gelletich *emend.* Khan & Martin 1971

Type species: *Polypodiisporites favus* (Potonié) Potonié 1934 (by monotypy)

Remarks: There is as yet no unequivocal differential diagnosis between the present genus and the genus *Thymospora* Wilson & Venkatachala 1963. However, various authors have discussed their views on the relationship of the two genera e.g. Playford and Dettmann (1965), Balme (1970), Foster (1979), and MacRae (1988). The opinion of Playford and Dettmann (1965) that *Thymospora* is a junior subjective synonym of *Polypodiisporites* is followed in this work. Variations based on separation of sculptural elements seem inadequate for separation as these could be transitional between end-members of the same genus.

Polypodiisporites mutabilis Balme 1970

Plate 5, figures 16 - 17

1969 *Polypodiisporites mutabilis* Balme, p.347; pl.6, figs.7-9.

Description: Spores monolete, bilateral; some specimens have asymmetrical trilete marks. Amb oval to elongately oval. Laesurae commonly obscured by sculpture; extend more than ½ length of spore. Exine 1 - 2µm; variously sculptured with winding, short to long, discontinuous and inter-connected grooves, 0.5 - 1µm wide, giving a fossulate to nearly reticulate pattern. Sculpturing may also be significantly foveolate. Equator outline undulating or corrugated with roundly depressions up to 1µm deep.

Dimensions: Length; 27(31)36µm, Breadth; 24(26)30µm (6 specimens, CKP6). Length; 28µm, 42µm, 42µm, Breadth; 22µm, 32µm, 34µm (3 specimens, STRAT 1).

Remarks: The specimens (pl. 6, figs 4-6) assigned by Balme (1970) to *Reticuloidosporites warchianus* appears identical to the present specimens; the latter however do not bear any coni or grana as described for the former. Forms that have trilete marks amongst the present specimens only differ from *Convolutispora intrareticulatus* (Anderson) Millstead 1999 in having a more pronounced oval amb.

Occurrence: STRAT 1, CKP6, ML1.

Previous records: Pakistan; Late Permian (Balme, 1970). South Africa; Late Permian (Anderson, 1977).

Polypodiisporites detritus (Leschik) Anderson 1977
Plate 5, figure 18a, b

1977 *Polypodiisporites detritus* (Leschik) Anderson, p.87; pl.79, figs.17-20 and 30-41.

Description: Spores bilateral, monolete. Amb elongate oval. Laesurae extend almost full length of long axis of the proximal surface. Exine 2µm. Distal surface clearly rugulate. Equator outline with roundly depressions or corrugation.

Dimensions: Length; 26µm, Breadth; 20µm (1 specimen, STRAT 1). Length; 29µm, 39µm, Breadth; 26µm, 31µm (2 specimens, CKP6).

Remarks: The present specimens are distinguished in having relatively coarse sculptural elements and also tend to depict a clear rugulate pattern.

Occurrence: STRAT 1, CKP6.

Previous records: South Africa; Permian (Anderson, 1977).

Anteturma **VARIEGERMINANTES** Potonié 1970

Turma **SACCITES** Erdtman 1947

Subturma **MONOSACCITES** Chitaley *emend.* Potonié & Kremp 1954

Infraturma **ALETESACCITI** Leschik 1955

Genus **FLORINITES** Schopf, Wilson & Bentall 1944

Type species: *Florinites pellucidus* (Wilson & Coe) Wilson 1958 (originally designated as *Endosporites pellucidus* Wilson & Coe, p.184, 1940).

Remarks: Explanation on the relationship of *Florinites antiquus* Schopf, Wilson & Bentall 1944 (originally designated type species) to *Florinites pellucidus* (Wilson & Coe) Wilson 1958 is outlined in MacRae (1988).

Florinites eremus Balme & Hennelly 1955
Plate 6, figure 1

Description: Pollen monosaccate, alete. Amb sub-circular to rarely oval. Corpus sub-circular, variably distinct to indistinct, diffused reticulum; may exhibit marginal

linear folds. Saccus appear distally detached within corpus region; infrastructure micro-vermiculate or punctate and finely reticulate with brochi 1 - 2µm wide.

Dimensions: Equatorial diameter; 32µm, 76µm, 78µm, 104µm (4 specimens, STRAT 1), Corpus diameter; 17µm, 29µm, 36µm (3 specimens, STRAT 1).

Remarks: Specimens rare and insufficient for detailed analyses. Some of the specimens (pl. 100, figs 1 – 3) assigned by Anderson (1977) to *Vestigisporites walikalensis* (Hoeg & Bose) may be related to the present specimens.

Occurrence: STRAT 1

Previous records: Australia; Permian (Balme & Hennelly, 1955; Foster, 1979). South Africa; Late Carboniferous to Early Permian (MacRae, 1988). South America.

Infraturma **STRIASACCITI** Bharadwaj 1962

Genus **STRIOMONOSACCITES** Bharadwaj 1962

For synonymy see Foster (p. 70, 1979)

Type species: *Striomonosaccites ovatus* Bharadwaj 1962 (by original designation).

Striomonosaccites brevis Bose & Kar 1966
Plate 6, figure 2

1966 *Striomonosaccites brevis* Bose & Kar, pp. 87 – 88; pl. 23, figs 7 – 8.

1970 *Striomonosaccites* sp. cf. *S. ovatus* (Bharadwaj) de Jersey, p. 19; pl. 8, figs 1 – 4.

Description: Pollen monosaccate, striate. Amb sub-circular. Corpus sub-circular, tending to oval, outline distinct with fine marginal folds. Cappa with fine weakly distinct striations extending full length of corpus; 17 or more. Cappula fine to coarsely reticulate, brochi 1-5µm wide. Saccus with irregular width, appear symmetrically dissected or may be just fractured, fine to coarsely reticulate i.e. brochi 1-4µm wide, slightly radially aligned.

Dimensions: Equatorial diameter; 78µm, Corpus diameter; 60µm (1 specimen, STRAT 1).

Remarks: The present specimen is distinguished from *Striomonosaccites ovatus* Bharadwaj 1962 in having a much smaller size, as well as numerous striae i.e. more than 17 in comparison to only 5-7 for the latter.

Occurrence: STRAT 1.

Previous records: Australia; Middle Permian – Early Triassic (de Jersey, 1970; Foster, 1979). Africa; Early Permian (Bose & Kar, 1966).

Striomonosaccites crucistriatus Ybert 1975

Plate 6, figure 3

1975 *Striomonosaccites crucistriatus* Ybert in Marques-Toigo and Klepzig, p. 125, 1995.

Description: Pollen monosaccate. Amb sub-circular to slightly oval. Corpus outline indistinct. About 5 and 16 cross-cutting or perpendicular striations; striations appear continuous over total grain length. Saccus width narrow, infrapunctate.

Dimensions: Equatorial diameter; 64µm (1 specimen, STRAT 1).

Remarks: Specimen rare.

Occurrence: STRAT 1.

Previous records: South America; Late Carboniferous to Early Permian (Marques-Toigo and Klepzig, 1995).

Striomonosaccites sp.

Plate 6, figure 4

Description: Pollen monosaccate. Amb sub-circular to elongate oval, with some tendency to polygonal. Corpus clearly distinct, darker, elongate oval, marginal folds in the long axis, 6 – 10 striations; finely granulate to punctate. Saccus strongly punctate; outline generally follow contour of corpus.

Dimensions: Equatorial diameter; 52µm, 73µm, Corpus; length 48µm, 62µm, breadth 37µm, 50µm (2 specimens, STRAT 1).

Remarks: The present specimens appear similar to the specimen (p. 126) assigned by Marques-Toigo and Klepzig (1995) to *Striomonosaccites ovatus* Bharadwaj 1962; the latter however has a much larger size range.

Occurrence: STRAT 1.

Infraturma **TRILETESACCITI** Leschik 1955

Genus **BARAKARITES** Bharadwaj & Tiwari 1964

Type species: *Barakarites rotatus* (Balme & Hennelly) Bharadwaj & Tiwari 1964 (originally designated as *Barakarites indicus* Bharadwaj & Tiwari 1964, p. 142).

Barakarites rotatus (Balme & Hennelly) Bharadwaj & Tiwari 1964
Plate 6, figure 5

1956 *Nuskoisporites rotatus* Balme & Hennelly, p. 254; pl. 8, figs 68 – 71.

1964 *Barakarites indicus* Bharadwaj & Tiwari, p. 142; pl. 1, figs 1 – 2.

1964 *Barakarites rotatus* (Balme & Hennelly) Bharadwaj & Tiwari, p. 142.

For additional synonymy see Foster (1979, p. 67) and Millsted (1999, pp. 20 – 21).

Description: Pollen monosaccate, trilete. Amb sub-circular to slightly broadly oval; rare specimen roundly sub-triangular. Margin generally smooth but may indicate slight shallow undulations or crenulations. Corpus poor to well-preserved, outline well discernible to distinct, sub-circular to broadly oval, laesurae poorly displayed; saccus attachment sub-equatorial and appear to overlap with prominent distal tenuitas. Saccus $\frac{1}{3}$ to $\frac{1}{4}$ of corpus radius, infrapunctate, infrareticulate or infravermiculate.

Dimensions: Equatorial diameter; 86 μ m, 87 μ m, 92, 125 μ m, Corpus diameter; 65 μ m, 67 μ m, 75 μ m, 92 μ m, Saccus width; 13 μ m, 13 μ m, 17 μ m, 20 μ m (4 specimens, STRAT 1). Equatorial diameter; 85 μ m, 100 μ m, 104 μ m, 112 μ m, Corpus diameter; 67 μ m, 82 μ m, 84 μ m, Saccus width; 7 μ m, 12 μ m, 13 μ m, 14 μ m (4 specimens, CKP6).

Remarks: The present specimens are distinguished in having a relatively narrow saccus width, forming a small fraction of the corpus radius. In addition, specimen characteristic of this species have in the literature been identified on the bases of a prominent narrow band or tenuitas, observed in the present material, and distally placed closer to the corpus margin.

Occurrence: STAT 1, CKP6.

Previous records: South Africa; Permian (Anderson, 1977; MacRae, 1988; Millsted, 1999). Australia; Permian (Balme & Hennelly, 1956; Foster, 1975; 1979; Rigby & Hekel, 1977). India; Permian (Bharadwaj & Tiwari, 1964).

Genus **BASCANISPORITES** Balme & Hennelly 1956

Type species: *Bascanisporites undosus* Balme & Hennelly 1956 (by original designation).

Bascanisporites undosus Balme & Hennelly 1956.
Plate 6, figure 6

1956 *Bascanisporites undosus* Balme & Hennesly, p. 256; pl. 10, figs 81 – 83.

Description: Pollen monosaccate; aperture indistinct. Amb sub-circular; outline lobate. Corpus sub-circular to slightly oval, distinct, dark. Intexine 1µm thick; laevigate or finely granulate. Saccus equatorially detached, with unequal width i.e depicts a haploxylon-like shape of bisaccate pollen grains; finely infrapunctate, infrareticulate or infravermiculate.

Dimensions: Equatorial diameter; 47µm, Corpus diameter; 41µm (1 specimen, STRAT 1).

Remarks: The present specimens indicate only 2 lobes as opposed to 5 in those from the type locality described in Balme and Hennesly (1956), in addition to a smaller size.

Occurrence: STRAT 1.

Previous records: Australia; Permian (Balme & Hennesly, 1956; Foster, 1975, 1979). Antarctica; Permian (Balme & Playford, 1967).

Genus CANNANOROPOLLIS Potonié & Sah 1960

Type species: *Cannanoropollis janakii* Potonié & Sah 1960 (by original designation).

Cannanoropollis janakii Potonie & Sah 1960
Plate 6, figure 7

1956 *Nuskoisporites gondwanensis* Balme & Hennesly, p. 253; pl. 6, figs 63 – 65.

1960 *Cannanoropollis janakii* Potonié & Sah, pp. 127 – 128; pl. 2, figs 66 – 67.

1968 *Parasaccites diffusus* Tiwari, p. 228; pl. 2, fig. 31.

For extended additional synonymy see Millstead (1999, p. 21).

Description: Pollen monosaccate, trilete; tetrad mark poorly defined to commonly indistinct. Amb circular to slightly broadly oval, outline smooth to weakly undulating. Laesurae simple, full extent obscured. Corpus poorly preserved and obscured, equator outline occasionally discernible, circular to oval and appear to follow contour of saccus, proximally micro-reticulate or micro-vermiculate. Saccus infrapunctate and infrareticulate, with radially elongate features.

Dimensions: Equatorial diameter; 79(107)125µm (10 specimens, STRAT1), 64(101)119 (8 specimens, CKP6). Corpus diameter; 56µm, 62µm, 62µm, 78µm (4 specimens, STRAT 1), 42µm, 56µm (2 specimens, CKP6). Saccus width; 11(21)34 (6 specimens, STRAT 1), 13(18)20 (8 specimens, CKP6).

Remarks: The present specimens are generally not very well preserved and it has not been possible to separate into more than one species in accordance with the observations of MacRae (1988) who separated similar specimens into *C. janakii* Potonie & Sah 1960 and *C. obscurus* (Lele) Bose & Maheshwari 1968.

Occurrence: STRAT 1, CKP6, ME58.

Previous records: Africa; Late Carboniferous to Late Permian (Anderson, 1977; MacRae, 1988; Millstead, 1999). Australia; Late Carboniferous to Late Permian (Balme & Hennelly, 1956; Foster, 1975, 1979). South America; Late Carboniferous to Early Permian (Archangelsky and Gamarro, 1979; Marques-Toigo and Klepzig, 1995).

Cannanoropollis sp.

Plate 6, figure 8

Description: Pollen monosaccate, trilete; tetrad mark weakly developed, extent of rays not discernible. Amb sub-circular or broadly oval to elongate; outline finely undulating. Corpus poorly preserved, outline discernible, broadly oval to elongate and generally follows saccus contour. Saccus uniformly broad, subequatorially attached; finely infrareticulate with radially arranged brochi.

Dimensions: Equatorial diameter; long axis 95(105)129 μ m (5 specimens, STRAT 1), short axis 84 μ m, 83 μ m, 83 μ m, 80 μ m (4 specimens, STRAT 1). Corpus diameter; long axis 57 μ m, 73 μ m, 84 μ m, short axis 48 μ m, 56 μ m, 56 μ m (3 specimens, STRAT 1).

Remarks: The present specimens are distinguished from *C. janakii* in having a more pronounced radial pattern of the saccus as well as a strongly oval amb. The specimens (pl. 31, figs 3, 7) assigned by MacRae (1988) to *C. janakii* appear very similar to the present specimens. There is also a close similarity with specimens Marque-Toigo and Klepzig (p. 34, 1995) also described a similar specimen and assigned it to *Cannanoropollis perfectus* (Bose & Maheshwari) Dias-Fab ricio 1981.

Occurrence: STRAT 1, NATA.

Genus PLICATIPOLLENITES Lele 1964

Type species: *Plicatipollenites gondwanensis* (Balme & Hennelly) Lele 1964; originally designated as *Plicatipollenites indicus* Lele 1964, and subsequently considered a synonym of *Cannanoropollis malabarensis* (Potonie & Sah)1960 and recombined by Foster (1975) to *Plicatipollenites malabarensis* (Potonie & Sah) Foster 1975,

which ultimately was considered a synonym of *Plicatipollenites gondwanensis* (Balme & Hennelly) Lele 1964 by MacRae (1988).

Remarks: The genus is adopted here for radial, trilete monosaccate pollen grains that often exhibit a conspicuous intexinal fold system, and are generally circular to slightly oval in amb. Forms of the present genus may also be distinguished from similar forms of the genus *Cannanoropollis* Potonié & Sah 1960 in having a relatively larger ratio of the saccus width to corpus diameter, as well as a relatively better preserved and distinct central body or corpus in most cases.

Plicatipollenites gondwanensis (Balme & Hennelly) Lele 1964
Plate 6, figure 9

- 1956 *Nuskoisporites gondwanensis* Balme & Hennelly, p. 253; pl. 7, figs 66 – 67.
1960 *Cannanoropollis malabarensis* Potonie & Sah, p. 128; pl. 2, figs 19 – 21; pl. 3, figs 22 – 23.
1964 *Plicatipollenites indicus* Lele, pp. 152 – 154; pl. 1, figs 6 – 10; text figs 3a-f, 12a.
1964 *Plicatipollenites gondwanensis* (Blame & Hennelly) Lele, pp. 154 – 156; pl. 2, fig. 11; text figs 4a-c, 12b.

For additional synonymy see Millstead (1999).

Description: Pollen monosaccate, trilete. Amb circular, sub-circular to occasionally slightly oval; margin smooth to slightly finely undulating or crenulated. Laesurae commonly distinct, even to occasionally variable lengths, extends $\frac{1}{4}$ - $\frac{2}{3}$ of corpus radius. Corpus distinct, circular, subcircular to broadly oval, with conspicuous distal intexinal circular to polygonal folds; proximally laevigate to rarely punctate. Saccus finely reticulate, brochi 1-3 μ m wide; width $\frac{1}{2}$ to nearly equal corpus radius. Saccus attachment proximally equatorial and distally sub-equatorial to mediway between equator and polar axes.

Dimensions: Equatorial diameter; 64(96)139 μ m (35 specimens, STRAT 1), 83(99)116 μ m (19 specimens, CKP6). Corpus diameter; 39(64)103 μ m (34 specimens, STRAT 1), 48(66)85 μ m (17 specimens, CKP6). Saccus width; 13(26)45 μ m (34 specimens, STRAT 1), 17(22)34 μ m (19 specimens, CKP6).

Remarks: The views of MacRae (1988) synonymising *Plicatipollenites malabarensis* (Potonié and Sah) Foster 1975 and *Plicatipollenites gondwanensis* (Balme & Hennelly) Lele 1964 are held, this owing to the recognition in this study of a variation and overlapping of the documented distinguishing characters for the two species. Although Foster (1975) distinguished *Plicatipollenites malabarensis* based on the existence of a continuous non-polygonal intexinal fold close to the corpus margin, in this study both non-polygonal and polygonal fold systems near or away from the corpus margin have been noted with no clear pattern of distinction. In some grains such intexinal folds vary within the same grain from

marginal to sub-equatorial regions of the corpus clearly indicating a transition between these characteristics. In various specimens trilete rays indicate equal to unequal lengths irrespective of the character of the amb or intexinal folds.

Occurrence: STRAT 1, CKP6, CKP9, KGO3, ME58.

Previous records: Africa; Late Carboniferous to Permian (Anderson, 1977; MacRae, 1988; Millstead, 1999). Australia; Late Carboniferous to Permian (Balme & Hennelly, 1956; Foster, 1975, 1979; Backhouse, 1991). South America; Late Carboniferous to Permian (Marques-Toigo & Klepzig, 1995).

Plicatipollenites densus Srivastava 1970
Plate 6, figure 10

1970 *Plicatipollenites densus* Srivastava, pp. 159 – 160; pl. 1, figs 7 – 8.

1968 *Cannanoropollis densus* (Lele) Bose & Maheshwari, p. 32; pl. 5, fig. 3.

For additional synonymy see Foster (1979), MacRae (1988).

Description: Pollen monosaccate, trilete. Amb circular to subcircular, outline generally uneven or irregular but may be occasionally smooth to slightly undulating. Laesurae poor to distinct, unequal, extends $\frac{1}{3}$ to $\frac{1}{2}$ of corpus radius. Corpus dark, distinct, outline well-defined, circular to occasionally broadly oval. Saccus infrareticulate to infrapunctate, radially elongate; width nearly equal corpus radius.

Dimensions: Equatorial diameter; 59(79)100 μ m (34 specimens, STRAT 1), 66(82)107 μ m (9 specimens, CKP6). Corpus diameter; 32(50)67 μ m (34 specimens, STRAT 1), 14(21)28 μ m (33 specimens, CKP6). Saccus width; 14(21)28 μ m (33 specimens, STRAT 1), 10(15)20 μ m (7 specimens, CKP6).

Remarks: The present species is distinguished from similar forms of the genus in having a darkened dense corpus.

Occurrence: STRAT 1, CKP6, CKP9, ML1.

Previous records: South Africa; Late Carboniferous to Early Permian (Anderson, 1977; MacRae, 1988). Australia; Early Permian (Foster, 1979). South America; Early Permian (Marques-Toigo & Klepzig, 1995).

Plicatipollenites trigonalis Lele 1964
Plate 6, figure 11

1964 *Plicatipollenites trigonalis* Lele, pp. 156 – 157; pl. 2, figs 13 – 14.

Description: Pollen monosaccate, trilete. Amb sub-circular or tending to just slightly triangular, outline weakly undulating to slightly irregular. Laesurae indistinct to discernible, extends $\frac{1}{3}$ to $\frac{1}{2}$ of corpus radius. Corpus roundly triangular, outline distinct; proximally laevigate or microgranulate, distally infrareticulate. Saccus finely reticulate, brochi 1 - 2 μ m wide and radially arranged.

Dimensions: Equatorial diameter; 84(93)112 μ m (7 specimens, STRAT 1), 69 μ m, 76 μ m, 76 μ m (3 specimens, CKP6). Corpus diameter; 47(59)75 μ m (7 specimens, STRAT 1), 39 μ m, 47 μ m, 54 μ m (3 specimens, CKP6). Saccus width; 17(22)34 μ m (7 specimens, STRAT 1), 14 μ m, 17 μ m (2 specimens, CKP6).

Remarks: The present specimens are distinguished from other forms of the genus on the basis of a sub-circular to triangular amb and corpus.

Occurrence: STRAT 1, CKP6, CKP9, KGO3.

Previous records: South Africa; Late Carboniferous to Permian (MacRae, 1988). South America; Early Permian (Marques-Toigo & Klepzig, 1995).

Plicatipollenites sp.

Plate 6, figure 12

Description: Pollen monosaccate, trilete. Amb sub-circular to polygonal, outline smooth or rarely slightly crenulated. Laesurae indistinct, discernible or distinct, slightly symmetric to non-symmetric, uneven lengths with a short and diminished third ray; longest ray extend $\frac{1}{3}$ radius of corpus. Corpus well defined, distinct, polygonal elongate or broadly oval to oval elongate with one side commonly narrower; characteristic marginal polygonal to circular intexinal folds, usually non-continuous on narrower end of corpus. Saccus infrareticulate, non-radial; width non-uniform, narrower at extreme end of corpus longer axis.

Dimensions: Equatorial diameter; 126 μ m, 134 μ m, 144 μ m, 152 μ m (4 specimens, STRAT 1), 196 μ m (1 specimen, CKP6). Corpus diameter; 93 μ , 100 μ m, 100 μ m, 112 μ m (4 specimens, STRAT 1), 95 μ m (1 specimen, CKP6). Saccus width; 34 μ m, 37 μ m, 45 μ m, 45 μ m (4 specimens, STRAT 1), 57 μ m (1 specimen, CKP6).

Remarks: The present specimens are distinguished from *Plicatipollenites gondwanensis* on the basis of a slightly polygonal form in amb and corpus as well as intexinal folds that are non-continuous. The specimens (pl. 3, fig. 11) assigned by Azcuy and Di Pasquo (2000) to *Circumplicatipollis plicatus* Ottone & Azcuy 1988 seem identical to the present specimens except no two intexinal fold systems have been recognized in this study as shown in their *text-fig. 4G* and the descriptions.

Occurrence: STRAT 1, CKP6.

Plicatipollenites sp. A

Plate 6, figure 13

Description: Pollen monosaccate, trilete. Amb oval elongate to broadly oval, outline uneven, corrugated or smooth. Laesurae distinct, asymmetrical, some with uneven ray lengths, some with characteristic y-shaped forms; longest rays extend $\frac{1}{3}$ to $\frac{1}{2}$ of corpus radius. Corpus distinct, oval elongate, proximally laevigate or infrapunctate, distally infrareticulate, discontinuous to continuous circular and slightly polygonal intexinal folds; folds sub-equatorial to midway between margin and polar axes. Saccus finely reticulate with brochi 1 - 4 μ m and moderate to strongly radial; saccus width $\frac{2}{3}$ to nearly equal corpus radius.

Dimensions: Equatorial diameter; long axis 73(91)112 μ m (7 specimens, STRAT 1), short axis 60 μ m, 74 μ m, 90 μ m (3 specimens, STRAT 1). Corpus diameter; long axis 46(60)76 μ m (7 specimens, STRAT 1), short axis 35 μ m, 45 μ m, 65 μ m, 66 μ m (4 specimens, STRAT 1). Saccus width; 11(21)26 μ m (7 specimens, STRAT 1).

Remarks: The present specimens appear similar to the specimen (pl. 3, fig. 8) assigned by Azcuy & Di Pasquo (2000) to *Circumplicatipollis stigmatus* (Lele & Karim) Ottone & Azcuy 1988; however, the two intexinal folds described by Azcuy & Di Pasquo (2000) are not apparent in the present specimens.

Occurrence: STRAT 1.

Plicatipollenites sp. B

Plate 6, figure 14

Description: Pollen monosaccate, trilete. Amb sub-circular to slightly broadly oval, outline smooth. Laesurae indistinct to poorly discernible. Corpus sub-circular to polygonal; cappula sub-equatorially detached from saccus, irregular outline, microrugulate. Saccus finely reticulate with brochi 1 - 2 μ m, radial.

Dimensions: Equatorial diameter; 39 μ m, 40 μ m, 48 μ m (3 specimens, STRAT 1). Corpus diameter; 27 μ m, 27 μ m, 28 μ m (3 specimens, STRAT 1). Saccus width; 9 μ m, 9 μ m, 20 μ m.

Remarks: The present specimens differ from other forms of this genus in having a much smaller size and also in showing a conspicuously detached saccus.

Occurrence: STRAT 1.

Infraturma **VESICULOMONORADITI** Pant 1954

Genus **CAHENIASACCITES** Bose & Kar 1966

Type species: Caheniasaccites flavatus Bose & Kar 1966 (by original designation).

Caheniasaccites ovatus Bose & Kar 1966

Plate 6, figure 15

1966 *Caheniasaccites ovatus* Bose & Kar, p. 87; pl. 26, figs 8 – 10.

Description: Pollen monosaccate; indistinct to weakly discernible monolete mark. Amb longitudinally oval, ratio of longitudinal to transverse axis approximately 1.5 : 1, outline finely irregular or corrugated. Corpus indistinct to poorly discernible, subcircular or slightly transversely oval. Saccus finely reticulate, radially elongate; width uneven, slightly constricted at center. Total grains indicate a haploxylonoid-like bisaccate shape.

Dimensions: Equatorial diameter; long axis 86µm, 110µm (2 specimens, STRAT 1), short axis 60µm, 80µm (2 specimens, STRAT 1). Corpus diameter; 60µm (1 specimen, STRAT 1).

Remarks: The present specimens are poorly preserved to provide a complete description and comparison with similar forms. However, following MacRae (1988), the present specimens have been assigned to *C. ovatus* on the basis of a more haploxylonoid-like amb and a sub-circular to transversely oval rather than longitudinally oval corpus.

Occurrence: STRAT 1.

Previous records: South Africa; Late Carboniferous to Permian (MacRae, 1988). DR-Congo; Early Permian (Bose and Kar, 1966).

Caheniasaccites flavatus Bose & Kar 1966

Plate 6, figure 16

1966 *Caheniasaccites flavatus* Bose & Kar, pp. 85 – 86; pl. 26, figs 4 – 5.

1979 *Caheniasaccites ovatus* (Bose & Kar) Archangelsky & Gamarro, p. 447; pl. 8, fig. 7; pl. 9, figs 1 – 3.

Description: Pollen monosaccate, monolete. Amb longitudinally oval, ratio of longitudinal to transverse axis approximately 2 : 1; outline uneven or corrugated. Corpus poorly preserved, outline discernible, longitudinally oval; infrareticulate.

Saccus finely reticulate, radial; width uneven, strongly constricted in middle indicating a bissacate shape.

Dimensions: Equatorial diameter; long axis 110µm, 114µm, 132µm, short axis 60µm, 62µm, 67µm (3 specimens, STRAT 1). Corpus diameter; long axis 47µm, 71µm, short axis 28µm, 50µm (2 specimens, STRAT 1).

Remarks: The present specimens are differentiated from *C. ovatus* in having a longitudinally oval corpus as well as a diploxytonoid-like amb, following the views of MacRae (1988).

Occurrence: STRAT 1.

Previous records: South Africa; Late Carboniferous to Permian (MacRae, 1988). South America; Late Carboniferous to Early Permian (Archangelsky & Gamero, 1979; Marques-Toigo & Klepzig, 1995). DR-Congo; Early Permian (Bose and Kar, 1966).

Genus POTONIEISPORITES Bhardwaj *emend.* Bharadwaj 1964

Type species: *Potonieisporites novicus* Bhardwaj 1954 (by original designation).

Remarks: An attempt has been made in this study, albeit with difficulty, to separate specimens attributed to the present genus into different species following the views of Azcuy and Di Pasquo (2000), in which specimens are differentiated by considering the nature of saccus attachment and corpus fold systems, and several other related aspects.

Potonieisporites novicus Bhardwaj 1954

Plate 6, figure 17

1954 *Potonieisporites novicus* Bhardwaj, pp. 520 – 521; text figs 9, 10.

1956 *Potonieisporites novicus* Bhardwaj, pp. 133 – 134; pl. 2, figs 13 – 14; text fig. 11.

For additional synonymy see MacRae (1988)

Description: Pollen monosaccate, monolete; straight or geniculate tetrad mark. Amb oval, outline generally smooth. Corpus distinct, broadly oval with slight elongation in transverse axis, with marginal or subequatorial transversely aligned folds. Laesurae extend $\frac{1}{3}$ diameter of corpus in longitudinal direction. Saccus infrareticulate; attachment equatorial to sub-equatorial.

Dimensions: Equatorial diameter; long axis 66(106)146µm (8 specimens, STRAT 1), 72(108)157µm (12 specimens, CKP6), short axis 55(77)97µm (8 specimens, STRAT 1), 50(78)121µm (12 specimens, CKP6). Corpus diameter; long axis

32(62)80 μm (6 specimens, STRAT 1), 55 μm , 60 μm , 62 μm (3 specimens, CKP6), short axis 42 μm , 51 μm , 56 μm (3 specimens, CKP6).

Remarks: In this study the present specimens are differentiated from other forms of the genus in having relatively distinct transversely aligned marginal or subequatorial folds as well as transversely elongate corpus.

Occurrence: STRAT 1, CKP6, CKP9.

Previous records: Australia; Late Carboniferous to Late Permian (Foster, 1975, 1979). Pakistan; Early Permian (Balme, 1970). South Africa; Late Carboniferous to Late Permian (MacRae, 1988; Millsted, 1999). South America; Late Carboniferous to Early Permian (Marque-Toigo & Klepzig, 1995).

Potonieisporites brasiliensis (Nahuys, Alpern & Ybert) Archangelsky & Gamero 1979
Plate 6, figure 18

For synonymy see Archangelsky and Gamero (1979)

Description: Pollen monosaccate, tetrad mark indistinct. Amb distinctively oval elongate. Corpus distinct, occasionally darker or dense, oval elongate in the longitudinal direction; discontinuous to continuous peripheral folds, sub-circular to locally polygonal. Saccus equatorially to sub-equatorially attached; reticulate, with brochi 2 - 4 μm and radially arranged.

Dimensions: Equatorial diameter; long axis 114(147)197 μm (5 specimens, STRAT 1), 54(96)150 μm (5 specimens, CKP6), short axis 60(94)112 μm (5 specimens, STRAT 1), 30(67)97 μm (5 specimens, CKP6). Corpus diameter; long axis 54(78)103 μm (5 specimens, STRAT 1), short axis 42(61)79 (5 specimens, STRAT 1).

Remarks: The present specimens are distinguished from other forms of the genus in having a much more pronounced oval elongate amb and central body.

Occurrence: STRAT 1, CKP6.

Previous records: South America; Late Carboniferous to Late Permian (Archangelsky & Gamero, 1979; Marques-Toigo & Klepzig, 1995; Azcuy & Di Pasquo, 2000).

Potonieisporites congoensis Bose & Maheshwari 1968
Plate 6, figure 19

For synonymy see Azcuy and Di Pasquo (2000)

Descriptions: Pollen monosaccate, monolete; tetrad mark may indicate short or diminished third ray. Amb with polygonal edges, slightly oval, elongate. Corpus distinctively sub-rectangular to slightly sub-circular; sub-equatorial continuous intexinal folds. Laesurae $\frac{1}{3}$ of corpus diameter in longitudinal axis. Saccus attachment equatorial to subequatorial; infrareticulate to infrapunctate, locally frilled.

Dimensions: Equatorial diameter; long axis 106(118)140 μm (5 specimens, STRAT 1), short axis 78(89)100 μm (5 specimens, STRAT 1). Corpus diameter; long axis 59(66)69 μm (5 specimens, STRAT 1), short axis 56 μm , 57 μm , 59 μm , 62 μm (4 specimens, STRAT 1).

Remarks: The present specimens differ from other forms of the genus in having a pronounced polygonal or sub-rectangular corpus.

Occurrence: STRAT 1.

Previous records: South America; Late Carboniferous to Early Permian (Azcuay and Di Pasquo, 2000; Playford and Dino, 2002). DR-Congo; Early Permian (Bose and Kar, 1966).

Subturma **DISACCITES** Cookson 1947

Infraturma **DISACCITRILETI** Leschik 1955

Genus **ILLINITES** Kosanke 1950

Type species: *Illinites unicus* Kosanke 1950 (by original designation)

Remarks: In this study specimens are assigned to the present genus based on the recognition of distinct trilete tetrad marks following the diagnosis of Kosanke (1950). Clarke (1965) and MacRae (1988) discuss the history of this genus in accordance with the original diagnosis of Kosanke (1950).

Illinites spectabilis (Leschik) *comb. nov.*

Plate 7, figure 1

1956 *Illinites spectabilis* Leschik, p. 131; pl. 21, fig. 7.

Description: Pollen disaccate, trilete. Amb haploxyelonoid to oval elongate. Laesurae asymmetric, appears bent, but with a distinctive third ray. Corpus distinct, sub-circular to oval elongate in transverse axis, sub-equatorial to medial transverse folds. Cappa finely reticulate, $\frac{1}{4}$ of corpus. Sacci seem attached by narrow lateral bladder; infrasculpture of micro-vermiculate or micro-punctate to finely reticulate, with brochi 1-2 μm wide.

Dimensions: Total length; 32µm, 58µm, 67µm, 85µm (4 specimens, STRAT 1). Saccus breadth; 21µm, 34µm, 45µm, 58µm (4 specimens, STRAT 1). Corpus breadth; 17µm, 32µm, 48µm (3 specimens, STRAT 1), Corpus length; 20µm, 39µm, 53µm (3 specimens, STRAT 1).

Remarks: Specimens assigned to the present genus are distinguished from those of the genus *Limitisporites* Leschik *emend.* Klaus 1963 in having convincingly trilete tetrad marks. The specimens (p.342; pl.44, figs. 3-4) assigned by Clarke (1965) to *Illinites delasaueci* (Potonié and Klaus) Grebe and Schweitzer 1962 are considered equivalent to the present specimens.

Occurrence: STRAT 1.

Previous records: Germany; Late Permian (Leschik, 1956). Great Britain; Late Permian (Clarke, 1965).

Genus LIMITISPORITES Leschik *emend.* Klaus 1963

Type species: *Limitisporites rectus* Leschik 1956 (by original designation).

Remarks: Specimens assigned to the present genus include those with straight monolete tetrad marks, as well as some that indicate slight bulging or widening of the tetrad mark in the middle, tending to dilete, but without a clear third ray developed. Following Schaaschmidt (1963), no attempt has been made in this study to assign specimens with bent monolete marks into a separate genus i.e. *Jugasporites* Leschik 1956, instead specimens with similar features are considered under the present genus.

Limitisporites rectus Leschik 1956

Plate 7, figure 2

1956 *Limitisporites rectus* Leschik, p.133; pl.21, fig. 15.

For synonymy see Foster (p.71, 1979)

Description: Pollen disaccate, monolete. Amb haploxytonoid to oval elongate or nearly so. Laesura straight to slightly undulate, narrow to almost striate form to widely opened in rare specimens; extend $\frac{4}{5}$ of the longitudinal diameter of the corpus. Corpus distinct, relatively darker than sacci, sub-circular to oval with long axis along grain's transverse axis, short sides nearly straight, commonly with equatorial to sub-equatorial transverse folds; intexine 1.5 - 2µm thick. Sacci crescentic to slightly more than semi-circular in outline, may be joined by narrow lateral bladder c. 1µm wide; infrasculpture finely reticulate, brochi 1-3µm wide, polygonal to radial.

Dimensions: Total length; 50(68)104 μm (14 specimens, STRAT 1), 50(57)65 μm (5 specimens, CKP6). Saccus breadth; 32(44)76 (14 specimens, STRAT 1), 32(37)40 μm (5 specimens, CKP6). Corpus breadth; 28(37)47 (8 specimens, STRAT 1), 29 μm , 30 μm , 31 μm (3 specimens, CKP6), Corpus length; 34(46)70 (12 specimens, STRAT 1), 29(34)37 μm (5 specimens, CKP6).

Remarks: The present specimens are distinguished from other forms of the genus in having a haploxyelonoid to elongate oval amb.

Occurrence: STRAT 1, ME58.

Previous records: South America; Early Permian (Marques-Toigo and Klepzig, 1995; Playford and Dino, 2002).

Limitisporites monstruosus (Luber in Luber and Waltz) Hart 1965
Plate 7, figure 3

1941 *Pemphygaletes monstruosus* Luber in Luber and Waltz, p.59; pl.12, fig.202.

1965 *Limitisporites monstruosus* (Luber in Luber and Waltz) Hart, p.80; text fig. 190.

For additional synonymy see MacRae (1988).

Description: Pollen disaccate, monolete. Amb slightly haploxyelonoid to diploxyelonoid. Laesura poorly distinct to discernible, straight to slight bending and widening in the center. Corpus distinct, darker, sub-circular to oval and occasionally slightly polygonal with near straight sides, transversely elongate, two or more transversely aligned to occasionally oblique and longitudinal intexinal folds; intexine 1 μm thick. Sacci crescentic to semi-circular in outline, joined by narrow lateral bladders 2 - 3 μm wide, slightly inclined distally; infrapunctate and finely reticulate, brochi 1 - 2 μm wide.

Dimensions: Total length; 70(80)104 μm (13 specimens, STRAT 1), 77(93)110 μm (5 specimens, CKP6). Saccus breadth; 39(51)78 μm (13 specimens, STRAT 1), 50(57)62 μm (5 specimens, CKP6). Corpus breadth; 35(47)50 μm (6 specimens, STRAT 1), 44(48)56 μm (5 specimens, CKP6), Corpus length; 42(52)67 μm (11 specimens, STRAT 1), 45(52)63 μm (5 specimens, CKP6).

Remarks: The present specimens are distinguished from other forms of the genus in having a slightly diploxyelonoid amb with occasionally distally inclined sacci.

Occurrence: STRAT 1, CKP6, CKP9, KGO3.

Previous records: South Africa; Late Carboniferous to Early Permian (MacRae, 1988).

Limitisporites perspicuus (Leschik) *comb. nov.*

Plate 7, figure 4

1956 *Jugasporites perspicuus* Leschik, p. 132; pl. 21, fig. 12.

Description: Pollen disaccate, monolete. Amb slightly diploxytonoid, tending to haploxytonoid. Laesura bent in the middle or dilete. Corpus distinct, prominently dark, circular to sub-circular. Sacci semi-circular, joined by narrow lateral bladders 2µm wide; fine to microreticulate, brochi radially arranged.

Dimensions: Total length; 47(63)74 (5 specimens, STRAT 1). Saccus breadth; 29(37)42 (5 specimens, STRAT 1). Corpus diameter; 30(37)40 (5 specimens, STRAT 1).

Remarks: The present specimens are in this study distinguished from other forms of the genus in having a bent monolete or dilete mark, as well as a more regularly circular and darker corpus. Specimens that exhibit a bent monolete or dilete mark have been assigned by other authors (e.g. Klaus, 1963; MacRae, 1988) to the genus *Jugasporites* Leschik 1956, however, this approach has not been followed in this study because it seems a less solid base to establish a separate genus rather than an additional species category under the present genus. The specimens (p.54; pl. 21, figs. 3-4) described by MacRae (1988) as *Jugasporites sp. 1* are considered equivalent to the present specimens. The figured specimen (p.287; pl.16, fig. 3) assigned by Backhouse (1991) to *Limitisporites rectus* Leschik 1956 is also considered equivalent to the present specimens.

Occurrence: STRAT 1.

Previous records: Australia; Permian (Backhouse, 1991). Germany; Late Permian (Leschik, 1956). South Africa; Late Carboniferous to Late Permian (MacRae, 1988).

Limitisporites sp.

Plate 7, figure 5

Description: Pollen disaccate, monolete. Amb slightly haploxytonoid to diploxytonoid, tending to longitudinally oval elongate. Laesura poorly distinct, appear to be straight, either bordered by some darkened areas or has a fold superimposed on it. Corpus distinct, dark, longitudinally elongate, oval to slightly polygonal in some specimens, longitudinal and rare transverse intexinal folds. Sacci semi-circular, joined on one side by narrow lateral bladder; infrareticulate.

Dimensions: Total length; 80µm, 90µm, 100µm (3 specimens, STRAT 1). Saccus breadth; 39µm, 39µm, 48µm (3 specimens, STRAT 1). Corpus breadth; 41µm,

47µm, 49µm (3 specimens, STRAT 1), Corpus length; 50µm, 64µm, 66µm (3 specimens, STRAT 1).

Remarks: The present specimens are differentiated from other forms of the genus in having a longitudinally elongate corpus. There appears to be close similarity between the present specimens and the descriptions by MacRae (p. 51, 1988) of the species he termed *Limitisporites* sp. The latter however has a much more pronounced lateral bladder joining the sacci.

Occurrence: STRAT 1.

Genus VESTIGISPORITES Balme & Hennelly *emend.* Jansonius 1976

Type species: *Vestigisporites rudis* Balme & Hennelly 1955 (by subsequent designation of Potonié, 1958).

Vestigisporites rudis Balme & Hennelly 1955
Plate 7, figure 6

1955 *Vestigisporites rudis* Balme & Hennelly, p. 95; pl. 6, figs 54 – 57.

Description: Pollen disaccate, monolete. Amb haploxyelonoid to weakly diploxyelonoid. Laesura occasionally distinct, straight, and extending approximately $\frac{1}{3}$ of the diameter of the corpus. Corpus distinct, some specimens extremely dark, circular to subcircular and oval (some specimens nearly hexagonal), longitudinal or transversely elongate, proximally laevigate to rarely micro-granulate; intexine 2 - 3µm thick. Sacci semi-circular to slightly more than semi-circular in shape, generally symmetrical on either side of the corpus, often joined by lateral bladders 1 - 13µm wide; finely reticulate with brochi 1 - 3µm wide and often radially arranged.

Dimensions: Total length; 53(94)146 (17 specimens, STRAT 1), 56µm, 78µm, 82µm (3 specimens, CKP6). Saccus breadth; 26(58)86 (17 specimens, STRAT 1), 34µm, 40µm, 42µm (3 specimens, CKP6). Corpus breadth; 30(44)55 (10 specimens, STRAT 1), 36µm (1 specimen, CKP6), Corpus length; 25(47)69 (17 specimens, STRAT 1), 28µm, 38µm, 42µm (3 specimens, CKP6).

Remarks: The present specimens appear very close to the specimens described and figured in Balme and Hennelly (1955, p. 95, pl. 6, figs 54 – 57) for *Vestigisporites rudis*, with remarkable similarities displayed by some that are identical to the specimen (fig. 54) nominated by Potonié (1958) as the lectotype. There are great similarities also with the specimens (pl. 84, figs 1 – 17) figured in Anderson (1977) and assigned to *Vestigisporites rudis* Balme and Hennelly 1955.

Occurrence: STRAT 1, CKP6, CKP9.

Previous records: Australia; Permian (Balme & Hennelly, 1955). South Africa; Late Carboniferous to Late Permian (Anderson, 1977; MacRae, 1988).

Vestigisporites ventrisaccatus Anderson 1977

Plate 7, figure 7

1955 *Vestigisporites spm.* "A" Balme & Hennelly, pp. 95 – 96; pl. 6, figs 58 – 64.

1977 *Vestigisporites ventrisaccatus* Anderson, p. 92; pl. 82, figs 1 – 27; pl. 83, figs 1 – 13.

Description: Pollen disaccate, monolete to rarely dilete. Amb haploxytonoid. Corpus distinct, dark, circular to sub-circular and broadly oval; intexine 1 - 2µm thick. Sacci crescentic to semi-circular in shape, commonly joined by narrow lateral bladders 0.5 - 1µm wide; infrareticulate with brochi 1µm wide, occasionally micro-punctate or micro-vermiculate.

Dimensions: Total length; 54(58)69µm (8 specimens, STRAT 1), 39µm, 56µm, 57µm, 65µm (4 specimens, CKP6). Saccus breadth; 28(37)45 (8 specimens, STRAT 1), 25µm, 25µm, 27µm, 45µm (4 specimens, CKP6). Corpus breadth; 28µm, 37µm, 40µm, 44µm (4 specimens, STRAT 1), 26µm (1 specimens, CKP6), Corpus length; 30(41)52µm (7 specimens, STRAT 1), 27µm, 34µm, 34µm, 40µm (4 specimens, CKP6).

Remarks: The present specimens differ from *Vestigisporites rudis* in having a clearly distinct haploxytonoid amb and generally smaller sacci relative to the corpus.

Occurrence: STRAT 1, CKP6.

Previous records: Australia: Permian (Balme & Hennelly, 1955). South Africa: Permian (Anderson, 1977; Millsted, 1999).

Infraturma **DISACCIATRILETI** Leschik *emend.* Potonié 1958

Genus **ALISPORITES** Daugherty 1941 *emend.* Jansonius 1971

Type species: *Alisporites opii* Daugherty 1941 (by monotypy)

Remarks: Much uncertainty surrounds the true identity of this genus due to the unequivocal nature of its diagnostic features, dominated by the character of the leptoma. The history of the genus has been fully discussed by several authors that include Balme (1970), Jansonius (1971), Foster (1979), and MacRae (1988). The material observed from this study does not allow any critical analyses for the

genus. Specimens considered under this genus are those that exhibit a reasonably well recognizable distal sulcus and are non-striate.

Alisporites ovatus (Balme & Hennelly) Jansonius 1962

Plate 7, figure 8

- 1955 *Florinites ovatus* Balme & Hennelly, p. 96; pl. 5, figs. 49 – 52.
1962 *Alisporites ovatus* (Balme & Hennelly) Jansonius, pp. 58 – 59; pl. 13, figs 3 – 5.
1975 *Scheuringipollenites ovatus* (Balme & Hennelly) Foster, pp. 19 – 20; pl. 6, figs 5 – 6.

For additional synonymy see MacRae (1988)

Description: Pollen disaccate, distally sulcate. Amb haploxyloloid, oval. Corpus elongate in transverse axis of grain, oval, outline poorly to rarely distinct. Sacci semi-elliptical, finely reticulate with brochi about 1 μ wide. Distal sacci attachment sub-parallel, defining margin to a narrow sulcus that extend full length of corpus.

Dimensions: Total length; 36(42)49 (13 specimens, STRAT 1), 37(51)58 (8 specimens, CKP6). Saccus breadth; 24(33)41 (13 specimens, STRAT 1), 28(37)42 (8 specimens, CKP6). Corpus breadth; 19(23)28 (7 specimens, STRAT 1), 21 μ m, 31 μ m (2 specimens, CKP6), Corpus length; 29(33)39 (7 specimens, STRAT 1), 28 μ m, 32 μ m (2 specimens, CKP6).

Remarks: The present specimens are distinguished in having an oval haploxyloloid amb with sacci breadth wider at middle of grain in polar view than at extreme end of long axis; the specimens also indicate a generally narrow, relatively straight-edged distal sulcus extending the full length of the corpus.

Occurrence: STRAT 1, CKP6, ML1.

Previous records: Widely recorded from the Permian of Gondwana (Balme & Hennelly, 1955; Bharadwaj, 1962; Maheshwari and Bose, 1969; Balme, 1970; Foster, 1975, 1979; MacRae, 1988).

Alisporites australis de Jersey 1962

Plate 7, figure 9

- 1962 *Alisporites australis* de Jersey, pp. 8 – 9; pl. 2, fig. 14; pl. 3, figs 3 – 4.

For synonymy see Foster (1979).

Description: Pollen disaccate, distally sulcate. Amb haploxytonoid to slightly diploxytonoid. Corpus distinct, darker, broadly oval to sub-circular, elongate in transverse or longitudinal axis of grain. Sacci crescentic in outline, discreet, finely reticulate with brochi 1 – 3µm wide.

Dimensions: Total length; 46(69)98 (6 specimens, STRAT 1), 86µm (1 specimen, CKP6). Saccus breadth; 28(40)49 (6 specimens, STRAT 1), 62µm (1 specimen, CKP6), Saccus length 27µm, 38µm, 42µm (3 specimens, STRAT 1). Corpus breadth; 24µm, 27µm, 34µm (3 specimens, STRAT 1), Corpus length 26(40)48 (5 specimens, STRAT 1).

Remarks: The present specimens are distinguished from other forms of the genus based on its tendency to a diploxytonoid amb, as well as a relatively darker corpus.

Occurrence: STRAT 1, CKP6.

Previous records: Australia; Permian (Foster, 1979). South America; Permian (Marques-Toigo & Klepzig, 1995).

Alisporites potonie (Lakhanpal, Sah & Dube) Somers 1968
Plate 7, figure 10

1960 *Pityosporites potonie* Lakhanpal, Sah & Dube, p. 115; pl. 2, figs 18 – 20.

1960 *Vesicaspora maxima* Hart, pp. 10 – 11; pl. 3, fig. 33.

1968 *Alisporites potonie* (Lakhanpal, Sah & Dube) Somers, p. 355.

For additional synonymy see MacRae (1988).

Descriptions: Pollen disaccate, distally sulcate. Amb haploxytonoid, outline circular to subcircular; slightly elongate in either transverse or longitudinal axis. Corpus poorly distinct, oval elongate in transverse direction. Sacci semicircular or nearly so, distal attachment lines parallel and almost in contact to closely separate defining margins to narrow sulcus. Sacci infrastructure fine to slightly coarse, brochi 1 - 4µm wide, polygonal.

Dimensions: Total length; 47µm, 74µm (2 specimens, STRAT 1), 48(62)78µm (5 specimens, CKP 6). Saccus breadth; 40µm, 66µm (2 specimens, STRAT 1), 45µm, 47µm, 52µm, 73µm (4 specimens, CKP6). Corpus breadth; 27µm (1 specimen, STRAT 1), Corpus length; 32µm (1 specimen, STRAT 1).

Remarks: Details surrounding delineation and definition, together with comparisons of this taxon are discussed by MacRae (1988). In this study the present specimens are distinguished from other forms of the genus in their tendency to a circular or

subcircular haploxytonoid amb, with the distal sacci attachment lines parallel and occasionally nearly in contact.

Occurrence: STRAT 1, CKP6.

Previous records: Africa; Permian (Anderson, 1977; MacRae, 1988). Australia; Permian (Foster, 1979).

Alisporites splendens (Leschik) Foster 1979
Plate 7, figure 11

1956 *Sulcatisporites splendens* Leschik, p. 137; pl. 22, fig. 10.

1970 *Falcisporites nuthallensis* (Clarke) Balme, p. 389; pl. 15, figs 15 – 18.

For synonymy see Foster (1979).

Description: Pollen disaccate. Amb haploxytonoid. Corpus poorly discernible to distinctive outline, broadly oval, rarely angular, elongate in transverse direction of grain. Sacci semicircular to just slightly more, discreet but may be joined by narrow lateral bladder. Sacci infrastructure clearly defined, fine to coarse reticulate, brochi 1 - 5µm wide; polygonal but tending to radially aligned near sacci roots. Sacci outline uniformly broadly rounded. Sulcus discernible but poorly defined; appears to have rounded ends.

Dimensions: Total length; 51(65)100µm (5 specimens, STRAT 1). Saccus breadth; 36(42)53µm (5 specimens, STRAT 1), Saccus length; 37µm (1 specimen, STRAT 1). Corpus breadth; 28µm, 34µm, 35µm (3 specimens, STRAT 1), Corpus length; 35µm, 36µm, 39µm (3 specimens, STRAT 1).

Remarks: The present specimens are distinguished from other forms of the genus in having a haploxytonoid amb of uniformly broad semi-circular sacci, and a well-defined fine to coarse reticulate infrastructure. Several of the specimens (e.g. pl.144, figs.18, 20; pl.145, fig. 42) assigned by Anderson (1977) to *Pityosporites ovatus* Balme and Hennelly 1955 are equivalent to the present specimens.

Occurrence: STRAT 1.

Previous records: Australia; Permian (Foster, 1975; 1979). DR-Congo; Late Permian (Maheshwari and Bose, 1969). South Africa; Permian (Anderson, 1977).

Genus PLATYSACCUS Naumova 1939 *ex* Ishchenko 1952

Type species: *Platysaccus papilionis* Potonié & Klaus 1954 (by subsequent designation of Potonié & Klaus 1954).

Platysaccus papilionis Potonié & Klaus 1954
Plate 7, figure 12

1954 *Platysaccus papilionis* Potonié & Klaus, p. 540 – 541; pl. 10, figs 11 – 12.

1955 *Lueckisporites fusus* Balme & Hennelly, p. 92; pl. 1, figs 6 – 10.

1975 *Platysaccus sp. A* of Foster, p. 146; pl. 6, figs 12 – 13.

Description: Pollen disaccate. Amb strongly diploxytonoid. Corpus distinct to clearly discernible, dark; outline subcircular to oval elongate in transverse direction of grain. Sacci much larger than corpus, greater than semicircular in shape, finely infrareticulate with superimposed vermiculate; brochi 1 - 2µm wide. Narrow cappula c. 2µm wide, extending full length of corpus.

Dimensions: Total length; 64µm, 65µm (2 specimens, STRAT 1), 48(58)73µm (6 specimens, CKP6). Saccus breadth; 39µm, 40µm (2 specimens, STRAT 1), 29(41)56µm (6 specimens, CKP6). Corpus breadth; 20µm, 20µm, 27µm (3 specimens, CKP6), Corpus length; 24µm, 28µm (2 specimens, STRAT 1), 22(24)33µm (5 specimens, CKP6).

Remarks: The present specimens are rare in the study material and are inadequate for complete comparative analyses. Their distinction is based on their large sacci relative to the small often darker corpus, as well as their non-striate character.

Occurrence: STRAT 1, CKP6, KGO3.

Previous records: Australia; Permian – Trissiac (Balme & Hennelly, 1955; Foster, 1975, 1979). India; Permian (Bharadwaj, 1962). South Africa; Permian (Anderson, 1977; MacRae, 1988).

Platysaccus sp.

Plate 7, figure 13

Description: Pollen disaccate. Amb moderately diploxytonoid. Corpus poorly preserved but discernible; outline broadly oval elongate in transverse direction of grain. Sacci slightly larger than semicircle in shape; infrastructure poorly discernible but seem infrapunctate and vermiculate, radially arranged.

Dimensions: Total length; 56µm, 57µm, 65µm, 66µm (4 specimens, STRAT 1), 53µm, 54µm (2 specimens, CKP6). Saccus breadth; 32µm, 36µm, 37µm, 40µm (4 specimens, STRAT 1), 30µm, 34µm (2 specimens, CKP6), length 18µm (1

specimen, STRAT 1). Corpus breadth; 24µm, 25µm, 28µm (3 specimens, STRAT 1), Corpus length; 25µm, 30µm, 31µm, 36µm (4 specimens, STRAT 1), 25µm, 30µm (2 specimens, CKP6).

Remarks: The present specimens are differentiated from *P. papilionis* in having a relatively moderate diploxytonoid amb and a less pronounced disparity in size between the sacci and corpus.

Occurrence: STRAT 1, CKP6, KGO3, ME58, ML1.

Genus PTERUCHIPOLLENITES Couper 1958

Type species: *Pteruchipollenites thomasii* Couper 1958

Remarks: The exact nature of this genus can not be explicitly articulated due to its remarkable similarities with other associated forms, particularly *Alisporites* Daugherty 1941. A brief history of this genus is discussed in MacRae (1988) where its main determining factor is considered to be the unavailability of a distal sulcus. In this study specimens considered under the present genus are those with a discernible cappula but without any clearly distinctive and unequivocal sulcus.

***Pteruchipollenites* sp.**

Plate 7, figure 14

Descriptions: Pollen disaccate. Amb haploxytonoid, slightly elongate along grain longitudinal axis. Corpus outline poor to clearly discernible, broadly oval to nearly subcircular, slightly elongate in transverse direction of grain. Sacci crescentic in outline, generally appears joined by narrow lateral band; infrastructure finely reticulate, brochi 1 - 2µm wide. Cappula with subparallel sides to nearly oval; breadth about $\frac{1}{3}$ of corpus.

Dimensions: Total length; 45µm, 50µm, 57µm, 62µm (4 specimens, STRAT 1), 97µm, 117µm (2 specimens, CKP6). Saccus breadth; 37µm, 37µm, 38µm, 42µm (4 specimens, STRAT 1), 70µm, 87µm (2 specimens, CKP6). Corpus breadth; 34µm, 35µm (2 specimens, STRAT 1), 67µm (1 specimen, CKP6), Corpus length; 32µm, 35µm, 35µm, 38µm (4 specimens, STRAT 1), 77µm (1 specimen, CKP6).

Remarks: Specimens are rare for detailed comparisons but seem distinguishable in having sacci joined with a resultant monosaccate-like form but with a relatively well-defined cappula. Some of the specimens assigned by Anderson (1977) to *Pityosporites ovatus* (e.g. pl.144, figs.30, 40, 44) and to *Pityosporites maximus* (e.g. pl.149, figs.6, 18) are considered equivalent with the present specimens.

Occurrence: STRAT 1, CKP6.

Previous records: South Africa; Permian (Anderson, 1977).

Infraturma **STRIATITI** Pant 1954

Genus **HAMIAPOLLENITES** Wilson *emend.* Tschudy and Kosanke 1966

Type species: *Hamiapollenites saccatus* Wilson 1962

Remarks: A brief insight into the nature and history of this genus is discussed in Jansonius (1962), Hart (1965), and Foster (1979). Specimens considered under the present genus consist of striations and taenae that are proximally parallel and distally perpendicular to grains longitudinal axes.

Hamiapollenites bullaeformis (Samoilovich) Jansonius 1962
Plate 7, figure 15

1953 *Protodiploxypinus bullaeformis* Samoilovich, p.33; pl. 4, figs.1a, b.

1962 *Hamiapollenites bullaeformis* (Samoilovich) Jansonius, p.72.

Description: Pollen disaccate, striate. Amb distinctly oval elongate, haploxyloid. Corpus distinct, broadly oval elongate in grain long axis. Proximal cap with sharply distinct 9 to 14 striations giving rise to 10 to 15 taenae, about 2 - 4µm wide, parallel to long axes of grain, and locally tapering and bifurcating; infrastructure micro-punctate or micro-reticulate. Narrow transversely oriented central distal keel, sharply distinct to faintly so, with weakly defined striations. Sacci crescentic to nearly semi-circular in shape, attachment subequatorial; infrastructure finely reticulate.

Dimensions: Total length; 59(65)69µm (5 specimens, STRAT 1), 68µm, 73µm, 74µm (3 specimens, CKP6). Total width of grain; 35(41)54 (5 specimens, STRAT 1), 35µm, 41µm, 47µm (3 specimens, CKP6).

Remarks: The present specimens are in this study distinguished from other forms of the genus in having a distinctively oval elongate haploxyloid amb, and from *H. saccatus* in having the corpus relatively wider along the long axis of the grain. The figured specimens in Kremp and Spackman (1961; Vol.13; p.13-127) of *Protodiploxypinus bullaeformis* Samoilovich 1953 and the specimen (p.65) assigned by Marques-Toigo and Klepzig (1995) to *Hamiapollenites tractiferinus* (Samoilovich) Jansonius 1962 have striking similarities and are considered equivalent.

Occurrence: STRAT 1, CKP6.

Previous records: Canada; Permian (Utting, 1994). Russia; Early Permian (Samoilovich, 1953).

Hamiapollenites fusiformis (Marques-Toigo) *emend.* Archangelsky & Gamero 1979
Plate 7, figure 16

1979 *Hamiapollenites fusiformis* (Marques-Toigo) Archangelsky & Gamero, pp. 457 – 461; pl. 12, figs 6 – 7.

Description: Pollen disaccate, striate. Amb oval, weakly disploxylonoid. Central body poorly defined in outline but seem longer in grain longitudinal axis. Proximal cap comprised of 14 striations giving rise to 15 taenae, some of which are bifurcating. Distal keel discernible, transversely oriented and centrally located. Sacci extremely smaller than central body; attachment equatorial.

Dimensions: Total length; 68µm, Total width; 35µm (1 specimen, CKP6).

Remarks: Species rare. Seem to have a remarkably smaller sacci in relation to the central body.

Occurrence: CKP6.

Previous records: South America; Permian (Archangelsky & Gamero, 1979; Marques-Toigo & Klepzig, 1995).

Hamiapollenites saccatus Wilson 1962
Plate 7, figure 17

1962 *Hamiapollenites saccatus* Wilson, pp. 23 – 24; pl. 3, fig. 7.

1962 *Hamiapollenites bifurcatus* Jansonius, pp. 72 – 73; pl. 15, figs 8 – 10.

1966 *Hamiapollenites perisporites* (Jizba) Tschudy and Kosanke, p.64; pl.1, figs.21-26.

Description: Pollen disaccate, striate. Amb haploxylonoid. Corpus distinct, darker, broadly oval elongate in transverse axis; proximally with finely separated 12 - 15 taenae oriented parallel to the longitudinal axis of the grain, distally with broad taenae highlighted by marginal intexinal folds oriented along grain transverse axis. Proximal taenae infrastructure minutely punctate, granulate, reticulate or vermiculate. Sacci much smaller than corpus, seem joined by narrow lateral bladder, nearly semi-circular in shape, attachment nearly equatorial to sub-equatorial; infrastructure finely reticulate, vermiculate or punctate.

Dimensions: Total length; 49µm, 50µm (2 specimens, STRAT 1). Saccus breadth; 26µm, 26µm (2 specimens, STRAT 1). Corpus breadth; 34µm (1 specimen, STRAT 1), Corpus length; 32µm, 41µm (2 specimens, STRAT 1).

Remarks: The present specimens are in this study distinguished from other forms of the genus in having a haploxyloid amb of characteristically smaller sacci, relative to the corpus breadth, and nearly semi-circular. Tschudy and Kosanke (1966) have noted the variability in form of specimens belonging to this genus particularly with regard to the number of taeniae, a feature which is evident in the present specimens. Wilson (1962) also acknowledged the rarity of *H. saccatus* from his material and that most specimens were distorted. Consequently, the present specimens have not been assigned based on the number of taeniae.

Occurrence: STRAT 1.

Previous records: North America; Late Permian (Wilson, 1962; Jansonius, 1962; Tschudy and Kosanke, 1966).

Hamiapollenites tractiferinus (Samoilovich) Jansonius 1962
Plate 7, figure 18

1953 *Protohaploxylinus tractiferinus* Samoilovich, p. 36; pl. 12, figs. 2a, 2b.

1962 *Hamiapollenites tractiferinus* (Samoilovich) Jansonius, p.72.

Description: Pollen disaccate, striate. Amb weakly diploxyloid. Corpus outline poorly distinct but discernible, subquadrangular with slight elongation parallel to the long axes of grains. Proximal cap display 7 striations parallel the long axes of grains, distal area indicate faint outline of centrally located keel and striations in transverse axes of grains. Taenae infrastructure micro-punctate and micro-vermiculate. Sacci semi-circular in shape, attachment equatorial to subequatorial, infrastructure finely reticulate; brochi 1 - 2µm wide.

Dimensions: Total length; 64µm, 84µm (2 specimens, STRAT 1). Saccus breadth; 37µm, 39µm (2 specimens, STRAT 1), Saccus length; 20µm, 25µm (2 specimens, STRAT 1). Corpus breadth; 34µm, 37µm (2 specimens, STRAT 1), Corpus length; 39µm, 42µm (2 specimens, STRAT 1).

Remarks: The present specimens appear different from other forms of the genus in this study in having a slightly subquadrangular corpus. The figured specimens (Vol.13; p.13-130) of *Protohaploxylinus tractiferinus* Samoilovich 1953 displayed in Kremp and Spackman (1961) are clearly identical to the present specimens.

Occurrence: STRAT 1.

Previous records: Russia; Early Permian (Samoilovich, 1953).

Hamiapollenites sp.

Plate 7, figure 19

Description: Pollen disaccate, striate. Amb diploxytonoid, with sacci and central body nearly identical in shape. Corpus distinct, sub-circular to broadly oval elongate in transverse or longitudinal axis. Proximal cap with 7 taenae oriented parallel to the long axis of the grain, approximately 5 taenae in the distal area oriented transversely. Taenae proximally infrapunctate and infrareticulate. Sacci nearly circular in shape, attached sub-equatorially.

Dimensions: Total length; 56µm (1 specimen, STRAT 1), 52µm, 63µm (2 specimen, CKP6). Saccus breadth; 22µm (1 specimen, STRAT 1), 22µm, 24µm (2 specimen, CKP6). Corpus breadth; 22µm, 22µm (2 specimens, CKP6), Corpus length; 27µm (1 specimen, STRAT 1), 25µm, 29µm (2 specimens, CKP6).

Remarks: The present specimens differ from other forms of the genus in having a distinctive three components figure characterized by nearly same size and shape of the sacci and central body; sacci are characteristically nearly circular in outline. The specimens (pl. 14, figs 1 – 3) assigned by Balme (1970) to *Hamiapollenites insolitus* (Bharadwaj & Salujha) Balme 1970 is closely similar to the present specimens, except the latter has a smaller size range. The present specimens also appear close to the specimen (p. 64) assigned by Marques-Toigo and Klepzig (1995) to *Hamiapollenites karroensis*. The latter however displays a prominent distal keel comprised of two transverse taenae flanking a central sulcus, a feature not easily identifiable in the present specimens but could not be ruled out completely.

Occurrence: STRAT 1, CKP6.

Genus LUECKISPORITES Potonié & Klaus 1954 *emend.* Jansonius 1962

Type species: *Lueckisporites virkkiae* Potonié & Klaus 1954 (by original designation)

Lueckisporites virkkiae Potonié and Klaus 1954

Plate 7, figure 20

1954 *Lueckisporites virkkiae* Potonié and Klaus, p. 534; pl.10, figs. 1, 3.

For synonymy see Millstead (1999)

Description: Pollen disaccate, taeniate. Amb diploxytonoid. Corpus distinct, subcircular to broadly oval with slight elongation in transverse or longitudinal axis of total grain. Proximal cap divided into half by narrow cleft that generally tapers on either ends, and extends full diameter of corpus along grain longitudinal axis; a monolete mark may be visible at the center of the cleft. Sacci semi-

circular in shape, distal attachment parallel defining margins to sulcus about 6µm wide; infrastructure fine to micro-punctate or vermiculate.

Dimensions: Total length; 49µm, 68µm (2 specimen, STRAT 1), 48µm, 66µm, 70µm (3 specimens, CKP6). Saccus breadth; 36µm, 45µm (2 specimen, STRAT 1), 36µm, 45µm, 48µm (3 specimens, CKP6). Corpus breadth; 29µm, 34µm (2 specimens, STRAT 1), 31µm, 36µm, 39µm (3 specimens, CKP6), Corpus length; 50µm (1 specimen, STRAT 1), 32µm, 45µm, 51µm (3 specimens, CKP6).

Remarks: Specimens recognised in this study are rare to obtain any detailed comparative analyses. The degree of variability displayed by forms assigned to this species was highlighted by Clarke (1965) and later discussed at detail by Millstead (1999). Interestingly, the present specimens indicate a remarkable similarity to the original figured specimens (p. 534; pl. 10, figs. 1, 3) of Potonié and Klaus (1954) that is highlighted by a transition from a specimen with a circular corpus to one with a longitudinally oval corpus.

Occurrence: STRAT 1, CKP6.

Previous records: South Africa; Permian (Anderson, 1977; Aitken, 1994; Millstead, 1999). Great Britain; Permian (Clarke, 1965). Germany; Late Permian (Potonié and Klaus, 1954).

Genus LUNATISPORITES Leschik *emend.* Mädler 1964

Type species: *Lunatisporites acutus* Leschik 1955 (by original designation)

Remarks: There is confusion and controversy surrounding usage of this genus owing to its close relationship to the genus *Taeniaesporites* Leschik 1955 because their type species are considered conspecific. A brief history on the relationship of the two genera has been discussed by several authors including Balme (1970) and Foster (1979) who hold different views and preference of usage. As a result specimens belonging to these genera have appeared in the literature by various authors (e.g. Jansonius, 1962; Hart, 1964, 1965; Archangelsky & Gamero, 1979; Foster, 1979; Marques-Toigo & Klepzig, 1995) under either of the genus. However, in this study, the views of Foster (1979) in which *Lunatisporites* is considered the senior synonym are followed; this is largely based on the consideration of Bharadwaj (1962) that *Taeniaesporites* is a junior synonym of *Lunatisporites*. Specimens described under the present genus are those characterized by wide longitudinal taeniae, generally four in number but may be more due to narrower subsidiary ones.

Lunatisporites nubilus (Leschik) *comb. nov.*

Plate 8, figure 1

1956 *Jugasporites nubilus* Leschik, p.133; pl. 21, fig. 14.

1962 *Striatites? nubilus* Jansonius, p. 69-70; pl. 14, fig. 20.

1965 *Taeniaesporites nubilus* (Leschik) Clarke, p. 336; pl.41, fig. 4.

1979 *Lueckisporites densicarpus* Archangelsky and Gamberro, p.450-451; pl.11, figs. 1-5.

Description: Pollen disaccate, taeniate. Amb strongly diploxylonoid. Corpus distinct, dark, circular, subcircular to slightly oval elongate in the longitudinal axis, discernible central striae or monolete mark; intexine 1.5 μ m. Proximal cap with hardly discernible to slightly discernible striations giving rise to approximately 4 to 5 longitudinal taeniae; infrastructure micro-reticulate or punctate. Sacci semi-circular to slightly more or less; infrastructure finely reticulate and punctate.

Dimensions: Total length; 65(80)100 μ m (6 specimens, STRAT 1). Saccus breadth; 40(55)65 μ m (6 specimens, STRAT 1), Saccus length; 28 μ m, 29 μ m, 31 μ m, 36 μ m (4 specimens, STRAT 1). Corpus breadth; 37 μ m, 39 μ m, 46 μ m (3 specimens, STRAT 1), Corpus length; 38(45)49 μ m (5 specimen, STRAT 1).

Remarks: The present specimens are characterized by a dark central body often making it difficult to discern striations and taeniae; as a result several specimens identical to the present specimens have been placed under different genera by most workers. A dumbbell-like outline (e.g. Jansonius, 1962; Clarke, 1965) also helps to distinguish this species.

Occurrence: STRAT 1.

Previous records: Great Britain; Late Permian (Clarke, 1965). Germany; Late Permian (Leschik, 1956). South America; Permian (Archangelsky and Gamberro, 1979).

Lunatisporites variesectus Archangelsky and Gamberro 1979

Plate 8, figure 2

1979 *Lunatisporites variesectus* Archangelsky and Gamberro, p.453-454; pl. 11, figs. 9-13.

Description: Pollen disaccate, taeniate. Amb strongly diploxylonoid. Corpus outline clearly distinct, subcircular to nearly subquadrangular, strongly undulating or corrugated at extreme ends due to termination of striations or taeniae; discernible bent monolete mark. Proximal cap with about five longitudinal taeniae; taeniae laterally irregular in outline due to curvilinear bounding striations. Sacci irregularly sub-circular in shape, bases sub-parallel and nearly touching.

Dimensions: Total length; 54(70)97 μ m (5 specimens, STRAT 1). Sacci breadth; 38(49)65 μ m (5 specimens, STRAT 1). Corpus breadth; 31(43)62 μ m (5 specimens, STRAT 1), Corpus length; 36 μ m, 45 μ m, 48 μ m, 57 μ m (4 specimens, STRAT 1).

Remarks: The present specimen differs from other forms of the genus in displaying irregular longitudinal taeniae some of which is bifurcating. The figured drawings in Kremp and Speckman (p.13-151, 1961) depicting the species *Pityosporites seawardi* from Virkki (1937) appear identical to the present specimen and could be equivalent.

Occurrence: STRAT 1.

Previous records: South America; Late Carboniferous to Early Permian (Archangelsky and Gamero, 1979; Playford and Dino, 2002).

Lunatisporites sp.

Plate 8, figures 3

Description: Pollen disaccate, taeniate. Amb moderate to slightly strongly diploxylonoid. Corpus well defined, subcircular with slight elongation in longitudinal axis of grain; center with discernible monolete mark occasionally enclosed within irregular cleft extending full diameter of corpus in longitudinal axis. Proximal cappa robust, divided into four longitudinal taeniae; micro-structure reticulate, punctate, vermiculate or granulate. Sacci semi-circular to larger than semi-circle in shape, distal attachment straight, leaving gap about 8 μ m - 12 μ m wide; infrastructure reticulate to vermiculate with puncta, occasionally radially arranged.

Dimensions: Total length; 67 μ m, 67 μ m, 74 μ m, 91 μ m (4 specimens, STRAT 1). Saccus breadth; 39 μ m, 41 μ m, 42 μ m, 45 μ m (4 specimens, STRAT 1). Corpus diameter; 31 μ m, 37 μ m, 39 μ m, 40 μ m (4 specimens, STRAT 1).

Remarks: The figured specimens (pl. 10, figs. 5, 7) assigned by Archangelsky and Gamero (1979) to *Lueckisporites stenotaeniatum* Menéndez 1976 are considered equivalent to the present specimens; the former clearly show more than two taeniae despite being described as having only two taeniae.

Occurrence: STRAT 1.

Previous records: South America; Late Permian (Archangelsky and Gamero, 1979).

Genus PROTOHAPLOXYPINUS Samoilovich *emend.* Morbey 1975

For synonymy see Foster 1979

Type species: *Pemphygaletes latissimus* Luber in Luber & Waltz 1941 (by designation of Samoilovich, 1953, p. 36).

Remarks: A brief history of this genus is well documented in Balme (1970), Foster (1979), and MacRae (1988). Specimens described under the present genus include those with dominantly haploxyelonoid to slightly diploxyelonoid amb, and with the proximal cap divided into six or more longitudinal taeniae.

Protohaploxypinus haigii Foster 1979

Plate 8, figure 4

1979 *Protohaploxypinus haigii* Foster, p. 88; pl.29, figs. 1-3.

Description: Pollen disaccate, taeniate. Amb haploxyelonoid to weakly diploxyelonoid. Corpus indistinct to distinct, oval with elongation in the longitudinal axis of the grain. Proximal cap with about 5 - 6 longitudinal taeniae. Sacci more than semi-circular; infrastructure punctate to vermiculate, and faint reticulate outlines with brochi 1 - 2 μ m wide.

Dimensions: Total length; 51 μ m, 70 μ m, 90 μ m (3 specimens, STRAT 1). Saccus breadth; 22 μ m, 31 μ m, 34 μ m (3 specimens, STRAT 1). Corpus breadth; 21 μ m, 37 μ m (2 specimens, STRAT 1), Corpus length; 31 μ m, 53 μ m (2 specimens, STRAT 1).

Remarks: The present specimens differ from other forms of the genus in having a pronounced elongation of the corpus in the longitudinal axis of the grain.

Occurrence: STRAT 1.

Previous records: Australia; Middle Permian (Foster, 1979).

Protohaploxypinus hartii Foster 1979

Plate 8, figure 5

1979 *Protohaploxypinus hartii*, pp. 88 – 89; pl. 30, figs. 1 – 4.

Description: Pollen disaccate, taeniate. Amb haploxyelonoid to weakly diploxyelonoid. Corpus distinct, sub-rectangular i.e. extreme ends flat to nearly so, longer sides convex; elongate in transverse axis of grain. Prominent exinal folds marginal to cappula or sacci attachment. Proximal cap with 6 – 11 longitudinal taeniae, regular to irregularly aligned, 3 - 5 μ m wide; infrastructure micro- reticulate to micro-punctate. Sacci semi-circular to slightly larger than semi-circular in outline, and may be joined by narrow lateral bladder; infrastructure punctate,

vermiculate or faintly reticulate with brochi 1 - 4µm wide. Cappula outline distinct to weakly discernible, rectangular to slightly oval, extend full dimension of corpus.

Dimensions: Total length; 57(80)112 (11 specimens, STRAT 1), 51(75)100µm (6 specimens, CKP6). Saccus breadth; 34(54)78µm (11 specimens, STRAT 1), 30µm, 39µm, 45µm, 73µm (4 specimens, CKP6), Saccus length; 20(32)46µm (6 specimens, STRAT 1). Corpus breadth; 31(45)65µm (7 specimens, STRAT 1), 53µm, 56µm (2 specimens, CKP6), Corpus length; 34(51)84µm (9 specimens, STRAT 1), 67µm, 84µm (2 specimens, CKP6).

Remarks: The present specimens are distinguished from other forms of the genus on the bases of a sub-rectangular corpus outline and a strong presence of exinal folds marginal to the cappula. The species *Protohaploxylinus chaloneri* (p.337-338; pl. 42, figs. 3-5), described by Clarke (1965), despite having a smaller size range show great similarity to the present species and is probably conspecific.

Occurrence: STRAT 1, CKP6.

Previous records: Australia; Permian (Foster, 1979). South America; Permian (Marques-Toigo & Klepzig, 1995).

Protohaploxylinus limpidus (Balme & Hennelly) Balme & Playford 1967
Plate 8, figure 6

1955 *Lueckisporites limpidus* Balme & Hennelly, p. 94; pl. 3, figs 29 – 32; pl. 4, figs 34 – 35.

1967 *Protohaploxylinus limpidus* (Balme & Hennelly) Balme & Playford, p. 185; pl. 1, fig. 15.

1977 *Pityosporites micros* (Hart) Anderson, p. 122; pl. 173, figs 1 – 47.

For additional synonymy see Foster (1979) and Millstead (1999).

Description: Pollen disaccate, taeniate. Amb haploxylinoid; oval elongate in longitudinal axis of grain. Corpus poorly distinct but generally discernible in outline; broadly oval elongate in transverse axis of grain. Proximal cap with 6 – 8 longitudinal taeniae, rarely branched and about 1 - 6µm wide; micro-infrareticulate to occasionally micro-granulate. Sacci semi-circular in outline, rarely joined; infrastructure finely reticulate with brochi 1-3µm wide, occasionally radial. Some degraded grains appear punctate to vermiculate in their entirety. Discernible narrow cappula, about ¼ to nearly ½ corpus breadth, with straight margins; exine faintly structured.

Dimensions: Total length; 41(55)70µm (11 specimens, STRAT 1), 45(59)76µm (10 specimens, CKP6). Saccus breadth; 29(38)50µm (11 specimens, STRAT 1),

29(39)45µm (10 specimens, CKP6), Saccus length; 27µm (1 specimen, STRAT 1). Corpus breadth; 27µm, 32µm (2 specimen, STRAT 1), 29µm (1 specimen, CKP6), Corpus length; 28µm, 32µm, 36µm, 45µm (4 specimens, STRAT 1), 34µm, 39µm (2 specimens, CKP6).

Remarks: The present specimens are distinguished from other forms of the genus in having a haploxytonoid oval amb with a relatively pronounced elongation in the longitudinal axis.

Occurrence: STRAT 1, CKP6, ME58, NATA, TLMB.

Previous records: Commonly found with Permian palynofloras of Gondwana continents (e.g. Anderson, 1977; Foster 1975, 1979; MacRae, 1988; Millsted, 1999 etc.).

Protohaploxylinus perexiguus (Bharadwaj and Salujha) Foster 1979
Plate 8, figure 7

For synonymy see Foster (1979)

Description: Pollen disaccate, taeniate. Amb haploxytonoid to slightly diploxytonoid, subcircular to oval. Corpus distinct, darker, oval elongate in transverse axis of grain; infrastructure punctate, finely reticulate and vermiculate. Proximal surface with about 8 – 10 longitudinal taeniae separated by narrow rather faint clefts or striations. Sacci about semi-circular in shape, either touching or linked by lateral bladder; infrastructure punctate or vermiculate. Cappula with one end constricted and the other fan-shaped, margins outlined by strong transverse exinal folds.

Dimensions: Total length; 69µm, 73µm (2 specimens, STRAT 1). Saccus breadth; 60µm, 67µm (2 specimens, STRAT 1). Corpus breadth; 46µm, 50µm (2 specimens, STRAT 1), Corpus length; 49µm, 67µm (2 specimens, STRAT 1).

Remarks: MacRae (1988) highlights the similarities between the present species and *Protohaploxylinus goraiensis* (Potonié and Lele) Hart 1964 and acknowledges the difficulties involving their classification. In this study *P. perexiguus* is separated based on a smaller size range as originally indicated in Bharadwaj and Salujha (1965). In addition, *P. perexiguus* seem to indicate a slightly more distinct corpus in comparison to *P. goraiensis*.

Occurrence: STRAT 1.

Previous records: Australia; Permian (Rigby and Hekel, 1977; Foster, 1979). India; Permian (Bharadwaj, 1962; Bharadwaj and Salujha, 1965). South Africa; Permian (Anderson, 1977). DR-Congo; Permian (Kar and Bose, 1976).

Protohaploxylinus rugatus Segroves 1969

Plate 8, figure 8

- 1969 *Protohaploxylinus rugatus* Segroves, pp. 200 – 201; pl. 7, figs. G – H; pl. 9, figs. D – I.
1977 *Pityosporites goraiensis* (Potonié and Lele) Anderson, p. 119; pl.154, fig. 49; pl. 156, figs. 30-31.

Description: Pollen disaccate, taeniate. Amb haploxylinoid to slightly diploxylinoid, slightly oval elongate in transverse axis of grain. Corpus distinct, broadly oval elongate in transverse axis of grain, short sides may be slightly flattened; infrastructure laevigate to rarely punctate. Proximal surface with approximately 10 longitudinal taeniae. Sacci largely distally confined, only marginally exposed, less than semi-circular in outline; infrastructure finely reticulate or vermiculate to grana or just rarely punctate in some specimens. Cappula sub-rectangular, extend full length of corpus, sides well-defined by distinct transverse folds; slightly widens at lateral extremities.

Dimensions: Total length; 39 μ m, 42 μ m (2 specimens, STRAT 1), 65 μ m (1 specimen, CKP6). Saccus breadth; 41 μ m (1 specimen, STRAT 1), 59 μ m (1 specimen, CKP6). Corpus breadth; 36 μ m (1 specimens, STRAT 1), Corpus length; 40 μ m (1 specimen, STRAT 1).

Remarks: The present specimens are distinguished in having a roundly oval elongate haploxylinoid amb in which the sacci is largely confined to the distal surface, beneath the corpus, with only a marginal rim exposed. The latter feature is comparable to a limboid sacci margin described in Foster (1979) for the specimens (pl. 33, figs. 5 – 6) assigned to the present species.

Occurrence: STRAT 1, CKP6, ME58.

Previous records: Australia; Permian (Foster, 1979; Rigby & Hekel, 1977). South Africa; Permian (Anderson, 1977).

Protohaploxylinus sp.

Plate 8, figure 9

Description: Pollen disaccate, taeniate. Amb haploxylinoid, subcircular to broadly oval. Corpus poorly distinct, outline broadly oval with elongation in transverse axis of the grain; some specimens bearing trilete marks. Proximal cap with about 6 – 9 relatively regular longitudinal taeniae separated by very fine striations; taeniae with well-defined curvi-linear terminations. Sacci crescentic to almost semi-circular in shape; infrastructure reticulate, brochi fine to moderate 1 – 3. Cappula sub-rectangular; narrow distal sulcus partially constricted at center, fan-shaped at one or both ends.

Dimensions: Total length; 54µm, 57µm (2 specimens, STRAT 1), 37µm, 49µm, 95µm, 96µm (4 specimens, CKP6). Saccus breadth; 49µm, 53µm (2 specimens, STRAT 1), 38µm, 45µm, 75µm, 76µm (4 specimens, CKP6), Saccus length; 18µm, 24µm (STRAT 1). Corpus breadth; 40µm, 42µm (2 specimens, STRAT 1), Corpus length; 50µm, 53µm (2 specimens, STRAT 1).

Remarks: The present specimens differ from similar forms of the genus in having a trilete mark.

Occurrence: STRAT 1, CKP6.

Genus STRIATOABIEITES Zoricheva & Sedova *ex* Sedova *emend.* Hart 1964

Type species: *Striatoabieites brickii* Sedova 1956 (by subsequent designation of Sedova, 1956).

Striatoabieites multistriatus (Balme & Hennelly) Hart 1964
Plate 8, figure 10

1955 *Luckisporites multistriatus* Balme & Hennelly, p. 93; pl. 2, figs. 16 – 20.

For additional synonymy see Foster (1979) and Millstead (1999).

Description: Pollen disaccate, multistriate or taeniate. Amb haploxyelonoid to weakly diploxyelonoid. Corpus distinct, circular to broadly oval, commonly with elongation in the longitudinal axis of the grain. The proximal face consists of 14 – 16 longitudinal taeniae extending full extent of corpus and divided by significantly narrow striations. Sacci crescentic to semi-circular in outline, distinctively distally inclined, base length less than transverse axis of corpus; infrasculpture very finely reticulate, vermiculate and punctate. Cappula poorly distinct; discernible in rare specimens as wide, a little over $\frac{1}{3}$ of corpus, and rectangular in outline.

Dimensions: Total length; 41µm, 53µm, 55µm, 64µm (4 specimens, STRAT 1). Saccus breadth; 27µm, 27µm (2 specimens, STRAT 1). Corpus breadth; 36µm, 37µm (2 specimens, STRAT 1), Corpus length; 42µm, 45µm (2 specimens, STRAT 1).

Remarks: The present specimens are distinguished on the basis of a multistriated proximal surface and sacci that is much smaller and distally inclined in relation to the corpus.

Occurrence: STRAT 1, CKP6.

Previous records: Australia; Late Carboniferous to Late Permian (Balme & Hennelly, 1955; Foster, 1975, 1979; Rigby & Hekel, 1977). South Africa; Late Carboniferous to Late Permian (Anderson, 1977; MacRae, 1988; Millsted, 1999).

Genus STRIATOPODOCARPITES Zoricheva & Sedova *ex* Sedova *emend.* Hart 1964

Type species: *Striatopodocarpites tojmensis* Sedova 1956 (by subsequent designation of Sedova, 1956).

Striatopodocarpites cancellatus (Balme & Hennelly) Hart 1963
Plate 8, figure 11

1955 *Lueckisporites cancellatus* Balme & Hennelly, pp. 92 – 93; pl. 2, figs. 11 – 15.

1963 *Striatopodocarpites cancellatus* (Balme & Hennelly) Hart, p. 10.

1965 *Striatopodocarpites cancellatus* (Balme & Hennelly) Clarke, p. 339; pl. 43, fig. 2.

For additional synonymy see Balme (1970) and Foster (1979).

Description: Pollen disaccate, taeniate. Amb diploxyloid. Corpus distinct, subcircular to rarely elongate in transverse or longitudinal axis. Proximal cap with 7 – 10 longitudinal taeniae, regular to occasionally wedge shaped; finely structured with micro-reticulate and punctate, or granulate. Sacci greater than semi-circle in outline, distally inclined; infrastructure fine to moderately reticulate with brochi about 1 - 3µm wide. Cappula poorly defined but appear parallel-sided, breadth $\frac{1}{5}$ to $\frac{1}{3}$ of corpus.

Dimensions: Total length; 35(44)65µm (8 specimens, STRAT 1), 49µm, 56µm, 66µm, 80µm (4 specimens, CKP6). Saccus breadth; 20(28)42µm (9 specimens, STRAT 1), 32µm, 32µm, 34µm, 39µm (4 specimens, CKP6), Saccus length; 29µm (1 specimen, STRAT 1). Corpus breadth; 17(21)29µm (5 specimens, STRAT 1), 22µm, 28µm (2 specimens, CKP6), Corpus length; 17(26)39µm (9 specimens, STRAT 1), 26µm, 26µm, 34µm, 45µm (4 specimens, CKP6).

Remarks: *Striatopodocarpites gondwanensis* Lakhanpal, Sah & Dube 1960 appear very similar to the present species but has a much larger size.

Occurrence: STRAT 1, CKP6.

Previous records: Widely reported from the Permian of Gondwana (Balme & Hennelly, 1955; Balme, 1970; Anderson, 1977; Foster, 1979; MacRae, 1988; Millsted, 1999).

Striatopodocarpites fusus (Balme & Hennelly) Potonié 1958
Plate 8, figure 12

1955 *Lueckisporites fusus* Balme & Hennelly, p. 92; pl. 1, figs 6 – 10.

1958 *Striatopodocarpites fusus* (Balme & Hennelly) Potonié, p. 54.

For additional and extensive synonymy see Foster (1975, 1979) and Millsted (1999).

Description: Pollen disaccate, taeniate. Amb strongly diploxylonoid. Corpus distinct, dark, circular to subcircular and oval elongate in transverse axis of grain; exoexine 1 - 2µm thick. Proximal cap with approximately 5 – 11 longitudinal taeniae, 2 – 3µm wide; finely infrapunctate or unstructured. Sacci extremely large, greater than semi-circular in outline, distal attachment convex to straight and often touching at middle or leaving a narrow gap; finely reticulate with brochi 2µm wide, radially arranged near base. Cappula constricted or slit-like to very narrow, of the order of $\frac{1}{10}$ of corpus.

Dimensions: Total length; 44(49)57µm (6 specimens, STRAT 1), 45(62)90µm (9 specimens, CKP6). Saccus breadth; 30(34)40µm (6 specimens, STRAT 1), 31(40)56µm (9 specimens, CKP6), Saccus length; 20µm, 22µm (2 specimens, STRAT 1). Corpus breadth; 19µm, 20µm, 21µm, 26µm (4 specimens, STRAT 1), 24µm, 24µm, 28µm (3 specimens, CKP6), Corpus length; 20(26)32µm (6 specimens, STRAT 1), 18µm, 28µm, 29µm (3 specimens, CKP6).

Remarks: The present specimens are distinguished from other forms of the genus in having a very strongly diploxylonoid amb with sacci much greater than semi-circular and distally inclined with attachment in the polar region.

Occurrence: STRAT 1, CKP6.

Previous records: Wide occurrence in the Permian of Gondwana (e.g. Balme & Hennelly, 1955; Bharadwaj, 1962; Bharadwaj and Salujah, 1964; Anderson, 1977; Foster, 1975; 1979; MacRae, 1988; Marques-Toigo & Klepzig, 1995; Millsted, 1999).

Striatopodocarpites pantii (Jansonius) Balme 1970
Plate 8, figure 13

1970 *Striatopodocarpites pantii* (Jansonius) Balme, p. 368 – 369; pl. 12, figs 7 – 9.

For additional synonymy see Balme (1970)

Description: Pollen disaccate, taeniate. Amb weak to moderately diploxylonoid. Corpus distinct, sub-circular to oval with elongation in the transverse axis of

grain; crescentic transverse folds associated with sacci bases. Proximal cap typically divided by longitudinal and oblique striations into approximately 6 – 9 taeniae, striations occasionally broader than usual; infrastructure punctate, micro-vermiculate and reticulate. Sacci slightly greater than semi-circular in outline; infrastructure finely reticulate, brochi 1-2µm wide.

Dimensions: Total length; 50(70)109µm (6 specimens, STRAT 1). Saccus breadth; 30(47)70µm (6 specimens, STRAT 1), Saccus length; 40µm (1 specimen, STRAT 1). Corpus breadth; 24(33)50µm (5 specimens, STRAT 1), Corpus length; 30(39)65µm (5 specimens, STRAT 1).

Remarks: The present specimens are distinguished from other forms of the genus in having oblique striations sub-parallel to the longitudinal axis of the grain.

Occurrence: STRAT 1.

Previous records: Pakistan; Permian (Balme, 1970). South Africa; Permian (MacRae, 1988; Aitken, 1994).

Striatopodocarpites rarus (Bharadwaj & Salujha) Balme 1970
Plate 8, figure 14

1964 *Lahirites rarus* Bharadwaj & Salujha, pp. 206 – 207; pl. 9, figs 128 – 130; text-fig. 6.

1970 *Striatopodocarpites rarus* (Bharadwaj & Salujha) Balme, pp. 367 – 368; pl. 12, figs 10 - 12.

For additional synonymy see Foster (1979)

Description: Pollen disaccate, taeniate. Amb moderate to strongly diploxylonoid. Corpus distinct, sub-circular to oval with elongation in the transverse axis, with extreme ends tending to flattening; displays crescentic transverse exinal folds. Proximally with 5 - 8 or more longitudinal taeniae, parallel to wedge-shaped and generally poorly defined; punctate or micro-vermiculate. Sacci larger than semicircle in outline, discreet, distal attachment commonly concave; infrastructure reticulate, brochi 1-2µm wide, weakly radially arranged. Cappula sub-rectangular, about $\frac{1}{3}$ breadth of corpus.

Dimensions: Total length; 63(83)112µm (5 specimens, STRAT 1), 100µm (1 specimen, CKP6). Saccus breadth; 44(57)67µm (6 specimens, STRAT 1), 59µm (1 specimen, CKP6), Saccus length; 31µm, 36µm, 37µm (3 specimens, STRAT 1). Corpus breadth; 27(38)56µm (5 specimens, STRAT 1), 45µm (1 specimen, CKP6), Corpus length; 35(48)59µm (5 specimens, STRAT 1), 53µm (1 specimen, CKP6).

Remarks: The present specimens are distinguished from other forms of the genus in having pronounced corpus elongation in the transverse axis as well as a moderate to strong diploxylonoid amb.

Occurrence: STRAT 1, CKP6, CKP9, ML1.

Previous records: Australia; Permian (Foster, 1979). India; Permian (Bharadwaj and Salujah, 1964). Pakistan; Early Permian (Balme, 1970). South Africa; Late Carboniferous to Late Permian (MacRae, 1988). South America; Permian (Marques-Toigo & Klepzig, 1995).

Turma **PLICATES** Naumova *emend.* Potonié 1960

Subturma **COSTATES** Potonié 1970

Infraturma **COSTATI** Jansonius 1962

Genus **EPHEDRIPITES** Bolkhovitina ex Potonié 1958

Type species: *Ephedripites mediolobatus* Bolkhovitina 1953 (by subsequent designation of Potonié 1958).

Remarks: A brief history surrounding this genus is given in Balme (1970), highlighting its valid publication by Potonié (1958) after selection of a type species and provision of a generic diagnosis. Due to inadequate specimens observed in this study, in addition to their poor preservation, it has not been possible to definitively differentiate some specimens of this genus from those of the genus *Gnetaceaepollenites* Thiergart 1938 with which it has a close morphological form. However, following the views of Balme and Playford (1967) specimens described under the present genus are those that indicate subdivision of the exine into narrow and regularly spaced taeniae-like ribs separated by well-defined clefts. In addition, Foster's (1979) illustrative diagram (p. 80, fig. 21) provides a useful comparison.

Ephedripites sp.

Plate 9, figure 1

Description: Pollen polylicate. Amb oval elongate. Exoexine divided into 5 – 8 taeniae-like ribs, 1 - 3µm wide, variably infrasculptured i.e. minutely granulate, punctate, reticulate, vermiculate, or structureless; sculpturing seems to represent various levels of preservation. Some specimens occasionally display a slightly more distinct, relatively wider, central cleft; probably incipient colpus.

Dimensions: Length; 31(43)49µm (7 specimens, STRAT 1), 40µm (1 specimen, CKP6). Breadth; 16(24)31 (7 specimens, STRAT 1), 17µm (1 specimen, CKP6).

Remarks: The present specimens are distinguished from similar forms in having relatively regularly spaced taeniae-like ribs clearly separated by distinct narrow clefts. The figured specimens (pl. 5, figs. 88-91) placed by Bharadwaj (1962) under the genus *Welwitschiapites* Bolkhovitina 1953 have striking similarities with the present specimens and are considered equivalent. *Ephedripites* sp. (p.112; pl. 28, fig. 15 and pl.34, figs.5-6) described by Bose and Kar (1966) is also considered equivalent to the present specimens.

Occurrence: STRAT 1, CKP6.

Previous records: Congo-DR; Permian (Bose and Kar, 1966). India; Permian (Bharadwaj, 1962).

Ephedripites sp. A

Plate 9, figure 2

Description: Pollen plicate. Amb oval elongate; generally pointed at extreme ends. Exoexine divided into 6 – 8 weakly defined taeniae-like ribs, separated by faint or poorly distinct but discernible clefts. Infrasculpture granulate or punctate. Discernible narrow or constricted colpus, extend total length.

Dimensions: Length; 58(60)65 μ m (9 specimens, STRAT 1), 42(54)62 μ m (12 specimens, CKP6). Breadth; 21(27)40 μ m (9 specimens, STRAT 1), 18(25)32 μ m (12 specimens, CKP6).

Remarks: The present specimens differ from *Ephedripites* sp. in its weak display of taeniae-like ribs as well as a larger size range. Several of the specimens considered here have forms that appear very similar to specimens of the genus *Cycadopites* Wodehouse 1933 except that they do indicate weak but discernible plicae.

Occurrence: STRAT 1, CKP6, CKP9, KGO3.

Genus VITTATINA Luber ex Samoilovich *emend.* Wilson 1962

Type species: *Vittatina subsaccata* Samoilovich ex Wilson 1962 (by designation of Wilson, 1962).

Remarks: The character of this genus has been discussed in the past by various authors amongst them Jansonius (p. 73-74, 1962), Wilson (p.24-25, 1962) and Clarke (p.340-341). In this study specimens that indicate what seem like under-developed sacci or rudimentary sacci (e.g. Jansonius, 1962; Clarke, 1965) have been included in the present genus.

Vittatina densa Anderson 1977

Plate 9, figure 3

1977 *Vittatina densa* Anderson, p. 107; pl. 132, figs 1 – 39.

Description: Pollen striate. Amb sub-circular to broadly oval. Proximal surface with about 12 – 15 longitudinal taeniae, some wedge-shaped and discontinuous or terminating in middle of grain; weakly micro-granulate to rarely infrapunctate or unstructured. Distal face indicate rare faint striations or taeniae perpendicular to those on proximal face.

Dimensions: Length; 44 μ m, 45 μ m (2 specimens, STRAT 1). Breadth; 38 μ m (1 specimen, STRAT 1).

Remarks: There appears to be a close similarity between the present specimens and the specimens (pl. 3, fig. 11) assigned by Wilson (1962) to *Vittatina lata*, however the latter species have a larger size range and fewer proximal longitudinal taeniae.

Occurrence: STRAT 1.

Previous records: South Africa; Late Permian (Anderson, 1977).

Vittatina foveolata Tschudy and Kosanke 1966

Plate 9, figure 4

1966 *Vittatina foveolata* Tschudy and Kosanke, p. 62; pl. 1, figs. 11-13.

Description: Pollen taeniate. Amb sub-circular or broadly oval. Proximal face with about 12 – 19 longitudinal taeniae, 1 - 3 μ m wide; taeniae strongly tapers at both ends and converge at extreme ends of grain. Faint but discernible transverse distal keel at center of grain, also faint striations.

Dimensions: Length; 38 μ m, 41 μ m (2 specimens, STRAT 1), 50 μ m (1 specimen, CKP6). Breadth; 28 μ m, 36 μ m (2 specimens, STRAT 1), 37 μ m (1 specimen, CKP6).

Remarks: The present specimens are distinguished from other forms of the genus in having a central distal keel as well as taeniae that tapers and converge at the extreme ends of the grains.

Occurrence: STRAT 1, CKP6.

Previous records: North America; Early Permian (Tschudy and Kosanke, 1966).

Vittatina scutata (Balme & Hennelly) Bharadwaj 1962
Plate 9, figure 5

1956 *Marsupipollenites scutatus* Balme & Hennelly, p. 62; pl. 2, figs. 38 – 41.

1962 *Vittatina scutata* (Balme & Hennelly) Bharadwaj, p. 100.

Description: Pollen striate. Amb oval but extreme ends commonly folded and flapped inwards, giving rise to a colpus-like feature in the middle of the grain. Approximately 10 – 20 taeniae perpendicular to long axis of grains, commonly segmented to give verrucate ornamentation.

Dimensions: Length; 36(44)55µm (7 specimens, STRAT 1), 36µm, 38µm, 39µm (3 specimens, CKP6). Breadth; 21(26)35µm (7 specimens, STRAT 1), 28µm, 29µm, 31µm (3 specimens, CKP6).

Remarks: Almost all specimens described under the present species are folded over at the lateral margins, a feature seemingly characteristic, however creating problems of incomplete dimensions.

Occurrence: STRAT 1, CKP6, CKP9.

Previous records: Australia; Permian (Balme & Hennelly, 1956; Backhouse, 1991).
India; Permian (Bharadwaj, 1962).

Vittatina minima Jansonius 1962
Plate 9, figure 6

1962 *Vittatina minima* Jansonius, p. 74; pl. 15, figs. 11-14.

Description: Pollen taeniate. Amb roundly oval with slight elongation in longitudinal axis of grain. Corpus distinct in rare specimens, commonly indistinctive, sub-circular to slightly oval elongate in longitudinal axis of grain. Proximal face with 6 – 10 longitudinal taeniae extending full extent of corpus; infrastructure laevigate to scabrate or punctate. Distal face micro-granulate. Sacci hardly discernible, only outline of dark image with straight possible sacci bases in the distal face. Discernible outline of cappula, about $\frac{1}{3}$ of corpus. Grains surrounded by a distinctive thickened equatorial rim, smooth to etched and punctate.

Dimensions: Length; 26(32)38µm (8 specimens, STRAT 1), 38µm (1 specimen, CKP6). Saccus breadth; 20(27)32µm (8 specimens, STRAT 1), 31µm (1 specimen, CKP6), Saccus length; 9µm (1 specimen, STRAT 1). Corpus breadth; 18µm (1 specimen, STRAT 1), Corpus length; 20µm (1 specimen, STRAT 1).

Remarks: The present specimens differ from *Vittatina saccifer* in having a smaller size range and a slightly broader equatorial rim.

Occurrence: STRAT 1, CKP6.

Previous records: Canada; Permian to Early Triassic (Jansonius, 1962).

Vittatina saccifer Jansonius 1962

Plate 9, figure 7

1962 *Vittatina saccifer* Jansonius, p. 74; pl. 15, figs. 15-17, 22-24.

Description: Pollen taeniate. Amb haploxytonoid, oval elongate in the longitudinal axis; rarely elongate in the transverse axis. Corpus distinct to indistinct, broadly oval with elongation in the longitudinal axis of the grain; rare specimens with poorly defined central tetrad mark, trilete or monolete. Proximal face with about 6 to 16 longitudinal taeniae, about 2 - 4µm wide; laevigate to rarely punctate. The sacci are very small and hardly distinctive, crescentic in outline, appear to be at an incipient stage of development; infrapunctate, reticulate or vermiculate. Discernible outline of cappula, rectangular, about $\frac{1}{3}$ to $\frac{1}{2}$ of corpus. A characteristic thickened equatorial rim surrounds grain in plan view, but may also appear much narrower or discontinuous along the straight or longer margins of the grains; infrastructure smooth or laevigate in the better preserved grains to etched, scabrate, or punctate in the relatively degraded specimens.

Dimensions: Length; 34(48)64 (12 specimens, STRAT 1), 40(44)50 (5 specimens, CKP6). Saccus breadth; 29(39)45 (11 specimens, STRAT 1), 32(37)45 (5 specimens, CKP6), Saccus length; 6µm, 13µm (2 specimens, STRAT 1). Corpus breadth; 39µm (1 specimens, STRAT 1), Corpus length; 38µm, 54µm (2 specimens, STRAT 1).

Remarks: The present specimens are distinguished by a roundly oval amb with hardly distinctive sacci and a pronounced equatorial rim.

Occurrence: STRAT 1, CKP6.

Previous records: Canada; Permian (Jansonius, 1962)

Vittatina subsaccata Samoilovich 1953

Plate 9, figure 8

1953 *Vittatina subsaccata* Samoilovich, p. 44; pl. 9, figs. 4a, b.

1977 *Vittatina fasciolata* (Balme and Hennelly) Anderson, p. 108; pl. 133, fig. 42.

Description: Pollen striate. Amb roundly oval. Proximal face with 11 – 14 longitudinal taeniae, 2 - 3µm wide; taeniae regular and appear to extend entire

proximal face, surrounded by distinct equatorial rim Possibility of distal transverse striations or taeniae at center of grain, however obscured as grain fractured in same zone.

Dimensions: Length; 53µm (1 specimen, STRAT 1), 51µm, 57µm (2 specimens, CKP6). Breadth; 37µm (1 specimen, STRAT 1), 36µm, 39µm (2 specimens, CKP6).

Remarks: The present specimen is distinguished from other forms in having a roundly oval amb with regular about 11 – 14 proximal longitudinal taeniae extending entire grain.

Occurrence: STRAT 1, CKP6.

Previous records: Russia; Early Permian (Samoilovich, 1953). South Africa; Early Permian (Anderson, 1977).

Vittatina sp.

Plate 9, figures 9-10

Description: Pollen striate. Amb oval elongate to sub-circular or broadly oval. Proximal surface with about 11 – 19 taeniae perpendicular or oblique to long axis of grain, 1 - 3µm wide; infrastructure finely granulate and punctate. Distally with 3 narrow grooves or sulcus, sharply tapered at either ends, and parallel to long axis of grain; one situated in the middle or pole, and two equatorial or sub-equatorial. Some specimens with a narrow distinct equatorial rim, finely infrapunctate.

Dimensions: Length; 40µm, 46µm, 59µm, 63µm (4 specimens, STRAT 1), 35µm, 47µm, 48µm, 50µm (4 specimens, CKP6). Breadth; 36µm, 39µm, 50µm (3 specimens, STRAT 1), 31µm, 45µm, 48µm (3 specimens, CKP6).

Remarks: The present specimens are distinguished from other forms of the genus in having 1 - 3 narrow and sharply distinct distal sulcus situated on the pole and equatorial regions. *Vittatina costabilis* (Wilson) Tschudy and Kosanke 1966 is distinguished in having taeniae or costae parallel the long axis of the grain. The specimen (pl. 1, fig. 10) referred to as *Vittatina* sp. B by Tschudy and Kosanke (1966) is considered an equivalent of the present specimens. Marques-Toigo and Klepzig (1995) also described an equivalent specimen (p.137), which they assigned to *Vittatina costabilis* (Wilson) emend. Tschudy and Kosanke 1966. Similarly Souza and Marques-Toigo (2005) had an equivalent specimen (Fig. 2f) assigned to *Vittatina costabilis*.

Occurrence: STRAT 1, CKP6.

Previous records: South America; Permian (Marques-Toigo & Klepzig, 1995). North America; Early Permian (Tschudy and Kosanke, 1966).

***Vittatina* sp. A**

Plate 9, figure 11

Description: Pollen striate. Amb oval elongate. Proximal face with approximately 6 - 10 longitudinal taeniae, about 3µm wide; irregular or wedge-shaped and discontinuous across face. Possible monolete mark; wide, irregular, roof-shaped.

Dimensions: Length; 35µm (1 specimen, STRAT 1), 48µm (1 specimen, CKP6). Breadth; 24µm (1 specimen, STRAT 1), 39µm (1 specimen, CKP6).

Remarks: The present specimens differ from other forms of the genus in having a pronounced oval elongate amb with relatively wider and irregular taeniae about 3µ wide. The specimens (pl. 127, fig. 8) assigned by Anderson (1977) to *Vittatina nonsaccata* appear very similar to the present specimens. *Vittatina vittifer* (Luber) forma *minor* and *Vittatina vittifer* (Luber) forma *cinctutus* (Samoilovich, 1953; p.45 – 46) bare some resemblance to the present specimens and may be equivalent.

Occurrence: STRAT 1, CKP6.

Genus WEYLANDITES Bharadwaj & Srivastava 1969

For synonymy see Foster (1979)

Type species: *Weylandites lucifer* (Bharadwaj & Salujha) Foster 1975 (originally designated as *Weylandites indicus* Bharadwaj & Srivastava, 1969).

Remarks: The history of this genus is well-explained in Foster (1979) and MacRae (1988) following the comprehensive account of Balme (1970) on the genus *Paravittatina* Balme 1970, ultimately considered a junior synonym of *Weylandites* Bharadwaj & Srivastava 1969. Specimens considered under the present genus are those that exhibit continuous proximal to distal taeniae or striations at perpendicular orientations on the respective faces.

Weylandites lucifer (Bharadwaj & Salujha) Foster 1975

Plate 9, figure 12

1964 *Decussatisporites lucifer* Bharadwaj & Salujha, p. 213; pl. 12, figs 169, 171.

1966 *Vittatina africana* Hart, pp. 38 – 41; text-figs. 2 – 10.

1969 *Weylandites indicus* Bharadwaj & Srivastava, p. 136; pl. 28, figs. 91 – 93.

- 1970 *Paravittatina lucifer* (Bharadwaj & Salujha) Balme, pp. 411 – 412; fig. 14; pl. 21, figs. 19 – 22.
1975 *Weylandites lucifer* (Bharadwaj & Salujha) Foster, p. 153; pl. 7, fig. 2.

For additional synonymy see Foster (1979).

Description: Pollen taeniate. Amb circular to sub-circular; occasionally broadly oval. Taeniae and striations continuous from the proximal to the distal surface; attains perpendicular orientation to each other at the junction between distal and proximal surfaces, and produces cross-cutting pattern with rectangular blocks. Proximal taeniae or striations aligned parallel to the sulcus. Taeniae locally weakly infrapunctate or unstructured. Sulcus distinct in some specimens, extend across entire grain, constricted at center; may display sharply distinct marginal folds.

Dimensions: Length; 27(34)40 μ m (10 specimens, STRAT 1), 56 μ m, 56 μ m (2 specimens, CKP6). Breadth; 24(29)36 μ m (9 specimens, STRAT 1), 35 μ m, 40 μ m (2 specimens, CKP6).

Remarks: The present specimens are distinguished from other similar forms of the genus in displaying sharp and closely spaced striations indicating a cross-hatching pattern.

Occurrence: STRAT 1, CKP6, KGO3.

Previous records: Africa; Permian (Hart, 1966; Anderson, 1977; MacRae, 1988; Millstead, 1999). Australia; Permian (Foster, 1975, 1979; Backhouse, 1991). India; Permian (Bharadwaj and Salujah, 1964).

Weylandites magmus (Bose and Kar) Backhouse 1991
Plate 9, figure 13

- 1966 *Decussatisporites magmus* Bose and Kar, p. 120; pl. 28, figs. 7-9.
1977 *Vittatina magma* (Bose and Kar) Anderson, p.106; pl. 130, figs. 55-62; pl.131, figs. 1-43.
1991 *Weylandites magmus* (Bose and Kar) Backhouse, p. 295; pl. 20, figs. 4-7.
1994 *Weylandites cincinnatus* (Luber ex. Varyukhina) Utting, p. 60-61; pl. 8, figs.15-16.

Description: Pollen taeniate. Amb sub-circular to oval with slight elongation parallel to a distal sulcus. Exine 0.5 – 1.5 μ m thick. Proximal surface with 10 – 16 taeniae, perpendicular to sulcus, 1 - 4 μ m wide; taeniae continuous on the distal surface, wedge-shaped or discontinuous and much wider, with reduced numbers. Sulcus distinct, extend entire grain long axis, slightly constricted at center, rarely funnel-shaped.

Dimensions: Length; 39(46)53 μ m (15 specimens, STRAT 1), 36(52)64 μ m (5 specimens, CKP6). Breadth; 28(39)52 μ m (15 specimens, STRAT 1), 34(37)45 μ m (5 specimens, CKP6).

Remarks: The present specimens differ from *Weylandites lucifer* in having fewer and broader taeniae on the distal surface.

Occurrence: STRAT 1, CKP6, CKP9, KGO3, ML1, TLMB.

Previous records: South Africa; Permian (Anderson, 1977). Australia; Permian (Backhouse, 1991). Canada; Late Permian (Utting, 1994). Congo-DR; Permian (Bose and Kar, 1966).

Subturma **STRIATICOLPATES** Bose & Kar 1966

Genus **PAKHAPITES** Hart 1965

1965 *Pakhapites* Hart, p. 104.

1966 *Fusacolpites* Bose & Kar, pp. 117 – 118; text-fig. 14B.

1968 *Striasulcites* Venkatachala & Kar, p. 164.

Type species: *Pakhapites fasciolatus* (Balme and Hennelly) Hart 1965 (by original designation).

Remarks: A brief history of the present genus and its relationship to *Fusacolpites* Bose & Kar 1966 and *Striasulcites* Venkatachala & Kar 1968 is outlined in Palyford and Dino (2000, 2002), and their view is followed in this study.

Pakhapites fusus (Bose and Kar) Menéndez 1971

Plate 9, figure 14

1966 *Fusacolpites fusus* Bose and Kar, p. 118-119; pl. 28, figs. 10-12.

1971 *Pakhapites fusus* (Bose and Kar) Menéndez, p. 297; pl. 6, fig. 7.

Description: Pollen monocolpate, taeniate. Amb longitudinally oval. Exine 1 – 1.5 μ m thick, infrapunctate or laevigate; divided into 10 – 14 transverse taeniae, 1 - 2 μ m wide. Colpus extending full length of grain, centrally constricted, margins occasionally overlapping, fan-shaped at both extremities.

Dimensions: Length; 32(38)47 μ m (12 specimens, STRAT 1), 24 μ m, 42 μ m, 45 μ m (2 specimens, CKP6). Breadth; 19(27)34 μ m (12 specimens, STRAT 1), 15 μ m, 31 μ m, 32 μ m (3 specimens, CKP6).

Remarks: The present specimens are distinguished from other forms of the genus in having a slightly narrower breadth and a characteristically constricted colpus in the polar region where the margins commonly touch or slightly overlap.

Occurrence: STRAT 1, CKP6.

Previous records: South America; Permian (Menéndez, 1971; Marque-Toigo and Klepzig, 1995; Playford and Dino, 2000, 2002). Congo-DR; Permian (Bose and Kar, 1966).

Pakhapites ovatus (Bose and Kar) Menéndez 1971
Plate 9, figure 15

1966 *Fusacolpites ovatus* Bose and Kar, p. 119-120; pl.28, figs. 13-14.

Description: Pollen monocolpate, taeniate. Amb broadly oval to nearly sub-circular. Exine 1 – 1.5 μ m thick, infrapunctate; divided into 10 – 18 transverse taeniae, 1 – 3 μ m wide. Colpus extending full length of grain, margins smooth, wide (22 μ m) to characteristically narrowed (8 μ m) in the middle.

Dimensions: Length; 38(42)47 μ m (7 specimens, STRAT 1), 36 μ m, 39 μ m (2 specimens, CKP6). Breadth; 30(35)44 μ m (7 specimens, STRAT 1), 26 μ m, 37 μ m (2 specimens, CKP6).

Remarks: The present specimens are distinguished from *Pakhapites fusus* in having a slightly broad breadth, leading to a broadly oval and occasionally sub-circular amb.

Occurrence: STRAT 1, CKP6.

Previous records: South America; Permian (Marques-Toigo and Klepzig, 1995; Playford and Dino, 2000). Congo-DR; Permian (Bose and Kar, 1966).

Subturma **PRAECOLPATES** Potonié & Kremp 1954

Genus **GNETACEAEPOLLENITES** Thiergart 1938

Type species: *Gnetaceaepollenites ellipticus* Thiergart 1938 (by subsequent designation in Potonié, 1958).

Remarks: The views of MacRae (1988) are followed in this study, in which the genus *Praecolpatites* Bharadwaj & Srivastava 1969 is considered a junior synonym of the present genus, due to inadequate differentiation parameters between the two.

***Gnetaceaepollenites* sp.**

Plate 9, figure 16

Description: Pollen polylicate. Amb longitudinally oval, occasionally arcuate; with nearly pointed to sharply rounded extreme ends. Exine 1 - 2 μ m thick. Infrasculpture laevigate to finely grana; rare specimen indicate verrucate elements. Exoexine with poorly defined or irregular clefts and folds.

Dimensions: Length; 67(79)91 μ m (5 specimens, STRAT 1), 96 μ m, 108 μ m (2 specimens, CKP6). Breadth; 34(41)54 μ m (5 specimens, STRAT 1), 36 μ m, 46 μ m (2 specimens, CKP6).

Remarks: The specimens referred to as *c.f. Gnetaceaepollenites* by Bharadwaj (1962; pl. 5, figs. 84-87 and 1964; pl. 12, fig. 168) are considered equivalent to the present specimens.

Occurrence: STRAT 1, CKP6.

Previous records: India; Late Permian (Bharadwaj, 1962, 1964).

Genus PRETRICOLPIPOLLENITES Danz -Corzin & Laveine 1963

Type species: *Pretricolpipollenites ovalis* Danz -Corzin & Laveine 1963 (by original designation).

***Pretricolpipollenites* sp.**

Plate 10, figure 1

Description: Amb longitudinally oval. Distinct central sulcus, largely constricted, widens or fan-shaped at one end of grain; two short or discontinuous narrow clefts on either side of the central sulcus. Exine 1 μ m thick; laevigate to weakly infrapunctate.

Dimensions: Length; 39(50)56 μ m, breadth; 22(27)30 μ m (6 specimens, STRAT 1).

Remarks: The present specimens are distinguished in having two narrow slit-like sulci on either side of the well-defined central sulcus. The specimens figured (pl. 21, figs. 1-7) in Balme (1970) and assigned to *Pretricolpipollenites bharadwaji* appear identical to the present specimens; the former however indicate a much smaller size range.

Occurrence: STRAT 1.

Genus MARSUPIPOLLENITES Balme & Hennelly 1956 *emend.* Balme 1970

Type species: *Marsupipollenites triradiatus* Balme & Hennelly 1956 (by original designation).

Marsupipollenites striatus (Balme & Hennelly) Foster 1975
Plate 10, figure 2

1956 *Marsupipollenites triradiatus* forma *striatus* Balme & Hennelly, p. 61; pl. 2, figs. 36 – 37.

1975 *Marsupipollenites striatus* (Balme & Hennelly) Foster, p. 154; pl. 8, figs. 4 – 5.

1977 *Vittatina triradiata* (Balme & Hennelly) Anderson, p. 109; pl. 134, figs. 13, 16, 18, 23, 33; pl. 135, figs. 13, 16.

Description: Pollen infrastriate, monosulcate, with small proximal trilete mark. Amb circular to sub-circular or slightly longitudinally oval. Laesurae poor to well distinct, extend about $\frac{1}{5}$ to $\frac{1}{2}$ radius of grain. Outline of sulcus weakly defined, extend full diameter but seem not to transcend outer margin or equatorial outline. Exine about 1 μ m thick. Infrasculpture in taeniae-like rows, 1 - 2 μ m wide, separated by striations that converge at three points around grain, forming triangular shape; sets of striations appear confined to different faces i.e. distal and proximal.

Dimensions: Length; 34(41)53 (14 specimens, STRAT 1). Breadth; 28(36)40 (9 specimens, STRAT 1).

Remarks: The present specimens are distinguished from other forms of the genus in having taeniae-like arrangement of the infrasculpture, particularly that which displays a triangular pattern, as well as in having a commonly subcircular amb.

Occurrence: STRAT 1, CKP9.

Previous records: Australia; Permian (Balme & Hennelly, 1956; Foster, 1979). South Africa; Permian (Anderson, 1977; MacRae, 1988).

Marsupipollenites triradiatus Balme & Hennelly 1956
Plate 10, figure 3

1956 *Marsupipollenites triradiatus* Balme & Hennelly, pp. 60 – 61; pl. 2, figs. 29 – 35.

1977 *Vittatina triradiata* (Balme & Hennelly) Anderson, p. 109; pl. 134, figs. 1 – 12, 14 – 15, 17, 19 – 22, 25 – 31; pl. 135, figs. 1 – 12, 14 – 15, 17 – 22, 27, 31.

Description: Pollen monosulcate; with small proximal trilete mark. Amb oval elongate to slightly sub-circular. Sulcus extend full length of grain. Infrasculpture grana to verrucae.

Dimensions: Length; 36(41)56, breadth; 16(24)38 (7 specimens, STRAT 1).

Remarks: The present specimens differ from *Marsupipollenites striatus* in lacking taeniae-like arrangement of the infrasculpture as well as in displaying a much more elongate amb.

Occurrence: STRAT 1.

Previous records: Australia; Permian (Balme & Hennelly, 1956; Foster, 1979). South Africa; Permian (Anderson, 1977; MacRae, 1988). Pakistan; Permian (Balme, 1970).

Subturma **MONOCOLPATES** Iverson & Troels-Smith 1950

Genus **CYCADOPITES** Wodehouse 1933

Type species: *Cycadopites follicularis* Wilson & Webster 1946 (by subsequent designation of Wilson & Webster 1946).

Cycadopites cymbatus (Balme & Hennelly) Hart 1965
Plate 10, figure 4

1956 *Entylissa cymbatus* Balme & Hennelly, p. 63; pl. 3, figs. 53 – 56.

1965 *Cycadopites cymbatus* (Balme & Hennelly) Hart, p. 110; text-fig 265.

Description: Pollen monosulcate. Amb longitudinally oval, occasionally broad; rounded to occasionally flat at extremities. Sulcus extend full length of grain, constricted in the middle; margins sometimes overlap. Exine 0.5 - 2µm thick; infrapunctate and granulate.

Dimensions: Length; 39(52)65µm (19 specimens, STRAT 1), 45(55)65µm (6 specimens, CKP6). Breadth; 20(28)34µm (19 specimens, STRAT 1), 19(29)37µm (6 specimens, CKP6).

Remarks: The present specimens do not have any significant distinctive characters from other forms of the genus; they are here mainly differentiated in having a generally well-defined sulcus that extends full length of grain, and is commonly constricted at middle. Most specimens appear rounded to flat at their extreme ends, and commonly appear infrapunctate and granulate.

Occurrence: STRAT 1, CKP6, CKP9, ME58.

Previous records: Australia; Permian (Balme & Hennelly, 1956). Antarctica; Permian (Lindström, 1995). Congo-DR; Late Permian (Maheshwari and Bose, 1969). South Africa; Late Permian (MacRae, 1988).

Cycadopites glaber (Luber & Waltz) Hart 1965
Plate 10, figure 5

1941 *Azonaletes glaber* Luber & Waltz

Description: Pollen monosulcate. Amb broadly oval to slightly ellipsoidal. Sulcus extend full length of grain, slightly widens at extreme ends; distinct marginal folds. Exine 0.5 - 1µm, laevigate.

Dimensions: Length; 24(33)42µm, breadth; 18(25)38µm (7 specimens, STRAT 1).

Remarks: The present specimens differ from other forms of the genus in having a pronounced broadly oval amb and a laevigate sculpture.

Occurrence: STRAT 1.

Previous records: South America; Permian (Marque-Toigo & Klepzig, 1995).

Cycadopites nevesi (Hart) Hart 1965
Plate 10, figure 6

1965 *Cycadopites nevesi* (Hart) Hart, p. 110; text-fig. 266.

Description: Pollen monosulcate. Amb circular, sub-circular or broadly oval elongate parallel to the sulcus. Sulcus extends across entire grain, slightly narrower in the middle, occasionally with well-distinct marginal folds. Some rare specimens indicate a proximal monolete suture. Sculpture; infragranulate, punctate or reticulate.

Dimensions: Length; 30(44)54µm, breadth; 21(38)50µm (22 specimens, STRAT 1).

Remarks: The present specimens are distinguished from other forms of the genus in having a dominantly circular or near circular amb. The specimens (p.41; pl. 7, figs. 4-5) assigned by Maheshwari and Bose (1969) to *Sulcatissporites maximus* (Hart) Singh 1964 is considered equivalent to the present specimens.

Occurrence: STRAT 1, CKP9.

Previous records: Africa; Permian (Hart, 1965). Antarctica; Permian (Lindström, 1995). Congo-DR; Permian (Maheshwari and Bose, 1969).

Cycadopites follicularis Wilson & Webster 1946
Plate 10, figure 7

For synonymy see Balme (1970; pp. 412 – 413).

Description: Pollen monosulcate. Amb oval, with pointed extreme ends. Exine 1 - 2 μ m thick; infrapunctate or laevigate. Sulcus extends full length of grain, extremely narrow or slit-like, occasionally slightly widens at one end.

Dimensions: Length; 47(56)66 μ m (13 specimens, STRAT 1), 40(57)75 μ m (18 specimens, CKP6). Breadth; 16(26)35 μ m (13 specimens, STRAT 1), 19(28)52 μ m (18 specimens, CKP6).

Remarks: The present specimens are distinguished from other forms of the genus in having marked pointed extremities and a generally narrow, slit-like sulcus.

Occurrence: STRAT 1, CKP6, CKP9.

Previous records: Reportedly stratigraphically and geographically wide ranging, and occurring in Late Carboniferous to recent sediments (Balme, 1970; Foster, 1979).

Cycadopites sp.
Plate 10, figure 8

Description: Pollen monosulcate. Amb oval elongate. Sulcus narrow, commonly constricted, extend full length of grain. Grains variably infrasculptured with fine granulate, punctate to vermiculate, as well as clearly reticulate forms with fine to coarse brochi about 1 - 5 μ m wide.

Dimensions: Length; 49 μ m, 60 μ m, 95 μ m (3 specimens, STRAT 1), 52 μ m, 64 μ m (2 specimens, CKP6). Breadth; 26 μ m, 40 μ m, 56 μ m (3 specimens, STRAT 1), 21 μ m, 44 μ m (2 specimens, CKP6).

Remarks: The present specimens form a group of very rare forms that indicate pronounced sculpturing, a feature uncommon with most forms of this genus, however they are tentatively included here in regard to their similar general form pending recognition of a suitable genus.

Occurrence: STRAT 1, CKP6.

Group **ACRITARCHA** Evitt 1963

Genus **INAPERTISPORITES** van der Hammen *ex* Rouse 1959

Type species: *Inapertisporites laevigatus* van der Hammen *ex* Rouse 1959

Remarks: A brief history of the present genus is briefly outlined in Falcon (1978); it was erected to include simple, small and thin walled alete forms bearing a laevigate to weakly sculptured exine, with variable splitting zones. The difficulty in classification and comparison of such featureless forms is highlighted in Martin (1993), in which such forms are considered better classed with the acritarch group. The latter view is followed in this study due to the lack of any characteristic distinctive features observed that could improve the classification level.

Inapertisporites inapertus (Anderson) Falcon 1978
Plate 10, figures 9 - 10

1977 *Inaperturosporites inapertus* Anderson, p. 78; pl. 75, figs. 1 – 19.

Description: Outline sub-circular to commonly oval elongate. Two distinct narrow crescentic exinal folds in middle of grain, as if marginal to a central colpus, parallel to longitudinal axis. Specimens commonly ruptured along longitudinal axis into two equal hemispheres, usually found still attached. Exine 0.5 μ m - 1 μ m thick. Sculpture laevigate to occasionally micro-grana, and rarely punctate.

Dimensions: Length; 45(62)107 μ m (21 specimens, STRAT 1), 62 μ m, 70 μ m (2 specimens, CKP6). Breadth; 40(48)57 μ m (5 specimens, STRAT 1).

Remarks: Forms similar to the present specimens have been described under various groups of classification, however as explained in the remarks above their featureless characteristics makes them difficult to adequately classify. The specimens (fig. 10.9, p. 813) described as Prasinophyta by Tappan (1980) and assigned to the genus *Leiosphaeridia* appears very similar to the present specimens. Some similarities exist between the present specimens and the specimens (pl. 2, figs. 1 – 9) assigned by Pocock and Sarjeant (1972) to *Thuledinium groenlandicum*.

Occurrence: STRAT 1, CKP6, ME58, ML1, NATA.

Previous records: Africa; Permian (Anderson, 1977; Falcon, 1978).

Genus MICRHYSTRIDIUM Deflandre *emend.* Staplin *emend.* Lister 1970

Type species: *Micrhystridium inconspicuum* (Deflandre) Deflandre 1937 (by original designation).

Micrhystridium sp.

Plate 11, figure 1

Description: Vesicle with circular amb; probably originally spheroidal. Distinct outer wall about 1 - 2 μ m thick; equator with densely populated processes, 1 μ m high, less than 1 μ m apart, conate-like to baculate-like.

Dimensions: Diameter of vesicle (including sculpture); 38 μ m, (1 specimen, STRAT 1).

Remarks: Specimen rare and poorly preserved; not adequate for a complete comparison with other known similar occurrences.

Occurrence: STRAT 1

Genus TETRAPORINA Naumova *ex* Naumova 1950

Type species: *Tetraporina antiqua* Naumova 1950 (by subsequent designation of Potonié, 1960).

Tetraporina sp.

Plate 11, figure 2

Description: Outline polygonal or irregularly rectangular; opposite sides slightly convex or concave. Multiporate or perforated; pores circular to rarely linear or curvilinear.

Dimensions: 40 μ m x 35 μ m (1 specimen, STRAT 1).

Remarks: Specimen rare for detailed comparisons. The specimens (pl. 16, figs. 4 – 5) assigned by Millstead (1999) to *Tetraporina tetragona* are very similar to the present specimen and are probably equivalent.

Occurrence: STRAT 1.

Genus VERYHACHIUM Deunff *emend.* Downie & Sarjeant *emend.* Turner 1984

Type species: *Veryhachium trisulcum* Deunff *ex* Deunff 1959 (by original designation)

Veryhachium sp. A

Plate 11, figure 3

Description: Vesicle triangular in outline, apices extend into distinctively long processes. Processes appear fluffy, crenulated, flat, and extremely narrow toward ends; about 30µm long. Vesicle with a distinctive dark circular opening or pylome near one apex; 10µm diameter.

Dimensions: Diameter of vesicle; 17µm.

Remarks: The present specimen harbours a circular or subcircular opening or pylome that makes it appear very close to the specimen (Pl. 3, fig. 6) described by Martin (1993) as *Veryhachium cf. V. downiei*. The latter specimen however appear relatively more robust in comparison to the present specimen.

Occurrence: STRAT 1

Veryhachium sp. B

Plate 11, figures 4 - 5

Description: Vesicle triangular in outline, apices extend to form narrow processes. Processes appear more firm or robust and cylindrical; 11µm long. Some specimens indicate possible pylome. Other specimens indicate a finely granulate ornamentation on vesicle and processes.

Dimensions: Diameter of vesicle; 20µm.

Remarks: The present specimens also appear closely comparable with the specimens (pl. 16, figs. 42 – 49) assigned by Jansonius (1962) to *Wilsonastrum colonicum*.

Occurrence: STRAT 1

Veryhachium sp. C

Plate 11, figure 6

Description: Vesicle triangular in outline, apices extend into long, narrow and crenulated processes. Processes about 22µm long. Vesicle and processes appear laevigate.

Dimensions: Diameter of vesicle; 18µm.

Remarks: The present specimen closely resembles *Veryhachium sp. A*, but differ in its generally delicate appearance.

Occurrence: STRAT 1

Genus UNCERTAIN

Species A

Plate 11, figure 7

Description: Vesicle with subcircular or spherical outline. Two or more processes extending from the vesicle; probably hollow, expanded at terminations or heads.

Dimensions: Diameter of vesicle (excluding processes); 12µm (1 specimen, STRAT 1).

Remarks: Specimen rare and poorly preserved to allow complete comparison. However, several line drawings in Cramer and Diez (1979) indicate possible similarities with the present specimen. A few of the comparable line drawings fall within the genera outlined below:

Umbellasphaeridium Jardiné et. al., 1972 (e.g. text-fig. 257, p. 105)

Multiplicisphaeridium Staplin 1961 (e.g. text-figs. 6 – 30, pp. 38 – 39)

Petaloferidium Jacobson 1978 (e.g. text-fig. 182, p. 96)

Occurrence: STRAT 1

Species B

Plate 11, figure 8

Description: Vesicle appears bent or compacted but with probable triangular form; apices extend into long flat-like processes. Bifurcation at tip or ends of processes. Granular ornamentation on vesicle and processes.

Remarks: Specimen rare. Probable comparable genera based on line drawings from Cramer and Diez (1979) include:

Multiplicisphaeridium Staplin 1961 (e.g. text-fig. 12, p. 38)

Ozotobrachion Loeblich Jr. and Drugg 1968 (e.g. text-fig. 172, p. 92)

Occurrence: STRAT 1

Species C

Plate 11, figure 9

Description: Vesicle oval-elongate; with rupture. Flat, curly processes on either end of long axis, appear to be slightly expanded at ends; process 11 μ m long on one side with better view.

Dimensions: Long axis 17 μ m, short axis 12 μ m.

Remarks: Specimen rare. Probable comparable genus based on line drawings from Cramer and Diez (1979) include:

Domasiella Cookson and Eisenack 1969 (e.g. text-fig. 72, p.75)

Occurrence: STRAT 1

Species D

Plate 11, figure 10

Description: Vesicle irregularly oval elongate. Irregular processes about 7 μ m long; bifurcating at ends. Vesicle and processes indicate groove-like features.

Remarks: Specimen rare. The specimens (fig. 3.31; 6, 7) assigned by Tappan (1980) to the species *Actinotophasis complurilata* Loeblich & Wincander, appears broadly similar to the present specimen.

Occurrence: STRAT 1

Species E

Plate 11, figure 11

Description: Vesicle broadly oval elongate. Irregular opening/slit off-center; parallel to long axis of vesicle, extend nearly full length. Weakly granulate.

Dimensions: Length 34 μ m, breadth 26 μ m.

Remarks: Specimen rare. Probable genera include:

Brazilea Tiwari & Navale 1967

Sulcatosphaeridium Umnova 1970 (e.g. Cramer & Diez, 1979; text-fig. 32, p. 27)

Occurrence: STRAT 1

Division **CHLOROPHYTA**

Genus **BOTRYOCOCCUS** Kützing 1849

Type species: *Botryococcus braunii* Kützing 1849 (by monotypy)

Botryococcus sp. cf. B. braunii Kützing 1849

Plate 11, figure 12

Description: An irregular grain comprised of an aggregate or cluster of irregularly-shaped components i.e. sub-circular to oval elongate with irregular outlines or contacts.

Remarks: The present specimen does not harbour variedly distinct features for a detailed comparison but generally appear similar to other specimens described under the present genus (*cf.* Segroves, 1967; Foster, 1979; MacRae, 1988; Millsted, 1999).

Occurrence: STRAT 1

Previous records: Australia; Permian (Segroves, 1967; Foster, 1979). South Africa; Late Carboniferous to Late Permian (MacRae, 1988; Millsted, 1999).

Division **PRASINOPHYTA**

Genus **ARABISPHAERA** Hemer & Nygreen 1967

Type species: *Arabisphaera bellula* Hemer and Nygreen 1967 (by original designation)

Arabisphaera bellula Hemer and Nygreen 1967

Plate 11, figure 13

1967 *Arabisphaera bellula* Hemer & Nygreen, p. 186; pl. 3, figs. 7 – 11.

1968 *Portalites gondwanensis* Nahuys, Alpern and Ybert, pp. 41 – 42.

Description: Outline circular or subcircular in compressed forms; with a distinctive and wide outer wall i.e. 2 - 3 μ m. Some specimens display a circular opening or pore. Commonly displays a faint outline of either a rupture or canal extending from wall, where it appears widened, and across much of the grain; linear to curved. Equator finely corrugated or corroded to give a micro-granulate appearance. Plan view with diffuse fossulate and reticulate outlines, with a commonly micro-pitted appearance.

Dimensions: Equatorial diameter; 24(29)34 μ m (6 specimens, STRAT 1).

Remarks: The present specimens indicate a smaller size range to that of *Arabisphaera* sp. below.

Occurrence: STRAT 1.

Previous records: Saudi Arabia; Early Carboniferous (Hemer & Nygreen, 1967). South America; Permian (Nahuys, Alpern & Ybert, 1968).

Arabisphaera sp.

Plate 11, figure 14

Description: Outline circular to sub-circular. Locally discernible outline of outer wall, about 3µm thick. Specimens indicate a generally pitted or spongy appearance.

Dimensions: Equatorial diameter; 29(39)47µm (5 specimens, CKP6).

Remarks: The present specimens are rare and poorly preserved for a complete comparison and identification of a suitable genus; their inclusion in the present genus is only based on their general similarity to *Arabisphaera bellula*, which is also found in the study material. However, the specimens (pl. 3, figs. 6 – 10) and (pl. 15, figs. 1 – 3) assigned by Segroves (1967) and Millsted (1999), respectively, to *Spongocystia eraduica* do appear to have some close similarity to the present specimens. Millsted (1999) considered *Maculatasporites eraduensis* (Segroves) Anderson 1977 a junior synonym of *Spongocystia eraduica* (spelt wrongly as *S. eraducia* by Millsted, 1999). In view of their relatively larger grain size, the species *Arabisphaera* sp. (this study), together with *S. eraduica* Segroves 1967 and *M. eraduensis* (Segroves) Anderson 1977, probably form the equivalent, and hence are junior synonyms, of the species *Arabisphaera fossilis* Hemer and Nygreen 1967. The latter was distinguished from *Arabisphaera bellula* by Hemer and Nygreen (1967) only on the basis of its larger size.

Occurrence: CKP6.

Genus CYMATIOSPHAERA O. Wetzel *ex* Deflandre 1954

Type species: *Cymatiosphaera radiata* O. Wetzel 1933 (by subsequent designation of Deflandre, 1954)

Cymatiosphaera gondwanensis (Tiwari) Backhouse 1991

Plate 11, figure 15

1991 *Cymatiosphaera gondwanensis* (Tiwari) Backhouse, pp. 299 – 302; pl. 22, figs 13 – 15.

For additional synonymy see Foster (1979).

Description: Outline circular to sub-circular and rarely oval; divided into an inner and outer body. Inner body dark, displays negative reticulum with brochi 1 - 5 μ m wide; diameter range 16 - 21 μ m. Outer body flange-like, lighter, with radially arranged elements; 3 - 8 μ m wide.

Dimensions: Equatorial diameter; 22(28)34 μ m (9 specimens, STRAT 1), 22 μ m (1 specimen, CKP6).

Remarks: The present specimens indicate a relatively smaller size range than those described in most literature (e.g. Foster, 1979; MacRae, 1988; Millsted, 1999), however, their size range is closely compatible with the specimens described by Anderson (1977).

Occurrence: STRAT 1, CKP6, CKP9.

Previous records: Africa; Permian (Anderson, 1977; MacRae, 1988; Millsted, 1999). Australia; Permian (Foster, 1979).

Cymatiosphaera sp. A

Plate 11, figure 16

Description: Outline sub-circular. Distinctively finely reticulate, with brochi about 1 - 2 μ m wide; bearing negative reticulum.

Dimensions: Equatorial diameter; 37 μ m, 41 μ m (2 specimens, CKP6).

Remarks: The present specimens are distinguished from *Cymatiosphaera gondwanensis* in having a relatively finer reticulum and also in not indicating any clear distinction between an inner or central body and an outer flange-like zone. The latter seem to be completely absent or entirely indistinctive in the present specimens. The specimens (pl. 2, figs. 31, 32) assigned by Anderson (1977) to *Mehlisphaeridium gondwanensis* have a close resemblance to the present specimens.

Occurrence: CKP6

Cymatiosphaera sp. B

Plate 11, figure 17

Description: Outline circular to sub-circular; equator comprised of irregular elements, about 3µm high. Plan view indicates weak display of reticulate pattern, with brochi about 1 - 2µm wide.

Dimensions: Equatorial diameter (excluding sculpture); 25µm, 28µm, 30µm (3 specimens, STRAT 1), 29µm (1 specimen, CKP6).

Remarks: The present specimens are rare and poorly preserved for a complete description and comparison. However, there seems to be close resemblance between the present specimens and the specimens (pl. 1, figs. 31 – 52) assigned by Anderson (1977) to *Mehlisphaeridium irregulare*. The latter species was recombined by Millstead (1999) to *Cymatiosphaera irregulare*.

Occurrence: STRAT 1, CKP6.

Genus MACULATASPORITES Tiwari 1964

Type species: *Maculatasporites indicus* Tiwari 1964 (by original designation).

Remarks: A brief note on the history of this genus is given in Fensome et. al. (1990); the genus was originally described to represent miospores but was later placed under the acritarcha group by several workers. The placement of this genus under the prasinophyta group in this study follows Tappan (1980).

Maculatasporites sp.

Plate 11, figure 18

Description: Outline sub-circular; body probably originally spherical. Distinctively reticulate with lumina sub-circular, oval or polygonal, 1 - 2µm in diameter; muri less than 1µm.

Dimensions: Equatorial diameter; 36µm (1 specimen, STRAT 1).

Remarks: The present specimen falls within the size range of *Maculatasporites minimus* Segroves 1967 but differ in having a much narrower lumina and muri. The occurrence of only one specimen observed in the study material makes it difficult to adequately classify the present specimen. Backhouse (1991) noted the occurrence of a wider range of morphology in his material that indicated the possibility of several end members of this form, in which the present specimen may well fall. Millstead (1999) gave a comprehensive account on the comparisons and possible synonymy of the type species, *Maculatasporites indicus*, and the specimens (pl. 3, figs. 11 – 14; figs. 15 – 18) assigned by

Segroves (1967) to *Maculatasporites minimus* and *Maculatasporites amplius*, respectively.

Occurrence: STRAT 1

Previous records: India; Early Permian (Tiwari, 1964). South Africa; Early Permian (Anderson, 1977; MacRae, 1988; Millsted, 1999).

Genus TASMANITES Newton 1875

Type species: *Tasmanites punctatus* Newton 1875 (by subsequent designation of Eisenack 1958).

***Tasmanites* sp.**

Plate 11, figure 19

Description: Outline circular to sub-circular. Multi-porate or with a perforated texture. Pores commonly circular, occasionally sub-circular to rarely oval or linear; sporadic coarse pores. Wall appear largely smooth and uniform with faint laminae, 2 - 3µm thick; pores rarely extend beyond wall structure, but are visible within wall as narrow radial elements.

Dimensions: Equatorial diameter; 36µm, 36µm (2 specimens, STRAT 1).

Remarks: The present specimens are rare in the study material. The illustrative figure (p. 105, text-fig. 236) representing the genus *Tasmanites* in Cramer and Diez (1979) appears identical to the present specimens.

Occurrence: STRAT 1

CHAPTER 5: RESULTS

The microscopic qualitative slide analyses undertaken on samples from the nine study boreholes (e.g. Figs. 13 – 21) revealed that only two (i.e. STRAT 1 and CKP6) yielded significant results in terms of palynomorph occurrences. Consequently, the results herein presented focuses on the analyses from the two boreholes, especially borehole STRAT 1, which was designated the reference section owing to a relatively better preservation potential. Nevertheless, the rest of the boreholes have yielded less significant but useful results that will also be considered in the discussions. In an effort to augment the qualitative analysis for the identification of important stratigraphic horizons, a quantitative data analysis approach was undertaken. Only borehole STRAT 1 was considered for the quantitative analyses due to resource limitations (i.e. time and finance). The qualitative and quantitative analyses determined in this study are summarized and illustrated in Figures 27 – 46.

5.1 Palynostratigraphy

Palynostratigraphic considerations in handling and illustration of the data were based on the definitions of Murphy and Salvador (1999) with regard to biostratigraphic units. The procedure to subdivide the borehole sections into palynozones was largely built around the following criteria:

1. The data was initially presented in species range charts, which represent the range of any particular species in the core, defined by its first and last occurrence.
 - This procedure allows for the recognition of biostratigraphic horizons or *biohorizons*, which are defined as stratigraphic boundaries, surfaces, or interfaces across which there is a significant change in biostratigraphic character, e.g. increase in species diversity or abundance etc.
2. The range charts were then analysed to identify certain palynomorph species or taxa whose range defines specific sections of the core.
 - The identification of taxa-specific sections of the core allows for the recognition of biostratigraphic zones or *biozones*, which represent bodies of strata defined on the basis of their fossil or taxa content.
 - The biohorizons may form major boundaries to the biozone.
3. Further analyses on the range charts were undertaken to determine the best kind of biozones suitable for subdivision of the core e.g. *Concurrent-range Zone*, *Assemblage Zone* etc.

The procedure outlined above, mainly based on data from the qualitative analyses, was then augmented with data from the quantitative analyses to determine significant horizons defining boundaries to biozones.

5.1.1 Qualitative Analysis

Details of the qualitative analyses are summarized in Figures 27 and 32, which represent the range charts of determined species described from the productive horizons of boreholes STRAT 1 and CKP6, respectively. Appendix I comprise a list of all taxa, including open-ended species, recognized from all the study boreholes, with the exception of borehole ML2 that was completely barren. Additional details are presented in Appendix II, which comprises all taxa occurrence charts for all boreholes, except ML2 and TLMB1, as well as all taxa range charts for boreholes STRAT 1, CKP6, and CKP9.

5.1.1.1 STRAT 1 Borehole

The range charts for STRAT 1 borehole are illustrated in Figures 27 and 28, with details of their characteristics summarized in Figure 29. A careful assessment of the range charts reveals the occurrence of three broad categories of taxa:

1. Long range taxa.

- These occur more or less throughout the entire sampled and productive section of the borehole. Such taxa are generally of little stratigraphic use owing to their long range and non-partitionable character of their ranges.
- Examples include: *Apiculatisporis levis*, *Cyclogranisporites gondwanensis*, *Granulatisporites angularis*, *Lundbladispota braziliensa*, *Inapertisporites inapertus*, *Potonieisporites novicus*, *Striatopodocarpites cancellatus* etc.

2. Medium range taxa.

- These occur within a specific, albeit broad, section of the borehole defined by finite points of origin or termination at one end of their stratigraphic range; either their upper limit or their lower limit extends beyond the extent of the borehole section. Such taxa are stratigraphically useful in sub-division of the borehole section.
- Examples include: *Apiculatisporites leptocaina*, *Cristatisporites morungavensis*, *Converrucosisporites naumoviae*, *Retusotriletes golatensis*, *Alisporites ovatus*, *Striatoabieites multistriatus*, *Marsupipollenites striatus* etc.

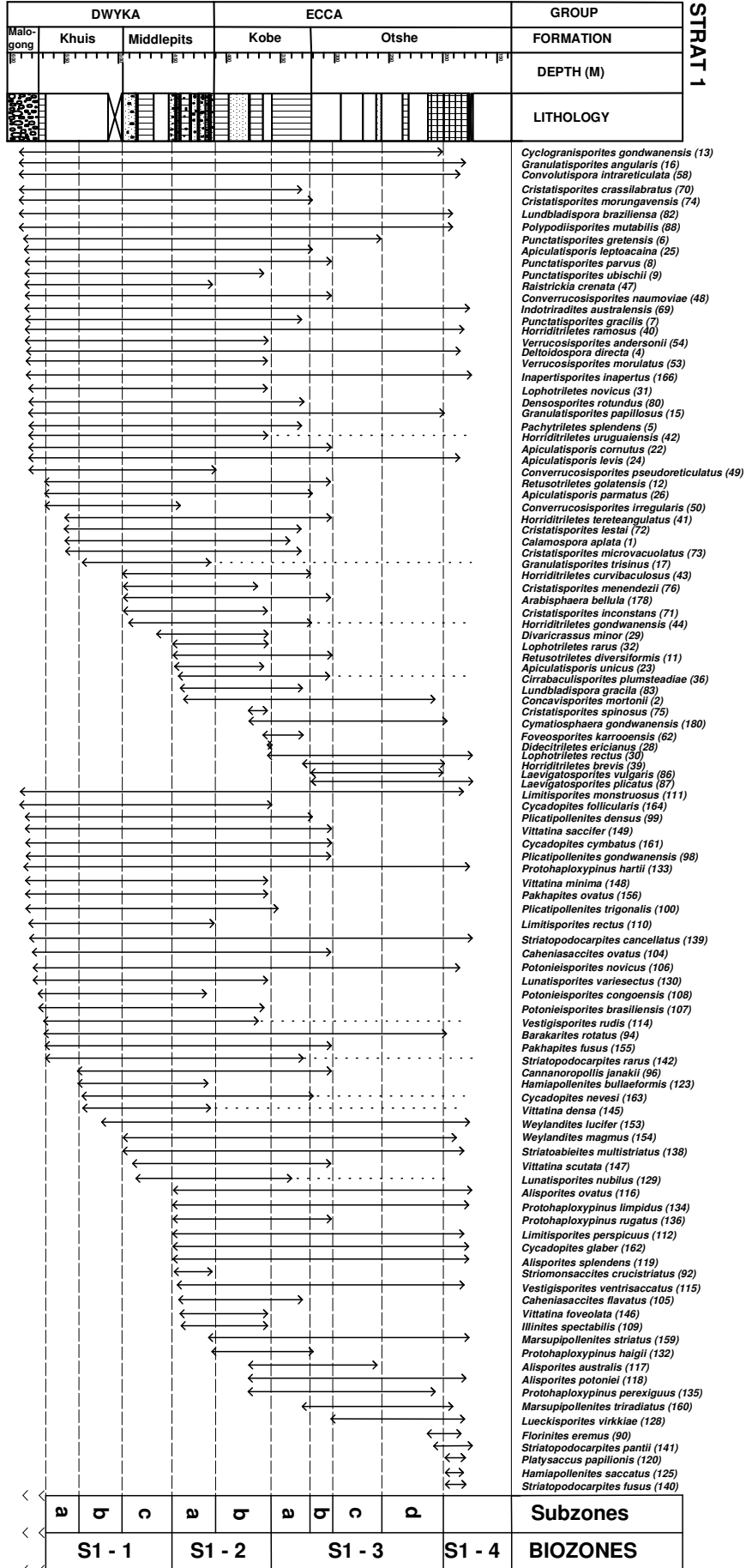

Figure 27: Stratigraphic range chart of determined taxa and biostratigraphic subdivision of STRAT 1 borehole section; broken lines reflect a zone of non-occurrence between the preceding relatively consistent occurrence and the last occurrence for the respective taxon.

3. Short range taxa.

- These occur within a relatively narrow section of the borehole, and their range is confined between finite points of origin and termination.
- Examples include: *Raistrickia crenata*, *Converrucosisporites pseudoreticulatus*, *Divaricrassus minor*, *Laevigatosporites vulgaris*, *Lueckisporites virkkiae*, *Striatopodocarpites pantii*, *Platysaccus papilionis* etc.

An overall assessment of taxa range in borehole STRAT 1 indicates that both the upper and lower limits are poorly constrained. The upper limit of taxa occurrence is determined by the highest level of sampling, which was constrained by the non-availability of core for sampling beyond the sampled level. The base of the borehole section, which shortly overlies older late Precambrian basement rock, determines the lower limit of taxa occurrence. Nevertheless, the productive zones of the section sampled allowed the sequence in borehole STRAT 1 to be subdivided into palynozones.

5.1.1.1.1 Biozones

Firstly, the range charts were analysed in terms of the *Range Zone* type of biozones, with boundaries defined by biohorizons characterized by first and last appearances of significant species. Four biozones are recognized (e.g. Figs. 27, 28, and 29), and are comprised of three concurrent range zones and one taxon range zone. Secondly, the range charts were considered in terms of the *Assemblage Zone* type of biozones, in order to increase the chances of correlation with the other borehole sections. Three assemblage zones are recognized (e.g. Fig. 30), which allows borehole STRAT 1 to be correlated with borehole CKP6. A summary of the biozones and their characteristic taxa is given below, in ascending order of the borehole section, whilst details are illustrated in Figures 29 and 31.

5.1.1.1.1.1 Range Zones

The Potoniesporites congoensis – Converrucosisporites irregularis Concurrent-range Zone (Biozone S1 – 1)

This zone has been defined on the basis of short to medium range taxa occurring in this section of the borehole. The lower limit of this zone is uncertain due to its close proximity to the base of the section, where several taxa appear to originate. However, the lower limit has been tentatively placed at the next distinct biohorizon (i.e. S1 A) after the lowermost defined by the majority of taxa emanating from near base. The most significant taxa characterizing this zone are:

Figure 28: Stratigraphic range chart of significant taxa and biostratigraphic subdivision of STRAT 1 borehole section.

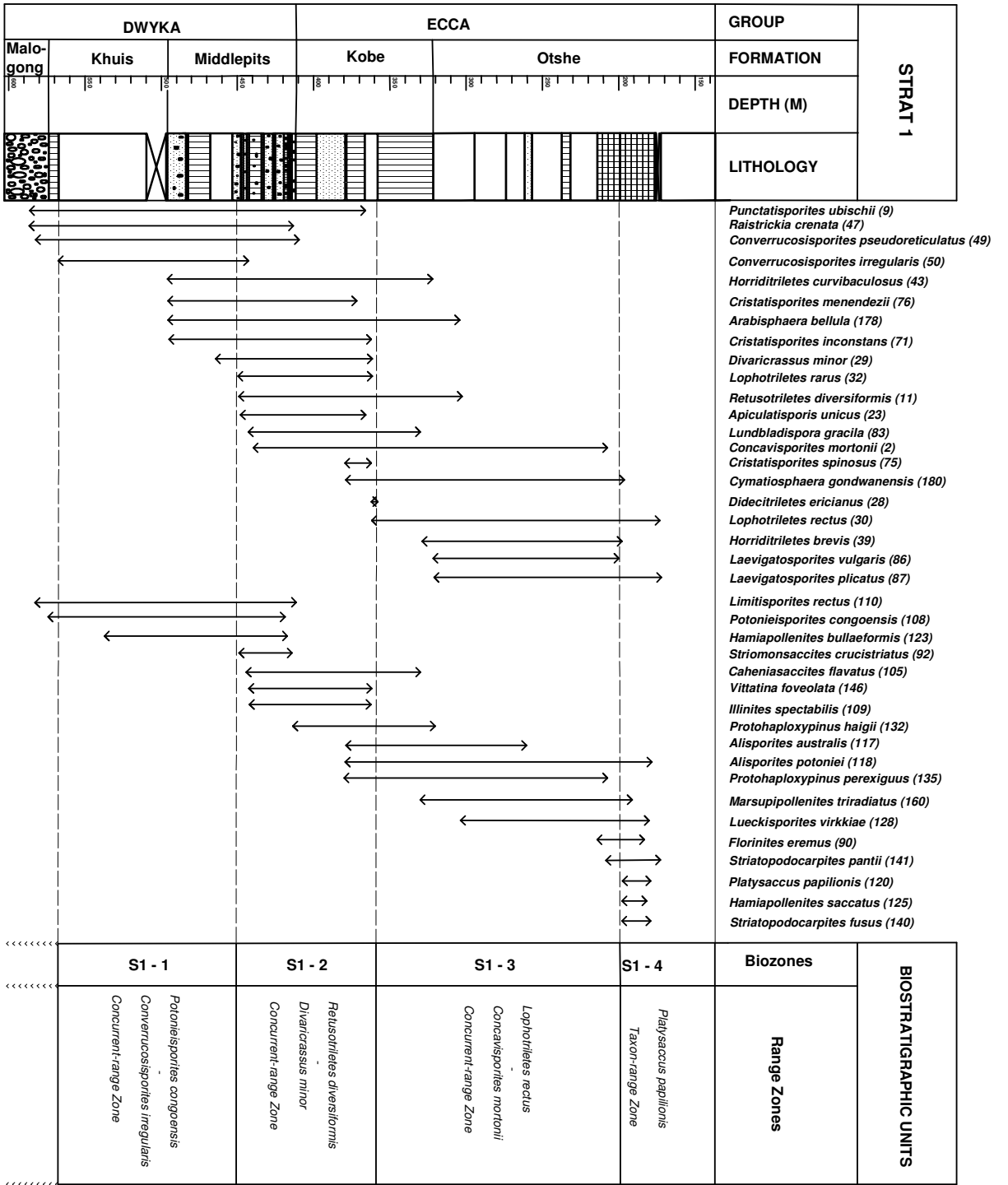

Raistrickia crenata, *Converrucosisporites pseudoreticulatus*, *Converrucosisporites irregularis*, *Potoniesporites congoensis*, *Limitisporites rectus*, and *Hamiapollenites bullaeformis*.

The lower limit is defined by the first occurrence of *Potoniesporites congoensis*, which is considered a very distinct and relatively easily recognizable species. The upper limit is defined by the last occurrence of *Converrucosisporites irregularis*, which although is not the most abundant, forms the only termination at this point. Nevertheless, both the lower and upper limits of this zone are associated with several species initiations, defining significant events. The zone has been subdivided into sub-zones on the basis of the associated biohorizons all characterized by species initiations.

The Retusotriletes diversiformis – Divaricrassus minor Concurrent-range Zone (Biozone S1 – 2)

This zone has been characterized on the basis of short and medium range taxa, and its boundaries corresponds to biohorizons S1 D and S1 F (Appendix II - 2), dominated by species initiations and species terminations, respectively. The most significant taxa characterizing this zone are:

Retusotriletes diversiformis, *Apiculatisporis unicus*, *Divaricrassus minor*, *Lophotriletes rarus*, *Horriditriletes curvibaculosus*, *Cristatisporites inconstans*, *Cristatisporites menendezii*, *Lundbladispota gracilis*, *Striomonosaccites crucistriatus*, *Caheniasaccites flavatus*, *Illinites spectabilis*, *Protohaploxylinus haigii*, *Protohaploxylinus rugatus*, *Vittatina foveolata*, and *Arabispheera bellula*.

The lower limit of this zone is characterized by the first appearance of *Retusotriletes diversiformis*, while the upper limit has been placed at the last appearance of *Divaricrassus minor*. The zone is divided into two subzones on the basis of species initiations and terminations that define the associated biohorizons.

The Lophotriletes rectus – Concavisporites mortonii Concurrent-range Zone (Biozone S1 – 3)

This zone occurs within the section bound by biohorizons S1 F and S1 J (Appendix II - 2), and is indicated to be the least productive palynologically, in terms of species occurrence data (e.g. Appendix II - 1). The most significant taxa that characterize this zone are:

Concavisporites mortonii, *Lophotriletes rectus*, *Horriditriletes brevis*, *Laevigatosporites vulgaris*, *Laevigatosporites plicatus*, *Alisporites australis*, *Alisporites potonieii*, *Lueckisporites virkkiae*, *Protohaploxylinus perexiguus*, *Marsupipollenites triradiatus*, and *Cymatiosphaera gondwanensis*.

GROUP	FORMATION	DEPTH (M)	LITHOLOGY	BIZONE	NOTABLE CHARACTERISTICS		SUBZONE	QUANTITATIVE CONTENT (Supra-generic)
					RANGE ZONE	Subzone		
STRAT 1	ECCA	150		S1 - 4	Possible angle subzone, upper limit uncertain. Species range initiation: <i>P. papilionis</i> , <i>H. sacculus</i> , <i>S. venus</i> . Species range termination: Species terminations not well-defined, determined by highest level sampled.	Possible angle subzone, upper limit uncertain. Species range initiation: <i>P. papilionis</i> , <i>H. sacculus</i> , <i>S. venus</i> . Species range termination: Species terminations not well-defined, determined by highest level sampled.	Azononites (<i>laevigata</i>): 0-2% Azononites (<i>apiculata</i>): 0-1% Zonammatinella: 0-1% Monostacys: 0-2% Blasactis non-striata: 0-5% Blasactis striata: 0-6%	Pinales: 0-3% Prasinophytes: 0-1%
		250		S1 - 2	Most significant species (restricted, and nearly so): <i>R. diversiformis</i> , <i>A. unicus</i> , <i>D. minor</i> , <i>L. reclus</i> , <i>L. pictus</i> , <i>A. australis</i> , <i>C. morioni</i> , <i>L. viridula</i> , <i>L. speciosus</i> , <i>P. hajgi</i> , <i>P. rugatus</i> , <i>V. foveolata</i> , <i>A. bellula</i> . Reticolites diversiformis - <i>Diversus minor</i> Concurrent-range zone	Most significant species (restricted, and nearly so): <i>R. diversiformis</i> , <i>A. unicus</i> , <i>D. minor</i> , <i>L. reclus</i> , <i>L. pictus</i> , <i>A. australis</i> , <i>C. morioni</i> , <i>L. viridula</i> , <i>L. speciosus</i> , <i>P. hajgi</i> , <i>P. rugatus</i> , <i>V. foveolata</i> , <i>A. bellula</i> . Reticolites diversiformis - <i>Diversus minor</i> Concurrent-range zone	Azononites (<i>laevigata</i>): 0-8% Azononites (<i>apiculata</i>): 2-20% Zonammatinella: 0-8% Monostacys: 0-3% Blasactis non-striata: 0-3% Blasactis striata: 0-3%	Pinales: 0-6% Prasinophytes: 0-1% Chlorophytes: 0-9%
		350		b	Most significant species (restricted, and nearly so): <i>A. unicus</i> , <i>D. minor</i> , <i>L. reclus</i> , <i>V. marulidus</i> , <i>V. andersoni</i> , <i>L. variegatus</i> , <i>V. foveolata</i> , <i>V. minima</i> , <i>P. swaini</i> , <i>P. ulrichi</i> . Species range initiation: <i>A. unicus</i> , <i>L. reclus</i> , <i>C. pseudoreticulatus</i> , <i>L. gracilis</i> , <i>L. speciosus</i> , <i>L. perigrinus</i> , <i>V. ventriculosus</i> , <i>A. onchus</i> , <i>A. spinulosus</i> , <i>P. rugatus</i> , <i>V. foveolata</i> , <i>M. striatus</i> , <i>C. glaber</i> . Species range termination: <i>R. ornata</i> , <i>C. pseudoreticulatus</i> , <i>P. congensis</i> , <i>L. reclus</i> (110), <i>H. bullaeformis</i> .	Most significant species (restricted, and nearly so): <i>A. unicus</i> , <i>D. minor</i> , <i>L. reclus</i> , <i>V. marulidus</i> , <i>V. andersoni</i> , <i>L. variegatus</i> , <i>V. foveolata</i> , <i>V. minima</i> , <i>P. swaini</i> , <i>P. ulrichi</i> . Species range initiation: <i>A. unicus</i> , <i>L. reclus</i> , <i>C. pseudoreticulatus</i> , <i>L. gracilis</i> , <i>L. speciosus</i> , <i>L. perigrinus</i> , <i>V. ventriculosus</i> , <i>A. onchus</i> , <i>A. spinulosus</i> , <i>P. rugatus</i> , <i>V. foveolata</i> , <i>M. striatus</i> , <i>C. glaber</i> . Species range termination: <i>R. ornata</i> , <i>C. pseudoreticulatus</i> , <i>P. congensis</i> , <i>L. reclus</i> (110), <i>H. bullaeformis</i> .	Azononites (<i>laevigata</i>): 0-6% Azononites (<i>apiculata</i>): 2-20% Zonammatinella: 0-8% Monostacys: 0-3% Blasactis non-striata: 0-3% Blasactis striata: 0-3%	Pinales: 0-6% Prasinophytes: 0-1% Chlorophytes: 0-9%
		450		a	Significant species: <i>C. pseudoreticulatus</i> , <i>L. reclus</i> (110), <i>P. ulrichi</i> . Dominantly long to medium-range species.	Significant species: <i>C. pseudoreticulatus</i> , <i>L. reclus</i> (110), <i>P. ulrichi</i> . Dominantly long to medium-range species.	Monostacys: 0-2% Pinales: 2-14% Prasinophytes: 0-1%	Chlorophytes: 0-9%
		550		a	Significant species: <i>C. pseudoreticulatus</i> , <i>L. reclus</i> (110), <i>P. ulrichi</i> . Dominantly long to medium-range species.	Significant species: <i>C. pseudoreticulatus</i> , <i>L. reclus</i> (110), <i>P. ulrichi</i> . Dominantly long to medium-range species.	Monostacys: 0-2% Pinales: 2-14% Prasinophytes: 0-1%	Chlorophytes: 0-9%

Figure 29: Summary of significant qualitative and quantitative analyses with subdivision of STRAT 1 borehole section.

The lower limit of this zone is defined by the first appearance of *Lophotriletes rectus* as well as the termination of several species most significant in the preceding zone. The upper limit of the zone is marked by the last appearance of *Concavisporites mortonii*, but is also associated with several species terminations and initiations. Although the least palynologically productive, this zone has been divisible into four subzones whose boundaries are largely dominated by species terminations.

The Platysaccus papilionis Taxon-range Zone (Biozone S1 – 4)

This zone has a rather limited range owing to a much narrower section of the borehole sampled, and most probably forms a single subzone. The upper limit of the zone is uncertain due to the fact that it is determined by the highest level of sampling, where most of the species appear to terminate. The zone has been characterized based on short-range taxa of which the most significant are:

Florinites eremus, *Platysaccus papilionis*, *Hamiapollenites saccatus*, *Striatopodocarpites fusus*, and *Striatopodocarpites pantii*.

Both the lower and upper limits of this zone are defined based on the range of occurrence of the species *Platysaccus papilionis*, which has also been recognized in other borehole sections. The lower limit of the zone corresponds to biohorizon S1 – J, which is defined based on several species terminations and initiations.

5.1.1.1.2 Assemblage Zones

As with the range zones, both the basal and top sections of the borehole are palynologically poorly constrained. The lowermost section is commonly dominated by long-range taxa, the lower limits of which are determined by the base, making it difficult to distinctively characterize. Consequently, a narrow, poorly defined and non-named zone or possibly subzone is indicated at the base of the assemblage zones determined. A summary of the assemblage zones proposed is given below while details are illustrated in Figures 30 and 31.

The Hamiapollenites bullaeformis Assemblage Zone (Biozone KK1)

This zone is characterized by an assemblage of fourteen taxa most of which are either restricted or nearly restricted to the zone. The bounding surfaces to this zone correspond to biohorizons S1 A and S1 G (Appendix II – 2), which are dominated by species initiations and terminations, respectively. The lower limit of the zone is placed at the lowermost occurrences of taxa *Apiculatisporis parmatus* and *Potonieisporites brasiliensis*. The upper limit of the zone is placed at the last occurrences of taxa *Punctatisporites gracilis*, *Densosporites rotundus*, and *Cristatisporites microvacuolatus*. The zone has been named after the species *Hamiapollenites bullaeformis*, which forms

Figure 30: Significant assemblage zone taxa with subdivision of STRAT 1 borehole section.

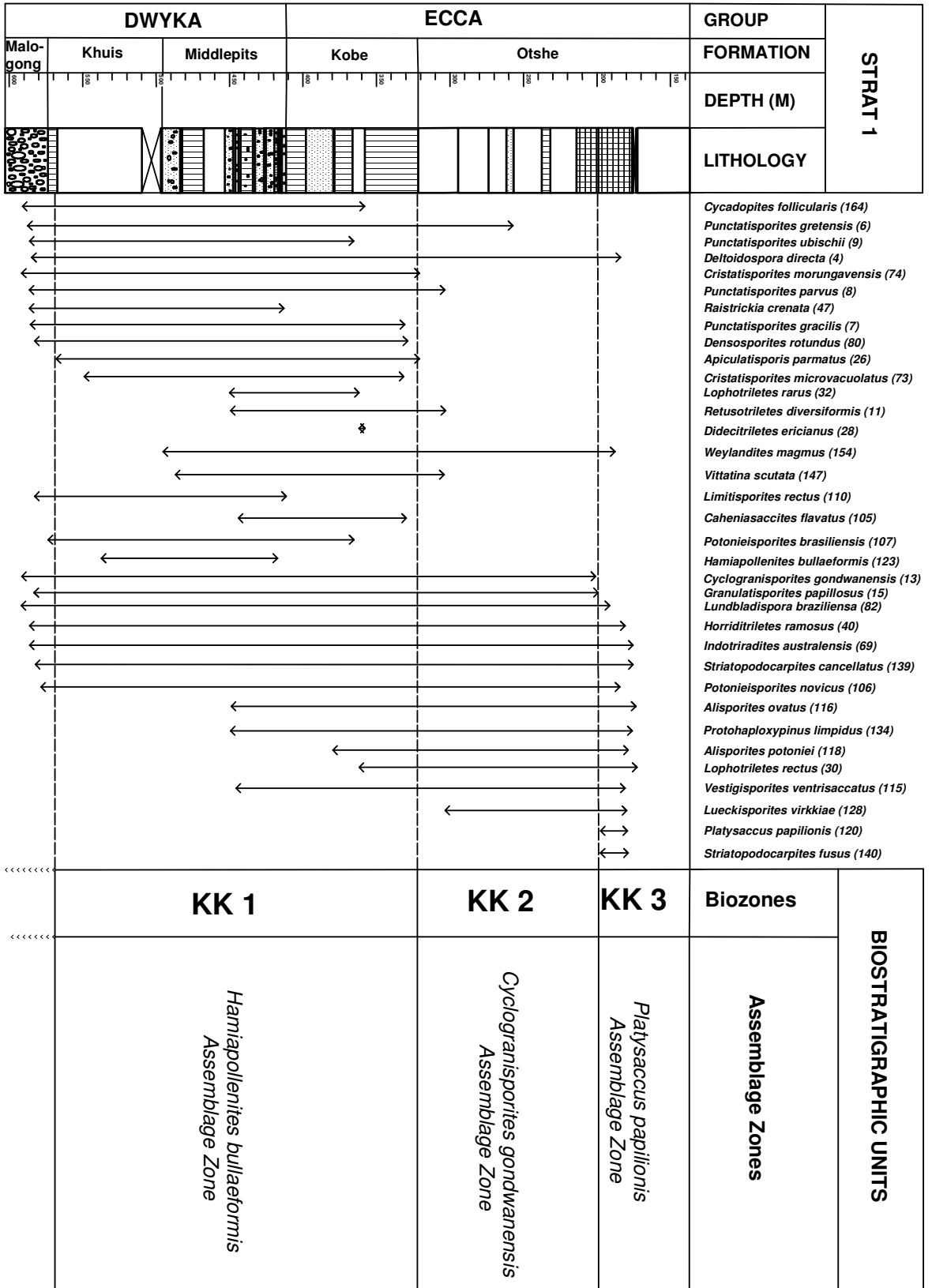

one of the diagnostic taxa, and is restricted to the zone as well as in CKP6, and occurs in other regionally associated areas.

The Cyclogranisporites gondwanensis Assemblage Zone (Biozone KK2)

This is a rather poorly defined zone, whose characterization is largely based on long-range and some medium-range taxa, owing to low palynomorph yields from this section of the borehole. The zone is confined between biohorizons S1 G and S1 J (Appendix II – 2), which are defined by species initiations and terminations. The lower limit of this zone is determined by the upper limit of the preceding zone i.e. *Hamiapollenites bullaeformis* *Assemblage Zone*. The upper limit of the zone is placed at the last occurrence of taxon *Cyclogranisporites gondwanensis*. The latter has provided a name for the zone because it is the only species that defines the upper limit in both boreholes STRAT 1 and CKP6.

The Platysaccus papilionis Assemblage Zone (Biozone KK3)

The upper limit of this zone is not defined due to the non-availability of core for sampling beyond the topmost sampled level. Consequently, this zone represents a narrow section of the borehole that possibly indicates a lowermost subzone of a broader zone. The lower boundary of the zone corresponds with biohorizon S1 J (Appendix II – 2), which is defined by species terminations and initiations. The lower limit of the zone is placed at the first occurrence of taxa *Platysaccus papilionis* and *Striatopodocarpites fusus*. The zone is named after *Platysaccus papilionis* because it forms one of the most significant taxa restricted within the zone, as noted in borehole STRAT 1 and CKP6, as well as in equivalent zones from other previous local studies.

ASSEMBLAGE ZONE	NOTABLE CHARACTERISTICS
<p style="text-align: center;"><i>Platysaccus papilionis</i> Assemblage Zone</p>	<p>Upper limit not defined due to poor preservation and non-occurrence associated with change in lithofacies.</p> <p>Diagnostic taxa: <i>L. rectus</i> (30) <i>V. ventrisaccatus</i> <i>A. ovatus</i> <i>P. papilionis</i> <i>L. virkkiae</i> <i>S. fusus</i></p> <p>Lower limit placed at the lowermost occurrence of taxa: <i>P. papilionis</i> and <i>S. fusus</i>.</p>
<p style="text-align: center;"><i>Cyclogranisporites gondwanensis</i> Assemblage Zone</p>	<p>Upper limit placed at the highest occurrence of taxon: <i>C. gondwanensis</i> (13).</p> <p>Diagnostic taxa: <i>C. gondwanensis</i>(13) <i>D. directa</i> <i>G. papillosus</i> <i>H. ramosus</i> <i>I. australensis</i> <i>L. braziliensis</i> <i>P. limpidus</i> <i>P. novicus</i> <i>S. cancellatus</i> <i>A. potonie</i></p> <p>Lower limit not defined, determined by upper limit of preceding zone.</p>
<p style="text-align: center;"><i>Hamiapollenites bullaeformis</i> Assemblage Zone</p>	<p>Upper limit placed at the highest occurrence of taxa: <i>P. gracilis</i>, <i>D. rotundus</i>, and <i>C. microvacuolatus</i>.</p> <p>Diagnostic taxa: <i>P. gracilis</i> <i>P. parvus</i> <i>R. diversiformis</i> <i>A. parmatus</i> <i>L. rarus</i> <i>R. crenata</i> <i>H. bullaeformis</i> <i>C. microvacuolatus</i> <i>C. morungavensis</i> <i>D. rotundus</i> <i>P. brasiliensis</i> <i>L. rectus</i>(110) <i>V. scutata</i> <i>W. magmus</i></p> <p>Lower limit placed at the lowermost occurrence of taxa: <i>A. parmatus</i> and <i>P. brasiliensis</i>.</p>
<p>Base of sections dominated by long range taxa.</p> <p>Common taxa: <i>D. directa</i>, <i>P. gretensis</i>, <i>P. ubischii</i>, and <i>C. follicularis</i>.</p> <p>Significant taxon: <i>P. ubischii</i>.</p>	

Figure 31: Summary of assemblage zones highlighting notable characteristics.

5.1.1.2 CKP 6 Borehole

The range charts for CKP 6 borehole are illustrated in Figures 32 and 33, with details of their characteristics summarized in Figure 34. A close examination of the range charts reveals three broad categories of taxa, as was the case with STRAT 1 range charts, namely, long, medium, and short-range taxa.

Examples of the long-range taxa include: *Deltoidospora directa*, *Punctatisporites gretensis*, *Granulatisporites angularis*, *Apiculatisporis levis*, *Protohaploxypinus limpidus*, *Cycadopites follicularis*, *Inapertisporites inapertus* etc.

The medium-range taxa include: *Pachytriletes splendens*, *Granulatisporites trisinus*, *Lophotriletes rarus*, *Verrucosisporites morulatus*, *Cristatisporites microvacuolatus*, *Weylandites magnus*, *Cycadopites cymbatus* etc.

The short-range taxa include: *Cirrabaculisporites lageniformis*, *Horriditriletes gondwanensis*, *Raistrickia crenata*, *Laevigatosporites vulgaris*, *Alisporites ovatus*, *Platysaccus papilionis*, *Striatopodocarpites fusus* etc.

An overall assessment of occurrence data and taxa range charts reveals that both the upper and lower limits are not unequivocal. The upper limit of taxa occurrence appear to be strongly determined by the vertical change in the lithostratigraphy, with the level of palynomorph yields and preservation dropping abruptly at the Ecca – Beaufort groups lithostratigraphic contact. The base of the borehole section, which shortly overlies older Precambrian basement rock, determines the lower limit of taxa occurrence and range. A lowermost section of the borehole with the lowest diversity of species, commonly long-range, has not been included into the main biozones but remains as a potential subzone.

5.1.1.2.1 Biozones

The range charts for borehole CKP 6 were similarly (*cf.* STRAT 1 borehole) analysed in terms of the *Range Zone* type of biozones as well as the *Assemblage Zone*. Four range zones are recognized (e.g. Figs. 32, 33, and 34), and are comprised of three concurrent range zones and one taxon range zone. Three assemblage zones are recognized, and are summarized and illustrated in Figure 35. A summary of the biozones and their characteristic taxa is given below, with details presented in Figures 31 and 34 for the assemblage zones and range zones, respectively.

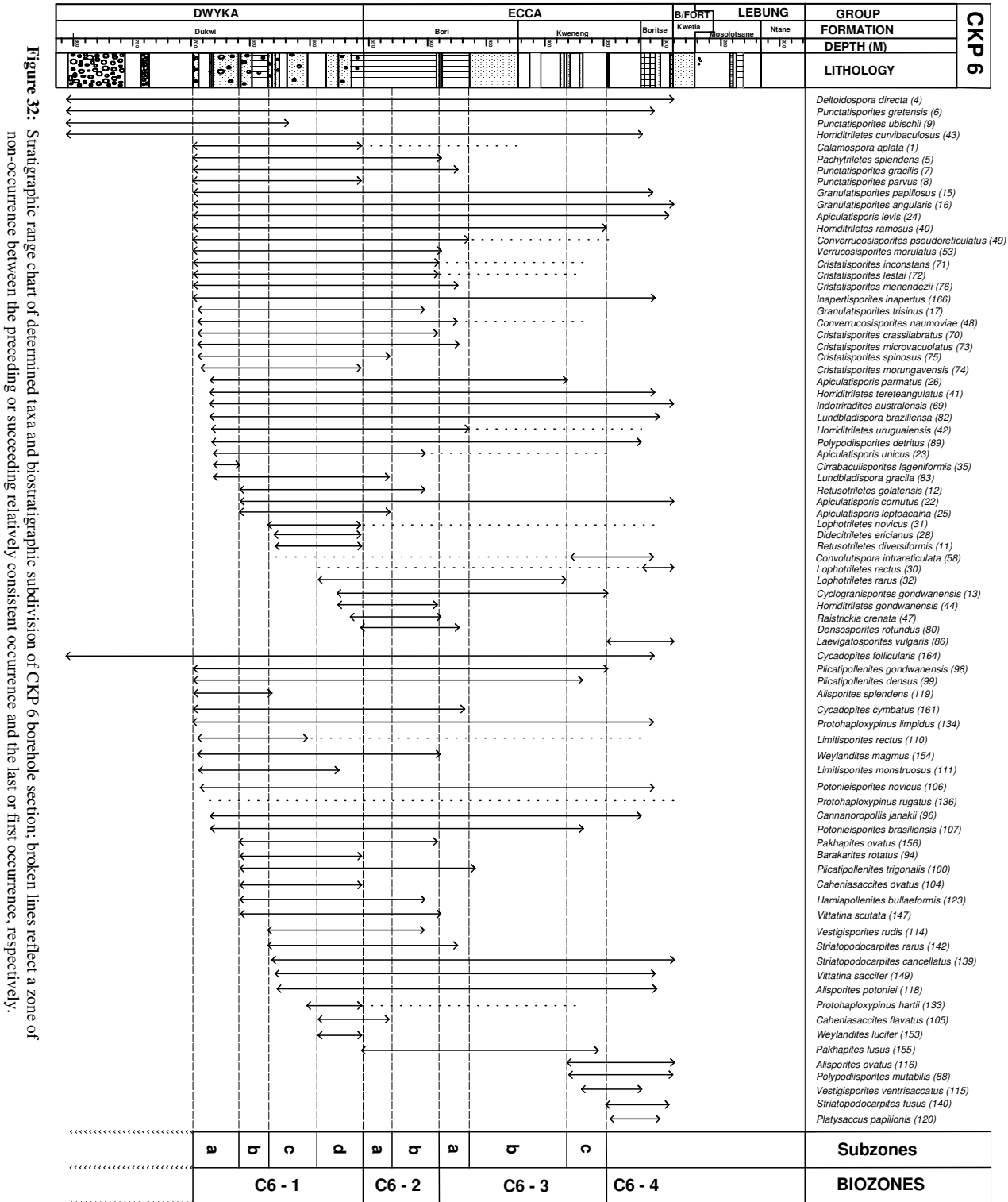

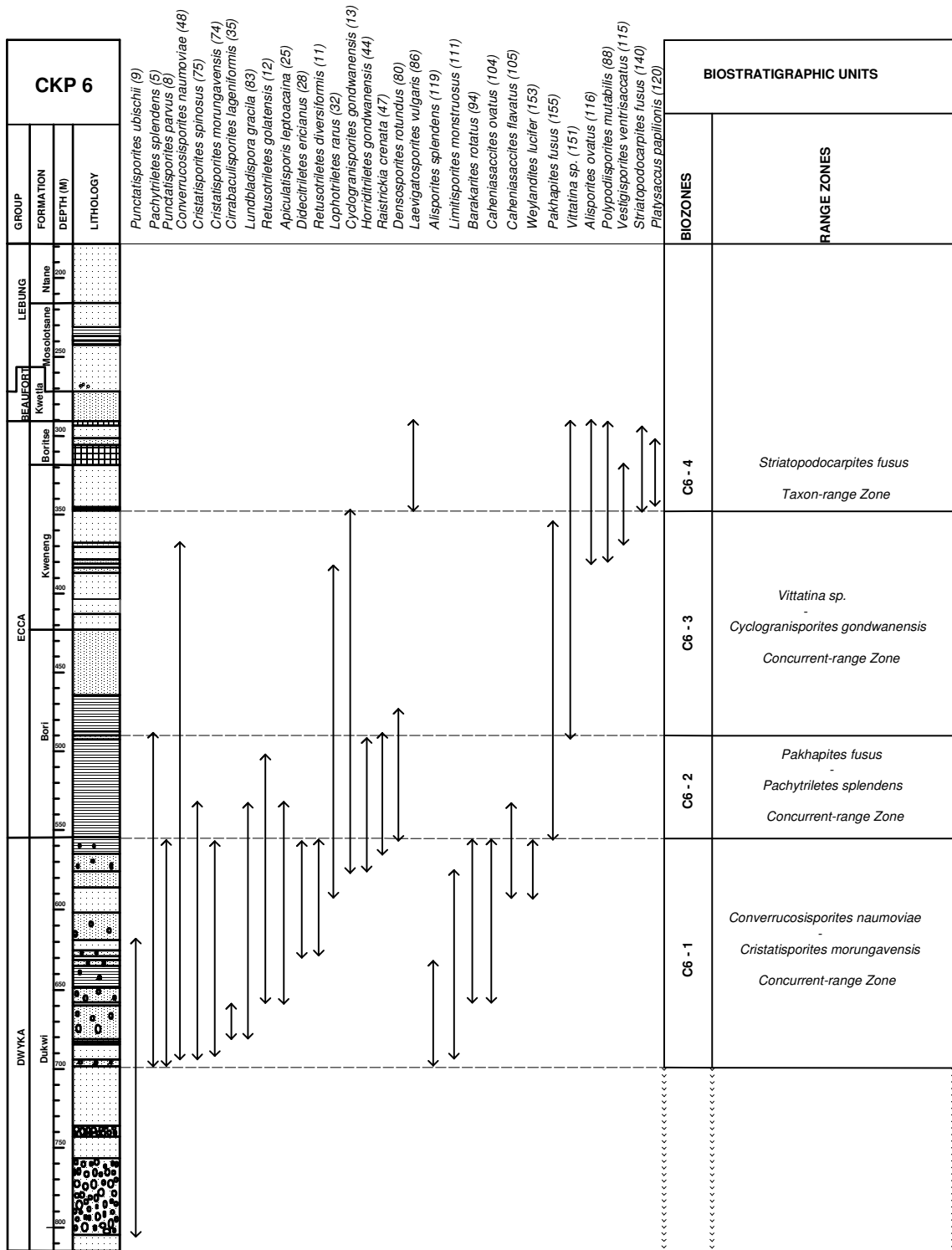

Figure 33: Stratigraphic range chart of significant taxa and biostratigraphic subdivision of CKP 6 borehole section.

5.1.1.2.1.1 Range Zones

The Converrucosisporites naumoviae – Cristatisporites morungavensis Concurrent-range Zone (Biozone C6 – 1)

This zone has been characterized on the basis of short to medium range taxa occurring in this section of the borehole. The lower and upper bounding surfaces to this zone correspond with biohorizons C6 A and C6 E (Appendix – 4), which are dominated by species initiations and terminations, respectively. The most significant taxa characterizing this zone are:

Punctatisporites parvus, *Retusotriletes diversiformis*, *Retusotriletes golatensis*, *Apiculatisporis leptocaina*, *Didecitriletes ericianus*, *Cirrabaculatisporites lageniformis*, *Cristatisporites morungavensis*, *Cristatisporites spinosus*, *Lundbladispora gracila*, *Caheniasaccites ovatus*, *Caheniasaccites flavatus*, *Limitisporites monstruosus*, *Alisporites splendens*, and *Weylandites lucifer*.

The lower limit of the zone is defined by the first occurrence of *Converrucosisporites naumoviae*, which is a relatively easily identifiable and recognizable species, and is commonly occurring in several borehole sections. The upper limit is placed at the last occurrence of *Cristatisporites morungavensis*, which appear well distinct from similar zonolaminatitriletes spores and can be easily identified. The zone has been subdivided into sub-zones on the basis of the associated biohorizons, which are largely characterized by species initiations.

The Pakhapites fusus – Pachytriletes splendens Concurrent-range Zone (Biozone C6 – 2)

This zone has been characterized on the basis of short and medium range taxa, and its boundaries corresponds to biohorizons C6 E and C6 G (Appendix II - 4), which are dominated by species terminations, respectively. The most significant taxa characterizing this zone are:

Horriditriletes gondwanensis, *Raistrickia crenata*, and *Densosporites rotundus*.

The lower limit of this zone is placed at the first occurrence of *Pakhapites fusus*, a common and easily identifiable species. The upper limit is defined by the last occurrence of *Pachytriletes splendens*, which is a distinct species that commonly occurs in other borehole sections. The zone is divided into two subzones on the basis of the associated biohorizons.

GROUP	FORMATION	DEPTH (M)	LITHOLOGY	BIOZONE	NOTABLE CHARACTERISTICS	
					Range Zone	Subzone
LEBUNG	Nirax	100-120	[Lithology pattern]	C6 - 4	C6 - 4	<p>Striatopodocarpites fusus Taxon-range Zone</p> <p>Upper limit of zone uncertain.</p> <p>Most significant species: <i>L. vulgaris</i>, <i>P. mutabilis</i>, <i>V. verticicollis</i>, <i>A. ovatus</i>, <i>P. papilionis</i>, <i>S. fusus</i>.</p> <p>Species range termination: Species terminations not well-defined, determined by change in lithostratigraphy.</p> <p>Species range initiation: <i>P. mutabilis</i>, <i>V. verticicollis</i>, <i>A. ovatus</i>.</p> <p>Species termination: <i>C. gondwanensis</i>, <i>P. demus</i>, <i>P. papilionis</i>, <i>P. fusus</i>.</p>
						<p>Vitales sp. (S1) - Cycloparisporites gondwanensis</p> <p>Concurrent-range Zone</p>
						<p>Most significant species: <i>C. mackayensis</i> (S1), <i>L. rarus</i>, <i>P. fusus</i>, <i>Vitales</i> sp. (S1).</p>
						<p>Species range termination: <i>A. parvus</i>, <i>L. rarus</i>, <i>P. papilionis</i>.</p>
ECCA	Kwenneng	100-120	[Lithology pattern]	C6 - 3	C6 - 3	<p>Pakiaules fusus - Puchyzylites splendens</p> <p>Concurrent-range Zone</p> <p>Most significant species: <i>H. gondwanensis</i>, <i>R. crenata</i>, <i>D. rotundus</i>.</p>
						<p>Species range termination: <i>P. gracilis</i>, <i>C. microreticulatus</i>, <i>C. menendahi</i>, <i>D. rotundus</i>, <i>S. rarus</i>, <i>C. cymbalius</i>.</p>
						<p>Species range initiation: <i>P. solidens</i>, <i>R. papilionis</i>, <i>G. resinus</i>, <i>H. gondwanensis</i>, <i>R. crenata</i>, <i>V. rotundus</i>, <i>C. crassilabris</i>, <i>V. rufis</i>, <i>H. bulbiformis</i>, <i>V. scutata</i>, <i>W. magnus</i>, <i>P. ovatus</i>.</p>
						<p>Species range termination: <i>D. rotundus</i>, <i>P. fusus</i>.</p>
Bori	Kwenneng	100-120	[Lithology pattern]	C6 - 2	C6 - 2	<p>Converrucosporites naumoviae</p> <p>Chetalosporites morongarensis</p> <p>Concurrent-range Zone</p> <p>Most significant species (restricted and nearly so): <i>P. parvus</i>, <i>R. diversiformis</i>, <i>H. ghalamensis</i>, <i>A. leptocoma</i>, <i>C. spinosus</i>, <i>L. gracilis</i>, <i>C. ovatus</i>, <i>C. flavatus</i>, <i>L. monosacrus</i>, <i>A. splendens</i>, <i>W. lufkeri</i>.</p> <p>The majority of species are initiated at the lower limit of this zone.</p>
						<p>Species range termination: <i>P. parvus</i>, <i>R. diversiformis</i>, <i>D. eichanus</i>, <i>C. moronguensis</i>, <i>B. rotatus</i>, <i>C. ovatus</i>, <i>W. lufkeri</i>.</p>
						<p>Species range initiation: <i>A. leptocoma</i>, <i>C. spinosus</i>, <i>L. gracilis</i>, <i>C. flavatus</i>.</p>
						<p>Species range termination: <i>P. parvus</i>, <i>R. diversiformis</i>, <i>D. eichanus</i>, <i>C. moronguensis</i>, <i>B. rotatus</i>, <i>C. ovatus</i>, <i>W. lufkeri</i>.</p>
DwYKA	Dukwii	100-120	[Lithology pattern]	C6 - 1	C6 - 1	<p>Species range termination: <i>R. diversiformis</i>, <i>D. eichanus</i>, <i>L. novius</i>, <i>V. rufis</i>, <i>A. potoniki</i>, <i>P. harti</i>, <i>S. cancellatus</i>, <i>S. rarus</i>, <i>V. sanctae</i>.</p>
						<p>Species range initiation: <i>R. papilionis</i>, <i>A. leptocoma</i>, <i>B. rotatus</i>, <i>P. papilionis</i>, <i>C. ovatus</i>, <i>H. bulbiformis</i>, <i>V. scutata</i>, <i>P. ovatus</i>.</p>
						<p>Species range termination: <i>A. splendens</i>.</p>
						<p>Species range initiation: <i>C. spata</i>, <i>P. splendens</i>, <i>P. gracile</i>, <i>P. parvus</i>, <i>G. papulosus</i>, <i>G. angulatus</i>, <i>G. resinus</i>, <i>A. unicus</i>, <i>A. leve</i>, <i>A. parvulus</i>, <i>C. leptiformis</i>, <i>H. ramosus</i>, <i>H. teretisepalatus</i>, <i>H. longicaulis</i>, <i>C. namoiensis</i>, <i>C. pseudoreticulatus</i>, <i>V. montivus</i>, <i>I. australiensis</i>, <i>C. crassilabris</i>, <i>C. incostans</i>, <i>C. lenti</i>, <i>C. microreticulatus</i>, <i>C. moronguensis</i>, <i>C. spinosus</i>, <i>C. menendahi</i>, <i>L. brazealensis</i>, <i>L. gracilis</i>, <i>P. dentus</i>, <i>C. jamaui</i>, <i>P. gondwanensis</i> (S6), <i>P. demus</i>, <i>P. novius</i>, <i>P. tridentatus</i>, <i>L. rotundus</i> (T10), <i>L. moronguensis</i>, <i>P. impatiens</i>, <i>W. magnus</i>, <i>C. cymbalius</i>, <i>I. angipennis</i>.</p>

Figure 34: Summary of significant qualitative analyses with subdivision of CKP 6 borehole section.

The Vittatina sp. – Cyclogranisporites gondwanensis Concurrent-range Zone (Biozone C6 – 3)

This zone occurs within the section bound by biohorizons C6 G and C6 J (Appendix II - 4), and is largely dominated by long-range species. The most significant taxa that characterize this zone are:

Cyclogranisporites gondwanensis, *Lophotriletes rarus*, *Pakhapites fusus*, and *Vittatina sp.*

The lower limit of this zone is poorly constrained and is mainly determined by the upper limit of the preceding zone, which is dominated by species terminations. However, consideration of the all-taxa range charts revealed that the lower limit of this zone could be defined in terms of the first occurrence of *Vittatina sp.* The latter species, although open-ended in this study, has been utilized in South America to define a biozone, where it is classified as *Vittatina costabilis* (e.g. Marques-Toigo and Klepzig, 1995; Souza and Marques-Toigo, 2005), but is here differentiated following Tschudy and Kosanke (1966). The upper limit of the zone is placed at the last occurrence of *Cyclogranisporites gondwanensis*, but is also associated with other species terminations and initiations.

The Striatopodocarpites fusus Taxon-range Zone (Biozone C6 – 4)

This zone has a limited range and most probably represents a subzone. The upper limit seems to be largely controlled by a change in the lithostratigraphy, which is associated with a rapid fall in palynomorph yields. The zone has been characterized based on short-range taxa of which the most significant are:

Laevigatosporites vulgaris, *Polypodiisporites mutabilis*, *Vestigisporites ventrisaccatus*, *Alisporites ovatus*, *Platysaccus papilionis*, and *Striatopodocarpites fusus*.

Both the lower and upper limits of this zone are defined based on the range of occurrence of the species *Striatopodocarpites fusus*, which also appear to co-exist with *Platysaccus papilionis* as evidenced by the two taxa ranges in boreholes STRAT 1 and CKP 6. The lower limit of the zone corresponds to biohorizon C6 – J, which is defined based on species terminations and initiations.

5.1.1.2.1.2 Assemblage Zones

The assemblage zones were determined based on close comparison with borehole STRAT 1, as a result the diagnostic taxa and hence the zones themselves are as described in section 5.1.1.1.2. Therefore, a full description of the assemblage zones characteristics will not be repeated in this section. In a similar situation to STRAT 1 borehole the basal and top sections of CKP 6 borehole are also poorly constrained. The lowermost section is palynologically less productive and comprised of long-range taxa,

the lower limits of which are determined by the base, making it difficult to distinctively characterize. A summary of the assemblage zones proposed is illustrated in Figures 31 and 35.

The Hamiapollenites bullaeformis Assemblage Zone

The lower and upper bounding surfaces to this zone correspond to biohorizons C6 A and C6 H, respectively (e.g. Appendix II – 4). The lower boundary typically marks the first appearances or initiations of the majority of taxa in the borehole, much of which are long-range species. On the contrary, the upper boundary is associated with the terminations of several taxa, dominated by medium-range species.

The Cyclogranisporites gondwanensis Assemblage Zone

This zone is confined between biohorizons C6 H and C6 J (Appendix II – 4), which defines the lower and upper boundaries of the zone, respectively. The lower boundary is characterized by species terminations from the preceding zone, while the upper boundary is associated with both species initiations and terminations. In general, this zone is characteristically less productive with regard to palynomorph yields, as compared to the preceding zone.

The Platysaccus papilionis Assemblage Zone

This zone represents the uppermost palynologically productive section of the borehole. The lower boundary of the zone corresponds with biohorizon C6 J (Appendix II – 4), while the last productive sampled level determines the upper boundary.

5.1.2 Quantitative Analysis

The quantitative data is firstly presented as relative abundance charts depicting the vertical distribution of the various categories of the sedimentary organic matter i.e. palynofacies. This is in order to explore the vertical stratigraphic trends indicated by the distribution of palynofacies relative to lithology, and ultimately define stratigraphic horizons or boundaries. Secondly, the data is further assessed using some selected statistical method to determine variations in the distribution of the palynofacies.

5.1.2.1 Palynofacies Horizons

Details of the vertical stratigraphic distributions, which comprise percentage data and ratios of selected palynofacies groups and categories, are illustrated in Figures 36 - 39. A visual assessment of the stratigraphic distribution charts reveals several relatively distinct

horizons sub-dividing the borehole section into palynofacies-determined units. The boundaries to the units (i.e. palynofacies horizons) are marked by either a rise or decline in the relative abundance of the palynofacies groups or categories. The palynofacies horizons were ultimately compared and correlated with the biohorizons from the qualitative analysis in order to determine consistent boundaries that could be utilized in local correlation. A correlation of the palynofacies horizons and the associated biohorizons, as well as some notable characteristics from the qualitative and quantitative analyses, is summarized in Appendix III - 1. Below is a summary of the major recognizable trends delineated from the vertical distribution charts (e.g. Figs. 36 – 39) for the different palynofacies groups and their respective categories.

5.1.2.1.1 Total sediment organic matter (TSOM)

Amorphous organic matter (AOM)

AOM is the least dominant category, and constitutes generally less than 10% of the total sediment organic matter. Its vertical distribution curve indicates isolated peaks at some levels of the borehole sequence. The most significant palynofacies horizons include A, C, and F, illustrated in Figure 36.

Total phytoclasts (TPh)

The phytoclast group is the most dominant within the total sediment organic matter, and ranges generally from about 40% to about 80% in relative abundance. The vertical distribution curve depicts a less readily distinct but recognizable general up-sequence decline within the Dwyka Group up to the lower part of the Kobe formation. The latter trend is followed by a general up-sequence rise within the rest of the Eccu section. The most significant palynofacies horizons include A, B, and D (Fig. 36).

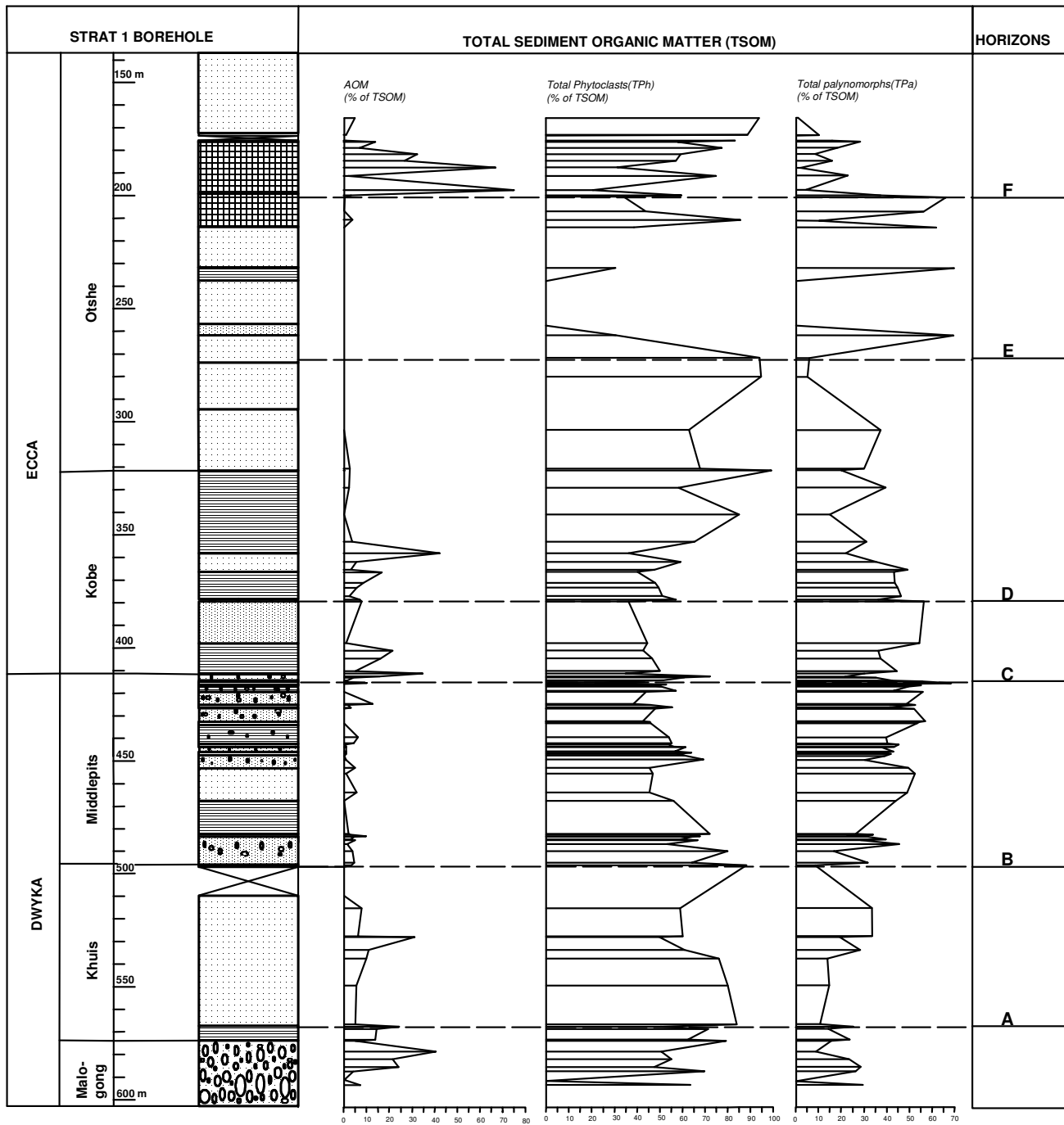

Figure 36: Relative abundance and stratigraphic distribution of 3 major groups of sediment organic matter and significant horizons (plotted as % of TSOM).

Total palynomorphs (TPa)

The palynomorphs form the next most significant group of the total sediment organic matter after the phytoclasts, and ranges from about 15% to about 45% in relative abundance. Generally, the vertical trend of the distribution curve indicates a gradual rise within the Dwyka Group up to the lower part of the Kobe formation, followed by a decline, which appear most distinct in the upper part of the Kobe formation up to the lower part of the Otshe formation. All the six palynofacies horizons, as illustrated in Figure 36, are significant.

5.1.2.1.2 Palynomorphs

The counting procedure for the palynomorphs included degraded and squashed grains, which eventually proportionately dominated the bulk of the counts. This resulted in low percentage values for the better preserved grains used to construct the distribution charts. In addition, a large percentage of the degraded palynomorphs appeared to be dominated by the saccate pollen, as a result creating a less representative outcome for the latter group. Nevertheless, the general trends obtained are considered significant and representative of the status of the palynomorphs character within the rock sequence. Details of the distribution patterns indicated by the relative abundance of the palynomorph categories are illustrated in Figure 37.

Azonotriletes – laevigate (AZLA)

This category of palynomorphs is relatively significant throughout the Dwyka Group, as well as up to the lower part of the Eccca Group represented by the Kobe formation. A slight rise in the relative abundance occurs in the uppermost section of the Otshe formation. The most significant palynofacies horizons include C, G, and H.

Azonotriletes – apiculate (AZAP)

This category generally indicates a similar trend of the relative abundance curve as that obtained from the AZLA category. However, in this case there are rare low peaks in the characteristically less productive lower sections of the Otshe formation. The seemingly higher percentages ranges are only a result of a wider diversity within this category, which includes granulate, spinose, and baculate spores. The most significant palynofacies horizons include E, F, and H.

Zonolaminatitriletes (ZOLA)

This category indicates isolated peaks at different levels of the section, but appears to be more significant in the upper parts of the Dwyka Group (i.e. Middlepits formation) and the lower parts of the Eccca Group. The most significant palynofacies horizons appear to be C and E.

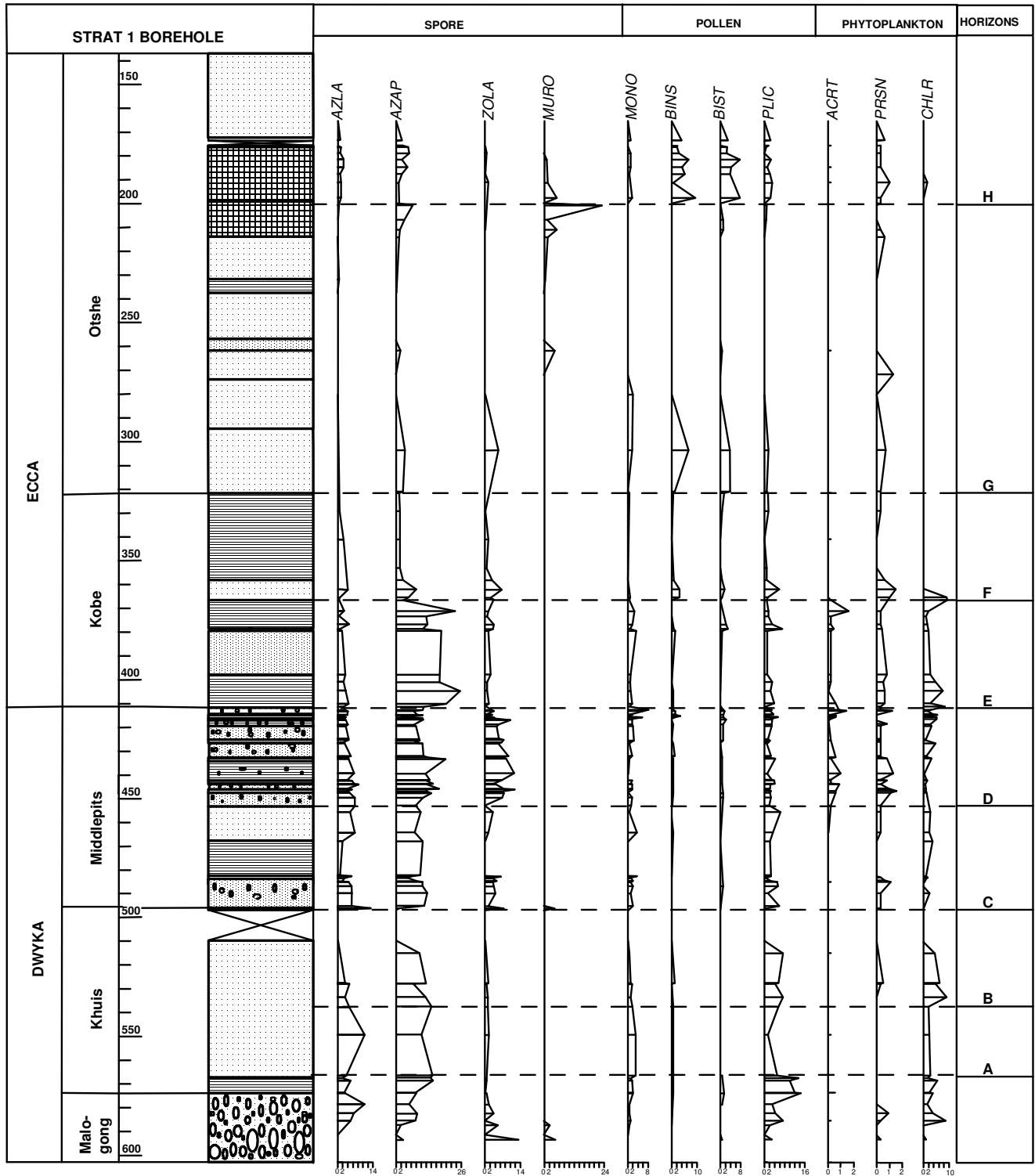

Figure 37: Relative abundance of 11 selected palynomorph groups depicting their stratigraphic distribution and significant horizons (plotted as % of TPa counted, including degraded palynomorphs not shown in figure).

Murornate (MURO)

This is relatively the least significant of all the palynomorph categories, dominated by non-occurrence throughout much of the borehole section. Only one notable peak is indicated in the upper parts of the Eccca Group, within the coal-bearing section of the Otshe formation. The most significant palynofacies horizon with respect to this category is H.

Monosaccates (MONO)

The Monosaccates indicates a generally less eventful distribution curve dominated by low percentage relative abundances. A minor potentially significant peak occurs at horizon E, probably the most important for this category.

Bisaccate non-striate (BINS)

The relative abundance of this category of palynomorphs is insignificant throughout the Dwyka Group as well as in the lowermost Kobe formation. There is generally a slight, but notable, rise in the relative abundances within the Otshe formation. The most significant palynofacies horizons relative to this category are F, G, and H.

Bisaccate striate (BIST)

The distribution curve for the bisaccate striate pollen is closely identical to that indicated by the non-striate bisaccate pollen (BINS), with a slight notable rise in the Otshe formation. The most significant palynofacies horizons in this category are G and H.

Plicates (PLIC)

This category of non-saccate pollen relatively dominates in the Dwyka Group, and to a lesser extent in the lower sections of the Kobe formation. A slight but notable rise in the relative abundances occurs in the upper sections of the Otshe formation. The significant palynofacies horizons relative to this category are A, D, and H.

Acritarchs (ACRT)

This category of the phytoplanktons display notable relative abundances in the uppermost section of the Dwyka Group i.e. top of the Middlepits formation, as well as in the lowermost section of the Eccca Group i.e. bottom of the Kobe formation. The most significant palynofacies horizons with respect to this category are D and F.

Prasinophytes (PRSN)

The relative abundances for this category of palynomorphs become noticeably significant in the uppermost section of the Dwyka Group (i.e. top of the Middlepits formation), and up-sequence. However, this category generally appears to indicate a slight but

appreciable local dominance paralleling that indicated by the arccritarchs. In addition, several isolated peaks occur throughout the borehole section. The most significant palynofacies horizon relative to this category is D.

Chlorophytes (CHLR)

This category, solely represented by *Botryococcus sp.* in this study, indicates relative dominance in the Dwyka Group, as well as the lower part of the Kobe formation. The palynofacies horizons of note include A, B, C, E, and F.

5.1.2.1.3 Phytoclasts

An overall assessment of the percentage relative abundances for the phytoclasts group indicates an overwhelming dominance of the equidimensional categories in comparison with the lath-shaped categories. Details of the stratigraphic distribution patterns and the palynofacies horizons of note are illustrated in Figure 38.

Black equidimensional (BLKE)

The relative abundance curve for this category of black equidimensional phytoclasts depicts a general rise in percentages up-sequence, punctuated by a substantial increase about the Dwyka – Eccca contact. Nevertheless, several sporadic levels of high peaks characterize the rest of the section. Generally, the percentage relative abundances range from about 15% to about 50%. The most significant palynofacies horizon with regard to this category is C.

Black lath-shaped (BLKL)

This category is relatively insignificant throughout the entire Dwyka Group, including the lower sections of the Kobe formation. A slight but notable rise is indicated from the top section of the Kobe formation, with a much more significant increase in the relative abundances recognized in the topmost section of the Otshe formation. BLKL constitutes generally less than 20% of the total phytoclasts. The palynofacies horizons of note in this category are B and F.

Brown equidimensional (BRNE)

The brown equidimensional phytoclasts generally dominates in the Dwyka Group in terms of the relative percentage abundances. However, there is a significant decline at the Dwyka – Eccca boundary, which is also marked by a rise in the percentage abundances of the black equidimensional phytoclasts. This category though also depicts an increase, albeit less definitive, in the mid- to upper sections of the Otshe formation. The percentage relative abundances generally range from about 15% to about 60%. All the six palynofacies horizons are significant, as they correspond to notable changes with regard to the vertical distribution patterns in this category.

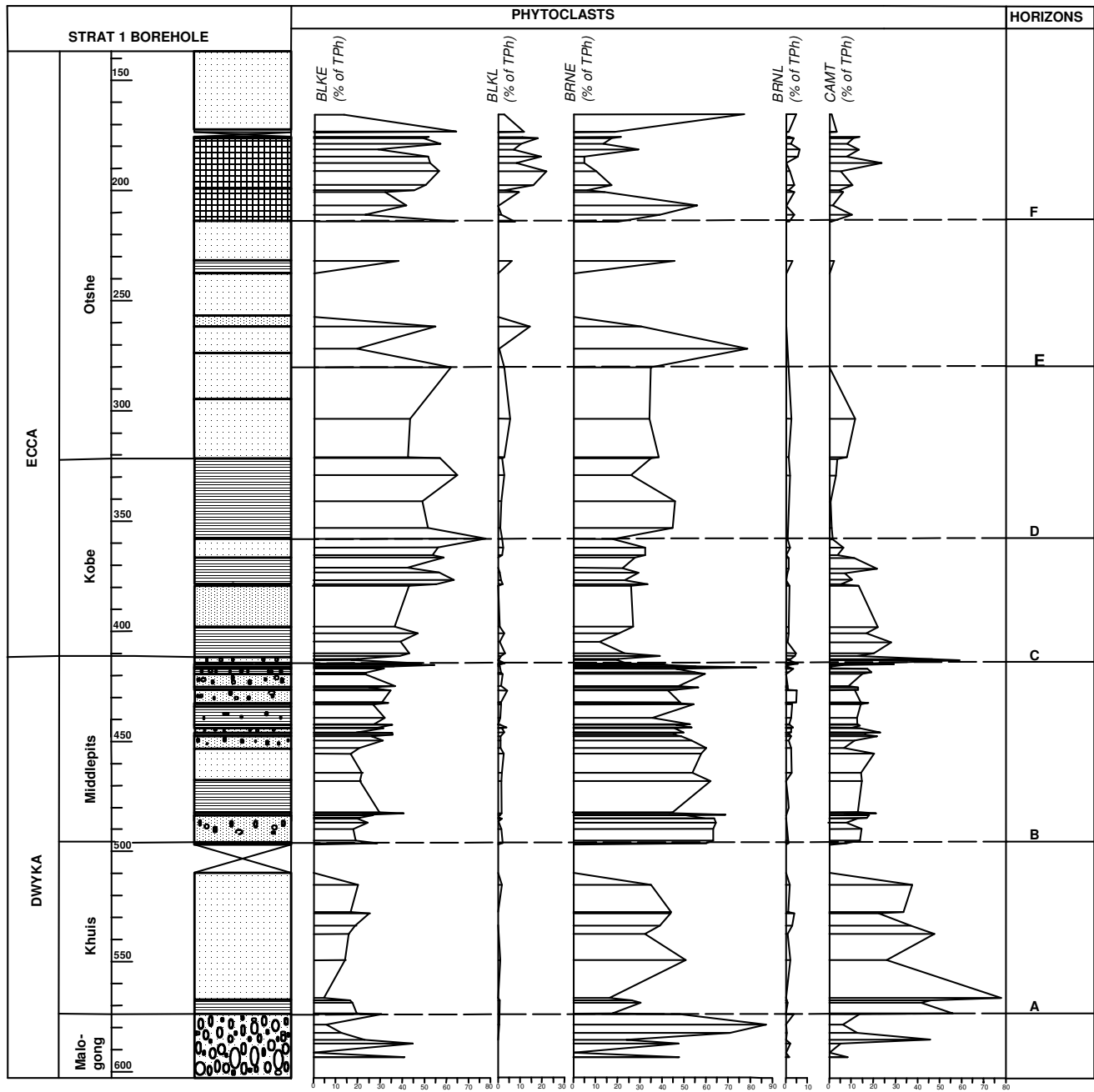

Figure 38: Relative abundance and stratigraphic distribution of 4 selected phytoclasts categories and significant horizons (plotted as % of TPh).

Brown lath-shaped (BRNL)

This category is the least significant within the phytoclasts group, attaining the lowest relative percentage abundances, not exceeding 10% of the total phytoclasts. Nevertheless, the brown lath-shaped phytoclasts are recognized throughout the borehole section. The most notable palynofacies horizon with regard to this category is F.

Cuticle and membranous tissues (CAMT)

The stratigraphic distribution of this category indicates strongly significant relative abundances in the lower sections of the Dwyka Group (i.e. Malogong and Khuis formations), followed by a major decline starting from the base of the Middlepits formation. A sharp, but isolated, peak occurs at the Dwyka – Eccca contact, perhaps reflecting a potentially significant event. All but horizon A appear to be of great significance with regard to this category.

5.1.2.1.4 Log₁₀ ratios

An overview of the stratigraphic distributions for the log₁₀ ratios reveals an outstanding dominance by equidimensional and spores categories in the phytoclasts and palynomorphs groups, respectively. A notable highlight is the striking contrast in stratigraphic distribution between the black and brown equidimensional phytoclasts, which displays a clear polarity at the Dwyka – Eccca contact. Details of the stratigraphic distribution patterns and the palynofacies horizons of note are illustrated in Figure 39.

Log₁₀ total phytoclasts equidimensional/lath-shaped (tphe/tphl)

The stratigraphic distribution curve obtained from the log₁₀ tphe/tphl ratios indicate a generally consistent and relatively constant trend up through the sequence. Nevertheless, there are several subtle but recognizable breaks that allowed the sequence to be subdivided in terms of palynofacies horizons. Overall the lath-shaped phytoclasts are insignificant throughout the sequence. All the eight proposed horizons are notably significant.

Log₁₀ black equidimensional/brown equidimensional (blke/brne)

The stratigraphic trend obtained from the log₁₀ blke/brne ratios reveals a clear dominance of the brown and the black phytoclasts in the Dwyka and Eccca groups, respectively. This observation highlights the most significant change at the Dwyka – Eccca boundary. The most notable palynofacies horizon is no doubt E, however several other horizons correspond with some less striking but significant breaks e.g. horizons A, B, C, G, and H.

Log₁₀ saccate pollen/spores (sapo/spor)

In this category the stratigraphic trend indicates that spores greatly dominate throughout the Dwyka Group, as well as in the lower sections of the Eccca Group, comprising the Kobe formation. Rare isolated peaks in the sandy middle parts of the Otshe formation also indicate a dominance of spores. Only the topmost section of the borehole reflects some input from the saccate pollen. Palynofacies horizons of note include A, E, G, and H.

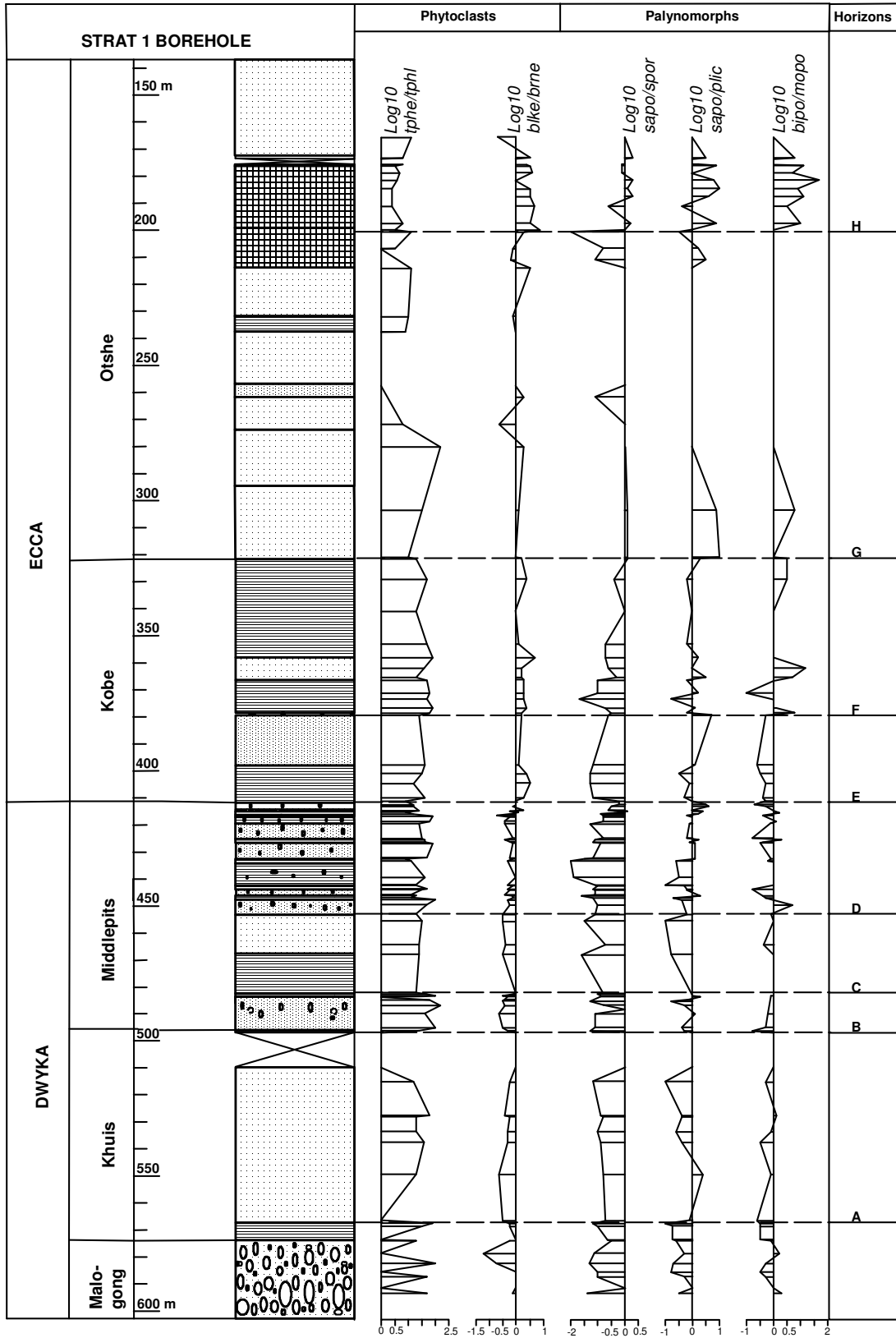

Figure 39: Stratigraphic distribution of selected log₁₀ ratios and significant horizons.

Log10 saccate pollen/plicates (sapo/plic)

The stratigraphic trend reveals that generally plicates dominate in the Dwyka Group, though less consistently so, whereas saccate pollen are relatively more significant in the upper sections of the Ecca Group i.e. Otshe formation. The palynofacies horizons of note in this category include A, C, E, F, G, and H.

Log10 bisaccate pollen/monosaccate pollen (bipo/mopo)

The trend in this category is less distinct but the overall pattern reflects that the monosaccate pollen are more significant in the Dwyka Group, as well as in the bottom section of the Kobe formation. The bisaccate pollen on the other hand becomes significant from the upper section of the Kobe formation up-sequence. The palynofacies horizons are difficult to contrast however the notable ones appear to be B, F, and H.

5.1.2.2 Statistical Analysis

The use of multivariate statistical methods is now a common technique employed by several workers for the management and interpretation of quantitative palaeontological data (Traverse, 1988; Miall, 1990; Tyson, 1995). The basis of such methods stems from their ability to segregate groups of data sets according to dominant variables influencing the data, and hence allowing for comparison and ultimately correlation. The quantitative palynofacies data in this study were analysed using the cluster analysis technique in PAST (Hammer et. al., 2006), which is a computer-based statistics program tailor-made for palaeontology. Cluster analysis produces a ‘dendrogram’ indicating several associations of samples created on the basis of similarity to each other. All ‘dendrograms’ were produced using the Q-mode clustering in the Ward’s method, and samples were compared on the basis of relative abundance data of the palynofacies categories.

The procedure of cluster analysis adopted in this study followed two steps. Firstly, all samples were plotted to investigate their similarities relative to the stratigraphic levels throughout the entire borehole section (e.g. Figs. 40 – 42). Secondly, samples were investigated relative to the current lithostratigraphic subdivision (e.g. Smith, 1984) at formation rank in order to detect small-scale variations (e.g. Figs. 43 – 46). The production of dendrograms involved the plotting of the relative abundance data of the following groups of palynofacies categories:

- i. Amorphous organic matter, total phytoclasts, and total palynomorphs.*
- ii. Spores, pollen, and microplanktons.*
- iii. Black and brown equidimensional phytoclasts, and cuticle and membranous tissues.*

The first group consisted of an analysis of the total sediment organic matter and the relationships between samples and the respective end-members. The second and third

groups consisted of analyses of the palynomorphs and phytoclasts, respectively, in terms of samples and their relationships to the palynofacies categories. Several major and small-scale clusters are recognizable for each group (e.g. Figs. 40 – 46), and are indicative of unique variables influencing the samples. A notable observation is the fact that samples from different levels of the stratigraphy indicate close similarities, probably reflecting a repeat or cycles of the influential variables.

The results of the cluster analysis are presented in the form of dendrograms illustrated in Figures 40 – 46 below. The significance of the various clusters is not readily evident, and hence requires further consideration with comparison to the results of other similar studies. An interpretation of these clusters is discussed in the next chapter where the respective dendrograms are converted into ternary plots and analysed for palaeo-depositional environments following Tyson (1995).

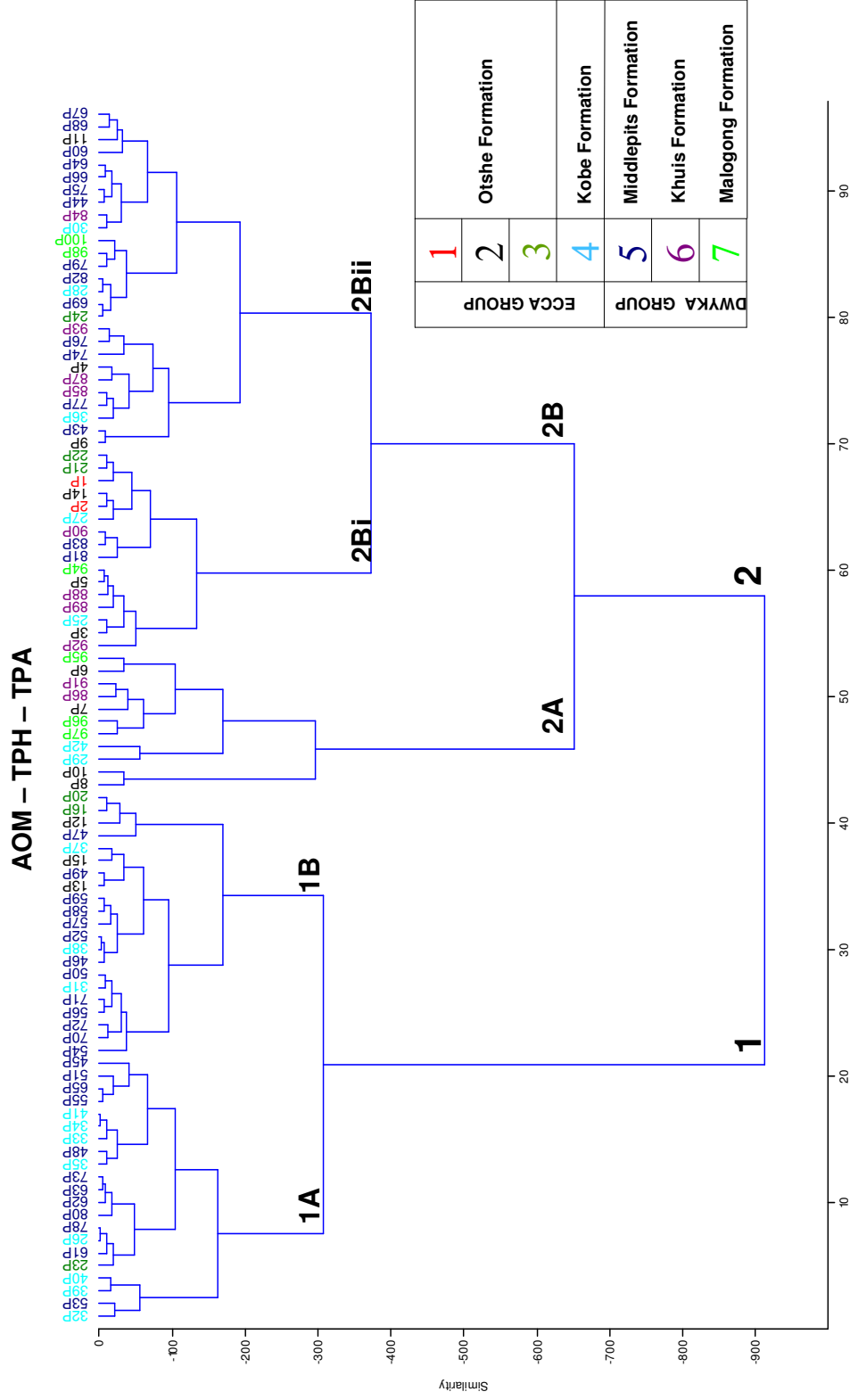

Figure 40: Cluster analysis dendrogram for total sediment organic matter counts i.e. AOM (Amorphous organic matter), TPH (Total phytoclasts), and TPA (Total palynomorphs).

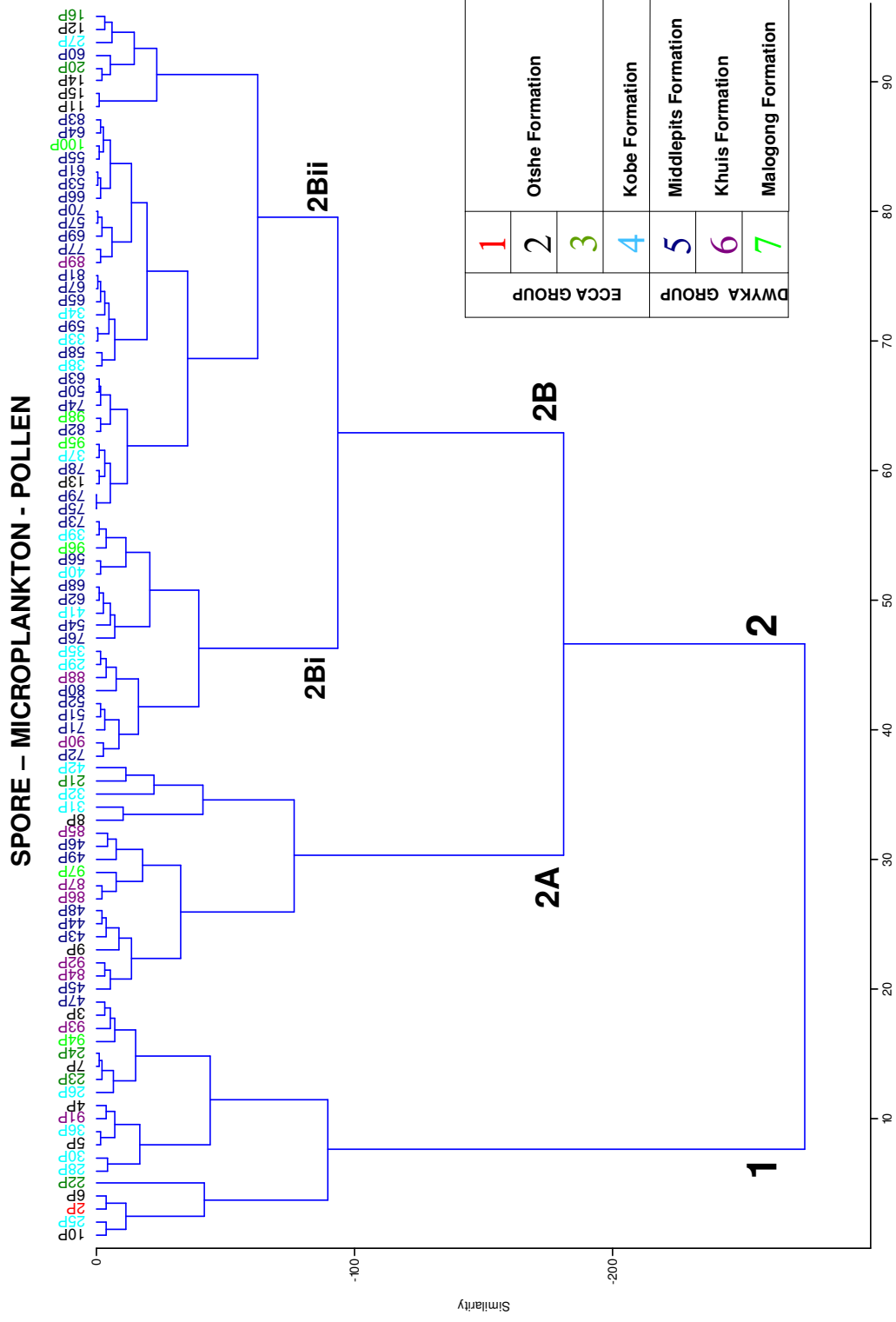

Figure 41: Cluster analysis dendrogram for spores, pollen, and microplanktons depicting several associations of samples.

BLKE – CAMT - BRNE

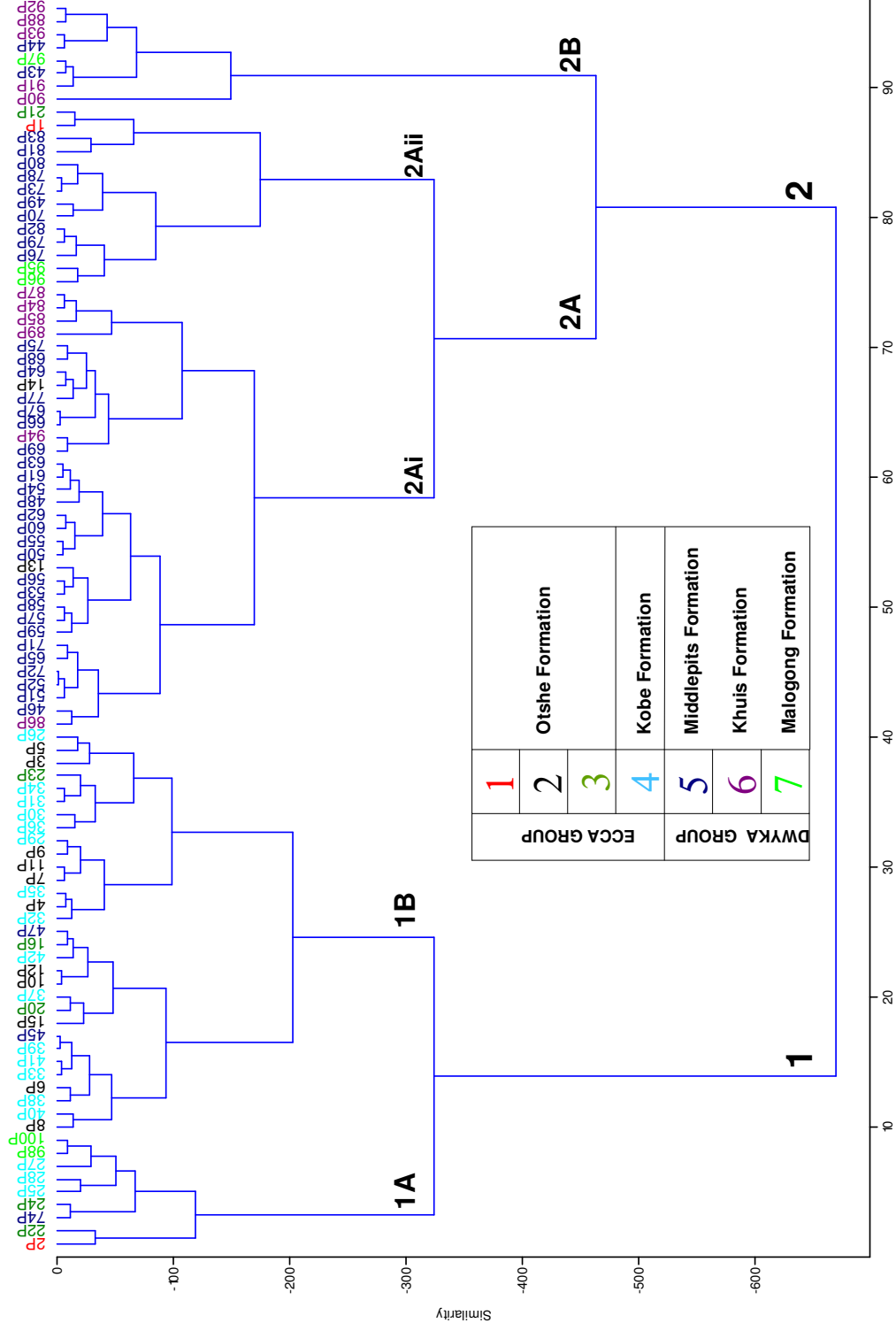

Figure 42: Cluster analysis dendrogram for selected categories of phytoclasts e.g. black equidimensional (BLKE), brown equidimensional (BRNE), and cuticular and membranous tissues (CAMT).

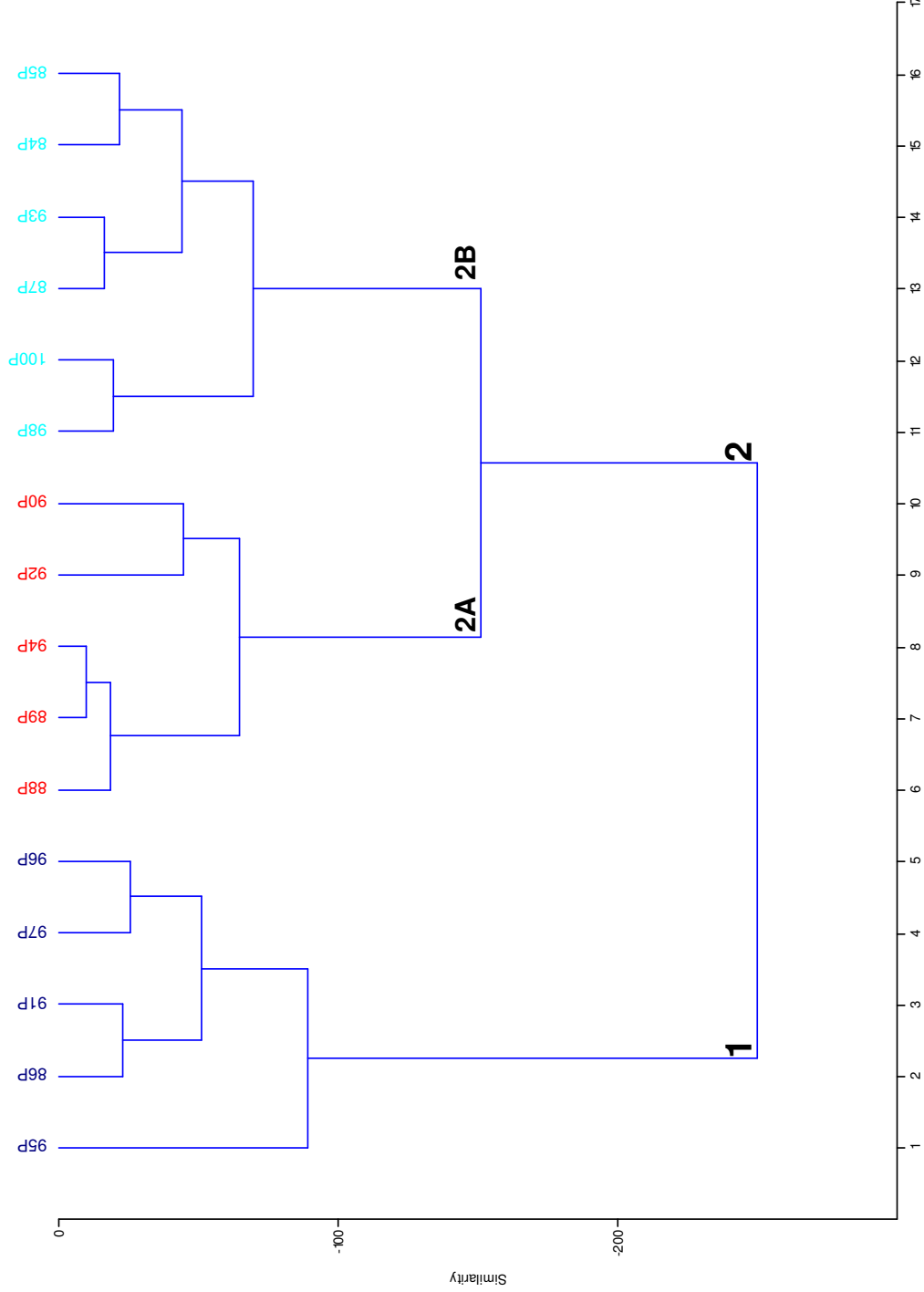

Figure 43: Cluster analysis dendrogram for total sediment organic matter using only samples from the Malogong and Khuis formations, Dwyka Group.

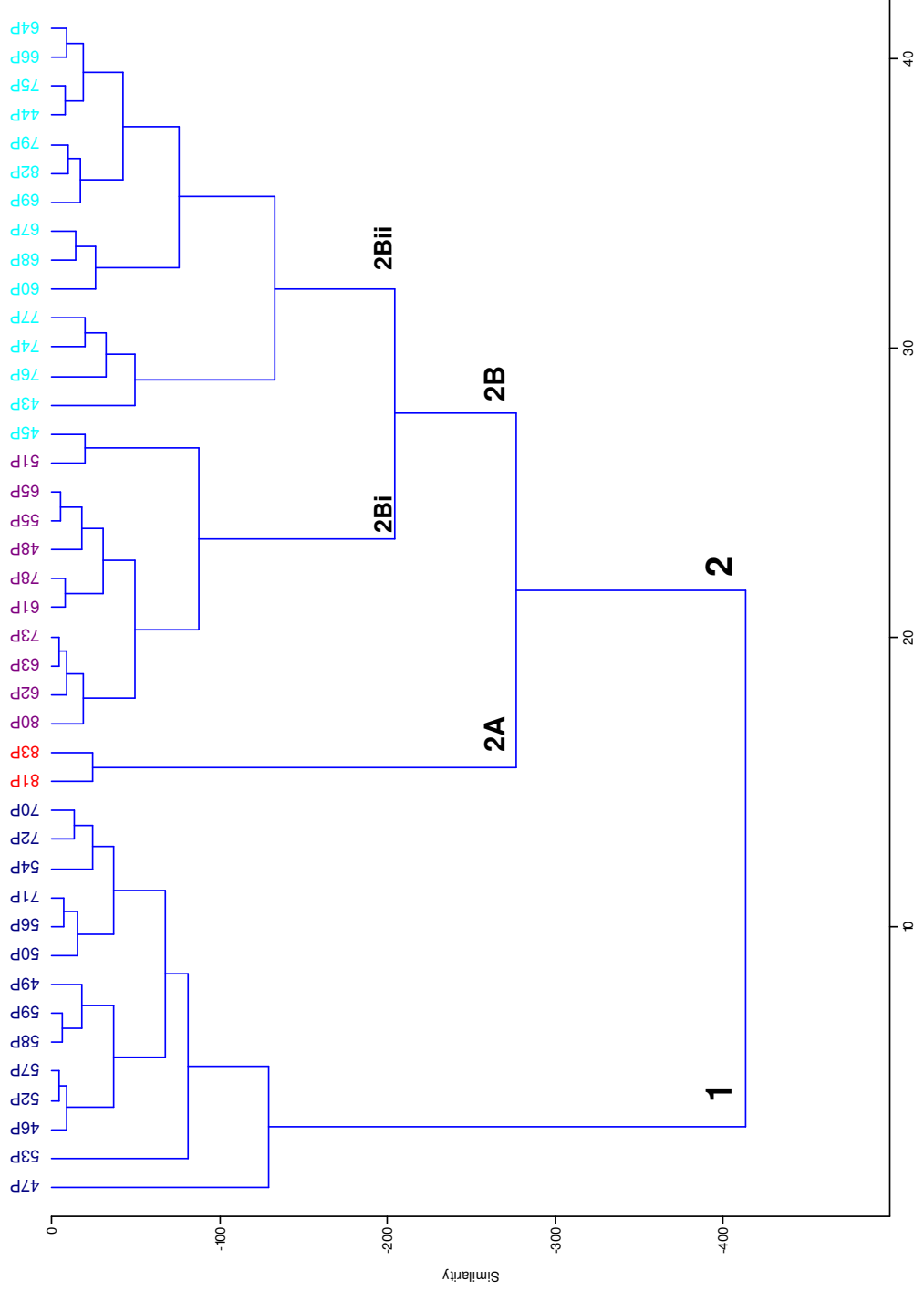

Figure 44: Cluster analysis dendrogram for total sediment organic matter using only samples from the Middlelepts formation, Dwyka Group.

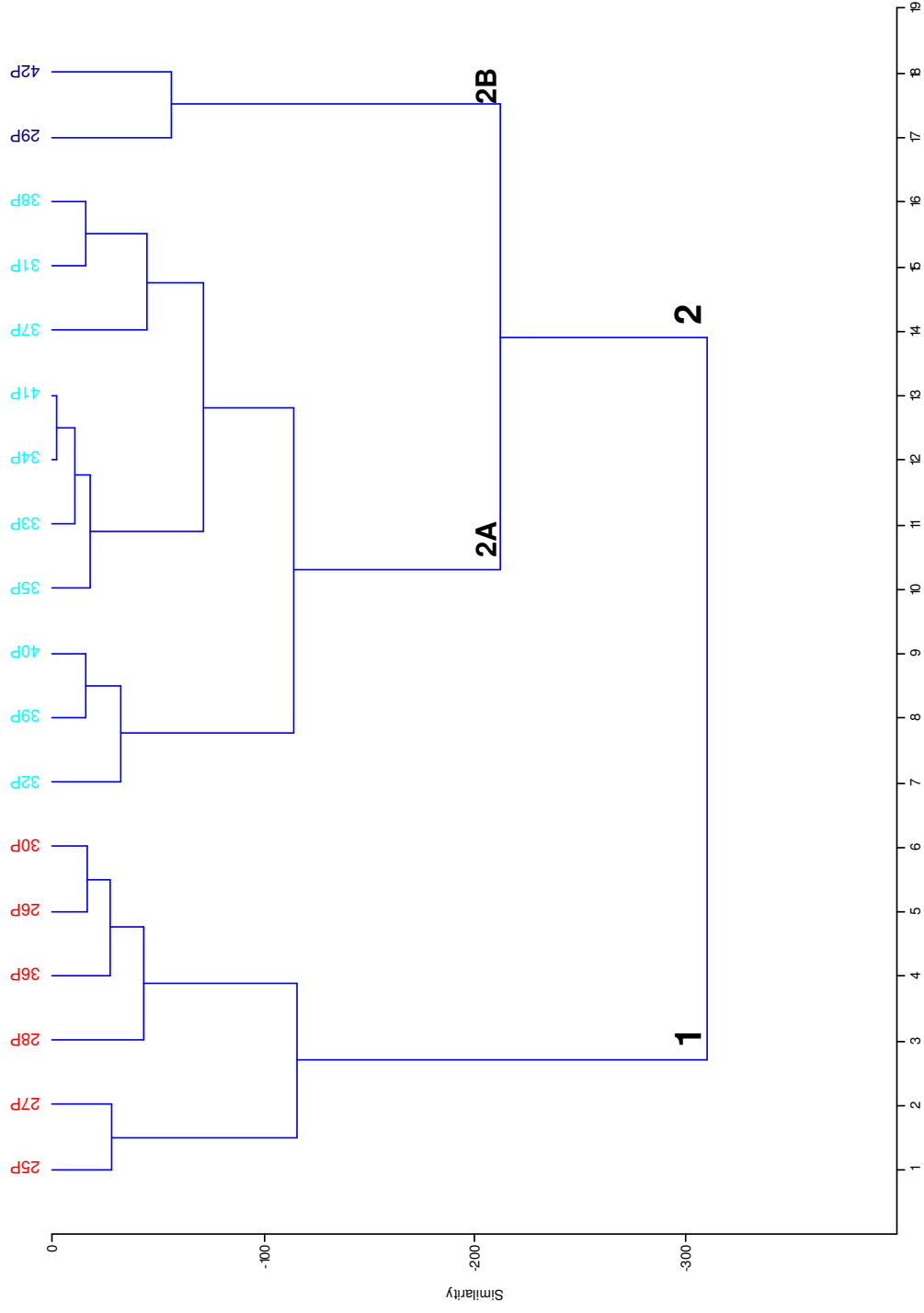

Figure 45: Cluster analysis dendrogram for total sediment organic matter using only samples from the Kobe formation, Ecce Group.

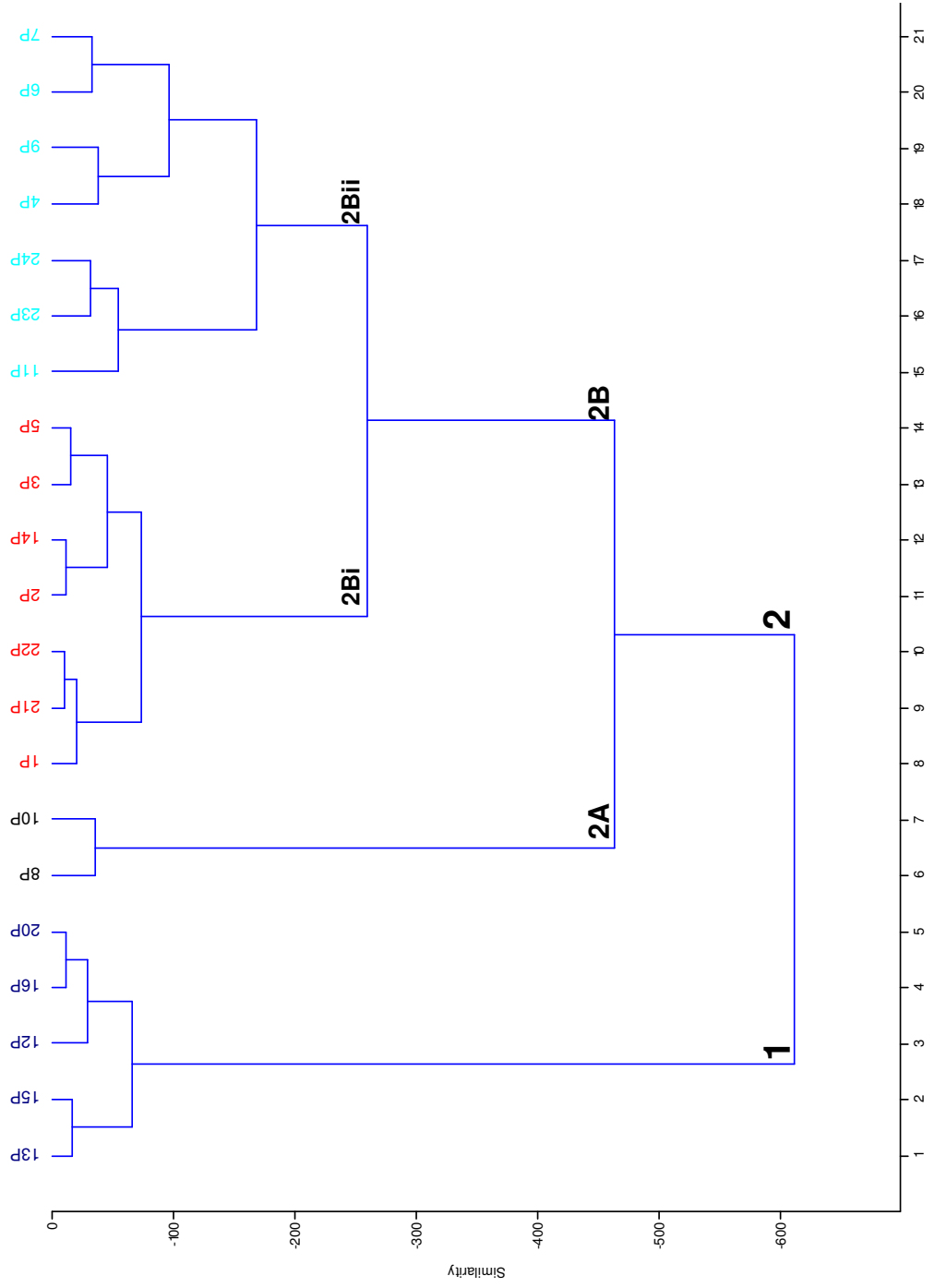

Figure 46: Cluster analysis dendrogram for total sediment organic matter using only samples from the Otshhe formation, Eccla Group.

CHAPTER 6: DISCUSSIONS

The results of both the qualitative and quantitative analyses give insight into the nature of the stratigraphic succession by revealing important palynomorph and palynofacies characteristics of the sequence studied. The intergration of all the notable characteristics allows for correlation and a comparative analysis with other sections, and ultimately age deductions.

6.1 Correlation

Stratigraphic trends of note revealed by the qualitative analysis are those defined on the basis of frequency distributions of taxa, and are largely dominated by taxon's first and last occurrences (e.g. Figs. 27, 29, 32, 34). The latter formed the basis for the creation of biohorizons, which provide the points of correlation between different stratigraphic sections. Other indicators for correlation are reflected by the decrease or increase in the relative abundances of taxa, as well as some subtle but significant changes in the diversification of species.

6.1.1 STRAT 1 correlation with CKP 6 and CKP 9

Out of the eight other (i.e. excluding STRAT 1) borehole core-sections sampled for this study only CKP 6 has yielded data that allows for a useful comparative analysis in terms of species range charts. Borehole CKP 9 on the other hand has yielded data sufficient only for a general but significant comparison. The rest of the borehole sections (e.g. Appendix II) yielded inadequate occurrence data that is either confined to one level or indicate short ranges for taxa that otherwise display a much extensive range in STRAT 1 or CKP6. Nevertheless, there is great similarity between all the borehole sections as reflected by the occurrence of common taxa, which indicates great potential for future comparative studies with more detailed and close-knit sampling.

CKP6

Range Zones

STRAT 1 and CKP6 consist of common taxa, and the range of species in each borehole has allowed the erection of four range zone biostratigraphic units. However, to a great extent the ranges of the most significant species do not make a close match between the two sections, with the exception of the uppermost zones e.g. S1-4/C6-4. The latter biostratigraphic units are closely comparable based on the common occurrence of the species *Platysaccus papilionis* and *Striatopodocarpites fusus*, which have been used to define and name taxon range zones for STRAT 1 and CKP6 boreholes, respectively. The two taxa could however be interchanged in naming the range zones between STRAT 1 and CKP 6, as they define a relatively similar stratigraphic range in both the borehole

sections. The upper limit of this zone is equally poorly defined in both STRAT 1 and CKP 6, and hence the full extent of the zone is uncertain. However, the lower limits for the two comparable zones are recognized in both sections as defined by the initiations of the two most significant common taxa. Details concerning the characteristics of the *Platysaccus papilionis* and the *Striatopodocarpites fusus* taxon range zones are illustrated in figures 28 – 29 and figures 33 – 34, respectively.

Assemblage Zones

Although the range zones could not produce a good correlation between STRAT 1 and CKP 6 consideration of the common taxa in terms of the assemblage zones allowed the strata in both sections to be subdivided into three biostratigraphic units. Consequently, a preliminary correlation between STRAT 1 and CKP 6 borehole sections has been possible, the results of which are illustrated in Figure 47. The three assemblage zones consist of, in ascending order of stratigraphy: *Hamiapollenites bullaeformis* Assemblage Zone, *Cyclogranisporites gondwanensis* Assemblage Zone, and *Platysaccus papilionis* Assemblage Zone. Details on the characteristics defining the zones are described in section 5.1.1.1.1.2.

Comparison of the data between STRAT 1 and CKP 6 indicates that the base of the sections is characterised by few common taxa of typically long range nature. There is some disparity in occurrence data between the two sections, which makes the level of comparison in the basal sections rather poorly constrained. The most significant taxon that reflects some degree of correlation between the basal sections is the rare, relatively short to medium range, *Punctatisporites ubischii* species. A perhaps significant point of consideration with regard to the basal sections is the fact that these marks the junction between older taxa of pre-Karoo strata and those originating in early Karoo times. However, in the case of this study the youngest pre-Karoo sequence consist of barren earliest Cambrian red beds, which unfortunately is not useful for stratigraphic review of taxa ranges.

The *Hamiapollenites bullaeformis* Assemblage Zone appears as a distinctive unit in both STRAT 1 and CKP 6 borehole sections, which makes the two sections clearly comparable and easy to correlate. The diagnostic taxa characteristic of this zone is dominated by spores. The most notable similarity between STRAT 1 and CKP 6, in terms of species range, is a major decrease in diversity indicated by the *Cristatisporites* spp. at the top of the zone. Coincidentally, the top of the zone in both sections also mark a major litho-facies change from a predominantly argillaceous facies, and hence reflecting the possibility of facies-control for the *Cristatisporites* spp. In general, the rest of the zone does indicate a close affinity between the ranges of the taxa and the lithofacies distribution, an observation that may indicate the restriction of ranges due to ecological variations and the geographical isolation of taxa (Miall, 1990). Nevertheless, some of the less common but significant and restricted species such as *Hamiapollenites bullaeformis* and *Raistrickia crenata* appear to have their terminations not closely associated with the top boundary of the zone and hence are probably not related to changes contributing to litho-facies variations. Therefore, the ranges of *Hamiapollenites*

CKP6

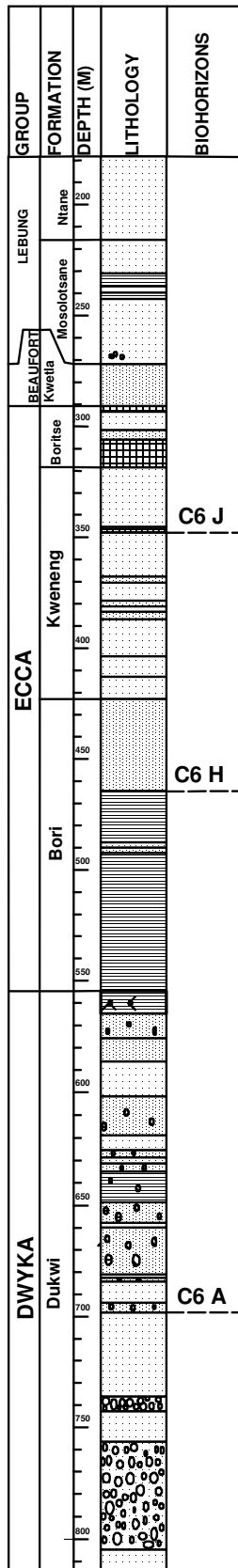

STRAT 1

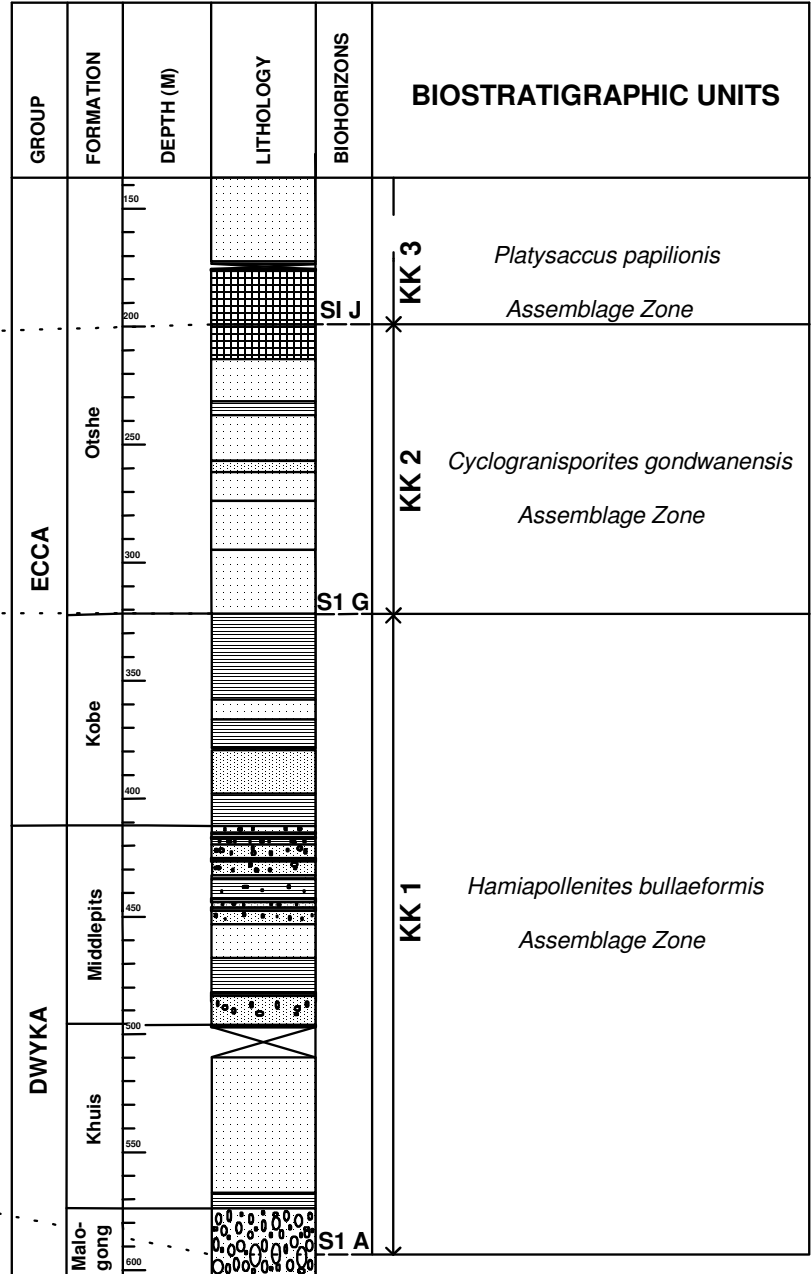

Figure 47: Biostratigraphic correlation of STRAT 1 and CKP 6 boreholes.

bullaeformis and *Raistrickia crenata* are considered to broadly represent time-equivalent events occurring in STRAT 1 and CKP 6. However, these events require to be verified from other sections as well as augmented with the search for other diagnostic taxa in future studies, in order to improve the confidence level in the reality of this zone. In terms of the lithostratigraphic divisions this zone corresponds to the lowermost Ecca Group (i.e. Bori/Kobe formations) and the Dwyka Group. However, the lower boundary of the zone indicate the possibility of diachronosity, with the upper Dwyka section in CKP 6 reflecting time equivalency with the lower Dwyka in STRAT 1 (e.g. Fig. 47).

The *Cyclogranisporites gondwanensis* Assemblage Zone is the least distinctive zone in terms of taxa range as it is defined largely on the basis of relatively long range species, in both STRAT 1 and CKP 6. Compared to the *Hamiapollenites bullaeformis* Assemblage Zone, this zone has only a slight dominance of spores over pollen in its list of diagnostic taxa. The most striking characteristic of this zone in both STRAT 1 and CKP 6 is a drop in the consistency of frequency of occurrence of taxa, a feature related with the change in the lithofacies observed at the upper limit of the *Hamiapollenites buellaeformis* Assemblage Zone. As a result there is a lack of common restricted species to form diagnostic taxa and provide time equivalent events for correlation. This zone is correlated on the basis of similarity at its upper boundary, which is defined by the last occurrence of *Cyclogranisporites gondwanensis*; the lower boundary has no common species initiations to provide a point of correlation but is defined on the basis of the upper boundary of the *Hamiapollenites bullaeformis* Assemblage Zone. The lower boundary of this zone indicate a reversal in diachronosity of the lithofacies, with the uppermost lower Ecca (i.e. uppermost Bori Formation) in CKP 6 correlating with the basal section of the Otshe Formation in STRAT 1 (e.g. Fig. 47).

The *Platysaccus papilionis* Assemblage Zone is the topmost zone and is essentially equivalent to the *Platysaccus papilionis* and *Striatopodocarpites fusus* taxon range zones of STRAT 1 and CKP 6, respectively. The diagnostic taxa characteristic of this zone is dominated by bisaccate pollen, of which the most significant in terms of correlating STRAT 1 to CKP 6 are the species *Platysaccus papilionis* and *Striatopodocarpites fusus*.

CKP 9

A comparison of STRAT 1 with CKP 9 reveals a common occurrence of taxa, however there is overwhelming disparity in the frequency of occurrence owing to the low level of sampling, with great distances apart, for the latter. Consequently, in CKP 9 several species indicate solitary occurrences while others depict short stratigraphic ranges whereas in STRAT 1 the same species indicate the opposite. Nevertheless, a general assessment of all common taxa reveals the possibility of a preliminary correlation between STRAT 1 and CKP 9 borehole sections.

There are two levels marked by biohorizons which generally subdivide the two sections into three broad zones (Fig. 48). A lower zone can be delineated from the base of the sections to the level marked by biohorizons S1 D and C9 D in STRAT 1 and CKP 9,

STRAT 1

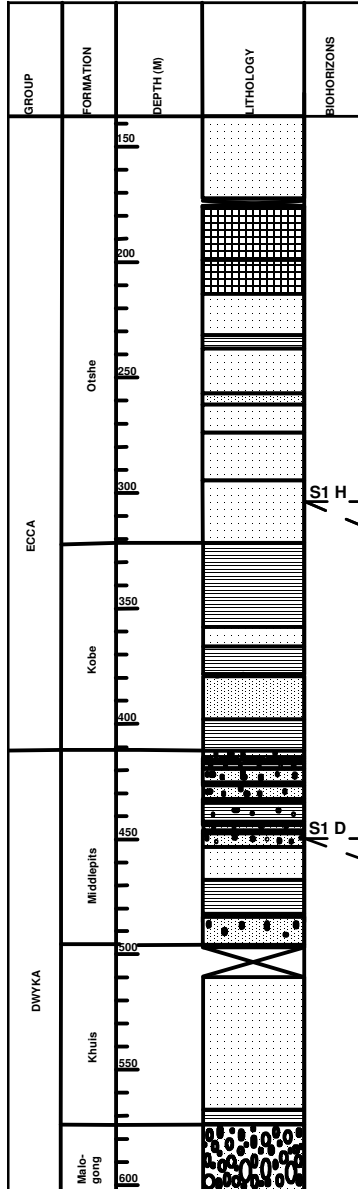

CKP 9

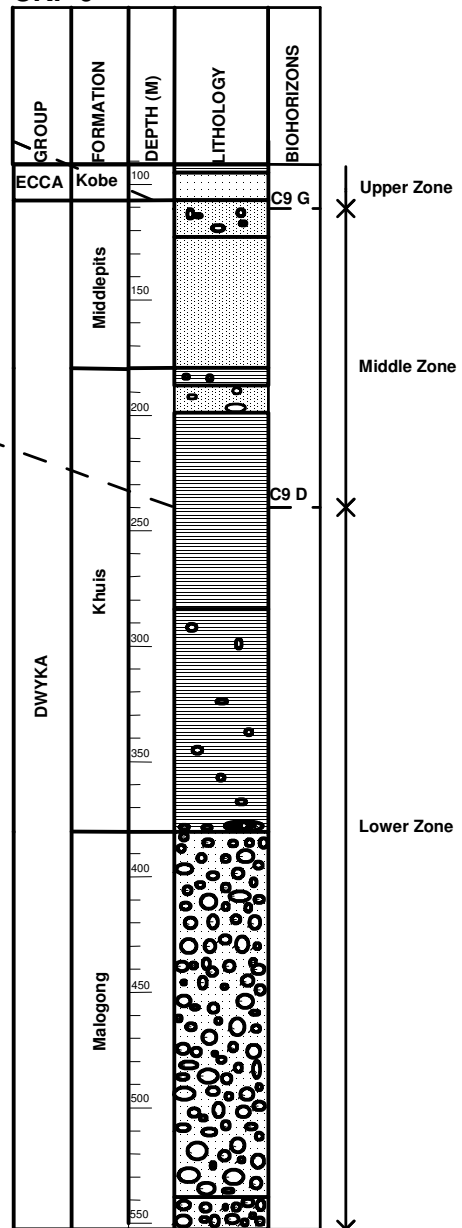

Figure 48: Tentative biostratigraphic correlation of STRAT 1 with CKP 9.

respectively (e.g. Appendix II). The common taxa occurring in this lower zone of the basal sections consist of *Deltoidospora directa*, *Punctatisporites gretensis*, *Punctatisporites gracilis*, *Horriditriletes uruguiensis*, *Converrucosisporites naumoviae*, *Converrucosisporites pseudoreticulatus*, *Verrucosisporites andersonii*, *Plicatipollenites densus*, and *Cycadopites cymbatus*. The latter constitute an assemblage of characteristically medium to long range taxa, which is overwhelmingly dominated by spores.

A middle zone can also be delineated, and is confined between the lower zone or the first occurrence of *Protohaploxylinus rugatus*, and biohorizons S1 H and C9 G of STRAT 1 and CKP 9, respectively (e.g. Appendix II). The common taxa that compare and correlate the middle zone consist of *Retusotriletes golasensis*, *Didecitriletes ericianus*, *Horriditriletes tereteangulatus*, *Cristatisporites inconstans*, *Cristatisporites spinosus*, *Cristatisporites menendezii*, *Plicatipollenites gondwanensis*, *Protohaploxylinus rugatus*, and *Marsupipollenites striatus*. A general assessment of the stratigraphic range of the common taxa relative to the lithofacies reflects a diachronous sequence. The latter is indicated by correlation of the Kobe Formation of the lower Ecca Group, as well as sections of the uppermost Dwyka Group in STRAT 1, with the uppermost section of the Dwyka Group in CKP 9.

The middle zone is succeeded by a poorly constrained upper zone which is only defined in terms of its lower boundary, represented by biohorizons S1 H and C9 G. This zone is correlated based on the occurrence of limited common taxa that comprises *Lophotriletes rectus*, *Potonieisporites novicus*, and *Cymatiosphaera gondwanensa*.

6.1.2 Local Correlations

Most of the limited palynology studies undertaken from Botswana either present only palynostratigraphic interpretations in terms of biostratigraphic units and their ages or assemblage descriptions without occurrence data (e.g. Dolby, 1990; Key et. al., 1995). This approach presents problems of comparison and correlation due to the unavailability of ranges of taxa, and as a result only broad comparisons are considered. Nevertheless, few of the previous studies (e.g. MacRae, 1978; ECL, 1990; Stephenson and McClean, 1999) do present results that give insight into the vertical characteristics of taxa, which allows for a limited but significant comparison and correlation of sections of the stratigraphic sequence. Below, a selected few previous studies from the Kalahari Karoo Basin are compared and correlated with the zonation obtained for STRAT 1 in this study. A summary of the correlation of STRAT 1 borehole section with some of the previous zonation schemes is illustrated in Figure 49.

Correlation with the zonation scheme of MacRae (1978)

Although displaying some considerable variations in taxonomic terminology, the unpublished work of MacRae (1978) from borehole N1/3 presents the first complete preliminary palynozonation scheme available for comparison and stratigraphic correlations. The scheme comprises three concurrent range zones based on the distribution of sixty eight miospore taxa, and are named zones I, II, and III, in ascending order of the stratigraphy. There is however difficulties in correlating the concurrent range zones proposed for STRAT 1 borehole with the scheme of MacRae (1978), due to the lack of significant marker characteristics, including taxa of preferably short range in both sections.

Broad comparisons indicate that the section of STRAT 1 which corresponds to biozones *S1 – 1*, *S1 – 2*, and inclusive of subzone *S1 – 3a* (Fig. 27), can be correlated with *Concurrent Range Zone I*. Species most significant and common to both sections include: *Vittatina minima*, *Caheniasaccites flavatus*, *Caheniasaccites ovatus*, *Plicatipollenites densus*, *Plicatipollenites gondwanensis*, *Punctatisporites gretensis*, and *Calamospora aplata*. The stratigraphic range of the common taxa indicate correlation of the middle to upper Dwyka Group (e.g. Khuis and Middlepits formations) and lower Ecca Group (e.g. Kobe Formation) in STRAT 1 with a much condensed similar section of the Karoo Supergroup in N1/3 borehole. The suprageneric quantitative trends are equally difficult to correlate, firstly due to a difference in the categories plotted, and secondly due to a non-uniform variation in the stratigraphic distributions of taxa. There are minor similarities in the distribution of zonolaminatitriletes spores which indicates significant relative abundances, as well as the bisaccate striate pollen with low relative abundances. The triletes spores and plicate pollen on the other hand indicates significant distribution levels in STRAT 1 whereas in N1/3 the distribution is lower, in comparison to succeeding zones.

The upper section of STRAT 1, which includes much of biozone *S1 – 3* and *S1 – 4*, can be broadly correlated with the section covered by concurrent range zones II and III in N1/3. Species common to both sections include: *Alisporites splendens*, *Striatopodocarpites fusus*, *Protohaploxylinus limpidus*, *Alisporites ovatus*, and *Laevigatosporites vulgaris*. A comparison of the suprageneric quantitative trends reveals a rise in the relative abundance of bisaccate striate pollen in both sections.

Overall, the zonal scheme of MacRae (1978) relative to the present palynological subdivision of STRAT 1 allows only a broad and general comparison, inadequate to undertake finer detailed correlation. As a result there are no visible details that make it possible to comparatively analyse the lithofacies for diachronous characteristics.

Correlation with the zonation scheme of ECL (1990)

ECL (1990) erected a regional zonation scheme comprised of five palynozones based on analysis of borehole and field samples from Namibia, Botswana, Zimbabwe, and Zambia. The zonation scheme was placed in a broad chronostratigraphic context following the scheme of Anderson (1977) and its subsequent correlation with an informal composite chronostratigraphic scheme based on ammonoid and fusulinid biostratigraphy from the former Soviet Union (ECL, 1990). The palynozonation scheme of ECL (1990) is largely based on variations determined by the relative abundance of taxa, which makes it difficult to correlate with the present study in which the zonation is largely based on species ranges. Nevertheless, few diagnostic taxa allow for a broad comparison and correlation.

Biozone S1 – 1 of STRAT 1 can be correlated with Zone I (MZI) on the basis of common taxa that are dominated by monosaccates and consist of *Plicatipollenites gondwanensis* (defined by ECL as *P. indicus*) and relatively diverse *Potoniesporites* spp. Other species of note in the two correlatable zones include *Vestigisporites rudis* (as *V. balmei*) and *Cristatisporites morungavensis* (as *Gondisporites variables*).

The upper part of Biozone S1 – 2 is correlated with Zone II (MZII) on the basis of the common occurrence of *Cirrabaculisporites plumsteadi* (described by ECL as *Microbaculispora plumsteadi*). A subtle but significant and comparable trend is an increase in non-striate pollen in the upper parts of the zones.

The lower part of Biozone S1 – 3 can be correlated with Zone III (MZIII) based on a common characteristic marked by the upper limit of the regular monosaccates i.e. *Plicatipollenites* and *Cannanoropollis* species. The upper part of Biozone S1 – 3 is correlated with Zone IV (MZIV) based on the occurrence of common significant taxa consisting of *Lueckisporites virkkiae*, *Marsupipollenites triradiatus*, and *Laevigatosporites* spp. Other characteristic taxa linking Zone IV (MZIV) to Biozone S1 – 3 includes *Protohaploxypinus* spp., *Weylandites lucifer*, and *Cycadopites cymbatus*.

The uppermost Biozone S1 – 4 of STRAT 1 is correlated with Zone V (MZV) based on a first appearance of *Striatopodocarpites pantii* as well as the following common taxa: *Lueckisporites virkkiae*, *Weylandites lucifer* (described by ECL as *Vittatina lucifera*), *Polypodiisporites mutabilis*, and *Laevigatosporites vulgaris* (defined by ECL as *L. colliensis*). The base of the zones is generally reflected by a marked increase in the relative abundance of the striate bisaccates.

Correlation with the zonation scheme of Dolby (1990)

Dolby (1990) described palynological Early Permian to Late Carboniferous assemblages from a lower Karoo section intersected during a hydrocarbon drilling investigation in the southwest of the Kalahari Karoo Basin. Two zones, namely Zone 1 and Zone 2, were erected consisting of an Early Permian (Sakmarian-Asselian) assemblage, and a Late Carboniferous (Gzhelian – Kasimovian) assemblage, respectively. Comparison of taxa content between STRAT 1 and the assemblages at Masetlheng Pan-1 Well described by

Dolby (1990) reveals rare similarities inadequate for a direct correlation. However, certain general trends are noticeable in both sections which allows for a broad correlation.

Zone 1 of Masetlheng Pan-1 Well section compares favourably with the section corresponding to biozones S1 – 2 up to S1 – 4 in STRAT 1 borehole. Only one species is confined to both sections, namely *Marsupipollenites striatus*. Other taxa of comparative significance include *Alisporites ovatus*, *Alisporites potonieii*, *Protohaploxypinus limpidus*, *Florinites spp.*, *Weylandites spp.*, and *Striomonosaccites spp.* The upward increase in the relative abundance of zonolaminatitriletes (e.g. Fig. 37 – horizon D) can be generally equated with the great abundance of *Gondisporites spp.* and related genera, reported in Dolby (1990).

Zone 2 of Masetlheng Pan-1 section is equated with Biozone S1 – 1, including the basal section of STRAT 1, on the basis of indirectly related trends. Among the notable trends is the downward decrease in the zonolaminatitriletes (e.g. Fig. 37 - horizon D), also highlighted above as an upward increase, which is equated with the downhole decrease in *Gondisporites spp.* and related genera described for Masetlheng Pan-1 Well. In STRAT 1 section there is a subtle but significant downhole increase in the relative abundance of Plicates, occurring also at horizon D of Figure 37, which can be equated with the downhole increase in *Cycadopites cymbatus* in Masetlheng Pan-1 Well. Also significant is the downhole increase in abundance of *Vallatisporites spp.* in Masetlheng Pan-1 Well, which seems to compare well with the appearance of *Vallatisporites spp.* in STRAT 1 section.

Correlation with the work of Stephenson and McLean (1999)

Stephenson and McLean (1999) described an Early Permian palynological assemblage from a lower Karoo sequence represented by the Morupule Formation in the eastern fringe of the Kalahari Karoo Basin. There is remarkable similarity between STRAT 1 and the Morupule section, in terms of taxa content, albeit with some variations in taxonomic terminology. However, the majority of the common species depict a long range characteristic in the relatively extensively sampled STRAT 1 section. Unfortunately, the Morupule Formation represents a narrow zone in terms of Karoo strata and only less than 15m was sampled by Stephenson and McLean (1999). Consequently, the initiations and terminations of most taxa highly likely fall outside of the sampled section and hence species ranges remain poorly constrained. Nevertheless, comparison of the common taxa allows only for a broad and general tentative correlation.

The most comparatively significant taxa that correlate STRAT 1 to the Morupule section include *Laevigatosporites vulgaris*, *Alisporites ovatus*, *Alisporites potonieii*, *Florinites eremus*, *Protohaploxypinus limpidus*, *Striatoabieites multistriatus*, and *Platysaccus spp.* The ranges of the significant taxa broadly corresponds to biozones S1 – 3 and S1 – 4 of STRAT 1, and hence correlates the Morupule section with a part of the Otshe Formation of the middle to upper Ecca Group.

STRAT 1 BOREHOLE (THIS STUDY)		PAN AFRICAN BASIN STUDY (ECL, 1990)	N 1/3 BOREHOLE (MacRee, 1978)	MASETLHENG PAN-1 WELL (Dolby, 1990)	MORUPULE (Stephenson & McLean, 1999)
Lithostratigraphy	Palynostratigraphy				
ECCA GROUP	Otshe Formation	S1 - 4	KK 3	MZ V	III --- --- ---
		S1 - 3			
			Kobe Formation	S1 - 2	MZ III
		Middlepits Formation			
	Khuis Formation		>	MZ I	I
DWYKA GROUP	Malogong Formation	>	>	>	>
		>	>	>	>

Figure 49: Biostratigraphic correlation chart of STRAT 1 borehole with other local previous studies.

6.1.3 Regional Correlations

Palynological studies pertinent to Karoo Supergroup stratigraphy have been undertaken by various workers in several of the contemporaneous Karoo basins of southwestern Gondwana (e.g. Manum and Duc Tien, 1973; Jardiné, 1974; Falcon, 1975; Utting, 1976; Anderson, 1977; Wright and Askin, 1987; MacRae, 1988; Hankel, 1992, 1993; d'Engelbronner, 1996; Nyambe and Utting, 1997; Kalkreuth et. al., 1999; Millsted, 1994, 1999; Semkiwa et. al., 2003 etc.). The results of such studies reveal some important common features that allow for a regional comparison and correlation of the Karoo sequence in the various basins. However, there are major limiting factors related to the variability in the level of details in these studies, such as sampling intervals and the type of analyses, including the choice of illustrations for presenting and comparing results. A select few of the regional studies are discussed below and compared with results from the present study.

South Africa

Correlation with the zonation scheme of MacRae (1988)

MacRae (1988) described upper Carboniferous to late Permian palynomorph assemblages from northern Karoo basins of South Africa (e.g. Fig. 4; Ellisras, Springbok Flats, and Tshipise basins), and subsequently erected six palynozones, namely biozones A – F, in ascending order of stratigraphy. Based on limited similarity of individual taxon ranges, a broad correlation of the zonation of MacRae (1988) with STRAT 1 assemblages is possible. Biozone A of MacRae (1988) is tentatively correlated with the basal section of STRAT 1 where although no significant taxa exist for direct correlation, occurs common taxa of rather long ranges. The top of biozone B can be equated with the top of biozone S1 – 2 based on the terminations of *Plicatipollenites trigonalis* and *Vestigisporites rudis*, both of which define the top of the zones. On the other hand, the base of biozone B favourably equates with the base of biozone S1 – 1 as defined on the basis of the initiations of the following species: *Weylandites lucifer*, *Verrucosiporites pseudoreticulatus*, *Horriditriteles tereteangulatus*, and *Striatoabieites multistriatus*.

Biozone C is described in MacRae (1988) as the least palynologically productive and characterized by low abundances as well as an increase in species absence. Such a description favourably equates the latter zone with biozone S1 – 3 of STRAT 1, the basal section of which is characterised by a remarkable decrease in the frequency of occurrence as well as the termination of most species. However, the top boundary of biozone S1 – 3 equates with the top boundary of biozone D on the basis of the range termination of *Laevigatosporites vulgaris*. Consequently, the basal section of biozone S1 – 3 is tentatively correlated with biozone C while the upper section is equated with biozone D.

Biozone S1 – 4 is equated to biozone E, albeit with difficulty, due to the lack of any common significant trends for direct correlation, which is compounded by the fact that it forms the termination zone of all species. A perhaps more significant observation is the

occurrence of *Platysaccus papilionis* and *Striatopodocarpites fusus*, both of which are restricted to this zone in STRAT 1. The assemblage of common taxa comprises: *Deltoidospora directa*, *Striatoabieites multistriatus*, *Weylandites lucifer*, *Alisporites potonieii*, *Indotriradites australensis*, *Apiculatisporis levis*, *Protohaploxypinus limpidus*, *Protohaploxypinus hartii*, and *Striatopodocarpites cancellatus*.

Lithologically, the overall trend deduced from the comparative analysis of the palynological assemblages reflects a diachronous Karoo sequence between the north Karoo basins of South Africa (e.g. borehole ET 61 in MacRae, 1988) and the sequence at STRAT 1 borehole, especially with regard to the basal successions. Biozones A and B of MacRae (1988), which largely falls within a lower Ecça Group succession (e.g. Wellington Formation) but also including a much condensed section of the Dwyka Group, correlates to a large extent with the Dwyka Group (i.e. Malogong, Khuis, and Middlepits formations), as well as a basal section of the Ecça Group (i.e. Kobe Formation), in STRAT 1 borehole. Similarly, biozone C (MacRae, 1988), which represent the lower parts of a middle Ecça succession (e.g. Enkelbult Formation), correlates with the uppermost part of the lower Ecça (i.e. Kobe Formation), but also encroaches into the basal section of the middle Ecça, in STRAT 1 borehole. The uppermost successions, although relatively poorly constrained due to low palynomorph yields, indicates a much closer lithological correlation between the respective successions. The latter reflects the possibility of a shift from a diachronous setting to a near time equivalent deposition during the middle to upper Ecça.

Zimbabwe

Correlation with the scheme of Falcon (1975)

Palynostratigraphic studies from the Mid-Zambezi Karoo Basin in Zimbabwe by Falcon (1975) allows for a limited and broad correlation, based on rare similarities reflected by qualitative and quantitative analyses. Falcon (1975) erected a zonation scheme that subdivide the Lower Karoo sequence into four major assemblage zones, including eight sub-zones, based on assemblages from the Matabola Flats borehole situated in the Mid-Zambezi basin (e.g. Fig. 4).

Biozones S1 – 1, S1 – 2, and including the lower sections of biozone S1 – 3 in STRAT 1 borehole can be equated with Assemblage I of Falcon (1975). One notable and comparable characteristic is the ranges of *Converrucosisporites pseudoreticulatus* and *Cycadopites cymbatus* species, both considered significant for Assemblage I. However, only *Converrucosisporites pseudoreticulatus* form a significant taxon in biozone S1 – 1 of STRAT 1 (e.g. Fig. 28). The quantitative analyses also indicate some rare but significant similarities, which includes a relatively marked upward increase in the zonolaminatitriletes, as well as an increase in the bisaccates pollen defining the top boundary. A rare direct comparison is reflected by the initiations of *Retusotriletes diversiformis* and *Alisporites ovatus*, which both correlates the base of Assemblage Sub-Zone B of Falcon (1975) with the base of biozone S1 – 2 of STRAT 1.

The upper parts of biozone S1 – 3, and including biozone S1 – 4, can be equated with Assemblage II of Falcon (1975), albeit with difficulties. The lower boundary for the correlated zones is placed at the level where bisaccate pollen indicates a marked upward increase in the relative abundances. This approximately correlates horizon G (Fig. 37) with the base of Assemblage Sub-Zone D. Taxa of notable and comparable ranges include *Marsupipollenites* spp., *Striatoabieites* spp., *Striatopodocarpites* spp., *Laevigatosporites* spp., *Alisporites splendens*, and *Alisporites potonieii*. The introduction of *Laevigatosporites* spp. appears to be the most significant in defining the lower boundary for correlation.

Zambia

Correlation with the zonation scheme of Utting (1976)

Two palynological assemblages described by Utting (1976) from the Lower Karoo Luwumbu Coal Formation of the Luangwa Valley in Zambia compares broadly with the assemblages identified in STRAT 1. Based on comparison of limited taxon ranges the section of borehole STRAT 1 corresponding to biozones S1 – 1 and S1 – 2, up to and including subzone S1 – 3a, can be equated with the older assemblages obtained from the Mukumba Siltstone Member. The few comparable and characteristic taxa, occasionally of variable taxonomic nomenclature, include *Plicatipollenites densus*, *Plicatipollenites trigonalis*, *Converrucosporites pseudoreticulatus*, and *Cristatisporites lestai*. The latter assemblage broadly correlates the Dwyka Group and the Kobe Formation (i.e. lower Ecca Group) of the Kalahari Karoo Basin with the Mukumba Siltstone Member of the Luwumbu Coal Formation in Zambia.

The upper section of STRAT 1 corresponding to the rest of biozone S1 – 3, as well as S1 – 4, compares favourably with the younger assemblage determined from the Mpwashii Carbonaceous Member. The most significant taxa in terms of comparative analysis of the ranges include *Laevigatosporites* spp., *Alisporites potonieii*, *Protohaploxypinus perexiguus*, *Marsupipollenites striatus*, *Weylandites lucifer*, and *Striatoabieites* spp. This assemblage allows for a broad correlation of a section of the Otshe Formation that corresponds to the middle Ecca, with the Mpwashii Carbonaceous Member of the Luwumbu Coal Formation in Zambia.

Tanzania

Correlation with the zonation scheme of Semkiwa et. al. (2003)

Semkiwa et. al. (2003) gave a brief account on palynological analysis from the Lower Karoo sequence of the Songwe-Kiwira Coalfield in Tanzania. A comparison of common taxa reflects the possibility of a broad correlation between STRAT 1 section and the sequence at Songwe-Kiwira Coalfield. Biozone S1 – 1, including the basal section of

STRAT 1, can be equated with the *Cannanoropollis-Plicatipollenites* zone on the basis of the common occurrence of monosaccates, dominated by *Cannanoropollis* spp. and *Plicatipollenites* spp. There is also a notable similarity with regard to the common occurrence of *Cristatisporites* spp. (as *Zinjisporites* spp.). This comparison generally correlates the Dwyka Group, in STRAT 1 section with the Idusi Formation at the Kiwira Coal Mine.

The upper sections of STRAT 1 reveal a much more evident similarity as reflected by the occurrence of several species of comparable ranges. The most significant taxa include *Alisporites ovatus*, *Alisporites potonie*, *Laevigatosporites* spp., *Marsupipollenites striatus*, *Protohaploxypinus limpidus*, *Protohaploxypinus rugatus*, *Vittatina scutata*, and *Weylandites lucifer*. This assemblage allows for a correlation of the section corresponding to biozones S1 – 2 and S1 – 3 with the *Scheuringipollenites-Protohaploxypinus* zone (e.g. Semkiwa et. al., 2003). This consequently equates a section of the uppermost Dwyka, as well as the Kobe Formation and much of the Otshe Formation, with the Mchuchuma Formation of the Songwe-Kiwira Coalfield in Tanzania.

Kenya

Correlation with the zonation scheme of Henkel (1992)

Henkel (1992) documented Late Permian to Early Triassic assemblages from the Karoo Sequence of the Mombasa Basin of Kenya. Sampling for this work covered a very narrow section of the Maji ya Chumvi Formation, which makes correlation very poor and largely inconclusive. Of the two assemblages described only the older assemblage, which unfortunately is limited to one sampling level, can be loosely equated with biozones S1 – 3 and S1 – 4 of STRAT 1 borehole. Taxa considered for comparative analysis includes: *Lueckisporites virkkiae*, *Weylandites* spp., *Plicatipollenites* spp., *Platysaccus* spp., *Striatopodocarpites* spp., and *Protohaploxypinus* spp.

Gabon

Correlation with the scheme of Jardiné (1974)

Palynological studies by Jardiné (1974) on Karoo equivalent sequences revealed three palynological assemblages from the “Série de l’Agoula”, which overlies glacial deposits considered to be correlates of the Dwyka Group. The lowermost assemblage PII can be equated with biozone S1 – 1 of STRAT 1 on the basis of common characteristic taxa such as *Pakhapites fusus*, *Pakhapites ovatus*, *Caheniasaccites ovatus*, and *Striomonosaccites* spp. The succeeding assemblage PIII is loosely correlated with biozone S1 – 2 based on the significant common occurrence of *Protohaploxypinus* spp. and *Striatoabieites* spp. In addition, the latter zone is, in the “Série de l’Agoula”, immediately succeeded by a non-productive interval, which compares well with biozone S1 – 2 that is also succeeded by the least productive biozone S1 – 3. Lastly, the uppermost assemblage PIV of the “Série

de l'Agoula' can be correlated with biozone S1 – 4 based on the common occurrence of *Lueckisporites virkkiae* and *Platysaccus papilionis*, which are both characteristic species in either of the sections.

Madagascar

Palynological assemblages described by Wright and Askin (1987) from Karoo sequences of the Morondava Basin in Madagascar indicate some comparable characteristics with the sequence at STRAT 1 borehole. The assemblage that characterizes the Lower Sakamena section of the Madagascar stratigraphy compares favourably with the assemblages of biozones S1 – 3 and S1 – 4 in STRAT 1. Taxa of closely comparable ranges of occurrence consist of *Lueckisporites virkkiae*, *Striatopodocarpites pantii*, *Alisporites ovatus*, *Plicatipollenites gondwanensis*, *Protohaploxylinus limpidus*, *Platysaccus spp.* and *Weylandites spp.*

6.1.4 Gondwana-wide Correlations

Although long-distance (e.g. between continents) palynostratigraphic correlation is a common practice among biostratigraphers, there is always a great deal of uncertainty associated with the frequency of distribution and the palaeogeography of the respective palynomorphs. Firstly, the frequency distribution of taxa, even at the local scale, is greatly skewed such that there are major disparities between different sections of investigation (Agterberg and Gradstein, 1999), which ultimately gives rise to imprecise correlations. The extrapolation of such inherent problems to a large-scale or long-distance correlation is likely to result in exaggeration and mis-correlations. A common problem observed in the present study, but also reported by other workers (e.g. Souza, 2006), involves the realization that certain short-range taxa occur as long-range taxa in other regions, making correlation impractical. Secondly, studies have revealed that global floras progressively became palaeogeographically restricted, particularly during the latest Carboniferous to Permian, a phenomenon that has greatly reduced the efficacy of long-distance palynostratigraphic correlation (Playford and Dino, 2005). The above observations call for a concerted effort to upgrade and refine palynological data at the local scale before attempting to erect long-distance correlation schemes. Nevertheless, the ultimate purpose of every scientific study is to advance our knowledge all around the globe, and hence the availing of new data always provides additional opportunities to enhance our understanding. Therefore, with the above limitations in mind, the results from the present study will be compared and correlated with a few selected Gondwana regions. A summary of the correlation of STRAT 1 borehole section with some of the previous regional and Gondwana-wide zonation schemes is illustrated in Figure 50.

South America

Correlation with the zonation scheme of Souza and Marques-Toigo (2003, 2005), and Souza (2006).

Palynological assemblages described by Souza and Marques-Toigo (2003, 2005) and Souza (2006), from the Brazilian Paraná Basin, indicates a remarkable similarity with the assemblages obtained from the Kalahari Karoo Basin in Botswana. Consequently, the palynozones erected for the sequence at STRAT 1 borehole can, to a certain degree, be compared and correlated. The lowermost basal section of STRAT 1 (e.g. below biozone S1 – 1) is poorly constrained but can be loosely correlated with the *Crucisaccites monoletus Interval Zone* on the basis of the common occurrence of monosaccates such as *Cannanoropollis spp.*, *Plicatipollenites spp.*, *Potoniesporites spp.*, and *Caheniasaccites spp.* In addition, both azonotriletes spores (laevigate and apiculate), comprising *Punctatisporites gretensis*, *Horriditriletes spp.* etc, and zonolaminatitriletes (e.g. *Cristatisporites spp.* and *Vallatisporites spp.*) form significant constituents.

The section of STRAT 1 borehole confined between the base of biozone S1 – 1 and the top of subzone S1 – 3b can be equated with the *Vittatina costabilis Interval Zone* on the basis of a notable incoming of several *Vittatina* species. In addition, the species after which the zone was named (e.g. Fig. 2f; Souza and Marques-Toigo, 2005) also form a significant species in STRAT 1 (described as *Vittatina sp.* in this study e.g. Plate 9; fig. 9, 10). The top of biozone S1 – 2 in STRAT 1 can be directly correlated with the top of the *Protohaploxylinus goraiensis Subzone* on the basis of the terminations of *Plicatipollenites trigonalis* and *Potoniesporites congoensis*. Quantitatively, some rare notable similarities include a relatively high frequency of polyplcate pollen grains.

The upper sections of STRAT 1 borehole, stretching from the base of subzone S1 – 3c up to and including biozone S1 – 4, compares favourably with the *Lueckisporites virkkiae Interval Zone*. Taxa considered pertinent in recognizing the basal sections of the zones of correlation comprise *Lueckisporites virkkiae* and *Laevigatosporites spp.* However, there is several other taxa characteristic of these zones, the most notable being: *Marsupipollenites striatus*, *Striatopodocarpites fusus*, *Striatopodocarpites pantii*, and *Weylandites lucifer*.

Australia

Correlation with the zonation scheme of Backhouse (1991)

Backhouse (1991) established the most widely compared palynostratigraphic scheme from the Gondwana Permian sequences of the Collie Basin of Australia. There is however some difficulties in correlating the zonation scheme established for STRAT 1 borehole with that of Backhouse (1991) for the Collie Basin. Firstly, the scheme of Backhouse (1991) is build upon interval zones, which do not reflect the range zone or concurrence of taxa, and hence make comparison with the type made in this study out of phase. Secondly, a perhaps more complex limitation is the fact that certain key species

reveal variable ranges and abundances between areas, an observation also recognized by Backhouse (1991) when comparing the assemblages from the Collie Basin with other Australian basins.

A quick comparison of the assemblages obtained from STRAT 1 borehole with that from the Collie Basin display a reversal of the order of appearance of certain taxa. For example, the order of appearance of *Protohaploxylinus rugatus* and *Didecitriletes ericianus* in STRAT 1 is in the opposite sense to that revealed by the assemblages at Collie Basin. Similarly, *Protohaploxylinus fusus* is in STRAT 1 borehole preceded by both *Protohaploxylinus rugatus* and *Didecitriletes ericianus* whereas at Collie Basin the opposite is true (e.g. Backhouse, 1991; p.254). A similar observation, albeit with different taxa, was also remarked upon by Stephenson and McLean (1999) when comparing assemblages from South America, which are here considered to compare favourably with those from STRAT 1, with assemblages from Australia. Cognisant of the difficulties outlined above, only a broad correlation, based on general similarities in the ranges of common taxa is considered here.

The most closely comparable assemblages indicates a probable correlation of biozones S1 – 3 (starting from subzone S1 – 3b) and S1 – 4, of STRAT 1 borehole, with the *Striatopodocarpites fusus* Zone of the Collie Basin. The most significant taxa pertinent to this correlation comprise *Florinites eremus*, *Laevigatosporites vulgaris*, and *Striatopodocarpites fusus*, all of which are initiated at the same level in the Collie Basin. Other significant species that indicate a comparable range with *Striatopodocarpites fusus* in the Collie Basin, and also form characteristic taxa in the correlatable section of STRAT 1 borehole includes: *Cymatiosphaera gondwanensis*, *Weylandites lucifer*, *Marsupipollenites triradiatus*, *Marsupipollenites striatus*, *Alisporites ovatus*, *Alisporites potonieii*, *Striatoabieites multistriatus*, and *Protohaploxylinus limpidus*.

Based on the range of a few selected taxa, the lower part of STRAT 1, starting from subzone S1 – 3b up to the base of the borehole section, compares favourably with the section at Collie Basin that precedes the *Striatopodocarpites fusus* zone, and includes Stage 2. The assemblage pertinent to this correlation includes: *Plicatipollenites* spp., *Convruccosporites naumoviae*, *Cycadopites cymbatus*, *Verrucosporites andersonii*, and *Cristatisporites* spp.

Antarctica

Palynological studies undertaken by various workers in the Antarctica reveal the occurrence of assemblages with common and comparable taxa to that recognized in this study. As a result, the sequence at STRAT 1 can be generally compared and broadly correlated with stratigraphic sections from the Antarctica.

Late Permian assemblages described by Farabee et. al. (1991), from the Buckley Formation of the central Transantarctic Mountains, closely compares with assemblages from the upper sections of STRAT 1 borehole. The most characteristic taxa pertinent to

correlation includes: *Marsupipollenites triradiatus*, *Marsupipollenites striatus*, *Protohaploxylinus limpidus*, and *Laevigatosporites spp.* The latter assemblage allows for a broad correlation of STRAT 1 section, represented by biozones S1 – 2, S1 – 3, up to and including S1 – 4, with the Buckley Formation.

Lindström (1995a, b) also described some palynomorph assemblages from the Antarctica, which compares favourably with those recognized from the sequence at STRAT 1 borehole. The assemblages recognized from the Vestfjella Mountain Range (e.g. Lindström, 1995a) compares favourably with that obtained from the upper sections of STRAT 1 borehole, which is represented by biozones S1 – 2, S1 – 3, up to and including S1 – 4, as was the case with the Buckley Formation above (e.g. Farabee et. al., 1991). The most significant taxa that compare STRAT 1 to the sequence at Vestfjella mountain-range includes: *Alisporites ovatus*, *Alisporites potoniei*, *Cymatiosphaera gondwanensis*, *Florinites eremus*, *Laevigatosporites vulgaris*, *Lueckisporites spp.*, *Marsupipollenites striatus*, *Marsupipollenites triradiatus*, *Striatopodocarpites fusus*, *Striatoabieites multistriatus*, *Weylandites lucifer*, and *Weylandites magmus*.

A comparison of the assemblages from STRAT 1 with that described by Lindström (1995b) from the Heimefrontfjella mountain-range reveal the occurrence of two groups of correlatable taxa. An older assemblage characterized by *Cahenniasaccites ovatus*, *Cycadopites nevesi*, *Limitisporites rectus*, and *Verrucosisporites andersonii*, broadly correlates the lower section of STRAT 1 i.e. biozone S1 – 1, including the basal section, with the lower half of Locality A of Lindström (1995b). A younger assemblage that correlates the upper section of STRAT 1 (i.e. biozones S1 – 2 until S1 – 4) with the upper half of Locality A (Lindström, 1995b) is comprised of typical taxa as observed from the earlier sections above. Such taxa includes: *Alisporites ovatus*, *Alisporites potoniei*, *Laevigatosporites vulgaris*, *Protohaploxylinus limpidus*, *Striatopodocarpites fusus*, *Striatoabieites multistriatus*, and *Weylandites magmus*.

Oman and Saudi Arabia

Palynological studies from Oman and Saudi Arabia (e.g. Besems and Schuurman, 1987; Stephenson and Osterloff, 2002; Stephenson, 2004 etc.) presents an opportunity to compare and correlate the sequence in the Kalahari Karoo Basin with the Late Palaeozoic Gondwana sequence of the Arabian Peninsula. However, there is a lack of any remarkable similarities between taxa from either area, and hence only a limited comparative analysis that allows only for a general and broad correlation is possible.

Besems and Schuurman (1987) described two palynological assemblages, namely, an older Assemblage Group A and a younger Assemblage Group B, based on samples from the Al Khlata Formation of Oman. Assemblage Group A, which is dominated by zonate trilete spores, such as *Cristatisporites spp.*, and monosaccate pollen that includes *Plicatipollenites spp.* and *Cannanoropollis spp.*, can be broadly equated with the lower sections of STRAT 1 borehole. The latter corresponds to biozones S1 – 1 and S1 – 2, including the lower parts of biozone S1 – 3 (e.g. subzone S1 – 3b) as well as the basal

section of the borehole. Assemblage Group B, which is characterized by striate and non-striate bisaccates, can be broadly correlated with the upper sections of STRAT 1 borehole i.e. the rest of biozone S1 – 3 and biozone S1 – 4.

Palynological assemblages from the Rahab and Lower Gharif members, of the Aklata and Gharif formations, respectively, described by Stephenson and Osterloff (2002), can also be compared in a general and broad perspective. Taxa characteristic of the *Microbaculispora tentula* and the *Converrucosisporites sp. A – Microbaculispora grandegrnulata* biozones reveal close similarities to that characterising biozones S1 – 1, S1 – 2, up to and including subzone S1 – 3b. The most significant taxa pertinent to this comparison includes: *Apiculatisporis cornutus*, *Apiculatisporis leptocaina*, *Apiculatisporis parmatus*, *Cycadopites cymbatus*, *Horriditriletes uruguaiensis*, *Pakhapites fusus*, and *Verrucosisporites andersonii*. The upper sections of STRAT 1 borehole is only poorly equated with the *Alisporites indarraensis* Biozone based on a common increase in diversity of bisaccate pollen. Rare significant taxa pertinent to this correlation include *Striatopodocarpites fusus* and *Protohaploxylinus limpidus*.

India

Correlation with the Gondwana Sequence of India is overwhelmingly limited despite several decades of palynological studies that generated a plethora of data on morphotaxonomy and palynostratigraphy (e.g. Bharadwaj, 1962; Bharadwaj and Salujha, 1964; Bharadwaj and Srivastava, 1969; Tiwari, 1964; Kar, 1968; Lele, 1973; Tiwari and Singh, 1981; Tiwari and Tripathi, 1992; Singh et. al., 1995; Meena, 1999; Jana et. al. 2002 etc.). Most palynostratigraphic studies involve quantitative analyses at the genus level and describe assemblages that are confined to and based on the litho-stratigraphic subdivision, making it difficult to compare and correlate in terms of species ranges. In addition, there is some noticeable degree of variation in taxonomical nomenclature, which also contributes to the difficulties of correlation. Tiwari and Tripathi (1992) compiled a species-determined composite palynozonation scheme based on stratigraphic distribution data obtained from previous studies undertaken in the Damodar Graben and several other pertinent basins of India. This work (e.g. Tiwari and Tripathi, 1992) allows for a limited but important comparative analysis of the assemblages from India and those recognized from the Kalahari Karoo Basin, as is described below.

A review of the ranges of common taxa reveals two groups of assemblages that broadly correlate the sequence at STRAT 1 borehole with the sequences in the Damodar-Rajmahal basins of India. The first group, comprising an older assemblage, is characterized by: *Caheniasaccites ovatus*, *Cannanoropollis spp.* (as *Parasaccites*), *Plicatipollenites spp.* (i.e. *P. gondwanensis*, *P. densus*, and *P. trigonalis*), and *Potonieisporites spp.*, which closely compares biozones S1 – 1 and S1 – 2 with assemblage zones I – III of Tiwari and Tripathi (1992). This comparison broadly equates the Dwyka Group and the lowermost Ecca Group in STRAT 1 with the Talchir Formation of India.

The second group, which forms a younger assemblage and is relatively more diverse, is characterized by the following taxa: *Alisporites ovatus* (as *Scheuringipollenites ovatus*), *Alisporites potonieii* (as *S. maximus*), *Laevigatosporites* spp., *Lophotriletes rectus*, *Marsupipollentites triradiatus*, *Marsupipollenites striatus*, *Protohaploxypinus limpidus* (as *Faunipollenites varius*), *Protohaploxypinus perexiguus* (as *F. perexiguus*), and *Weylandites lucifer*. The latter assemblage favourably compares the upper section of STRAT 1 borehole i.e. biozones S1 – 3 and S1 - 4, with assemblage zones III – VIII of Tiwari and Tripathi (1992). Such a comparison broadly correlates much of the Ecca Group in STRAT 1 section, with the Karharbari, Barakar, and Kulti formations, as well as basal sections of the Raniganj Formation.

6.2 Age

Age determinations for biostratigraphic units depend on reliable correlation with marine sequences containing age-definitive faunas from which internationally agreed reference sections or stratotypes have been developed (Dunn, 2001; Playford and Dino, 2005). Most of the early reference sections used to erect international standard stages, with respect to the relative geological time-scale, developed in Europe largely based on the distribution of ammonoids, conodonts, and foraminifers (Christopher and Goodman, 1996). For most Gondwana sequences, where there is a general lack of marine fossils and zonation schemes are largely based on terrestrial stratigraphic intervals, precise dating and correlation remains uncertain. This is compounded by the geographic restriction of most Permian assemblages, which resulted from the existence of distinct palaeoclimatic zones with associated floral provinces (ECL, 1990; Playford and Dino, 2005). In addition, radiometric age determinations from Upper Palaeozoic strata of Gondwana are scarce (Souza, 2006), and hence age control for the diagnostic assemblages remains equivocal. Consequently, age control for assemblages, and hence the zonation scheme, from the present study is inferred from comparison with other Gondwana palynofloras, and as a result remains tentative.

Comparison of the palynological assemblages from the poorly constrained basal sections of the Karoo sequence considered in this study, with other previous works (e.g. MacRae, 1988; Dolby, 1990; Souza, 2006), indicate Late Carboniferous ages (i.e. Kasimovian – Gzhelian). The latter is seemingly typified, in Gondwana sequences, by the common dominance of monosaccates and trilete spores when compared with the dominance of bisaccate pollen (e.g. MacRae, 1988; Souza, 2006). Late Carboniferous ages have also been suggested from equivalent lithofacies (e.g. Dwyka Group), by Key et. al. (1995) based on studies from southwest Botswana, as well as Visser (1990) who studied glaciogene deposits from southern Africa. Souza (2006) gives a brief account of limited radiometric ages from the Dwyka Group, which also indicates late Carboniferous stages.

Preliminary correlation of the biozones from STRAT 1 with other relevant palynological studies from Gondwana sequences (e.g. Wright and Askin, 1987; ECL, 1990; Hankel, 1992; Farabee et. al., 1991; Lindström, 1995a, b; Souza, 2006; generally reveal Early Permian ages from the base of the zone S1 – 1 to approximately subzone S1 – 3b,

Period	Epoch	Stage	Age	SOUTH AMERICA (Souza and Marques-Filho, 2003; Souza et al., 2006)		STRAT I BOREHOLE (This Study)		SOUTH AFRICA (MacRae, 1988)		ZIMBABWE (Falcon, 1975)	ZAMBIA (Ullrig, 1976)	TANZANIA (Semkwa et al., 2003)	GABON (Jardine, 1974)	MADAGASCAR (Wright & Askin, 1987)	AUSTRALIA (Backhouse, 1991)	ANTARCTICA (Lindstrom, 1995a, b; Farabee et al., 1991)												
				Interval Zone	Sub-interval	Sub-interval	Sub-interval	Sub-interval	Sub-interval	Sub-interval	Sub-interval	Sub-interval	Sub-interval	Sub-interval	Sub-interval	Sub-interval	Sub-interval											
UPPER CARBONIFEROUS	Pennsylvanian	Kasimovian	296.5 ± 1.3	<i>Cruciacella monolepis</i> Interval Zone	>>>>>>>>>	A	I	II	Cannanoropolis Plicatipollenites Zone	P II	Lower Sakamena	S1 - 1	Pseudoreticulata?	Locality A (lower)	Locality A (upper)	Buckley Formation	B	Stage 2?										
			293.9 ± 0.9																I	D	Mukumba Shistone Member	P III	Muyashi Carbonaceous Member	Scheuringipollenites Prototaphoxyphus Zone	P III	Vestfjella Mountain Ranger Locality A (upper)	Vestfjella Mountain Ranger Locality A (upper)	Striatopodocarpiflexus Zone
			284.6 ± 0.8																									
	284.4 ± 0.7	I	D	Mukumba Shistone Member	P III	Muyashi Carbonaceous Member	Scheuringipollenites Prototaphoxyphus Zone	P III	Vestfjella Mountain Ranger Locality A (upper)	Vestfjella Mountain Ranger Locality A (upper)	Striatopodocarpiflexus Zone																	
	275.6 ± 0.7											I	D	Mukumba Shistone Member	P III	Muyashi Carbonaceous Member	Scheuringipollenites Prototaphoxyphus Zone	P III	Vestfjella Mountain Ranger Locality A (upper)	Vestfjella Mountain Ranger Locality A (upper)	Striatopodocarpiflexus Zone							
	270.6 ± 0.7	I	D	Mukumba Shistone Member	P III	Muyashi Carbonaceous Member	Scheuringipollenites Prototaphoxyphus Zone	P III	Vestfjella Mountain Ranger Locality A (upper)	Vestfjella Mountain Ranger Locality A (upper)	Striatopodocarpiflexus Zone																	
	260.4 ± 0.7											I	D	Mukumba Shistone Member	P III	Muyashi Carbonaceous Member	Scheuringipollenites Prototaphoxyphus Zone	P III	Vestfjella Mountain Ranger Locality A (upper)	Vestfjella Mountain Ranger Locality A (upper)	Striatopodocarpiflexus Zone							
	260.4 ± 0.7	I	D	Mukumba Shistone Member	P III	Muyashi Carbonaceous Member	Scheuringipollenites Prototaphoxyphus Zone	P III	Vestfjella Mountain Ranger Locality A (upper)	Vestfjella Mountain Ranger Locality A (upper)	Striatopodocarpiflexus Zone																	
	260.4 ± 0.7											I	D	Mukumba Shistone Member	P III	Muyashi Carbonaceous Member	Scheuringipollenites Prototaphoxyphus Zone	P III	Vestfjella Mountain Ranger Locality A (upper)	Vestfjella Mountain Ranger Locality A (upper)	Striatopodocarpiflexus Zone							
	251.0 ± 0.4	I	D	Mukumba Shistone Member	P III	Muyashi Carbonaceous Member	Scheuringipollenites Prototaphoxyphus Zone	P III	Vestfjella Mountain Ranger Locality A (upper)	Vestfjella Mountain Ranger Locality A (upper)	Striatopodocarpiflexus Zone																	
	251.0 ± 0.4											I	D	Mukumba Shistone Member	P III	Muyashi Carbonaceous Member	Scheuringipollenites Prototaphoxyphus Zone	P III	Vestfjella Mountain Ranger Locality A (upper)	Vestfjella Mountain Ranger Locality A (upper)	Striatopodocarpiflexus Zone							

Figure 50: Biostratigraphic correlation chart of STRAT I borehole with selected regional and Gondwana-wide zonation schemes. Chronostratigraphic units are sourced from the International Stratigraphic Chart based on Gradstein et al. (2004).

whereas the remaining sections i.e. biozones S1 – 3 (subzones c, d) and S1 – 4 are generally of early Late Permian stages. There is however difficulties in defining stage boundaries, which requires more refined data to allow direct correlation at short stratigraphic intervals. Nevertheless, tentative age inferences for the present zonation scheme from the Kalahari Karoo Basin are made based on comparison with the zonation schemes for the Paraná Basin of Brazil in South America (e.g. Di Pasquo et. al., 2003a, b; Souza and Marques-Toigo, 2003, 2004; Souza, 2006), where there appear to be a relatively close similarity. It is worth noting also that the similarities indicated by the assemblage taxa from the Kalahari Karoo Basin and the Paraná Basin are also corroborated by the palaeogeographic similarities of the two basins as reflected by several illustrations of their Late Palaeozoic reconstruction (e.g. Kalkreuth et. al., 1999; Turner, 1999; Wopfner, 1999; Golonka and Ford, 2000 etc.).

As described earlier above, biozones S1 – 1, S1 – 2, up to and including subzone S1 – 3b, from STRAT 1 borehole, generally correlates with the *Vittatina costabilis Interval Zone* (Souza, 2006). From the latter correlation Early Permian to mid Early Permian ages ranging from the Asselian stage to the Artinskian stage are deduced. Subzones S1 – 3c and S1 – 3d, as well as biozone S1 – 4, generally correlates with the *Lueckisporites virkkiae Interval Zone* (Souza, 2006), although the upper limit in STRAT 1 remains uncertain. Consequently, a tentative late Early Permian to earliest Late Permian age range is proposed for the upper biozones of STRAT 1 borehole. A rare absolute age of 270 Ma reported from the Collingham Formation of South Africa (e.g. Turner, 1999; Souza, 2006), which overlies the Whitehill Formation, supports a late Early Permian age (i.e. Kungurian) for the uppermost part of biozone S1 – 3. The latter represent a lithofacies section indicated in Johnson et. al. (1996) to immediately overlie the Whitehill Formation in the Kalahari Karoo Basin, and hence probably equates with the Collingham Formation. Comparisons of the assemblage characteristic of biozone S1 – 4 with several regional and Gondwana-wide studies indicates Late Permian ages (e.g. Wright and Askin, 1987; Farabee et. al., 1991; Hankel, 1992;. Lindström, 1995a). Because the top of biozone S1 – 3 is considered to represent late Early Permian ages, as discussed above, the succeeding biozone S1 - 4 is considered to represent early Late Permian ages (i.e. Roadian). Consequently, the base of biozone S1 – 4 is tentatively equated with the boundary between Early and Late Permian for the sequence at STRAT 1 borehole in the Kalahari Karoo Basin.

CHAPTER 7: PALAEOENVIRONMENTAL INTERPRETATIONS

Besides stratigraphic correlations, palynological analyses (i.e. both qualitative and quantitative) have great potential to aid in the environmental interpretations of sedimentary sequences, as demonstrated in several past studies (e.g. Sah and Kar, 1969; Van de Laar and Fermont, 1990; Van Bergen and Kerp, 1990; Mussard et. al., 1994; Ollivier–Pierre and Sittler, 1994; Broutin et. al., 1995; Tyson, 1995; Batten, 1996; Pittet and Gorin, 1997; Schiøler et. al., 2002). This is because the occurrence and composition of organic matter, which form the basis for the description of palynofacies, reflect the effects of global factors that controlled the nature and distribution of the host sediments or sedimentary rocks (Batten, 1996). Such factors, the relative importance of which is variable between different environments, comprises a host of interrelated controls that include sedimentary processes, sediment supply, climate, tectonics, sea-level changes, water chemistry, and biological activity (Reading, 1986). In this study the results of the qualitative and quantitative analyses reveal notable palynomorph and palynofacies characteristics the nature of which are interpreted below in terms of palaeoenvironmental changes.

It is important though to note that the observed distribution and preservation of the sediment organic matter is only a reflection of the remaining fraction of the original material produced and accessible to the palaeo-depositional basin. The rest of the original organic matter would have been made inaccessible for preservation in the basin of interest depending on a complexity of factors that are beyond the scope of this study. Such factors include, but are not limited to, the production and dispersal characteristics of the parent plants, the morphology of the grains with regard to ease of transport, characteristics of the medium of transportation i.e. water and wind, removal and destruction by erosion, and lastly, sedimentary facies characteristics i.e. host-rock grain-size (Traverse, 1988; Cleal, 1991; Smith, 1994; Batten, 1996). Nevertheless, the subtle trends observed from the qualitative and quantitative analyses in this study are considered a reflection of the major changes and controls affecting the palaeo-depositional environment.

7.1 Qualitative Analysis

In terms of the qualitative analysis two general observations are apparent from a study of the range charts (e.g. Fig. 27, 32), which allows for the sequence in the Kalahari Karoo Basin to be placed on a palaeoenvironmental setting. Firstly, there occurs some general increase or decrease in diversity of certain major evolving taxa, coupled with species terminations and initiations at distinct intervals, which is considered to be associated with factors influencing the changing palaeoclimates. Secondly, there are some notable variations in the frequency of occurrence of taxa, the causes of which may be varied, but appear to be closely linked to the depositional history of the sedimentary sequence. In addition, the recognition of other microfossils such as acritarchs and prasinophytes give further perspective about the broad nature of the depositional environment.

Sporomorphs (pollen, spores)

General taxa diversity is relatively pronounced in pollen groups, when compared to spores, the most notable being the increase in bisaccates i.e. *Alisporites spp.* and *Protohaploxylinus spp.*, from the base of biozone S1 – 2 (or biohorizon S1D e.g. Appendix II - 2) in STRAT 1 borehole. Both genera indicate an increase in diversity from two species to four species. A notable contrast to the latter increase in diversity of bisaccates is the decrease in diversity displayed by the *Plicatipollenites spp.* from five species to one species terminating at the top of subzone S1-3b (or biohorizon S1H e.g. Appendix II – 2). Overall, the monosaccates pollen indicates a more pronounced presence in the lower sections of the sequence whereas the bisaccates pollen are more prominent in the upper sections. This trend generally coincides with the lithofacies transition from glacial facies of the Dwyka Group to postglacial facies of the Ecca Group and is considered to reflect changing palaeoclimates from cold to warm (e.g. Sah and Kar, 1969; Kar, 1976; Broutin et. al., 1995). Parallel to the decrease in diversity indicated by the *Plicatipollenites spp.* is the disappearance of all *Cristatisporites spp.*, also observed in CKP6 borehole, which is here considered to highlight the widely reported co-occurrence of monosaccates and trilete spores in Permo-carboniferous glaciogene sequences of Gondwana (e.g. Kar, 1976; MacRae, 1988). The latter association is interpreted to indicate the possibility of proglacial to periglacial sub-environments (e.g. glaciolacustrine) that was able to support spores and monosaccate pollen producing vegetation. Such an interpretation is supported by the lithofacies association that is also characterized by sedimentary structures and textures of typical glacial sub-environments i.e. rhythmically laminated argillites with dropstones (Section 2.4).

In addition to the palaeo-trends indicated by taxa diversity there is also the conspicuous trends represented by the origination and termination of species, defining several biohorizons in the stratigraphic sequence (e.g. Appendix II – 2). The occurrence of several biohorizons may be caused by a complex set of factors that determines species originations and terminations, such as; environmental shift and the creation of a suitable habitat, adaptation of species due to genetic modification, the extinction of species less favoured by the habitat and the freeing of a niche suitable for others, and the introduction of species that migrated from other habitats (Sah and Kar, 1969; Miall, 1990; Cleal, 1991). Among the factors outlined above, environmental shift has perhaps the most common effect due to its frequent regulation by climatic changes as evidenced by the occurrence of several glacial and non-glacial periods in the geological past (Crowell, 1983; Edwards, 1986; Tucker, 1991; Eyles, 1993). A number of the more significant biohorizons are associated with some notable characteristics discussed below.

The most significant biohorizon from STRAT 1 borehole is S1D (Appendix II – 2), described above as marking the increase in diversity of bisaccates pollen. The latter biohorizon occurs in upper Dwyka proglacial facies, and the indicated proliferation of new species at this horizon could be interpreted to reflect the onset of a major and final deglaciation phase due to pronounced climatic warming. The latter culminated in the accumulation of the Kobe Formation, dominated by grey to dark, finely laminated

mudstones, considered to be the product of the deglaciation phase. The other biohorizons that occurs within biozone S1 – 1 (e.g. S1A – S1C), confined within the Dwyka Group, are possibly associated with climatic cyclicity during the glaciation (e.g. Edwards, 1986), during which new species were progressively being introduced parallel with the overall climatic amelioration.

A remarkable disappearance of large numbers of species is apparent throughout the deglaciation facies of the Kobe Formation, and is highlighted at biohorizons S1E, S1F, and S1G (Appendix II – 2). This trend is similarly displayed within the deglaciation sequence at CKP 6 borehole (e.g. Appendix II – 4). The latter observation is not considered to be a feature of facies control as most of the species disappearing originated from near the base of the sequence, rather than within the Kobe Formation. A perhaps unexpected observation is a relative drop in the frequency of distribution of taxa across the dominantly argillaceous Kobe Formation, whose grain-size is considered the most suitable for palynomorph preservation with regard to preferential grain-size sorting (e.g. Traverse, 1988; Tyson, 1995). It is therefore not clear what change may have caused the disappearance of large numbers of species at the time when the climate is indicated to have been improving to one that is more suitable for a proliferation of vegetation. However, one possibility is that the climate may have gradually changed to much more drier non-humid conditions, less suitable especially for the life cycles of spores (e.g. Traverse, 1988). A drier and arid environment was also attributed to a low abundance of taxa in a sequence of the Indian strata commonly referred to in the literature as the Barren Measures (e.g. Sah and Kar, 1969). In an alternative consideration, the process of deglaciation may have resulted in flooding of the formerly restricted proglacial environments, resulting in destruction of several of the local vegetation. Incidentally, palaeoenvironmental interpretations based on the deglaciation lithofacies of the Prince Albert Formation in Namibia and South Africa, which form the equivalent of the Kobe Formation, support the development of a broad epicontinental sea (e.g. Smith et. al, 1993; Johnson et. al., 1996).

Undoubtedly, the disappearance of several taxa, as highlighted above, signify a major change in the broader palaeoenvironment, which can be equated with the end of the deglaciation period. The latter was succeeded by an evidently distinct postglacial era whose qualitative character is however less discernible due to a seemingly strong facies influence. The overwhelming lack of new species initiations at the beginning of the Otshe Formation is closely related to the influx of arenaceous facies, which typically have low concentrations of sporomorphs, and most palynomorphs in general, as a result of preferential sorting at the time of deposition (Traverse, 1988; Tyson, 1995). The seemingly abrupt termination of species at biohorizon S1H of STRAT 1 borehole, although also probably related to the end of the deglaciation period, is possibly largely a reflection of the change in grain size of the lithofacies. This is supported by a major drop in the frequency of occurrence of all taxa in general as illustrated in Appendix II (1, 3). The introduction of new species, both spores and pollen, at the top of the sequence i.e. biohorizon S1J (Appendix II – 2) probably reflects a combination of both climatic influence and lithofacies control.

Microphytoplanktons (acritarchs, prasinophytes, chlorophytes)

In addition to the sporomorphs (i.e. spores and pollen), the volumetrically insignificant remains of phytoplanktons obtained in this study, and attributable to variable groups such as acritarchs, prasinophytes, and chlorophytes (classification based on Tappan, 1980), reflect a wide range of sub-environments. Acritarchs are in general widely reported to have dominated the marine environment, after appearing first in the Precambrian until recent times (Downie, C., 1973; Cramer, F. H., 1979; Martin, F., 1993). However, many acritarchs attributable to environments that range from brackish-water to fresh-water have also been reported (Playford and Dino, 2005). There is little work available in the literature that detail the association of acritarchs with specific palaeoenvironments, and hence only broad considerations are possible in this work. The most notable taxa among the acritarchs is the genus *Veryhachium*, which makes a limited stratigraphic occurrence in the upper parts and lower parts of the Kobe and Otshe formations, respectively. The delicate nature of the *Veryhachium spp.*, in addition to the low abundance levels, is perhaps indicative of their source from a low energy environment, of probable open marine setting where they are reported to dominate, with subsequent introduction through a marine incursion to marginal marine and continental sub-environments. Additional evidence that could corroborate the present interpretation for marine influence in the sequence studied includes the documented occurrence of a shallow marine bivalve *Eurydesma* (e.g. Ellis, 1979), from earlier studies of the same sequence in southwest Botswana. Other acritarchs of uncertain palaeoenvironmental character, also occurring in the studied sequence includes the genera: *Inapertisporites*, *Micrhystridium*, and *Tetraporina*.

Prasinophytes form another of the rare groups of phytoplanktons recognized in this study, and is comprised of the following genera: *Arabisphaera*, *Cymatiosphaera*, *Maculatasporites*, and *Tasmanites*. As with the acritarchs, the palaeoenvironmental significance of the prasinophytes is not documented to any specific degree in the literature. Generally, the prasinophytes are regarded to have adapted to a wider range of aquatic environments that includes marine, brackish, and fresh-water settings (Martin, 1993; Playford and Dino, 2005). The genus *Arabisphaera bellula*, which makes a significant occurrence in the upper Dwyka glacial facies, as well as in the deglaciation facies of the Kobe Formation, is reported (e.g. Kalkreuth et. al., 1999) to frequently occur (as *Portalites gondwanensis*) within the coals of the Rio Bonito Formation in the Paraná Basin. The occurrence of *A. bellula* within such varied sequence supports a range of palaeoenvironments that transcends brackish to fresh-water settings for the prasinophytes group. Nevertheless, many previous palynological studies indicate that an abundance of prasinophyte algae closely correlate with the occurrence of organic-rich finely-laminated shelf and oceanic deposits, highlighting the dominance of the marine environment (Tyson, 1995). The palaeoclimatic environments for the prasinophytes remains equivocal as some studies have inferred cold water climatic environments based on their common occurrence in high palaeolatitude facies, while other studies also reported significant occurrences in temperate and warm conditions (Martin, 1993; Tyson, 1995; Batten, 1996). The rare occurrences of the prasinophytes in this study (e.g. STRAT 1 borehole) do not reveal any clear facies-association that could be detailed in terms of the

palaeoclimatic conditions. Needless to say, *Arabispheera spp.* and *Cymatiosphaera spp.* indicate some degree of association with sequences of the Dwyka Group of relatively colder glacial to glacially influenced conditions, and the post-glacial sequences of the Ecça Group of relatively warmer conditions, respectively. On the contrary, the occurrence of *Tasmanites spp.* is not facies-restricted, instead reveals a much wider distribution that transcends both the Dwyka and Ecça sequences.

The last group of the phytoplanktons recognized is the Chlorophytes, which in this study is represented by only one taxon of uncertain specificity, belonging to the genus *Botryococcus*, and seemingly close to *Botryococcus braunii*. Many occurrences of *Botryococcus* are reported to be indicative of non-marine, fresh or brackish water conditions, however, studies of modern settings have also revealed river discharge of *Botryococcus* colonies into the marine realm (MacRae, 1988; Van Bergen and Kerp, 1990; Tyson, 1995; Batten, 1996). A significant presence of *Botryococcus*, therefore, is considered to reflect strong fresh-water influence on the depositional environment. The palaeoclimatic preferences for *Botryococcus* colonies are not clearly understood, however, the modern environment is reported to indicate a wide dispersal of *Botryococcus* in temperate and tropical regions, but also with tolerance of seasonally cold climates (Batten and Grenfell, 1996).

7.2 Quantitative Analysis

The results of the quantitative analysis, outlined in section 5.1.2, allow the sequence at STRAT 1 borehole to be considered in terms of the palaeoenvironmental setting. Much like the variations observed with taxa range above, the relative frequency distributions depicted by the palynofacies is a reflection of the variable factors influencing the depositional environment (Courtinat et. al, 2003). The stratigraphic distribution patterns (e.g. Figs. 36-39) of the palynofacies give insight into the vertical progression of the basin of deposition, particularly in terms of local to regional factors that influenced the basin at the time of deposition. Such factors may include; the availability of sediments, rate of accumulation, proximity and composition of terrestrial vegetation, and the chemical composition of the water and the biological activity within it (e.g. Batten, 1996). The statistical method used to analyse the quantitative data in this study (i.e. section 7.2.2), allows for the palaeodepositional environment to be considered in terms of its lateral changes. This helps to recognize the occurrence of several sub-environments, which are characterized by the lateral distribution of the various palynofacies categories.

7.2.1 Relative Abundance Distributions

Amorphous organic matter (AOM)

The relative percentage abundances of the AOM are illustrated in Figure 36, with details of their characteristics summarized in section 5.1.2.1.1. However, the exact nature of the amorphous organic matter observed (Plate PF2, figs. 1, 2) in this study remain uncertain,

in so far as its source is concerned. Nevertheless, the overwhelming continental aspect of the Karoo sequence as well as the high percentages of the associated phytoclasts and sporomorphs (e.g. Batten, 1996), in general, favours derivation from biodegradation of terrestrial material, as compared to phytoplankton or bacteria-derived organic matter (e.g. Tyson, 1995). There is generally a notable, albeit relatively subdued, presence of the AOM in much of the Dwyka Group and lowermost Ecca Group of the STRAT 1 sequence, which reflects an environment of relatively poor AOM preservation. Although poor AOM preservation may be due to variable factors, a comparison with the relative abundances of other components of the total sediment organic matter (i.e. phytoclasts and palynomorphs) reflects the possibility of preferential sorting by the hydrodynamic parameters. Hence, the environment depicted is one of proximal settings characterised by relatively high energy not suitable for the settling of finely dispersed material, and with well oxygenated conditions prone to the destruction of organic matter (Tissot and Welte, 1978; Tyson, 1995; Schiøler et. al., 2002).

The occurrence of local peaks depicted by the relative abundances (e.g. Fig. 36) probably reflect intervals of dysoxic-anoxic conditions in the depositional basin, at the site of STRAT 1 borehole, possibly associated with rising water levels at the sediment/water interface (e.g. Batten, 1996; Schiøler et. al., 2002). Some broad intervals with peaks in the AOM percentages are apparent in the Malogong and Khuis formations of the Dwyka Group, and also in the Kobe Formation and the carbonaceous and coaly mudstones of the Otshe Formation. The higher AOM percentages in the Kobe Formation, which corresponds to a slight drop in the phytoclasts abundances, are considered to reflect a rise in the water levels during the deglaciation period. In addition, a marine incursion suggested earlier on the basis of the occurrence of *Veryhachium spp.* also occurs in this section of the sequence, indicating the possibility of a transgressive system. The peak in AOM percentages within the carbonaceous and coaly sequences of the Otshe Formation probably indicate the occurrence of dysoxic-anoxic conditions associated with the wet environments typified by the coal-forming processes. Other evidence for the occurrence of deep water conditions, with the possibility of oxygen deficiency, include the recognition of fining-up rhythmic lamination in the carbonaceous mudstones, which typically reflect suspension deposition in low energy environments.

Phytoclasts

The relative percentage abundances for the Phytoclasts group are illustrated in figures 36 and 38, and their characteristics are summarized in sections 5.1.2.1.1 and 5.1.2.1.3. The various categories (e.g. Table 2) of phytoclasts observed in this study are shown in plates PF1 and PF3. Overall, the Phytoclasts group, when compared to the other components of the total sediment organic matter (i.e. AOM and Palynomorphs), indicates a greater presence in the sequence at STRAT 1 borehole. In terms of the palaeo-depositional basin, the latter observation reflects a depositional environment situated in a position to receive maximum discharge of terrestrially sourced organic matter. Similar to detrital components, the bulk of sedimentary organic matter is largely dependent on entrainment by rivers and streams to reach the basins of deposition (e.g. Tyson, 1995). Consequently,

the most probable palaeo-depositional environment consisted of a marginal basinal setting comprised of sub-environments such as deltas, estuarine and nearshore zones.

The overwhelming discrepancy between the relative abundances of the equidimensional and lath-shaped phytoclasts (e.g. Fig. 38) is considered to represent the effects of hydrodynamic sorting (Pittet and Gorin, 1997) during transportation, and also possibly during post-depositional reworking. The lath-shaped phytoclasts are regarded to form the remains of chipped-off fragments of the larger particles, with the bulk of the material having been broken into finer debris during transportation or reworking, and eventually deposited from suspension in the distal zones, much like the AOM. The bulk of the coarser particles, dominated by the equidimensional phytoclasts, were themselves probably deposited in the proximal zones of the depositional basin (e.g. Courtinat et. al., 2002).

There is a remarkable inverse relationship shown in the comparison between the relative abundances, plotted as \log_{10} ratios, of the black (BLKE) and brown (BRNE) equidimensional phytoclasts (e.g. Fig. 39). The dominance of the brown equidimensional phytoclasts within the glacial facies of the Dwyka Group is regarded to reflect the lower rates of degradation and oxidation of organic matter commonly associated with cool environments of poorly oxygenated conditions (Batten, 1996). In addition, the glacial sub-environments (e.g. subglacial, glaciolacustrine etc.) typically seem largely accessible only to locally derived material, with the possibility of immediate cover minimizing the length of exposure to oxidation, and to some extent degradation by micro-organisms. Van Bergen and Kerp (1990) also considered the dominance of brown phytoclasts to be associated with short distance transportation into the depositional basin.

The category of cuticles and membranous tissues (CAMT), which is comprised of predominantly brown matter, display a similar general trend to that shown by the brown equidimensional phytoclasts, and most probably reflect the same palaeoenvironmental setting. The CAMT display a significant presence in the Dwyka Group but diminishes gradually up sequence (Fig. 38). In modern settings (*personal observation*) the leafy remains of most plants appear to accumulate in the vicinity of parent plants and where transported into water courses seem to preferentially occupy restricted low-lying sites in the proximal settings of course ways. The latter seems to be associated with the tendency of leaves to become rapidly waterlogged and sink faster into low depths of typically oxygen-deficient waters (e.g. Tyson, 1995). In general a predominance of leaves can be regarded to reflect deposition in a low energy and calm environment, most likely proximal to source (Martín-Closas et. al., 2005), that allows for a concentration rather than dispersal of such a hugely light material.

The dominance shown by black equidimensional phytoclasts, on the other hand, is closely related to the gradually warming palaeoclimatic conditions during deposition of the postglacial sequences of the Ecca Group. The warmed-up climatic conditions are considered to have been associated with well-oxygenated environments, which subsequently resulted in accelerated rates of oxidation of woody material (e.g. Van Bergen and Kerp, 1990). Black phytoclasts are reported (e.g. Tyson, 1995; Schiøler et.

al., 2002; Courtinat et. al., 2003) to be relatively more resistant and less biodegradable than brown phytoclasts and hence their dominance may reflect the products of distally sourced terrestrial material, an observation documented in Pittet and Gorin (1997). Consequently, this would imply a palaeo-environment dominated by a highly active fluvial system characterized by high river discharge bringing material from the terrestrial interior. The possibility of a highly active fluvial system, as suggested above, when considered together with the development of coal forming conditions, which is a common phenomenon in the Ecca Group, favours a wet palaeoclimatic environment. Coal fragmentation is also likely to have significantly increased the amount of black equidimensional phytoclasts observed in this study.

Other observations pertinent to the nature of black phytoclasts include the recognition of charred and structured phytoclasts of probable charcoal affinity. Although the distinction of charcoal from other black phytoclasts is a difficult one Batten (1996) considers fragments with regularly perforated structure or bordered pits to be representative (e.g. Plate PF 3, fig. 5). The recognition of charcoal is indicative of wildfires, which may occur in a broad range of terrestrial environments that include swamps and bogs. The final deposition of charcoal fragments may also transcend a range of environments beginning with local depositional centers and reaching fluvial, lacustrine or nearshore marine settings. Additional evidence corroborating the occurrence of wildfires is indicated by the recognition of charred palynomorphs such as illustrated in Plate PF 2 (fig. 8).

Palynomorphs

The relative abundance charts for the Palynomorphs group are presented in figures 36 and 37 whilst details on their characteristics are summarized in sections 5.1.2.1.1 and 5.1.2.1.2. Overall, the palynomorphs group when compared to the other major components of the total sedimentary organic matter make a significant presence throughout the sequence, although less dominating than the group of phytoclasts. According to Traverse (1988) much of the total production of spores and pollen is eventually entrained in water courses to reach the basins of deposition. Therefore, the bulk of the sporomorphs from the terrestrial realm is considered to be deposited in the basins marginal settings, notwithstanding further entrainment by post-depositional reworking processes. When compared with the relative abundances of the AOM the palynomorphs group indicate an overwhelming dominance that can be interpreted to reflect hydrodynamic sorting, resulting in a proximal and distal setting for the palynomorphs and AOM, respectively. In general, the relative abundance data for the palynomorphs, as also reflected by the phytoclasts group, indicates that the sequence at STRAT 1 borehole was deposited in a basin margin environment, of relatively proximal setting zones.

The vertical distribution trend displayed by the total palynomorphs (TPa) chart (e.g. Fig. 36) generally indicates a steady rise in the relative abundances that becomes more apparent in the upper Dwyka (i.e. Middlepits Formation). The latter trend is interpreted to reflect the gradually improving climatic conditions during the earliest stages leading to

deglaciation, with subsequent proliferation of source vegetation. Although the distribution charts for the various categories of palynomorphs considered (Fig. 37) appear less distinctive, the rather subdued trends allows for broad comparative interpretations. The categories of trilete spores (i.e. AZLA, AZAP, ZOLA) indicate a relative dominance in the Dwyka Group and lowermost Kobe Formation perhaps signifying the occurrence of wet and humid environments that sustained the life cycles of spores (e.g. Traverse, 1988). Spores are generally believed to be transported by water, and hence, their dominance in the depositional basin is considered to reflect fresh-water input (e.g. Van Bergen and Kerp, 1990). The upper sections of the Ecca Group on the other hand show negligible abundances for the trilete spores, and a marginally significant presence of the saccate pollen, indicating comparatively drier conditions. The extremely low percentages indicated by the microphytoplanktons (i.e. ACRT, PRSN), which are commonly associated with the marine realm, in comparison to the sporomorphs, highlight the overwhelmingly continental nature of the palaeo-depositional environment. The notable presence of *Botryococcus*, which is the sole representative of the chlorophytes category (i.e. CHLR), through much of the Dwyka Group and lowermost Kobe Formation also reflect a largely continental influenced sequence.

7.2.2 Statistical Analysis

Several studies have been undertaken in which statistical methods have been variously employed for the quantitative assessment of palynofacies data to determine palaeo-environmental characteristics (e.g. Mussard et. al., 1994; Tyson, 1995; Courtinat et. al., 2002, 2003). In this study the method preferred is that of the Cluster Analysis, briefly outlined in section 5.1.2.2, which has been used to generate clusters or an association of samples with similar palynofacies affinity. In order to understand the significance of the sample associations, with regard to the palaeo-depositional environment, the different clusters, illustrated in terms of “dendrograms”(e.g. Figs. 40-42), were converted into ternary diagrams.

7.2.2.1 Ternary Plots

Ternary total sediment organic matter (TSOM) plot

The dendrogram of Figure 40 was converted into an AOM-TPH-TPA ternary plot and assessed based on comparison with the palynofacies fields and environments defined by Tyson (1995). The latter, although defined on the bases of marine facies, generally reveal a basinal configuration for the sequence at STRAT 1 borehole, which is indicated by a proximal-distal pattern of distribution of the sedimentary organic matter. The total sediment organic matter ternary plot (Fig. 51a) generally indicates a strong clustering of the data in proximity to the phytoclasts - palynomorphs axis, albeit with a positive skew to the phytoclasts segment. A comparison with the palynofacies and environmental fields (Fig. 51b) of Tyson (1995) reflects a clear configuration of a palaeo-basin that was

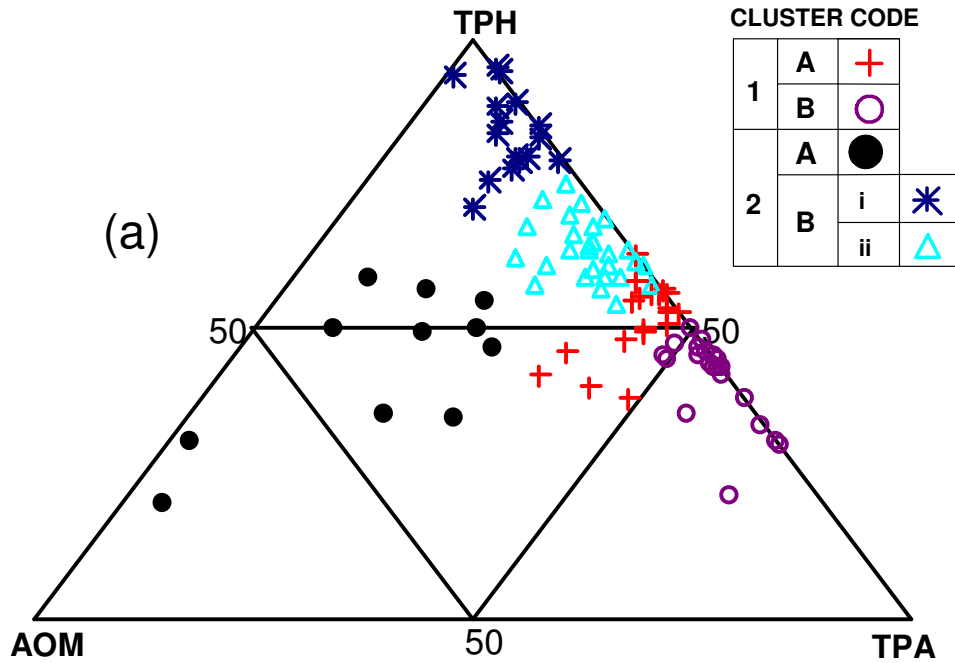

(b)

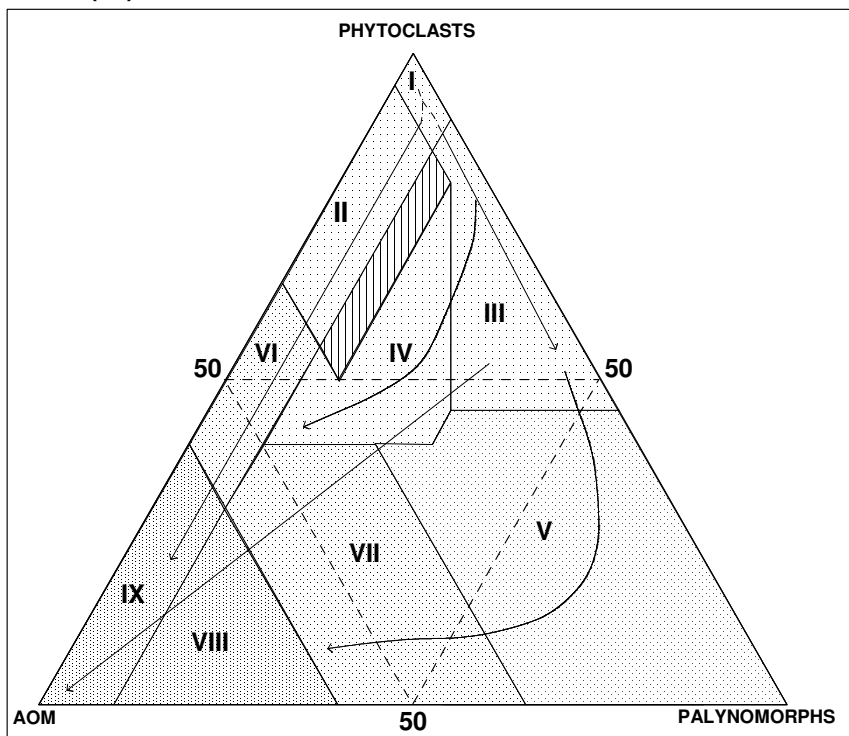

(after Tyson, 1995)

Figure 51: Ternary AOM-total phytoclasts-total palynomorphs plot: (a) ternary plot based on dendrogram of Figure 40, (b) palynofacies fields and environments (see Table 3 for explanations).

Table 3: Summary explanation of palynofacies fields and environments (from Tyson, 1995).

PALYNOFACIES FIELD AND ENVIRONMENT	
I	<i>Highly proximal shelf or basin</i>
II	<i>Marginal dysoxic-anoxic basin</i>
III	<i>Heterolithic oxic shelf ('proximal shelf')</i>
IV	<i>Shelf to basin transition</i>
V	<i>Mud-dominated oxic shelf ('distal shelf')</i>
VI	<i>Proximal suboxic-anoxic shelf</i>
VII	<i>Distal dysoxic-anoxic 'shelf'</i>
VIII	<i>Distal dysoxic-oxic shelf</i>
IX	<i>Distal suboxic-anoxic basin</i>
<p>—————→ <i>Proximal - distal sediment transport (basinward)</i></p>	

STRAT 1 MOST DOMINANT FIELD: III

Characteristics:

High spores : bisaccates ratio.

Phytoclasts abundance dependent on actual proximity to fluvio-deltaic source.

Oxidation and reworking common.

Low AOM preservation.

dominated by highly-proximal to proximal depositional settings, where the bulk of the terrestrially sourced sediment organic matter, dominated by phytoclasts, was deposited. The palaeo-depositional basin is also indicated to have consisted of distinctive transitional to distal settings, where conditions became favourable for the preservation of some rare but significant AOM. Overall, much of the data from STRAT 1 borehole is mostly concentrated in field III (Tyson, 1995), which can be considered to represent a proximal setting of high terrestrial sedimentary discharge, and characterized by oxic conditions and low AOM preservation.

A close analysis of the dendrogram on total sediment organic matter (Fig. 40), in comparison with the ternary plot (Fig. 51), reveal a clear segregation or clustering of the

data in patterns that allow for a palaeo-environmental interpretation based on the fields of Tyson (1995). Figure 51a comprises a clustering code that represents the clusters in Figure 40, whose distribution is illustrated in the associated ternary plot. Cluster 1, which comprises two sub-clusters (i.e. 1A and 1B), form the extreme end of a largely proximal setting. The latter could be likened to the pattern generated by fan-lobes in an alluvial fan system or similarly to patterns of the delta environment such as the delta front to prodelta sub-environments. In terms of the palynofacies fields in Figure 51b, Cluster 1 falls within a zone between and inclusive of parts of fields III and V, and hence represents the proximal to distal transitional palaeo-depositional setting. Cluster 1A represents a more proximal setting while cluster 1B represents a more distal setting.

Cluster B, which also consist of two sub-clusters (i.e. 2A and 2B), indicates a complete gradation from the proximal through transitional to the distal palaeo-depositional settings. Sub-cluster 2A, much like cluster 1, represents the transitional zones between the proximal and distal settings of the palaeo-basin. The former however is characterized by a distinct variation from suboxic to anoxic palaeo-depositional conditions, which culminated in the preservation of some AOM. Sub-cluster 2B, which comprises two components (i.e. 2Bi, ii) form the most proximal and well oxygenated basinal setting, which could be likened to a variety of environments that may include basin shores, delta plains, mouth bars etc. Sub-cluster 2Bi represents a highly proximal setting of distinctively phytoclasts discharge, whereas 2Bii represents the mid- to distal zones of the broader proximal regime, which is characterized by a progressive increase in mixing of the sedimentary organic matter (i.e. phytoclasts and palynomorphs).

Ternary palynomorphs plot

The cluster analysis “dendrogram” of Figure 41 was converted into a palynomorph (i.e. spore-microplankton-pollen) ternary plot to investigate basinal settings in accordance with similar plots by Düringer and Doubinger (1985), Traverse (1988), and Tyson (1995). The resultant ternary plot (Fig. 52a) indicates a strong concentration of the data in the spore segment. Comparison with the ternary palynomorph plot illustrated in Figure 52b (e.g. after Düringer and Doubinger, 1985; Traverse, 1988; Tyson, 1995) reveal an overwhelming deltaic character for the sequence at STRAT 1 borehole. It is important to note however that the data used comes from a variety of facies that include the glacial sub-environments. And therefore, the exact nature and transformation of the palaeo-depositional basin up-sequence is not clearly understood.

Overall though, the distribution of the data depicts a seemingly less extensive basin or restricted basin dominated by the proximal to near-proximal distal settings, probably akin to a shallow water lacustrine environment. A comparative review of the “dendrogram” clusters of Figure 41 with regard to the ternary palynomorph plot (e.g. Fig. 52a) reveals the occurrence of a distinctive segregation or clustering in the latter. Cluster 1 represents a relatively distal setting in terms of the distribution pattern of all data, and occurs at the median zone between spores and pollen. Cluster 2 generally defines a short-range gradation from proximal (i.e. 2B) basinal margin to distal (i.e. 2A) settings.

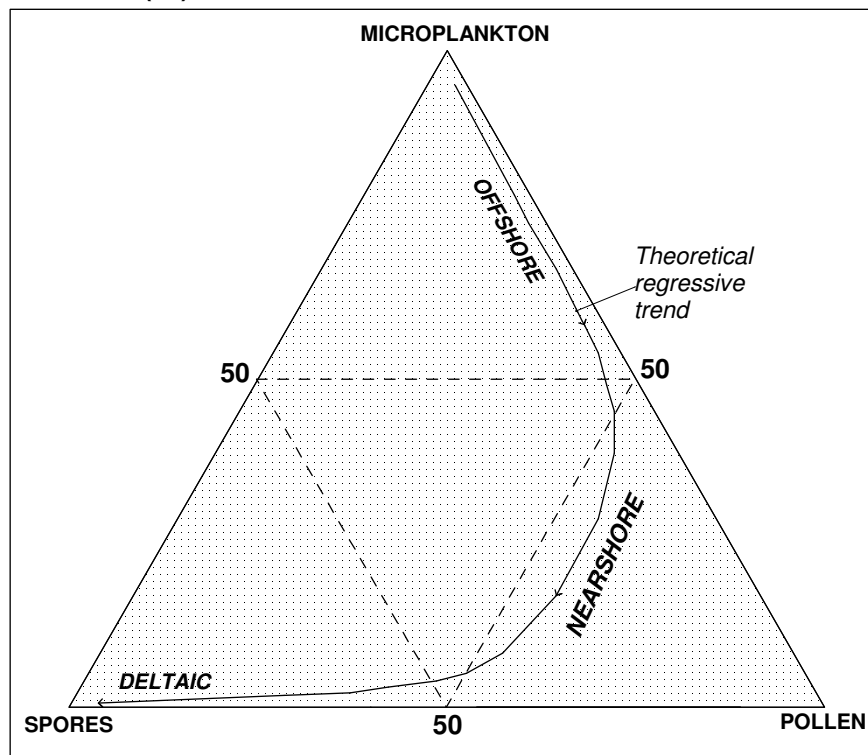
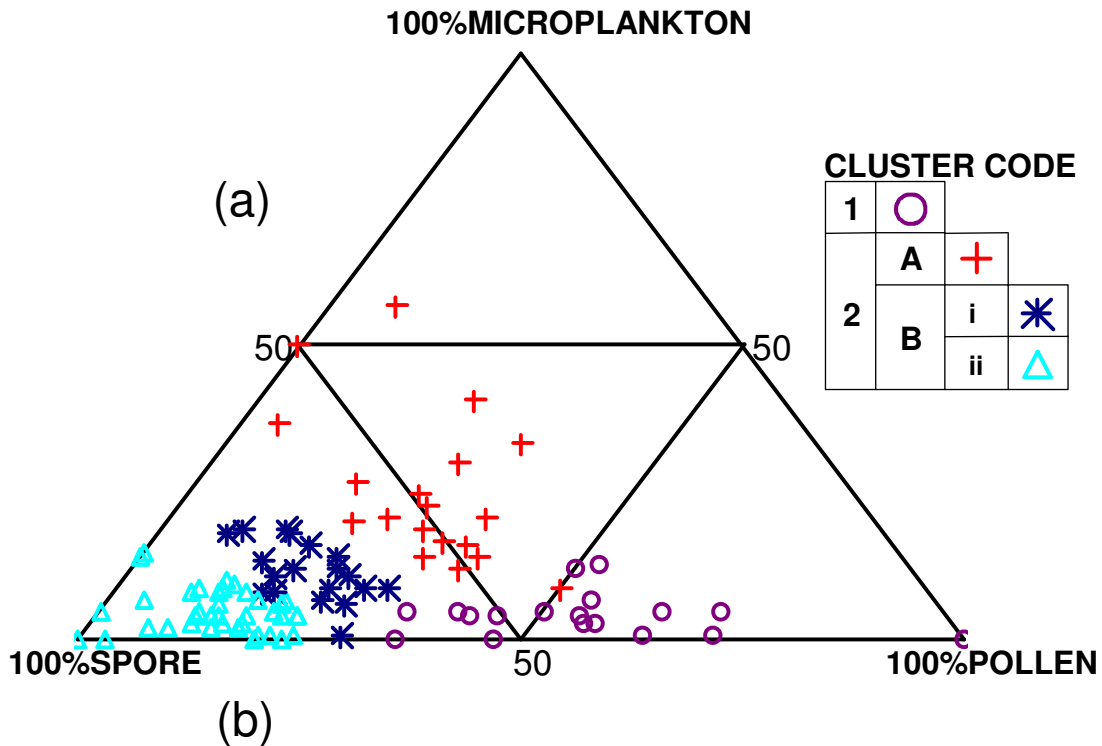

(after Düringer and Doubinger, 1985; Traverse, 1988; Tyson, 1995)

Figure 52: Ternary microplankton-spore-pollen palynomorph plot: (a) ternary plot based on dendrogram of Figure 41, (b) ternary diagram for palynomorphs indicating the characteristic depositional environments.

Ternary phytoclasts plot

Although no suitable phytoclasts plots were found for comparative analysis the “dendrogram” of Figure 42 was nevertheless converted into a BLKE-CAMT-BRNE ternary plot. The latter indicates a remarkable clustering pattern that separates samples of the Dwyka Group from those of the Ecca Group. A close analysis of the “dendrogram” clusters of Figure 42, and their comparison to the ternary plot (Fig. 53), reveals that clusters 1 and 2 directly correlates with the Ecca and Dwyka groups, respectively, with the exception of only a few samples. This is another presentation that highlights the dominance of black and brown phytoclasts in the Ecca and Dwyka groups, respectively, as earlier discussed in section 7.2.1. Although the results from the ternary total sediment organic matter (Fig. 51a) and palynomorph (Fig. 52a) plots support a palaeo-basin dominated by proximal depositional settings for the entire sequence at STRAT 1 borehole, the ternary phytoclasts plot (Fig. 53) highlights the occurrence of separate depositional settings for the Ecca and Dwyka groups. This therefore indicates a distinct basinal history during the development of the sequence at STRAT 1 borehole, and equally provides additional evidence to distinguish litho-stratigraphic sequences assigned to the Ecca Group from those of the Dwyka Group.

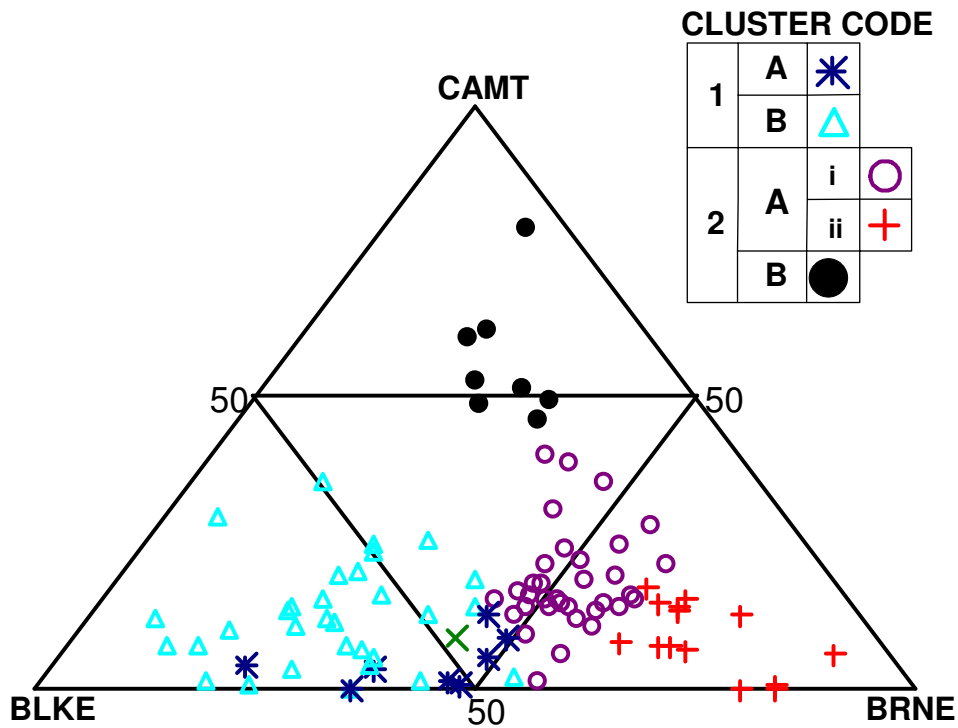

Figure 53: Ternary black equidimensional (BLKE)-brown equidimensional (BRNE)-cuticular and membranous tissues (CAMT) phytoclasts plot, based on dendrogram of Figure 42.

A close inspection of the ternary phytoclasts plot (Fig. 53) reveals a restricted pattern for cluster 1 (i.e. Ecça Group) when compared to cluster 2 (Dwyka Group), which itself indicates a much more diverse cluster distribution. This may be interpreted to reflect diversity in the palaeo-depositional settings, with variable potential for deposition and preservation of the different categories of phytoclasts. Although cluster 1 is divisible into two sub-clusters (e.g. Fig. 42) the result of the ternary plot (Fig. 53) indicates distribution of the data in the same segment. The latter probably reflect strong influence from the broader environment for cluster 1, with presumably less distinctive sub-environments, such that separation into sub-clusters is less significant. Sub-cluster 1A, the smaller of the two, may perhaps reflect the effects of mixed-source rather than a different palaeo-depositional setting.

Cluster 2 (i.e. Dwyka Group) on the other hand is distinctively diverse and display a clear distribution gradation from brown equidimensional phytoclasts (BRNE) towards cuticular and membranous tissues (CAMT). Sub-cluster 2A is considered to represent a relatively high energy depositional setting in which BRNE phytoclasts were deposited in proximal (e.g. 2Aii) and distal (e.g. 2Ai) zones. In terms of the glacial nature of the Dwyka Group the most probable palaeo-environment may include the transition from glaciofluvial to glaciolacustrine sub-environments. Sub-cluster 2B, which indicates a strong presence of CAMT, is interpreted to represent a low-energy and oxygen deficient depositional environment, perhaps of the form of proglacial lacustrine zones.

Overall, the results of the ternary phytoclasts plot reflect the possibility of a diverse palaeo-basinal system during deposition of the Dwyka Group, characterized by favourable conditions for the preservation of brown phytoclasts, which probably indicates rapid deposition and/ lower rates of degradation or oxidation. The Ecça Group on the other hand reflects a largely uniform depositional system dominated by the more resistive black phytoclasts. The latter are considered to represent the products of distally sourced terrestrial organic matter that has been overly exposed to oxidation during transportation as well as during post-depositional reworking events.

7.2.2.2 Stratigraphic Trends

The results from the ternary plots discussed above, when considered together for the entire sequence at STRAT 1 borehole, reflects deposition of the sequence within a proximal basinal setting of the broader depositional environment. A close review of the distribution characteristics of the samples in the ternary total sediment organic matter plots and their vertical stratigraphic positions reveal the occurrence of several small-scale cycles. In other words samples plotting in a particular cluster are indicated to come from different levels of the stratigraphic sequence, which represents shifts in the palaeo-depositional setting at the site of STRAT 1 borehole. Such shifts in the depositional settings are considered to reflect fluctuations in the water levels and depositional conditions, which are commonly associated with transgressive and regressive episodes. The latter then result in samples showing close similarity because of their deposition in similar conditions (i.e. proximal or distal), but at different levels of the stratigraphy, and

hence plot in the same clusters of the ternary plot. Fluctuations in the depositional conditions may also relate to variations in the depositional energies of fluvial-dominated systems. Progressively waning depositional energies as well as channel abandonment processes can create conditions comparable to proximal and distal settings in which samples of similar palynofacies character can be deposited.

Details of the stratigraphic cycles for the sequence at STRAT 1 borehole are illustrated in figures 54 – 57, based on ternary total sediment organic matter plots at formation ranks. This is however a preliminary investigation which still requires additional work with much more close-knit sampling, in order to determine the exact nature of the stratigraphic cycles. Palynofacies determined stratigraphic cycles of this nature appear to have great potential for correlation in multi-sections of a local basin, and hence may add value to improve other pre-existing methods of stratigraphic sub-division. The cluster patterns illustrated in the ternary plots of figures 54 – 57 represent the clusters obtained from the “dendrograms” of figures 43 – 46, respectively. The results indicated by the ternary plots are interpreted in terms of proximal to distal depositional settings on the basis of close similarity with the palynofacies fields and environments (Fig. 51b, Table 2) of Tyson (1995). The stratigraphic order of samples when presented on the basis of their clustering patterns, reveal proximal to distal trends that indicate fluctuations in the depositional conditions for the respective formations, which can be interpreted in terms of changing water levels or depositional energies. The latter are shown in Figures 54a – 57a as red and green arrows indicating shifts toward proximal and distal settings, respectively, and also in Figures 54b – 57b as proximal to distal palaeoenvironmental cycles.

Malogong – Khuis formations

The results from the ternary plot for the Malogong and Khuis formations (Fig. 54a) indicates palaeo-depositional environments comprised of highly proximal (sub-cluster 2A), proximal (sub-cluster 2B), and proximal to distal settings (cluster 1). Generally, the overall cluster pattern does not reveal a clear basinal system as nearly all samples plot in the proximal fields of the ternary plot, with no definitive distal characteristics reflected by the data spread. This is interpreted to represent the broad character of the Dwyka Group glacial environment which is indicated, lithologically, to be dominated by tillites of probable basal or subglacial zones, with mudstones and sandstone facies of the proglacial sub-environments. The weakly developed distal pattern indicated by the ternary plot (Fig. 54a) indicate the occurrence of only local, probably restricted, depositional environments of small magnitude such as glaciofluvial to glaciolacustrine as opposed to a fully-fledged wider and open basin.

Three general vertical stratigraphic trends (e.g. Fig. 54b) are recognizable for the Malogong and Khuis formations, and are considered to represent lateral shifts in the palaeo-depositional environment at the site of STRAT 1 borehole. The vertical stratigraphic trends are interpreted to form part of much broader glacial sedimentary cycles associated with either cyclicity of climates or expansion and deglaciation episodes (e.g. Edwards, 1986). The first trend at the base of the section indicates a change from

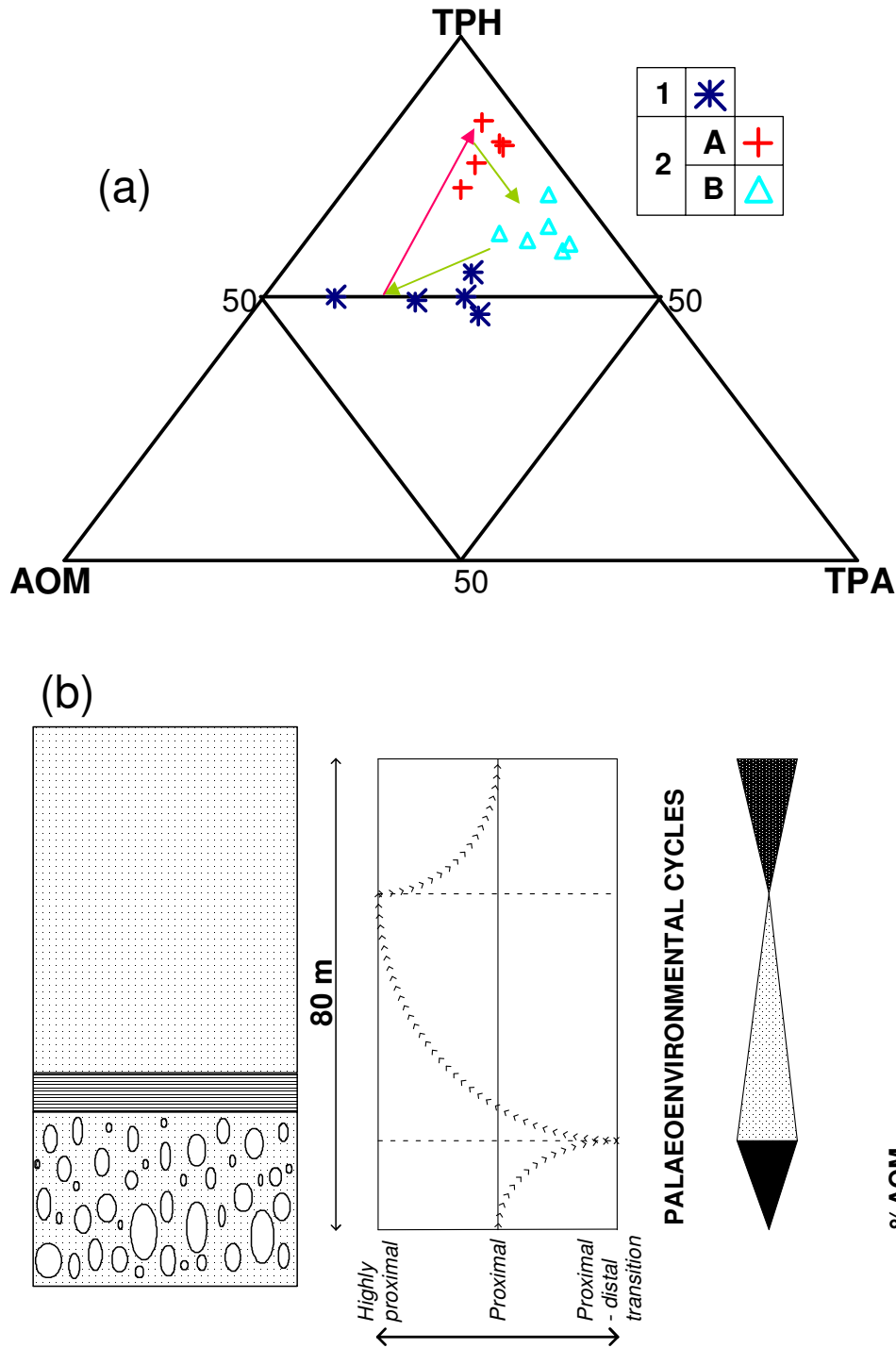

Figure 54: Small-scale palaeoenvironmental stratigraphic cycles in the Malogong and Khuis formations: (a) ternary AOM-TPH-TPA plot based on dendrogram of Figure 43, (b) proximal-distal trends, and notable relative abundances for the AOM.

proximal settings (sub-cluster 2B) to proximal-distal transitional zones (cluster 1), which lithologically corresponds to a change from diamictite to interbedded thin mudstone beds. This trend is interpreted to reflect changing depositional conditions from those depositing coarse sub-glacial debris to those of fine proglacial deposits of probable fluvio-lacustrine systems. The second trend depicts a shift toward highly proximal palaeo-depositional settings, and is shown to be associated with a sandstone-dominated facies. This is interpreted to reflect depositional sub-environments of the form of glaciofluvial outwash systems. The third and final trend at the top of the sequence is associated with fining-up intervals of sandstone beds that are topped by mudstone laminations. The latter is interpreted to represent the products of progressively waning depositional current energies of fluvial-dominated systems, which in this case was comprised of the glaciofluvial environment.

Middlepits Formation

The ternary total sediment organic matter plot for the Middlepits Formation (e.g. Fig. 55a) displays a cluster pattern that is indicative of a basin configuration. The cluster pattern is strongly controlled by the distribution of the phytoclasts and to a lesser extent the palynomorphs, which is considered to reflect proximity to source and hence a probable basin margin setting. A close comparison with the palynofacies fields and environment interpretations (Fig. 51b, Table 2) of Tyson (1995) indicate the occurrence of a palaeo-basin comprised of a complete gradation from highly proximal (sub-cluster 2A) to proximal (sub-cluster 2B) and distal settings (cluster 1) of characteristically oxic conditions.

The Middlepits Formation reveals approximately four broad vertical stratigraphic trends (Fig. 55b) that represent shifts in the palaeo-depositional environments. The environmental shifts are considered to reflect fluctuations in the palaeo-basin water levels (e.g. transgressive-regressive cycles) and depositional conditions at the site of STRAT 1 borehole. Considering the proglacial nature of the Middlepits Formation, the cause of such fluctuations can be explained in terms of the glacial sedimentary cycles, caused by climatic cyclicity and glacial response, as noted for the Malogong and Khuis formations. The vertical stratigraphic trends also show a close association with some rare peaks in the relative abundances of the phytoclasts (%TPh) and the palynomorphs (%TPa). The notable observations consist of a rise in the phytoclasts abundances associated with proximal settings, and hence a drop in water levels, whereas the palynomorphs display peaks that parallel a change toward distal settings, signaling a progressive rise in water levels.

Kobe Formation

The results of the ternary plot (Fig. 56a) obtained for the Kobe Formation display a distribution pattern that portrays a definitive basin configuration in terms of proximal to distal characteristics. A comparison with the palynofacies fields and environment

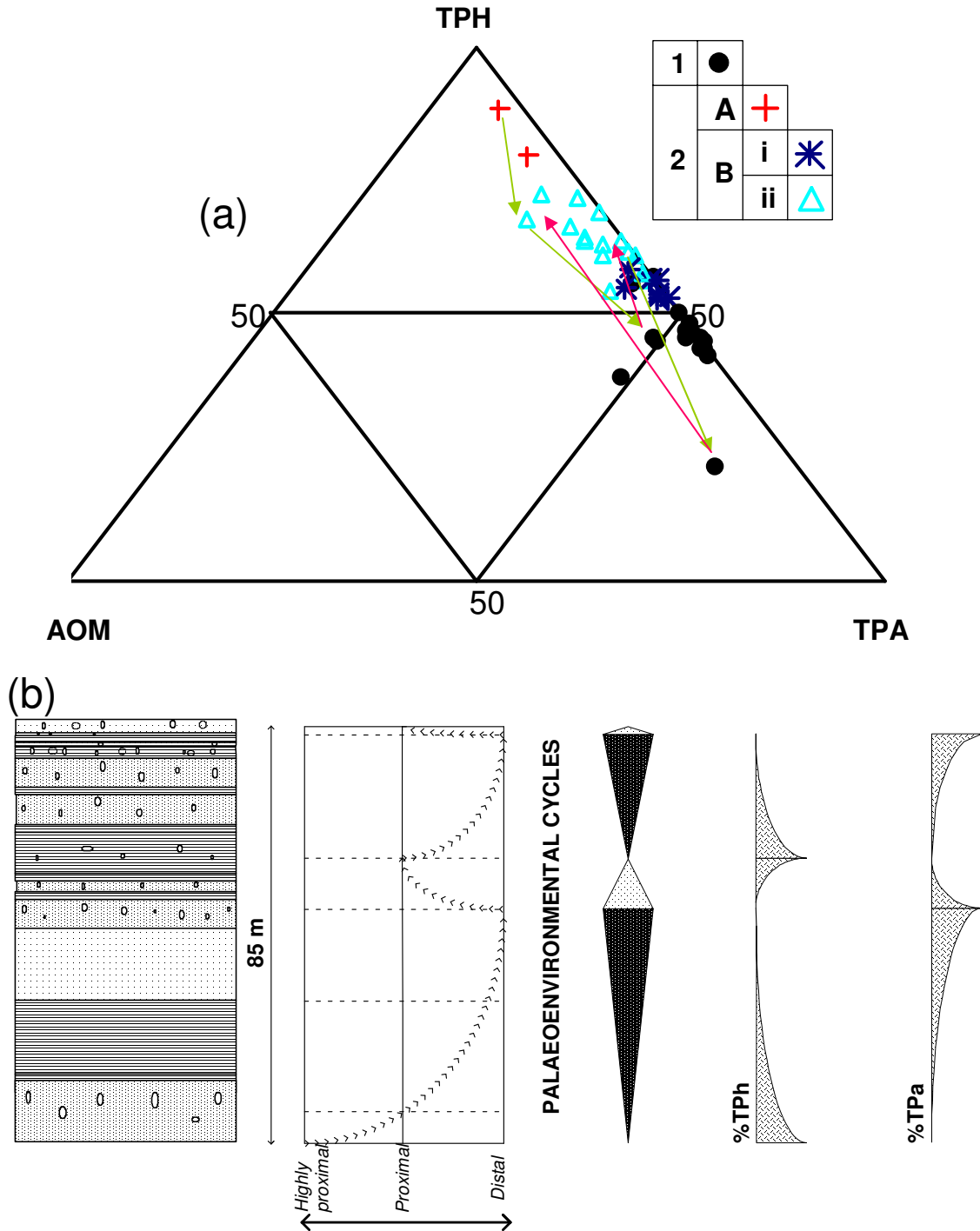

Figure 55: Small-scale palaeoenvironmental stratigraphic cycles in the Middlepits Formation: (a) ternary AOM-TPH-TPA plot based on dendrogram of Figure 44, (b) proximal-distal trends, and notable relative abundances for total phytoclasts (TPh) and total palynomorphs (TPa).

interpretations (Fig. 51b) of Tyson (1995) reveals a palaeo-basin that consisted of depositional settings ranging from proximal (cluster 1), through proximal - distal transition (sub-cluster 2A), to distal (sub-cluster 2B). In contrast to the Middlepits Formation where the distal setting was characterized by oxic conditions, the distal environment for the Kobe Formation is shown to have been set in relatively dysoxic-anoxic conditions. In terms of the palaeo-depositional site at STRAT 1 borehole the transition from oxic conditions to dysoxic-anoxic conditions is considered to reflect a rise in the water level with consequent deepening of the sediment-water interface, and the creation of oxygen deficient conditions. In general, the latter observation is considered to reflect a widening or broadening of the depositional basin in association with the deglaciation episode, during which there probably were pronounced transgressive trends. In addition, the possibility of a transgressive system linked to a marine incursion during the Kobe Formation has been discussed earlier on the basis of the recognition of *Veryhachium spp.* (section 7.1) as well as on the basis of the relative abundances of AOM (section 7.2.1).

The vertical stratigraphic trends (Fig. 56b), which are defined on the basis of proximal to distal shifts, are considered to reflect fluctuations in the basinal water levels, associated with transgressive-regressive trends. The exact nature of these transgressive-regressive trends can not be explicitly defined, however they are considered to have been strongly influenced by factors associated with the deglaciation episode. The lower section of the formation depicts a distal to proximal trend (e.g. sub-cluster 2B to cluster 1) which appear to be strongly associated with the lithofacies change from very fine to relatively coarse clastics, perhaps signaling the possibility of a regressive trend. The latter trend is succeeded by a shift from the proximal (cluster 1) to the proximal-distal transition (sub-cluster 2A), which is associated with fine clastics, and probably reflect relative deepening or a transgressive episode. The next shift is a reversal of the latter trend to the proximal zone (cluster 1) of a characteristically sandstone-dominated facies, which reflects relative shallowing, and a probable regressive trend. The latter trend is reversed to the distal zones (sub-cluster 2B), at the base of a mudstone-dominated facies, indicating the possibility of a transgressive trend. The final trend depicts a shift from distal to proximal zones (cluster 1), possibly signaling a drop in the water levels in association with a regressive trend. However, the associated lithofacies is dominated by mudstones rather than coarse clastics as may be expected, which can be interpreted to reflect a general absence of coarse clastic-detritals due to reduced sediment supply and slow rates of sedimentation, with replacement by fine sediments dominated by fine particulate organic matter.

There is some subtle but notable correlation between the proximal-distal trends and the relative abundances of the respective components of the total sediment organic matter. For example, the relative abundance trend for the AOM displays peaks that correspond with a shift towards the distal setting. However, the phytoclasts reveal a rather unusual pattern that show a peak that correspond with the distal setting at the bottom of the sequence, and then another peak corresponding to the proximal setting at the top of the sequence. This is interpreted to reflect increased supply due to proximity to source at higher water levels at the base of the sequence, whereas the top peak corresponds to a

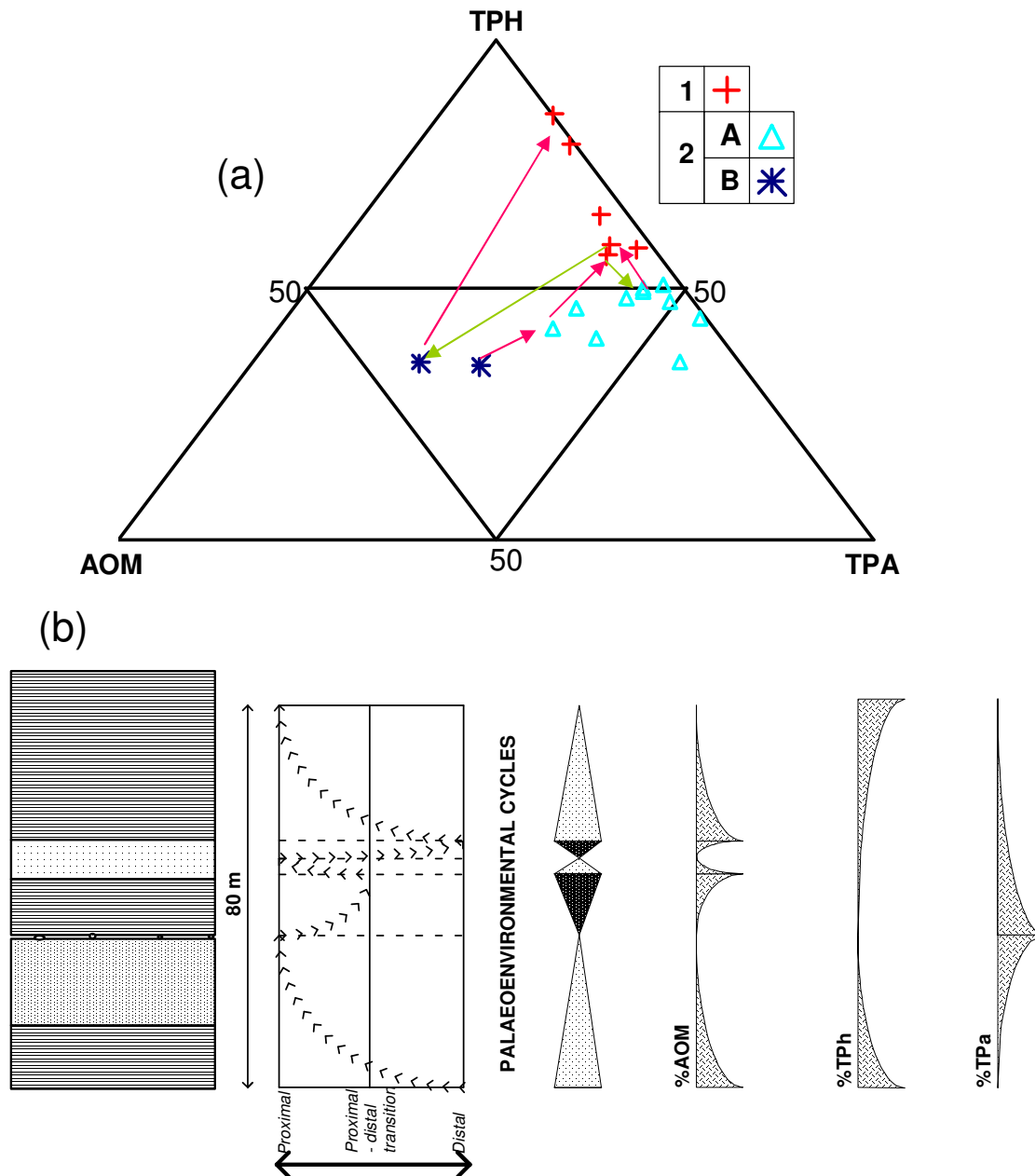

Figure 56: Small-scale palaeoenvironmental stratigraphic cycles in the Kobe Formation: (a) ternary AOM-TPH-TPA plot based on dendrogram of Figure 45, (b) proximal-distal trends, and notable relative abundances for total sediment organic matter.

drop in the water level with normal deposition in the established proximal environment. It must be noted that the Kobe Formation form the stage in the vertical succession where the relative abundances of the black phytoclasts sharply increases to surpass that of the brown phytoclasts. This observation seems to indicate an increased supply of phytoclasts

into the general depositional environment, and hence can be used to explain the rise in the total phytoclasts at the base of the Kobe Formation (e.g. Fig. 56b).

Otshe Formation

The ternary total sediment organic matter plot (Fig. 57a) for the Otshe Formation depicts a relatively varied pattern that probably signals the occurrence of diverse palaeo-depositional settings. In general, the distribution pattern shown on the ternary plot (Fig. 57a) portrays the occurrence of two distinct palaeo-depositional settings, with one dominated by the distribution of phytoclasts and palynomorphs, while the other is seemingly characterised by the occurrence of AOM. In terms of the palynofacies fields and environment interpretations of Tyson (1995) the two distinct environments corresponds with highly proximal to distal settings with oxic conditions, and highly proximal to distal with suboxic to anoxic conditions, respectively. The exact nature of the depositional environment is not clearly understood, however, the sudden influx of a sandstone-dominated succession in association with coal, following the relatively uniform mudstone-dominated basin-fill sequence of the Kobe Formation is generally considered to indicate a broad palaeo-depositional system of a largely deltaic setting (section 2.4). In addition, the ternary palynomorphs plot (Fig. 51a) for the entire sequence at STRAT 1 borehole also indicates a strong deltaic characteristic for the palaeo-depositional basin.

Stratigraphic variations for the respective palaeo-depositional settings can be highlighted in terms of four broad and generalized vertical trends (Fig. 57b). The first trend, in ascending order of stratigraphy, indicates a shift from the proximal-distal transition (sub-cluster 2Bii) into the highly proximal (sub-cluster 2Bi) zones. This trend is interpreted to represent delta progradation as evidenced by the sudden influx of a sandstone-dominated facies immediately succeeding the Kobe Formation. In terms of the deltaic profile the vertical trend is considered to represent the encroachment and establishment of the delta plain sub-environment at the site of STRAT 1 borehole. Although the exact regional nature of this progradational trend is not understood it is considered to be associated with a drop in the basin water levels as well as increased sediment supply in response to isostatic readjustments at the end of the deglaciation period.

The second trend defines a shift to a predominantly distal (cluster 1) palaeo-depositional setting of rather shallow water and well-oxygenated conditions. This trend is considered to be associated with the inception of delta abandonment, as evidenced by the progressive notable occurrence of argillaceous facies of characteristically slow rates of sedimentation. The latter is interpreted to represent the deposition of fine sediment within the interdistributary areas (e.g. cluster 1) of a fluvial-dominated delta plain environment. Sediment supply rates appear to have been still relatively high though, with a dominance of sand-grade facies.

The third trend depicts a shift from the distal zones into the proximal-distal transitional zones (sub-cluster 2Bii) albeit with fluctuations that includes some incursions of distal

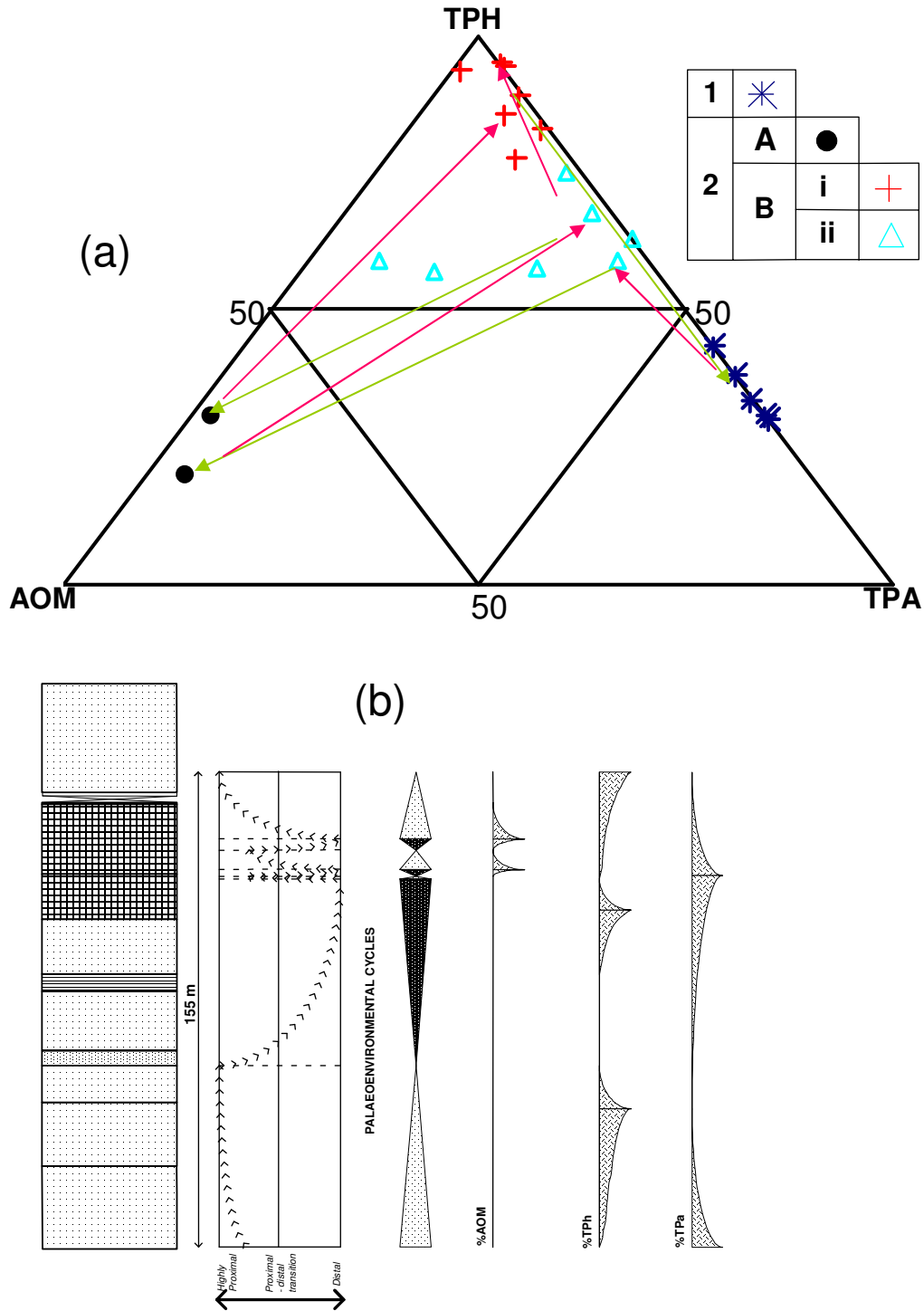

Figure 57: Small-scale palaeoenvironmental stratigraphic cycles in the Otshé Formation: (a) ternary AOM-TPH-TPA plot based on dendrogram of Figure 46, (b) proximal-distal trends, and notable relative abundances for total sediment organic matter.

suboxic-anoxic settings (sub-cluster 2A), as evidenced by the rare peaks of AOM relative abundances. Overall, this trend is considered to represent the culmination of delta abandonment with the establishment of an extensive swampy regime of occasionally deep water settings. The cause for deep water fluctuations is not certain but may be explained in terms of flooding events due to probable wet weather conditions that ensured the continued supply of terrestrially sourced organic matter into the depositional environment. The associated lithofacies indicates drastically reduced rates of supply for coarse clastics, with replacement by fine sediments of characteristically high sediment organic matter content deposited from suspension. The bulk of this detrital sediment organic matter is considered to have ultimately formed the carbonaceous mudstones and thin coal beds, an observation reported earlier by Smith (1984) for most Botswana coals.

The final and fourth trend depicts a shift from the proximal-distal transitional (sub-cluster 2Bii) settings to highly proximal settings (sub-cluster 2Bi). This trend is considered to represent another episode of delta progradation associated with increased sediment supply rates, as evidenced by the sudden influx of a sandstone facies immediately overlying the mudstone-dominated carbonaceous association.

CHAPTER 8: CONCLUSIONS

A core function of geological surveys and other similar organizations around the world is to manage the exploration and exploitation of earth mineral resources for economic benefits (Stephenson & Penn, 2005). However, a successful mineral development programme calls for a continuous improvement in mineral assessment studies using alternative tools and methods, driven by innovative creativity. Most of the world's nonrenewable fuel resources and many of its metals and minerals are known to be hosted by sedimentary sequences, and hence, their successful exploration and exploitation directly relates to geological knowledge on the palaeo-basin history (Miall, 1990). Studies on the palaeo-basin history, commonly termed basin analysis, largely embrace aspects of stratigraphy, structure, and sedimentology, albeit with varied coverage depending on the nature of the respective basins. The Karoo Supergroup in Botswana is one among such mineral-hosting sedimentary sequences, the history of which has been investigated over decades in studies associated with its coal-bearing characteristics (e.g. Green, 1966; Baldock et. al., 1977; Farr, 1981; Clark et. al., 1986; Williamson, 1996; ECL, 1998; ARI, 2003).

Studies from the Kalahari Karoo Basin however are greatly hampered by the lack of exposure, and hence, have been largely limited to borehole lithostratigraphic analysis, which remains inadequate for an improved analysis of the basin sequence. It is imperative therefore that a variety of methods and ideas are considered from time to time for future investigations to further enhance our limited knowledge on the nature of the sequence in the Kalahari Karoo Basin. The present study was conceived with the latter reason in mind and its main objective was to augment the database on Karoo stratigraphy with emphasis on correlation of strata at the local level to aid in fieldmapping and preliminary resource evaluations. The focus on palaeopalynology for biostratigraphic purposes in the present study is seen as a great improvement and an alternative method in geological investigations by the Department of Geological Survey. The results of the palynological study are summarized below.

Palynomorph yields and preservation

1. Only one (e.g. ML2) out of the nine corehole sections sampled for the study did not yield any palynomorphs, while the rest had variable status of palynomorph yields. STRAT1, CKP6, and to a lesser extent CKP9, yielded sufficient palynomorphs for analysis whereas the rest of the corehole sections (i.e. TLMB1, ML1, KGO3, ME58, and NATA) had poor results owing to inadequate sampling extent.
2. In general, there is an overwhelming presence of the terrestrially-sourced palynomorphs e.g. pollen and spores, albeit with variable preservation status relative to the respective localities. STRAT1 had the best yields and preservation status, while CKP6 on the other hand also produced relatively good yields however with poor preservation status of the palynomorphs. The difference in the preservation potential between the two boreholes is considered to reflect variable

influence from local factors that affected the palaeo-depositional settings for the host sedimentary sequence. This disparity in the preservation status of palynomorphs is also generally considered to confirm the existence of two separate sub-basins of the Kalahari Karoo Basin, namely, South West Botswana and Western Central Kalahari, from which STRAT1 and CKP6 are located, respectively.

3. The rate of palynomorph yields indicates a strong lithofacies influence, with the sandstone facies recording the poorest yields in comparison with the siltstone and mudstone facies, an observation that reflect preferential sorting with respect to grain-size. Apparently, palynomorph grains are generally of silt-grade size, and hence, their concentration in especially well-sorted sand-grade and clay-grade facies is largely negligible.
4. Samples obtained from the red beds facies, belonging to the Upper Karoo sequence, did not yield any palynomorphs. This observation is considered to reflect the effects of oxidation, which attacks the protective layer i.e. sporopollenin and chitin, and exposes the palynomorphs to destruction and ultimately non-preservation.

Overall, evidence on palynomorph yields obtained in microscopic investigations of the samples considered signify great potential in the use of palaeopalynology as an additional mapping tool for the Karoo Supergroup in the Kalahari Karoo Basin. A more detailed and focused sampling procedure, with a perhaps more sample-specific preparation procedures, in future investigations can yield exceptional results.

Biozonation

1. The stratigraphic range of species were determined, defined on the basis of first and last occurrences datum, which allowed for the creation of *biohorizons* and subsequent erection of *biozones*. Taxa range analysis revealed the occurrence of long, medium, and short range species for both STRAT 1 and CKP6 borehole sections. Three concurrent range zones with a taxon range zone and three assemblage zones have been erected for each of STRAT 1 and CKP6 borehole sections. In both sections, the lower and upper limits of the biozones are poorly constrained. The lower limit is determined by the base of the section, which shortly overlies older basement rock, whereas the upper limit is determined by a relatively abrupt disappearance of taxa in association with the upward change in lithostratigraphy, representing the Ecca – Beaufort transition.
2. The range zones established for STRAT1 comprises, in ascending order of stratigraphy, the *Potoniesporites congoensis* – *Convencosisporites irregularis* Concurrent Range Zone (Biozone S1-1), the *Retusotriletes diversiformis* – *Divaricrassus minor* Concurrent Range Zone (Biozone S1-2), the *Lophotriletes rectus* – *Concavisporites mortonii* Concurrent Range Zone (Biozon S1-3), and finally, the *Platysaccus papilionis* Taxon Range Zone (Biozone S1-4).

3. The range zones established for CKP6 comprises, in ascending order of stratigraphy, the *Converrucosisporites naumoviae* – *Cristatisporites morungavensis* Concurrent Range Zone (Biozone C6-1), the *Pakhapites fusus* – *Pachytriletes splendens* Concurrent Range Zone (Biozone C6-2), the *Vittatina sp.* – *Cyclogranisporites gondwanensis* Concurrent Range Zone (Biozone C6-3), and lastly, the *Striatopodocarpites fusus* Taxon Range Zone (Biozone C6-4).
4. The assemblage zones erected are common to both STRAT1 and CKP6, and are comprised of, in ascending order of stratigraphy, the *Hamiapollenites bullaeformis* Assemblage Zone (Biozone KK1), the *Cyclogranisporites gondwanensis* Assemblage Zone (Biozone KK2), and the *Platysaccus papilionis* Assemblage Zone (Biozone KK3).
5. Quantitative data on sedimentary organic matter allowed subdivision of STRAT1 borehole section into palynofacies horizons, which are comparable to biohorizons and can be utilized for correlation purposes.

Although there appears to be considerable variation in taxa ranges between the sections considered, the frequent occurrence of common events nevertheless highlights great potential for palynological zonations. The concurrent range zones erected for STRAT1 and CKP6, although not directly correlating, demonstrates options available to biostratigraphically subdivide and compare any borehole sections in future studies. Discrepancies in taxa ranges between sections can be greatly improved through detailed, rigorous and close-knit sampling procedures. Palynofacies data revealed great possibilities in the delineation of local within-basin marker horizons for comparative stratigraphic analysis.

Correlations

1. Correlation based on the concurrent range zones is difficult to realize between STRAT1 and CKP6 borehole sections, owing to the discrepancies in the ranges of the most significant species between the two sections. Only the taxon range zones (i.e. biozones S1-4 and C6-4), which represent the upper sections of the sequence, indicates comparable taxa ranges that allow for a limited direct correlation between STRAT1 and CKP6.
2. A preliminary direct correlation between STRAT1 and CKP6 borehole sections is attainable on the basis of the three assemblage zones common to both sections (i.e. biozones KK1, KK2, and KK3). Lithologically, the assemblage zones indicate some aspects of diachronicity, where the Dwyka glacial facies appear relatively older in CKP6, and hence, reflecting the possibility of glacial migration from the northeast toward the southwest. However, the middle Ecca sequence appears older in STRAT1, signifying a reversal in basin-fill migration. Nevertheless, the latter observations, based on preliminary investigations, remain tentative until confirmed by further detailed analyses

3. STRAT 1 borehole can be weakly correlated with CKP9 on the basis of common occurrence of taxa. However there is overwhelming disparity in the frequency of occurrence of the common taxa, owing to the low level of sampling, with great distances apart, in CKP9.
4. Only limited comparisons and broad correlations with other local previous palynology studies have been established, owing to the non-availability of taxa range data in most such studies. The Assemblage Zones KK1 – KK3 is weakly correlated with MacRae's (1978) Zones I – III, whilst Stephenson and McLean's (1999) Morupule Section compares favourably with Zones KK2 – KK3 of this study.
5. Comparison and tentative correlation of STRAT 1 zones with similar zones erected in the region as well as Gondwana-wide has been established, albeit cautiously, in recognition of several limiting factors that commonly hampers long-distance correlations. Amongst the notable limiting factors is the disparity in the frequency distribution of taxa between sections, also relatively common in local correlations, and factors of global scale such as palaeogeographic restriction of flora or provincialism, which is considered to have been well-established during the latest Carboniferous to Permian times.

Despite several limiting factors in palynostratigraphic correlations the present study has demonstrated that palaeopalynology is a feasible practical tool for comparative studies and correlation of the sequence in the Kalahari Karoo Basin of Botswana. Many of the factors that hamper regional correlations are within human control and hence can be overcome. Factors commonly observed include variations in taxonomic terminology in the published literature, and the variability in the level of details in these studies such as sampling intervals and the type of analyses as well as the choice of illustrations for presenting and comparing results.

Age

1. Age control for the zonation scheme erected in this study is inferred on the basis of comparison with other Gondwana works of similar assemblages, and hence, remains tentative.
2. Assemblages from the poorly constrained basal sections of the Lower Karoo sequence, in both STRAT1 and CKP6, compare with other assemblages from local, regional, and Gondwana-wide studies, assigned to Late Carboniferous ages of the Kasimovian – Gzhelian stages range.
3. STRAT1 biozones S1-1, S1-2, including the lower parts of biozone S1-3 (i.e. S1-3a-b), compares favourably with assemblages assigned to Early Permian ages of the Asselian – Artinskian stages range. The upper parts of biozone S1-3 (i.e. S1-3c-d) is assigned to late Early Permian ages of the Kungurian stage. Biozone S1-

4, which represents the topmost section of the sequence at STRAT1, is assigned to earliest Late Permian ages of the Roadian stage, and its base is tentatively equated with the boundary between Early and Late Permian.

In general, age determinations for biostratigraphic units depend on reliable correlation with marine sequences containing age-definitive faunas from which internationally agreed reference sections or stratotypes have been developed. Unfortunately, zonation schemes from most Gondwana sequences are largely based on terrestrial stratigraphic intervals, and hence, precise dating remains uncertain. The latter is also compounded by the common scarcity of radiometric age determinations from Upper Palaeozoic strata of Gondwana. Notwithstanding the above limitations, a concerted effort through major scientific research initiatives, aimed at the precise determination of stratigraphically significant taxa, with a rigorous global comparative analysis could greatly enhance stratigraphic age relations between variable sequences.

Palaeoenvironmental interpretations

1. Interpretations based on general taxa diversity, such as the relatively pronounced occurrence of monosaccate pollen, in the lower sections of the sequence in contrast to the bisaccate pollen, slightly common in the upper sections, support the general change in palaeoclimatic conditions of the Lower Karoo sequence from cold to warm. This trend generally coincides with the lithofacies transition from glacial facies of the Dwyka Group to postglacial facies of the Ecca Group.
2. Trilete spores display a relative dominance within the glacial facies indicating the possibility of humid and wet conditions, favourable for the life cycles of spores.
3. The deglaciation facies of the Kobe formation, in both STRAT1 and CKP6 boreholes, indicates a remarkable disappearance of a large number of taxa, which probably reflects a palaeoclimatic change to a drier and arid environment.
4. Rare but significant occurrences of acritarchs and prasinophytes, which typically dominate the marine environments, indicate the possibility of a marine incursion. The most notable taxa among the acritarchs is the genus *Veryhachium*, which makes a limited stratigraphic occurrence in the upper parts and lower parts of the Kobe and Otshe formations, respectively.
5. In general, palynofacies data indicates an overwhelming dominance by phytoclasts and sporomorphs, in comparison to AOM, and hence reflect a palaeo-depositional environment of typically proximal settings in a marginal basin area.
6. Palynofacies analysis based on comparison of the relative abundances of phytoclasts indicates significantly high percentages of brown and black phytoclasts, in the Dwyka and Ecca groups, respectively. This is interpreted to reflect lower rates of degradation and oxidation in response to cool climatic environments of typically poorly-oxygenated conditions during the deposition of

the Dwyka sequence. Black phytoclasts dominating the Ecca sequence reflect warm palaeo-climates with a well-oxygenated environment, and prolonged exposure of the phytoclasts during transportation from distal sources.

7. The recognition of charcoal as well as charred palynomorphs indicates the occurrence of wildfires in the palaeoenvironment.
8. Statistical analysis of the palynofacies data revealed the occurrence of clusters or associations of samples that allowed the sequence at STRAT1 borehole to be considered in terms of lateral shifts or cycles in the palaeo-depositional settings. The overall data on total sediment organic matter reveal a strong lineage towards a proximal palaeo-depositional setting, albeit with rare incursions into the distal settings.

The use of palynological and palynofacies analyses for palaeoenvironmental interpretations is not a common practice in the Karoo basins, and hence there is a general lack of previous records for comparative analysis. Nevertheless, the present study has demonstrated the potential for such data to augment conventional sedimentological studies in palaeoenvironmental considerations for the Kalahari Karoo Basin and other similar basins.

Other important observations

1. Palynofacies data on the relative abundances of brown and black phytoclasts has allowed for a clear distinction between Dwyka and Ecca groups facies, the junction of which coincide with the lithostratigraphic boundary. This observation provides an additional or alternative method to distinguish the Dwyka-Ecca boundary in future geological investigations where conventional stratigraphic and sedimentological practices may be inadequate.
2. The sedimentary organic matter found in the Karoo Sequence, which is dominantly of terrestrial origin, helps to rapidly distinguish Karoo strata of the Kalahari Karoo Basin from older sedimentary sequences, the youngest of which is comprised of latest Neoproterozoic sequences. The latter does not have any terrestrially-sourced sedimentary organic matter, because earlier than the Devonian the sole primary producers of organic matter were marine phytoplanktons. The distinction of Karoo strata from older sedimentary sequences form a crucial element in Kimberlite geology during investigations for diamond deposits in some parts of Botswana, in cases where the Karoo sequence may form cap rocks to prospective pipes.

The observations outlined above further demonstrates, albeit in a small way, varied aspects through which palynological analysis can be utilized to enhance knowledge and improve effectiveness in geological and resource investigations associated with the sequence in the Kalahari Karoo Basin.

PALYNOMORPHS PLATES

All figures are digital images. A scale bar is included for size estimates. The original slides from which the illustrations were sourced are kept at the Department of Geological Survey, Lobatse, Botswana.

PLATE 1

	<i>B/hole</i>	<i>Depth(m)</i>	<i>Slide no.</i>	<i>E/Finder</i>
1. <i>Calamospora aplata</i>	ST1	549,1	1642	T43.3
2. <i>Concavisporites mortonii</i>	ST1	232,1	1593	O22.1
3. <i>Concavisporites sp.</i>	ST1	181,0	1555	N49.1
4. <i>Deltoidospora directa</i>	ST1	376,4	1562	C19.4
5. <i>Pachytriletes splendens</i>	ST1	414,6	1610	Q32.1
6. <i>Punctatisporites gretensis</i>	ST1	490,1	1638	F25.3
7. <i>Punctatisporites gracilis</i>	ST1	371,2	1602	H47.1
8. <i>Punctatisporites parvus</i>	ST1	320,7	1579	W30
9. <i>Punctatisporites ubischii</i>	ST1	527,5	1571	T47.4
10. <i>Punctatisporites sp.</i>	ST1	197,5	1559	K39.3
11. <i>Retusotriletes diversiformis</i>	ST1	373,4	1603	S20.1
12. <i>Retusotriletes golatensis</i>	ST1	485,1	1636	U23
13. <i>Cyclogranisporites gondwanensis</i>	ST1	361,9	1599	P39.3
14. <i>Cyclogranisporites sp.</i>	ST1	232,1	1593	G46.2
15. <i>Granulatisporites papillosus</i>	ST1	365,5	1600	U22.1
16. <i>Granulatisporites angularis</i>	ST1	366,5	1601	K38.1
17. <i>Granulatisporites trisinus</i>	ST1	486,8	1637	U33
18. <i>Granulatisporites sp.</i> (a – proximal, b – distal)	ST1	303,5	1578	R30.2
19. <i>Granulatisporites sp.B</i> (a – proximal, b – distal)	ST1	303,5	1578	G35.1

PLATE 1

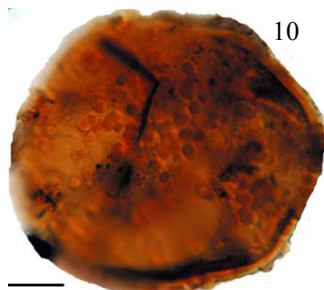
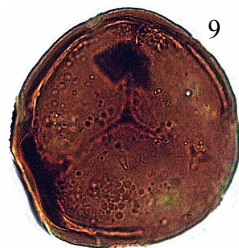
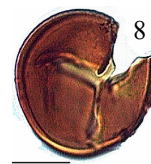
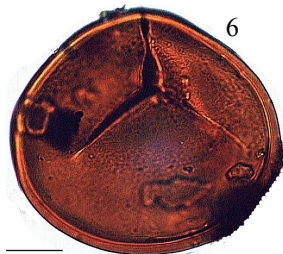
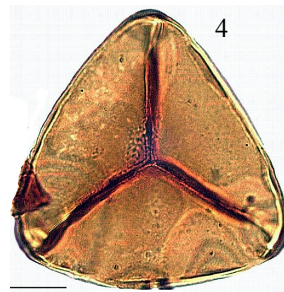
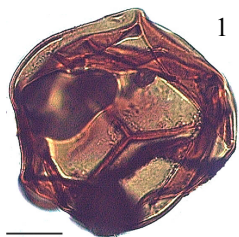

10μm

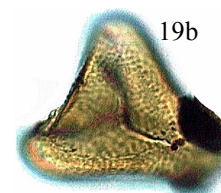
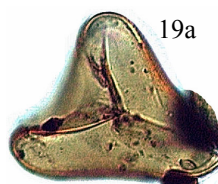
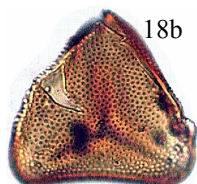
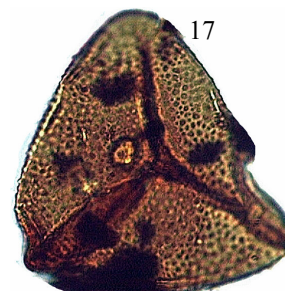
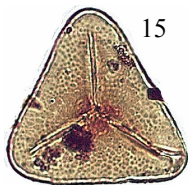
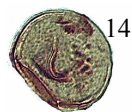
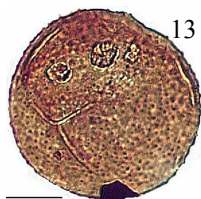
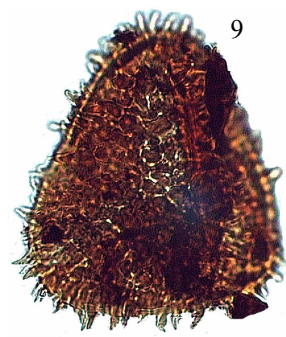
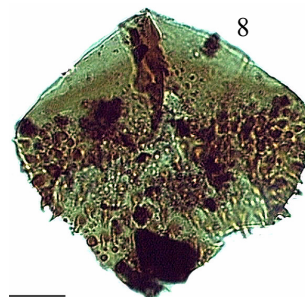
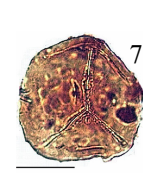
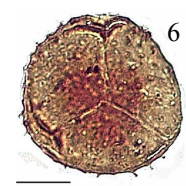
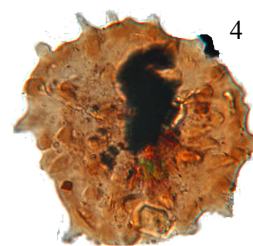
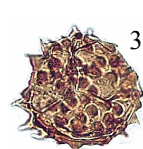
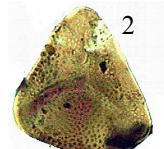
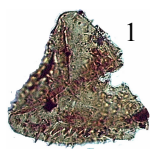

PLATE 2

	<i>B/hole</i>	<i>Depth(m)</i>	<i>Slide no.</i>	<i>E/Finder</i>
1. <i>Anacanthotriletes sp.</i>	ST1	320,7	1579	K17
2. <i>Anacanthotriletes sp. A</i>	ST1	178,9	1554	G23.2
3. <i>Apiculatisporis cornutus</i>	ST1	484,5	1635	C43.4
4. <i>Apiculatisporis unicus</i>	CKP6	628,9	1727	T44
5. <i>Apiculatisporis levis</i>	ST1	443,9	1625	T43
6. <i>Apiculatisporis leptocaina</i>	ST1	361,9	1599	H40.3
7. <i>Apiculatisporis parmatus</i>	ST1	373,4	1603	V49.3
8. <i>Didictriletes eoericiana</i>	ST1	593,4	1577	K28.1
9. <i>Didictriletes ericianus</i>	ST1	357,9	1598	K45.1
10. <i>Divaricrassus minor</i>	ST1	361,9	1599	R22.4
11. <i>Lophotriletes rectus</i>	ST1	353,5	1383	J34
12. <i>Lophotriletes novicus</i>	ST1	378,6	1563	T29.2
13. <i>Lophotriletes rarus</i>	ST1	425,2	1619	F37
14. <i>Lophotriletes sp.</i>	ST1	376,4	1562	N48.3
15. <i>Lophotriletes sp. A</i>	ST1	455,6	1566	O24
16. <i>Cirrabaculisporites lageniformis</i>	ST1	379,5	1564	K38.3
17. <i>Cirrabaculisporites plumsteadiae</i> (a – proximal, b – distal)	ST1	303,5	1578	D43.3
18. <i>Cirrabaculisporites ramosus</i>	ST1	353,5	1383	U39.2
19. <i>Cirrabaculisporites sp.</i>	ST1	321,6	1580	M20.1

PLATE 2



10μm

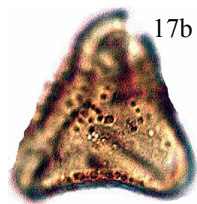
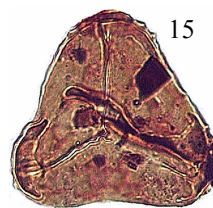
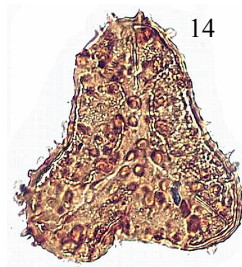
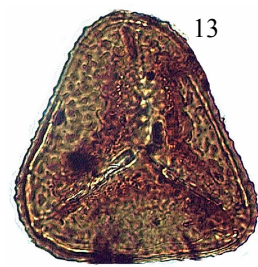
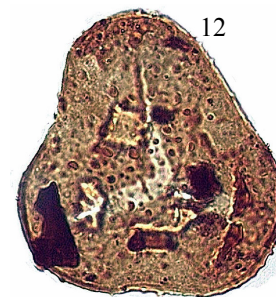
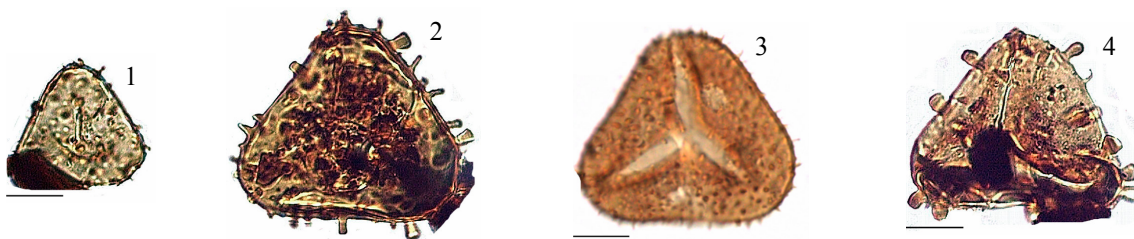

PLATE 3

	<i>B/hole</i>	<i>Depth(m)</i>	<i>Slide no.</i>	<i>E/Finder</i>
1. <i>Horriditriletes brevis</i>	ST1	303,5	1578	Q41.2
2. <i>Horriditriletes ramosus</i>	ST1	412,5	1608	T30.4
3. <i>Horriditriletes tereteangulatus</i>	ST1	368,3	1495	E36.1
4. <i>Horriditriletes uruguayensis</i>	ST1	442,2	1622	M35.2
5. <i>Horriditriletes curvibaculosus</i>	ST1	321,6	1580	H50.1
6. <i>Horriditriletes gondwanensis</i>	ST1	321,6	1580	E19
7. <i>Horriditriletes sp.</i> (a – proximal, b – distal)	ST1	365,5	1600	Y40.3
8. <i>Horriditriletes sp. A</i>	ST1	442,2	1622	E39.4
9. <i>Raistrickia crenata</i>	ST1	446,2	1627	N37.4
10. <i>Convruccosporites naumoviae</i>	ST1	426,5	1586	U46.1
11. <i>Convruccosporites pseudoreticulatus</i>	CKP6	563,4	1717	W49
12. <i>Convruccosporites irregularis</i>	ST1	566,6	1643	U43.3
13. <i>Convruccosporites sp.</i> (a – proximal, b – distal)	ST1	414,6	1610	K30.4
14. <i>Convruccosporites sp. A</i>	ST1	464,1	1567	L39.2
15. <i>Verrucosporites morulatus</i>	ST1	573,8	1647	L28.1
16. <i>Verrucosporites andersonii</i>	ST1	361,9	1599	Y47
17. <i>Verrucosporites triseccatus</i>	ST1	379,5	1564	O28
18. <i>Verrucosporites sp.</i>	ST1	573,8	1647	H31.2

PLATE 3



10μm

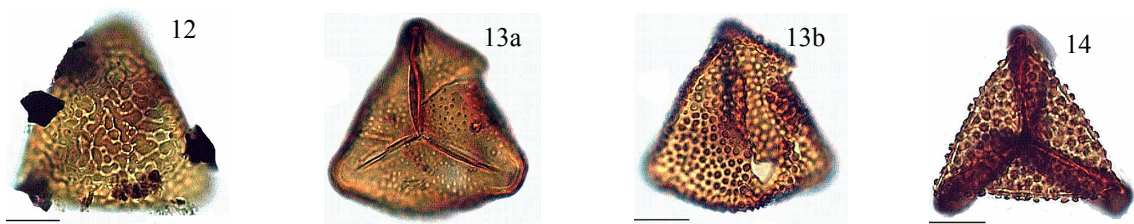
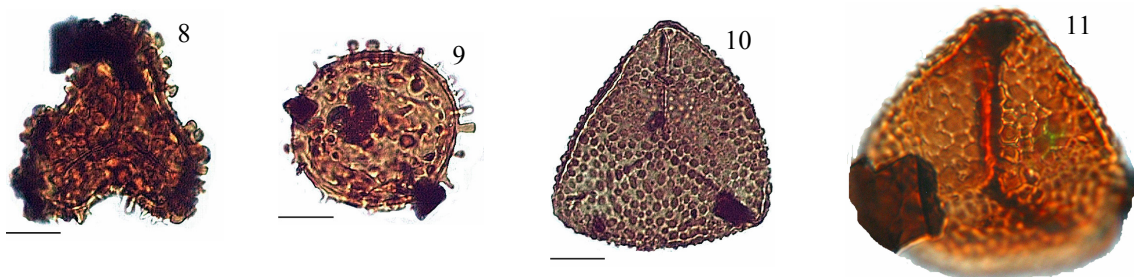
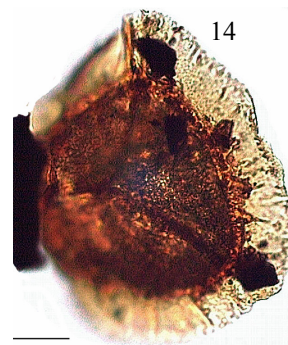
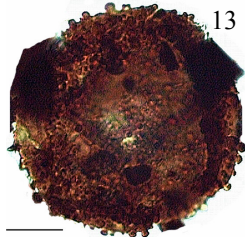
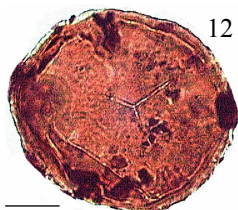
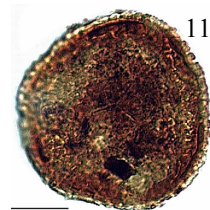
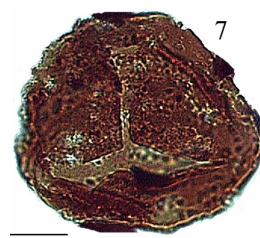
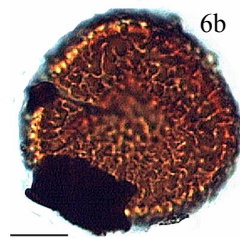
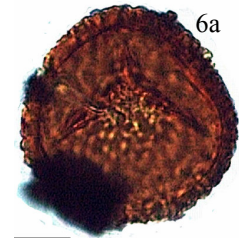
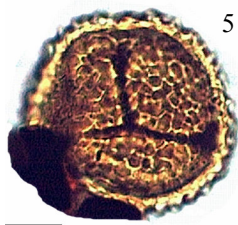
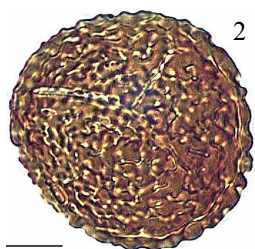
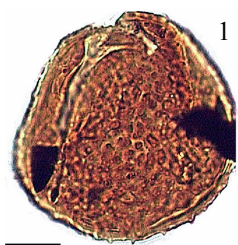

PLATE 4

	<i>B/hole</i>	<i>Depth(m)</i>	<i>Slide no.</i>	<i>E/Finder</i>
1. <i>Verrucosisporites sp. A</i>	ST1	527,5	1571	J35.1
2. <i>Convolutispora intrareticulatus</i>	ST1	200,8	1561	P30.2
3. " "	ST1	197,5	1559	N38.2
4. <i>Convolutispora sp.</i>	ST1	593,4	1577	D28.1
5. <i>Convolutispora sp. A</i>	ST1	593,4	1577	L32
6. <i>Convolutispora sp. B</i> (a – proximal, b – distal)	ST1	320,7	1579	U44.1
7. <i>Foveosporites karrooensis</i>	ST1	340,8	1596	T34.1
8. <i>Foveosporites sp.</i>	ST1	321,6	1580	S50.1
9. <i>Foveosporites sp. A</i>	ST1	340,8	1596	Q26.1
10. <i>Foveosporites sp. B</i>	ST1	593,4	1577	K25.3
11. <i>Microreticulatisporites sp.</i>	ST1	197,5	1559	N21
12. <i>Microreticulatisporites sp. A</i>	ST1	187,8	1557	L43.1
13. <i>Clavatisporites sp.</i>	ST1	176,1	1553	L36.2
14. <i>Indotriradites australensis</i>	ST1	303,5	1578	P24.2
15. <i>Cristatisporites crassilabratus</i>	ST1	496,4	1640	P32.1
16. <i>Cristatisporites inconstans</i>	ST1	371,2	1602	Q37.3
17. <i>Cristatisporites lestai</i>	ST1	398,1	1393	M38.2

PLATE 4



10μm

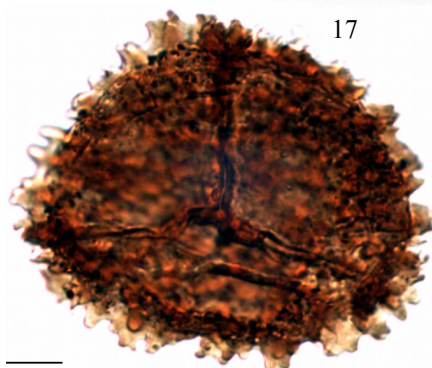
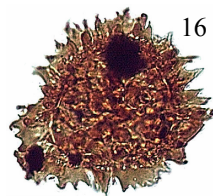
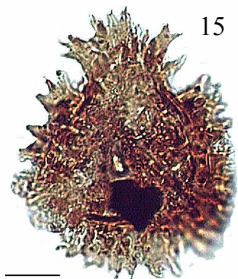
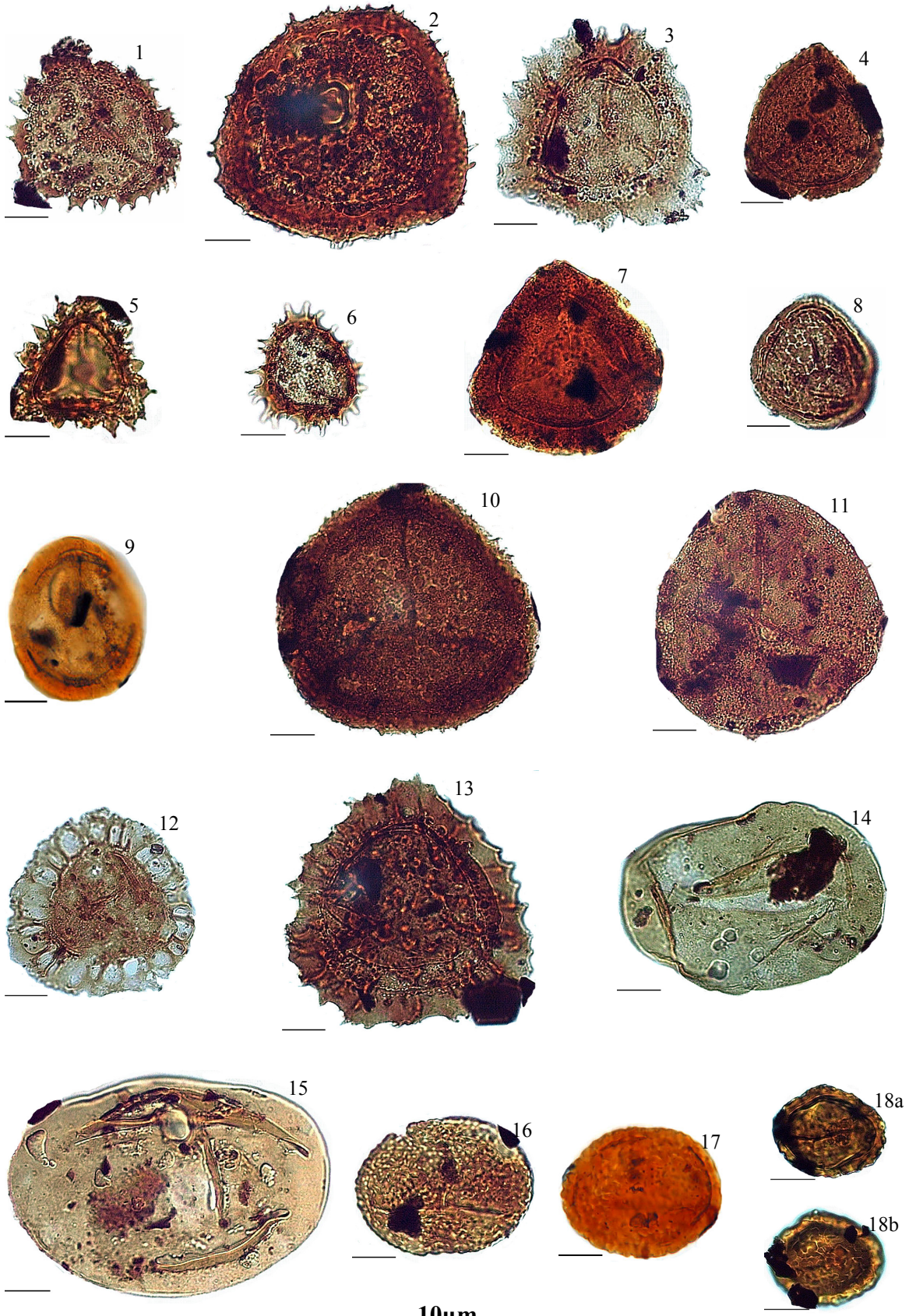

PLATE 5

	<i>B/hole</i>	<i>Depth(m)</i>	<i>Slide no.</i>	<i>E/Finder</i>
1. <i>Cristatisporites microvacuolatus</i>	ST1	357,9	1598	D39.3
2. <i>Cristatisporites morungavensis</i>	ST1	442,2	1622	J31.2
3. <i>Cristatisporites spinosus</i>	ST1	365,5	1600	Y48.3
4. <i>Cristatisporites menendezii</i>	ST1	376,4	1562	H26.3
5. <i>Cristatisporites sp.</i>	ST1	365,5	1600	V23.1
6. <i>Cristatisporites sp. A</i>	ST1	365,5	1600	X17
7. <i>Densoisporites sp.</i>	ST1	371,2	1602	Y42.1
8. <i>Densosporites rotundus</i>	ST1	329,3	1581	R21.4
9. <i>Densosporites sp.</i>	CKP6	474,4	1711	K40.1
10. <i>Lundbladispora braziliensis</i>	ST1	361,9	1599	K42
11. <i>Lundbladispora gracilis</i>	ST1	357,9	1598	M38.2
12. <i>Vallatisporites sp.</i>	ST1	414,8	1611	N31.3
13. <i>Vallatisporites sp. A</i>	ST1	443,9	1624	Q45
14. <i>Laevigatosporites vulgaris</i>	ST1	321,6	1580	G33
15. <i>Laevigatisporites plicatus</i>	ST1	200,8	1561	T30.3
16. <i>Polypodiisporites mutabilis</i>	ST1	593,4	1577	M23.1
17. " "	CKP6	308,2	1667	K48.3
18. <i>Polypodiisporites detritus</i> (a – proximal, b – distal)	ST1	587,3	1575	Q20.1

PLATE 5



10µm

PLATE 6

	<i>B/hole</i>	<i>Depth(m)</i>	<i>Slide no.</i>	<i>E/Finder</i>
1. <i>Florinites eremus</i>	ST1	187,8	1557	G39.2
2. <i>Striomonosaccites brevis</i>	ST1	303,5	1578	K32.3
3. <i>Striomonosaccites crucistriatus</i>	ST1	445,4	1626	W24.1
4. <i>Striomonosaccites sp.</i>	ST1	533,6	1573	V38.3
5. <i>Barakarites rotatus</i>	ST1	303,5	1578	E28.2
6. <i>Bascanisporites undosus</i>	ST1	181,1	1555	O46.4
7. <i>Cannanoropollis janakii</i>	CKP6	346,7	1675	T28.2
8. <i>Cannanoropollis sp.</i>	ST1	365,5	1600	D24.3
9. <i>Plicatipollenites gondwanensis</i>	ST1	418,9	1616	H35.3
10. <i>Plicatipollenites densus</i>	ST1	495,2	1639	O46.2
11. <i>Plicatipollenites trigonalis</i>	ST1	365,5	1600	N39.1
12. <i>Plicatipollenites sp.</i>	ST1	414,8	1611	C35.3
13. <i>Plicatipollenites sp. A</i>	ST1	416,0	1613	V42
14. <i>Plicatipollenites sp. B</i>	ST1	379,5	1564	V43.3
15. <i>Caheniasaccites ovatus</i>	ST1	357,9	1598	F44
16. <i>Caheniasaccites flavatus</i>	ST1	371,2	1602	S22.1
17. <i>Potonieisporites novicus</i>	ST1	495,2	1639	C21.3
18. <i>Potonieisporites brasiliensis</i>	ST1	573,5	1646	Q29.1
19. <i>Potonieisporites congoensis</i>	ST1	447,7	1629	K17.2

PLATE 6

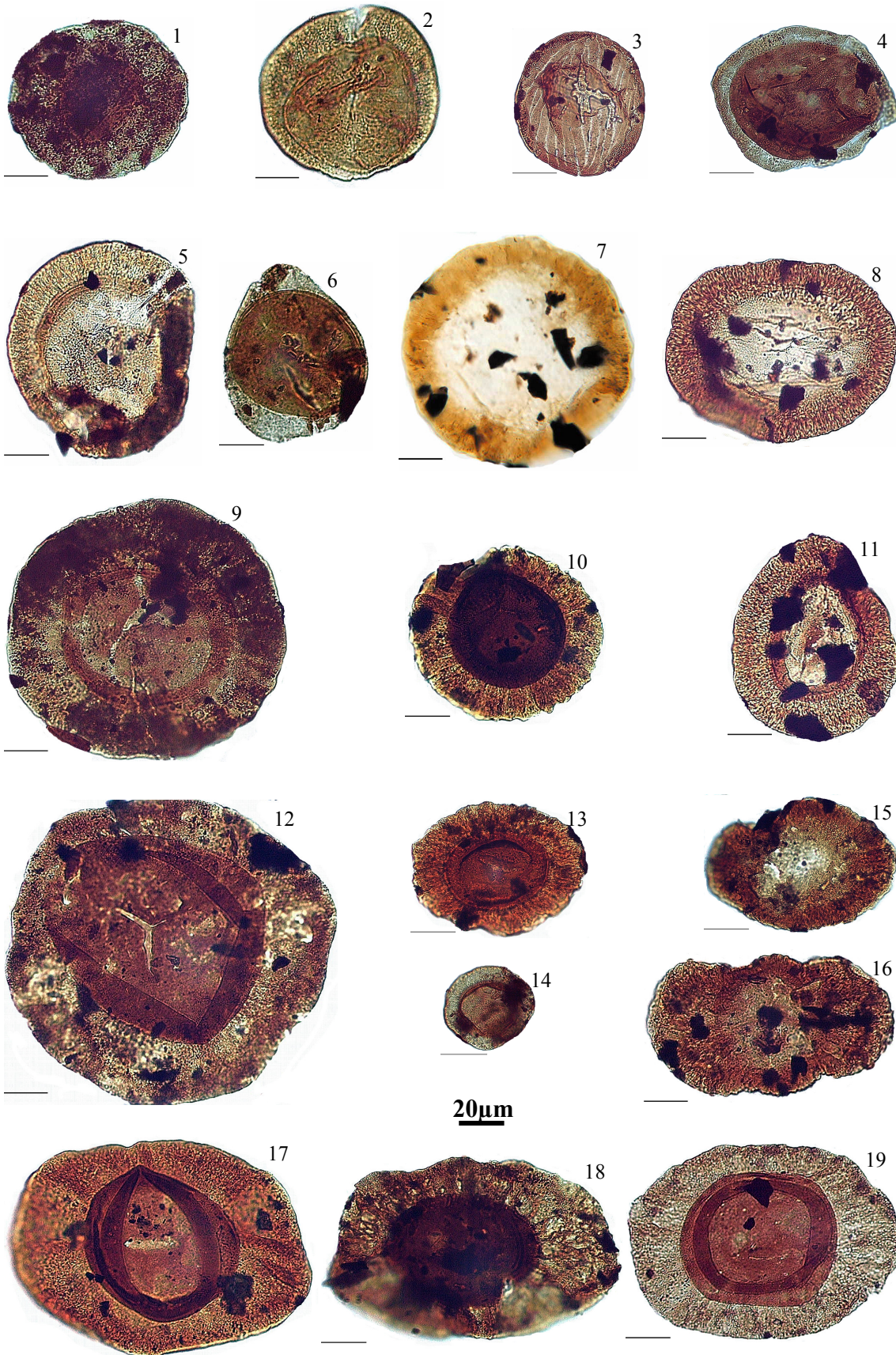
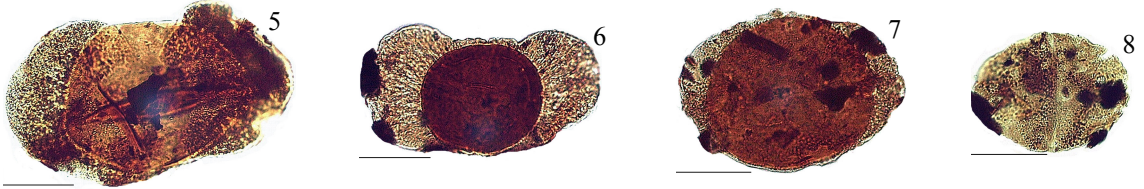
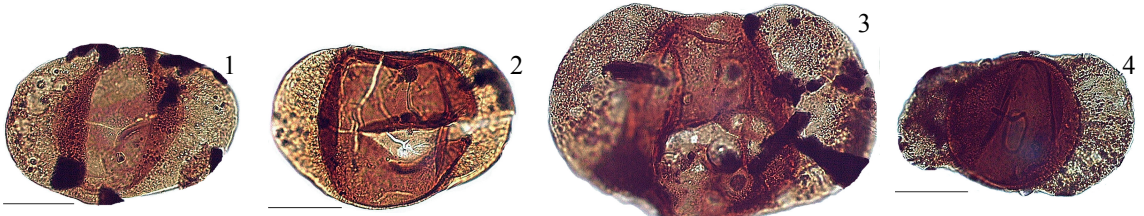

PLATE 7

	<i>B/hole</i>	<i>Depth(m)</i>	<i>Slide no.</i>	<i>E/Finder</i>
1. <i>Illinites spectabilis</i>	ST1	432,5	1588	W26.2
2. <i>Limitisporites rectus</i>	ST1	527,5	1571	T24
3. <i>Limitisporites monstruosus</i>	ST1	533,6	1573	W21.1
4. <i>Limitisporites perspicuus</i>	ST1	418,9	1616	L33.1
5. <i>Limitisporites sp.</i>	ST1	181,1	1555	P49
6. <i>Vestigisporites rudis</i>	ST1	533,6	1573	X44
7. <i>Vestigisporites ventrisaccatus</i>	ST1	184,7	1556	W42.2
8. <i>Alisporites ovatus</i>	ST1	173,2	1551	O32.4
9. <i>Alisporites australis</i>	ST1	379,5	1564	V21.3
10. <i>Alisporites potonieii</i>	ST1	320,7	1579	D18.3
11. <i>Alisporites splendens</i>	ST1	365,5	1600	L32.3
12. <i>Platysaccus papilionis</i>	ST1	178,9	1554	E47
13. <i>Platysaccus sp.</i>	ST1	173,2	1551	C49.4
14. <i>Pteruchipollenites sp.</i>	ST1	365,5	1600	X42.3
15. <i>Hamiapollenites bullaeformis</i>	ST1	442,5	1623	T35.4
16. <i>Hamiapollenites fusiformis</i>	CKP6	691,7	1741	S39.4
17. <i>Hamiapollenites saccatus</i>	ST1	181,1	1555	Q49.4
18. <i>Hamiapollenites tractiferinus</i>	ST1	361,9	1599	N40.2
19. <i>Hamiapollenites sp.</i>	CKP6	348,1	1676	L21.1
20. <i>Lueckisporites virkkiae</i>	ST1	181,1	1555	E21

PLATE 7



20μm

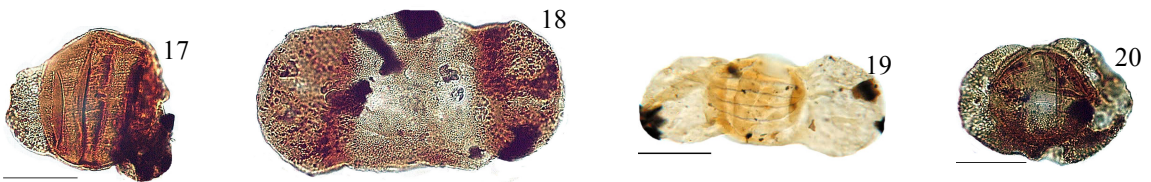
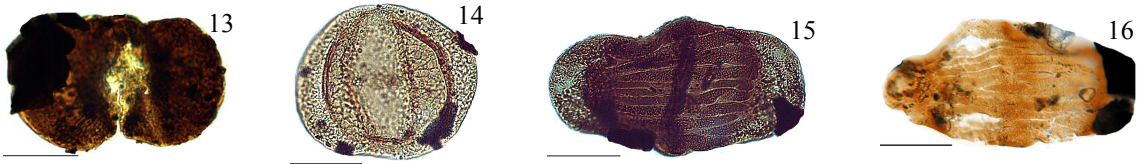
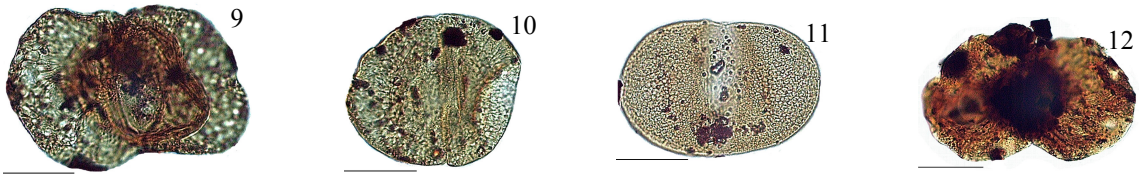
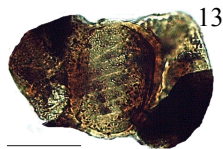
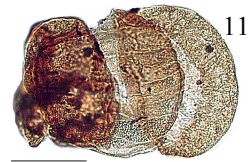
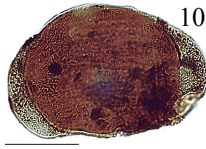
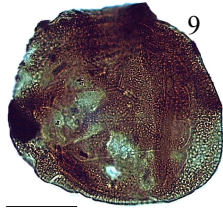
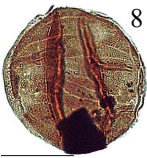
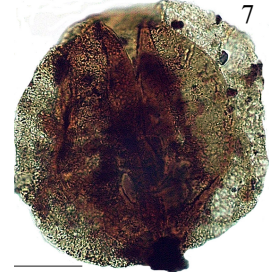
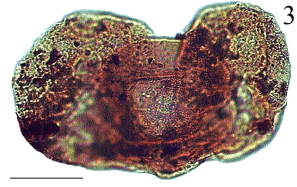
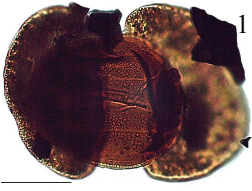

PLATE 8

	<i>B/hole</i>	<i>Depth(m)</i>	<i>Slide no.</i>	<i>E/Finder</i>
1. <i>Lunatisporites nubilus</i>	ST1	446,2	1627	E44
2. <i>Lunatisporites variesectus</i>	ST1	515,2	1570	G45.2
3. <i>Lunatisporites sp.</i>	ST1	187,8	1557	P29.3
4. <i>Protohaploxypinus haigii</i>	ST1	413,1	1609	E41.3
5. <i>Protohaploxypinus hartii</i>	ST1	447,7	1629	V33.1
6. <i>Protohaploxypinus limpidus</i>	ST1	376,4	1562	P24.4
7. <i>Protohaploxypinus perexiguus</i>	ST1	197,5	1559	T24.4
8. <i>Protohaploxypinus rugatus</i>	ST1	449,5	1630	T43.4
9. <i>Protohaploxypinus sp.</i>	ST1	585,5	1574	G25.3
10. <i>Striatoabieites multistriatus</i>	ST1	181,1	1555	T50.4
11. <i>Striatopodocarpites cancellatus</i>	ST1	303,5	1578	Q22
12. <i>Striatopodocarpites fusus</i>	ST1	320,7	1579	V17.4
13. <i>Striatopodocarpites pantii</i>	ST1	197,5	1559	G43.3
14. <i>Striatopodocarpites rarus</i>	ST1	361,9	1599	Q34.3

PLATE 8



20µm

PLATE 9

	<i>B/hole</i>	<i>Depth(m)</i>	<i>Slide no.</i>	<i>E/Finder</i>
1. <i>Ephedripites sp.</i>	ST1	397,9	1565	L19.3
2. <i>Ephedripites sp. A</i>	ST1	379,5	1564	P44.4
3. <i>Vittatina densa</i>	ST1	533,6	1573	N34.1
4. <i>Vittatina foveolata</i>	ST1	361,9	1599	W47.1
5. <i>Vittatina scutata</i>	ST1	397,9	1565	Q23
6. <i>Vittatina minima</i>	ST1	378,6	1563	R29.1
7. <i>Vittatina saccifer</i>	ST1	361,9	1599	W34.4
8. <i>Vittatina subsaccata</i>	ST1	175,8	1552	N38.3
9. <i>Vittatina sp.</i>	ST1	439,5	1621	Y26.2
10. "	ST1	432,5	1587	L31.1
11. <i>Vittatina sp. A</i>	ST1	329,3	1581	Y35.2
12. <i>Weylandites lucifer</i>	ST1	191,1	1558	O37.1
13. <i>Weylandites magmus</i>	ST1	378,6	1563	V30.3
14. <i>Pakhapites fusus</i>	ST1	416,0	1613	W37.1
15. <i>Pakhapites ovatus</i>	ST1	412,5	1608	V40.2
16. <i>Gnetaceaepollenites sp.</i>	ST1	197,5	1559	U50.3

PLATE 9

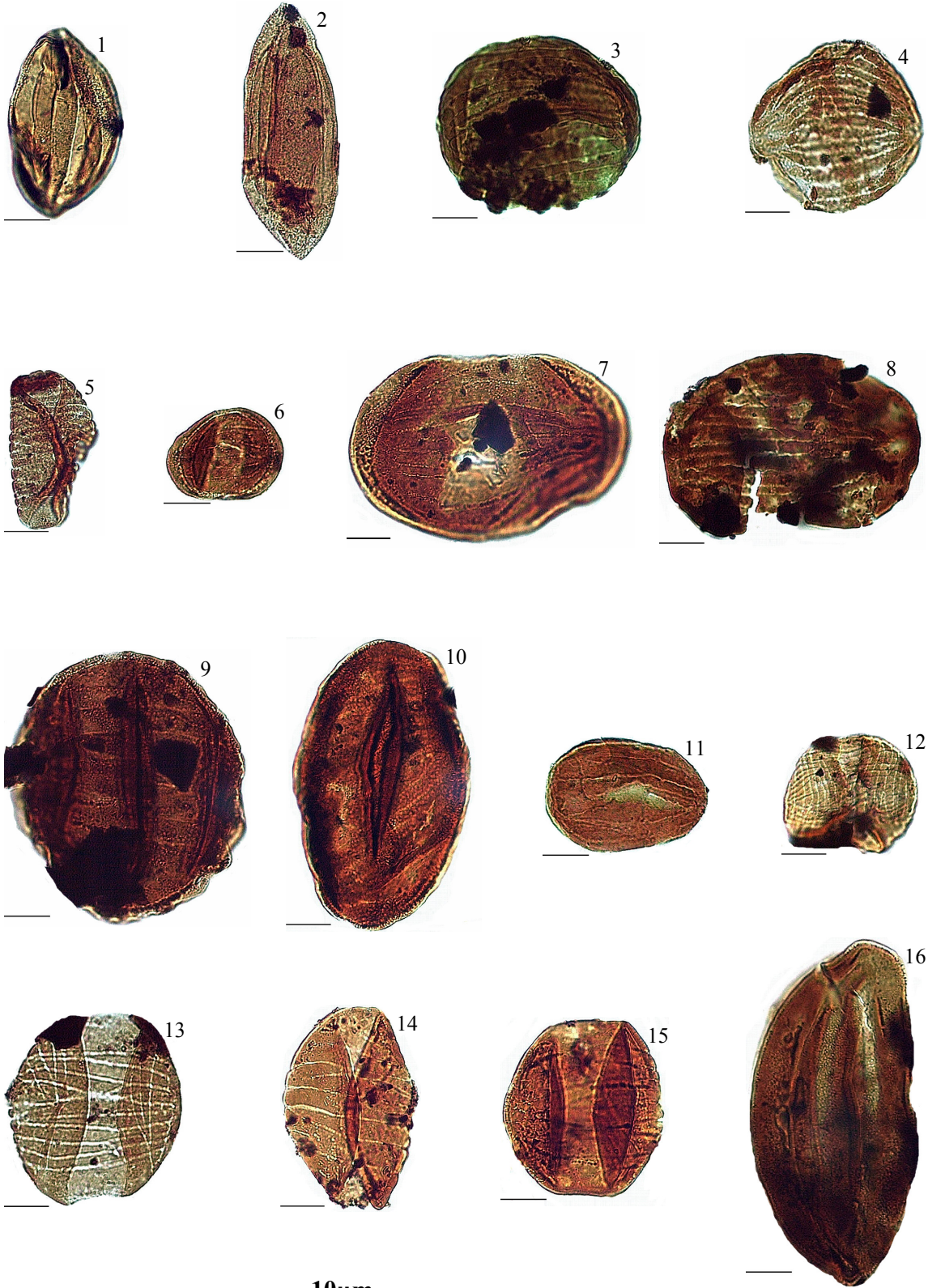

10µm

PLATE 10

	<i>B/hole</i>	<i>Depth(m)</i>	<i>Slide no.</i>	<i>E/Finder</i>
1. <i>Pretricolpipollenites sp.</i>	ST1	445,4	1626	F25.2
2. <i>Marsupipollenites striatus</i>	ST1	320,7	1579	P21.3
3. <i>Marsupipollenites triradiatus</i>	ST1	197,5	1559	M44.1
4. <i>Cycadopites cymbatus</i>	ST1	533,6	1573	S29.2
5. <i>Cycadopites glaber</i>	ST1	320,7	1579	W33.1
6. <i>Cycadopites nevesi</i>	ST1	361,9	1599	W23.3
7. <i>Cycadopites follicularis</i>	ST1	578,6	1648	V28
8. <i>Cycadopites sp.</i>	ST1	303,5	1578	S38.4
9. <i>Inapertisporites inapertus</i>	ST1	425,2	1619	V47
10. " "	ST1	361,9	1599	X35

PLATE 10

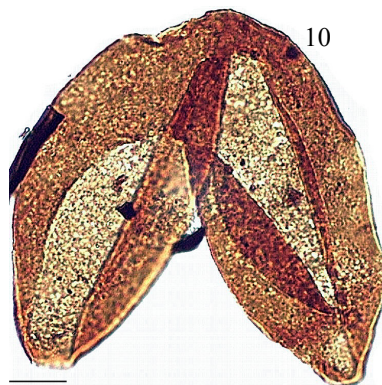
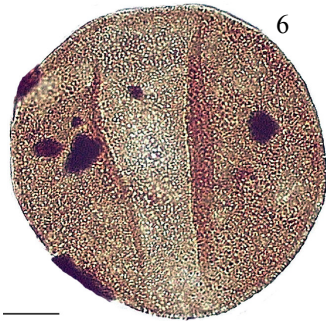

10μm

PLATE 11

	<i>B/hole</i>	<i>Depth(m)</i>	<i>Slide no.</i>	<i>E/Finder</i>
1. <i>Micrhystridium sp.</i>	ST1	445,4	1626	P38.1
2. <i>Tetraporina sp.</i>	ST1	340,8	1596	P44
3. <i>Veryhachium sp. A</i>	ST1	267,8	1391	D27.1
4. <i>Veryhachium sp. B</i>	ST1	267,8	1391	E25.3
5. " "	ST1	267,8	1391	R45
6. <i>Veryhachium sp. C</i>	ST1	336,2	1392	R43
7. <i>Species A</i>	ST1	267,8	1391	D29.2
8. <i>Species B</i>	ST1	267,8	1391	H24
9. <i>Species C</i>	ST1	267,8	1391	O32
10. <i>Species D</i>	ST1	349,2	1496	T26.4
11. <i>Species E</i>	ST1	321,6	1580	N44.2
12. <i>Botryococcus sp.</i> <i>cf. B. braunii</i>	ST1	336,2	1392	E22
13. <i>Arabisphaera bellula</i>	ST1	439,5	1621	M50.2
14. <i>Arabisphaera sp.</i>	CKP6	682,5	1738	J26.3
15. <i>Cymatiosphaera gondwanensis</i>	ST1	378,6	1563	V39.3
16. <i>Cymatiosphaera sp. A</i>	CKP6	348,1	1676	K29.2
17. <i>Cymatiosphaera sp. B</i>	ST1	321,6	1580	Y36.4
18. <i>Maculatasporites sp.</i>	ST1	180,4	1482	L44.2
19. <i>Tasmanites sp.</i>	ST1	340,8	1596	N29.1

PLATE 11

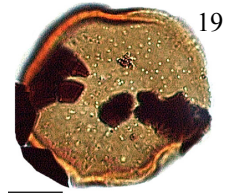
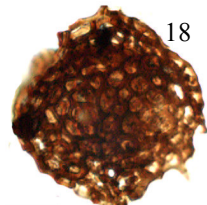
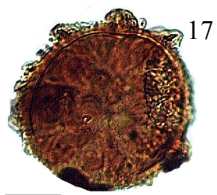
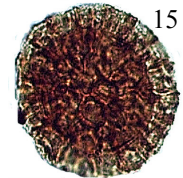
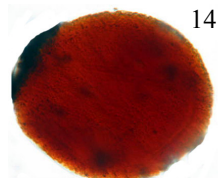
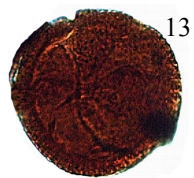
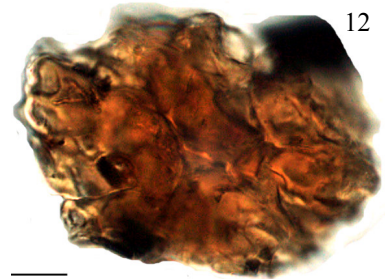
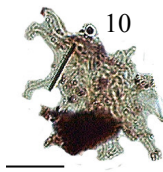
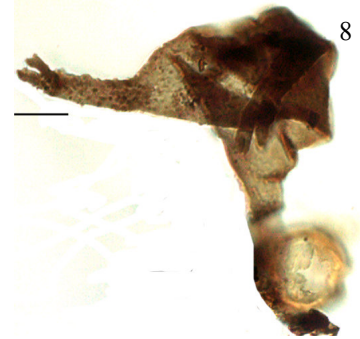
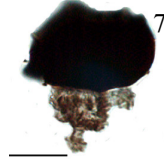
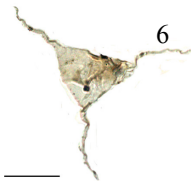
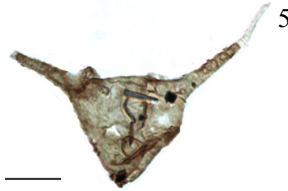
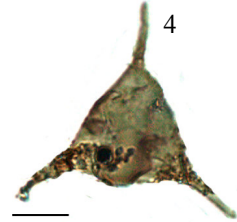
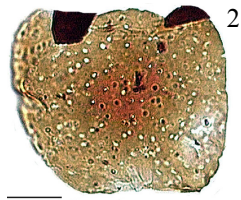
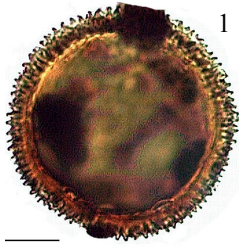

PALYNOFACIES PLATES

All figures are digital images. Magnifications are x1075, unless otherwise stated.

PLATE PF1

1. Assemblage of diverse palynofacies categories comprising amorphous organic remains of probable terrestrial origin (AOM), sporomorph palynomorphs (SPOR, DGPA), and oxidized woody organic remains or phytoclasts (BLKE). *STRAT 1 Sample/Slide: 100P – 02/1577, Depth: 593.5m, England Finder: H30.4.*
2. Palynofacies dominated by equidimensional black and brown phytoclasts (BLKE, BRNE), with sporomorph palynomorphs (SPOR, DGPA). *STRAT 1 Sample/Slide: 98P – 02/1575, Depth: 587.3m, England Finder: N34.*
3. Black or opaque lath-shaped phytoclasts (BLKL). *STRAT 1 Sample/Slide: 58P – 02/1588, Depth: 432.5m, England Finder: N38.4.*
4. Dark brown lath-shaped phytoclast with tracheidal biostructure (BRNL), and a sporomorph palynomorph (SPOR). *STRAT 1 Sample/Slide: 48P – 02/1613, Depth: 416.0m, England Finder: O18.3.*
5. Brown cuticular (CAMT) and woody (BRNE) organic remains. *STRAT 1 Sample/Slide: 43P – 02/1608, Depth: 412.5m, England Finder: P32.3.*
6. Palynofacies dominated by colonies of *Botryococcus*. *STRAT 1 Sample/Slide: 31P – 02/1600, Depth: 365.5m, England Finder: G41.4.*
7. Brown lath-shaped phytoclasts (BRNL), cuticular and membranous tissue (CAMT), and a trilete miospore (SPOR). *STRAT 1 Sample/Slide: 24P – 02/1579, Depth: 320.7m, England Finder: N29.3.* Magnification x 250.
8. Palynofacies of varied organic remains content i.e. phytoclasts (BRNE, CAMT), amorphous organic matter (AOM), and a sporomorph palynomorph (SPOR). *STRAT 1 Sample/Slide: 32P – 02/1601, Depth: 366.5m, England Finder: R28.*

PLATE PF1

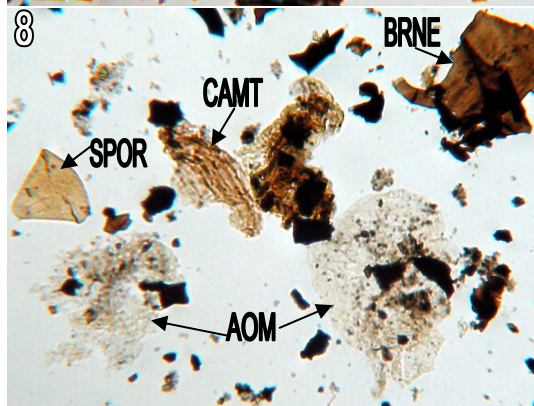
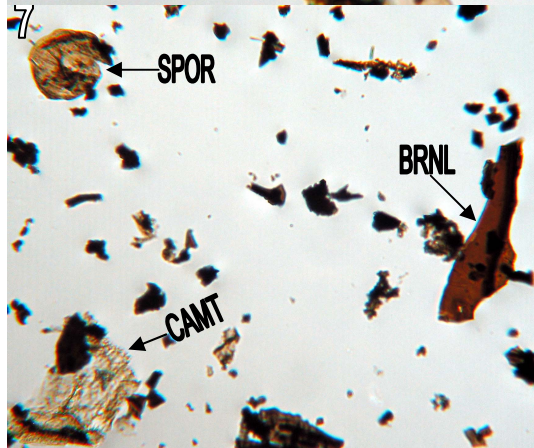
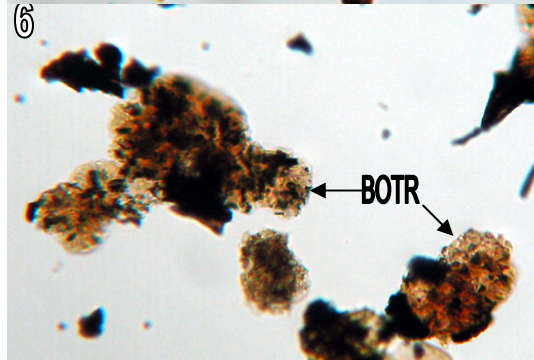
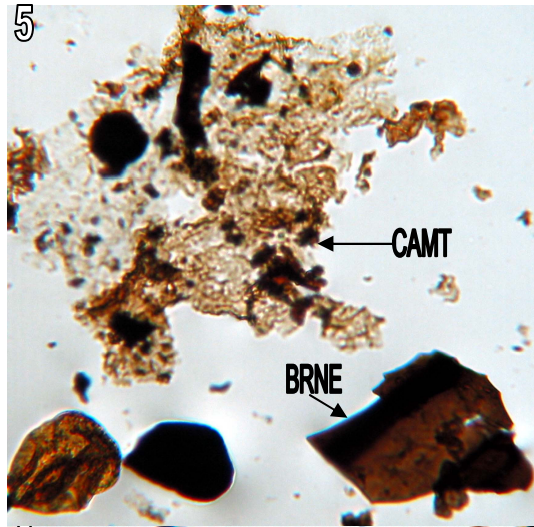
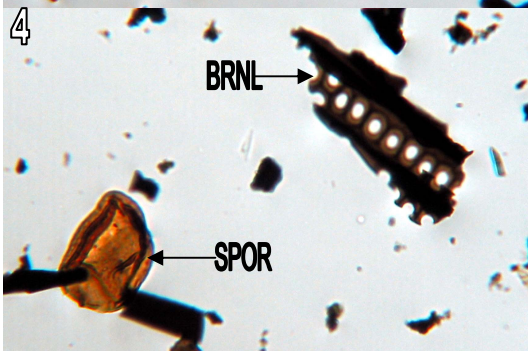
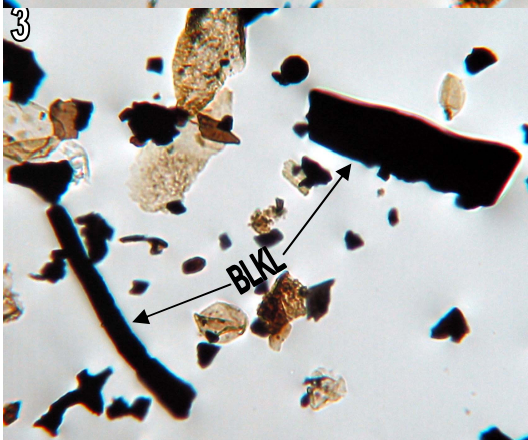
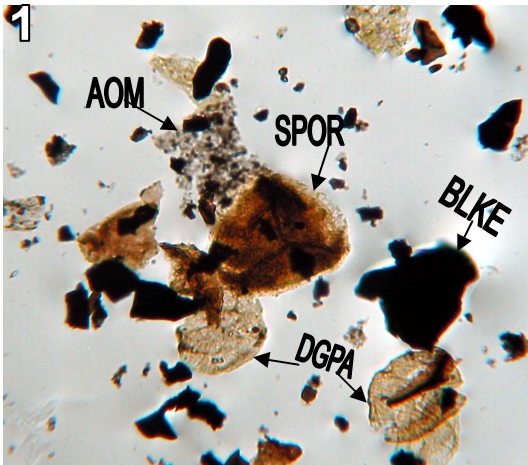

PLATE PF2

1. A large discreet AOM fragment with dark finer inclusions. *STRAT 1 Sample/Slide: 76P – 02/1633, Depth: 483.2m, England Finder: V39.3.*
2. Palynofacies dominated by fine and widely distributed AOM forming the bulk of the groundmass. *STRAT 1 Sample/Slide: 29P – 02/1598, Depth: 357.9m, England Finder: V27.4.*
3. Acritarch (ACRT) microphytoplankton of the genus *Veryhachium* in palynofacies dominated by degraded sporomorphs and black woody phytoclasts. *STRAT 1 Sample/Slide: 11P – 01/1392, Depth: 336.2m, England Finder: R43.*
4. *Botryococcus* colony in a background dominated by finely disseminated AOM. *STRAT 1 Sample/Slide: 39P – 02/1604, Depth: 401.0m, England Finder: O27.1.*
5. Prasinophyte microphytoplankton of the genus *Tasmanites* (TASM) in association with abundant miospores. *STRAT 1 Sample/Slide: 38P – 02/1565, Depth: 397.9m, England Finder: N21.4.*
6. Palynofacies dominated by sporomorph palynomorphs, as well as numerous fine black woody phytoclasts. *STRAT 1 Sample/Slide: 50P – 02/1615, Depth: 417.0m, England Finder: H18.2.*
7. Degraded bisaccate pollen grain in palynofacies dominated by very fine equidimensional black phytoclasts, with rare cuticular and membranous material. *STRAT 1 Sample/Slide: 25P – 02/1580, Depth: 321.6m, England Finder: P45.*
8. Charred bisaccate pollen grain. *STRAT 1 Sample/Slide: 75P – 02/1632, Depth: 482.5m, England Finder: U33.2.*

PLATE PF2

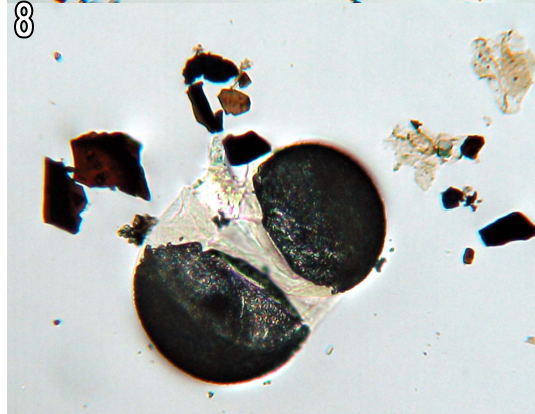
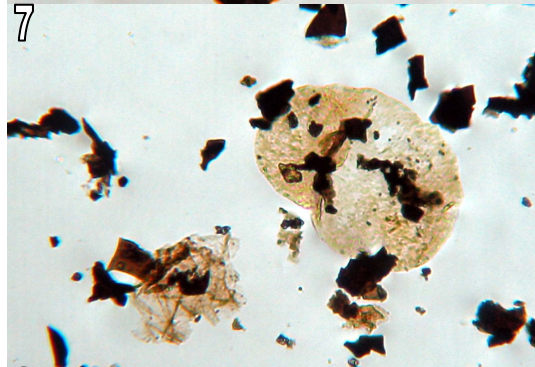
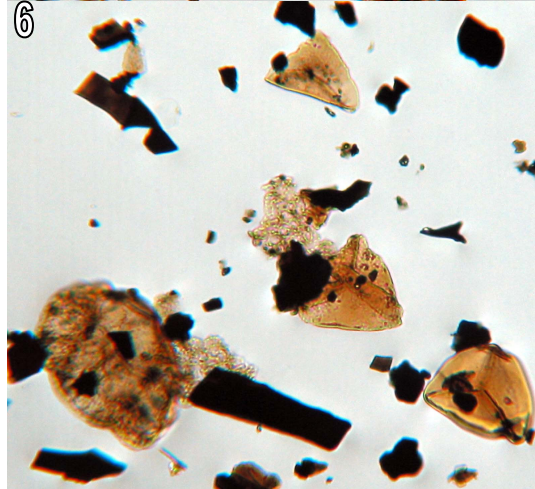
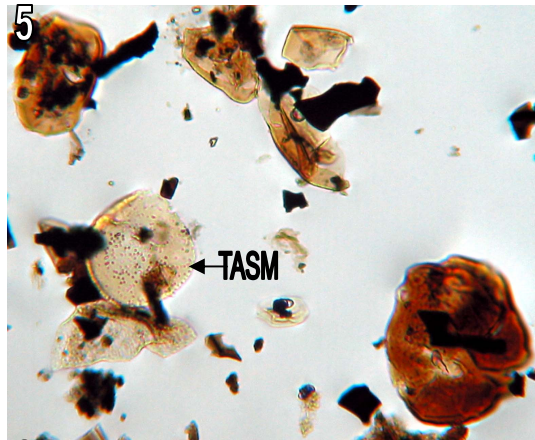
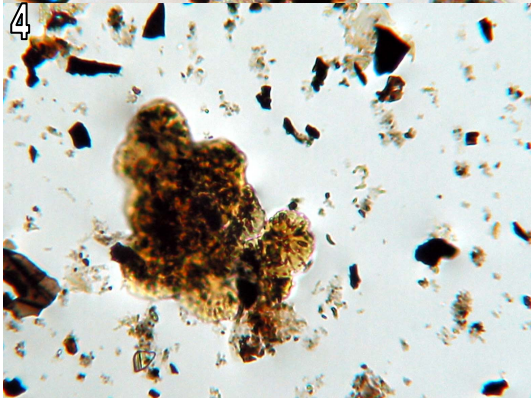
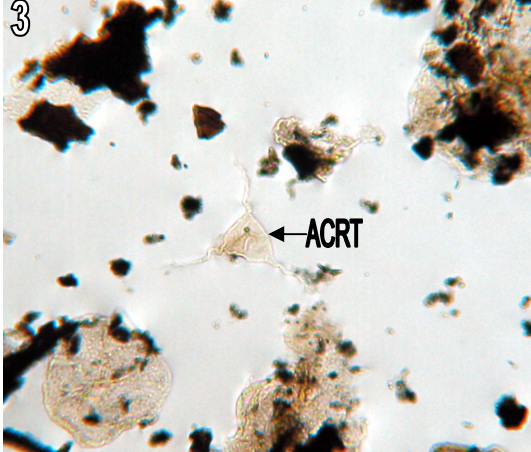
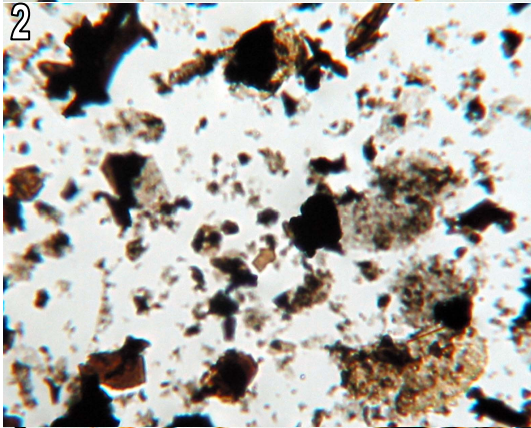
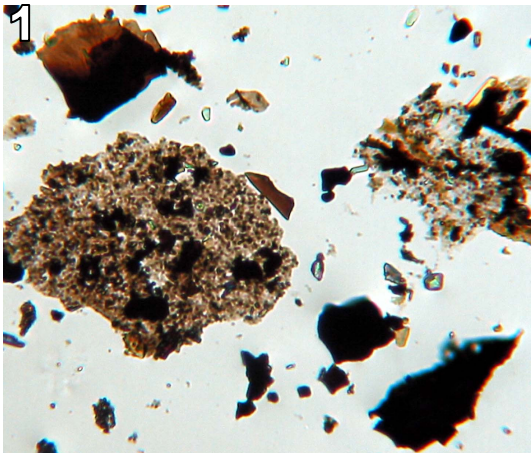
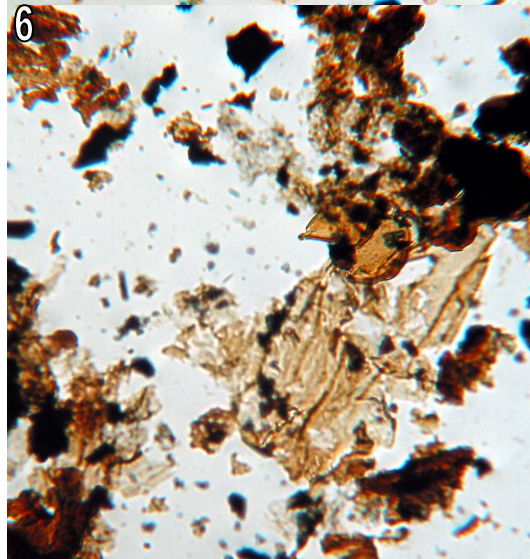
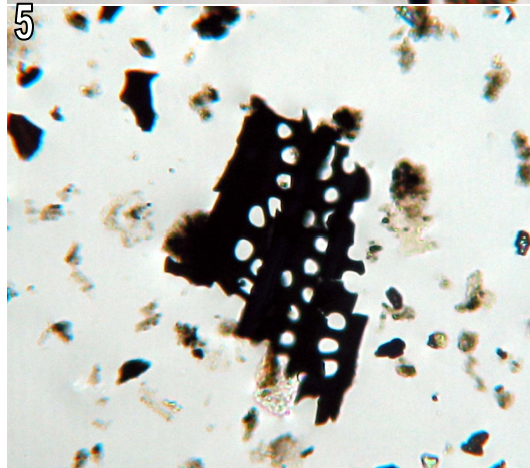
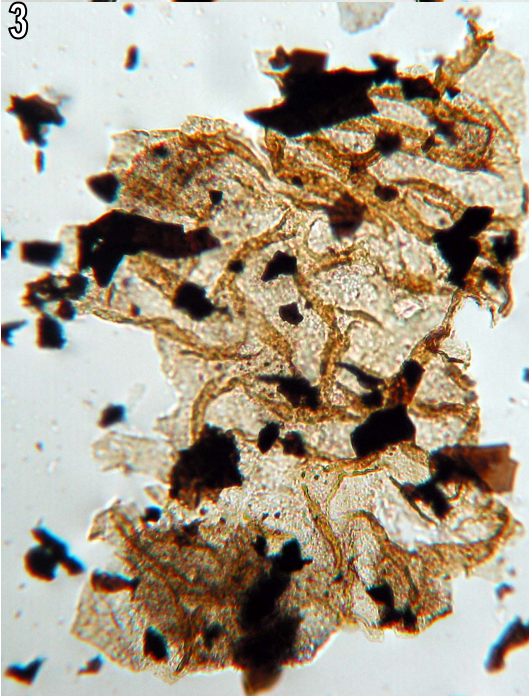
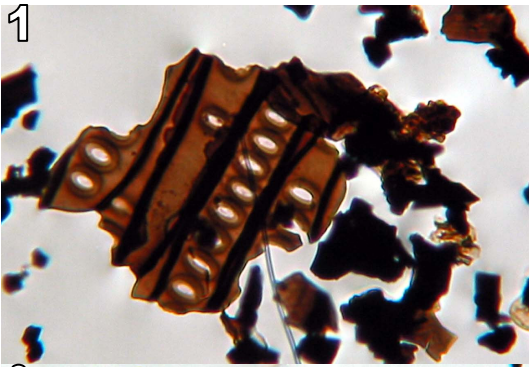

PLATE PF3

1. Brown equidimensional phytoclast displaying tracheidal biostructure with bordered pits. *STRAT 1 Sample/Slide: 59P – 02/1589, Depth: 433.2, England Finder: N25.3.*
2. Black lath-shaped phytoclast with traces of biostructure represented by minute bordered pits (visible in lower part of phytoclast). *STRAT 1 Sample/Slide: 44P – 02/1609, Depth: 413.1m, England Finder: K25.3.*
3. Dispersed cuticle phytoclast with irregular traces of cellular outlines. *STRAT 1 Sample/Slide: 30P – 02/1599, Depth: 361.9m, England Finder: V36.4 (Magnification x250).*
4. Brown lath-shaped and striped tracheidal phytoclast. *STRAT 1 Sample/Slide: 57P – 02/1587, Depth: 432.4, England Finder: O45.*
5. Black equidimensional phytoclast displaying tracheidal biostructure with bordered pits. *STRAT 1 Sample/Slide: 86P – 02/1572, Depth: 528.1m, England Finder: O40.4.*
6. Cuticular and membranous tissues locally degraded to generate fine AOM material. *STRAT 1 Sample/Slide: 90P – 02/1643, Depth: 566.6m, England Finder: P43 (Magnification x250).*

PLATE PF3



REFERENCES

- Archangelsky, S., Gamero, J. C., 1979. Palinología del paleozoico en el subsuelo de la Cuenca Chacoparanense, Republica Argentina. I. Estudio sistemático de los palinomorfos de tres perforaciones de la provincial de Córdoba. *Revista Española de Micropaleontología* XI, 3, 417 – 478.
- Advanced Resources International Inc., 2003. Results of the Central Kalahari Karoo Basin Coalbed Methane Feasibility Study. Technical Report Geological Survey Botswana, GC 154.
- Aldiss, D. T., 1983a. The geology of the Tsetsebjwe area. *Bulletin Geological Survey Botswana* 24, 86pp.
- Aldiss, D. T., 1983b. The geology of the Semolale area. *Bulletin Geological Survey Botswana* 25, 64pp.
- Aldiss, D. T., Benson, J. M., Rundle, C. C., 1984. Early Jurassic pillow lavas and palynomorphs in the Karoo of eastern Botswana. *Nature* 310, 302 – 304.
- Agterberg, F. P., Gradstein, F. M., 1999. The RASC method of ranking and scaling of biostratigraphic events. *Earth-Science Reviews* 46, 1 – 25.
- Aitken, G. A., 1994. Permian palynomorphs from the number 5 seam, Ecca Group, Witbank/Highveld coalfields, South Africa. *Palaeont. afr.* 31, 97 – 109.
- Anderson, J. M., 1977. The Biostratigraphy of the Permian and Triassic. Part 3: A review of Gondwana Permian palynology with particular reference to the northern Karoo Basin, South Africa. *Memoir, Botanical Survey South Africa* 41.
- Azcuy, C. L., di Pasquo, M., 2000. Palynology of the Late Carboniferous from the Tarija Basin, Argentina: a systematic review of monosaccate pollen genera. *Palaeontographica Abteilung B*, 253, 107 – 137.
- Backhouse, J., 1988. Permian trilete spores from the Collie Basin, Western Australia. *Memoir, Association Australasian Palaeontologists* 5, 53 – 72.
- Backhouse, J., 1991. Permian palynostratigraphy of the Collie Basin, Western Australia. *Review of Palaeobotany and Palynology* 67, 237-314.
- Baldock, J. W., Hepworth, J. V., Marengwa, B. S. I., 1977. Resources Inventory of Botswana: Metallic Minerals, Mineral Fuels and Diamonds. *Geological Survey Botswana, Mineral Resources Report* 4, 699pp.
- Balme, B. E., 1970. Palynology of the Permian and Triassic strata in the Salt Range and Surghar Range, West Pakistan. In: B. Kummel and C. Teichert (Eds) *Stratigraphic boundary problems: Permian and Triassic of West Pakistan*. University Press of Kansas, Department of Geology Special Publication 4, 306 – 453.
- Balme, B. E., Hennelly, J. P. F., 1955. Bisaccate sporomorphs from Australian Permian coals. *Australian Journal Botany* 3, 1, 89-98.
- Balme, B. E., Hennelly, J. P. F., 1956a. Monolete, Monocolpate, and Alete sporomorphs from Australian Permian sediments. *Australian Journal Botany* 4, 1, 54-67.
- Balme, B. E., Hennelly, J. P. F., 1956b. Trilete sporomorphs from Australian Permian sediments. *Australian Journal Botany* 4, 3, 240-260.
- Balme, B. E., Playford, G., 1967. Late Permian plant microfossils from the Prince Charles Mountains, Antarctica. *Revue de Micropalaeontologie* 10, 3, 179 – 192.
- Batten, D. J., 1996. Chapter 26A. Palynofacies and palaeoenvironmental interpretation. In: Jansonius, J and McGregor, D. C. (eds.), *Palynology: principles and applications; American Association of Stratigraphic Palynologists Foundation* 3, 1011 – 1084.
- Batten, D. J., Grenfell, H. R., 1996. Chapter 7D. Green and blue-green algae: Botryococcus. In: Jansonius, J.,

- McGregor, D. C. (eds.), *Palynology: principles and applications*. American Association of Stratigraphic Palynologists Foundation 1, 205-214.
- Besems, R. E., Schuurman, W. M. L., 1987. Palynostratigraphy of Late Paleozoic glacial deposits of the Arabian Peninsula with special reference to Oman. *Palynology* 11, 37 – 53.
- Bharadwaj, D. C., 1962. The miospore genera in the coals of Raniganj Stage (Upper Permian), India. *The Palaeobotanist* 9, 68-106.
- Bharadwaj, D. C., Salujha, S. K., 1964. Sporological study of seam VIII in Raniganj Coalfield, Bihar (India). Part 1 – Description of sporae dispersae. *The Palaeobotanist* 12, 181 – 215.
- Bharadwaj, D. C., Salujha, S. K., 1965. A sporological study of seam VII (Jote Dhemu Colliery) in the Raniganj Coalfield, Bihar (India). *The Palaeobotanist* 13, 30 – 41.
- Bharadwaj, D. C., Srivastava, S. C., 1969. Some new miospores from Barakar Stage Lower Gondwana, India: *The Palaeobotanist* 17, p. 220 – 229.
- Bharadwaj, D. C., Tiwari, R. S., 1964. On two monosaccate genera from Barakar Stage, India. *Palaeobotanist* 12, 2, 139 – 146.
- Bose, M. N., Kar, R. K., 1966. Palaeozoic sporae dispersae from Congo I. – Kindu/Kalima and Walikale regions. *Annales Musee Royal De L'Afrique Central – Sciences Géologiques, Sériu in-8°*, 53, 1 – 238.
- Broutin, J., Roger, J., Platel, J. P., Angiolini, L., Baud, A., Bucher, H., Marcoux, J., Al Hasmi, H., 1995. The Permian Pangea. Phytogeographic implications of new paleontological discoveries in Oman (Arabian Peninsula). *Concise Review Paper. Académie des Sciences Paris* 321, Series II, 1069 – 1086.
- Cadman, C., 1995. Report on samples submitted for palynological analysis from Botswana Karoo boreholes. *Bernard Price Institute of Palaeontology*, 7pp.
- Carney, J., Aldiss, D. T., Lock, N. P., 1994. The geology of Botswana. *Bulletin Geological Survey Botswana* 37, 113pp.
- Christopher, R. A., Goodman, D. K., 1996. Introduction to biostratigraphy and time scales. In: Jansonius, J. and McGregor, D. C. (eds.), *Palynology: principles and applications*. American Association of Stratigraphic Palynologists Foundation 2, 463 – 492.
- Clark, G. C., Lock, N. P., Smith, R. A., 1986. Coal resources of Botswana. In: Anhaeusser, C. R. and Maske, S. (eds.). *Mineral Deposits of Southern Africa*. Geological Society of South Africa, Johannesburg, 2071 – 2085.
- Clarke, R. F. A., 1965. British Permian saccate and monosulcate miospores. *Palaeontology* 8, 322 – 354.
- Cleal, C. J., 1991. Plant fossils in Geological Investigation. *The Palaeozoic*. Ellis Horwood Ltd., 233pp.
- Combaz, A., 1964. Les palynofacies. *Revue de Micropaléontologie* 7, 309 – 321.
- Courtinat, B., Rio, M., Malartre, F., 2002. Palynofacies of marginal marine deposits: The Rhaetian of the east margin of the Massif Central (France). *Revue de micropaléontologie* 45, 1, 47 – 55.
- Courtinat, B., Piriou, S., Rio, M., 2003. Phytoclasts in palynofacies definition: the example of Rhaetian sedimentary organic matter in SE France. *Revue de micropaléontologie* 46, 11 – 21.
- Cox, K. G., 1992. Karoo igneous activity, and the early stages of the break-up of Gondwanaland. In: Storey, B. C., Alabaster, T. and Pankhurst, R. J. (eds.). *Magmatism and the Causes of Continental Break-up*. Geological Society Special Publication 68, 137-148.
- Cramer, F. H., Diez, M. d. C. R., 1979. Lower Paleozoic acritarchs. *Palinologia* 1, 17-160.
- Crowell, J. C., 1983. Ice ages recorded on Gondwanan continents: Alex. L. du Toit Memorial No.18. *Transactions Geological Society South Africa* 86, 237-262

- Daly, M. C., Lawrence, S. R., Kimun'a, D., Binga, M., 1991. Late Palaeozoic deformation in central Africa: a result of distant collision? *Nature* 350, 605 – 607.
- Deflandre, G., 1954. Systématique de hystrichosphaeridés: sur l'acceptation de genre *Cymatiosphaera* O. Wetzel. *Compte Rendu, Societe Géologique de France* 12, 257 – 259.
- De Jersey, N. J., 1970. Early Triassic miospores from the Rewan Formation. *Publications Geological Survey Queensland* 345, Palaeontological papers 19, 29pp.
- d'Engelbronner, E. R., 1996. New palynological data from Karoo sediments, Mana Pools basin, northern Zimbabwe. *Journal of African Earth Sciences* 23, 1, 17 – 30.
- Di Pasquo, M., Azcuy, C. L., Souza, P. A., 2003a. Palinología del Carbonífero Superior del Subgrupo Itararé en Itaporanga, Cuenca Paraná, Estado de São Paulo, Brasil. Parte 1: sistemática de esporas y paleofitoplancton. *Ameghiniana* 40, 3, 277 – 296.
- Di Pasquo, M., Azcuy, C. L., Souza, P. A., 2003b. Palinología del Carbonífero Superior del Subgrupo Itararé en Itaporanga, Cuenca Paraná, Estado de São Paulo, Brasil. Parte 2: sistemática de polen y significado paleoambiental y estratigráfico. *Ameghiniana* 40, 3, 297 – 313.
- Dolby, G., 1990. The biostratigraphy of the G.S.D./P.C.I.A.C Masetlheng Pan-1 well, Botswana. *Geological Survey Botswana*, 23pp.
- Downie, C., 1973. Observations on the nature of the acritarchs. *Palaeontology* 16, 2, 239 – 259.
- Dunn, M. T., 2001. Palynology of the Carboniferous-Permian boundary stratotype, Aidaralash Creek, Kazakhstan. *Review of Palaeobotany and Palynology* 116, 175 – 194.
- Duringer, P., Doubinger, J., 1985. La palynologie: un outil de caractérisation des faciés marins et continentaux á la limite Muschelkalk supérieur – Lettenkohle. *Palynology: a means of characterizing marine and continental facies at the Upper Muschelkalk – Lettenkohle boundary. Sciences Géologiques Bulletin* 38, 1, 19 – 34.
- Du Toit, A. L., 1954. *Geology of South Africa*. 3rd Ed. Oliver and Boyd, Edinburgh. 611p.
- Du Toit, A. L., 1916. Notes on the Karoo System in the southern Kalahari. *Transactions Geological Society South Africa* 19, 1 – 13.
- Edwards, M., 1986. Glacial Environments. In: Reading, H. G. (ed.), *Sedimentary environments and facies*. 2nd. Edtn. Blackwell Scientific, Oxford, pp445-470.
- Ellis, C. J. R., 1979. Report on the exploration of Block "W" Botswana. Shell Coal Botswana (Pty) Ltd. Geological Survey Botswana.
- Exploration Consultants Ltd., 1998. Petroleum Potential of the Karoo of Botswana. Volume 1 – Report GC 122/2/1a. Geological Survey Botswana.
- Exploration Consultants Ltd., 1990. Pan African Basin Study. Geological Survey Botswana.
- Eyles, N., 1993. Earth's glacial record and its tectonic setting. *Earth-Science Reviews* 35, 1 – 248.
- Falcon, R., 1975. Palyno-stratigraphy of the Lower Karroo sequence in the central Sebungwe District, Mid-Zambezi Basin, Rhodesia. *Palaeont. afr.* 18, 1-29.
- Falcon, R., 1978. New Permian miospores from Rhodesia. *Arnoldia Rhodesia* 8, 24, 1 – 32.
- Farabee, M. J., Taylor, E. L., Taylor, T. N., 1991. Late Permian palynomorphs from the Buckley Formation, central Transantarctic Mountains, Antarctica. *Review of Palaeobotany and Palynology* 69, 353-368.
- Farr, J. L., 1981. Distribution of the Karoo in Botswana. 1 : 2 000 000 map. Geological Survey Botswana.
- Fensome, R. A., Williams, G. L., Barss, M. S., Freeman, J. M., Hill, J. M., 1990.

- Acritarchs and Fossil Prasinophytes: an index to genera, species and infraspecific taxa. AASP Contributions Series Number 25. American Association of Stratigraphic Palynologists Foundation.
- Foster, C. B., 1975. Permian plant microfossils from the Blair Athol Coal Measures, central Queensland, Australia. *Palaeontographica Abteilung B* 154, 121 – 171.
- Foster, C. B., 1979. Permian plant microfossils of the Blair Athol Coal Measures, Baralaba Coal Measures, and Basal Rewan Formation of Queensland. Publication 372, *Palaeontological paper* 45. Geological Survey Queensland.
- Golonka, J., Ford, D., 2000. Pangean (Late Carboniferous – Middle Jurassic) palaeoenvironmental and lithofacies. *Palaeogeography, Palaeoclimatology, Palaeoecology* 161, 1 – 34.
- Green, D., 1966. The Karoo System of Bechuanaland. *Bulletin Geological Survey Bechuanaland Protectorate* 2, 74pp.
- Green, D., Crockett, R. N., Jones, M. T., 1980. Tectonic control of Karoo sedimentation in mid-eastern Botswana. *Transactions Geological Society South Africa* 83, 213 – 219.
- Gwosdz, W., Sekwale, M., 1982. Brick-Earth and Clay resources of eastern Botswana. *Mineral Resources Report Geological Survey Botswana* 5.
- Hammer, Ø, Harper, D. A. T., Ryan, P. D., 2006. PAST – Palaeontological Statistics, ver. 1.48. <http://folk.uio.no/ohammer/past>.
- Hankel, O., 1992. Late Permian to Early Triassic microfloral assemblages from the Maji ya Chumvi Formation, Kenya. *Review of Palaeobotany and Palynology* 72, 129-147.
- Hankel, O., 1993. Early Triassic plant microfossils from Sakamena sediments of the Majunga Basin, Madagascar. *Review of Palaeobotany and Palynology* 77, 213 – 233.
- Hart, G. F., 1963. A probable *pre-Glossopteris* micro-floral assemblage from Lower Karoo sediments. *South African Journal Science* 59, 135-146.
- Hart, G. F., 1964. A review of the classification and distribution of the Permian miospore: *Disaccate striatiti*. *Cinquieme Congres International de Stratigraphie et de Geologie du Carbonifere, Comptu Rendu*, 1171-1199.
- Hart, G. F., 1965. The systematics and distribution of Permian miospores. Witwatersrand University Press, Johannesburg, 253pp.
- Hart, G. F., 1966. *Vittatina africana*, a new miospore from the Lower Permian of South Africa. *Micropaleontology* 12, 1, 37-42.
- Hemer, D. O., Nygreen, P. W., 1967. Algae, acritarchs and other microfossils *incertae sedis* from the Lower Carboniferous of Saudi Arabia. *Micropaleontology* 13, 2, 183 – 194.
- Hoen, P. (ed.), 1999. *Glossary of Pollen and Spore Terminology*, 2nd.edtn. (web-edition). Laboratory of Palaeobotany and Palynology.
- Holzforster, F., Stollhofen, H., Stanistreet, I. G., 1999. Lithostratigraphy and depositional environments in the Waterberg-Erongo area, central Namibia, and correlation with the main Karoo Basin, South Africa. *Journal African Earth Sciences* 29, 1, 105-123.
- Jana, B. N., Bhattacharyya, A. P., Chakraborti, B., 2002. Permian Palynological Succession from Mand – Raigarh Coalfield, Chhattisgarh. *Journal Geological Society of India* 59, 537 – 546.
- Jansonius, J., 1962. Palynology of Permian and Triassic sediments, Peace River Area, Western Canada. *Palaeontographica Abteilung B* 110, 35-98.
- Jansonius, J., 1971. Emended diagnosis of *Alisporites* Daugherty 1941. *Pollen et Spores* 13, 349-357
- Jansonius, J., Hills, L. V., 1976. Genera file of fossil spores. Special Publication,

- Department of Geology, University of Calgary, Canada.
- Jansonius, J., McGregor, D. C., 1996. Chapter 1. Introduction. In: Jansonius, J. & McGregor, D. C. (ed.), *Palynology: principles and applications*; American Association of Stratigraphic Palynologists, Vol. 1, p. 1-10.
- Jardiné, S., 1974. Microflores des formations du Gabon attribuées au Karroo (Microfloras from formations in Gabon attributed to the Karroo). *Review of Palaeobotany and Palynology* 17, 75 – 112.
- Johnson, M. R., 1991. Sandstone petrography, provenance and plate tectonic setting in Gondwana context of the southeastern Cape-Karoo Basin. *South Africa Journal Geology* 94, 2/3, 137 – 154.
- Johnson, M. R., Van Vuuren, C. J., Hegenberger, W. F., Key, R., Shoko, U., 1996. Stratigraphy of the Karoo Supergroup in southern Africa: an overview. *Journal of African Earth Sciences* 23, 1, 3-15.
- Jones, M. J., Truswell, E. M., 1992. Late Carboniferous and Early Permian palynostratigraphy of the Joe Joe Group, southern Galilee Basin, Queensland, and implications for Gondwana stratigraphy. *Bureau of Mines and Mineral Resources Journal of Australian Geology and Geophysics* 13, 143 – 185.
- Jourdan, F., Féraud, G., Bertrand, H., Kampunzu, A. B., Tshoso, G., Le Gall, B., 2005. The Karoo Large Igneous Province: brevity, origin and relation with mass extinction in question from new $^{40}\text{Ar}/^{39}\text{Ar}$ age data. *Geology* 33, 745-748.
- Kalkreuth, W., Holz, M., Cazzulo-Klepzig, M., Marques-Toigo, M., Utting, J., Semkiwa, P., 1999. A comparative study of the geology, petrology and palynology of Permian coals in Tanzania and southern Brazil. *Journal African Earth Sciences* 29, 1, 91 – 104.
- Kar, R. K., 1968. Palynology of the Barren Measures sequence from Jharia Coalfield, Bihar, India. 2. General palynology. *Palaeobotanist* 16, 2, 115 – 140.
- Kar, R. K., 1976. Miofloristic evidences for climatic vicissitudes in India during Gondwana. *Geophytology* 6, 2, 230-244.
- Kar, R. K., Bose, M. N., 1976. Palaeozoic spores dispersae from Zaire (Congo) XI. – Assise à couches de houille from Greinerville region. *Annales Musee Royal De L’Afrique Central – Sciences Géologiques, Sériu in-8°, 77, 21 – 133.*
- Key, R. M., McGeorge, I., Aitken, G., Cadman, A., Tidi, J., Anscombe, J., 1995. The Karoo supergroup of south-west Botswana; new detailed information on the Dwyka and Ecca groups. *Centennial Geocongress Extended Abstracts, Geological Society South Africa*, 781 – 784.
- Klaus, W., 1963. Sporen aus dem südalpinen Perm. *Jahrbuch der Geologischen Bundesanstalt, Wien* 106, 229-361
- Kosanke, R. M., 1950. Pennsylvanian spores of Illinois and their use in correlation. *Bulletin Illinois State Geological Survey* 74, 1-128.
- Kremp, G. O. W., 1965. *Morphologic Encyclopedia of Palynology*. The University of Arizona Press, Tucson, 263pp.
- Kremp, G. O. W., Spackman, W., 1961. *Catalog of Fossil Spores and Pollen*, 13. The Pennsylvania State University.
- Lele, K. M., 1973. Studies in the Talchir flora of India – 10. Early and late Talchir microfloras from the West Bokaro Coalfield, Bihar. *The Palaeobotanist* 22, 3, 219 – 235.
- Leschik, G., 1956. Sporen aus dem Salzton des Zechsteins von Neuhof (bei Fulda). *Palaeontographica B* 100, 122 – 142.
- Lindström, S., 1995a. Early Late Permian palynostratigraphy and palaeobiogeography of Vestfjella, Dronning Maud Land, Antarctica. *Review of Palaeobotany and Palynology* 86, 157 – 173.
- Lindström, S., 1995b. Early Permian palynostratigraphy of the northern

- Heimefrontfjella mountain-range, Dronning Maud Land, Antarctica. Review of Palaeobotany and Palynology 89, 359-415.
- MacRae, C. S., 1978. Palaeozoic palynology of Botswana. M.Sc. Thesis 98pp. Witwatersrand University, Johannesburg, South Africa.
- MacRae, C. S. 1988., Palynostratigraphic correlation between the Lower Karoo sequence of the Waterberg and Pafuri coal-bearing basins and the Hammanskraal plant macrofossil locality, Republic of South Africa. Memoir Geological Survey 75, 217pp.
- Maheshwari, H. K., Bose, M. N., 1969. Palaeozoic spores dispersae viii. --- The Kibamba River (Lukuga Coalfield area). Annales Musee Royal de L'Afrique Centrale, Série 8, 63, 3 – 60.
- Mapeo, R. B., 1987. The geology and hydrocarbon potential of Botswana. Paper G. SADCC Energy Sector Seminar, Arusha, Tanzania, 151 – 182.
- Manum, S. B., Tien, N. D., 1973. Palynostratigraphy of the Ketewaka Coalfield (Lower Permian), Tanzania. Review of Palaeobotany and Palynology 16, 213 – 227.
- Marques-Toigo, M., Picarelli, A. T., 1984. On the morphology and affinities of *Lundbladispora* Balme 1963 in the Permian of the Paraná Basin, Brazil. Boletim IG-USP, Instituto de Geociências, Universidade de São Paulo 15, 46-52.
- Marques-Toigo, M., Klepzig, M. C., 1995. Catálogo de Esporos e Pólen fósseis do Paleozóico. Boletim de Geociências da Petrobras 1, 9, 151pp.
- Martín-Closas, C., Permanyer, A., Vila, M-J., 2005. Palynofacies distribution in a lacustrine basin. Geobios 38, 197 – 210.
- Martin, F. 1993., Acritarchs: a review. Biol. Rev. 68, 475 – 538.
- Masselter, T., Hofmann, C-C., 2005. Palynology and palynofacies of Miocene coal-bearing (clastic) sediments of the Hausruck area (Austria). Geobios 38, 127 – 138.
- Meena, K. L., 1999. Palynostratigraphic studies of sub-surface Raniganj – Barren Measures sediments from Mand-Raigarh Coalfield, Son-Mahanadi, Madhya Pradesh, India. Palaeobotanist 48, 214 – 224.
- Meixner, H. M., Peart, R. J., 1984. The Kalahari Drilling Project: a report on the geophysical and geological results of follow-up drilling to the Aeromagnetic Survey of Botswana. Bulletin Geological Survey Botswana 27, 224pp.
- Menéndez, C. A., 1971. Estudio palinológico del Pérmico de Bajo de Vélez, provincial de San Luis. Revista del Museo Argentino de Ciencias Naturales “Bernardino Rivadavia” e Instituto Nacional de Investigación de las Ciencias Naturales, Paleontología I, 263 – 306.
- Miall, A. D., 1990. Principles of Sedimentary Basin Analysis. 2nd. Edtn. Springer-Verlag New York Inc., 668pp.
- Millsted, B. D., 1994. Palynological evidence for the age of the Permian Karoo coal deposits near Vereeniging, northern Orange Free State, South Africa. South African Journal of Geology 97, 1, 15 – 20.
- Millsted, B. D., 1999. Palynology of the Early Permian coal-bearing deposits near Vereeniging, Free State, South Africa. Bulletin of the Council for Geoscience 124, 81pp.
- Modie, B. N., 1996. The geology of the Ghanzi Ridge. District Memoir Geological Survey Botswana 7, 81pp.
- Modie, B. N., 1999. The geology of the area around Mochudi. Bulletin Geological Survey Botswana 48, 122pp.
- Modie, B. N., 2000. The Karoo Supergroup of the Kalahari Basin: report on field visit to exposures in the Kalahari Karoo basin of Botswana. Internal Report Geological Survey Botswana BNM/5/2000, 57pp.
- Murphy, M. A., Salvador, A., 1999. International Stratigraphic Guide - An abridged version. Episodes 22, 4, 255 – 271.

- Mussard, J. M., Gérard, J., Ducazeaux, J., Bégouen, V., 1994. Quantitative palynology: a tool for the recognition of genetic depositional sequences. Application to the Brent Group. Bulletin des Centres de Recherches d'Elf Aquitaine Exploration-Production 18, 2, 463-474.
- Nahuys, J., Alpern, B., Ybert, J. P. 1968. Estudo palinológico de alguns carvões do sul Brazil. Boletim, Instituto Tecnológico do Rio Grande do Sul 46, 3-61.
- Norris, G., 1965. Triassic and Jurassic miospores and acritarchs from the Beacon and Ferrar Groups, Victoria Land, Antarctica. New Zealand Journal of Geology and Geophysics 8, 236-277.
- Nyambe, I. A., Utting, J., 1997. Stratigraphy and palynostratigraphy, Karoo Supergroup (Permian and Triassic), mid-Zambezi Valley, southern Zambia. Journal of African Earth Sciences 24, 4, 563 – 583.
- Oosterlen, P. M., Millsted, B. D., 1994. Lithostratigraphy, palaeontology, and sedimentary environments of the western Cabora Bassa Basin, Lower Zambezi Valley, Zimbabwe. South African Journal Geology 97, 205 – 224.
- Ollivier-Pierre, M-F., Sittler, C., 1994. Palynology and palynofacies analyses: some essential clues to assess and identify West-European tertiary depositional environments in terms of relative high or lowstands. Application to the case of three Eocene and Oligocene sections in France. Bulletin des Centres de Recherches d'Elf Aquitaine Exploration-Production 18, 2, 381-527.
- Orpen, J. L., Swain, C. J., Nugent, C., Zhou, P. P., 1989. Wrench-fault and half-graben tectonics in the development of the Palaeozoic Zambezi Karoo Basins in Zimbabwe – the “Lower Zambezi” and “Mid-Zambezi” basins respectively – and regional implications. Journal African Earth Sciences 8, 2/3/4, 215 – 229.
- Pant, D. D., Srivastava, G. K. 1965. Some Lower Gondwana miospores from Brazil. Micropaleontology 11, 4, 468 – 478.
- Playford, G., 1965. Plant microfossils from Triassic sediments near Poatina, Tasmania. Journal Geological Society Australia 12, 2, 173 – 210.
- Playford, G., Dettmann, M. E., 1965. Rhaeto – Liassic plant microfossils from the Leigh Creek Coal Measures, South Australia. Seckenberg. Leth. 46 (2 and 3), 127 – 181.
- Playford, G., Dettmann, M. E., 1996. Chapter 8, Spores. In: Jansonius, J. and McGregor, D. C. (eds.). Palynology: principles and applications. American Association of Stratigraphic Palynologists Foundation 1, 227 – 260.
- Playford, G., Dino, R., 2002. Permian palynofloral assemblages of the Chaco-Paraná Basin, Argentina: systematics and stratigraphic significance. Revista Española de Micropaleontología 34, 235-288.
- Playford, G., Dino, R., 2005. Carboniferous and Permian palynostratigraphy. In: Koutsoukos, E. A. M. (ed.), Applied Stratigraphy, Springer, Dordrecht, pp.101-121.
- Pittet, B., Gorin, G. E., 1997. Distribution of sedimentary organic matter in a mixed carbonate-siliciclastic platform environment: Oxfordian of the Swiss Jura Mountains. Sedimentology 44, 915-937.
- Pocock, S. A. J., Sarjeant, W. A. S., 1972. Partitomorphae, a new subgroup of Triassic and Jurassic acritarchs. Bulletin Geological Society Denmark 21, 346 – 357.
- Potonié, R., 1958. Synopsis der Gattungen der *Sporae dispersae* II. Teil: Sporites, Saccites, Aletes, Praecolpates, Polyplicates, Monocolpates. Beihefte Geologischen Jahrbuch 31, 1-114.
- Potonié, R., Kremp, G. O. W., 1954. Die Gattungen der palaözoischen *Sporae dispersae* und ihre Stratigraphie. Beihefte Geologischen Jahrbuch 69, 111-194.

- Potonié, R., Kremp, G. O. W., 1956. Die *Sporae dispersae* des Ruhrkarbons ihre Morpographie und Stratigraphie mit Ausblicken auf Arten anderer Gebiete und Zeitabschnitte. Teil 3. *Palaeontographica* B 100, (4-6), 65-121.
- Reading, H. G., 1986. *Sedimentary Environments and Facies*. 2nd. Edtn. Blackwell Scientific Publications, 615pp.
- Roncaglia, L. 2004., Palynofacies analysis and organic-walled dinoflagellate cysts as indicators of palaeo-hydrographic changes: an example from Holocene sediments in Skálafjord, Faroe Islands. *Marine Micropalaeontology* 50, 21 – 42.
- Rigby, J. F., Hekel, H., 1977. Palynology of the Permian sequence in the Springsure Anticline, central Queensland. Publication 363, *Palaeontological Papers* 37. Geological Survey Queensland.
- SADC., 2001. SADC Trade, Industry and Investment Review 2001, 5th Anniversary Edition. South African Marketing Co., 8pp.
- Sah, S. C. D., Kar, R. K., 1969. Palynological interpretations of palaeoenvironments with reference to India. *The Palaeobotanist* 19, 86-94.
- Samoilovich, S. R., 1953. Pollen and spores from the Permian deposits of the Cherdyn' and Akt'ubinsk areas, Cis-Urals. *Trudy Vses Nauchno-issled. Geol. Razve. Inst. n.s.*, 75, *Palaeobot. Sb.*, 5-57 (in Russian).
- Schaarschmidt, F., 1963. Sporen und Hystriospherideen aus dem Zechstein von Büdingen in der Wetterau. *Palaeontographica Abteilung* B 113, 38-91.
- Schiøler, P., Crampton, J. S., Laird, M. G., 2002. Palynofacies and sea-level changes in the Middle Coniacian – Late Campanian (Late Cretaceous) of the East Coast Basin, New Zealand. *Palaeogeography, Palaeoclimatology, Palaeoecology* 188, 101-125.
- Sedova, M. A., 1956. The definition of 4 genera of Disaccate striatiti. *Palynologic Translations* (Hart, G. F. – translator, 1962) Sheffield 1, 1-10
- Segroves, K. L., 1967. Cutinized microfossils of probable nonvascular origin from the Permian of Western Australia. *Micropaleontology* 13, 289-305.
- Segroves, K. L., 1970. Permian spores and pollen grains from the Perth Basin, Western Australia. *Grana Palynologica* 10, 43-73.
- Semkiwa, P., Kalkreuth, W., Utting, J., Mpanju, F., Hagemann, H., 2003. The geology, petrology, palynology and geochemistry of Permian coal basins in Tanzania: 2. Songwe-Kiwira Coalfield. *International Journal of Coal Geology* 55, 157-186.
- Smith, A. B., 1994. Systematics and the fossil record: documenting evolutionary patterns. Blackwell Science, 223pp.
- Smith, R. A., 1984. The lithostratigraphy of the Karoo Supergroup in Botswana. *Bulletin Geological Survey Botswana* 26, 239pp.
- Smith, A. H. V., Butterworth, M. A., 1967. *Special Papers in Palaeontology* No. 1. Miospores in the coal seams of the Carboniferous of Great Britain. The Palaeontological Association, London, 324pp.
- Smith, R. M. H., Eriksson, P. G., Botha, W. J., 1993. A review of the stratigraphy and sedimentary environments of the Karoo-aged basins of Southern Africa. *Journal African Earth Sciences* 16, 143 – 169.
- South African Committee for Stratigraphy (SACS), 1980. Part 1: Lithostratigraphy of the Republic of South Africa, South West Africa/Namibia, and the republics of Bophuthatswana, Transkei and Venda. Handbook 8, Geological Survey South Africa, 690pp.
- Souza, P. A., 2006. Late Carboniferous palynostratigraphy of the Itararé Subgroup, northeastern Paraná Basin,

- Brazil. Review of Palaeobotany and Palynology 138, 9-29.
- Souza, P. A., Marques-Toigo, M., 2003. An overview on the Palynostratigraphy of the Upper Paleozoic strata of the Brazilian Paraná Basin. *Revista del Museo Argentino de Ciencias Naturales*, n.s. 5, 2, 205-214.
- Souza, P. A., Marques-Toigo, M., 2005. Progress on the palynostratigraphy of the Permian strata in Rio Grande do Sul State, Paraná Basin, Brazil. *Annals of the Brazilian Academy of Sciences* 77, 2, 353-365.
- Stansfield, G., 1973. The geology of the area around Dukwe and Tlalamabele, Central District, Botswana. *District Memoir Geological Survey Botswana* 1, 74pp.
- Staplin, F. L., 1960. Upper Mississippian plant spores from the Golata Formation, Alberta, Canada. *Palaeontographica Abteilung B* 107, 1-40.
- Stephenson, M. H., 2004. Early Permian spores from Oman and Saudi Arabia. In: Al-Husseini, M. I. (ed.). *Carboniferous, Permian and Early Triassic Arabian stratigraphy. GeoArabia Special Publication* 3, 185 – 215.
- Stephenson, M. H., McLean, D., 1999. International correlation of Early Permian palynofloras from the Karoo sediments of Morupule, Botswana. *South African Journal Geology* 102, 1, 3 – 14.
- Stephenson, M. H., Filatoff, J., 2000. Correlation of Carboniferous-Permian palynological assemblages from Oman and Saudi Arabia. In: Al-Hajri, S. and Owens, B. (eds.). *Stratigraphic Palynology of the Palaeozoic of Saudi Arabia. GeoArabia Special Publication* 1, Gulf PetroLink, Bahrain, 168 – 191.
- Stephenson, M. H., Osterloff, P. L., 2002. Palynology of the deglaciation sequence represented by the Lower Permian Rahab and Lower Gharif members, Oman. *American Association Stratigraphic Palynologists, Contributions Series Number* 40.
- Stephenson, M. H., Penn, I. E. 2005. Capacity building of developing country public sector institutions in the natural resource sector. In: Marker, B. R., Petterson, M. G., McEvoy, F. and Stephenson, M. H. (eds.), *Sustainable Minerals Operations in the Developing World. Geological Society, London, Special Publications* 250, 185 – 194.
- Singh, T., Tiwari, R. S., Vijaya., Awatar-Ram., 1995. Stratigraphy and palynology of Carboniferous-Permian-Triassic succession in Spiti Valley, Tethys Himalaya, India. *Journal of The Palaeontological Society of India* 40, 55 – 76.
- Tappan, H., 1980. *The Paleobiology of Plant Protists. W. H. Freeman and Company, San Francisco, 1028pp.*
- Tissot, B. P., Welte, D. H., 1978. *Petroleum Formation and Occurrence: A New Approach to Oil and Gas Exploration. Springer-Verlag, Berlin, 538pp.*
- Tiwari, R. S., 1964. New miospore genera in the coals of Barakar Stage (Lower Gondwana) of India. *Palaeobotanist* 12, 3, 250 – 259.
- Tiwari, R. S., Singh, V., 1981. Morphographic study of some dispersed trilete miospores (Sub-infraturma-Varitritei) from the Lower Gondwana of India. *The Palaeobotanist* 27, 3, 253 – 296.
- Tiwari, R. S., Tripathi, A., 1992. Marker Assemblage-Zones of spores and pollen species through Gondwana Palaeozoic and Mesozoic sequence in India. *Palaeobotanist* 40, 194 – 236.
- Traverse, A., 1988. *Palaeopalynology. Unwin Hyman, Boston, 600pp.*
- Tschudy, R. H., Kosanke, R. M., 1966. Early Permian vesiculate pollen from Texas, USA. *The Palaeobotanist* 15, 59-71.
- Tucker, M. E., 1991. *Sedimentary Petrology. 2nd.Edtn. Blackwell Scientific, 260p.*
- Turner, B. R., 1999. Tectonostratigraphical development of the Upper Karoo foreland basin: orogenic unloading versus thermally-induced Gondwana

- rifting. *Journal African Earth Sciences* 28, 215-238.
- Tyson, R. V., 1995. *Sedimentary Organic Matter: organic facies and palynofacies*. Chapman and Hall, London, xviii + 615pp., 6 pl.
- Utting, J., 1976. Pollen and Spore assemblages in the Luwumbu Coal Formation (Lower Karroo) of the north Luangwa Valley, Zambia, and their biostratigraphic significance. *Review of Palaeobotany and Palynology* 21, 295-315.
- Utting, J., 1994. Palynostratigraphy of Permian and Lower Triassic rocks, Sverdrup Basin, Canadian Arctic Archipelago. *Bulletin Geological Survey Canada* 478, 107pp.
- Van Bergen, P. F., Kerp, J. H. F., 1990. Palynofacies and sedimentary environments of a Triassic section in southern Germany. In: Fermont, W. J. J., Weegink, J. W., (eds.) *The proceedings of the International Symposium on Organic Petrology*. Mededelingen rijks geologische dienst 45, 23-36.
- Van de Laar, H. G. M., Fermont, W. J. J., 1990. The impact of marine transgressions on palynofacies; the Carboniferous Aegir marine band in borehole Kemperkoul-1. In: Fermont, W. J. J., Weegink, J. W., (eds.) *The proceedings of the International Symposium on Organic Petrology*. Mededelingen rijks geologische dienst 45, 75-88.
- Venkatachala, B. S., Kar, R. K., 1965. Two new trilete spore genera from the Permian of India. *The Palaeobotanist* 13, 3, 337 – 340.
- Verniers, J., Jourdan, P. P., Paulis, R. V., Frasca-Spada, L., De Bock, F. R., 1989. The Karroo Graben of Metangula, Northern Mozambique. *Journal African Earth Sciences* 9, 1, 137 – 158.
- Visser, J. N. J., 1990. The age of the late Palaeozoic glacial deposits in southern Africa. *South African Journal of Geology* 93, 2, 366 – 375.
- Visser, J. N. J., Looek, J. C., 1982. An investigation of the basal Dwyka tillite in the southern part of the Karoo basin, South Africa. *Transactions Geological Society South Africa* 85, 179-187
- Von Brunn, V., Gravenor, C. P., 1983. A model for late Dwyka glaciomarine sedimentation in the eastern Karoo basin. *Transactions Geological Society South Africa* 86, 199-209
- Williamson, I. T., 1996. The geology of the area around Mmamabula and Dibete: including an account of the Greater Mmamabula Coalfield. *District Memoir Geological Survey Botswana* 6, 239pp.
- Wilson, L. R., 1962. Permian plant microfossils from the Flowerpot Formation, Greer County, Oklahoma. *Oklahoma Geological Survey Circular* 49, 50pp.
- Wood, G. D., Gabriel, A. M., Lawson, J. C., 1996. Chapter 3. Palynological techniques – processing and microscopy; in: Jansonius, J. and McGregor, D. C. (eds.), *Palynology: principles and applications*; American Association of Stratigraphic Palynologists Foundation 1, 29-50.
- Wopfner, H., 1999. The Early Permian deglaciation event between East Africa and northwestern Australia. *Journal African Earth Sciences* 29, 1, 77 – 90.
- Wright, R. P., Askin, R. A., 1987. The Permian-Triassic boundary in the southern Morondava Basin of Madagascar as defined by plant microfossils. *American Geophysical Union*, 157-166.

APPENDICES

APPENDIX I – SPECIES INDEX

	Page
<i>Calamospora aplata</i> Bharadwaj and Salujha 1964 (Plate 1, figure 1).....	43
<i>Concavisorites mortonii</i> (de Jersey) de Jersey 1962 (Plate 1, figure 2).....	44
<i>Concavisorites sp.</i> (Plate 1, figure 3).....	44
<i>Deltoidospora directa</i> (Balme & Hennelly) Norris 1965 (Plate 1, figure 4).....	45
<i>Pachytriletes splendens</i> (Saksena) Millstead 1999 (Plate 1, figure 5).....	45
<i>Punctatisporites gretensis</i> Balme & Hennelly 1956 (Plate 1, figure 6).....	46
<i>Punctatisporites gracilis</i> Anderson 1977 (Plate 1, figure 7).....	47
<i>Punctatisporites parvus</i> Anderson 1977 (Plate 1, figure 8).....	47
<i>Punctatisporites ubischii</i> Foster 1979 <i>comb. nov.</i> (Plate 1, figure 9).....	48
<i>Punctatisporites sp.</i> (Plate 1, figure 10).....	48
<i>Retusotriletes diversiformis</i> (Balme & Hennelly) Balme & Playford 1967 (Plate 1, figure 11).....	49
<i>Retusotriletes golatensis</i> Staplin 1960 (Plate 1, figure 12).....	49
<i>Cyclogranisorites gondwanensis</i> Bharadwaj & Salujha 1964 (Plate 1, figure 13).....	50
<i>Cyclogranisorites sp.</i> (Plate 1, figure 14).....	50
<i>Granulatisporites papillosus</i> Hart 1965 (Plate 1, figure 15).....	51
<i>Granulatisporites angularis</i> (Staplin) Ybert 1975 (Plate 1, figure 16).....	52
<i>Granulatisporites trisinus</i> Balme & Hennelly 1956 (Plate 1, figure 17).....	52
<i>Granulatisporites sp.</i> (Plate 1, figure 18a, b.).....	53
<i>Granulatisporites sp. A</i> (Plate 1, figure 19a, b.).....	53
<i>Anacanthotriletes sp.</i> (Plate 2, figure 1).....	54
<i>Anacanthotriletes sp. A.</i> (Plate 2, figure 2).....	54
<i>Apiculatisporis cornutus</i> (Balme & Hennelly) HØeg & Bose 1960 (Plate 2, figure 3).....	55
<i>Apiculatisporis unicus</i> (Tiwari) Bharadwaj & Srivastava <i>comb. nov.</i> (Plate 2, figure 4).....	56
<i>Apiculatisporis levis</i> (Balme & Hennelly) Segroves 1970 (Plate 2, figure 5).....	56
<i>Apiculatisporis leptocaina</i> (Jones & Truswell) <i>comb. nov.</i> (Plate 2, figure 6).....	57
<i>Apiculatisporis parmatus</i> (Balme & Hennelly) <i>comb. nov.</i> (Plate 2, figure 7).....	57
<i>Didecitriletes eoericiana</i> (Anderson) Millstead 1999 (Plate 2, figure 8).....	58
<i>Didecitriletes ericianus</i> (Venkatachala & Kar 1965) (Plate 2, figure 9).....	59
<i>Divaricrassus minor</i> (Anderson) Millstead 1999 (Plate 2, figure 10).....	59
<i>Lophotriletes rectus</i> Bharadwaj & Salujha 1964 (Plate 2, figure 11).....	60
<i>Lophotriletes novicus</i> Singh 1964 (Plate 2, figure 12).....	61
<i>Lophotriletes rarus</i> Bharadwaj and Salujha 1964 (Plate 2, figure 13).....	61
<i>Lophotriletes sp.</i> (Plate 2, figure 1).....	62
<i>Lophotriletes sp. A</i> (Plate 2, figure 15).....	62
<i>Cirrabaculisporites lageniformis</i> (Anderson) <i>comb. nov.</i> (Plate 2, figure 16).....	63
<i>Cirrabaculisporites plumsteadi</i> (Hart) Anderson <i>comb. nov.</i> (Plate 2, figure 17).....	64
<i>Cirrabaculisporites ramosus</i> Maheshwari and Bose 1969 (Plate 2, figure 18).....	64
<i>Cirrabaculisporites sp.</i> (Plate 2, figure 19).....	65
<i>Horriditriletes brevis</i> Bharadwaj and Salujha 1964 (Plate 3, figure 1).....	65

<i>Horriditriletes ramosus</i> (Balme & Hennelly) Bharadwaj & Salujha 1964 (Plate 3, figure 2).....	66
<i>Horriditriletes tereteangulatus</i> (Balme & Hennelly) Backhouse 1991 (Plate 3, figure 3).....	67
<i>Horriditriletes uruguaiensis</i> (Marques-Toigo) Archangelsky & Gamero 1979 (Plate 3, figure 4).....	67
<i>Horriditriletes curvibaculosus</i> Bharadwaj & Salujha 1964 (Plate 3, figure 5).....	68
<i>Horriditriletes gondwanensis</i> (Tiwari & Moiz) Foster 1975 (Plate 3, figure 6).....	69
<i>Horriditriletes</i> sp. (Plate 3, figure 7a, b).....	69
<i>Horriditriletes</i> sp. A (Plate 3, figure 8).....	70
<i>Raistrickia crenata</i> Foster 1979 (Plate 3, figure 9).....	70
<i>Convruccosisporites naumoviae</i> (Hart) Backhouse 1991(Plate 3, figure 10).....	71
<i>Convruccosisporites pseudoreticulatus</i> (Balme & Hennelly) <i>comb. nov.</i> (Plate 3, figure 11).....	71
<i>Convruccosisporites irregularis</i> (Anderson) <i>comb. nov.</i> (Plate 3, figure 12).....	72
<i>Convruccosisporites</i> sp. (Plate 3, figure 13a, b).....	73
<i>Convruccosisporites</i> sp. A (Plate 3, figure 14).....	73
<i>Vruccosisporites morulatus</i> (Knox) <i>emend.</i> Smith & Butterworth 1967 (Plate 3, figure 15).....	74
<i>Vruccosisporites andersonii</i> (Anderson) Backhouse 1988 (Plate 3, figure 16).....	74
<i>Vruccosisporites triseccatus</i> Balme & Hennelly 1956 (Plate 3, figure 17).....	75
<i>Vruccosisporites</i> sp. (Plate 3, figure 18).....	75
<i>Vruccosisporites</i> sp. A (Plate 4, figure 1).....	76
<i>Convolutispora intrareticulata</i> (Anderson) <i>comb. nov.</i> (Plate 4, figures 2 – 3).....	76
<i>Convolutispora</i> sp. (Plate 4, figure 4).....	77
<i>Convolutispora</i> sp. A (Plate 4, figure 5).....	78
<i>Convolutispora</i> sp. B (Plate 4, figure 6a, b).....	78
<i>Foveosporites karrooensis</i> Anderson <i>comb. nov.</i> (Plate 4, figure 7).....	79
<i>Foveosporites</i> sp. (Plate 4, figure 8).....	79
<i>Foveosporites</i> sp. A (Plate 4, figure 9).....	79
<i>Foveosporites</i> sp. B (Plate 4, figure 10).....	80
<i>Microreticulatisporites</i> sp. (Plate 4, figure 11).....	80
<i>Microreticulatisporites</i> sp. A (Plate 4, figure 12).....	81
<i>Clavatisporites</i> sp. (Plate 4, figure 13).....	81
<i>Indotriradites australensis</i> (Hart) Millsted 1999 (Plate 4, figure 14).....	82
<i>Cristatisporites crassilabratus</i> Archangelsky and Gamero 1979 (Plate 4, figure 15).....	83
<i>Cristatisporites inconstans</i> Archangelsky and Gamero 1979 (Plate 4, figure 16).....	84
<i>Cristatisporites lestai</i> Archangelsky and Gamero 1979 (Plate 4, figure 17).....	84
<i>Cristatisporites microvacuolatus</i> (Dias-Fabrício) <i>emend.</i> Picarelli & Dias-Fabrício 1990 (Plate 5, figure 1).....	85
<i>Cristatisporites morungavensis</i> (Dias-Fabrício) <i>emend.</i> Picarelli & Dias-Fabrício 1990 (Plate 5, figure 2).....	85
<i>Cristatisporites spinosus</i> (Menendez & Azcuy) Playford 1978 (Plate 5, figure 3).....	86
<i>Cristatisporites menendezii</i> Playford 1978 (Plate 5, figure 4).....	87
<i>Cristatisporites</i> sp. (Plate 5, figure 5).....	87
<i>Cristatisporites</i> sp. A (Plate 5, figure 6).....	88
<i>Densoisporites</i> sp. (Plate 5, figure 7).....	88
<i>Densosporites rotundus</i> Falcon 1978 (Plate 5, figure 8).....	89
<i>Densosporites</i> sp. (Plate 5, figure 9).....	89
<i>Lundbladispora braziliensa</i> (Pant & Srivastava) <i>emend.</i> Marques-Toigo & Picarelli 1984 (Plate 5, figure 10).....	90

68 genera (30 spores, 29 pollen, 4 acritarchs, 4 prasinophytes, 1 chlorophyte)
184 species (89 spores, 76 pollen, 11 acritarchs, 7 prasinophytes, 1 chlorophyte)

<i>Lundbladispora gracila</i> Stephenson and Osterloff 2002 (Plate 5, figure 11).....	90
<i>Vallatisporites sp.</i> (Plate 5, figure 12).....	91
<i>Vallatisporites sp. A</i> (Plate 5, figure 13).....	92
<i>Laevigatosporites vulgaris</i> (Ibrahim) Ibrahim 1933 (Plate 5, figure 14).....	92
<i>Laevigatosporites plicatus</i> Kar 1968 (Plate 5, figure 15).....	93
<i>Polypodiisporites mutabilis</i> Balme 1970 (Plate 5, figures 16 – 17).....	94
<i>Polypodiisporites detritus</i> (Leschik) Anderson 1977 (Plate 5, figure 18a, b).....	95
<i>Florinites eremus</i> Balme & Hennelly 1955 (Plate 6, figure 1).....	95
<i>Striomonosaccites brevis</i> Bose & Kar 1966 (Plate 6, figure 2).....	96
<i>Striomonosaccites crucistriatus</i> Ybert 1975 (Plate 6, figure 3).....	97
<i>Striomonosaccites sp.</i> (Plate 6, figure 4).....	97
<i>Barakarites rotatus</i> (Balme & Hennelly) Bharadwaj & Tiwari 1964 (Plate 6, figure 5).....	98
<i>Bascanisporites undosus</i> Balme & Hennelly 1956 (Plate 6, figure 6).....	98
<i>Cannanoropollis janakii</i> Potonie & Sah 1960 (Plate 6, figure 7).....	99
<i>Cannanoropollis sp.</i> (Plate 6, figure 8).....	100
<i>Plicatipollenites gondwanensis</i> (Balme & Hennelly) Lele 1964 (Plate 6, figure 9).....	101
<i>Plicatipollenites densus</i> Srivastava 1970 (Plate 6, figure 10).....	102
<i>Plicatipollenites trigonalis</i> Lele 1964 (Plate 6, figure 11).....	102
<i>Plicatipollenites sp.</i> (Plate 6, figure 12).....	103
<i>Plicatipollenites sp. A</i> (Plate 6, figure 13).....	104
<i>Plicatipollenites sp. B</i> (Plate 6, figure 14).....	104
<i>Caheniasaccites ovatus</i> Bose & Kar 1966 (Plate 6, figure 15).....	105
<i>Caheniasaccites flavatus</i> Bose & Kar 1966 (Plate 6, figure 16).....	105
<i>Potonieisporites novicus</i> Bhardwaj 1954 (Plate 6, figure 17).....	106
<i>Potonieisporites brasiliensis</i> (Nahuys, Alpern & Ybert) Archangelsky & Gamero 1979 (Plate 6, figure 18).....	107
<i>Potonieisporites congoensis</i> Bose & Maheshwari 1968 (Plate 6, figure 19).....	107
<i>Illinites spectabilis</i> (Leschik) <i>comb. nov.</i> (Plate 7, figure 1).....	108
<i>Limitisporites rectus</i> Leschik 1956 (Plate 7, figure 2).....	109
<i>Limitisporites monstruosus</i> (Luber <i>in</i> Luber and Waltz) Hart 1965 (Plate 7, figure 3).....	110
<i>Limitisporites perspicuous</i> (Leschik) <i>comb. nov.</i> (Plate 7, figure 4).....	111
<i>Limitisporites sp.</i> (Plate 7, figure 5).....	111
<i>Vestigisporites rudis</i> Balme & Hennelly 1955 (Plate 7, figure 6).....	112
<i>Vestigisporites ventrisaccatus</i> Anderson 1977 (Plate 7, figure 7).....	113
<i>Alisporites ovatus</i> (Balme & Hennelly) Jansonius 1962 (Plate 7, figure 8).....	114
<i>Alisporites australis</i> de Jersey 1962 (Plate 7, figure 9).....	114
<i>Alisporites potonieii</i> (Lakhanpal, Sah & Dube) Somers 1968 (Plate 7, figure 10).....	115
<i>Alisporites splendens</i> (Leschik) Foster 1979 (Plate 7, figure 11).....	116
<i>Platysaccus papilionis</i> Potonié & Klaus 1954 (Plate 7, figure 12).....	117
<i>Platysaccus sp.</i> (Plate 7, figure 13).....	117
<i>Pteruchipollenites sp.</i> (Plate 7, figure 14).....	118
<i>Hamiapollenites bullaeformis</i> (Samoilovich) Jansonius 1962 (Plate 7, figure 15).....	119
<i>Hamiapollenites fusiformis</i> (Marques-Toigo) <i>emend.</i> Archangelsky & Gamero 1979 (Plate 7, figure 16).....	120
<i>Hamiapollenites saccatus</i> Wilson 1962 (Plate 7, figure 17).....	120
<i>Hamiapollenites tractiferinus</i> (Samoilovich) Jansonius 1962 (Plate 7, figure 18).....	121
<i>Hamiapollenites sp.</i> (Plate 7, figure 19).....	122
<i>Lueckisporites virkkiae</i> Potonié and Klaus 1954 (Plate 7, figure 20).....	122
<i>Lunatisporites nubilus</i> (Leschik) <i>comb. nov.</i> (Plate 8, figure 1).....	124

<i>Lunatisporites variesectus</i> Archangelsky and Gamarro 1979 (Plate 8, figure 2).....	124
<i>Lunatisporites sp.</i> (Plate 8, figure 3).....	125
<i>Protohaploxypinus haigii</i> Foster 1979 (Plate 8, figure 4).....	126
<i>Protohaploxypinus hartii</i> Foster 1979 (Plate 8, figure 5).....	126
<i>Protohaploxypinus limpidus</i> (Balme & Hennelly) Balme & Playford 1967 (Plate 8, figure 6).....	127
<i>Protohaploxypinus perexiguus</i> (Bharadwaj and Salujha) Foster 1979 (Plate 8, figure 7).....	128
<i>Protohaploxypinus rugatus</i> Segroves 1969 (Plate 8, figure 8).....	129
<i>Protohaploxypinus sp.</i> (Plate 8, figure 9).....	129
<i>Striatoabieites multistriatus</i> (Balme & Hennelly) Hart 1964 (Plate 8, figure 10).....	130
<i>Striatopodocarpites cancellatus</i> (Balme & Hennelly) Hart 1963 (Plate 8, figure 11).....	131
<i>Striatopodocarpites fusus</i> (Balme & Hennelly) Potonié 1958 (Plate 8, figure 12).....	132
<i>Striatopodocarpites pantii</i> (Jansonius) Balme 1970 (Plate 8, figure 13).....	132
<i>Striatopodocarpites rarus</i> (Bharadwaj & Salujha) Balme 1970 (Plate 8, figure 14).....	133
<i>Ephedripites sp.</i> (Plate 9, figure 1).....	134
<i>Ephedripites sp. A</i> (Plate 9, figure 2).....	135
<i>Vittatina densa</i> Anderson 1977 (Plate 9, figure 3).....	136
<i>Vittatina foveolata</i> Tschudy and Kosanke 1966 (Plate 9, figure 4).....	136
<i>Vittatina scutata</i> (Balme & Hennelly) Bharadwaj 1962 (Plate 9, figure 5).....	137
<i>Vittatina minima</i> Jansonius 1962 (Plate 9, figure 6).....	137
<i>Vittatina saccifer</i> Jansonius 1962 (Plate 9, figure 7).....	138
<i>Vittatina subsaccata</i> Samoilovich 1953 (Plate 9, figure 8).....	138
<i>Vittatina sp.</i> (Plate 9, figures 9-10).....	139
<i>Vittatina sp. A</i> (Plate 9, figure 11).....	140
<i>Weylandites lucifer</i> (Plate 9, figure 12).....	140
<i>Weylandites magmus</i> (Bose and Kar) Backhouse 1991 (Plate 9, figure 13).....	141
<i>Pakhapites fusus</i> (Bose and Kar) Menéndez 1971 (Plate 9, figure 14).....	142
<i>Pakhapites ovatus</i> (Bose and Kar) Menéndez 1971 (Plate 9, figure 15).....	143
<i>Gnetaceaepollenites sp.</i> (Plate 9, figure 16).....	144
<i>Pretricolpipoollenites sp.</i> (Plate 10, figure 1).....	144
<i>Marsupipollenites striatus</i> (Balme & Hennelly) Foster 1975 (Plate 10, figure 2).....	145
<i>Marsupipollenites triradiatus</i> Balme & Hennelly 1956 (Plate 10, figure 3).....	145
<i>Cycadopites cymbatus</i> (Balme & Hennelly) Hart 1965 (Plate 10, figure 4).....	146
<i>Cycadopites glaber</i> (Luber & Waltz) Hart 1965 (Plate 10, figure 5).....	147
<i>Cycadopites nevesi</i> (Hart) Hart 1965 (Plate 10, figure 6).....	147
<i>Cycadopites follicularis</i> Wilson & Webster 1946 (Plate 10, figure 7).....	148
<i>Cycadopites sp.</i> (Plate 10, figure 8).....	148
<i>Inapertisporites inapertus</i> (Anderson) Falcon 1978 (Plate 10, figures 9 – 10).....	149
<i>Micrhystridium sp.</i> (Plate 11, figure 1).....	150
<i>Tetraporina sp.</i> (Plate 11, figure 2).....	150
<i>Veryhachium sp. A</i> (Plate 11, figure 3).....	151
<i>Veryhachium sp. B</i> (Plate 11, figures 4 – 5).....	151
<i>Veryhachium sp. C</i> (Plate 11, figure 6).....	151
<i>Species A</i> (Plate 11, figure 7).....	152
<i>Species B</i> (Plate 11, figure 8).....	152
<i>Species C</i> (Plate 11, figure 9).....	153
<i>Species D</i> (Plate 11, figure 10).....	153
<i>Species E</i> (Plate 11, figure 11).....	153
<i>Botryococcus sp. cf. B. braunii</i> (Plate 11, figure 12).....	154
<i>Arabisphaera bellula</i> Hemer and Nygreen 1967 (Plate 11, figure 13).....	154

<i>Arabisphaera sp.</i> (Plate 11, figure 14).....	155
<i>Cymatiosphaera gondwanensis</i> (Tiwari) Backhouse 1991 (Plate 11, figure 15).....	155
<i>Cymatiosphaera sp. A</i> (Plate 11, figure 16).....	156
<i>Cymatiosphaera sp. B</i> (Plate 11, figure 17).....	157
<i>Maculatasporites sp.</i> (Plate 11, figure 18).....	157
<i>Tasmanites sp.</i> (Plate 11, figure 19).....	158

Malopong	DWYKA		ECCA		GROUP
	Khula	Middlepits	Kobe	Otsho	
					FORMATION
					DEPTH (M)
					LITHOLOGY

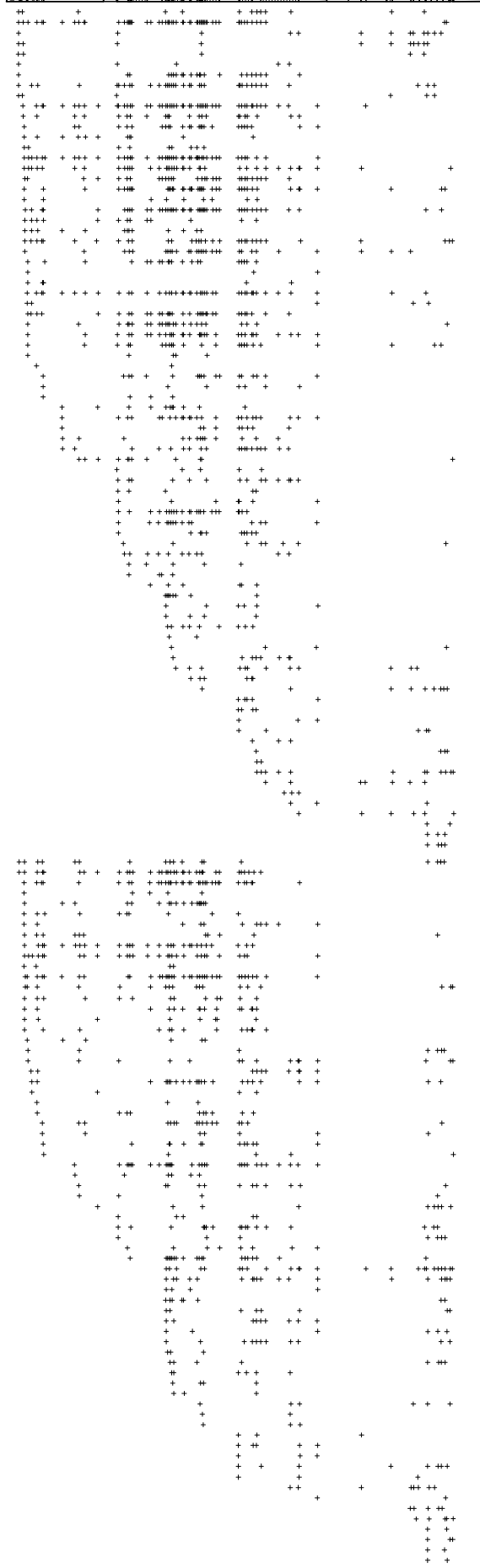

- Cyclogranisporites gondwanensis* (13)
- Granulatisporites angularis* (16)
- Convolutispora intrareticulata* (58)
- Convolutispora* sp. (59)
- Convolutispora* sp. A (60)
- Cristatisporites crassilabrus* (70)
- Cristatisporites morungavensis* (74)
- Lundbladispora braziliensis* (82)
- Polypodisporites mutabilis* (86)
- Punctatisporites gretensis* (6)
- Apiculatisporites leptocaina* (25)
- Punctatisporites parvus* (8)
- Punctatisporites obscuri* (9)
- Raistrickia crenata* (47)
- Converrucosporites naumoviae* (48)
- Indotritrites australensis* (69)
- Punctatisporites gracilis* (7)
- Horriditrites ramosus* (40)
- Verrucosporites andersonii* (54)
- Deltoidospora directa* (4)
- Verrucosporites morulatus* (53)
- Vallatisporites* sp. (84)
- Inapertisporites inapertus* (166)
- Tasmanites* sp. (184)
- Lophotrites novicus* (31)
- Cristatisporites* sp. A (78)
- Densosporites rotundus* (80)
- Granulatisporites papillosus* (15)
- Gnetaceapollenites* sp. (157)
- Fachytriletes splendens* (5)
- Horriditrites uruguiensis* (42)
- Apiculatisporites cornutus* (22)
- Apiculatisporites levis* (24)
- Converrucosporites pseudoreticulatus* (49)
- Vallatisporites* sp. A (85)
- Retusotrites golatensis* (12)
- Apiculatisporites parvatus* (26)
- Converrucosporites irregularis* (50)
- Converrucosporites* sp. A (52)
- Horriditrites lereteangulatus* (41)
- Cristatisporites lestai* (72)
- Calamospora aplata* (1)
- Cristatisporites microvacuolatus* (73)
- Granulatisporites trisetus* (17)
- Densosporites* sp. (79)
- Horriditrites curvibaculosus* (43)
- Horriditrites* sp. (45)
- Granulatisporites* sp. A (19)
- Cristatisporites menendezii* (76)
- Arabisphaera bellula* (178)
- Cristatisporites inconstans* (71)
- Horriditrites gondwanensis* (44)
- Tetraporia* sp. (168)
- Lophotrites* sp. (33)
- Lophotrites* sp. A (34)
- Divaricrassus minor* (29)
- Lophotrites rarus* (32)
- Retusotrites diversiformis* (11)
- Arabisphaera* sp. (179)
- Apiculatisporites unicus* (23)
- Mlychrytidium* sp. (167)
- Cirrabaculisporites plumsteadiae* (36)
- Lundbladispora gracila* (83)
- Concavisporites mortonii* (2)
- Cristatisporites* sp. (77)
- Concavisporites* sp. (3)
- Granulatisporites* sp. (18)
- Cristatisporites spinosus* (75)
- Cirrabaculisporites* sp. (38)
- Cymatospaera gondwanensis* (180)
- Foveosporites karooensis* (62)
- Anacanthotrites* sp. A (21)
- Didecitrites ericianus* (28)
- Lophotrites rectus* (30)
- Cyclogranisporites* sp. (14)
- Cymatospaera* sp. B (182)
- Horriditrites brevis* (39)
- Laevigatosporites plicatus* (87)
- Cavatrisporites* sp. (68)
- Microreticulatisporites* sp. (66)
- Microreticulatisporites* sp. A (67)
- Limitisporites monstruosus* (111)
- Cycadophites follicularis* (164)
- Plicatipollenites densus* (99)
- Plicatipollenites* sp. (101)
- Plicatipollenites* sp. A (102)
- Plicatipollenites* sp. B (103)
- Vittatina sacciflor* (149)
- Ephedripites* sp. (143)
- Ephedripites* sp. A (144)
- Cycadophites cymbatus* (161)
- Protohaploxypinus* sp. (137)
- Plicatipollenites gondwanensis* (98)
- Protohaploxypinus hartii* (133)
- Vittatina minima* (148)
- Pakhapites ovatus* (156)
- Pretricolipollenites* sp. (158)
- Plicatipollenites trigonalis* (100)
- Limitisporites rectus* (110)
- Limitisporites* sp. (113)
- Striatopodocarpites cancellatus* (139)
- Caheniasaccites ovatus* (104)
- Potonieisporites novicus* (106)
- Lunatisporites varisectus* (130)
- Potonieisporites congoensis* (108)
- Potonieisporites brasiliensis* (107)
- Vestligisporites rudis* (114)
- Barakarites rotatus* (84)
- Pakhapites fusus* (155)
- Striatopodocarpites rarus* (142)
- Cannanoropollis janakii* (96)
- Hamiapollenites bullaeformis* (123)
- Cycadophites nevesi* (163)
- Vittatina densa* (145)
- Weylandites lucifer* (153)
- Vittatina* sp. (151)
- Weylandites magnus* (154)
- Striatoabieites multistriatus* (138)
- Vittatina scutata* (147)
- Lunatisporites rubilus* (129)
- Alisporites ovatus* (116)
- Protohaploxypinus limpudus* (134)
- Protohaploxypinus rugatus* (136)
- Limitisporites perspicuus* (112)
- Cycadophites glaber* (162)
- Cannanoropollis* sp. (97)
- Lunatisporites* sp. (131)
- Alisporites splendens* (119)
- Striomonsacclites cruciatus* (92)
- Vestligisporites ventrisaccatus* (115)
- Caheniasaccites flavatus* (105)
- Vittatina foveolata* (146)
- Illinites spectabilis* (109)
- Marsupipollenites striatus* (159)
- Vittatina* sp. A (152)
- Protohaploxypinus haigii* (132)
- Alisporites australis* (117)
- Pteruchipollenites* sp. (122)
- Cycadophites* sp. (165)
- Alisporites potoniei* (118)
- Protohaploxypinus perexiguus* (135)
- Marsupipollenites triadialis* (160)
- Lueckisporites virkiae* (128)
- Florinites eremus* (90)
- Striatopodocarpites pantli* (141)
- Platysaccus papillorhis* (120)
- Platysaccus* sp. (121)
- Hamiapollenites saccatus* (125)
- Striatopodocarpites fusus* (140)

1. STRAT I ALL TAXA OCCURRENCE CHART.

APPENDIX II

Mafogong	DWYKA		ECCA		GROUP
	Khuis	Middlepits	Kobe	Otshe	FORMATION
					DEPTH (M)
					LITHOLOGY
					<i>Cyclogranisporites gondwanensis</i> (13) <i>Granulatisporites angularis</i> (16) <i>Convolutispora intrareticulata</i> (58) <i>Convolutispora</i> sp. (59) <i>Convolutispora</i> sp. A (60) <i>Cristatisporites crassibratus</i> (70) <i>Cristatisporites morungavensis</i> (74) <i>Lundbladisporella braziliensis</i> (82) <i>Polyodisporites mutabilis</i> (88) <i>Punctatisporites grellensis</i> (6) <i>Apiculatisporites leptocaina</i> (25) <i>Punctatisporites parvus</i> (8) <i>Punctatisporites ubischii</i> (9) <i>Raistrickia crenata</i> (47) <i>Convruccosporites naumoviae</i> (48) <i>Indotriletes australensis</i> (69) <i>Punctatisporites gracilis</i> (7) <i>Horriditriletes ramosus</i> (40) <i>Verrucosporites andersonii</i> (54) <i>Deltoispora directa</i> (4) <i>Verrucosporites moriatius</i> (53) <i>Vallatisporites</i> sp. (84) <i>Inapertisporites inapertus</i> (166) <i>Tasmanites</i> sp. (184) <i>Lophotriletes novicus</i> (31) <i>Cristatisporites</i> sp. A (78) <i>Densosporites rotundus</i> (80) <i>Granulatisporites papillosus</i> (15) <i>Gnetaceapollenites</i> sp. (157) <i>Pachytriletes splendens</i> (5) <i>Horriditriletes uruguanensis</i> (42) <i>Apiculatisporites cornutus</i> (22) <i>Apiculatisporites levis</i> (24) <i>Convruccosporites pseudoreticulatus</i> (49) <i>Vallatisporites</i> sp. A (85) <i>Retusotriletes golatensis</i> (12) <i>Apiculatisporites parmatius</i> (26) <i>Convruccosporites irregularis</i> (50) <i>Convruccosporites</i> sp. A (52) <i>Horriditriletes tereteangulatus</i> (41) <i>Cristatisporites lestai</i> (72) <i>Calamospora apitata</i> (1) <i>Cristatisporites microvacuolatus</i> (73) <i>Granulatisporites trisinus</i> (17) <i>Densosporites</i> sp. (79) <i>Horriditriletes curvabaculosus</i> (43) <i>Horriditriletes</i> sp. (45) <i>Granulatisporites</i> sp. A (19) <i>Cristatisporites menendezii</i> (76) <i>Arabispheera bellula</i> (178) <i>Cristatisporites inconstans</i> (71) <i>Horriditriletes gondwanensis</i> (44) <i>Tetraspora</i> sp. (168) <i>Lophotriletes</i> sp. (33) <i>Lophotriletes</i> sp. A (34) <i>Diversosporites minor</i> (29) <i>Lophotriletes rarus</i> (32) <i>Retusotriletes diversiformis</i> (11) <i>Arabispheera</i> sp. (179) <i>Apiculatisporites unicus</i> (23) <i>Mychrystridium</i> sp. (167) <i>Cirrabaculisporites plumsteadiae</i> (35) <i>Lundbladisporella gracilis</i> (83) <i>Concavisporites mortonii</i> (2) <i>Cristatisporites</i> sp. (77) <i>Concavisporites</i> sp. (3) <i>Granulatisporites</i> sp. (18) <i>Cristatisporites spinosus</i> (75) <i>Cirrabaculisporites</i> sp. (38) <i>Cymatiosphaera gondwanensis</i> (180) <i>Foveosporites karroensis</i> (62) <i>Anacanthotriletes</i> sp. A (21) <i>Dioctritriletes ericanius</i> (28) <i>Lophotriletes rectus</i> (30) <i>Cyclogranisporites</i> sp. (14) <i>Cymatiosphaera</i> sp. B (182) <i>Horriditriletes brevis</i> (35) <i>Laevigatosporites plicatus</i> (87) <i>Clavatisporites</i> sp. (68) <i>Microreticulatisporites</i> sp. (66) <i>Microreticulatisporites</i> sp. A (67) <i>Limitisporites monstruosus</i> (111) <i>Cycloptiles foliularis</i> (164) <i>Plicatipollenites densus</i> (99) <i>Plicatipollenites</i> sp. (101) <i>Plicatipollenites</i> sp. A (102) <i>Plicatipollenites</i> sp. B (103) <i>Vittatina saccifer</i> (149) <i>Ephedripites</i> sp. (143) <i>Ephedripites</i> sp. A (144) <i>Cycadopytes cymbatus</i> (161) <i>Protohaploxylinus</i> sp. (137) <i>Plicatipollenites gondwanensis</i> (98) <i>Protohaploxylinus hartii</i> (135) <i>Vittatina minima</i> (148) <i>Pakhapites ovatus</i> (156) <i>Ptericolpoidites</i> sp. (158) <i>Plicatipollenites trigonalis</i> (100) <i>Limitisporites rectus</i> (110) <i>Limitisporites</i> sp. (113) <i>Striatopodocarpites cancellatus</i> (139) <i>Caheniasaccites ovatus</i> (104) <i>Potonieisporites novicus</i> (106) <i>Lunatisporites variusacutus</i> (130) <i>Potonieisporites congoensis</i> (108) <i>Potonieisporites brasiliensis</i> (107) <i>Vestigisporites rudis</i> (114) <i>Barkarites rotatus</i> (94) <i>Pakhapites fusus</i> (155) <i>Striatopodocarpites rarus</i> (142) <i>Cannanopollis janakii</i> (86) <i>Hamiapollenites bullaeformis</i> (123) <i>Cycadopytes nevesi</i> (163) <i>Vittatina densa</i> (145) <i>Weylandites lucifer</i> (153) <i>Vittatina</i> sp. (151) <i>Weylandites magnus</i> (154) <i>Striatobielles multistriatus</i> (138) <i>Vittatina scutata</i> (147) <i>Lunatisporites nubilus</i> (129) <i>Alisporites ovatus</i> (116) <i>Protohaploxylinus limpudus</i> (134) <i>Protohaploxylinus rugatus</i> (136) <i>Limitisporites perspicuus</i> (112) <i>Cycadopytes glaber</i> (162) <i>Cannanopollis</i> sp. (87) <i>Lunatisporites</i> sp. (131) <i>Alisporites splendens</i> (119) <i>Strimonasaccites cruciatus</i> (92) <i>Vestigisporites ventrisaccatus</i> (115) <i>Caheniasaccites flavatus</i> (105) <i>Vittatina foveolata</i> (146) <i>Illinites spectabilis</i> (109) <i>Marsupipollenites striatus</i> (159) <i>Vittatina</i> sp. A (152) <i>Protohaploxylinus haigii</i> (132) <i>Alisporites australis</i> (117) <i>Pteruchipollenites</i> sp. (122) <i>Cycadopytes</i> sp. (165) <i>Alisporites potonei</i> (118) <i>Protohaploxylinus pereziguus</i> (135) <i>Marsupipollenites triadriatus</i> (160) <i>Lueckisporites virkikiae</i> (128) <i>Florinites eremus</i> (90) <i>Striatopodocarpites pantii</i> (141) <i>Platysaccus papilionis</i> (120) <i>Platysaccus</i> sp. (121) <i>Hamiapollenites saccatus</i> (125) <i>Striatopodocarpites fusus</i> (140)
					<p>.....</p> <p>S1 A</p> <p>S1 B</p> <p>S1 C</p> <p>S1 D</p> <p>S1 E</p> <p>S1 F</p> <p>S1 G</p> <p>S1 H</p> <p>S1 I</p> <p>S1 J</p> <p>.....</p>
					BIOHORIZONS

STRATI 1

2. STRATI ALL TAXA RANGES WITH BIOHORIZONS.

4. CKP6 ALL TAXA RANGES WITH BIOHORIZONS

CKP 6

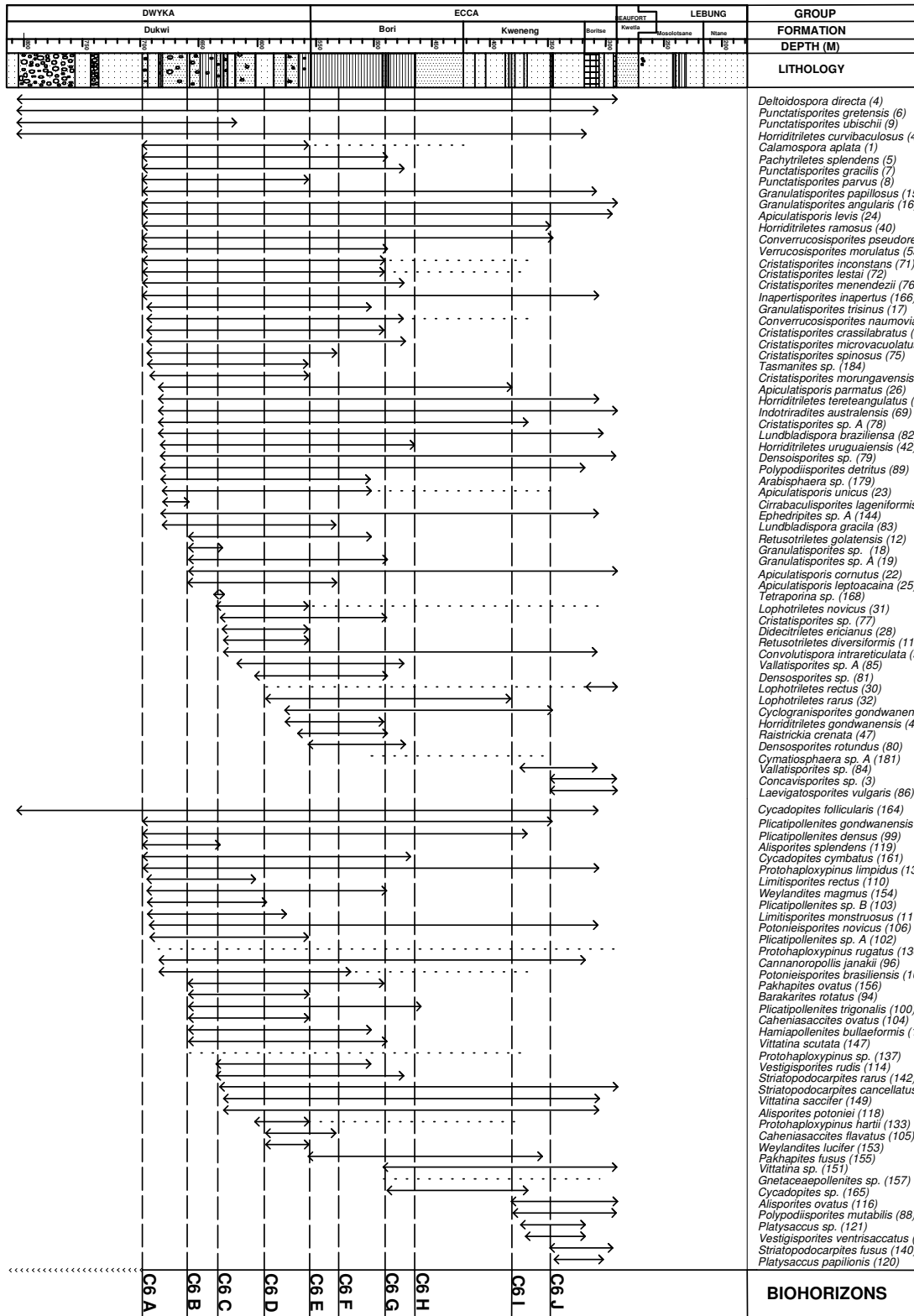

5. CKP9 ALL TAXA OCCURRENCE CHART

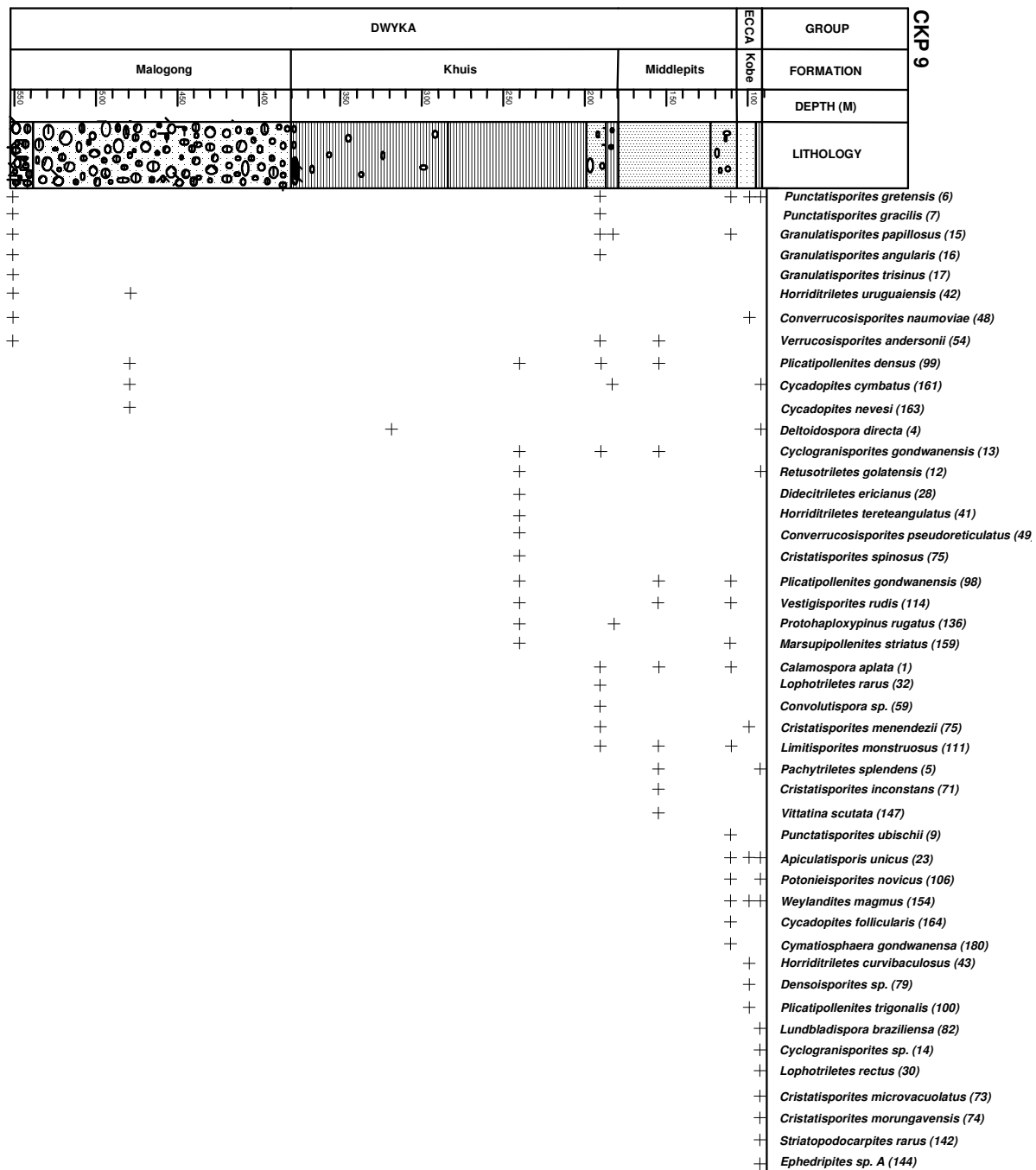

6. CKP9 ALL TAXA RANGES WITH BIOHORIZONS

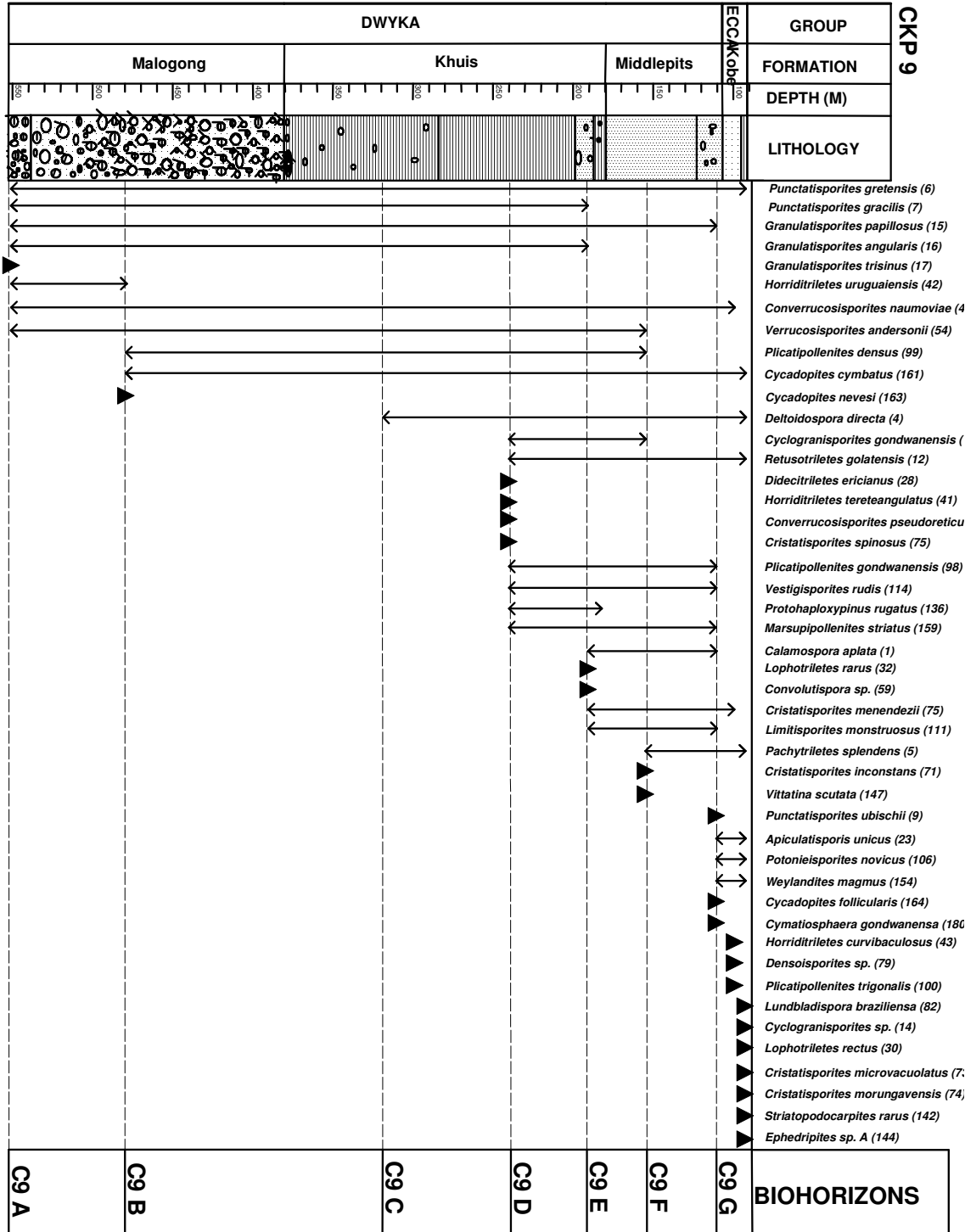

7. KGO3 ALL TAXA OCCURRENCE CHART.

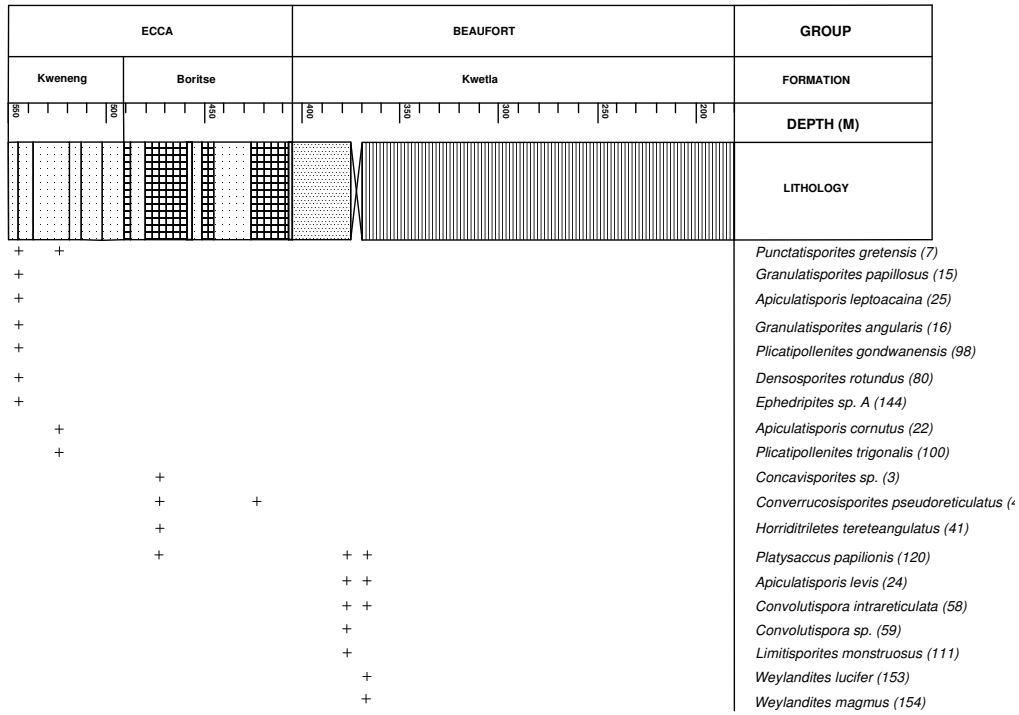

8. MLI1 ALL TAXA OCCURRENCE CHART.

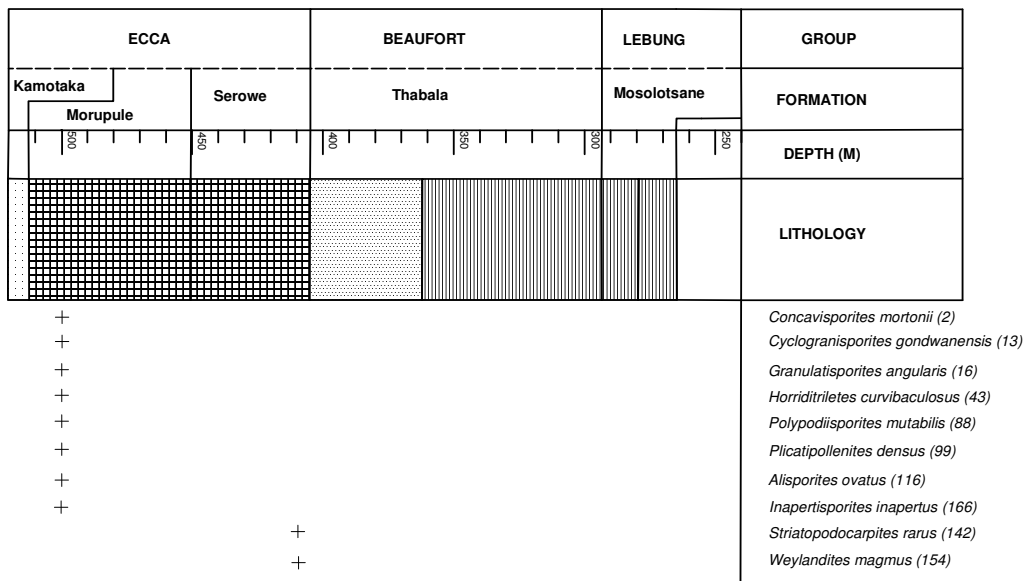

9. NATA ALL TAXA OCCURRENCE CHART.

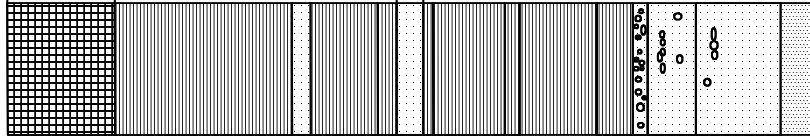
ECCA	BEAUFORT		LEBUNG		GROUP	
Tlapana	Thabala		Pandamatenga	Ngwasha	FORMATION	
550	500	550	500	450	400	DEPTH (M)
					LITHOLOGY	
+	+				<i>Punctatisporites gretensis</i> (6)	
+	+				<i>Granulatisporites angularis</i> (16)	
+					<i>Converrucosporites naumoviae</i> (48)	
+					<i>Inapertisporites inapertus</i> (166)	
		+			<i>Deltoidospora directa</i> (4)	
		+			<i>Lundbladispora braziliensa</i> (82)	
		+			<i>Cannanoropollis</i> sp. (97)	
		+			<i>Protohaploxypinus limpidus</i> (134)	

10. MES8 ALL TAXA OCCURRENCE CHART.

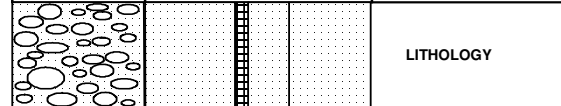
DWYKA	ECCA		GROUP			
Dukwi	Mosomane		FORMATION			
70	50	40	30	20	10	DEPTH (M)
					LITHOLOGY	
+						<i>Granulatisporites papillosus</i> (15)
+		+				<i>Granulatisporites angularis</i> (16)
+	+					<i>Granulatisporites trisinus</i> (17)
	+					<i>Calamospora aplata</i> (1)
	+	+				<i>Punctatisporites gretensis</i> (6)
	+		+			<i>Plicatipollenites gondwanensis</i> (98)
	+					<i>Cycadopites cymbatus</i> (161)
	+					<i>Inapertisporites inapertus</i> (166)
		+				<i>Cirrabaculisporites</i> sp. (38)
		+				<i>Lophotriletes rectus</i> (30)
		+				<i>Cannanoropollis janakii</i> (96)
			+			<i>Apiculatisporis levis</i> (24)
			+			<i>Apiculatisporis parmatus</i> (26)
			+			<i>Lundbladispora gracila</i> (83)
			+			<i>Vallatisporites</i> sp. A (85)
			+			<i>Limitisporites rectus</i> (110)
			+			<i>Protohaploxypinus limpidus</i> (134)
			+			<i>Platysaccus</i> sp. (121)
				+		<i>Apiculatisporis cornutus</i> (22)
				+		<i>Protohaploxypinus rugatus</i> (136)
					+	<i>Anacanthotriletes</i> sp. A (21)