



HAL
open science

Comportement dynamique de réseaux d'automates

Eric Goles Chacc

► **To cite this version:**

Eric Goles Chacc. Comportement dynamique de réseaux d'automates. Modélisation et simulation. Université Joseph-Fourier - Grenoble I, 1985. tel-00314526

HAL Id: tel-00314526

<https://theses.hal.science/tel-00314526>

Submitted on 27 Aug 2008

HAL is a multi-disciplinary open access archive for the deposit and dissemination of scientific research documents, whether they are published or not. The documents may come from teaching and research institutions in France or abroad, or from public or private research centers.

L'archive ouverte pluridisciplinaire **HAL**, est destinée au dépôt et à la diffusion de documents scientifiques de niveau recherche, publiés ou non, émanant des établissements d'enseignement et de recherche français ou étrangers, des laboratoires publics ou privés.

THESE

Informatique, Mathématiques Appliquées de Grenoble
CNRS - INPG - USMG
MÉDIATHÈQUE

présentée à

l'Université Scientifique et Médicale de Grenoble

B.P. 68
38000 GRENOBLE
FRANCE
Tél. (76) 51.46.36

par

Eric GOLES CHAGG

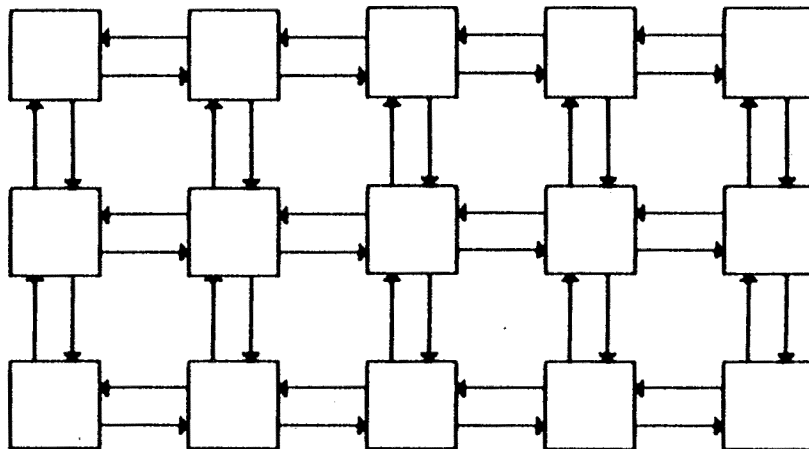

COMPORTEMENT DYNAMIQUE DE RESEAU D'AUTOMATES.



Thèse soutenue le 6 février 1985 devant la Commission d'Examen :

M. NIVAT	Président
C. BENZAKEN	} Examineurs
Ph. JORRAND	
M. MENDES-FRANCE	
D. PERRIN	
F. ROBERT	
G. WEISBUCH	

UNIVERSITE SCIENTIFIQUE ET MEDICALE DE GRENOBLE

Année universitaire 1982-1983

Président de l'Université : M. TANCHE

MEMBRES DU CORPS ENSEIGNANT DE L'U.S.M.G.

(RANG A)

SAUF ENSEIGNANTS EN MEDECINE ET PHARMACIE

PROFESSEURS DE 1ère CLASSE

ARNAUD Paul	Chimie organique
ARVIEU Robert	Physique nucléaire I.S.N.
AUBERT Guy	Physique C.N.R.S.
AYANT Yves	Physique approfondie
BARBIER Marie-Jeanne	Electrochimie
BARBIER Jean-Claude	Physique expérimentale C.N.R.S. (labo de magnétisme)
BARJON Robert	Physique nucléaire I.S.N.
BARNOUD Fernand	Biosynthèse de la cellulose-Biologie
BARRA Jean-René	Statistiques - Mathématiques appliquées
BELORISKY Elie	Physique
BENZAKEN Claude (M.)	Mathématiques pures
BERNARD Alain	Mathématiques pures
BERTRANDIAS Françoise	Mathématiques pures
BERTRANDIAS Jean-Paul	Mathématiques pures
BILLET Jean	Géographie
BONNIER Jean-Marie	Chimie générale
BOUCHEZ Robert	Physique nucléaire I.S.N.
BRAVARD Yves	Géographie
CARLIER Georges	Biologie végétale
CAUQUIS Georges	Chimie organique
CHIBON Pierre	Biologie animale
COLIN DE VERDIERE Yves	Mathématiques pures
CRABBE Pierre (détaché)	C.E.R.M.O.
CYROT Michel	Physique du solide
DAUMAS Max	Géographie
DEBELMAS Jacques	Géologie générale
DEGRANGE Charles	Zoologie
DELOBEL Claude (M.)	M.I.A.G. Mathématiques appliquées
DEPORTES Charles	Chimie minérale
DESRE Pierre	Electrochimie
DOLIQUE Jean-Michel	Physique des plasmas
DUCROS Pierre	Cristallographie
FONTAINE Jean-Marc	Mathématiques pures
GAGNAIRE Didier	Chimie physique

.../...

GASTINEL Noël	Analyse numérique - Mathématiques appliquées
GERBER Robert	Mathématiques pures
GERMAIN Jean-Pierre	Mécanique
GIRAUD Pierre	Géologie
IDELMAN Simon	Physiologie animale
JANIN Bernard	Géographie
JOLY Jean-René	Mathématiques pures
JULLIEN Pierre	Mathématiques appliquées
KAHANE André (détaché DAFCO)	Physique
KAHANE Josette	Physique
KOSZUL Jean-Louis	Mathématiques pures
KRAKOWIAK Sacha	Mathématiques appliquées
KUPTA Yvon	Mathématiques pures
LACAZE Albert	Thermodynamique
LAJZEROWICZ Jeannine	Physique
LAJZEROWICZ Joseph	Physique
LAURENT Pierre	Mathématiques appliquées
DE LEIRIS Joël	Biologie
LLIBOUTRY Louis	Géophysique
LOISEAUX Jean-Marie	Sciences nucléaires I.S.N.
LOUP Jean	Géographie
MACHE Régis	Physiologie végétale
MAYNARD Roger	Physique du solide
MICHEL Robert	Minéralogie et pétrographie (géologie)
MOZIERES Philippe	Spectrométrie - Physique
OMONT Alain	Astrophysique
OZENDA Paul	Botanique (biologie végétale)
PAYAN Jean-Jacques (détaché)	Mathématiques pures
PEBAY PEYROULA Jean-Claude	Physique
PERRIAUX Jacques	Géologie
PERRIER Guy	Géophysique
PIERRARD Jean-Marie	Mécanique
RASSAT André	Chimie systématique
RENARD Michel	Thermodynamique
RICHARD Lucien	Biologie végétale
RINAUDO Marguerite	Chimie CERMAV
SENGEL Philippe	Biologie animale
SERGERAERT Francis	Mathématiques pures
SOUTIF Michel	Physique
VAILLANT François	Zoologie
VALENTIN Jacques	Physique nucléaire I.S.N.
VAN CUTSEN Bernard	Mathématiques appliquées
VAUQUOIS Bernard	Mathématiques appliquées
VIALON Pierre	Géologie

PROFESSEURS DE 2ème CLASSE

ADIBA Michel	Mathématiques pures
ARMAND Gilbert	Géographie

AURIAULT Jean-Louis	Mécanique
BEGUIN Claude (M.)	Chimie organique
BOEHLER Jean-Paul	Mécanique
BOITET Christian	Mathématiques appliquées
BORNAREL Jean	Physique
BRUN Gilbert	Biologie
CASTAING Bernard	Physique
CHARDON Michel	Géographie
COHENADDAD Jean-Pierre	Physique
DENEUVILLE Alain	Physique
DEPASSEL Roger	Mécanique des fluides
DOUCE Roland	Physiologie végétale
DUFRESNOY Alain	Mathématiques pures
GASPARD François	Physique
GAUTRON René	Chimie
GIDON Maurice	Géologie
GIGNOUX Claude (M.)	Sciences nucléaires I.S.N.
GUITTON Jacques	Chimie
HACQUES Gérard	Mathématiques appliquées
HERBIN Jacky	Géographie
HICTER Pierre	Chimie
JOSELEAU Jean-Paul	Biochimie
KERCKOVE Claude (M.)	Géologie
LE BRETON Alain	Mathématiques appliquées
LONGEQUEUE Nicole	Sciences nucléaires I.S.N.
LUCAS Robert	Physiques
LUNA Domingo	Mathématiques pures
MASCLE Georges	Géologie
NEMOZ Alain	Thermodynamique (CNRS - CRTBT)
OUDET Bruno	Mathématiques appliquées
PELMONT Jean	Biochimie
PERRIN Claude (M.)	Sciences nucléaires I.S.N.
PFISTER Jean-Claude (détaché)	Physique du solide
PIBOULE Michel	Géologie
PIERRE Jean-Louis	Chimie organique
RAYNAUD Hervé	Mathématiques appliquées
ROBERT Gilles	Mathématiques pures
ROBERT Jean-Bernard	Chimie physique
ROSSI André	Physiologie végétale
SAKAROVITCH Michel	Mathématiques appliquées
SARROT REYNAUD Jean	Géologie
SAXOD Raymond	Biologie animale
SOUTIF Jeanne	Physique
SCHOOL Pierre-Claude	Mathématiques appliquées
STUTZ Pierre	Mécanique
SUBRA Robert	Chimie
VIDAL Michel	Chimie organique
VIVIAN Robert	Géographie

**COMPORTEMENT
DYNAMIQUE DE RESEAUX
D'AUTOMATES**

**La lluvia de nuevo y
este invierno de cara
al más inmediato por venir
en Santiago del único extremo
queriéndolo como el patio de las
paulonias en verano allá y está
nuestra porfía y la certeza
afirmandonos para los tiempos
que corren**

Grenoble Febrero 1985

Monsieur le Professeur M. NIVAT m'a fait l'honneur de présider le Jury de cette Thèse. Je lui adresse mes plus vifs remerciements.

Monsieur le Professeur F. ROBERT m'a proposé ce sujet de recherche dès le début de mon troisième cycle, et je veux lui exprimer ici ma plus profonde gratitude. Il n'a jamais cessé de m'encourager, et j'ai apprécié toutes ses qualités, tant scientifiques qu'humaines.

Monsieur le Professeur D. PERRIN a suivi et encouragé mes recherches depuis mon entrée au CNRS et jugé ce travail, je lui exprime toute ma reconnaissance.

Je remercie également Monsieur le Professeur M. MENDES-FRANCE pour l'intérêt qu'il a manifesté pour mes recherches et pour avoir accepté de juger cette Thèse.

Je tiens à exprimer ici toute ma reconnaissance à Monsieur le Professeur G. WEISBUCH pour les discussions que nous avons eues autour de mes travaux et leurs relations avec des problèmes physiques et pour avoir accepté de siéger dans le Jury.

Je remercie aussi Messieurs les Professeurs C. BENZAKEN et P. JORRAND de participer au Jury.

Beaucoup des travaux de cette Thèse ont été menés en commun avec différents chercheurs. Je leur exprime ici toute ma reconnaissance, tout particulièrement à mes amis M. COSNARD, J. DEMONGEOT, F. FOGELMAN, S. MARTINEZ et M. TCHUENTE. Je témoigne du grand plaisir que j'ai eu à travailler avec eux.

Je remercie le DEPARTAMENTO DE MATEMATICAS de l'Ecole d'Ingénieurs de l'UNIVERSITE du CHILI, où je me suis initié à la recherche, ainsi que l'Equipe d'ALGORITHMIQUE MATHEMATIQUE du Laboratoire TIM-3.

Comment ne pas remercier ici HAYDEE, DALMA, leurs parents et les miens pour leur patience, leurs encouragements et, presque en Espagnol, tant de vécu que je leur dois.

Finalement, je tiens à remercier le Service de Reprographie pour sa gentillesse et sa compétence.

TABLE DES MATIERES

INTRODUCTION	3
CHAPITRE I : PERIODICITE ET OPERATEURS INVARIANTS	15
- <i>Comportement itératif des fonctions de majorité</i>	19
- <i>Comportement dynamique de réseaux neuronaux</i>	33
- <i>Convergence d'automates à seuil</i>	51
- <i>Périodicité d'automates à multiseuil</i>	73
CHAPITRE II : DYNAMIQUE D'AUTOMATES UNIDIMENTIONNELS	79
- <i>Points fixes et périodes d'automates à seuil dans \mathbb{Z}</i>	83
- <i>Automates effaceurs à multiseuil</i>	109
CHAPITRE III : ENERGIE ASSOCIEE AUX RESEAUX D'AUTOMATES	125
- <i>Energie associée à l'itération Série</i>	153
- <i>Vitesse de convergence</i>	159
CHAPITRE IV : RESEAUX POSITIFS	173
CHAPITRE V : STRUCTURE CYCLIQUE D'UNE EQUATION NEURONALE	209
- <i>Comportement dynamique d'un automate à mémoire</i>	213
- <i>Structure des bifurcations d'une équation neuronale</i>	225
ANNEXE	267
- <i>Caractérisation des réseaux booléens</i>	271
- <i>Réseaux de contrôle logique</i>	287
REFERENCES	309

INTRODUCTION

INTRODUCTION

Le thème central de l'ensemble d'articles présentés dans cette thèse, est l'étude de la dynamique des réseaux d'automates non-uniformes. Ces réseaux peuvent être décrits comme des systèmes constitués d'éléments répartis aux sommets d'un graphe, non nécessairement régulier, chaque élément interagissant avec ses voisins (au sens d'un graphe de connexion). Un élément peut être décrit par une machine déterministe recevant des signaux d'entrée (provenant des autres éléments), susceptible de prendre un nombre fini d'états et dont la fonction de transition ne dépend que des états des éléments voisins, la sortie étant identique à son état interne.

Un réseaux d'automates est constitué donc, par un grand nombre de telles "machines" (ou "cellules") interconnectées. La dynamique d'un tel réseaux est définie par l'évolution, dans une échelle temporelle discrète, de l'état de chaque élément du réseau. Cette évolution peut s'effectuer en parallèle (toutes les machines changeant d'état de manière synchrone en fonction de l'état du réseau à l'étape précédente), avec mémoire (l'état à l'instant t dépend des états aux instants $t-1, t-2, \dots, t-k$; k étant appelée la longueur de la mémoire), en série (les machines changent d'état l'une après l'autre, selon une séquence prédéterminée),

Exemple: Ensemble d'états $E = \{0,1\}$

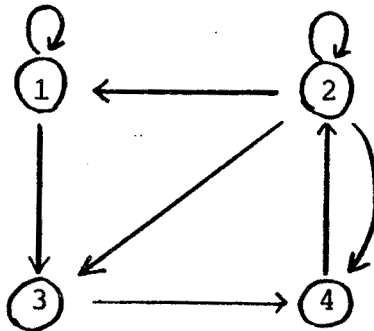

fonctions associées à chaque machine:

$$f_1(x_1, x_2) = \mathbb{I}[x_1 + x_2 - 1] ; f_2(x_2, x_4) = \mathbb{I}[x_2 + x_4 - 2]$$

$$f_3(x_1, x_2) = \mathbb{I}[x_1 + x_2 - 1] ; f_4(x_2, x_3) = \mathbb{I}[x_2 + x_3 - 2]$$

$$\text{où } \mathbb{I}[u] = \begin{cases} 0 & \text{si } u < 0 \\ 1 & \text{sinon} \end{cases}$$

et $(x_1, x_2, x_3, x_4) \in \{0,1\}^4$

Itération parallèle:

$$x_1(t+1) = f_1(x_1(t), x_2(t)) ; x_2(t+1) = f_2(x_2(t), x_4(t))$$

$$x_3(t+1) = f_3(x_1(t), x_2(t)) ; x_4(t+1) = f_4(x_2(t), x_3(t))$$

Prenons la configuration initiale:

$$(x_1(0), x_2(0), x_3(0), x_4(0)) = (1, 1, 0, 1) :$$

t = 0 t = 1 t = 2 t = 3

(1,1,0,1) → (1,1,1,0) → (1,0,1,1) → (1,0,1,0) point fixe.

Itération série: On choisit l'ordre de balayage: 4,3,2,1. En partant de la même configuration initiale on a l'évolution suivante:

t = 0 t = 1

(1,1,0,1) → (1,0,1,0) point fixe

Le type de fonctions de l'exemple précédent est en fait très important dans le contexte de cette thèse.

Ces fonctions ont été conçues par W.Mc.Culloch et M.Pitts [69] pour décrire certaines propriétés du système nerveux et appelées neurones formels. Un neurone formel est une machine possédant n entrées $x_1, x_2, \dots, x_n \in \{0,1\}$ et une sortie, y. Et caractérisé par un seuil, b, et des poids a_1, a_2, \dots, a_n associés aux n entrées. Le neurone formel travaille avec une échelle de temps discret, $t = 0, 1, 2, \dots$, et il calcule sa sortie, à l'étape t+1, selon la fonction:

$$y = f(x_1, \dots, x_n) = \text{III} \left[\sum_{j=1}^n a_j x_j - b \right]$$

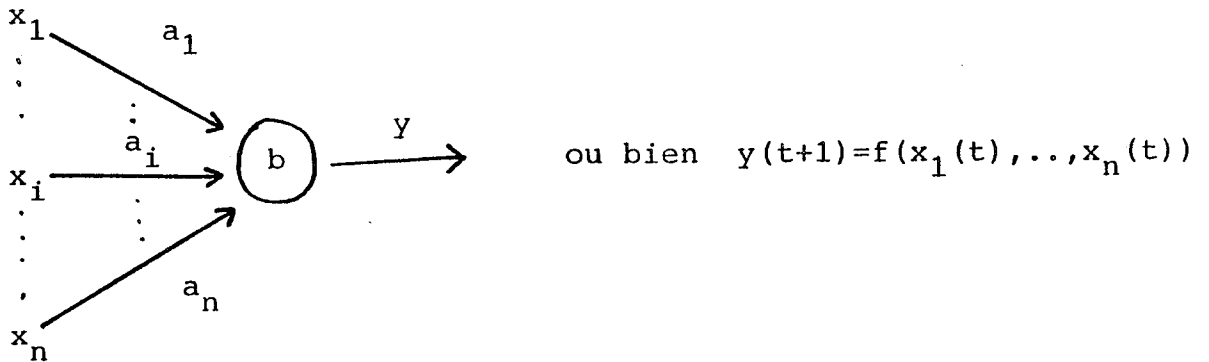

Les poids a_j positifs correspondent à des "synapses" excitatrices et ceux négatifs aux "synapses" inhibitrices.

On appelle fonction à seuil celle qui définit un neurone formel.

Il est clair qu'on peut relier plusieurs neurones formels et de cette manière construire un réseau d'automates appelé réseau neuronal. De plus, on a démontré, qu'en interconnectant des neurones formels, on peut simuler n'importe quel automate fini [60,69], ce qui met en évidence la richesse dynamique d'un tel modèle.

La dynamique de ces réseaux a été très étudiée, aussi bien du point de vue théorique que appliqué; cf. [23,24,25,41,43,54,57,68,76,81,82,84,85,96].

Dans cette thèse on étudie de façon générale des propriétés dynamiques de réseaux proches aux réseaux neuronaux. Les études antérieures consacrées à ce sujet

utilisent des outils très liés à la topologie du réseau aussi bien qu'à la nature de la fonction locale de transition (en général la même sur tout le réseau). Mon approche du problème est différente, car j'ai recherché des outils mathématiques de nature globale permettant d'étudier la dynamique d'une large classe de réseaux, dont les réseaux neuronaux. Ces outils tiennent compte de propriétés très générales du réseau (tels que la symétrie) permettant alors d'englober de larges classes d'automates. Ces outils sont essentiellement de deux types: Un opérateur monotone associé au réseau et un autre de nature algébrique. Le premier est présenté sous le nom d'opérateur d'énergie. Il consiste à associer à un automate une fonction qui décroît au cours de la phase transitoire et permet d'obtenir des bornes sur la longueur du transitoire. Le deuxième outil, de nature beaucoup plus algébrique, est un invariant qui prend en compte la structure globale du réseau et le type d'itération envisagé; cette approche s'avère très féconde pour l'étude de la structure des cycles.

La théorie des réseaux d'automates s'est beaucoup développée au cours des années 60 en liaison avec l'informatique. Les développements récents (dont ceux présentés dans cette thèse) témoignent d'un changement d'optique profond, car ils montrent clairement un glissement vers des applications en biologie et en physique, en adoptant même un langage assez proche de celui d'un physicien. La conclusion qui se dégage donc de cette étude est que l'interaction entre réseaux d'automates et certains phénomènes physiques ne se situe pas au niveau d'une simple analogie. En effet, cette interaction a permis d'une part une meilleure

compréhension de certains problèmes rencontrés en physique; c'est, par exemple, le cas de l'itération du type Monte - Carlo appliquée à la recherche d'un fondamental du problème de verres de spins (convergence lente, règle du spin fou, [40,57,76,], etc...). D'autre part, le concept physique d'énergie s'avère très puissant pour l'étude d'une large classe de réseaux d'automates pour lesquels les approches de type combinatoire avaient échoué.

Contenu de la thèse

Au premier chapitre on étudie le comportement périodique de divers réseaux d'automates. L'hypothèse de base pour mener à bien cette étude est la symétrie du réseau; c'est-à-dire que si la cellule i est connectée à la cellule j , avec un poids a , alors on a la même interaction entre j et i :

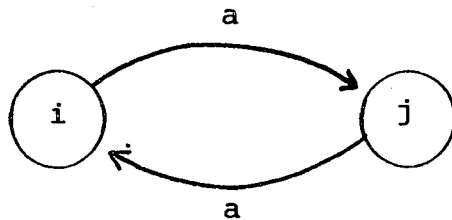

Cette hypothèse, malgré sa particularité, est l'une des conditions de base dans les modèles d'automates uniformes.

En général et sauf cas particuliers, on travaille sur un graphe fini où chaque machine ne prend qu'un nombre fini d'états; en conséquence, au bout d'un

nombre fini d'itérations le réseau se trouve en régime stationnaire parcourant nécessairement une orbite finie (cycle ou point fixe).

Je propose pour l'étude de la longueur des cycles une approche algébrique basée sur un invariant associé à l'itération. On montre ainsi que:

- Sous certaines hypothèses de symétrie; la longueur des cycles associés à l'itération avec mémoire de longueur k , est un diviseur de $k+1$.
- Sous des hypothèses de positivité des coefficients du réseau, les itérations série-parallèle convergent toujours vers des points fixes.

Les résultats précédents s'appliquent aux réseaux neuronaux, de majorité, de fonctions à seuil et à multiseuils.

Au chapitre deux on se place dans le cadre d'automates uniformes, à seuil et à multiseuils, unidimensionnels; le graphe de connexion étant identifié à \mathbb{Z} et chaque machine i ne dépendant que de r voisines à gauche et à droite:

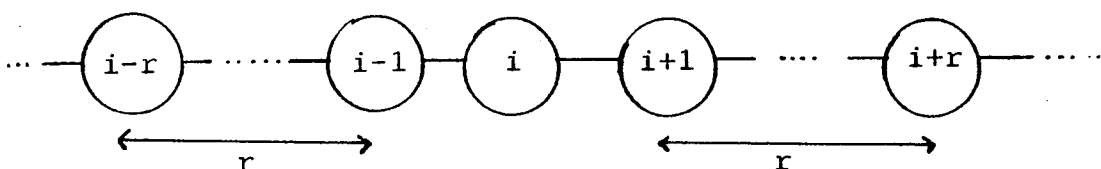

Dans ce contexte j'étudie les problèmes suivants:

- Détermination de la taille critique du voisinage pour laquelle la dynamique change (passage d'un comportement stable à un comportement cyclique). On montre notamment que, dans le cas particulier de l'automate majorité (où chaque machine i attribue un poids $a \in \mathbb{N}$ à elle-même et 1 à ses voisines: $\{i-r, \dots, i+r\}$) alors pour $r < \frac{9a}{2}$ on a un comportement stable (la dynamique n'aboutit qu'à des points fixes) et pour $r > 5a-2$ on peut avoir des cycles.
- D'autre part, dans le cadre des fonctions à multiseuils, on étudie la complexité de la reconnaissance d'un automate "effaceur", c'est-à-dire, celui qui ramène toute configuration initiale finie à la configuration où toutes les machines sont à l'état de repos.

Après avoir caractérisé par des inéquations les automates effaceurs à deux et trois états, on montre que, dans la classe d'automates à quatre états, les vecteurs de seuil correspondant aux effaceurs ne forment pas un ensemble convexe, ce qui illustre la complexité du problème.

Ce type de problèmes avait été étudié par divers auteurs, entre autres [36,91,92].

Il faut signaler que si j'ai pu mener à bien ces études c'est grâce aux résultats présentés au premier chapitre et à ceux obtenus par M.Tchuinte [84].

Au chapitre trois on étudie la dynamique des diverses itérations conduites sur un réseau d'automates à seuil symétrique. L'idée de base, consiste à associer au réseau un fonctionnel d'énergie qui permet l'étude de l'évolution, tant en régime transitoire que dans la phase stationnaire.

La fonction d'énergie introduite est très proche de celle associée au verres de spins [17,57], pour lesquels on étudie ici la dynamique d'itérations déterministes (en série) conduites sur des fonctions de majorité.

On montre notamment que pour divers modes opératoires il est possible d'associer à un réseau symétrique un opérateur monotone décroissant, ce qui permet de donner:

- Une borne assez réaliste sur la longueur du transitoire (linéaire par rapport au nombre des machines dans le cas d'un réseau uniforme)
- Des résultats sur la dynamique d'une itération série dans le cadre de fonctions de majorité; on montre notamment le rôle joué par des autointeractions négatives (spin fou) dans l'apparition des cycles.
- Une nouvelle démonstration de certains résultats obtenus au chapitre-I sur la longueur des cycles.

D'autre part, on exhibe une famille de réseaux à seuils symétriques où la longueur du transitoire en mode parallèle est exponentielle en fonction du nombre de machines.

Finalement on montre la relation existant entre les opérateurs algébriques du chapitre-I et la fonction d'énergie introduite ici.

Au chapitre quatre on donne un cadre mathématique général qui permet de caractériser une large classe de fonctions locales pour lesquelles il est possible d'associer un opérateur d'énergie au réseau. La classe des réseaux ainsi définie admet, entre autres, comme cas particulier, les réseaux à seuil et de majorité généralisée.

Evidemment, l'énergie associée à un tel réseau gère toute sa dynamique; elle permet donc de l'étudier.

Au chapitre cinq on étudie le comportement itératif d'un modèle neuronal introduit par R.Caianello [1,2,23,24]. Ce modèle correspond à l'étude d'une itération avec mémoire conduite sur une fonction à seuil. Notamment, on caractérise la structure de bifurcations dans le cas de mémoire bornée et on montre que le nombre de rotations en fonction de la valeur du seuil est une approximation discrète d'un escalier du diable ou fonction de Cantor.

Dans le contexte de mémoire non bornée, on ramène l'étude au cas d'un système dynamique géré par une fonction linéaire par morceaux, ce qui permet de caractériser son évolution et notamment de retrouver un escalier du diable.

Enfin, dans l'annexe on présente deux études de réseaux d'automates booléens motivées par des problèmes de nature biologique, notamment la description des phénomènes de

contrôle génétique.

- Dans le premier papier on étudie des propriétés spatio-temporelles d'un réseau bidimensionnel de fonctions booléennes.
- Dans le deuxième on caractérise le comportement dynamique des itérations asynchrones des fonctions booléennes pour une classe particulière de réseaux.

En conclusion, il est important de signaler le fait suivant: Étant donnée la nature discrète des structures étudiées, les résultats dynamiques très généraux connus sont assez rares. Dans cette optique, je pense que mon travail a au moins le mérite de donner un cadre mathématique pour l'étude d'une classe non triviale d'automates non-uniformes, permettant ainsi de répondre aux divers problèmes posés par un processus itératif associé au réseau.

Enfin, je tiens à souligner pour terminer, que ce document de thèse regroupe divers articles élaborés tout au cours des quatre dernières années; On voit bien alors la progression de la démarche; certains résultats ont été obtenus de deux façons différentes d'autres constituent des généralisations, etc...

Cette présentation "chronologique" illustre le cheminement de mon travail dans un domaine où la démarche principale consiste en la recherche et la mise au point des outils mathématiques pertinents.

CHAPITRE I
PERIODICITE ET OPERATEURS
INVARIANTS

CHAPITRE-IPERIODICITE ET OPERATEURS INVARIANTS

Dans ce chapitre nous étudions le comportement périodique de divers réseaux d'automates. Pour ceci, nous avons développé une technique des opérateurs invariants associés aux réseaux [43,45,73]. L'idée de base est la suivante:

Considérons un réseau composé de n cellules C_i ; $i=1, \dots, n$; où chacune d'entre elles interagit avec ses voisines selon des fonctions:

$$f_i: Q^{r_i} \rightarrow Q \quad ; \quad Q \text{ un ensemble fini}$$

Nous nous intéressons à l'étude de la structure des périodes de l'itération parallèle sur le réseau :

$$x_i(t+1) = f_i(x(t)) \quad i=1, \dots, n$$

$$x(t) = (x_1(t), \dots, x_n(t)) \in Q^n$$

Comme Q^n est un ensemble fini, nous pouvons nous placer en régime stationnaire. Soit donc:

$$x_i = (x_i(0), \dots, x_i(T-1)) \quad i=1, \dots, n$$

l'orbite associée à la cellule C_i , où T est la période du réseau.

Pour les automates étudiés dans ce chapitre nous déterminons un opérateur $E(x_i, x_j)$ à valeurs réels ($i, j=1, \dots, n$), tel que:

$$\sum_{i,j} L(x_i, x_j) = 0 \quad (1)$$

$$\sum_{i,j} L(x_i, x_j) = 0 \quad \text{si } T \mid q \quad (2)$$

$$\sum_{i,j} L(x_i, x_j) < 0 \quad \text{si } T \nmid q \quad (3)$$

Evidemment, de (1), (2) et (3) on obtient que les périodes du réseau sont diviseurs de q . Bien sur, tout le problème est de déterminer la valeur de q qui convient (beaucoup de simulations ou... l'intuition) et, d'autre part, déterminer L .

Dans ce chapitre, nous présentons trois réussites de "à la recherche de l'opérateur caché", mais il est clair que cette technique n'est pas du tout "passe-partout" et, d'autre part, elle ne donne pas de renseignements sur d'autres aspects de la dynamique du réseau.

Les réseaux présentés ici viennent de divers domaines: biologie (réseaux neuronaux), dynamique des populations (majorité généralisée) et problèmes en relation avec les verres de spin (itérations série-parallèle).

Finalement, nous étudions aussi la structure des cycles des réseaux à multiseuil, en établissant un morphisme entre eux et un réseau à seuil, cas particulier d'un réseau neuronal.

**COMPORTEMENT ITERATIF
DES FONCTIONS DE MAJORITE
GENERALISEES**



ITERATIVE BEHAVIOUR OF GENERALIZED MAJORITY FUNCTIONS

Math. Soc. Sciences, 4, 1982
en collaboration avec M. Tchuente

1 - INTRODUCTION

Let n, p be two positive integers, let $\{\sigma_i; 1 \leq i \leq n\}$ be a collection of n permutations over $\{1, 2, \dots, n\}$ and let α be a mapping from $\{1, 2, \dots, p\}$ into \mathbb{R} .

We consider the mapping

$$\phi : \{1, 2, \dots, p\}^n \rightarrow \{1, 2, \dots, p\}^n$$

$$x = (x_1, \dots, x_n) \rightarrow (\phi_1(x), \dots, \phi_n(x))$$

defined by

$$\phi_i(x) = k \Leftrightarrow \begin{cases} \alpha(k) \sum_{x_j=k} a_{ij} \geq \alpha(r) \sum_{x_j=r} a_{ij} & \text{if } \sigma_i(k) \geq \sigma_i(r) \\ \alpha(k) \sum_{x_j=k} a_{ij} > \alpha(r) \sum_{x_j=r} a_{ij} & \text{if } \sigma_i(k) < \sigma_i(r) \end{cases}$$

where $a_{ij} \in \mathbb{R}$, $a_{ij} = a_{ji}$ for $i, j \in \{1, \dots, n\}$.

2 - PARALLEL ITERATION

In this section we study the iterative behaviour of ϕ , i.e. sequences of the form

$$x^0 \in \{1, 2, \dots, p\}^n, \quad x^{r+1} = \phi(x^r) \quad \text{for } r \geq 0$$

The behaviour of this model has been characterized by Póljak and Sura (1982) as follows :

THEOREM 1

For any $x^0 \in \{1, \dots, p\}^n$ there exists an integer s such that :

$$x^{r+2} = x^r \quad \text{for any } r \geq s .$$

COMMENTS

The Poljak and Sura's proof has been given in the particular case where

$$\alpha(k) = 1 \quad \text{for } k \in \{1, \dots, p\} \quad \text{and} \quad \sigma_i = \varepsilon_n$$

for $i \in \{1, \dots, n\}$

(ε_n denotes the identity permutation).

The interest of our proof is to provide an algebraic invariant associated with the iteration. This approach was introduced by Goles (1980), Goles and Olivos (1980), for the study of the iterative behaviour of symmetric threshold and multithreshold functions.

APPLICATION

Let us consider a society of n persons named P_1, P_2, \dots, P_n and let $\{\theta_1, \theta_2, \dots, \theta_p\}$ be the set of opinions which may be assumed by any person. The parameters of the problem can be interpreted as follows :

- $\alpha(k)$ is the weight of opinion θ_k
- a_{ij} is the weight of the interaction between P_i and P_j
- permutation σ_i is a local hierarchy adopted by P_i with respect to the different opinions.

Let $x = (x_1, x_2, \dots, x_n)$ represent the state of the society at instant t , i.e. P_i has opinion x_i . Clearly, with respect

to opinion θ_k , P_i is subjected to an influence whose total weight is

$$\alpha(k) = \sum_{x_j=k} a_{ij}$$

The function ϕ_i can be interpreted by saying that, at instant $t+1$, P_i selects the opinion of maximum hierarchy among those of maximum weight. If

$a_{ij} \in \{0,1\}$ for $j=1, \dots, n$ and if $\sum_{1 \leq j \leq n} a_{ij}$ is odd then ϕ_i is the classical majority transformation.

Theorem 1 says that in such a society, the opinion of any member P_i , after a certain number of steps either remains constant or oscillates between two values.

Let us now introduce some notations and definitions.

Since $\{1, \dots, p\}^n$ is finite, the sequence :

$$x^{r+1} = \phi(x^r), \quad r \geq 0; \quad x^0 \in \{1, 2, \dots, p\}^n$$

is ultimately periodic, i.e. there exist two positive integers s, T such that :

$$x^{r+T} = x^r \quad \text{for any } r \geq s$$

Let us denote

$$y^t = x^{s+t} \quad \text{for } t \geq 0$$

and let γ_i be the period of the sequence

$$\{y_i^t; t \geq 0\}$$

Clearly, any y_i^t , $i=1, \dots, p$ can be identified with the boolean vector

$$(y_i^{1,t}, \dots, y_i^{p,t}) \quad \text{where} \quad y_i^{k,t} = \begin{cases} 1 & \text{if } y_i^t = k \\ 0 & \text{otherwise} \end{cases}$$

We are now ready to introduce the algebraic invariant associated with the iteration, i.e.

$$L = \sum_{0 \leq t \leq T-1} \sum_{1 \leq i, j \leq n} L_{i,j}^t$$

where

$$L_{i,j}^t = a_{ij} \sum_{1 \leq k \leq p} \alpha(k) y_i^{k,t} (y_j^{k,t+1} - y_j^{k,t-1})$$

LEMMA 1 :

$$L = 0$$

PROOF :

Since

$$a_{ij} = a_{ji} \quad \text{for any } i, j=1, \dots, n$$

it is easily verified that :

$$\begin{aligned} \sum_{0 \leq t \leq T-1} L_{i,j}^t &= a_{ij} \sum_{0 \leq t \leq T-1} \sum_{1 \leq k \leq p} \alpha(k) y_i^{k,t} (y_j^{k,t+1} - y_j^{k,t-1}) \\ &= -a_{ji} \sum_{0 \leq t \leq T-1} \sum_{1 \leq k \leq p} \alpha(k) y_j^{k,t} (y_i^{k,t+1} - y_i^{k,t-1}) \\ &= - \sum_{0 \leq t \leq T-1} L_{j,i}^t \end{aligned}$$

Therefore

$$2L = \sum_{1 \leq i, j \leq n} \left(\sum_{0 \leq t \leq T-1} L_{i,j}^t + L_{j,i}^t \right) = 0$$

hence

$$L = 0 .$$

□

LEMMA 2 :

$$\text{If } \gamma_i \leq 2 \text{ then } S_i = \sum_{0 \leq t \leq T-1} \sum_{1 \leq j \leq n} L_{i,j}^t = 0$$

otherwise $S_i < 0$.

PROOF :

$$\begin{aligned} S_i &= \sum_{0 \leq t \leq T-1} \sum_{1 \leq j \leq n} a_{ij} \sum_{1 \leq k \leq p} \alpha^{(k)} y_i^{k,t} (y_j^{k,t+1} - y_j^{k,t-1}) \\ &= \sum_{0 \leq t \leq T-1} \sum_{1 \leq j \leq n} a_{ij} \sum_{1 \leq k \leq p} \alpha^{(k)} y_j^{k,t} (y_i^{k,t-1} - y_i^{k,t+1}) \end{aligned}$$

If $\gamma_i \leq 2$ then

$$y_i^{k,t-1} = y_i^{k,t+1} \text{ for } t \geq 0$$

hence

$$S_i = 0$$

Let us now assume that $\gamma_i > 2$. We can write

$$S_i = \sum_{0 \leq t \leq T-1} B_t$$

where

$$\begin{aligned}
 B_t &= \sum_{1 \leq j \leq n} a_{ij} \sum_{1 \leq k \leq p} \alpha^{(k)} y_j^{k,t} y_i^{k,t-1} \\
 &\quad - \sum_{1 \leq j \leq n} a_{ij} \sum_{1 \leq k \leq p} \alpha^{(k)} y_j^{k,t} y_i^{k,t+1} \\
 &= \alpha(y_i^{t-1}) \sum_{\substack{t \\ y_j = y_i^{t-1}}} a_{ij} - \alpha(y_i^{t+1}) \sum_{\substack{t \\ y_j = y_i^{t+1}}} a_{ij}
 \end{aligned}$$

Since $y_i^{t+1} = \phi_i(y_i^t)$, it follows from the definition of ϕ_i that :

$$\sigma_i(y_i^{t-1}) \geq \sigma_i(y_i^{t+1}) \text{ implies } B_t \leq 0$$

and

$$\sigma_i(y_i^{t-1}) < \sigma_i(y_i^{t+1}) \text{ implies } B_t < 0$$

Since $\gamma_i > 2$, there exists $\bar{t} \in \{0, 1, \dots, T-1\}$ such that

$$\sigma_i(y_i^{\bar{t}-1}) < \sigma_i(y_i^{\bar{t}+1})$$

hence

$$B_{\bar{t}} < 0 \text{ and } S_i = \sum_{0 \leq t \leq T-1} B_t < 0 .$$

□

PROOF OF THE THEOREM :

$$L = \sum_{1 \leq i \leq n} S_i = 0 \text{ (Lemma 1)}$$

where

$$S_i \leq 0 \text{ for } i=1, \dots, n \text{ (Lemma 2).}$$

Thus

$$S_i = 0 \quad \text{for } i=1, \dots, n$$

and from the proof of the preceding lemma, it follows that

$$\gamma_i \leq 2 \quad \text{for } i=1, \dots, n$$

□

3 - SEQUENTIAL ITERATION

Now we consider, for the generalized majority rule, the sequential iteration defined by $x^0 \in \{1, \dots, p\}^n$ and :

$$\begin{aligned} x_1^{t+1} &= \phi_1(x_1^t, \dots, x_n^t) \\ &\vdots \\ x_i^{t+1} &= \phi_i(x_1^{t+1}, \dots, x_{i-1}^{t+1}, x_i^t, \dots, x_n^t) \\ &\vdots \\ x_n^{t+1} &= \phi_n(x_1^{t+1}, \dots, x_{n-1}^{t+1}, x_n^t) \end{aligned}$$

Such an iteration modelizes a situation where, at instant t , person P_1 first adjusts its opinion, followed by P_2, P_3, \dots, P_n ; the linear order $P_1 < P_2 < P_3 < \dots < P_n$ associated with such an iteration, may correspond, for instance to a hierarchy in the population.

The dynamical behaviour is then given by the following result.

THEOREM 2 :

If $\alpha(k) a_{ii} \geq 0$ for any $k \in \{1, \dots, p\}$ and $i \in \{1, \dots, n\}$ then the sequential iteration only admits fixed points, i.e. for any $x^0 \in \{1, 2, \dots, p\}^n$, there exists an integer s such that :

$$x^{r+1} = x^r \quad \text{for any } r \geq s .$$

PROOF : (Similar to the proof of theorem 1)

There exist two positive integers s, T such that

$$x^{r+T} = x^r \quad \text{for any } r \geq s$$

Let us denote $y^t = x^{r+t}$, $t \geq 0$, and let γ_i be the period of $\{y_i^t; t \geq 0\}$. We introduce the algebraic invariant :

$$L = \sum_{0 \leq t \leq T-1} \sum_{1 \leq i, j \leq n} L_{i,j}^t$$

where

$$L_{i,j}^t = \begin{cases} a_{ij} \sum_{1 \leq k \leq p} \alpha(k) y_i^{k,t} (y_j^{k,t+1} - y_j^{k,t}) & \text{if } j < i \\ 0 & \text{if } j = i \\ a_{ij} \sum_{1 \leq k \leq p} \alpha(k) y_i^{k,t} (y_j^{k,t} - y_j^{k,t-1}) & \text{if } j > i \end{cases}$$

It is easily verified that for any $i, j \in \{1, \dots, n\}$

$$L_{i,j} = \sum_{0 \leq t \leq T-1} L_{i,j}^t = - \sum_{0 \leq t \leq T-1} L_{j,i}^t = -L_{j,i}$$

hence

$$L = \sum_{1 \leq i, j \leq n} L_{i,j} = 0$$

Let us consider

$$S_i = \sum_{0 \leq t \leq T-1} \sum_{1 \leq j \leq n} L_{i,j}^t = \sum_{0 \leq t \leq T-1} (U_t - V_t)$$

$$\text{where } U_t = \sum_{1 \leq k \leq p} \alpha(k) y_i^{k,t} \left(\sum_{j < i} a_{ij} y_j^{k,t+1} + \sum_{j > i} a_{ij} y_j^{k,t} \right)$$

and

$$V_t = \sum_{1 \leq k \leq p} \alpha(k) y_i^{k,t} \left(\sum_{j < i} a_{ij} y_j^{k,t} + \sum_{j > i} a_{ij} y_j^{k,t-1} \right)$$

Clearly, we can write

$$S_i = \sum_{0 \leq t \leq T-1} (U_t - V_{t+1})$$

Let us denote $z^t = (y_1^{t+1}, \dots, y_{i-1}^{t+1}, y_i^t, \dots, y_n^t)$ and

$$\delta(a,b) = \begin{cases} 1 & \text{if } a=b \\ 0 & \text{otherwise} \end{cases}$$

It is easily verified that

$$\begin{aligned} B_t &= U_t - V_{t+1} + \alpha(y_i^t) a_{ii} [1 - \delta(y_i^t, y_i^{t+1})] \\ &= \sum_{z_j^t = y_i^t} a_{ij} \alpha(z_j^t) - \sum_{z_j^t = y_i^{t+1}} a_{ij} \alpha(z_j^t) \end{aligned}$$

Since $y_i^{t+1} = \phi_i(z_1^t, \dots, z_n^t)$ it follows that

$$\sigma_i(y_i^{t+1}) \geq \sigma_i(y_i^t) \text{ implies } B_t \leq 0$$

$$\sigma_i(y_i^{t+1}) < \sigma_i(y_i^t) \text{ implies } B_t < 0$$

If $\gamma_i \geq 2$, then there exists \bar{t} such that

$$\sigma_i(y_i^{\bar{t}+1}) < \sigma_i(y_i^{\bar{t}})$$

thus

$$U_t - V_{t+1} \leq B_t < 0$$

The rest of the proof is similar to the proof of theorem 1. □

5 - OTHER EXTENSIONS

5.1. SEQUENTIAL-PARALLEL ITERATION

We can consider, for the generalized majority rule the general case of "sequential-parallel iteration".

Let $\{J_1, \dots, J_q\}$ be an ordered partition of the set $\{1, \dots, n\}$, i.e. if $k < m$, the integers belonging to J_k are smaller than those in J_m .

We define the "sequential-parallel iteration" as follows

For $i \in J_m$:

$$x_i^{t+1} = k \Leftrightarrow \begin{cases} \alpha(k) \left[\sum_{j \in A_m} x_j^{t+1} + \sum_{j \in \bar{A}_m} x_j^t \right] \geq \alpha(r) \left[\sum_{j \in A_m} x_j^{t+1} + \sum_{j \in \bar{A}_m} x_j^t \right] & \text{if } \sigma_i(k) \geq \sigma_i(r) \\ \alpha(k) \left[\sum_{j \in A_m} x_j^{t+1} + \sum_{j \in \bar{A}_m} x_j^t \right] > \alpha(r) \left[\sum_{j \in A_m} x_j^{t+1} + \sum_{j \in \bar{A}_m} x_j^t \right] & \text{if } \sigma_i(k) < \sigma_i(r) \end{cases}$$

where $A_m = \bigcup_{1 \leq s \leq m-1} J_s$; $\bar{A}_m = \bigcup_{m \leq s \leq q} J_s$, $m \in \{1, \dots, q\}$

This iteration modelizes a situation where , at instant t , persons in J_1 first adjust their opinions in parallel , followed by the persons of J_2, J_3, \dots, J_q .

The preceding dynamic rules are limit cases of "sequential-parallel iteration" ; if $J_1 = \{1, 2, \dots, n\}$ we have a parallel iteration and if $J_i = \{i\}$, $i = 1, \dots, n$, we have a sequential iteration .

The dynamical behaviour of this model is given by the following result :

THEOREM 3

If the ordered partition $P = \{J_1, \dots, J_q\}$ is such that for each set J_ℓ

$$\alpha(k) a_{ii} \geq |\alpha(k)| \sum_{\substack{j \in J_\ell \\ j \neq i}} |a_{ij}|, \text{ for each } i \in J_\ell, k = 1, \dots, p$$

then the sequential-parallel iteration associated with P only admits fixed points

PROOF :

Using the notations introduced in the preceding sections one proceeds as in the proof of theorems 1 and 2 , with the following algebraic invariant :

$$L = \sum_{0 \leq t \leq T-1} \sum_{1 \leq i, j \leq n} L_{i,j}^t$$

where

$$L_{i,j}^t = \begin{cases} a_{ij} \sum_{1 \leq k \leq p} \alpha(k) y_i^{k,t} (y_j^{k,t+1} - y_j^{k,t}) & \text{if } i \in J_m, j \in J_s, m > s \\ a_{ij} \sum_{1 \leq k \leq p} \alpha(k) y_i^{k,t} (y_j^{k,t+1} - y_j^{k,t-1}) & \text{if } i, j \in J_m \\ a_{ij} \sum_{1 \leq k \leq p} \alpha(k) y_i^{k,t} (y_j^{k,t} - y_j^{k,t-1}) & \text{if } i \in J_m, j \in J_s, m < s \end{cases}$$

For more details see Goles (1981) \square

COMMENT

The hypothesis of theorem 3 is a sort of diagonal dominance condition ; clearly, if such a property is true for a partition P then it holds for any partition P' finer than P .

5.1. ITERATION WITH MEMORY

Let us assume that each person has a memory of length q , $q > 1$, i.e $x(t+1)$ is a function of $x(t), x(t-1), \dots, x(t-q+1)$. In the particular case of linear memory, that is to say

$$x_i^{t+1} = k \Leftrightarrow \begin{cases} \alpha(k) \sum_{0 \leq l \leq q-1} \sum_{x_j^{t-l} = k} a_{ij} \geq \alpha(r) \sum_{0 \leq l \leq q-1} \sum_{x_j^{t-l} = r} a_{ij} & \text{if } \sigma_i(k) \geq \sigma_i(r) \\ \alpha(k) \sum_{0 \leq l \leq q-1} \sum_{x_j^{t-l} = k} a_{ij} < \alpha(r) \sum_{0 \leq l \leq q-1} \sum_{x_j^{t-l} = r} a_{ij} & \text{if } \sigma_i(k) < \sigma_i(r) \end{cases}$$

It can be shown, using the same idea of algebraic invariant, that the only possible periods of the model are the divisors of $q+1$, see Goles (1980) in a similar context. This is consistent with theorem 1 when $q = 1$.

REFERENCES

- E.Goles, Comportement oscillatoire d'une famille d'automates cellulaires non uniformes, Thesis, IMAG, University of Grenoble (1980)
- E.Goles, Fixed point behaviour of threshold functions on a finite set, Technical Report, Depto. Mathematicas, University of Chile, (1981)
- E.Goles and J.Olivos, Comportement itératif des fonctions à multiseuil, Inf. and Control vol 45 3(1980) 300-313
- S. Poljak and M.Sura, On periodical behaviour in societies with symmetrical relations, Combinatorica (1982) to appear
- M.Tchuenta, Evolution de certains automates cellulaires uniformes binaires à seuil, S.A.N.G n°265, University of Grenoble, (1977)

**COMPORTEMENT DYNAMIQUE
DE RESEAUX NEURONAUX**

DYNAMICAL BEHAVIOUROF NEURAL NETWORKS

à paraitre: *SIAM Journal on
Algebraic and Disc. Methods.*

ABSTRACT.

We characterize the cyclic behaviour of a threshold neural network defined by an iteration with memory. Our study is based in an algebraic approach that consists in defining and invariant associated with the dynamic of the network.

1. INTRODUCTION

A mathematical model of neural networks proposed by E.R. Caianello [1,2] is represented by a set of equations:

$$y_i(t) = 1 \left[\sum_{j=1}^n \sum_{s=1}^k a_{ij}(s) y_j(t-s) - \theta_i \right] \quad \text{for } i=1, \dots, n$$

where $y_j^*(t) \in \{0, 1\}$ for $j=1, \dots, n$ and

$$1[u] = \begin{cases} 0 & \text{if } u < 0 \\ 1 & \text{otherwise} \end{cases}$$

The dynamic of this model has been studied in some particular cases:

-For a single neuron equation; ie:

$$y(t) = 1 \left[\sum_{s=1}^k a(s) y(t-s) - \theta \right]$$

T. Kitagawa [4], Nagami, Kitahashi, Tanaka, Poljak [6,7] have characterized the dynamical behaviour of the system (convergence to stable configurations, reverberations cycles, etc) with hypothesis on the coupling coefficients, $a(s)$. The principal results are the following:

-If the coupling coefficients are all nonnegative, any initial configuration converges to a stable configuration (the fixed points $\vec{0}$ or $\vec{1}$) [6].

-If the coupling coefficients are all nonpositive, there exist reverberation cycles when $\sum_{s=1}^k a(s) < \theta < 0$. If the $a(s)$ are nonpositive and identical; $a(s) = a < 0$, the cycle length, T , is a divisor of $k+1$ [6].

-For a neural equation that evolve in parallel; ie $k=1$ and:

$$y_i(t) = 1 \left[\sum_{j=1}^n a_{ij} y_j(t-1) - \theta_i \right]; \quad i=1, \dots, n$$

we have proved in the symmetrical case, ie $A = (a_{ij})$ symmetric that the cycle length, T , is one or two [3].

- If A is non symmetric the associated dynamic is very complicated because this class of networks is a Mc. Culloch-Pitts net and it simulates any finite automata [5]

In this paper we study some aspects of the dynamical behaviour of neural networks with non trivial memory ($k > 1$). Our analysis will be based on an algebraic discrete invariant associated with the network.

2. NON UNIFORM COUPLING COEFFICIENTS

Let us consider the set of neural equations:

$$y_i(t) = 1 \left[\sum_{j=1}^n \sum_{s=1}^k a_{ij}(s) y_j(t-s) - \theta_i \right]$$

for $i=1, \dots, n$; $y_j(*) \in \{0, 1\}$; $a_{ij}(*), \theta_i \in \mathbb{R}$

with the hypothesis:

$$a_{ij}(k-s+1) = a_{ji}(s) \quad \text{for } s=1, \dots, k \text{ and } i, j=1, \dots, n$$

We will prove that, in a such a network, the cycle length, T , is a divisor of $k+1$.

Let us denote $y(t) = (y_1(t), \dots, y_n(t))$. Since $y(t) \in \{0, 1\}^n$ it is obvious that for any initial configuration $y(0), \dots, y(k-1)$ the iteration on the neural network is ultimately periodic; that is to say: there exist $r, T \in \mathbb{N}$ and vectors $y(r), \dots, y(r+T-1)$ such that:

$$y_i(m) = 1 \left[\sum_{j=1}^n \sum_{s=1}^k a_{ij}(s) y_j(m-s) - \theta_i \right]$$

for $m=r, \dots, r+T-1$ and $i=1, \dots, n$

where the indexes are taken modulo T

We can then associate with any cell i of the network the "cycle-vector":

$$x_i = (x_i(0), \dots, x_i(T-1)) = (y_i(r), \dots, y_i(r+T-1))$$

Algebraic Invariant

Let E be the operator:

$$E(x_i, x_j) = \sum_{t=0}^{T-1} x_i(t) \left\{ \sum_{s=1}^k a_{ij}(k-s+1) x_j(t+s) - \sum_{s=1}^k a_{ij}(s) x_j(t-s) \right\}$$

for $i, j=1, \dots, n$

where the indexes are taken modulo T

Properties of E

1- $E(x_i, x_j) + E(x_j, x_i) = 0$ for $i, j=1, \dots, n$

Proof. We have:

$$E(x_i, x_j) = - \sum_{t=0}^{T-1} x_j(t) \left\{ \sum_{s=1}^k a_{ij}(s) x_i(t+s) - \sum_{s=1}^k a_{ij}(k-s+1) x_i(t-s) \right\}$$

Since $a_{ij}(s) = a_{ji}(k-s+1)$, $a_{ij}(k-s+1) = a_{ji}(s)$, hence

$$E(x_i, x_j) = -E(x_j, x_i) \quad \blacksquare$$

2- Let γ_i the period of vector x_i , then if $\gamma_i \nmid k+1$ then:

$$E(x_i, x_j) = 0 \text{ for any } j=1, \dots, n$$

Proof. Since T is the period of the network, we have $T = \beta \gamma_i$ and by hypothesis $k+1 = \theta \gamma_i$

Let C_m be the set

$$C_m = \{m, m+\gamma_i, m+2\gamma_i, \dots, m+(\beta-1)\gamma_i\}$$

$$m=0, \dots, \gamma_i-1$$

since $T = \beta \gamma_i$ we have

$$E(x_i, x_j) = \sum_{m=0}^{\gamma_i-1} \sum_{t \in C_m} x_i(t) \left\{ \sum_{s=1}^k a_{ij}(k-s+1) x_j(t+s) - \sum_{s=1}^k a_{ij}(s) x_j(t-s) \right\}$$

Let $M(i, j, m)$ be:

$$M(i, j, m) = \sum_{t \in C_m} x_i(t) \left\{ \sum_{s=1}^k a_{ij}(k-s+1) x_j(t+s) - \sum_{s=1}^k a_{ij}(s) x_j(t-s) \right\}$$

Since γ_i is the period of vector x_i :

$$x_j(t) = x_j(t + q\gamma_i) \quad \text{for any } q \in \mathbb{N}, \text{ hence}$$

$$M(i, j, m) = x_i(m) \sum_{s=1}^k a_{ij}(s) \sum_{t \in C_m} \{x_j(t+k+1-s) - x_j(t-s)\}$$

since $k+1 = \theta\gamma_i$

$$M(i, j, m) = x_i(m) \sum_{s=1}^k a_{ij}(s) \left\{ \sum_{t=0}^{\beta-1} x_j(m+(t+\theta)\gamma_i - s) - \sum_{t=0}^{\beta-1} x_j(m+t\gamma_i - s) \right\}$$

since T is the period of the network and $T = \beta\gamma_i$, it is easy to see that:

$$\sum_{t=0}^{\beta-1} x_j(m+(t+\theta)\gamma_i - s) = \sum_{t=0}^{\beta-1} x_j(m+t\gamma_i - s)$$

hence $M(i, j, m) = 0$

$$\text{then } E(x_i, x_j) = \sum_{m=0}^{\gamma_i-1} M(i, j, m) = 0 \quad \blacksquare$$

3. If $\gamma_i \nmid k+1$ then $\sum_{j=1}^n E(x_i, x_j) < 0$

Before proving this property let us denote

$$\text{Sup}(x_i) = \{t \in \{0, \dots, T-1\} / x_i(t) = 1\}$$

and let $\{C_i^m\}_{m=0}^P$ be the partition of $\text{Sup}(x_i)$ defined as follows:

Let $C_i^0 = \{t/\{t+(k+1), t+2(k+1), \dots, t-(k+1)\} \subseteq \text{Sup}(x_i)$

In particular $C_i^0 = \emptyset$ if $(k+1) \nmid T$

Let C_i^1, \dots, C_i^p the maximal subsets of $\text{Sup}(x_i) \setminus C_i^0$ having the form:

$$C_i^m = \{t_m, t_m + (k+1), \dots, t_m + q_m(k+1)\}$$

for $m = 1, \dots, p$

Exemple: $k=3$ with $T = \gamma_i = 16$.

t	0	1	2	3	4	5	6	7	8	9	10	11	12	13	14	15
x_i	0	1	1	1	0	1	1	1	0	1	1	1	0	1	1	0

$$A_0 = \{1, 5, 9, 13\} \quad A_1 = \{2, 6, 10, 14\}$$

$$C_i^0 = \{1, 2, 5, 6, 9, 10, 13, 14\}$$

$$C_i^1 = \{3, 7, 11\}$$

Proof of property 3

From the partition intruduced above we have:

$$\sum_{j=1}^n E(x_i, x_j) = \sum_{j=1}^n \sum_{m=0}^p \sum_{t \in C_i^m} x_i(t) \left\{ \sum_{s=1}^k a_{ij}(k-s+1) x_j(t+s) - \sum_{s=1}^k a_{ij}(s) x_j(t-s) \right\}$$

$$\text{Let } R(i, j, m) = \sum_{t \in C_i^m} x_i(t) \left\{ \sum_{s=1}^k a_{ij}(k-s+1) x_j(t+s) - \sum_{s=1}^k a_{ij}(s) x_j(t-s) \right\}$$

Clearly

$$R(i, j, m) = \sum_{s=1}^k a_{ij}(s) \sum_{t \in C_i^m} (x_j(t+k-s+1) - x_j(t-s))$$

From definition of C_i^0 , it is easy to see that $R(i, j, 0) = 0$

Since $\gamma_i \nmid k+1$, we have at least $C_i^1 \neq \emptyset$, hence

$$R(i, j, m) = \sum_{s=1}^k a_{ij}(s) \sum_{t=0}^{q_m} (x_j(t_m + (k+1)t + k+1-s) - x_j(t_m + (k+1)t - s))$$

then

$$R(i, j, m) = \sum_{s=1}^k a_{ij}(s) (x_j(t_m + (k+1)(q_m+1) - s) - x_j(t_m - s))$$

hence

$$\sum_{j=1}^n R(i, j, m) = \sum_{j=1}^n \sum_{s=1}^k a_{ij}(s) x_j(t_m + (k+1)(q_m+1) - s) - \sum_{j=1}^n \sum_{s=1}^k a_{ij}(s) x_j(t_m - s)$$

since $x_i(t_m + (k+1)(q_m+1)) = 0$, $x_i(t_m) = 1$ and by definition of

the neuron equation:

$$\sum_{j=1}^n \sum_{s=1}^k a_{ij}(s) x_j(t_m + (k+1)(q_m+1) - s) < \theta_i$$

$$\sum_{j=1}^n \sum_{s=1}^k a_{ij}(s) x_j(t_m - s) \geq \theta_i$$

it follows that:

$$\sum_{j=1}^n R(i, j, m) < 0, \text{ hence}$$

$$\sum_{j=1}^n E(x_i, x_j) = \sum_{j=1}^n \sum_{m=0}^p R(i, j, m) < 0 \quad \blacksquare$$

The properties above can be summarized as follows:

THEOREM-1 If we have:

$$a_{ij}(k-s+1) = a_{ji}(s) \quad \text{for } i, j = 1, \dots, n \text{ and } s = 1, \dots, k$$

then, for any initial configuration $y(0), \dots, y(k-1) \in \{0, 1\}^n$ the neural network converges towards a cycle of length T , such that $T \mid k+1$.

Proof: If T is not a divisor of $k+1$, there exists at least one index $i \in \{1, \dots, n\}$ such that $\gamma_i \nmid k+1$, hence from properties 2 and 3 we conclude:

$$\sum_{i=1}^n \sum_{j=1}^n E(x_i, x_j) < 0$$

and from property one:

$$\sum_{i=1}^n \sum_{j=1}^n E(x_i, x_j) = 0$$

which is a contradiction, therefore $T \mid k+1$ ■

COMMENTS

If $k=1$ and $A=(a_{ij})$ is a symmetric matrix, we have the two-cycle behaviour studied in the context of non uniform cellular automata [3].

As a particular case of the preceding result we can consider the case of uniform coupling coefficients with a non-connected memory structure; i.e. a set of neural equations :

$$y_i(t) = 1 \left[\sum_{j=1}^n a_{ij} \sum_{s=1}^k x_j(t-p_s) - \theta_i \right]$$

where (a_{ij}) is a symmetric matrix and the memory steps

$p_1 > p_2 > \dots > p_k > 1$ verify:

$$(H) \begin{cases} p_1 + p_{2r} = p_2 + p_{2r-1} = \dots = p_r + p_{r+1} & \text{if } k=2r \\ p_1 + p_{2r-1} = p_2 + p_{2r-2} = \dots = p_{r-1} + p_{r+1} = 2p_r & \text{if } k=2r-1 \end{cases}$$

It is easy to see that this system is equivalent to the following:

$$y_i(t) = 1 \left[\sum_{j=1}^n \sum_{s=1}^q a_{ij}(s) x_j(t-s) - \theta_i \right]$$

$$\text{where } a_{ij}(s) = \begin{cases} a_{ij} & \text{if } s \in \{p_1, \dots, p_k\} \\ 0 & \text{otherwise} \end{cases}$$

$$\text{and } q = p_1 + p_k - 1$$

furthermore, from hypothesis (H) and A being a symmetric matrix, we have:

$$a_{ij}(q-s+1) = a_{ji}(s) \quad \text{for } s=1, \dots, q$$

then we have the corollary:

COROLLARY. If we have hypothesis (H), then for any initial configuration $y(0), \dots, y(p_1-1) \in \{0,1\}^n$, the neural network converges towards a cycle of length T, such that $T \mid p_1 + p_k$

Proof. Directly from previous comment. ■

Remark. We can also prove this corollary by introducing a particular algebraic invariant. With the notations above. Let us define:

$$E(x_i, x_j) = a_{ij} \sum_{t=0}^{T-1} x_i(t) \left(\sum_{s=1}^k x_j(t+p_s) - \sum_{s=1}^k x_j(t-p_s) \right)$$

for $i, j=1, \dots, n$

From hypothesis (H) and the symmetrical property of A it is easy to prove that E verifies properties 1, 2, 3, hence $T \mid p_1 + p_k$ ■

3. SOME REMARKS ON SINGLE NEURONIC EQUATION

In the particular case of a single neuron equation; i.e.

$$y(t) = 1 \left[\sum_{s=1}^k a(s)y(t-s) - \theta \right]$$

we generalize to non-connected memory structure the result of Nagami [6], obtaining it as a particular case of Theorem-1; i.e.

If $a(s) = a \neq 0$, for $s=1, \dots, k$ then $T \mid (k+1)$

Furthermore, we can interpret the single neuron equation with memory of length k as a directed graph with one threshold cell and $k-1$ transfer cells which only transmit their binary input. For instance, if we have $k=4$ and $a(s)=a$ for $s=1,2,3,4$, the associated graph is:

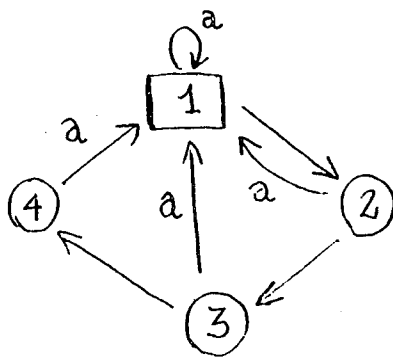

□ : threshold cell

○ : transfer cell

where:

$$y_1(t) = 1 \left[a \sum_{j=1}^4 y_j(t-1) - \theta \right]$$

$$y_j(t) = y_{j-1}(t-1) \quad j=2,3,4$$

4. NON CONNECTED MEMORY COEFFICIENTS

Let us take the following neural equation:

$$y_i(t) = \prod \left[\sum_{j=1}^n \sum_{s=p}^k a_{ij}(s) y_j(t-s) - b_i \right] \quad \text{for } i=1, \dots, n$$

$y_j(*) \in \{0,1\}$ and $a_{ij}(*), b_i \in \mathbb{R}$

with hypothesis:

$$A(s) = (a_{ij}(s)) = A^t(k-s+1) \quad \text{for } s=p, \dots, k.$$

Example: $n=1$:

$$y(t) = \prod \left[\sum_{s=p}^k a(s) y(t-s) - b \right]$$

and coefficients verify: $a(s) = a(k-s+1)$, $s=p, \dots, k$. There we have that memory coefficients, for $s=1, \dots, p-1$ are zero. That is to say, step t depends only of steps $t-p, \dots, t-k$. In previous cases we applied symmetrical hypothesis to coefficients $a(1), \dots, a(k)$; here we applied symmetry only to $a(p), \dots, a(k)$.

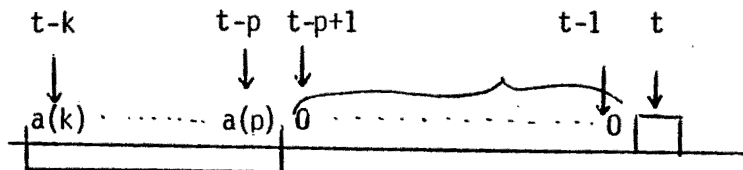

In this case we define, in a similar way that previous cases, the algebraic invariant:

$$E(x_i, x_j) = \sum_{t=0}^{T-1} x_i(t) \left\{ \sum_{s=p}^k a_{ij}(k+p-s)x_j(t+s) - \sum_{s=p}^k a_{ij}(s)x_j(t-s) \right\}$$

Properties on E:

- 1) $E(x_i, x_j) + E(x_j, x_i) = 0 \quad \forall i, j = 1, \dots, n$
- 2) If $\gamma_i \nmid k+p \implies E(x_i, x_j) = 0 \quad \forall j = 1, \dots, n$

The proof is similar to analogous properties in precedents cases.

- 3) If $\gamma_i \nmid k+p \implies \sum_{j=1}^n E(x_i, x_j) < 0$

For the proof it is sufficient to take partition $\{C_i^\ell\}_{\ell=0}^m$ of $\text{sup}(x_i)$ defined as follows:

Let $C_i^0 = \{t / \{t, t+k+p, t+2(k+p), \dots, t-(k+p)\} \subset \text{sup}(x_i)\}$

In particular $C_i^0 = \emptyset$ if $k+p \nmid T$.

Let C_i^1, \dots, C_i^p the maximal subsets of $\text{sup}(x_i) \setminus C_i^0$ having the form:

$$C_i^m = \{t_m, t_m + (k+p), \dots, t_m + q_m(k+p)\}$$

(i.e. : $t_m - (k+p), t_m + (q_m+1)(k+p) \notin \text{sup}(x_i) \setminus C_i^0$)

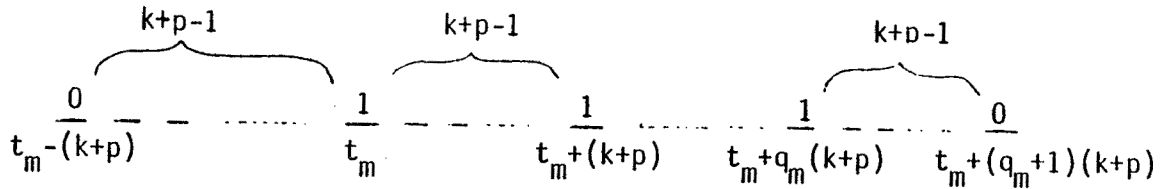

From this partition we prove property 3 in a similar way that in the previous paragraph.

Hence we may conclude:

Theorem: If we have:

$$A(s) = A(k+p-s) \quad \text{for } s=p, \dots, k$$

then, for any initial configuration, the neural network converges towards a cycle of length T such that $T/k+p$.

Proof. Directly from properties 1,2,3.



Remark: By this way we can obtained the following cycles:

P	T
1	$T/k+1 \rightarrow$ connected memory
2	$T/k+2$
\vdots	\vdots
k	$T/2k$

It is always possible to build networks with cycles T divisors of $k+p$. As a particular case we may obtain maximum divisors; i.e. in a one-dimensional neural-network:

$$x(t) = \prod \left[\frac{1}{2} - \sum_{s=p}^k x(t-s) \right] \quad \text{with } 1 \leq p \leq k$$

we have the cycle $(1^p 0^k) = (\underbrace{1 \dots 1}_p \underbrace{0 \dots 0}_k)$

The preceding remarks show that our analysis can be considered as a first step towards the study of the dynamical behaviour of nonsymmetric threshold networks, i.e. directed graphs where each node is a threshold cell.

A first problem to study should be the cyclic behaviour of arbitrary directed networks of order n consisting of one threshold cell and $n-1$ transfert cells.

Finally, the approach introduced here seems to be the appropriate tool for this study because it takes into account both the structure of the network and the iteration scheme in an algebraic fashion.

REFERENCES

- 1 E.R. CAIANELLO, Decision equations and reverberations, Kybernetik, 3, 1966
- 2 E.R. CAIANELLO, De LUCA, L. RICCIARDI, Reverberations and control of neural networks, Kybernetik, 4, 1967
- 3 E. GOLES, J. OLIVOS, Comportement periodique des fonctions à seuil binaires et applications, Disc. Applied Math, 3, 1981
- 4 T. KITAGAWA, Dynamical systems and operators associated with a single neuron equation, Math Biosci, 18, 1973
- 5 W. MCCULLOCH, W. PITTS, A logical calculus of the ideas immanent in nervous activity, Bull Math Biophys, 5, 1943
- 6 H. NAGAMI, KITAHASHI, TANAKA, Characterization of dynamical behaviour associated with a single neural equation, Math Biosci, 32, 1976
- 7 S. POLJAK and D. SURA, On periodical behaviour in societies with symmetric influences, combinatorica 1983, to appear.

**CONVERGENCE D'AUTOMATES
A SEUIL VERS DES POINTS
FIXES**

FIXED POINT BEHAVIOUR OF
THRESHOLD FUNCTIONS ON A FINITE SET

SIAM J. Alg. and Disc. Meth., Vol 3,4,82

ABSTRACT:

Let Δ be an application from $\{0,1\}^n$ into itself, whose components are threshold functions with separator $\sum_{j=1}^n a_{ij}y_j - \theta_i$, ($y_i \in \{0,1\}$, $a_{ij}, \theta_i \in \mathbb{R}$; $i, j \in \{1, \dots, n\}$).

In this paper we determine a sufficient condition on $A = (a_{ij})$, a real symmetric $n \times n$ matrix, so that the blocks Gauss-Seidel iteration over Δ only admits fixed points on the steady state.

1. PRESENTATION OF THE PROBLEM.

Let $\Delta: \{0,1\}^n \rightarrow \{0,1\}^n$

$$y = (y_1, \dots, y_n) \rightarrow (\phi_1(y), \dots, \phi_n(y))$$

be an application, in which:

$$\phi_i(y) = \begin{cases} 0 & \text{if } \sum_{j=1}^n a_{ij}y_j < \theta_i \\ 1 & \text{otherwise} \end{cases}$$

$A = (a_{ij})$ being a real simetric $n \times n$ matrix and $\vec{\theta} = (\theta_1, \dots, \theta_n)^T \in \mathbb{R}^n$.

Consider a ordered partition $\{J_1, \dots, J_p\}$ of the set $\{1, \dots, n\}$. That is to say, if $k < m$, the integers belonging to J_k are smaller than those in J_m . For instance, if $n=8$:

$$J_1 = \{1,2\}, \quad J_2 = \{3\}, \quad J_3 = \{4,5,6\}, \quad J_4 = \{7,8\}$$

This condition on the partition is not restrictive, since it is easy to obtain a general partition by reordering the componentes of Δ .

We define the "block Gauss-Seidel" iteration over $\{J_1, \dots, J_p\}$ in the following way:

If $i \in J_m$

$$y_i^{r+1} = \begin{cases} 0 & \text{if } \sum_{\substack{j \in \cup_{s=1}^{m-1} J_s}} a_{ij} y_j^{r+1} + \sum_{\substack{j \in \cup_{s=m}^p J_s}} a_{ij} y_j^r < \theta_i \\ 1 & \text{otherwise} \end{cases}$$

$r = 0, 1, 2, \dots$

$$y^0 \in \{0, 1\}^n, \quad m \in \{1, \dots, p\}$$

Since $\{0, 1\}^n$ is a finite set, it is obvious that starting with any initial vector, the iteration converges to a cycle of period $T \leq 2^n$. This means that for every $y^0 \in \{0, 1\}^n$, there is an $s \in \mathbb{N}$ such that:

$$y^s \rightarrow y^{s+1} \rightarrow \dots \rightarrow y^{s+T-1}$$

There are two well known iterative strategies:

- $J_1 = \{1, \dots, n\}$ corresponding to the "parallel" or "Jacobi" iteration on Δ :

$$y^{r+1} = \Delta y^r, \quad r=0, 1, 2, \dots; \quad y^0 \in \{0, 1\}^n$$

This strategy is usual in the context of classic automata, and only, with the symmetrical hypothesis on A we have $T \leq 2$.

- $J_i = \{i\}$, $i \in \{1, \dots, n\}$ corresponding to the "serie" or "Gauss-Seidel" iteration, a strategy used in "spin glass" simulation.

We are interested in determining a simple condi-

tion on $A = (a_{ij})$ so that the block Gauss - Seidel iteration admits only fixed points.

THEOREM: Let $P = \{J_1, \dots, J_p\}$ be an ordered partition on $\{1, \dots, n\}$ such that, for each set J_ℓ we have:

$$a_{ii} \geq \sum_{\substack{j \in J_\ell \\ j \neq i}} |a_{ij}| ; \quad \text{for each } i \in J_\ell$$

Then, the block Gauss-Seidel iteration associated to P only admits fixed points.

Note: If $J_i = \{i\}$, for some i , we shall assume $\sum_{\substack{j \in J_i \\ j \neq i}} |a_{ij}| = 0$.

We will need some definitions and basic proposition to prove this result.

2. PROOF OF THE THEOREM.

Since the iteration converges, starting with any initial vector $y \in (0,1)^n$, it is possible to associate an $n \times T$ matrix to each y :

$$X(y, T) = \begin{pmatrix} x_1(0) & \dots & x_1(T-1) \\ x_n(0) & \dots & x_n(T-1) \end{pmatrix} = (y^s, y^{s+1}, \dots, y^{s+T-1})$$

in which (y^s, \dots, y^{s+T-1}) is the vector matrix of the cycle with period T , to which the iterations converges, starting with the vector $y \in \{0,1\}^n$.

Let $S = \{x_1, \dots, x_n\}$ be the row set of $X(y, T)$, and let L be the application:

$$L: S \times S \rightarrow \mathbb{R}$$

$$(x_i, x_j) \rightarrow L(x_i, x_j)$$

$$L(x_i, x_j) = \begin{cases} a_{ij} \sum_{\ell=0}^{T-1} x_i(\ell) (x_j(\ell) - x_j(\ell-1)) & \text{if } i \in J_m, j \in J_k; m < k \\ a_{ij} \sum_{\ell=0}^{T-1} x_i(\ell) (x_j(\ell+1) - x_j(\ell-1)) & \text{if } i, j \in J_m \\ a_{ij} \sum_{\ell=0}^{T-1} x_i(\ell) (x_j(\ell+1) - x_j(\ell)) & \text{if } i \in J_m, j \in J_k; m > k \end{cases}$$

with $i, j \in \{1, \dots, n\}$

Note: The indexes ℓ are taken modulo T .

It is easy to prove, considering the definitions and the symmetry of $A = (a_{ij})$, that L has the following properties:

(1) L is antisymmetric:

$$L(x_i, x_j) + L(x_j, x_i) = 0 \quad \text{for all } i, j \in \{1, \dots, n\}$$

(2) If we note γ_i the period of row x_i (γ_i is necessarily a divisor of T), then:

$$\text{if } \gamma_i = 1 \Rightarrow L(x_i, x_j) = 0 \quad \text{for all } j \in \{1, \dots, n\}$$

On the other hand, if $\gamma_i \geq 2$, for some $i \in \{1, \dots, n\}$, we note:

$$\text{sup}(x_i) = \{\ell \in \{0, \dots, T-1\} / x_i(\ell) = 1\}$$

and we built a partition on $\text{sup}(x_i)$:

$$C_1 = \{\ell_1 + s / \ell_1 + s \in \text{sup}(x_i), s=0, \dots, q_1\}$$

where $\ell_1 \in \text{sup}(x_i)$ is the first index such that $x_i(\ell_1 - 1) = 0$ and q_1 the first of the following indexes such that $x_i(\ell_1 + q_1 + 1) = 0$.

Similarly:

$$C_r = \{\ell_r + s / \ell_r + s \in \text{sup}(x_i), s=0, \dots, q_r\}; \quad r \in \{2, \dots, q\}$$

where $\ell_r = \ell_{r-1} + w \pmod{T} \in \text{sup}(x_i)$ $\{\ell_1, \dots, \ell_{r-1}\}$ is the first index such that $x_i(\ell_r - 1) = 0$ and q_r the first of the following such that $x_i(\ell_r + q_r + 1) = 0$.

It is obvious that this partition exists, since $\gamma_i \geq 2$.

Example:

$$x_i = (0 \ 0 \ 0 \ 0 \ \underbrace{1 \ 1 \ 1}_{c_1} \ 0 \ 0 \ 0 \ \underbrace{1}_c \ 0 \ 0 \ \underbrace{1}_c \ 0 \ 0 \ \underbrace{1 \ 1 \ 1 \ 1}_{c_4} \ 0 \ 0)$$

Lemma: Let $\gamma_i \geq 2$, with $i \in J_m$ such that:

$$a_{ii} \geq \sum_{\substack{j \in J_m \\ j \neq i}} |a_{ij}|$$

then

$$\sum_{j=1}^n L(x_i, x_j) < 0$$

Proof: We have:

$$\sum_{j=1}^n L(x_i, x_j) = \sum_{\substack{j \in \cup_{s=1}^{m-1} J_s}} L(x_i, x_j) + \sum_{j \in J_m} L(x_i, x_j) + \sum_{\substack{j \in \cup_{s=m+1}^p J_s}} L(x_i, x_j)$$

as the partition is ordered, let us suppose:

$J_m = \{j_1, j_1+1, \dots, j_2\}$, then

$$\begin{aligned} \sum_{j=1}^n L(x_i, x_j) &= \sum_{j=1}^{j_1-1} a_{ij} \sum_{\ell=0}^{T-1} x_i(\ell)(x_j(\ell+1) - x_j(\ell)) + \\ &+ \sum_{j=j_1}^{j_2} a_{ij} \sum_{\ell=0}^{T-1} x_i(\ell)(x_j(\ell+1) - x_j(\ell-1)) + \\ &+ \sum_{j=j_2+1}^n a_{ij} \sum_{\ell=0}^{T-1} x_i(\ell)(x_j(\ell) - x_j(\ell-1)) \end{aligned}$$

$$\text{since } \sup(x_i) = \bigcup_{r=1}^q C_r$$

where $C_r = \{\ell_r, \ell_r+1, \dots, \ell_r+q_r\}$, we have:

$$\begin{aligned} \sum_{j=1}^n L(x_i, x_j) &= \sum_{r=1}^q \left[\sum_{j=1}^{j_1-1} a_{ij} \sum_{s=0}^{q_r} (x_j(\ell_r+s+1) - x_j(\ell_r+s)) + \right. \\ &\quad + \sum_{j=j_1}^{j_2} a_{ij} \sum_{s=0}^{q_r} (x_j(\ell_r+s+1) - x_j(\ell_r+s-1)) + \\ &\quad \left. + \sum_{j=j_2+1}^n a_{ij} \sum_{s=0}^{q_r} (x_j(\ell_r+s) - x_j(\ell_r+s-1)) \right] \end{aligned}$$

Let D_r be defined as:

$$\begin{aligned} D_r &= \sum_{j=1}^{j_1-1} a_{ij} \sum_{s=0}^{q_r} (x_j(\ell_r+s+1) - x_j(\ell_r+s)) + \\ &\quad + \sum_{j=j_1}^{j_2} a_{ij} \sum_{s=0}^{q_r} (x_j(\ell_r+s+1) - x_j(\ell_r+s-1)) + \\ &\quad + \sum_{j=j_2+1}^n a_{ij} \sum_{s=0}^{q_r} (x_j(\ell_r+s) - x_j(\ell_r+s-1)) \end{aligned}$$

so

$$\sum_{j=1}^n L(x_i, x_j) = \sum_{r=1}^q D_r$$

Looking at the sign of D_r , we notice that:

$$\begin{aligned}
 D_r = & \sum_{\substack{j \in \cup_{s=1}^{m-1} J_s \\ s=1}}^{m-1} a_{ij} x_j(\ell_r + q_r + 1) + \sum_{\substack{j \in \cup_{s=m}^p J_s \\ s=m}}^p a_{ij} x_j(\ell_r + q_r) + \\
 & - \left(\sum_{\substack{j \in \cup_{s=1}^{m-1} J_s \\ s=1}}^{m-1} a_{ij} x_j(\ell_r) + \sum_{\substack{j \in \cup_{s=m}^p J_s \\ s=m}}^p a_{ij} x_j(\ell_r - 1) \right) + \\
 & + \sum_{j \in J_m} a_{ij} (x_j(\ell_r + q_r + 1) - x_j(\ell_r))
 \end{aligned}$$

since $x_i(\ell_r + q_r + 1) = 0$, $x_i(\ell_r) = 1$:

$$\sum_{\substack{j \in \cup_{s=1}^{m-1} J_s \\ s=1}}^{m-1} a_{ij} x_j(\ell_r + q_r + 1) + \sum_{\substack{j \in \cup_{s=m}^p J_s \\ s=m}}^p a_{ij} x_j(\ell_r + q_r) < \theta_i$$

and

$$\sum_{\substack{j \in \cup_{s=1}^{m-1} J_s \\ s=1}}^{m-1} a_{ij} x_j(\ell_r) + \sum_{\substack{j \in \cup_{s=m}^p J_s \\ s=m}}^p a_{ij} x_j(\ell_r - 1) \geq \theta_i$$

so the difference between both terms is strictly negative.

Moreover, since $x_i(\ell_r) = 1$, we have:

$$\begin{aligned}
E_m &= \sum_{j \in J_m} a_{ij} (x_j(\ell_r + q_r + 1) - x_j(\ell_r)) = \\
&= \sum_{\substack{j \in J_m \setminus \{i\} \\ a_{ij} > 0}} a_{ij} (x_j(\ell_r + q_r + 1) - x_j(\ell_r)) + \\
&\quad + \sum_{\substack{j \in J_m \setminus \{i\} \\ a_{ij} < 0}} a_{ij} (x_j(\ell_r + q_r + 1) - x_j(\ell_r)) - a_{ii}
\end{aligned}$$

then

$$E_m \leq \sum_{\substack{j \in J_m \setminus \{i\} \\ a_{ij} > 0}} a_{ij} - \sum_{\substack{j \in J_m \setminus \{i\} \\ a_{ij} < 0}} a_{ij} - a_{ii}$$

but, by hypothesis: $a_{ii} \geq \sum_{j \in J_m \setminus \{i\}} |a_{ij}|$

so $E_m < 0$, and then $D_r < 0$ and this implies:

$$\sum_{j=1}^n L(x_i, x_j) = \sum_{r=1}^q D_r < 0$$

— 0 —

This lemma and the two properties of L , are helpful in the proof of the main theorem. Let us suppose that there exists $y \in \{0,1\}^n$ such that the block Gauss-Seidel iteration converges, with y as a initial vector, to a cycle of period $T \geq 2$, whose associated matrix is $X(y, T)$.

$$\text{Let } A_1 = \{i \in \{1, \dots, n\} / \gamma_i = 1\}$$

$$A_2 = \{i \in \{1, \dots, n\} / \gamma_i \geq 2\}$$

Property (2) implies:

$$\sum_{i \in A_1} \sum_{j=1}^n L(x_i, x_j) = 0$$

On the other hand, applying the hypothesis on A , and the lemma, we have:

$$\sum_{i \in A_2} \sum_{j=1}^n L(x_i, x_j) < 0$$

Moreover, as $T \geq 2$, the set A_2 is nonempty.

From both equations we get:

$$\sum_{i=1}^n \sum_{j=1}^n L(x_i, x_j) < 0$$

and this contradicts the fact that L is antisymmetric, so we must have $T=1$.

— 0 —

If P' is a finer partition than P , in other words, P' is a subpartition of P , we can prove the following:

Corollary 1: Let $P = \{J_1, \dots, J_p\}$ be an ordered partition of $\{1, \dots, n\}$ such that, for each set J_ℓ we have:

$$a_{ii} \geq \sum_{\substack{j \in J_\ell \\ j \neq i}} |a_{ij}|, \quad i \in J_\ell \quad (1)$$

Then, for each ordered partition P' finer than P , the block Gauss-Seidel iteration, associated to P' , over Δ , admits only fixed points.

Proof: It is sufficient to see that if $P' = \{J'_1, \dots, J'_q\}$ is finer than P , then hypothesis (1) implies that for each set J'_ℓ :

$$a_{ii} \geq \sum_{\substack{j \in J'_\ell \\ j \neq i}} |a_{ij}|, \quad i \in J'_\ell$$

— 0 —

A particular case of this corollary is the following global convergence condition:

Corollary 2: If $a_{ii} \geq \sum_{\substack{j=1 \\ j \neq i}}^n |a_{ij}|$ for $i \in \{1, \dots, n\}$, then each block

Gauss-Seidel iteration over Δ , admits only fixed points

Another interesting condition is the following:

Corollary 3: If $a_{ii} > 0$ for $i \in \{1, \dots, n\}$ then the "serie" or Gauss-Seidel iteration over Δ admits only fixed points.

We use the following exemple as an illustration of the preceding results. Let Δ defined by:

$$A = \begin{pmatrix} 2 & -1 & 0 & -1 \\ -1 & 4 & 2 & 0 \\ 0 & 2 & 5 & 1 \\ -1 & 0 & 1 & 2 \end{pmatrix} \quad \vec{\theta} = \begin{pmatrix} 2 \\ 5 \\ 7 \\ 3 \end{pmatrix}$$

If we note partition $\{J_1, \dots, J_p\}$ as $(J_1)(J_2) \dots (J_p)$, the behaviour of the block Gauss-Seidel iteration associated to different partitions of $\{1, 2, 3, 4\}$ is the following(*):

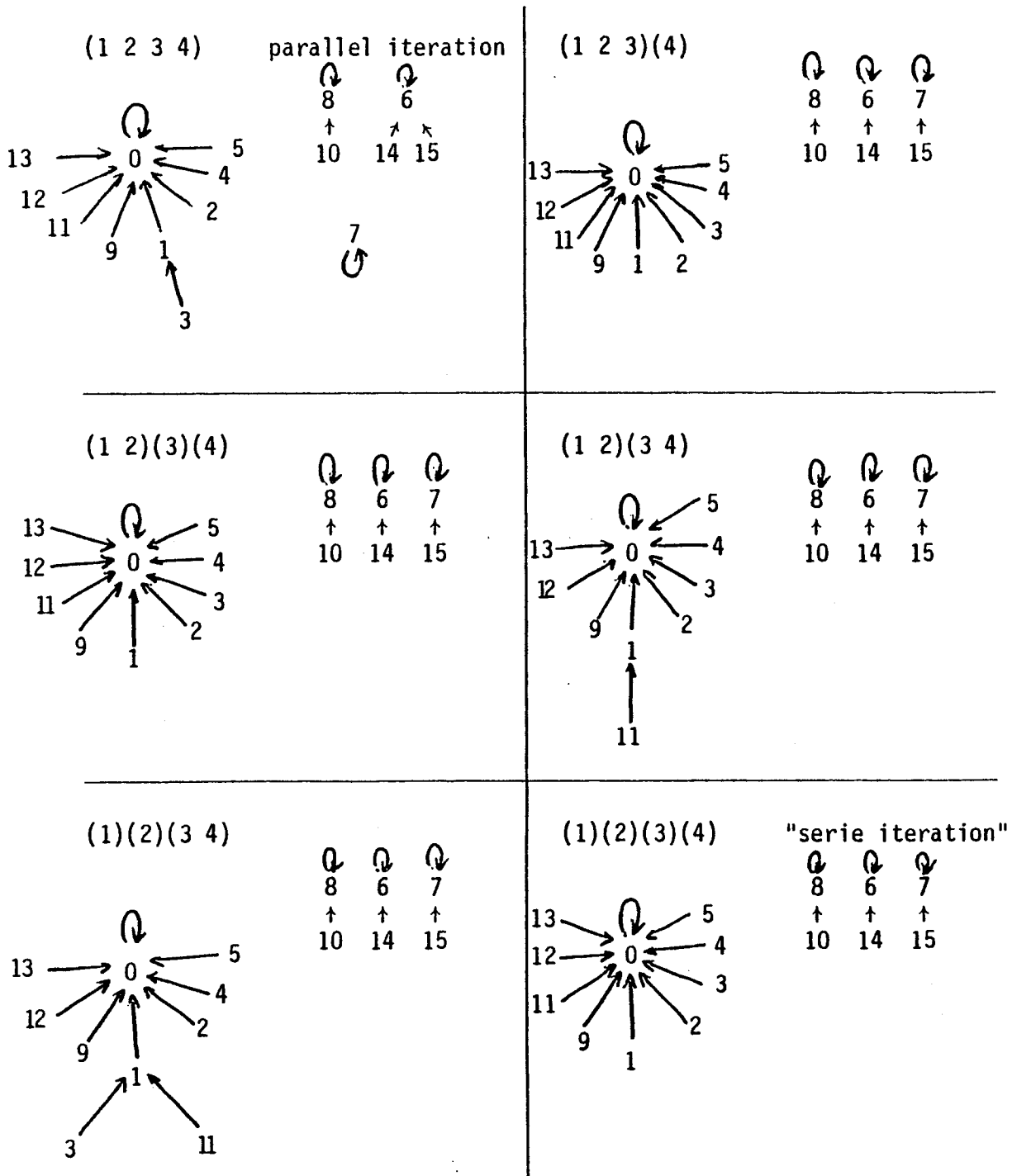

(*): The numbers are the binary representation of the boolean vector.

An other example is the following:

$$A = \begin{pmatrix} 2 & 1 & 4 & 0 \\ 1 & 1 & 0 & 3 \\ 4 & 0 & 2 & 1 \\ 0 & 3 & 1 & 1 \end{pmatrix} \quad \vec{\theta} = \begin{pmatrix} 4 \\ 3 \\ 4 \\ 3 \end{pmatrix}$$

(1 2 3 4) Parallel iteration: there is not diagonal dominance property

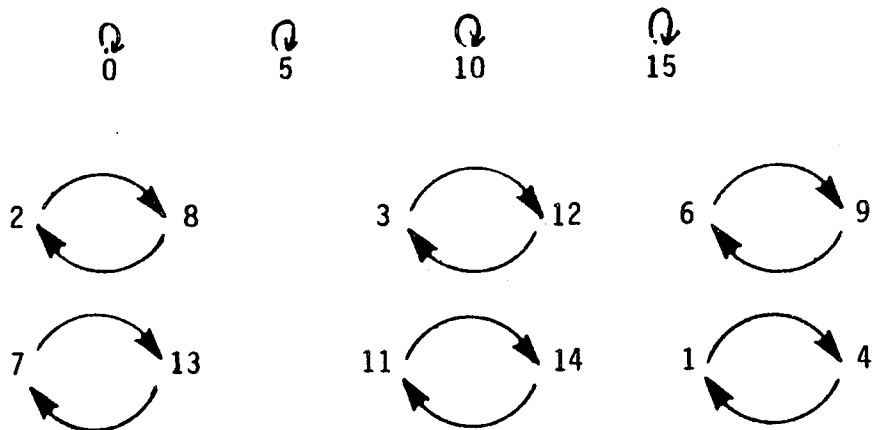

(1 2)(3 4) there is diagonal dominance property

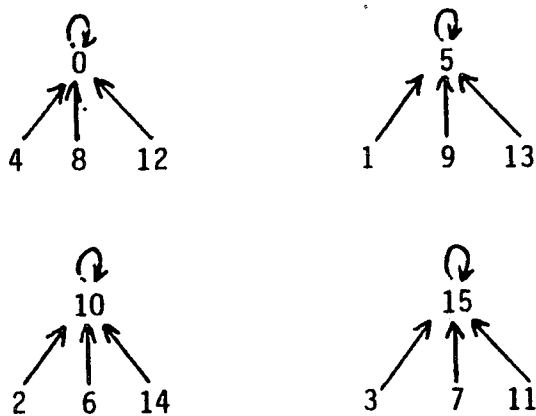

If we eliminate the symmetric hypothesis it is not hard to find threshold function families so that the block Gauss-Seidel iteration admits long cycles.

Analogously, if we suppress the diagonal dominance hypothesis we obtain long cycles too.

3. "SERIE" ITERATION OVER A TORUS.

Let us consider the torus $T(n,n)$

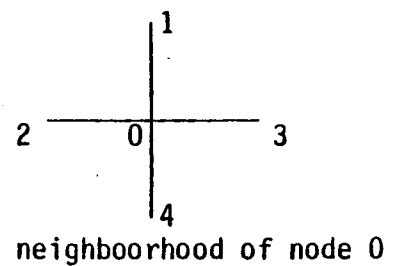
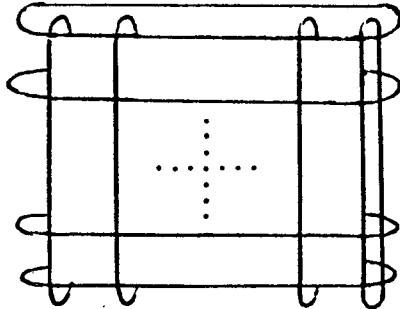

where each arc is associated to a plus (+) or minus (-) sign.

We can associate a transition rule to each node such that, given an initial configuration of zeros and ones on the vertices, it will evolve following the transition rule associated to each node. Moreover, this evolution is accomplished in "serie", that is to say, by fixing a sequential run on the torus.

The study of "spin glass problem" is the inspira-

tion for the iteration on a torus. In this context, each vertex represents a spin that can take two orientations, which are symbolized by variable $y_i \in \{0,1\}$, and each arc represent the energetic interaction (which can be positive or negative) between both spins.

The physical problem consists in determining a spin configuration that minimizes the unbalanced interactions, in which, a interaction of arc (i,j) is unbalanced if:

$$\left(\begin{array}{l} y_i = y_j \quad \text{and} \quad (i,j) \text{ is marked minus } (-) \\ y_i \neq y_j \quad \text{and} \quad (i,j) \text{ is marked plus } (+) \end{array} \right)$$

Angles d'Auriac, Maynard, Robert have suggested an algorithm that follows a local majority rule (each spin tries to orient itself in the same direction as its positive bond neighbours, and in opposite direction to its negative bond neighbours).

This algorithm converges, in "serie" iteration to a fixed point, which is a local minimum of the number of unbalanced interactions. On the other hand for some majority rules, the "serie" iteration admits cycles.

We are interested in determining the conditions under which a local majority rule selection implies a "serie" iteration with or without cycles.

If we note the neighborhood of a node in the torus $T(n,n)$:

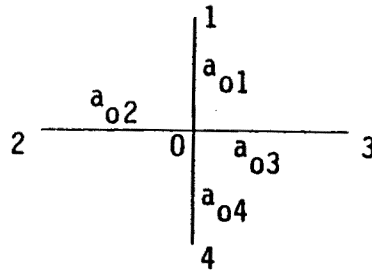

The majority rules which we will consider are:

$$A_{maj}(y_0, y_1, y_2, y_3, y_4) = \begin{cases} 0 & \text{if } \alpha y_0 + \sum_{j=1}^4 c(y_j) < 3 \\ 1 & \text{otherwise} \end{cases}$$

$$B_{maj}(y_0, y_1, y_2, y_3, y_4) = \begin{cases} 0 & \text{if } -\alpha y_0 + \sum_{j=1}^4 c(y_j) < 2 \\ 1 & \text{otherwise} \end{cases}$$

$\alpha \in [0, +\infty[$, $c(y_j) = y_j$ if $a_{0j} = +$, $1 - y_j$; otherwise.

For the first rule, A_{maj} , the spin tries to take the majority between the orientations of the spin neighbors that interact with a plus (+) and the opposite of the ones that interact with a minus (-). If there is a draw, the spin will try (depending of the weight α) to stay invariant.

For the B_{maj} rule, the transition is the same, excepting the case of a draw, in which case the spin tries to change its orientation.

From Corollary 3 we can state the following result:

Proposition: If we carry out the "serie" iteration on the torus, we have:

- If we use the A_{maj} rule on each node, for any initial configuration the iteration converges to a fixed point (not necessarily unique).

- If we use the B_{maj} rule on each node, with $\alpha \in]0, +\infty[$, we cannot be assured of the convergence to a fixed point. (cycles could possibly exist).

Examples: Torus $T(3,3)$, serie iteration by rows

(i) $a_{ij} = +$ for each arc (i,j)

$\begin{array}{c} 0 + 1 + 0 \\ + + + \\ 1 + 0 + 1 \\ + + + \\ 0 + 1 + 0 \end{array}$	\longrightarrow	$\begin{array}{c} 0 + 0 + 0 \\ + + + \\ 0 + 0 + 0 \\ + + + \\ 0 + 0 + 0 \end{array}$	<p>A_{maj}, fixed point</p>
--	-------------------	--	--

$\begin{array}{c} 0 + 1 + 0 \\ + + + \\ 1 + 0 + 1 \\ + + + \\ 0 + 1 + 0 \end{array}$		$\begin{array}{c} 1 + 0 + 1 \\ + + + \\ 0 + 1 + 0 \\ + + + \\ 1 + 0 + 1 \end{array}$	<p>B_{maj}, cycle of period 2</p>
--	---	--	--

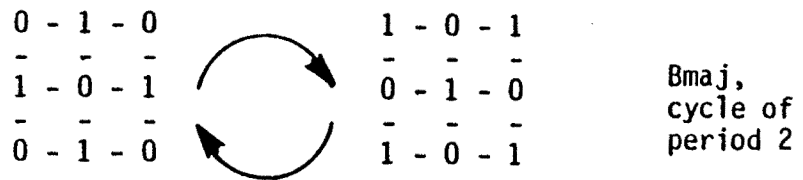
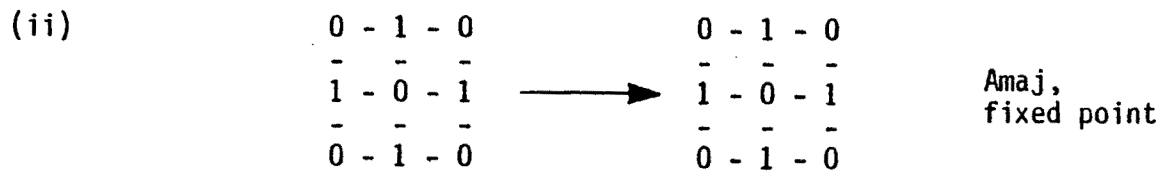

(iii) , $\alpha > 2$, $a_{ij} = -$, B_{maj}:

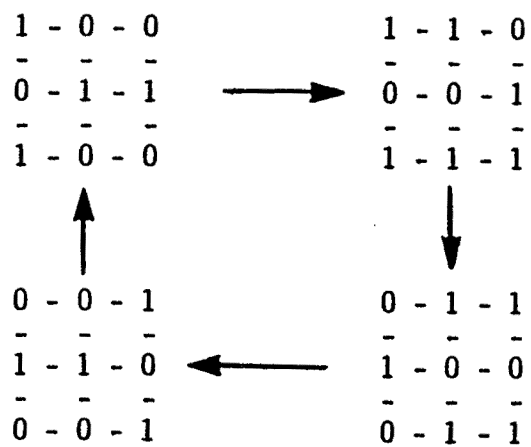

cycle of period 4

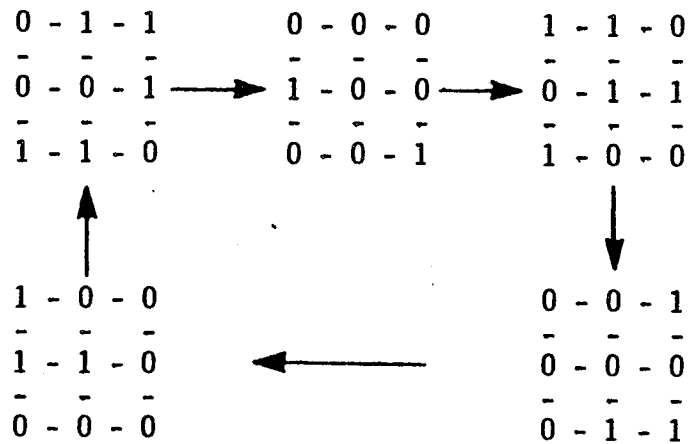

cycle of period 5.

We can see that, using rule Bmaj, we obtain very long cycles. Simulation experiments confirm this tendency.

**PERIODICITE D'AUTOMATES
A MULTISEUIL**

A Short Proof on the Cyclic Behaviour of Multithreshold Symmetric Automata

ERIC GOLES CH. AND SERVET MARTINEZ A.

*Departamento de Matemáticas y Ciencias de la Computación,
Facultad de Ciencias Físicas y Matemáticas, Universidad de Chile.
Casilla 5272 - Correo 3 Santiago, Chile*

It is shown that there exists a monomorphism from a multithreshold symmetric automata into a binary threshold symmetric automata. This implies that both automata have the same transient and cyclic behaviour. By a theorem proved in Goles and Olivos (1981) we conclude that a multithreshold symmetric automata does not have cycles of length greater than two.

1. THRESHOLD AUTOMATA

By a finite system we shall mean a couple (X, ϕ) where X is a finite set (the state space) and ϕ is a function from X into itself (the transition function). For every point $x \in X$ we can define the number $p(x)$, $t(x)$ called, respectively, the cycle length and the transient length, as the smallest integers that satisfy: $\phi^{q+p(x)}(x) = \phi^q(x)$ for each $q \geq t(x)$, being $p(x) > 0$, $t(x) \geq 0$.

We shall call ψ a monomorphism from the finite system (X_1, ϕ_1) into the finite system (X_2, ϕ_2) if $\psi: X_1 \rightarrow X_2$ is an injection and $\psi \circ \phi_1 = \phi_2 \circ \psi$. In this case we obtain: $p(x) = p(\psi(x))$ and $t(x) = t(\psi(x))$ for each $x \in X_1$.

Now consider a finite set $E = \{\theta_0, \dots, \theta_{p-1}\} \subset \mathbb{R}_+$ ($0 \leq \theta_0 < \theta_1 < \dots < \theta_{p-1}$). A multithreshold symmetric automata (MSA) is a special class of finite system, being its state space E^n and the transition function ϕ being characterized by means of two real matrices:

$$A = (a_{ij} / 1 \leq i, j \leq n),$$

$$B = (b_{ik} / 1 \leq i \leq n, 1 \leq k \leq p-1),$$

where A is symmetric and B satisfies

$$b_{i,k-1} < b_{i,k} \quad \text{for each } k \in \{2, \dots, p-1\},$$

ϕ is defined as follows: for each $x = (x_1, \dots, x_n)^T \in E^n$ we have $(\phi(x))_i = \theta_k$ if

GOLES AND MARTINEZ

We shall note by (E^n, A, B) the MSA defined by the matrices A, B .

A binary symmetric threshold automata (BSA) will be a MSA satisfying $E = \{0, 1\}$.

In Goles and Olivos (1981) it has been proved that the BSA satisfies the following property: $p(x) \leq 2$ for each $x \in \{0, 1\}^n$. This result was extended in Goles and Olivos (1980) for the MSA, the proof in this case uses the properties of an algebraic operator associated to the limit cycle behaviour of the MSA. In this note we shall prove the result for the MSA by means of a canonical monomorphism among them and the BSA. The existence of the canonical monomorphism allows us to show the equivalence of the transient and cyclic lengths of these two class of finite systems, then the two cycle property follows from Goles and Olivos (1981).

2. MONOMORPHISMS FROM MSA INTO BSA

We define the following injection from $E = \{\theta_0, \dots, \theta_{p-1}\}$ into $\{0, 1\}^p$:

$$\psi_0(\theta_k) = (1, \dots, 1, 0, \dots, 0)^T \in \{0, 1\}^p$$

└ $(k+1)$ th coordinate.

This function induces a canonical injection from E^n into $\{0, 1\}^{pn}$:

$$\bar{\psi}((x_1, \dots, x_n)^T) = (\psi_0(x_1), \dots, \psi_0(x_n))^T.$$

THEOREM. *Let (E^n, A, B) be a MSA. There exist \bar{A} , a $np \times np$ symmetric matrix, and \bar{B} a $np \times 1$ matrix such that $\bar{\psi}$ is a monomorphism among (E^n, A, B) and $(\{0, 1\}^{np}, \bar{A}, \bar{B})$.*

Proof. Define the following $p \times p$ symmetric matrix:

$$C = (c_{lk} / 0 \leq l, k \leq p-1),$$

where

$$c_{lk} = (\theta_l - \theta_0)(\theta_k - \theta_0) \quad \text{for } 1 \leq k, l \leq p-1,$$

$$c_{00} = \theta_0^2, \quad c_{0k} = c_{k0} = \theta_0(\theta_k - \theta_0) \quad \text{for } k \geq 1.$$

Now define the following $np \times np$ matrix:

$$\bar{A} = \begin{bmatrix} \bar{A}_{11} & \dots & \bar{A}_{1j} & \dots & \bar{A}_{1n} \\ \vdots & & \vdots & & \vdots \\ \bar{A}_{i1} & \dots & \bar{A}_{ij} & \dots & \bar{A}_{in} \\ \vdots & & \vdots & & \vdots \\ \bar{A}_{..} & \dots & \bar{A}_{..} & \dots & \bar{A}_{..} \end{bmatrix},$$

MULTITHRESHOLD SYMMETRIC AUTOMATA

where \bar{A}_{ij} is the following $p \times p$ matrix: $\bar{A}_{ij} = a_{ij}C$. The symmetry of A and C implies the symmetry of \bar{A} . Take $\bar{B} = (\bar{B}_1 \cdots \bar{B}_n)^T$ where $\bar{B}_i \in \mathbb{R}^p$:

$$\bar{B}_i = (b_{i0}^*, b_{i1}(\theta_1 - \theta_0), \dots, b_{ik}(\theta_k - \theta_0), \dots, b_{i,p-1}(\theta_{p-1} - \theta_0))^T,$$

where b_{i0}^* satisfies:

$$b_{i0}^* < \text{Inf}\{(Ax)_i \theta_0 / i \in \{1 \cdots n\}, x \in E^n\}.$$

We have $\bar{A}\bar{\psi}(x) = \bar{A}((\psi_0(x_1) \cdots \psi_0(x_n))^T) = (y_1 \cdots y_n)^T$ where the y_i are vectors of length p . It is easy to see that the k th coordinate of y_i is

$$\begin{aligned} y_i^k &= \left(\sum_{j=1}^n a_{ij} x_j \right) (\theta_{k-1} - \theta_0) & \text{if } k > 1 \\ &= \left(\sum_{j=1}^n a_{ij} x_j \right) \theta_0 & \text{if } k = 1. \end{aligned}$$

Then $\bar{\phi}(\bar{\psi}(x)) = (z_1 \cdots z_n)^T$ where z_i is a vector of length p satisfying

$$z_i = (1 \cdots 1 \quad 0 \cdots 0) \\ \quad \quad \quad \downarrow \\ \quad \quad \quad \text{\(\rightarrow\) } k\text{th coordinate,}$$

where $k + 1$ is the first coordinate for which

$$\left(\sum_{j=1}^n a_{ij} x_j \right) (\theta_k - \theta_0) < b_{i,k-1}(\theta_k - \theta_0) \quad \text{being } k \geq 1.$$

Then we obtain $\bar{\phi} \circ \bar{\psi}(x) = \bar{\psi} \circ \phi(x) \forall x \in E^n$.

Q.E.D.

This theorem implies, directly from Goles and Olivos (1981), that a MSA does not have cycles of length greater than two.

When $\theta_0 = 0$ it is easy to obtain a monomorphism $\bar{\psi}$ from (E^n, A, B) into a BSA supported by $\{0, 1\}^{n(p-1)}$ (see Goles and Martinez (1982)).

RECEIVED: May 24, 1982.

REFERENCES

- GOLES, E., AND OLIVOS, J. (1981), Comportement periodique des fonctions a seuil binaires et applications, *Discrete Appl. Math.* 3, 93-105.
- GOLES, E. AND OLIVOS, J. (1980), Comportement iteratif des fonctions a multiseuil, *Inform. Contr.* 45.
- GOLES, E. AND MARTINEZ, S. (1982), "Monomorphisms from multi-threshold symmetric automata into binary symmetric automata," Technical Report, Departamento de Matematicas y Ciencias de la Computación, Universidad de Chile.

CHAPITRE II
DYNAMIQUE D'AUTOMATES
UNIDIMENTIONNELS

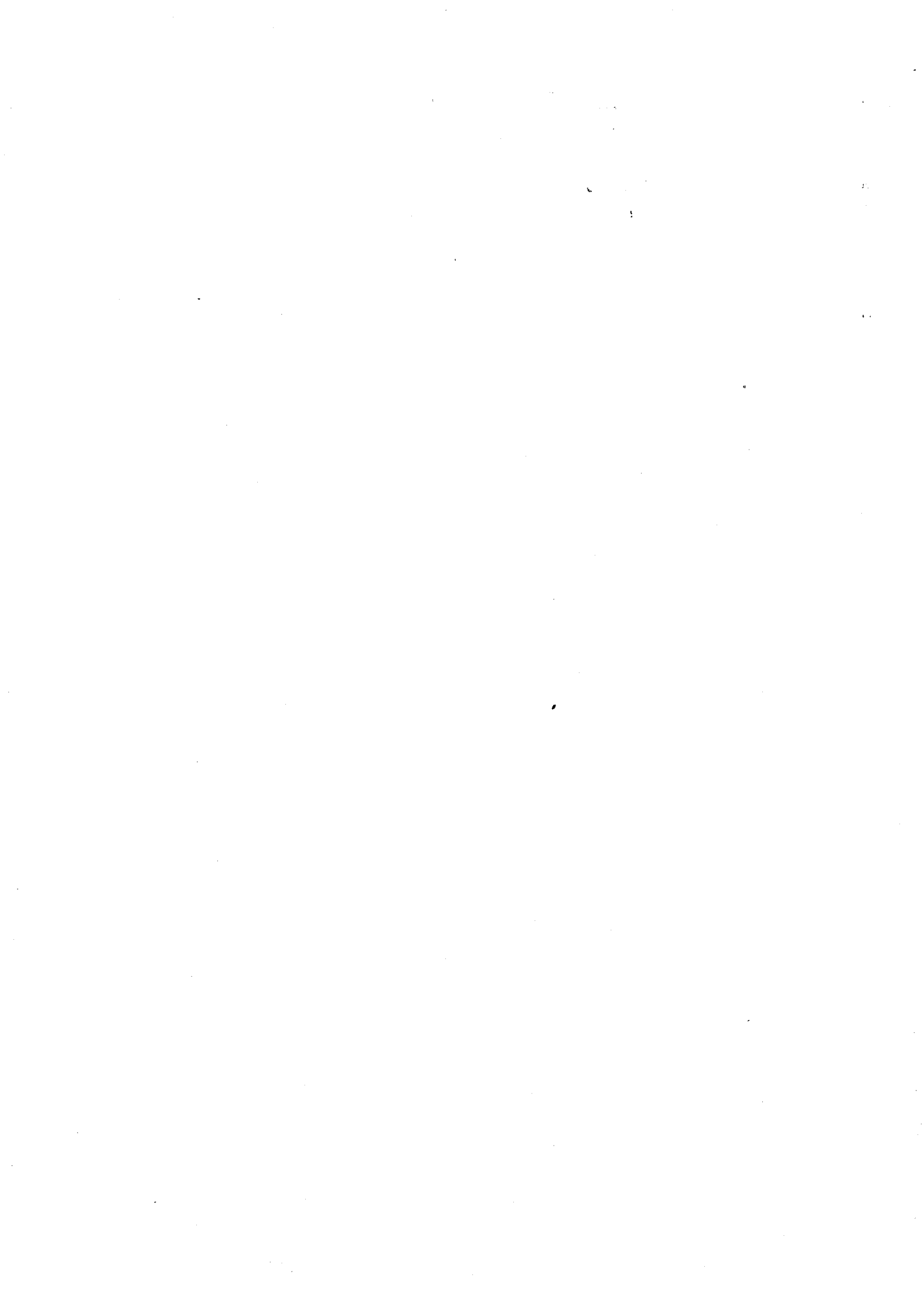

CHAPITRE-IIDYNAMIQUE D'AUTOMATES
UNIDIMENSIONNELS

A la lumière des résultats obtenus dans le Chapitre-I et dans [84], nous étudions les problèmes suivants:

- 1- Déterminer la longueur critique du voisinage dans un automate à seuil ou multiseuil unidimensionnel (l'espace cellulaire est \mathbb{Z}) tel que, pour cette valeur critique, la dynamique change d'un comportement stable à un comportement deux cyclique. Aussi, nous généralisons certains de ces résultats au cas bidimensionnel.

- 2- Une classe assez étudiée d'automates est celle d'automates "effaceurs" [36], c'est-à-dire, celui qui ramènent toute configuration finie, dans un nombre fini d'applications de la fonction globale, à la configuration où chaque cellule est à l'état de repos.

Le problème de caractériser un tel réseau d'automates a été résolu dans le cas bidimensionnel pour les automates monotones uniformes à deux états 01, mais pour plusieurs états le problème, même à une dimension, n'est pas évident. Dans [36], on donne un théorème de caractérisation des effaceurs monotones unidimensionnels, mais les conditions restent assez difficiles à vérifier du point de vue algorithmique. Dans cette optique, nous étudions ce problème pour les fonctions à multiseuil, sur l'espace cellulaire \mathbb{Z} , en essayant de donner une mesure de la complexité du problème de reconnaissance d'un effaceur.



**POINTS FIXES ET PERIODES
D'AUTOMATES A SEUIL
DANS Z**

FIXED POINT CONVERGENCE AND
PERIODICITY IN ONE DIMENSIONAL THRESHOLD AUTOMATA

En collaboration avec M. Tchuente
Disc. Math., 84

ABSTRACT

We study the iterative behaviour of some uniform one-dimensional threshold automata. In order to carry this study we use an algebraic approach based on two results previously obtained by the authors [2,3,15].

Some extensions and counter examples are given in the two dimensional case.

1. INTRODUCTION.

We are interested in the dynamical behaviour of cellular automata, i.e. networks of cells interconnected in a regular way. This problem has previously been studied by many authors: T. Kitagawa [6], A. Waksman [16], M. Tchuente [13,14], R. Shingai [11], Gales, Olivos [2,3], A.L. Toom [13], G. Galperin [4], J.M. Greenberg et al [5], S. Poljak and M. Sura [9]. The interest of such a study is to see how simple local interactions can induce a global behaviour in a complex structure. The domains of applications of cellular models range from population dynamics [3,9], Spin glass problem [3], chemistry [5] and neurophysiology [1,11].

In this paper we focuss our attention on the particular case of binary threshold networks. The underlying mathematical problem is the study of the iterative behaviour of functions of the form:

$$F : \{0,1\}^L \rightarrow \{0,1\}^L$$

$$X : (x_1, \dots, x_L) \rightarrow F(x) = (y_1, \dots, y_L) :$$

$$y_i = \begin{cases} 1 & \text{if } \sum_{j=1}^L a_{ij}x_j \geq \theta_i \\ 0 & \text{otherwise} \end{cases}$$

where $L \in \mathbb{N}$, $\theta \in \mathbb{R}^L$ and $A = (a_{ij}) \in M_{L \times L}(\mathbb{R})$

Our analysis will be based on two results, obtained

previously by the authors, and which can be stated as follows:

- (i) If A is symmetric, then, for any $x \in \{0,1\}^L$, there exists $s \in \mathbb{N}$ such that $F^{s+2}(x) = F^s(x)$, [2,3].
- (ii) If A is a symmetric matrix such that, for any $u \in \{-1,0,1\}^L$, there exists an index i for which $u_i (Au)_i \geq 0$, then, for any $x \in \{0,1\}^L$, there exists $s \in \mathbb{N}$ such that:

$$F^{s+1}(x) = F^s(x), \quad |15|$$

The latter result holds for instance if A is positive semidefinite, i.e. for any $x \in \mathbb{R}^L$, $x^t Ax \geq 0$; this particular case has also been obtained by P.D. Tao [12], in a context of convex analysis.

2. NOTATIONS AND DEFINITIONS.

A cellular structure of size L can formally be defined as a couple (G,Q) , where $G = (V,U)$ is a directed graph of order L and Q is a finite non empty set; every vertex i of G is associated with a cell Π_i with Q as state-set, and whose inputs are the states of the cells Π_j such that $(j,i) \in U$. More precisely, if $s(i,t)$ denotes the state of Π_i at time t , if $\{i_1, \dots, i_r\} = \{j / (j,i) \in U\}$ and if $f_i: Q^r \rightarrow Q$ denotes the local transition function of Π_i , then:

$$s(i,t+1) = f_i(s(i_1,t), \dots, s(i_r,t))$$

The mapping obtained by the simultaneous applications

previously by the authors, and which can be stated as follows:

- (i) If A is symmetric, then, for any $x \in \{0,1\}^L$, there exists $s \in \mathbb{N}$ such that $F^{s+2}(x) = F^s(x)$, [2,3].
- (ii) If A is a symmetric matrix such that, for any $u \in \{-1,0,1\}^L$, there exists an index i for which $u_i (Au)_i \geq 0$, then, for any $x \in \{0,1\}^L$, there exists $s \in \mathbb{N}$ such that:

$$F^{s+1}(x) = F^s(x), \quad |15|$$

The latter result holds for instance if A is positive semidefinite, i.e. for any $x \in \mathbb{R}^L$, $x^t Ax \geq 0$; this particular case has also been obtained by P.D. Tao [12], in a context of convex analysis.

2. NOTATIONS AND DEFINITIONS.

A cellular structure of size L can formally be defined as a couple (G,Q) , where $G = (V,U)$ is a directed graph of order L and Q is a finite non empty set; every vertex i of G is associated with a cell Π_i with Q as state-set, and whose inputs are the states of the cells Π_j such that $(j,i) \in U$. More precisely, if $s(i,t)$ denotes the state of Π_i at time t , if $\{i_1, \dots, i_r\} = \{j / (j,i) \in U\}$ and if $f_i: Q^r \rightarrow Q$ denotes the local transition function of Π_i , then:

$$s(i,t+1) = f_i(s(i_1,t), \dots, s(i_r,t))$$

The mapping obtained by the simultaneous applications

of the local transition functions of all the cells π_i , $1 \leq i \leq L$, is called the global transition function of the network. Since $\{0,1\}^L$ is a finite set of cardinality 2^L , any sequence $\{F^S(x); x \in \mathbb{N}\}$ is ultimately periodic. The maximum period of such sequences is called the maximum period of the structure and will be denoted by T .

3. ONE-DIMENSIONAL STRUCTURES.

In this section we study the particular case of binary scope n one-dimensional structures, i.e.:

- $Q = \{0,1\}$
- $V = \{1,2,\dots,L\}$, $U = \{(j,i) / |i-j| \leq n\}$
- The local transition function of π_i is a threshold function:

$$s(i,t+1) = \begin{cases} 1 & \text{if } \sum_{j=1}^L a_{ij} s(j,t) \geq \theta_i \\ 0 & \text{otherwise} \end{cases}$$

where $\theta = (\theta_1, \dots, \theta_L) \in \mathbb{R}^L$ and $A \in M_{L \times L}(\mathbb{R})$ is a Toeplitz matrix defined by:

$$a_{ij} = \begin{cases} a(k) & \text{for } |i-j| = k \leq n \\ 0 & \text{otherwise} \end{cases}$$

It is known that:

- (i) If $a(k) = a \geq 0$ for $k=0, \dots, n$ and $\theta_i = \theta$ for $i=1, \dots, L$, then $T=1$, [14,15].

- (ii) If $n=1$, and $\theta_i = \theta$ for any $i \in \mathbb{Z}$, then $T \leq 4$, [11].
- (iii) If $a(-k) = a(k)$ for $k=1, \dots, n$, then $T \leq 2$, [2,3].
- (iv) If $n=1$ and $a(0), a(1) \geq 0$ then $T \leq 2$, [10].

Since the coefficient $a(k)$ stands for the interaction between two cells Π_i, Π_j such that $|i-j|=k$, we are going to study some particular cases where $a(k)$ is a decreasing function of k ; this hypothesis is consistent with what happens for instance in physical phenomena.

PROPOSITION 1. Let us assume that $a(0) = a \in \mathbb{N}$ and $a(k) = 1$ for $1 \leq k \leq n$

- (i) If $n < \frac{9a}{2} - 2$ then $T=1$,
- (ii) If $n \geq 5a-2$ then $T=2$ and this bound is attainable for an appropriate choice of $L \in \mathbb{N}$ and $\theta \in \mathbb{R}^L$.

Before coming to the proof, we are going to introduce some notations, definitions and lemmas.

If any cell Π_j in the neighborhood of a cell Π_i , is represented by the coefficient a_{ij} , then we obtain the following figure:

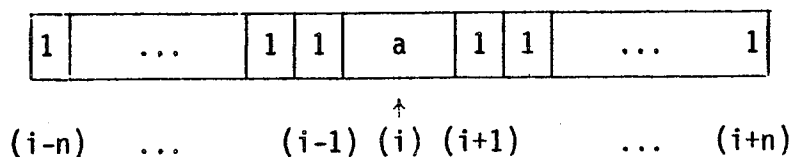

Figure 1

Let $x, y \in \{0,1\}^L$, $x \neq y$ be such that $Fx=y$, $Fy=x$;
i.e. vectors x and y are a two cycle of the automata.

Let us denote $u=(u_1, \dots, u_L) = x-y$. It is known
that:

$$(1) \quad u_i \neq 0 \implies u_i (a u_i + \sum_{k=1}^n (u_{i-k} + u_{i+k})) < 0 \quad |15|$$

thus, if $S(i) = \sum_{k=-n}^n u_{i+k}$, we conclude from (1):

$$(2) \quad u_i = 1 \implies S(i) \leq -a$$

$$(3) \quad u_i = -1 \implies S(i) \geq a$$

On the other hand, from definition on $S(i)$ it is
easy to see that:

$$S(i+1) - S(i) = u_{i+1+n} - u_{i-n}$$

thus, if $i < j$ and $u_i u_j = -1$ we have:

$$\begin{aligned} S(j) - S(i) &= \sum_{r=i}^{j-1} (S(r+1) - S(r)), \text{ hence} \\ &= \sum_{r=i}^{j-1} (u_{r+1+n} - u_{r-n}) \end{aligned}$$

hence:

$$|S(j) - S(i)| \leq \sum_{r=i}^{j-1} |u_{r+1+n} - u_{r-n}| \leq 2(j-i)$$

on the other hand, from (2) and (3) we have:

$|S(j) - S(i)| \geq 2a$, then:

$$(4) \quad i < j \text{ and } u_i u_j = -1 \implies j - i \geq a$$

$$(5) \quad i < j, u_i u_j = -1 \text{ and } u_r = 0 \text{ for } i < r < j \implies j - i \geq 2a$$

Properties (2), (3), (4) and (5) will be the principals tools in order to prove theorem 1.

Let us define $a_i, b_i, p_i, i=1, \dots, q$ as follows:

$$a_1 = \min \{j / u_j \neq 0\}$$

without any lost of generality we can assume $u_{a_1} = 1$.

$$b_i = \max \{j / u_j \neq 0 \text{ and } u_{a_i} u_s \geq 0, a_i \leq s \leq j\} \quad i=1, \dots, q$$

$$a_{i+1} = \min \{j / j > b_i \text{ and } u_{b_i} u_j < 0\} \quad i=1, \dots, q-1$$

$$p_i = \text{card} \{j / a_i \leq j \leq b_i \text{ and } u_j \neq 0\} \quad i=1, \dots, q$$

Example:

$$u = (0, 1, 0, -1, -1, 0, 0, -1, 1, 1, 0, 0, -1, 0, 0)$$

$$a_1 = b_1 = 2; a_2 = 4, b_2 = 8; a_3 = 9, b_3 = 10, a_4 = b_4 = 13$$

with this definitions we partition vector u into class such that each class has only components of the same sign or zero.

Proof. of Theorem 1.

Since $a(k) = a(-k)$ for $k=1, \dots, n$, the maximum period of the automata is $T \leq 2 \lfloor 2,3 \rfloor$.

(i) We only need to show that $T \neq 2$.

Therefore, let us assume the existence of a two cycle, i.e. vectors $x, y \in \{0,1\}^L$, $x \neq y$, such that $Fx=y$, $Fy=x$ and let us adopt the previous notations.

Since $u_{a_1}=1$, from property (2) we have: $S(a_1) \leq -a < 0$ and since by definition of partition $u_j \geq 0$ for $j \leq b_1$, it is clear that $S(a_1)$ takes into account elements of negative block $[a_2, b_2]$, hence:

$$(6) \quad n + a_1 > a_2$$

as a consequence we have $u_{k-n} = 0$ for $b_1 \leq k < a_2$ hence, by property (5):

$$u_{a_1} u_{b_1} = -1, \quad b_1 < a_2 \implies a_2 - b_1 \geq 2a$$

On the other hand if $n+a_1 \geq a_4$

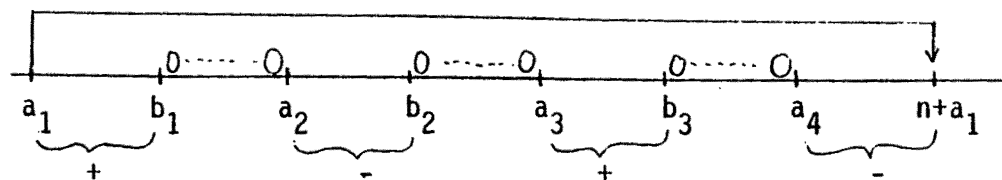

then $n \geq (a_2 - b_1) + (a_3 - b_2) + (a_4 - b_3)$

and it is easy to see that from property (5):

$$a_3 - b_2 \geq 2a \quad \text{and} \quad a_4 - b_3 \geq 2a$$

hence $n \geq 6a$, which contradicts to the assumption (i) of the theorem.

Then:

$$(7) \quad n + a_1 < a_4$$

From properties (2) and (7) we can write:

$$p_1 - p_2 \leq S(a_1) \leq -a, \text{ hence}$$

$$(8) \quad p_2 \geq a + p_1$$

Inequality (8) implies that the right neighborhood of a_1 take account at least $a + p_1$ elements of the negative block $[a_2, b_2]$.

If $n + a_1 \geq a_3$, from properties (5) and (8) we have:

$$\begin{aligned} n \geq a_3 - a_1 &\geq (a_3 - b_2) + (b_2 - a_2) + (a_2 - b_1) \\ &\geq 2a + p_2 - 1 + 2a \geq 5a + p_1 - 1 \geq 5a \end{aligned}$$

which contradicts to the assumption (i) of the theorem hence:

$$(9) \quad n + a_1 < a_3$$

If $a_2 + n < a_3$, let us:

$$p_2' = \text{card}\{j \in [a_1, a_1+n] \cap [a_2, b_2] / u_j = -1\}$$

$$p_2'' = \text{card}\{j \in [a_2, a_2+n] \cap [a_2, b_2] / u_j = -1\}$$

Clearly $p_2' \leq p_2'' \leq p_2$ and we have from properties (2) and (3):

$$-a \geq S(a_1) = p_1 - p_2' \quad \text{and} \quad a \leq S(a_2) = p_1 - p_2''$$

hence $p_2' > p_2''$, which is a contradiction. hence

$$(10) \quad n + a_2 \geq a_3$$

hence, from property (3):

$$S(a_2) = p_1 - p_2 + \sum_{a_3 \leq i \leq a_2+n} u_i \geq a$$

and from (8):

$$(11) \quad \sum_{a_3 \leq i \leq a_2+n} u_i \geq 2a$$

If $a_2 + n \geq a_4$, then

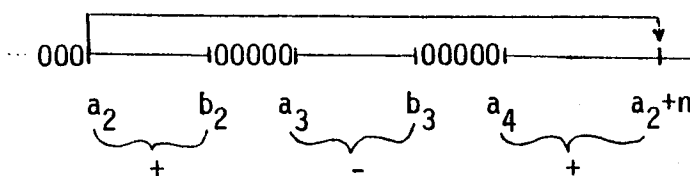

$$\begin{aligned}
 n &\geq (b_2 - a_2) + (a_3 - b_2 - 1) + \sum_{a_3 \leq i \leq b_3} u_i + (a_4 - b_3 - 1) + \sum_{a_4 \leq i \leq a_2 + n} u_i \\
 &\geq (b_2 - a_2) + (a_3 - b_2 - 1) + (a_4 - b_3 - 1) + \sum_{a_3 \leq i \leq a_2 + n} u_i
 \end{aligned}$$

and from properties (4), (8), (11) and definition of the blocks:

$$\begin{aligned}
 n &\geq (p_2 - 1) + (a - 1) + (a - 1) + 2a \\
 &\geq (a + p_1 - 1) + (a - 1) + (a - 1) + 2a \geq 5a - 2 > \frac{9a}{2} - 2
 \end{aligned}$$

which is a contradiction with the hypothesis (i)

hence:

$$(12) \quad a_2 + n < a_4$$

as a consequence:

$$a \leq S(a_2) \leq p_1 - p_2 + p_3'$$

where $p_3' = \text{card}\{j \in [a_2, a_2 + n] \cap [a_3, b_3] / u_j = 1\}$ hence from (8):

$$(13) \quad p_3 \geq p_3' \geq a + p_2 - p_1 \geq 2a$$

On the other hand if $a_3 + n \geq a_6$

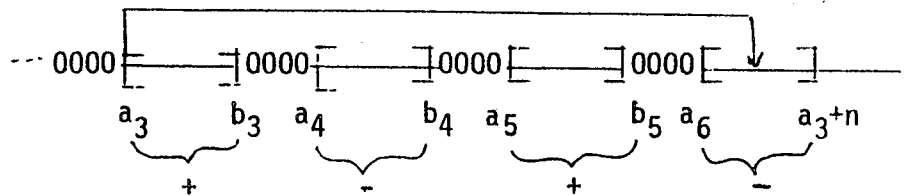

then, from (4) and (13):

$$\begin{aligned} n &\geq (p_3-1) + (a_4-b_3-1) + p_4 + (a_5-b_4-1) + p_5 + (a_6-b_5-1) \\ &\geq (2a-1) + (a-1) + 1 + (a-1) + 1 + (a-1) \\ &\geq 5a - 2 > \frac{9a}{2} - 2, \end{aligned}$$

which is a contradiction with assumption (i) of the theorem. Then:

$$(14) \quad a_3 + n < a_6$$

Let us denote $p_4 = \text{card}\{j \in [a_4, b_4] \cap [a_3, a_3+n] / u_j=1\}$

From (3) and (12) it is clear that:

$$S(a_2) = p_1 - p_2 + p_3' \geq a, \text{ then}$$

$$(15) \quad p_2 \leq p_1 + p_3' - a$$

On the other hand from (10) and (12)

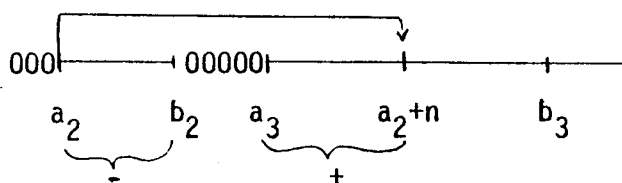

$$(16) \quad n \geq (p_2-1) + (a_3-b_2-1) + p_3'$$

and from (4), (8) and (13):

$$n \geq (a+p_1-1) + (a-1) + 2a, \text{ hence}$$

$$(17) \quad n \geq 4a + p_1 - 2$$

If $a_3 + n < a_4$, we have:

$$-a \geq S(a_3) \geq -p_2 + 2a \implies p_2 \geq 3a$$

and from (16):

$$n \geq (3a-1) + (a-1) + 2a = 6a - 2 > \frac{9a}{2} - 2$$

which is a contradiction, hence:

$$(18) \quad a_3 + n \geq a_4, \text{ then; from (2):}$$

$$-a \geq S(a_3) \geq -p_2 + p_3 - p_4'$$

and from (15):

$$p_4' \geq a - p_1 - p_3' + a + p_3,$$

since $p_3 \geq p_3'$ then $p_4' \geq 2a - p_1$, hence from (4), (13),

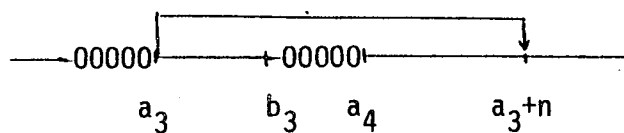

$$\begin{aligned} n &\geq (p_3-1) + (a_4-b_3-1) + p_4' \\ &\geq (2a-1) + (a-1) + 2a - p_1 \end{aligned}$$

(19) $n \geq 5a - p_1 - 2$

It follows from (17) and (19) that:

$2n \geq 9a - 4$, then $n \geq \frac{9a}{2} - 2$

which is a contradiction with the hypothesis of the theorem ■

(ii) Here, we just need to exhibit, $L \in \mathbb{N}$, $\Theta \in \mathbb{R}^L$, and two vectors $x, y \in \{0,1\}^L$ such that:

$x \neq y$, $F(x) = y$ and $F(y) = x$

Case 1: $a = 2r$; $n = 10r - 2$

$C_{u,v} =$	u...u	0...0	v...v	0...0	u...u	0...0	v...v	0...0	u...u	0...0	v...v
length	r	n+1-4r	3r	n+1-7r	4r	3r-1	4r	n+1-7r	3r	n+1-4r	r
threshold	$\Theta = 3r$	$\Theta > 5r$	$\Theta = 5r$	$\Theta > 7r$	$\Theta = 6r$	$\Theta > 7r$	$\Theta = 6r$	$\Theta > 7r$	$\Theta = 5r$	$\Theta > 5r$	$\Theta = 3r$

Figure 2

Clearly, $C_{0,1} \neq C_{1,0}$ and $F(C_{0,1}) = C_{1,0}$; $F(C_{1,0}) = C_{0,1}$

Case 2: $a = 2r + 1$; $n = 10r + 3$

$C_{u,v} =$	u...u	0...0	v...v	0...0	u...u	0...0	v...v	0...0	u...u	0...0	v...v
length	r+1	n-4r-2	3r+2	n-7r-3	4r+2	3r	4r+2	n-7r-3	3r+2	n-4r-2	r+1
threshold	$\Theta = 3r+2$	$\Theta > 5r+3$	$\Theta = 5r+3$	$\Theta > 7r+4$	$\Theta = 6r+4$	$\Theta > 7r+4$	$\Theta = 6r+4$	$\Theta > 7r+4$	$\Theta = 5r+3$	$\Theta > 5r+3$	$\Theta = 3r+2$

Figure 3

Clearly, $C_{0,1} \neq C_{1,0}$, $F(C_{0,1}) = C_{1,0}$, $F(C_{1,0}) = C_{0,1}$.

Comment. We think that $T = 1$ for $9a/2 - 2 \leq n < 5a - 2$ but the proof seems very difficult.

PROPOSITION 2. If $a(k) = n - |k|$, for $k = -n, -n+1, \dots, n$; $n \in \mathbb{N}$, then $T=1$.

PROOF. Let $A \in M_{L \times L}(\mathbb{R})$ be the matrix associated with the network. A is a Toeplitz matrix defined by:

$$a_{ij} = n - |i-j|$$

From [15], it is sufficient to prove that A is positive definite. For any $r \in \mathbb{Z}$, let us denote by $A^{(r)} \in M_{L \times L}(\mathbb{R})$ the matrix defined by:

$$a_{ij}^{(r)} = \begin{cases} 1 & \text{if } \max\{1, r\} \leq i, j \leq \min\{n, r+n-1\} \\ 0 & \text{otherwise} \end{cases}$$

It is easily verified that:

$$A = \sum_{r=-n+1}^n A^{(r)}$$

Since

$$x^t A^{(r)} x = \left(\sum_{i=\max\{1, r\}}^{\min\{n, r+n-1\}} x_i \right)^2;$$

for any $x \in \mathbb{R}^L$ it follows that:

$$x^t A x = \sum_{r=-n+1}^n x^t A^{(r)} x \geq 0;$$

for any $x \in \mathbb{R}^L$ and the result holds.



The following example shows that Proposition 2 cannot be extended to all cellular structures where $a(k)$ decreases in an arithmetic manner, i.e.: $a(k) = n - |k\lambda|$, $k=0,1,\dots$

Example:

$$n = 3, L = 8, \quad = (9, 12, 14, 14, 14, 14, 12, 9)$$

$$a(k) = 7 - |k|, \quad k=-3, \dots, 3$$

It is easily verified that:

$$x = F^2(x) = (0, 0, 1, 1, 0, 0, 0, 1)$$

$$F(x) = (1, 0, 0, 0, 1, 1, 0, 0)$$

Clearly, in the particular case $n=q\lambda$, $q \in \mathbb{N}$, with $a(k) = n - |k\lambda|$, $k=0,1,\dots,q$, it is direct from the proof above that the matrix A associated with the structure is a Toeplitz positive definite matrix, hence $T = 1$.

4. TWO-DIMENSIONAL STRUCTURES.

A finite cellular structure is said to be two-dimensional of size $L_1 \times L_2$, if the underlying graph can be coded into the form $G = (V,U)$ where:

$$V = \{I=(r,s) / 1 \leq r \leq L_1, 1 \leq s \leq L_2\}$$

$$U = \{(I, I+V_j) / 1 \leq j \leq m\},$$

where $\Gamma = \{V_1, \dots, V_m\} \subseteq \mathbb{Z}^2$

As in the preceding section, the local transition function is of the form:

$$s(I, t+1) = \begin{cases} 1 & \text{if } \sum_{i=1}^m a(V_i) s(I+V_i, t) \geq \theta_I \\ 0 & \text{otherwise} \end{cases}$$

We are going to study some extensions of Proposition 1,2 to such structures.

Let us first consider the generalized scope $-n$ Von-Neumann neighborhood; i.e.:

$$\Gamma = \{(0,r), (r,0) / -n \leq r \leq n\}$$

as illustrated in the example below, Proposition 1,2 cannot be extended directly.

Example:

$$a(0,0) < \lambda = \min\{a(0,1)+a(1,0), a(0,-1)+a(1,0), a(0,1)+a(-1,0), a(0,-1)+a(-1,0)\}$$

$$L_1 = L_2 = 2, \theta_I = \lambda \quad \text{for any } I$$

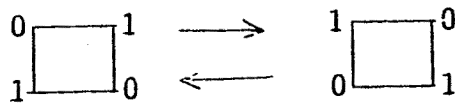

Figure 4

However, we can prove the following:

PROPOSITION 3. If $a(0,0) \geq 2n$ and $a(0,r) = a(r,0) = n - |r|$, for $r = -n, \dots, n$; then $T = 1$.

PROOF. Let us consider such a structure with size $L_1 \times L_2$ and let $B \in M_{L_1 \times L_2}(\mathbb{R})$, $L = L_1 L_2$; denote the associated matrix; clearly, B is symmetric.

For $x \in \mathbb{R}^L$ we write:

$$x = (x_{11}, \dots, x_{1L_2}, x_{21}, \dots, x_{2L_2}, \dots, x_{L_1 1}, \dots, x_{L_1 L_2})$$

$$x_{i \cdot} = (x_{i1}, \dots, x_{iL_2}) \in \mathbb{R}^{L_2}; \quad i=1, \dots, L_1$$

$$x_{\cdot j} = (x_{1j}, \dots, x_{L_1 j}) \in \mathbb{R}^{L_1}; \quad j=1, \dots, L_2$$

with these notations it is easily verified that:

$$x^t B x = (a(0,0) - 2n) \sum_{i,j} x_{i,j}^2 + \sum_{i=1}^{L_1} x_{i \cdot}^t A_1 x_{i \cdot} + \sum_{j=1}^{L_2} x_{\cdot j}^t A_2 x_{\cdot j}$$

where $A_1 \in M_{L_1 \times L_1}(\mathbb{R})$ and $A_2 \in M_{L_2 \times L_2}(\mathbb{R})$ are Toeplitz matrices whose (i,j) -entry is:

$$\alpha_{ij} = \begin{cases} n - |i-j| & \text{is } |i-j| \leq n \\ 0 & \text{otherwise} \end{cases}$$

From Proposition 2, it follows that:

$$x_i^t A_1 x_i \geq 0 \quad \text{and} \quad x_j^t A_2 x_j \geq 0, \quad \text{for } i=1, \dots, L_1; \\ j=1, \dots, L_2.$$

Hence $x^t B x \geq 0$ for any $x \in \mathbb{R}^L$ and the Proposition holds



Let us now consider the generalized scope - pxq Moore- neighborhood, i.e.:

$$\Gamma = \{(r,s) \mid -p \leq r \leq p; -q \leq s \leq q\}$$

Case 1: $a(r,s) = 1$ for any $(r,s) \in \Gamma \setminus \{(0,0)\}$

Let us assume the existence of $x, y \in \mathbb{R}^L$ such that $x \neq y$, $F(x) = y$, $F(y) = x$.

If $C = \{(i,j) \mid x_{i,j} \neq y_{i,j}\}$, then the application of property (2) of section 3 to the leftmost cell on the upper boundary

of C shows that:

$$a(0,0) < p \cdot q$$

On the other hand, the example below shows that the structure may have maximum period, $T = 2$, when $a(0,0) \geq \frac{5}{2} p \cdot q$; however, the case:

$$p \cdot q < a(0,0) < \frac{5}{2} p \cdot q$$

seems very difficult to handle.

Example: $\lambda \in \mathbb{N}$; $a(0,0) = 4\lambda^2$; $p = 5\lambda$; $q = 4\lambda$

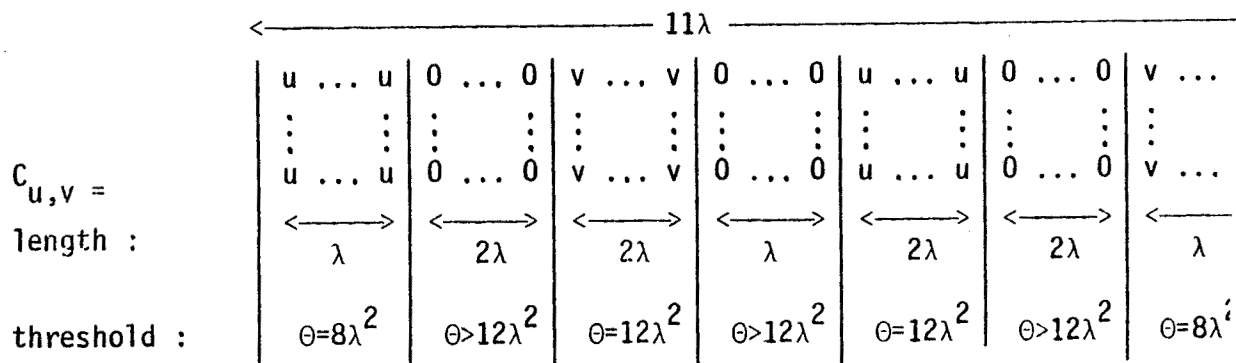

Figure 5

Clearly, $C_{0,1} \neq C_{1,0}$; $F(C_{0,1}) = C_{1,0}$; $F(C_{1,0}) = C_{0,1}$

Case 2: $a(r,s) = n - (|r| + |s|)$

This is the two-dimensional analog of the one-dimensional

structure studied in Proposition 2. As shown in the following figure, it is always possible to choose the thresholds I in order to obtain a maximum period $T=2$.

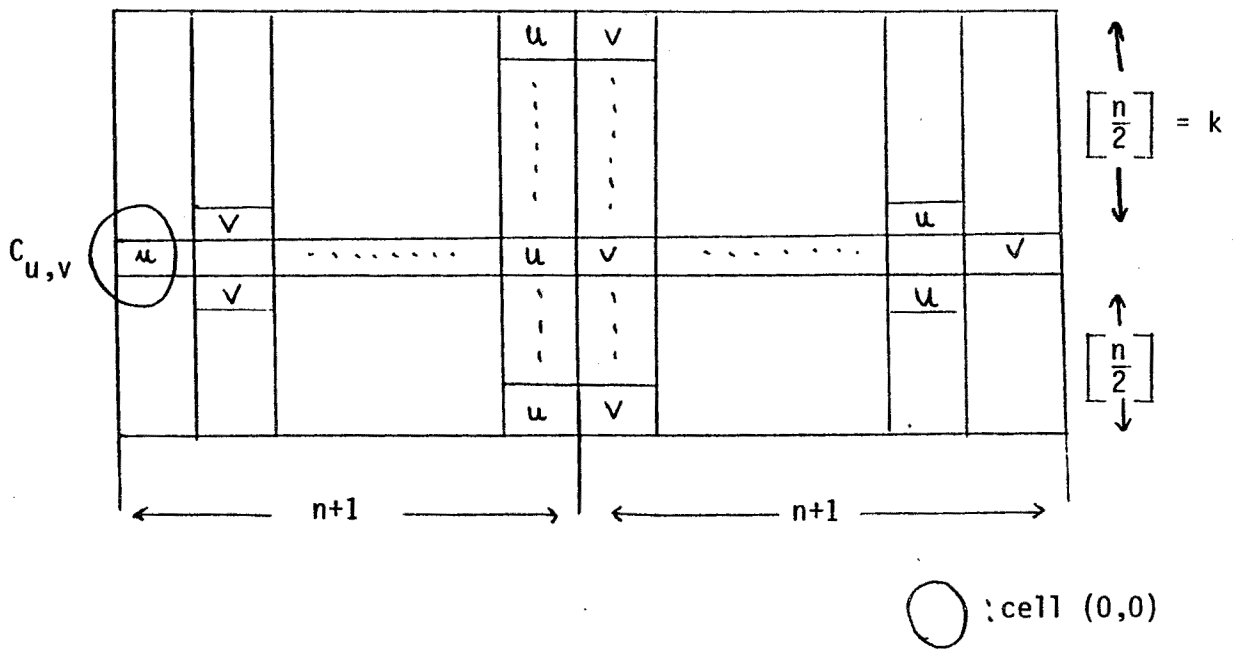

Figure 6

$$C_{u,v}(i,j) = \begin{cases} u & \text{if } (i,j) \text{ is represented by } \boxed{u} \\ v & \text{if } (i,j) \text{ is represented by } \boxed{v} \\ 0 & \text{otherwise} \end{cases}$$

$$\theta_{0,0} = \theta_{0,2n+1} = 2n-2; \quad \theta_{1,1} = \theta_{-1,1} = \theta_{1,2n} = \theta_{-1,2n} = 2n-1$$

for $-k < i < k$:

$$\theta_{k-i,n} = \theta_{k-i,n+1} = \theta_{k+i,n} = \theta_{k+i,n+1} = \sum_{\ell=1}^i (n-\ell) + \sum_{\ell=0}^{n-i} (n-\ell) + 1$$

$$\theta_{ij} = n^2 \text{ otherwise}$$

Clearly, $C_{0,1} \neq C_{1,0}$ and $F(C_{0,1}) = C_{1,0}$, $F(C_{1,0}) = C_{0,1}$

REFERENCES.

- [1] M.A. ARBIB, Brains, Machines and Mathematics, Mc. Graw Hill, Paperbacks, 1964.
- [2] E. GOLES and J. OLIVOS, Comportement oscillatoire des fonctions a multiseuil. Information and Control 45 (3), (1980), 300-313.
- [3] E. GOLES, Comportement oscillatoire d'une famille d'automates cellulaires uniformes, Thesis, I.M.A.G., University of Grenoble, 1980).
- [4] G. GALPERIN, One-dimensional automaton networks with monotonic interaction, Problemy Peredachi Informatsii, Vol.12, N°4, (1976).
- [5] J.M. GREENBERG, C. GREENE and S.P. HASTINGS, A combinatorial problem arising in the study of reaction-diffusion equation, SIAM J. Alg. Disc. Math. Vol.1 (1980) 34-42.
- [6] T.KITAGAWA, Cell space approaches in biomathematics. Mathematical Biosciences, 19, (1974) 27-71.
- [7] E.F. MOORE, Machine models of self reproduction, Proc. Symp. Applied Math. XIV, (1961) 17-33.
- [8] J.V. NEUMANN, Theory of self-reproducing automata, A.W. Burks ed. University of Illinois Press, (1966).
- [9] S. POLJAK and M. SURA, On periodical behaviour in societies with symmetrical relations, To appear, in Combinatorica.

- |10| Y. ROBERT and M. TCHUENTE, Relations entre le graphe de connexion et le graphe d'iteration d'une fonction booléenne monotone, R.R. I.M.A.G. N°307 (Grenoble).
- |11| R. SHINGAI, Periodic behaviours of one-dimensional uniform threshold circuits, Trans. IECE Japan, J59-A,6, (June 1976).
- |12| PHAM DIN TAO, Comportement iteratif de point fixe des opérateurs monotones. Submitted for publication.

**AUTOMATES EFFACEURS
A MULTISEUIL**

ERASING MULTITHRESHOLD AUTOMATA

En collaboration avec M. Tchuente
à paraître en *Dynamical Systems and
Automata Networks*, Ac. Press, 85

1. INTRODUCTION

The one-dimensional multithreshold automata studied here are discrete dynamical systems $A = (Z, [K], b, h)$ in which any cell $x \in Z$ can assume an integer state in the range 0 through K , and where the state $c(x, t)$ of any cell x at time t is determined by the states of the cells in a neighborhood of radius h as follows :

$$c(x, t) = f(c(x-h, t-1), \dots, c(x+h, t-1)) = i$$

$$\Leftrightarrow b_{i-1} \leq \sum_{j=-h}^h c(x+j, t-1) < b_i .$$

f is called the local transition function, and

$b = (b_0, b_1, \dots, b_{K-1}) \in \mathbb{R}^K$ is called the threshold vector ;

$c(\cdot, t) : Z \rightarrow [K] = \{0, 1, \dots, K\}$ is called a configuration

and we write $c(\cdot, t) = F(c(\cdot, t-1))$ where F denotes the global transition function.

A configuration $c : Z \rightarrow [K]$ is said to be finite if there are only a finite number of cells such that $c(x) \neq 0$. In this paper, we are interested in the particular case of erasing multithreshold automata, i.e. those where, for any

evolution $\{c(\cdot, t) = F^t(c(\cdot, 0)) ; t \geq 0\}$ starting from a finite configuration $c(\cdot, 0)$, there exists an integer s such that $c(\cdot, s)$ is the null configuration, i.e.

$c(x, s) = 0$ for any $x \in Z$. This problem has previously been studied by Toom (10) and Galperin (1,2), for general monotonic local interactions ; however, the results of Toom

concern only the binary case while those of Galperin are difficult to handle algorithmically. The analysis presented in this paper for $K = 2$ and $K = 3$, is based on very simple algorithms and it illustrates the complexity of the problem. The reader interested in more general results about the dynamic behaviour of multithreshold automata, may refer to (3,4,5,6,7,8,9).

2. NOTATIONS AND DEFINITIONS

A stair e is a configuration such that

$x \leq y$ implies $e(x) \leq e(y)$; and $0 = \lim_{x \rightarrow -\infty} e(x) \neq \lim_{x \rightarrow +\infty} e(x)$.

We always assume that $e(0) = 0$; as a consequence, we only need to specify the states of the cells $x \geq 1$; for ins-

tance , $e = \overrightarrow{00011112} = \overrightarrow{00^2 1^4 2}$ is such that

$e(x) = 0$ for $x \leq 2$, $e(x) = 1$ for $3 \leq x \leq 6$,

$e(x) = 2$ for $x \geq 7$.

$\tau_+(e)$ is the stair obtained from e by a right-shift and is defined by $\tau_+(e)(x) = e(x-1)$ for any $x \in \mathbb{Z}$.

We shall assume that any constant configuration is invariant , i.e. $f(a,a,\dots,a) = a$ for any $a \in [K]$; it follows that $(2h+1)(i-1) < b_{i-1} \leq (2h+1)i$ for any $i \geq 1$.

Clearly, A is erasing if and only if, for any stair e , there exists an integer t such that $F^t(e) \leq \tau_+(e)$. As a consequence, it is sufficient, as suggested in Galperin (1,2) to study the evolution of stairs.

If $K = 1$, then it is trivial that A is erasing if and only if $b_0 \geq h+2$; let us now turn to the case $k = 2$.

3. 2-STATE MULTITHRESHOLD AUTOMATA

Proposition 1 :

Let $A = (Z, [2], b, h)$; $b \in \mathbb{N}^2$, $h \in \mathbb{N}$ be a one-dimensional multithreshold automaton in which any constant configuration is invariant (i.e.

$b_0 \leq 2h+1 < b_1 \leq 4h+2$) . A is erasing if and only if

$h+2 \leq b_0 \leq 2h+1$, $2h+3 \leq b_1 \leq 4h+2$ and $4h+5 \leq b_0 + b_1$.

Proof : Necessary condition : We are going to prove that if one of these conditions does not hold, then there exists a stair e such that $F(e) \geq e$. If $b_0 \leq h+1$ (resp. $b_1 \leq 2h+2$) then the stair $e = \overrightarrow{01}$ (resp. $e = \overrightarrow{02}$) verifies $F(e) \geq e$.

If $h+2 \leq b_0 \leq 2h+1$, $2h+3 \leq b_1 \leq 4h+2$ and $b_0+b_1 \leq 4h+4$ then we can write $b_0 = h+1+t$, $b_1 = 3h+3-s$ where $1 \leq t \leq s \leq h$ and it is easily verified that the stair $e = \overrightarrow{01^{h+1-t}2}$ is such that $F(e) \geq e$.

Sufficient condition : Let $h+2 \leq b_0 \leq 2h+1$, $2h+3 \leq b_1 \leq 4h+2$ and $b_0+b_1 \geq 4h+5$ we can write $b_0 = h+1+t$, $1 \leq t \leq h$ and it is easily verified that the stair $e = \overrightarrow{01^{h+1-t}2}$ is such that $F^2(e) \leq \tau_+(e)$. Thus A is erasing.

Comment : Since the local transition function of a multi-threshold automaton is defined in terms of linear inequalities, one may expect the set E of threshold vectors associated with erasing automata, to be a convex region. Theorem 1 shows that this convexity property holds when the threshold vectors are restricted to be in \mathbb{N}^2 ; however, as shown below, this is not true in \mathbb{R}^2 .

$$\begin{array}{l}
 - 1 - \quad b' = (h+1.1, 3h+2.1) \in E \\
 \quad \quad b'' = (h+2.1, 3h+1.1) \in E \\
 \quad \quad b = \frac{1}{2}(b+b') = (h+1.6, 3h+1.6) \notin E \\
 \\
 - 2 - \quad b' = (h+2, 3h+2) \notin E \\
 \quad \quad b'' = (h+3, 3h+1) \notin E \\
 \quad \quad b = \frac{1}{2}(b+b') = (h+2.5, 3h+1.5) \in E
 \end{array}$$

Let us now study the case when any elementary cell can assume four states (i.e. $K=3$).

4. 3-STATE MULTITHRESHOLD AUTOMATA

Lemma 2 : If $A = (Z, [3], b, h)$, $b \in \mathbb{N}^3$, $h \in \mathbb{N}$ is such that $h+2 \leq b_0 \leq 2h+1$, $2h+3 \leq b_1 \leq 4h+2$, $4h+3 \leq b_2 \leq 5h+3$ and $b_0+b_1 \leq 4h+5$ then there exists a stair $e = \overrightarrow{01\dots 12\dots 23}$ such that $F(e) \geq e$ or $F(e) \leq e$.

Proof : For any stair $e = \overleftarrow{0}1^r2^s\overrightarrow{3}$; $1 \leq r, s$ we denote
 $e_{(i)} = \min \{x : e(x) = i\}$ for $i = 1, 2, 3$;

$S(e, x) = \sum_{j=-h}^{j=h} e(x+j)$ for any $x \in Z$. It is sufficient to

exhibit a stair e such that

(*) $F(e)(e_{(i)}-1) = i-1$ and $F(e)(e_{(i)}) = i$ for two distinct values of i . Indeed, if for instance property (*) holds with $i=1, 3$, then $F(e)(e_{(2)}) \geq 2$ (resp. $F(e)(e_{(2)}) \leq 1$) implies $F(e) \geq e$ (resp. $F(e) \leq e$) .

Let us denote $b_0 = h+1+t$; $s = h+1-t = 2(h+1)-b_0$

$a^{(r)} = \overleftarrow{0}1^s2^{t+r}\overrightarrow{3}$ for $r \geq 0$;

$c^{(r)} = \overleftarrow{0}1^{s+r}2^{t-2r}\overrightarrow{3}$ for $0 \leq r \leq \frac{t}{2}$

Clearly, $a^{(0)} = c^{(0)}$; $F(e)(e_{(1)}-1) = 0$ and

$F(e)(e_{(1)}) = 1$ for $e \in \{a^{(r)}, c^{(r)} ; r \geq 0\}$.

Case 1 : $S(a^{(0)}, a_{(3)}^{(0)}-1) = b_0 + 3h = b_2-1$

$a^{(0)}$ verifies property (*) with $i=1, 3$. Let $e = a^{(0)}$;

$S(e, e_{(2)}) = 6(h+1)-2b_0$. If $6(h+1)-2b_0 \geq b_1$ then $F(e) \geq e$, otherwise $F(e) \leq e$.

Case 2 : $S(a^{(0)}, a_{(3)}^{(0)}-1) = b_0 + 3h \leq b_2-2$

Clearly, $S(a^{(r)}, a_{(3)}^{(r)}) = S(a^{(r)}, a_{(3)}^{(r)}-1)+2$ for $r=1, \dots, s-1$

$S(a^{(r)}, a_{(3)}^{(r)}-1) = S(a^{(r-1)}, a_{(3)}^{(r-1)}-1)+1$ for $r=1, \dots, s-1$

$S(a^{(s-1)}, a_{(3)}^{(s-1)}-1) = 5h+1 \geq b_2-2$

Let $e = a^{(p)}$, where $p = b_2-2-(b_0+3h)$; e verifies property (*) with $i=1, 3$ and $S(e, e_{(2)}) = b_0+3s-p = 9h+8-b_0-b_2$.

If $9h+8-b_0-b_2 \geq b_1$ then $F(e) \geq e$, otherwise $F(e) \leq e$.

Case 3 : $S(a^{(0)}, a_{(3)}^{(0)}-1) = b_0+3h \geq b_2$

It follows that $4h+3 \leq b_2 \leq b_0+3h = h+1+t+3h$, hence $t \geq 2$.

On the other hand it is easily verified that :

$$\begin{aligned}
S(c^{(r)}, c_{(3)}^{(r)} - 1) &= S(c^{(r-1)}, c_{(3)}^{(r-1)} - 1) - 3 \quad \text{for } 1 \leq r \leq q = \frac{t}{2} \\
S(c^{(r)}, c_{(3)}^{(r)}) &= S(c^{(r)}, c_{(3)}^{(r)} - 1) + 3 \quad \text{for } 1 \leq r \leq q \\
S(c^{(q)}, c_{(3)}^{(q)} - 1) &= b_0 + 3h - 3q \\
&= h + 1 + t + 3h - 3 \frac{t}{2} \leq 4h + 1 < b_2
\end{aligned}$$

Let $e = c^{(p)}$ where $p = \frac{b_0 + 3h - b_2 + 2}{3}$; clearly,

$$\begin{aligned}
S(e, e_{(3)} - 1) &= b_2 - \varepsilon, \quad S(e, e_{(3)}) = b_2 + \varepsilon' \quad \text{where } 1 \leq \varepsilon; \\
0 \leq \varepsilon' \quad \text{and} \quad \varepsilon + \varepsilon' &= 3, \quad \text{and}
\end{aligned}$$

$$S(e, e_{(2)}) = b_0 + 3s + 3p = 6(h+1) - 2b_0 + 3 \frac{b_0 + 3h - b_2 + 2}{3}$$

If $S(e, e_{(2)}) \geq b_1$ then $F(e) \geq e$, otherwise $F(e) \leq e$.

Comment : Clearly, the proof of Lemma 2 can be written as a sequential program containing only elementary operations on numbers with the same order of magnitude as h ; as a consequence, a stair such that $F(e) \leq e$ or $F(e) \geq e$ can be constructed in constant time (if we take as unit, the maximum delay necessary to perform a comparison, addition, multiplication or division).

Lemma 3 :

For any $A = (Z, [3], b, h)$, $b \in \mathbb{N}^3$, $h \in \mathbb{N}$ such that

$$h + 2 \leq b_0 \leq 2h + 1, \quad 2h + 3 \leq b_1 \leq 4h + 2,$$

$$3h + 3 \leq b_2 \leq 5h + 3, \quad b_0 + b_1 \geq 4h + 5$$

the question of the existence of invariant stairs, can be answered in constant time.

Proof : From proposition 1, any invariant stair is of one of the following forms :

$$(i) \quad e = \overset{\leftarrow}{0} \overset{\leftarrow}{1} \overset{\leftarrow}{r} \overset{\leftarrow}{2} \overset{\leftarrow}{s} \overset{\leftarrow}{2} \overset{\leftarrow}{t} \overset{\leftarrow}{3} \quad ; \quad 1 \leq r, s; \quad r + s = h + 1; \quad 0 \leq t; \quad s + t \leq h$$

$$(ii) \quad e = \overset{\leftarrow}{0} \overset{\leftarrow}{1} \overset{\leftarrow}{r} \overset{\leftarrow}{2} \overset{\leftarrow}{s} \overset{\leftarrow}{3} \quad ; \quad 1 \leq r; \quad 0 \leq s; \quad r + s \leq h$$

e is of the form (i) if and only if

$$\begin{aligned} b_0 + \varepsilon &= h+1+s && = S(e, e_{(1)}) \\ b_1 + \varepsilon' &= b_0 + \varepsilon + 3r - t && = S(e, e_{(2)}) \\ b_2 + \varepsilon'' &= b_1 + \varepsilon' + 3s + 2t - 1 && = S(e, e_{(3)}) \end{aligned}$$

Where $r, s, t \in \mathbb{N}$; $\varepsilon \in \{0, 1\}$; $\varepsilon' \in \{0, 1, 2\}$; $\varepsilon'' \in \{0, 1\}$

e is of the form (ii) if and only if

$$\begin{aligned} b_0 + \varepsilon &= r + 2s + 3(h+1-r-s) \\ b_1 + \varepsilon' &= b_0 + \varepsilon + 3r \\ b_2 + \varepsilon'' &= b_1 + \varepsilon' + 3s \end{aligned}$$

where $\varepsilon, \varepsilon', \varepsilon'' \in \{0, 1, 2\}$; $r, s \in \mathbb{N}$

Clearly, for any $h \in \mathbb{N}$, these systems of linear equations can be solved in constant time.

We are now ready τ_0 to prove the main Theorem.

Theorem 4 :

Erasing multithreshold automata $A = (Z, [3], b, h)$ in which any constant configuration is invariant, can be recognized in constant time.

Proof : If $b_2 \geq 5h+4$, then, for any stair $e = \vec{0} \ 1^r \ 2^s \ \vec{3}$, $F(e)(e_{(3)}) = 2$; as a consequence, A is erasing if and only if (see Proposition 1),

$$h+2 \leq b_0 \leq 2h+1, \quad 2h+3 \leq b_1 \leq 4h+2 \quad \text{and} \quad b_0 + b_1 \geq 4h+5.$$

If $b_2 \leq 5h+3$, then A is erasing if and only if (see Lemma 2, 3)

$$\begin{aligned} h+2 \leq b_0 \leq 2h+1, \quad 2h+3 \leq b_1 \leq 4h+2; \quad b_0 + b_1 \geq 4h+5, \\ 4h+3 \leq b_2 \leq 5h+3 \end{aligned}$$

and there is no stair e such that $F(e) \geq e$; moreover, these conditions can be tested in constant time.

The examples below show that the set E of threshold vectors associated with erasing automata is not convex.

$$\begin{aligned} 1 - \quad b' &= (h+2, 3h+2, 5h+4) \in \bar{E}; \\ \quad b'' &= (h+3, 3h+1, 5h+4) \in \bar{E} \\ \quad b &= \frac{1}{2} (b' + b'') = (h+2.5, 3h+1.5, 5h+4) \in E \end{aligned}$$

$$\begin{aligned}
2 - \quad & b' = (h+1, 1, 3h+2, 1, 5h+4) \in E ; \\
& b'' = (h+2, 1, 3h+1, 1, 5h+4) \in E \\
& b = \frac{1}{2} (b' + b'') = (h+1.6, 3h+1.6, 5h+4) \in \bar{E} \\
3 - \quad & h = 4 ; \quad b' = (8, 16, 21) \in E \cap \mathbb{N}^3 ; \\
& b'' = (8, 18, 19) \in E \cap \mathbb{N}^3 \\
& b = \frac{1}{2} (b' + b'') = (8, 17, 20) \in \bar{E} \cap \mathbb{N}^3
\end{aligned}$$

However, we can prove the following

Proposition 5 :

Let $A = (Z, [3], b, h)$, $b \in \mathbb{N}^3$, $h \in \mathbb{N}$ be such that
 $h+2 \leq b_0 \leq 2h+1$, $2h+3 \leq b_1 \leq 4h+2$,
 $4h+3 \leq b_2 \leq 5h+3$, $b_0 + b_1 \geq 4h+5$

(i) If $b_0 + b_1 + b_2 \geq 9h+10$ then A is erasing

(ii) If $b_0 + b_1 + b_2 \leq 9h+8$ then A is not erasing.

Proof : (i) $b_0 + b_1 + b_2 \geq 9h+10$. Let e be a stair such that $F(e) \geq e$.

If $e = \overset{\uparrow}{0} \overset{\uparrow}{1} \overset{\uparrow}{2}$ then $b_0 + b_1 \leq S(e, e_{(1)})$; $S(e, e_{(2)}) = 4h+4$ and this contradicts $b_0 + b_1 \geq 4h+5$.

If $e = \overset{\uparrow}{0} \overset{\uparrow}{1} \overset{\uparrow}{3}$ then $h+2 \leq b_0 \leq S(e, e_{(1)})$, thus $r \leq h$; on the other hand, $4h+3 \leq b_2 \leq S(e, e_{(3)}) = r+3(h+1)$, thus $r = h$ and $b_0 \leq h+3$; as a consequence,

$b_1 \geq 9h+10 - b_0 - b_2 \geq 4h+4$ and this contradicts $b_1 \leq 4h+2$.

If $e = \overset{\uparrow}{0} \overset{\uparrow}{2} \overset{\uparrow}{3}$ then $2h+3 \leq b_1 \leq S(e, e_{(2)})$, thus $r \leq h$;

$b_1 + b_2 \leq S(e, e_{(2)}) + S(e, e_{(3)}) = 6(h+1) + r \leq 7h+6$ hence

$b_0 \geq 9h+10 - b_1 - b_2 \geq 2h+3$ and this contradicts $b_0 \leq 2h+1$.

If $e = \overset{\uparrow}{0} \overset{\uparrow}{1} \overset{\uparrow}{2} \overset{\uparrow}{3}$; $1 \leq r, s$ then

$b_0 + b_1 + b_2 \leq S(e, e_{(1)}) + S(e, e_{(2)}) + S(e, e_{(3)}) \leq 9h+9$ and this contradicts $b_0 + b_1 + b_2 \geq 9h+10$.

It follows that, if e is the stair exhibited in Lemma 2, then $\{F^t(e); t \geq 0\}$ is a strictly decreasing sequence; hence A is erasing.

(ii) $b_0 + b_1 + b_2 = 9h + 8$; let e be the stair exhibited in Lemma 2 ; if $F(e) \geq e$, then A is not erasing, otherwise, we are in one of the following situations (we use the notations introduced in the proof of Lemma 2).

Case 1 : $b_0 + 3h = b_2 - 1$; $e = \overleftarrow{0} \ 1^s \ 2^t \ \overrightarrow{3}$; $s+t = h+1$;
 $S(e, e_{(1)}) = b_0$, $S(e, e_{(2)}) = b_1 - 1$, $S(e, e_{(3)}) = b_2 + 1$; thus
 $F^3(e) = F^2(e)$.

Case 2 : $b_0 + 3h \leq b_2 - 2$; $e = \overleftarrow{0} \ 1^s \ 2^{t+p} \ \overrightarrow{3}$
 $S(e, e_{(1)}) = b_0$, $S(e, e_{(2)}) = b_1$, $S(e, e_{(3)}) = b_2$; thus
 $F(e) = e$.

Case 3 : $b_0 + 3h \geq b_2$; $e = \overleftarrow{0} \ 1^{s+p} \ 2^{t-2p} \ \overrightarrow{3}$
 $S(e, e_{(1)}) = b_0$, $S(e, e_{(2)}) = b_1 - \varepsilon$, $S(e, e_{(3)}) = b_2 + \varepsilon'$;
 $\varepsilon' = \varepsilon + 1$; thus $F^3(e) = F^2(e)$.

Comment : This result shows that the region where $E \cap \mathbb{N}^3$ and $\bar{E} \cap \mathbb{N}^3$ "merge" , is contained in the hyperplane

$$H = \{b \in \mathbb{N}^3 : b_0 + b_1 + b_2 = 9h + 9\} .$$

5 OSCILLATING STAIRS

Since the interaction coefficients of the multithreshold automata studied here are symmetric, we know from Goles (3,4) that if e is a stair and $F^t(e) = e$ then $t \leq 2$. In this paragraph, we are interested in the existence of oscillating stairs, i.e. stairs

$$e, e' \text{ such that } e \neq e', F(e) = e' \text{ and } F(e') = e.$$

We show that if $k \leq 4$ then there are no oscillating stairs; then for $k \geq 6$ we exhibit a multithreshold automaton for which there are oscillating stairs.

Let us first introduce some notations and definitions:

If e, e' are two oscillating stairs, we denote

$$d = e' - e = \sum_{1 \leq i \leq m} \varepsilon_i \chi_{[a_i, b_i]}$$

$$\text{where } \varepsilon_i \in \{+1, +2, \dots, +k\}; a_i \leq b_i < a_{i+1} \text{ for } i \geq 1$$

$$\chi_{[a_i, b_i]}(x) = \begin{cases} 1 & \text{if } a_i \leq x \leq b_i \\ 0 & \text{otherwise} \end{cases}$$

$$S(x) = \sum_{-h \leq j \leq h} e(x+j); \quad S'(x) = \sum_{-h \leq j \leq h} e'(x+j); \quad T(x) = S'(x) - S(x)$$

EXAMPLE

$$e' = \bar{0}00234477\bar{9}$$

$$e = \bar{0}12233388\bar{9}$$

$$d = -\chi_{[1,1]} - 2\chi_{[2,2]} + \chi_{[5,6]} - \chi_{[7,8]}$$

Clearly, as pointed out in Tchente(9)

If $d(x) > 0$ then $F(e)(x) = e'(x) > e(x) = F(e')(x)$ hence $T(x) < 0$

Similarly

If $d(x) < 0$ then $T(x) > 0$

Lemma 6 :

The difference $d = \sum_{1 \leq i \leq m} \epsilon_i \chi_{[a_i, b_i]}$ between two oscillating stairs cannot verify; for a fixed $s \in \mathbb{N}$, $1 < s \leq m$, $\epsilon_i > 0$ for $i < s$ and $\epsilon_i < 0$ for $i \geq s$

Proof : Let us assume the existence of such stairs and let $\alpha = \sum_{i < s} \epsilon_i (b_i - a_i + 1)$; $\beta = \sum_{i \geq s} -\epsilon_i (b_i - a_i + 1)$

Since $d(a_1) > 0$ it follows that $\alpha - \beta \leq T(a_1) < 0$ (i)

Since $d(b_m) < 0$ it follows that $0 < T(b_m) \leq \alpha - \beta$ (ii)

Clearly, (i) and (ii) are contradictory .

Lemma 7 :

The difference $d = \sum_{1 \leq i \leq m} \epsilon_i \chi_{[a_i, b_i]}$ between two oscillating stairs cannot verify for a fixed $s \in \mathbb{N}$, $1 < s < m$ $\epsilon_i > 0$ for $i \neq s$ and $\epsilon_s = -1$

Proof : Let us assume the existence of such stairs and let

$$\alpha = \sum_{i < s} \epsilon_i (b_i - a_i + 1), \quad \beta = b_s - a_s + 1, \quad \gamma = \sum_{i > s} \epsilon_i (b_i - a_i + 1)$$

Since $d(a_1) > 0$ it follows that $T(a_1) < 0$, hence $\alpha < \beta$ (i)

Since $d(b_m) > 0$ it follows that $T(b_m) < 0$, hence $\gamma < \beta$ (ii)

As a consequence, $\beta \geq 2$, i-e $b_s > a_s$

Since $F(e')(a_s) = e(a_s) > e'(b_s) = F(e)(b_s)$ it follows that

$$\begin{aligned} 0 > S(b_s) - S'(a_s) &= (S(b_s) - S(a_s)) + (S(a_s) - S'(a_s)) \\ &= \sum_{a_s \leq a < b_s} (S(a+1) - S(a)) + (S(a_s) - S'(a_s)) \\ &\geq \beta - 1 + (-\alpha + \beta - \gamma) \end{aligned}$$

thus $\alpha + \gamma \geq 2\beta$ (iii)

Clearly, (i) (ii) and (iii) are contradictory .

Lemma 8 :

The difference $d = \sum_{1 \leq i \leq m} \epsilon_i \chi_{[a_i, b_i]}$ between two oscillating stairs

cannot verify for a fixed $s \in \mathbb{N}$, $1 < s < m$ $\epsilon_i > 0$ for $i \neq s$ and $\epsilon_s = -2$

Proof : Let us assume the existence of such stairs, and let

$$\alpha = \sum_{i < s} \epsilon_i (b_i - a_i + 1) ; \quad \beta = b_s - a_s + 1 ; \quad \gamma = \sum_{i > s} \epsilon_i (b_i - a_i + 1)$$

Since $d(a_1) > 0$ it follows that $T(a_1) < 0$, hence $\alpha < 2\beta$

or in other words $\alpha \leq 2\beta - 1$ (i)

In a similar way, it is easily shown that $\gamma \leq 2\beta - 1$ (ii)

On the other hand, since $d(a_s) < 0$ it follows that

$$0 < T(a_s) \leq \alpha - 2\beta + \gamma \quad \text{hence} \quad 2\beta \leq \alpha + \gamma - 1 \quad \text{(iii)}$$

From (i) (ii) (iii) it follows that $\beta \geq 2$ i-e $b_s > a_s$

Since $F(e')(a_s) = e(a_s) > e'(b_s) = F(e)(b_s)$, it follows that

$$\begin{aligned} 0 > S(b_s) - S'(a_s) &= (S(b_s) - S(a_s)) + (S(a_s) - S'(a_s)) \\ &\geq 2(\beta - 1) - \alpha + 2\beta - \gamma \end{aligned}$$

hence $\alpha + \gamma > 4\beta - 2$ (iv)

Clearly, (i) (ii) (iv) are contradictory .

Lemma 9 :

The difference $d = \sum_{1 \leq i \leq m} \epsilon_i \chi_{[a_i, b_i]}$ between two oscillating stairs cannot verify, for a fixed $s \in \mathbb{N}$, $1 < s < m$
 $\epsilon_i = 1$ for $i \notin \{s, s+1\}$ and $\epsilon_s = \epsilon_{s+1} = -1$

Proof : Let us assume the existence of such stairs and let

$$\alpha = \sum_{i < s} (b_i - a_i + 1) ; \quad \beta = b_s - a_s + 1 ; \quad \delta = \sum_{i > s+1} (b_i - a_i + 1), \quad \gamma = b_{s+1} - a_{s+1} + 1$$

Case 1 $\alpha < \beta$ (or symmetrically $\delta < \gamma$)

Since $T(a_s) > 0$ and $\alpha < \beta$ it follows that

$$\beta + \gamma < \alpha + \delta \quad \text{and} \quad a_s + h > a_m \quad (1)$$

On the other hand , since $\beta \geq 2$ and

$F(e')(a_s) = e(a_s) > e'(b_s) = F(e)(b_s)$, it follows that

$$\begin{aligned} 0 > S(b_s) - S'(a_s) &= (S(b_s) - S(a_s)) + (S(a_s) - S'(a_s)) \\ &\geq \beta - 1 - \alpha + \beta - \delta + \gamma \end{aligned}$$

thus $\alpha + \delta \geq 2\beta + \gamma$

hence $\delta \geq \beta + \gamma$

and this contradicts the fact that $T(a_m) < 0$

Case 2 $\alpha \geq \beta$ and $\delta \geq \gamma$ (2)

Since $T(a_1) < 0$, it follows that $\alpha < \beta + \gamma$ and $a_1 + h \geq a_{s+1}$ (3)

Since $T(b_m) < 0$ it follows that $\delta < \beta + \gamma$ and $b_m - h \leq b_s$ (4)

hence $a_{s+1} - h \leq a_1 \leq b_m \leq a_{s+1} + h$ (5)

Subcase 2-a $\beta = \gamma = 1$

It is easily verified that $\alpha = \delta = 1$, $m = 4$ and $s = 2$.

Since $a_s + h \geq b_m$ it follows that $T(a_s) = \alpha - \beta - \gamma + \delta = 0$

and this contradicts the fact that $T(a_s) > 0$

Subcase 2-b $\beta = 1$ and $\gamma \geq 2$ (or symmetrically $\beta \geq 2$ and $\gamma = 1$)

Since $T(a_1) < 0$ and $T(b_m) < 0$ it follows that

$\alpha \leq \gamma$ and $\delta \leq \gamma$ (6)

Since $F(e')(a_{s+1}) = e(a_{s+1}) > e'(b_{s+1}) = F(e)(b_{s+1})$

it follows from (5) and (6) that

$$\begin{aligned} 0 > S(b_{s+1}) - S'(a_{s+1}) &= (S(b_{s+1}) - S(a_{s+1})) + (S(a_{s+1}) - S'(a_{s+1})) \\ &\geq (2(\alpha - 1) + \gamma - \alpha) + (-\alpha + \beta + \gamma - \delta) \end{aligned}$$

hence $2\gamma \leq \delta$

and this contradicts (6).

Subcase 2-c $\beta \geq 2$ and $\gamma \geq 2$ (7)

Since $e(a_s) > e'(b_s)$ it follows that

$$\begin{aligned} 0 > S(b_s) - S'(a_s) &= (S(b_s) - S(a_s)) + (S(a_s) - S'(a_s)) \\ &\geq 2(\beta - 1) + (-\alpha + \beta + \gamma - \delta) \end{aligned}$$

hence $3\beta + \gamma - 1 \leq \alpha + \delta$

In a similar way, it can be shown that

$$3\gamma + \beta - 1 \leq \alpha + \delta$$

Thus $2(\beta + \gamma) - 1 \leq \alpha + \delta$

and this contradicts (3) and (4)

Lemma 10 :

The difference d between two oscillating stairs cannot be of the form $\chi[a_1, b_1] - \chi[a_2, b_2] + \chi[a_3, b_3] - \chi[a_4, b_4]$

Proof : Let us assume the existence of such stairs and let

$$\alpha = b_1 - a_1 + 1 ; \beta = b_2 - a_2 + 1 ; \gamma = b_3 - a_3 + 1 ; \delta = b_4 - a_4 + 1$$

Case 1 $\alpha \geq \beta$ (or symmetrically $\delta \geq \gamma$) (1)

Since $T(a_1) < 0$ it follows that

$$\alpha + \gamma < \beta + \delta \quad \text{and} \quad a_1 + h > a_4 \quad (2)$$

Since $T(a_4) > 0$ and $a_4 - h < a_1$ it follows that

$$\beta + \delta < \alpha + \gamma$$

and this contradicts (2)

Case 2 $\alpha < \beta$ and $\delta < \gamma$ (3)

Since $T(a_2) > 0$ it follows that $\beta < \alpha + \gamma$ and $a_2 + h > a_3$ (4)

Since $T(b_3) < 0$ it follows that $\gamma < \beta + \delta$ and $b_3 - h < b_2$ (5)

Since $\beta \geq 2$ and $e(a_2) > e'(b_2)$ it follows from (3) that

$$\begin{aligned} 0 > S(b_2) - S'(a_2) &= (S(b_2) - S(a_2)) + (S(a_2) - S'(a_2)) \\ &\geq (2\alpha + \beta - 1 - \alpha) + (-\alpha + \beta - \gamma) \end{aligned}$$

hence $2\beta \leq \gamma$ (6)

It follows from (5) and (6) that $a_3 + h \geq a_4$ and $\delta > \beta$ (7)

hence $\delta \geq 2$

Since $e'(b_4) < e(a_4)$ it follows that

$$\begin{aligned} 0 > S(b_4) - S'(a_4) &= (S(b_4) - S(a_4)) + (S(a_4) - S'(a_4)) \\ &\geq 2(\delta - 1) + \delta - \gamma \end{aligned}$$

hence $3\delta \leq \gamma + 1$ (8)

From (5) (6) (8) it follows that

$$\gamma < \beta + \delta \leq \gamma/2 + (\gamma + 1)/3$$

Clearly, this last inequality contradicts the fact that $\gamma \geq 2$

As a direct consequence of the preceding lemmas, we can state the following result :

Theorem 11 :

For $k \leq 4$ there are no oscillating stairs .

COMMENTS :

- Theorem 11 holds even if, in the multithreshold automaton, the constant configurations are not invariant, i-e $f(a, \dots, a) \neq a$.
- For $k = 5$ we think that there are no oscillating stairs, but a formal proof based on the approach introduced here is very lengthy.
- As shown in the example below, there exist oscillating stairs in some multithreshold automata with $k = 6$.

EXAMPLE $h = 4 ; b = (8, 16, 26, 31, 36, 48)$
 $e = \vec{001223345566}$
 $e' = \vec{011122455556}$

REFERENCES

- [1] Galperin, G. (1976). One-dimensional automaton networks with monotonic local interaction. Problemi Peredachi Informatsii . 12,4, 74-87.
- [2] Galperin, G. (1977). Rates of interaction propagation in one-dimensional automaton networks. Problemy Peredachi Informatsii, 13,1, 73-81.
- [3] Goles, E. (1980). Comportement oscillatoire d'une famille d'automates cellulaires non uniformes, Thèse USMG, Grenoble.
- [4] Goles, E. and Olivos, J. (1981). Comportement périodique des fonctions à seuil binaires et applications. Discrete Applied Mathematics 3, 2 pp. 93-105.
- [5] Goles, E. and Tchuente, M. (1983). Dynamic behaviour of one-dimensional threshold automata, R.R. n° 350, I.M.A.G., Grenoble.
- [6] Robert, Y. and Tchuente, M. (1982). Relations entre le graphe de connexion et le graphe d'itération d'une fonction booléenne monotone, R.R. n° 307, IMAG, Grenoble.
- [7] Shingai R. (1976). Periodic behaviour of one-dimensional uniform threshold circuits. Trans. IECE, Japan J59, A6.
- [8] Tchuente, M. (1977). Evolution de certains automates cellulaires uniformes binaires à seuil. S.A.N.G. N°265, Grenoble, I.M.A.G.
- [9] Tchuente, M. (1982). Contribution à l'étude des méthodes de calcul pour des systèmes de type coopératif. Thèse d'Etat, Grenoble, I.M.A.G.
- [10] Toom, A.L. (1976). Monotonic binary cellular automata. Problemy Peredachi Informatsii, 12, 1, 48-54.

**CHAPITRE III
ENERGIE ASSOCIEE
AU RESEAU D'AUTOMATES
A SEUIL**

CHAPITRE-III

ENERGIE ASSOCIEE AU RESEAU D'AUTOMATES A SEUIL ET APPLICATIONS

Dans ce chapitre, nous étudions la dynamique des réseaux d'automates à seuil avec une optique différente. Comme nous disions au chapitre-I, la technique des invariants, quoique très jolie, n'est pas un outil suffisant pour étudier d'autres aspects de la dynamique, en particulier le comportement du réseau en régime transitoire.

Notre réussite ici est la détermination, pour les réseaux à seuil, d'une fonction d'énergie ou fonction de Lyapunov qui gère toute la dynamique de l'automate, permettant donc d'étudier, aussi bien, le transitoire que la périodicité. De plus, cette énergie permet une interprétation en termes physiques du problème qui jusqu'à maintenant était traité plutôt comme un problème de nature discrète, donc avec des outils issus de la combinatoire. Dans ce contexte, il est intéressant de signaler les analogies existant entre ce problème de nature informatique et le traitement mathématique du problème de^s verres de spin 34, 17, 57, 54 .

Les principaux sujets abordés ici sont les suivants:

- Détermination des fonctions d'énergie associées à un processus itératif conduit sur les fonctions à seuil.
- Etude du régime transitoire: vitesse de convergence en fonction de la matrice des poids, $A=(a_{ij})$ et le vecteur des seuils (b_1, \dots, b_n) , en mettant en évidence une conver-

gence rapide pour les réseaux uniformes et une famille avec convergence exponentielle.

- Etude du régime stationnaire: caractérisation de la périodicité.
- Itérations série-parallèle et applications au réseau de spins généralisés avec ballotage.

En collaboration avec F. Fojelman,
et D. Pellegrin

scumis à Disc. App. Math.

1- DEFINITIONS

Let $F: \{0,1\}^n \rightarrow \{0,1\}^n$ be a mapping whose components

f_1, \dots, f_n are threshold functions :

$$\forall i(1, \dots, n), \forall x \in \{0,1\}^n, f_i(x) = \mathbf{1} \left[\sum_{j=1}^n a_{ij} x_j - b_i \right]$$

$$\text{where } \mathbf{1}[u] = \begin{cases} 1 & \text{if } u \geq 0 \\ 0 & \text{otherwise} \end{cases}$$

and $A = (a_{ij})$ is a real $n \times n$ matrix and (b_1, \dots, b_n) is the real threshold vector.

It is easy to see that, for any f_i , there exists a threshold function g_i such that:

$$* \text{ for all } x \in \{0,1\}^n, f_i(x) = g_i(x)$$

$$* g_i(x) = \begin{cases} 1 & \text{if } \sum_{j=1}^n a_{ij} x_j - \bar{b}_i > 0 \\ 0 & \text{if } \sum_{j=1}^n a_{ij} x_j - \bar{b}_i < 0 \end{cases}$$

We shall say that g_i is a strict threshold function. In the following, we always assume that functions f_i have strict threshold.

An ordered partition of the set $\{1, \dots, n\}$ is a partition

$(I_k)_{k=1, \dots, p}$ such that:

$$\forall x \in I_i, \forall y \in I_j, i < j \Rightarrow x < y.$$

The block sequential iteration on F associated to the ordered

partition $(I_k)_k$ is defined by:

$$\forall k(1, \dots, p), \forall i \in I_k, x_i(t+1) = f_i(y^k(t))$$

where $y^1(t) = x(t)$

$$\left\{ \begin{array}{l} \forall k(2, \dots, p), y_j^k(t) = \begin{cases} x_j(t+1) & \text{if } j \in I_1 \cup \dots \cup I_{k-1} \\ x_j(t) & \text{otherwise} \end{cases} \end{array} \right.$$

Particular cases of block sequential iterations correspond to particular choices of the partition:

- when the partition is $(\{k\})_{k=1, \dots, n}$, the iteration is called a sequential iteration on F .
- when the partition is trivially reduced to the unique set $\{1, \dots, n\}$, the iteration is called a parallel iteration on F .

Clearly, since $\{0,1\}^n$ is a finite set, all the trajectories, $(x(t)_{t \geq 0})$, of any block sequential iteration are ultimately periodic.

Hence, for every $x \in \{0,1\}^n$, there exist numbers $p(x)$, $t(x)$ such that:

$$x(t+p(x)) = x(t) \text{ for any } t \geq t(x)$$

$$\text{and } x(t+q) \neq x(t) \text{ for any } t < t(x), q < p(x).$$

$$\text{We denote } T(A,b) = \text{Max} \{ t(x) / x \in \{0,1\}^n \}$$

$$p(A,b) = \text{Max} \{ p(x) / x \in \{0,1\}^n \}$$

and call them the transient and cycle lengths of the mapping F defined by $A = (a_{ij})$ and $b = (b_1, \dots, b_n)$.

It is clear that the different block sequential iterations on F , for the different ordered partitions of $\{1, \dots, n\}$, have the same fixed points. But they may have limit cycles (of length larger than 1) which are different.

In this paper, we will give a characterization of the limit cycles structure and transient length of block sequential iterations on F , depending on specific assumptions on F .

2- CONDITIONS FOR CONVERGENCE TO FIXED POINTS

This formalism has mainly been introduced in models of neural networks and spin glasses. The various techniques used to study the dynamics of this model range from classical algebra [5] to statistical mechanics [11] . One feature of the model which proved to be particularly useful is the existence of a monotonic operator (or Lyapunov function) defined on the trajectories: in the case of the spin glass problem [1] , this operator is the spin glass interaction energy .

In our general framework, we define the energy associated to F as:

$$\forall x \in \{0,1\}^n, E(x) = -\frac{1}{2} \sum_{i=1}^n \sum_{j=1}^n a_{ij} x_i x_j + \sum_{i=1}^n b_i x_i$$

Lemma 1 . Let F be a threshold network whose matrix A is symmetric . Then, for any ordered partition $(I_k)_{k=1,\dots,p}$, if $A_k = (a_{ij})_{i,j \in I_k}$ is non negative definite on the set $\{-1,0,1\}$, for all $k(1,\dots,p)$, the block sequential iteration on F associated to $(I_k)_k$ is such that:

$$\forall t, x(t+1) \neq x(t) \Rightarrow E(x(t+1)) < E(x(t))$$

Proof

Let decompose the block sequential iteration on F at time t into p successive steps, where at time $t+k/p$, $k=1,\dots,p$, elements in block I_k only change states:

$$x(t) = (x_1(t), \dots, x_n(t))$$

$$\forall k(1, \dots, p), x_j(t+k/p) = \begin{cases} f_j(x(t+\frac{k-1}{p})) & \forall j \in I_k \\ x_j(t+\frac{k-1}{p}) & \forall j \notin I_k \end{cases}$$

$$\begin{aligned} \text{Let } \Delta_t E &= E[x(t+1)] - E[x(t)] \\ &= \sum_{k=1}^p \left\{ E[x(t+k/p)] - E[x(t+\frac{k-1}{p})] \right\} \end{aligned}$$

If A is symmetric, we have:

$$\begin{aligned} \Delta_t E &= - \sum_{k=1}^p \left\{ \sum_{i \in I_k} [x_i(t+1) - x_i(t)] \left[\sum_{\substack{j \in \cup I_k \\ j_k < k}} a_{ij} x_j(t+1) + \right. \right. \\ &\quad \left. \sum_{\substack{j \in \cup I_k \\ j_k > k}} a_{ij} x_j(t) - b_i \right] + 1/2 \sum_{i \in I_k} x_i(t+1) \sum_{j \in I_k} a_{ij} x_j(t+1) \\ &\quad \left. - 1/2 \sum_{i \in I_k} x_i(t) \sum_{j \in I_k} a_{ij} x_j(t) \right\} \end{aligned}$$

Let us denote:

$$\begin{aligned} \delta_k^1 E &= - \sum_{i \in I_k} [x_i(t+1) - x_i(t)] \left[\sum_{\substack{j \in \cup I_k \\ j_k < k}} a_{ij} x_j(t+1) \right. \\ &\quad \left. + \sum_{j \in I_k} a_{ij} x_j(t) + \sum_{\substack{j \in \cup I_k \\ j_k > k}} a_{ij} x_j(t) - b_i \right] \end{aligned}$$

$$\delta_k^2 E = -1/2 \sum_{i \in I_k} [x_i(t+1) - x_i(t)] \sum_{j \in I_k} a_{ij} [x_j(t+1) - x_j(t)]$$

$$\text{Then: } \Delta_t E = \sum_{k=1}^p [\delta_k^1 E + \delta_k^2 E]$$

As each f_i is a strict threshold function, it follows that:

$$x(t+1) \neq x(t) \Rightarrow \delta_k^1 E \leq 0$$

and there exists at least one $k \in \{1, \dots, p\}$ such that

$$\delta_k^1 E < 0$$

Moreover, since $x_i(t+1) - x_i(t) \in \{-1, 0, 1\}$ the

assumption on each block A_k implies that: $\delta_k^2 E \leq 0$.

Hence $\Delta_t E < 0$.

Remark . The diagonal dominance assumption on A_k :

$$\forall i \in I_k, a_{ii} > \sum_{\substack{j \in I_k \\ j \neq i}} |a_{ij}|$$

is a sufficient condition to ensure the non negative definite condition. Thus this condition generalizes results (cf. Goles[6]) based on the diagonal dominance assumption. It is not a necessary condition.

Proposition 1

Let $F=(A,b)$ be a threshold network and $(I_k)_{k=1\dots p}$ be an ordered partition of $\{1,\dots,n\}$ such that:

- * A is a symmetric matrix.
- * $\forall k(1,\dots,p), A_k=(a_{ij})_{i,j \in I_k}$ is a non negative definite matrix on the set $\{-1,0,1\}$.

Then the block sequential iteration on F associated to $(I_k)_k$ is such that:

(i) $P(A,b) = 1$: the iteration only has fixed points.

(ii) $T(A,b) \leq \frac{1}{\varepsilon(A,b)} [1/2 \sum_{i,j=1}^n |a_{ij}| + \sum_{i=1}^n |b_i|]$

where $\varepsilon(A,b) = \text{Min} \{ |E(x(t)) - E(x(t+1))| / x(0) \in \{0,1\}^n, x(t) \neq x(t+1) \}$

Proof

Suppose the iteration has a limit cycle of period $T > 1$:

$x(0), x(1), \dots, x(T-1)$.

Then: $\forall t(0, \dots, T-1), x(t) \neq x(t+1)$

Hence lemma 1 implies that:

$$E(x(0)) > E(x(1)) > \dots > E(x(T-1)) > E(x(0))$$

which is impossible.

Thus $T=1$, which proves (i).

It is easy to see that, for any $x \in \{0,1\}^n$:

$$\sum_{i:b_i < 0} b_i - 1/2 \sum_i \sum_{j:a_{ij} > 0} a_{ij} \leq E(x) \leq \sum_{i:b_i > 0} b_i - 1/2 \sum_i \sum_{j:a_{ij} < 0} a_{ij}$$

hence:

$$T(A,b) \cdot \varepsilon(A,b) \leq \left[-\frac{1}{2} \sum_i \sum_{j:a_{ij}<0} a_{ij} + \sum_{i:b_i>0} b_i \right] - \left[-\frac{1}{2} \sum_i \sum_{j:a_{ij}>0} a_{ij} + \sum_{i:b_i<0} b_i \right]$$

which proves (ii).

Remark :

In the particular case of a sequential iteration, proposition 1 applies and provides a bound for $T(A,b)$. This result had been directly proven in [4] .

In the case where $a_{ij} \in \mathbb{Z}$, it is possible to find a uniform bound on $\varepsilon(A,b)$: suppose that $b_i \in [k_i, k_{i+1}[$, with $k_i \in \mathbb{Z}$, for all $i(1, \dots, n)$. Then for each function f_i , there exists a function g_i with strict threshold $k_i + 1/2$ such that $f_i = g_i$. Hence, we can assume that $b_i - 1/2 \in \mathbb{Z}$.

We then have:

Corollary 1

If A is a symmetric integer matrix with non negative definite blocks A_k , then the block sequential iteration on F associated to the ordered partition $(I_k)_k$ is such that:

$$T(A,b) \leq \sum_{i,j=1}^n |a_{ij}| + 2 \sum_{i=1}^n |b_i|$$

Proof

In lemma 1, we have shown that:

$$\Delta_t E = \sum_{k=1}^p [\delta_k^1 E + \delta_k^2 E]$$

and that: $\delta_k^2 E \leq 0 \quad \forall k(1, \dots, p)$

$$\delta_k^1 E \leq 0$$

and $\delta_k^1 E < 0$ for one k at least, if $x(t+1) \neq x(t)$.

Hence $\Delta_t E \leq \delta_k^1 E$ where $\delta_k^1 E < 0$

From the strict threshold assumption, it is easy to show that:

$$a_{ij} \in \mathbb{Z} \Rightarrow \sum_{j \in I_k, j < k} a_{ij} x_j^{(t+1)} - \sum_{j \in I_k, j > k} a_{ij} x_j^{(t) - (b_i - 1/2)} \in \mathbb{Z} \setminus \{0\}$$

$$\Rightarrow \delta \frac{1}{k} E \leq -1/2$$

$$\Rightarrow |\Delta_t E| \geq 1/2 \Rightarrow \varepsilon(A, b) \geq 1/2$$

The result then follows from proposition 1.

An interesting case corresponds to $a_{ij} \in \{-1, 0, 1\}$: these are classically the interaction coefficients in spin glass problems.

Corollary 2

If A is a symmetric matrix, with elements in $\{-1, 0, 1\}$ and non negative definite blocks A_k , then the block sequential iteration on F associated to the ordered partition $(I_k)_k$ is such that:

$$T(A, b) \leq 3n^2.$$

(the bound on the transient is quadratic).

Furthermore, if $|V(i)| = \text{card}\{j(1, \dots, n) : a_{ij} \neq 0\}$ is uniformly (in i) bounded by some constant v , then the bound is linear:

$$T(A, b) \leq 3nv.$$

Proof

It is easy to see that:

$$V_i(1, \dots, n) - |V(i)| \leq \sum_j a_{ij} x_j \leq |V(i)|$$

hence:

- * if $b_i \notin [-|V(i)|, |V(i)|]$ the i -th cell is fixed by the iteration into one value (0 if $b_i \geq |V(i)|$, 1 if $b_i \leq -|V(i)|$) in one step.

* otherwise, corollary 1 leads to:

$$\begin{aligned}
 T(A,b) &\leq \sum_{i,j} |a_{ij}| + 2 \sum_i |b_i| \\
 &\leq 3 \sum_i |V(i)|
 \end{aligned}$$

The bounds follow immediately.

We have seen that there were different block sequential iterations corresponding to the different ordered partitions. We now introduce an order on the partitions which will allow to compare the corresponding block sequential iterations.

Let $P = (I_1, \dots, I_p)$ and $P' = (I'_1, \dots, I'_q)$ be two ordered partitions of the set $\{1, \dots, n\}$. Then P' is finer than P , which we denote $P' \lesssim P$, iff any block I_k , $k=1, \dots, p$, is the reunion of some I'_j .

Remark

Endowed with this relation, the set of ordered partitions of $\{1, \dots, n\}$ is a partially ordered set which is a lattice.

Lemma 2

Let P be an ordered partition. Then if F satisfies the assumptions of lemma 1, any partition P' finer than P also satisfies them.

This means that, as soon as one partition P satisfies the required assumptions, any $P' \lesssim P$ has only fixed points (those of P) and has a bounded transient length.

The proof is obvious.

Example

$$A = \begin{pmatrix} 1 & 1 & -1 & 1 \\ 1 & 2 & 1 & -2 \\ -1 & 1 & 1 & 1 \\ 1 & -2 & 1 & 2 \end{pmatrix} \quad b = \begin{pmatrix} 1 \\ 1 \\ 1 \\ 1 \end{pmatrix}$$

The ordered partitions lattice is the following:

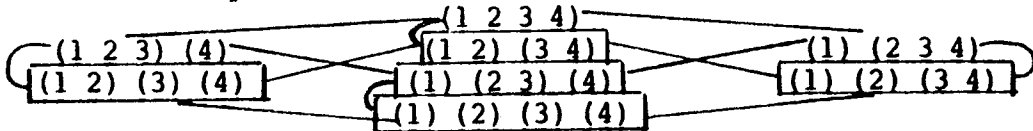

Circled ordered partitions satisfy the assumptions of lemma 1.

And, according to lemma 2, all descendants of a circled partition are also circled.

The iteration graphs of the different block sequential iterations on F are as follows (they all have the same fixed points):

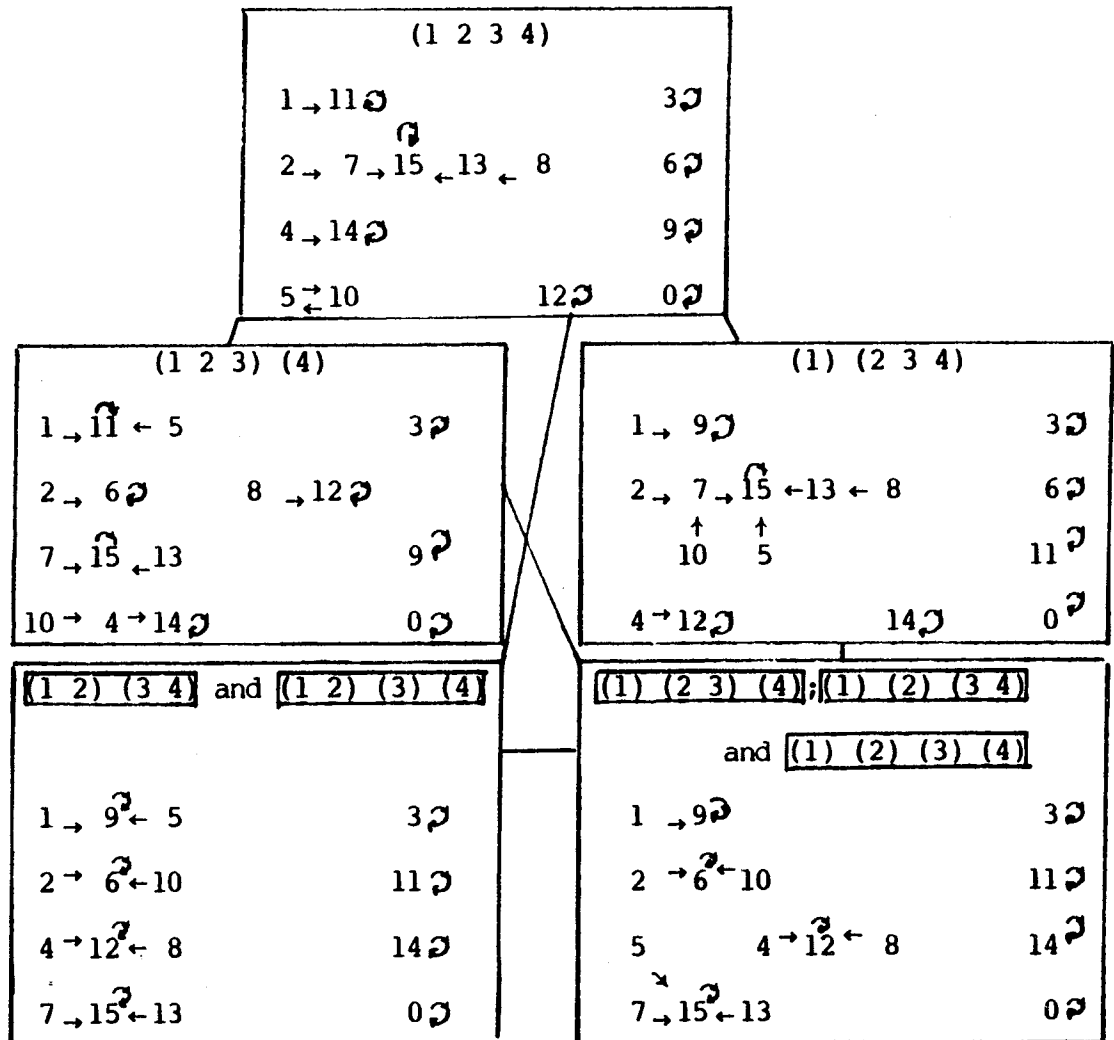

3- PARALLEL ITERATIONS

In this paragraph, we will study the parallel iterations of strict threshold mappings. This is a particular case of paragraph 3, which results therefore apply in this section. However, the non negative definite assumption on matrix A is very restrictive and results are known [5] when A is simply symmetric: the parallel iteration has only limit cycles of period 2 or fixed points. In [5], GOLES has used an algebraic invariant to produce this result.

We will here make use of an "energy" which will allow us to give an other proof of the previous result and moreover provide a bound on the transient length.

Proposition 2

Let $F=(A,b)$ be a threshold network such that A is a symmetric matrix.

Then, the parallel iteration on F is such that:

$$(i) \quad P(A,b) \leq 2$$

$$(ii) \quad T(A,b) \leq \frac{1}{\varepsilon(A,b)} \left[\frac{1}{2} \sum_{i,j} |a_{ij}| + \sum_i |b_i| \right]$$

Proof

$$\text{Let } E(x(t)) = \varphi(x(t), x(t-1))$$

$$\text{with } \varphi(u,v) = - \sum_{i=1}^n u_i \sum_{j=1}^n a_{ij} v_j + \sum_{i=1}^n b_i (u_i + v_i)$$

Then

$$\Delta_t E = E[x(t+1)] - E[x(t)]$$

$$\Delta_t E = - \sum_{i=1}^n x_i(t+1) \sum_{j=1}^n a_{ij} x_j(t) + \sum_{i=1}^n b_i [x_i(t+1) + x_i(t)]$$

$$+ \sum_{i=1}^n x_i(t) \sum_{j=1}^n a_{ij} x_j(t-1) + \sum_{i=1}^n b_i [x_i(t) + x_i(t-1)]$$

$$\Delta_t E = - \sum_{i=1}^n [x_i(t+1) - x_i(t-1)] [\sum_{j=1}^n a_{ij} x_j(t) - b_i]$$

because A is symmetric.

And thus, either $x(t) = x(t+1)$ and $\Delta_t E = 0$

or $x(t) \neq x(t+1)$ and $\Delta_t E < 0$

which proves that $P(A,b)$ is either 2 or 1 (on any limit cycle $x(t+1)$ must be equal to $x(t-1)$, for any t).

$$\varphi(u,v) = - \sum_{i=1}^n u_i \left[\sum_{j:a_{ij}>0} a_{ij} v_j + \sum_{j:a_{ij}<0} a_{ij} v_j \right]$$

$$+ \sum_{i:b_i>0} b_i [u_i + v_i] + \sum_{i:b_i<0} b_i [u_i + v_i]$$

if $(u,v) \in (0,1)^2$:

$$- \sum_{i=1}^n \sum_{j:a_{ij}>0} a_{ij} + 2 \sum_{i:b_i<0} b_i \leq \varphi(u,v)$$

$$\leq - \sum_{i=1}^n \sum_{j:a_{ij}<0} a_{ij} + 2 \sum_{i:b_i>0} b_i$$

$$\Rightarrow T(A,b) \leq 1/2 \frac{\sum_{i,j} |a_{ij}| + 2 \sum_i |b_i|}{\varepsilon(A,b)}$$

with

$$\varepsilon(A,b) = \min \{ |\rho(F^2(x), F(x)) - \varphi(F(x), x)| \mid x \in \{0,1\}^n, x \neq F^2(x) \}$$

As in corollary 1, it follows that:

Corollary 3

If A is a symmetric integer matrix ($a_{ij} \in \mathbb{Z}$) then:

(i) the parallel iteration on F is such that:

$$T(A,b) \leq \sum_{i,j} |a_{ij}| + 2 \sum_i |b_i|$$

(ii) If, in addition, $a_{ij} \in \{-1, 0, 1\}$, $\forall i, j$ then:

$$T(A,b) \leq 3n^2$$

Furthermore, if $|V(i)| = v$ then $T(A,b) \leq 3nv$.

Proof : as in corollary 2.

Corollary 3 shows that for parallel iterations on threshold networks with symmetric matrix of elements $-1, 0$ or $+1$ and regular neighbourhood, the transient length is linear in n ($O(n)$). When the a_{ij} are arbitrary, the transient length may be much larger : see GOLES-OLIVOS [7] for an example of convergence in $O(2^{n/3})$.

Corollary 4 .

Let $F = (A, b)$ be a threshold network. Then there exists a uniform bound on the transient lengths of the different iterations on F , T_{iter} , provided A fulfills the corresponding assumptions:

$$\exists \epsilon > 0: T_{iter}(A, b) \leq \frac{1}{\epsilon} \left[\frac{1}{2} \sum_{i,j} |a_{ij}| + \sum_i |b_i| \right].$$

Proof : there only exists a finite number of iterations on F : parallel, sequential, and block sequential. Hence proposition 1, corollary 1 and proposition 2 prove the existence, under the suitable assumptions, of a finite number of coefficients $\epsilon^k(A, b)$.

The corollary follows by taking $\epsilon = \min_k \epsilon^k(A, b)$.

Remark : $\epsilon \neq \epsilon_0 = \min\{ |E(x) - E(y)| / x, y \in \{0, 1\}^n, x \neq y \}$.

ϵ_0 will often be 0, which corresponds to the high degeneracy usually observed in the physical systems (see spin glasses [1]).

4- SEQUENTIAL ITERATIONS OF MAJORITY FUNCTIONS .

In this paragraph, we will study sequential iterations of a particular class of threshold functions, namely majority functions, which have been introduced in the framework of social systems ([5], [8]). In the following section, we apply our results to a model of spin glasses.

Let $n \in \mathbb{N}$ be given and I_0, I_1 be a partition of $\{1, \dots, n\}$.

A majority function is defined as follows:

$$\forall i \in I_0, \forall x \in \{0,1\}^n,$$

$$f_i(x) = \begin{cases} 1 & \text{if } \sum_{j \neq i} a_{ij} x_j - b_i > 0 \\ x_i & \text{if } \sum_{j \neq i} a_{ij} x_j - b_i = 0 \\ 0 & \text{if } \sum_{j \neq i} a_{ij} x_j - b_i < 0 \end{cases}$$

$$\forall i \in I_1, \forall x \in \{0,1\}^n,$$

$$f_i(x) = \begin{cases} 1 & \text{if } \sum_{j \neq i} a_{ij} x_j - b_i > 0 \\ 1 - x_i & \text{if } \sum_{j \neq i} a_{ij} x_j - b_i = 0 \\ 0 & \text{if } \sum_{j \neq i} a_{ij} x_j - b_i < 0 \end{cases}$$

The two different formulations for $i \in I_0$ and $i \in I_1$ model the two possible reactions in case of a tie: if

$\sum_{j \neq i} a_{ij} x_j - b_i = 0$, element i can either keep its state ($i \in I_0$) or reverse it ($i \in I_1$).

It is easy to see that for any majority function f_i there exists a threshold function g_i such that:

$$* \forall x \in \{0,1\}^n, f_i(x) = g_i(x)$$

$$* g_i(x) = \mathbf{1} \left[\sum_{j=1}^n a_{ij} x_j - \bar{b}_i \right]$$

Proof :

it is sufficient to take:

$$\text{for } i \in I_0, \bar{b}_i = b_i + 1/2 \cdot a_{ii}$$

$$a_{ii} \in [0, m_+^i [$$

$$\text{for } i \in I_1, \bar{b}_i = b_i$$

$$a_{ii} \in]-m_+^i, 0[$$

with:

$$m_+^i = \text{Min} \left\{ \sum_{j \neq i} a_{ij} x_j - b_i \mid x \in \{0,1\}^n : \sum_{j \neq i} a_{ij} x_j - b_i > 0 \right\}$$

Remarks

1- Note that :

$$\forall i \in I_0, a_{ii} \geq 0$$

$$\forall i \in I_1, a_{ii} < 0$$

2- According to this last result, majority functions are a subclass of threshold functions, namely those with diagonal elements bounded by some given constants m_+^i .

In the following, we always assume that these conditions are satisfied.

Let $F: \{0,1\}^n \rightarrow \{0,1\}^n$ be a mapping whose components f_1, \dots, f_n are majority functions.

We define the energy associated to the sequential iteration on F as follows:

$$\forall x \in \{0,1\}^n,$$

$$E(x) = -\frac{1}{2} \sum_i x_i \sum_{j \neq i} a_{ij} x_j + \sum_{i=1}^n b_i x_i$$

Proposition 3 .

Let $F = (A, b)$ be a mapping whose components are majority functions. If A is a symmetric matrix, then the sequential

iteration on F is such that:

$$(i) \quad \forall k \in I_0, x_k(t + \frac{k}{n}) \neq x_k(t + \frac{k-1}{n}) \Rightarrow E(x(t + \frac{k}{n})) - E(x(t + \frac{k-1}{n})) < 0$$

$$(ii) \quad \forall k \in I_1, x_k(t + \frac{k}{n}) \neq x_k(t + \frac{k-1}{n}) \Rightarrow E(x(t + \frac{k}{n})) - E(x(t + \frac{k-1}{n})) \leq 0$$

Proof

Let decompose the sequential iteration on F at time t into n successive steps, where at time $t + \frac{k}{n}$,

$k=1, \dots, n$, element k only changes states (we assume, for sake of simplicity, that the sequential iteration corresponds to the identical permutation).

$$\text{Let } \Delta_t E = E(x(t+1)) - E(x(t))$$

$$\Delta_t E = \sum_{k=1}^n \delta_t^k E$$

$$\text{with } \delta_t^k E = E(x(t + \frac{k}{n})) - E(x(t + \frac{k-1}{n}))$$

(i) if $k \in I_0$, then:

$$\delta_t^k E = -[x_k(t + \frac{k}{n}) - x_k(t + \frac{k-1}{n})] [\sum_{j \neq k} a_{kj} x_j(t + \frac{k-1}{n}) - b_k]$$

then it is easy to see, from the definition of f_k that:

$$\delta_t^k E < 0$$

(ii) if $k \in I_1$, then:

$$\delta_t^k E = -[x_k(t + \frac{k}{n}) - x_k(t + \frac{k-1}{n})] [\sum_{j \neq k} a_{kj} x_j(t + \frac{k-1}{n}) - b_k]$$

we then have: $\delta_t^k E \leq 0$ and $\delta_t^k E = 0$ if and only if

$$\sum_{j \neq k} a_{kj} x_j(t + \frac{k-1}{n}) - b_k = 0$$

which ends the proof.

Corollary 4 .

If A is symmetric, then:

$$(i) \quad \forall t, x(t+1) \neq x(t) \Rightarrow \Delta_t E \leq 0$$

(ii) Furthermore, if $\exists k \in I_0: x_k(t+1) \neq x_k(t)$, then: $\Delta_t E < 0$.

(iii) If $\exists k \in I_1: x_k(t+1) \neq x_k(t)$ and there is no tie for k , then $\Delta_t E < 0$.

(iv) In any limit cycle, all elements i with $i \in I_0$ are stable, all elements i with $i \in I_1$ change states only when there is a tie.

Proof

obvious from proposition 3.

Remark :

When $I_1 = \emptyset$, this result is a particular case of proposition 1.

5- MODELLING SPIN GLASSES BY MAJORITY FUNCTIONS .

We will now address ourselves to a particular case of block sequential iteration of threshold networks which has been introduced in solid states physics.

Some magnetic alloys are obtained by diluting magnetic impurities in a non magnetic metal. These systems are called spin glasses . Their magnetic properties can be deduced from the study of an Hamiltonian

$$H = - \sum_{i,j} J_{ij} \vec{S}_i \cdot \vec{S}_j - \vec{F} \cdot \sum_i \vec{S}_i$$

where \vec{S}_i is the spin (or magnetic moment) of impurity i , J_{ij} is the interaction between impurities i and j (J_{ij} is chosen at random), \vec{F} is a magnetic field .

The ground states of a spin glass are associated to a minimum of the energy H . Physicists have introduced many methods to study these problems [1] . One model is the 2D Ising model: the impurities are supposed to be distributed regularly at the nodes of a grid, normally toric. Each spin may only have 2 values: -1 (down) or +1 (up). In the absence of magnetic field, the energy is then:

$$H(\omega) = - \sum_{i,j} J_{ij} S_i S_j$$

where ω is the state vector (S_i) and the sum runs on couples (i,j) which are neighbours on the grid.

It has been shown that, in the 2D problem, ground states could be determined in polynomial time, whereas this problem in 2D with magnetic field or 3D is NP-complete [2] . In these cases, heuristic methods have been designed to find approximate solutions [3,10] : these methods usually rely on Monte Carlo iterations.

Formally, these methods consist in updating a given spins configuration by choosing one spin at random and eventually changing its state with a probability depending on a local majority rule.

We will study here sequential iterations of deterministic such rules, which corresponds in the spin glass context to a zero temperature: the choice of the spin which is to change states is not random, but fixed by a given permutation of $\{1, \dots, n\}$ which will be assumed in the following to be the identity.

We suppose in the following that all spins are located at the nodes of an $n \times n$ grid drawn on a torus: lines 1 and n are connected, columns 1 and n also. Each spin i may interact with its four neighbours on the grid with interaction coefficients $a_{ij} \in \{-1, 0, +1\}$.

Let $n \in \mathbb{N}$ be given and I_0, I_1 be a partition of $\{1, \dots, n\}$.

A generalized spin glass is a mapping $F: \{0, 1\}^n \rightarrow \{0, 1\}^n$ whose components f_1, \dots, f_n satisfy:

$$\forall i \in I_0, \forall x \in \{0, 1\}^n,$$

$$f_i(x) = \begin{cases} 1 & \text{if } \sum_{j \neq i} c(x_j) - 2 > 0 \\ x_i & \text{if } \sum_{j \neq i} c(x_j) - 2 = 0 \\ 0 & \text{if } \sum_{j \neq i} c(x_j) - 2 < 0 \end{cases}$$

$$\forall i \in I_1, \forall x \in \{0,1\}^n,$$

$$f_i(x) = \begin{cases} 1 & \text{if } \sum_{j \neq i} c(x_j) - 2 > 0 \\ 1-x_i & \text{if } \sum_{j \neq i} c(x_j) - 2 = 0 \\ 0 & \text{if } \sum_{j \neq i} c(x_j) - 2 < 0 \end{cases}$$

$$\text{with } c(x_j) = \begin{cases} x_j & \text{if } a_{ij} = +1 \\ 1-x_j & \text{if } a_{ij} = -1 \end{cases}$$

It is clear that f_i is a majority function as defined in the previous section, with coefficients $b_i = \sum_{j \neq i: a_{ij} = -1} a_{ij} + 2$

Lemma 3

A generalized spin glass F with interaction coefficients

$(a_{ij})_{j \neq i}$ is a threshold network with matrix $A=(a_{ij})$ iff:

$$\forall i \in \{1, \dots, n\}, a_{ii} \in]-1, +1[.$$

Proof .

as here all coefficients a_{ij} are in $\{-1, 0, +1\}$, $m_+^i = 1$, which ends the proof, using the results of the previous section.

In the following, we will always assume that the coefficients a_{ii} are in $] -1, +1 [$.

In a spin glass, each spin intends to get parallel to the neighbours with which it is positively connected ($a_{ij}=+1$) and antiparallel otherwise. Of course, these conditions may be contradictory and it is usually assumed that the spin takes on the majority direction: in case of a tie, the spin may either keep its direction ($i \in I_0$) or reverse it ($i \in I_1$). In this last case, it is called a crazy spin .

Corollary 5

For any sequential iteration of a generalized spin glass $F = (A, b)$, with diagonal elements a_{ii} in $] -1, +1 [$ and symmetric matrix A ,

- (i) $\forall i(1, \dots, n), a_{ii} \geq 0 \Rightarrow x_i(t)$ is constant.
- (ii) All oscillating elements i have their coefficients $a_{ii} < 0$ and change states only in case of a tie.

Proof : obvious from corollary 4.

Remarks .

1- Oscillating regions in the limit cycle are made up from connected elements $i \in I_1$ (see figure 1).

2- It is clear that elements i in I_0 help to stabilize the network: neighbours of such -stable- elements tend to be stable also.

Furthermore, oscillating elements i , with i in I_1 , are scarce, since the combinatorics needed for this situation makes it occur very rarely: a tie must happen at each instant when the element is supposed to change states. Simulations usually exhibited less than 20% of the elements i in I_1 oscillating.

3- If condition $a_{ii} \in] -1, +1 [$ is violated, some elements $i \in I_0$ may oscillate (see figure 2).

6- CONCLUSION

In this paper, we have shown that the general concept of energy, first introduced in the spin glasses, allows a very good understanding of the different iterations of threshold networks.

In particular, it has been shown that block sequential iterations with symmetric matrix A and non negative definite blocks could only lead to fixed points.

Furthermore, the transient length of the different iterations is uniformly bounded, by a linear bound (in the size of the network) in spin glasses.

Finally, application of the same ideas in a spin glass model allows to predict the stability of individual spins in sequential iterations: these results may provide an insight into the problem of rigid clusters [3].

Simulations were run on a PDP 11-23, with programs in Fortran and Pascal.

REFERENCES

- 1- BALIAN R., MAYNARD R., TOULOUSE G. (Eds): Ill Condensed Matter. Proceedings of Les Houches 1978 Summer School. North Holland, 1979.
- 2- BARAHONA F.: Application de l'optimisation combinatoire à certains modèles de verres de spins. Thèse IMAG - GRENOBLE 1980.
- 3- BIECHE I., MAYNARD R., RAMMAL R., UHRY J.P.: On the ground states of the frustration model of a spin glass by a matching method of graph theory. J.Phys.A 13, pp 2553-2576, 1980.
- 4- FOGELMAN F., GOLES E., WEISBUCH G.: Transient length in sequential iteration of threshold functions. Discrete Applied Math. 6, pp95-98, 1983.
- 5- GOLES-CHACC E.: Comportement oscillatoire d'une famille d'automates cellulaires non uniformes. Thèse IMAG - GRENOBLE, 1980.
- 6- GOLES-CHACC E.: Fixed point behaviour of threshold functions on a finite set. SIAM J. on Alg. and Appl. Maths , 3, n°4, 1982.
- 7- GOLES E., OLIVOS J.: The convergence of symmetric threshold automata. Information and Control , 51, n°2, 1981.
- 8- GOLES E., TCHUENTE M.: Iterative behaviour of generalized majority functions. Math. Soc. Sci. 4, pp197-204, 1983.
- 9- HOPFIELD J.: Neural networks and physical systems with emergent computational abilities. Proc. Nat. Acad. Sci. USA , 79, pp2554-2558, 1982.
- 10- KIRKPATRICK S., GELATT C.D., VECCHI M.P.: Optimization by simulated annealing. Science , 220, n°4598, pp671-680, 1983.
- 11- PERETTO P.: Collective properties of neural networks, a statistical physics approach. Biol. Cyb. , 50, pp51-62, 1984.

Figure 1

This figure shows a limit cycle for a given generalized spin glass.

The network is supposed to be drawn on a torus, its size is $n = 8 \times 8$.

The interactions are shown below (right): "+" indicates a coefficient $a_{ij} = +1$ and "-" a coefficient $a_{ij} = -1$, between elements i and j (marked *).

The D-matrix gives the diagonal coefficients a_{ii} .

For a given initial condition, the limit cycle has been computed. The period is 12. Elements in I_0 were all found stable, either in 0 or in 1 (marked so on the picture). Some elements in I_1 were stable (marked 0 or 1 as before), but 14 of them were oscillating (marked 3 -left- or M -right- on the pictures).

$$D = \begin{pmatrix} -0.5 & 0.9 & 0.1 & -0.2 & -0.2 & 0.2 & 0.6 & 1.0 \\ -1.0 & -0.8 & -0.1 & -0.9 & 0.1 & -1.0 & 0.8 & 0.0 \\ 0.7 & -0.4 & -0.9 & -0.4 & -0.2 & 0.8 & 0.6 & -0.8 \\ -0.8 & 0.0 & -0.9 & 0.3 & -0.5 & 0.3 & 0.9 & 0.1 \\ 0.5 & -0.3 & -0.1 & 0.0 & -0.5 & 0.8 & -0.4 & 0.9 \\ 0.4 & -0.5 & 0.4 & 0.4 & -0.6 & 0.8 & 0.7 & 0.4 \\ 1.0 & 0.0 & 0.3 & -1.0 & -0.7 & 0.1 & 0.0 & -0.2 \\ 0.9 & 0.3 & -0.2 & -1.0 & 1.0 & -0.6 & 0.1 & -0.9 \end{pmatrix}$$

1 0 0 3 0 0 0 1	*-+*-M+***-+*
	- + + - + - - -
0 0 0 3 0 1 1 3	*+***+M+*-+**+M-
	- + + - + + + -
1 0 0 3 3 1 1 1	*+***+M-M+*-+**+
	+ - - - - + + +
0 1 1 1 1 1 0 1	*-+***+***-*-*-
	- - + + + - + +
1 3 1 1 1 0 1 0	*+M+***+*-*-*-
	+ - + - - + + +
1 3 1 1 1 0 1 0	*-M+***+*-*-*-
	- + + - - - + -
1 1 1 3 0 1 3 3	*+***+M+*-*-M+M-
	- - - - - + +
0 0 3 3 1 3 1 3	*+*-M-M+**+M+*-M+
	- + - - - + + +

Figure 2

This figure shows a generalized spin glass with diagonal elements not in]-1,+1[. The connection structure and notations are similar to those in figure 1.

This simulation shows that some elements i in I_0 may oscillate if some coefficients a_{ii} lie outside]-1,+1[.

These elements are marked P -right- on the figure.

$$D = \begin{pmatrix} 1.3 & 0.7 & -1.1 & -1.0 & 0.3 & -1.1 & 0.4 & -0.5 \\ -1.5 & -1.2 & -0.3 & -0.1 & 0.5 & 1.2 & 1.6 & 0.3 \\ 0.5 & -1.8 & -0.4 & -1.3 & -1.0 & 0.2 & -1.9 & 0.6 \\ -1.2 & 1.9 & 1.8 & -1.8 & -0.2 & 0.7 & 0.2 & -1.3 \\ 1.6 & -0.9 & 2.0 & -0.2 & 1.0 & -0.3 & 0.0 & 0.1 \\ -0.4 & 1.3 & -0.3 & 0.8 & 0.5 & -1.8 & -1.5 & 0.8 \\ 0.9 & -1.3 & -1.9 & -0.1 & -0.9 & -1.7 & -0.1 & 1.8 \\ 0.3 & 1.3 & -1.0 & 0.4 & 1.5 & 0.1 & 1.6 & 1.7 \end{pmatrix}$$

0 3 3 3 1 3 1 1	*+P-M-M+*-M+*+*-
	- - - - - - - +
3 3 3 3 0 1 0 1	M-M+M+M+*-*-+*+*
	+ + + + + + + +
0 3 3 3 0 1 3 1	*-M-M+M+*-+M-*-
	- - + - - - - -
3 0 1 3 1 0 0 3	M-*-*+M-*-*+*-M+
	- - - + + - - -
1 3 0 3 1 1 1 1	*-M+*-M-*+*+*+*
	+ - + - + - - -
3 0 0 0 1 3 3 0	M+*+*+*-+M-M-*-
	+ - + - + - - +
0 3 3 1 1 3 3 0	*+M-M-*+*+M-M+*
	+ - - - - + + +
0 0 1 0 0 3 0 1	*+*-*-*-P+*-*-
	+ - - - - + - +

**ENERGIE ASSOCIEE
A L'ITERATION SERIE**



TRANSIENT LENGTH IN
SEQUENTIAL ITERATION OF THRESHOLD FUNCTIONS

En collaboration avec F. Fogelman,
 G. Weisbuch, Disc. App. Math., 6, 84

Let F be a function from $\{0,1\}^n$ into itself whose components are symmetric threshold functions. We give a general bound on the transient length for a sequential iteration on F . For this we use a monotonic operator analogous to the spin glass interaction energy (see in a similar context [1,3]).

1 - Definitions

Let $F : \{0,1\}^n \rightarrow \{0,1\}^n$ be a mapping whose components, f_1, f_2, \dots, f_n , are threshold functions :

$$\forall i (1, \dots, n), \forall x \in \{0,1\}^n, f_i(x) = \begin{cases} 1 & \text{if } \sum_{j=1}^n a_{ij} x_j - \theta_i \geq 0 \\ 0 & \text{otherwise} \end{cases}$$

where $A = (a_{ij})$ is a real $n \times n$ symmetric matrix and $(\theta_1, \dots, \theta_n)$ is the real threshold vector.

It is easy to see that, for any f_i there exists another threshold $\hat{\theta}_i$ such that:

$$f_i(x) = \begin{cases} 1 & \text{if } \sum_{j=1}^n a_{ij} x_j - \hat{\theta}_i > 0 \\ 0 & \text{if } \sum_{j=1}^n a_{ij} x_j - \hat{\theta}_i < 0 \end{cases}$$

We shall say that $\hat{\theta}_i$ is a strict threshold. In the following we always assume that functions f_i are defined by strict threshold.

The sequential iteration associated with F is defined by :

$$x_i(t+1) = f_i(x_1(t+1), \dots, x_{i-1}(t+1), x_i(t), \dots, x_n(t))$$

$$t \in \mathbb{N}, x(0) \in \{0,1\}^n, i \in \{1, \dots, n\}$$

Clearly, since $\{0,1\}^n$ is a finite set, all the trajectories, $(x(t))_{t \geq 0}$ of the sequential iteration are ultimately periodic. Hence, for every $x \in \{0,1\}^n$ there exist numbers $p(x)$, $t(x)$, called respectively the cycle and the transient lengths, such that :

$$x(t+p(x)) = x(t) \text{ for any } t \geq t(x)$$

and $x(t+q) \neq x(t)$ for any $t < t(x)$ or $0 < q < p(x)$

We denote $T(F) = \text{Max} \left\{ t(x) / x \in \{0,1\}^n \right\}$, and call it the transient length of F .

The energy associated with the sequential iteration on F is the function $E : \{0,1\}^n \rightarrow \mathbb{R}$, defined by :

$$\forall x \in \{0,1\}^n, E(x) = -\frac{1}{2} \sum_{i=1}^n x_i \sum_{j \neq i} a_{ij} x_j + \sum_{i=1}^n (\theta_i - a_{ii}) x_i$$

For any trajectory $(x(t))_{t \geq 0}$ we will denote $E(t) = E(x(t))$.

2 - A general bound on $T(F)$

Lemma 1. If $A = (a_{ij})$ is a symmetric matrix with non-negative diagonal elements, then :

$$x(t+1) \neq x(t) \Rightarrow E(t+1) < E(t)$$

Proof. Let $\Delta_t E = E(t+1) - E(t)$. The sequential iteration on F at time t can be decomposed into n successive steps, where at time $t + i/n$, element i only changes state, that is to say :

$$x(t) = (x_1(t), \dots, x_n(t))$$

$$x(t + \frac{k}{n}) = (x_1(t+1), \dots, x_k(t+1), x_{k+1}(t), \dots, x_n(t)), \quad 1 < k \leq n$$

$$\text{Hence } \Delta_t E = \sum_{k=1}^n (E(t + \frac{k}{n}) - E(t + \frac{k-1}{n}))$$

and, since A is symmetric :

$$\Delta_t E = \sum_{k=1}^n \left(x_k \left(t + \frac{k}{n} \right) - x_k \left(t + \frac{k-1}{n} \right) \right) \left(- \sum_{j \neq k} a_{kj} x_j \left(t + \frac{k-1}{n} \right) + \theta_k - a_{kk} \right)$$

$$\text{Let } \delta_k E = \left(x_k \left(t + \frac{k}{n} \right) - x_k \left(t + \frac{k-1}{n} \right) \right) \left(- \sum_{j \neq k} a_{kj} x_j \left(t + \frac{k-1}{n} \right) + \theta_k - a_{kk} \right)$$

Since, for any $k \in \{1, \dots, n\}$, f_k has a strict threshold and $a_{kk} \geq 0$, it follows that :

$$x_k \left(t + \frac{k}{n} \right) \neq x_k \left(t + \frac{k-1}{n} \right) \Rightarrow \delta_k E < 0$$

thus, $x(t) \neq x(t+1)$ implies $\Delta_t E < 0$

This lemma gives another direct proof that all the trajectories may only have fixed points as limit cycles. [2]

Lemma 2. If A is a symmetric matrix with non-negative diagonal elements, then :

$$T(F) \leq \frac{1}{\epsilon(F)} \sum_{i=1}^n \left(\frac{1}{2} \sum_{j \neq i} |a_{ij}| + |a_{ii}| + |\theta_i| \right)$$

with $\epsilon(F) = \text{Min} \{ |E(x(t)) - E(x(t+1))| / x(0) \in (0, 1)^n, x(t) \neq x(t+1) \}$

Proof. It is easy to see that for any $x \in \{0, 1\}^n$

$$-\frac{1}{2} \sum_{i=1}^n \sum_{\substack{j \neq i \\ a_{ij} > 0}} a_{ij} + \sum_{i=1}^n \theta_i - \sum_{i=1}^n a_{ii} \leq E(x) \leq -\frac{1}{2} \sum_{i=1}^n \sum_{\substack{j \neq i \\ a_{ij} < 0}} a_{ij} + \sum_{i=1}^n \theta_i$$

On the other hand, for $t < t(x)$, $x(t+1) \neq x(t)$ implies $|\Delta_t E| \geq \epsilon(F) > 0$, and thus from Lemma 1 :

$$T(F) \leq \frac{1}{\epsilon(F)} \left\{ \frac{1}{2} \sum_{i=1}^n \sum_{j \neq i} |a_{ij}| + \sum_{i=1}^n |a_{ii}| + \sum_{i=1}^n |\theta_i| \right\}$$

A uniform bound on $\epsilon(F)$ can be obtained when $a_{ij} \in \mathbb{Z}$:

suppose that $\theta_i \in [k_i, k_{i+1}[$, $k_i \in \mathbb{Z}$, for any $i \in \{1, \dots, n\}$, then, each function f_i may be defined by a strict threshold

$$k_i + \frac{1}{2}.$$

Hence we can assume that $\theta_i - \frac{1}{2} \in \mathbb{Z}$.

Theorem. If A is a symmetric integer matrix with non-negative diagonal elements, then :

$$T(F) \leq \sum_{i=1}^n \sum_{j \neq i} |a_{ij}| + 2 \left(\sum_{i=1}^n |a_{ii}| + \sum_{i=1}^n |\theta_i| \right)$$

Proof. Since,

$$|\delta_k E| = \begin{cases} \left| \sum_{j \neq k} a_{kj} x_j(t + \frac{k-1}{n}) - \theta_k + a_{kk} \right|, & \text{if } x_k(t + \frac{k}{n}) \neq x_k(t + \frac{k-1}{n}) \\ 0 & \text{otherwise} \end{cases}$$

for any $k \in \{1, \dots, n\}$, from the preceding comments we conclude that $\varepsilon(F) \geq 1/2$ and from Lemma 2, we obtain the result. ■

An interesting particular case with applications to group dynamics and spin glass simulations [1,2], corresponds to $a_{ij} \in \{-1, 0, 1\}$:

Corollary. if A is a symmetric matrix with $a_{ij} \in \{-1, 0, 1\}$ for any $i, j \in \{1, \dots, n\}$ and non-negative diagonal elements, then :

$$T(F) \leq 3 \sum_{i=1}^n |V(i)| + 2 \sum_{i=1}^n |a_{ii}| \leq n(3n - 1)$$

(quadratic bound)

where $|V(i)| = \text{card} \{ j \in \{1, \dots, n\} / a_{ij} \neq 0, j \neq i \}$

Furthermore, if $|V(i)| \leq K$ for $i \in \{1, \dots, n\}$, then : $T(F) \leq (3K+2)n$ (linear bound).

Proof. If $\theta_i \notin [-|V(i)|, |V(i)|]$ the i -th cell is fixed by the sequential iteration in one step.

If $\theta_i \in [-|V(i)|, |V(i)|]$ the bounds follow from the theorem. ■

REFERENCES

- 1 - ANGLÉS D'AURIAC J., Méthodes numériques pour l'étude de la dynamique des phénomènes critiques, thèse IMAG, Grenoble 1981.
- 2 - GOLES E., Comportement oscillatoire d'une famille d'automates cellulaires non uniformes, thèse IMAG, Grenoble 1980.
- 3 - HOPFIELD J., Neural networks and physical systems with emergent collective computational abilities, Proc. Nac. Acad. Sci, USA, Vol 79, pp 2554-2558, Ap. 1982.

VITESSE DE CONVERGENCE

THE CONVERGENCE OF
SYMMETRIC THRESHOLD AUTOMATA

En collaboration avec J.Olivos,
Inf. and Control, Vol 51,2,1981

ABSTRACT

We study the length of the transient in a threshold automata with values on the set $\{0,1\}$. The original conjecture was that in the symmetric case, this length was a linear function of the number of cells in the automata [2,5]. We shall show that this length can be exponential.

I. PRELIMINARIES.

Let Δ be the threshold function given by:

$$\Delta: \{0,1\}^n \rightarrow \{0,1\}^n \\ x \rightarrow (\phi_1(x), \dots, \phi_n(x))$$

with

$$\phi_i(x) = \begin{cases} 0 & \text{if } \sum_{j=1}^n a_{ij}x_j < \theta_i \\ 1 & \text{if } \sum_{j=1}^n a_{ij}x_j \geq \theta_i \end{cases} \quad i \in \{1, \dots, n\}$$

where $A = (a_{ij})$ is a real symmetric $n \times n$ matrix, $\theta = (\theta_1, \dots, \theta_n) \in \mathbb{R}^n$. We define the symmetric threshold automata associated to Δ as the iteration:

$$x^{r+1} = \Delta x^r \quad r=0,1,2,\dots; x^0 \in \{0,1\}^n.$$

It is obvious that, as $\{0,1\}^n$ is finite, this iteration converges to a cycle in a finite number of steps (with a period less than or equal to two [1,3]).

We define the transient corresponding to the threshold automata associated to the couple (A, θ) as follows:

$$\ell(A, \theta, n) = \text{Max}_{x \in \{0,1\}^n} \ell(x, n, \Delta)$$

where $\ell(x, n, \Delta)$ is the number of steps that the iteration needs, with x as starting vector, to arrive at the steady state.

We will show the existence of symmetric threshold automata with exponential transients compared to the number, n , of cell. This means that the convergence of the iteration to the steady state can be extremely slow. It is convenient to point out that in general threshold automata (A not necessarily symmetric) exponential convergence is obvious, because in this case we have an arbitrary McCulloch - Pittsnet, which can simulate the evolution of any finite automata [4].

II. STRICT THRESHOLD AUTOMATA.

Without any loss of generality we can suppose that each application ϕ_i is defined by a strictly separating hyperplane:

$$\phi_i(x) = \begin{cases} 0 & \text{if } \sum_{j=1}^n a_{ij}x_j < \theta_i \\ 1 & \text{if } \sum_{j=1}^n a_{ij}x_j > \theta_i \end{cases}$$

Indeed, if we have indexes $i \in \{1, \dots, n\}$ such that:

$$\sum_{j=1}^n a_{ij}x_j - \theta_i = 0 \quad \text{for some } x \in \{0,1\}^n$$

Let $U(i, -) = \{y \in \{0,1\}^n / \sum_{j=1}^n a_{ij}y_j < \theta_i\}$

If $U(i, -) = \emptyset$, it is obvious that the automata associated to the couple (A, θ') with:

$$\theta'_j = \begin{cases} \theta_j & \text{if } j \neq i \\ \theta_i - \epsilon_i, & \epsilon_i > 0 \end{cases}$$

has the same behaviour that the initial one.

In the case $U(i, -) \neq \emptyset$, let:

$$\sum_{j=1}^n a_{ij} z_j = \max_{y \in U(i, -)} \left(\sum_{j=1}^n a_{ij} y_j \right)$$

as $\sum_{j=1}^n a_{ij} z_j < \theta_i$, we can determine $\epsilon_i > 0$ such that:

$$\sum_{j=1}^n a_{ij} y_j \leq \sum_{j=1}^n a_{ij} z_j < \theta_i - \epsilon_i, \text{ for any } y \in U(i, -)$$

so taking $\theta'_i = \theta_i - \epsilon_i$ and $\theta'_j = \theta_j$ for $j \neq i$ we have the same behaviour for the automata associated to (A, θ) and (A, θ') .

III. DUALITY.

Given the strict symmetric threshold automata associated to the couple (A, θ) , we define its dual function, Δ^* , as the follow

$$\begin{aligned} \Delta^*: \{0,1\}^n &\rightarrow \{0,1\}^n \\ x &\rightarrow (\phi_1^*(x), \dots, \phi_n^*(x)) \end{aligned}$$

associated to the pair (A, θ^*) where:

$$\theta_i^* = -\theta_i + \sum_{j=1}^n a_{ij} \quad \text{for } i \in \{1, \dots, n\}$$

It is obvious from this equation that duality is reflexive ($\Delta^{**} = \Delta$). Furthermore the primal and dual functions satisfy:

$$\Delta x = y \iff \Delta^* \bar{x} = \bar{y}$$

where $\bar{z} = (\bar{z}_1, \dots, \bar{z}_n)$ is the boolean negation in each component.

This equivalence implies that the primal and dual automata have the same behaviour. On the other hand, if we do not have the strict threshold property this equivalence is false.

EXAMPLE 1. Let Δ be defined by:

$$A = \begin{pmatrix} -6 & 11 \\ 11 & 12 \end{pmatrix} \quad \theta = \begin{pmatrix} -5 \\ 10 \end{pmatrix}$$

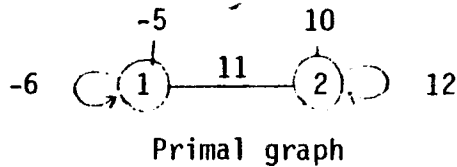

$0 \rightarrow 1 \rightarrow 0 \rightarrow 1 \rightarrow 1$ fixed point
 Primal evolution

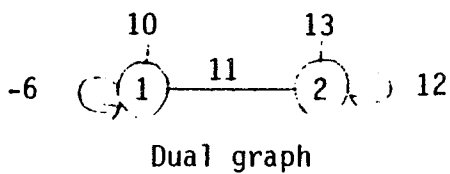

$1 \rightarrow 0 \rightarrow 1 \rightarrow 0$ fixed point
 Dual evolution

Figure - 1

III. CONSTRUCTION OF AN EXPONENTIAL FAMILY.

Using a recursive procedure, we will build a family of symmetric threshold automata with exponential transient growth.

We shall use the duality in order to add three cells to the automata in way that doubles the length of the transient. For instance, if we have the automata:

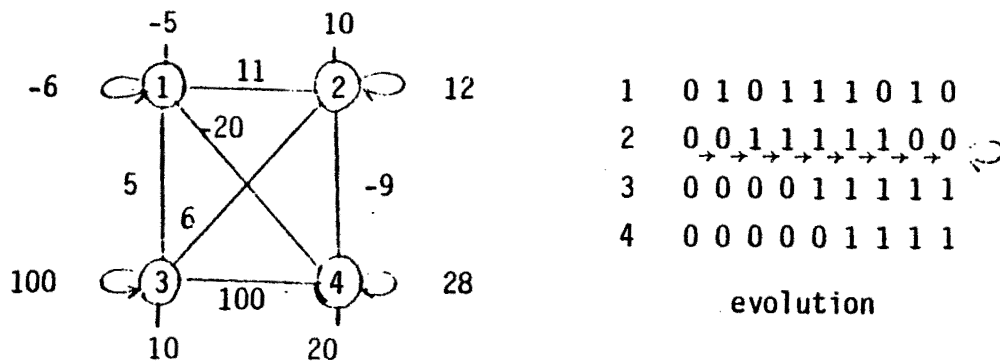
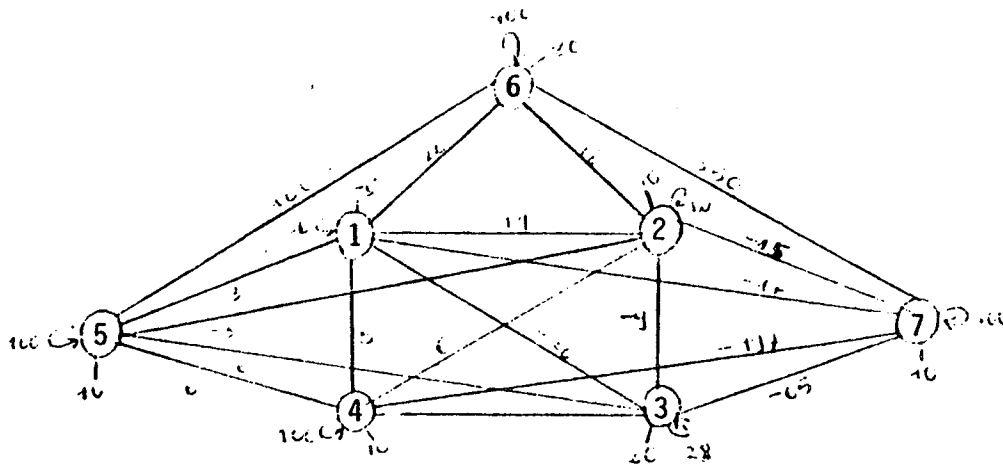

Figure-2

We can add three cells to this graph such that they will stay at the 0-level while the original cells evolve according to the primal automata. Afterwards they will take the 1-level, and contribute to the weights, a_{ij} , that will permit the dual evolution (see Fig.3.)



	Primal evolution									Dual evolution										
1	0	1	0	1	1	1	0	1	0	0	0	1	0	1	0	0	0	1	0	1
2	0	0	1	1	1	1	1	0	0	0	0	1	1	0	0	0	0	0	1	1
3	0	0	0	0	1	1	1	1	1	1	1	1	1	1	1	0	0	0	0	0
4	0	0	0	0	0	1	1	1	1	1	1	1	1	1	1	1	0	0	0	0
5	0	0	0	0	0	0	0	0	0	0	1	1	1	1	1	1	1	1	1	1
6	0	0	0	0	0	0	0	0	0	0	1	1	1	1	1	1	1	1	1	1
7	0	0	0	0	0	0	0	0	0	0	1	1	1	1	1	1	1	1	1	1

Primal - Dual evolution

Figure-3

with the same idea, we have the following result:

THEOREM: Given a symmetric strict threshold automata associated to the couple (A, θ) , with the evolution:

$$x(0) \rightarrow x(1) \rightarrow \dots \rightarrow x(T)$$

where $x(0) = \bar{0}$ and $x(T)$ is a fixed point, it is possible to build a symmetric strict threshold automata by adding three cells, so that it has the following transition:

Steps:	0	1	T	T+1	T+2	T+3.....	2T+3
	$x(0)$	$\rightarrow x(1)$	$\rightarrow \dots$	$\rightarrow x(T)$	$\rightarrow x(T)$	$\rightarrow x(T)$	$\rightarrow \bar{x}(0)$	$\rightarrow \dots \rightarrow \bar{x}(T)$
n+1	0	0	0	1	1	1	1	1
n+2	0	0	0	0	1	1	1	1
n+3	0	0	0	0	0	1	1	1

PROOF: In order to obtain the behaviour of cell n+1:

$$x_{n+1}(\ell) = \begin{cases} 1 & \ell \geq T+1 \\ 0 & \ell \leq T \end{cases}$$

it suffices to choose $\theta_{n+1} > 0$ and:

$$\left(\begin{array}{l} a_{n+1k} = \theta_{n+1} + \delta, \delta > 0 \\ a_{n+1j} = -(\delta + \epsilon), \epsilon > 0, j \neq k \end{array} \right) \quad \begin{array}{l} \text{if } X(T) = \{k\} \\ j \in \{1, \dots, n\} \end{array}$$

$$\left(\begin{array}{l} a_{n+1j} = -(\delta + \epsilon) \text{ if } j \notin X(T) \\ a_{n+1j} = \frac{\theta_{n+1} + \delta}{\text{card}X(T)} \text{ if } j \in X(T) \\ \text{with } \epsilon > 0 \text{ and } 0 < \delta < \frac{\theta_{n+1}}{\text{card}X(T) - 1} \end{array} \right) \quad \begin{array}{l} \text{if } \text{card} X(T) \geq 2 \\ j \in \{1, \dots, n\} \end{array}$$

where $X(T) = \{j \in \{1, \dots, n\} / x_j(T) = 1\}$

and

$$a_{n+1,n+1} > \theta_{n+1} - \sum_{a_{n+1j} < 0} a_{n+1,j}$$

Furthermore, as $a_{n+1j} > 0$ for $j \in X(T)$ and $a_{n+1j} < 0$ otherwise, the vector $x(T)$ does not change in steps $T+1$ and $T+2$.

Behaviour of cell $n+2$: The role of this cell is to produce the vector $\bar{x}(0)$ in the step $T+3$. This behaviour is accomplished if:

$$a_{n+2,j} = \begin{cases} 0 & \text{if } x_j(T) = 1 \\ M + \theta_i - \sum_{\substack{j \in X(T) \\ a_{ij} < 0}} a_{ij}; & M > 0, \text{ otherwise} \end{cases}$$

In order to have $x_{n+2}(\ell) = 0$ for $\ell \leq T+1$, and $x_{n+2}(\ell) = 1$ for $\ell \geq T+2$ we have to choose:

$$\theta_{n+2} > \sum_{j=1}^n a_{n+2j}$$

$$a_{n+1,n+2} > \theta_{n+2} - \sum_{a_{n+2j} < 0} a_{n+2j}$$

Behaviour of cell $n+3$: This cell must contribute the weights associated to cells $1, \dots, n$ in order to have the dual thresholds $\theta_1^*, \dots, \theta_n^*$, then:

$$a_{in+3} = 2\theta_i - \sum_{j=1}^{n+2} a_{ij} \quad \text{for } i \in \{1, \dots, n\}$$

On the other hand, if we choose

$$\theta_{n+3} > \sum_{j=1}^n a_{jn+3} \quad \text{and} \\ a_{jn+3} > 0$$

$$\theta_{n+3, n+2} = \theta_{n+3} - \sum_{j=1}^n a_{jn+3}^{+N}, \quad N > 0 \\ a_{jn+3} < 0$$

we will have:

$$x_{n+3}(\ell) = \begin{cases} 0 & \text{if } \ell \leq T+2 \\ 1 & \text{if } \ell \geq T+3 \end{cases}$$

since the cell $n+3$ (when $x_{n+3}(\ell) = 1$) changes θ_i for θ_i^* , we will have the dual behaviour of the cells $1, \dots, n$ beginning at the step $T+3$.

Taking as a basis the theorem and the example for $n=7$ (see Fig. 3), we can work recursively with the previous construction. By this means, the number, $T(n)$, of transition vectors in this automata with n cells verifies:

$$T(n+3) = 2T(n) + 2; \quad T(7) = 20$$

from which we get $T(n) = 11 \cdot 2^{\frac{n-4}{3}} - 2$ so $\ell(0, n, \Delta) = T(n) - 1$ implies:

$$\ell(A, \theta, n) \geq 11 \cdot 2^{\frac{n-4}{3}} - 2$$

This shows that there exist symmetric threshold automata with transients of order $2^{n/3}$.

It is interesting to point out that in random simulations of very large symmetric threshold automata, it is extremely difficult to find long transients, in general they are shorter than n .

REFERENCES.

- [1] GOLES E., J. OLIVOS A., "Comportement périodique des fonctions a multisenil". Inf. and Control, Vol. 45, N°3, June 1980.
- [2] GOLES E., "Comportement oscillatoire d'une famille d'automates cellulaires non uniformes", These, IMAG, Grenoble, France, 1981.
- [3] GOLES E., J. OLIVOS A., "Comportement periodique des fonctions a senil binaires et applications", Disc. App. Math., 93-105,3, 1981.
- [4] Mc. CULLOCH, PITTS W., "A logical calculus of the ideas immanent in nervous activity", Bull. Math. Biophys., 5, 115-133, 1943.
- [5] OLIVOS, J., "Contribution a l'algorithmique", These, Orsay, 1979.

**CHAPITRE IV
FORMALISME POUR
L'ETUDE DES RESEAUX
POSITIFS**

CHAPITRE-IVFORMALISME GENERAL
POUR L'ETUDE DES RESEAUX POSITIFS

Dans ce chapitre, nous donnons un cadre mathématique suffisant pour l'étude d'une classe des réseaux d'automates: les réseaux positifs, lesquels contiennent comme cas particuliers certains des réseaux étudiés précédemment.

Le principal résultat obtenu ici est que ce type d'automate admet toujours une fonction de Lyapunov ou d'énergie, laquelle gère toute la dynamique, dans et hors l'équilibre.

Physiquement parlant, nous pouvons dire que chaque cellule admet un potentiel local qui induit une fonction d'énergie sur le réseau et, à cet égard, une itération n'est pas autre chose que la recherche d'un régime stationnaire qui soit un minimum, local ou global, de l'énergie.

On donne aussi des résultats de caractérisation de cette classe de réseaux et des exemples d'applications.



DYNAMICS ON POSITIVE

AUTOMATA NETWORKS

Soumis à Journal of Theor. Comp. Sci.

1.- INTRODUCCION.

Many authors have studied the dynamical behaviour of automata networks; see for instance [1,3,6,7,9,10,14,15,18,23,25,27,28,29,30,31]. However, a rather difficult combinatorial analysis is needed in order to handle the discrete nature of the problem (transitions functions on a finite set, discrete cellular spaces, etc) and hence fully general results are not commonly available.

In recent years automata networks have been introduced as a modelling tool in several fields: neural networks in biology [2,3,4,9,15,16,18,19,27], majority networks in the spin glass problem and others physical models [5,6,7,15,17,25,30,31], chemistry and social dynamics [1,13,14,23], and parallel algorithms and systolic arrays [21,29].

In this paper we present a mathematical framework for the treatment of an important class of such networks which will be called positive automata networks. Much of the cases of applications cited above are included in this class. Among the relevant ones we find: threshold networks [6,7,8,10,11,15,19,27,28] and majority networks [13,23].

By the way, this theoretical framework proves to be useful in the complete characterization of the positive automata networks dynamics (cycle length, convergence speed, etc). Recently obtained results appear in this context as particular cases [6,8,9,10,12,13,15,23,27,28,29]. We are also able to deal with the rate of convergence towards the steady state while the works cited above do not give any information about.

The presentation is organized as follows: we first define what positive functions are, which will be the local transition functions of the automata network. Examples are given as well as characterizations. We then give the principal theorems on dynamics of positive networks by introducing an energy functional called Lyapunov function. Finally we exhibit some examples of applications.

2.- POSITIVE FUNCTIONS.

In this paragraph we give some definitions and properties on positive functions as well as cyclically monotone applications, usually used in convex analysis [26]. Relations between convex analysis and some transition functions of automata networks have been remarked in [22] in particular cases, but no general dynamics theorems have been obtained. In [24] the authors study dynamics on cyclically monotone networks but no result is given for the transient behaviour of such a network, furthermore all cyclically monotone applications explicitated there, are also positive.

It seems that the deepest property associated to any precedent network is the positivity. In a physical view, positivity represents a local potential that permits to establish a global energy (Liapunov function) associated to the positive network.

Let S, Q be two sets in \mathbb{R}^p and f a function from S into Q . f will be called positive if:

$$\langle fx - fy, x \rangle_p \geq 0 \quad \forall x, y \in S \quad (1)$$

where $\langle \cdot, \cdot \rangle_p$ is an inner product in \mathbb{R}^p . We shall say that f is strictly positive if equality holds only for $x=0$ or $fx=fy$.

This kind of functions is related with monotone and cyclically monotone functions usually used in convex analysis [26]

The function f is called cyclically monotone if:

For any $n \in \mathbb{N}$, $n \geq 2$, and any vector $(x_0, \dots, x_{n-1}) \in S^n$ we have:

$$\sum_{i=0}^{n-1} \langle x_i - x_{i+1}, fx_i \rangle_p \geq 0, \quad (2)$$

where indexes are taken modulo n . It is easy to see that condition (2) is equivalent to the following:

$$\sum_{i=0}^{n-1} \langle fx_{i+1} - fx_i, x_{i+1} \rangle_p \geq 0 \quad (3)$$

The function f is said to be monotone iff:

$$\langle fx - fy, x - y \rangle_p \geq 0 \quad \text{for any } x, y \in S$$

It is clear that: f positive \implies f cyclically monotone, and f cyclically

monotone \implies f monotone. Furthermore, if $S, 0 \in \mathbb{R}$ (i.e. $p=1$) we have: f cyclically monotone \iff f monotone \iff f nondecreasing, but for $p>1$, a function cyclically monotone is not necessarily monotone [26].

For positive functions there is not equivalence with the other two classes. For instance the real function $fx=x$ is monotone but it is not positive.

If $S \subset \mathbb{R}^p$ is a convex set we may characterize cyclically monotone functions:

Lemma 1. f is cyclically monotone iff there exists a convex function $\phi: S \rightarrow \mathbb{R}$ such that f is a subgradient of ϕ :

$$\phi(x) \geq \phi(y) + \langle fy, x-y \rangle_p \quad \forall x, y \in S$$

Proof.: The proof is a particular case of a theorem in [25, pag.238]: Clearly if f is a subgradient of ϕ and if we take a cyclic vector (x_0, \dots, x_{n-1}) we have:

$$\phi(x_i) - \phi(x_{i+1}) \geq \langle fx_{i+1}, x_i - x_{i+1} \rangle_p$$

hence

$$\sum_{i=0}^{n-1} \langle fx_{i+1}, x_{i+1} - x_i \rangle_p \geq 0$$

then f is cyclically monotone.

On the other hand, let us suppose f cyclically monotone and let ϕ be the following function:

$$\phi(x) = \text{Sup}\{\langle x - x_m, f(x_m) \rangle_p + \dots + \langle x_1 - x_0, f(x_0) \rangle_p\}$$

where the supremum is taken over all finite set $\{x_0, \dots, x_m\}_{m \geq 0}$.

Since ϕ is the supremum of a collection of affine function ϕ is a convex function.

Furthermore, since f is cyclically monotone $\phi(x_0) \leq 0$ (hence $\phi(x_0) = 0$), hence ϕ is a proper convex function.

Furthermore,

$$\phi(\xi) \geq \langle \xi - x_{m+1}, f(x_{m+1}) \rangle_p + \dots + \langle x_1 - x_0, f(x_0) \rangle_p$$

setting $x_{m+1} = x$, we have:

$$\phi(\xi) \geq \langle \xi - x, f(x) \rangle_p + \langle x - x_m, f(x_m) \rangle_p + \dots + \langle x_1 - x_0, f(x_0) \rangle_p$$

for any set $\{x_0, \dots, x_m\} \subset S$

hence

$$\phi(\xi) \geq \phi(x) + \langle f(x), \xi - x \rangle_p$$

then f is a subgradient of ϕ . □

Hence we may conclude that, if S is a convex set any positive function is a subgradient of a convex function.

If f is a real function we have:

Lemma 2. Let f be a real function then, it is positive iff it is threshold function; i.e.

$$f(x) = \begin{cases} \alpha & \text{if } x < 0 \\ \delta & \text{if } x = 0 \\ \beta & \text{if } x > 0 \end{cases}$$

with $\alpha < \beta$, $\delta \in [\alpha, \beta]$.

Proof.: If f is a threshold function:

$$(fx - fy)x = \begin{cases} (\alpha - \beta)x & \text{if } x < 0 \text{ and } y > 0 \\ (\beta - \alpha)x & \text{if } x > 0 \text{ and } y < 0 \\ 0 & \text{otherwise} \end{cases}$$

hence, from definition of positivity we conclude that f is positive.

On the other hand, if f is a real positive function:

$$(fx - fy)x \geq 0 \quad \forall x, y \in \mathbb{R} \quad (4)$$

and

$$(fy - fx)y \geq 0 \quad \forall x, y \in \mathbb{R} \quad (5)$$

$$\text{hence: } x, y < 0 \implies f(x) = f(y) = \alpha$$

$$x, y > 0 \implies f(x) = f(y) = \beta$$

If $x > 0$ and $y < 0$: $(\beta - \alpha)x > 0 \implies \beta > \alpha$ and by application of inequality (4) for $y = 0$, we conclude that $\alpha < f(0) = \delta < \beta$.

□

Example:

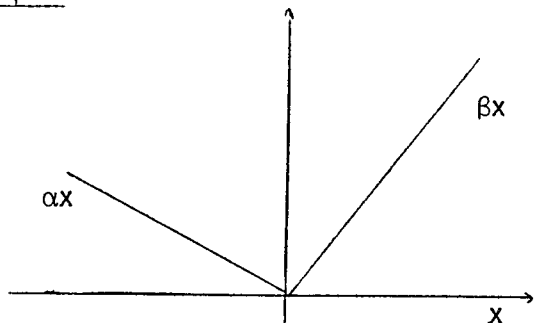

$$\phi(x) = \begin{cases} \beta x, & x \geq 0 \\ \alpha x, & x \leq 0 \end{cases}$$

convex function ϕ

hence:

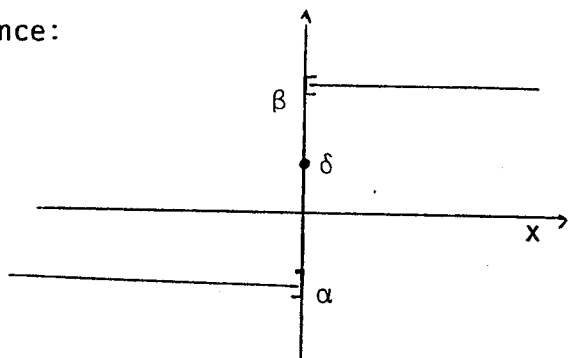

f a subgradient of ϕ .

$$f(x) = \begin{cases} \beta & \text{if } x < 0 \\ \delta & \text{if } x = 0 \\ \alpha & \text{if } x > 0 \end{cases}$$

It is interesting to see that if f is positive and $h: U \rightarrow S$ we have:

$$\langle f(hu) - f(hv), hu \rangle_p \geq 0 \quad \text{for any } u, v \in U$$

This property will be essential in the next paragraph.

By composition and \sum of functions we can build:

$$g(x) = \begin{cases} \alpha_1 + \dots + \alpha_q & \text{if } x < b_1 \\ \beta_1 + \alpha_2 + \dots + \alpha_q & b_1 \leq x < b_2 \\ \vdots & \vdots \\ \beta_1 + \dots + \beta_q & \text{if } x \geq b_q \end{cases} \quad ; \quad b_1 < b_2 < \dots < b_q$$

with $g(x) = \sum_{i=1}^q f_i(x-b_i); \quad f_i(x-b_i) = \begin{cases} \alpha_i & \text{if } x < b_i \\ \beta_i & \text{if } x \geq b_i \end{cases} \quad \alpha_i < \beta_i$

These functions are named multithreshold functions [12]. Since each f_i is a positive function each member of the sum verifies:

$$\langle f_i(x-b_i) - f_i(y-b_i), x-b_i \rangle_p \geq 0 \quad i=1, \dots, q$$

Although $g(x)$ is not positive, the positivity of each f_i shall be sufficient in order to study this kind of functions.

Since in many applications, functions f are defined in real finite sets S, Q , it is interesting the following lemma:

Lemma 3. Let $f: S \rightarrow Q$, with S, Q real finite sets, then:

f monotone \iff f cyclically monotone \iff f is a multithreshold function.

Proof.: The first equivalence holds from the previous properties.

Furthermore if f is multithreshold

$$f(x) = \begin{cases} \gamma_1 & \text{if } x < b_1 \\ \gamma_2 & \text{if } b_1 \leq x < b_2 \\ \vdots & \\ \gamma_q & \text{if } b_{q-1} \leq x \end{cases} \quad \begin{matrix} \gamma_1 \leq \gamma_2 \leq \dots \leq \gamma_q \\ b_1 < b_2 < \dots < b_{q-1} \end{matrix}$$

Clearly f is monotone (non decreasing). On the other hand, let us suppose

$$f: \{x_1 < x_2 < \dots < x_s\} \rightarrow \{f(x_1), \dots, f(x_s)\} = \{y_1, \dots, y_s\}$$

without loss of generality we may assume that f is strictly monotone:

$$x_i < x_j \implies f x_i < f x_j \quad \forall i \neq j$$

Let us take $b_1, b_2, \dots, b_s \in]x_1, x_s[$ with $x_1 < b_1 < x_2 < b_2 < \dots < b_{s-1} < x_s$ and the functions: $f: S \rightarrow Q$ defined by:

$$f(x) = \begin{cases} y_1 & \text{if } x < b_1 \\ y_2 & \text{if } b_1 \leq x < b_2 \\ \vdots & \vdots \\ y_s & \text{if } b_{s-1} \leq x \end{cases}$$

hence $f(x) = f(x) \quad \forall x \in S = \{x_1, \dots, x_s\}$

□

Now we give some examples of positive functions on \mathbb{R}^p .

Let $\sigma = (\sigma(1), \dots, \sigma(p))$ be a permutation on the set $\{1, \dots, p\}$, we define a total order on σ as follows:

$$\sigma(i) \geq \sigma(j) \iff j \geq i$$

Let us set the function:

$$f: \mathbb{R}^p \rightarrow \{e_1, \dots, e_p\} \quad (\text{where } e_i = (0 \dots \underset{\substack{\uparrow \\ i}}{1} \dots 0))$$

defined by:

$$f(x) = e_k \iff \begin{cases} x_k \geq x_i & \forall i \text{ such that } \sigma(k) \geq \sigma(i) \\ x_k > x_i & \forall i \text{ such that } \sigma(k) < \sigma(i) \end{cases}$$

Clearly f is positive:

$$\langle fx - fy, x \rangle_p = \langle e_k - e_m, x \rangle_p = x_k - x_m \geq 0$$

Furthermore f is the subgradient of the convex function: $\phi: \mathbb{R}^D \rightarrow \mathbb{R}$:

$$\phi(x) = x_k \iff \begin{cases} x_k \geq x_i & \forall i \text{ } \sigma(k) \geq \sigma(i) \\ x_k > x_i & \forall i \text{ } \sigma(k) < \sigma(i) \end{cases}$$

If $\phi(x) = x_k$ and $\phi(y) = y_m$, we have

$$\phi(x) - \phi(y) - \langle f(y), x - y \rangle_p = x_k - y_m - \langle e_m, x - y \rangle_p =$$

$$x_k - y_m - x_m + y_m = x_k - x_m \geq 0,$$

hence f is a subgradient of ϕ .

Other positive functions are the following :

$$g(x) = \begin{cases} \vec{0} & \text{if } x \leq \vec{0} \\ f(x) & \text{otherwise} \end{cases}$$

$$g(x) = e_{ij} \iff \begin{cases} x_i - x_j \geq x_{\ell} - x_{\ell'}, & \ell \neq \ell' \text{ if } |i-j| \geq |\ell-\ell'| \\ x_i - x_j > x_{\ell} - x_{\ell'}, & \text{if } |i-j| < |\ell-\ell'| \end{cases}$$

$$\text{where } e_{ij} = (0 \dots 0 \underset{\substack{\uparrow \\ i}}{1} 0 \dots 0 \underset{\substack{\uparrow \\ j}}{-1} 0 \dots 0)$$

$$\langle g(x) - g(y), x \rangle_p = \langle e_{ij} - e_{i',j'}, x \rangle_p = x_i - x_j - (x_{i'} - x_{j'}) \geq 0$$

□

3.- DYNAMICS BEHAVIOUR ON POSITIVE NETWORKS

Let f_1, \dots, f_n be positive functions from S into Q , where S and Q are finite sets in \mathbb{R}^p .

Let us define the following linear operators:

$$A_i: Q^n \rightarrow S$$

$$x = (x_1, \dots, x_n) \rightarrow A_i x$$

and the linear operator:

$$A: Q^n \rightarrow Q^n$$

$$x = (x_1, \dots, x_n) \rightarrow (A_1 x, \dots, A_n x)$$

If F is the function:

$$F: Q^n \rightarrow Q^n$$

$$x \rightarrow (f_1(A_1 x - b^1), \dots, f_n(A_n x - b^n)), \text{ with } A_i x - b^i \in S$$

$b^i \in \mathbb{R}^p$ and $A_i x - b^i \neq 0$ for any $x \in Q^n$. We shall study the dynamics of different iterations on F .

1. Parallel Iteration.

$$x(t+1) = Fx(t); \quad t = 0, 1, \dots; \quad x(0) \in Q^n$$

Clearly, since Q^n is a finite set, parallel iteration converges, for any vector $x(0)$, to a finite cycle. Hence, for every $x \in Q^n$ there exist numbers $p(x)$, $t(x)$ called respectively the cycle and

transient length, such that:

$$F_x^{s+p(x)} = F_x^s \quad \text{for any } s \geq t(x)$$

and $F_x^{s+q} \neq F_x^s$ for any $s < t(x)$ or $0 < q < p(x)$

we denote:

$$P(F) = \max\{p(x)/x \in Q^n\}$$

$$T(F) = \max\{t(x)/x \in Q^n\}$$

as the maximum period and transient associated to F.

In order to determine bounds on cycles and transients of a such dynamical system we define:

$$E(x,y) = -\langle x, Ay \rangle_n + \langle x+y, b \rangle_n \quad \text{where } b = (b^1, \dots, b^n) \in S^n.$$

E is called the Lyapunov function associated to F.

Lemma 1. If the functions (f_i) are positive and A is a symmetric linear operator we have:

$$x(t+1) \neq x(t-1) \implies E(x(t+1), x(t)) < E(x(t), x(t-1))$$

Proof. Let us define $\Delta_t E = E(x(t+1), x(t)) - E(x(t), x(t-1))$

The symmetry of A implies:

$$\Delta_t E = -\langle x(t+1) - x(t-1), Ax(t) - b \rangle_n$$

hence:

$$\Delta_t E = - \sum_{i=1}^p \langle x_i(t+1) - x_i(t-1), A_i x(t) - b^i \rangle_p$$

since $x_i(t+1) = f_i(A_i x(t) - b^i)$, $x_i(t-1) = f_i(A_i x(t-2) - b^i)$ from positivity on (f_i)

$$\langle f_i(A_i x(t) - b^i) - f_i(A_i x(t-2) - b^i), A_i x(t) - b^i \rangle_p \geq 0 \quad \forall i=1, \dots, n$$

As $x(t+1) \neq x(t-1)$ and $A_i x(t) - b^i \neq 0$ there exist indexes such that the previous inequality is strict, hence, $\Delta_t E < 0$

□

Theorem 1. If the functions (f_i) are positive and A is a symmetric linear operator then: the maximum period verifies: $P(F) \leq 2$.

Proof. Let us suppose that there exists a T -cycle:

$$(x(0), \dots, x(T-1)) \quad \text{with } T \geq 3$$

hence, from lemma 1:

$$E(x(1), x(0)) < E(x(0), x(T-1)) < \dots < E(x(1), x(0))$$

which is a contradiction

□

Since Q^n is a finite set there exist the following quantities:

$$E_M = \max_{x,y \in Q^n} E(x,y)$$

$$E_m = \min_{x,y \in Q^n} E(x,y)$$

$$\epsilon(F) = \min\{\langle F^2 x - x, AFx - b \rangle_n / F^2 x \neq x, x \in Q^n\}$$

and we establish the following result:

Theorem 2. If (f_i) are positive functions and A is a symmetric linear operator:

$$T(F) \leq \frac{E_M - E_m}{\epsilon(F)} \quad \text{if} \quad \epsilon(F) \neq 0$$

$$T(F) = 0 \quad \text{if} \quad \epsilon(F) = 0$$

Proof. If $F^2 x = x, \forall x \in Q^n$ we get directly $T(F) = 0$. Let us suppose that $\epsilon(F) \neq 0$. Since (f_i) are positive functions then $\langle F^2 x - x, AFx - b \rangle_n > 0$ for $F^2 x \neq x$ hence $\epsilon(F) > 0$ and from lemma 1 we have:

$$\forall t \in \mathbb{N} \text{ such that } x(t+1) \neq x(t-1):$$

$$|\Delta_t E| \geq \epsilon(F)$$

then we have:

$$E_m \leq E(x(t+1), x(t)) \leq E_M - t\epsilon(F)$$

hence
$$T(F) \leq \frac{E_M - E_m}{\epsilon(F)}$$

□

From this theorem we may give a general bound on $T(F)$.

For any $x, y \in Q^n$ we have:

$$|E(x, y)| \leq \|x\|_n \|y\|_n \|A\| + \|b\|_n (\|x\|_n + \|y\|_n)$$

since Q^n is finite we take $\alpha = \max_{z \in Q^n} \|z\|_n$,

hence:

$$|E(x, y)| \leq \alpha^2 \|A\| + 2\alpha \|b\|_n,$$

where $\|\cdot\|_n$ is a norm associated to the inner product $\langle \cdot, \cdot \rangle_n$ and $\|A\|$ is the induced norm on the linear operator A .

hence:
$$T(F) \leq \frac{2\alpha^2 \|A\| + 4\alpha \|b\|_n}{\epsilon(F)}$$

If we know the nature of the operator A , we may give some better bounds on $T(F)$. In the general case is not easy to calculate a bound for $\epsilon(F)$. In the next paragraph we shall study some particular cases.

2. ITERATION WITH MEMORY.

In a more general frame, we shall study the following iteration on positive functions:

$$x_i(t) = f_i \left(\sum_{s=1}^k A_i(s) x(t-s) - b^i \right); \quad i=1, \dots, n$$

where $b^i \in \mathbb{R}^P$ and the $A_i(s)$ are linear operators:

$$A_i(s): Q^n \rightarrow S \subset R^P \quad \text{for } i=1, \dots, n$$

$$u \rightarrow A_i(s)u \quad s=1, \dots, k$$

If we define the linear operator:

$$A(s): Q^n \rightarrow S^n \quad \text{for } s=1, \dots, k$$

$$u \rightarrow \begin{bmatrix} A_1(s) \\ \vdots \\ A_n(s) \end{bmatrix} u$$

we can write the following Lyapunov function associated to the iteration:

$$E(y^0, \dots, y^k) = - \sum_{\ell=0}^{k-1} \langle y^\ell, \sum_{s=\ell+1}^k A(s-\ell)y^s \rangle_n + \sum_{\ell=0}^k \langle y^\ell, b \rangle_n$$

where $y^\ell \in Q^n$ and $b = (b^1, \dots, b^n) \in Q^n$

Theorem 3. If (f_i) are positive functions and the linear operators $A(1), \dots, A(k)$ verify:

$$A(s) = A^t(k-s+1) \quad \text{for } s=1, \dots, k$$

then the cycles of the iteration with memory are divisor of $k+1$.

Proof. Similary to lemma 1 we have that if $x(t) \neq x(t-k-1)$ we get:

$$\Delta_t E = - \sum_{\ell=0}^{k-1} \langle x(t-\ell), \sum_{s=\ell+1}^k A(s-\ell)x(t-s) \rangle_n + \sum_{\ell=0}^k \langle x(t-\ell), b \rangle_n +$$

$$- \sum_{\ell=0}^{k-1} \langle x(t-1-\ell), \sum_{s=\ell+1}^k A(s-\ell)x(t-1-s) \rangle_n - \sum_{\ell=0}^k \langle x(t-1-\ell), b \rangle_n$$

where: $\Delta_t E = E(x(t), \dots, x(t-k)) - E(x(t-1), \dots, x(t-k-1))$

hence:

$$\begin{aligned} \Delta_t E &= -\langle x(t) - x(t-(k+1)), \sum_{s=1}^k A(s)x(t-s) - b \rangle_n \\ &= -\sum_{i=1}^p \langle x_i(t) - x_i(t-(k+1)), \sum_{s=1}^k A_i(s)x_i(t-s) - b^i \rangle_p \end{aligned}$$

since $x_i(t) \neq x_i(t-(k+1))$, $\sum_{s=1}^k A_i(s)x_i(t-s) - b^i \neq 0$ and (f_i) are

positive functions we have:

$$\Delta_t E < 0$$

hence, as in theorem 1 the cycles compatibles with the Lyapunov function must be divisors of $k+1$.



As a particular case we have that the maximum period, $P(F)$, is $k+1$.

For the transient length we may do an analogous analysis to theorem 2.

3. SEQUENTIAL ITERATION ON F.

Let us take the following iteration on (f_i) :

$$\begin{aligned} x_1(t) &= f_1(A_1 x(t-1) - b^1) \\ &\vdots \\ x_i(t) &= f_i(A_i(x_1(t), \dots, x_{i-1}(t), x_i(t), \dots, x_n(t)) - b^i) \\ &\vdots \\ x_n(t) &= f_n(A_n(x_1(t), \dots, x_{n-1}(t), x_n(t-1)) - b^n) \end{aligned}$$

For this iteration we may define the following Lyapunov function:

$$E(x) = -\frac{1}{2} \langle x, Ax \rangle_n + \langle x, b \rangle_n$$

and, in a similar way of precedent results we may prove the following theorem:

Theorem 4. If the (f_i) are positive functions and A is a symmetric nonnegative definite linear operator then $P(F) = 1$.

The proof of theorem 4 is analogous to previous theorems and a particular case can be seen in [6].

Obviously, we can also give bounds for $T(F)$.

This kind of iteration has been used in the spin glass problem as a tool in order to reach a fundamental state in an spin networks [6,15,17,25].

Comment. In we have a functions define as a sum of composite positive functions:

$$\sum_{i=1}^q F_i(x)$$

with

$$F_i: Q^n \rightarrow Q^n$$

$$x \rightarrow (f_{i1}(A_{i1}x - b_{i1}), \dots, f_{in}(A_{in}x - b_{in}))$$

where the (f_{ij}) are positive functions.

Although $\sum F_i(x)$ it is not necessarily positive we may study iterations on this function in the following way:

If we take, for instance, parallel iteration:

$$x(t+1) = \sum_{i=1}^q F_i(x(t))$$

we define $x_i(t+1) = F_i(x(t)) \quad i=1, \dots, q$

hence we can write:

$$x_i(t+1) = F_i\left(\sum_{k=1}^q x_k(t)\right) = F_i(L(x_1(t), \dots, x_q(t)))$$

for $i=1, \dots, q$

where L is the linear operator $L(y_1, \dots, y_q) = \sum_{i=1}^q y_i$ hence:

$$(x_1(t+1), \dots, x_q(t+1)) = F(x_1(t), \dots, x_q(t)),$$

with $F: Q^{nq} \rightarrow Q^{nq}$

$$y = (y_1, \dots, y_q) \rightarrow (F_1(Ly), \dots, F_q(Ly)) =$$

$$(f_{11}(A_{11}Ly) - b_{11}), \dots, f_{qn}(A_{qn}Ly - b_{qn})$$

Since the (f_{ij}) are positive and the $A_{ij}L$ linear operators, we may study the dynamics analogous to the previous theorems; i.e. if $(A_{11}L, \dots, A_{nq}L)$ is symmetric then $P(\sum_{i=1}^q F_i(x)) \leq 2$ and also we can give bounds on $T(\sum F_i(t))$.

In the next paragraph we shall study a particular case of sum of positive functions; multithreshold functions.

4.- EXAMPLES.1. THRESHOLD NETWORKS [3,7,10,11,15,19,27,28]

Let us consider the parallel iteration

$$x_i(t+1) = f_i\left(\sum_{j=1}^n a_{ij}x_j(t) - b_i\right) \quad i=1, \dots, n$$

where $x(t) \in 0^n = \{0,1\}^n$, $A = (a_{ij})$ a symmetric $n \times n$ real matrix, b_i a real threshold and:

$$f_i(u) = \begin{cases} 0 & \text{if } u < 0 \\ 1 & \text{otherwise} \end{cases} \quad \text{is a positive function}$$

It is easy to see that without loss of generality we may assume that:

$$\sum_{j=1}^n a_{ij}y_j - b_i \neq 0 \quad \forall y \in \{0,1\}^n \quad \text{and } i=1, \dots, n$$

The Lyapunov function associated with parallel iteration is the following:

$$E(x,y) = -\sum_{i=1}^n x_i \sum_{j=1}^n a_{ij}y_j + \sum_{i=1}^n b_i(x_i + y_i)$$

From previous results we have $P(F) \leq 2$.

Furthermore, in this particular case we can give an explicit bound of $T(F)$ in the context of uniform threshold networks:

Let us take $V(i) = \{j \in \{1, \dots, n\} / a_{ij} \neq 0\}$

and let us suppose that $|V(i)| = K$ and $a_{ij} \in \{-1, 0, 1\}$ for any $i, j=1, \dots, n$.

Since the interesting cases are $b_i \in [-K, K]$ (otherwise we have convergence in one step) we can give the following bound of E :

$$2 \sum_{b_i < 0} b_i - \sum_{i=1}^n \sum_{a_{ij}=1} a_{ij} \leq E(x,y) \leq - \sum_{i=1}^n \sum_{a_{ij}=-1} a_{ij} + 2 \sum_{b_i > 0} b_i$$

and, since $a_{ij} \in \{-1, 0, 1\}$ it is easy to see that $\varepsilon(F) \geq \frac{1}{2}$ [6]

hence:

$$T(F) \leq 2 \left(\sum_{i=1}^n \sum_{j=1}^n |a_{ij}| + 2 \sum_{i=1}^n |b_i| \right)$$

$$T(F) \leq 2nK + 4nK = 6nK \quad (\text{linear bound})$$

Then we conclude that the convergence in uniform threshold networks is very fast; for instance in a two dimensional torus, $Z_{n \times n}$:

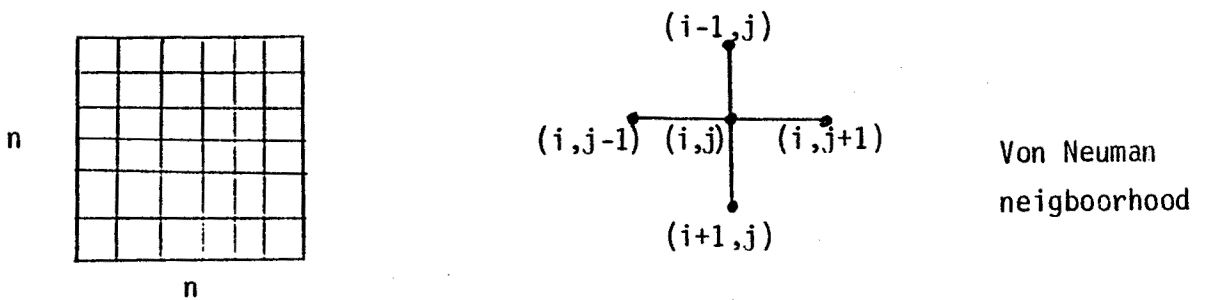

$$V(i,j) = \{(i,j-1), (i,j+1), (i-1,j), (i+1,j)\}$$

with

$$x_{ij}(t+1) = \begin{cases} 0 & \text{if } \sum_{\ell \in V(i,j)} x_{\ell} < b_{ij} \\ 1 & \text{otherwise} \end{cases}$$

we have $T(F) \leq 24N$, where $N = n^2$.

In general case; i.e. A a nxn real symmetric matrix, we can give nonuniform threshold networks such that $T(F) = O(2^{n/3})$ [11].

If we consider an iteration with memory on threshold functions:

$$x_i(t) = f_i\left(\sum_{s=1}^k \sum_{j=1}^n a_{ij}(s)x_j(t-s) - b_i\right) \text{ for } i=1, \dots, n$$

where $x(t-s) \in Q^n = \{0,1\}^n$, $s=1, \dots, k$, and

$$A(s) = (a_{ij}(s)) = A^t(k-s+1) \text{ for } s=1, \dots, k$$

From precedent results we conclude that the period of a such iteration are divisors of $k+1$. Furthermore, we may exhibit networks having cycles of any divisor [7]. Also we can give bounds on $T(F)$ in a similar way of parallel iteration.

2. MULTITHRESHOLD NETWORKS [7,12,21,22]

Let us take multithreshold functions:

$$\sum_{k=0}^{p-1} f_{ik}\left(\sum_{j=1}^n a_{ij}x_j - b_{ik}\right) \quad i=1, \dots, n$$

with $b_{i0} < b_{i1} < \dots < b_{i(p-1)}$, $A = (a_{ij})$ a symmetric nxn matrix.

$$f_{ik}(u) = \begin{cases} 0 & \text{if } u < 0 \\ 1 & \text{otherwise} \end{cases}$$

It is clear that we can write:

$$\sum_{k=0}^{p-1} f_{ik} \left(\sum_{j=1}^n a_{ij} x_j - b_{ik} \right) = \begin{cases} 0 & \text{if } \sum_{j=1}^n a_{ij} x_j < b_{i0} \\ \vdots & \\ q & \text{if } b_{iq-1} \leq \sum_{j=1}^n a_{ij} x_j < b_{iq} \\ \vdots & \\ p & \text{if } b_{ip-1} \leq \sum_{j=1}^n a_{ij} x_j \end{cases}$$

From the last comment in previous paragraph, for studying the parallel iteration on the sum is sufficient to study the parallel iteration on components:

$$x_{ik}(t+1) = f_{ik} \left(\sum_{j=1}^n a_{ij} \sum_{\ell=0}^{p-1} x_j(t) - b_{ik} \right)$$

$i=1, \dots, n; k=0, \dots, p-1$

from $\{0,1\}^{np}$ into itself.

In this case, the associated linear operator is the following:

$$\tilde{A} = A \otimes M_{pxp} \quad (\otimes: \text{tensorial product})$$

$$\tilde{A} = A \otimes M_{pxp} = \begin{array}{c} \begin{array}{|c|c|c|c|} \hline a_{11} \dots a_{11} & a_{12} \dots a_{12} & \dots & a_{1n} \dots a_{1n} \\ \hline \vdots & \vdots & & \vdots \\ \hline a_{11} \dots a_{11} & a_{12} \dots a_{12} & & a_{1n} \dots a_{1n} \\ \hline \vdots & \vdots & & \vdots \\ \hline a_{n1} \dots a_{n1} & \dots & \dots & a_{nn} \dots a_{nn} \\ \hline \vdots & \vdots & & \vdots \\ \hline a_{n1} \dots a_{n1} & & & a_{nn} \dots a_{nn} \\ \hline \end{array} & \begin{array}{c} \leftarrow p \rightarrow \\ \uparrow p \\ \downarrow p \end{array} \end{array}$$

where $M_{pxp} = \begin{bmatrix} 1 & \dots & 1 \\ \vdots & & \vdots \\ 1 & \dots & 1 \end{bmatrix}$ a pxp matrix

clearly \tilde{A} is symmetric hence $P(F) \leq 2$ and when we have a uniform network: (i.e.: $a_{ij} \in \{-1, 0, 1\}$, $|V(i)| = K$) we conclude that $T(F) = 0$ (Knp).

3. MAJORITY NETWORKS [13,23]

Let n, p be two positive integers and the finite set $E = \{1, \dots, p\}$. We define the functions:

$$f_i: E^n \rightarrow E, \quad \text{where}$$

$$f_i(x) = k \iff \sum_{x_j=k} a_{ij} + b_{ik} = \text{Max} \left(\sum_{x_j=r} a_{ij} + b_{ir} \right)$$

where $(A=(a_{ij}))$ is a symmetric $n \times n$ real matrix and $(b_{i1}, \dots, b_{ip}) = b_i$ a real vector.

It is easy to see that always we can take vector b_i such that there is not equality for the maximum.

This class of functions can be interpreted in the following way; let us consider a society of n persons P_1, \dots, P_n and let $1, \dots, p$ a set of opinions which may assume by any person of a such society.

In this context b_{i1}, \dots, b_{ip} represent the local hierarchy adopted by P_i for the different opinions; i.e.:

$b_{i1} > b_{i2} > \dots > b_{ip}$ minds that P_i prefers opinion s to opinion k for any $b_{is} > b_{ik}$ and numbers b_{is} are the weights of each preference.

On the other hand, a_{ij} represents the degree of

interaction (friend, unfriend, indifference) between P_i and P_j .

Finally local function associated to P_i , selects next opinion as the maximum hierarchy among those of maximum weight.

Let us take now affine operators:

$$A_i + b_i: \{e_1, \dots, e_p\}^n \rightarrow S \subset \mathbb{R}^p$$

$$(u_{11}, \dots, u_{1p}; \dots; u_{n1}, \dots, u_{np}) \rightarrow \left(\sum_{j=1}^n a_{ij} u_{j1} + b_{i1}, \dots, \sum_{j=1}^n a_{ij} u_{jp} + b_{ip} \right)$$

where $e_i = (0 \dots 1 \dots 0)$
 \uparrow
 i

and functions:

$$\tilde{f}_i: S \rightarrow \{e_1, \dots, e_p\}$$

such that $\tilde{f}_i(x) = e_k \iff x_k = \max_{1 \leq i \leq p} (x_i)$

where $S = \{x \in \mathbb{R}^p / x_i \neq x_j \text{ for any } i \neq j\}$

It is clear that

$$\tilde{f}_i \circ (A_i + b_i)u = e_k \iff \sum_{j=1}^n a_{ij} u_{jk} + b_{ik} = \max_{1 \leq r \leq p} \left(\sum_{j=1}^n a_{ij} u_{jr} + b_{ir} \right)$$

and functions f_i and \tilde{f}_i are equivalent if we change state q by e_q .

Furthermore functions \tilde{f}_i are positive, and, in this case, the linear operator is the following:

REFERENCES

- [1] J. P. ALLOUCHE, C. REDER, Oscillations spatio-temporelles engendrées par un automata cellulaire. R.R. 8207, Math. et Inf. Bordeaux 1, 1982.
- [2] H. ATLAN, F. FOGELMAN, S. SALOMON, G. WEISBUCH, Random Boolean networks, *Cybernetics and Systems*, 12, 1981.
- [3] E. CAIANELLO, D. LUCA, RICCIARDI, Reverberations and control of neural networks, *kybernetik* 4(1), 1967.
- [4] R. DOBRUSHIN, I. KRYUKOV, A. TOOM, Locally interacting systems and their applications in biology, *Procc. of school seminar on Markov interaction processes in biology, Lec. Notes in Math.*, Springer-Verlag 653, 1978.
- [5] FARMER J.D., T. TOFFOLI S. WOLFRAM, Cellular Automata, *Procc. of Los Alamos workshop, 1983, to appear in North-Holland Pub.*
- [6] F. FOGELMAN, E. GOLES, G. WEISBUCH, Transient length in sequential iteration of threshold functions *Disc. Applied Math.* 6, 1983.
- [7] E. GOLES, Comportement oscillatoire d'une famille d'automates cellulaires non uniformes, These, IMAG, Grenoble, France, 1980.
- [8] E. GOLES, Fixed point behaviour of threshold functions on a finite set, *SIAM J. Alg. Disc. Meth.* Vol.3., N°4, 1982.

- [9] E. GOLES, Dynamical behaviour of neural networks, R.R. 386, IMAG, Grenoble, France, 1983, to appear in SIAM J. Alg. Disc. Meth.
- [10] E. GOLES, J. OLIVOS, Comportement periodique des fonctions a seuil binaires et applications, Disc. App. Math., 3, 1981.
- [11] E. GOLES, J. OLIVOS, The convergence of symmetric threshold automata, Inf. and Control, Vol.51, Nov. 1981.
- [12] E. GOLES, S. MARTINEZ, A short proof of the cyclic behaviour of multithreshold symmetric automata, Inf. and Control, Vol.51, N°2, Nov. 1981.
- [13] E. GOLES, M. TCHUENTE, Iterative behaviour of generalized majority functions, Math, Soc. Sciences, 4, 1983.
- [14] J.M. GREENBERG, S. HASTINGS, Spatial patterns for discrete models in excitable media, SIAM J. Appl. Math., Vol. 34, 1978.
- [15] J.H. HOPFIELD, Neural networks and physical systems with emergent collective computational habilities, Proc. Nac. Acad. Sci, U.S.A., Vol. 79, Biophisics, 1982.
- [16] S. KAUFFMAN, Behaviour of randomly constructed genetics nets, "Towards a theoretical biology", Vol.3, Edimburg Univ. Press, 1970.
- [17] S. KIRKPATRIK, Frustration and ground state degeneracy in spin glasses problem, Physics Rew., B16, 1977.

- [18] T. KITAGAWA, Cell Space approaches in biomathematics, Math. Bios, 19, 1974.
- [19] W. Mc. CULLOCH, W.S. PITTS, A logical calculus of the ideas immanent in nervous activity, Bull. of Math. Biophysics, 5, 1943.
- [20] CH. LEISERSON, Area efficient VLSI computation, MIT Press, 1983.
- [21] S. MARTINEZ, J. OLIVOS, Asymptotic behaviour and entropy operator of generalized multithreshold automata, R.R. Dept. Math, U. de Chile, 1983.
- [22] PHAM DIN TAO, Comportement itératif de point fixe des operateurs monotones, R.R., IMAG, Grenoble, France, 1983.
- [23] S. POLJAK, M. SURA, On periodical behaviour in societies with symmetric influences, Combinatorica, to appear.
- [24] S. POLJAK, D. TURZIK, On systems, periods and semipositive mappings, R.R. Technical University, Thakurova, Czechoslovakia, 1983.
- [25] F. ROBERT, Itérations Discretes, USMG, IMAG, cours policopié, 1981.
- [26] T. ROCKAFELLAR, Convex Analysis, Princ. Univ. Press, 1970.
- [27] R. SHINGAI, Maximum period of two dimensional uniform neural networks, Inf. and Control, 41, 1979.

- [28] M. TCHUENTE, Evolution de certains automatas cellulaires uniformes a seuil, SANG265, IMAG, Grenoble, France, 1977.
- [29] M. TCHUENTE, Contribution a l'etude des methodes de calcul cooperatif, These d'Etat, IMAG, Grenoble, Nov. 1982.
- [30] Y. G. VICHNIAC, Simulating physics with cellular automata, R.R. MIT, Computer Sciences Lab. 1983.
- [31] S.WOLFRAM, Statistical mechanics of cellular automata, Rev. of Mod. physics, Vol.55, July 1983.

CHAPITRE V
STRUCTURE CYCLIQUE
D'UNE EQUATION NEURONALE

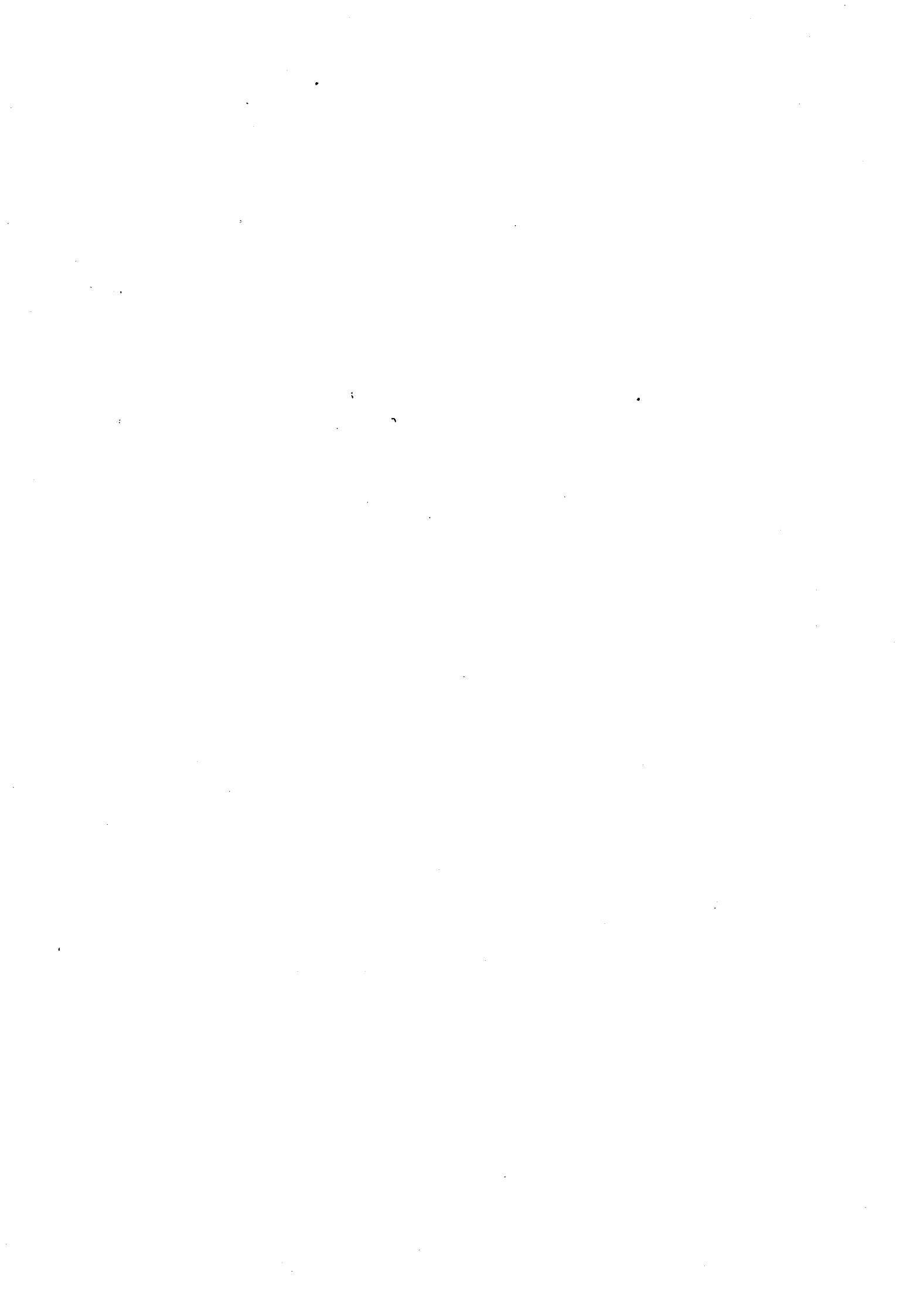

CHAPITRE-VSTRUCTURE CYCLIQUE
D'UNE EQUATION NEURONALE

Dans ce chapitre, nous étudions la dynamique de l'équation:

$$x_{n+1} = 1 \left[\theta - \sum_{i=0}^{k-1} b^i x_{n-i} \right] \quad x_j \in \{0, 1\}$$

avec $\theta \in \mathbb{R}$ et $0 < b < 1/2$

C'est-à-dire, on fait une itération avec k pas de mémoire, conduite sur une fonction à seuil.

Etant donnée la nature des coefficients de mémoire, il n'est plus possible d'appliquer les outils et résultats obtenus précédemment, pour caractériser le comportement dynamique de cette itération. Malgré cela, nous présentons une technique originale pour y aboutir.

D'autre part, nous étudions aussi cette itération dans le cas de mémoire non bornée :

$$x_{n+1} = 1 \left[\theta - \sum_{i=0}^n b^i x_{n-i} \right]$$

**COMPORTEMENT DYNAMIQUE
D'UN AUTOMATE A MEMOIRE**

COMPORTEMENT DYNAMIQUE D'UN AUTOMATE A MEMOIRE

ANALOGIE AVEC LE FONCTIONNEMENT D'UN NEURONE

En collaboration avec M. Cosnard
à paraître aux Eds. du CNRS

I - INTRODUCTION

La théorie des automates a souvent été utilisée pour modéliser des propriétés élémentaires du système nerveux (7), (8), (9), (10), (11), (12). Dans leur majorité, ces modèles discrétisent l'influx nerveux sous la forme d'une variable tout ou rien : 0 ou 1. En dépit de cette hypothèse simplificatrice, leur comportement dynamique est en général complexe. Dans ce contexte, le premier modèle proposé, les réseaux de neurones de Mac Culloch et Pitts (8), est aussi général qu'une machine de Turing, ce qui met en évidence la richesse de sa dynamique. Il est basé sur l'interconnexion de modules réagissant suivant des lois représentées par des fonctions à seuil :

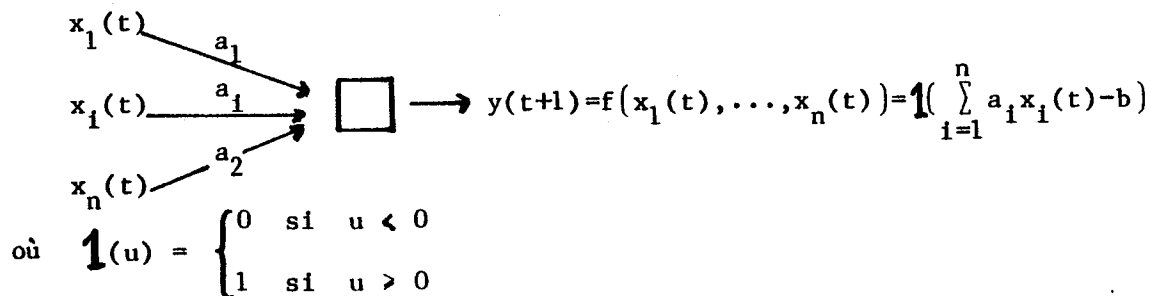

et $x_1(t), \dots, x_n(t)$ correspondent aux signaux (0 ou 1) que reçoit le module, ou "neurone formel", à l'instant t . Il est important de noter que, dans ce modèle, seul l'état actuel du neurone est pris en compte pour le calcul du nouvel état. Le module ne possède qu'une possibilité réduite de mémorisation ce qui ne permet pas de tenir compte de la période d'inhibition du neurone.

Cet aspect est introduit dans le modèle proposé par Caianello (2), (3) qui considère pour le calcul du nouvel état, soit tous les états antérieurs, soit un nombre fixé d'entre eux :

$$y(t+1) = \mathbf{1} \left(\theta - \sum_{\ell=0}^{k-1} a(\ell) y(t-\ell) - \sum_{i=1}^n a_i(\ell) x_i(t-\ell) \right)$$

Chaque unité mémorise ses derniers k états, ainsi que ceux des unités connectées avec elle.

La dynamique de ce modèle est très complexe et n'a donc été étudiée que dans des cas particuliers, en imposant des hypothèses sur les coefficients $a(\ell)$, $a_i(\ell)$.

Dans ce travail, nous présentons les résultats obtenus dans des cas particuliers du modèle suivant :

$$x_{n+1} = \mathbf{1} \left(\theta - \sum_{i=0}^{k-1} a(i) x_{n-i} \right)$$

Dans ce modèle, pour calculer un nouvel état (0 ou 1), le neurone pondère linéairement ses k états précédents.

A titre d'exemple, nous allons étudier l'automate pour des valeurs de paramètres égales à : $k=4$, $a(0)=a(1)=a(2)=0$, $a(3)=1/2$, $\theta=1/2$.

Autrement dit, x_{n+1} est égal à 0 si x_{n-3} est égal à 1. Supposons que les 4 états initiaux soient égaux à 0 : $x_0 = x_1 = x_2 = x_3 = 0$, l'état suivant est égal à 1. Représentant les 4 derniers états, on obtient alors l'évolution suivante :

$$\begin{array}{cccc} 0000 & \rightarrow & 0001 & \rightarrow & 0011 & \rightarrow & 0111 \\ & & \uparrow & & \downarrow & & \\ 1000 & \leftarrow & 1100 & \leftarrow & 1110 & \leftarrow & 1111 \end{array} \quad \text{cycle de longueur 8}$$

ce qui peut être écrit sous la forme réduite : $(11110000) = (1^4 0^4)$.

Si nous prenons comme états initiaux $x_0 = x_2 = x_3 = 0$ et $x_1 = 1$, l'évolution de l'automate est :

Plus généralement, nous avons démontré dans (5) les propriétés suivantes qui permettent de comprendre complètement la dynamique de l'équation (2) :

1 - Pour tout θ , k , , le modèle admet un cycle unique, globalement attractif.

2 - La période de chaque cycle est inférieur à $k + 1$.

3 - Si $p < k + 1$, il existe un seuil θ tel que l'équation (2) admet un cycle de longueur p .

On déduit donc de ces résultats que, quels que soient les k premiers états, l'automate va engendrer, au bout d'un temps fini, une suite périodique qui ne dépend que de k et de θ . On remarquera de plus que la longueur de cette suite est inférieur à $k + 1$, ce qui est faible par rapport au maximum théorique de 2^k . La relation entre k , θ , et la période du cycle n'est pas encore complètement élucidée. Les deux résultats qui suivent permettent de la préciser. Pour cela nous introduisons le nombre de rotation, $\rho(\theta)$, associé à un cycle de (2) :

$$\rho(\theta) = \frac{\text{nombre de 1 dans le cycle}}{\text{période du cycle}}$$

4 - $\rho(\theta)$ est une fraction irréductible.

5 - k étant fixé, quelle que soit la fraction irréductible p/q , avec $q \leq k + 1$, il existe une valeur de θ telle que :

$$\rho(\theta) = p/q$$

c'est à dire que l'équation (2) avec cette valeur de θ possède un cycle dont le nombre de rotation est p/q .

6 - k étant fixé, ρ est une fonction croissante de θ . Lorsque $k \rightarrow \infty$, le graphe de la fonction ρ est une approximation discrète d'une fonction de Cantor (escalier du diable).

Les résultats 5 et 6 permettent d'obtenir la liste des périodes de tous les cycles pour une valeur de k fixée et pour θ variant de 0 à 2.

Il suffit pour cela d'écrire toutes les fractions irréductibles de dénominateur inférieur à $k + 1$, de les ordonner par ordre croissant et de considérer la suite des dénominateurs. Celle-ci est la suite des périodes.

Le tableau et la figure suivants illustrent ces résultats pour $k = 8$. θ_{\max} correspond à la valeur maximale de θ pour laquelle le système admet le cycle C. T est la période correspondante et $\rho(\theta)$ le nombre de rotation de C. On remarquera que la suite des fractions est croissante. Les périodes obtenus sont les dénominateurs de ces fractions.

θ_{\max}	C	T	$\rho(\theta)$
0	0	1	0
b^7	10^8	9	$1/9$
b^6	10^7	8	$1/8$
b^5	10^6	7	$1/7$
b^4	10^5	6	$1/6$
b^3	10^4	5	$1/5$
$b^3 + b^7$	$10^4 10^3$	9	$2/9$
$b^2 + b^6$	10^3	4	$1/4$
$b^2 + b^5$	$10^3 10^2$	7	$2/7$
$b + b^4 + b^7$	10^2	3	$1/3$
$b + b^4 + b^6$	$10^2 10^2 10$	8	$3/8$
$b + b^3 + b^6$	$10^2 10$	5	$2/5$
$b + b^3 + b^5$	$10^2 (10)^2$	7	$3/7$
$b + b^3 + b^5 + b^7$	$10^2 (10)^3$	9	$4/9$
$1 + b^2 + b^4 + b^6$	10	2	$1/2$

III - MEMOIRE NON BORNEE

La majorité des résultats présentés dans le cas précédent (avec k pas de mémoire et des coefficients en progression géométrique), peut être généralisée au cas d'une mémoire non bornée :

$$x_{n+1} = \mathbf{1} \left[\theta - \sum_{i=0}^n b^i x_{n-i} \right]$$

Une étude détaillée de cet automate nécessite un formalisme mathématique qui dépasse le cadre de ce travail. En particulier, les notions de convergence et d'attraction ne sont plus aussi simples : une suite A convergera vers une autre suite B s'il existe dans A des mots (un mot est une suite finie) de taille de plus en plus grande qui coïncident avec le début de B . Cet automate n'engendre donc pas uniquement des suites périodiques à partir d'un certain rang, mais peut engendrer des suites non périodiques. Les résultats qui suivent permettent de préciser suivant les valeurs des paramètres les occurrences de ces deux cas :

1 - Pour tout θ , le modèle précédent admet un attracteur unique. Cet attracteur est soit un cycle, soit un ensemble de Cantor pour la topologie induite par la notion de convergence précédente.

2 - Pour tout n , il existe θ tel que le modèle admette un cycle d'ordre n .

Comme dans le modèle à mémoire bornée, il est possible de définir, pour θ fixé, le nombre de rotation associé. Il est égal à :

$$\rho(\theta) = \lim_{n \rightarrow \infty} \left(\sum x_i / n \right)$$

3 - Si $\rho(\theta)$ est rationnel, alors le modèle admet un cycle attractif, sinon il admet un attracteur cantorien.

4 - ρ est une fonction de θ qui est continue, monotone croissante et dont la dérivée est presque partout nulle (escalier du diable).

IV - MEMOIRE PALINDROMIQUE

Retournons maintenant à l'étude de l'automate à mémoire bornée, mais avec des coefficients de mémoire différents :

$$x_n = \mathbf{1} \left[\theta - \sum_{s=p}^k a(s) x_{n-s} \right]$$

avec $a(s) = a(k+p-s)$ pour $s = p, \dots, k$. Le vecteur de mémoire $a(p), \dots, a(k)$ a donc une structure de palindrome. On peut alors démontrer le résultat suivant :

1 - Pour des valeurs fixées des paramètres, le modèle précédent peut amettre plusieurs cycles en même temps, mais la période de ces cycles divise $k+p$.

Ce résultat peut être étendu au cas d'un réseau de neurones à mémoire palindromique :

$$y_i(t) = \mathbf{1} \left[\theta - \sum_{j=1}^n \sum_{s=p}^k a_{i,j}(s) y_j(t-s) \right] \quad i=1, \dots, n$$

dont la matrice des coefficients $A(s) = \left(a_{i,j}(s) \right)_{1 \leq i, j \leq n}$ vérifie :

$$A(s) = {}^t A(k+p-s) \quad s=p, \dots, k$$

A titre d'exemple, signalons que l'équation :

$$x_n = \mathbf{1} \left[1/2 - \sum_{s=5}^{10} x_{n-s} \right]$$

possède le cycle de période 15 : $1^5 0^{10}$.

V - CONCLUSION

La complexité des résultats précédents illustre la richesse des modèles. On peut cependant, en déduire certaines caractéristiques : nombre faible de cycles, unicité de l'attracteur dans de nombreux cas, longueur de la période variant linéairement avec la taille de la mémoire, alors que le nombre de suites différentes croît exponentiellement. Les expériences

numériques et les résultats théoriques nous conduisent à conjecturer que la période des cycles est inférieure ou égale au double de la taille de la mémoire.

REFERENCES

- (1) - ALLOUCHE, J.P. et COSNARD, M. (1983)
Itérations de fonctions unimodales et suites engendrées par automates. C. R. Acad. Sc. 296 : 159-162
- (2) - CAIANELLO, E.R. et DE LUCA, A. (1966)
Decision equation for binary systems. Application to neuronal behaviour. Kibernetik 3 : 33-40
- (3) - CAIANELLO, E.R., DE LUCA, A. et RICCIARDI, L. (1967)
Reverberations and control of neural networks. Kibernetik 4
- (4) - COSNARD, M. et GOLES, E. (1984)
Dynamique d'un automate à mémoire modélisant le fonctionnement d'un neurone. C. R. Acad. Sc. 299 : 459-461
- (5) - COSNARD, M. et GOLES, E. (1984)
Bifurcation structure of a discrete neuronal equation. Preprint
- (6) - GOLES, E. (à paraître)
Dynamical behaviour of neural networks. SIAM J. Alg. Disc. Meth.
- (7) - KITAGAWA, T. (1973)
Dynamical systems and operators associated with a single neuron equation. Math. Biosc. 18
- (8) - MAC CULLOCH, W. and PITTS, W. (1943)
A logical calculus of the ideas immanent in nervous activity. Bull. Math. Biophys. 5 : 115-133
- (9) - NAGAMI, H., KITAHASHI and TANAKA (1976)
Characterization of dynamical behaviour associated with a single

neural equation. Math. Biosc. 32

- (10) - NAGUMO, J. and SATO, S. (1972)
On a response characteristic of a mathematical neuron model.
Kibernetik 3 : 155-166
- (11) - YAMAGUTI, M. and HATA, M. (1982)
On the mathematical neuron model. Proceedings "Competition and
cooperation in neural nets, Lect. Notes Biomath. 45 Springer
Verlag : 171-177
- (12) - YOSCHIZAWA, S. (1982)
Periodic sequences generated by an analogic neuron model.
Proceedings "Competition and cooperation in neural nets, Lect.
Notes Biomath. 45 Springer Verlag : 155-170

**STRUCTURE DES BIFURCATIONS
D'UNE EQUATION NEURONALE**



SYSTÈMES DYNAMIQUES. — Dynamique d'un automate à mémoire modélisant le fonctionnement d'un neurone.

Note de Michel Cosnard et Eric Goles, présentée par René Thom.

Remise le 18 juin 1984.

Nous décrivons la structure de bifurcations de deux automates à mémoire, définis par des fonctions à seuil. Ces automates admettent un attracteur unique, périodique si la mémoire est bornée, périodique ou cantorien sinon. Nous montrons que le nombre de rotation associé est une fonction croissante du paramètre, constante par morceaux. Dans le cas d'une mémoire non bornée, cette fonction est un escalier du diable.

DYNAMICAL SYSTEMS. — Dynamics of a Threshold Automaton with Memory Used as a Neuron Model.

We present the bifurcations diagram of two threshold automata with memory. These automata have a unique attractor which is periodic if the memory is bounded, periodic or cantorien if it is unbounded. We show that the associated rotation number is an increasing piecewise constant function of the parameter. If the memory is unbounded, this function is a devil's staircase.

0. INTRODUCTION. — L'utilisation de réseaux d'automates et d'automates cellulaires a conduit à de nombreux modèles de réseaux de neurones. Caiannelo ([3], [4]) a proposé le modèle suivant :

$$(0) \quad y_i(t) = \mathbf{1} \left(\sum_{j=1}^n \sum_{s=1}^k a_{i,j}(s) y_j(t-s) - \theta_i \right); \quad i = 1, \dots, n,$$

où $y_j \in \{0, 1\}$ et $\mathbf{1}(u)$ est la fonction caractéristique de u . La dynamique de ce modèle est extrêmement riche et seuls des cas particuliers ont été étudiés par Kitagawa [14], Nagami et coll. [16], Nagumo et Sato [17], Goles [6]. De tels automates modélisent aussi le fonctionnement de réseaux électriques, des processus biologiques (voir par exemple Baconnier et coll. [2], Glass et Perez [9]) ou informatiques (Tchunte [18]).

Dans ce travail, nous étudions la dynamique de l'itération à k pas de mémoire :

$$(1) \quad x_{n+1} = \mathbf{1} \left(\theta - \sum_{i=0}^{k-1} b^i x_{n-i} \right),$$

où $x_j \in \{0, 1\}$, $\theta \in \mathbf{R}$ et $0 < b \leq 1/2$. Nous décrivons complètement la structure de bifurcations de (1) lorsque θ varie. Nous montrons ainsi que le nombre de rotation de (1) est fonction croissante de θ .

Le modèle à mémoire non bornée :

$$(2) \quad x_{n+1} = \mathbf{1} \left(\theta - \sum_{i=0}^n b^i x_{n-i} \right),$$

est isomorphe à l'itération d'une injection continue du cercle. En complétant des résultats de Keener [13], nous décrivons sa structure de bifurcations et étudions les propriétés du nombre de rotation associé.

1. Modèle à k pas de mémoire. — Le comportement itératif de [1] et de [2] dépend fortement de la position de θ par rapport aux sommes partielles de b^i . Comme $0 < b \leq 1/2$, il n'est pas difficile de montrer que le problème peut être réduit à $b = 1/2$.

THÉORÈME 1. — 1° $\forall \theta$, (1) admet un cycle globalement attractif unique.

2° Il existe θ tel que (1) admette un p -cycle si et seulement si $p \leq k+1$.

La longueur maximale des cycles de (1) est donc $k+1$ et $\forall p \leq k+1$ l'automate admet un cycle de période p . Étudions maintenant la structure d'un cycle. Soit (x_0, \dots, x_{T-1}) un T -cycle, il n'est pas difficile de montrer que $\forall i \in [0, T-1]$, $x_i \cdot x_{i+1} = 0$. De plus si $\theta \leq 1$ (≥ 1) alors $x_i = 1$ implique $x_{i+1} = 0$ (resp. $x_i = 0$ implique $x_{i+1} = 1$).

LEMME 2. — Si (x_0, \dots, x_{T-1}) est un T -cycle de (1) avec $\theta \leq 1$, alors (x_0, \dots, x_{T-1}) est un T -cycle de (1) avec $\theta' = \sum_{i=0}^{k-1} b^i \theta$.

Considérons les substitutions suivantes :

$$\forall r \in \mathbb{N}: \quad \tau_{r,0}: \begin{cases} 0 \rightarrow 10^r \\ 1 \rightarrow 10^{r+1} \end{cases} \quad \tau_{r,1}: \begin{cases} 1 \rightarrow 10^r \\ 0 \rightarrow 10^{r+1} \end{cases}$$

THÉORÈME 2. — $X = (x_0, \dots, x_{T-1})$ est un T -cycle de (1) avec $\theta \leq 1$ si et seulement si :

1° $T \leq k+1$;

2° il existe une permutation circulaire $\mathcal{P}(X)$ et $\{(r_i, s_i) \in \mathbb{N} \times \{0,1\}, i \leq n\}$ tels que $\tau_{r_n, s_n} \circ \dots \circ \tau_{r_1, s_1}(0) = \mathcal{P}(X)$.

Pour terminer cette description, il suffit de connaître l'ordre d'apparition des cycles en fonction de θ . Il est clair que θ et k étant fixés, $\rho = \lim_{n \rightarrow \infty} \left(\sum_{i=1}^n x_i/n \right)$ existe et est indépendant de (x_0, \dots, x_{k-1}) . $\rho(k, \theta)$ sera appelé le nombre de rotation de (1). Si (x_0, \dots, x_{T-1}) est un T -cycle de (1) pour (k, θ) fixés, alors $\rho(k, \theta)$ est égal au nombre de 1 dans (x_0, \dots, x_{T-1}) divisé par T . C'est donc un élément de \mathbb{Q} .

THÉORÈME 3. — Soit k fixé.

1° Pour tout θ , $\rho(k, \theta)$ est une fraction irréductible.

2° Si p/q est une fraction irréductible avec $p \leq q \leq k+1$, alors il existe θ tel que $\rho(k, \theta) = p/q$.

3° $\rho(k, \theta)$ est une fonction croissante de θ .

2. Modèle à mémoire non bornée. — Considérons maintenant le modèle (2). Le changement de variable (voir [17]) :

$$y_n = \theta - \sum_{i=0}^{k-1} b^i x_{n-i}$$

conduit à la récurrence suivante :

$$(3) \quad y_{n+1} = by_n + (1-b)\theta + 1(y_n), \quad y_0 = \theta.$$

Le comportement itératif de (2) est donc équivalent à celui d'une injection linéaire du cercle. Inversement, si nous appliquons à (3) une technique de codage identique à celle employée dans la théorie des itinéraires (voir Collet et Eckmann [5]), nous pouvons montrer que (2) génère l'itinéraire maximal de (3) (suite de pétrissage). (3) fait partie d'une classe de systèmes très étudiés actuellement (Feigenbaum [8], Glass et Perez [9], Kadanoff [11], Kaneko [12], Tresser [19]), le modèle « logistique » étant :

$$x_{n+1} = x_n + a + b \sin(2\pi x_n) \pmod{1}.$$

En appliquant les résultats de Keener et en généralisant les techniques utilisées dans la démonstration des théorèmes 1, 2, 3, nous obtenons les résultats suivants.

THÉORÈME 4. — 1° Pour tout θ , (2) et (3) admettent un attracteur global unique qui est soit un cycle, soit un ensemble de Cantor de mesure nulle (pour la topologie et la mesure induites par celles de \mathbf{R} dans $\{0,1\}^N$).

2° Pour tout n , il existe θ tel que (2) et (3) admettent un cycle d'ordre n .

Le lemme 2 se généralise dans ce cas et il est possible d'obtenir une description des attracteurs.

THÉORÈME 5. — $A \in \{0,1\}^N$ est un attracteur de (2) avec $\theta \leq 1$ si et seulement s'il existe une suite B décalée de A d'un nombre fini de positions et une suite $(r_i, s_i) \in \mathbf{N} \times \{0,1\}$ telles que :

1° soit $(\tau_{r_n, s_n} \circ \dots \circ \tau_{r_1, s_1})(0)^\infty = B$;

2° soit $\lim_{n \rightarrow \infty} \tau_{r_n, s_n} \circ \dots \circ \tau_{r_1, s_1}(0) = B$.

De manière classique, on peut définir le nombre de rotation associé à (3) pour θ fixé. Il est égal à $\rho(\theta) = \lim_{n \rightarrow \infty} (\sum x_i/n)$. Il est clair que si $\rho(\theta)$ est rationnel, alors (2) admet un cycle attractif tandis que, dans le cas contraire, (2) admet un attracteur cantorien.

THÉORÈME 6. — ρ est une fonction continue monotone croissante dont la dérivée est presque partout nulle (escalier du diable).

Si $b=1$, la dynamique de (2) est simple : x_n est égal à 0 à partir d'un certain rang. Le cas $b>1$ est plus intéressant puisqu'il peut conduire à des suites chaotiques.

3. CONCLUSION. — Il n'est pas très étonnant que le modèle à mémoire bornée engendre des comportements proches du modèle à mémoire non bornée lorsque k est très grand (les coefficients décroissant géométriquement). La richesse des comportements obtenus montre la complexité de l'étude théorique de modèles aussi généraux que le modèle (0).

Le lien que nous avons établi entre l'automate (2) et l'itération unidimensionnelle (3) constitue une réciproque à la technique des itinéraires et des suites de pétrissage. Elle peut se généraliser à une application continue par morceaux quelconque de \mathbf{R} .

RÉFÉRENCES BIBLIOGRAPHIQUES

- [1] J.-P. ALLOUCHE et M. COSNARD, *Comptes rendus*, 296, série I, 1983, p. 159-162.
- [2] P. BACONNIER et coll., *Lectures Notes Biomath. Rhythms in biology and other fields of applications*, COSNARD et coll. éd., Springer, 1983, p. 2-16.
- [3] E. R. CAIANELLO, *Kybernetik*, 3, 1966, p. 33-40.
- [4] E. R. CAIANELLO et coll., *Kybernetik*, 4, 1967.
- [5] P. COLLET et J.-P. ECKMANN, *Iterated Maps of the Interval as Dynamical Systems*, Birkhäuser, Basel, 1980.
- [6] E. GOLES, Prepublication I.M.A.G., 386, 1983.
- [7] M. FEIGENBAUM, *J. Stat. Phys.*, 19, 1978, p. 25-52.
- [8] M. FEIGENBAUM et coll., *Physica*, 5D, 1982, p. 370-375.
- [9] L. GLASS et R. PEREZ, *Phys. Rev. Lett.*, 48, 1982, p. 1772-1774.
- [10] M. HERMAN, *Publ. I.H.E.S.*, 49, 1979.
- [11] L. KADANOFF, *J. Stat. Phys.*, 31, n° 1, 1983, p. 1-27.
- [12] K. KANEKO, *Prog. Theo. Phys.*, 69, 1983, p. 403-414.
- [13] J. KEENER, *Trans. A.M.S.*, 261, n° 2, 1980, p. 589-604.
- [14] T. KITAGAWA, *Math. Biosci.*, 18, 1973.
- [15] W. McCULLOCH et W. PITTS, *Bull. Math. Biophys.*, 5, 1943, p. 115-133.
- [16] H. NAGAMI et coll., *Math. Biosci.*, 32, 1976.
- [17] J. NAGUMO et S. SATO, *Kybernetik*, 3, 1972, p. 155-164.
- [18] M. TCHUENTE, *Thèse*, 1982.
- [19] C. TRESSER, *Comptes rendus*, 296, série I, 1983, p. 739-742.

BIFURCATION STRUCTURE OF A DISCRETE NEURONAL EQUATION

En collaboration avec M.Cosnard
soumis à Disc. Math.

1. INTRODUCTION

Automata theory is often used to modelize elementary properties of the nervous system [3,4,6,14,15,16,17,19,20]. Most of these models discretize the nervous signal and then treat only boolean information. In spite of the simplicity of such an assumption, dynamical behaviour of this models is extremely rich. Then it is necessary to analyze them through difficult mathematical studies. For example, the neural model proposed by Mc.Culloch and W.Pitts can simulate every finite automaton [15].

R.Cianello generalized the above model in order to take into account the refractory character of the neural response. He introduced a memory associated to the system. More precisely, he proposed to simulate the neural response by the following equation :

$$x_{n+1} = \text{III} \left[\theta - \sum_{i=0}^n a(i)x_{n-i} \right]$$

where $x_i \in \{0,1\}$, $\theta \in \mathbb{R}$, $a(i) \in \mathbb{R}$, and

$$\Pi[u] = \begin{cases} 0 & \text{if } u < 0 \\ 1 & \text{otherwise} \end{cases}$$

This model is based on an unbounded memory since the convolution between the \vec{a} and \vec{x} vectors goes from 0 to n and hence uses all the previous states of the boolean automaton.

The dynamical analysis of this equation has been done only in particular cases; is $a(i) = a$; $a(i) = b^i$ for some $0 < b \leq 1/2$ [14,16,17,19 20]. In the last case the previous equation is equivalent to a one dimensional real recurrence equation [16,17]. In section 3 of this paper we recall basic dynamical properties of this model. However the bulk of our work is devoted to the bounded memory case :

$$x_{n+1} = \Pi \left[\theta - \sum_{i=0}^{k-1} a(i)x_{n-i} \right]$$

where k is a given integer.

In section two we consider $a(i) = b^i$

for $0 < b \leq 1/2$. For all k and b , we describe completely the bifurcations structure of this equation when θ varies. In particular we show that this recurrence has a unique cycle whose length is less than or equal to $k+1$. We associate to this cycle a rational rotation number. These numbers form a Farey sequence of rational fractions. The graph of the rotation number in function of θ is then a truncated devil staircase.

In section four we assume that the coefficients $a(i)$ have a palindromic structure; i.e $a(i) = a(k-i-1)$ for $i = 0, \dots, k$. In this context we characterize the lengths of the cycles.

Clearly the results presented in this paper are only partial analysis of the previous equations. They show however the complexity of the dynamical behaviour of a such neural model.

2. BOUNDED MEMORY MODEL

Let us consider the iteration with k -steps memory :

$$x_{n+1} = \prod \left[\theta - \sum_{i=0}^{k-1} b^i x_{n-i} \right] \quad (1)$$

where $x_i \in \{0,1\}$, $\theta \geq 0$, $0 < b \leq 1/2$

It is clear that the dynamical behaviour of (1) depends heavily on the position of θ with respect to the different partial sums of b^i . Since $0 < b \leq 1/2$, the next lemma shows that we can reduce the problem to $b = 1/2$

Lemma 1 : There exists $\lambda \geq 0$ such that (1) is equivalent to

$$x_{n+1} = \prod \left[\lambda - \sum_{i=0}^{k-1} 2^{-i} x_{n-i} \right]$$

Proof : Let $(\alpha_0, \dots, \alpha_{k-1}) ; (\beta_0, \dots, \beta_{k-1}) \in \{0,1\}^k$ be such that

$$\theta - \sum_{i=0}^{k-1} b^i \alpha_i = \min \left\{ \theta - \sum_{i=0}^{k-1} b^i \beta_i / \theta - \sum_{i=0}^{k-1} b^i \beta_i \geq 0 \right\} \quad \beta_i \in \{0,1\}$$

$$\theta - \sum_{i=0}^{k-1} b^i \beta_i = \max \left\{ \theta - \sum_{i=0}^{k-1} b^i \gamma_i / \theta - \sum_{i=0}^{k-1} b^i \gamma_i < 0 \right\}$$

Clearly, $\sum_{i=0}^{k-1} b^i \alpha_i \leq \theta < \sum_{i=0}^{k-1} b^i \beta_i$

Define $\lambda = \sum_{i=0}^{k-1} 2^{-i} \alpha_i$. A direct computation shows that

$$\prod_{i=0}^{k-1} \left[\theta - \sum_{i=0}^{k-1} b^i \gamma_i \right] = \prod_{i=0}^{k-1} \left[\lambda - \sum_{i=0}^{k-1} 2^{-i} \gamma_i \right] \quad \forall \gamma_i \in \{0,1\}$$

From now on we assume that $b = 1/2$. We can code the partial sums as follows. Let $I \subset \{0, \dots, k-1\}$, define ϕ as :

$$\sum_{i \in I} 2^{-i} \overset{\phi}{x}_I = (x_0, \dots, x_{k-1}) \in \{0,1\}^k \text{ with } x_i = 1 \iff i \in I.$$

Clearly, if $\phi^{-1}a < \theta < \phi^{-1}b$ where $a, b \in \{0,1\}^k$, then

$$F_\theta(x) = \prod_{i=0}^{k-1} \left[\theta - \sum_{i=0}^{k-1} 2^{-i} x_i \right] = \begin{cases} 1 & \text{if } \phi^{-1}(x) < \phi^{-1}(a) \\ 0 & \text{otherwise} \end{cases}$$

ϕ^{-1} induces on $\{0,1\}^k$ a total ordering relation which

coincides with the natural lexicographical ordering.

If x belongs to $\{0,1\}^k$, we write \bar{x} the dual of x : $\bar{x} = (\bar{x}_0, \dots, \bar{x}_{k-1})$

Lemma 2 : Let $\phi^{-1}a < \theta < \phi^{-1}b < 1$. If $\phi^{-1}\bar{b} < \bar{\theta} < \phi^{-1}\bar{a}$, then

$$F_{\theta}(x) = F_{\bar{\theta}}(\bar{x})$$

Proof : It is sufficient to see that :

$$x \leq a \implies F_{\theta}(x) = 1 \qquad \bar{x} \geq \bar{a} \implies F_{\bar{\theta}}(\bar{x}) = 0 \quad \blacksquare$$

Lemma 2 implies that we can assume $\theta < 1$.

If $\theta < 0$, then there exists a globally attracting fixed point, namely 0. As a dual consequence, if $\theta > \sum_{i=0}^{k-1} 2^{-i}$, then there exists a globally attracting fixed point, namely 1.

We shall now study the stationary state of (1) : the relationship between the cycles and the values of θ . Let us write a T-cycle as $C = (C(T-1), \dots, C(0))$

with $T \geq 1$ and

$$C(n+1) = F_{\theta}(C(n), \dots, C(n-k+1)) \quad n = 0, \dots, T-1.$$

where the indexes are taken modulo T . We assume that $T \geq 2$ and that T is minimal.

Lemma 3 : If C is a T -cycle of (1) then

$$\forall \ell \in \{0, \dots, T-1\} \quad C(\ell) \cdot C(\ell+1) = 0$$

Proof : If $C(\ell) = C(\ell+1) = 1$ for some ℓ in $\{0, \dots, T-1\}$, then

$$C(\ell+1) = \prod_{i=0}^{k-1} \left[\theta - \sum_{i=0}^{k-1} 2^{-i} C(\ell-i) \right] = 1$$

this implies that $\theta > 1$ which contradicts our assumption ■

Lemma 3 implies that we can write a T -cycle in the two following ways :

$$C_0 = 0 \ 0 \ 0^{d_0-1} \ 1 \ 0 \ 1^{d_1} \ 1 \dots 1 \ 0^p \ 1 \quad \forall i, d_i > 1$$

$$C_1 = 1 \ 0^{\delta_0} \ 1 \ 0^{\delta_1} \ 1 \dots 1 \ 0^{\delta_{p-1}} \ 0 \quad \forall i, \delta_i \geq 1$$

where $(d_0, d_1, \dots, d_p) = \max\{(d_i, d_{i+1}, \dots, d_{i-1}) / i \in \{0, \dots, T-1\}\}$

$$(\delta_0, \delta_1, \dots, \delta_p) = \min\{\delta_i, \delta_{i+1}, \dots, \delta_{i-1} / i \in \{0, \dots, T-1\}\}$$

with the lexicographical ordering relation. C_0 and C_1 are called the max and the min decomposition of C .

Definition : C is admissible if there exist k and θ such that

$$C(\ell) = \prod_{i=0}^{k-1} [\theta - \sum_{i=0}^{k-1} C(\ell-1-i)] \quad \forall \ell \in \{0, \dots, T-1\}$$

Lemma 4 : C is admissible if and only if $\tilde{C}_0 > \tilde{C}_1$ where

$$\tilde{C}_0 = C_0(T-2), \dots, C_0(0) \quad \tilde{C}_1 = C_1(T-2), \dots, C_1(0)$$

Proof : Let k and θ be such that C is admissible and assume that $\tilde{C}_1 > \tilde{C}_0$. Since $\tilde{C}_0 \neq \tilde{C}_1$ we must have $\tilde{C}_1 > \tilde{C}_0$. Let j be the greatest integer such that $\tilde{C}_0(j) = 0$ and $\tilde{C}_1(j) = 1$.

$$\text{In order that } C_0(T-1) = 0 \text{ and } C_1(T-1) = 1$$

we have

$$k \geq T-1-j$$

$$\theta < C_0(T-2) + \dots + C_0(j) 2^{-(T-2-j)} + \dots$$

$$\theta \geq C_1(T-2) + \dots + C_1(j) 2^{-(T-2-j)} + \dots$$

which is impossible since $C_0(T-2) = C_1(T-2), \dots, C_0(j+1) = C_1(j+1)$.

Assume now that $\tilde{C}_0 > \tilde{C}_1$. Set $k = T-1$ and let

θ be such that

$$\sum_{i=0}^{k-1} 2^{-i} C_1(k-1-i) < \theta < \sum_{i=0}^{k-1} 2^{-i} C_0(k-1-i)$$

we deduce that

$$C_0(T-1) = \prod_{i=0}^{k-1} \left[\theta - \sum_{i=0}^{k-1} 2^{-i} C_0(T-2-i) \right] = 0$$

$$C_1(T-1) = \prod_{i=0}^{k-1} \left[\theta - \sum_{i=0}^{k-1} 2^{-i} C_1(T-2-i) \right] = 1$$

It is now clear that the definition by min-max of C_0 and C_1 implies that

$$C_0(l) = \prod_{i=0}^{k-1} \left[\theta - \sum_{i=0}^{k-1} 2^{-i} C_0(l-1-i) \right]$$

$$C_1(l) = \prod \left[\theta - \sum_{i=0}^{k-1} 2^{-i} C_1(l-1-i) \right]$$

where the indexes are taken modulo T . ■

If $T = 2, 10$ is the only 2-cycle. Let now $T \geq 3$.

Theorem 1 : Let C be a T -cycle. C is admissible if and only if

$$\forall i, 1 < i < T-2 \quad C_0(i) = C_1(i)$$

Proof : Assume that the condition holds. We have

$$\tilde{C}_0 = C_0(T-2) \dots C_0(1)1 = C_1(T-2) \dots C_1(1)1 >$$

$$> C_1(T-2) \dots C_1(1)0 = \tilde{C}_1$$

and lemma 4 implies that C is admissible.

Let now C be an admissible cycle. Set $(d_0, \dots, d_p) = (\delta_q, \delta_{q+1}, \dots, \delta_{q-1})$ for some $q \in [0, p]$.

From Lemma 4 we deduce that $\tilde{C}_0 > \tilde{C}_1$ which implies

$$(\delta_{q-1}, \delta_{q+1}, \dots, \delta_{q-1}) \leq (\delta_0, \delta_1, \dots, \delta_{p-1}) \text{ (max-min condition)}$$

If $p = 0$, then clearly : $\forall i, 1 \leq i \leq T-2, C_0(i) = C_1(i) = 0$

Assume now that $p \geq 1$. If $(\delta_{q-1}, \delta_{q+1}, \dots, \delta_{q-1}) = (\delta_0, \delta_1, \dots, \delta_{p-1})$, the conclusion is trivial. If $(\delta_{q-1}, \delta_{q+1}, \dots, \delta_{q-1}) < (\delta_0, \delta_1, \dots, \delta_{p-1})$, it is clear that the theorem does not hold. Let us show that this cannot happen :

$$\text{Assume that: } \max_i \{(\delta_{i-1}, \delta_{i+1}, \dots, \delta_{i-1})\} < \min_i \{(\delta_i, \dots, \delta_{i-1})\}$$

$$\text{Hence: } \delta_{q-1} = \max_i \delta_{i-1} < \min_i \delta_i = \delta_0 \implies \max_i \delta_i < \min_i \delta_{i+1}.$$

If $\max_i \delta_i = \min_i \delta_{i+1}$, then $\forall_i \delta_i = \delta_0$ which contradicts the minimality of T.

Hence $\delta_q = \max_i \delta_i = \min_i \delta_{i+1} = \delta_0 + 1$. The max-min condition implies that $\delta_{q+1} < \delta_1$. If this inequality is strict, we have $\delta_{q+1} = \delta_0$ and $\delta_1 = \delta_0 + 1$ which implies that $\delta_{2i} = \delta_0$ and $\delta_{2i+1} = \delta_0 + 1$ which is in contradiction with a strict inequality in the max-min condition

Hence $\delta_{q+1} = \delta_1$.

Let us consider two cases.

Case 1 : If $\delta_1 = \delta_0+1 = \delta_{q+1}$, we deduce that δ_0 is always followed by δ_0+1 . Introduce the following substitution operator :

$$\forall r \in \mathbb{N} \quad \tau_{r,0} : \begin{cases} 10^r \rightarrow 0 \\ 10^{r+1} \rightarrow 1 \end{cases} \quad \tau_{r,1} : \begin{cases} 10^r \rightarrow 1 \\ 10^{r+1} \rightarrow 0 \end{cases}$$

Apply $\tau_{\delta_0,1}$ to C and define $S_1 = \tau_{\delta_0,1} C_1$ and $S_0 = \tau_{\delta_0,1} C_0$.

The max-min condition implies that S_0 and S_1 are the max-min decomposition of a cycle S and that $\tilde{S}_0 > \tilde{S}_1$. From Lemma 4 we deduce that S is an admissible T' -cycle with $T' < T$.

Case 2 : If $\delta_1 = \delta_0 = \delta_{q+1}$, we deduce that δ_0+1 is always followed by δ_0 . Apply $\tau_{\delta_0,0}$ to C and define $S_1 = \tau_{\delta_0,0} C_0$ and $S_0 = \tau_{\delta_0,0} C_1$.

The max-min condition implies that S_0 and S_1 are the max-min decomposition of a cycle S and that $\tilde{S}_0 > \tilde{S}_1$. Once again S is an admissible T' -cycle with $T' < T$.

We can repeat the first part of the proof to S . The strict inequality in the max-min condition on C implies the same strict inequality in the max-min condition on S . Repeating this construction we obtain a cycle of the form 10^r for which the inequality is not strict which contradicts the assumption and concludes the proof. ■

Theorem 1 has very important consequences on the dynamical behavior of (1).

Definition : C is k -admitted if there exists θ such that the iteration (1) with k -steps memory admits C as a cycle. If k and θ are given, C is (k, θ) - admitted if (1) with k and θ admits C as a cycle.

Corollary 1 : A cycle is k -admitted if and only if it is an admissible T -cycle with $T \leq k+1$.

Proof : The if part is proven at the end of the proof of lemma 4.

Assume that C is a k -admitted T -cycle with $T > k+1$. Theorem 1 implies that

$$\begin{aligned} 0 = C_0(T-1) &= F_\theta(C_0(T-2), \dots, C_0(T-k-1)) \\ &= F_\theta(C_1(T-2), \dots, C_1(T-k-1)) = C_1(T-1) = 1 \end{aligned}$$

which is false. ■

Corollary 2 : If C is k -admitted then $\forall k' > k$, C is k' -admitted

Proof : Direct consequence of theorem 1 and corollary 1.

If C is a binary sequence composed only with 10^r and 10^{r+1} , recall that $\tau_{r,s} C$ ($r \in \mathbb{N}$, $s \in \{0,1\}$) is defined to be the binary sequence obtained by replacing each occurrences of 10^{r+s} (resp. $10^{r+\bar{s}}$) by 0 (resp, 1). It is clear that $\tau_{r,s}$ acts on C as a renormalization operator. A consequence of the proof of theorem-1 is that τ and τ^{-1}

transform admissible cycles into admissible cycles. More precisely we have :

Corollary 3 : 1) If C is a k -admitted cycle different from 0 , there exist $(r_1, s_1) \dots (r_n, s_n)$ such that $\tau_{r_n, s_n} \circ \dots \circ \tau_{r_1, s_1} C = 0$

2) If C is admissible, then $\forall (r, s) \in \mathbb{N} \times \{0, 1\}$, $\tau_{r, s}^{-1} C$ is admissible.

From the definition of τ , we deduce that an admissible cycle has a structure which is almost self similar (but with a finite number of steps). We shall see later on that this is closely related with exact self similarity. In fact if we call S the infinite sequence defined as $S = \lim_{n \rightarrow \infty} \tau_{r, s}^{-n} 0$ then we have $\tau_{r, s} S = S$. Note that S is not cyclic. Moreover Corollary 3 gives us an algorithm to construct all the k -admitted cycles: the cycles $\tau_{r_n, s_n}^{-1} \circ \dots \circ \tau_{r_1, s_1}^{-1} 0$ with length less than $k+1$.

Corollary 4 : A k -admitted cycle C different from 0 , is (k, θ) -admitted if and only if $\theta_{\min}(C) < \theta < \theta_{\max}(C)$ where

$$\theta_{\min}(C) = \phi^{-1}(C_1(T-2), \dots, C_1(T-k-1)), \theta_{\max}(C) = \phi^{-1}(C_0(T-2), \dots, C_0(T-k-1))$$

and the indexes are taken modulo k .

Proof : Direct consequence of theorem 1 and the proof of lemma 4.

Lemma 5 : If C and S are k -admitted cycles such that $S_1 > C_1$ then $\theta_{\min}(S) \geq \theta_{\max}(C)$.

Proof : Let T_C and T_S be the period of C and S and $T = \min(T_C, T_S)$.

Since $S_1 > C_1$, we have $S_1(T_S-2), \dots, S_1(T_S-T+1) \geq C_1(T_C-2), \dots, C_1(T_C-T+1)$

Theorem 1 implies that $C_0(T_C-2), \dots, C_0(T_C-T+1) = C_1(T_C-2), \dots, C_1(T_C-T+1)$

From the monotonicity of ϕ^{-1} and corollary 4 we deduce the result. ■

We are now ready to summarize the above results and study the stationnary states of (1).

Theorem 2 : 1) For all θ and k , (1) admits a unique globally attracting cycle.

- 2) The period of a cycle of (1) is less than or equal to $k+1$.
- 3) If $p \leq k+1$, then there exists θ such that (1) admits a p -cycle.

Proof : 1) The unicity is a direct consequence of lemma 5.

2) Follows from Corollary 1.

3) Let $C = 10^{p-1}$. C is k -admitted. ■

From theorem 2 we know what are the possible periods of a cycle of (1) and that there exists only one cycle for a given k . Corollary 3 gives us a way to construct such cycles. However, we do not know completely the bifurcation structure : what is the sequence of the periods as θ varies? Table-1 shows this structure for $k = 8$ and $\theta \leq 1$ (the structure is clearly symmetrical).

θ_{\max}	C	T	$\rho(\theta)$
0	0	1	0
b^7	10^8	9	$1/9$
b^6	10^7	8	$1/8$
b^5	10^6	7	$1/7$
b^4	10^5	6	$1/6$
b^3	10^4	5	$1/5$
b^3+b^7	$10^4 10^3$	9	$2/9$
b^2+b^6	10^3	4	$1/4$
b^2+b^5	$10^3 10^2$	7	$2/7$
$b+b^4+b^7$	10^2	3	$1/3$
$b+b^4+b^6$	$10^2 10^2 10$	8	$3/8$
$b+b^3+b^6$	$10^2 10$	5	$2/5$
$b+b^3+b^5$	$10^2 (10)^2$	7	$3/7$
$b+b^3+b^5+b^7$	$10^2 (10)^3$	9	$4/9$
$1+b^2+b^4+b^6$	10	2	$1/2$

Table 1 : The rotation number is listed for increasing values of θ for $k = 8$

In order to understand the sequence of periods we define the rotation number of a cycle. Let C be a cycle of length q and let p be the number of 1 in C . The rotation number of C is defined to be $\rho(C) = p/q$. We consider p/q as a fraction but do not allow for reduction. Later on, if,

for some value θ , (1) admits a cycle C , we shall use $\rho(\theta)$ instead of $\rho(C)$.

Lemma 6 : 1) If C is a q -cycle, then $\rho(C) = p/q$ is irreducible.

2) Let p/q be an irreducible fraction with $q \leq k+1$. Then there exists a unique q -cycle C such that $\rho(C) = p/q$.

Proof : We shall prove 2) first. We assume without loss of generality that $p/q < 1/2$ and prove it by induction on q . If $q = 1$ then $p = 0$ and $C = 0$. Assume 2) has been proved for $q' < q$. If $p = 1$, then $C = 10^{q-1}$. Let β and γ be such that :

$$q = \beta p + \gamma \quad \text{with} \quad 0 < \gamma < p$$

this implies that C is composed of γ packages 10^β and $p-\gamma$ packages $10^{\beta-1}$. Assume that $p-\gamma < \gamma$ (the equality is impossible since p/q is irreducible and the other inequality lead to the same reasoning). Let $p' = p-\gamma$ and $q' = \gamma$. Clearly p'/q' is irreducible. Let C' be the unique cycle such that $\rho(C') = p'/q'$. Let $C = \tau_{\beta-1,1}^{-1}(C')$. C is a

k-admitted cycle and $\rho(C) = p/q$. It is clear that C is unique. If $\gamma < p-\gamma$, we set $p' = \gamma$ and $q' = p-\gamma$ and use $\tau_{\beta-1,0}^{-1}$ instead of $\tau_{\beta-1,1}^{-1}$ to conclude the proof.

1) Assume now that p/q is reducible and let C be such that $\rho(C) = p/q$. Call $\delta = \gcd(p,q)$ and let β and γ be such that $q = \beta q + \gamma$ with $0 < \gamma < p$. If $\gamma = 0$, then $C = (10^{\beta-1})^p$ which is impossible since C is minimal. If $\gamma \neq 0$, we assume that $p-\gamma \leq \gamma$ and set $p' = p-\gamma$, $q' = \gamma$. We have $\gcd(p',q') = \delta$. Let $C' = \tau_{\beta-1,1}(C)$. We have $\rho(C') = p'/q'$. Repeating the process we obtain lastly that $\rho(C^*) = p^*/q^*$ with $q^* = \delta p^*$. This implies that $C^* = (10^{p^*-1})^{\delta}$ which contradicts the minimality of C^* ■

Lemma 7 : Let C_1 and C_2 correspond to θ_1 and θ_2 ($C_1 \neq C_2$) and assume that $\Gamma_1 = \tau_{r,s} C_1$ and $\Gamma_2 = \tau_{r,s} C_2$ exist for some $r,s \in \mathbb{N}^* \times \{0,1\}$. If Γ_1 and Γ_2 correspond to θ_1' and θ_2' then

$$\theta_1 < \theta_2 \iff \begin{cases} \theta_1' < \theta_2' & \text{if } s = 1 \\ \theta_1' > \theta_2' & \text{if } s = 0 \end{cases}$$

Proof : Direct consequence of Lemma 5 and of the following:

$$0 < 1 \iff \begin{cases} 10^r = \tau_{r,0}^0 > \tau_{r,0}^1 = 10^{r+1} \\ 10^{r+1} = \tau_{r,1}^0 < \tau_{r,s}^1 = 10^r \end{cases}$$



Theorem 3 : ρ is a monotone increasing surjection from \mathbb{R} on to the set of irreducible fraction with denominators not greater than $k+1$.

Proof : Lemma 6 proves that ρ is a surjection. Let us prove that it is monotone increasing. Let $\theta_1 < \theta_2$ and let us assume that

$$\rho(\theta_1) = \frac{p_1}{q_1} \neq \rho(\theta_2) = \frac{p_2}{q_2}$$

We use induction proof on q_1 and q_2 . If $q_1, q_2 \leq 2$ then $\frac{p_1}{q_1} = \frac{0}{1} < \frac{p_2}{q_2} = \frac{1}{2}$. Assume it is true for $q_1, q_2 \leq Q$ and let

$q_1, q_2 \leq Q+1$. Define $q_1 = \beta_1 p_1 + \gamma_1$, $q_2 = \beta_2 p_2 + \gamma_2$ with

$0 < \gamma_1 < p_1$ and $0 < \gamma_2 < p_2$.

If $\beta_2 \neq \beta_1$ then Lemma 5 implies that $\beta_2 < \beta_1$ and hence $\frac{p_1}{q_1} < \frac{p_2}{q_2}$.
 If $\beta_2 = \beta_1$ and $\gamma_1 < p_1 - \gamma_1$, Lemma 5 implies that $\gamma_2 < p_2 - \gamma_2$.
 Consider $\Gamma_1 = \tau_{\beta-1,0} C_1$ and $\Gamma_2 = \tau_{\beta-1,0} C_2$ where C_1 and C_2 correspond to θ_1 and θ_2 and let θ'_1 and θ'_2 correspond to Γ_1 and Γ_2 . Lemma 7 implies that $\theta'_1 > \theta'_2$. The recurrence hypothesis implies that $\rho(\theta'_1) > \rho(\theta'_2)$:

$$\rho(\theta'_1) = \frac{\gamma_1}{p_1} > \rho(\theta'_2) = \frac{\gamma_2}{p_2} \implies \frac{p_1}{q_1} < \frac{p_2}{q_2}$$

If $\gamma_1 > p_1 - \gamma_1$ and $\gamma_2 < p_2 - \gamma_2$, Lemma 5 implies that $\frac{p_1}{q_1} < \frac{p_2}{q_2}$.

If $\gamma_1 > p_1 - \gamma_1$ and $\gamma_2 > p_2 - \gamma_2$, consider $\Gamma_1 = \tau_{\beta-1,1} C_1$ and

$\Gamma_2 = \tau_{\beta-1,1} C_2$. Lemma 7 implies that $\theta'_1 < \theta'_2$. The recurrence hypothesis implies that

$$\rho(\theta'_1) = \frac{p_1 - \gamma_1}{p_1} < \rho(\theta'_2) = \frac{p_2 - \gamma_2}{p_2} \implies \frac{p_1}{q_1} < \frac{p_2}{q_2}$$



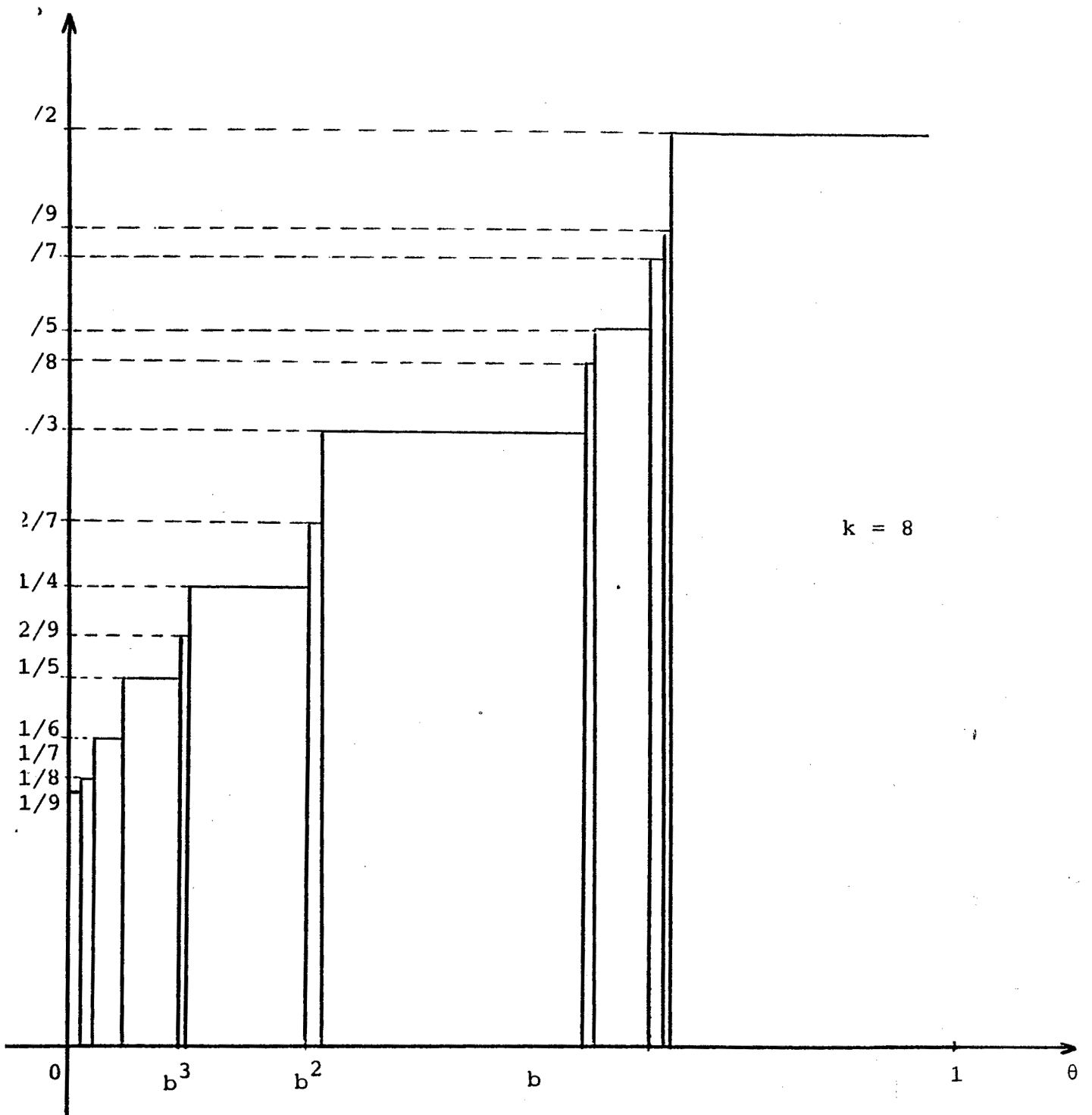

Fig 2

Figure 2 illustrates theorem 3 and shows that ρ is discrete approximation of a devil staircase.

The preceding results give us a way to obtain the bifurcation structure of (1). Consider the set of irreducible fractions with denominators not greater than $k+1$ and list them in increasing order.

The list of their denominators is the ordered list of the periods of the attractive cycles of (1). Using their numerators we deduce the values of θ_{\max} . Hence given a value of θ , we can obtain easily the period of the corresponding cycle.

From a more general point of view, the theorems imply that a simple iteration formula can lead to a very rich structure of bifurcations. Remark, however, that the lengths of the cycles is linear in k compared to the 2^k possible states.

3 UNBOUNDED MODEL

In order to have a better understanding of the behaviour of (1), let us consider the iteration with

an unbounded memory :

$$x_{n+1} = \prod \left[\theta - \sum_{i=0}^n b^i x_{n-i} \right] \quad (2)$$

where $x_j \in \{0,1\}$, $\theta \in \mathbb{R}$, $1 > b > 0$.

The following results have been obtained by Keener [13], Nagumo et Sato [17], Yoschizawa [20], Yamaguti and Hata [19].

Let us introduce first the change of variable

$$y_n = \theta - \sum_{i=0}^n b^i x_{n-i}$$

It is not difficult to show that y_n satisfies :

$$y_{n+1} = \begin{cases} b y_n + (1-b)\theta & \text{if } y_n < 0 \\ b y_n + (1-b)\theta - 1 & \text{if } y_n > 0 \end{cases} \quad (3)$$

Conversely, if we apply Nilnor and Thurston's

itinerary theory, we can see that $\{x_n\}$ is the kneading sequence associated to (3). Hence (2) is equivalent to (3) with $y_0 = \theta$.

Theorem 4 : i) For all b and θ , (2) has a unique global attractor which is either a cycle or a Cantor set.

ii) Let b be fixed. For all positive integer p , there exists θ such that (2) has a p -cycle.

iii) Let b be fixed. The set of θ values such that (2) has a Cantor attractor is a Cantor set of Lebesgue measure zero.

Let us consider now the rotation number associated with (3) :

$$\rho_b(\theta) = \lim_{q \rightarrow \infty} \frac{1}{q} \sum_{n=0}^{q-1} \mathbb{1}(y_n) = \lim_{q \rightarrow \infty} \frac{1}{q} \sum_{n=0}^{q-1} x_{n+1}$$

Theorem 5 : i) For all b and θ , $\rho(\theta)$ is independent of y_0 . If $\rho(\theta)$ is a rational p/q , then (2) has a globally attracting q -cycle. If $\rho_b(\theta)$ is irrational, then (2) has

a globally attracting Cantor set.

ii) Let b be fixed. ρ_b is a continuous monotone increasing function from \mathbb{R} on $[0,1]$, whose derivative is zero almost everywhere (devil's staircase).

The correspondance between θ and $\rho_b(\theta)$ is explicitly given in Yamaguti and Hata [19].

From theorems 4 and 5, we deduce that (1) can be viewed as a troncation of (2) : if we consider and unbounded memory we can obtain a cycle of infinite length (Cantor set), but if we restrict the memory to k steps, the cycle is limited to $k+1$.

We can conclude that the iterative behaviour of (2) is equivalent to that of a linear injection of the circle (equation (3)). Conversely if we apply to (3) a coding technique similar to this used in the itinerary theory [5], we can show that (2) generalize the kneading sequence of (3).

Finally, equation (3) belongs to a class of systems studied by several authors [7,8,9,11,12,18], the logistic model being

$$x_{n+1} = x_n + a + b \sin(2\pi x_n) \pmod{1}.$$

4. PALINDROMIC MEMORY COEFFICIENTS

We study in this section the iterative behavior of

$$x_n = \prod \left[b - \sum_{s=p}^k a(s)x_{n-s} \right]$$

when k and p are given integers and $1 \leq p \leq k$. Furthermore we assume that the coefficients have a palindromic structure:

$$a(s) = a(k+p-s) \quad s = p, \dots, k$$

Remark that for $s = 1, \dots, p-1$, $a(s)$ is zero. Hence the state of the automaton at step n depends only of the states

of steps $n-p, \dots, n-k$.

To each initial configuration we associate a cycle of length $T : X = (x(0), \dots, x(T-1))$. For such a cycle consider the following operator :

$$E(X) = \sum_{t=0}^{T-1} x(t) \left(\sum_{s=p}^k a(k+p-s)x(t+s) - \sum_{s=p}^k a(s)x(t-s) \right)$$

where the indexes are taken modulo T .

It is easy to show that the palindromic structure of the coefficients implies that $E(X) = 0$.

We can now prove a theorem on the length of the cycles.

Theorem 6: If the coefficients have a palindromic structure, then the length of the cycle is a divisor of $k+p$.

Proof : We prove that if T is not a divisor of $k+p$, then $E(x) > 0$.

Define $\text{Sup}(x) = \{t \in \{0, \dots, T-1\} / x(t) = 1\}$

Consider the following partition of $\text{sup}(x)$.

$$C_0 = \{t / \{t, t+k+p, t+2(k+p), \dots, t-(k+p)\} \in \text{sup}(x)\}$$

eventually $C_0 = \phi$

For $m = 1, \dots, q$, C_m are maximal subsets of $\text{sup}(x) \setminus C_0$ such that:

$$C_m = \{t_m, t_m + (k+p), \dots, t_m + q_m(k+p)\}$$

where $t_m - (k+p)$ and $t_m + (q_m+1)(k+p) \notin \text{sup}(x) \setminus C_0$

we then have

$$E(x) = \sum_{m=0}^q \sum_{t \in C_m} \left(\sum_{s=p}^k a(k+p-s)x(t+s) - \sum_{s=p}^k a(s)x(t-s) \right)$$

The palindromic structure and definition of C_0 implies that

$$\sum_{t \in C_0} \left(\sum_{s=p}^k a(k+p-s)x(t+s) - \sum_{s=p}^k a(s)x(t-s) \right) = 0$$

Since T is not a divisor of $k+p$, $C_1 \neq \emptyset$.

For $m = 1, \dots, q$ we have :

$$\begin{aligned}
 \psi_m &= \sum_{t \in C_m} \left(\sum_{s=p}^k a(k+p-s)x(t+s) - \sum_{s=p}^k a(s)x(t-s) \right) \\
 &= \sum_{t \in C_m} \left(\sum_{s=p}^k a(s)x(t+p+k-s) - \sum_{s=p}^k a(s)x(t-s) \right) \\
 &= \sum_{s=p}^k a(s) \sum_{t=0}^{q_m} (x(t_m+t(k+p)+p+k-s) - x(t_m+t(k+p)-s)) \\
 &= \sum_{s=p}^k a(s) \sum_{t=0}^{q_m} (x(t_m+(t+1)(k+p)-s) - x(t_m+t(k+p)-s)) \\
 &= \sum_{s=p}^k a(s)x(t_m+(q_m+1)(k+p)-s) - \sum_{s=p}^k a(s)x(t_m-s)
 \end{aligned}$$

The construction of C_m implies that :

$$x(t_m+(q_m+1)(k+p)) = 0 \Rightarrow \sum_{s=p}^k a(s)x(t_m+(q_m+1)(k+p)-s) - b > 0$$

$$x(t_m) = 1 \Rightarrow \sum_{s=p}^k a(s)x(t_m-s) - b \leq 0$$

Hence $\psi_m > 0$ and $E(x) = \sum_{m=0}^q \psi_m > 0$ which concludes the proof.



On the other hand it is easy to construct examples with a T-cycle for any divisor of $k+p$. For instance consider the case $p = 1$ and let $1 < p_1 < p_2 < \dots < p_q = k+1$ be the divisor of $k+1$. The equation :

$$x_n = \prod \left[b - \sum_{s=1}^k x_{n-s} \right]$$

where $b \in [\alpha_i - 1, \alpha_i[$ with $\alpha_i p_i = k+1$

has the following cycle: 10^{p_i-1} of length p_i .

Moreover the equation:

$$x_n = \prod \left[1/2 - \sum_{s=p}^k x_{n-s} \right] \quad 1 < p < k$$

has a cycle of length $p+k$: $(1^p 0^k)$.

We conclude this section by remarking that these results can be extended to the general context of a network of automata in a similar way to [6].

REFERENCES

- [1] J.P.ALLOUCHE and M.COSNARD : "Itérations de fonctions unimodales et suites engendrées par automates", C.R. Acad. Sc. 296 (1983) 159-162
- [2] P.BACONNIER et al : "Simulation of the entrainment of the respiratory rhythm by two conceptually different models", Lect. Notes Biomath. Rhythms in biology and other fields of applications, M.Cosnard et al Eds., Springer (1983) 2-16
- [3] E.R.CAIANELLO and A. De LUCA : "Decision equation for binary systems. Application to neuronal behavior, Kybernetik 3 (1966) 33-40
- [4] E.R.CAIANELLO, DE LUCA and L.RICCIARDI : "Reverberations and control of neural networks", Kybernetik 4 (1967)

- [5] P.COLLET and J.P.ECKMANN : Iterated maps of the interval as dynamical systems, Birkhauser Basel (1980)

- [6] E.GOLES : Dynamical behaviour of neural networks , R.R.IMAG 386 (1983)

- [7] M.FEIGENBAUM : Quantitative universality for a class of nonlinear transformations , J.Stat. Phys. 19 (1978) 25-52

- [8] M.FEIGENBAUM, L.KADANOFF and S.SHENKER : "Quasiperiodicity in dissipative systems : a renormalization group", Physica 5D (1982) 370-375

- [9] L.GLASS and R.PEREZ : "The fine structure of phase locking", Phys. Rev. Lett. 48 (1982) 1772-1774

- [10] M.HERMAN : "Sur la conjugaison differentiable des diffeomorphismes du cercle à des rotations", Publ. IHES 49 (1979)

- [11] L.KADANOFF : "Supercritical behavior of an ordered trajectory", J.Stat. Phys. 31, 1 (1983) 1-27

- [12] K.KANEKO : "Similarity structure and scaling property of the period adding phenomena", Prog. Theo. Phys. 69-2 (1983) 403-414

- [13] J.KEENER : "Chaotic behavior in piecewise continuous difference equations", Trans.A.M.S. 261, 2 (1980) 589-604
- [14] T.KITAGAWA : "Dynamical systems and operators associated with a single neuron equation", Math. Biosci. 18 (1973)
- [15] W.Mc.CULLOCH and W.PITTS : "A logical calculus of the ideas immanent in nervous activity", Bull. Math. Biophys. 5 (1943) 115-133
- [16] H.NAGAMI, KITAHASHI and TANAKA : "Characterization of dynamical behaviour associated with a single neural equation", Math. Biosci. 32 (1976)
- [17] J.NAGUMO and S.SATO : "On a response characteristic of a mathematical neuron model", Kybernetik 3 (1972) 155-166
- [18] C.TRESSER : "Nouveaux types de transitions vers une entropie topologique positive", C.R.Acad.Sc.A (1983)
- [19] M.YAMAGUTI and M.HATA : "On the mathematical neuron model" in Proc. of Competition and Cooperation in Neural Nets, Lect. Notes Biomath., Springer Verlag, 45, (1982), 171-177
- [20] S.YOSCHIZAWA : "Periodic Pulse Sequences generated by an Analog Neuron Model", in Proc. of Competition and Cooperation in Neural Nets, Lect. Notes Biomath., Springer Verlag, 45, (1982) 155-170.

ANNEXE



ANNEXE

Dans cette annexe, nous présentons deux applications de réseaux d'automates pour certains modèles d'origine biologique.

Dans le premier papier on fait un étude expérimentale (simulations sur ordinateur) et aussi théorique des réseaux booléens orientés, où chaque cellule ne dépend que de deux voisins.

Dans le deuxième papier, nous déterminons le comportement dynamique de certains réseaux issus d'un modèle asynchrone de contrôle génétique 86 .



SPECIFIC ROLES OF THE DIFFERENT BOOLEAN MAPPINGS IN RANDOM NETWORKS*

- F. FOGELMAN-SOULIE
UER de Mathématiques,
Université de Paris V,
12 rue Cujas,
75005 Paris, France

- E. GOLES-CHACC
Departamento de Matematicas,
Universidad de Chile,
Cas. 5272, Correo 3,
Santiago, Chile

- G. WEISBUCH
Département de Physique,
Case 901,
Faculté de Luminy,
13288 Marseille Cédex 2, France

Random Boolean networks have striking properties of self-organization. In this paper we propose an algorithm based on the different roles of Boolean mappings and on the connection structure to analyze the organization of the network. For a few cases—transfer mappings, AND/OR, equivalence/XOR—rigorous results are obtained about the dynamics of homogeneous networks. Conclusions are then drawn concerning the non-homogeneous networks.

1. Introduction. Boolean networks have been used to simulate complex systems composed of many interacting elements. This modelling is very relevant in biology, where it has been proposed for systems of interacting genes (Kauffman, 1969, 1970a) or for regulatory systems in immunology (Thomas, 1979); but it may also be adequate in more general contexts, such as, for example, in management theory (Walker and Gelfand, 1979; Gelfand and Walker, 1980).

Because of these stimulating possibilities, numerous attempts were made to explain the dynamical behavior of Boolean networks. Due to the large number of elements in any relevant system, the exact structure of the connections (or 'wiring pattern') and the distribution of the functions of all elements are generally unknown: usually, connections and Boolean

*This paper is dedicated to the Soviet cybernetician Victor Brailovski.

functions will be assumed to be distributed at random. Hence, many authors tried to derive descriptions of random Boolean networks. Their behavior proved to be surprisingly stable. Although a network composed of N modules could occupy a great number of possible states (2^N), in fact it exhibits a much simpler behavior; after a short transient time it enters a state limit cycle, where it stays forever. The number of possible limit cycles and the lengths of these are usually very small (as compared to the total number of possible states).

Numerous results have been given about this temporal organization of Boolean networks (Walker and Ashby, 1966; Walker 1971; Gelfand and Walker, 1977) in the form of statistical descriptions. Using computer simulations Kauffman (1969) provided his so-called 'square-root law', relating the median cell-cycle time (or state-cycle length) to the estimated number of genes per cell (or number of elements in the network).

On the other hand, very few formal analytical results are available. After the attempts by Kauffman (1971) and Aleksander (1973), Sherlock (1979) proposed a formal analysis; using the state transition graph he derived the distribution of limit-cycle lengths. His theoretical results agree with experimental data in the case of totally connected networks. But for the low connectivity case, he faces "serious quantitative discrepancies" (Sherlock, 1979).

It seems to us that a possible reason for this partial failure is that any theoretical understanding should include both of the following ingredients: the structure of the connections, and the nature of Boolean mappings; so far, they have only been studied separately.

In his seminal paper, Holland (1960) developed the first point. He raised the question whether "the full range of logical net behavior could be obtained from nets using cycles of limited complexity", and answered negatively "not because we restricted the complexity of the switching elements used, but because the cycles were limited in the complexity of their feedback patterns". Hence the "number of feedback loops . . . is a salient point of the study of cycles in logical nets". This limiting factor must be taken into account.

The different roles of Boolean mappings have been much investigated and different concepts have proved to be useful. These include: forcibility (Kauffman, 1971, 1979); internal homogeneity (Walker and Ashby, 1966). Walker and Gelfand (1979) proved that these two concepts were 'highly correlated'; extended threshold (Gelfand and Walker, 1980); and liveliness (Aleksander, 1973), which also includes properties of the connection structure.

But all these authors used these concepts in the perspective of yielding statistical results, irrespective of the possible structure of the network

which was always "taken to be fixed but unknown in detail" (Walker and Gelfand, 1979).

In this paper we want to use these different results in the framework of a general non-statistical analysis of Boolean networks. We make use of some analytical results (Goles-Chacc, 1980; Snoussi, 1980) to study the dynamics of homogeneous networks by rigorous methods, taking into account the constraints imposed by the connection structure. Finally, we propose a general algorithm for non-homogeneous networks based on concepts and results previously discussed.

2. Definitions. We consider networks made of many interacting modules. A module can be at time t in a state 0 or 1, depending upon the states of its two input modules at time $t - 1$: all N modules of a net of size N are connected in such a way that each module receives signals from 2 input modules and sends a signal (its internal state) to other output modules. Each module is an automaton which computes its internal state using a Boolean function of 2 variables (its input signals).

The restriction to connectance $k = 2$ (2 inputs per module) is obviously limiting. It has been proved (Kauffman, 1970a; Walker and Gelfand, 1979) that nets with connectance $k = 2$ or 3 were much more stable than for higher values of k . But we want here to propose a solution as rigorous and complete as possible and hence we begin with the simpler case. For this reason, we also assume that each module sends its signal to 2 output modules.

A network is thus specified by its incidence matrix A which has N lines and N columns. Element $A_{ij} = 1$ if module i has module j as one of its inputs, or 0 otherwise. Hence, matrix A has two 1's per line and per column; and its Boolean function matrix F which has N lines. Element F_i specifies the number of the Boolean function which allows one to compute the output of module i (see Table I).

Starting from an initial condition matrix X_0 describing the states of all modules at time $t = 0$, it is then possible to compute the different X_1, X_2, \dots, X_n matrices representing the state of the network at time 1, 2, \dots, n . After some time m , the sequence of matrices $X_m, X_{m+1}, \dots, X_{m+T-1}$ reproduces itself with a period T :

$$X_{m+T} = X_m.$$

The network is said to have entered a limit cycle. The classification of the limit cycles that can be reached according to the different initial states characterizes what we refer to as the dynamics of the system.

It has been shown [see Kauffman (1970a) for more details] that 'random' nets (for which matrices A , F and X_0 are set at random), with connectance $k = 2$, do evolve towards limit cycles whose periods are relatively short compared to the amount of initially possible states (2^N for a net of size N). Furthermore, Kauffman (1969) noted that "most modules are constant throughout the cycle". In a previous paper (Atlan *et al.*, 1981) we introduced the concept of *subnet*: a subnet is an aggregate of oscillating modules (during the limit cycle they change state at least once), closely connected. Subnets are separated by those modules which remain constant (see Figure 1).

In order to get a geometrical representation of this fact, we present results on a particular class of networks, plane lattices with connections

TABLE I
Boolean Functions numbered 0.....15 According to the Decimal Representation of Their Table of Values)

<table style="border-collapse: collapse; margin: auto;"> <tr><td style="border-right: 1px solid black; padding: 2px 5px;">2</td><td style="padding: 2px 5px;">0</td><td style="padding: 2px 5px;">1</td></tr> <tr><td style="border-right: 1px solid black; padding: 2px 5px;">1</td><td style="padding: 2px 5px;">0</td><td style="padding: 2px 5px;">0</td></tr> <tr><td style="border-right: 1px solid black; padding: 2px 5px;">0</td><td style="padding: 2px 5px;">0</td><td style="padding: 2px 5px;">0</td></tr> <tr><td style="border-right: 1px solid black; padding: 2px 5px;">1</td><td style="padding: 2px 5px;">0</td><td style="padding: 2px 5px;">0</td></tr> </table>	2	0	1	1	0	0	0	0	0	1	0	0	<table style="border-collapse: collapse; margin: auto;"> <tr><td style="border-right: 1px solid black; padding: 2px 5px;">2</td><td style="padding: 2px 5px;">0</td><td style="padding: 2px 5px;">1</td></tr> <tr><td style="border-right: 1px solid black; padding: 2px 5px;">1</td><td style="padding: 2px 5px;">1</td><td style="padding: 2px 5px;">0</td></tr> <tr><td style="border-right: 1px solid black; padding: 2px 5px;">0</td><td style="padding: 2px 5px;">1</td><td style="padding: 2px 5px;">0</td></tr> <tr><td style="border-right: 1px solid black; padding: 2px 5px;">1</td><td style="padding: 2px 5px;">0</td><td style="padding: 2px 5px;">0</td></tr> </table>	2	0	1	1	1	0	0	1	0	1	0	0	<table style="border-collapse: collapse; margin: auto;"> <tr><td style="border-right: 1px solid black; padding: 2px 5px;">2</td><td style="padding: 2px 5px;">0</td><td style="padding: 2px 5px;">1</td></tr> <tr><td style="border-right: 1px solid black; padding: 2px 5px;">1</td><td style="padding: 2px 5px;">0</td><td style="padding: 2px 5px;">1</td></tr> <tr><td style="border-right: 1px solid black; padding: 2px 5px;">0</td><td style="padding: 2px 5px;">0</td><td style="padding: 2px 5px;">0</td></tr> <tr><td style="border-right: 1px solid black; padding: 2px 5px;">1</td><td style="padding: 2px 5px;">1</td><td style="padding: 2px 5px;">0</td></tr> </table>	2	0	1	1	0	1	0	0	0	1	1	0	<table style="border-collapse: collapse; margin: auto;"> <tr><td style="border-right: 1px solid black; padding: 2px 5px;">2</td><td style="padding: 2px 5px;">0</td><td style="padding: 2px 5px;">1</td></tr> <tr><td style="border-right: 1px solid black; padding: 2px 5px;">1</td><td style="padding: 2px 5px;">1</td><td style="padding: 2px 5px;">1</td></tr> <tr><td style="border-right: 1px solid black; padding: 2px 5px;">0</td><td style="padding: 2px 5px;">1</td><td style="padding: 2px 5px;">1</td></tr> <tr><td style="border-right: 1px solid black; padding: 2px 5px;">1</td><td style="padding: 2px 5px;">1</td><td style="padding: 2px 5px;">0</td></tr> </table>	2	0	1	1	1	1	0	1	1	1	1	0
2	0	1																																																	
1	0	0																																																	
0	0	0																																																	
1	0	0																																																	
2	0	1																																																	
1	1	0																																																	
0	1	0																																																	
1	0	0																																																	
2	0	1																																																	
1	0	1																																																	
0	0	0																																																	
1	1	0																																																	
2	0	1																																																	
1	1	1																																																	
0	1	1																																																	
1	1	0																																																	
0 Contradiction	1 NOR	2 \implies	3 \bar{t}_2																																																
<table style="border-collapse: collapse; margin: auto;"> <tr><td style="border-right: 1px solid black; padding: 2px 5px;">2</td><td style="padding: 2px 5px;">0</td><td style="padding: 2px 5px;">1</td></tr> <tr><td style="border-right: 1px solid black; padding: 2px 5px;">1</td><td style="padding: 2px 5px;">0</td><td style="padding: 2px 5px;">1</td></tr> <tr><td style="border-right: 1px solid black; padding: 2px 5px;">0</td><td style="padding: 2px 5px;">0</td><td style="padding: 2px 5px;">1</td></tr> <tr><td style="border-right: 1px solid black; padding: 2px 5px;">1</td><td style="padding: 2px 5px;">0</td><td style="padding: 2px 5px;">0</td></tr> </table>	2	0	1	1	0	1	0	0	1	1	0	0	<table style="border-collapse: collapse; margin: auto;"> <tr><td style="border-right: 1px solid black; padding: 2px 5px;">2</td><td style="padding: 2px 5px;">0</td><td style="padding: 2px 5px;">1</td></tr> <tr><td style="border-right: 1px solid black; padding: 2px 5px;">1</td><td style="padding: 2px 5px;">1</td><td style="padding: 2px 5px;">1</td></tr> <tr><td style="border-right: 1px solid black; padding: 2px 5px;">0</td><td style="padding: 2px 5px;">1</td><td style="padding: 2px 5px;">1</td></tr> <tr><td style="border-right: 1px solid black; padding: 2px 5px;">1</td><td style="padding: 2px 5px;">0</td><td style="padding: 2px 5px;">0</td></tr> </table>	2	0	1	1	1	1	0	1	1	1	0	0	<table style="border-collapse: collapse; margin: auto;"> <tr><td style="border-right: 1px solid black; padding: 2px 5px;">2</td><td style="padding: 2px 5px;">0</td><td style="padding: 2px 5px;">1</td></tr> <tr><td style="border-right: 1px solid black; padding: 2px 5px;">1</td><td style="padding: 2px 5px;">0</td><td style="padding: 2px 5px;">1</td></tr> <tr><td style="border-right: 1px solid black; padding: 2px 5px;">0</td><td style="padding: 2px 5px;">0</td><td style="padding: 2px 5px;">1</td></tr> <tr><td style="border-right: 1px solid black; padding: 2px 5px;">1</td><td style="padding: 2px 5px;">1</td><td style="padding: 2px 5px;">0</td></tr> </table>	2	0	1	1	0	1	0	0	1	1	1	0	<table style="border-collapse: collapse; margin: auto;"> <tr><td style="border-right: 1px solid black; padding: 2px 5px;">2</td><td style="padding: 2px 5px;">0</td><td style="padding: 2px 5px;">1</td></tr> <tr><td style="border-right: 1px solid black; padding: 2px 5px;">1</td><td style="padding: 2px 5px;">1</td><td style="padding: 2px 5px;">1</td></tr> <tr><td style="border-right: 1px solid black; padding: 2px 5px;">0</td><td style="padding: 2px 5px;">1</td><td style="padding: 2px 5px;">1</td></tr> <tr><td style="border-right: 1px solid black; padding: 2px 5px;">1</td><td style="padding: 2px 5px;">1</td><td style="padding: 2px 5px;">0</td></tr> </table>	2	0	1	1	1	1	0	1	1	1	1	0
2	0	1																																																	
1	0	1																																																	
0	0	1																																																	
1	0	0																																																	
2	0	1																																																	
1	1	1																																																	
0	1	1																																																	
1	0	0																																																	
2	0	1																																																	
1	0	1																																																	
0	0	1																																																	
1	1	0																																																	
2	0	1																																																	
1	1	1																																																	
0	1	1																																																	
1	1	0																																																	
4 \Leftarrow	5 \bar{t}_1	6 XOR	7 NAND																																																
<table style="border-collapse: collapse; margin: auto;"> <tr><td style="border-right: 1px solid black; padding: 2px 5px;">2</td><td style="padding: 2px 5px;">0</td><td style="padding: 2px 5px;">1</td></tr> <tr><td style="border-right: 1px solid black; padding: 2px 5px;">1</td><td style="padding: 2px 5px;">0</td><td style="padding: 2px 5px;">1</td></tr> <tr><td style="border-right: 1px solid black; padding: 2px 5px;">0</td><td style="padding: 2px 5px;">0</td><td style="padding: 2px 5px;">0</td></tr> <tr><td style="border-right: 1px solid black; padding: 2px 5px;">1</td><td style="padding: 2px 5px;">0</td><td style="padding: 2px 5px;">1</td></tr> </table>	2	0	1	1	0	1	0	0	0	1	0	1	<table style="border-collapse: collapse; margin: auto;"> <tr><td style="border-right: 1px solid black; padding: 2px 5px;">2</td><td style="padding: 2px 5px;">0</td><td style="padding: 2px 5px;">1</td></tr> <tr><td style="border-right: 1px solid black; padding: 2px 5px;">1</td><td style="padding: 2px 5px;">1</td><td style="padding: 2px 5px;">0</td></tr> <tr><td style="border-right: 1px solid black; padding: 2px 5px;">0</td><td style="padding: 2px 5px;">1</td><td style="padding: 2px 5px;">0</td></tr> <tr><td style="border-right: 1px solid black; padding: 2px 5px;">1</td><td style="padding: 2px 5px;">0</td><td style="padding: 2px 5px;">1</td></tr> </table>	2	0	1	1	1	0	0	1	0	1	0	1	<table style="border-collapse: collapse; margin: auto;"> <tr><td style="border-right: 1px solid black; padding: 2px 5px;">2</td><td style="padding: 2px 5px;">0</td><td style="padding: 2px 5px;">1</td></tr> <tr><td style="border-right: 1px solid black; padding: 2px 5px;">1</td><td style="padding: 2px 5px;">0</td><td style="padding: 2px 5px;">1</td></tr> <tr><td style="border-right: 1px solid black; padding: 2px 5px;">0</td><td style="padding: 2px 5px;">0</td><td style="padding: 2px 5px;">0</td></tr> <tr><td style="border-right: 1px solid black; padding: 2px 5px;">1</td><td style="padding: 2px 5px;">1</td><td style="padding: 2px 5px;">1</td></tr> </table>	2	0	1	1	0	1	0	0	0	1	1	1	<table style="border-collapse: collapse; margin: auto;"> <tr><td style="border-right: 1px solid black; padding: 2px 5px;">2</td><td style="padding: 2px 5px;">0</td><td style="padding: 2px 5px;">1</td></tr> <tr><td style="border-right: 1px solid black; padding: 2px 5px;">1</td><td style="padding: 2px 5px;">1</td><td style="padding: 2px 5px;">1</td></tr> <tr><td style="border-right: 1px solid black; padding: 2px 5px;">0</td><td style="padding: 2px 5px;">1</td><td style="padding: 2px 5px;">0</td></tr> <tr><td style="border-right: 1px solid black; padding: 2px 5px;">1</td><td style="padding: 2px 5px;">1</td><td style="padding: 2px 5px;">1</td></tr> </table>	2	0	1	1	1	1	0	1	0	1	1	1
2	0	1																																																	
1	0	1																																																	
0	0	0																																																	
1	0	1																																																	
2	0	1																																																	
1	1	0																																																	
0	1	0																																																	
1	0	1																																																	
2	0	1																																																	
1	0	1																																																	
0	0	0																																																	
1	1	1																																																	
2	0	1																																																	
1	1	1																																																	
0	1	0																																																	
1	1	1																																																	
8 AND	9 Equivalence	10 t_1	11 \Leftarrow																																																
<table style="border-collapse: collapse; margin: auto;"> <tr><td style="border-right: 1px solid black; padding: 2px 5px;">2</td><td style="padding: 2px 5px;">0</td><td style="padding: 2px 5px;">1</td></tr> <tr><td style="border-right: 1px solid black; padding: 2px 5px;">1</td><td style="padding: 2px 5px;">0</td><td style="padding: 2px 5px;">1</td></tr> <tr><td style="border-right: 1px solid black; padding: 2px 5px;">0</td><td style="padding: 2px 5px;">0</td><td style="padding: 2px 5px;">1</td></tr> <tr><td style="border-right: 1px solid black; padding: 2px 5px;">1</td><td style="padding: 2px 5px;">0</td><td style="padding: 2px 5px;">1</td></tr> </table>	2	0	1	1	0	1	0	0	1	1	0	1	<table style="border-collapse: collapse; margin: auto;"> <tr><td style="border-right: 1px solid black; padding: 2px 5px;">2</td><td style="padding: 2px 5px;">0</td><td style="padding: 2px 5px;">1</td></tr> <tr><td style="border-right: 1px solid black; padding: 2px 5px;">1</td><td style="padding: 2px 5px;">1</td><td style="padding: 2px 5px;">1</td></tr> <tr><td style="border-right: 1px solid black; padding: 2px 5px;">0</td><td style="padding: 2px 5px;">1</td><td style="padding: 2px 5px;">1</td></tr> <tr><td style="border-right: 1px solid black; padding: 2px 5px;">1</td><td style="padding: 2px 5px;">0</td><td style="padding: 2px 5px;">1</td></tr> </table>	2	0	1	1	1	1	0	1	1	1	0	1	<table style="border-collapse: collapse; margin: auto;"> <tr><td style="border-right: 1px solid black; padding: 2px 5px;">2</td><td style="padding: 2px 5px;">0</td><td style="padding: 2px 5px;">1</td></tr> <tr><td style="border-right: 1px solid black; padding: 2px 5px;">1</td><td style="padding: 2px 5px;">1</td><td style="padding: 2px 5px;">1</td></tr> <tr><td style="border-right: 1px solid black; padding: 2px 5px;">0</td><td style="padding: 2px 5px;">0</td><td style="padding: 2px 5px;">1</td></tr> <tr><td style="border-right: 1px solid black; padding: 2px 5px;">1</td><td style="padding: 2px 5px;">1</td><td style="padding: 2px 5px;">1</td></tr> </table>	2	0	1	1	1	1	0	0	1	1	1	1	<table style="border-collapse: collapse; margin: auto;"> <tr><td style="border-right: 1px solid black; padding: 2px 5px;">2</td><td style="padding: 2px 5px;">0</td><td style="padding: 2px 5px;">1</td></tr> <tr><td style="border-right: 1px solid black; padding: 2px 5px;">1</td><td style="padding: 2px 5px;">1</td><td style="padding: 2px 5px;">1</td></tr> <tr><td style="border-right: 1px solid black; padding: 2px 5px;">0</td><td style="padding: 2px 5px;">1</td><td style="padding: 2px 5px;">1</td></tr> <tr><td style="border-right: 1px solid black; padding: 2px 5px;">1</td><td style="padding: 2px 5px;">1</td><td style="padding: 2px 5px;">1</td></tr> </table>	2	0	1	1	1	1	0	1	1	1	1	1
2	0	1																																																	
1	0	1																																																	
0	0	1																																																	
1	0	1																																																	
2	0	1																																																	
1	1	1																																																	
0	1	1																																																	
1	0	1																																																	
2	0	1																																																	
1	1	1																																																	
0	0	1																																																	
1	1	1																																																	
2	0	1																																																	
1	1	1																																																	
0	1	1																																																	
1	1	1																																																	
12 t_2	13 \implies	14 OR	15 Tautology																																																

Table $\begin{pmatrix} d & b \\ c & a \end{pmatrix}$ is numbered: $a(2)^3 + b(2)^2 + c(2) + d$.

between nearest neighbours. Such a network is shown in Figure 2. This lattice has a periodic structure of connections. At the edges circular connections are established: for instance, the node l, j takes its inputs from (respectively sends outputs to) nodes $1, j$ and $l-1, j$ if j is odd (respectively even). The network can be viewed as drawn on a torus. Of course, with such a structure we have lost the randomness of con-

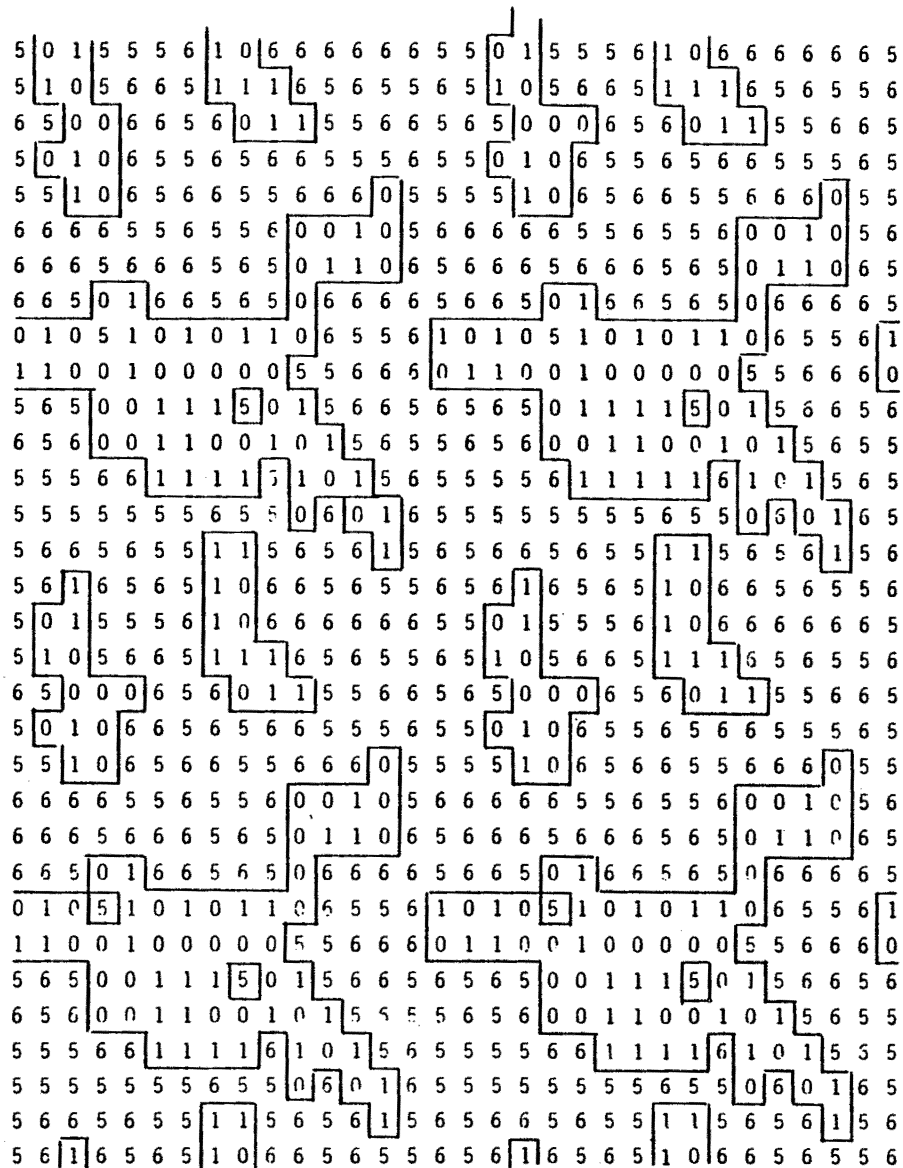

Figure 1. State of a random boolean network at a given time of the limit cycle. 0 and 1 correspond to oscillating modules; 5 and 6 correspond to modules which remain in a constant state (0 or 1) during the limit cycle. This figure is obtained from a 16×16 modules plane lattice, the connections of which are shown on Figure 2. Boolean mappings are distributed at random on the different modules, excluding constant mappings (Nos 0 and 15). We have extended (by two translations) this lattice to a 32×32 lattice in order to visualize the connections in the oscillating subnets. We are in the presence here of three different oscillating subnets separated by a stable component.

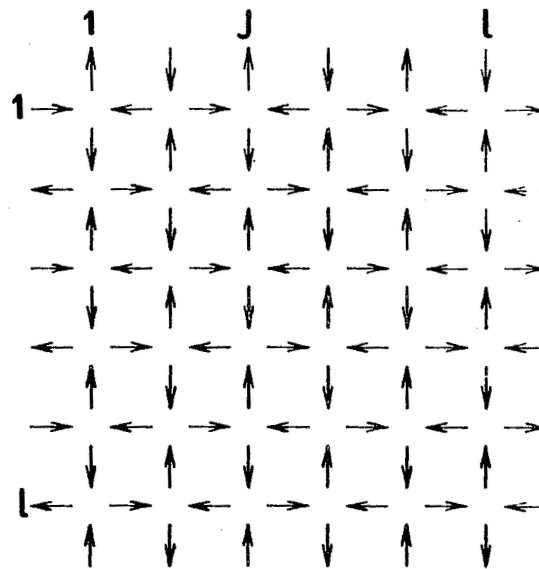

Figure 2. Scheme of connections of the planar lattice, a state of which is shown on Figure 1. A module takes its inputs and outputs among its neighbours. The structure is completed at the boundaries by connecting symmetrical nodes. The directions of the arrows are periodic of period 2 and yield, in particular, the shortest feedback loops.

nections, but we kept the randomness for the distributions of mappings and initial states.

The system has evolved from a situation where at the beginning, all modules were fully interacting to an organization in independent subnets where modules in different subnets behave as if there were no functional connections. Another important point is the partial loss of the random character of the network. At time 0 the system is in a random state and interactions are set at random. Once the system has reached the limit cycle, the property of oscillation is not random any more. Strong local correlation exists since a node has far greater chances to oscillate if its neighbours oscillate. The network has undergone a process of self-organization.

The period of the limit cycle is the least common multiple of the periods of the subnets.

This subnet organization has been shown to be relatively stable against perturbations such as 'amputation', 'immersion' or application of external noise on one module (Atlan *et al.*, 1981). Roughly speaking, perturbations can only propagate through subnets.

All the results about organization into subnets exist for random connection networks and not only for planar lattices. 'Local' properties ('neighbors') are always meant with respect to the underlying connection structure. Usually these properties are shown on figures where regular connections are used, which allow for a simple geometrical

```

0 0 0 0 0 0 0 0 0 0 0 0 0 0 1 0 0 0
0 0 0 0 1 0 0 0 0 0 0 0 0 0 0 0 0 0
1 0 0 0 0 0 0 0 0 0 0 0 0 0 0 0 0 0
0 0 1 0 0 0 0 0 0 0 0 0 0 1 0 0 0 0
0 0 0 1 0 0 0 0 0 0 0 0 0 0 0 0 0 0
0 0 0 0 0 0 0 0 0 0 0 0 0 0 0 0 0 2
0 0 0 0 0 2 0 1 0 0 0 0 1 2 0 0 0 0
0 1 0 0 0 0 0 0 0 0 0 0 0 0 0 0 0 0
0 0 0 0 0 0 1 0 0 0 0 0 0 0 0 0 0 0
0 0 0 0 0 0 0 0 1 0 0 0 0 0 0 0 0 0
0 0 0 0 0 0 0 0 0 0 0 0 0 1 1 1 0 0
0 0 1 0 0 0 0 0 0 0 0 0 0 0 0 0 0 0
0 0 0 0 0 0 0 0 0 0 0 0 0 0 0 0 0 0
1 0 0 0 0 0 0 1 0 0 0 0 0 0 0 0 0 0
0 0 1 0 0 0 0 0 0 0 0 0 0 0 0 0 1 0
0 0 0 0 0 0 0 0 0 0 0 0 0 0 1 0 0 0

```

Figure 3. Representation of the state of a 256-module boolean network with random connections, during the limit cycle. The 0's correspond to the stable modules. Notice that this network, though randomly connected, still exhibits an organization into subnets (there are 2 oscillating subnets here, whose nodes are indicated by 1 and 2 on the figure). The geometrical representation proposed here does not allow one to visualize the connections between the different modules of each subnet.

representation (see Figure 3 for an organization into subnets in the case of non-regular, random connections). When properties are valid only for regular connections, specific mention will be made.

3. Role of the Different Boolean Mappings. Table 1 gives the different Boolean mappings of 2 inputs. Their roles are, of course, not equivalent and we propose the following classification, based on the concepts of internal homogeneity and forcibility (see Walker and Gelfand, 1979): internal homogeneity 4 (mappings with 4 identical outputs): contradiction (No. 0) and tautology (No. 15). Kauffman (1969) already noticed these could be excluded; internal homogeneity 3: we call them reducing mappings. They reduce the amount of information which was present at the inputs (Nos. 1, 2, 4, 7, 8, 11, 13 and 14). The reducing mappings are forcible on 2 inputs: for one value of each input, their value is independent of the other input; and internal homogeneity 2: 6 mappings among which 4 are forcible on 1 input: we call them transfer maps. Numbers 3 and 5 transfer an output equal to their forcing input, and Nos 10 and 12 the inverse of the forcing input; the remaining 2 are not forcible: Nos 6 and 9. They fully depend on their 2 inputs.

Notice that there are only 2 non-forcible maps and 14 which are forcible on at least 1 input. Kauffman (1969, 1970b) established that this was the main reason for the stability of random networks with connectance 2.

This classification is based on the properties which are of interest for our problem. In some cases it is useful to note that it also corresponds to a partition between affine and non-affine functions. For nets made of affine functions only (Nos 0, 15; 3, 5, 10, 12; 6, 9), the dynamics of the network can be represented by an equation $X_t = AX_{t-1} + b$ (where A is the incidence matrix and b is a matrix depending on the Boolean function matrix F). As can be inferred from previous works by Kauffman (1969) and Walker and Gelfand (1979), the dynamical properties of random networks composed of only one class of mappings differ according to the class. In the following we give rigorous results for some cases of homogeneous networks (using only one class of mappings).

4. Non-forcible Mappings. Homogeneous networks exclusively using these mappings are known to have very long limit cycles (Walker and Gelfand, 1979).

Holland (1960) stated that it was even possible to build a network (a 'locally balanced cycle') having a state limit cycle including all 2^N possible states. This property is used in shift registers with feedback loops.

Figure 4 represents a shift register containing n gates. The state of a gate at time t is given by the state of its left neighbour at time $t-1$ (transfer mapping), except for the leftmost gate whose state is obtained by application of a Boolean mapping to inputs coming from gates numbered m and n ($n > m$).

If the Boolean mapping is of the type 6 or 9, by appropriately choosing the gates used as inputs for the feedback, the maximum period $2^n - 1$ can be reached. Such systems are used as pseudo-random sequence generators.

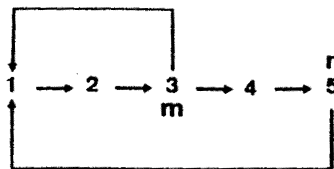

Figure 4. Shift register with feedback loops. The line of modules 1-5 defines a shift register of size 5. The input gate (module 1) receives the signals coming from modules m and n and transforms them according to a boolean mapping. If this mapping is non-forcible (Nos 6 or 9), the period of the limit cycle of the output sequence (of states of module n) is large (31 in the case shown here). If it is an OR or AND mapping, this period is short (1 in the case shown here).

Simulations run on homogeneous networks with random connections exhibit these long periods: there exists no stable component and the period of the limit cycle increases in proportion with 2^N . Such networks have a behavior very different from Kauffman networks, although they are built by random repartition of connections and mappings.

But, in the particular case of plane lattices with loop connections, the results can be very different: suppose a network made of $N \times N$ modules having only mappings Nos 6 or 9. Then if $N = 2^k$, there is a unique fixed point independent of initial conditions: there is no limit cycle of period $T > 1$. From any initial condition X_0 , the network reaches a stable asymptotic state where no module oscillates (see appendix 3); if N is not a power of 2, there are limit cycles whose periods are relatively small.

The differences seem to be related to the very short feedback effects in loop connections, which help to stabilize the network. It also exemplifies the importance of the connection structure in the asymptotic behavior of the network (see Holland, 1960).

5. Transfer Mappings. In this case, one of the inputs is ineffective and the mappings are in fact only one-input mappings. The dynamics of such networks can be seen in Figure 5. The following features are apparent.

Since every node has one effective input, a node has 0, 1 or 2 effective output(s). The network is readily decomposed into independent sub-

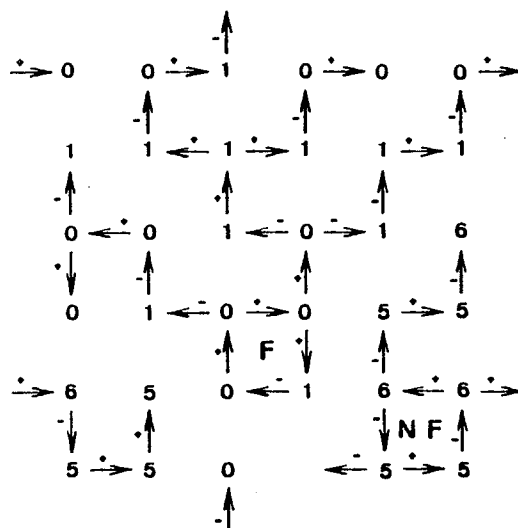

Figure 5. State and functional connections of a 6×6 planar lattice built only with transfer mappings. The arrows show which input is functional, and the - and + signs show whether the input is inverting or not. One can notice the existence of two independent subnetworks. Each subnetwork is made of a 4-module loop sending information along the arms. Letters F and NF refer to the frustration of the loop (frustrated and non-frustrated respectively). The stable component corresponds to the non-frustrated loop.

networks [this fact had been noticed by Kauffman (1969)]. These subnetworks are all composed of loops and arms: a loop is a closed path (or circuit), an arm is a path which is not closed. If we consider the state of a module as a signal, this signal propagates across modules with or without change according to whether the mapping is inverting or not (mappings Nos 3 and 5 are inverting, Nos 10 and 12 are not). The signal propagates around a loop or leaves the loop at modules with two outputs, but it cannot enter a loop since all the modules of a loop have their only input node in the loop. The signal flows, then, from the loop towards the end of the arms. A subnetwork has only one loop since the signal flows from the loops (if two loops had a common arm, contradiction would occur about the direction of propagation along the arm).

Since the signal flows out from the loop, the period of a subnetwork is determined by the loop which plays the role of a pacemaker. We are then led to define the frustration of the loop, in accordance with the definition used in the spin glass problem (Balian *et al.*, 1979) or in psychology (Harary and Cartwright, 1956). The frustration is 0 if the parity of the number of inverting nodes is even, and 1 if otherwise. If frustration is 0, the signal comes back identical to itself after it has gone through the loop. The period of the loop, and hence that of the connected subnetwork, can be any divisor of n , the number of nodes of the loop. Such a loop can also remain in a stationary state if the initial conditions allow it. If frustration is 1, the signal comes back identical to itself after having gone twice through the loop. The period is $2k$, where k is any divisor of n by an odd number. Hence it cannot be less than 2 (there may be no stationary state).

Stable components can then include non-frustrated loops exclusively. A few initial conditions allow such a loop to be stable: hence stable components are very restricted. Contrary to the case of networks including all Boolean mappings, homogeneous networks with transfer mappings have the majority of their elements oscillating during limit cycles.

The period of the full network is the least common multiple of the periods of the subnetworks. The derivation of these results is given in Appendix 1.

The results presented here generalize those given by Holland [see theorem 5 in Holland (1960)]: our concept of frustration is related to Holland's notions of 'normally oriented' and 'inversely oriented' cycles.

6. *Reducing Mappings.* Using Goles-Chacc's results (1980), it is possible to design an algorithm to obtain the maximum period of a homogeneous network composed of either mapping AND or mapping OR. An example is given in Figure 6. A brief outline of the proof is given in

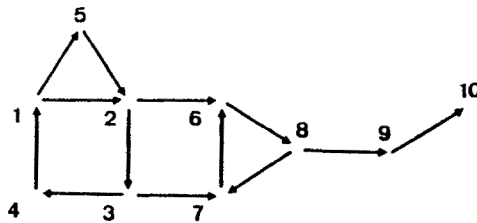

Figure 6. Network composed of two fully connected subnetworks (modules 1, 2, 3, 4, and 5 on the one hand, and modules 6, 7 and 8 on the other). Subnetwork 1, 2, 3, 4, 5 contains 2 loops: 1, 5, 2, 3, 4 and 1, 2, 3, 4. Hence its only possible period is 1. Thus the full network, if only composed of AND or OR modules, has a maximum period of 3, according to the algorithm given in the text.

Appendix 2. The algorithm is the following: decompose the network into fully connected subnetworks $G_1 \dots G_k$; this means that in G_i , any point can be reached from any other point in G_i by a series of oriented arrows; decompose each fully connected subnetwork into loops (elementary circuits); any period of a loop divides the number of nodes of the loop; any period of a fully connected subnetwork G_i is a divisor of the highest common factor $g(G_i)$ of the lengths of all the loops that can be drawn in the subnetwork; the maximum period of the network is then the least common multiple of the maximum periods $g(G_i)$ of the fully connected subnetworks.

In a fully connected subnetwork with a large number of loops of different lengths the highest common factor is often one, which explains the easy formation of large regions of fixed nodes. The derivation of the algorithm is based on the fact that laws AND and OR are monotonic, and thus that the dynamics of the network can be represented in matrix form by an equation $\mathbf{X}_t = \mathbf{A}\mathbf{X}_{t-1}$ or $\mathbf{X}_t = \mathbf{A}'\mathbf{X}_0$, where \mathbf{X}_0 is the initial conditions matrix (see Appendix 2).

This algorithm is thus based on the consideration of the connection structure. We show that the periods are related to the number and size of loops in the network or equivalently, stated in Holland's words (1960), that the complexity of the state transition graph depends on the complexity of the feedback loops in the net.

Of course, these results cannot be easily generalized to any combination of mappings, but the concepts of fully connected network and loops remain important.

7. The General Case: Non-homogeneous Networks. In this section we propose an algorithm to predict the possible periods and organization into subnets of a Boolean network whose connection structure is completely determined. In real-world situations it may happen that the connections are not known in full detail; our algorithm could then be used in an

heuristic fashion to provide some insight into the real connection structure.

This algorithm works in 3 steps.

(i) *The search for the stable components.* The network is decomposed into fully connected subnetworks. In each subnetwork, elementary circuits or loops are investigated. If all inputs coming from elements outside the loop are held constant, the apparent function of each element of the loop is then a transfer mapping. Hence, for each combination of external inputs, the loop can be viewed as a homogeneous loop with transfer mappings. We can then find if it is frustrated or not, and which configurations of internal states can make it stable.

Once this analysis has been made for all the loops we have to select for every pair of connected loops only those configuration which are consistent, namely those for which the connection nodes are in the same state.

We have thus selected configurations of elements which could belong to the stable component.

(ii) *The search for frontiers.* The next step is to look for the input frontier of the stable component. Such a frontier is made of stable elements with one of their inputs oscillating, the other being stable. These elements may have as Boolean mappings: transfer functions, the functional input of which comes from the stable component; reducing functions, the state of which is fully determined by their input from the stable component: their forcing input is stable.

In no case can such an element have a No. 6 or 9 mapping.

These two first steps allow one to predict the stable components and thus to define the different oscillating subnets.

(iii) *The dynamics of the oscillating subnets.* These have to be directly investigated by ordinary methods. Since the subnets are smaller than the entire network, this analysis is simpler (since the number of states varies as 2^N).

8. Conclusion. The analysis given above is not easily implemented for large, non-homogeneous networks. The corresponding algorithm is not as fast as those given for homogeneous networks of either transfer or reducing mappings. Nethertheless, it allows us to understand the origin of the organization of the whole network into stable components and oscillating subnets.

The analysis exemplifies the differences of roles of Nos 6 and 9 mappings and reducing or transfer mappings. Only reducing or transfer mappings can play the role of frontiers, allowing the existence of a stable component (and thus the particular behavior of Kauffman's networks).

The main reason for the existence of short periods is not randomness since random networks composed of Nos 6 and 9 nodes have large periods and no structure. Short periods are due to the presence of nodes with reducing or transfer mappings, which allow the appearance of frontiers separating oscillating regions from the stable component.

The analysis also shows the role of the intricacy of connections in the asymptotic organization of the network; fully connected components and feedback loops must be taken into account to explain periods and subnets.

These two points have previously been developed separately in the literature. This paper shows that both must be considered in a comprehensive study of Boolean networks.

APPENDIX I

Homogeneous Networks of Transfer Mappings. We determine the periods of the different limit cycles of a loop (we characterize only the smallest periods: any period is then a multiple of these).

Let us describe the state of module i at time t as a signal $S(i, t)$ moving along the loop. Since the loop has no external input, to determine $S(i, t)$ from the state vector of the loop at time $t - p$, we only need to know the state of module $i - p$ ($i - p$ is to be understood as a congruence class modulo n where n is the number of modules in the loop). This is written

$$S(i, t) = g_{i-p}^p[S(i-p, t-p)],$$

where g_{i-p}^p is the equivalent of a propagator or a Green function. Its determination is very easy: we calculate the parity of the number of inverting modules between $i - p$ and i . If it is odd the signal is inverted, otherwise it is not.

(a) *Case of non-frustrated loops.*

PROPOSITION 1. *The period of a non-frustrated loop of n modules can be any divisor k of n .*

Proof. The n modules loop can be divided into l segments of length k (with $n = kl$). It is then possible to build an initial state vector X_0 which leads to a limit cycle of period k in the following way.

On the first segment the initial state of modules $1 \dots k$ are chosen arbitrarily: $x_1^0 \dots x_k^0$. We take as initial states x_j^0 of the second segment, the transform of the states of the first segment by functions g_{j-k}^k :

$$x_j^0 = g_{j-k}^k(x_{j-k}^0) \quad \text{for } j = k+1, \dots, 2k.$$

This operation is done for all the other segments in the same way: the state of a module in segment i ($i = 2, \dots, l$) is determined by application of a function g^k to the initial state, previously computed, of the corresponding module in segment $i - 1$.

$X_0 = (x_1^0 \dots x_n^0)$ is then a fixed point of F^k [where the dynamics of the loop are represented by $X_{t+1} = F(X_t)$]. To prove this it is sufficient to prove that any segment is stable under g^k . (A_1).

This is true by construction for the $(l - 1)$ last segments. The state of any module of the first segment is

$$x_i^k = S(i, k) = g_{i-k}^k S(i-k, 0) = g_{i-k}^k \circ g_{i-2k}^k \circ \dots \circ g_i^k S(i, 0),$$

since $i - n \equiv i \pmod{n}$. The successive applications of functions g^k l times correspond to a

full turn along the loop, which restores the signal identical to itself. Proposition (A₁) is then also true for the first segment.

k is then the period of the limit cycle corresponding to X_0 .

Conversely, let us suppose that there exists a period q which is not a divisor of n . Since the signal is always restored after one turn around the loop, n is also a period. There exists then a smaller period which is the HCF of n and q . The period is then a divisor of n .

(b) *Frustrated loops.*

PROPOSITION 2. *The period of a frustrated loop of n modules is $2k$, where k is any divisor of n such that n/k is odd.*

Proof. The idea is to build an initial state vector X_0 in a similar manner as we did for non-frustrated loops. But since after one turn around the loop the signal is inverted, we have to choose the segments in such a way as to close the loop in the process of composing function g^p after two turns, which restores the signal.

The n -modules loop is divided into $2l + 1$ segments of length k [with $n = (2l + 1)k$]. On the first segment, the initial states of modules $1 \dots k$ are chosen arbitrarily: $x_1^0 \dots x_k^0$. The state of a module in segment 3 is defined by

$$x_j^0 = g_{j-2k}^{2k}(x_{j-2k}^0) \quad j = 2k + 1, \dots, 3k.$$

The state of a module in segment i ($i = 3, 5, \dots, 2l + 1, 2, 4, \dots, 2l$) is determined by the image under g^{2k} of the initial state of the corresponding module in segment $i - 2$ ($2l + 1$ if $i = 2$).

$X_0 = (x_1^0 \dots x_n^0)$ is then a fixed point under F^{2k} . By construction, segments $2 \dots 2l + 1$ are stable under g^{2k} . The state of a module in segment 1 is such that

$$x_i^{2k} = g_{i-2k}^{2k} \circ \dots \circ g_i^{2k}(x_i^0).$$

The successive applications of functions g^{2k} $2l + 1$ times correspond to two full turns around the loop, which restores the signal. This is the reason why n/k must be odd: otherwise the composition process could be closed after an odd number of turns around the loop, leaving the signal inverted (because of frustration).

Hence segment 1 is also stable under g^{2k} , which ends the proof of proposition 2.

The preceding discussion was concerned with loops without periodicity in the distribution of mappings. In the case of a loop built according to q repetitive patterns of mappings, the periods are those of a loop of length n/q , whose frustration is the frustration of the pattern.

Remark. Non-frustrated loops have also been called 'positive loops' (see Thomas, 1979). They play an important role in models of control of immunity.

APPENDIX 2

Homogeneous Networks 'OR' (see Goles-Chacc, 1980). We consider here a homogeneous network where all n modules have the same Boolean function OR (No. 14). To this network corresponds a graph G , the vertices of which are the modules of the network. Arc (i, j) exists if module j receives an input from module i . Then if A is its incidence matrix, the dynamics of the network can be represented by the equation

$X_{t+1} = AX_t$, with $X_t = \begin{pmatrix} x_1^t \\ \vdots \\ x_n^t \end{pmatrix}$ and the matrix-operations are OR(+) and AND(\times), as usually in graph theory.

Let $\begin{pmatrix} A_{11} & \dots & A_{1k} \\ \vdots & \ddots & \vdots \\ 0 & \dots & A_{kk} \end{pmatrix}$ be the normal form of A (see Varga, 1962). Let $g(A_{ii})$ be the HCF of the lengths (number of vertices) of the elementary circuits of graph $G(A_{ii})$ (fully

connected component of graph G associated with A_{ii}). Take $g(A_{ii}) = 0$ if there is no circuit and let $p(A)$ be the least common multiple of $g(A_{ii})$ ($i = 1 \dots k$).

PROPOSITION. *Cycles are of length $T \leq p(A)$. If A is irreducible, then for any divisor k of $p(A)$ there exists a cycle of length k .*

The proof (see Goles-Chacc, 1980) makes use of the decomposition of irreducible matrices (see Gantmacher, 1959).

Remark. The AND function is the dual of the OR function [AND $(x_1, x_2) = \overline{\text{OR}(\bar{x}_1, \bar{x}_2)}$, where $\bar{0} = 1$ and $\bar{1} = 0$].

Hence all results for homogeneous 'OR' networks stand for homogeneous 'AND' networks (eventually exchanging the roles of 0 and 1).

APPENDIX 3

Homogeneous Networks of No. 6 and No. 9 Mappings. We consider here a homogeneous network where all n modules have Boolean function No. 6 or No. 9. If A is the incidence matrix of this network, the dynamics can be represented by the equation:

$$\mathbf{X}_{i+1} = \mathbf{A}\mathbf{X}_i + \mathbf{b}, \text{ where } \mathbf{X}_i = \begin{pmatrix} x_i^1 \\ \vdots \\ x_i^n \end{pmatrix} \text{ and } \mathbf{b} = \begin{pmatrix} b_1 \\ \vdots \\ b_n \end{pmatrix},$$

with $b_i = 0$ if module i has mapping No. 6 (XOR), or 1 if module i has mapping No. 9 (equivalence), and matrix operations are made in $\mathbb{Z}/2$ (+ is function XOR and \times is function AND).

Then there are two cases: A is nilpotent: there exists r such that $A^r = 0$ (take r as the smallest integer which satisfies this relation). Then the network has a unique fixed point which is given by: $\mathbf{X} = (\mathbf{A}^{r-1} + \dots + \mathbf{A} + \mathbf{I})\mathbf{b}$, and thus is independent of the initial conditions \mathbf{X}_0 ; A is not nilpotent: let r and q be the smallest integers such that $A^{r+q} = A^r$. Then the network has limit cycles whose lengths are divisors of nq [see Snoussi (1980) for proofs].

Applying these two results to plane lattices with loop connections and mappings No. 6 and No. 9 only, we can prove the results obtained by computer simulations: if $n = N \times N$ and $N = 2^k$, matrix A is nilpotent and there is a unique fixed point; otherwise there are limit cycles of length the divisors of N^2q . To our knowledge the problem of finding a bound for q is unsolved, except in particular cases (see Snoussi, 1980): hence the theoretical law describing the dependence of periods on N is still unknown.

We thank Prof. H. Atlan for helpful discussions and Dr J. Salomon for help in programming. We also want to acknowledge criticism and remarks made by the referees. This research was supported by a CNRS grant (ATP Analyse de Systèmes-ERA No. 373) and an INSERM (France)-CNRD (Israel) grant.

LITERATURE

- Aleksander, I. 1973. "Random Logic Nets: Stability and Adaptation". *Int. J. Man-Mach. Stud.* 5, 115-131.
- Atlan, H., F. Fogelman-Soulié, J. Salomon, G. Weisbuch. 1981. "Random Boolean Networks". *Cybernet. Systems* 12, 103-121.
- Balian, R., R. Maynard and G. Toulouse. (Eds.) 1979. "Ill Condensed Matter". Proceedings of Les Houches 1978, Summer School (North Holland).
- Gantmacher, F. 1959. *Applications of the Theory of Matrices*. New York: Wiley-Interscience.
- Gelfand, A. E. and C. C. Walker. 1977. "The Distribution of Cycle Lengths in a Class of Abstract Systems". *Int. J. Gen. Systems* 4, 39-45.



ETUDE DU GRAPHE DES CHEMINS
POUR DES RESEAUX DE CONTROLE LOGIQUE

En collaboration avec H. Snoussi,
Journal de la Soc. Franç. de Biometrie,
1981

Résumé : De récents travaux de R. THOMAS modélisent des phénomènes de contrôle génétique par une représentation booléenne. Ils posent le problème de l'étude du graphe des chemins construit à partir de fonctions booléennes compatibles avec un réseau de contrôle logique. P. VAN HAM et I. LASTERS ont établi des méthodes de réduction permettant de ramener le problème à l'étude de fonctions booléennes du type suivant :

$$F : \{0,1\}^n \rightarrow \{0,1\}^n$$

$$f_1(x) = g(x_2, \dots, x_n)$$

$$f_i(x) = x_i, \quad 2 \leq i \leq n$$

Ils ont étudié les fonctions g du type "and" et "or" pour le cas où $n=3$. Nous généralisons ce travail au cas où n est quelconque et où g est du type "and", "or", "or-exclusif" ou fonction à seuil.

Abstract : Recents research of R. THOMAS modelize genetic control phenomena by means of boolean representation. They pose the problem of studying the graph constructed from boolean functions which are derived from a logical control network. P. VAN HAM and I. LASTERS established methods reducing the problem to the study of boolean functions of the following type :

$$F : \{0,1\}^n \rightarrow \{0,1\}^n$$

$$f_1(x) = g(x_2, \dots, x_n)$$

$$f_i(x) = x_i, \quad 2 \leq i \leq n$$

They present results for functions g of "and" and "or" type in case $n = 3$. We generalize this work with any n and g of type "and", "or", "exclusive-or" and "threshold".

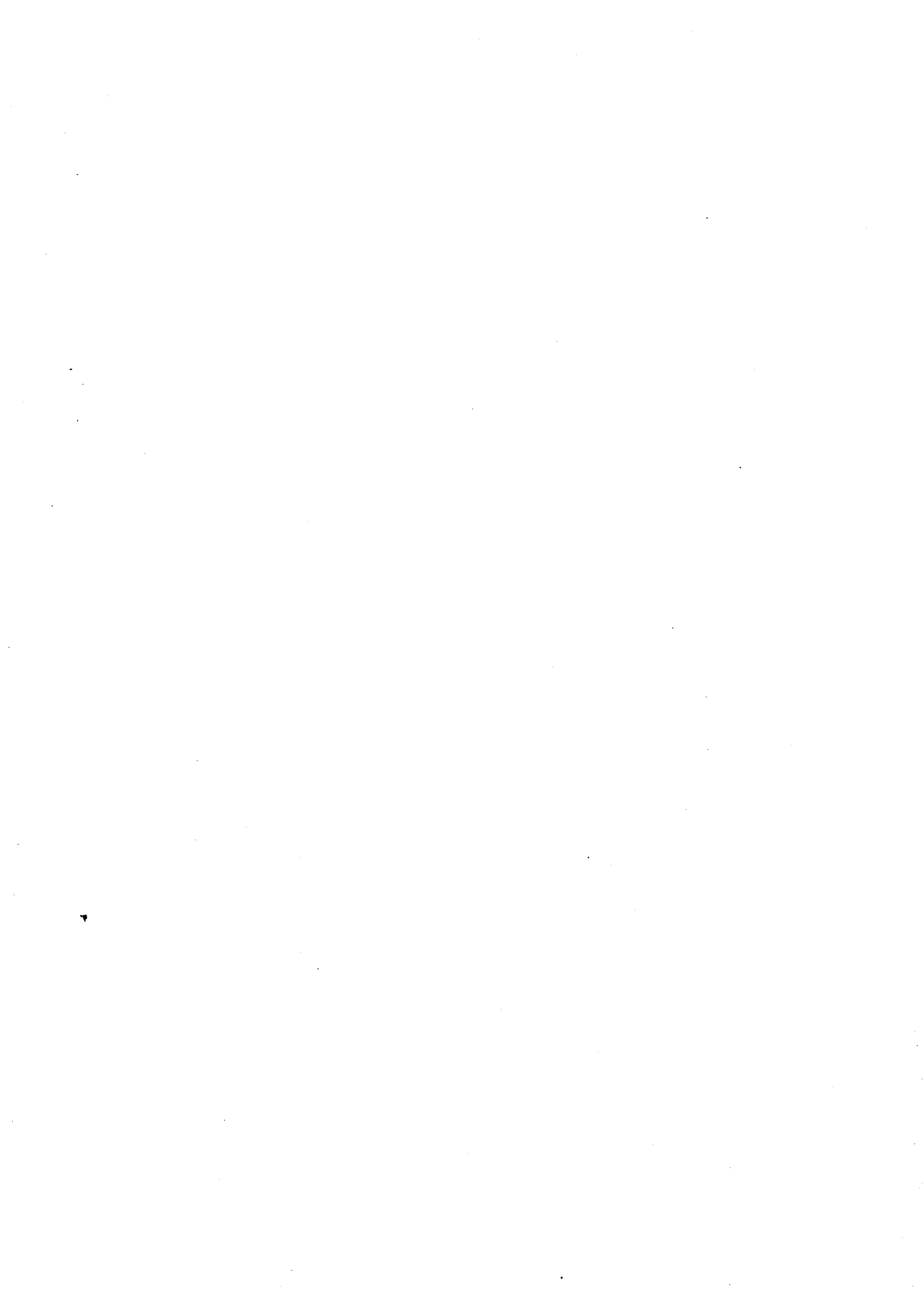

GRAPHE DES CHEMINS POUR
DES RESEAUX DE CONTROLE LOGIQUE

INTRODUCTION :

De récents travaux [1,2] ont modélisé les situations complexes de contrôle génétique à l'aide d'une représentation booléenne. Cette formulation ramène le problème de l'étude du comportement d'un gène, à la construction d'un graphe compatible avec une fonction booléenne.

$$F : \{0,1\}^n \rightarrow \{0,1\}^n$$

P. VANHAM et I. LASTERS [3] ont introduit des techniques de réduction permettant de se limiter à l'analyse des séquences temporelles d'états décrites par un système d'équations logiques du type suivant :

$$F : \{0,1\}^n \rightarrow \{0,1\}^n$$

$$x = (x_1, \dots, x_n) \rightarrow F(x) = (f_1(x), \dots, f_n(x))$$

avec $f_1(x)$ ne dépendant pas de x_1 et $f_i(x) = x_i$, $2 \leq i \leq n$

Dans ce travail, nous généralisons les résultats de VAN HAM et LASTERS, établis pour $n = 3$ et f_1 du type "et" et "ou", au cas où n est quelconque et f_1 du type "et", "ou", "ou-exclusif" ou fonction à seuil.

I - DEFINITIONS :

1 - graphe des chemins :

Pour une fonction $F : \{0,1\}^n \rightarrow \{0,1\}^n$, on définit le graphe des chemins G_F comme étant le graphe orienté des 2^n états possibles, et un successeur d'un sommet ρ est un sommet ρ' tel que :

$$\text{si } F(\rho) = \rho' \text{ alors } \rho' = \rho$$

sinon, ρ' vérifie :

$$d(\rho, \rho') = 1 \text{ et } d(F(\rho), \rho') = d(F(\rho), \rho) - 1$$

$$\text{avec } d(x, y) = \sum_{i=1}^n |x_i - y_i|$$

2 - état stable :

Un sommet ρ de G_F est un état stable si $F(\rho) = \rho$

3 - cycle instable :

C'est un circuit élémentaire de G_F qui contient au moins un sommet ayant un successeur hors du circuit.

4 - jardin d'Eden :

C'est un sommet n'ayant pas d'antécédent.

5 - ensemble attractif d'un état stable :

Soit ρ un état stable de G_F , on définit l'ensemble attractif de ρ , noté A_ρ , par

$$\rho \in A_\rho \text{ et}$$

si un sommet appartient à A_ρ alors tous ses successeurs appartiennent à A_ρ

Exemple :

$$f_1(x_1, x_2, x_3) = x_2 \bar{x}_3$$

$$f_2(x_1, x_2, x_3) = x_1$$

$$f_3(x_1, x_2, x_3) = x_1$$

x_1	x_2	x_3	f_1	f_2	f_3
0	0	0	0	0	0
0	0	1	0	0	0
0	1	0	1	0	0
0	1	1	0	0	0
1	0	0	0	1	1
1	0	1	0	1	1
1	1	0	1	1	1
1	1	1	0	1	1

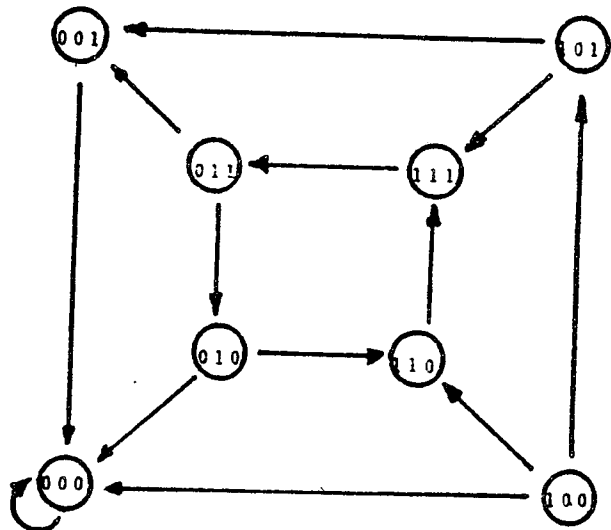

- * l'état (000) est un état stable
- * l'ensemble attractif de (000) est $\{(000), (001)\}$
- * $\{(011), (010), (110), (111)\}$ est un cycle instable
- * (100) est un jardin d'Eden.

Notation :

soient $x = (x_1, x_2, \dots, x_n) \in \{0, 1\}^n$ et $\alpha = (\alpha_1, \alpha_2, \dots, \alpha_n) \in \{0, 1\}^n$

on pose $x^\alpha = (x_1^{\alpha_1}, \dots, x_n^{\alpha_n})$

avec $x_i^{\alpha_i} = \begin{cases} x_i & \text{si } \alpha_i = 1 \\ \bar{x}_i & \text{si } \alpha_i = 0 \end{cases}$

II - ETUDE DES FONCTIONS DE "TYPE PRODUIT" :

Une fonction de type produit est définie de la manière suivante :

$$F_{\alpha} : \{0,1\}^n \rightarrow \{0,1\}^n$$

$$(x_1, x_2, \dots, x_n) \rightarrow (f_1(x), x_1, \dots, x_n)$$

avec $f_1(x) = x_2^{\alpha_2} \dots x_n^{\alpha_n}$.

$\alpha = (\alpha_2, \dots, \alpha_n) \in \{0,1\}^{n-1}$ étant fixé, une telle fonction possède les propriétés élémentaires suivantes :

a - $F_{\alpha} (1, \alpha_2, \dots, \alpha_n) = (1, 1, \dots, 1)$

b - $F_{\alpha} (0, \alpha_2, \dots, \alpha_n) = (1, 0, \dots, 0)$

c - $F_{\alpha} (1, x_2, \dots, x_n) = (0, 1, \dots, 1)$ si $(x_2, \dots, x_n) \neq \alpha$

d - $F_{\alpha} (0, x_2, \dots, x_n) = (0, 0, \dots, 0)$ si $(x_2, \dots, x_n) \neq \alpha$

e - si $\alpha = (1, 1, \dots, 1) \in \{0,1\}^{n-1}$, alors $(0, 0, \dots, 0)$ et $(1, 1, \dots, 1)$ sont les uniques points fixes de F_{α}

f - si $\alpha = (0, 0, \dots, 0) \in \{0,1\}^{n-1}$, alors F_{α} n'a pas de point fixe

g - si $\alpha \neq (1, 1, \dots, 1)$ et $\alpha \neq (0, 0, \dots, 0)$, alors $(0, 0, \dots, 0)$ est l'unique point fixe de F_{α}

Pour la construction du graphe des chemins G_{α} , nous utiliserons la notation condensée suivante :

$$X_k^{\epsilon} = \{x \in \{0,1\}^n ; x_1 = \epsilon, \sum_{i=2}^n x_i = k \text{ et } (x_2, \dots, x_n) \neq (\alpha_2, \dots, \alpha_n)\}$$

Théorème :

Le graphe des chemins G_{α} , associé à F_{α} , possède les propriétés suivantes :

1) Si $\alpha \neq (0, 0, \dots, 0)$ et $\alpha \neq (1, 1, \dots, 1)$

* l'état $(0, 0, \dots, 0)$ est l'unique état stable et son domaine d'attraction est l'ensemble $\bigcup_{i=1}^p X_i^0$ où $p = \sum_{i=2}^n \alpha_i$.

* G_{α} possède des cycles instables de longueur $2k$ pour $k = 2, 3, \dots, (n-p)$

* $(1, 0, \dots, 0)$ est un jardin d'Eden

2) si $\alpha = (0, 0, \dots, 0)$

* $G_{\mathbb{F}}$ n'a pas d'état stable

* $G_{\mathbb{F}}$ possède des cycles instables de longueur $2k$, $k = 2, 3, \dots, n$

3) si $\alpha = (1, 1, \dots, 1)$

* $(0, 0, \dots, 0)$ et $(1, 1, \dots, 1)$ sont les uniques états stables de $G_{\mathbb{F}}$

* le domaine d'attraction de $(0, 0, \dots, 0)$ est $\bigcup_{i=1}^{n-2} X_i^0$

* le domaine d'attraction de $(1, 1, \dots, 1)$ est vide

* $G_{\mathbb{F}}$ n'admet pas de cycles

* $(0, 1, 1, \dots, 1)$ et $(1, 0, \dots, 0)$ sont des jardins d'Eden

Démonstration :

Tous les résultats énoncés se déduisent directement de la construction du graphe $G_{\mathbb{F}}$

1er cas : $\alpha \neq (0, 0, \dots, 0)$ et $\alpha \neq (1, 1, \dots, 1)$,, posons $p = \sum_{i=2}^n \alpha_i$

* soit $x \in X_k^0$, $k \neq 0$, alors $F_{\mathbb{F}}(x) = (0, 0, \dots, 0)$

Un suivant ξ de x est tel que $\xi_1 = 0$ et une composante de x non nulle et une seule prend la valeur 0, donc $\xi \in X_{k-1}^0$

Dans le cas où $k = 0$ i.e $x = (0, 0, \dots, 0)$ alors x est un état stable

* soit maintenant $x \in X_k^1$ alors $F_{\mathbb{F}}(x) = (0, 1, \dots, 1)$

si $k \neq n-1$, x possède, dans $G_{\mathbb{F}}$, deux types de successeur l'un appartenant à X_k^0 l'autre à X_{k+1}^1

si $k = n-1$, i.e $x = (1, 1, \dots, 1)$, x possède un seul successeur $(0, 1, \dots, 1)$

* si $x = (0, \alpha_2, \dots, \alpha_n)$ alors $F_{\mathbb{F}}(x) = (1, 0, \dots, 0)$ et x possède deux successeurs $(1, \alpha_2, \dots, \alpha_n)$, ou bien un élément de X_{p-1}^0

* si $x = (1, \alpha_2, \dots, \alpha_n)$ alors $F_{\mathbb{F}}(x) = (1, 1, \dots, 1)$

et un successeur ξ de x est tel que une composante nulle (et une seule) de

α prenne la valeur 1, c'est-à-dire que $\xi \in X_{p+1}^1$; d'où le graphe des chemins :

ler cas : $\alpha \neq (0, \dots, 0)$ et $\alpha \neq (1, \dots, 1)$

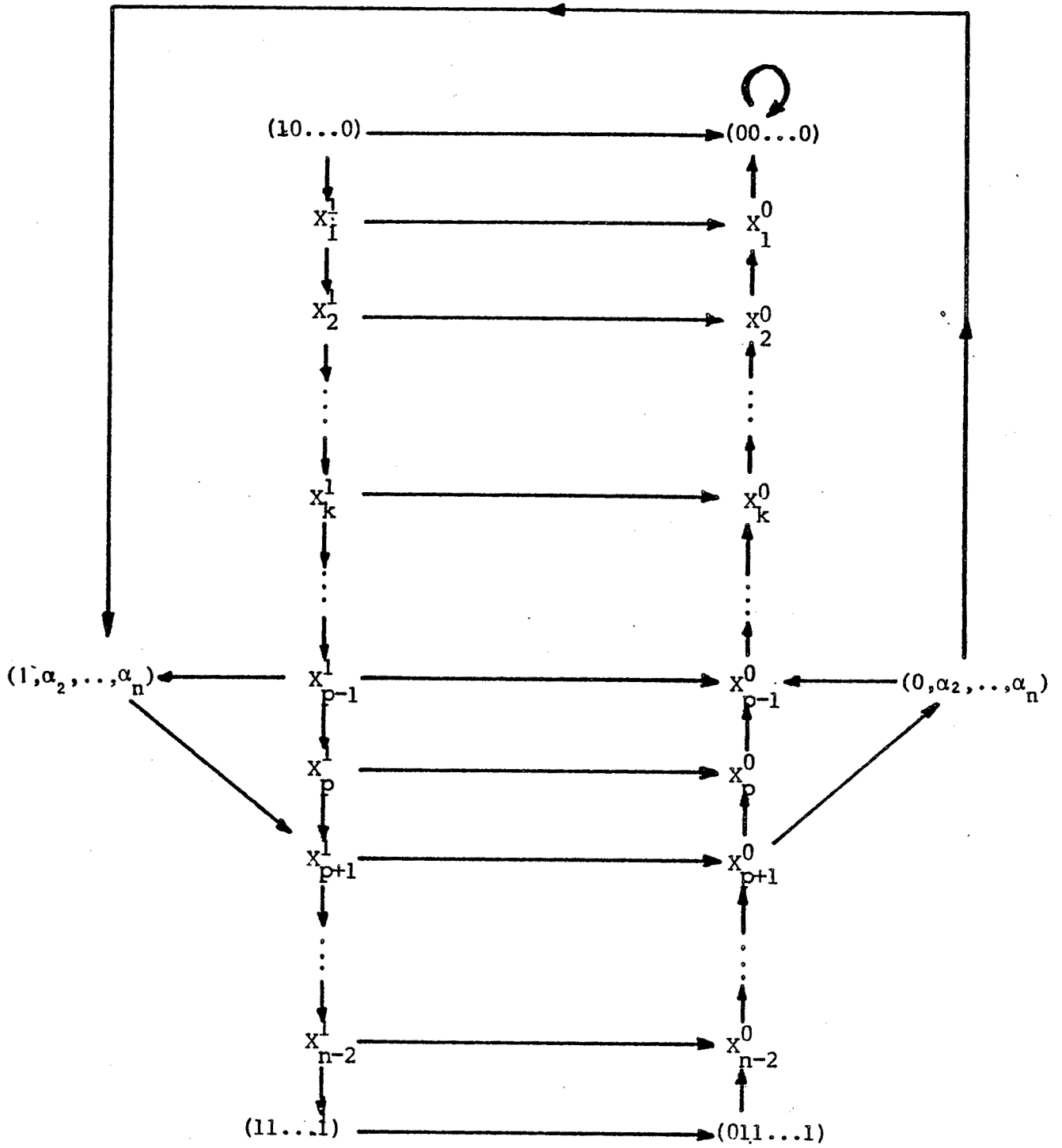

2e cas : $\alpha = (0,0,\dots,0)$

On obtient le graphe suivant :

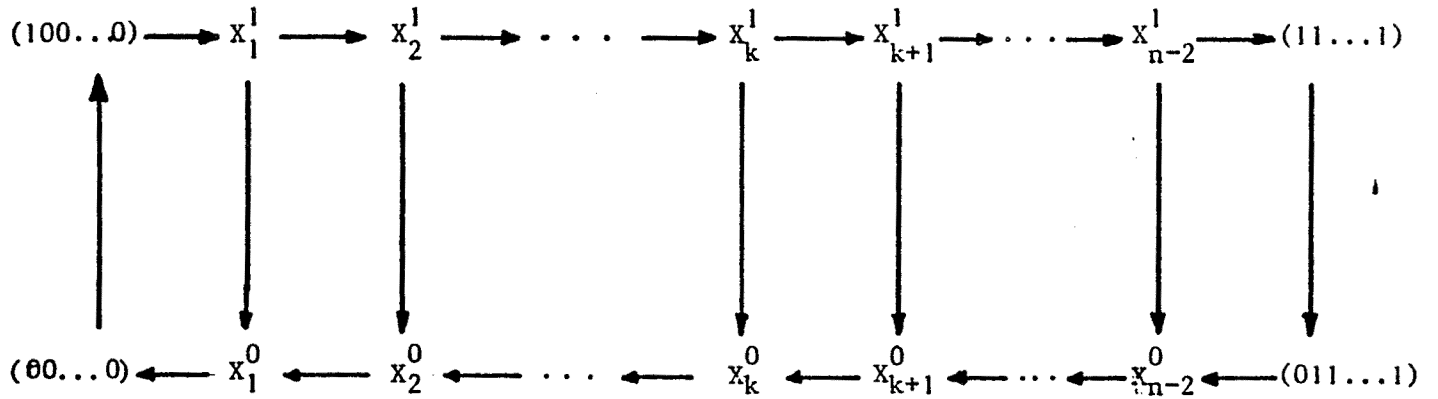

3e cas : $\alpha = (1,1,\dots,1)$

On obtient le graphe suivant :

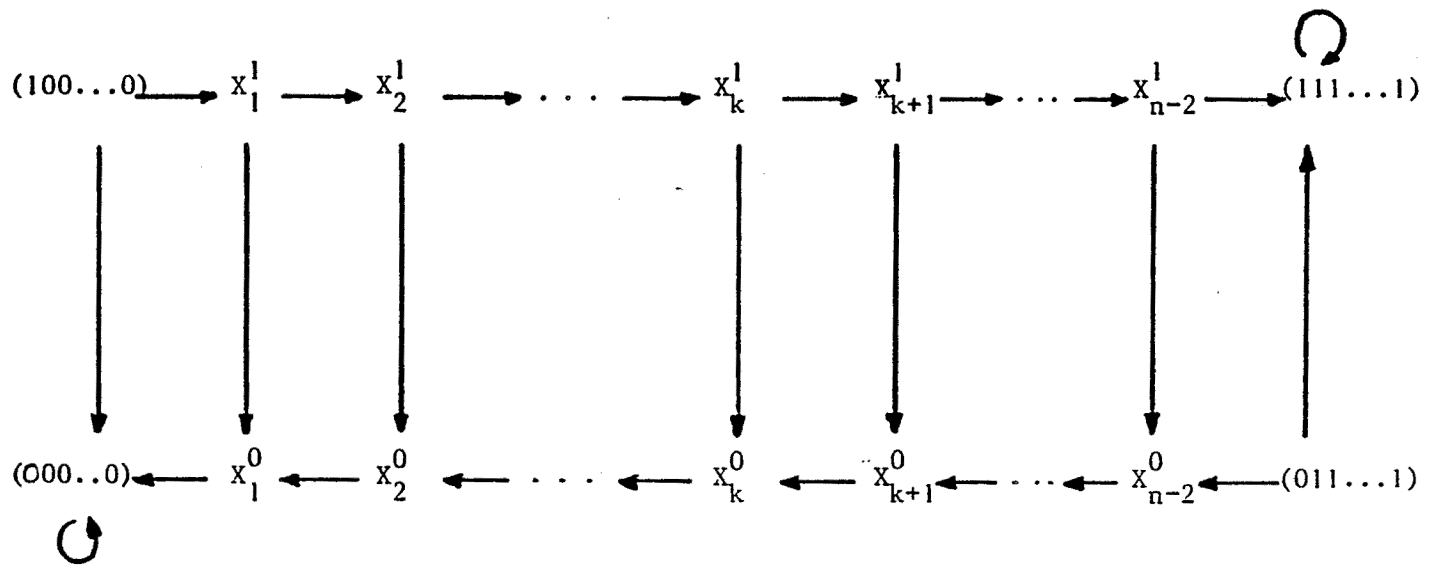

III - ETUDE DES FONCTIONS DE "TYPE SOMME" :

$$\text{Soit } F_{\Sigma} : \{0,1\}^n \rightarrow \{0,1\}^n$$

$$(x_1, x_2, \dots, x_n) \rightarrow (f_1(x), x_1, \dots, x_1)$$

$$\text{où } f_1(x) = \sum_{i=2}^n x_i^{\alpha_i} \quad (\Sigma : \text{somme booléenne}).$$

La construction de G_{Σ} , associé à F_{Σ} , se déduit de G_{η} associé à F_{η} , d'après la proposition suivante :

Proposition :

Les graphes G_{η} et G_{Σ} se déduisent l'un de l'autre par l'isomorphisme :

$$x \rightarrow \bar{x} .$$

Démonstration :

Il suffit de montrer que si x est un successeur de y sur G_{η} alors \bar{x} est un successeur de \bar{y} sur G_{Σ} et réciproquement.

Posons :

Γ_x^{η} l'ensemble des successeurs de x dans G_{η}

et Γ_x^{Σ} l'ensemble des successeurs de x dans G_{Σ}

Notons d'abord que y est un état stable pour G_{η} si et seulement si \bar{y} est un état stable pour G_{Σ} . Il suffit de remarquer que :

$$\forall x \in \{0,1\}^n : F_{\Sigma} \bar{x} = \overline{F_{\eta} x} .$$

Soit x un état non stable de G_{η} (et de G_{Σ})

alors $y \in \Gamma_x^{\eta} \Leftrightarrow d(x, y) = 1$ et $d(F_{\eta} x, y) = d(F_{\eta} x, x) - 1$

$$\Leftrightarrow d(\bar{x}, \bar{y}) = 1 \text{ et } d(\overline{F_{\eta} x}, \bar{y}) = d(\overline{F_{\eta} x}, \bar{x}) - 1$$

$$\Leftrightarrow d(\bar{x}, \bar{y}) = 1 \text{ et } d(F_{\Sigma} \bar{x}, \bar{y}) = d(F_{\Sigma} \bar{x}, \bar{x}) - 1$$

$$\Leftrightarrow \bar{y} \in \Gamma_{\bar{x}}^{\Sigma} .$$

Le théorème 1 nous permet alors d'affirmer les propriétés suivantes du graphe G_{Σ} :

1) Si $\alpha \neq (0,0,\dots,0)$ et $\alpha \neq (1,1,\dots,1)$

* l'état $(1,1,\dots,1)$ est l'unique état stable et son domaine d'attraction est l'ensemble $\bigcup_{i=2}^{p+1} X_i^{n-i}$ où $p = \sum_{j=2}^n \alpha_j$

* G_Σ possède des cycles instables de longueur $2k$, $k = 2,3,\dots, (n-p)$

* $(0,1,1,\dots,1)$ est un jardin d'Eden

2) Si $\alpha = (0,0,\dots,0)$

* G_Σ n'a pas d'état stable

* G_Σ possède des cycles instables de longueur $2k$ $k = 2,3,\dots,n$

3) Si $\alpha = (1,1,\dots,1)$

* $(0,0,\dots,0)$ et $(1,1,\dots,1)$ sont les uniques états stables de G_Σ

* le domaine d'attraction de $(0,0,\dots,0)$ est vide et celui de $(1,1,\dots,1)$ est l'ensemble $\bigcup_{i=1}^{n-2} X_i^1$

* G_Σ n'a pas de cycle

* $(0,1,1,\dots,1)$ et $(1,0,\dots,0)$ sont des jardins d'Eden.

IV - ETUDE DES FONCTIONS DE "TYPE OU-EXCLUSIF" :

Soit

$$F_{\oplus} : \{0,1\}^n \rightarrow \{0,1\}^n$$

$$(x_1, \dots, x_n) \rightarrow (f_1(x), x_1, x_1, \dots, x_1)$$

avec $f_1(x) = \bigoplus_{i=2}^n x_i^{\alpha_i}$

$$\alpha = (\alpha_2, \dots, \alpha_n) \in \{0,1\}^{n-1}$$

\oplus : somme dans le corps $\mathbb{Z}/2\mathbb{Z}$

Une telle fonction peut s'écrire sous la forme :

$$F_{\oplus}(x) = A x \oplus b$$

avec

$$A = \begin{bmatrix} 0 & 1 & 1 & \dots & 1 \\ 1 & 0 & 0 & \dots & 0 \\ \cdot & & & & \\ \cdot & & & & \\ \cdot & & & & \\ 1 & 0 & 0 & \dots & 0 \end{bmatrix}$$

matrice $(n \times n)$ à éléments dans $\mathbb{Z}/2\mathbb{Z}$

$$b = \begin{bmatrix} \varepsilon \\ 0 \\ \cdot \\ \cdot \\ \cdot \\ 0 \end{bmatrix} \in \{0,1\}^n$$

$$\text{et } \varepsilon = \begin{cases} 1 & \text{si } |\bar{\alpha}| = \sum_{i=2}^n \bar{\alpha}_i \text{ est impair} \\ 0 & \text{sinon} \end{cases}$$

Remarque : Il est clair que l'analyse du graphe des chemins G_{\oplus} dépend de la parité de $|\bar{\alpha}|$ et de n .

La fonction F_{\oplus} ainsi définie possède les propriétés élémentaires suivantes :

- * Si $|\bar{\alpha}|$ est pair et n pair alors $(0,0,\dots,0)$ et $(1,1,\dots,1)$ sont les uniques états stables de G_{\oplus} ,
- * Si $|\bar{\alpha}|$ pair et n impair alors $(0,0,\dots,0)$ est l'unique état stable de G_{\oplus} ,
- * Si $|\bar{\alpha}|$ impair et n impair alors $(1,1,\dots,1)$ est l'unique état stable de G_{\oplus} ,
- * Si $|\bar{\alpha}|$ impair et n pair alors G_{\oplus} n'a pas d'état stable.

Construction des graphes des chemins.

Nous considérons, comme précédemment, les ensembles :

$$X_k^{\varepsilon} = \{ x \in \{0,1\}^n ; x_1 = \varepsilon \text{ et } \sum_{i=2}^n x_i = k \}$$

La construction des graphes repose sur le principe suivant :

supposons que $|\bar{\alpha}|$ est pair et n est pair et soit $x \in X_k^0$ par exemple .

On a alors : $F_{\oplus}(x) = (f_1(x), 0, 0, \dots, 0)$

$$\text{avec } f_1(x) = \begin{cases} 1 & \text{si } k \text{ est impair} \\ 0 & \text{sinon} \end{cases}$$

Donc si k est pair, un successeur ξ de x s'obtient en changeant une composante non nulle de x (et une seule) par 0 ; i.e $\xi \in X_{k-1}^0$

Si k est impair, $F_{\oplus}(x) = (1, 0, \dots, 0)$, et x admet deux types de successeurs

ξ et ζ : ξ s'obtient en changeant seulement $x_1 = 0$ par $x_1 = 1$ i.e $\xi \in X_k^1$

et ζ s'obtient en changeant une composante non nulle de x par 0 i.e $\zeta \in X_{k-1}^0$

Un raisonnement analogue permet de construire le graphe des chemins et établir le théorème suivant :

Théorème :

Le graphe des chemins G_{\oplus} , associé à la fonction F_{\oplus} possède les propriétés suivantes :

- 1) si $|\bar{\alpha}|$ est pair et n pair

- * $(0,0,\dots,0)$ et $(1,1,\dots,1)$ sont les uniques états stables de G_{\oplus} et leur domaine d'attraction est vide,
- * $(0,1,1,\dots,1)$ et $(1,0,0,\dots,0)$ sont des jardins d'Eden,
- * G_{\oplus} possède des cycles instables de longueur $2k$, $k = 2,4,6,\dots,n-2$,

2) si $|\bar{\alpha}|$ est pair et n impair

- * $(0,0,\dots,0)$ est l'unique état stable de G_{\oplus} , et son domaine d'attraction est vide,
- * $(1,0,\dots,0)$ est un jardin d'Eden,
- * G_{\oplus} admet des cycles instables de longueur $2k$, $k = 2,4,6,\dots,n-1$

3) si $|\bar{\alpha}|$ est impair et n impair

- * $(1,1,\dots,1)$ est l'unique état stable de G_{\oplus} , et son domaine d'attraction est vide,
- * $(0,1,1,\dots,1)$ est un jardin d'Eden,
- * G_{\oplus} admet des cycles instables de longueur $2k$, $k = 2,4,6,\dots,n-1$

4) si $|\bar{\alpha}|$ est impair et n pair

- * il n'y a pas d'état stable ni de jardin d'Eden,
- * G_{\oplus} admet des cycles instables de longueur $2k$, $k = 2,4,\dots,n$.

Grphe des chemins pour $|\bar{\alpha}|$ pair et n pair :

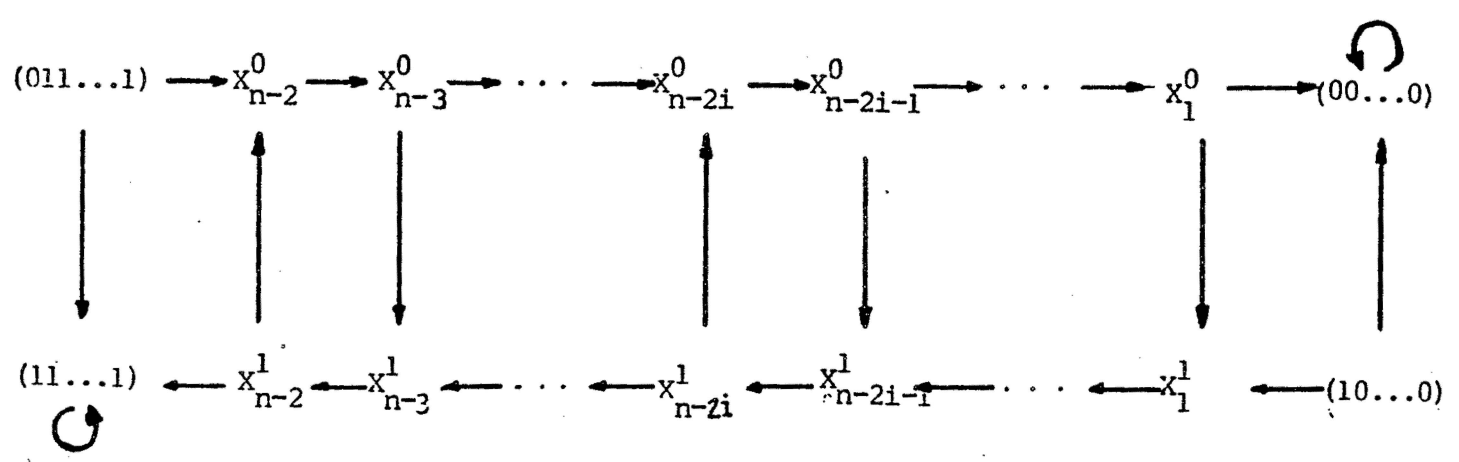

Grphe des chemins pour $|\bar{\alpha}|$ pair et n impair :

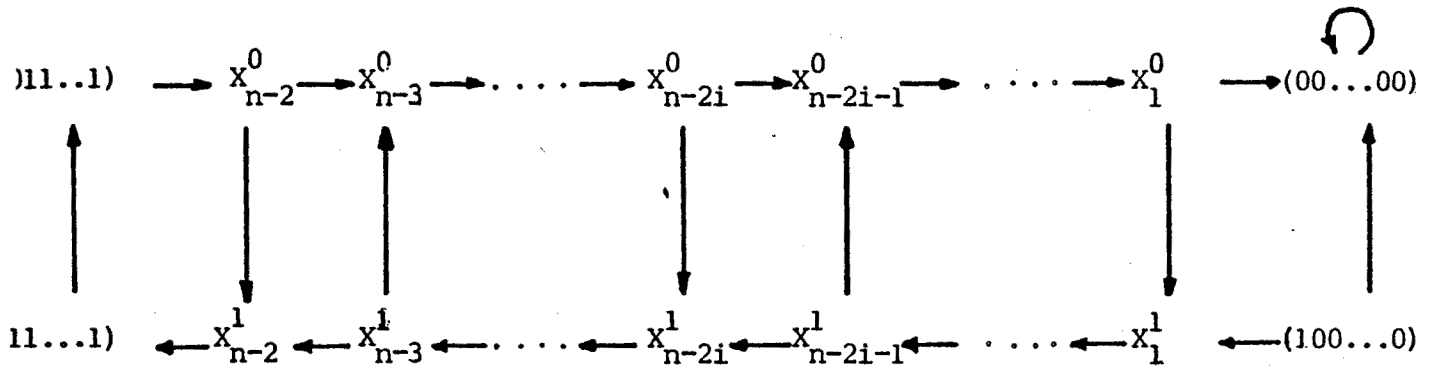

Grphe des chemins pour $|\bar{\alpha}|$ impair et n impair :

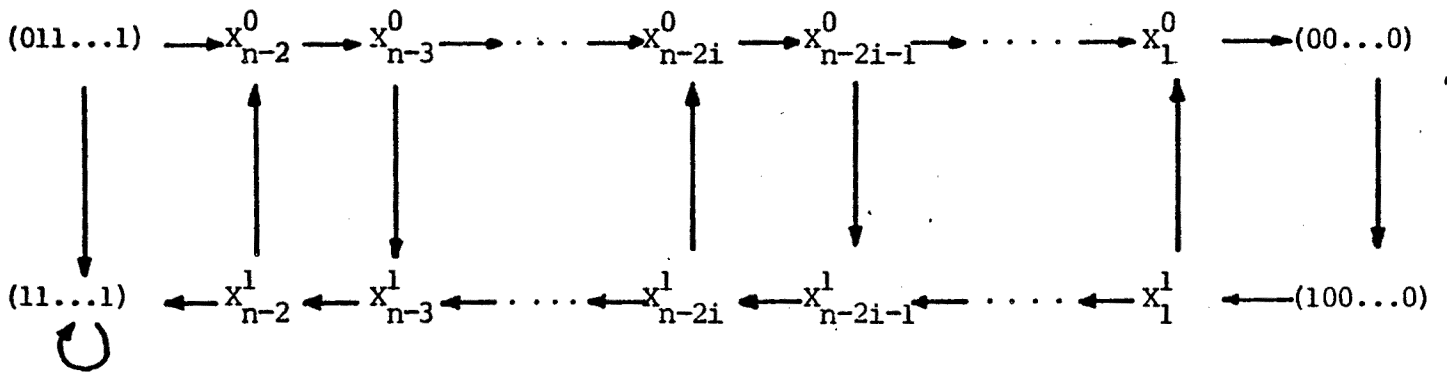

Grphe des chemins pour $|\bar{\alpha}|$ impair et n pair :

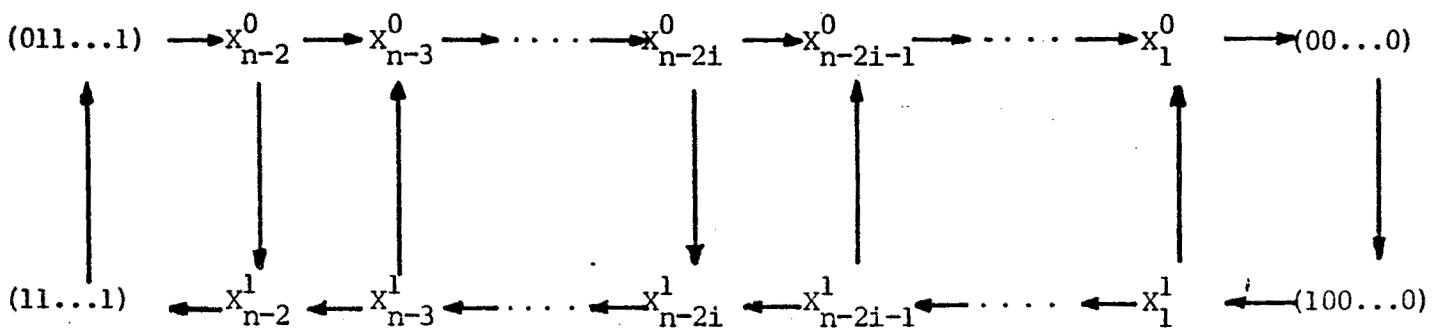

V - ETUDE DES FONCTIONS DE TYPE "SYMETRIQUES ELEMENTAIRES"

Soit $k \in \{0, 1, \dots, n-1\}$, considérons la fonction

$$F_k : \{0, 1\}^n \rightarrow \{0, 1\}^n$$

$$(x_1, \dots, x_n) \rightarrow (f_1(x), x_1, \dots, x_1)$$

avec $f_1(x) = \begin{cases} 1 & \text{si } \sum_{i=2}^n x_i = k \\ 0 & \text{sinon} \end{cases}$

La fonction F_k ainsi définie vérifie les propriétés élémentaires suivantes :

$$* F_k(1, x_2, \dots, x_n) = (1, 1, \dots, 1) \quad \text{si } \sum_{i=2}^n x_i = k$$

$$* F_k(0, x_2, \dots, x_n) = (1, 0, \dots, 0) \quad \text{si } \sum_{i=2}^n x_i = k$$

$$* F_k(1, x_2, \dots, x_n) = (0, 1, \dots, 1) \quad \text{si } \sum_{i=2}^n x_i \neq k$$

$$* F_k(0, x_2, \dots, x_n) = (0, 0, \dots, 0) \quad \text{si } \sum_{i=2}^n x_i \neq k$$

* F_0 n'a pas d'état stable

* F_{n-1} admet $(0, 0, \dots, 0)$ et $(1, 1, \dots, 1)$ comme uniques états stables

* Si $k \in \{1, \dots, n-2\}$, F_k admet $(0, 0, \dots, 0)$ comme unique état stable.

Pour la construction du graphe des chemins G_k , associé à F_k , nous utilisons la notation :

$$X_k^\varepsilon = \{x \in \{0, 1\}^n, x_1 = \varepsilon \text{ et } \sum_{i=2}^n x_i = k\}, \varepsilon \in \{0, 1\}$$

L'analyse du graphe G_k permet d'établir le théorème suivant :

Théorème :

Le graphe des chemins G_k , associé à la fonction F_k , possède les propriétés suivantes :

1) Si $k = 0$

* G_k n'a pas d'état stable,

* G_k admet des cycles instables de longueur $2k$, $k = 2, 3, \dots, n$.

2) Si $k = n-1$

* G_k admet $(0, 0, \dots, 0)$ et $(1, 1, \dots, 1)$ comme uniques états stables

* le domaine d'attraction de $(0, 0, \dots, 0)$ est l'ensemble $\bigcup_{i=1}^{n-2} X_i^0$ et celui de $(1, 1, \dots, 1)$ est vide

* G_k n'admet aucun cycle

3) Si $k \in \{1, \dots, n-2\}$

* $(0, 0, \dots, 0)$ est l'unique état stable de G_k et son domaine d'attraction est $\bigcup_{i=1}^{k-1} X_i^0$

* G_k admet des cycles instables de longueur $2k'$, $k' = 2, 3, \dots, n-k$.

* l'état $(1, 0, \dots, 0)$ est un jardin d'Eden

La démonstration est immédiate à partir de la construction des graphes G_k

Graphe des chemins pour $k = 0$

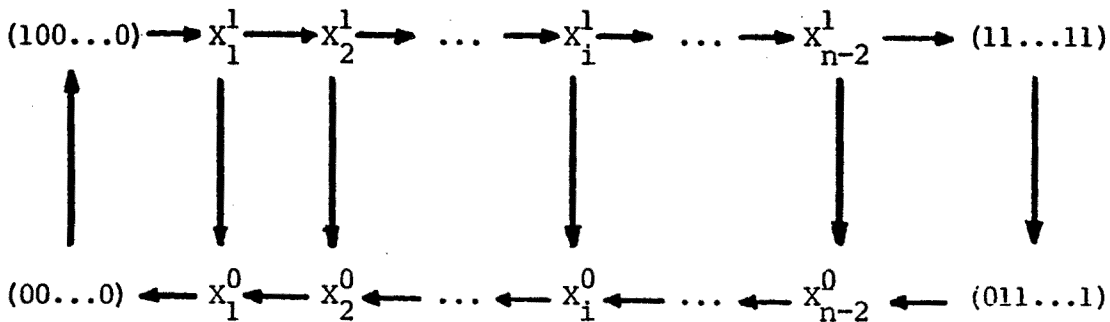

Grphe des chemins pour $k = n-1$

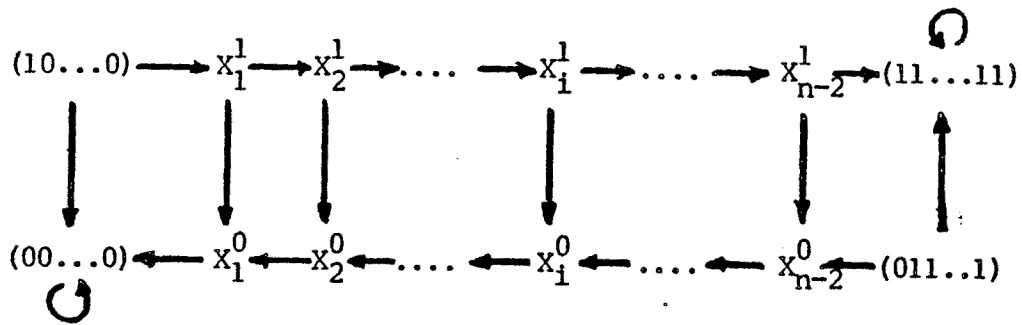

Grphe des chemins pour $k \in \{1, 2, \dots, n-2\}$

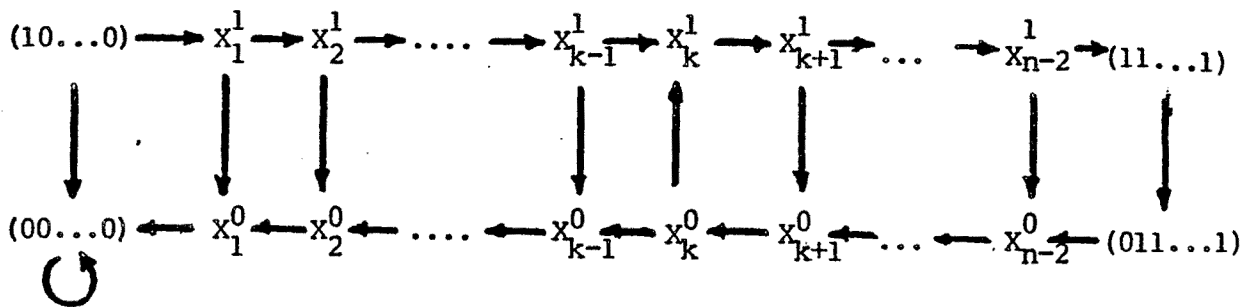

VI - ETUDE DES FONCTIONS DE "TYPE SEUIL"

Considérons la fonction F_S définie par :

$$F_S : \{0,1\}^n \rightarrow \{0,1\}^n$$

$$(x_1, \dots, x_n) \rightarrow (f_1(x), x_1, \dots, x_n)$$

$$\text{avec } f_1(x) = \begin{cases} 1 & \text{si } \sum_{i=2}^n x_i \geq k, \quad k \in \{1, \dots, n-1\} \\ 0 & \text{sinon} \end{cases}$$

La fonction F_S ainsi définie possède les propriétés élémentaires suivantes :

$$* F_S(1, x_2, \dots, x_n) = \begin{cases} (11\dots 1) & \text{si } \sum_{i=2}^n x_i \geq k \\ (01\dots 1) & \text{sinon} \end{cases}$$

$$* F_S(0, x_2, \dots, x_n) = \begin{cases} (100\dots 0) & \text{si } \sum_{i=2}^n x_i \geq k \\ (00\dots 0) & \text{sinon} \end{cases}$$

* $(00\dots 0)$ et $(11\dots 1)$ sont les uniques états stables.

Posons

$$X_p^\varepsilon = \{x \in \{0,1\}^n, x_1 = \varepsilon \text{ et } \sum_{i=2}^n x_i = p\}, \varepsilon \in \{0,1\}$$

Construction du graphe des chemins G_S , associé à F_S :

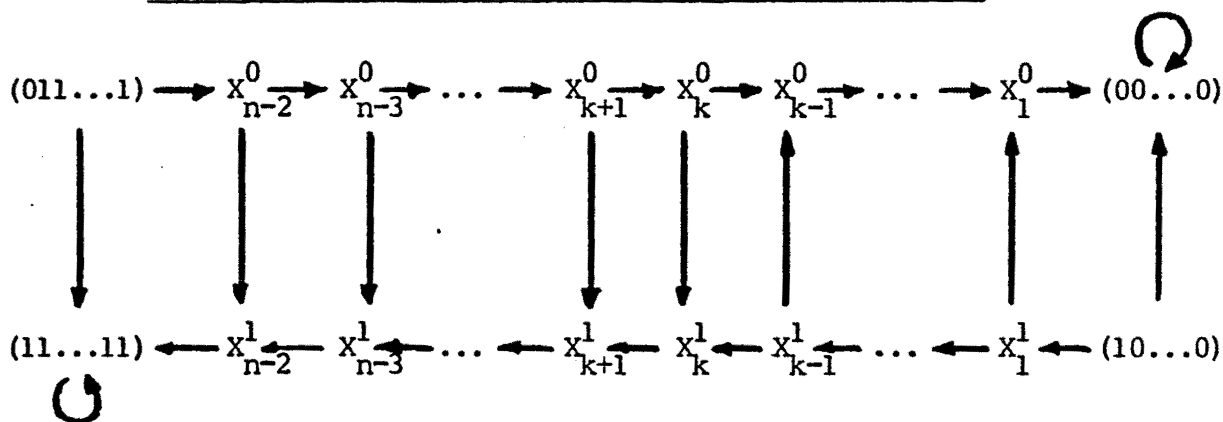

Théorème :

Le graphe des chemins G_S associé à F_S possède les propriétés suivantes :

* G_S admet $(0,0,\dots,0)$ et $(1,1,\dots,1)$ comme uniques états stables

* Le domaine d'attraction de $(000\dots 0)$ est $\bigcup_{i=1}^{k-1} X_i^0$
 et celui de $(1,1,\dots,1)$ est $\bigcup_{i=k}^{n-2} X_i^1$

* G_S n'admet pas de cycle

* $(011\dots 1)$ et $(100\dots 0)$ sont des jardins d'Eden

306
TABLEAU RECAPITULATIF

TYPE DE FONCTION	ETATS STABLES	DOMAINE D'ATTRACTION	JARDINS D'EDEN	LONGUEUR DES CYCLES INSTABLES	
F_{Π}	$\alpha \neq \vec{0}, \vec{1}$	$\vec{0}$	$\bigcup_{i=1}^p x_i^0, \alpha =p$	$(100\dots 0)$	$4, 6, 8, \dots, 2(n-p)$
	$\alpha = \vec{0}$	\emptyset	\emptyset	\emptyset	$4, 5, 3, \dots, 2n$
	$\alpha = \vec{1}$	$\vec{0}$ $\vec{1}$	$\bigcup_{i=1}^{n-2} x_i^0$ \emptyset	$(011\dots 1)$ $(100\dots 0)$	/
F_{Σ}	$\alpha \neq \vec{0}, \vec{1}$	$\vec{1}$	$\bigcup_{i=2}^{p+1} x_{n-i}^1, \alpha =p$	$(011\dots 1)$	$4, 6, 8, \dots, 2(n-p)$
	$\alpha = \vec{0}$	\emptyset	\emptyset	\emptyset	$4, 6, 8, \dots, 2n$
	$\alpha = \vec{1}$	$\vec{0}$ $\vec{1}$	$\bigcup_{i=1}^{n-2} x_i^1$	$(011\dots 1)$ $(100\dots 0)$	/
F_s	$\vec{0}$ $\vec{1}$	$\bigcup_{i=1}^{k-1} x_i^0$ $\bigcup_{i=k}^{n-2} x_i^1$	$(011\dots 1)$ $(100\dots 0)$	/	
F_k	$k = 0$	\emptyset	\emptyset	\emptyset	$4, 6, 8, \dots, 2n$
	$k = n-1$	$\vec{0}$ $\vec{1}$	$\bigcup_{i=1}^{n-2} x_i^0$ \emptyset	$(10\dots 0)$ $(01\dots 1)$	/
	$k \in \{1, \dots, n-2\}$	$\vec{0}$	$\bigcup_{i=1}^{k-1} x_i^0$	$(100\dots 0)$	$4, 6, 8, \dots, 2(n-k)$
F_{Θ}	$ \bar{\alpha} $ pair n pair	$\vec{0}$ $\vec{1}$	\emptyset	$(01\dots 1)$ $(10\dots 0)$	$4, 8, 12, \dots, 2n-4$
	$ \bar{\alpha} $ pair n impair	$\vec{0}$	\emptyset	$(1000\dots 0)$	$4, 8, 12, \dots, 2n-2$
	$ \bar{\alpha} $ impair n impair	$\vec{1}$	\emptyset	$(011\dots 1)$	$4, 8, 12, \dots, 2n-2$
	$ \bar{\alpha} $ impair n pair	\emptyset	\emptyset	\emptyset	$4, 8, 12, \dots, 2n$

BIBLIOGRAPHIE

- (1) THOMAS R. "Boolean formalization of genetic control circuits"
J. Theor. Biol. (1973) 42, 563
- (2) THOMAS R. "Logical Analysis of systems comprising feedback loops"
J. Theor. Biol. (1978) 73, 631-656
- (3) P. VAN HAM and I. LASTERS "Reduction Methods for logical control networks"
J. Theor. Biol. (1978) 72, 269-291

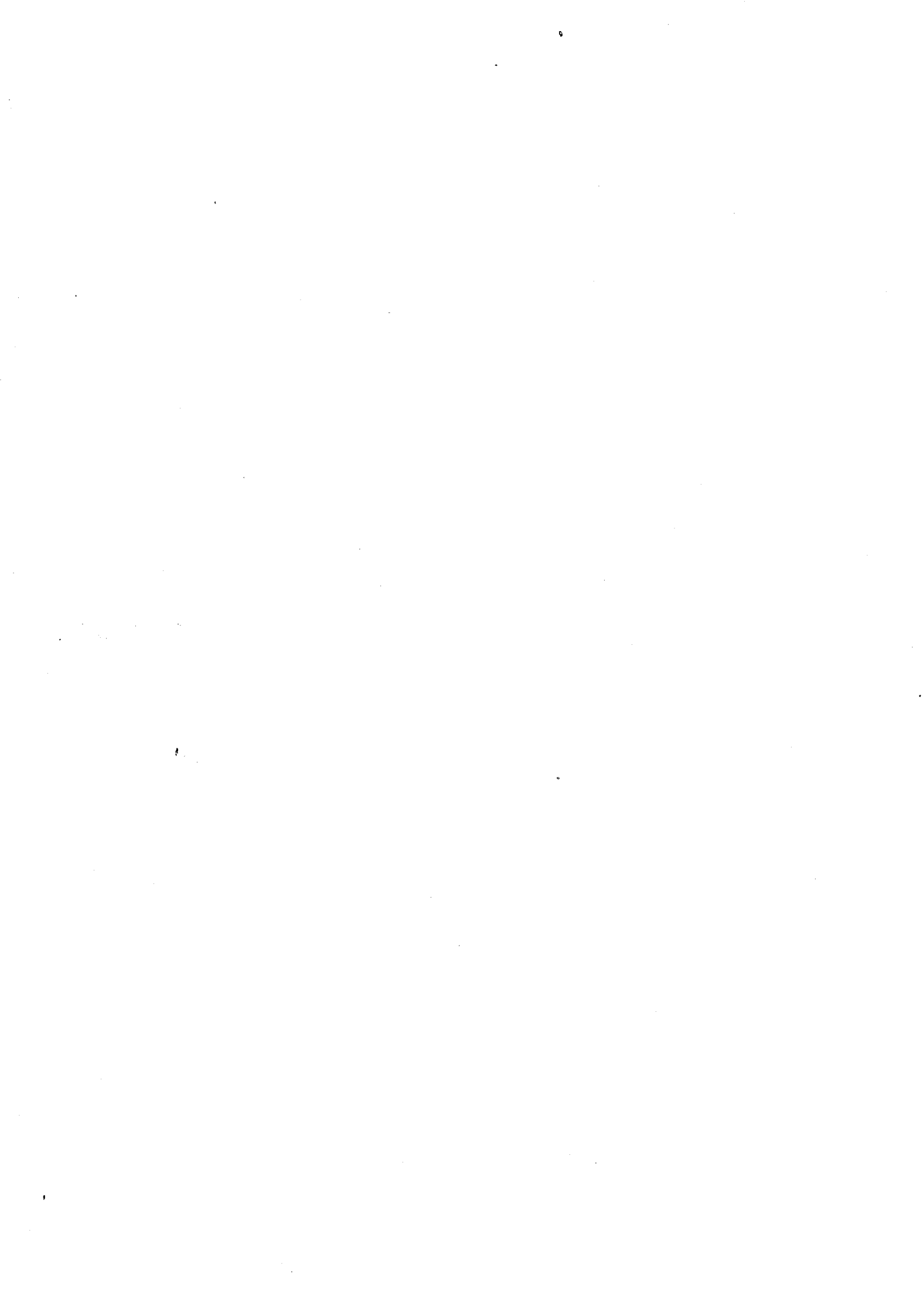

REFERENCES



REFERENCES

- 1 - L.Accardi, Rank and reverberations in neural networks, *Kybernetik* 8, 1971.
- 2 - L.Accardi, A.Aiello, Some global properties of neural networks, *Kybernetik*, 1972.
- 3 - Aggarwal. S., 1973. "Local and global garden of eden theorem", University of Michigan technical rept. 147.
- 4 - Aladyev. V., 1974, "Survey of Research in the theory of homogeneous structures and their applications", *Math. Biosci.* 22, 121.
- 5 - Aladyev, V., 1976. "The behavioural properties of homogeneous structures". *Math. Biosci.* 29,99.
- 6 - Alekseev. V. M. and M. V. Yakobson 1981. "Symbolic Dynamics and hyperbolic dynamic systems". *Phys. Rep.* 75.287.
- 7 - J.P.Allouche, C.Reder, Oscillations spatio-temporelles engendrées par un automata cellulaire, R.R. 8207, *Math. et Inf. Bordeaux* 1, 1982.
- 8 - S.Amari, Homogeneous nets of neuron-like elements, *Bio. Cybernetics*, Vol 17, 1975.

- 9 - Amoroso. S. and G. Cooper. 1971. "Tessellation structures of arbitrary patterns". J.Comp. Sys. Sci. 3. 453.
- 10- Amoroso S, G.Cooper "The garden eden theorem for finite configuration", Proc. Am. Math Soc.
- 11- Arbib M.A. Simple self-reproducing universal automata", Inf and Control 9(1966).
- 12- M.A.Arbib, Brains, machines and mathematics, Mac. Graw Hill Paperbacks, 1964.
- 13- Arbib, M.A. 1969, Theories of abstract automata, Prentice-Hall.
- 14- H.Atlan, F.Fogelman, S.Salomon, C.Weisbuch, "Random boolean networks, Cybernetics and systems, 12, 1981.
- 15- Baer. R.M. and H.M.Martinez, 1974. "Automata and biology". Ann. Rev. Biophys. 255.
- 16- Banks. E.R. 1971. "Information processing and transmission in cellular automata". MIT Project MAC report TR-81.
- 17- Barahona F., Applications de l'optimization combinatoire a certains modelos de verres de spins: complexité et simulations, thèse, IMAG, Grenoble, France, 1980.

- 18 - Berlekamp. E.R., J.H. Conway and R. K. Guy. 1982, Winning Ways, for your mathematical plays, vol. 2, Academic Press, chap. 25.
- 19 - Buckingham, D.J., 1978, "Some facts of life". Byte 3, 54.
- 20 - Burks, A.W., 1970, Essays on cellular automata, Univ. of Illinois press.
- 21 - Burks, A.W., 1973, "Cellular automata and natural systems", Proc. 5th Congress Deutsche Gessellschaft fur Kybernetic, Nuremberg.
- 22 - Butler. J.T. and S.C.Ntafos. 1977, "The vector string descriptor as a tool in the analysis of cellular automata Systems", Math. Biosci. 35,55.
- 23 - E.R. Caianiello, Decision equations and reverberations, Kybernetik, 3(2), 1966.
- 24 - E.R.Caianiello, A de Luca, L.M.Ricciardi, reverberations and control of neural network, Kybernetik 4(1), 1967.
- 25 - Choi M.Y. Huberman B.A, Dynamic bahaviour of non linear networks, Physics Review A, 1983.
- 26 - Codd, E.F., 1968, Cellular automata, Academic Press.

- 27 - Cole, S.N., 1969. "Real-time computation by n-dimensional iterative arrays of finite-state machines", IEEE Trans. Comput. C-18,349.
- 28 - Cosnard M, Demongeot J, Le Breton A., Rhythms in biology and other fields of application, lec. notes in Biomaths 49 Springer-Verlag, 1983.
- 29 - D'Humières H, Huberman B.A, Dynamics of selforganization in complex adaptative networks, R.R. xerox. Palo Alto Research Center, 1983.
- 30 - Dobrushin R.L, Kryukov V.I, Toom A.L. Locally interacting systems and their application in biology, procc of School Seminar on Markov interaction processes in biology, Lec. Notes in Math. Springer Verlag 653,1978.
- 31 - Farmer J.O, Toffoli T., Wolfram S., Cellular automata, proc of Los Alamos workshop, 1983, to appear in phys. D. and North-Holland Pub. Co, Dec 83.
- 32 - Fredkin E, unpublished and PERQ computer demonstration (three rivers comp. corp.) 1981.
- 33 - Fogelman F., Goles E., Weisbuch G., Specific roles of different boolean mapping in random networks. Bull.Math.Biol, Vol 44, 1982.

- 34 - Fogelman, Goles E., Weisbuch G., Transient length in sequential iteration of threshold functions-Disc.Appl.Math 6, 83.
- 35 - Gach P., G. L. Kurdyunov and L. A. Levin. 1978, "One-dimensional uniform arrays that wash out finite islands", Prob. Pered. Info., 14,92.
- 36 - G. Galperin, One-dimensional automata networks with monotonic interaction, problemy peredachi informatsii, Vol 12, N°4, 1976.
- 37 - Gardner.M., 1971, "Mathematical Games", Sci.Amer. 224. #2 112: #3 106: #4 114.
- 38 - Gardner. M. 1972. "Mathematical Games", Sci.Amer. 226. #1 104.
- 39 - Geffen. Y., A. Aharony. B. B. Mandelbrot and S. Kirkpatrick. "Solvable fractal family, and its possible relation to the backbone at percolation", Phys. Rev.Lett 47, 1771.
- 40 - Goles E, Comportement oscillatoire d'une famille d'automates cellulaires non uniformes, thèse, IMAG, Grenoble, France, 1980.
- 41 - Goles E, Fixed point behaviour of threshold functions on a finite set, SIAM J.ALG. DISC.Math. Vol 3, N° 4, Dec 82.

- 42 - Goles E, Dynamical behaviour of neural networks Res.Repp. 386, IMAG, Grenoble, France, 1983.
- 43 - Goles E, Olivos J, Comportement periodique des fonctions á seuil binaires et applications, Disc. Appl. Math. 3, 1981.
- 44 - Goles E, Martinez S, A short proof of the cyclic behaviour of multithreshold symmetric automata, Inf. and control, 1981.
- 45 - Goles E. Tchuente M, Iterative behaviour of generalized majority functions, Math. Soc. Sciences 4, 1983.
- 46 - Goles E, Tchuente M, Dynamic behaviour of one-dimensional threshold automata R.R. 350, IMAG, Grenoble, France, 1983.
- 47 - J.M. Greenberg., S.P. Hasting, "Spatial patems for discrete models in excitable media" SIAM J.Appl.Math, Vol 34, 1978.
- 48 - Grassberger, P., 1982, "A new mechanism for deterministic difusion", Wuppertal preprint WU B 82-18.
- 49 - Greenberg. J.M., B.D.Hassard and S.P.Hastings, 1978, "Pattern formation and periodic structures in systems modelled by reaction-difusion equations", Bull Amer. Math. Soc. 84, 1296.

- 50 - M.Haraó and S.Noguchi, On some dynamical properties of finite cellular automaton, IEEE Trans Comp. Vol C27, 1973.
- 51 - Hardouin-Duparc. J., 1974, "Paradis terrestre dans l'automate cellulaire de Conway", R.A.I.R.O. 8 R-3, 63.
- 52 - Hardouin-Duparc J. Autocell, Dossier de programme, Rapport Greco 9.81. Univ de Bordeaux I, 1981.
- 53 - Hinton G.E, Sejnowski J.T., optimal perceptual inference Procc. IEEE Conf. in Comp. Vision and Pattern recognition June 1983.
- 54 - Hopfield J.H. Neural networks and physical systems with emergent collective computational abilities Proc Natt. Acad Sci. USA, Vol 79, 1982 Biophysics,1982.
- 55 - Kauffman, Behaviour of randomly constructed genetics nets, in "Towards a theoretical Biology (vol.3) ed. C.H. Waddington, Edinburgh, Univ. Press. 1970.
- 56 - S.Kauffman, Metabolic stability and epigenesis in randomly constructed genetic nets", J.Theor, Biol, 22, 1969.
- 57 - Kirkpatrik S., Frustration and ground state degeneracy in spin glasses prob, Phys. Rew. B 16. 1977.

- 58 - Kirkpatrick S., Gelatt C.D, Vecchi M.P, Optimization by simulated annealing, Science, Vol 220, N° 4598, 1983.
- 59 - Kitagawa T., Cell space approach in biomathematics, Math. Bios, 19, 1974.
- 60 - Kleene S.C. "Representation of events in nerve nets and finite automata", Automata studies, Ed. by C.E. Shannon-J. Mac Carthy, Princeton Univ.Press, 1956.
- 61 - Y.Kobuchi, "Signal propagation in two dimensional threshold cellular space", J. Math, Biol. 3(1976).
- 62 - Kosaraju. S.R., 1974, "On some open problems in the theory of cellular automata", IEEE trans. Comput. C-23, 561.
- 63 - M.Legendre, Analyse et simulations de reseaux d'automates, thèse USMG, Grenoble, 1982.
- 64 - Lindenmayer. A., 1968, "Mathematical models for cellular interactions in development", J. Theoret. Biol. 18, 280.
- 65 - Mandelbrot, B., 1977, Fractals: Form, Chance and dimension, Freeman.
- 66 - Mandelbrot. B., 1982. The fractal geometry of nature, Freeman.

- 67 - Martin O., A. Odlyzko and S. Wolfram, 1983, "Algebraic properties of cellular automata", Bell Laboratories report, in preparation.
- 68 - Masako Sato, Chaiki Tonaka, Characterization and constructions of reverberating networks, Math. Bios 62,1982.
- 69 - Mc Culloch W.S., M. Pitts W., "A logical calculus of the ideas immanent in nervous activity, Bull. of Mathematical Biophysics 5(1943).
- 70 - Moore E.F., "Machine models of self-reproduction (see Burks)
- 71 - Myhill J. "The converse of Moore's garden of eden problem, Proc of the Am. Math. Soc. 14(1963)
- 72 - Nishio. H., 1981. "Real time sorting of binary numbers by 1-dimensional cellular automata", Kyoto University Report.
- 73 - Olivos J., Contribution á l'algorithmique, thèse, Orsay France, 1980.
- 74 - S. Poljak, M. Sura, On periodical behaviour in societies with symmetric influences, combinatorica,1983, to appear.
- 75 - Robert F., Itérations sur des ensembles finis et automatas cellulaires contractants, Lin.Alg and Its applic. 29,1980.

- 76 - Robert F, Itérations discrètes: une étude métrique, USMG, IMAG, polycopie, 1981.
- 77 - Robert Y., M.Tchunte, Relations entre le graphe de connexions et le graphe d'iterations d'une fonctions booléenne monotone, R.R 307, 1982.
- 78 - Roseblatt F., Principles of perceptrons Spartan Washington, 1962.
- 79 - H.D. Schultz. "Zellular automaten zur bearbeitung der lokal-global problematik. Thèse, Darmstadt Tech. Inst. (RFA) 1981.
- 80 - Shannon C.E and Mc Carthy ed. Automata studies, annals of math studies n° 34, Princæton Univ. Press, 1956.
- 81 - Shingai R., Periodic behaviours of one-dimensional uniform threshold circuits, Trans IEEE, Japan, J59-A,G, 1976.
- 82 - Shingai R., Maximun period of two dimensional uniform neural networks, Inf and Control 41, 1979.
- 83 - Smith. A.R. 1971, "Simple computation-universal cellular spaces". J.ACM 18.
- 84 - Tchunte M, "Contribution a l'étude des methodes de calcul pour des systèmes de type cooperatif thèse d'etat, IMAG, Grenoble, 1982.

- 85 - Tchuente M, Evolution de certains automates cellulaires uniformes binaires á seuil, Sang 265, IMAG, Grenoble, France 1977.
- 86 - Thomas R, Kinetic logic, Lec notes in Biomathematics, Springer-Verlag, vol 29, 1979.
- 87 - Toffoli T., 1977a. "Computation and construction universality of reversible cellular automata". J.Comp. Sys. Sci. 15, 218.
- 88 - Toffoli T., 1977b. "Cellular automata mechanics". logic of computers Group. Univ. Michigan.
- 89 - Toffoli T., 1980. "Reversible computing". MIT report MIT/LOS/TM-151.
- 90 - Toffoli T., 1983. "Squareland: A Hardware cellular automaton simulator", MIT LOS preprint. in preparation.
- 91 - Toom A.L, Monotonic evolutions in real spaces, locally interacting systems and their application in biology, Lec Notes in Math, 653, 1978.
- 92 - Toom A.L, Monotone binary tessellation automata, Problemy Peredavci Informacii 12, 1976.

- 93 - Turing.A.M. 1936. "On computable numbers, with an application to the eatscheidungsproblem", Proc. Lond. Math. Soc. (ser. 2) 42, 230: 43, 544E. reprinted in ed. M.Davis, "The undecidable", Raven Press (1965).
- 94 - Turing.A.M., 1952, "The chemical basis of morphogenesis", Phil. Trans. B237.37. Ulam. S., 1974, "Some ideas and prospects in Biomathematics". Ann. Rev. Bio., 255.
- 95 - Ulam S.M. In some mathematical problems connected with patherms of growth figure, see Burks, page 219-231.
- 96 - Vichniac Y.G, Simulating physicc with cellular automata R.R. MIT. computer science Lab, 1983.
- 97 - Von Neumann. J., "The general and logical theory of automata", in J. von Neumann. Collected Works, Edited by A.H. Taub, 5, 288.
- 98 - Von Neumann. J., 1966, Theory of Self-Reproducing automata, edited by A.W. Burks, Univ. of Illinois press.
- 99 - Yamada H, Amoroso S. Structural and behavioral equivalence of tessellation automata, Inf and Control, Vol 18, 1971.
- 100- Waksman A. 1969, "A model of replication", J.ACM 16, 178.

- 101 - Willson. S., 1982, "Cellular automata can generate fractals", Iowa University pre-print.
- 102 - Witten. T. A. and L. M. Sander, 1981: "Diffusion-limited aggregation a kinetic critical phenomenon", Phys. Rev. Lett. 47, 1400.
- 103 - Wolfram, S., 1982a "Cellular automata as simple self-organizing systems", Caltech preprint CALT-58-938 (submitted to Nature).
- 104 - Wolfram. S., 1982b, "Geometry of binomial coefficients", to be published in Amer Math. Monthly.
- 105 - Wolfram, S., Statistical mechanics of cellular automata, Rev. of modern physics vol 55, N°3, July 1983.

AUTORISATION DE SOUTENANCEDOCTORAT D'ETAT

Vu les dispositions de l'article 5 de l'arrêté du 16 avril 1974,

Vu les rapports de M.^r ...D....PERRIN.....

M.^r ...M....TENDRES:FRANCE.....

M.^r ...F....ROBERT.....

M.^rEric.....GODES-CHACC..... est autorisé à
présenter une thèse en vue de l'obtention du grade de DOCTEUR D'ETAT ES SCIENCES.

Fait à Grenoble, le 8 JAN

Le Président de l'U.S.M.G.

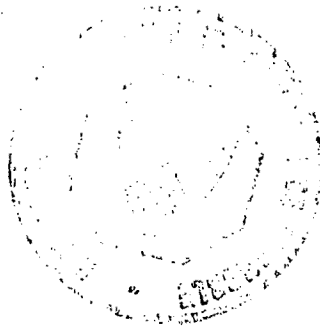

W. Tauche