

UNIVERSITÉ DE NANTES  
UFR HISTOIRE, HISTOIRE DE L'ART & ARCHÉOLOGIE

Année 2008

Numéro attribué par la bibliothèque

--	--	--	--	--	--	--	--	--	--

THÈSE

pour obtenir le grade de  
DOCTEUR DE L'UNIVERSITÉ DE NANTES

Discipline : Archéologie

Présentée et soutenue publiquement par

Guillaume Robin

le 14 novembre 2008

Titre :

**L'art pariétal des tombes à couloir néolithiques autour de la Mer d'Irlande  
Iconographie et organisation spatiale**

Volume 2 : figures

---

Directeurs de thèse :

M. Serge Cassen (Chargé de Recherche, CNRS)

M. Muiris O'Sullivan (Professor, University College Dublin)

*Convention de cotutelle internationale de thèse*

---

JURY

M. Serge Cassen	Chargé de Recherche, CNRS	Directeur
M. Muiris O'Sullivan	Professor, University College Dublin	Directeur
M. André D'Anna	Directeur de Recherche, CNRS	Rapporteur
M. Julian Thomas	Professor, University of Manchester	Rapporteur
Mme Elizabeth Shee Twohig	Senior Lecturer, University College Cork	Examinatrice
M. Alasdair Whittle	Professor, Cardiff University	Examineur



## Liste des figures

0.1	Représentation schématique de l'étude .....	242
1.1	Carte de répartition des tombes à couloir avec cairn circulaire et cairn allongé dans les Iles Britanniques.....	243
1.2	Carte de répartition des tombes à couloir et autres architectures présentant des gravures pariétales autour de la Mer d'Irlande .....	244
1.3	Carte topographique de localisation du site de Carnanmore.....	245
1.4	Carte topographique de localisation des sites de Knockmany et Sess Kilgreen.....	246
1.5	Carte de répartition des tombes à couloir et autres architectures présentant des gravures pariétales dans le comté de Meath .....	247
1.6	Carte topographique de l'ensemble monumentale Loughcrew-Kings Mountain-Clonasillagh.....	248
1.7	Carte topographique de la nécropole de Loughcrew (Slieve na Calliagh) .....	249
1.8	Carte topographique de la nécropole de la vallée de la Boyne (Brugh na Boinne).....	250
1.9	Carte de répartition des tombes à couloir gravées dans l'archipel des Orcades .....	251
1.10	Base de données des dalles gravées .....	252-9
1.11	Positionnement du matériel de prise de vue .....	260
1.12	Traitements préliminaires des photographies .....	261
1.13	Relevé au dessin des gravures .....	262
1.14	Relevés de gravures à Loughcrew F.....	263
1.15	Relevés de gravures à Loughcrew H et I .....	264
1.16	Relevés de gravures à Loughcrew O et S.....	265
1.17	Relevés de gravures à Loughcrew T.....	266
1.18	Relevés de gravures à Loughcrew T (suite).....	267
1.19	Relevés de gravures à Loughcrew U et Carnanmore .....	268
1.20	Relevés de gravures à Knockroe.....	269
1.21	Modélisation tridimensionnelle d'une dalle gravée à partir de photographies numériques .....	270
3.1	Tableau typologique des signes circulaires.....	271
3.2	Tableau typologique des signes en spirale .....	271
3.3	Tableau des associations entre types de spirales et dalles gravées .....	272-5
3.4	Tableau typologique des signes en arceau .....	276
3.5	Orientation des signes en arceaux .....	276
3.6	Tableau des associations entre types d'arceaux et dalles gravées.....	277-81
3.7	Tableau typologique des signes circulaires radiés .....	282
3.8	Tableau des associations entre types de signes circulaires radiés et dalles gravées .....	283
3.9	Tableau typologique des signes semi-circulaires radiés .....	284
3.10	Tableau des associations entre types de signes semi-circulaires radiés et dalles gravées.....	285
3.11	Les signes semi-circulaires radiés de type 2c .....	286
3.12	Tableau typologique des signes en chevrons.....	287
3.13	Tableau des associations entre types de chevrons et dalles gravées .....	288-90
3.14	Tableau typologique des signes triangulaires .....	290
3.15	Tableau des associations entre types de signes triangulaires et dalles gravées .....	291
3.16	Tableau typologique des signes quadrangulaires .....	292
3.17	Tableau des associations entre types de signes quadrangulaires et dalles gravées .....	293-6
3.18	Tableau typologique des signes scalariformes.....	297
3.19	Tableau des associations entre types de signes scalariformes et dalles gravées .....	298
3.20	Les signes ondulés et en chevrons.....	299
3.21	Les signes ondulés se terminant par une spirale .....	300

3.22	Les signes ondulés comme extrémité interne d'une spirale.....	300
3.23	Les signes ondulés avec appendice.....	301
3.24	Tableau 1 des associations entre types de signes ondulés et dalles gravées .....	302
3.25	Les signes ondulés avec une extrémité épaissie .....	303
3.26	Les signes ondulés avec une extrémité en cercle .....	303
3.27	Les signes ondulés avec une extrémité en « 8 ».....	304
3.28	Les signes ondulés avec une extrémité en angle .....	304
3.29	Les signes ondulés avec une extrémité quadrangulaire ou triangulaire.....	304
3.30	Les signes ondulés avec une extrémité en V.....	304
3.31	Tableau 2 des associations entre types de signes ondulés et dalles gravées .....	305
3.32	Tableau typologique des signes ondulés .....	306
3.33	Les signes rares.....	307
3.34	Tableau synthétique des signes élémentaires.....	308
4.1	Tableau des associations de signes : données en nombre total d'associations.....	310
4.2	Tableau des associations de signes : illustration graphique .....	311
4.3	Tableau des associations de signes : données en pourcentage relatif.....	312
4.4	Représentation graphique de la proportion des associations signe par signe .....	313
4.5	Représentation graphique de la proportion des couples de signes.....	314
4.6	Les regroupements de cercles simples .....	315
4.7	Les lignes de cercles simples .....	316
4.8	Les lignes de cupules .....	317
4.9	Les lignes de signes circulaires complexes.....	318
4.10	Les lignes de signes circulaires radiés.....	319
4.11	Les lignes d'arceaux simples (1/2).....	320
4.12	Les lignes d'arceaux simples (2/2).....	321
4.13	Les rangées d'arceaux simples.....	322
4.14	Les paires d'arceaux opposés .....	323
4.15	Les chevrons simples emboîtés .....	324
4.16	Les chevrons simples emboîtés avec ligne centrale.....	325
4.17	Les chevrons emboîtés.....	326
4.18	Les chevrons emboîtés avec ligne centrale.....	326
4.19	Les rangées de triangles.....	327
4.20	Les rangées de triangles parallèles.....	328
4.21	Les triangles opposés par la pointe .....	329
4.22	Les lignes de losanges vides.....	330
4.23	Les lignes de losanges pleins .....	331
4.24	Les quadrillages simples .....	332
4.25	Les quadrillages en damier.....	333
4.26	Les quadrillages de carrés pleins .....	334
4.27	Les lignes ondulées parallèles verticales.....	335
4.28	Les lignes ondulées parallèles horizontales.....	336
4.29	Spirales inscrites dans un cercle .....	337
4.30	Cercles au centre d'une spirale .....	338
4.31	Les signes circulaires avec arceaux en appendice .....	339
4.32	Les assemblages de chevrons, losanges et triangles.....	340
4.33	Chevrons inscrits dans un losange.....	341
4.34	Signes divers inscrits dans un cercle.....	342
4.35	Signes divers inscrits dans un arceau.....	343
4.36	Signes divers entourés par une ligne ondulée.....	344
4.37	Chevrons simples entre deux spirales .....	345
4.38	Carré entre deux spirales.....	346
4.39	Carré ou triangle entre deux cercles ou cupules .....	347
4.40	Assemblage de spirale, chevrons et losange .....	348
4.41	Spirale(s) au-dessus de chevrons .....	349
4.42	Signes divers reliés au sommet d'un arceau.....	350
4.43	Signe ondulé relié à une ligne de losanges .....	351

4.44	Signe ondulé et arceaux en ligne ou colonne.....	352
4.45	Cupule(s) entre les méandres d'un signe ondulé.....	353
4.46	Signe ondulé et signe circulaire .....	354
4.47	Les arceaux avec bâtonnet central .....	354
4.48	Les signes scalariformes avec cercle en position axiale.....	355
4.49	Tableau synthétique des assemblages de signes .....	356
4.50	Tableau synthétique de l'iconographie de l'art pariétal autour de la Mer d'Irlande.....	357
5.1	Arceaux de type 2b en position sommitale.....	359
5.2	Arceaux de type 4 en position basale .....	360
5.3	Signes scalariformes en limite supérieure de dalle de péristalithe.....	361
5.4	Signe semi-circulaire radié de grande dimension en position centrale.....	361
5.5	Ligne centrale, alignement de cupules et signes ondulés .....	362
5.6	Arceaux au contact d'un bord de dalle.....	363
5.7	Arceaux au contact d'une ligne de relief .....	364
5.8	Décor des céramiques carénées d'Achnacreebeag et de Ballymacaldrack .....	365
5.9	Signes ondulés gravés le long d'une ligne de relief .....	366
5.10	Signes ondulés gravés sur la tranche.....	367
5.11	Motifs ramiformes sur une ligne de relief horizontale .....	368
5.12	Modélisation tridimensionnelle de l'orthostate 19 du Mané Kerioned.....	369
5.13	Modélisation tridimensionnelle de l'orthostate C2 de Loughcrew U.....	370
6.1	Tableau de répartition des surfaces gravées dans les tombes à couloir .....	371
6.2	Représentation modélisée de la répartition des surfaces gravées dans les tombes à couloir.....	372
6.3	Distribution spatiale des signes dans les tombes à couloir.....	373
6.4	Assemblage de spirale et chevrons sur la partie est du péristalithe .....	374
6.5	Paires d'arceaux opposés sur le péristalithe de Knowth .....	375
6.6	Signes scalariformes sur le péristalithe de Newgrange, Knowth et Dowth .....	376
6.7	Signes scalariformes sur le péristalithe de Newgrange L et Loughcrew H.....	377
6.8	L'axe de la tombe matérialisé par une ligne centrale verticale gravée .....	378
6.9	Knockroe : l'axe de la tombe ouest et la dalle 15 du péristalithe.....	379
6.10	Carnanmore : ligne d'arceaux simples orientée dans l'axe de la tombe .....	380
6.11	Knockroe West : lignes d'arceaux simples orientées dans l'axe de la tombe .....	381
6.12	Loughcrew F : lignes d'arceaux simples orientées dans l'axe de la tombe .....	382
6.13	Péristalithe de Knowth : lignes d'arceaux simples orientées dans l'axe de la tombe.....	383
6.14	Loughcrew T : motif en arceaux emboîtés répété le long de l'axe de la tombe.....	384
6.15	Knowth East et West : motif en arceaux emboîtés répété le long de l'axe de la tombe.....	385
6.16	Opposition de groupes de signes de chaque côté de l'axe.....	386
6.17	Knowth 13 : opposition de signes et de textures géologiques .....	387
6.18	Newgrange : opposition entre spirale et signe ondulé .....	388
6.19	Opposition dans l'orientation des arceaux à l'entrée des tombes est et ouest de Knowth.....	389
6.20	Lignes de chevrons parallèles et limites internes à Fourknocks.....	390
6.21	Lignes de chevrons parallèles et limites internes à Knowth East.....	391
6.22	Lignes de chevrons parallèles et limites internes à Loughcrew.....	392
6.23	Lignes de chevrons parallèles et limites internes à Newgrange et Barclodiad y Gawres.....	393
6.24	Composition en spirale, chevrons et losanges à l'entrée de la chambre dans les tombes de Knowth 17 et Barclodiad y Gawres .....	394
6.25	Répartition des spirales, chevrons et losanges à Barclodiad y Gawres .....	395
6.26	Lignes de chevrons parallèles et limites internes au Petit Mont .....	396
6.27	Lignes de chevrons parallèles et limites internes à Gavrinis .....	397
6.28	Chevrons simples emboîtés avec espace central associés à des limites internes.....	398
6.29	Signes scalariformes et limites internes à Dowth North.....	399
6.30	Signes scalariformes et limites internes à Dowth South .....	400
6.31	Signes scalariformes et limites internes à Knowth .....	401

6.32	Signes scalariformes et limites internes à Newgrange.....	402
6.33	Signes scalariformes et limites internes à Loughcrew F et I.....	403
6.34	Signes scalariformes et limites internes à Loughcrew T.....	404
6.35	Signes scalariformes et limites internes à Loughcrew S et U.....	405
6.36	Signe scalariforme et limite interne à la Table des Marchands.....	406
6.37	Signes scalariformes et limites internes aux Pierres Plates .....	407
6.38	Synthèse des rapports entre signes scalariformes et limites internes .....	408
6.39	Lignes de signes circulaires et limites internes .....	409
6.40	Le signe rare n°2 et les limites internes à Knowth .....	410
6.41	Répartition des signes en arceaux inversés dans la tombe de Loughcrew T.....	411
6.42	Répartition des signes en arceaux inversés dans les tombes de Loughcrew I et U .....	412
6.43	Répartition des signes en arceaux inversés dans les tombes de Knowth East et Knowth 14.....	413
6.44	Répartition des signes en arceaux inversés dans la tombe de Loughcrew L.....	414
6.45	Répartition des motifs en triangles opposés dans les tombes de Newgrange et Loughcrew L .....	415
6.46	Disposition des signes scalariformes dans les niches funéraires.....	416
6.47	Disposition des lignes de signes circulaires dans les niches funéraires.....	417
6.48	Disposition des signes circulaires avec arceaux en appendice dans les niches funéraires .....	418
6.49	Signe ondulé avec extrémité en « 8 » associé à trois spirales .....	419
6.50	Signe circulaire et ligne de relief reliés par une ligne courbe.....	420
6.51	Synthèse des principales relations entre iconographie et structure architecturale.....	421
6.52	Relations entre formes et emplacements du signe scalariforme .....	422
7.1	Structures tumulaires de Knowth 2 et 12 .....	423
7.2	Structures tumulaires de Knowth 15 et 16 .....	424
7.3	Structures tumulaires de Newgrange K, L et Z .....	425
7.4	Structure tumulaire de Newgrange.....	426
7.5	Structure tumulaire de Barclodiad y Gawres.....	427
7.6	Encéintes concentriques à Carrowmore 4, 7 et 27.....	428
7.7	Encéintes concentriques à Townleyhall, Ballycarty et Knowth 4.....	429
7.8	Encéintes concentriques à Banagher, Baunfree et Bryn Celli Ddu .....	430
7.9	Tableau de synthèse des structures tumulaires .....	431
7.10	Knowth : relations entre le cairn central et les seuils des tombes est et ouest .....	432
7.11	Couverture de Knowth et Newgrange : structure en U à l'abord du cairn central .....	433
7.12	Hypogée IV de Pubusattile.....	434
7.13	Cairn de Slievenamon.....	435
7.14	Tombes à couloir avec mise en valeur du côté droit.....	436
7.15	Tombes à couloir avec mise en valeur du côté droit (suite).....	437
7.16	Système d'opposition à la base des cairns de Baltinglass et Carrowmore 7.....	438
7.17	Opposition de mobiliers funéraires dans les tombes de Newgrange et Knowth East .....	439
7.18	Opposition de mobiliers funéraires dans les tombes de Newgrange L et Knowth 2 .....	440
7.19	Opposition de mobiliers funéraires dans les tombes de Loughcrew F et H et Tara .....	441
7.20	Classement et opposition de défunts dans les tombes de West Kennet, Burn Ground et Notgrove (groupe Severn-Cotswold).....	442
7.21	Schéma synthétique de l'organisation spatiale des structures dans les tombes à couloir .....	443
7.22	Le jeu de la marelle .....	444
8.1	Gravures en surface obstruée.....	445
8.2	Gravures sur la base enterrée d'orthostates et de dalles de péristalithe .....	446
8.3	Gravures sur la face arrière de dalles de péristalithe .....	447
8.4	Gravures sur la face arrière d'orthostates .....	448
8.5	Gravures sur la face supérieure de dalles de couverture.....	449
8.6	Gravures sur dalles enfouies dans la masse tumulaire .....	450
8.7	Tableau de synthèse des gravures cachées .....	451-2

8.8	Graphes statistiques sur l'iconographie de l'art caché.....	453
8.9	Les relations entre familles de signes et types de surfaces cachées .....	454
8.10	Newgrange et Bryn Celli Ddu : reconstitution de la position d'origine de dalles en réemploi d'après l'emplacement des gravures et la forme de la dalle.....	455
8.11	Knowth : reconstitution de la position d'origine de dalles en réemploi d'après l'emplacement des gravures et la forme de la dalle .....	456
8.12	Reconstitution de la position d'origine de la dalle de couverture RS28 de Knowth d'après la position et l'orientation du signe gravé.....	457
8.13	Reconstitution de la position d'origine de la dalle de couverture de Carnanmore d'après la position et l'orientation du signe gravé.....	458
8.14	Reconstitution de la position d'origine de dalle en réemploi d'après l'emplacement et l'orientation de signes en chevrons .....	459
8.15	Reconstitution de la position d'origine de dalle en réemploi d'après l'emplacement et l'orientation de signes en chevrons et spirales.....	460
8.16	Reconstitution de la position d'origine de l'orthostate 17 de Knowth West d'après la position et l'orientation des signes gravés .....	461
8.17	Reconstitution de la position d'origine de la dalle libre 23 de Knowth d'après la position et l'orientation des signes gravés .....	462
8.18	Newgrange et Knowth : orientation des signes semi-circulaires radiés de type 2c en surface cachée.....	463

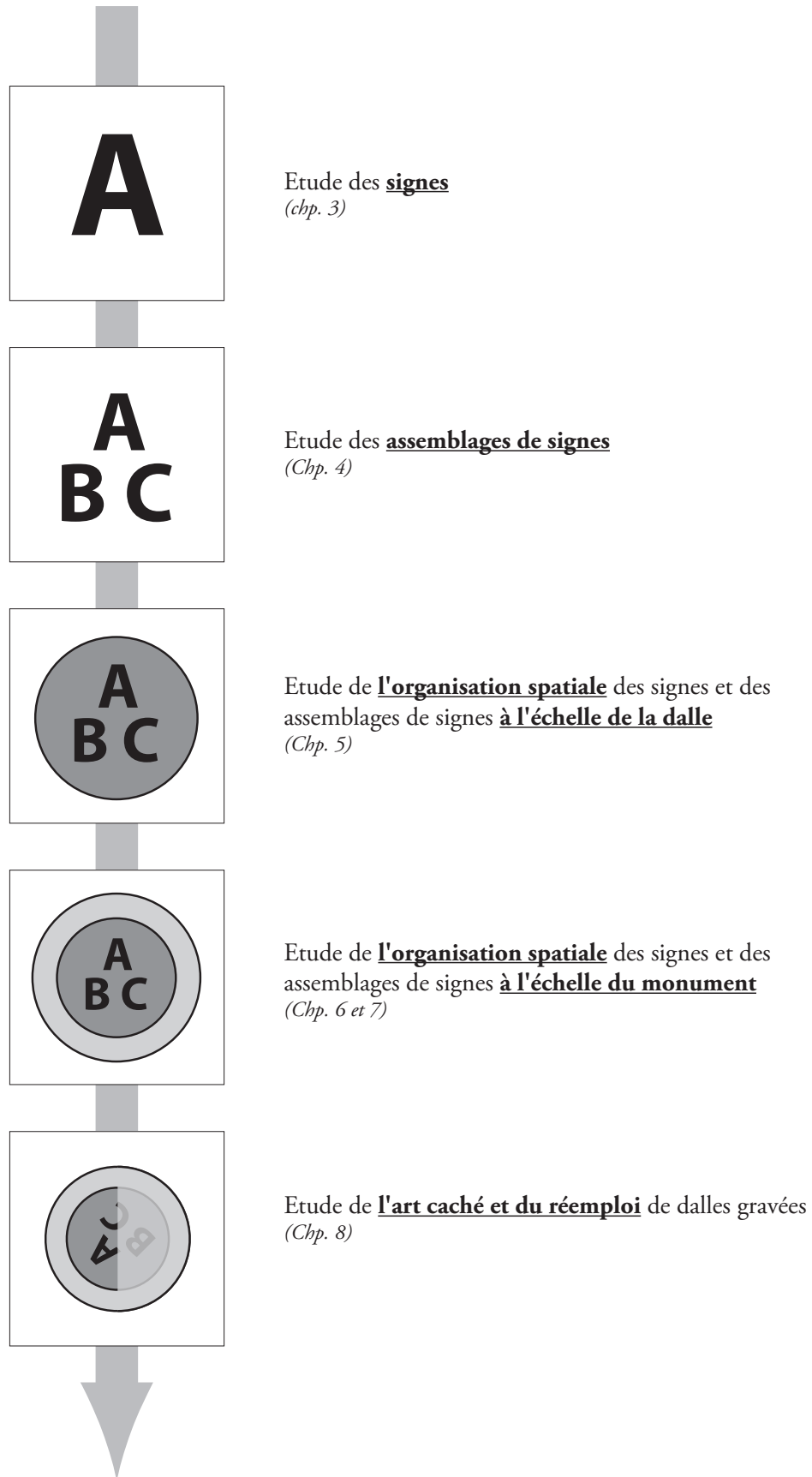
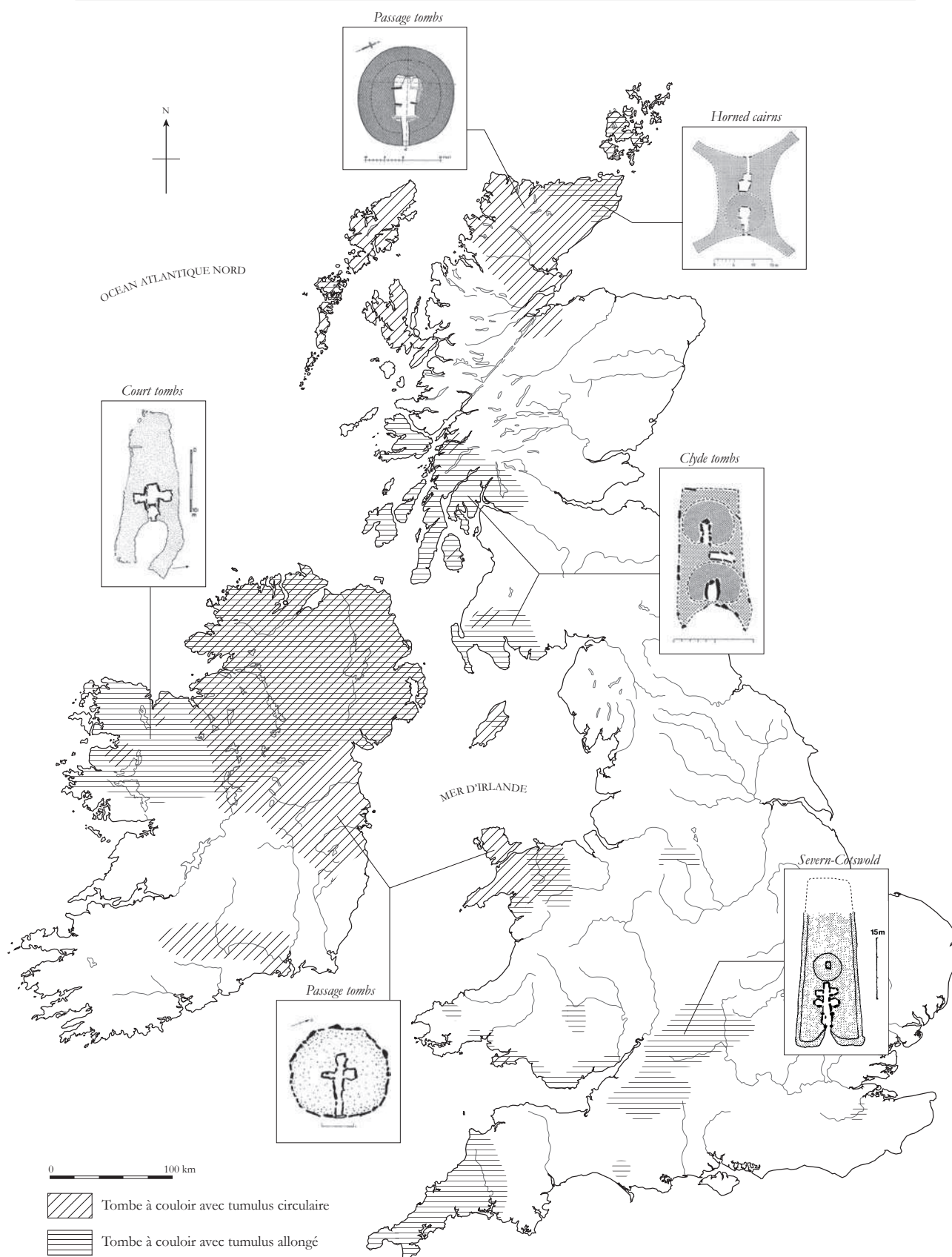

Figure 0.1 : Représentation schématique de l'étude





Sources : Davies 1945 ; Daniel & Powell 1949 ; Daniel 1950 ; De Valera 1960, 1965 ; Henshall 1963, 1972 ; Herity 1974 ; Darvill 1982 ; Eogan 1986 ; Davidson & Henshall 1991 ; Kinnes 1992 ; McMann 1993 ; Henshall & Ritchie 1995, 2001.

Figure 1.1 : Carte de répartition des tombes à couloir avec cairn circulaire et cairn allongé dans les Iles Britanniques

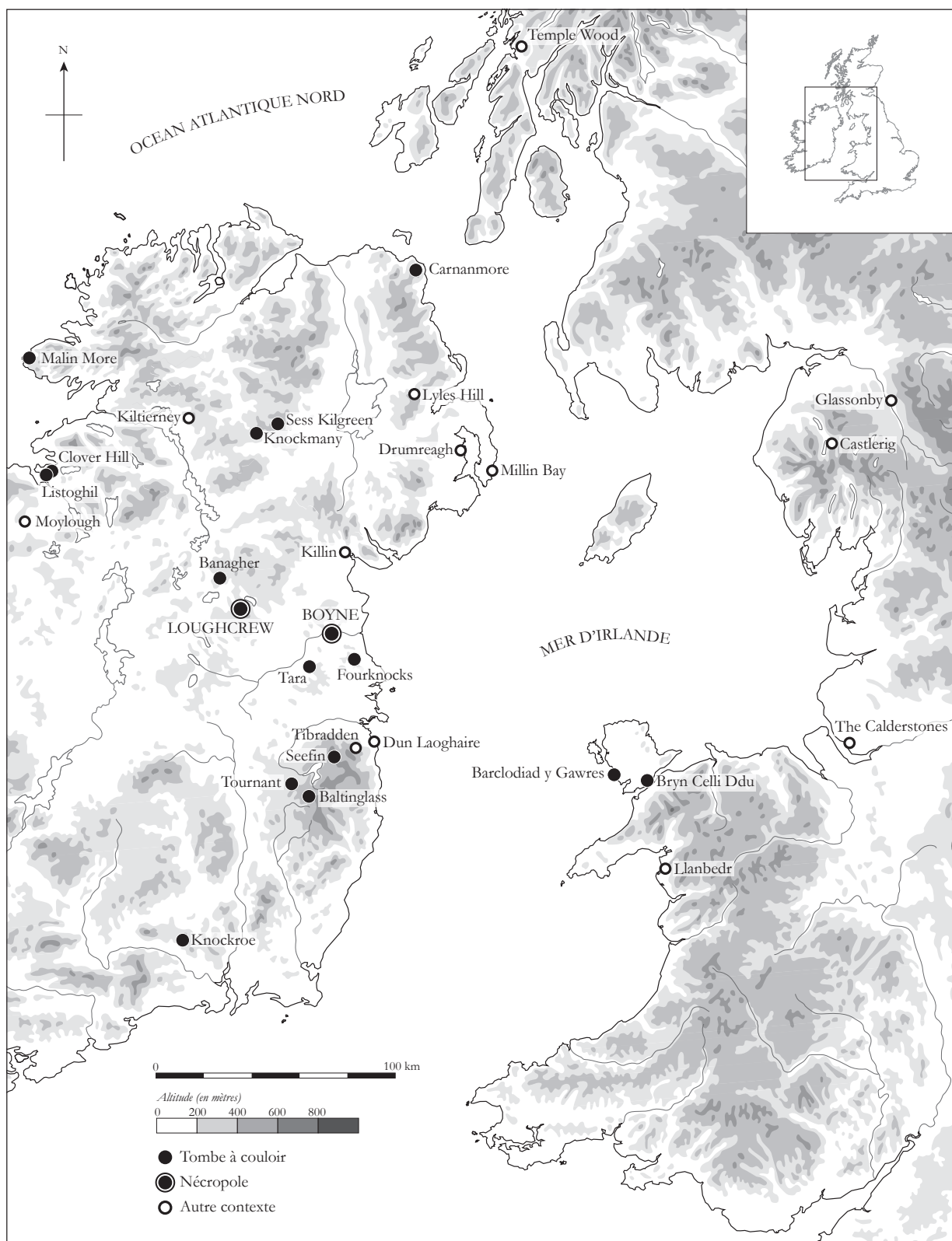

Figure 1.2 : Carte de répartition des tombes à couloir et autres architectures présentant des gravures pariétales autour de la Mer d'Irlande

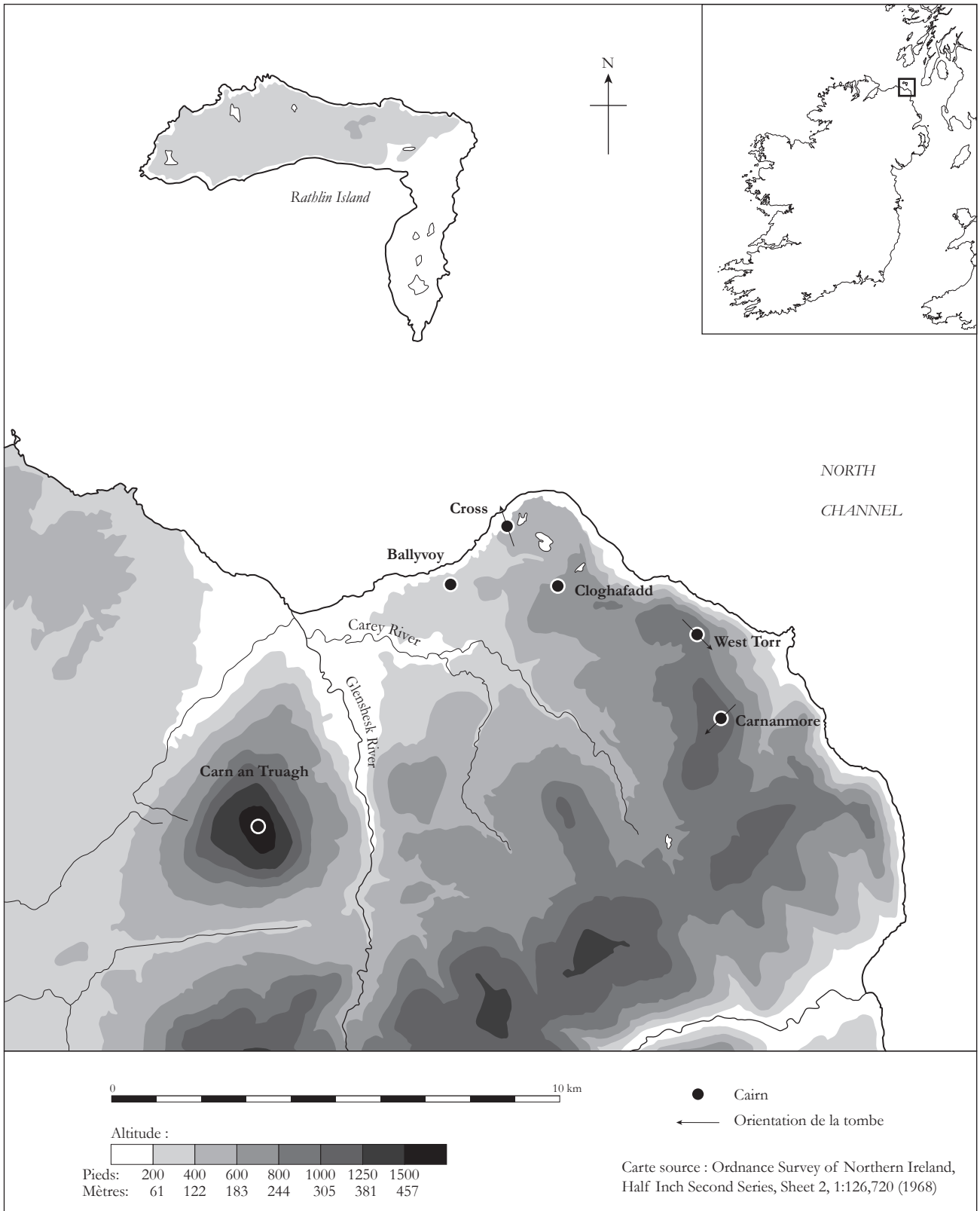

Figure 1.3 : Carte topographique de localisation du site de Carnanmore

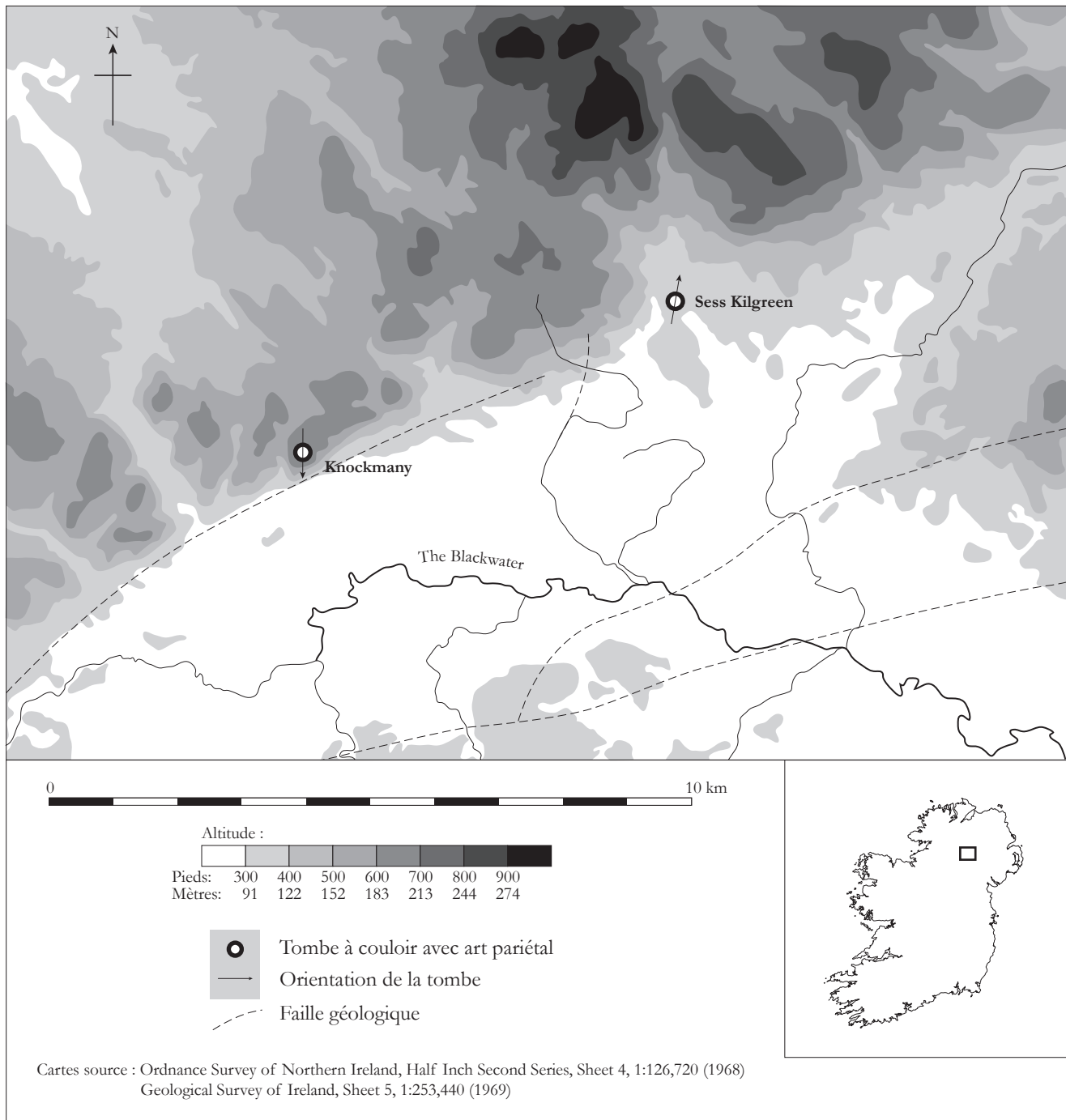

Figure 1.4 : Carte topographique de localisation des sites de Knockmany et Sess Kilgreen

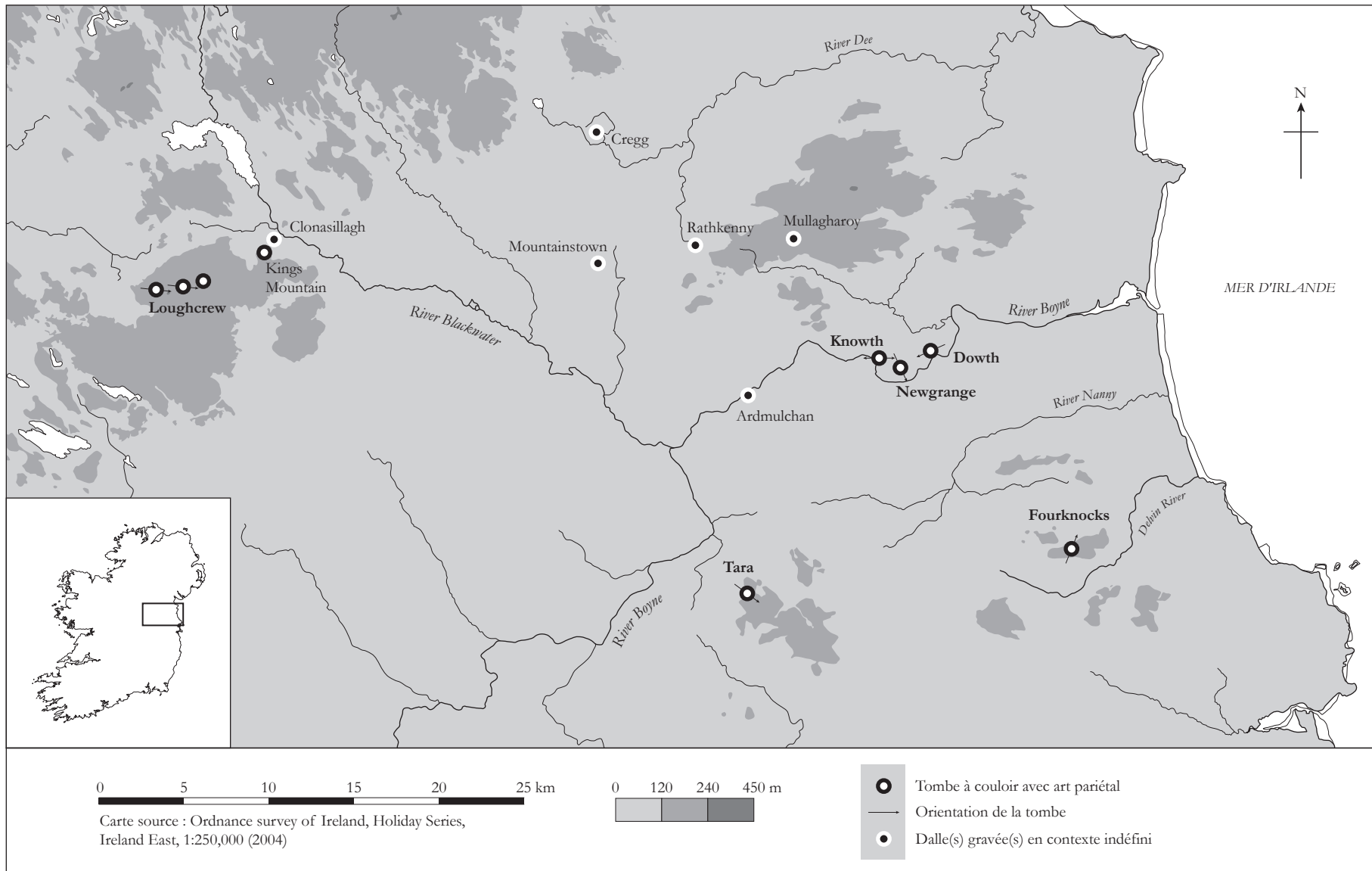

Figure 1.5 : Carte de répartition des tombes à couloir et autres architectures présentant des gravures pariétales dans le comté de Meath

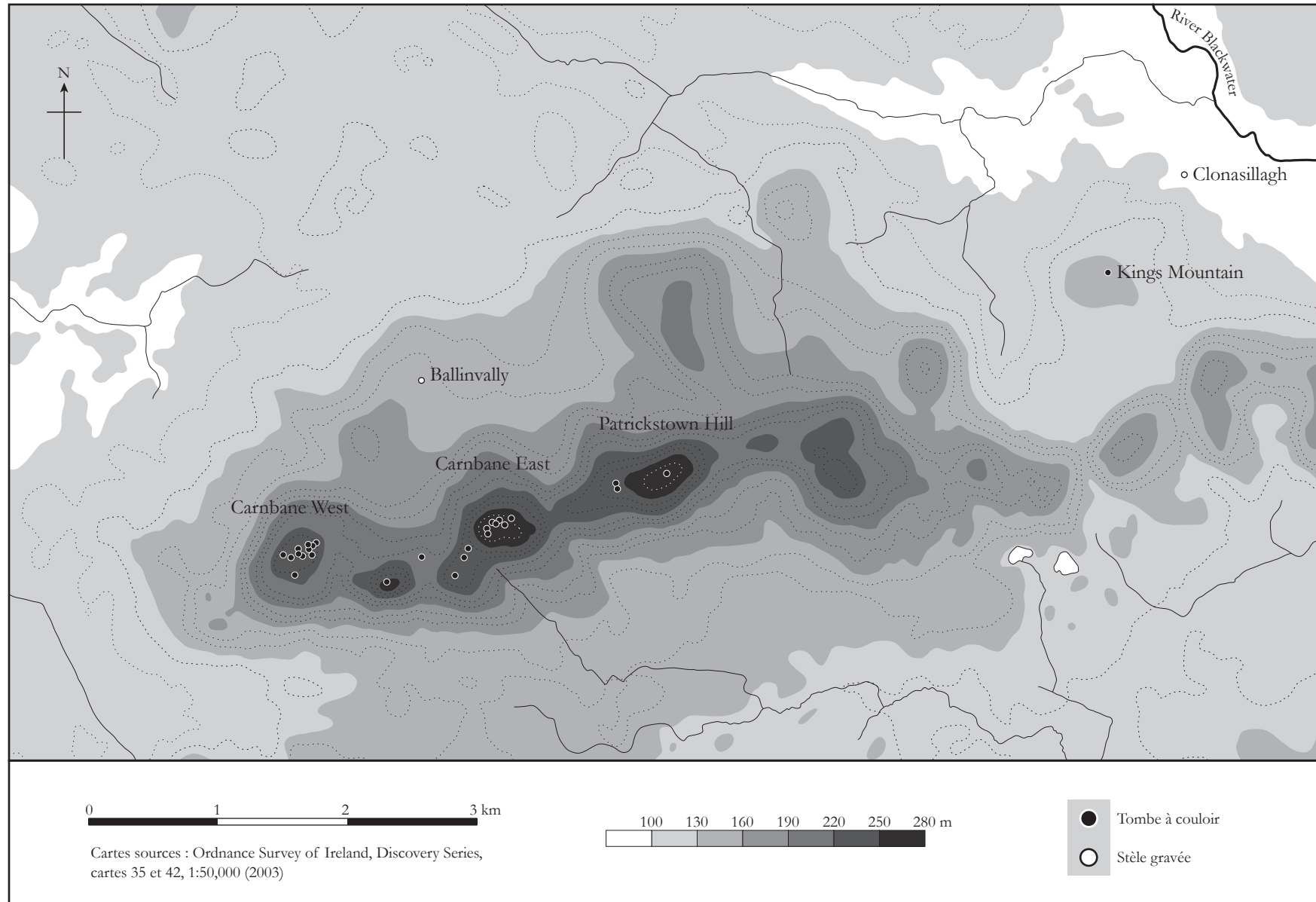

Figure 1.6 : Carte topographique de l'ensemble monumentale Loughcrew-Kings Mountain-Clonasillagh

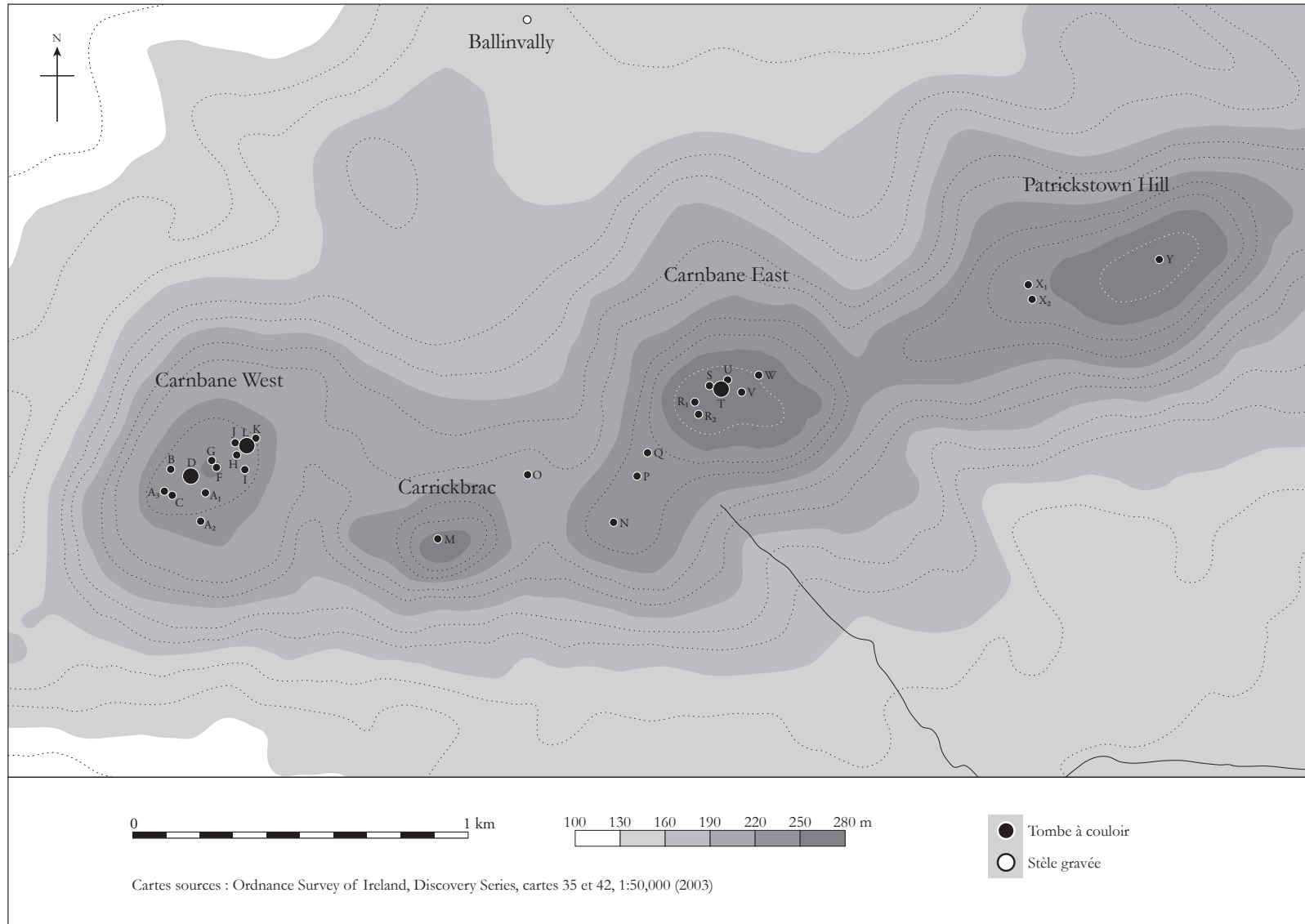

Figure 1.7 : Carte topographique de la nécropole de Loughcrew (Slieve na Calliagh)

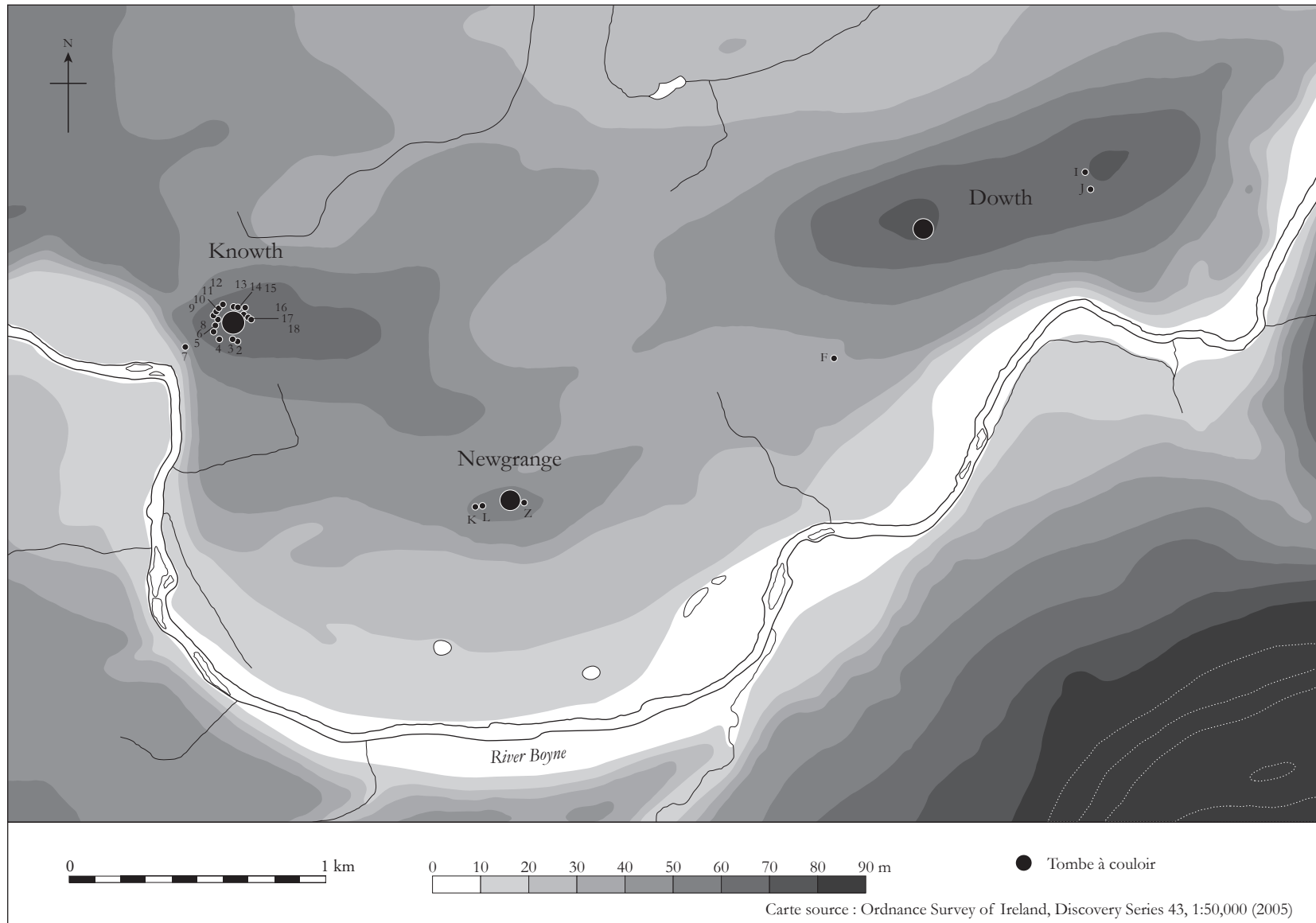

Figure 1.8 : Carte topographique de la nécropole de la vallée de la Boyne (Brugh na Boinne)



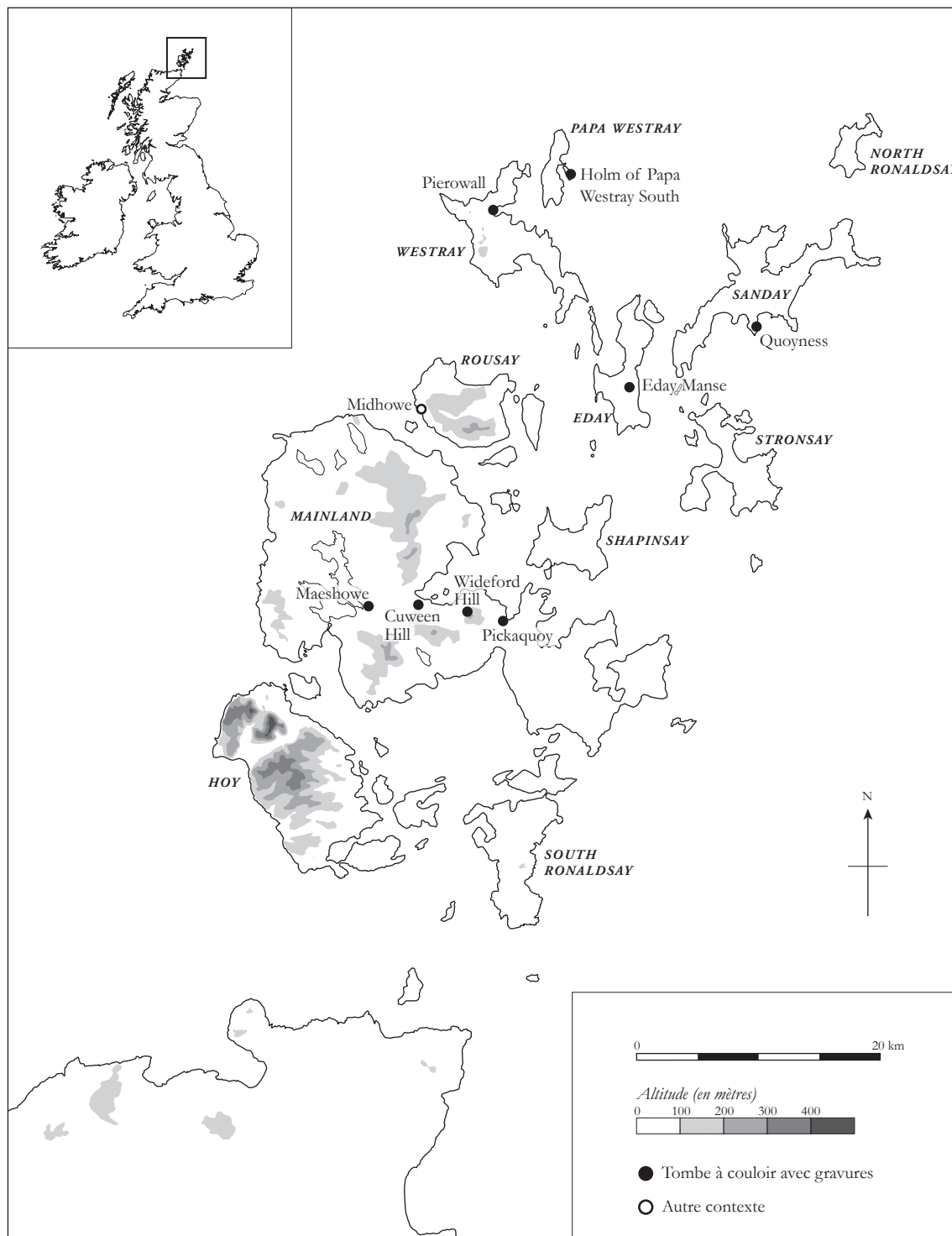

Figure 1.9 : Carte de répartition des tombes à couloir gravées dans l'archipel des Orcades

Première partie - Cadre de l'étude

Abbréviation	Pays	Comté	Site	●	○	⊙	⤿	✳	✻	⌚	▲	◇	≡	⌘	Source bibliographique	Peristalthe	Coalbir	Chambre	Callule
Am.1	IRL	Meath	Ardmulchan												Eogan 1974				
Am.2	IRL	Meath	Ardmulchan												Eogan 1974				
Bv4	IRL	Meath	Ballinvally 4												Shee Twohig 2001				
Bg.F	IRL	Meath	Baltinglass												Shee Twohig 1981				
Bg.G	IRL	Meath	Baltinglass												Shee Twohig 1981				
Bg.H	IRL	Meath	Baltinglass												Shee Twohig 1981				
Bg.I	IRL	Meath	Baltinglass I												Shee Twohig 1981				
Bg.II.K	IRL	Meath	Baltinglass II												Shee Twohig 1981				3
Bg.II.L	IRL	Meath	Baltinglass II												Shee Twohig 1981				1
Bh	IRL	Cavan	Banagher										?		Cody 2002				
Cm.Co1	IRL	Antrim	Carnanmore												Robin 2007				
Cm.Co2	IRL	Antrim	Carnanmore																
Cd	IRL	Kildare	Castledermot												Roe 1967				
Ci	IRL	Cork	Clear Island												Shee Twohig 1981				
Cn	IRL	Meath	Clonasillaigh										?		Eogan 2000				
Ch.loose	IRL	Sligo	Cloverhill												Shee Twohig 1981				
Ch.C3	IRL	Sligo	Cloverhill												Shee Twohig 1981				
Ch.C8	IRL	Sligo	Cloverhill												Shee Twohig 1981				
Ch.C9	IRL	Sligo	Cloverhill												Shee Twohig 1981				
Cg	IRL	Meath	Cregg												Corlett 1996				
Dh.K1	IRL	Meath	Dowth												O'Kelly & O'Kelly 1983				
Dh.K2	IRL	Meath	Dowth												O'Kelly & O'Kelly 1983				
Dh.K7	IRL	Meath	Dowth												O'Kelly & O'Kelly 1983				
Dh.K12	IRL	Meath	Dowth												O'Kelly & O'Kelly 1983				
Dh.K13	IRL	Meath	Dowth												O'Kelly & O'Kelly 1983				
Dh.K14	IRL	Meath	Dowth												O'Kelly & O'Kelly 1983				
Dh.K16	IRL	Meath	Dowth												O'Kelly & O'Kelly 1983				
Dh.K17	IRL	Meath	Dowth												O'Kelly & O'Kelly 1983				
Dh.K34	IRL	Meath	Dowth												O'Kelly & O'Kelly 1983				
Dh.K36	IRL	Meath	Dowth												O'Kelly & O'Kelly 1983				
Dh.K50b	IRL	Meath	Dowth												O'Kelly & O'Kelly 1983				
Dh.K51	IRL	Meath	Dowth												O'Kelly & O'Kelly 1983				
Dh.K51b	IRL	Meath	Dowth												O'Kelly & O'Kelly 1983				
Dh.K52	IRL	Meath	Dowth												O'Kelly & O'Kelly 1983				
Dh.K53	IRL	Meath	Dowth												O'Kelly & O'Kelly 1983				
Dh.K88	IRL	Meath	Dowth												O'Kelly & O'Kelly 1983				
Dh.N.I.4	IRL	Meath	Dowth N												O'Kelly & O'Kelly 1983				
Dh.N.I.5	IRL	Meath	Dowth N												O'Kelly & O'Kelly 1983				
Dh.N.R5	IRL	Meath	Dowth N												O'Kelly & O'Kelly 1983				
Dh.N.C1	IRL	Meath	Dowth N												O'Kelly & O'Kelly 1983				
Dh.N.C2	IRL	Meath	Dowth N												O'Kelly & O'Kelly 1983				1
Dh.N.C7	IRL	Meath	Dowth N												O'Kelly & O'Kelly 1983				
Dh.N.C8	IRL	Meath	Dowth N										?		O'Kelly & O'Kelly 1983				2
Dh.N.C18	IRL	Meath	Dowth N												O'Kelly & O'Kelly 1983				3
Dh.N.C19	IRL	Meath	Dowth N												O'Kelly & O'Kelly 1983				
Dh.N.RS4	IRL	Meath	Dowth N												O'Kelly & O'Kelly 1983				
Dh.N.CoR7/R8	IRL	Meath	Dowth N												O'Kelly & O'Kelly 1983				
Dh.S.R1	IRL	Meath	Dowth S												O'Kelly & O'Kelly 1983				
Dh.S.R2	IRL	Meath	Dowth S												O'Kelly & O'Kelly 1983				
Dh.S.C6	IRL	Meath	Dowth S												O'Kelly & O'Kelly 1983				
Dh.S.C7	IRL	Meath	Dowth S												O'Kelly & O'Kelly 1983				
Dh.S.C8	IRL	Meath	Dowth S												O'Kelly & O'Kelly 1983				
Dh.S.C9	IRL	Meath	Dowth S												O'Kelly & O'Kelly 1983				
Dh.S.C10	IRL	Meath	Dowth S												O'Kelly & O'Kelly 1983				3
Dh.S.C11	IRL	Meath	Dowth S												O'Kelly & O'Kelly 1983				3
Dh.S.C12	IRL	Meath	Dowth S												O'Kelly & O'Kelly 1983				3
Dh.S.C13	IRL	Meath	Dowth S												O'Kelly & O'Kelly 1983				
Dh.S.C15	IRL	Meath	Dowth S												O'Kelly & O'Kelly 1983				
Dh.S.RS2	IRL	Meath	Dowth S												O'Kelly & O'Kelly 1983				
Dh.S.Ir	IRL	Meath	Dowth S												O'Kelly & O'Kelly 1983				3
Dh.loose1	IRL	Meath	Dowth												O'Kelly 1967				
Dh.loose2	IRL	Meath	Dowth												O'Kelly 1967				
Dr	IRL	Down	Drumreagh												Shee Twohig 1981				
DL.1	IRL	Dublin	Dun Laoghaire												Ronan 1932				
DL.2	IRL	Dublin	Dun Laoghaire												Gogan 1932				
Fk.L4	IRL	Meath	Fourknocks I												Shee Twohig 1981				
Fk.R2	IRL	Meath	Fourknocks I												Shee Twohig 1981				
Fk.R5	IRL	Meath	Fourknocks I												Shee Twohig 1981				
Fk.C1	IRL	Meath	Fourknocks I												Shee Twohig 1981				
Fk.C5b	IRL	Meath	Fourknocks I												Shee Twohig 1981				1
Fk.A	IRL	Meath	Fourknocks I												Shee Twohig 1981				
Fk.B	IRL	Meath	Fourknocks I												Shee Twohig 1981				
Fk.C	IRL	Meath	Fourknocks I												Shee Twohig 1981				
Fk.D	IRL	Meath	Fourknocks I												Shee Twohig 1981				3
Fk.E	IRL	Meath	Fourknocks I												Shee Twohig 1981				2
Fk.F	IRL	Meath	Fourknocks I												Shee Twohig 1981				3
Kl	IRL	Louth	Killin												Shee Twohig 1981				
Kt.E	IRL	Fermanagh	Kiltierney											?	Shee Twohig 1981				
Kt.W	IRL	Fermanagh	Kiltierney												Shee Twohig 1981				
KM	IRL	Meath	Kings Mountain												Shee Twohig 1981				
Km.C3	IRL	Tyrone	Knockmany											?	Shee Twohig 1981				
Km.C4	IRL	Tyrone	Knockmany											?	Shee Twohig 1981				
Km.C5	IRL	Tyrone	Knockmany												Shee Twohig 1981				
Km.C6	IRL	Tyrone	Knockmany											?	Shee Twohig 1981				
Km.C7	IRL	Tyrone	Knockmany												Shee Twohig 1981				
Km.C9	IRL	Tyrone	Knockmany											?	Shee Twohig 1981				
Km.C10	IRL	Tyrone	Knockmany												Shee Twohig 1981				

1 - Objet, sujet et méthodologie

Abréviation	Pays	Comté	Site	●	○	⊙	⤿	✳	✻	⌚	▲	◇	≡	⌘	Source bibliographique	Per.	Co.	Ch.	Col.
Km.C11	IRL	Tyrone	Knockmany					?							Shee Twohig 1981				
Km.C12	IRL	Tyrone	Knockmany												Shee Twohig 1981				
Kr.K32	IRL	Kilkenny	Knockroe												O'Sullivan 1987				
Kr.K31	IRL	Kilkenny	Knockroe												O'Sullivan 1987				
Kr.K30	IRL	Kilkenny	Knockroe										?		O'Sullivan 1987				
Kr.K29	IRL	Kilkenny	Knockroe										?		O'Sullivan 1987				
Kr.K28	IRL	Kilkenny	Knockroe												O'Sullivan 1987				
Kr.K26	IRL	Kilkenny	Knockroe						?						O'Sullivan 1987				
Kr.K15	IRL	Kilkenny	Knockroe												Robin				
KrE.29	IRL	Kilkenny	Knockroe E		?	?									O'Sullivan 1987				
KrE.35	IRL	Kilkenny	Knockroe E												O'Sullivan 1987				
KrW.L3	IRL	Kilkenny	Knockroe W												O'Sullivan 1987				
KrW.L6	IRL	Kilkenny	Knockroe W												O'Sullivan 1987				
KrW.backst	IRL	Kilkenny	Knockroe W												O'Sullivan 1987				
KrW.R6	IRL	Kilkenny	Knockroe W												O'Sullivan 1987				
KrW.R4	IRL	Kilkenny	Knockroe W										?		O'Sullivan 1987				
KrW.R3	IRL	Kilkenny	Knockroe W												O'Sullivan 1987				
KrW.RS	IRL	Kilkenny	Knockroe W												Robin				
Kh.K1b	IRL	Meath	Knowth												Eogan 2008				
Kh.K2	IRL	Meath	Knowth												O'Sullivan 1988				
Kh.K4	IRL	Meath	Knowth												Eogan 1996				
Kh.K5	IRL	Meath	Knowth												Eogan 1996				
Kh.K7	IRL	Meath	Knowth												O'Sullivan 1988				
Kh.K8	IRL	Meath	Knowth												O'Sullivan 1988				
Kh.K10	IRL	Meath	Knowth												Eogan 1996				
Kh.K11	IRL	Meath	Knowth												Eogan 1996				
Kh.K12	IRL	Meath	Knowth												Eogan 1996				
Kh.K13	IRL	Meath	Knowth												O'Sullivan 1988				
Kh.K13b	IRL	Meath	Knowth												Eogan 2008				
Kh.K14	IRL	Meath	Knowth												O'Sullivan 1988				
Kh.K15	IRL	Meath	Knowth												O'Sullivan 1988				
Kh.K16	IRL	Meath	Knowth												O'Sullivan 1988				
Kh.K17	IRL	Meath	Knowth												O'Sullivan 1988				
Kh.K19	IRL	Meath	Knowth												O'Sullivan 1988				
Kh.K23	IRL	Meath	Knowth								?				O'Sullivan 1988				
Kh.K26	IRL	Meath	Knowth												Eogan 1996				
Kh.K27	IRL	Meath	Knowth												Eogan 1996				
Kh.K28	IRL	Meath	Knowth												Eogan 1996				
Kh.K29	IRL	Meath	Knowth												O'Sullivan 1988				
Kh.K30	IRL	Meath	Knowth												O'Sullivan 1988				
Kh.K32	IRL	Meath	Knowth												O'Sullivan 1988				
Kh.K38	IRL	Meath	Knowth									?			O'Sullivan 1988				
Kh.K39	IRL	Meath	Knowth												O'Sullivan 1988				
Kh.K40	IRL	Meath	Knowth												O'Sullivan 1988				
Kh.K41	IRL	Meath	Knowth												O'Sullivan 1988				
Kh.K42	IRL	Meath	Knowth												O'Sullivan 1988				
Kh.K46	IRL	Meath	Knowth												O'Sullivan 1988				
Kh.K47	IRL	Meath	Knowth												O'Sullivan 1988				
Kh.K48	IRL	Meath	Knowth												O'Sullivan 1988				
Kh.K49	IRL	Meath	Knowth								?				O'Sullivan 1988				
Kh.K51	IRL	Meath	Knowth												O'Sullivan 1988				
Kh.K52	IRL	Meath	Knowth												O'Sullivan 1988				
Kh.K56	IRL	Meath	Knowth												Eogan 1996				
Kh.K57	IRL	Meath	Knowth												Eogan 1996				
Kh.K59	IRL	Meath	Knowth												O'Sullivan 1988				
Kh.K60	IRL	Meath	Knowth												O'Sullivan 1988				
Kh.K61	IRL	Meath	Knowth												O'Sullivan 1988				
Kh.K63	IRL	Meath	Knowth												O'Sullivan 1988				
Kh.K64	IRL	Meath	Knowth												O'Sullivan 1988				
Kh.K65	IRL	Meath	Knowth									?			O'Sullivan 1988				
Kh.K66	IRL	Meath	Knowth												O'Sullivan 1988				
Kh.K67	IRL	Meath	Knowth												O'Sullivan 1988				
Kh.K68	IRL	Meath	Knowth												O'Sullivan 1988				
Kh.K69	IRL	Meath	Knowth												O'Sullivan 1988				
Kh.K70	IRL	Meath	Knowth												O'Sullivan 1988				
Kh.K71	IRL	Meath	Knowth												O'Sullivan 1988				
Kh.K72	IRL	Meath	Knowth												O'Sullivan 1988				
Kh.K73	IRL	Meath	Knowth												O'Sullivan 1988				
Kh.K74	IRL	Meath	Knowth												Eogan 1996				
Kh.K75	IRL	Meath	Knowth												O'Sullivan 1988				
Kh.K76	IRL	Meath	Knowth												O'Sullivan 1988				
Kh.K77	IRL	Meath	Knowth												O'Sullivan 1988				
Kh.K78	IRL	Meath	Knowth												O'Sullivan 1988				
Kh.K79	IRL	Meath	Knowth												O'Sullivan 1988				
Kh.K80	IRL	Meath	Knowth												O'Sullivan 1988				
Kh.K81	IRL	Meath	Knowth												O'Sullivan 1988				
Kh.K82	IRL	Meath	Knowth												O'Sullivan 1988				
Kh.K83	IRL	Meath	Knowth												O'Sullivan 1988				
Kh.K84	IRL	Meath	Knowth												O'Sullivan 1988				
Kh.K85	IRL	Meath	Knowth												O'Sullivan 1988				
Kh.K86	IRL	Meath	Knowth												O'Sullivan 1988				
Kh.K87	IRL	Meath	Knowth												Eogan 1968				
Kh.K88	IRL	Meath	Knowth												Eogan 1968				
Kh.K89	IRL	Meath	Knowth												Eogan 1968				
Kh.K90	IRL	Meath	Knowth												Eogan 1968				
Kh.K91	IRL	Meath	Knowth												Eogan 1968				
Kh.K92	IRL	Meath	Knowth												Eogan 1968				
Kh.K93	IRL	Meath	Knowth												Eogan 1968				
Kh.K94	IRL	Meath	Knowth												Eogan 1968				

Première partie - Cadre de l'étude

Abréviation	Pays	Comté	Site	●	○	◎	∩	*	✦	⋈	▲	◇	≡	⋈	Source bibliographique	Per.	Co.	Ch.	Ed.
Kh.K95	IRL	Meath	Knowth												Eogan 1968				
Kh.K97	IRL	Meath	Knowth												Eogan 1968				
Kh.K98	IRL	Meath	Knowth												Eogan 1968				
Kh.K113	IRL	Meath	Knowth												Eogan 1968				
Kh.K116	IRL	Meath	Knowth												Eogan 1968				
Kh.K118	IRL	Meath	Knowth												Eogan 1968				
Kh.K119	IRL	Meath	Knowth												Eogan 1968				
Kh.K120	IRL	Meath	Knowth												Eogan 1968				
Kh.K124	IRL	Meath	Knowth												Eogan 1996				
Kh.K126	IRL	Meath	Knowth												O'Sullivan 1988				
Kh.K127	IRL	Meath	Knowth												O'Sullivan 1988				
KhE.Or1	IRL	Meath	Knowth E												O'Sullivan 1988				
KhE.Or2	IRL	Meath	Knowth E												O'Sullivan 1988				
KhE.Or3	IRL	Meath	Knowth E												O'Sullivan 1988				
KhE.Or11	IRL	Meath	Knowth E												O'Sullivan 1988				
KhE.Or24	IRL	Meath	Knowth E												O'Sullivan 1988				
KhE.Or25	IRL	Meath	Knowth E												O'Sullivan 1988				
KhE.Or33	IRL	Meath	Knowth E											?	O'Sullivan 1988				
KhE.Or36	IRL	Meath	Knowth E								?			?	O'Sullivan 1988				
KhE.Or37	IRL	Meath	Knowth E												Eogan 1990				
KhE.Or43	IRL	Meath	Knowth E												O'Sullivan 1988				2
KhE.Or45	IRL	Meath	Knowth E								?				O'Sullivan 1988				2
KhE.Or47	IRL	Meath	Knowth E												O'Sullivan 1988				2
KhE.Or48	IRL	Meath	Knowth E												O'Sullivan 1988				2
KhE.Or49	IRL	Meath	Knowth E								?				O'Sullivan 1988				2
KhE.Or50	IRL	Meath	Knowth E												O'Sullivan 1988				2
KhE.iL.cellN	IRL	Meath	Knowth E												O'Sullivan 1988				
KhE.Or52	IRL	Meath	Knowth E												O'Sullivan 1988				3
KhE.Or53	IRL	Meath	Knowth E												O'Sullivan 1988				3
KhE.Or54	IRL	Meath	Knowth E												O'Sullivan 1988				3
KhE.Or55	IRL	Meath	Knowth E								?				O'Sullivan 1988				3
KhE.Or56	IRL	Meath	Knowth E							?	?				O'Sullivan 1988				3
KhE.iR.cellN	IRL	Meath	Knowth E												O'Sullivan 1988				
KhE.Or57	IRL	Meath	Knowth E												O'Sullivan 1988				
KhE.Or58	IRL	Meath	Knowth E												O'Sullivan 1988				
KhE.Or64	IRL	Meath	Knowth E												O'Sullivan 1988				
KhE.Or68	IRL	Meath	Knowth E												O'Sullivan 1988				
KhE.Or69	IRL	Meath	Knowth E												O'Sullivan 1988				
KhE.Or92	IRL	Meath	Knowth E											?	O'Sullivan 1988				
KhE.Or93	IRL	Meath	Knowth E											?	O'Sullivan 1988				
KhE.RS2	IRL	Meath	Knowth E												O'Sullivan 1988				
KhE.RS8	IRL	Meath	Knowth E												O'Sullivan 1988				
KhE.RS10	IRL	Meath	Knowth E												O'Sullivan 1988				
KhE.RS20	IRL	Meath	Knowth E												O'Sullivan 1988				
KhE.RS21	IRL	Meath	Knowth E												O'Sullivan 1988				
KhE.RS26	IRL	Meath	Knowth E											?	O'Sullivan 1988				
KhE.RS28	IRL	Meath	Knowth E												O'Sullivan 1988				
KhE.RS30	IRL	Meath	Knowth E							?					O'Sullivan 1988				
KhE.RS32	IRL	Meath	Knowth E												O'Sullivan 1988				
KhE.RS34	IRL	Meath	Knowth E											?	O'Sullivan 1988				
KhE.RS37	IRL	Meath	Knowth E												O'Sullivan 1988				
KhE.RS38	IRL	Meath	Knowth E							?					O'Sullivan 1988				
KhE.RS41	IRL	Meath	Knowth E												O'Sullivan 1988				
KhE.RS49	IRL	Meath	Knowth E												O'Sullivan 1988				
KhE.RS50	IRL	Meath	Knowth E												O'Sullivan 1988				
KhE.RScellN	IRL	Meath	Knowth E												O'Sullivan 1988				3
KhE.b.Co39i	IRL	Meath	Knowth E												O'Sullivan 1988				1
KhE.b.CoEvi	IRL	Meath	Knowth E												O'Sullivan 1988				
KhE.Co65	IRL	Meath	Knowth E												O'Sullivan 1988				
KhE.Co86/87	IRL	Meath	Knowth E												O'Sullivan 1988				
KhE.Co12/13	IRL	Meath	Knowth E			?								?	O'Sullivan 1988				
KhE.Co40-1	IRL	Meath	Knowth E												O'Sullivan 1988				1
KhE.Co40-5	IRL	Meath	Knowth E												O'Sullivan 1988				1
KhE.Co41-2	IRL	Meath	Knowth E							?		?			O'Sullivan 1988				1
KhE.Co52-3	IRL	Meath	Knowth E												O'Sullivan 1988				3
KhE.Co54-1	IRL	Meath	Knowth E											?	O'Sullivan 1988				3
KhE.Co59/60-3	IRL	Meath	Knowth E												O'Sullivan 1988				
KhE.Co63/64-1	IRL	Meath	Knowth E												O'Sullivan 1988				
KhE.CoA6	IRL	Meath	Knowth E												O'Sullivan 1988				
KhE.CoA10	IRL	Meath	Knowth E							?					O'Sullivan 1988				
KhE.CoD7	IRL	Meath	Knowth E												O'Sullivan 1988				
KhE.CoE6	IRL	Meath	Knowth E												O'Sullivan 1988				
KhE.CoF10	IRL	Meath	Knowth E												O'Sullivan 1988				
KhE.B	IRL	Meath	Knowth E												O'Sullivan 1988				
KhE.bas.cellW	IRL	Meath	Knowth E									?		?	O'Sullivan 1988				
KhW.Or16	IRL	Meath	Knowth W			?									O'Sullivan 1988				
KhW.Or17	IRL	Meath	Knowth W									?			O'Sullivan 1988				
KhW.Or18	IRL	Meath	Knowth W												O'Sullivan 1988				
KhW.Or33	IRL	Meath	Knowth W												O'Sullivan 1988				
KhW.Or34	IRL	Meath	Knowth W												O'Sullivan 1988				
KhW.Or38	IRL	Meath	Knowth W			?									O'Sullivan 1988				
KhW.Or39	IRL	Meath	Knowth W									?			O'Sullivan 1988				
KhW.Or40	IRL	Meath	Knowth W												O'Sullivan 1988				
KhW.Or41	IRL	Meath	Knowth W											?	O'Sullivan 1988				
KhW.Or42	IRL	Meath	Knowth W												O'Sullivan 1988				
KhW.Or44	IRL	Meath	Knowth W												O'Sullivan 1988				
KhW.Or48	IRL	Meath	Knowth W								?			?	O'Sullivan 1988				
KhW.Or50	IRL	Meath	Knowth W												O'Sullivan 1988				
KhW.Or51	IRL	Meath	Knowth W												O'Sullivan 1988				

1 - Objet, sujet et méthodologie

Abréviation	Pays	Comté	Site	●	○	◎	∩	*	☀	⋈	▲	◇	≡	⋈	Source bibliographique	Pet.	Cont.	Ch.	Cel.
KhW.Or74	IRL	Meath	Knowth W												O'Sullivan 1988				
KhW.Or81	IRL	Meath	Knowth W												O'Sullivan 1988				
KhW.RS3	IRL	Meath	Knowth W												O'Sullivan 1988				
KhW.RS5	IRL	Meath	Knowth W												O'Sullivan 1988				
KhW.RS10	IRL	Meath	Knowth W												O'Sullivan 1988				
KhW.Co37-38	IRL	Meath	Knowth W											?	Eogan 1997				
KhW.A	IRL	Meath	Knowth W						?						O'Sullivan 1988				
Kh2.K28	IRL	Meath	Knowth 2												Eogan 1974				
Kh2.Or14	IRL	Meath	Knowth 2												Eogan 1974				
Kh2.Or25	IRL	Meath	Knowth 2												Eogan 1974				3
Kh2.Or29	IRL	Meath	Knowth 2												Eogan 1974				
Kh3.K10	IRL	Meath	Knowth 3												Eogan 1974				
Kh4.A	IRL	Meath	Knowth 4								?			?	Eogan 1974				
Kh5.8	IRL	Meath	Knowth 5												Eogan 1974				
Kh8.K5	IRL	Meath	Knowth 8												Eogan 1974				
Kh8.K11	IRL	Meath	Knowth 8		?										Eogan 1974				
Kh12.K6	IRL	Meath	Knowth 12												Eogan 1968				
Kh13.K15	IRL	Meath	Knowth 13												Eogan 1968				
Kh13.K16	IRL	Meath	Knowth 13												Eogan 1968				
Kh13.K17	IRL	Meath	Knowth 13												Eogan 1968				
Kh13.K24	IRL	Meath	Knowth 13												Eogan 1968				
Kh13.Or3	IRL	Meath	Knowth 13												Eogan 1968				
Kh13.drain	IRL	Meath	Knowth 13												Eogan 1968				
Kh14.K4	IRL	Meath	Knowth 14												Eogan 1968				
Kh14.K6	IRL	Meath	Knowth 14												Eogan 1968				
Kh14.Or4	IRL	Meath	Knowth 14												Eogan 1968				
Kh14.Or7	IRL	Meath	Knowth 14												Eogan 1968				
Kh14.Or8	IRL	Meath	Knowth 14												Eogan 1968				
Kh14.Or13	IRL	Meath	Knowth 14												Eogan 1968				
Kh15.K6	IRL	Meath	Knowth 15									?			Eogan 1984				
Kh15.Or1	IRL	Meath	Knowth 15												Eogan 1984				
Kh15.silC	IRL	Meath	Knowth 15												Eogan 1984				
Kh15.Or14	IRL	Meath	Knowth 15												Eogan 1984				
Kh16.Or4	IRL	Meath	Knowth 16												Eogan 1984				
Kh16.Or7	IRL	Meath	Knowth 16												Eogan 1984				
Kh16.Or9	IRL	Meath	Knowth 16						?				?		Eogan 1984				
Kh16.Or13	IRL	Meath	Knowth 16												Eogan 1984				
Kh16.Co10	IRL	Meath	Knowth 16												Eogan 1984				
Kh16.Co12	IRL	Meath	Knowth 16												Eogan 1984				
Kh17.Or6	IRL	Meath	Knowth 17												Eogan 1984				
Kh17.Or7	IRL	Meath	Knowth 17												Eogan 1984				
Kh17.Or13	IRL	Meath	Knowth 17												Eogan 1984				
Kh17.Or15	IRL	Meath	Knowth 17											?	Eogan 1984				
Kh17.Or16	IRL	Meath	Knowth 17									?			Eogan 1984				
Kh18.Or11	IRL	Meath	knowth 18												Eogan 1984				2
Kh.loose1	IRL	Meath	Knowth												O'Sullivan 1988				
Kh.loose2	IRL	Meath	Knowth												Eogan 1968				
Kh.loose3	IRL	Meath	Knowth												O'Sullivan 1988				
Kh.loose4	IRL	Meath	Knowth												O'Sullivan 1988				
Kh.loose5	IRL	Meath	Knowth												O'Sullivan 1988				
Kh.loose7	IRL	Meath	Knowth												O'Sullivan 1988				
Kh.loose9	IRL	Meath	Knowth												O'Sullivan 1988				
Kh.loose10	IRL	Meath	Knowth												O'Sullivan 1988				
Kh.loose22	IRL	Meath	Knowth												Eogan 1968				
Kh.loose23	IRL	Meath	Knowth												O'Sullivan 1988				
Lh.RS	IRL	Sligo	Listoghil												Curran-Mulligan 1994				
LcF.L1	IRL	Meath	Loughcrew F												Shee Twohig 1981				
LcF.L3	IRL	Meath	Loughcrew F												Shee Twohig 1981				
LcF.L4	IRL	Meath	Loughcrew F												Shee Twohig 1981				
LcF.R2	IRL	Meath	Loughcrew F												Shee Twohig 1981				
LcF.R4	IRL	Meath	Loughcrew F					?	?						Shee Twohig 1981				
LcF.C1	IRL	Meath	Loughcrew F												Shee Twohig 1981				1
LcF.C5	IRL	Meath	Loughcrew F												Shee Twohig 1981				2
LcF.loose	IRL	Meath	Loughcrew F												Frazer 1893				
LcH.K8	IRL	Meath	Loughcrew H												Shee Twohig 1981				
LcH.L2	IRL	Meath	Loughcrew H												Shee Twohig 1981				
LcH.R2	IRL	Meath	Loughcrew H												Shee Twohig 1981				
LcH.C5	IRL	Meath	Loughcrew H												Shee Twohig 1981				1
LcH.C11	IRL	Meath	Loughcrew H												Shee Twohig 1981				2
LcH.C14	IRL	Meath	Loughcrew H												Shee Twohig 1981				3
LcH.sill	IRL	Meath	Loughcrew H												Shee Twohig 1981				3
LcH.C18	IRL	Meath	Loughcrew H												Shee Twohig 1981				3
LcI.R2	IRL	Meath	Loughcrew I												Shee Twohig 1981				
LcI.C1	IRL	Meath	Loughcrew I												Shee Twohig 1981				1
LcI.C4	IRL	Meath	Loughcrew I												Shee Twohig 1981				1
LcI.C5	IRL	Meath	Loughcrew I												Shee Twohig 1981				1
LcI.s.cell3	IRL	Meath	Loughcrew I									?			Shee Twohig 1981				1
LcI.C13	IRL	Meath	Loughcrew I						?			?			Shee Twohig 1981				3
LcI.C15	IRL	Meath	Loughcrew I												Shee Twohig 1981				3
LcI.C17	IRL	Meath	Loughcrew I												Shee Twohig 1981				3
LcJ.C4	IRL	Meath	Loughcrew J												Shee Twohig 1981				3
LcJ.loose1	IRL	Meath	Loughcrew J									?			Frazer 1893				
LcJ.loose2	IRL	Meath	Loughcrew J												Shee Twohig 1981				
LcK.C3	IRL	Meath	Loughcrew K												Shee Twohig 1981				2
LcL.L1	IRL	Meath	Loughcrew L												Shee Twohig 1981				
LcL.L3	IRL	Meath	Loughcrew L												Shee Twohig 1981				
LcL.L4	IRL	Meath	Loughcrew L										?		Shee Twohig 1981				
LcL.R1	IRL	Meath	Loughcrew L		?	?									Shee Twohig 1981				
LcL.R3	IRL	Meath	Loughcrew L											?	Shee Twohig 1981				

Première partie - Cadre de l'étude

Abbréviation	Pays	Comté	Site	●	○	◎	∩	*	✱	⋈	▲	◇	≡	∞	Source bibliographique	Per.	Co.	Ch.	Ed.
LcL.R4	IRL	Meath	Loughcrew L												Shee Twohig 1981				
LcL.C1	IRL	Meath	Loughcrew L												Shee Twohig 1981				1
LcL.C3	IRL	Meath	Loughcrew L												Shee Twohig 1981				1
LcL.C4	IRL	Meath	Loughcrew L									?	?		Shee Twohig 1981				1
LcL.C5	IRL	Meath	Loughcrew L												Shee Twohig 1981				1
LcL.C8	IRL	Meath	Loughcrew L												Shee Twohig 1981				2
LcL.C9	IRL	Meath	Loughcrew L		?										Shee Twohig 1981				2
LcL.C11	IRL	Meath	Loughcrew L												Shee Twohig 1981				2
LcL.C16	IRL	Meath	Loughcrew L												Shee Twohig 1981				3
LcL.C17	IRL	Meath	Loughcrew L												Shee Twohig 1981				3
LcL.C18	IRL	Meath	Loughcrew L												Shee Twohig 1981				3
LcL.C19	IRL	Meath	Loughcrew L								?				Shee Twohig 1981				3
LcL.Co1/C16	IRL	Meath	Loughcrew L												Shee Twohig 1981				3
LcL.Co4/C2-4	IRL	Meath	Loughcrew L												Shee Twohig 1981				1
LcL.loose	IRL	Meath	Loughcrew L												Shee Twohig 1981				
LcO	IRL	Meath	Loughcrew O												Robin				
LcR2	IRL	Meath	Loughcrew R2												Shee Twohig 1981				
LcS.L3	IRL	Meath	Loughcrew S												Shee Twohig 1981				
LcS.L4	IRL	Meath	Loughcrew S												Shee Twohig 1981				
LcS.R2	IRL	Meath	Loughcrew S												Shee Twohig 1981				
LcS.C2	IRL	Meath	Loughcrew S												Shee Twohig 1981				3
LcS.C6	IRL	Meath	Loughcrew S												Shee Twohig 1981				
LcT.L1	IRL	Meath	Loughcrew T												Shee Twohig 1981				
LcT.L2	IRL	Meath	Loughcrew T												Shee Twohig 1981				
LcT.L3	IRL	Meath	Loughcrew T				?								Shee Twohig 1981				
LcT.L4	IRL	Meath	Loughcrew T												Shee Twohig 1981				
LcT.L5	IRL	Meath	Loughcrew T												Shee Twohig 1981				
LcT.R2	IRL	Meath	Loughcrew T										?		Shee Twohig 1981				
LcT.R4	IRL	Meath	Loughcrew T				?								Shee Twohig 1981				
LcT.R5	IRL	Meath	Loughcrew T				?								Shee Twohig 1981				
LcT.sill1	IRL	Meath	Loughcrew T												Shee Twohig 1981				
LcT.C1	IRL	Meath	Loughcrew T												Shee Twohig 1981				
LcT.C2	IRL	Meath	Loughcrew T												Shee Twohig 1981				1
LcT.C3	IRL	Meath	Loughcrew T												Shee Twohig 1981				1
LcT.C4	IRL	Meath	Loughcrew T												Shee Twohig 1981				1
LcT.C5	IRL	Meath	Loughcrew T					?							Shee Twohig 1981				
LcT.sill3	IRL	Meath	Loughcrew T												Shee Twohig 1981				
LcT.C6	IRL	Meath	Loughcrew T				?								Shee Twohig 1981				2
LcT.C8	IRL	Meath	Loughcrew T												Shee Twohig 1981				2
LcT.C9	IRL	Meath	Loughcrew T										?		Shee Twohig 1981				2
LcT.C10	IRL	Meath	Loughcrew T											?	Shee Twohig 1981				
LcT.C11	IRL	Meath	Loughcrew T												Shee Twohig 1981				3
LcT.C14	IRL	Meath	Loughcrew T												Shee Twohig 1981				3
LcT.C15	IRL	Meath	Loughcrew T												Shee Twohig 1981				
LcT.Co1/C2	IRL	Meath	Loughcrew T												Shee Twohig 1981				1
LcT.Co1/C4	IRL	Meath	Loughcrew T				?								Shee Twohig 1981				1
LcT.Co2.C2	IRL	Meath	Loughcrew T					?							Shee Twohig 1981				1
LcT.lecl1	IRL	Meath	Loughcrew T				?								Shee Twohig 1981				1
LcT.lecl2	IRL	Meath	Loughcrew T												Shee Twohig 1981				2
LcT.RScell2	IRL	Meath	Loughcrew T												Shee Twohig 1981				2
LcT.RScell3	IRL	Meath	Loughcrew T		?										Shee Twohig 1981				3
LcT.fragment	IRL	Meath	Loughcrew T												Shee Twohig 1981				
LcU.L2	IRL	Meath	Loughcrew U			?	?	?					?	?	Shee Twohig 1981				
LcU.R2	IRL	Meath	Loughcrew U												Shee Twohig 1981				
LcU.R3	IRL	Meath	Loughcrew U											?	Shee Twohig 1981				
LcU.C2	IRL	Meath	Loughcrew U												Shee Twohig 1981				1
LcU.C3	IRL	Meath	Loughcrew U												Shee Twohig 1981				1
LcU.C4	IRL	Meath	Loughcrew U				?								Shee Twohig 1981				1
LcU.C5	IRL	Meath	Loughcrew U												Shee Twohig 1981				2
LcU.C6	IRL	Meath	Loughcrew U							?					Shee Twohig 1981				2
LcU.C7	IRL	Meath	Loughcrew U								?			?	Shee Twohig 1981				2
LcU.C8	IRL	Meath	Loughcrew U												Shee Twohig 1981				3
LcU.C9	IRL	Meath	Loughcrew U												Shee Twohig 1981				3
LcU.C10	IRL	Meath	Loughcrew U												Shee Twohig 1981				3
LcU.C11	IRL	Meath	Loughcrew U												Shee Twohig 1981				3
LcU.fragment	IRL	Meath	Loughcrew U		?	?	?								Shee Twohig 1981				
LcV.C1	IRL	Meath	Loughcrew V												Shee Twohig 1981				1
LcV.C3	IRL	Meath	Loughcrew V												Shee Twohig 1981				1
LcV.C4	IRL	Meath	Loughcrew V												Shee Twohig 1981				1
LcV.C8	IRL	Meath	Loughcrew V												Shee Twohig 1981				3
LcW.R1	IRL	Meath	Loughcrew W												Shee Twohig 1981				
LcW.C2	IRL	Meath	Loughcrew W		?										Shee Twohig 1981				
LcW.C3	IRL	Meath	Loughcrew W												Shee Twohig 1981				
LcW.C4	IRL	Meath	Loughcrew W												Frazer 1893				
LcX1	IRL	Meath	Loughcrew X1												Shee Twohig 1981				
LH	IRL	Antrim	Lyles Hill												Evans 1953				
MM.1	IRL	Donegal	Malin More			?									Shee Twohig 1981				
MM.2	IRL	Donegal	Malin More			?				?				?	Shee Twohig 1981				
MB.2	IRL	Down	Millin Bay												Collins & Waterman 1955				
MB.3	IRL	Down	Millin Bay												Collins & Waterman 1955				
MB.4	IRL	Down	Millin Bay												Collins & Waterman 1955				
MB.5	IRL	Down	Millin Bay											?	Collins & Waterman 1955				
MB.6	IRL	Down	Millin Bay												Collins & Waterman 1955				
MB.7	IRL	Down	Millin Bay												Collins & Waterman 1955				
MB.10	IRL	Down	Millin Bay									?			Collins & Waterman 1955				
MB.11	IRL	Down	Millin Bay												Collins & Waterman 1955				
MB.13	IRL	Down	Millin Bay												Collins & Waterman 1955				
MB.18	IRL	Down	Millin Bay		?									?	Collins & Waterman 1955				
MB.19	IRL	Down	Millin Bay			?									Collins & Waterman 1955				

1 - Objet, sujet et méthodologie

Abréviation	Pays	Comté	Site	●	○	◎	◡	✱	✻	⋈	▲	◇	≡	⋈	Source bibliographique	Per.	C.Ou.	Ch.	C.d.
MB.20	IRL	Down	Millin Bay												Collins & Waterman 1955				
MB.22	IRL	Down	Millin Bay												Collins & Waterman 1955				
MB.31	IRL	Down	Millin Bay												Collins & Waterman 1955				
MB.38	IRL	Down	Millin Bay												Collins & Waterman 1955				
MB.40	IRL	Down	Millin Bay									?			Collins & Waterman 1955				
MB.47	IRL	Down	Millin Bay												Collins & Waterman 1955				
MB.49	IRL	Down	Millin Bay		?		?								Collins & Waterman 1955				
MB.M1	IRL	Down	Millin Bay		?		?								Collins & Waterman 1955				
MB.M2	IRL	Down	Millin Bay												Collins & Waterman 1955				
MB.M3	IRL	Down	Millin Bay												Collins & Waterman 1955				
MB.M5	IRL	Down	Millin Bay												Collins & Waterman 1955				
MB.M6	IRL	Down	Millin Bay										?		Collins & Waterman 1955				
MB.M7	IRL	Down	Millin Bay				?								Collins & Waterman 1955				
MB.M8	IRL	Down	Millin Bay											?	Collins & Waterman 1955				
MB.M9	IRL	Down	Millin Bay												Collins & Waterman 1955				
MB.M10	IRL	Down	Millin Bay												Collins & Waterman 1955				
MB.M11	IRL	Down	Millin Bay							?					Collins & Waterman 1955				
MB.M12	IRL	Down	Millin Bay												Collins & Waterman 1955				
MB.M16	IRL	Down	Millin Bay				?								Collins & Waterman 1955				
MB.M17	IRL	Down	Millin Bay							?					Collins & Waterman 1955				
MB.M18	IRL	Down	Millin Bay		?		?								Collins & Waterman 1955				
MB.M19	IRL	Down	Millin Bay												Collins & Waterman 1955				
MB.M20	IRL	Down	Millin Bay			?		?							Collins & Waterman 1955				
MB.M21	IRL	Down	Millin Bay									?			Collins & Waterman 1955				
MB.M22	IRL	Down	Millin Bay												Collins & Waterman 1955				
MB.M23	IRL	Down	Millin Bay												Collins & Waterman 1955				
MB.M24	IRL	Down	Millin Bay									?			Collins & Waterman 1955				
MB.M26	IRL	Down	Millin Bay												Collins & Waterman 1955				
MB.M27	IRL	Down	Millin Bay		?		?					?			Collins & Waterman 1955				
MB.M28	IRL	Down	Millin Bay												Collins & Waterman 1955				
MB.M30	IRL	Down	Millin Bay												Collins & Waterman 1955				
Mt	IRL	Meath	Mountainstown											?	O'Broin 2000				
Ml	IRL	Sligo	Moylough												Morris 1929				
Mg	IRL	Meath	Mullagharoy												Eogan & O'Broin 1998				
Ng.K1	IRL	Meath	Newgrange												O'Kelly 1982				
Ng.K2	IRL	Meath	Newgrange											?	O'Kelly 1982				
Ng.K3	IRL	Meath	Newgrange												O'Kelly 1982				
Ng.K4	IRL	Meath	Newgrange												O'Kelly 1982				
Ng.K5	IRL	Meath	Newgrange							?		?		?	O'Kelly 1982				
Ng.K6	IRL	Meath	Newgrange												O'Kelly 1982				
Ng.K7	IRL	Meath	Newgrange												O'Kelly 1982				
Ng.K8	IRL	Meath	Newgrange												O'Kelly 1982				
Ng.K9	IRL	Meath	Newgrange											?	O'Kelly 1982				
Ng.K11b	IRL	Meath	Newgrange					?							O'Kelly 1982				
Ng.K12	IRL	Meath	Newgrange								?				O'Kelly 1982				
Ng.K13b	IRL	Meath	Newgrange												O'Kelly 1982				
Ng.K16	IRL	Meath	Newgrange												O'Kelly 1982				
Ng.K17	IRL	Meath	Newgrange												O'Kelly 1982				
Ng.K18b	IRL	Meath	Newgrange												O'Kelly 1982				
Ng.K50	IRL	Meath	Newgrange												O'Kelly 1982				
Ng.K51	IRL	Meath	Newgrange												O'Kelly 1982				
Ng.K52	IRL	Meath	Newgrange												O'Kelly 1982				
Ng.K54	IRL	Meath	Newgrange									?			O'Kelly 1982				
Ng.K67	IRL	Meath	Newgrange												O'Kelly 1982				
Ng.K82	IRL	Meath	Newgrange												O'Kelly 1982				
Ng.K83	IRL	Meath	Newgrange												O'Kelly 1982				
Ng.K85	IRL	Meath	Newgrange												O'Kelly 1982				
Ng.K88	IRL	Meath	Newgrange											?	O'Kelly 1982				
Ng.K89	IRL	Meath	Newgrange							?					O'Kelly 1982				
Ng.K90	IRL	Meath	Newgrange												O'Kelly 1982				
Ng.K91	IRL	Meath	Newgrange					?							O'Kelly 1982				
Ng.K93	IRL	Meath	Newgrange		?		?								O'Kelly 1982				
Ng.L12	IRL	Meath	Newgrange												O'Kelly 1982				
Ng.L13	IRL	Meath	Newgrange												O'Kelly 1982				
Ng.L15	IRL	Meath	Newgrange								?				O'Kelly 1982				
Ng.L17	IRL	Meath	Newgrange												O'Kelly 1982				
Ng.L19	IRL	Meath	Newgrange												O'Kelly 1982				
Ng.L20	IRL	Meath	Newgrange											?	O'Kelly 1982				
Ng.L22	IRL	Meath	Newgrange												O'Kelly 1982				
Ng.R3	IRL	Meath	Newgrange												O'Kelly 1982				
Ng.R5	IRL	Meath	Newgrange												O'Kelly 1982				
Ng.R8	IRL	Meath	Newgrange												O'Kelly 1982				
Ng.R10	IRL	Meath	Newgrange												O'Kelly 1982				
Ng.R12	IRL	Meath	Newgrange												O'Kelly 1982				
Ng.R18	IRL	Meath	Newgrange												O'Kelly 1982				
Ng.R19	IRL	Meath	Newgrange								?				O'Kelly 1982				
Ng.R20	IRL	Meath	Newgrange												O'Kelly 1982				
Ng.R21	IRL	Meath	Newgrange												O'Kelly 1982				
Ng.C2	IRL	Meath	Newgrange												O'Kelly 1982				1
Ng.C3	IRL	Meath	Newgrange		?										O'Kelly 1982				1
Ng.C4	IRL	Meath	Newgrange												O'Kelly 1982				1
Ng.C8	IRL	Meath	Newgrange												O'Kelly 1982				2
Ng.C10	IRL	Meath	Newgrange								?				O'Kelly 1982				2
Ng.C11	IRL	Meath	Newgrange												O'Kelly 1982				
Ng.C15	IRL	Meath	Newgrange												O'Kelly 1982				3
Ng.C16	IRL	Meath	Newgrange												O'Kelly 1982				3
Ng.R51	IRL	Meath	Newgrange												O'Kelly 1982				
Ng.RBlintel	IRL	Meath	Newgrange												O'Kelly 1982				
Ng.RB	IRL	Meath	Newgrange								?				O'Kelly 1982				

Première partie - Cadre de l'étude

Abréviation	Pays	Comté	Site	●	○	◎	∩	*	✱	⋈	⚡	◊	≡	⋈	Source bibliographique	Per.	Con.	Ch.	Cal.
Ng.Co3/L5-6	IRL	Meath	Newgrange									?			O'Kelly 1982				
Ng.Co3/R4-5	IRL	Meath	Newgrange												O'Kelly 1982				
Ng.RS3	IRL	Meath	Newgrange												O'Kelly 1982				
Ng.RS7	IRL	Meath	Newgrange												O'Kelly 1982				
Ng.RS17	IRL	Meath	Newgrange												O'Kelly 1982				
Ng.X	IRL	Meath	Newgrange												O'Kelly 1982				
Ng.Y	IRL	Meath	Newgrange									?			O'Kelly 1982				
Ng.Z	IRL	Meath	Newgrange												O'Kelly 1982				
Ng.Co1/C2	IRL	Meath	Newgrange			?	?								O'Kelly 1982				1
Ng.Co1/C7	IRL	Meath	Newgrange												O'Kelly 1982				2
Ng.Co1/C10	IRL	Meath	Newgrange											?	O'Kelly 1982				2
Ng.Co1/C11	IRL	Meath	Newgrange												O'Kelly 1982				
Ng.Co1/C12-13	IRL	Meath	Newgrange												O'Kelly 1982				3
Ng.Co1/C15-16	IRL	Meath	Newgrange												O'Kelly 1982				3
Ng.Co2/C11	IRL	Meath	Newgrange												O'Kelly 1982				2
Ng.Co2/C14	IRL	Meath	Newgrange												O'Kelly 1982				3
Ng.Co4/C8	IRL	Meath	Newgrange			?							?		O'Kelly 1982				2
Ng.RScellE(f)	IRL	Meath	Newgrange												O'Kelly 1982				3
Ng.RScellE	IRL	Meath	Newgrange									?			O'Kelly 1982				3
NgK.K4	IRL	Meath	Newgrange K		?			?							O'Kelly et al. 1978				
NgK.A	IRL	Meath	Newgrange K												O'Kelly et al. 1978				
NgK.sill1	IRL	Meath	Newgrange K							?				?	O'Kelly et al. 1978				
NgK.2a	IRL	Meath	Newgrange K												O'Kelly et al. 1978				
NgK.2	IRL	Meath	Newgrange K											?	O'Kelly et al. 1978				
NgK.4	IRL	Meath	Newgrange K		?										O'Kelly et al. 1978				
NgK.5	IRL	Meath	Newgrange K		?										O'Kelly et al. 1978				
NgK.11	IRL	Meath	Newgrange K					?							O'Kelly et al. 1978				3
NgK.9	IRL	Meath	Newgrange K												O'Kelly et al. 1978				
NgK.10	IRL	Meath	Newgrange K												O'Kelly et al. 1978				
NgL.B	IRL	Meath	Newgrange L												O'Kelly et al. 1978				
NgL.kiln	IRL	Meath	Newgrange L							?	?				O'Kelly et al. 1978				
NgL.A	IRL	Meath	Newgrange L										?		O'Kelly et al. 1978				
NgL.C1	IRL	Meath	Newgrange L								?				O'Kelly et al. 1978				1
NgL.C3	IRL	Meath	Newgrange L	x	?		?								O'Kelly et al. 1978				1
NgL.C5	IRL	Meath	Newgrange L												O'Kelly et al. 1978				2
NgL.C9	IRL	Meath	Newgrange L		?		?								O'Kelly et al. 1978				3
NgZ.fragment	IRL	Meath	Newgrange Z												O'Kelly et al. 1978				
NgZ.basin	IRL	Meath	Newgrange Z					?							O'Kelly et al. 1978				
Rk.A	IRL	Meath	Rathkenny												Shee Twohig 1981				
Rk.B	IRL	Meath	Rathkenny												Shee Twohig 1981				
SfL4	IRL	Wicklow	Seefin							?					Shee Twohig 1981				
SfR4	IRL	Wicklow	Seefin												Shee Twohig 1981				
SK.stele	IRL	Tyrone	Sess Kilgreen												Shee Twohig 1981				
SK.C2	IRL	Tyrone	Sess Kilgreen											?	Shee Twohig 1981				
SK.C3	IRL	Tyrone	Sess Kilgreen												Shee Twohig 1981				
SK.C4	IRL	Tyrone	Sess Kilgreen												Shee Twohig 1981				
SK.C5	IRL	Tyrone	Sess Kilgreen							?					Shee Twohig 1981				
SK.C6	IRL	Tyrone	Sess Kilgreen												Shee Twohig 1981				
SK.C8	IRL	Tyrone	Sess Kilgreen												Shee Twohig 1981				
Tr.L2	IRL	Meath	Tara												Shee Twohig 1981				
Td	IRL	Dublin	Tibradden				?								?				
Ta	IRL	Wicklow	Tournant												Shee Twohig 1981				
ByG.L8	GAL	Anglesey	Barclodiad y Gawres												Shee Twohig 1981				
ByG.C1	GAL	Anglesey	Barclodiad y Gawres												Shee Twohig 1981				
ByG.C3	GAL	Anglesey	Barclodiad y Gawres							?					Shee Twohig 1981				1
ByG.C13	GAL	Anglesey	Barclodiad y Gawres												Shee Twohig 1981				3
ByG.C14	GAL	Anglesey	Barclodiad y Gawres										?		Shee Twohig 1981				3
ByG.C16	GAL	Anglesey	Barclodiad y Gawres												Shee Twohig 1981				
BCD.stele	GAL	Anglesey	Bryn Celli Ddu												Shee Twohig 1981				
Lb	GAL	Meirionnydd	Llanbedr									?			Lynch 1992				
Cs.A	ANG	Liverpool	Calderstones							?					Shee Twohig 1981				
Cs.B	ANG	Liverpool	Calderstones												Shee Twohig 1981				
Cs.C	ANG	Liverpool	Calderstones												Shee Twohig 1981				
Cs.D	ANG	Liverpool	Calderstones												Shee Twohig 1981				
Cs.E	ANG	Liverpool	Calderstones												Shee Twohig 1981				
Cs.F	ANG	Liverpool	Calderstones									?			Shee Twohig 1981				
Cr.5	ANG	Cumbria	Castlerigg												Beckensall 1999				
Cr.10	ANG	Cumbria	Castlerigg												Beckensall 1999				
Cr.11	ANG	Cumbria	Castlerigg				disparu								Beckensall 1999				
Cr.27	ANG	Cumbria	Castlerigg												Beckensall 1999				
Gb	ANG	Cumbria	Glassonby												Beckensall 1999				
TW.9	ANG	Argyll	Temple Wood												Scott 1988				
TW.11	ANG	Argyll	Temple Wood												Scott 1988				
CH.1	ECO	Orcades	Cuween Hill												Bradley et al. 1998				
CH.2	ECO	Orcades	Cuween Hill												Bradley et al. 1998				
CH.3	ECO	Orcades	Cuween Hill												Bradley et al. 1998				
EM	ECO	Orcades	Eday Manse												Shee Twohig 1981				
Ft	ECO	Orcades	Frith												Beckensall 1999				
HPW.A	ECO	Orcades	Holm of Papa Westray												Shee Twohig 1981				2
HPW.B	ECO	Orcades	Holm of Papa Westray												Shee Twohig 1981				2
HPW.C	ECO	Orcades	Holm of Papa Westray												Shee Twohig 1981				3
HPW.D	ECO	Orcades	Holm of Papa Westray			?									Shee Twohig 1981				3
HPW.E	ECO	Orcades	Holm of Papa Westray												Shee Twohig 1981				3
HPW.F	ECO	Orcades	Holm of Papa Westray												Shee Twohig 1981				
HPW.4	ECO	Orcades	Holm of Papa Westray												Bradley et al. 1998				
Mh.22	ECO	Orcades	Maeshowe												Bradley et al. 1998				
Mh.12	ECO	Orcades	Maeshowe												Bradley et al. 1998				
Mh.14	ECO	Orcades	Maeshowe												Bradley et al. 1998				
Mh.15	ECO	Orcades	Maeshowe												Bradley et al. 1998				



Abréviation	Pays	Comté	Site	●	○	◎	◡	✳	☼	⌚	▲	◇	≡	⌘	Source bibliographique	Per.	Com.	Ch.	Cel.
Mh.17	ECO	Orcades	Maeshowe												Bradley et al. 1998				
Mh.18	ECO	Orcades	Maeshowe												Bradley et al. 1998				2
Mh.19	ECO	Orcades	Maeshowe												Bradley et al. 1998				1
Mh.20	ECO	Orcades	Maeshowe												Bradley et al. 1998				
Mh.21	ECO	Orcades	Maeshowe							?					Bradley et al. 1998				
Pq	ECO	Orcades	Pickaquooy												Shee Twohig 1981				
Pw.665	ECO	Orcades	Pierowall												Sharples 1984				
Pw.666	ECO	Orcades	Pierowall												Sharples 1984				
Pw.667	ECO	Orcades	Pierowall												Sharples 1984				
Qn.5	ECO	Orcades	Quoyness												Bradley et al. 1998				2
Qn.6	ECO	Orcades	Quoyness												Bradley et al. 1998				
Qn.7	ECO	Orcades	Quoyness												Bradley et al. 1998				3
WH.8	ECO	Orcades	Wideford Hill												Bradley et al. 1998				
WH.9	ECO	Orcades	Wideford Hill												Bradley et al. 1998				
WH.10	ECO	Orcades	Wideford Hill												Bradley et al. 1998				1
WH.11	ECO	Orcades	Wideford Hill												Bradley et al. 1998				3
<b>Total</b>			<b>644</b>	<b>180</b>	<b>305</b>	<b>165</b>	<b>342</b>	<b>49</b>	<b>22</b>	<b>194</b>	<b>70</b>	<b>150</b>	<b>77</b>	<b>218</b>		<b>202</b>	<b>141</b>	<b>95</b>	<b>128</b>

Figure 1.10 : Base de données des dalles gravées

*Positionnement de l'appareil photo*

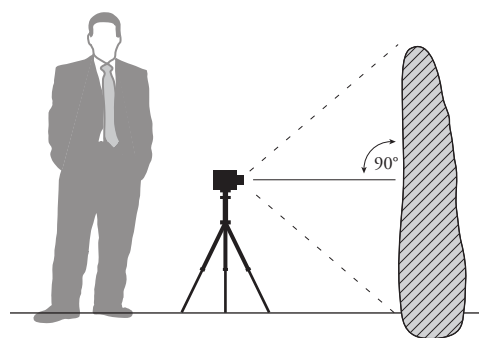

*Elaboration d'une "chambre noire"*



*Positions et directions des éclairages rasants*

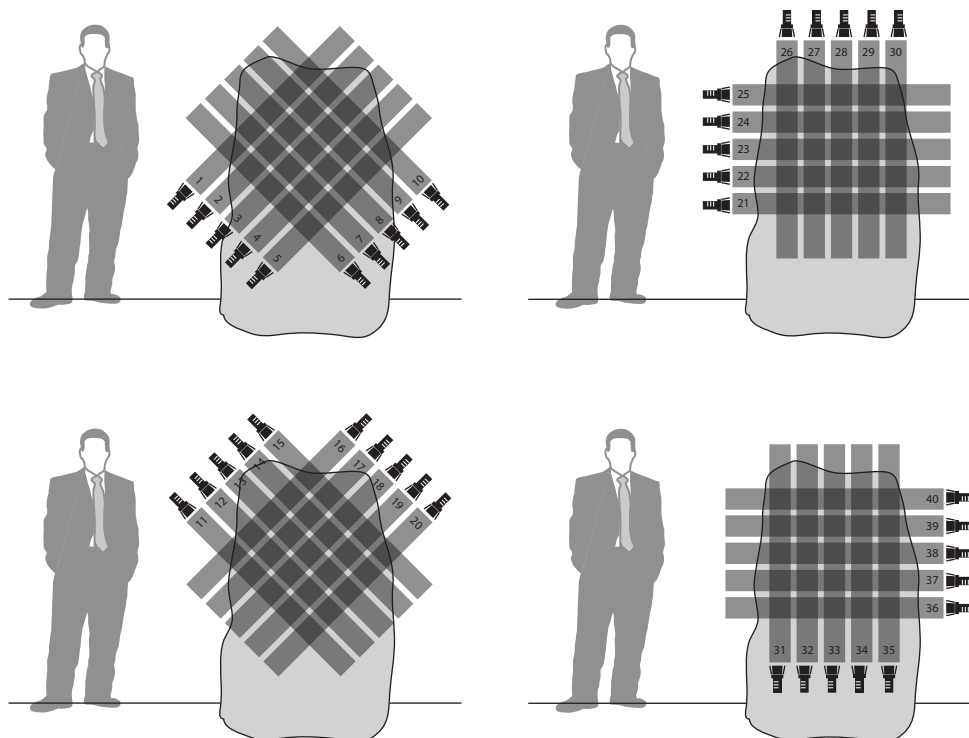

Figure 1.11 : Positionnement du matériel de prise de vue

*Processus d'égalisation sous Photoshop*



*Processus de dilatation sous Illustrator*

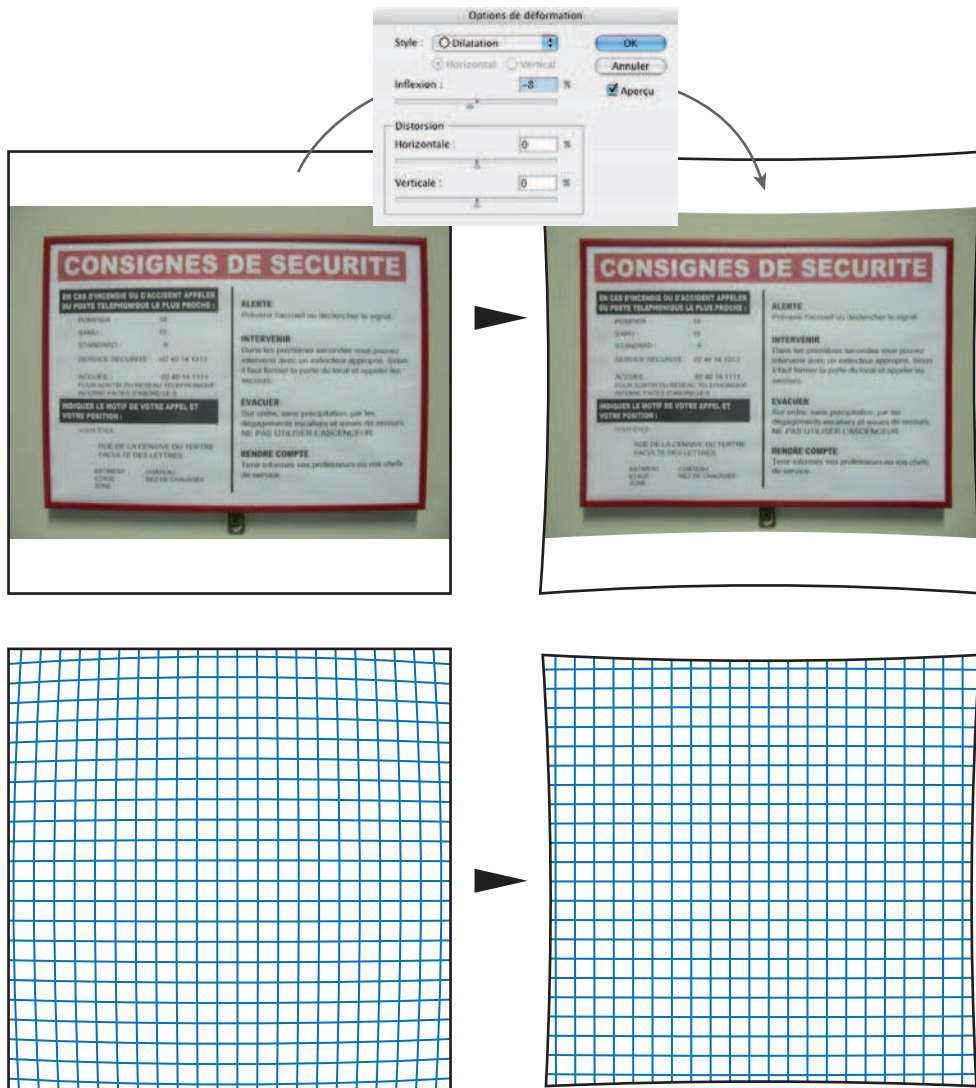
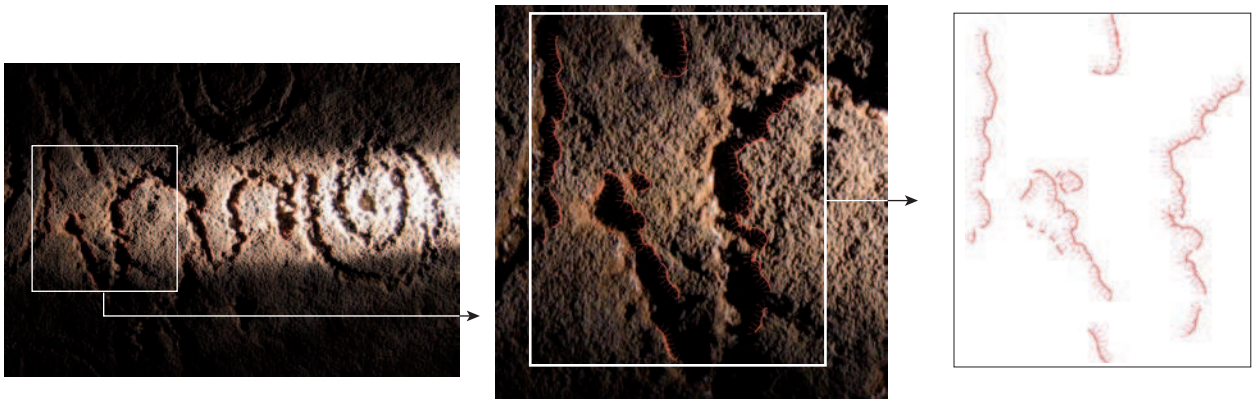
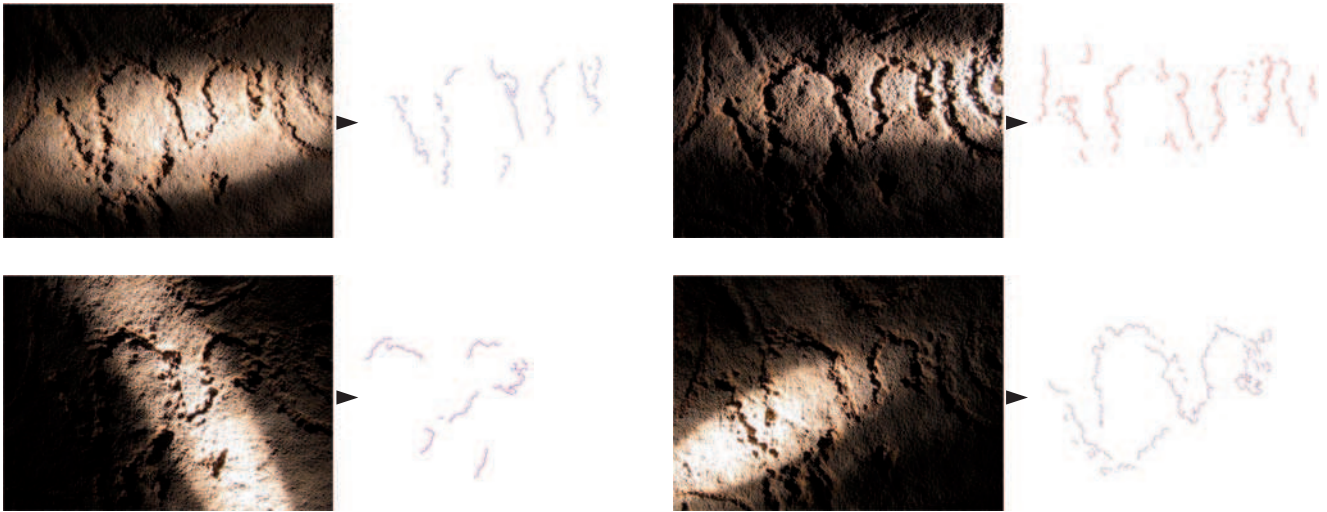

Figure 1.12 : Traitements préliminaires des photographies

*Dessin au trait barbelé*



*Relevé des gravures sur chaque photographie*



*Synthèse des tracés et dessin final*

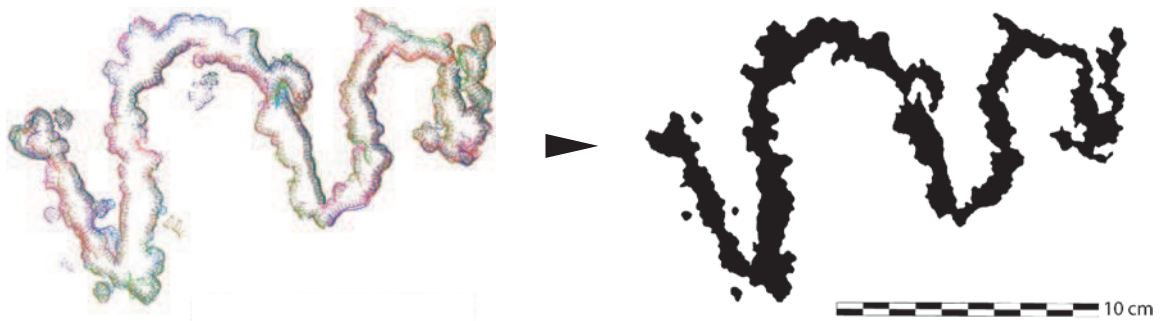

Figure 1.13 : Relevé au dessin des gravures

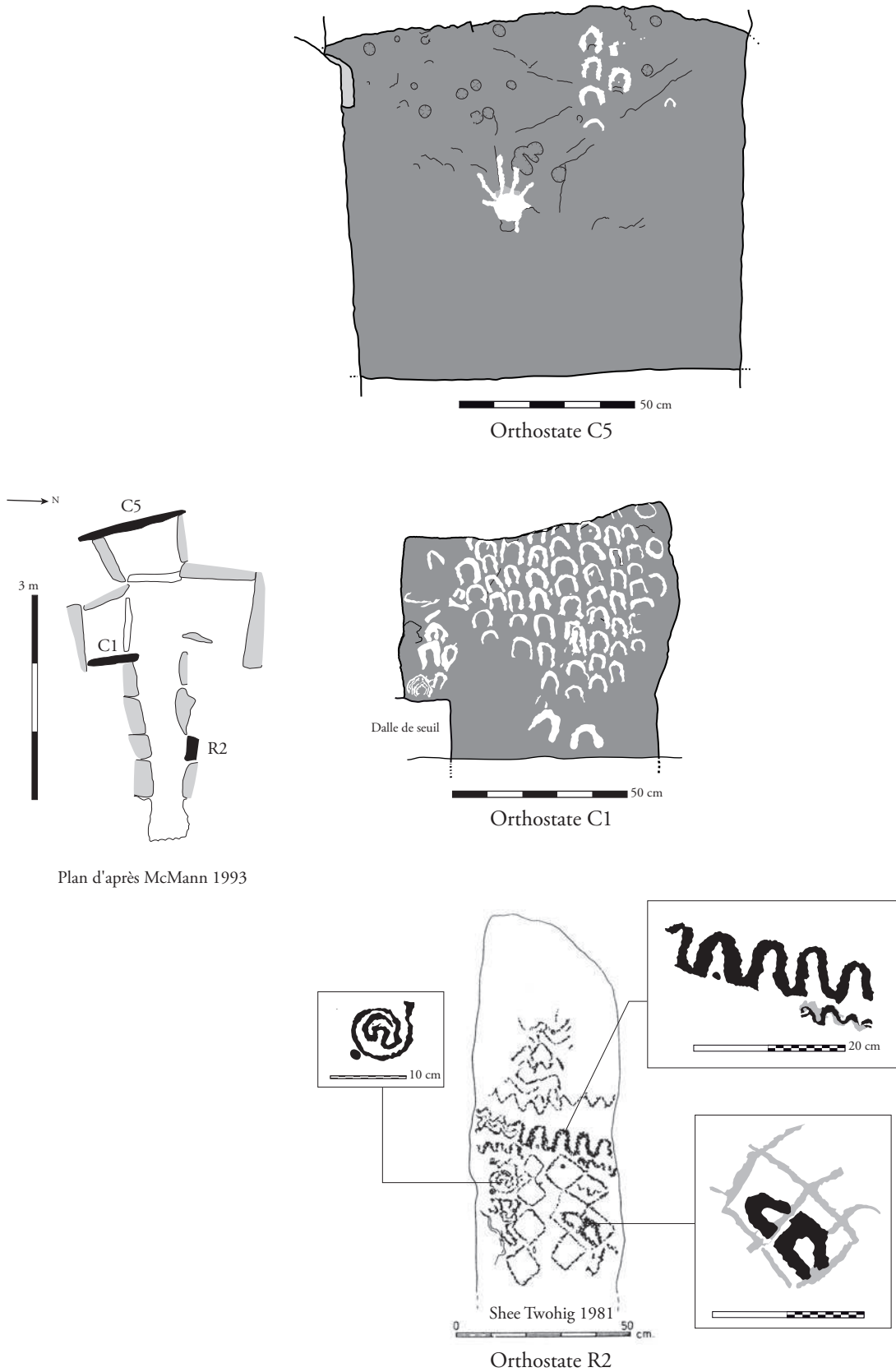
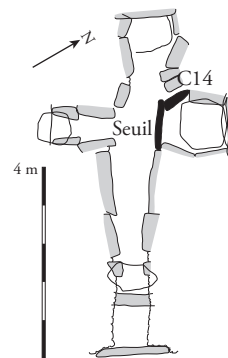
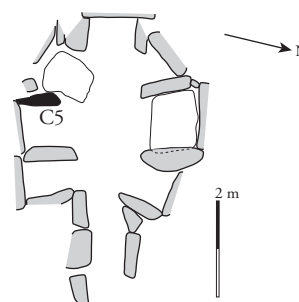
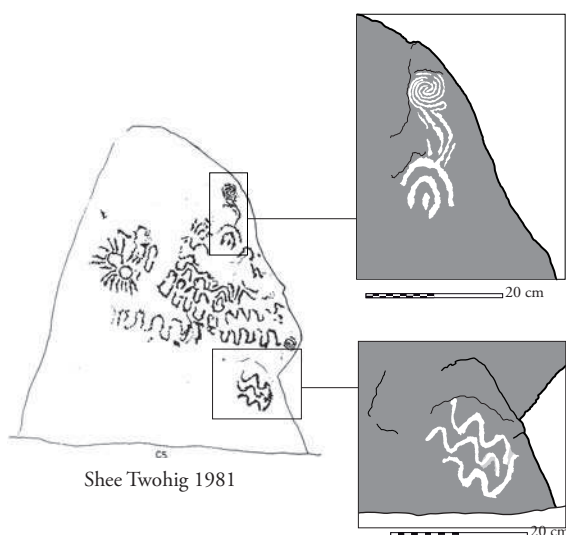

Figure 1.14 : Relevés de gravures à Loughcrew F



Plan d'après McMann 1993

Loughcrew H, orthostate C14 et seuil de la cellule nord



Loughcrew I, orthostate C5

Figure 1.15 : Relevés de gravures à Loughcrew H et I



Loughcrew O, dalle libre

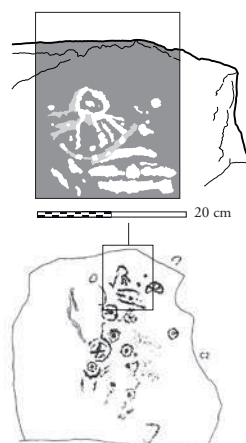

Shee Twohig 1981

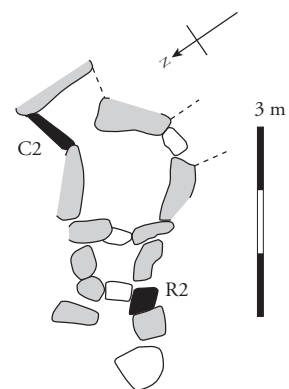

Plan d'après McMann 1993

Loughcrew I, orthostates C2 et R2

Figure 1.16 : Relevés de gravures à Loughcrew O et S

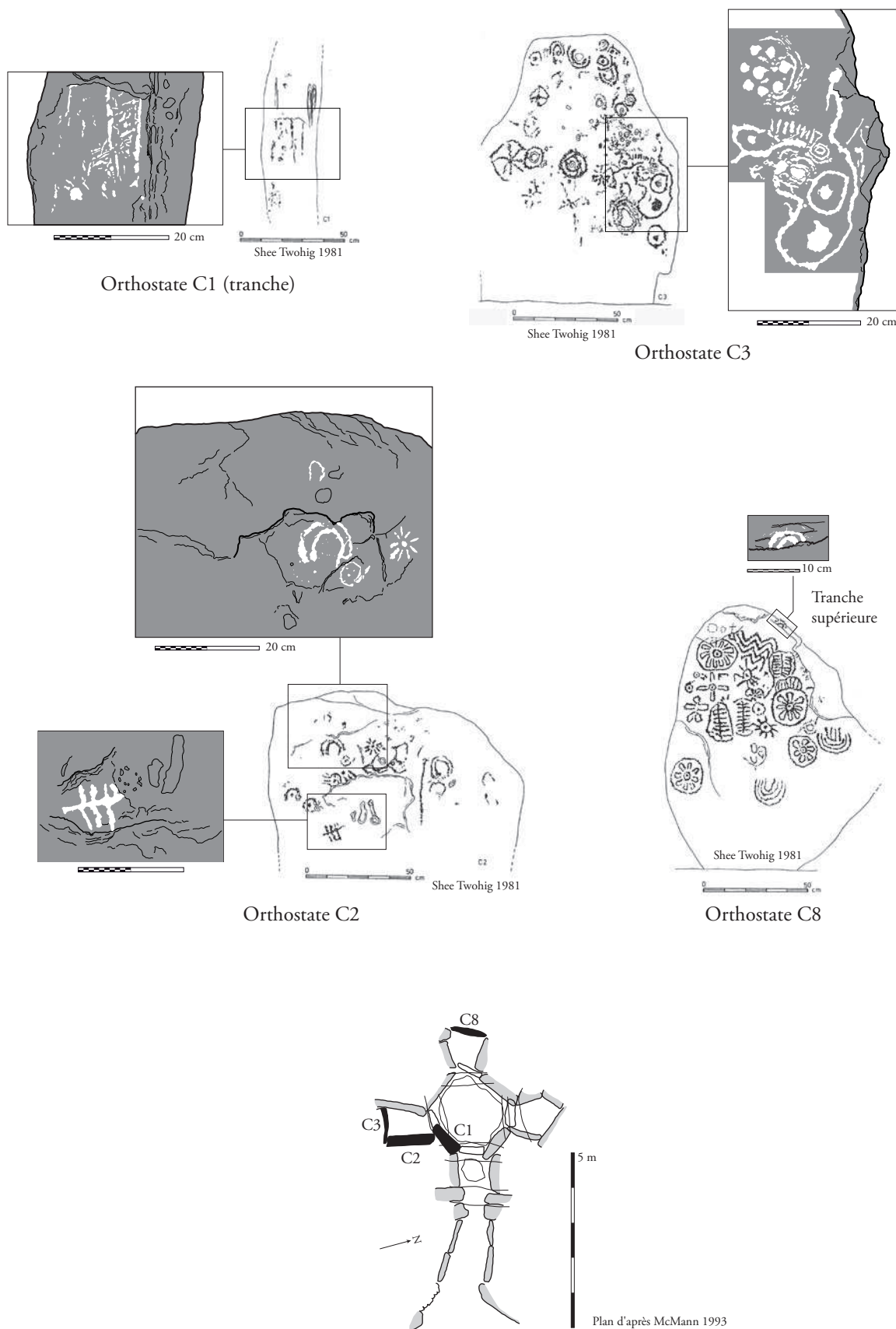
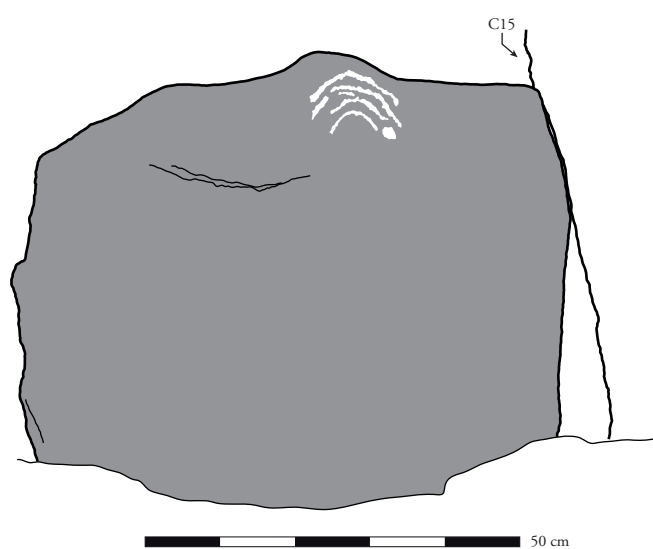
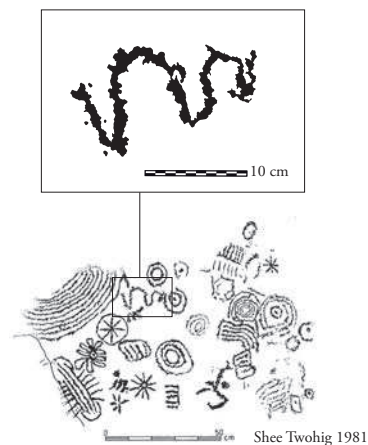

Figure 1.17 : Relevés de gravures à Loughcrew T





Seuil 1



Dalle de couverture de la cellule 2



Seuil 3

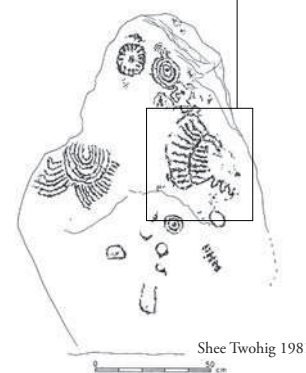
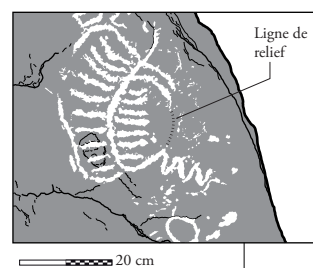

Orthostate C14

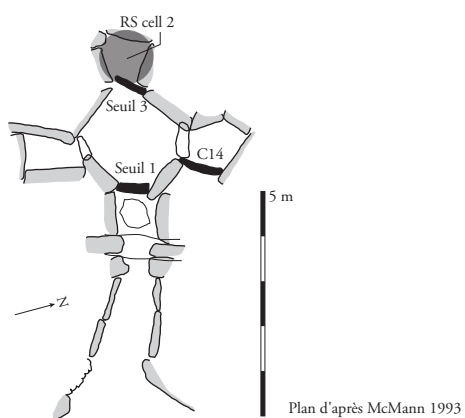

Plan d'après McMann 1993

Figure 1.18 : Relevés de gravures à Loughcrew T (suite)



Frazer 1893

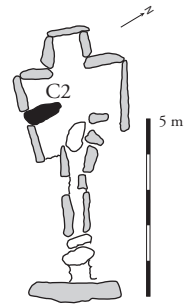
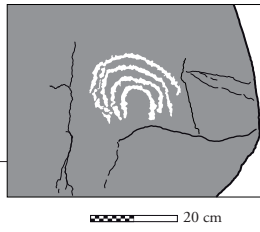

Plan d'après McMann 1993

Loughcrew U, orthostate C2

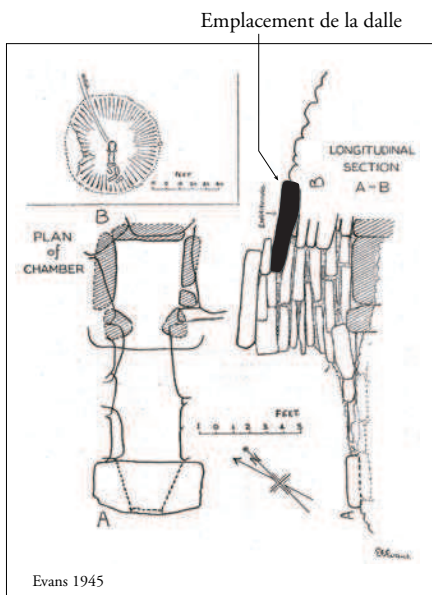

Evans 1945

Face supérieure

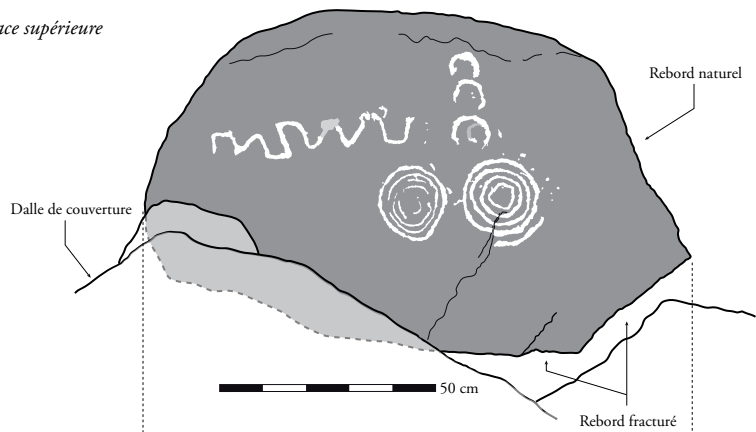

Face latérale

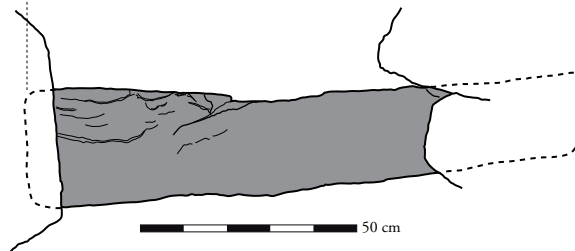

Carnanmore, dalle de couverture

Figure 1.19 : Relevés de gravures à Loughcrew U et Carnanmore

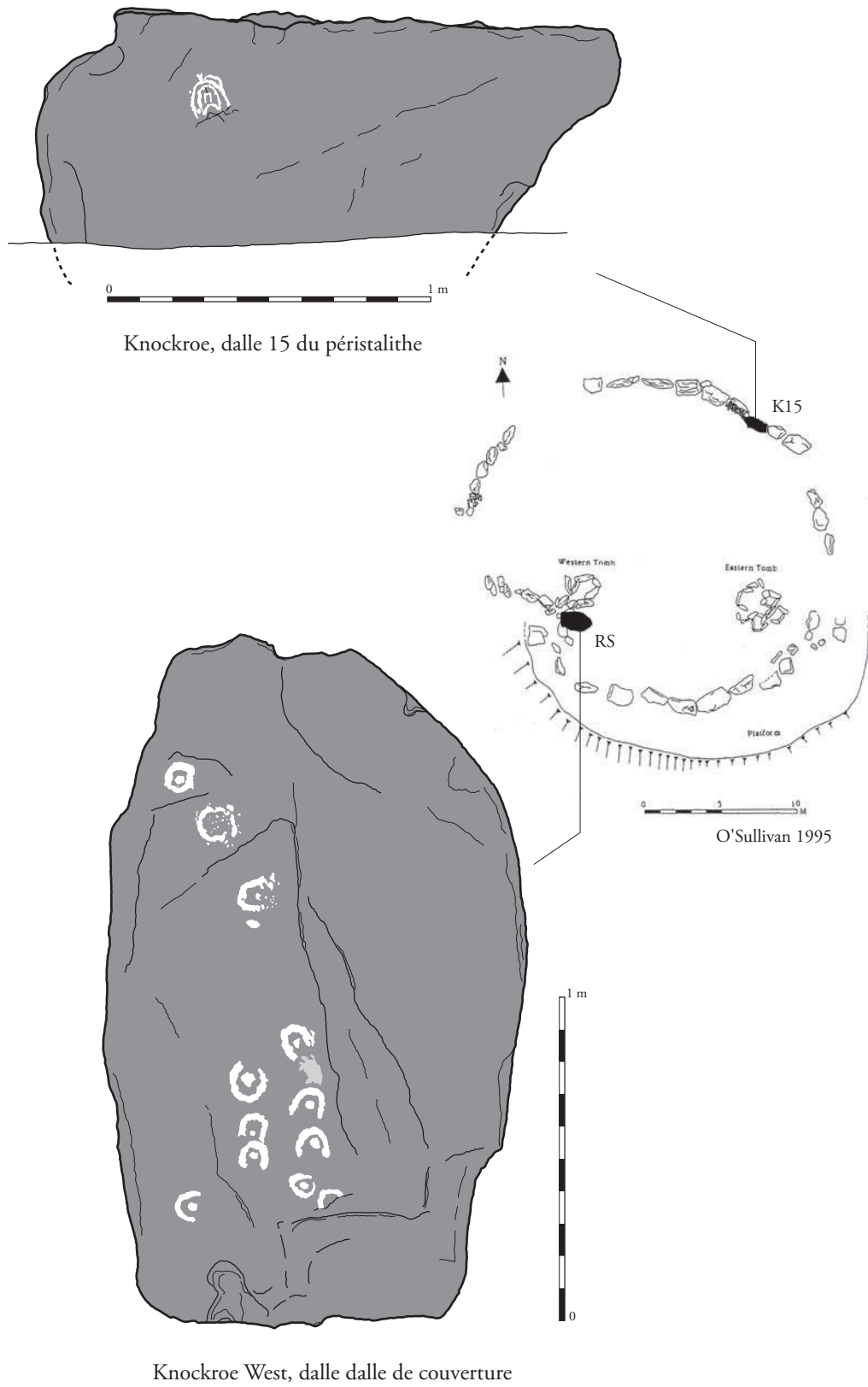

Figure 1.20 : Relevés de gravures à Knockroe

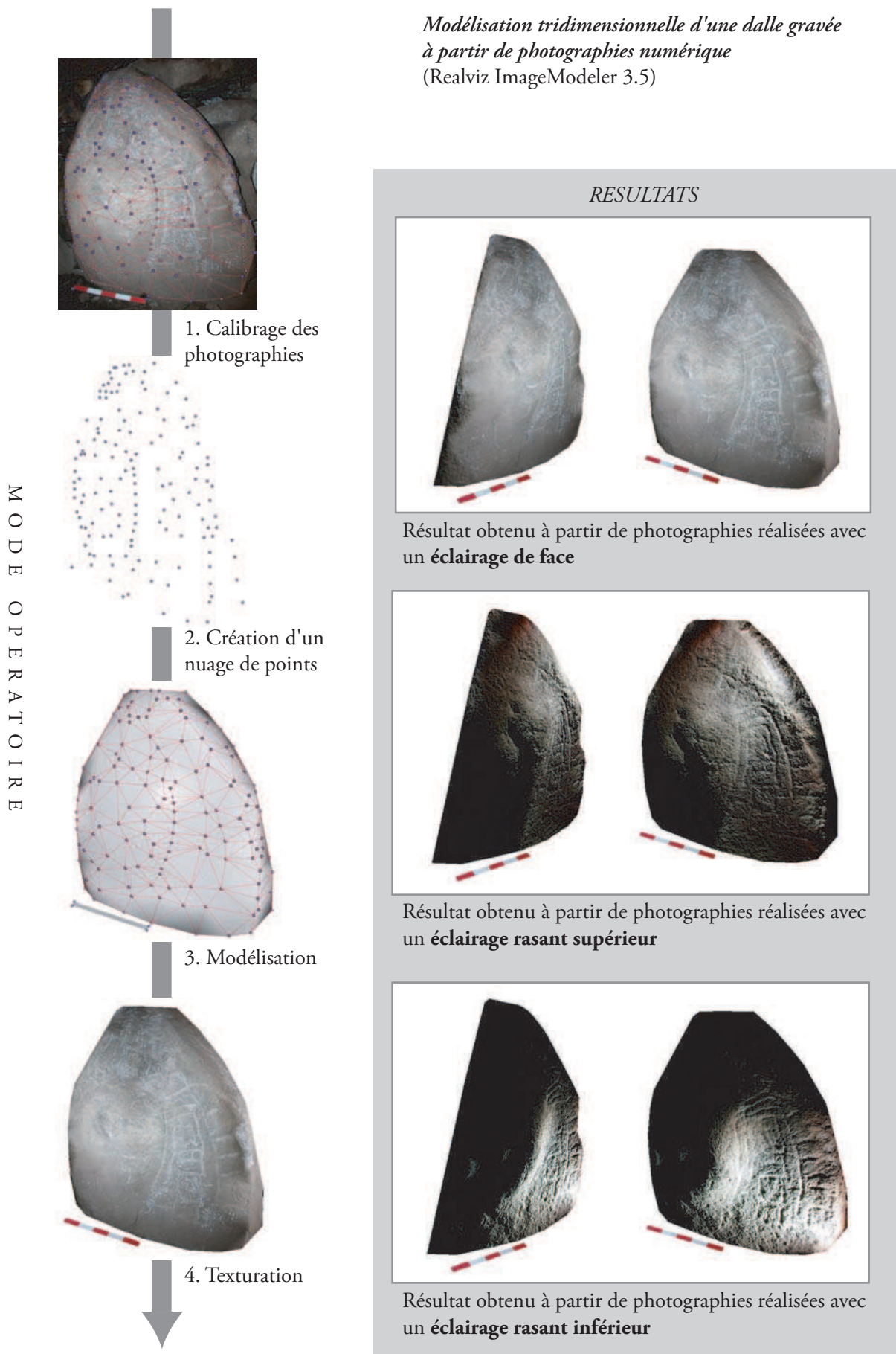

Figure 1.21 : Modélisation tridimensionnelle d'une dalle gravée à partir de photographies numériques

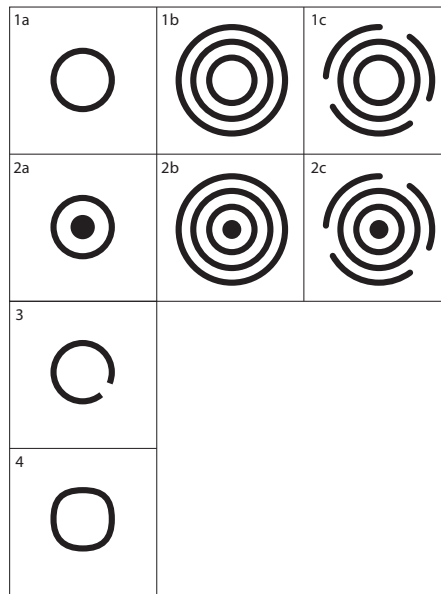
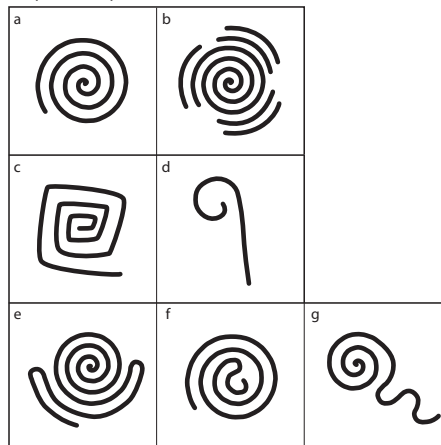
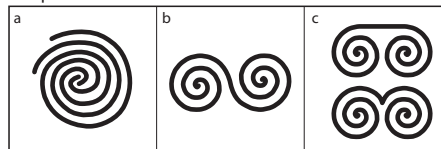

Figure 3.1 : Tableau typologique des signes circulaires

1- Spirales simples



2 - Spirales doubles



3 - Spirales triples

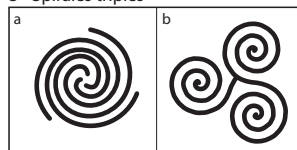













Figure 3.2 : Tableau typologique des signes en spirale

Dalle	Type 1							Type 2			Type 3		Source iconographique
													
Bg.H													Shee Twohig 1981
BgII.K													Shee Twohig 1981
Dh.K1													O'Kelly & O'Kelly 1983
DhS.C8													O'Kelly & O'Kelly 1983
DhS.C12													O'Kelly & O'Kelly 1983
DL.1													Gogan 1932
Fk.A													Shee Twohig 1981
Kr.K29													O'Sullivan 1987
KrW.backst													O'Sullivan 1987
Kh.K2													O'Sullivan 1988
Kh.K4													O'Sullivan 1988
Kh.K11													Eogan 1996
Kh.K15													O'Sullivan 1988
Kh.K32													O'Sullivan 1988
Kh.K65													O'Sullivan 1988
Kh.K67													O'Sullivan 1988
Kh.K72													O'Sullivan 1988
Kh.K77													O'Sullivan 1988
Kh.K79													O'Sullivan 1988
Kh.K80													O'Sullivan 1988
Kh.K82													O'Sullivan 1988
Kh.K83													O'Sullivan 1988
Kh.K87													O'Sullivan 1988
Kh.K95													Eogan 1996
Kh.K127													Eogan 1996
KhE.Or2													O'Sullivan 1988
KhE.RS26													O'Sullivan 1988
KhE.RS30													O'Sullivan 1988
KhE.beside.CoEvi													O'Sullivan 1988
KhE.CoFx													O'Sullivan 1988
KhW.Or16													O'Sullivan 1988
KhW.RS10													O'Sullivan 1988
Kh13.K15													Eogan 1984
Kh14.K6													Eogan 1984
Kh14.Or4													Eogan 1984
Kh15.Or14													Eogan 1984
Kh17.Or13													Eogan 1984









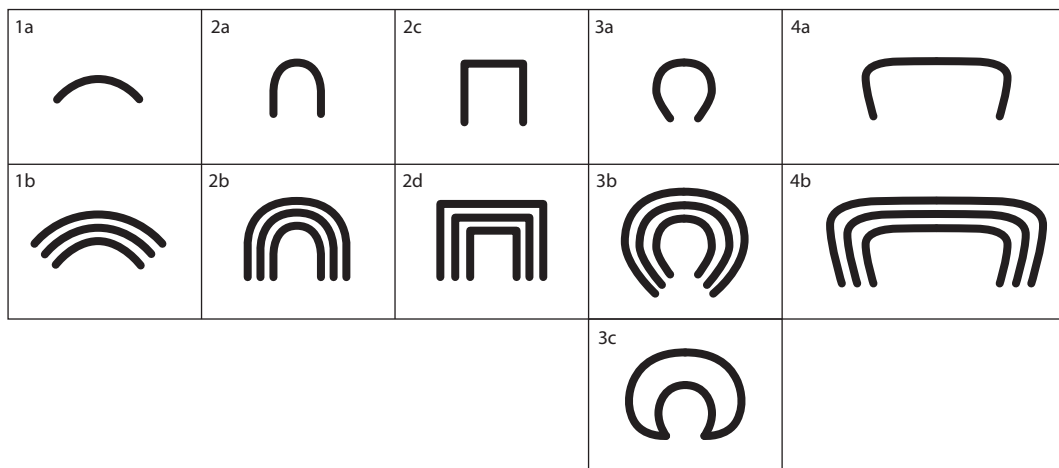

Figure 3.4 : Tableau typologique des signes en arceau

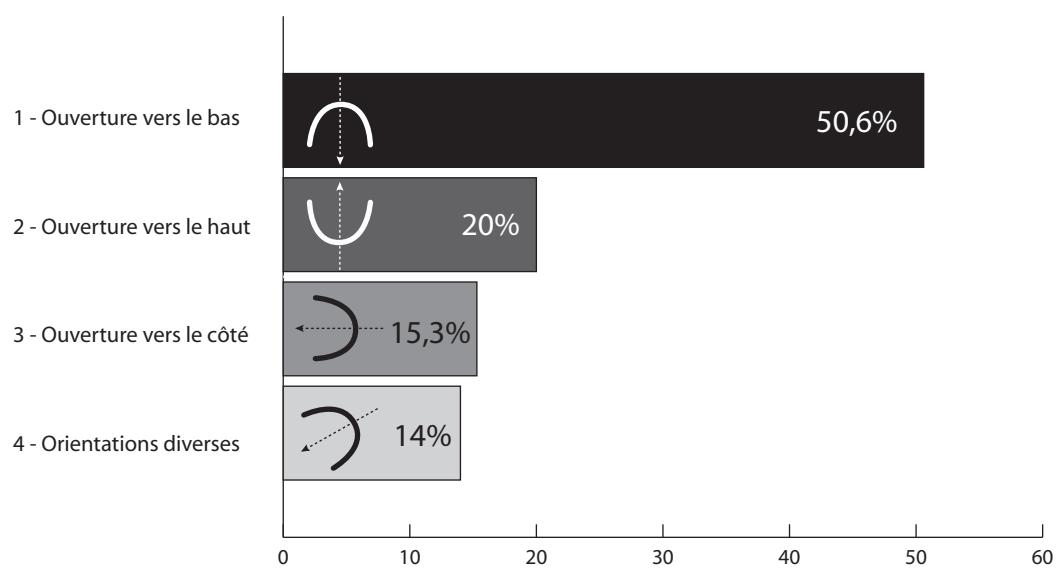













Figure 3.5 : Orientation des signes en arceaux

Dalles	Type 1		Type 2				Type 3			Type 4		Source iconographique
												
Dh.K12												O'Kelly & O'Kelly 1983
Dh.K17												O'Kelly & O'Kelly 1983
DhS.C9												O'Kelly & O'Kelly 1983
KhE.Or93												O'Sullivan 1988
Kh2.Or14												Eogan 1984
Kh15.Or14												Eogan 1984
LcH.C5												Shee Twohig 1981
Rk.A												Shee Twohig 1981
Rk.B												Shee Twohig 1981
LcF.C5												Shee Twohig 1981
Ch.C9												Shee Twohig 1981
DhN.RS4												O'Kelly & O'Kelly 1983
Fk.C1												Shee Twohig 1981
Kt.E												Shee Twohig 1981
Kt.W												Shee Twohig 1981
Km.C9												Shee Twohig 1981
Km.C10												Shee Twohig 1981
Km.C11												Shee Twohig 1981
Kr.K30												O'Sullivan 1987
Kh.K2												O'Sullivan 1988
Kh.K14												O'Sullivan 1988
Kh.K17												O'Sullivan 1988
Kh.K48												O'Sullivan 1988
Kh.K56												Eogan 1996
Kh.K60												O'Sullivan 1988
Kh.K116												Eogan 1974
LcI.C4												Shee Twohig 1981
LcT.R5												Shee Twohig 1981
LcT.sill1												Shee Twohig 1981
LcT.C3												Shee Twohig 1981
LcV.C4												Shee Twohig 1981
MM.1												Shee Twohig 1981
Ng.K1												O'Kelly 1982
Ng.K51												O'Kelly 1982
Ng.K54												O'Kelly 1982
NgK.2a												O'Kelly et al. 1978



Kh.K29												O'Sullivan 1988
Kh.K76												O'Sullivan 1988
Cs.D												Shee Twohig 1981
Kh.K41												O'Sullivan 1988
Kh.K77												O'Sullivan 1988
Kh.K93												Eogan 1974
DhS.RS2												O'Kelly & O'Kelly 1983
Kl												Shee Twohig 1981
Kh.K1b												Eogan 2008
Kr.K15												Robin
Kh.K16												O'Sullivan 1988
Kh.K67												O'Sullivan 1988
Kh.K95												Eogan 1974
KhE.Or25												O'Sullivan 1988
KhE.Or47												O'Sullivan 1988
KhE.Or54												O'Sullivan 1988
KhE.RS37												O'Sullivan 1988
KhW.Or44												O'Sullivan 1988
KhW.Or48												O'Sullivan 1988
Kh4.A												Eogan 1984
LcI.ls.cell3												Shee Twohig 1981
LcJ.C4												Shee Twohig 1981
LcS.L3												Shee Twohig 1981
LcS.R2												Shee Twohig 1981
LcT.C8												Shee Twohig 1981
LcT.C9												Shee Twohig 1981
LcT.C15												Shee Twohig 1981
LcT.lcell2												Shee Twohig 1981
LcU.R3												Shee Twohig 1981
LcU.C2												Shee Twohig 1981
LcU.C6												Shee Twohig 1981
LcU.C9												Shee Twohig 1981
LcU.C11												Shee Twohig 1981
LcW.C2												Shee Twohig 1981
Ng.K4												O'Kelly 1982
Ng.RS7												O'Kelly 1982
NgK.4												O'Kelly et al. 1978
Tr.L2												Shee Twohig 1981
Tn												Shee Twohig 1981
Cs.B												Shee Twohig 1981



Kh.K68												O'Sullivan 1988
Kh.K82												O'Sullivan 1988
Kh.K86												O'Sullivan 1988
LcT.C10												Shee Twohig 1981
Kh.K30												O'Sullivan 1988
MB.M2												Shee Twohig 1981
Kh.K11												Eogan 1996
Kh.K12												Eogan 1996
Kh.K74												Eogan 1996
KhW.Or42												O'Sullivan 1988

Figure 3.6 : Tableau des associations entre types d'arceaux et dalles gravées

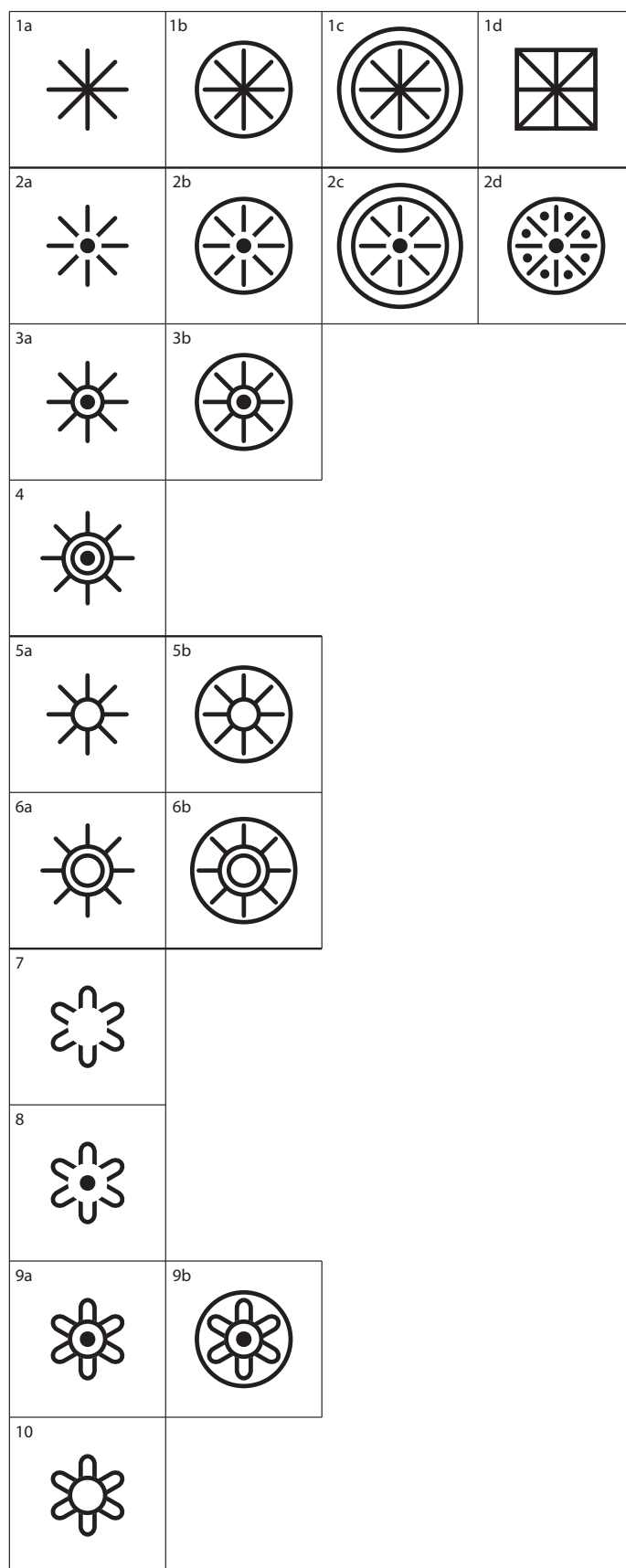

Figure 3.7 : Tableau typologique des signes circulaires radiés



Dalles	Type 1				Type 2				Type 3		T. 4	Type 5		Type 6		T. 7	T. 8	Type 9		T. 10	Source iconographique
	1a	1b	1c	1d	2a	2b	2c	2d	3a	3b	4	5a	5b	6a	6b	7	8	9a	9b	10	
LcL.R3																					Shee Twohig 1981
LcW.C2																					Shee Twohig 1981
LcT.C3	?																				Shee Twohig 1981
LcT.RScell2																					Shee Twohig 1981
LcL.C1																					Shee Twohig 1981
LcT.C11																					Shee Twohig 1981
DhS.C12																					O'Kelly & O'Kelly 1983
DhN.C2																					O'Kelly & O'Kelly 1983
Kh.K68																					O'Sullivan 1988
LcS.C2																					Shee Twohig 1981
DhN.C7																					O'Kelly & O'Kelly 1983
LcF.R4																					Shee Twohig 1981
LcF.C5																					Shee Twohig 1981
LcL.ls.cell3																					Shee Twohig 1981
LcT.R5																					Shee Twohig 1981
LcT.C2																					Shee Twohig 1981
LcU.L2																					Shee Twohig 1981
LcU.C2																					Shee Twohig 1981
LcU.C9																					Shee Twohig 1981
Mg																					O'Sullivan 1988
SK.stele																					Shee Twohig 1981
LcT.sill3																					Robin
LcT.C14																					Shee Twohig 1981
LcU.C5																					Shee Twohig 1981
Dh.K51																					O'Kelly & O'Kelly 1983
LcT.C8																					Shee Twohig 1981
LcX1																					Shee Twohig 1981
LcT.L1																					Shee Twohig 1981
KhE.Or54																					O'Sullivan 1988
KhE.Co40v																					O'Sullivan 1988
LcF.loose																					Frazer 1893
LcT.C15																					Shee Twohig 1981
NgK.11																					O'Kelly et al. 1978
KhW.Or42																					O'Sullivan 1988
LcI.R2																					Shee Twohig 1981
LcI.C5																					Shee Twohig 1981
NgK.K4																					O'Kelly et al. 1978
NgL.A																					O'Kelly et al. 1978
NgZ.bassin																					O'Kelly et al. 1978
LcS.L4																					Shee Twohig 1981
Dh.K88																					O'Kelly & O'Kelly 1983
LcI.C13																					Shee Twohig 1981
LcU.C3																					Shee Twohig 1981
LcL.L3																					Shee Twohig 1981
Ng.K11b																					O'Kelly 1982

Figure 3.8 : Tableau des associations entre types de signes circulaires radiés et dalles gravées

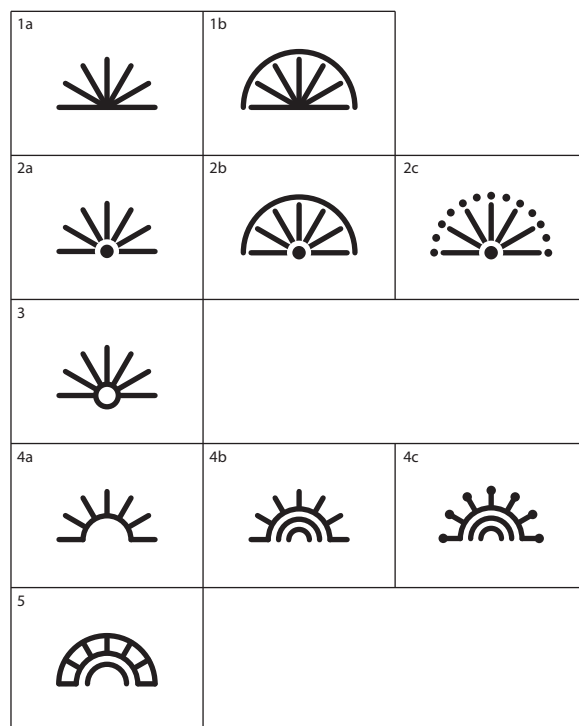

Figure 3.9 : Tableau typologique des signes semi-circulaires radiés











Dalles	Type 1		Type 2			Type 3	Type 4			Type 5	Source iconographique
											
Kh.K46											O'Sullivan 1988
LcS.C2											Shee Twohig 1981 / Robin
LcF.R4			?								Shee Twohig 1981
Ng.Co1/C7											O'Kelly 1982
Ng.K88											O'Kelly 1982
Kh.K7											O'Sullivan 1988
Kh.K15											O'Sullivan 1988
Kh14.Or8											Eogan 1984
LcI.C13					?						Shee Twohig 1981
LcX1											Shee Twohig 1981
Ng.K6											O'Kelly 1982
Ng.RS1											O'Kelly 1982
Ng.RB											O'Kelly 1982
LcL.C17											Shee Twohig 1981
NgL.B											O'Kelly et al. 1978
LcT.C9											Shee Twohig 1981
LcT.C14											Shee Twohig 1981
LcU.C11											Shee Twohig 1981
DL.2											Gogan 1932
Km.C9											Shee Twohig 1981
LcI.C1											Shee Twohig 1981
LcU.C6											Shee Twohig 1981

Figure 3.10 : Tableau des associations entre types de signes semi-circulaires radiés et dalles gravées

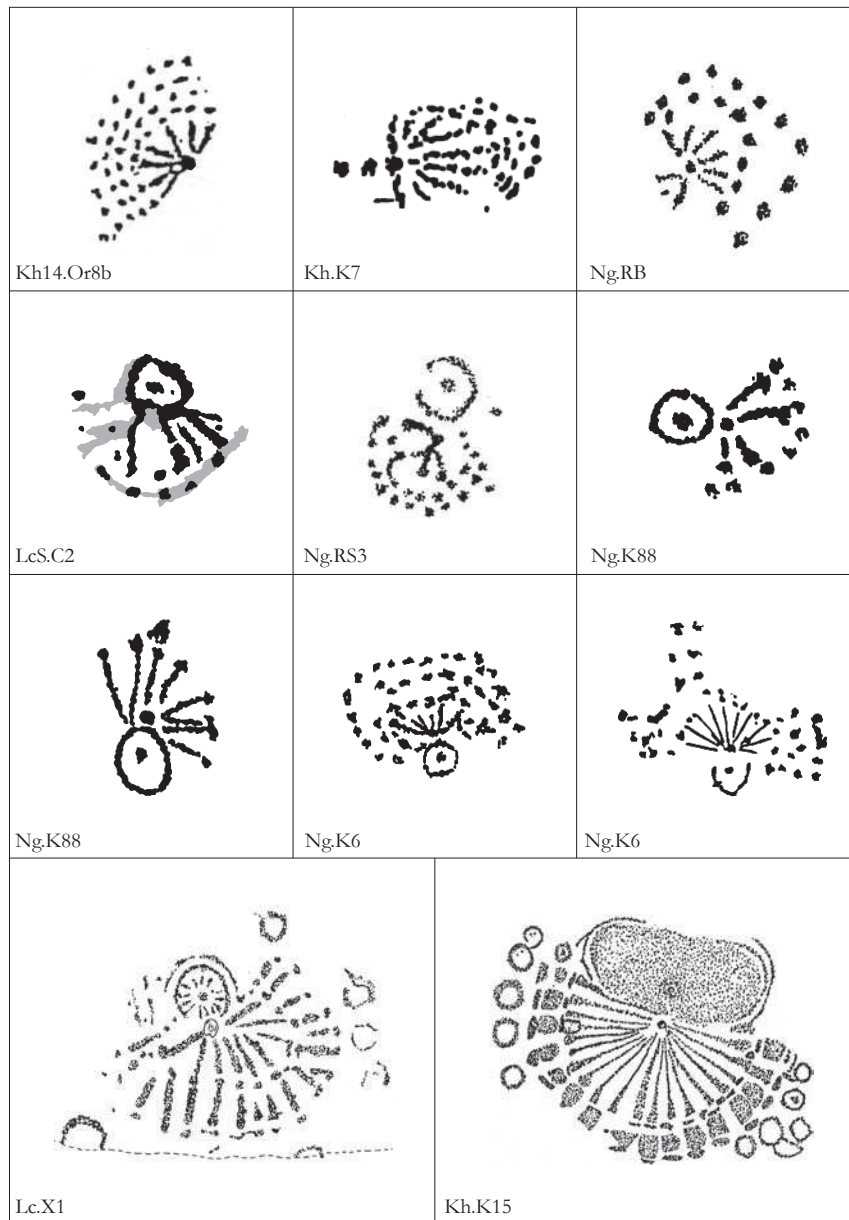

Figure 3.11 : Les signes semi-circulaires radiés de type 2c

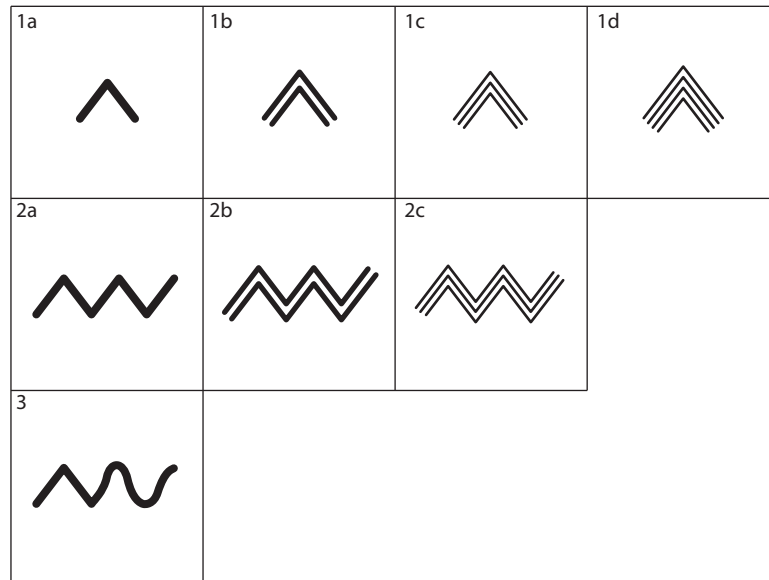









Figure 3.12 : Tableau typologique des signes en chevrons

Dalles	Type 1				Type 2			Type 3	Source iconographique
									
Cg									Corlett 1996
Dh.K51									O'Kelly & O'Kelly 1983
DhN.C7									O'Kelly & O'Kelly 1983
DhS.C12									O'Kelly & O'Kelly 1983
Km.C11									Shee Twohig 1981
Kh.K56									Eogan 1996
KhE.beside.CoEvi									O'Sullivan 1988
KhW.Or16									O'Sullivan 1988
KhW.Or50									O'Sullivan 1988
Kh2.Or29									Eogan 1984
Kh16.Or4									Eogan 1984
Kh16.Or7									Eogan 1984
Ng.K12									O'Kelly 1982
Ng.R20									O'Kelly 1982
NgZ.bassin									O'Kelly et al. 1978
Sf.R4									Shee Twohig 1981
ByG.C1									Shee Twohig 1981
Cs.C									Shee Twohig 1981
CH.1									Bradley et al. 1998
CH.2									Bradley et al. 1998
Qn.5									Bradley et al. 1998
Qn.7									Bradley et al. 1998
WH.8									Bradley et al. 1998
WH.9									Bradley et al. 1998
Kh.K12									Eogan 1996
LcW.C4									Frazer 1893
Ng.K18b									O'Kelly 1982
Ng.K85									O'Kelly 1982
Mh.12									Bradley et al. 1998
Ng.X									O'Kelly 1982
KhW.Co37-38									Eogan 1997
Kh14.Or8									Eogan 1984
Ng.K67									O'Kelly 1982
KhW.Or38									O'Sullivan 1988
Ng.K13b									O'Kelly 1982
Ng.K1									O'Kelly 1982
LH									Evans 1953
ByG.C3									Shee Twohig 1981
Gb									Beckensall 1999
Dh.K17									O'Kelly & O'Kelly 1983
Dh.loose2									O'Kelly 1967
DL.2									Gogan 1932
Fk.L4									Shee Twohig 1981
Fk.R5									Shee Twohig 1981
Fk.C									Shee Twohig 1981
Fk.E									Shee Twohig 1981
Fk.F									Shee Twohig 1981
Kh.K1b									Eogan 2008
Kh.K5									Eogan 1996
Kh.K15									O'Sullivan 1988
Kh.K23									O'Sullivan 1988
Kh.K28									O'Sullivan 1988
Kh.K38									O'Sullivan 1988
Kh.K65									O'Sullivan 1988
Kh.K85									O'Sullivan 1988
Kh.K127									O'Sullivan 1988
KhE.Or2									O'Sullivan 1988
KhE.Or3									O'Sullivan 1988
KhE.Or36									O'Sullivan 1988
KhE.Or48									O'Sullivan 1988
KhE.Or49									O'Sullivan 1988
KhE.Or55									O'Sullivan 1988
KhE.Or57									O'Sullivan 1988
KhE.RS34									O'Sullivan 1988
KhE.RS49									O'Sullivan 1988
KhE.RS50									O'Sullivan 1988
KhE.Co65									O'Sullivan 1988
KhE.Co40i									O'Sullivan 1988
KhE.Co52iii									O'Sullivan 1988
KhE.CoAvi									O'Sullivan 1988
KhE.CoDvii									O'Sullivan 1988
KhW.Or17									O'Sullivan 1988

KhW.Or40								O'Sullivan 1988
KhW.Or41								O'Sullivan 1988
KhW.Or48								O'Sullivan 1988
KhW.RS3								O'Sullivan 1988
KhW.RS5								O'Sullivan 1988
KhW.RS10								O'Sullivan 1988
Kh4.A								Eogan 1984
Kh14.Or13								Eogan 1984
Kh15.sillC								Eogan 1984
Kh16.Or13								Eogan 1984
Kh16.C10								Eogan 1984
Kh17.Or6								Eogan 1984
Kh17.Or13								Eogan 1984
Kh17.Or15								Eogan 1984
LcF.R4								Shee Twohig 1981
LcJ.loose1								Shee Twohig 1981
LcL.C19								Shee Twohig 1981
LcT.C8								Shee Twohig 1981
LcT.RScell3								Shee Twohig 1981
LcU.R2								Shee Twohig 1981
LcU.C7								Shee Twohig 1981
MB.M18								Collins & Waterman 1955
MB.M24								Collins & Waterman 1955
Ng.K7								O'Kelly 1982
Ng.K16								O'Kelly 1982
Ng.K52								O'Kelly 1982
Ng.K88								O'Kelly 1982
Ng.K89								O'Kelly 1982
Ng.K93								O'Kelly 1982
Ng.L12								O'Kelly 1982
Ng.L19								O'Kelly 1982
Ng.L22								O'Kelly 1982
Ng.R12								O'Kelly 1982
Ng.R18								O'Kelly 1982
Ng.C4								O'Kelly 1982
Ng.C8								O'Kelly 1982
Ng.C10								O'Kelly 1982
Ng.RS3								O'Kelly 1982
Ng.Z								O'Kelly 1982
Ng.Co1/C2								O'Kelly 1982
Ng.Co1/C10								O'Kelly 1982
Ng.Co1/C11								O'Kelly 1982
Ng.Co1/C12-13								O'Kelly 1982
Ng.Co2/C14								O'Kelly 1982
Ng.RScellE(f)								O'Kelly 1982
Ng.RScellE								O'Kelly 1982
NgK.A								O'Kelly et al. 1978
NgK.sill1								O'Kelly et al. 1978
NgK.9								O'Kelly et al. 1978
NgZ.fragment								O'Kelly et al. 1978
ByG.L8								Shee Twohig 1981
ByG.C16								Shee Twohig 1981
HPW.B								Shee Twohig 1981
HPW.F								Shee Twohig 1981
HPW.4								Bradley et al. 1998
Mh.15								Bradley et al. 1998
Mh.18								Bradley et al. 1998
Qn.6								Bradley et al. 1998
WH.10								Bradley et al. 1998
WH.11								Bradley et al. 1998
KhE.Or45								O'Sullivan 1988
KhW.Or81								O'Sullivan 1988
CI								Shee Twohig 1981
Dh.K12								O'Kelly & O'Kelly 1983
DhN.C19								O'Kelly & O'Kelly 1983
Kh.K10								Eogan 1996
Kh.K13								O'Sullivan 1988
Kh.K41								O'Sullivan 1988
KhE.Or54								O'Sullivan 1988
KhE.RS26								O'Sullivan 1988
KhE.RS32								O'Sullivan 1988
KhE.RS41								O'Sullivan 1988
KhE.CoEvi								O'Sullivan 1988
KhE.CoFx								O'Sullivan 1988
KhW.Or74								O'Sullivan 1988
LcF.R2								Shee Twohig 1981

LcI.C17									Shee Twohig 1981
IcU.C8									Shee Twohig 1981
Ng.K2									O'Kelly 1982
Ng.K4									O'Kelly 1982
Ng.K9									O'Kelly 1982
Ng.K51									O'Kelly 1982
NgK.5									O'Kelly et al. 1978
NgL.A									O'Kelly et al. 1978
NgL.B									O'Kelly et al. 1978
DhN.C8									O'Kelly & O'Kelly 1983
Fk.A									Shee Twohig 1981
KhE.jR.cellN									O'Sullivan 1988
KhE.B									O'Sullivan 1988
Kh.K71									O'Sullivan 1988
LcI.ls.cell3									Shee Twohig 1981
Km.C9									Shee Twohig 1981
DhS.C7									O'Kelly & O'Kelly 1983
KhE.Or33									O'Sullivan 1988
KhE.Or92									O'Sullivan 1988
KhE.RS38									O'Sullivan 1988
KhW.Or18									O'Sullivan 1988
Kh16.Or9									Eogan 1984
LcL.R3									Shee Twohig 1981
MM.1									Shee Twohig 1981
Mt									O'Broin 2000

Figure 3.13 : Tableau des associations entre types de chevrons et dalles gravées

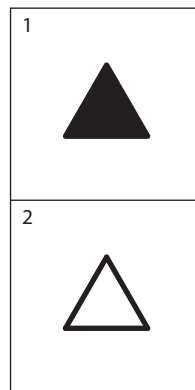

Figure 3.14 : Tableau typologique des signes triangulaires





Dalles	Type 1	Type 2	Sources iconographiques
			
Ch.C3			Shee Twohig 1981
Fk.E			Shee Twohig 1981
Fk.F			Shee Twohig 1981
Kh.K13b			Eogan 2008
Kh.K15			O'Sullivan 1988
Kh.K72			O'Sullivan 1988
Kh.K85			O'Sullivan 1988
KhE.Or48			O'Sullivan 1988
KhE.Or54			O'Sullivan 1988
KhE.jR.cellN			O'Sullivan 1988
KhW.Or41			O'Sullivan 1988
LcH.C11			Shee Twohig 1981
LcI.C13			Shee Twohig 1981
LcL.C16			Shee Twohig 1981
LH			Evans 1953
Ng.K1			O'Kelly 1982
Ng.K4			O'Kelly 1982
Ng.K52			O'Kelly 1982
Ng.K67			O'Kelly 1982
Ng.K88			O'Kelly 1982
Ng.L22			O'Kelly 1982
Ng.R5			O'Kelly 1982
Ng.R8			O'Kelly 1982
Ng.R12			O'Kelly 1982
Ng.C8			O'Kelly 1982
Ng.C16			O'Kelly 1982
Ng.RBlintel			O'Kelly 1982
Ng.RB	?		O'Kelly 1982
Ng.X			O'Kelly 1982
Ng.Y			O'Kelly 1982
Ng.Co1/C2			O'Kelly 1982
Ng.Co1/C10			O'Kelly 1982
Ng.Co1/C12-13			O'Kelly 1982
Ng.Co2/C11			O'Kelly 1982
NgL.B			O'Kelly et al. 1978
NgL.A			O'Kelly et al. 1978
NgL.C9			O'Kelly et al. 1978
DhS.C6			O'Kelly & O'Kelly 1983
KhW.Or40			O'Sullivan 1988
Kh14.Or8			Eogan 1984
Ng.K18b			O'Kelly 1982
Ng.R21			O'Kelly 1982
Ng.Co2/C14			O'Kelly 1982
Ch.C8			Shee Twohig 1981
Ch.C9			Shee Twohig 1981
Km.C9		?	Shee Twohig 1981
KhE.behind.Co39i			O'Sullivan 1988
Ng.K12		?	O'Kelly 1982
Ng.K13b			O'Kelly 1982
Ng.R19		?	O'Kelly 1982
Mh.12			Bradley et al. 1998

Figure 3.15 : Tableau des associations entre types de signes triangulaires et dalles gravées

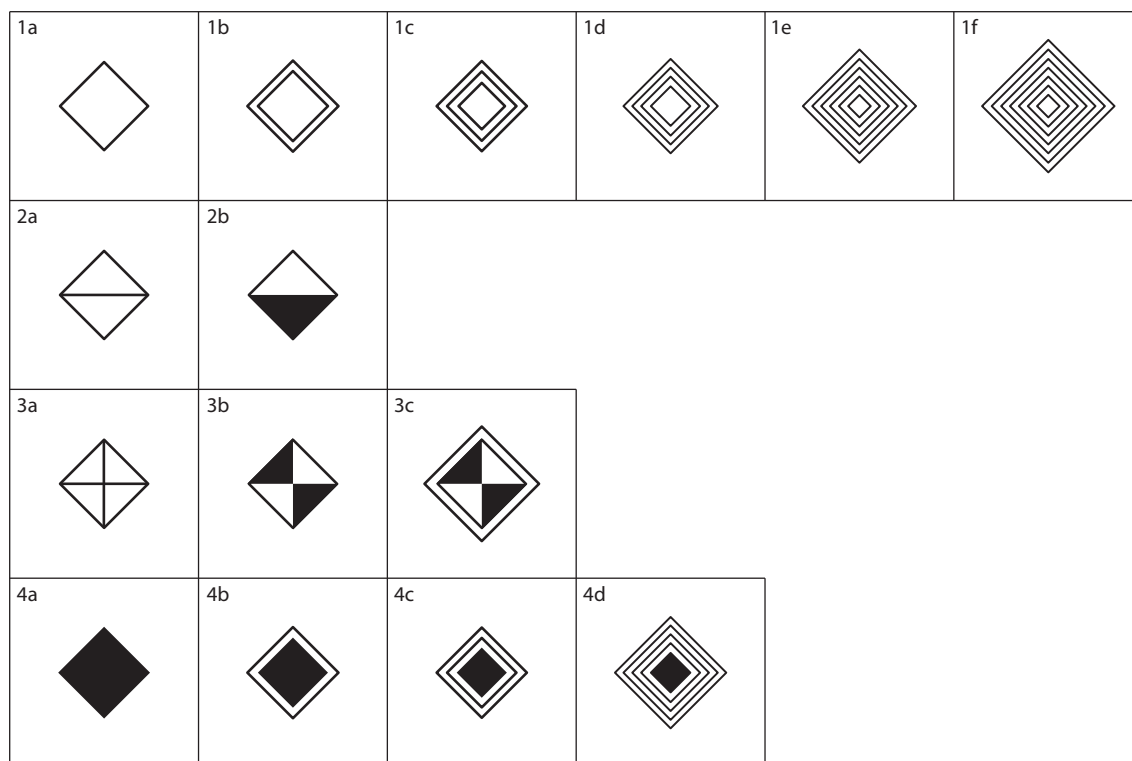

















Figure 3.16 : Tableau typologique des signes quadrangulaires

Dalles	Type 1						Type 2		Type 3			Type 4				Source iconographique
																
Am.A																Eogan 1974
Cd																Roe 1967
Dh.K51																O'Kelly & O'Kelly 1983
DL.2																Gogan 1932
Fk.R2																Shee Twohig 1981
Km.C6	?															Shee Twohig 1981
Kh.K38																O'Sullivan 1988
Kh.K41																O'Sullivan 1988
Kh.K72																O'Sullivan 1988
Kh.K75																O'Sullivan 1988
Kh.K84																O'Sullivan 1988
Kh.K116																Eogan 1974
Kh.K120																Eogan 1974
KhE.Or52																O'Sullivan 1988
KhE.Co41ii																O'Sullivan 1988
KhE.Co51i	?															O'Sullivan 1988
KhE.Co54i	?															O'Sullivan 1988
KhW.Or17	?															O'Sullivan 1988
Kh15.sillC																Eogan 1984
Kh16.Co10																Eogan 1984
Kh17.Or15																Eogan 1984
LcF.R2																Shee Twohig 1981
LcL.C11																Shee Twohig 1981
LcL.C17																Shee Twohig 1981
LcT.C6	?															Shee Twohig 1981
LcT.C11																Shee Twohig 1981
LcU.C5																Shee Twohig 1981
LcL.Co1/C16																Shee Twohig 1981
MM.1																Shee Twohig 1981
MB.47																Collins & Waterman 1955
MB.M18																Collins & Waterman 1955
Ng.K5	?															O'Kelly 1982
Ng.K9	?															O'Kelly 1982
Ng.K13b																O'Kelly 1982
Ng.K18b																O'Kelly 1982
Ng.K54	?															O'Kelly 1982

Ng.K85																		O'Kelly 1982
Ng.K88	?																	O'Kelly 1982
Ng.L17																		O'Kelly 1982
Ng.L19																		O'Kelly 1982
Ng.R10																		O'Kelly 1982
Ng.R19																		O'Kelly 1982
Ng.Co4/C8																		O'Kelly 1982
NgK.2a																		O'Kelly et al. 1978
NgL.C3																		O'Kelly et al. 1978
ByG.L8																		Shee Twohig 1981
Cr.10																		Beckensall 1999
Cr.27																		Beckensall 1999
HPW.A																		Shee Twohig 1981
Mh.14																		Bradley et al. 1998
Mh.19																		Bradley et al. 1998
Mh.20																		Bradley et al. 1998
Mh.21	?																	Bradley et al. 1998
Ng.RScellE																		O'Kelly 1982
KhW.Or44																		O'Sullivan 1988
Kh17.Or13																		Eogan 1984
KhE.Or45																		O'Sullivan 1988
Kh16.Co12																		Eogan 1984
KhE.Or55																		O'Sullivan 1988
KhE.Or56																		O'Sullivan 1988
KhW.Or48																		O'Sullivan 1988
Ng.Z																		O'Kelly 1982
LcL.C16																		Shee Twohig 1981
LcL.C19																		Shee Twohig 1981
LcO																		Robin
Kh.K13																		O'Sullivan 1988
Kh.K23																		O'Sullivan 1988
Kh.K15																		O'Sullivan 1988
Kh4.A																		Eogan 1984
Kh14.Or8																		Eogan 1984
Ng.K67																		O'Kelly 1982
Ng.L22																		O'Kelly 1982
Ng.C2																		O'Kelly 1982
NgL.A																		O'Kelly et al. 1978
Ng.X																		O'Kelly 1982
ByG.C1																		Shee Twohig 1981



Kh2.Or29																	Eogan 1984
Kh.loose7																	O'Sullivan 1988
Kh.loose23																	O'Sullivan 1988
LcI.C13																	Shee Twohig 1981
Ng.K52																	O'Kelly 1982
Ng.C8																	O'Kelly 1982
Ng.C15																	O'Kelly 1982
Ng.C16																	O'Kelly 1982
Ng.RB																	O'Kelly 1982
Ng.Co1/C15-16																	O'Kelly 1982
Ng.Co2/C11																	O'Kelly 1982
Ng.RScellE(f)																	O'Kelly 1982
NgL.B																	O'Kelly et al. 1978
NgL.C9																	O'Kelly et al. 1978
Ng.K1																	O'Kelly 1982
NgK.sill1																	O'Kelly et al. 1978

Figure 3.17 : Tableau des associations entre types de signes quadrangulaires et dalles gravées







1a 	1b 
2a 	2b 
3a 	3b 
4 	

Figure 3.18 : Tableau typologique des signes scalariformes



















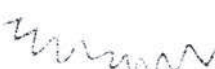

Dalles	Type 1		Type 2		Type 3		Type 4	Source iconographique
								
DhN.C7								O'Kelly & O'Kelly 1983
DhN.C18								O'Kelly & O'Kelly 1983
DhS.C12								O'Kelly & O'Kelly 1983
DhS.C13								O'Kelly & O'Kelly 1983
DhS.lr								O'Kelly & O'Kelly 1983
Kl	?							Shee Twohig 1981
Km.C3	?							Shee Twohig 1981
Km.C6								Shee Twohig 1981
Kh.K79								O'Sullivan 1988
KhE.Or1								O'Sullivan 1988
KhE.CoAx								O'Sullivan 1988
Kh4.A								Eogan 1984
LcF.L1								Shee Twohig 1981
LcI.R2								Shee Twohig 1981
LcL.L4	?							Shee Twohig 1981
LcL.C5								Shee Twohig 1981
LcS.C6	?							Shee Twohig 1981
LcT.L2								Shee Twohig 1981
LcT.R5								Shee Twohig 1981
LcT.C9								Shee Twohig 1981
LcT.lcell2								Shee Twohig 1981
LcU.L2								Shee Twohig 1981
LcU.C5								Shee Twohig 1981
LcW.C3	?							Shee Twohig 1981
Ng.R12								O'Kelly 1982
Ng.R20								O'Kelly 1982
Ng.R21								O'Kelly 1982
Ng.RS3								O'Kelly 1982
SK.stele	?							Shee Twohig 1981
ByG.C14								Shee Twohig 1981
Cs.A								Shee Twohig 1981
LcT.C15								Shee Twohig 1981 / Frazer 1893
LcT.C8								Shee Twohig 1981
LcT.C14								Shee Twohig 1981
LcT.RScell2								Shee Twohig 1981
Kh17.Or15								Eogan 1984
LcL.C17								Shee Twohig 1981
LcT.Co1/C2		?						Shee Twohig 1981
LcU.C2						?		Shee Twohig 1981 / Frazer 1893
Km.C12								Shee Twohig 1981
LcT.lcell1								Shee Twohig 1981
DhN.C19			?					O'Kelly & O'Kelly 1983
DhN.R5								O'Kelly & O'Kelly 1983
Ng.C4								O'Kelly 1982
Dh.K51								O'Kelly & O'Kelly 1983
Km.C4					?			Shee Twohig 1981
Kh.K4								Eogan 1996
KhE.Co41ii								O'Sullivan 1988
KhW.Or38								O'Sullivan 1988
LcH.R2								Shee Twohig 1981
LcI.ls.cell3								Shee Twohig 1981
LcT.C1					?			Robin
LcT.C2								Shee Twohig 1981
LcU.C6								Shee Twohig 1981
Ng.K7								O'Kelly 1982
Ng.K13b								O'Kelly 1982
NgL.B								O'Kelly et al. 1978
Kh14.Or8								Eogan 1984
DhN.C2								O'Kelly & O'Kelly 1983
LcH.K8								Shee Twohig 1981
LcI.C13								Shee Twohig 1981
DhN.L5								O'Kelly & O'Kelly 1983
KhW.Or51								O'Sullivan 1988
LcS.L4								Shee Twohig 1981

Figure 3.19 : Tableau des associations entre types de signes scalariformes et dalles gravées



Ligne ondulée et en chevron

 Kh.K13	 Dh.N.C19	 Dh.K12
 Kh.E.Or33	 Kh14.Or8	 Kh.K10
 Ng.K4	 Kh.W.Co37-38	 Kh.E.RS41
 Dh.S.C7	 Kh.E.RS26	 Ng.L.A
 Kh.E.Or92	 Kh16.Or9	

Ligne ondulée et crénelée





 Kh14.Or8	 Kh14.Or8	 Kh.K93	 Cm.Co1
-------------------------------------------------------------------------------------------------	-------------------------------------------------------------------------------------------------	------------------------------------------------------------------------------------------------	-------------------------------------------------------------------------------------------------

Figure 3.20 : Les signes ondulés et en chevrons

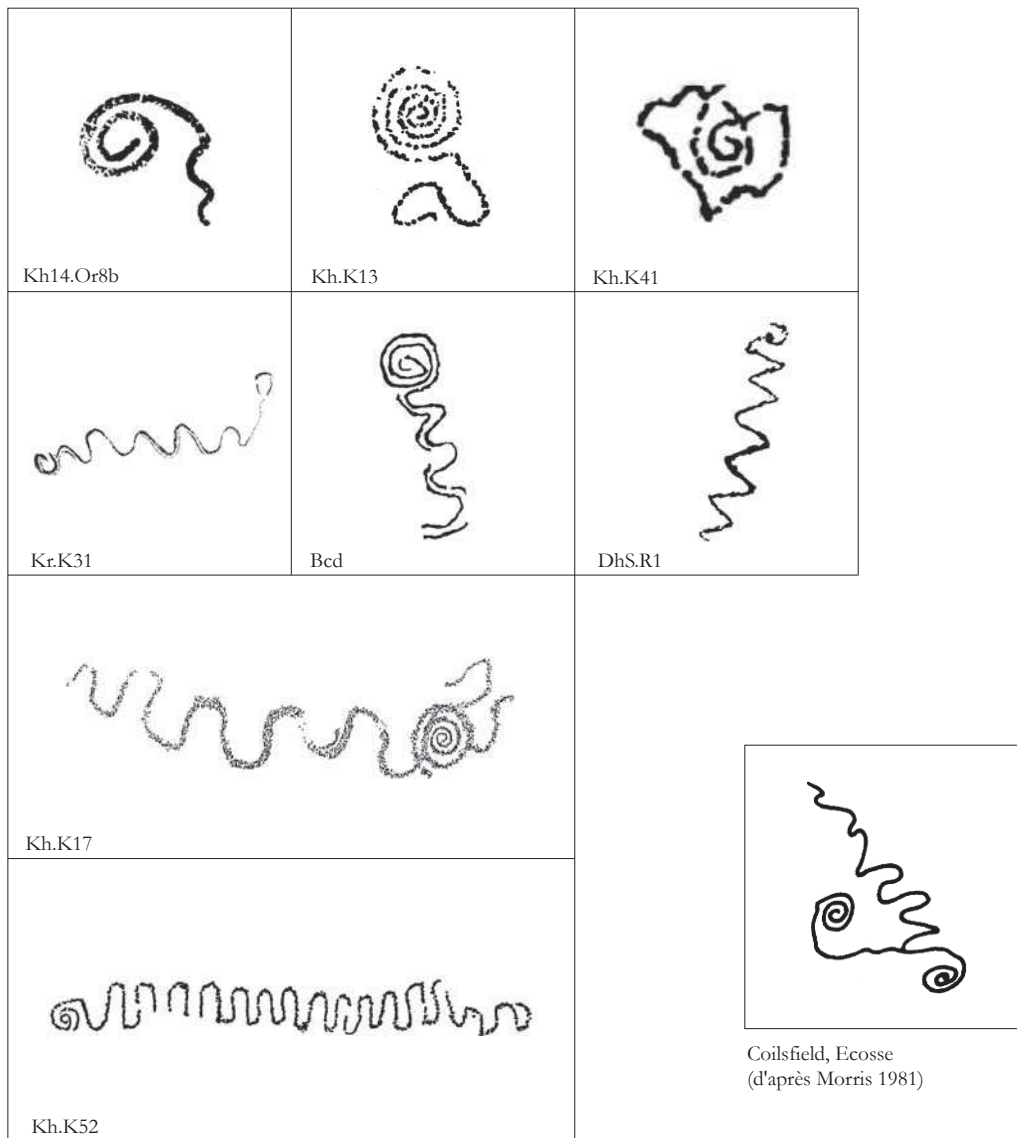

Figure 3.21 : Les signes ondulés se terminant par une spirale



Figure 3.22 : Les signes ondulés comme extrémité interne d'une spirale

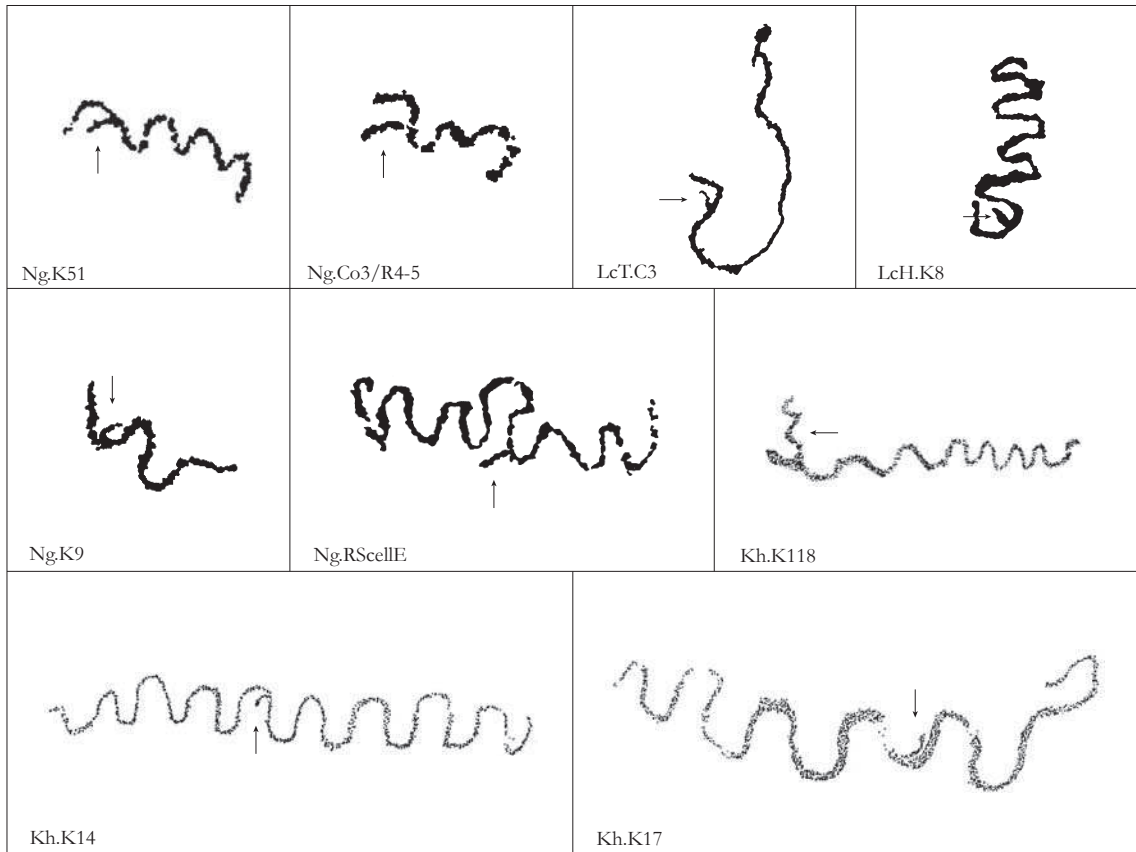

Figure 3.23 : Les signes ondulés avec appendice





Dalles	Type 1	Type 2	Type 3a	Type 3b	Sources iconographiques
CI					Shee Twohig 1981
DhN.C7					O'Kelly & O'Kelly 1983
DhN.C19					O'Kelly & O'Kelly 1983
Kh.K10					O'Sullivan 1988
KhE.Or33					O'Sullivan 1988
KhE.Or54					O'Sullivan 1988
KhE.Or92					O'Sullivan 1988
KhE.RS26					O'Sullivan 1988
KhE.RS38					O'Sullivan 1988
KhE.RS41					O'Sullivan 1988
KhE.CoEvi					O'Sullivan 1988
KhE.CoFx					O'Sullivan 1988
KhW.Or18					O'Sullivan 1988
KhW.Or38					O'Sullivan 1988
KhW.Or74					O'Sullivan 1988
KhW.Co37-38					Eogan 1997
Kh16.Or9					Eogan 1984
LcL.ls.cell3					Shee Twohig 1981
LcL.C17					Shee Twohig 1981
LcL.R3					Shee Twohig 1981
LcU.C8					Shee Twohig 1981
MM.1	?				Shee Twohig 1981
Mt					O'Broin 2000
Ng.K2					O'Kelly 1982
Ng.K4					O'Kelly 1982
Ng.K9					O'Kelly 1982
Ng.K13b					O'Kelly 1982
Ng.K51					O'Kelly 1982
NgK.5					O'Kelly et al. 1978
NgL.B					O'Kelly et al. 1978
NgL.A					O'Kelly et al. 1978
Kh14.Or8					Eogan 1984
Kh.K13					O'Sullivan 1988
Kh.K41					O'Sullivan 1988
KhE.RS32			?		O'Sullivan 1988
Dh.K12					O'Kelly & O'Kelly 1983
LcF.R2					Robin
Cm.Co1					Robin
Kh.K93					Eogan 1974
DhS.R1					O'Kelly & O'Kelly 1983
Kr.K31					O'Sullivan 1987
Kh.K17					O'Sullivan 1988
Kh.K52					O'Sullivan 1988
BCD.stele					Shee Twohig 1981
Dh.K14					O'Kelly & O'Kelly 1983
Kh.K73					O'Sullivan 1988

Figure 3.24 : Tableau 1 des associations entre types de signes ondulés et dalles gravées

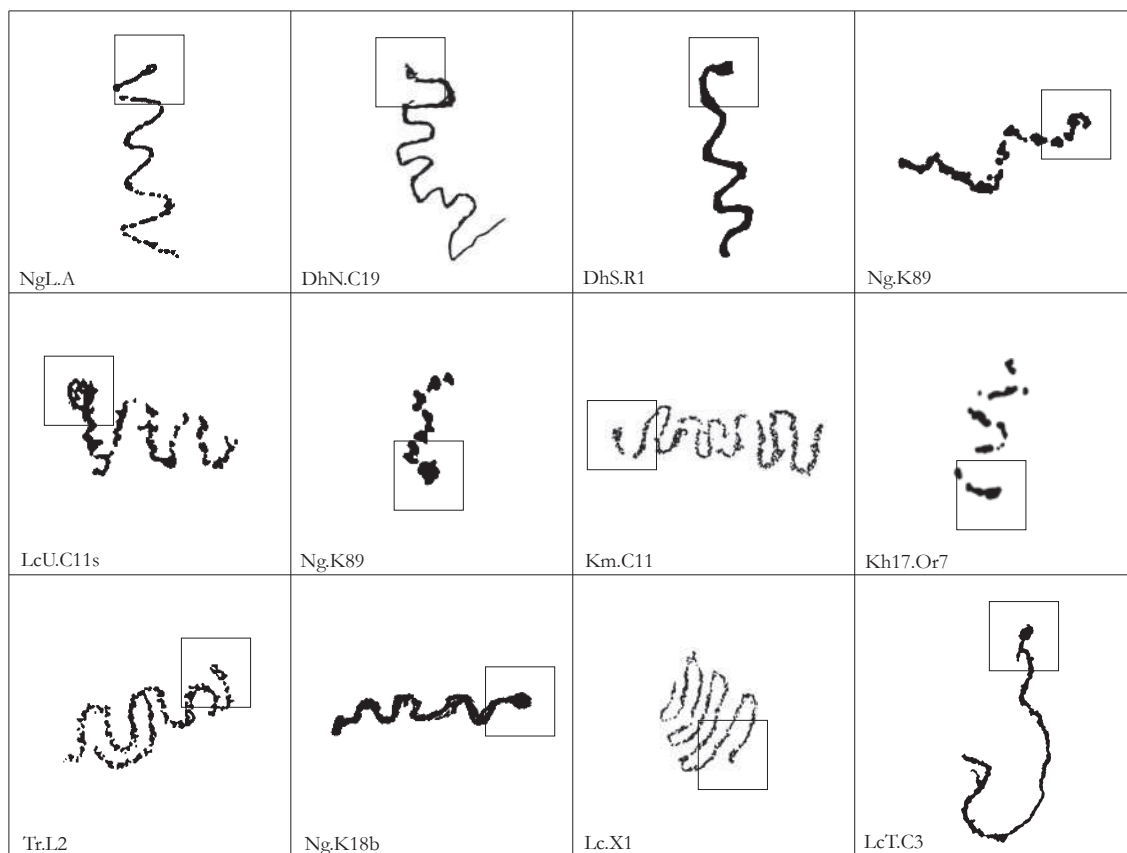

Figure 3.25 : Les signes ondulés avec une extrémité épaissie

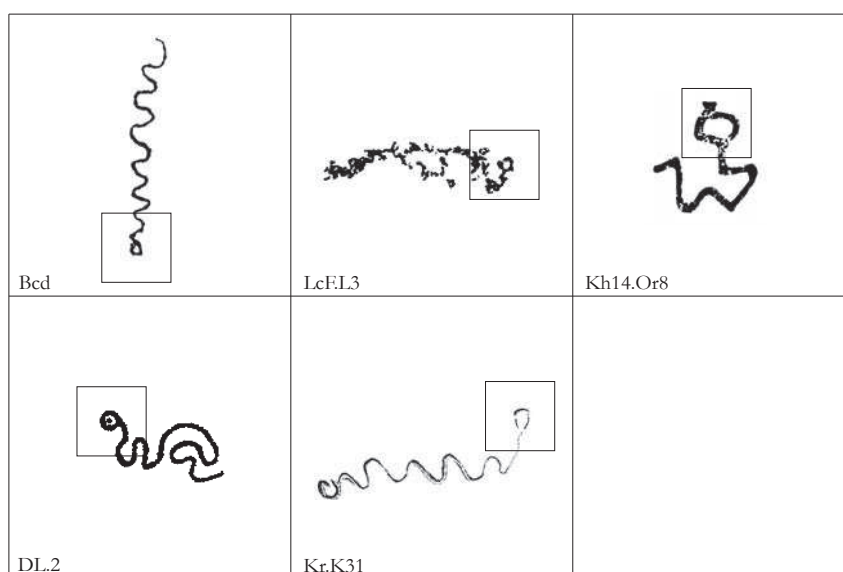

Figure 3.26 : Les signes ondulés avec une extrémité en cercle

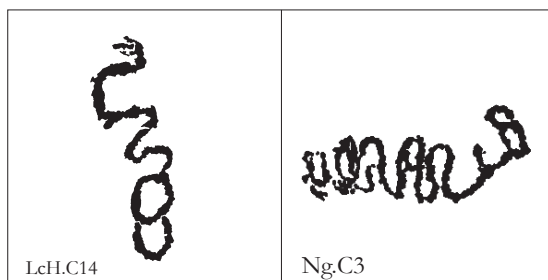

Figure 3.27 : Les signes ondulés avec une extrémité en « 8 »

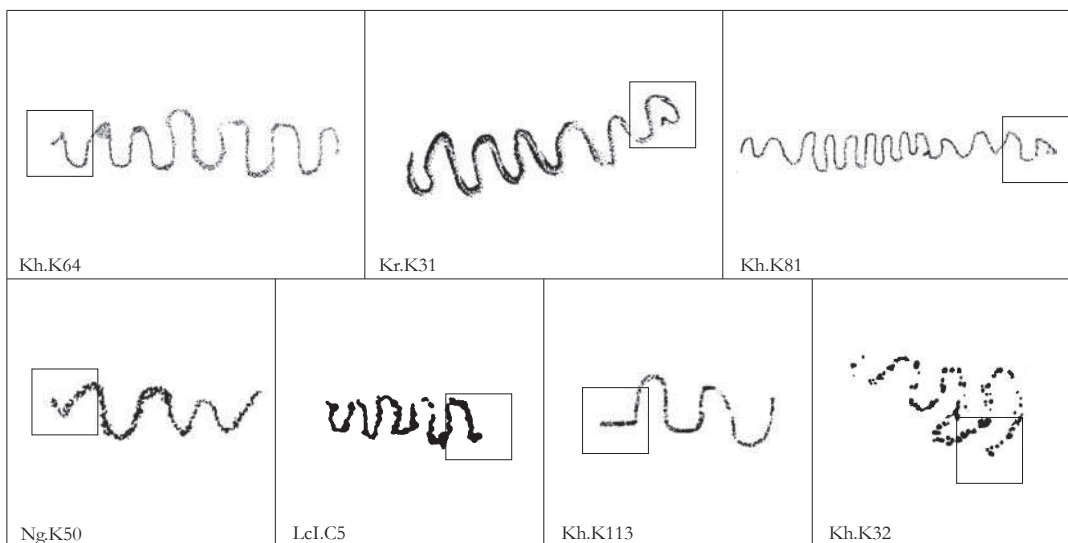

Figure 3.28 : Les signes ondulés avec une extrémité en angle

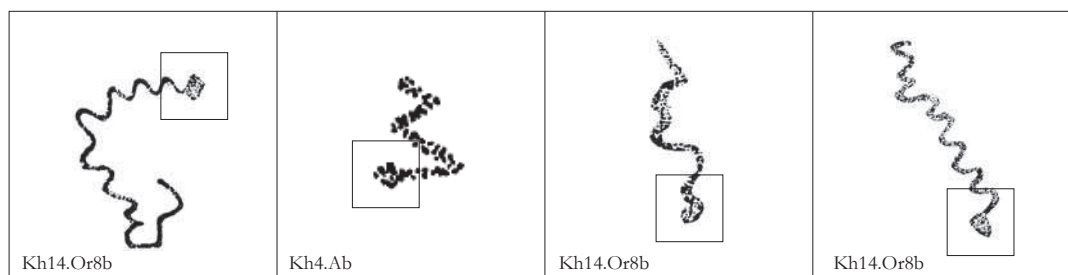

Figure 3.29 : Les signes ondulés avec une extrémité quadrangulaire ou triangulaire

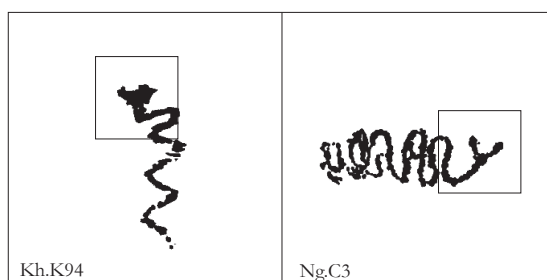

Figure 3.30 : Les signes ondulés avec une extrémité en V







	Type 1	Type 2	Type 3	Type 4	Type 5	Type 6	Type 7	
Dalles								Sources iconographiques
Ng.K18b								O'Kelly 1982
DhN.C19								O'Kelly & O'Kelly 1983
DhS.R1								O'Kelly & O'Kelly 1983
Dh.loose1								O'Kelly 1967
Km.C11								Shee Twohig 1981
Kh17.Or7								Eogan 1984
LcT.C3								Shee Twohig 1981
LcU.C11								Shee Twohig 1981
LcX1								Shee Twohig 1981
Ng.K89								O'Kelly 1982
NgL.A								O'Kelly et al. 1978
Tr.L2								Shee Twohig 1981
DL.2								Gogan 1932
LcF.L3								Shee Twohig 1981
BCD.stele								Shee Twohig 1981
Kr.K31								O'Sullivan 1987
Kh14.Or8								Eogan 1984
LcH.C14								Shee Twohig 1981
Ng.C3								O'Kelly 1982
Kr.K32								O'Sullivan 1987
Kh.K64								O'Sullivan 1988
Kh.K81								O'Sullivan 1988
Kh.K113								Eogan 1974
LcI.C5								Shee Twohig 1981
Ng.K50								O'Kelly 1982
Kh4.A								Eogan 1974
Kh.K94								Eogan 1984

Figure 3.31 : Tableau 2 des associations entre types de signes ondulés et dalles gravées

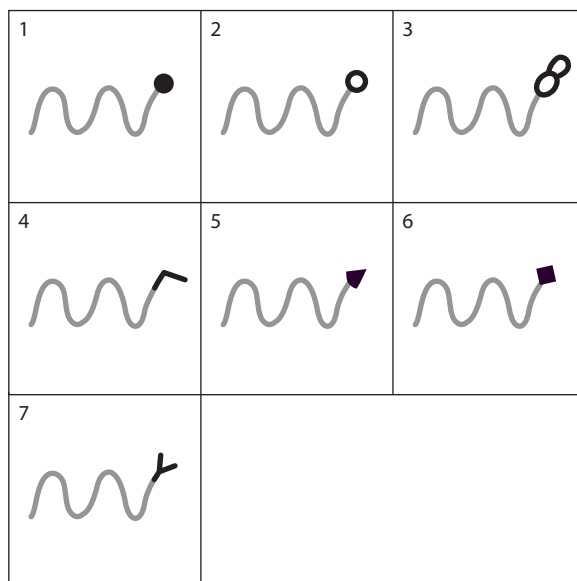
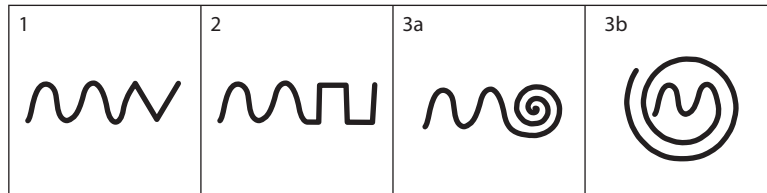

Figure 3.32 : Tableau typologique des signes ondulés



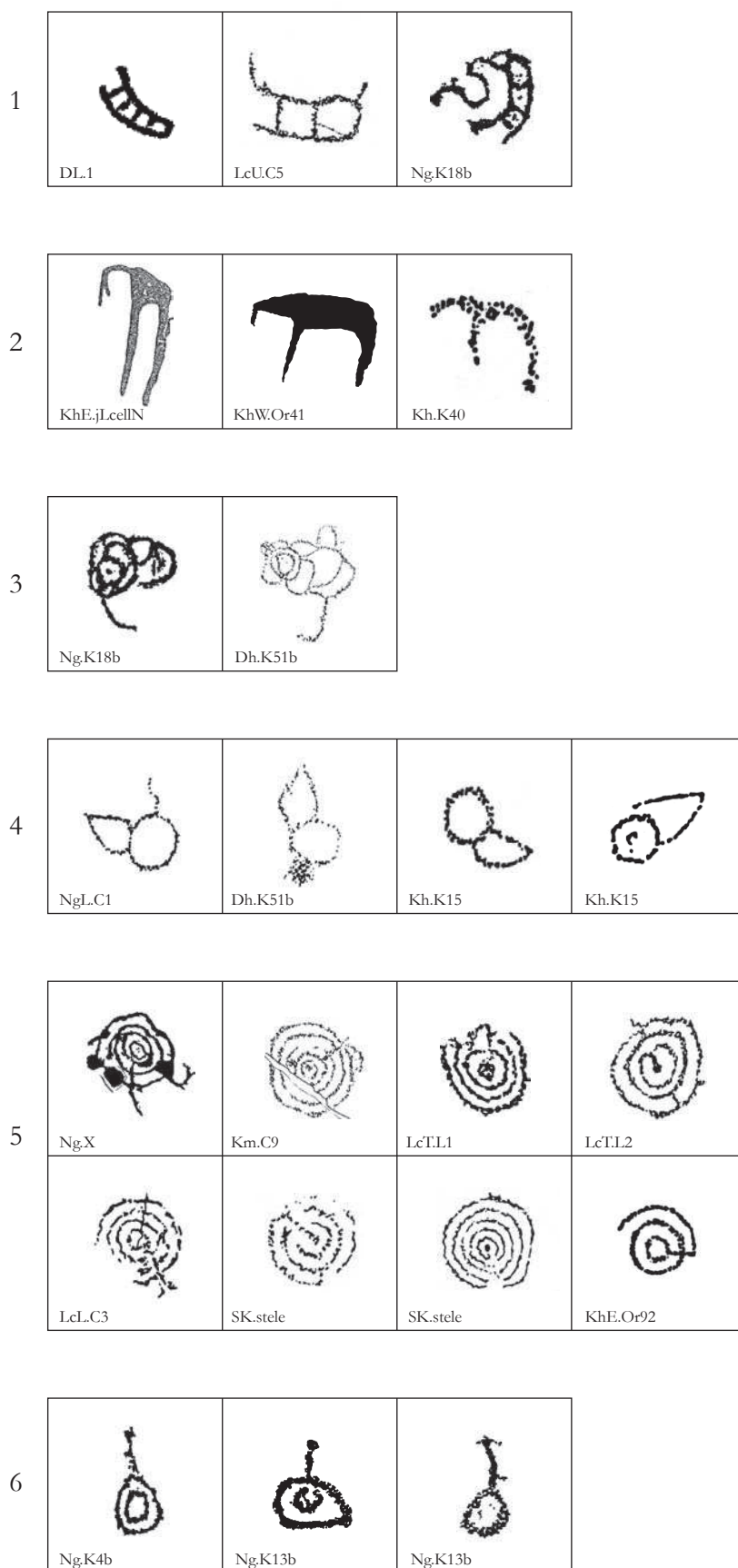

Figure 3.33 : Les signes rares

































Formes élémentaires	Signes circulaires et semi-circulaires					Signes angulaires				Signe ondulé	
	•	○	⊙	∩	✳	☂	∧	▲	◇	≡	〰
											
	 	 	 	 	 	 	 	 	 	 	 

Figure 3.34 : Tableau synthétique des signes élémentaires

























Nbr total												
178												
282		121										
153		57	88									
322		136	203	97								
39		26	30	9	34							
20		16	16	7	18	2						
172		43	62	51	68	8	6					
47		16	20	16	20	3	4	29				
120		39	45	31	54	8	7	57	28			
56		31	40	15	42	17	5	16	6	12		
191		69	102	58	115	21	10	47	12	31	22	

Figure 4.1 : Tableau des associations de signes : données en nombre total d'associations

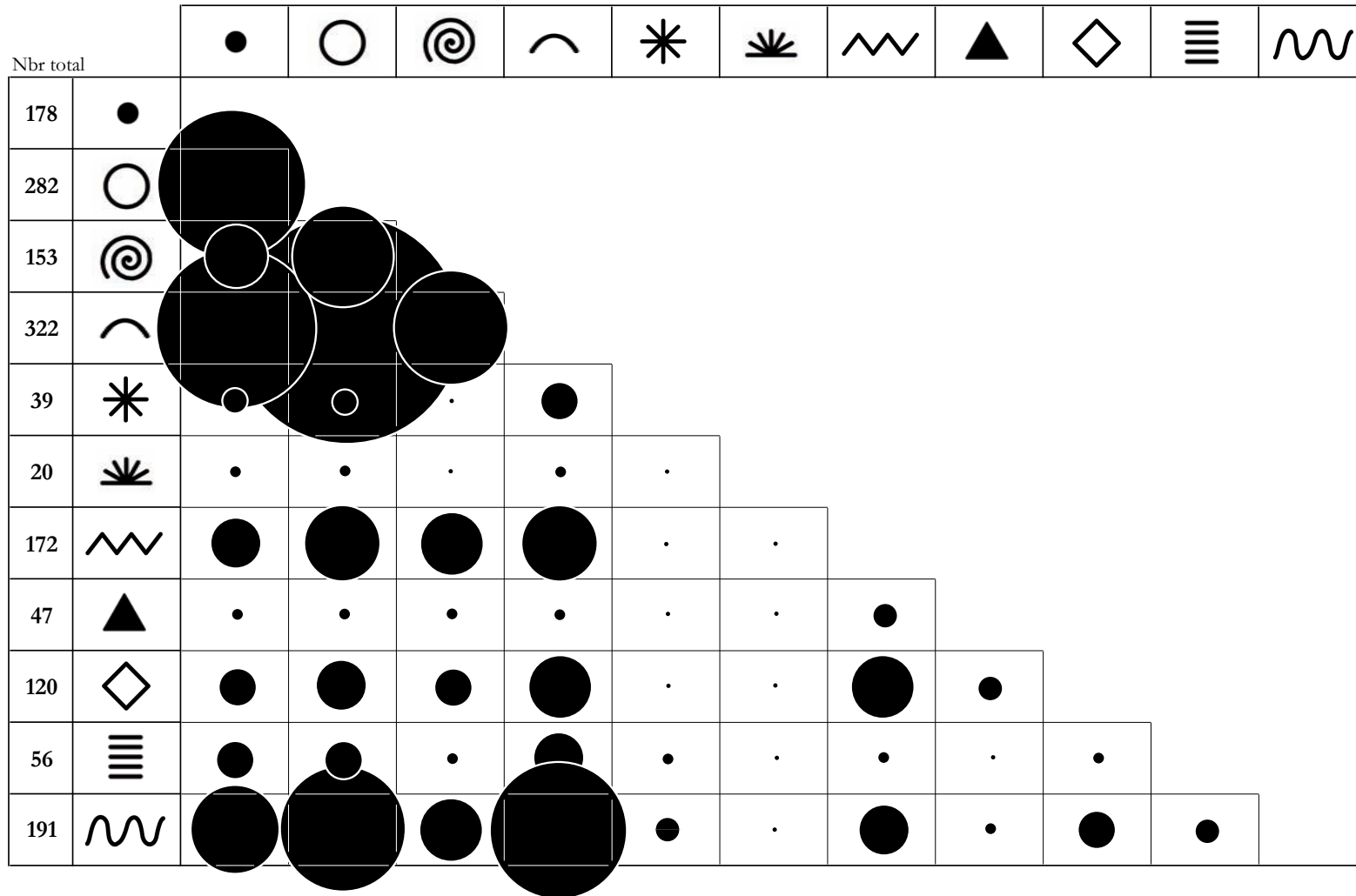

Figure 4.2 : Tableau des associations de signes : illustration graphique

		Signes associés (résultat en pourcentage)										
Nbr tot:	Signes référents	●	○	⊙	⤿	✳	☂	⚡	▲	◇	≡	〰
178	●		68	32	76,4	14,6	9	24,2	9	21,9	17,4	38,8
282	○	42		31,2	72	10,6	5,7	22	7,1	16	14,2	36,2
153	⊙	37,3	57,5		63,4	5,9	4,6	33,3	10,5	20,3	9,8	37,9
322	⤿	42,2	63	32,1		10,6	5,6	21,1	6,2	16,8	13	35,7
39	✳	66,7	76,9	23	90		5,1	20,5	7,7	20,5	43,6	53,8
20	☂	80	80	35	90	10		30	25	35	25	50
172	⚡	25	36	29,7	39,5	4,7	3,5		16,9	33,1	9,3	27,3
47	▲	34	42,6	34	42,6	6,4	8,5	61,7		59,6	3,5	18
120	◇	32,5	37,5	25,8	45	6,7	5,8	47,5	23,3		10	25,8
56	≡	55,4	71,4	26,8	75	30,4	8,9	28,6	10,7	21,4		39,3
191	〰	36,1	53,4	30,4	60,2	11	5,2	24,6	6,3	16,2	11,5	

Figure 4.3 : Tableau des associations de signes : données en pourcentage relatif

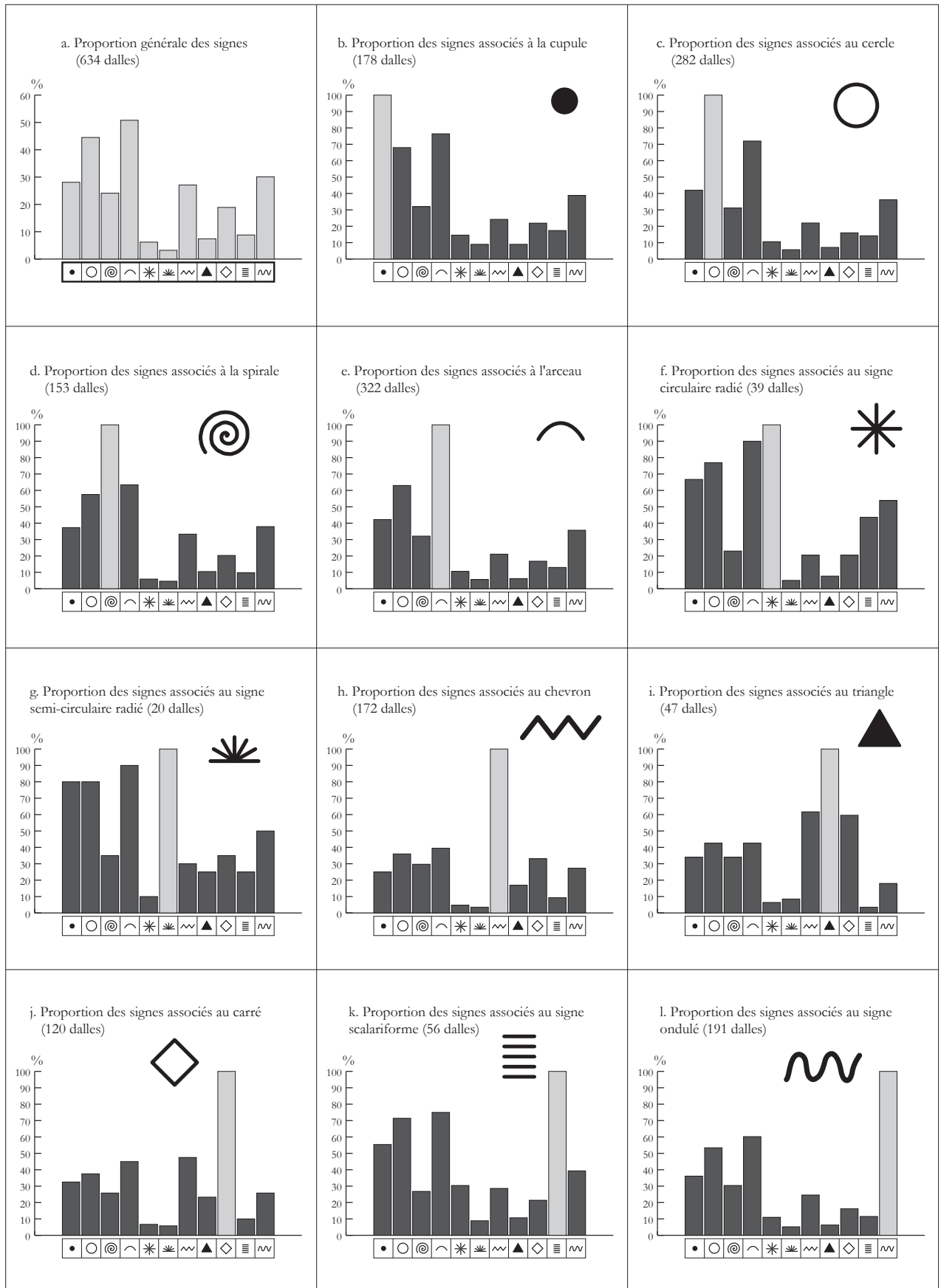

Figure 4.4 : Représentation graphique de la proportion des associations signe par signe

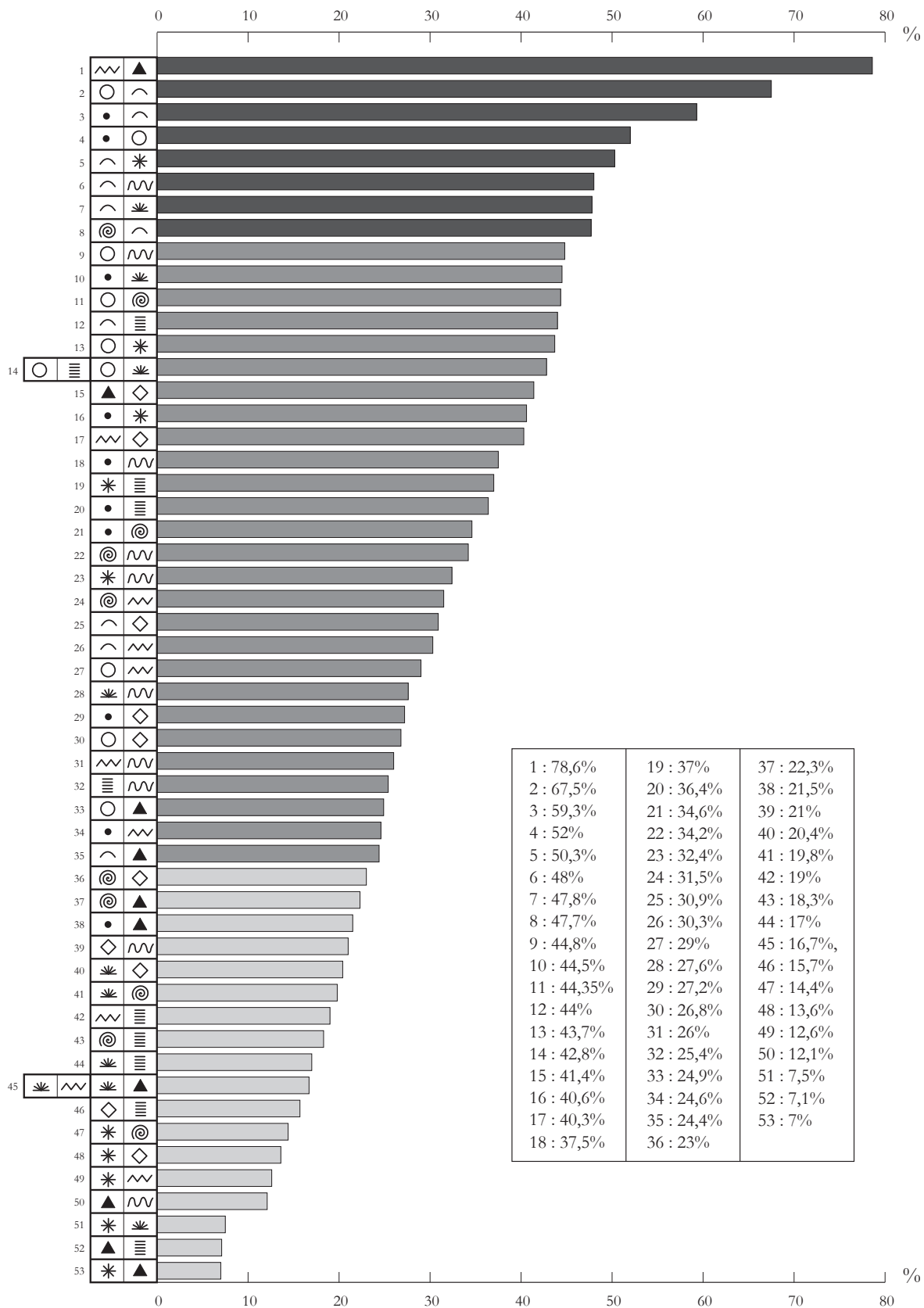

Figure 4.5 : Représentation graphique de la proportion des couples de signes



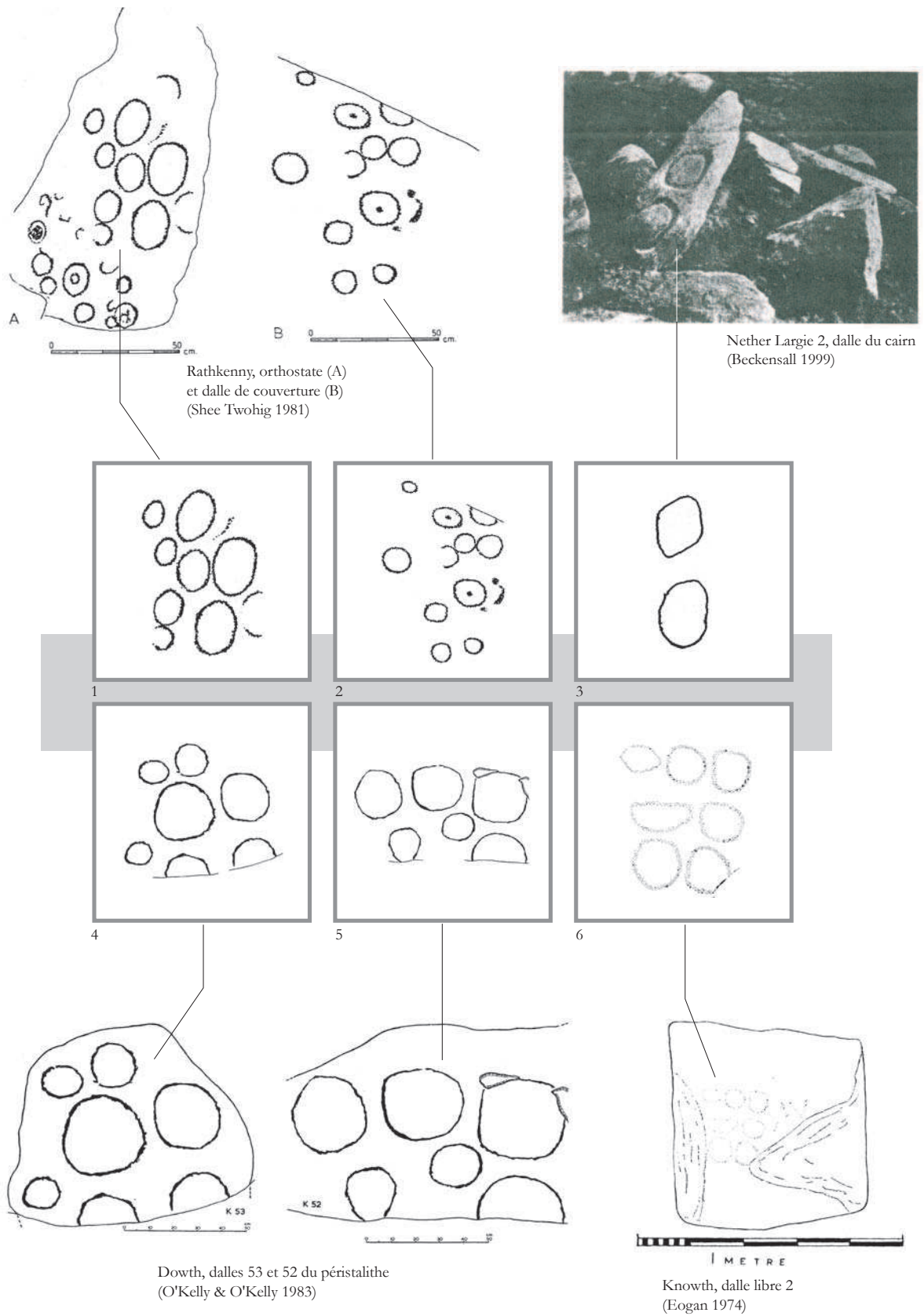

Figure 4.6 : Les regroupements de cercles simples

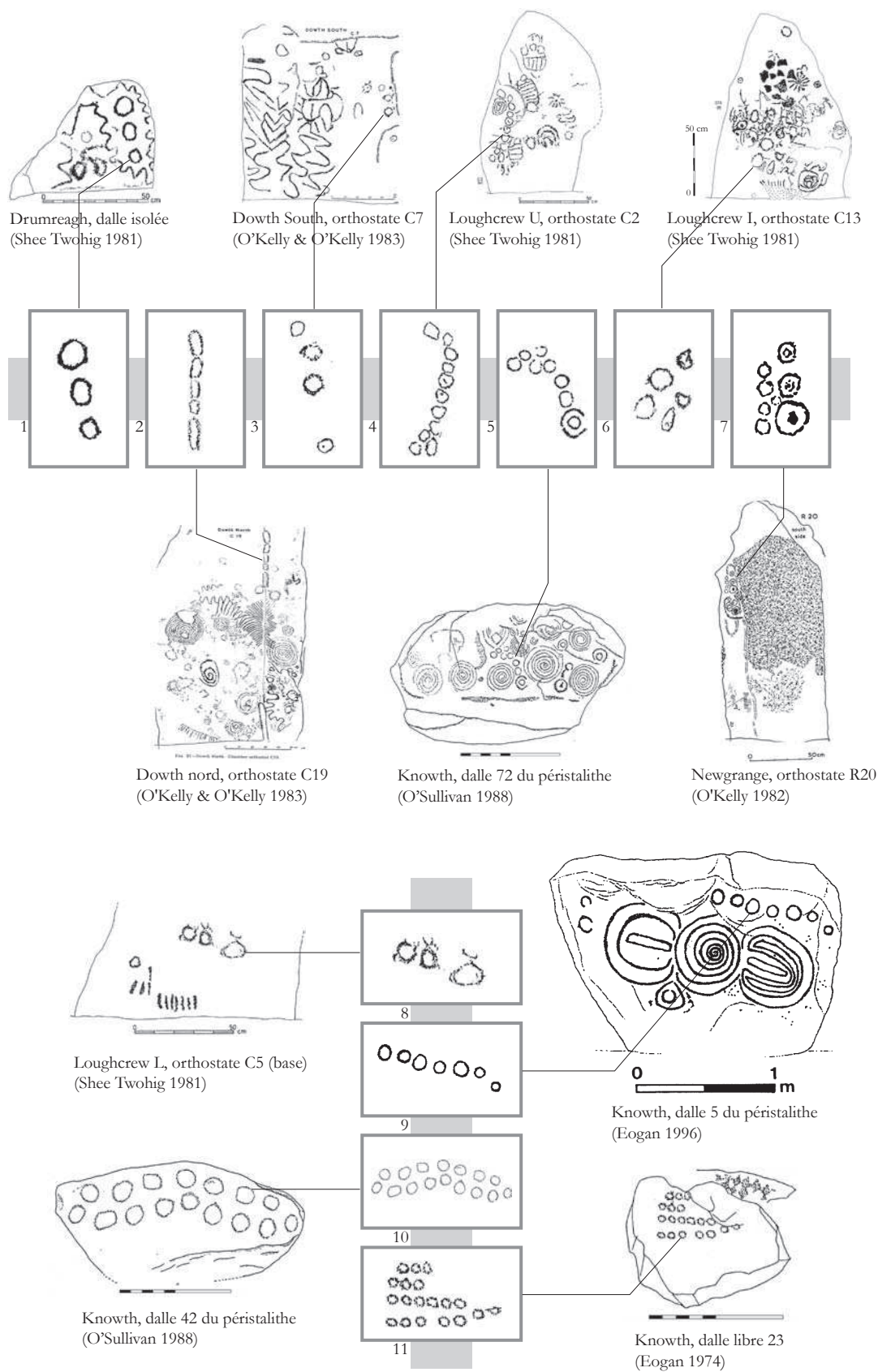

Figure 4.7 : Les lignes de cercles simples

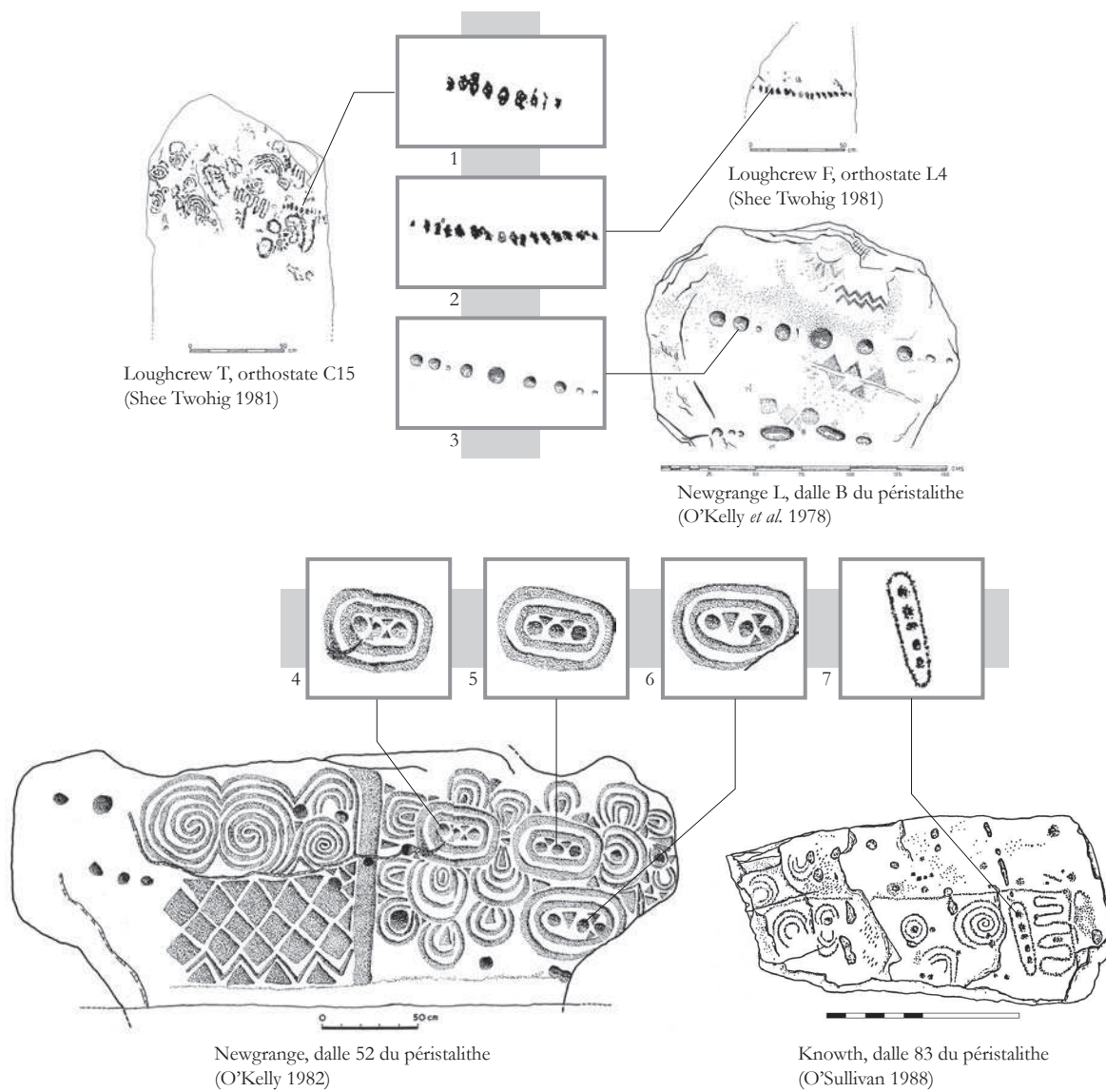

Figure 4.8 : Les lignes de cupules

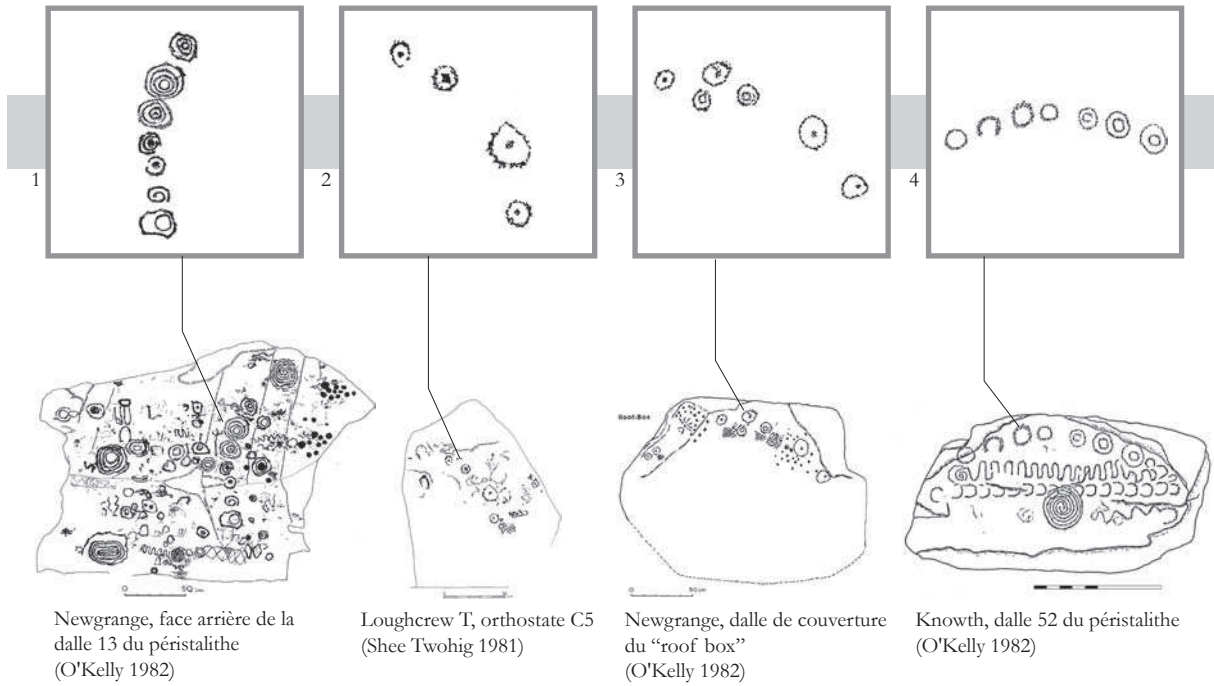

Figure 4.9 : Les lignes de signes circulaires complexes

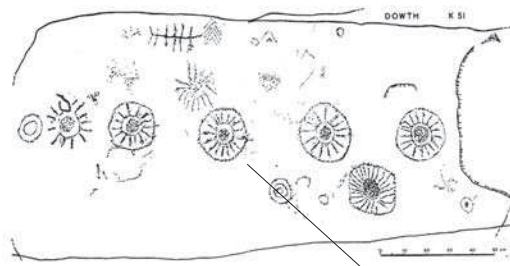
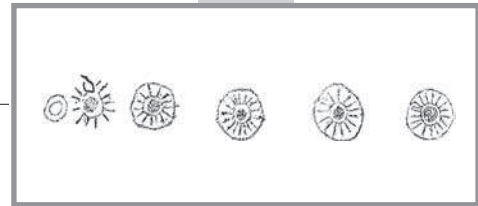

FIG. 15—Kilbstone 51, front.

Dowth, dalle 51 du péristalithe  
(O'Kelly & O'Kelly 1983)



1



FIG. 26—Dowth South. Recess orthostat C12.

Dowth South, orthostate C12  
(O'Kelly & O'Kelly 1983)

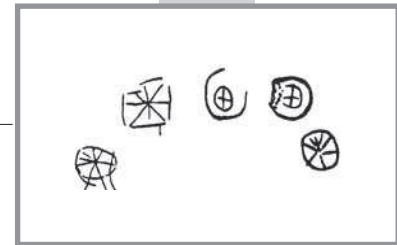

2



FIG. 29—Dowth North. Chauder orthostat C7.

Dowth North, orthostate C7  
(O'Kelly & O'Kelly 1983)

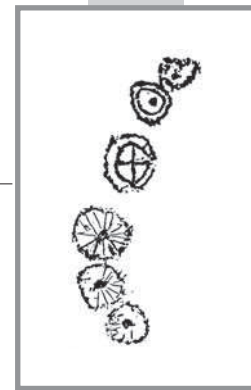

3

Figure 4.10 : Les lignes de signes circulaires radiés

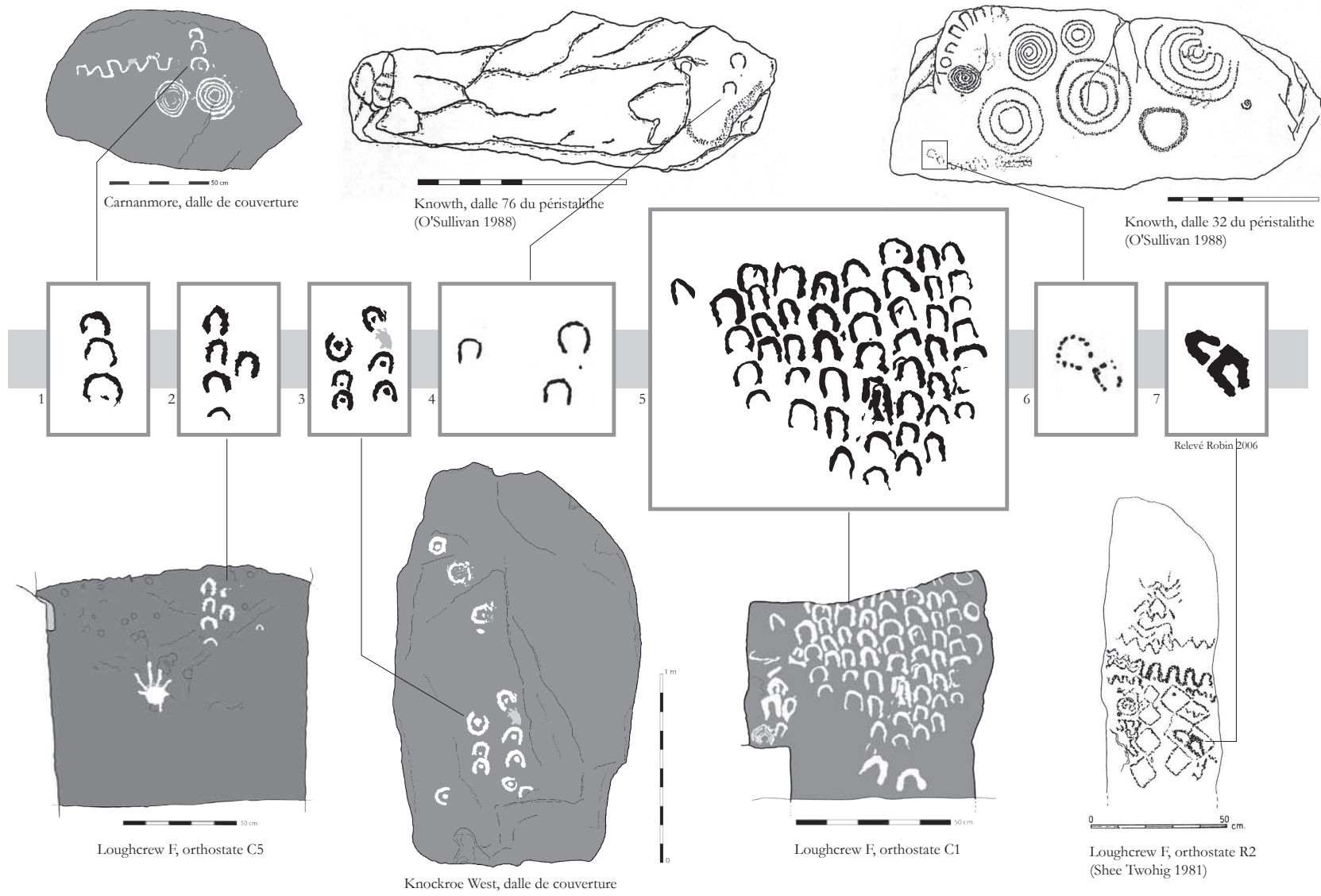

Figure 4.11 : Les lignes d'arceaux simples (1/2)

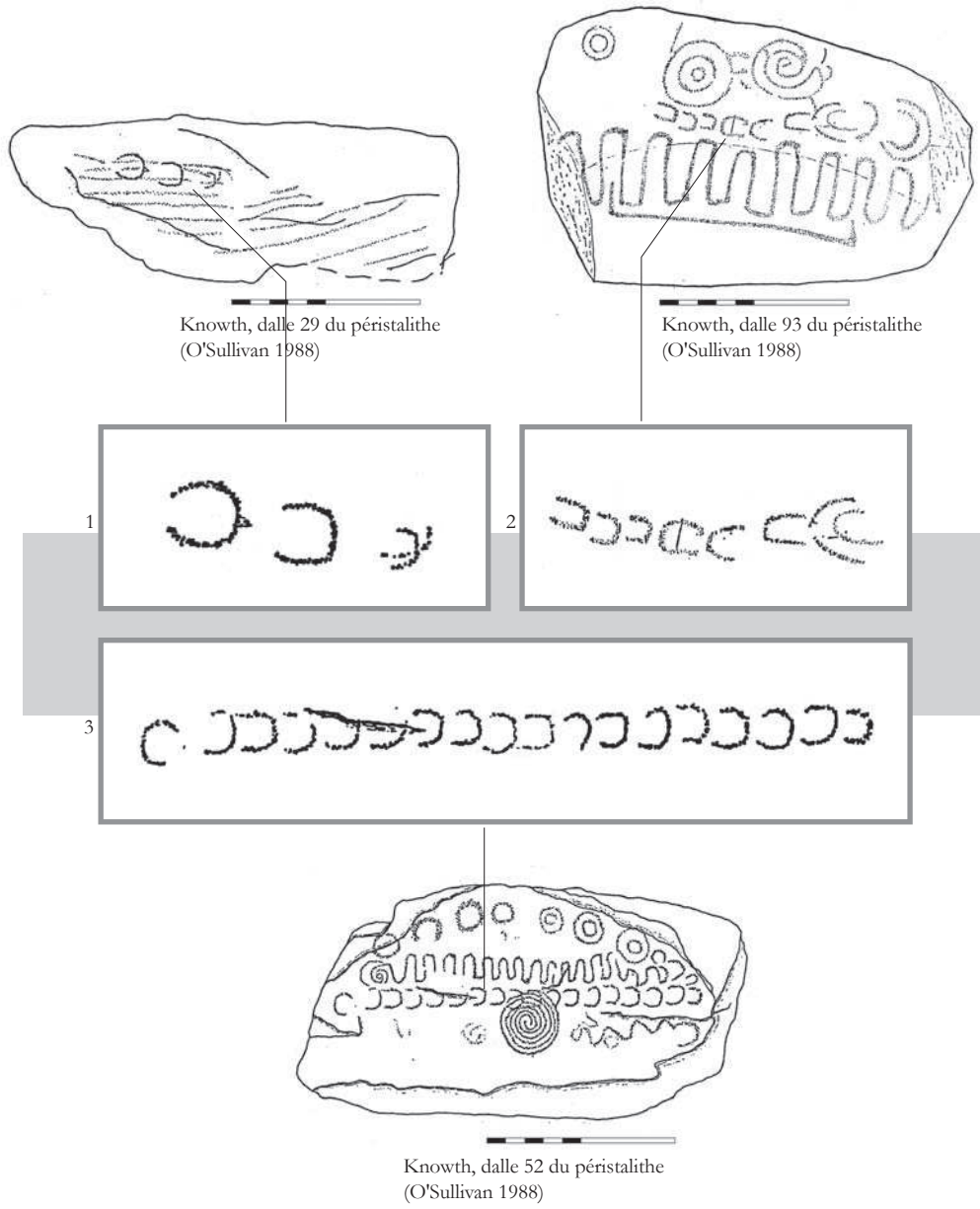

Figure 4.12 : Les lignes d'arceaux simples (2/2)

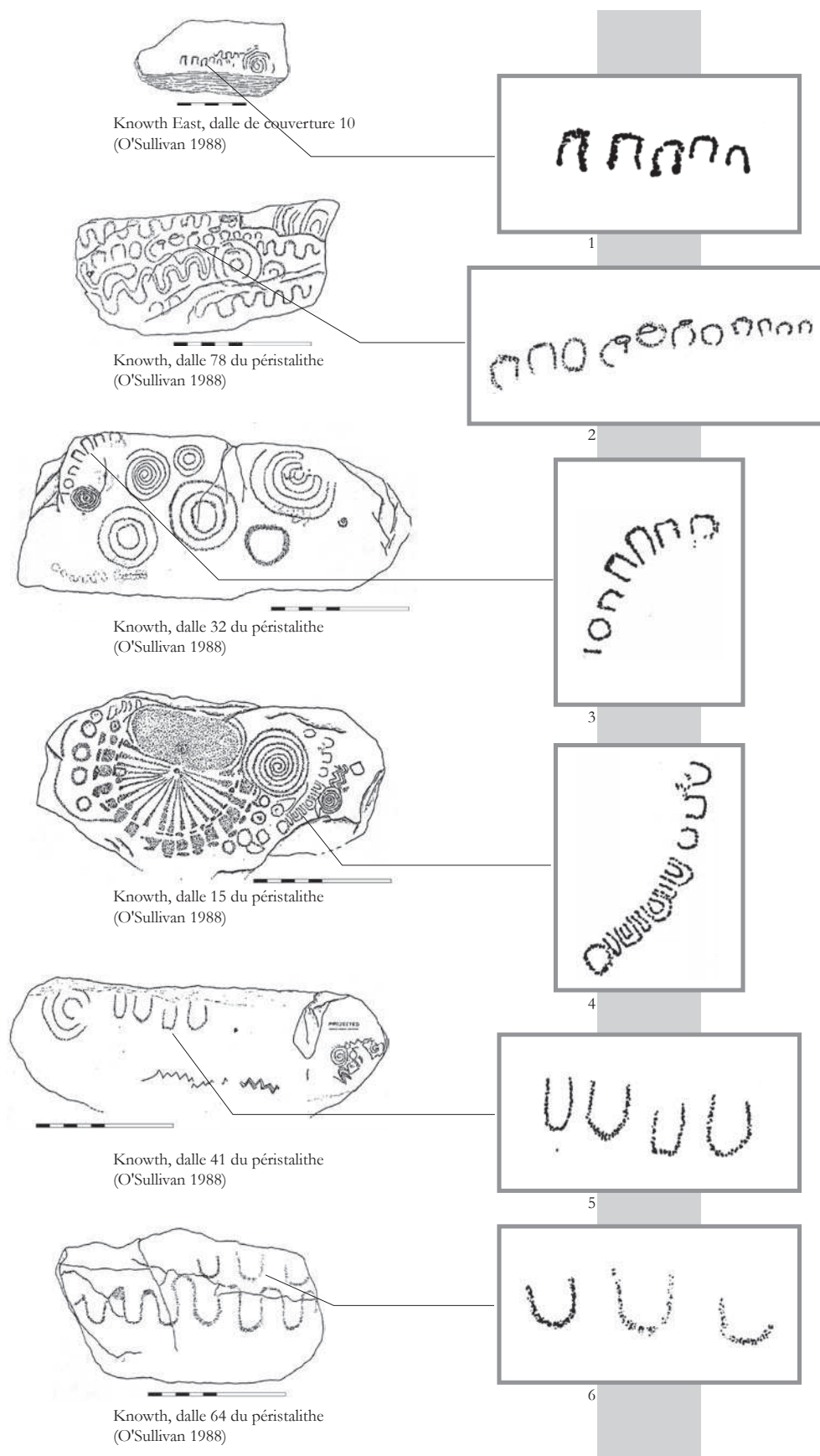
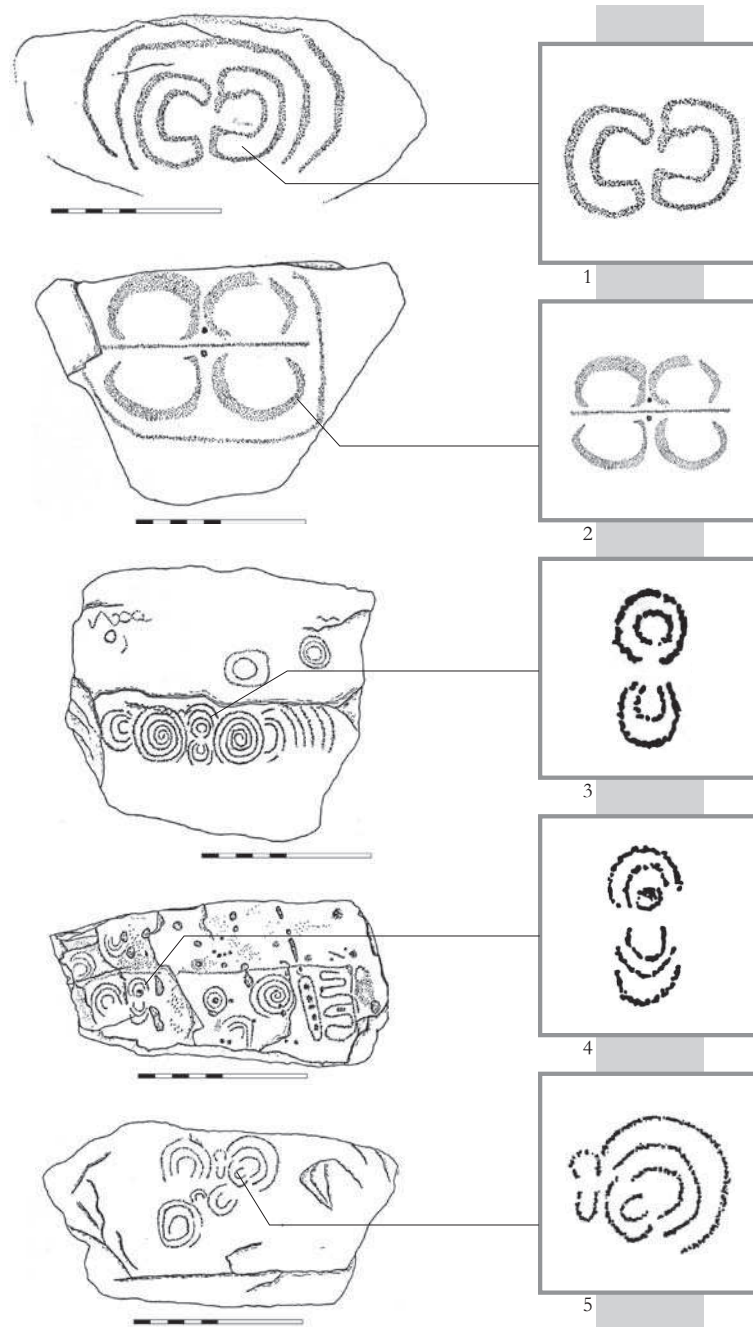

Figure 4.13 : Les rangées d'arceaux simples





Knowth, dalles 30, 86, 65, 83 et 80 du péristicalithe  
(O'Sullivan 1988)

Figure 4.14 : Les paires d'arceaux opposés

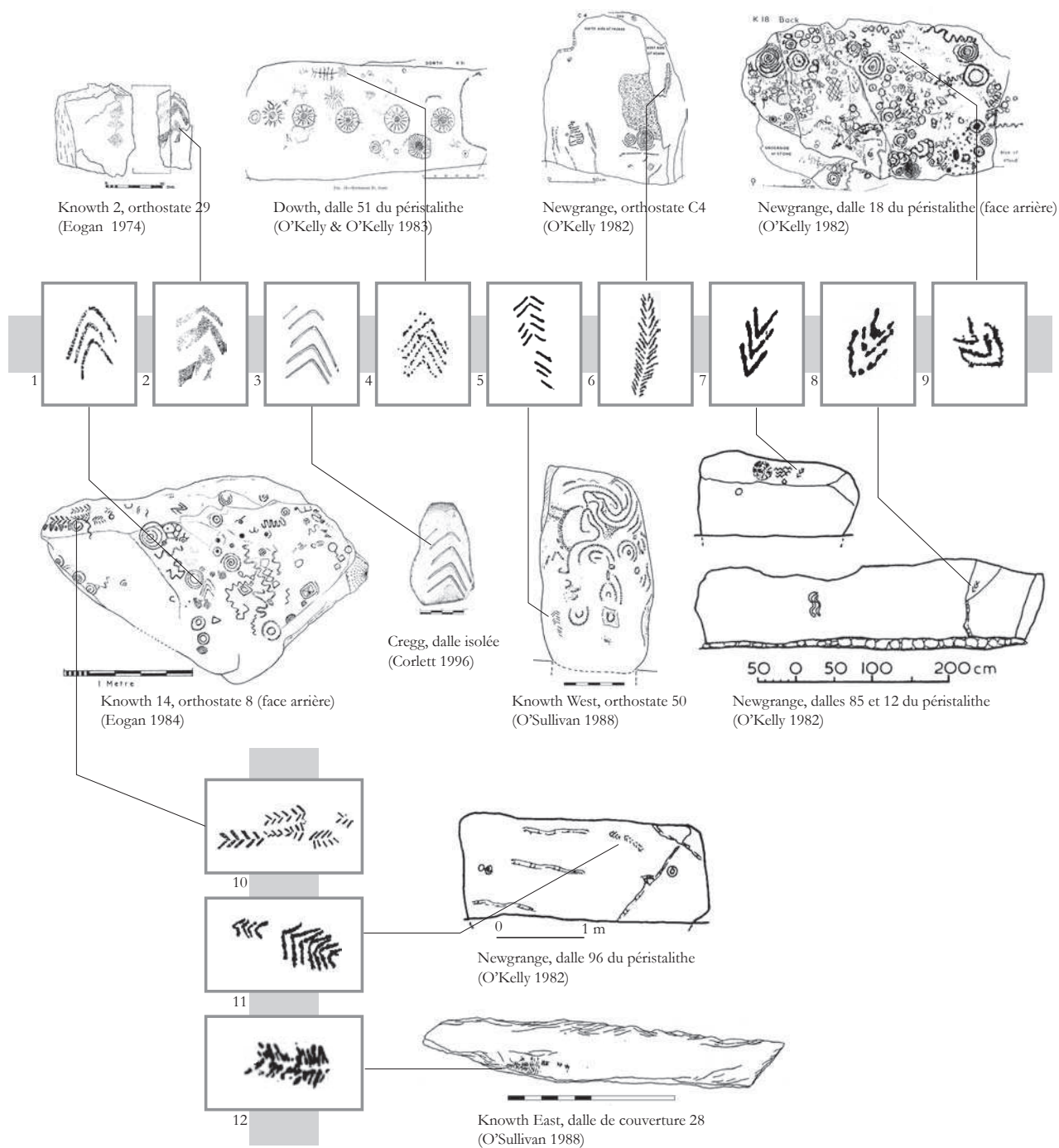

Figure 4.15 : Les chevrons simples emboîtés

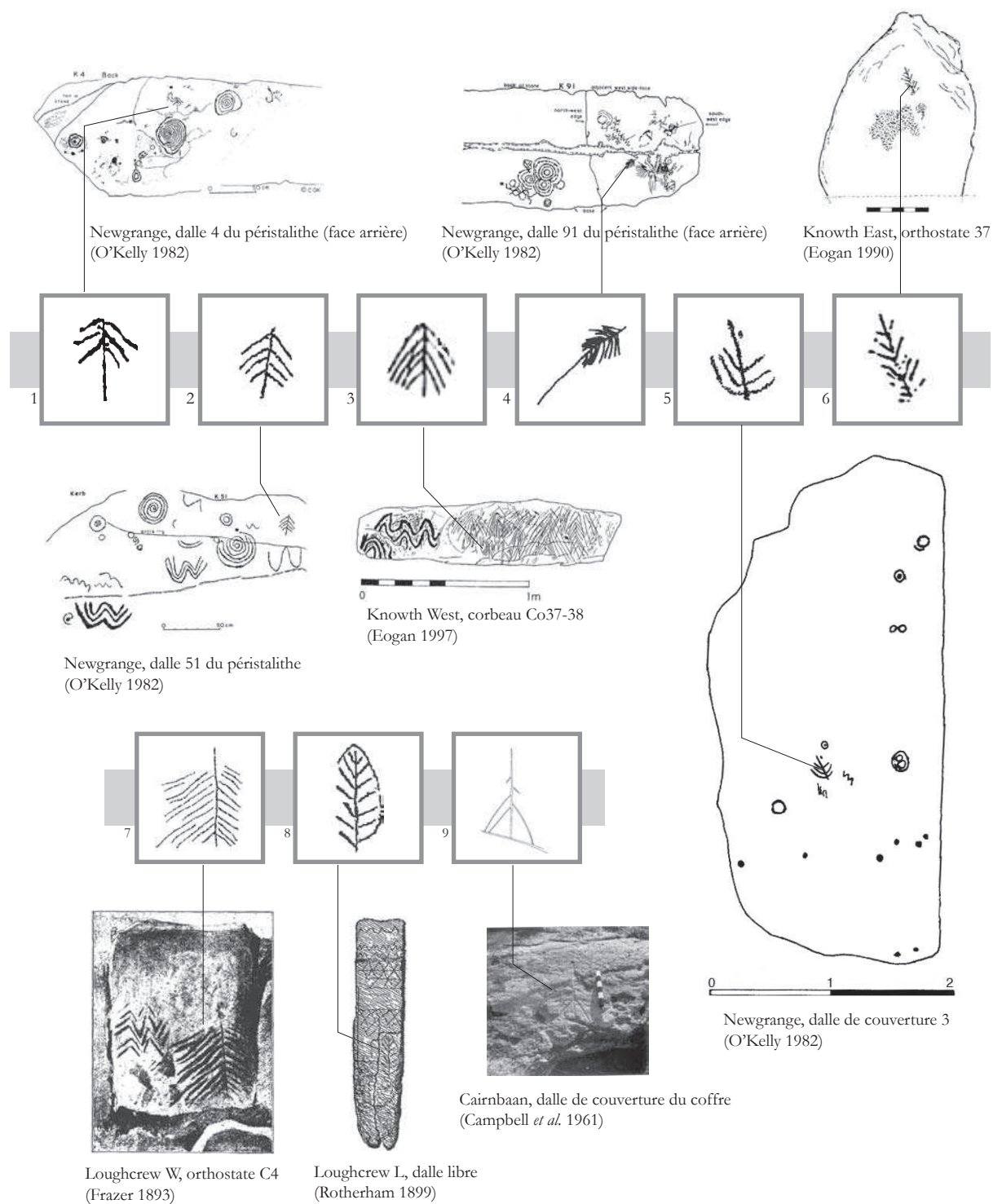

Figure 4.16 : Les chevrons simples emboîtés avec ligne centrale



Dh.loose1 ; DL.2 ; Fk.A ; Fk.C ; Fk.E ; Fk.F ; Kh.K12 ; Kh.K13 ; Kh.K15 ; Kh.K28 ; Kh.K85b ; KhE.Or2 ; KhE.Or48 ; KhE.Or49 ; KhE.Or55 ; KhE.RS32 ; KhE.RS41 ; KhE.RS49 ; KhE.RS50 ; KhE.CoA6 ; KhE.CoE6 ; KhE.CoF10 ; KhW.Or16 ; KhW.Or17 ; KhW.Or18 ; KhW.Or40 ; KhW.Or48 ; KhW.Or74 ; KhW.Or81 ; KhW.RS3 ; KhW.RS5 ; KhW.RS10 ; Kh14.Or8 ; Kh17.Or13 ; Kh17.Or15 ; LcI.lscell3 ; LcI.C17 ; LcT.C8 ; LcT.RScell3 ; LcU.R2 ; LcU.C7 ; LcU.C8 ; LcW.C4 ; Ng.K67 ; Ng.K85 ; Ng.K93 ; Ng.L19 ; Ng.L22 ; Ng.R18 ; Ng.Co1/C2 ; Ng.Co2/C14 ; Ng.RScellE ; NgK.A ; NgL.B ; ByG.L8 ; ByG.C16 ; HPW.B.

Figure 4.17 : Les chevrons emboîtés

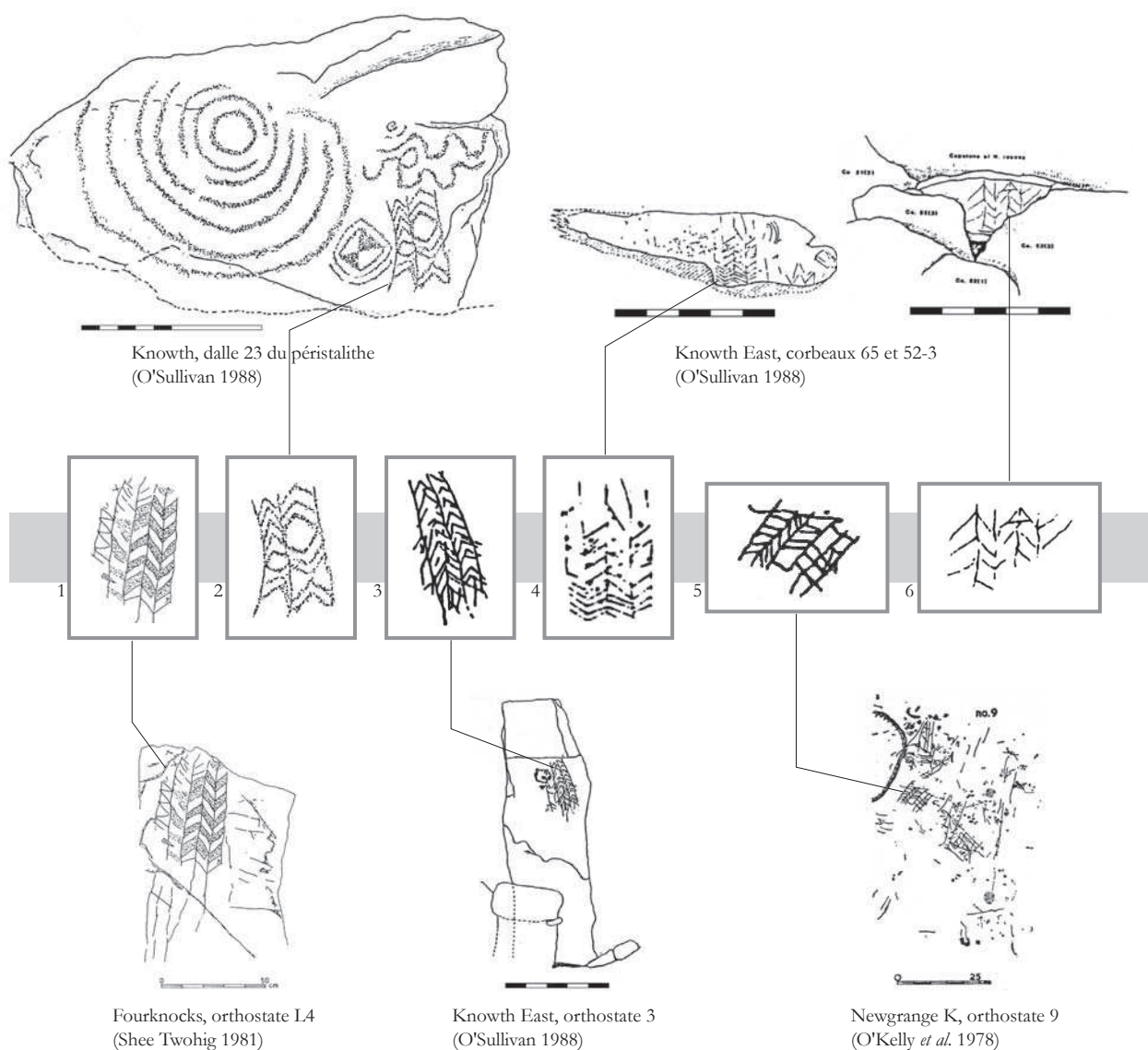

Figure 4.18 : Les chevrons emboîtés avec ligne centrale

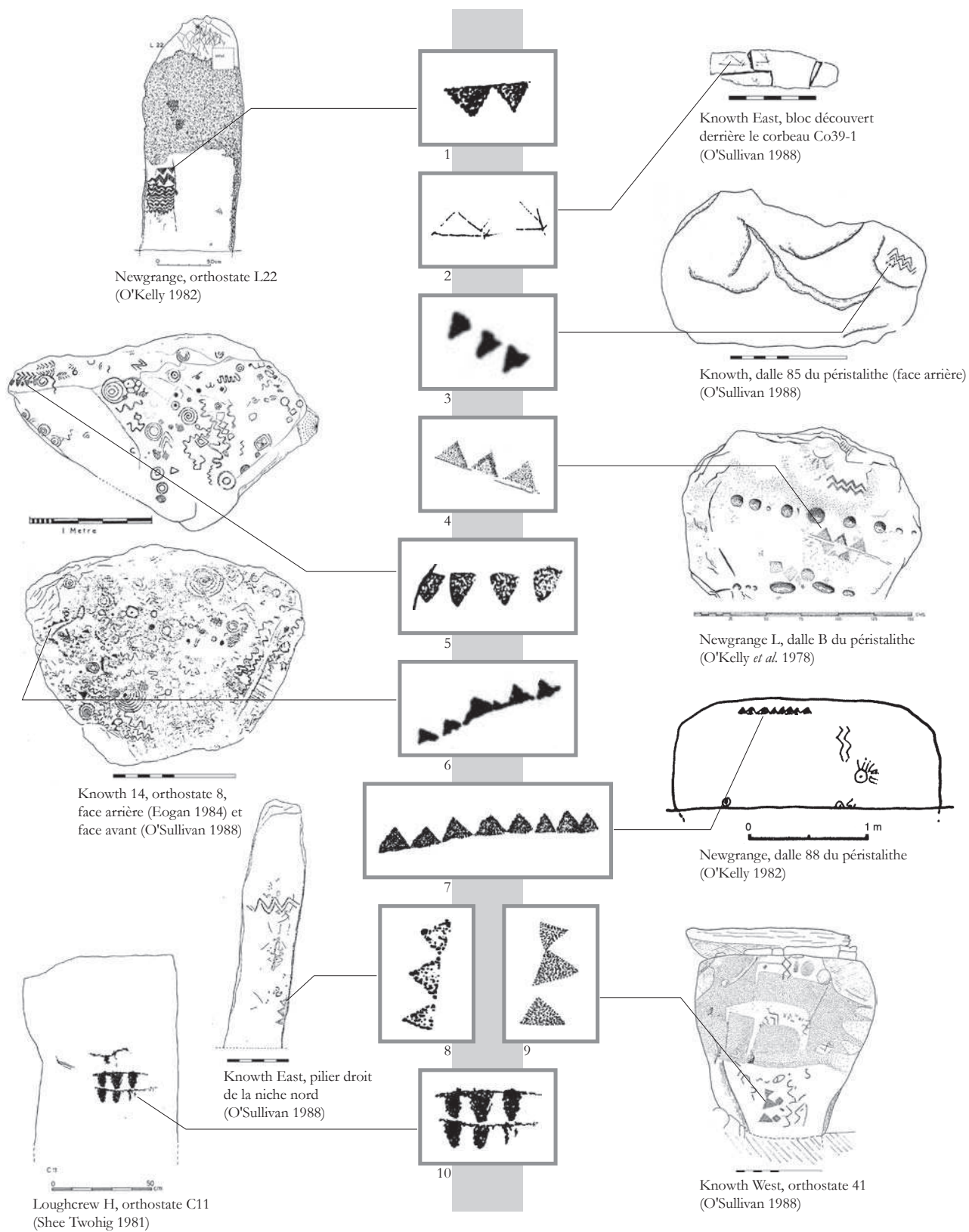

Figure 4.19 : Les rangées de triangles

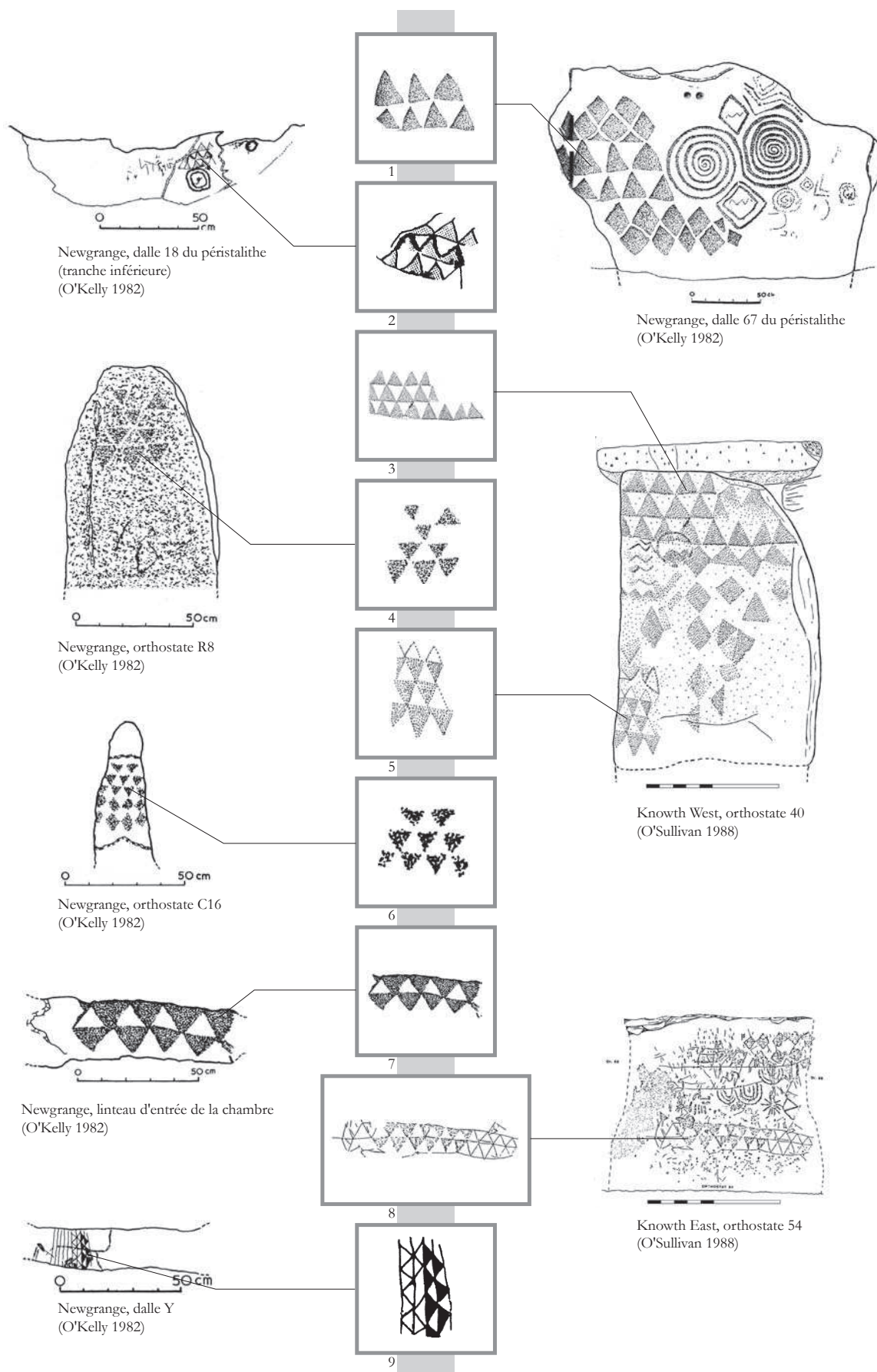

Figure 4.20 : Les rangées de triangles parallèles

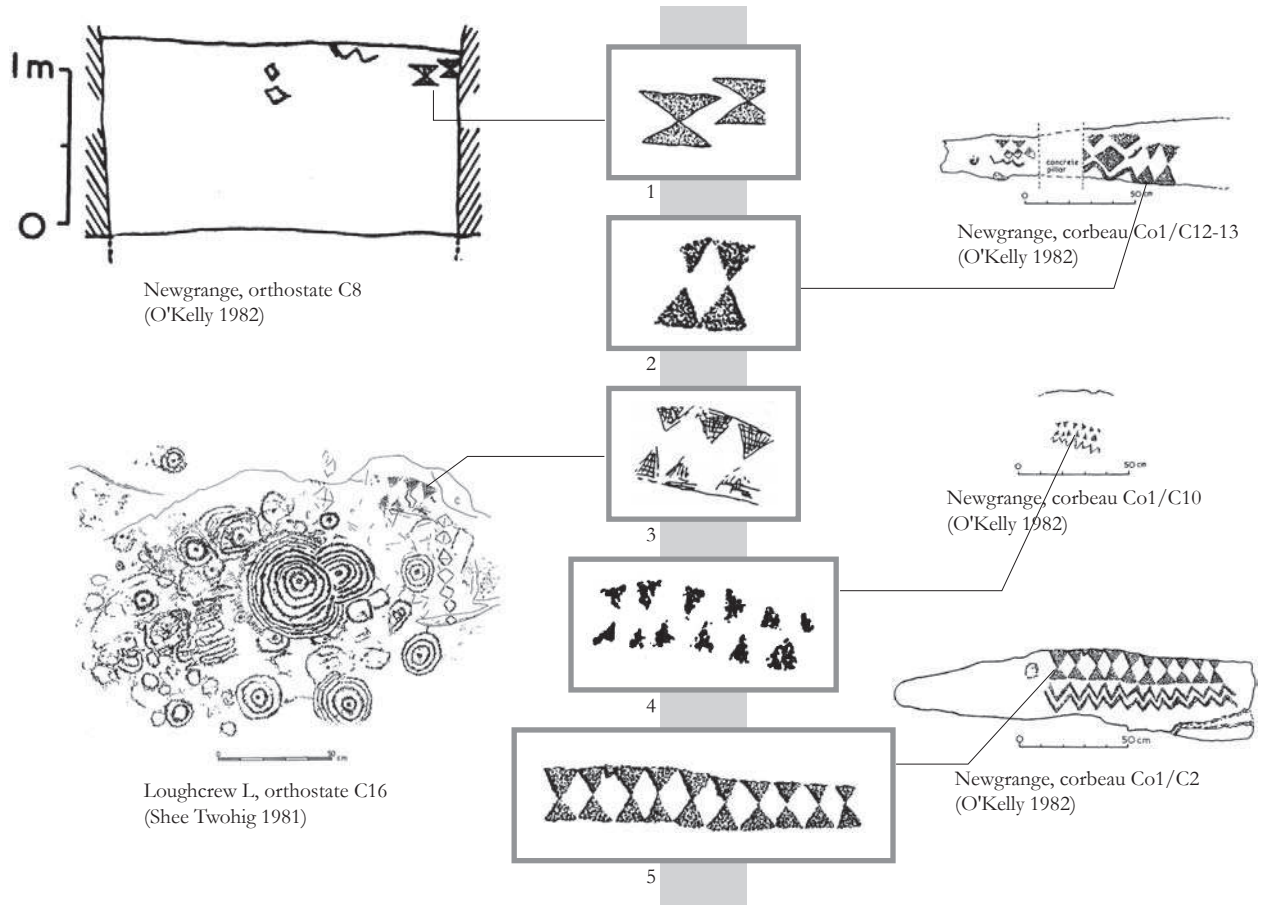

Figure 4.21 : Les triangles opposés par la pointe

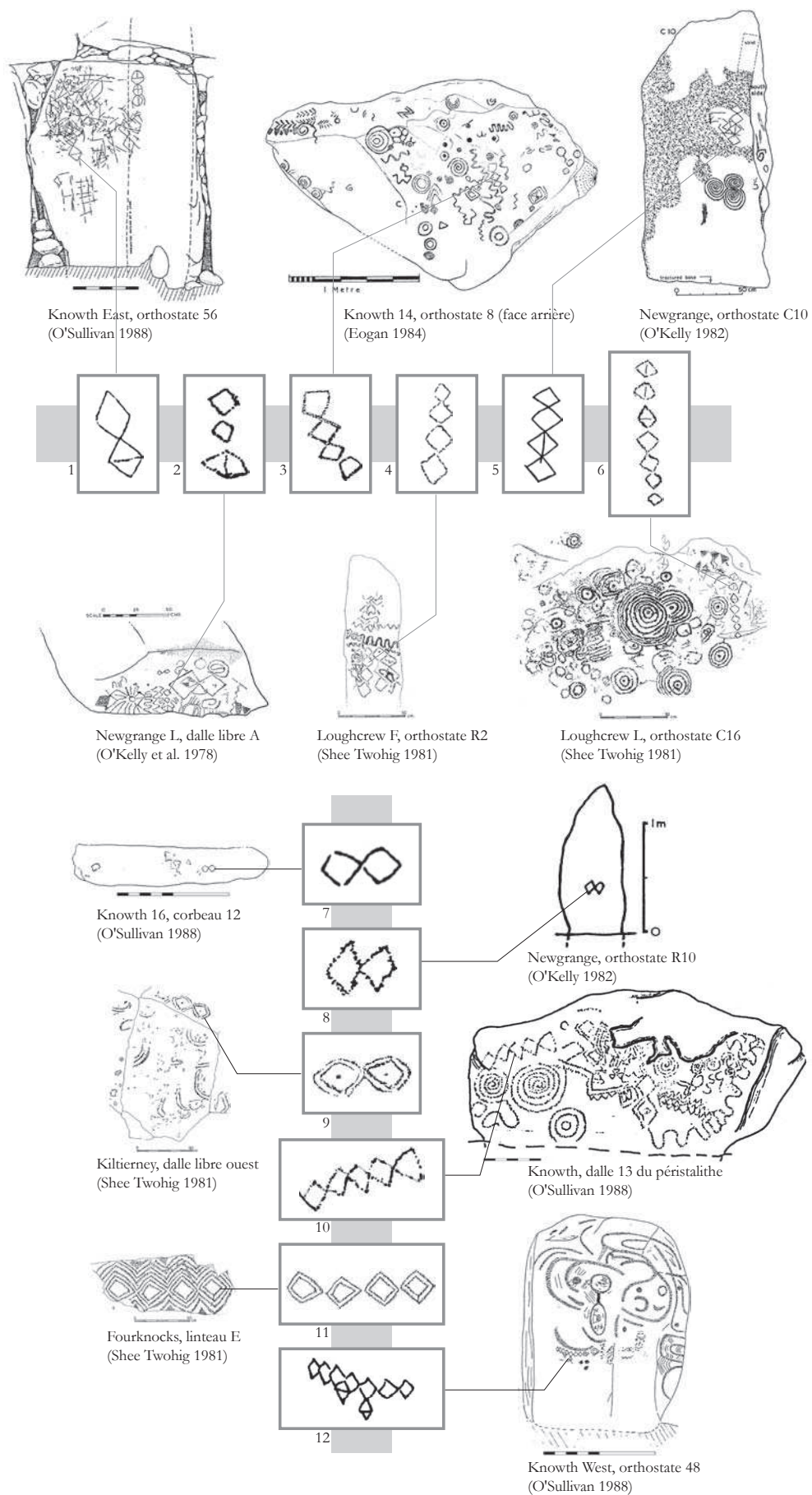

Figure 4.22 : Les lignes de losanges vides



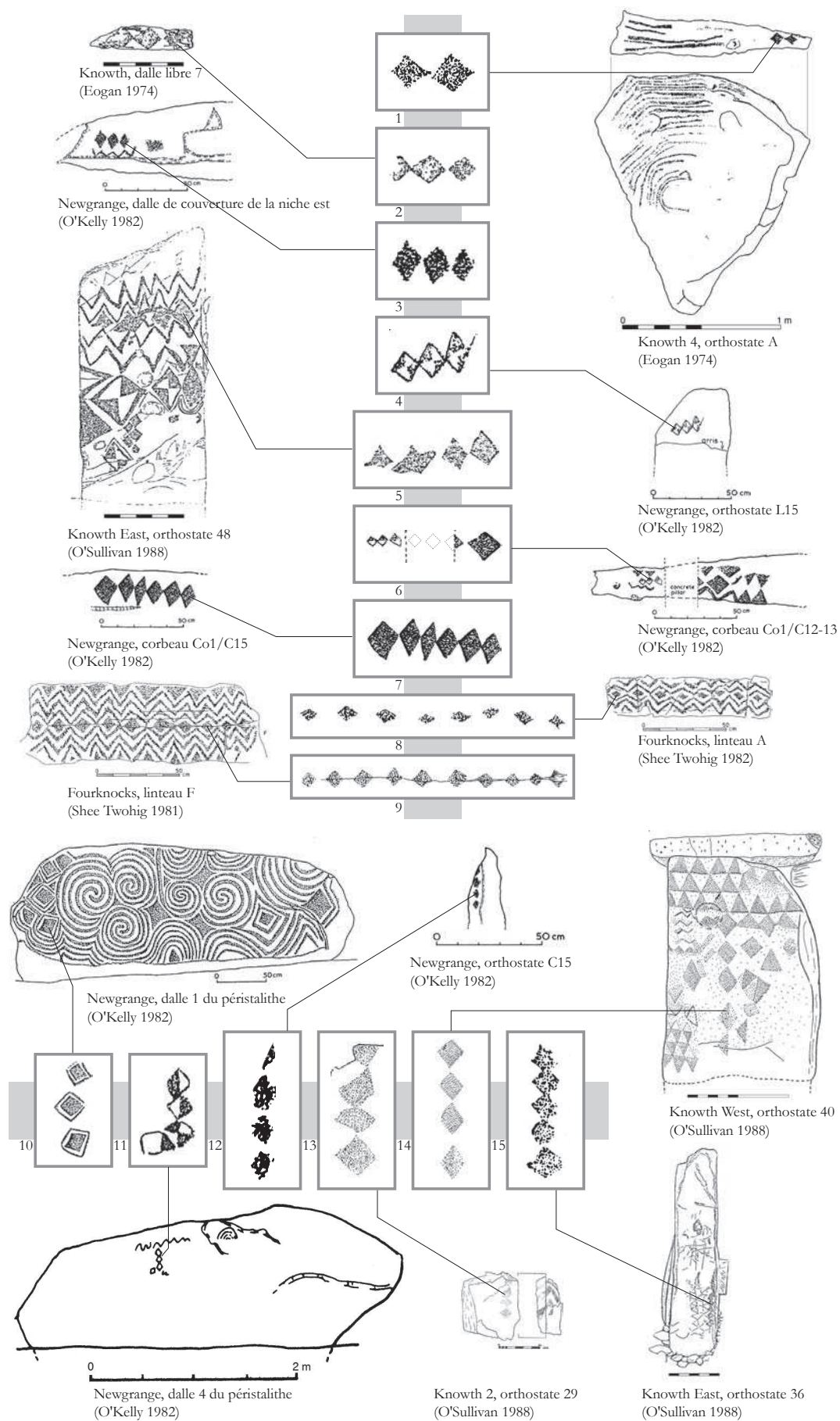

Figure 4.23 : Les lignes de losanges pleins

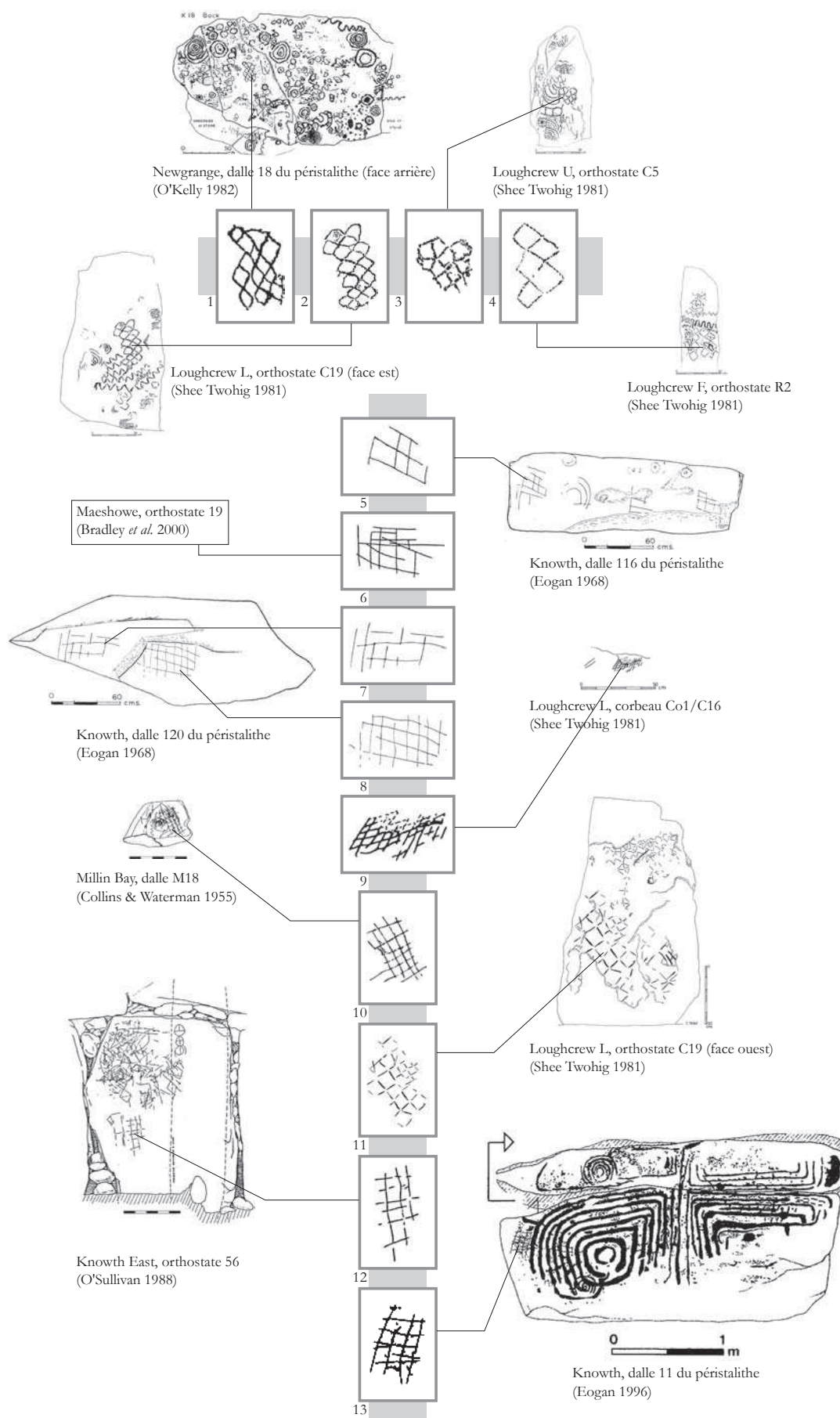

Figure 4.24 : Les quadrillages simples

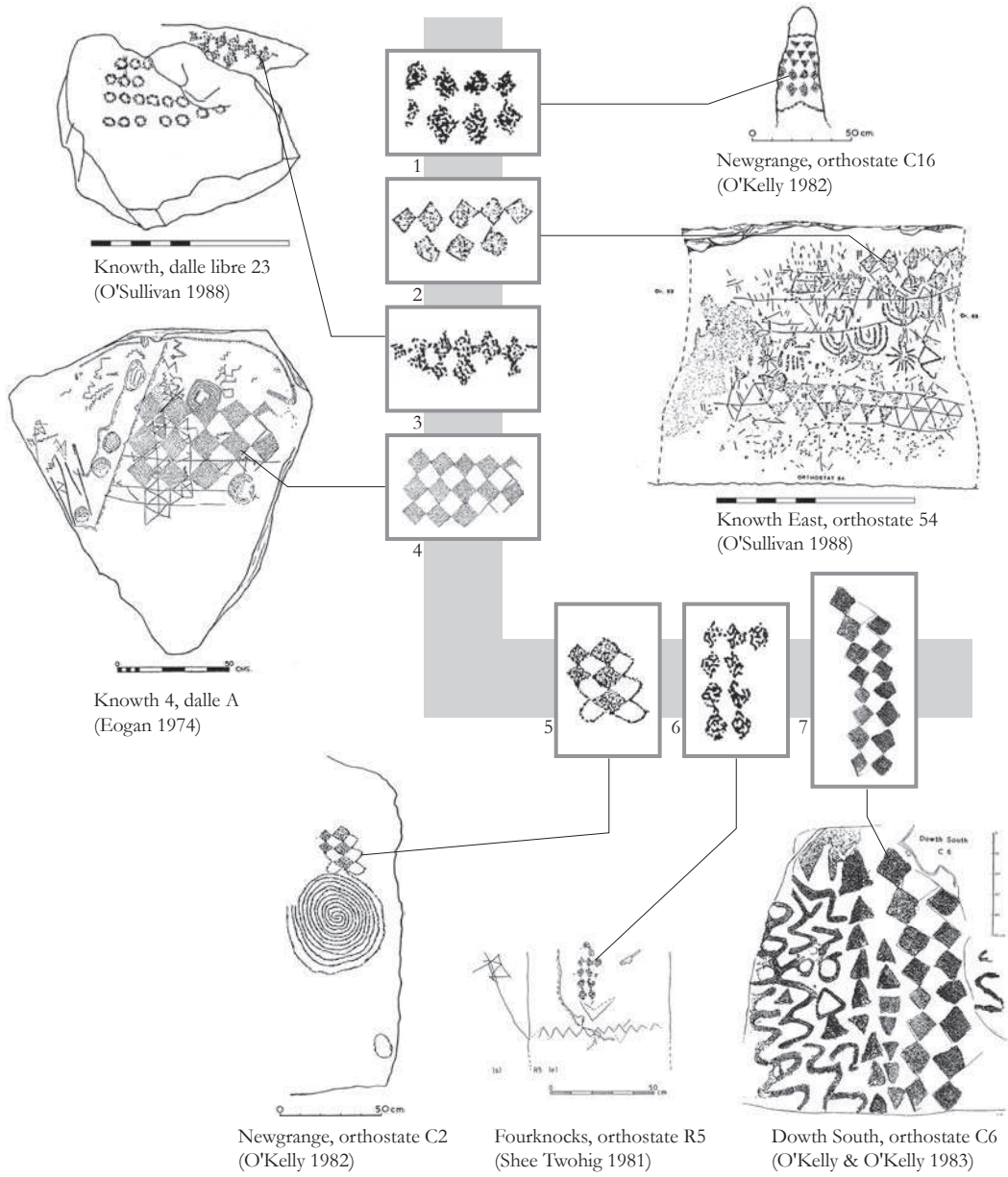

Figure 4.25 : Les quadrillages en damier

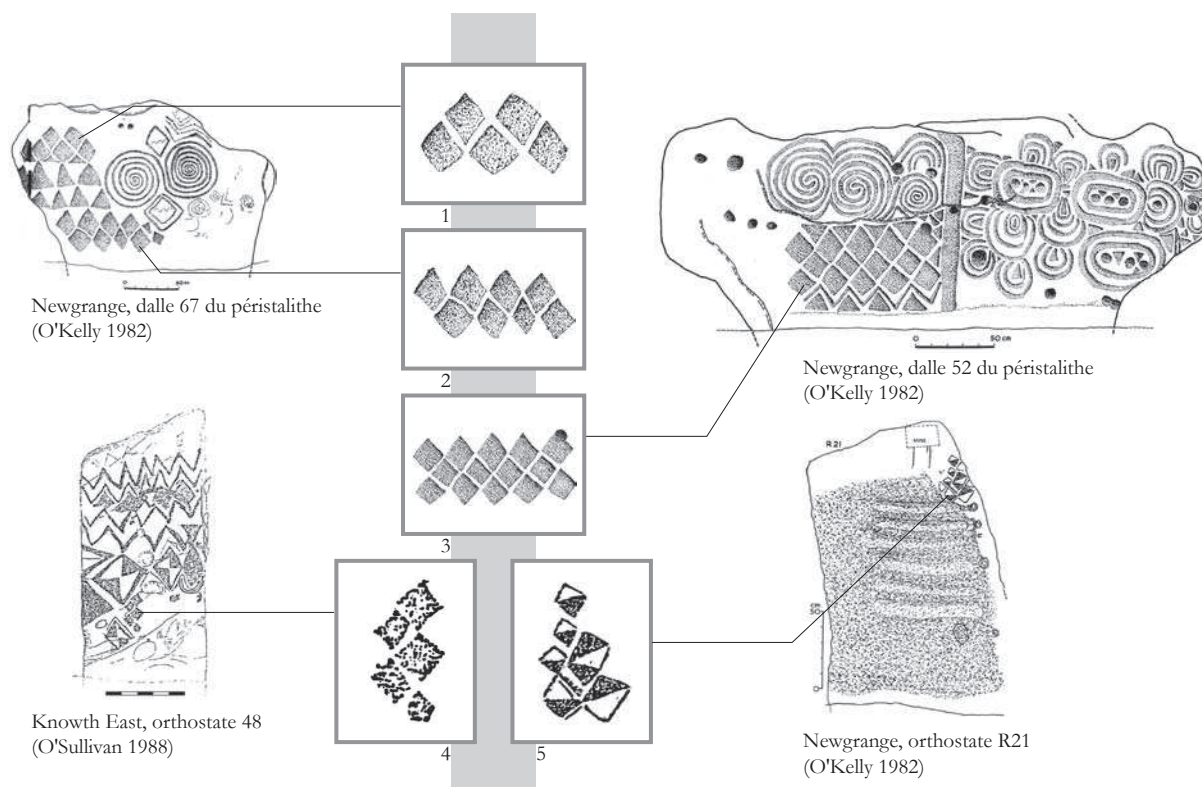

Figure 4.26 : Les quadrillages de carrés pleins

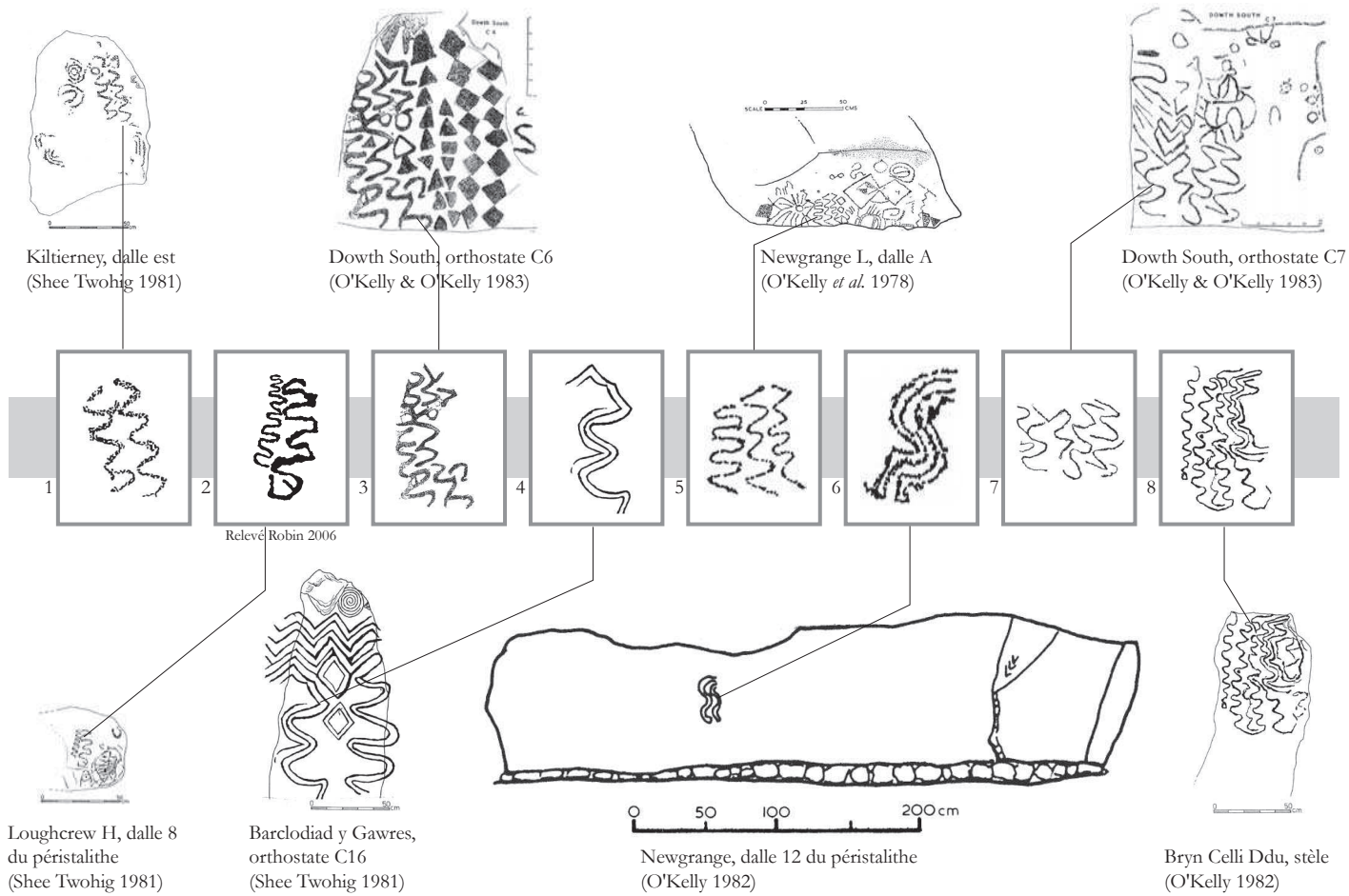

Figure 4.27 : Les lignes ondulées parallèles verticales

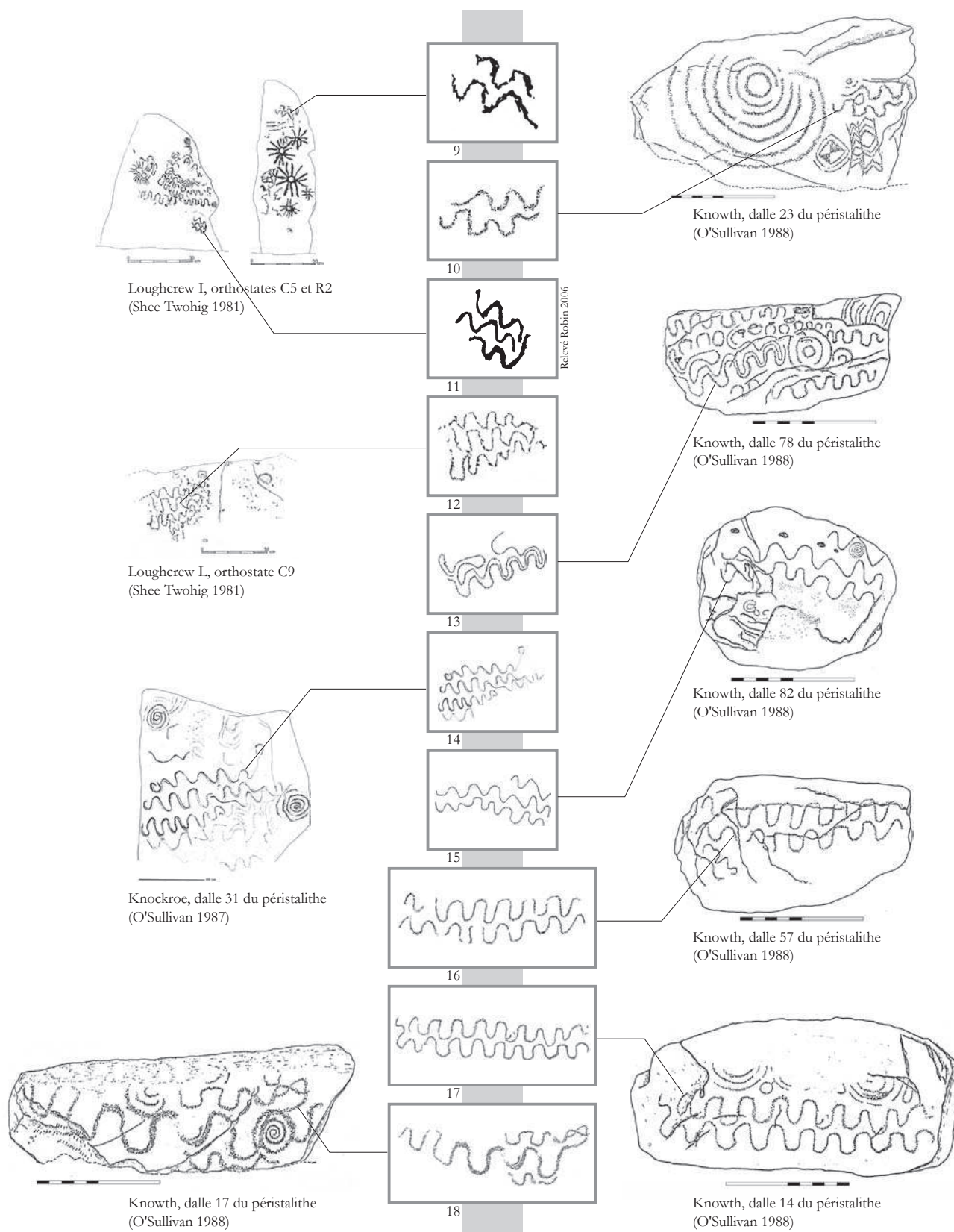

Figure 4.28 : Les lignes ondulées parallèles horizontales

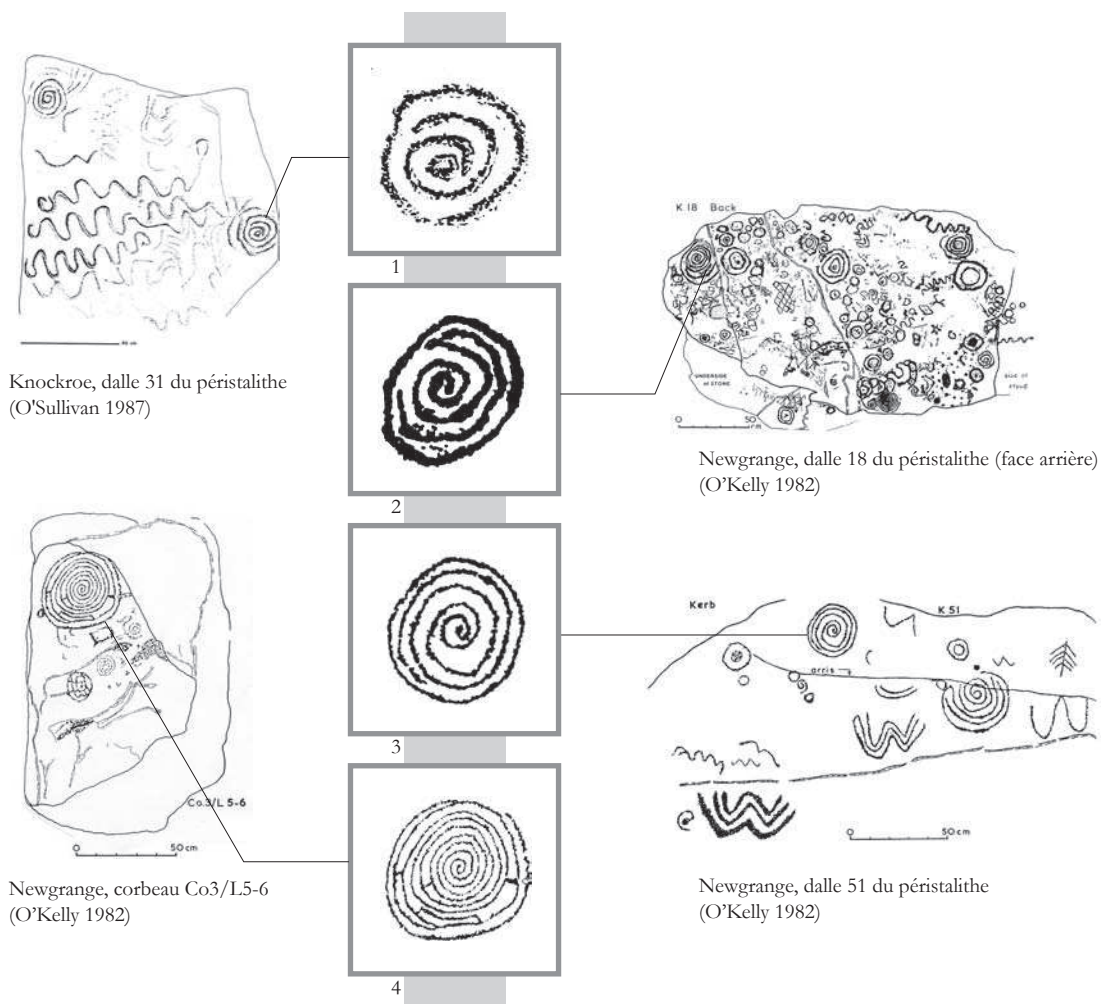

Figure 4.29 : Spirales inscrites dans un cercle

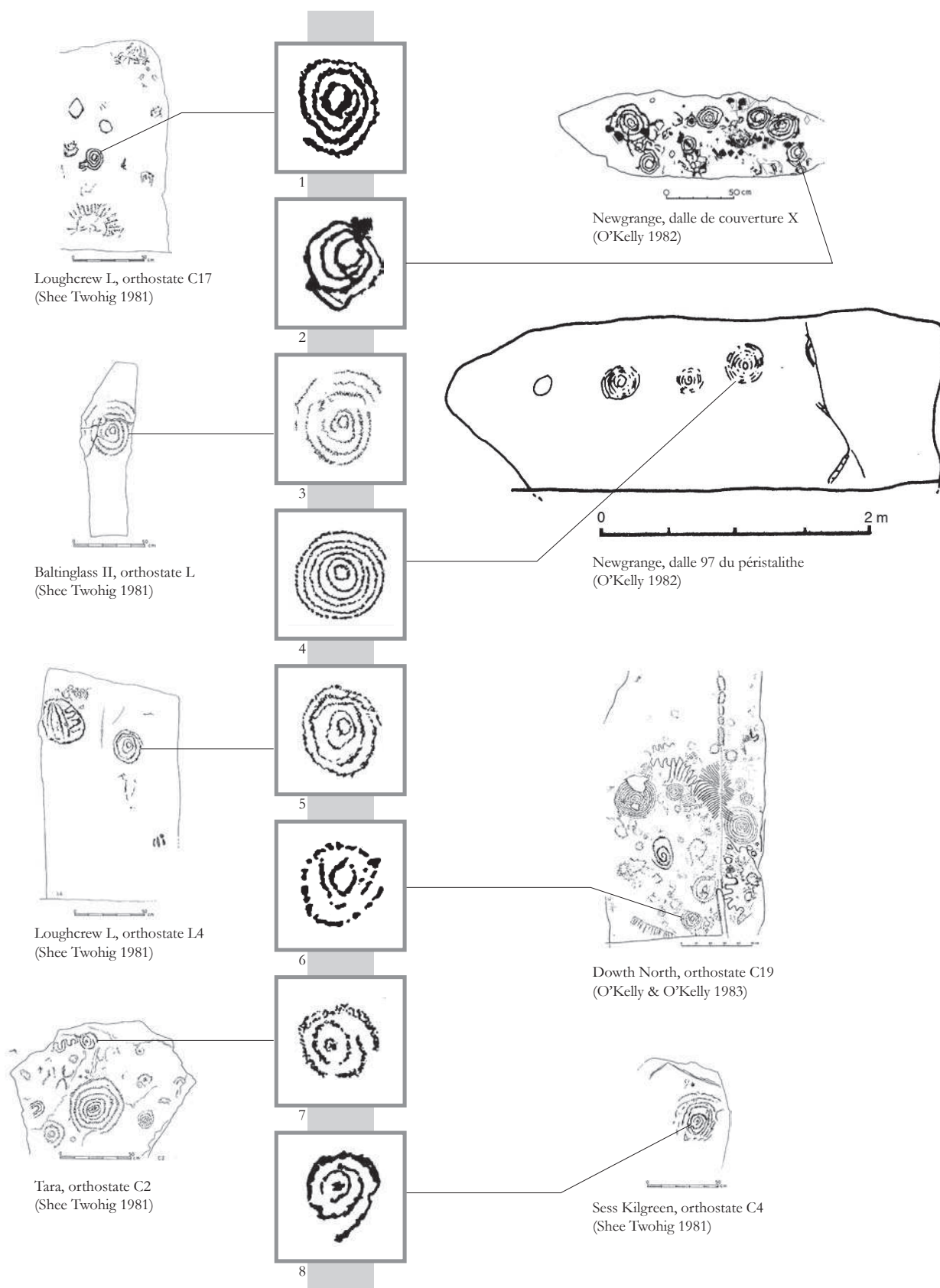

Figure 4.30 : Cercles au centre d'une spirale



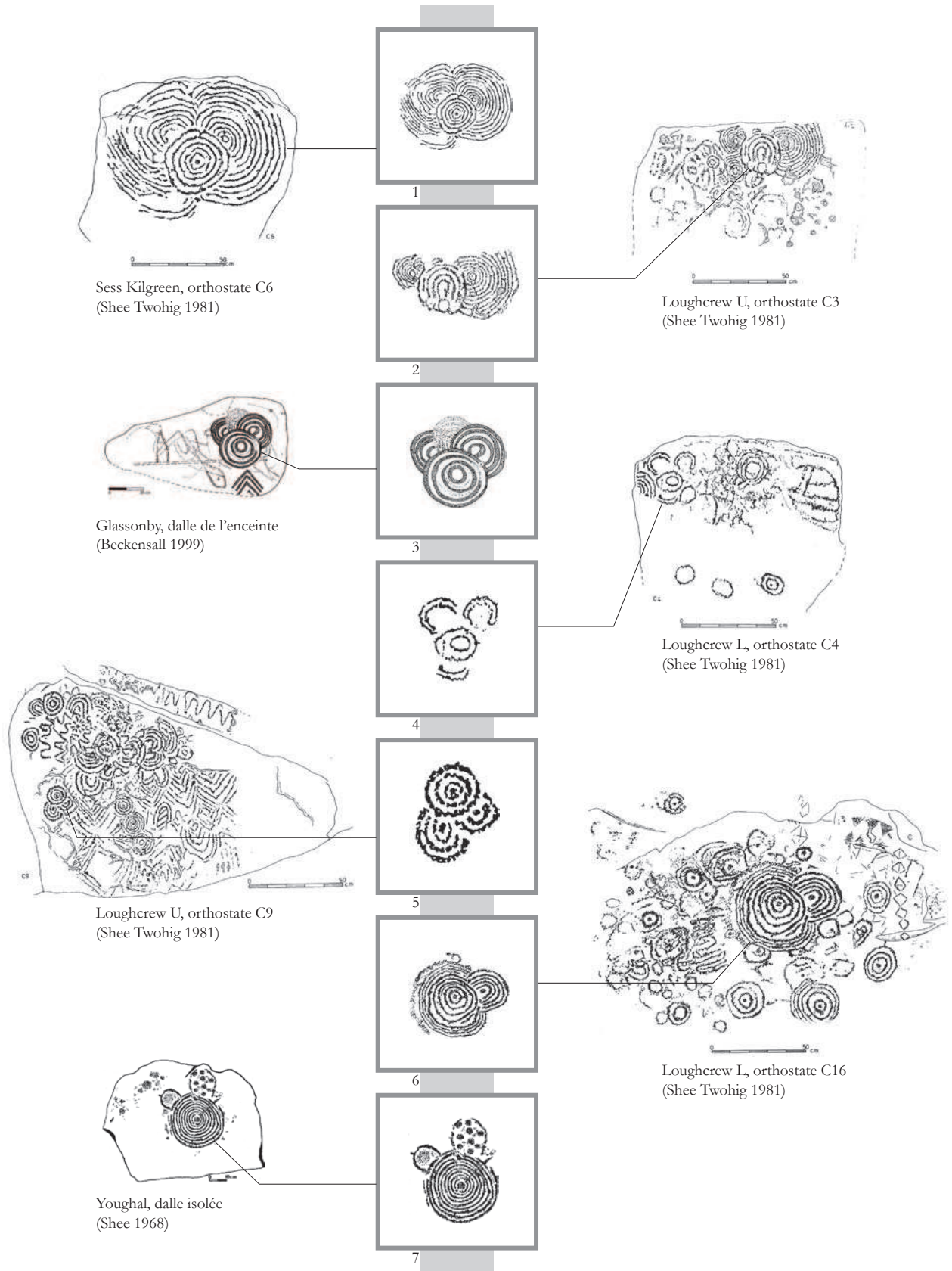

Figure 4.31 : Les signes circulaires avec arceaux en appendice

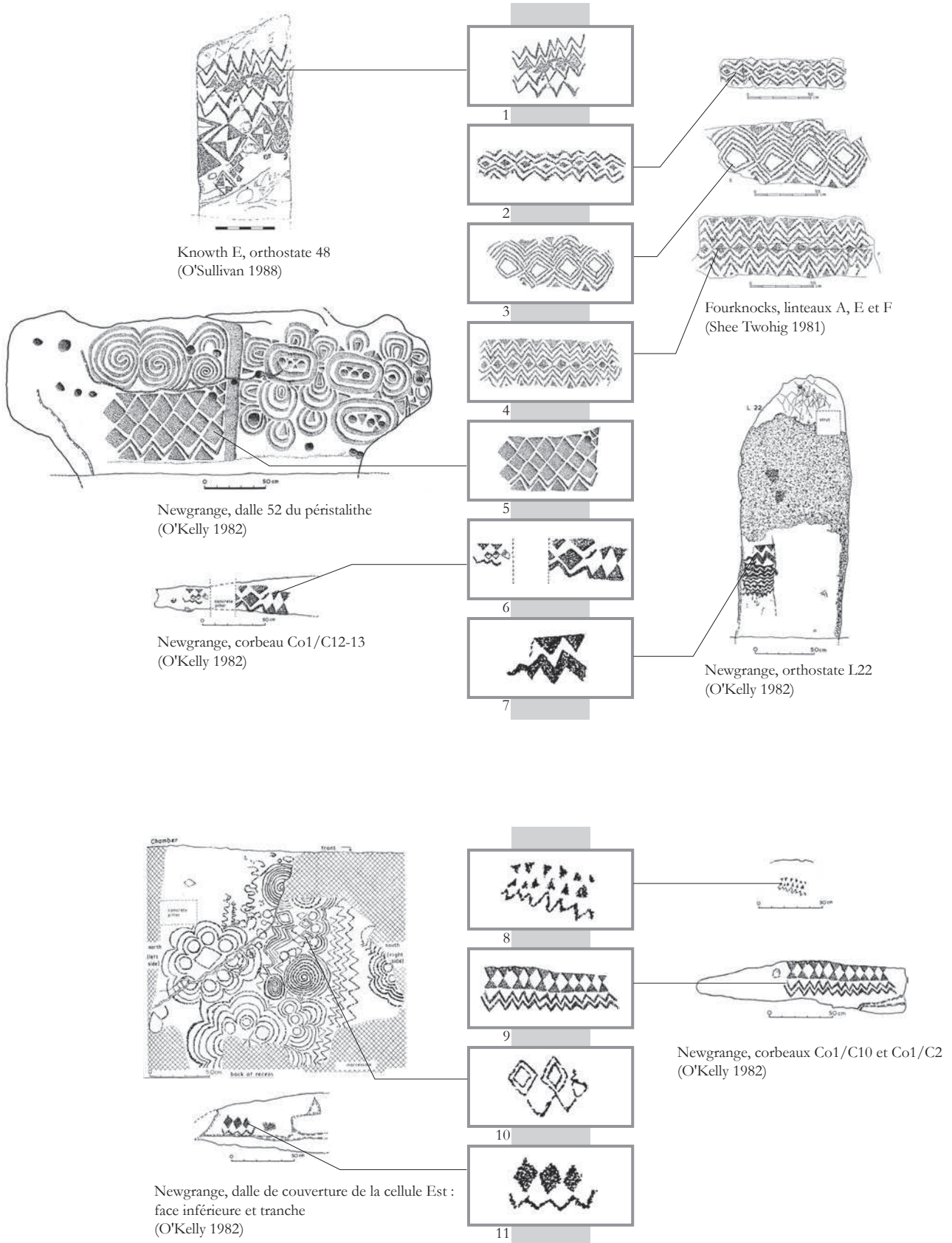

Figure 4.32 : Les assemblages de chevrons, losanges et triangles

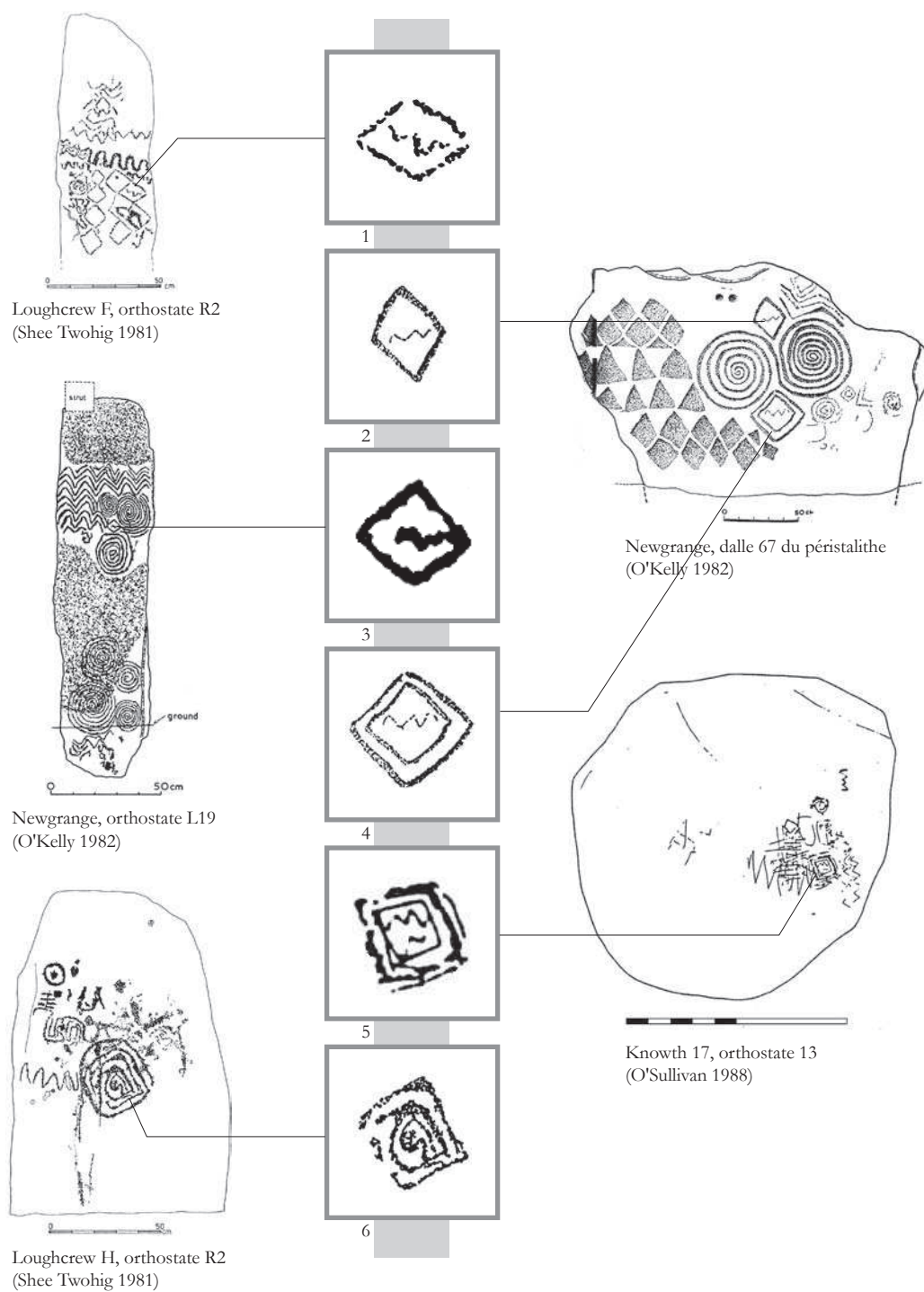

Figure 4.33 : Chevrons inscrits dans un losange

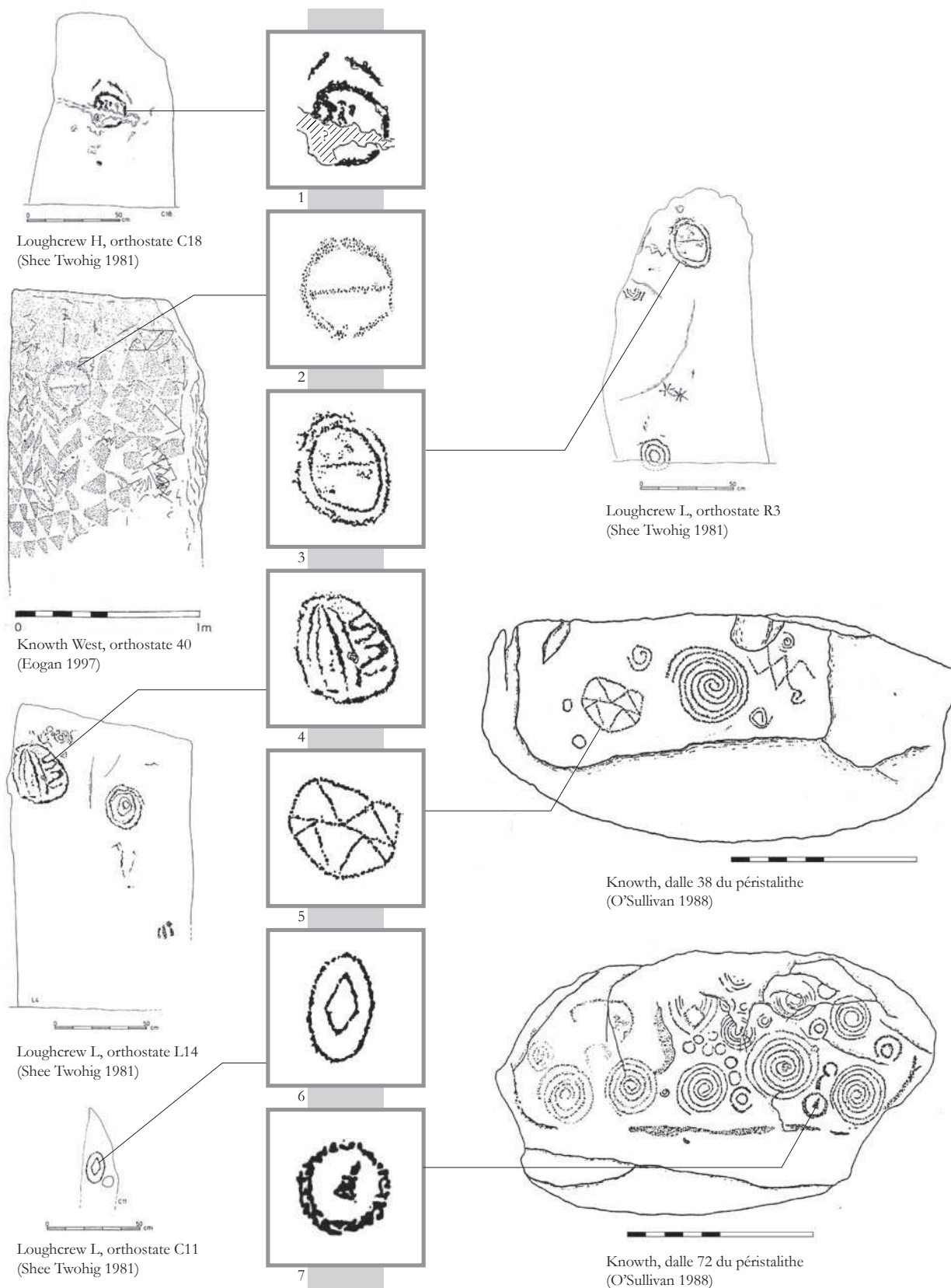

Figure 4.34 : Signes divers inscrits dans un cercle

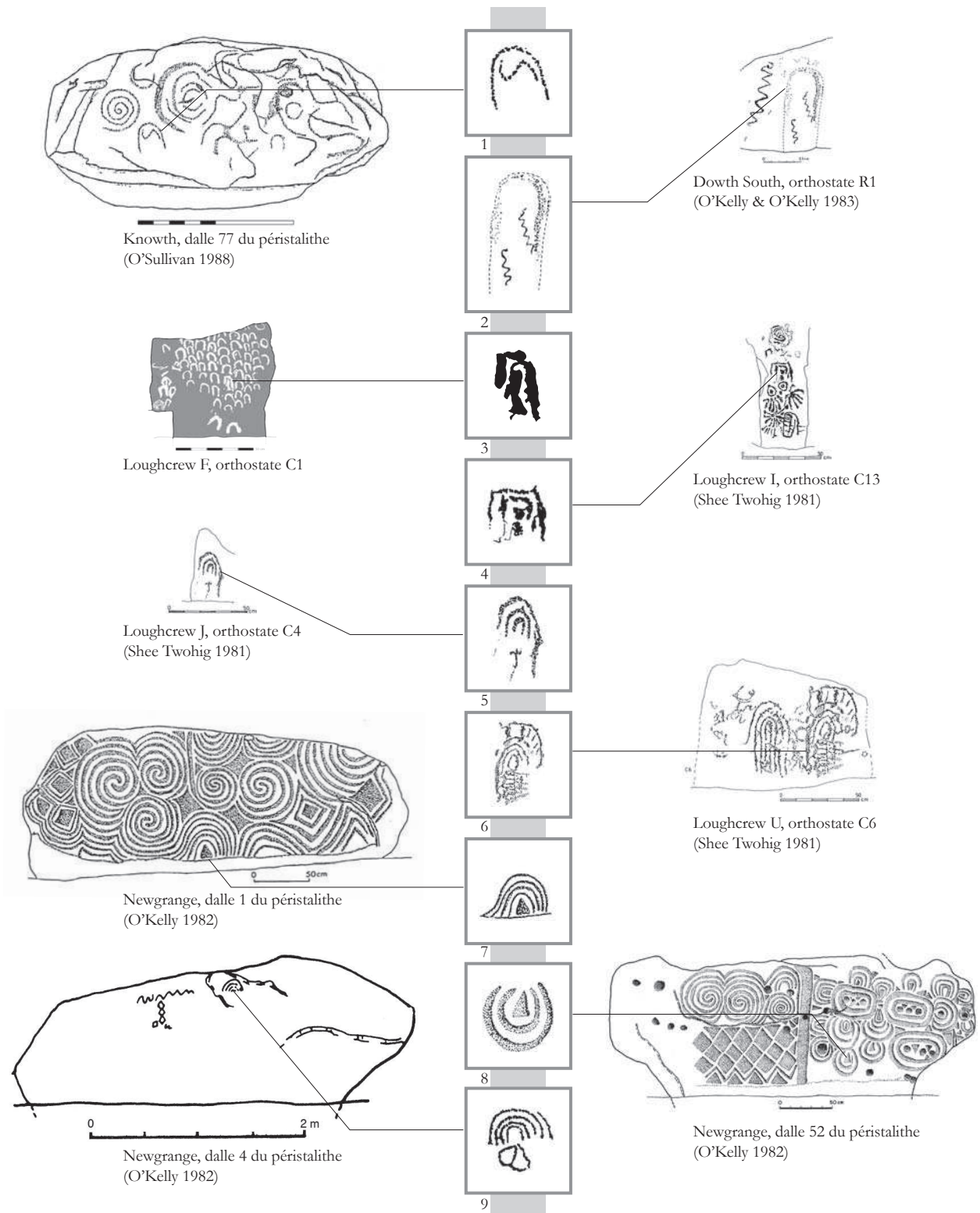

Figure 4.35 : Signes divers inscrits dans un arceau

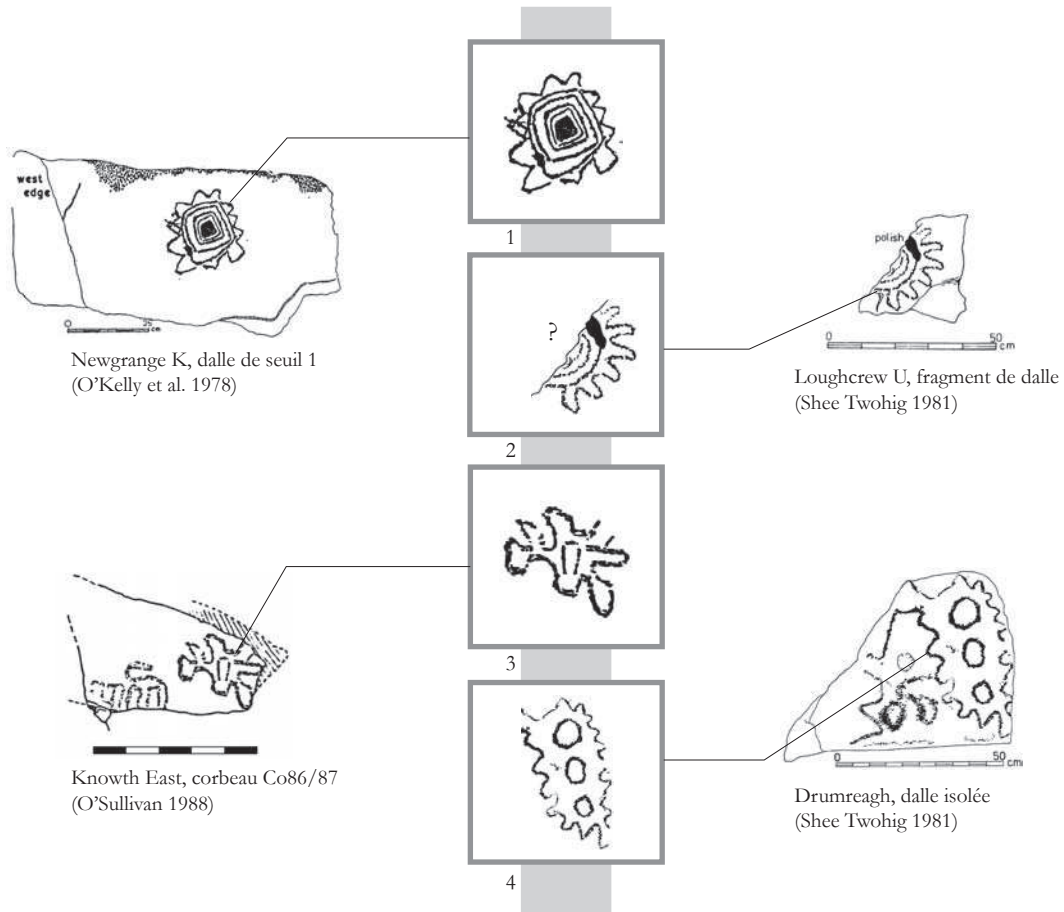

Figure 4.36 : Signes divers entourés par une ligne ondulée

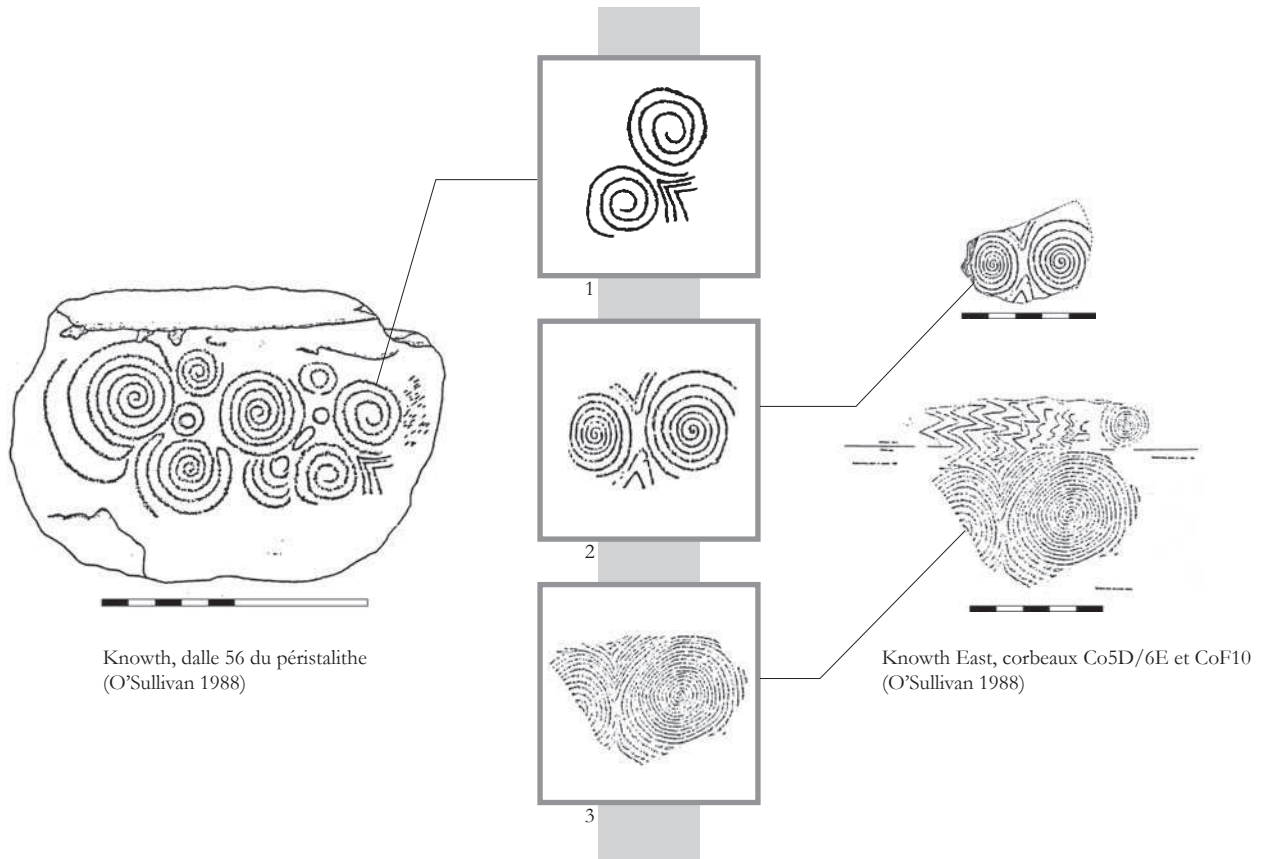

Figure 4.37 : Chevrons simples entre deux spirales

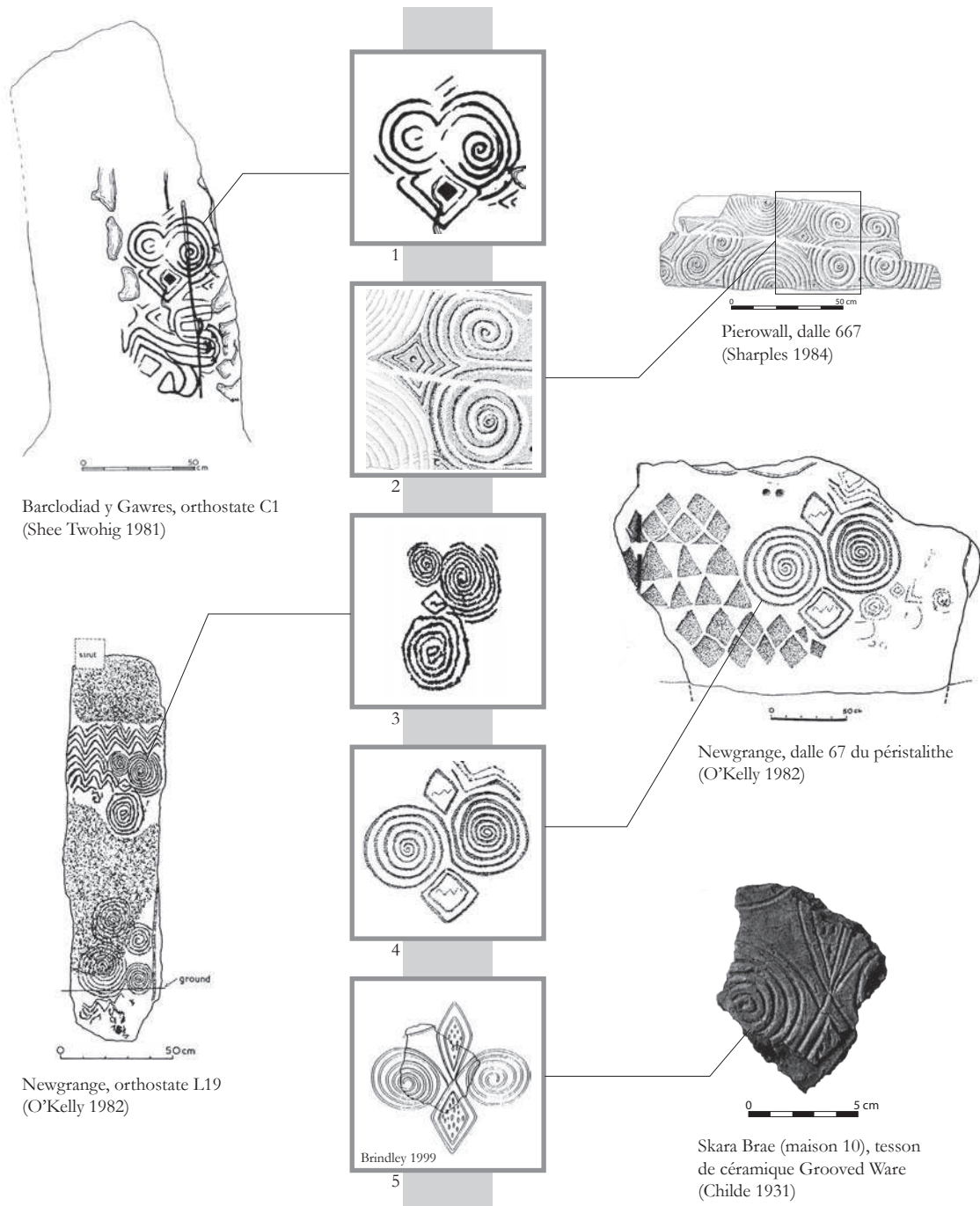

Figure 4.38 : Carré entre deux spirales



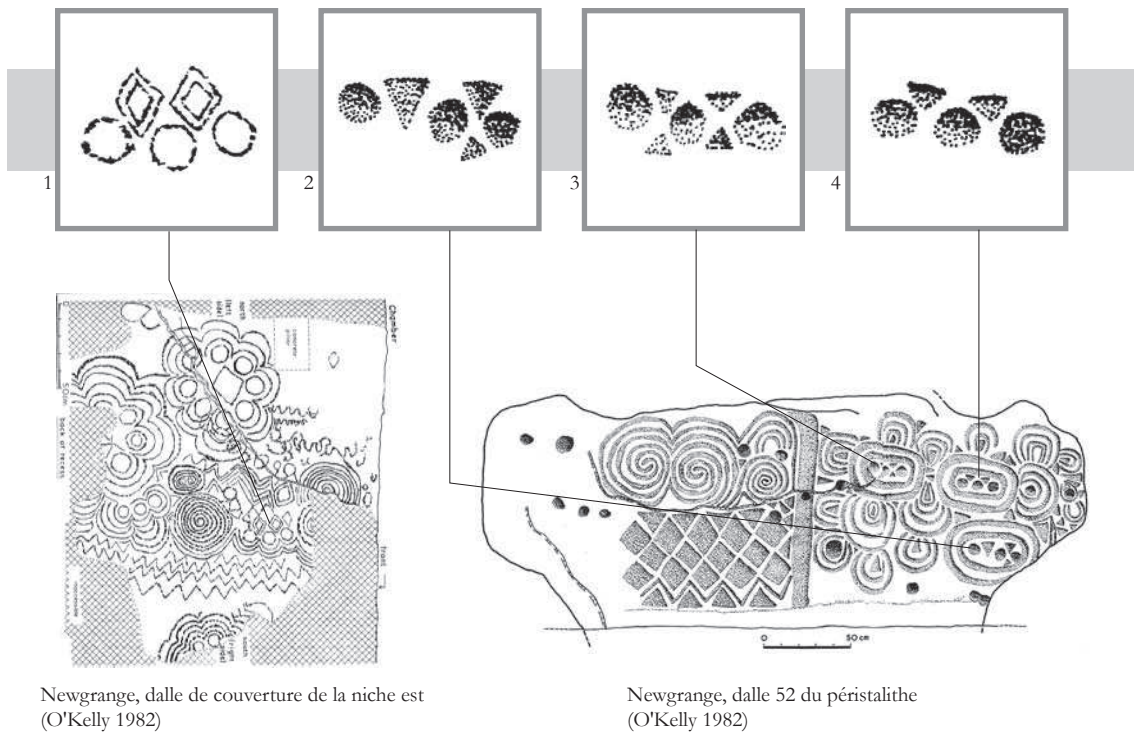
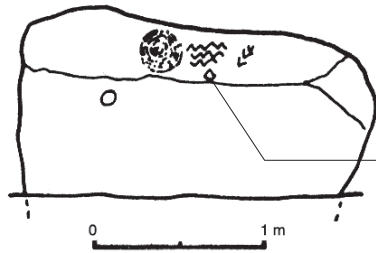
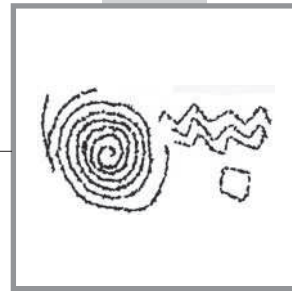

Figure 4.39 : Carré ou triangle entre deux cercles ou cupules



Newgrange, dalle 85 du péristicalithe  
(O'Kelly 1982)



1

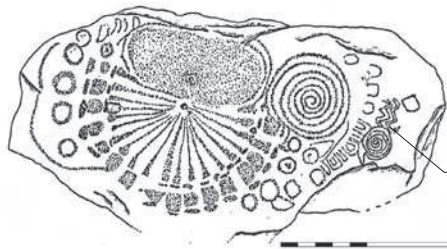

Knowth, dalle 15 du péristicalithe  
(O'Sullivan 1988)

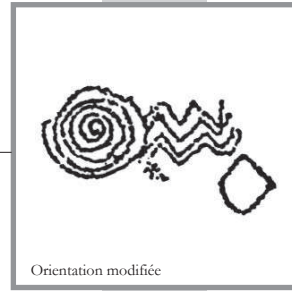

Orientation modifiée

2

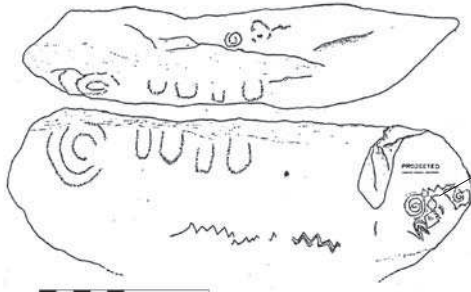

Knowth, dalle 41 du péristicalithe  
(O'Sullivan 1988)



3

Figure 4.40 : Assemblage de spirale, chevrons et losange

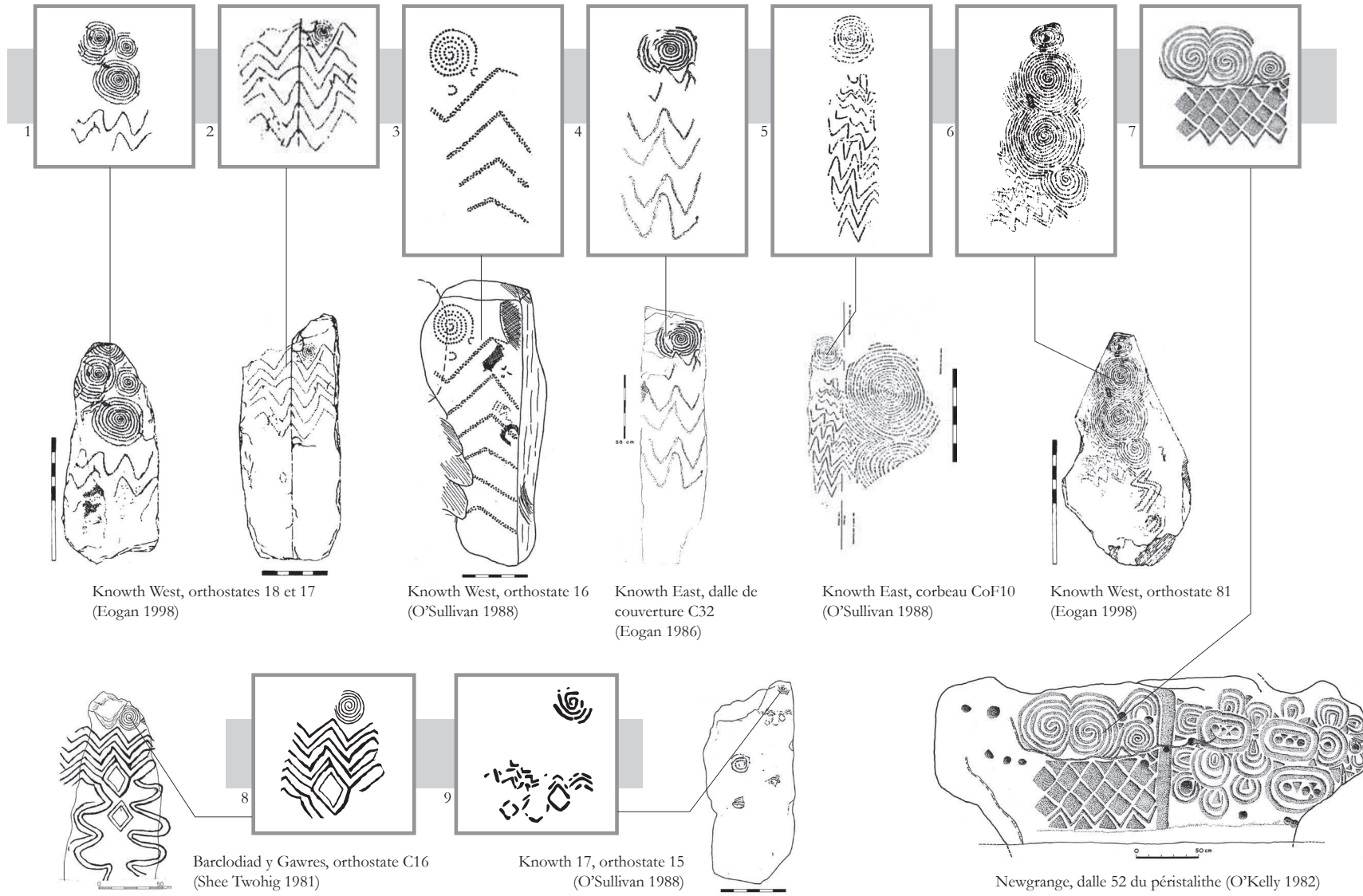

Knowth West, orthostates 18 et 17 (Eogan 1998)

Knowth West, orthostate 16 (O'Sullivan 1988)

Knowth East, dalle de couverture C32 (Eogan 1986)

Knowth East, corbeau CoF10 (O'Sullivan 1988)

Knowth West, orthostate 81 (Eogan 1998)

Barclodiad y Gawres, orthostate C16 (Shee Twohig 1981)

Knowth 17, orthostate 15 (O'Sullivan 1988)

Newgrange, dalle 52 du péristalithe (O'Kelly 1982)

Figure 4.41 : Spirale(s) au-dessus de chevrons

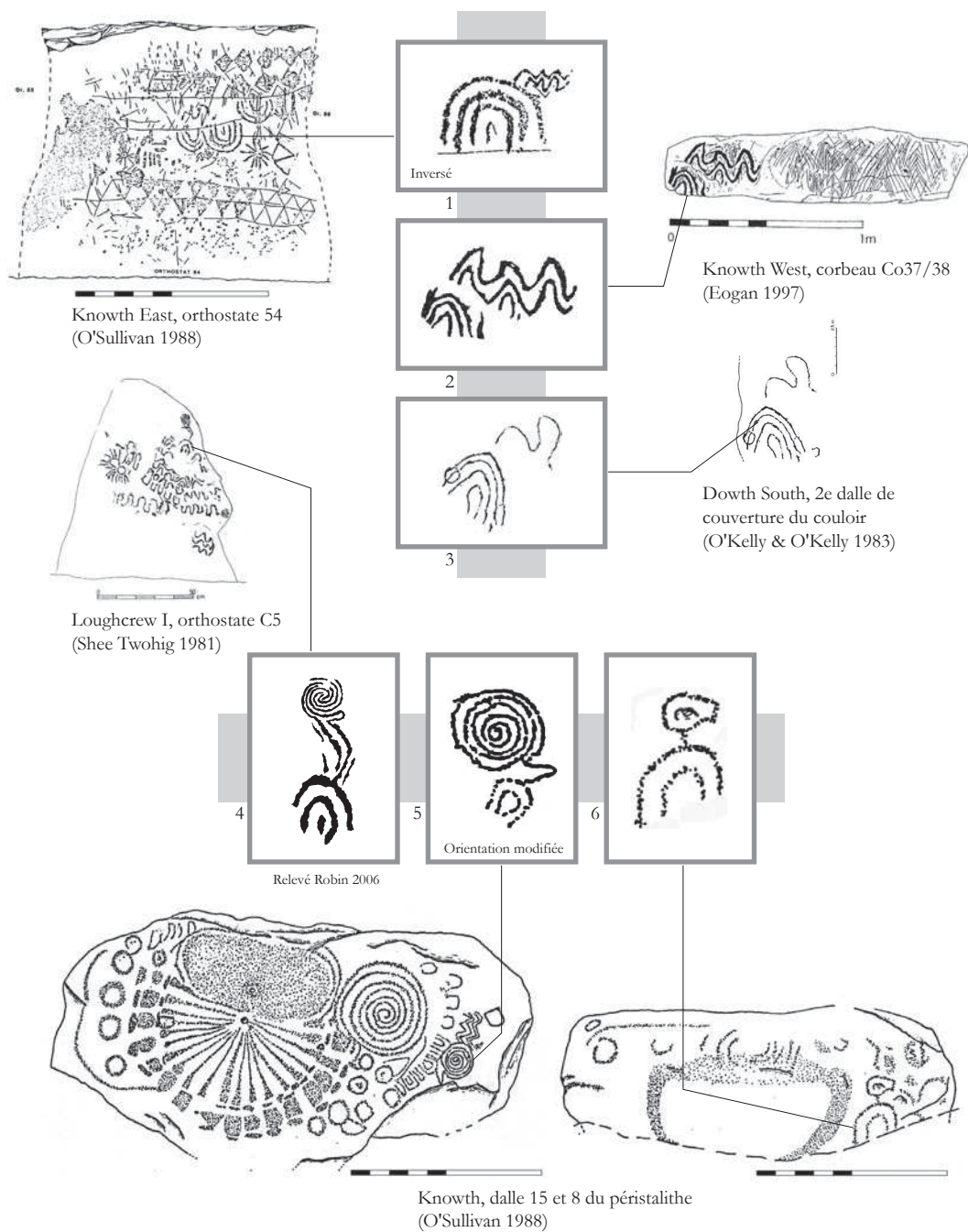

Figure 4.42 : Signes divers reliés au sommet d'un arceau

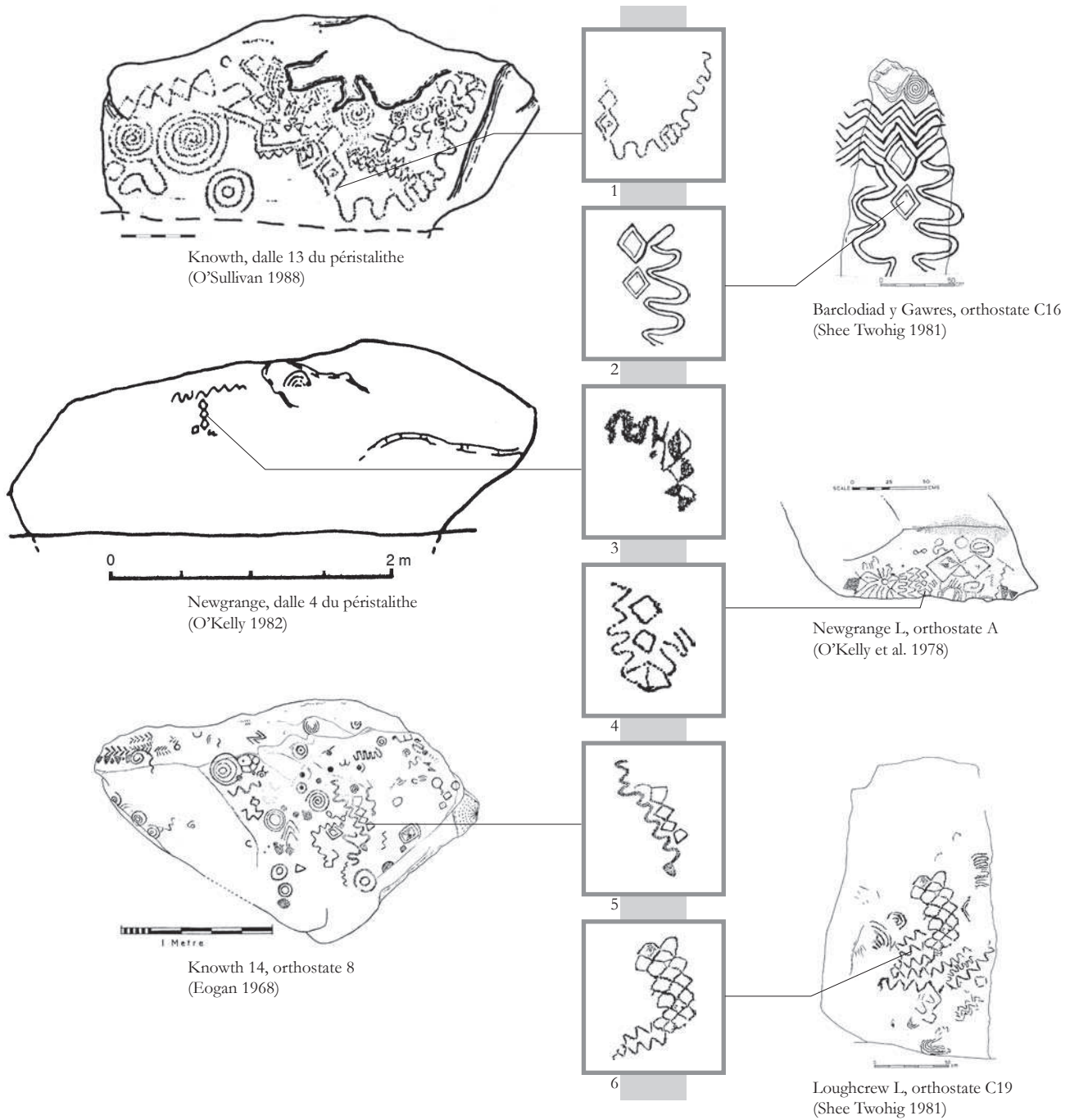

Figure 4.43 : Signe ondulé relié à une ligne de losanges

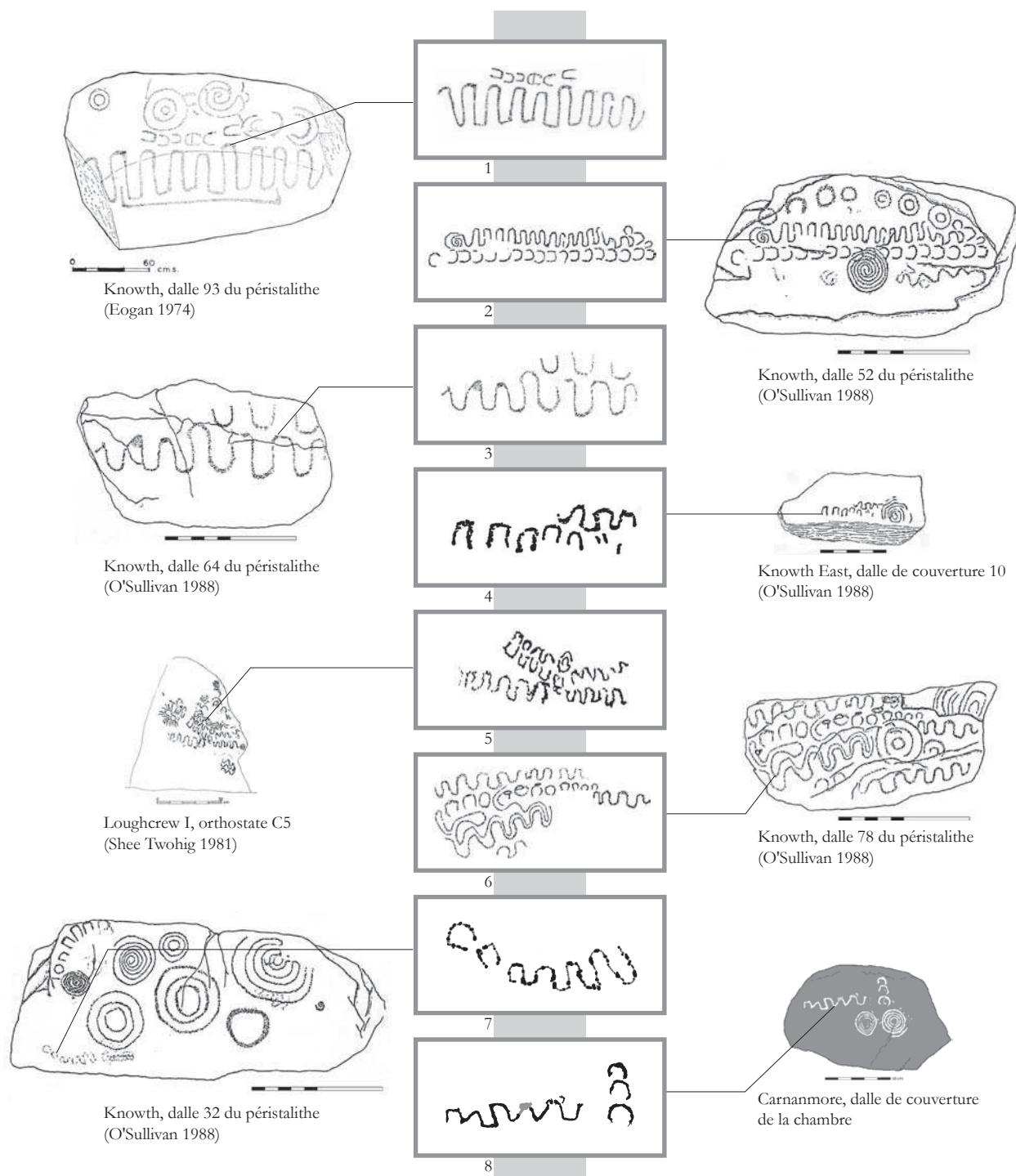

Figure 4.44 : Signe ondulé et arceaux en ligne ou colonne

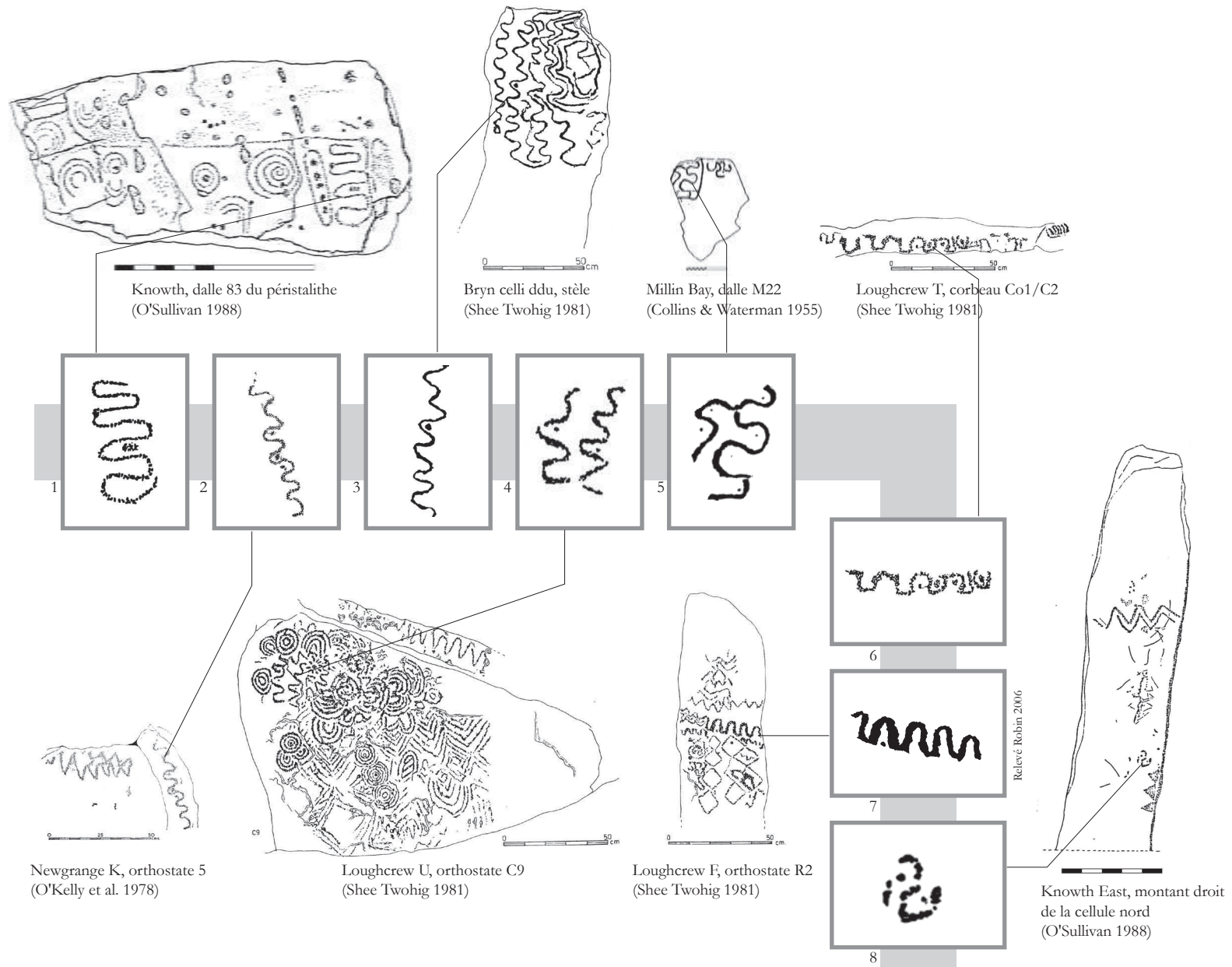

Figure 4.45 : Cupule(s) entre les méandres d'un signe ondulé

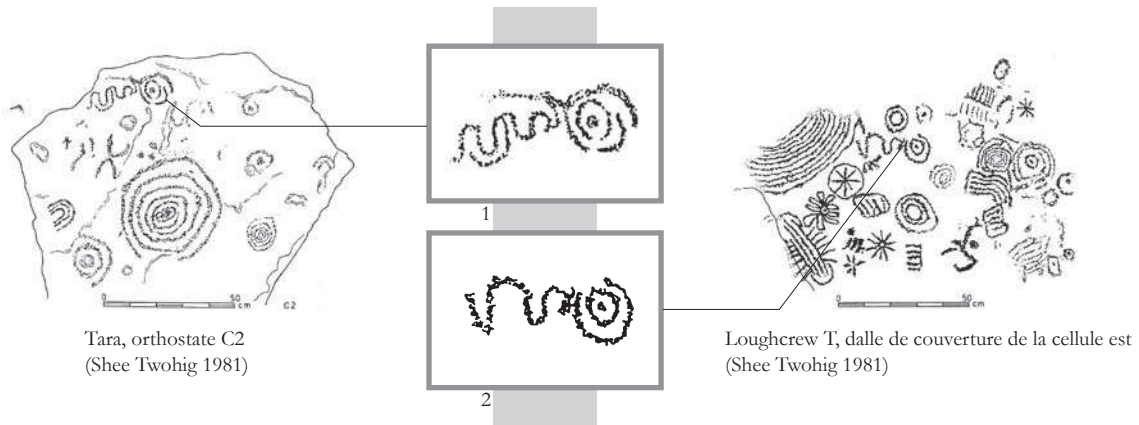

Figure 4.46 : Signe ondulé et signe circulaire

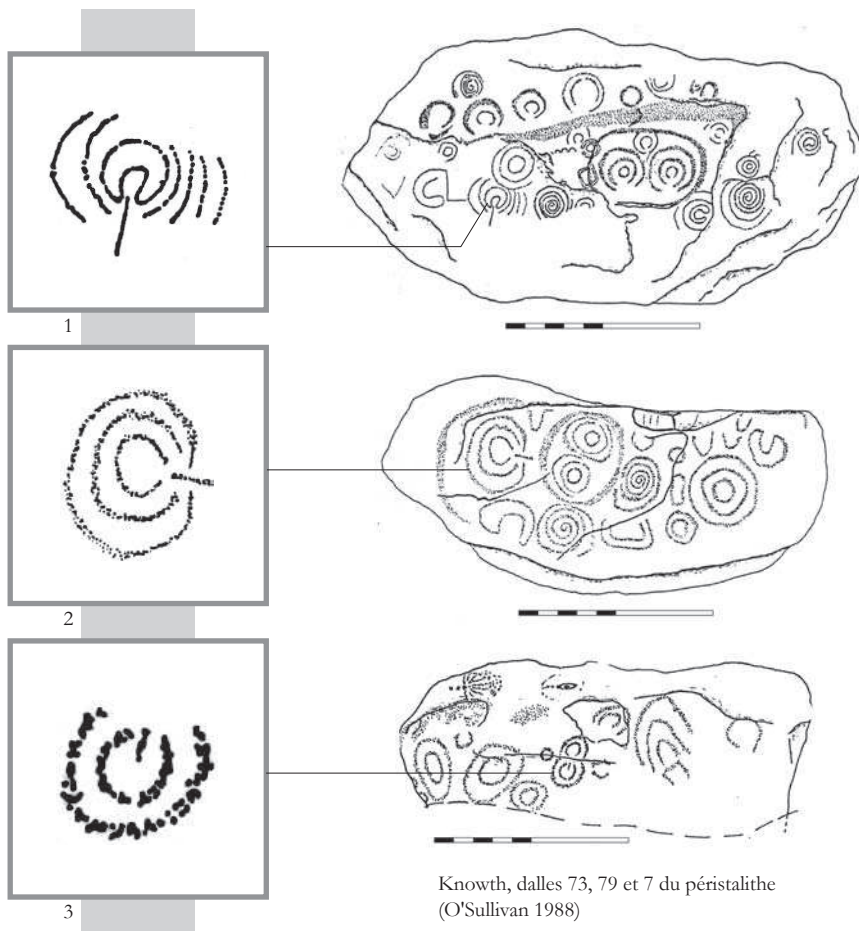

Figure 4.47 : Les arceaux avec bâtonnet central



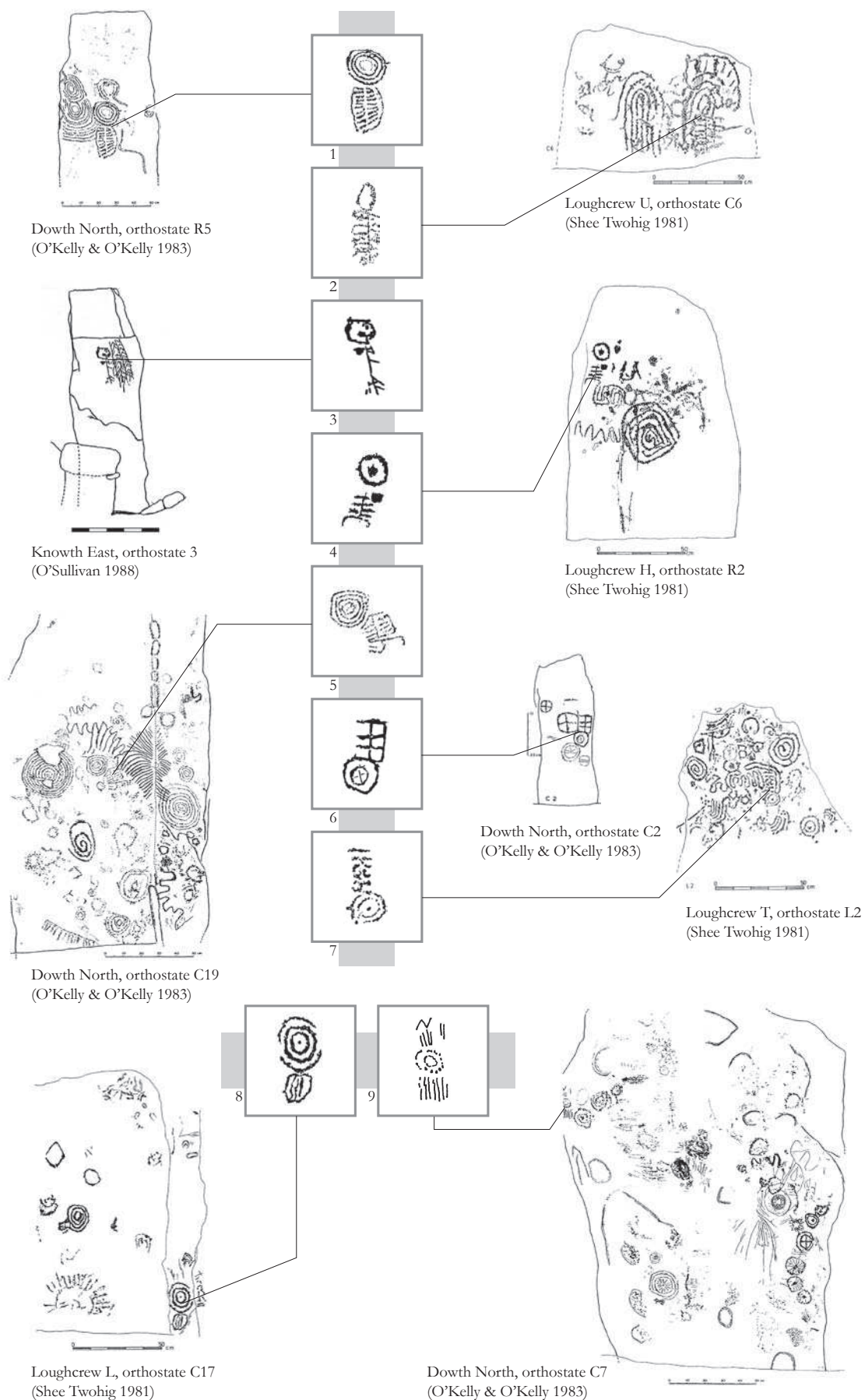

Figure 4.48 : Les signes scalariformes avec cercle en position axiale

		Signes circulaires et semi-circulaires					Signes angulaires				Signe ondulé
		●	○	◎	⌋	✱	∧	▲	◇	≡	〰
Assemblages de signes identiques	●●●● ●●	○○○○ ○○○○ ●●●● ○○○○		cccc uuu GG	⊗⊗⊗⊗		∧∧∧ ∧∧∧ ∧∧∧ ∧∧∧	▲▲▲ ▲▲▲ ▲▲▲	◇◇◇ ◇◇◇ ◇◇◇ ◇◇◇		〰〰〰
		◎◎◎ ◎◎◎									
Assemblages de signes distincts		◎◎◎ ◎◎◎					◇∧	▲◇	▲◇	〰	
		◇◎ 〰	◎ ◎	◎ ◎	◎ ◎	◎ ◎	◎ ◎	◎ ◎	◎ ◎	◎ ◎	◎ ◎

Figure 4.49 : Tableau synthétique des assemblages de signes





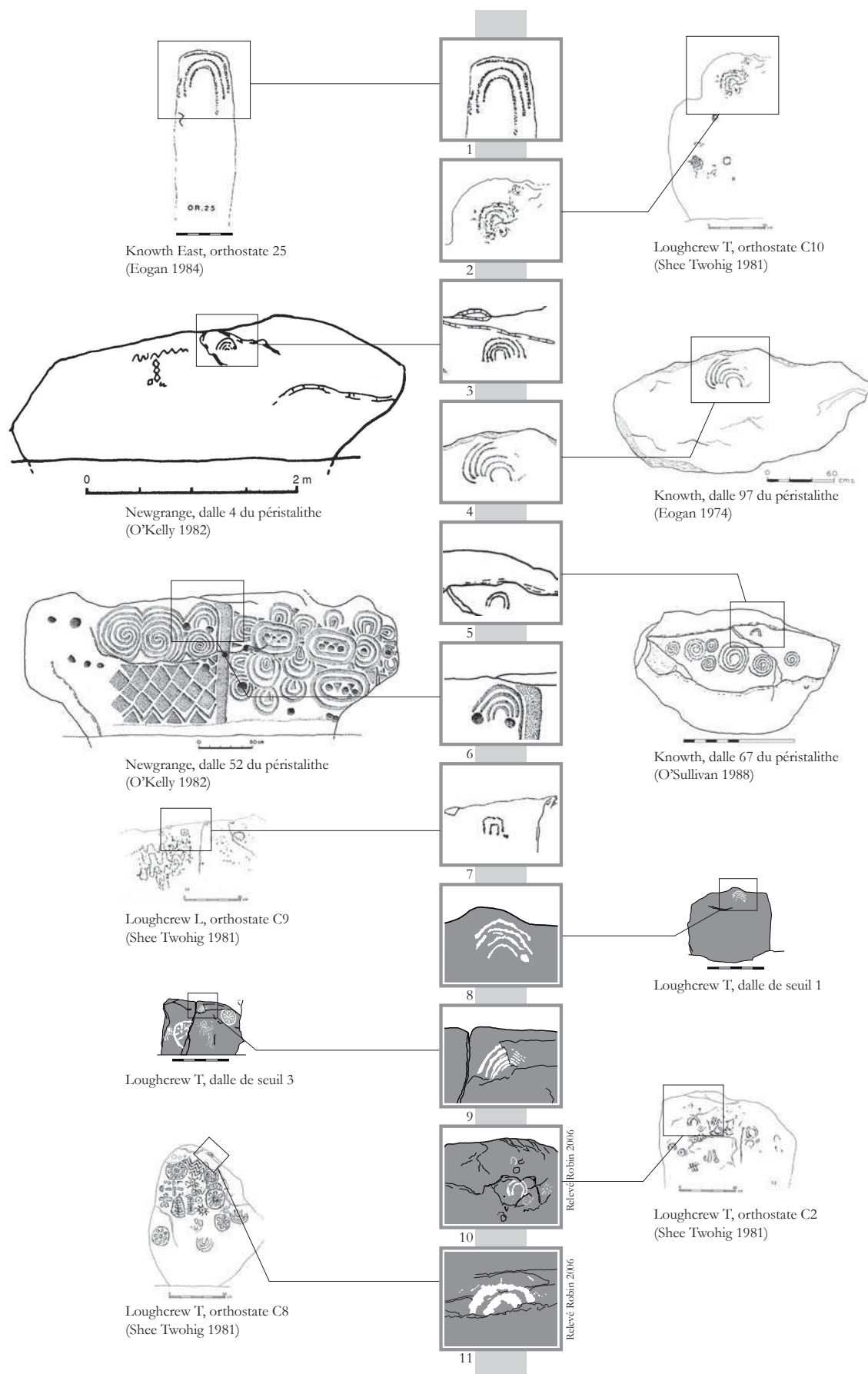

Figure 5.1 : Arceaux de type 2b en position sommitale

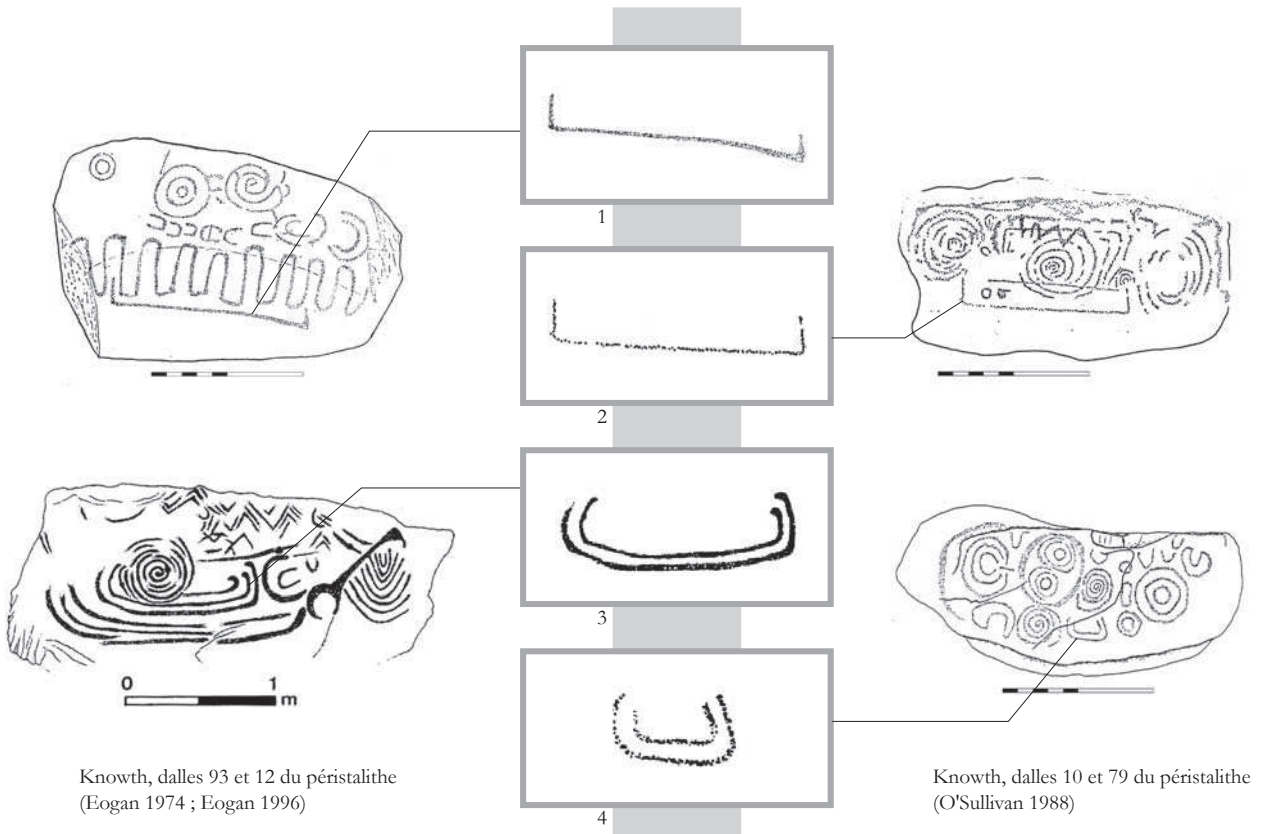

Figure 5.2 : Arceaux de type 4 en position basale

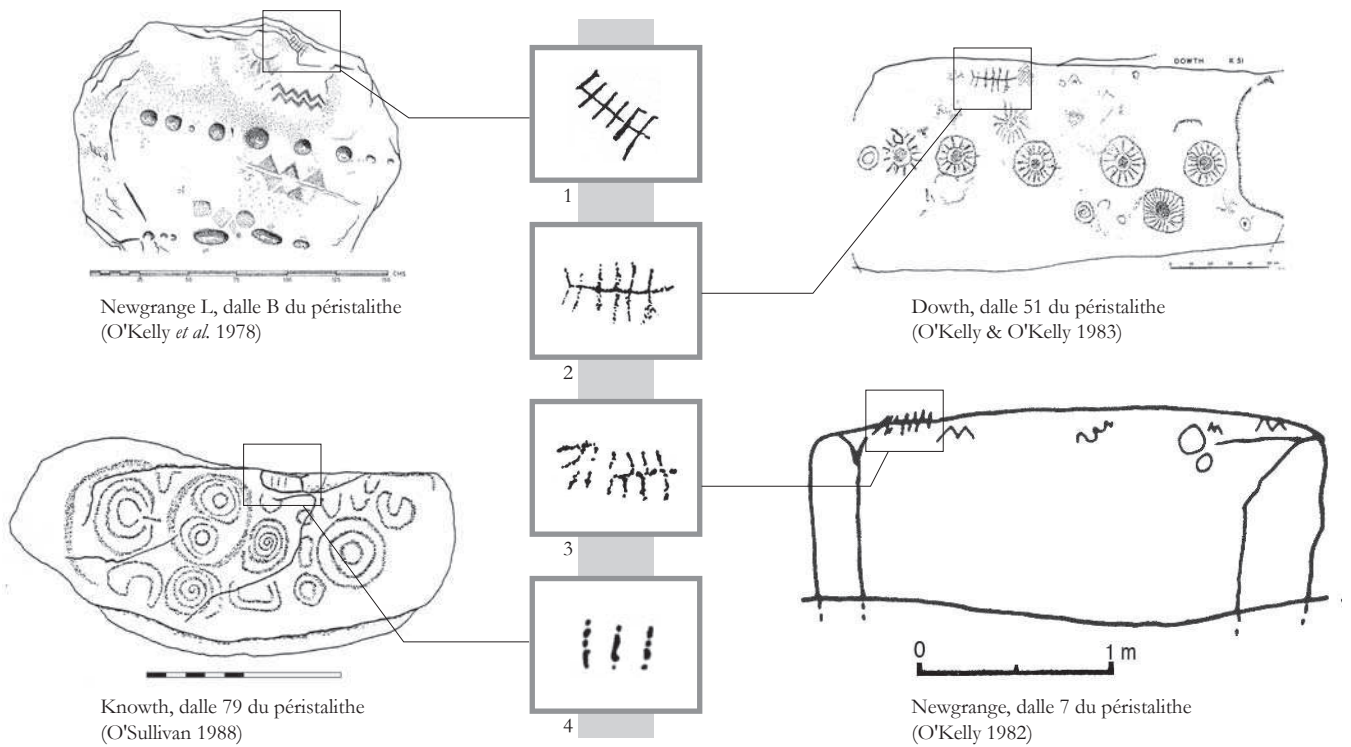

Figure 5.3 : Signes scalariformes en limite supérieure de dalle de péristicalithe

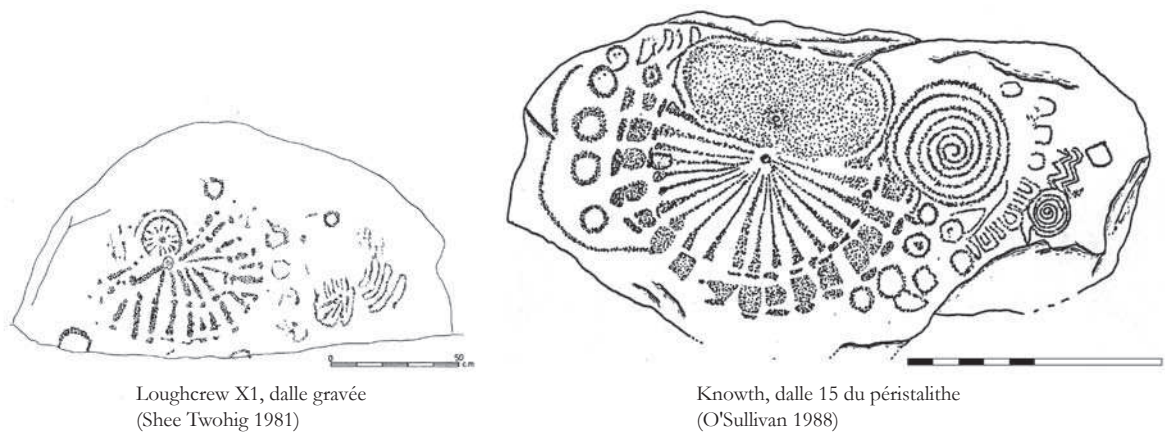
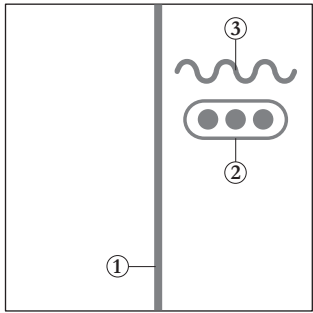
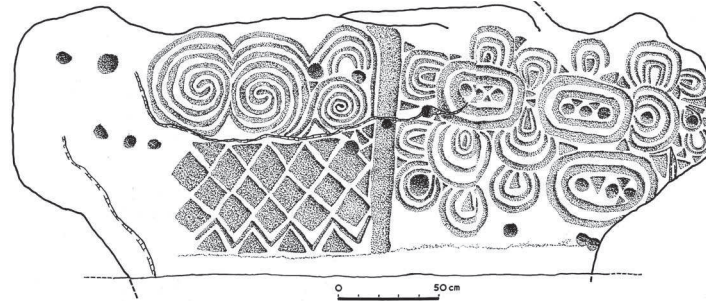
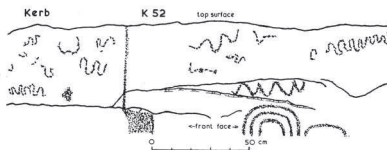
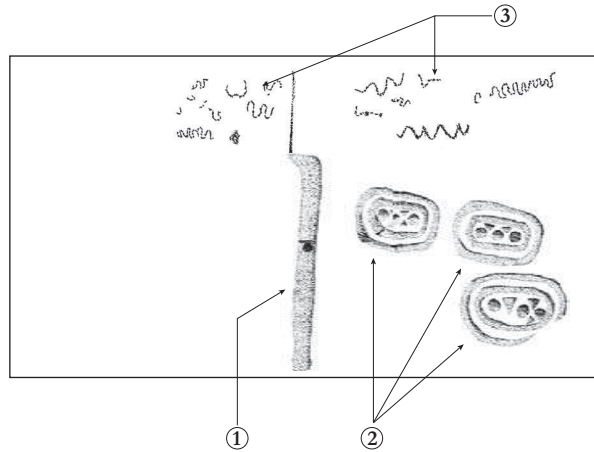

Figure 5.4 : Signe semi-circulaire radié de grande dimension en position centrale



- 1. Ligne centrale
- 2. Alignement de cupules inscrit dans une figure ovale
- 3. Signes ondulés



Newgrange, dalle 52 du péristalithe (O'Kelly 1982)

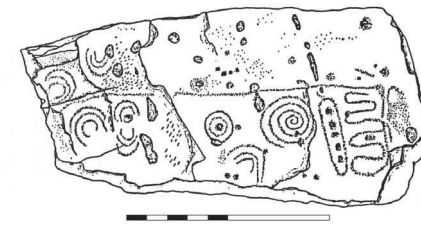
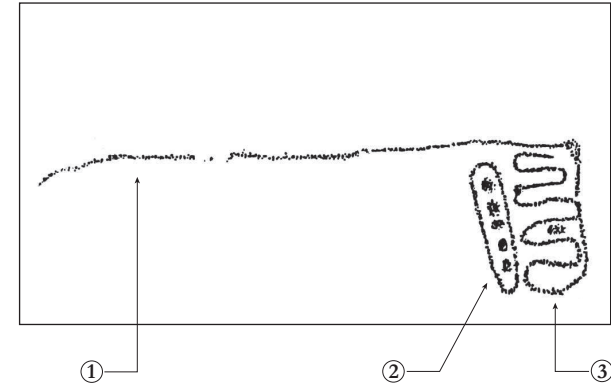

Knowth, dalle 83 du péristalithe (O'Sullivan 1988)

Figure 5.5 : Ligne centrale, alignement de cupules et signes ondulés



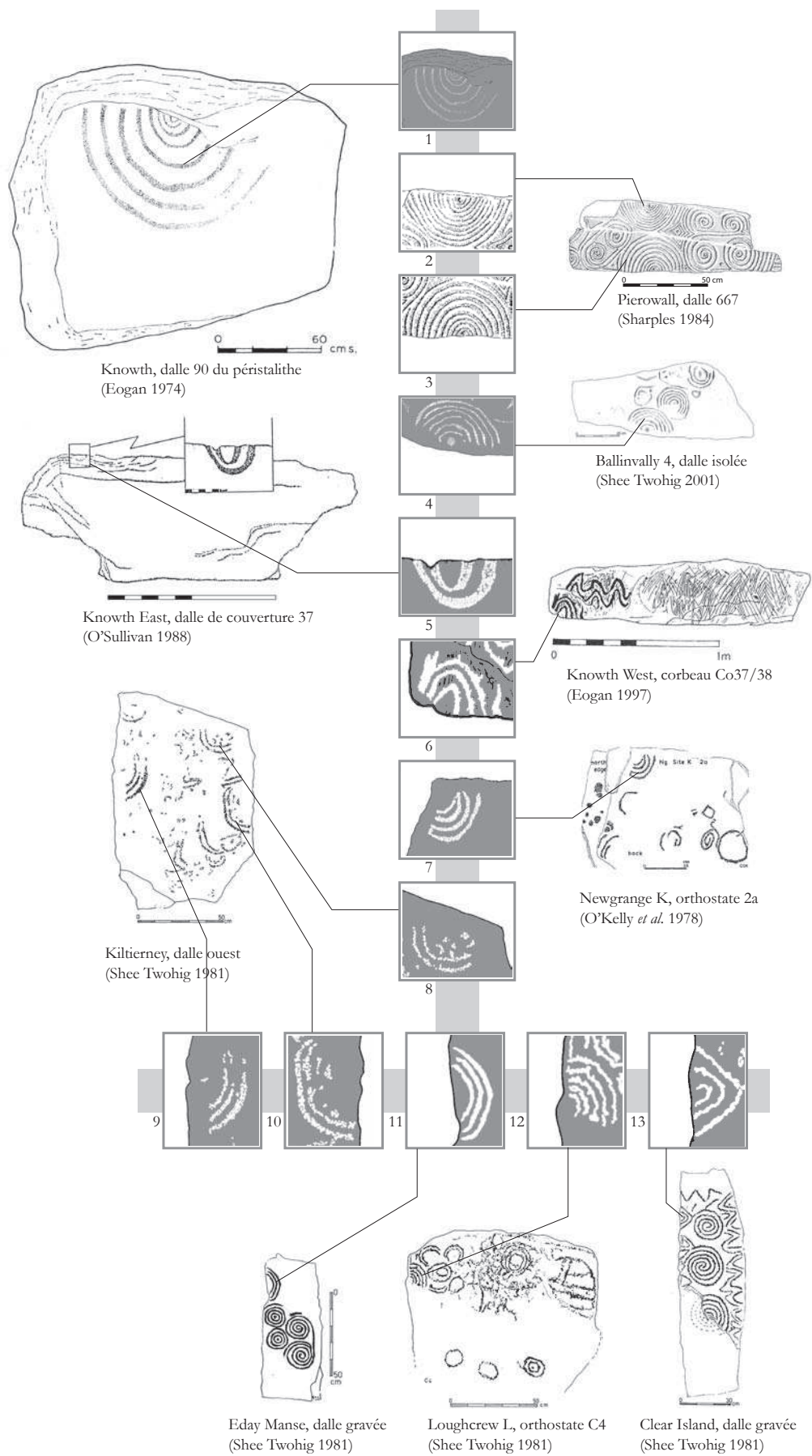

Figure 5.6 : Arceaux au contact d'un bord de dalle

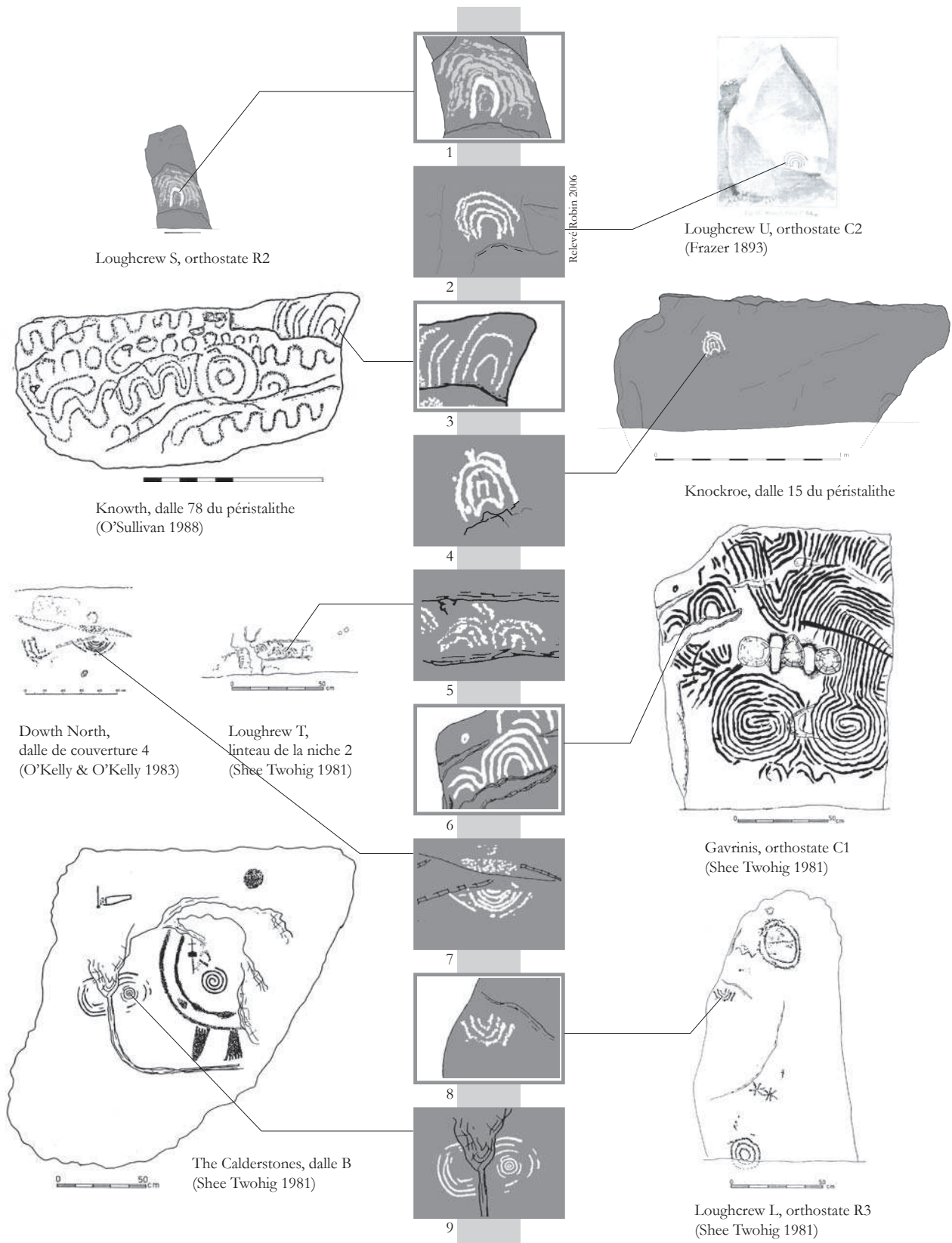

Figure 5.7 : Arceaux au contact d'une ligne de relief

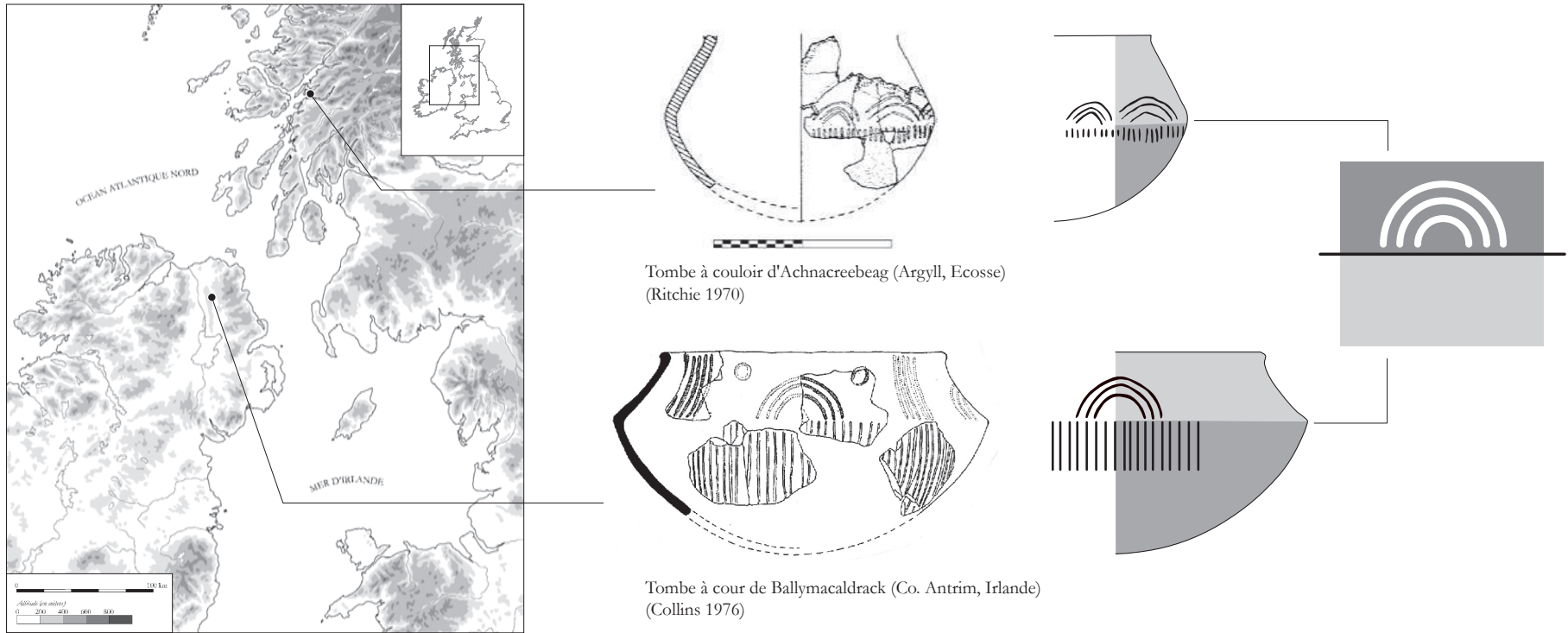

Figure 5.8 : Décor des céramiques carénées d'Achnacreebeag et de Ballymacaldrack

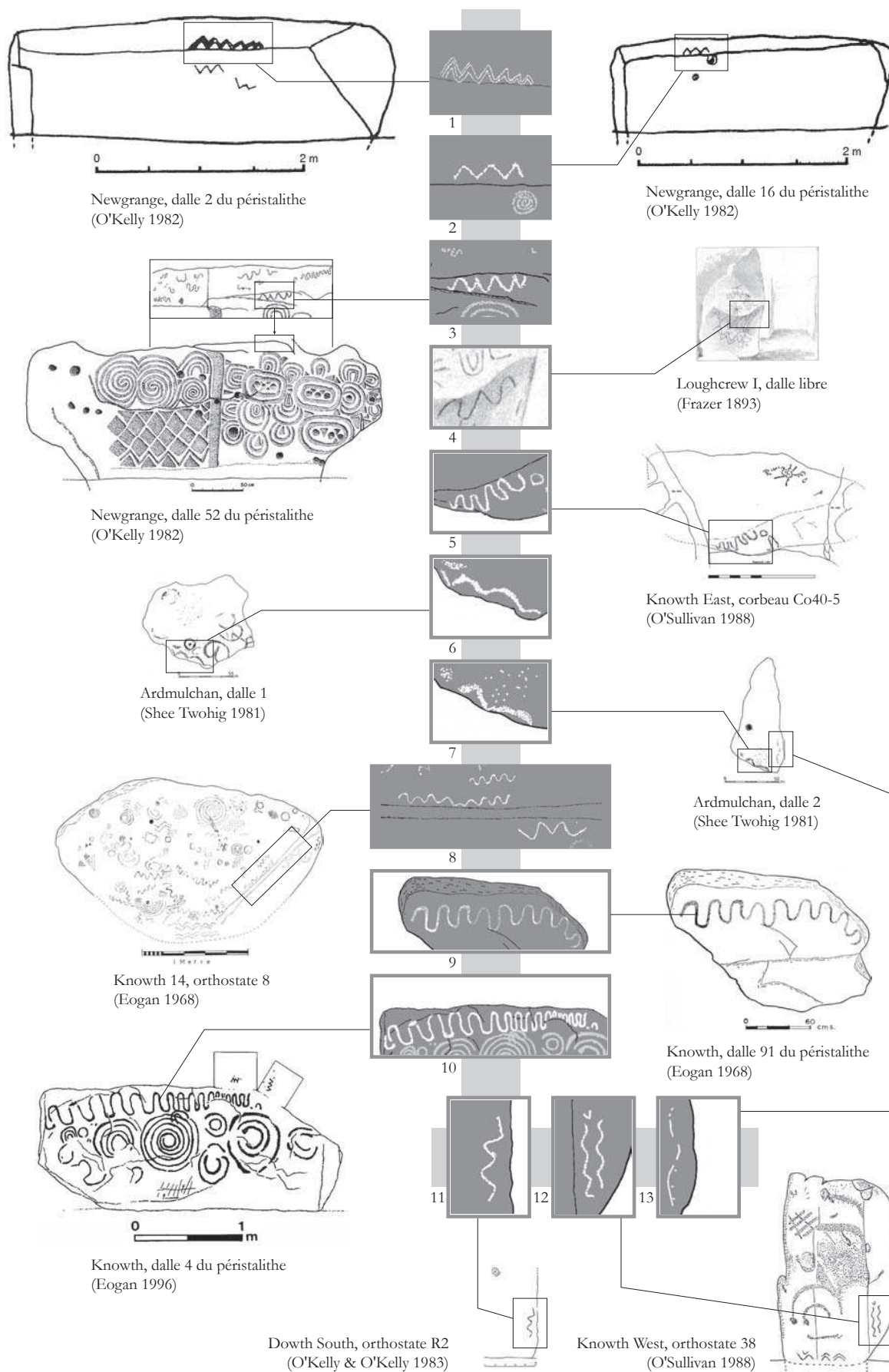

Figure 5.9 : Signes ondulés gravés le long d'une ligne de relief

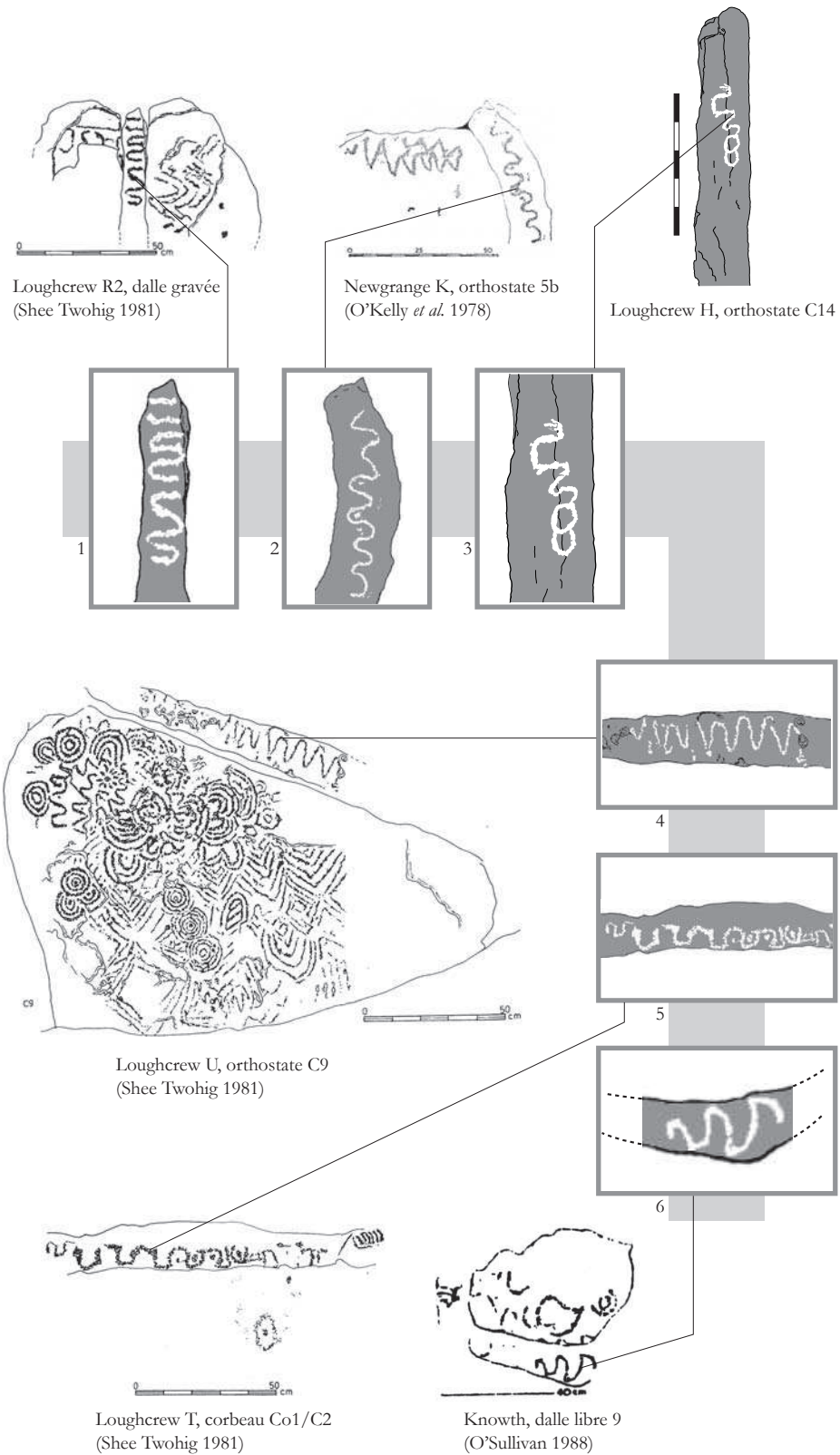
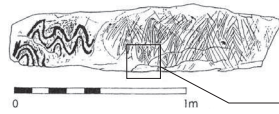
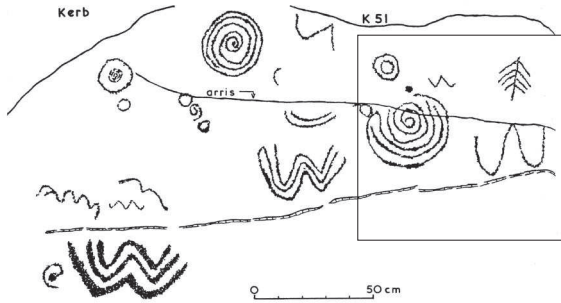
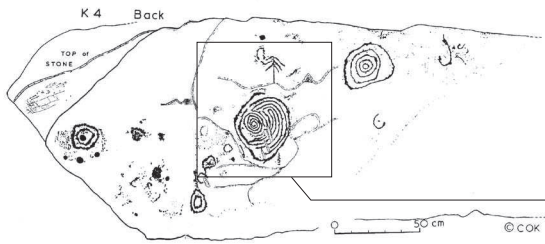

Figure 5.10 : Signes ondulés gravés sur la tranche

IRLANDE



Knowth West, corbeau Co37/38  
(Eogan 1997)



Newgrange, dalles 4 et 51 du péristalithe  
(O'Kelly 1982)

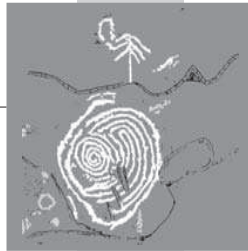

BRETAGNE

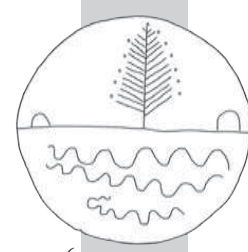

Lannec er Gadouer, céramique  
(Cassen 2000)

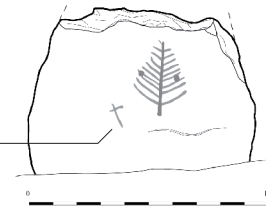

Guib, stèle  
(Cassen 2000)

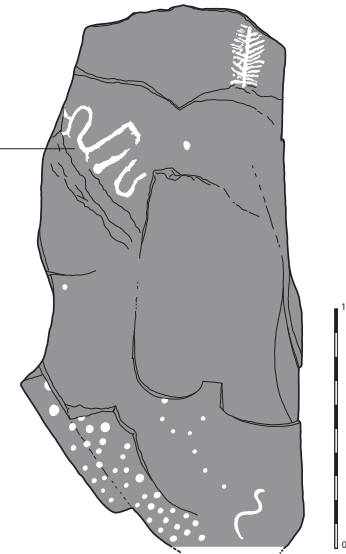
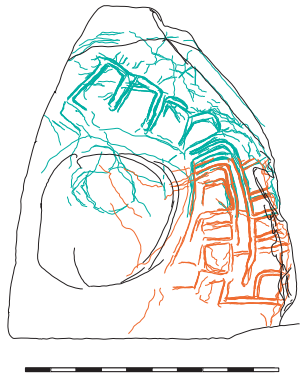

Table des Marchands, orthostate 3

Figure 5.11 : Motifs ramiformes sur une ligne de relief horizontale



Mané Kerioned B, orthostate 19

MODELISATION

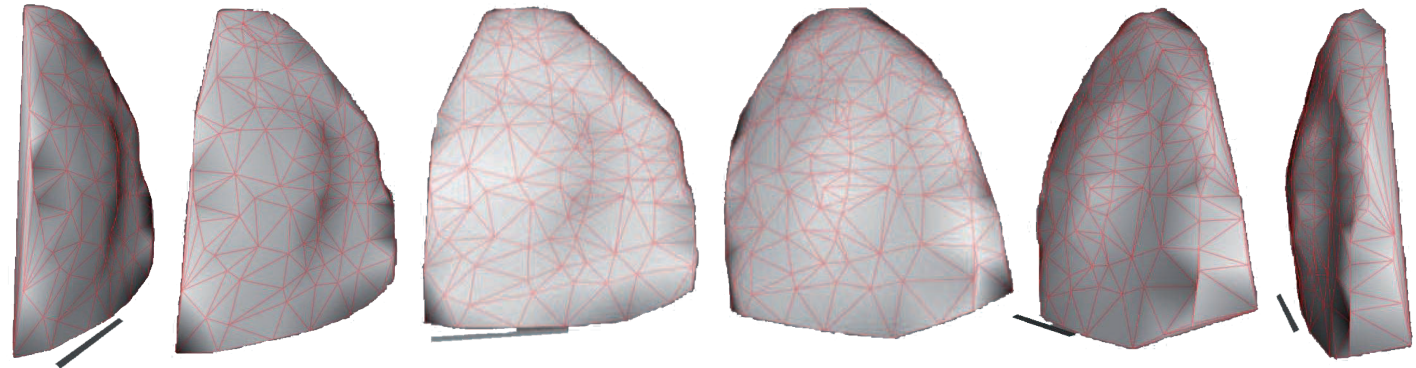

TEXTURATION  
d'après photographies avec éclairages rasants

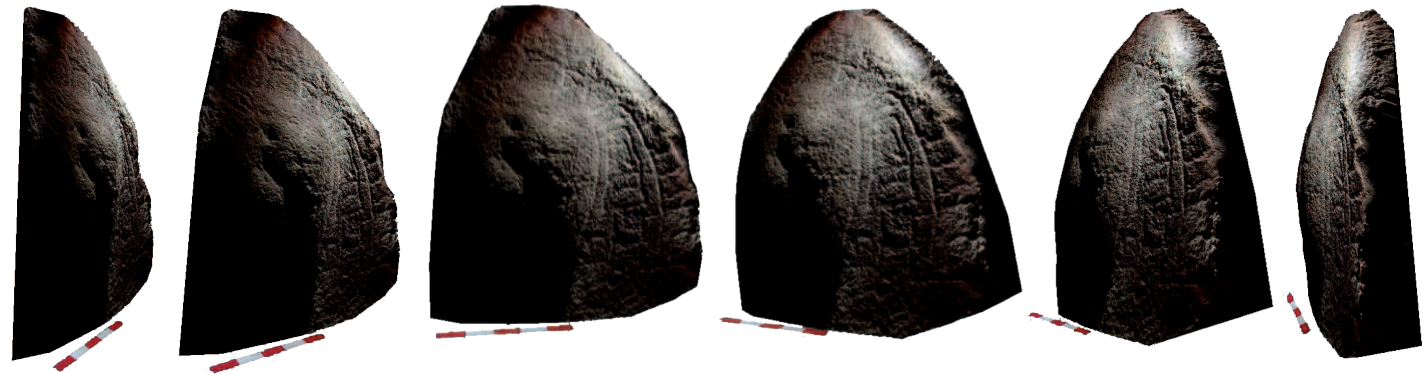

Figure 5.12 : Modélisation tridimensionnelle de l'orthostate 19 du Mané Kerioned

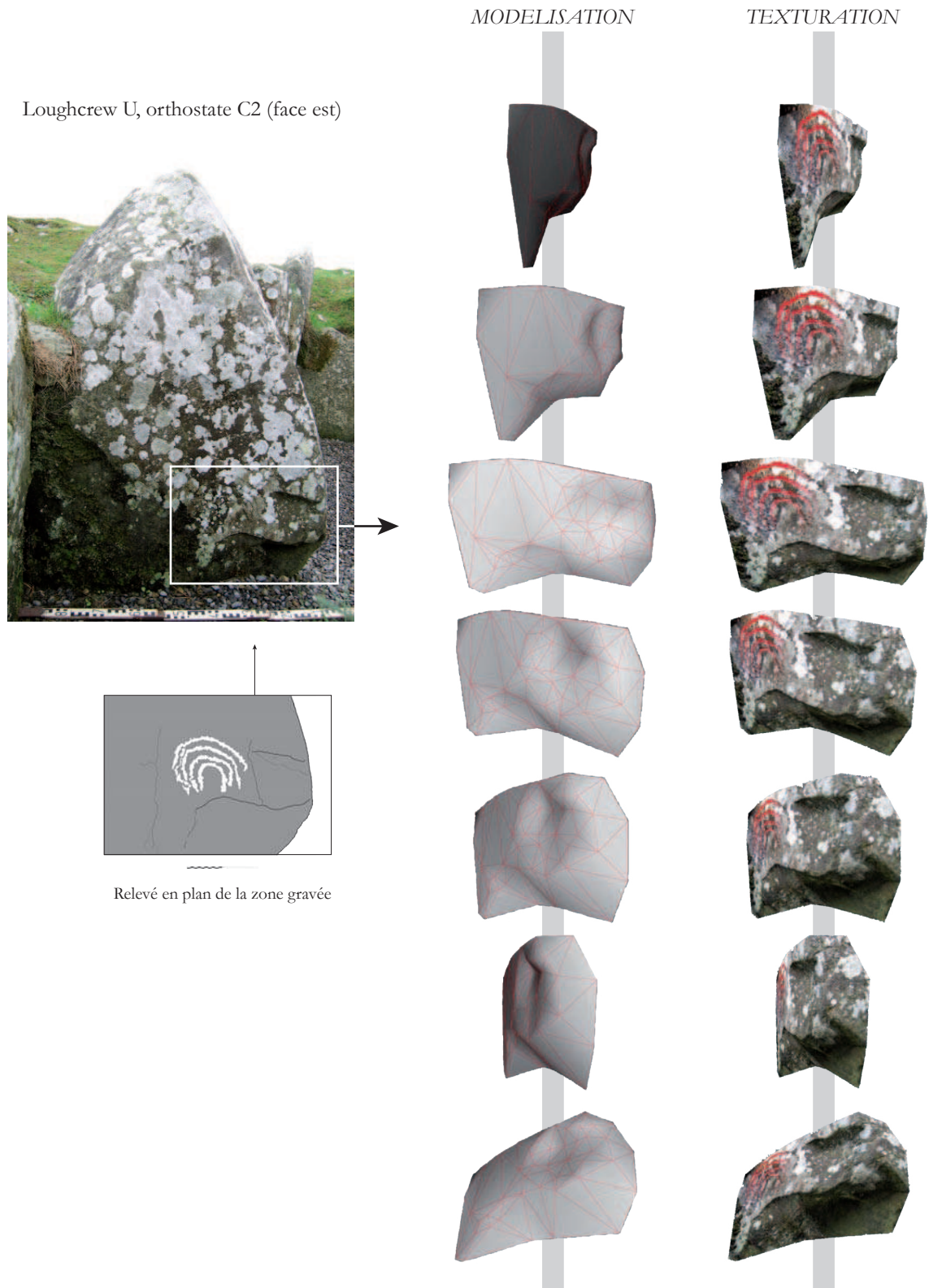

Figure 5.13 : Modélisation tridimensionnelle de l'orthostate C2 de Loughcrew U



Tombe	Couloir extérieur				Couloir intérieur				Chambre				Niche latérale gauche					Niche latérale droite					Niche terminale					
	Seuil entrée couloir	Paroi droite	Paroi gauche	Couverture	Seuil milieu couloir	Paroi droite	Paroi gauche	Couverture	Seuil entrée chambre	Paroi droite	Paroi gauche	Couverture	Seuil ou linteau	Paroi droite	Paroi gauche	Paroi de fond	Couverture	Seuil ou linteau	Paroi droite	Paroi gauche	Paroi de fond	Couverture	Seuil ou linteau	Paroi droite	Paroi gauche	Paroi de fond	Couverture	
BgII	-	0%	0%	-	-	0%	0%	-	-	0%	0%	-	0%	0%	30%	0%	0%	0%	30%	0%	0%	0%	0%	0%	0%	0%	0%	0%
Bcd	-	0%	0%	0%	-	0%	0%	0%	-	0%	50%	0%	-	-	-	-	-	-	-	-	-	-	-	-	-	-	-	-
Cm	-	0%	0%	-	-	0%	0%	-	-	0%	0%	50%	-	-	-	-	-	-	-	-	-	-	-	-	-	-	-	-
CH	0%	0%	0%	0%	0%	0%	0%	0%	0%	50%	25%	0%	-	-	-	-	-	-	-	-	-	-	-	-	-	-	-	-
DhN	0%	0%	25%	25%	0%	20%	20%	25%	0%	50%	100%	0%	0%	0%	0%	0%	0%	50%	0%	0%	0%	0%	0%	0%	0%	50%	0%	0%
DhS	0%	100%	0%	50%	0%	50%	0%	0%	0%	66%	28%	-	-	-	-	-	-	50%	100%	100%	100%	0%	-	-	-	-	-	-
Fk	-	30%	0%	-	-	50%	50%	-	-	14%	25%	-	0%	0%	0%	0%	0%	50%	100%	100%	100%	0%	50%	0%	0%	100%	0%	0%
Km	-	-	-	-	-	-	0%	-	-	100%	100%	-	-	-	-	-	-	-	-	-	-	-	-	-	-	-	-	-
KrW	-	-	-	-	-	-	-	-	-	50%	33%	-	-	-	-	-	-	-	-	-	-	-	-	-	-	-	-	-
KhE	-	11%	22%	26%	0%	92%	92%	50%	0%	66%	33%	-	0%	0%	50%	100%	-	100%	100%	100%	100%	-	-	100%	100%	100%	-	-
KhW	-	7%	11%	12,5%	-	50%	29%	0%	0%	25%	75%	0%	-	-	-	-	-	-	-	-	-	-	-	-	-	-	-	-
Kh2	-	-	-	-	-	-	-	-	-	-	-	-	-	-	-	-	-	0%	100%	-	0%	-	-	-	-	-	-	-
Kh14	-	33%	0%	-	-	0%	50%	-	0%	100%	0%	-	-	-	-	-	-	-	-	-	-	-	-	-	-	-	-	-
Kh15	-	0%	25%	-	0%	0%	0%	-	0%	0%	0%	-	-	-	-	-	-	-	-	-	-	-	100%	100%	-	-	-	-
Kh16	-	0%	0%	-	0%	0%	25%	-	0%	33%	66%	-	-	-	-	-	-	-	-	-	-	-	0%	50%	50%	0%	-	-
Kh17	-	-	-	-	-	-	50%	-	-	-	-	-	-	-	-	-	-	-	-	-	100%	-	-	-	-	-	-	-
Kh18	-	-	-	-	-	-	-	-	-	-	-	-	-	-	-	-	-	-	-	-	-	-	-	100%	-	-	-	-
LcF	-	50%	50%	-	-	50%	100%	-	-	-	-	-	0%	0%	100%	0%	-	-	0%	0%	0%	-	0%	0%	0%	100%	-	-
LcH	0%	-	-	-	0%	50%	50%	-	-	0%	0%	-	-	50%	0%	0%	-	100%	50%	50%	0%	-	-	50%	0%	0%	-	-
LcI	0%	-	-	-	-	50%	0%	-	-	-	-	-	-	50%	50%	50%	-	-	100%	50%	0%	-	-	0%	0%	0%	-	-
LcL	0%	50%	50%	-	-	100%	100%	-	-	-	-	-	0%	100%	100%	50%	-	-	66%	66%	50%	-	50%	0%	100%	100%	-	-
LcS	-	50%	0%	-	0%	0%	100%	-	0%	50%	50%	-	-	-	100%	0%	-	0%	-	-	-	-	-	-	-	-	-	-
LcT	-	33%	100%	0%	-	66%	100%	0%	100%	100%	100%	-	0%	100%	100%	100%	-	0%	100%	100%	0%	-	100%	100%	100%	50%	100%	-
LcU	0%	0%	0%	-	-	100%	100%	-	-	-	-	-	-	100%	100%	50%	-	-	100%	100%	100%	-	-	100%	100%	100%	-	-
LcV	-	-	-	-	-	-	-	-	-	-	-	-	-	50%	100%	-	-	-	0%	-	50%	-	0%	-	-	0%	-	-
LcW	-	-	-	-	-	100%	-	-	-	0%	66%	-	-	-	-	-	-	-	-	-	-	-	-	-	-	-	-	-
Ng	-	36%	0%	55%	-	50%	60%	12,5%	-	50%	0%	-	-	100%	100%	100%	0%	-	100%	0%	0%	100%	-	50%	0%	100%	50%	-
NgK	0%	0%	50%	-	0%	50%	33%	-	-	0%	100%	-	-	-	-	-	-	100%	0%	0%	0%	-	-	-	-	-	-	-
NgL	-	-	-	-	-	-	-	-	-	-	-	-	-	100%	-	0%	-	-	-	-	-	-	-	0%	100%	0%	-	-
SK	-	-	-	-	-	-	-	-	-	33%	80%	-	-	-	-	-	-	-	-	-	-	-	-	-	-	-	-	-
<b>Total</b>	<b>0%</b>	<b>21%</b>	<b>18%</b>	<b>21%</b>	<b>0%</b>	<b>40%</b>	<b>42%</b>	<b>11%</b>	<b>10%</b>	<b>37%</b>	<b>44%</b>	<b>10%</b>	<b>0%</b>	<b>50%</b>	<b>64%</b>	<b>35%</b>	<b>0%</b>	<b>45%</b>	<b>63%</b>	<b>51%</b>	<b>37,5%</b>	<b>20%</b>	<b>33%</b>	<b>43%</b>	<b>46%</b>	<b>46%</b>	<b>30%</b>	

Figure 6.1 : Tableau de répartition des surfaces gravées dans les tombes à couloir

### Modèle de tombe à couloir décomposée en 6 ensembles spatiaux

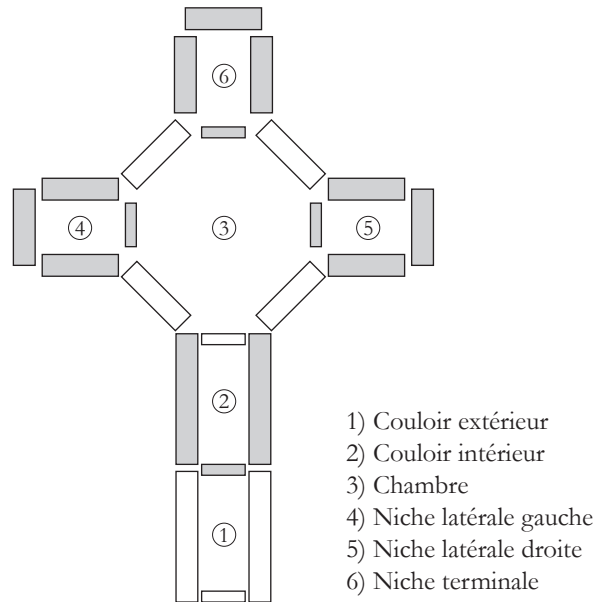

### Répartition des surfaces gravées dans les tombes à couloir

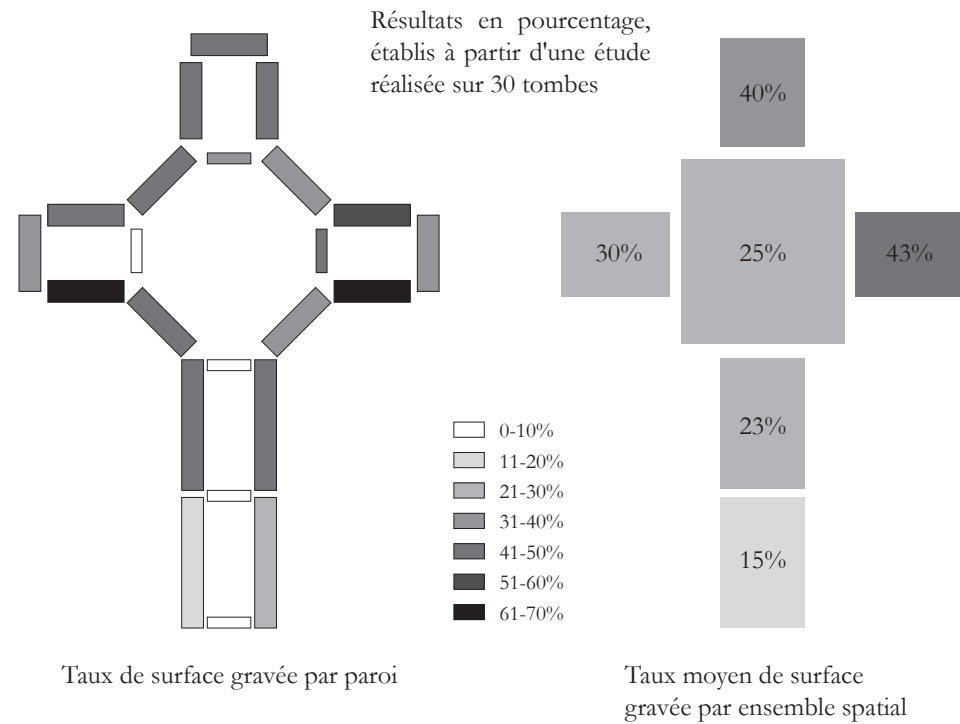

Figure 6.2 : Représentation modélisée de la répartition des surfaces gravées dans les tombes à couloir

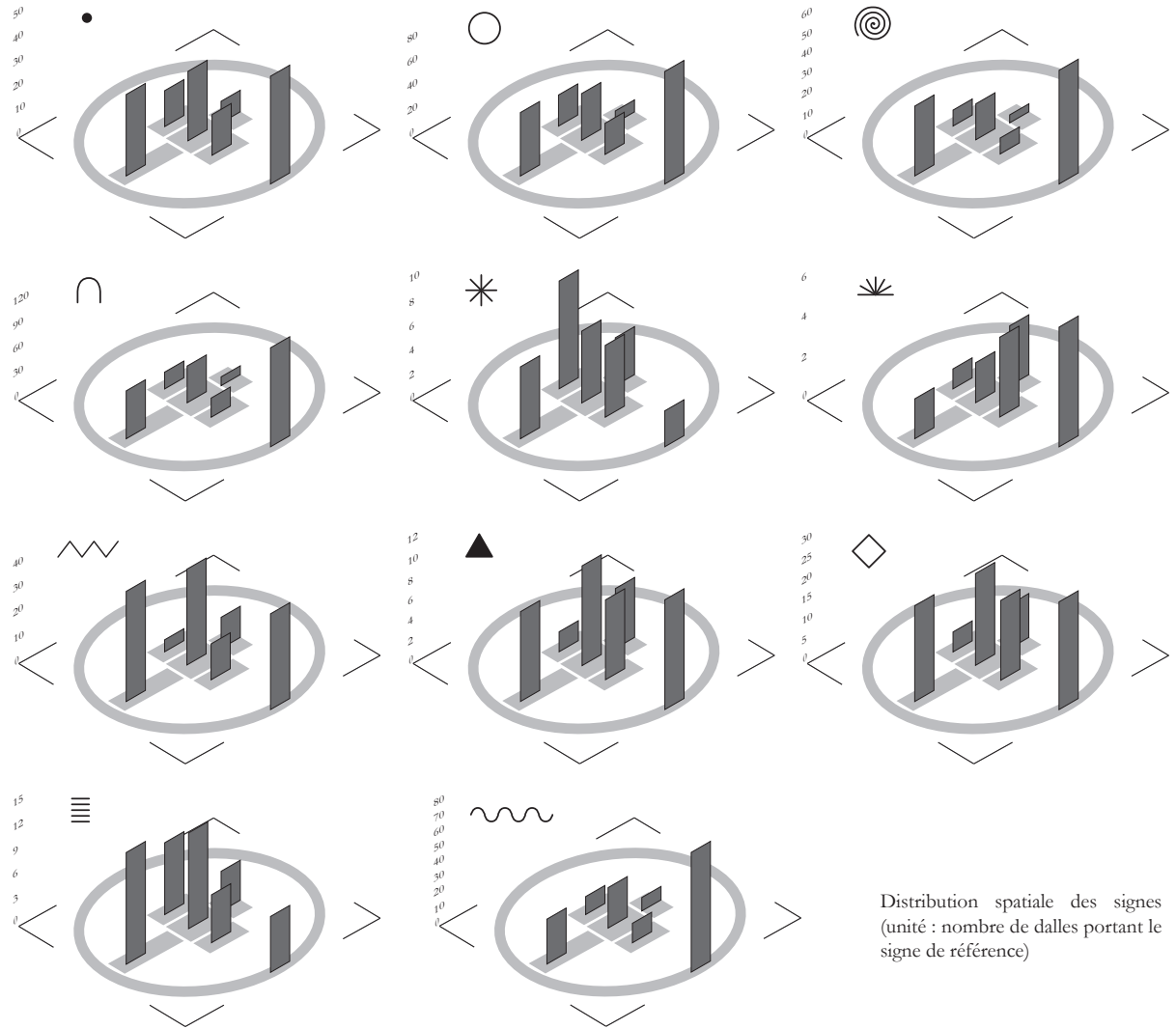
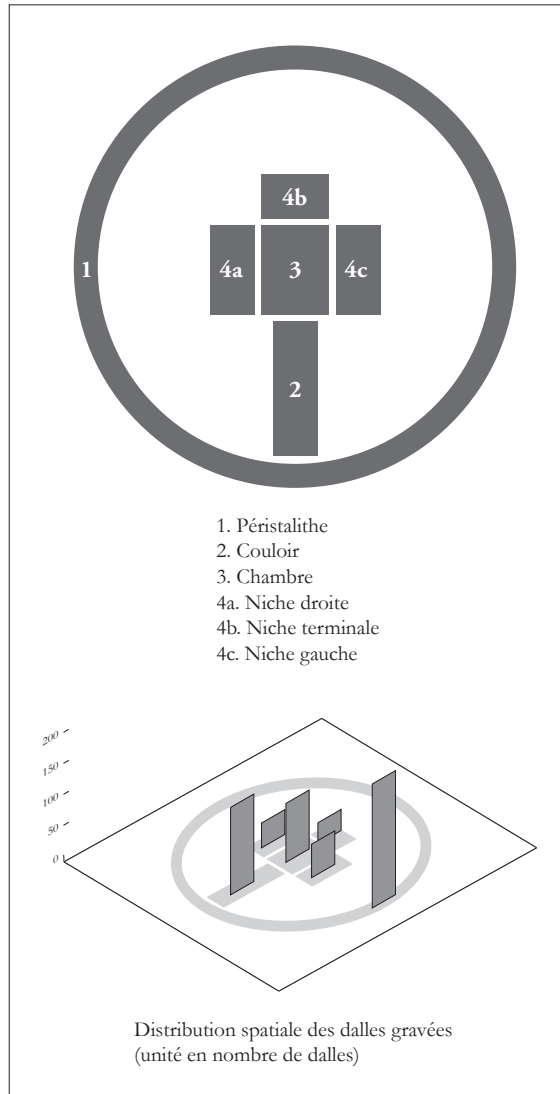

Figure 6.3 : Distribution spatiale des signes dans les tombes à couloir

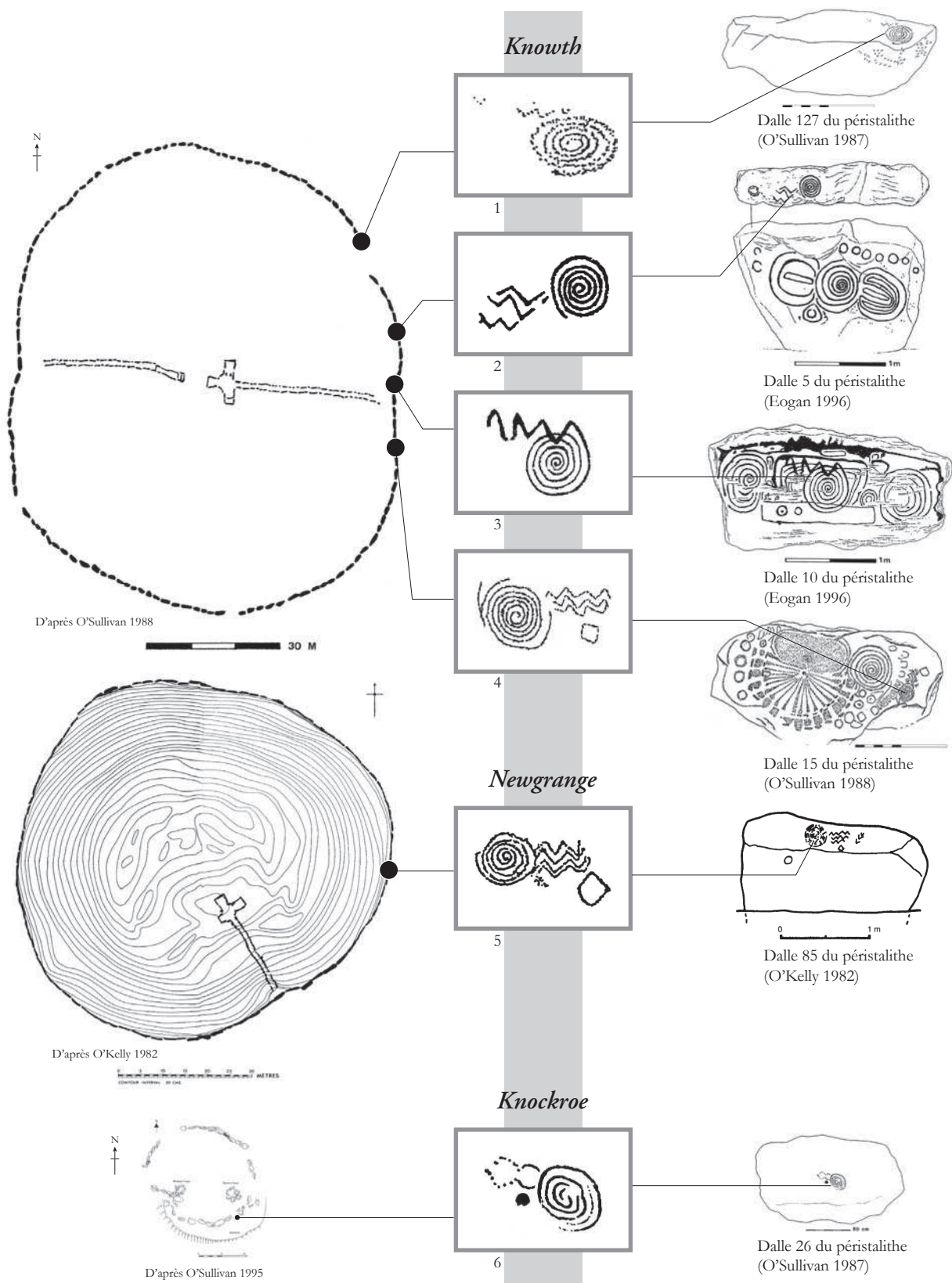

Figure 6.4 : Assemblage de spirale et chevrons sur la partie est du péréalithe

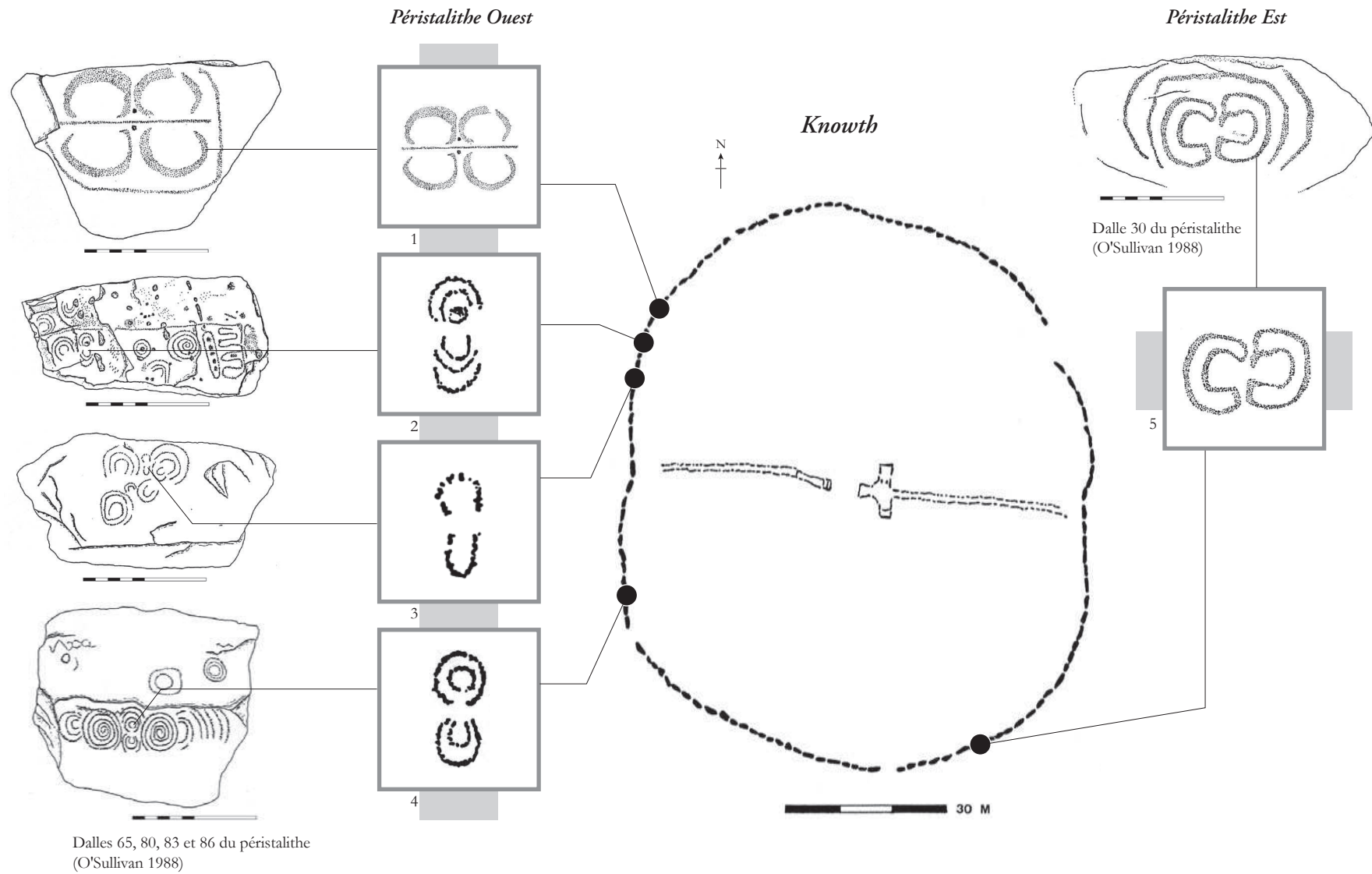

Figure 6.5 : Paires d'arceaux opposés sur le péristalithe de Knowth

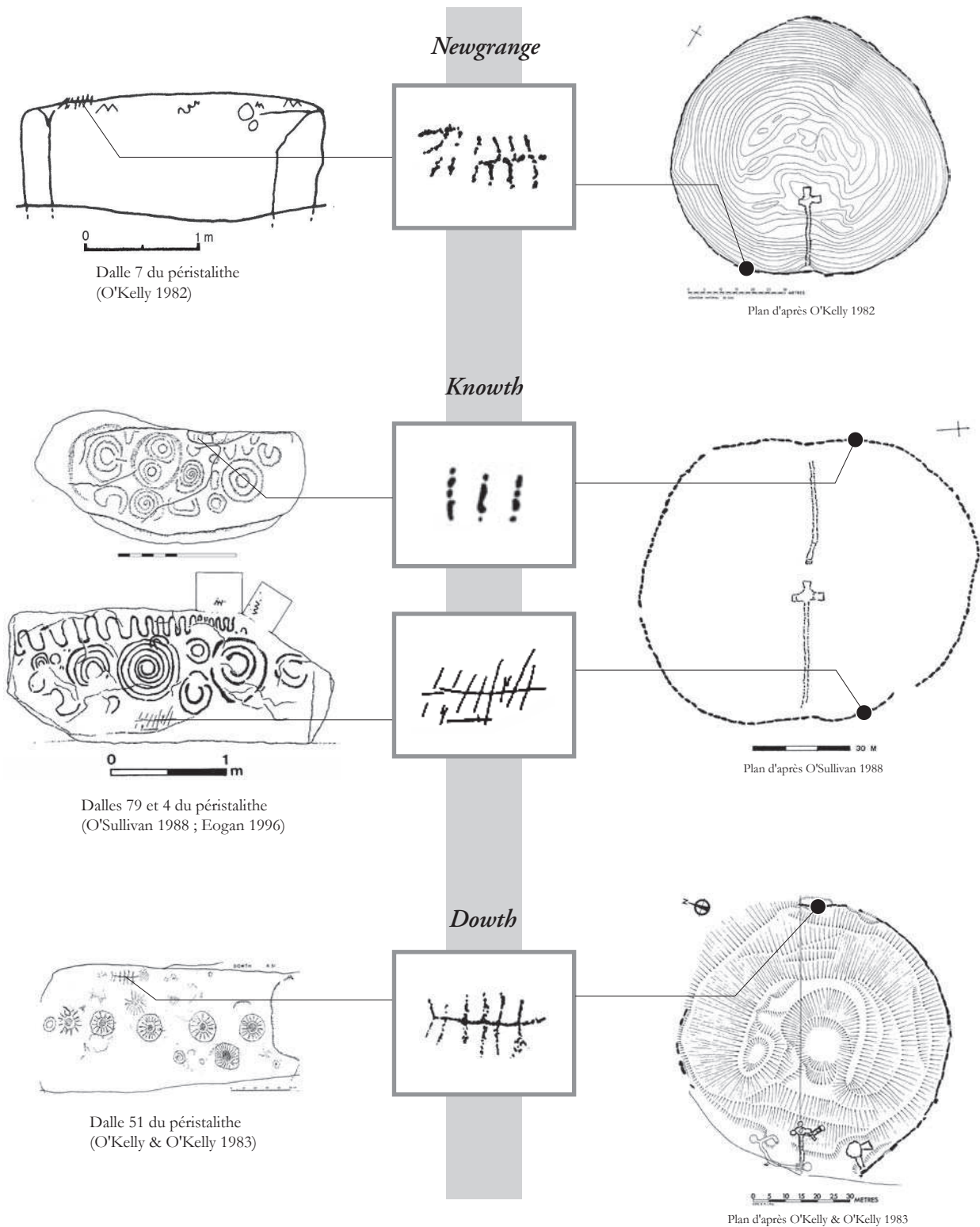
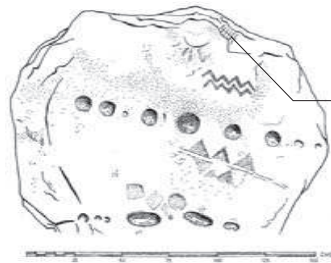
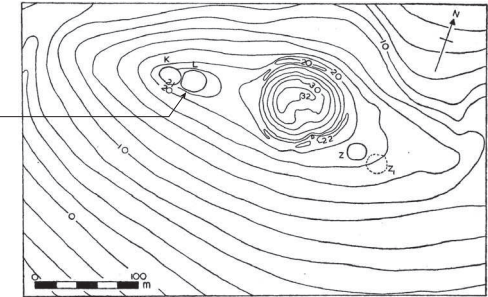
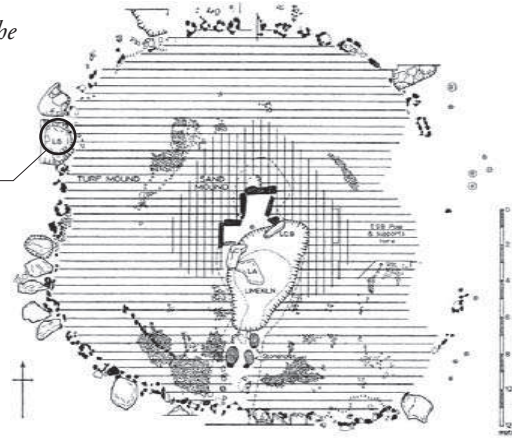

Figure 6.6 : Signes scalariformes sur le péristalithe de Newgrange, Knowth et Dowth

*Newgrange L, dalle B du périlistithe*



D'après O'Kelly *et al.* 1978



Plan et carte d'après O'Kelly *et al.* 1978

*Loughcrew H, dalle 8 du périlistithe*

D'après Shee Twohig 1981

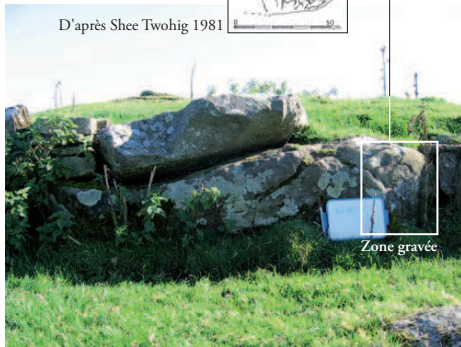

Zone gravée

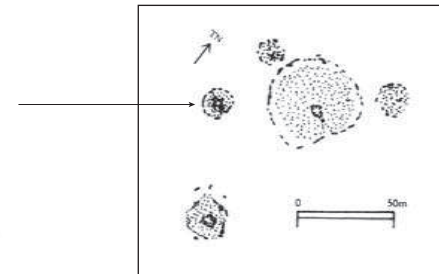
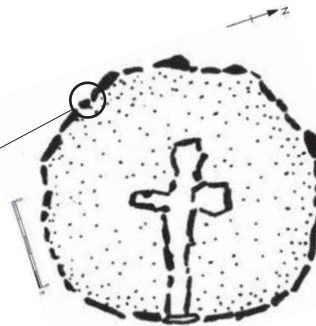

Plan et carte d'après McMann 1993

Figure 6.7 : Signes scalariformes sur le périlistithe de Newgrange L et Loughcrew H

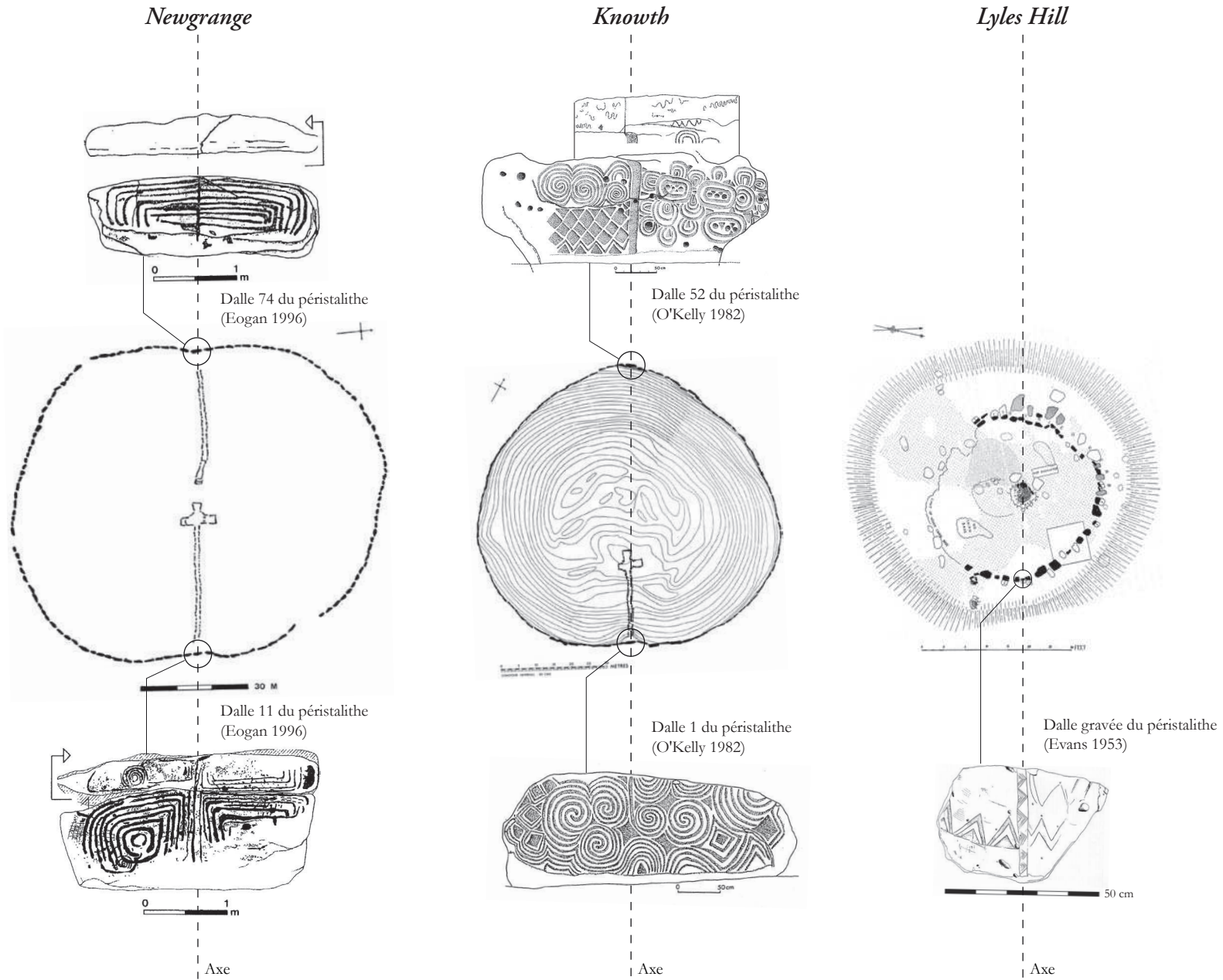
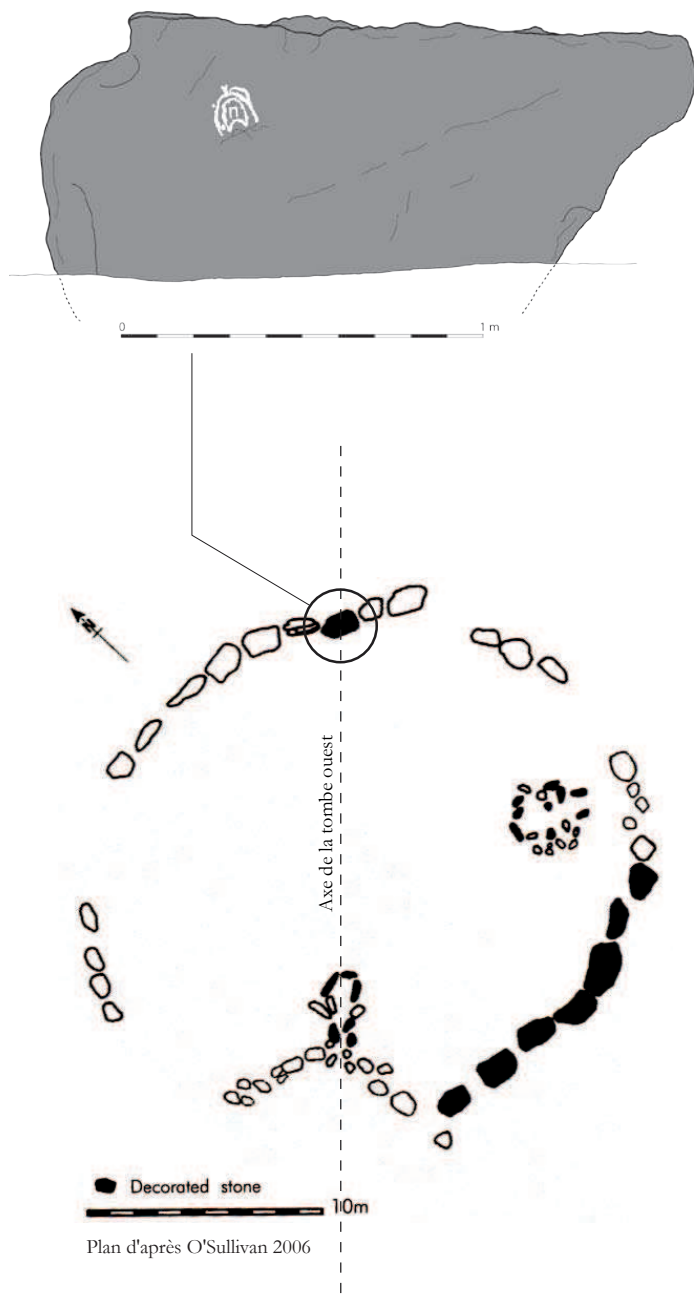

Figure 6.8 : L'axe de la tombe matérialisé par une ligne centrale verticale gravée



*Knockroe, dalle 15 du péristalithe*



Vue de la dalle depuis le nord avec la tombe ouest en arrière plan



Vue de la tombe ouest depuis le sud avec la dalle K15 indiquée dans son axe

Figure 6.9 : Knockroe : l'axe de la tombe ouest et la dalle 15 du péristalithe

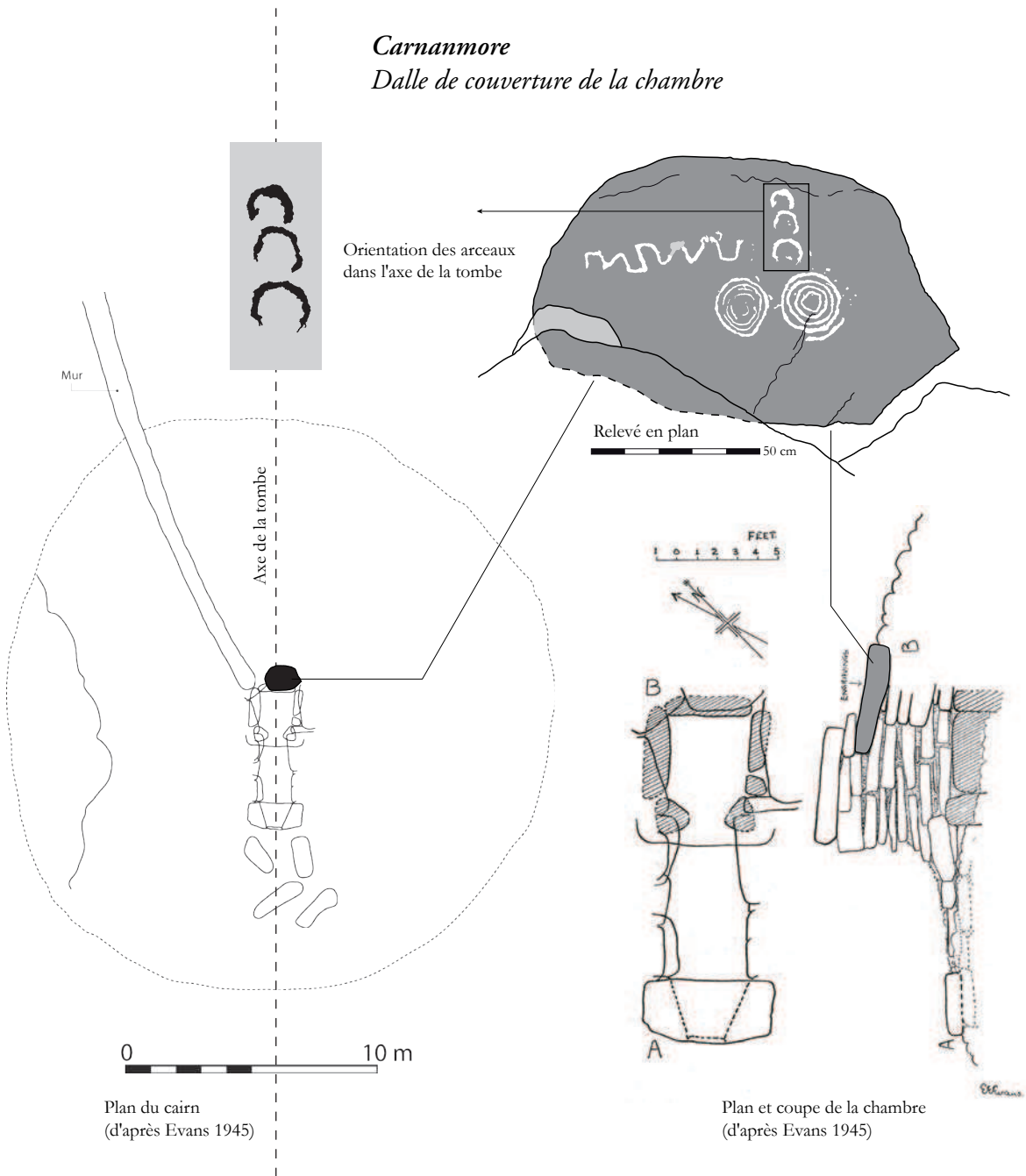

Figure 6.10 : Carnanmore : ligne d'arceaux simples orientée dans l'axe de la tombe

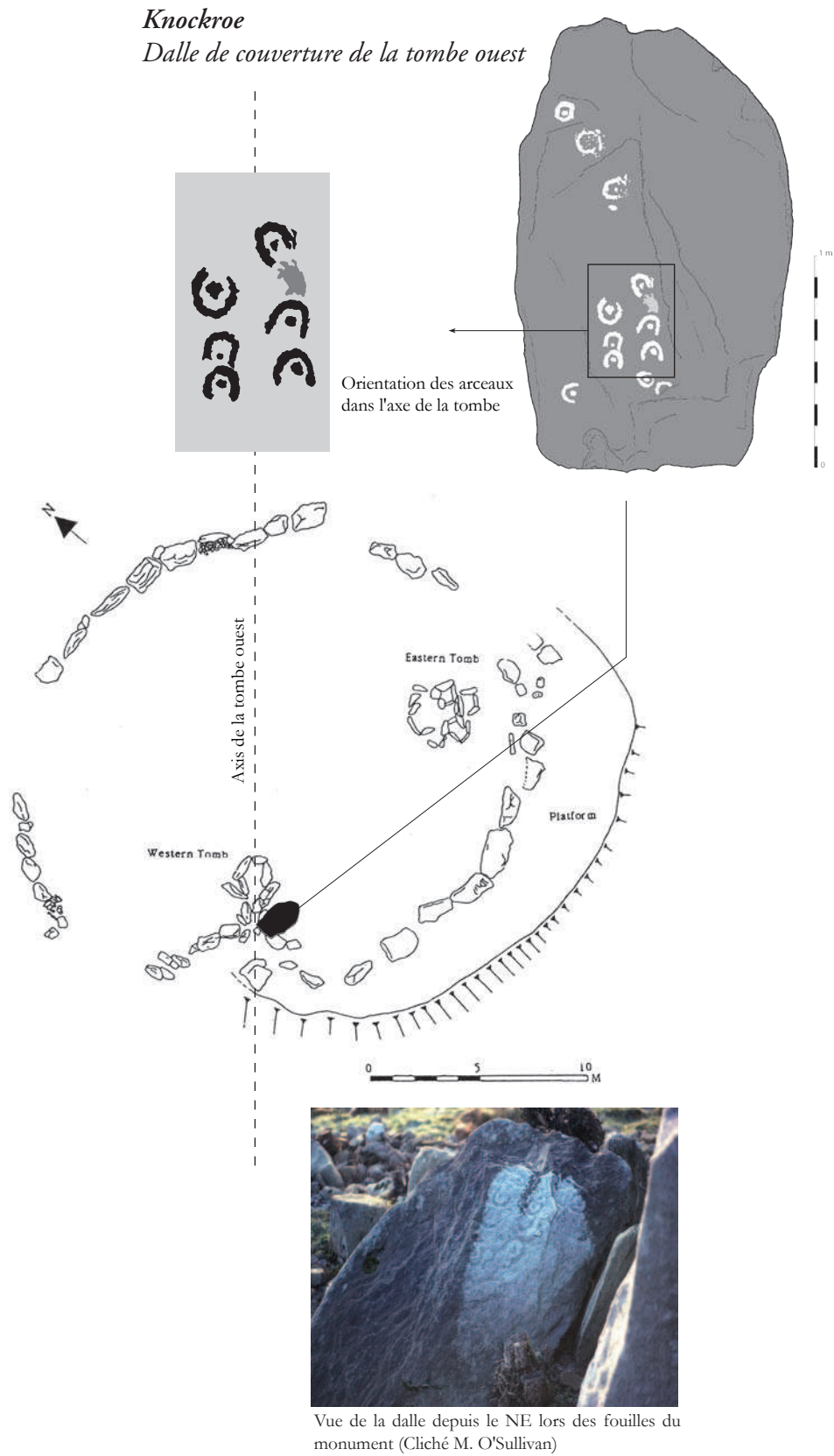

Figure 6.11 : Knockroe West : lignes d'arceaux simples orientées dans l'axe de la tombe

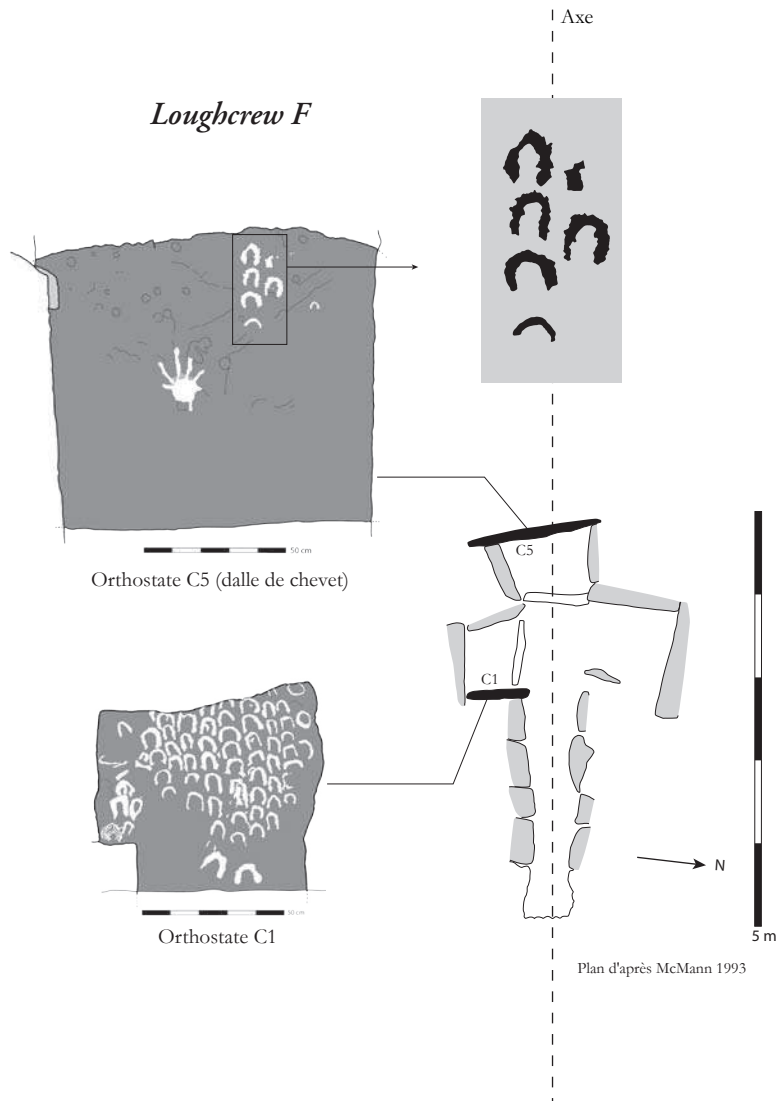

Figure 6.12 : Loughcrew F : lignes d'arceaux simples orientées dans l'axe de la tombe

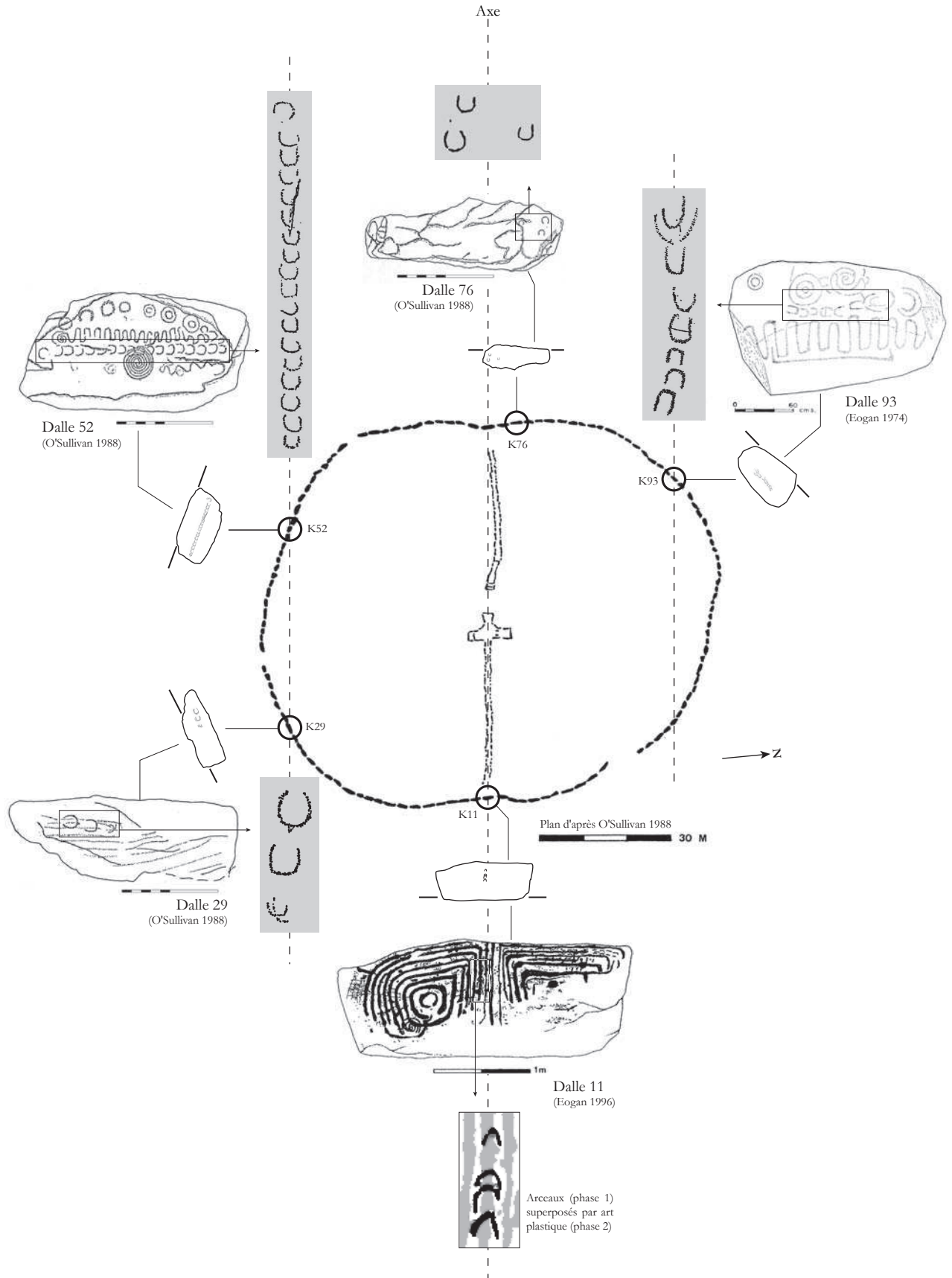

Figure 6.13 : Péristalithe de Knowth : lignes d'arceaux simples orientées dans l'axe de la tombe

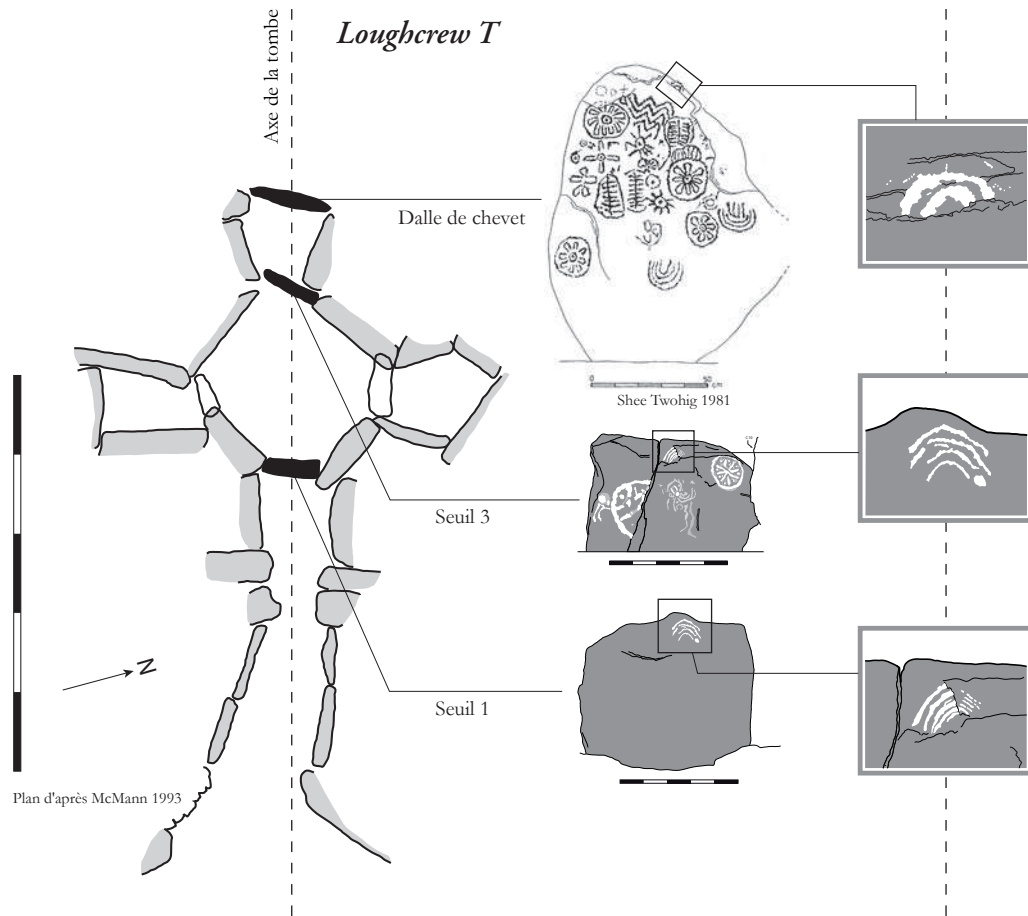

Figure 6.14 : Loughcrew T : motif en arceaux emboîtés répété le long de l'axe de la tombe

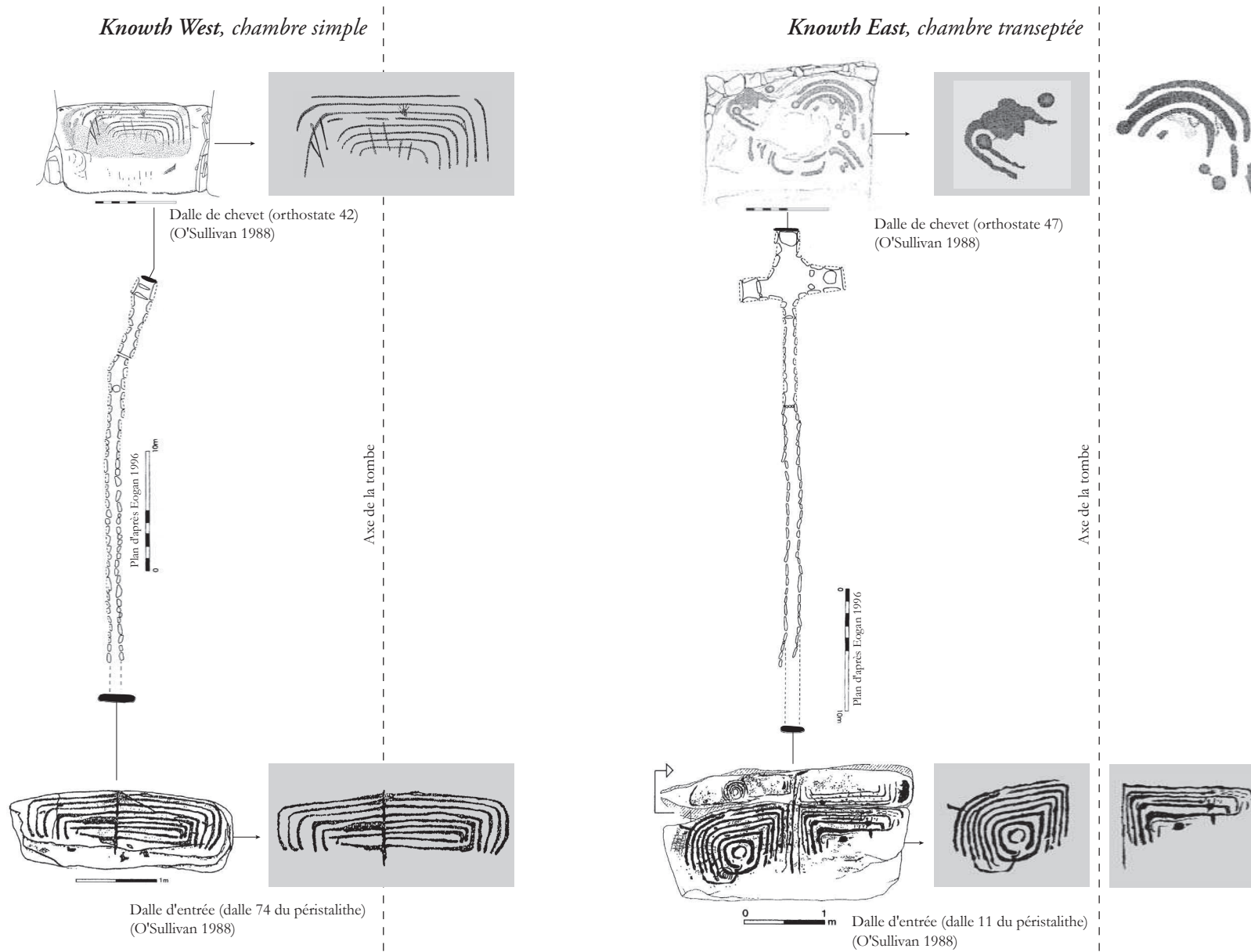

Figure 6.15 : Knowth East et West : motif en arceaux emboîtés répété le long de l'axe de la tombe

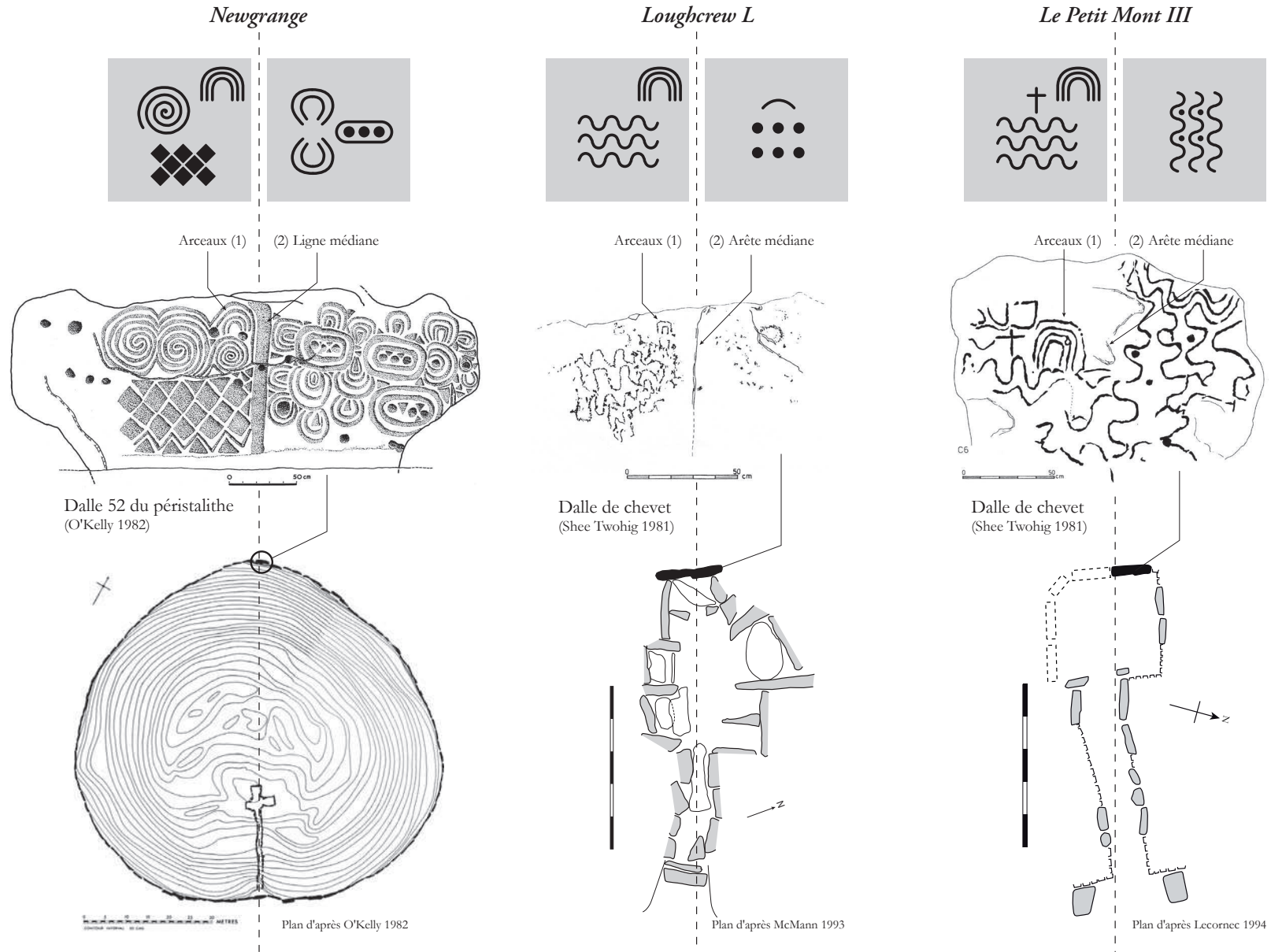

Figure 6.16 : Opposition de groupes de signes de chaque côté de l'axe



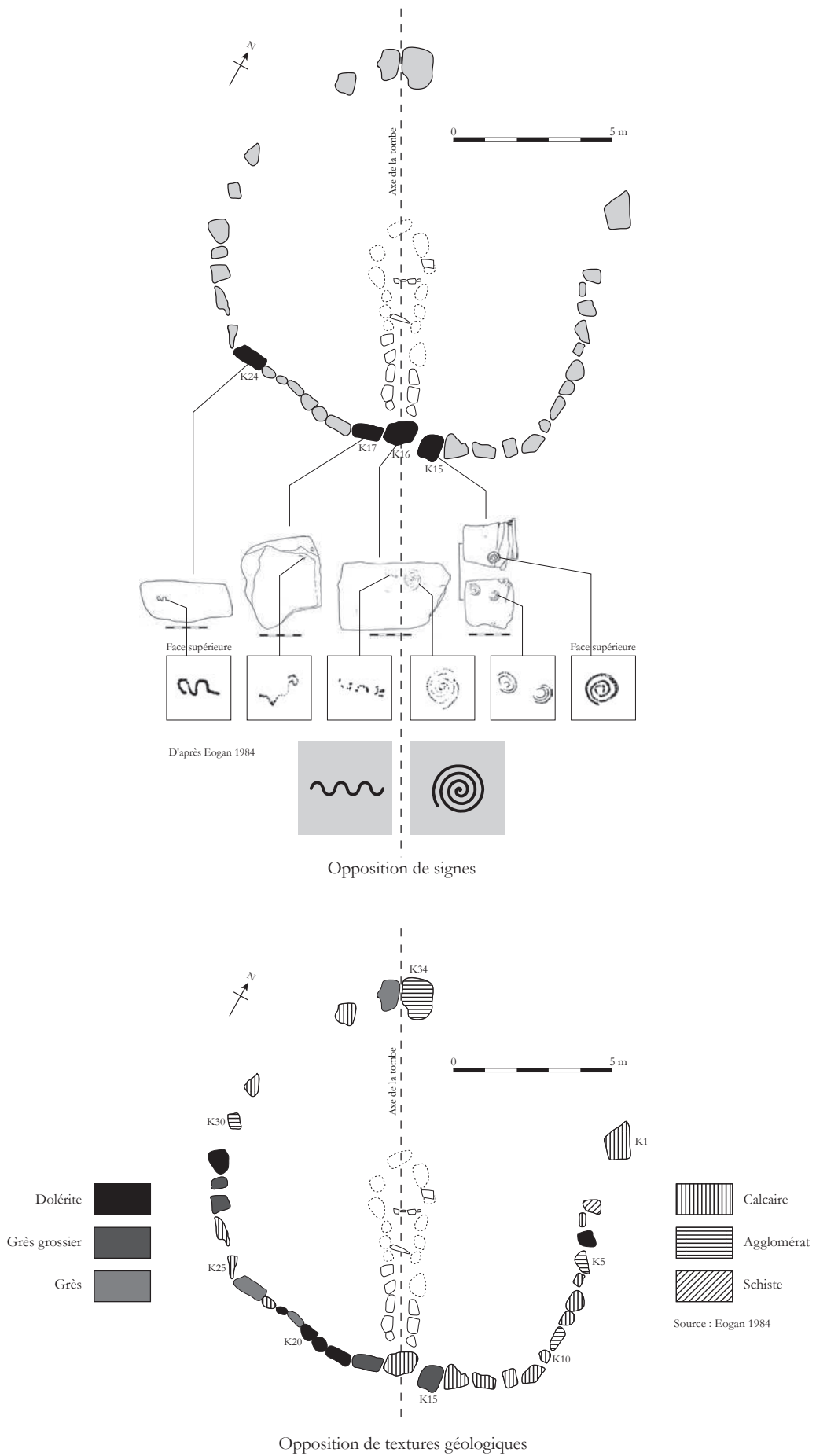

Figure 6.17 : Knowth 13 : opposition de signes et de textures géologiques

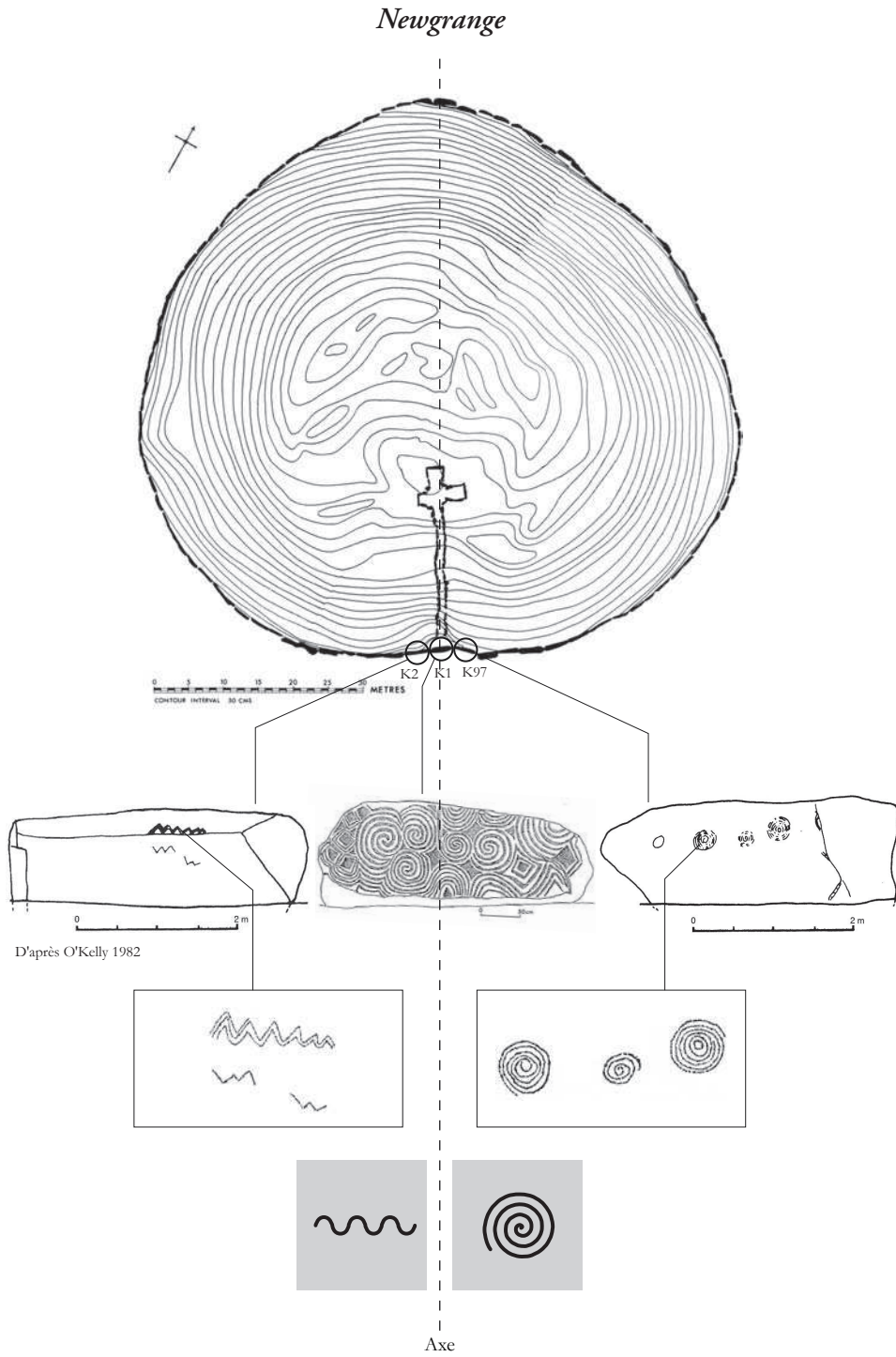

Figure 6.18 : Newgrange : opposition entre spirale et signe ondulé

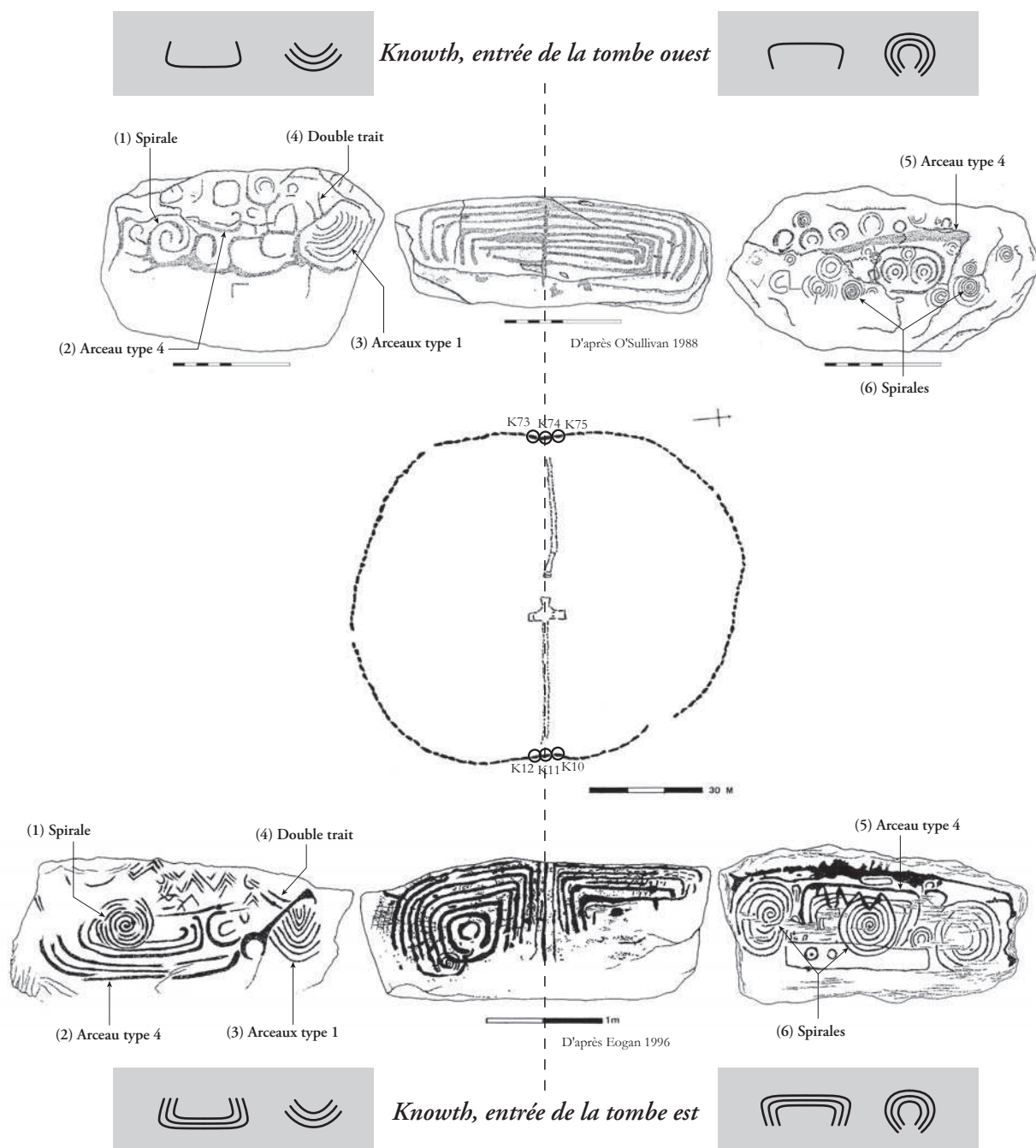

Figure 6.19 : Opposition dans l'orientation des arceaux à l'entrée des tombes est et ouest de Knowth

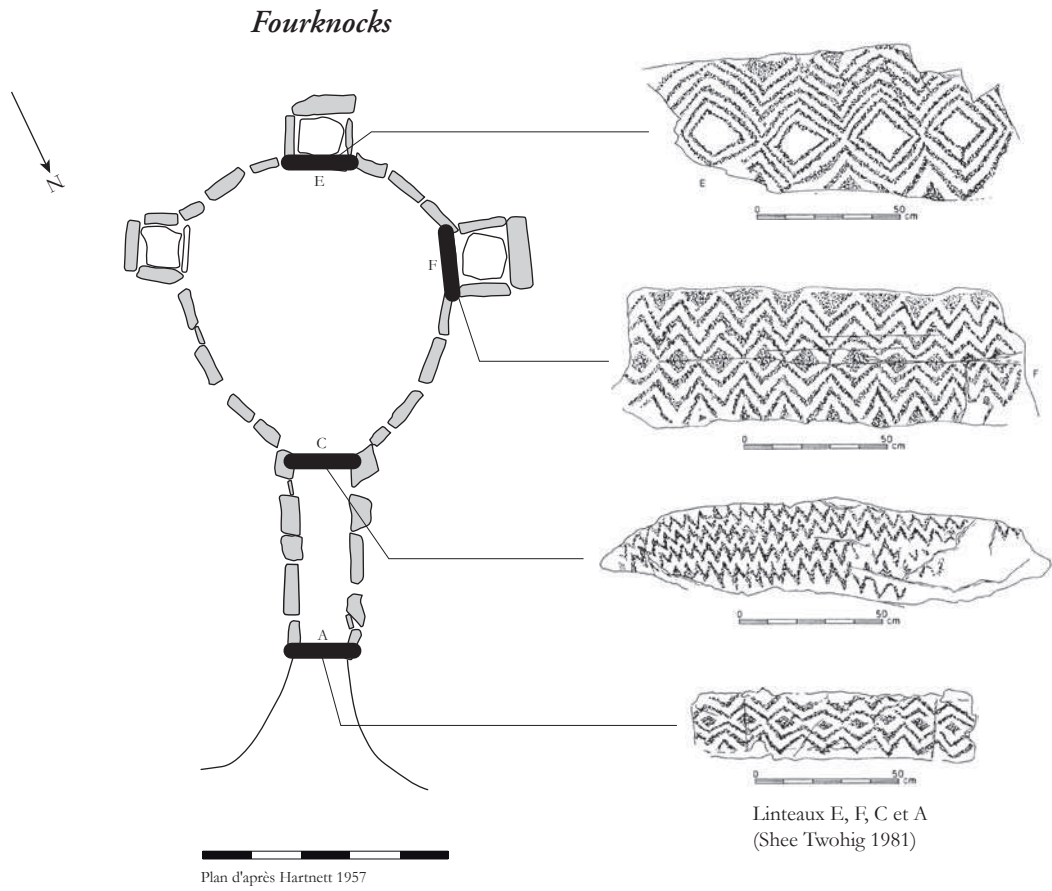

Figure 6.20 : Lignes de chevrons parallèles et limites internes à Fourknocks

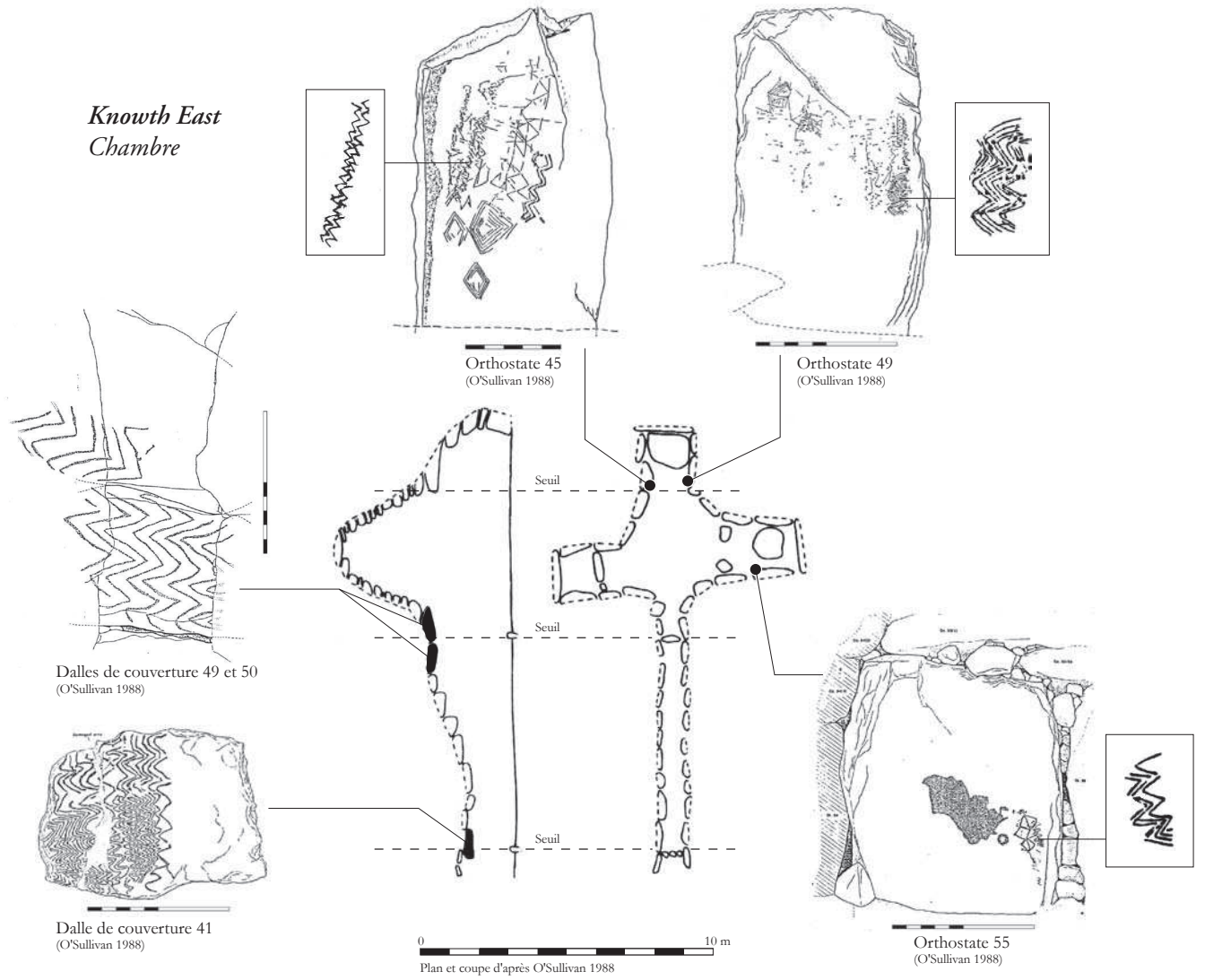

Figure 6.21 : Lignes de chevrons parallèles et limites internes à Knowth East

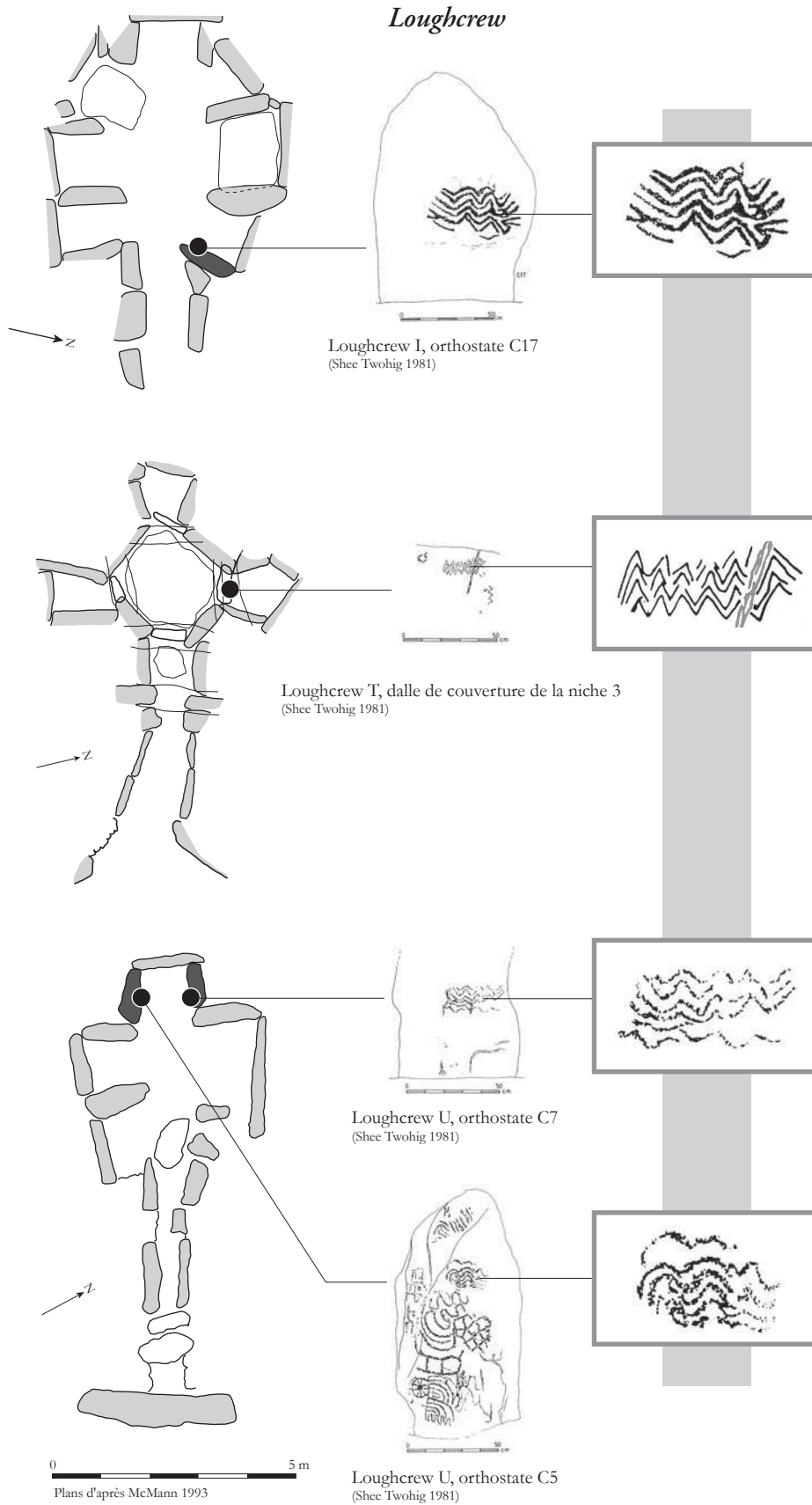

Figure 6.22 : Lignes de chevrons parallèles et limites internes à Loughcrew

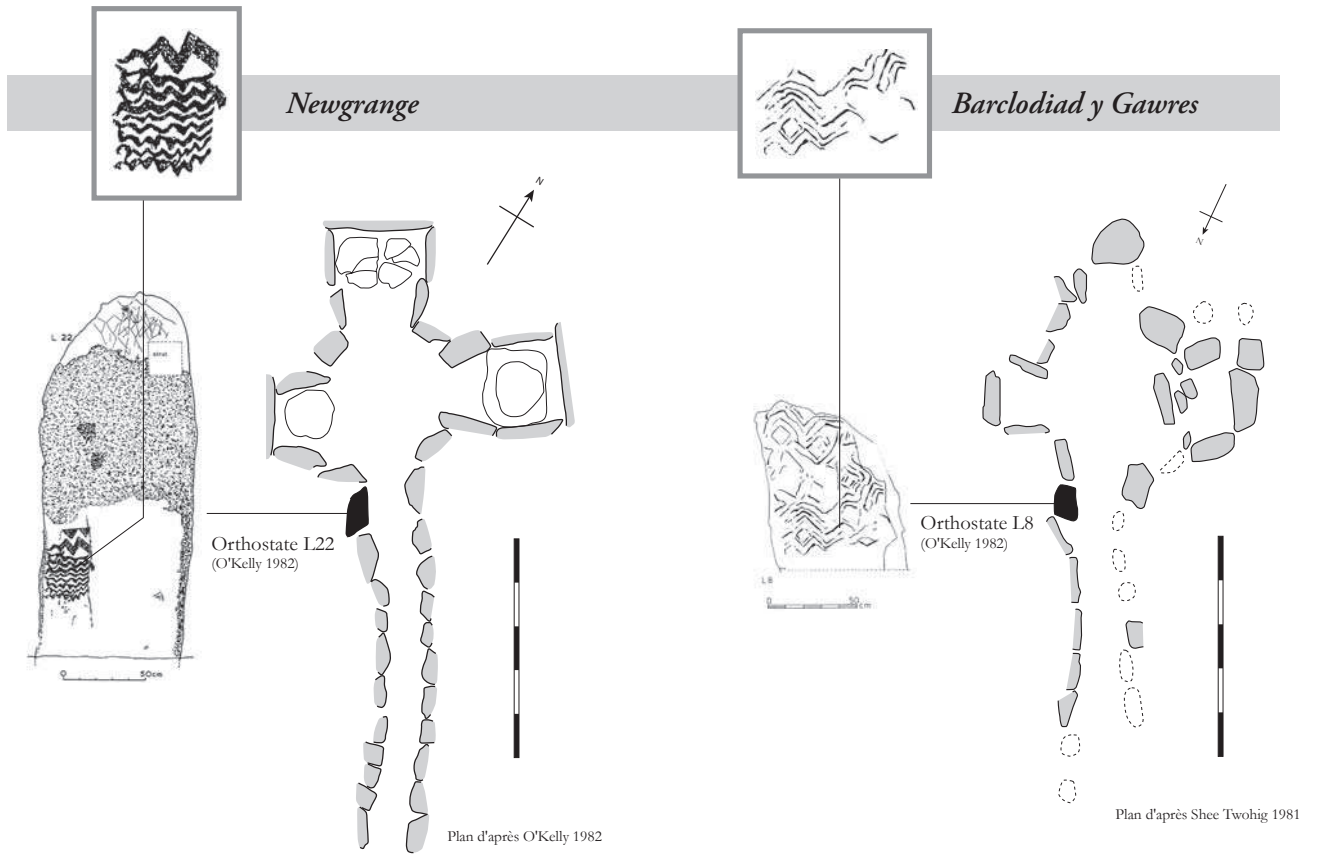

Figure 6.23 : Lignes de chevrons parallèles et limites internes à Newgrange et Barclodiad y Gawres

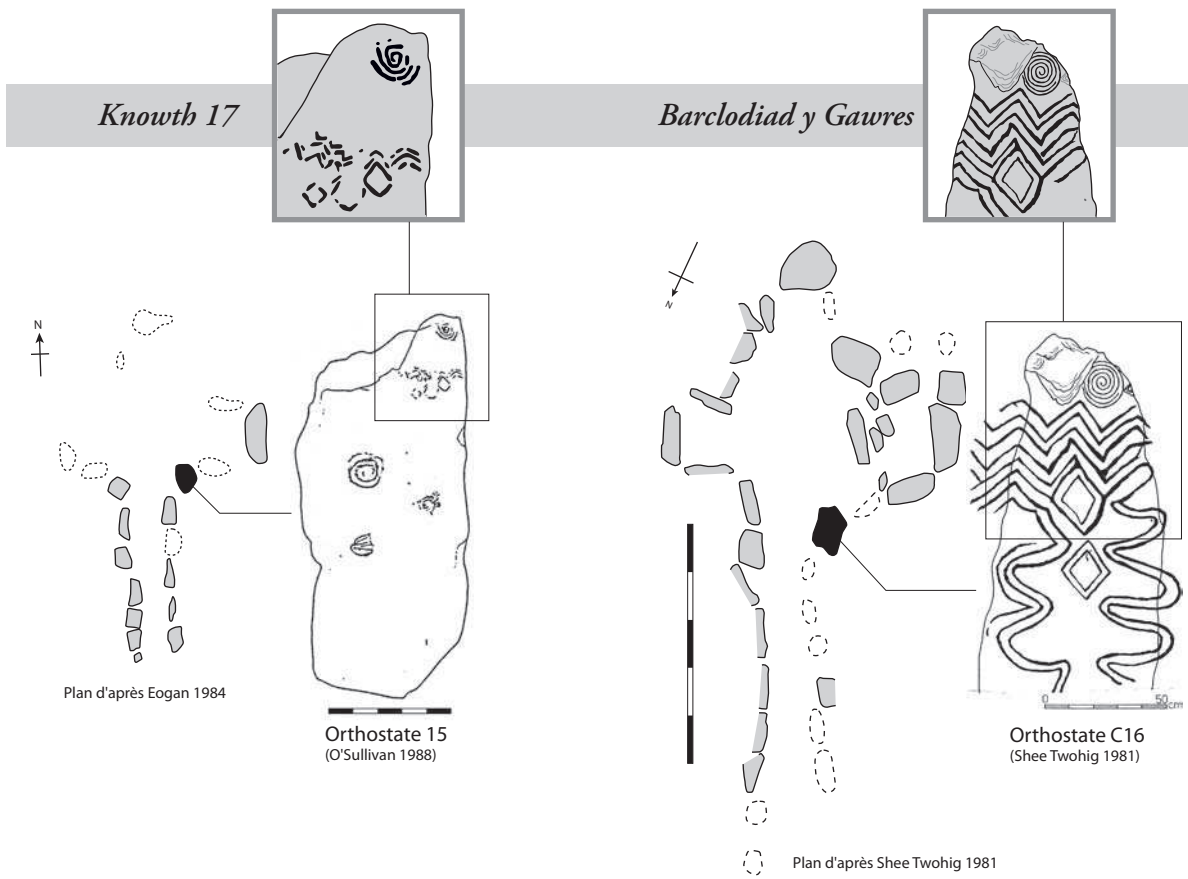

Figure 6.24 : Composition en spirale, chevrons et losanges à l'entrée de la chambre dans les tombes de Knowth 17 et Barclodiad y Gawres



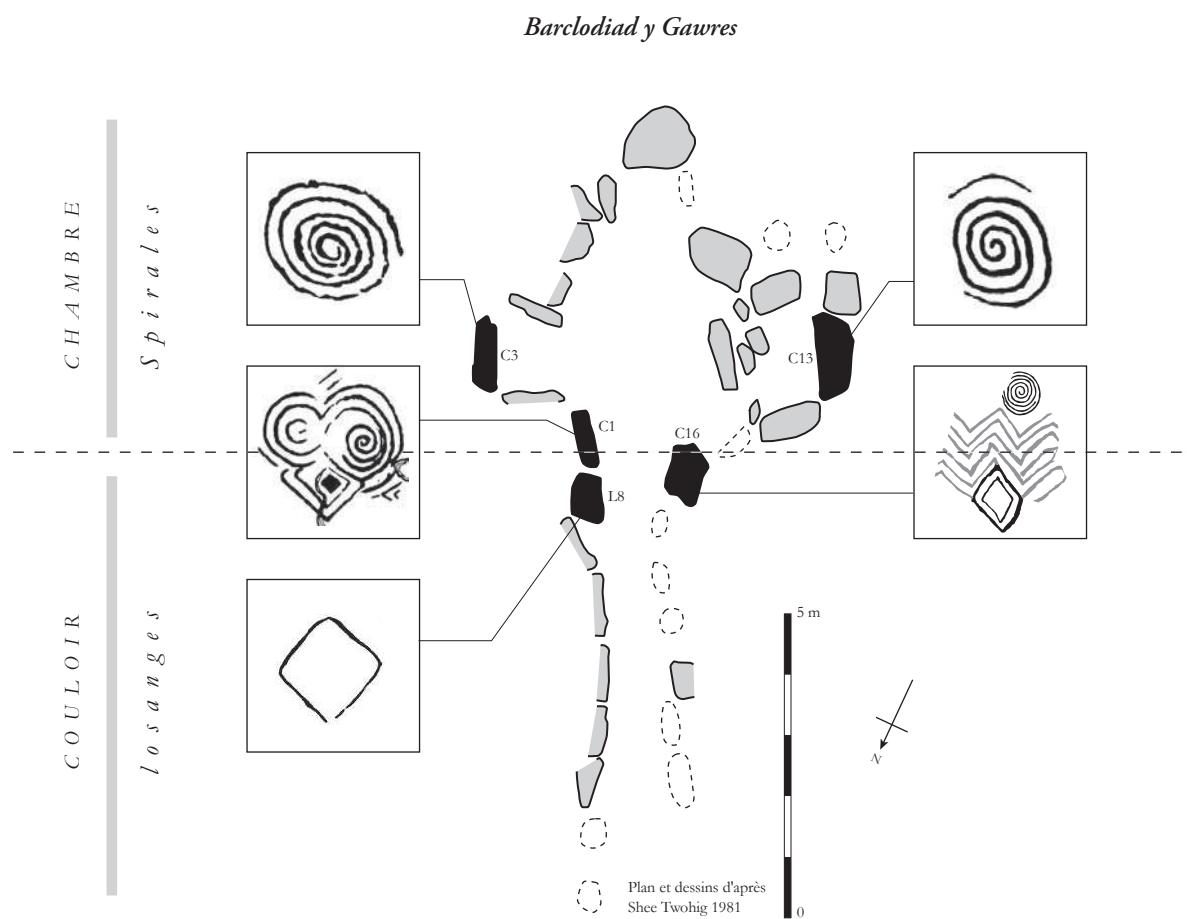

Figure 6.25 : Répartition des spirales, chevrons et losanges à Barclodiad y Gawres

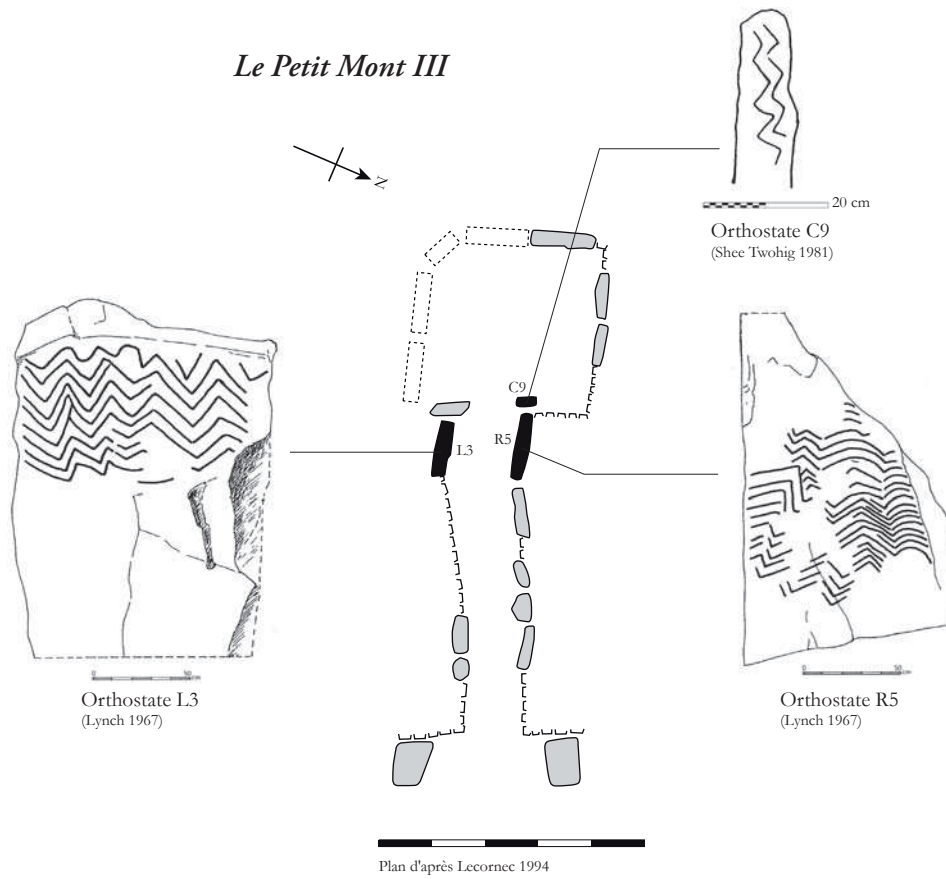

Figure 6.26 : Lignes de chevrons parallèles et limites internes au Petit Mont

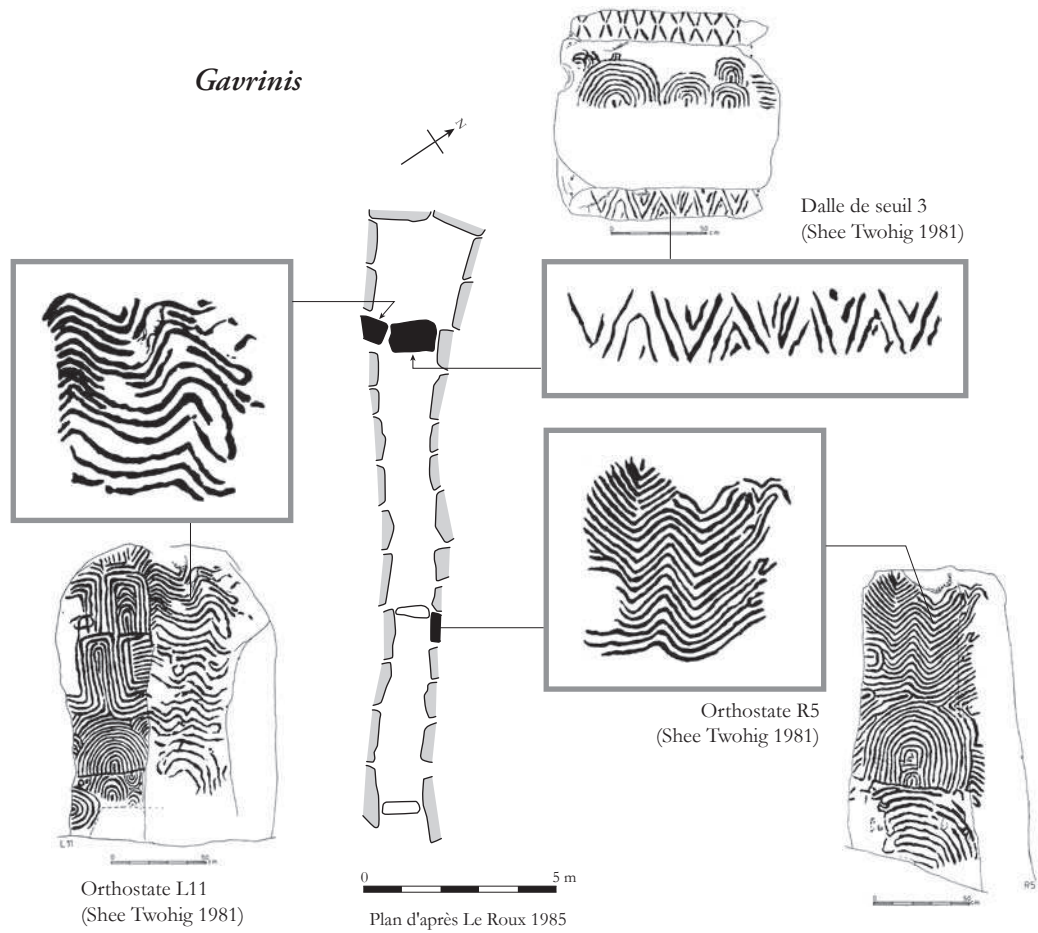

Figure 6.27 : Lignes de chevrons parallèles et limites internes à Gavrinis

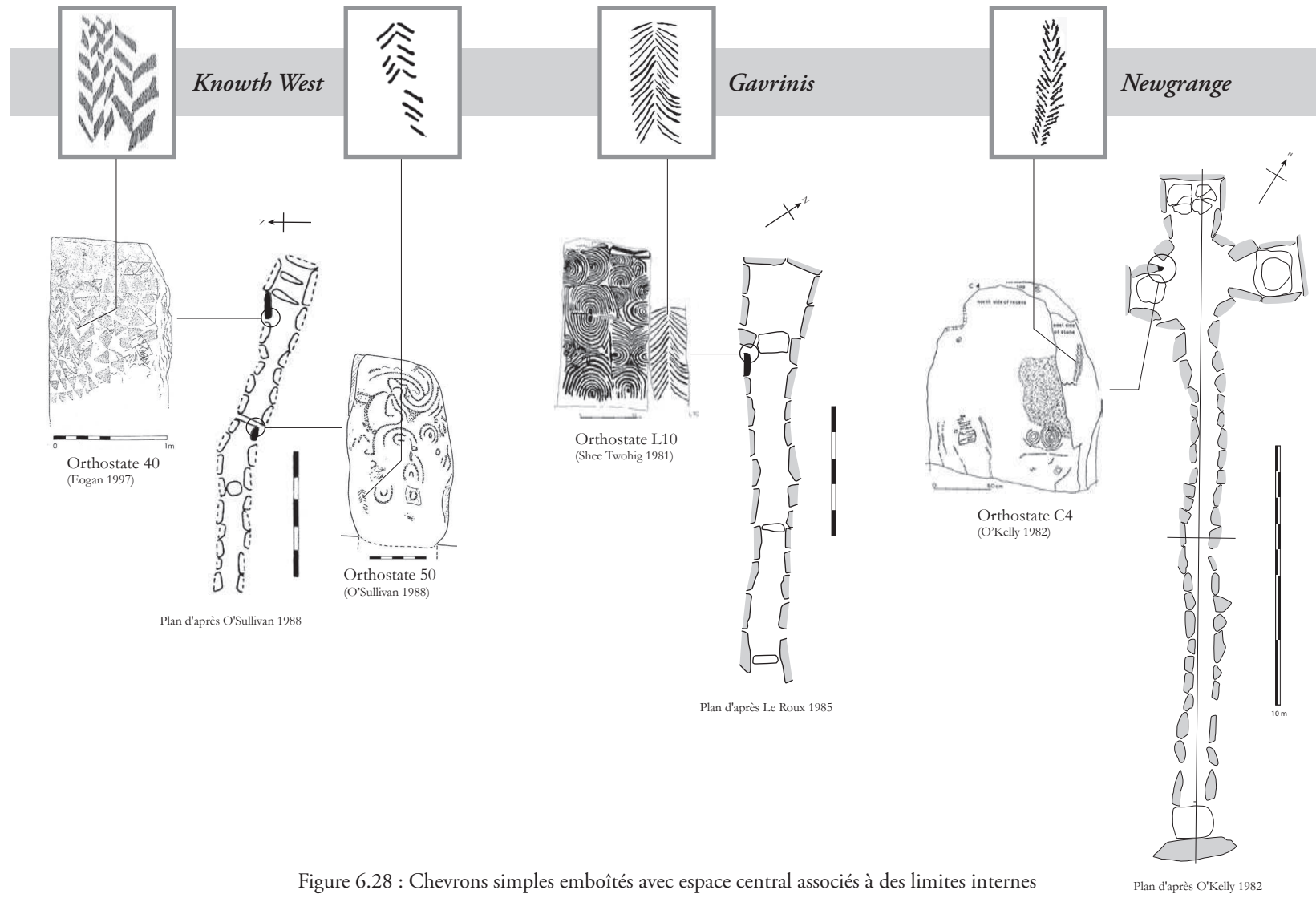

Figure 6.28 : Chevrons simples emboîtés avec espace central associés à des limites internes

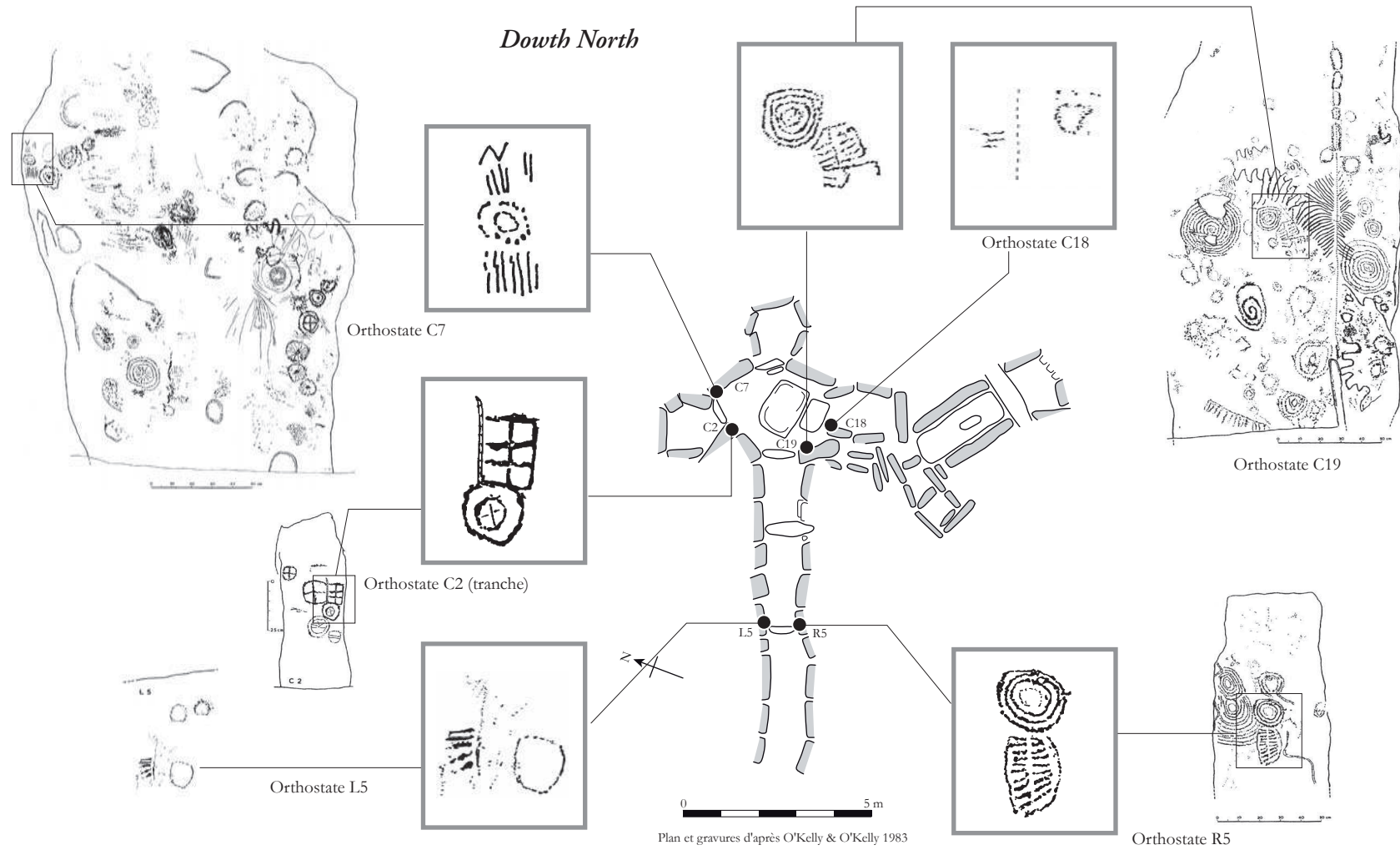

Figure 6.29 : Signes scalariformes et limites internes à Dowth North

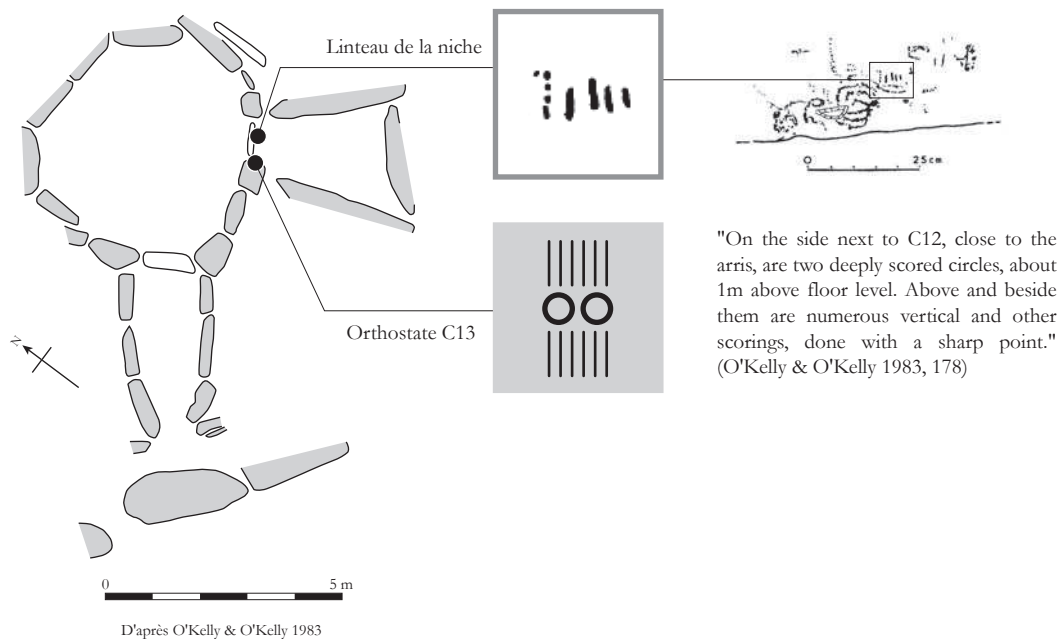
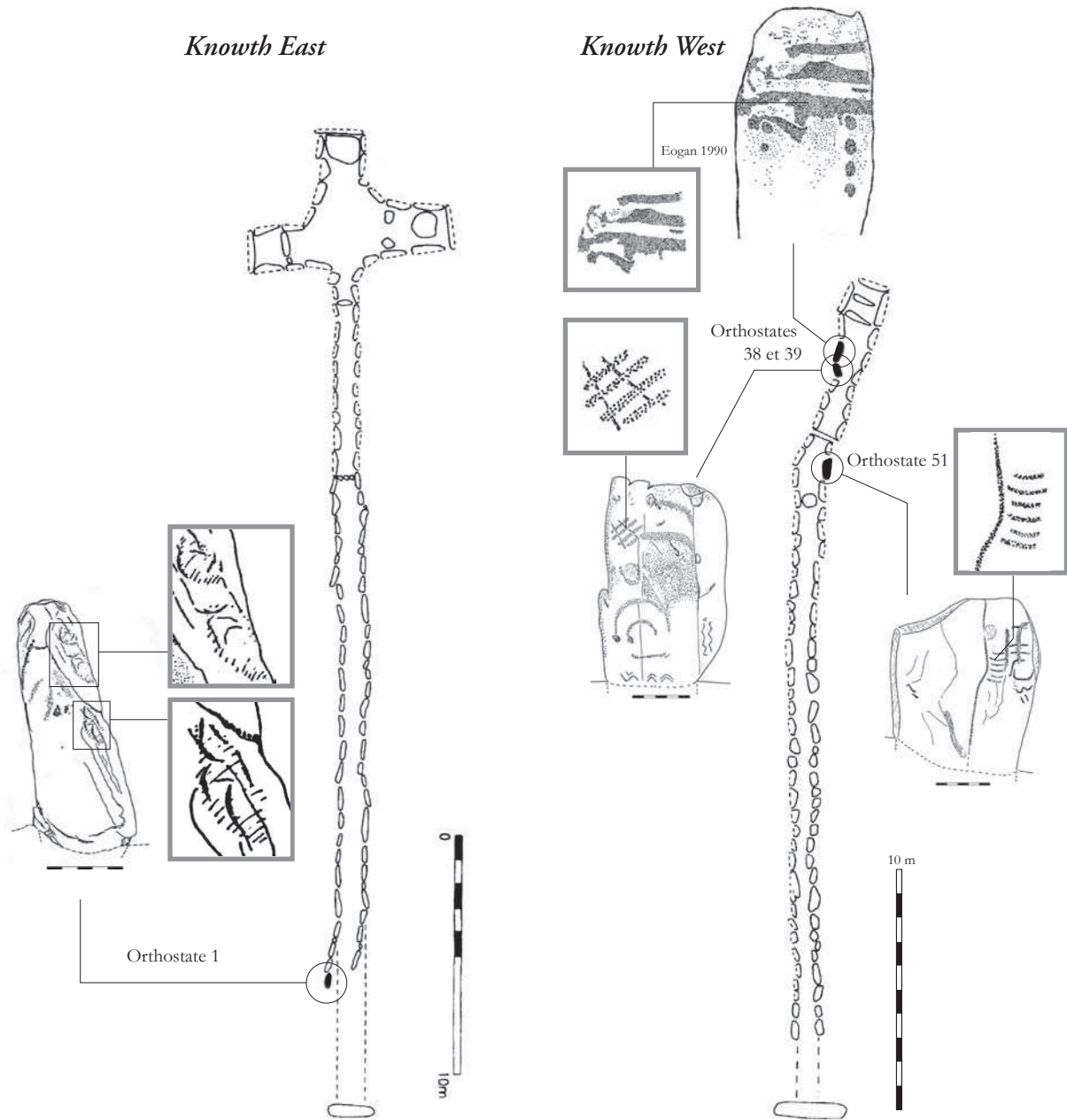

Figure 6.30 : Signes scalariformes et limites internes à Douth South



Plans et gravures d'après O'Sullivan 1988

Figure 6.31 : Signes scalariformes et limites internes à Knowth

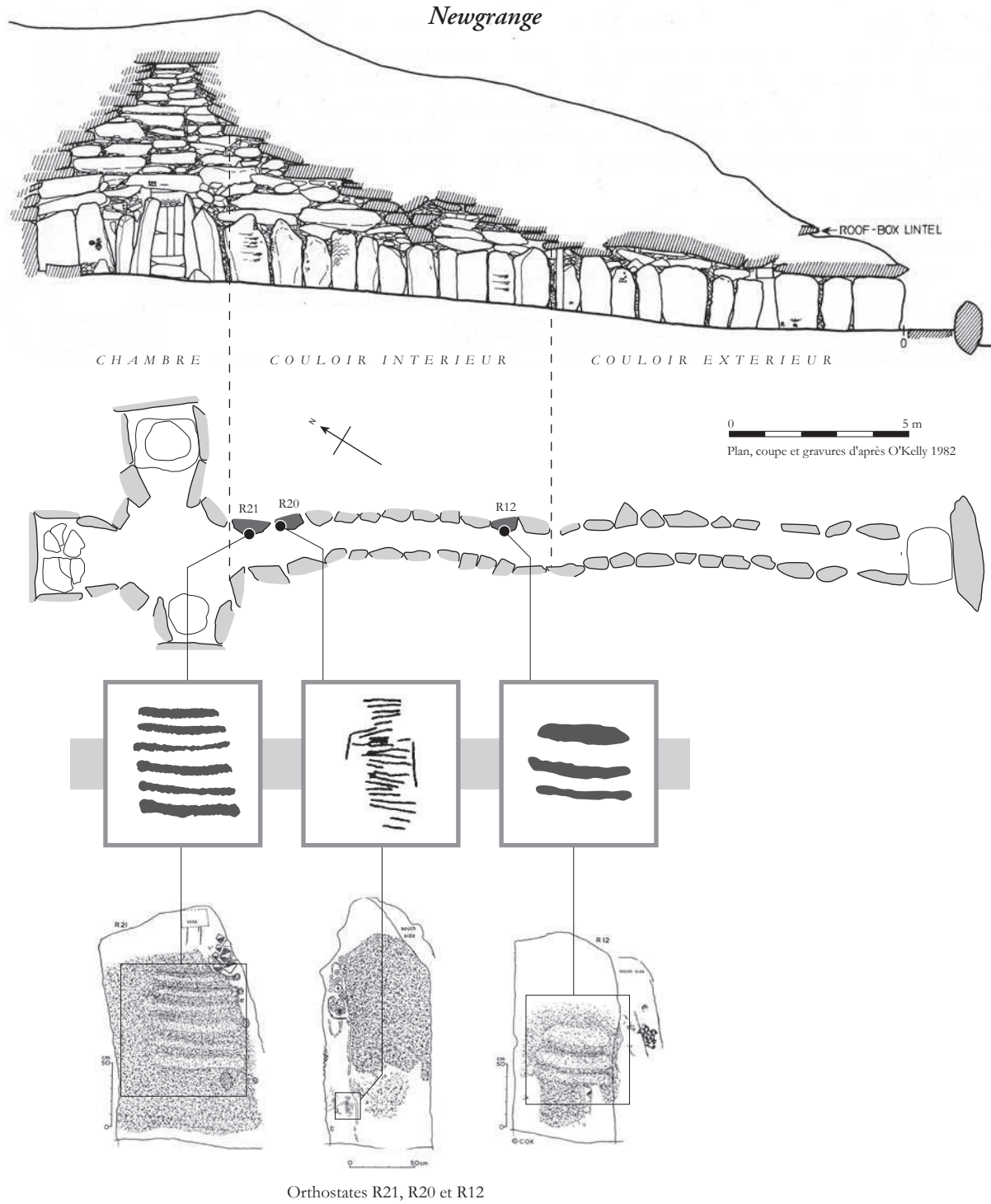

Figure 6.32 : Signes scalariformes et limites internes à Newgrange



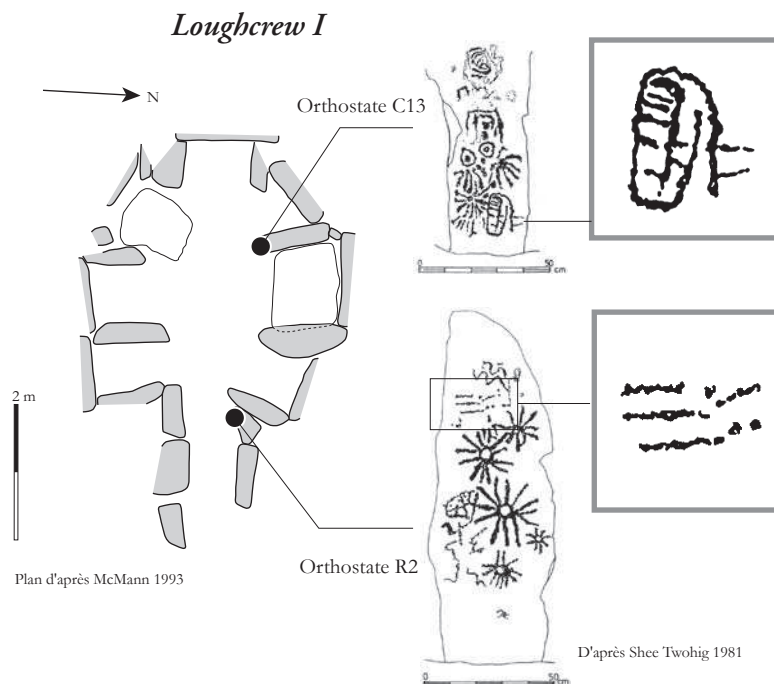
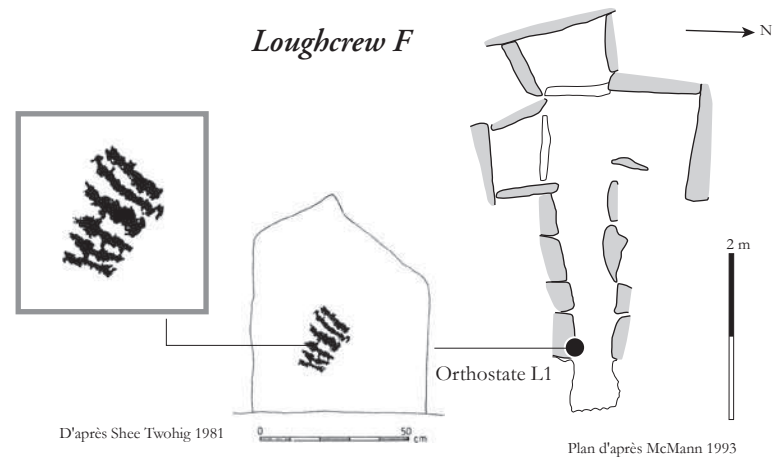

Figure 6.33 : Signes scalariformes et limites internes à Loughcrew F et I

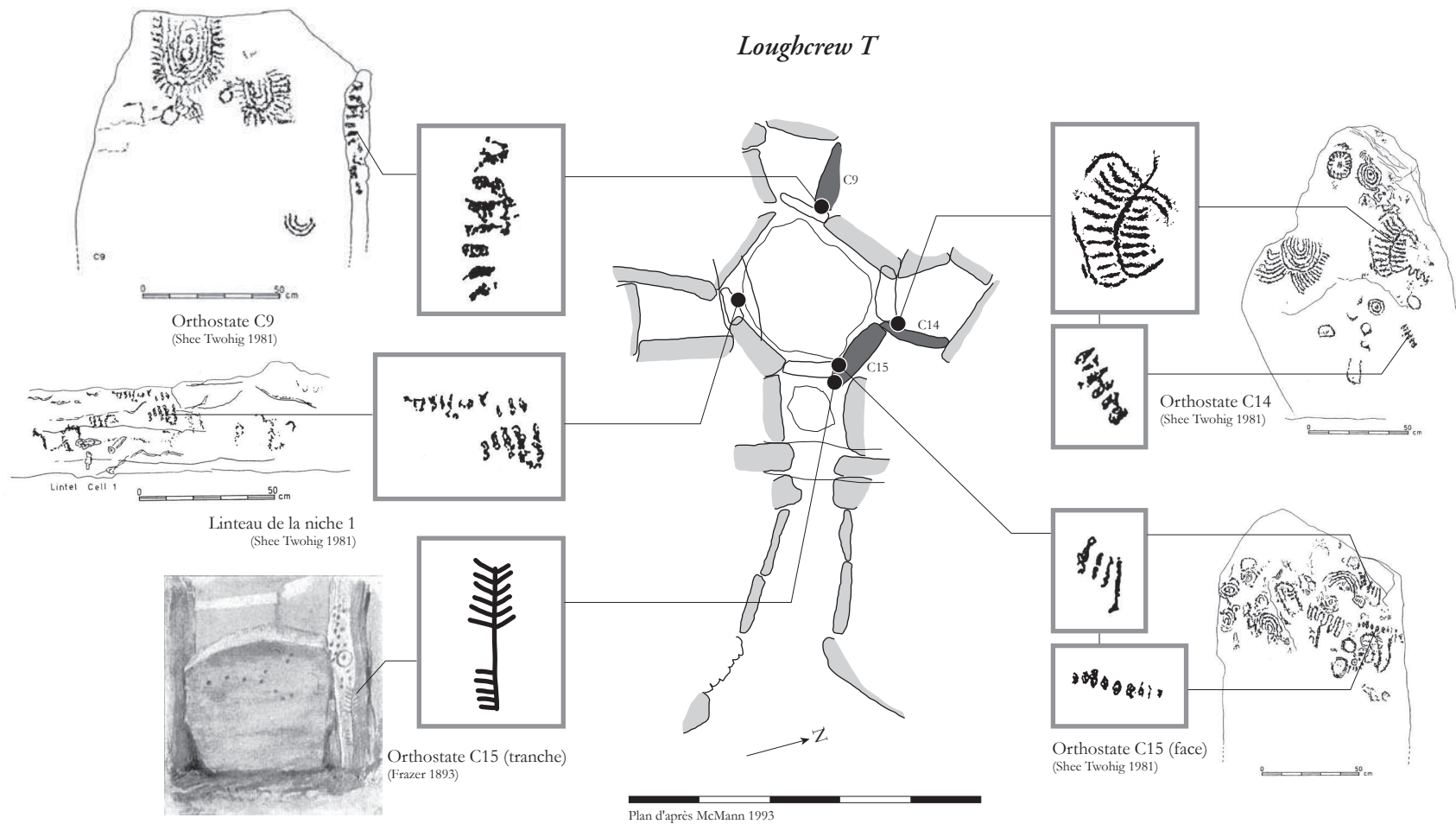

Figure 6.34 : Signes scalariformes et limites internes à Loughcrew T

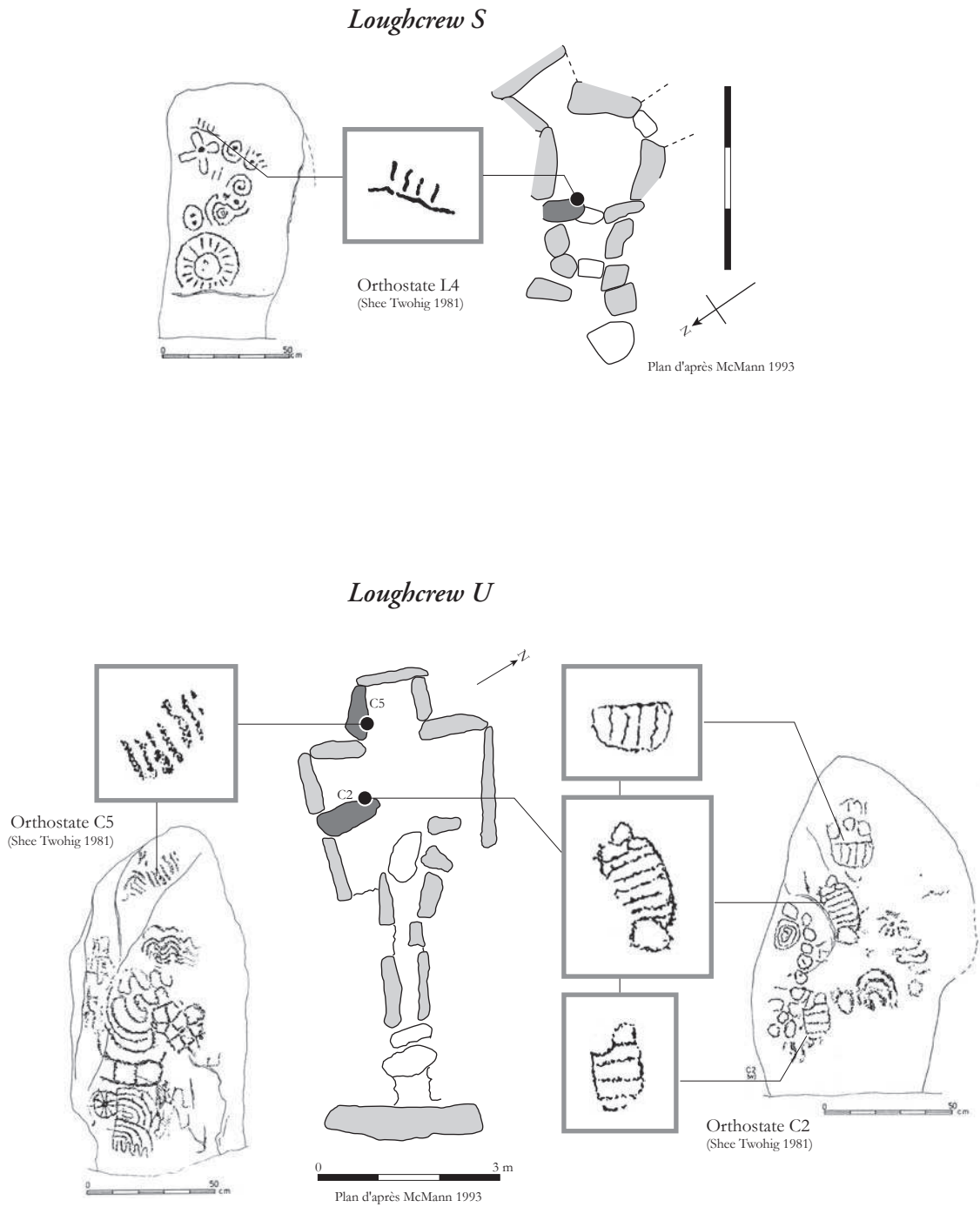

Figure 6.35 : Signes scalariformes et limites internes à Loughcrew S et U

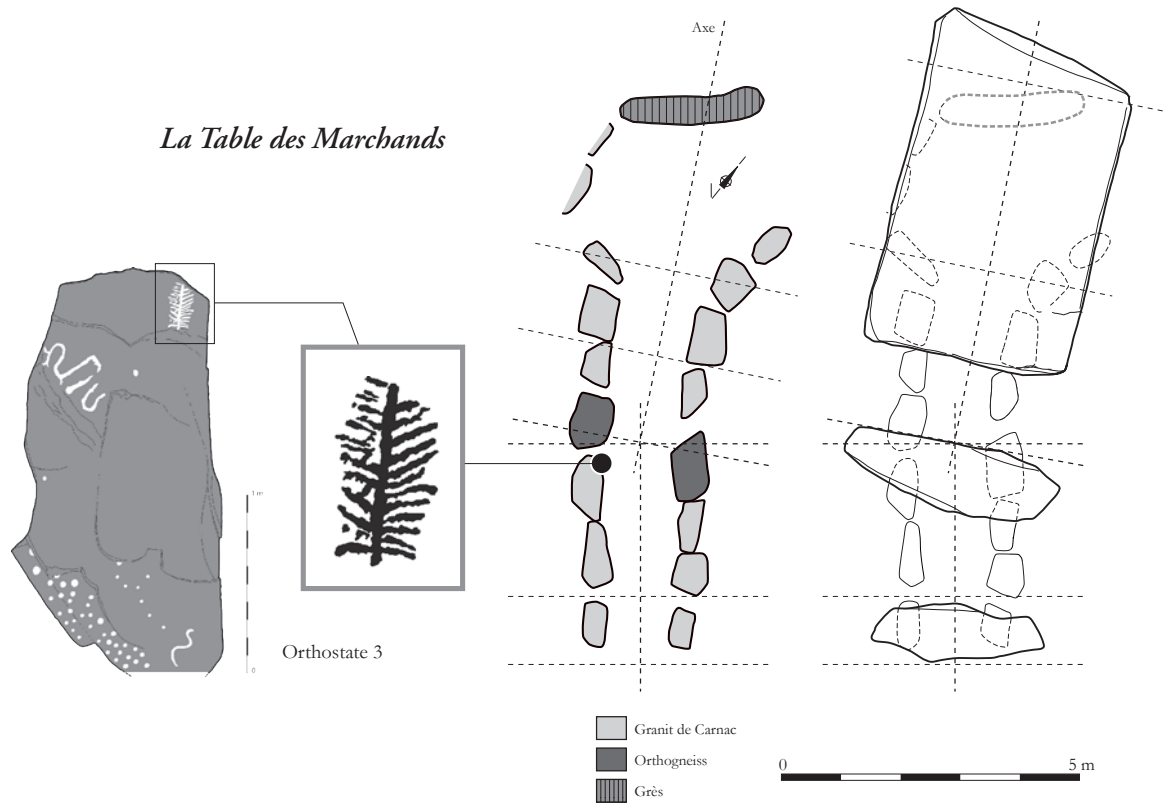

Figure 6.36 : Signe scalariforme et limite interne à la Table des Marchands

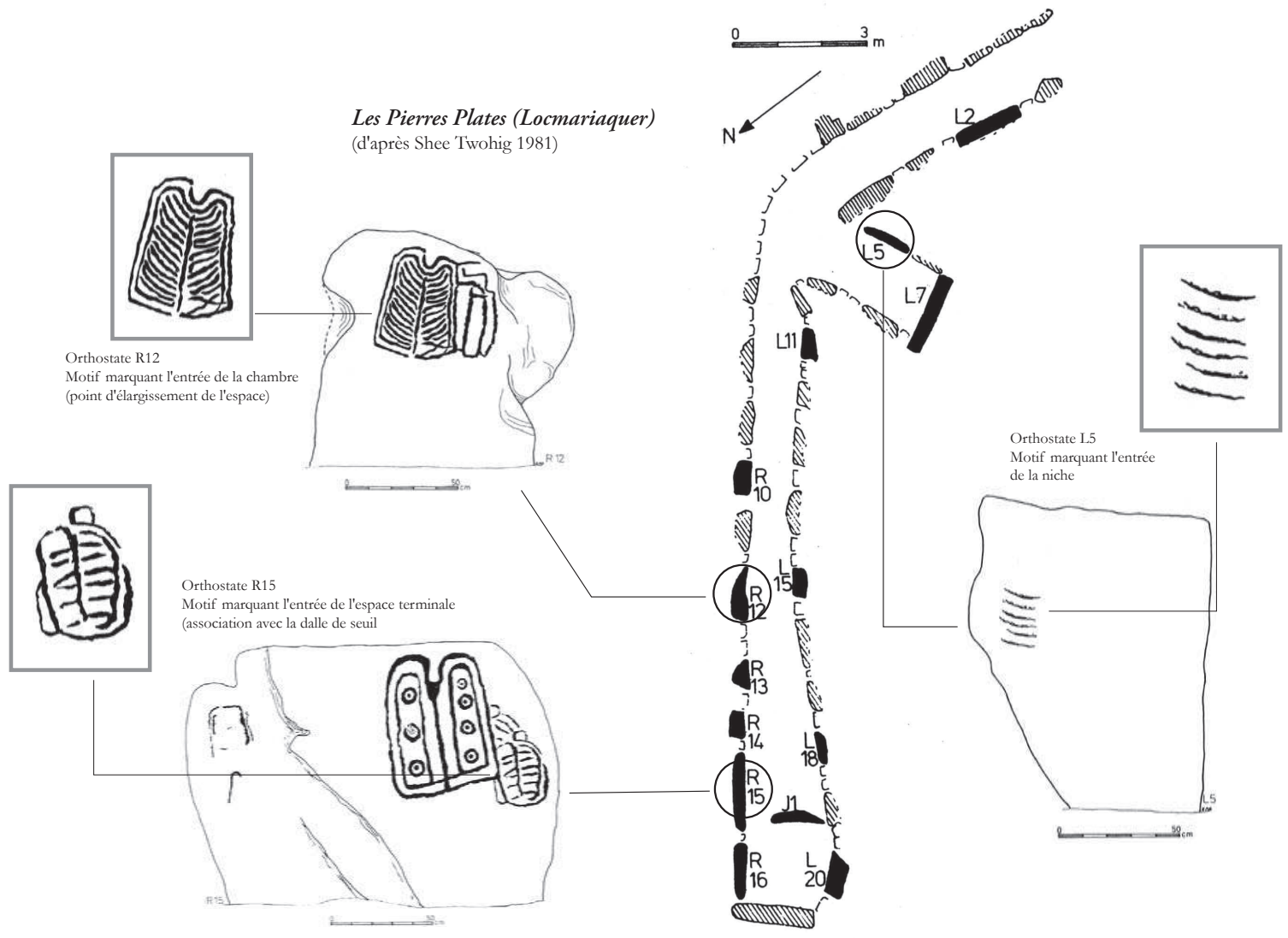

Figure 6.37 : Signes scalariformes et limites internes aux Pierres Plates



































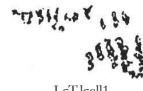





Limites architecturales				
	Extérieur/couloir	Couloir intérieur/ couloir extérieur	Couloir/chambre	Chambre/niches
 Type 1a	 KhE.Or1   LeER1	 NgR12	 KhW.Or39  LeT.C15   NgR21  NgR20   LeT.R5	 DhN.C7  DhN.C18  DhS.lr   DhS.C13  LeUC5  LeTC14   Kh4.A  LeTC9
 Type 1b				 LeUC2  LeUC2  LeUC2
 Type 2a			 LeI.R2  Km.C12	 LeT.lecl1
 Type 2b		 DhN.R5		
 Type 3a		 LeH.R2	 KhW.Or38  LeT.C15	 LeI.C13
 Type 3b			 DhN.C19	 DhN.C2  LeT.C14
 Type 4		 DhN.L5  KhW.Or51	 LeS.L4	

Figure 6.38 : Synthèse des rapports entre signes scalariformes et limites internes

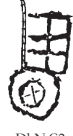
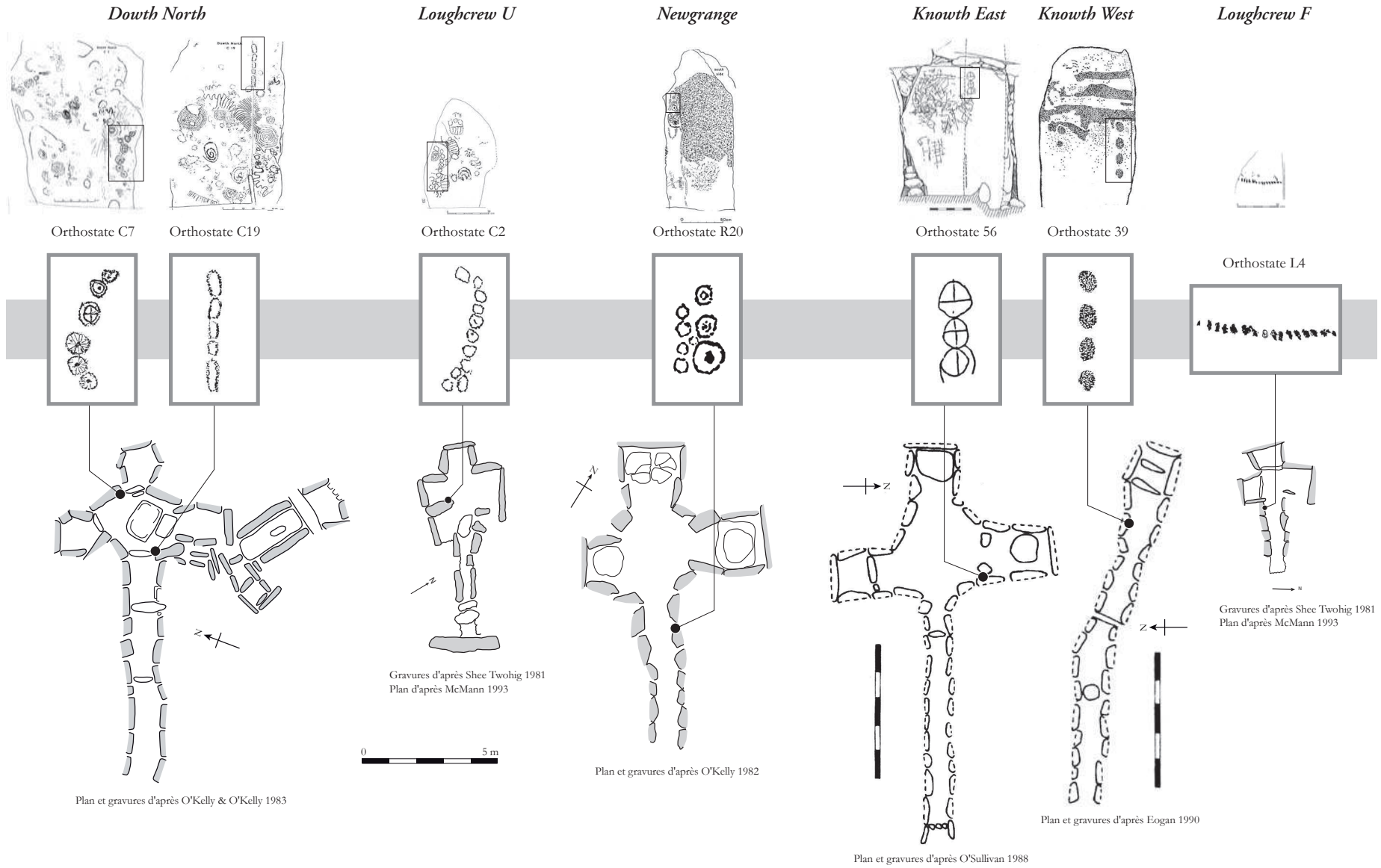

Figure 6.39 : Lignes de signes circulaires et limites internes

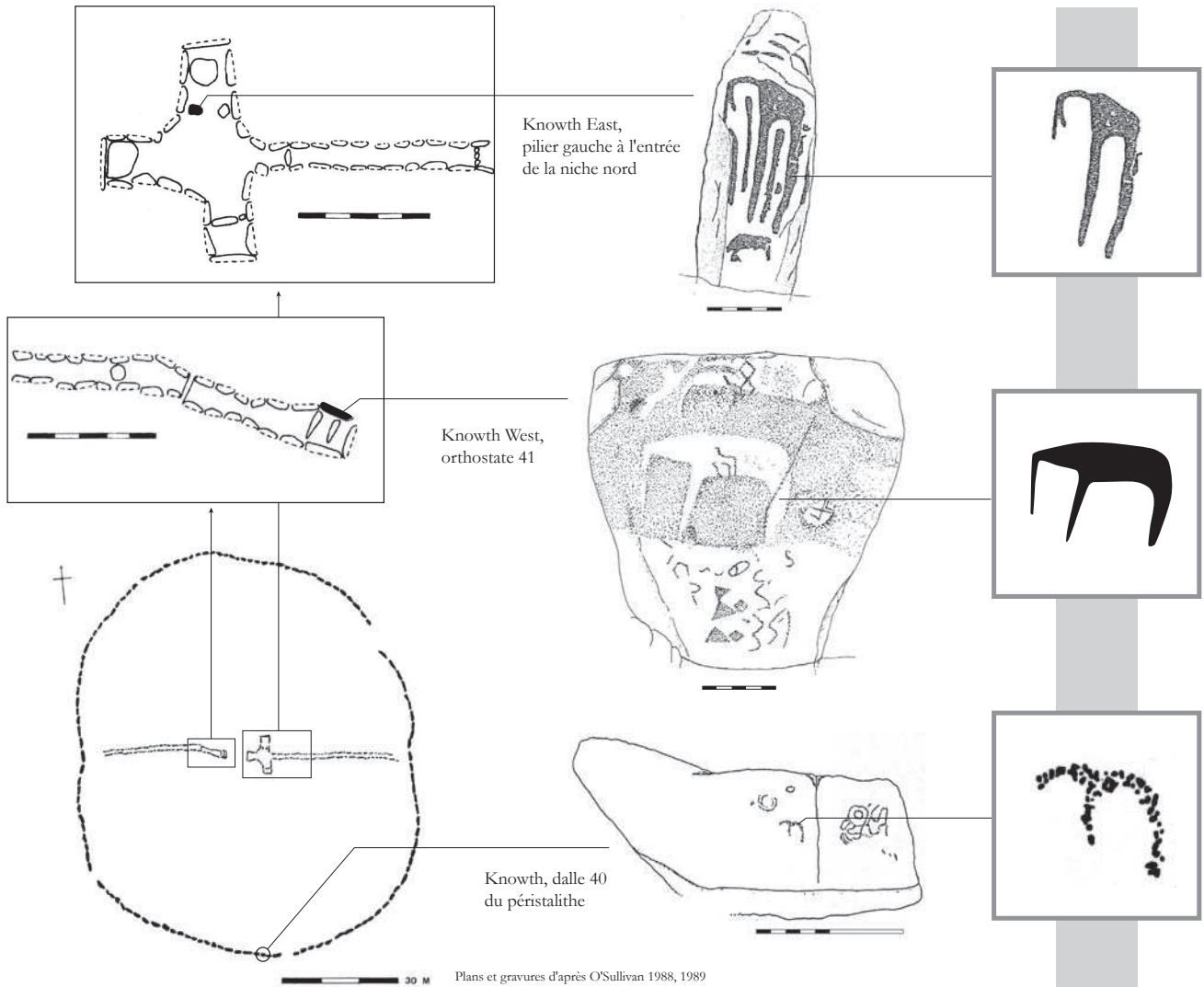

Figure 6.40 : Le signe rare n°2 et les limites internes à Knowth



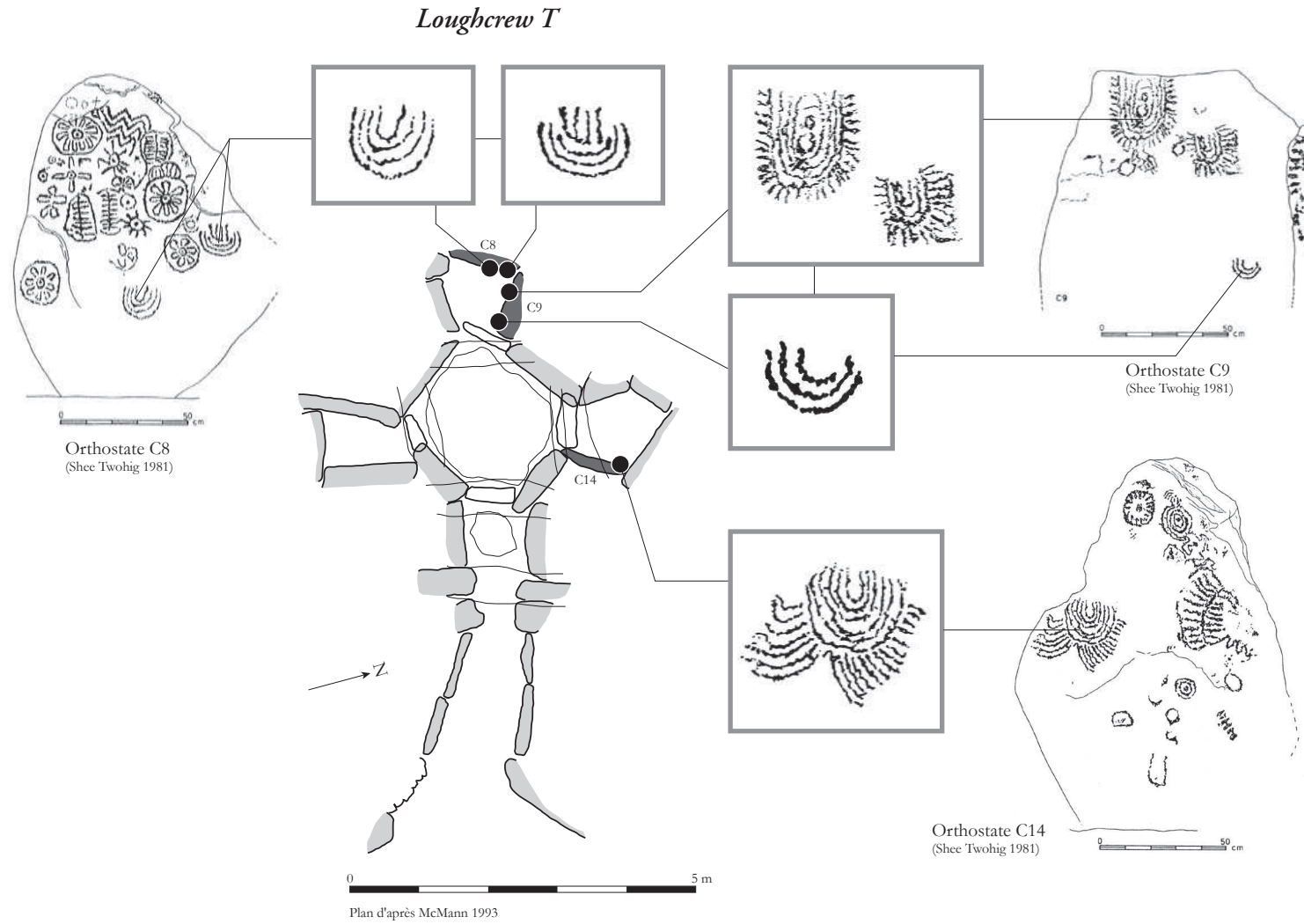

Figure 6.41 : Répartition des signes en arceaux inversés dans la tombe de Loughcrew T

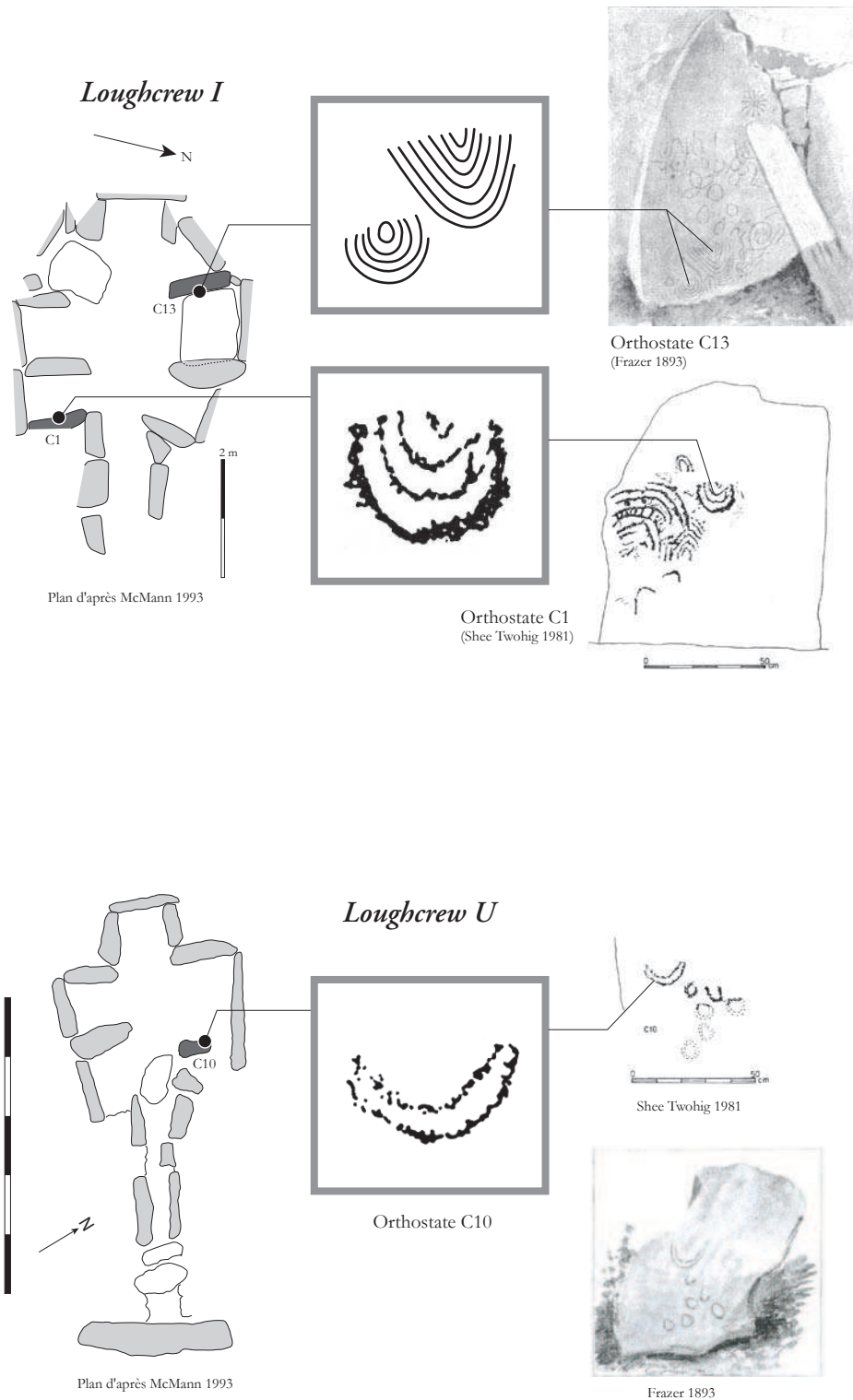

Figure 6.42 : Répartition des signes en arceaux inversés dans les tombes de Loughcrew I et U

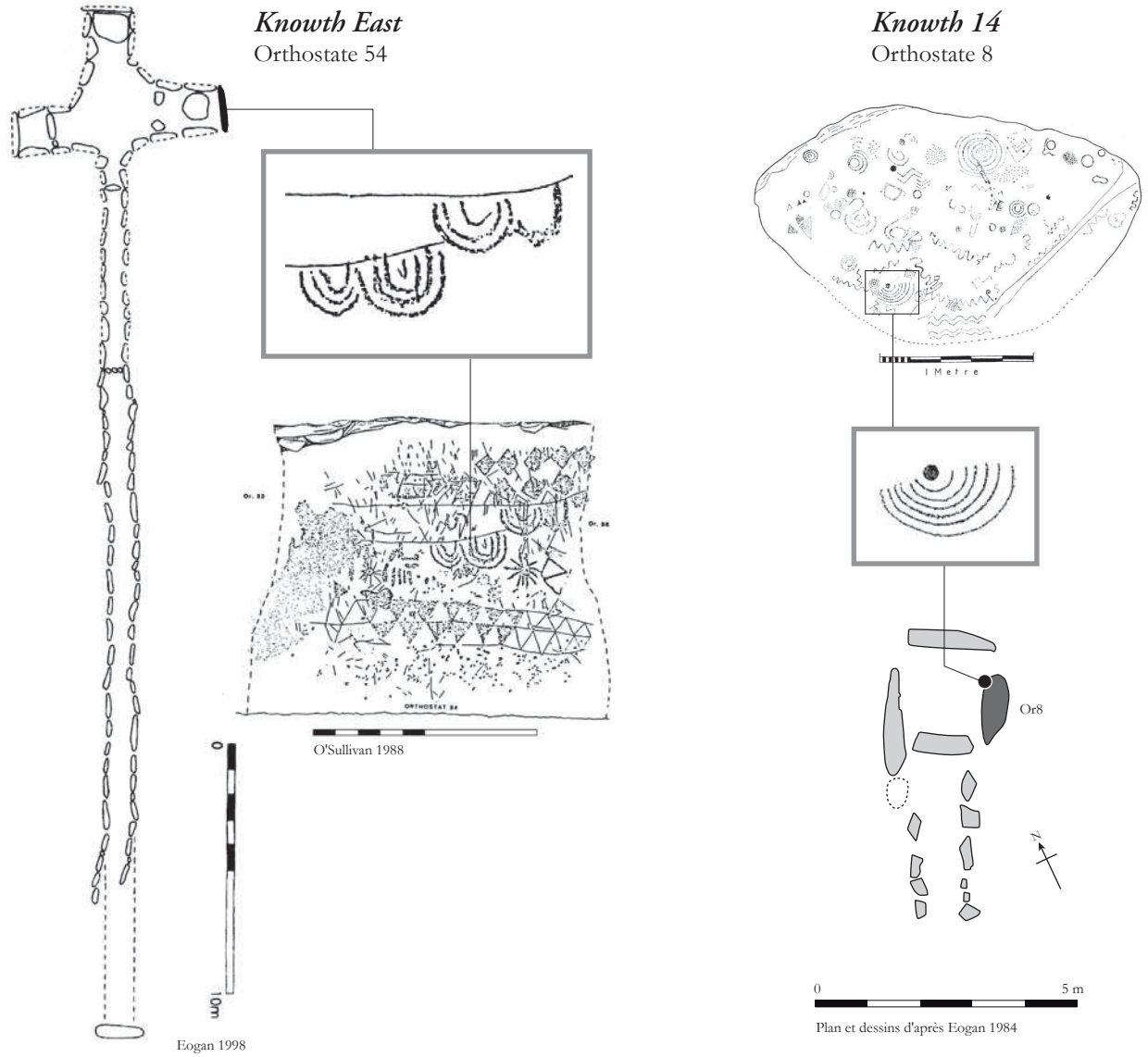

Figure 6.43 : Répartition des signes en arceaux inversés dans les tombes de Knowth East et Knowth 14

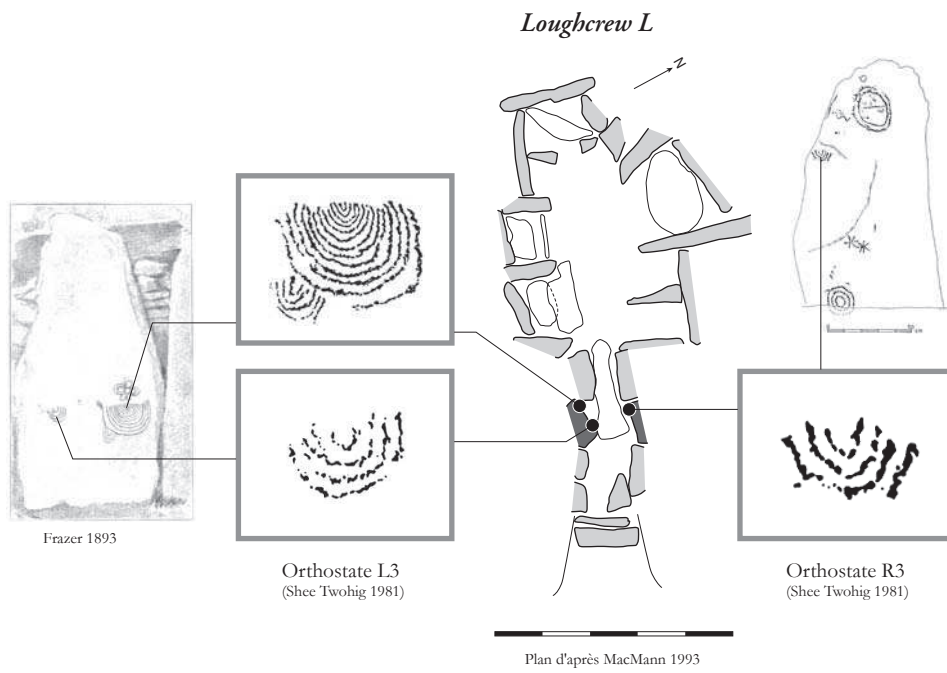

Figure 6.44 : Répartition des signes en arceaux inversés dans la tombe de Loughcrew L

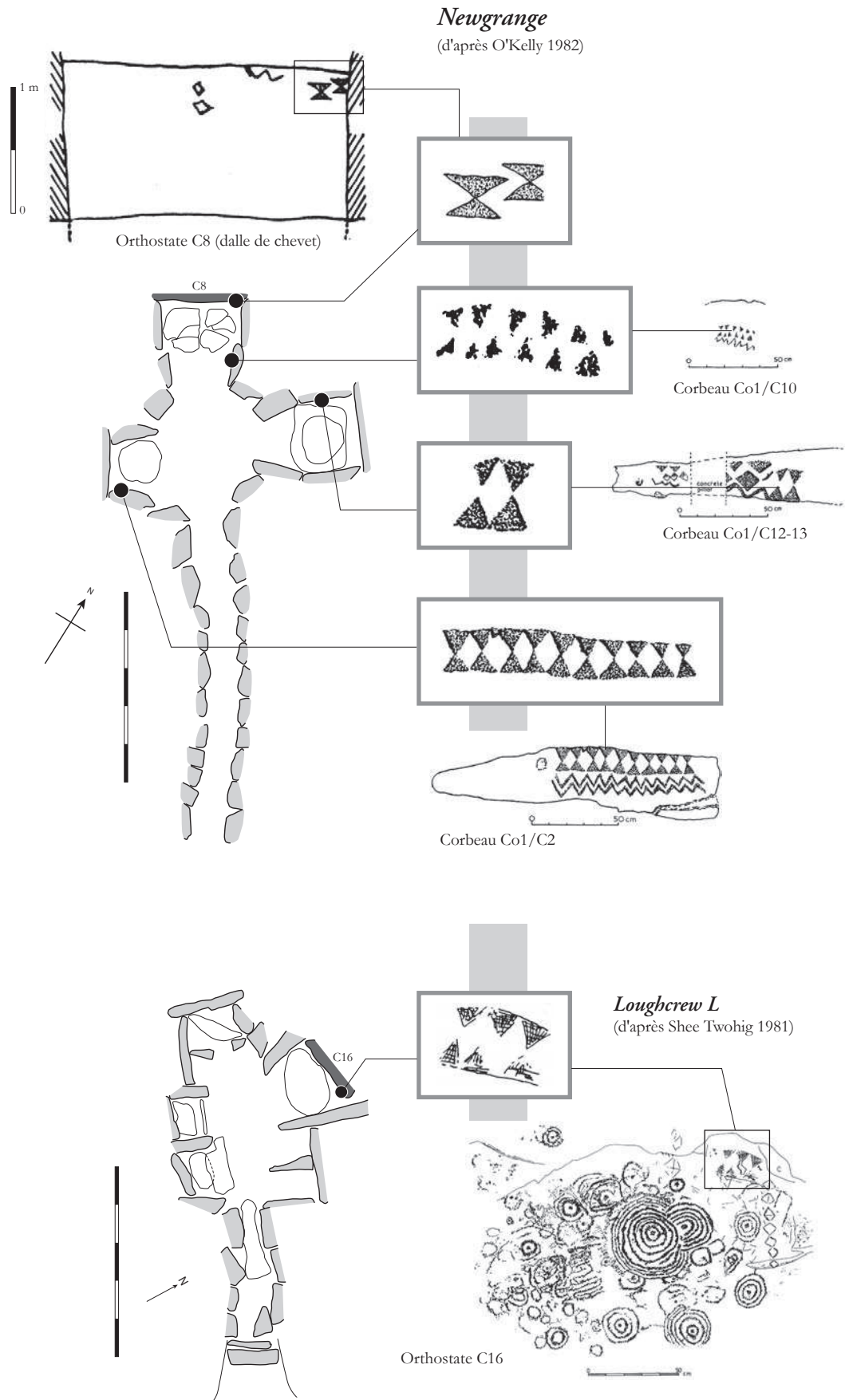

Figure 6.45 : Répartition des motifs en triangles opposés dans les tombes de Newgrange et Loughcrew L

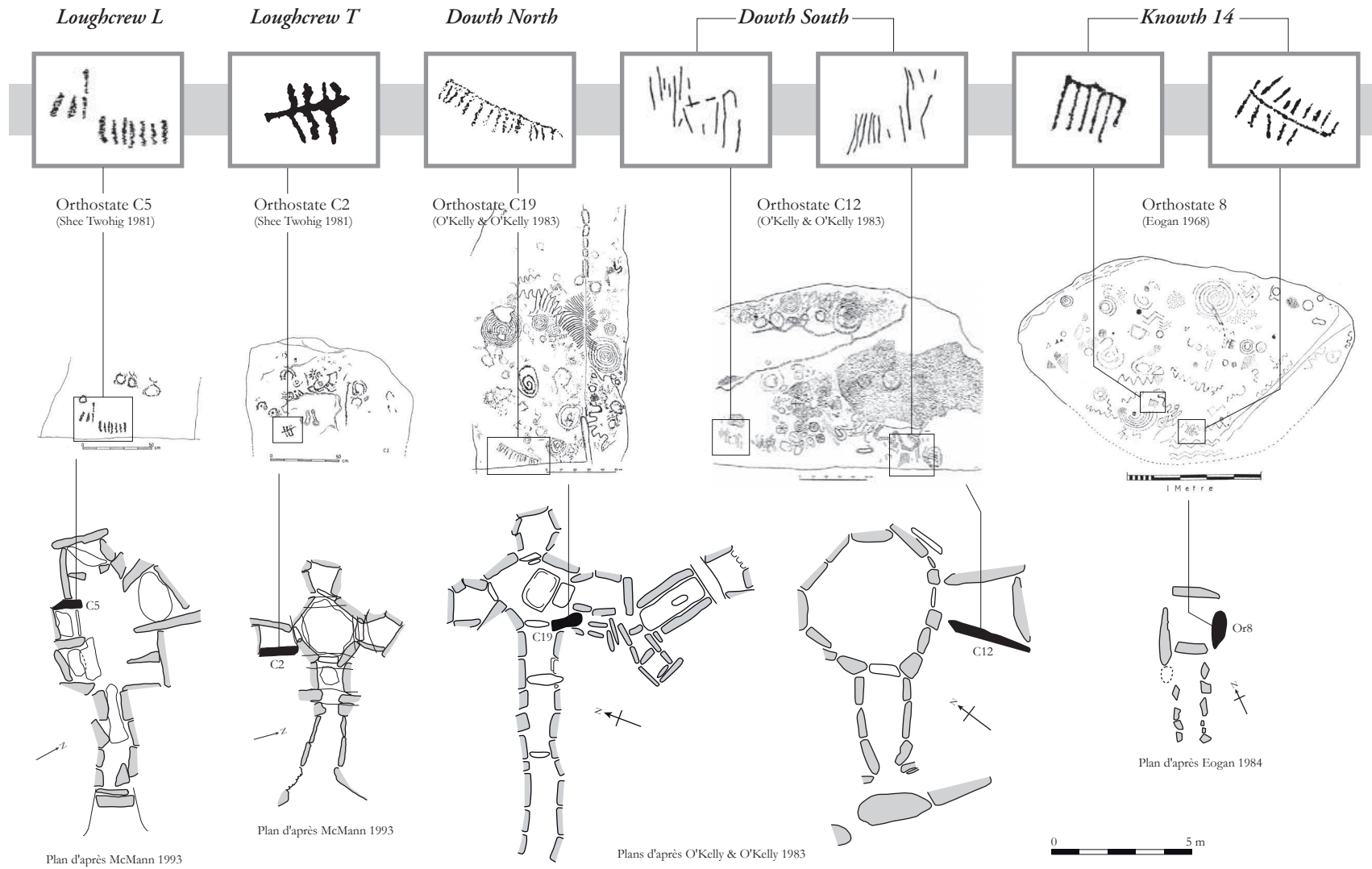

Figure 6.46 : Disposition des signes scalariformes dans les niches funéraires

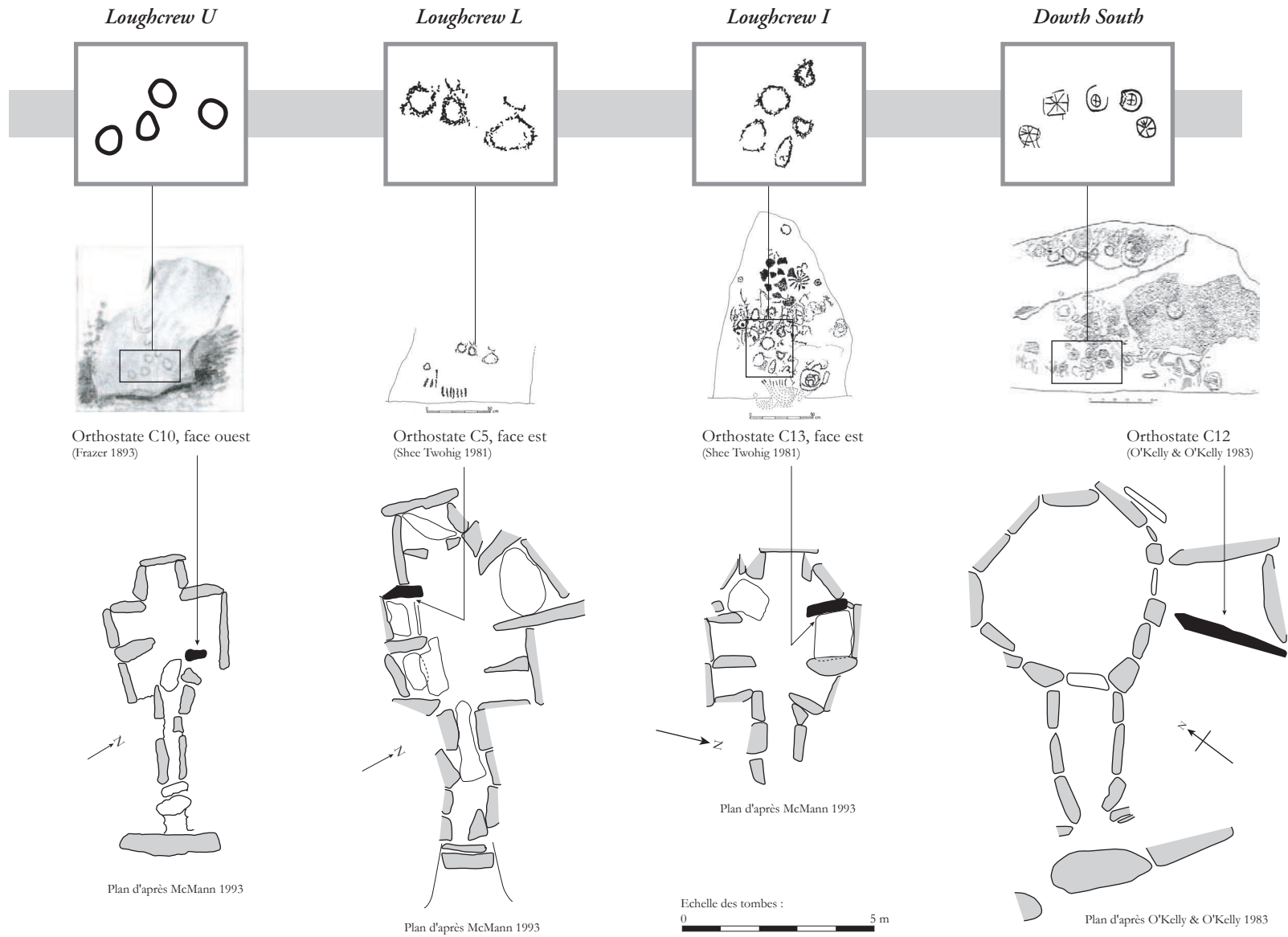

Figure 6.47 : Disposition des lignes de signes circulaires dans les niches funéraires

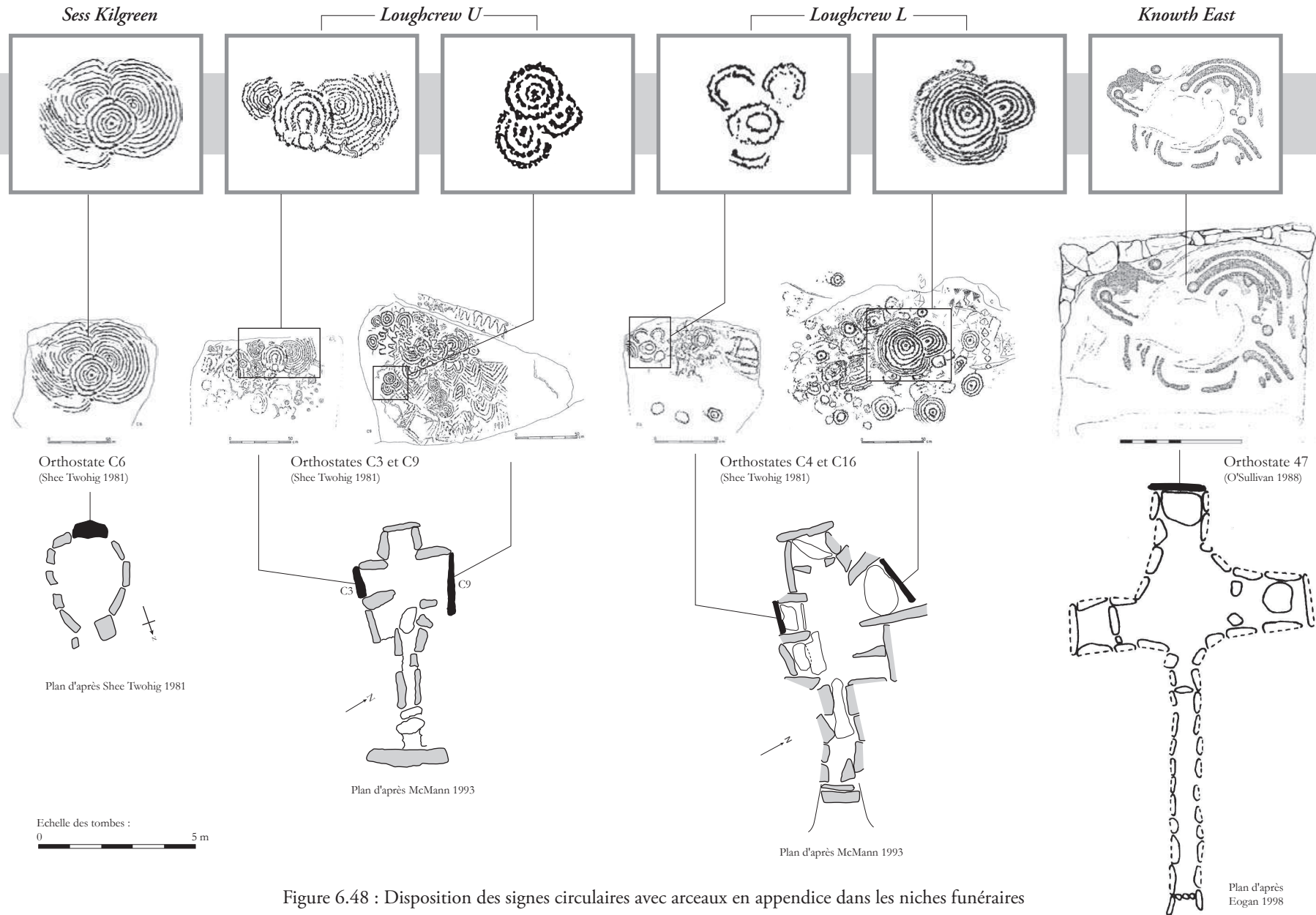

Figure 6.48 : Disposition des signes circulaires avec arceaux en appendice dans les niches funéraires



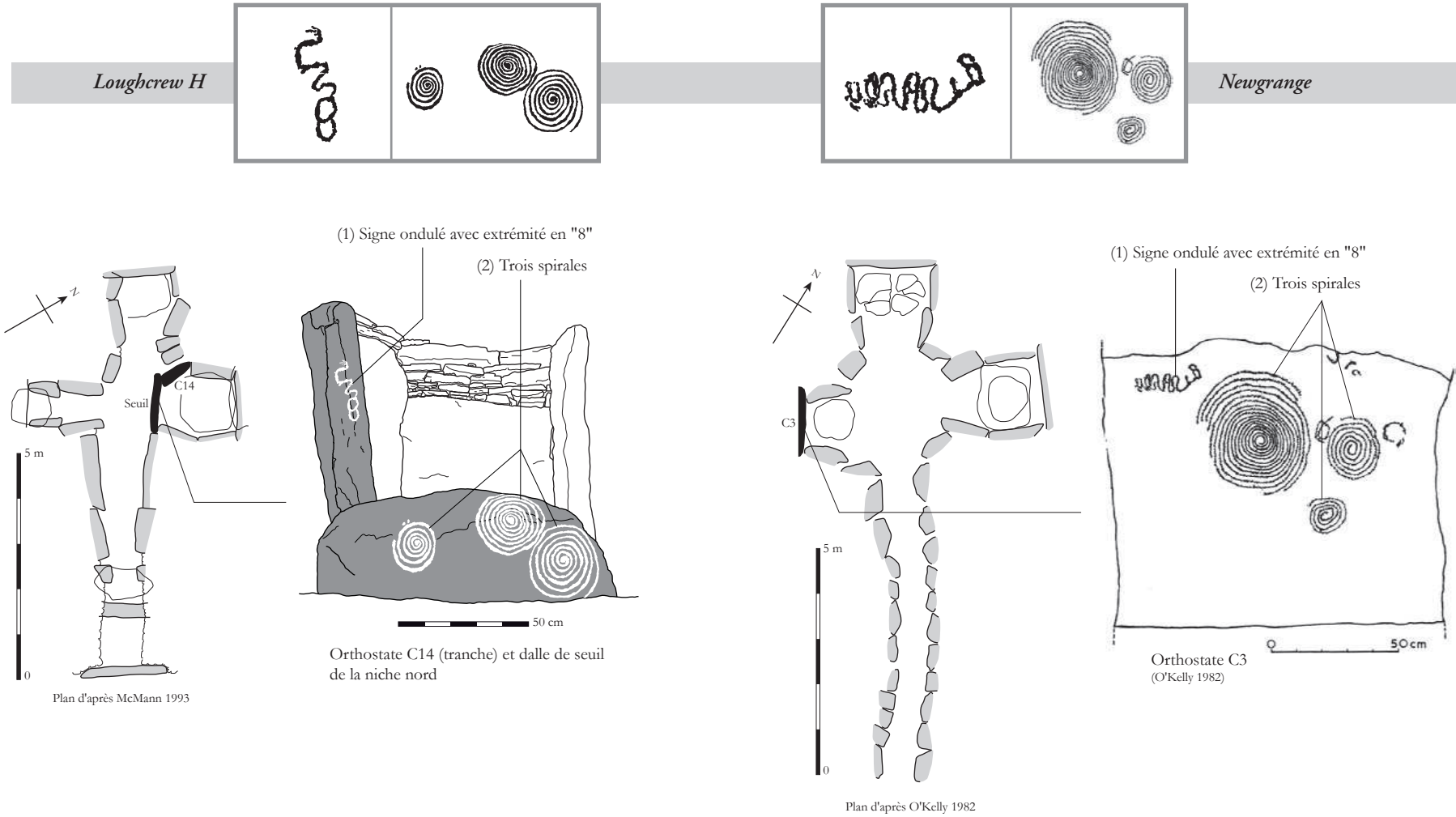

Figure 6.49 : Signe ondulé avec extrémité en « 8 » associé à trois spirales

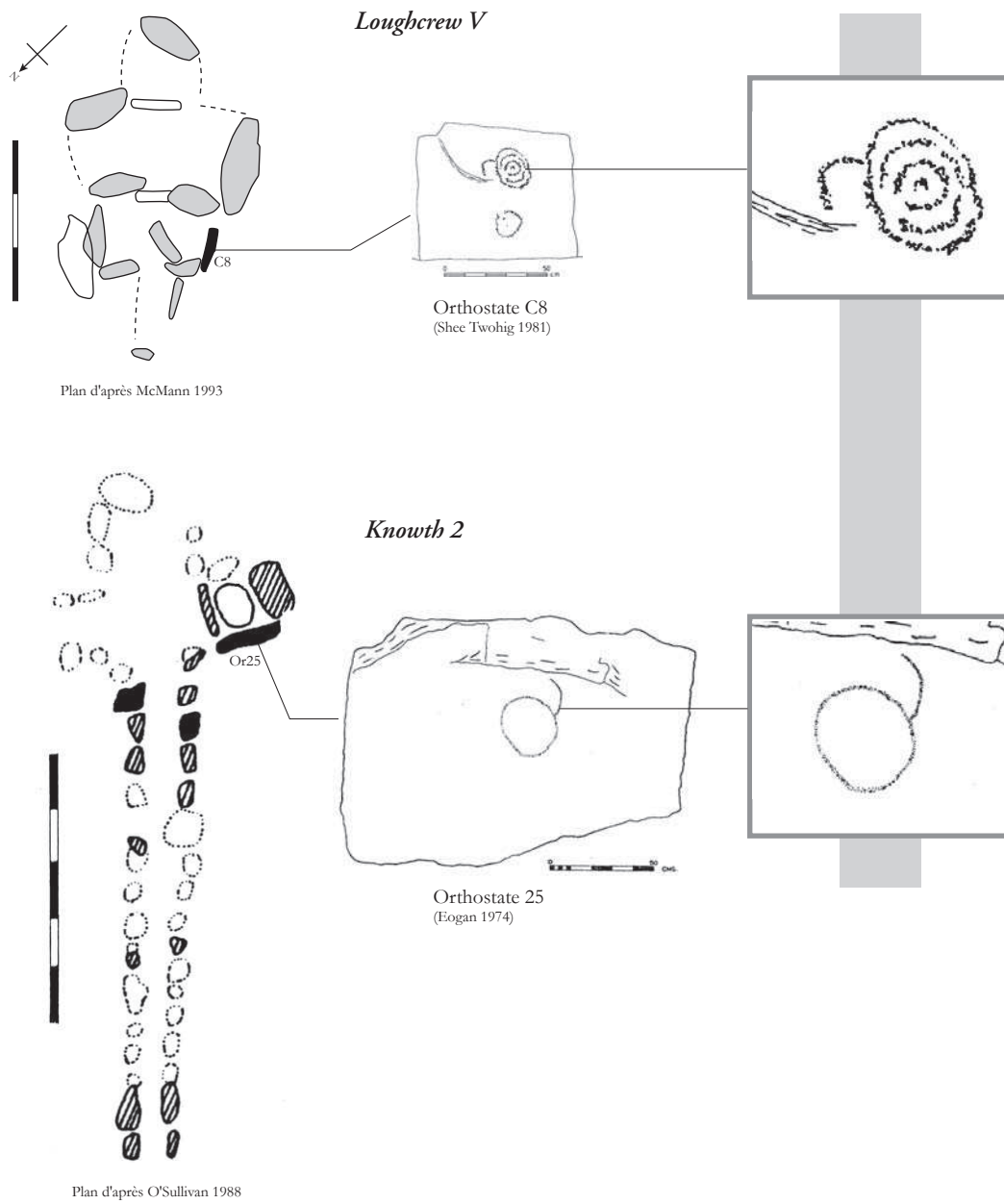

Figure 6.50 : Signe circulaire et ligne de relief reliés par une ligne courbe

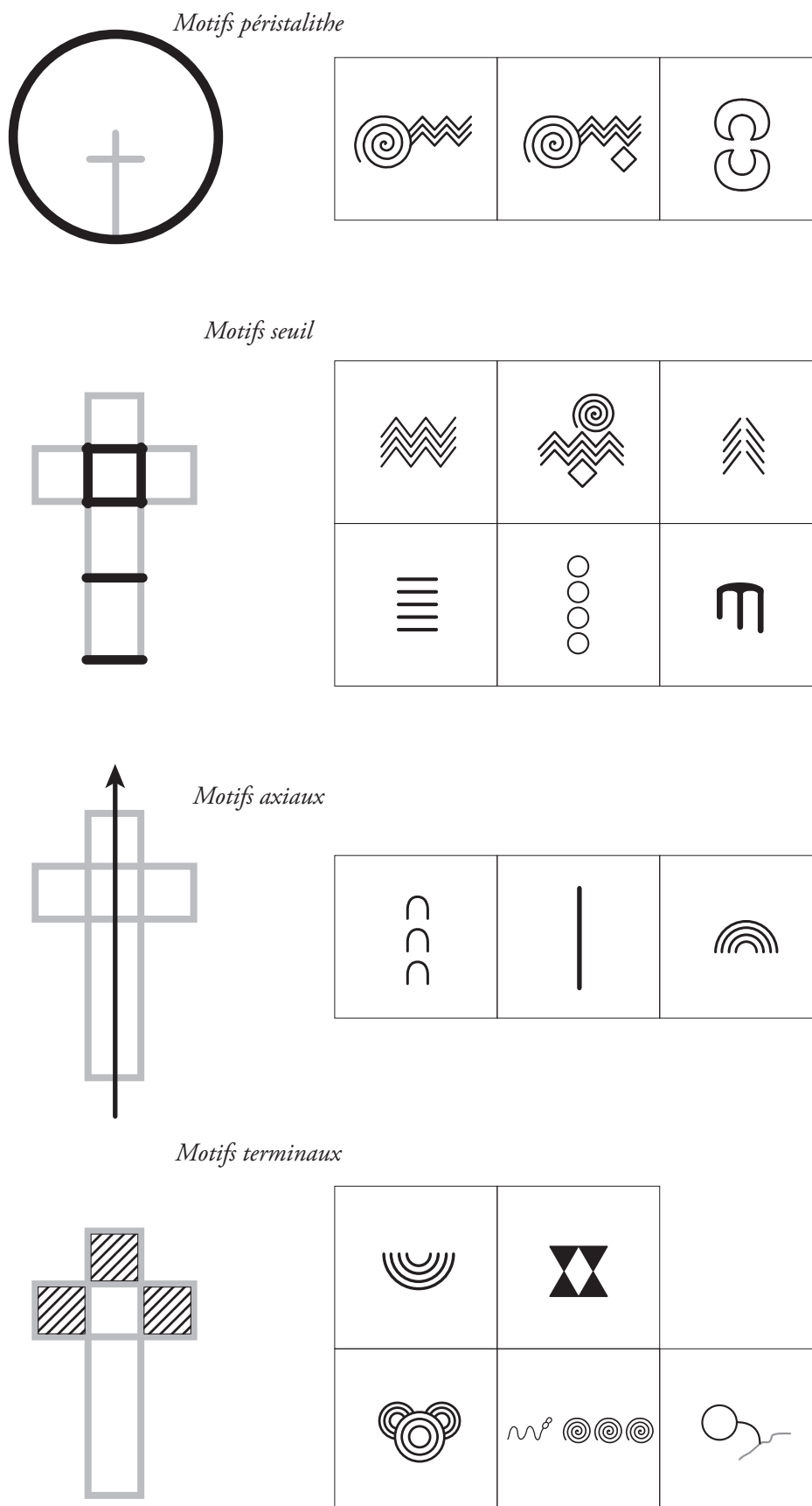

Figure 6.51 : Synthèse des principales relations entre iconographie et structure architecturale

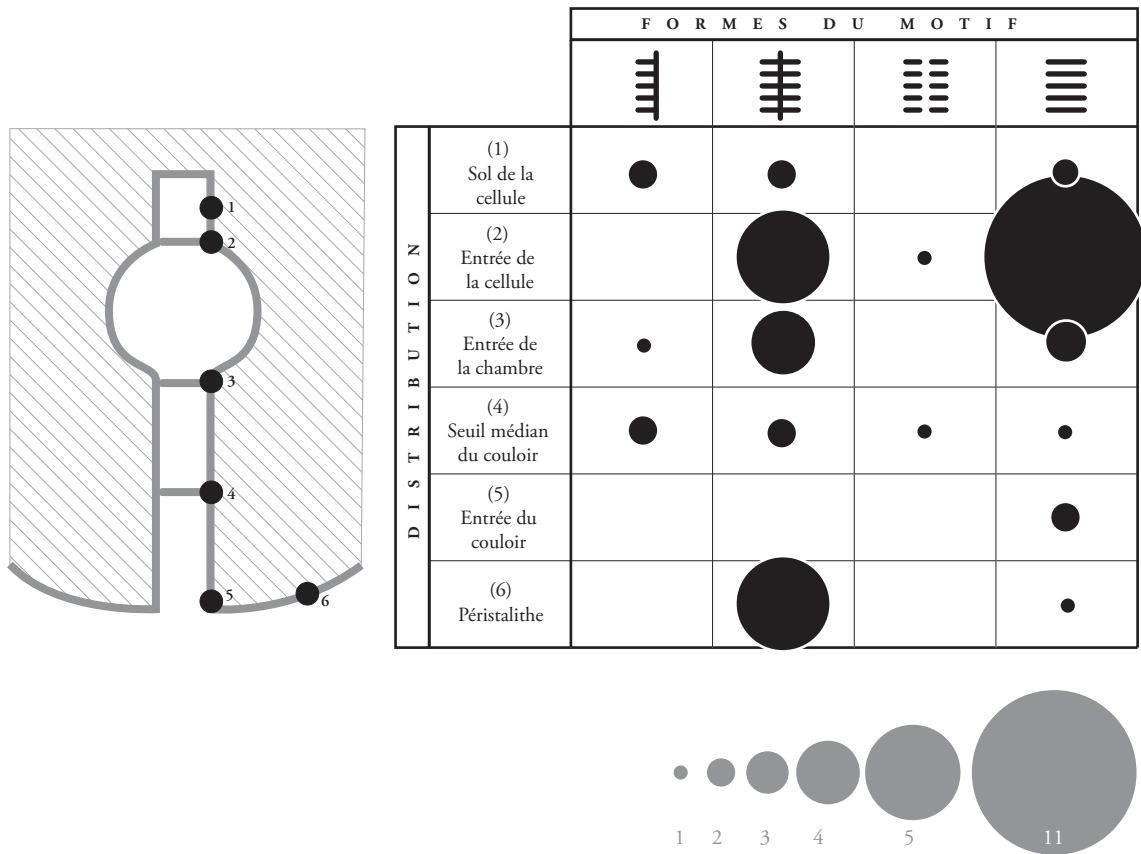
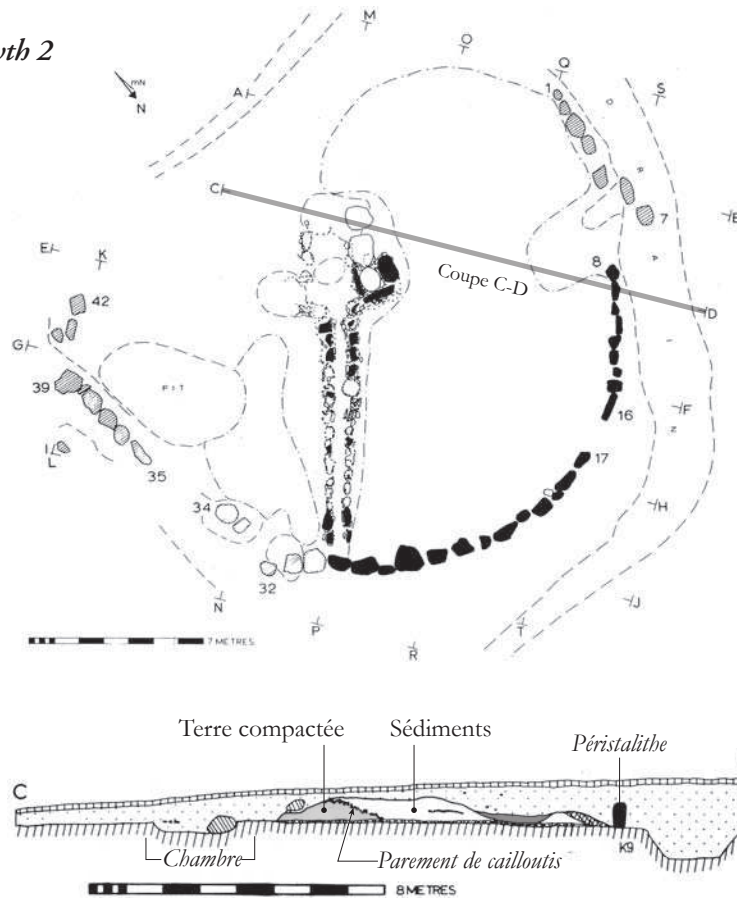
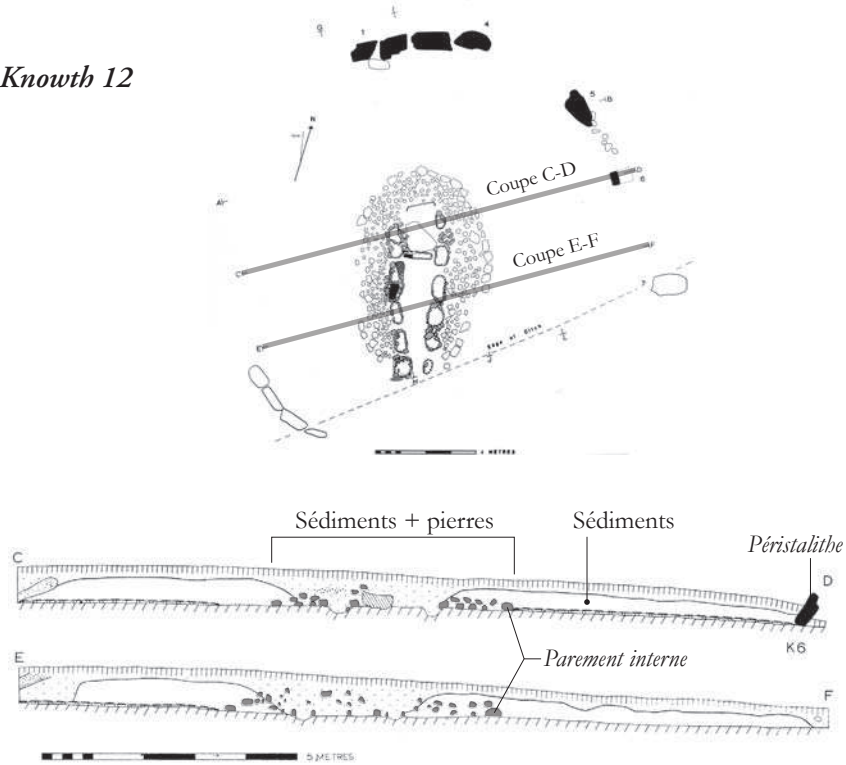

Figure 6.52 : Relations entre formes et emplacements du signe scalariforme

*Knowth 2*



*Knowth 12*



D'après Eogan 1984a

Figure 7.1 : Structures tumulaires de Knowth 2 et 12

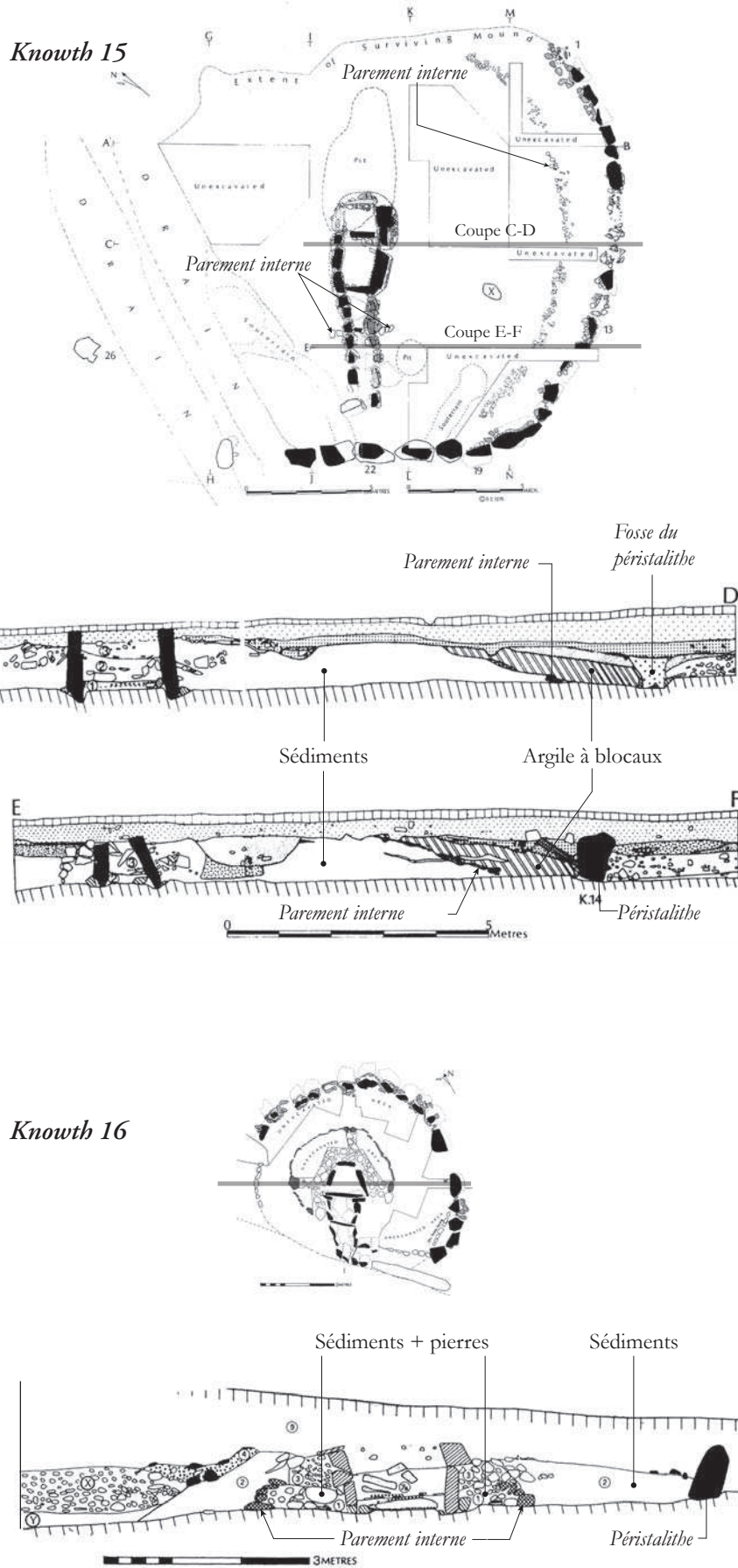

D'après Eogan 1984a

Figure 7.2 : Structures tumulaires de Knowth 15 et 16

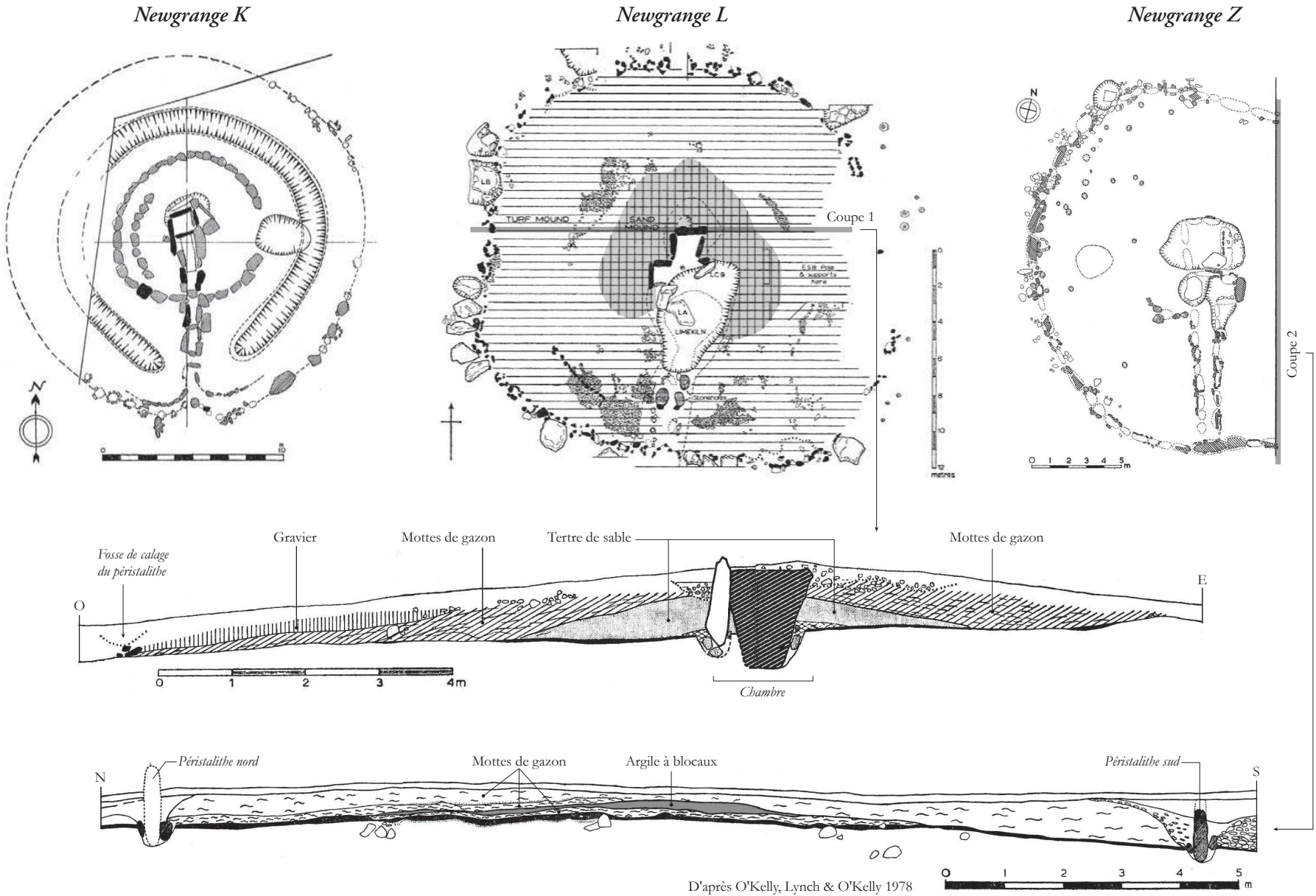
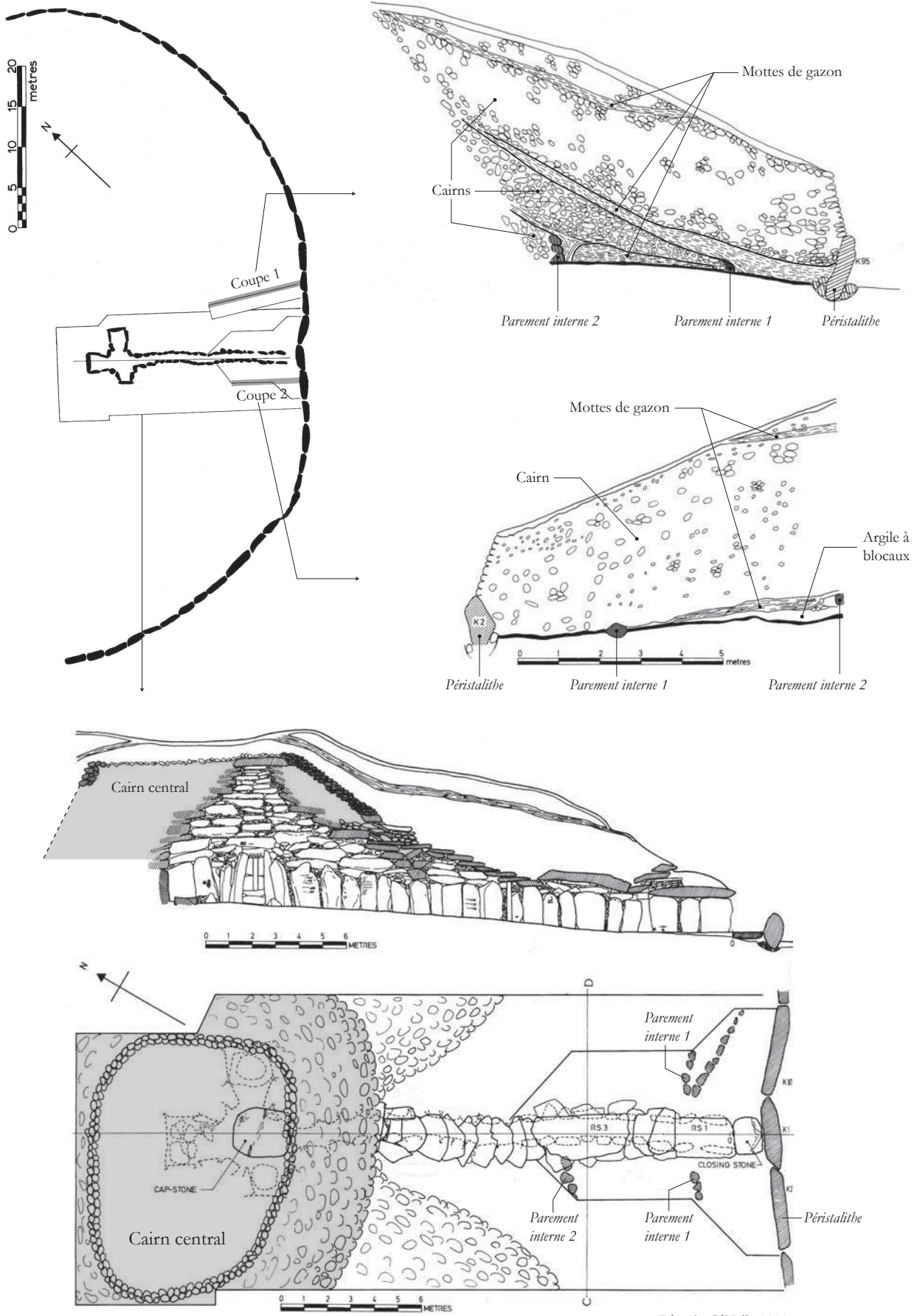

Figure 7.3 : Structures tumulaires de Newgrange K, L et Z

Newgrange



D'après O'Kelly 1982

Figure 7.4 : Structure tumulaire de Newgrange



*Barclodiad y Gawres*  
(d'après Powell & Daniel 1956)

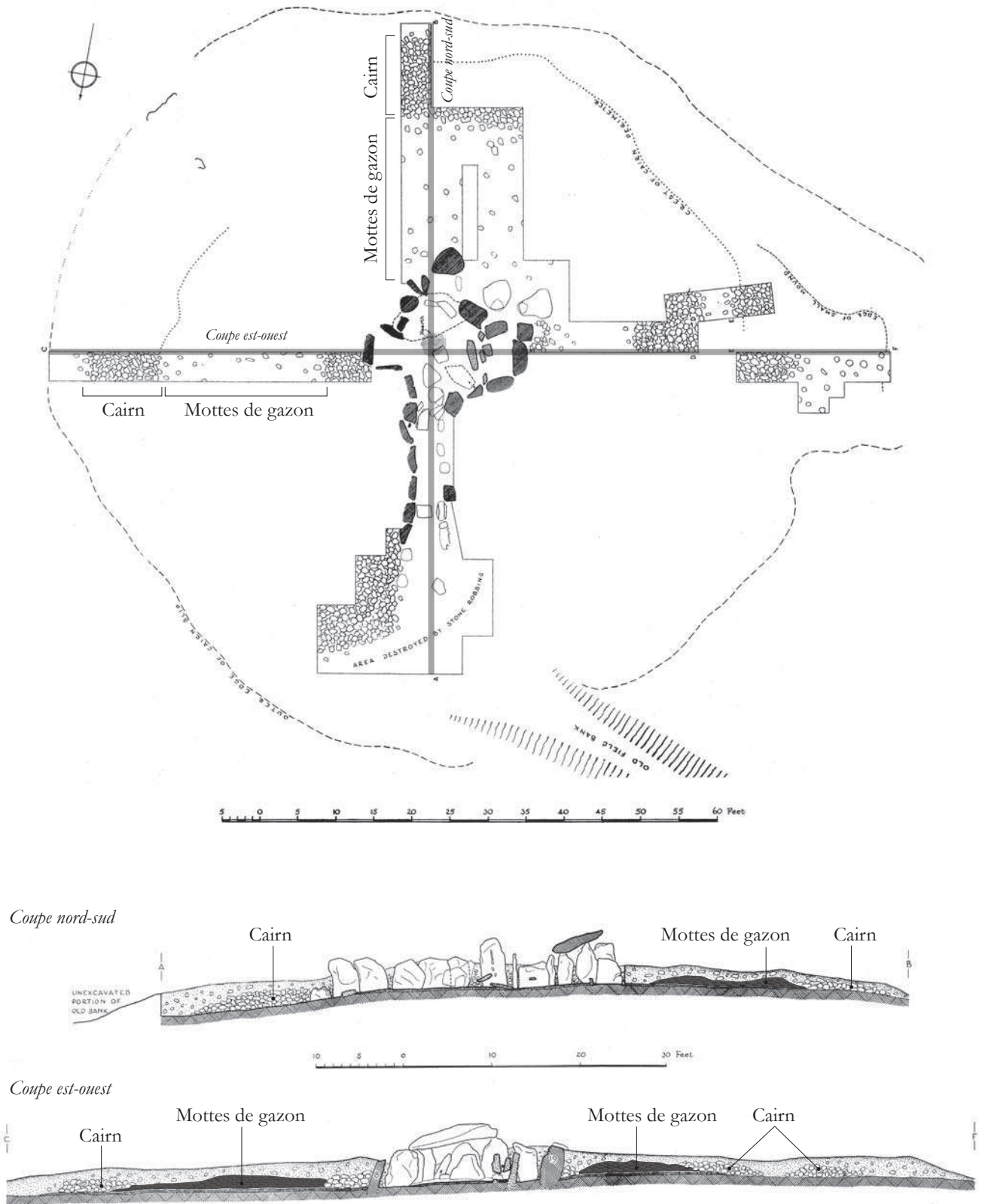
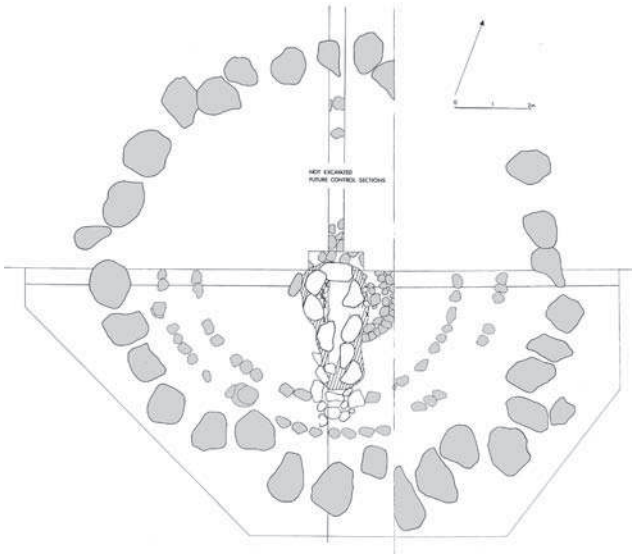
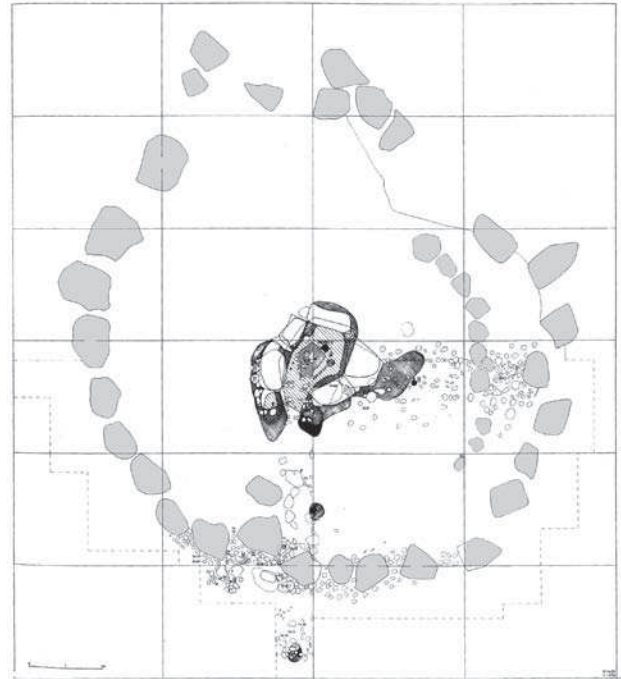

Figure 7.5 : Structure tumulaire de Barclodiad y Gawres

*Carrowmore 4*



*Carrowmore 7*



*Carrowmore 27*

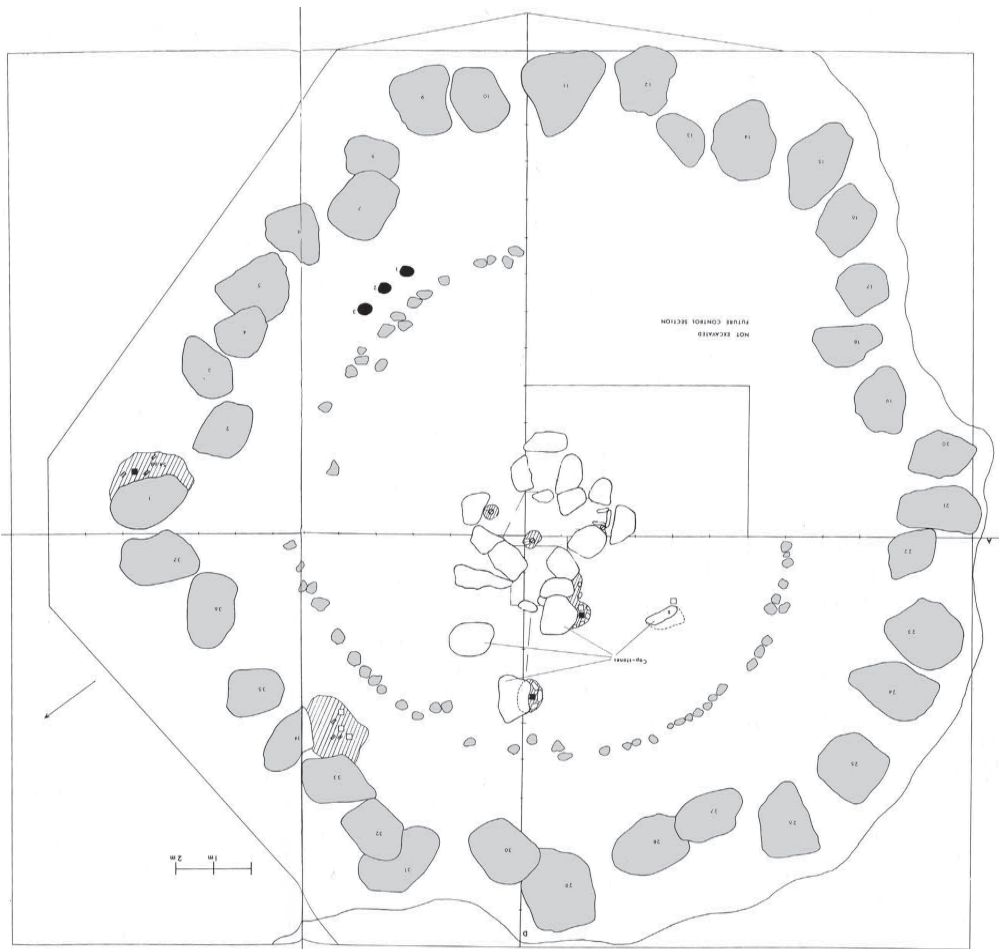

D'après Burenhult 1980

Figure 7.6 : Enceintes concentriques à Carrowmore 4, 7 et 27

*Townleyhall*

(d'après Eogan 1963)



*Ballycarty (phase 1)*

(d'après Connolly 1999)



*Knowth 16*

(d'après Eogan 1984)

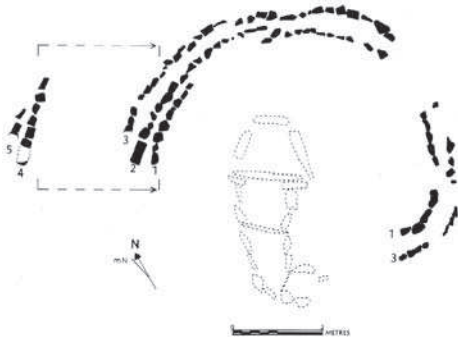

*Knowth 4*

(d'après Eogan 1984)

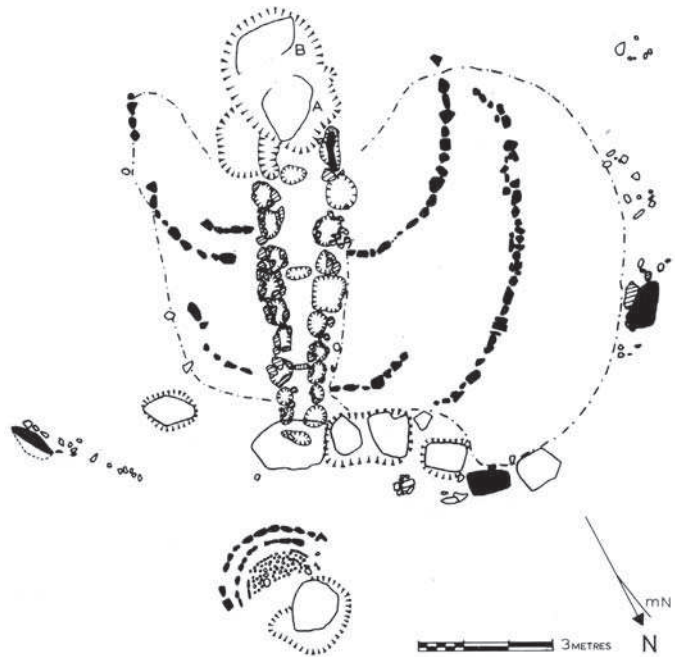
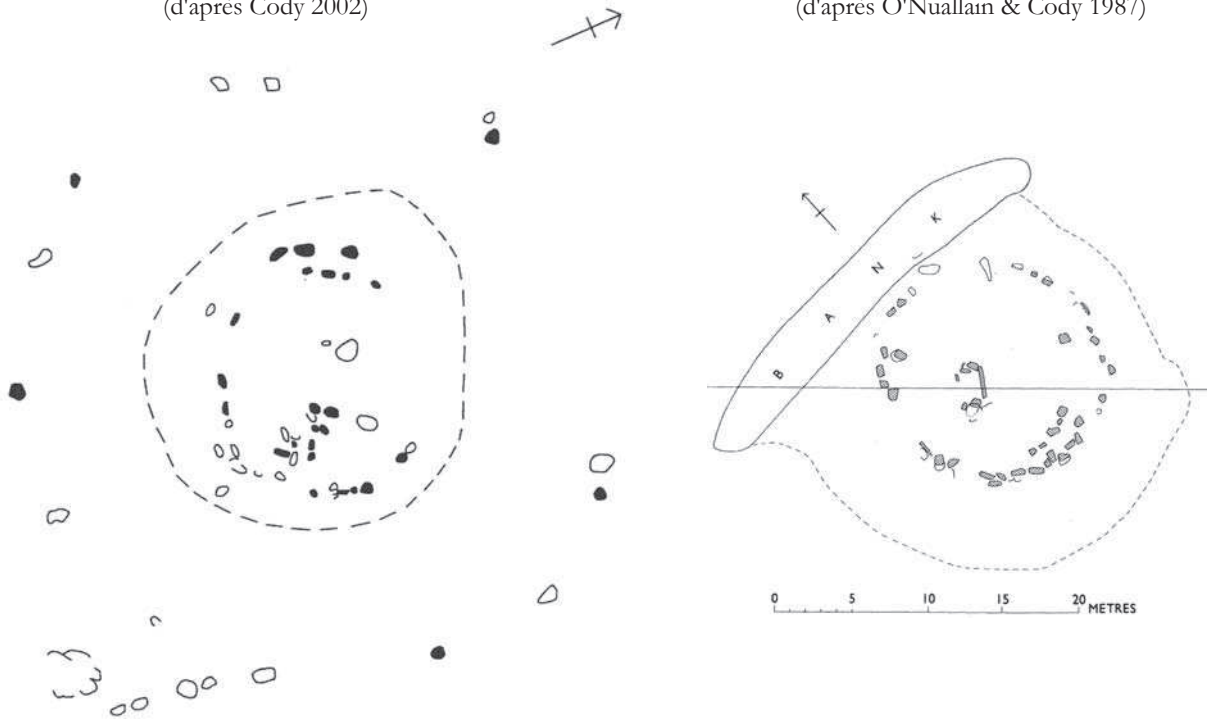

Figure 7.7 : Enceintes concentriques à Townleyhall, Ballycarty et Knowth 4

**Banagher (Co. Cavan)**  
(d'après Cody 2002)

**Baunfree (Co. Kilkenny)**  
(d'après O'Nuallain & Cody 1987)



**Bryn Celli Ddu (Anglesey)**  
(d'après Hemp 1930)

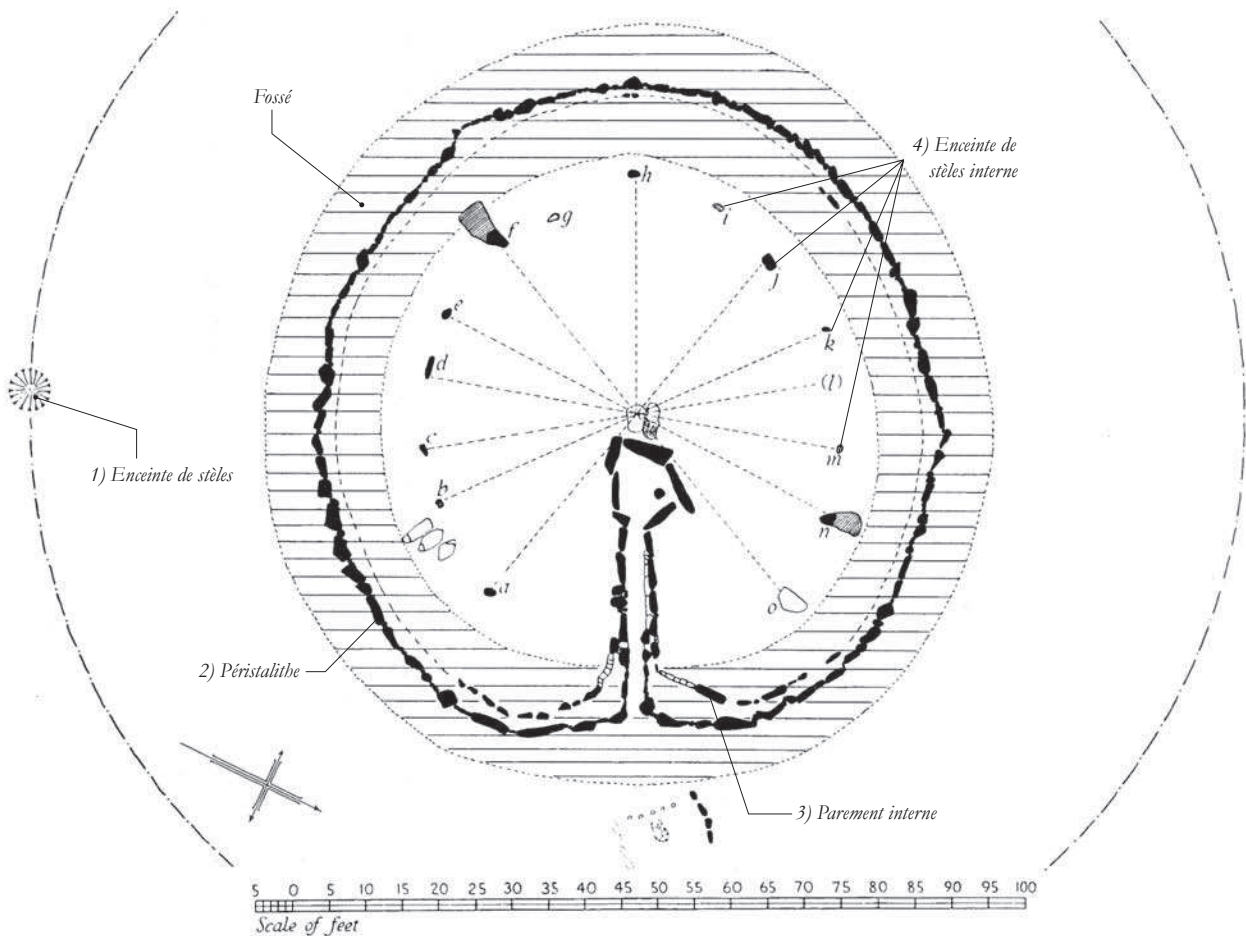
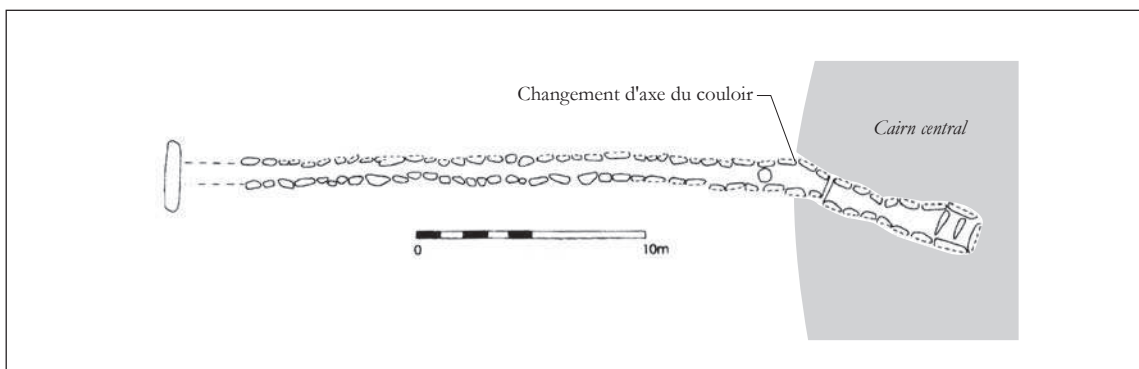
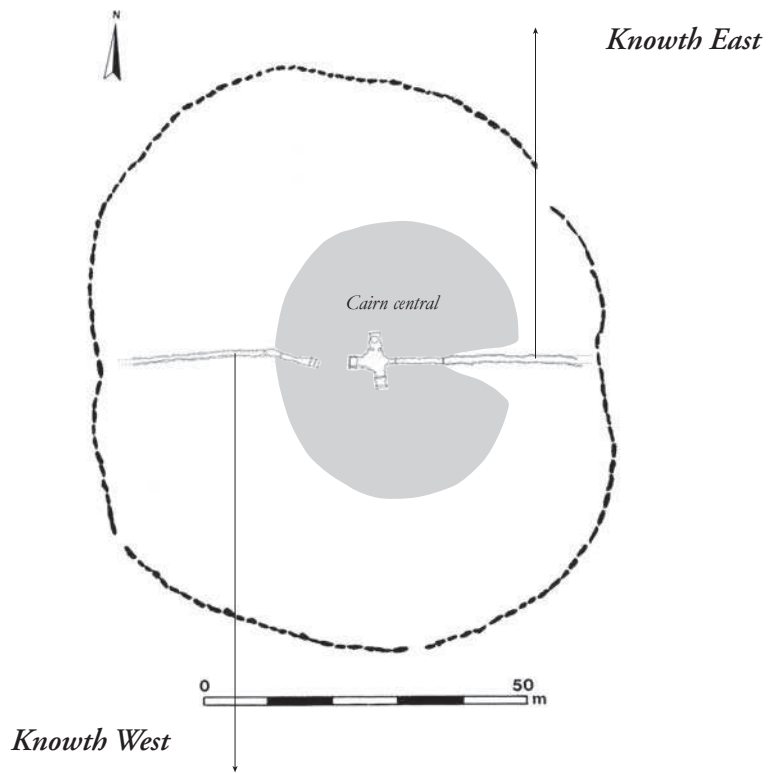
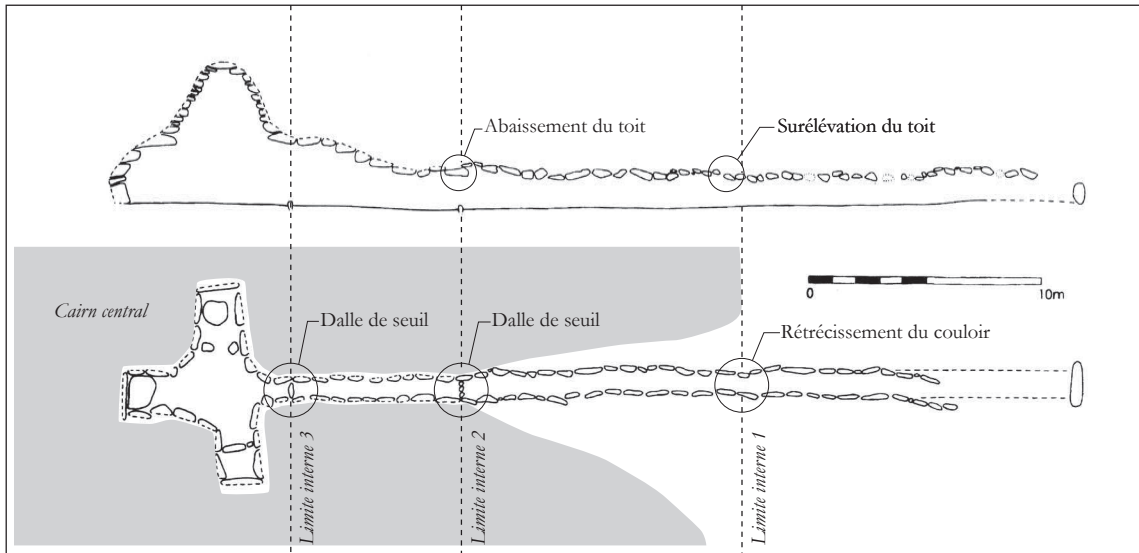

Figure 7.8 : Enceintes concentriques à Banagher, Baunfree et Bryn Celli Ddu

Sites	Différenciation spatiale des matériaux	Enceintes internes	Enceintes externes
Ballycarty		1 parement	1 péristalithe
Banagher		1 parement	1 péristalithe ; 1 enceinte de stèles
Barclodiad y Gawres	Mottes de gazon ; pierres		
Baunfree		1 parement	1 péristalithe
Bryn Celli Ddu		1 parement ; 1 enceinte de stèles	1 péristalithe ; 1 enceinte de stèles
Carrowmore 1		1 parement	1 péristalithe
Carrowmore 4		3 parements	1 péristalithe
Carrowmore 7		1 parement	1 péristalithe
Carrowmore 27		1 parement	1 péristalithe
Carrowmore 37		1 parement	1 péristalithe
Grange North		1 parement	1 péristalithe
Knocklea	Coquillages ; sédiments		1 péristalithe
Knockmany	Pierres ; sédiments		1 parement
Knocknarea 1			1 péristalithe ; 1 talus
Knowth 1			1 péristalithe
Knowth 2	Terre compactée ; sédiments		1 péristalithe
Knowth 4		3 parements	1 péristalithe
Knowth 12	Pierres ; sédiments	1 parement	1 péristalithe
Knowth 15	Sédiments ; argile à blocs	2 parements	1 péristalithe
Knowth 16	Pierres ; sédiments	4 parements	1 péristalithe
Knowth 18		1 parement	1 péristalithe
Newgrange	Pierres ; mottes de gazon	3 parements	1 péristalithe ; 1 enceinte de stèles
Newgrange K		3 parements ; 1 fossé	1 péristalithe
Newgrange L	Sable ; mottes de gazon	1 parement	1 péristalithe
Newgrange Z	Mottes de gazon ; argile à blocs	1 parement	1 péristalithe
Tara	Sédiments ; pierres		
Townleyhall	Pierres ; sable	4 parements	1 péristalithe

Figure 7.9 : Tableau de synthèse des structures tumulaires



Plans d'après Eogan 1998  
 Plan du cairn central d'après Eogan ([www.heritagecouncil.ie/archaeology/bru\\_na\\_boinne/abstracts.html](http://www.heritagecouncil.ie/archaeology/bru_na_boinne/abstracts.html))

Figure 7.10 : Knowth : relations entre le cairn central et les seuils des tombes est et ouest

*Knowth : structure en U à la jonction du cairn central (Eogan 1990 : fig. 2)*

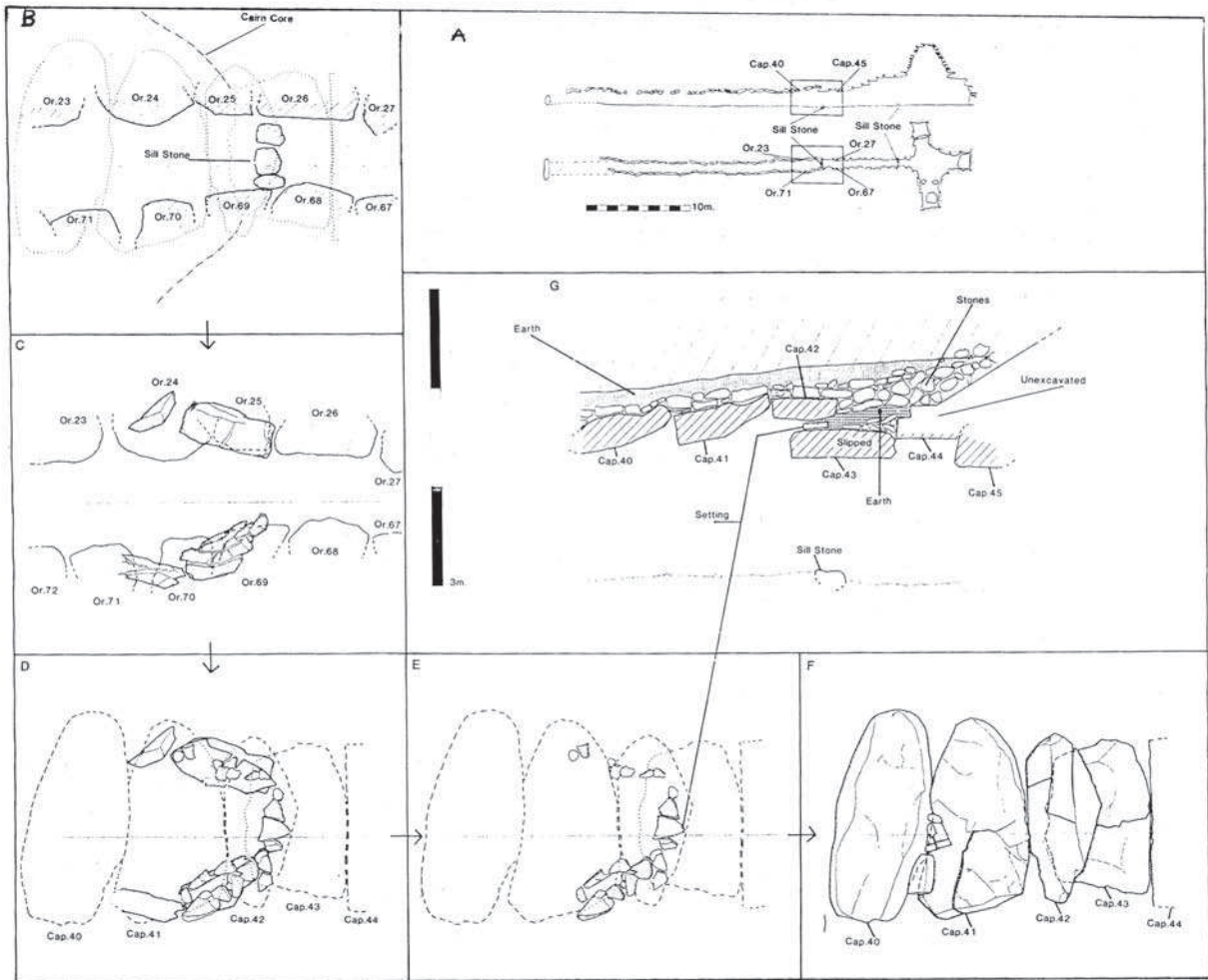

*Newgrange : structure en U à la jonction du cairn central (d'après O'Kelly 1982)*

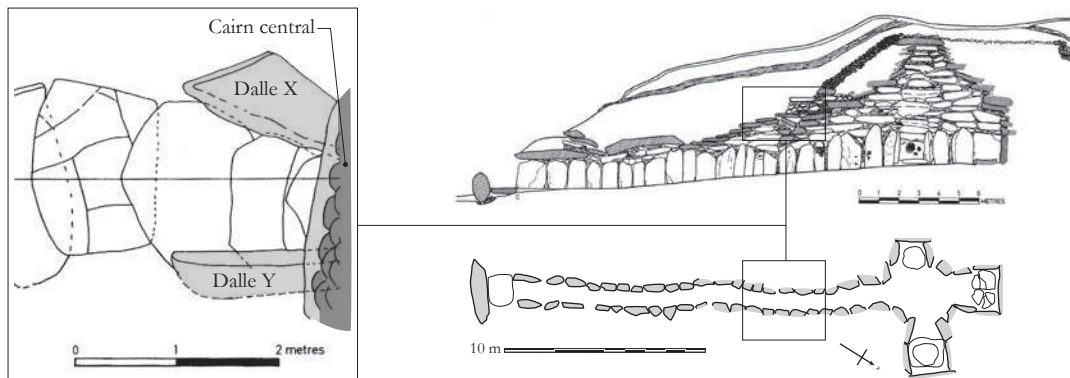
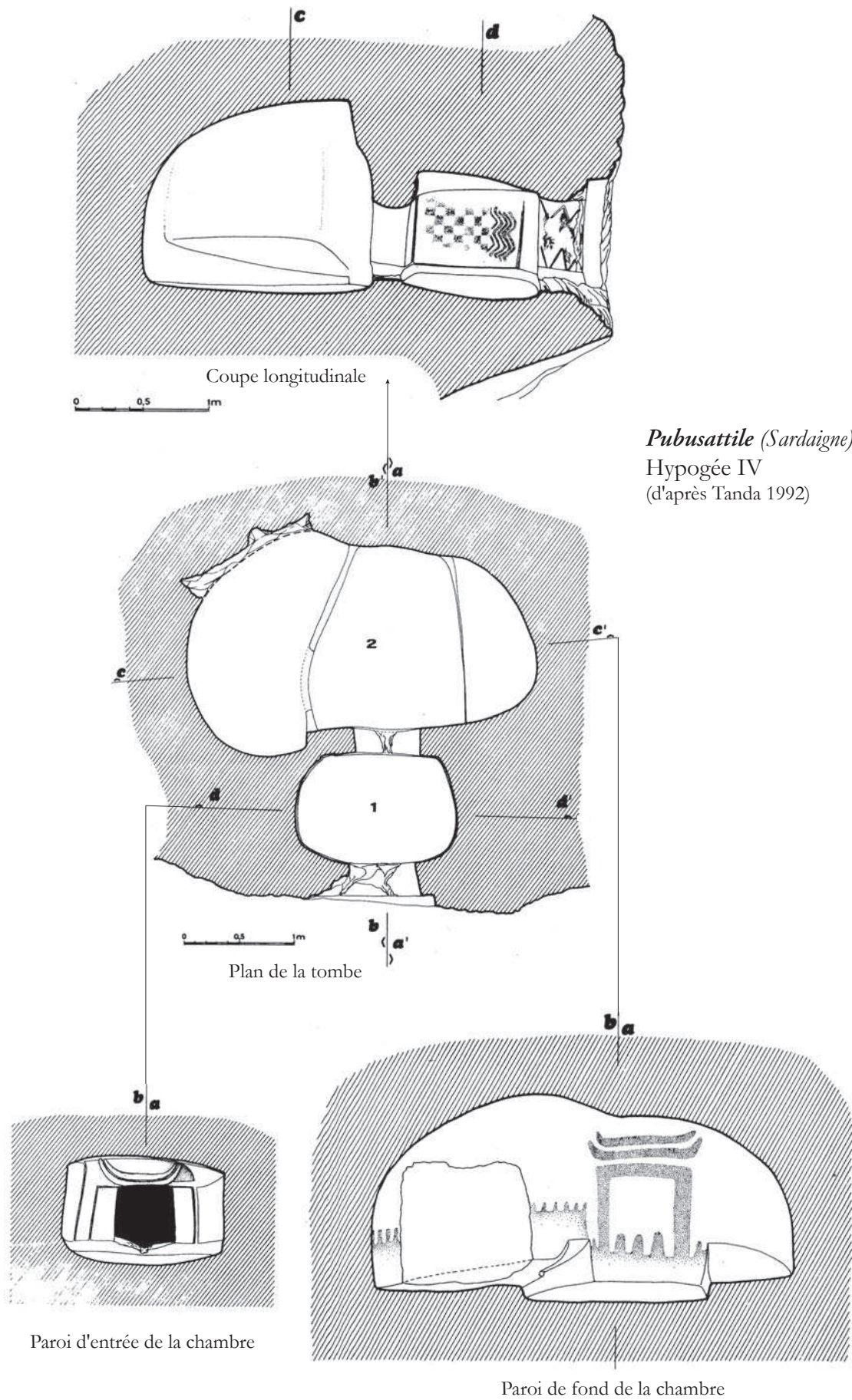

Figure 7.11 : Couverture de Knowth et Newgrange : structure en U à l'abord du cairn central



*Pubusattile* (Sardaigne)  
Hypogée IV  
(d'après Tanda 1992)

Figure 7.12 : Hypogée IV de Pubusattile



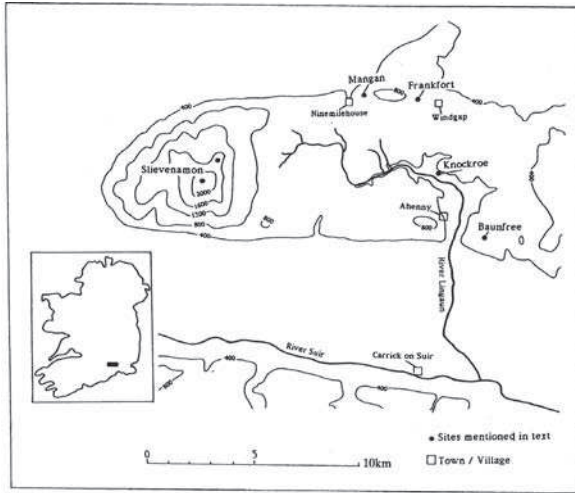

Carte de localisation (O'Sullivan 1993)

*Cairn de Slievenamon (Co. Tipperary)*



Formation naturelle vue du nord



Formation naturelle vue du nord-ouest



Vue du cairn depuis le nord



Vue du cairn depuis le sud

Figure 7.13 : Cairn de Slievenamon

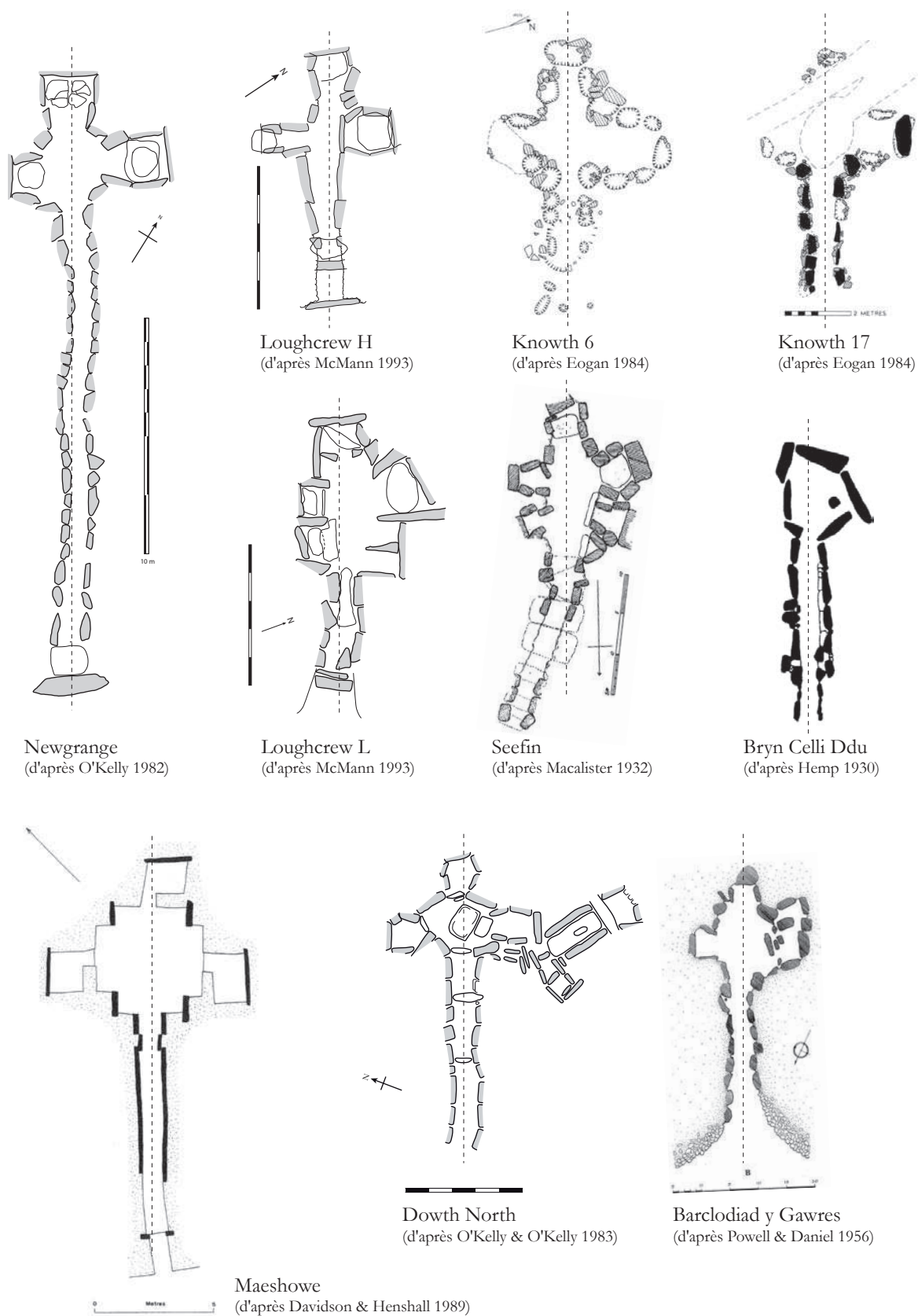

Figure 7.14 : Tombes à couloir avec mise en valeur du côté droit

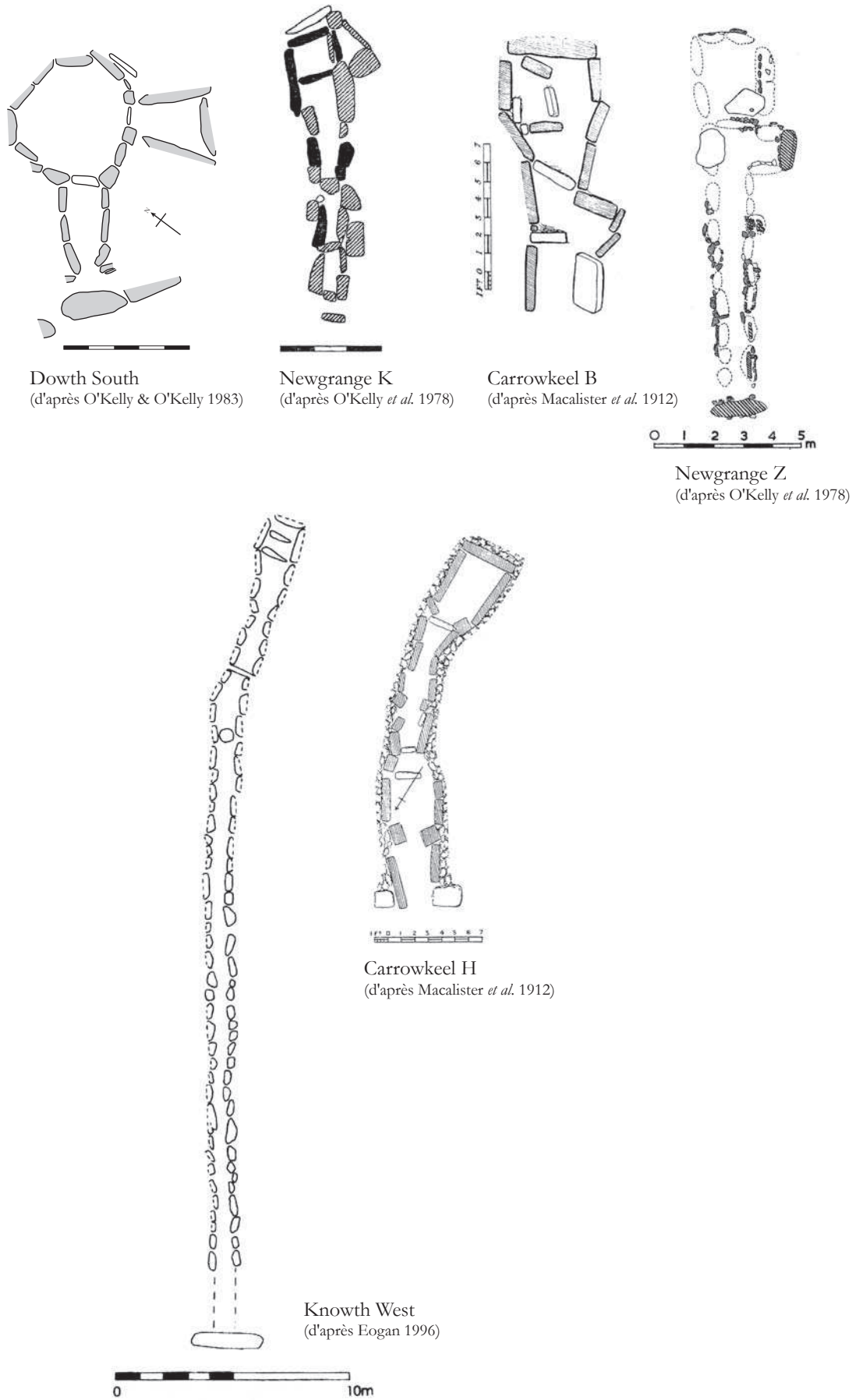

Figure 7.15 : Tombes à couloir avec mise en valeur du côté droit (suite)

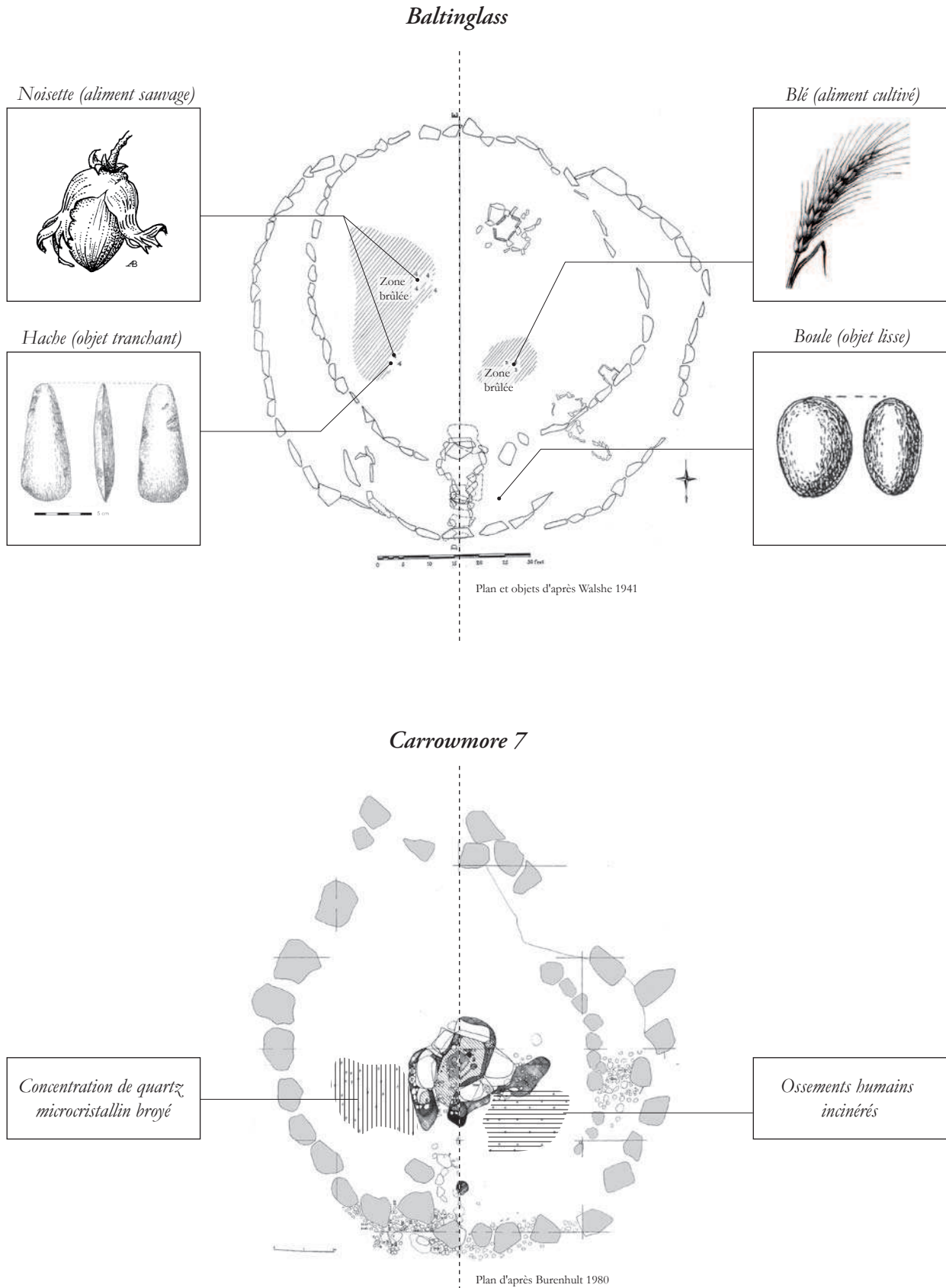

Figure 7.16 : Système d'opposition à la base des cairns de Baltinglass et Carrowmore 7

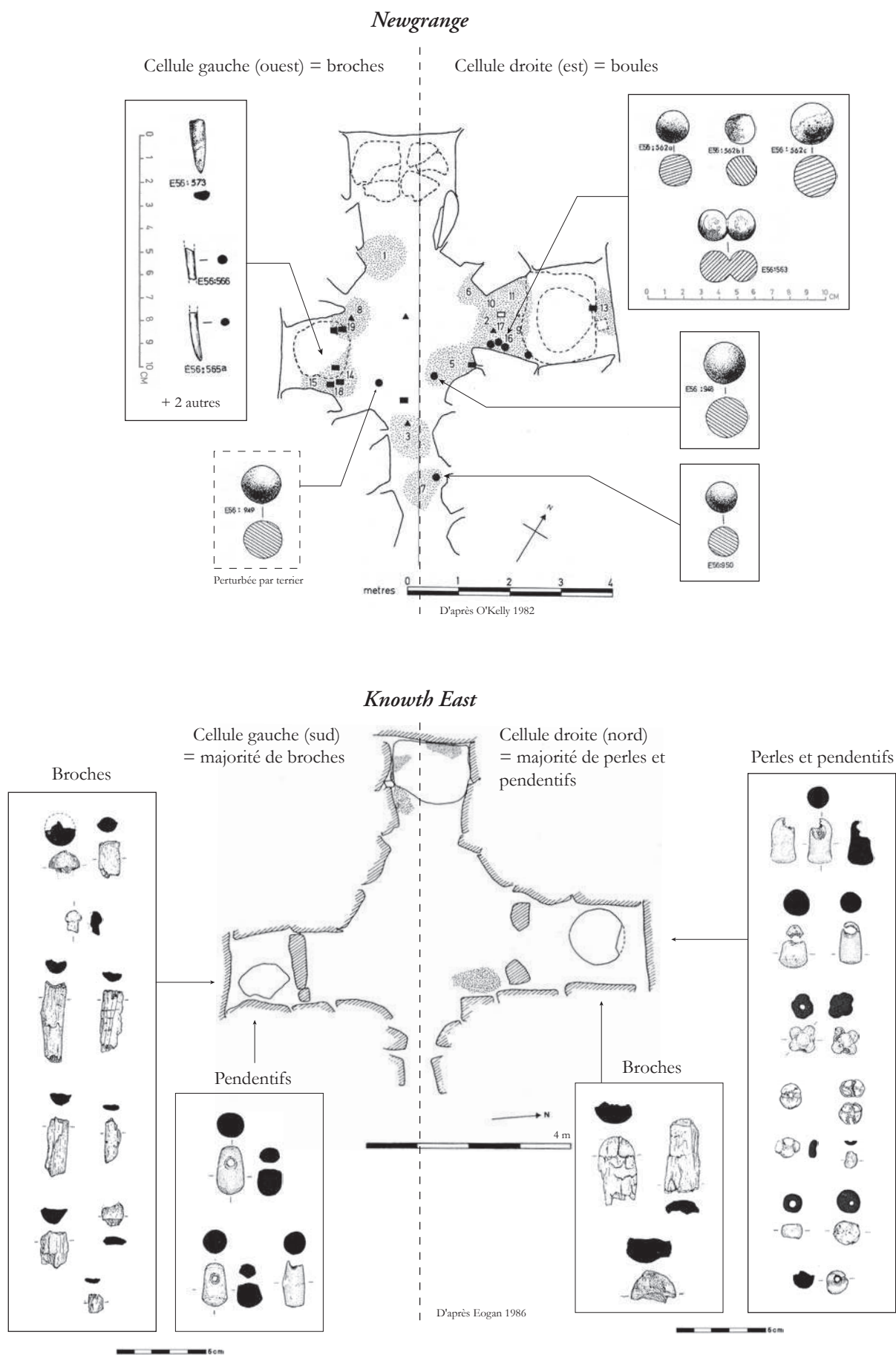

Figure 7.17 : Opposition de mobiliers funéraires dans les tombes de Newgrange et Knowth East

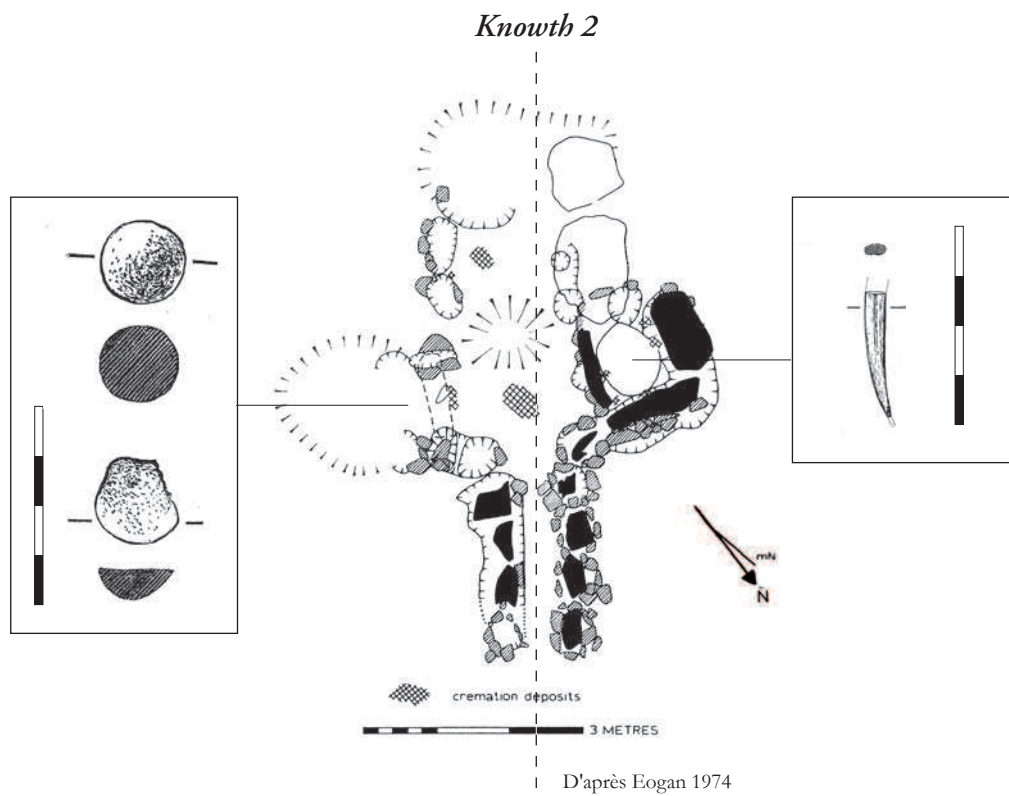
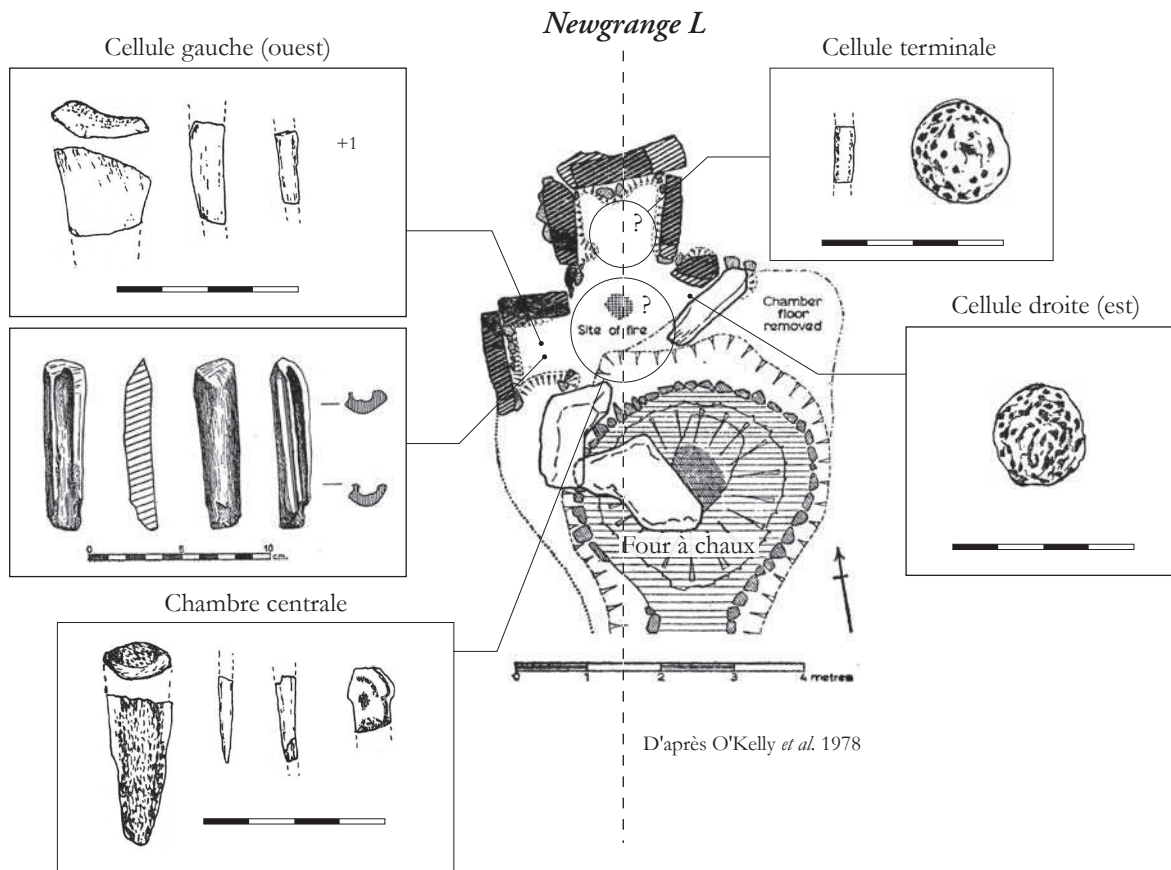

Figure 7.18 : Opposition de mobiliers funéraires dans les tombes de Newgrange L et Knowth 2

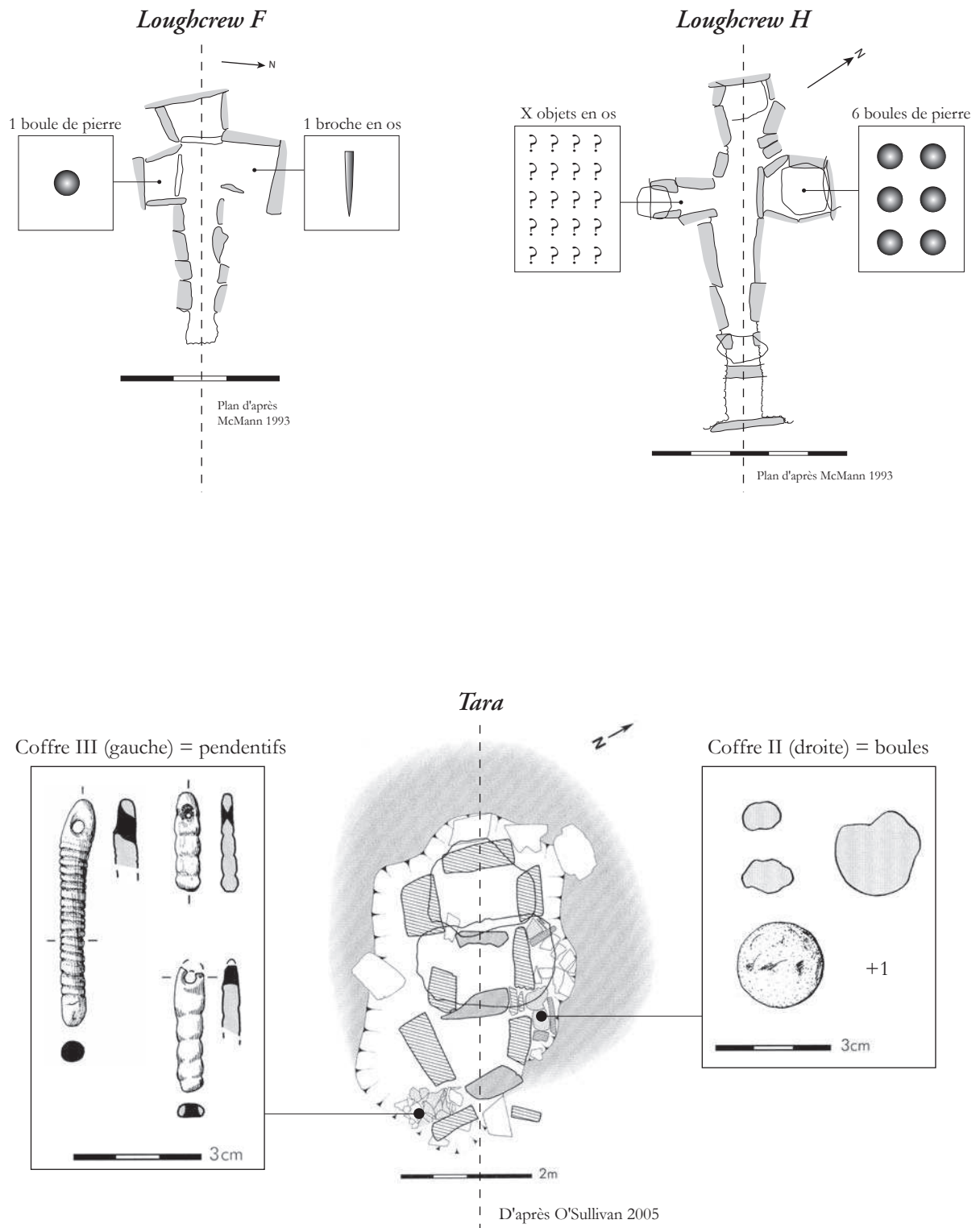

Figure 7.19 : Opposition de mobiliers funéraires dans les tombes de Loughcrew F et H et Tara

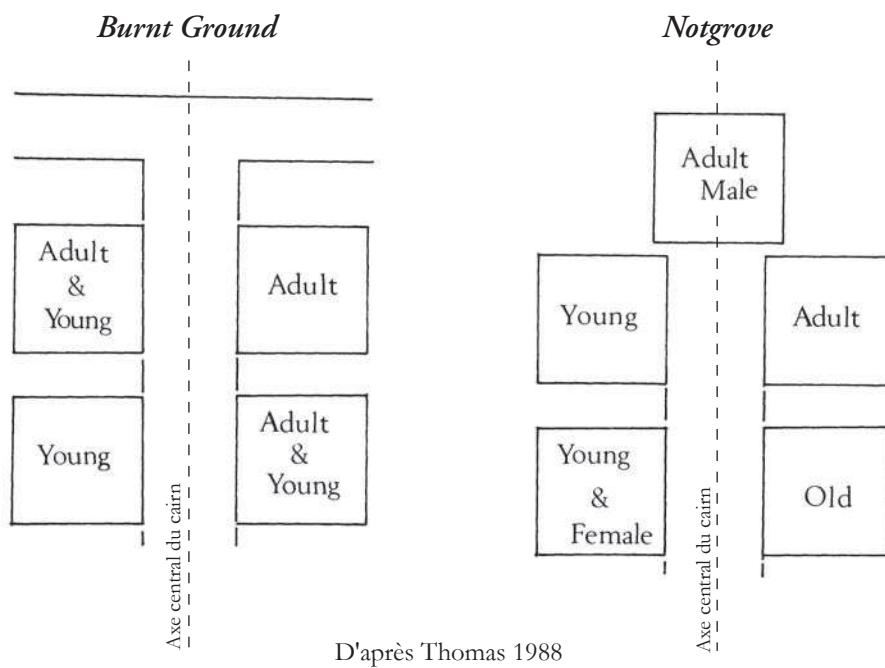
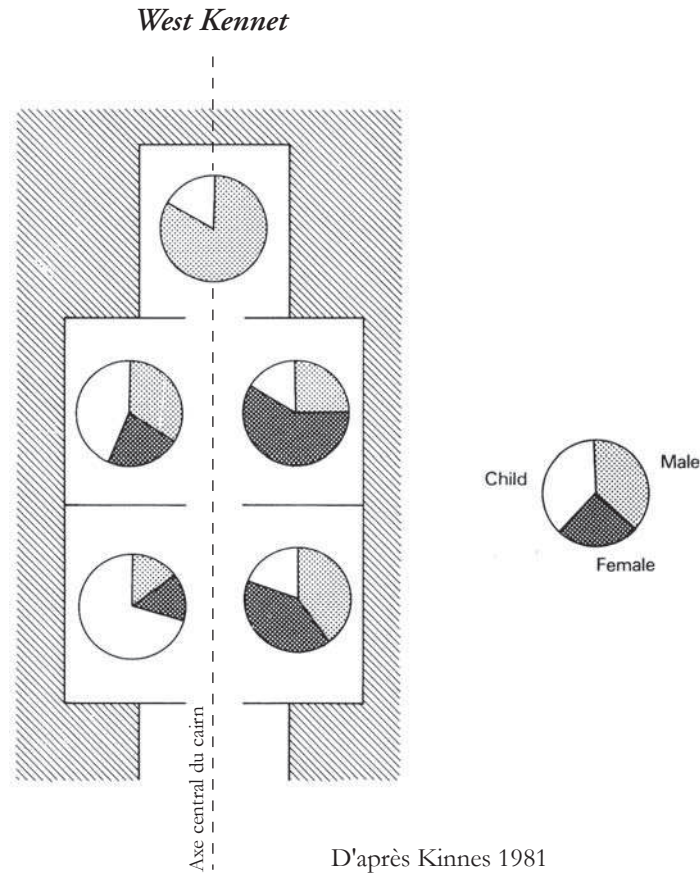
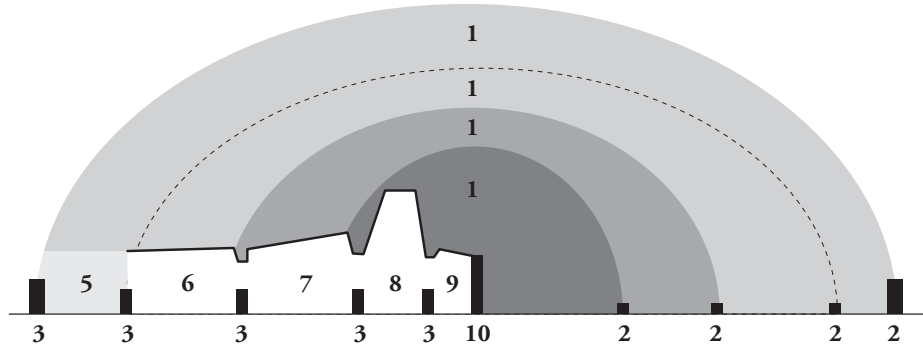

Figure 7.20 : Classement et opposition de défunts dans les tombes de West Kennet, Burnt Ground et Notgrove (groupe Severn-Cotswold)



Représentation en coupe



Représentation en plan

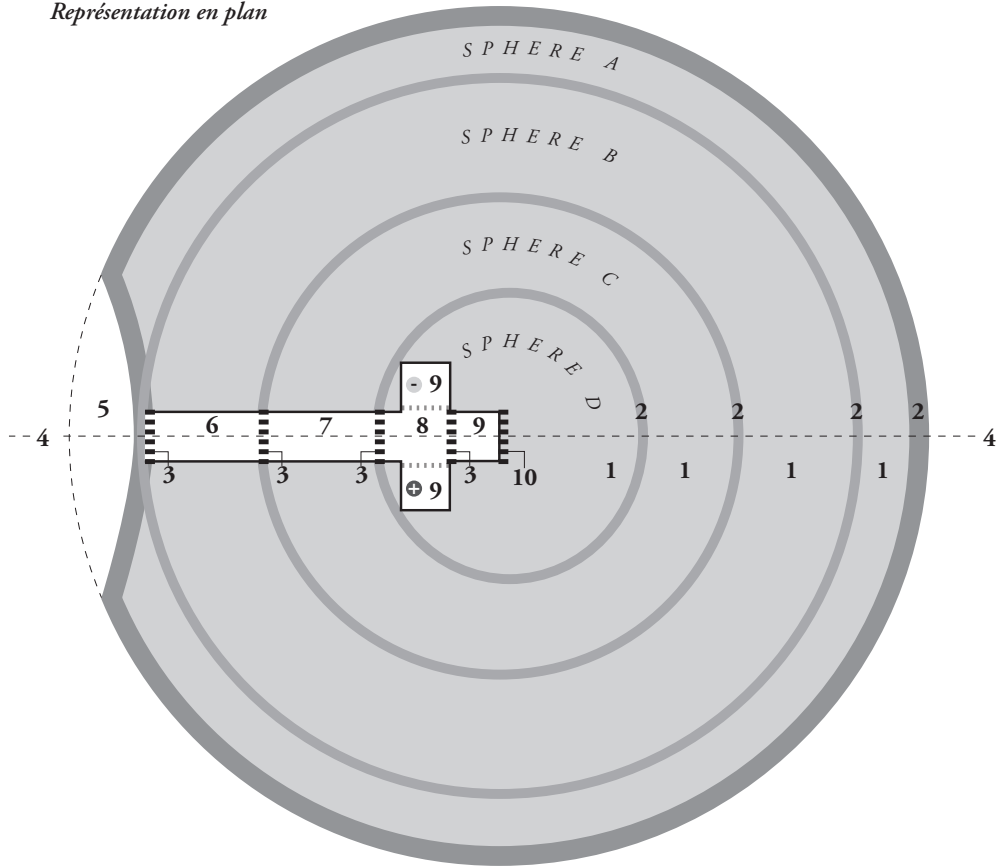

	<i>Eléments matériels</i>	<i>Lecture symbolique</i>
1	Couches tumulaires	Espaces concentriques
2	Enceintes	Limites invisibles
3	Seuils	Limites visibles
4	Axe	Chemin
5	Cour d'entrée	Premier sas
6	Couloir	Deuxième sas
7	Antichambre	Troisième sas
8	Chambre	Quatrième sas
9	Cellules	Espaces terminaux
10	Dalle de chevet	Ultime porte

Figure 7.21 : Schéma synthétique de l'organisation spatiale des structures dans les tombes à couloir

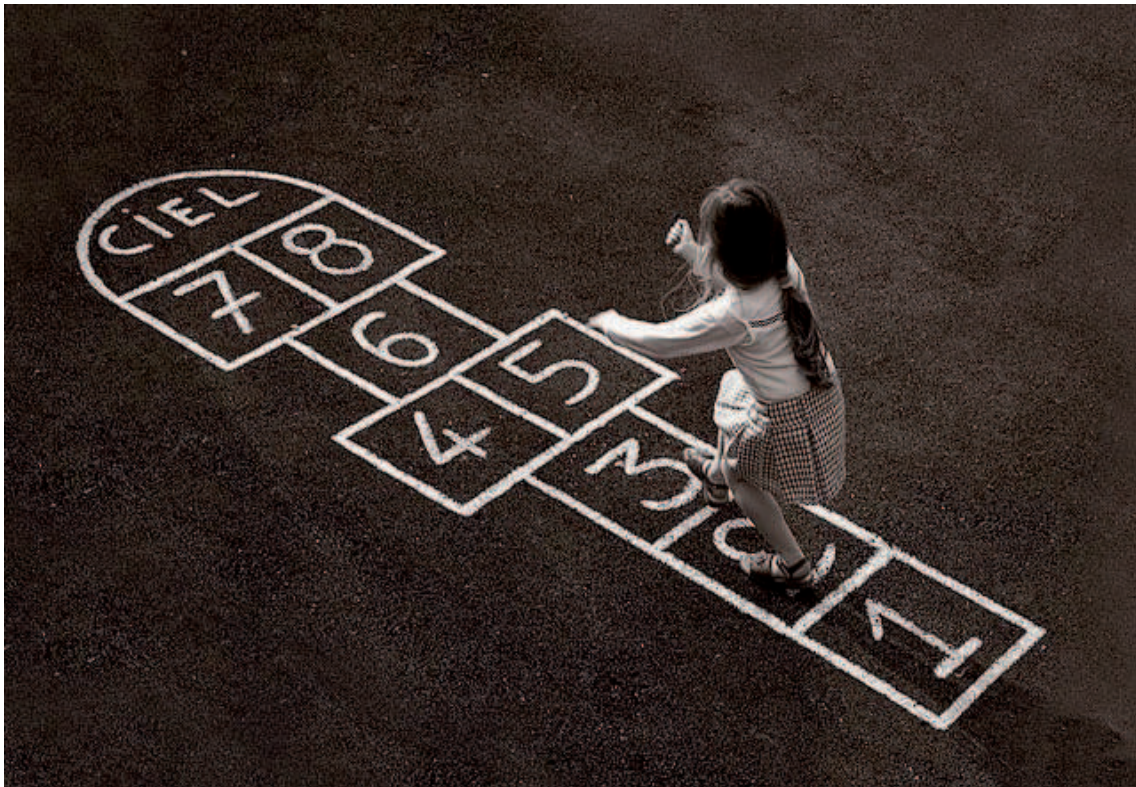
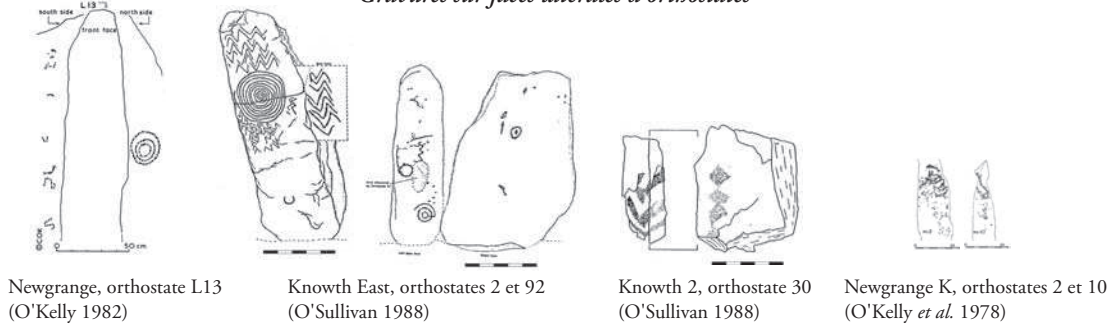
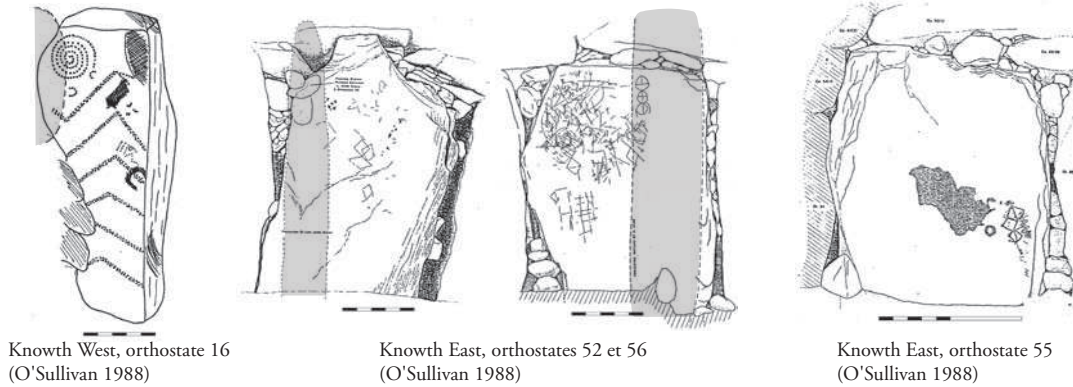

Figure 7.22 : Le jeu de la marelle

*Gravures sur faces latérales d'orthostates*



*Gravures sur orthostates obstrués par dalles adjacentes*



*Gravures bouchardées*

*Gravures sur face inférieure obstruée de dalles de couverture*

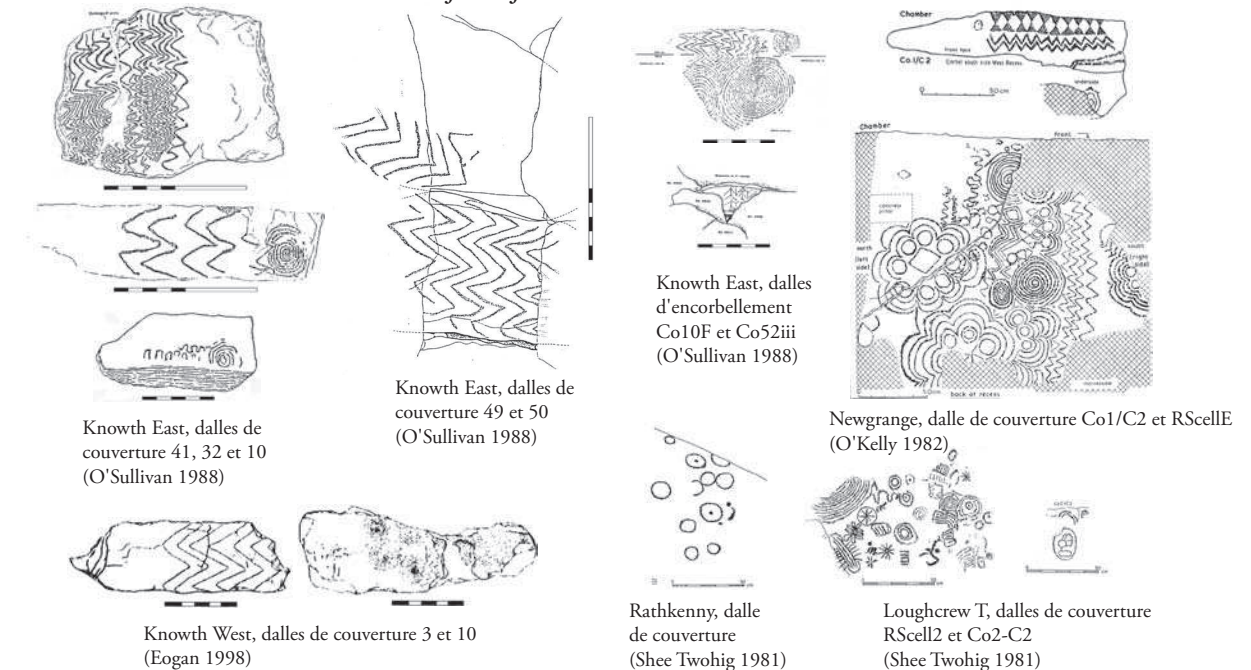

*Gravures sur face supérieure obstruée de dalles de couverture*

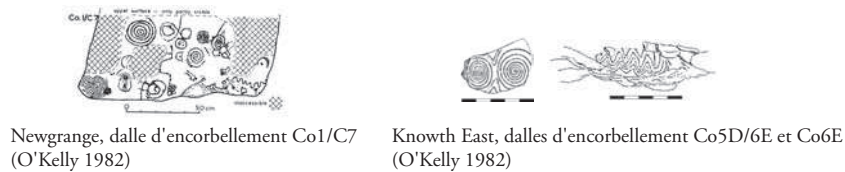
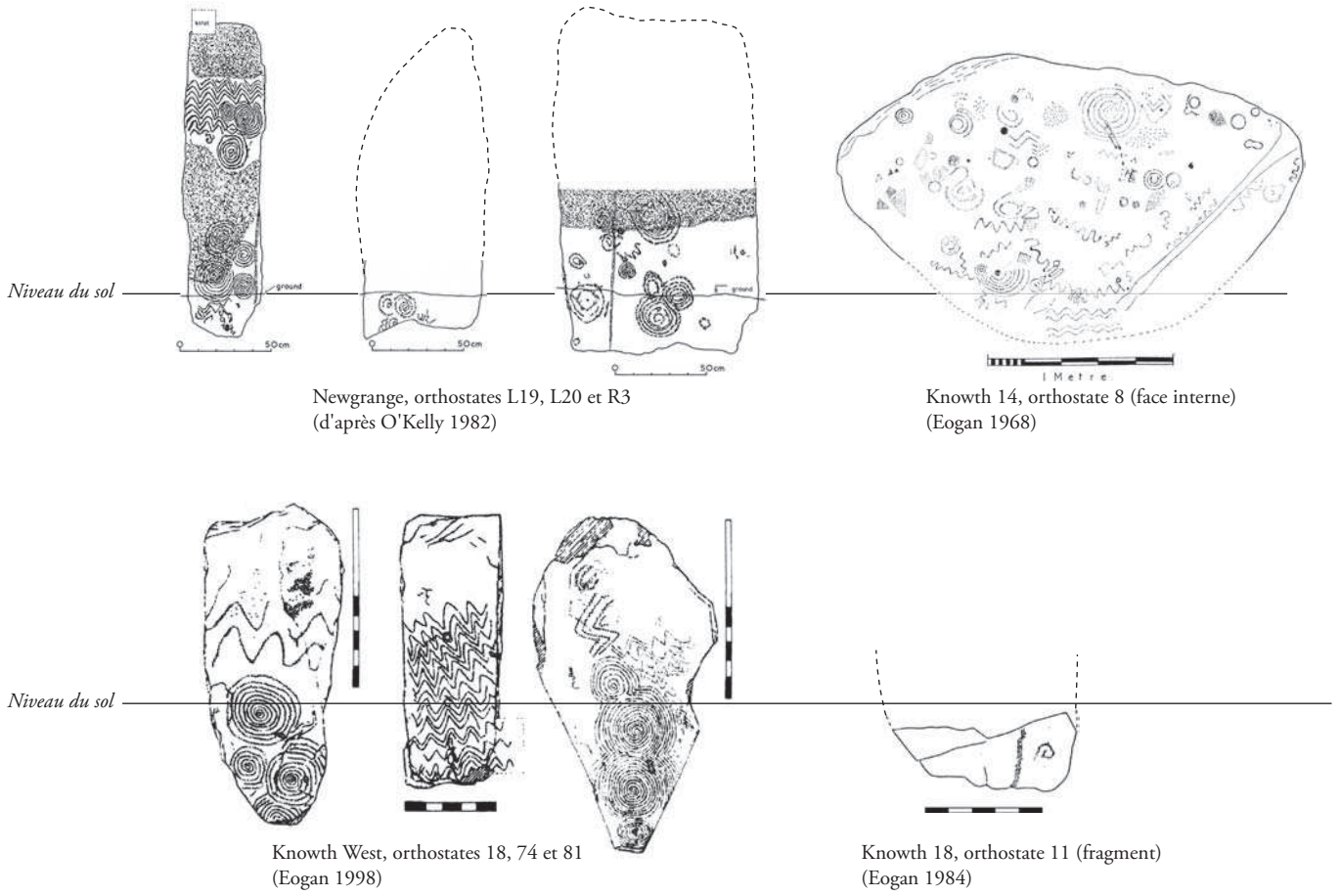
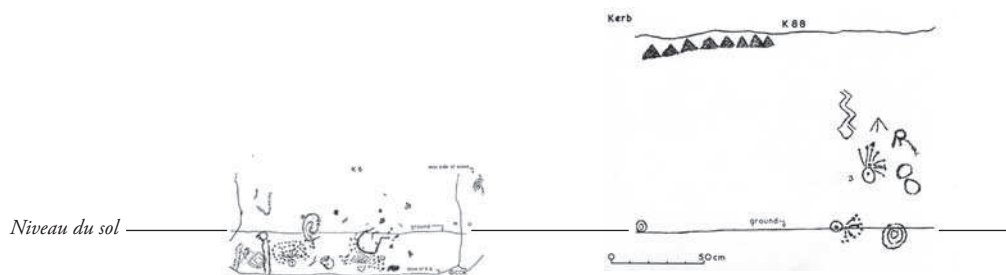

Figure 8.1 : Gravures en surfaces obstruées

*Gravures sur la base enterrée d'orthostates*



*Gravures sur la base enterrée de dalles de péristalithe*



Newgrange, dalles 6 et 88 du péristalithe  
(d'après O'Kelly 1982)

Figure 8.2 : Gravures sur la base enterrée d'orthostates et de dalles de péristalithe

Gravures sur la face arrière de dalles de péristicalithe

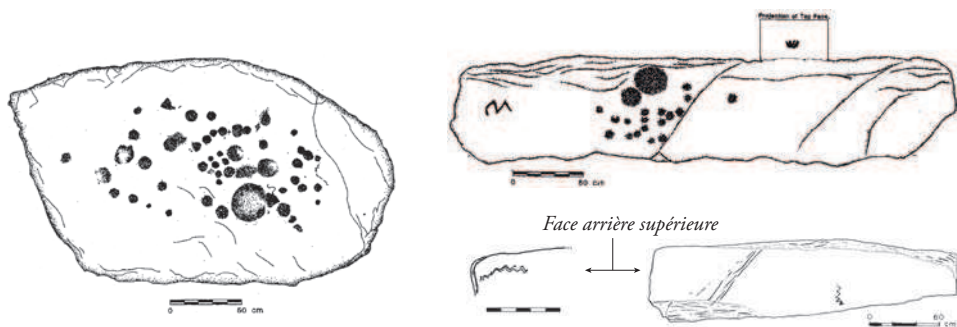

Knowth, dalles 13, 1, 71 et 94 du péristicalithe  
(Eogan 1968, 2008 ; O'Sullivan 1988)



Douth, dalles 50 et 51 du péristicalithe  
(O'Kelly & O'Kelly 1983)



Newgrange L, dalle B du péristicalithe  
(O'Kelly *et al* 1978)



Newgrange, dalles 11, 13, 18, 91 et 4 du péristicalithe  
(O'Kelly 1982)

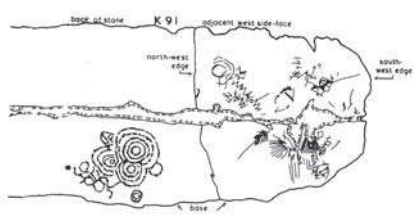

Loughcrew T, dalle 29 du péristicalithe  
(Shee Twohig 1981)

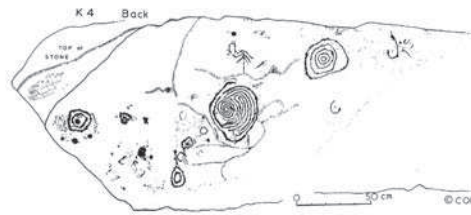

Newgrange K, dalle 4 du péristicalithe  
(O'Kelly *et al.* 1978)

Figure 8.3 : Gravures sur la face arrière de dalles de péristicalithe

Gravures sur la face arrière d'orthostates

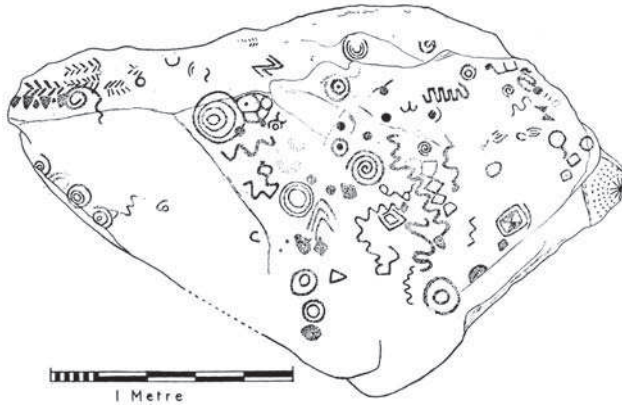

Knowth 14, orthostate 8  
(Eogan 1968)

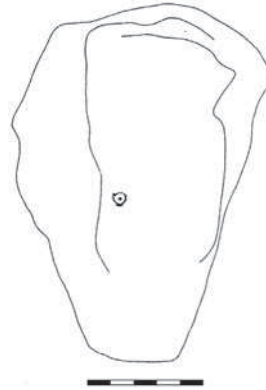

Knowth 15, orthostate 14  
(Eogan 1984)

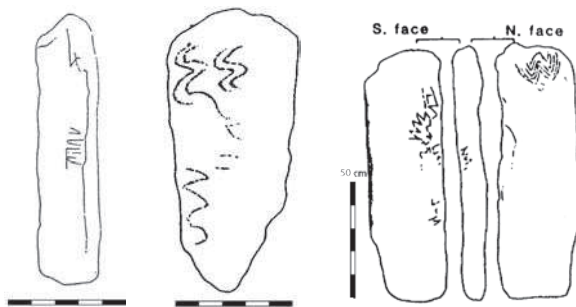

Knowth 16, orthostates 4, 9 et 13  
(Eogan 1984)



Knowth West, orthostate 17  
(Eogan 1998)

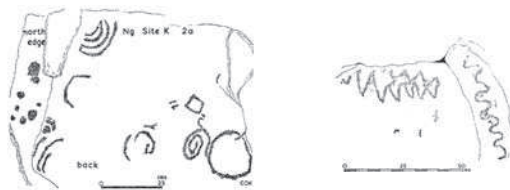

Newgrange K, orthostates 2a et 5  
(O'Kelly *et al.* 1978)



Knockmany, orthostates 5, 6 et 7  
(Shee Twohig 1981)

Figure 8.4 : Gravures sur la face arrière d'orthostates

Gravures sur la face supérieure de dalles de couverture

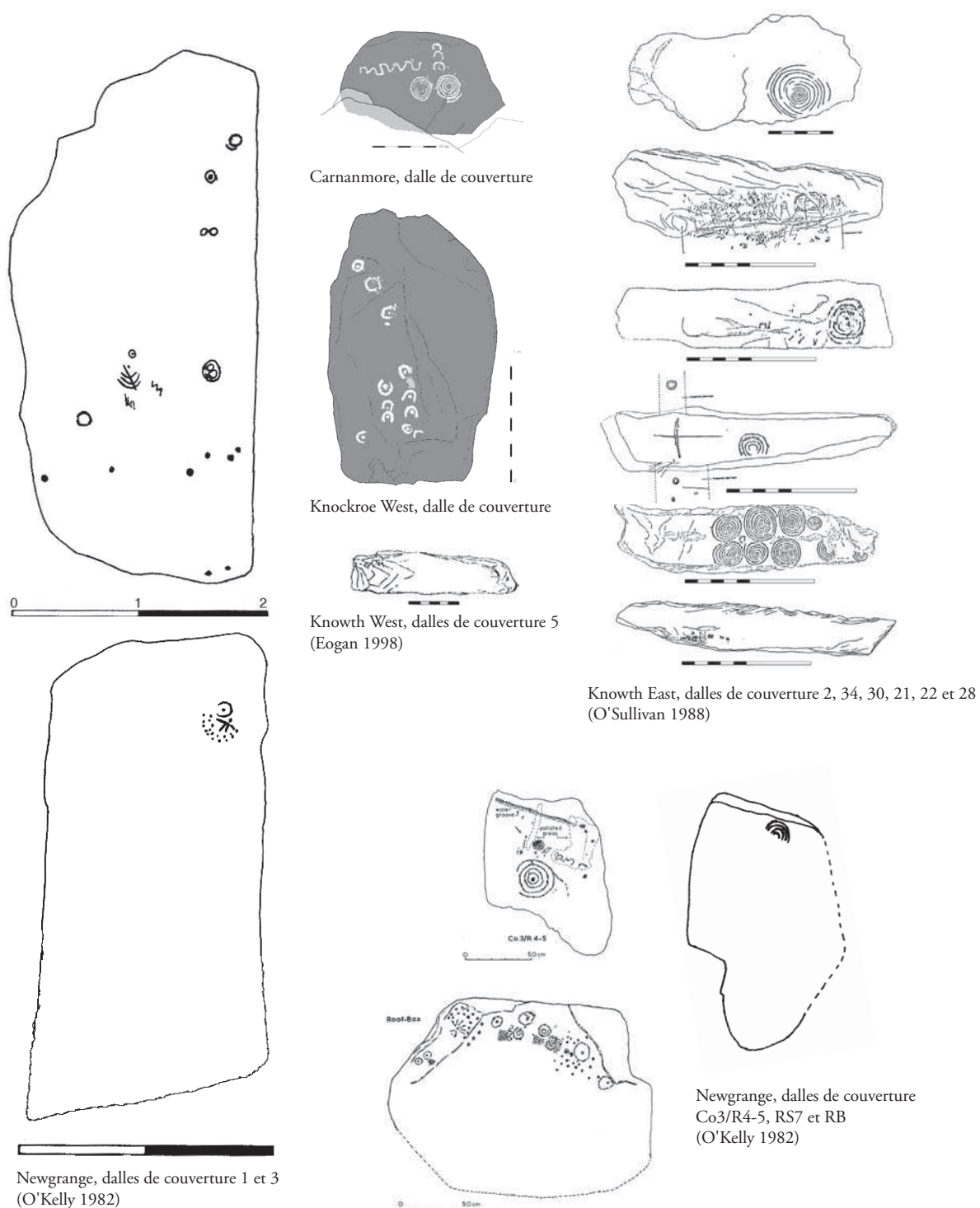

Figure 8.5 : Gravures sur la face supérieure de dalles de couverture

Gravures sur dalles enfouies dans la masse tumulaire

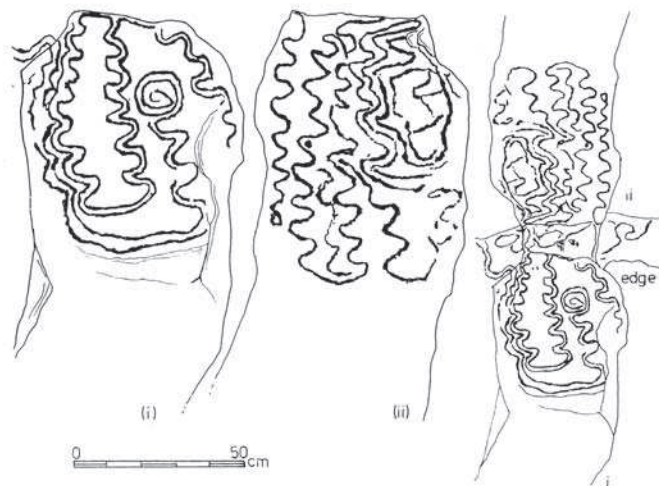
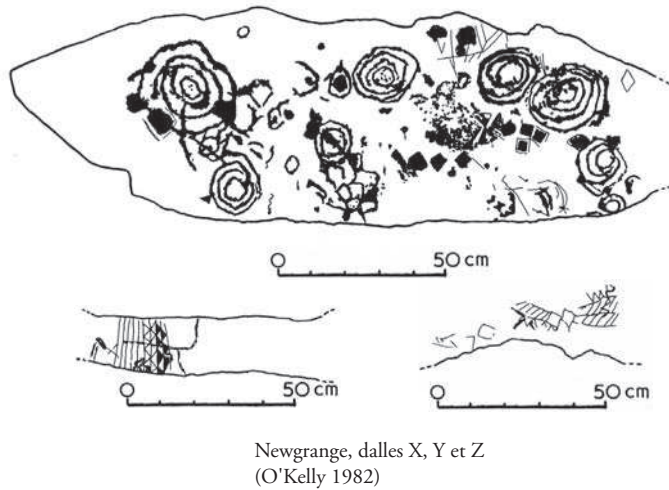
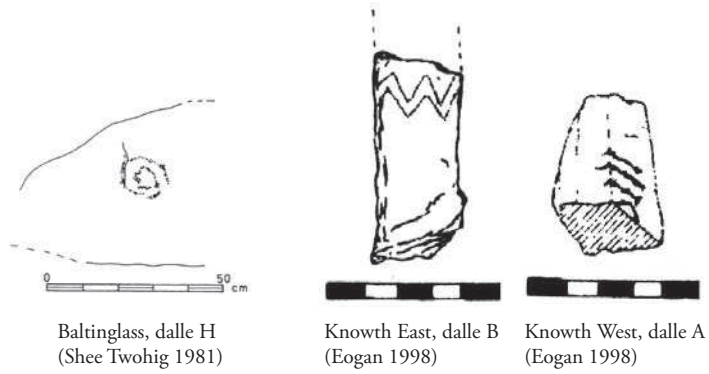

Figure 8.6 : Gravures sur dalles enfouies dans la masse tumulaire



Dalle				Emplacement des gravures cachées					
Pays	site	nom	fonction	face obstruée	Gravure bouchardée	base enterrée	face arrière	face supérieure	Masse du tumulus
IRL	Balinglass	H	Péristalithe						
IRL	Carnanmore	Co1	Couverture						
		Co2	Couverture						
IRL	Dowth	K50	Péristalithe						
		K51	Péristalithe						
	Tombe sud	C12	Orthostate						
IRL	Fourknocks	C5	Orthostate						
IRL	Knockmany	C5	Orthostate						
		C6	Orthostate						
		C7	Orthostate						
IRL	Knockroe W	RS	Couverture						
IRL	Knowth 1	K1	Péristalithe						
		K13	Péristalithe						
		K14	Péristalithe						
		K15	Péristalithe						
		K16	Péristalithe						
		K46	Péristalithe						
		K61	Péristalithe						
		K68	Péristalithe						
		K71	Péristalithe						
		K94	Péristalithe						
	Tombe est	Or2	Orthostate						
		Or36	Orthostate						
		Or43	Orthostate						
		Or52	Orthostate						
		Or55	Orthostate						
		Or56	Orthostate						
		Or92	Orthostate						
		RS2	Couverture						
		RS7	Couverture						
		RS10	Couverture						
		RS18	Couverture						
		RS20	Couverture						
		RS21	Couverture						
		RS26	Couverture						
		RS28	Couverture						
		RS30	Couverture						
		RS32	Couverture						
		RS34	Couverture						
		RS37	Couverture						
		RS41	Couverture						
		RS49	Couverture						
		RS50	Couverture						
		Co40i	Encorbellement						
		Co52iii	Encorbellement						
		CoD4	Encorbellement						
		CoE6	Encorbellement						
		CoF10	Encorbellement						
		Co5D/6E	Encorbellement						
		B	?						
	Tombe ouest	Or16	Orthostate						
		Or17	Orthostate						
		Or18	Orthostate						
		Or74	Orthostate						
		Or81	Orthostate						
		RS3	Couverture						
		RS5	Couverture						
		RS10	Couverture						
		RS21	Couverture						
		A	?						
IRL	Knowth 2	Or30	Orthostate						
IRL	Knowth14	K5	Péristalithe						
		Or8	Orthostate						
IRL	Knowth 15	Or14	Orthostate						
IRL	Knowth 16	Or2	Orthostate						
		Or4	Orthostate						
		Or7	Orthostate						
		Or9	Orthostate						
		Or13	Orthostate						
		Co12	Encorbellement						
IRL	Knowth 18	Or11	Orthostate						
IRL	Loughcrew L	L1	Orthostate						
IRL	Loughcrew S	C2	Orthostate						
IRL	Loughcrew T	K29	Péristalithe						
		Co2/C2	Encorbellement						
		RScell2	Couverture						
IRL	Loughcrew U	C9	Orthostate						

IRL	Newgrange	K4	Péristalithe						
		K6	Péristalithe						
		K7	Péristalithe						
		K11	Péristalithe						
		K13	Péristalithe						
		K18	Péristalithe						
		K56	Péristalithe						
		K58	Péristalithe						
		K66	Péristalithe						
		K88	Péristalithe						
		K91	Péristalithe						
		L13	Orthostate						
		L19	Orthostate						
		L20	Orthostate						
		R3	Orthostate						
		Co1/C2	Encorbellement						
		Co1/C7	Encorbellement						
		RScelle	Couverture						
		RS1	Couverture						
		RB	Couverture						
		Co3/R4-5	Encorbellement						
		Co3/L5-6	Encorbellement						
		RS3	Couverture						
RS7	Couverture								
X	Couverture								
Y	Couverture								
Z	Couverture								
IRL	Newgrange K	K4	Péristalithe						
		2	Orthostate						
		10	Orthostate						
		2a	Orthostate						
		5	Orthostate						
IRL	Newgrange L	B	Péristalithe						
IRL	Rathkenny	B	Couverture						
IRL	Tara	R2	Orthostate						
GAL	Barclodiad y G.		Couverture						
GAL	Bryn Celli Ddu		?						
<b>Total</b>	<b>23</b>		<b>112</b>	<b>27</b>	<b>4</b>	<b>10</b>	<b>45</b>	<b>30</b>	<b>4</b>

Figure 8.7 : Tableau de synthèse des gravures cachées

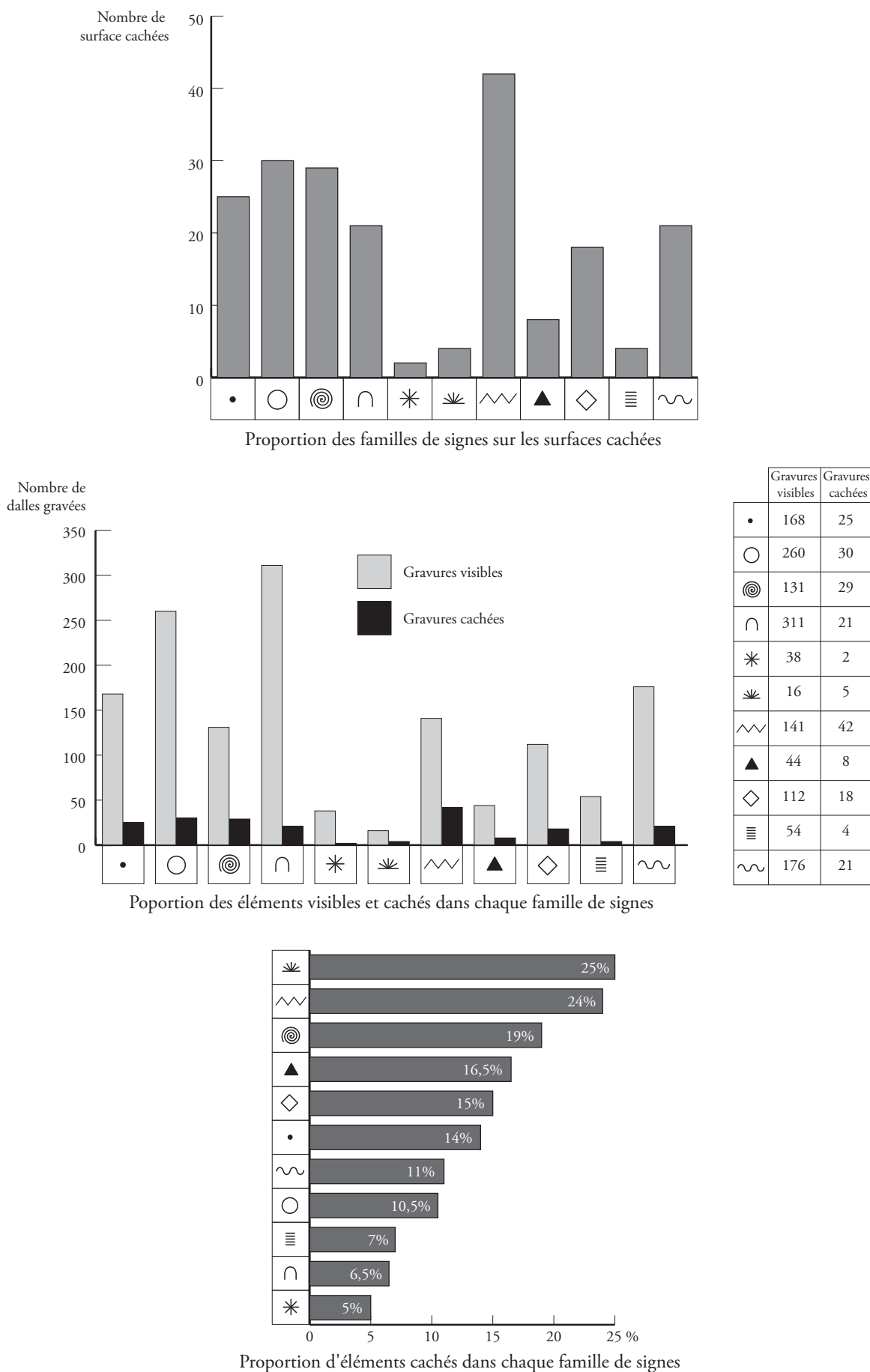

Figure 8.8 : Graphes statistiques sur l'iconographie de l'art caché

	Face obstruée	Base enterrée	Face arrière	Face supérieure	Masse tumulaire
•	•	•	●	●	•
○	●	•	●	●	•
◎	●	●	●	●	•
∩	•	•	●	●	•
*			•		
☀		•	•	•	
⚡	●	•	●	●	•
▲	•		●	•	•
◇	•	•	●	•	•
≡	•		•	•	
〰	•		●	●	•

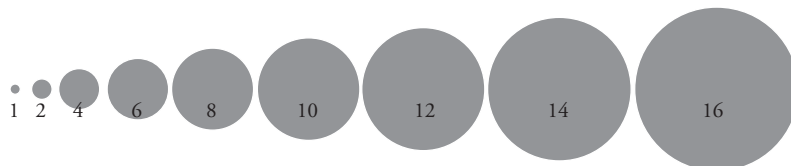

Figure 8.9 : Les relations entre familles de signes et types de surfaces cachées

*Dalles en position secondaire : reconstitution hypothétique de la position d'origine d'après l'emplacement des gravures et la forme de la dalle*

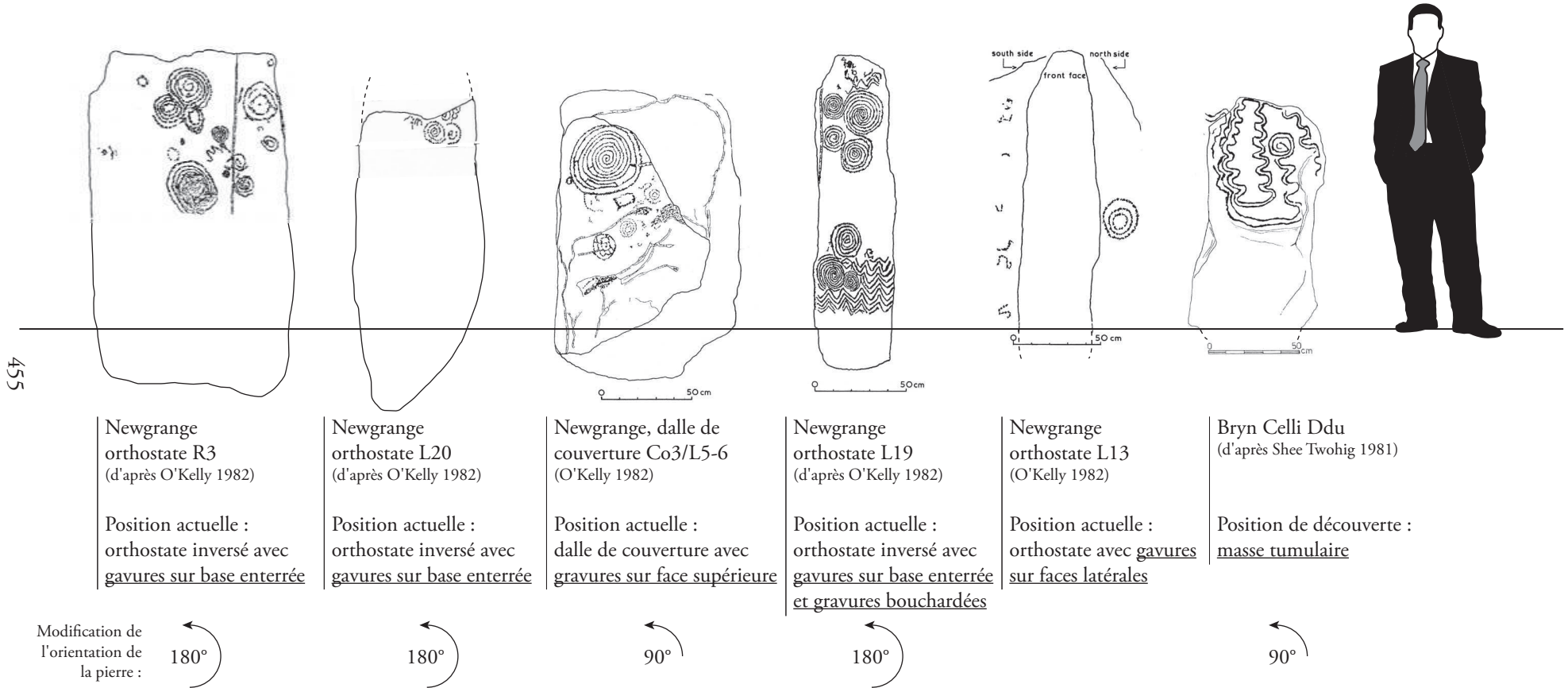

Figure 8.10 : Newgrange et Bryn Celli Ddu : reconstitution de la position d'origine de dalles en réemploi d'après l'emplacement des gravures et la forme de la dalle

*Dalles en position secondaire : reconstitution hypothétique de la position d'origine d'après l'emplacement des gravures et la forme de la dalle*

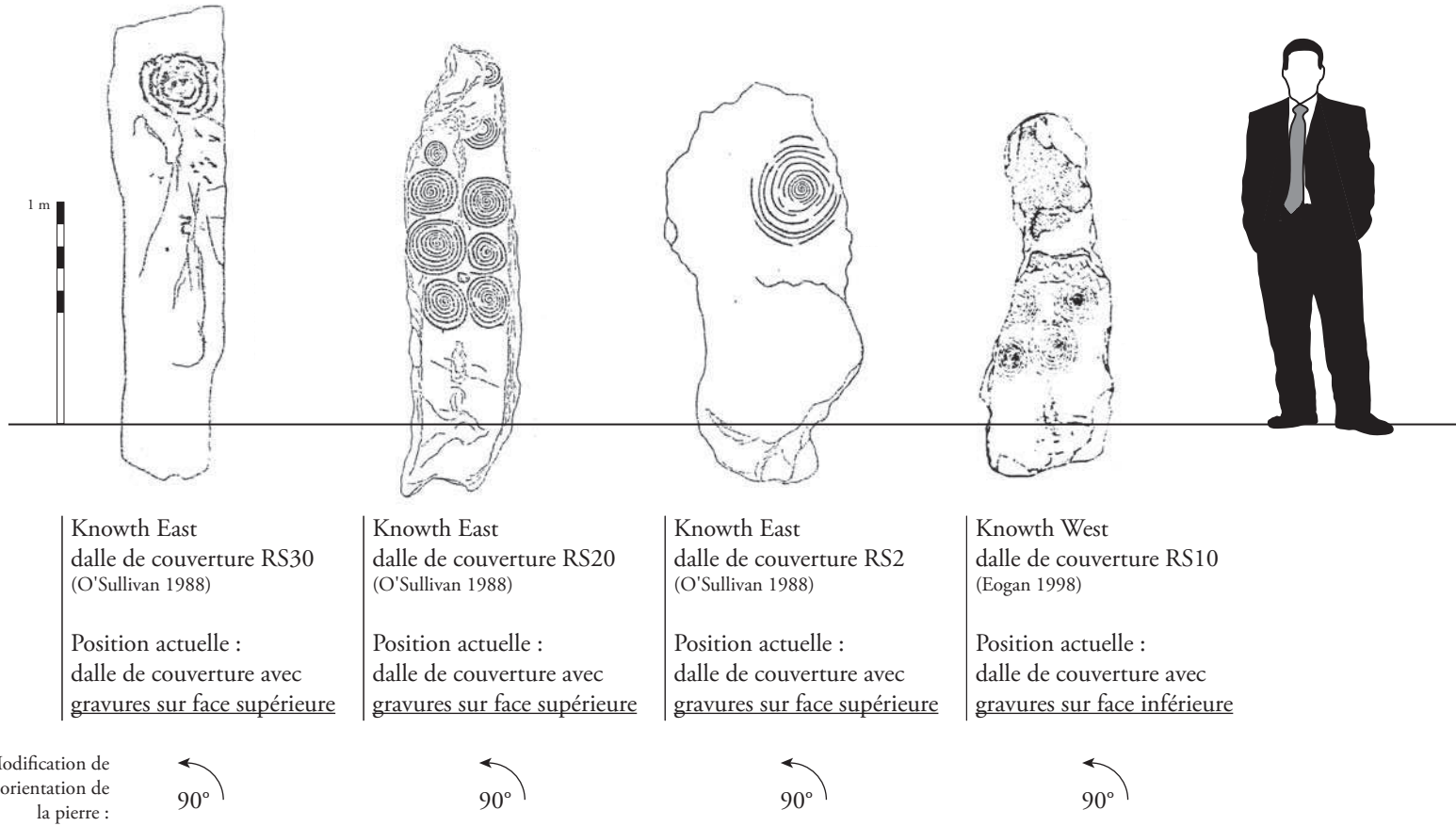

Figure 8.11 : Knowth : reconstitution de la position d'origine de dalles en réemploi d'après l'emplacement des gravures et la forme de la dalle

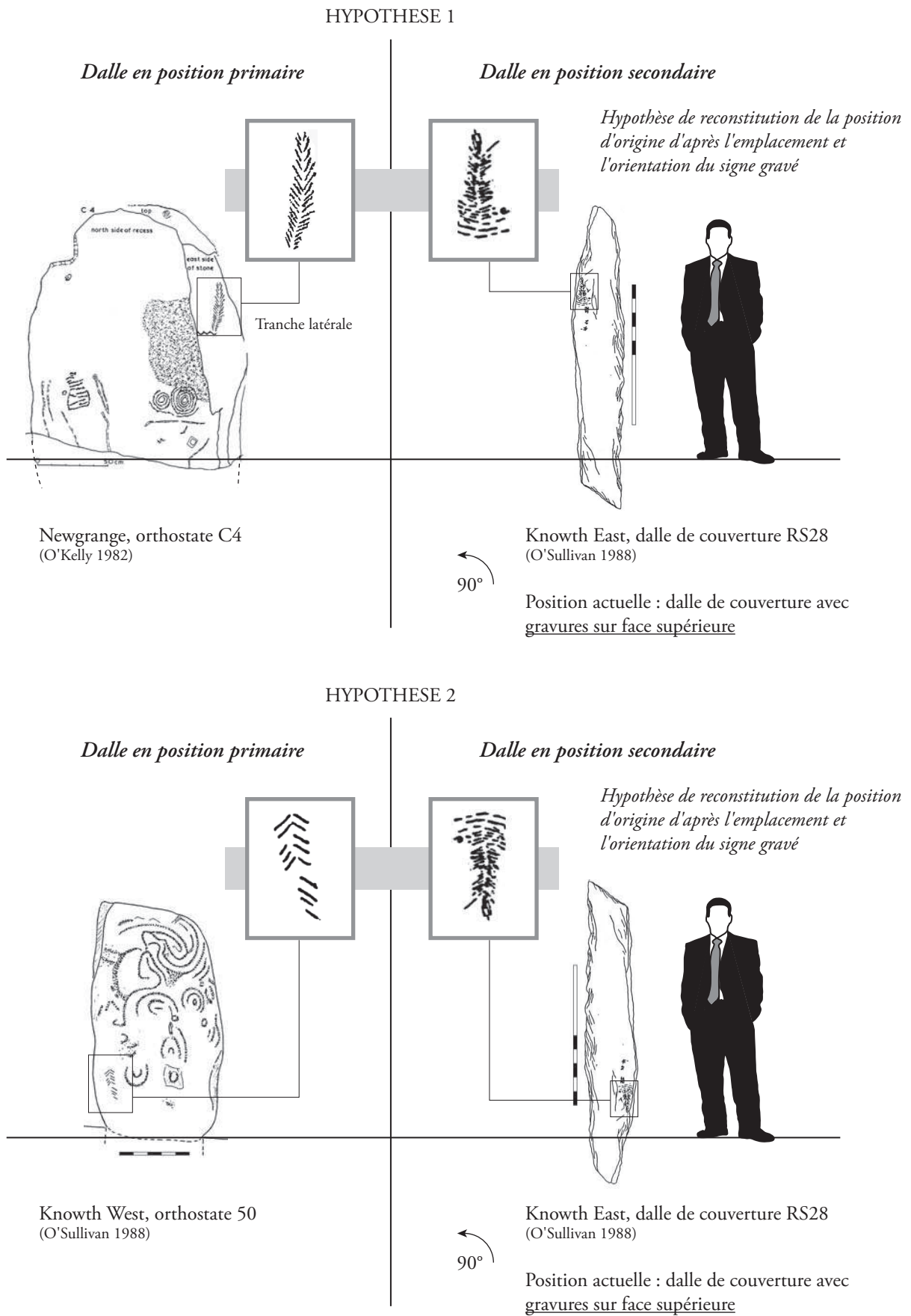

Figure 8.12 : Reconstitution de la position d'origine de la dalle de couverture RS28 de Knowth d'après la position et l'orientation du signe gravé

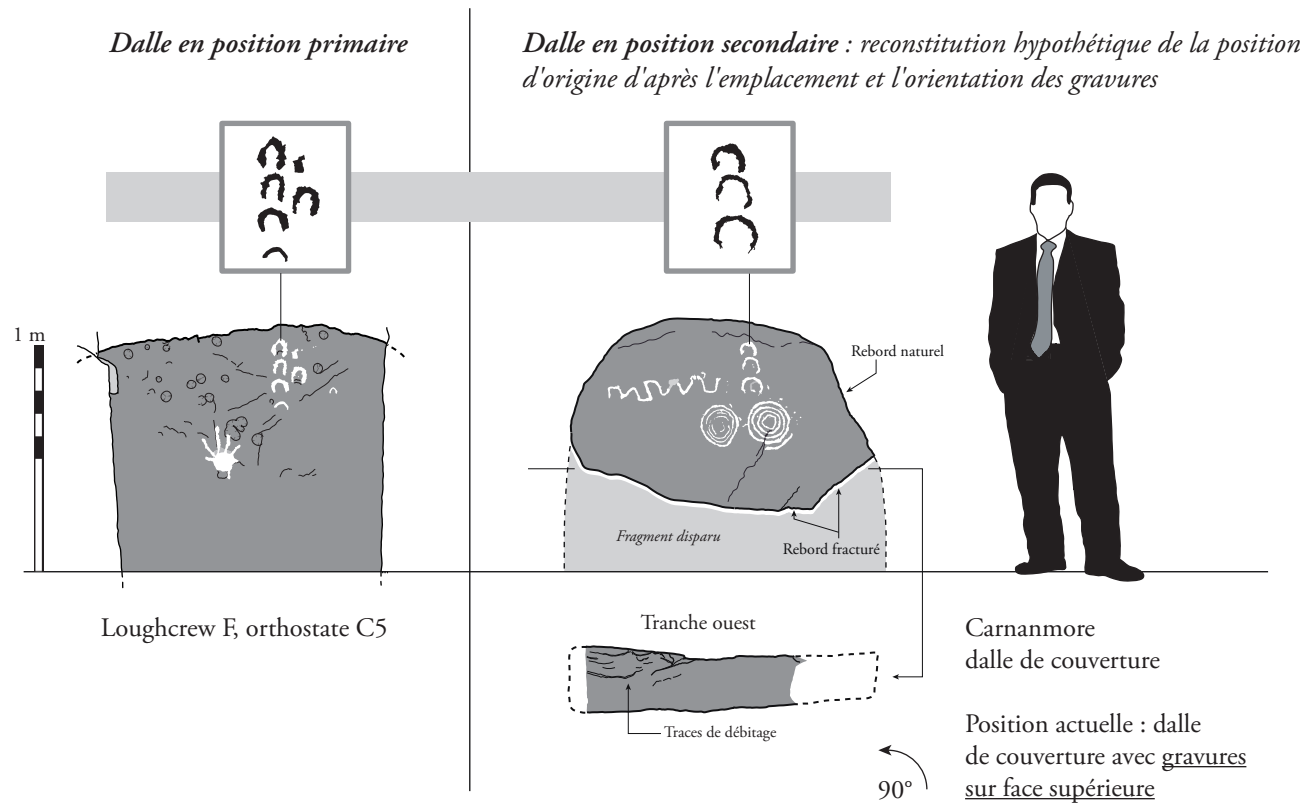

Figure 8.13 : Reconstitution de la position d'origine de la dalle de couverture de Carnanmore d'après la position et l'orientation du signe gravé



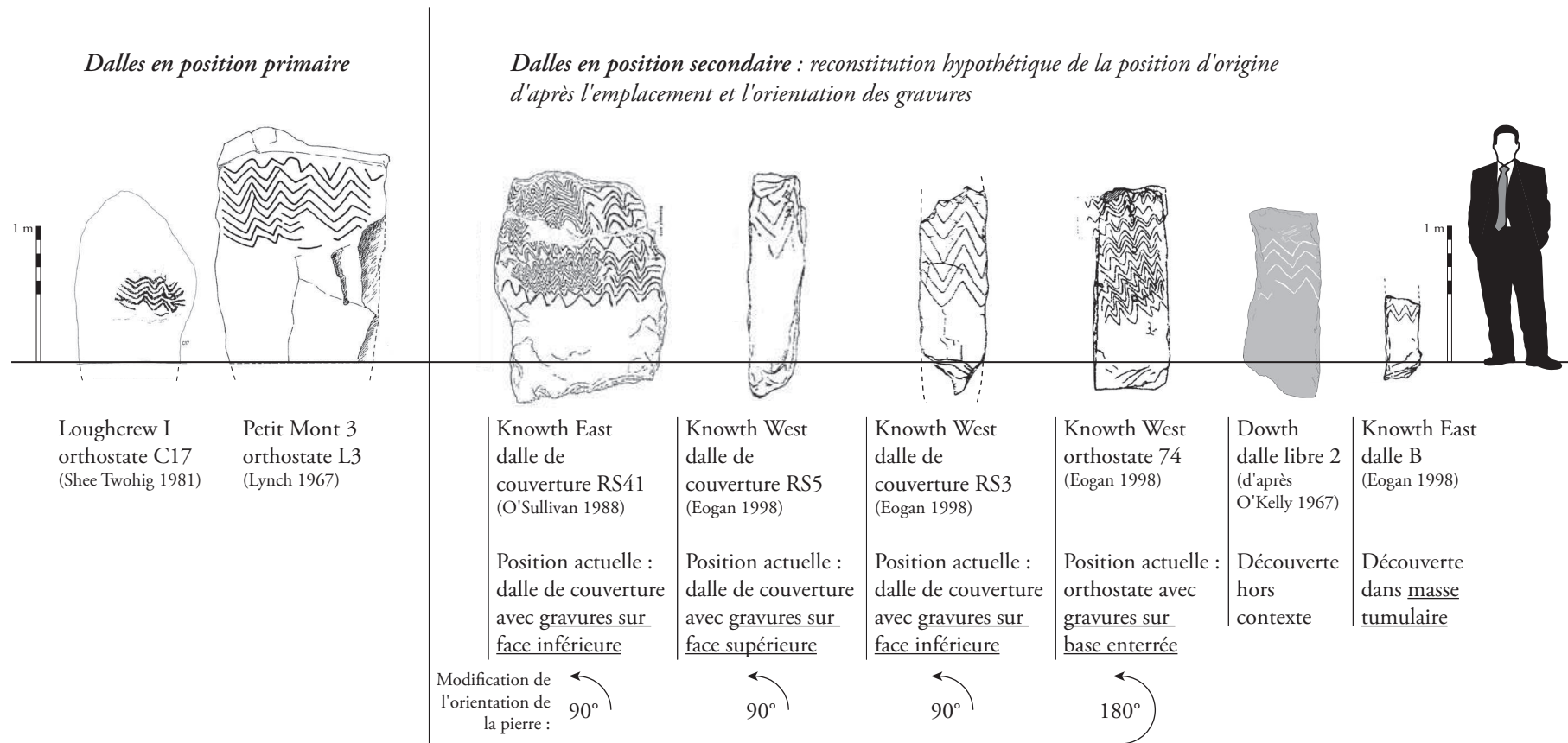

Figure 8.14 : Reconstitution de la position d'origine de dalle en réemploi d'après l'emplacement et l'orientation de signes en chevrons

*Dalle en position primaire*

*Dalles en position secondaire : reconstitution hypothétique de la position d'origine d'après l'emplacement et l'orientation des gravures*

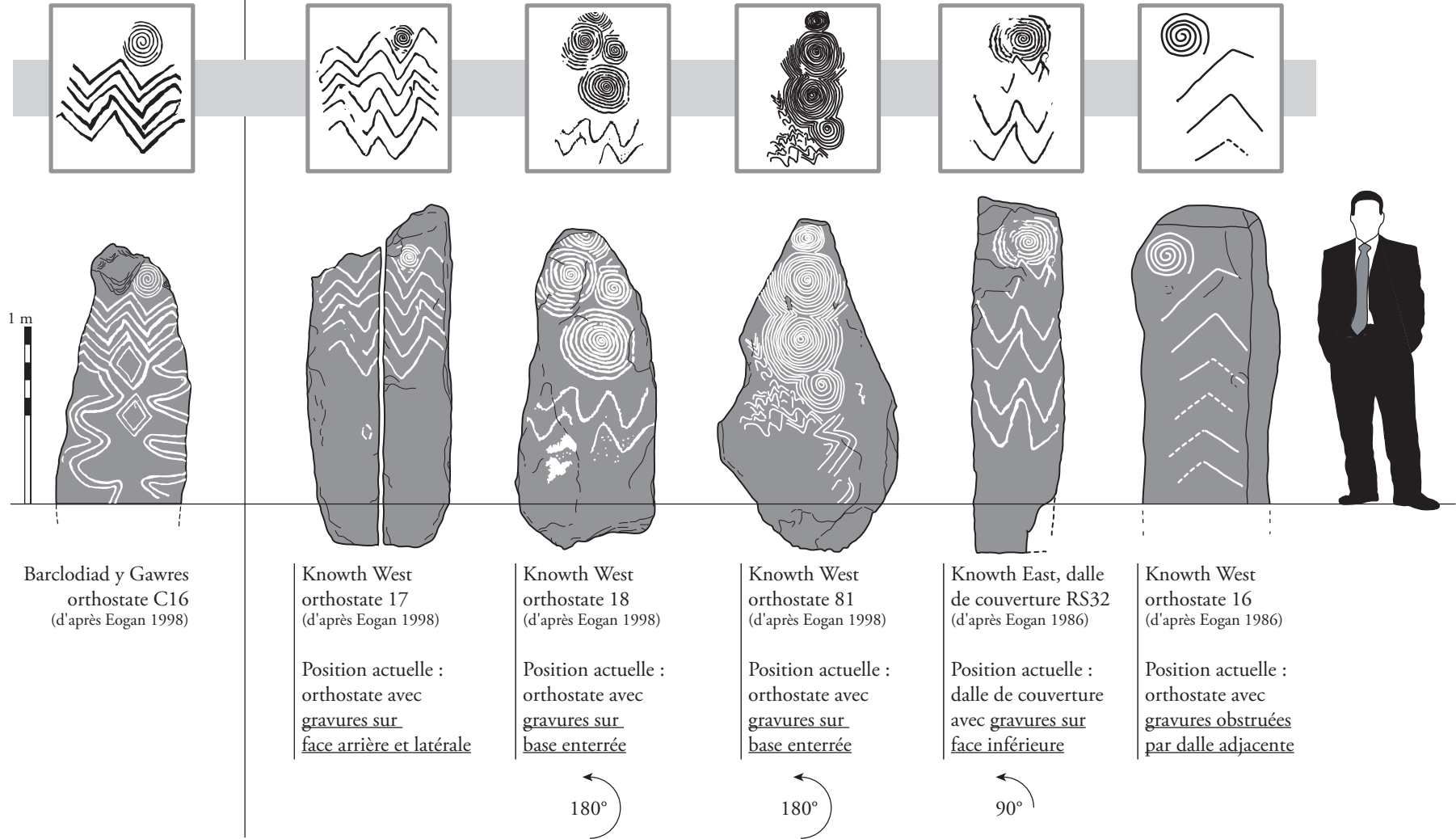
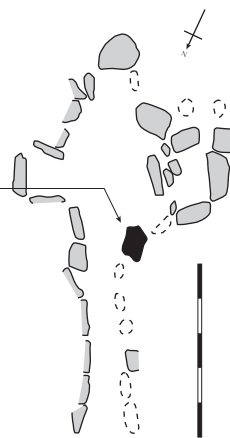

Figure 8.15 : Reconstitution de la position d'origine de dalle en réemploi d'après l'emplacement et l'orientation de signes en chevrons et spirales

*Dalles en position primaire à la jonction du couloir et de la chambre*



Barclodiad y Gawres  
orthostate C16  
(d'après Shee Twohig 1981)



Plan d'après Shee Twohig 1981

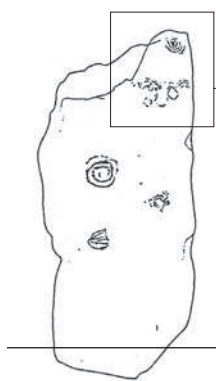

Knowth 17  
orthostate 15  
(O'Sullivan 1988)

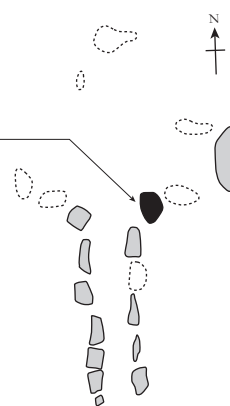

Plan d'après Eogan 1984

*Dalle en position secondaire*

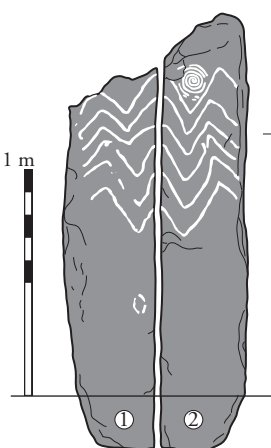

Knowth West  
orthostate 17  
(d'après Eogan 1998)



*Reconstitutions hypothétiques de l'emplacement d'origine d'après la position et l'orientation des gravures*

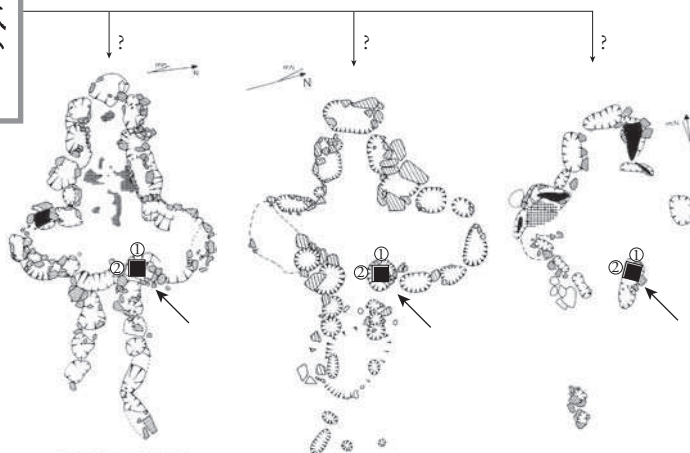

Knowth 6, 9 et 18  
(d'après Eogan 1984)

Figure 8.16 : Reconstitution de la position d'origine de l'orthostate 17 de Knowth West d'après la position et l'orientation des signes gravés

*Dalles en position primaire dans le péristalithe de Knowth*

*Dalle en position secondaire : restitution hypothétique  
comme dalle de péristalithe d'après l'emplacement  
et l'orientation des gravures*

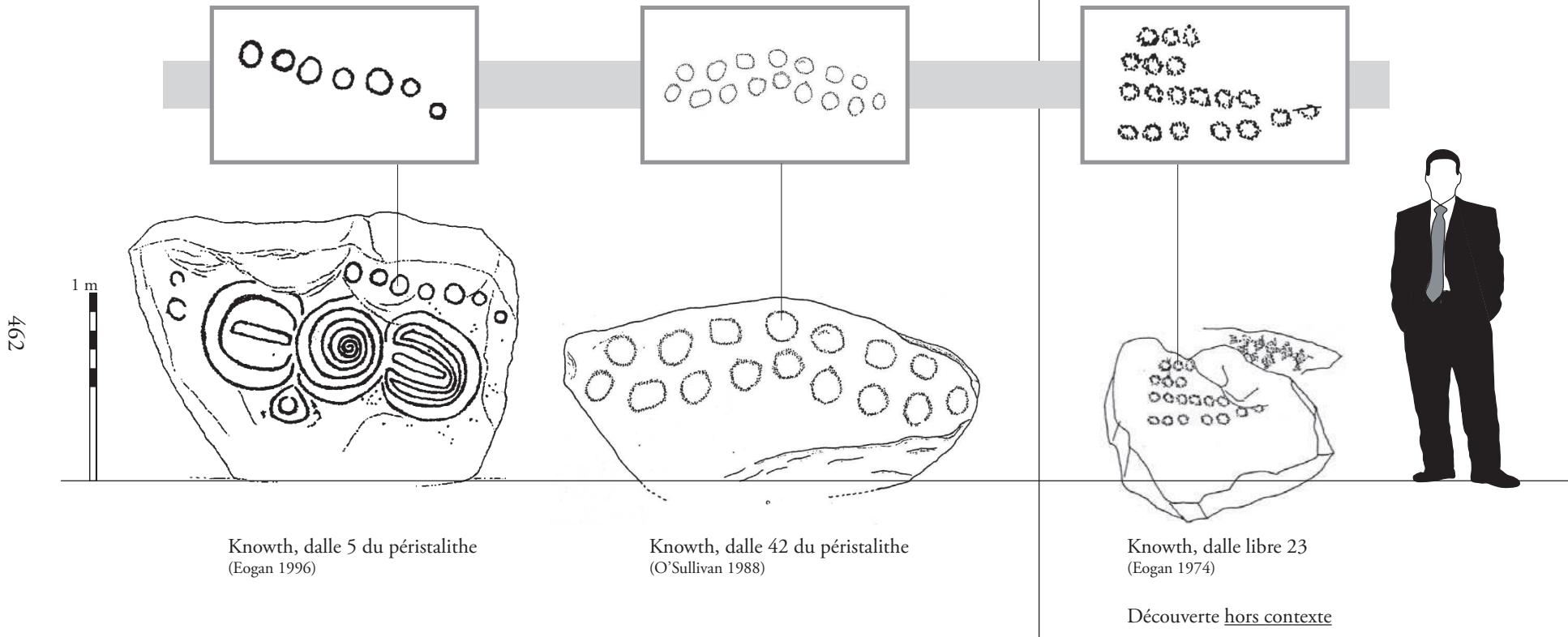

Figure 8.17 : Reconstitution de la position d'origine de la dalle libre 23 de Knowth d'après la position et l'orientation des signes gravés

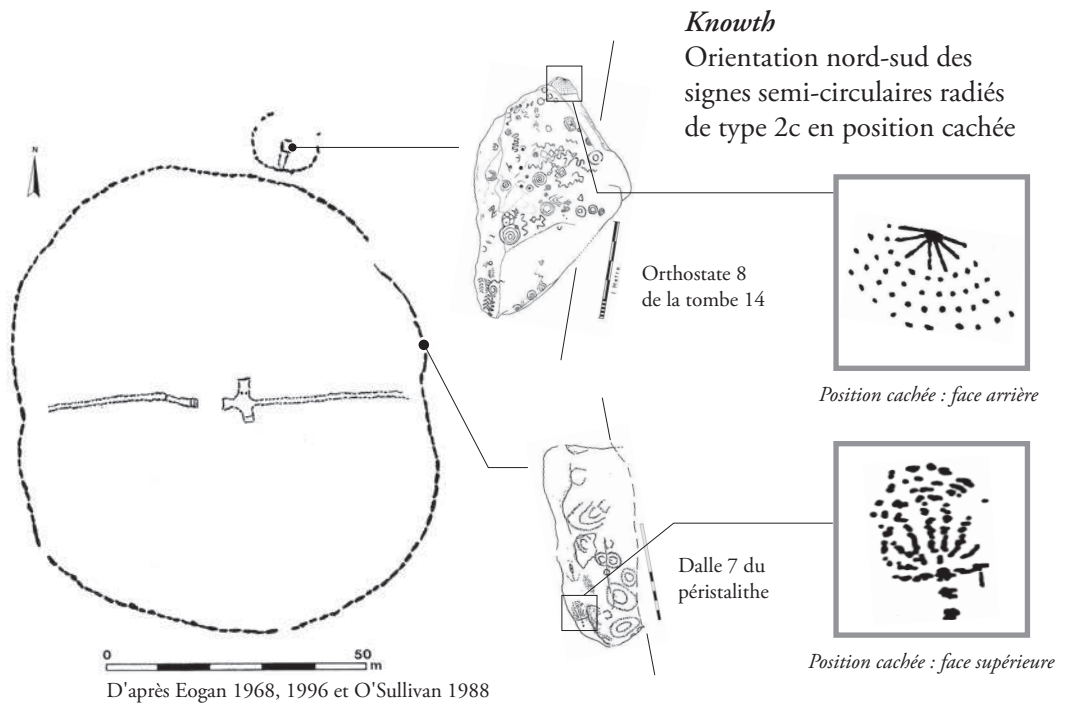
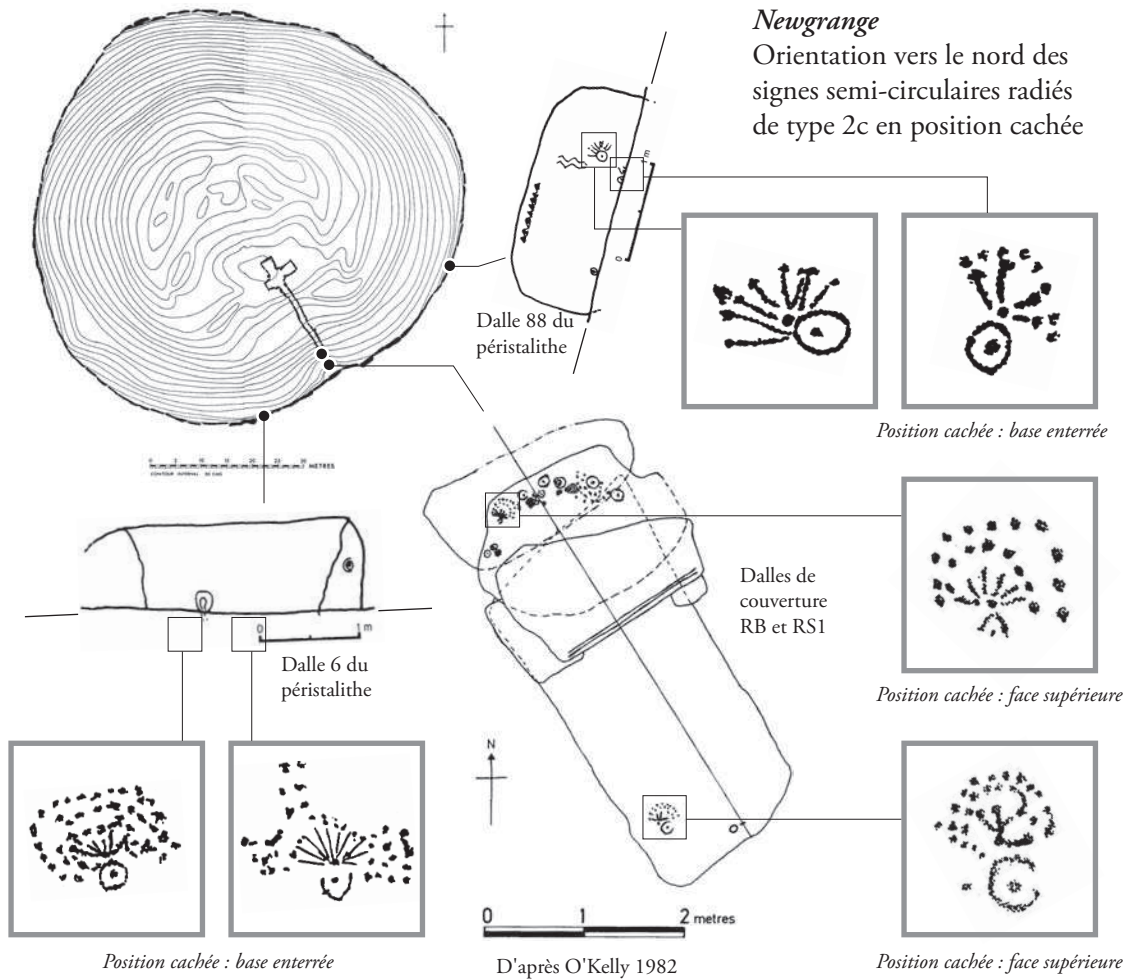

Figure 8.18 : Newgrange et Knowth : orientation des signes semi-circulaires radiés de type 2c en surface cachée

