



HAL
open science

L'art pariétal des tombes à couloir néolithiques autour de la Mer d'Irlande : iconographie et organisation spatiale

Guillaume Robin

► **To cite this version:**

Guillaume Robin. L'art pariétal des tombes à couloir néolithiques autour de la Mer d'Irlande : iconographie et organisation spatiale. Sciences de l'Homme et Société. Université de Nantes, 2008. Français. NNT: . tel-00360165

HAL Id: tel-00360165

<https://theses.hal.science/tel-00360165>

Submitted on 10 Feb 2009

HAL is a multi-disciplinary open access archive for the deposit and dissemination of scientific research documents, whether they are published or not. The documents may come from teaching and research institutions in France or abroad, or from public or private research centers.

L'archive ouverte pluridisciplinaire **HAL**, est destinée au dépôt et à la diffusion de documents scientifiques de niveau recherche, publiés ou non, émanant des établissements d'enseignement et de recherche français ou étrangers, des laboratoires publics ou privés.

UNIVERSITÉ DE NANTES
UFR HISTOIRE, HISTOIRE DE L'ART & ARCHÉOLOGIE

Year 2008

Number assigned by the library

--	--	--	--	--	--	--	--	--	--	--	--	--	--	--	--	--	--	--	--

Thesis

to obtain the degree of

DOCTEUR DE L'UNIVERSITÉ DE NANTES

Discipline : Archaeology

Presented and defended in public by

Guillaume Robin

on the 14th of November 2008

Title :

**Neolithic passage tomb art around the Irish Sea
Iconography and spatial organisation**

Volume 2 : figures

Supervisors:

Mr Serge Cassen (Chargé de Recherche, CNRS)

Mr Muiris O'Sullivan (Professor, University College Dublin)

International PhD cotutelle convention

JURY

Mr Serge Cassen	Chargé de Recherche, CNRS	Supervisor
Mr Muiris O'Sullivan	Professor, University College Dublin	Supervisor
Mr André D'Anna	Directeur de Recherche, CNRS	Rapporteur
Mr Julian Thomas	Professor, University of Manchester	Rapporteur
Mrs Elizabeth Shee Twohig	Senior Lecturer, University College Cork	Examiner
Mr Alasdair Whittle	Professor, Cardiff University	Examiner

List of figures

0.1	Schematic representation of the study.....	234
1.1	Distribution map of passage tombs with circular and long cairn in the British Isles	235
1.2	Distribution map of passage tombs and other architectures with parietal carvings around the Irish Sea.....	236
1.3	Topographic map of location of the site of Carnanmore.....	237
1.4	Topographic map of location of the sites of Knockmany and Sess Kilgreen	238
1.5	Distribution map of passage tombs and other architectures with parietal carvings in county Meath	239
1.6	Topographic map of location of the sites of Loughcrew-Kings Mountain- Clonasillagh	240
1.7	Topographic map of Loughcrew necropolis (Slieve na Calliagh).....	241
1.8	Topographic map of the Boyne valley necropolis (Brugh na Boinne).....	242
1.9	Distribution map of carved passage tombs in Orkney.....	243
1.10	Database of carved stones	244-51
1.11	Positioning of the photographic equipment	252
1.12	Preliminary processings of the photographs	253
1.13	Drawing of the carvings.....	254
1.14	Carvings recorded in Loughcrew F.....	255
1.15	Carvings recorded in Loughcrew H and I.....	256
1.16	Carvings recorded in Loughcrew O and S.....	257
1.17	Carvings recorded in Loughcrew T (1/2).....	258
1.18	Carvings recorded in Loughcrew T (2/2).....	259
1.19	Carvings recorded in Loughcrew U and Carnanmore	260
1.20	Carvings recorded in Knockroe.....	261
1.21	Three-dimensional modelling of a carved stone from digital photographs.....	262
3.1	Typological table of the circular signs.....	263
3.2	Typological table of the spirals.....	263
3.3	Table of associations between types of spirals and carved stones.....	264-7
3.4	Typological table of the arcs.....	268
3.5	Orientation of the arcs.....	268
3.6	Table of associations between types of arcs and carved stones.....	269-73
3.7	Typological table of the radiate circular signs	274
3.8	Table of associations between types of radiate circular signs and carved stones	275
3.9	Typological table of the radiate semicircular signs	276
3.10	Table of associations between types of radiate semicircular signs and carved stones.....	277
3.11	Radiate semicircular signs type 2c.....	278
3.12	Typological table of the chevrons.....	279
3.13	Table of associations between types of chevrons and carved stones.....	280-2
3.14	Typological table of the triangles.....	282
3.15	Table of associations between types of triangles and carved stones	283
3.16	Typological table of the quadrangular signs	284
3.17	Table of associations between types of quadrangular signs and carved stones.....	285-8
3.18	Typological table of the scalariform signs	289
3.19	Table of associations between types of scalariform signs and carved stones	290
3.20	Meandering signs with chevrons.....	291
3.21	Meandering signs ending with a spiral	292
3.22	Meandering signs at the inner end of a spiral.....	292
3.23	Meandering signs with appendage.....	293
3.24	Table 1 of associations between types of meandering signs and carved stones.....	294

3.25	Meandering signs with thickened end	295
3.26	Meandering signs with circular end.....	295
3.27	Meandering signs with 8-shaped end	296
3.28	Meandering signs with angular end.....	296
3.29	Meandering signs with quadrangular ou triangular end	296
3.30	Meandering signs with V-shaped end	296
3.31	Table 2 of associations between types of meandering signs and carved stones	297
3.32	Typological table of the meandering signs.....	298
3.33	The rare signs	299
3.34	Synthetic table of elementary signs.....	300
4.1	Table of signs associations: data in total number of associations.....	302
4.2	Table of signs associations: graphical illustration	303
4.3	Table of signs associations: data in relative percentage	304
4.4	Graphical representation of the proportion of associations sign by sign.....	305
4.5	Graphical representation of the proportion of signs couples	306
4.6	Groups of simple circles	307
4.7	Lines of simple circles	308
4.8	Lines of cupmarks.....	309
4.9	Lines of complex circular signs.....	310
4.10	Lines of radiate circular signs	312
4.11	Lines of simple arcs (1/2).....	313
4.12	Lines of simple arcs (2/2).....	314
4.13	Rows of simple arcs.....	315
4.14	Pairs of opposed arcs.....	316
4.15	Boxed simple chevrons	317
4.16	Boxed simple chevrons with central line	318
4.17	Boxed zigzag chevrons.....	318
4.18	Boxed zigzag chevrons with central line.....	318
4.19	Rows of triangles.....	319
4.20	Parallel rows of triangles	320
4.21	Triangles opposed by the point	321
4.22	Lines of empty lozenges.....	322
4.23	Lines of solid lozenges	323
4.24	Simple grids.....	324
4.25	Chessboard-like grids	325
4.26	Grids of solid squares.....	326
4.27	Vertical parallel meandering lines.....	327
4.28	Horizontal parallel meandering lines.....	328
4.29	Spirals inserted in a circle.....	329
4.30	Circles in the center of a spiral.....	330
4.31	Circular signs with arc appendages.....	331
4.32	Combinations od chevrons, lozenges and triangles	332
4.33	Chevrons inserted in a lozenge	333
4.34	Various signs inserted in a circle.....	334
4.35	Various signs inserted in an arc.....	335
4.36	Various signs enclosed by a meandering line	336
4.37	Simple chevrons between two spirals.....	337
4.38	Square between two spirals.....	338
4.39	Triangle or lozenge between three circles or cups.....	339
4.40	Combination of spiral, chevrons and lozenge.....	340
4.41	Spiral(s) over chevrons.....	341
4.42	Various signs connected to the top of an arc.....	342
4.43	Meandering sign connected to a line of lozenges	343
4.44	Meandering sign and line or row of arcs.....	344
4.45	Cup(s) inside the curves of a meandering sign	345
4.46	Meandering sign and circular sign	346

4.47	Arc with central line	346
4.48	Scalariform sign with axial circle	347
4.49	Synthetic table of signs combinations	348
4.50	Synthetic table of passage tomb iconography around the Irish Sea	349
5.1	Arcs of type 2b in top position	351
5.2	Arcs of type 4 in lowermost position	352
5.3	Scalariform signs in upper limit of kerbstones	353
5.4	Radiate semicircular signs of large dimension carved in central position	353
5.5	Central line, cups alignment and meandering signs	354
5.6	Arcs in contact with the stone edge	355
5.7	Arcs in contact with a line of relief	356
5.8	Decoration of the carinated bowls of Achnacreebeag and Ballymacaldrack	357
5.9	Meandering signs carved along a line of relief	358
5.10	Meandering signs carved along a side face of stone	359
5.11	Ramiform motifs on a horizontal natural line	360
5.12	Three-dimensional modelling of orthostat 19 in Mané Kerioned	361
5.13	Three-dimensional modelling of orthostat C2 in Loughcrew U	362
6.1	Table of distribution of carved surfaces in passage tombs	363
6.2	Modelled representation of the distribution of the carved surfaces in passage tombs	364
6.3	Spatial distribution of the signs in passage tombs	365
6.4	Combination of spiral and chevrons in the eastern part of the kerb	366
6.5	Pairs of opposed arcs on Knowth kerb	367
6.6	Scalariform signs on the kerb of Newgrange, Knowth and Dowth	368
6.7	Scalariform signs on the kerb of Newgrange L and Loughcrew H	369
6.8	The axis represented by a carved vertical central line	370
6.9	Knockroe : the axis of the western tomb and kerbstone 15	371
6.10	Carnanmore : lines of single arcs oriented in the tomb axis	372
6.11	Knockroe West : lines of single arcs oriented in the tomb axis	373
6.12	Loughcrew F : lines of single arcs oriented in the tomb axis	374
6.13	Knowth kerb : lines of single arcs oriented in the tomb axis	375
6.14	Loughcrew T : boxed arcs motif repeated along the axis	376
6.15	Knowth East and West : boxed arcs motif repeated along the axis	377
6.16	Opposition of group of signs on each side of the axis	378
6.17	Knowth 13 : opposition of signs and geological textures	379
6.18	Newgrange : opposition between spiral and meandering signs	380
6.19	Opposition in the orientation of arcs at the entrance of Knowth East and Knowth West	381
6.20	Parallel lines of chevrons and internal limits in Fourknocks	382
6.21	Parallel lines of chevrons and internal limits in Knowth East	383
6.22	Parallel lines of chevrons and internal limits in Loughcrew	384
6.23	Parallel lines of chevrons and internal limits in Newgrange and Barclodiad y Gawres	385
6.24	Combination of spiral, chevrons and lozenges at the passage-chamber junction in Knowth 17 and Barclodiad y Gawres	386
6.25	Distribution of the spirals, chevrons and lozenges in Barclodiad y Gawres	387
6.26	Parallel lines of chevrons and internal limits in Le Petit Mont	388
6.27	Parallel lines of chevrons and internal limits in Gavrinis	389
6.28	Boxed simple chevrons with central space associated with internal limits	390
6.29	Scalariform signs and internal limits in Dowth North	391
6.30	Scalariform signs and internal limits in Dowth South	392
6.31	Scalariform signs and internal limits in Knowth	393
6.32	Scalariform signs and internal limits in Newgrange	394
6.33	Scalariform signs and internal limits in Loughcrew F and I	395
6.34	Scalariform signs and internal limits in Loughcrew T	396

6.35	Scalariform signs and internal limits in Loughcrew S and U.....	397
6.36	Scalariform signs and internal limits in Table des Marchands	398
6.37	Scalariform signs and internal limits in Les Pierres Plates.....	399
6.38	Synthesis of the relations between scalariform signs and internal limits	400
6.39	Lines of circular signs and internal limits.....	401
6.40	The rare sign n°2 and internal limits in Knowth	402
6.41	Distribution of inverted arcs in Loughcrew T.....	403
6.42	Distribution of inverted arcs in Loughcrew I and U.....	404
6.43	Distribution of inverted arcs in Knowth East and Knowth 14.....	405
6.44	Distribution of inverted arcs in Loughcrew L	406
6.45	Distribution of opposed triangles in Newgrange and Loughcrew L.....	407
6.46	Layout of the scalariform signs in funerary recesses.....	408
6.47	Layout of lines of circular signs in funerary recesses.....	409
6.48	Layout of circular signs with arc appendages in funerary recesses.....	410
6.49	Meandering sign with 8-shaped end associated with three spirals	411
6.50	Circular sign and line of relief linked by a curved line	412
6.51	Synthesis of the main relations between iconography and architectural structure.....	413
6.52	Relations between forms and location of the scalariform sign	414
7.1	Tumular structure of Knowth 2 and 12.....	415
7.2	Tumular structure of Knowth 15 and 16.....	416
7.3	Tumular structure of Newgrange K, L and Z.....	417
7.4	Tumular structure of Newgrange	418
7.5	Tumular structure of Barclodiad y Gawres	419
7.6	Concentric enclosures in Carrowmore 4, 7 and 27.....	420
7.7	Concentric enclosures in Townleyhall, Ballycarty and Knowth 4.....	421
7.8	Concentric enclosures in Banagher, Baunfree and Bryn Celli Ddu	422
7.9	Table of synthesis of the tumular structures	423
7.10	Knowth : relations between the core cairn and the thresholds inside tombs East and West	424
7.11	Knowth and Newgrange passage roof: U-shaped structure at the limit of the core cairn	425
7.12	Hypogeum IV of Pubusattile	426
7.13	Slievenamon cairn.....	427
7.14	Passage tombs with emphasis on the right-hand side (1/2).....	428
7.15	Passage tombs with emphasis on the right-hand side (2/2).....	429
7.16	System of opposition under the cairn of Baltinglass and Carrowmore 7.....	430
7.17	Opposition of grave furniture in Newgrange and Knowth East.....	431
7.18	Opposition of grave furniture in Newgrange L and Knowth 2.....	432
7.19	Opposition of grave furniture in Loughcrew F and H and Tara.....	433
7.20	Classifications and oppositions of human remains in West Kennet, Burn Ground and Notgrove (Severn-Cotswold group).....	434
7.21	Schematic representation of the spatial organization of passage tomb structures	435
7.22	The hopscotch game	436
8.1	Carvings on obscured surface	437
8.2	Carvings on the buried base of orthostats and kerbstones	438
8.3	Carvings on the backface of kerbstones	439
8.4	Carvings on the backface of orthostats.....	440
8.5	Carvings on the upper face of capstones.....	441
8.6	Carvings on stones buried in the tumulus	442
8.7	Table of synthesis of hidden carvings	443-4
8.8	Statistical graphs on hidden art iconography.....	445
8.9	The relations between families of signs and types of hidden surfaces.....	446
8.10	Newgrange and Bryn Celli Ddu : reconstitution of the original position of reused stone after the location of the carvings and the shape of the stone	447
8.11	Knowth : reconstitution of the original position of reused stone after the location	

	of the carvings and the shape of the stone.....	448
8.12	Reconstitution of the original position of Knowth RS28 after the position and orientation of the carved sign	449
8.13	Reconstitution of the original position of Carnanmore roofstone after the position and orientation of the carved signs	450
8.14	Reconstitution of the original position of reused stones after the location and orientation of the carved chevrons.....	451
8.15	Reconstitution of the original position of reused stones after the location and orientation of the carved combination of chevrons and spirals	452
8.16	Reconstitution of the original position of Knowth West orthostat 17 after the position and orientation of the carved signs	453
8.17	Reconstitution of the original position of Knowth loose stone 23 after the position and orientation of the carved signs.....	454
8.18	Newgrange et Knowth : orientation of the radiate semicircular signs of type 2c in hidden surface.....	455

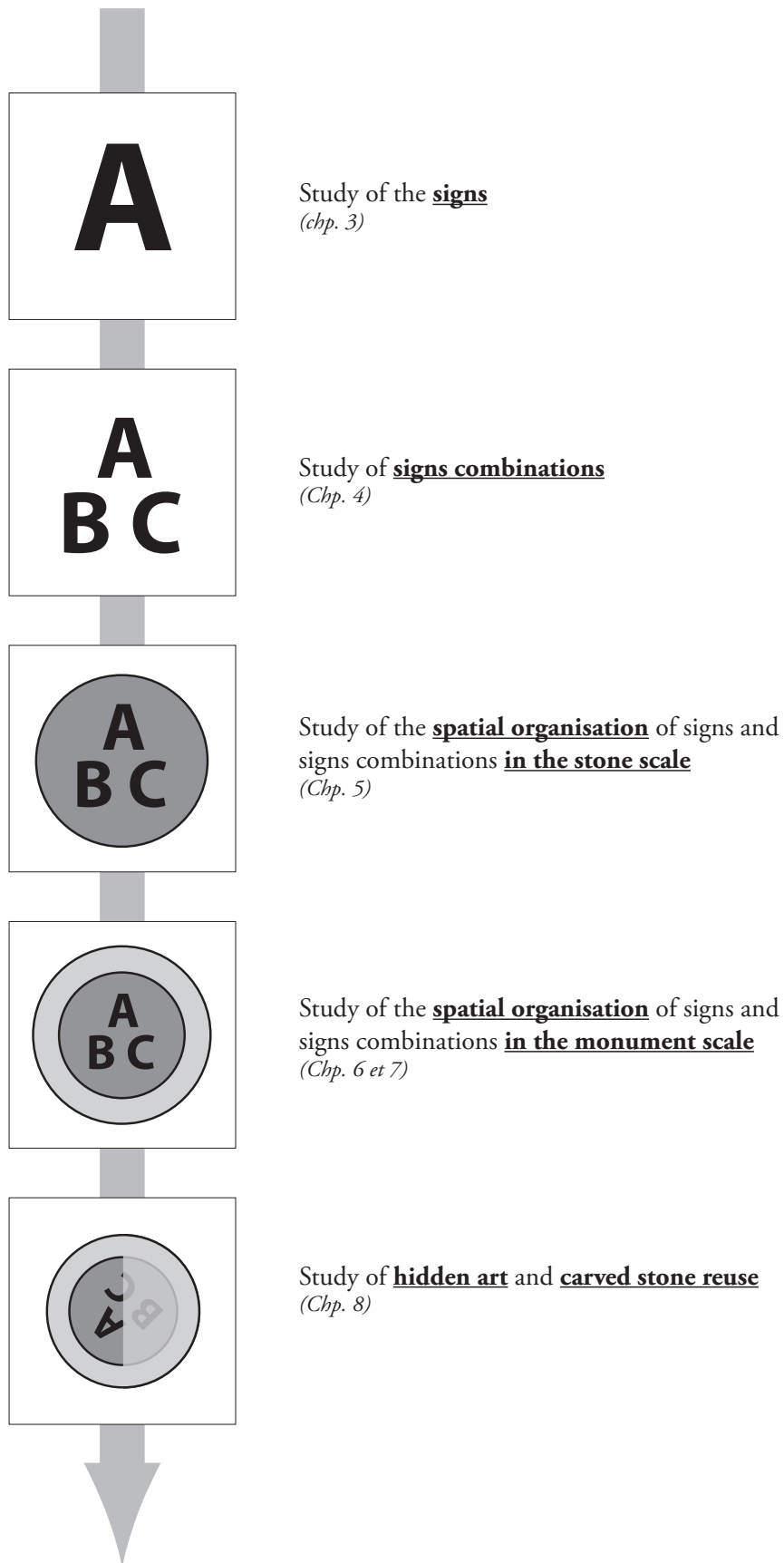
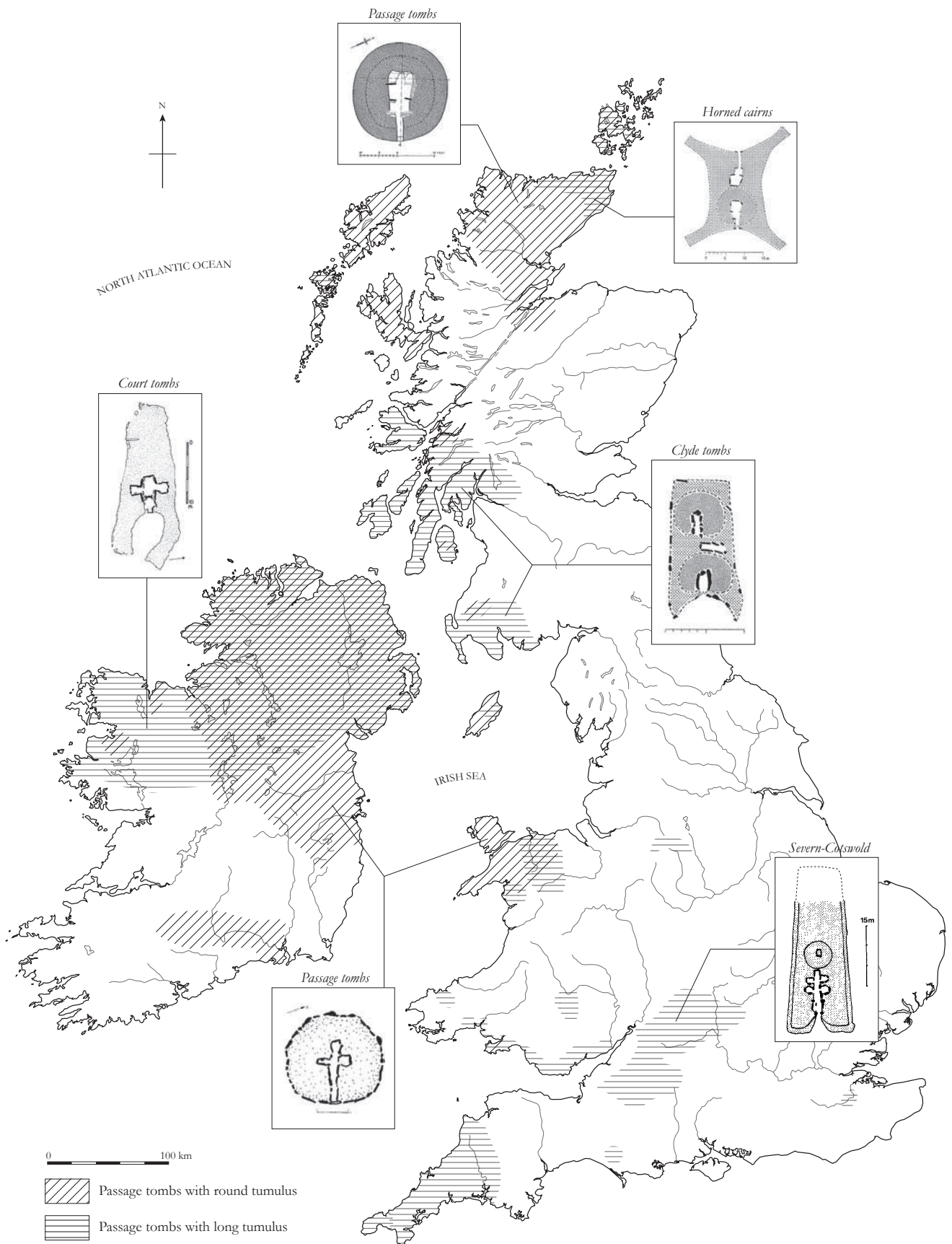


Figure 0.1 : Schematic representation of the study



Sources : Davies 1945 ; Daniel & Powell 1949 ; Daniel 1950 ; De Valera 1960, 1965 ; Henshall 1963, 1972 ; Herity 1974 ; Darvill 1982 ; Eogan 1986 ; Davidson & Henshall 1991 ; Kinnes 1992 ; McMann 1993 ; Henshall & Ritchie 1995, 2001.

Figure 1.1 : Distribution map of passage tombs with circular and long cairn in the British Isles

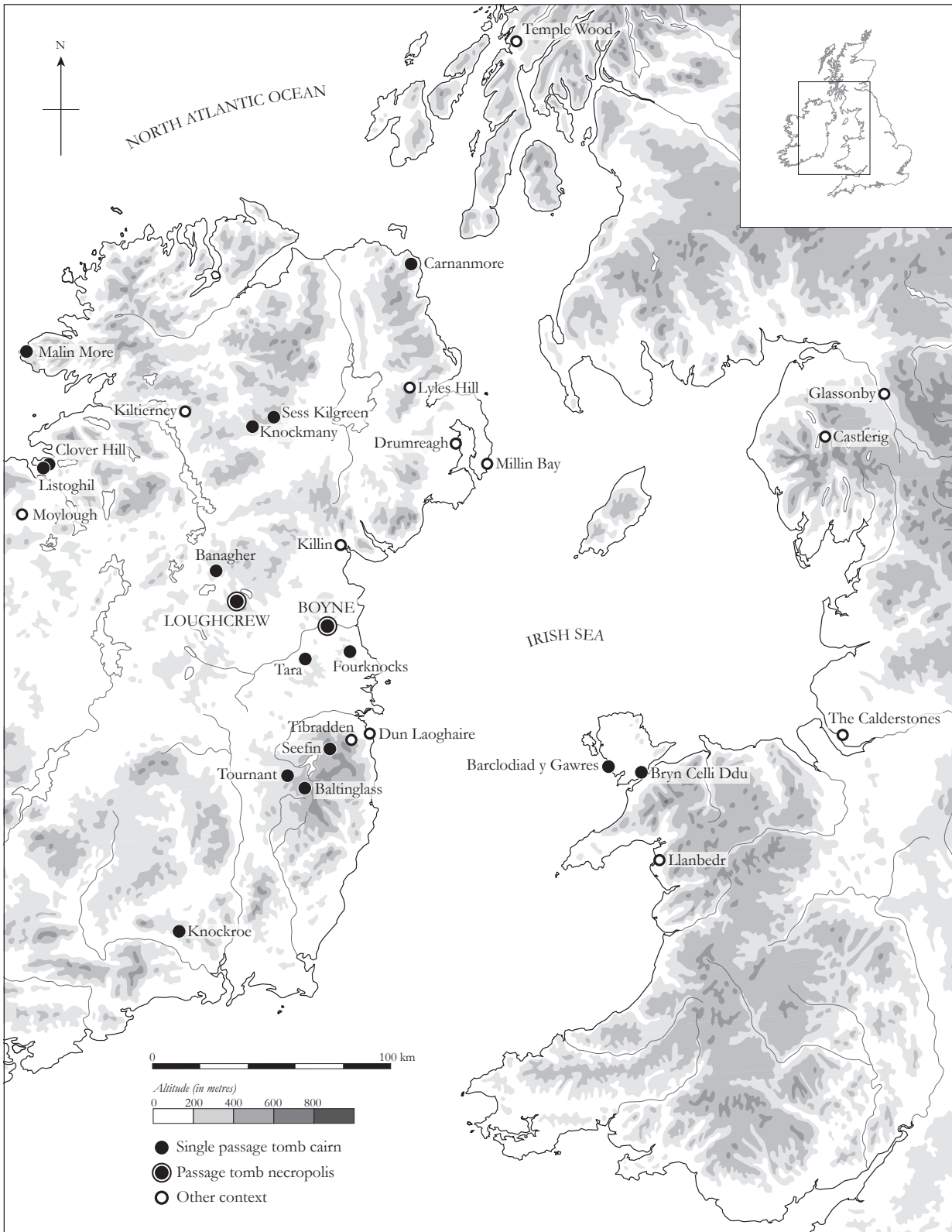


Figure 1.2 : Distribution map of passage tombs and other architectures with parietal carvings around the Irish Sea

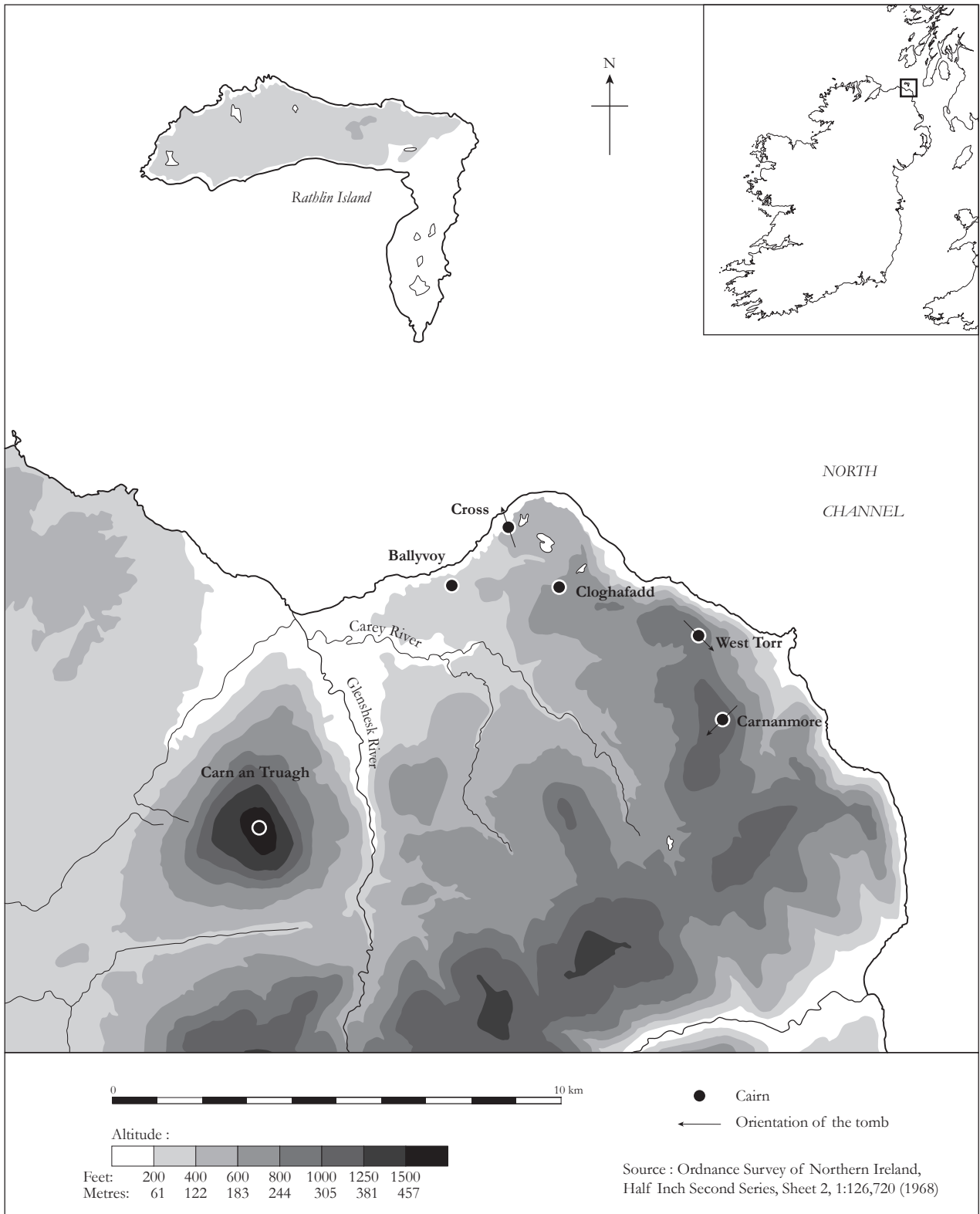


Figure 1.3 : Topographic map of location of the site of Carnanmore

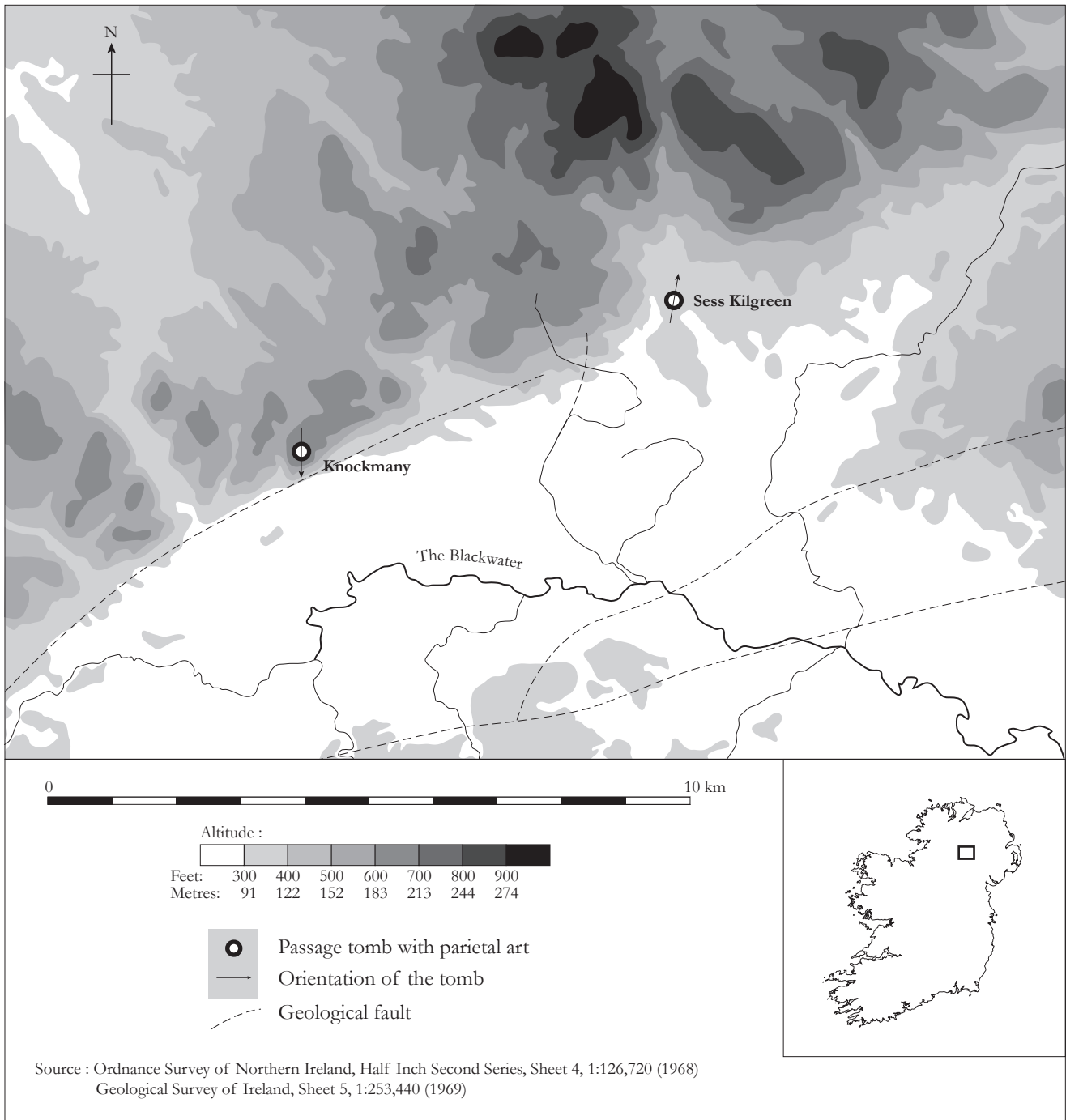


Figure 1.4 : Topographic map of location of the sites of Knockmany and Sess Kilgreen

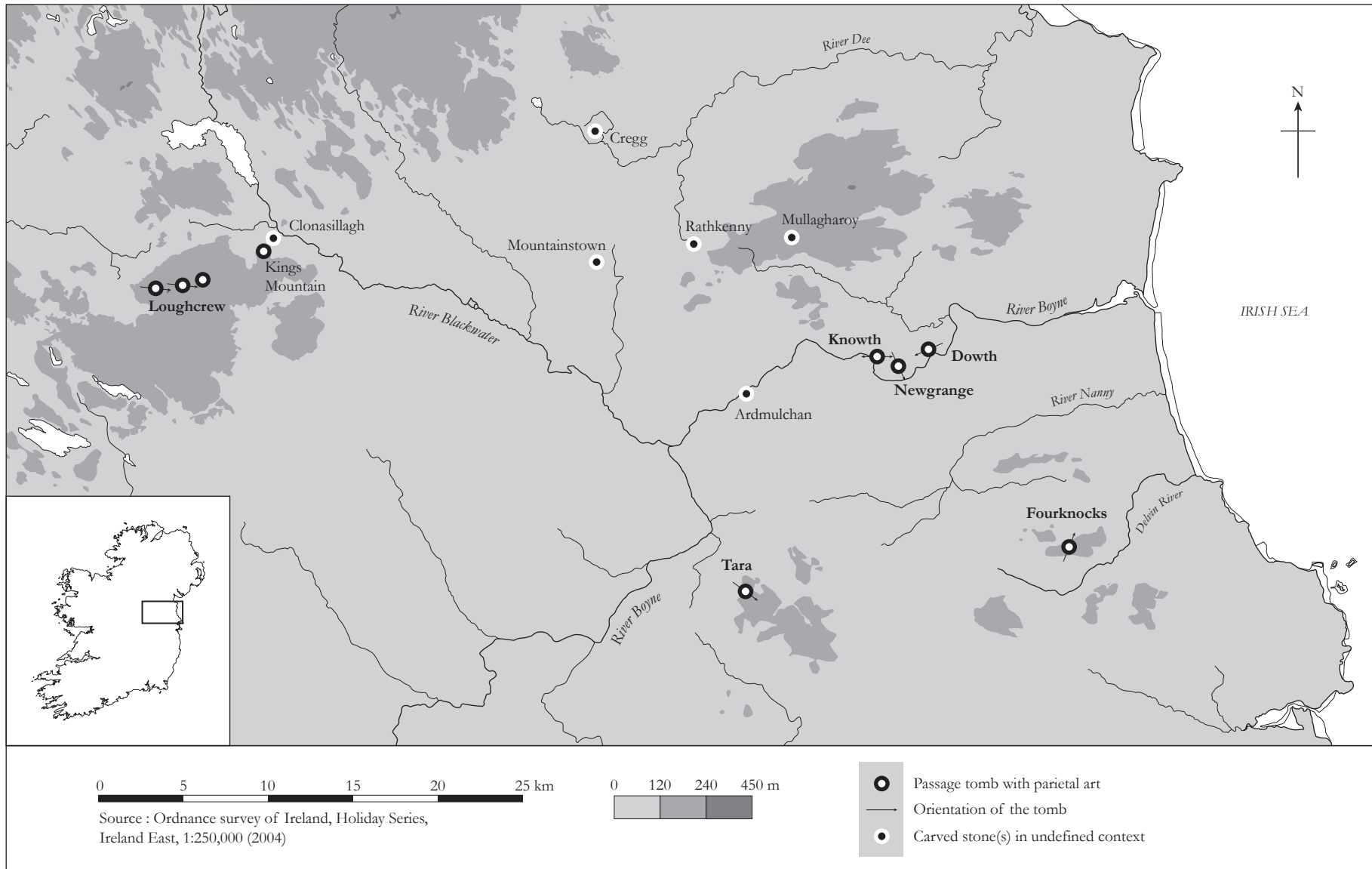


Figure 1.5 : Distribution map of passage tombs and other architectures with parietal carvings in county Meath

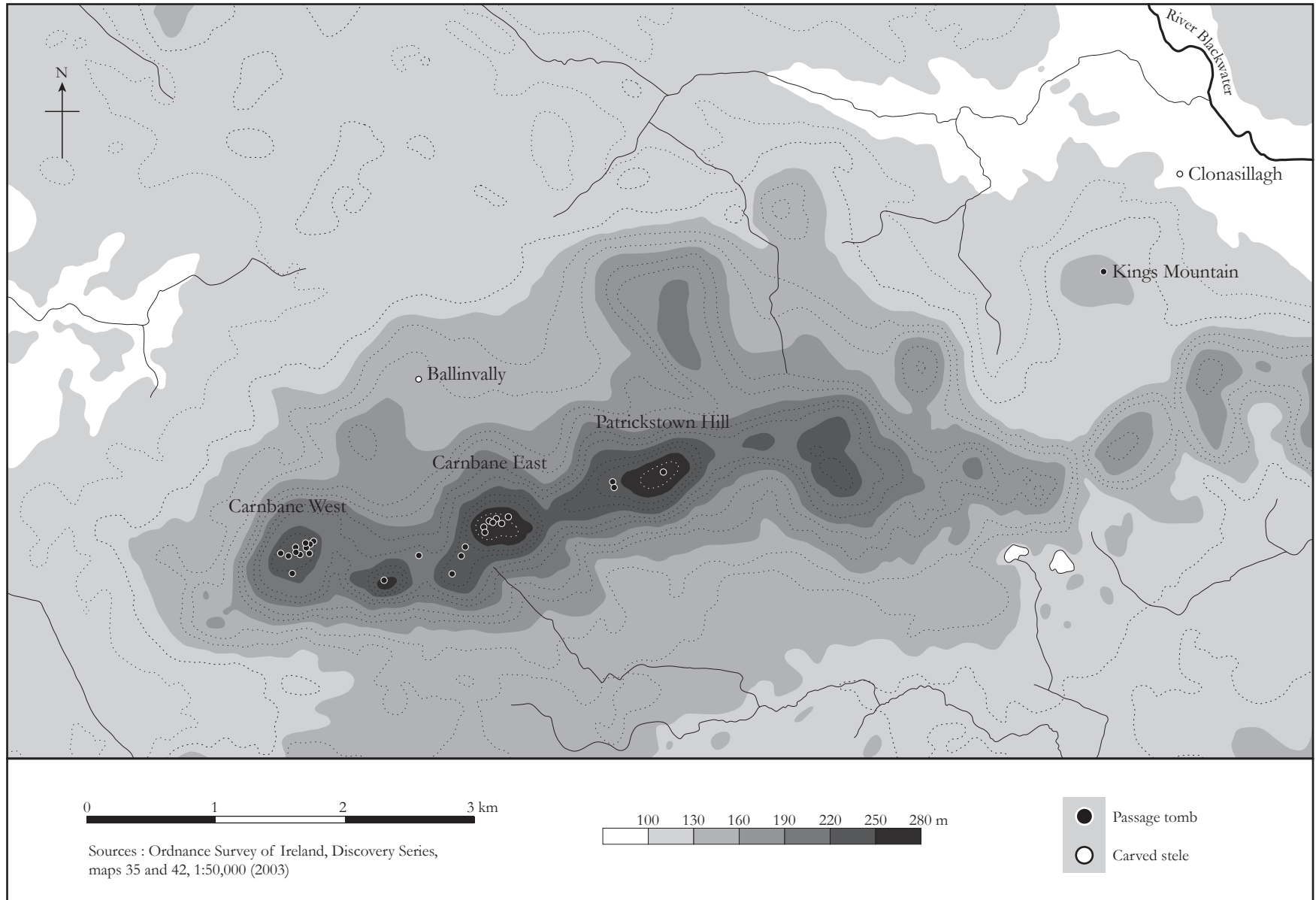
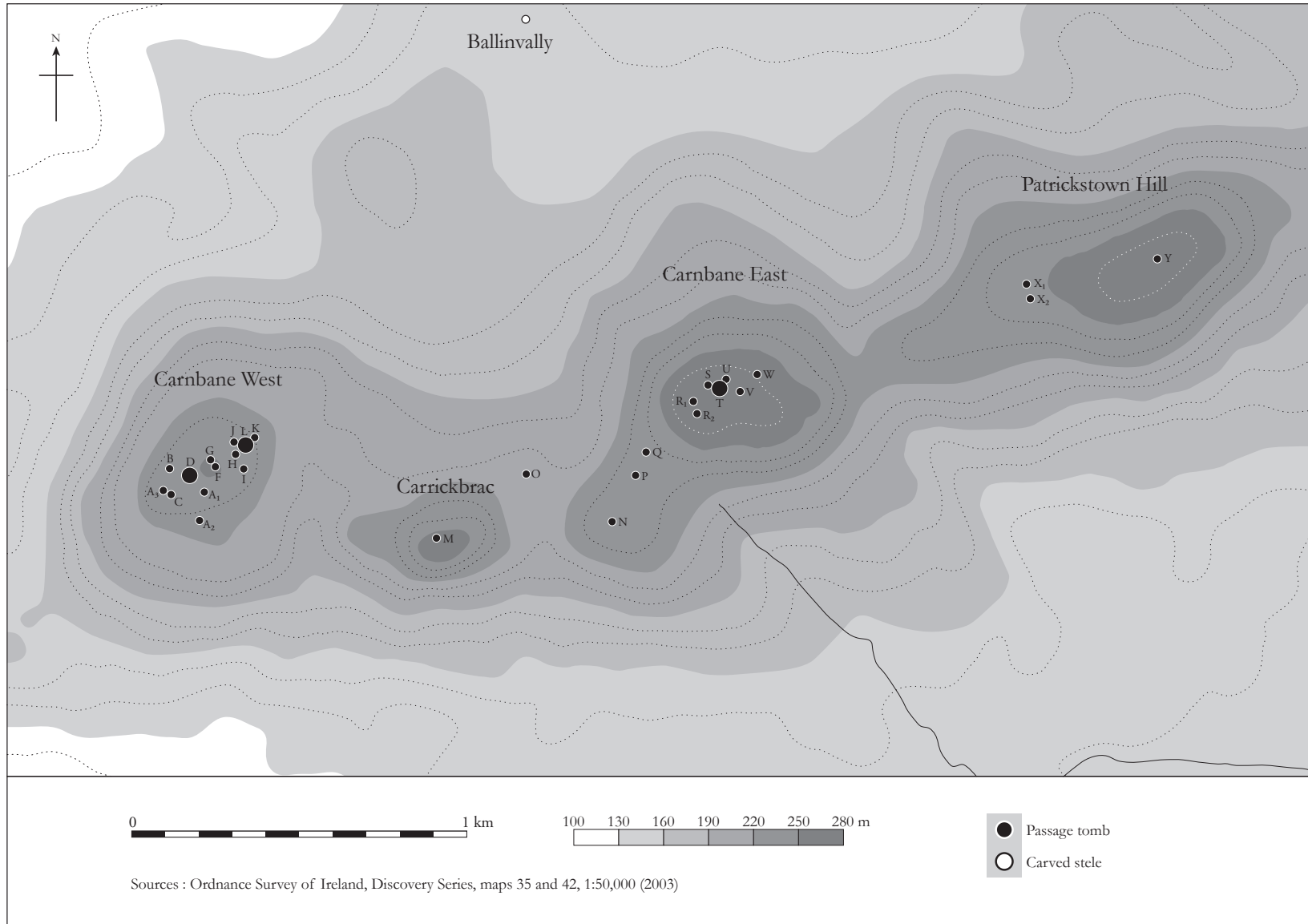


Figure 1.6 : Topographic map of location of the sites of Loughcrew-Kings Mountain-Clonasillagh



Sources : Ordnance Survey of Ireland, Discovery Series, maps 35 and 42, 1:50,000 (2003)

Figure 1.7 : Topographic map of Loughcrew necropolis (Slieve na Calliagh)

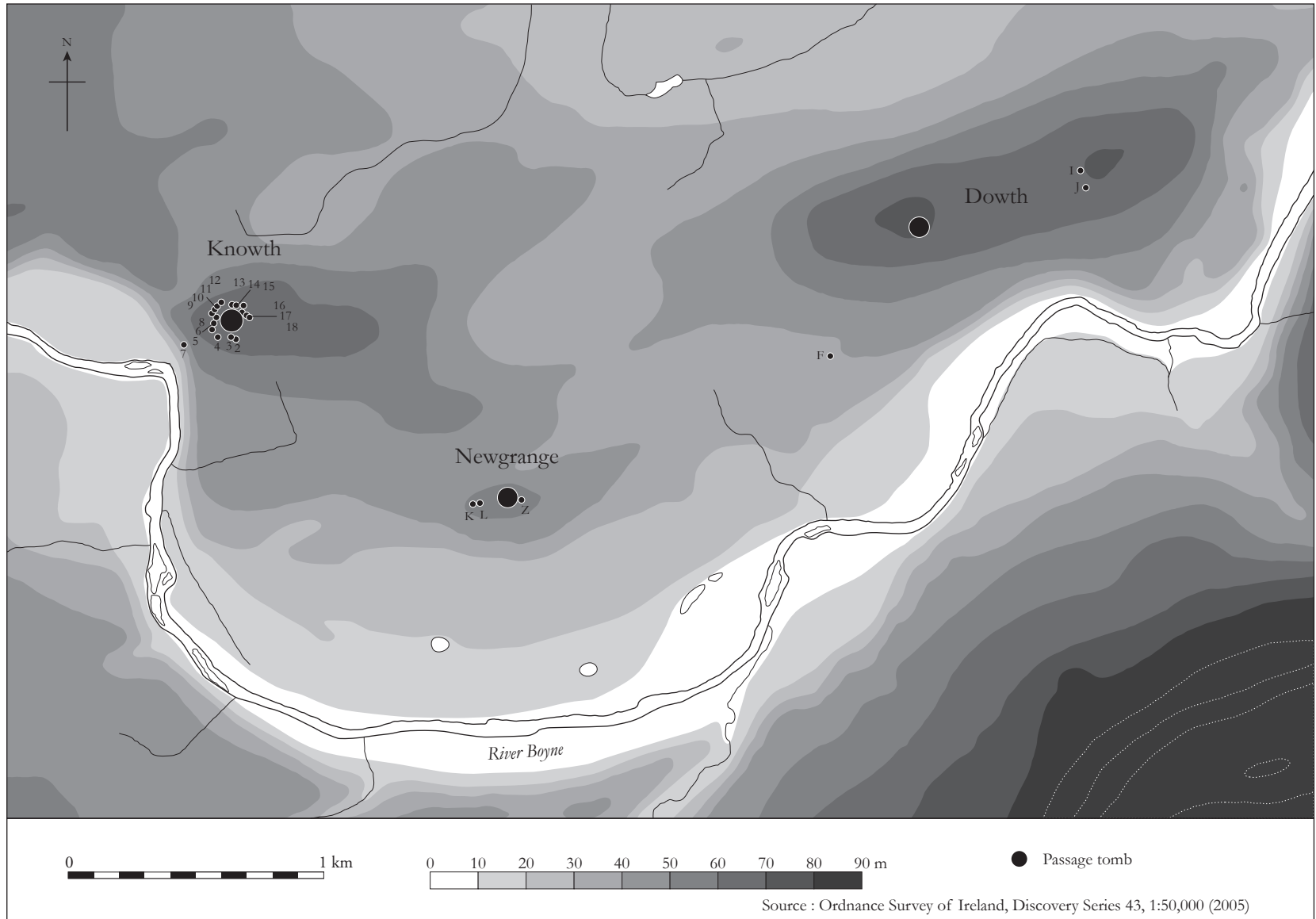


Figure 1.8 : Topographic map of the Boyne valley necropolis (Brugh na Boinne)

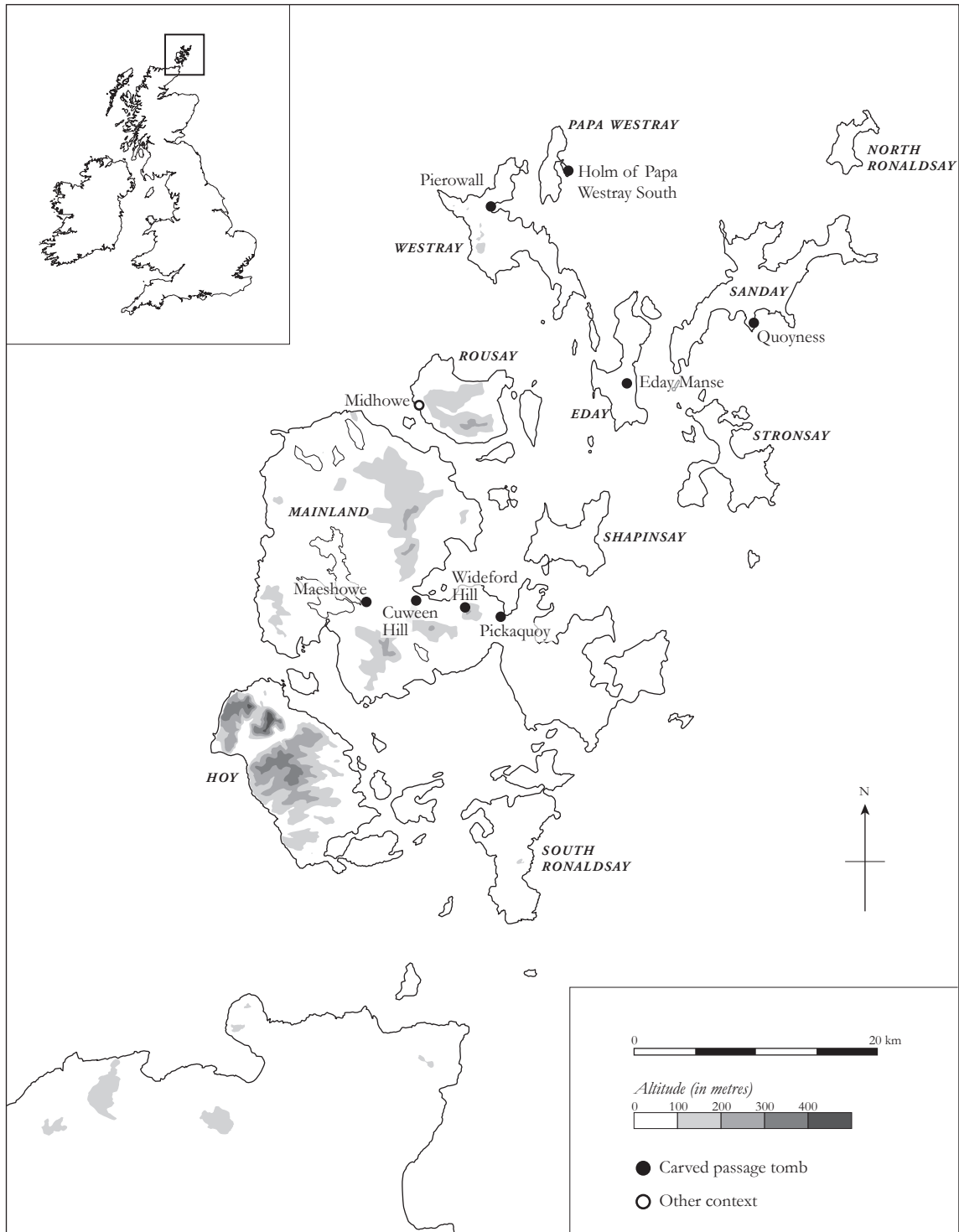


Figure 1.9 : Distribution map of carved passage tombs in Orkney

Abbreviation	Country	County	Site	●	○	⊙	∩	*	☀	∞	▲	◇	≡	∞	Bibliographical source	Kerb	Passage	Chamber	Cell
Am.1	IRL	Meath	Ardmulchan												Eogan 1974				
Am.2	IRL	Meath	Ardmulchan												Eogan 1974				
Bv4	IRL	Meath	Ballinvally 4												Shee Twohig 2001				
Bg.F	IRL	Meath	Baltinglass												Shee Twohig 1981				
Bg.G	IRL	Meath	Baltinglass												Shee Twohig 1981				
Bg.H	IRL	Meath	Baltinglass												Shee Twohig 1981				
Bg.I	IRL	Meath	Baltinglass I												Shee Twohig 1981				
Bg.II.K	IRL	Meath	Baltinglass II												Shee Twohig 1981				3
Bg.II.L	IRL	Meath	Baltinglass II												Shee Twohig 1981				1
Bh	IRL	Cavan	Banagher										?		Cody 2002				
Co.Co1	IRL	Antrim	Carmanmore												Robin 2007				
Co.Co2	IRL	Antrim	Carmanmore																
Cd	IRL	Kildare	Castledermot												Roe 1967				
CI	IRL	Cork	Clear Island												Shee Twohig 1981				
Cn	IRL	Meath	Clonasillagh										?		Eogan 2000				
Ch.loose	IRL	Sligo	Cloverhill												Shee Twohig 1981				
Ch.C3	IRL	Sligo	Cloverhill												Shee Twohig 1981				
Ch.C8	IRL	Sligo	Cloverhill												Shee Twohig 1981				
Ch.C9	IRL	Sligo	Cloverhill												Shee Twohig 1981				
Cg	IRL	Meath	Cregg												Corlett 1996				
Dh.K1	IRL	Meath	Dowth												O'Kelly & O'Kelly 1983				
Dh.K2	IRL	Meath	Dowth												O'Kelly & O'Kelly 1983				
Dh.K7	IRL	Meath	Dowth												O'Kelly & O'Kelly 1983				
Dh.K12	IRL	Meath	Dowth												O'Kelly & O'Kelly 1983				
Dh.K13	IRL	Meath	Dowth												O'Kelly & O'Kelly 1983				
Dh.K14	IRL	Meath	Dowth												O'Kelly & O'Kelly 1983				
Dh.K16	IRL	Meath	Dowth												O'Kelly & O'Kelly 1983				
Dh.K17	IRL	Meath	Dowth												O'Kelly & O'Kelly 1983				
Dh.K34	IRL	Meath	Dowth												O'Kelly & O'Kelly 1983				
Dh.K36	IRL	Meath	Dowth												O'Kelly & O'Kelly 1983				
Dh.K50b	IRL	Meath	Dowth												O'Kelly & O'Kelly 1983				
Dh.K51	IRL	Meath	Dowth												O'Kelly & O'Kelly 1983				
Dh.K51b	IRL	Meath	Dowth												O'Kelly & O'Kelly 1983				
Dh.K52	IRL	Meath	Dowth												O'Kelly & O'Kelly 1983				
Dh.K53	IRL	Meath	Dowth												O'Kelly & O'Kelly 1983				
Dh.K88	IRL	Meath	Dowth												O'Kelly & O'Kelly 1983				
Dh.N.L4	IRL	Meath	Dowth N												O'Kelly & O'Kelly 1983				
Dh.N.L5	IRL	Meath	Dowth N												O'Kelly & O'Kelly 1983				
Dh.N.R5	IRL	Meath	Dowth N												O'Kelly & O'Kelly 1983				
Dh.N.C1	IRL	Meath	Dowth N												O'Kelly & O'Kelly 1983				
Dh.N.C2	IRL	Meath	Dowth N												O'Kelly & O'Kelly 1983				1
Dh.N.C7	IRL	Meath	Dowth N												O'Kelly & O'Kelly 1983				
Dh.N.C8	IRL	Meath	Dowth N										?		O'Kelly & O'Kelly 1983				2
Dh.N.C18	IRL	Meath	Dowth N												O'Kelly & O'Kelly 1983				3
Dh.N.C19	IRL	Meath	Dowth N												O'Kelly & O'Kelly 1983				
Dh.N.RS4	IRL	Meath	Dowth N												O'Kelly & O'Kelly 1983				
Dh.N.CoR7/R8	IRL	Meath	Dowth N												O'Kelly & O'Kelly 1983				
Dh.S.R1	IRL	Meath	Dowth S												O'Kelly & O'Kelly 1983				
Dh.S.R2	IRL	Meath	Dowth S												O'Kelly & O'Kelly 1983				
Dh.S.C6	IRL	Meath	Dowth S												O'Kelly & O'Kelly 1983				
Dh.S.C7	IRL	Meath	Dowth S												O'Kelly & O'Kelly 1983				
Dh.S.C8	IRL	Meath	Dowth S												O'Kelly & O'Kelly 1983				
Dh.S.C9	IRL	Meath	Dowth S												O'Kelly & O'Kelly 1983				
Dh.S.C10	IRL	Meath	Dowth S												O'Kelly & O'Kelly 1983				3
Dh.S.C11	IRL	Meath	Dowth S												O'Kelly & O'Kelly 1983				3
Dh.S.C12	IRL	Meath	Dowth S												O'Kelly & O'Kelly 1983				3
Dh.S.C13	IRL	Meath	Dowth S										?		O'Kelly & O'Kelly 1983				
Dh.S.C15	IRL	Meath	Dowth S												O'Kelly & O'Kelly 1983				
Dh.S.RS2	IRL	Meath	Dowth S												O'Kelly & O'Kelly 1983				
Dh.S.lr	IRL	Meath	Dowth S												O'Kelly & O'Kelly 1983				3
Dh.loose1	IRL	Meath	Dowth												O'Kelly 1967				
Dh.loose2	IRL	Meath	Dowth												O'Kelly 1967				
Dr	IRL	Down	Drumreagh												Shee Twohig 1981				
DL.1	IRL	Dublin	Dun Laoghaire												Ronan 1932				
DL.2	IRL	Dublin	Dun Laoghaire												Gogan 1932				
Fk.L4	IRL	Meath	Fourknocks I												Shee Twohig 1981				
Fk.R2	IRL	Meath	Fourknocks I												Shee Twohig 1981				
Fk.R5	IRL	Meath	Fourknocks I												Shee Twohig 1981				
Fk.C1	IRL	Meath	Fourknocks I												Shee Twohig 1981				
Fk.C5b	IRL	Meath	Fourknocks I												Shee Twohig 1981				1
Fk.A	IRL	Meath	Fourknocks I												Shee Twohig 1981				
Fk.B	IRL	Meath	Fourknocks I												Shee Twohig 1981				
Fk.C	IRL	Meath	Fourknocks I												Shee Twohig 1981				
Fk.D	IRL	Meath	Fourknocks I												Shee Twohig 1981				3
Fk.E	IRL	Meath	Fourknocks I												Shee Twohig 1981				2
Fk.F	IRL	Meath	Fourknocks I												Shee Twohig 1981				3
Kl	IRL	Louth	Killin												Shee Twohig 1981				
Kt.E	IRL	Fermanagh	Kiltierney										?		Shee Twohig 1981				
Kt.W	IRL	Fermanagh	Kiltierney												Shee Twohig 1981				
KM	IRL	Meath	Kings Mountain												Shee Twohig 1981				
Km.C3	IRL	Tyrone	Knockmany										?		Shee Twohig 1981				
Km.C4	IRL	Tyrone	Knockmany										?		Shee Twohig 1981				
Km.C5	IRL	Tyrone	Knockmany												Shee Twohig 1981				
Km.C6	IRL	Tyrone	Knockmany										?		Shee Twohig 1981				
Km.C7	IRL	Tyrone	Knockmany												Shee Twohig 1981				
Km.C9	IRL	Tyrone	Knockmany									?			Shee Twohig 1981				
Km.C10	IRL	Tyrone	Knockmany												Shee Twohig 1981				

1 - Object, subject and methodology

Abbreviation	Country	County	Site	●	○	◎	⤿	✳	☀	⚡	▲	◇	≡	⋈	Bibliographical source	Kerb	Pass	Ch.	Call
Km.C11	IRL	Tyrone	Knockmany					?							Shee Twohig 1981				
Km.C12	IRL	Tyrone	Knockmany												Shee Twohig 1981				
Kr.K32	IRL	Kilkenny	Knockroe												O'Sullivan 1987				
Kr.K31	IRL	Kilkenny	Knockroe												O'Sullivan 1987				
Kr.K30	IRL	Kilkenny	Knockroe											?	O'Sullivan 1987				
Kr.K29	IRL	Kilkenny	Knockroe											?	O'Sullivan 1987				
Kr.K28	IRL	Kilkenny	Knockroe												O'Sullivan 1987				
Kr.K26	IRL	Kilkenny	Knockroe							?					O'Sullivan 1987				
Kr.K15	IRL	Kilkenny	Knockroe												Robin				
Kr.E.29	IRL	Kilkenny	Knockroe E		?	?									O'Sullivan 1987				
Kr.E.35	IRL	Kilkenny	Knockroe E												O'Sullivan 1987				
KrW.L3	IRL	Kilkenny	Knockroe W												O'Sullivan 1987				
KrW.L6	IRL	Kilkenny	Knockroe W												O'Sullivan 1987				
KrW.backst	IRL	Kilkenny	Knockroe W												O'Sullivan 1987				
KrW.R6	IRL	Kilkenny	Knockroe W												O'Sullivan 1987				
KrW.R4	IRL	Kilkenny	Knockroe W											?	O'Sullivan 1987				
KrW.R3	IRL	Kilkenny	Knockroe W												O'Sullivan 1987				
KrW.RS	IRL	Kilkenny	Knockroe W												Robin				
Kh.K1b	IRL	Meath	Knowth												Eogan 2008				
Kh.K2	IRL	Meath	Knowth												O'Sullivan 1988				
Kh.K4	IRL	Meath	Knowth												Eogan 1996				
Kh.K5	IRL	Meath	Knowth												Eogan 1996				
Kh.K7	IRL	Meath	Knowth												O'Sullivan 1988				
Kh.K8	IRL	Meath	Knowth												O'Sullivan 1988				
Kh.K10	IRL	Meath	Knowth												Eogan 1996				
Kh.K11	IRL	Meath	Knowth												Eogan 1996				
Kh.K12	IRL	Meath	Knowth												Eogan 1996				
Kh.K13	IRL	Meath	Knowth												O'Sullivan 1988				
Kh.K13b	IRL	Meath	Knowth												Eogan 2008				
Kh.K14	IRL	Meath	Knowth												O'Sullivan 1988				
Kh.K15	IRL	Meath	Knowth												O'Sullivan 1988				
Kh.K16	IRL	Meath	Knowth												O'Sullivan 1988				
Kh.K17	IRL	Meath	Knowth												O'Sullivan 1988				
Kh.K19	IRL	Meath	Knowth												O'Sullivan 1988				
Kh.K23	IRL	Meath	Knowth								?				O'Sullivan 1988				
Kh.K26	IRL	Meath	Knowth												Eogan 1996				
Kh.K27	IRL	Meath	Knowth												Eogan 1996				
Kh.K28	IRL	Meath	Knowth												Eogan 1996				
Kh.K29	IRL	Meath	Knowth												O'Sullivan 1988				
Kh.K30	IRL	Meath	Knowth												O'Sullivan 1988				
Kh.K32	IRL	Meath	Knowth												O'Sullivan 1988				
Kh.K38	IRL	Meath	Knowth									?			O'Sullivan 1988				
Kh.K39	IRL	Meath	Knowth												O'Sullivan 1988				
Kh.K40	IRL	Meath	Knowth												O'Sullivan 1988				
Kh.K41	IRL	Meath	Knowth												O'Sullivan 1988				
Kh.K42	IRL	Meath	Knowth												O'Sullivan 1988				
Kh.K46	IRL	Meath	Knowth												O'Sullivan 1988				
Kh.K47	IRL	Meath	Knowth												O'Sullivan 1988				
Kh.K48	IRL	Meath	Knowth												O'Sullivan 1988				
Kh.K49	IRL	Meath	Knowth								?				O'Sullivan 1988				
Kh.K51	IRL	Meath	Knowth												O'Sullivan 1988				
Kh.K52	IRL	Meath	Knowth												O'Sullivan 1988				
Kh.K56	IRL	Meath	Knowth												Eogan 1996				
Kh.K57	IRL	Meath	Knowth												Eogan 1996				
Kh.K59	IRL	Meath	Knowth												O'Sullivan 1988				
Kh.K60	IRL	Meath	Knowth												O'Sullivan 1988				
Kh.K61	IRL	Meath	Knowth												O'Sullivan 1988				
Kh.K63	IRL	Meath	Knowth												O'Sullivan 1988				
Kh.K64	IRL	Meath	Knowth												O'Sullivan 1988				
Kh.K65	IRL	Meath	Knowth											?	O'Sullivan 1988				
Kh.K66	IRL	Meath	Knowth												O'Sullivan 1988				
Kh.K67	IRL	Meath	Knowth												O'Sullivan 1988				
Kh.K68	IRL	Meath	Knowth												O'Sullivan 1988				
Kh.K69	IRL	Meath	Knowth												O'Sullivan 1988				
Kh.K70	IRL	Meath	Knowth												O'Sullivan 1988				
Kh.K71	IRL	Meath	Knowth												O'Sullivan 1988				
Kh.K72	IRL	Meath	Knowth												O'Sullivan 1988				
Kh.K73	IRL	Meath	Knowth												O'Sullivan 1988				
Kh.K74	IRL	Meath	Knowth												Eogan 1996				
Kh.K75	IRL	Meath	Knowth												O'Sullivan 1988				
Kh.K76	IRL	Meath	Knowth												O'Sullivan 1988				
Kh.K77	IRL	Meath	Knowth												O'Sullivan 1988				
Kh.K78	IRL	Meath	Knowth												O'Sullivan 1988				
Kh.K79	IRL	Meath	Knowth												O'Sullivan 1988				
Kh.K80	IRL	Meath	Knowth												O'Sullivan 1988				
Kh.K81	IRL	Meath	Knowth												O'Sullivan 1988				
Kh.K82	IRL	Meath	Knowth												O'Sullivan 1988				
Kh.K83	IRL	Meath	Knowth												O'Sullivan 1988				
Kh.K84	IRL	Meath	Knowth												O'Sullivan 1988				
Kh.K85	IRL	Meath	Knowth												O'Sullivan 1988				
Kh.K86	IRL	Meath	Knowth												O'Sullivan 1988				
Kh.K87	IRL	Meath	Knowth												Eogan 1968				
Kh.K88	IRL	Meath	Knowth												Eogan 1968				
Kh.K89	IRL	Meath	Knowth												Eogan 1968				
Kh.K90	IRL	Meath	Knowth												Eogan 1968				
Kh.K91	IRL	Meath	Knowth												Eogan 1968				
Kh.K92	IRL	Meath	Knowth												Eogan 1968				
Kh.K93	IRL	Meath	Knowth												Eogan 1968				
Kh.K94	IRL	Meath	Knowth												Eogan 1968				

Part one - Framework of the study

Abbreviation	Country	County	Site	●	○	◎	◡	✳	☀	⋈	▲	◇	≡	⋈	Bibliographical source	Kcarb	Pass	Ch.	Cell
Kh.K95	IRL	Meath	Knowth												Eogan 1968				
Kh.K97	IRL	Meath	Knowth												Eogan 1968				
Kh.K98	IRL	Meath	Knowth												Eogan 1968				
Kh.K113	IRL	Meath	Knowth												Eogan 1968				
Kh.K116	IRL	Meath	Knowth												Eogan 1968				
Kh.K118	IRL	Meath	Knowth												Eogan 1968				
Kh.K119	IRL	Meath	Knowth												Eogan 1968				
Kh.K120	IRL	Meath	Knowth												Eogan 1968				
Kh.K124	IRL	Meath	Knowth												Eogan 1996				
Kh.K126	IRL	Meath	Knowth												O'Sullivan 1988				
Kh.K127	IRL	Meath	Knowth												O'Sullivan 1988				
KhE.Or1	IRL	Meath	Knowth E												O'Sullivan 1988				
KhE.Or2	IRL	Meath	Knowth E												O'Sullivan 1988				
KhE.Or3	IRL	Meath	Knowth E												O'Sullivan 1988				
KhE.Or11	IRL	Meath	Knowth E												O'Sullivan 1988				
KhE.Or24	IRL	Meath	Knowth E												O'Sullivan 1988				
KhE.Or25	IRL	Meath	Knowth E												O'Sullivan 1988				
KhE.Or33	IRL	Meath	Knowth E											?	O'Sullivan 1988				
KhE.Or36	IRL	Meath	Knowth E								?				O'Sullivan 1988				
KhE.Or37	IRL	Meath	Knowth E												Eogan 1990				
KhE.Or43	IRL	Meath	Knowth E												O'Sullivan 1988				2
KhE.Or45	IRL	Meath	Knowth E								?				O'Sullivan 1988				2
KhE.Or47	IRL	Meath	Knowth E												O'Sullivan 1988				2
KhE.Or48	IRL	Meath	Knowth E												O'Sullivan 1988				2
KhE.Or49	IRL	Meath	Knowth E								?				O'Sullivan 1988				2
KhE.Or50	IRL	Meath	Knowth E												O'Sullivan 1988				2
KhE.jL.cellN	IRL	Meath	Knowth E												O'Sullivan 1988				
KhE.Or52	IRL	Meath	Knowth E												O'Sullivan 1988				3
KhE.Or53	IRL	Meath	Knowth E												O'Sullivan 1988				3
KhE.Or54	IRL	Meath	Knowth E												O'Sullivan 1988				3
KhE.Or55	IRL	Meath	Knowth E								?				O'Sullivan 1988				3
KhE.Or56	IRL	Meath	Knowth E								?	?			O'Sullivan 1988				3
KhE.jR.cellN	IRL	Meath	Knowth E												O'Sullivan 1988				
KhE.Or57	IRL	Meath	Knowth E												O'Sullivan 1988				
KhE.Or58	IRL	Meath	Knowth E												O'Sullivan 1988				
KhE.Or64	IRL	Meath	Knowth E												O'Sullivan 1988				
KhE.Or68	IRL	Meath	Knowth E												O'Sullivan 1988				
KhE.Or69	IRL	Meath	Knowth E												O'Sullivan 1988				
KhE.Or92	IRL	Meath	Knowth E											?	O'Sullivan 1988				
KhE.Or93	IRL	Meath	Knowth E									?			O'Sullivan 1988				
KhE.RS2	IRL	Meath	Knowth E												O'Sullivan 1988				
KhE.RS8	IRL	Meath	Knowth E												O'Sullivan 1988				
KhE.RS10	IRL	Meath	Knowth E												O'Sullivan 1988				
KhE.RS20	IRL	Meath	Knowth E												O'Sullivan 1988				
KhE.RS21	IRL	Meath	Knowth E												O'Sullivan 1988				
KhE.RS26	IRL	Meath	Knowth E											?	O'Sullivan 1988				
KhE.RS28	IRL	Meath	Knowth E												O'Sullivan 1988				
KhE.RS30	IRL	Meath	Knowth E								?				O'Sullivan 1988				
KhE.RS32	IRL	Meath	Knowth E												O'Sullivan 1988				
KhE.RS34	IRL	Meath	Knowth E											?	O'Sullivan 1988				
KhE.RS37	IRL	Meath	Knowth E												O'Sullivan 1988				
KhE.RS38	IRL	Meath	Knowth E								?				O'Sullivan 1988				
KhE.RS41	IRL	Meath	Knowth E												O'Sullivan 1988				
KhE.RS49	IRL	Meath	Knowth E												O'Sullivan 1988				
KhE.RS50	IRL	Meath	Knowth E												O'Sullivan 1988				
KhE.RScellN	IRL	Meath	Knowth E												O'Sullivan 1988				3
KhE.b.Co39i	IRL	Meath	Knowth E												O'Sullivan 1988				1
KhE.b.CoEvi	IRL	Meath	Knowth E												O'Sullivan 1988				
KhE.Co65	IRL	Meath	Knowth E												O'Sullivan 1988				
KhE.Co86/87	IRL	Meath	Knowth E												O'Sullivan 1988				
KhE.Co12/13	IRL	Meath	Knowth E			?								?	O'Sullivan 1988				
KhE.Co40-1	IRL	Meath	Knowth E												O'Sullivan 1988				1
KhE.Co40-5	IRL	Meath	Knowth E												O'Sullivan 1988				1
KhE.Co41-2	IRL	Meath	Knowth E								?	?			O'Sullivan 1988				1
KhE.Co52-3	IRL	Meath	Knowth E												O'Sullivan 1988				3
KhE.Co54-1	IRL	Meath	Knowth E									?			O'Sullivan 1988				3
KhE.Co59/60-3	IRL	Meath	Knowth E												O'Sullivan 1988				
KhE.Co63/64-1	IRL	Meath	Knowth E												O'Sullivan 1988				
KhE.CoA6	IRL	Meath	Knowth E												O'Sullivan 1988				
KhE.CoA10	IRL	Meath	Knowth E								?				O'Sullivan 1988				
KhE.CoD7	IRL	Meath	Knowth E												O'Sullivan 1988				
KhE.CoE6	IRL	Meath	Knowth E												O'Sullivan 1988				
KhE.CoF10	IRL	Meath	Knowth E												O'Sullivan 1988				
KhE.B	IRL	Meath	Knowth E												O'Sullivan 1988				
KhE.bas.cellW	IRL	Meath	Knowth E									?		?	O'Sullivan 1988				
KhW.Or16	IRL	Meath	Knowth W												O'Sullivan 1988				
KhW.Or17	IRL	Meath	Knowth W									?			O'Sullivan 1988				
KhW.Or18	IRL	Meath	Knowth W			?									O'Sullivan 1988				
KhW.Or33	IRL	Meath	Knowth W												O'Sullivan 1988				
KhW.Or34	IRL	Meath	Knowth W												O'Sullivan 1988				
KhW.Or38	IRL	Meath	Knowth W			?									O'Sullivan 1988				
KhW.Or39	IRL	Meath	Knowth W												O'Sullivan 1988				
KhW.Or40	IRL	Meath	Knowth W												O'Sullivan 1988				
KhW.Or41	IRL	Meath	Knowth W												O'Sullivan 1988				
KhW.Or42	IRL	Meath	Knowth W											?	O'Sullivan 1988				
KhW.Or44	IRL	Meath	Knowth W												O'Sullivan 1988				
KhW.Or48	IRL	Meath	Knowth W								?			?	O'Sullivan 1988				
KhW.Or50	IRL	Meath	Knowth W												O'Sullivan 1988				
KhW.Or51	IRL	Meath	Knowth W												O'Sullivan 1988				

1 - Object, subject and methodology

Abbreviation	Country	County	Site	●	○	⊙	∩	*	☀	⚡	▲	◇	≡	⋈	Bibliographical source	Kerb	Pass.	Ch.	Cell
KhW.Or74	IRL	Meath	Knowth W												O'Sullivan 1988				
KhW.Or81	IRL	Meath	Knowth W												O'Sullivan 1988				
KhW.RS3	IRL	Meath	Knowth W												O'Sullivan 1988				
KhW.RS5	IRL	Meath	Knowth W												O'Sullivan 1988				
KhW.RS10	IRL	Meath	Knowth W												O'Sullivan 1988				
KhW.Co37-38	IRL	Meath	Knowth W											?	Eogan 1997				
KhW.A	IRL	Meath	Knowth W						?						O'Sullivan 1988				
Kh2.K28	IRL	Meath	Knowth 2												Eogan 1974				
Kh2.Or14	IRL	Meath	Knowth 2												Eogan 1974				
Kh2.Or25	IRL	Meath	Knowth 2												Eogan 1974				3
Kh2.Or29	IRL	Meath	Knowth 2												Eogan 1974				
Kh3.K10	IRL	Meath	Knowth 3												Eogan 1974				
Kh4.A	IRL	Meath	Knowth 4								?			?	Eogan 1974				
Kh5.8	IRL	Meath	Knowth 5												Eogan 1974				
Kh8.K5	IRL	Meath	Knowth 8												Eogan 1974				
Kh8.K11	IRL	Meath	Knowth 8		?										Eogan 1974				
Kh12.K6	IRL	Meath	Knowth 12												Eogan 1968				
Kh13.K15	IRL	Meath	Knowth 13												Eogan 1968				
Kh13.K16	IRL	Meath	Knowth 13												Eogan 1968				
Kh13.K17	IRL	Meath	Knowth 13												Eogan 1968				
Kh13.K24	IRL	Meath	Knowth 13												Eogan 1968				
Kh13.Or3	IRL	Meath	Knowth 13												Eogan 1968				
Kh13.drain	IRL	Meath	Knowth 13												Eogan 1968				
Kh14.K4	IRL	Meath	Knowth 14												Eogan 1968				
Kh14.K6	IRL	Meath	Knowth 14												Eogan 1968				
Kh14.Or4	IRL	Meath	Knowth 14												Eogan 1968				
Kh14.Or7	IRL	Meath	Knowth 14												Eogan 1968				
Kh14.Or8	IRL	Meath	Knowth 14												Eogan 1968				
Kh14.Or13	IRL	Meath	Knowth 14												Eogan 1968				
Kh15.K6	IRL	Meath	Knowth 15									?			Eogan 1984				
Kh15.Or1	IRL	Meath	Knowth 15												Eogan 1984				
Kh15.sillC	IRL	Meath	Knowth 15												Eogan 1984				
Kh15.Or14	IRL	Meath	Knowth 15												Eogan 1984				
Kh16.Or4	IRL	Meath	Knowth 16												Eogan 1984				
Kh16.Or7	IRL	Meath	Knowth 16												Eogan 1984				
Kh16.Or9	IRL	Meath	Knowth 16						?				?		Eogan 1984				
Kh16.Or13	IRL	Meath	Knowth 16												Eogan 1984				
Kh16.Co10	IRL	Meath	Knowth 16												Eogan 1984				
Kh16.Co12	IRL	Meath	Knowth 16												Eogan 1984				
Kh17.Or6	IRL	Meath	Knowth 17												Eogan 1984				
Kh17.Or7	IRL	Meath	Knowth 17												Eogan 1984				
Kh17.Or13	IRL	Meath	Knowth 17												Eogan 1984				
Kh17.Or15	IRL	Meath	Knowth 17											?	Eogan 1984				
Kh17.Or16	IRL	Meath	Knowth 17									?			Eogan 1984				
Kh18.Or11	IRL	Meath	knowth 18												Eogan 1984				2
Kh.loose1	IRL	Meath	Knowth												O'Sullivan 1988				
Kh.loose2	IRL	Meath	Knowth												Eogan 1968				
Kh.loose3	IRL	Meath	Knowth												O'Sullivan 1988				
Kh.loose4	IRL	Meath	Knowth												O'Sullivan 1988				
Kh.loose5	IRL	Meath	Knowth												O'Sullivan 1988				
Kh.loose7	IRL	Meath	Knowth												O'Sullivan 1988				
Kh.loose9	IRL	Meath	Knowth												O'Sullivan 1988				
Kh.loose10	IRL	Meath	Knowth												O'Sullivan 1988				
Kh.loose22	IRL	Meath	Knowth												Eogan 1968				
Kh.loose23	IRL	Meath	Knowth												O'Sullivan 1988				
Ih.RS	IRL	Sligo	Listoghil												Curran-Mulligan 1994				
LeF.L1	IRL	Meath	Loughcrew F												Shee Twohig 1981				
LeF.L3	IRL	Meath	Loughcrew F												Shee Twohig 1981				
LeF.L4	IRL	Meath	Loughcrew F												Shee Twohig 1981				
LeF.R2	IRL	Meath	Loughcrew F												Shee Twohig 1981				
LeF.R4	IRL	Meath	Loughcrew F					?	?						Shee Twohig 1981				
LeF.C1	IRL	Meath	Loughcrew F												Shee Twohig 1981				1
LeF.C5	IRL	Meath	Loughcrew F												Shee Twohig 1981				2
LeF.loose	IRL	Meath	Loughcrew F												Frazer 1893				
LeH.K8	IRL	Meath	Loughcrew H												Shee Twohig 1981				
LeH.L2	IRL	Meath	Loughcrew H												Shee Twohig 1981				
LeH.R2	IRL	Meath	Loughcrew H												Shee Twohig 1981				
LeH.C5	IRL	Meath	Loughcrew H												Shee Twohig 1981				1
LeH.C11	IRL	Meath	Loughcrew H												Shee Twohig 1981				2
LeH.C14	IRL	Meath	Loughcrew H												Shee Twohig 1981				3
LeH.sill	IRL	Meath	Loughcrew H												Shee Twohig 1981				3
LeH.C18	IRL	Meath	Loughcrew H												Shee Twohig 1981				3
LeI.R2	IRL	Meath	Loughcrew I												Shee Twohig 1981				
LeI.C1	IRL	Meath	Loughcrew I												Shee Twohig 1981				1
LeI.C4	IRL	Meath	Loughcrew I												Shee Twohig 1981				1
LeI.C5	IRL	Meath	Loughcrew I												Shee Twohig 1981				1
LeI.s.cell3	IRL	Meath	Loughcrew I									?			Shee Twohig 1981				1
LeI.C13	IRL	Meath	Loughcrew I						?			?			Shee Twohig 1981				3
LeI.C15	IRL	Meath	Loughcrew I												Shee Twohig 1981				3
LeI.C17	IRL	Meath	Loughcrew I												Shee Twohig 1981				3
LeJ.C4	IRL	Meath	Loughcrew J												Shee Twohig 1981				3
LeJ.loose1	IRL	Meath	Loughcrew J									?			Frazer 1893				
LeJ.loose2	IRL	Meath	Loughcrew J												Shee Twohig 1981				
LeK.C3	IRL	Meath	Loughcrew K												Shee Twohig 1981				2
LeL.L1	IRL	Meath	Loughcrew L												Shee Twohig 1981				
LeL.L3	IRL	Meath	Loughcrew L												Shee Twohig 1981				
LeL.L4	IRL	Meath	Loughcrew L											?	Shee Twohig 1981				
LeL.R1	IRL	Meath	Loughcrew L		?	?									Shee Twohig 1981				
LeL.R3	IRL	Meath	Loughcrew L											?	Shee Twohig 1981				

Part one - Framework of the study

Abbreviation	Country	County	Site	●	○	◎	∩	*	✦	∞	▲	◇	≡	∞	Bibliographical source	Kerb	Pass	Ch.	Call
LeL.R4	IRL	Meath	Loughcrew L.												Shee Twohig 1981				
LeL.C1	IRL	Meath	Loughcrew L.												Shee Twohig 1981				1
LeL.C3	IRL	Meath	Loughcrew L.												Shee Twohig 1981				1
LeL.C4	IRL	Meath	Loughcrew L.									?	?		Shee Twohig 1981				1
LeL.C5	IRL	Meath	Loughcrew L.												Shee Twohig 1981				1
LeL.C8	IRL	Meath	Loughcrew L.												Shee Twohig 1981				2
LeL.C9	IRL	Meath	Loughcrew L.		?										Shee Twohig 1981				2
LeL.C11	IRL	Meath	Loughcrew L.												Shee Twohig 1981				2
LeL.C16	IRL	Meath	Loughcrew L.												Shee Twohig 1981				3
LeL.C17	IRL	Meath	Loughcrew L.												Shee Twohig 1981				3
LeL.C18	IRL	Meath	Loughcrew L.												Shee Twohig 1981				3
LeL.C19	IRL	Meath	Loughcrew L.								?				Shee Twohig 1981				3
LeL.Co1/C16	IRL	Meath	Loughcrew L.												Shee Twohig 1981				3
LeL.Co4/C2-4	IRL	Meath	Loughcrew L.												Shee Twohig 1981				1
LeL.loose	IRL	Meath	Loughcrew L.												Shee Twohig 1981				
LeO	IRL	Meath	Loughcrew O												Robin				
LeR2	IRL	Meath	Loughcrew R2												Shee Twohig 1981				
LeS.L3	IRL	Meath	Loughcrew S												Shee Twohig 1981				
LeS.L4	IRL	Meath	Loughcrew S												Shee Twohig 1981				
LeS.R2	IRL	Meath	Loughcrew S												Shee Twohig 1981				
LeS.C2	IRL	Meath	Loughcrew S												Shee Twohig 1981				3
LeS.C6	IRL	Meath	Loughcrew S												Shee Twohig 1981				
LeT.L1	IRL	Meath	Loughcrew T												Shee Twohig 1981				
LeT.L2	IRL	Meath	Loughcrew T												Shee Twohig 1981				
LeT.L3	IRL	Meath	Loughcrew T				?								Shee Twohig 1981				
LeT.L4	IRL	Meath	Loughcrew T												Shee Twohig 1981				
LeT.L5	IRL	Meath	Loughcrew T												Shee Twohig 1981				
LeT.R2	IRL	Meath	Loughcrew T										?		Shee Twohig 1981				
LeT.R4	IRL	Meath	Loughcrew T				?								Shee Twohig 1981				
LeT.R5	IRL	Meath	Loughcrew T			?									Shee Twohig 1981				
LeT.sill1	IRL	Meath	Loughcrew T												Shee Twohig 1981				
LeT.C1	IRL	Meath	Loughcrew T												Shee Twohig 1981				
LeT.C2	IRL	Meath	Loughcrew T												Shee Twohig 1981				1
LeT.C3	IRL	Meath	Loughcrew T												Shee Twohig 1981				1
LeT.C4	IRL	Meath	Loughcrew T												Shee Twohig 1981				1
LeT.C5	IRL	Meath	Loughcrew T				?								Shee Twohig 1981				
LeT.sill3	IRL	Meath	Loughcrew T												Shee Twohig 1981				
LeT.C6	IRL	Meath	Loughcrew T				?								Shee Twohig 1981				2
LeT.C8	IRL	Meath	Loughcrew T												Shee Twohig 1981				2
LeT.C9	IRL	Meath	Loughcrew T										?		Shee Twohig 1981				2
LeT.C10	IRL	Meath	Loughcrew T											?	Shee Twohig 1981				
LeT.C11	IRL	Meath	Loughcrew T												Shee Twohig 1981				3
LeT.C14	IRL	Meath	Loughcrew T												Shee Twohig 1981				3
LeT.C15	IRL	Meath	Loughcrew T												Shee Twohig 1981				
LeT.Co1/C2	IRL	Meath	Loughcrew T												Shee Twohig 1981				1
LeT.Co1/C4	IRL	Meath	Loughcrew T				?								Shee Twohig 1981				1
LeT.Co2.C2	IRL	Meath	Loughcrew T					?							Shee Twohig 1981				1
LeT.lecl1	IRL	Meath	Loughcrew T				?								Shee Twohig 1981				1
LeT.lecl2	IRL	Meath	Loughcrew T												Shee Twohig 1981				2
LeT.RScell2	IRL	Meath	Loughcrew T												Shee Twohig 1981				2
LeT.RScell3	IRL	Meath	Loughcrew T		?										Shee Twohig 1981				3
LeT.fragment	IRL	Meath	Loughcrew T												Shee Twohig 1981				
LeU.L2	IRL	Meath	Loughcrew U			?	?	?					?	?	Shee Twohig 1981				
LeU.R2	IRL	Meath	Loughcrew U												Shee Twohig 1981				
LeU.R3	IRL	Meath	Loughcrew U											?	Shee Twohig 1981				
LeU.C2	IRL	Meath	Loughcrew U												Shee Twohig 1981				1
LeU.C3	IRL	Meath	Loughcrew U												Shee Twohig 1981				1
LeU.C4	IRL	Meath	Loughcrew U				?								Shee Twohig 1981				1
LeU.C5	IRL	Meath	Loughcrew U												Shee Twohig 1981				2
LeU.C6	IRL	Meath	Loughcrew U						?						Shee Twohig 1981				2
LeU.C7	IRL	Meath	Loughcrew U							?				?	Shee Twohig 1981				2
LeU.C8	IRL	Meath	Loughcrew U												Shee Twohig 1981				3
LeU.C9	IRL	Meath	Loughcrew U												Shee Twohig 1981				3
LeU.C10	IRL	Meath	Loughcrew U												Shee Twohig 1981				3
LeU.C11	IRL	Meath	Loughcrew U												Shee Twohig 1981				3
LeU.fragment	IRL	Meath	Loughcrew U		?	?	?								Shee Twohig 1981				
LeV.C1	IRL	Meath	Loughcrew V												Shee Twohig 1981				1
LeV.C3	IRL	Meath	Loughcrew V												Shee Twohig 1981				1
LeV.C4	IRL	Meath	Loughcrew V												Shee Twohig 1981				1
LeV.C8	IRL	Meath	Loughcrew V												Shee Twohig 1981				3
LeW.R1	IRL	Meath	Loughcrew W												Shee Twohig 1981				
LeW.C2	IRL	Meath	Loughcrew W		?										Shee Twohig 1981				
LeW.C3	IRL	Meath	Loughcrew W												Shee Twohig 1981				
LeW.C4	IRL	Meath	Loughcrew W												Frazer 1893				
LeX1	IRL	Meath	Loughcrew X1												Shee Twohig 1981				
LH	IRL	Antrim	Lyles Hill												Evans 1953				
MM.1	IRL	Donegal	Malin More			?									Shee Twohig 1981				
MM.2	IRL	Donegal	Malin More			?		?					?		Shee Twohig 1981				
MB.2	IRL	Down	Millin Bay												Collins & Waterman 1955				
MB.3	IRL	Down	Millin Bay												Collins & Waterman 1955				
MB.4	IRL	Down	Millin Bay												Collins & Waterman 1955				
MB.5	IRL	Down	Millin Bay											?	Collins & Waterman 1955				
MB.6	IRL	Down	Millin Bay												Collins & Waterman 1955				
MB.7	IRL	Down	Millin Bay												Collins & Waterman 1955				
MB.10	IRL	Down	Millin Bay									?			Collins & Waterman 1955				
MB.11	IRL	Down	Millin Bay												Collins & Waterman 1955				
MB.13	IRL	Down	Millin Bay												Collins & Waterman 1955				
MB.18	IRL	Down	Millin Bay		?									?	Collins & Waterman 1955				
MB.19	IRL	Down	Millin Bay			?									Collins & Waterman 1955				

1 - Object, subject and methodology

Abbreviation	Country	County	Site	●	○	◎	⤿	✳	☀	⚡	▲	◇	≡	⋈	Bibliographical source	Kerb	Pass	Ch.	Cell
MB.20	IRL.	Down	Millin Bay												Collins & Waterman 1955				
MB.22	IRL.	Down	Millin Bay												Collins & Waterman 1955				
MB.31	IRL.	Down	Millin Bay												Collins & Waterman 1955				
MB.38	IRL.	Down	Millin Bay												Collins & Waterman 1955				
MB.40	IRL.	Down	Millin Bay									?			Collins & Waterman 1955				
MB.47	IRL.	Down	Millin Bay												Collins & Waterman 1955				
MB.49	IRL.	Down	Millin Bay		?		?								Collins & Waterman 1955				
MB.M1	IRL.	Down	Millin Bay		?		?								Collins & Waterman 1955				
MB.M2	IRL.	Down	Millin Bay												Collins & Waterman 1955				
MB.M3	IRL.	Down	Millin Bay												Collins & Waterman 1955				
MB.M5	IRL.	Down	Millin Bay												Collins & Waterman 1955				
MB.M6	IRL.	Down	Millin Bay											?	Collins & Waterman 1955				
MB.M7	IRL.	Down	Millin Bay				?								Collins & Waterman 1955				
MB.M8	IRL.	Down	Millin Bay									?			Collins & Waterman 1955				
MB.M9	IRL.	Down	Millin Bay												Collins & Waterman 1955				
MB.M10	IRL.	Down	Millin Bay												Collins & Waterman 1955				
MB.M11	IRL.	Down	Millin Bay							?					Collins & Waterman 1955				
MB.M12	IRL.	Down	Millin Bay												Collins & Waterman 1955				
MB.M16	IRL.	Down	Millin Bay				?								Collins & Waterman 1955				
MB.M17	IRL.	Down	Millin Bay							?					Collins & Waterman 1955				
MB.M18	IRL.	Down	Millin Bay		?		?								Collins & Waterman 1955				
MB.M19	IRL.	Down	Millin Bay												Collins & Waterman 1955				
MB.M20	IRL.	Down	Millin Bay			?		?							Collins & Waterman 1955				
MB.M21	IRL.	Down	Millin Bay									?			Collins & Waterman 1955				
MB.M22	IRL.	Down	Millin Bay												Collins & Waterman 1955				
MB.M23	IRL.	Down	Millin Bay												Collins & Waterman 1955				
MB.M24	IRL.	Down	Millin Bay									?			Collins & Waterman 1955				
MB.M26	IRL.	Down	Millin Bay												Collins & Waterman 1955				
MB.M27	IRL.	Down	Millin Bay		?		?					?			Collins & Waterman 1955				
MB.M28	IRL.	Down	Millin Bay												Collins & Waterman 1955				
MB.M30	IRL.	Down	Millin Bay												Collins & Waterman 1955				
Mt	IRL.	Meath	Mountainstown											?	O'Broin 2000				
Ml	IRL.	Sligo	Moylough												Morris 1929				
Mg	IRL.	Meath	Mullagharoy												Eogan & O'Broin 1998				
Ng.K1	IRL.	Meath	Newgrange												O'Kelly 1982				
Ng.K2	IRL.	Meath	Newgrange											?	O'Kelly 1982				
Ng.K3	IRL.	Meath	Newgrange												O'Kelly 1982				
Ng.K4	IRL.	Meath	Newgrange												O'Kelly 1982				
Ng.K5	IRL.	Meath	Newgrange							?		?		?	O'Kelly 1982				
Ng.K6	IRL.	Meath	Newgrange												O'Kelly 1982				
Ng.K7	IRL.	Meath	Newgrange												O'Kelly 1982				
Ng.K8	IRL.	Meath	Newgrange												O'Kelly 1982				
Ng.K9	IRL.	Meath	Newgrange									?			O'Kelly 1982				
Ng.K11b	IRL.	Meath	Newgrange					?							O'Kelly 1982				
Ng.K12	IRL.	Meath	Newgrange								?				O'Kelly 1982				
Ng.K13b	IRL.	Meath	Newgrange												O'Kelly 1982				
Ng.K16	IRL.	Meath	Newgrange												O'Kelly 1982				
Ng.K17	IRL.	Meath	Newgrange												O'Kelly 1982				
Ng.K18b	IRL.	Meath	Newgrange												O'Kelly 1982				
Ng.K50	IRL.	Meath	Newgrange												O'Kelly 1982				
Ng.K51	IRL.	Meath	Newgrange												O'Kelly 1982				
Ng.K52	IRL.	Meath	Newgrange												O'Kelly 1982				
Ng.K54	IRL.	Meath	Newgrange									?			O'Kelly 1982				
Ng.K67	IRL.	Meath	Newgrange												O'Kelly 1982				
Ng.K82	IRL.	Meath	Newgrange												O'Kelly 1982				
Ng.K83	IRL.	Meath	Newgrange												O'Kelly 1982				
Ng.K85	IRL.	Meath	Newgrange												O'Kelly 1982				
Ng.K88	IRL.	Meath	Newgrange									?			O'Kelly 1982				
Ng.K89	IRL.	Meath	Newgrange							?					O'Kelly 1982				
Ng.K90	IRL.	Meath	Newgrange												O'Kelly 1982				
Ng.K91	IRL.	Meath	Newgrange								?				O'Kelly 1982				
Ng.K93	IRL.	Meath	Newgrange		?		?								O'Kelly 1982				
Ng.L12	IRL.	Meath	Newgrange												O'Kelly 1982				
Ng.L13	IRL.	Meath	Newgrange												O'Kelly 1982				
Ng.L15	IRL.	Meath	Newgrange								?				O'Kelly 1982				
Ng.L17	IRL.	Meath	Newgrange												O'Kelly 1982				
Ng.L19	IRL.	Meath	Newgrange												O'Kelly 1982				
Ng.L20	IRL.	Meath	Newgrange											?	O'Kelly 1982				
Ng.L22	IRL.	Meath	Newgrange												O'Kelly 1982				
Ng.R3	IRL.	Meath	Newgrange												O'Kelly 1982				
Ng.R5	IRL.	Meath	Newgrange												O'Kelly 1982				
Ng.R8	IRL.	Meath	Newgrange												O'Kelly 1982				
Ng.R10	IRL.	Meath	Newgrange												O'Kelly 1982				
Ng.R12	IRL.	Meath	Newgrange												O'Kelly 1982				
Ng.R18	IRL.	Meath	Newgrange												O'Kelly 1982				
Ng.R19	IRL.	Meath	Newgrange								?				O'Kelly 1982				
Ng.R20	IRL.	Meath	Newgrange												O'Kelly 1982				
Ng.R21	IRL.	Meath	Newgrange												O'Kelly 1982				
Ng.C2	IRL.	Meath	Newgrange												O'Kelly 1982				1
Ng.C3	IRL.	Meath	Newgrange		?										O'Kelly 1982				1
Ng.C4	IRL.	Meath	Newgrange												O'Kelly 1982				1
Ng.C8	IRL.	Meath	Newgrange												O'Kelly 1982				2
Ng.C10	IRL.	Meath	Newgrange								?				O'Kelly 1982				2
Ng.C11	IRL.	Meath	Newgrange												O'Kelly 1982				
Ng.C15	IRL.	Meath	Newgrange												O'Kelly 1982				3
Ng.C16	IRL.	Meath	Newgrange												O'Kelly 1982				3
Ng.RS1	IRL.	Meath	Newgrange												O'Kelly 1982				
Ng.RBlintel	IRL.	Meath	Newgrange												O'Kelly 1982				
Ng.RB	IRL.	Meath	Newgrange								?				O'Kelly 1982				

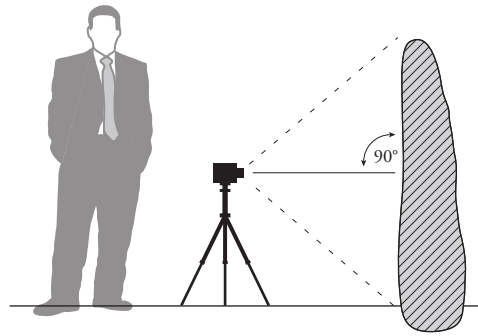
Part one - Framework of the study

Abbreviation	Country	County	Site	●	○	◎	∩	*	✱	⚡	▲	◇	≡	⋈	Bibliographical source	Kerb	Pass	Ch.	Cell
Ng.Co3/1.5-6	IRL	Meath	Newgrange									?			O'Kelly 1982				
Ng.Co3/R4-5	IRL	Meath	Newgrange												O'Kelly 1982				
Ng.RS3	IRL	Meath	Newgrange												O'Kelly 1982				
Ng.RS7	IRL	Meath	Newgrange												O'Kelly 1982				
Ng.RS17	IRL	Meath	Newgrange												O'Kelly 1982				
Ng.X	IRL	Meath	Newgrange												O'Kelly 1982				
Ng.Y	IRL	Meath	Newgrange									?			O'Kelly 1982				
Ng.Z	IRL	Meath	Newgrange												O'Kelly 1982				
Ng.Co1/C2	IRL	Meath	Newgrange			?	?								O'Kelly 1982				1
Ng.Co1/C7	IRL	Meath	Newgrange												O'Kelly 1982				2
Ng.Co1/C10	IRL	Meath	Newgrange										?		O'Kelly 1982				2
Ng.Co1/C11	IRL	Meath	Newgrange												O'Kelly 1982				
Ng.Co1/C12-13	IRL	Meath	Newgrange												O'Kelly 1982				3
Ng.Co1/C15-16	IRL	Meath	Newgrange												O'Kelly 1982				3
Ng.Co2/C11	IRL	Meath	Newgrange												O'Kelly 1982				2
Ng.Co2/C14	IRL	Meath	Newgrange												O'Kelly 1982				3
Ng.Co4/C8	IRL	Meath	Newgrange			?							?		O'Kelly 1982				2
Ng.RScellE(f)	IRL	Meath	Newgrange												O'Kelly 1982				3
Ng.RScellE	IRL	Meath	Newgrange								?				O'Kelly 1982				3
Ng.K.K4	IRL	Meath	Newgrange K		?			?							O'Kelly et al. 1978				
Ng.K.A	IRL	Meath	Newgrange K												O'Kelly et al. 1978				
Ng.K.sill1	IRL	Meath	Newgrange K						?					?	O'Kelly et al. 1978				
Ng.K.2a	IRL	Meath	Newgrange K												O'Kelly et al. 1978				
Ng.K.2	IRL	Meath	Newgrange K											?	O'Kelly et al. 1978				
Ng.K.4	IRL	Meath	Newgrange K		?										O'Kelly et al. 1978				
Ng.K.5	IRL	Meath	Newgrange K		?										O'Kelly et al. 1978				
Ng.K.11	IRL	Meath	Newgrange K					?							O'Kelly et al. 1978				3
Ng.K.9	IRL	Meath	Newgrange K												O'Kelly et al. 1978				
Ng.K.10	IRL	Meath	Newgrange K												O'Kelly et al. 1978				
Ng.L.B	IRL	Meath	Newgrange L												O'Kelly et al. 1978				
Ng.L.kiln	IRL	Meath	Newgrange L							?	?				O'Kelly et al. 1978				
Ng.L.A	IRL	Meath	Newgrange L										?		O'Kelly et al. 1978				
Ng.L.C1	IRL	Meath	Newgrange L								?				O'Kelly et al. 1978				1
Ng.L.C3	IRL	Meath	Newgrange L	x	?		?								O'Kelly et al. 1978				1
Ng.L.C5	IRL	Meath	Newgrange L												O'Kelly et al. 1978				2
Ng.L.C9	IRL	Meath	Newgrange L		?		?								O'Kelly et al. 1978				3
Ng.Z.fragment	IRL	Meath	Newgrange Z												O'Kelly et al. 1978				
Ng.Z.basin	IRL	Meath	Newgrange Z					?							O'Kelly et al. 1978				
Rk.A	IRL	Meath	Rathkenny												Shee Twohig 1981				
Rk.B	IRL	Meath	Rathkenny												Shee Twohig 1981				
Sf.L4	IRL	Wicklow	Seefin						?						Shee Twohig 1981				
Sf.R4	IRL	Wicklow	Seefin												Shee Twohig 1981				
SK.stele	IRL	Tyrone	Sess Kilgreen												Shee Twohig 1981				
SK.C2	IRL	Tyrone	Sess Kilgreen										?		Shee Twohig 1981				
SK.C3	IRL	Tyrone	Sess Kilgreen												Shee Twohig 1981				
SK.C4	IRL	Tyrone	Sess Kilgreen												Shee Twohig 1981				
SK.C5	IRL	Tyrone	Sess Kilgreen						?						Shee Twohig 1981				
SK.C6	IRL	Tyrone	Sess Kilgreen												Shee Twohig 1981				
SK.C8	IRL	Tyrone	Sess Kilgreen												Shee Twohig 1981				
Tr.L2	IRL	Meath	Tara												Shee Twohig 1981				
Td	IRL	Dublin	Tibradden				?								?				
Tn	IRL	Wicklow	Tournant												Shee Twohig 1981				
ByG.L8	GAL	Anglesey	Barclodiad y Gawres												Shee Twohig 1981				
ByG.C1	GAL	Anglesey	Barclodiad y Gawres												Shee Twohig 1981				
ByG.C3	GAL	Anglesey	Barclodiad y Gawres						?						Shee Twohig 1981				1
ByG.C13	GAL	Anglesey	Barclodiad y Gawres												Shee Twohig 1981				3
ByG.C14	GAL	Anglesey	Barclodiad y Gawres									?			Shee Twohig 1981				3
ByG.C16	GAL	Anglesey	Barclodiad y Gawres												Shee Twohig 1981				
BCD.stele	GAL	Anglesey	Bryn Celli Ddu												Shee Twohig 1981				
Lb	GAL	Meirionnydd	Llanbedr								?				Lynch 1992				
Cs.A	ANG	Liverpool	Calderstones					?							Shee Twohig 1981				
Cs.B	ANG	Liverpool	Calderstones												Shee Twohig 1981				
Cs.C	ANG	Liverpool	Calderstones												Shee Twohig 1981				
Cs.D	ANG	Liverpool	Calderstones												Shee Twohig 1981				
Cs.E	ANG	Liverpool	Calderstones												Shee Twohig 1981				
Cs.F	ANG	Liverpool	Calderstones									?			Shee Twohig 1981				
Cr.5	ANG	Cumbria	Castlerigg												Beckensall 1999				
Cr.10	ANG	Cumbria	Castlerigg												Beckensall 1999				
Cr.11	ANG	Cumbria	Castlerigg			vanished									Beckensall 1999				
Cr.27	ANG	Cumbria	Castlerigg												Beckensall 1999				
Gb	ANG	Cumbria	Glassonby												Beckensall 1999				
TW.9	ANG	Argyll	Temple Wood												Scott 1988				
TW.11	ANG	Argyll	Temple Wood												Scott 1988				
CH.1	ECO	Orcades	Cuween Hill												Bradley et al. 1998				
CH.2	ECO	Orcades	Cuween Hill												Bradley et al. 1998				
CH.3	ECO	Orcades	Cuween Hill												Bradley et al. 1998				
EM	ECO	Orcades	Eday Manse												Shee Twohig 1981				
Ft	ECO	Orcades	Frith												Beckensall 1999				
HPW.A	ECO	Orcades	Holm of Papa Westray												Shee Twohig 1981				2
HPW.B	ECO	Orcades	Holm of Papa Westray												Shee Twohig 1981				2
HPW.C	ECO	Orcades	Holm of Papa Westray												Shee Twohig 1981				3
HPW.D	ECO	Orcades	Holm of Papa Westray		?										Shee Twohig 1981				3
HPW.E	ECO	Orcades	Holm of Papa Westray												Shee Twohig 1981				3
HPW.F	ECO	Orcades	Holm of Papa Westray												Shee Twohig 1981				
HPW.4	ECO	Orcades	Holm of Papa Westray												Bradley et al. 1998				
Mh.22	ECO	Orcades	Maeshowe												Bradley et al. 1998				
Mh.12	ECO	Orcades	Maeshowe												Bradley et al. 1998				
Mh.14	ECO	Orcades	Maeshowe												Bradley et al. 1998				
Mh.15	ECO	Orcades	Maeshowe												Bradley et al. 1998				

Abbreviation	Country	County	Site	●	○	◎	⤿	✳	☼	⚡	▲	◇	≡	⚡	Bibliographical source	Kerb	Pass.	Ch.	Cell
Mh.17	ECO	Orcades	Maeshowe												Bradley et al. 1998				
Mh.18	ECO	Orcades	Maeshowe												Bradley et al. 1998				2
Mh.19	ECO	Orcades	Maeshowe												Bradley et al. 1998				1
Mh.20	ECO	Orcades	Maeshowe												Bradley et al. 1998				
Mh.21	ECO	Orcades	Maeshowe								?				Bradley et al. 1998				
Pq	ECO	Orcades	Pickaquooy												Shee Twohig 1981				
Pw.665	ECO	Orcades	Pierowall												Sharples 1984				
Pw.666	ECO	Orcades	Pierowall												Sharples 1984				
Pw.667	ECO	Orcades	Pierowall												Sharples 1984				
Qn.5	ECO	Orcades	Quoyness												Bradley et al. 1998				2
Qn.6	ECO	Orcades	Quoyness												Bradley et al. 1998				
Qn.7	ECO	Orcades	Quoyness												Bradley et al. 1998				3
WH.8	ECO	Orcades	Wideford Hill												Bradley et al. 1998				
WH.9	ECO	Orcades	Wideford Hill												Bradley et al. 1998				
WH.10	ECO	Orcades	Wideford Hill												Bradley et al. 1998				1
WH.11	ECO	Orcades	Wideford Hill												Bradley et al. 1998				3
Total			644	180	305	165	342	49	22	194	70	150	77	218		202	141	95	128

Figure 1.10 : Database of carved stones

Positioning of the camera



Construction of a "dark room"



Positions and directions of the oblique lights

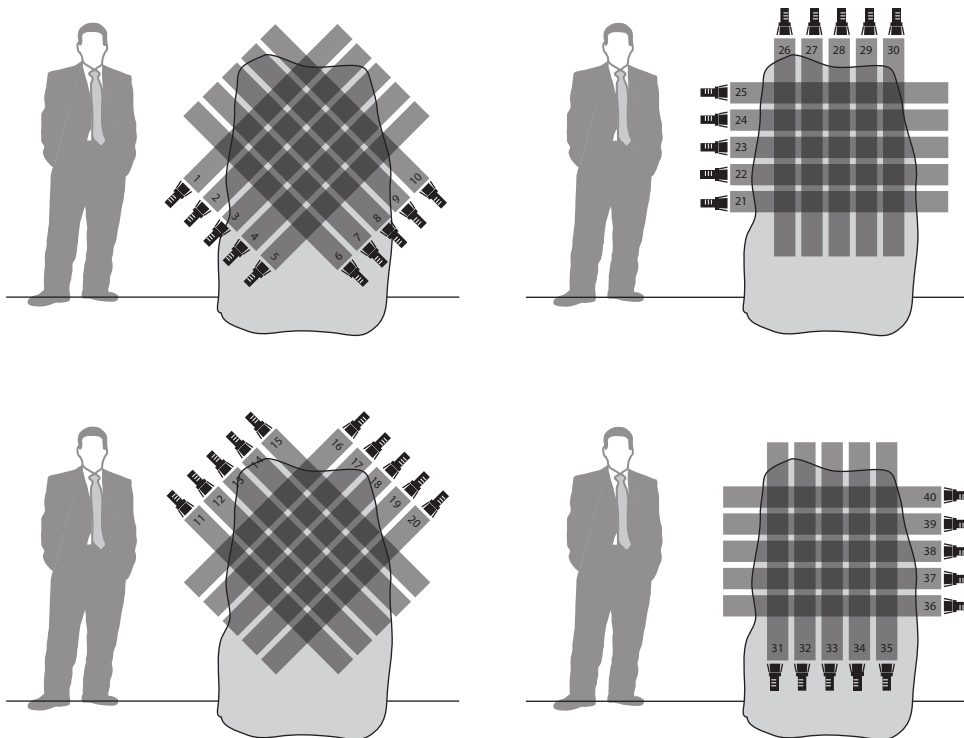


Figure 1.11 : Positioning of the photographic equipment

Equalization processing in Adobe Photoshop



Dilation processing in Adobe Illustrator

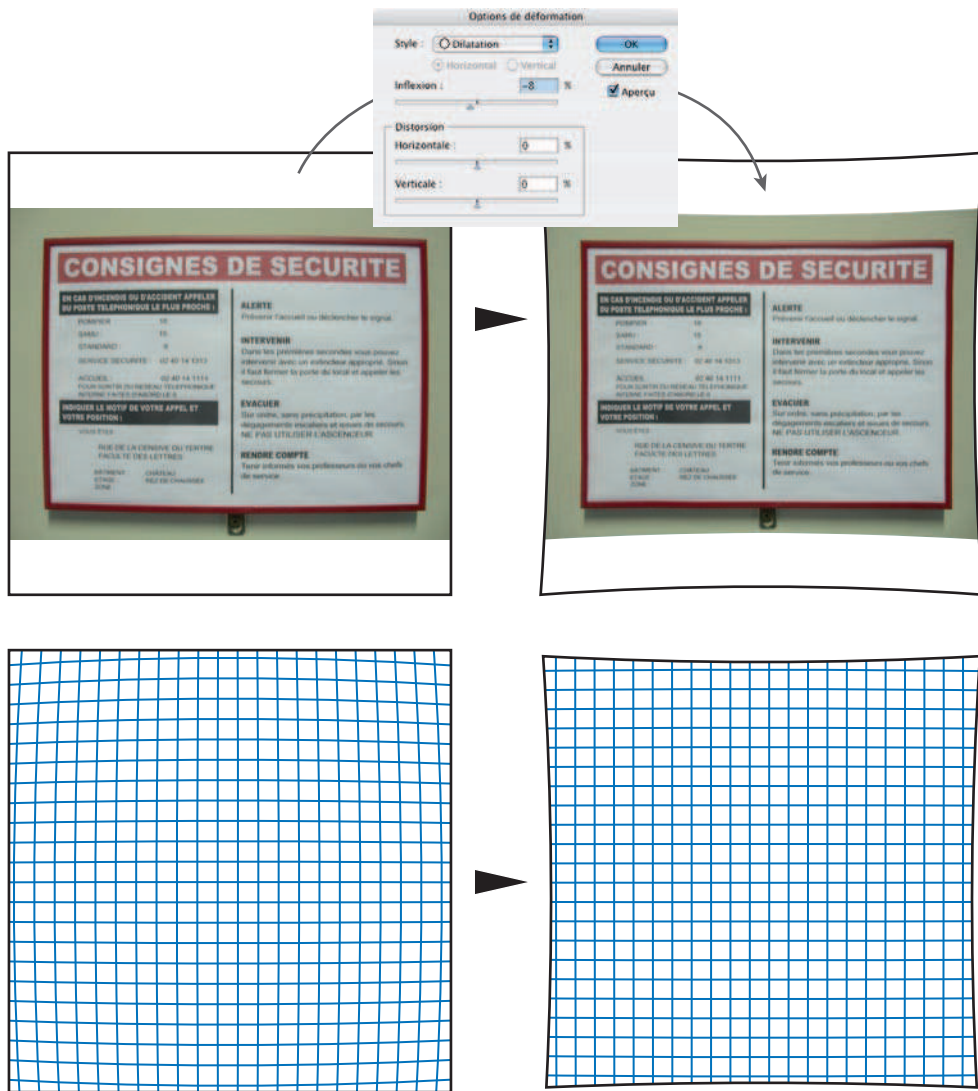
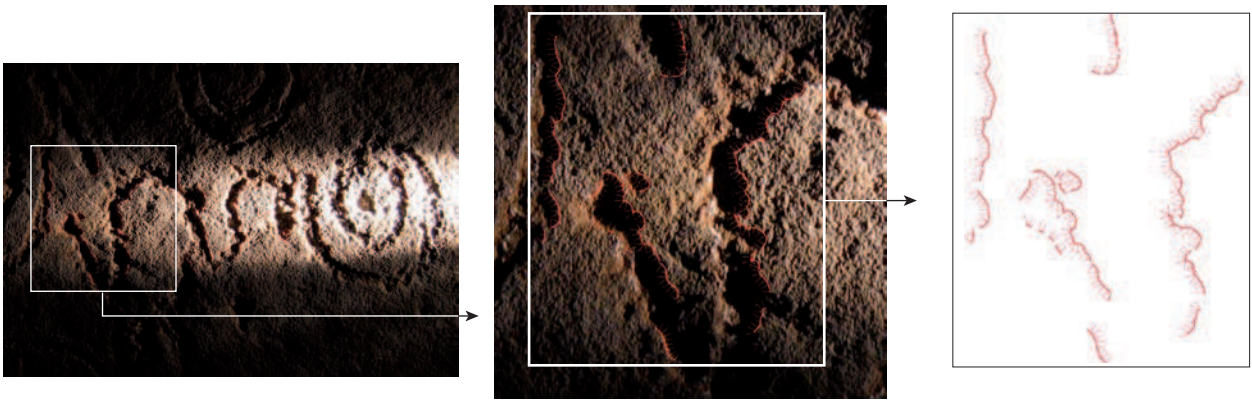
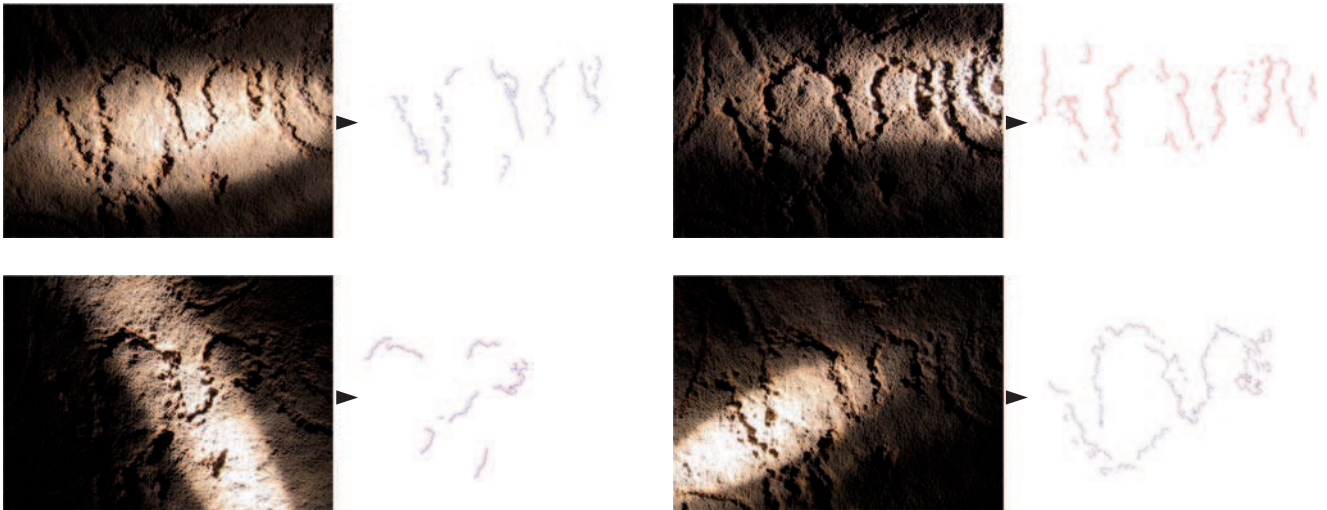


Figure 1.12 : Preliminary processings of the photographs

Drawing with offset line



Drawing of the carvings on each photograph



Synthesis and final drawing

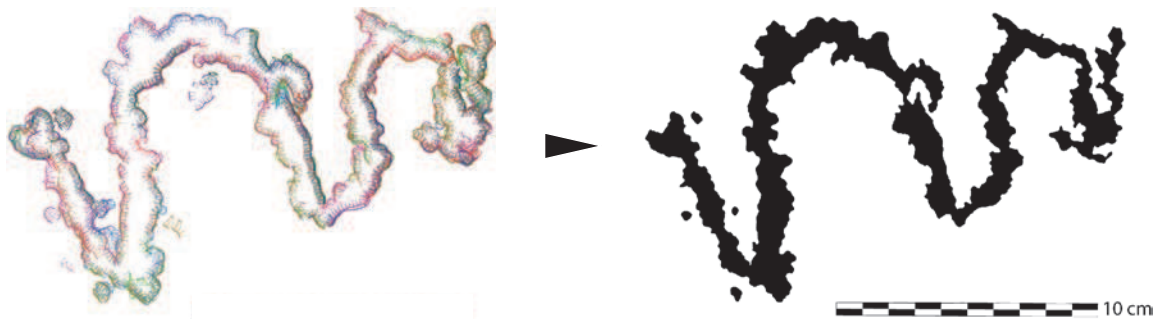


Figure 1.13 : Drawing of the carvings

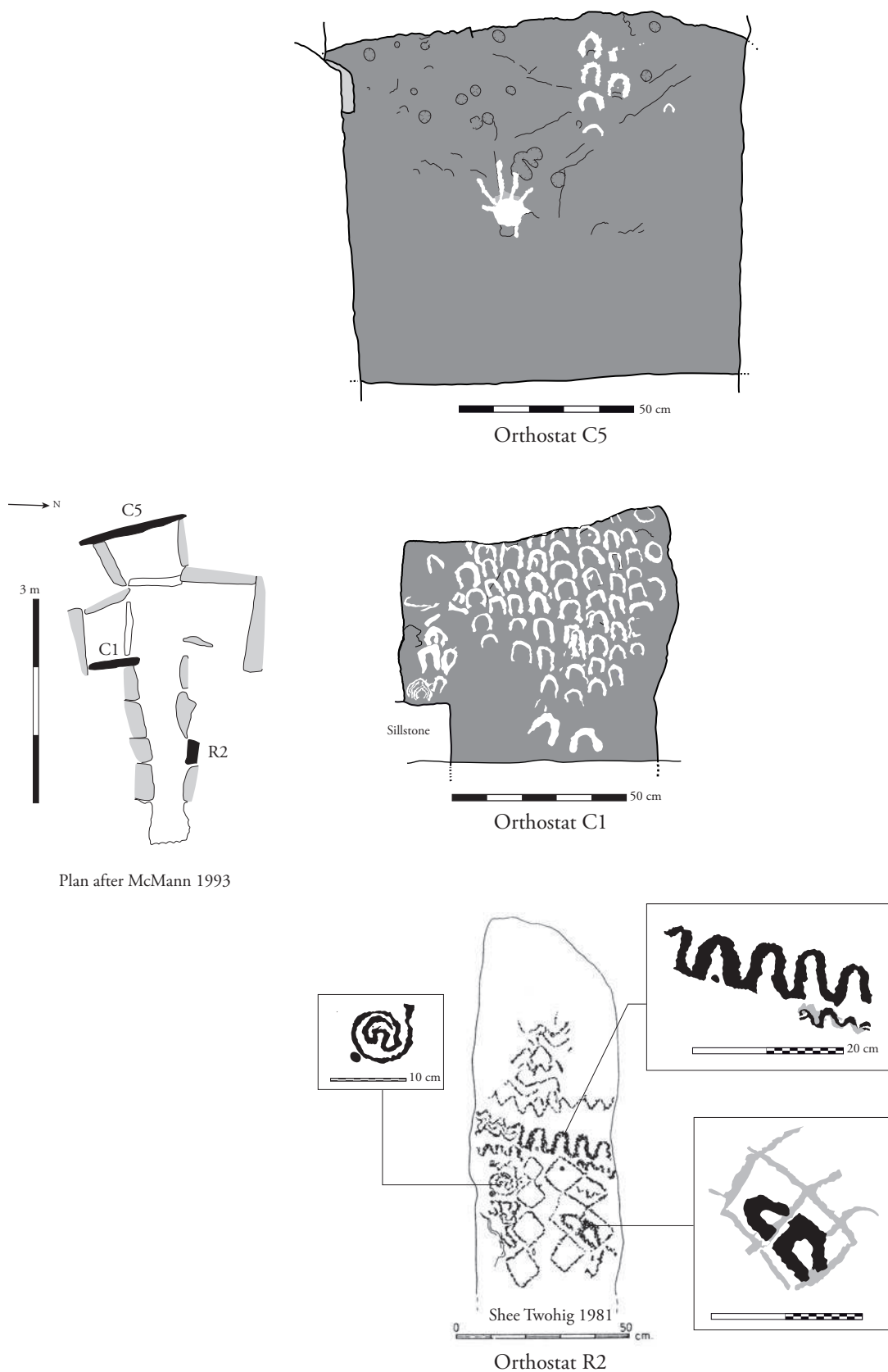
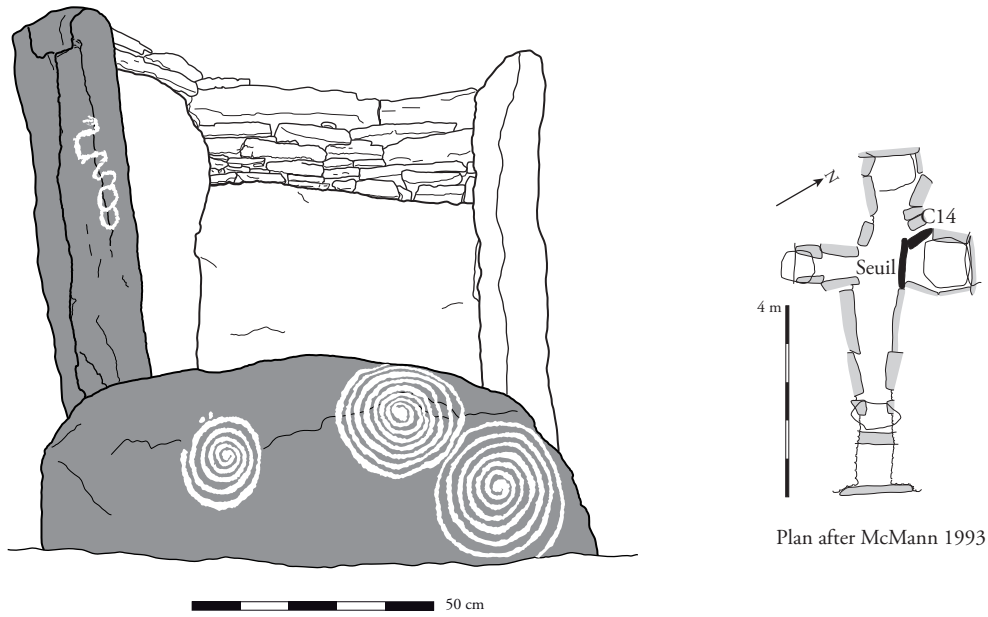
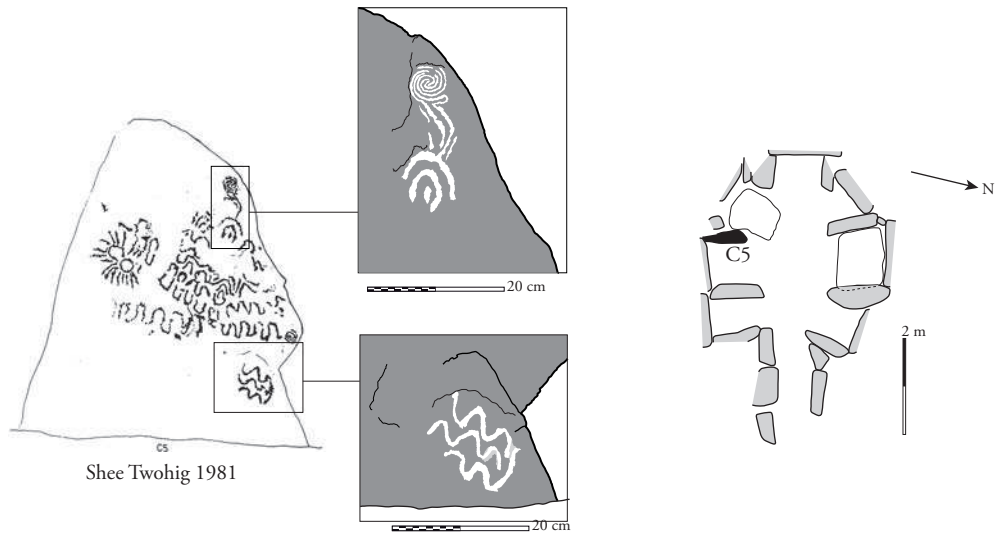


Figure 1.14 : Carvings recorded in Loughcrew F

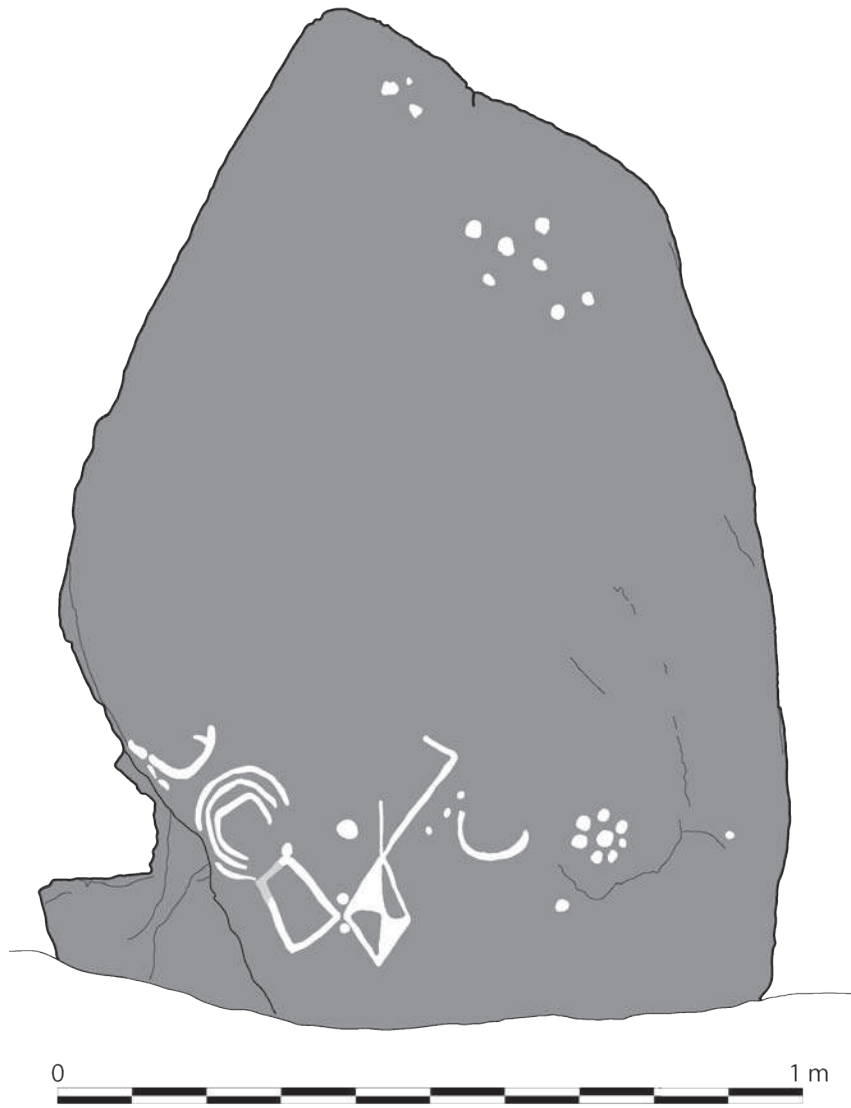


Loughcrew H, orthostat C14 and sillstone of the northern cell

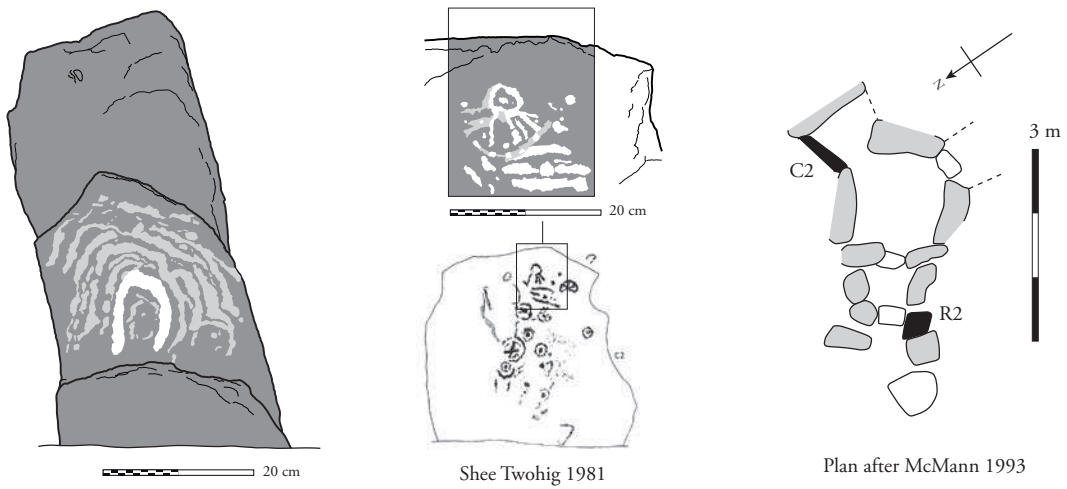


Loughcrew I, orthostat C5

Figure 1.15 : Carvings recorded in Loughcrew H and I



Loughcrew O, loose stone



Loughcrew I, orthostats C2 and R2

Figure 1.16 : Carvings recorded in Loughcrew O and S

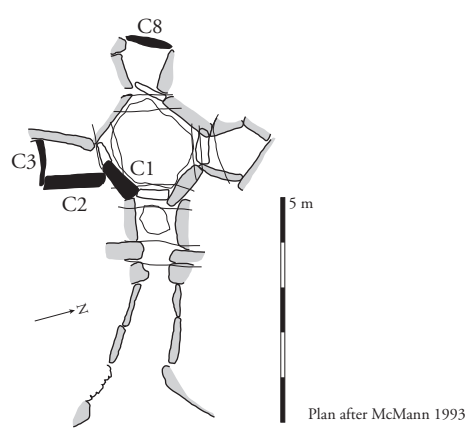
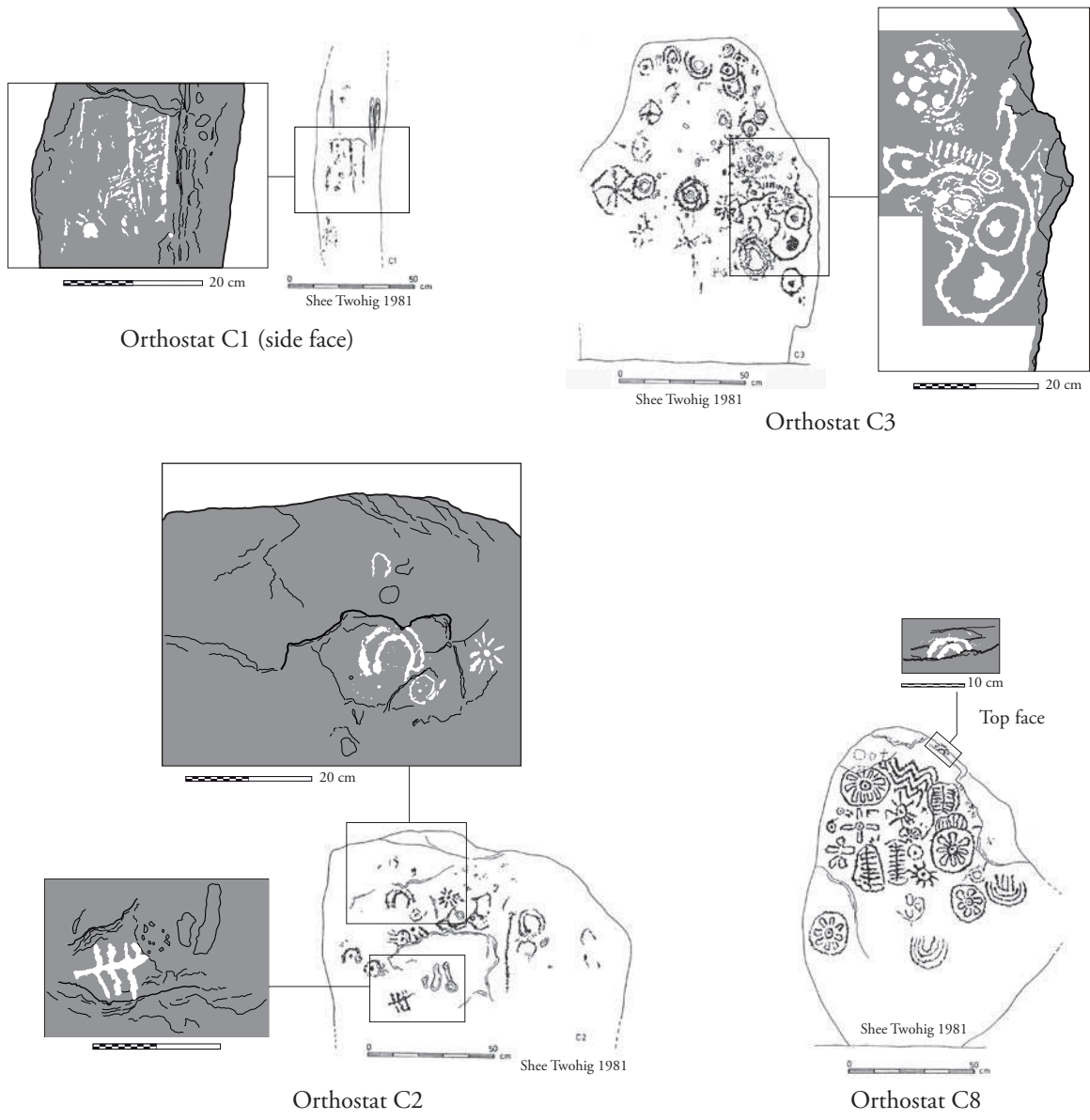
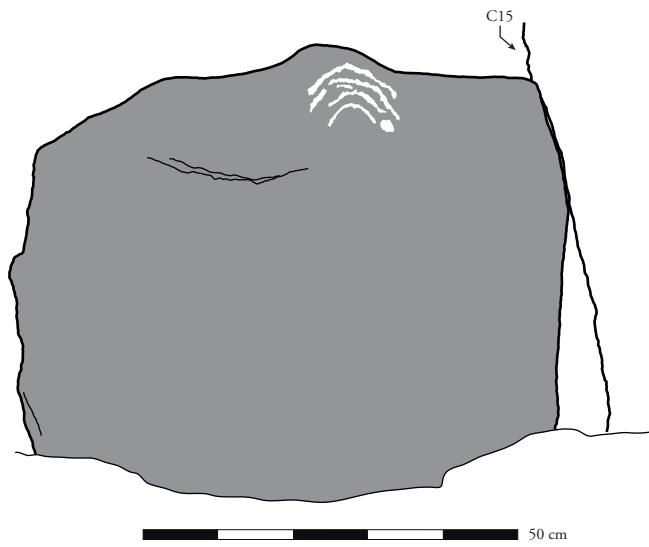
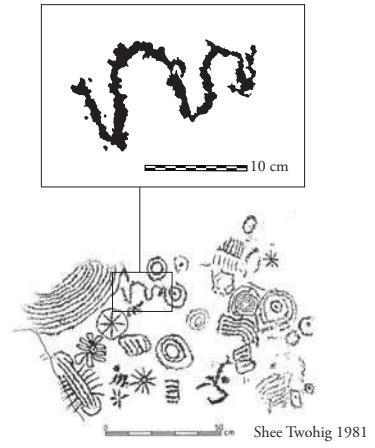


Figure 1.17 : Carvings recorded in Loughcrew T (1/2)



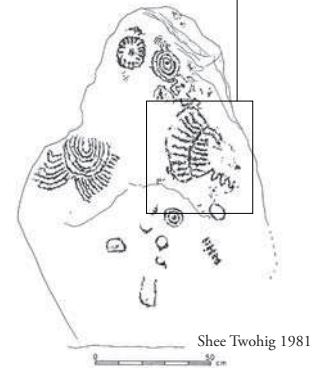
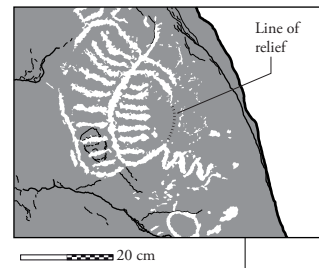
Sillstone 1



Roofstone of cell 2



Sillstone 3



Orthostat C14

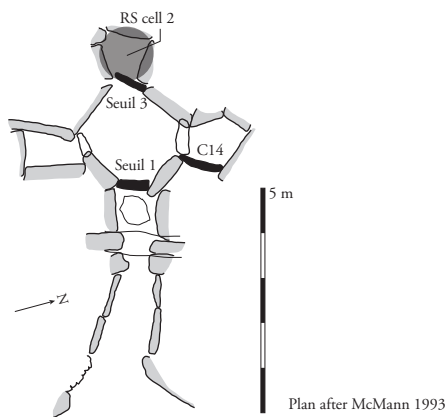
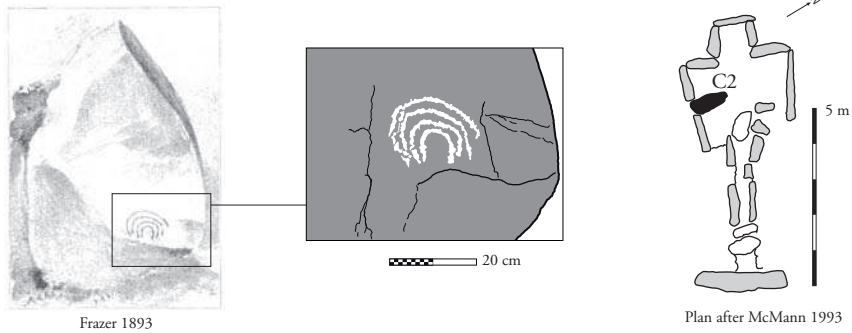


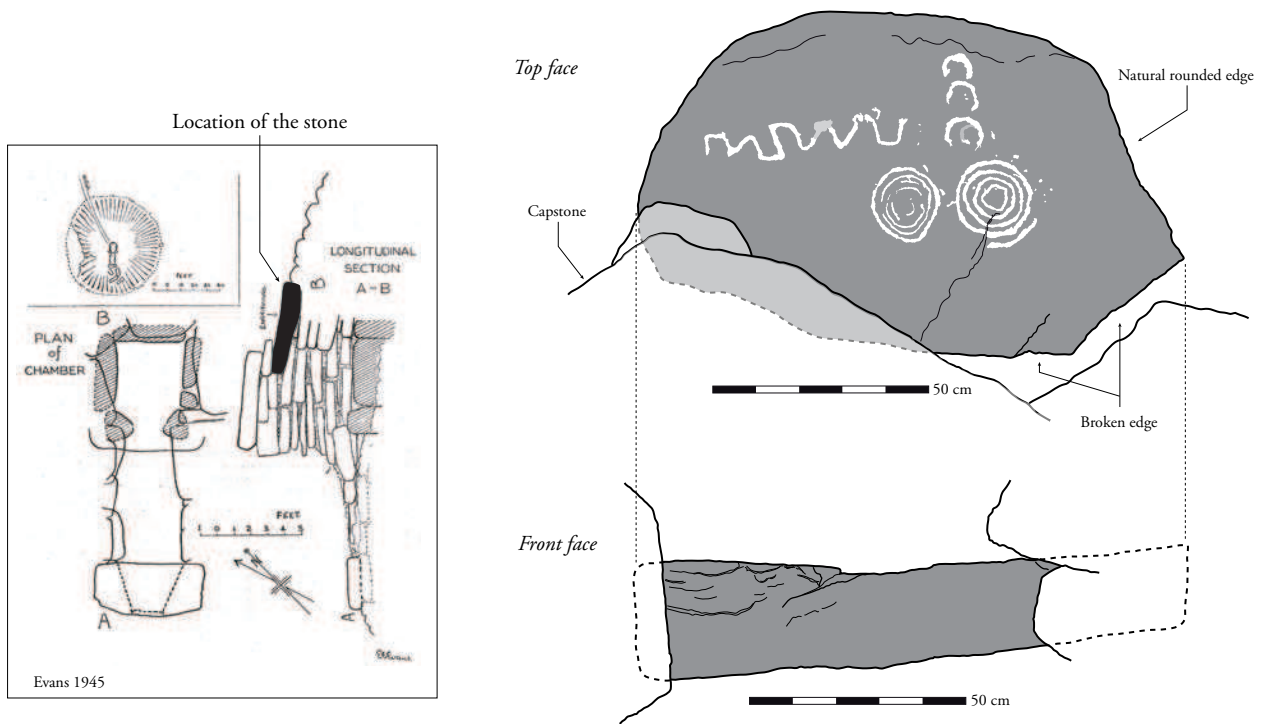
Figure 1.18 : Carvings recorded in Loughcrew T (2/2)



Frazer 1893

Plan after McMann 1993

Loughcrew U, orthostat C2



Evans 1945

Carnanmore, chamber capstone

Figure 1.19 : Carvings recorded in Loughcrew U and Carnanmore

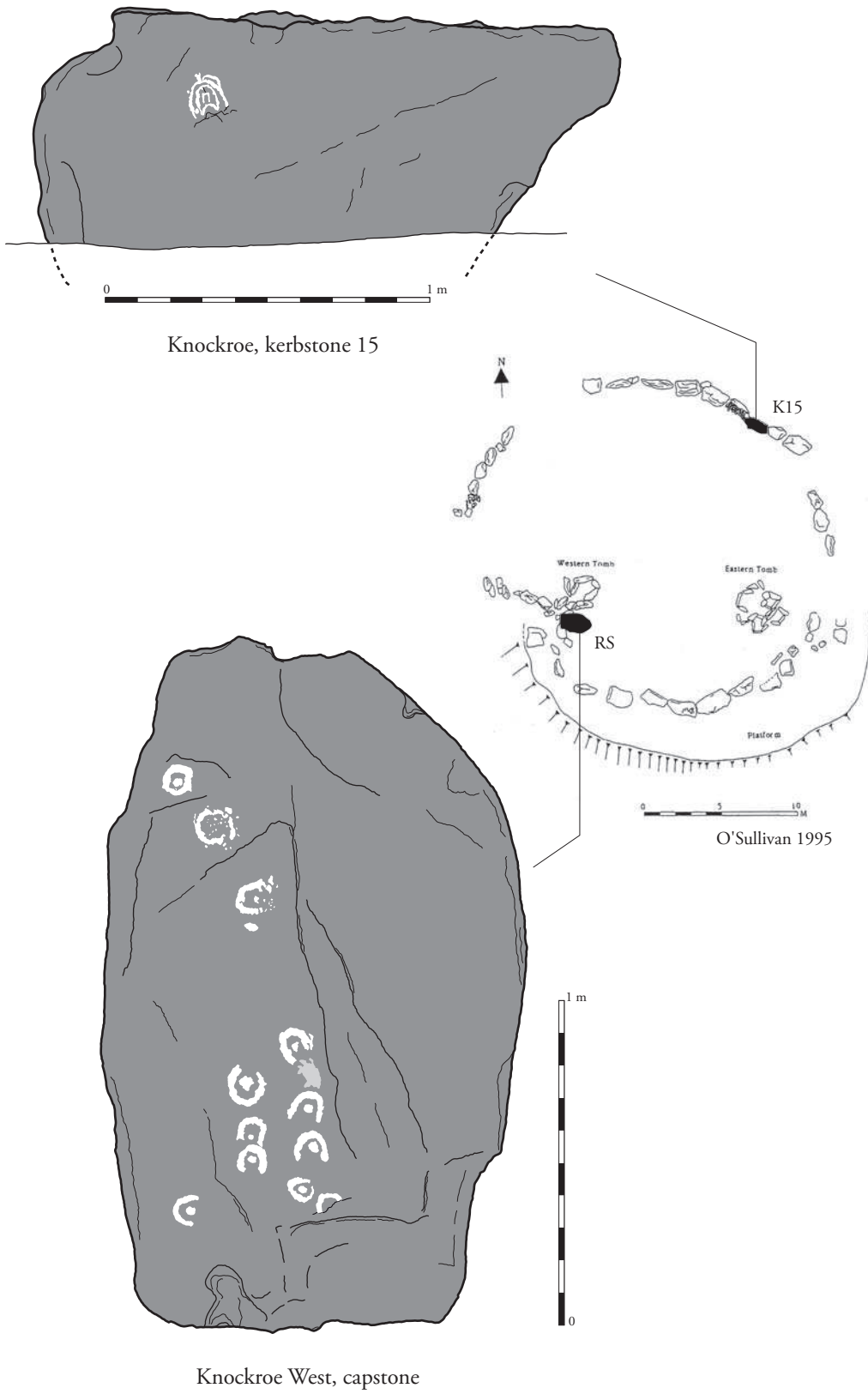


Figure 1.20 : Carvings recorded in Knockroe

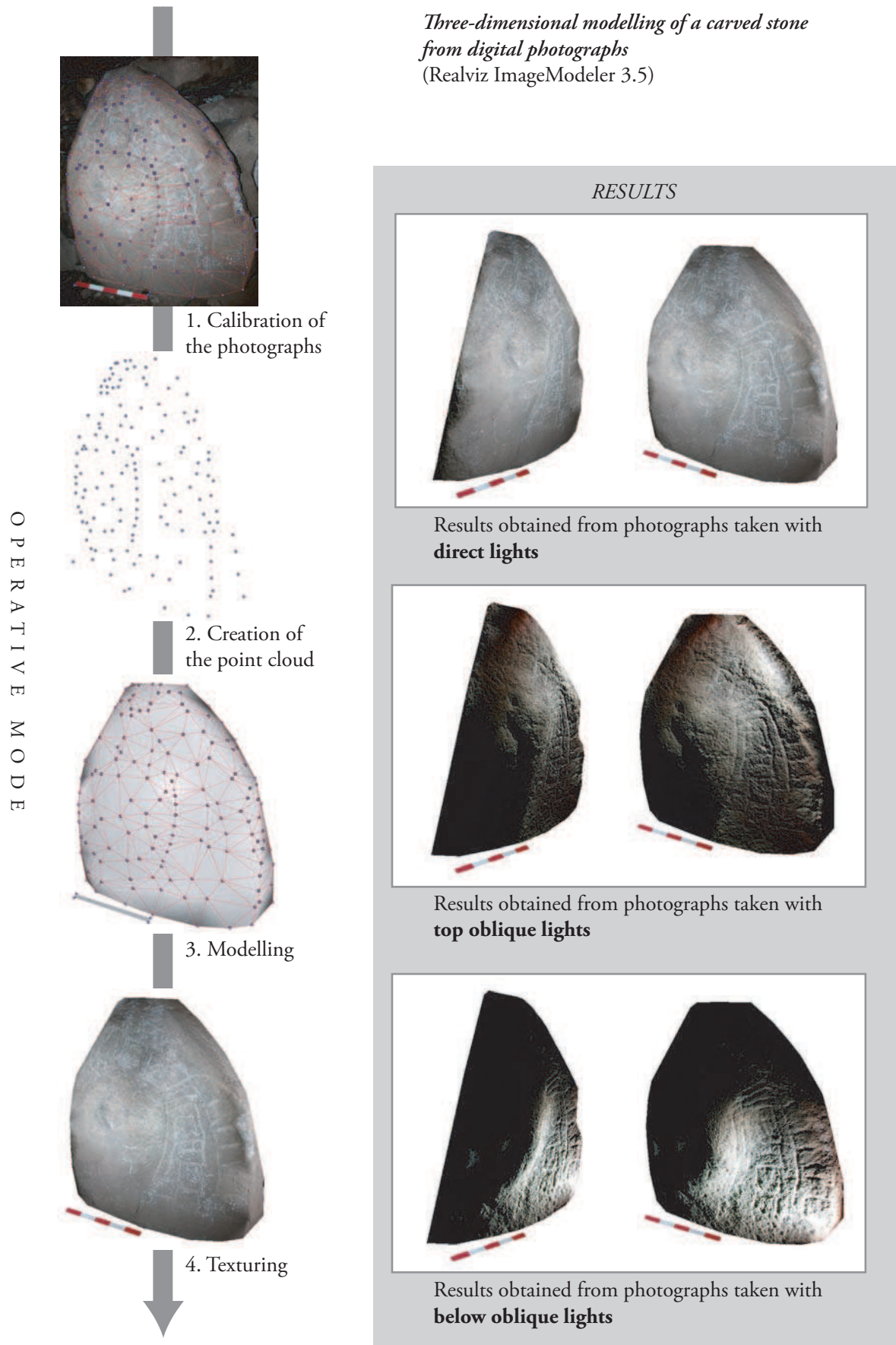


Figure 1.21 : Three-dimensional modelling of a carved stone from digital photographs

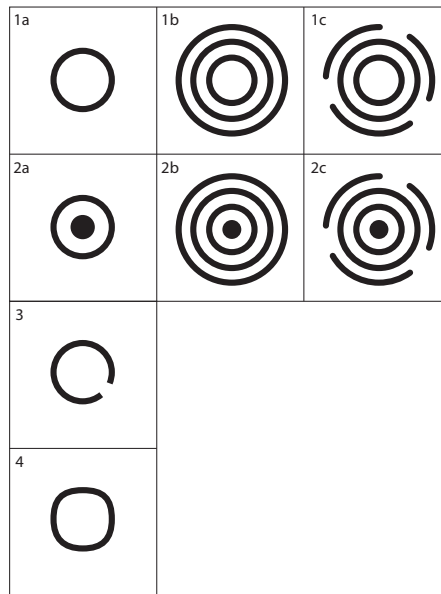
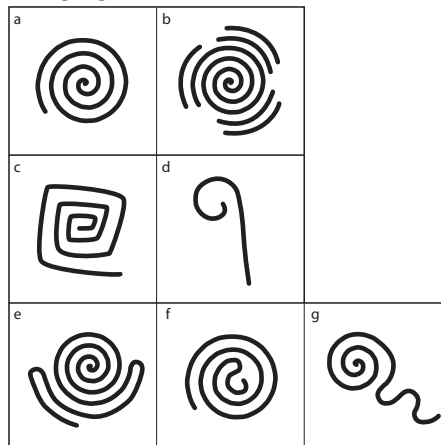
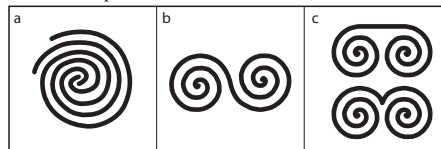


Figure 3.1 : Typological table of the circular signs

1. Simple spirals



2. Double spirals



3. Triple spirals

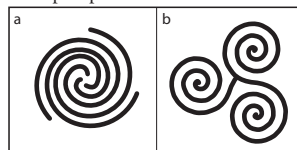














Figure 3.2 : Typological table of the spirals

Stone	Type 1							Type 2			Type 3		Bibliographical source
													
Bg.H													Shee Twohig 1981
BgII.K													Shee Twohig 1981
Dh.K1													O'Kelly & O'Kelly 1983
DhS.C8													O'Kelly & O'Kelly 1983
DhS.C12													O'Kelly & O'Kelly 1983
DL.1													Gogan 1932
Fk.A													Shee Twohig 1981
Kr.K29													O'Sullivan 1987
KrW.backst													O'Sullivan 1987
Kh.K2													O'Sullivan 1988
Kh.K4													O'Sullivan 1988
Kh.K11													Eogan 1996
Kh.K15													O'Sullivan 1988
Kh.K32													O'Sullivan 1988
Kh.K65													O'Sullivan 1988
Kh.K67													O'Sullivan 1988
Kh.K72													O'Sullivan 1988
Kh.K77													O'Sullivan 1988
Kh.K79													O'Sullivan 1988
Kh.K80													O'Sullivan 1988
Kh.K82													O'Sullivan 1988
Kh.K83													O'Sullivan 1988
Kh.K87													O'Sullivan 1988
Kh.K95													Eogan 1996
Kh.K127													Eogan 1996
KhE.Or2													O'Sullivan 1988
KhE.RS26													O'Sullivan 1988
KhE.RS30													O'Sullivan 1988
KhE.beside.CoEvi													O'Sullivan 1988
KhE.CoFx													O'Sullivan 1988
KhW.Or16													O'Sullivan 1988
KhW.RS10													O'Sullivan 1988
Kh13.K15													Eogan 1984
Kh14.K6													Eogan 1984
Kh14.Or4													Eogan 1984
Kh15.Or14													Eogan 1984
Kh17.Or13													Eogan 1984

Kh18.Or11													Eogan 1984
Kh.loose1													O'Sullivan 1988
Kh.loose4													O'Sullivan 1988
Kh.loose22													O'Sullivan 1988
LcH.sill													Shee Twohig 1981
LcL.L1													Shee Twohig 1981
LcL.L4													Shee Twohig 1981
LcL.C17													Shee Twohig 1981
LcS.L4													Shee Twohig 1981
LcT.L1													Shee Twohig 1981
LcT.L2													Shee Twohig 1981
LcT.L4													Shee Twohig 1981
LcT.L5													Shee Twohig 1981
LcT.R2													Shee Twohig 1981
LcW.C2													Shee Twohig 1981
Ng.K8													O'Kelly 1982
Ng.K11b													O'Kelly 1982
Ng.K16													O'Kelly 1982
Ng.K91													O'Kelly 1982
NgK.2a													O'Kelly et al. 1978
NgL.B													O'Kelly et al. 1978
Tr.L2													Shee Twohig 1981
Td													?
Tn													Shee Twohig 1981
Lb													Lynch 1992
Cs.A													Shee Twohig 1981
Cs.B													Shee Twohig 1981
Ft													Beckensall 1999
DhN.C19													O'Kelly & O'Kelly 1983
KM													Shee Twohig 1981
KrW.R6													O'Sullivan 1987
Kh.K5													O'Sullivan 1988
Kh.K10													Eogan 1996
KhE.RS20													O'Sullivan 1988
KhW.Or18													O'Sullivan 1988
Kh17.Or15													Eogan 1984
Kh.loose3													O'Sullivan 1988
LcL.C3													Shee Twohig 1981
Ng.K51													O'Kelly 1982
Ng.L20													O'Kelly 1982
Ng.C3													O'Kelly 1982
Ng.Co3/L5-6													O'Kelly 1982

Ng.Co1/C7													O'Kelly 1982
Km.C9													Shee Twohig 1981
Ng.K13b													O'Kelly 1982
Ng.K18b													O'Kelly 1982
Kh.K56													O'Sullivan 1988
Kh.K17													O'Sullivan 1988
Kh.K41													O'Sullivan 1988
Kh14.Or8													Eogan 1984
CI													Shee Twohig 1981
Kh.K38													O'Sullivan 1988
Kh.K51													Eogan 1996
Ng.R3													O'Kelly 1982
Ng.C4													O'Kelly 1982
Ng.X													O'Kelly 1982
Kh.K13													O'Sullivan 1988
Ng.K67													O'Kelly 1982
Ng.L19													O'Kelly 1982
Ng.K52													O'Kelly 1982
ByG.C3													Shee Twohig 1981
Cs.C												?	Shee Twohig 1981
Pw.665													Sharples 1984
Ng.C10													O'Kelly 1982
BgI.L													Shee Twohig 1981
KrW.R4													O'Sullivan 1987
Kh.K12													Eogan 1996
KhE.RS2													O'Sullivan 1988
KhE.RS10													O'Sullivan 1988
KhW.Or17													O'Sullivan 1988
KhW.Or81													O'Sullivan 1988
LcI.C13													Shee Twohig 1981
Ng.K85													O'Kelly 1982
Ng.RScellE													O'Kelly 1982
ByG.C13													Shee Twohig 1981
ByG.C16													Shee Twohig 1981
Cs.F													Shee Twohig 1981
SK.C4													Shee Twohig 1981
Pw.666													Sharples 1984
Kh.K73													O'Sullivan 1988
Kr.K31													O'Sullivan 1987
ByG.C1													Shee Twohig 1981
Cs.E													Shee Twohig 1981
LcH.R2													Shee Twohig 1981

NgL.A													O'Kelly et al. 1978
Ch.C3													Shee Twohig 1981
Ch.C8													Shee Twohig 1981
Ch.C9													Shee Twohig 1981
LcT.C3													Shee Twohig 1981
Rk.A													Shee Twohig 1981
Km.C11													Shee Twohig 1981
Kh.K93													O'Sullivan 1988
Dh.K12													O'Kelly & O'Kelly 1983
Dh.K14													O'Kelly & O'Kelly 1983
LcF.R2													Shee Twohig 1981
DhS.R1													O'Kelly & O'Kelly 1983
KhE.RS32													O'Sullivan 1988
BCD.stele													Shee Twohig 1981
Kh.K52													O'Sullivan 1988
Dh.K7													O'Kelly & O'Kelly 1983
Dh.K17													O'Kelly & O'Kelly 1983
Kr.K26													O'Sullivan 1987
KrW.L3													O'Sullivan 1987
Kh.K39													O'Sullivan 1988
Kh.K46													Eogan 1996
Kh.K47													Eogan 1996
Kh.K75													O'Sullivan 1988
Kh13.K16													Eogan 1984
LcT.RScell2													Shee Twohig 1981
LcU.C8													Shee Twohig 1981
Ng.K6													O'Kelly 1982
Ng.C2													O'Kelly 1982
Ng.K1													O'Kelly 1982
TW.9													Scott 1988
EM													Shee Twohig 1981
Pw.667													Sharples 1984
LcI.C5													Robin

Figure 3.3 : Table of associations between types of spirals and carved stones

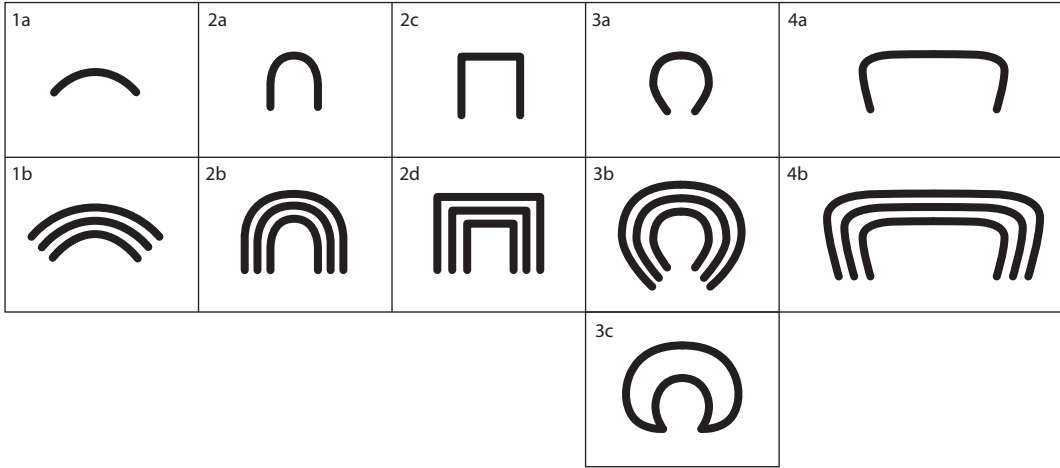


Figure 3.4 : Typological table of the arcs

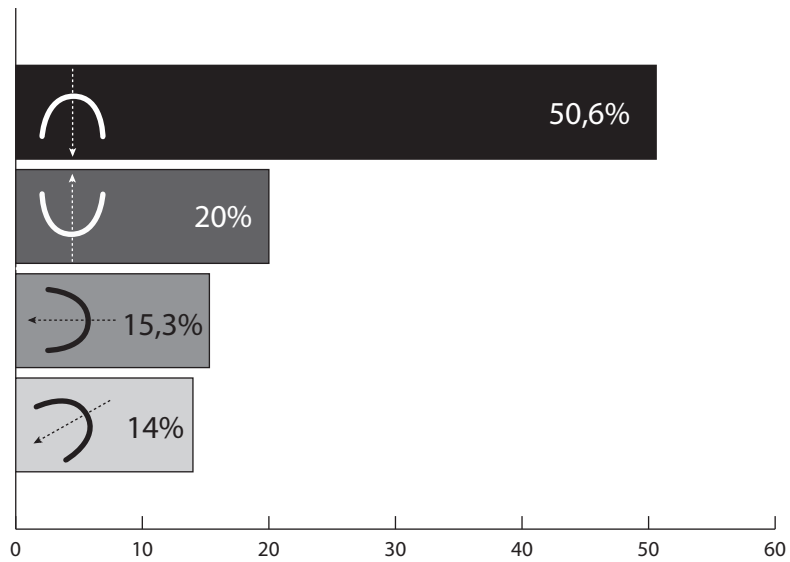













Figure 3.5 : Orientation of the arcs

Stones	Type 1		Type 2				Type 3			Type 4		Bibliographical source
												
Dh.K12												O'Kelly & O'Kelly 1983
Dh.K17												O'Kelly & O'Kelly 1983
DhS.C9												O'Kelly & O'Kelly 1983
KhE.Or93												O'Sullivan 1988
Kh2.Or14												Eogan 1984
Kh15.Or14												Eogan 1984
LcH.C5												Shee Twohig 1981
Rk.A												Shee Twohig 1981
Rk.B												Shee Twohig 1981
LcF.C5												Shee Twohig 1981
Ch.C9												Shee Twohig 1981
DhN.RS4												O'Kelly & O'Kelly 1983
Fk.C1												Shee Twohig 1981
Kt.E												Shee Twohig 1981
Kt.W												Shee Twohig 1981
Km.C9												Shee Twohig 1981
Km.C10												Shee Twohig 1981
Km.C11												Shee Twohig 1981
Kr.K30												O'Sullivan 1987
Kh.K2												O'Sullivan 1988
Kh.K14												O'Sullivan 1988
Kh.K17												O'Sullivan 1988
Kh.K48												O'Sullivan 1988
Kh.K56												Eogan 1996
Kh.K60												O'Sullivan 1988
Kh.K116												Eogan 1974
LcI.C4												Shee Twohig 1981
LcT.R5												Shee Twohig 1981
LcT.sill1												Shee Twohig 1981
LcT.C3												Shee Twohig 1981
LcV.C4												Shee Twohig 1981
MM.1												Shee Twohig 1981
Ng.K1												O'Kelly 1982
Ng.K51												O'Kelly 1982
Ng.K54												O'Kelly 1982
NgK.2a												O'Kelly et al. 1978

NgZ.bassin												O'Kelly et al. 1978
EM												Shee Twohig 1981
LcI.C1												Shee Twohig 1981
LcL.L3												Shee Twohig 1981
LcL.C19												Shee Twohig 1981
KhE.Or68												O'Sullivan 1988
Kh.K75												O'Sullivan 1988
Kh.K89												Eogan 1974
Kh14.Or8												Eogan 1984
LcL.C4												Shee Twohig 1981
Am.A												Eogan 1974
Cm.Co1												Robin 2007
Dh.K51												O'Kelly & O'Kelly 1983
DhS.R1												O'Kelly & O'Kelly 1983
DhS.C7												O'Kelly & O'Kelly 1983
KrW.RS												Robin
Kh.K13												O'Sullivan 1988
Kh.K52												O'Sullivan 1988
Kh.K63												O'Sullivan 1988
Kh.K64												O'Sullivan 1988
Kh.K85												O'Sullivan 1988
KhE.Or64												O'Sullivan 1988
KhE.Co86/87												O'Sullivan 1988
KhW.Or38												O'Sullivan 1988
KhW.Or41												O'Sullivan 1988
Kh15.sillC												Eogan 1984
LcF.R2												Shee Twohig 1981
LcH.R2												Shee Twohig 1981
LcU.C10												Shee Twohig 1981
Ng.Co1/C7												O'Kelly 1982
Cs.A												Shee Twohig 1981
Kh.K19												O'Sullivan 1988
Kh.K78												O'Sullivan 1988
Kh.K80												O'Sullivan 1988
LcI.C5												Robin
LcT.C14												Shee Twohig 1981
KhE.Or50												O'Sullivan 1988
KhE.RS10												O'Sullivan 1988
LcF.C1												Shee Twohig 1981
Kh.K15												O'Sullivan 1988

Pw.667												Sharples 1984
Kh.K7												O'Sullivan 1988
Kh.K66												O'Sullivan 1988
Kh.K4												Eogan 1996
Kh.K83												O'Sullivan 1988
Ng.K52												O'Kelly 1982
LcT.C2										?		Shee Twohig 1981
Kh.K8												O'Sullivan 1988
Kh.K10												Eogan 1996
LcI.C13												Shee Twohig 1981
Kh.K32												O'Sullivan 1988
Kh.K26												Eogan 1996
LcL.C9												Shee Twohig 1981
Kh.K5												Eogan 1996
KhE.Or2												O'Sullivan 1988
Kh.loose10												O'Sullivan 1988
KhE.Or69												O'Sullivan 1988
Kh.K28												Eogan 1996
Kh.K47												O'Sullivan 1988
Kh.K59												O'Sullivan 1988
Kh.K61												O'Sullivan 1988
Kh.K65												O'Sullivan 1988
Kh.K69												O'Sullivan 1988
Kh.K84												O'Sullivan 1988
Kh.K94												Eogan 1974
Kh.K97												Eogan 1974
Kh.K119												Eogan 1974
Kh.K124												Eogan 1996
KhE.Or58												O'Sullivan 1988
KhE.RS21												O'Sullivan 1988
KhE.Co54i												O'Sullivan 1988
KhW.Or50												O'Sullivan 1988
Kh13.K15												Eogan 1984
Kh17.Or16												Eogan 1984
Lh.RS												Curran-Mulligan 1994
LcU.C3												Shee Twohig 1981
Kh.K71												O'Sullivan 1988
Kh.K73												O'Sullivan 1988
Kh.K79												O'Sullivan 1988
Fk.D												Hartnett 1957

Kh.K68												O'Sullivan 1988
Kh.K82												O'Sullivan 1988
Kh.K86												O'Sullivan 1988
LcT.C10												Shee Twohig 1981
Kh.K30												O'Sullivan 1988
MB.M2												Shee Twohig 1981
Kh.K11												Eogan 1996
Kh.K12												Eogan 1996
Kh.K74												Eogan 1996
KhW.Or42												O'Sullivan 1988

Figure 3.6 : Table of associations between types of arcs and carved stones

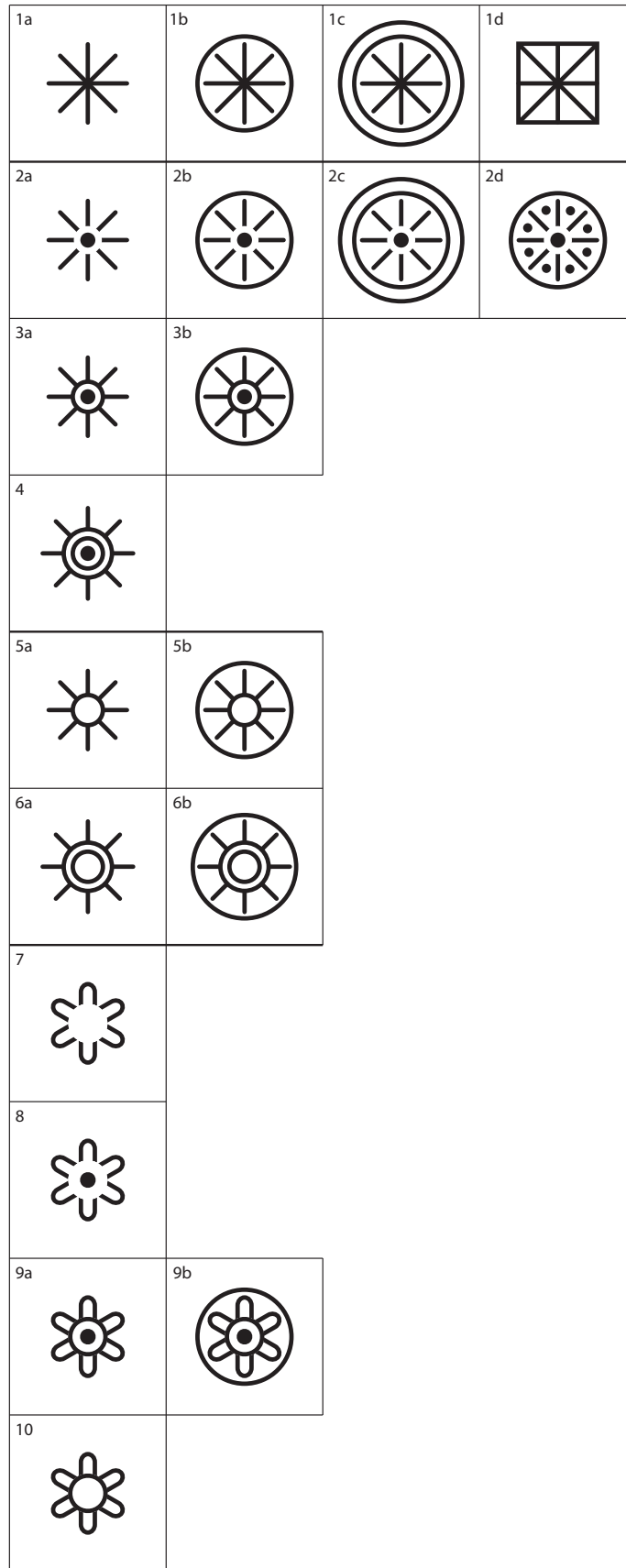


Figure 3.7 : Typological table of the radiate circular signs

Stones	Type 1				Type 2				Type 3		T. 4	Type 5		Type 6		T. 7	T. 8	Type 9		T. 10	Bibliographical source
	1a	1b	1c	1d	2a	2b	2c	2d	3a	3b	4	5a	5b	6a	6b	7	8	9a	9b	10	
LcL.R3																					Shee Twohig 1981
LcW.C2																					Shee Twohig 1981
LcT.C3	?																				Shee Twohig 1981
LcT.RScell2																					Shee Twohig 1981
LcL.C1																					Shee Twohig 1981
LcT.C11																					Shee Twohig 1981
DhS.C12																					O'Kelly & O'Kelly 1983
DhN.C2																					O'Kelly & O'Kelly 1983
Kh.K68																					O'Sullivan 1988
LcS.C2																					Shee Twohig 1981
DhN.C7																					O'Kelly & O'Kelly 1983
LcF.R4																					Shee Twohig 1981
LcF.C5																					Shee Twohig 1981
LcI.ls.cell3																					Shee Twohig 1981
LcT.R5																					Shee Twohig 1981
LcT.C2																					Shee Twohig 1981
LcU.I.2																					Shee Twohig 1981
LcU.C2																					Shee Twohig 1981
LcU.C9																					Shee Twohig 1981
Mg																					O'Sullivan 1988
SK.stele																					Shee Twohig 1981
LcT.sill3																					Robin
LcT.C14																					Shee Twohig 1981
LcU.C5																					Shee Twohig 1981
Dh.K51																					O'Kelly & O'Kelly 1983
LcT.C8																					Shee Twohig 1981
LcX1																					Shee Twohig 1981
LcT.L1																					Shee Twohig 1981
KhE.Or54																					O'Sullivan 1988
KhE.Co40v																					O'Sullivan 1988
LcF.loose																					Frazer 1893
LcT.C15																					Shee Twohig 1981
NgK.11																					O'Kelly et al. 1978
KhW.Or42																					O'Sullivan 1988
LcI.R2																					Shee Twohig 1981
LcI.C5																					Shee Twohig 1981
NgK.K4																					O'Kelly et al. 1978
NgL.A																					O'Kelly et al. 1978
NgZ.bassin																					O'Kelly et al. 1978
LcS.I4																					Shee Twohig 1981
Dh.K88																					O'Kelly & O'Kelly 1983
LcI.C13																					Shee Twohig 1981
LcU.C3																					Shee Twohig 1981
LcL.L3																					Shee Twohig 1981
Ng.K11b																					O'Kelly 1982

Figure 3.8 : Table of associations between types of radiate circular signs and carved stones

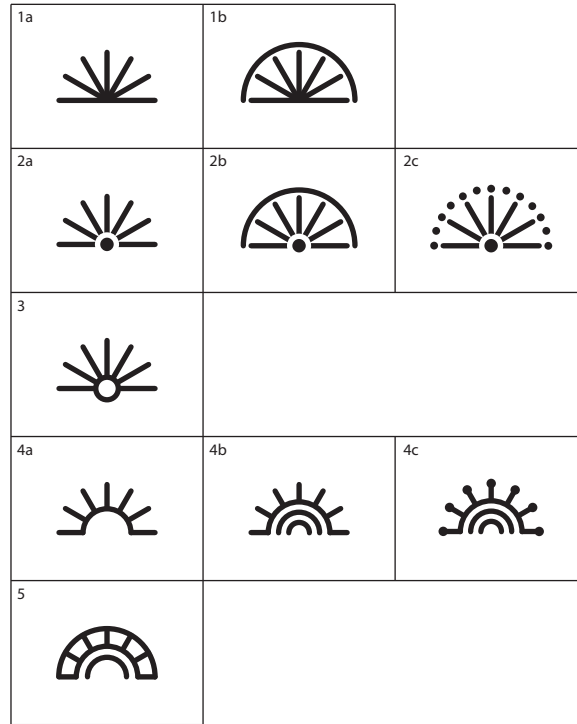


Figure 3.9 : Typological table of the radiate semicircular signs











Stones	Type 1		Type 2			Type 3	Type 4			Type 5	Bibliographical source
											
Kh.K46											O'Sullivan 1988
LcS.C2											Shee Twohig 1981 / Robin
LcF.R4			?								Shee Twohig 1981
Ng.Co1/C7											O'Kelly 1982
Ng.K88											O'Kelly 1982
Kh.K7											O'Sullivan 1988
Kh.K15											O'Sullivan 1988
Kh14.Or8											Eogan 1984
LcI.C13					?						Shee Twohig 1981
LcX1											Shee Twohig 1981
Ng.K6											O'Kelly 1982
Ng.RS1											O'Kelly 1982
Ng.RB											O'Kelly 1982
LcL.C17											Shee Twohig 1981
NgL.B											O'Kelly et al. 1978
LcT.C9											Shee Twohig 1981
LcT.C14											Shee Twohig 1981
LcU.C11											Shee Twohig 1981
DL.2											Gogan 1932
Km.C9											Shee Twohig 1981
LcI.C1											Shee Twohig 1981
LcU.C6											Shee Twohig 1981

Figure 3.10 : Table of associations between types of radiate semicircular signs and carved stones

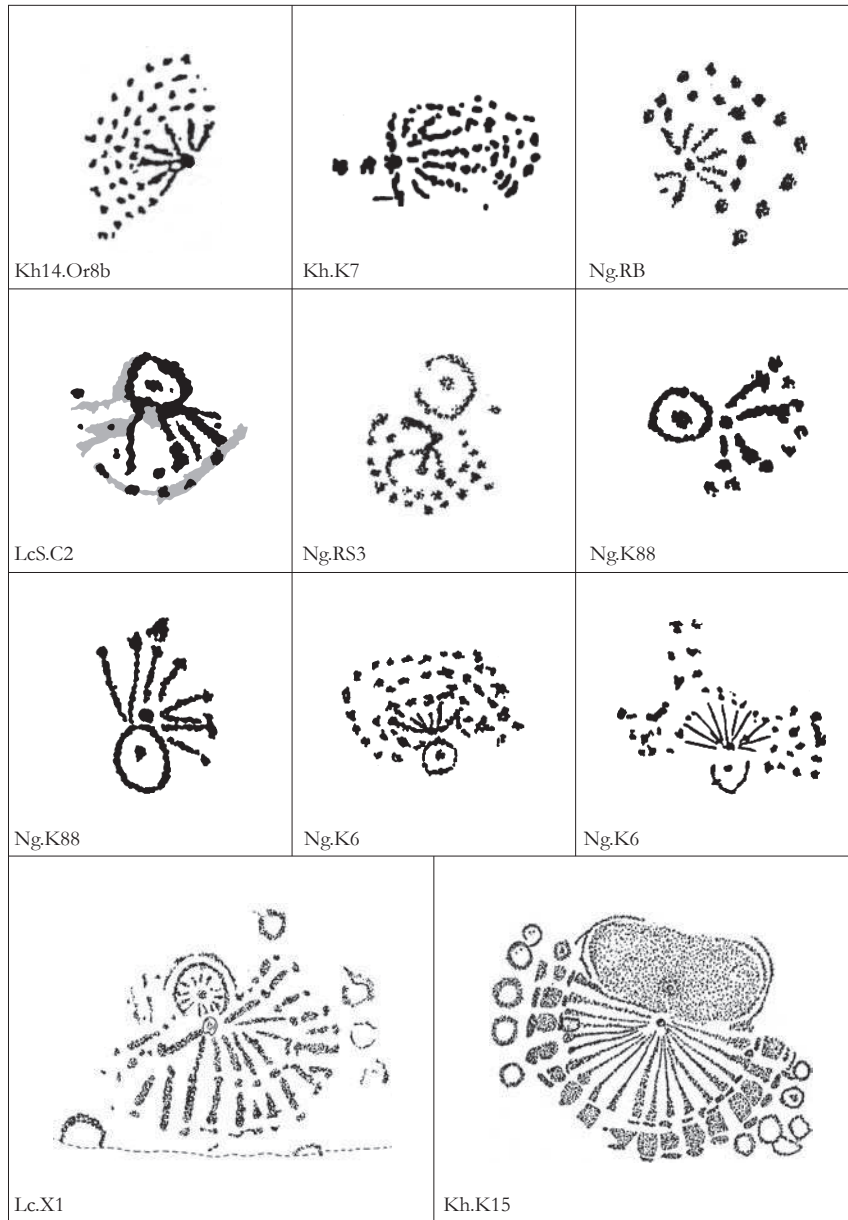


Figure 3.11 : Radiate semicircular signs type 2c

















1a 	1b 	1c 	1d 
2a 	2b 	2c 	
3 			

Figure 3.12 : Typological table of the chevrons

Part two - The iconographic repertoire of passage tomb art

Stones	Type 1				Type 2			Type 3	Bibliographical source
									
Cg									Corlett 1996
Dh.K51									O'Kelly & O'Kelly 1983
DhN.C7									O'Kelly & O'Kelly 1983
DhS.C12									O'Kelly & O'Kelly 1983
Km.C11									Shee Twohig 1981
Kh.K56									Eogan 1996
KhE.beside.CoEvi									O'Sullivan 1988
KhW.Or16									O'Sullivan 1988
KhW.Or50									O'Sullivan 1988
Kh2.Or29									Eogan 1984
Kh16.Or4									Eogan 1984
Kh16.Or7									Eogan 1984
Ng.K12									O'Kelly 1982
Ng.R20									O'Kelly 1982
NgZ.bassin									O'Kelly et al. 1978
Sf.R4									Shee Twohig 1981
ByG.C1									Shee Twohig 1981
Cs.C									Shee Twohig 1981
CH.1									Bradley et al. 1998
CH.2									Bradley et al. 1998
Qn.5									Bradley et al. 1998
Qn.7									Bradley et al. 1998
WH.8									Bradley et al. 1998
WH.9									Bradley et al. 1998
Kh.K12									Eogan 1996
LeW.C4									Frazer 1893
Ng.K18b									O'Kelly 1982
Ng.K85									O'Kelly 1982
Mh.12									Bradley et al. 1998
Ng.X									O'Kelly 1982
KhW.Co37-38									Eogan 1997
Kh14.Or8									Eogan 1984
Ng.K67									O'Kelly 1982
KhW.Or38									O'Sullivan 1988
Ng.K13b									O'Kelly 1982
Ng.K1									O'Kelly 1982
LH									Evans 1953
ByG.C3									Shee Twohig 1981
Gb									Beckensall 1999
Dh.K17									O'Kelly & O'Kelly 1983
Dh.loose2									O'Kelly 1967
DL.2									Gogan 1932
Fk.L4									Shee Twohig 1981
Fk.R5									Shee Twohig 1981
Fk.C									Shee Twohig 1981
Fk.E									Shee Twohig 1981
Fk.F									Shee Twohig 1981
Kh.K1b									Eogan 2008
Kh.K5									Eogan 1996
Kh.K15									O'Sullivan 1988
Kh.K23									O'Sullivan 1988
Kh.K28									O'Sullivan 1988
Kh.K38									O'Sullivan 1988
Kh.K65									O'Sullivan 1988
Kh.K85									O'Sullivan 1988
Kh.K127									O'Sullivan 1988
KhE.Or2									O'Sullivan 1988
KhE.Or3									O'Sullivan 1988
KhE.Or36									O'Sullivan 1988
KhE.Or48									O'Sullivan 1988
KhE.Or49									O'Sullivan 1988
KhE.Or55									O'Sullivan 1988
KhE.Or57									O'Sullivan 1988
KhE.RS34									O'Sullivan 1988
KhE.RS49									O'Sullivan 1988
KhE.RS50									O'Sullivan 1988
KhE.Co65									O'Sullivan 1988
KhE.Co40i									O'Sullivan 1988
KhE.Co52iii									O'Sullivan 1988
KhE.CoAvi									O'Sullivan 1988
KhE.CoDvii									O'Sullivan 1988
KhW.Or17									O'Sullivan 1988

KhW.Or40									O'Sullivan 1988
KhW.Or41									O'Sullivan 1988
KhW.Or48									O'Sullivan 1988
KhW.RS3									O'Sullivan 1988
KhW.RS5									O'Sullivan 1988
KhW.RS10									O'Sullivan 1988
Kh4.A									Eogan 1984
Kh14.Or13									Eogan 1984
Kh15.sillC									Eogan 1984
Kh16.Or13									Eogan 1984
Kh16.C10									Eogan 1984
Kh17.Or6									Eogan 1984
Kh17.Or13									Eogan 1984
Kh17.Or15									Eogan 1984
LcF.R4									Shee Twohig 1981
LcJ.loose1									Shee Twohig 1981
LcL.C19									Shee Twohig 1981
LcT.C8									Shee Twohig 1981
LcT.RScell3									Shee Twohig 1981
LcU.R2									Shee Twohig 1981
LcU.C7									Shee Twohig 1981
MB.M18									Collins & Waterman 1955
MB.M24									Collins & Waterman 1955
Ng.K7									O'Kelly 1982
Ng.K16									O'Kelly 1982
Ng.K52									O'Kelly 1982
Ng.K88									O'Kelly 1982
Ng.K89									O'Kelly 1982
Ng.K93									O'Kelly 1982
Ng.L12									O'Kelly 1982
Ng.L19									O'Kelly 1982
Ng.L22									O'Kelly 1982
Ng.R12									O'Kelly 1982
Ng.R18									O'Kelly 1982
Ng.C4									O'Kelly 1982
Ng.C8									O'Kelly 1982
Ng.C10									O'Kelly 1982
Ng.RS3									O'Kelly 1982
Ng.Z									O'Kelly 1982
Ng.Co1/C2									O'Kelly 1982
Ng.Co1/C10									O'Kelly 1982
Ng.Co1/C11									O'Kelly 1982
Ng.Co1/C12-13									O'Kelly 1982
Ng.Co2/C14									O'Kelly 1982
Ng.RScellE(f)									O'Kelly 1982
Ng.RScellE									O'Kelly 1982
NgK.A									O'Kelly et al. 1978
NgK.sill1									O'Kelly et al. 1978
NgK.9									O'Kelly et al. 1978
NgZ.fragment									O'Kelly et al. 1978
ByG.L8									Shee Twohig 1981
ByG.C16									Shee Twohig 1981
HPW.B									Shee Twohig 1981
HPW.F									Shee Twohig 1981
HPW.4									Bradley et al. 1998
Mh.15									Bradley et al. 1998
Mh.18									Bradley et al. 1998
Qn.6									Bradley et al. 1998
WH.10									Bradley et al. 1998
WH.11									Bradley et al. 1998
KhE.Or45									O'Sullivan 1988
KhW.Or81									O'Sullivan 1988
CI									Shee Twohig 1981
Dh.K12									O'Kelly & O'Kelly 1983
Dh.N.C19									O'Kelly & O'Kelly 1983
Kh.K10									Eogan 1996
Kh.K13									O'Sullivan 1988
Kh.K41									O'Sullivan 1988
KhE.Or54									O'Sullivan 1988
KhE.RS26									O'Sullivan 1988
KhE.RS32									O'Sullivan 1988
KhE.RS41									O'Sullivan 1988
KhE.CoEvi									O'Sullivan 1988
KhE.CoFx									O'Sullivan 1988
KhW.Or74									O'Sullivan 1988
LcF.R2									Shee Twohig 1981

LcI.C17									Shee Twohig 1981
LcU.C8									Shee Twohig 1981
Ng.K2									O'Kelly 1982
Ng.K4									O'Kelly 1982
Ng.K9									O'Kelly 1982
Ng.K51									O'Kelly 1982
NgK.5									O'Kelly et al. 1978
NgL.A									O'Kelly et al. 1978
NgL.B									O'Kelly et al. 1978
DhN.C8									O'Kelly & O'Kelly 1983
Fk.A									Shee Twohig 1981
KhE.jR.cellN									O'Sullivan 1988
KhE.B									O'Sullivan 1988
Kh.K71									O'Sullivan 1988
LcI.ls.cell3									Shee Twohig 1981
Km.C9									Shee Twohig 1981
DhS.C7									O'Kelly & O'Kelly 1983
KhE.Or33									O'Sullivan 1988
KhE.Or92									O'Sullivan 1988
KhE.RS38									O'Sullivan 1988
KhW.Or18									O'Sullivan 1988
Kh16.Or9									Eogan 1984
LcL.R3									Shee Twohig 1981
MM.1									Shee Twohig 1981
Mt									O'Broin 2000

Figure 3.13 : Table of associations between types of chevrons and carved stones

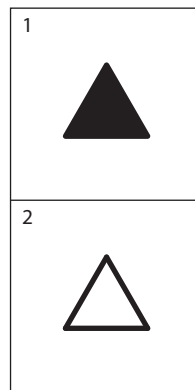


Figure 3.14 : Typological table of the triangles



Stones	Type 1	Type 2	Bibliographical source
			
Ch.C3			Shee Twohig 1981
Fk.E			Shee Twohig 1981
Fk.F			Shee Twohig 1981
Kh.K13b			Eogan 2008
Kh.K15			O'Sullivan 1988
Kh.K72			O'Sullivan 1988
Kh.K85			O'Sullivan 1988
KhE.Or48			O'Sullivan 1988
KhE.Or54			O'Sullivan 1988
KhE.jR.cellN			O'Sullivan 1988
KhW.Or41			O'Sullivan 1988
LcH.C11			Shee Twohig 1981
LcI.C13			Shee Twohig 1981
LcL.C16			Shee Twohig 1981
LH			Evans 1953
Ng.K1			O'Kelly 1982
Ng.K4			O'Kelly 1982
Ng.K52			O'Kelly 1982
Ng.K67			O'Kelly 1982
Ng.K88			O'Kelly 1982
Ng.L22			O'Kelly 1982
Ng.R5			O'Kelly 1982
Ng.R8			O'Kelly 1982
Ng.R12			O'Kelly 1982
Ng.C8			O'Kelly 1982
Ng.C16			O'Kelly 1982
Ng.RBintel			O'Kelly 1982
Ng.RB	?		O'Kelly 1982
Ng.X			O'Kelly 1982
Ng.Y			O'Kelly 1982
Ng.Co1/C2			O'Kelly 1982
Ng.Co1/C10			O'Kelly 1982
Ng.Co1/C12-13			O'Kelly 1982
Ng.Co2/C11			O'Kelly 1982
NgL.B			O'Kelly et al. 1978
NgL.A			O'Kelly et al. 1978
NgL.C9			O'Kelly et al. 1978
DhS.C6			O'Kelly & O'Kelly 1983
KhW.Or40			O'Sullivan 1988
Kh14.Or8			Eogan 1984
Ng.K18b			O'Kelly 1982
Ng.R21			O'Kelly 1982
Ng.Co2/C14			O'Kelly 1982
Ch.C8			Shee Twohig 1981
Ch.C9			Shee Twohig 1981
Km.C9		?	Shee Twohig 1981
KhE.behind.Co39i			O'Sullivan 1988
Ng.K12		?	O'Kelly 1982
Ng.K13b			O'Kelly 1982
Ng.R19		?	O'Kelly 1982
Mh.12			Bradley et al. 1998

Figure 3.15 : Table of associations between types of triangles and carved stones

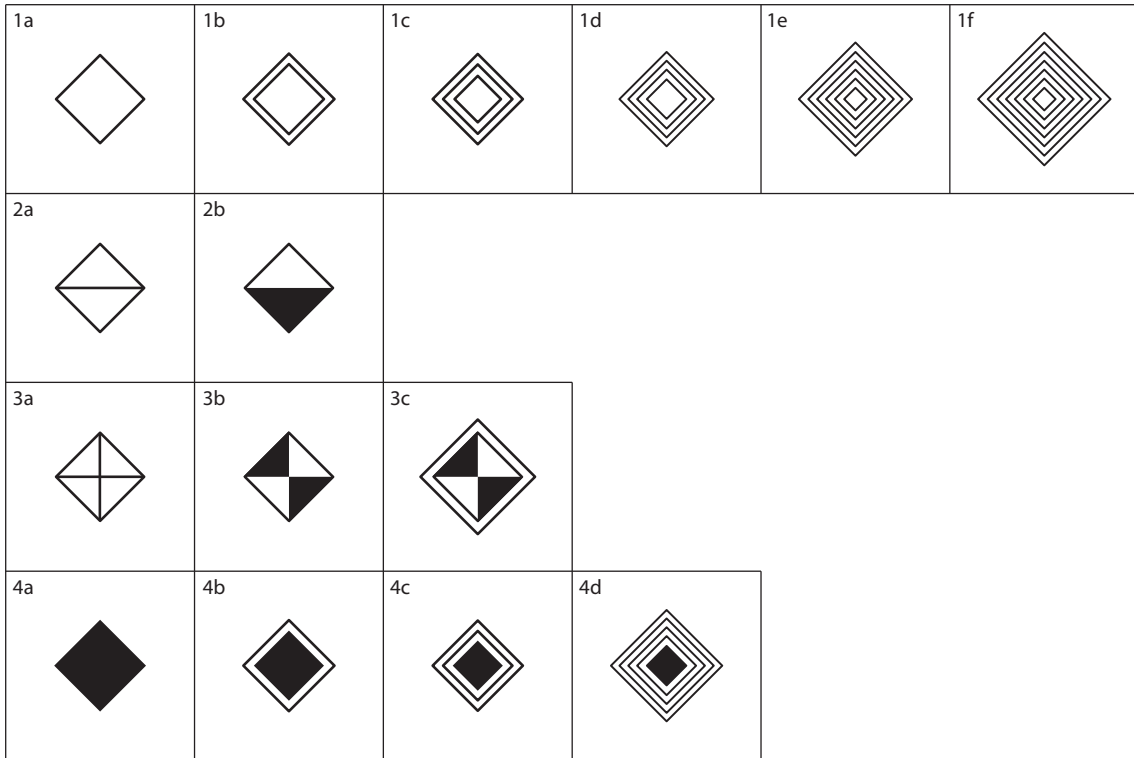

















Figure 3.16 : Typological table of the quadrangular signs

Stones	Type 1						Type 2		Type 3			Type 4				Bibliographical source
																
Am.A																Eogan 1974
Cd																Roe 1967
Dh.K51																O'Kelly & O'Kelly 1983
DL.2																Gogan 1932
Fk.R2																Shee Twohig 1981
Km.C6	?															Shee Twohig 1981
Kh.K38																O'Sullivan 1988
Kh.K41																O'Sullivan 1988
Kh.K72																O'Sullivan 1988
Kh.K75																O'Sullivan 1988
Kh.K84																O'Sullivan 1988
Kh.K116																Eogan 1974
Kh.K120																Eogan 1974
KhE.Or52																O'Sullivan 1988
KhE.Co41ii																O'Sullivan 1988
KhE.Co51i	?															O'Sullivan 1988
KhE.Co54i	?															O'Sullivan 1988
KhW.Or17	?															O'Sullivan 1988
Kh15.sillC																Eogan 1984
Kh16.Co10																Eogan 1984
Kh17.Or15																Eogan 1984
LcF.R2																Shee Twohig 1981
LcL.C11																Shee Twohig 1981
LcL.C17																Shee Twohig 1981
LcT.C6	?															Shee Twohig 1981
LcT.C11																Shee Twohig 1981
LcU.C5																Shee Twohig 1981
LcL.Co1/C16																Shee Twohig 1981
MM.1																Shee Twohig 1981
MB.47																Collins & Waterman 1955
MB.M18																Collins & Waterman 1955
Ng.K5	?															O'Kelly 1982
Ng.K9	?															O'Kelly 1982
Ng.K13b																O'Kelly 1982
Ng.K18b																O'Kelly 1982
Ng.K54	?															O'Kelly 1982

Ng.K85																	O'Kelly 1982
Ng.K88	?																O'Kelly 1982
Ng.L17																	O'Kelly 1982
Ng.L19																	O'Kelly 1982
Ng.R10																	O'Kelly 1982
Ng.R19																	O'Kelly 1982
Ng.Co4/C8																	O'Kelly 1982
NgK.2a																	O'Kelly et al. 1978
NgL.C3																	O'Kelly et al. 1978
ByG.L8																	Shee Twohig 1981
Cr.10																	Beckensall 1999
Cr.27																	Beckensall 1999
HPW.A																	Shee Twohig 1981
Mh.14																	Bradley et al. 1998
Mh.19																	Bradley et al. 1998
Mh.20																	Bradley et al. 1998
Mh.21	?																Bradley et al. 1998
Ng.RScellE																	O'Kelly 1982
KhW.Or44																	O'Sullivan 1988
Kh17.Or13																	Eogan 1984
KhE.Or45																	O'Sullivan 1988
Kh16.Co12																	Eogan 1984
KhE.Or55																	O'Sullivan 1988
KhE.Or56																	O'Sullivan 1988
KhW.Or48																	O'Sullivan 1988
Ng.Z																	O'Kelly 1982
LcL.C16																	Shee Twohig 1981
LcL.C19																	Shee Twohig 1981
LcO																	Robin
Kh.K13																	O'Sullivan 1988
Kh.K23																	O'Sullivan 1988
Kh.K15																	O'Sullivan 1988
Kh4.A																	Eogan 1984
Kh14.Or8																	Eogan 1984
Ng.K67																	O'Kelly 1982
Ng.L22																	O'Kelly 1982
Ng.C2																	O'Kelly 1982
NgL.A																	O'Kelly et al. 1978
Ng.X																	O'Kelly 1982
ByG.C1																	Shee Twohig 1981

Kh2.Or29																	Eogan 1984
Kh.loose7																	O'Sullivan 1988
Kh.loose23																	O'Sullivan 1988
LcI.C13																	Shee Twohig 1981
Ng.K52																	O'Kelly 1982
Ng.C8																	O'Kelly 1982
Ng.C15																	O'Kelly 1982
Ng.C16																	O'Kelly 1982
Ng.RB																	O'Kelly 1982
Ng.Co1/C15-16																	O'Kelly 1982
Ng.Co2/C11																	O'Kelly 1982
Ng.RScellE(f)																	O'Kelly 1982
NgL.B																	O'Kelly et al. 1978
NgL.C9																	O'Kelly et al. 1978
Ng.K1																	O'Kelly 1982
NgK.sill1																	O'Kelly et al. 1978

Figure 3.17 : Table of associations between types of quadrangular signs and carved stones








1a 	1b 
2a 	2b 
3a 	3b 
4 	

Figure 3.18 : Typological table of the scalariform signs











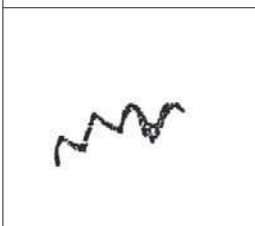
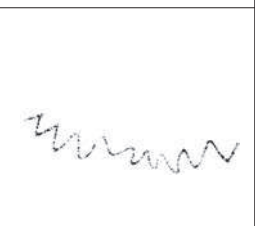
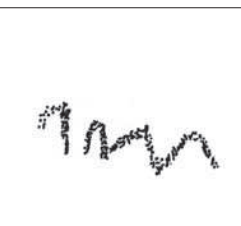
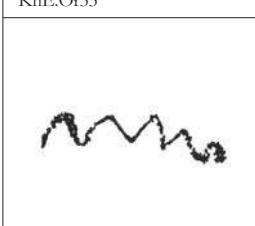
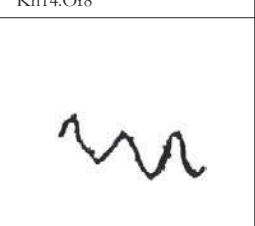
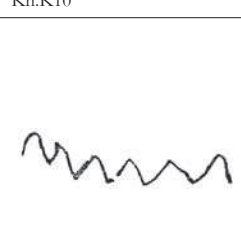
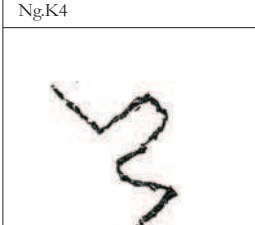
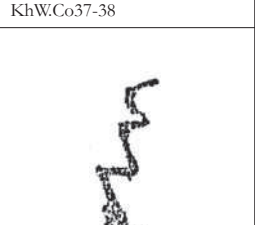

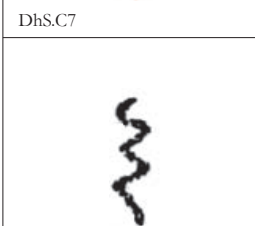
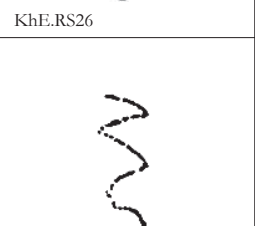
Stones	Type 1		Type 2		Type 3		Type 4	Bibliographical source
								
DhN.C7								O'Kelly & O'Kelly 1983
DhN.C18								O'Kelly & O'Kelly 1983
DhS.C12								O'Kelly & O'Kelly 1983
DhS.C13								O'Kelly & O'Kelly 1983
DhS.lr								O'Kelly & O'Kelly 1983
Kl	?							Shee Twohig 1981
Km.C3	?							Shee Twohig 1981
Km.C6								Shee Twohig 1981
Kh.K79								O'Sullivan 1988
KhE.Or1								O'Sullivan 1988
KhE.CoAx								O'Sullivan 1988
Kh4.A								Eogan 1984
LcF.L1								Shee Twohig 1981
LcI.R2								Shee Twohig 1981
LcL.L4	?							Shee Twohig 1981
LcL.C5								Shee Twohig 1981
LcS.C6	?							Shee Twohig 1981
LcT.I.2								Shee Twohig 1981
LcT.R5								Shee Twohig 1981
LcT.C9								Shee Twohig 1981
LcT.lcell2								Shee Twohig 1981
LcU.I.2								Shee Twohig 1981
LcU.C5								Shee Twohig 1981
LcW.C3	?							Shee Twohig 1981
Ng.R12								O'Kelly 1982
Ng.R20								O'Kelly 1982
Ng.R21								O'Kelly 1982
Ng.RS3								O'Kelly 1982
SK.stele	?							Shee Twohig 1981
ByG.C14								Shee Twohig 1981
Cs.A								Shee Twohig 1981
LcT.C15								Shee Twohig 1981 / Frazer 1893
LcT.C8								Shee Twohig 1981
LcT.C14								Shee Twohig 1981
LcT.RScell2								Shee Twohig 1981
Kh17.Or15								Eogan 1984
LcL.C17								Shee Twohig 1981
LcT.Co1/C2		?						Shee Twohig 1981
LcU.C2						?		Shee Twohig 1981 / Frazer 1893
Km.C12								Shee Twohig 1981
LcT.lcell1								Shee Twohig 1981
DhN.C19			?					O'Kelly & O'Kelly 1983
DhN.R5								O'Kelly & O'Kelly 1983
Ng.C4								O'Kelly 1982
Dh.K51								O'Kelly & O'Kelly 1983
Km.C4						?		Shee Twohig 1981
Kh.K4								Eogan 1996
KhE.Co41ii								O'Sullivan 1988
KhW.Or38								O'Sullivan 1988
LcH.R2								Shee Twohig 1981
LcI.ls.cell3								Shee Twohig 1981
LcT.C1						?		Robin
LcT.C2								Shee Twohig 1981
LcU.C6								Shee Twohig 1981
Ng.K7								O'Kelly 1982
Ng.K13b								O'Kelly 1982
NgL.B								O'Kelly et al. 1978
Kh14.Or8								Eogan 1984
DhN.C2								O'Kelly & O'Kelly 1983
LcH.K8								Shee Twohig 1981
LcI.C13								Shee Twohig 1981
DhN.L5								O'Kelly & O'Kelly 1983
KhW.Or51								O'Sullivan 1988
LcS.L4								Shee Twohig 1981

Figure 3.19 : Table of associations between types of scalariform signs and carved stones

 Kh.K13	 Dh.N.C19	 Dh.K12
 Kh.E.Or33	 Kh14.Or8	 Kh.K10
 Ng.K4	 Kh.W.Co37-38	 Kh.E.RS41
 Dh.S.C7	 Kh.E.RS26	 Ng.L.A
 Kh.E.Or92	 Kh16.Or9	

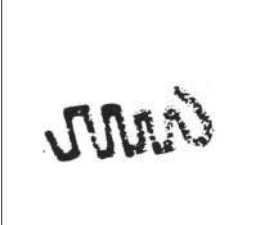



 Kh14.Or8	 Kh14.Or8	 Kh.K93	 Cm.Co1
---	---	--	---

Figure 3.20 : Meandering signs with chevrons

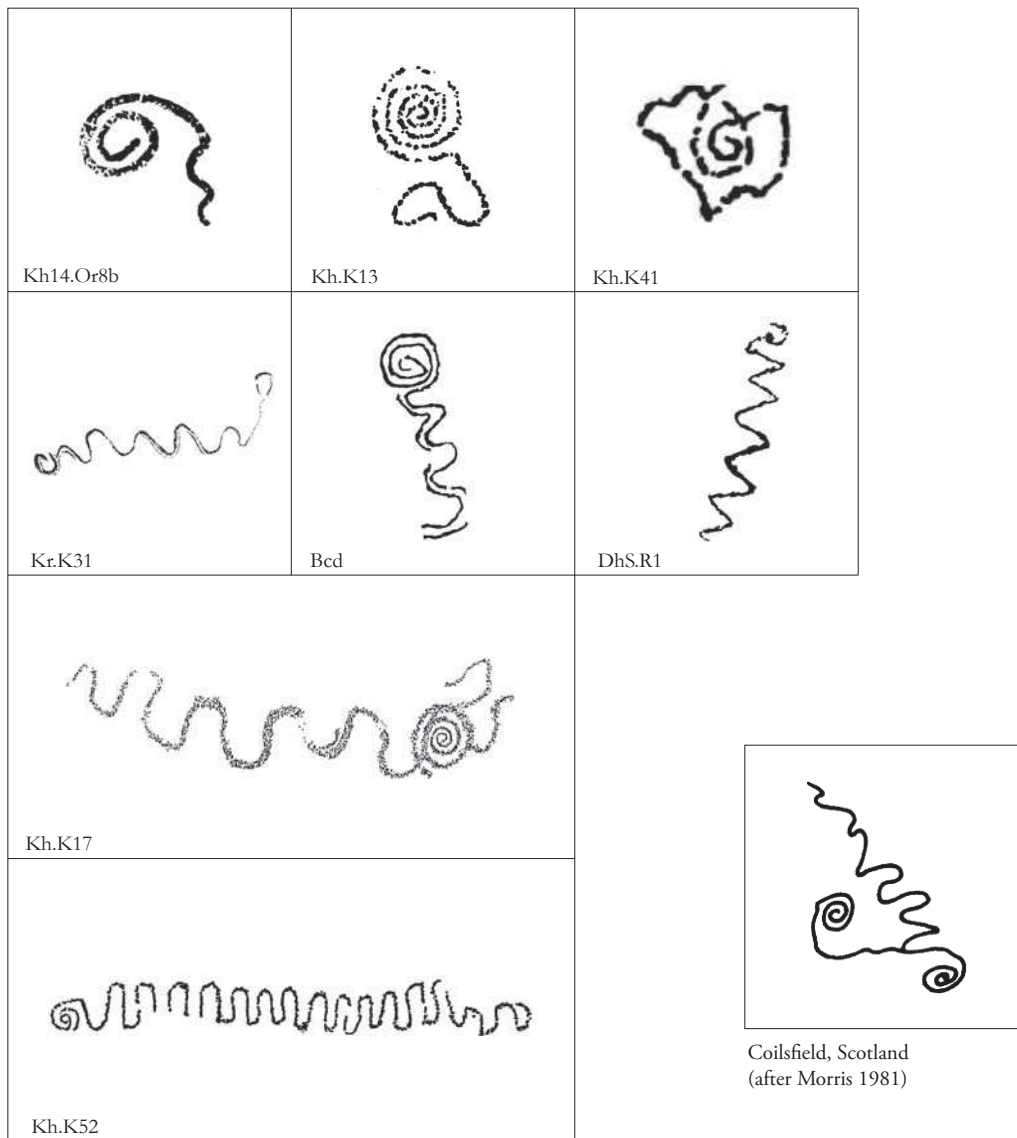


Figure 3.21 : Meandering signs ending with a spiral



Figure 3.22 : Meandering signs at the inner end of a spiral

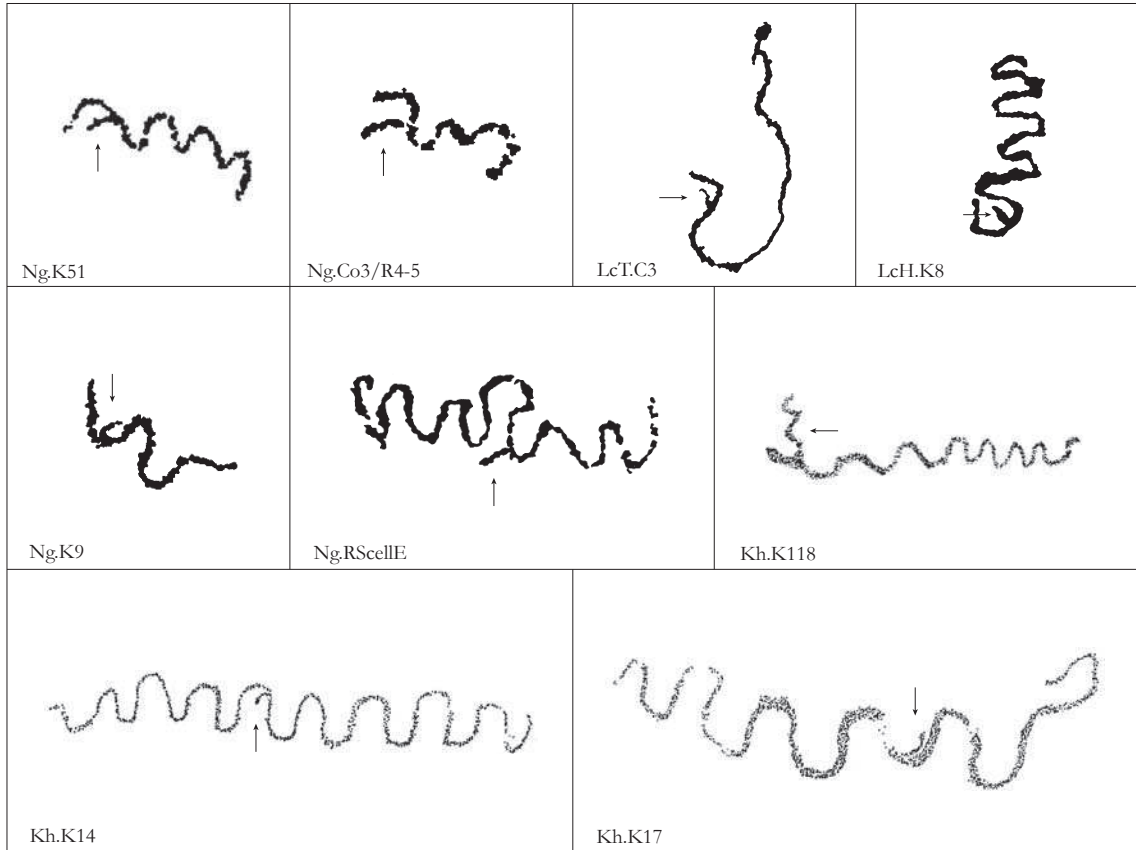


Figure 3.23 : Meandering signs with appendage





	Type 1	Type 2	Type 3a	Type 3b	
Stones					Bibliographical source
CI					Shee Twohig 1981
DhN.C7					O'Kelly & O'Kelly 1983
DhN.C19					O'Kelly & O'Kelly 1983
Kh.K10					O'Sullivan 1988
KhE.Or33					O'Sullivan 1988
KhE.Or54					O'Sullivan 1988
KhE.Or92					O'Sullivan 1988
KhE.RS26					O'Sullivan 1988
KhE.RS38					O'Sullivan 1988
KhE.RS41					O'Sullivan 1988
KhE.CoEvi					O'Sullivan 1988
KhE.CoFx					O'Sullivan 1988
KhW.Or18					O'Sullivan 1988
KhW.Or38					O'Sullivan 1988
KhW.Or74					O'Sullivan 1988
KhW.Co37-38					Eogan 1997
Kh16.Or9					Eogan 1984
LcI.ls.cell3					Shee Twohig 1981
LcI.C17					Shee Twohig 1981
LcL.R3					Shee Twohig 1981
LcU.C8					Shee Twohig 1981
MM.1	?				Shee Twohig 1981
Mt					O'Broin 2000
Ng.K2					O'Kelly 1982
Ng.K4					O'Kelly 1982
Ng.K9					O'Kelly 1982
Ng.K13b					O'Kelly 1982
Ng.K51					O'Kelly 1982
NgK.5					O'Kelly et al. 1978
NgL.B					O'Kelly et al. 1978
NgL.A					O'Kelly et al. 1978
Kh14.Or8					Eogan 1984
Kh.K13					O'Sullivan 1988
Kh.K41					O'Sullivan 1988
KhE.RS32			?		O'Sullivan 1988
Dh.K12					O'Kelly & O'Kelly 1983
LcF.R2					Robin
Cm.Co1					Robin
Kh.K93					Eogan 1974
DhS.R1					O'Kelly & O'Kelly 1983
Kr.K31					O'Sullivan 1987
Kh.K17					O'Sullivan 1988
Kh.K52					O'Sullivan 1988
BCD.stele					Shee Twohig 1981
Dh.K14					O'Kelly & O'Kelly 1983
Kh.K73					O'Sullivan 1988

Figure 3.24 : Table 1 of associations between types of meandering signs and carved stones

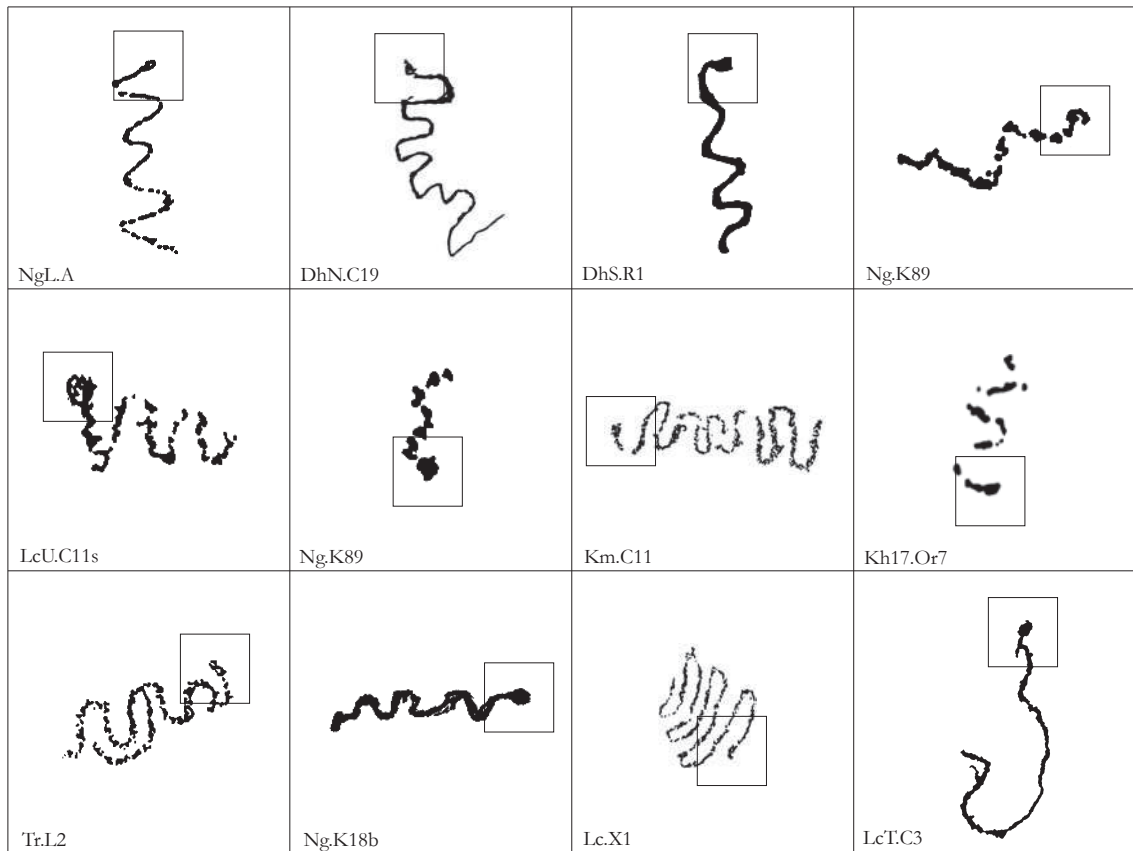


Figure 3.25 : Meandering signs with thickened end

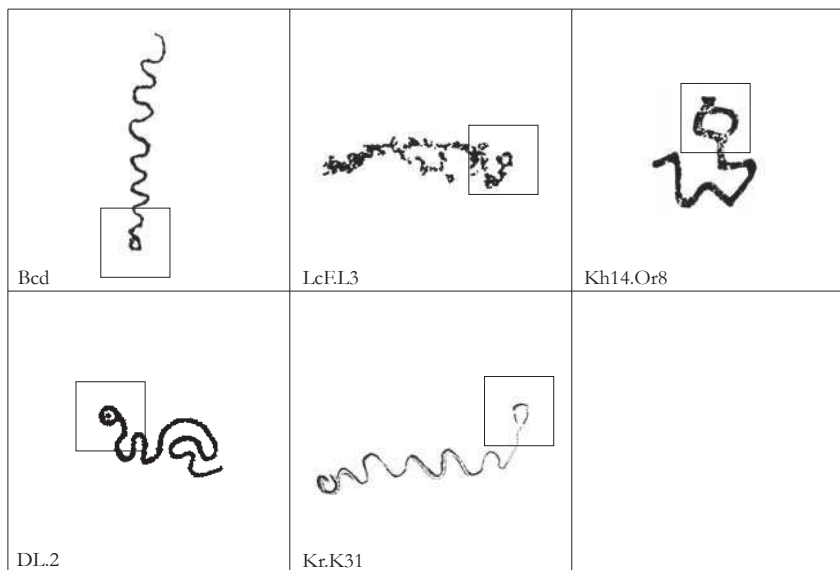


Figure 3.26 : Meandering signs with circular end

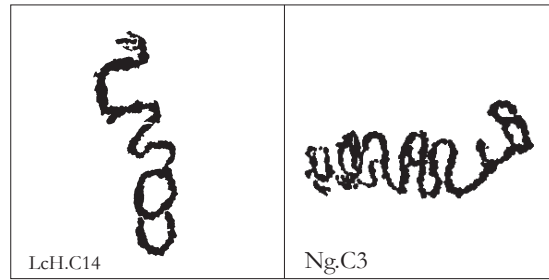


Figure 3.27 : Meandering signs with 8-shaped end

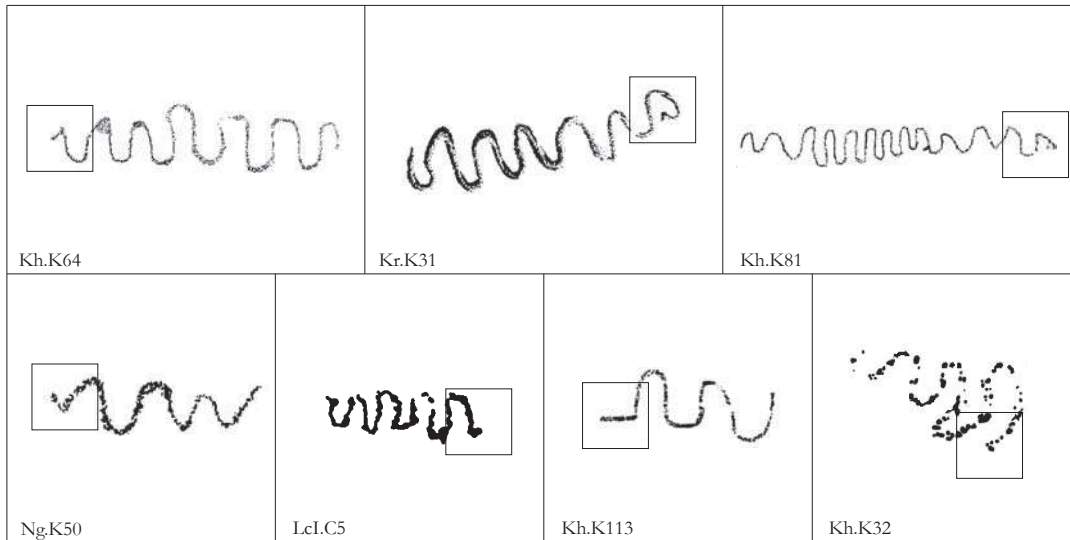


Figure 3.28 : Meandering signs with angular end

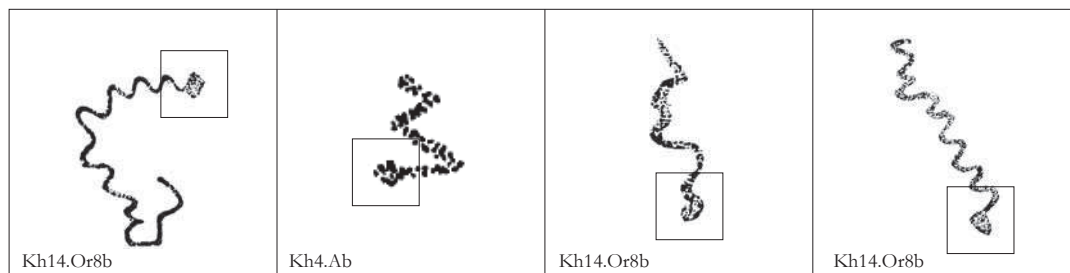


Figure 3.29 : Meandering signs with quadrangular ou triangular end

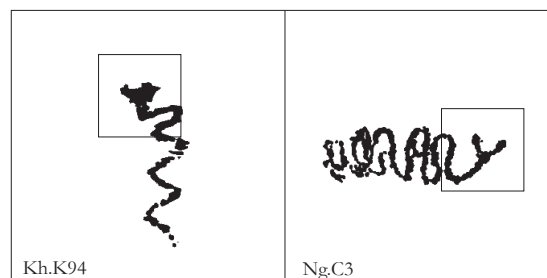


Figure 3.30 : Meandering signs with V-shaped end








	Type 1	Type 2	Type 3	Type 4	Type 5	Type 6	Type 7	
Stones								Bibliographical source
Ng.K18b								O'Kelly 1982
DhN.C19								O'Kelly & O'Kelly 1983
DhS.R1								O'Kelly & O'Kelly 1983
Dh.loose1								O'Kelly 1967
Km.C11								Shee Twohig 1981
Kh17.Or7								Eogan 1984
LcT.C3								Shee Twohig 1981
LcU.C11								Shee Twohig 1981
LcX1								Shee Twohig 1981
Ng.K89								O'Kelly 1982
NgL.A								O'Kelly et al. 1978
Tr.L2								Shee Twohig 1981
DL.2								Gogan 1932
LcF.L3								Shee Twohig 1981
BCD.stele								Shee Twohig 1981
Kr.K31								O'Sullivan 1987
Kh14.Or8								Eogan 1984
LcH.C14								Shee Twohig 1981
Ng.C3								O'Kelly 1982
Kr.K32								O'Sullivan 1987
Kh.K64								O'Sullivan 1988
Kh.K81								O'Sullivan 1988
Kh.K113								Eogan 1974
LcI.C5								Shee Twohig 1981
Ng.K50								O'Kelly 1982
Kh4.A								Eogan 1974
Kh.K94								Eogan 1984

Figure 3.31 : Table 2 of associations between types of meandering signs and carved stones

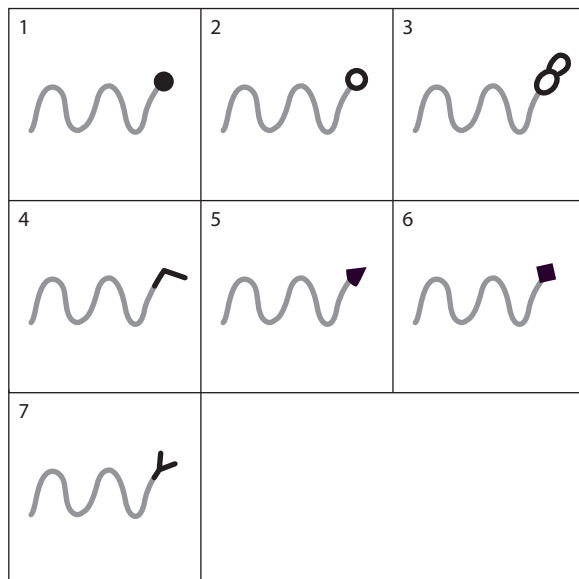
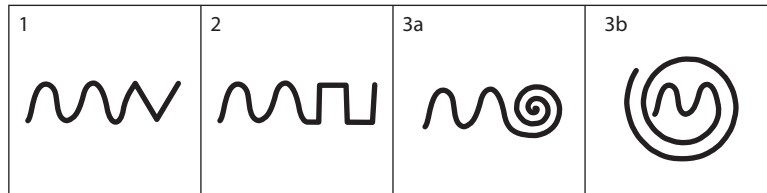


Figure 3.32 : Typological table of the meandering signs

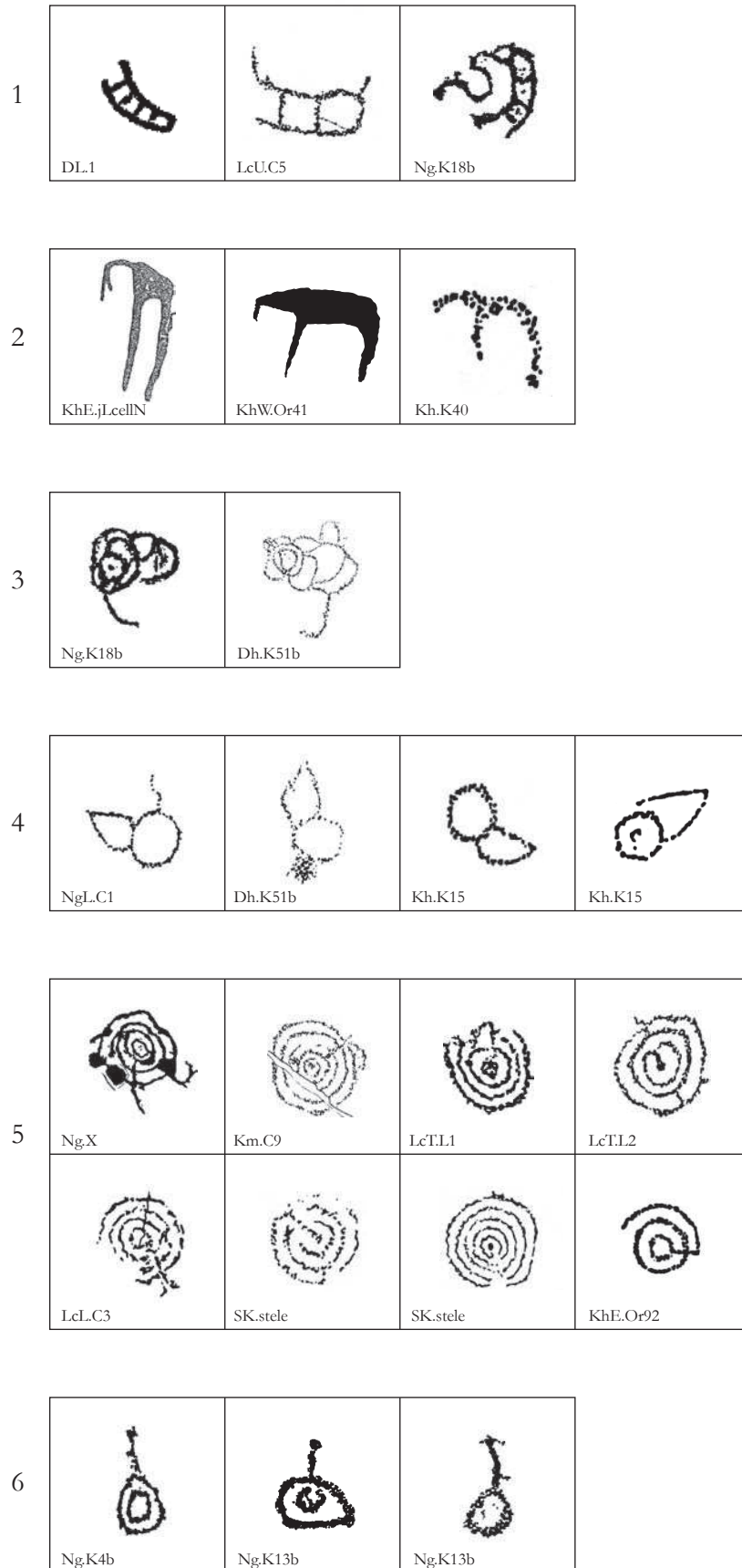


Figure 3.33 : The rare signs























Total number											
178											
282		121									
153		57	88								
322		136	203	97							
39		26	30	9	34						
20		16	16	7	18	2					
172		43	62	51	68	8	6				
47		16	20	16	20	3	4	29			
120		39	45	31	54	8	7	57	28		
56		31	40	15	42	17	5	16	6	12	
191		69	102	58	115	21	10	47	12	31	22

Figure 4.1 : Table of signs associations: data in total number of associations

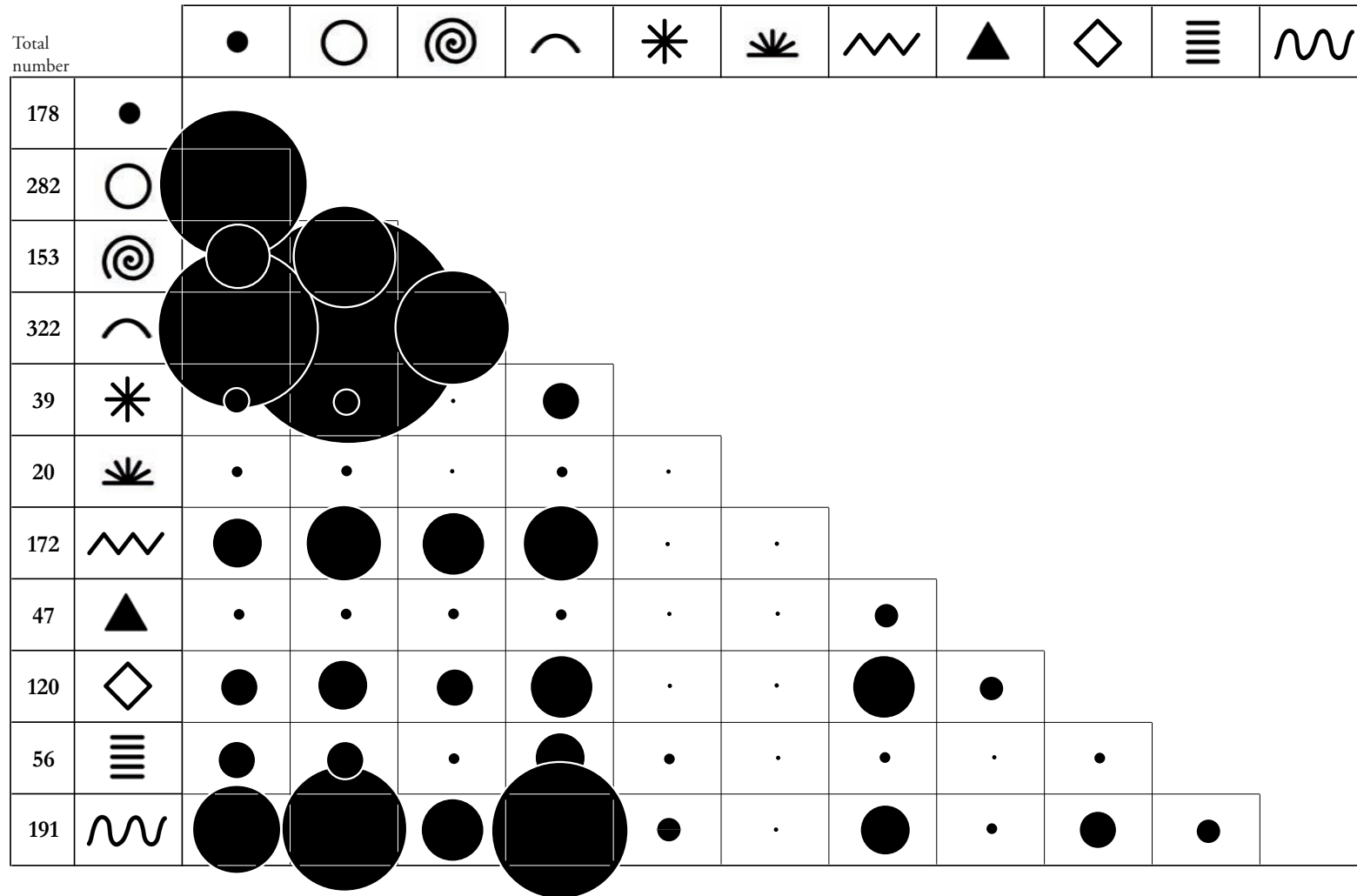


Figure 4.2 : Table of signs associations: graphical illustration

Associated signs (in percentage)

Total number	Sign of reference	Associated signs (in percentage)										
		●	○	⊙	⤿	✳	☂	⚡	▲	◇	≡	〰
178	●		68	32	76,4	14,6	9	24,2	9	21,9	17,4	38,8
282	○	42		31,2	72	10,6	5,7	22	7,1	16	14,2	36,2
153	⊙	37,3	57,5		63,4	5,9	4,6	33,3	10,5	20,3	9,8	37,9
322	⤿	42,2	63	32,1		10,6	5,6	21,1	6,2	16,8	13	35,7
39	✳	66,7	76,9	23	90		5,1	20,5	7,7	20,5	43,6	53,8
20	☂	80	80	35	90	10		30	25	35	25	50
172	⚡	25	36	29,7	39,5	4,7	3,5		16,9	33,1	9,3	27,3
47	▲	34	42,6	34	42,6	6,4	8,5	61,7		59,6	3,5	18
120	◇	32,5	37,5	25,8	45	6,7	5,8	47,5	23,3		10	25,8
56	≡	55,4	71,4	26,8	75	30,4	8,9	28,6	10,7	21,4		39,3
191	〰	36,1	53,4	30,4	60,2	11	5,2	24,6	6,3	16,2	11,5	

Figure 4.3 : Table of signs associations: data in relative percentage

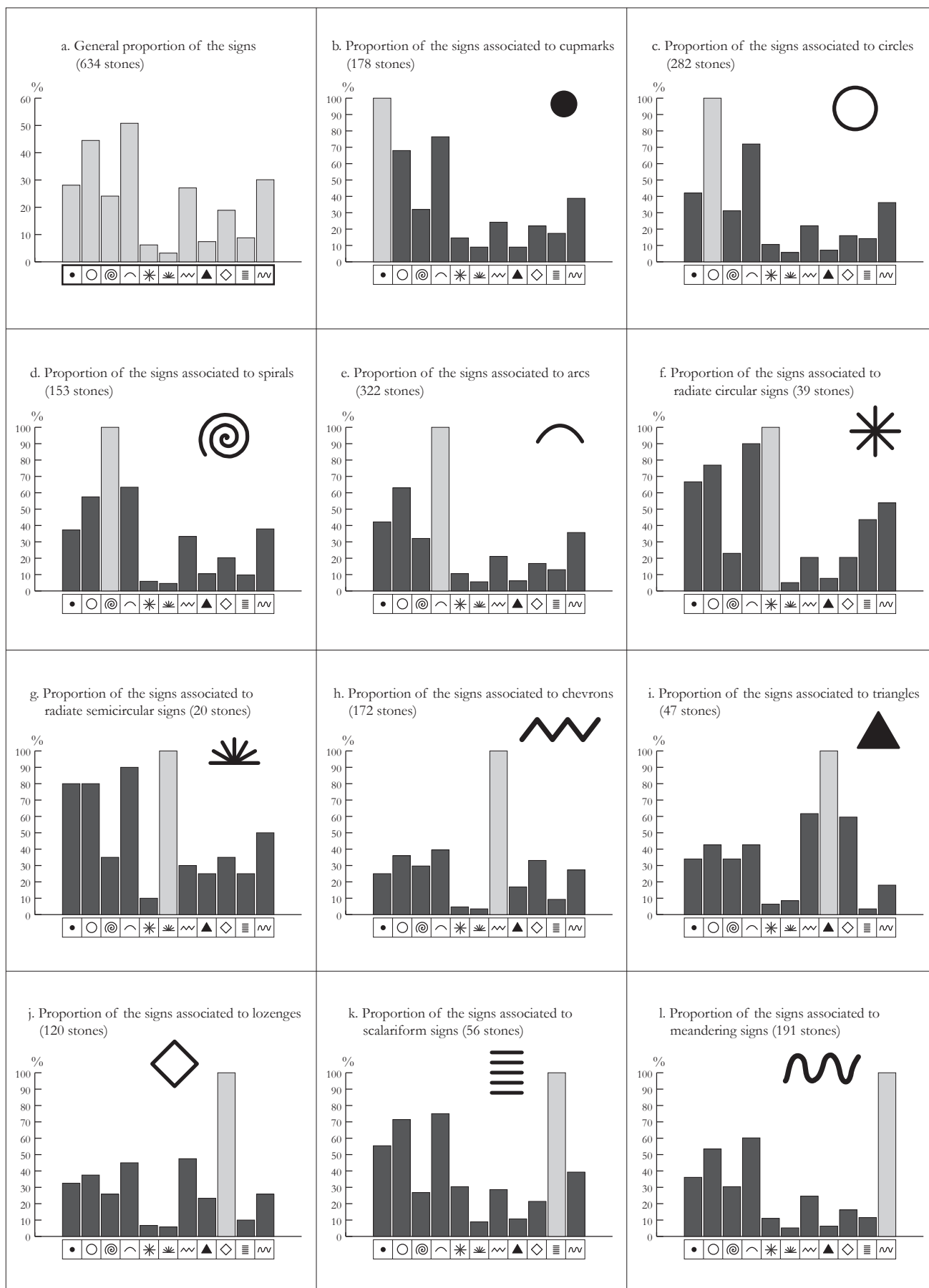


Figure 4.4 : Graphical representation of the proportion of associations sign by sign

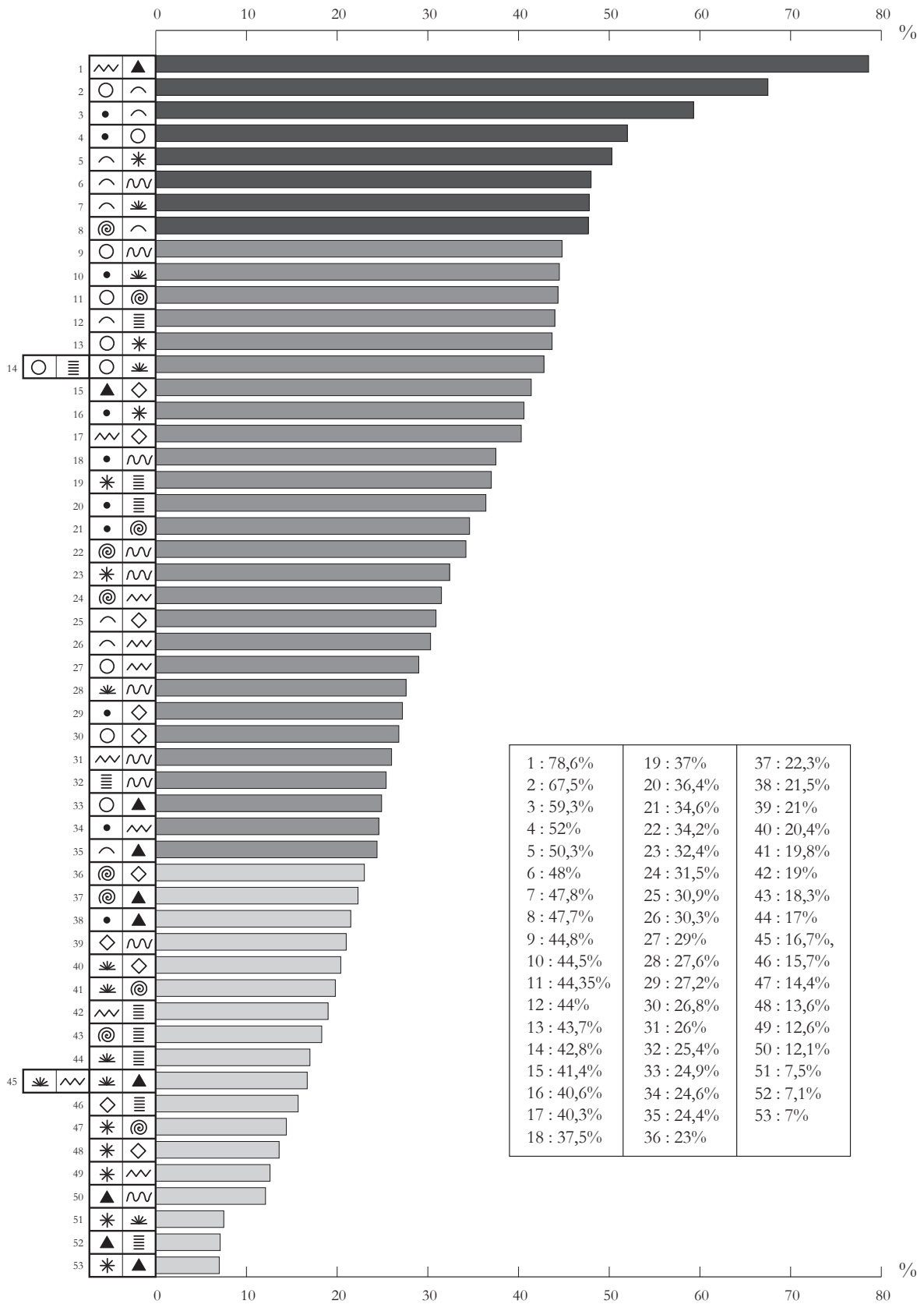


Figure 4.5 : Graphical representation of the proportion of signs couples

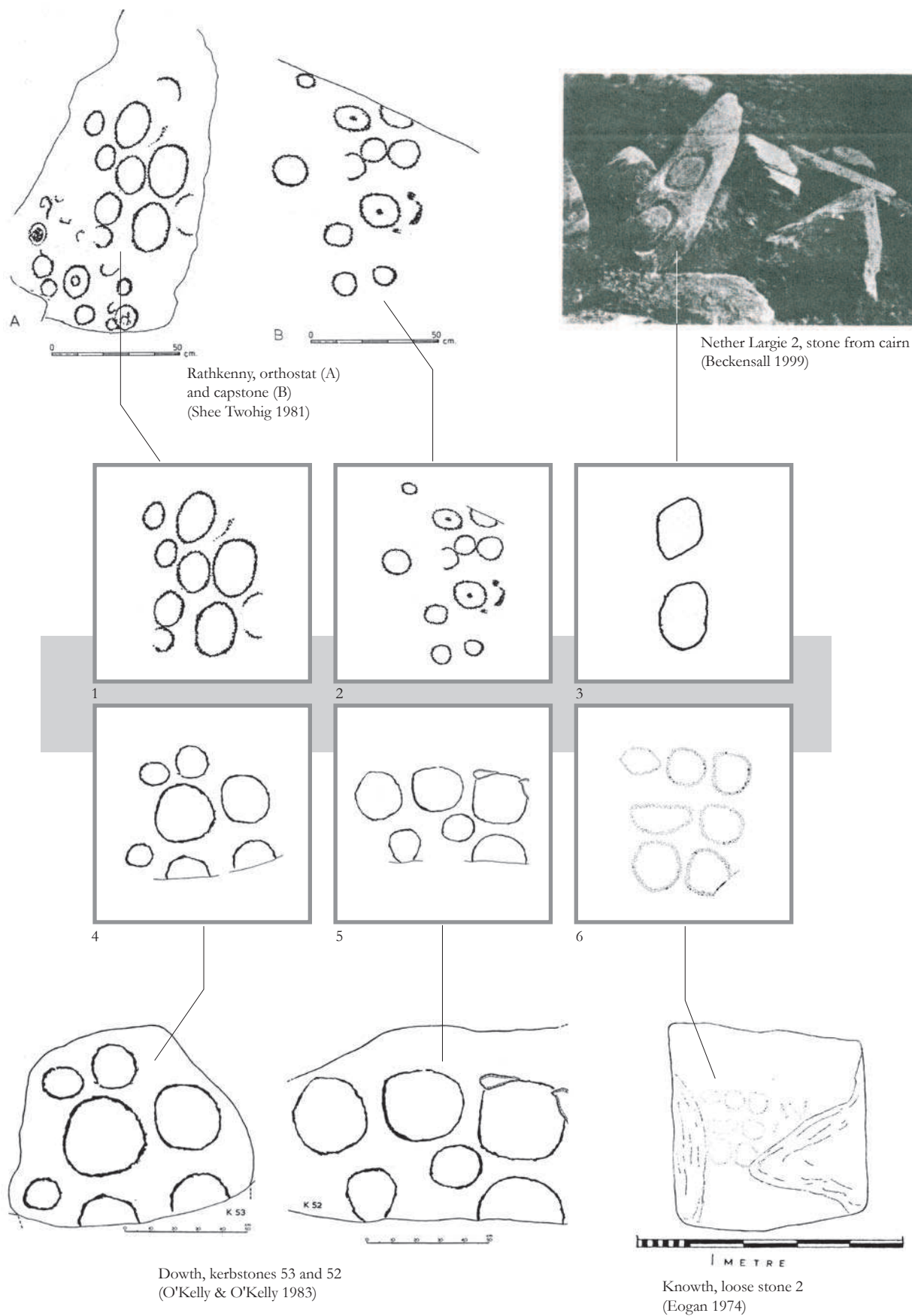


Figure 4.6 : Groups of simple circles

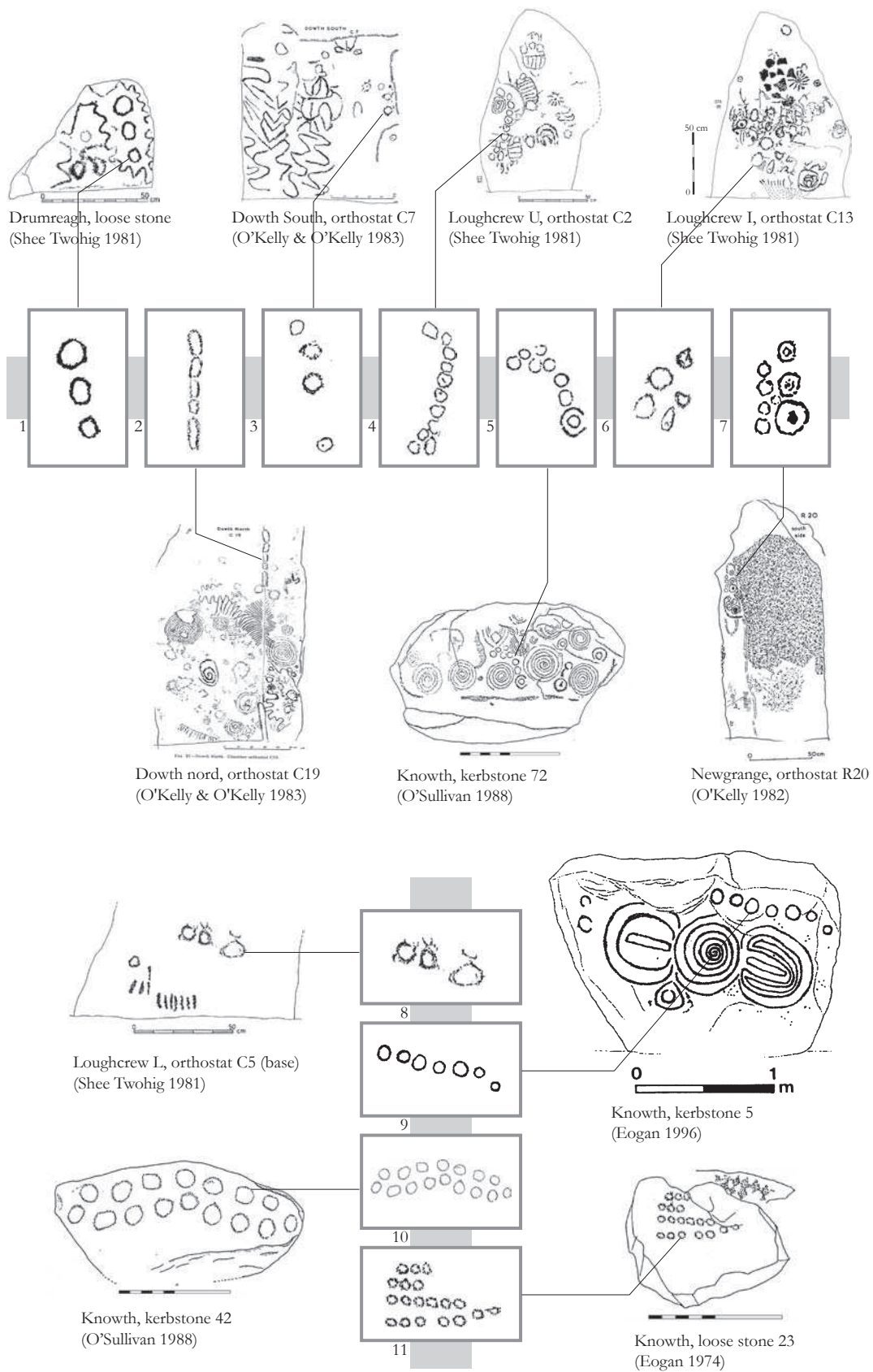


Figure 4.7 : Lines of simple circles

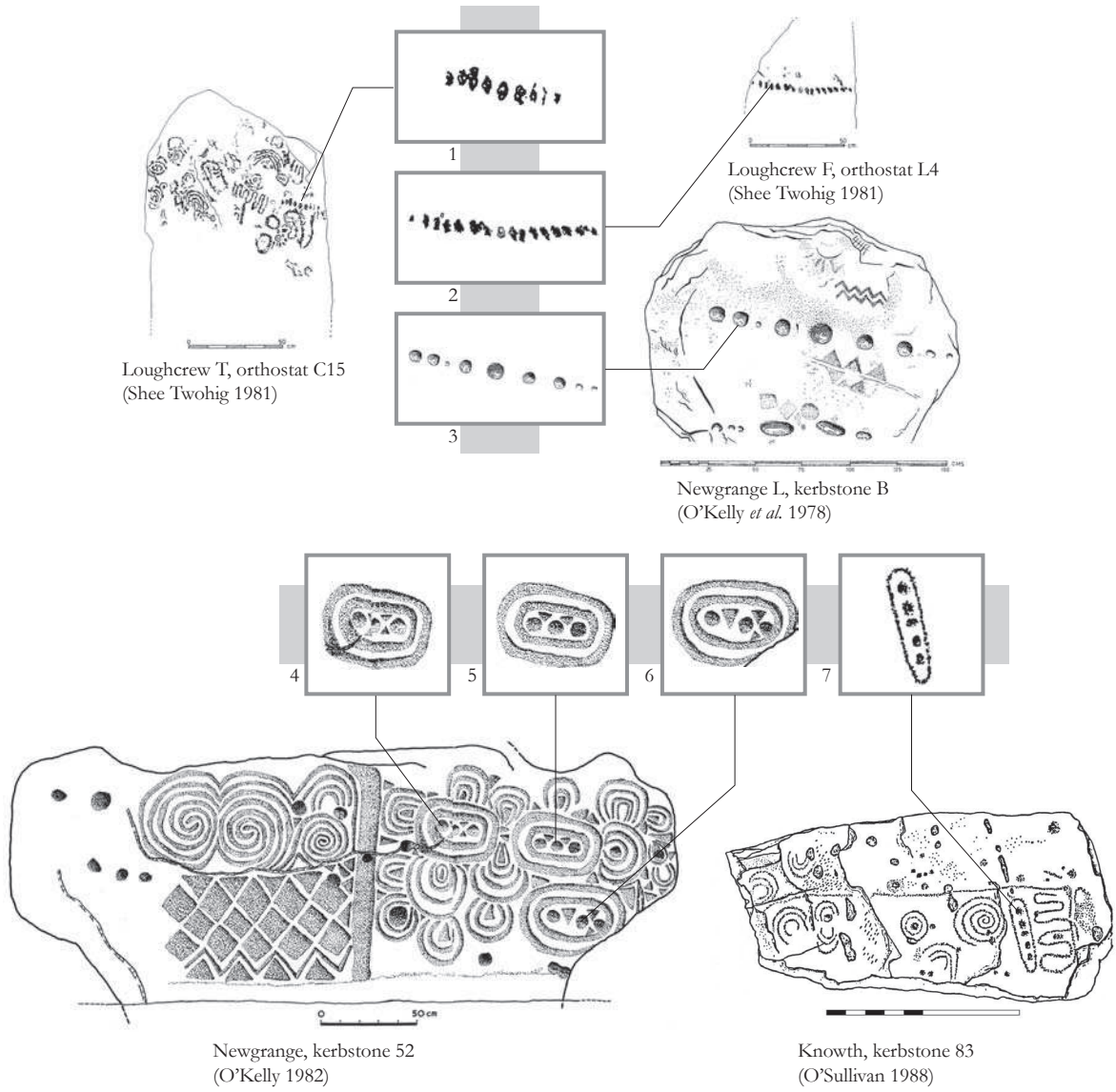


Figure 4.8 : Lines of cupmarks

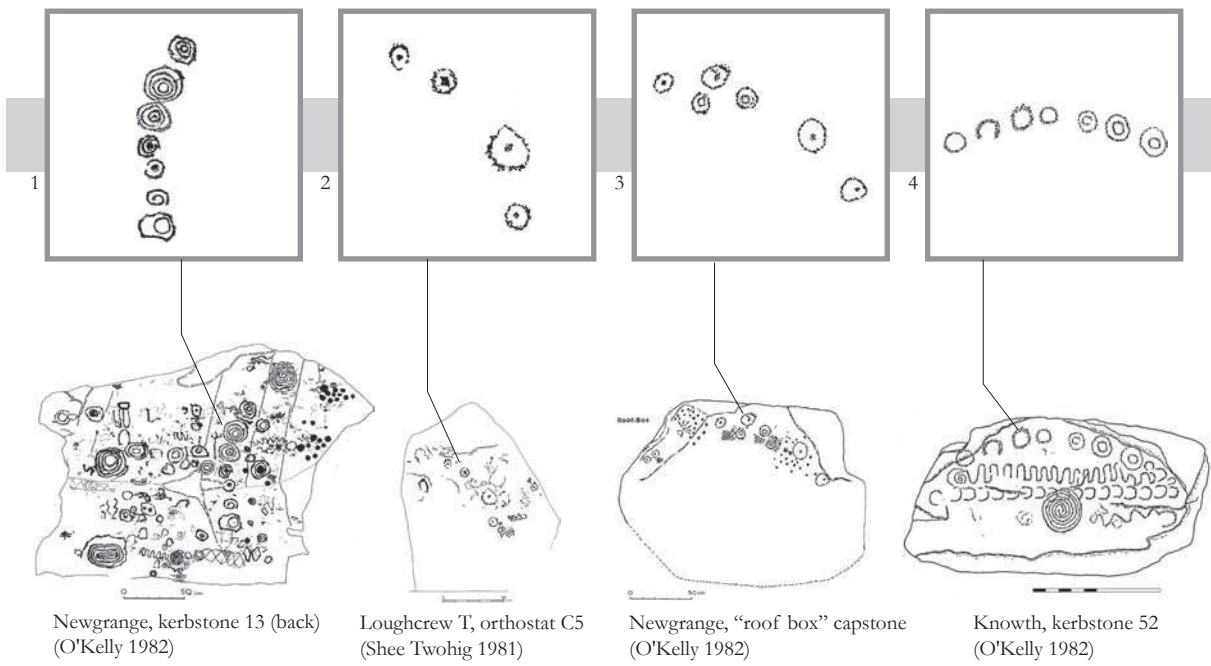


Figure 4.9 : Lines of complex circular signs

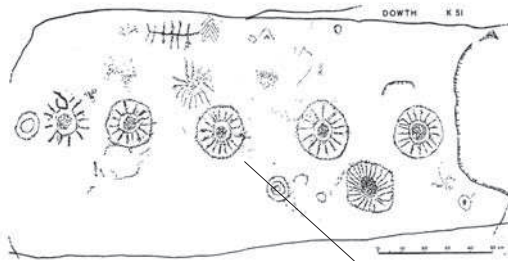


FIG. 15—Kerbstone 51, front.

Dowth, kerbstone 51
(O'Kelly & O'Kelly 1983)

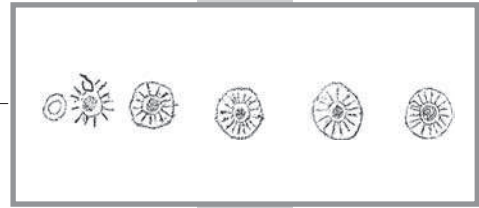


FIG. 26—Dowth South. Recess orthostat C12.

Dowth South, orthostat C12
(O'Kelly & O'Kelly 1983)

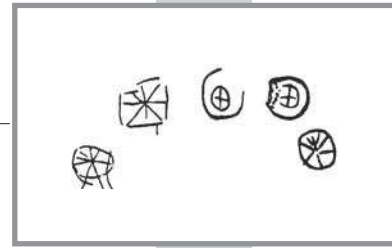


FIG. 29—Dowth North. Chamber orthostat C7.

Dowth North, orthostat C7
(O'Kelly & O'Kelly 1983)

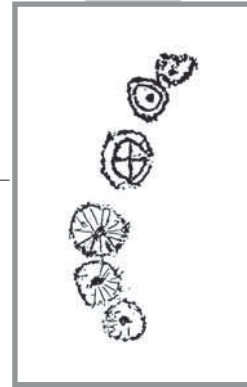


Figure 4.10 : Lines of radiate circular signs

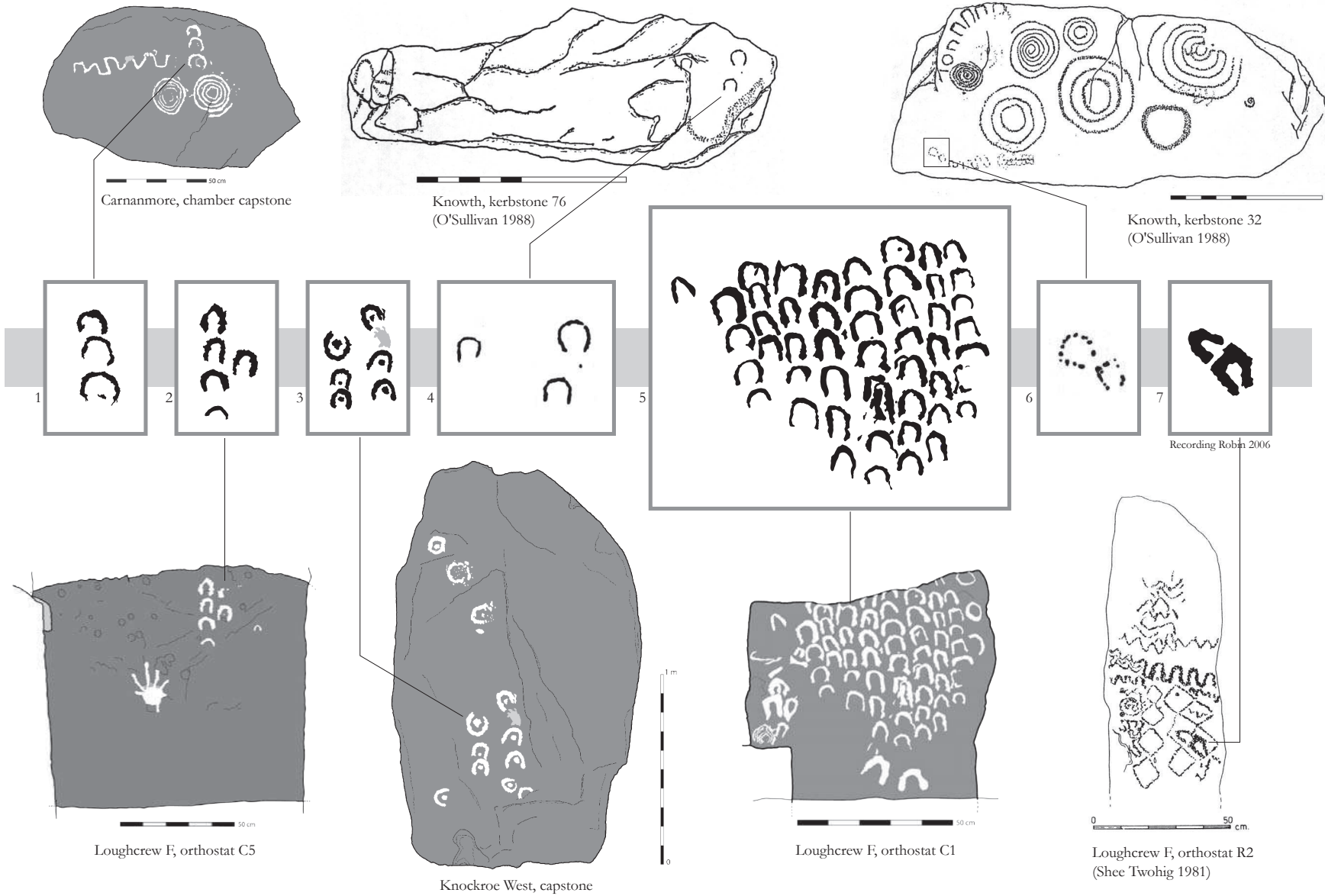


Figure 4.11 : Lines of simple arcs (1/2)

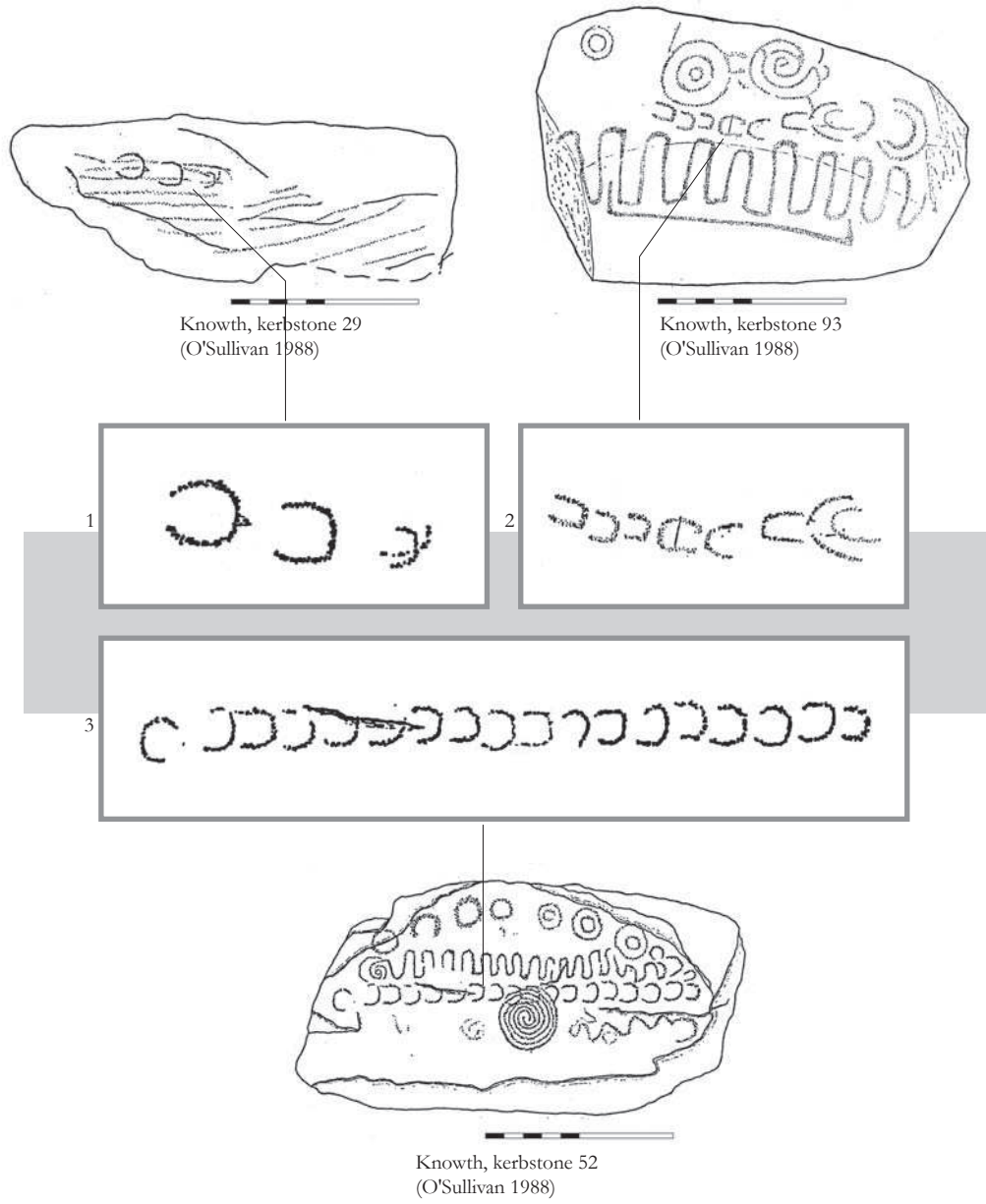


Figure 4.12 : Lines of simple arcs (2/2)

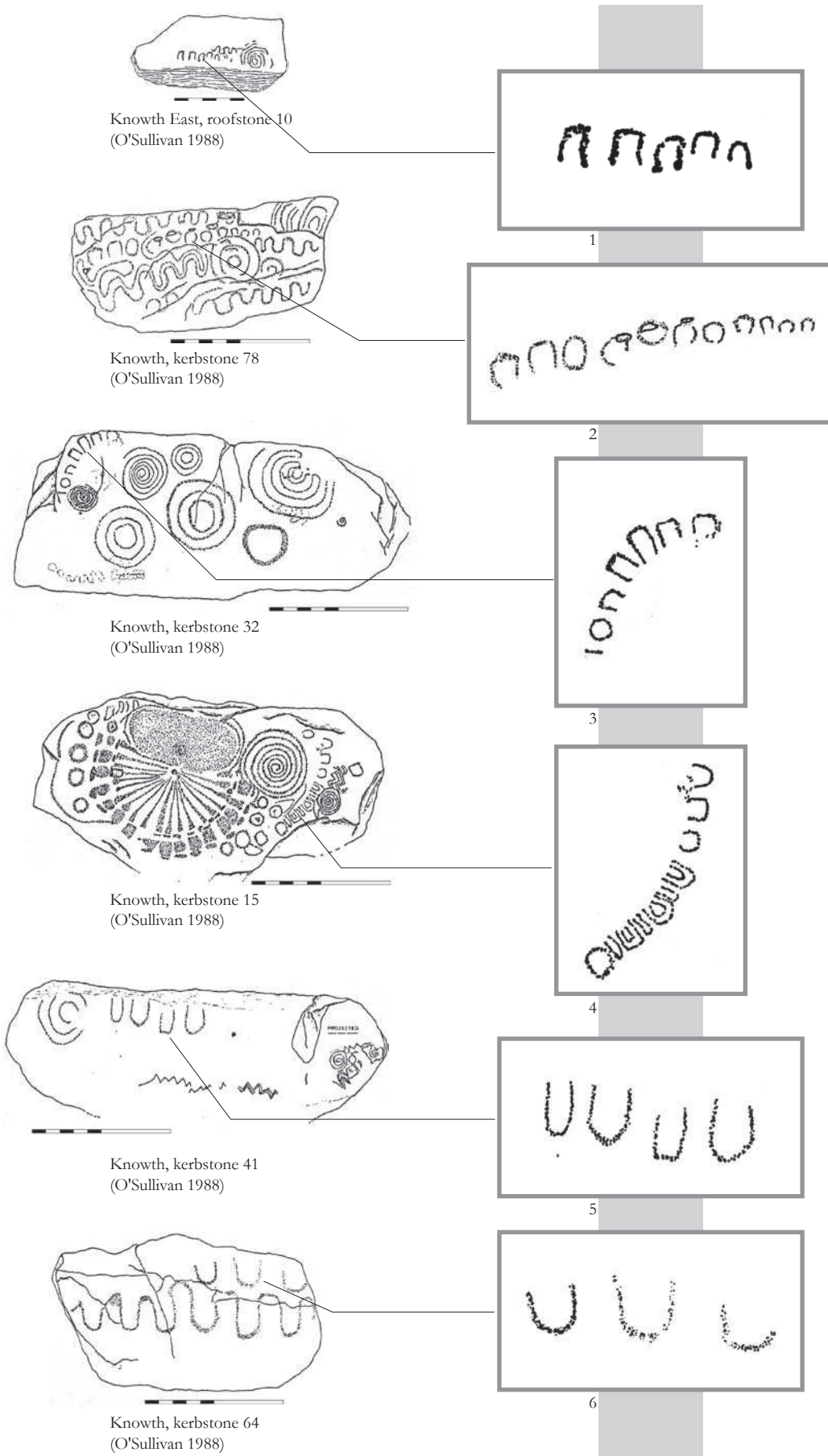
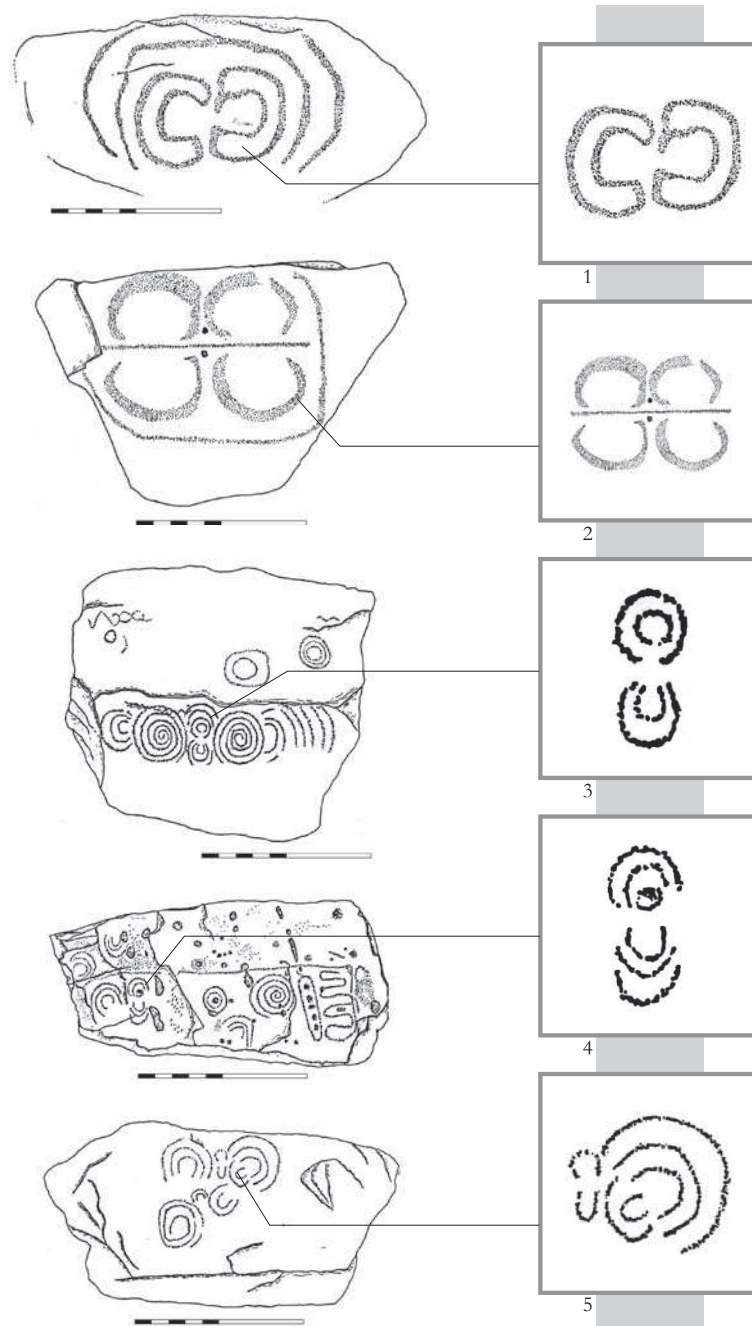


Figure 4.13 : Rows of simple arcs



Knowth, kerbstones 30, 86, 65, 83 and 80
(O'Sullivan 1988)

Figure 4.14 : Pairs of opposed arcs

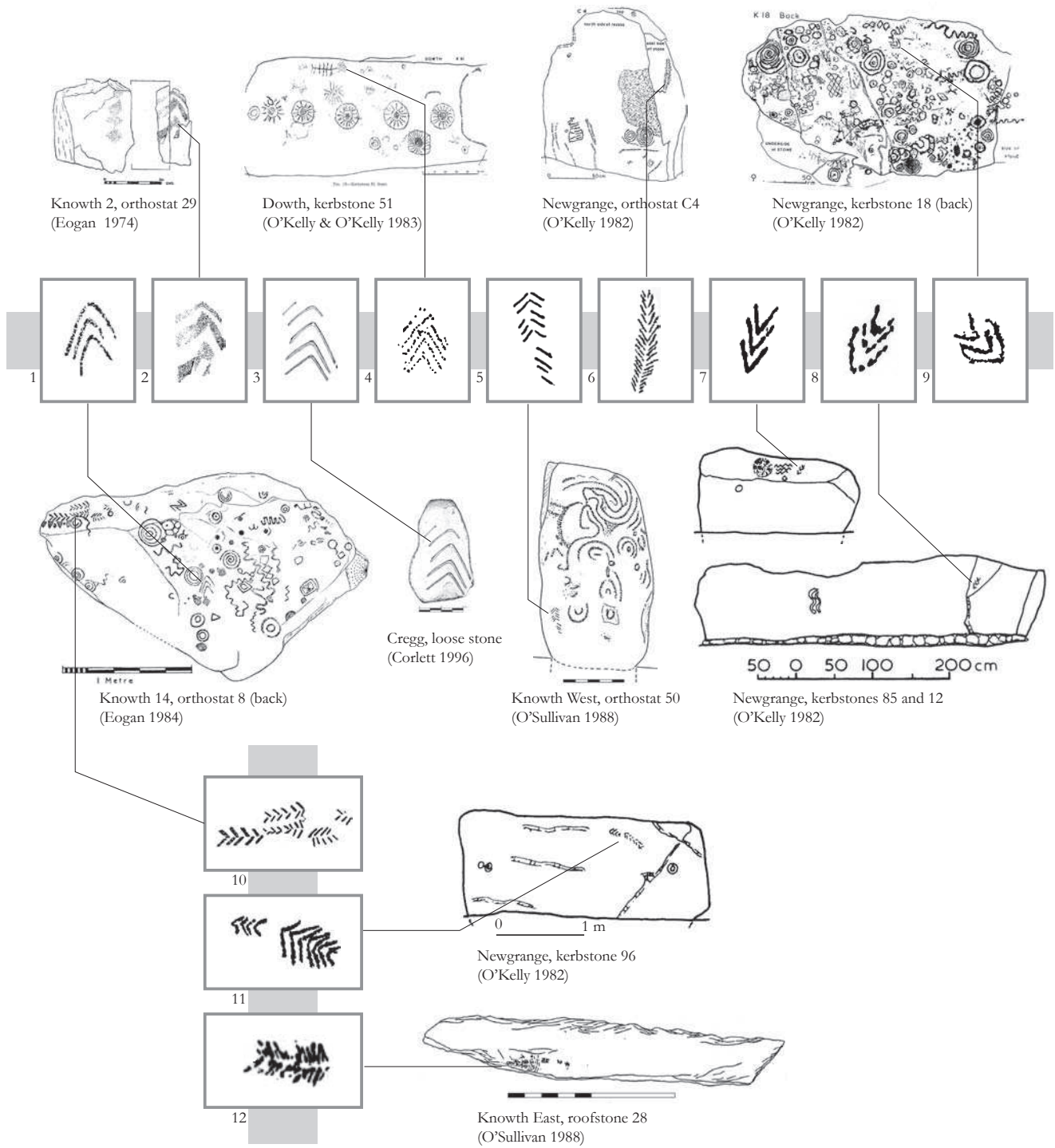


Figure 4.15 : Boxed simple chevrons

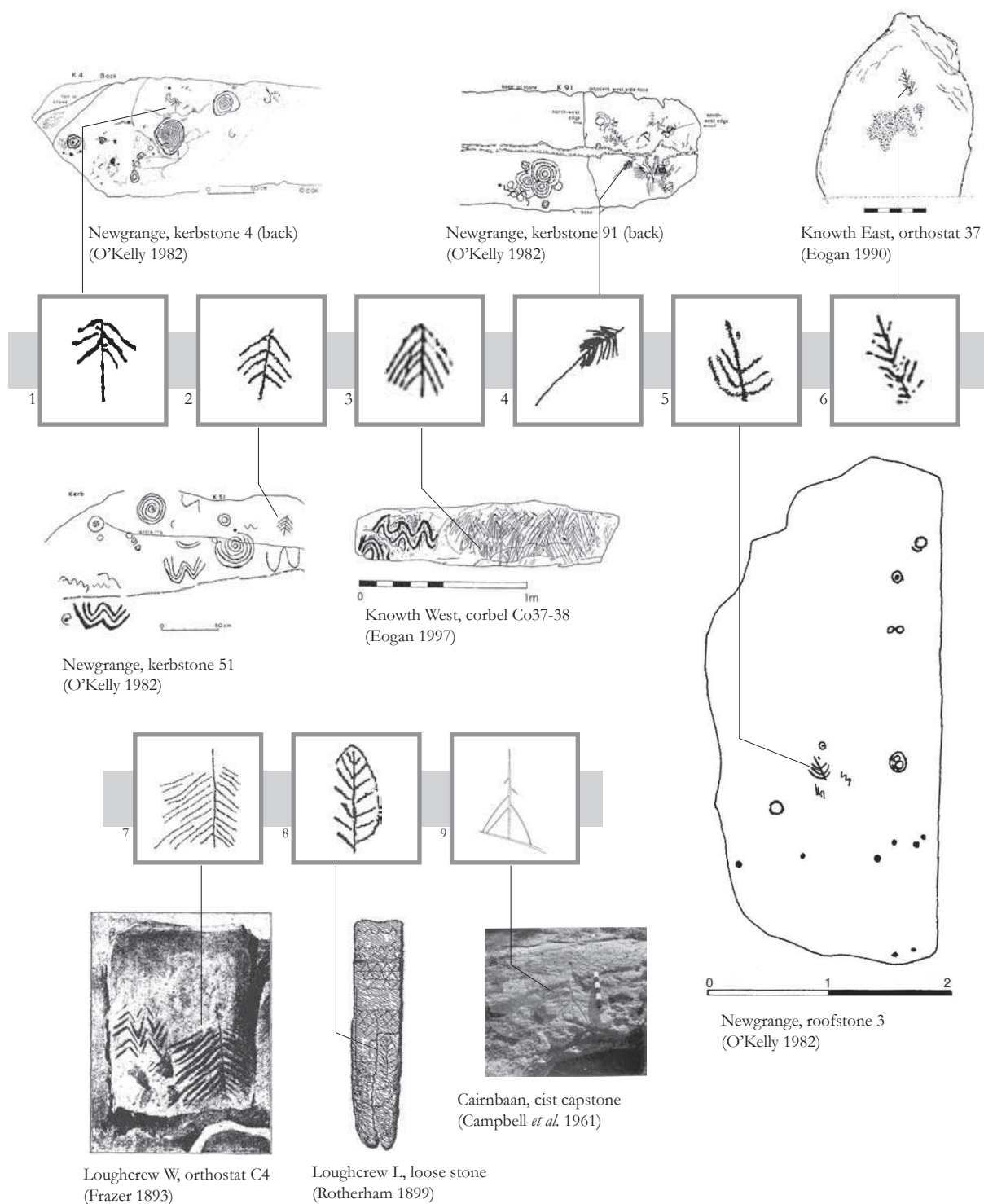


Figure 4.16 : Boxed simple chevrons with central line



Dh.loose1 ; DL.2 ; Fk.A ; Fk.C ; Fk.E ; Fk.F ; Kh.K12 ; Kh.K13 ; Kh.K15 ; Kh.K28 ; Kh.K85b ; KhE.Or2 ; KhE.Or48 ; KhE.Or49 ; KhE.Or55 ; KhE.RS32 ; KhE.RS41 ; KhE.RS49 ; KhE.RS50 ; KhE.CoA6 ; KhE.CoE6 ; KhE.CoF10 ; KhW.Or16 ; KhW.Or17 ; KhW.Or18 ; KhW.Or40 ; KhW.Or48 ; KhW.Or74 ; KhW.Or81 ; KhW.RS3 ; KhW.RS5 ; KhW.RS10 ; Kh14.Or8 ; Kh17.Or13 ; Kh17.Or15 ; LcI.lscell3 ; LcI.C17 ; LcT.C8 ; LcT.RScell3 ; LcU.R2 ; LcU.C7 ; LcU.C8 ; LcW.C4 ; Ng.K67 ; Ng.K85 ; Ng.K93 ; Ng.L19 ; Ng.L22 ; Ng.R18 ; Ng.Co1/C2 ; Ng.Co2/C14 ; Ng.RScellE ; NgK.A ; NgL.B ; ByG.L8 ; ByG.C16 ; HPW.B.

Figure 4.17 : Boxed zigzag chevrons

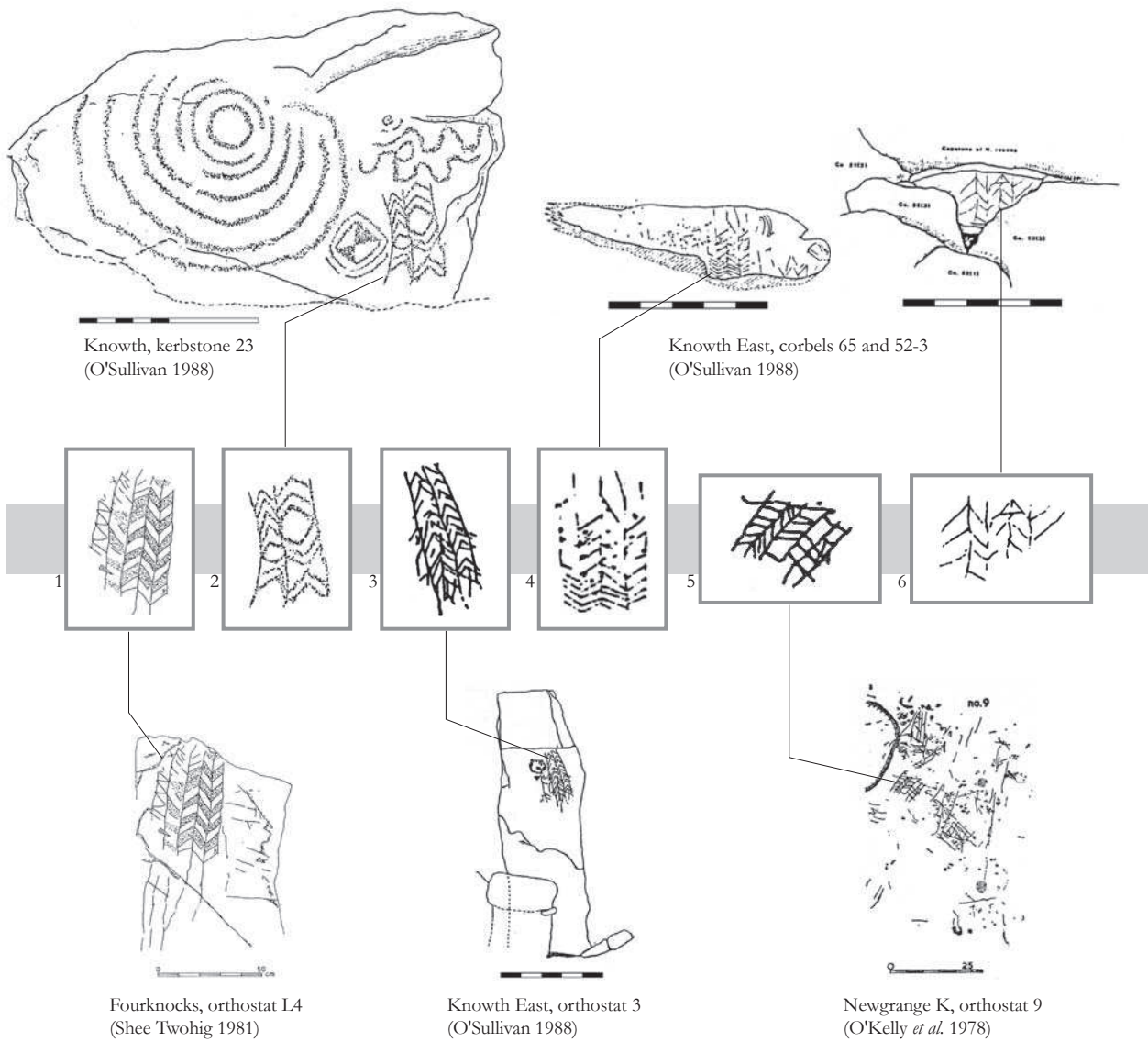


Figure 4.18 : Boxed zigzag chevrons with central line

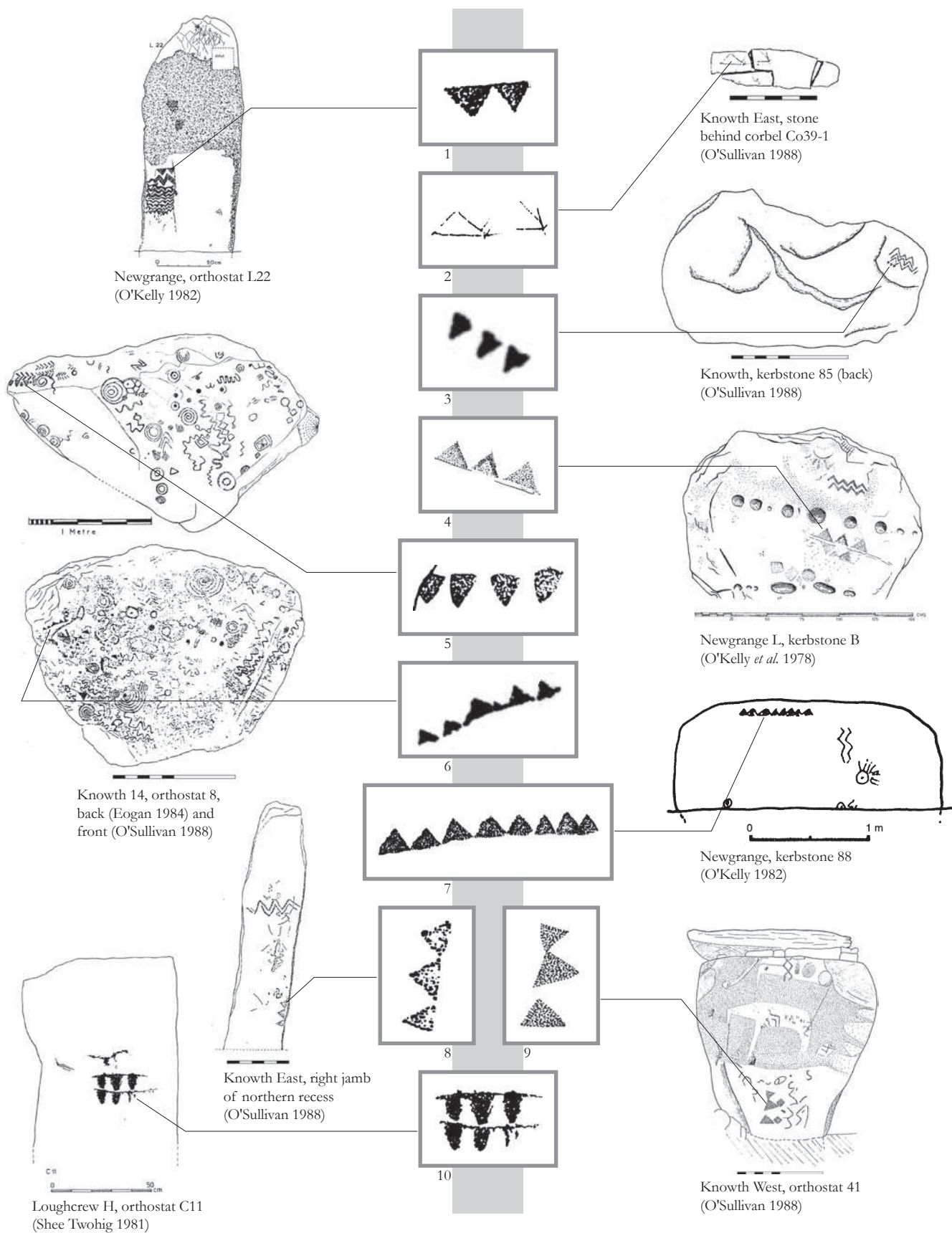


Figure 4.19 : Rows of triangles

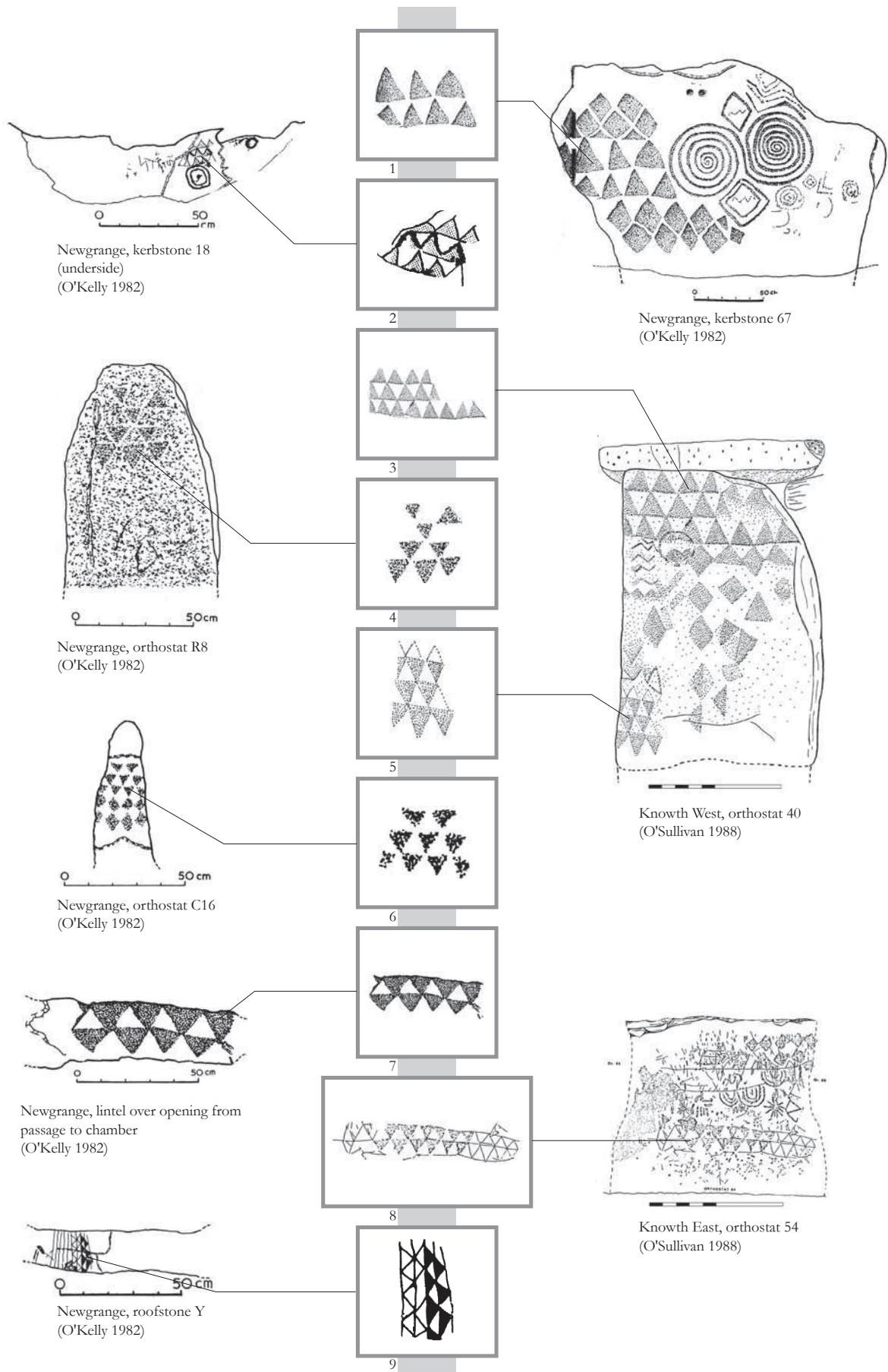


Figure 4.20 : Parallel rows of triangles

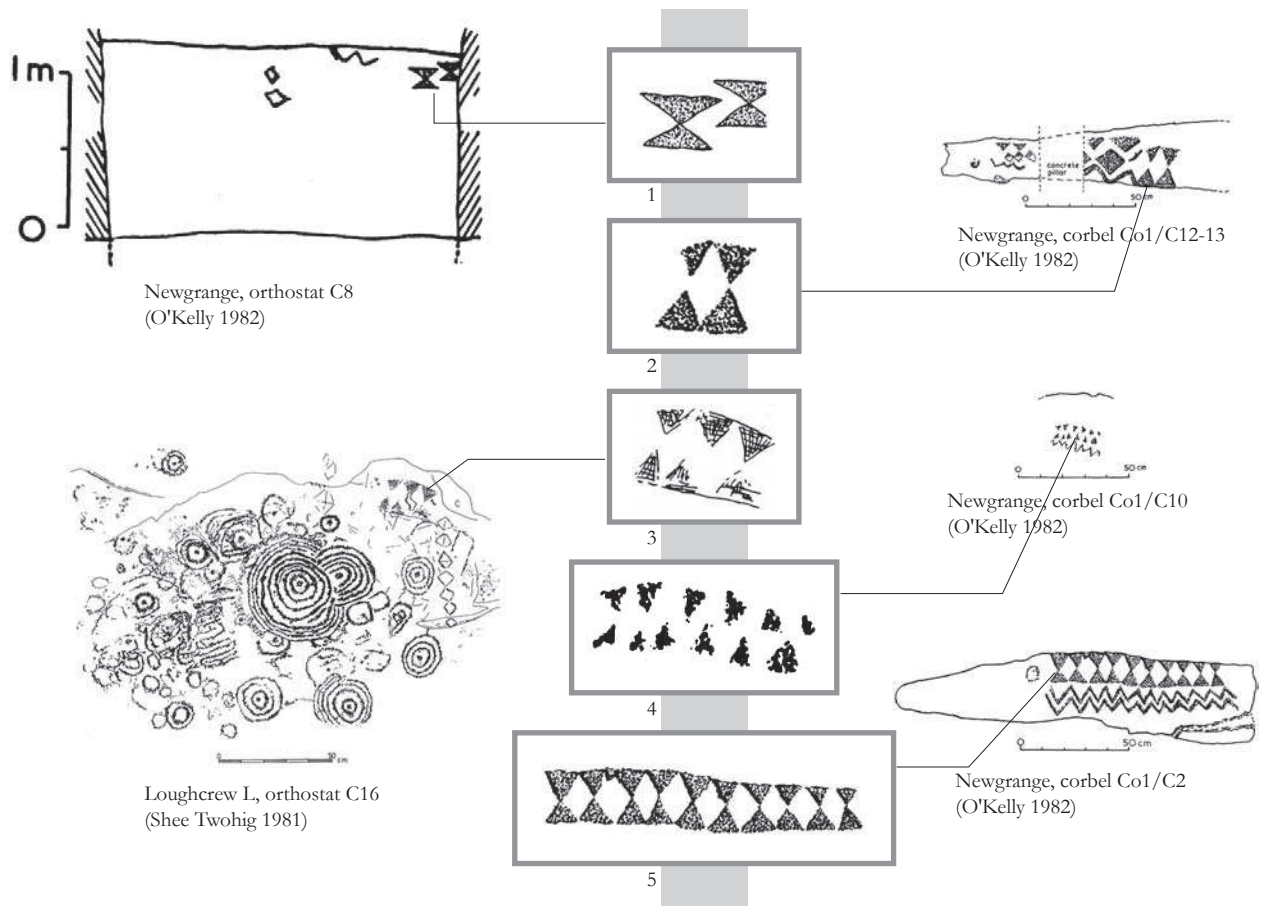


Figure 4.21 : Triangles opposed by the point

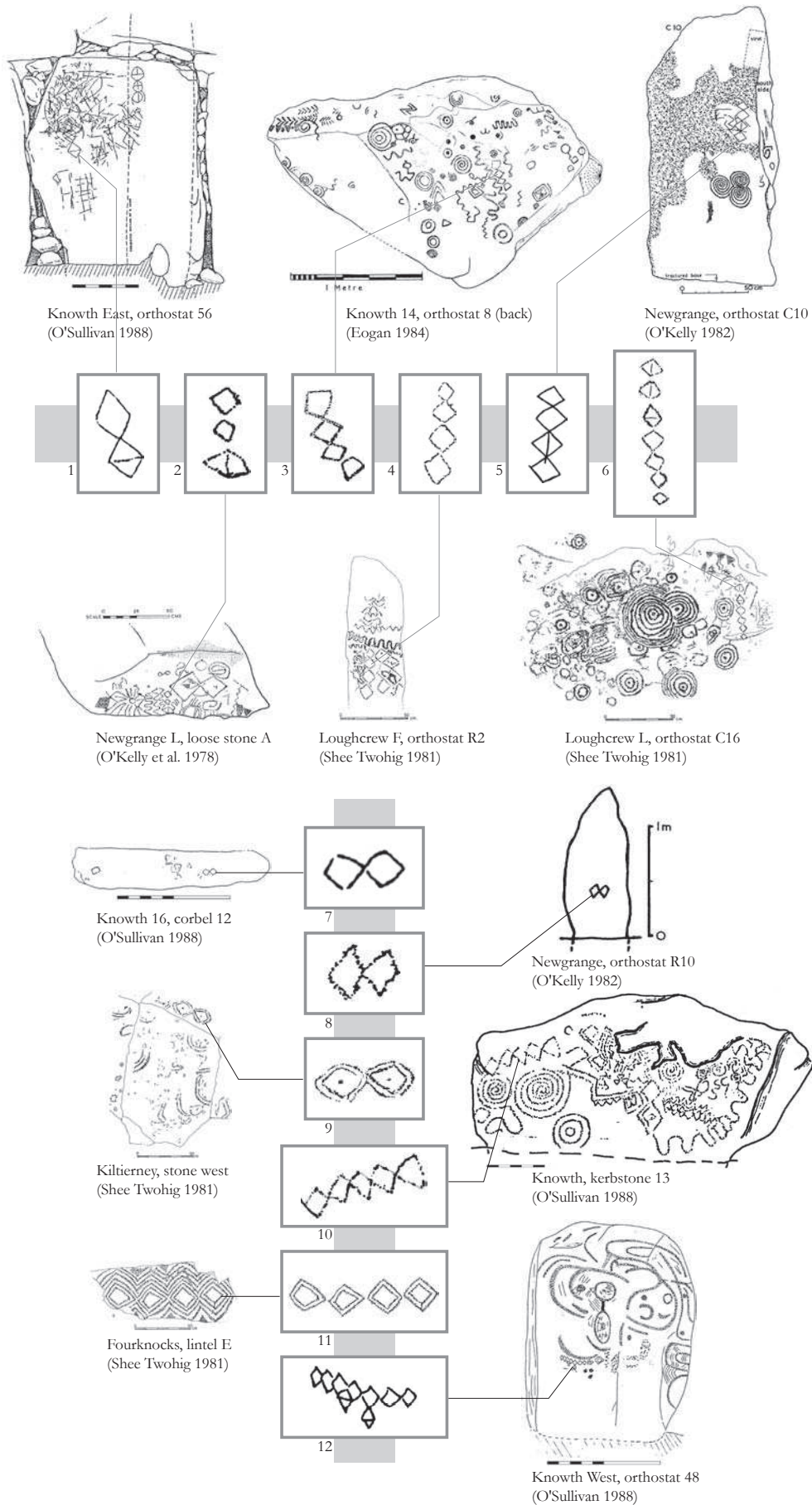


Figure 4.22 : Lines of empty lozenges

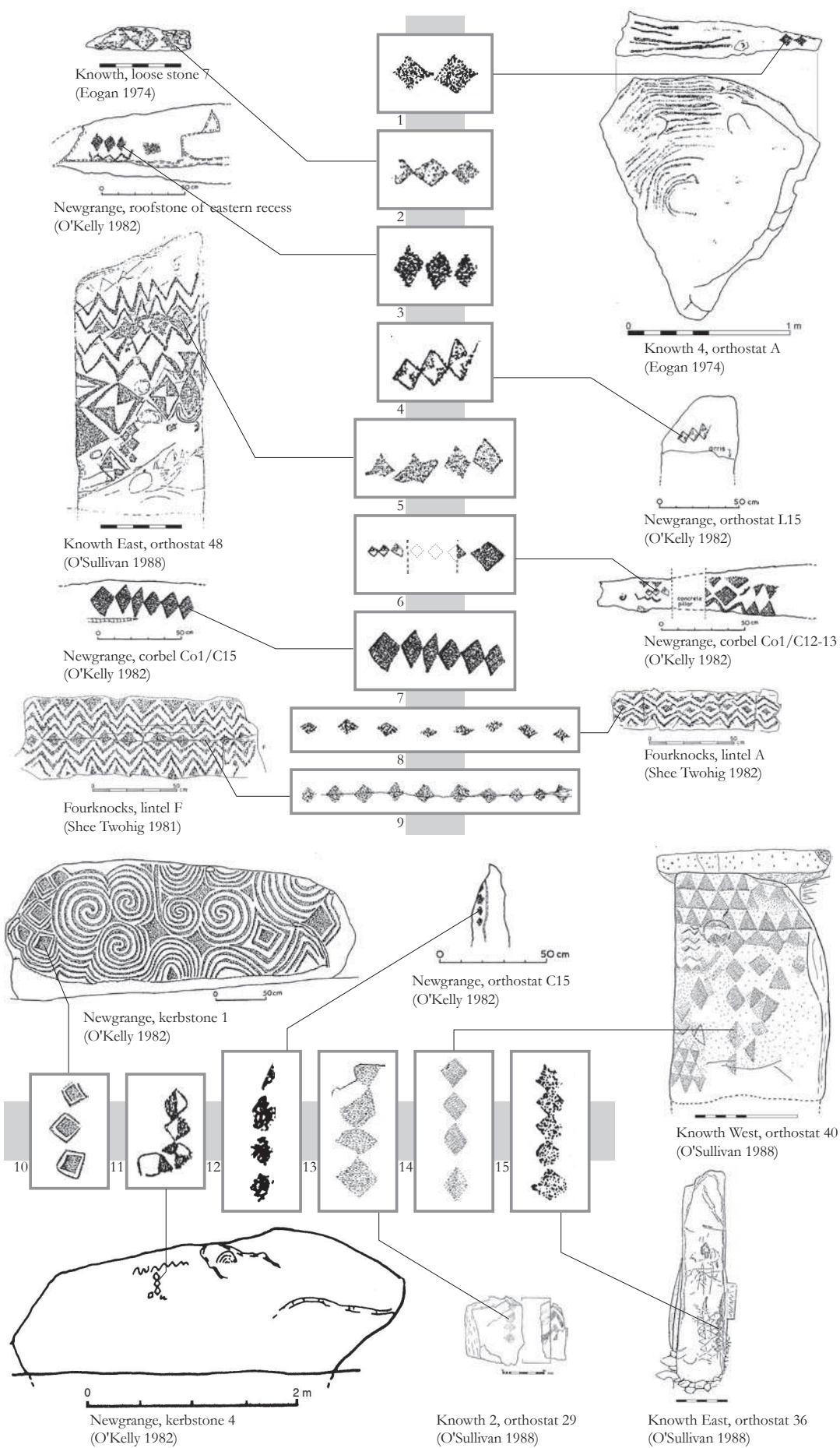


Figure 4.23 : Lines of solid lozenges

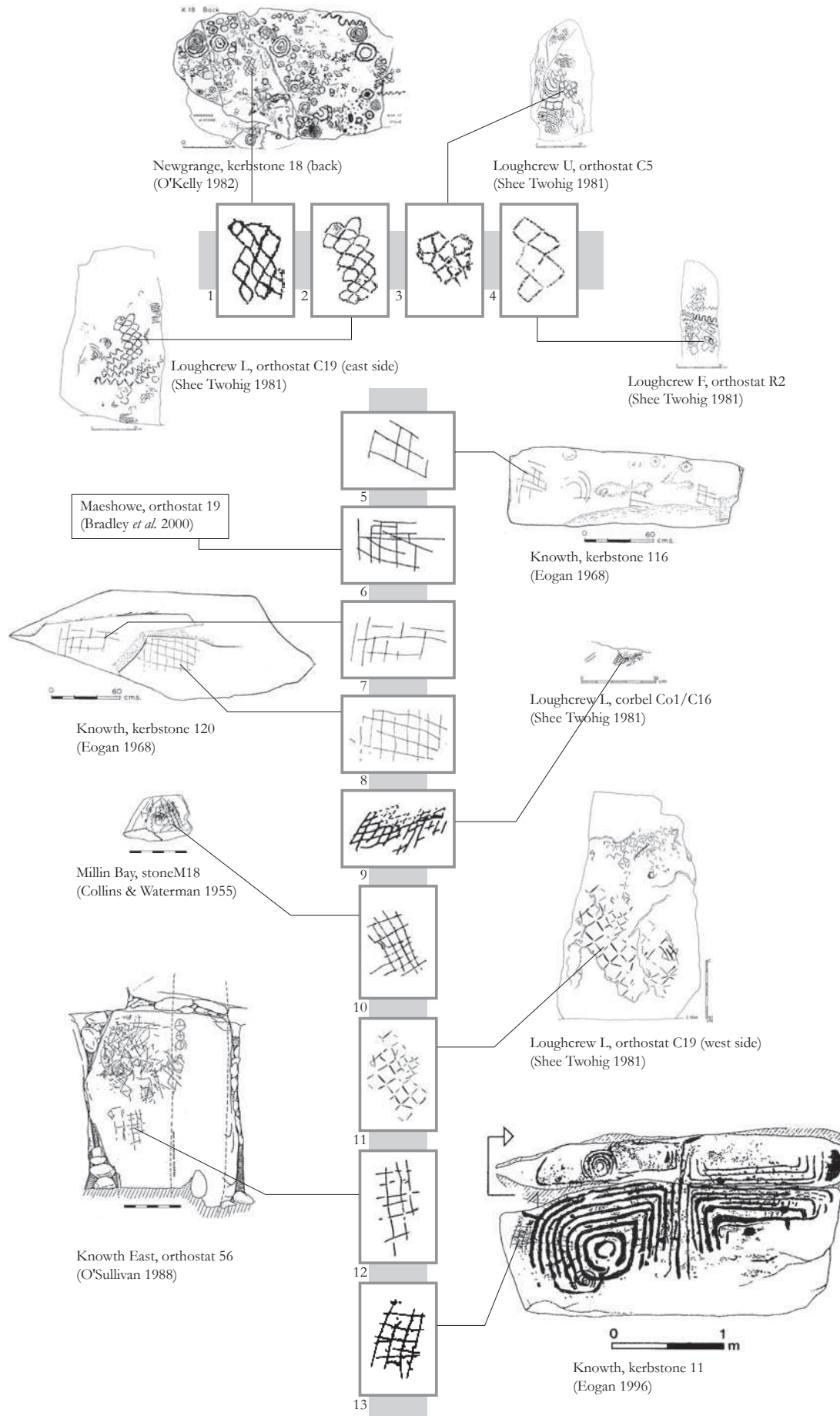


Figure 4.24 : Simple grids

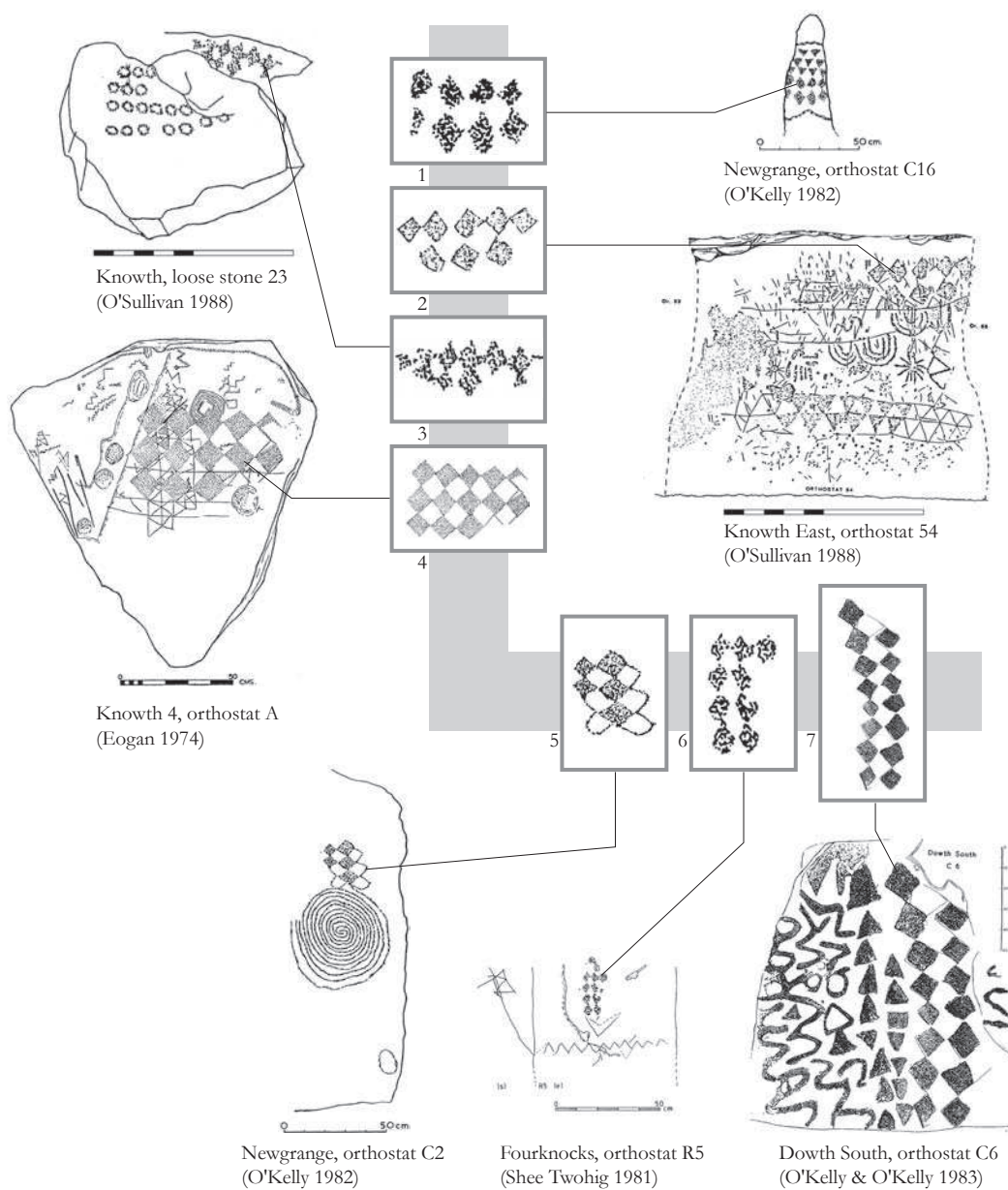


Figure 4.25 : Chessboard-like grids

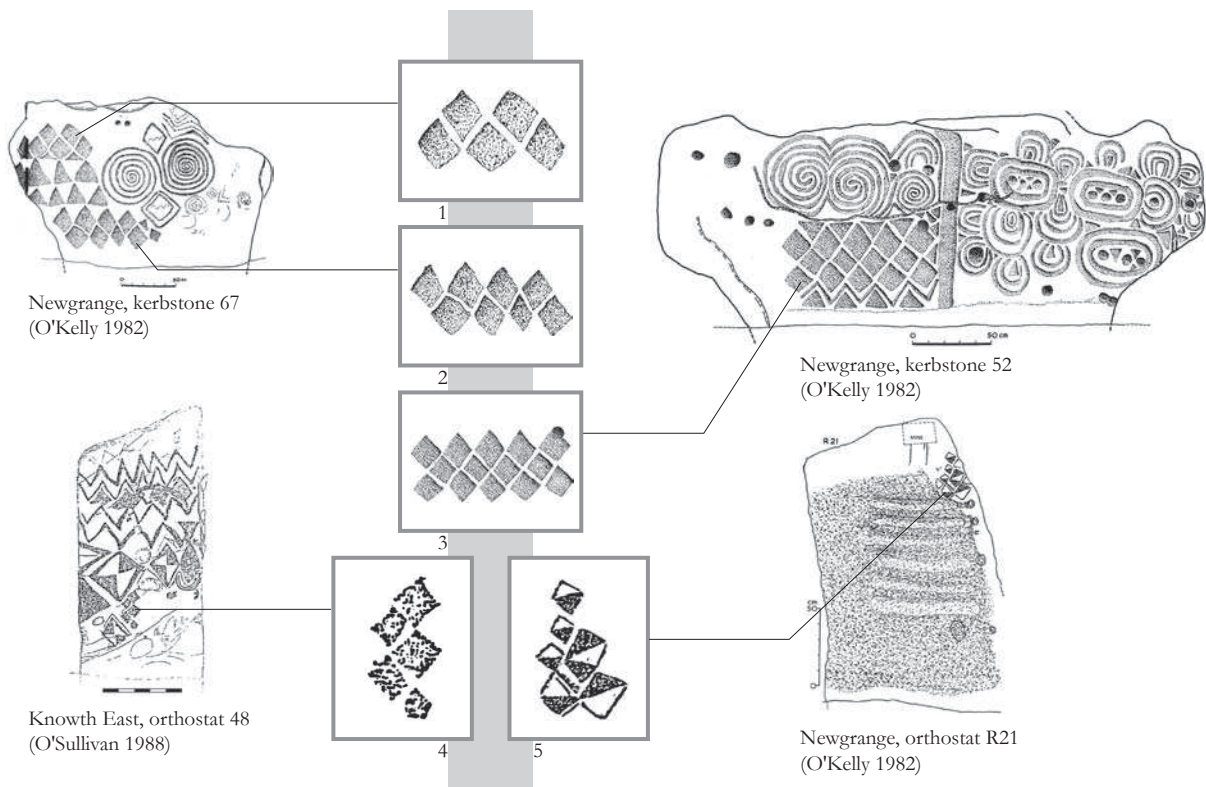


Figure 4.26 : Grids of solid squares

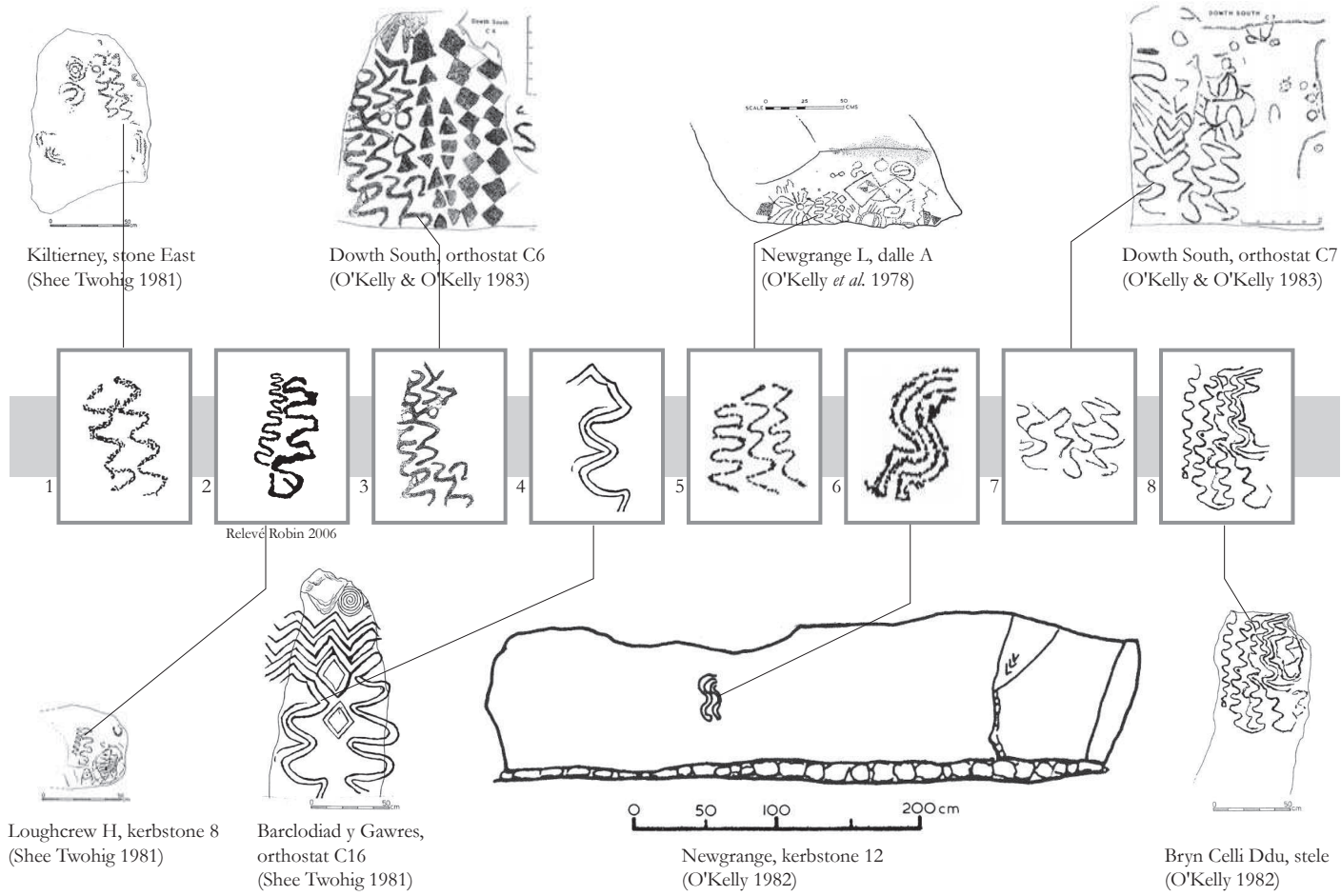


Figure 4.27 : Vertical parallel meandering lines

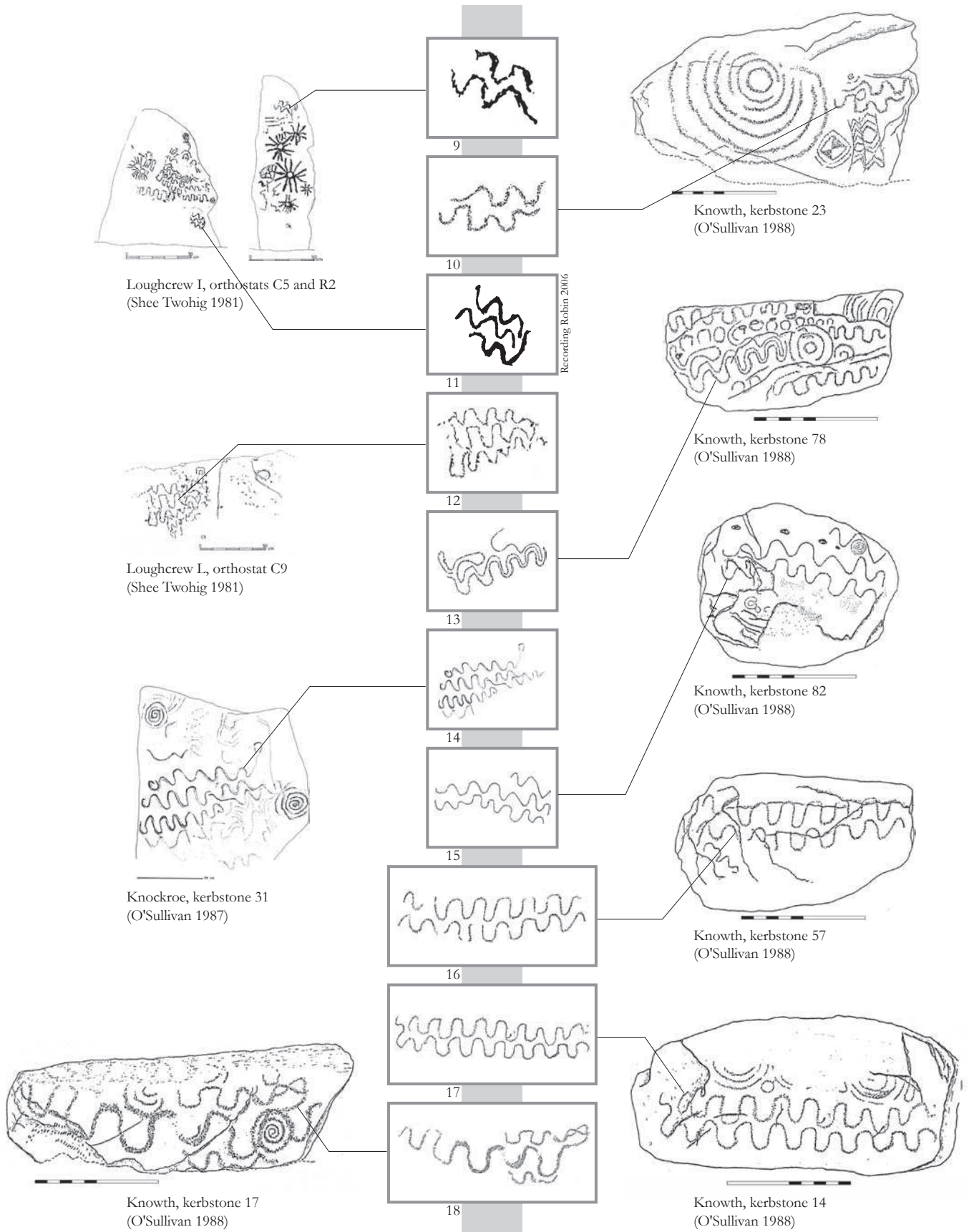


Figure 4.28 : Horizontal parallel meandering lines

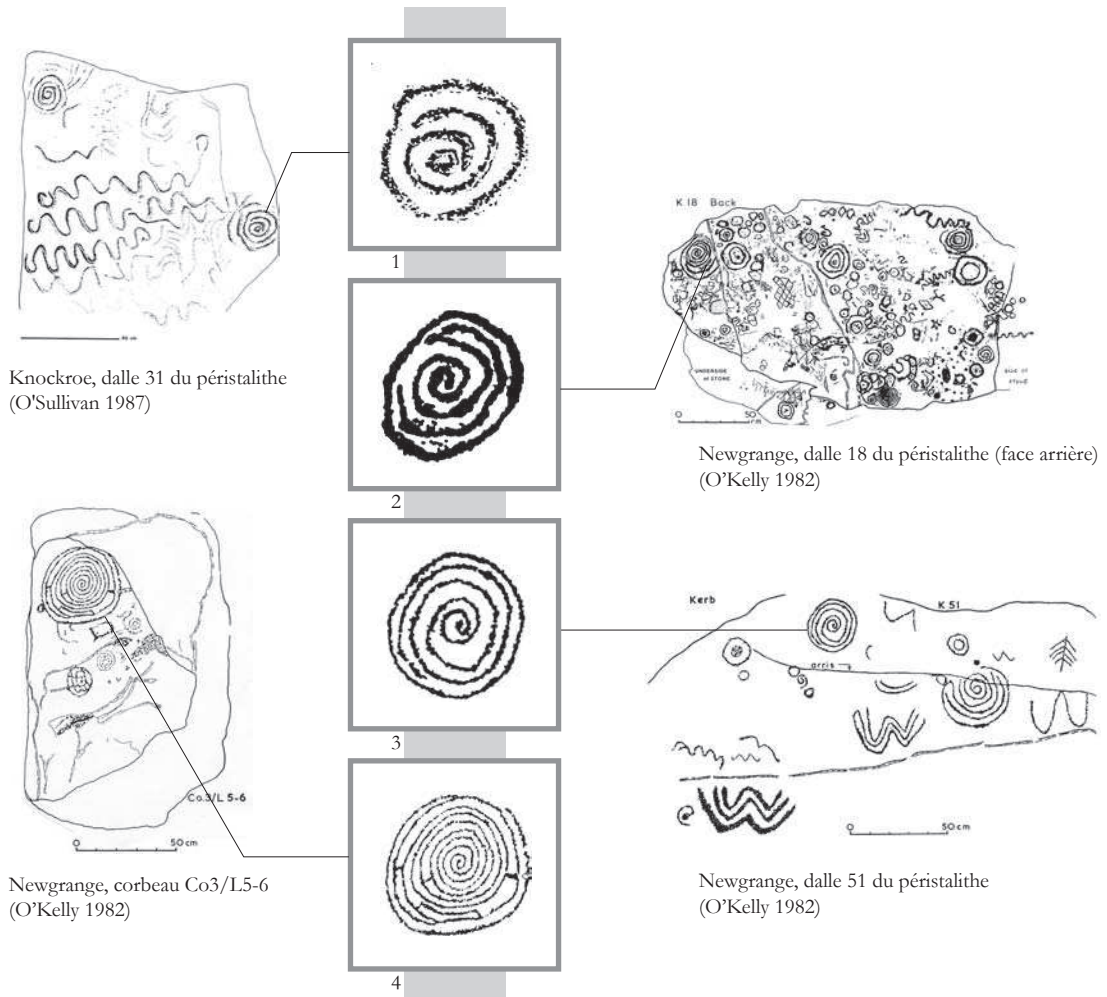


Figure 4.29 : Spirals inserted in a circle

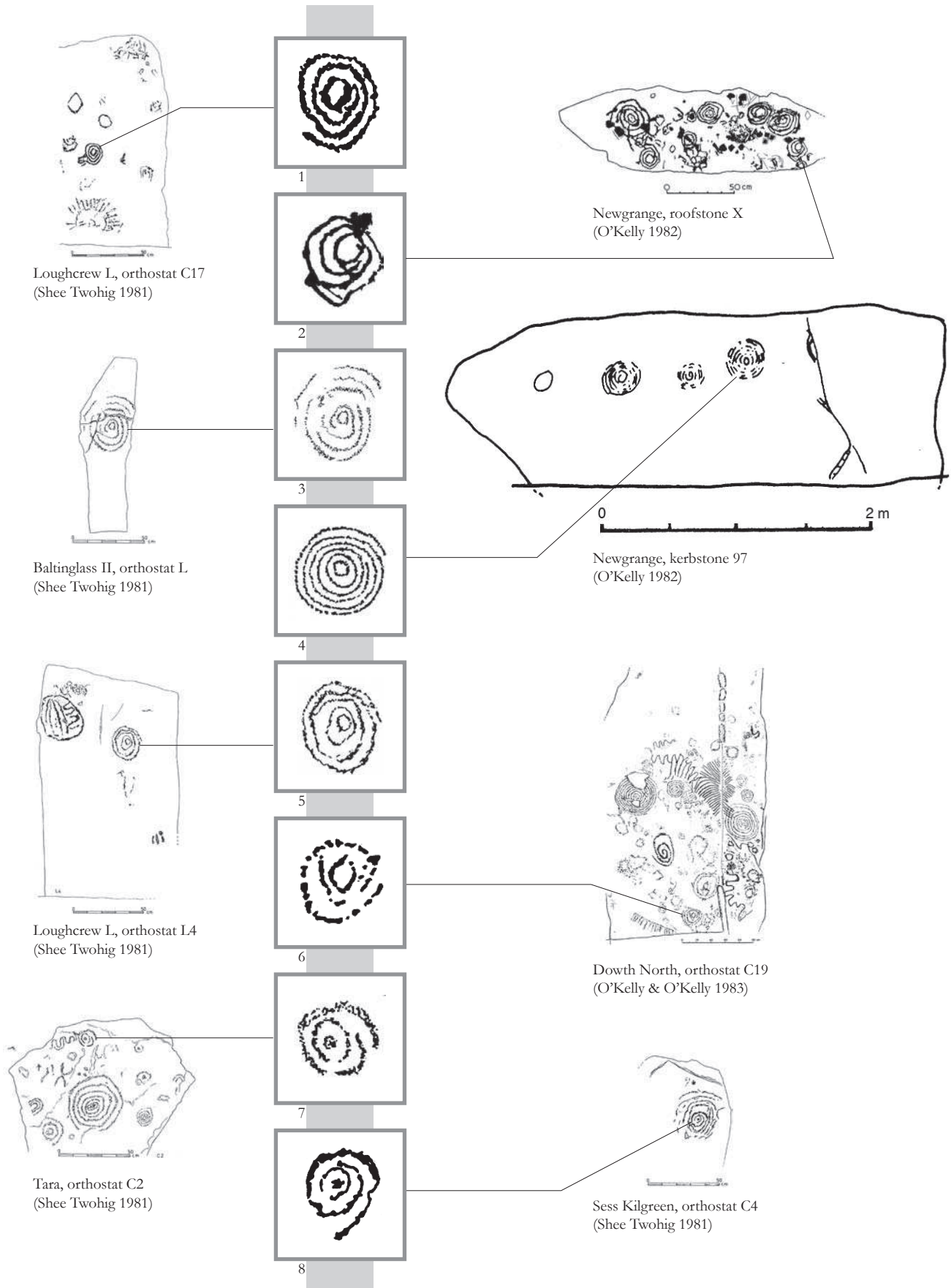


Figure 4.30 : Circles in the center of a spiral

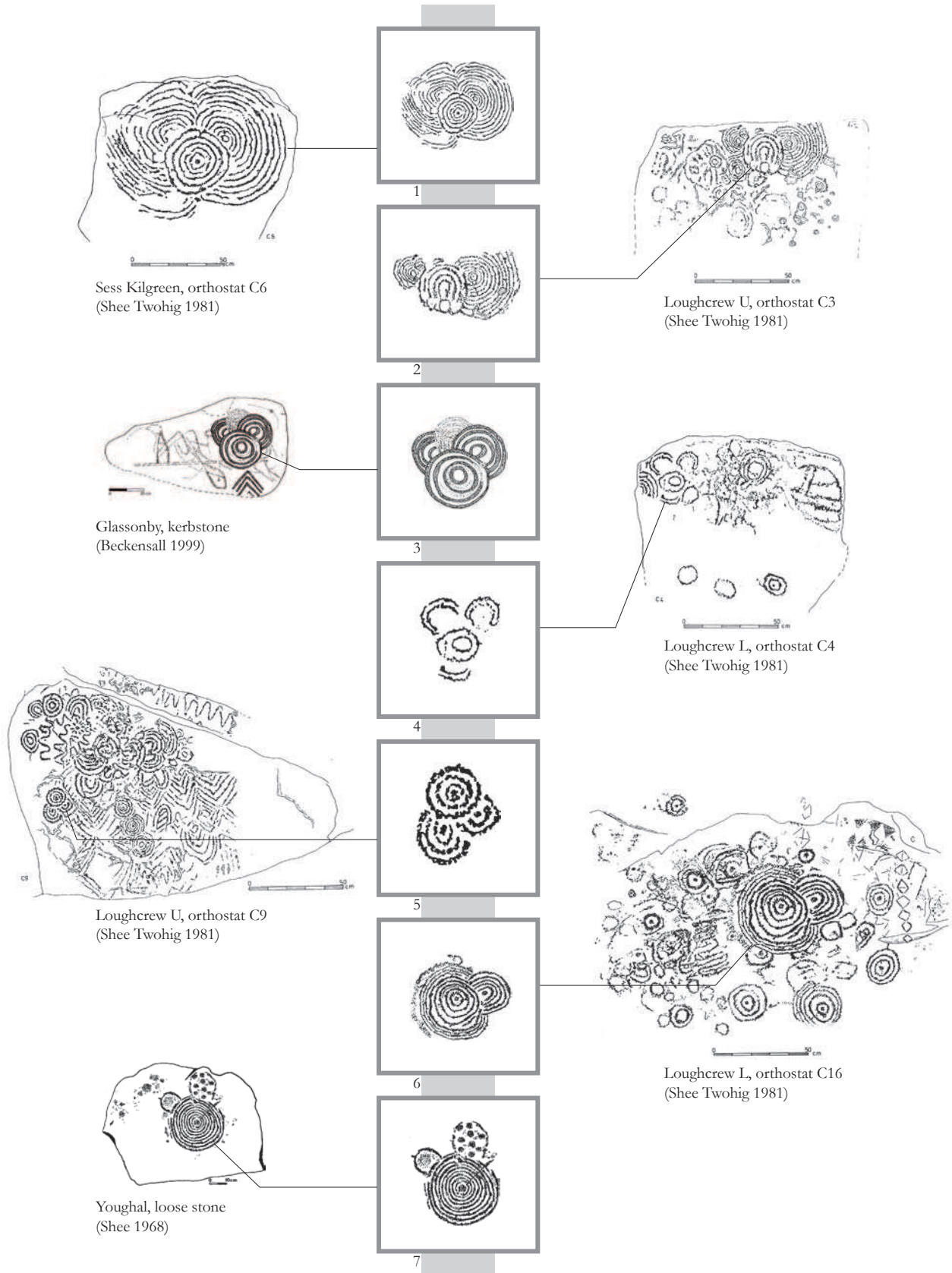


Figure 4.31 : Circular signs with arc appendages

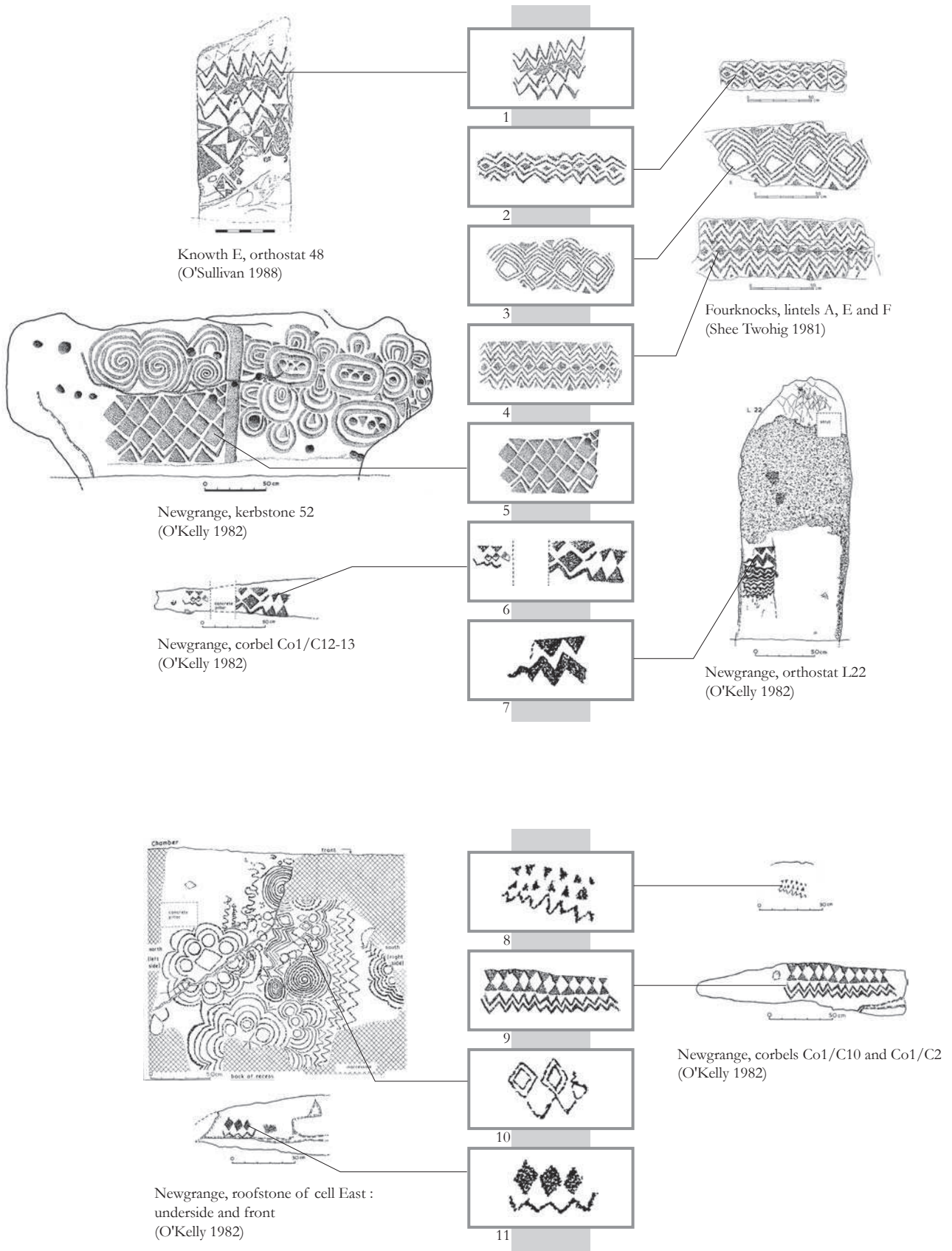


Figure 4.32 : Combinations of chevrons, lozenges and triangles

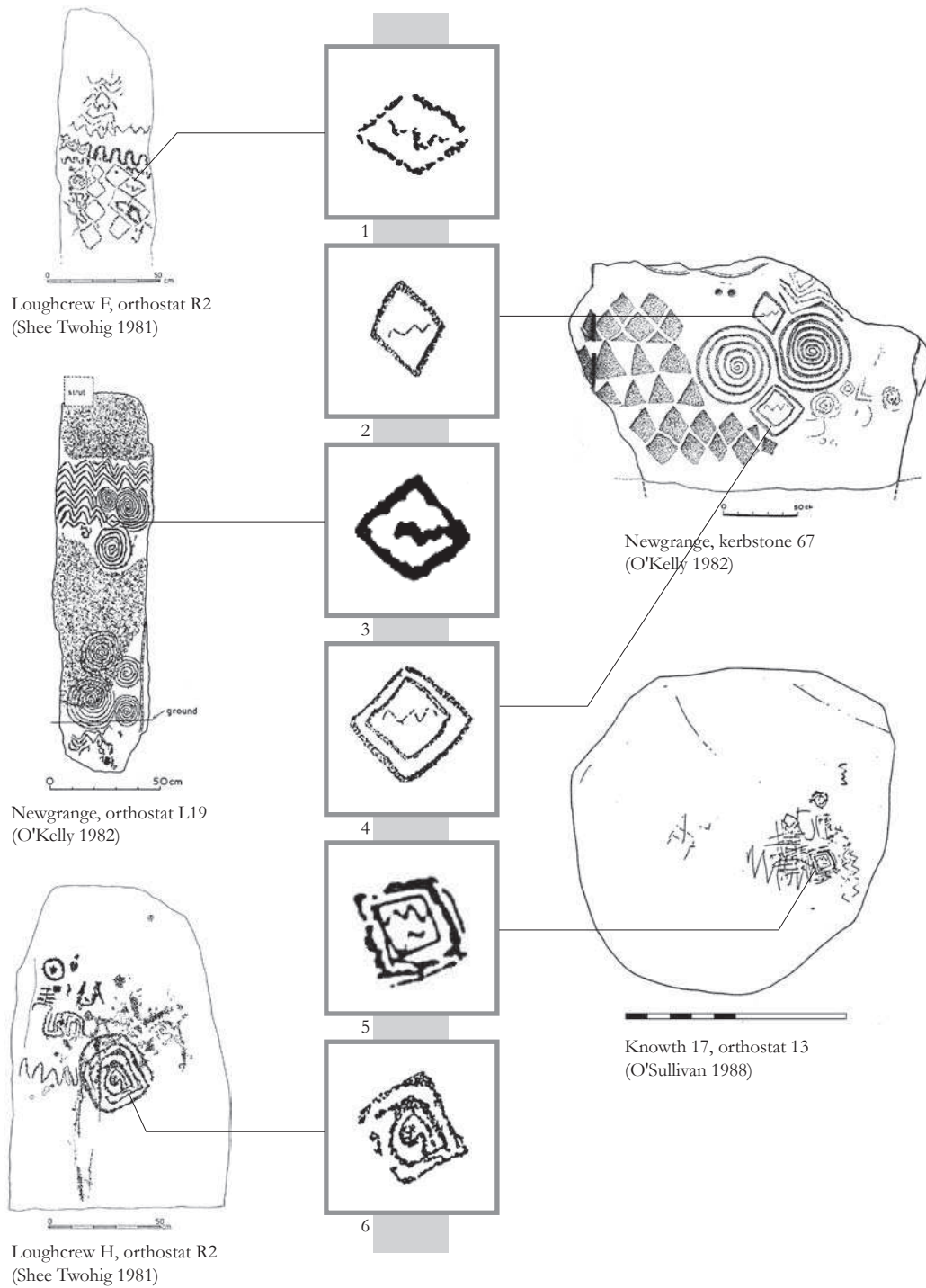


Figure 4.33 : Chevrons inserted in a lozenge

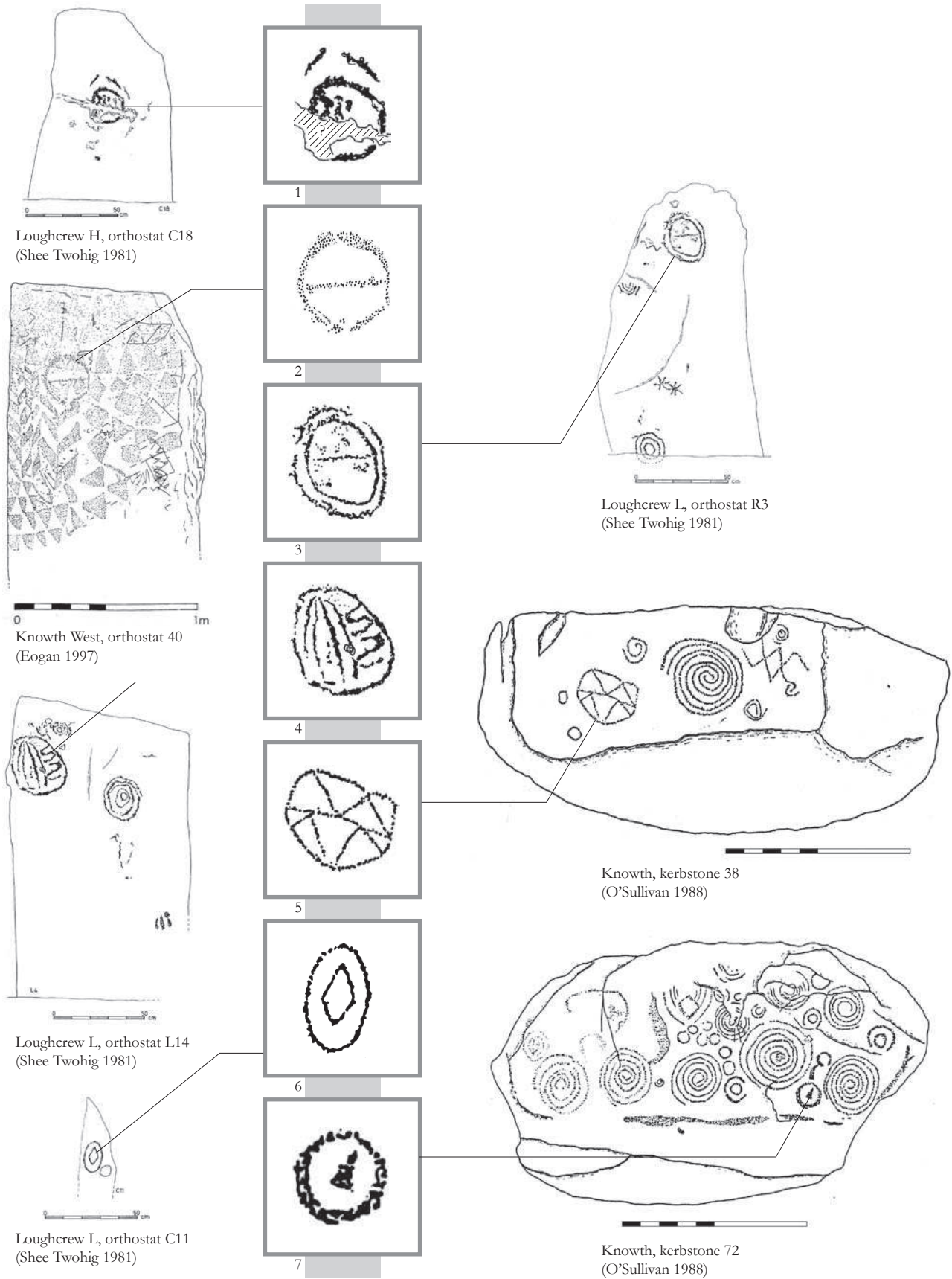


Figure 4.34 : Various signs inserted in a circle

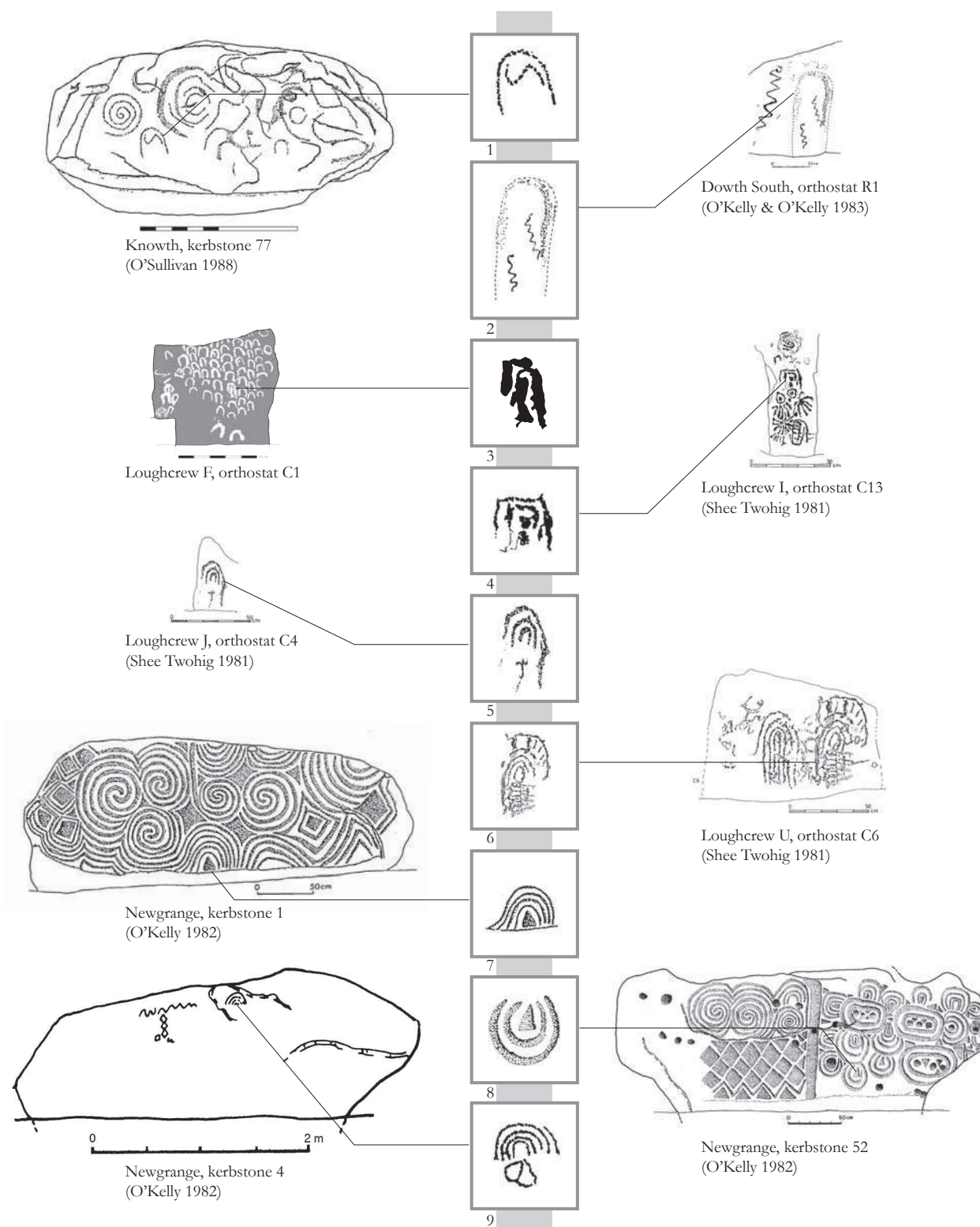


Figure 4.35 : Various signs inserted in an arc

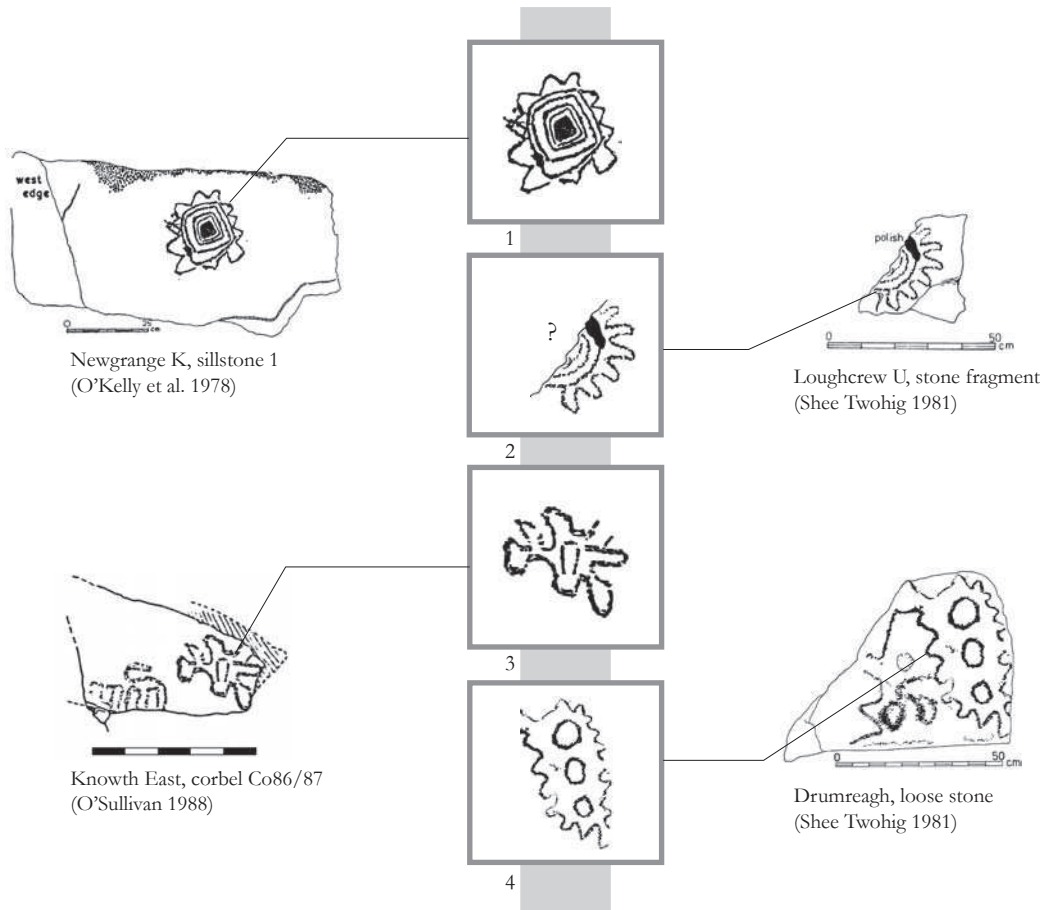


Figure 4.36 : Various signs enclosed by a meandering line

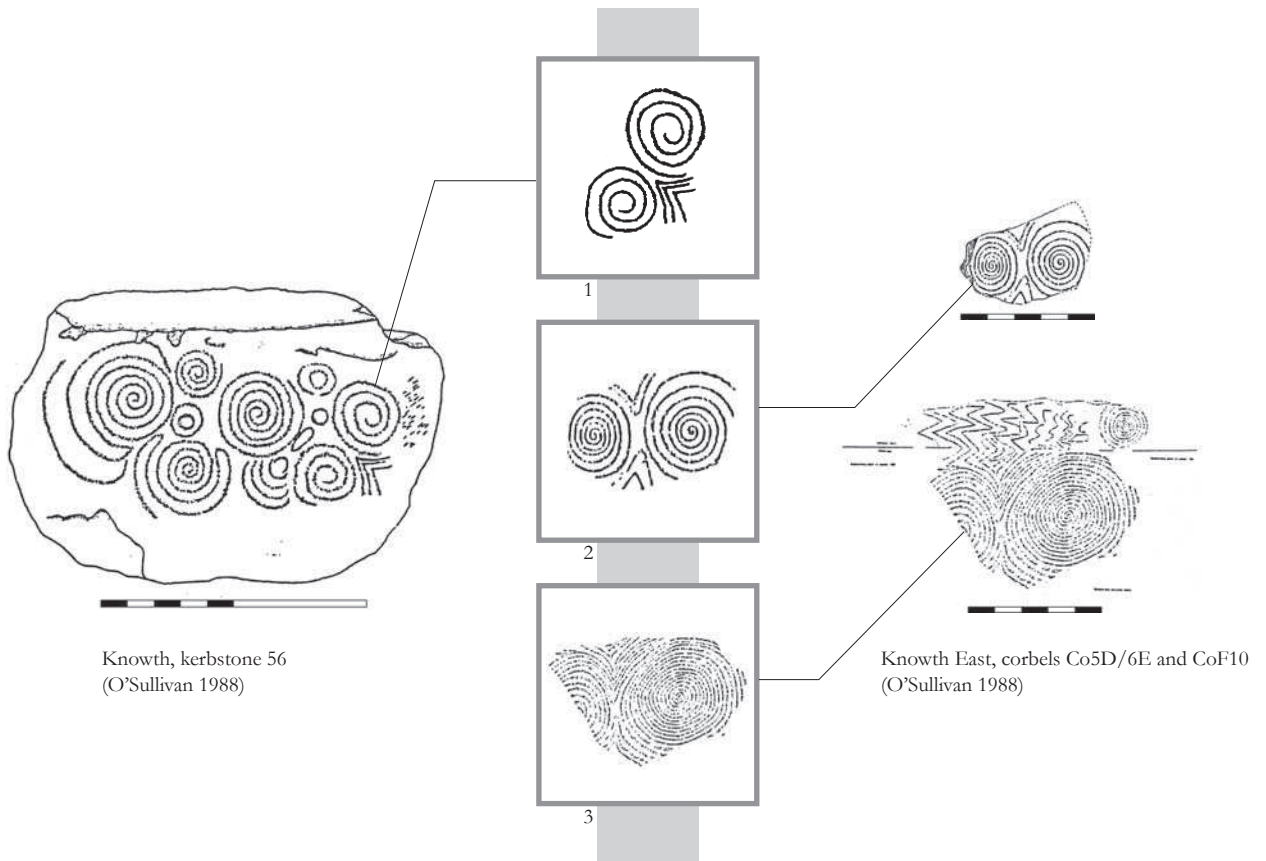


Figure 4.37 : Simple chevrons between two spirals

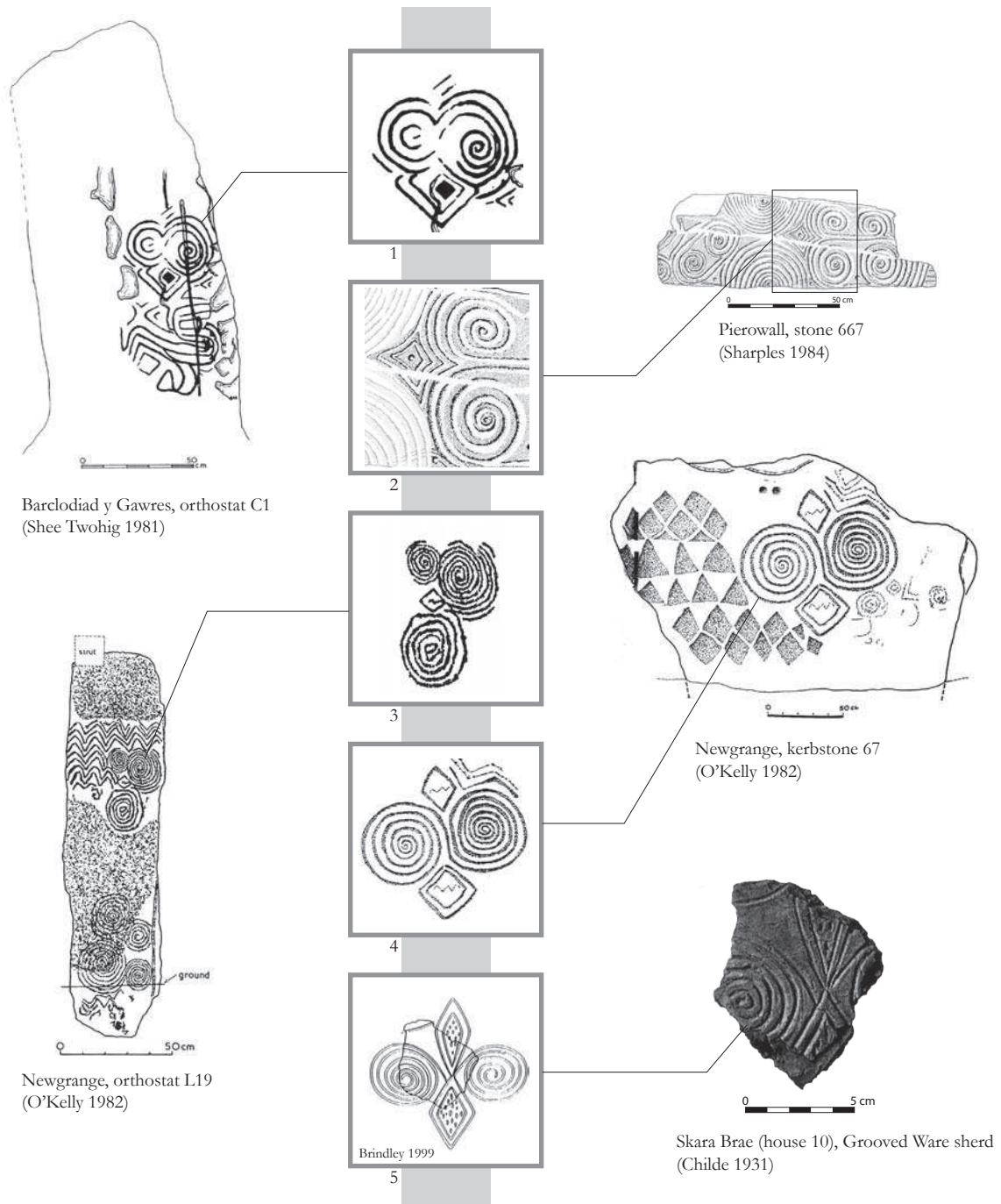


Figure 4.38 : Square between two spirals

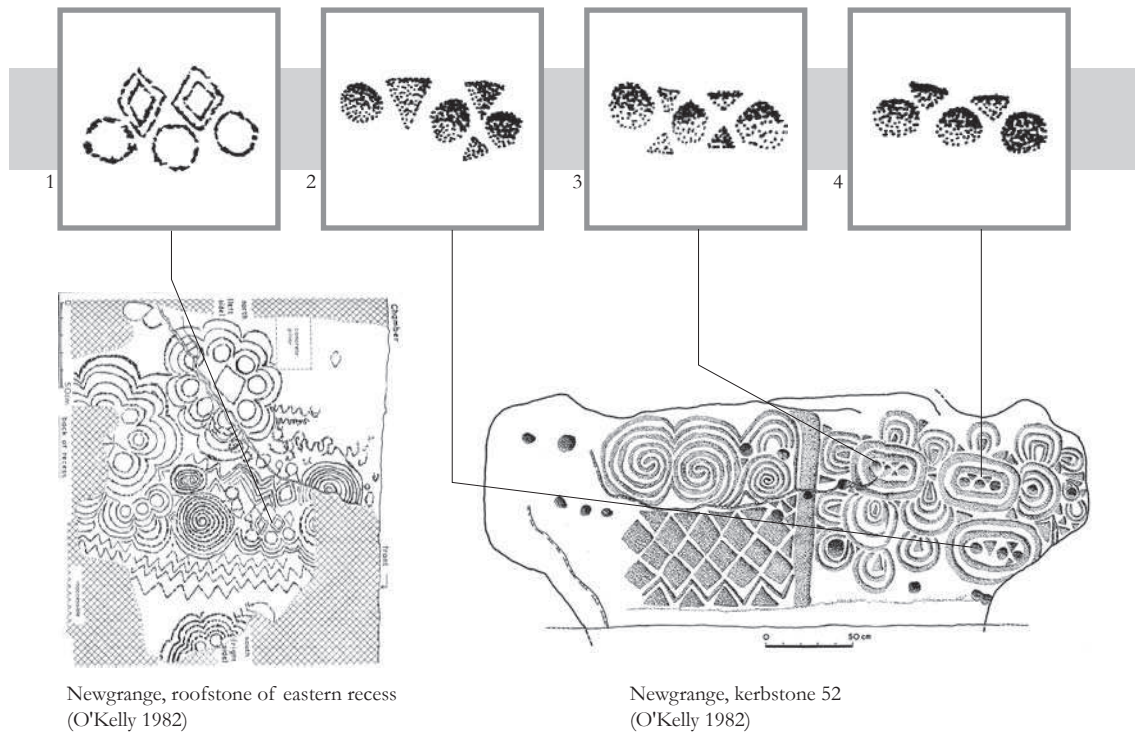


Figure 4.39 : Triangle or lozenge between three circles or cups

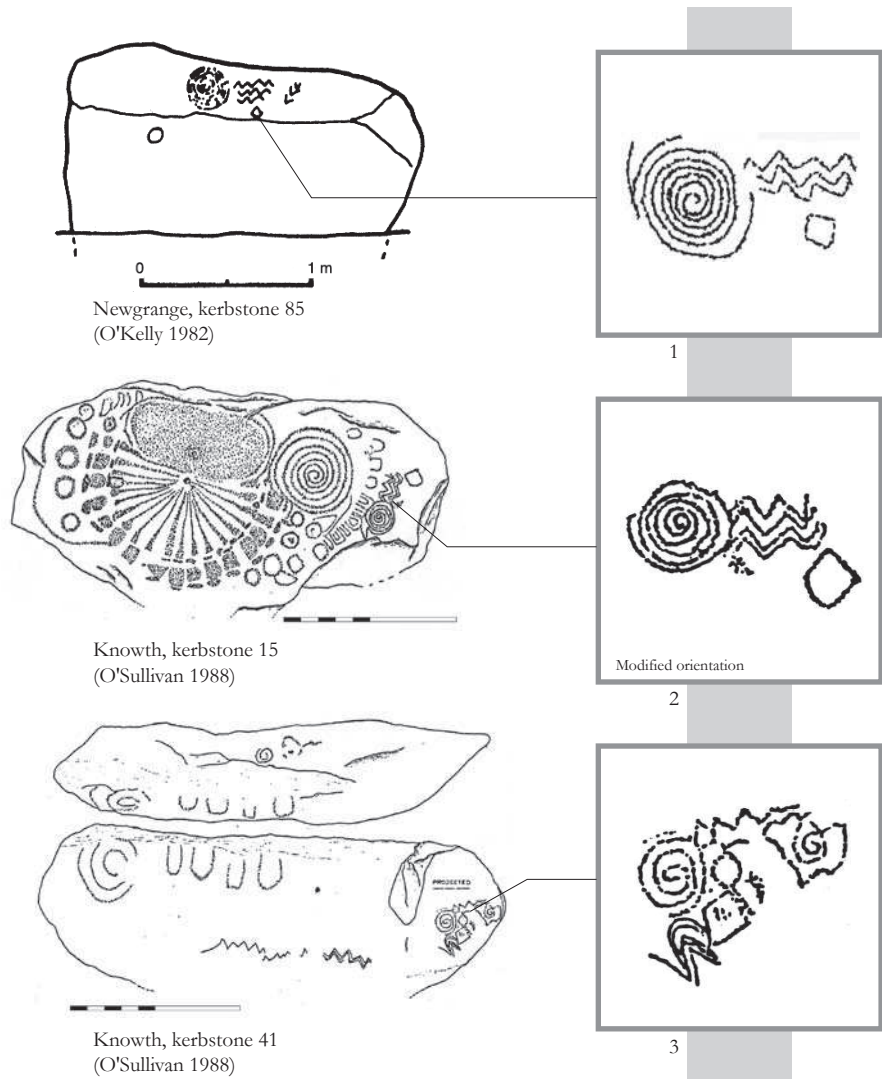
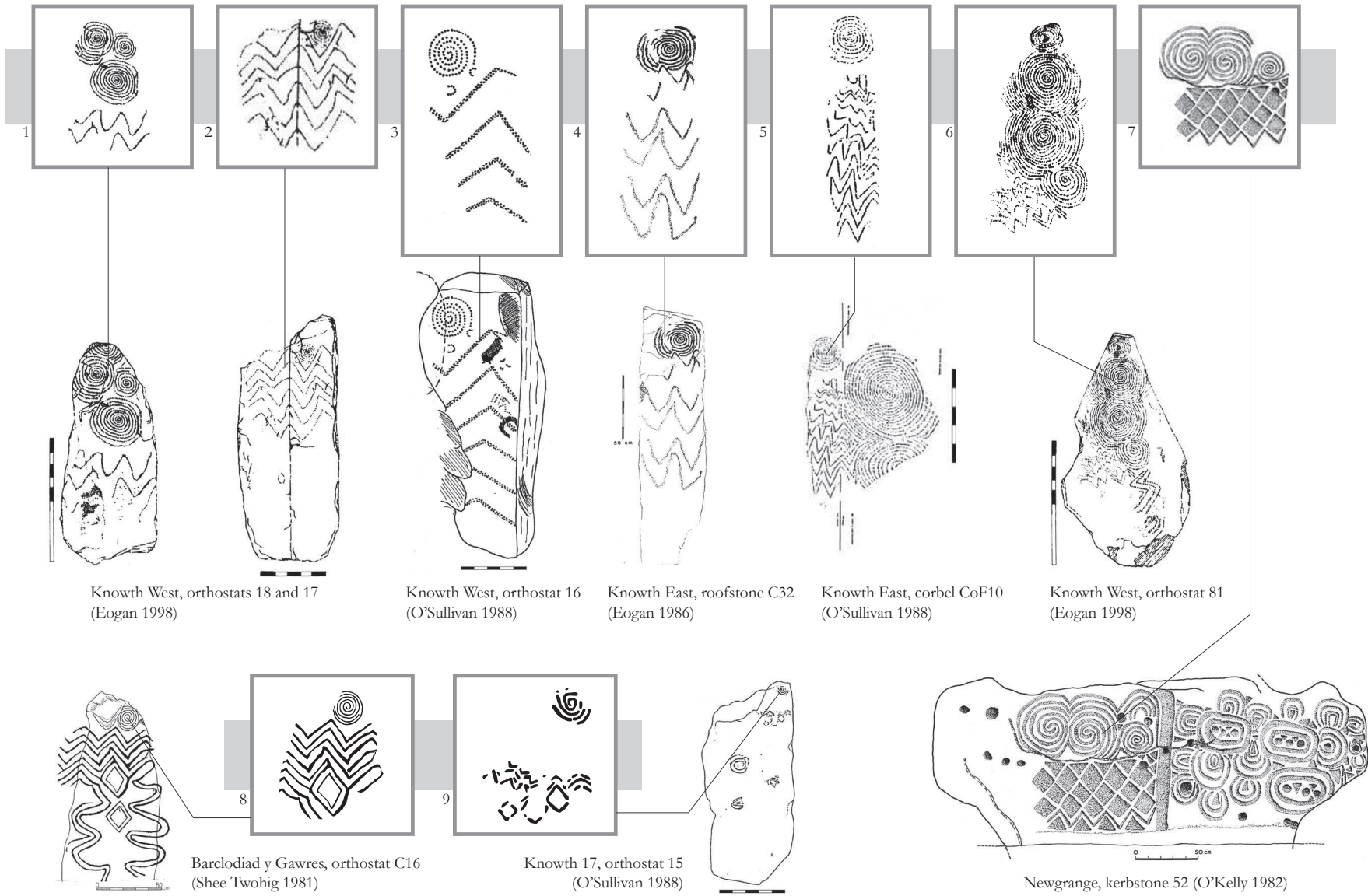


Figure 4.40 : Combination of spiral, chevrons and lozenge



Knowth West, orthostats 18 and 17 (Eogan 1998)

Knowth West, orthostat 16 (O'Sullivan 1988)

Knowth East, roofstone C32 (Eogan 1986)

Knowth East, corbel CoF10 (O'Sullivan 1988)

Knowth West, orthostat 81 (Eogan 1998)

Barclodiad y Gawres, orthostat C16 (Shee Twohig 1981)

Knowth 17, orthostat 15 (O'Sullivan 1988)

Newgrange, kerbstone 52 (O'Kelly 1982)

Figure 4.41 : Spiral(s) over chevrons

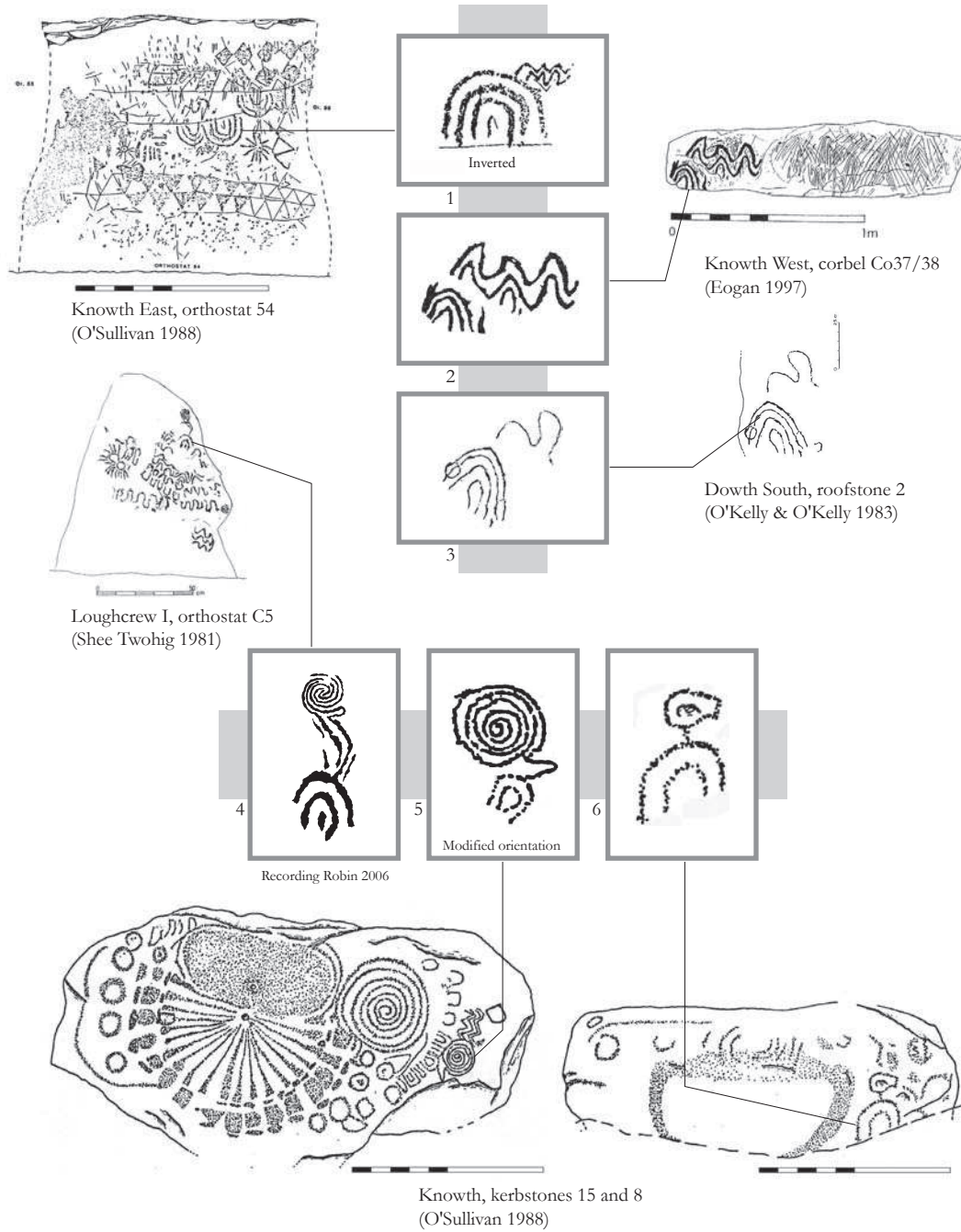


Figure 4.42 : Various signs connected to the top of an arc

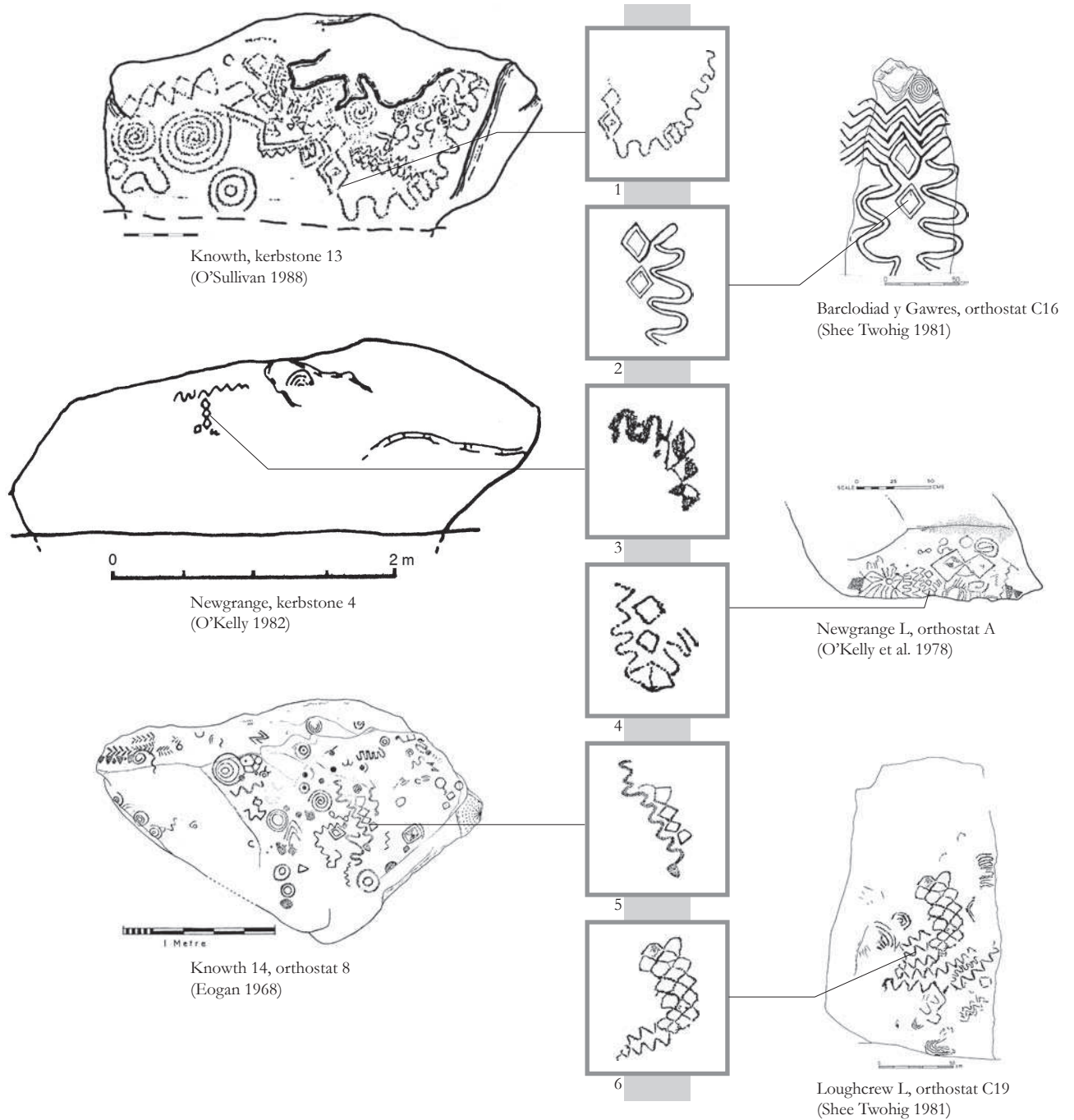


Figure 4.43 : Meandering sign connected to a line of lozenges

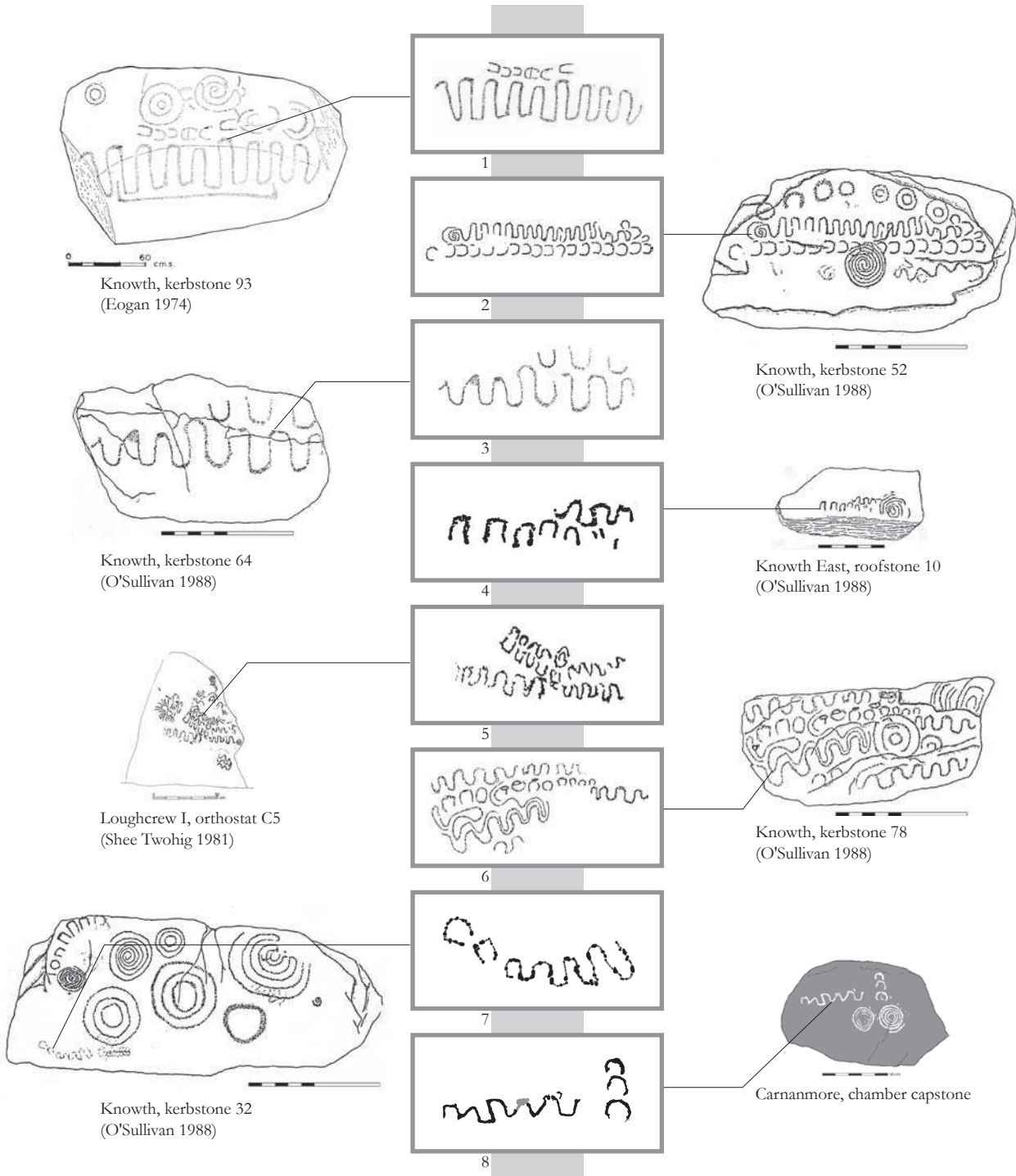


Figure 4.44 : Meandering sign and line or row of arcs

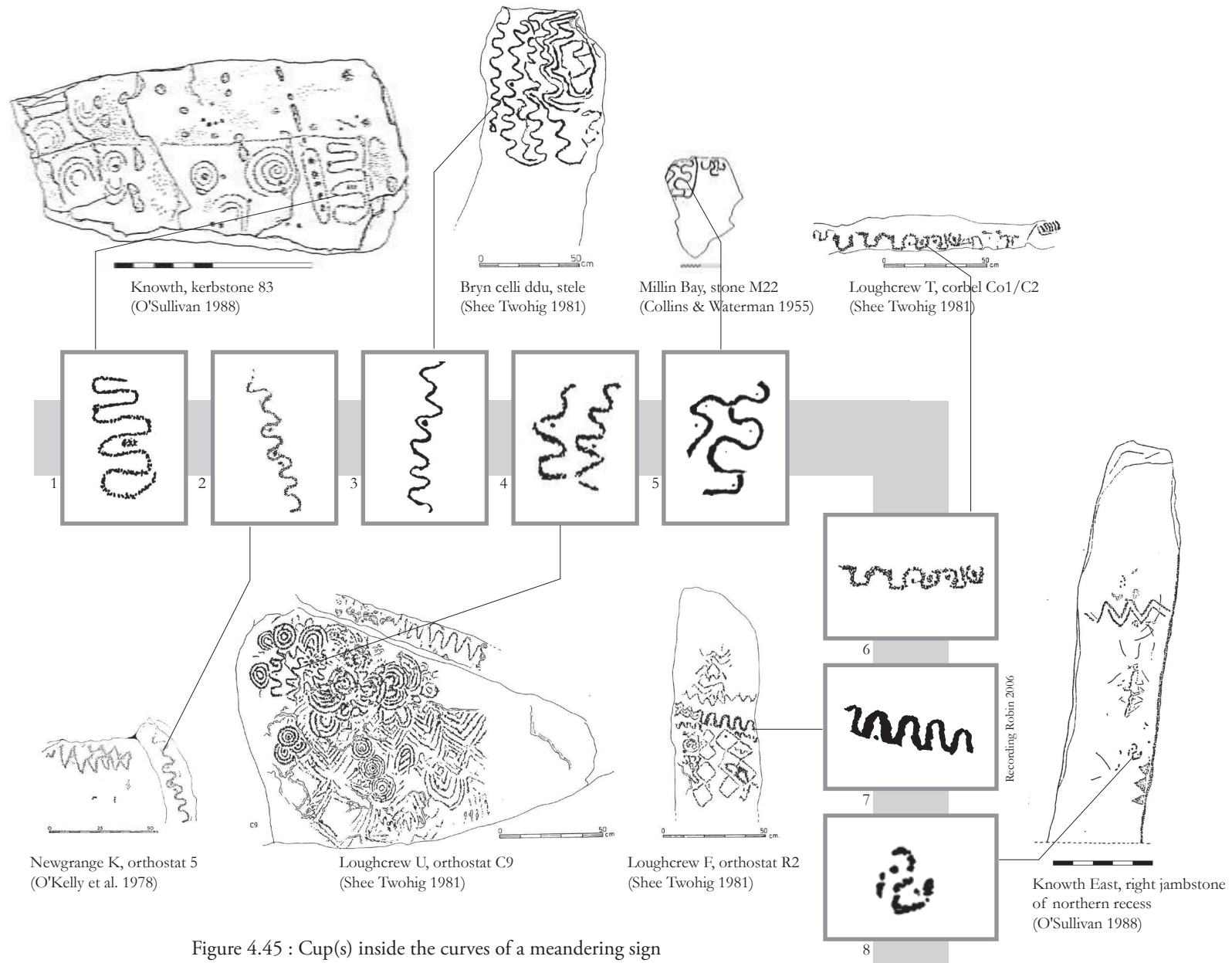


Figure 4.45 : Cup(s) inside the curves of a meandering sign

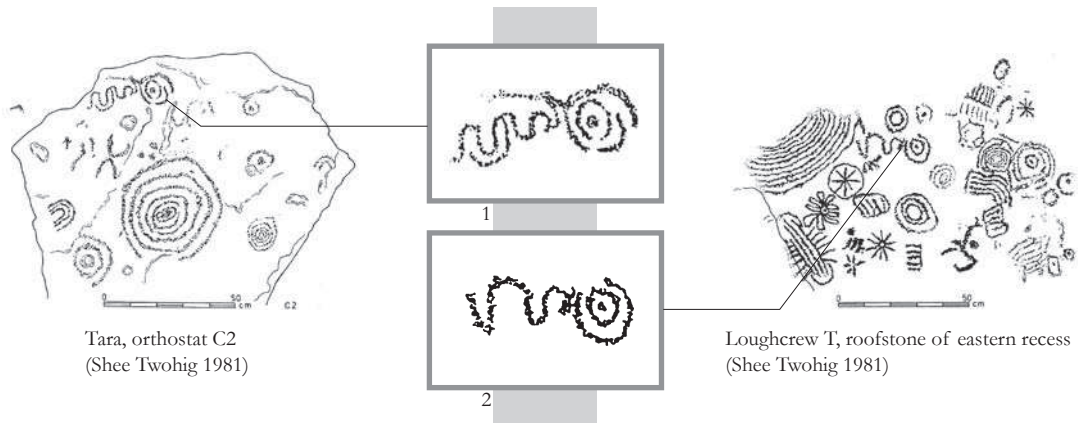


Figure 4.46 : Meandering sign and circular sign

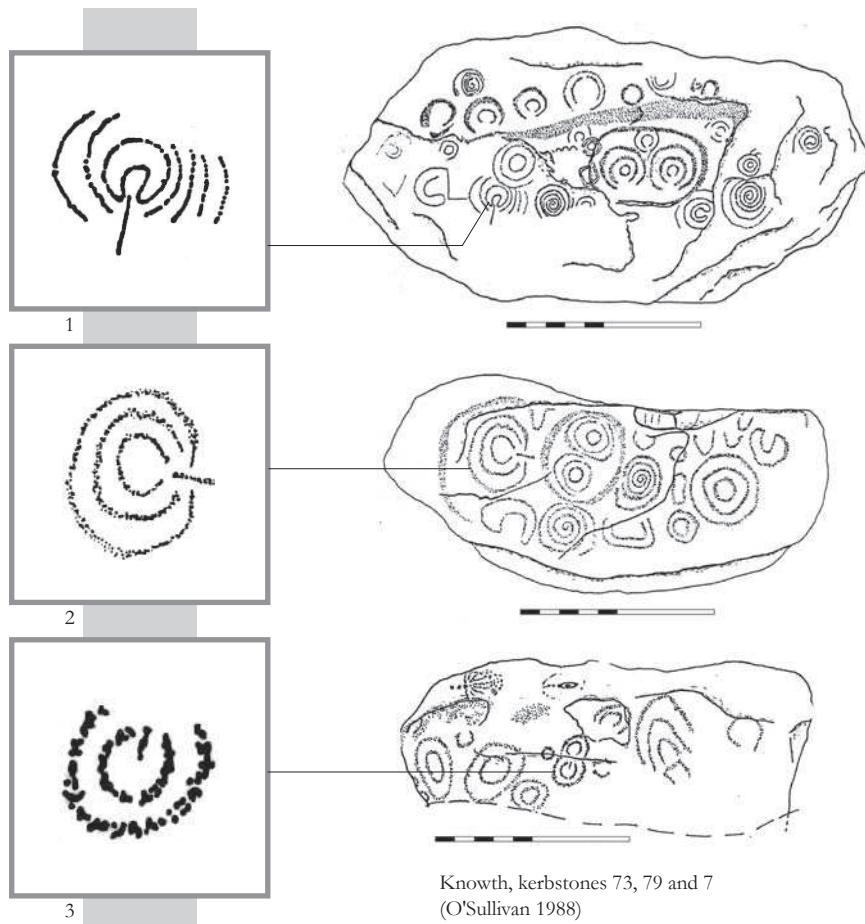


Figure 4.47 : Arc with central line

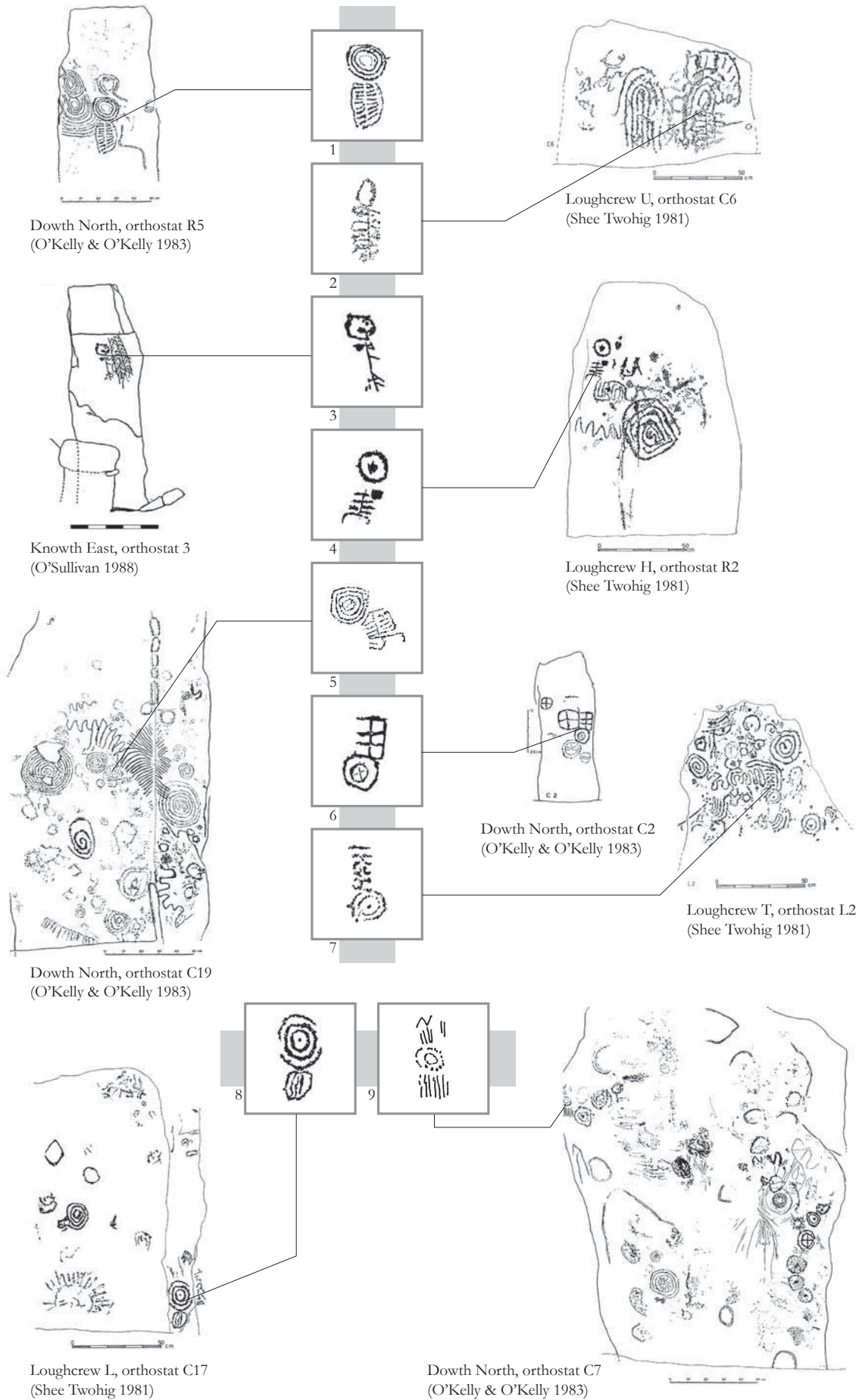


Figure 4.48 : Scalariform sign with axial circle

	Circular and semicircular signs					Angular signs				Meandering signs	
Combinations of identical signs	 	 		 			 	 	 		
Combinations of distinct signs	 					 					

Figure 4.49 : Synthetic table of signs combinations

	Circular and semicircular signs					Angular signs				Meandering signs
	•	○	⊙	∩	✳	∧	▲	◊	≡	〰
Elementary forms										
Combinations of identical signs										
Combinations of distinct signs										

Figure 4.50 : Synthetic table of passage tomb iconography around the Irish Sea

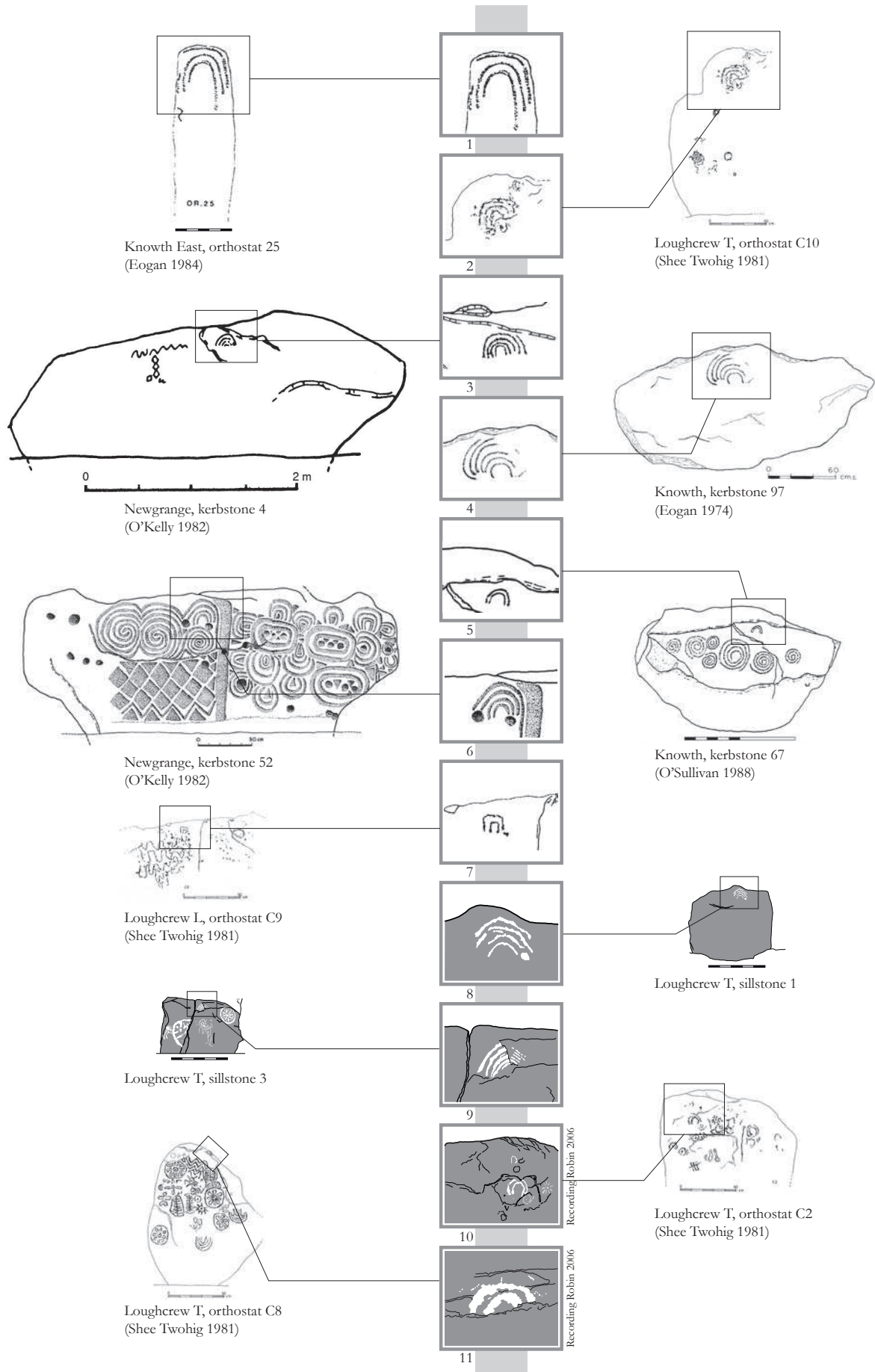


Figure 5.1 : Arcs of type 2b in top position

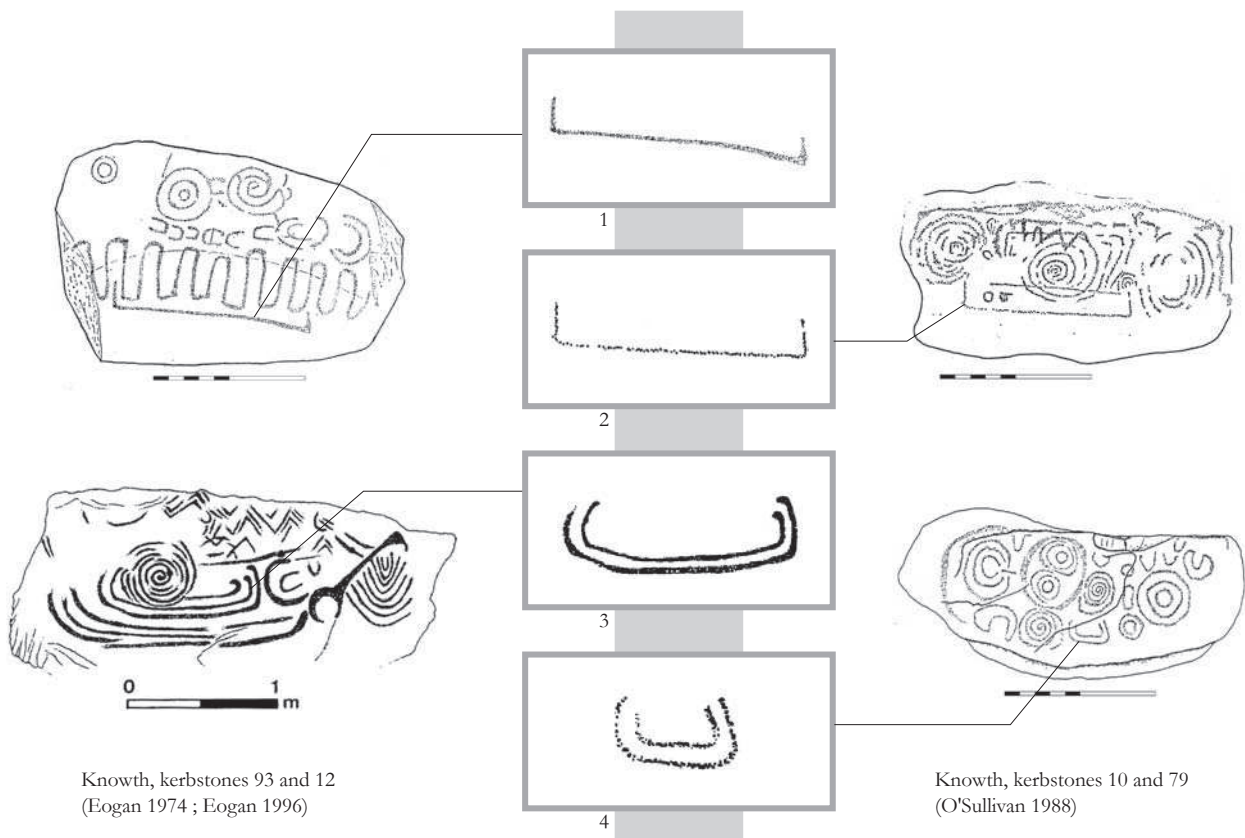


Figure 5.2 : Arcs of type 4 in lowermost position

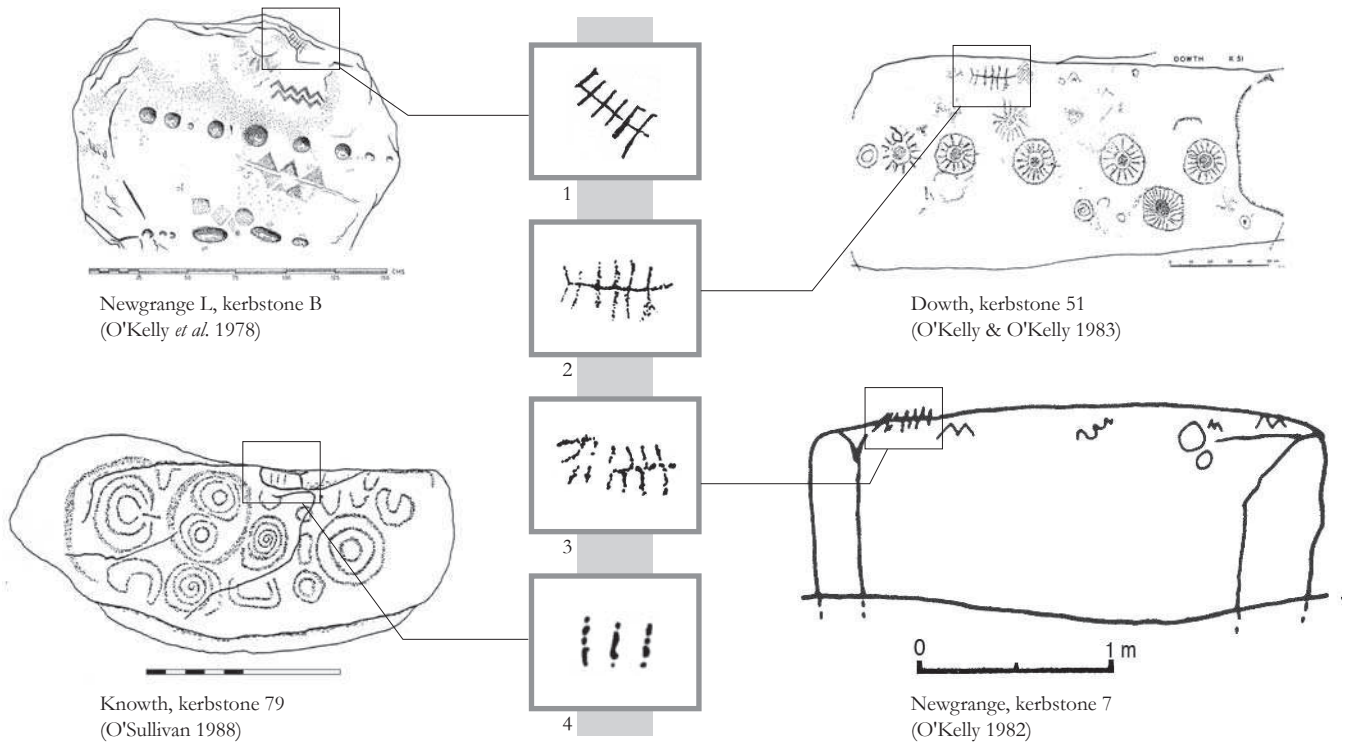


Figure 5.3 : Scalariform signs in upper limit of kerbstones

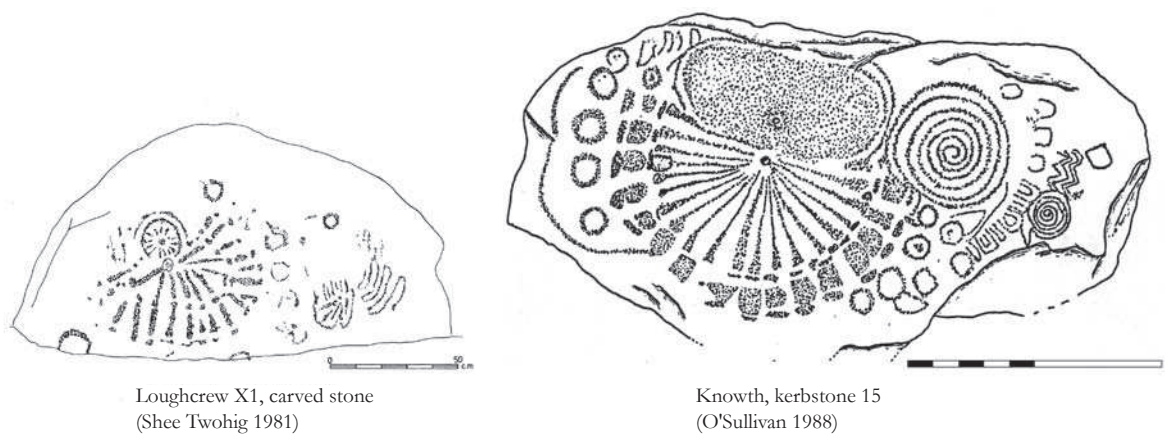
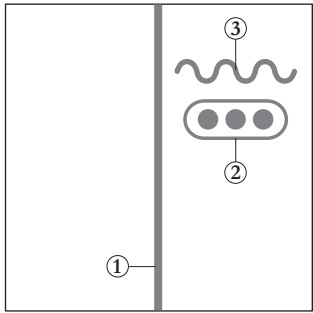
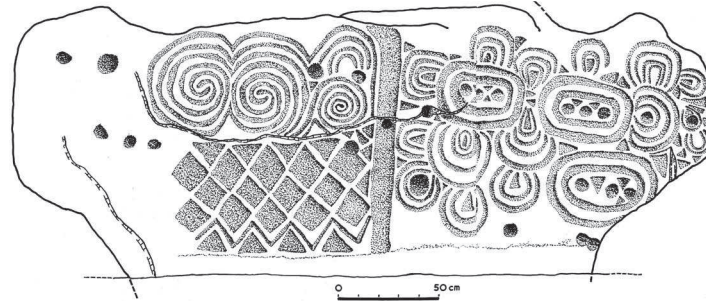
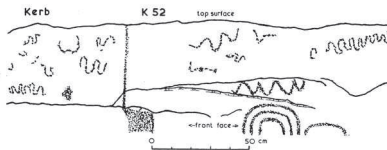
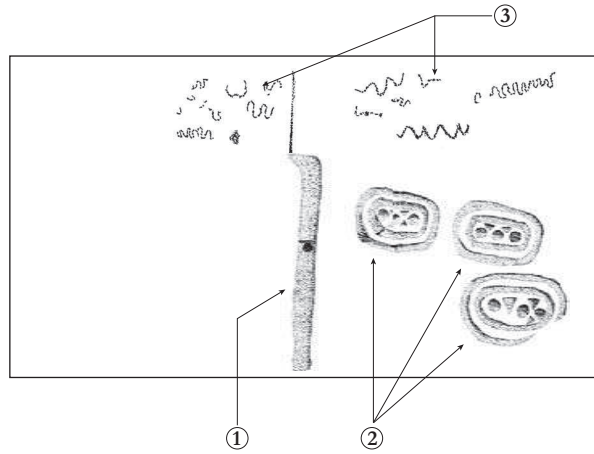


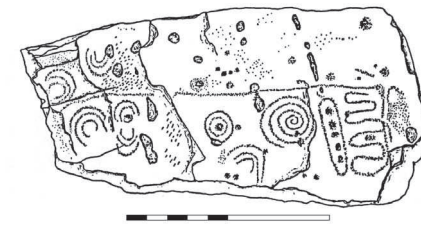
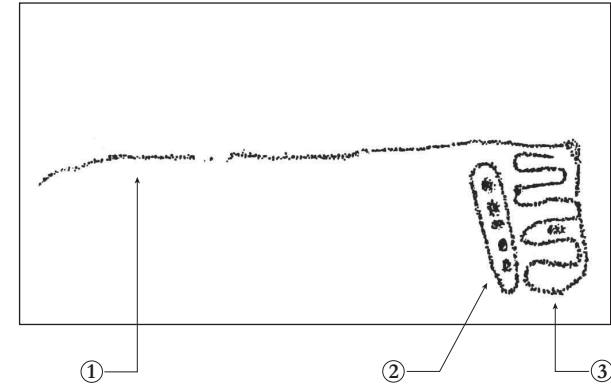
Figure 5.4 : Radiate semicircular signs of large dimension carved in central position



- 1. Central line
- 2. Cups alignment enclosed in an oval figure
- 3. Meandering sign



Newgrange, kerbstone 52
(O'Kelly 1982)



Knowth, kerbstone 83
(O'Sullivan 1988)

Figure 5.5 : Central line, cups alignment and meandering signs

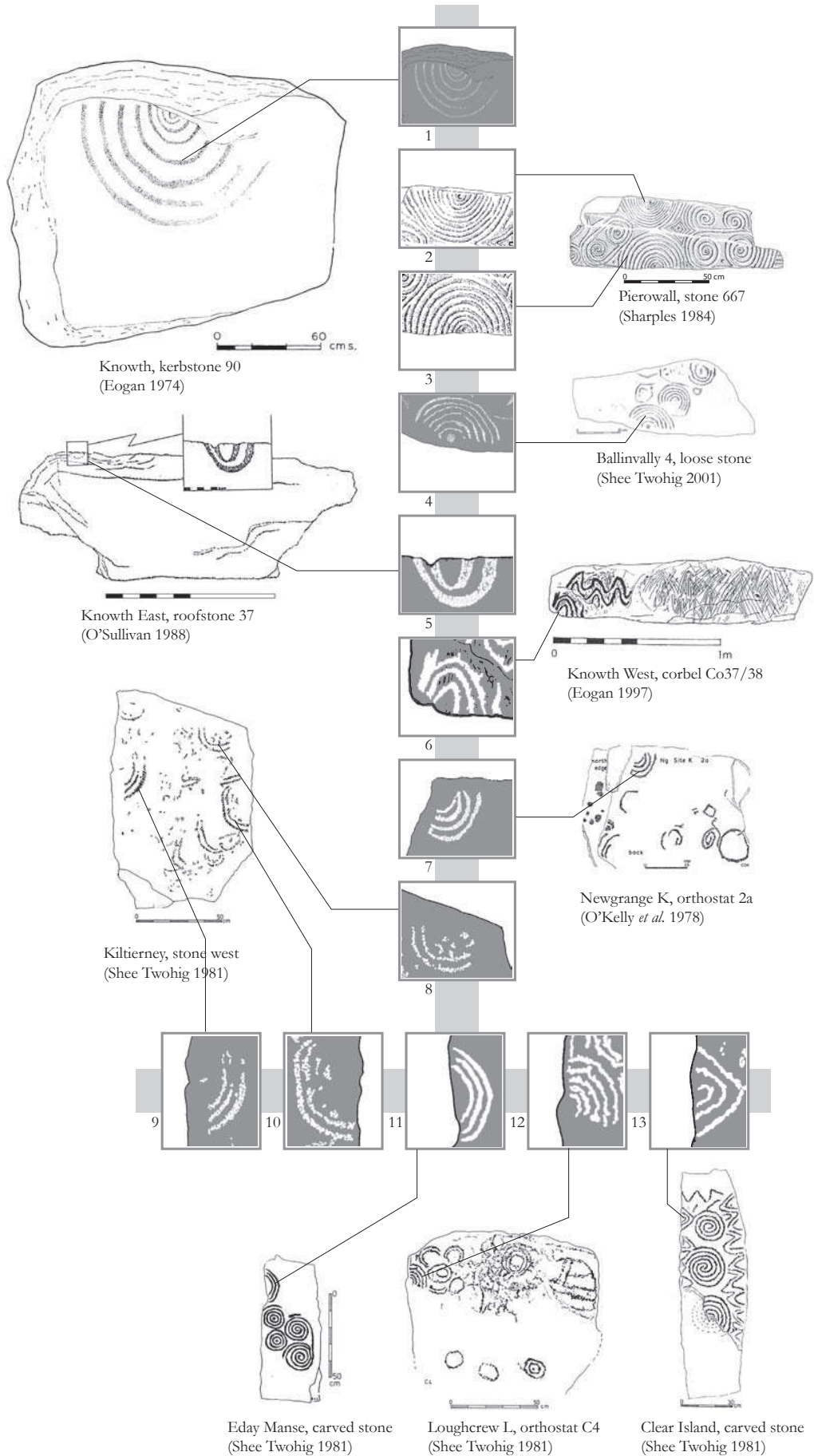


Figure 5.6 : Arcs in contact with the stone edge

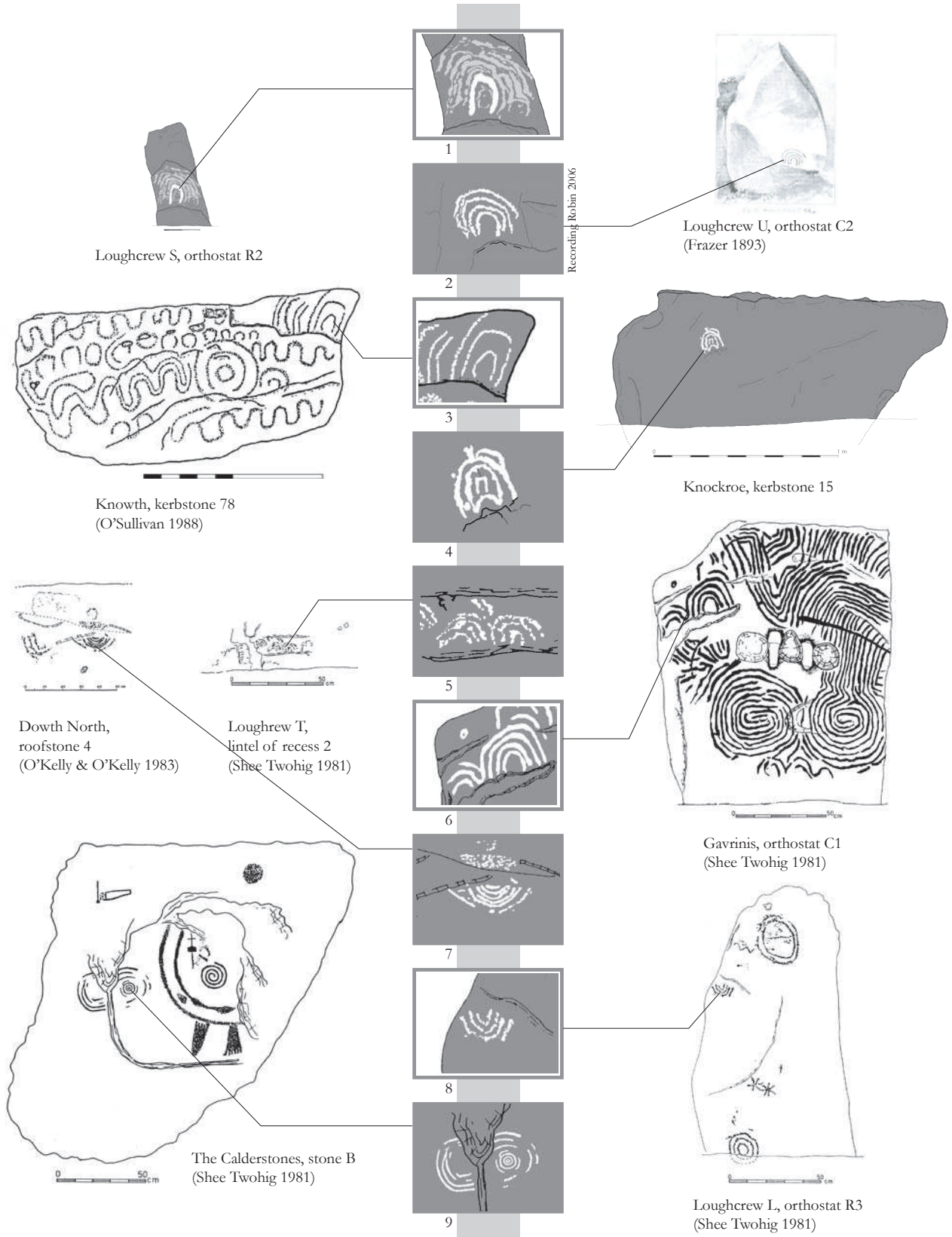
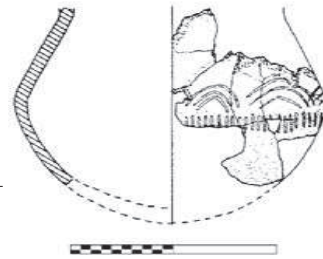
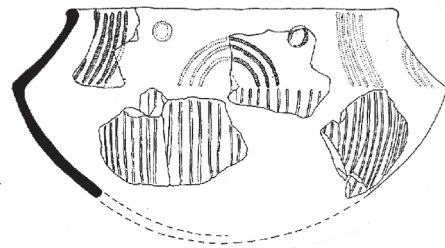


Figure 5.7 : Arcs in contact with a line of relief



Achnacreebeag passage tomb (Argyll, Scotland)
(Ritchie 1970)



Ballymacaldrack court tomb (Co. Antrim, Ireland)
(Collins 1976)

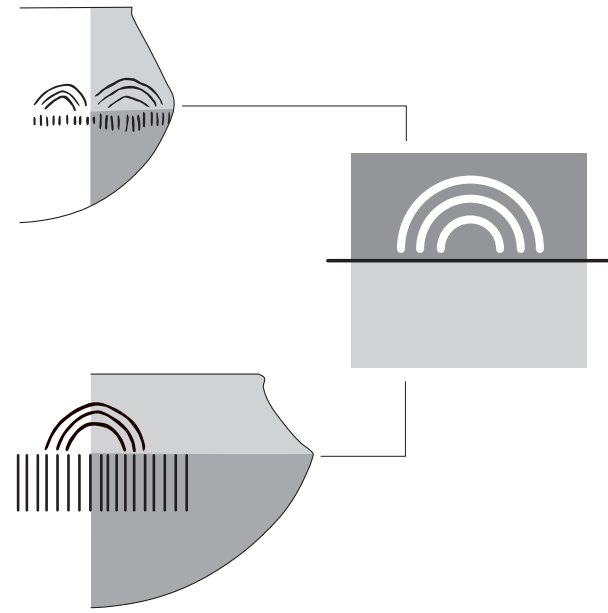


Figure 5.8 : Decoration of the carinated bowls of Achnacreebeag and Ballymacaldrack

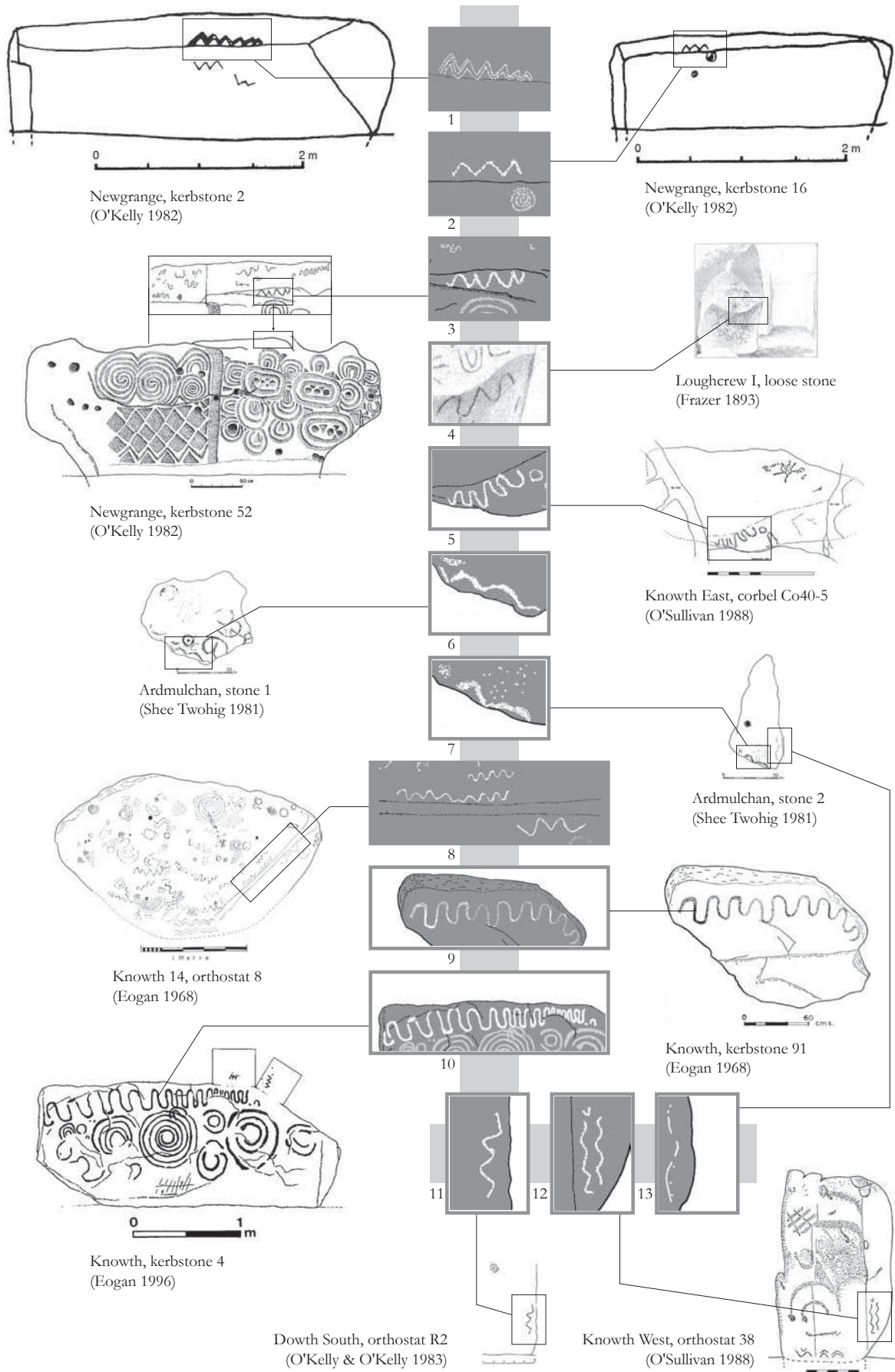


Figure 5.9 : Meandering signs carved along a line of relief

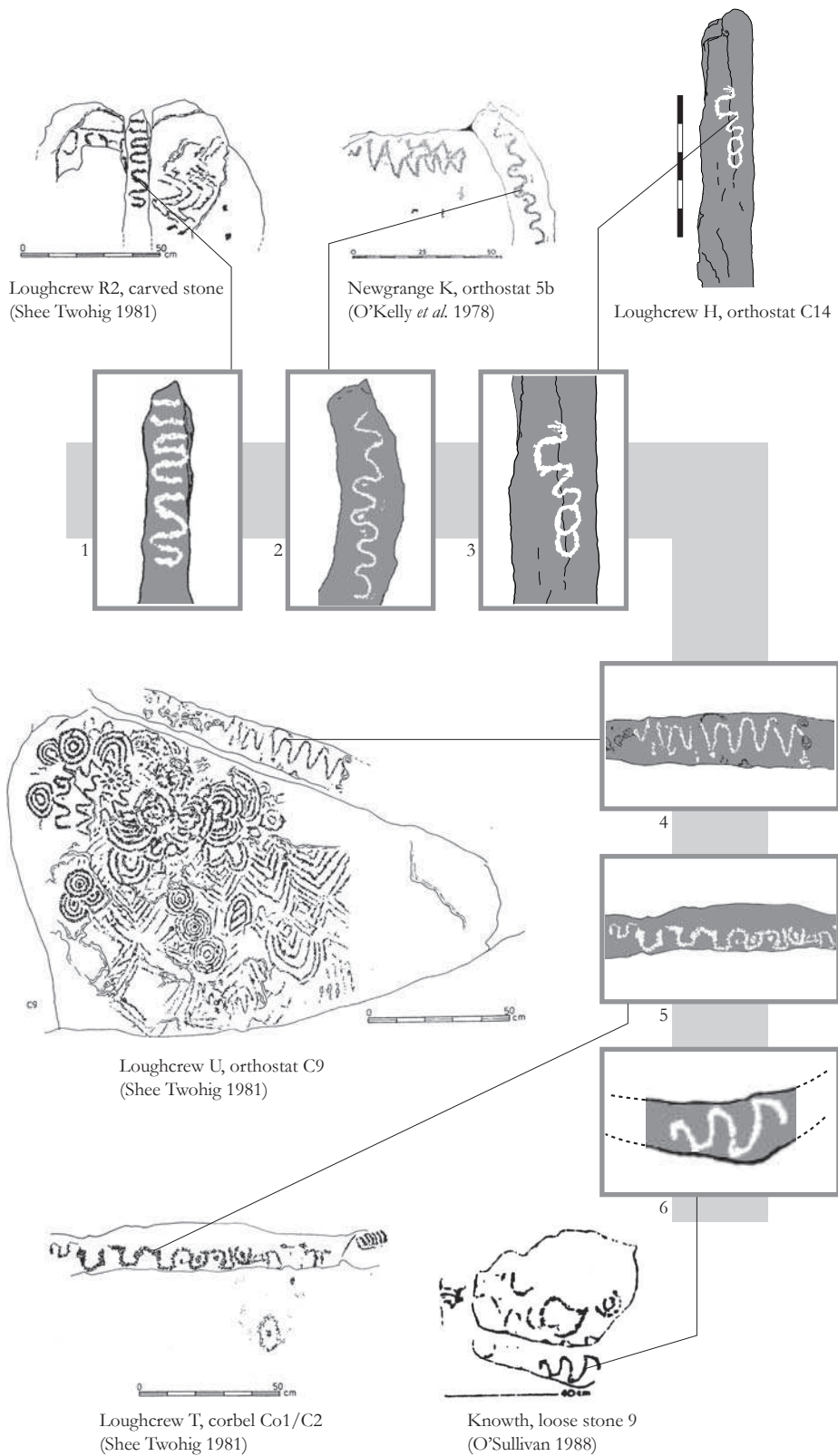


Figure 5.10 : Meandering signs carved along a side face of stone

IRELAND

BRITTANY

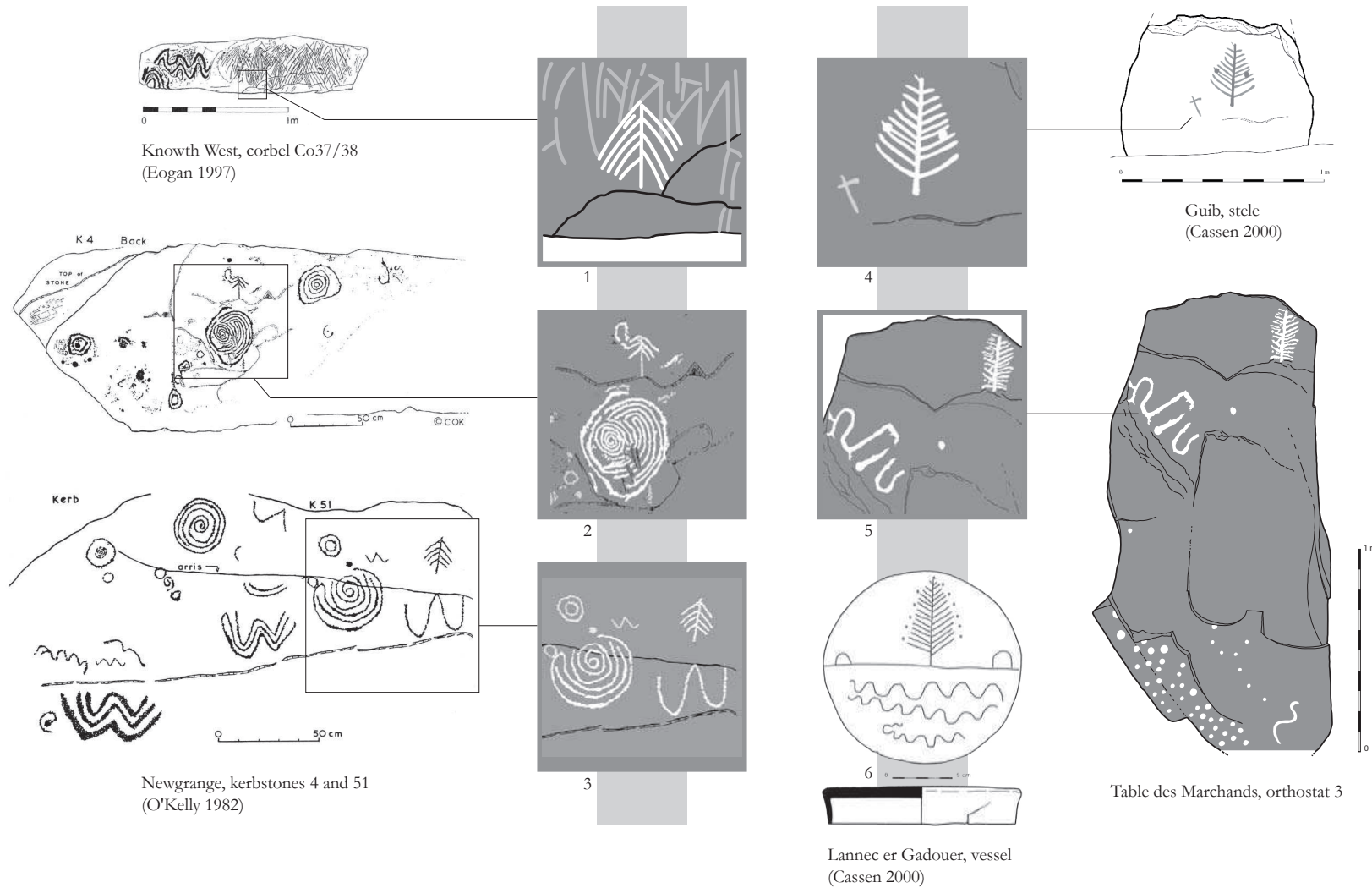
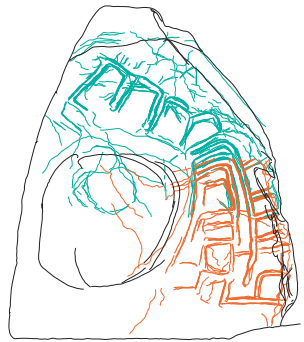
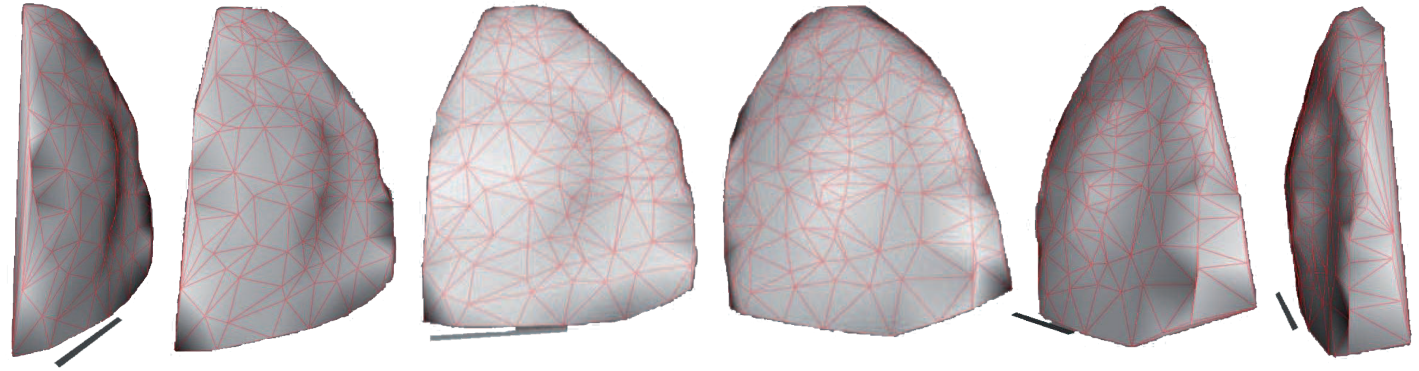


Figure 5.11 : Ramiform motifs on a horizontal natural line



Mané Kerioned B, orthostat 19

M O D E L



T E X T U R E
from photographs with oblique lights



Figure 5.12 : Three-dimensional modelling of orthostat 19 in Mané Kerioned

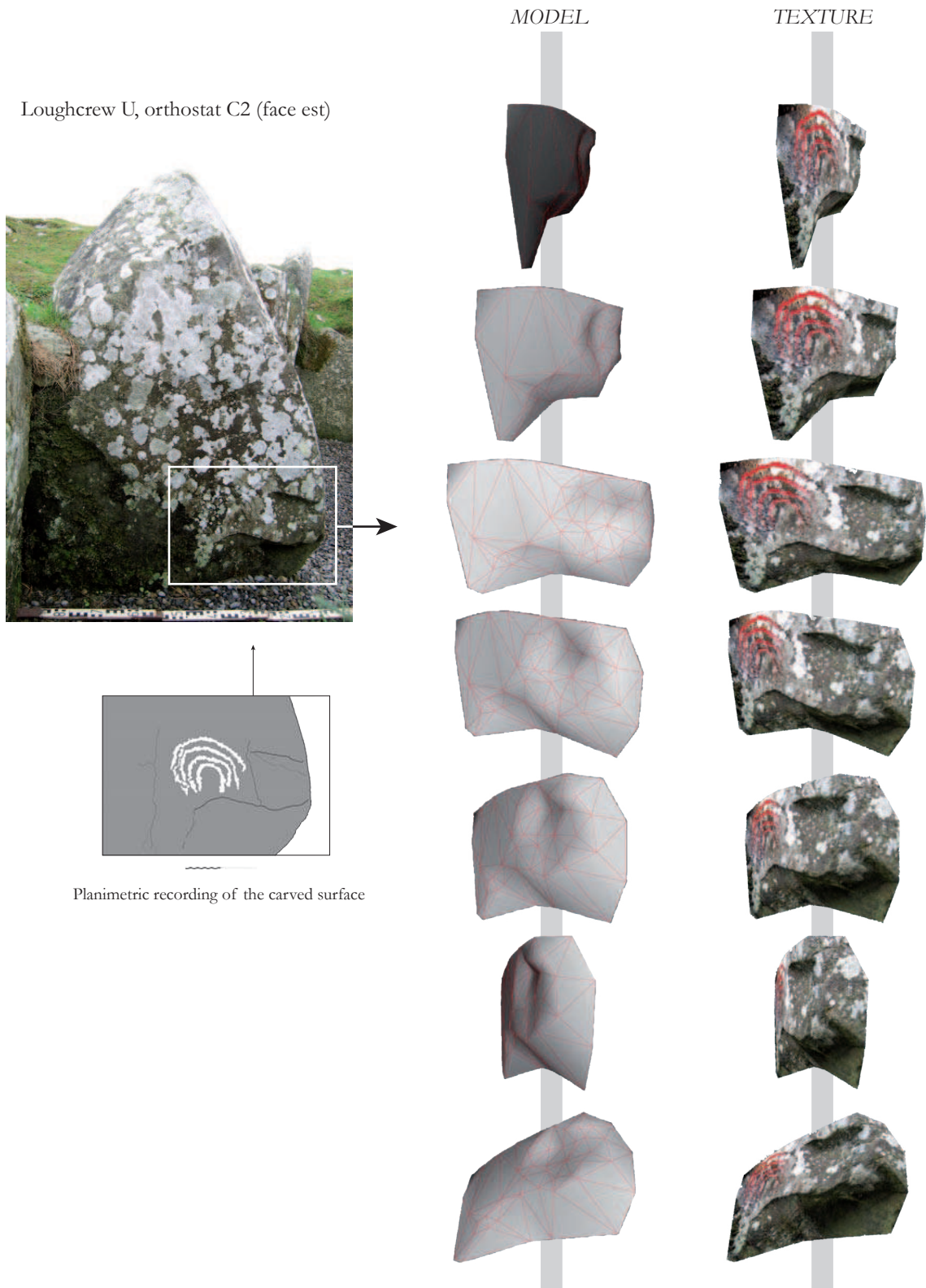
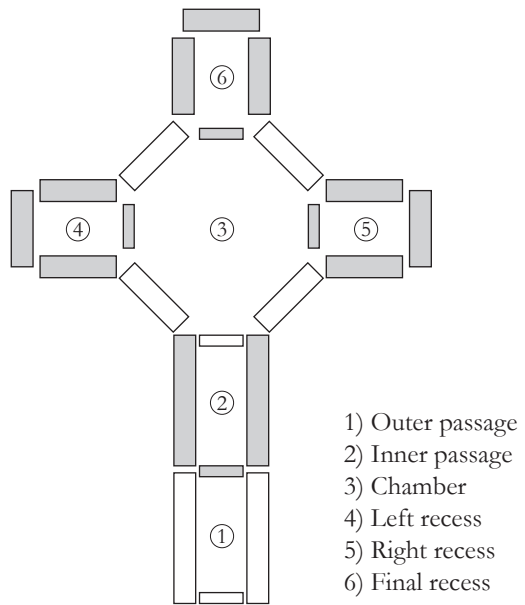


Figure 5.13 : Three-dimensional modelling of orthostat C2 in Loughcrew U

Tomb	Outer passage				Inner passage				Chamber			Left recess					Right recess					Final recess					
	Sill entrance passage	Right wall	Left wall	Roof	Sill middlepassage	Right wall	Left wall	Roof	Sill entrance chamber	Right wall	Left wall	Roof	Sill or lintel	Right wall	Left wall	Back wall	Roof	Sill or lintel	Right wall	Left wall	Back wall	Roof	Sill or lintel	Right wall	Left wall	Back wall	Roof
BgH	-	0%	0%	-	-	0%	0%	-	-	0%	0%	-	0%	0%	30%	0%	0%	0%	30%	0%	0%	0%	0%	0%	0%	0%	0%
Bcd	-	0%	0%	0%	-	0%	0%	0%	-	0%	50%	0%	-	-	-	-	-	-	-	-	-	-	-	-	-	-	-
Cm	-	0%	0%	-	-	0%	0%	-	-	0%	0%	50%	-	-	-	-	-	-	-	-	-	-	-	-	-	-	-
CH	0%	0%	0%	0%	0%	0%	0%	0%	0%	50%	25%	0%	-	-	-	-	-	-	-	-	-	-	-	-	-	-	-
DhN	0%	0%	25%	25%	0%	20%	20%	25%	0%	50%	100%	0%	0%	0%	0%	0%	0%	50%	0%	0%	0%	0%	0%	0%	50%	0%	0%
DhS	0%	100%	0%	50%	0%	50%	0%	0%	0%	66%	28%	-	-	-	-	-	-	50%	100%	100%	100%	0%	-	-	-	-	-
Fk	-	30%	0%	-	-	50%	50%	-	-	14%	25%	-	0%	0%	0%	0%	0%	50%	100%	100%	100%	0%	50%	0%	0%	100%	0%
Km	-	-	-	-	-	-	0%	-	-	100%	100%	-	-	-	-	-	-	-	-	-	-	-	-	-	-	-	-
KrW	-	-	-	-	-	-	-	-	-	50%	33%	-	-	-	-	-	-	-	-	-	-	-	-	-	-	-	-
KhE	-	11%	22%	26%	0%	92%	92%	50%	0%	66%	33%	-	0%	0%	50%	100%	-	100%	100%	100%	100%	-	-	100%	100%	100%	-
KhW	-	7%	11%	12,5%	-	50%	29%	0%	0%	25%	75%	0%	-	-	-	-	-	-	-	-	-	-	-	-	-	-	-
Kh2	-	-	-	-	-	-	-	-	-	-	-	-	-	-	-	-	-	0%	100%	-	0%	-	-	-	-	-	-
Kh14	-	33%	0%	-	-	0%	50%	-	0%	100%	0%	-	-	-	-	-	-	-	-	-	-	-	-	-	-	-	-
Kh15	-	0%	25%	-	0%	0%	0%	-	0%	0%	0%	-	-	-	-	-	-	-	-	-	-	-	100%	100%	-	-	-
Kh16	-	0%	0%	-	0%	0%	25%	-	0%	33%	66%	-	-	-	-	-	-	-	-	-	-	-	0%	50%	50%	0%	-
Kh17	-	-	-	-	-	-	50%	-	-	-	-	-	-	-	-	-	-	-	-	-	100%	-	-	-	-	-	-
Kh18	-	-	-	-	-	-	-	-	-	-	-	-	-	-	-	-	-	-	-	-	-	-	-	100%	-	-	-
LcF	-	50%	50%	-	-	50%	100%	-	-	-	-	-	0%	0%	100%	0%	-	-	0%	0%	0%	-	0%	0%	0%	100%	-
LcH	0%	-	-	-	0%	50%	50%	-	-	0%	0%	-	-	50%	0%	0%	-	100%	50%	50%	0%	-	-	50%	0%	0%	-
LcI	-	-	-	-	-	50%	0%	-	-	-	-	-	-	50%	50%	50%	-	-	100%	50%	0%	-	-	0%	0%	0%	-
LcL	0%	50%	50%	-	-	100%	100%	-	-	-	-	-	0%	100%	100%	50%	-	-	66%	66%	50%	-	50%	0%	100%	100%	-
LcS	-	50%	0%	-	0%	0%	100%	-	0%	50%	50%	-	-	-	100%	0%	-	0%	-	-	-	-	-	-	-	-	-
LcT	-	33%	100%	0%	-	66%	100%	0%	100%	100%	100%	-	0%	100%	100%	100%	-	0%	100%	100%	0%	-	100%	100%	100%	50%	100%
LcU	0%	0%	0%	-	-	100%	100%	-	-	-	-	-	-	100%	100%	50%	-	-	100%	100%	100%	-	-	100%	100%	100%	-
LcV	-	-	-	-	-	-	-	-	-	-	-	-	-	50%	100%	-	-	-	0%	-	50%	-	0%	-	-	0%	-
LcW	-	-	-	-	-	100%	-	-	-	0%	66%	-	-	-	-	-	-	-	-	-	-	-	-	-	-	-	-
Ng	-	36%	0%	55%	-	50%	60%	12,5%	-	50%	0%	-	-	100%	100%	100%	0%	-	100%	0%	0%	100%	-	50%	0%	100%	50%
NgK	0%	0%	50%	-	0%	50%	33%	-	-	0%	100%	-	-	-	-	-	-	100%	0%	0%	0%	-	-	-	-	-	-
NgL	-	-	-	-	-	-	-	-	-	-	-	-	-	100%	-	0%	-	-	-	-	-	-	-	0%	100%	0%	-
SK	-	-	-	-	-	-	-	-	-	33%	80%	-	-	-	-	-	-	-	-	-	-	-	-	-	-	-	-
Total	0%	21%	18%	21%	0%	40%	42%	11%	10%	37%	44%	10%	0%	50%	64%	35%	0%	45%	63%	51%	37,5%	20%	33%	43%	46%	46%	30%

Figure 6.1 : Table of distribution of carved surfaces in passage tombs

Model of passage tomb decomposed into six spatial elements



- 1) Outer passage
- 2) Inner passage
- 3) Chamber
- 4) Left recess
- 5) Right recess
- 6) Final recess

Distribution of the carved surfaces inside passage tombs

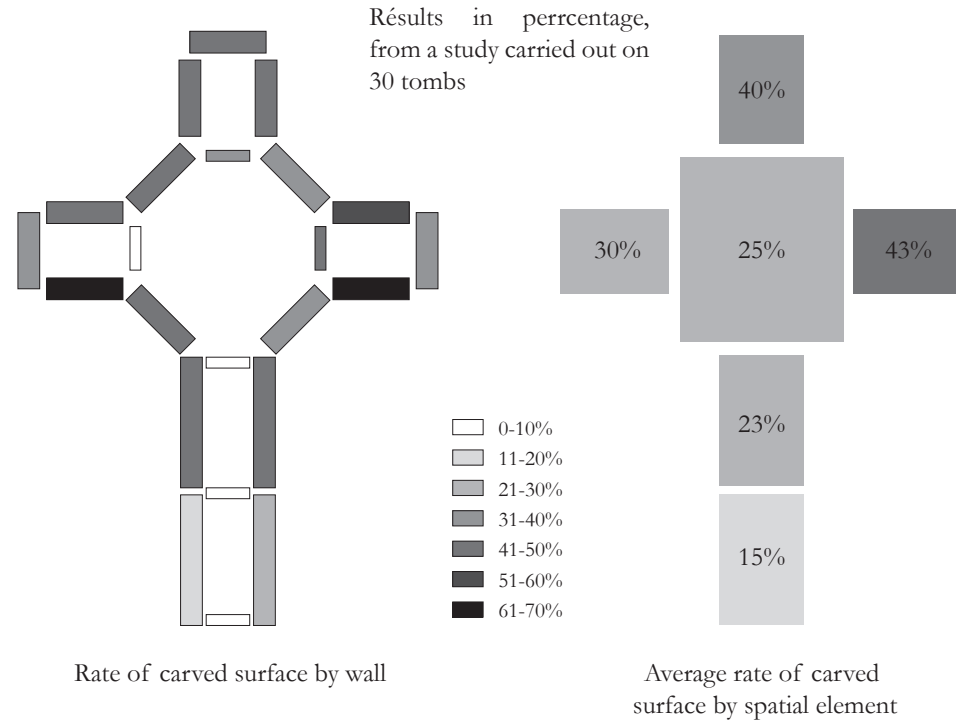


Figure 6.2 : Modelled representation of the distribution of the carved surfaces in passage tombs

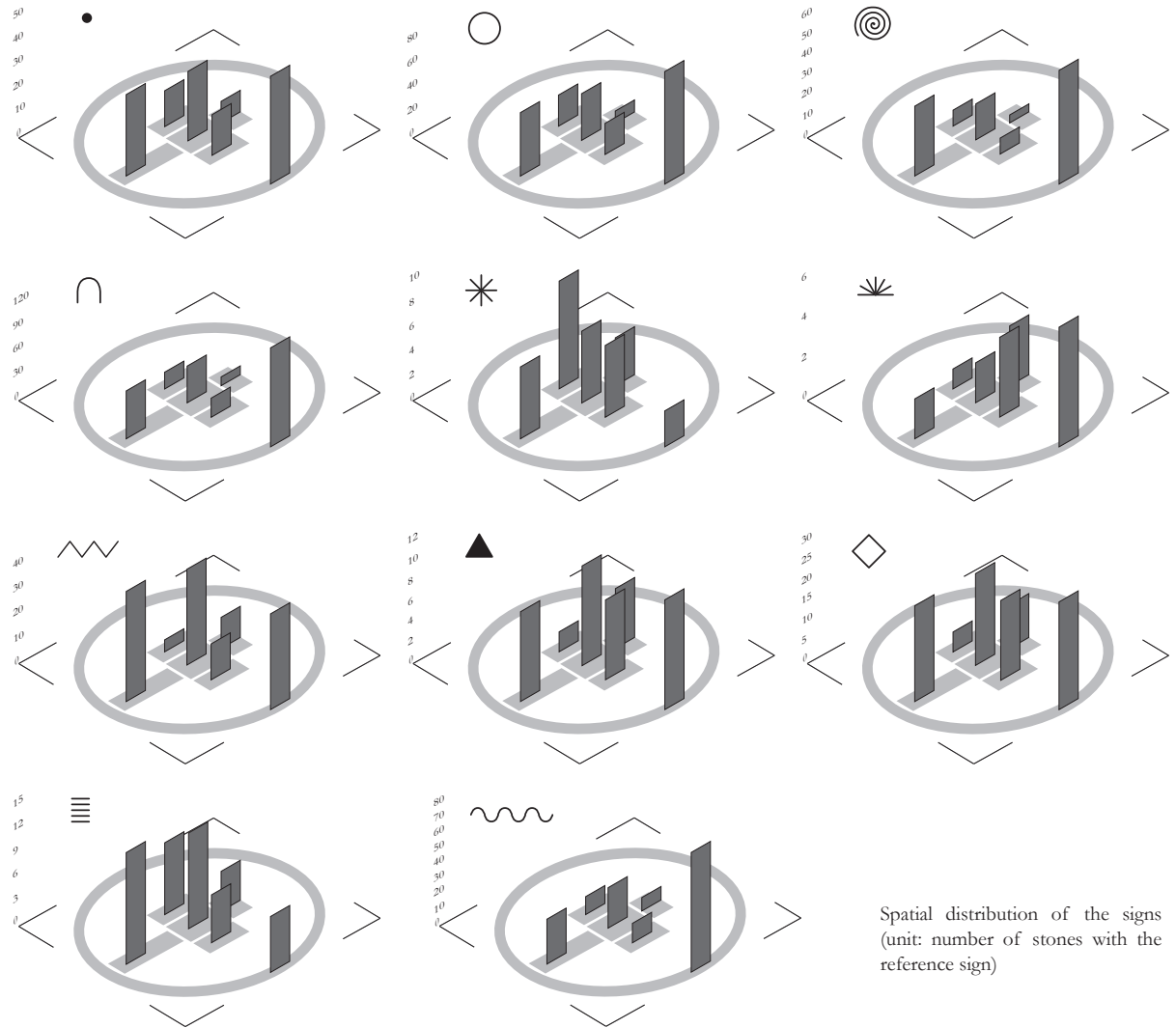
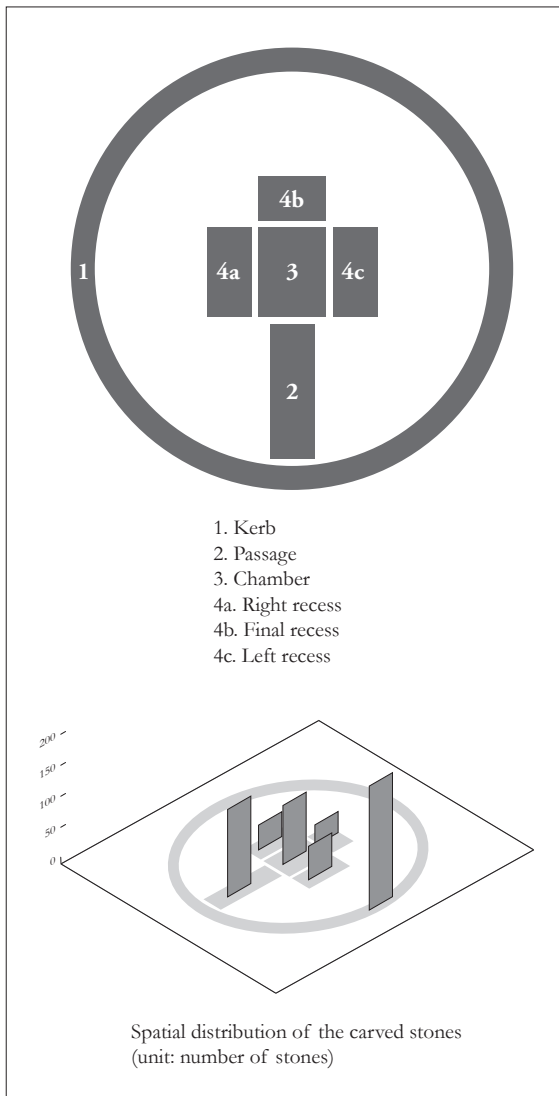


Figure 6.3 : Spatial distribution of the signs in passage tombs

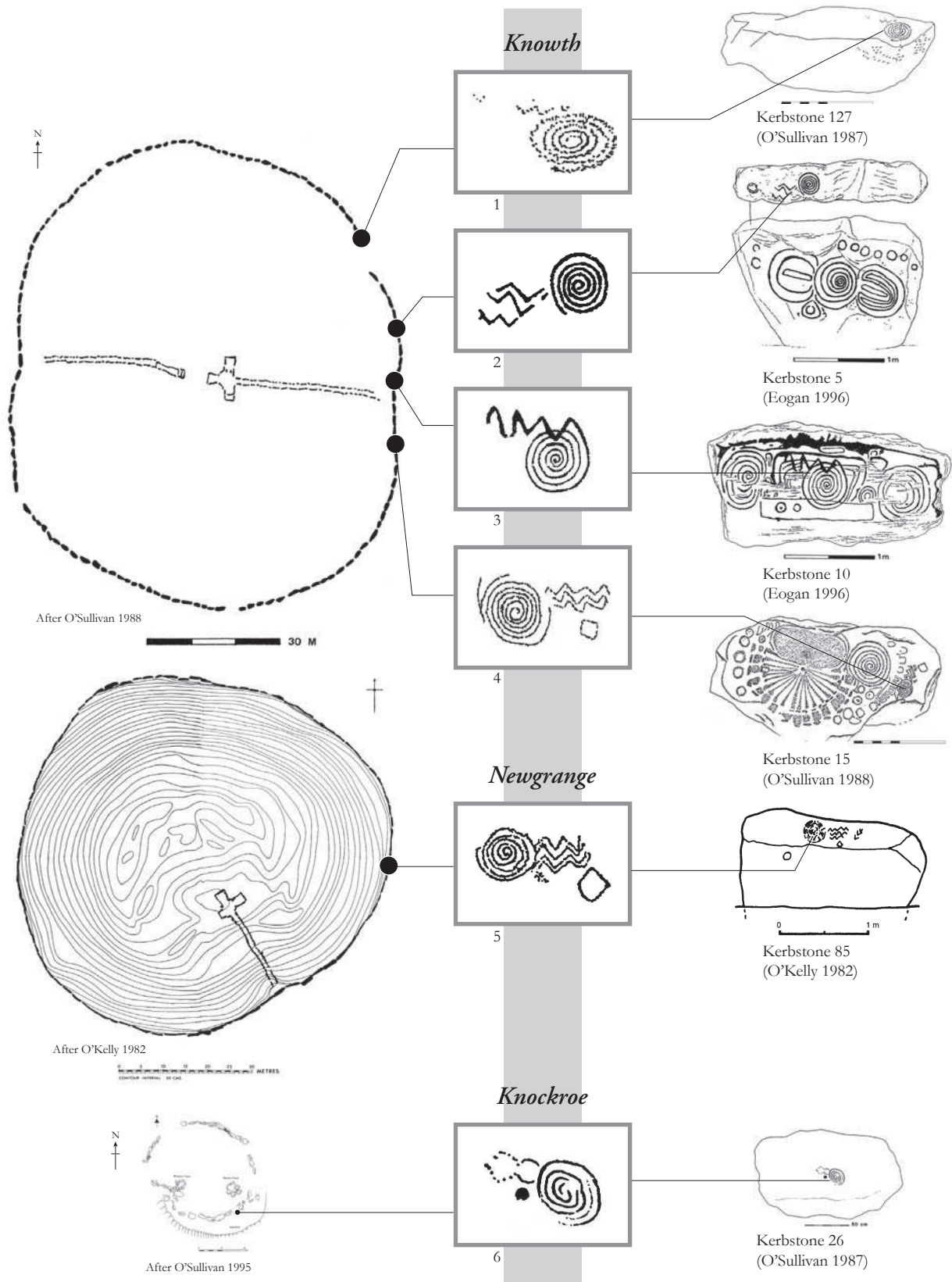


Figure 6.4 : Combination of spiral and chevrons in the eastern part of the kerb

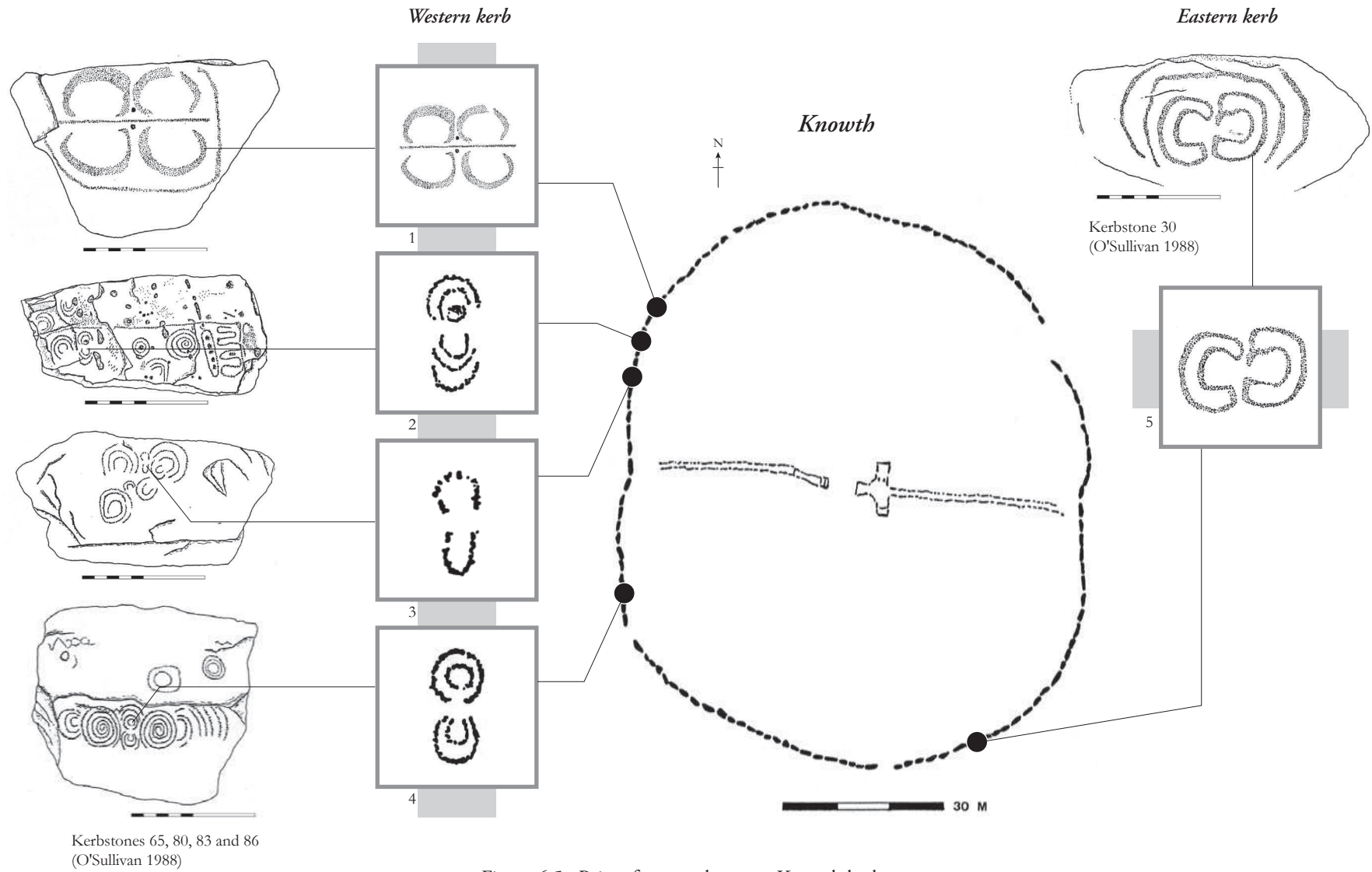


Figure 6.5 : Pairs of opposed arcs on Knowth kerb

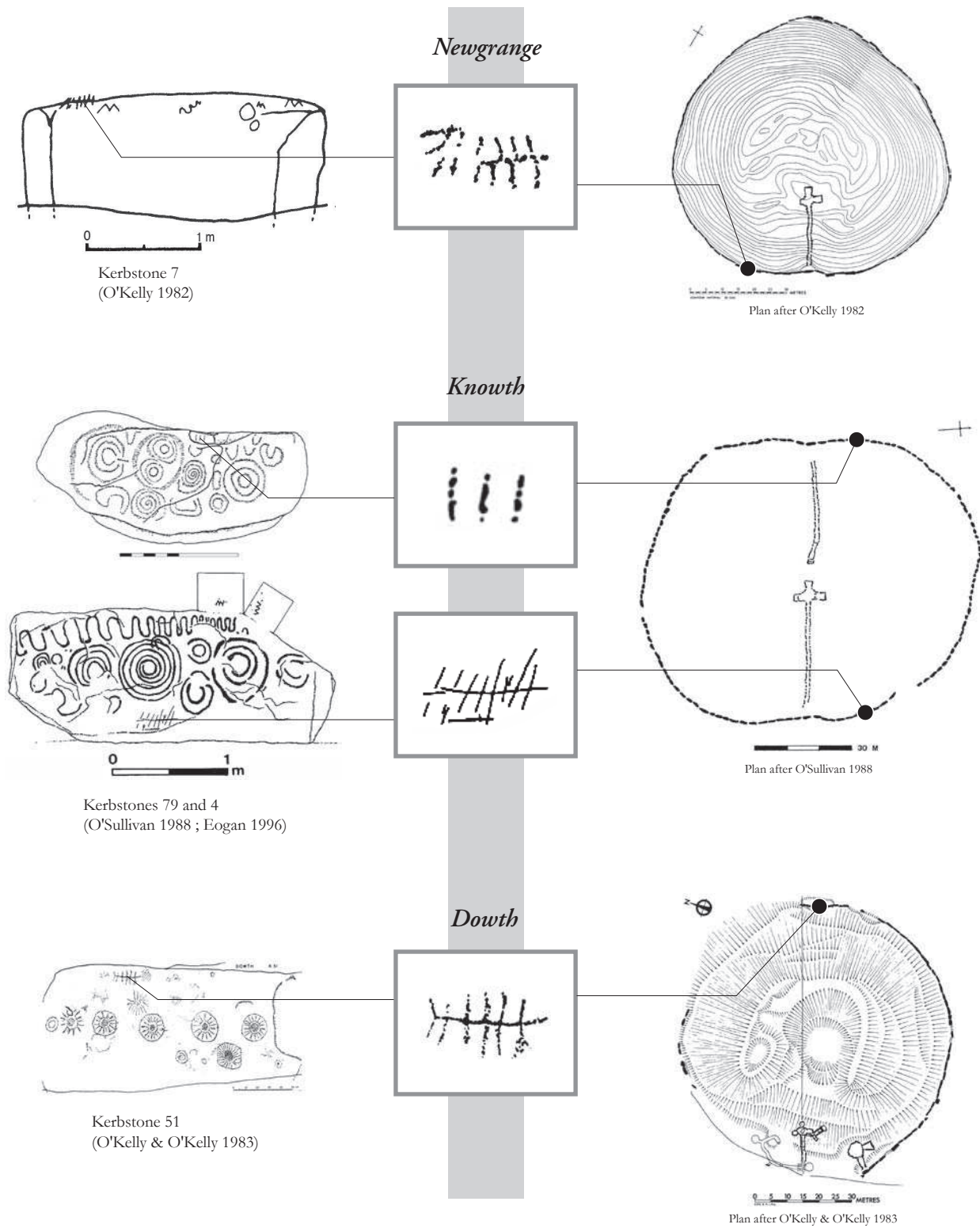


Figure 6.6 : Scalariform signs on the kerb of Newgrange, Knowth and Dowth

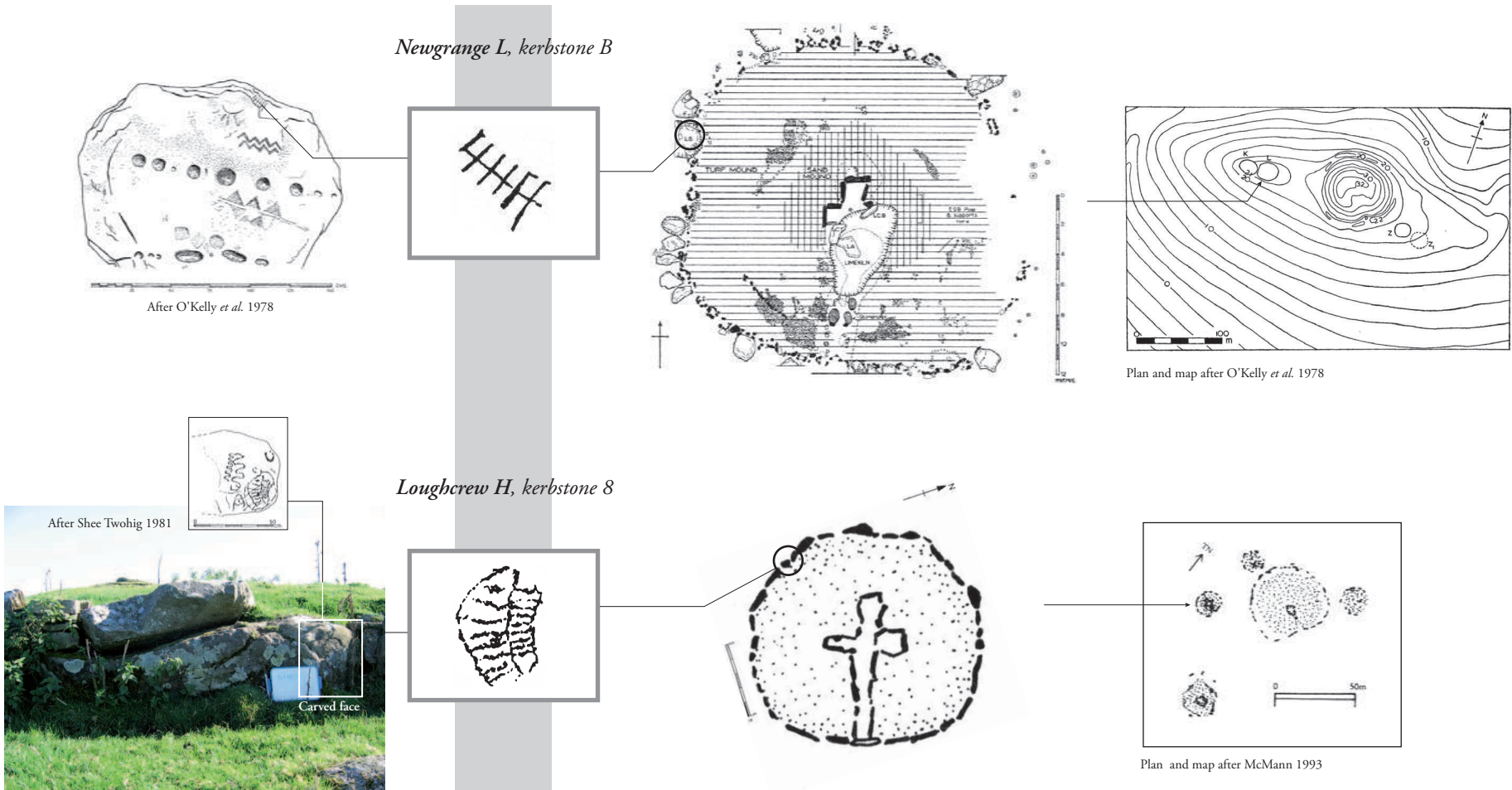


Figure 6.7 : Scalariform signs on the kerb of Newgrange L and Loughcrew H

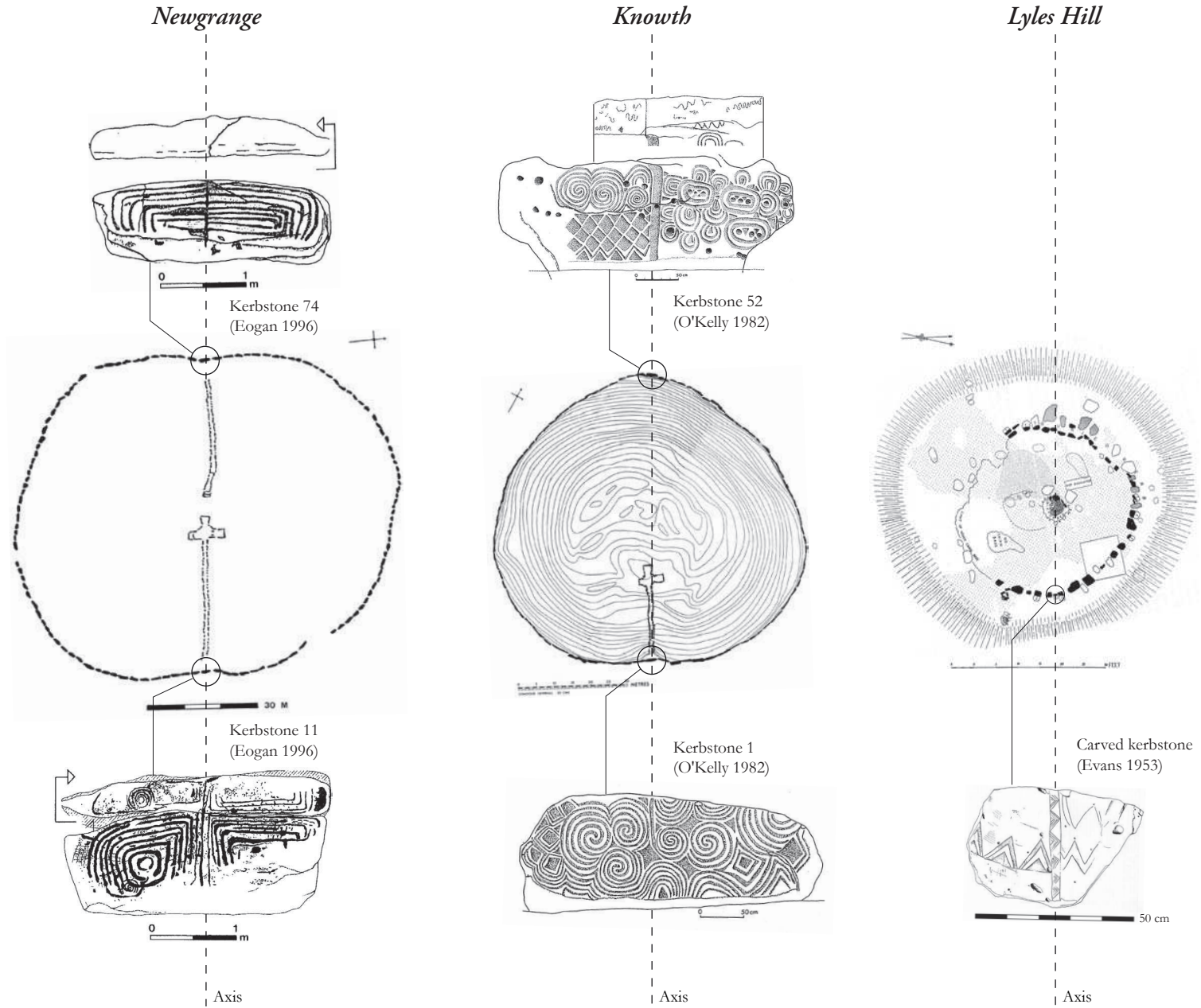
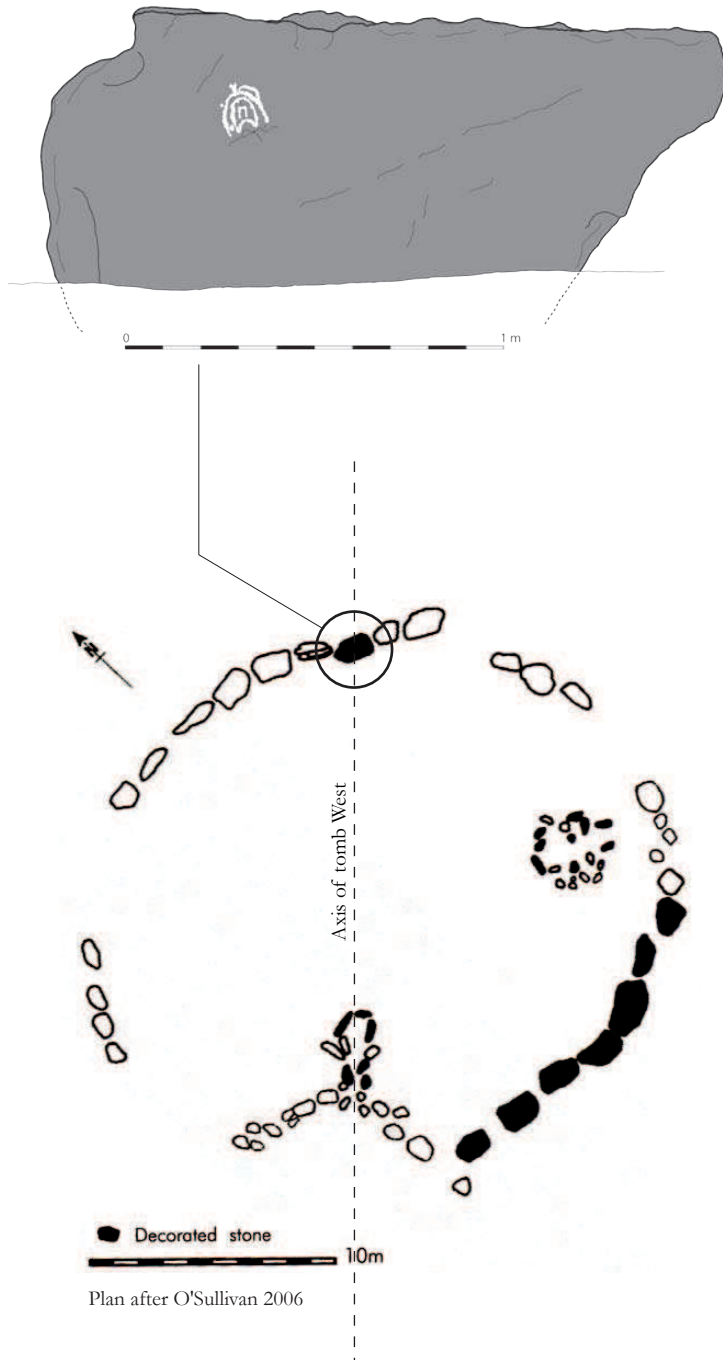


Figure 6.8 : The axis represented by a carved vertical central line

Knockroe, kerbstone 15



View of the kerbstone from North with tomb West in the background



View of tomb West from South with kerbstone K15 signalled in its axis

Figure 6.9 : Knockroe : the axis of the western tomb and kerbstone 15

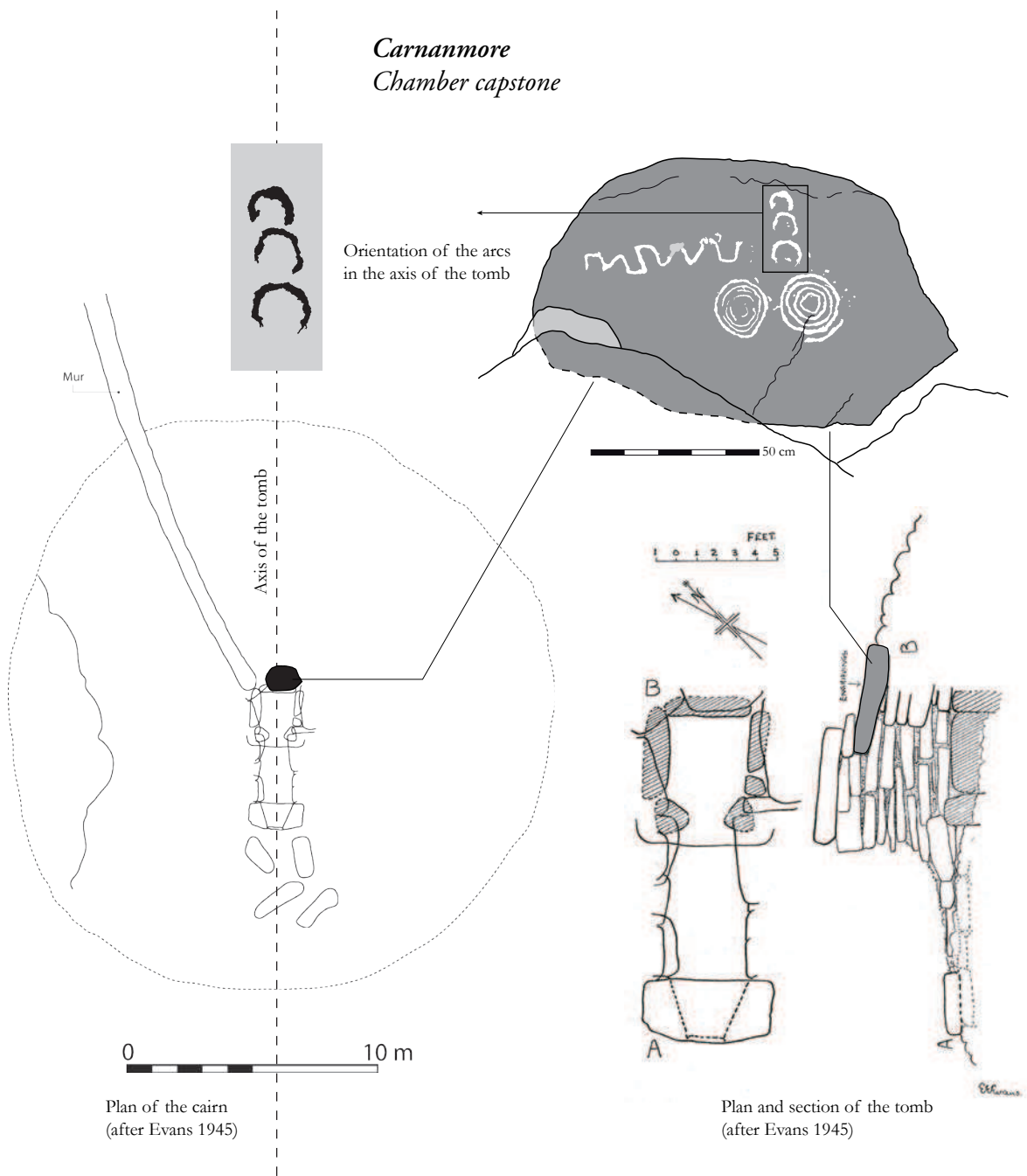


Figure 6.10 : Carnanmore : lines of single arcs oriented in the tomb axis

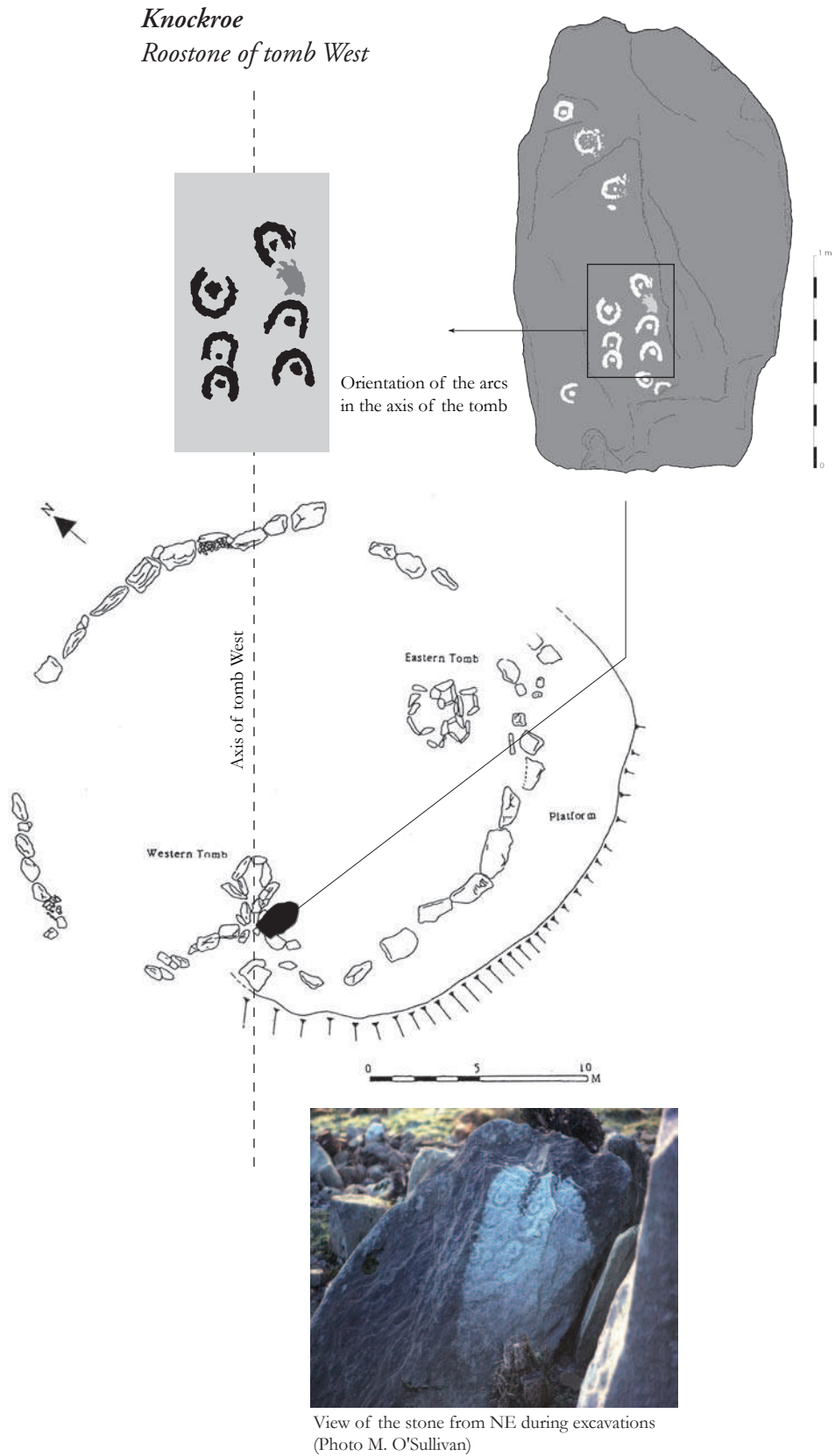


Figure 6.11 : Knockroe West : lines of single arcs oriented in the tomb axis

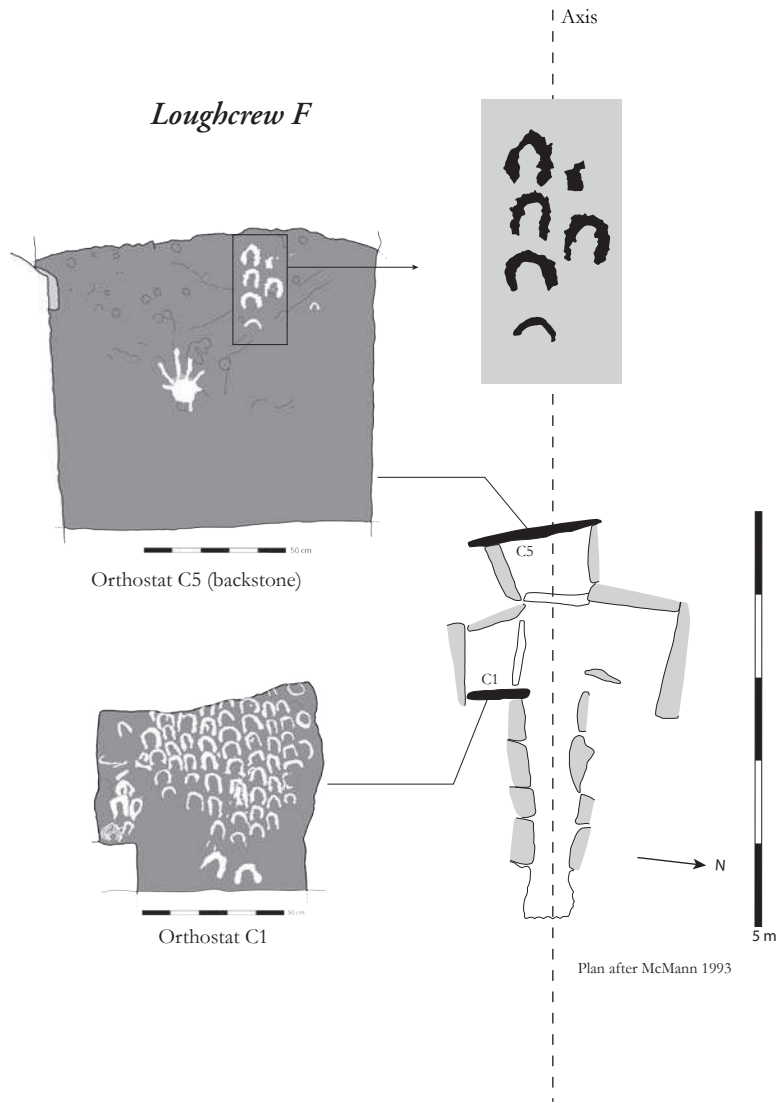


Figure 6.12 : Loughcrew F : lines of single arcs oriented in the tomb axis

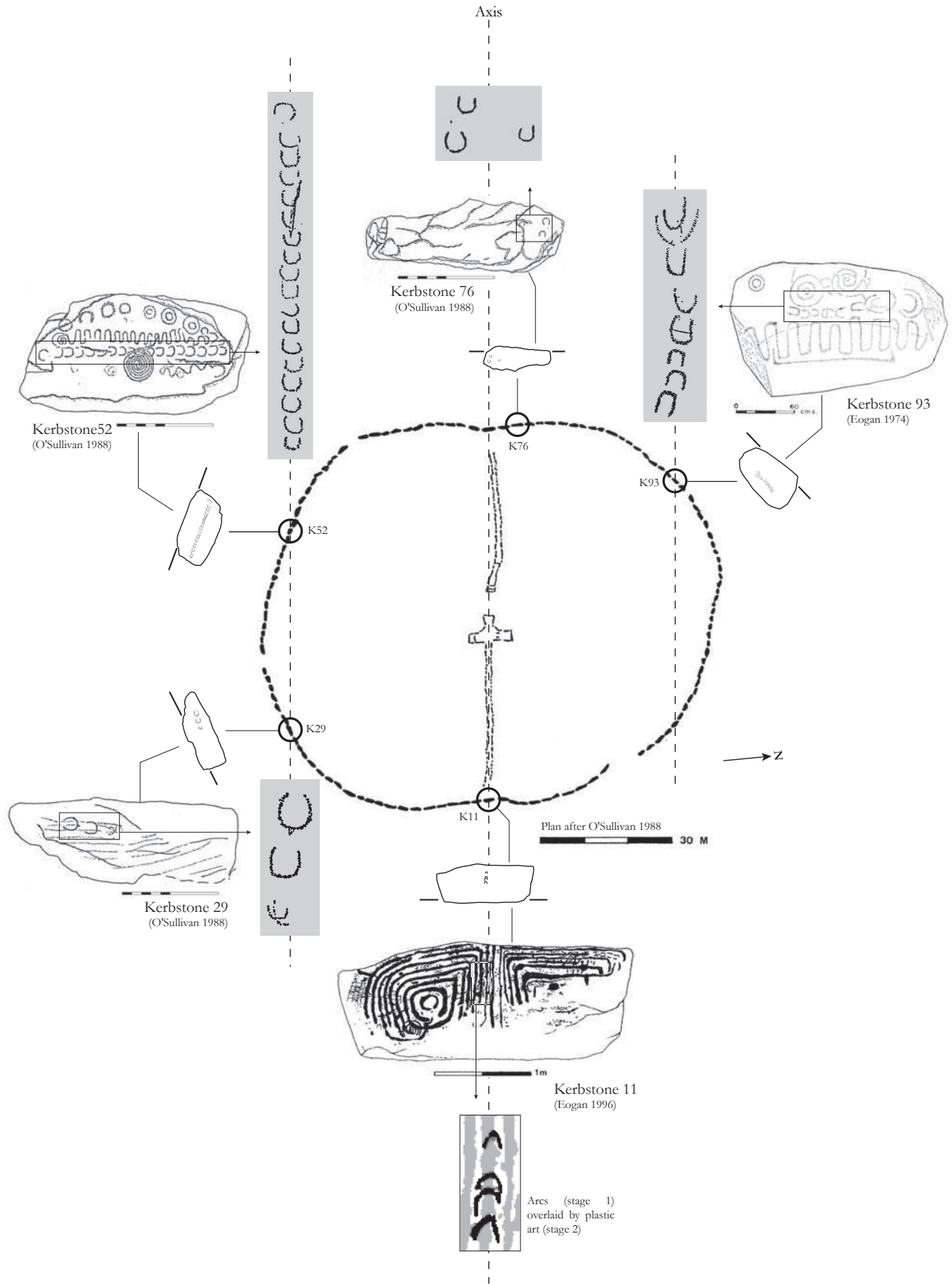


Figure 6.13 : Knowth kerb : lines of single arcs oriented in the tombs axis

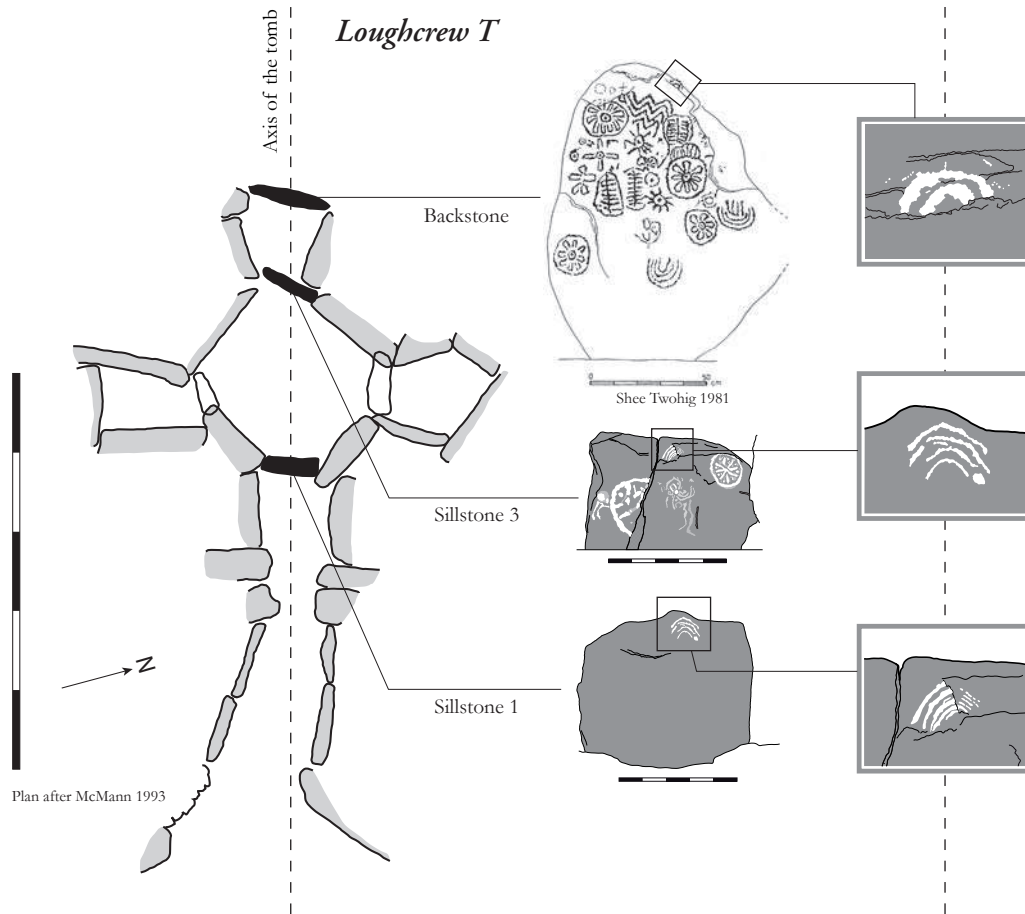


Figure 6.14 : Loughcrew T : boxed arcs motif repeated along the axis

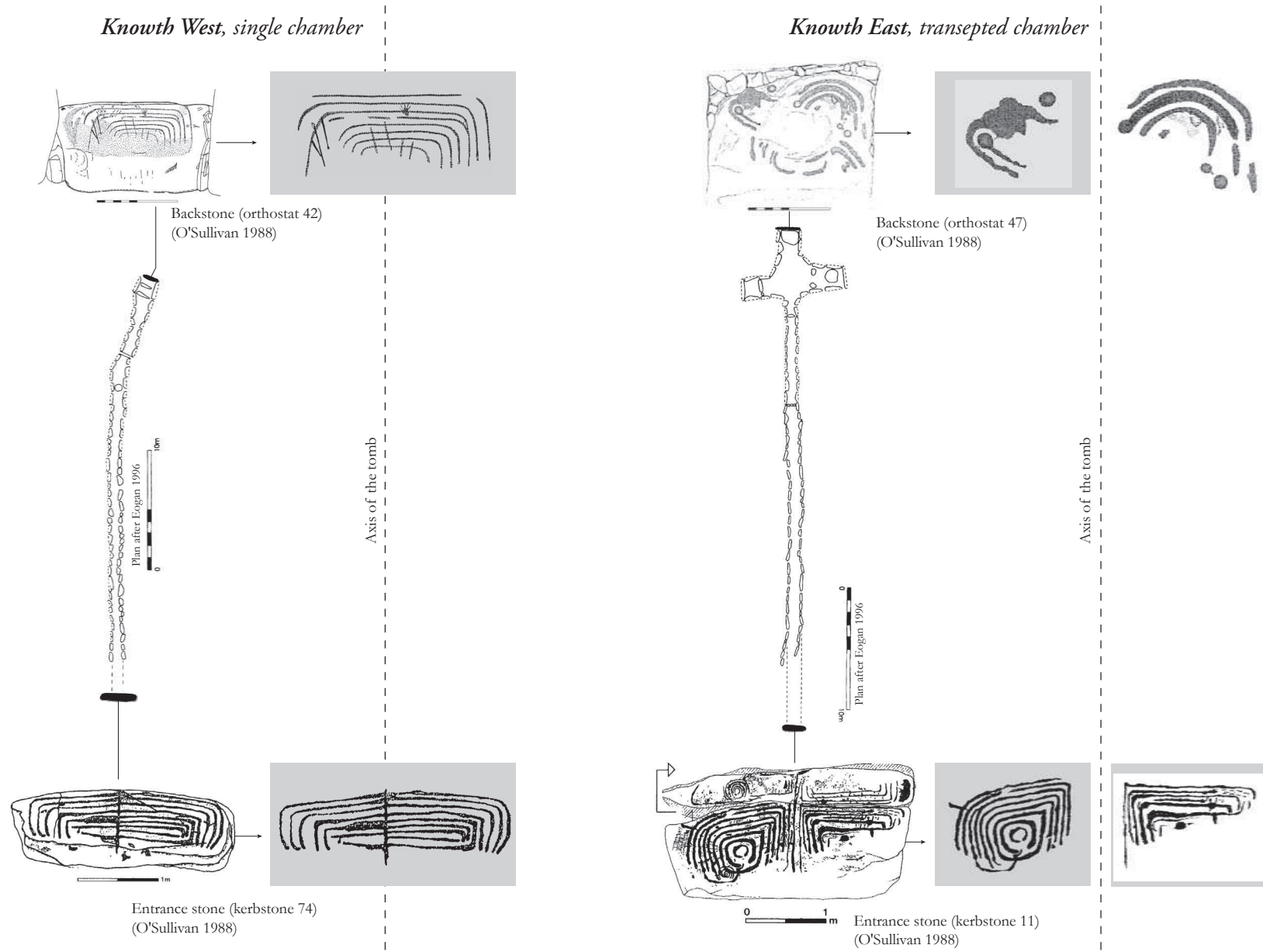


Figure 6.15 : Knowth East and West : boxed arcs motif repeated along the axis

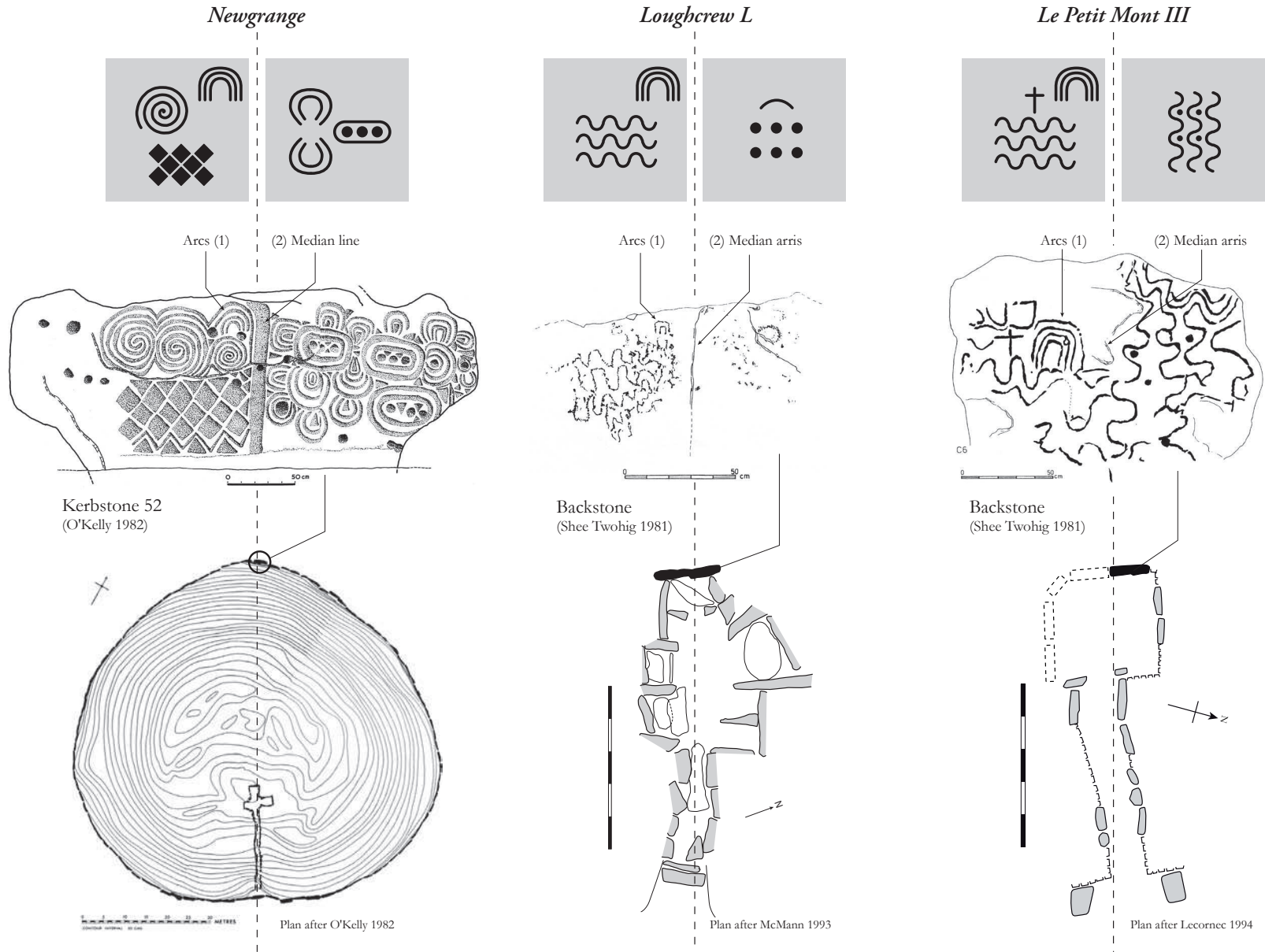


Figure 6.16 : Opposition of group of signs on each side of the axis

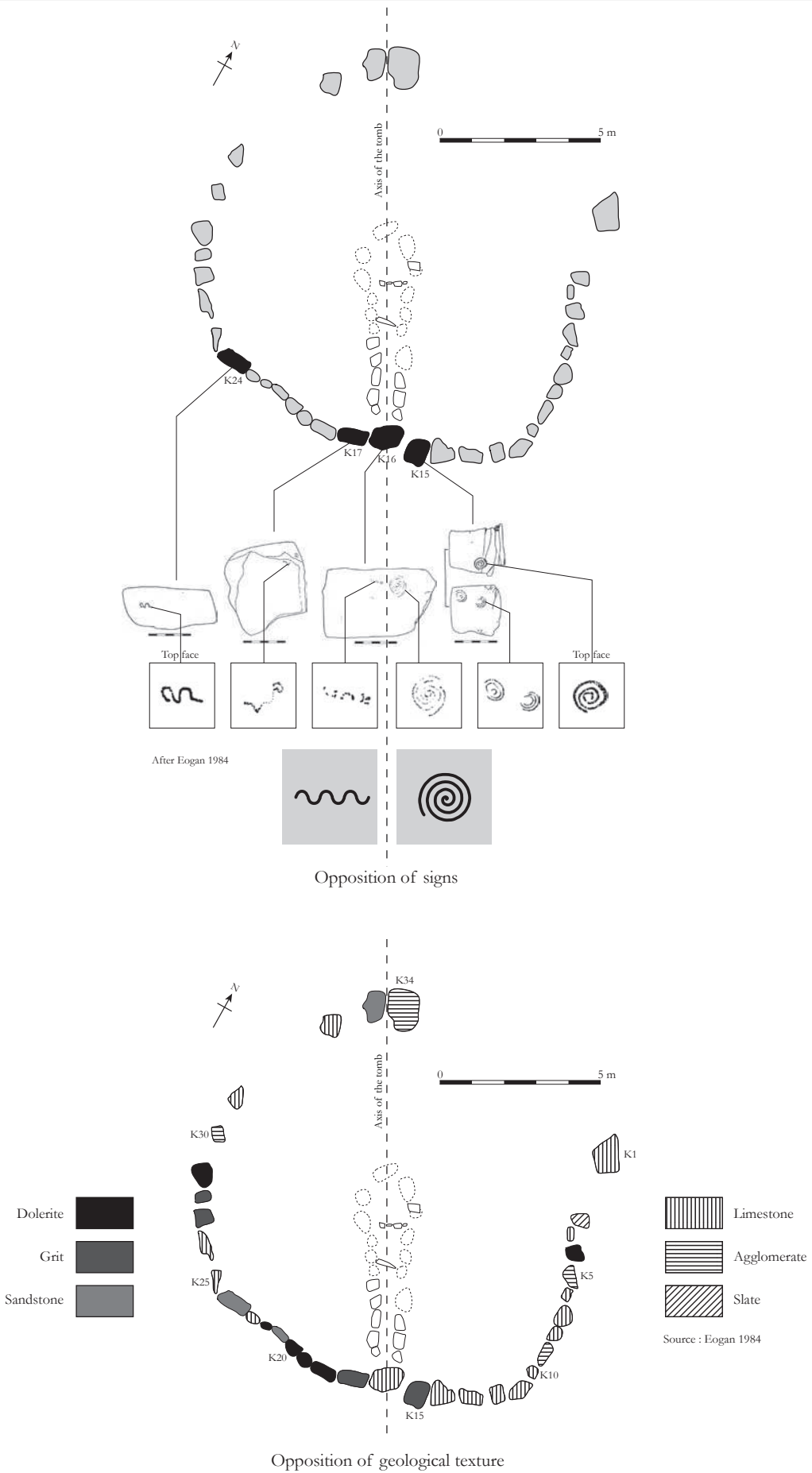


Figure 6.17 : Knowth 13 : opposition of signs and geological textures

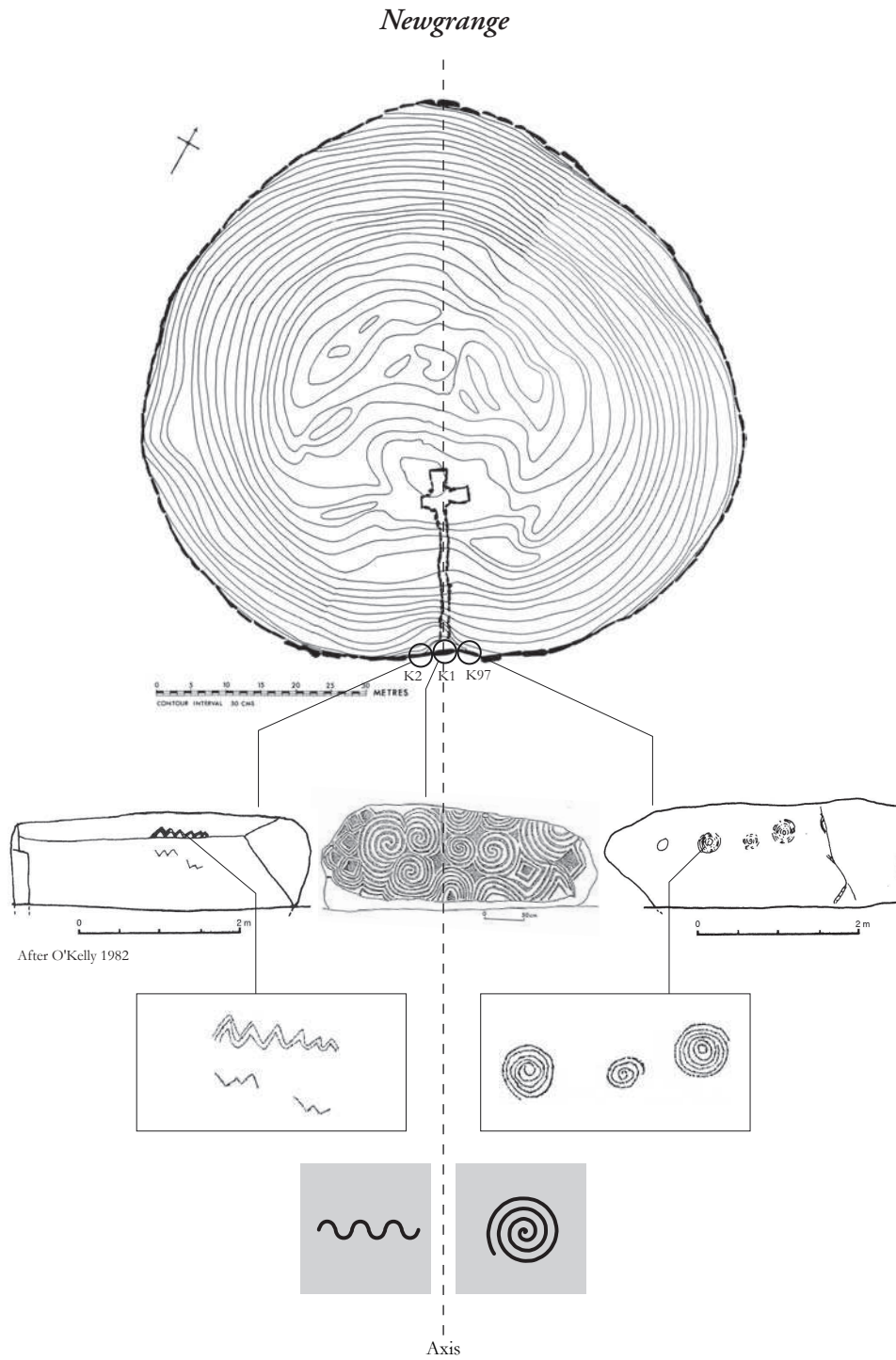


Figure 6.18 : Newgrange : opposition between spiral and meandering signs

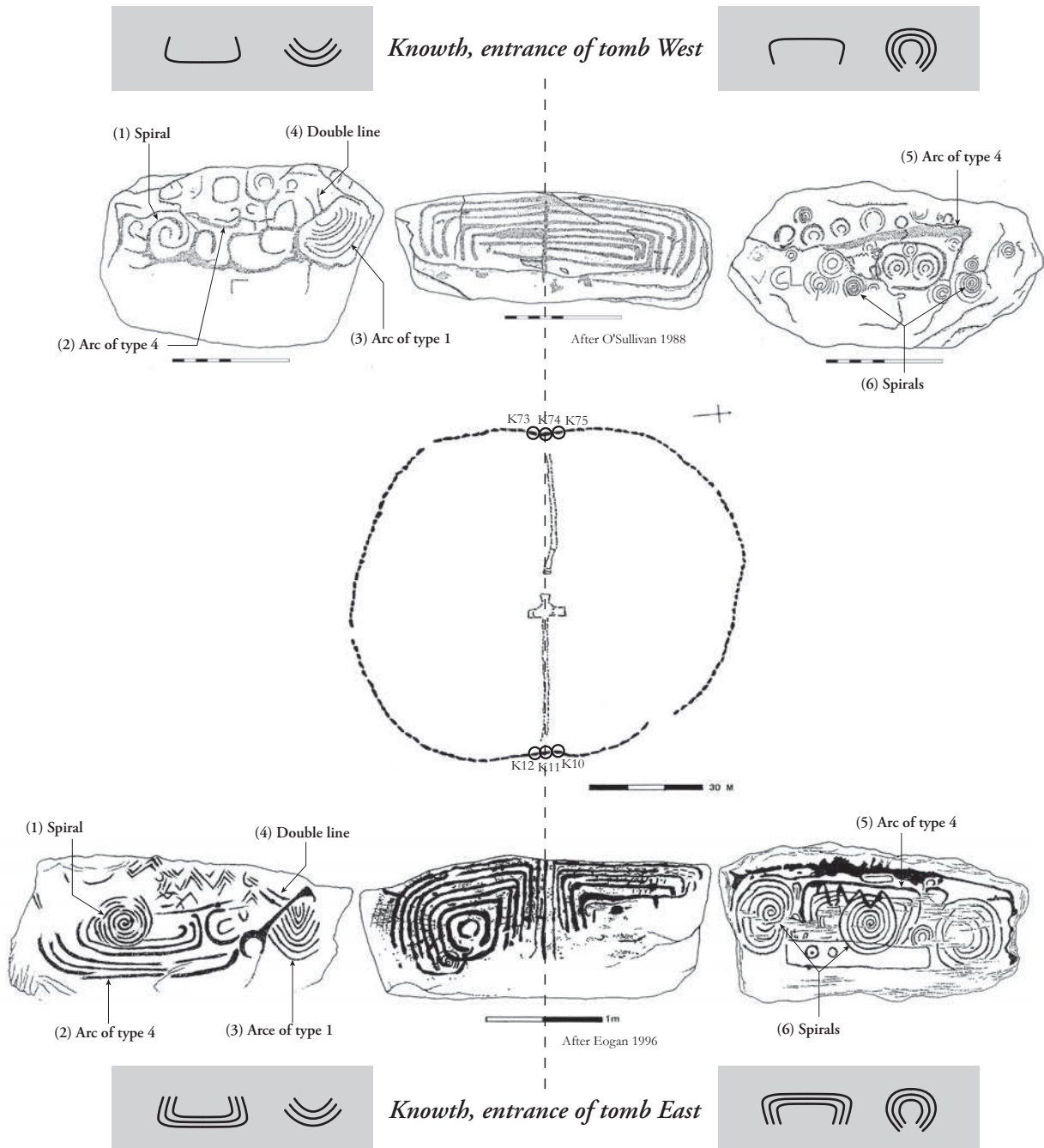


Figure 6.19 : Opposition in the orientation of arcs at the entrance of Knowth East and Knowth West

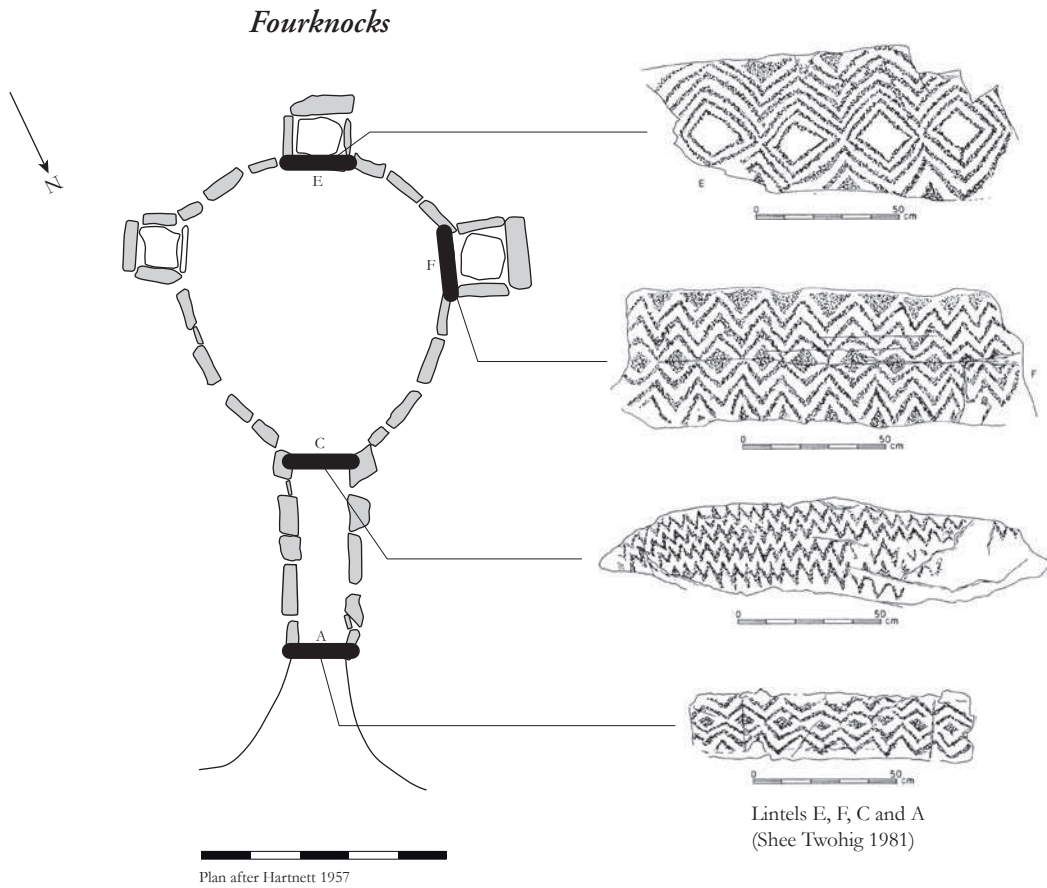


Figure 6.20 : Parallel lines of chevrons and internal limits in Fourknocks

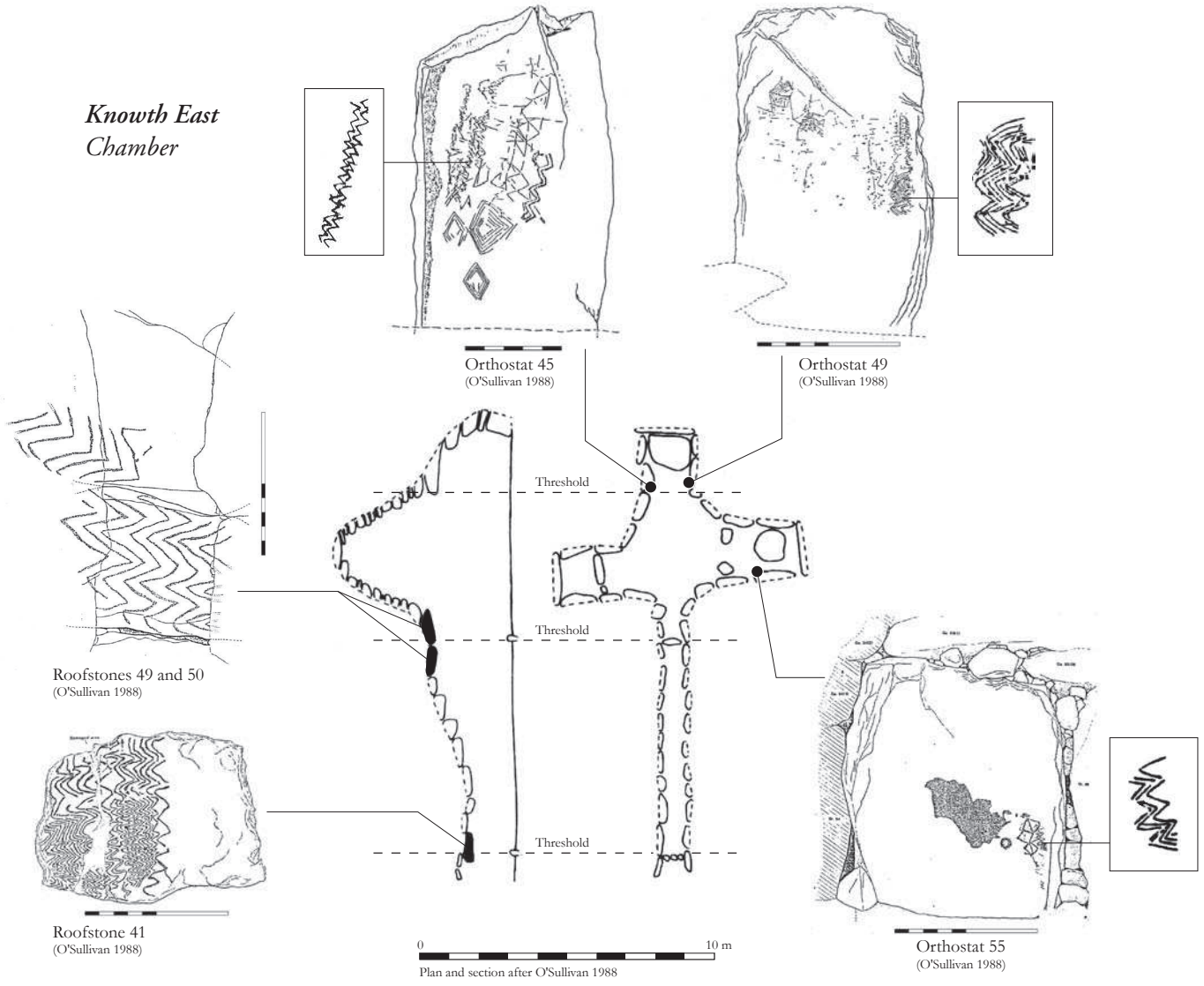


Figure 6.21 : Parallel lines of chevrons and internal limits in Knowth East

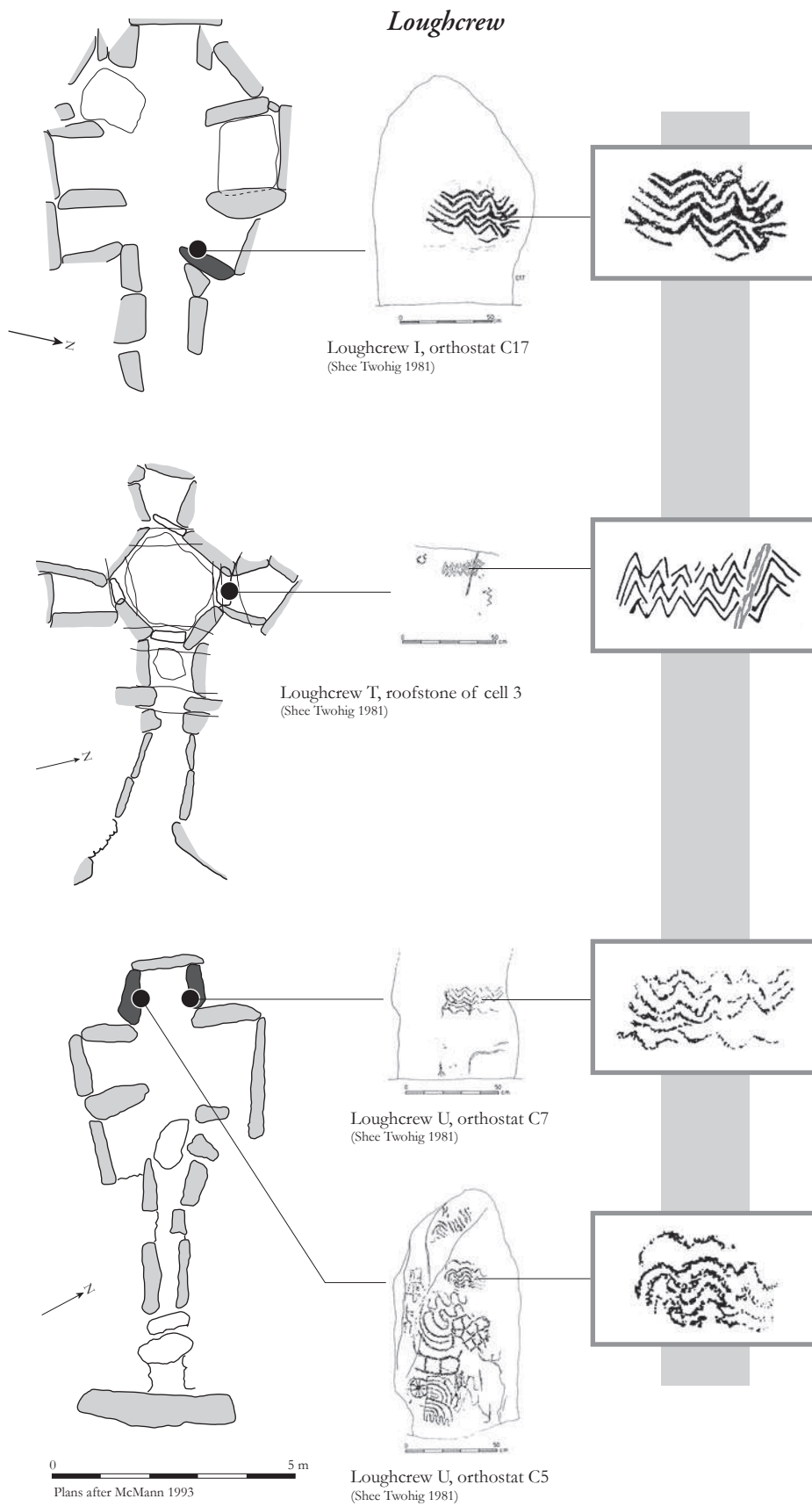


Figure 6.22 : Parallel lines of chevrons and internal limits in Loughcrew

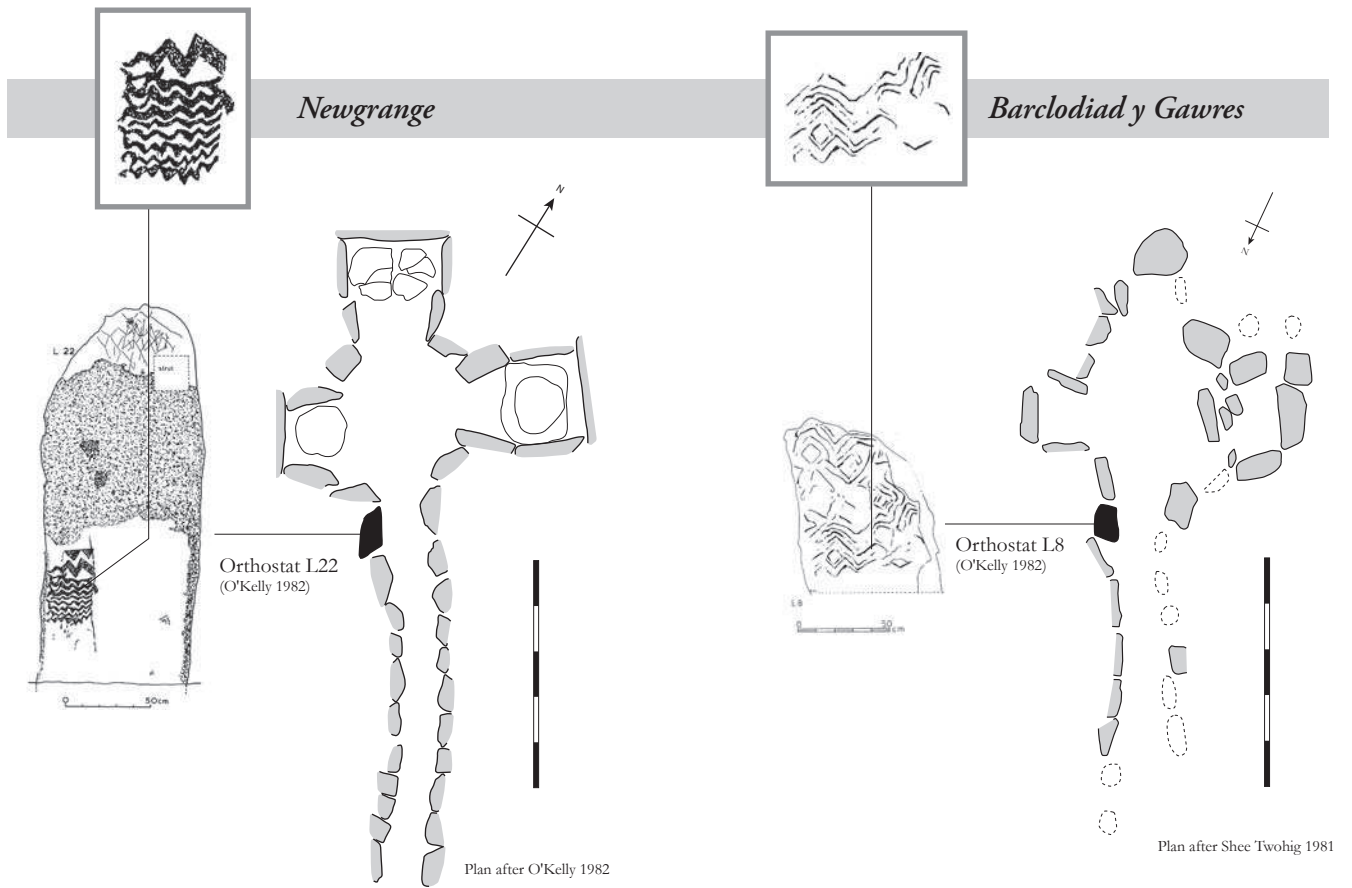


Figure 6.23 : Parallel lines of chevrons and internal limits in Newgrange and Barclodiad y Gawres

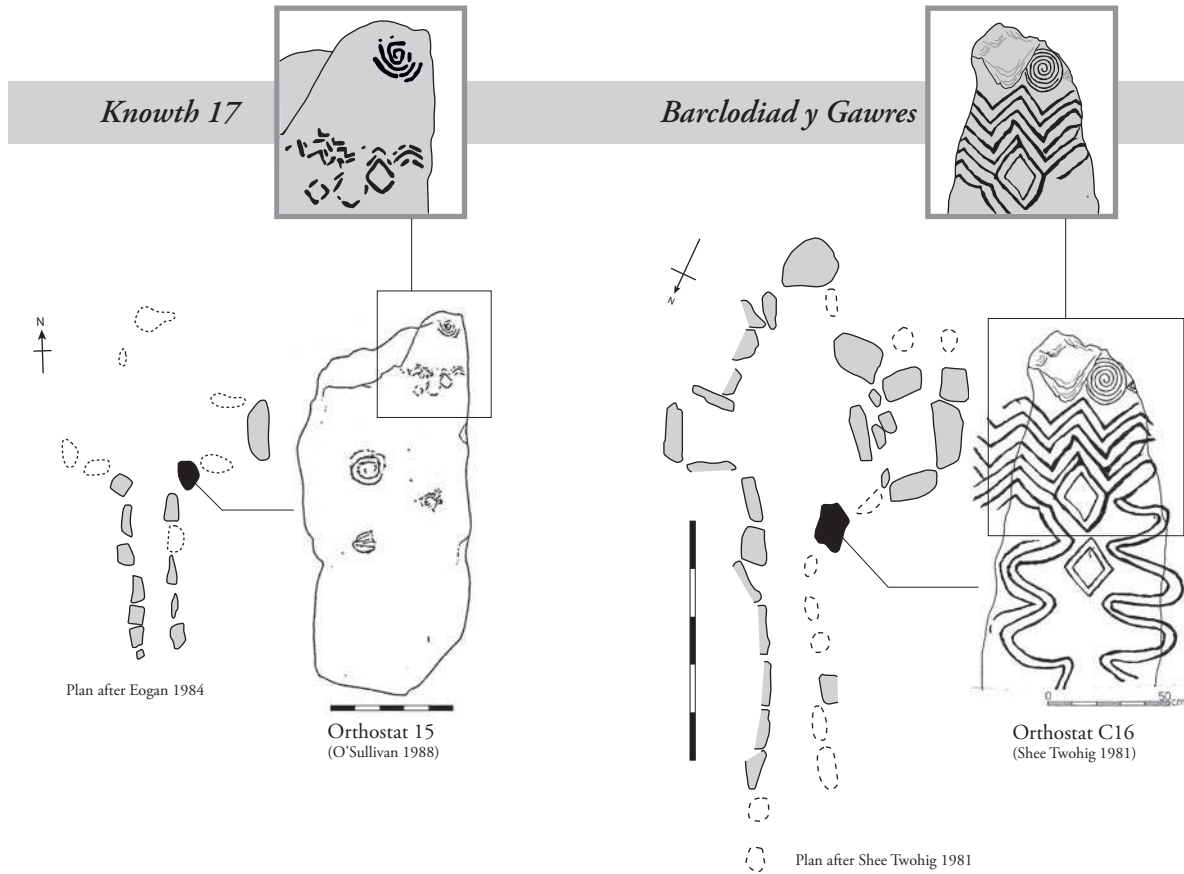


Figure 6.24 : Combination of spiral, chevrons and lozenges at the passage-chamber junction in Knowth 17 and Barclodiad y Gawres

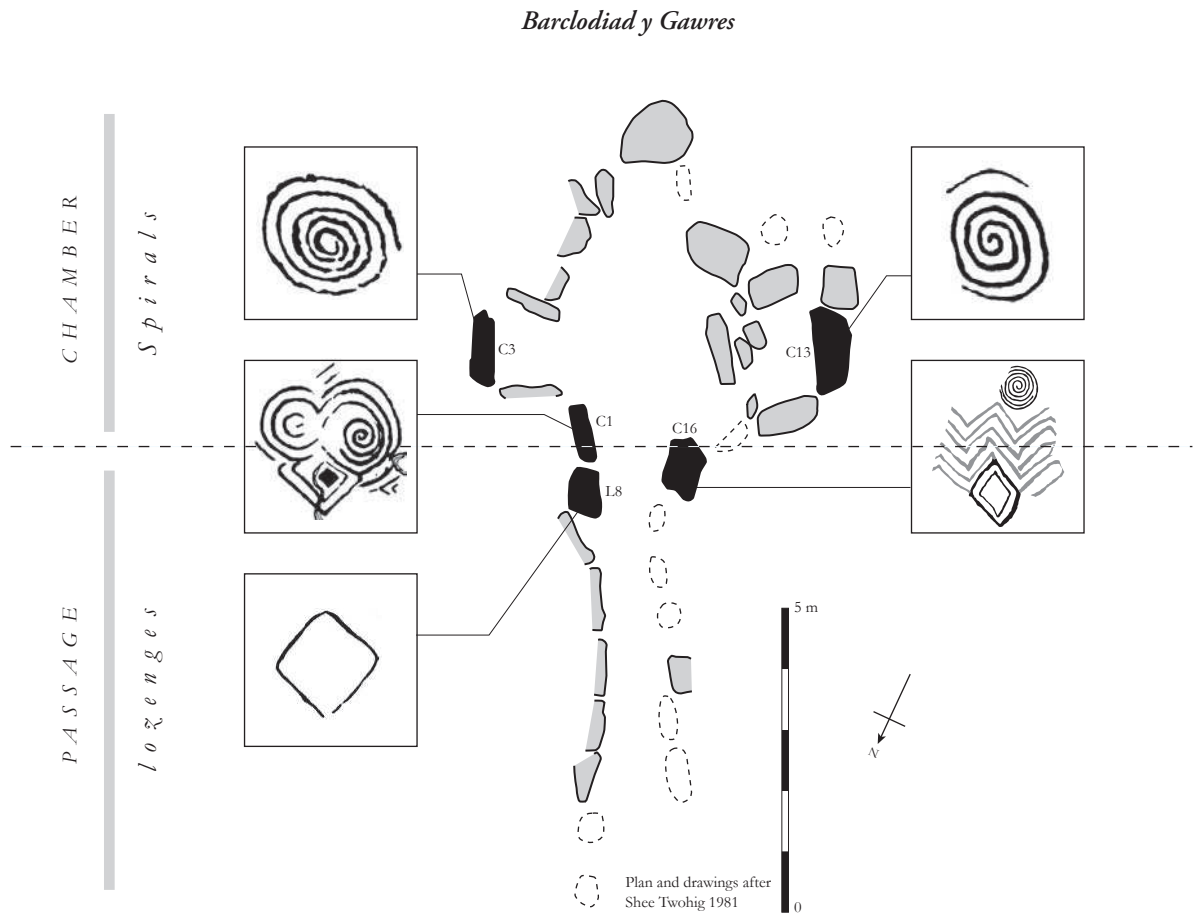


Figure 6.25 : Distribution of the spirals, chevrons and lozenges in Barclodiad y Gawres

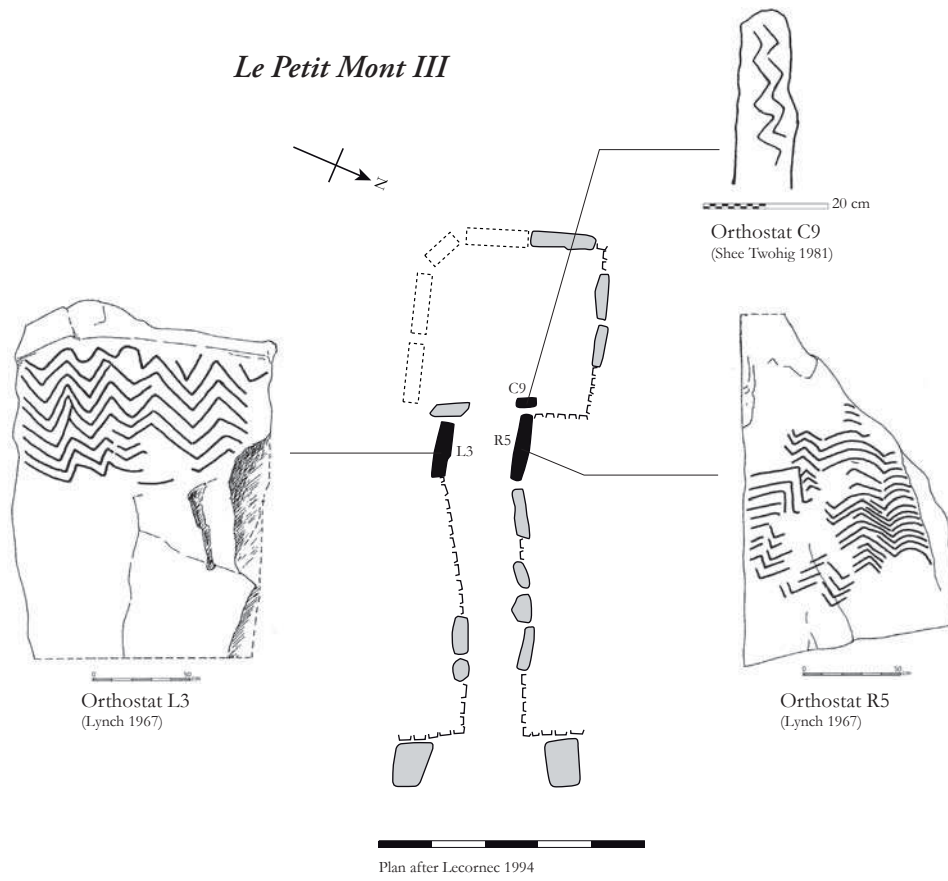


Figure 6.26 : Parallel lines of chevrons and internal limits in Le Petit Mont

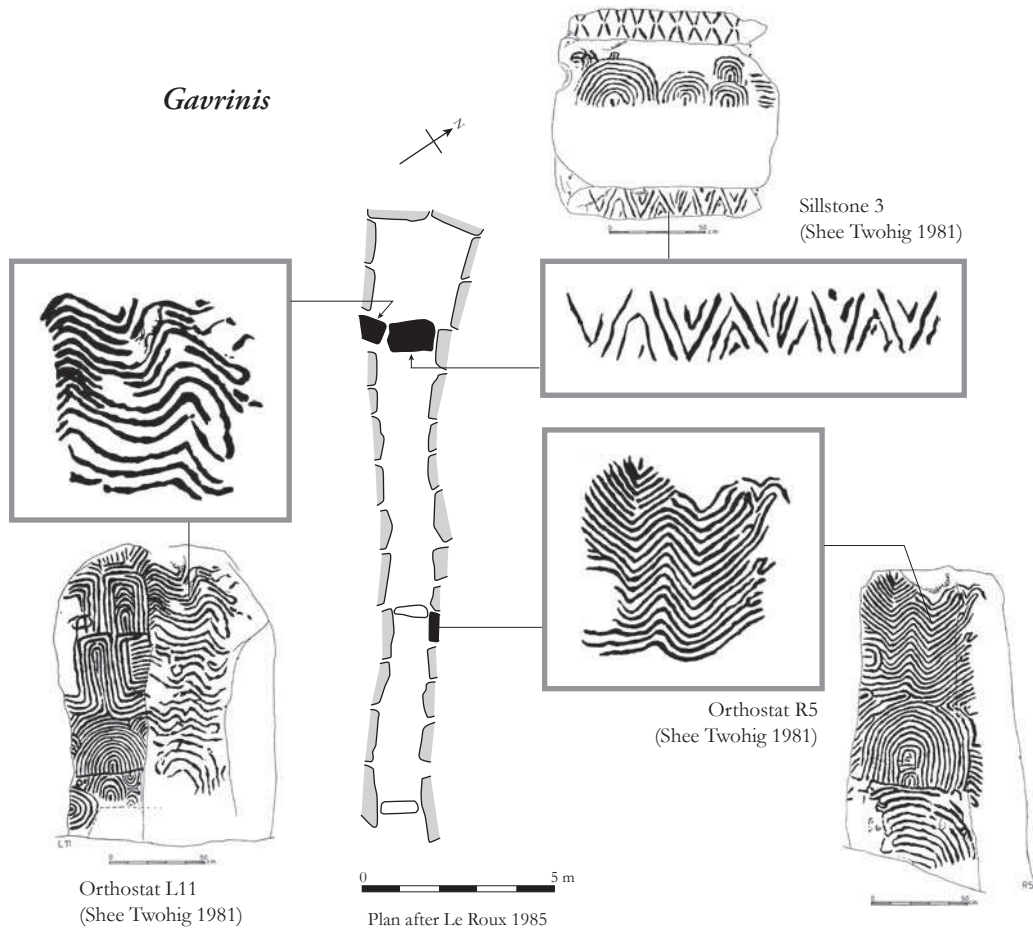


Figure 6.27 : Parallel lines of chevrons and internal limits in Gavrinis

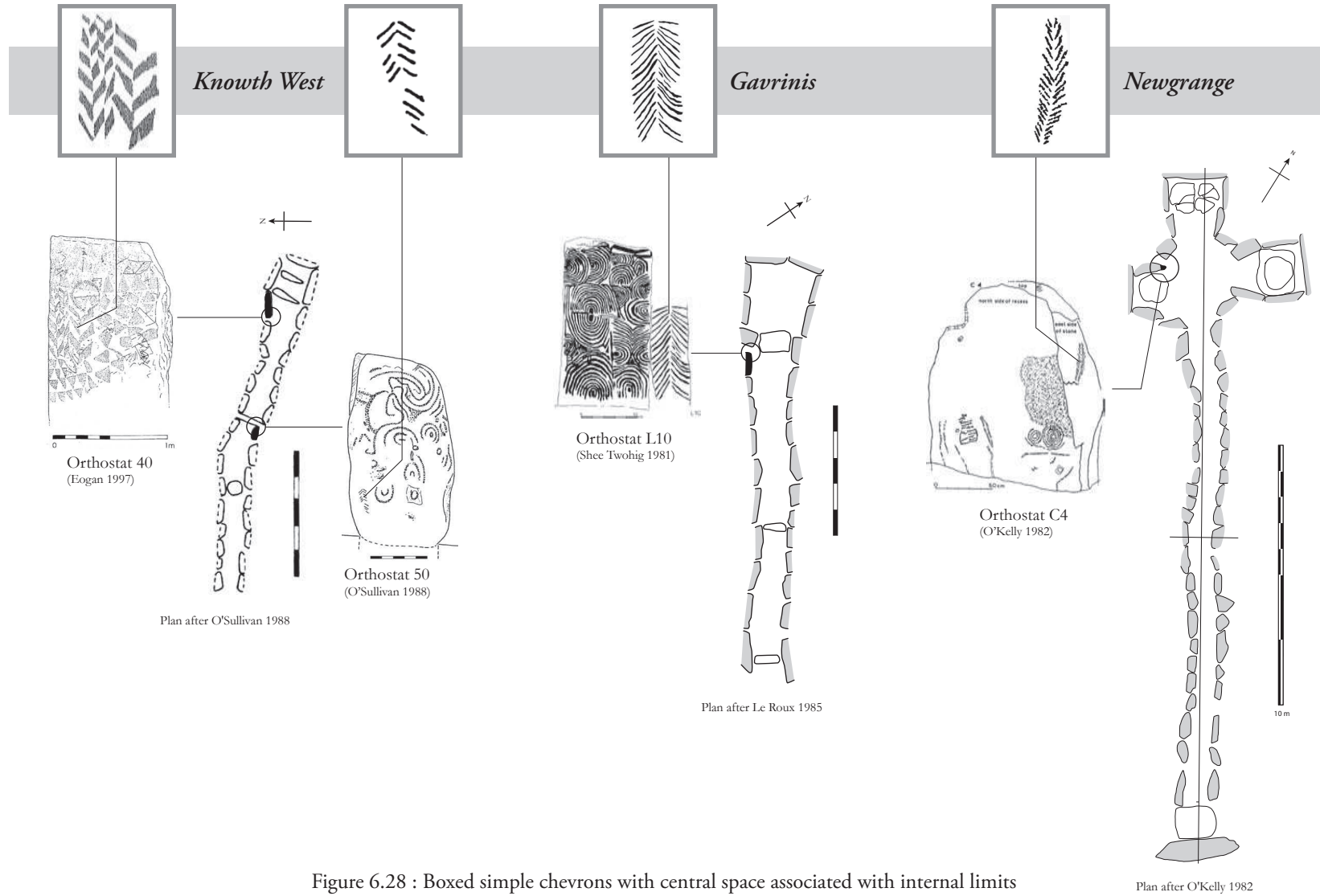


Figure 6.28 : Boxed simple chevrons with central space associated with internal limits

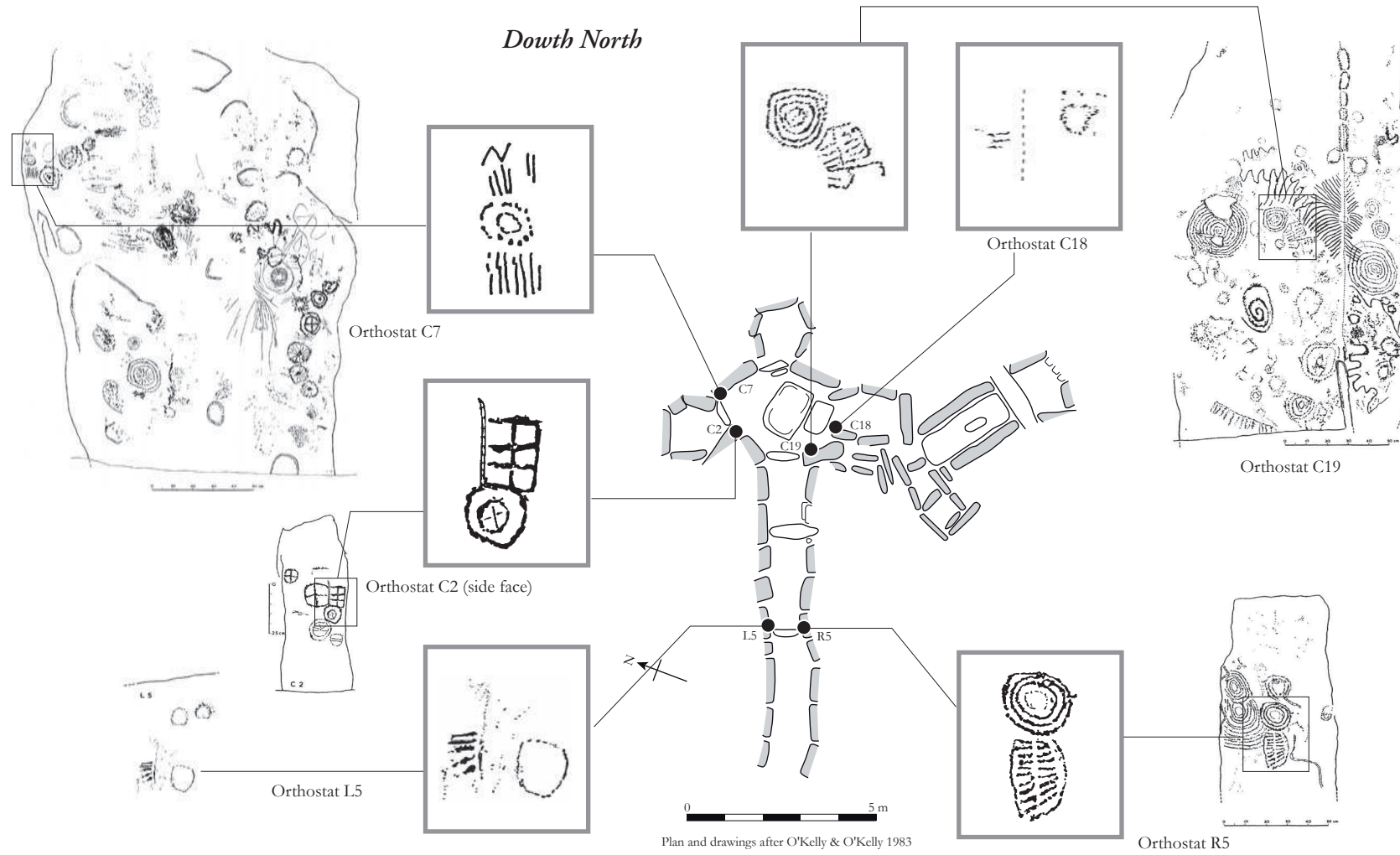


Figure 6.29 : Scalariform signs and internal limits in Dowth North

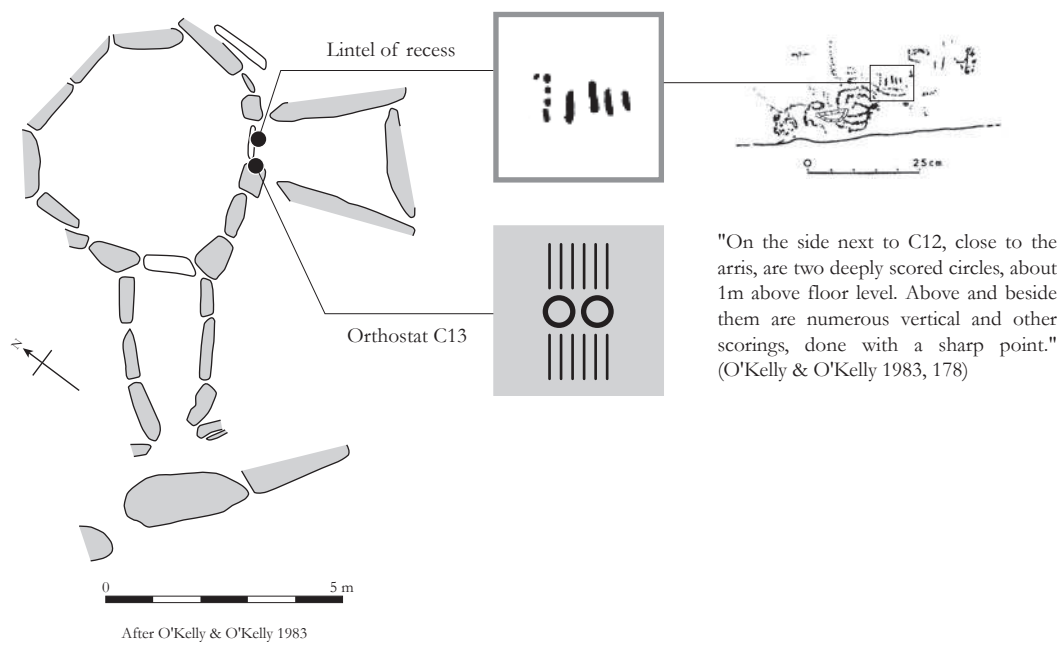
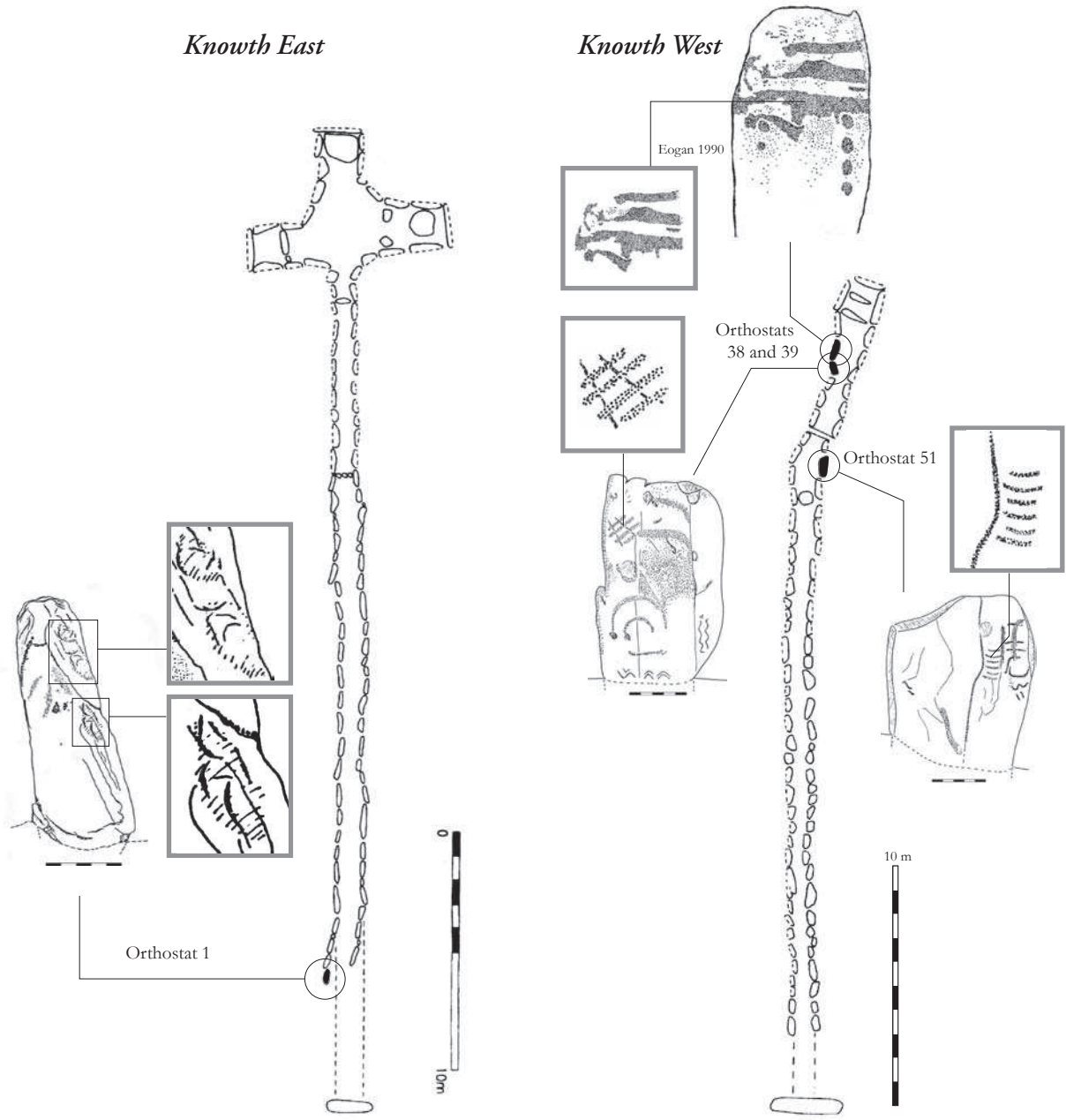


Figure 6.30 : Scalariform signs and internal limits in Dowth South



Plans and drawings after O'Sullivan 1988

Figure 6.31 : Scalariform signs and internal limits in Knowth

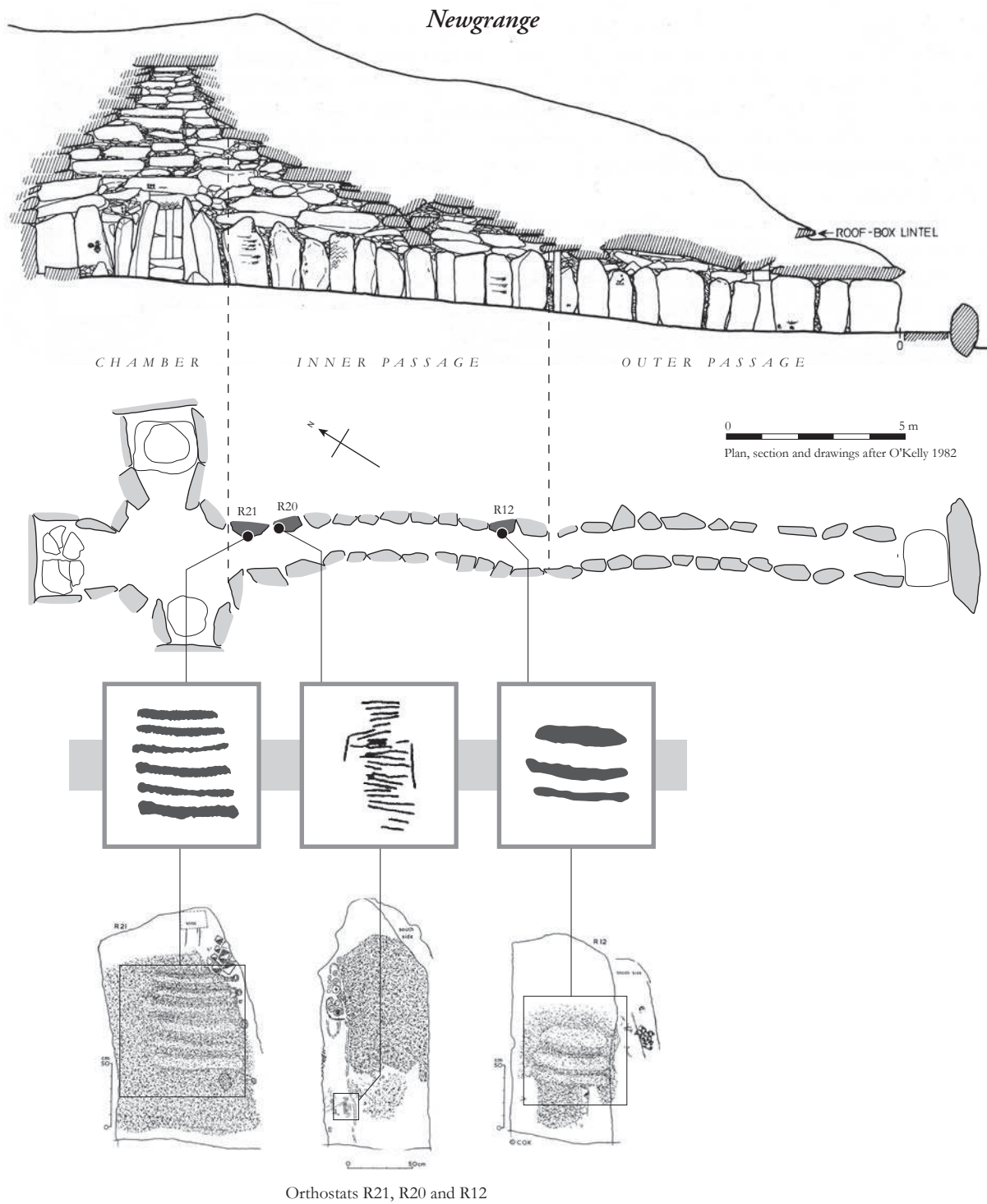


Figure 6.32 : Scalariform signs and internal limits in Newgrange

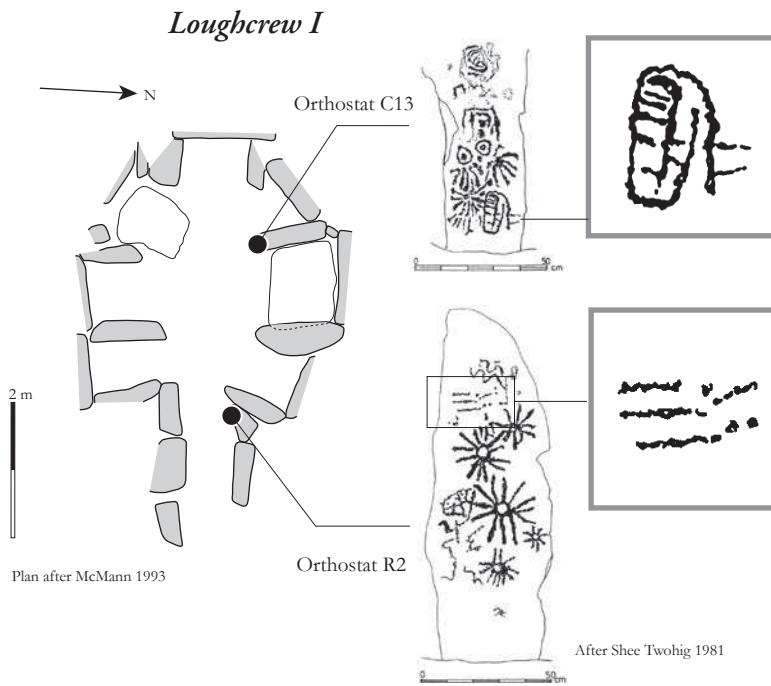
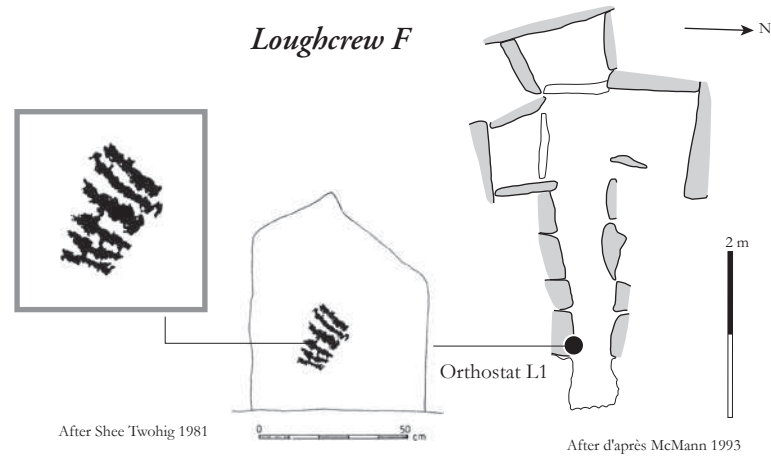


Figure 6.33 : Scalariform signs and internal limits in Loughcrew F and I

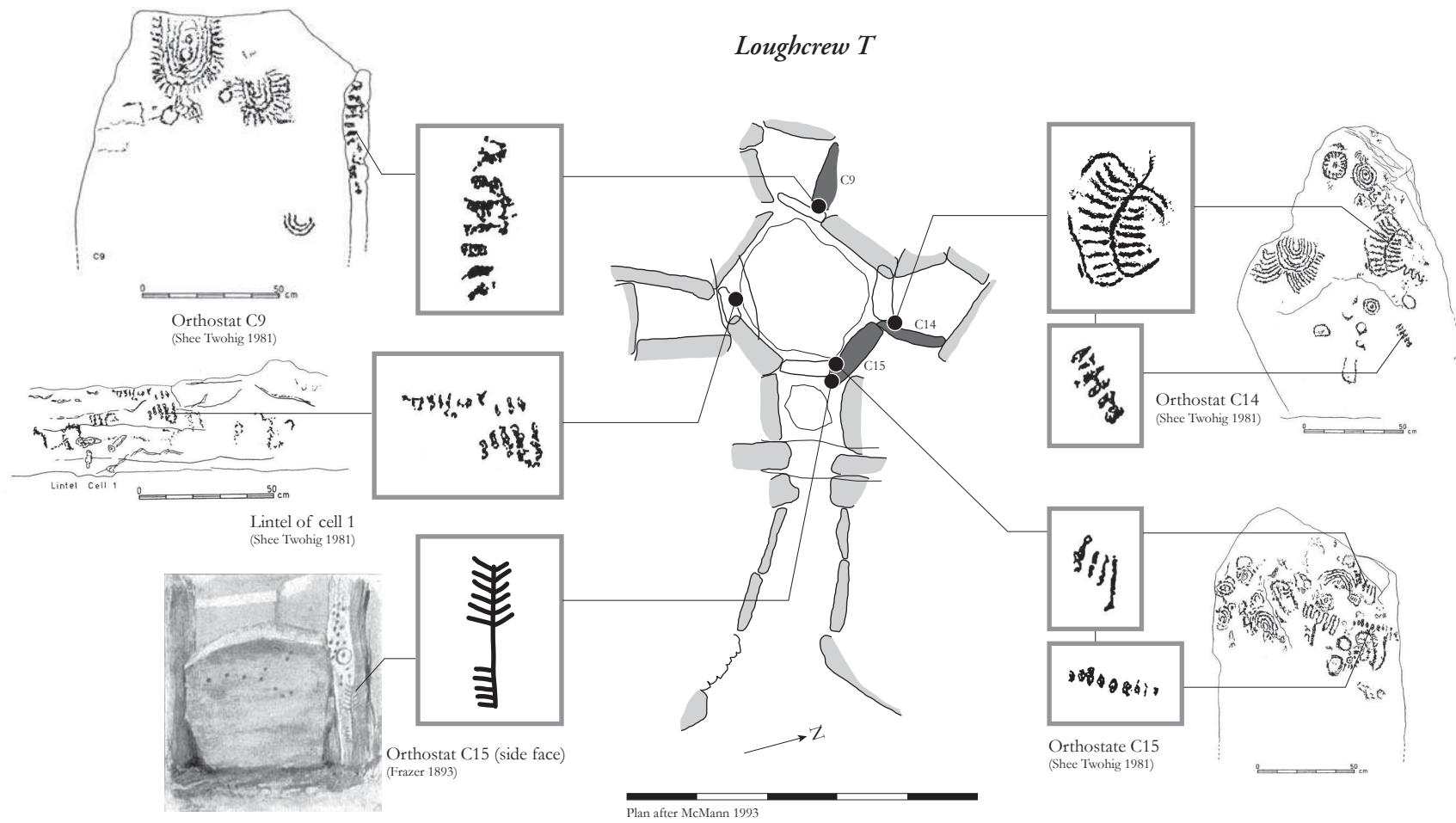


Figure 6.34 : Scalariform signs and internal limits in Loughcrew T

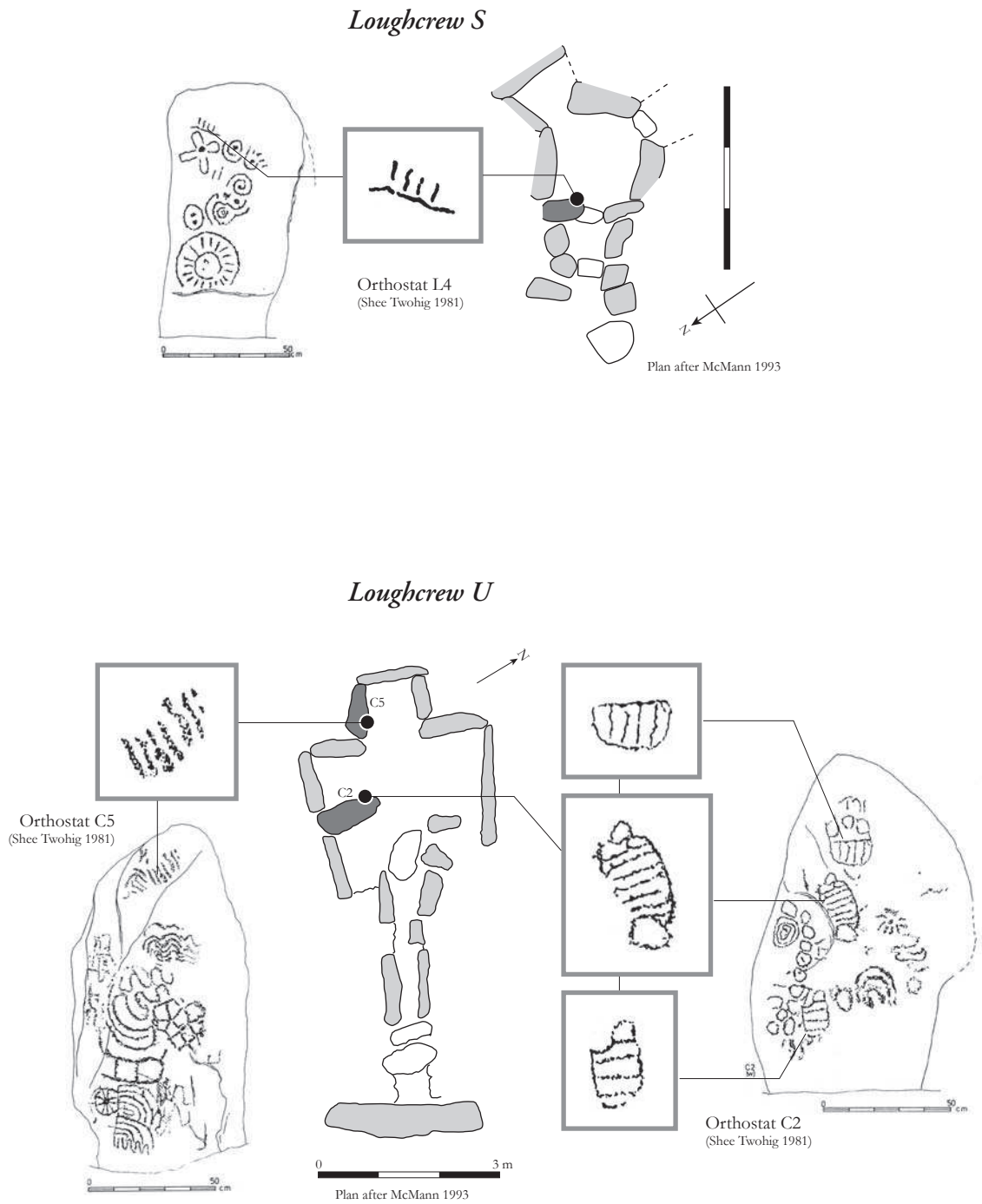


Figure 6.35 : Scalariform signs and internal limits in Loughcrew S and U

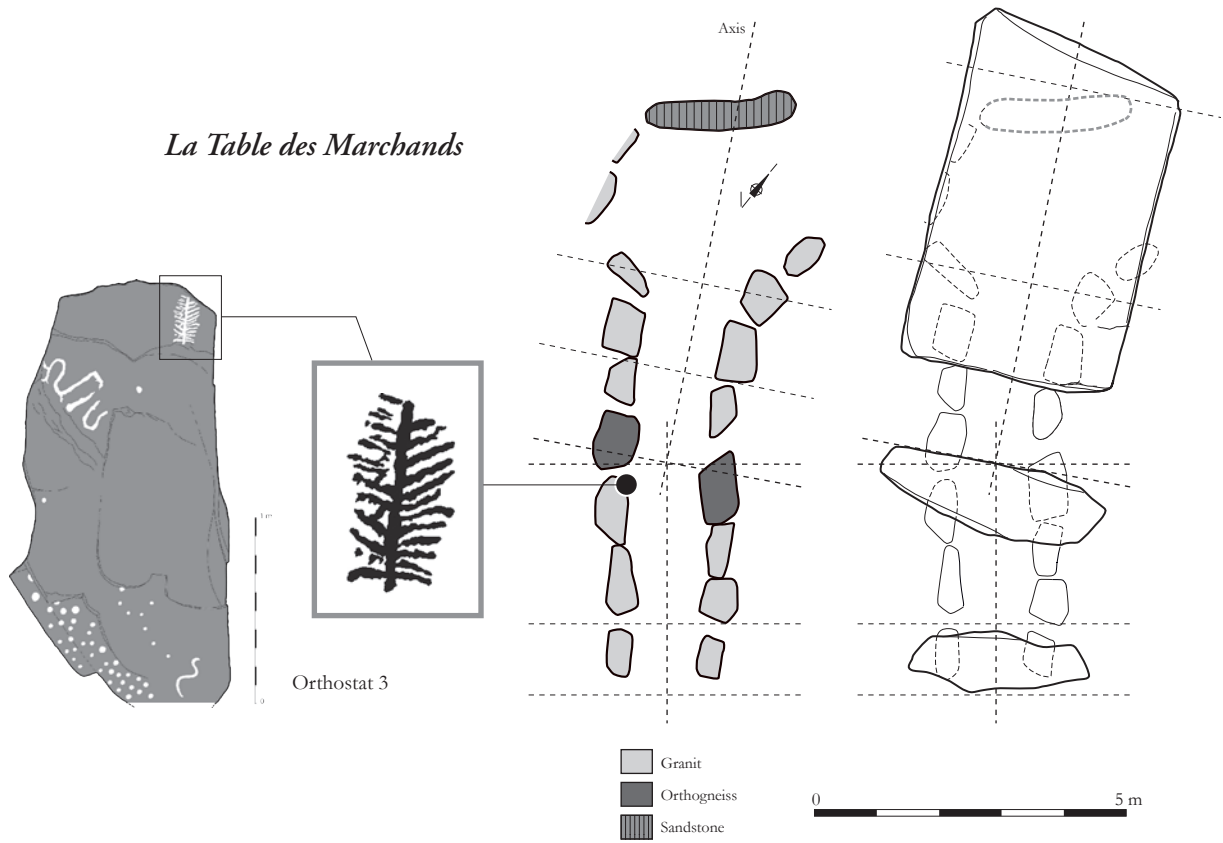


Figure 6.36 : Scalariform signs and internal limits in La Table des Marchands

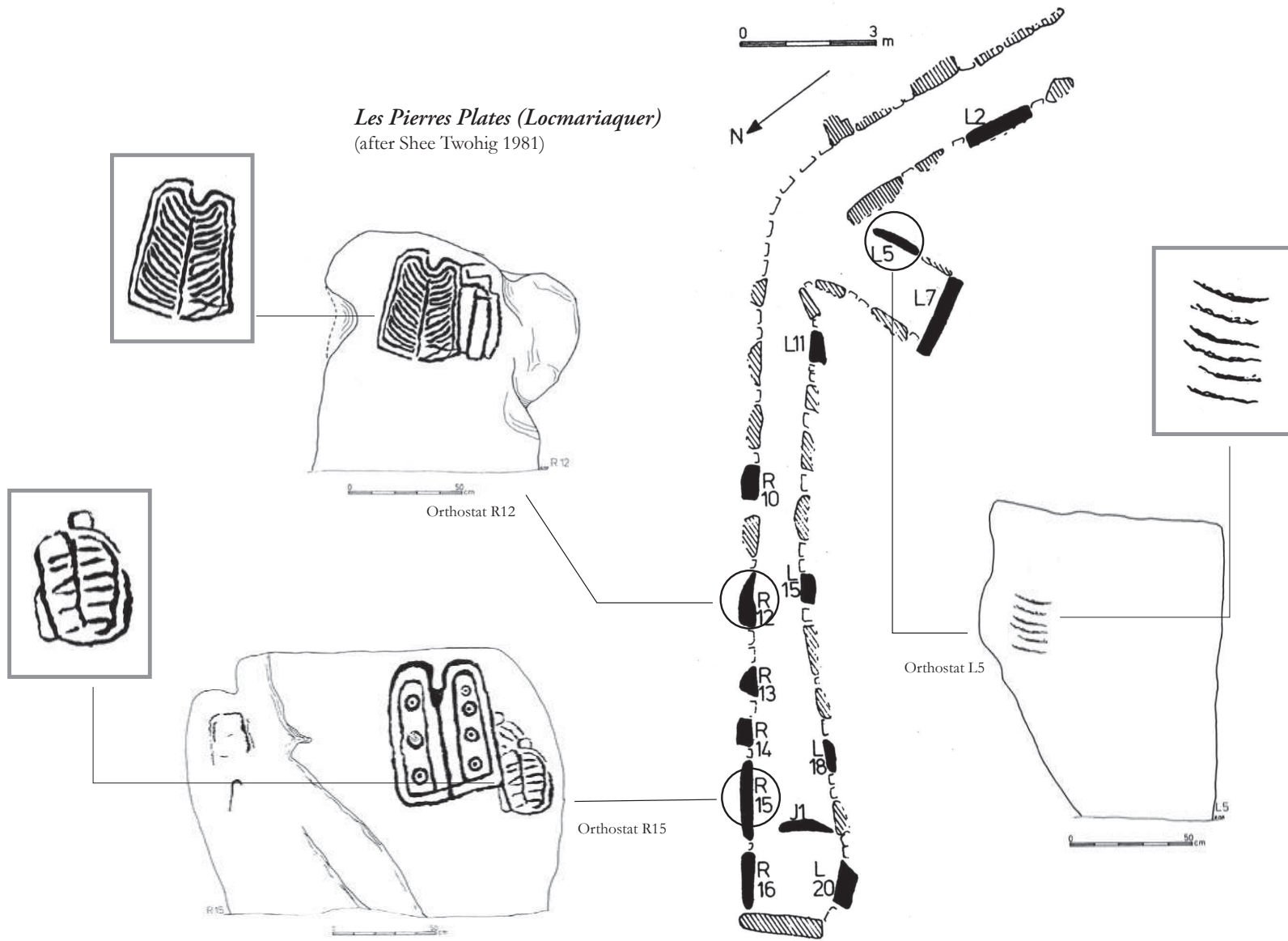


Figure 6.37 : Scalariform signs and internal limits in Les Pierres Plates

















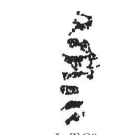

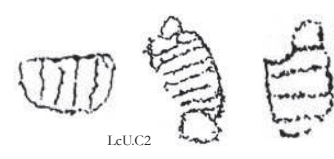















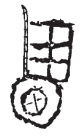



	Architectural limits			
	Outside/passage	Outer passage/ inner passage	Passage/chamber	Chamber/recesses
 Type 1a	 KhE.Or1  LcFR1	 Ng.R12	 KhW.Or39  LcT.C15  Ng.R21  Ng.R20  LcT.R5	 DhN.C7  DhN.C18  DhSlr  DhS.C13  LcUC5  LcT.C14  Kh4.A  LcTC9
 Type 1b				 LcUC2
 Type 2a			 LcL.R2  Km.C12	 LcT.lcell1
 Type 2b		 DhN.R5		
 Type 3a		 LcH.R2	 KhW.Or38  LcT.C15	 LcL.C13
 Type 3b			 DhN.C19	 DhN.C2  LcT.C14
 Type 4		 DhNL5  KhW.Or51	 LcSL4	

Figure 6.38 : Synthesis of the relations between scalariform signs and internal limits

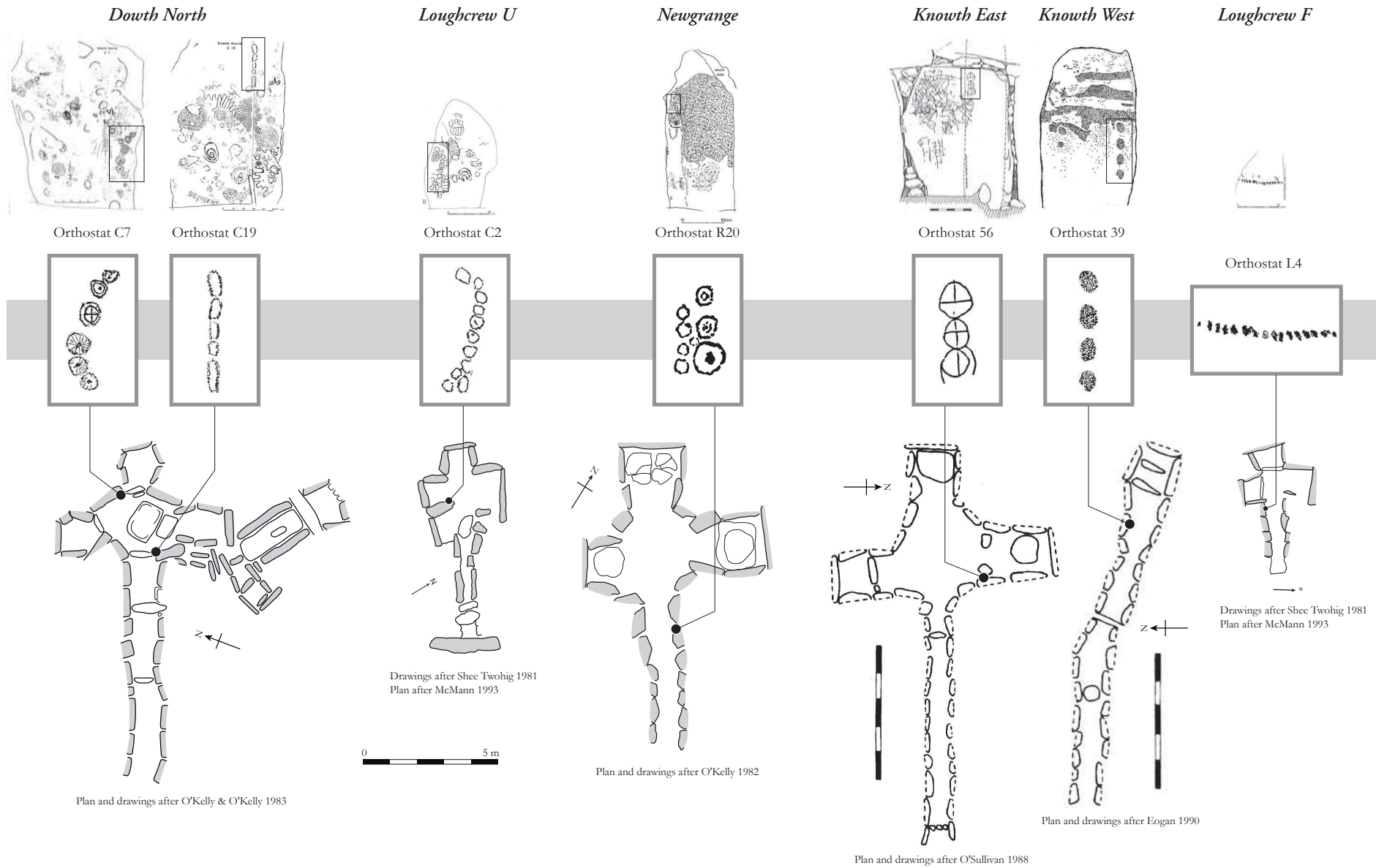


Figure 6.39 : Lines of circular signs and internal limits

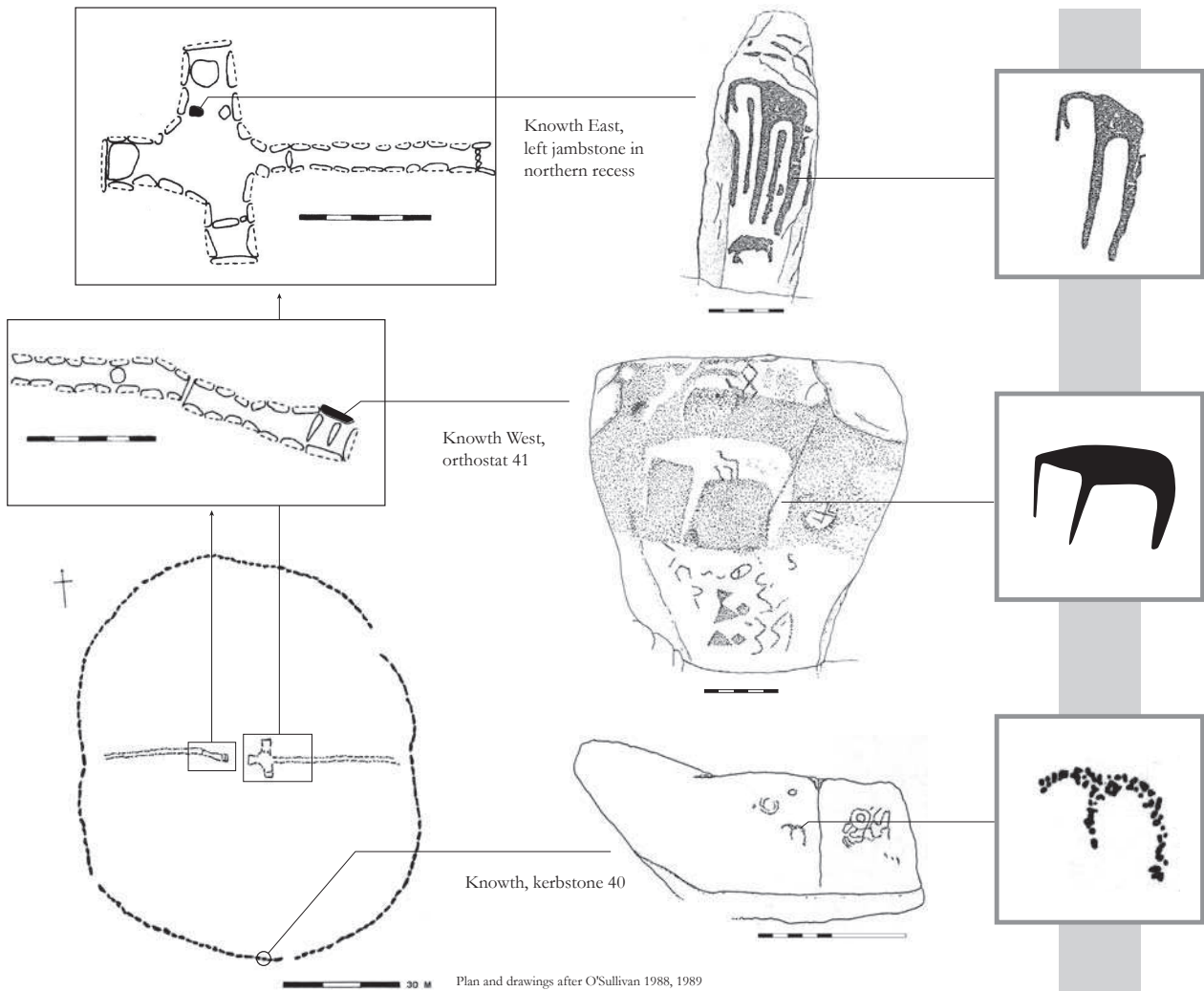


Figure 6.40 : The rare sign n°2 and internal limits in Knowth

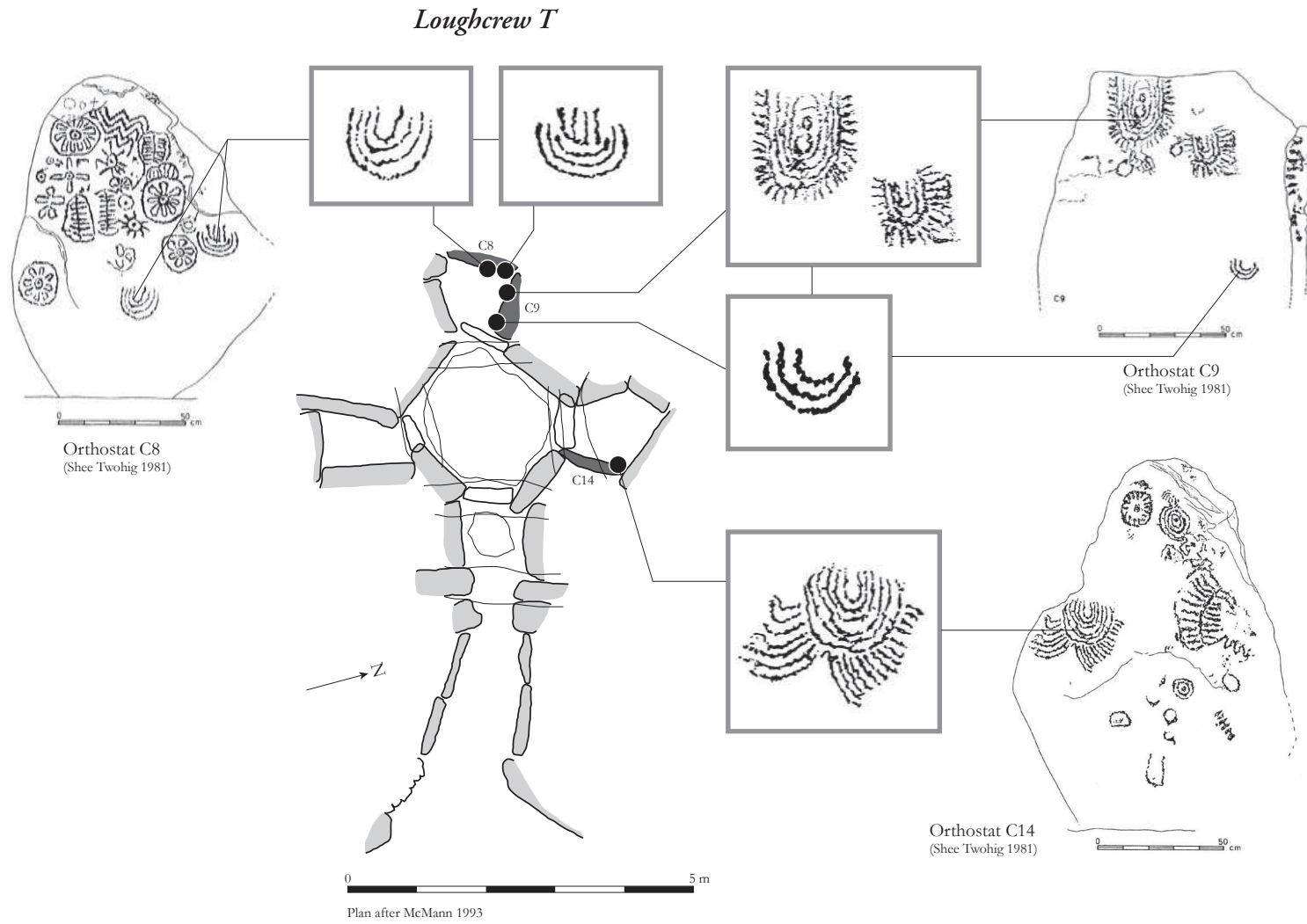


Figure 6.41 : Distribution of inverted arcs in Loughcrew T

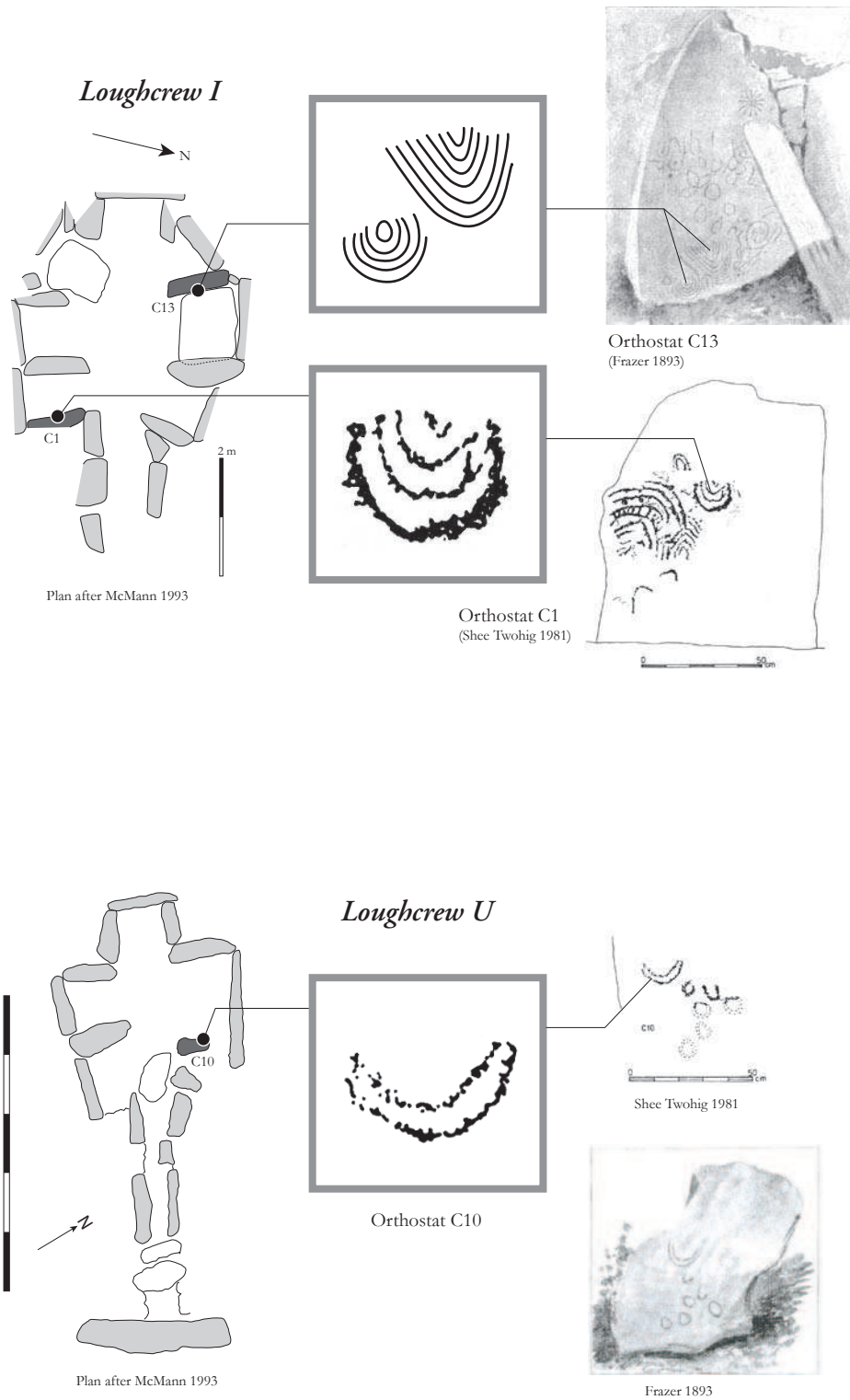


Figure 6.42 : Distribution of inverted arcs in Loughcrew I and U

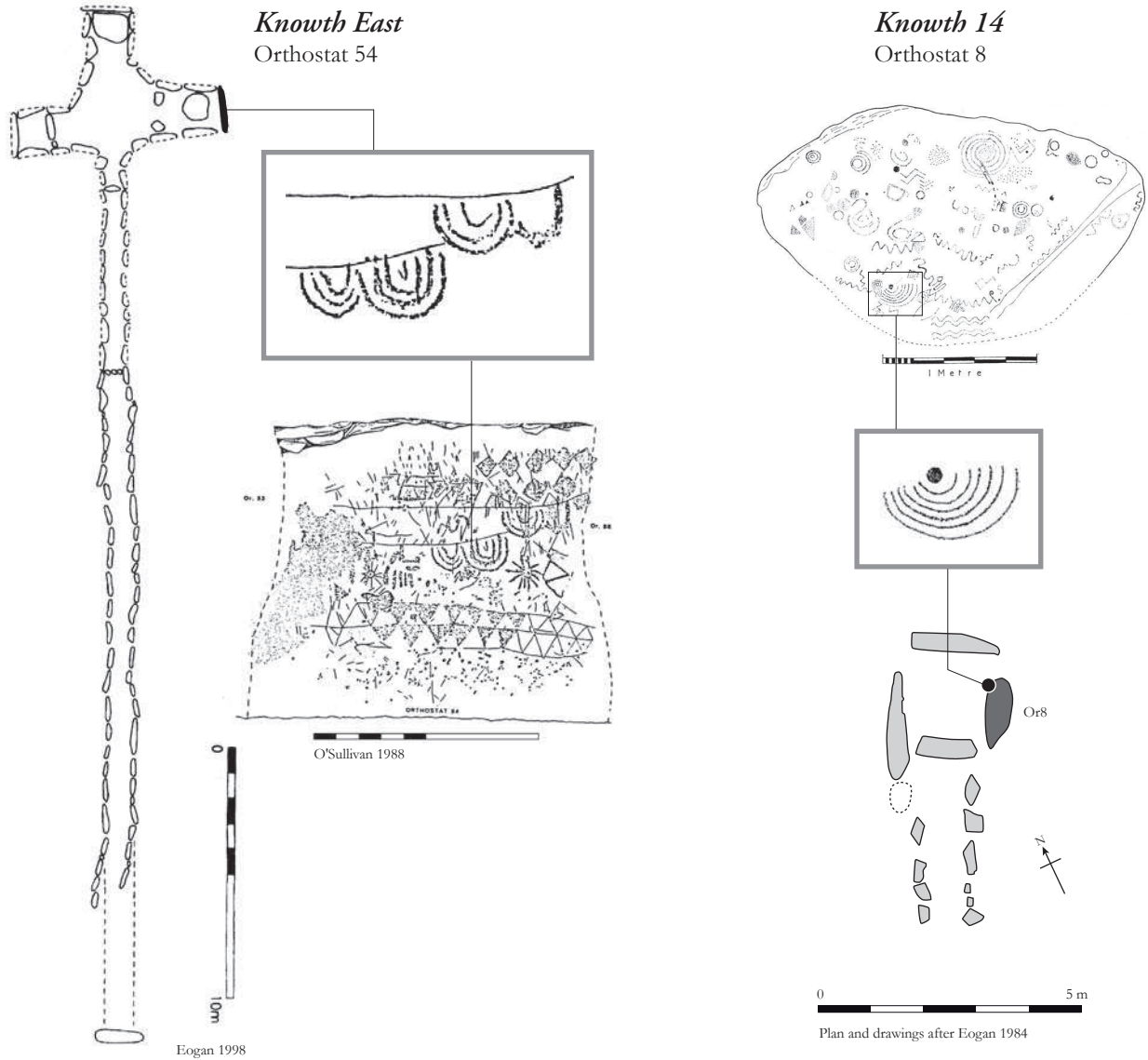


Figure 6.43 : Distribution of inverted arcs in Knowth East and Knowth 14

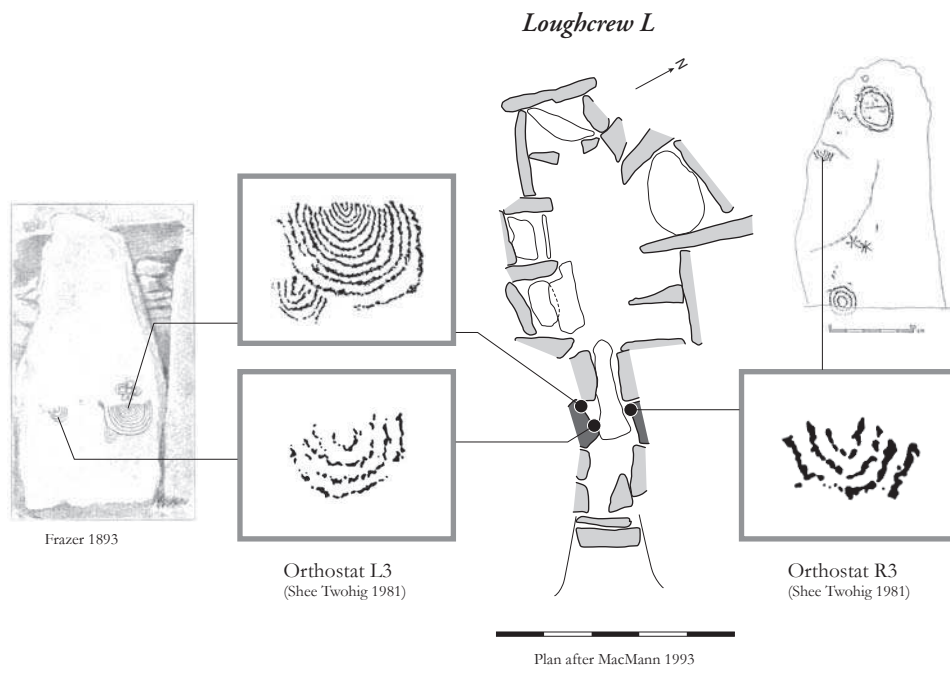


Figure 6.44 : Distribution of inverted arcs in Loughcrew L

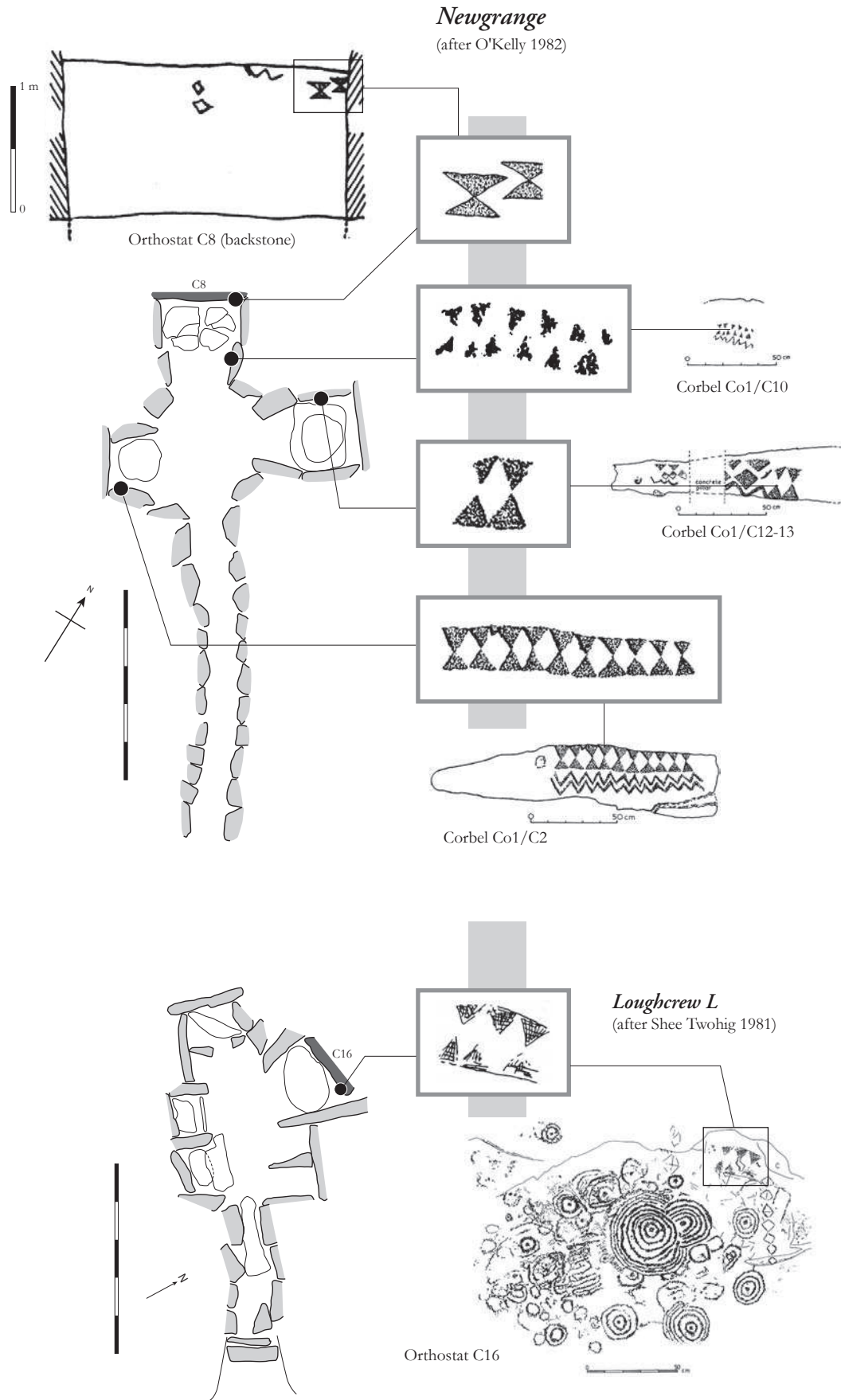


Figure 6.45 : Distribution of opposed triangles in Newgrange and Loughcrew L

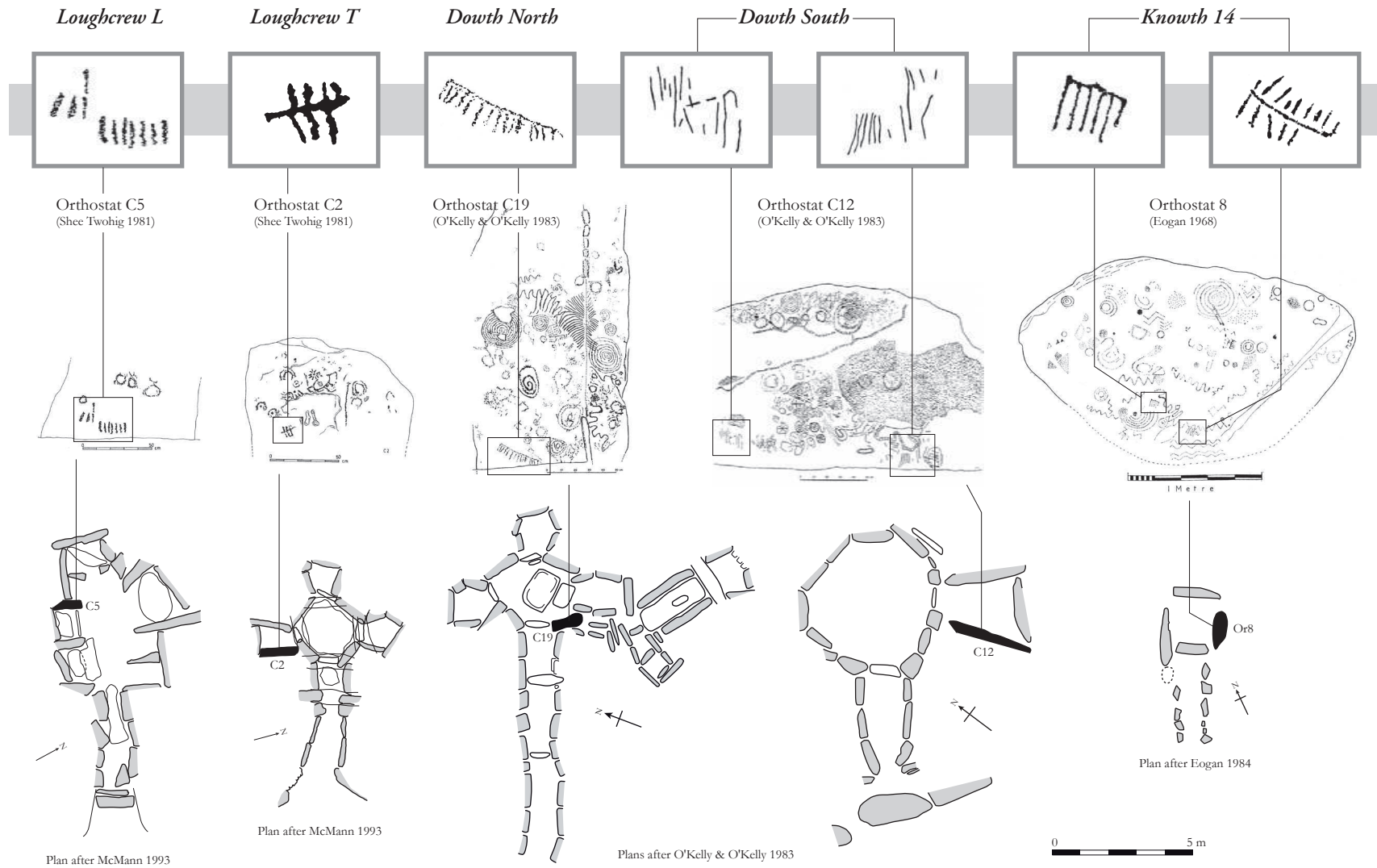


Figure 6.46 : Layout of the scalariform signs in funerary recesses

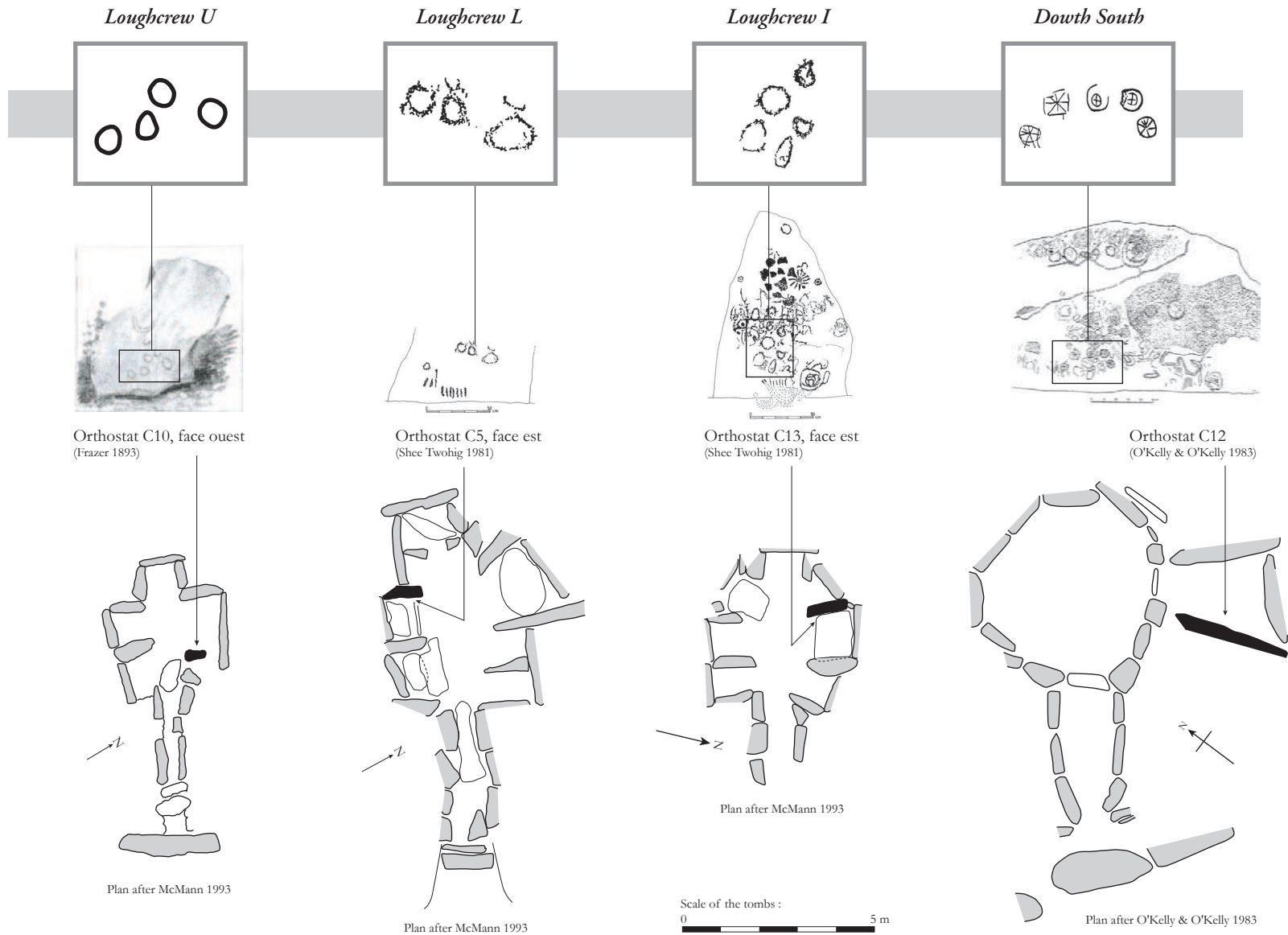


Figure 6.47 : Layout of lines of circular signs in funerary recesses

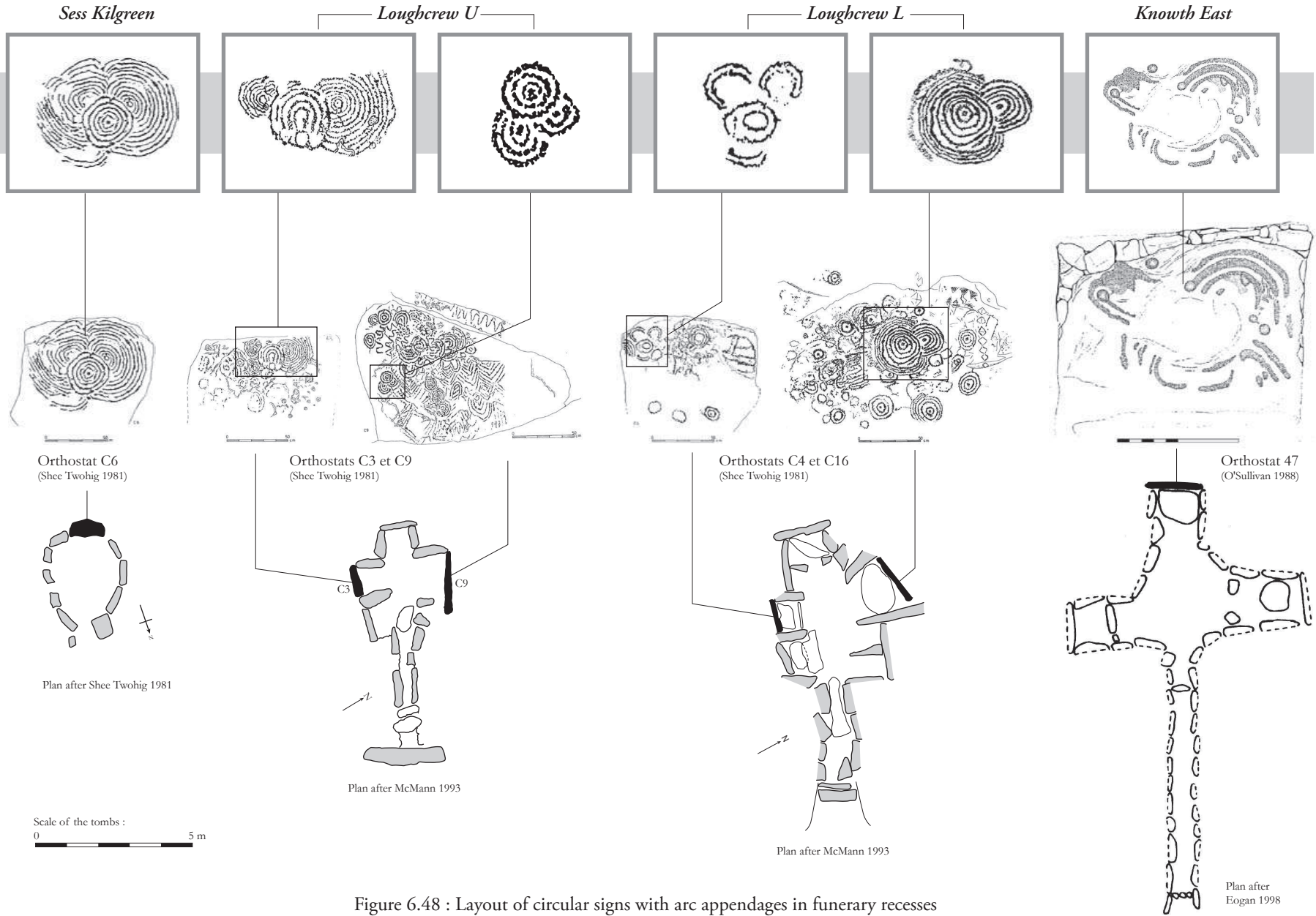


Figure 6.48 : Layout of circular signs with arc appendages in funerary recesses

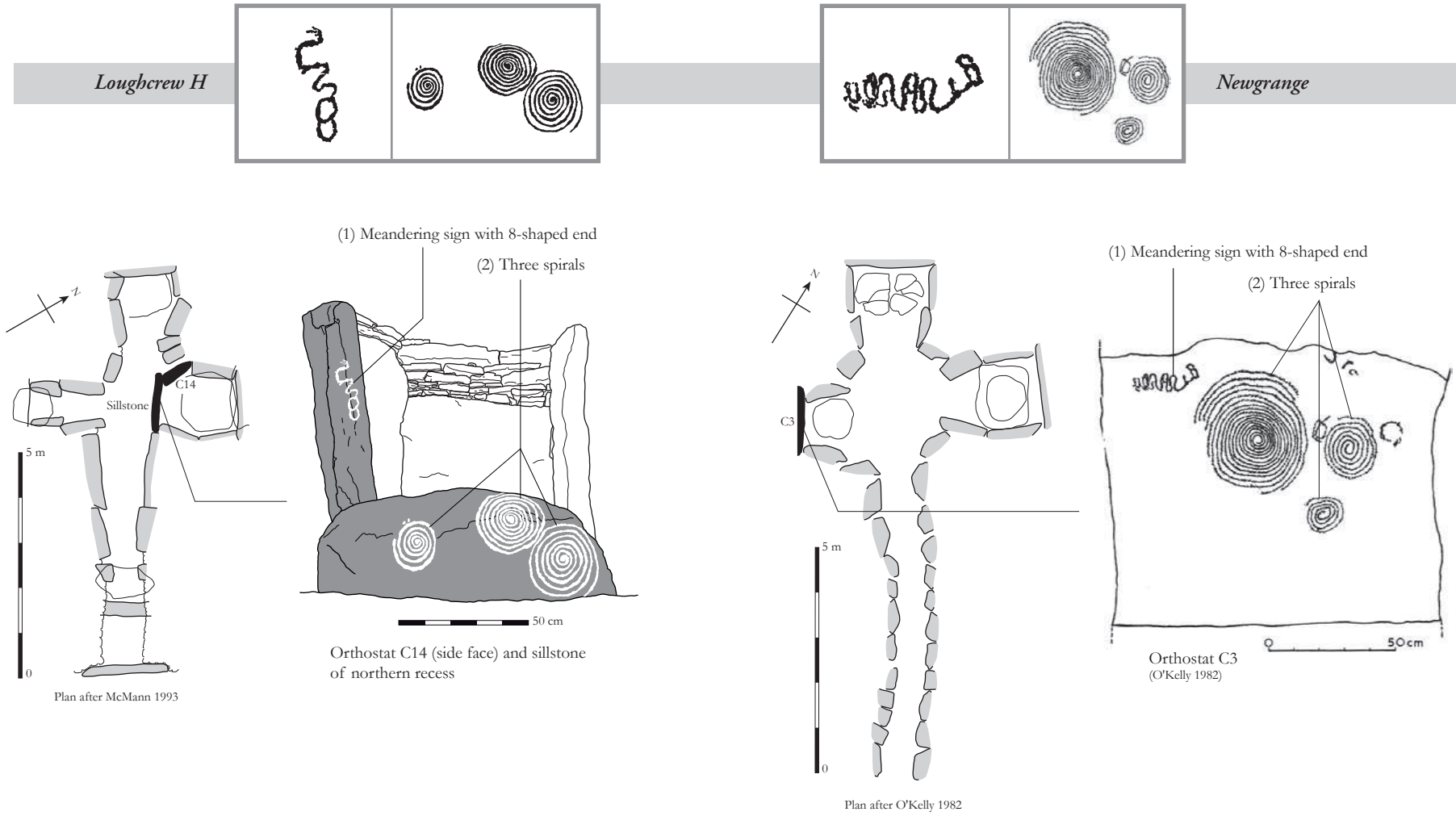


Figure 6.49 : Meandering sign with 8-shaped end associated with three spirals

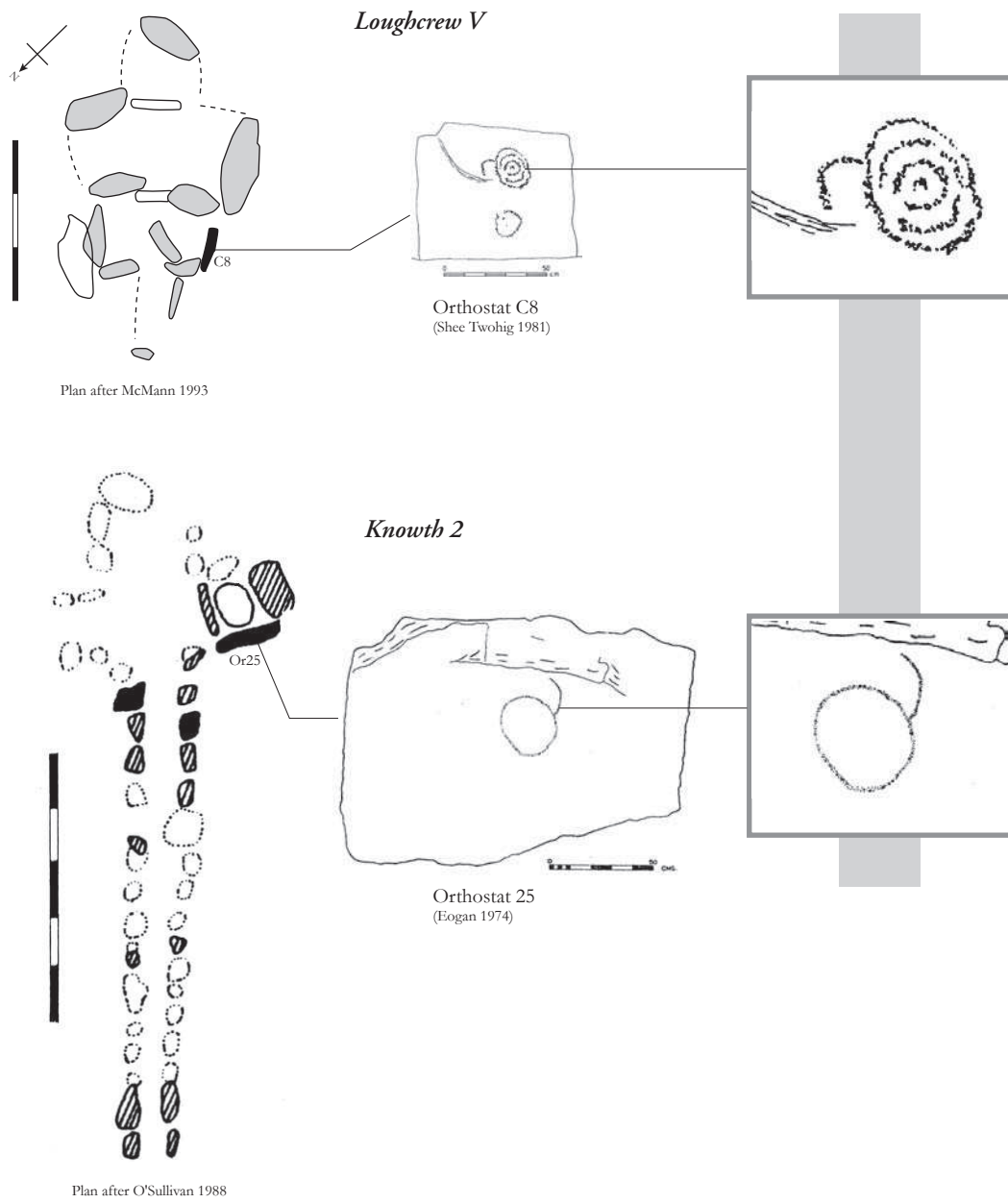


Figure 6.50 : Circular sign and line of relief linked by a curved line

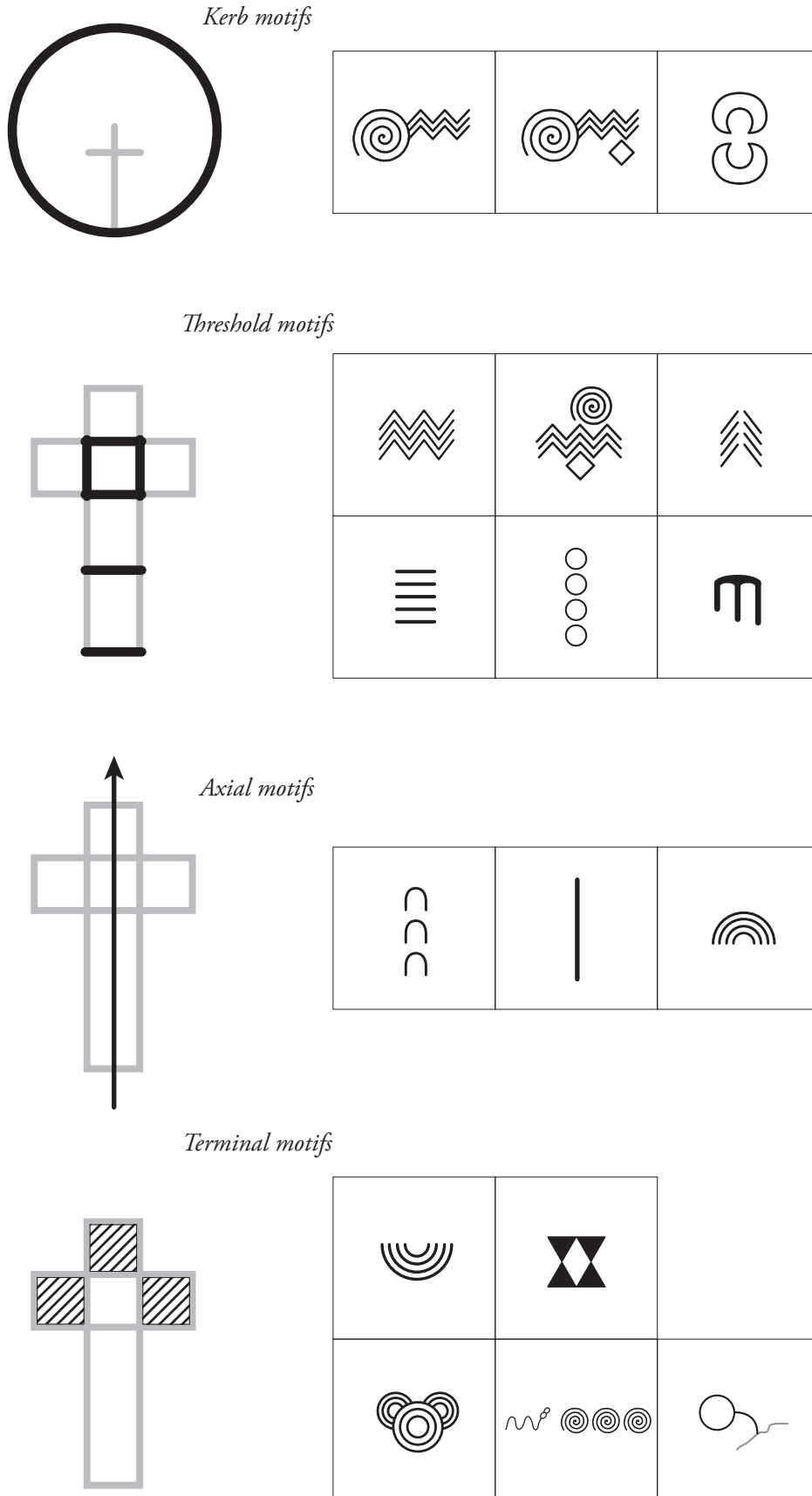


Figure 6.51 : Synthesis of the main relations between iconography and architectural structure

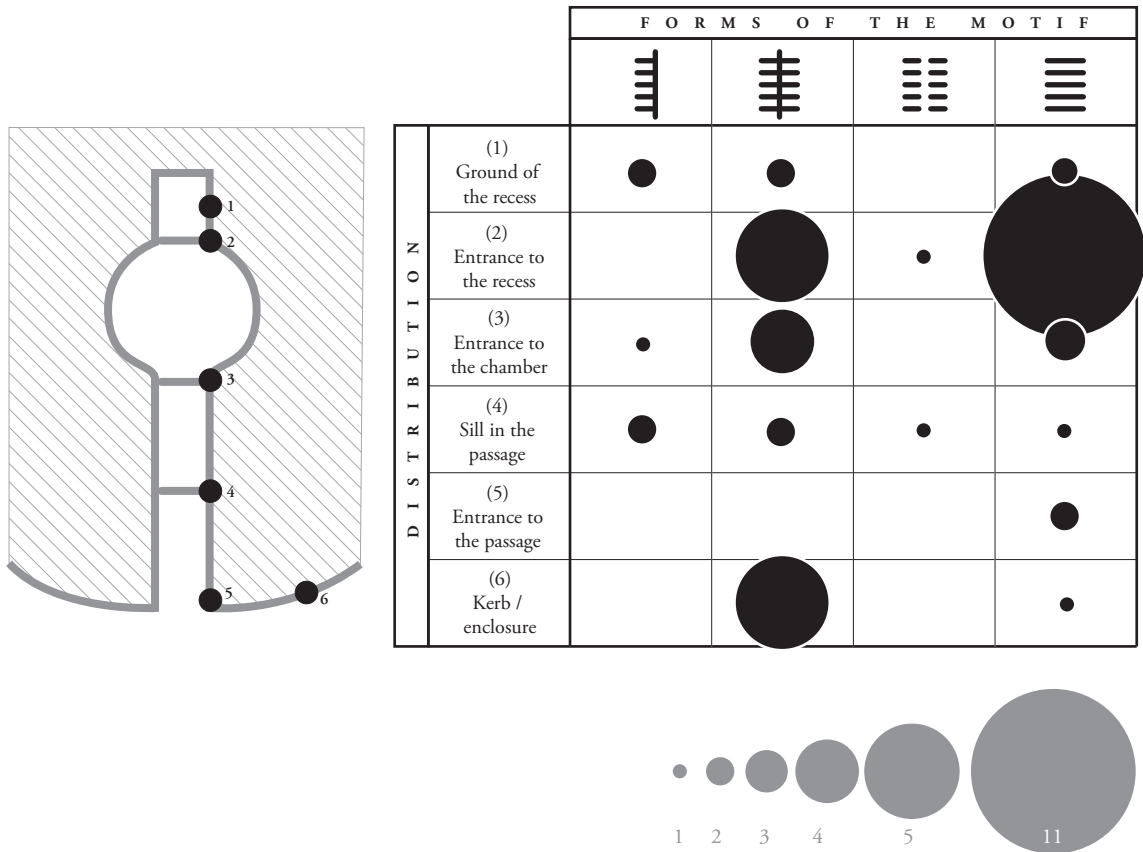
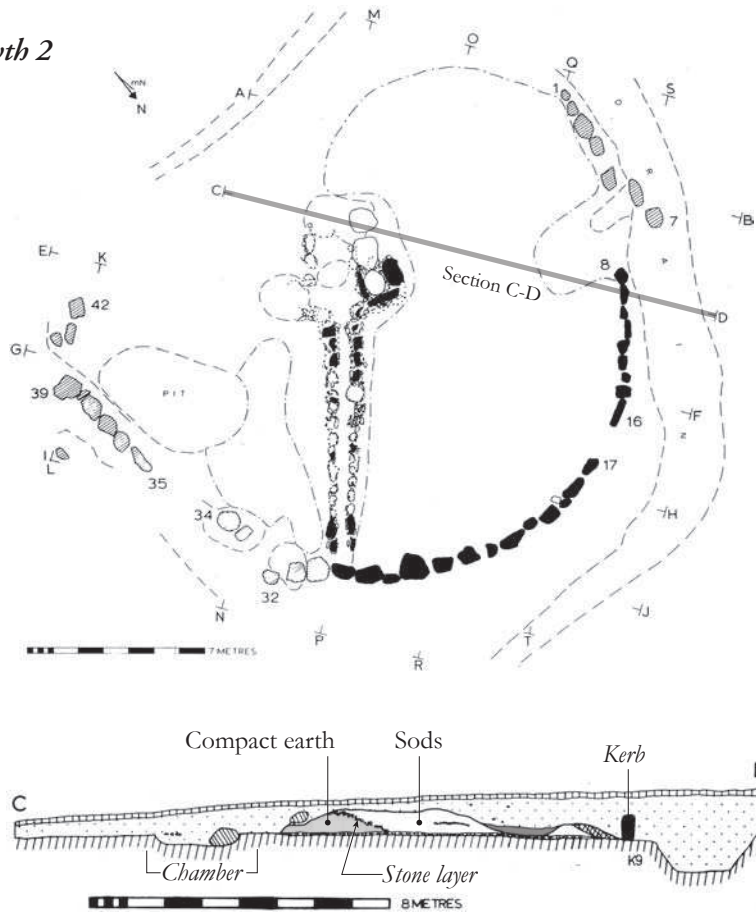
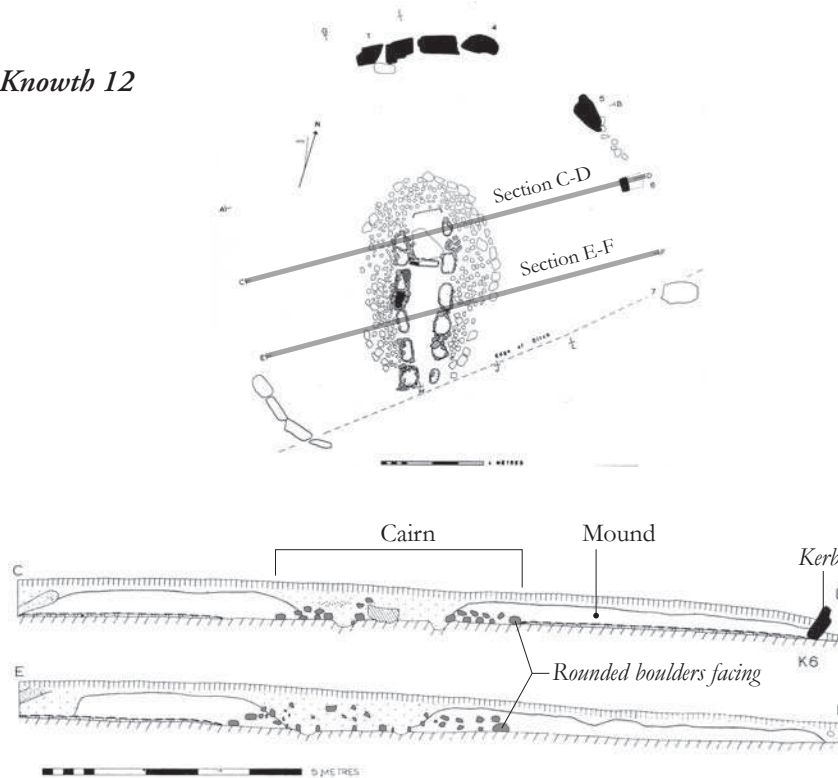


Figure 6.52 : Relations between forms and location of the scalariform sign

Knowth 2



Knowth 12



After Eogan 1984a

Figure 7.1 : Tumularly structure of Knowth 2 and 12

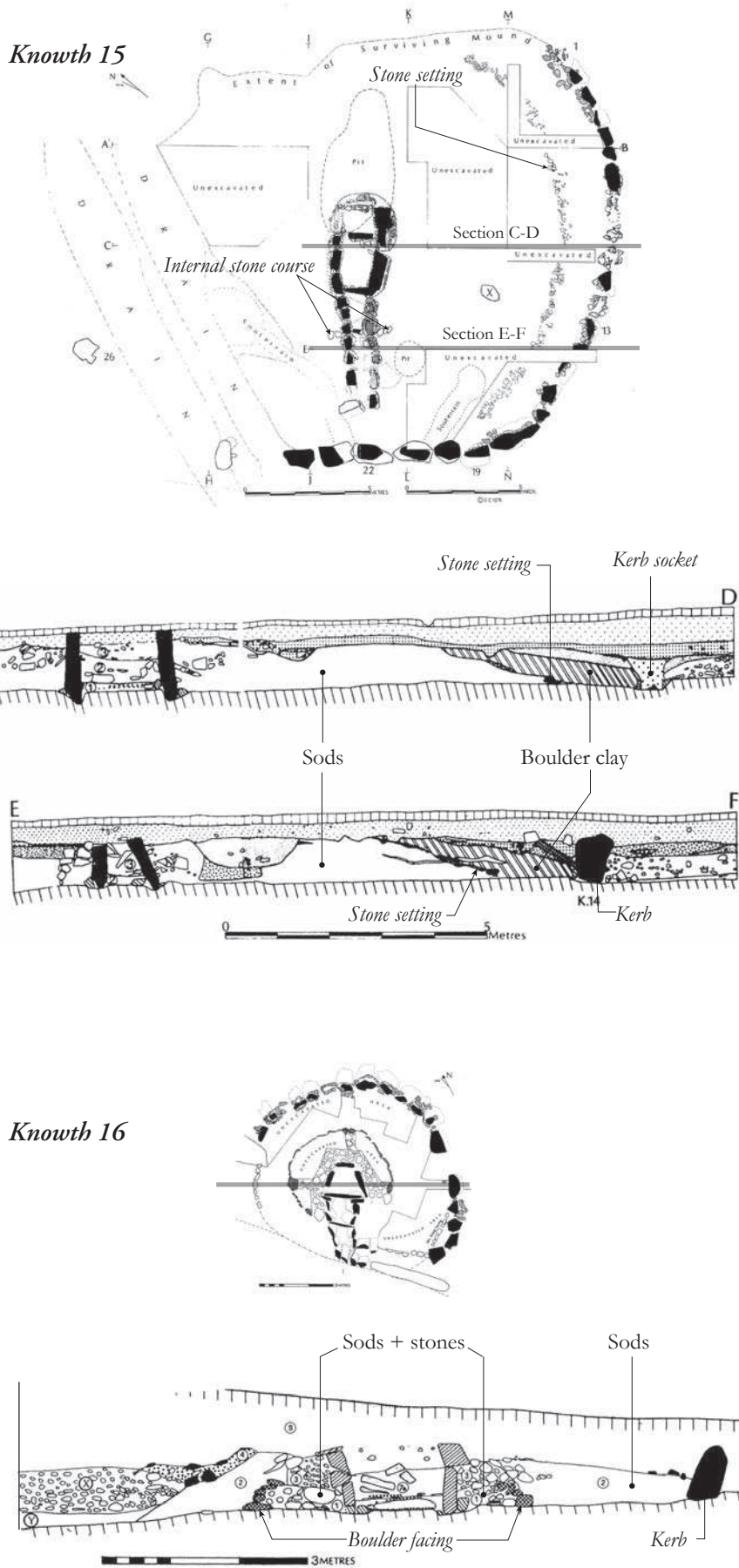
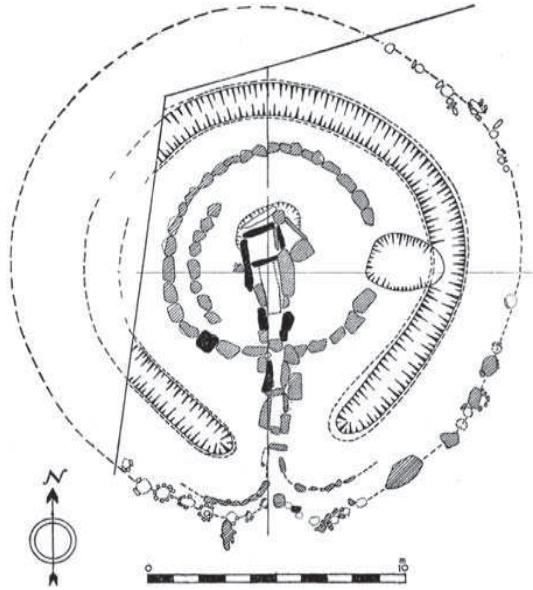
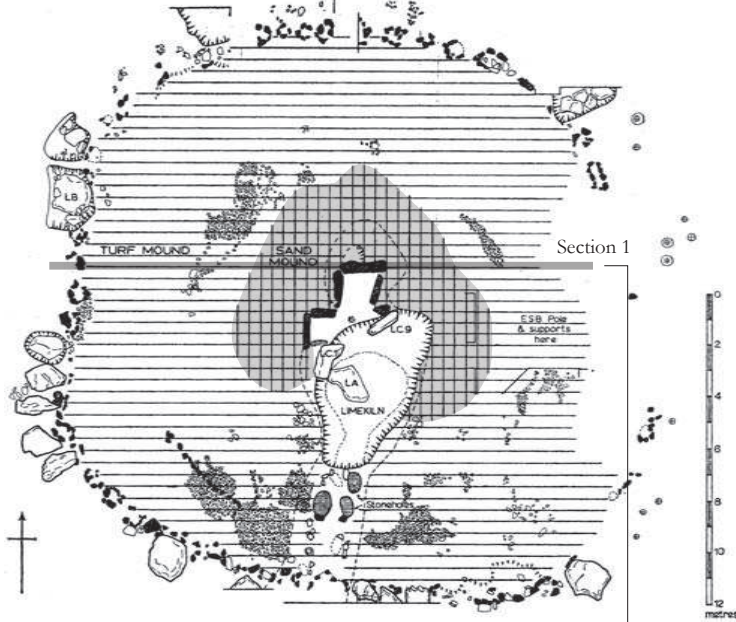


Figure 7.2 : Tumular structure of Knowth 15 and 16

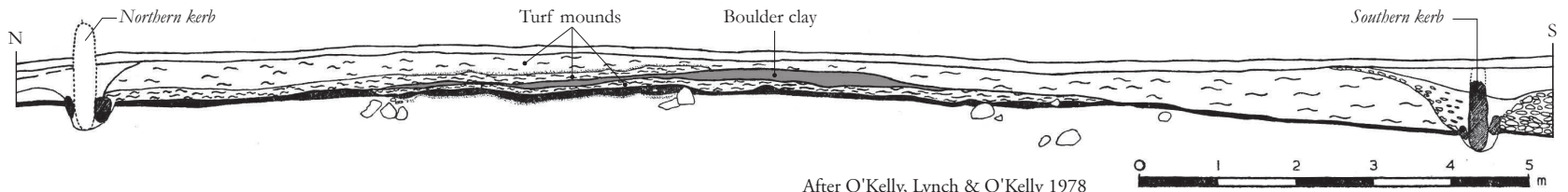
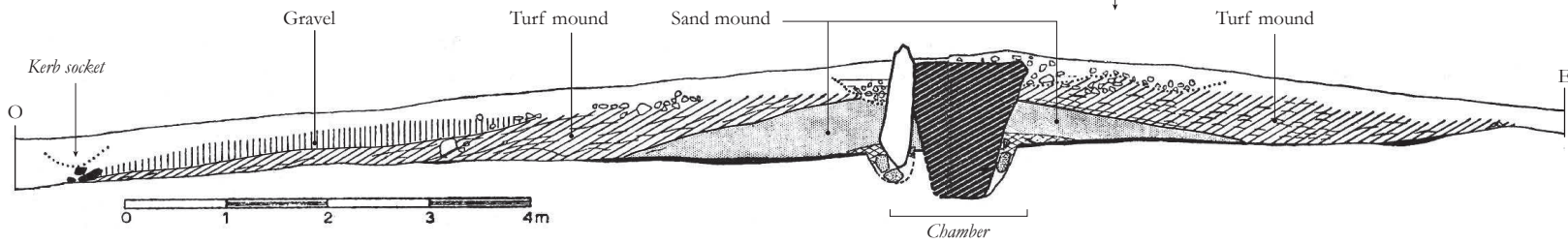
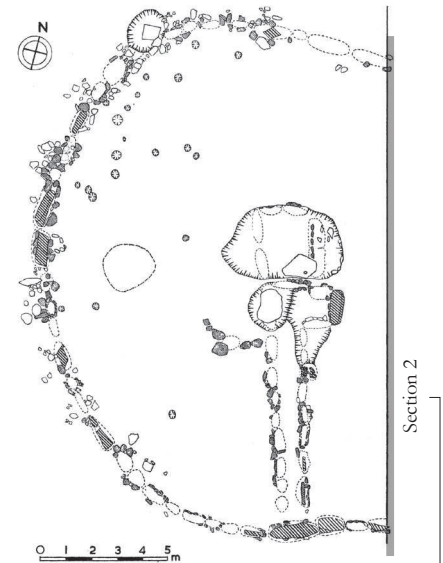
Newgrange K



Newgrange L



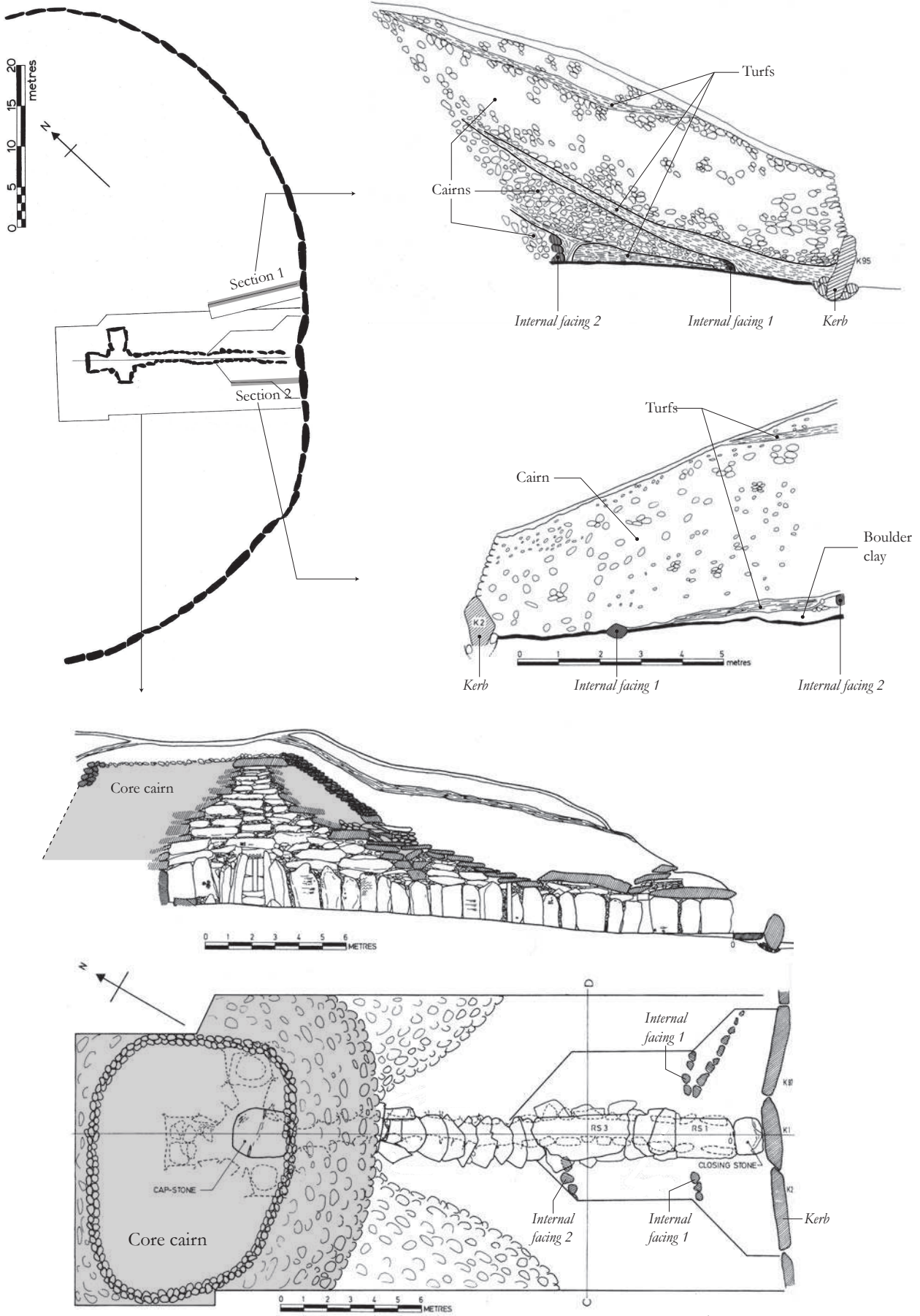
Newgrange Z



After O'Kelly, Lynch & O'Kelly 1978

Figure 7.3 : Tumularly structure of Newgrange K, L and Z

Newgrange



After O'Kelly 1982

Figure 7.4 : Tumular structure of Newgrange

Barclodiad y Gawres

(after Powell & Daniel 1956)

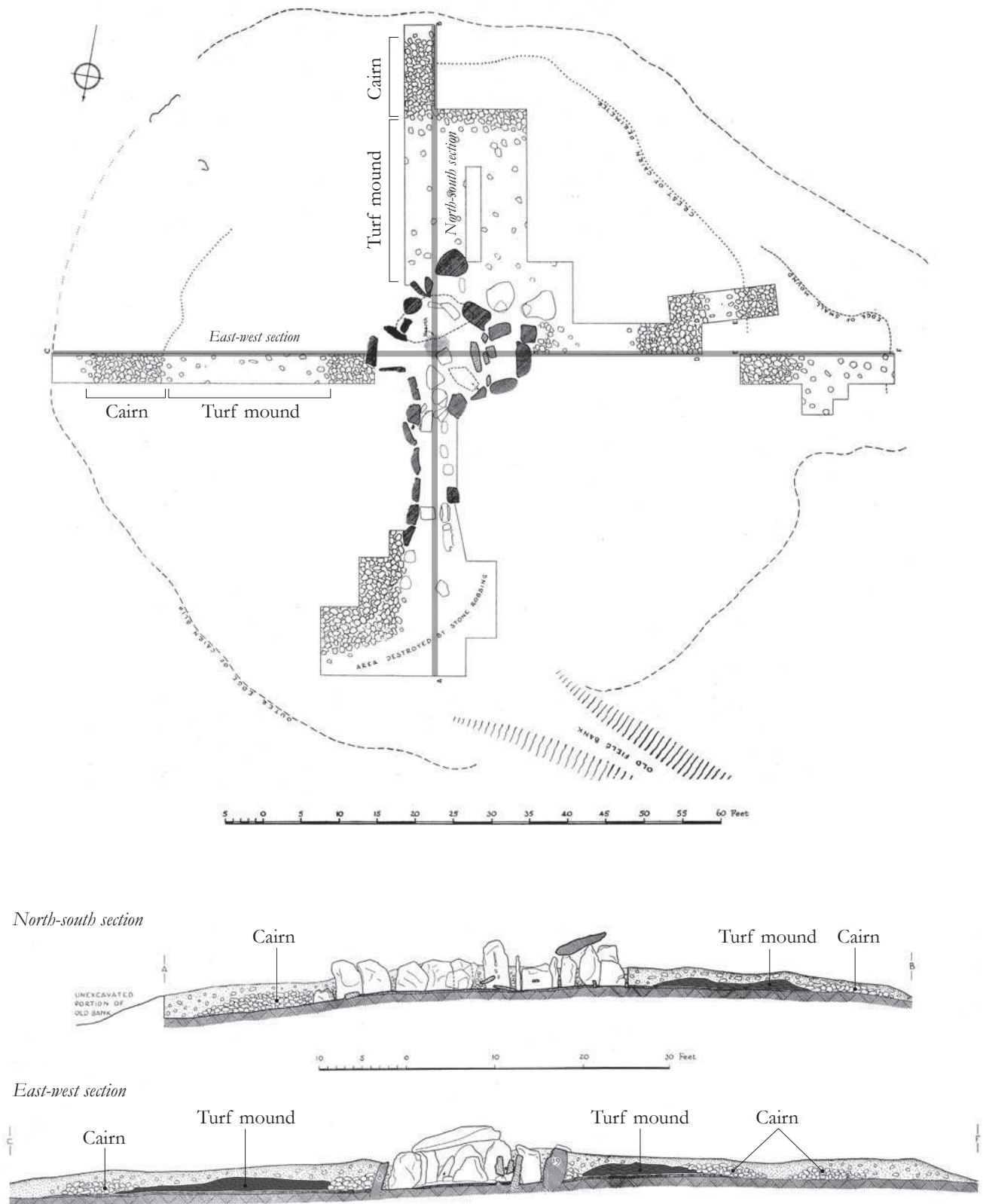
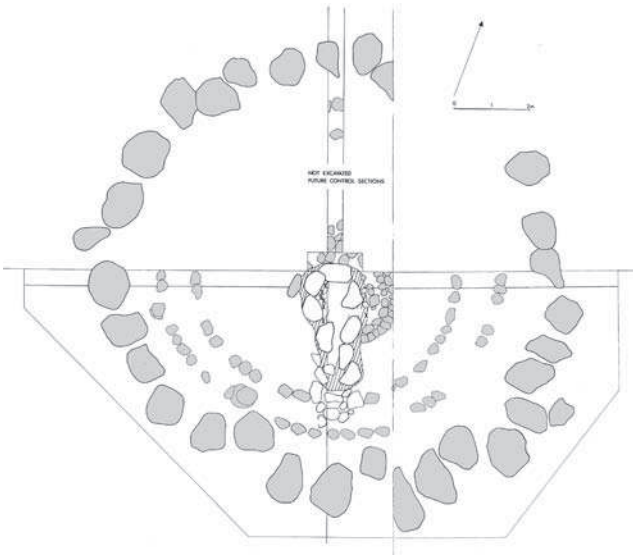
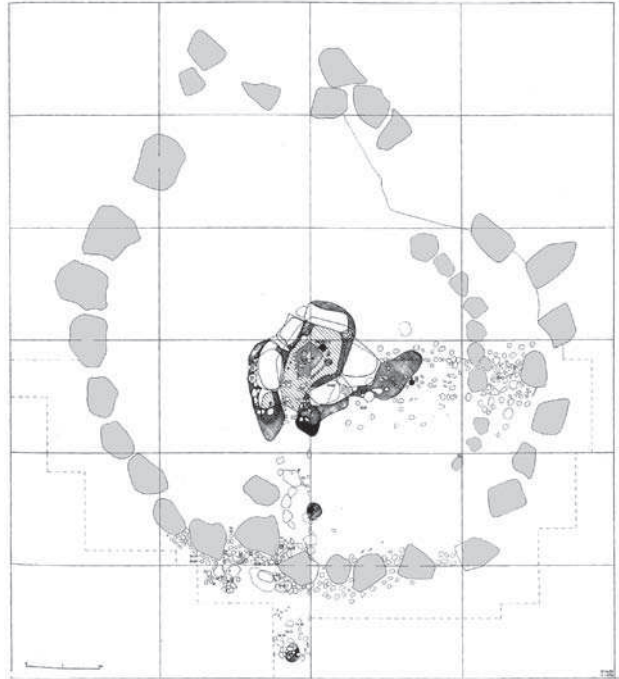


Figure 7.5 : Tumulary structure of Barclodiad y Gawres

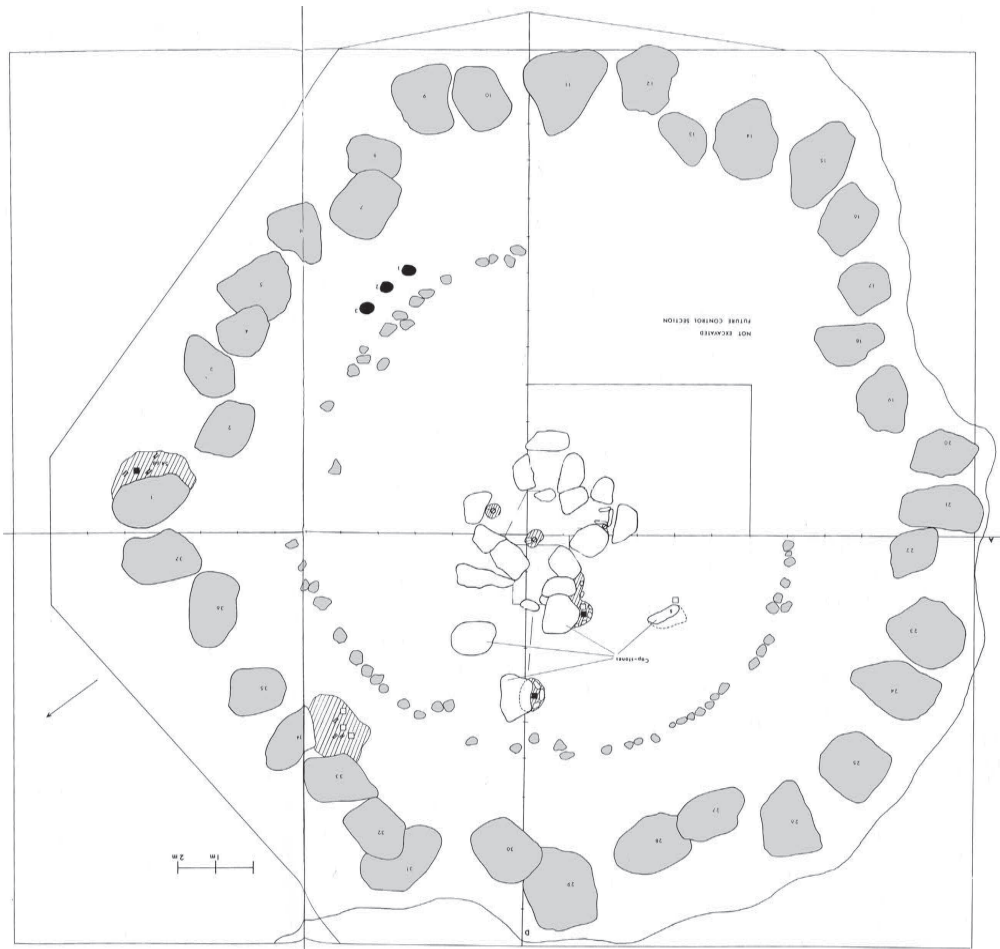
Carrowmore 4



Carrowmore 7



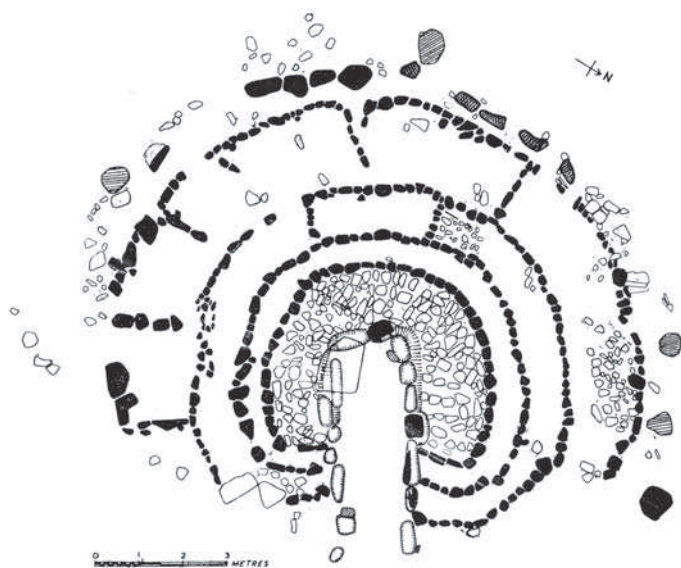
Carrowmore 27



After Burenhult 1980

Figure 7.6 : Concentric enclosures in Carrowmore 4, 7 and 27

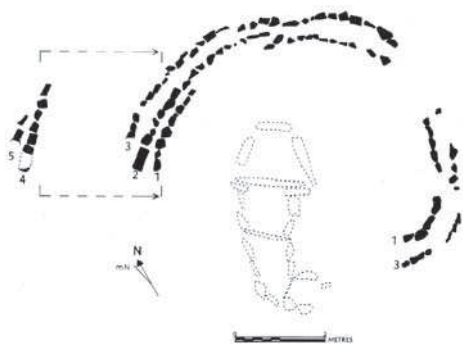
Townleyhall
(after Eogan 1963)



Ballycarty (stage 1)
(after Connolly 1999)



Knowth 16
(after Eogan 1984)



Knowth 4
(after Eogan 1984)

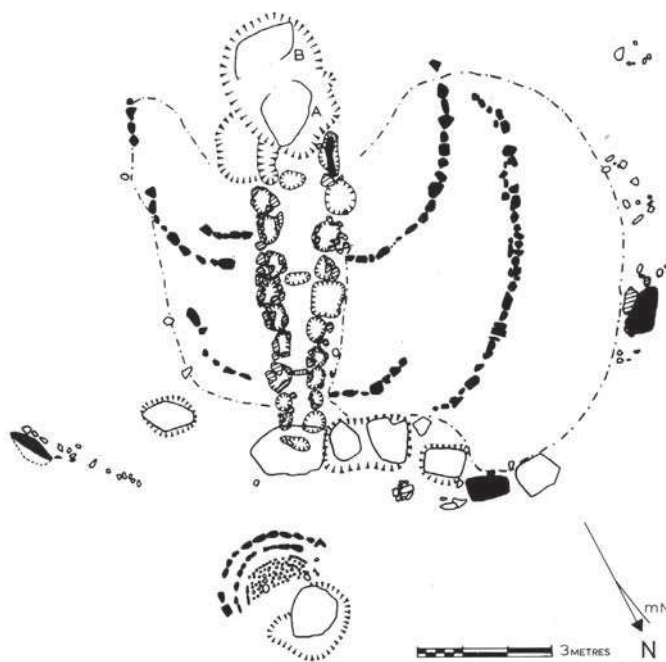
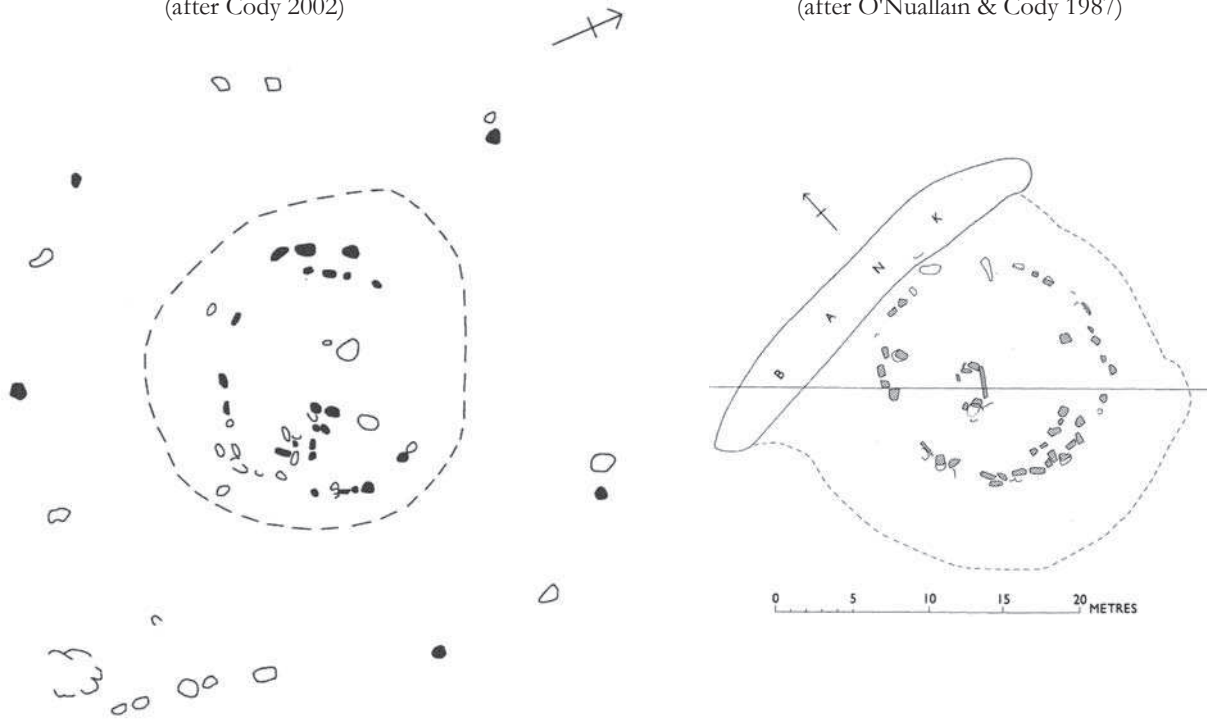


Figure 7.7 : Concentric enclosures in Townleyhall, Ballycarty and Knowth 4

Banagher (Co. Cavan)
(after Cody 2002)

Baunfree (Co. Kilkenny)
(after O'Nuallain & Cody 1987)



Bryn Celli Ddu (Anglesey)
(after Hemp 1930)

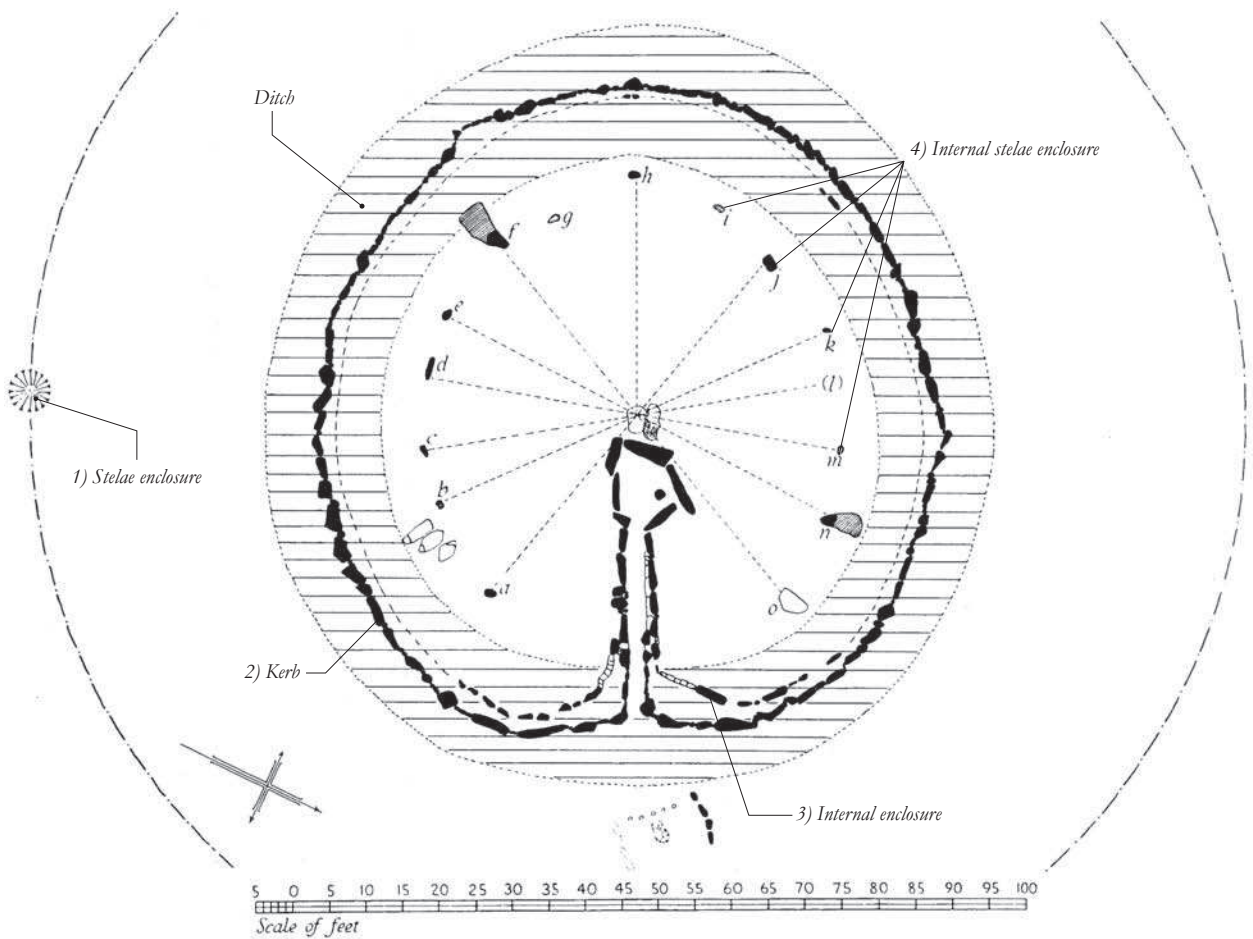
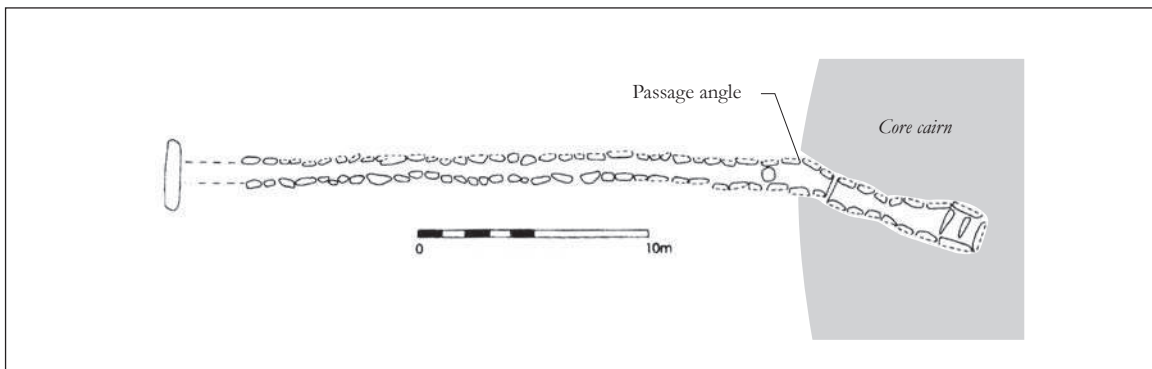
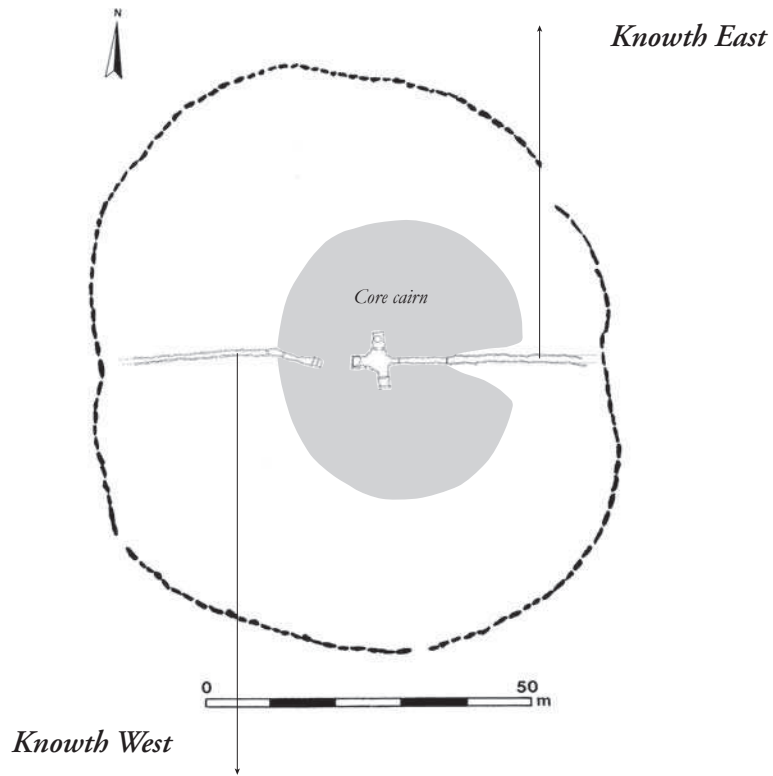
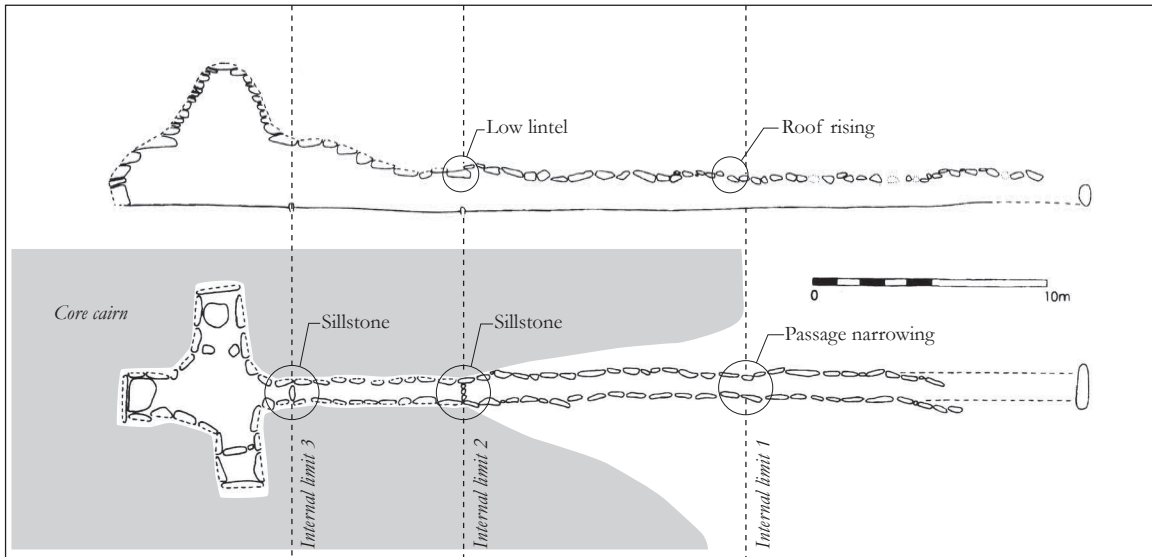


Figure 7.8 : Concentric enclosures in Banagher, Baunfree and Bryn Celli Ddu

Sites	Spatial differentiation of tumulary materials	Internal enclosures	External enclosures
Ballycarty		1 stone enclosure	1 kerb
Banagher		1 stone enclosure	1 kerb ; 1 stelae enclosure
Barclodiad y Gawres	Turfs ; stones		
Baunfree		1 stone enclosure	1 kerb
Bryn Celli Ddu		1 stone enclosure ; 1 stelae enclosure	1 kerb ; 1 stelae enclosure
Carrowmore 1		1 stone enclosure	1 kerb
Carrowmore 4		3 stone enclosures	1 kerb
Carrowmore 7		1 stone enclosure	1 kerb
Carrowmore 27		1 stone enclosure	1 kerb
Carrowmore 37		1 stone enclosure	1 kerb
Grange North		1 stone enclosure	1 kerb
Knocklea	Shells ; sods		1 kerb
Knocknarea 1			1 kerb ; 1 bank
Knockmany	Stones ; sods		1 loose stone facing
Knowth 1			1 kerb
Knowth 2	Compact earth ; sods		1 kerb
Knowth 4		3 stone enclosures	1 kerb
Knowth 12	Stones ; sods	1 stone enclosure	1 kerb
Knowth 15	Sods ; boulder clay	2 stone enclosures	1 kerb
Knowth 16	Stones ; sods	4 stone enclosures	1 kerb
Knowth 18		1 stone enclosure	1 kerb
Newgrange	Stones ; turfs	3 stone enclosures	1 kerb ; 1 stelae enclosure
Newgrange K		3 stone enclosures ; 1 ditch	1 kerb
Newgrange L	Sand ; turfs	1 stone enclosure	1 kerb
Newgrange Z	Turfs ; boulder clay	1 stone enclosure	1 kerb
Tara	Sods ; stones		
Townleyhall	Stones ; sand	4 stone enclosures	1 kerb

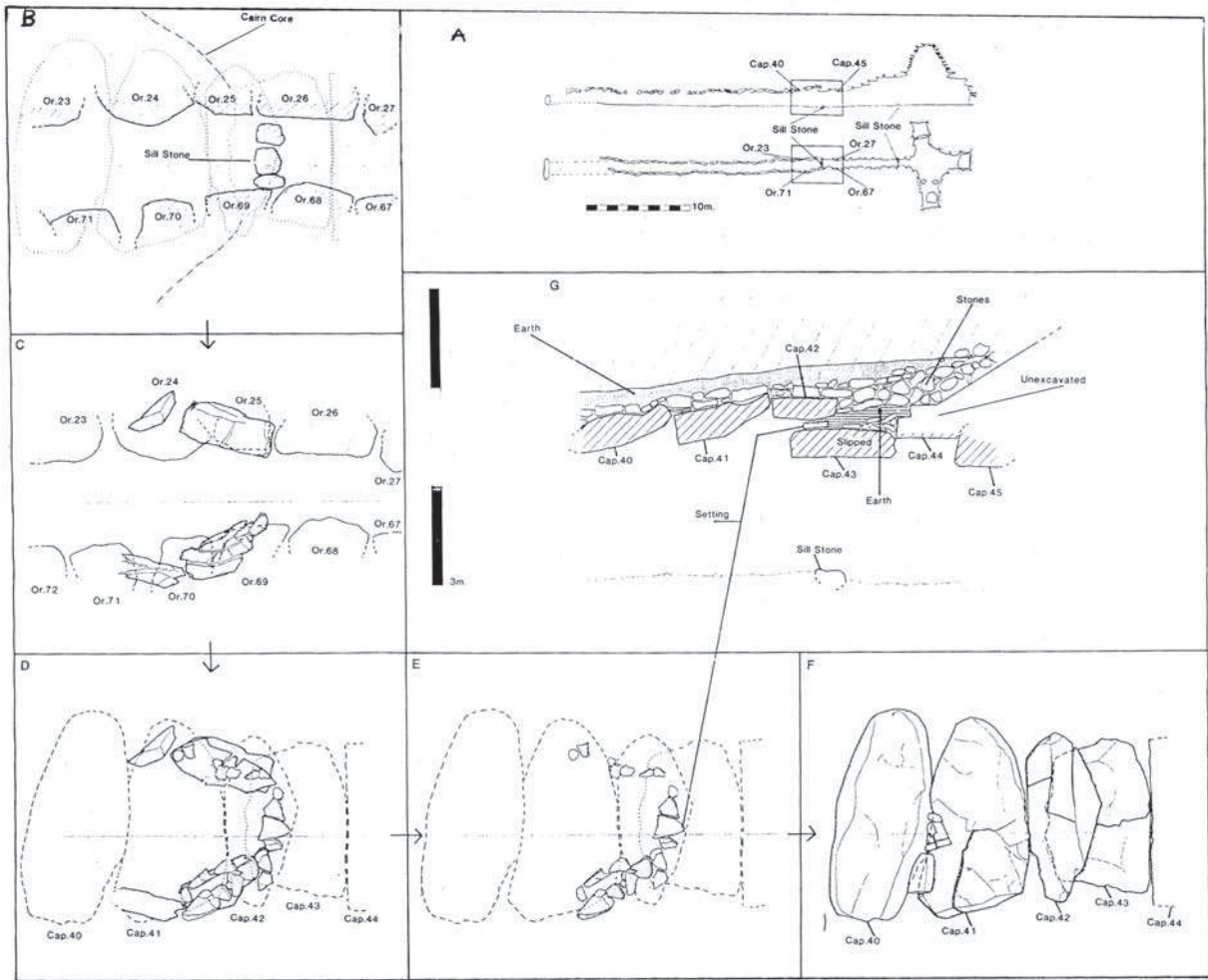
Figure 7.9 : Table of synthesis of the tumulary structures



Plans after Eogan 1998
 Core cairn plan after Eogan (www.heritagecouncil.ie/archaeology/bru_na_boinne/abstracts.html)

Figure 7.10 : Knowth : relations between the core cairn and the thresholds inside tombs East and West

Knowth : U-shaped stone setting at the junction of the core cairn (Eogan 1990 : fig. 2)



Newgrange : U-shaped stone setting at the limit of the core cairn (after O'Kelly 1982)

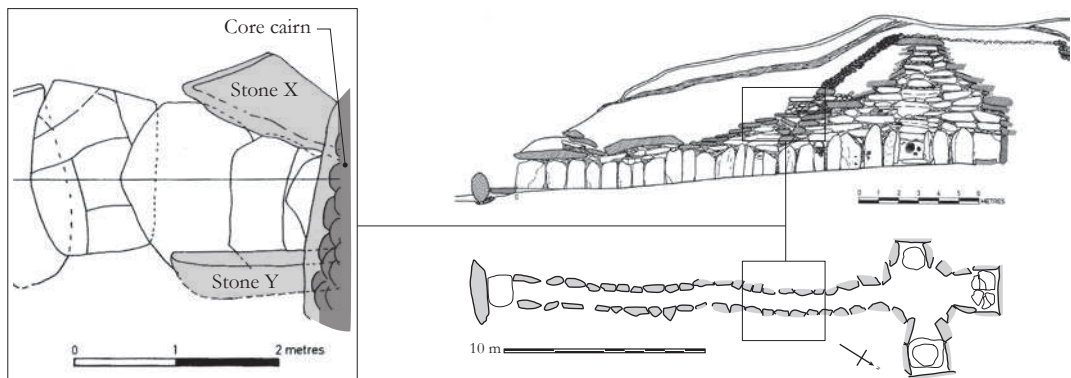


Figure 7.11 : Knowth and Newgrange passage roof: U-shaped structure at the limit of the core cairn

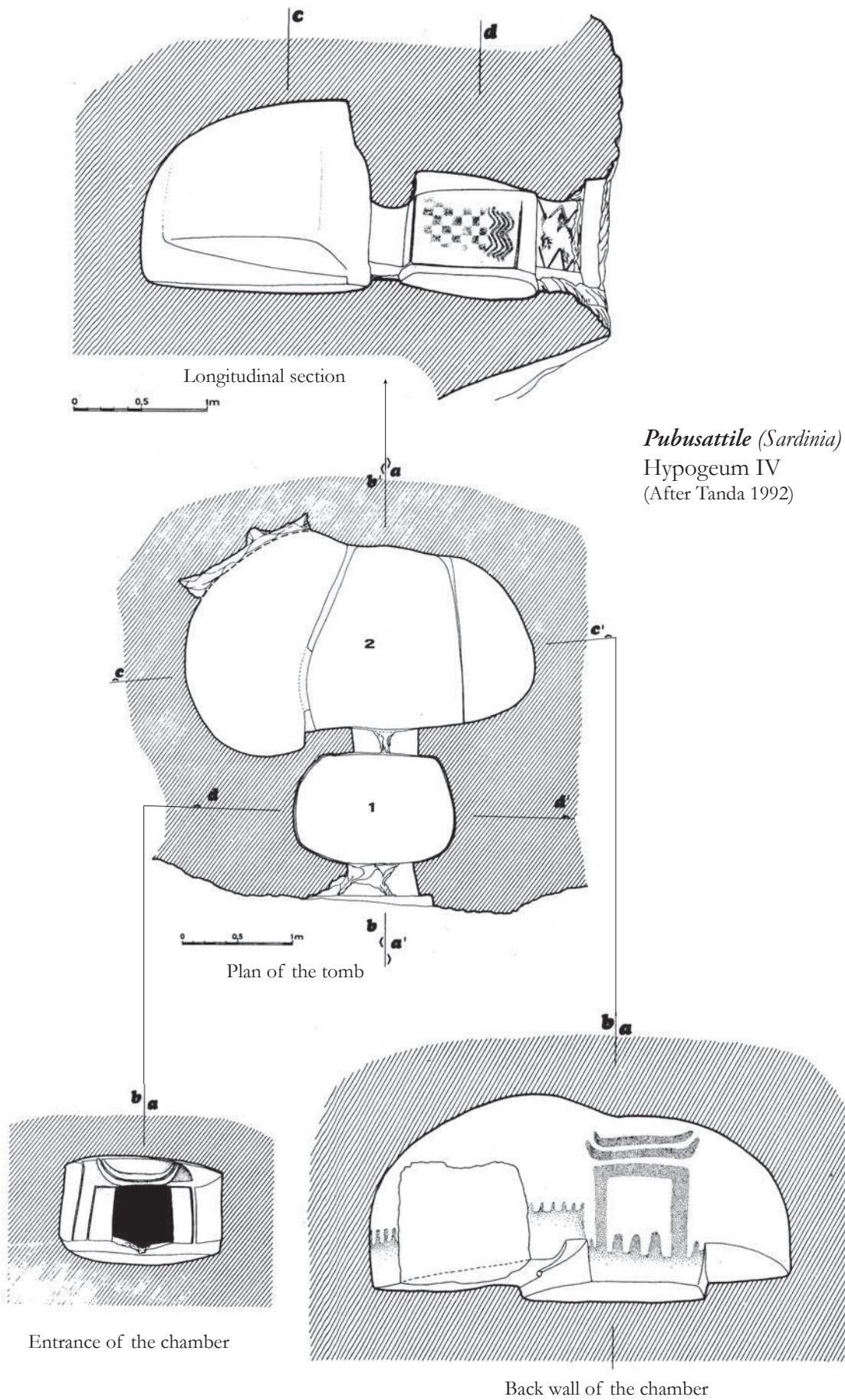
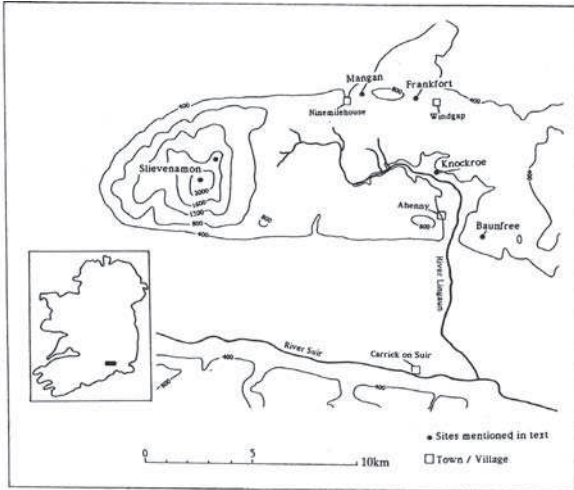


Figure 7.12 : Hypogeum IV of Pubusattile



Localization map (O'Sullivan 1993)

Slievenamon Cairn (Co. Tipperary)



Natural formation from north



Natural formation from north-west



Cairn from north



Cairn from south

Figure 7.13 : Slievenamon cairn

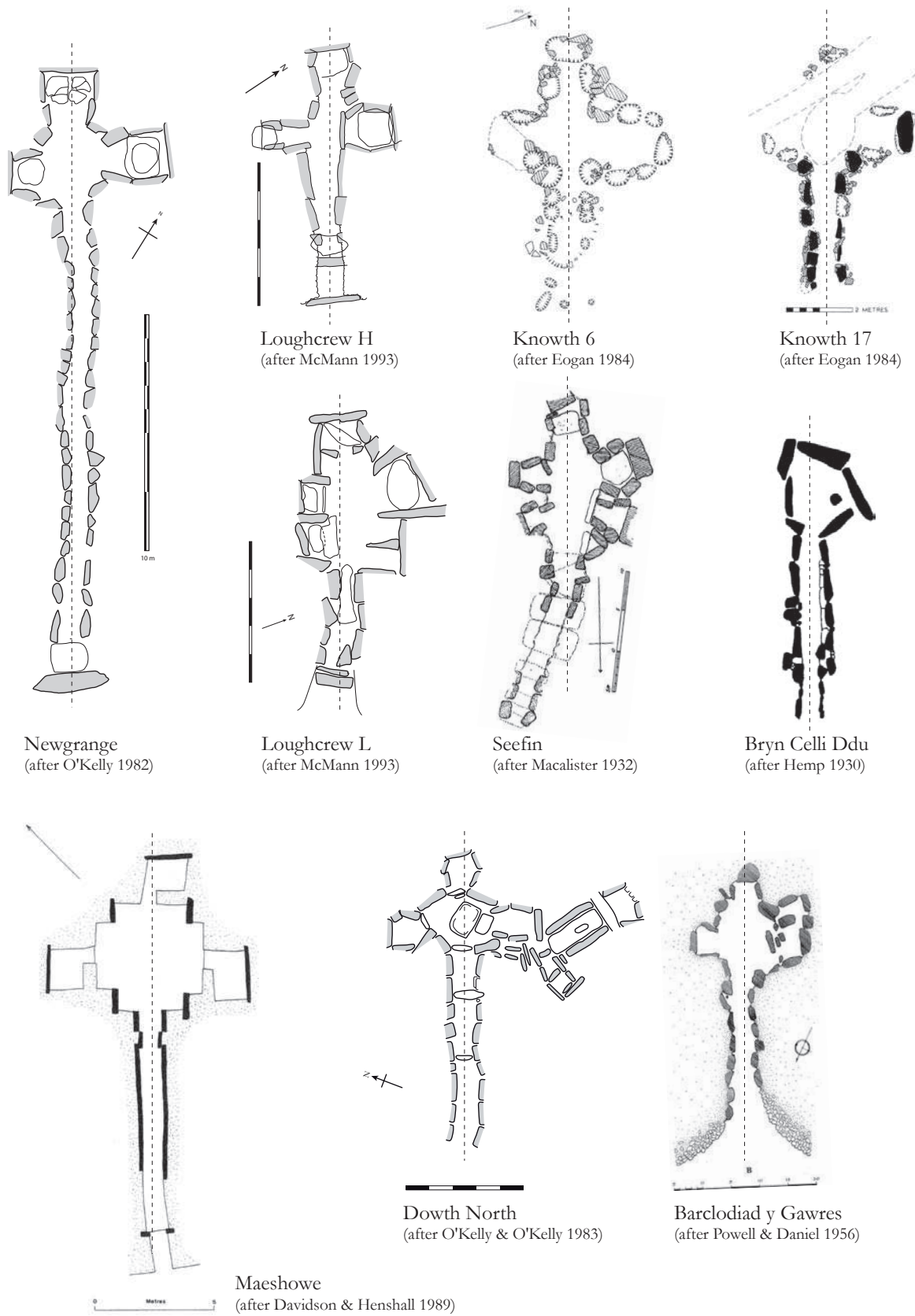


Figure 7.14 : Passage tombs with emphasis on the right-hand side (1/2)

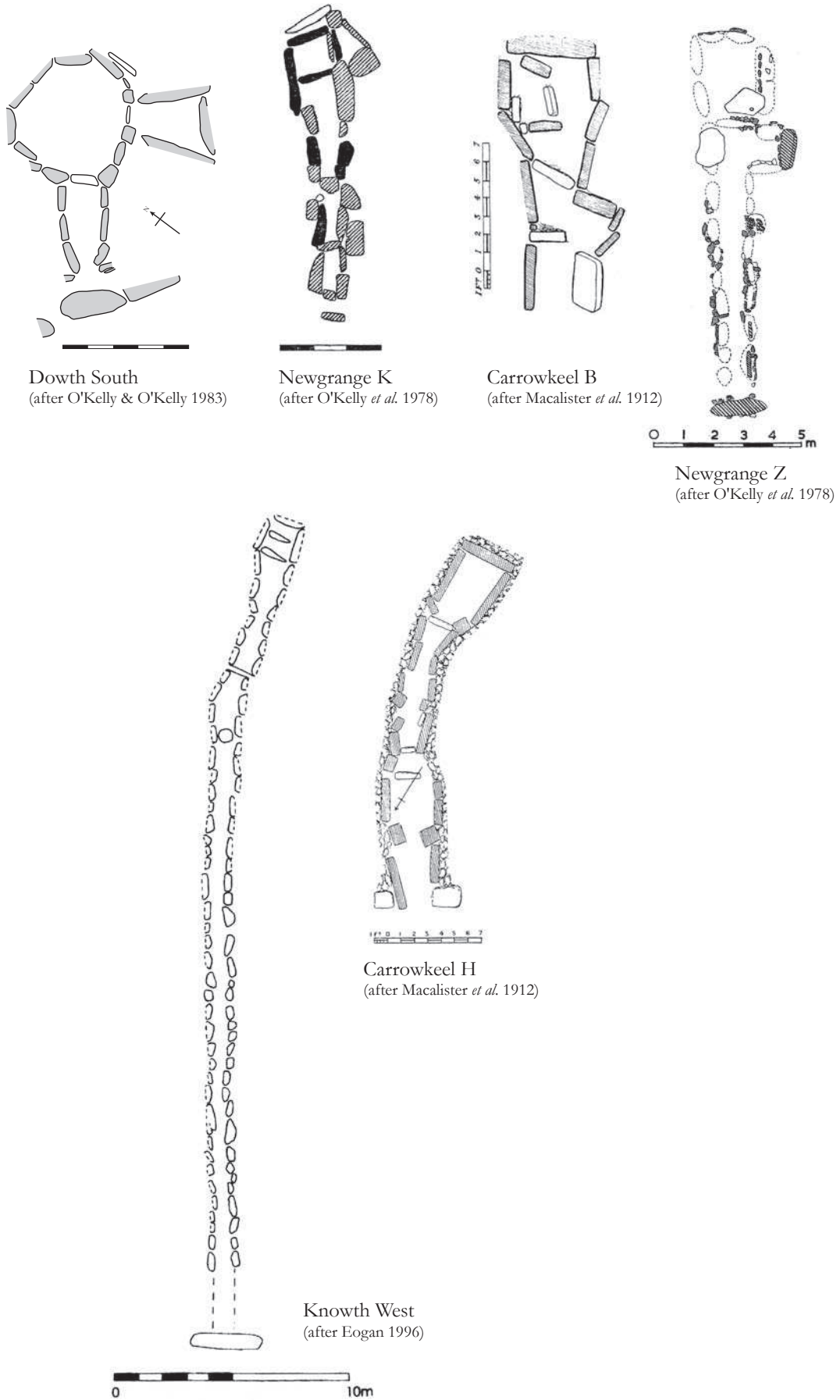
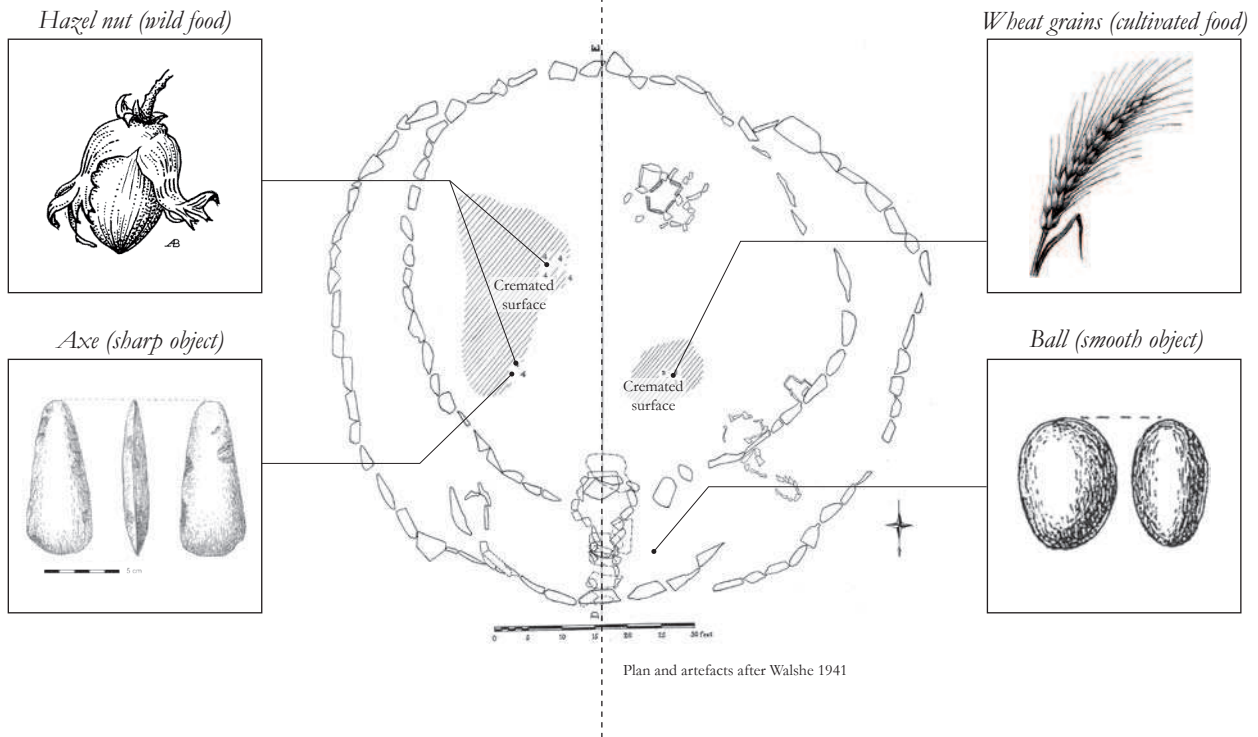


Figure 7.15 : Passage tombs with emphasis on the right-hand side (2/2)

Baltinglass



Carrowmore 7

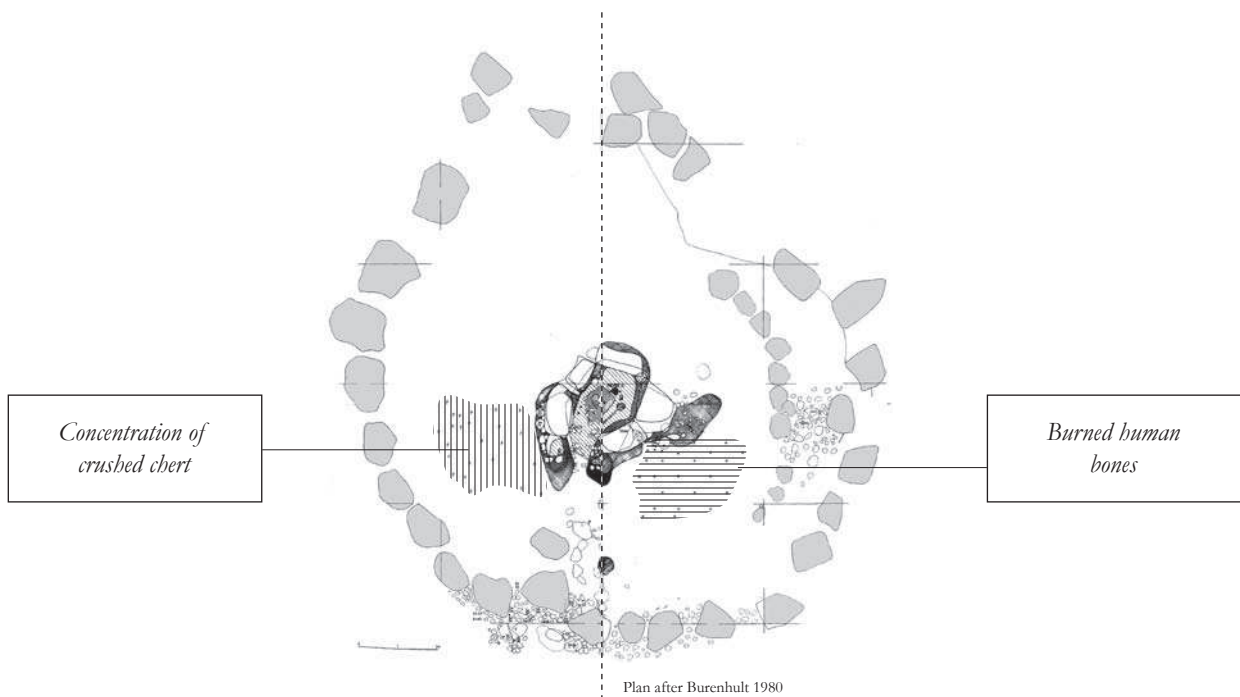


Figure 7.16 : System of opposition under the cairn of Baltinglass and Carrowmore 7

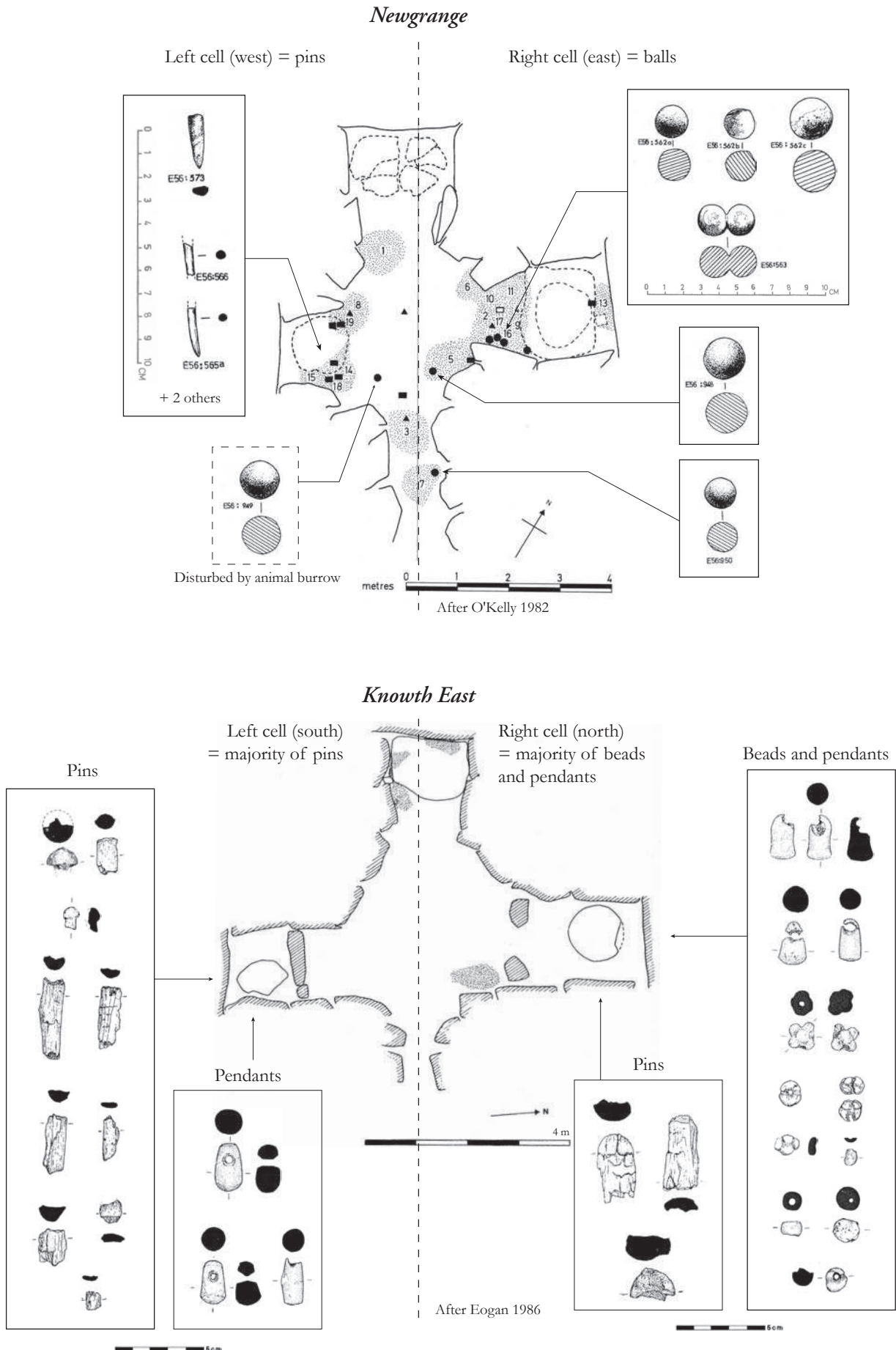


Figure 7.17 : Opposition of grave furniture in Newgrange and Knowth East

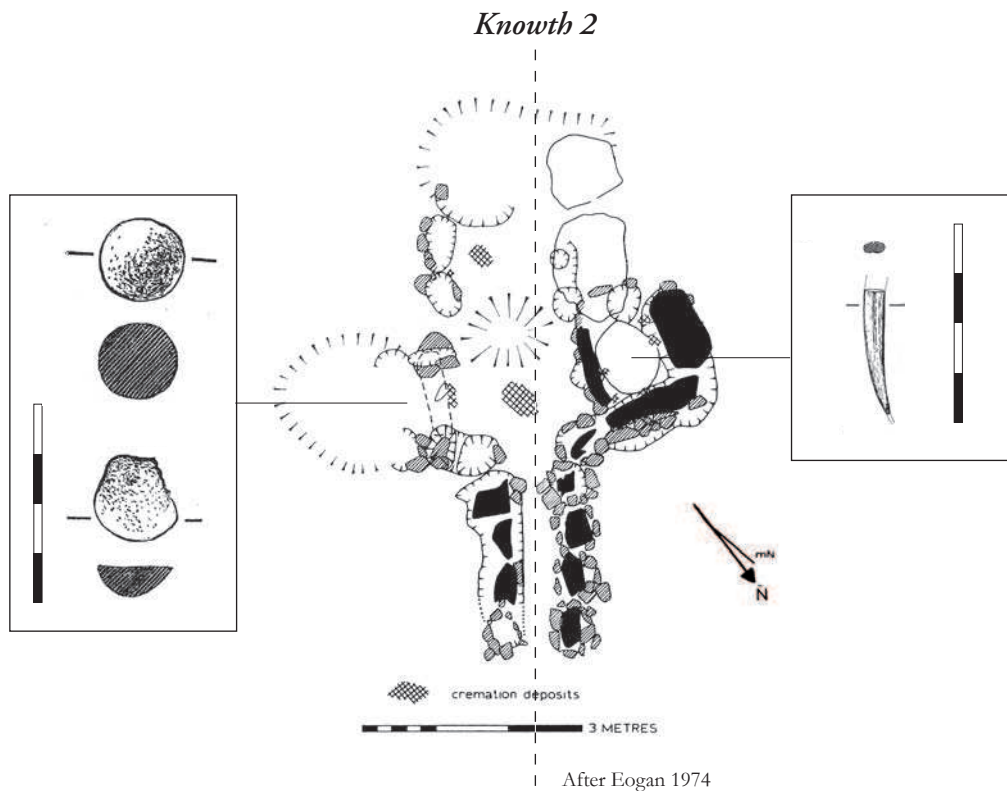
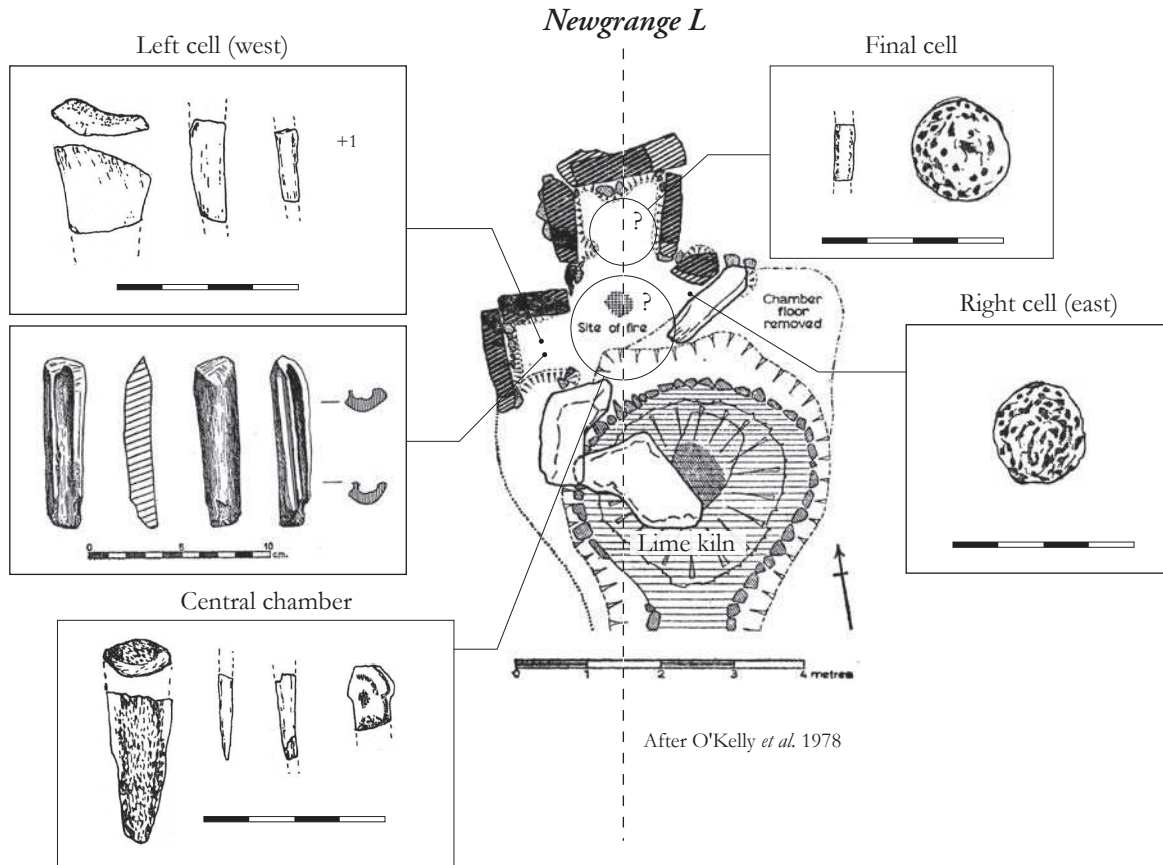


Figure 7.18 : Opposition of grave furniture in Newgrange L and Knowth 2

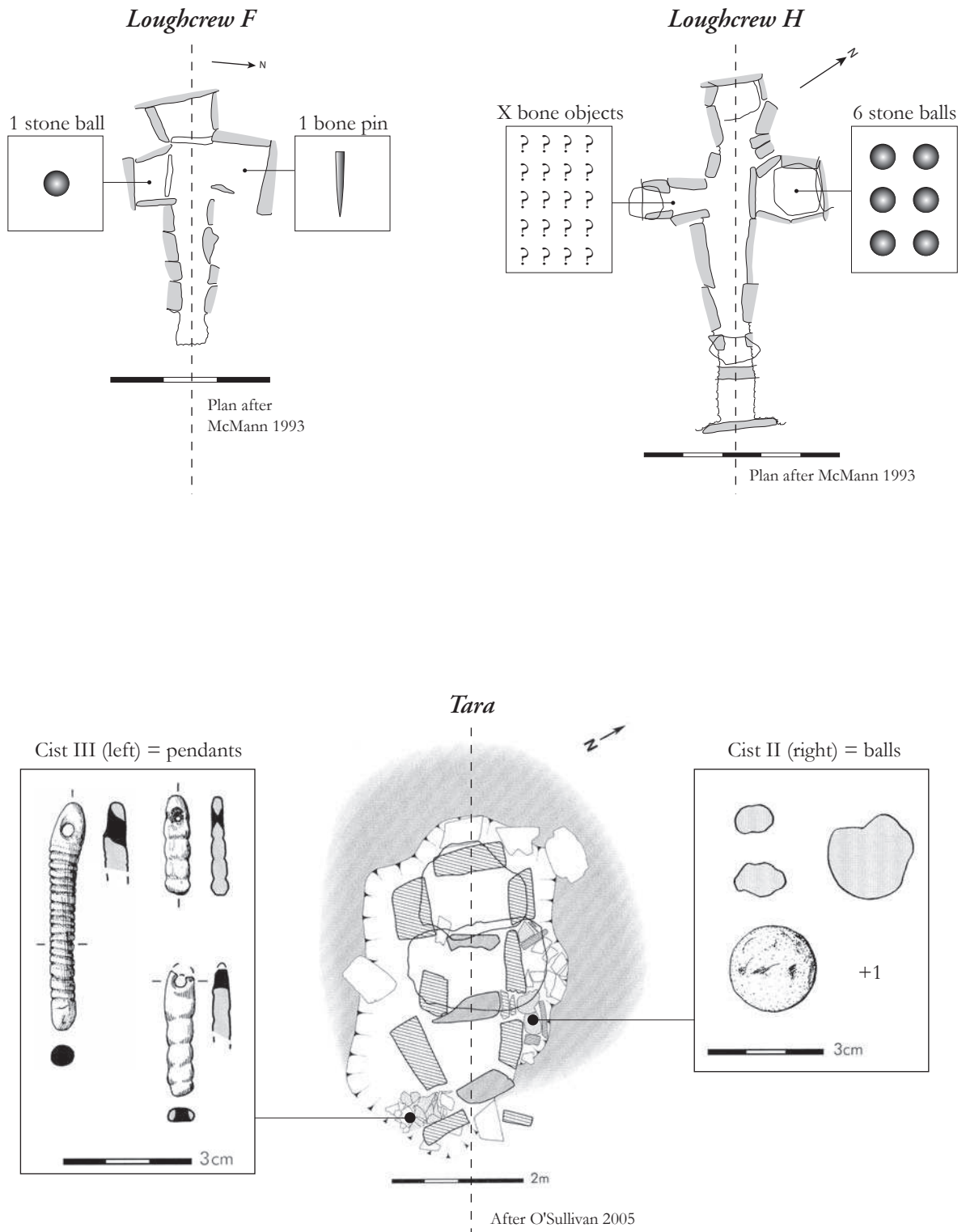


Figure 7.19 : Opposition of grave furniture in Loughcrew F and H and Tara

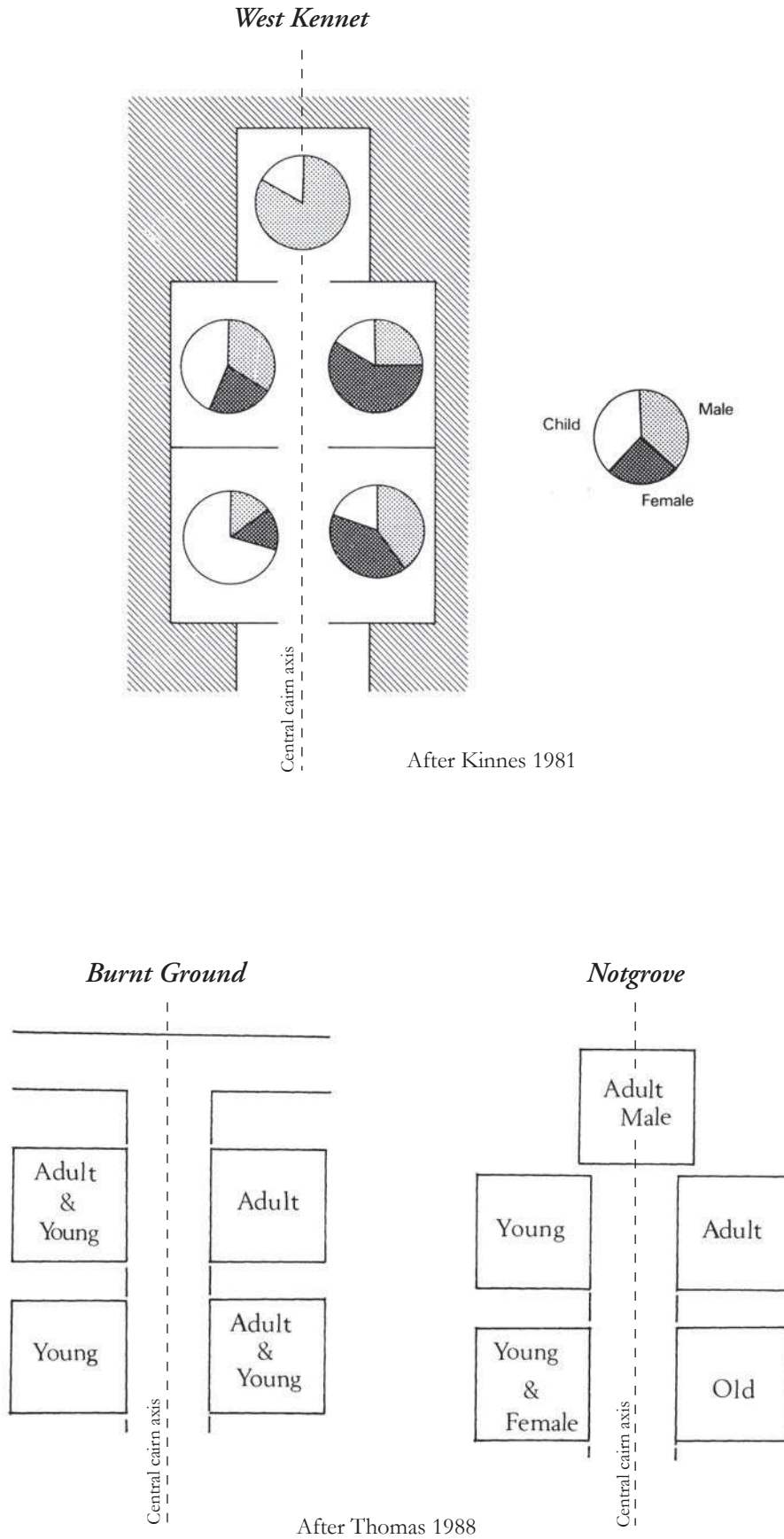
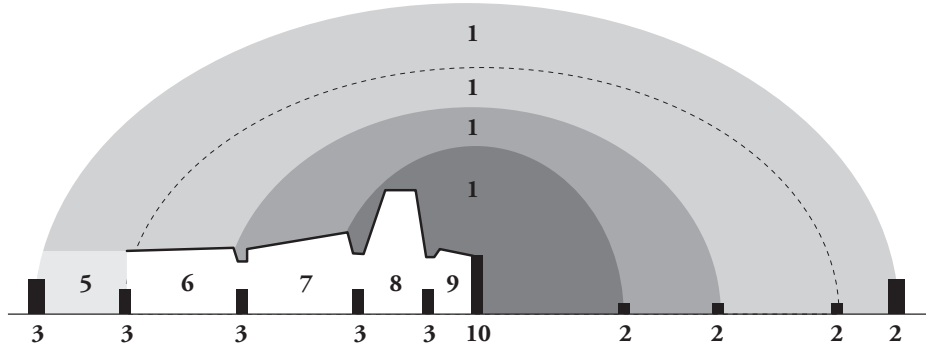
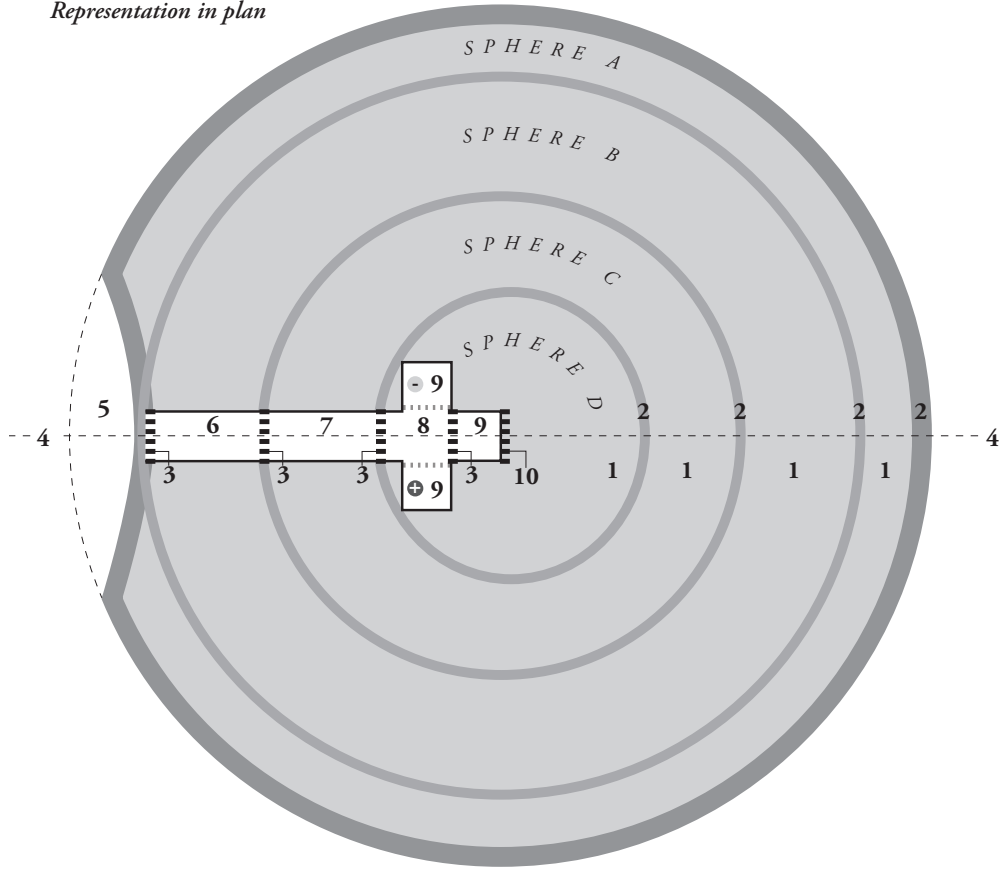


Figure 7.20 : Classifications and oppositions of human remains in West Kennet, Burnt Ground and Notgrove (Severn-Cotswold group)

Sectional representation



Representation in plan



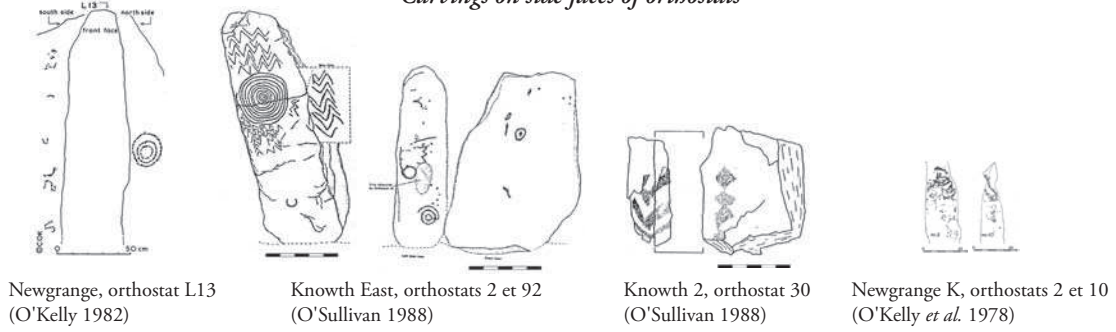
	<i>Material elements</i>	<i>Symbolical reading</i>
1	Tumulary layers	Concentric spaces
2	Enclosures	Invisible limits
3	Thresholds	Visible limits
4	Axis	Pathway
5	Forecourt	First lock
6	Passage	Second lock
7	Antechamber	Third lock
8	Chamber	Fourth lock
9	Cells	Terminal spaces
10	Backstone	Ultimate doorway

Figure 7.21 : Schematic representation of the spatial organization of passage tomb structures

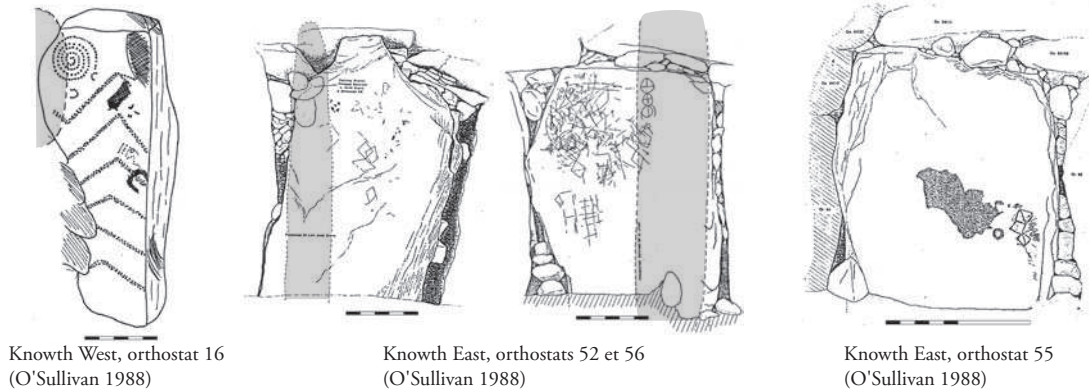


Figure 7.22 : The hopscotch game

Carvings on side faces of orthostats

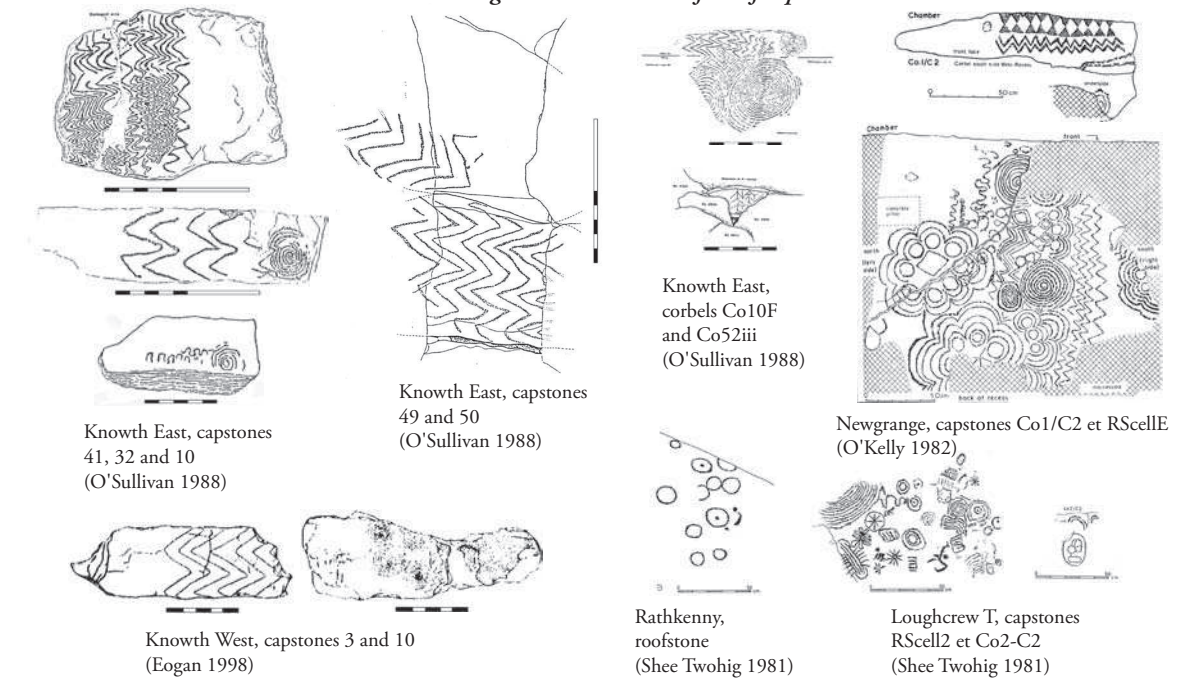


Carvings on orthostats obscured by adjacent stones



Over-picked carvings

Carvings on obscured lower face of capstones



Carvings on obscured upper face of capstones

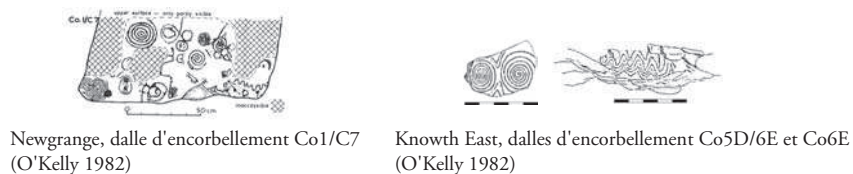
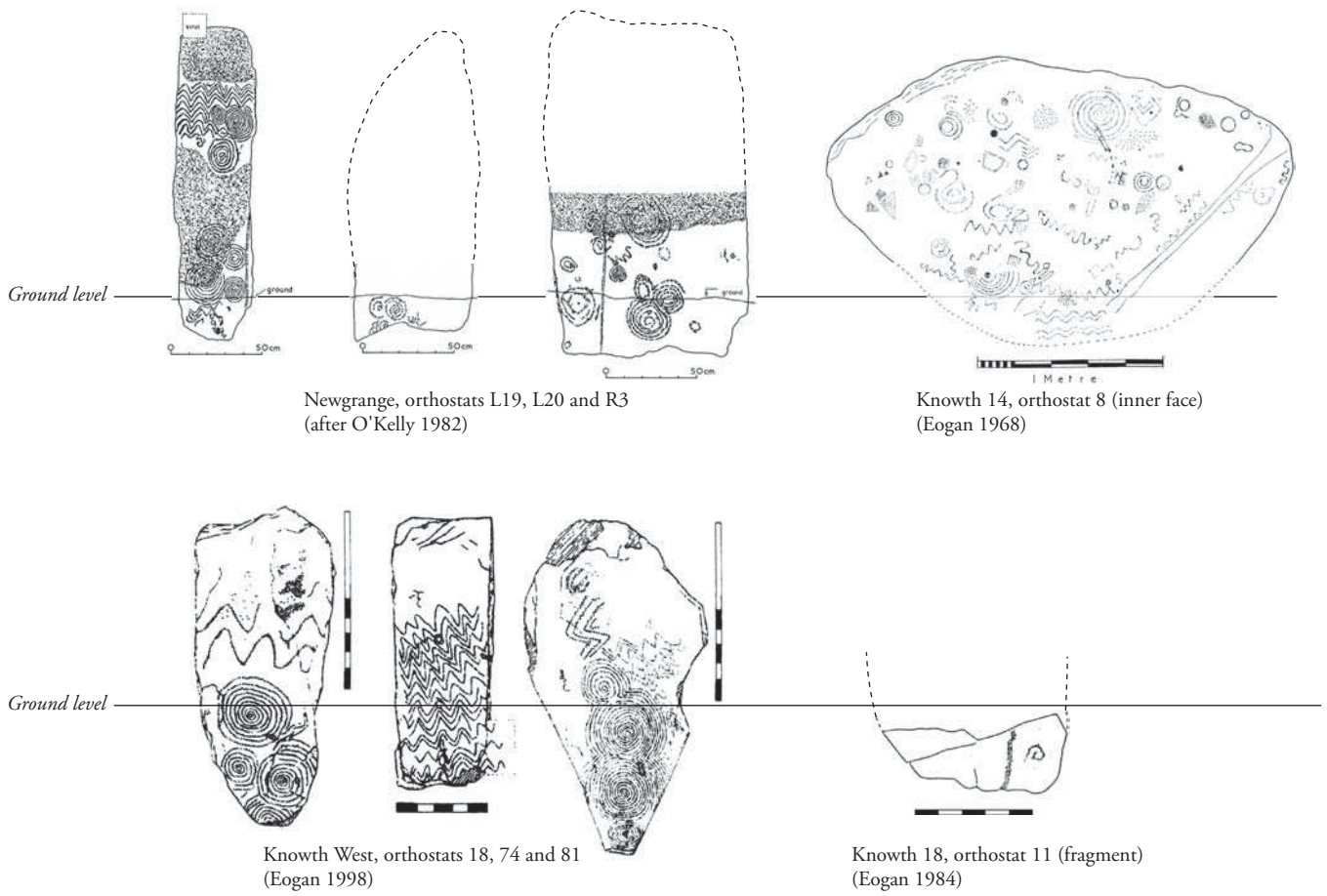


Figure 8.1 : Carvings on obscured surface

Carvings on buried base of orthostats



Carvings on buried base of kerbstones

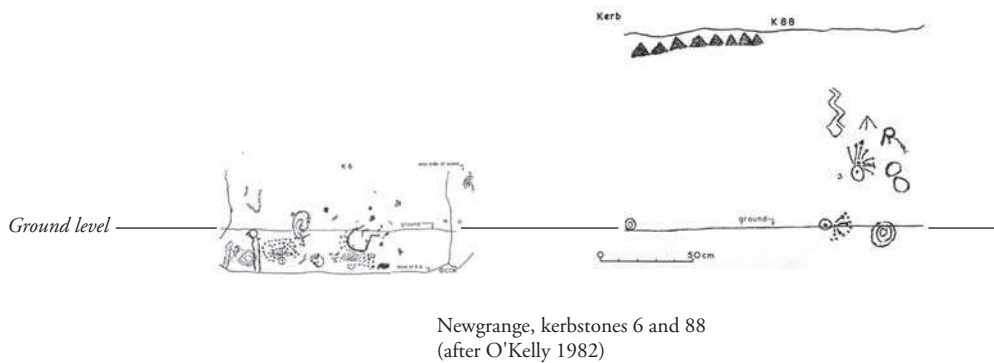
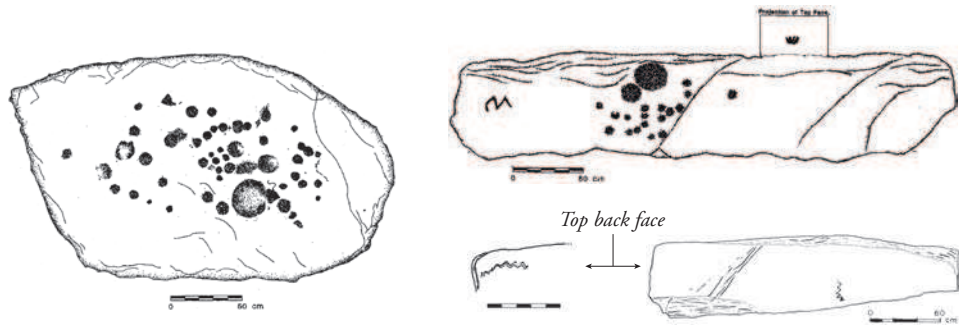


Figure 8.2 : Carvings on the buried base of orthostats and kerbstones

Carvings on back face of kerbstones

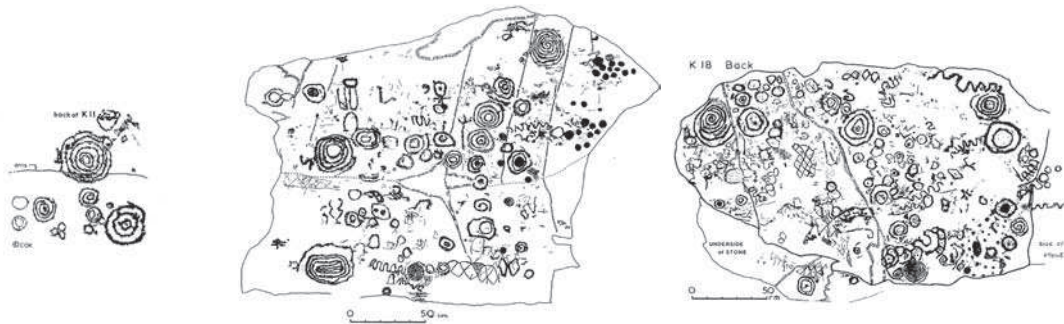


Knowth, kerbstones 13, 1, 71 and 94
(Eogan 1968, 2008 ; O'Sullivan 1988)

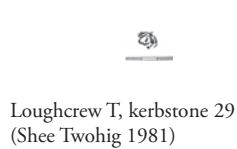


Dowth, kerbstones 50 and 51
(O'Kelly & O'Kelly 1983)

Newgrange L, kerbstone B
(O'Kelly *et al* 1978)



Newgrange, kerbstones 11, 13, 18, 91 and 4
(O'Kelly 1982)



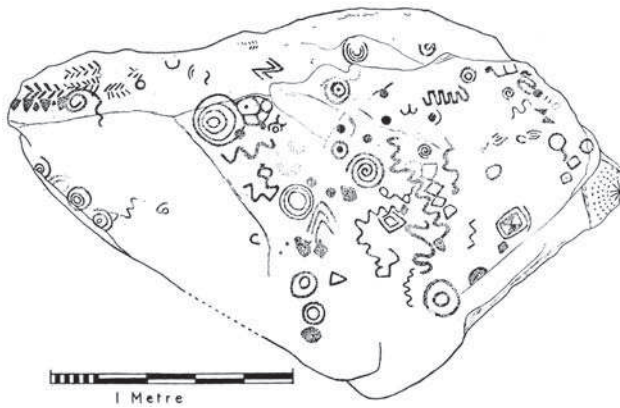
Loughcrew T, kerbstone 29
(Shee Twohig 1981)



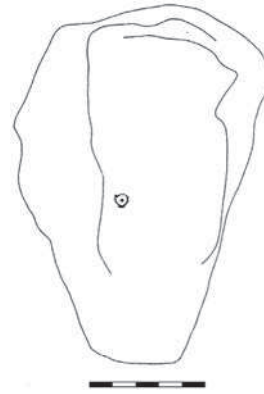
Newgrange K, kerbstone 4
(O'Kelly *et al.* 1978)

Figure 8.3 : Carvings on the backface of kerbstones

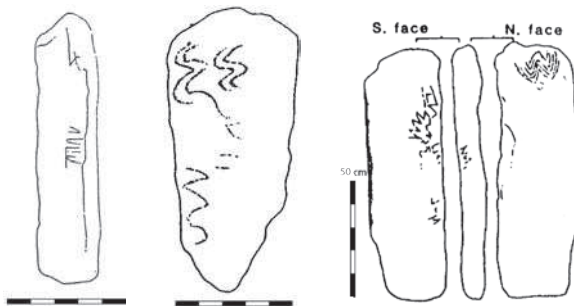
Carvings on back face of orthostats



Knowth 14, orthostat 8
(Eogan 1968)



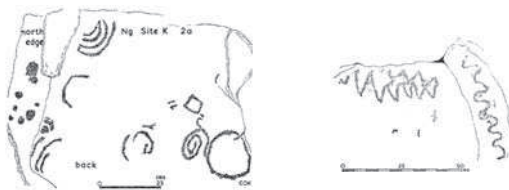
Knowth 15, orthostat 14
(Eogan 1984)



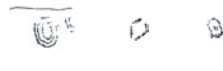
Knowth 16, orthostats 4, 9 and 13
(Eogan 1984)



Knowth West, orthostat 17
(Eogan 1998)



Newgrange K, orthostats 2a and 5
(O'Kelly *et al.* 1978)



Knockmany, orthostats 5, 6 and 7
(Shee Twohig 1981)

Figure 8.4 : Carvings on the backface of orthostats

Carvings on upper face of roofstones

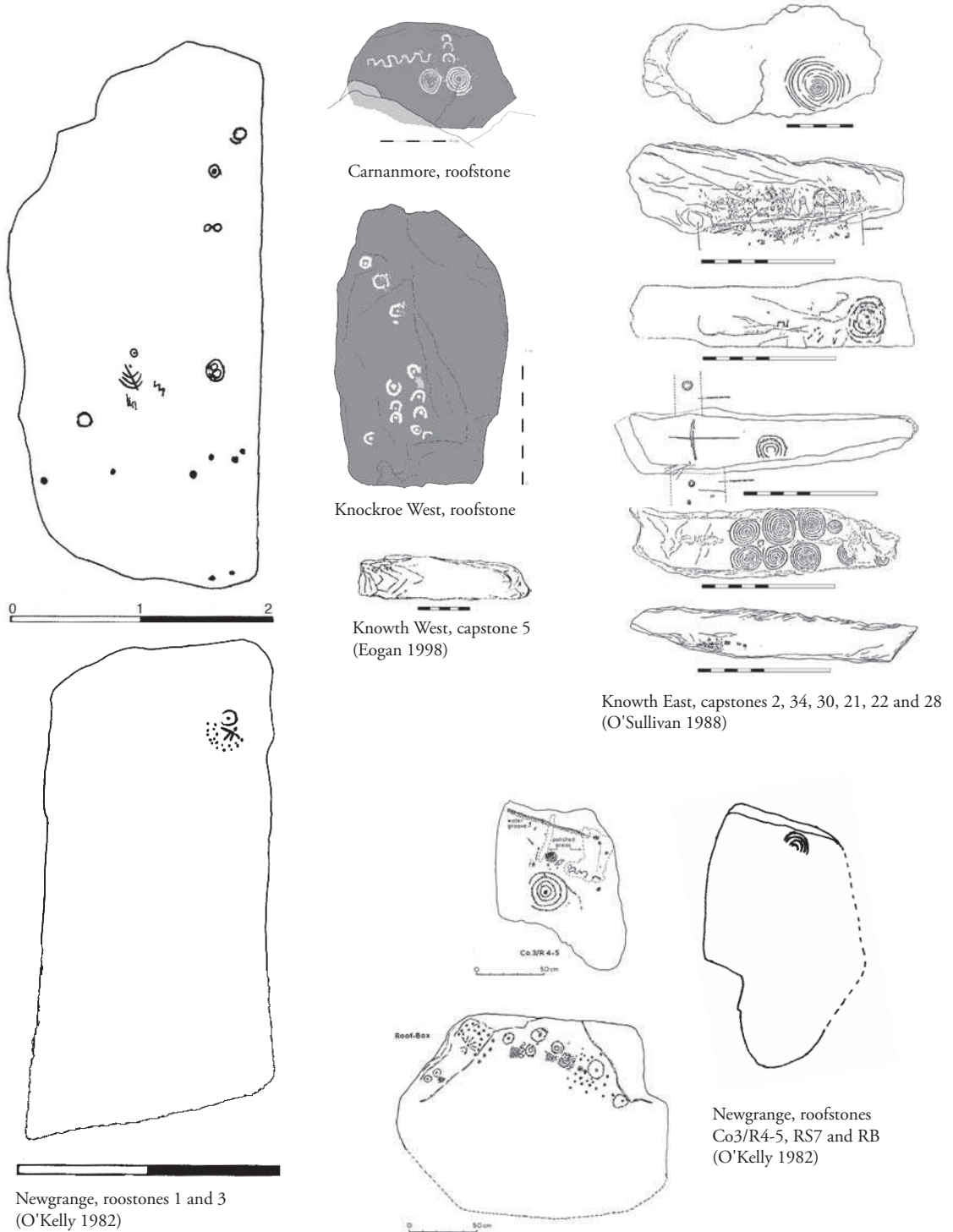


Figure 8.5 : Carvings on the upper face of capstones

Carvings on stones buried in tumulus

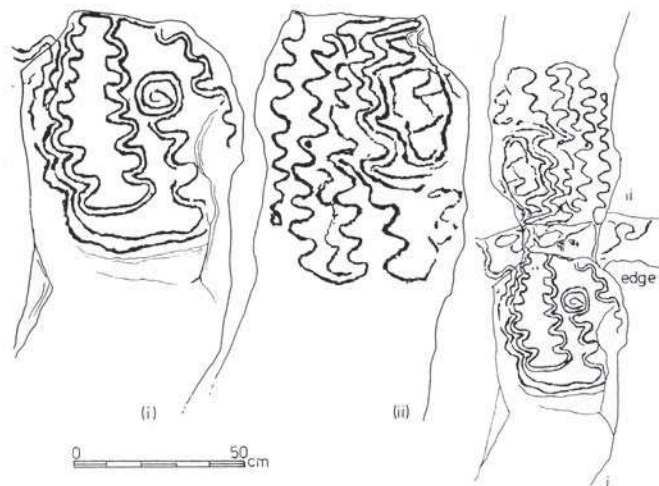
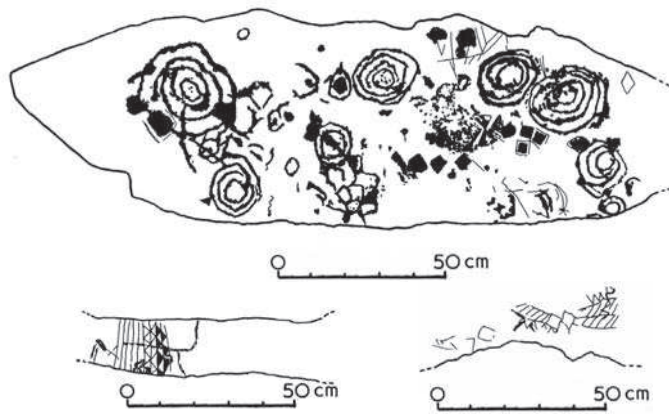
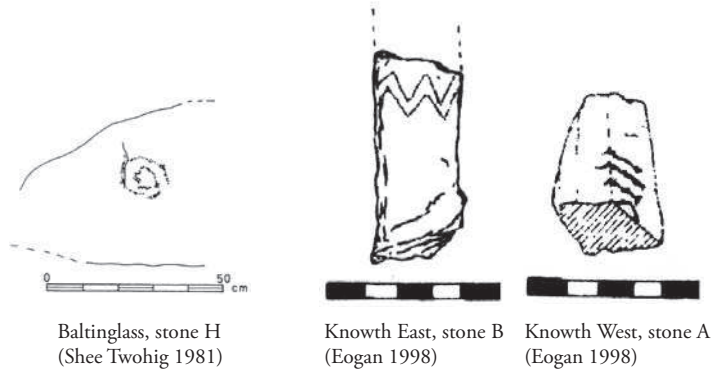


Figure 8.6 : Carvings on stones buried in the tumulus

Stone				Location of hidden carvings						
Land	Site	Name	Function	Obscured face	Overpicked carving	Buried base	Back face	Upper face	Tumulus	
IRL.	Balinglass	H	Kerb							
IRL.	Carnanmore	Co1	Cover							
		Co2	Cover							
IRL.	Dowth Tombe sud	K50	Kerb							
		K51	Kerb							
		C12	Orthostat							
IRL.	Fourknocks	C5	Orthostat							
IRL.	Knockmany	C5	Orthostat							
		C6	Orthostat							
		C7	Orthostat							
IRL.	Knockroe W	RS	Cover							
IRL.	Knowth 1	K1	Kerb							
		K13	Kerb							
		K14	Kerb							
		K15	Kerb							
		K16	Kerb							
		K46	Kerb							
		K61	Kerb							
		K68	Kerb							
		K71	Kerb							
		K94	Kerb							
		Tombe East	Or2	Orthostat						
			Or36	Orthostat						
			Or43	Orthostat						
			Or52	Orthostat						
			Or55	Orthostat						
			Or56	Orthostat						
			Or92	Orthostat						
			RS2	Cover						
			RS7	Cover						
			RS10	Cover						
			RS18	Cover						
			RS20	Cover						
			RS21	Cover						
			RS26	Cover						
			RS28	Cover						
			RS30	Cover						
			RS32	Cover						
	RS34		Cover							
	RS37		Cover							
	RS41		Cover							
	RS49	Cover								
	RS50	Cover								
	Co40i	Corbel								
	Co52iii	Corbel								
	CoD4	Corbel								
	CoE6	Corbel								
	CoF10	Corbel								
	Co5D/6E	Corbel								
	B	?								
	Tombe West	Or16	Orthostat							
		Or17	Orthostat							
		Or18	Orthostat							
		Or74	Orthostat							
		Or81	Orthostat							
		RS3	Cover							
		RS5	Cover							
		RS10	Cover							
		RS21	Cover							
	A	?								
IRL.	Knowth 2	Or30	Orthostat							
IRL.	Knowth14	K5	Kerb							
		Or8	Orthostat							
IRL.	Knowth 15	Or14	Orthostat							
IRL.	Knowth 16	Or2	Orthostat							
		Or4	Orthostat							
		Or7	Orthostat							
		Or9	Orthostat							
		Or13	Orthostat							
	Co12	Corbel								
IRL.	Knowth 18	Or11	Orthostat							
IRL.	Loughcrew L	L1	Orthostat							
IRL.	Loughcrew S	C2	Orthostat							
IRL.	Loughcrew T	K29	Kerb							
		Co2/C2	Corbel							
		RScell2	Cover							
IRL.	Loughcrew U	C9	Orthostat							

IRL	Newgrange	K4	Kerb						
		K6	Kerb						
		K7	Kerb						
		K11	Kerb						
		K13	Kerb						
		K18	Kerb						
		K56	Kerb						
		K58	Kerb						
		K66	Kerb						
		K88	Kerb						
		K91	Kerb						
		L13	Orthostat						
		L19	Orthostat						
		L20	Orthostat						
		R3	Orthostat						
		Co1/C2	Corbel						
		Co1/C7	Corbel						
		RScellE	Cover						
		RS1	Cover						
		RB	Cover						
		Co3/R4-5	Corbel						
		Co3/L5-6	Corbel						
		RS3	Cover						
RS7	Cover								
X	Cover								
Y	Cover								
Z	Cover								
IRL	Newgrange K	K4	Kerb						
		2	Orthostat						
		10	Orthostat						
		2a	Orthostat						
		5	Orthostat						
IRL	Newgrange L	B	Kerb						
IRL	Rathkenny	B	Cover						
IRL	Tara	R2	Orthostat						
GAL	Barclodiad y G.		Cover						
GAL	Bryn Celli Ddu		?						
Total	23	112	27	4	10	45	30	4	

Figure 8.7 : Table of synthesis of hidden carvings

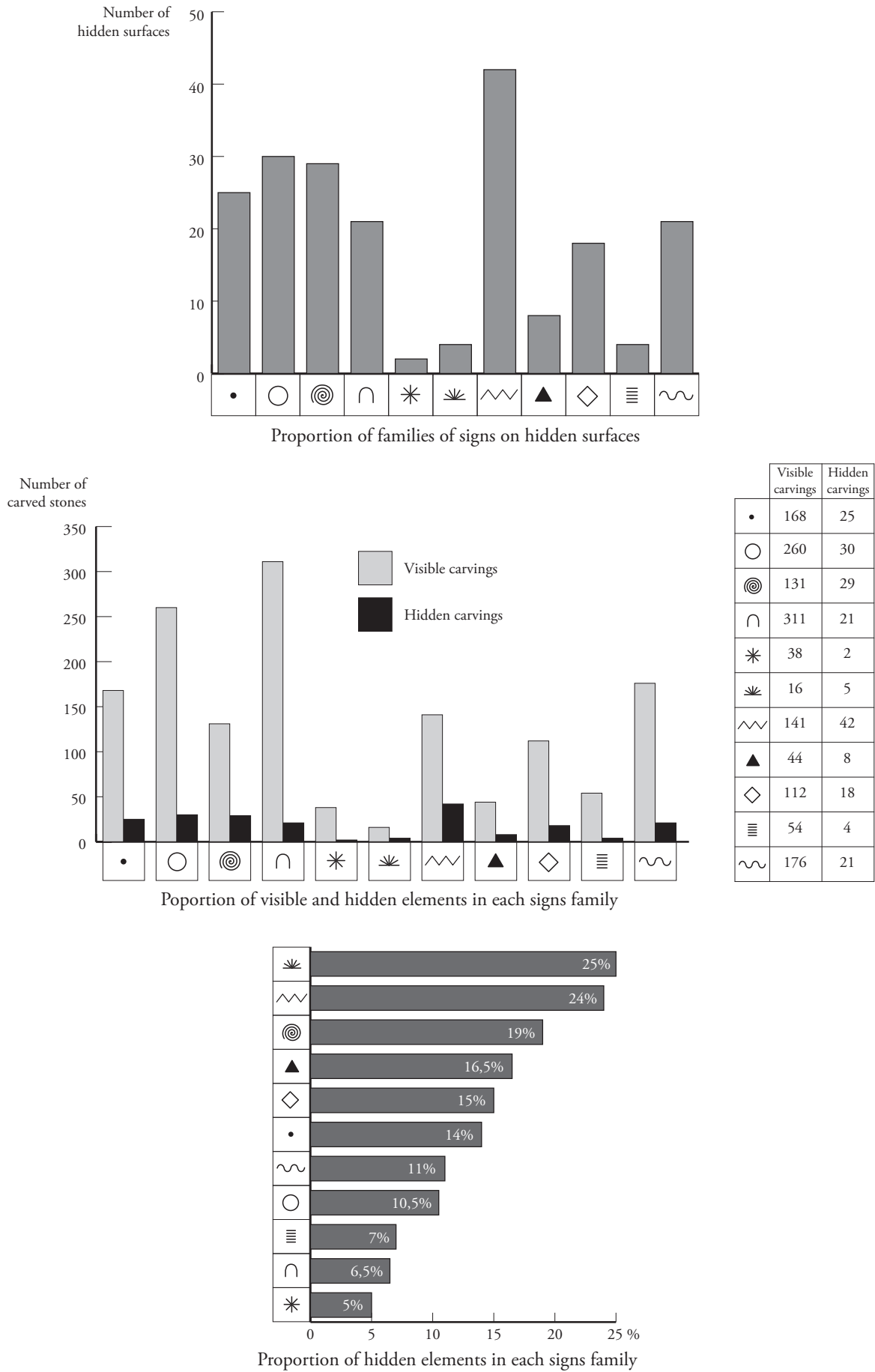


Figure 8.8 : Statistical graphs on hidden art iconography

	Obscured face	Buried base	Back face	Upper face	Tumulus
•	•	•	●	●	●
○	●	•	●	●	•
◎	●	●	●	●	•
∩	•	•	●	●	•
✱			•		
☀		•	•	•	
⚡	●	•	●	●	•
▲	•		●	•	•
◇	•	•	●	•	●
≡	•		•	•	
〰	•		●	●	•

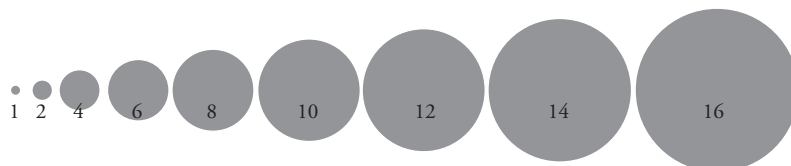


Figure 8.9 : The relations between families of signs and types of hidden surfaces

Stones in secondary position: hypothetical reconstruction of the original position after the location of the carvings and the shape of the stone

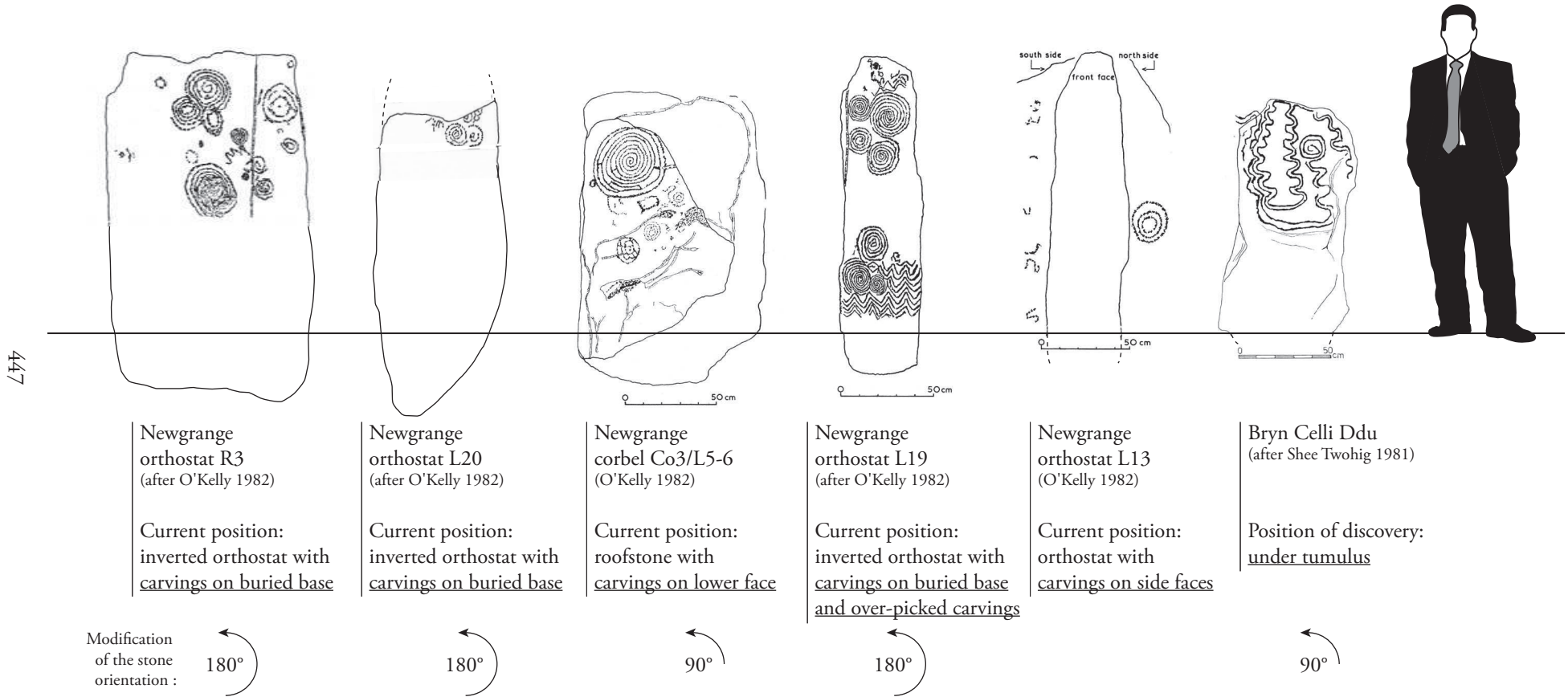


Figure 8.10 : Newgrange and Bryn Celli Ddu : reconstitution of the original position of reused stone after the location of the carvings and the shape of the stone

Stones in secondary position: hypothetical reconstruction of the original position after the location of the carvings and the shape of the stone

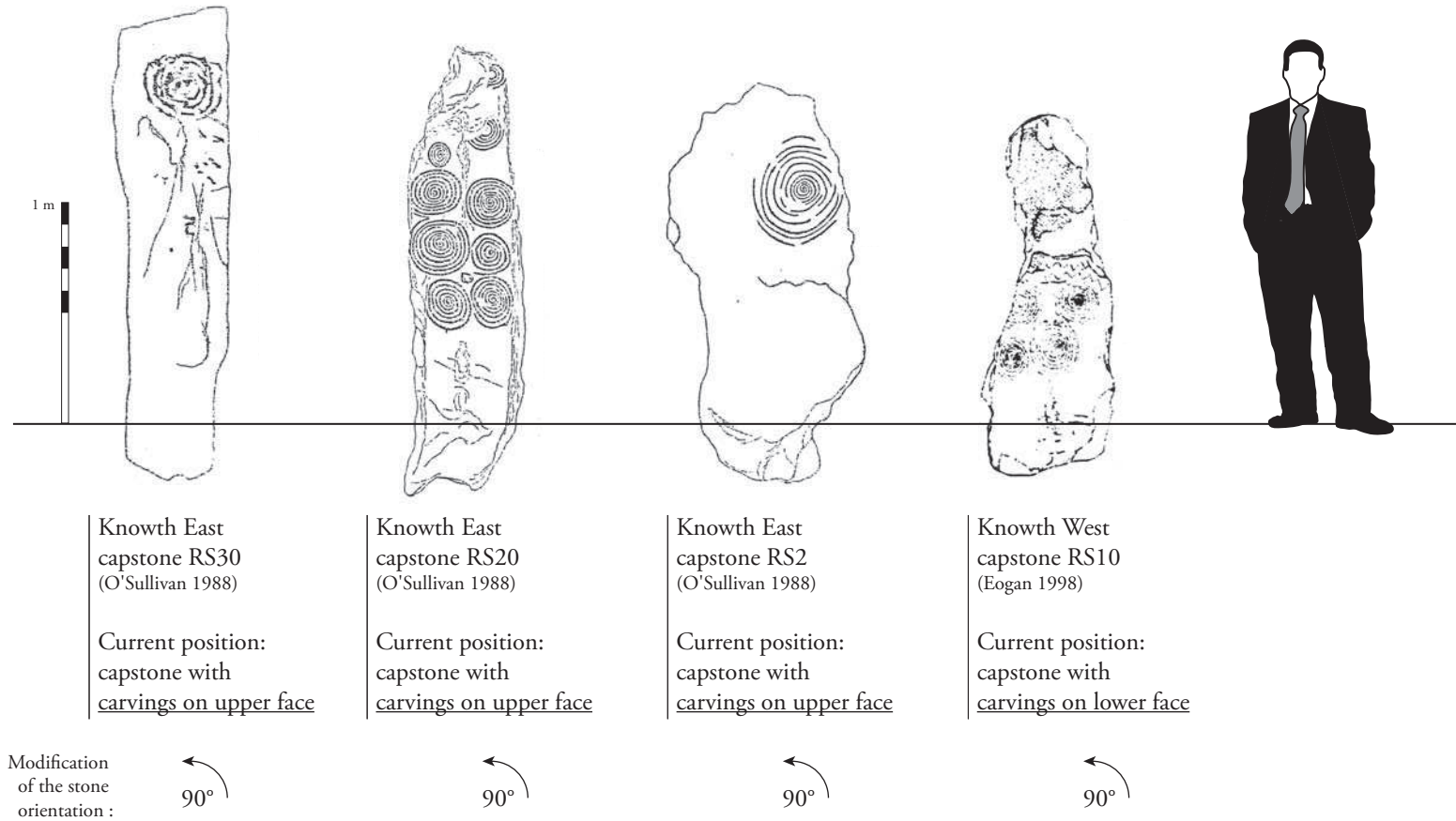


Figure 8.11 : Knowth : reconstitution of the original position of reused stone after the location of the carvings and the shape of the stone

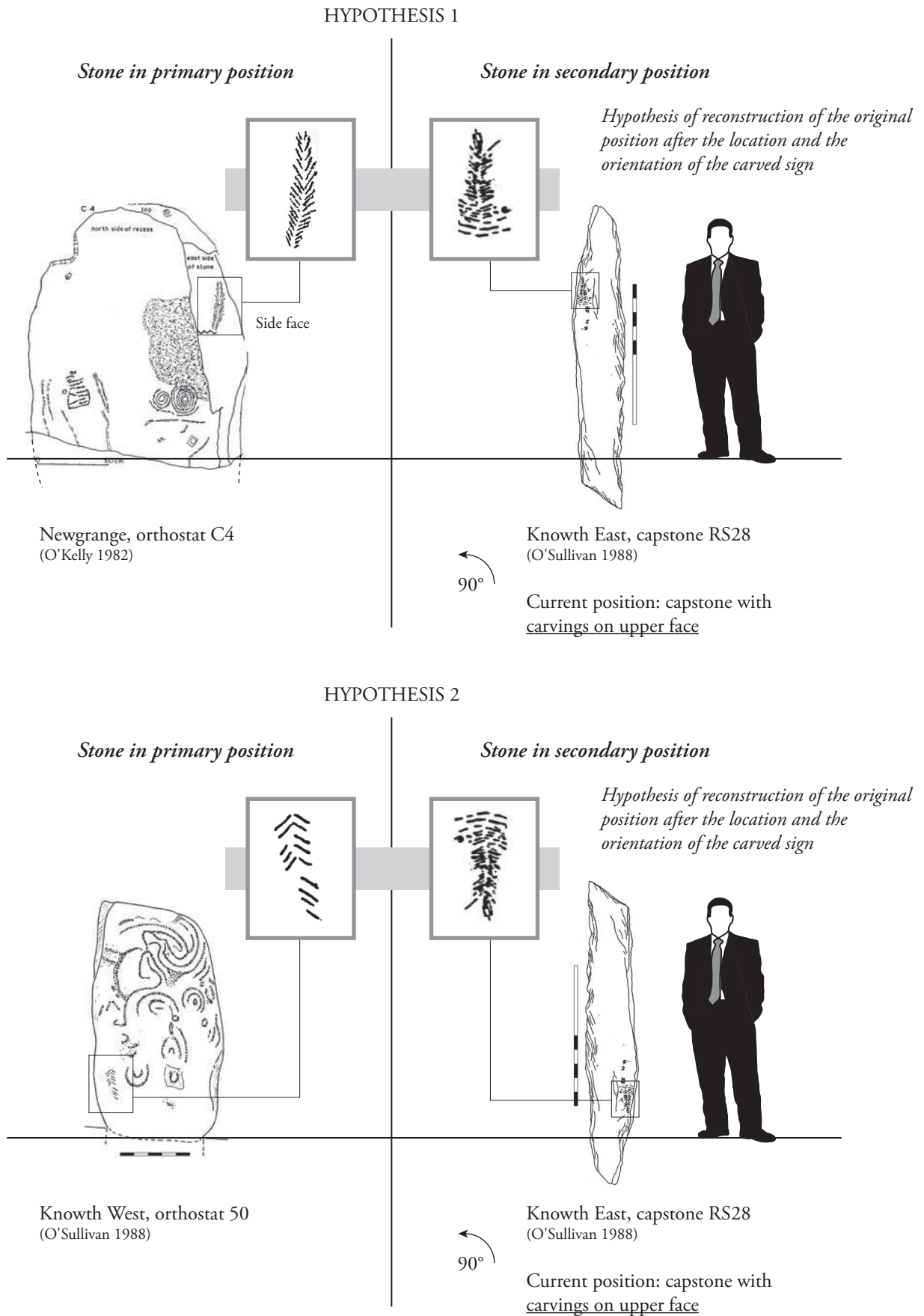


Figure 8.12 : Reconstitution of the original position of Knowth RS28 after the position and orientation of the carved sign

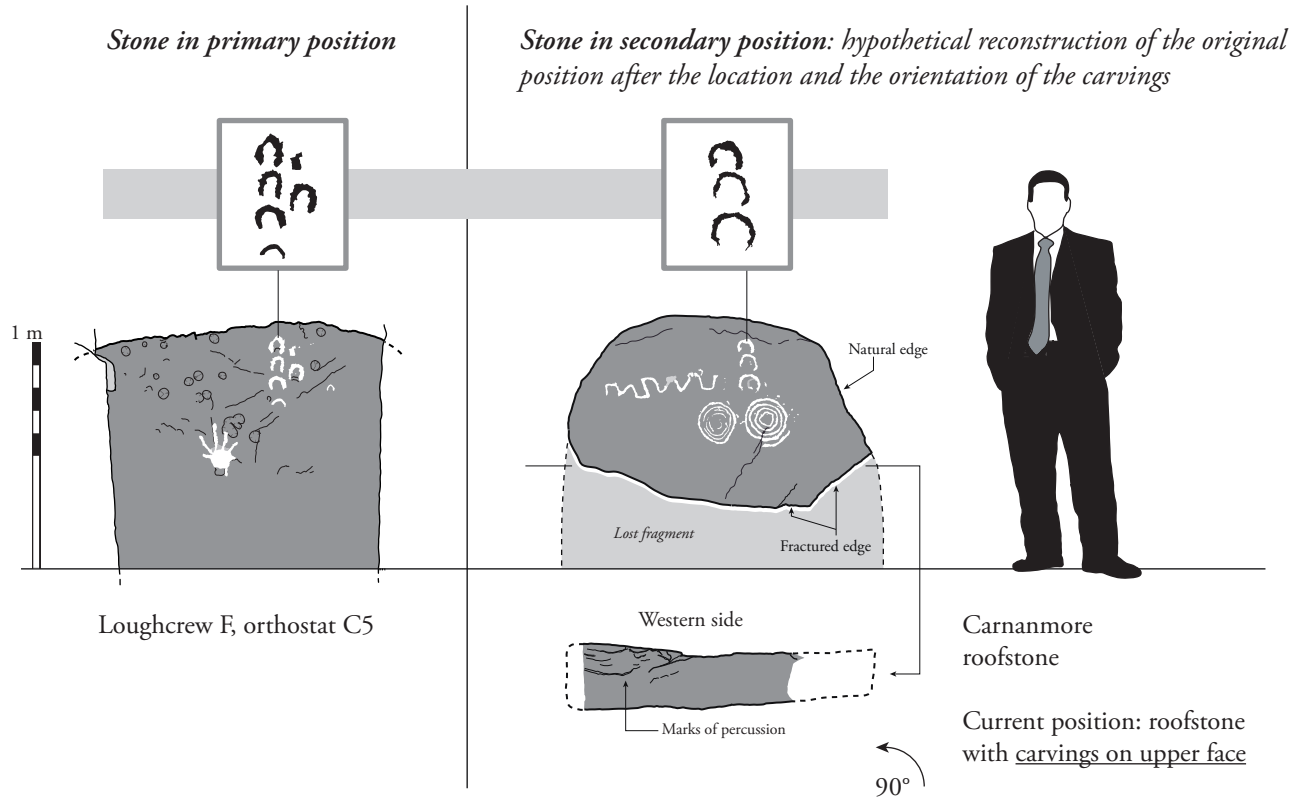


Figure 8.13 : Reconstitution of the original position of Carnanmore roofstone after the position and orientation of the carved signs

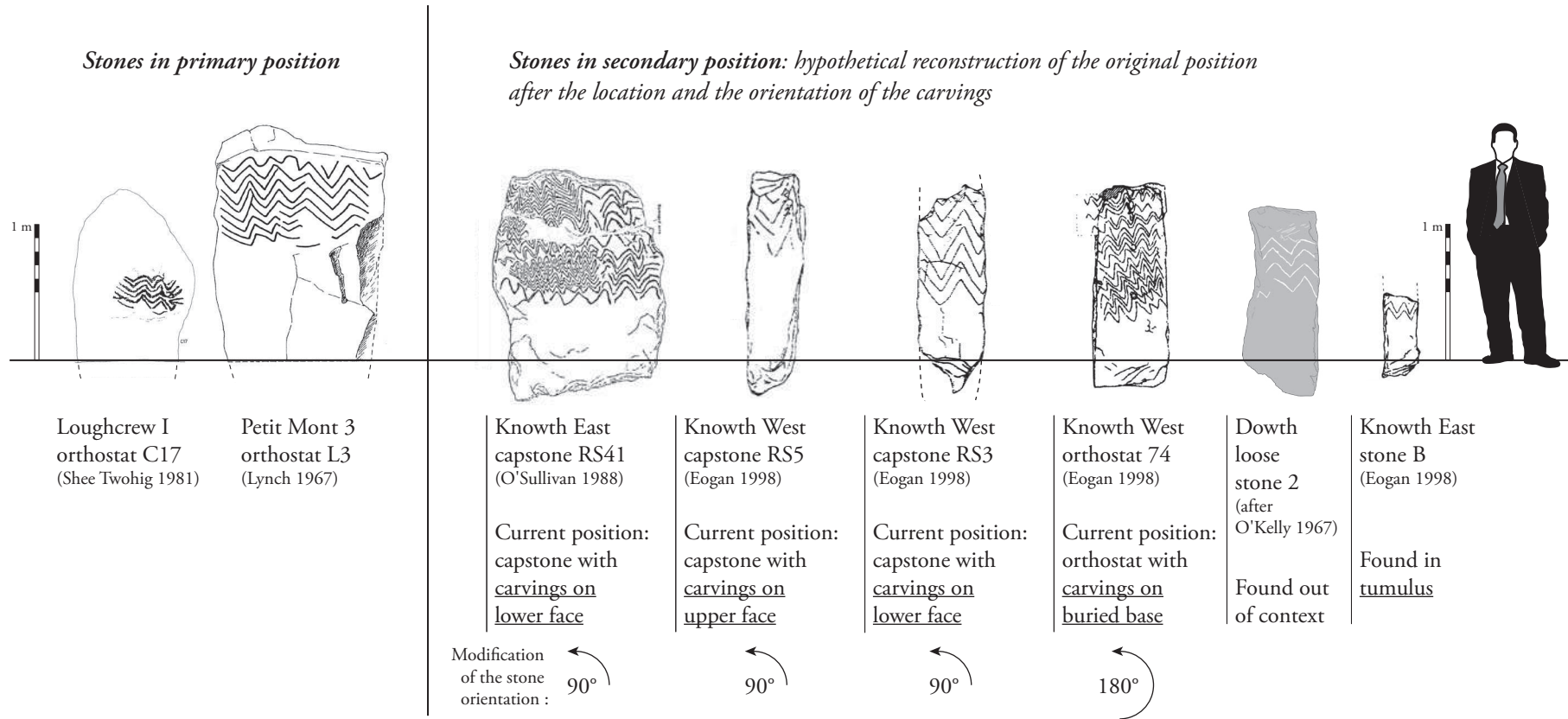


Figure 8.14 : Reconstitution of the original position of reused stones after the location and orientation of the carved chevrons

Stones in primary position

Stones in secondary position: hypothetical reconstruction of the original position after the location and the orientation of the carvings

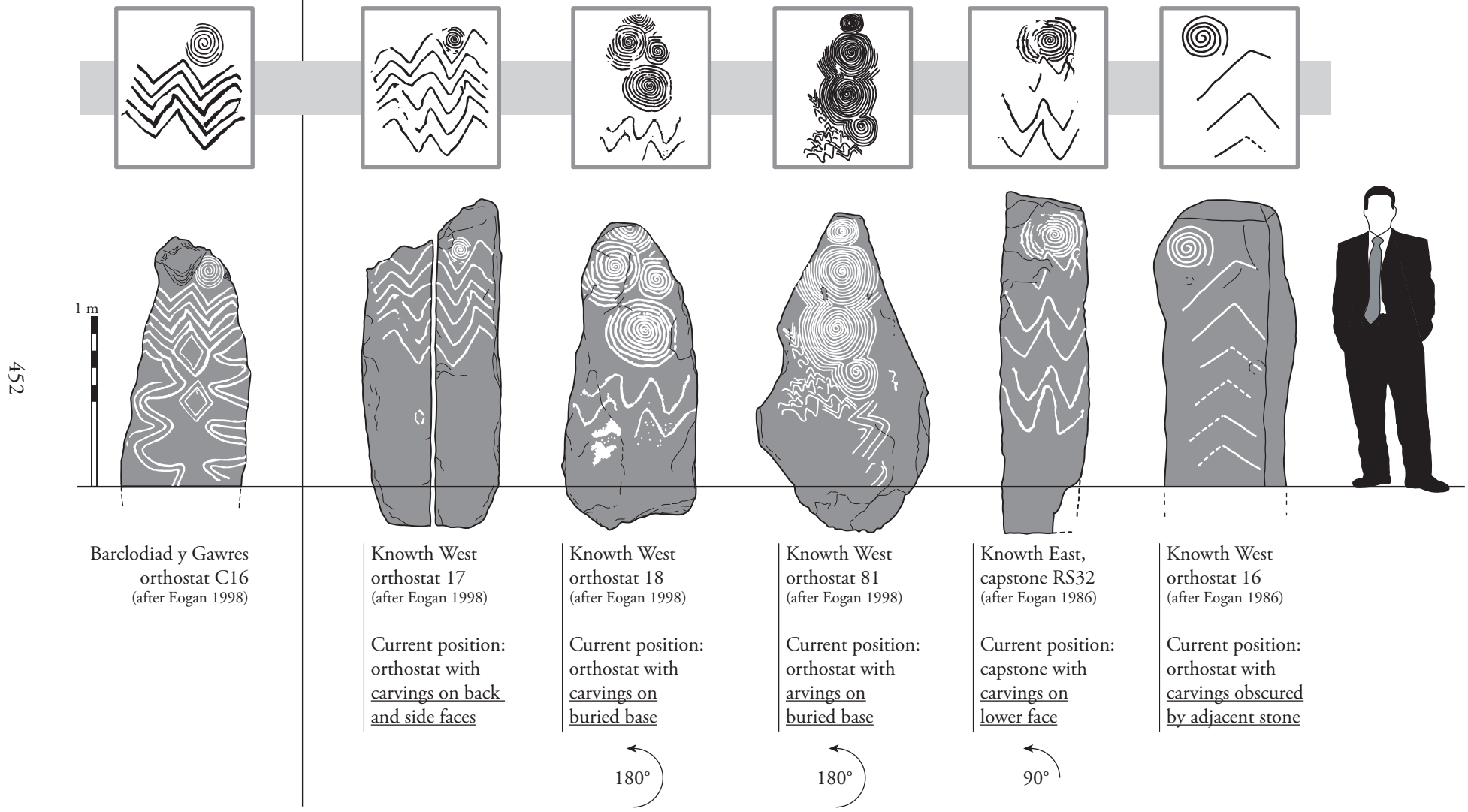
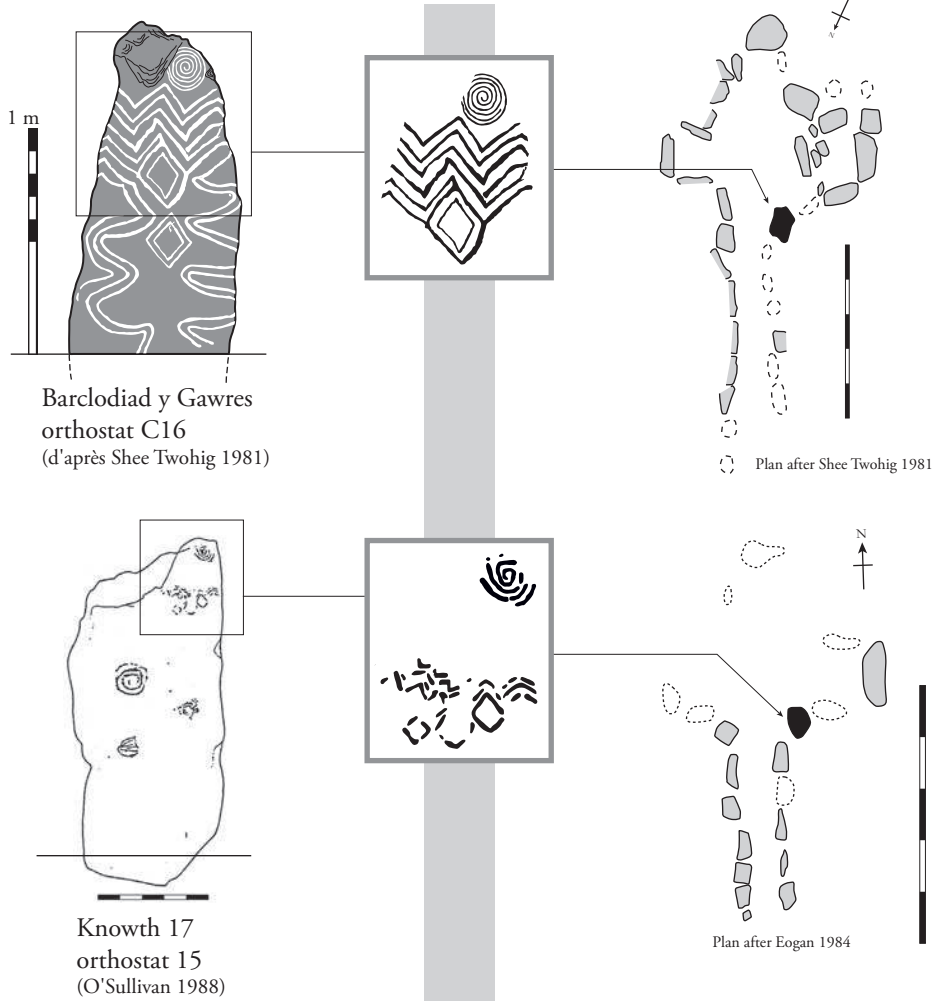
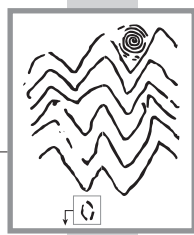
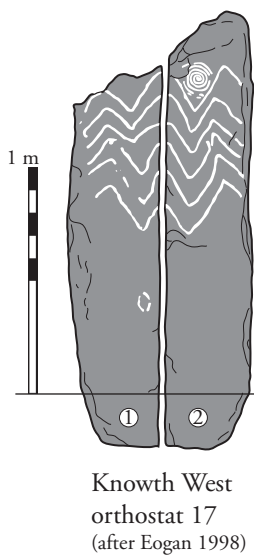


Figure 8.15 : Reconstitution of the original position of reused stones after the location and orientation of the carved combination of chevrons and spirals

Stones in primary position at the junction of passage and chamber



Stone in secondary position



Hypothetical reconstruction of the original location after the position and the orientation of the carvings

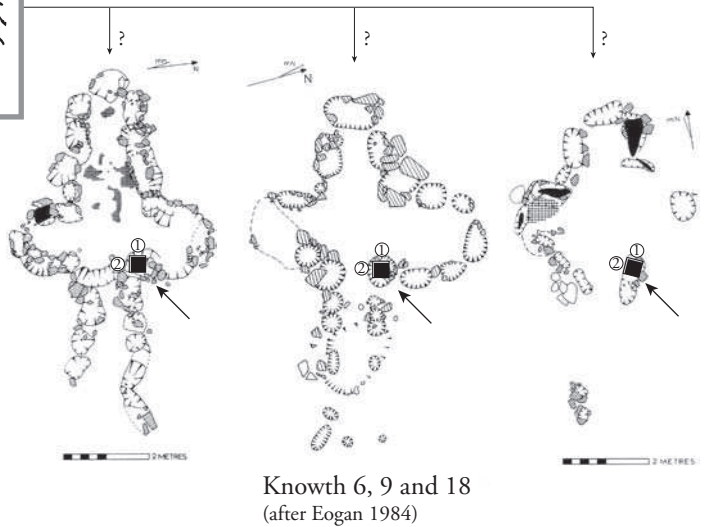


Figure 8.16 : Reconstitution of the original position of Knowth West orthostat 17 after the position and orientation of the carved signs

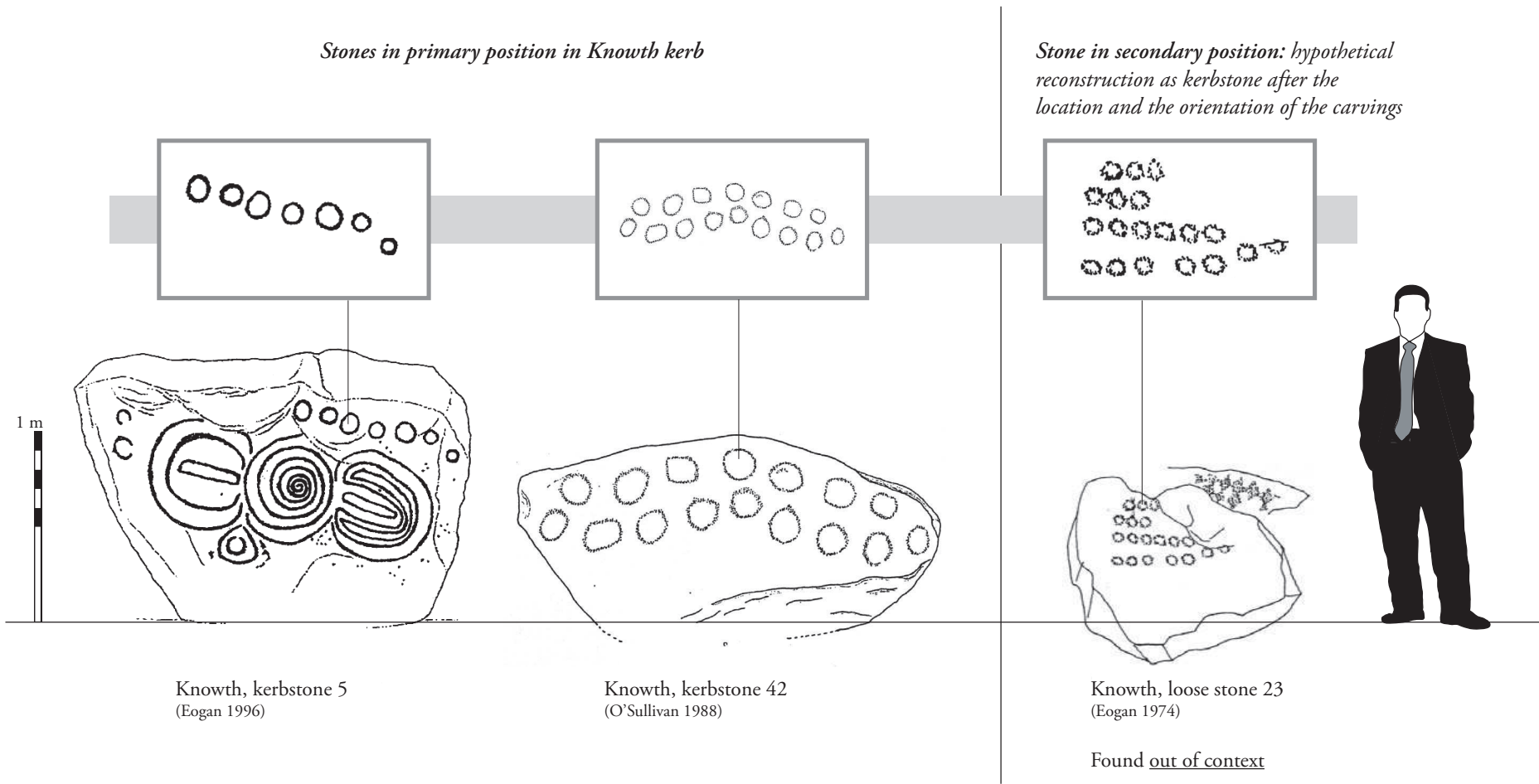


Figure 8.17 : Reconstitution of the original position of Knowth loose stone 23 after the position and orientation of the carved signs

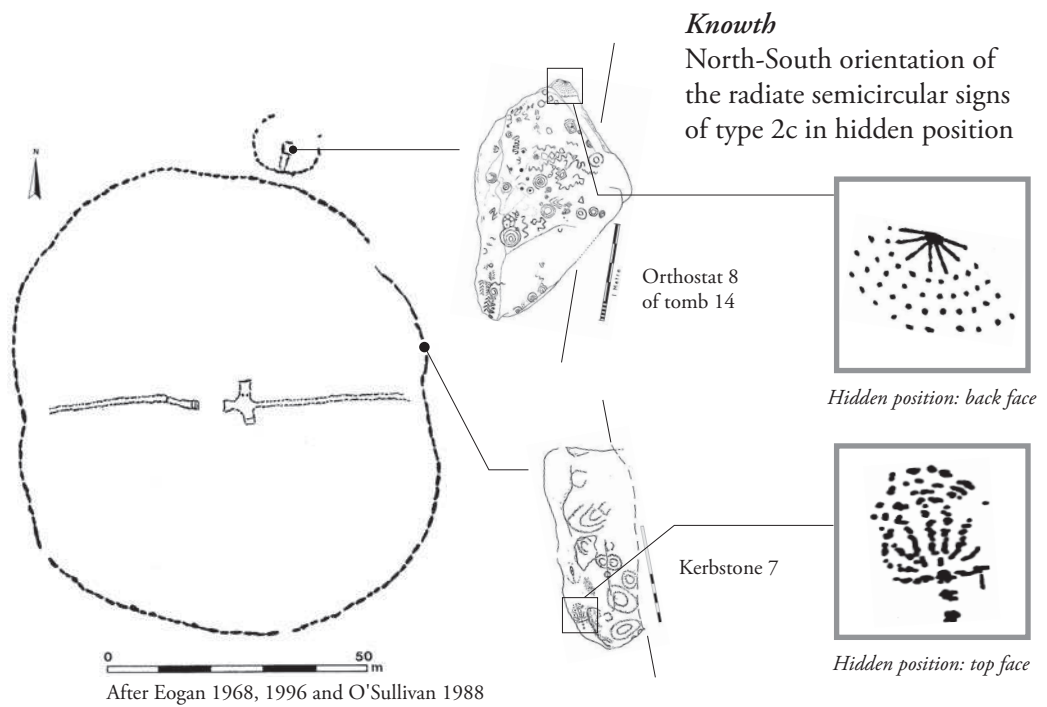
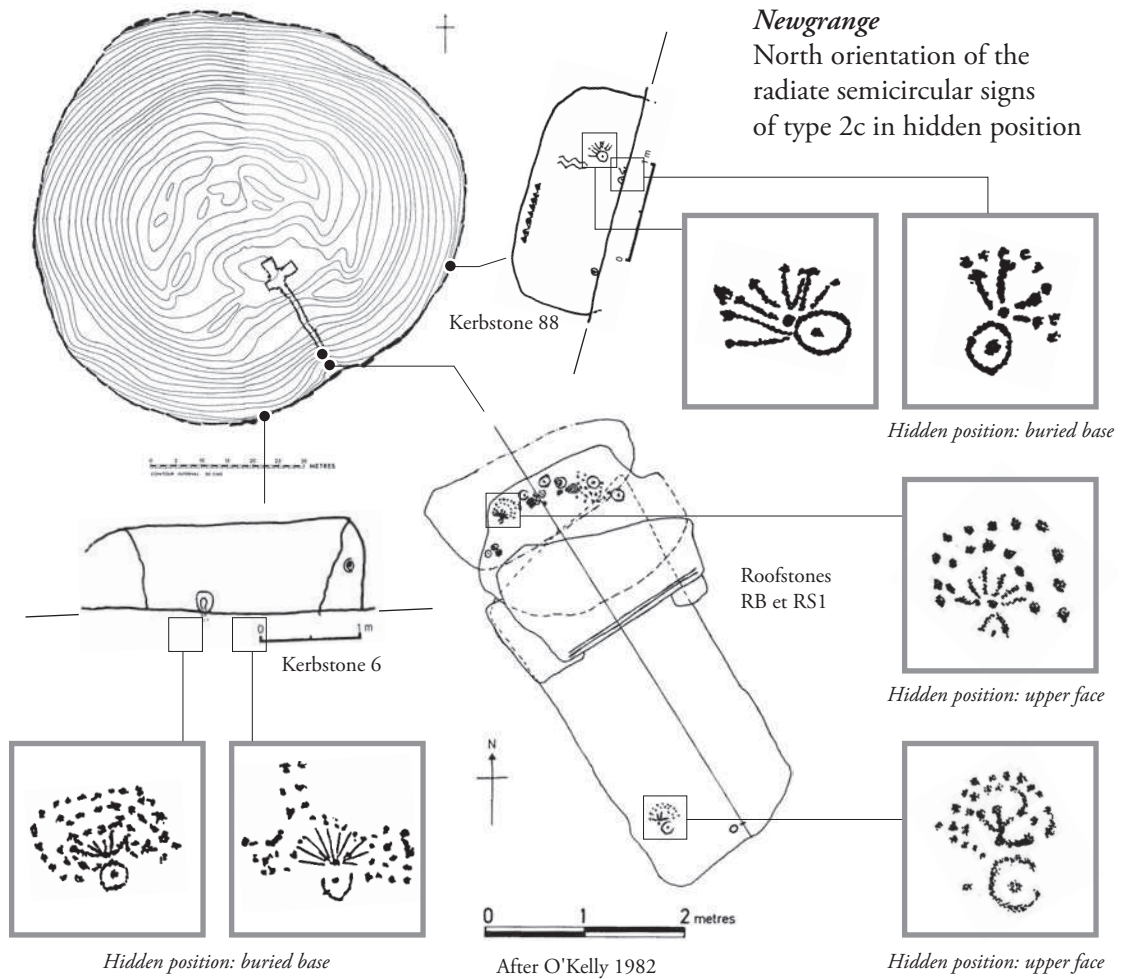


Figure 8.18 : Newgrange et Knowth : orientation of the radiate semicircular signs of type 2c in hidden surface

