



HAL
open science

Use and disuse of plugs in foliations

Ana Rechtman

► **To cite this version:**

Ana Rechtman. Use and disuse of plugs in foliations. Mathematics [math]. Ecole normale supérieure de lyon - ENS LYON, 2009. English. NNT: . tel-00361633

HAL Id: tel-00361633

<https://theses.hal.science/tel-00361633>

Submitted on 16 Feb 2009

HAL is a multi-disciplinary open access archive for the deposit and dissemination of scientific research documents, whether they are published or not. The documents may come from teaching and research institutions in France or abroad, or from public or private research centers.

L'archive ouverte pluridisciplinaire **HAL**, est destinée au dépôt et à la diffusion de documents scientifiques de niveau recherche, publiés ou non, émanant des établissements d'enseignement et de recherche français ou étrangers, des laboratoires publics ou privés.

N° d'ordre : 509

N° attribué par la bibliothèque : 07ENSL0 509

THÈSE

en vue d'obtenir le grade de

Docteur de l'Université de Lyon - École Normale Supérieure de Lyon

spécialité : Mathématiques

Laboratoire UMPA

École Doctorale de Mathématiques et Informatique fondamentale

présentée et soutenue publiquement le 06/02/09 par

Ana RECHTMAN

Titre :

Pièges dans la théorie des feuilletages : exemples et contre-exemples

Directeur de thèse M. Étienne GHYS

Après avis de M. Fernando ALCALDE CUESTA
M. Patrice LE CALVEZ

Devant la Commission d'examen formée de

M. Fernando ALCALDE CUESTA	<i>membre, rapporteur</i>
M. Sorin DUMITRESCU	<i>membre</i>
M. Damien GABORIAU	<i>membre</i>
M. Étienne GHYS	<i>directeur</i>
M. Patrice LE CALVEZ	<i>membre, rapporteur</i>

Para la mujer de los ojos de agua
y el corazón de oro.

Remerciements

Je tiens tout d'abord à remercier Étienne Ghys pour son accueil à Lyon et pour avoir encadré mon master et ma thèse. Grâce à sa disponibilité et son enthousiasme j'ai pu apprendre de belles mathématiques pendant ces années.

Je voudrais également remercier mon pays, le Mexique, qui, grâce au Consejo Nacional de Ciencia y Tecnología (CONACyT) m'a permis d'étudier en France.

Je remercie Fernando Alcalde Cuesta et Patrice Le Calvez pour leur lecture attentive de ma thèse et leurs précieux commentaires. Ceux-ci m'ont permis d'améliorer les résultats de ma thèse. Je remercie également Sorin Dumitrescu et Damien Gaboriau qui ont accepté de participer au jury.

Je veux remercier Alberto Verjovsky pour m'avoir introduite à la recherche durant mes études au Mexique et m'avoir encouragé à étudier à l'étranger.

Un grand merci à Aurélien Alvarez, François Bolley, Maxime Bourrigan, Pierre Bousquet, Andrea Davini, Pierre Dehornoy, Hélène Eynard, Antonin Guilloux, Emmanuel Giroux, Viktor Kleptsyn, Paul Laurain, Valérie Le Blanc, Ezequiel Maderna, Patrick Massot, Tomasz Miernowski, Klaus Nierderkrueger, Yaxin Peng, Bruno Sevens, Jean-Claude Sikorav, Abdelghani Zeghib, et tous les membres de l'UMPA pour avoir rendu mon passage à l'UMPA agréable et enrichissant. Merci à Claire Desecures, Virginia Gallardo, Hélène Koch, Gérard Lasseur, Magalie Le Borgne, ainsi que le personnel de la bibliothèque de l'ENS Lyon pour leur aide pendant ces quatre années. Je remercie également Lucina Parra Aguilar pour son aide bibliographique à travers l'atlantique.

Je remercie l'Agence Nationale de la Recherche pour son soutien à travers le projet Symplexe.

Je remercie chaleureusement Tomasz, Stéphanie et François pour tous les souvenirs des sorties dans les Alpes. À Hamish, Norma, Chris, Marie-Claire et Gilles pour m'avoir accueilli chez eux comme leur fille. À Woody et Rachel pour avoir partagé l'expérience d'être étranger à Lyon pendant deux ans. À Jenny, Pierre et Roland pour toutes les heures passées à faire du yoga ensemble et tout ce qu'ils m'ont appris. À Antonin, Stéphanie et Aurélien pour leur amitié. À Lili pour sa compagnie et son soutien. À Anne-Marie pour ses rires. À Karla pour avoir été là et pour être une mexicaine avec qui je peux partager plus qu'un mole. À Klaus pour tous les cafés que nous avons partagé dans la salle passerelle et ailleurs. Aux habitants du 14 rue de Platière, quatrième étage à gauche, pour leur joyeux accueil et les petits diners de François. Je remercie aussi Dino, José, Santiago, Francisco et tous les latinoaméricains avec qui j'ai mangé tant de fois. À Stéphane et

tous les clients quotidiens de son café, leur sourires ont rempli tant de mes matinées à Lyon.

Un énorme merci à Paula, ma compagne de toujours, qui m'a donné la force et la compagnie nécessaires pour poursuivre jour après jour mes études et ma vie. À Mila qui a toujours été au bout du fil quand j'en avais besoin, et pour avoir fait intervenir dans mon effort divers types de forces surnaturelles. À Raúl pour la sincérité de ses réponses et les longs mails qui ont occupé mes jours de solitude. À tous les trois pour m'avoir aidé tout au long de ma vie. À tous mes grands-parents, particulièrement à Nena et Bobby, pour leur soutien inconditionnel. À Laila, Ivo et Lola pour ne m'avoir jamais oublié et me recevoir toujours avec enthousiasme.

Merci également à Pierre pour m'avoir aidée dès mon premier jour à l'UMPA. Sans son soutien quotidien, ses rires et sa compagnie cette thèse n'aurait pas vu le jour.

Je souhaite également remercier Sofia pour sa présence à tant de moments importants de ma vie, et particulièrement le jour où je présente cette thèse. À Braulio pour m'avoir accompagné les premières années. À Nydia et Laia, mes soeurs adoptives, avec qui j'ai partagé des moments en France et tant d'histoires. À Emiliano C. pour être le frère que je n'ai jamais eu. À Toño, Abril, Alejandro, Armando, Emiliano M., Gabriel, Emiliano L., Javier, Rodrigo, Lilian y Gonzalo pour leur amitié qui, même à distance, rend chaque jour plus savoureux. À Daniel pour les horoscopes mayas et les bonnes ondes. J'espère que le 6 février sera un bon jour pour le *Dragon Lunaire*. À Aisha qui m'a écoutée quand j'en ai eu besoin. À Lourdes (et ses vitamines B) qui m'a aidé à trouver un chemin dans les moments de crise. Je lui dois ce que j'ai appris de plus précieux pendant ces années.

Finalement merci à tous ceux qui m'ont raconté avec amour leurs expériences et opinions. En citant Paulo Freire, il n'y a pas de dialogue s'il n'existe pas un amour profond pour le monde et pour les hommes.

Contents

Introduction	vi
1 Periodic orbits of non singular vector fields on 3-manifolds	1
1.1 Results on periodic orbits	3
1.1.1 Construction of K. Kuperberg's plug	7
1.2 Geodesible vector fields	12
1.2.1 Foliation cycles and transverse invariant measures	17
1.2.2 D. Sullivan's characterization of geodesible vector fields	21
1.3 Geodesible vector fields on 3-manifolds	24
1.4 Periodic orbits of geodesible vector fields on 3-manifolds	26
1.4.1 Plugs are not geodesible	27
1.4.2 Periodic orbits of real analytic geodesible vector fields	29
1.4.3 Aperiodic volume preserving real analytic vector fields	34
1.4.4 Periodic orbits of volume preserving geodesible vector fields	35
1.5 Embedded tori	41
1.6 Pseudoholomorphic curves and dynamics	44
1.6.1 Contact structures and characteristic foliations	46
1.6.2 Pseudoholomorphic curves in H. Hofer's theorem	48

1.6.3	Finite energy foliations	54
1.6.4	Reeb vector fields on manifolds with boundary	55
2	Følner leaves and amenable foliations	61
2.1	Foliations with Følner leaves	63
2.2	Amenable foliations	66
2.3	A non-amenable Følner foliation	73
2.3.1	Construction of the plug	75
2.3.2	The non-amenable Følner foliation	79
2.4	Harmonic measures	79
2.4.1	The diffusion semigroup	81
2.4.2	Characterization of harmonic measures	83
2.4.3	Ergodic theorems	86
2.5	Minimal foliations	90
2.6	Minimal Følner foliations are amenable	94
	References	98

Introduction

*Nella vita accadono cose che sono come domande,
passa un attimo, o pure anni, e la vita risponde.*

*Alessandro Baricco,
Castelli di rabbia.*

Dans ce travail, nous nous intéressons à deux questions. La première est de savoir si la conjecture de Herbert Seifert est valable pour les champs de vecteurs *géodésibles*. La seconde étudie les relations entre les feuilletages *moyennables* et les feuilletages dont toutes les feuilles sont *Følner*. Chacun des deux chapitres de ce texte est consacré à l'une des questions.

Le point en commun entre les deux sujets est l'utilisation des *pièges*. Un piège est une variété à bord P munie d'un feuilletage non singulier. La propriété importante est que l'on peut utiliser les pièges pour changer localement, c'est-à-dire à l'intérieur d'une carte feuilletée, le feuilletage. Il y a au moins une feuille qui intercepte le piège de telle façon que dans le nouveau feuilletage, la feuille correspondante ne soit pas compacte et qu'un de ses bouts soit contenu dans le piège. On dit que la feuille est piégée par P .

Dans la recherche de champs de vecteurs sans orbites périodiques, les pièges ont été largement utilisés pour construire des exemples ayant un nombre fini d'orbites périodiques, ou même sans orbite périodique. Dans ce cas, le feuilletage, défini par les orbites du champ de vecteurs, est de dimension un. On peut citer les constructions de F. Wesley Wilson [81], Paul A. Schweitzer [67], Jenny Harrison [38], Krystyna Kuperberg [52] et Greg Kuperberg [51], entre autres. Cependant, on va montrer que les pièges ne peuvent pas être utilisés dans la catégorie des champs de vecteurs géodésibles.

En 1983, Robert Brooks avait annoncé qu'un feuilletage dont presque toutes les feuilles sont *Følner* est moyennable. À l'aide d'un piège, on va construire un contre-exemple à cette affirmation, c'est-à-dire un feuilletage non moyennable dont toutes les feuilles sont *Følner*.

La conjecture de Seifert pour les champs de vecteurs géodésibles

Préliminaires

En 1950, H. Seifert a montré que tout champ de vecteurs de classe C^1 et C^0 proche du champ de vecteurs de Hopf a une orbite périodique, voir [69]. On appelle champ de vecteurs de Hopf un champ de vecteurs non singulier qui est tangent au feuilletage de Hopf. Suite à ce résultat, H. Seifert pose la question suivante :

est-ce-que tout champ de vecteurs non singulier sur \mathbb{S}^3 a au moins une orbite périodique ?

La réponse affirmative à cette question est devenue la conjecture de Seifert. On sait, maintenant, que cette conjecture est fautive : on connaît des exemples de champs de vecteurs non singuliers et sans orbites périodiques sur toute variété fermée de dimension trois. Dans le reste de cette introduction, on écrira simplement champ de vecteurs à la place de champ de vecteurs non singulier.

Commençons par quelques rappels concernant la construction des contre-exemples à la conjecture. En 1966, F. W. Wilson a montré qu'il existe des champs de vecteurs ayant un nombre fini d'orbites périodiques sur toute variété fermée de dimension trois, voir [81]. Pour cela, il modifie localement un champ de vecteurs donné en y insérant des pièges. Toutes les orbites sont alors piégées : elles rentrent dans un des pièges et n'en sortent pas. En fait, elles s'accumulent sur une orbite périodique contenue dans le piège. Toutes les orbites périodiques des champs de vecteurs construits par F. W. Wilson sont contenues dans les pièges insérés. On va construire le piège de F. W. Wilson dans la section 1.1. En dimension plus grande, il s'avère que la construction de F. W. Wilson peut être faite sans orbites périodiques. Cela lui permet d'établir le résultat suivant : *toute variété fermée de dimension a au moins quatre et admettant un champ de vecteurs non singulier admet un champ de vecteurs sans orbite périodique*, voir [81].

En dimension trois, les premiers exemples de champs de vecteurs sans orbites périodiques ont été construits par P. A. Schweitzer. Cependant, ces exemples sont seulement de classe C^1 , voir [67]. J. Harrison a amélioré la construction en obtenant un champ de vecteurs de classe C^2 [38]. Finalement, K. Kuperberg a construit un piège muni d'un champ de vecteurs de classe C^∞ , et même analytique réelle, sans orbites périodiques. Ceci implique que *sur toute variété fermée de dimension trois il existe un champ de vecteurs dont aucune orbite n'est périodique*, voir [52].

On peut désormais se demander si la conjecture de Seifert est vraie pour des familles plus restrictives de champs de vecteurs. On peut, par exemple, imposer que le champ préserve un volume ou qu'il soit *géodésible*. Le sujet principal du premier chapitre de ce texte, est la conjecture de Seifert pour les champs de vecteurs géodésibles.

Avant de passer aux champs de vecteurs géodésibles, nous allons rappeler les résultats de G. Kuperberg autour de la conjecture de Seifert pour les champs de vecteurs qui préservent un volume, voir [51]. Premièrement, il a construit des champs de vecteurs préservant un volume avec un nombre fini d'orbites périodiques. Ces exemples sont de classe C^∞ . La construction est basée sur l'existence d'un piège dont le champ de vecteurs préserve un volume, qu'il utilise pour faire des chirurgies de Dehn. Ce piège a deux orbites périodiques. Rappelons nous que toute variété fermée peut être obtenue à partir de \mathbb{T}^3 par un nombre fini de chirurgies de Dehn. Donc, partant du tore \mathbb{T}^3 muni d'un champ de vecteurs linéaire à pente irrationnelle, il réalise les chirurgies de Dehn avec son piège, pour construire sur toute variété fermée de dimension trois un champ de vecteurs qui préserve le volume et qui n'a qu'un nombre fini d'orbites périodiques.

G. Kuperberg a aussi construit une version du piège de P. A. Schweitzer dont le champ préserve le volume. Donc sur toute variété fermée de dimension trois, il existe un champ de vecteurs de classe C^1 qui préserve le volume sans orbites périodiques.

Retournons aux champs de vecteurs géodésibles. On dit qu'un champ de vecteurs, sur une variété fermée M , est géodésible s'il existe une métrique riemannienne g pour laquelle toutes les orbites sont des géodésiques. Donc, être géodésible est une propriété du 1-feuilletage défini par les orbites du champ. Soit X un champ de vecteurs géodésible sur M . Considérons la forme différentielle $\alpha = \iota_X g$. Elle va jouer un rôle important dans l'étude du champ X . Nous allons voir que X est contenu dans le noyau de la 2-forme $d\alpha$. De plus, modulo un reparamétrage qui rend X unitaire on peut supposer que $\alpha(X) = 1$. Ceci assure que α est invariante par X . Le noyau de la forme α définit un champ d'hyperplans ξ , orthogonal à X . Ce champ d'hyperplans est invariant par X .

En dimension trois, ce champ de plans peut être une *structure de contact*. C'est le cas lorsque $\alpha \wedge d\alpha \neq 0$. On obtient que X est le *champ de vecteurs de Reeb* associé, et par le théorème suivant il a des orbites périodiques.

Théorème (Hofer, Taubes) *Soit X le champ de Reeb défini par une forme de contact α sur une variété fermée orientable de dimension trois. Alors X possède une orbite périodique.*

Le théorème a été prouvé par Helmut Hofer lorsque la variété est diffeomorphe à \mathbb{S}^3 ou encore lorsque son second groupe d'homotopie n'est pas trivial, voir [41]. La généralisation à toute variété a été prouvée, récemment, par Clifford H. Taubes, voir [75]. Les champs de Reeb préservent le volume donné par la forme $\alpha \wedge d\alpha$. Donc les exemples de G. Kuperberg ne sont pas des champs de Reeb. La méthode de H. Hofer est basée sur l'utilisation des courbes pseudoholomorphes dans une symplectisation de la variété ambiante. Dans ce texte nous allons utiliser cette méthode pour montrer l'existence d'orbites périodiques de champs de Reeb sur certaines variétés à bord.

Par ailleurs, si la forme α est fermée, le champ de plans ξ est tangent à un feuilletage transverse à X . En particulier, X a une section globale : il existe une surface fermée transverse à X qui intersecte toutes les orbites. Nous affirmons que les champs de Reeb n'ont pas de section globale. En fait, supposons que X soit un champ de Reeb d'une forme de contact α , ayant une section globale S . Alors, la restriction à S de $d\alpha$ est une forme d'aire. Mais, le théorème d'Arnold P. Stokes implique que l'intégrale de $d\alpha$ sur S est égale à zéro. Ceci prouve l'affirmation : les champs de Reeb n'ont pas de section globale.

Reciproquement, un champ de vecteurs qui admet une section globale est géodésible, ainsi que les champs de Reeb. Pour ces derniers on peut construire une métrique riemannienne telle que le champ de vecteurs est unitaire et la structure de contact est orthogonal au champ. Il s'avère que pour une telle métrique les orbites du champ sont des géodésiques. Donc, la famille des champs géodésibles est plus vaste que celle des champs de Reeb.

Présentation des résultats

Nous souhaitons donc savoir si les champs de vecteurs géodésibles sur une variété fermée M de dimension trois ont des orbites périodiques. Commençons d'abord par établir une relation

entre les champs de vecteurs géodésibles et certaines solutions de l'équation d'Euler, en dimension trois. Dans une variété munie d'une métrique riemannienne g et d'une forme volume μ (pas nécessairement le volume riemannien), on définit le rotationnel d'un champ de vecteurs X comme l'unique champ de vecteurs $\text{rot}(X)$ tel que

$$\iota_{\text{rot}(X)}\mu = d\alpha,$$

où α est la forme différentielle $\iota_X g$. On en déduit qu'un champ de vecteurs est géodésible si et seulement s'il est colinéaire à son rotationnel, c'est-à-dire

$$\text{rot}(X) = fX, \tag{1}$$

pour une fonction $f : M \rightarrow \mathbb{R}$. Dans le cas où μ est invariante, f est constante le long des orbites. Nous allons voir que ces champs de vecteurs sont des solutions de l'équation d'Euler pour les fluides non visqueux et pour lesquels le champ de vitesses est indépendant du temps. En fait, dans une variété de dimension trois on peut mettre l'équation d'Euler sous la forme :

$$X \wedge \text{rot}(X) = \text{grad}(b),$$

où b est la fonction de *Bernoulli* de X . Les solutions de cette équation avec b constante sont connues comme des champs de vecteurs de *Beltrami*.

Ceci établit un lien entre les champs de vecteurs géodésibles et les champs de vecteurs de Beltrami : les résultats présentés dans ce texte sont donc valables pour les champs de vecteurs de Beltrami.

On montrera que la méthode des pièges, introduite par F. W. Wilson, ne peut pas être utilisée pour les champs de vecteurs géodésibles. Cette affirmation est une conséquence du théorème suivant de Dennis Sullivan, qui caractérise les champs géodésibles, voir [74] : *un champ de vecteurs est géodésible si et seulement s'il n'existe pas de suite de 2-chaînes tangentes au champ, dont les bords approchent un cycle feuilleté*. Dans le chapitre 1, on étudiera cette caractérisation plus en détail.

Les résultats principaux de cette partie du texte établissent l'existence d'orbites périodiques pour certains champs de vecteurs géodésibles. Supposons d'abord que le champ de vecteurs X est géodésible et analytique réel. Dans ce cas-ci on supposera aussi que la métrique riemannienne est analytique réelle.

Théorème A *Soit X un champ de vecteurs géodésible analytique réel sur une variété fermée orientable de dimension trois M . Si X préserve un volume analytique réel, alors ou bien X a une orbite périodique ou la variété M est un fibré en tores sur le cercle.*

On suppose aussi que le volume préservé est donné par une forme analytique réelle. Remarquons qu'il y a trois cas à considérer : X est un champ de Reeb ; X a une section globale ; X est un champ de Reeb dans un ouvert non vide de M , distinct de M . Ces trois cas se traduisent par les propriétés suivantes de la forme différentielle α :

- (I) $\alpha \wedge d\alpha \neq 0$, ceci équivaut à dire que la fonction f ne s'annule pas ;
- (II) $\alpha \wedge d\alpha = 0$, ceci équivaut à dire que f est identiquement nulle ;
- (III) f est non constante et égale à zéro dans un ensemble fermé non vide.

Comme on suppose que X préserve un volume, la fonction f est constante le long des orbites, autrement dit, les niveaux de f sont invariants sous X .

Dans le premier cas on a toujours une orbite périodique, comme conséquence du théorème de H. Hofer et C. H. Taubes. Pour le deuxième cas, on va utiliser un théorème de David Tischler : *si*

une variété admet une 1-forme fermée non singulière, elle est un fibré sur le cercle, voir [76]. En fait, la condition $\alpha \wedge d\alpha = 0$ est équivalente à $d\alpha = 0$. Jusqu'à ce point nous n'avons pas utilisé le fait que X est analytique réel. Plaçons nous dans le cas où f n'est pas constante et où elle s'annule dans un ensemble fermé non vide distinct de M . On va se servir de la théorie des singularités de Hassler Whitney pour les ensembles analytiques réels [80]. Sous l'hypothèse que X n'a pas d'orbites périodiques on montrera, à l'aide de cette théorie, que chaque niveau de f est formé d'une collection finie de tores invariants. Ceci va nous permettre de conclure que M est un fibré en tores sur le cercle.

Lorsque l'on ne suppose plus que le flot de X préserve le volume, nous pouvons établir le résultat suivant :

Théorème B *Soit X un champ de vecteurs géodésible sur une variété M orientable fermée de dimension trois. Supposons que M est difféomorphe à \mathbb{S}^3 ou que M a un second groupe d'homotopie non trivial. Si X est analytique réel, il possède une orbite périodique.*

Sous les hypothèses de ce théorème, f n'est plus constante le long des orbites de X , mais $f^{-1}(0)$ est un ensemble compact et invariant. Dans les cas (I) et (II) la preuve du théorème précédent peut être adaptée sans modifications significatives. Comme avant, c'est dans le cas (III) que nous utiliserons le fait que X est analytique réel. Avec la théorie de H. Whitney, on montrera que si X n'a pas d'orbites périodiques dans $f^{-1}(0)$, cet ensemble est formé d'une collection de tores tangents à X . En découpant la variété le long de ces tores, on obtiendra une composante connexe dont la fermeture est une variété compacte à bord B qui vérifie l'une des deux hypothèses suivantes :

- B est difféomorphe au tore plein ($B \simeq \mathbb{S}^1 \times \mathbb{D}^2$) ;
- B a son second groupe d'homotopie non trivial.

Rappelons nous que $\xi = \{\ker(\alpha)\}$ est un champ de plans invariant. Dans l'intérieur de la variété B , ce champ de plans est une structure de contact. Ici, on va trouver une structure de contact dans B telle que son champ de vecteurs de Reeb est X et elle est C^∞ -proche de ξ . Le théorème suivant permet donc d'achever la preuve du théorème B.

Théorème 1.27 *Soit X un champ de Reeb sur une variété compacte à bord de dimension trois B , tel que X est tangent aux composantes de bord. Si B est un tore plein ou s'il a un second groupe d'homotopie non trivial, X possède une orbite périodique.*

John Etnyre et Robert Ghrist avaient montré le théorème pour le cas du tore plein, voir [23]. On utilise la même méthode pour le généraliser aux variétés dont le π_2 n'est pas trivial.

Finalement, en ne supposant plus le champ de vecteurs analytique réel, mais en supposant à nouveau qu'il préserve le volume, on montrera :

Théorème C *Soit X un champ de vecteurs géodésible sur une variété orientable fermée de dimension trois M . Supposons que M est difféomorphe à \mathbb{S}^3 ou que M a un second groupe d'homotopie non trivial. Alors si X est de classe C^∞ et préserve un volume, il a une orbite périodique.*

Comme précédemment, le cas difficile est le cas (III). On ne peut plus conclure que les niveaux de f , qui sont tous invariants sous X , sont des tores. En fait, on a que les niveaux correspondant aux valeurs régulières de f sont des tores, mais on ne peut rien dire sur la topologie des niveaux singuliers. Si zéro est une valeur régulière, la preuve suit les lignes de la preuve du théorème B. Sinon, on va considérer une valeur régulière a assez petite, et telle que $-a$ est aussi une valeur

régulière. En découpant M le long des tores dans l'ensemble $f^{-1}(\pm a)$, on obtiendra une variété à bord B , qui est un tore plein ou bien a un second groupe d'homotopie non trivial. Le premier cas à considérer est le cas où B ne rencontre pas le niveau $f^{-1}(0)$. Alors, l'existence d'une orbite périodique est une conséquence du théorème 1.27. Si maintenant on se place dans le cas $\{f^{-1}(0)\} \cap B \neq \emptyset$, on va trouver une 1-forme dans M telle que dans B elle est transverse à X et fermée. En appliquant le théorème du point fixe de Brouwer on montrera l'existence d'une orbite périodique.

À la fin de la préparation de ce travail, Michael Hutchings et C. H. Taubes ont annoncé le résultat suivant, voir [46].

Théorème (Hutchings, Taubes) *Soit M un variété fermée orientable de dimension trois avec une structure Hamiltonienne stable. Si M n'est pas un fibré en tores sur le cercle, le champ de vecteurs de Reeb associé à la structure Hamiltonienne stable a une orbite périodique.*

Ceci généralise le théorème C. En effet, une structure Hamiltonienne stable sur une variété fermée de dimension trois est définie comme la donnée d'une 1-forme α et d'une 2-forme fermée ω , non singulières et satisfaisant

$$\alpha \wedge \omega > 0 \quad \text{et} \quad \ker(\omega) \subset \ker(d\alpha).$$

Le champ de Reeb associé est défini par les équations

$$\alpha(X) = 1 \quad \text{et} \quad X \in \ker(\omega).$$

Ceci implique que le champ de Reeb d'une structure Hamiltonienne stable est un champ de vecteurs géodésible qui préserve un volume car $X \in \ker(d\alpha)$ et $L_X(\alpha \wedge \omega) = d\omega = 0$. Inversement, un champ de vecteurs géodésible qui préserve un volume μ est le champ de Reeb d'une structure Hamiltonienne stable car $\omega = \iota_X \mu$ satisfait les conditions précédentes.

Feuilletages moyennables et feuilles Følner

Définitions

Dans le deuxième chapitre de ce texte on s'intéressera à la relation entre les *feuilletages moyennables* et les feuilletages dont toutes les *feuilles sont Følner*. Comme on l'expliquera, la moyennabilité d'un feuilletage est définie par rapport à une mesure transverse invariante. Ces deux notions sont motivées par les notions correspondantes pour les groupes de type fini. Un groupe de type fini est moyennable si et seulement s'il est Følner. Nous verrons que ce n'est plus le cas pour les feuilletages.

Nous rappelons maintenant les définitions de ces notions, pour les groupes d'abord, pour les feuilletages ensuite. On dit qu'un groupe de type fini G est moyennable s'il existe une moyenne invariante par translations. Une moyenne est une fonctionnelle linéaire sur l'espace de Banach $L^\infty(G)$ qui envoie la fonction constante égale à un sur un, et les fonctions positives sur les nombres positifs. Par ailleurs, on dit que G est Følner si

$$\inf_E \frac{|\partial E|}{|E|} = 0,$$

où $|\cdot|$ est le cardinal d'un ensemble et E décrit tous les sous-ensembles finis de G . L'ensemble ∂E est formé des éléments $g \in E$ tels qu'il existe un générateur γ de G pour lequel $\gamma g \notin E$. L'équivalence de ces deux notions a été établie par Erling Følner, voir [25].

Nous passons maintenant aux définitions correspondantes pour les feuilletages. Soit \mathcal{F} un feuilletage d'une variété fermée M . Notons d sa dimension et q sa codimension. Il définit une relation d'équivalence sur une transversale totale. Pour expliquer cette affirmation, considérons un atlas feuilleté fini $\{U_i, \phi_i\}$ tel que

$$\phi_i(U_i) \simeq \mathbb{D}^d \times \mathbb{D}^q,$$

où \mathbb{D}^d est un disque ouvert de dimension d dans \mathbb{R}^d . On dit que

- $\phi_i^{-1}(\mathbb{D}^d \times \{\cdot\})$ sont les *plaques* de \mathcal{F} dans U_i ;
- $T_i = \phi_i^{-1}(\{0\} \times \mathbb{D}^q)$ sont les *transversales locales* et $T = \cup_i T_i$ est une *transversale totale*.

Nous utiliserons toujours des atlas vérifiant les conditions suivantes. Premièrement, si l'intersection $U_i \cap U_j$ est non vide, chaque plaque dans U_i rencontre au plus une plaque dans U_j . Deuxièmement, on va supposer que le volume (de dimension d) des plaques et le volume (de dimension $(d-1)$) de leurs bords, sont uniformément bornés.

On a une relation d'équivalence R naturelle sur T : deux points sont équivalents si et seulement s'ils appartiennent à la même feuille de \mathcal{F} . Comme on suppose que la variété ambiante est compacte, cette relation peut être engendrée par l'action d'un pseudo-groupe Γ de type fini d'homéomorphismes locaux de T . Les classes d'équivalence peuvent être munies d'une structure de graphe : les sommets sont les points de la classe d'équivalence, qu'on note $R[x]$, et il y a une arête entre deux sommets x et y si la plaque de \mathcal{F} qui contient x intersecte la plaque qui contient y . En fait, les arêtes représentent les générateurs du pseudo-groupe Γ . La structure de graphe dépend donc de l'atlas. Si on munit la variété ambiante M d'une métrique riemannienne, on obtient par restriction une métrique sur les feuilles. Les graphes, munis de la métrique des mots relative à un système de générateurs, sont *quasi-isométriques* aux feuilles de \mathcal{F} .

On dit que le feuilletage \mathcal{F} , qui a une mesure transverse invariante μ , est moyennable si la relation d'équivalence R est moyennable, par rapport à la mesure μ . La propriété d'être moyennable ne dépend pas du choix de la transversale T .

Pour définir ce qu'est une relation d'équivalence moyennable, rappelons d'abord quelques définitions. Un *espace mesurable standard* (X, \mathcal{B}) est un espace mesurable où X est *polonais* : un espace topologique séparable admettant une métrique complète. Soient (X, \mathcal{B}) un espace mesurable standard et R une relation d'équivalence sur X . On dit que

- R est une *relation d'équivalence discrète standard* si, le graphe de R est mesurable dans $X \times X$ et que la classe d'équivalence de tout point $x \in X$ est dénombrable ;
- dans une telle situation, une mesure ν sur (X, \mathcal{B}) est *quasi-invariante* si le saturé par R de tout élément de \mathcal{B} de mesure nulle est aussi de mesure nulle. On dit alors que R est une *relation d'équivalence discrète mesurée* sur (X, \mathcal{B}, ν) ;
- une telle relation est *ergodique* si pour tout ensemble $B \in \mathcal{B}$, saturé par R , on a $\nu(B) = 0$ ou $\nu(X \setminus B) = 0$.

On dit qu'une relation d'équivalence discrète mesurée R sur (X, \mathcal{B}, ν) est moyennable s'il est possible d'associer à ν -presque tout point $x \in X$ une moyenne m_x sur $R[x]$, de sorte que les deux propriétés suivantes soient satisfaites :

- pour ν -presque tout x on a $m_x = m_y$, pour tout $y \in R[x]$;
- si \tilde{f} est une fonction mesurable définie sur le graphe de $R \subset X \times X$, la fonction $f : X \rightarrow \mathbb{R}$ définie par $f(x) = m_x(\tilde{f}(x, \cdot))$ est aussi mesurable.

Si, par exemple, une relation d'équivalence discrète mesurée R est engendrée par l'action d'un groupe dénombrable G , alors la moyennabilité du groupe entraîne la moyennabilité de R . La réciproque est fautive. Cependant, elle est valable dans le cas d'une action qui préserve une mesure de probabilité et qui est *essentiellement libre*, c'est-à-dire si la mesure de l'ensemble de points fixes de l'action de tout élément $g \in G$ est nulle, voir [84].

Passons à la définition de feuille Følner. Une feuille L est une variété riemannienne de dimension d . Elle est Følner si

$$\inf_V \frac{\text{volume}_{(d-1)}(\partial V)}{\text{volume}_d(V)} = 0,$$

où V décrit l'ensemble des sous-variétés de dimension d compactes à bord de L . La notion correspondante pour les graphes des classes d'équivalence est la suivante :

$$\inf_E \frac{|\partial_\Gamma E|}{|E|} = 0,$$

où E décrit les sous-ensembles finis de sommets, et

$$\partial_\Gamma E = \{x \in E \mid \exists \gamma \in \Gamma \text{ générateur, } \gamma(x) \notin E\}.$$

Un résultat classique, qu'on démontrera plus tard (voir proposition 2.5), est que l'existence d'une feuille Følner L entraîne l'existence d'une mesure transverse invariante pour \mathcal{F} , dont le support est contenu dans \overline{L} , voir par exemple [33].

Présentation des résultats

Rappelons d'abord un peu les résultats autour des relations entre les feuilletages moyennables et les feuilletages dont toutes les feuilles sont Følner. Remarquons qu'une feuille à croissance sous-exponentielle est Følner. Comme premier résultat, on peut citer le théorème suivant, dû à Caroline Series [70], et indépendamment à Manuel Samuëlidès [64], dans le cas des feuilletages dont les feuilles sont à croissance polynomiale. V. A. Kaimanovich a donné une preuve à l'énoncé suivant.

Théorème 2.8 *Soient \mathcal{F} un feuilletage et μ une mesure transverse invariante. Si μ -presque toute feuille est à croissance sous-exponentielle, (\mathcal{F}, μ) est moyennable.*

Dans [7], R. Brooks a affirmé que si \mathcal{F} est un feuilletage, avec une mesure transverse invariante μ et que μ -presque toute feuille est Følner, \mathcal{F} est moyennable. L'unique indication donnée par R. Brooks pour établir ce fait est de suivre les arguments donnés par C. Series.

L'affirmation de R. Brooks est fautive, Vadim A. Kaimanovich a construit un contre-exemple : un feuilletage avec une mesure transverse invariante, qui est non moyennable et dont les feuilles sont Følner, [49]. Un défaut de la construction de V. A. Kaimanovich est que la mesure obtenue lors de la construction n'est pas localement finie. Dans ce texte on va construire un feuilletage avec un volume transverse invariant, qui est non moyennable et dont les feuilles sont Følner.

Théorème D *Il existe un feuilletage \mathcal{F} analytique réel non moyennable, possédant un volume transverse invariant et ergodique, dont toutes les feuilles sont Følner.*

L'idée est construire un feuilletage \mathcal{F}_1 , de dimension deux et codimension deux, non moyennable en utilisant la suspension de l'action d'un groupe non moyennable sur la sphère de dimension deux. Les feuilles de \mathcal{F}_1 ne sont pas Følner. À l'aide d'un piège feuilleté, dont le feuilletage a un volume transverse invariant, on va modifier localement \mathcal{F}_1 pour rendre les feuilles Følner. La construction du piège est une adaptation de celle de F. W. Wilson [81], pour satisfaire la condition de l'existence d'un volume transverse invariant.

En 1985, Yves Carrière et Étienne Ghys (voir [11]), en réponse à une question posée par R. Brooks, ont montré

Théorème 2.9 *Soit \mathcal{F} un feuilletage possédant une mesure transverse invariante μ , dont μ presque toutes les feuilles sont sans holonomie. Si \mathcal{F} est moyennable pour μ , toutes ses feuilles sont Følner.*

Dans [49], V. A. Kaimanovich demande si l'affirmation de R. Brooks est vraie pour les feuilletages *minimaux*, c'est-à-dire pour les feuilletages dont toutes les feuilles sont denses. Ici on va montrer que ceci est une condition suffisante.

Théorème E *Soit \mathcal{F} un feuilletage minimal d'une variété compacte M . Si μ est une mesure transverse invariante et μ -presque toutes les feuilles sont Følner, \mathcal{F} est moyennable par rapport à μ .*

Pour la preuve on utilisera le critère suivant, dû à V. A. Kaimanovich [49] : une relation d'équivalence R sur un espace mesurable standard (X, \mathcal{B}, ν) est moyennable s'il existe des suites de mesures de probabilité $\{\lambda_x^n\}_{x \in X, n \in \mathbb{N}}$ sur $R[x]$, avec $x \in \text{supp}(\lambda_x^n)$ pour tout n , et telles que

$$\|\lambda_x^n - \lambda_y^n\| \rightarrow 0 \quad \text{quand} \quad n \rightarrow \infty$$

pour ν -presque tout couple $(x, y) \in R$. On note $\|\cdot\|$ la norme dans l'espace des mesures de probabilité sur $R[x]$. L'application $x \mapsto \lambda_x^n$ doit être mesurable pour tout n , c'est-à-dire si \tilde{f} est une fonction mesurable défini sur le graphe de $R \subset X \times X$, la fonction $f_n : X \rightarrow \mathbb{R}$ définie par $f_n(x) = \lambda_x^n(\tilde{f}(x, \cdot))$ est aussi mesurable pour tout n .

Prenons une suite de Følner, c'est-à-dire une suite d'ensembles finis $E_n \subset R[x]$ telle que

$$\frac{|\partial_\Gamma E_n|}{|E_n|} \rightarrow 0.$$

Cette suite définit une suite de mesures $\{\lambda_x^n\}_{n \in \mathbb{N}}$ qui converge faiblement vers une mesure transverse invariante pour \mathcal{F} .

Pour pouvoir appliquer le résultat de V. A. Kaimanovich, il nous faut donc construire des suites de Følner autour de chaque point d'une feuille. Pour ceci on va utiliser un théorème dû à Daniel Cass, voir [12], qui établit l'existence des certaines applications entre des ouverts dans une feuille minimale. Comme on verra, ces applications vont nous permettre de construire des suites de Følner partout, puis de montrer que les suites de mesures correspondantes convergent fortement.

On remarque que le théorème est valide sous l'hypothèse que le feuilletage est *uniquement ergodique*. On dit qu'un feuilletage est uniquement ergodique s'il possède une unique mesure harmonique de probabilité. Un feuilletage uniquement ergodique est minimal.

Les feuilletages possédant des mesures transverses invariantes sont plutôt rares. Cependant, Lucy Garnett a introduit un autre type de mesures pour les feuilletages : les mesures dites *harmoniques*. On va définir ces mesures dans la section 2.4. Contrairement aux mesures transverses

invariantes, les mesures harmoniques ont l'avantage de toujours exister. Un fait important pour nous est qu'une mesure harmonique admet localement une décomposition comme produit d'une mesure sur une transversale locale et d'une mesure sur les feuilles. De plus, ces mesures transverses invariantes, quand elles existent, donnent naissance à des mesures harmoniques. On obtient localement la mesure harmonique correspondante en effectuant le produit de la mesure transversale avec la densité du volume dans les feuilles. Ces mesures sont parfois appelées mesures *complètement invariantes*.

Chapter 1

Periodic orbits of non singular vector fields on 3-manifolds

The research on the existence of vector fields without periodic orbits on 3-manifolds began in 1950 as a consequence of Herbert Seifert's result: *a C^1 vector field on \mathbb{S}^3 which is C^0 close to the Hopf vector field has at least one periodic orbit*. The Hopf vector field is tangent to the Hopf fibration of \mathbb{S}^3 by circles. H. Seifert then asked if every non singular vector field on \mathbb{S}^3 has periodic orbits [69]. The positive answer to this question became Seifert's conjecture. As we will discuss, the conjecture is false. Nevertheless, it is still open in more restrictive families of vector fields.

In the way to disprove the conjecture, F. Wesley Wilson proved in 1966 the existence of non singular vector fields with a finite number of periodic orbits on any closed 3-manifold. His proof is based on the use of *plugs*. Plugs are 3-manifolds with boundary endowed with a non singular vector field that is either transverse or parallel to the boundary. They are used to modify a vector field inside a flow box, *trapping* periodic orbits: there are orbits, in the modified vector field, that *enter* the plug and stay in it. We will give a precise definition of plugs and explain how they are used in section 1.1.

Almost 30 years later, Krystyna Kuperberg showed that Seifert's conjecture is false. In fact, she constructed a plug that allows us to find on any closed 3-manifold a non singular vector field without periodic orbits [52]. Nowadays, we can study the validity of Seifert's conjecture for different categories of vector fields: for example volume preserving or *geodesible*. This last category will be the main subject of this chapter.

Definition 1.6 *A vector field X on a closed manifold M is geodesible if there exists a Riemannian metric g on M making the orbits of X geodesics.*

Modulo a reparameterization of X , a geodesible vector field leaves invariant the differential 1-form $\alpha(\cdot) = g(X, \cdot)$. Since X is non singular we can assume $\alpha(X) = 1$ and, as we will explain,

$X \in \ker(d\alpha)$. The kernel of α defines an invariant plane field, orthogonal to X . Conversely, the existence of a non singular differential 1-form α satisfying $\alpha(X) > 0$ and $X \in \ker(d\alpha)$, implies that X is geodesible.

The set of geodesible vector fields contains vector fields with a global section, and Reeb vector fields associated to a contact form. The second case arises when the 1-form α above is a contact form. Theorems by Helmut Hofer and Clifford H. Taubes guarantee the existence of a periodic orbit for Reeb vector fields on any orientable closed 3-manifold. The question we deal with in this chapter is

do geodesible vector fields on closed 3-manifolds have periodic orbits?

As a first approach, we will show that K. Kuperberg's examples are not geodesible. In general, the technique of plugs does not apply to geodesible vector fields. We will give a positive answer to the question assuming some extra hypothesis: either when the vector field and the metric are real analytic, or when the vector field preserves a volume. We will also restrain ourselves to 3-manifolds that are either diffeomorphic to \mathbb{S}^3 or have non trivial second homotopy group. We will say that a geodesible vector field is real analytic, if the vector field and the Riemannian metric are real analytic. We will prove the following theorems.

Theorem A *Assume that X is a geodesible volume preserving vector field on an orientable closed 3-manifold M , that is not a torus bundle over the circle. Then if X is real analytic and preserves a real analytic volume form, it possesses a periodic orbit.*

Theorem B *Assume that X is a geodesible vector field on an orientable closed 3-manifold M , that is either diffeomorphic to \mathbb{S}^3 or has non trivial π_2 . Then if X is real analytic, it possesses a periodic orbit.*

Theorem C *Assume that X is a geodesible vector field on an orientable closed 3-manifold M , that is either diffeomorphic to \mathbb{S}^3 or has non trivial π_2 . Then if X is C^∞ and preserves a volume, it possesses a periodic orbit.*

When X is a Reeb vector field, the theorems are particular cases of H. Hofer and C. H. Taubes' theorems. For the case where X has a cross section, we will use results as David Tischler's theorem: *if a closed n -manifold admits a non singular closed 1-form, it is a fiber bundle over the circle*, see [76].

The biggest difficulty in the proofs of the previous theorems is to deal with the invariant set A where α is a closed form, and A is neither empty nor all of M . In the real analytic case, Hassler Whitney's singularity theory allows us to describe the topology of this set. We will prove that if X has no periodic orbits on A , the set A is a finite union of invariant two dimensional tori. In order to deal with A in the C^∞ case, we will assume that X preserves a volume form. As we will show, this hypothesis implies that there is a first integral of X : a function on M whose levels are invariant under X . The regular levels of this function are formed by invariant tori.

The chapter is organized as follows. In section 1.1, we will review the definition of plugs, their construction and the technique to use them. In particular, we will construct F. W. Wilson's plug from [81] and K. Kuperberg's plug from [52]. The last one allows us to give examples of aperiodic vector fields on any closed 3-manifold. We will also state the known results regarding Seifert's conjecture for volume preserving vector fields.

Examples of geodesible vector fields and a characterization theorem are presented in section 1.2. The characterization, due to D. Sullivan [74], allows us to prove that plugs cannot be used in the category of geodesible vector fields. In section 1.3 we will establish an equivalence between

geodesible vector fields and a class of hydrodynamical vector fields: these are *Beltrami* vector fields, not necessarily volume preserving. Thus the theorems above are valid for Beltrami vector fields.

The proofs of theorems A, B and C, are presented in section 1.4. The rest of the chapter is devoted to the proof of two results used to establish the theorems above. The first one deals with the study of the complement of families of two dimensional embedded tori in closed 3-manifolds. Section 1.5 is devoted to this result. The second one asserts the existence of a periodic orbit of a Reeb vector field on some compact 3-manifolds with boundary. In order to prove it we will have to review the method used by H. Hofer. We will leave this discussion for section 1.6.

1.1 K. Kuperberg's and H. Hofer's results on periodic orbits

We will start by introducing plugs and the construction of F. W. Wilson [81], giving an exemplification of the use of plugs. As we said, he proved that there are non singular vector fields on any closed 3-manifold with a finite number of periodic orbits, namely two. From now on, if not otherwise stated, we will always write flow for non singular flow and vector field for non singular vector field. As we are interested mainly in C^∞ dynamical systems, we will talk of flows and vector fields indistinctively. Let us define what a plug is.

Definition 1.1 *A plug is a manifold P endowed with a vector field X satisfying the following characteristics. The 3-manifold P is of the form $D \times [-1, 1]$, where D is a compact 2-manifold with boundary, and the vector field X satisfies the conditions:*

- (i) $X = \frac{\partial}{\partial z}$ in a neighborhood of ∂P , where z is the coordinate of the interval $[-1, 1]$. We will call $\frac{\partial}{\partial z}$ the vertical direction;
- (ii) ∂P is divided in three different types regarding the relation with X :
 - the transverse boundary composed by $D \times \{-1\}$ and $D \times \{1\}$, that are the entry and exit regions, respectively;
 - the parallel boundary $\partial D \times [-1, 1]$;
 - the corners, where the previous two meet, namely $\partial D \times \{\pm 1\}$;
- (iii) the entry-exit condition: if a point $(x, -1)$ is in the same trajectory that $(y, 1)$, then $x = y$. That is an orbit that traverses P , exits just in front of its entry point;
- (iv) there is at least one entry point whose entire positive orbit is contained in P , we will say that its orbit is trapped by P ;
- (v) there is an embedding $i : P \rightarrow \mathbb{R}^3$ that preserves the vertical direction.

We will call the set of entry points whose orbits are trapped the *trapped set*. If a manifold P endowed with a vector field X as above, satisfies all conditions except (iii), we will call it a *semi-plug*. The concatenation of a semi-plug with an inverted copy of it, that is a copy where the direction of the flow is inverted, is a plug. This is a very useful construction. Note that we can generalize the previous definition to higher dimensions: just take the manifold D of dimension $n - 1$, where n is the dimension of the ambient manifold of the flow.

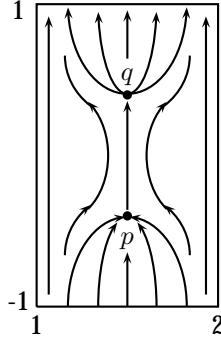
Figure 1.1: Vector field X_1

To fix ideas, let us construct F. W. Wilson's plug. Start considering the rectangle $[1, 2] \times [-1, 1]$ with coordinates (r, s) and the vector field X_1 whose orbits are as in figure 1.1. Take the manifold $P = \mathbb{S}^1 \times [1, 2] \times [-1, 1]$ endowed with the vector field $X = X_1 + f \frac{\partial}{\partial \theta}$, where θ is the \mathbb{S}^1 coordinate and f is a C^∞ bump function $f : [1, 2] \times [-1, 1] \rightarrow \mathbb{R}$ that assumes the value zero near the boundary of the rectangle, is strictly positive in one of the singularities of X_1 , and strictly negative in the other one. In order to satisfy the entry-exit condition, we will take f anti-symmetric with respect to the line $\{z = 0\}$.

Observe that the vector field has two periodic orbits that correspond to the two singularities of X_1 . Moreover, the set of points whose orbits are trapped is an annulus with non empty interior: it is composed of the cross product of \mathbb{S}^1 with the set of points in the bottom boundary of the rectangle $[1, 2] \times [-1, 1]$ whose X_1 orbits converge to the singularity p . Thus in the product manifold P , there is an annulus in the entry region whose orbits converge to the periodic orbit described by p .

To finish the construction of the plug we need to consider the embedding of P into the manifold $\mathbb{D}^2 \times [-1, 1]$, where \mathbb{D}^2 is the closed two dimensional disc of radius two, that sends a point (θ, r, z) to $(r \cos \theta, r \sin \theta, z)$ and filling the exterior of the image of P with the vertical vector field $\frac{\partial}{\partial z}$. We will call this plug \mathcal{P} .

Let us describe how to use the plug to prove F. W. Wilson's result: *any closed 3-manifold admits a non singular vector field with a finite number of periodic orbits*. Start by considering a non singular vector field on a closed 3-manifold M . The existence of a non singular vector field follows from the fact that any compact 3-manifold has zero Euler characteristic. Observe that when we replace the interior of one flow box with a copy of \mathcal{P} , the entry-exit condition assures that we do not change the type of a non trapped orbit: a periodic orbit will still be a periodic orbit after the insertion of \mathcal{P} , and the same for non periodic orbits. We can find a finite number of flow boxes such that when we replace their interiors with copies of \mathcal{P} , each orbit is trapped by at least one of the inserted plugs. We get a new vector field on M with a finite number of periodic orbits: the only periodic orbits are the ones in the plugs. Since we picked the flow boxes in such a way that each orbit is trapped by at least one of the inserted plugs, the orbits that are not contained in the plugs cannot be periodic.

In F. W. Wilson's language the fact that there exists a finite collection of flow boxes such that when we replace their interiors with copies of \mathcal{P} , all the orbits of the initial vector field are trapped,

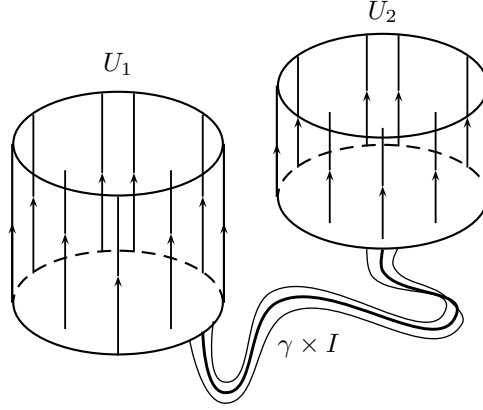

Figure 1.2: A transversal band between two flow boxes

is referred as a finite collection of flow boxes that *saturates* the original vector field. We can prove that one flow box is enough to saturate a vector field. For this, consider two flow boxes U_1 and U_2 in the finite collection and assume first that they are disjoint from each other. We will show that there is one flow box that contains a segment of each orbit intersecting their union. There exists an embedded arc $\gamma : [0, 1] \rightarrow M$ that goes from the boundary of the entry region of U_1 to the boundary of the entry region of U_2 and such that the vector field associated to the flow is never tangent to γ . We can expand γ to a transverse band $\gamma \times I$ in the complement of the flow boxes, where $I = [0, 1]$, and in such a way that $\gamma(0) \times [0, 1] \in \partial U_1$ and $\gamma(1) \times [0, 1] \in \partial U_2$, as in figure 1.2. Then making a flow box with entry region $\gamma \times I$, we get a new flow box that contains a segment of the orbits intersecting

$$U_1 \cup U_2 \cup (\gamma \times I \times I).$$

Observe that if $U_1 \cap U_2 \neq \emptyset$, there is a flow box that contains their intersection and a segment of each orbit in their union. We can then insert one plug that traps the orbits that were trapped by the plugs inserted inside U_1 and U_2 . These facts imply that it is enough to insert one plug to trap all the orbits. We get a new vector field on M with only two periodic orbits.

It is worth mentioning that F. W. Wilson solved the periodic orbit problem in manifolds of dimension n strictly greater than three. His construction has generalizations to higher dimensions: for the n dimensional plug we need to consider the product of the rectangle in figure 1.1 with a torus of dimension $n - 2$. In analogy with the previous construction, this manifold is endowed with the vector field $X_1 + fL$, where L is an irrational flow in \mathbb{T}^{n-2} . Then the minimal sets are two $n - 2$ dimensional tori, in place of the two periodic orbits when $n = 3$. The vector field is aperiodic. Thus, F. W. Wilson proved

Theorem 1.2 (Wilson) *On any connected closed manifold M with Euler characteristic zero and dimension greater or equal to four, there is a non singular vector field without periodic orbits.*

Let us come back to Seifert's conjecture in dimension three. In the way to disprove it, a next possible step was to construct a plug without periodic orbits. The first one who achieved such a construction was Paul A. Schweitzer in 1974, the flow in his plug being only of class C^1 [67]. The same construction was then improved for C^2 flows by Jenny Harrison [38]. The breakthrough

came with K. Kuperberg's construction, the flow in her plug is C^∞ or even real analytic. We will describe briefly her construction in section 1.1.1.

The volume preserving version of Seifert's conjecture is an open problem, nonetheless, Greg Kuperberg showed that there are such flows on any 3-manifold with a finite number of periodic orbits (theorem 2 of [51]). His technique is different from the one of F. W. Wilson, because in the volume preserving category plugs cannot have a trapped set with non empty interior. This last claim is a consequence of Henri Poincaré's recurrence theorem: *if a flow on a compact manifold preserves volume, then on each non empty open set there exist orbits that intersect the set infinitely often.*

To overcome this difficulty, G. Kuperberg uses the fact that an orientable compact 3-manifold M can be obtained from the three torus \mathbb{T}^3 by a finite series of Dehn surgeries. Let us start with \mathbb{T}^3 endowed with an irrational vector field, hence aperiodic. A Dehn surgery can be seen as the insertion of a volume preserving plug into \mathbb{T}^3 . The plugs he uses differ from the ones defined above: the flow is not vertical on the boundary, it turns to allow us to perform the Dehn twist in the surgery and change the topology of the manifold. Since the plug has two periodic orbits, the construction gives a vector field with a finite number of periodic orbits on any closed 3-manifold.

One possible procedure to disprove the conjecture in this category, would be to construct a volume preserving aperiodic plug. K. Kuperberg's plug is not volume preserving because the trapped set contains an open annulus, for a proof of this claim we refer to page 20 of Étienne Ghys' paper [27]. G. Kuperberg also achieved the construction of a volume preserving version of P. A. Schweitzer's plug, showing that there are volume preserving C^1 vector fields without periodic orbits, see theorem 1 of [51]. The construction uses Denjoy's vector field on a two dimensional torus: a non singular vector field without periodic orbits that leaves invariant a closed set with empty interior. This vector field is only of class C^1 .

Let us mention that a volume preserving non singular vector field on a compact manifold of dimension greater or equal to four can be changed into one without periodic orbits. In fact, F. W. Wilson's plug can be chosen divergence free. In particular this yields to an aperiodic volume preserving vector field on \mathbb{S}^{2n+1} , for $n \geq 2$.

As a counterpart to these results we have the next theorem by H. Hofer and C. H. Taubes, that assures the existence of a periodic orbit for Reeb vector fields on closed 3-manifolds [41], [75]. Reeb vector fields are associated with contact forms: a contact form is a 1-form α such that $\alpha \wedge d\alpha$ is never zero. The Reeb vector field X associated to α is defined by the equations

$$\alpha(X) = 1 \quad \text{and} \quad \iota_X d\alpha = 0.$$

The kernel of α defines a contact structure ξ , a plane field in TM that is nowhere integrable. The equation above implies that X and ξ are transverse to each other. Reeb vector fields are volume preserving since the form $\alpha \wedge d\alpha$ is an invariant volume form. We can now state the theorem.

Theorem 1.3 (Hofer, Taubes) *The Reeb vector field associated to a contact form α on an orientable closed 3-manifold M has a periodic orbit.*

H. Hofer proved the theorem when M is diffeomorphic to \mathbb{S}^3 or if $\pi_2(M) \neq 0$. In section 1.6.2 we will present a sketch of his proof that uses pseudoholomorphic curves in a symplectisation of M . The generalization to any closed 3-manifold is due C. H. Taubes, see [75].

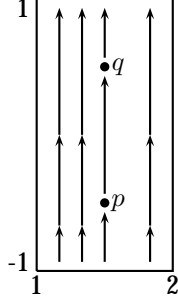
Figure 1.3: Vector field \mathcal{W}_1

1.1.1 Construction of K. Kuperberg's plug

In this section we will sketch the construction of K. Kuperberg's plug that, used as we used F. W. Wilson's plug, allows us to prove

Theorem 1.4 (K. Kuperberg) *On every closed 3-manifold M there is a real analytic non singular vector field without periodic orbits.*

As we said the vector field in this plug is C^∞ , or even C^ω . We will start the construction with a modification of F. W. Wilson's plug. Consider the rectangle $[1, 2] \times [-1, 1]$ with the vector field \mathcal{W}_1 described in figure 1.3. The vector field \mathcal{W}_1 is everywhere vertical and has two singularities p and q . Take the manifold $P = \mathbb{S}^1 \times [1, 2] \times [-1, 1]$ with the vector field $\mathcal{W} = \mathcal{W}_1 + f \frac{\partial}{\partial \theta}$, where (θ, r, z) are the coordinates of P . The C^∞ function $f : [1, 2] \times [-1, 1] \rightarrow \mathbb{R}$ assumes the value zero near the boundary of the rectangle, is strictly positive in one of the singularities of \mathcal{W}_1 and strictly negative in the other one. In order to satisfy the entry-exit condition for plugs, described in definition 1.1, we will ask f to be anti-symmetric with respect to the line $\{z = 0\}$.

Observe that the vector field \mathcal{W} is vertical near the boundary of P and horizontal in the periodic orbits, O_1 and O_2 , described by the singularities of \mathcal{W}_1 . Also, it is tangent to the cylinders $\{r = \text{const.}\}$ and the orbits described in each cylinder are as in figure 1.4. Clearly, the periodic orbits are in the cylinder $\{r = \frac{3}{2}\}$. In this way, we get a plug P naturally embedded in \mathbb{R}^3 , whose set of entry points with trapped orbits is the entry circle $\mathbb{S}^1 \times \{\frac{3}{2}\} \times \{-1\}$.

Let us continue with K. Kuperberg's construction: the difficult part comes now. The manifold P can be embedded in \mathbb{R}^3 as a *folded eight*, as shown in figure 1.5. The embedding preserves the vertical direction. We are going to insert parts of P in itself in such a way that the two periodic orbits will be trapped by these auto-intersections. Consider in each annulus $A = \mathbb{S}^1 \times [1, 2]$ the topological closed discs L_i , for $i = 1, 2$, whose boundaries are composed by two arcs: α'_i in the interior of A and α_i in the boundary circle $\{r = 2\} \subset \partial A$, as shown in figure 1.6. We define the *tongues* as the sets $L_i \times [-1, 1] \subset P$. We will choose the discs L_i in such a way that the tongues are disjoint and each one contains a rectangle of the cylinder $\{r = \frac{3}{2}\}$.

We are going to insert the tongues in P . For this consider two disjoint arcs β_i in the circle $\{r = 1\} \subset \partial A$ and two C^∞ embeddings $\sigma_i : L_i \times [-1, 1] \rightarrow P$, for $i = 1, 2$, such that

- $\sigma_i(\alpha'_i \times [-1, 1]) = \beta_i \times [-1, 1]$;

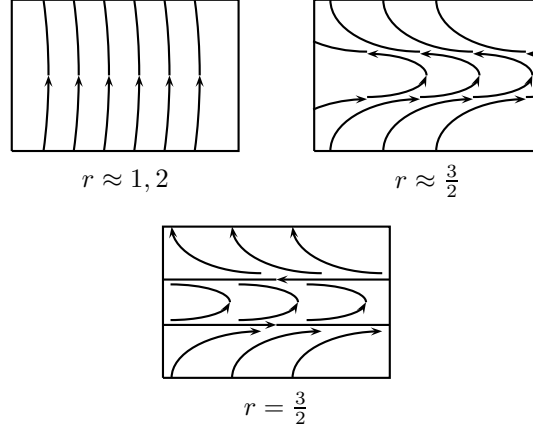
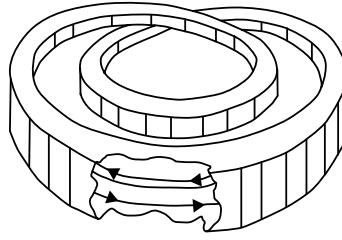
Figure 1.4: \mathcal{W} orbits in the cylinders $\{r = \text{const.}\}$ Figure 1.5: Embedding of P

- $(L_i \times [-1, 1]) \cap \sigma_i(L_i \times [-1, 1]) = \emptyset$;
- $\sigma_i(L_i \times \{\cdot\})$ is transverse to the vector field \mathcal{W} . Since \mathcal{W} is vertical near ∂P and horizontal in the two periodic orbits, this condition means that the surfaces $\sigma_i(L_i \times \{\cdot\})$ make *half a turn* as in figure 1.7. Also, we will require that $\sigma_i(L_i \times \{\cdot\})$ intersects the periodic orbit O_i and not the other one.

The vector field in $\sigma_i(L_i \times [-1, 1])$ is the image of the vector field $\mathcal{W}|_{L_i \times [-1, 1]}$. The idea of the embeddings is to trap the two periodic orbits of P with the same plug. We obtain K. Kuperberg's plug K , with the vector field \mathcal{K} , shown in figure 1.8.

In order to make the vector field aperiodic, we need to impose the following two conditions:

- K1 the disc L_i contains a point $(\theta_i, \frac{3}{2})$ such that the image under σ_i of the vertical segment $(\theta_i, \frac{3}{2}) \times [-1, 1]$ is an arc of the periodic orbit O_i of \mathcal{W} ;
- K2 if a point $(\bar{\theta}, \bar{r}) \in L_1 \cup L_2$ goes under σ_1 or σ_2 on a point (θ, r, z) , then $\bar{r} > r$ unless $(\bar{\theta}, \bar{r})$ is one of the points $(\theta_i, \frac{3}{2})$.

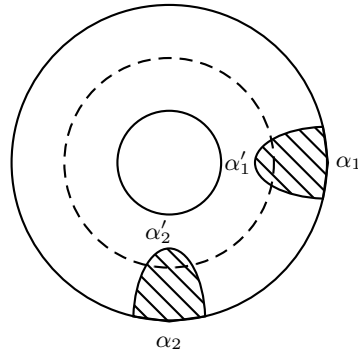

Figure 1.6: L_1 and L_2

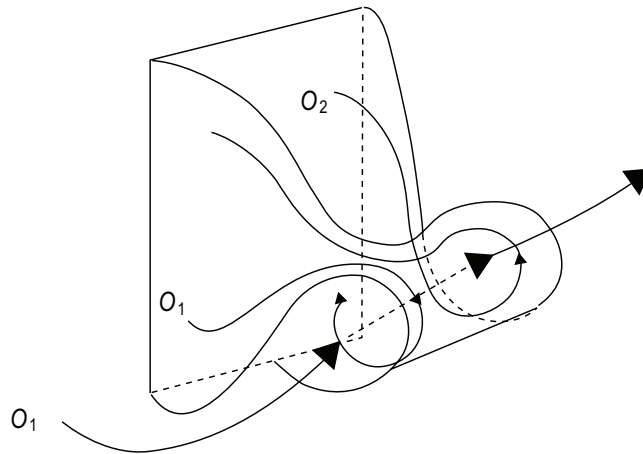

Figure 1.7: The set $\sigma_i(L_i \times [-1, 1])$

For a proof of the aperiodicity of \mathcal{K} and a description of the dynamics in the interior of K we refer the reader to section 6 of É. Ghys' article [27].

Before ending the section, let us describe the reasons why plugs and plug insertions can be made real analytic, implying the existence of real analytic non singular flows without periodic orbits on every closed 3-manifold. Let us come back to the notation of definition 1.1. First observe that the condition

$$(i) \quad w = \frac{\partial}{\partial z} \text{ in a neighborhood of } \partial P,$$

cannot be satisfied in the real analytic category. In fact, this will imply that the vector field is vertical everywhere. So we will replace it by condition

$$(i') \quad w = \frac{\partial}{\partial z} \text{ on } \partial P.$$

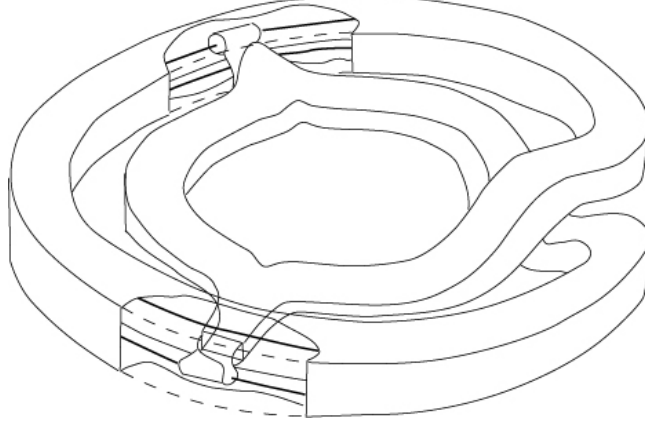
Figure 1.8: K. Kuperberg's plug K

Let us take an open neighborhood U of the plug $P = D \times [-1, 1]$ in \mathbb{R}^3 , such that

$$U \simeq B \times (-(1 + \epsilon), 1 + \epsilon)$$

and B is an open two dimensional ball containing D . We can extend the vector field w from the plug to U in such a way that the vector field in $U \setminus P$ is *almost vertical*. By almost vertical we mean that:

- the flow line passing through a point $(x, 1)$, respectively $(x, -1)$, contains the point $(x, (1 + \epsilon))$ in $\partial\bar{U}$, respectively $(x, -(1 + \epsilon))$, but it is not vertical all the way between these two points. The reason for this condition is to maintain the entry-exit property satisfied;
- the points $(x, \pm(1 + \epsilon)) \in \partial\bar{U}$, belong to the same flow line for every $x \in B \setminus D$.

Consider now a real analytic 3-manifold M endowed with a real analytic vector field X . The flow box theorem is also valid in this category, so we can take one flow box F and an open neighborhood $F \subset V \subset M$. We claim that there exists an analytic map $h : U \setminus P \rightarrow V \setminus F$ such that the vector field in $U \setminus P$ is mapped to X in $V \setminus F$. To proof the claim, consider an embedding \tilde{h} of B into $V \setminus F$, which is transverse to X . For any $(x, z) \in U \setminus P$ let $h(x, z) = (\tilde{h}(\mathcal{O}_{(x,z)}), z)$ where $\mathcal{O}_{(x,z)}$ is the intersection point between the orbit through (x, z) and $B \times \{1 + \epsilon\}$. Then h is defined on $U \setminus P$ and is real analytic. Observe that it cannot be extended to the rest of U . Hence using h , we can map $w|_{U \setminus P}$ to X in $V \setminus F$. We can put P at the place of F , changing the vector field on the manifold. We will call this new vector field \bar{X} .

The manifold M had a real analytic structure that we will call \mathcal{U}_1 . When we insert the plug in a chart, we produce a new analytic structure \mathcal{U}_2 , that is equal to \mathcal{U}_1 away from V .

Theorem 1.5 *Two real analytic manifolds which are diffeomorphic, are real analytically diffeomorphic.*

In other words, if a manifold has a real analytic structure it is unique. The fact that the real analytic structure is unique is a consequence of Hans Grauert's result [34] that states that $C^\omega(M, N)$

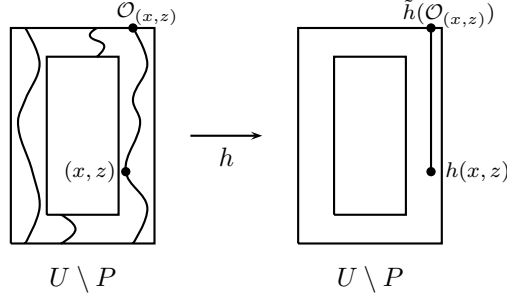
Figure 1.9: The real analytic map h .

is dense in $C^r(M, N)$, for $0 \leq r \leq \infty$, where M and N are real analytic manifolds. Coming back to the insertion of plugs, the theorem implies that there is a real analytic diffeomorphism

$$\Phi : (M, \mathcal{U}_2) \rightarrow (M, \mathcal{U}_1),$$

that maps the new vector field \bar{X} to a vector field \tilde{X} on (M, \mathcal{U}_1) . These vector fields are conjugated, thus they have the same orbit structure. This map is not the identity map. We conclude that plug insertions can be made real analytic without changing the real analytic structure of the ambient manifold.

Finally, we will mention some remarks. First, as we mentioned in the previous section the construction of a C^∞ , or even C^2 , aperiodic volume preserving plug is an open problem. We can construct a version of F. W. Wilson's plug that is volume preserving (see section 2.3.1), but we do not know how to make the auto-intersections. Secondly, the vector field \mathcal{K} is homotopic to the vertical vector field in the set of non singular vector fields. Thus we can find an aperiodic vector field in each homotopy class of non singular vector fields on a closed 3-manifold.

The vector field of a plug defines a 1-foliation. So we can generalize the use of plugs to the context of foliations of codimension two of a n -manifold. For example, we can use (foliated) plugs $K \times \mathbb{T}^{n-3}$ to construct examples without compact leaves. Here \mathbb{T}^{n-3} stands for the torus of dimension $n - 3$ and the foliation of the plug is defined by the product of the orbits of \mathcal{K} with \mathbb{T}^{n-3} . For foliations of codimension $q \geq 2$, P. A. Schweitzer introduced a way to use his plug: in a trivially foliated open set that intersects a compact leaf, he inserts the product of his plug with a $q - 2$ dimensional sphere [67]. Thus constructing a C^1 foliation without compact leaves. Using K. Kuperberg's plug in the same way, we get that: *every manifold that admits a C^∞ (or C^ω) foliation of codimension $q \geq 2$, admits a C^∞ (or C^ω) foliation without compact leaves.*

For codimension one foliations P. A. Schweitzer showed that, when the dimension of the ambient manifold is greater or equal to four, a non singular foliation can be changed into one without compact leaves of class C^1 , see [68].

1.2 Geodesible vector fields

We mentioned that H. Hofer's theorem 1.3 states the existence of periodic orbits for the Reeb vector field associated to any contact structure on \mathbb{S}^3 . A larger class of vector fields are *geodesible* ones, that we will study in this chapter.

Definition 1.6 *Let X be a vector field on a closed manifold M . We will say that it is geodesible, or that the associated flow is geodesible, if there exists a Riemannian metric g on M such that the orbits of X are geodesics. We can reparameterize X to make it of unit length.*

These vector fields were first studied by Herman Gluck. He was interested in filling manifolds with geodesics, in other words which manifolds can be foliated by geodesics. We owe him the definition of geodesible vector fields, we refer to [32]. Later on, D. Sullivan gave a characterization of such vector fields in terms of *tangent homologies*, see [74], that we will introduce in section 1.2.2.

We just claimed that Reeb vector fields are geodesible. In order to prove this, consider a Reeb vector field X associated to a contact structure $\xi = \ker(\alpha)$ on a closed 3-manifold M . Observe that since $\alpha(X) = 1$ and $\iota_X d\alpha = 0$, the contact structure is transverse to X . So we can choose on M a Riemannian metric g , such that

- $g(X, X) = 1$;
- X is orthogonal to ξ .

The metric satisfying the conditions above is such that $\alpha_x(Y) = g(X_x, Y)$ for any vector $Y \in T_x M$. Let now $Y \in TM$ be a vector field. We have that

$$\begin{aligned} (L_X \alpha)(Y) &= L_X g(X, Y) - g(X, L_X Y) \\ &= g(\nabla_X X, Y) + g(X, \nabla_X Y) - g(X, \nabla_X Y) + g(X, \nabla_Y X) \\ &= g(\nabla_X X, Y), \end{aligned} \tag{1.1}$$

where ∇ stands for the Levi-Civita connection and L for the Lie derivative. Since X is the Reeb vector field of α , we have that

$$L_X \alpha = d\iota_X \alpha + \iota_X d\alpha = 0,$$

thus $\nabla_X X = 0$ which means that the orbits of X are geodesics.

We claim that the set of geodesible vector fields is larger than the one of Reeb vector fields. Observe that if a vector field X is geodesible for a Riemannian metric g on M , then there is an invariant one form defined by $\alpha(\cdot) = g(X, \cdot)$ which is non singular. We have that $\iota_X d\alpha = 0$, but α may not be a contact form. For example, if it is a closed form the plane field defined by its kernel is integrable. Thus there is a codimension one foliation transverse to X .

Definition 1.7 *A global cross section to a flow on a closed manifold M , is a closed submanifold S of dimension one less than M , transverse to X and meeting every orbit in at least one point.*

When α is a closed form, the vector field associated to X has a global cross section. The reason for this is that we can perturb α in order that its periods are rational, and then multiply it in such a way that the periods are integers. Thus α defines a submersion of M onto the circle, and any fiber gives us a global cross section of X . This argument proves D. Tischler's theorem (theorem 1 of [76]).

Theorem 1.8 (Tischler) *Let M be a closed n -manifold. Assume that M admits a non singular closed 1-form, then M is a fiber bundle over the circle.*

A vector field with a cross section cannot be the Reeb vector field of a contact form α , because $d\alpha$ restricted to the cross section is an exact area form. Using Arnold P. Stokes' theorem we get that the area of the cross section has to be zero. This proves our claim: geodesible vector fields form a larger class than Reeb vector fields.

Observe that in the case of geodesible vector fields the form $\alpha \wedge d\alpha$ is zero if and only if α is closed. This follows from the fact that the kernel of α consists of the vectors that are perpendicular to X . Then if α is not closed and $\alpha \wedge d\alpha = 0$ we get the contradiction $\ker(d\alpha) \subset \ker(\alpha)$.

Proposition 1.9 *Vector fields with section are geodesible. Hence any manifold which fibers over the circle can be filled by geodesics for a suitable metric.*

Proof. Let X be a vector field on a manifold M and S a section to the vector field. Cutting M along S yields to $S \times [0, 1]$, with the orbits of X being the segments $\{\cdot\} \times [0, 1]$. We can reassemble M identifying $(x, 1)$ with $(h(x), 0)$, for some diffeomorphism h of S induced by the flow associated to X . Let g be a metric on S , and g_t a metric path between $g = g_0$ and the pullback $h^*g = g_1$. We will ask that $g_t = g_0$ for t near 0 and $g_t = g_1$ for t near 1. Then the metric $g_t + dt^2$ on $S \times [0, 1]$ induces a Riemannian metric on M . Since the segments $\{\cdot\} \times [0, 1]$ are geodesics, the orbits are geodesics in M .

□

Summarizing, geodesible vector fields contain Reeb vector fields associated to a contact structure and vector fields with section. Let us mention some examples of geodesible vector fields.

1. *Geodesic flow on a Riemannian surface M .* We will explain that the geodesic flow is geodesible in T^1M and does not admit cross sections.

Take the cotangent bundle, that is the *symplectic manifold* $(T^*M, \hat{\omega})$. The word symplectic means that the differential 2-form $\hat{\omega}$ is non degenerated and closed. Consider a chart that trivializes the cotangent bundle

$$T^*M|_{\mathcal{U}} \simeq \mathcal{U} \times \mathbb{R}^n$$

where \mathcal{U} is an open subset of the manifold M . Denote the coordinates of the chart as (p_1, p_2, x_1, x_2) . In this coordinates the symplectic form $\hat{\omega}$ is the differential of the *Liouville 1-form* (or *canonical 1-form*) given locally by

$$\hat{\lambda} = \sum_{j=1}^2 x_j dp_j.$$

Put

$$\begin{aligned} \pi_M : TM &\rightarrow M \\ p_M : T^*M &\rightarrow M, \end{aligned}$$

the natural projections. From the Riemannian metric g we get a bundle isomorphism ψ , such that the following diagram is commutative

$$\begin{array}{ccc} TM & \xrightarrow{\psi} & T^*M \\ \downarrow \pi_M & & \downarrow p_M \\ M & \xrightarrow{Id} & M \end{array}$$

Here, $\psi(X) = \iota_X g$. By ω we denote the pull back of the symplectic form $\hat{\omega}$ to TM . The geodesic vector field is the Hamiltonian vector field of the kinetic energy defined by

$$E(X) = \frac{1}{2}g(X, X),$$

on TM with respect to the form ω . That is, it is the unique vector field $V_E \in TTM$ satisfying $\iota_{V_E} \omega = -dE$. Denote by ϕ_t the associated geodesic flow, acting on TM . As we will explain, the flow line $\phi_t(X)$ projects under π_M to the geodesic $\gamma_X(t)$ determined by $\dot{\gamma}_X(0) = X$ and $\phi_t(X) = \dot{\gamma}_X(t)$, for every $X \in TM$.

The tangent space $T_X TM$ of TM , splits into the horizontal and vertical subspaces $T_{Xh} TM$ and $T_{Xv} TM$ with respect to the Levi-Civita connection ∇ :

$$T_X TM = T_{Xh} TM \oplus T_{Xv} TM.$$

Each of these subspaces is canonically isomorphic to $T_p M$, for $p = \pi_M(X) \in M$.

Lemma 1.10 *The symplectic 2-form ω on TM can be described by the formula*

$$\omega(U, V) = g(U_h, V_v) - g(U_v, V_h). \quad (1.2)$$

Here, the $U, V \in T_X TM$ are decomposed into their horizontal and vertical components, and g denotes the Riemannian metric on $T_p M$, where $p = \pi_M(X)$.

For a proof we refer to section 1.3.2 of [60]. The *horizontal lift* at $X \in TM$ is the map

$$H_X : T_p M \rightarrow T_X TM$$

where $p = \pi_M(X)$, defined as follows. Given $Y \in T_p M$ and $\lambda : (-\epsilon, \epsilon) \rightarrow M$ a curve such that $\dot{\lambda}(0) = Y$, let $Z(t)$ be the parallel transport of X along λ . Take $\sigma : (-\epsilon, \epsilon) \rightarrow TM$ the curve defined by $\sigma(t) = (\lambda(t), Z(t))$. Then

$$H_X(Y) = \dot{\sigma}(0) \in T_X TM.$$

We claim that the geodesic vector field V_E is horizontal, that is $V_E \in T_{Xh} TM$. Take $X \in T_p M$ and $U \in T_X TM$. Let $\sigma : (-\epsilon, \epsilon) \rightarrow TM$ be a curve such that $\dot{\sigma}(0) = U$ and write $\sigma(t) = (\lambda(t), Z(t))$ for a curve λ in M as above. Then

$$\begin{aligned} dE_X(U) &= \left. \frac{d}{dt} \right|_{t=0} E(\sigma(t)) \\ &= \left. \frac{d}{dt} \right|_{t=0} \frac{1}{2} g(Z(t), Z(t)) \\ &= g((\nabla_{\dot{\lambda}} Z)(0), Z(0)) \\ &= g(U_v, V_E(X)). \end{aligned}$$

Proving that $V_E(X) = (X, 0) \in T_X hTM \oplus T_X vTM$.

Let $\gamma(t)$ be a geodesic in M , then the equation $\nabla_{\dot{\gamma}(t)} \dot{\gamma}(t) = 0$ now reads locally as

$$\frac{d}{dt} \dot{\gamma}(t) = (\dot{\gamma}(t), 0) = V_E(\dot{\gamma}(t)).$$

Thus $\dot{\gamma}(t) = \phi_t(\dot{\gamma}(0))$. This implies that $\pi_M(\phi_t(X))$ is a geodesic in M .

We can define a scalar product on $T_X TM$ by letting the horizontal and the vertical spaces be orthogonal and taking on each one of these spaces the scalar product defined by the scalar product of $T_p M$, using the canonical identifications. This defines a Riemannian metric on TM known as the *Sasaki metric*. Denote this metric by g_S . Let $J : T_X TM \rightarrow T_X TM$ be the almost complex structure (i.e. $J^2 = -Id$) defined by

$$J(U_h, U_v) = (-U_v, U_h).$$

Then $\omega(U, V) = g_S(JU, V)$.

Recall that for a Hamiltonian flow, the levels of the Hamiltonian function are invariant. Moreover, the geodesic flow on a given level $E = a > 0$ is a reparameterization of the flow in any other level $E = b > 0$. Thus, in order to study the geodesic flow we can restrain our attention to $\phi_t|_{T^1 M}$ on the unit tangent bundle. Hence, the projected curves $\pi_M(\phi_t(X))$ are parameterized by arc length.

On TM define the one form α by

$$\alpha_X(U) = g_S(U, V_E(X)) = g(U_h, X),$$

for $U \in T_X TM$.

Proposition 1.11 *We have that $\omega = -d\alpha$.*

For a proof we refer the reader to proposition 1.24 of Gabriel P. Paternain's book [60]. Then we have that $\alpha_X(V_E(X)) = 1$. Consider $U \in T_X T^1 M$, then

$$\iota_{V_E(X)} d\alpha(U) = -\omega(V_E(X), U) = dE(U) = 0$$

since E is constant on $T^1 M$.

We conclude that the geodesic vector field is geodesible, its orbits are geodesics in $T^1 M$ for the Sasaki metric. Moreover, it is the Reeb vector field of the 1-form α , and thus it does not admit cross sections.

2. **Killing vector fields.** Let M be a Riemannian manifold, with metric g . A vector field X on M which generates an isometric flow on M is a Killing vector field. In other words X is Killing if $L_X g = 0$. We claim that there exists a Riemannian metric g' on M , conformal to g , for which the trajectories of X are geodesics. To construct the new metric take $f : M \rightarrow \mathbb{R}$ defined by $f(x) = g(X_x, X_x)^{-1}$, and define $g' = fg$. Then

$$L_X f = g(X, X)^{-2} L_X(g(X, X)) = g(X, X)^{-2} (L_X g)(X, X) = 0,$$

implying that $L_X(fg) = 0$. Then, with respect to the metric g' , the flow generated by X is isometric and it preserves the subspace of vectors orthogonal to X . Thus the trajectories of X are geodesics for this metric, in other words X is geodesible.

For example, rotating the plane about the origin gives a non singular isometric flow of the punctured plane whose orbits are concentric circles. Changing the metric, we can turn the punctured plane into a cylinder and the orbits become geodesics.

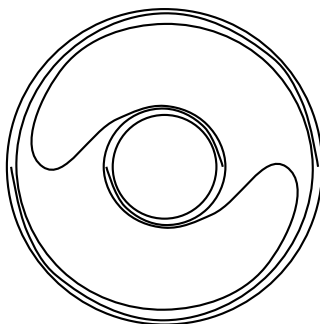

Figure 1.10: Reeb foliation of the annulus

3. *Vector fields tangent to 1-foliations by closed curves.* Consider a manifold M foliated by closed curves. Andrew W. Wadsley showed that there is a Riemannian metric on M making these curves geodesics if and only if their lengths are bounded, [78]. David B. A. Epstein had previously showed that this bounded length condition is always satisfied in dimension three, [20]. In [72], D. Sullivan showed that it can fail in dimension strictly greater than four by constructing a foliation by closed leaves of $\mathbb{S}^3 \times \mathbb{S}^1 \times \mathbb{S}^1$ with unbounded length. D. B. A. Epstein and Elmar Vogt constructed a vector field on a compact 4-manifold such that all the orbits are circles with unbounded length [21]. Thus in dimension three a one dimensional foliation by closed curves can be seen as the orbits of a geodesible vector field.

In dimension three, these examples are contained in the precedent ones. Observe that there is a vector field tangent to the foliation by circles whose flow is given by a locally free action of \mathbb{S}^1 , see [20]. Such a vector field is Killing. The invariant metric is obtained as follows: beginning with any metric on M , we take the mean of the transformations of the metric under the \mathbb{S}^1 action, relatively to the Haar measure on \mathbb{S}^1 .

As an example, consider \mathbb{S}^3 as the unit sphere in \mathbb{C}^2 with coordinates (z_1, z_2) . The flow

$$\phi_t(z_1, z_2) = (e^{ipt} z_1, e^{iqt} z_2),$$

with $p, q \in \mathbb{R}^+$, is isometric for the standard metric on \mathbb{S}^3 . If $\frac{p}{q}$ is a rational number, the orbits are all circles, and ϕ_t can be defined by a locally free action of \mathbb{S}^1 . We get one of the previous examples. If $\frac{p}{q}$ is irrational, the flow has exactly two periodic orbits given by the equation $z_i = 0$, for $i = 1, 2$. The other orbits are dense in the tori $|z_1| = k$, for $k \in (0, 1)$.

This yields, in particular, the Hopf fibration of \mathbb{S}^3 . To describe it consider $\mathbb{S}^3 \subset \mathbb{C}^2$ as above. Each complex line intersects the sphere in a great circle. These circles are called the Hopf circles. Since exactly one Hopf circle passes through each point of \mathbb{S}^3 , the circles fill up the sphere. Observe that the circles are in one-to-one correspondence with the complex lines of \mathbb{C}^2 , they are thus in relation with the Riemann sphere $\mathbb{C}P^1 \simeq \mathbb{S}^2$. We get a fiber bundle $\mathbb{S}^3 \rightarrow \mathbb{S}^2$ with fiber \mathbb{S}^1 . This is the Hopf fibration of \mathbb{S}^3 .

Finally, we will describe an obstruction for a vector field to be geodesible: the existence of a tangent *Reeb annulus* in the associated 1-foliation. We will call a Reeb annulus an annulus foliated as in the figure 1.10. Let us note R the foliation. In this foliation the two boundary circles are leaves, and the interior leaves are all homeomorphic to \mathbb{R} and asymptotic to both boundaries. A vector field tangent to R is not geodesible. In fact, Poincaré-Bendixson's theorem implies that any

vector field transverse to the foliation R must have a limit cycle in the interior of the annulus. But, if the curves of R can be made geodesics, for a Riemannian metric g , the orthogonality is preserved: the images of the leaves of the orthogonal foliation, under the flow associated to the unitary vector field X tangent to R , are orthogonal to R . The reason that justifies this last claim is that the differential form given by $\alpha = \iota_X g$ is invariant under the action of X . Thus, the associated flow preserves its kernel, that defines the orthogonal foliation. When we push the limit cycle, we will eventually cover the annulus with circle leaves orthogonal to R . This is a contradiction since the foliation by circles cannot be orthogonal to the boundary leaves.

This obstruction is a special case of D. Sullivan's characterization of geodesible vector fields that we will describe in section 1.2.2. In the particular case of vector fields on surfaces, the existence of a Reeb annulus is actually the only obstruction to being geodesible, as was proved by H. Gluck in section I.3 of [32].

1.2.1 Foliation cycles and transverse invariant measures

For this section we will place ourselves in the context of C^∞ foliations, of any dimension and codimension, of closed C^∞ manifolds M . We will quickly review several concepts of *currents* and *foliation cycles* that we will use throughout the text. The main references for this section are Georges DeRham's book [15], Herbert Federer's book [24] and D. Sullivan's paper [73]. Foliation cycles are currents associated to a foliation. These were defined by D. Sullivan in [73], and generalize the concept of *asymptotic cycles* of Sol Schwartzman, introduced in [66]. A relevance of foliation cycles is that they are in one-to-one correspondence with transversal invariant measures of the foliation.

We will begin the section with a review of the space of currents. Then we will define foliation cycles and state some of the results in D. Sullivan's article [73] that we will use later. In particular, we will study a characterization of geodesible vector fields in terms of foliation cycles. Section 1.2.2 is devoted to this characterization.

Currents theory was first developed by G. DeRham in the 1950's. This theory is an analogue of *distributions'* theory by Laurent Schwartz from the late 1940's (we refer to his book [65]). Distributions are continuous functionals on the space of compactly supported functions on a manifold. Currents are continuous functionals on the space of compactly supported differential forms. In this section we will restrain to C^∞ differential forms, but the theory of currents exists for differential forms of class C^r , with $r < \infty$. We will note Ω_d the space of differential d -forms.

Let \mathcal{D}_d denote the dual space of $\Omega_d(M)$, this is the space of d -currents. Under the weak topology, a sequence of d -currents C_i converges to a current C if $C_i(\alpha) \rightarrow C(\alpha)$ for every $\alpha \in \Omega_d(M)$. For further details on the topology of this space we refer to section 4.1.7 of [24].

Definition 1.12 Let $x \in M$ and $X_x \in \bigwedge^d(T_x M)$. The current $\delta_x : \Omega_d(M) \rightarrow \mathbb{R}$ defined by

$$\delta_x(\alpha) = \alpha_x(X_x),$$

is the Dirac current of X_x .

Definitions for currents are by duality with differential forms. For example, the boundary of a d -current C is the $(d-1)$ -current defined by

$$\partial C(\alpha) = C(d\alpha).$$

This allows us to define the subspaces of *cycles*

$$\mathcal{Z}_d = \{C \in \mathcal{D}_d \mid \partial C = 0\},$$

and *boundaries*

$$\mathcal{B}_d = \{C \in \mathcal{D}_d \mid \exists B \in \mathcal{D}_{d+1}, \partial B = C\}.$$

We say that a subset $V \subset \mathcal{D}_d$ is bounded if for every bounded set $W \subset \Omega_d(M)$

$$\{C(\alpha) \mid C \in V, \alpha \in W\} \subset \mathbb{R}$$

is bounded. A linear operator is bounded if the image of a bounded set is itself bounded. A linear bounded operator between two spaces of currents is continuous. The operator ∂ is bounded, and thus continuous. Continuing with the analogy, define the support of a current C as the smallest closed set $S \subset M$ such that

$$\text{supp}(\alpha) \cap S = \emptyset \Rightarrow C(\alpha) = 0,$$

for every differential d -form α .

Definition 1.13 Let μ be a probability measure on M . Consider a d -vector field $X \in \wedge^d(TM)$ and define

$$C_{X,\mu}(\alpha) = \int_M \alpha(X) d\mu$$

for every $\alpha \in \Omega_d(M)$. Currents of this form are known as *integral currents*.

Observe that the boundary of an integral current $C_{X,\mu}$ over a manifold with boundary is, by A. P. Stokes' theorem, an integral current over the boundary of the manifold. Another class of currents are *normal* ones. We will say that a current C is normal if C and ∂C are representable as linear combinations of integral currents. Let us define two seminorms on the space of normal currents. For more details on this definitions we refer to sections 4.1.7 and 4.1.12 of [24] and section 4.5 of Frank Morgan's book [58].

- The *mass* of a current:

$$M(C) = \sup\{C(\alpha) \mid \|\alpha\| \leq 1\},$$

where $\|\alpha\| = \sup\{|\alpha(X)| \mid X \text{ is a unit } d\text{-vector}\}$.

- The *flat norm* of a current:

$$F(C) = \inf\{M(A) + M(B) \mid C = A + \partial B, A, B \text{ are normal currents}\}.$$

We will now give the definition of foliation currents. Consider a C^∞ transversely oriented d -foliation \mathcal{F} of an n -manifold M . Assume that M is closed. For a point $x \in M$, let L be the leaf of \mathcal{F} through x , then the space $\wedge^d(T_x L)$ has dimension one. Consider $X_x \in \wedge^d(T_x L)$, we can define the (foliated) Dirac current as before.

Definition 1.14 The closure of the set of currents generated by the (foliated) Dirac currents, are the *foliation currents*. The set $\mathcal{C}_{\mathcal{F}} \subset \mathcal{D}_d$ of foliation currents that are closed (i.e. $\partial c = 0$, for a foliation current c) is the set of *foliation cycles*.

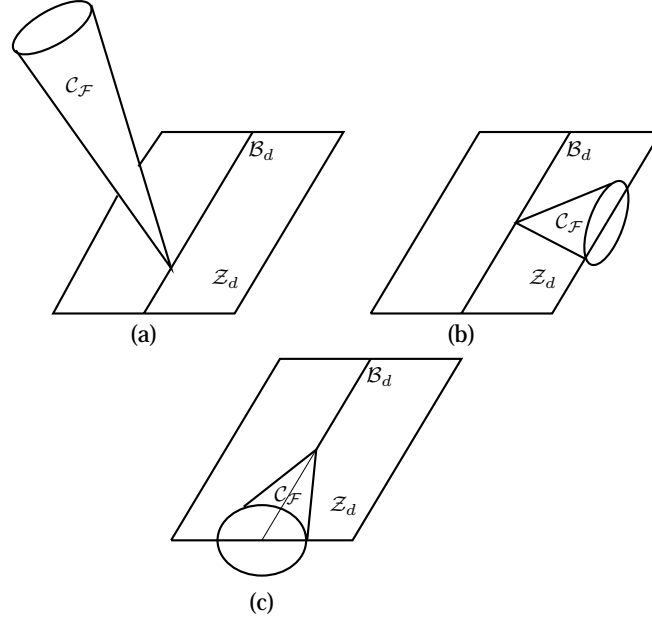

Figure 1.11: The possible intersections between $\mathcal{C}_{\mathcal{F}}$ and the spaces Z_d, \mathcal{B}_d

For non singular vector fields we can define foliation currents as the foliation currents of the 1-foliation defined by the orbits of the vector field. In this case we will simply denote the set of foliation cycles by \mathcal{C} .

The set $\mathcal{C}_{\mathcal{F}}$ is a compact convex cone. This means that there is a continuous linear functional $L : \mathcal{D}_d \rightarrow \mathbb{R}$ such that $L(c) > 0$ for all non zero $c \in \mathcal{C}_{\mathcal{F}}$ and $L^{-1}(1) \cap \mathcal{C}$ is compact.

Definition 1.15 A 1-form α is transversal to a non singular vector field X if $\alpha_x(X_x) > 0$ for all $x \in M$. If c is a foliation current and α is a transversal form we have that $c(\alpha) > 0$.

Equivalently, a d -form is transversal to a d -foliation if it is positive on the leaves.

The different intersections of the cone $\mathcal{C}_{\mathcal{F}}$ with the subspaces of cycles and boundaries are illustrated in figure 1.11. Using the duality with differential forms, we can summarize them as follows

- there is an exact d -form transverse to \mathcal{F} if and only if zero is the only foliation cycle. This corresponds to figure (a).
- there is a closed d -form transverse to \mathcal{F} if and only if zero is the only foliation cycle that is a boundary. This corresponds to (a) and (b).
- there are no closed d -forms transverse to \mathcal{F} , thus we are in the situation sketched in (c).

The next theorem implies that for one dimensional foliations, the situation illustrated by (a) does not exist.

Theorem 1.16 (Sullivan) *Let X be a non singular vector field on a closed manifold M , then X has non zero foliation cycles.*

Proof. Assume that there are no non zero foliation cycles, that is $\mathcal{Z}_1 \cap \mathcal{C} = \{0\}$. Then by the Hahn-Banach theorem there exists a continuous linear functional $L : \mathcal{D}_1 \rightarrow \mathbb{R}$ such that $L(\mathcal{Z}_1) = 0$ and $L(c) > 0$ for all $0 \neq c \in \mathcal{C}$. As a consequence of the duality between Ω_1 and \mathcal{D}_1 , there is a 1-form α representing L : that is $L(c) = c(\alpha)$ for all $c \in \mathcal{D}_1$. Since $c(\alpha) = 0$ when $c \in \mathcal{Z}_1$, the form α is exact. But $c(\alpha) > 0$ when $c \in \mathcal{C}$, thus $\alpha(X) > 0$ always. Thus α is transversal to X . This is a contradiction because if $\alpha = df$ for a function f on M and $x \in M$ is a local maximum for f , then α is degenerated at x . Thus $\mathcal{Z}_1 \cap \mathcal{C} \neq \{0\}$. □

Let us come back to the context of a C^∞ foliation \mathcal{F} of a compact manifold M .

Definition 1.17 *Let D_1 and D_2 be two q dimensional submanifolds, possibly with boundary, which are everywhere transversal to \mathcal{F} . Then \mathcal{F} gives rise to a collection of homeomorphisms between open subsets of D_1 and D_2 that preserve each leaf of the foliation. The collection of all such homeomorphisms between subsets of all possible pairs of transversal submanifolds generates the holonomy pseudogroup.*

A transverse invariant measure is a measure invariant under the action of the holonomy pseudogroup.

Theorem 1.18 (Sullivan) *Given M and \mathcal{F} as above, there is a canonical one-to-one correspondence between foliation cycles and transverse invariant measures.*

Beginning with a transverse invariant measure μ , we are going to construct a foliation cycle. For this we need to introduce some notation. Let $\{U_i, \phi_i\}_{i \in I}$ be a regular foliated atlas. This means in particular that

$$\phi_i(U_i) \simeq \mathbb{D}^d \times \mathbb{D}^q,$$

where $q = n - d$ and \mathbb{D}^d is a d dimensional disc. Let $T_i = \phi_i^{-1}(\mathbb{D}^q)$ be the local transversals and $\pi_i : U_i \rightarrow T_i$ the projection.

For each U_i we can integrate a differential d -form α over each *plaque* $\pi_i^{-1}(x)$, where $x \in T_i$. We get a continuous function $T_i \rightarrow \mathbb{R}$ that we can integrate with respect to the measure $\mu|_{T_i}$. To define the integral we need to consider a partition of the unity $\{\lambda_i\}_{i \in I}$ associated to the foliated atlas. We can define a current c_μ as follows

$$c_\mu(\alpha) = \sum_{i \in I} \int_{T_i} \left(\int_{\pi_i^{-1}(x)} \lambda_i \alpha \right) d\mu.$$

The definition of c_μ is independent of the choice of the partition of the unity and the atlas. We will call c_μ the current associated to the measure μ . We claim that c_μ is an example of a foliation cycle. In fact, for a differential $(d - 1)$ -form α we have that

$$\partial c_\mu(\alpha) = \sum_{i \in I} \int_{T_i} \left(\int_{\pi_i^{-1}(x)} d\lambda_i \alpha \right) d\mu.$$

Using A. P. Stokes' theorem and the fact that $\text{supp}(\lambda_i) \subset U_i$, we get that $\partial c_\mu = 0$.

The current c_μ that we constructed for a transverse invariant measure μ , proves one implication of the theorem. For the other one, the idea is to show that every foliation cycle is of the form c_μ for some transverse invariant measure μ . For a proof we refer to D. Sullivan's paper, theorem **I.13** of [73], or to section **10.2.B** of [9].

1.2.2 D. Sullivan's characterization of geodesible vector fields

As we previously said, if a non singular vector field X on a C^∞ manifold M is geodesible then there is a 1-form α such that

$$\alpha(X) = 1 \quad \text{and} \quad \iota_X d\alpha = 0.$$

Conversely, the existence of such a form implies that X is geodesible, this follows from equation 1.1. The characterization we want to introduce here is in terms of tangent homologies, using foliation cycles. The next result is the main theorem from D. Sullivan's paper [74].

Theorem 1.19 (Sullivan) *Let X be a smooth non singular vector field on an oriented closed manifold M . Then, X is geodesible if and only if no non zero foliation cycle can be arbitrarily well approximated by the boundary of a 2-chain tangent to X .*

Thus a vector field is geodesible if we have the situation illustrated in figure 1.11 (b). The cone of foliation currents \mathcal{C} has non trivial intersection with the subspace of cycles \mathcal{Z}_1 . We now ask whether \mathcal{C} meets the closed subspace $\mathcal{B}_1 \subset \mathcal{Z}_1$ of boundaries. We have two possibilities: there are non trivial foliation cycles that are boundaries ($\mathcal{C} \cap \mathcal{B}_1 \neq \{0\}$) or the cone \mathcal{C} does not intersect the boundaries subspace.

Lemma 1.20 *$\mathcal{C} \cap \mathcal{B}_1 = \{0\}$ if and only if there exists a closed 1-form α transverse to X .*

To prove this lemma one has to use the same arguments that we used in the proof of 1.16. The next theorem due to S. Schwartzman is a consequence of the lemma and D. Tischler's theorem 1.8, for a proof we refer the reader to section 7 of [66].

Theorem 1.21 (Schwartzman) *A non singular vector field X on a closed manifold M admits a cross section if and only if no non trivial foliation cycle bounds.*

Let us now proceed with the proof of D. Sullivan's theorem.

Proof of theorem 1.19. Let X be a non singular vector field on a smooth closed manifold M . Assume first that X is geodesible for a Riemannian metric g and that there is a sequence $\{c_n\}_{n \in \mathbb{N}}$ of 2-chains whose boundaries approach a foliation cycle z . Let α be as always the 1-form defined by $\alpha = \iota_X g$. Then $\iota_X d\alpha = 0$ and α is transversal to X , thus $z(\alpha) > 0$. This implies that

$$0 = c_n(d\alpha) = \partial c_n(\alpha) \rightarrow z(\alpha) > 0,$$

which is a contradiction.

For the other implication assume that no foliation cycle can be approximated by the boundary of a 2-chain tangent to X . Consider the closed linear subspace of \mathcal{D}_1 generated by the boundaries of all tangent 2-chains. Let us call it $\overline{\{\partial b\}}$. Again, using the Hahn-Banach theorem, we have a linear functional $L : \mathcal{D}_1 \rightarrow \mathbb{R}$ such that

$$L(\overline{\{\partial b\}}) = 0 \quad \text{and} \quad L(c) > 0 \quad \forall 0 \neq c \in \mathcal{C}.$$

This functional corresponds to a 1-form α such that $\partial b(\alpha) = 0$ for all tangent 2-chains and $c(\alpha) > 0$ for all non zero foliation cycles. The first condition is equivalent to $\iota_X d\alpha = 0$ and the second one to $\alpha(X) > 0$. Thus X is geodesible.

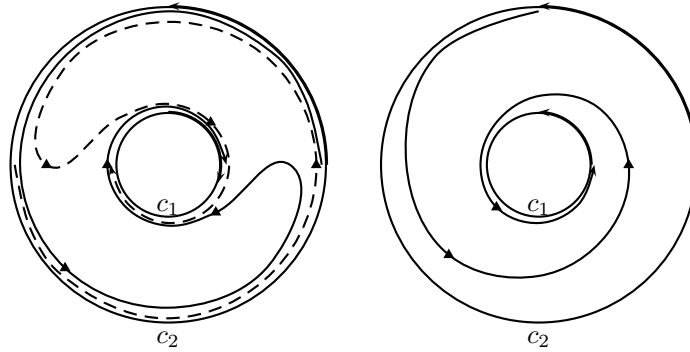

Figure 1.12: Foliations of the annulus

□

Before finishing the section we will give some examples where we can use the characterization of D. Sullivan.

1. *Foliations of the annulus.* Let us analyze the two oriented foliations of the annulus in figure 1.12. The one on the left is the foliation that is the Reeb annulus that is not geodesible. Call c_1 and c_2 the two border components with the orientations in each figure. The integration over $a_1c_1 + a_2c_2$, for $a_1, a_2 \geq 0$ are foliation cycles for both foliations. The whole annulus is a tangent 2-chain for both. For the Reeb annulus the border of this 2-chain is $c_1 + c_2$: a foliation cycle. For the other foliation the border is $c_1 - c_2$: not a foliation cycle. Theorem 1.19 implies that the foliation of the Reeb annulus is not geodesible.

Observe that in the second foliation a small transversal to c_1 is mapped, under the Poincaré first return map, to a proper subset of itself. This argument implies that the only (locally finite) transverse invariant measures are the ones with non zero weight just at c_1 and c_2 . Hence, the one-to-one correspondence between foliation cycles and transverse invariant measures, theorem 1.18, implies that the only foliation cycles are of the form $a_1c_1 + a_2c_2$, for $a_1, a_2 \geq 0$. Thus no foliation cycle bounds any tangent 2-chain, and the second foliation is geodesible.

2. *A theorem of D. Asimov and H. Gluck.* They used the characterization to prove

Theorem 1.22 (Asimov, Gluck) *A non singular Morse-Smale vector field on a closed manifold is geodesible if and only if it is a suspension. In particular the manifold must fiber over the circle.*

We refer to [4] for a proof.

3. *Horocycle flows.* We can use D. Sullivan's characterization to show that on a compact hyperbolic surface S the horocycle flow is not geodesible.

Let \mathbb{D} be the Poincaré disc and $T^1\mathbb{D}$ de unit tangent space. A horocycle is a circle in \mathbb{D} that is tangent to the boundary of the disc. The positive horocycle flow h_t on \mathbb{D} is the flow on $T^1\mathbb{D}$ which moves a unit tangent vector along the horocycle, in the positive direction and at unit speed. A compact hyperbolic surface can be written as $S = \Lambda \backslash \mathbb{D}$ where Λ is a cocompact torsion free discrete subgroup of the group of $PSL(2, \mathbb{R})$. The positive horocycle vector field

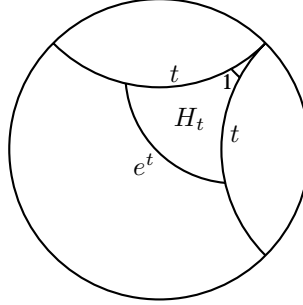

Figure 1.13: Tangent 2-chain to the horocycle flow

descends to a vector field on T^1S . We will call this vector field the positive horocycle vector field of S and we will keep the notation h_t .

Consider the positive horocycle vector field in the unit tangent bundle and the sequence of tangent 2-chains $e^{-t}H_t$, that are the projection of the 2-chains in figure 1.13. These are the two currents of integration over the surface H_t multiplied by e^{-t} . Their boundaries are the projections of the 1-currents

$$e^{-t}\partial H_t = e^{-t} \left(\int_{e^t} - \int_t - \int_1 + \int_t \right),$$

where we write \int_t for the integration current of a one form over the segment of length t in the figure. These currents have bounded mass. Thus, using the mass topology in the space of currents, we have that the next limit exists

$$C = \lim_{t \rightarrow \infty} e^{-t}\partial H_t = \lim_{t \rightarrow \infty} e^{-t} \int_{e^t}.$$

Then C is a cycle and a foliation current: C is a foliation cycle. Thus h_t is not geodesible.

Let us now describe the horocycle flow in a different way. Consider the group of isometries of the Poincaré disc, $PSL(2, \mathbb{R})$ and its Lie algebra $\mathfrak{psl}(2, \mathbb{R})$ generated by the elements

$$A = \begin{pmatrix} 1 & 0 \\ 0 & -1 \end{pmatrix}, \quad B = \begin{pmatrix} 0 & 1 \\ 0 & 0 \end{pmatrix} \quad \text{and} \quad C = \begin{pmatrix} 0 & 0 \\ 1 & 0 \end{pmatrix}.$$

Satisfying the relations

$$[A, B] = 2B, \quad [A, C] = -2C \quad \text{and} \quad [B, C] = A,$$

where $[A, B] = AB - BA$. We can identify the unit tangent space of the Poincaré disc and the Lie group $PSL(2, \mathbb{R})$. The positive horocycle flow is generated by the action of B : the action of the exponential of B on $PSL(2, \mathbb{R})$. This action is well defined on the unitary tangent space of any hyperbolic surface. Using the identification above, the unit tangent space of a hyperbolic surface is identified with $PSL(2, \mathbb{R})$ modulo a lattice Λ .

Let us prove again that the horocycle flow is not geodesible. Assume that the flow generated by the action of B is geodesible. Then there is a 1-form α on $PSL(2, \mathbb{R})$ modulo Λ , such that $\alpha(B) = 1$ and $B \in \ker(d\alpha)$. Using the relation $d\alpha(A, B) = A \cdot \alpha(B) - B \cdot \alpha(A) - \alpha([A, B])$, we get that

$$B \cdot \alpha(A) = -\alpha([A, B]) = -\alpha(2B) = -2,$$

since $\alpha(B) = 1$. Let us take an invariant measure μ of B . We claim that the integral of $B \cdot f$ is zero for any C^∞ function f . Recall that a measure is ergodic if any measurable invariant set has zero or full measure. Since any invariant measure decomposes into ergodic measures, it is enough to prove our claim under the assumption that μ is ergodic. For a proof of this statements, we refer to chapter II of Ricardo Mañé's book [55].

Let μ be an ergodic invariant measure. Denote by ϕ_t the induced flow and $\mathcal{O}(x, t)$ the orbit segment of a point x that lies between x and $\phi_t(x)$. Since the measure is ergodic, there are orbits such that the integral

$$\frac{1}{t} \int_{\mathcal{O}(x, t)} B \cdot f d\mu$$

converges as $t \rightarrow \infty$ to the integral of $B \cdot f$ on the ambient manifold, with respect to μ . The integral above is equal to $\frac{1}{t}(f(x) - f(\phi_t(x)))$, that converges to zero as $t \rightarrow \infty$. This proves our claim.

Hence $B \cdot \alpha(A)$ cannot be constant, which is a contradiction. Then there is no differential 1-form such that $\alpha(B) = 1$ and $B \in \ker(d\alpha)$. We conclude that the horocycle flow is not geodesible.

1.3 Geodesible vector fields on 3-manifolds

In this section we will consider geodesible vector fields on compact 3-manifolds. We will establish a correspondence between geodesible vector fields and some solutions of the Euler equation of an ideal stationary fluid. Our result generalizes theorem 2.1 of [22] by John Etnyre and Robert Ghrist: *the class of Reeb vector fields of a contact structure on a 3-manifold is identical to the class of vector fields that have non zero curl and are colinear with it, for a suitable Riemannian metric.*

Proposition 1.23 *Let M be an orientable 3-manifold. Any C^∞ vector field that is parallel to its curl, for a Riemannian metric, is geodesible. Conversely, any geodesible vector field, modulo a reparameterization, is parallel to its curl.*

The definition of the curl of a vector field in \mathbb{R}^3 depends upon a Riemannian metric. We adopt the following definition: the curl of a vector field X on a Riemannian 3-manifold M , with metric g and arbitrary distinguished volume form μ , is the unique vector field $\text{curl}(X)$ given by

$${}^t\text{curl}(X)\mu = d\iota_X g.$$

The uniqueness comes from the fact that for a fixed volume form μ , contraction of μ is an isomorphism between vector fields and differential 2-forms. Taking the curl with respect to an arbitrary volume form makes the subsequent results valid for a more general class of fluids: for example *basotropic flows*, these are compressible for the Riemannian volume and incompressible for a rescaled volume form. We refer the reader to section VI.2.A of Vladimir I. Arnold and Boris A. Khesin's book [3]. When μ is the Riemannian volume the curl assumes the more common form

$$\text{curl}(X) = \psi(*d\iota_X g),$$

where $*$ is the Hodge star operator, and ψ is the isomorphism between vector fields and differential 1-forms derived from g .

Definition 1.24 *The Euler equation of an ideal incompressible fluid on a Riemannian manifold M endowed with a volume form μ , is given by*

$$\begin{aligned}\frac{\partial X_t}{\partial t} &= -\nabla_{X_t} X_t - \text{grad}(p) \\ L_{X_t} \mu &= 0,\end{aligned}$$

where the velocity vector field X_t and the function p are time dependent. The second equation means that X_t preserves the volume form μ .

We refer the reader to section I.7.A of [3] for more details on this equation. We will deal with the Euler equation of an ideal steady fluid on M . That is, the vector field X will be time independent and not necessarily volume preserving. We get

$$\nabla_X X = -\text{grad}(p)$$

for a pressure function p . Using the identity $\nabla_X X = X \times \text{curl}(X) + \frac{1}{2} \text{grad} \|X\|^2$, from page 474 of [1], where \times is the cross product between vector fields; we can reduce the equation to the form

$$X \times \text{curl}(X) = \text{grad}(b) \tag{1.3}$$

where $b = -p - \frac{1}{2} \|X\|^2$. The function b is known as the *Bernoulli function* of X .

Proof of proposition 1.23. Assume first that X is a geodesible vector field. We know that there exists a Riemannian metric g such that, modulo a reparameterization of the vector field, $\iota_X g = \alpha$ is an invariant 1-form and that X is in $\ker(d\alpha)$. Using the definition of the curl we have that $\iota_{\text{curl}(X)} \mu = d\alpha$, thus $X \in \ker(\iota_{\text{curl}(X)} \mu)$. Since μ is a volume form we have that

$$\text{curl}(X) = fX$$

for a function $f : M \rightarrow \mathbb{R}$. Observe that this function can be zero.

Conversely, if a vector field X is such that $\text{curl}(X) = fX$ with respect to a Riemannian metric g , then setting $\iota_X g = \alpha$ we have that

$$\alpha(X) > 0 \quad \text{and} \quad \iota_X d\alpha = \iota_X \iota_{fX} \mu = 0.$$

Since X is non singular, we can rescale X using a non zero function, so that $\|X\| = 1$. The vector field X is geodesible. □

Definition 1.25 *A vector field such that $\text{curl}(X) = fX$ for a function f on M is a Beltrami vector field in hydrodynamics. In magnetodynamics these vector fields are known as force-free vector fields.*

Before finishing this section let us analyze some properties of volume preserving geodesible vector fields, for a given volume form μ . Let X be a volume preserving geodesible vector field. An important consequence of the results above is that the function f is constant along the orbits of X . This follows from

$$0 = L_{\text{curl}(X)} \mu = L_{fX} \mu = f d\iota_X \mu + df \wedge \iota_X \mu.$$

Since $d\iota_X \mu = 0$, we have that f is a first integral of X . We can distinguish the following three situations.

1. *Reeb vector fields.* When f is different from zero, X is a Reeb vector field of the contact form α . The reason for this is that $d\alpha = f\iota_X\mu \neq 0$, implying that $\alpha \wedge d\alpha \neq 0$. This means that the kernel of α defines a contact structure.

We can choose the volume form $\mu = \alpha \wedge d\alpha$ and thus $f = 1$. Examples coming from hydrodynamics are the *ABC* vector fields on the three torus \mathbb{T}^3 . Take the coordinates $\{(x, y, z) \mid \text{mod } 2\pi\}$. An *ABC* vector field $v = (v_x, v_y, v_z)$ is defined by the equations

$$\begin{aligned} v_x &= A \sin z + C \cos y \\ v_y &= B \sin x + A \cos z \\ v_z &= C \sin y + B \cos x. \end{aligned}$$

They preserve the unit volume form and have $\text{curl}(v) = v$. These vector fields were first studied by I. S. Gromeka in 1881, rediscovered by E. Beltrami in 1889, and largely studied in the context of hydrodynamics during the last century. When one of the parameters A , B or C vanishes, the flow is integrable. By symmetry of the parameters, we may assume that $1 = A \geq B \geq C \geq 0$.

In 1986, T. Dombre, U. Frisch, J. Greene, M. Hénon, A. Mehr and A. Soward [16], showed the absence of integrability when $ABC \neq 0$. They also showed that under the precedent convention, the flow is non singular if and only if $B^2 + C^2 < 1$. Though the list of publications concerning *ABC* vector fields is extensive, there is very little known about the global features of these flows, apart from cases when C is zero or a perturbation thereof. The correspondence between these vector fields and Reeb vector fields is a useful tool for their global study.

2. *Vector fields transverse to a 2-foliation.* When f is identically zero D.Tischlers theorem implies that the manifold is a fiber bundle over the circle. Then, in particular, there are no geodesible vector fields with $f = 0$ on \mathbb{S}^3 .
3. *Combined case.* When f is not constant and the set $A = f^{-1}(0)$ is non empty. The regular levels of f are surfaces tangent to X . Assuming that M is orientable and X is non singular, we get that the regular levels of f are finite collections of tori. Moreover in the components of $M \setminus A$, the vector field X is a Reeb vector field.

Let us make a final remark. If we forget the hypothesis that X preserves a volume form and assume that the set $A = f^{-1}(0) \neq \emptyset$, we get that A is invariant and does not change when we change the volume form. In fact, given two volume forms μ_1 and μ_2 , we get two functions f_1 and f_2 on M defined by the equation

$$\iota_{f_i X} \mu_i = d\alpha,$$

for $i = 1, 2$. Clearly, if $f_1(x) = 0$ the form $d\alpha$ is zero at x and thus $f_2(x) = 0$.

1.4 Periodic orbits of geodesible vector fields on 3-manifolds

The set of geodesible vector fields contains Reeb vector fields, which have periodic orbits. We can ask ourselves if geodesible vector fields on closed 3-manifolds have periodic orbits, or more specifically on \mathbb{S}^3 . In this section we will show that we cannot construct flow plugs whose vector field is geodesible. This prevents us from constructing geodesible vector fields on 3-manifolds

without periodic orbits using plugs, as in section 1.1. The main purpose of this section is to prove the existence of periodic orbits for geodesible vector fields on closed orientable 3-manifolds, assuming some extra hypothesis.

The section is organized as follows. We will begin, in section 1.4.1, by proving that the vector field of a plug is not geodesible. In 1.4.2 we will prove that C^ω geodesible vector fields have periodic orbits if the ambient manifold M is diffeomorphic to \mathbb{S}^3 or has non trivial second homotopy group ($\pi_2(M) \neq 0$). Moreover, if we assume that the vector field is also volume preserving, we will show that it has a periodic orbit if M is not a torus bundle over the circle. In 1.4.4 we will prove the existence of periodic orbits for volume preserving C^∞ geodesible vector fields on \mathbb{S}^3 or a manifold M such that $\pi_2(M) \neq 0$. Finally, in section 1.4.3 we will study volume preserving C^ω geodesible vector fields without periodic orbits on torus bundles over the circle.

There are two results we will use in sections 1.4.2 and 1.4.4, that we state here.

Proposition 1.26 *Let S be a finite collection of disjoint embedded tori in \mathbb{S}^3 or a closed orientable 3-manifold M with $\pi_2(M) \neq 0$. Then there is a connected component B of $\mathbb{S}^3 \setminus S$, respectively $M \setminus S$, such that either \overline{B} is a solid torus or $\pi_2(\overline{B}) \neq 0$.*

We will give a proof of this proposition in section 1.5: proposition 1.42 for the \mathbb{S}^3 case and proposition 1.43 for manifolds with non trivial second homotopy group.

The second result is a generalization of theorem 6.1 in [23] by J. Etnyre and R. Ghrist.

Theorem 1.27 *Let X be a Reeb vector field on a compact 3-manifold \overline{B} , with $\partial\overline{B} \neq \emptyset$ and X tangent to the boundary. If either \overline{B} is a solid torus or has non trivial second homotopy group, X possesses a periodic orbit.*

The proof is based on the method that H. Hofer used to prove theorem 1.3. As H. Hofer's theorem, it is valid for C^2 contact forms. In section 1.6 we will review this method, and prove the theorem above.

Before passing to the next section let us introduce some definitions.

Definition 1.28 *Given an embedded surface S in a 3-manifold M , a contact structure ξ on M defines on S a singular 1-foliation S_ξ generated by the line field $TS \cap \xi$, that is called the characteristic foliation of S .*

Definition 1.29 *A positive confoliation of a closed orientable 3-manifold M is a plane field ξ defined by a differential 1-form α such that*

$$\alpha \wedge d\alpha \geq 0.$$

Thus contact structures and foliations are confoliations. We refer to Yakov Eliashberg and William P. Thurston's book [19] for more details.

1.4.1 Plugs are not geodesible

We will begin by a general result for geodesible vector fields, that is a consequence of D. Sullivan's characterization from section 1.2.2. As we will explain, the proposition below implies that there are no plugs in the geodesible category.

Proposition 1.30 *Let X be a geodesible vector field and D_1, D_2 two transversal discs satisfying that there is a point $x \in D_1$ such that its orbit hits D_2 after a finite time. Let h be the holonomy homeomorphism*

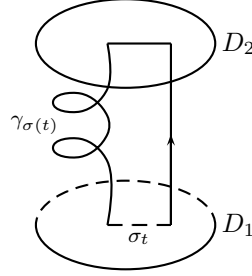
Figure 1.14: The 2-chain A_t

between D_1 and D_2 , and assume that there is a maximal connected open set $D \subset D_1$ that contains x where h is defined. Let $\sigma : [0, 1] \rightarrow D_1$ be a curve such that $\sigma([0, 1)) \subset D$ and $\sigma(1) \in \partial D$, and assume that the map $h \cdot \sigma$ is uniformly continuous.

Then either, $\sigma(1) \in \partial D_1$ or $\lim_{t \rightarrow 1} h(\sigma(t))$ is in ∂D_2 .

Proof. Assume that $\sigma(1)$ is not in ∂D_1 and that $\lim_{t \rightarrow 1} h(\sigma(t))$ is not in ∂D_2 . Observe that by the uniform continuity the map

$$h \cdot \sigma : [0, 1) \rightarrow D_2,$$

can be extended so that $h(\sigma(1))$ is defined. Let $\tau(t)$ be the time that takes the point $\sigma(t) \in D$ to reach the disc D_2 under the flow defined by X . Then, $\lim_{t \rightarrow 1} \tau(t) = +\infty$.

To find a contradiction we want to show that X is not geodesible. Using D. Sullivan's theorem 1.19 we know that it is enough to find a tangent 2-chain such that its boundary is arbitrarily close to a foliation cycle. Consider the curve $\sigma_t = \sigma([0, t])$, for $t \in [0, 1]$. For $t < 1$, the orbits of the points in σ_t hit D_2 after a finite time. Let A_t be the tangent surface (as in figure 1.14) defined by the union of the flowlines γ of the points in σ_t , that lie between D_1 and D_2 ,

$$A_t = \{\gamma(\sigma_t) \mid t \in [0, 1]\}.$$

Consider now a sequence $\{t_n\}_{n \in \mathbb{N}}$ that converges to one and the sequence of 2-currents

$$\frac{1}{|\gamma_{\sigma(t_n)}|} A_{t_n}(\lambda) = \frac{1}{|\gamma_{\sigma(t_n)}|} \int_{A_{t_n}} \lambda,$$

where λ is any 2-form, $\gamma_{\sigma(t_n)}$ is the orbit of the endpoint of σ_{t_n} , and $|\cdot|$ denotes the length. Clearly, the length of $\gamma_{\sigma(t_n)}$ goes to infinity as $n \rightarrow \infty$. The currents $\frac{1}{|\gamma_{\sigma(t_n)}|} A_{t_n}$ form a sequence of tangent 2-chains, so we just need to prove that their boundaries approach a foliation cycle.

Lemma 1.31 $\lim_{n \rightarrow \infty} \frac{1}{|\gamma_{\sigma(t_n)}|} \partial A_{t_n}$ is a foliation cycle.

Consider D_1 with the weak topology. In the subspace of normal currents the weak topology coincides with the one defined by the flat norm

$$F(S) = \min\{M(A) + M(B) \mid S = A + \partial B\}$$

where M is the mass of a current and S , A and B are normal currents.

Proof. Consider the sequence of foliation currents $\frac{1}{|\gamma_{\sigma(t_n)}|} \gamma_{\sigma(t_n)}$, we have that

$$M \left(\frac{1}{|\gamma_{\sigma(t_n)}|} \partial A_{t_n} - \frac{1}{|\gamma_{\sigma(t_n)}|} \gamma_{\sigma(t_n)} \right) \leq \frac{1}{|\gamma_{\sigma(t_n)}|} (|\sigma_1| + |h(\sigma_1)| + |\gamma_{\sigma(1)}|),$$

hence, the difference converges to zero as $n \rightarrow \infty$. The flat norm of the currents $\frac{1}{|\gamma_{\sigma(t_n)}|} \gamma_{\sigma(t_n)}$ is less or equal to one, because they have mass one. Since the space \mathcal{D}_1 is Montel, there is a convergent subsequence $\frac{1}{|\gamma_{\sigma(t_{n_k})}|} \gamma_{\sigma(t_{n_k})}$. Hence, the limit defines the current

$$S = \lim_{k \rightarrow \infty} \frac{1}{|\gamma_{\sigma(t_{n_k})}|} \partial A_{t_{n_k}} = \lim_{k \rightarrow \infty} \frac{1}{|\gamma_{\sigma(t_{n_k})}|} \gamma_{\sigma(t_{n_k})}.$$

The operator ∂ is continuous which implies that S is a cycle. Since the space of foliation currents is a compact convex cone \mathcal{C} containing the sequence $\frac{1}{|\gamma_{\sigma(t_{n_k})}|} \gamma_{\sigma(t_{n_k})}$, it contains its limit. Then S is a foliation cycle.

□

We get to the contradiction that X is not geodesible. Hence the boundary of D is formed either by arcs contained in ∂D_1 or arcs such that their images under h are in ∂D_2 .

□

Corollary 1.32 *The vector field of a plug is not geodesible.*

Proof. Let P be a plug and assume that its vector field is geodesible. We can take as the disc D_1 in the proposition the entry region of the plug, and as D_2 the exit region. The vector field of the plug is vertical in an open neighborhood of the boundary (condition (i) of definition 1.1), thus ∂D_1 is mapped to ∂D_2 under the holonomy map h .

Let D be as in the proposition and such that $\partial D_1 \subset \overline{D}$. Let σ be an uniformly continuous curve as above and such that $\sigma(1) \in \{\partial D \setminus \partial D_1\}$. We claim that $h \cdot \sigma$ is uniformly continuous. This follows directly from the entry-exit condition of plugs (condition (iii) of definition 1.1). Then the proposition implies that the maximal connected open set of definition of the holonomy is all of D_1 . This contradicts the fact that the plug has trapped orbits.

□

1.4.2 Periodic orbits of real analytic geodesible vector fields

As we said in the introduction, a geodesible vector field is real analytic if the vector field is real analytic and we can find a real analytic Riemannian metric making its orbits geodesics. In this section we will prove the next two theorems.

Theorem A *Assume that X is a geodesible volume preserving vector field on an orientable closed 3-manifold M , that is not a torus bundle over the circle. Then if X is real analytic and preserves a real analytic volume form, it possesses a periodic orbit.*

Theorem B *Assume that X is a geodesible vector field on an orientable closed 3-manifold M , that is either diffeomorphic to \mathbb{S}^3 or has non trivial π_2 . Then if X is real analytic, it possesses a periodic orbit.*

The methods we are going to use to prove the theorems are quite similar. We will give the entire proof of the first theorem. For the second one we will concentrate on the difficult case.

Proof of theorem A We know, from section 1.3 that $\text{curl}(X) = fX$ for a real analytic function $f : M \rightarrow \mathbb{R}$. Further, since X preserves a volume given by a real analytic differential form that we will call μ , the function f is a first integral of X . We can distinguish the next three cases:

- (I) f is never zero. In this case the plane field $\xi = \ker(\alpha)$ is a contact structure and X is the associated Reeb vector field. Thus H. Hofer's and C. H. Taubes' theorems, imply the existence of a periodic orbit of the vector field X on any orientable closed 3-manifold.
- (II) f is identically zero. As we previously said, this implies that the 1-form α is closed. Thus the vector field has a section T . As we discussed, T is an oriented closed surface without boundary. We claim that if X has no periodic orbits, T is a torus. Observe that the flow associated to X defines a diffeomorphism, the first return map, h of T without periodic points, in particular without fixed points. Thus T must be a torus by the Lefschetz fixed point theorem, we refer to theorem 8.6.2 of [50].

The torus does not separate M . Cutting M along T yields $T \times [0, 1]$, with the orbits of X being the segments $\{\cdot\} \times [0, 1]$. When we identify $(x, 1)$ with $(h(x), 0)$, we get that M is a torus bundle over the circle.

We conclude that if M is not a torus bundle over the circle, the vector field X has a periodic orbit.

- (III) f is equal to zero on a compact invariant set $f^{-1}(0) = A \subset M$. As we previously said A is the set where α is closed. Observe that for a regular value a of f , the compact set $f^{-1}(a)$ is a finite union of disjoint invariant tori. Here we used the fact that M is orientable, without this hypothesis the levels could be Klein bottles.

Let us study the topology of the critical levels. Consider now a critical value c of f .

Lemma 1.33 *If X does not have periodic orbits in $f^{-1}(c)$, then each connected component C of $f^{-1}(c)$ is homeomorphic to a torus and $X|_C$ is topologically conjugate to a linear irrational vector field.*

Proof. Since f is a real analytic function, C is a real analytic set, thus it is a Whitney stratified set: it can be decomposed into manifolds of dimension less or equal to two. Take $x \in C$. The non singularity of the vector field X yields to the existence of a flow box $N \simeq D \times [-1, 1]$ with D a transverse disc. Assume that $x \in D_0 = D \times \{0\}$. Since C is invariant under the flow induced by X we have that

$$N \cap C \simeq (D \cap C) \times [-1, 1].$$

We know that the dimension of the strata manifolds that compose C is at most two. Using H. Whitney's theory, we get that $D_0 \cap C$ is homeomorphic to a radial k -tree centered at x , as in figure 1.15. This k -tree is invariant under the flow. We refer the reader to H. Whitney's book [80].

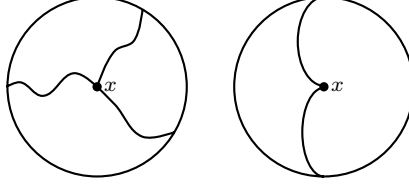
Figure 1.15: A 3-tree and a singular 2-tree centered at x

If $k = 0$, the set C is of dimension one and compact, thus it is a periodic orbit, a contradiction to the hypothesis of the lemma. If $k > 2$, the point x is contained in a dimension one submanifold of C . This submanifold is a periodic orbit, again a contradiction to the hypothesis of the lemma. In figure 1.15 we have the case of a 3-tree. Then for any $x \in C$, the intersection $D_0(x) \cap C$ is homeomorphic to an invariant 2-tree, thus C is an invariant surface. The argument we used in the case $k > 2$, implies also that the 2-tree is a non singular C^ω curve in the disc, and thus C is a non singular real analytic oriented surface that admits a non singular vector field. Then C is a torus. Since X has no periodic orbits on C it is topologically conjugate to a linear irrational vector field.

□

Let us come back to the ambient manifold M , that is foliated by invariant tori. Locally, that is near a torus in the inverse image of a regular value, the function f works as a projection to an interval of \mathbb{R} . Near a torus in the inverse image of a critical value the set of nearby tori has also the structure of an interval. This implies that the set of invariant tori has a manifold structure, this manifold has dimension one and is compact. Since the only compact 1-manifold is the circle, we conclude that M is a torus bundle over the circle.

Then if M is not a torus bundle over the circle the vector field X possesses a periodic orbit.

□

Proof of theorem B Take a real analytic volume form on the ambient manifold, and let f be the real analytic function satisfying $\text{curl}(X) = fX$. Observe that for the cases (I) and (II) in the precedent proof we did not use the volume preserving hypothesis. Since a torus bundle over the circle is irreducible, its universal cover is \mathbb{R}^3 . Hence, for M diffeomorphic to \mathbb{S}^3 or M satisfying $\pi_2(M) \neq 0$, the previous theorem implies the existence of a periodic orbit of X . We will analyze case (III) below.

Denote by ξ the plane field defined by the kernel of the differential 1-form $\alpha = \iota_X g$, where g is the Riemannian metric making the orbits of X geodesics.

(III) The function f is equal to zero on a compact invariant set $A \subset M$. Moreover, A is real analytic. Assume that X does not have any periodic orbit on A , by lemma 1.33 the set A is a finite union of invariant tori. Using proposition 1.26 with A the finite collection of tori, we obtain a connected component $B \subset M \setminus A$ that satisfies one of the following conditions:

- \overline{B} is diffeomorphic to a solid torus $\mathbb{S}^1 \times \mathbb{D}^2$, where \mathbb{D}^2 is a two dimensional closed disc;
- \overline{B} is a manifold with boundary whose second homotopy group π_2 is non trivial.

Assume that $\alpha \wedge d\alpha \geq 0$ in \overline{B} . The case where $\alpha \wedge d\alpha \leq 0$ being equivalent. Let us consider $\overline{B} \subset M$.

The idea of the rest of the proof is to approximate the confoliation ξ on \overline{B} by a contact structure, that is transverse to X . The vector field X will be a Reeb vector field of the new contact structure. Then by theorem 1.27 we conclude that X possesses a periodic orbit in \overline{B} .

Observe that the one foliation $\partial\overline{B}_\xi$ of $\partial\overline{B}$, defined by the line field $\partial\overline{B} \cap \xi$ has no Reeb annuli (see figure 1.10). This follows from the assumption that X has no periodic orbits on $\partial\overline{B}$, because Poincaré-Bendixson's theorem implies that a 1-foliation transverse to the foliation of a Reeb annulus possesses a limit circle.

We will use the following proposition, similar to the main result of S. J. Altschuler's article [2]. His proof uses partial differential equations. The proof below, without partial differential equations, follows the proof of proposition 2.8.1 in [19].

Proposition 1.34 *The C^∞ confoliation ξ can be C^∞ approximated by a contact structure η . Moreover, a Reeb vector field of η is X .*

The class of smoothness of a confoliation is understood as the class of smoothness of the corresponding plane field. Observe that in foliations theory the class of smoothness is usually understood as the class of smoothness of the transition maps. A foliation which is C^k in the second sense is C^k in the first one, but possibly for a different but equivalent C^k structure of the ambient manifold. Conversely, a foliation that is C^k in the first sense is C^k in the second one.

To prove the proposition we will begin by a lemma. Consider \mathbb{R}^3 with coordinates (x, y, t) .

Lemma 1.35 *Let ξ be a positive C^k confoliation on*

$$V = \{|x| \leq 1, |y| \leq 1, 0 \leq t \leq 1\} \subset \mathbb{R}^3,$$

given by the 1-form $\beta = dx - a(x, y, t)dy$. Suppose that the confoliation is contact near $\{t = 1\}$. Then ξ can be approximated by a confoliation ξ' which coincides with ξ together with all its derivatives along ∂V and is contact inside V .

Proof. Observe that ξ is transversal to the x -curves and tangent to the t -curves. We have that

$$\beta \wedge d\beta = \frac{\partial a}{\partial t}(x, y, t)dx \wedge dy \wedge dt \geq 0,$$

then $\frac{\partial a}{\partial t}(x, y, t) \geq 0$ in V and $\frac{\partial a}{\partial t}(x, y, 1) > 0$. Then there exists a function $\tilde{a}(x, y, t)$ such that

$$\frac{\partial \tilde{a}}{\partial t}(x, y, t) > 0$$

in the interior of V and coincides with a along ∂V . Moreover, along ∂V all the derivatives of a and \tilde{a} coincide. Then the confoliation

$$\xi' = \{\ker(dx - \tilde{a}(x, y, t)dy)\}$$

is the perturbation with the required properties. □

Proof of the proposition. Let ξ be the transitive positive confoliation of \overline{B} of class C^∞ and $C(\xi) = B$ its contact part. For every point $p \in \partial\overline{B}$, choose a simple curve γ_p which is tangent to ξ , begins at p and ends at a point $p' \in C(\xi)$. Let $S_p : [0, 1] \times [0, 1] \rightarrow M$ be an embedding such that the image of $[0, 1] \times \{\frac{1}{2}\}$ is γ_p and gives us a surface in M that is transverse to X , and such that $S_p([0, 1] \times \{\cdot\})$ is tangent to ξ . Moreover, we will ask that the image of $\{0\} \times [0, 1]$ is contained in $\partial\overline{B}$.

Observe that since the orbits of X are geodesics its flow ϕ_s preserves orthogonality. Then the images under the flow of the curves $S_p([0, 1] \times \{\cdot\})$ are tangent to ξ . Pushing the above surface with the flow we get a region

$$\mathcal{V}_p = \{\phi_s \cdot S_p([0, 1] \times [0, 1]) \mid s \in [-\epsilon, \epsilon]\},$$

for a given ϵ . Observe that part of the boundary of this region is in $\partial\overline{B}$ and the surface $\phi_s \cdot S_p([0, 1] \times [0, 1])$ is transverse to X for every s .

Denote $V = [-1, 1] \times [-1, 1] \times [0, 1]$ with coordinates (x, y, t) . Then, there exists an embedding

$$F_p : V \rightarrow \mathcal{V}_p \subset \overline{B}$$

satisfying

- (i) the line segment $(0, 0, t)$, with $t \in [0, 1]$, is mapped to γ_p ;
- (ii) the images of the t -curves are tangent to ξ ;
- (iii) the the vector field $\frac{\partial}{\partial x}$ is mapped to X ;
- (iv) the image of $(x, y, 1)$ is in $C(\xi)$ for all pairs (x, y) ;
- (v) the image of $(x, y, 0)$ is in $\partial\overline{B}$ for all pairs (x, y) .

Let W be the interior of $[-\frac{1}{2}, \frac{1}{2}] \times [-\frac{1}{2}, \frac{1}{2}] \times [0, 1]$ and W' the interior of $[-\frac{3}{4}, \frac{3}{4}] \times [-\frac{3}{4}, \frac{3}{4}] \times [0, 1]$. In the manifold \overline{B} we can find a finite number of points p_1, p_2, \dots, p_n and corresponding paths, such that the open sets $W_i = F_{p_i}(W)$ cover an open neighborhood of $\partial\overline{B}$. Set

$$W'_i = F_{p_i}(W') \quad \text{and} \quad V_i = F_{p_i}(V).$$

Thus we have that $W_i \subset W'_i \subset V_i$ for every i . The pull back $\beta_i = (F_{p_i})^* \alpha$ is a 1-form such that $\frac{\partial}{\partial t}$ is in its kernel, $\beta_i(\frac{\partial}{\partial x}) = 1$ and $\frac{\partial}{\partial x}$ is in the kernel of $d\beta_i$. Thus we can write

$$\beta_i = dx - a_i(x, y, t)dy,$$

The condition $\frac{\partial}{\partial x} \in \ker(d\beta_i)$ implies that the function a_i must be independent of x . Hence, $\beta_i = dx - a_i(y, t)dy$ and $\frac{\partial a_i}{\partial y} = 0$ only on the surface $\{t = 0\}$.

Applying the lemma, we can perturb ξ_1 into a confoliation ξ'_1 which is contact in W' . Since ξ'_1 is defined by the kernel of the differential form $dx - \tilde{a}_1(y, t)dy$. The latter form coincides with β'_i along the $\partial V \setminus \{t = 0\}$. The vector field X is in the kernel of $\frac{\partial \tilde{a}_1}{\partial t}(y, t)dy \wedge dt$. The push forward of ξ'_1 defines a perturbation of ξ in \overline{B} that is contact in W'_1 , and in W'_1 a Reeb vector field of the new plane field is X .

Unfortunately, we cannot simply continue the process because the perturbation inside V_1 affects the properties of the rest of the embeddings. However, if the perturbation is small enough, it is possible to modify the embeddings, for $i = 2, 3, \dots, n$, into F'_{p_i} satisfying conditions (ii) through (iv), and the condition

$$W_i \subset F'_{p_i}(W') \quad \text{for} \quad i = 2, 3, \dots, n,$$

at the place of (i). This is sufficient to continue with the process of perturbation. Since the W_i cover a neighborhood of $\partial\bar{B}$, we get a contact structure η in \bar{B} such that one of its Reeb vector fields is parallel to X .

□

Hence we have a contact structure η on \bar{B} that has a Reeb vector field that is parallel to X . Then by theorem 1.27 we have a periodic orbit of X in \bar{B} . This finishes the proof of the theorem.

□

1.4.3 Aperiodic volume preserving real analytic vector fields

We want to describe aperiodic geodesible vector fields that are real analytic and preserve a volume. Theorem A implies that the ambient manifold must be a torus bundle over the circle. A torus bundle over the circle has the form of a quotient

$$M_\Phi = T \times [0, 1] / (x, 0) \sim (\Phi(x), 1),$$

for some diffeomorphism $\Phi \in GL(2, \mathbb{Z})$ of the torus T . This follows because every diffeomorphism $h : T \rightarrow T$ is isotopic to a linear diffeomorphism $\Phi \in GL(2, \mathbb{Z})$. Moreover, Φ is uniquely determined by h , since it is essentially the map on $H_1(T, \mathbb{Z}) \simeq \mathbb{Z}^2$ induced by h . We restrict our attention to orientable 3-manifolds, this means restricting Φ to be in $SL(2, \mathbb{Z})$.

Theorem 1.36 *The manifold M_Φ is diffeomorphic to M_Ψ if and only if Φ is conjugate to Ψ^\pm in $GL(2, \mathbb{Z})$.*

For a proof we refer the reader to theorem 2.6 of [39].

Let us begin by assuming that X is an aperiodic real analytic geodesible vector field that preserves a volume on a torus bundle over the circle M . Let μ be the invariant volume form. Recall that there is a function f that is a first integral of X . Theorem A yields f identically zero or f non constant and equal to zero in a proper non empty set $A \subset M$.

Assume that f is identically zero. Then X has a cross section that is a torus. Cutting M along it, gives us $T \times [0, 1]$, since $\{\cdot\} \times [0, 1]$ are segments of orbit. Moreover, X is transverse to the product foliation by tori, *i.e.* to the torus $T_t = T \times \{t\}$ for every $t \in [0, 1]$. By the discussion above, the diffeomorphism type of the manifold M is given by the first return map h of X to T_0 . We can define a function $g : T_0 \rightarrow \mathbb{R}$ that is the first return time: for a point $x \in T_0$, the value of $g(x)$ is the time the orbit of x takes to return to T_0 . Reparameterizing the flow of X with g , we get that it is C^ω conjugated to the suspension of the diffeomorphism h .

Assume now that f is not constant and equal to zero in the compact set $\emptyset \neq A \neq M$. Using lemma 1.33, we have that all levels of f are invariant tori. Take one torus and cut M along it. We distinguish two cases: when the torus is compressible and when it is not. Recall that an oriented surface S embedded in an orientable 3-manifold is incompressible if for each disc D such that $D \cap S = \partial D$ there is a disc $D' \subset S$ with $\partial D' = \partial D$, see definition 1.41.

When the torus we took is incompressible, the manifold we obtain when cutting along the torus, is diffeomorphic to $T \times [0, 1]$ (see for example lemma 2.7 of [39]). If on the contrary the

torus is compressible we have that either it bounds a solid torus or it is contained in a three dimensional ball embedded in the manifold M . But these cannot happen since all the levels of f are tori.

Hence, we get $T \times [0, 1]$ and X tangent to the tori $T_t = T \times \{t\}$. Moreover, X preserves the area form defined in the tori by the invariant volume, and is aperiodic. Denote ϕ_s the flow of X . As a consequence of Denjoy's theorem on diffeomorphisms of the circle, we have

Proposition 1.37 *Let ψ_s be a C^k flow of \mathbb{T}^2 preserving a C^r area form, and let $n = \min(k, r + 1)$. Then ψ_s is C^n conjugate to a suspension of a rotation of the circle.*

For a proof we refer the reader to proposition 14.2.5 of [50]. Thus in our case, on each torus T_t the flow ϕ_s is C^∞ conjugate to the suspension of a circle rotation. Moreover, the rotation has an irrational rotation number ρ_t .

We claim that ϕ_s on $T \times [0, 1]$ is C^∞ conjugate to the suspension of an annulus rotation, such that each concentric circle is rotated by a constant ρ , that does not depend upon the circle. Thus we need to prove that the function $t \mapsto \rho_t$ is constant in a neighborhood of t . Let γ_t be a transversal to X on T_t . We can take a band $\Gamma = \gamma_t \times I$, with I an interval, transverse to X . There is an $\epsilon > 0$ such that $\Gamma \cap T_{t \pm \epsilon}$ is a closed curve and we can assume that it is transverse to X . Thus for each $|\delta| < \epsilon$ we have a rotation number $\rho_{t+\delta}$ defined by ϕ_s in the corresponding torus. Since the function $\delta \mapsto \rho_{t+\delta}$ is continuous and X is aperiodic, we get that $\rho_{t+\delta} = \rho_t$ for every δ . This proves our claim, that is ϕ_s is C^∞ conjugate to the suspension of the annulus rotation that rotates each concentric circle by a constant $\rho = \rho_t$.

If the number ρ is *Diophantine*, the conjugation above is real analytic, we refer to theorem 12.3.1 of [50]. The number ρ is Diophantine if there exist $c > 0$ and $d > 1$ such that for any $p, q \in \mathbb{Z}$ we have $|q\rho - p| > cq^{-d}$.

We conclude that the real analytic volume preserving aperiodic geodesible vector fields on torus bundles over the circle are trivial examples: their flows are C^∞ conjugated to suspensions either

- of a diffeomorphism of a torus without periodic points;
- or of a rotation of an annulus.

1.4.4 Periodic orbits of volume preserving geodesible vector fields

In this section we will change the hypothesis so that X is of class C^∞ and preserves a volume.

Theorem C *Assume that X is a geodesible vector field on an orientable closed 3-manifold M , that is either diffeomorphic to S^3 or has non trivial π_2 . Then if X is C^∞ and volume preserving, it possesses a periodic orbit.*

Proof. Denote by μ the invariant volume form. We know from section 1.3 that $\text{curl}(X) = fX$ for a C^∞ function $f : M \rightarrow \mathbb{R}$. Moreover, the function f is a first integral of the vector field X . We can distinguish the three cases as in the proof of theorem A. When $f \neq 0$ and when f is identically zero, that is cases (I) and (II), the proof is the same. We will deal here with case (III).

- (III) f is equal to zero on a compact invariant set $f^{-1}(0) = A \subset M$. As we previously said A is the set where the differential form $\alpha = \iota_X g$ is closed. Here g is the Riemannian metric making the orbits of X geodesics. Observe that for a regular value a of f , the compact set $f^{-1}(a)$ is a finite union of disjoint invariant tori.

If zero is a regular value, A is a finite union of invariant tori. Let ϵ be small enough to guarantee that the values in $[-\epsilon, \epsilon]$ are all regular. Then $f^{-1}([-\epsilon, \epsilon])$ is composed by manifolds diffeomorphic to $T \times [0, 1]$ where T is a two dimensional torus and the tori $T \times \{s\}$ are tangent to X for every $s \in [0, 1]$. Using proposition 1.26, there is a connected component of $M \setminus \{f^{-1}([-\epsilon, \epsilon])\}$ such that \overline{B} is either a solid torus or a manifold with non trivial π_2 . In this manifold \overline{B} the vector field X is tangent to the boundary and is a Reeb vector field since the restriction of α to \overline{B} is a contact form. Thus using theorem 1.27 we conclude that X has a periodic orbit.

Assume now that zero is a critical value of f . For $\epsilon > 0$ small enough let

$$S_\epsilon = f^{-1}(\epsilon) \cup f^{-1}(-\epsilon).$$

Assume that $\pm\epsilon$ are regular values, then S_ϵ is a finite collection of invariant tori. Consider $M \setminus S_\epsilon$. By proposition 1.26, there is a connected component B of $M \setminus S_\epsilon$, such that its closure is of one of the following two types:

- a solid torus $\mathbb{S}^1 \times \mathbb{D}^2$, where \mathbb{D}^2 is a two dimensional closed disc;
- a manifold with boundary whose second homotopy group π_2 is non trivial.

As before, denote by ξ the plane field defined by the kernel of the 1-form α . If $B \cap A = \emptyset$, we have that $\xi|_{\overline{B}}$ is a contact structure, and thus by theorem 1.27 we conclude that X possesses a periodic orbit in \overline{B} .

We have to consider the case $B \cap A \neq \emptyset$. The plane field ξ is contact in a neighborhood of $\partial\overline{B}$. We will prove that for ϵ small enough there is a closed 1-form that is transverse to X in \overline{B} . Then by D. Tischler's theorem (theorem 1.8) the vector field $X|_{\overline{B}}$ has a section and \overline{B} is a fiber bundle over the circle. Hence \overline{B} is a solid torus $\mathbb{S}^1 \times \mathbb{D}^2$ (since a fiber bundle over the circle cannot have non trivial π_2), and X is transverse to the discs $\{\cdot\} \times \mathbb{D}^2$. Then Brouwer's fixed point theorem implies that X must have a periodic orbit in \overline{B} .

Let $\overline{B} \subset \mathcal{B} = f^{-1}([-\epsilon, \epsilon])$. For ϵ small enough, we will construct a closed 1-form that is transverse to X in \mathcal{B} . We will divide the proof of the existence of the closed 1-form in two parts: first we will give explicit expressions for X , the forms α and $\iota_X \mu$ near \mathcal{B} , and then we will construct the closed 1-form.

Let $0 \leq \delta < \epsilon$ be small enough to guarantee that the values in the intervals $[\epsilon, \epsilon + \delta]$ and $[-\epsilon - \delta, -\epsilon]$ are all regular. Let $\mathcal{D} = f^{-1}([-\epsilon - \delta, \epsilon + \delta])$. Then $\mathcal{D} \setminus \mathcal{B}$ is foliated by tori that are tangent to X . Consider a connected component D of $\mathcal{D} \setminus \mathcal{B}$ where f is positive, and denote each invariant torus in it by T_t , where the f equals $\epsilon + t$ on this torus and $t \in [0, \delta]$. We will do the construction in D but it is analogous in the rest of \mathcal{D} .

On each torus there is a non singular vector field Y defined by the equation $\alpha(Y) = 0$ and $\iota_Y \iota_X \mu = df$. The reason why it is non singular is that the characteristic foliation of the torus is non singular. Observe that Y is tangent to each torus and is in ξ .

Explicit expression for X in D

Assume that X has no periodic orbits in $\partial\overline{B}$, then $\partial\overline{B}_\xi$ has no Reeb annuli. The restriction of X to $\partial\overline{B}$ has a closed transversal section on each torus (see theorem 14.2.1 of [50]): a circle

that intersects every orbit. In D the vector fields X and Y are linearly independent and commute.

Lemma 1.38 *There are C^∞ functions a_1, a_2, a_3, a_4 defined on $[0, \delta]$ such that the vector fields*

$$a_1(t)X + a_2(t)Y \quad \text{and} \quad a_3(t)X + a_4(t)Y$$

are linearly independent on T_t and all their orbits are periodic of period one.

Proof. Fix $t \in [0, \delta]$. Denote by ϕ_s the flow of X and ψ_s the flow of Y on T_t . For a fixed point $x \in T_t$, consider the map

$$\begin{aligned} \Phi : \mathbb{R}^2 &\rightarrow T_t \\ (s_1, s_2) &\mapsto \phi_{s_1}\psi_{s_2}(x) \end{aligned}$$

Since X and Y are linearly independent and commute, Φ is a covering map. Then for $y \in T_t$, the inverse image $\Phi^{-1}(y)$ is a lattice in \mathbb{R}^2 .

Define the functions a_i for $i = 1, 2, 3, 4$ such that $(a_1(t), a_2(t))$ and $(a_3(t), a_4(t))$ form a basis for the lattice for each t . Then the vector fields

$$a_1(t)X + a_2(t)Y \quad \text{and} \quad a_3(t)X + a_4(t)Y$$

are linearly independent and have closed orbits of period one. □

Hence in D we have a system of coordinates (x, y, t) such that $f(x, y, t) = \epsilon + t$, and X is a linear flow on each torus T_t that can be written as

$$X = \tau_1(t) \frac{\partial}{\partial x} + \tau_2(t) \frac{\partial}{\partial y}.$$

Since X is aperiodic the ratio $\frac{\tau_1(t)}{\tau_2(t)}$ is constant and equal to an irrational number. We claim that τ_1 and τ_2 are independent of t . Since $L_X \alpha = 0$ we have that

$$L_X \left(\alpha \left(\frac{\partial}{\partial t} \right) \right) = -\alpha \left(\tau_1'(t) \frac{\partial}{\partial x} + \tau_2'(t) \frac{\partial}{\partial y} \right) = -\frac{\tau_1'(t)}{\tau_1(t)}.$$

The right side of the equation depends only on t and is constant on each torus T_t . It is a coboundary, so it is zero on each torus. This implies that τ_1 is constant, and since $\frac{\tau_1}{\tau_2}$ is constant, the function τ_2 is constant. Thus,

$$X = \tau_1 \frac{\partial}{\partial x} + \tau_2 \frac{\partial}{\partial y}.$$

Explicit expression for $\iota_X \mu$ in D

In this system of coordinates, we can write $\mu = \beta(x, y, t) dx \wedge dy \wedge dt$ for a positive function β . Then in D we have that

$$\iota_X \mu = \tau_1 \beta(x, y, t) dy \wedge dt - \tau_2 \beta(x, y, t) dx \wedge dt,$$

is a closed form. Hence, $L_X\beta = 0$ and since X has dense orbits in each torus T_t , we get $\tau_1 \frac{\partial \beta}{\partial x}(x, y, t) = -\tau_2 \frac{\partial \beta}{\partial y}(x, y, t)$. Thus β is just a function of t and we have

$$\iota_X \mu = \beta(t) dt \wedge (\tau_2 dx - \tau_1 dy).$$

Explicit expression for α in D

The 1-form α can be written as

$$\alpha = A_1 dx + A_2 dy + A_3 dt,$$

where A_1, A_2 and A_3 are functions of (x, y, t) . Using the fact that $\alpha(X) = 1$ we get that $A_2 = \frac{1 - \tau_1 A_1}{\tau_2}$. Then,

$$d\alpha = \left(\frac{\partial A_3}{\partial x} - \frac{\partial A_1}{\partial t} \right) dx \wedge dt + \left(\frac{\partial A_3}{\partial y} + \frac{\tau_1}{\tau_2} \frac{\partial A_1}{\partial t} \right) dy \wedge dt - \left(\frac{\tau_1}{\tau_2} \frac{\partial A_1}{\partial x} + \frac{\partial A_1}{\partial y} \right) dx \wedge dy.$$

Looking at the third term in the expression of $\iota_X d\alpha$ and using that $X \in \ker(d\alpha)$, we get that

$$-\frac{\tau_1^2}{\tau_2} \frac{\partial A_1}{\partial x} = \tau_1 \frac{\partial A_1}{\partial y}.$$

Hence, A_1 and A_2 are functions of t . Moreover, we can put

$$A_1(t) = \gamma(t)\tau_2 + c \quad \text{and} \quad A_2(t) = -\gamma(t)\tau_1 + \frac{1 - c\tau_1}{\tau_2},$$

where we added the second term in both expressions to satisfy the condition $\alpha(X) = 1$ and c is any non zero constant. Let us now look at the first two terms in the expression of $\iota_X d\alpha$, we obtain

$$\begin{aligned} \tau_1 \frac{\partial A_3}{\partial x} - \tau_1 A_1' + \tau_2 \frac{\partial A_3}{\partial y} + \tau_1 A_1' &= 0 \\ \tau_1 \frac{\partial A_3}{\partial x} &= -\tau_2 \frac{\partial A_3}{\partial y}. \end{aligned}$$

Then A_3 is a function of t and

$$\alpha = \gamma(t)(\tau_2 dx - \tau_1 dy) + A_3(t)dt + \frac{c\tau_2 dx + (1 - c\tau_1)dy}{\tau_2}.$$

Using the fact that $d\alpha = f \iota_X \mu$, we get that $\gamma'(t) = (\epsilon + t)\beta(t)$.

The existence of a closed 1-form in \mathcal{B} transverse to X

Now that we have local expressions for the forms α and $\iota_X \mu$, we will begin the construction of the closed 1-form. Take a C^∞ function $p : [0, 1] \rightarrow [0, 1]$ such that $p(s) = 1$ for $s < \frac{1}{3}$, for $s > \frac{2}{3}$ we set $p(s) = 0$, and $p'(s) \leq 0$. Define a 1-form $\tilde{\alpha}$ in D as

$$\tilde{\alpha} = \left[\gamma(0) + p\left(\frac{t}{\delta}\right) (\gamma(t) - \gamma(0)) \right] (\tau_2 dx - \tau_1 dy) + \frac{c\tau_2 dx + (1 - c\tau_1)dy}{\tau_2} + A_3(t)dt,$$

for $t \in [0, \delta]$. We can define this form in each component of $\mathcal{D} \setminus \mathcal{B}$ and extended it by α in \mathcal{B} , since $\alpha = \tilde{\alpha}$ when $t = 0$. We have that

$$d\tilde{\alpha} = \left[\frac{1}{\delta} p' \left(\frac{t}{\delta} \right) (\gamma(t) - \gamma(0)) + p \left(\frac{t}{\delta} \right) \gamma'(t) \right] dt \wedge (\tau_2 dx - \tau_1 dy).$$

In $\mathcal{D} \setminus \mathcal{B}$ the function γ' is never zero, and using the fact that $\beta(t) = \frac{\gamma'(t)}{\epsilon+t}$ there is a function $h(t)$ such that $d\tilde{\alpha} = h(t)\iota_X\mu$. We have that

$$h(t) = \frac{\epsilon+t}{\gamma'(t)\delta} p' \left(\frac{t}{\delta} \right) (\gamma(t) - \gamma(0)) + (\epsilon+t)p \left(\frac{t}{\delta} \right), \quad (1.4)$$

hence $h(0) = \epsilon$ and $h(\delta) = 0$. Thus we get a 1-form $\tilde{\alpha}$ in M such that $d\tilde{\alpha} = h(t)\iota_X\mu$, where h equals f in \mathcal{B} and is equal to zero in $M \setminus \mathcal{D}$. In particular, $\tilde{\alpha}$ is closed outside \mathcal{D} .

We claim that there is a positive constant C independent of ϵ such that $|h| \leq C\epsilon$. In the region D we have that

$$p \left(\frac{t}{\delta} \right) (\epsilon+t) < 2\epsilon.$$

If we choose δ small enough we can assume that $\beta(s) \leq 2\beta(t)$ for every $s \in [0, t]$ and $t \leq \delta$. Then

$$\begin{aligned} |\gamma(t) - \gamma(0)| &= \left| \int_0^t (\epsilon+s)\beta(s)ds \right| \\ &\leq 2 \left| \beta(t) \left(\epsilon t + \frac{t^2}{2} \right) \right| \\ &\leq 3|\beta(t)|\epsilon\delta. \end{aligned}$$

Putting the inequalities in equation 1.4 we get that

$$|h(t)| \leq 2\epsilon \left| p' \left(\frac{t}{\delta} \right) + 1 \right| \leq 2\epsilon \sup_t \left| p' \left(\frac{t}{\delta} \right) + 1 \right|,$$

This proves our claim.

Recall that we are looking for a 1-form in M whose restriction to \mathcal{B} is closed and transverse to X . We will now study the cohomology class of $h\iota_X\mu$ to find a 1-form different from α and such that its derivative is equal to $d\tilde{\alpha}$ in \mathcal{B} .

The cohomology class of $h\iota_X\mu$ on M

Consider the exact sequence of homologies with real coefficients

$$\dots \rightarrow H_1(M \setminus A) \rightarrow H_1(M) \rightarrow H_1(M, M \setminus A) \rightarrow \dots$$

Consider a finite collection of embedded curves $\sigma_1, \sigma_2, \dots, \sigma_n$ in $M \setminus A$ such that they form a basis for the kernel of the map $H_1(M) \rightarrow H_1(M, M \setminus A)$. These curves are at positive distance from A , then for ϵ small enough we can assume that the σ_i are at positive distance from \mathcal{B} .

Using the duality of Poincaré (see for example chapter 26 of [36]) we have that $H_1(M) \simeq H^2(M)$ and hence for every $i = 1, 2, \dots, n$ we can find a 2-form ω_i that is the dual of σ_i and whose support is contained in a tubular neighborhood of σ_i contained in $M \setminus \mathcal{B}$.

Lemma 1.39 *For ϵ small enough there are unique real numbers r_1, r_2, \dots, r_n such that*

$$[h\iota_X\mu] = \sum_{i=1}^n r_i[\omega_i]$$

in $H^2(M)$. Moreover, there exists a constant C' independent of ϵ such that $|r_i| \leq C'\epsilon$ for every i .

Proof. For ϵ small we can assume that \mathcal{B} does not intersect the supports of the forms ω_i . Denote by

$$\begin{aligned} f_1 : H_1(M) &\rightarrow H_1(M, M \setminus \mathcal{B}) \\ f_2 : H^2(M) &\rightarrow H^2(\mathcal{B}). \end{aligned}$$

Using the isomorphism given by the duality of Poincaré we have a map $\ker(f_1) \rightarrow \ker(f_2)$ that is injective. Recall that $h\iota_X\mu$ is exact in \mathcal{B} . Then to prove the existence and uniqueness of the numbers r_i we need to prove that the precedent map is surjective.

Take an element ω in the kernel of f_2 . It can be represented by a form whose support is in $M \setminus \mathcal{B}$, then $[\omega] \in H_c^2(M \setminus \mathcal{B})$ (since it has compact support). The dual of this class under the duality of Poincaré is an homology class $\sigma \in H_1(M \setminus \mathcal{B})$ satisfying that for every element $S \in H_2(M \setminus \mathcal{B}, \partial\mathcal{B})$

$$\sigma \cdot S = \int_S \omega.$$

Using the inclusion $i : M \setminus \mathcal{B} \rightarrow M$, we get

$$i_*\sigma \cdot S = \int_S \omega,$$

for all $S \in H_2(M)$. Then $i_*\sigma \in H_1(M)$ is the dual of $[\omega] \in H^2(M)$, and $f_1(i_*\sigma) = 0$. Then the map is surjective.

We need to prove now that the r_i are bounded. For $i = 1, 2, \dots, n$ fix an oriented embedded surface S_i in M that intersects the σ_j . Then

$$r_i = \int_{S_i} \sum_{j=1}^n r_j \omega_j = \int_{S_i} h\iota_X\mu.$$

Using the bound on h we get a constant C' that is independent of ϵ and such that $|r_i| \leq C'\epsilon$. □

The differential 2-form given by $\gamma = h\iota_X\mu - \sum_{i=1}^n r_i \omega_i$ is closed and exact in M . The next step is to find a primitive of γ that is bounded by a constant multiplied by ϵ .

Recall that we can define a norm on the space of d -forms $\Omega_d(M)$ as

$$\|\beta\| = \sup\{|\beta(V)| \mid V \text{ is a unit } d\text{-vector}\}.$$

The bounds above imply that $\|\gamma\| \leq C''\epsilon$ for a positive constant C'' independent of ϵ . We need to find a primitive λ whose norm is bounded by the norm of γ . The existence of such a primitive is given by combining the main result of François Laudenbach's paper [53] and theorem 1.1 of Jean-Claude Sikorav's paper [71]. The first one gives a method to find a primitive and the second one a bound for it. We get,

Lemma 1.40 *There exists a 1-form λ such that $d\lambda = \gamma$ and $\|\lambda\| \leq \hat{C}\|\gamma\|$, where \hat{C} is a constant independent of ϵ .*

The constant \hat{C} depends on a fixed triangulation of the manifold M . Then, using the previous bounds we have $\|\lambda\| \leq \hat{C}C''\epsilon$. Thus the 1-form $\alpha - \lambda$ satisfies that

$$d(\alpha - \lambda) = f\iota_X\mu - h\iota_X\mu + \sum_{i=1}^n r_i\omega_i,$$

is equal to zero in \mathcal{B} , and $(\alpha - \lambda)(X) > 0$ as a consequence of the bounds we found and the fact that they are independent of ϵ . Then this is the 1-form we were looking for: a closed 1-form in \mathcal{B} that is transverse to X . This finishes the proof of the theorem. □

Let us finish this section with a remark. We say that a vector field is minimal if all its orbits are dense in the ambient manifold. The still open Walter H. Gottschalk conjecture asserts that there are no minimal vector fields on \mathbb{S}^3 . Observe that a geodesible vector field on \mathbb{S}^3 cannot be minimal, in fact the only minimal geodesible vector fields on closed 3-manifolds are the suspensions of minimal diffeomorphisms of a two dimensional torus. To prove this claim consider a minimal geodesible vector field on a closed 3-manifold M . Then the invariant set $A = f^{-1}(0)$ must be equal to M or empty. In the latter case the vector field is a Reeb vector field of a contact structure, then it cannot be minimal since it possesses a periodic orbit. If $A = M$, the vector field admits a global section that must be a torus since X is aperiodic. Then it is the suspension of a minimal diffeomorphism of a two dimensional torus and M is a torus bundle over the circle.

1.5 Embedded tori

As announced, in this section we will prove proposition 1.26. We will consider a collection of tori embedded in a 3-manifold, and study its complement. The three manifold will be either \mathbb{S}^3 or will have non trivial second homotopy group. Recall that in this latter situation the sphere theorem implies the existence of an embedded sphere that is non homotopic to a point.

Let us start with the definition of an *incompressible surface*. We say that an embedded surface S in a 3-manifold M is *2-sided* if the normal bundle $S \times I$ is trivial. If M and S are oriented, S is always a 2-sided surface.

Definition 1.41 *A 2-sided surface without \mathbb{S}^2 or \mathbb{D}^2 components is incompressible if for each disc $D \subset M$ with $D \cap S = \partial D$ there is a disc $D' \subset S$ with $\partial D' = \partial D$, as in figure 1.16. A disc D with $D \cap S = \partial D$ will be called a *compressing disc* for S , whether or not the disc D' exists.*

Observe that if a surface has more than one connected component, it is incompressible if and only if each component is incompressible. Let S be an embedded surface in a 3-manifold M , deleting a small tubular neighborhood of S from M , we obtain a 3-manifold that we will denote by $M \setminus S$. Here are some preliminary remarks about incompressible surfaces:

- (i) a connected 2-sided surface which is not a sphere nor a disc is incompressible if the map $\pi_1(S) \rightarrow \pi_1(M)$ induced by inclusion is injective. In fact, if we consider $D \subset M$ a compressing disc, then ∂D is nullhomotopic in M and by assumption also in S . Thus ∂D bounds a disc in S . The converse of this claim is also true and is a consequence of the loop theorem, we refer to chapter 3 of Allen Hatcher notes [39].

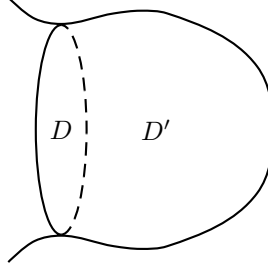

Figure 1.16: Incompressible surface

- (ii) a 2-sided torus T , in an *irreducible* 3-manifold M , is compressible if and only if either T bounds a solid torus or T lies in a ball in M . Recall that a 3-manifold is irreducible if every embedded two sphere bounds an embedded 3-ball. To prove the claim consider a compressible torus $T \subset M$. There is a surgery of T along some disc D , such that ∂D is a meridian of T , that turns T into a sphere. This sphere bounds a 3-ball \mathbb{B} and there are two possible cases. If $\mathbb{B} \cap D = \emptyset$, reversing the surgery glues two discs in the boundary of \mathbb{B} to create a solid torus bounded by T . If, on the contrary, $\mathbb{B} \cap D \neq \emptyset$ we have that $D \subset \mathbb{B}$ and then $T \subset \mathbb{B}$.

Note that if $M = \mathbb{S}^3$ we can choose \mathbb{B} disjoint from D . Since $\pi_1(\mathbb{S}^3) = 0$ there are no incompressible surfaces (different from the sphere and from the disc) in \mathbb{S}^3 , thus every embedded two torus bounds a solid torus on one side or the other.

- (iii) if $S \subset M$ is incompressible, then M is irreducible if and only if $M \setminus S$ is irreducible. Suppose that M is irreducible, then a 2-sphere in $M \setminus S$ bounds a ball in M , which must be disjoint of S . Thus $M \setminus S$ is irreducible. Conversely, given a sphere $\mathbb{S}^2 \subset M$, consider a circle of $S \cap \mathbb{S}^2$ bounding a disc D in the sphere with $D \cap S = \partial D$. By the incompressibility of S , ∂D bounds a disc $D' \subset S$. The sphere $D \cup D'$ bounds a ball $\mathbb{B} \subset M$. We have that $\mathbb{B} \cap S = D'$, otherwise the component of S containing D' would be contained in \mathbb{B} . We can push D across \mathbb{B} to D' and beyond, by an isotopy that eliminates the circle ∂D from $S \cap \mathbb{S}^2$. Repeating this step, if necessary, we get $\mathbb{S}^2 \subset M \setminus S$, so \mathbb{S}^2 bounds a ball and M is irreducible.

We are now able to prove one of the results contained in proposition 1.26.

Proposition 1.42 *Let S be a finite collection of disjoint embedded tori in \mathbb{S}^3 . Then there is a connected component B of $\mathbb{S}^3 \setminus S$ such that \overline{B} is a solid torus or $\pi_2(\overline{B}) \neq 0$.*

Proof. Remark that in this case the tori are 2-sided. There are none incompressible surfaces in \mathbb{S}^3 , thus any torus $T \in S$ is compressible and thus by the remark (ii) it bounds a solid torus in one side or the other. Assume that none of the connected components of $\mathbb{S}^3 \setminus S$ is a solid torus. Since S is finite there is one torus T_1 such that one of the connected components of $\mathbb{S}^3 \setminus T_1$ does not contain another torus of S . We will say that such a component is *S-empty*. Let us call this component B_1 . By assumption $\overline{B_1}$ is not a solid torus, thus consider the solid torus $W_1 = \mathbb{S}^3 \setminus B_1$. There is a torus $T_2 \in S$ such that one of the components of $W_1 \setminus T_2$ is *S-empty*. Let us call it B_2 . As before, by assumption we have that its closure is not a solid torus. If B_2 has non trivial π_2 we are done, if not consider the manifold $W_2 = W_1 \setminus B_2$.

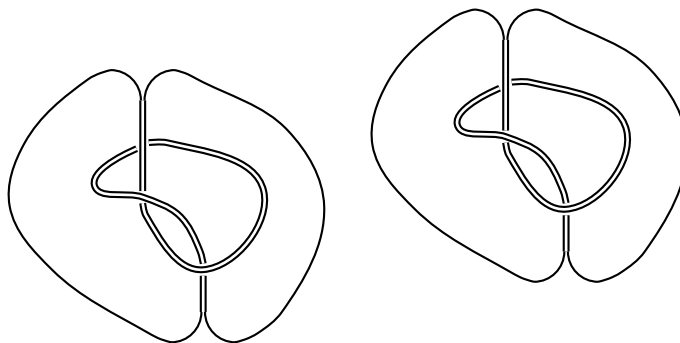

Figure 1.17: Two embedded tori

We claim that $\pi_2(W_2) \neq 0$. Observe that W_1 is irreducible, since it is homeomorphic to a solid torus. Thus using remark (ii) we have that T_2 either bounds a solid torus or is contained in a ball in W_1 . Since it does not bound a solid torus, it is contained in a ball \mathbb{B} . This proves our claim.

The ball $\mathbb{B} \subset W_1$ that contains the torus T_2 has the property that $\partial\mathbb{B} \subset W_2$ and it is not compressible. If we take the connected component of $\mathbb{S}^3 \setminus S$ that contains a not compressible sphere homotopic to $\partial\mathbb{B}$, we get the manifold we were looking for since it has non trivial second homotopy group. The situation is as in figure 1.17: we illustrate the case where there are three connected components. None of them is a solid torus, but one has non trivial π_2 .

□

We will now place ourselves in the case of a 3-manifold M with $\pi_2(M) \neq 0$. Let T be an embedded torus in M , observe that $M \setminus T$ can have one or two connected components. Let us begin with some remarks:

- (I) if T is incompressible, $\pi_2(M \setminus T) \neq 0$. In fact, remark (iii) above implies that in $M \setminus T$ there is an embedded two sphere non homotopic to a point. Thus there is at least one connected component with non trivial π_2 .
- (II) if T is compressible, then either $\pi_2(M \setminus T) \neq 0$ or there is a connected component that is a solid torus. By definition, there exists a disc $D \subset M$ with $D \cap T = \partial D$ such that D is homotopic to a point in M and there is not $D' \subset T$ such that $\partial D' = \partial D$. Thus we can cut T along D and get a two sphere S embedded in M . If S bounds a ball, T is the boundary of a solid torus. If not, there is one connected component in $M \setminus T$ that contains S and thus has non trivial π_2 .

Note that in this case we cannot assure that a component of $M \setminus T$ has non trivial second homotopy group. Think in $\mathbb{S}^2 \times \mathbb{S}^1$ and the torus defined by $T = C \times \mathbb{S}^1$ with C an embedded circle in \mathbb{S}^2 . Then $M \setminus T$ is formed by two solid tori.

We can prove the second part of proposition 1.26.

Proposition 1.43 *Assume that M is an orientable closed three manifold with $\pi_2(M) \neq 0$. Let S be a finite collection of disjoint embedded 2-sided tori in M . Then there is a connected component B of $M \setminus S$ such that either \overline{B} is a solid torus or $\pi_2(\overline{B}) \neq 0$.*

Proof. If S consists of just one torus, we are done by the two remarks above. If not, let T_1, T_2, \dots, T_k be the compressible tori in S and P_1, P_2, \dots, P_k the incompressible ones. Denote $W_1 = M \setminus T_1$, if one of its components (there can be just one component) is a solid torus, call it B_1 . As before, we will say that \overline{B}_1 is S -empty if it does not contain tori of S . So if \overline{B}_1 is S -empty we are done, if not let $S_1 \subset S$ the set of tori contained in \overline{B}_1 . Each torus in S_1 separates \overline{B}_1 , meaning that $\overline{B}_1 \setminus T$ has two connected components. One of the components is a solid torus or has non trivial π_2 . This last claim follows from remarks (I) and (II). Following the same procedure as in proposition 1.42 we can find a connected component of $\overline{B}_1 \setminus S_1$ such that it is either a solid torus or has non trivial π_2 .

The case we have to consider now is when none of the components of W_1 is a solid torus, in this case we have a non S -empty component U_1 with non trivial π_2 . In fact if U_1 was S -empty, setting $B = U_1$ will finish the proof of the lemma. Denote by R_1 the collection of tori contained in U_1 . Assume there is $T_2 \in R_1$ compressible. Consider $W_2 = \overline{U}_1 \setminus T_2$, that has one or two components. Remark (II) above implies that at least one of them is either a solid torus or has non trivial π_2 . In the first case we are done: we can follow the proof of proposition 1.26 to get the connected component B we are looking for. In the second one, we can continue the procedure of taking the complement of the compressible tori until we get to one of the following situations

- (a) a solid torus;
- (b) a S -empty component with non trivial π_2 ;
- (c) a component U with non trivial π_2 , and such that any tori embedded in U is incompressible.

For (a) we need to proceed as in proposition 1.26. In (b) we are done. Let us analyze case (c). Take P_1 an incompressible torus in U . Then one component of $\overline{U} \setminus P_1$ has non trivial π_2 . If it is S -empty we are done, if not we can continue to take away the tori. With this procedure we will eventually get to an S -empty component of $M \setminus S$ with non trivial π_2 . The last argument applies to the case where all the tori in S are incompressible, thus it finishes the proof of the proposition. □

1.6 Pseudoholomorphic curves and dynamics

The aim of this section is to study the proof of J. Etnyre and R. Ghrist theorem regarding the existence of periodic orbits for Reeb vector fields on solid tori (theorem 6.1 from [23]), and adapt it for 3-manifolds with boundary \overline{B} satisfying that $\pi_2(\overline{B}) \neq 0$. We will prove

Theorem 1.27 *Let X be a Reeb vector field on a compact 3-manifold \overline{B} , with $\partial\overline{B} \neq \emptyset$ and X tangent to the boundary. If either \overline{B} is a solid torus or has non trivial second homotopy group, X possesses a periodic orbit.*

We will begin by an historical review of the quest for periodic orbits of Reeb vector fields, that will take us to describe the relation between Reeb vector fields and Hamiltonian vector fields. In section 1.6.1 we will study some results about contact structures and in section 1.6.2 we will sketch H. Hofer's proof. We will use his technique to prove theorem 1.27.

H. Hofer's theorem is a partial answer to Alan Weinstein's conjecture. This conjecture was motivated by the results of Paul H. Rabinowitz and A. Weinstein, from 1978. The first result, proves the existence of a periodic orbit on every smooth star shaped regular surface of a Hamiltonian system on \mathbb{R}^{2n} with respect to the standard symplectic form defined below, see [62]. A. Weinstein improved this result: he showed that it is valid on smooth regular energy surfaces bounding a convex domain, see [79]. Both results are particular cases of a later theorem of Claude Viterbo that we discuss below, see [77].

Before stating the conjecture we need to introduce some notions. As we previously said a symplectic form is a closed non degenerated two form on an even dimensional manifold. Recall that we say that a manifold W is symplectic if it is endowed with a symplectic form. As an example, consider \mathbb{R}^{2n} equipped with the symplectic form ω_0 defined by

$$\omega_0 = \sum_{i=1}^n dx_i \wedge dy_i,$$

where $(x_1, y_1, \dots, x_n, y_n)$ are the coordinates on \mathbb{R}^{2n} . We will call this form the standard symplectic form. Take an autonomous Hamiltonian $H : \mathbb{R}^{2n} \rightarrow \mathbb{R}$. The associated Hamiltonian vector field X_H is defined by the equation

$$\iota_{X_H} \omega_0 = -dH.$$

We get the Hamiltonian system $\dot{x} = X_H(x)$. It is not difficult to see that every orbit of the system stays in an energy level of H . Moreover, $L_{X_H} \omega_0 = 0$, thus X_H preserves the form ω_0 and the volume form given by the product of n times ω_0 : that is $\omega_0^n = \omega_0 \wedge \dots \wedge \omega_0$. The fact that this $2n$ -form is a volume follows from the fact that ω_0 is non degenerated. In the same way, given a Hamiltonian function H on a symplectic manifold (W, ω) , we can define a Hamiltonian vector field preserving ω and the energy levels of H .

We can now state A. Weinstein's conjecture, that was finally proven for every closed 3-manifold by C. H. Taubes [75] using Floer homology.

Conjecture (Weinstein) *Assume that H is an autonomous Hamiltonian on a symplectic manifold (W, ω) . Let $\Sigma = H^{-1}(E)$ be a compact regular level. Assume that there exists a 1-form α on Σ such that $d\alpha = \omega|_{\Sigma}$ and $\alpha_x(X_H) \neq 0$ for every $x \in \Sigma$. Then there exists a periodic orbit of X_H on Σ .*

We know that periodic orbits are abundant for autonomous Hamiltonian systems in $(\mathbb{R}^{2n}, \omega_0)$, as the next theorem by H. Hofer and Eduard J. Zehnder states. For a proof we refer to [45].

Theorem 1.44 (Hofer, Zehnder) *Consider a Hamiltonian H in $(\mathbb{R}^{2n}, \omega_0)$ such that $H(x) \rightarrow \infty$ when $|x| \rightarrow \infty$. Then the Lebesgue measure of the values E of H such that on $H^{-1}(E)$ there are no periodic orbits is zero.*

Results by Viktor L. Ginzburg [28], [29] and Michel R. Herman [40] show that we cannot expect to have a periodic orbit on every regular level of all Hamiltonians H .

Theorem 1.45 (Ginzburg, Herman) *Let H be a proper Hamiltonian on $(\mathbb{R}^{2n}, \omega_0)$. If $n \geq 3$ there exists a smooth compact regular energy level S in $(\mathbb{R}^{2n}, \omega_0)$ admitting no periodic orbits.*

The techniques of V. L. Ginzburg are plug based. We would like to point out that there are also examples of Hamiltonian systems having regular energy surfaces without periodic orbits in (\mathbb{R}^4, ω_0) , but only of class C^2 . These were constructed by V. L. Ginzburg and Başak Z. Gürel using plugs [30]. The question whether any smooth compact regular energy surface in \mathbb{R}^4 has a closed characteristic is still open. Let us now state C. Viterbo's theorem, that proves A. Weinstein's conjecture when the symplectic manifold is $(\mathbb{R}^{2n}, \omega_0)$. For a proof see [77].

Theorem 1.46 (Viterbo) *Let $\Sigma = H^{-1}(E) \subset (\mathbb{R}^{2n}, \omega)$ be a compact smooth energy level for some regular value $E \in \mathbb{R}$ of a Hamiltonian H . If there exists a 1-form α on Σ satisfying $d\alpha = \omega|_{\Sigma}$ and $\alpha_x(X_H) \neq 0$ for every $x \in \Sigma$, then X_H possesses a periodic orbit on Σ .*

An interesting fact is that the orbits of a Hamiltonian system depend only on the symplectic form ω that we consider and on the hypersurface Σ . To explain this claim, let us define the characteristic line bundle of Σ . Let us place ourselves in the more general case of a symplectic manifold (W, ω) .

Definition 1.47 *Let $\Sigma \subset (W, \omega)$ be a hypersurface. The 2-form ω restricted to the odd dimensional subspace $T_x\Sigma \subset T_xW$ is degenerate. The kernel of this restriction is of dimension one, because ω is non degenerated on T_xW . Thus ω defines the characteristic line bundle $\mathcal{L}_{\Sigma} \subset T\Sigma$*

$$\mathcal{L}_{\Sigma} = \{v \in T_x\Sigma \mid \omega_x(v, w) = 0 \ \forall w \in T_x\Sigma\}.$$

The previous claim follows from the fact that the foliation defined by the orbits of X_H on a regular energy level $\Sigma \subset (W, \omega)$ coincides with the 1-foliation tangent to the characteristic line bundle of the hypersurface. For further details we refer to section 4.2 of the book [45].

The relation between A. Weinstein's conjecture and H. Hofer's theorem follows from the observation that when $\omega|_{\Sigma} = d\alpha$, the form α is a contact form and $\iota_{X_H}d\alpha = \iota_{X_H}\omega|_{\Sigma} = -dH|_{\Sigma} = 0$. Thus X_H , restricted to Σ , is a reparameterization of the Reeb vector field associated to α . Conversely, a Reeb vector field on a closed 3-manifold M is a Hamiltonian vector field on the non compact manifold $W = \mathbb{R} \times M$ with the Hamiltonian $H(t, x) = t$ and a suitable symplectic form. We identify M with $M \times \{0\}$, the Hamiltonian vector field X_H satisfies, at any point $(0, x)$, that it is a reparameterization of the Reeb vector field. We will describe this last construction in detail below. Thus in dimension three we can reformulate A. Weinstein's conjecture: *every Reeb vector field on a closed 3-manifold has a periodic orbit*. H. Hofer's theorem gives a positive answer to the conjecture for some manifolds. As we said this result was generalized to every closed 3-manifold by C. H. Taubes [75].

1.6.1 Contact structures and characteristic foliations

A contact structure ξ on a manifold M defines an orientation of M , given by the sign of the non vanishing differential 3-form $\alpha \wedge d\alpha$, where α is a form whose kernel defines ξ . The sign is independent of the choice of α . On the other hand, if the manifold is already oriented one can distinguish between positive and negative contact structures depending on whether $\alpha \wedge d\alpha$ is positive or negative. Jean Martinet showed that there is a contact structure on every closed oriented 3-manifold [56].

As an example of a contact structure, consider the standard contact structure on \mathbb{R}^3 defined by

the kernel of the contact form $dz + xdy$. This kernel consists of tangent planes in \mathbb{R}^3 which satisfy

$$\frac{dz}{dy} = -x.$$

Along the (y, z) -plane, the contact plane field has slope zero meaning that they are horizontal. As one moves in the x direction the planes twist counterclockwise.

Given an embedded surface S in M , a contact structure ξ defines on S a singular 1-foliation S_ξ , generated by the line field $TS \cap \xi$, that is called the *characteristic foliation* of S . Observe that generically S is tangent to ξ in a finite number of points that are the singularities of S_ξ . This one foliation is locally orientable, therefore, the index of a singular point is well defined. In the generic case the index is equal to ± 1 . A singular point is *elliptic* if the index is equal to 1 and *hyperbolic* if the index is equal to -1 .

If S is oriented or cooriented, it is possible to induce an orientation on the characteristic foliation S_ξ . In this situation the singularities are endowed with a sign when we compare the orientation of ξ and TS , that coincide in the singularity as planes. This means that positive elliptic points are sources and negative ones are sinks. For hyperbolic points the difference between positive and negative is more subtle: it is a C^1 rather than a topological invariant. We refer the reader to section 1.2 of Y. Eliashberg's article [18]. We will always assume that S_ξ is oriented.

We will say that two contact structures are *contactomorphic* if there is a diffeomorphism of M that takes one to the other.

Theorem 1.48 (Moser, Weinstein) *Two contact structures that induce the same characteristic foliation on a surface are contactomorphic in a neighborhood of the surface.*

Locally all contact structures look the same, as a consequence of Gaston Darboux's theorem: *all contact structures on a 3-manifold are locally contactomorphic to the standard contact structure on \mathbb{R}^3* . Another local result in contact topology is John W. Gray's theorem, for a proof we refer to theorem 5.2.1 of [35].

Theorem 1.49 (Gray) *If α_t is a smooth family of contact forms, then there is a smooth family of diffeomorphisms ϕ_t of M such that $\alpha_t = f_t \cdot \phi_t^*(\alpha_0)$, for some functions $f_t : M \rightarrow (0, \infty)$.*

We will distinguish two classes of contact structures: a contact structure is *overtwisted* if there is an embedded disc $\mathbb{D} \hookrightarrow M$ whose characteristic foliation contains a limit cycle; otherwise, we will say that the contact structure is *tight*. Note that J. W. Gray's theorem implies that tight and overtwisted contact structures are stable up to deformation: we cannot have a smooth family of contact structures that changes from tight to overtwisted. The main tool for simplifying the characteristic foliation of a surface is Emmanuel Giroux's elimination lemma from [31]. Assume that we have a surface with a characteristic foliation which contains an elliptic and a hyperbolic singularities with the same sign and lying in the closure of the same leaf of the foliation. The two singularities can be eliminated via a C^0 small perturbation of the surface with support in a neighborhood of such a leaf. Thus we get a new surface whose characteristic foliation has two singularities less. As a non trivial corollary to the elimination lemma, in an overtwisted contact structure we can assume that there exists an embedded disc \mathcal{D} whose characteristic foliation \mathcal{D}_ξ has a unique elliptic singularity and the boundary $\partial\mathcal{D}$ is the limit cycle, as in the figure 1.18. We will call such a disc an *overtwisted disc*. For a visual proof of this corollary we refer to pages 28 and 29 of [42].

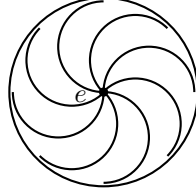

Figure 1.18: Overtwisted disc

As an example, consider now the three sphere $\mathbb{S}^3 = \{(z_1, z_2) \in \mathbb{C}^2 \mid |z_1|^2 + |z_2|^2 = 1\}$, where $z_j = x_j + iy_j$, for $j = 1, 2$. The standard contact structure ξ_0 is defined by the restriction to \mathbb{S}^3 of the form

$$\alpha_0 = \frac{1}{2} \sum_{j=1}^2 (x_j dy_j - y_j dx_j). \quad (1.5)$$

The contact structure ξ_0 is formed by orthogonal planes to the Hopf fibration, where the orthogonality is taken with respect to the standard Riemannian metric. Daniel Bennequin showed that this structure is tight. We refer to theorem 1 from [5].

Y. Eliashberg classified all contact structures on the three sphere up to isotopy, in particular, ξ_0 is the only tight contact structure modulo isotopy. Fix now a trivialization of $T\mathbb{S}^3$. The homotopy classes of the oriented plane fields can be identified with the homotopy classes

$$[\mathbb{S}^3, \mathbb{S}^2] = \pi_3(\mathbb{S}^2) = \mathbb{Z}.$$

Thus we can name the classes: $A_0, A_{\pm 1}, \dots$ with $\xi_0 \in A_0$, and where $A_{\pm i}$ are two classes depending on the orientation. The following theorem is due to Y. Eliashberg, we refer the reader to theorem 2.1.2 from [18].

Theorem 1.50 (Eliashberg) *The class A_0 contains exactly two non isotopic positive contact structures: the standard one and one overtwisted. All other classes contain exactly one overtwisted contact structure.*

Thus on \mathbb{S}^3 two overtwisted contact structures are isotopic through contact structures if and only if they are homotopic as plane fields.

1.6.2 Pseudoholomorphic curves in H. Hofer's theorem

The aim of this section is to sketch the proof of theorem 1.3. Let us begin by giving a more precise statement.

Theorem 1.51 (Hofer) *Let X be the Reeb flow associated to a contact form α on a closed 3-manifold M . Let ξ be the contact structure defined by the kernel of α , then X has a periodic orbit in any of the following situations:*

- M is diffeomorphic to \mathbb{S}^3 ;
- ξ is overtwisted;

- $\pi_2(M) \neq 0$.

Observe that $TM = \xi \oplus X$, and the restriction of $d\alpha$ to any plane of ξ is a non degenerated 2-form. This follows from the fact that $\alpha \wedge d\alpha \neq 0$. Remark that in the family of vector fields that preserve the contact structure ξ , Reeb ones are those who are transverse to ξ . In fact, if Y is a vector field transverse to ξ and preserving it, we can find a Riemannian metric of the manifold such that Y is of unit length and is orthogonal to ξ . The 1-form defined by the contraction of the metric with Y is a contact form defining ξ .

The case of \mathbb{S}^3 equipped with a tight contact structure is treated separately using the fact that all tight contact structures are isotopic. Let us sketch the proof of the theorem when M is diffeomorphic to \mathbb{S}^3 and ξ is tight. The classification result of Y. Eliashberg, implies that if α_1 and α_2 are two tight contact forms on \mathbb{S}^3 there exists a smooth function $f : \mathbb{S}^3 \rightarrow \mathbb{R} \setminus \{0\}$ and a diffeomorphism $\phi : \mathbb{S}^3 \rightarrow \mathbb{S}^3$ satisfying

$$\phi^* \alpha_2 = f \alpha_1.$$

As before, represent \mathbb{S}^3 as the unit sphere in \mathbb{C}^2 with the standard contact form α_0 defined by the restriction of the form in equation 1.5. We know that it is tight. Observe that

$$d\alpha_0 = dx_1 \wedge dy_1 + dx_2 \wedge dy_2 = \omega_0,$$

the standard symplectic form on $\mathbb{R}^4 \simeq \mathbb{C}^2$. So given any other tight contact form α on \mathbb{S}^3 , we have that

$$\phi^* \alpha = f \alpha_0|_{\mathbb{S}^3}.$$

Hence the Reeb flows of α and $f \alpha_0|_{\mathbb{S}^3}$ are conjugated: it is enough to show that the Reeb vector field $X_{f \alpha_0|_{\mathbb{S}^3}}$ has a periodic orbit. Observe that $X_{f \alpha_0|_{\mathbb{S}^3}} = -X_{-f \alpha_0|_{\mathbb{S}^3}}$, so we can assume that f is positive. We claim that there is a smooth hypersurface $S \subset \mathbb{C}^2$ bounding a star shaped domain, and a diffeomorphism $\psi : \mathbb{S}^3 \rightarrow S$ such that

$$T\psi(\mathcal{L}_{f \alpha_0|_{\mathbb{S}^3}}) = \mathcal{L}_S.$$

Here $\mathcal{L}_{f \alpha_0|_{\mathbb{S}^3}}$ is the line bundle defined by the Reeb vector field of $f \alpha_0|_{\mathbb{S}^3}$ and \mathcal{L}_S is the characteristic line field induced on S by the symplectic form ω_0 . Indeed, just define S by

$$S = \{\sqrt{f(z)}z \mid z \in \mathbb{S}^3\} \subset \mathbb{C}^2,$$

and $\psi(z) = \sqrt{f(z)}z$. Finally, observe that $\alpha_0(Z) = \frac{1}{2}\omega_0(Z, \cdot)$ for every $Z \in \mathbb{C}^2$. Thus, if we consider $z \in \mathbb{S}^3$ and $Y \in T_z \mathbb{S}^3$, we have that

$$\begin{aligned} \psi^*(\alpha_0|_S)_z(Y) &= \frac{1}{2}\omega_0\left(\sqrt{f(z)}z, (d\sqrt{f(z)}Y)z + \sqrt{f(z)}Y\right) \\ &= f(z)\frac{1}{2}\omega_0(z, Y) \\ &= f(z)(\alpha_0|_{\mathbb{S}^3})_z(Y). \end{aligned}$$

This implies that the existence of a periodic orbit for \mathbb{S}^3 with a tight contact structure is a consequence of the theorem of P. H. Rabinowitz. Recall that P. H. Rabinowitz's result states that the boundary of a star shaped domain in (\mathbb{R}^4, ω_0) has a closed characteristic.

The proof in the other two cases, that is when ξ is overtwisted and when $\pi_2(M) \neq 0$, uses pseudoholomorphic curves in a symplectisation of the manifold M . We are looking for periodic

orbits, that we will denote by (x, T) where $x : \mathbb{S}^1 \rightarrow M$, of the vector field X . Here T is the minimal period of the periodic orbit. Define the functional $\Phi : C^\infty(\mathbb{S}^1, M) \rightarrow \mathbb{R}$ by

$$\Phi(x) = \int_{\mathbb{S}^1} x^* \alpha.$$

Proposition 1.52 *If x is a critical point of Φ and $\Phi(x) > 0$, then there exists a closed integral curve P of the Reeb vector field X so that $x : \mathbb{S}^1 \rightarrow P$ is a map of positive degree. Conversely, given a closed integral curve P for X and a map $x : \mathbb{S}^1 \rightarrow P$ of positive degree, the loop x is a critical point of Φ satisfying $\Phi(x) > 0$.*

As we said $d\alpha$ is a non degenerated closed 2-form on the plane field ξ , so we can choose a compatible complex structure $J^\xi : \xi \rightarrow \xi$. The compatibility means that $d\alpha(v, J^\xi v) > 0$ for every vector $v \in \xi$. The set of such complex structures is an open non empty contractible set. The manifold M is now equipped with the Riemannian metric g_{J^ξ} defined by

$$g_{J^\xi}(h, k) = d\alpha(\pi(h), J^\xi \pi(k)) + \alpha(h)\alpha(k),$$

where $\pi : TM \rightarrow \xi$ is the projection along the orbits of X and $h, k \in TM$.

Observe that the functional Φ and the equation $d\Phi(x) = 0$ do not control the map x in the X direction. Such a control will be desirable for using variational methods. Formally, the L^2 -gradient of the functional Φ on the loop space $C^\infty(\mathbb{S}^1, M)$ associated with $d\Phi$ is the vector field $J^\xi(x)\pi\dot{x}$. The negative gradient solves the equation

$$x = y(s) \quad \frac{dy}{ds} = -\nabla\Phi(x),$$

where $y : \mathbb{R} \rightarrow C^\infty(\mathbb{S}^1, M)$ is a smooth arc. We can define a map $v : \mathbb{R} \times \mathbb{S}^1 \rightarrow M$, where $v(s, t) = y(s)(t) = x(t)$, that satisfies the partial differential equation

$$\partial_s v + J^\xi(v)\pi(\partial_t v) = 0. \quad (1.6)$$

This is a first order elliptic system in the ξ direction. Remark that it lacks of ellipticity in the X direction.

In order to control the X direction, we will construct the symplectisation of M . Consider the non compact manifold $W = \mathbb{R} \times M$ equipped with the symplectic form

$$\omega = d(e^t \alpha) = e^t(dt \wedge \alpha + d\alpha),$$

where t is the \mathbb{R} coordinate. We will call (W, ω) the symplectisation of (M, α) . Using J^ξ we can define an almost complex structure J on the symplectisation W by

$$J_{(a, h)}(b, k) = (-\alpha_h(k), J_h^\xi \pi(k) + bX_h), \quad (1.7)$$

where $(b, k) \in T_{(a, h)}W$, and X_h is the Reeb vector field on M at the point h . Consider the Hamiltonian H that is the projection from W to \mathbb{R} . The restriction of the Hamiltonian flow of H to M coincides with the flow of the Reeb vector field of the contact form α .

Consider now a closed Riemann surface (Σ, j) , where j is a complex structure, and take Γ a finite set of points of Σ . A map $u : \Sigma \setminus \Gamma \rightarrow W$ is called J -holomorphic if

$$du \circ j = J \circ du.$$

Lemma 1.53 *If Γ is empty the map u is constant.*

Proof. Let $p(u)$ be the function $\Sigma \setminus \Gamma \rightarrow \mathbb{R}$ defined by u and the projection from $W \rightarrow \mathbb{R}$. Then $e^{p(u)}$ is *strictly subharmonic*, that is its Laplacian is strictly positive outside the singularities of u . In fact, denote J^t the transposed of J . The differential 2-form

$$-d(J^t de^p) = d(e^p \alpha)$$

is positive on the J -complex lines of TW . On the other hand, $-\Delta e^{p(u)} = u^*(d(J^t de^p))$. Thus if $\Gamma = \emptyset$, we get a subharmonic function on a closed surface, hence the function is constant. We conclude that $u^* \alpha = 0$ and $\pi \circ du = 0$, implying that $du = 0$. Then u is constant. \square

Let $u = (a, v) : \mathbb{R}^+ \times \mathbb{S}^1 \rightarrow W$, where $a : \mathbb{R}^+ \times \mathbb{S}^1 \rightarrow \mathbb{R}$ is an auxiliary map. We can write equation 1.6 as the next system

$$\begin{aligned} \pi(\partial_s v) + J^\xi(v)\pi(\partial_t v) &= 0 \\ \alpha(\partial_t v) &= \partial_s a \\ -\alpha(\partial_s v) &= \partial_t a \end{aligned} \tag{1.8}$$

We have a first order elliptic system that controls the X direction. Let us define the energy of the map u as

$$E(u) = \sup_{f \in \Delta} \int_{\Sigma \setminus \Gamma} u^* d(f\alpha),$$

where $\Delta = \{f : \mathbb{R} \rightarrow [0, 1] \mid f' \geq 0\}$, and the one form $f\alpha$ on $\mathbb{R} \times M$ is defined by

$$(f\alpha)_{(a,h)}(b, k) = f(a)\alpha_h(k).$$

At this point, H. Hofer establishes, in [42], an equivalence between finding periodic orbits of X on M and the existence of J -holomorphic maps that are solutions of equation 1.8 with finite energy. More precisely

Theorem 1.54 (Hofer) *Let $\Gamma \subset \Sigma$ be a finite non empty set of points. There is a finite energy non constant J -holomorphic map $u : \Sigma \setminus \Gamma \rightarrow W$ if and only if the Reeb vector field X has a periodic orbit.*

If a map $u = (a, v)$ as in the theorem exists, in the particular case where $\Sigma = \mathbb{R} \times \mathbb{S}^1$, we have as a consequence of the energy bound that the following limit exists

$$\lim_{s \rightarrow \infty} \int_{\mathbb{S}^1} v(s, \cdot)^* \alpha := T \in \mathbb{R}.$$

If $T \neq 0$, then there exists a $|T|$ -periodic orbit x of the Reeb vector field X and there exists a sequence $s_n \rightarrow \infty$, satisfying $v(s_n, t) \rightarrow x(t \bmod T)$ as $n \rightarrow \infty$, where $t \in \mathbb{S}^1$ and with convergence in $C^\infty(\mathbb{S}^1, M)$. The solution x is then a periodic orbit of X with period T .

For the other implication of the theorem above, assume that X admits a T -periodic orbit x , that is a periodic orbit of minimal period T . We have to find a J -holomorphic map with finite energy. Define a map from the Riemann sphere minus two points to the symplectisation of M ,

$$\begin{aligned} u_\pm = (a_\pm, v_\pm) : \mathbb{R} \times \mathbb{S}^1 &\rightarrow W \\ u_\pm(s, t) &= (\pm Ts + c, x(\pm Tt + d)) \end{aligned}$$

for two constants c and d . These are J -holomorphic maps with zero energy, and thus solutions of the first order elliptic system 1.8. Clearly,

$$\int_{\mathbb{S}^1} v_{\pm}(s, \cdot)^* \alpha = \pm T$$

is constant in $s \in \mathbb{R}$.

We conclude, that for proving the existence of periodic orbits we need to find a finite energy non constant J -holomorphic map in the following two situations: when ξ is an overtwisted contact structure and when ξ is tight on a manifold with $\pi_2(M) \neq 0$.

Overtwisted case.

Let us begin with the overtwisted case. Consider thus an overtwisted disc \mathcal{D} in M , oriented in such a way that the unique elliptic singularity e of \mathcal{D}_{ξ} is positive. We can explicitly construct a one dimensional family of small J -holomorphic discs in W with their boundaries on $\{0\} \times \mathcal{D}$ that pop out the singularity $(0, e)$. For a proof of the following theorem we refer to [6]. We will call such a family a Bishop family. The detailed description of a Bishop family is described in the theorem.

Theorem 1.55 *There is a continuous map*

$$\Psi : \mathbb{D}^2 \times [0, \epsilon) \rightarrow W,$$

$\epsilon > 0$, so that for each $u_t(\cdot) = \Psi(\cdot, t)$ we have that

- $u_t : \mathbb{D}^2 \rightarrow W$ is J -holomorphic;
- $u_t(\partial\mathbb{D}^2) \subset (\mathcal{D} \setminus \{e\}) \subset \{0\} \times M$;
- $u_t|_{\partial\mathbb{D}^2} : \partial\mathbb{D}^2 \rightarrow (\mathcal{D} \setminus \{e\})$ has winding number 1;
- $\Psi|_{\mathbb{D}^2 \times (0, \epsilon)}$ is a smooth map;
- $\Psi(z, 0) = e$ for all $z \in \mathbb{D}^2$.

It is important to notice that

$$u_t|_{\partial\mathbb{D}^2} : \partial\mathbb{D}^2 \rightarrow (\mathcal{D} \setminus \{e\})$$

is an embedding transversal to the characteristic foliation of \mathcal{D} . Following H. Hofer's proof (see [42]), we have that using the implicit function theorem we can find a *maximal Bishop family*

$$\Psi_{\max} : \mathbb{D}^2 \times [0, 1) \rightarrow W.$$

The transversality between $u_t(\partial\mathbb{D}^2)$ and \mathcal{D}_{ξ} , implies that $\Psi(\partial\mathbb{D}^2 \times [0, 1))$ cannot fill all of \mathcal{D} . We claim that the gradient of Ψ_{\max} has to blow, that is there exist sequences $t_k \rightarrow 1$ and $z_k \rightarrow z_0 \in \mathbb{D}^2$ such that

$$|\nabla \Psi_{\max}(z_k, t_k)| \rightarrow \infty.$$

If this was not the situation, the sequence $\Psi_{\max}(\cdot, t_k)$ would converge to a J -holomorphic disc which will allow us to extend the maximal family Ψ_{\max} . This is a contradiction. Thus

$$|\nabla \Psi_{\max}(z_k, t_k)| \rightarrow \infty$$

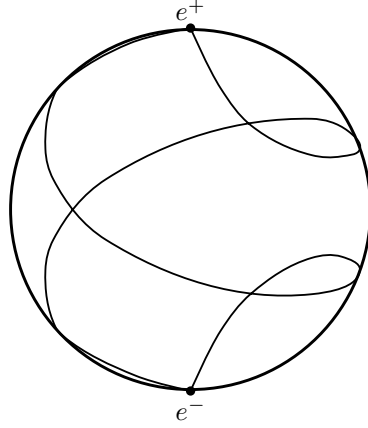
Figure 1.19: Foliation F_ξ

and we can assume, modulo reparameterization, that the z_k are bounded away from $\partial\mathbb{D}^2$. Hence the gradients are blowing up in the interior of \mathbb{D}^2 . Let us assume that $z_k = 0$ for all k and that the norm of the gradient $\nabla\Psi_{\max}$ is maximal at the origin. Write

$$\Psi_{\max}(z, t_k) = (a_k(z), u_k(z)) \in \mathbb{R} \times M.$$

Define a sequence of maps $v_k : D_k \rightarrow W$, where D_k is a two dimensional disc of radius R_k equal to $|\nabla\Psi_{\max}(0, t_k)|$, as

$$v_k(z) = \left(a_k \left(\frac{z}{R_k} \right) - a_k(0), u_k \left(\frac{z}{R_k} \right) \right).$$

The gradient of v_k does not blow up. H. Hofer then shows that the sequence $\{v_k\}$ converge to a non constant J -holomorphic finite energy plane $v : \mathbb{C} = \mathbb{S}^2 \setminus \{\infty\} \rightarrow W$. We have constructed a finite energy J -holomorphic map, thus X has a periodic orbit. This finishes the proof for the overtwisted case.

The tight case where $\pi_2(M) \neq 0$.

The sphere theorem implies that there is an embedded non contractible 2-sphere F in M . Using again E. Giroux's elimination lemma, we have an embedded sphere F such that F_ξ has only two elliptic tangencies as in figure 1.19.

As before we can start a Bishop family of J -holomorphic discs at each one of the singularities. Assume that we have a uniform bound for the gradient of the two families. Under this hypothesis, we can show that the two families match up when they meet. Hence we get a continuous map $\mathbb{D} \times [-1, 1] \rightarrow W$ such that $\mathbb{D} \times \{-1\}$ is mapped to one singularity and $\mathbb{D} \times \{1\}$ to the other. That is, we get a map from the closed three dimensional ball \mathbb{D}^3 to W which induces an homeomorphism from $\mathbb{S}^2 = \partial\mathbb{D}^3 \rightarrow F$. This implies that F is contractible, which is clearly, a contradiction.

Hence we cannot have a uniform bound for the gradient of the two families, and thus, we obtain a Bishop family of J -holomorphic discs such that the gradients blow up. As in the overtwisted case, we can suppose that they blow up at the center of the disc and construct a J -holomorphic non constant finite energy plane which yields to the existence of a periodic orbit of X .

1.6.3 Finite energy foliations

In this section we will discuss briefly some results of H. Hofer, Krzysztof Wysocki and E. J. Zehnder from [43] and [44], concerning *finite energy foliations*. We will use them at the end of next section when proving theorem 1.27. Let us start with the definition. As before, M is a closed 3-manifold, $\xi = \ker(\alpha)$ is a contact structure, and J is the almost complex structure defined in equation 1.7.

Definition 1.56 *A finite energy foliation of M is a two dimensional foliation \mathcal{F} of $W = \mathbb{R} \times M$ which is invariant under the translation along \mathbb{R} and whose leaves are J -holomorphic surfaces having uniformly bounded energies.*

Proposition 1.57 *Let \mathcal{F} be a finite energy foliation of (M, α) ,*

- *if L is a leaf of \mathcal{F} invariant under some translation along \mathbb{R} , then $L = \mathbb{R} \times O$ where O is a periodic orbit of the Reeb vector field X associated to α .*
- *if a leaf L is not invariant under any translation then its projection \tilde{L} to M is an embedded submanifold of M transverse to X .*
- *if the projection of two leaves \tilde{L} and \tilde{G} intersect in M , then L is a translate of G and $\tilde{L} = \tilde{G}$.*

Thus the projection of \mathcal{F} to M is a singular two dimensional foliation, transverse to X outside the set of periodic orbits and singular along the periodic orbits. We will say that a periodic orbit is non degenerated if the Poincaré first return map has no eigenvalue equal to one. A contact form will be non degenerated if all the periodic orbits of the associated Reeb vector field X are non degenerated. Such forms are abundant, as the following proposition from [43] indicates.

Proposition 1.58 *Fix a contact form α on a closed 3-manifold M . Consider the subset $\Theta \subset C^\infty(M, (0, \infty))$ consisting of those f for which $f\alpha$ is non degenerated, then Θ is a Baire subset.*

Proof. Consider the manifold $W = \mathbb{R} \times M$ equipped with the symplectic form $\omega = d(e^t\alpha)$ and identify M with $\{0\} \times M$. Recall that the Hamiltonian flow associated to the Hamiltonian H that is the projection from W to \mathbb{R} , coincide on M with the flow of the Reeb vector field of the contact form α .

Let $N \subset W$ be a hypersurface close to M . Then N can be represented as the graph of a function $\phi : M \rightarrow \mathbb{R}$, and thus we have a diffeomorphism $\Phi : M \rightarrow N$ defined by $m \mapsto (\phi(m), m)$. We can define a 1-form α_N as

$$\alpha_N = \Phi^*(e^t\alpha|_N).$$

If N is C^∞ close to M , the 1-form α_N is also C^∞ close to α . A deformation theorem of J. W. Gray states, that in this situation there exists a diffeomorphism Ψ of M that is C^∞ close to the identity map such that $\Psi^*\alpha_N = g\alpha$, for a function $g : M \rightarrow (0, \infty)$ that is C^∞ close to the constant map equal to one. We refer the reader to [35]. Then the Hamiltonian dynamics on a hypersurface close to M is conjugated to the dynamics of the Reeb vector field associated to the contact form $g\alpha$. A theorem of R. Clark Robinson states that non degenerated Hamiltonian vector fields are residual among hypersurfaces, we refer to the main theorem from [63]. Thus close to M there is a non degenerated level hypersurface of H , that is a hypersurface such that all its periodic orbits are non degenerated. Therefore, we find smooth functions $g : M \rightarrow (0, \infty)$ close to the constant equal to one map, such that the periodic orbits of the contact forms $g\alpha$ are non degenerated.

Given a function $f : M \rightarrow (0, \infty)$, we can apply the arguments below to the manifold $(M, f\alpha)$ at the place of (M, α) . Thus the subset Θ is dense in $C^\infty(M, (0, \infty))$.

□

Finally we can state the main result regarding finite energy foliations

Theorem 1.59 (Hofer, Wysocki, Zehnder) *If α is a non degenerated tight contact form on \mathbb{S}^3 , there is a Baire set of admissible complex structures J^ξ on ξ for which $(\mathbb{S}^3, \alpha, J)$ admits a finite energy foliation.*

1.6.4 Reeb vector fields on manifolds with boundary

The aim of this section is to prove the theorem 1.27. In their article [23], J. Etnyre and R. Ghrist proved that every Reeb vector field on a solid torus possesses a periodic orbit. We will generalize their theorem to 3-manifolds with boundary and with non trivial homotopy group π_2 .

Theorem 1.27 *Let X be a Reeb vector field on a compact 3-manifold \overline{B} , with $\partial\overline{B} \neq \emptyset$ and X tangent to the boundary. If either \overline{B} is a solid torus or has non trivial second homotopy group, X possesses a periodic orbit.*

Assume that $X|_{\partial\overline{B}}$ has no periodic orbits. Note first that $\partial\overline{B}$ is the union of invariant 2-tori, and the vector field X is topologically conjugated to a linear vector field with irrational slope on them. Assume that $\alpha|_{\overline{B}}$ is a positive contact form. Consider as in the previous section the manifold $W = \mathbb{R} \times \overline{B}$ with the symplectic form

$$\omega = d(e^t \alpha) = e^t(dt \wedge \alpha + d\alpha).$$

We will choose a complex structure J^ξ on $\xi = \ker(\alpha)$, such that $d\alpha(v, J^\xi v) > 0$ on \overline{B} , for every non zero $v \in \xi$. We will use the almost complex structure J defined in equation 1.7. The next lemma is immediate.

Lemma 1.60 *The boundary of W is Levi flat with respect to J , in other words ∂W is foliated by the J -complex surfaces $\mathbb{R} \times \gamma$, where γ is an orbit of X .*

We will use the next result by Dusa McDuff from [57] that studies the intersection between almost complex surfaces.

Theorem 1.61 (McDuff) *Two closed distinct J -holomorphic curves C and C' in an almost complex 4-manifold (W, J) have only a finite number of intersection points. Each such a point contributes with a positive number to the algebraic intersection number $C \cdot C'$.*

Proof of theorem 1.27 in the overtwisted case and when $\pi_2(B) \neq 0$. Assume first that ξ is overtwisted. We begin by completing B to a closed 3-manifold M and extending the contact structure α to M (see theorem 5.8 of [23]). Take an overtwisted disc \mathcal{D} embedded in the interior of B . Let $W \subset W'$ be the symplectisation of M . There exists a maximal Bishop family of J -holomorphic discs

$$\Psi : \mathbb{D}^2 \times [0, 1) \rightarrow W'$$

satisfying the conditions of theorem 1.55. Observe that $\Psi(\partial\mathbb{D}^2, t) \subset \mathcal{D} \subset \{0\} \times B$. We claim that $\Psi(\mathbb{D}^2, t) \subset \mathbb{R} \times B$. Assume that this is not the case, then one of the $u_t(\mathbb{D}^2) = \Psi(\mathbb{D}^2, t)$ touches the

boundary of W tangentially. Since ∂W is foliated by J -holomorphic surfaces, $u_t(\mathbb{D}^2)$ intersects one of the surfaces $\mathbb{R} \times \gamma$, where γ is an orbit of X . Since $u_t(\mathbb{D}^2)$ is homotopic to a point and its boundary through the homotopy is in the interior of B , the algebraic intersection number between $u_t(\mathbb{D}^2)$ and $\mathbb{R} \times \gamma$ is zero. Applying theorem 1.61 we get a contradiction. Thus the discs in the Bishop family are inside W .

Recall that following the proof of H. Hofer we get a finite energy plane $v : \mathbb{C} \rightarrow W$. Since all the $\Psi(\mathbb{D}^2, t)$ are contained in the interior of W , so does $v(\mathbb{C})$ and thus we obtain a periodic orbit in B . Observe that we did not use the hypothesis on the topology of B , thus we have proved that in a manifold with boundary a Reeb vector field, tangent to the boundary and associated to an overtwisted contact structure has a periodic orbit.

The same arguments are valid when $\pi_2(B) \neq 0$. Consider a non contractible 2-sphere F embedded inside B . Using again E. Giroux's elimination lemma, we have an embedded sphere F such that F_ξ has only two elliptic tangencies as in figure 1.19. We can start a Bishop family of J -holomorphic discs at each one of the singularities. Using D. McDuff's theorem we can show that such families are contained in the symplectic manifold $\mathbb{R} \times B$.

Assuming that we have a uniform bound for the gradient of the two families, we have that the two families match up when they meet. Hence we get a continuous map from $\mathbb{D} \times [-1, 1] \rightarrow W$ such that $\mathbb{D} \times \{-1\}$ is mapped to one singularity and $\mathbb{D} \times \{1\}$ to the other one. That is, we get a map from the closed three dimensional ball \mathbb{D}^3 to $\mathbb{R} \times B$ which induces an homeomorphism from $\mathbb{S}^2 = \partial\mathbb{D}^3 \rightarrow F$. This implies that F is contractible, which is clearly a contradiction. Hence we can construct a J -holomorphic non constant finite energy plane whose image is contained in the interior of $\mathbb{R} \times B$. Thus X possesses a periodic orbit.

□

We have not proved the theorem when B is a solid torus and ξ is a tight contact structure. We will begin by studying tight contact structures on solid tori. We will introduce some results from Sergei Makar Limanov's article [54]. From now on, all the contact structures considered are tight, unless otherwise stated.

In general, a curve Γ on a contact manifold (B, ξ) is called transversal if it is transversal to ξ . Consider a transversal curve Γ spanned by an embedded surface S , this means that $\partial S = \Gamma$. We can choose along Γ a non vanishing vector field $Y \in \xi|_S$. Since Γ is transversal to ξ , it is transversal to Y , and we can push Γ along Y and obtain a curve Γ' disjoint from Γ . Define the self linking number $l(\Gamma)$ of Γ as the intersection number of Γ' and S . The self linking number is well defined and does not depend on the choice of S , we refer to [54]. It is important to notice that the intersection number of Γ' and S depends on their orientation, but there is a natural one. Transversal curves come with a natural orientation given by the coorientation of the contact structure: a non zero vector v tangent to Γ gives the correct orientation if $\alpha(v) > 0$. The curve Γ' inherits the orientation from Γ . For S we will take the orientation for which the leaves of S_ξ exit through the boundary Γ .

D. Bennequin showed that in \mathbb{S}^3 with the standard contact structure $l(\Gamma) \leq \chi(S)$, where $\chi(S)$ is the Euler characteristic of S . See theorem 11 from [5]. Y. Eliashberg showed that this inequality holds on all tight contact manifolds. He also proved that if the characteristic foliation of the surface S has only elliptic and hyperbolic singularities, the self linking number is equal to

$$e_- + h_+ - (e_+ + h_-),$$

where e_{\pm} and h_{\pm} denotes the number of positive, negative elliptic and hyperbolic singularities of S_{ξ} , respectively. We refer to section 3.1 of [18]. In particular, if S is a disc all negative elliptic and positive hyperbolic singularities may be eliminated by a C^0 small isotopy of the disc that fixes a neighborhood of the boundary. Hence the self linking number of a curve that spans a disc is negative and it is equal to $-(e_+ + h_-)$.

From now on we will consider tight contact structures, we will denote \mathbb{T} for a solid torus and T for a 2-dimensional torus embedded in a tight contact manifold, eventually $T = \partial\mathbb{T}$. A curve in T is called a *super-transversal* if it is transversal to the characteristic foliation T_{ξ} and intersects every leaf at least once. Assume that T_{ξ} is non singular and does not contain Reeb annuli. Consider the homology group $H_1(T, \mathbb{Z})$, an homology class is called *Legendrian* if it can be represented by a closed leaf of T_{ξ} . Note that a transversal curve which represents a non Legendrian class is homologous to a super-transversal, in fact in each non Legendrian class of curves there is at least one super-transversal. Finally there is, at most, one Legendrian homology class up to orientation. These reasons allows us to give the next definition. For the proofs of the claims above we refer to section 4 of [54].

Definition 1.62 *Let $m \in \partial\mathbb{T}$ be a super-transversal that is a meridian, then the self-linking number of \mathbb{T} is defined as $l(\mathbb{T}) = l(m)$.*

Then the self linking number does not depend on m , it depends on the tight contact structure in it. The self-linking number is a contact invariant: two contactomorphic solid tori have the same self-linking number, see [54].

Definition 1.63 *A tight contact structure ξ on a 3-manifold M is virtually overtwisted if there is a finite cover of M such that ξ is overtwisted.*

Theorem 1.64 (Makar-Limanov) *Let ξ be a tight contact structure on a solid torus \mathbb{T} for which T_{ξ} is non singular and has no Reeb annuli, $T = \partial\mathbb{T}$. The contact structure is virtually overtwisted if and only if the self-linking number of the torus is less than -1.*

Observe that in the situation of theorem 1.27, X is tangent to the boundary torus T and thus the 1-foliation T_{ξ} is non singular. Also, it does not have Reeb annuli because we assume that X does not posses periodic orbits on T ; and by tightness the foliation T_{ξ} does not have circle leaves that are homotopic to meridians. The latter theorem is theorem 9.1 from [54], we will prove below. Observe that since $l(\mathbb{T}) = l(m)$, where m is a meridian on T ,

$$l(\mathbb{T}) = -(e_+ + h_-), \quad (1.9)$$

where the singularities are in the characteristic foliation of a disc D spanned by m . Note also that since T_{ξ} is non singular, it defines a return map Φ on m , to which we can associate a rotation number $r(\Phi) \in [0, 1]$ as for homeomorphisms of the circle. To proof theorem 1.64 we need lemmas 1.65 and 1.67 below. Let \mathbb{T} be a solid torus endowed with a tight contact structure ξ and $T = \partial\mathbb{T}$.

Lemma 1.65 *Assume that \mathbb{T} has a deformation and retraction to a solid torus $\mathbb{T}' \subset \mathbb{T}$ for which T'_{ξ} is non singular. If, for any such a \mathbb{T}' , the return map Φ' for the meridian $m' = D \cap T'$ has an irrational rotation number and the self linking number is strictly less than -1, then \mathbb{T} has an overtwisted finite cover.*

Proof. Since the self-linking number of m' is strictly less than -1 , equation 1.9 implies that there is at least one hyperbolic point in the characteristic foliation of the disc D' spanned by m' ,

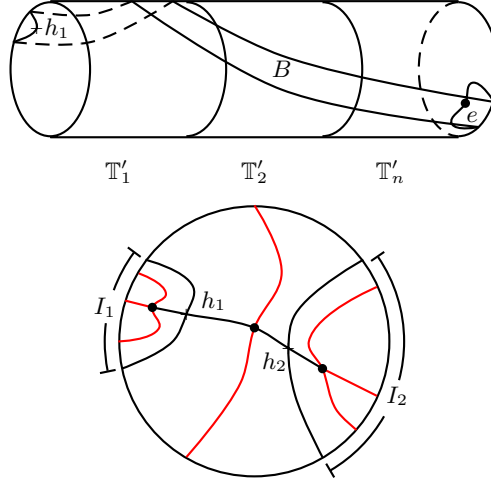

Figure 1.20: Overtwisted finite cover

that is $\partial D' = m'$. If there is only one such a singularity, m' is divided into two open intervals I_1 and I_2 by the ends of the unstable manifold of the hyperbolic point. Otherwise, we can find two hyperbolic singularities, h_1 and h_2 , such that for each one their unstable foliation $W^u(h_j)$, for $j = 1, 2$, divides D' in two discs and one of them contains just one singularity, that has to be elliptic. Denote I_j the arc in m' that is in the boundary of each one of these discs, as in figure 1.20.

We claim that some iterate of the map Φ' maps I_1 to I_2 , or viceversa. This follows from the fact that Φ' is conjugated to the irrational rotation of the circle, thus the iterates of Φ' map the clockwise endpoint of I_1 arbitrarily close to the clockwise endpoint of I_2 . So either I_1 is mapped into I_2 , or I_2 is mapped into I_1 for some iterated of Φ' , or the length of the two intervals is the same. In the latter situation, we can shrink the torus in order to change the length of one of the intervals. This proves our claim.

Let us assume now that $(\Phi')^n(I_1) \subset I_2$. Then the $n + 1$ fold cover of \mathbb{T} contains an overtwisted disc as in the figure 1.20. Let us describe the figure: the cover is composed of n copies of \mathbb{T} cut along the meridional disc D . Inside of these copies there are copies of \mathbb{T}' labeled \mathbb{T}'_i , $1 \leq i \leq n$, cut along D' . In \mathbb{T}'_1 we have a disc $D_{h_1} \subset D'$ whose boundary is composed by I_1 and the unstable leaves of h_1 , that we will denote by $W^u(h_1)$. Let C be the disc that consists of all the leaves of the characteristic foliation of $\cup_i \mathbb{T}'_i$ that begin in I_1 and finish in $I_2 \subset \mathbb{T}'_n$. Recall that $(\Phi')^n$ is defined by this characteristic foliation. Finally, in $D' \subset \mathbb{T}'_n$ we take the disc D_e consisting of the leaves of the foliation D'_ξ that emanate from the interval $C \cap I_2$ and have as limit point the elliptic singularity. We will use lemma 2.9 from [54], stated below as lemma 1.66, that allows us to smooth the corners of the disc $D_{h_1} \cup C \cup D_e$ without changing the characteristic foliation. We obtain a disc D_0 , such that ∂D_0 is tangent to the characteristic foliation and contains one hyperbolic and one elliptic singularity. Using E. Giroux's elimination lemma we may cancel these singularities leaving ∂D_0 a closed leaf of the characteristic foliation. This disc is then an overtwisted disc.

□

Lemma 1.66 (Makar Limanov) *Let $F \subset (M, \xi)$ be a piecewise smooth surface with transversal corner singularities. Then there exists a C^0 small piecewise smooth isotopy $h_t : M \rightarrow M$ such that*

- (i) h_0 is the identity;
- (ii) h_t is supported on a arbitrarily small tubular neighborhood $U \subset M$ of the singularities of F (that is the corners of F);
- (iii) $h_1(F)$ is smooth;
- (iv) any two points $x, y \in F \setminus U$ which could be connected by a piecewise smooth Legendrian curve in F , will lie in the same leaf of the characteristic foliation $(h_1(F))_\xi$;
- (v) $(h_1(F))_\xi$ has no new singularities.

Lemma 1.67 *Under the hypothesis of theorem 1.64, there is a near-identity deformation retraction \mathbb{T}' of \mathbb{T} such that T'_ξ is non-singular and Φ' has an irrational rotation number.*

Proof. Recall that the characteristic foliation of T has a closed transversal. Thus we can consider a solid torus $V \subset \mathbb{S}^1 \times \mathbb{R}^2$ with polar coordinates (ϕ, r, θ) , which is endowed with the contact structure $\xi_0 = \ker(r^2 d\theta + d\phi)$. This is the restriction of the standard contact structure of \mathbb{R}^3 defined in equation 1.5. Let $s < 0$ be the slope of the foliation T_ξ (up to topological conjugacy), choose V to be the torus defined by $\{r \leq \sqrt{s}\}$. Then ∂V_{ξ_0} and T_ξ agree, and thus by theorem 1.48 they are contactomorphic in a neighborhood of their boundaries.

Shrinking ∂V radially gives us a 1-parameter family of nearby 2-tori with linear characteristic foliations varying non trivially and continuously. Hence near ∂V there are tori with irrational linear characteristic foliations. Thus we can retract V and then use the contactomorphism to obtain the desired retraction of \mathbb{T} . □

Proof of theorem 1.64. Given a solid torus \mathbb{T} with $l(\mathbb{T}) < -1$ we may deform it by a retraction to obtain a solid torus \mathbb{T}' such that T'_ξ is linear with irrational slope. The restriction of D to \mathbb{T}' is also a meridional disc with transverse boundary and the same self-linking number. Then by lemma 1.65 it has an overtwisted finite cover.

Now assume that the self-linking number of \mathbb{T} is -1 . The lemma 4.4 of S. Makar-Limanov's article [54] states that (\mathbb{T}, ξ) is contactomorphic to

$$V = \{(\phi, r, \theta) \in \mathbb{S}^1 \times \mathbb{R}^2 \mid r \leq f(\phi, \theta)\},$$

for some function $f : \mathbb{S}^1 \times \mathbb{S}^1 \rightarrow \mathbb{R}$. The manifold V is equipped with the tight contact structure $\xi_0 = \ker(r^2 d\theta + d\phi)$. By lifting along the coordinate ϕ , one obtains an infinite cylinder \tilde{V} in $(\mathbb{R}^1 \times \mathbb{R}^2, r^2 d\theta + d\tilde{\phi})$. The kernel of this contact form defines the standard contact structure on \mathbb{R}^3 in polar coordinates. This contact structure is tight, see [5]. Thus any finite cover of V yields to a tight contact structure, and (\mathbb{T}, ξ) is not virtually overtwisted. □

Proof of theorem 1.27 on a solid torus with a tight contact structure. We will suppose that X does not posses periodic orbits on the boundary of the solid torus and that the contact structure

is tight. Let T be the boundary of the torus. By tightness the characteristic foliation of every embedded torus S near T has no meridians and thus we can find a meridian curve transverse to T_ξ defining the self-linking number of \mathbb{T} .

If $l(\mathbb{T}) < -1$, theorem 1.64 implies that there is an overtwisted finite cover. Using the first part of theorem 1.27 the associated Reeb vector field possesses a periodic orbit in this finite cover. Under the covering map flowlines are mapped into flowlines, and hence X must have a periodic orbit.

If $l(\mathbb{T}) = -1$ assume that X does not possess a periodic orbit. By theorem 5.4 of [54] there exists a map h from \mathbb{T} into a tubular neighborhood V of an unknot transversal to the standard contact structure ξ_0 of the sphere \mathbb{S}^3 such that

$$h_*(\xi|_{\mathbb{T}}) = \xi_0.$$

Thus, we can push forward the 1-form $\alpha|_{\mathbb{T}}$ to V and extend it to a contact form λ on \mathbb{S}^3 , such that its contact structure is tight. Thus we have a Reeb vector field X_λ associated to the tight contact structure on \mathbb{S}^3 . The vector field X_λ coincides with X on $h(\mathbb{T}) \subset V$ and all its periodic orbits must, by assumption, lie outside V . Recall that a contact form is non degenerated if the Poincaré first return map, associated to the periodic orbits of the Reeb vector field, has no eigenvalue equal to one.

Lemma 1.68 *There exists a perturbation of λ fixing V that is a non degenerated contact form.*

The proof of this lemma is the same as the one of proposition 1.58. The only extra observation we need is that R. C. Robinson's theorem holds for open manifolds in the strong C^∞ topology. Thus we can perturb \mathbb{S}^3 on the complement of V , to get a hypersurface close to \mathbb{S}^3 where the periodic orbits are non degenerated.

Let us call λ the non degenerated contact form. Thus theorem 1.59 guarantees the existence of a finite energy foliation \mathcal{F} of (\mathbb{S}^3, λ) . The projection of the foliation \mathcal{F} to \mathbb{S}^3 is a foliation transversal to the vector field X_λ on the complement of the periodic orbits. Since the periodic orbits are in $\mathbb{S}^3 \setminus V$, the finite energy foliation $\mathcal{F}|_V$ is transversal to X and non singular. Then $\mathcal{F}|_{\partial h(\mathbb{T})}$ is a 1-foliation by circles, and since $X|_V$ does not have periodic orbits, it must be a foliation by meridional circles. We get a contradiction, a vector field on a solid torus transverse to such a foliation has a periodic orbit by L. Brouwer's fixed point theorem.

□

Chapter 2

Følner leaves and amenable foliations

In the context of finitely generated groups, an *amenable* group is *Følner*, and viceversa. We will study the relation between these two notions in the context of compact foliated manifolds. Both definitions, for foliations, are motivated by the corresponding ones on groups. Let us start by defining the two notions for finitely generated group. A finitely generated group G is said to be amenable if there is a translation invariant *mean*. A mean is a linear functional on the Banach space $L^\infty(G)$ which maps the constant function equal to one to one, and non negative functions to non negative numbers. On the other hand, we say that the group G is Følner if

$$\inf_E \frac{|\partial E|}{|E|} = 0,$$

where $|\cdot|$ denotes the cardinality of a set, and $E \subset G$ describes the finite subsets. The set ∂E is the boundary of E with respect to a given set of generators of G . Erling Følner showed that if G is a finitely generated group, G is amenable if and only if it is Følner. We refer to E. Følner's paper [25] or to Frederick P. Greenleaf's book [37].

Consider now a foliation of a compact manifold. Assume that the ambient manifold is endowed with a Riemannian metric, this metric defines a metric on the leaves. Given a foliated atlas, a foliation defines an equivalence relation on a *total transversal*: two points are equivalent if they belong to the same leaf. As we will explain, the equivalence classes have a graph structure. These graphs, endowed with the natural metric, are *roughly quasi-isometrically equivalent* to the corresponding leaves of \mathcal{F} .

Amenable foliations and *Følner leaves* can be defined in terms of the equivalence relation and are independent of the choice of the foliated atlas. Roughly, amenability is the property of having a mean on almost all the equivalence classes, with respect to a transverse invariant measure of \mathcal{F} . We will explain this definition in section 2.2. On the other hand, a leaf is Følner if there are finite

subsets A of vertices in the graph of an equivalence class, with arbitrary small isoperimetric ratio

$$\frac{|\partial A|}{|A|},$$

where ∂A is the boundary of A .

In 1983, Robert Brooks stated, without proving: *let \mathcal{F} be a foliation with a transverse invariant measure μ . If μ -almost all leaves are Følner, \mathcal{F} is amenable with respect to μ .* (example-theorem 4.3 from [7]). Some years later, Yves Carrière and Étienne Ghys proved that an amenable foliation has almost all its leaves Følner (theorem 4 from [11]), asserting the equivalence of the two notions.

One of the aims of the present chapter is to show that amenability cannot be deduced from the condition of having Følner leaves, thus disproving R. Brooks statement. We will prove

Theorem D *There exists a non-amenable real analytic foliation \mathcal{F} of a compact manifold M with a transverse invariant ergodic volume, and such that all the leaves are Følner.*

In 2001, Vadim A. Kaimanovich had already constructed an example of a non-amenable foliation with Følner leaves. The foliation has Reeb components, and thus the invariant measure is not locally finite. We refer the reader to theorem 3 of [49]. An improvement, in our example, is the transverse invariant measure.

The construction in the proof of the theorem uses the plug technique, introduced in the previous chapter, this time for two dimensional foliations. Actually, we will use a volume preserving version of F. W. Wilson's plug to make the leaves of a non-amenable foliation Følner.

The other aim of the chapter is to give a sufficient condition to guarantee that a foliation with Følner leaves is amenable. In [49], V. A. Kaimanovich asked if the *minimality* of the foliation guarantees the equivalence between the two notions. We will show that this is indeed the case.

Theorem E *Let \mathcal{F} be a minimal foliation of a compact manifold M . If μ is a transverse invariant measure and μ -almost all the leaves are Følner, \mathcal{F} is amenable for μ .*

A stronger hypothesis will be to ask for a *uniquely ergodic* foliation. A foliation is uniquely ergodic if it has a unique *harmonic measure*. Such foliations are minimal. Harmonic measures were introduced by Lucy Garnett in [26]. In contrast with transverse invariant measures, harmonic measures always exist and thus they give a framework to develop an ergodic theory. An important fact for us, regarding harmonic measures, is that a transverse invariant measure of a foliation combined with the density volume on the leaves, defines a harmonic measure. Thus if a uniquely ergodic foliation has a transverse invariant measure, the latter measure is unique.

The chapter is organized as follows. In the first section we will define the notion of Følner leaf as well as other invariants associated to the Riemannian geometry of leaves, like the *type of growth* and *Jeff Cheeger's isoperimetric constant* [13]. As we will see, some are related to the existence of transverse invariant measures. In the second section we will define amenability, and study the relation between this notion and the previous invariants of the leaves.

The example proving theorem D is constructed in section 2.3. We will review the theory of harmonic measures, and some aspects of their ergodic theory, in section 2.4. In section 2.5 we will prove a theorem by Daniel Cass from [12], that studies minimal leaves of foliations. We will use this result to prove theorem E. The proof is given in section 2.6.

2.1 Foliations with Følner leaves

In this section we will introduce a reduction of a foliation to the measure theoretical category, consisting in choosing a foliated atlas and considering the induced equivalence relation on the union of transversals. The obtained equivalence relation can be given a graph structure. The resulting leafwise graphs are *roughly quasi-isometric* to the leaves.

The section is organized as follows. We will start by describing the equivalence relation and its graph structure. We will continue by introducing some invariants of the leaves of a foliation: J. Cheeger's isoperimetric constant and the type of growth. The first invariant will allow us to define what a Følner leaf is. Finally, we will state some results relating these notions with the existence of transverse invariant measures for the foliation.

Consider a smooth foliation \mathcal{F} of a compact n -manifold M . We will call q the codimension and d the dimension of \mathcal{F} , so that $n = q + d$. Let us give a definition that we will use frequently in this chapter.

Definition 2.1 *Let L and L' be Riemannian manifolds whose metrics are g and g' , respectively. We say that L and L' are quasi-isometrically equivalent if there exists a diffeomorphism $\phi : L \rightarrow L'$ and a constant $k \geq 1$ such that*

$$\frac{1}{k}g_1(V) \leq g_2(\phi^*(V)) \leq kg_1(V),$$

for every tangent vector $V \in TL'$. The constant k is the dilatation bound.

Two metrics on a Riemannian manifold are quasi-isometrically equivalent if there is an automorphism of the manifold satisfying the corresponding inequalities above.

Note that a leaf L of \mathcal{F} carries a natural quasi-isometric class of metrics: those which are restrictions of Riemannian metrics on M .

The foliation defines a natural equivalence relation on a *total transversal*. Let us describe this in detail: take an atlas of foliated charts $\{U_i, \phi_i\}_{i \in I}$

$$\phi_i(U_i) \simeq \mathbb{D}^d \times \mathbb{D}^q,$$

where \mathbb{D}^d is the d -dimensional open disc in \mathbb{R}^d . We say that

- $\phi_i^{-1}(\mathbb{D}^d \times \{\cdot\})$ are the *plaques* of \mathcal{F} in U_i ;
- $T_i = \phi_i^{-1}(\{0\} \times \mathbb{D}^q)$ are the *local transversals* and $T = \coprod_i T_i$ is a *total transversal*.

We will require the atlas to have some nice properties. First, if the intersection $U_i \cap U_j$ is not empty then each plaque in U_i should meet at most one plaque in U_j . Secondly, we will assume that the d -volume of the plaques and the $(d-1)$ -volume of their boundaries are uniformly bounded. For a proof of the existence of an atlas satisfying the conditions above we refer to section 1.2 of A. Candel and L. Conlon book [9].

An equivalence relation R is naturally defined on T : two points $x, y \in T$ are equivalent if and only if they are in the same leaf of \mathcal{F} .

From another point of view, we can see the equivalence relation R as the orbit equivalence relation of the pseudogroup Γ of $(\mathcal{F}, \{U_i, \phi_i\})$. This pseudogroup is generated by the local diffeomorphisms γ_{ij} such that for $x \in T_i$ we have $\gamma_{ij}(x) = y \in T_j$, if the plaque through x meets the

plaque through y , whenever $U_i \cap U_j \neq \emptyset$. We will choose the γ_{ij} to have maximal domain. Clearly, this domain needs not be all T_i . It is important to emphasize that $\{\gamma_{ij}\}$ forms a finite symmetric set of generators of Γ , that we will call Γ_1 . The equivalence relation R is then generated by Γ : two points are equivalent if they belong to the same Γ orbit.

A leaf of the foliation corresponds to an equivalence class. Notice that we can visualize the equivalence class $R[x]$, of a point $x \in T$, as a graph: the vertices are the points in $R[x]$ and there is an edge between x and y if there is an element $\gamma \in \Gamma_1$ such that $\gamma(x) = y$. We will note $\widetilde{R[x]} = \widetilde{\Gamma(x)}$ the graph. We can define a metric d_Γ , the graph metric, on $\widetilde{R[x]}$ by

$$d_\Gamma(x, y) = \min_n \{ \exists g \in \Gamma_n | g(x) = y \},$$

where $\Gamma_n \subset \Gamma$ are the elements that can be expressed like words of length at most n in terms of the generating set. This metric is not quasi-isometric to a metric on the leaves induced by a Riemannian metric on the compact ambient manifold M , because two points in a leaf are identified to one point in the graph if they belong to the same plaque. But we will say that they are *roughly* quasi-isometric to any metric on the leaves induced by a Riemannian metric on the compact ambient manifold M , because we can find a dilatation bound k and a positive constant C such that

$$\frac{1}{k}d_\Gamma - C \leq d \leq kd_\Gamma + C,$$

where d a distance in the leaves. Abusing of the notation we will say that a leaf L through a point $x \in T$ is roughly quasi-isometric to the corresponding graph $\widetilde{L[x]}$.

We will now give some invariants of the leaves. If the leaves of \mathcal{F} are endowed with a Riemannian metric, we define J. Cheeger's isoperimetric constant for a leaf L by

$$h(L) = \inf_V \frac{\text{area}(\partial V)}{\text{volume}(V)},$$

where V ranges over compact d -submanifolds of L with smooth boundary. Here, area denotes the $(d-1)$ -volume and volume the d -volume. This invariant was introduced by J. Cheeger's in [13]. Note that if we consider two metrics g_1, g_2 on L that are quasi-isometrically equivalent, $h(L)$ changes by a multiplicative factor between $\frac{1}{k}$ and k . Thus the condition $h(L) = 0$ is independent of the metric on L . Using A. P. Stokes' theorem it is possible to prove the following proposition.

Proposition 2.2 *Let V be a compact domain in a complete simply connected n -manifold with sectional curvature bounded from above by $-K$, with $K > 0$. Then*

$$\frac{\text{area}(\partial V)}{\text{volume}(V)} \geq (n-1)\sqrt{K}.$$

For a proof we refer to proposition 3 of Shing Tung Yau's paper [82]. This implies, in particular, that for the n dimensional hyperbolic space, $h(\mathbb{H}^n) > 0$. We can easily verify that $h(\mathbb{R}^n) = 0$: consider \mathbb{R}^n with the euclidean metric and the sequence of discs centered at the origin and radius $r \rightarrow \infty$.

We can define another isoperimetric constant for the leaves, this time in terms of the pseudogroup Γ . Let

$$h_\Gamma(L) = \inf_E \frac{|\partial_\Gamma E|}{|E|}$$

where $E \subset L \cap T$ are finite subsets, $|\cdot|$ stands for the cardinality and

$$\partial_\Gamma E = \{y \in E \mid \gamma_{ij}y \notin E \text{ for some } \gamma_{ij} \in \Gamma_1\}.$$

This constant is motivated by the definition of Følner finitely generated groups. We have that

Definition 2.3 *A leaf L is said to be Følner if $h_\Gamma(L) = 0$.*

Observe that $h_\Gamma(L) = 0$ if and only if $h(L) = 0$. Even better, there exist positive constants a and b , depending on Γ and the choice of metric on M , such that

$$ah_\Gamma(L) \leq h(L) \leq bh_\Gamma(L),$$

for every leaf L . We refer to lemma 2.4 in [8].

Continuing with the invariants we want to introduce in this section, we get to the type of growth of a leaf. For a leaf L of the foliation consider the limits

$$\begin{aligned} \bar{\alpha}(L) &= \limsup_{r \rightarrow \infty} \frac{1}{r} \log[\text{volume}(B(x, r))] \\ \underline{\alpha}(L) &= \liminf_{r \rightarrow \infty} \frac{1}{r} \log[\text{volume}(B(x, r))] \end{aligned}$$

where $B(x, r)$ is the closed ball centered at x of radius r in L . It is easy to check that $\bar{\alpha}$ and $\underline{\alpha}$ are independent of the point x . Furthermore, if the metric on L is changed to a quasi-isometrically equivalent metric, $\bar{\alpha}$ (respectively, $\underline{\alpha}$) will lie between $\frac{1}{k}\bar{\alpha}$ and $k\bar{\alpha}$ (respectively, between $\frac{1}{k}\underline{\alpha}$ and $k\underline{\alpha}$), where k is the dilatation bound. We say that L has *sub-exponential growth* if $\underline{\alpha}(L) = 0$. If $\underline{\alpha}(L) = \bar{\alpha}(L) = 0$, we will say that L has *quasi-polynomial growth*. Observe that for a leaf being Følner is a weaker condition than having sub-exponential growth: *i.e.* the condition $\underline{\alpha}(L) = 0$ implies that $h(L) = 0$.

We will now give some results relating the previous definitions with transverse invariant measures. Recall that a transverse invariant measure is a measure invariant under the action of the holonomy pseudogroup. We will start with Joseph F. Plante's theorem, for a proof we refer to theorem 6.3 of [61].

Theorem 2.4 (Plante) *The support of any transverse invariant measure of a codimension one C^0 foliation consists of leaves with polynomial growth.*

For foliations of any codimension, J. F. Plante also proved: *the existence of a leaf with sub-exponential growth, implies the existence of a transverse invariant measure whose support is contained in the closure of the leaf* (theorem 4.1 of [61]). The following proposition is due to Sue Goodman and J. F. Plante (corollary 2.2 of [33]).

Proposition 2.5 (Goodman, Plante) *A Følner leaf gives rise to a transverse invariant measure μ whose support is contained in the leaf closure.*

Proof. Let L be a Følner leaf and $E_i \subset L \cap T$ be a sequence of finite subsets such that

$$\frac{|\partial_\Gamma E_i|}{|E_i|} \rightarrow 0.$$

Consider the sequence of foliation currents given by

$$\xi_i(\alpha) = \frac{1}{\text{volume}(V_i)} \int_{V_i} \alpha,$$

where V_i is the closure of the union of the plaques through the points of E_i and α is a differential d -form. Note that the mass of ξ_i is one and the mass of $\partial\xi_i$ is equal to $\frac{\text{area}(\partial V_i)}{\text{volume}(V_i)}$ which converges to zero. Then there is a convergent subsequence in the mass topology (see section 1.2.1). Thus the limit current $\xi = \lim_{i \rightarrow \infty} \xi_i$ is a foliation cycle and we have an invariant measure by D. Sullivan's theorem (theorem 1.18 of the first chapter): *foliations cycles are in one-to-one correspondence with transverse invariant measures*. For a proof we refer to theorem I.13 of [73]. The support of the transverse invariant measure is contained in $\overline{\lim_{i \rightarrow \infty} V_i} \subset \overline{L}$.

□

2.2 Amenable foliations

In this section we will define amenable foliations, using the fact that we previously described: a foliation \mathcal{F} of a compact manifold M defines an equivalence relation R on a total transversal. After enunciating some notions equivalent to amenability for a foliation, we will study the relation between this concept and the condition of having Følner leaves.

A *Borel measure space* (X, \mathcal{B}, ν) , is a set X where \mathcal{B} is a σ -algebra of subsets of X and ν is a finite measure that is positive on (X, \mathcal{B}) . A *standard Borel measure space* is a Borel measure space associated to a *Polish space* X : a topological metric space such that the metric defines the topology of X and makes it a complete separable metric space.

Definition 2.6 Consider a standard Borel measure space (X, \mathcal{B}, ν) . Let R be an equivalence relation on X . We have the following definitions:

- R is discrete if every equivalence class $R[x]$ is at most countable.
- R is measurable if its graph in $X \times X$ is measurable.
- for a measurable equivalence relation R , the measure ν on (X, \mathcal{B}) is quasi-invariant if for every Borel set $B \in \mathcal{B}$ with $\nu(B) = 0$, the saturation of B

$$S(B) = \bigcup_{x \in B} R[x]$$

is also of measure zero.

- if R is as above and discrete, we say that R is a discrete measurable equivalence relation on (X, \mathcal{B}, ν) . Such an equivalence relation R is ergodic if for every set $B \in \mathcal{B}$ that is saturated by R , either $\nu(B) = 0$ or $\nu(X \setminus B) = 0$.
- a discrete measurable equivalence relation R on (X, \mathcal{B}, ν) is amenable if for ν -almost all $x \in X$ there is a mean. A mean is a linear map

$$m_x : L^\infty(R[x]) \rightarrow \mathbb{R},$$

such that

- $m_x(f) \geq 0$ for $f \geq 0$ and for ν -almost all $x \in X$;
- $m_x(1) = 1$;
- for ν -almost all $x \in X$, $m_x = m_y$ for all $y \in R[x]$;
- the function $x \mapsto m_x$ on R is measurable, in the sense that for a measurable function \tilde{f} defined on the couples of equivalent points in $X \times X$, the function defined by $f(x) = m_x(\tilde{f}(x, \cdot))$ is measurable.

A transverse invariant measure of \mathcal{F} gives us an invariant measure for the induced equivalence relation R . If a foliation is ergodic with respect to a transverse invariant measure, the corresponding equivalence relation is a discrete measurable ergodic equivalence relation. We will say that a foliation \mathcal{F} with a transverse invariant measure of a compact manifold is amenable if the equivalence relation R is amenable with respect to the corresponding measure. This definition is independent of the choices we made to define the equivalence relation. The notion was introduced by Robert J. Zimmer [83].

For the purposes of this chapter we will focus on equivalence relations that have invariant measures, since we are interested in foliations with transverse invariant measures. Nonetheless, let us discuss briefly quasi-invariant measures. Consider as above a discrete measurable equivalence relation R on a standard Borel measure space (X, \mathcal{B}, ν) . Integrating the counting measures on the fibers of the left projection $(x, y) \mapsto x$ from R to X with respect to ν , gives the *left counting measure* $d\tilde{\nu}(x, y) = d\nu(x)$. The same is valid for the right projection, we get the *right counting measure* $d\tilde{\nu}^{-1}(x, y) = d\tilde{\nu}(y, x) = d\nu(y)$. Then ν is quasi-invariant if and only if $\tilde{\nu}$ and $\tilde{\nu}^{-1}$ are equivalent; in which case the Radon-Nikodym derivative

$$\delta(x, y) = \frac{d\nu}{d\tilde{\nu}}(x, y)$$

is called the *Radon-Nikodym cocycle* of ν with respect to R . If $\delta = 1$ always, ν is invariant. For any measurable set $A \subset R$, we define the *cross sections* by

$$\begin{aligned} A_x &= \{y \mid (x, y) \in A\} \\ A^y &= \{x \mid (x, y) \in A\}, \end{aligned}$$

Let $|\cdot|_x$ be the measure on the equivalence class of x defined as $|y|_x = \delta(x, y)$. In other words, the weights $|y|_x$ of the measure $|\cdot|_x$ are proportional to $d\nu(x)$. We have that

$$\begin{aligned} \tilde{\nu}(A) &= \int |A_x|_x d\nu(x) \\ &= \int \chi_A(x, y) d\tilde{\nu}(x, y) \\ &= \int \chi_A(x, y) \delta(x, y) d\tilde{\nu}(y, x) \\ &= \int |A^y|_y d\nu(y). \end{aligned}$$

We can define, in this context, a δ -Følner equivalence class as an equivalence class for which

$$\inf_E \frac{|\partial_\Gamma E|_x}{|E|_x} = 0,$$

where E describes the finite sets in the equivalence class. Theorems 2.8 and 2.9 below are valid in this more general setting.

Let us study some equivalent definitions for amenability of an equivalence relation and thus of a foliation.

Theorem 2.7 *Let R be a discrete measurable equivalence relation on a standard Borel measure space (X, \mathcal{B}, ν) , where ν is an invariant or quasi-invariant measure. The following are equivalent:*

- (i) R is amenable;
- (ii) there exist sequences of probability measures $\{\lambda_x^n\}_{x \in X, n \in \mathbb{N}}$ on $R[x]$, with $x \in \text{supp}(\lambda_x^n)$ for all n , and such that

$$\|\lambda_x^n - \lambda_y^n\| \rightarrow 0$$

for ν -almost all $(x, y) \in R$. Here $\|\cdot\|$ is the norm in the space of probability measures on $R[x]$. The map $x \mapsto \lambda_x^n$ is measurable for all n , in the same sense as in definition 2.6. We will call this the sequences of measures criterion;

- (iii) R is hyperfinite: there exists an increasing sequence of finite measurable equivalence relations R_n on (X, \mathcal{B}, ν) such that $R[x] = \bigcup_n R_n[x]$.

The equivalence between (i) and (iii) is a theorem of Alain Connes, Joel Feldman and Benjamin Weiss [14]. They proved also that an amenable equivalence relation is generated by an action of \mathbb{Z} . More precisely, if $R \subset X \times X$ is a discrete amenable equivalence relation there exists a borelian isomorphism f of the space X , preserving the measure ν , such that up to a null set

$$R = \{(x, f^n(x)) | x \in X, n \in \mathbb{Z}\},$$

where $f^n = \underbrace{f \cdot f \cdots f}_{n\text{-times}}$. That is the equivalence class of x consists of x and its images under all the iterates of f .

The sequences of measures criterion is due, at least in this form, to V. A. Kaimanovich. We refer to page 154 of his article [49]. In the case of finitely generated groups, the analogue to this criterion is *Reiter's condition*, see section 3.2 of [37].

As an example of an amenable equivalence relation, consider a countable group that acts freely on a standard Borel measure space (X, \mathcal{B}, ν) . If such an action preserves a measure, the orbits define a discrete measurable equivalence relation R . For an equivalence relation like this, the amenability of the group implies the amenability of the equivalence relation. This follows from the fact that any Følner sequence on the group determines a sequence of measures as in the sequences of measures criterion in the theorem. Observe that for foliations this implies that when the pseudogroup Γ is actually a group, the amenability of Γ implies the amenability of the foliation.

The converse of the last claim is not true: the action of a non-amenable group may define an amenable equivalence relation. The simplest example of a non-amenable group is the free group with two generators \mathbb{F}_2 , and the action of this group may be amenable. Thus the orbit equivalence relation can be amenable. If the action of a non-amenable group preserves a probability measure and it is *essentially free*, i.e. the fixed point set is of measure zero, the corresponding equivalence relation is non-amenable (for a proof we refer to section 4.3 of [84]). In particular, theorem 1 of

Y. Carrière and É. Ghys' paper [11], gives necessary conditions for an action of \mathbb{F}_2 to induce a non-amenable equivalence relation.

We will now describe an action of \mathbb{F}_2 that is amenable with respect to a quasi-invariant measure. Denote by $\partial\mathbb{F}_2$ the space of *ends* of \mathbb{F}_2 : the space of infinite words in the two generators. Let ν be the equidistributed probability measure on $\partial\mathbb{F}_2$, meaning that the measures of the cylinders consisting of infinite words with fixed first n letters are equal. This is a quasi-invariant measure. Then the orbit equivalence relation of the free action of \mathbb{F}_2 on $\partial\mathbb{F}_2$ coincides with the orbit equivalence relation of the unilateral shift in the space of infinite words. Hence, it can be seen as an action of \mathbb{Z} and thus it is amenable.

Almost all equivalence classes are δ -Følner with respect to the quasi-invariant measure. Let us find δ -Følner sequences of sets. Let $x \in \partial\mathbb{F}_2$ be an element with trivial stabilizer in \mathbb{F}_2 . We identify the classes $R[x]$ with \mathbb{F}_2 by the map $g \mapsto g^{-1}x$, and endow them with the Cayley graph structure. Denote by b_x the *Busemann function* on \mathbb{F}_2 with respect to x defined as

$$b_x(g) = \lim_{n \rightarrow \infty} (d_{\mathbb{F}_2}(g, x_{[n]}) - d_{\mathbb{F}_2}(Id, x_{[n]})),$$

where $(Id, x_{[1]}, x_{[2]}, \dots)$ is the geodesic ray joining the identity and x . Then $x_{[n]}$ consists of the n initial letters of the infinite word x . The level sets

$$\mathcal{B}_k(x) = \{g \in \mathbb{F}_2 \mid b_x(g) = k\}$$

are the *horospheres* in \mathbb{F}_2 with center point x . The previous definition of the Busemann function implies that b_x goes to $-\infty$ along geodesic rays that converge to x . Thus the larger the index k of the horosphere is, the farther the horosphere is from x .

The Radon-Nikodym cocycle of the measure ν is given by

$$\delta(g^{-1}x, x) = \frac{d\nu}{d\nu}(x) = 3^{-b_x(g)}.$$

Using the identification between $R[x]$ and \mathbb{F}_2 , we define on \mathbb{F}_2 the measure

$$|g|_x = |g^{-1}x|_x = \delta(g^{-1}x, x) = 3^{-b_x(g)}.$$

We can then exhibit the δ -Følner sequence with respect to the measure (although the Cayley graph of \mathbb{F}_2 does not have a usual Følner sequence). Let

$$E_n = \{g \in \mathbb{F}_2 \mid 0 \leq b_x(g) = d_{\mathbb{F}_2}(Id, g) \leq n\},$$

i.e. the set of all words g of length at most equal to n , such that their first letter is not $x_{[1]}$. Then

$$|E_n \cap \mathcal{B}_k(x)|_x = 1,$$

for all $0 \leq k \leq n$ and hence $|E_n|_x = n + 1$. On the other hand,

$$\partial E_n = \{Id\} \cup \{E_n \cap \mathcal{B}_n(x)\},$$

implying that $|\partial E_n|_x = 2$. Proving that the equivalence classes are δ -Følner, with respect to the measures $|\cdot|_x$.

Let us come back to the context of foliations. From now on, μ will be a transverse invariant measure for the foliation \mathcal{F} . The following theorem states a relation between the growth of the

leaves and the amenability of the foliation. This theorem is, in one sense, a particular case of C. Series' theorem (we refer to theorem 2.2 in [70]): *an equivalence relation R generated by the action of a pseudogroup Γ of polynomial growth, that possesses an invariant measure μ , is hyperfinite with respect to μ* . We know now that hyperfinite equivalence relations are amenable. Her proof is similar to Rohlin's lemma that approximates every measure preserving borelian isomorphism without periodic points by periodic transformations. C. Series' theorem was improved for quasi-invariant measures by M. Samuélidès [64]. Both theorems were generalized by several authors to sub-exponential growth instead of polynomial growth.

Theorem 2.8 (Series, Kaimanovich) *A foliation such that μ -almost all its leaves have sub-exponential growth is amenable.*

We will give a proof, due to V. A. Kaimanovich, using the sequences of measures criterion from theorem 2.7. We will denote by $\Gamma_n(x)$ the set composed by the translates of x by elements in Γ that are words of length at most n in terms of a fixed generating set Γ_1 .

Proof. Take $x \in T \cap L$ and consider $\Gamma_n(x)$. Since μ -almost all the leaves have sub-exponential growth, for μ -almost all $x \in T \cap L$ we have that

$$\liminf_{n \rightarrow \infty} \frac{1}{n} \log |\Gamma_n(x)| = 0.$$

Observe that we are using the fact that the leaves and the graphs $\widetilde{R[x]}$ are roughly quasi-isometric. Let π_x^n be the uniform distribution on the ball $\Gamma_n(x)$. Take two points x, y in $T \cap L$, with $d_\Gamma(x, y) = r$, where d_Γ is the graph distance. We have that

$$\begin{aligned} \|\pi_x^n - \pi_y^n\| &\leq \|\pi_x^n - \pi_x^{n-r}\| + \|\pi_y^n - \pi_x^{n-r}\| \\ &= 2 \left(1 - \frac{|\Gamma_{n-r}(x)|}{|\Gamma_n(x)|}\right) + 2 \left(1 - \frac{|\Gamma_{n-r}(x)|}{|\Gamma_n(y)|}\right) \\ &\leq 4 \left(1 - \frac{|\Gamma_{n-r}(x)|}{|\Gamma_{n+r}(x)|}\right). \end{aligned}$$

Finally, consider the sequence of measures $\lambda_x^n = \frac{(\pi_x^1 + \pi_x^2 + \dots + \pi_x^n)}{n}$. Then

$$\begin{aligned} \|\lambda_x^n - \lambda_y^n\| &\leq 4 - \frac{4}{n} \sum_{j=r+1}^n \frac{|\Gamma_{j-r}(x)|}{|\Gamma_{j+r}(x)|} \\ &\leq 4 - \frac{4(n-r)}{n} \left(\prod_{j=r+1}^n \frac{|\Gamma_{j-r}(x)|}{|\Gamma_{j+r}(x)|} \right)^{\frac{1}{n-r}} \\ &\leq 4 - \frac{4(n-r)}{n} |\Gamma_{n+r}(x)|^{-\frac{2r}{n+r}} \\ &\rightarrow 0. \end{aligned}$$

So the equivalence relation generated by Γ is amenable, in other words \mathcal{F} is amenable. □

Some years later Y. Carrière and É. Ghys proved the following theorem, we refer theorem 4 of [11].

Theorem 2.9 (Carrière, Ghys) *Let \mathcal{F} be a foliation of a compact manifold M with a transverse invariant measure μ and such that μ -almost all its leaves do not have holonomy. If \mathcal{F} is amenable, all the leaves are Følner.*

Proof. Assume that μ is a probability measure on a total transversal T . We know that the equivalence relation R on T , associated to \mathcal{F} , is amenable and thus hyperfinite. Let R_n be an increasing sequence of measurable finite equivalence relations on (T, μ) such that $R[x] = \bigcup_n R_n[x]$ for μ -almost all $x \in T$. Let $f : T \rightarrow \mathbb{R}$ be a measurable function and

$$f_n(x) = \frac{1}{|R_n[x]|} \sum_{y \in R_n[x]} f(y).$$

Then $\int_T f_n d\mu = \int_T f d\mu$. Consider now the sequence of integrable functions

$$g_n(x) = \frac{|\partial_\Gamma R_n[x]|}{|R_n[x]|},$$

and let $\partial_\Gamma R_n$ be the union of $\partial_\Gamma R_n[x]$ over the $x \in T$. We have that

$$\int_T g_n d\mu = \int_T \chi_{\partial_\Gamma R_n[x]} d\mu = \mu(\partial_\Gamma R_n),$$

where χ denotes the characteristic function. Since the sequence of equivalence relations is increasing with $R[x] = \bigcup_n R_n[x]$, we get that $\mu(\partial_\Gamma R_n)$ goes to zero as $n \rightarrow \infty$. Then by Pierre Fatou's lemma

$$0 = \liminf_{n \rightarrow \infty} \mu(\partial_\Gamma R_n) = \liminf_{n \rightarrow \infty} \int_T g_n d\mu \geq \int_T (\liminf_{n \rightarrow \infty} g_n) d\mu$$

and thus $\liminf_{n \rightarrow \infty} g_n$ is zero μ -almost always. This implies that μ -almost all the leaves of the foliation are Følner. □

For equivalence relations, an important difference between amenability and being Følner is that the first one is inherited when passing to the restriction to a smaller subset, contrary to the second one that may not pass to a subset. The next theorem, due to V. A. Kaimanovich, shows that this is the only reason of discrepancy between the two notions. We refer to theorem 2 of his paper [48]. In the theorem below we will consider that ν is a quasi-invariant probability measure and we will use the measures $|\cdot|_x$ defined above with the Radon-Nikodym cocycle.

Theorem 2.10 (Kaimanovich) *Let (T, ν, R) be a discrete ergodic equivalence relation. Then R is amenable if and only if for any non trivial measurable set $T_0 \subset T$ with $\nu(T_0) \neq 0$ and for ν -almost every $x \in T$, there exists a family of finite subsets $E_n \subset R[x] \cap T_0$ such that*

$$\frac{|\partial_{T_0} E_n|_x}{|E_n|_x} \rightarrow 0,$$

where $\partial_{T_0} E_n$ is the restriction of the boundary of E_n to T_0 .

In 1983, Robert Brooks claimed: *let \mathcal{F} be a foliation with an invariant measure μ . If μ -almost all leaves are Følner, \mathcal{F} is amenable with respect to μ (example-theorem 4.3 of his paper [7]).* His paper

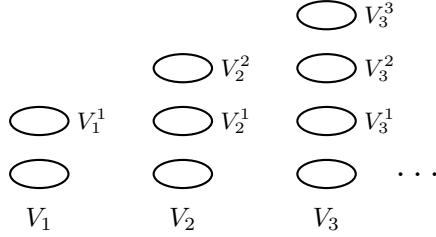
Figure 2.1: The space X'

does not contain a proof. We will give a counterexample to his example-theorem in the next section: a non-amenable real analytic foliation of a compact manifold, possessing a transverse invariant volume and having Følner leaves.

In 2001, V. A. Kaimanovich constructed a smooth non-amenable foliation with almost all its leaves Følner. The foliation has Reeb components, this implies that any transverse invariant measure is not locally finite. The reason for this is that if we take a small open set in a transversal that intersects the compact leaf, it is mapped under the holonomy to a proper subset of itself. We refer the reader to theorem 3 in [49]. The counterexample we present in this text, has the nice property that the transverse invariant measure is a finite volume. Remark that when looking for such counterexamples we have to think in at least codimension two and dimension two foliations. The reason is that, for codimension one foliations J. F. Plante's theorem 2.4 implies that the leaves in the support of an invariant measure have sub-exponential growth and thus, by theorem 2.8, the foliation is amenable. If the dimension of \mathcal{F} is one the leaves have also sub-exponential growth.

Before passing to the next section, let us construct a non-amenable equivalence relation with a Følner equivalence class in the measured category. Consider a standard Borel measure space (X, \mathcal{B}, μ) with an equivalence relation $S \subset X \times X$. In an equivalence class we can take a sequence $\{V_n\}_{n \in \mathbb{N}}$ for n bigger than a certain N , of Borel subsets such that $\mu(V_n) = \frac{1}{2^n}$. We want to find a new standard Borel measure space (X', \mathcal{B}', μ') , with $X \subset X'$ and an equivalence relation R with an equivalence class that is Følner.

To construct X' put over n copies of V_n over it, so that

$$X' = X \cup \left(\bigcup_{k=1}^n V_n^k \right).$$

For defining the additive measure let $\mu'(B) = \mu(B)$ if $B \in \mathcal{B}$ and $\mu'(V_n^k) = \mu(V_n)$, for every k . Put $V_n^0 = V_n$. Since

$$\sum_{i=1}^{\infty} \sum_{k=0}^i \mu(V_i^k) = \sum_{i=1}^{\infty} \frac{i}{2^i} < \infty,$$

the measure μ' is finite. For the equivalence relation on X' set S on X and the points we added are equivalent to their copies: for $1 \leq k \leq n-1$ a point $x^k \in V_n^k$ is equivalent to $x^{k-1} \in V_n^{k-1}$ and to $x^{k+1} \in V_n^{k+1}$, and x^n is equivalent only to x^{n-1} . This defines an equivalence relation R on X' .

We claim that R has an equivalence class that is Følner. Denote by \tilde{R} the graph of R and E_n^k the set of vertices that corresponds to V_n^k . We have that the graph \tilde{S} is a subgraph of \tilde{R} . The sets

we added to X form in \tilde{R} antennas of length n over each point in the sets $E_n = E_n^0$. The sets

$$F_n = \bigcup_{k=0}^n E_n^k.$$

form the Følner sequence we need since

$$\frac{|\partial F_n|}{|F_n|} = \frac{|\partial E_n|}{n|E_n|} \rightarrow 0, \quad \text{as } n \rightarrow \infty.$$

Thus R has a Følner equivalence class.

2.3 A Følner foliation that is non-amenable and has a transverse invariant volume

In this section we are going to construct a non-amenable real analytic foliation \mathcal{F} of a compact manifold M , of dimension and codimension two, whose leaves are Følner. We will start by constructing a non-amenable foliation \mathcal{F}_1 of a closed manifold M and then we will perform a local modification to make its leaves Følner. For the local modification we will use a volume preserving version of F. W. Wilson's plug. The original construction was described in section 1.1.

The section is organized as follows. We will begin by constructing the foliation \mathcal{F}_1 and the manifold M . In section 2.3.1, we will describe the plug and the plug insertion in M . Finally, in section 2.3.2 we will analyze the foliation \mathcal{F} . Thus, we will prove

Theorem D *There exists a non-amenable real analytic foliation \mathcal{F} of a compact manifold M with a transverse invariant ergodic volume μ , such that all the leaves are Følner.*

Proof. To construct the non-amenable foliation \mathcal{F}_1 we will use the suspension of an essentially free action of a non-amenable group on the sphere.

Let us begin by considering an oriented surface Σ_2 of genus two. The fundamental group $\pi_1(\Sigma_2, x_0)$, with base point x_0 , is generated by four loops $\sigma_1, \sigma_2, \sigma_3, \sigma_4$, as in figure 2.2, satisfying the relation $[\sigma_1, \sigma_4] = [\sigma_2, \sigma_3]$. Take now a homomorphism $\phi : \pi_1(\Sigma_2, x_0) \rightarrow SO(3)$ such that $\phi(\sigma_4) = Id$. The last condition implies that $[\phi(\sigma_2), \phi(\sigma_3)] = Id$. Recall that $SO(3)$ can be seen as the group of rotations of the two dimensional sphere.

Observe that $SO(3)$ is a non-amenable group since it contains a subgroup isomorphic to the free group on two generators. For a proof of this claim we refer to example 1.2.8 of F. P. Greenleaf's book [37]. We choose $\phi(\sigma_1)$ and $\phi(\sigma_2)$ in such a way that they generate a subgroup isomorphic to the free group with two generators, and such that their action on \mathbb{S}^2 is minimal. Thus, $\phi(\pi_1(\Sigma_2, x_0))$ is a non-amenable group. The normalized area form Ω of \mathbb{S}^2 is invariant under the action of $\phi(\pi_1(\Sigma_2, x_0))$.

Denote by \mathbb{H} the hyperbolic plane. We know that \mathbb{H} is the universal covering space of Σ_2 : in other words $\Sigma_2 = \mathbb{H}/\pi_1(\Sigma_2, x_0)$. Consider the product manifold $\mathbb{H} \times \mathbb{S}^2$ and the equivalence relation given by the action of $\pi_1(\Sigma_2, x_0)$ via ϕ . Hence $(z, y) \sim (z', y')$ if and only if $z' = \gamma \cdot z$ and $y' = \phi(\gamma) \cdot y$ for some $\gamma \in \pi_1(\Sigma_2, x_0)$. So we can consider the compact 4-manifold

$$M = \mathbb{H} \times \mathbb{S}^2 / \pi_1(\Sigma_2, x_0).$$

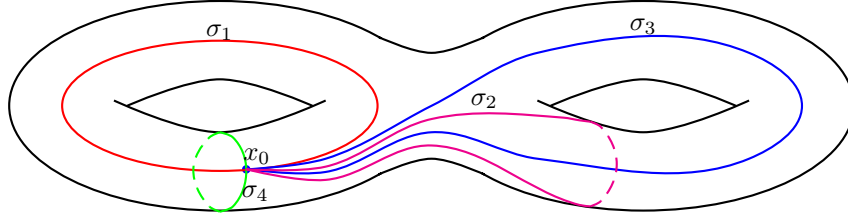
Figure 2.2: Σ_2 with the generators of π_1

On $\mathbb{H} \times \mathbb{S}^2$ take the trivial two dimensional foliation $\mathbb{H} \times \{\cdot\}$, which is transverse to $\{x_0\} \times \mathbb{S}^2$. Taking the quotient we obtain a non singular real analytic foliation \mathcal{F}_1 of M . Since $\phi(\pi_1(\Sigma_2, x_0)) \subset SO(3)$, the action preserves Ω . Thus Ω is a transverse invariant volume for the foliation \mathcal{F}_1 . Moreover, since the orbits of the action of $\phi(\pi_1(\Sigma_2, x_0))$ are everywhere dense, \mathcal{F}_1 is uniquely ergodic. The group $\phi(\pi_1(\Sigma_2, x_0))$ is the holonomy group of \mathcal{F}_1 .

Observe that a generic leaf of \mathcal{F}_1 is not Følner. This follows because the leaves of \mathcal{F}_1 are quotients of the hyperbolic plane and the projection of $M \rightarrow \Sigma_2$ restricted to a leaf is a covering map. Then there is a Riemannian metric on the leaves such that the curvature is negative, and proposition 2.2 implies that they are not Følner.

Lemma 2.11 *The foliation \mathcal{F}_1 is non-amenable.*

Proof. Consider the submanifold $T = p(\{x_0\} \times \mathbb{S}^2)$, where p is the projection from $\mathbb{H} \times \mathbb{S}^2$ to M . Then T is a transversal to \mathcal{F}_1 diffeomorphic to \mathbb{S}^2 . Since the corresponding equivalence relation on T coincides with the orbit equivalence relation on T of the Ω preserving essentially free action of the non-amenable group $\phi(\pi_1(\Sigma_2, x_0))$, it is non-amenable. Therefore, \mathcal{F}_1 is a non-amenable foliation. □

Summarizing, we have a non-amenable foliation \mathcal{F}_1 of M , whose leaves are not Følner, it has a transverse invariant volume and it is uniquely ergodic.

Before beginning the construction of the plug, we are going to find a place in M to insert it. We are looking for a submanifold U diffeomorphic to $D \times I \times \mathbb{S}^1$ where I is a closed interval, D is a two dimensional disc transverse to \mathcal{F}_1 and U is foliated by the cylinders $\{\cdot\} \times I \times \mathbb{S}^1$. For this consider a small disc D in the transversal $T = p(\{x_0\} \times \mathbb{S}^2)$. There is a tubular neighborhood of D diffeomorphic to $D \times \mathbb{D}^2$ by a diffeomorphism preserving the foliation structure.

The group $\phi(\pi_1(\Sigma_2, x_0))$ is the holonomy group of the foliation \mathcal{F}_1 . Consider in M the inverse images under the projection $p : M \rightarrow \Sigma_2$ of a loop representing σ_4 , such that it intersects D transversally. Since $\phi(\sigma_4) = Id$, the holonomy near this loop is trivial. This implies that locally the leaves are cylinders with trivial holonomy. Thus we can find a small neighborhood U of the disc D that is diffeomorphic to $D \times (I \times \mathbb{S}^1)$, via a diffeomorphism that preserves the foliation by cylinders $\{\cdot\} \times I \times \mathbb{S}^1$.

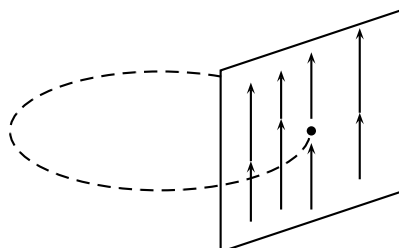

Figure 2.3: Poincaré's map near a periodic orbit.

2.3.1 Construction of the plug

The foliated plug Q will be a manifold with boundary of dimension four endowed with a two dimensional foliation \mathcal{G} . To construct it, we will use the direct product of a modification of F. W. Wilson's plug with \mathbb{S}^1 . We will call this modification P : a 3-manifold with boundary endowed with a one dimensional foliation. To prove theorem D, we need a transverse invariant volume for the foliation \mathcal{G} . Since the foliation will be the product of the 1-foliation of P with \mathbb{S}^1 , we need a transverse invariant volume for this 1-foliation. The 1-foliation will be given by the orbits of a real analytic vector field, thus we are asking the vector field to be volume preserving.

Let us begin by explaining the reason why F. W. Wilson's plug, and even the modification we used in section 1.1.1, are not volume preserving. For the explanation we will adopt the notation we used in sections 1.1 and 1.1.1. F. W. Wilson's plug is not volume preserving because it *stops an open set*: the trapped set of the plug is an annulus with non empty interior. This open set is then an open set of non recurrent points. The existence of such a set is a contradiction to H. Poincaré's recurrence theorem.

Recall that the version of F. W. Wilson's plug that we used to construct K. Kuperberg's plug does not stop an open set: the trapped set is a circle. The reason why it is not volume preserving is more subtle. Consider H. Poincaré's map near one of the periodic orbits. We get a diffeomorphism of a two dimensional disc with a fixed point and such that the rest of the points move vertically in the same direction, as in figure 2.3. We claim that such a diffeomorphism cannot preserve an area form. This follows from the fact that an area preserving homeomorphism ψ of the plane endowed with a system of coordinates (x, y) , that moves the points vertically must be of the form $\psi(x, y) = (x, y + g(x))$ for a function g . Then, it cannot have an isolated fixed point. Thus the vector field in the plug cannot preserve a volume.

1. A volume preserving version of F. W. Wilson's plug.

We will start the construction in the 3-manifold $P = \mathbb{S}^1 \times [1, 2] \times [-1, 1]$ with coordinates (θ, r, z) . We will construct a non singular vector field that preserves a volume making P a semi-plug. Note that we want the plug to be real analytic. As we said at the end of section 1.1.1, the vector field of a real analytic plug has to be vertical only on the boundary.

Consider the rectangle $[1, 2] \times [-1, 1]$ with an area form μ . We need a vector field on the rectangle such that it has a singularity, it is transverse to $[1, 2] \times \{\pm 1\}$ and parallel to $\{1\} \times [-1, 1]$ and $\{2\} \times [-1, 1]$. Moreover, the orbit through a point $(r, -1)$ passes through the point $(r, 1)$, for all $r \in [1, 2]$ except for the orbit that converges to the singularity. An area preserving vector field satisfying this conditions is given by the Hamiltonian vector field H_1 on

$[1, 2] \times [-1, 1]$ of the function

$$h(r, z) = \left(r - \frac{3}{2}\right)^3 + \left(z^2 - \frac{1}{2}z^4\right)g(r),$$

where $g : [1, 2] \rightarrow \mathbb{R}^+$ is a C^ω function such that:

- $g(1) = g(2) = 0$;
- $3\left(r - \frac{3}{2}\right)^2 + \left(z^2 - \frac{1}{2}z^4\right)g'(r)$ is positive for all (r, z) non equal to $(\frac{3}{2}, 0)$.

To be precise, H_1 is the vector field satisfying the equation $\iota_{H_1}\mu = -dh$, thus the conditions above guarantee that H_1 is vertical on the boundary of the rectangle and its only singularity is $(\frac{3}{2}, 0)$. The curves where h is constant are illustrated in figure 2.4. The vector field H_1 is tangent to these curves.

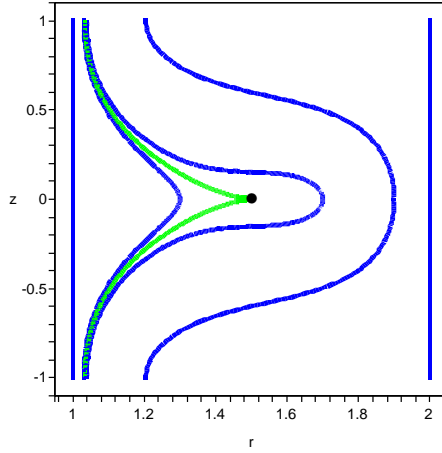

Figure 2.4: Flow lines of H_1 .

Take on the manifold P the vector field tangent to each $\{\cdot\} \times [1, 2] \times [-1, 1]$ and equal to H_1 on this rectangles. This vector field has a circle of singularities. Finally, consider

$$H_2 = H_1 + f \frac{\partial}{\partial \theta},$$

where $f : [1, 2] \times [-1, 1] \rightarrow \mathbb{R}^+$ is a C^ω function that assumes the value zero on the boundary of the rectangle and is strictly positive on the singularity. Thus H_2 is non singular in P and the circle of singularities in H_1 becomes a periodic orbit. The reason why H_2 preserves the volume form $d\theta \wedge \mu$ is that both terms in the previous sum preserve it.

Then we have endowed the manifold P with the vector field H_2 , making a semi-plug. We can use the mirror-image construction to get a plug: take another copy of P with the vector field $-H_2$, so we exchange the entry and the exit regions. Consider the concatenation of these two semi-plugs and their vector fields. We can rescale them to make them fit in P , getting a plug that we will still denote P , with a vector field H .

Observe that H is vertical on the boundary of P , satisfies the entry-exit condition of definition 1.1, and has two periodic orbits O_1 and O_2 . There is a two foliation of P that is tangent

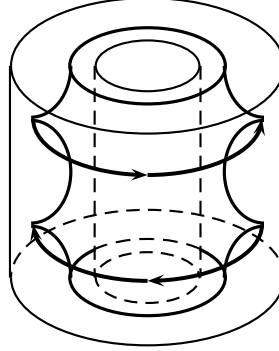

Figure 2.5: The *singular cylinder* in P

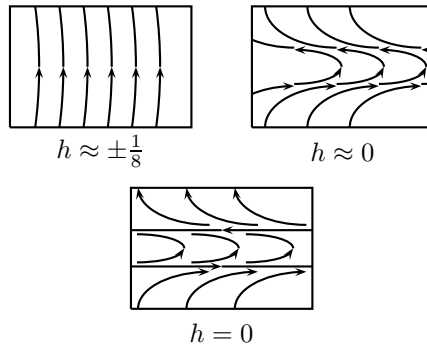

Figure 2.6: Orbits of H in the *cylinders* $\{h = \text{const.}\}$

to H : it is given by the product of the curves in figure 2.4 and \mathbb{S}^1 . This leaves are defined by the equation $h = \text{const.}$ It is convenient to use the system of coordinates (θ, h, z) , where h is constant in the leaves of the 2-foliation. The singular leaf of this foliation, that contains the periodic orbits, is illustrated in figure 2.5. Let \mathcal{H} be the 1-foliation defined by the orbits of H . Summarizing, we have that:

- the 1-foliation \mathcal{H} of P has a transverse invariant volume, given by the differential 2-form $\omega = \iota_H(d\theta \wedge \mu)$;
- \mathcal{H} satisfies the entry-exit condition: the points $(\theta, h, \pm 1)$ belong to the same leaf if and only if $h \neq 0$;
- \mathcal{H} has infinite and semi-infinite leaves. The leaves through the points in $(\theta, 0, z)$ are infinite or semi-infinite, except for the two circles O_1 and O_2 ;
- there is an embedding $j : P \rightarrow \mathbb{R}^3$ that preserves the vertical direction $\frac{\partial}{\partial z}$.

2. *Construction of the foliated plug.*

We want to construct a foliation \mathcal{G} of the manifold $Q = (\mathbb{S}^1 \times [1, 2] \times [-1, 1]) \times \mathbb{S}^1$, such that:

(i) there is an embedding $i : Q \rightarrow \mathbb{R}^3 \times \mathbb{S}^1$ that preserves the vertical cylinders

$$\{\cdot\} \times [-1, 1] \times \mathbb{S}^1,$$

i.e. the product of a vertical line in \mathbb{R}^3 with \mathbb{S}^1 ;

(ii) \mathcal{G} has a transverse invariant volume.

Let $Q = P \times \mathbb{S}^1$ foliated by the product foliation $\mathcal{G} = \mathcal{H} \times \mathbb{S}^1$. This plug satisfies conditions (i) and (ii) above, the volume is given by the 2-form ω . Observe that the entry region is $\mathbb{S}^1 \times [1, 2] \times \{-1\} \times \mathbb{S}^1$, the cross product of an annulus with a circle, foliated by circles. The circles $(\theta, h, \pm 1, \beta)$, for $\beta \in \mathbb{S}^1$ belong to the same leaf of the foliation \mathcal{G} when $h \neq 0$.

3. Insertion of the plug.

An insertion map for the plug (Q, \mathcal{G}) into the foliated manifold (M, \mathcal{F}_1) is an embedding of the entry region of P , into $D \subset T \subset M$ which is transverse to the foliation. Here D is the disc considered at the end of section 2.3. Such an insertion map can be extended to an embedding $\eta : Q \rightarrow U \subset M$. The image of a fiber $\{x\} \times [-1, 1] \times \mathbb{S}^1$, with x in the entry region of P , is contained in a leaf of \mathcal{F}_1 . The plug Q is *insertible* since it admits an embedding $i : Q \rightarrow \mathbb{R}^3 \times \mathbb{S}^1$ that maps the cylinders $\{x\} \times [-1, 1] \times \mathbb{S}^1$ to the product of the vertical lines and the circle.

Repeating the procedure we described in section 1.1.1, we can make the plug insertion in the real analytic category. In the submanifold U above, we can take a region of the form $A \times [-1, 1] \times \mathbb{S}^1$ where A is an annulus transverse to \mathcal{F}_1 . Let N be a neighborhood of

$$A \times [-1, 1] \times \mathbb{S}^1 \subset U.$$

The next step in the plug insertion is to remove N from M , and glue the open circular band $N \setminus (A \times [-1, 1] \times \mathbb{S}^1)$ to Q by a leaf preserving map $\phi : N \rightarrow N_Q$, where N_Q is an open neighborhood of ∂Q outside of Q in $\mathbb{R}^3 \times \mathbb{S}^1$. We fill N_Q with a foliation of almost vertical cylinders, as we did in section 1.1.1. Moreover, ϕ should satisfy that $\phi(a, -1, \beta)$ (respectively $\phi(a, 1, \beta)$) is the entry point (respectively, the exit point) of the leaf through $\{a\} \times \mathbb{S}^1$, for every $\beta \in \mathbb{S}^1$. We can then put Q at the place of $A \times [-1, 1] \times \mathbb{S}^1$. This allows us to make the plug insertion real analytic. Since every manifold has a unique analytic structure (theorem 1.5), we have not changed the structure of the ambient manifold.

The entry region R of a plug with an invariant measure is measured. By Jürgen Moser's theorem from [59], the only relevance of this structure is that the embedding of R with large volume into a disc of small volume is inconvenient, although not impossible. One way to overcome this inconvenience is to rescale the transverse invariant measure of the plug to make the measure of R small enough.

The differential form ω gives us a transverse invariant volume for the foliation \mathcal{G} of Q . The kernel of ω defines a plane field that is tangent to the foliation. We want to make the insertion of the plug in such a way that the resulting foliation \mathcal{F} has a transverse invariant volume. Using ϕ we get that the pull back of ω is a positive multiple of the volume form Ω , the latter is the transverse invariant volume of \mathcal{F}_1 . The kernel of both forms define the same plane field. Thus, we can insert the plug in such a way that the resulting foliation has a transverse invariant volume that matches Ω outside U . We will call this transverse invariant volume $\hat{\Omega}$.

2.3.2 The foliation \mathcal{F}

After the insertion of the plug Q , we have a real analytic foliation \mathcal{F} of M with a transverse invariant volume $\hat{\Omega}$. We need to show that \mathcal{F} is non-amenable and that all its leaves are Følner. To check the first characteristic notice that the equivalence relation on any transversal, that does not intersect the inserted plug, has not changed, this is the reason why we needed the entry-exit condition. Thus \mathcal{F} is non-amenable.

For the second point, let us analyze the leaves of the foliation \mathcal{F} . The leaves that entry Q in points of the form $\eta(\theta, h, 1, \beta)$ for $\theta, \beta \in \mathbb{S}^1$ and $h \approx \pm \frac{1}{8}$ do not change: we just remove a cylinder and put the same back in its place. As $h \rightarrow 0$ the cylinder we glue back becomes longer, it turns inside Q as the flow lines of H in P (see figure 2.6). For each leaf of \mathcal{F} that meets points of the form $\eta(\theta, 0, \pm 1, \beta)$ we remove a cylinder and glue back two semi-infinite cylinders, $[0, \infty) \times \mathbb{S}^1$, contained in the interior of the inserted plug. We have also created new leaves: two compact tori $O_i \times \mathbb{S}^1$, for $i = 1, 2$, and infinite cylinders that correspond to the flow lines in the singular cylinder of P that lie between the two periodic orbits, see figure 2.6. Clearly, all the leaves that meet this singular cylinder become Følner and the new compact and non-compact leaves are Følner. Since we took the action of $\phi(\pi_1(\Sigma_2, x_0))$ on the transverse $T = p(\{x_0\} \times \mathbb{S}^2)$ minimal, every leaf gets arbitrarily close to the sets $\eta(\theta, 0, \pm 1, \beta)$. Thus we are gluing to every leaf either an arbitrarily long cylinder or two semi-infinite cylinders, contained in the plug Q . In the latter situation the leaves become Følner. We claim that also in the first situation the leaves become Følner. Lets think of the long cylinders as $\mathbb{S}^1 \times [-l, l]$, where l is arbitrarily big. Then taking a sequence of annuli $\mathbb{S}^1 \times [-a_n, a_n]$ with $a_n < a_{n+1}$ for every n , we get that a leaf having such a cylinder is Følner since the length of the boundary of the annuli divided by their area goes to zero. Thus, every leaf becomes Følner.

Finally, observe that the transverse invariant volume given by $\hat{\Omega}$ is ergodic. Further, the foliation \mathcal{F} is not uniquely ergodic since it has two compact leaves, thus it possesses several transverse invariant measures. □

In [49], V. A. Kaimanovich asked if a *minimal* foliation with all its leaves Følner is amenable. A foliation is minimal if every leaf is a minimal set. A stronger hypothesis will be to ask for a *uniquely ergodic* foliation. A foliation is uniquely ergodic if it has a unique *harmonic measure*. Such foliations are minimal. Harmonic measures were introduced by Lucy Garnett in [26]. In contrast with transverse invariant measures, harmonic measures always exist and thus they give a framework to develop an ergodic theory. An important fact, regarding harmonic measures, is that a transverse invariant measure of a foliation combined with the density volume on the leaves, defines a harmonic measure. Thus if a uniquely ergodic foliation has a transverse invariant measure, the latter measure is unique. This is the case when the leaves are Følner.

2.4 Harmonic measures

We can now ask ourselves under which conditions a foliation of a compact manifold with a finite transverse invariant measure and with Følner leaves, is amenable. As suggested by V. A. Kaimanovich, we can require the *minimality* of \mathcal{F} : that is that the leaves of \mathcal{F} are dense in the support of the measure. In section 2.6 we will prove that this is indeed a good hypothesis. In

particular, a sufficient condition is the *unique ergodicity* of the foliation. Uniquely ergodic foliations are minimal. We will define uniquely ergodic foliations and show that such foliations have minimal leaves.

The aim of the present paragraph is to introduce ergodic theory for foliations. In comparison with the ergodic theory for flows, the ergodic theory for foliations is at a rather underdeveloped stage. One reason for this is that foliations that have invariant measures are rather scarce. L. Garnett in [26] introduced another type of measure for a foliation, proved that such measures always exist, and exhibited facts of ergodic theory with respect to them. These measures, called *harmonic measures*, will be studied in this section.

Let us begin by introducing harmonic measures and proving their existence. We will, in section 2.4.1, study the diffusion semigroup that will allow us to determine some characterizations of harmonic measures. Section 2.4.2 deals with this characterizations. Finally, in section 2.4.3 we will discuss some aspects of the ergodic theory for foliations and define uniquely ergodic foliations. As before, we will consider foliated compact manifolds, but the theory of harmonic measures applies also to foliated spaces, or *laminations*, where the leaves have *bounded geometry*. Having bounded geometry means that the leaves, seen as Riemannian manifolds, have a lower bound for the injectivity radius and that the sectional curvature belongs to an interval $[a, b]$, with a, b constants. Such bounds do not depend on the leaf.

Let (M, \mathcal{F}) be a compact foliated manifold. It is always possible to endow M with a smooth leafwise metric tensor. In a foliated chart $U \subset M$ with coordinates $(x, y) = (x_1, x_2, \dots, x_d, y)$, where d is the leaf dimension, such a metric tensor g has the local expression

$$g = \sum_{ij=1}^d g_{ij}(x_1, x_2, \dots, x_d, y) dx_i \otimes dx_j$$

where the matrix of smooth functions g_{ij} is symmetric and positive definite. If (g^{ij}) denotes the inverse of the matrix (g_{ij}) and $|g|$ its determinant, the leafwise Laplacian $\Delta = \operatorname{div} \cdot \operatorname{grad}$ has the local expression,

$$\Delta f = \frac{1}{\sqrt{|g|}} \sum_{j=1}^d \frac{\partial}{\partial x_j} \left(\sum_{i=1}^d g^{ij} \sqrt{|g|} \frac{\partial}{\partial x_i} f \right),$$

in an exponential chart. Thus,

$$\Delta = \sum_{i,j=1}^d \frac{\partial^2}{\partial x_j \partial x_i} + \text{first order terms}$$

and Δ , restricted to the leaves, is an elliptic operator that annihilates constants. We refer the reader to definition **B.1.1** of [10] and the discussion within. The metric tensor on M induces a metric tensor on each leaf and thus a Laplacian on each leaf. If f is a continuous function on M that is of class C^2 on each leaf, Δf is the union of the leaf Laplacians. Thus the leafwise Laplacian Δ is defined (at least) on continuous functions that are of class C^2 on each leaf.

Definition 2.12 *Let M be a foliated compact manifold and Δ a Laplacian. A measure m on M is said to be harmonic (with respect to Δ) if*

$$\int_M \Delta f(x) dm(x) = 0,$$

for every $f \in C(M)$ that is of class C^2 along each leaf.

To prove the existence of harmonic measures, recall the following fact. Let f be a continuous function on M which is of class C^2 on each leaf. If f has a local maximum (respectively, a local minimum) at x_0 , then $\Delta f(x_0) \leq 0$ (respectively, $\Delta f(x_0) \geq 0$). Using the ellipticity of the Laplacian and the Hahn-Banach theorem we can prove the existence of a harmonic measure. We are following the approach that A. Candel and L. Conlon present in their book [10]. The original proof by L. Garnett uses a different method: she uses Markov-Kakutami fixed point theorem. We refer the reader to her paper [26].

Theorem 2.13 (Garnett) *Let M be a compact foliated manifold and Δ a leafwise Laplacian on M . Then there exists a probability measure m such that*

$$\int_M \Delta f(x) dm(x) = 0$$

for continuous functions on M that are C^2 along the leaves.

Proof. Since M is compact, $C(M)$ the space of continuous functions on M equipped with the uniform norm, is a Banach space. By the Riesz representation theorem, a probability measure is the same as a continuous functional on $C(M)$ of norm one and such that the value on the constant function equal to one is one. Thus, a harmonic probability measure is a linear functional on $C(M)$ that vanishes on continuous functions of the form Δf . By the Hahn-Banach theorem such a functional exists if the closure of the range of the operator Δ does not contain constant functions. Thus the next lemma finishes the proof.

Lemma 2.14 *The closure of the range of Δ in $C(M)$ does not contain constant functions.*

Proof. The range of Δ is, by definition, the collection of continuous functions on M that are of the form Δf , for $f \in C(M)$ and of class C^2 on each leaf. Assume that there is a sequence of functions $\{f_n\}$ such that Δf_n converges to the constant function equal to one. Then there is an n_0 such that $\Delta f_n(x) \geq \frac{1}{2}$ for all $x \in M$ and for all $n \geq n_0$. This is a contradiction since Δf_n must vanish at some point. □

2.4.1 The diffusion semigroup

The diffusion semigroup is a semigroup of operators associated to the Laplacian, that will allow us to analyze the structure of harmonic measures. If M is a compact foliated manifold with metric tensor g , each leaf with the induced metric is a complete Riemannian manifold of bounded geometry. On such a manifold L , the heat diffusion is introduced as follows. Let f be a bounded continuous function on L , the heat equation with initial condition f asks for a bounded solution $u \in C^{2,1}(L \times (0, \infty))$ to the partial differential equation

$$\frac{\partial}{\partial t} u(x, t) = \Delta u(x, t),$$

such that uniformly on compact subsets $\lim_{t \rightarrow 0} u(x, t) = f(x)$. The latter condition is abbreviated by $u(x, 0) = f(x)$. A fundamental theorem states that such a solution exists and is unique. We refer to theorem B.6.8 in the appendix of [10].

The heat equation on $(L, g|_L)$ admits a fundamental solution, called the *heat kernel*. The heat kernel is a function $p(x, y; t)$ that, for each $y \in L$, satisfies

$$\frac{\partial}{\partial t} p(x, y; t) = \Delta_L p(x, y; t),$$

and has the property that if f is bounded on L then

$$D_{L,t}f(x) = \int_L f(y)p(x, y; t)dy$$

is the bounded solution to the heat equation on L with initial condition f . The operators $D_{L,t}$ form the semigroup of diffusion operators of the manifold $(L, g|_L)$. For an introduction to the heat diffusion we refer to the appendix **B** of [10]. The construction of the heat kernel is described in section 5 of this appendix.

The union of the various semigroups for the different leaves L , defines a semigroup D_t of operators on continuous functions on M . If f is a function on the foliated space M , then $D_t f$ is the function that at the point $x \in M$ has the value of the diffusion of f on the leaf L_x through x . Thus,

$$D_t f(x) = \int_{L_x} f(y)p(x, y; t)dy.$$

The smoothness class of $D_t f$ is the same as the smoothness class of f , see proposition 2.17 below.

Let us define properly what a semigroup is.

Definition 2.15 *A one parameter family $\{T_t | t \geq 0\}$ of bounded linear operators on the Banach space $C(M)$ endowed with the uniform norm, is called a contraction semigroup of operators if it satisfies the following conditions:*

- (i) $T_{t+s} = T_t \cdot T_s$ for all $s, t > 0$;
- (ii) $\lim_{t \rightarrow 0} \|T_t f - f\| = 0$ for every $f \in C(M)$;
- (iii) the operator norm $\|T_t\| \leq 1$, for $t \geq 0$.

The infinitesimal generator of a contraction semigroup T_t is defined by the formula

$$A(f) = \lim_{t \rightarrow 0} \frac{T_t f - f}{t}.$$

Its domain \mathcal{D}_A consists of the elements in $C(M)$ for which the limit exists in $C(M)$.

The domain of the infinitesimal generator of a semigroup is dense in $C(M)$. For a proof of this fact we refer to theorem 2.2.8 of [10]. The idea now, is to show that if Δ is the Laplacian on a compact foliated manifold, then there is a contraction semigroup of operators on the Banach space $C(M)$ whose infinitesimal generator agrees with Δ in a dense subspace of $C(M)$. The semigroup of operators we are looking for is the diffusion semigroup defined previously.

We will not give the proof of the following results, we will just refer to chapter 2 of A. Candel and L. Conlon's book [10] for a proof that uses an adaptation of the construction of the heat kernel on a compact Riemannian manifold.

Theorem 2.16 *Let M be a compact foliated manifold with metric g and associated Laplacian Δ . The leafwise diffusion operators $\{D_{L,t}\}$ define a semigroup of operators D_t on $C(M)$ whose infinitesimal generator agrees with Δ in a dense subset of $C(M)$.*

An important property is that D_t transforms continuous functions into continuous functions.

Proposition 2.17 *Let $f \in C(M)$, then there is a unique 1-parameter family of continuous functions $D_t f$ on $M \times (0, \infty)$ of class C^2 on each leaf, such that*

$$\Delta D_t f(x) = \frac{\partial}{\partial t} D_t f(x)$$

for each $x \in M$ and $t > 0$.

Indeed, if $f \in C(M)$ and L is a leaf, then $D_t f|_L$ is a bounded solution to the heat equation on L with initial condition f . Since M is compact, the leaves have bounded geometry: $f|_L$ and $D_t f|_L$ are bounded. Theorem B.6.8 of [10] states that $D_t f$ is unique and is given by the equation

$$D_t f(x) = \int_L p(x, y; t) f(y) dy,$$

for every $x \in L$. Thus, we have that D_t is a semigroup of operators with the properties listed in definition 2.15. Furthermore, if $f \in C(M)$ is of class C^2 on each leaf,

$$\lim_{t \rightarrow 0} \frac{D_t f(x) - f(x)}{t} = \Delta f(x)$$

for every $x \in M$. The convergence is uniform on each compact subset of the leaves of \mathcal{F} . The domain of the infinitesimal generator contains, but generally is not equal to, the space of all continuous functions that are C^2 along the leaves and such that Δf is in $C(M)$.

2.4.2 Characterization of harmonic measures

We saw that by definition, a measure m on the foliated manifold M is harmonic if

$$\int_M \Delta f dm = 0,$$

for a suitable collection of continuous functions f . Two other characterizations of harmonic measures will be described in this section.

Observe that the diffusion semigroup D_t preserves positive functions as well as constants. Then, by duality between continuous functions and measures, it acts on a measure by the adjoint construction. That is, the measure $D_t m$ is defined by

$$\int_M f d(D_t m) = \int_M D_t f dm.$$

This action preserves probability measures on M because D_t is a positive operator which leaves invariant constant functions. The first characterization of harmonic measures is as fixed points of D_t .

Proposition 2.18 *A measure m on M is harmonic if and only if $D_t m = m$.*

Proof. Assume that m is harmonic, then there is a dense subspace $\mathcal{A} \subset C(M)$, contained in the domain of the infinitesimal generator of D_t and consisting on the functions that are C^2 along the leaves and such that Δf is continuous on M . Since \mathcal{A} is dense in $C(M)$ we need to show that $\int_M f dm = \int_M D_t f dm$ for every $f \in \mathcal{A}$ and $t \geq 0$. Observe that for these functions $\Delta D_t f(x) = \frac{\partial}{\partial t} D_t f(x)$, then the function

$$t \in [0, \infty) \mapsto \int_M D_t f dm$$

is continuous and has continuous right derivative. Hence it is differentiable. The derivative with respect to t is given by

$$\frac{d}{dt} \left(t \mapsto \int_M D_t f dm \right) = \int_M \Delta D_t f dm = 0.$$

Thus the function is constant, and hence m is diffusion invariant.

Suppose now that m is diffusion invariant. Using the fact that the leaves have bounded geometry and the properties of D_t , we have that

$$\lim_{t \rightarrow 0} \frac{D_t f(x) - f(x)}{t} = \Delta f(x),$$

for each $x \in M$ and for functions of class C^2 on M . Integrating this identity, and using the bounded convergence theorem, we get that m is harmonic. □

We say that a measure m on M is *absolutely continuous* with respect to a measure m' , if for any Borel set $B \subset M$,

$$m'(B) = 0 \quad \text{implies that} \quad m(B) = 0.$$

We denote this by $m \ll m'$. If $m \ll m' \ll m$ we say that they are equivalent, or that belong to the same *measure class*. A measure class is denoted by $[m]$. A measure on (M, \mathcal{F}, g) is *leafwise smooth* if the Borel sets of zero measure are, precisely, those sets whose leaf slices have Riemannian measure zero, for all but a null set of leaves. That is to say that, for a Borel set B , $m(B) = 0$ if

$$\{y \mid dx(B \cap L_y) > 0\}$$

is a Borel set of measure zero. Here dx denotes the Riemannian measure on the leaf, and L_y is the leaf through y .

Corollary 2.19 (lemma A of [26]) *Every harmonic measure m on M is leafwise smooth. Furthermore, the diffusion semigroup D_t , converts arbitrary measures into leafwise smooth measures. Finally,*

$$[D_t m] = [m]$$

for $t > 0$, if and only if m is leafwise smooth.

The second characterization of harmonic measures is of local nature and exhibits their analogy with transverse invariant measures.

Proposition 2.20 *A measure m on M is harmonic if and only if on any given foliated chart $\phi(U) \simeq \mathbb{D}^d \times \mathbb{D}^q$, m admits a decomposition of the form*

$$m = h(x, y)dx \otimes \nu(y)$$

where dx is the measure induced by the metric tensor on the leaves, ν is a measure on the transversal T , and $h(\cdot, y)$ is a positive harmonic function on the plaques for ν -almost all $y \in T$.

Proof. Assume first that m is a harmonic probability measure. Let z be a point in M . On a foliated chart U around z , write $z = (x, y)$ with y the coordinate on the transversal. Denote $\phi(U) \simeq D \times T$, where D is a d dimensional disc and T is the transversal. The local decomposition of the measure m is provided by the disintegration of the measure with respect to the fibration $p : D \times T \rightarrow T$, which is constant on the leaves. The projection p pushes m forward to a measure $\nu = p_*(m|U)$ on T . There is a measurable way to assign a probability measure μ_y on $D \times \{y\}$ such that

$$\int_M f(z)dm(z) = \int_T \left(\int_{D \times \{y\}} f(x, y)d\mu_y(x) \right) d\nu(y),$$

for ν -almost all $y \in T$, and for every smooth function f with compact support in U . Since the support of Δf is contained in the support of f , a partition of the unity argument implies that the measure is harmonic if and only if

$$\int_T \left(\int_{D \times \{y\}} \Delta f(x, y)d\mu_y(x) \right) d\nu(y) = 0, \quad (2.1)$$

for all foliated charts and all f compactly supported in U .

Consider leafwise smooth functions of the form $f(x, y) = f(x)$, that are constant in y and compactly supported in a foliated chart. These are bounded on U and are limits in the C^2 topology of sequences of functions that are compactly supported in U . Hence equation 2.1 holds for these functions also. Let A be a countable C^2 dense subset of these functions, then for $f \in A$ we have that

$$\int_{D \times \{y\}} \Delta f(x)d\mu_y(x) = 0, \quad (2.2)$$

where y ranges over a subset $T_f \subset T$ of full ν -measure. The set $T_* = \bigcap_{f \in A} T_f$ has also full measure. Thus equation 2.2 holds for all compactly supported smooth functions on D and for ν -almost all $y \in T$. By regularity results for elliptic partial differential equations (we refer the reader to theorem B.4.5 and its corollary B.4.6 of [10]), this is equivalent to the existence of a measurable function $h(x, y)$ on U , such that

- $h(\cdot, y)$ is harmonic on $D \times \{y\}$ for ν -almost every $y \in T$;
- $\mu_y(x) = h(x, y)dx$ for ν -almost all $y \in T$.

The converse implication follows from the Green-Stokes theorem. □

Since constant functions are harmonic we have the next corollary.

Corollary 2.21 *A transverse invariant measure, when combined with the volume density along the leaves, is a harmonic measure. Such a harmonic measure is said to be completely invariant.*

2.4.3 Ergodic theorems

In this section we will state the ergodic theorem for the diffusion semigroup. We will then define uniquely ergodic foliations and study their leaves.

Theorem 2.22 *Let (M, \mathcal{F}) be a compact foliated manifold endowed with a harmonic measure m . If f is an m -integrable function on M , then*

$$f^*(x) = \lim_{n \rightarrow \infty} \frac{1}{n} \sum_{k=1}^{n-1} D_1^k f(x)$$

exists for m -almost all $x \in M$. Moreover, f^ is a diffusion invariant m -integrable function, that is constant along m -almost every leaf and such that*

$$\int_M f(x) dm(x) = \int_M f^*(x) dm(x).$$

Remark an implicit fact of the theorem: the diffusion of m -integrable functions is defined and yields m -integrable functions. The next two results give the precise statement, for a proof we refer to propositions 2.5.2 and 2.5.4 of [10].

Proposition 2.23 *If m is a harmonic probability measure on M and if $f \in L^1(M, m)$, then the diffusion $D_t f$ is defined. Moreover, $D_t f \in L^1(M, m)$ for all $t \geq 0$ and $\|D_t f\|_1 \leq \|f\|_1$.*

In $L^1(M, m)$ we have that $D_t f \rightarrow f$ as $t \rightarrow 0$, with the topology given by the L^1 norm. Then D_t is a semigroup of bounded linear operators on $L^1(M, m)$ with L^1 norm bounded by one. Since the measure m is finite, the space of essentially bounded functions $L^\infty(M, m)$ is a subspace of $L^1(M, m)$, and so D_t is defined on it.

Proposition 2.24 *The diffusion operators D_t map essentially bounded functions to essentially bounded functions, and $\|D_t f\|_\infty \leq \|f\|_\infty$ for every $t \geq 0$.*

We will now state the ergodic theorem for operators of the type of D_t on Banach spaces. For a proof we refer to section VIII.5 of Nelson Dunford and Jacob T. Schwartz's book [17].

Theorem 2.25 *Let (X, μ) be a finite measure space. Let D be a linear operator acting on $L^1(X, \mu)$, that maps essentially bounded functions to essentially bounded functions, with $\|D\|_1 \leq 1$ and $\|D\|_\infty \leq 1$. Let D^n denote the n composition and D^0 the identity operator. Then, for every μ -integrable function the limit*

$$f^*(x) = \lim_{n \rightarrow \infty} \frac{1}{n} \sum_{k=1}^{n-1} D^k f(x)$$

exists for μ -almost all $x \in X$. Moreover, f^ is a D -invariant μ -integrable function and*

$$\int_X f(x) d\mu(x) = \int_X f^*(x) d\mu(x).$$

The previous theorem can be applied to the diffusion operators at time $t = 1$, thus proving the existence of a function f^* that is invariant under D_1^n . It remains to prove that this function is actually constant on each leaf in a saturated set of full m -measure. The next result is due to L. Garnett, see theorem 1(b) of [26].

Proposition 2.26 *Let f be a measurable function on M that is m -integrable and such that $D_{t_0}f = f$ for a positive time t_0 . Then the class of f in $L^1(M, m)$ contains a function f' that is constant along each leaf of \mathcal{F} .*

Proof. For each nonnegative rational number we can define $f_r = \min\{f, r\}$. Then $|f_r| \leq |f|$, so f_r is m -integrable. By proposition 2.23, $D_t f_r$ is also m -integrable for all $t \geq 0$. Write $D = D_{t_0}$, for a fixed t_0 . It can be shown that D preserves constant functions, that is $Dr = r$. Thus the inequalities $f_r \leq f$ and $f_r \leq r$ imply that

$$\begin{aligned} Df_r &\leq Df = f, \\ Df_r &\leq Dr = r, \end{aligned}$$

proving that $Df_r \leq f_r$. Observe that if $f_r < r$ on a set of positive Riemannian measure of a leaf L , then $Df_r(x) < r$ for every $x \in L$.

Since m is harmonic we have that

$$\int_M Df_r(x) dm(x) = \int_M f_r(x) dm(x).$$

By corollary 2.19 we know that m is leafwise smooth, then there exists a saturated set B_r of full measure such that for each leaf L in B_r , the set

$$\{x \in L \mid Df_r(x) < f_r(x)\}$$

has Riemannian measure zero. Thus, $Df_r = f_r$ almost everywhere on each leaf $L \subset B_r$, with respect to the Riemannian measure on L . Furthermore, there is a point $x \in L$ satisfying that $f(x) = Df(x) > r$ if and only if $f > r$ on a set of positive Riemannian measure in L . In this case, f_r is equal to its maximum value r on that set. But since $Df_r = f_r$ almost everywhere on L , we have that $f_r = r$ almost everywhere on L . Equivalently, $f \geq r$ almost everywhere on L . Thus, for each leaf $L \subset B_r$, either $f \leq r$ or $f \geq r$ almost everywhere on L .

We had assumed that r is a nonnegative rational number, but applying the same reasoning to $-f$ shows that r may be any rational number. The saturated set

$$B = \bigcap_{r \in \mathbb{Q}} B_r,$$

has full m -measure and, for each leaf $L \subset B$, the function $f|_L$ is almost everywhere constant. Using the local characterization of m , we get that f agrees m -almost everywhere in M with a function f' that is constant along each leaf in B .

□

Definition 2.27 *A harmonic measure of a foliated manifold is ergodic if every saturated set of leaves has zero or full measure.*

Another way to write proposition 2.26 is the following: *any bounded m -integrable function f which is harmonic on each leaf must be constant on almost all leaves.* Then a harmonic probability measure is ergodic if and only if any bounded leaf harmonic function which is m -integrable is

constant on a saturated set of full measure. As a corollary to theorem 2.22 we have that if m is an ergodic harmonic probability measure for M and if f is m -integrable, then

$$f^*(x) = \int_M f(x) dm(x),$$

m -almost everywhere.

Definition 2.28 A foliation of a compact manifold is uniquely ergodic if there exists a unique ergodic harmonic probability measure.

Theorem 2.29 A foliation is uniquely ergodic if and only if for all continuous functions f on M ,

$$\frac{1}{n} \sum_{k=1}^{n-1} D_1^k f(x)$$

converges uniformly to a constant.

Proof. Let us begin by assuming that \mathcal{F} is a uniquely ergodic foliation of a compact manifold M . Let m be the harmonic measure and take a continuous function f , and $f^*(x)$ be as in theorem 2.22. Assume that the implication in the theorem is false. Then there exist $\epsilon > 0$ and a sequence of integers $n_k \rightarrow \infty$ such that

$$\sup_{x \in M} \left\{ \left| \frac{1}{n_k + 1} \sum_{i=0}^{n_k} D_1^i f(x) - f^*(x) \right| \right\} \geq \epsilon.$$

Then we have a sequence of points $x_k \in M$ such that

$$\left| \frac{1}{n_k + 1} \sum_{i=0}^{n_k} D_1^i f(x_k) - f^*(x_k) \right| \geq \epsilon.$$

Using Riesz representation theorem, there exist probability measures ν_k such that

$$\frac{1}{n_k + 1} \sum_{i=0}^{n_k} D_1^i f(x_k) = \int_M f d\nu_k.$$

Passing to a subsequence we can assume that the probability measures converge: $\nu_k \rightarrow \nu$. Clearly, $\nu \neq m$, since

$$\left| \int_M f d\nu - \int_M f dm \right| = \left| \int_M f d\nu - f^* \right| \geq \epsilon.$$

Thus, if we show that ν is a harmonic measure we will get a contradiction. Using proposition 2.18 we need to prove that $D_t \nu = \nu$, or in other words

$$\int_M D_t f d\nu = \int_M f d\nu.$$

We have that

$$\begin{aligned}
\int_M D_1 f d\nu &= \lim_{n_k \rightarrow \infty} \int_M D_1 f d\nu_k \\
&= \lim_{n_k \rightarrow \infty} \frac{1}{n_k + 1} \sum_{i=0}^{n_k} D_1^{i+1} f(x_k) \\
&= \lim_{n_k \rightarrow \infty} \int_M f d\nu_k - \lim_{n_k \rightarrow \infty} \frac{1}{n_k + 1} f(x_k) + \lim_{n_k \rightarrow \infty} \frac{1}{n_k + 1} D_1^{n_k+1} f(x_k) \\
&= \int_M f d\nu.
\end{aligned}$$

Since \mathcal{F} is uniquely ergodic we get a contradiction, proving the forward implication in the theorem.

Assume now that for all continuous function f on M ,

$$\frac{1}{n} \sum_{k=1}^{n-1} D_1^k f(x)$$

converges uniformly to a constant that we will call c_f . The map $f \mapsto c_f$ is a positive linear functional on $C(M)$. Then there exists a harmonic probability measure m such that $c_f = \int_M f dm$. We will show that m is unique.

Let μ be a harmonic probability measure on M , and f a continuous function. By theorem 2.22 we have that for μ -almost all $x \in M$

$$f^*(x) = \lim_{n \rightarrow \infty} \frac{1}{n} \sum_{k=0}^{n-1} D_1^k f(x),$$

and $\int_M f^*(x) d\mu(x) = \int_M f(x) d\mu(x)$. Then $f^*(x) = c_f$ for μ -almost all x , and integrating we get that

$$\int_M f(x) d\mu(x) = \int_M f^*(x) d\mu(x) = c_f = \int_M f(x) dm(x).$$

Showing that $m = \mu$ and thus that \mathcal{F} is uniquely ergodic. □

Definition 2.30 A minimal set in a foliation is a non empty saturated closed set that has no proper subsets satisfying this conditions. A minimal leaf is a leaf whose closure is a minimal set. A foliation is minimal if all its leaves are dense.

We want to prove that for uniquely ergodic foliations there is a unique minimal set of full measure. In order to prove this we will need to introduce the concept of lamination, that is a generalization of foliations to metric spaces.

Definition 2.31 Let N be a compact metric space. A d dimensional lamination \mathcal{L} is a decomposition of N into d -manifolds. More precisely, there is an open cover $\{U_i, \phi_i\}$ of N such that

$$\phi_i(U_i) \simeq \mathbb{D}^d \times T_i,$$

where T_i is some topological space. The maps $\phi_{ij} = \phi_j \circ \phi_i^{-1}$ are of the form

$$\phi_{ij}(x, t) = (h_{ij}(x, t), f_{ij}(t)).$$

The theory of harmonic measures presented previously, generalizes without any substantial changes to laminations. In particular, there exists a harmonic probability measure for any lamination.

Proposition 2.32 *Let \mathcal{F} be a uniquely ergodic foliation, then every leaf is minimal.*

Proof. Let L be a leaf of the foliation and m the harmonic measure. Assume that L is not minimal. Then its closure \bar{L} defines a lamination. A lamination has at least one harmonic measure m' , such that its support is contained in \bar{L} . Then m' is invariant under the action of the diffusion semigroup attached to the foliation, and m' is also a harmonic measure for \mathcal{F} . Since L is not minimal, $m' \neq m$, a contradiction. □

2.5 Minimal foliations

In this section, we will introduce a result of D. Cass [12] on minimal leaves of foliations. We will use this theorem in section 2.6, for proving that minimal foliations with Følner leaves are amenable. The idea is that the minimality of the leaves implies that there are Følner sequences everywhere.

We will begin by a discussion on the topology of the leaves that will let us prove D. Cass' theorem. As before, let \mathcal{F} be a foliation of a compact manifold M . We will take a Riemannian metric on M inducing a distance ρ along the leaves. We can see the manifold M as the zero section of its tangent bundle TM , thus we have the exponential map $\exp : TM \rightarrow M$ defined in a neighborhood of M . The tangent bundle $T\mathcal{F}$ of the foliation is a subbundle of TM .

A key element in what follows is the existence of maps between nearby leaves. To define them we need to fix in advance an $\tilde{\epsilon} > 0$ with a subbundle $N \subset TM$ which is complementary to $T\mathcal{F}$. The bundle N satisfies the next condition

- for any leaf L of \mathcal{F} and any point $x \in L$, there is a ρ -neighborhood $V \subset L$ of x such that $\exp : N_{\tilde{\epsilon}}(V) \rightarrow M$ is an embedding.

We denote by $N_{\tilde{\epsilon}}(V)$ the $\tilde{\epsilon}$ -neighborhood of V in N . If the leaves are of class C^2 , the bundle N may be the normal bundle to the foliation. If K is a subset of L , we will write $N_{\tilde{\epsilon}}(K)$ in place of the embedded neighborhood $\exp(N_{\tilde{\epsilon}}(K))$.

We would like to use the disc bundle $N_{\tilde{\epsilon}}$ in order to construct maps via *path lifting* from discs in a leaf to discs in nearby leaves. By path lifting we mean that a path in a leaf will be mapped to a path in a nearby leaf. Let L_x be the leaf through x . Denote by $B_M(x, r)$ the ball of radius r centered at x in M , and by $B(x, r)$ the ball in the leaf through x .

We say that a diffeomorphism f , between two Riemannian manifolds (L_1, g_1) and (L_2, g_2) , has dilatation bound $k \geq 1$ if

$$\frac{1}{k}g_1(V) \leq g_2(f_*(V)) \leq kg_1(V),$$

for every $V \in TL_2$.

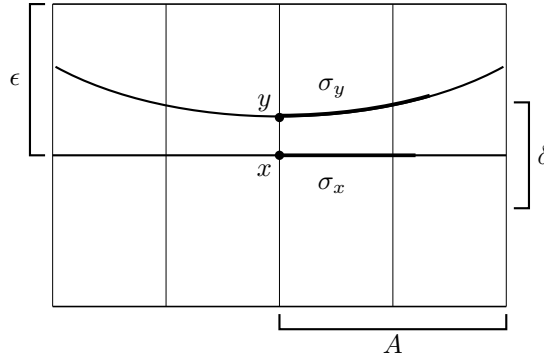

Figure 2.7: The bundle $N_{\tilde{\epsilon}}(L_x)$ and the path lifting map.

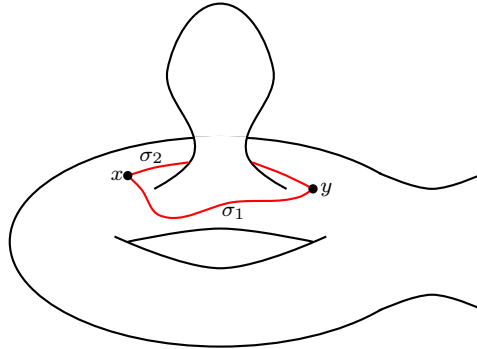

Figure 2.8: σ_1, σ_2 are homotopic paths that represent different points in $\tilde{B}(x, A)$.

Proposition 2.33 *Given $\epsilon < \tilde{\epsilon}$ and $A > 0$, there exists $\delta > 0$ such that for any $x \in M$ and every $y \in N_{\delta}(x)$, any path $\sigma_x \subset L_x$ of length less or equal to A , will lift via the disc bundle $N_{\epsilon}(B(x, A))$ to a path $\sigma_y \subset L_y$.*

The situation in the proposition is illustrated in figure 2.7. The idea behind the proof is the decomposition in plaques of the foliation, using a foliated atlas. Observe that on a leaf two paths of length less than A may be homotopic only through longer paths, as in figure 2.8. In order to make the path lifting map well defined we will consider the restricted homotopy classes defined below.

Definition 2.34 *The ball $\tilde{B}(x, A)$ consists of the equivalence classes of paths in the leaf L_x , starting at x and of length less or equal to A . The equivalence is the homotopy with fixed endpoints and through paths of length less or equal to A .*

Proposition 2.35 *Given $\epsilon < \tilde{\epsilon}$ and $A > 0$, there exists $\delta > 0$ such that for every $x \in M$ and every $y \in N_{\delta}(x)$ the path lifting map*

$$f : B(x, A) \rightarrow L_y$$

taking $\sigma_x \mapsto \sigma_y$ is a local immersion with dilatation bound 2^ϵ . The path σ_y has as starting point y . Moreover, two paths in the same class in $\tilde{B}(x, A)$ are mapped under f to paths with the same endpoint.

We say that a map $f : B(x, A) \rightarrow L_y$ is *endpoint monic* if whenever $f(\sigma_1)$ and $f(\sigma_2)$ have the same endpoint, the two paths σ_1 and σ_2 have the same endpoint. Observe that such a map can take two different classes in $\tilde{B}(x, A)$ to paths with the same endpoint. The map in the previous proposition is endpoint monic.

Definition 2.36 We say that a leaf L , of a foliation of a compact manifold, is

- *recurrent, if for every $\epsilon > 0$ there exists $A > 0$ such that*

$$L \subset B_M(B(x, A), \epsilon),$$

where A depends only on ϵ , and $B_M(B(x, A), \epsilon)$ is the ϵ -neighborhood of the ball $B(x, A)$.

- *quasi-homogeneous if there exists $k \geq 1$ and*
 - *for all $a > 0$, there exists $A > 0$, such that for every $B(x, a)$ there exists an immersion $f : B(x, a) \rightarrow B(y, A)$, for any $y \in L$ with dilatation bound k .*
 - *given $B(x, a)$ there exists $A' > A$ and $f : B(x, a) \rightarrow B(y, A')$ as before that is also endpoint monic.*

Moreover, we will ask the map f , in both cases, to satisfy that two paths representing the same class in $\tilde{B}(x, a)$ are mapped to paths with common endpoint.

We can now state and prove D. Cass' theorem.

Theorem 2.37 (Cass) Let L be a leaf of the foliation \mathcal{F} of a compact manifold M . Then L is minimal if and only if one of the following conditions is satisfied:

- (i) L is recurrent;
- (ii) L is quasi-homogeneous.

Proof.

- (i) Let us start with the forward implication: a minimal leaf must be recurrent. Let L be a minimal leaf with closure \bar{L} . Assume also that L is not recurrent. Then we can find $\epsilon > 0$, a sequence T_n going to ∞ , and sequences of points $p_n, q_n \in L$ such that: the distance between q_n and the ball $B(p_n, T_n) \subset L$ is bigger than ϵ . The distance is measured in M , not in the leaf. Since \bar{L} is compact we can pass to subsequences and suppose that $p_n \rightarrow p, q_n \rightarrow q$. Consider the leaf L_p passing through p .

We claim that every point x of L_p is at least at distance $\epsilon/3$ from the point q in M . This claim implies a contradiction to minimality because $L_p \subset \bar{L}$ and its closure does not contain q . Hence a proof of this will finish the proof that a minimal leaf must be recurrent.

To prove the claim let us pick a point on L_p , and connect it to p via a path σ with $\sigma(0) = p$. If n is large enough, proposition 2.33 implies σ will lift via $N_{\bar{\epsilon}}$ to a path $\bar{\sigma}$ in L , that is the leaf through p_n . The endpoint $\bar{\sigma}(1)$ will be in $B(p_n, T_n)$ as long as T_n is larger than two times the

length of σ . Increasing n we can ensure that the distance between $\bar{\sigma}(1)$ and x is smaller than $\epsilon/3$. Then by the assumption that L is not recurrent, we get that the distance between $\bar{\sigma}(1)$ and q_n is bigger than ϵ .

Let us write $d(\cdot, \cdot)$ for the distance in M . Using the triangle inequality we have that

$$d(\bar{\sigma}(1), q_n) < d(\bar{\sigma}(1), x) + d(x, q) + d(q, q_n).$$

Then

$$d(x, q) > d(\bar{\sigma}(1), q_n) - d(\bar{\sigma}(1), x) - d(q, q_n) > \epsilon - \epsilon/3 - \epsilon/3 = \epsilon/3.$$

Thus, every point $x \in L_p$ is at least at distance $\epsilon/3$ from q . This finishes the proof of the forward implication.

We need to prove the other implication in (i): a recurrent leaf is minimal. Assume that L is recurrent with closure \bar{L} and that is not minimal. Then some leaf $K \in \bar{L}$ has closure $\bar{K} \neq \bar{L}$. Then, L is not contained in \bar{K} , so pick a point $x \in L$ at a distance ϵ_1 from the compact set \bar{K} . For a point $y \in K$ we can pick a sequence $y_n \in N_{\bar{\epsilon}}(y) \cap L$ with $y_n \rightarrow y$.

The recurrence assumption produces $T = T(\epsilon_1/3)$ large enough, and such that any ball of radius T in L approximates the whole leaf within $\epsilon_1/3$. Now by proposition 2.33 with $\epsilon = \epsilon_1/3$ and $A = T$, we get that for n large enough, paths σ in $B(y_n, T)$ of length less than T will lift to paths $\bar{\sigma}$ in $B(y, T)$ satisfying

$$d(\sigma(t), \bar{\sigma}(T)) < \epsilon_1/3,$$

for every t .

The ball $B(y_n, T)$ must approximate all of L within $\epsilon_1/3$. In particular, x is within $\epsilon_1/3$ from a point $z \in B(y_n, T)$ in the distance of M . But if σ is a path in L starting at y_n and going to z of length smaller than T , then the endpoint of its lift $z' = \bar{\sigma}(1)$ will be within $\epsilon_1/3$ of the point z . Then

$$d(x, z') < d(x, z) + d(z, z') < 2\epsilon_1/3,$$

contradicting the fact that x is at distance ϵ_1 from K and $z' \in K$. This contradiction completes the proof of the first part of the theorem: a leaf is minimal if and only if it is recurrent.

- (ii) Assume that L is minimal, then L is recurrent. Let $a > 1$ be given, we will find an A satisfying the first part of the definition of a quasi-homogeneous leaf. Set $a_1 = a + 1$ and apply proposition 2.35 with an $\epsilon < 1$. This assures us that the maps that come from path lifting will have dilatation bound $1 \leq 2^\epsilon < 2$. We have a $\delta_1 > 0$ such that for any $x \in L$ and $z \in N_{\delta_1}(x)$, we can define a path lifting map $f : B(x, a_1) \rightarrow L_z$. We will assume that $\delta_1 < \frac{1}{2}$. Now we choose δ_2 small enough so that

$$B_M(x, \delta_2) \subset N_{\delta_1}(B(x, \delta_1)).$$

The existence of such a δ_2 follows from the fact that M is compact and is the zero section of $N_{\bar{\epsilon}}$. We now use the fact that L is recurrent for $\epsilon = \delta_2 \leq \delta_1$, that is in the definition the constant $k = 2^{\delta_2}$. We get $T(\delta_2)$ such that

$$L \subset B_M(B(x, T(\delta_2)), \delta_2).$$

We claim that the first part of the quasi-homogeneity of L is satisfied for $A = T(\delta_2) + 2a_1$. To check our claim, assume we are given $B(x, a)$ and $B(y, A)$ in L . Since L is recurrent, there

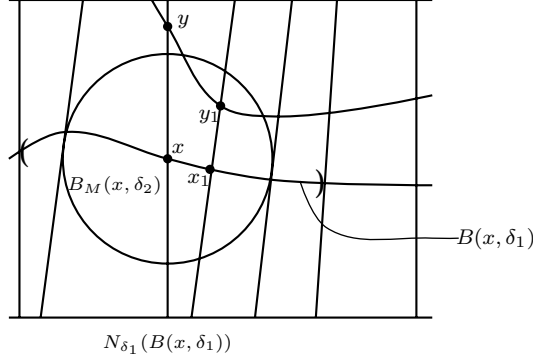
Figure 2.9: $y_1 \in B(y, T(\delta_2))$

exists a point $y_1 \in B(y, T(\delta_2))$ such that the distance to x in M is less than δ_2 . Then we have an $x_1 \in L$ such that $y_1 \in N_{\delta_2}(x_1)$ and $x_1 \in B(x, \delta_1)$.

Then we get the path lifting map $f : B(x_1, a_1) \rightarrow L$. Since f has dilatation bound $2^{\delta_2} < 2$, the image $f(B(x_1, a_1)) \subset B(y_1, 2a_1)$. The assumption $\delta_1 < \frac{1}{2}$ assures us that

$$B(x, a) \subset B(x_1, a_1)$$

and also we have that $B(y_1, 2a_1) \subset B(y, A)$. Thus the map we are looking for is the restriction of f to $B(x, a)$.

For the proof of the second part of the definition of a quasi-homogeneous leaf, we need to consider a fixed ball $\tilde{B}(x, a)$. We will follow the precedent proof adjusting δ_2 and $T(\delta_2)$. First we apply proposition 2.35 to $a_1 = a + 1$ and ϵ . We will not only assume that $\epsilon < 1$, this time we will take ϵ such that $N_\epsilon(B(x, a))$ is embedded by the exponential map in M . This can be done because $\epsilon < \tilde{\epsilon}$ and \exp is an embedding of $N_{\tilde{\epsilon}}$.

Thus any map $f : B(x, a) \rightarrow L_y$, defined by path lifting within the disc bundle $N_\epsilon(B(x, a))$, will be endpoint monic. This follows from the fact that the fibers $N_\epsilon(z)$ for $z \in B(x, a)$ are pairwise disjoint. Observe that δ_2 becomes smaller and $T(\delta_2)$ larger. Thus, defining A' with the new $T(\delta_2)$ we have that $A' > A$.

□

Let us make two remarks about the quantifiers involve in the quasi-homogeneity that we will use later. First, observe that the dilatation of the map f can be taken arbitrarily close to one. This follows because the dilatation of f is 2^{δ_2} and $\delta_2 \leq \delta_1$. The δ_1 is taken such that for every $z \in N_{\delta_1}(x)$ the path lifting map $f : B(x, a) \rightarrow L_z$ is defined. Then δ_1 can be taken arbitrarily close to zero. Secondly, if we fix δ_1 we get that A and A' are equal to a constant plus $2a$, that is they depend linearly on a .

2.6 Minimal Følner foliations are amenable

We can now prove that a minimal foliation with Følner leaves is amenable. We will fix a foliated atlas satisfying the conditions of section 2.1, and a Riemannian metric on the ambient manifold.

Call ρ the distance on the leaves.

Theorem E *Let \mathcal{F} be a minimal foliation of a compact manifold M . If μ is a transverse invariant measure and μ -almost all the leaves are Følner, \mathcal{F} is amenable for μ .*

Proof. The idea of the proof is the following. First, theorem 2.37 tell us that the leaves are quasi-homogeneous. This fact will allow us to construct sequences of measures satisfying the criterion in theorem 2.7. We will use the notation and quantifiers of the proof of theorem 2.37.

Consider a minimal leaf L , since it is Følner there exist a sequence of submanifolds V_i of dimension d such that

$$\lim_{i \rightarrow \infty} \frac{\text{area}(\partial V_i)}{\text{volume}(V_i)} = 0.$$

For any point $x \in V_i$ there exist a_x such that $V_i \subset B(x, a_x)$. Put $x_i \in V_i$, such that $a_{x_i} = a_i$ is minimal. Take a point $y \in L$, we claim that there exists a sequence of compact submanifolds $\{W_i\}$, containing y , such that

$$\frac{\text{area}(\partial W_i)}{\text{volume}(W_i)} \rightarrow 0 \quad (2.3)$$

as $i \rightarrow \infty$.

To make the notation simpler, we will forget for a moment of the index i . Beginning with a submanifold $V \subset L$ we will construct a submanifold $W \subset L$ around any given point $y \in L$. By assumption the leaf L is minimal. Using the quasi-homogeneous hypothesis, we have that there exist $A' > 0$ and a map

$$f : B(x, a) \rightarrow B(y, A')$$

into any ball $B(y, A') \subset L$. The map has dilatation bound $k = 2^{\delta_2} \leq 2^{\delta_1}$, then a path $\sigma_x \subset B(x, a)$ starting at x is mapped to a path $f(\sigma_x) \subset B(y, A')$ such that

$$\frac{1}{k} \leq \frac{\text{lenght}(f(\sigma_x))}{\text{lenght}(\sigma_x)} \leq k.$$

Moreover, there exist $y_1 \in B_M(x, \delta_2)$ and $x_1 \in B(x, \delta_1)$ such that $y_1 \in N_{\delta_1}(x_1)$. The map was constructed by lifting paths starting at x_1 to paths starting at y_1 .

Put $\widetilde{W} = f(V)$. Then there exist constants c and C , depending only on $\delta_2 \leq \delta_1$ and the dimension d of L , such that

$$\begin{aligned} c &\leq \frac{\text{volume}(\widetilde{W})}{\text{volume}(V)} \leq C \\ c &\leq \frac{\text{area}(\partial \widetilde{W})}{\text{area}(\partial V)} \leq C. \end{aligned}$$

In fact $c \sim (2^{-\delta_2})^d$ and $C \sim (2^{\delta_2})^d$. The way f was constructed implies that \widetilde{W} may not contain y . To overcome this difficulty let $l = \rho(\widetilde{W}, y) < A'$, and take a path σ from y to \widetilde{W} of length l . Let P_1, P_2, \dots, P_k be a finite covering by plaques of σ , and set

$$W = \widetilde{W} \cup \left(\bigcup_{i=1}^k P_i \right).$$

Consider for V the d -current

$$\xi(\alpha) = \frac{1}{\text{volume}(V)} \int_V \alpha.$$

Since f is locally Lipschitz, we can define the image of ξ as the d -current

$$f_*\xi(\alpha) = \frac{1}{\text{volume}(V)} \int_V f^*\alpha = \frac{1}{\text{volume}(V)} \int_{f(V)} \alpha.$$

Let us come back to the Følner sequence. Starting with the sequence V_i we obtain the sequence W_i satisfying 2.3. Observe that we get a sequence δ_1^i of the number δ_1 we used above. Since $\delta_2^i \leq \delta_1^i$ can be taken arbitrarily close to zero, the constants C_i and c_i are close to one. As in proposition 2.5, the sequences V_i and W_i of submanifolds define the sequences of d -currents

$$\begin{aligned} \xi_i(\alpha) &= \frac{1}{\text{volume}(V_i)} \int_{V_i} \alpha \\ \eta_i(\alpha) &= \frac{1}{\text{volume}(W_i)} \int_{W_i} \alpha, \end{aligned}$$

that give rise to a sequences of measures λ_x^i and λ_y^i , respectively. Such sequences converge weakly to transverse invariant measures λ_x and λ_y for \mathcal{F} , respectively.

Using the sequences of measures criterion of V. A. Kaimanovich, we get that for proving the amenability of \mathcal{F} we need to prove that $\|\lambda_x^i - \lambda_y^i\| \rightarrow 0$, or equivalently that

$$M(\xi_i - \eta_i) \rightarrow 0,$$

as $i \rightarrow \infty$, where M denotes de mass of a current. But

$$\begin{aligned} M(\xi_i - \eta_i) &\leq M\left(\xi_i - \frac{1}{\text{volume}(W_i)} \int_{\widetilde{W}_i} \alpha\right) \\ &\leq \sup_{\alpha, \|\alpha\|=1} \left(\frac{1}{\text{volume}(V_i)} \int_{V_i} (1 - f_i^*)\alpha \right) + M\left(\frac{|\text{volume}(V_i) - \text{volume}(W_i)|}{\text{volume}(V_i)\text{volume}(W_i)} \int_{\widetilde{W}_i} \alpha\right) \\ &\rightarrow 0, \end{aligned}$$

The convergence follows because the sequences C_i and c_i converge to one as we make $\delta_1^i \rightarrow 0$. Hence, $\|\lambda_x^i - \lambda_y^i\| \rightarrow 0$.

The above construction can be done for every point $y \in L$ and for any minimal Følner leaf L of \mathcal{F} . Thus \mathcal{F} satisfies the measures of sequences criterion from theorem 2.7. Hence, \mathcal{F} is amenable. \square

Clearly, the theorem is valid under the assumption that the foliation is uniquely ergodic. There are known examples of minimal foliations that posses several transverse invariant probability measures, hence not uniquely ergodic.

Consider a foliation \mathcal{F} of a compact manifold with a harmonic measure μ . We say that the foliation is Liouville, with respect to μ if μ -almost every leaf have the Liouville property: that is there is no non constant bounded harmonic function on it. Proposition 20 of [14] states that a Liouville foliation is amenable. An open question is

does a minimal foliation with all its leaves Følner is Liouville?

A positive answer to this question would imply that if we have a minimal foliation of a compact manifold with all its leaves Følner, all the harmonic measures are completely invariant measures. This follows from corollary of theorem 4 of [47].

Bibliography

- [1] Ralph Abraham, Jerrold E. Marsden, and Tudor Ratiu. *Manifolds, tensor analysis, and applications*, volume 75 of *Applied Mathematical Sciences*. Springer-Verlag, New York, second edition, 1988.
- [2] Steven J. Altschuler. A geometric heat flow for one-forms on three-dimensional manifolds. *Illinois J. Math.*, 39(1):98–118, 1995.
- [3] Vladimir I. Arnold and Boris A. Khesin. *Topological methods in hydrodynamics*, volume 125 of *Applied Mathematical Sciences*. Springer-Verlag, New York, 1998.
- [4] Daniel Asimov and Herman Gluck. Morse-Smale fields of geodesics. In *Global theory of dynamical systems (Proc. Internat. Conf., Northwestern Univ., Evanston, Ill., 1979)*, volume 819 of *Lecture Notes in Math.*, pages 1–17. Springer, Berlin, 1980.
- [5] Daniel Bennequin. Entrelacements et équations de Pfaff. In *Third Schnepfenried geometry conference, Vol. 1 (Schnepfenried, 1982)*, volume 107 of *Astérisque*, pages 87–161. Soc. Math. France, Paris, 1983.
- [6] Errett Bishop. Differentiable manifolds in complex Euclidean space. *Duke Math. J.*, 32:1–21, 1965.
- [7] Robert Brooks. Some Riemannian and dynamical invariants of foliations. In *Differential geometry (College Park, Md., 1981/1982)*, volume 32 of *Progr. Math.*, pages 56–72. Birkhäuser Boston, Mass., 1983.
- [8] Robert Brooks. The spectral geometry of foliations. *Amer. J. Math.*, 106(4):1001–1012, 1984.
- [9] Alberto Candel and Lawrence Conlon. *Foliations. I*, volume 23 of *Graduate Studies in Mathematics*. American Mathematical Society, Providence, RI, 2000.
- [10] Alberto Candel and Lawrence Conlon. *Foliations II*, volume 60 of *Graduate Studies in Mathematics*. American Mathematical Society, 2000.
- [11] Yves Carrière and Étienne Ghys. Relations d'équivalence moyennables sur les groupes de Lie. *C. R. Acad. Sci. Paris Sér. I Math.*, 300(19):677–680, 1985.

- [12] Daniel M. Cass. Minimal leaves in foliations. *Trans. Amer. Math. Soc.*, 287(1):201–213, 1985.
- [13] Jeff Cheeger. A lower bound for the smallest eigenvalue of the Laplacian. In *Problems in analysis (Papers dedicated to Salomon Bochner, 1969)*, pages 195–199. Princeton Univ. Press, Princeton, N. J., 1970.
- [14] Alain Connes, Joel Feldman, and Benjamin Weiss. An amenable equivalence relation is generated by a single transformation. *Ergodic Theory Dynamical Systems*, 1(4):431–450 (1982), 1981.
- [15] Georges de Rham. *Variétés différentiables. Formes, courants, formes harmoniques*. Hermann, Paris, 1973. Troisième édition revue et augmentée, Publications de l'Institut de Mathématique de l'Université de Nancago, III, Actualités Scientifiques et Industrielles, No. 1222b.
- [16] T. Dombre, U. Frisch, J. Greene, M. Hénon, A. Mehr, and A. Soward. Chaotic streamlines in the *abc* flows. *J. Fluid Mech.*, 167:353–391, 1986.
- [17] Nelson Dunford and Jacob T. Schwartz. *Linear Operators, Part I: General Theory*. A Wiley-Interscience Publication. John Wiley and Sons, Inc., New York, 1988.
- [18] Yakov Eliashberg. Contact 3-manifolds twenty years since J. Martinet's work. *Ann. Inst. Fourier (Grenoble)*, 42(1-2):165–192, 1992.
- [19] Yakov Eliashberg and William P. Thurston. *Confoliations*, volume 13 of *University Lecture Series*. American Mathematical Society, Providence, RI, 1998.
- [20] David B. A. Epstein. Periodic flows on three-manifolds. *Ann. of Math. (2)*, 95(1):66–82, 1972.
- [21] David B. A. Epstein and Elmar Vogt. A counterexample to the periodic orbit conjecture in codimension 3. *Ann. of Math. (2)*, 108(3):539–552, 1978.
- [22] John Etnyre and Robert Ghrist. Contact topology and hydrodynamics. I. Beltrami fields and the Seifert conjecture. *Nonlinearity*, 13(2):441–458, 2000.
- [23] John Etnyre and Robert Ghrist. Contact topology and hydrodynamics. II. Solid tori. *Ergodic Theory Dynam. Systems*, 22(3):819–833, 2002.
- [24] Herbert Federer. *Geometric measure theory*. Die Grundlehren der mathematischen Wissenschaften, Band 153. Springer-Verlag New York Inc., New York, 1969.
- [25] Erling Følner. On groups with full Banach mean value. *Math. Scand.*, 3:243–254, 1955.
- [26] Lucy Garnett. Foliation, the ergodic theorem and Brownian motion. *J. Funct. Anal.*, 51(3):285–311, 1983.
- [27] Étienne Ghys. Construction de champs de vecteurs sans orbite périodique (d'après Krystyna Kuperberg). *Astérisque*, (227):Exp. No. 785, 5, 283–307, 1995. Séminaire Bourbaki, Vol. 1993/94.
- [28] Viktor L. Ginzburg. An embedding $S^{2n-1} \rightarrow \mathbf{R}^{2n}$, $2n - 1 \geq 7$, whose Hamiltonian flow has no periodic trajectories. *Internat. Math. Res. Notices*, (2):83–97 (electronic), 1995.
- [29] Viktor L. Ginzburg. A smooth counterexample to the Hamiltonian Seifert conjecture in \mathbf{R}^6 . *Internat. Math. Res. Notices*, (13):641–650, 1997.

- [30] Viktor L. Ginzburg and Başak Z. Gürel. A C^2 -smooth counterexample to the Hamiltonian Seifert conjecture in \mathbb{R}^4 . *Ann. of Math. (2)*, 158(3):953–976, 2003.
- [31] Emmanuel Giroux. Convexité en topologie de contact. *Comment. Math. Helv.*, 66(4):637–677, 1991.
- [32] Herman Gluck. Dynamical behavior of geodesic fields. In *Global theory of dynamical systems (Proc. Internat. Conf., Northwestern Univ., Evanston, Ill., 1979)*, volume 819 of *Lecture Notes in Math.*, pages 190–215. Springer, Berlin, 1980.
- [33] Sue E. Goodman and Joseph F. Plante. Holonomy and averaging in foliated sets. *J. Differential Geom.*, 14(3):401–407 (1980), 1979.
- [34] Hans Grauert. On Levi’s problem and the imbedding of real-analytic manifolds. *Ann. of Math. (2)*, 68:460–472, 1958.
- [35] John W. Gray. Some global properties of contact structures. *Ann. of Math. (2)*, 69:421–450, 1959.
- [36] Marvin Greenberg. *Lectures on algebrain geometry*. Northeastern University. W. A. Benjamin Inc., 1971.
- [37] Frederick P. Greenleaf. *Invariant means on topological groups and their applications*. Van Nostrand Mathematical Studies, No. 16. Van Nostrand Reinhold Co., New York, 1969.
- [38] Jenny Harrison. C^2 counterexamples to the Seifert conjecture. *Topology*, 27(3):249–278, 1988.
- [39] Allen Hatcher. *Notes on Basic Topology of 3-Manifolds*. <http://www.math.cornell.edu/hatcher/3M/3Mdownloads.html>. 2000.
- [40] Michel R. Herman. Examples of compact hypersurfaces in \mathbb{R}^{2p} , $2p \geq 6$, with no periodic orbits. In *Hamiltonian systems with three or more degrees of freedom (S’Agaró, 1995)*, volume 533 of *NATO Adv. Sci. Inst. Ser. C Math. Phys. Sci.*, page 126. Kluwer Acad. Publ., Dordrecht, 1999.
- [41] Helmut Hofer. Pseudoholomorphic curves in symplectizations with applications to the Weinstein conjecture in dimension three. *Invent. Math.*, 114(3):515–563, 1993.
- [42] Helmut Hofer. Holomorphic curves and dynamics in dimension three. In *Symplectic geometry and topology (Park City, UT, 1997)*, volume 7 of *IAS/Park City Math. Ser.*, pages 35–101. Amer. Math. Soc., Providence, RI, 1999.
- [43] Helmut Hofer, Krzysztof Wysocki, and Eduard Zehnder. The dynamics on three-dimensional strictly convex energy surfaces. *Ann. of Math. (2)*, 148(1):197–289, 1998.
- [44] Helmut Hofer, Krzysztof Wysocki, and Eduard Zehnder. Finite energy foliations of tight three-spheres and Hamiltonian dynamics. *Ann. of Math. (2)*, 157(1):125–255, 2003.
- [45] Helmut Hofer and Eduard Zehnder. *Symplectic invariants and Hamiltonian dynamics*. Birkhäuser Advanced Texts: Basler Lehrbücher. [Birkhäuser Advanced Texts: Basel Textbooks]. Birkhäuser Verlag, Basel, 1994.
- [46] Michael Hutchings and Clifford H. Taubes. The weinstein conjecture for stable hamiltonian structures. <http://arxiv.org/abs/0809.0140>, 31 august, 2008.

- [47] Vadim A. Kaimanovich. Brownian motion on foliations: entropy, invariant measures, mixing. *Functional Anal. Appl.*, 22(4):326–328, 1988.
- [48] Vadim A. Kaimanovich. Amenability, hyperfiniteness, and isoperimetric inequalities. *C. R. Acad. Sci. Paris Sér. I Math.*, 325(9):999–1004, 1997.
- [49] Vadim A. Kaimanovich. Equivalence relations with amenable leaves need not be amenable. In *Topology, ergodic theory, real algebraic geometry*, volume 202 of *Amer. Math. Soc. Transl. Ser. 2*, pages 151–166. Amer. Math. Soc., Providence, RI, 2001.
- [50] Anatole Katok and Boris Hasselblatt. *Introduction to the modern theory of dynamical systems*, volume 54 of *Encyclopedia of Mathematics and its Applications*. Cambridge University Press, Cambridge, 1995. With a supplementary chapter by Katok and Leonardo Mendoza.
- [51] Greg Kuperberg. A volume-preserving counterexample to the Seifert conjecture. *Comment. Math. Helv.*, 71(1):70–97, 1996.
- [52] Krystyna Kuperberg. A smooth counterexample to the Seifert conjecture. *Ann. of Math. (2)*, 140(3):723–732, 1994.
- [53] François Laudenbach. Relèvement linéaire des cobords. *Bull. Soc. Math. France*, 111(2):147–150, 1983.
- [54] Sergei Makar-Limanov. Tight contact structures on solid tori. *Trans. Amer. Math. Soc.*, 350(3):1013–1044, 1998.
- [55] Ricardo Mañé. *Introdução à teoria ergódica*, volume 14 of *Projeto Euclides [Euclid Project]*. Instituto de Matemática Pura e Aplicada (IMPA), Rio de Janeiro, 1983.
- [56] Jean Martinet. Formes de contact sur les variétés de dimension 3. In *Proceedings of Liverpool Singularities Symposium, II (1969/1970)*, pages 142–163. Lecture Notes in Math., Vol. 209, Berlin, 1971. Springer.
- [57] Dusa McDuff. The local behaviour of holomorphic curves in almost complex 4-manifolds. *J. Differential Geom.*, 34(1):143–164, 1991.
- [58] Frank Morgan. *Geometric measure theory*. Academic Press Inc., Boston, MA, 1988. A beginner’s guide.
- [59] Jürgen Moser. On the volume elements on a manifold. *Trans. Amer. Math. Soc.*, 120:286–294, 1965.
- [60] Gabriel P. Paternain. *Geodesic flows*, volume 180 of *Progress in Mathematics*. Birkhäuser Boston Inc., Boston, MA, 1999.
- [61] Joseph F. Plante. Foliations with measure preserving holonomy. *Ann. of Math. (2)*, 102(2):327–361, 1975.
- [62] Paul H. Rabinowitz. Periodic solutions of Hamiltonian systems. *Comm. Pure Appl. Math.*, 31(2):157–184, 1978.
- [63] R. Clark Robinson. A global approximation theorem for Hamiltonian systems. In *Global Analysis (Proc. Sympos. Pure Math., Vol. XIV, Berkeley, Calif., 1968)*, pages 233–243. Amer. Math. Soc., Providence, R.I., 1970.

- [64] Manuel Samuélidès. Tout feuilletage à croissance polynomiale est hyperfini. *J. Funct. Anal.*, 34(3):363–369, 1979.
- [65] Laurent Schwartz. *Théorie des distributions*. Publications de l’Institut de Mathématique de l’Université de Strasbourg, No. IX-X. Nouvelle édition, entièrement corrigée, refondue et augmentée. Hermann, Paris, 1966.
- [66] Sol Schwartzman. Asymptotic cycles. *Ann. of Math. (2)*, 66:270–284, 1957.
- [67] Paul A. Schweitzer. Counterexamples to the Seifert conjecture and opening closed leaves of foliations. *Ann. of Math. (2)*, 100:386–400, 1974.
- [68] Paul A. Schweitzer. Codimension one foliations without compact leaves. *Comment. Math. Helv.*, 70(2):171–209, 1995.
- [69] Herbert Seifert. Closed integral curves in 3-space and isotopic two-dimensional deformations. *Proc. Amer. Math. Soc.*, 1:287–302, 1950.
- [70] Caroline Series. Foliations of polynomial growth are hyperfinite. *Israel J. Math.*, 34(3):245–258 (1980), 1979.
- [71] Jean-Claude Sikorav. Growth of a primitive of a differential form. *Bull. Soc. Math. France*, 129(2):159–168, 2001.
- [72] Dennis Sullivan. A counterexample to the periodic orbit conjecture. *Inst. Hautes Études Sci. Publ. Math.*, (46):5–14, 1976.
- [73] Dennis Sullivan. Cycles for the dynamical study of foliated manifolds and complex manifolds. *Invent. Math.*, 36:225–255, 1976.
- [74] Dennis Sullivan. A foliation of geodesics is characterized by having no “tangent homologies”. *J. Pure Appl. Algebra*, 13(1):101–104, 1978.
- [75] Clifford H. Taubes. The seiberg-witten equations and the weinstein conjecture ii: More closed integral curves of the reeb vector field. *arxiv:math/0702366*, 2007.
- [76] David Tischler. On fibering certain foliated manifolds over S^1 . *Topology*, 9:153–154, 1970.
- [77] Claude Viterbo. A proof of Weinstein’s conjecture in \mathbb{R}^{2n} . *Ann. Inst. H. Poincaré Anal. Non Linéaire*, 4(4):337–356, 1987.
- [78] Andrew W. Wadsley. Geodesic foliations by circles. *J. Differential Geometry*, 10(4):541–549, 1975.
- [79] Alan Weinstein. On the hypotheses of Rabinowitz’ periodic orbit theorems. *J. Differential Equations*, 33(3):353–358, 1979.
- [80] Hassler Whitney. *Complex analytic varieties*. Addison-Wesley Publishing Co., Reading, Mass.-London-Don Mills, Ont., 1972.
- [81] F. Wesley Wilson, Jr. On the minimal sets of non-singular vector fields. *Ann. of Math. (2)*, 84:529–536, 1966.
- [82] Shing Tung Yau. Isoperimetric constants and the first eigenvalue of a compact Riemannian manifold. *Ann. Sci. École Norm. Sup. (4)*, 8(4):487–507, 1975.

- [83] Robert J. Zimmer. Curvature of leaves in amenable foliations. *Amer. J. Math.*, 105(4):1011–1022, 1983.
- [84] Robert J. Zimmer. *Ergodic theory and semisimple groups*, volume 81 of *Monographs in Mathematics*. Birkhäuser Verlag, Basel, 1984.

Résumé

Dans ce travail, nous nous intéressons à deux questions. La première est de savoir si les champs de vecteurs non singuliers et géodésibles sur une variété fermée de dimension trois ont des orbites périodiques. La seconde, étudie les relations entre les feuilletages moyennables et les feuilletages dont toutes les feuilles sont Følner. L'idée commune dans ces deux problèmes est l'utilisation de pièges: un outil qui nous permet de changer un feuilletage à l'intérieur d'une carte feuilletée.

Dans le premier chapitre nous abordons la première question. On dit qu'un champ de vecteurs non singulier est géodésible s'il existe une métrique riemannienne sur la variété ambiante pour laquelle toutes les orbites sont des géodésiques. Soit X un tel champ de vecteurs sur une variété fermée de dimension trois. Supposons que la variété est difféomorphe à \mathbb{S}^3 ou son deuxième groupe d'homotopie est non trivial. Pour ces variétés, on montre que si X est analytique réel ou s'il préserve une forme volume, il possède une orbite périodique.

Le deuxième chapitre est dédié à la seconde question. En 1983, R. Brooks avait annoncé qu'un feuilletage dont presque toutes les feuilles sont Følner est moyennable. À l'aide d'un piège, on va construire un contre-exemple à cette affirmation, c'est-à-dire un feuilletage non moyennable dont toutes les feuilles sont Følner. Nous cherchons ensuite des conditions suffisantes sur le feuilletage pour que l'énoncé de R. Brooks soit valable. Comme suggéré par V. A. Kaimanovich, une possibilité est supposer que le feuilletage soit minimal. On montre que cette hypothèse est suffisante en utilisant un théorème de D. Cass que décrit les feuilles minimales.

Abstract

In this text we deal with two main questions. The first one is to know if geodesible vector fields on closed 3-manifolds have periodic orbits. The second one studies the relation between the concepts of amenability and having Følner leaves in the context of foliations. The common point is the use of plugs. Plugs are a useful tool for changing a foliation inside a foliated chart.

The first chapter is dedicated to the first question. A non singular vector field is geodesible if there is a Riemannian metric of the ambient manifold making the orbits of the vector field geodesics. Let X be a geodesible vector field on a closed oriented 3-manifold, and assume that the 3-manifold is either diffeomorphic to \mathbb{S}^3 or has non trivial second homotopy group. The main theorems of this chapter said that under this assumptions X has a periodic orbit if it is real analytic or if it preserves a volume.

In the second chapter we talk about the second question. In 1983, R. Brooks stated that a foliation with all its leaves Følner is amenable, with respect to an invariant measure. Using a plug, we will construct a counter-example of this statement, that is a non-amenable foliation whose leaves are Følner. We will then show that if we assume that the foliation is minimal, that is that all the leaves are dense, the fact that the leaves are Følner implies that the foliation is amenable. This hypothesis was suggested by V. A. Kaimanovich. The proof uses a theorem by D. Cass that describes minimal leaves.