



HAL
open science

A Comprehensive Assessment of Markets for Frequency and Voltage Control Ancillary Services

Yann Rebours

► **To cite this version:**

Yann Rebours. A Comprehensive Assessment of Markets for Frequency and Voltage Control Ancillary Services. Electric power. University of Manchester, 2008. English. NNT : . tel-00370805

HAL Id: tel-00370805

<https://theses.hal.science/tel-00370805>

Submitted on 25 Mar 2009

HAL is a multi-disciplinary open access archive for the deposit and dissemination of scientific research documents, whether they are published or not. The documents may come from teaching and research institutions in France or abroad, or from public or private research centers.

L'archive ouverte pluridisciplinaire **HAL**, est destinée au dépôt et à la diffusion de documents scientifiques de niveau recherche, publiés ou non, émanant des établissements d'enseignement et de recherche français ou étrangers, des laboratoires publics ou privés.

A Comprehensive Assessment of Markets for Frequency and Voltage Control Ancillary Services

A thesis submitted to The University of Manchester for the degree of

Doctor of Philosophy

in the Faculty of Engineering and Physical Sciences

2008

Yann Rebours

School of Electrical and Electronic Engineering

CONTENTS

Contents	3
List of tables	9
List of figures	11
Abstract	17
Declaration	19
Copyright	21
Acknowledgement	23
Abbreviations and acronyms	25
Symbols	33
Chapter 1 Introduction	43
1.1 Increasing Welfare of Power System Users	43
1.2 Stakeholders	46
1.3 Marketplaces	49
1.3.1 Basic features of a marketplace	49
1.3.2 Generation markets	51

1.3.3	Transmission markets	53
1.3.4	Retail markets	54
1.3.5	Other markets	54
1.4	Fundamentals of Frequency Control	55
1.4.1	Frequency and active power	55
1.4.2	Dynamic and quasi-steady-state frequency deviations	57
1.4.3	Self-regulation of load	57
1.4.4	Speed control of generators	58
1.4.5	Combined effect of speed control and self-regulation	59
1.4.6	Frequency characteristics	60
1.4.7	Management of an imbalance in an interconnected power system	62
1.5	Fundamentals of Voltage Control	65
1.5.1	Apparent, active and reactive powers	65
1.5.2	Voltages and reactive power	69
1.5.3	Reactive power from a generating unit	71
1.5.4	Reactive power from a line	73
1.5.5	Management of a voltage drop in a power system area	77
1.6	Technologies Used to provide Ancillary Services	77
1.6.1	Generating units	78
1.6.2	Basic transmission and distribution assets	79
1.6.3	Purpose-built devices	80
1.6.4	Loads	80
1.7	Summary	81
Chapter 2	Delivery of ancillary services	83
2.1	Introduction	83
2.2	Needs of Users for System Services	84
2.2.1	Reliability	84
2.2.2	Power quality	86
2.2.3	Optimal utilisation of resources	87
2.2.4	Specification of the needs	87

2.3	Specification of the Quality of Ancillary Services	88
2.3.1	Optimal specifications	89
2.3.2	Elementary specifications	91
2.3.3	Functional specifications	93
2.3.4	Actual specifications	99
2.3.5	Standardised specifications	114
2.4	Quantity of Ancillary Services	118
2.4.1	Optimal definition of the quantity of system services	118
2.4.2	Definitions used within the UCTE	119
2.4.3	Discussion of the UCTE recommendation	121
2.4.4	Innovative methods	127
2.4.5	Actual requirements across countries	132
2.5	Location of Ancillary Services	135
2.5.1	Impact of the location of ancillary services	135
2.5.2	Location in actual systems	137
2.6	Conclusion	140
Chapter 3	Cost of ancillary services	143
3.1	Introduction	143
3.2	Main Cost Components of Ancillary Services	144
3.2.1	Fixed costs	144
3.2.2	Variable costs	146
3.3	Methodology and Hypotheses to Estimate Cost	149
3.3.1	Time horizon for a generating company	149
3.3.2	The daily optimisation process at EDF Producer	151
3.3.3	Principle of the de-optimisation cost calculation	154
3.3.4	Data considered	155
3.3.5	Hardware and software used	157
3.3.6	Cost calculation	162
3.4	Day-Ahead De-Optimisation Cost for a Producer	165

3.4.1	De-optimisation cost over two and a half years	165
3.4.2	Seasonality of the de-optimisation cost	168
3.4.3	Parameters affecting the de-optimisation cost	171
3.4.4	De-optimisation cost and demand for reserves	176
3.5	Marginal Costs of Frequency Control for a Producer	179
3.5.1	Study of the binding constraints	179
3.5.2	Study of the non-binding constraints	181
3.6	Cost of Time Control in France	182
3.7	Conclusion	183
Chapter 4	Procurement of System Services	187
4.1	Introduction	187
4.2	Nominating the Entity Responsible of Procurement	189
4.3	Matching Supply and Demand	190
4.3.1	Long-term matching	190
4.3.2	Short-term matching	191
4.4	Choosing the Relevant Procurement Methods	193
4.4.1	Identified procurement methods	193
4.4.2	Procurement methods in practice	196
4.5	Defining the Structures of Offers and Payments	197
4.5.1	Identified structures of offers and payments	197
4.5.2	Structures of offers and payments in practice	200
4.5.3	Price sign and symmetry	202
4.6	Organizing the Market Clearing Procedure	202
4.6.1	Structural arrangement	203
4.6.2	Types of auction	204
4.6.3	The scoring problem	209
4.6.4	Coordination of the different markets	210
4.6.5	The settlement rule	213
4.6.6	The timing of markets	216

4.7	Avoiding Price Caps	220
4.8	Providing Appropriate Incentives	222
4.8.1	Stakeholders that should have incentives	222
4.8.2	Allocation of system services costs	223
4.8.3	Transmission of data	227
4.8.4	Monitoring	228
4.8.5	Penalties and rewards	231
4.9	Assessing the Procurement Method	232
4.9.1	An effective procurement process	232
4.9.2	Low running cost	232
4.9.3	Economic efficiency	233
4.10	Summary	238
Chapter 5	Conclusions and Future Research	241
5.1	Rationale for the Thesis	241
5.2	Contributions to Knowledge	242
5.3	Short-Term Evolutions Desirable in France	247
5.4	Suggestions for Future Work	248
	References	251
	References by categories	279
	Publications	287
	The author	289
	Appendices	291
A.1	Basics of Statistics	291
A.1.1	Univariate data	291
A.1.2	Bivariate data	294

A.1.3	Time-dependent data	295
A.1.4	Descriptive analysis	296
A.2	Technical Description of OTESS	299
A.2.1	Basic functionalities	299
A.2.2	Hardware architecture	300
A.2.3	Software architecture	301
A.2.4	Parameters for data analysis	304
A.2.5	Screenshots	307
A.2.6	Code example	310
Index		315

LIST OF TABLES

Table 1.1: Characteristics of a 50-Hz transmission line impedance for one phase. Based on Kundur (1994) and EDF internal documents	74
Table 1.2: Possible generation variation as a function of unit type. Based on UCTE (2004b)	78
Table 2.1: General versus precise specifications of AS qualities	90
Table 2.2: Capabilities and controllers related to functional ancillary services	93
Table 2.3: Basic information on systems studied	100
Table 2.4: Vocabulary used to name frequency control reserves in various systems	102
Table 2.5: Frequency deviation for which the entire primary frequency reserve is deployed as a function of the droop and the primary frequency control reserve	104
Table 2.6: Technical comparison of primary frequency control parameters in various systems	106
Table 2.7: Impact of the K-factor on secondary frequency control	108
Table 2.8: Technical comparison of secondary frequency control parameters in various systems	110
Table 2.9: Technical comparison of voltage control parameters in various systems	113
Table 2.10: Recommendations for secondary reserve in some systems within the UCTE	121
Table 2.11: Repartition of a population for a normal distribution	124

Table 2.12: Example of a Groves-Clarke tax	130
Table 3.1: Daily management of frequency control reserves provided by EDF Producer	153
Table 3.2: Periods considered in the present study	156
Table 4.1: Parameters influencing the choice of AS-procurement method	195
Table 4.2: Procurement methods chosen across various systems as of October 2006	196
Table 4.3: Structures of payment chosen across various systems as of October 2006	201
Table 4.4: Example 1 of a Vickrey-Clarke-Groves auction	207
Table 4.5: Example 2 of a Vickrey-Clarke-Groves auction	207
Table 4.6: Synopsis of the usual auction methods	208
Table 4.7: Parameters of the demand in the considered examples of market coordination	212
Table 4.8: Parameters of the offers in the considered examples of market coordination	212
Table 4.9: Result of the clearing processes in the examples of market coordination	212
Table 4.10: Settlement rules chosen across various systems as of October 2006	216
Table 4.11: Frequencies of market clearing across various systems as of October 2006	217
Table 4.12: Frequencies of reviews of the needs across various systems as of October 2006	218
Table 4.13: Price caps across various systems as of October 2006	222
Table A.2.1: Structure of the table “unit”	302
Table A.2.2: Structure of the table “demand”	302
Table A.2.3: Structure of the table “supply”	303
Table A.2.4: Structure of the table “global_dispatch_statement”	303



LIST OF FIGURES

Figure 1.1: Distinction between ancillary and system services. Based on Eurelectric (2000)	44
Figure 1.2: Basic layout of a power system	49
Figure 1.3: Market equilibrium	51
Figure 1.4: Principle of a generating unit	56
Figure 1.5: Dynamic and quasi-steady-state frequency deviations. Based on UCTE (2004b)	57
Figure 1.6: Simplified regulation scheme of a generating unit	59
Figure 1.7: Example of instantaneous and average frequency characteristics of a power system	62
Figure 1.8: Configuration of a zone ζ	63
Figure 1.9: Configuration of the zone 0 with the loss of a generating unit	64
Figure 1.10: A dipole (receiving convention)	65
Figure 1.11: Temporal representation of voltage, current and instantaneous power (inductive dipole)	66
Figure 1.12: Temporal representation of the three instantaneous powers (inductive dipole)	67
Figure 1.13: Representation of the powers in the complex plane (inductive dipole)	68
Figure 1.14: Electrical representation of an R-X dipole	69

Figure 1.15: Phasor representation associated with Figure 1.14	70
Figure 1.16: Typical P-Q diagram from the stator side. Based on Testud (1991)	73
Figure 1.17: π -representation of a line	74
Figure 1.18: Reactive power consumption of a 400 kV / 2 000 MVA line as a function of the phase current	76
Figure 2.1: (a) Centralised and (b) decentralised dependent controllers	92
Figure 2.2: The three functional frequency controls considering a generating unit	95
Figure 2.3: Frequency and French regulation signal on 31 March 2005 [Tesson (2008)]	96
Figure 2.4: The three functional voltage controls considering a generating unit	99
Figure 2.5: Representation of responses of an AS provider for two different inputs	115
Figure 2.6: Classification of AS based on frequency-domain characterisation	116
Figure 2.7: Proposed standardised definition of quality of a frequency or voltage control AS	117
Figure 2.8: Representation of the actual response of the group versus its estimate	117
Figure 2.9: Utilisation of a profile to define a category of AS quality	118
Figure 2.10: Deployment of secondary and tertiary controls	123
Figure 2.11: Probability density of the necessary frequency control power	124
Figure 2.12: Empirical and normal cumulative distribution functions of the activated tertiary control power in 2006 in France	126
Figure 2.13: Cost curves of system services	129
Figure 2.14: Allocation of SS costs between four groups of users	131
Figure 2.15: Value of SS for a group of user	131
Figure 2.16: Representation of the optimal quantity q^* of SS	132

Figure 2.17: Frequency control reserve indicators in 2004-5 across systems surveyed	135
Figure 2.18: Direct control by the reserve receiving TSO [UCTE (2005)]	139
Figure 2.19: Control through the reserve connecting TSO [UCTE (2005)]	139
Figure 3.1: Representation of two over-sized elements because of voltage control	145
Figure 3.2: Schematic dispatches to understand de-optimisation and opportunity costs	148
Figure 3.3: Overview of the optimisation process at EDF Producer [based on Ernu (2007)]	151
Figure 3.4: The two datasets considered to calculate the de-optimisation cost	155
Figure 3.5: APOGEE algorithm	160
Figure 3.6: Principle of OTESS	161
Figure 3.7: Frequency distributions of the gap between APOGEE dispatch and APOGEE demand for all the studied time steps between 1 and 48	164
Figure 3.8: Evolution of the relative de-optimisation cost from 01/01/2005 to 30/08/2007	166
Figure 3.9: Frequency distribution of the relative de-optimisation cost for all the studied days	167
Figure 3.10: Frequency distribution of the variation of de-optimisation cost over two days for all the studied days	168
Figure 3.11: Autocorrelation function of the de-optimisation cost up to 1-year period	169
Figure 3.12: Partial autocorrelation function of the de-optimisation cost up to 1-year period	170
Figure 3.13: Partial autocorrelation function of the de-optimisation cost around a 3-month period	170
Figure 3.14: Partial autocorrelation function of the de-optimisation cost around a 1-month period	170
Figure 3.15: Partial autocorrelation function of the de-optimisation cost around a 1-week period	171

Figure 3.16: Normalized de-optimisation cost as a function of the average normalized weighted marginal cost of reserves for all the studied days ($r_{xy} = 0.94$)	172
Figure 3.17: Normalized de-optimisation cost as a function of the average normalized marginal cost of reserves for all the studied days	172
Figure 3.18: Normalized de-optimisation cost as a function of the maximum normalized primary reserve demand for all the studied days ($r_{xy} = 0.39$)	174
Figure 3.19: Normalized de-optimisation cost as a function of the maximum normalized primary reserve demand from 01/08/2006 to 31/07/2007 ($r_{xy} = 0.71$)	174
Figure 3.20: Normalized de-optimisation cost as a function of the maximum normalized primary reserve demand from 01/01/2005 to 31/12/2005 ($r_{xy} = 0.13$)	174
Figure 3.21: Normalized de-optimisation cost as a function of the mean normalized primary reserve demand for all the studied days ($r_{xy} = 0.38$)	175
Figure 3.22: Normalized de-optimisation cost as a function of the mean normalized secondary reserve demand for all the studied days ($r_{xy} = -0.18$)	175
Figure 3.23: Normalized de-optimisation cost as a function of the minimum reserve share provided by thermal units for all the studied days ($r_{xy} = 0.44$)	176
Figure 3.24: Relative de-optimisation cost as a function of the new demand for reserve for 24/05/2007	178
Figure 3.25: Simplified relative de-optimisation cost as a function of the new demand for reserve for 24/05/2007	179
Figure 3.26: Percentage of time when marginal costs of energy are higher than marginal costs of reserves as a function of the time step for all the studied days	180
Figure 3.27: Percentage of time when marginal costs of primary reserve are higher than marginal costs of secondary reserve as a function of the time step for all the studied days	180
Figure 3.28: Percentage of time when marginal costs of reserves are null as a function of the time of the day for all the studied time steps	181

Figure 3.29: Frequency distribution of the relative de-optimisation cost due to time control with $f_t = 49.99$ Hz for all the studied days from 01/01/2005	183
Figure 3.30: Frequency distribution of the relative de-optimisation cost due to time control $f_t = 50.01$ Hz for all the studied days from 01/01/2005	183
Figure 4.1: Impact of the demand responsiveness on market clearing	192
Figure 4.2: NYISO's demand curve for secondary frequency control. Data based on NYISO (2008)	193
Figure 4.3: Same utilisation payments for two different utilisations	199
Figure 4.4: Representation of the generic frequency control ancillary service trapezium used in Australia. Based on NEMMCO (2001)	201
Figure 4.5: Reactive power capability curve in Great Britain [National Grid (2008c)]	202
Figure 4.6: Illustration of a gaming possibility with a real-time reactive power market	217
Figure 4.7: Supply curves for different due dates	220
Figure 4.8: Effect of an offer cap (a) and a purchase cap (b)	221
Figure 4.9: Four intensities of an incentive scheme [Keller and Franken (2006)]	232
Figure 4.10: Ancillary services cost indicators across systems surveyed in 2004-5	235
Figure A.1.1: Example of a frequency distribution	294
Figure A.1.2: Schematic representation of the smoothing process	297
Figure A.2.3: Hardware architecture of OTESS	301
Figure A.2.4: Entity relation modelling of the main tables of OTESS	302
Figure A.2.5: Modification and import of datasets with OTESS (operations 2 and 6 in section A.2.2)	308
Figure A.2.6: Management of data in the database (operation 7 in section A.2.2)	308

Figure A.2.7: Creation of new data in the database (operation 7 in section A.2.2)	309
Figure A.2.8: Basic calculation on the data (operation 7 in section A.2.2)	309
Figure A.2.9: Display of a graph with OTESS (operation 7 in section A.2.2)	310
Figure A.2.10: Analysis of data with OTESS (operation 7 in section A.2.2)	310

■

ABSTRACT

All users of an electrical power system expect that the frequency and voltages are maintained within acceptable boundaries at all times. Some participants, mainly generating units, provide the necessary frequency and voltage control services, called ancillary services. Since these participants are entitled to receive a payment for the services provided, markets for ancillary services have been developed along with the liberalisation of electricity markets. However, current arrangements vary widely from a power system to another.

This thesis provides a comprehensive assessment of markets for frequency and voltage control ancillary services along three axes: (a) defining the needs for frequency and voltages, as well as specifying the ancillary services that can fulfil these needs; (b) assessing the cost of ancillary services for a producer; and (c) discussing the market design of an efficient procurement of ancillary services.

Such a comprehensive assessment exhibits several advantages: (a) stakeholders can quickly grasp the issues related to ancillary services; (b) participants benefit from a standardised method to assess their system; (c) solutions are proposed to improve current arrangements; and (d) theoretical limitations that need future work are identified.

This work, titled *A Comprehensive Assessment of Markets for Frequency and Voltage Control Ancillary Services*, was submitted in 2008 by Yann Rebours to The University of Manchester for the degree of Doctor of Philosophy. ■

DECLARATION

No portion of the work referred to in this thesis has been submitted in support of an application for another degree or qualification of this or any other university or other institute of learning. ■

COPYRIGHT

The author of the thesis (including any appendices and/or schedules to this thesis) owns any copyright in it (the “Copyright”) and s/he has given The University of Manchester the right to use such Copyright for any administrative, promotional, educational and/or teaching purposes.

Copies of this thesis, either in full or in extracts, may be made only in accordance with the regulations of the John Rylands University Library of Manchester. Details of these regulations may be obtained from the Librarian. This page must form part of any such copies made.

The ownership of any patents, designs, trade marks and any and all other intellectual property rights except for the Copyright (the “Intellectual Property Rights”) and any reproductions of copyright works, for example graphs and tables (“Reproductions”), which may be described in this thesis, may not be owned by the author and may be owned by third parties. Such Intellectual Property Rights and Reproductions cannot and must not be made available for use without the prior written permission of the owner(s) of the relevant Intellectual Property Rights and/or Reproductions.

Further information on the conditions under which disclosure, publication and exploitation of this thesis, the Copyright and any Intellectual Property Rights and/or Reproductions described in it may take place is available from the Head of the School of Electrical and Electronic Engineering. ■

ACKNOWLEDGEMENT

First, I would like to sincerely thank Pr Daniel Kirschen, who was really an amazing supervisor during these three years. He took the time to discuss and read, had great ideas, made numerous useful comments, showed an open-mindedness and was not bothered by my French accent.

I would also like to thank the people at Electricité de France (EDF) that make this PhD happens, and in particular the persons that got closely involved with this work: Etienne Monnot, Bruno Prestat, Sébastien Rossignol and Marc Trotignon. Moreover, I address particular thanks to Duane Robinson who helped me to find this thesis. Lastly, I would like to thank EDF for its funding over the three years. However, the views expressed in this work are not necessarily those of EDF.

This thesis, though meaning some lonely hard time, matured in an environment both nice and studious. I thus would like to address many thanks to all the fellows from the University of Manchester that helped me enjoy this thesis, and in particular: Chandra for his knowledge of the Curry Mile; Jerry for his pertinent philosophical thoughts; Miguel for his daily quotes from The Simpsons; Ricardo for his enthusiasm to visit the U.K.; Sky for the badminton games; and Vera for the walks in the Peak District. Many thanks also to all my colleagues from EDF, and especially the colourful R12 group, who constantly showed support, suggested ideas and had good cheer. I would like to thank in particular: Sébastien, my first Jedi master; Etienne, who made me run and was constantly of good counsel; Bruno and Méhana, for their support over these three years; Marc, who spent hours reading and discussing the ideas laid in this thesis and others; Stefan, who has always good ideas, especially at Miami Beach or in a squash court; Frédéric, who has unfailingly interesting discussions that pop, from Into the Wild to the amount of wind blowing in Corsica; Jean-

Pierre, with whom we tried to solve the world's problems (we are still working on it); and Jérôme for his explanations about APOGEE clearer than those about squash.

As it is not possible to find all the information in books, papers or on the Internet, a part of the information given in this thesis come from discussions with various people, in particular: Richard Bénéjean and Jean-Michel Tesson for historical procedures on frequency control; Jean-Louis Bousquet for transmission lines; Alain Chollois for contracts between landlords and wind producers; Renaud Crinon and Jean-Paul Echivard for the regulation of a nuclear power plant; Arnaud Fauchille for time control; Christian Launay and Romuald Texier-Pauton for EDF's operational process to dispatch generating units; Virginie Pignon for various subjects in economics; Alain Tanguy for high-voltage transformers; Luc Tran for the behaviour of French hydro units; and François Bouffard and Julián Barquín for their numerous useful comments on the final draft of this thesis. The surveys of the various systems have been possible only with the kind participations of Jürgen Apfelbeck, Christer Bäck, Noel Janssens, Ton Kokkelink, Thomas Meister, Luis Rouco, Ilya Usov and Raymond Vice.

Lastly, I would like to express my thanks to my family and my friends who provide me constant support over these three years and who even got the curiosity to read some of this work. I wish that you keep drying your hair every morning thinking about frequency and voltage controls.

This work is dedicated to Solenne. ■

ABBREVIATIONS AND ACRONYMS

AC	Alternative Current
ACE	Area Control Error
ACF	AutoCorrelation Function
ADSB	Adaptive Deterministic Security Boundaries
AER	Australian Energy Regulator (Australia)
AS	Ancillary Service
AU	Australia
AVR	Automatic Voltage Regulator
BDEW	<i>Bundesverband der Energie- und Wasservirtschaft e.V</i> (Federal association for the energy and water management) (Germany)
BE	Belgium
BNA	<i>Bundesnetzagentur</i> (regulator of the federal grid) (Germany)
CAISO	California Independent System Operator (USA)
CAL	California
CER	Commission for Energy Regulation

CI	Cost Indicator
Cigré	<i>Conseil International des Grands Réseaux Electriques</i> (International Council on Large Electric Systems)
CNSE	<i>Comisión Nacional del Sistema Eléctrico</i> (National Commission of the Electrical System) (Spain)
CO ₂	Carbon dioxide
CPS	Control Performance Standard (North America)
CRE	<i>Commission de Régulation de l'Energie</i> (Commission of Energy Regulation) (France)
CREG	<i>Commission de Régulation de l'Electricité et du Gaz</i> (Commission of Electricity and Gas Regulation) (Belgium)
CSV	Comma-Separated Values
DC	Direct Current
DCS	Disturbance Control Standard (North America)
DE	Germany
DG	Distributed Generation
DGEMP	<i>Direction Générale de l'Energie et des Matières Premières</i> (General Direction of Energy and Raw Materials) (France)
DIDEME	<i>DIrection de la DEmande et des Marchés Energétiques</i> (Direction of the Demand and Energy Markets) (France)
DNO	Distribution Network Operator
DO	Distribution Owner
DP	Dynamic Programming
DSO	Distribution System Operator

DTe	<i>Directie Toezicht Energie</i> (Supervision Department of Energy) (The Netherlands)
EDF	<i>Electricité de France SA</i> (Electricity of France) (France)
EENS	Expected Energy Not Served
EnBW	<i>EnBW Transportnetze AG</i> (Germany)
E.ON	<i>E.ON Netz GmbH</i> (Germany)
ERAP	Entity Responsible for Ancillary services Procurement
ERCIM	European Research Consortium for Informatics and Mathematics (Europe)
ES	Spain
ETSO	European Transmission System Operators (Europe)
FACTS	Flexible Alternating Current Transmission System
FERC	Federal Energy Regulatory Commission (USA)
FQ	First Quartile
FR	France
FTP	File Transfer Protocol
FTR	Financial Transmission Right
GB	Great Britain or Gigabyte
GPS	Global Positioning System
HHI	Herfindahl-Hirschman Index
Hi.	High frequency response (Great Britain)
HMI	Human-Machine Interface

I	Intentional or Integral
IEA	International Energy Agency
IEEE	Institute of Electrical and Electronics Engineers
IET	Institution of Engineering and Technology
IMF	International Monetary Fund
INPG	<i>Institut National Polytechnique de Grenoble</i> (National Polytechnical Institute of Grenoble) (France)
INSTN	<i>Institut National des Sciences et Techniques Nucléaires</i> (National Institute of Nuclear Science and Techniques) (France)
IQR	InterQuartile Range
ISO	Independent System Operator
KSH	Korn Shell
LAMP	Linux, Apache, MySQL and PHP
LEG	<i>Laboratoire d'Electrotechnique de Grenoble</i> (Electrotechnical Laboratory of Grenoble) (France)
LMP	Locational Marginal Price
LP	Linear Programming
LSE	Load-Serving Entity (USA)
MB	Megabyte
MO	Market Operator
NAG	Numerical Algorithms Group

NERC	North American Electric Reliability Corporation (North America)
NEMMCO	National Electricity Market Management Company (Australia)
NI	Non Intentional
NL	The Netherlands
NOx	Nitrogen Oxide
No rec.	No recommendation
NYISO	New York Independent System Operator (USA)
NZ	New Zealand
Ofgem	Office of Gas and Electricity Markets (Great Britain)
OMEL	<i>Operador del Mercado ELéctrico</i> (Electric Market Operator) (Spain)
OTC	Over-The-Counter
OTESS	<i>OuTil pour l'Etude des Services Système</i> (Tool for the study of ancillary services)
P	Proportional
PACF	Partial AutoCorrelation Function
PHP	PHP: Hypertext Preprocessor
PI	Proportional Integral
PMU	Phasor Measurement Unit
POD	Point of Delivery
Pri.	Primary frequency response (Great Britain)
PSS	Power System Stabilizer
RAM	Random Access Memory

RCT	Reserve Connecting TSO (UCTE)
REE	<i>Red Eléctrica de España</i> (Spanish Electrical Grid) (Spain)
RI	Reserve Indicator
RMS	Root Mean Square
RRT	Reserve Receiving TSO (UCTE)
RSI	Residual Supply Index
RTE	<i>Réseau de Transport d'Electricité</i> (Electrical Transmission Grid) (France)
RTO	Regional Transmission Organisation (USA)
RWE	<i>RWE Transportnetz Strom GmbH</i> (Germany)
SE	Sweden
Sec.	Secondary frequency response (Great Britain)
SO	System Operator
SO-CDU	<i>System Operator-Central Dispatching Upravlenie</i> (Russia)
SS	System Service
Stem	<i>Statens Energimyndighet</i> (Swedish Energy Agency) (Sweden)
SVC	Static var Compensator
SvK	<i>Svenska Kraftnät</i> (Sweden)
T	Total
TO	Transmission Owner
TQ	Third Quartile
TSO	Transmission System Operator

UCEI	University of California Energy Institute (USA)
UCPTE	Union for the Co-ordination of Production and Transmission of Electricity (Europe)
UCTE	Union for the Co-ordination of Transmission of Electricity (Europe)
UPFC	Unified Power Flow Controller
UPS	Unified Power Systems of Russia (Europe and Asia)
VCG	Vickrey-Clarke-Groves
VET	<i>Vattenfall Europe Transmission GmbH</i> (Germany)
VOLL	Value of Lost Load
XML	Extensible Mark-up Language

■

SYMBOLS

ACE_{NERC}^z	ACE of zone z according to NERC (in W)
ACE_{UCTE}^z	ACE of zone z according to the UCTE (in W)
B	susceptance of the capacitance (in S)
B^z	frequency bias setting of zone z (in W/0.1 Hz)
c_i	cost paid by user i (in €)
C	capacitance (in F)
$C(\bar{q})$	cost of the SS deployed (in €)
C^D	dispatch cost of the day D (in €)
$C_{de-optimisation}^D$	de-optimisation cost due to frequency control of the day D (in €)
C_b^D	hydro dispatch cost of the day D (in €)
$C_{relative\ de-optimisation}^D$	relative de-optimisation cost due to frequency control of the day D (no unit)
C_{th}^D	thermal dispatch cost of the day D (in €)
$C_{with\ reserves}^D$	dispatch cost while providing reserves during the day D (in €)

-
- $C_{without\ reserves}^D$ dispatch cost while not providing reserves during the day D (in €)
- $C_{with\ X\ \% \ of\ initial\ reserve}^D$ dispatch cost with the demand for reserves equals to X % of the initial demand of the day D (in €)
- C_{AS}^z annual cost of a given ancillary service for zone z (in €/year)
- C_{energy}^z annual wholesale energy cost for zone z (in €/year)
- CI_{AS}^z cost indicator for a given ancillary service for zone z (no unit)
- D self-regulation of the load (in %·Hz⁻¹)
or day (an integer)
- $D_{Kolmogorov}$ deviation between the empirical $F^*(x)$ and the modelled $F(x)$ series, used in the Kolmogorov test
- $E_{consumption}^z$ hourly average energy consumption of the zone z (in MWh/h)
- $E_{generation}^z$ hourly average energy production of the zone z (in MWh/h)
- $f(x_1, x_2, \dots, x_n)$ objective function (usually in €)
- f actual system electrical frequency at the considered point (in Hz)
- f_n nominal electrical frequency of the power system (in Hz)
- f_{qss} quasi-steady-state electrical frequency of the power system (in Hz)
- f_t target system electrical frequency (in Hz)
- f_m^i system electrical frequency measured by generating unit i (in Hz)
- f_n^i the nominal frequency of the power system set in the controller of generating unit i (in Hz)

f_m^z	system electrical frequency measured by zone z (in Hz)
$F(x)$	modelled series related to the empirical series $F^*(x)$
$F^*(x)$	empirical series
g	generating unit number
\hat{h}^z	estimated power deviation of the zone z related to $P_{max\ day}^z$ (in %)
H	hour
i	current (in A) or user i in a Groves-Clarke tax system or in the Aumann-Shapley method (integer) or time step i in APOGEE (integer)
I	root mean square current (in A)
\underline{I}	complex representation (phasor) of the current (in A)
I_{base}	base current for a given per-unit representation (in A)
I_c	characteristic current of a line (in A)
$I_{conductor}$	maximal permanent current in a line conductor (in A)
\underline{I}_k	complex representation (phasor) of the current flowing in the electrical node k (in A)
I_{ME}^z	factor to compensate the difference between the integration of the instantaneous power exchanged and the demand's energy measurements of zone z
j	constraint number (an integer)
J	total moment of inertia of the rotor masses (in kg.m ²)

k	electrical node
K	proportional gain of a first order system (in output unit/input unit)
K^z	K-factor of zone z (in W/Hz)
L	inductance (in H) or Lagrangian function (usually in €)
LI	Lerner index (no unit)
n	number of variables to optimise (an integer)
n_i	net value got by the user i (in €)
N_G	number of generating units providing speed control
p	instantaneous power (in VA)
p_m	number of poles of an electrical rotating machine
p_r	instantaneous active power (in W)
p_x	instantaneous reactive power (in var)
$P_{consumption}$	total active power consumed in the power system (in W)
$\hat{P}_{consumption}^z$	estimate of the internal consumption of the zone z (in MW)
$\hat{P}_{max\ consumption}^z$	estimate of the maximal internal consumption of the zone z (in MW)
P	average instantaneous active power or simply active power (in W)
\underline{P}	complex representation (phasor) of the active power (in W)
P_0	electrical active power consumed and produced before the perturbation (in W)
P_e	electrical active power (in W)
$P_{generation}$	total active power generated in the power system (in W)

P_k	active power flowing through the electrical node k (in W)
P_l	power losses in the process (in W)
P_m	mechanical active power sent to an electrical rotating machine (in W)
P_n	nominal active power produced by the generating unit (in W)
P_{demand}^i	demand for power generation for the time step i (in MW)
$P_{dispatch}^i$	power generation dispatched during the time step i (in MW)
P_{G0}^i	active power set-point of the generating unit i without any frequency control (in W)
P_{Gn}^i	nominal output active power of the generating unit i (in W)
$P_{interconnection}^z$	active power exported by the zone z to the power system (in W)
$P_{interconnection 0}^z$	scheduled active power exported by the zone z to the power system (in W)
$P_{interconnection m}^z$	measured value of the total power exchanged by the zone with other zones, where a positive value represents exports (in W)
$\hat{P}_{max\ generation}^z$	estimate of the peak generation for the zone z for the day (in MW)
PC	price cap (in €/MW)
$Penalty_P^i$	penalty due to the power mismatch for the time step i (in €)
$Penalty_{R_{pri}}^i$	penalty due to the primary frequency control reserve mismatch for the time step i (in €)
$Penalty_{R_{sec}}^i$	penalty due to the secondary frequency control reserve mismatch for the time step i (in €)
pf	power factor (in per-unit)

q^*	clearing quantity (in good unit)
\bar{q}^*	quantities of SS actually used (e.g., in MWh)
q_i	quantity of SS actually used by user i (e.g., in MWh)
Q	maximum of the instantaneous reactive power or simply the reactive power (in var)
\mathcal{Q}	complex representation (phasor) of the reactive power (in var)
Q_k	reactive power flowing through the electrical node k (in var)
Q_n	nominal reactive power produced by the generating unit (in var)
Q_{POD}	reactive power flowing through the point of delivery (in var)
r_{xy}	cross-correlation between two series (no unit)
R	resistance (in Ω)
R_{pri}^{ζ}	primary frequency control reserve of the zone ζ (in MW)
$R_{pri\ demand}^i$	demand for primary frequency control reserve for the time step i (in MW)
$R_{pri\ dispatch}^i$	primary frequency control reserve dispatched during the time step i (in MW)
$R_{pri\ dispatch\ th}^i$	primary frequency control reserve dispatched on thermal units during the time step i (in MW)
R_{sec}^{ζ}	secondary frequency control reserve of the zone ζ (in MW)
$R_{sec\ demand}^i$	demand for secondary frequency control reserve for the time step i (in MW)
$R_{sec\ dispatch}^i$	secondary frequency control reserve dispatched during the time step i (in MW)
$R_{sec\ dispatch\ th}^i$	secondary frequency control reserve dispatched on thermal units during the time step i (in MW)

RI_{pri}^{ζ}	reserve indicator for the primary frequency control reserve of the zone ζ (in %)
RI_{sec}^{ζ}	reserve indicator for the secondary frequency control reserve of the zone ζ (in %)
S	apparent power (in VA)
\underline{S}	complex representation (phasor) of the apparent power (in VA)
S_{base}	base apparent power for a given per-unit representation (in VA)
S_{line}	apparent power admissible by the line (in VA)
S_n	nominal apparent power produced by an electrical machine (in VA)
s_G^i	droop of the generating unit i (in per-unit)
$share_{th}^i$	thermal reserve share for time step i (no unit)
t	time (in s)
$t_{deployment}^a$	deployment time a (in s)
$t_{deployment}^b$	deployment time b (in s)
T	cycle time (in s) or time constant of a first order system (in s)
T_e	electrical torque (in N.m)
T_m	mechanical torque exercised on the rotor of an electrical rotating machine (in N.m)
u	voltage across a dipole (in V)
U	root mean square voltage of u (in V)
U_{dim}	network dimensioning voltage (in V)

U_n	network nominal voltage (in V)
v_i	value put by the user i (in €)
V	average voltage between two electrical nodes (in V)
V_{base}	base voltage for a given per-unit representation (in V)
V_k	root mean square voltage from the ground to the electrical node k (in V)
\underline{V}_k	complex representation (phasor) of the voltage from the ground to the electrical node k (in V)
$V_{line-line}$	the voltage line-to-line of the line (in V)
$\omega_j(x_1, x_2, \dots, x_n)$	constraint function (in various units)
<i>window</i>	the width of the extrapolation (an odd integer larger or equal to three)
x	data of the temporal series (in series' unit)
$x_{extrapolated}$	extrapolated data to complete the temporal series (in series' unit)
x_n	primal variable to optimise (various units)
X	reactance of an inductance (in Ω) or the amount of the initial demand for reserves (in %)
ξ	power system zone number (integer)
Z	impedance (in Ω)
Z_{base}	base impedance for a given per-unit representation (in Ω)
Z_c	characteristic impedance of a line (in Ω)
δ	angle between two voltages (in rad)
ϵ	accuracy of measurement (in % or in Hz)

$\Delta\%C_{de-optimisation}^D$	relative variation of the de-optimisation cost for D in comparison to $D-1$ (no unit)
Δf	quasi-steady-state frequency deviation from the nominal frequency f_n (in Hz)
Δf_m^i	measured frequency deviation by the generating unit i (in Hz)
ΔP	quasi-steady-state power unbalance
$\Delta P_{consumption}$	consumption change following a quasi-steady-state frequency deviation (in W)
$\Delta P_{generation}$	generation change following a quasi-steady-state frequency deviation (in W)
ΔP_G^i	change in the active power set-point of the generating unit i for any frequency deviation (in W)
$\Delta P_{consumption}^{\varkappa}$	consumption change in zone \varkappa following a quasi-steady-state frequency deviation (in W)
$\Delta P_{generation}^{\varkappa}$	generation change in zone \varkappa following a quasi-steady-state frequency deviation (in W)
$\Delta P_{interconnection}^{\varkappa}$	change in the power transfer between the zone and the other interconnected power systems (in W)
ΔV	voltage difference between two electrical nodes (in V)
φ	lag between current and voltage (in rad)
λ	instantaneous frequency characteristic (in W/Hz)
λ_j	Lagrange multiplier related to the constraint j (usually in €/unit of the constraint)
λ_P^i	marginal cost of power for the time step i (in €/MWh)
λ_R^i	weighted marginal cost of reserves for the time step i (in (€/MW)/h)

$\lambda_{R_{pri}}^i$	marginal cost of primary frequency control reserves for the time step i (in (€/MW)/h)
$\lambda_{R_{sec}}^i$	marginal cost of secondary frequency control reserves for the time step i (in (€/MW)/h)
Λ	frequency characteristic of the power system for a given frequency deviation (in W/Hz)
Λ^z	frequency characteristic of the zone z for a given frequency deviation (in MW/Hz)
π^*	clearing price (in currency unit/good unit)
$\tilde{\pi}$	simulated competitive price (in currency unit/good unit)
π_i	price paid by user i (in €/MW)
σ	standard deviation (in the unit of the value considered)
τ	delay (in s)
ω	electrical angular frequency (in rad.s ⁻¹)
ω_m	angular velocity of an electrical rotating machine (in rad.s ⁻¹)

■

CHAPTER 1

INTRODUCTION

*Never be entirely idle; but either be reading, or writing, or praying
or meditating or endeavouring something for the public good.*

Thomas a Kempis (1380 - 1471)

1.1 Increasing Welfare of Power System Users

A USER connected to a power system (e.g., a generating unit or a consumer) wishes to have access to a system that meets a certain standard of quality. In particular, this user expects that the frequency and voltage will stay close to their nominal values because most electrical appliances are designed for a particular frequency and a given voltage. Failure to meet these frequency and voltage standards would lead to losses for the users that may range from a burnt bulb to the loss of production in an expensive process (e.g., in an automobile factory). Efficient frequency and voltage controls are thus essential to maintain a high welfare for all power system users.

The frequency and voltage control services are called *system services* (SS) because they are delivered by the power system to all the users. Some users of the system, such as generators, contribute to these system services by acting on the frequency of the system or the voltage at the point where they are connected to the system. Because these services

provided by users are ancillary to the production or consumption of energy, they are called *ancillary services* (AS). This distinction between system and ancillary services is depicted in Figure 1.1.

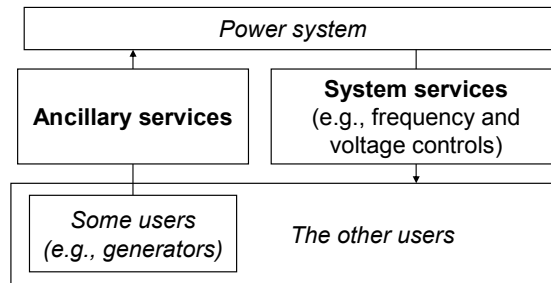

Figure 1.1: Distinction between ancillary and system services. Based on Eurelectric (2000)

Ancillary services have been provided by users of the power system since its early days, more than one hundred years ago. However, it is only since the recent liberalization of the electricity sector that ancillary services have been treated as a commodity by themselves. Indeed, the reform of the electricity sector has led to a separation between network and generation activities (see section 1.2). Markets for ancillary services resulting from this separation have been developed independently across countries, depending on the previous historical procedures or market architecture. Markets for ancillary services are thus currently very different across systems. In addition, while ancillary services are commodities that differ in many ways from the electrical energy product, efforts in the liberalization process were concentrated on the main product, i.e. electrical energy and its transmission. Therefore, the theoretical framework is much less advanced for ancillary services than it is for energy and transmission markets. Lastly, the structure of power systems is currently evolving fast, driven by high energy prices, aging infrastructures, increasing environmental constraints, an intensified competition and the appearance of new technologies. For example, new generation technologies are developed, interconnections between countries are used closer to their limit and consumers are getting more active. Hence, markets for ancillary services have to be adapted to this evolving structure.

In summary, markets for ancillary services are disparate across countries; they lack from a consistent theoretical framework; and they have to be constantly adapted to the changing structure of power systems. It is thus essential to assess current markets for ancillary services to avoid inappropriate architectures that would lead to inefficiencies and thus a reduced global welfare. However, stakeholders do not have a general and systematic

tool that would help them assess the current markets for ancillary services and thus improve current practices. Therefore, this thesis proposes to fill this gap by providing the tools to perform a comprehensive assessment of markets for ancillary services along three aspects: the technical definition of ancillary services, the cost of provision and the market design.

First, contrary to previous works that were concentrated on specific aspects of markets for ancillary services, this thesis gives a complete picture of the issues by developing the technique, the cost and the market design together. Indeed, these three aspects are linked. For example, the technical definition of an ancillary service will have an impact on the cost to provide it (e.g., a more complex service is likely to be more expensive to provide than a simpler one); the cost structure influences the market design (e.g., a cost that is constant over time makes a short-term market unnecessary); and the technical characteristics of an ancillary service may not be suitable for some particular market design (e.g., it is useless to build a market over a large geographical area if a product is useful only in a given power system region).

Second, the proposed assessment is based on a framework that can be applied to any system. This framework is developed as follows: (a) identifying features; (b) expressing the issues related to each feature; (c) describing the actual solutions adopted in various systems across the world; (d) proposing innovative solutions. Therefore, both theoretical and practical aspects are tackled. At the end of each core chapter, an assessment checklist is proposed to help stakeholders improve their system by implementing new solutions or by fostering more research on a specific feature. Indeed, by putting together issues and solutions for each feature, a global solution to manage ancillary services becomes much clearer.

This thesis is organised in five chapters. Chapter 1 presents the basic layout, the stakeholders and the marketplaces of a power system. The basic concepts underlying frequency and voltage controls are then introduced. Even if this thesis is focused on the ancillary services provided by conventional large generating units, most of the concepts are applicable to any provider of ancillary services as well. The explanations are intended to be suitable for all readers irrespective of their technical background. In particular, the concept of reactive power is explained. Nevertheless, readers familiar with frequency control will notice that the new concepts of average and instantaneous frequency characteristics are defined. Lastly, technologies providing ancillary services are presented.

Chapter 2 focuses on the delivery of ancillary services. First, the needs of users in terms of system services are examined. To meet these needs, ancillary services have to be provided by some users of the system. Therefore, the specification of the quality of ancillary services is discussed. Lastly, the optimal quantity and location of the ancillary services are debated. In particular, Chapter 2 shows that the amount of ancillary services currently provided does not correspond to the actual needs of users in terms of system services.

Chapter 3 describes the main costs incurred by the provision of ancillary services by a producer. A practical methodology to evaluate the cost of frequency control due to the day-ahead capacity reservation is then proposed and successfully applied to Electricité de France (EDF) Producer's portfolio. In particular, this study gives interesting insights on the parameters affecting the cost of frequency control. Lastly, the cost of the time control (i.e., the cost to maintain the frequency average at 50 Hz) is assessed for France.

Chapter 4 reviews the numerous issues related to the procurement of ancillary services, namely: (a) nominating the responsible entity of procurement; (b) matching supply and demand; (c) choosing the relevant procurement method; (d) defining the structures of offers and payments; (e) organizing the market clearing procedure; (f) avoiding price caps; (g) providing appropriate incentives; (h) assessing the procurement method. Practical and innovative solutions are proposed for each issue.

Lastly, Chapter 5 provides a summary of this thesis, some scenarios of evolutions and possible future work.

1.2 Stakeholders

Broadly speaking, the elements of a power system are physically divided into three main categories: generating units, the network and loads. The network, which provides the electrical link between loads and generating units, is actually divided into two main parts (see Figure 1.2). The *transmission network* is meshed and operated at high voltages (e.g., 63 kV to 400 kV in France), while the *distribution network* is usually operated in a radial fashion and at lower voltages (e.g., 400 V to 20 kV in France). Networks are mainly constituted of lines,

transformers¹ and various controllers. Conventional *large generation* (e.g., coal, nuclear, large hydro, gas or fuel) are connected to the transmission network, while smaller generation (e.g., wind, small hydro, combined heat-power plant or photovoltaic) tend to be connected to the distribution network, which led to the term of *distributed generation* (DG) to designate this kind of generating units. Lastly, *consumers* withdraw energy from the system, either at the transmission level (large consumers) or at the distribution level (small consumers).

The various elements of a power system are owned by different parties. Prior to liberalisation, most of them were owned by vertically-integrated companies, which owned at the same time generation, transmission, distribution and retail. Currently, the ownership of these activities tends to be separated. Large generating units are owned by *generation companies*, which most of the time finds their roots in the historical vertically-integrated companies. The transmission network is owned by a few entities (*Transmission Owners*, TO, or *transmission companies*), whereas distribution networks are usually owned by many entities (*Distribution Owners*, DO, or *distribution companies*), such as the city councils in France. Lastly, *end users* are obviously owned by a large number of stakeholders. Therefore, end users are usually gathered in *consumer associations* to get a more powerful representation. In addition, they deal with *retailers* (or *suppliers*), which buy large volumes of energy from generation companies and is in relation with the intermediate stakeholders, such as distribution and transmission operators. In certain cases, retailers can also buy the electricity produced by the end users who own generating assets. Note that retailers generally do not own significant physical assets, except intelligent meters in some cases.

A liberalised power system is complex to run because of the number of participants involved. In addition, it has been recognized that the operation of electrical networks is a natural monopoly. Therefore, independent bodies have to be designated to manage the power system (the *system operators*, or SO). The Transmission System Operator (TSO) operates the power system at the transmission level, while the Distribution System Operator (DSO) is in charge of the distribution level. Therefore, from the TSO's perspective, a DSO is equivalent to a large consumer. Note that the terms Distribution Network Operator

¹ A transformer allows to convert energy from a given voltage to another level with the help of two windings around a magnetic circuit. The first winding brings power into the magnetic circuit, while the second winding withdraws power from it. A difference in the number of turns for each winding leads to a voltage change, but with a similar power transmitted. Note that Figure 1.2 did not explicitly display any transformers.

(DNO), Regional Transmission Organisation (RTO) and Independent System Operator (ISO) can also be found, with responsibility and authority varying amongst systems.

The competitive sectors of the electricity industry, i.e. generation and retail, need marketplaces to trade products (see next section). The *Market Operators* (MO) are in charge of these marketplaces. In addition, other participants may provide additional services in the marketplace, such as the *brokers*, who help bring buyers and sellers together.

To foster fair relations between stakeholders, three basic functions should be performed: (a) setting the rules; (b) monitoring that the rules are respected; and (c) enforcing the rules if necessary. Arrangements to perform these three functions vary from one system to another. The rules are usually set by the *legislator*, which is most of the time the legislative body of the government. The *regulator*, which is independent, then checks whether the rules are respected by the participants. It also collects complaints from stakeholders. It may also propose some rule modifications to the legislator. Lastly, it oversees the quality of services provided by participants. Depending on the countries considered, the power of regulators to enforce rules varies. Some of these powers may be entrusted to other entities, such as an *anti-trust commission* or a *market monitoring entity*.

Frequency and voltage controls involve all the stakeholders described above. Indeed, generation companies, system operators and end users modify the frequency and voltages through their actions, as explained in Chapters 1 and 2. In addition, the market operators, the regulator and the legislator design the rules used to manage frequency and voltage controls, as shown in Chapters 2 and 4.

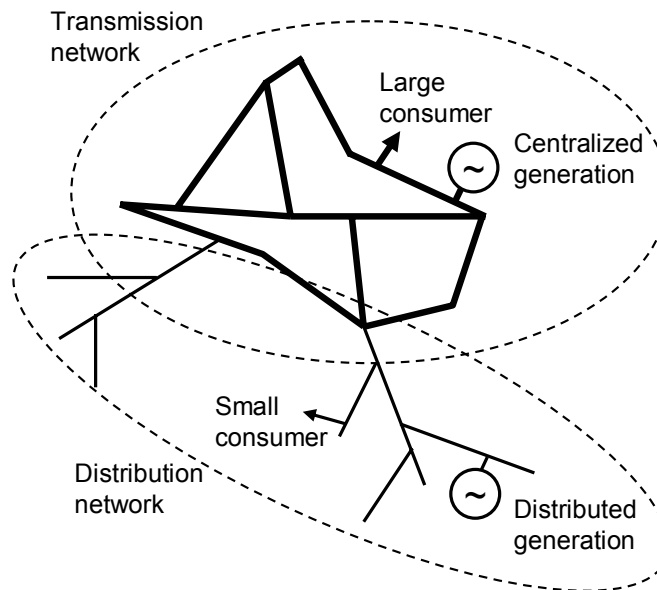

Figure 1.2: Basic layout of a power system

1.3 Marketplaces

In order to facilitate exchanges of products between stakeholders and to send signals to all the participants, markets have been developed along with the liberalization. Section 1.3.1 presents the basic features of a marketplace, while sections 1.3.2 to 1.3.5 introduce the main marketplaces that one is likely to find in the electrical industry.

1.3.1 Basic features of a marketplace

The goal of a marketplace is to bring a buyer and a seller together, so they can exchange a given good at an agreed price. If the delivery of the good is instantaneous (e.g., when one buys some Camembert cheese at a favourite dairy shop), or if the good cannot be resold by the buyer before the delivery (e.g., when one buys a Norman wardrobe to be delivered to the buyer the next day), the market is called a *spot market*. Otherwise, the quality of the good has to be described, as well as the date of delivery and the price to be paid at delivery. Such a market where commodities are traded for delivery in the future is named *futures* (or sometimes forward) *market*. In practice, there are several futures markets, which deal with a particular product (e.g., 1-year or 6-month delivery). Obviously, the products of the 1-year futures market can be traded 6 month later in the 6-month futures market. Futures markets

are useful to participants to hedge against risk associated with the volatility of the spot prices.

To trade these products (spot or future), the marketplace can be organised in two ways. A *centralised market* is cleared by a unique entity that collects the *offers to sell* (supply curve) and the *bids to buy* (demand curve). A unique price π^* is seen by both buyers and sellers, and a quantity q^* is traded. This price and this quantity correspond to the point where supply and demand match (see Figure 1.3). Note that it can be easily proven that the price π^* is equal to the *marginal cost* of the producer² providing the last offer (considering a perfectly competitive market³). On the other hand, in a *decentralised market*, sellers and buyers can enter directly into contracts to buy and sell (sometimes without knowing each other's identity). The transaction is thus bilateral. In such a market, there is no "official price", but there may be mechanisms that allow all the participants to be informed of either the price of the last trade or a weighted average of recent transactions.

An important feature of a marketplace is liquidity. Market liquidity characterises the market's ability to quickly match any bid to buy with an offer to sell without changing the market price. The liquidity incorporates four features: the tightness (i.e., the capability to avoid a large spread between the highest demand price and the lowest supply price); the depth (i.e., the capability to absorb large trade volumes without significant price changes); the immediacy (i.e., the capability to quickly meet the demand to sell or buy); and the resilience (i.e., the capability to recover after a price change) [IMF (2006)].

The participants can also decide not to meet in a public marketplace, but to agree on a *bilateral contract* outside any organised structure. This kind of transaction, which is very popular in the electricity industry to manage long-term contracts, is called *over-the-counter* (OTC)⁴. Such transactions are usually facilitated by brokers. If the bilateral contract is firm, it is called a *forward contract*. On the other hand, if the delivery is optional, it is called an *option*. Several types of options are possible: European (a unique date of delivery), American (which can be exercised once before a given date), swing (which can be exercised several

² The marginal cost is the cost to provide an additional good in the delivery (one MWh in the case of an energy market).

³ A perfect competitive market is a market where no participant uses its dominant position to distort the signals sent by the market to participants.

⁴ On the down side, OTC contracts cannot guarantee the product provision, whereas the market operator has the provision liability in an organised market.

times, but there is a limit in terms of energy), Asian (which is a variant of European: the average price of the good is taken instead of the spot price) or Bermuda (which can be exercised at some given dates). Kluge (2006) describes in depth methods to price options in electricity markets.

Both organised and OTC markets lead to an equilibrium, i.e. a set of operations by stakeholders that equals supply and demand. This equilibrium can be either *Pareto efficient*, i.e. it is impossible to increase the benefit of a party without decreasing the benefit of the others, or qualified as a *Nash equilibrium*, i.e. in which no participant has interest to change its position. Note that a Pareto equilibrium takes into account potential cooperative behaviours by stakeholders, whereas a Nash equilibrium is obtained only with the help of unilateral decisions. Therefore, a Nash equilibrium is often not Pareto efficient.

Kirschen and Strbac (2004a) provide a comprehensive introduction to the marketplaces in the electrical industry. Varian (1999) gives a more general and more theoretical view on marketplaces. Furthermore, Chapter 4 is dedicated to the design of a marketplace for ancillary services.

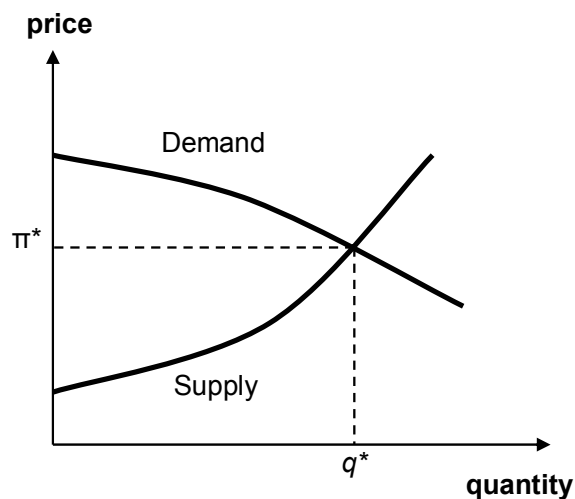

Figure 1.3: Market equilibrium

1.3.2 Generation markets

Generation markets help generation companies find buyers for their products, i.e. energy and ancillary services. Because generating units have a large investment cost, may require a long building period (e.g., around ten years to design a nuclear power plant and up to seven years to build it) and have lifetimes that usually span over tens of years, generation

companies need to find buyers for their products over a long period to reduce risks. In particular, sufficient revenues are essential for generation companies to invest and thus to maintain sufficient capacity in the long-run⁵. Therefore, long-term markets are essential in generation markets. In practice, the generation companies secure their investment with long-term OTC bilateral contracts or vertical integration. However, futures markets in electricity are deemed to provide unreliable signals. In fact, the price of futures tends to be constant whatever is the delivery date (e.g., 1-year, 2-year or 3-year delivery) [e.g., Powernext (2008)], whereas the price of electricity is likely to increase in the future. Therefore, long-term generation markets are still an issue in electricity markets.

Once the generating units have been built and most of the power traded in an OTC manner, generation companies and the buyers of their products enter in the short-term futures markets (i.e., one-month or shorter) to balance their positions. Finally, the market closest to real-time is the spot market. This spot market can be organised either with a centralised (pool) or a decentralised (exchange) unit commitment, as discussed in section 4.6.1. If the delivery delay of the spot market is too long (e.g., more than 15 minutes), an additional market is necessary to balance the positions of the participants. This additional market is called the *balancing mechanism* (or balancing market). This kind of market is more restrictive than the day-ahead market⁶ in order to avoid the exercise of market power by some participants (e.g., prices cannot be changed easily) and is usually operated by the system operator.

Markets for ancillary services, which are described in depth in Chapter 4, are part of the generation markets. In particular, markets for ancillary services and for energy are tightly linked, since a generation company can make the choice to allocate one MW of production capacity as an ancillary service or as energy.

For further information on generation markets, see for example Wilson (2002), Kirschen and Strbac (2004a), Baldick *et al.* (2005) or Joskow (2006). DGEMP/DIDEME (2003) provides reference prices for generating plants, as well as their building time.

⁵ Building sufficient generating capacity in the long-term is part of the power system *adequacy* issue described in section 2.2.1.

⁶ The day-ahead market trades one-day futures.

1.3.3 Transmission markets

To allow sellers and buyers to trade in the generation markets, a transmission network is necessary. Such a network exhibits some particularities. First, electricity follows physics and not the financial rules, so the impact of an injection or a withdrawal of electrical power does not have necessarily a logical consequence from a business point of view (e.g., an increase in electrical power consumption can *reduce* the price of this power). Second, it is difficult to build competing transmission lines, so the access to the transmission network has to be managed by an independent entity (the TSO)⁷.

Since the transmission network has a cost, participants have to pay for the right to use it. To charge users, Transmission System Operators rely on two methods. First, they can charge the users with an *ex-ante* price, i.e. the users know in advance the price that they are going to pay for their transmission use. A typical example of an *ex-ante* price is the postage stamp, for which the users pay a transmission fee that does not depend on the location of the energy generation or consumption. This tariff is designed to recover the cost of transmission expansion and operation, but the signals sent to participants may be too weak to foster an optimal use of the transmission network (e.g., to encourage the construction of new generation plants in a congested area). On the other hand, an *ex-post* price is possible. Such a price is calculated after (and not prior) the actual use of the network. To allow hedging, some *ex-post* price estimates are given to the participants. *Ex-post* prices are often used for competitive procurements of the available transmission capacity. However, the actual implementation of such competitive procurements is still under debate. A popular approach in USA is to link transmission and generation markets by defining energy prices at each node of the system. Such prices are called Locational Marginal Prices (LMP) and are precisely computed *ex-post*. The differences between the LMPs then provide an income to the owner of the line between the two nodes. Such nodal energy markets are completed with financial instruments that allow a party to hedge against price differences between two nodes of the network (the Financial Transmission Rights, or FTR). Quintana and Bautista (2006) give a short and comprehensible introduction to this topic.

⁷ However, the actual construction of the lines may be done by entities under competition (the Transmission Owners).

In the same manner as generation markets, transmission markets involve both short and long terms. Therefore, the network charges should allow the transmission owners to raise enough money to develop the network, in addition to give short-term signals to optimally use the available transmission capacity and to charge the users fairly. But because generation and transmission investments are linked it may be difficult to reflect the optimal allocation between generation companies and transmission owners.

For further reading, Kirschen and Strbac (2004a) provide a good introduction to the issues and solutions of transmission markets. Pignon (2003) analyses the transmission tariffs in Europe, while Rious (2007) discusses the coordination between generation and transmission investments in a deregulated environment.

1.3.4 Retail markets

The idea of a retail market is to allow all end-users to freely choose their supplier of electricity. Retail markets are deemed to improve services and prices offered to the end users. However, competition in retail markets is currently quite limited [e.g., see CRE (2008) for France]. In addition, retail markets are not complete. Indeed, end users sign only long-term OTC contracts with their supplier because of the technical limitations. It is thus not possible for a user to swap from one supplier to another in real-time, as it would be the case in a perfect decentralised market.

1.3.5 Other markets

The markets described previously are directly linked to the generation, transmission and consumption of electricity. However, these markets rely on other commodities. First, they are sensitive to the various fuel markets (e.g., coal, gas or nuclear). Second, they are also impacted by the environment markets that price the pollution, such as the nitrogen oxides (NO_x) and the carbon dioxide (CO₂), or guarantee the renewable provenance of electricity (the so-called green certificates in Europe). Lastly, the cost of generating units may be impacted by the prices of other commodities, in particular raw materials such as steel or copper.

1.4 Fundamentals of Frequency Control

This section introduces the main principles and definitions that are necessary to understand frequency control. In particular, the new concept of instantaneous frequency characteristic is introduced in section 1.4.6.

1.4.1 Frequency and active power

The electrical frequency f of a power system is the same across the entire synchronous zone⁸. Therefore, all the rotors of the alternators from this area rotate at the same angular velocity ω_m (in rad.s^{-1})⁹, times a factor that is a function of their number of poles p , as shown in (1.1) [Grainger and Stevenson (1994)].

$$f = \frac{p}{2} \times \frac{\omega_m}{2\pi} \quad (1.1)$$

As shown in Figure 1.4, the electrical power provided by a generating unit comes from the alternator. The mechanical rotation of the rotor creates a rotating magnetic field, which is then converted into an alternative current in the stator. The rotor is driven by the prime mover, which can use different types of fluids such as steam, water or wind. The mechanical power P_m provided to the prime mover creates a torque T_m on the shaft (the mechanical torque). On the other hand, the electrical power P_e delivered by the generator creates an opposite torque T_e on the rotor (the electrical torque). If these two torques equal each other, the rotor's speed will not change. However, if the mechanical torque is larger than the electrical torque, the rotor will accelerate. Conversely, if T_m is lower than T_e , the alternator will slow down. This relation can be easily modelled mathematically with the so-called swing equation given in (1.2), where J is the total moment of inertia of the rotor masses (in kg.m^2), $d^2\omega_m/dt^2$ the rotor acceleration (in rad.s^{-2}) and P_l the power lost in the process (in W) [Grainger and Stevenson (1994)].

⁸ A synchronous zone is an area interconnected through alternative current. In transient state, the frequency actually varies slightly from one part of the network to another, especially in a large interconnected network. An illustration with the North American network is given by Zhong *et al.* (2005), while Kundur (1994) describes the theoretical fundamentals.

⁹ A power system is like a tandem, on which all the cyclists have to pedal at the same speed to transmit power.

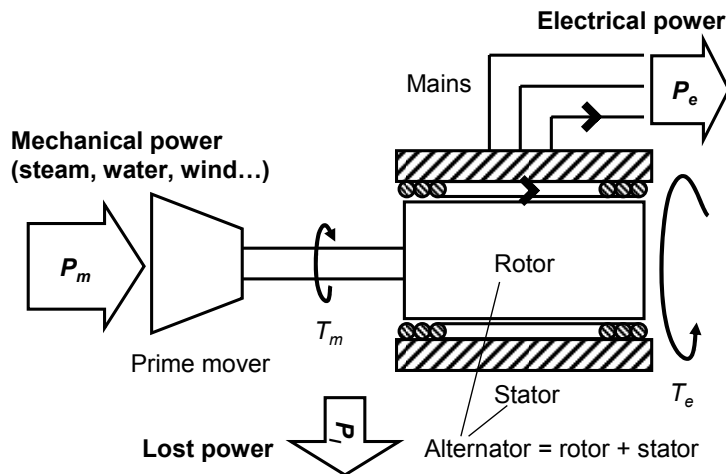

Figure 1.4: Principle of a generating unit

$$J\omega_m \frac{d^2\omega_m}{dt^2} = P_m - P_e - P_l \quad (1.2)$$

Equation (1.2) is very important for dynamic studies since it shows the behaviour of a particular unit in response to mechanical or electrical power changes. From the generating unit's perspective, P_e is imposed by the network, as it is equal to the difference between the consumption and generation of active power at the terminals of the generator¹⁰. If the electrical power drawn by the power system decreases (i.e., if P_e decreases), the electrical machine will start accelerating. In addition, all the generating units across the system will also accelerate, according to the same reasoning¹¹. Therefore, the mechanical power injected into the machines has to be reduced to slow down the rotors. Conversely, if the electrical power drawn by the system increases (i.e., if P_e increases), the generating units will slow down and the mechanical power will have to be increased to maintain the same speed.

In conclusion, the active power injected in or withdrawn from the power system affects the frequency of the system. By adapting the mechanical power provided to generating units, the rotor speed (and thus the electrical frequency) can be controlled. Similarly, the frequency can also be controlled by adapting the consumption of electricity by the loads.

¹⁰ Obviously, the active power provided by the generator is not included in this difference.

¹¹ This reasoning is true if the network capacity is sufficient. Otherwise, power oscillations can appear, i.e. some generating units can accelerate while others are slowing down.

1.4.2 Dynamic and quasi-steady-state frequency deviations

As any physical value, the frequency goes through a transitory state in response to a perturbation before stabilising to a new value. The maximum deviation from the target frequency during the transitory period is called the *dynamic frequency deviation*. The deviation between the target value and the final value is called the *quasi-steady-state deviation* (see Figure 1.5). The term “quasi” is used here because a steady-state analysis is performed on a dynamical system¹². Though, the dynamics considered are slow enough to allow such a definition. The quasi-steady state is usually defined with the help of a maximum gradient that the frequency should not exceed [UCTE (2004b)]. Note that similar definitions exist for voltage deviations.

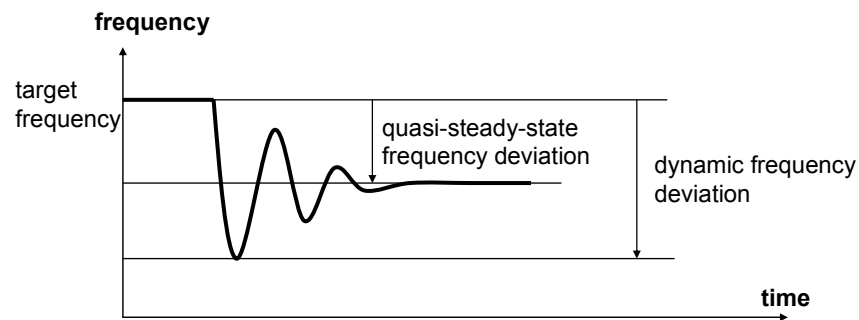

Figure 1.5: Dynamic and quasi-steady-state frequency deviations. Based on UCTE (2004b)

1.4.3 Self-regulation of load

The active power consumed by a load depends in part on the frequency, especially for motors. In general, a frequency increase leads to a load increase, and vice-versa. However, some loads such as arc furnaces have an opposite behaviour [Kundur (1994), p. 310].

To make explicit this relation between load and frequency, let us consider a stable power system state, in which the same amount of active power P_0 is consumed and produced at the nominal frequency f_n . A quasi-steady-state frequency deviation Δf from the nominal frequency f_n (i.e., usually 50 Hz or 60 Hz) will lead to a consumption change $\Delta P_{consumption}$ according to the Equation (1.4).

$$\Delta f = f_{qs} - f_n \quad (1.3)$$

¹² A power system never reaches a steady state because various parameters are always fluctuating. For example, the frequency usually comes back to its target value after a perturbation with the help of various controls (see Chapter 2).

$$\Delta P_{consumption} = D \times P_0 \times \Delta f \quad (1.4)$$

where f_{qss} is the quasi-steady-state electrical frequency of the power system (in Hz); and D , positive and expressed in %/Hz, is called *self-regulation of the load*. It depends on the structure of the power system, in particular on the number and the types of loads on-line. The term “self-regulation” is used because this effect tends to be naturally opposed to frequency variations. However, it is usually not sufficient to compensate imbalances without a large quasi-steady-state frequency deviation since the value of this parameter is usually between 1 or 2 %/Hz [UCTE (2004b)].

1.4.4 Speed control of generators

Most generating units have a controller that adjusts the mechanical power P_m provided by the prime mover as a function of the rotor speed ω_m (see Figure 1.4). This speed control is performed by a simple feedback loop (see Figure 1.6) with an adjustable parameter $1/s_G^i$, where s_G^i is called the *droop* of the generating unit i (in per-unit and positive). The relation between the power set-point of the generating unit, the droop and the frequency deviation is given in (1.5) [UCTE (2004b)]. Therefore, the lower the droop, the stronger is the generating unit’s response. This Equation can be compared to (1.4) concerning the self-regulation of load.

$$s_G^i = -\frac{\frac{\Delta f_m^i}{f_n^i}}{\frac{\Delta P_G^i}{P_{Gn}^i}} = -\frac{\frac{f_m^i - f_n^i}{f_n^i}}{\frac{P_G^i - P_{G0}^i}{P_{Gn}^i}} \quad (1.5)$$

$$\Leftrightarrow \Delta P_G^i = -\frac{1}{f_n^i \times s_G^i} \times P_{Gn}^i \times \Delta f_m^i$$

where ΔP_G^i is the change in the power set-point of the generating unit i for any measured frequency deviation Δf_m^i (e.g., dynamic or quasi-steady state), P_{Gn}^i the generating unit’s nominal output power, P_{G0}^i the power set-point without any frequency control and f_n^i the nominal frequency of the power system registered in the generating unit’s controller. Note that the negative sign can be sometimes omitted to define the droop s_G^i , which thus leads to negative droops (e.g., -4 % instead of 4 %).

Consequently, the production of N_G generating units providing speed control will increase by $\Delta P_{generation}$ following a quasi-steady-state frequency deviation Δf , $\Delta P_{generation}$ expressed as follows (if the maximum outputs of the generating units are not reached):

$$\begin{aligned}\Delta P_{generation} &= \sum_{k=1}^{N_G} \Delta P_G^k \\ &= - \left(\sum_{k=1}^{N_G} \frac{P_{Gn}^k \times \Delta f_m^k}{f_n^k \times s_G^k} \right) \\ \Delta P_{generation} &\approx - \left(\sum_{k=1}^{N_G} \frac{P_{Gn}^k}{s_G^k} \right) \times \frac{\Delta f}{f_n}\end{aligned}\quad (1.6)$$

The droop is individual to each generator and is generally set at around similar values in order to avoid the non-linearities that can appear if generating units reach their maximal outputs for different frequency deviations¹³. In practice, droops range between 4 and 20 % (see section 2.3.4.2), which lead to very different responses.

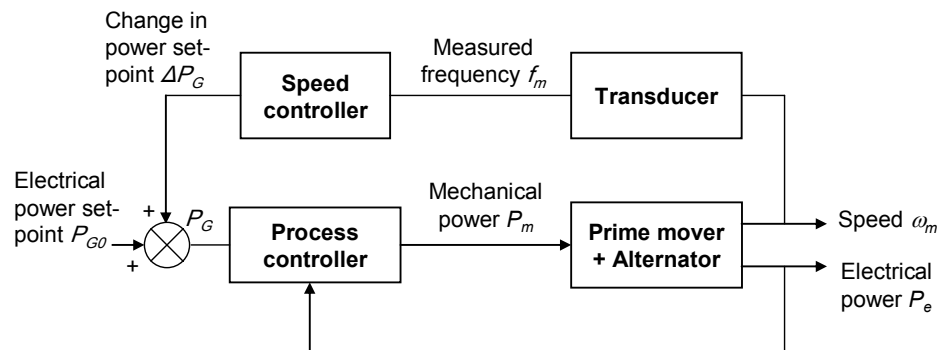

Figure 1.6: Simplified regulation scheme of a generating unit

1.4.5 Combined effect of speed control and self-regulation

At the quasi-steady state, consumption and production are equal. Therefore, a quasi-steady-state power imbalance ΔP (a positive value indicates an excess in consumption) is compensated by the combined effect of generating units $\Delta P_{generation}$ (via the speed regulation) and loads $\Delta P_{consumption}$ (via the self-regulation), as shown in (1.7).

¹³ The non-linearities can be spotted easily with the concept of instantaneous frequency characteristic developed in section 1.4.6.

$$\begin{aligned}
\Delta P + \Delta P_{consumption} - \Delta P_{generation} &= 0 \\
\Leftrightarrow \Delta P &= \Delta P_{generation} - \Delta P_{consumption} \\
\Leftrightarrow \Delta P &\approx - \left(\sum_{k=1}^{N_G} \frac{P_G^k}{s_G^k} \right) \times \frac{\Delta f}{f_n} - D \times P_0 \times \Delta f
\end{aligned} \tag{1.7}$$

Therefore, the quasi-steady-state frequency deviation following a power imbalance is equal to:

$$\Delta f \approx - \frac{\Delta P}{D \times P_0 + \frac{1}{f_n} \sum_{k=1}^{N_G} \frac{P_G^k}{s_G^k}} \tag{1.8}$$

The number N_G and the droops s_G^k of the generating units providing speed control actually vary over time, as well as the self-regulation D . However, for a given imbalance ΔP (i.e., for a few tens of minutes), these parameters can be assumed to be constant. In addition, the nominal powers P_G^k and the nominal frequency f_n are also constant, so the following simple linear relation can be deduced:

$$- \frac{\Delta P}{\Delta f} = C^{te} > 0 \tag{1.9}$$

In other words, a quasi-steady-state frequency deviation depends exclusively on this constant if only the droops and self-regulation are considered. This constant, expressed in MW/Hz, is sometimes called the *composite frequency response characteristic* or the *stiffness of the system* [Kundur (1994)].

1.4.6 Frequency characteristics

In addition to the automatic actions of the generating units (i.e., speed control) and loads (i.e., self-regulation), the entity responsible for the power system (i.e., the system operator) can take several additional actions to restore frequency:

- ✓ With regard to the generation:
 - Modify the generation output;
 - Stop or start new generating units.

- ✓ With regard to the consumption¹⁴:
 - Modify consumption (e.g., a residential load may shut down its electrical heating upon request);
 - Disconnect or connect loads.

Therefore, in the same manner as for (1.9), but considering any actions that can be taken as a function of frequency, a simple linear relation can be assumed between the power imbalance ΔP (a positive value indicates an excess in consumption) and the quasi-steady state frequency deviation Δf :

$$\Lambda(\Delta f) = -\frac{\Delta P}{\Delta f} \quad (1.10)$$

where $\Lambda(\Delta f)$, positive and expressed in MW/Hz, is the *frequency characteristic of the power system for the quasi-steady state frequency deviation* Δf [UCTE (2004b)].

The definition of the frequency characteristic described above does not show the regulating capacity actually available for a frequency different from f_n . To fill this gap, it is proposed to introduce the concept of *instantaneous frequency characteristic* λ , defined for an elementary quasi-steady-state variation of the frequency ∂f_{qss} as in (1.11). The partial derivation is used since the active power consumed or generated in the system can vary along with other parameters such as voltage. The frequency characteristic for a given perturbation Λ , which represents the average of the instantaneous frequency characteristic, can then be easily calculated through an appropriate integration, as shown in (1.12).

$$\lambda(f_{qss}) = -\frac{\partial P(f_{qss})}{\partial f_{qss}} \quad (1.11)$$

$$\lambda(f_{qss}) = \frac{\partial P_{consumption}(f_{qss})}{\partial f_{qss}} - \frac{\partial P_{generation}(f_{qss})}{\partial f_{qss}}$$

$$\Lambda(\Delta f) = \frac{1}{\Delta f} \int_0^{\Delta f} \lambda(f_{qss}) \times df_{qss} \quad (1.12)$$

¹⁴ Network assets are considered here as consumers of active power (e.g., see section 1.5.4 for the consumption of a line).

Figure 1.7 shows the interest of this new definition. First, the instantaneous frequency characteristic λ of the regulating devices can be easily calculated. Therefore, the frequency characteristic $\Lambda(\Delta f)$ can be conveniently deduced for any frequency deviation. Second, the contributions of the different regulating devices are clear in the top graph (e.g., the participation of a particular generator becomes recognisable), whereas it is much more difficult to identify them in the bottom graph. Last, non-linear behaviours of the system are spotted easily (e.g., in this case, the system does not react anymore to frequency changes beyond a certain point).

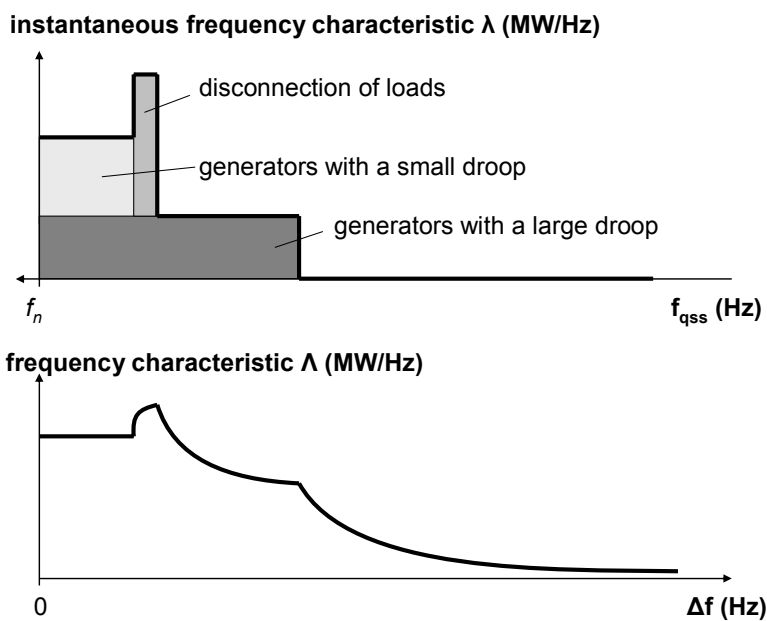
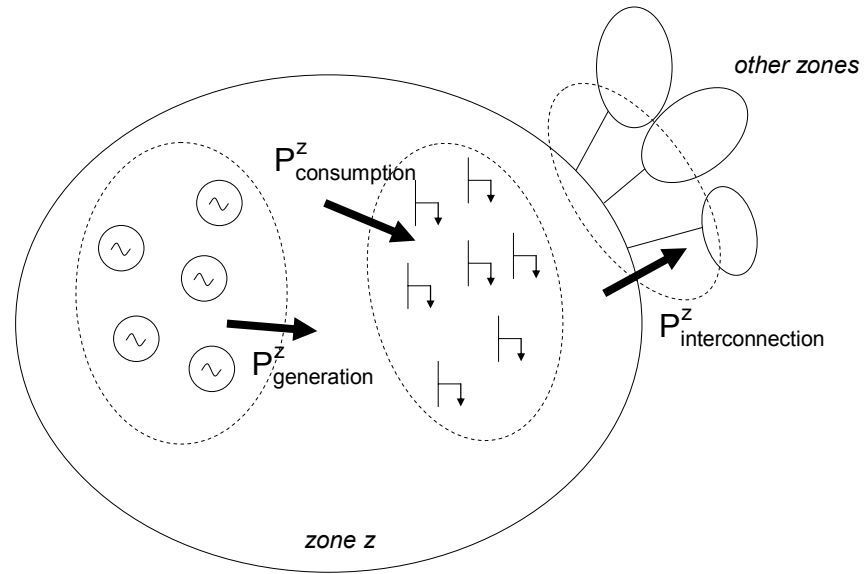

Figure 1.7: Example of instantaneous and average frequency characteristics of a power system

1.4.7 Management of an imbalance in an interconnected power system

As frequency is a value common to the whole interconnected power system, an active power imbalance in one part of the system will lead to a reaction from across the whole system. Figure 1.8 shows a zone z , which is interconnected with the other zones of the system and exports a power $P_{interconnection}^z$.

Figure 1.8: Configuration of a zone z

In the case of a quasi-steady-state frequency deviation Δf , the generation and the consumption of the zone is affected, because of the Equation (1.10), as expressed in (1.13). In other words, a frequency change leads to a deviation from the scheduled power transfer between the zone z and its neighbouring zones.

$$\begin{aligned}
 \Delta P_{generation}^z - \Delta P_{consumption}^z - \Delta P_{interconnection}^z &= 0 \\
 \Leftrightarrow -\Lambda^z(\Delta f) \times \Delta f - \Delta P_{interconnection}^z &= 0 \\
 \Leftrightarrow \Delta P_{interconnection}^z &= \Lambda^z(\Delta f) \times \Delta f
 \end{aligned} \tag{1.13}$$

Then, let us suppose that the zone 0 loses generating unit 1 that produces P_G^1 (see Figure 1.9).

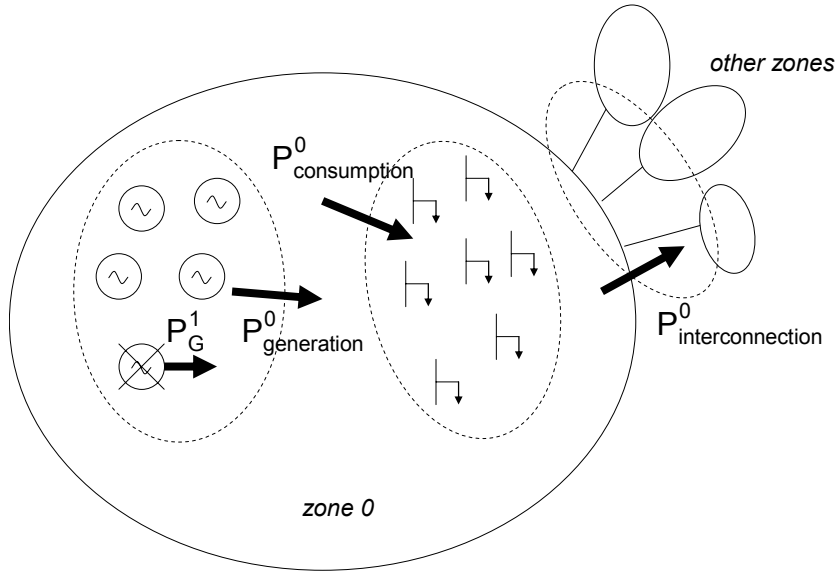

Figure 1.9: Configuration of the zone 0 with the loss of a generating unit

Following this loss, the frequency of the whole power system starts to decrease (see section 1.4.1). Therefore, each zone starts to increase its exchange according to Equation (1.13). For all the zones except zone 0, the change in generation $\Delta P_{generation}^z$ is only due to frequency control, so the exchange deviations $\Delta P_{interconnection}^z$ are equal to:

$$\Delta P_{interconnection}^z = -\Lambda^z(\Delta f) \times \Delta f, \quad \forall z \neq 0 \quad (1.14)$$

On the other hand, zone 0 has the following exchange deviation because both P_G^1 and frequency control have to be considered in $\Delta P_{generation}^0$:

$$\Delta P_{interconnection}^0 = -\Lambda^0(\Delta f) \times \Delta f - P_G^1 \quad (1.15)$$

The algebraic sum of all the exchanges at the various interconnections is zero because all the exchanges are considered twice: once positive and once negative, which leads to:

$$\sum_i \Delta P_{interconnection}^i = 0 \quad (1.16)$$

Therefore:

$$\begin{aligned} -\sum_{i \neq 0} \Lambda^i(\Delta f) \times \Delta f - \Lambda^0(\Delta f) \times \Delta f - P_G^1 &= 0 \\ \Leftrightarrow P_G^1 &= -\Delta f \times \sum_i \Lambda^i(\Delta f) \end{aligned} \quad (1.17)$$

In conclusion, the imbalance between generation and consumption in zone 0 is compensated by the whole interconnected power system (1.17). However, unscheduled exchanges appear at the interconnections, as shown in (1.14) and (1.15). Therefore, the frequency has to be brought back to its target value in order to remove these unscheduled exchanges. This is done using complementary controls described in section 2.3.3.1.

1.5 Fundamentals of Voltage Control

This section introduces the main principles and definitions that are necessary to understand voltage control. In particular, the concept of reactive power is explained in section 1.5.1.

1.5.1 Apparent, active and reactive powers

Let us consider a passive dipole¹⁵, in which a current $i(t)$ flows and with a voltage $u(t)$ between its terminals¹⁶ (see Figure 1.10). The *instantaneous power* $p(t)$ absorbed by this dipole is equal to the product of $i(t)$ and $u(t)$. Figure 1.11 shows these three values as a function of time when they are sinusoidal quantities, assuming a 50-Hz frequency f and a 30° lag φ between current and voltage¹⁷. Equations from (1.18) to (1.21) give the mathematical expressions of $i(t)$, $u(t)$ and $p(t)$, where ω is called the angular frequency, U the Root Mean Square (RMS) voltage and I the RMS current.

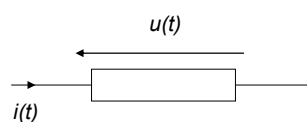

Figure 1.10: A dipole (receiving convention)

$$\omega = 2\pi \times f \quad (1.18)$$

$$u(t) = U\sqrt{2} \sin(\omega t) \quad (1.19)$$

¹⁵ A passive dipole is an electrical element with two nodes and without any internal energy source.

¹⁶ The current quantifies the debit of electrons and the voltage the electrical pressure that is exerted on the electrons.

¹⁷ A lag of 30° is equivalent to $\pi/6$ radians. As the current lags the voltage in this case, the dipole is said to be *inductive*.

$$i(t) = I\sqrt{2} \sin(\omega t - \varphi) \quad (1.20)$$

$$p(t) = u(t) \times i(t) \quad (1.21)$$

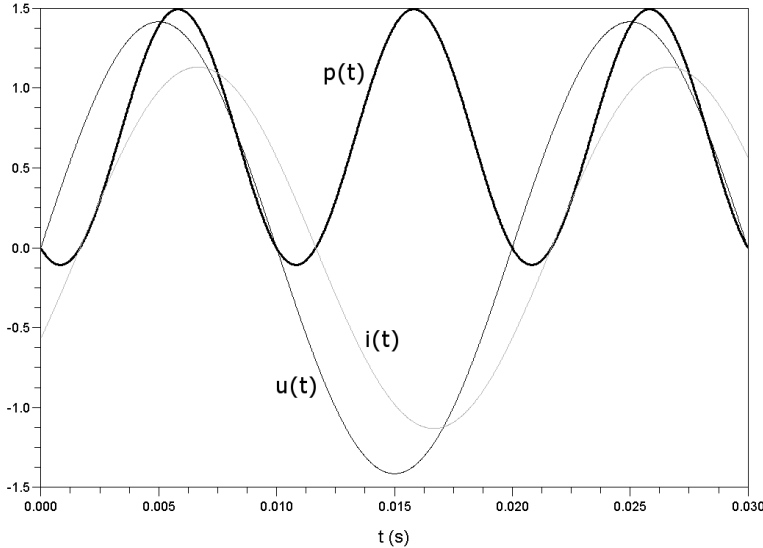

Figure 1.11: Temporal representation of voltage, current and instantaneous power (inductive dipole)

Figure 1.11 shows that the absorbed power $p(t)$ is sometimes negative (i.e., when $u(t)$ and $i(t)$ have opposite signs), which means that the dipole provides power during this time. Since the dipole does not have any internal source of energy, it has to sometimes withdraw more energy from the source before giving it back later on. This storage/release can be mathematically isolated in two components as follows [Bastard (1998)]:

- ✓ $p_x(t)$, called *instantaneous reactive power*, is null on average and represents the alternation between the storage and release of energy by the dipole;
- ✓ $p_r(t)$, called *instantaneous active power*, is always positive and represents the power actually used by the dipole.

Equations from (1.22) to (1.26) give the mathematical expressions for $p_x(t)$ and $p_r(t)$, where P is the average of the instantaneous active power (or simply the *active power*) and Q the maximum of the instantaneous reactive power (or simply the *reactive power*). Note that $\cos \varphi$ is usually called power factor and noted pf . Figure 1.12 shows the temporal representation of the three instantaneous powers for the same dipole as considered in Figure 1.11.

$$p(t) = u(t) \times i(t) = p_r(t) + p_x(t) \quad (1.22)$$

$$p_r(t) = P \times [1 - \cos(2\omega t)] \quad (1.23)$$

$$P = UI \cos \varphi \quad (1.24)$$

$$p_x(t) = -Q \times \sin(2\omega t) \quad (1.25)$$

$$Q = UI \sin \varphi \quad (1.26)$$

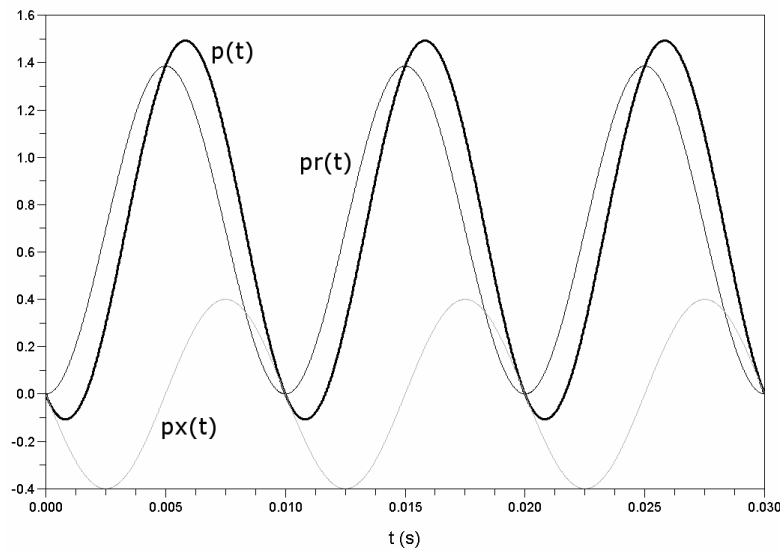

Figure 1.12: Temporal representation of the three instantaneous powers (inductive dipole)

Temporal representations are not very easy to handle because the sine and cosine functions lead to complex calculations when added or multiplied. A practical manner to handle sinusoidal values is to transform them into the complex plane, where the sinusoidal values can be seen as vectors that are rotating in this plane. Equation (1.27) shows the transformation used in this example, while Equation (1.28) gives the result of this transformation for the three instantaneous powers, where \underline{P} , \underline{Q} and \underline{S} are complex values. S is called the *apparent power* because it is related to the instantaneous power, i.e. the physical power used by the dipole. Equation (1.29) expresses the link between instantaneous powers and their complex representations. Equation (1.30) shows the simple link between the three powers. Lastly, Figure 1.13 shows the representation of the three powers in the complex plane. The projection of these vectors on the real axis gives the instantaneous physical values, because of Equation (1.29). Note that the power vectors are rotating in a clock-wise

manner at twice the angular frequency ω ¹⁸, whereas the voltage and the current rotate trigonometrically at the angular frequency.

$$A \in \mathfrak{R}^+; B \in \mathfrak{R}; X = A \sin(B) \mapsto \underline{X} = A e^{j(B - \frac{\pi}{2})} = A [\sin(B) - j \cos(B)] \quad (1.27)$$

$$\begin{cases} \underline{P} = P e^{j(-2\omega t - \pi)} \\ \underline{Q} = Q e^{j(-2\omega t - \frac{\pi}{2})} \\ \underline{S} = \underline{P} + \underline{Q} = S e^{j\varphi} \end{cases} \quad (1.28)$$

$$\begin{cases} p_r(t) = P + \text{Re}(\underline{P}) \\ p_x(t) = \text{Re}(\underline{Q}) \\ p(t) = P + \text{Re}(\underline{S}) \end{cases} \quad (1.29)$$

$$S^2 = P^2 + Q^2 \quad (1.30)$$

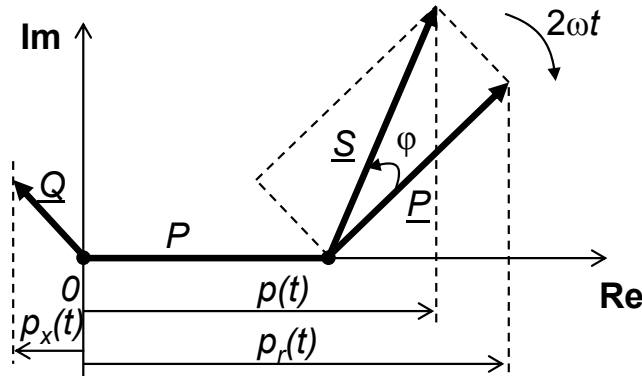

Figure 1.13: Representation of the powers in the complex plane (inductive dipole)

To conclude, dipoles can store electrical energy in a magnetic manner (e.g., generating units, lines or transformers) or under an electric form (e.g., capacitor, underground cables) before releasing it quickly. This release/storage of energy creates a phase difference between voltage and current, which leads to the use of reactive power. Note first that other elements based on power electronics can also produce a phase difference between current and voltage and thus reactive power. Second, reactive power is essential for the good working of essential power system elements. For example,

¹⁸ The alternating component of active power that can be seen in a two-phase system creates vibrations in a rotating machine. However, in an equilibrated three-phase system, the sum of the three power vectors leads to a constant power, as the three alternating components are cancelled.

transformers need an alternating magnetic field (and thus a storage/release of magnetic energy) to transfer power from one winding to another. Third, reactive power is a value that is limited to alternative-current power systems: it is never drawn away from the system. For example, the prime mover of a generating unit only provides active power to the alternator and the end-user motor only provides active power to the shaft. However, even if the reactive power cannot be lost, it increases the active power losses through the Joule effect (see section 1.5.4).

1.5.2 Voltages and reactive power

To illustrate the link between voltages and reactive power, the dipole of Figure 1.10 is described more precisely in this section. Indeed, Figure 1.14 shows two electrical points connected through a *resistance* R and a *reactance* X ¹⁹. In practice, such an electrical link is equivalent²⁰ to a short aerial transmission line (where \underline{V}_1 and \underline{V}_2 are the voltages at each terminal, see section 1.5.4 for a more precise model) or a simplified synchronous machine (where \underline{V}_i is the internal voltage, see section 1.5.3) [Grainger and Stevenson (1994)]. The electrical point 1 produces an active power P_1 and a reactive power Q_1 . The electrical point 2 consumes an active power P_2 and a reactive power Q_2 . Current \underline{I} lags voltage $\underline{V}_1 - \underline{V}_2$ because of the inductance. The associated phasor representation in the complex plane of the voltages is shown in Figure 1.15²¹.

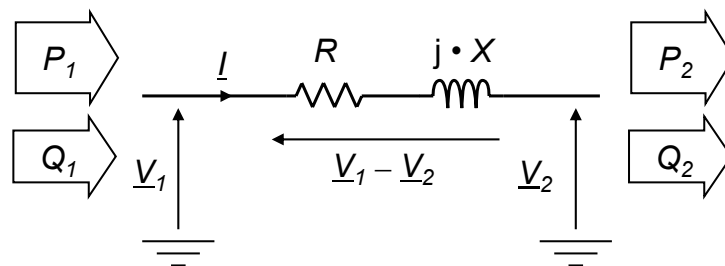

Figure 1.14: Electrical representation of an R-X dipole

¹⁹ The reactance X is the imaginary part of the *impedance* Z . Here, X is equal to $L\omega$, where L is the physical characteristic of the element and is called the *inductance* (see section 1.5.4).

²⁰ A single dipole is equivalent to a three-phase electrical element by considering that the three phases are equilibrated and that the single dipole represents one phase. Therefore, the three-phase power is equal to three times the single-phase power.

²¹ See section 1.5.1 for a short explanation on the phasor representation of electrical values. See for example Grainger and Stevenson (1994) for the link between voltage and current.

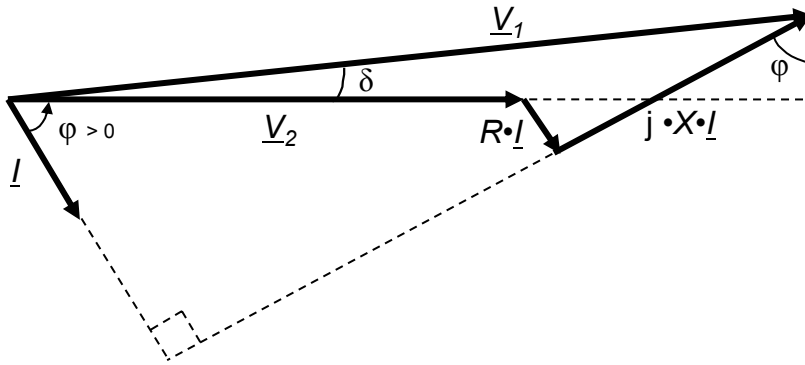

Figure 1.15: Phasor representation associated with Figure 1.14

From Figure 1.15, by using δ and squaring the trigonometric expressions, we have [Bastard (1998)]:

$$\frac{\Delta V}{V} = \frac{\frac{1}{2}R \times RI^2 + \frac{1}{2}X \times XI^2 + RP_2 + XQ_2}{V^2} \quad (1.31)$$

where:

$$\begin{aligned} V &= \frac{V_1 + V_2}{2} \\ \Delta V &= V_1 - V_2 \end{aligned} \quad (1.32)$$

For a transmission line, the term XQ_2 is predominant²², so Equation (1.31) can be approximated as follows²³ [Bastard (1998)]:

$$\frac{\Delta V}{V} \approx \frac{XQ_2}{V^2} \quad (1.33)$$

Therefore, supposing that V_1 is constant (e.g., with the help of a controlling device such as a generating unit), any change in the consumption of the reactive power by the end terminal will result in a voltage drop. Therefore, by controlling the consumption of reactive power Q_2 , the voltage V_2 can be maintained at this terminal. In other words, by maintaining voltage and current in phase (and thus limiting the reactive power consumed by the line), voltage drops/rises can be limited in the transmission network. This direct link between

²² Because I is low, $P_2/Q_2 \approx 3$ (i.e., $pf \approx 0.95$) and $X/R \approx 10$ (see section 1.5.4)

²³ Because of the strong approximation, relation (1.33) should be used only to give an order of magnitude. Otherwise, (1.31) should be preferred.

voltage and reactive power is less strong for distribution networks because the ratio X/R is lower (see section 1.5.4), so the term RP_2 is not negligible anymore, and both active and reactive power consumption have to be controlled to maintain voltage.

1.5.3 Reactive power from a generating unit

As shown in Figure 1.4, the mechanical power P_m of a generating unit is converted into electrical power P_e through the alternator. The rotor of an alternator is equivalent to a large rotating magnet. This rotating magnetic field then induces an alternative voltage (the *internal voltage*) in the windings of the stator. The latter are connected to the system through the mains, and provide the *stator voltage*. The internal voltage is proportional to the amplitude of the magnetic flux. Therefore, the voltage at the stator of the transformer is controlled by adjusting the magnetic field of the rotor, which is itself regulated by the field current flowing in the windings of the rotor (the *exciter current*) [Grainger and Stevenson (1994)].

In practice, the Automatic Voltage Regulator (AVR) controls the exciter current to maintain the stator voltage at the given value. The exact configuration and tuning of such system varies from one technology to another and relies on the local condition of the machine. In addition, the AVR can include a Power System Stabilizer (PSS). A PSS takes into account the speed or the active power of the machine to act on the exciter current. Kundur (1994) provides much detail on the configurations and tuning of AVR and PSS.

To understand the link between the stator voltage and the reactive power produced/absorbed by the generating units, Figure 1.14 and Figure 1.15 can be used. Figure 1.14 is an equivalent of a stator, where X and R represent the impedance of the stator; \underline{V}_1 the internal voltage; \underline{V}_2 the stator voltage; \underline{I} the stator current (i.e. the current flowing out of the terminals of the generator). Note that the internal voltage \underline{V}_1 is physically created along the whole stator windings. Therefore, the proposed model is only an equivalent, in which the internal voltage source and the impedance are separated (a Thévenin model). The stator voltage \underline{V}_2 always lags the internal voltage \underline{V}_1 in generator mode. However, the stator voltage can either lag or lead the stator current \underline{I} . If the generator is over-excited, the stator current \underline{I} lags the stator voltage \underline{V}_2 and the generator delivers reactive power (as represented in Figure 1.15). In this case, the system consumes

reactive power in this case because Q_2 is positive²⁴. On the other hand, if the generator is under-excited, the stator current leads the stator voltage, the generator absorbs reactive power and the system provides reactive power ($Q_2 < 0$) [Grainger and Stevenson (1994)].

The capability of a generating unit to provide or absorb reactive power is limited, and depends on the active power produced and the stator voltage. A P - Q diagram is convenient to represent such capabilities. Figure 1.16 shows a typical P - Q diagram from the stator side for a given stator voltage²⁵. Therefore, when a generator is producing/absorbing reactive power, active power may have to be reduced, which may create an opportunity cost (see section 3.2.2). However, this opportunity cost is theoretical because the connecting conditions for generating units usually impose large reactive power capabilities (see section 2.3.4.4).

Most of the time, a generating unit controls the voltage (and thus the reactive power produced or consumed by the generator) at its stator. However, the system operator may ask the operator of the generating unit to express its reactive power capability at the Point of Delivery (POD) instead of the stator. The POD is the point owned by the generator that is the electrically closest to the network (see Figure 3.1). As rule-of-thumb, at the nominal apparent power S_n of the generating unit, the reactive power absorbed by the auxiliaries²⁶, the step-up transformer²⁷, and the transmission line up to the POD is usually around 15% of S_n ²⁸. Therefore, the reactive power Q_{POD} supplied by the generator to the network can be estimated using Equation (1.34).

$$\begin{aligned} Q_{POD} &\approx Q_2 - 0,15 \times S_n \\ Q_{POD} &\approx Q_2 - 0,15 \times \frac{P_n}{pf} \end{aligned} \tag{1.34}$$

²⁴ $Q_2 = V_2 I \sin \varphi$ according to (1.26), and $\sin \varphi > 0$.

²⁵ Similarly, a U/Q diagram can be built for a given active power output.

²⁶ The auxiliaries are all the elements that a power plant needs to run, such as pumps, controllers or light.

²⁷ The nominal stator voltage is generally lower (e.g., 20 kV) than the nominal voltage at the POD (e.g., 400 kV). The producer thus needs to step-up the voltage through a transformer.

²⁸ The major component of the 15 % is due to the impedance of the step-up transformer, which is around 13 % (see note 74 p. 145).

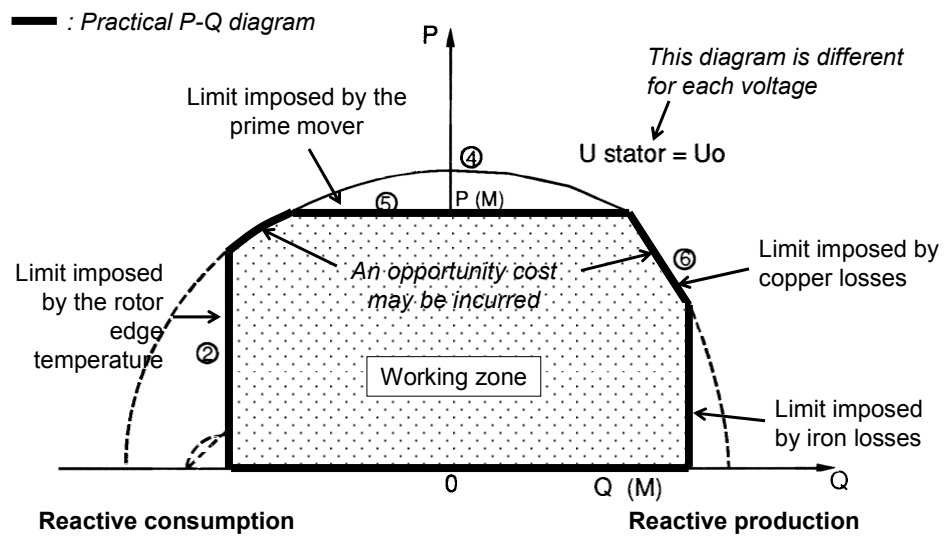

Figure 1.16: Typical P-Q diagram from the stator side. Based on Testud (1991)

1.5.4 Reactive power from a line

To study the contribution of a line to the absorption/generation of reactive power, a better model than the one described in Figure 1.14 has to be used. This new model is shown in Figure 1.17. It is a single-phase π -representation of the three-phase line. R and L represent the resistance and the inductance of the line, respectively. Their values depend on the cable section, the type of material (e.g., steel with aluminium or copper), the number of conductors, the configuration of the cables and the temperature [Johannet (1997)]. C , which mainly depends on the configuration of the cables, is the equivalent *capacitance* of the line lumped at each extremity²⁹. This modelling simplifies reality because the capacitance is actually distributed along the whole line. However, this is a good approximation for a line of medium length (less than 200 km) and if the electromagnetic transients are neglected [Bastard (1998)]. Lastly, the *conductance*, i.e. the resistance between the line and the ground is neglected here. Table 1.1 gives typical values of these parameters for different voltages. It is clear that the ratio L/R of the inductance over the resistance increases with the line voltage because high-voltage line have larger sections and thus lower resistance than low-voltage lines, whereas the inductance stays relatively constant.

²⁹ $C\omega$ is called the *susceptance* of the capacitance and is often denoted B . Note that the reactance of the capacitance is equal to $1/C\omega$.

Figure 1.17: π -representation of a line

Table 1.1: Characteristics of a 50-Hz transmission line impedance for one phase. Based on Kundur (1994) and EDF internal documents

Voltage (kV)	Aerial line						Underground cable	
	R (Ω/km)	L (mH/km)	$L\omega$ (Ω/km)	$L\omega/R$	C (nF/km)	$C\omega$ ($\mu\text{S}/\text{km}$)	C (nF/km)	$C\omega$ ($\mu\text{S}/\text{km}$)
45	0.22	1.14	0.36	1.7	10.3	3.25	-	-
63	0.24	1.31	0.41	1.8	8.9	2.79	≈ 400	≈ 126
90	0.16	1.28	0.40	2.6	9.1	2.84	≈ 300	≈ 94
150	0.14	1.36	0.43	3.0	8.6	2.69	-	-
225	0.083	1.26	0.40	4.9	9.4	2.95	≈ 200	≈ 63
400	0.034	1.08	0.34	10.2	11.0	3.46	≈ 150	≈ 47
500	0.028	0.86	0.27	9.6	13.8	5.20	-	-
765	0.012	0.87	0.27	22.8	13.2	4.98	-	-

To express the reactive power consumed or produced by the line shown in Figure 1.17, the current flowing to the ground through the capacities is supposed to be negligible in comparison with the current flowing into the line. In addition, the voltage amplitudes are supposed to be identical at both terminals of the line, for example with the help of two generators that maintain these two voltages. These assumptions on currents and voltages can be expressed as in (1.35).

$$\begin{aligned} I_1 &\approx I_2 = I \\ V_1 &\approx V_2 = V \end{aligned} \quad (1.35)$$

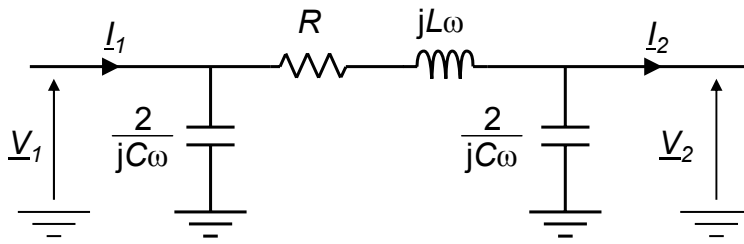
So the consumption of the line in active P and reactive Q powers is as follows, where RI^2 are the Joule losses; $-BV^2$ the reactive power provided by the capacitance; and XI^2 the reactive power consumed by the inductance³⁰ [Johannet (1997)]:

$$\begin{aligned} P &= RI^2 \\ Q &= XI^2 - BV^2 \end{aligned} \quad (1.36)$$

Therefore, the following power balance can be deduced:

$$\begin{aligned} P_l &= P_2 + RI^2 \\ Q_l &= Q_2 + XI^2 - BV^2 \end{aligned} \quad (1.37)$$

To illustrate the reactive power consumption of the line, let us consider a 400 kV / 2 000 MVA line. To give an idea, this kind of line has usually a bundle three 570-mm² conductors per phase. For this kind of conductor, the maximal permanent current $I_{conductor}$ is between 900 and 1 100 A per conductor, depending on the season, so less than 2 A/mm² (note that the steel core is included in this calculation). Therefore, the maximal power S_{line} admissible by this line is between 1 870 MVA and 2 290 MVA and mathematically expressed in (1.38), where $V_{line-line}$ is the voltage line-to-line. But usually the line is operated between 40 and 60 % of this power in order to respect the N-1 criterion³¹.

$$\begin{aligned} S_{line} &= 3 \times S \\ &= 3 \times V \times I \\ &= \sqrt{3} \times V_{line-line} \times 3 \times I_{conductor} \\ S_{line} &= \sqrt{3} \times 400\,000 \times 3 \times I_{conductor} \end{aligned} \quad (1.38)$$

The reactive power consumption as a function of the current has been calculated using (1.36) and Table 1.1, and is shown in Figure 1.18 for three 400 kV / 2 000 MVA lines of different lengths, for which the base parameters³² are given in (1.39). Four remarks can be drawn. First, a line can produce reactive power, which leads to a voltage difference between the two terminals of the line (see section 1.5.2). In particular, the voltage rise at no load is called the *Ferranti effect*. Second, it is clear that a long line requires more reactive

³⁰ When the line is heavily loaded, the term $-BV^2$ becomes negligible in comparison to XI^2 , which leads to the simplified model of section 1.5.2.

³¹ The N-1 criterion states that the loss of an element (e.g., a line) should not jeopardize the security of the system.

³² The absolute value is found by multiplying the base value by the per-unit value.

support than a short line. Third, for any line length, the reactive power consumption is always null for a given power, called the characteristic power, which corresponds to a current I_c given by (1.40), where Z_c is called the *characteristic line impedance*. Lastly, it is important to note that an underground cable produces much more reactive than an aerial line because of its high susceptance B (see Table 1.1). This high reactive power leads to strong voltage rises that limit the length of underground cables.

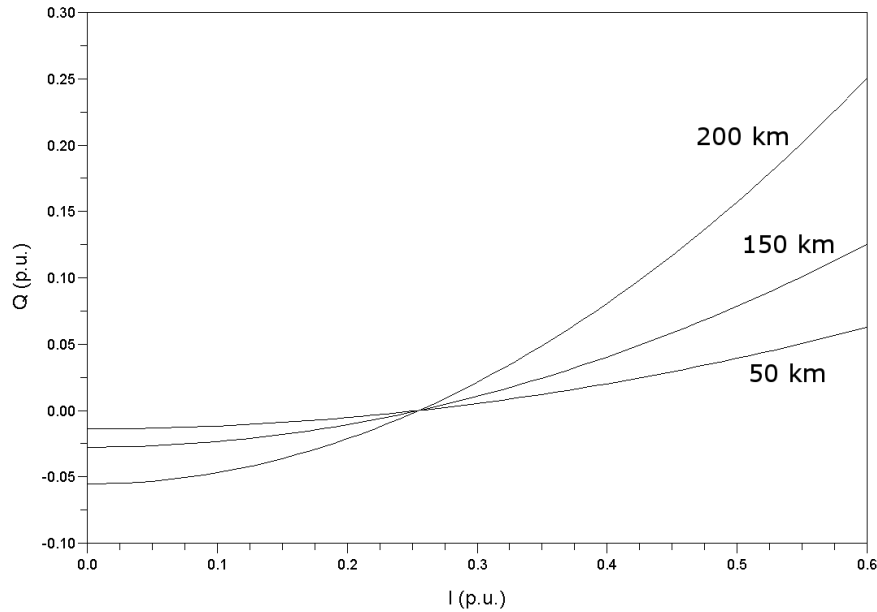

Figure 1.18: Reactive power consumption of a 400 kV / 2 000 MVA line as a function of the phase current

$$V_{base} = 400 \text{ kV}$$

$$S_{base} = 2\,000 \text{ MVA}$$

$$Z_{base} = \frac{V_{base}^2}{S_{base}} = 80 \, \Omega \quad (1.39)$$

$$I_{base} = \frac{V_{base}}{Z_{base}} = 5\,000 \text{ A}$$

$$I_c = \frac{V}{Z_c} \quad (1.40)$$

$$Z_c = \sqrt{\frac{L}{C}} \quad (1.41)$$

In conclusion, an increase in the reactive power Q_l produced at one terminal of the line leads to an increase in the current I flowing in the line for an identical active power

transmitted P_r (see section 1.5.1). This larger current causes more reactive power Q to be consumed in the line (see Figure 1.18). Therefore, the reactive power Q_r sent by one side of the line is not fully transmitted to the other side. This phenomenon also appears for active power, but to a lesser extent because the resistance is much lower than the reactance (see Table 1.1). Therefore, it is not possible to transmit reactive power over long distances.

1.5.5 Management of a voltage drop in a power system area

Contrary to frequency control, a voltage change in a particular area of a power system will usually not be seen by the whole interconnected area because the impedance is getting very high when the bus considered is far from the voltage drop. The mitigation of voltage drops is however more complex than for frequency drops. Indeed, a voltage drop may be created by a fault, such as a short circuit between a line and a tree. Injecting more reactive power is useless in this case, as it would lead to very high current. Therefore, the fault needs to be isolated first. Fault isolation is one of the areas that the power system protection discipline covers. See for example Anderson (1999) for more details on the adopted strategies.

If the voltage is still low when all the faults have been cleared (i.e., considering a quasi-steady state), more reactive power has to be injected as close as possible to the voltage drop. This compensation is mainly done by using the capability of generating units, as described in section 1.5.3. Other techniques can also be deployed and are described in the following section. As there are hundreds of buses in the transmission network (and thousands considering the distribution network), the voltage is actually controlled at key points, which leads the other bus voltages to follow. The control of key points is described in section 2.3.3.3.

1.6 Technologies Used to provide Ancillary Services

This section provides an overview of the current technologies that can be used to control frequency and voltage. For further details, Hirst and Kirby (1998) provide a comprehensive comparison between most of the technologies mentioned in this section.

1.6.1 Generating units

Generating units are the main providers of active and reactive powers in the system. A distinction can be made between two main families:

- ✓ Thermal units, which are based on a temperature difference between a hot and a cold source that makes a fluid flowing (usually steam, but also hot gas, for example in the case of a gas turbine or a diesel generator). This family uses energy resources such as coal, fuel, gas, nuclear or the Earth's heat in the case of geothermal energy;
- ✓ Non-thermal units, which are based on the natural flow of a fluid, such as wind or water, or other technologies, such as photovoltaic electricity generation. This family is getting more important, since they usually produce little greenhouse gas (e.g., CO₂) over their lifetime.

Generating units are technically limited in terms of frequency and voltage controls. These limits are due in particular to the boiler output flow, to the lag induced by controllers, to the thermal gradient that is bearable by the unit, to the inertia of the process, or to environmental constraints (e.g., the maximum water level variation for a hydro unit). Table 1.2 gives an idea of the possibilities of some typical generating units, where the possible generation variation is expressed in percentage of the nominal output power of the unit per minute. The difference between hydro and thermal units essentially comes from the inertia and the thermal constraints of the boiler of the thermal units. The differences across thermal generating units are due to the various complexities in changing the flow of combustible in the process [Wood and Wollenberg (1996)].

Table 1.2: Possible generation variation as a function of unit type. Based on UCTE (2004b)

Lignite ³³	Nuclear	Coal ³³	Fuel or gas	Hydro
1 to 2 %/min	1 to 5 %/min	2 to 4 %/min	8 %/min	90 to 150 %/min

³³ Coal is constituted between 75 and 91.5 % of carbon, whereas lignite has between 50 and 60 % of carbon [Hoinkis and Lindner (2007)].

To control the temperature of the boiler, most of the thermal generating units rely on the variation of the energy flow. However, in the case of nuclear power plant, nuclear material cannot be removed or added in operation. Therefore, nuclear generating units use two principles, which have an impact on the possible variation of active power [Gautier (1990)]:

- ✓ Change the boron concentration in the reactor core. This technique has a large time constant (tens of minutes to change output by a few tens of percent);
- ✓ Use the control rods to regulate the neutron flow. Control rods can be either “black” or “grey”. The former can only shut down the reactor, whereas the latter ones can tune more precisely the reaction. The technology of “grey” control rods was developed during the eighties. Therefore, only nuclear plants built after this period and that have installed this system may modulate their active power relatively quickly. Power plants with the regulating control rod can vary their power up to 5 %/min.

1.6.2 Basic transmission and distribution assets

Transmission and distribution networks consist mostly of lines and transformers. Therefore, it is efficient to use their capabilities to control frequency and voltages. First, the transformation ratio of the transformers can be changed within real-time operation. This is done by selecting the appropriate position amongst around ten taps [Grainger and Stevenson (1994)]. However, such a system is quite slow. For example, it takes 30 s for French transmission transformers and 10 s for French distribution transformers to change their first tap (and then 1 tap/10 s). Moreover, this technique creates short over-voltages, is limited in amplitude and can lead to a voltage collapse when a transformer tries to absorb a constant amount of power that the system is not able to provide.

Second, because lines and transformers have a relative high inductance, they draw large amounts of reactive power. In addition, the resistance of these elements induces active power losses (see section 1.5.4). Therefore, the impedance of the network can be modified by taking transmission lines in or out of service. This method creates over-voltages, increases the chances of incident during the manoeuvre and is limited in amplitude. In conclusion, the basic transmission and distribution assets are useful but have a limited manoeuvrability by comparison with the generating units.

1.6.3 Purpose-built devices

To increase the manoeuvrability of the system in terms of frequency and voltage controls, purpose-built devices can be installed.

First, passive elements such as capacitances and inductances can be added to change the reactive power consumption/production at different points of the network. They can be switched on or off either manually or remotely. They are cheap and very helpful, but create transients, can introduce resonance problems and their reactive power compensation depends on the voltage.

Some power electronics can be added to these passive elements to increase their capabilities. These devices belong to the large family of the *Flexible Alternating Current Transmission Systems* (FACTS). Their cost is obviously higher than for passive elements, but they allow a continuous regulation similar to generating units. Some FACTS are dedicated to voltage control, such as Static var Compensators (SVCs), while others are intended for flow control but can perform voltage control as well, such as Unified Power Flow Controllers (UPFCs) [Hingorani and Gyugyi (2000)].

High-inertia rotating machines can be used as well. They can provide both high quality reactive power control (they are said to work as *synchronous compensators*) and a short-term active power control through their inertia (they are said to work as *energy storage devices*). They are usually expensive because of their moving parts, and their capabilities in terms of frequency control are limited. Therefore, the improvement in the storage of electricity may help the development of new devices purpose-built to provide ancillary services.

1.6.4 Loads

The power system end-users are large consumers of ancillary services because their consumption of active and reactive powers varies a lot over time. They can thus have a big role to play to improve the control of frequency and voltages. However, their availability is often not predictable, their rating is typically small (which increases management costs), and their participation is most of the time not continuous. However, the development of low-cost information systems in parallel with high energy prices (because of more environmental constraints and less available energy resources) may foster a more active participation of loads in the future.

1.7 Summary

Consumers, generating units and system operators expect an appropriate standard for the frequency and the voltages across the system. Such a standard refers to the system services. In practice, the global frequency and the local voltages depend on the balances between consumption and generation of active and reactive powers across the power system. However, these balances are constantly perturbed by users. Therefore, some users have to act on the active and reactive power balances in order to improve the frequency and voltages, instead of perturb them. Such contributions by the users are called ancillary services. Users hence can benefit from system services, consume them, provide ancillary services or do all of these.

The developments in information technology, power electronics and electricity markets forces all users to face their double responsibilities as a consumer of system services and a provider of ancillary services. However, to grasp fully this opportunity, the users need an appropriate framework to manage ancillary services. Unfortunately, current frameworks are disparate, and none can claim to be fully efficient. Therefore, this thesis provides the tools necessary to assess any market for ancillary services and gives essential elements to improve it. The assessment developed in this thesis is based on three objectives: define the technical needs and solutions to meet the expectations of the users (Chapter 2); assess the cost of these solutions (Chapter 3); and design an efficient marketplace for ancillary services (Chapter 4). It is then the responsibility of the appropriate stakeholders to apply this assessment to their system. ■

CHAPTER 2

DELIVERY OF ANCILLARY SERVICES

- Vincent: *You know what they call a Quarter Pounder with Cheese in Paris?*
- Jules: *They don't call it a Quarter Pounder with Cheese?*
- Nab, man, they got the metric system. [...] *They call it a "Royale with Cheese".*
Pulp Fiction movie (1994)

2.1 Introduction

Chapter 1 has shown that users expect a certain standard for the frequency and voltages. In addition, users can provide ancillary services to help maintain this standard. Therefore, Chapter 2 assesses the delivery of ancillary services. First, section 2.2 makes explicit the needs of users in terms of system services. Section 2.3 then introduces the various specifications that define the different qualities of ancillary services that users can provide. From the needs of the users and the available qualities of ancillary services, the quantity of each AS quality can then be determined, as presented in section 2.4. Lastly, section 2.5 discusses the issues related to the delivery location of ancillary services.

2.2 Needs of Users for System Services

The needs of users can be expressed as appropriate reliability, power quality and power system utilisation. System services, by controlling reactive and active power balances, help to meet these three objectives. This section reviews these objectives and shows that they may be contradictory. Therefore, a trade-off has to be found and the best objective function depends on the system considered.

2.2.1 Reliability

The *reliability* of a power system is the probability that the system will be able to serve consumers. Adequacy and security underlie the concept of reliability. An *adequate system* is a system with sufficient facilities (e.g., transmission lines and generation) to satisfy the consumers, while considering static conditions. A *secure system* is able to respond to contingencies, i.e. considering dynamic conditions [Billinton and Allan (1996)]. Therefore, day after day, the adequacy and the security of a power system constitute its reliability.

Obviously, system services are essential to maintain the security of the system (see sections 1.4 and 1.5). But they also affect the adequacy decisions. First, enough capabilities to provide reactive and active powers have to be built in the long-term in order to respond to contingencies in the short-term (see section 4.3.1). Second, AS capabilities and transmission capacity are linked (e.g., reactive support can increase transmission capacity and transmission capacity can increase frequency control capabilities), so they have to be coordinated. Therefore, system services deeply influence the reliability of power systems from both security and adequacy aspects.

Even if reliability (and therefore security) is a quality and not a good, reliability can be considered as a *public good* in economic language [Abbott (2001), Boucher *et al.* (2006)]. Indeed, the characteristics of a public good are (a) the impossibility (or high difficulty) to exclude a consumer and (b) the inexistence of competition in the consumption: what one consumes does not deprive another one [Varian (1999)]. Reliability fits this definition, because separating the reliability of two users is very difficult, especially with more and more interconnected systems, and because any user can enjoy the reliability of the power system without depriving the others. Note that system services are not a perfect public good since over-consumption by a participant may hamper the welfare of the others, in the

same manner as the over-consumption of a freeway reduce the welfare of drivers because they are travelling more slowly.

Unfortunately, users of a same power system have very different points of view on what the reliability of the electric system, i.e. the level of public service, should be. To consider a well-known example, a semi-conductor factory and a residential consumer do not give the same value³⁴ to a reliable source of electricity. In addition, reliability is at least 100 times more valuable to consumers than it is to generators [Kirschen (2002)]. The value of security³⁵ is even more complex to calculate than the value of reliability because the value of security varies in real-time whereas reliability is defined over a given period. For example, a residential consumer would value short-term security much more while watching the final of the world cup on TV than while sleeping. Lastly, this problem increases with the size of the synchronous network. For example, all the users of the synchronous continental European network have to agree on consistent reliability criteria. Consequently, an independent party has to define the appropriate level of security for the power system³⁶. This independent party may be either the system operator or the regulator on behalf of the consumers. Two approaches can be adopted to define the necessary level of security.

On the one hand, *deterministic security criteria* can be adopted, such as the famous N-1 criterion. According to this criterion, the power system has to be able to continue operating without a major component (e.g., a transmission line or a large generator). This criterion is therefore binary (the system is declared as secure or not) [Kirschen (2002)] and relatively easy to calculate. A flaw of this system is to consider only a predefined set of contingencies, and to ignore completely events with a low probability of occurrence. Another flaw is to consider that all the events are statistically independent, whereas the recent North American³⁷ and European³⁸ experiences show that the increasing complexity

³⁴ The *customer damage function* gives the cost of an outage for a given customer. From the customer damage functions, the Value Of Lost Load (VOLL), which is determined through surveys, expresses the value that the average consumer places on being deprived of one kWh without warning [Kariuki and Allan (1996), Joskow and Tirole (2004)].

³⁵ Practically, The Expected Energy Not Served (EENS) may be used to measure the security of a power system [Kirschen and Jayaweera (2007)]. Note that the EENS does not take into account the value of energy.

³⁶ In any case, a power system is never totally secure [Kirschen (2002)]. However, it can have a certain level of security. This level of security has then an impact on the reliability of the system.

³⁷ The North-East of the USA and the South-East of Canada had a blackout on the 14th of August 2003 that affected around 50 millions people [U.S.-Canada Power System Outage Task Force (2004)].

of the system multiplies dependencies [Kirschen and Strbac (2004b)]. In addition, for a given operating point, the risk of outage (and so the value of security) relies heavily on the weather conditions [Kirschen and Jayaweera (2007)]. Therefore, deterministic criteria of security do not reflect the real level of security of the system, but are very practical in the day-to-day operation of the system.

On the other hand, a *risk-based approach* may be preferred. In such a case, an optimisation problem has to be solved. For example, it may consist in maximizing the value minus the cost of security, based on the probability of occurrence of different incidents within the system. The cost of security can be computed because its cost components are calculable (e.g., the cost of building an additional line, the cost of installing a larger transformer...), even if some of them are rather difficult to determine (e.g., a faster aging of generators because of providing reactive support). However, the value of security is very difficult to compute because it differs widely between users and varies with time as explained previously. This last problem may be solved in part if a certain reliability separation can be attained in the future with individually interruptible loads [Cramton and Stoft (2005)]. Another problem is that computing resources are today too low to achieve a probabilistic approach on-line. However, new deterministic criteria could be adopted like the Adaptive Deterministic Security Boundaries (ADSB) proposed by Kirschen and Jayaweera (2007).

2.2.2 Power quality

Power quality is “the concept of powering and grounding sensitive equipment in a manner that is suitable to the operation of that equipment” [IEEE Std 1159-1995 (1995)]. In particular, power quality is related to electrical phenomena such as voltage sags or harmonics, which are local problems, whereas security is a global problem. However, a clear separation between power quality and security can be difficult. For example, a voltage within the security margins increases both quality and security. Moreover, increasing the meshing of a network increases the reliability because it makes more paths available for the delivery of energy, but it may also increase the number and severity of voltage sags seen by consumers. On the other hand, some quality parameters, like the level of harmonics, are not

³⁸ The whole Italy (around 60 millions people) was plunged in the dark on the 28th September 2003 [UCTE (2004a)] and 15 millions European households were disconnected during the incident of the 4th November 2006 that originated in Germany [UCTE (2007)].

directly related to the security of the system. Hence, quality and security can be separated only for a small set of quality parameters.

In conclusion, frequency and voltage controls impact the quality of power supply. Therefore, the quality has to be included in the objective function for system services.

2.2.3 Optimal utilisation of resources

A system with appropriate levels of security and power quality is not necessarily *run in an optimal manner*. For example, more reactive power injected at the terminals of a transmission line can increase the active power transit capacity (see section 1.5.4). Similarly, if some transmission capacities are reserved to allow the supply of ancillary services, less power for energy can be transmitted. Moreover, the provision of ancillary services plays a role in the amount of losses and impacts the aging of infrastructures. More generally, the consequences on the various resources of the power system have to be taken into account while using ancillary services in order to use the resources of the system in an optimal manner.

2.2.4 Specification of the needs

Because system services are public goods, it seems logical that an independent party with a system perspective, such as the system operator (SO), be in charge of specifying the needs for system services (see section 1.2). Ideally, this specification should take into account the expectations of all the users in terms of the quality of service (i.e., reliability, power quality and utilisation) that they expect for a given period, as well as the price that they are willing to pay for this quality. Since different qualities of service cannot be delivered with the current technology, the SO must define a single quality of service that represents a compromise between the expectations of all the users using an objective function³⁹. This quality of service should then be converted into the quantity, quality and location of system services that the SO has to provide during the period considered.

Unfortunately, this ideal procedure is very difficult to implement in practice. First, since it is impossible to ascertain the expectations of all the users, a representative cross-section of the population has to be chosen instead. Second, defining the quality of service

³⁹ In particular, in interconnected systems, policies regarding the necessary system services must be decided in coordination with the other systems, because the security of the whole interconnected power system is at stake.

accurately is difficult and translating this definition into the specification of a quantity and quality of system services is even more difficult, as will be shown in sections 2.3 and 2.4. Third, system services, especially frequency control, are shared by all the areas of an interconnected power system (see section 1.4). Therefore, all system operators within an interconnected system should have coherent policies, which may be difficult if users have contractory objectives. Last, the ideal objective function is difficult to implement.

A first objective function that can be adopted is the cost-effectiveness (also called the rational-buyer) approach, which tries to *minimize the procurement cost* for an *ex-ante* SS specification. Obviously, this simple policy does not guarantee that a Pareto-efficient SS specification is attained (see section 1.3.1). However, it is very easy to implement because the procurement cost is usually better known than the value of system services.

On the other hand, the cost-benefit approach tries to *maximize the global welfare*, i.e. the sum of the individual profits and surpluses. This situation is always Pareto-efficient in theory [Kirschen and Strbac (2004a)]. However, determining the surpluses or the profits of the participants depending on the system services can be quite complex, because users give different values to security and these values are hard to define, as shown previously. In addition, it often implies a probabilistic computation, which is computationally demanding (e.g., the Monte-Carlo method) [Bhattacharya and Zhong (2001)].

In other words, the cost-effectiveness objective function only takes into account the cost of system services, while the cost-benefit approach takes into account both the cost and the value of system services. The latter objective function is the most desirable, but it is also the least practical. Therefore, the optimisation problem is often solved by subdividing the system into subsystems (e.g., transmission, energy, frequency control...), then by optimising the necessary system services separately with a cost-benefit objective function, and lastly by refining the needs to take into account the dependencies.

2.3 Specification of the Quality of Ancillary Services

The first task required to fulfil the expectations of users in terms of system services is to define the ancillary services that are able to meet the needs. As the definitions of AS differ widely from the classical energy product by many ways, this section investigates how to separate AS in different products according to various specifications (namely: optimal,

elementary, functional, actual and standardised) and therefore to be able to specify the quality of ancillary services needed.

2.3.1 Optimal specifications

A power system usually has numerous potential AS providers with different capabilities. Ancillary services that can be provided are much more differentiated than energy products⁴⁰. The differentiation for each characteristic of a product⁴¹ can be either vertical or horizontal. *Vertical differentiation* is related to the quality of the product by itself (the common understanding of the quality is the same everywhere, such as an oily fish'n chip is of lower quality than a grilled fish). On the other hand, *horizontal differentiation* is related to the different perception that two users may have of the same product (e.g., a fish'n chip cooked in Boston has more value in Boston than in Paris). In particular, frequency products are mainly vertically differentiated, whereas voltage control ancillary services tend to be horizontally differentiated.

As product differentiation reduces competition, a policy maker may want to homogenise products by for example: (a) reducing the product space; (b) fixing prices; (c) aggregating firms [Tirole (1988)]. On the other hand, removing differentiation may lead to a decrease in quality down to the one providing the lowest quality (assuming that quality has a cost).

Optimal specifications have to be found. They correspond to a trade-off between too general (i.e., a few differentiated AS products) and too precise (i.e., a lot of differentiated AS products) specifications. This trade-off differs from a power system to another because motivations may vary (e.g., a system may want to give priority to the reduction of the transaction costs). General specifications have the advantages of increasing the number of potential providers and fostering innovation. On the other hand, precise specifications take into account the specificities of the providers, increase the understanding of the AS but can potentially increase the complexity of trading (see Table 2.1). Note that precise specifications are not always a barrier to innovation because tight rules may force the players to find innovative solutions that follow new rules at the least cost. For example,

⁴⁰ More generally, when getting closer to the real-time, the products are getting more and more differentiated (e.g., base/peak, then hour by hour, then 15 min...).

⁴¹ Several products can be bundled to obtain a given bundle of characteristics.

older wind farms cannot withstand voltage sags as severe as those that more recent ones can withstand, because of the new rules that have been imposed.

Table 2.1: General versus precise specifications of AS qualities

	Specifications	
	General	Precise
Increase the number of providers for a given specification	+++	+
Foster innovation	+++	++
Reduce transaction costs	++	+
Recognize the capabilities of providers	+	+++
Help understand the behaviour of providers	+	+++

The SO should specify the ancillary services needed for both the long and short term. Regarding the *long term*, each power system has to define at the time of connection of new users (i.e., as part of the connecting conditions) the compulsory quality needed. A good principle is to avoid scarcity for ancillary services to guarantee the adequacy of the system, but without making the connection of new participants unreasonably expensive (see section 4.3.1). A good practice is probably to implement a basic requirement for every unit and to allow the grouping of a few devices to provide the final required quality. In case of compulsory provision, these connecting requirements should be remunerated in order to have a transparent energy price and to avoid distortion of competition between two producers that were connected at different times under different rules. Lastly, it may be useful for developers to benefit from standard connecting requirements across several systems, because this will reduce the cost of procuring standard devices (e.g. a standard alternator for a given power). Note that since frequency is shared by all the participants, frequency control ancillary services are more likely to benefit from standardised connection rules than voltage control ancillary services.

In the *short term*, the SO has to define the global specification for the system (see section 2.2.4). To fulfil this need, it can either require a standardised quality for each provider, or the quality can be part of the provider's offer. The choice will impact the market design (see section 4.4.1). In practice, most systems define a standard quality that any provider has to meet if it wants to provide the service considered (see section 2.3.4). Such a practice limits the number of participants but eases the settlement. Some devices could be grouped in order to achieve the requirement together (but without necessarily

fulfilling the requirements alone). In other words, several devices could be considered as one AS provider.

2.3.2 Elementary specifications

As explained in sections 1.4 and 1.5, the frequency is shared by the whole synchronous system, while voltages are local to each node of the system. Frequency and voltages can be used as indicators to monitor the global balance between production and consumption of active power, and the local balances between production and consumption of reactive power.

To maintain the frequency and voltages within their defined ranges and therefore to keep the balances of active and reactive powers, devices with one or more of the four following capabilities can be used:

- ✓ Devices that are able to control the active power and therefore mainly help control the global frequency:
 - *Up active power balancing*: devices that increase the active power injection or decrease the active power absorption;
 - *Down active power balancing*: devices that decrease the active power injection or increase the active power absorption.
- ✓ Devices that are able to control the reactive power and therefore mainly help control local voltages:
 - *Up reactive power balancing*: devices that increase the reactive power injection or decrease the reactive power absorption;
 - *Down reactive power balancing*: devices that decrease the reactive power injection or increase the reactive power absorption.

Such devices basically consist of two main components. First, the available resource (e.g., the headroom of a generator) and the different actuators (e.g., the exciter of a generator) form the active part of the device that we will call *capability of control*. This capability can be discrete (e.g., a capacitor bank) or continuous (e.g., a synchronous condenser), which leads to different impacts on the stability of the system. Most of the time, discrete capabilities of control are cheaper and simpler, but usually stress more the system during switching (see section 1.6).

Second, the capability of control has to be governed by a *controller*. Controllers can be gathered in two families. On the one hand, independent controllers are fully independent and respond to local conditions. The main advantage of these controllers is their robustness, because they just rely on themselves. However, they can be difficult to design. The speed control of a generating unit is a good example of an independent controller (see section 1.4.4). On the other hand, dependent controllers rely on data sent by other devices. Obviously, such controllers simplify the coordination and can facilitate bilateral contracts. The main drawback of such devices is that they rely on the transmission of data, which may increase the risk of failure and may be more expensive. The Internet technology helps develop the implementation of such controllers [Kirby and Hirst (2003)]. Nevertheless, the security of the data channel is an important issue because an Internet server does not work without electricity and is sensitive to cyber attacks. As illustrated in Figure 2.1, a dependent controller may be controlled by a central entity (e.g., in the case of secondary frequency control, see section 2.3.3) or may communicate directly with other devices (e.g., a generator following a specific load, as described by Nobile *et al.* (2001), and used for example in Sweden). In any case, because of the complexity of electrical systems, controllers cannot be completely autonomous. Human oversight is always included at some point in order to maintain the stability and the security of the system, even if power systems tend to be more and more automated (e.g., concepts of the European “smart grid” or the American “intelligrid”). In some cases, the capability relies solely on sole human judgment, so there is no specific controller.

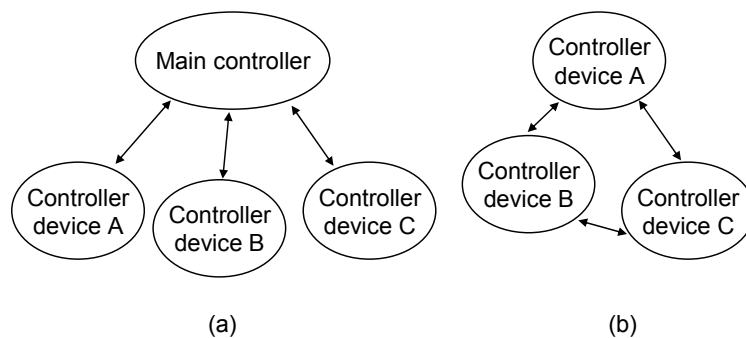

Figure 2.1: (a) Centralised and (b) decentralised dependent controllers

In conclusion, an ancillary service consists of a capability of control and a controller. A capability can be a combination of four different types: active or reactive power and up or down. This specification is very general, so it is useful only to identify devices that can

potentially provide ancillary services. The following sections improve these elementary specifications.

2.3.3 Functional specifications

From a functional point of view, frequency and voltage control ancillary services can be classified into six categories commonly agreed by the whole community, but with different vocabulary (see section 2.3.4.1). The idea is to separate ancillary services in function of their controllers, as shown in Table 2.2.

Table 2.2: Capabilities and controllers related to functional ancillary services

Functional ancillary service	Capability	Controller
Primary	up & down	independent
Secondary	up & down	dependent centralised
Tertiary	up & down	none

2.3.3.1 Frequency control

Figure 2.2 provides a schematic representation of the three functional frequency controls provided by a generating unit. *Primary frequency control* is a local automatic control that adjusts the active power generation of the generating units and the consumption of controllable loads to restore quickly the balance between load and generation and counteract frequency variations. In particular, it is designed to stabilize the frequency following large generation or load outages. It is thus indispensable for the stability of the power system. All the generators that are located in a synchronous zone and are fitted with a speed governor perform this control automatically (see section 1.4.4). The demand side also participates in this control through the self-regulating effect of frequency-sensitive loads, such as induction motors (see section 1.4.3), or the action of frequency-sensitive relays which disconnect some loads at given frequency thresholds⁴². However, this demand-side contribution is not always taken into account in the calculation of the primary frequency control response [UCTE (2004b)]. The provision of this primary control is subject to some constraints. Some generating units that increase their output in response to a frequency

⁴² For small frequency thresholds, loads usually participate on a voluntary basis, as for example in Australia [NEMMCO (2004)]. However, for large frequency excursions, the system operator has to perform compulsory load-shedding through a defined protection scheme [e.g., UCTE (2004b)]. Lastly, we can also imagine systems in which additional loads are connected as a function of frequency.

drop cannot sustain this response for an indefinite period of time. Their contribution must therefore be replaced before it runs out.

Secondary frequency control is a centralised automatic control that adjusts the active power production of the generating units to restore the frequency and the interchanges with other systems to their target values following an imbalance [Jaleeli *et al.* (1992)]. In other words, while primary control limits and stops frequency excursions, secondary control brings the frequency back to its target value. Only the generating units that are located in the area where the imbalance originated should participate in this control, as it is the responsibility of each area to maintain its load and generation in balance (see section 1.4.7). Note that loads usually do not participate in secondary frequency control. Contrary to primary frequency control, secondary frequency control is not indispensable. This control is thus not implemented in some power systems where the frequency is regulated using only automatic primary and manual tertiary control. However, secondary frequency control is used in all large interconnected systems because manual control does not remove overloads on the tie lines quickly enough. For example, Figure 2.3 shows the action of the French secondary frequency control on a day. The regulation signal is comprised between -1 and 1 , and the deployed secondary frequency control power depends on the reserved capacity.

Tertiary frequency control refers to manual changes in the dispatching and commitment of generating units and loads. This control is used to restore the primary and secondary frequency control reserves, to manage congestions in the transmission network, and to bring the frequency and the interchanges back to their target value when the secondary control is unable to perform this last task. Some aspects of tertiary control relate to the trading of energy for balancing purposes. This thesis does not deal with these aspects because they do not represent a service provided to the TSO by the market participants but a mechanism for the participants to balance their financial positions.

By counting the number of oscillations of the alternative current of the electrical supply and by knowing the nominal frequency of the network (e.g., 50 or 60 Hz), one can estimate the time. However, since the frequency of the system actually varies over time, the time given by the electrical network, also called *synchronous time*, may not be accurate. Therefore, frequency control can be used to perform the so-called *time control*. This historical control was very useful when a lot of synchronous clocks were used, in particular for trains.

However, with the development of quartz- or GPS⁴³-based devices, synchronous clocks are now getting rare, though still used by some household appliances such as washing machines [Bosch (2006)].

A certain amount of active power, usually called *frequency control reserve*, is kept available to perform these controls. The positive frequency control reserve designates the active power reserve used to compensate for a drop in frequency (it is thus provided by devices with up active power balancing capabilities, as described in section 2.3.2). On the other hand, the deployment of negative frequency control reserve helps decrease the frequency.

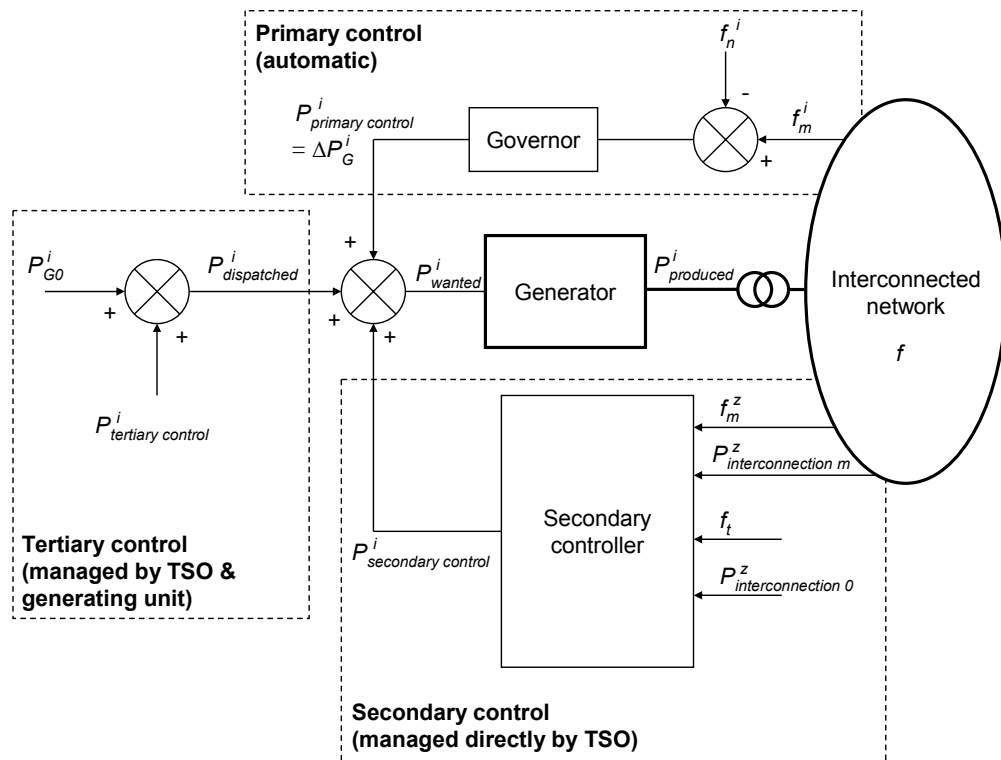

Figure 2.2: The three functional frequency controls considering a generating unit

⁴³ GPS stands for Global Positioning System. This system is based on a network of satellites that send information to ground devices, such as the universal time or the position of the device.

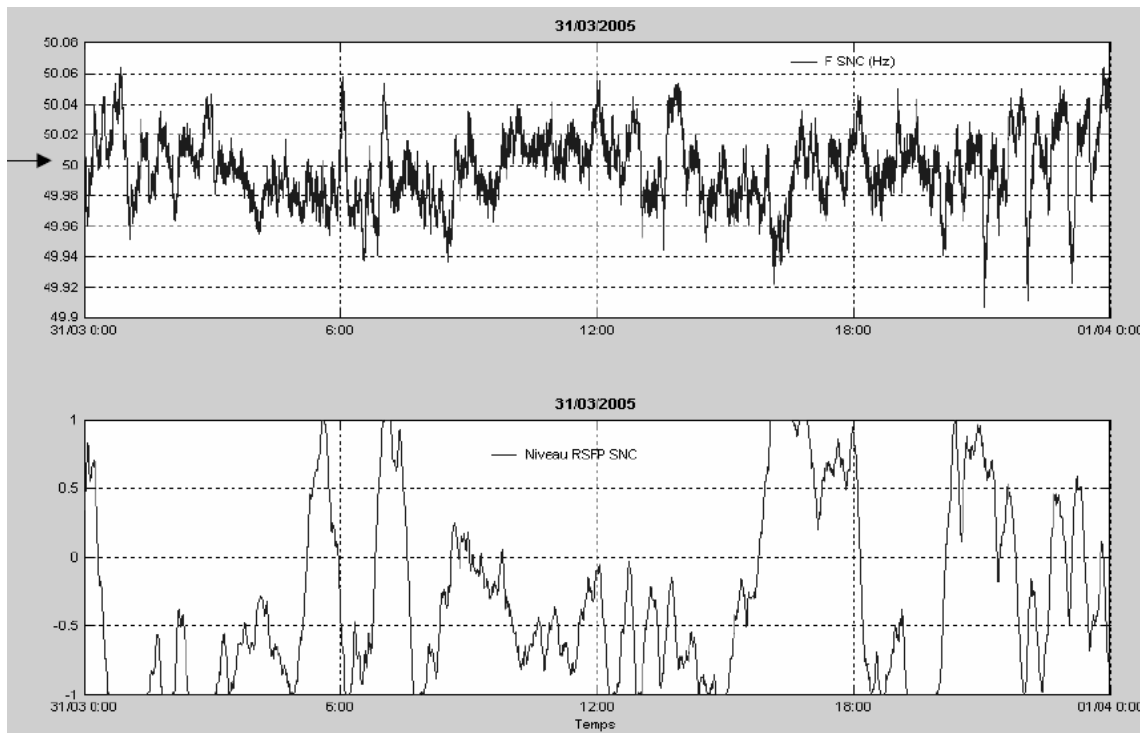

Figure 2.3: Frequency and French regulation signal on 31 March 2005 [Tesseron (2008)]

2.3.3.2 Spinning reserve

The term “spinning reserve” is very popular to designate some frequency control reserves. In particular, many authors use this term without defining it because they assume that its meaning is obvious and unambiguous. However, a partial survey of the literature produces very different definitions:

- ✓ British Electricity International (1991): “the additional output which a part-loaded generating plant is able to supply and sustain within 5 minutes. This category also includes pumped-storage plant [...] operating in the pumping mode, whose demand can be disconnected within 5 minutes”;
- ✓ Wood and Wollenberg (1996): the total synchronised capacity, minus the losses and the load;
- ✓ Hirst and Kirby (1998): “generators online, synchronized to the grid, that can increase output immediately in response to a major outage and can reach full capacity within 10 minutes”;
- ✓ Zhu *et al.* (2000): “the unloaded section of synchronized generators that is able to respond immediately to serve load, and is fully available within ten minutes”;
- ✓ NERC (2006): “Unloaded generation that is synchronized and ready to serve additional demand”.

These definitions disagree (or remain silent) on some important issues:

- ✓ Who provides spinning reserve? Is it limited to generators or can the demand-side participate?
- ✓ What is the time frame for responding to a request? When should it start and end?
- ✓ How is this reserve activated? Does it happen automatically or is it only done at the request of the Transmission System Operator (TSO)?

Therefore, a definition which fits all systems would be helpful. First, it seems essential to remove the idea of time, as each system has its particularities. Second, there is a system operator in any system. Third, the term spinning reserve is used in the optimization literature as a capacity that can be re-dispatched (scheduling objective), which can be different from the operational capacity (stability objective). Fourth, it seems interesting to get detached from the terms such as “generator” or “demand-side”, to reduce ambiguities. The following definition is therefore proposed in this thesis: *the spinning reserve is the unused capacity which can be activated on decision of the system operator and which is provided by devices which are synchronized to the network and able to affect the active power.*

Some important comments must be made on this definition:

- ✓ The beginning of the reserve deployment and the duration of the deployment do not appear in the definition, as they are not relevant for a general definition of the spinning reserve. In fact, each country has its own definition, depending on parameters such as the size of the synchronous network or the market structure (see section 2.3.4);
- ✓ The primary frequency control reserve, which is not controlled by the SO, has to be excluded from the spinning reserve. Moreover, the self-regulating effect of the loads, which has an effect similar to the primary reserve, is also excluded from the spinning reserve. In fact, these two items are more important for system stability than for balancing consumption and production over a longer period of time;
- ✓ The secondary frequency control reserve should be considered as spinning reserve. In fact, the power deployed by the SO through this reserve equilibrates the consumption and the production and has to be kept as long as required;
- ✓ The spinning reserve also includes the synchronized tertiary frequency control reserve, as this reserve is deployed on the instruction of the SO;

- ✓ If a generator decides not to provide reserve, its spare synchronized capacity is *not* spinning reserve, as it cannot be activated by the system operator. However, in many systems, generators have to offer all their spare synchronized capacity in the balancing mechanism (see section 1.3.2). Therefore, in this case, the system operator has the possibility to call upon all the synchronized capacity;
- ✓ A consumer can provide spinning reserve, if it agrees to be disconnected or to reduce its load upon request from the SO. For example, pump loads are good candidates for the provision of spinning reserve from the demand side.

2.3.3.3 Voltage control

Figure 2.4 provides a schematic representation of the three functional voltage controls provided by a generating unit. *Primary voltage control* is a local automatic control that maintains the voltage at a given bus (at the stator terminals in the case of a generating unit) at its set point. Automatic Voltage Regulators (AVRs) fulfil this task for generating units. Other controllable devices, such as static voltage compensators, can also participate in this primary control (see section 1.6).

Secondary voltage control is a centralised automatic control that coordinates the actions of local regulators in order to manage the injection of reactive power within a regional voltage zone. This uncommon technology is used in France and Italy [Paul *et al.* (1990), Corsi *et al.* (1995) and Vu *et al.* (1996)].

Tertiary voltage control refers to the manual optimisation of the reactive power flows across the power system. This is performed by either modifying the set-point of pilot voltages in case of a secondary control, or by directly modifying the voltage set-point of the unit. Tertiary voltage control also includes the startup of additional units and the operation of other means such as capacitor banks.

these in terms of the systems studied and the framework used to compare the features of the ancillary services. In addition, the reader should keep in mind that specifications change over time. Therefore, such a survey should be updated regularly to remain relevant.

Table 2.3: Basic information on systems studied

System	Abbreviation	Regulator	TSO
Australia	AU	AER	NEMMCO
Belgium	BE	CREG	Elia
California	CAL	FERC	CAISO
France	FR	CRE	RTE
Germany	DE	BNA	EnBW, E.ON, RWE and VET
Great Britain	GB	Ofgem	National Grid
The Netherlands	NL	DTe	TenneT
New Zealand	NZ	Electricity Commission	Transpower
PJM	PJM	FERC	PJM ISO
Spain	ES	CNSE	REE
Sweden	SE	Stem	SvK
UPS	UPS	Federal tariff service	SO-CDU

2.3.4.1 Vocabulary

The profusion of terms used for ancillary services may lead to some misunderstandings and confusion when one tries to compare services from different power systems or jurisdictions. Table 2.4 classifies the services considered in the survey with the help of the functional framework developed in section 2.3.3. The names are shown in the original languages to avoid misinterpretation. In this table, for each type of control, the reserves are ordered from the fastest (left) to the slowest (right). Reserves within a given column are thus similar. Within a system, terms are classified from the most general (up) to the most specific (down). A dashed line means that positive and negative reserves have different names. For instance, in Great Britain, the terms “primary response” and “secondary response” are used for the positive primary frequency control reserve and “high frequency response” for the negative one. In some cases (e.g., Australia), the name of a service is used as the corresponding reserve does not have a name.

A number of observations can be drawn from this Table. First, it is clear that care must be taken when comparing services defined in different systems. For example, the terms “secondary response” (GB), “secondary control reserve” (UCTE) and “secondary

reserve” (PJM) describe three completely different services. Even the term “reserve” may lead to some misunderstandings. For example, in Australia, “reserve” designates investments in generation capacity and not the frequency control reserves as defined in this thesis. “Spinning reserve” is another example of an ill-defined term, as explained in section 2.3.3.2.

Besides differences in terminology, there are also significant differences in implementation. In Sweden, Great Britain, New Zealand and Australia, the primary frequency control reserves have been divided in different categories. On the other hand, in the other systems, a single reserve is defined for this type of control. This difference may be explained by the fact that smaller systems are subject to larger frequency deviations than the large interconnected systems of North America, mainland Europe and Russia. Reserve that can be used for very fast primary frequency control reserve is therefore more valuable in these smaller systems and making a distinction between different categories of primary reserve is technically and commercially worthwhile. Only one type of reserve is defined for performing secondary frequency control, except in Sweden and Great Britain where secondary control is not used. Since the whole of the British system is operated by a single TSO (and is not synchronous with the Western European interconnected system), secondary control is not needed to correct deviations from interchange schedules. While Sweden is interconnected with other countries, its TSO can rely on numerous fast manual tertiary control offers provided by the large hydro generation capacity (see section 2.4.3.1). Tertiary frequency control reserves do not lend themselves to easy comparisons because TSOs have adopted widely different limits for deployment times and various approaches to the treatment of non-synchronized generating units.

From the perspective of providers of voltage control services, it is convenient to divide the production of reactive power into a basic and an enhanced reactive power service. The *basic or compulsory reactive power service* encompasses the requirements that generating units must fulfill to be connected to the network. The *enhanced reactive power service* is a non-compulsory service that is provided on top of the basic requirements. The terminology of voltage control is much more uniform than for frequency control and does not need to be discussed further.

Table 2.4: Vocabulary used to name frequency control reserves in various systems⁴⁶

	Primary frequency control reserves	Secondary frequency control reserves	Tertiary frequency control reserves		
PJM	Frequency response	Operating reserve			Reserve > 30 min
		Regulation	Primary reserve	Secondary reserve	
CAL	(no name)	Operating reserve		Replacement reserve and supplemental energy	
		Regulating reserve	Contingency reserve		
		Spinning reserve		Non-Spinning reserve	
BE	<i>Réserve de puissance pour réglage primaire</i>	<i>Réserve de puissance pour réglage secondaire</i>	<i>Réserve de puissance pour réglage tertiaire</i>		
DE	<i>Primärregelreserve</i>	<i>Sekundärregelreserve</i>	<i>Minutenreserve</i> ⁴⁸		
ES	<i>Reserva de regulación primaria</i>	<i>Reserva de regulación secundaria</i>	<i>Reserva de regulación terciaria</i>		
FR	<i>Réserve primaire</i>	<i>Réserve secondaire</i>	<i>Réserve tertiaire</i>		
			<i>Réserve tertiaire rapide 15 minutes</i>	<i>Réserve tertiaire complémentaire 30 minutes</i>	<i>Réserve à échéance ou différée</i>
NL	<i>Primaire reserve</i>	<i>Secundaire reserve</i>	<i>Tertiaire reserve</i>		
GB	Operating reserve	(does not exist)	Operating reserve		Contingency reserve
	Response		Fast start	Short-time	Balancing mechanism start-up
	Primary Secondary ----- High frequency				
SE	Frekvensstyrd Normaldriftsreserv and Störningsreserv	(does not exist)	Seven different types of reserves		
UPS	<i>Pervitchnyi reserve</i>	<i>Vtoritchnyi reserve</i>	<i>Tretitchnyi reserve</i>		
AU	Contingency services	Regulating services and network loading control	Short-term capacity reserve		
	Fast Slow Delayed				
NZ	Instantaneous Reserves	Frequency regulating (or keeping) reserve	(no name)		
	Fast Sustained ----- Over frequency				

⁴⁶ References - AU: NEMMCO (2001), NEMMCO (2004) and NEMMCO (2005); BE: Belgium economic department (2002); CAL: CAISO (2005a) and CAISO (2005b); DE: BDEW (2007a); ES: Spanish industry and energy department (2006b); FR: RTE (2004); GB: National Grid (2007) and National Grid (2008a); NL: TenneT (2003); NZ: NZIER (2005); PJM: PJM (2006); SE: Nordel (2004).

⁴⁷ In 2006, PJM changed the denomination “spinning reserve” to “synchronized reserve”.

⁴⁸ Germany recently removed Studienreserve and Notreserve from tertiary frequency control reserves.

2.3.4.2 Primary frequency control

Policy makers tend to specify various parameters that have a significant effect on primary frequency control. The most important technical parameters for frequency-related ancillary services are the deployment times. The maximum amount of time that can elapse between the request from the TSO and the beginning of the response by the service provider will be called the *deployment start*. *Full availability* is the maximum time that can elapse between the moment when the provider receives the request and the moment at which it delivers its full response. Lastly, *deployment end* is the maximum amount of time during which the service must be provided starting from the time of the request.

The *accuracy of the measurements* is another important issue because it affects the efficiency of the control and the payments to the providers. For example, if the instrumentation at a generating unit overestimates the frequency, its response to frequency deviations will be inadequate and the generating unit may be paid more than what it deserves. However, it is generally in the interest of producers to measure accurately so they can argue more persuasively with the TSO in case of a dispute.

The *droop of a generating unit* is an important parameter of primary frequency control (see section 1.4.4). A lower droop increases the response of a unit but would cause more stress in the generating unit as it would react more strongly to each deviation. On the other hand, a unit with a low droop is more likely to succeed in switching to islanded mode in case of a major disturbance and tends to reduce the quasi-steady state frequency deviation following an imbalance. Adjusting the droop is not always easy because it often requires that the plant be shut down.

The *frequency deviation for which the entire primary frequency reserve has to be deployed* is also an important parameter. Indeed, using this information, the value of the droop and Equation (1.5) of p. 58, one can calculate the maximal share of the nominal power output that a generating unit must keep in reserve to provide the required primary frequency control power. For example, Table 2.5 shows the frequency deviation for which the entire primary frequency reserve is deployed as a function of the droop and the primary frequency control reserve.

The *frequency characteristic* represents the total action of the primary frequency control provided by generators and the self-regulating effect of the load (see section 1.4.6). In

North America, the terms of “Beta” or “frequency governing characteristic” are preferred to designate this parameter [Ingleson and Ellis (2005)].

The *insensitivity* of a primary controller is the frequency band within which the controller does not change its output. Two insensitivities should be distinguished: the non-intentional insensitivity, which is intrinsic to the controller, and the intentional insensitivity, which is added on purpose. In Europe, the non-intentional insensitivity is sometimes simply called insensitivity while the intentional insensitivity is called dead band. The sum of these two insensitivities gives the total insensitivity. If two generators have different total insensitivities, it means that the one with the smallest insensitivity will participate to the primary frequency control before and probably more frequently than the other one.

Table 2.5: Frequency deviation for which the entire primary frequency reserve is deployed as a function of the droop and the primary frequency control reserve

		Droop s_G^i	
		4 %	5.7 %
Reserve relative to P_{Gn}^i	2 %	40 mHz	57 mHz
	7 %	140 mHz	200 mHz

Table 2.6 summarizes the primary frequency control parameters in nine different systems⁴⁹. Since units providing primary frequency control must respond immediately to a change in frequency, the “deployment start” does not appear in this Table.

Deployment times are the same all across the systems within the UCTE because it is important to have a homogeneous response in the synchronous zone. On the other hand, NERC does not make any recommendations on the value of this parameter. A faster primary frequency control is used in Great Britain because the size of this system makes it more susceptible to frequency variations.

The *frequency characteristic* of the Eastern interconnection of North America was around 31,000 MW/Hz in 2004 [Ingleson and Ellis (2005), NERC (2005)]. The requirements for the national systems within the UCTE are estimated based on their annual electricity production [IEA (2005)] and the total UCTE’s requirement (20,570 MW/Hz [TenneT (2006)]). Lastly, the frequency characteristic in Great Britain is

⁴⁹ The following abbreviations are used: No rec.: no recommendation; Pri., Sec. or Hi.: primary, secondary or high frequency response; I: intentional; NI: non intentional; T: total.

estimated from requirements in the tendering process for primary frequency control service [National Grid (2008b)].

Within the UCTE, the *full deployment of the primary frequency reserve* must occur before a deviation of ± 200 mHz has happened. Hence, TSOs with a tight requirement for the *droop* (i.e., a small droop, such as in France) would need to reserve a large headroom for their generating units if they want to provide their primary frequency control continuously until ± 200 mHz. However, in practice, units with a small droop attain their maximum before the limit of ± 200 mHz, so they do better than what the UCTE recommends. In Belgium and Germany, no general condition is applied to the droop as this parameter is agreed between the generators and the TSO during the procurement process (see Chapter 4). Lastly, the full deployment of the British primary frequency reserve happens for larger deviations than in the UCTE because the British power system has a smaller inertia.

Policies on *controller insensitivity* are similar in all systems, except in Great Britain, where the requirement is less strict. NERC has recently changed its policy and no longer recommends any insensitivity. Before, a total insensitivity of 36 mHz (30 mHz if a 50/60 coefficient is applied to account for the difference in nominal frequency) was required [NERC (2004)], which is three times the UCTE's requirement (10 mHz). However, the UCTE's requirement applies only to the controller [UCTE (2004b)], while NERC former recommendation was for the "governor" [NERC (2004)]. This last term is not formally defined, but is commonly understood to include both the primary frequency controller and the actuators (e.g., jacks and valve). Therefore, in this table, the insensitivity of the controller only and the insensitivity of the whole generator unit are not distinguished. Finally, the *accuracy of the frequency measurement* is not addressed explicitly in most systems.

Table 2.6: Technical comparison of primary frequency control parameters in various systems

	NERC	UPS	UCTE	DE	FR	ES	NL	BE	GB
References	NERC (2004), NERC (2005), NERC (2006)	-	UCTE (2004b), TenneT (2006)	BDEW (2007a), BDEW (2007b)	French economic and industry department (2003), RTE (2004)	Spanish industry and energy department (1998)	TenneT (2003), DT'e (2005), TenneT (2006)	Belgium economic department (2002)	National Grid (2008a), National Grid (2008b)
Full availability	No rec.	≤ 30 s	≤ 30 s	≤ 30 s	≤ 30 s	≤ 30 s	≤ 30 s	≤ 30 s	Pri.: ≤ 10 s Sec.: ≤ 30 s Hi.: ≤ 10 s
Deployment end	No rec.	≥ 15 min	≥ 15 min	≥ 15 min	≥ 15 min	≥ 15 min	≥ 15 min	≥ 15 min	Pri.: ≥ 30 s Sec.: ≥ 30 min Hi.: as long as required
Frequency characteristic requirement	10 % of the balancing authority's estimated yearly peak demand/Hz	No rec.	20,570 MW/Hz	$\approx 4,200$ MW/Hz	$\approx 4,200$ MW/Hz	$\approx 1,800$ MW/Hz	≈ 740 MW/Hz	≈ 600 MW/Hz	Variable $\approx 2,000$ MW/Hz
Droop of generators	5 % in 2004; no rec. anymore	3-6 %	No rec.	No rec.	3-6 %	≤ 7.5 %	5-60 MW: 10 % > 60 MW: 4-20 %	No rec.	3-5 %
Is an adjustable droop compulsory?	No rec.	Yes	No rec.	Yes	Yes	No rec.	5-60 MW: No rec. > 60 MW: Yes	No	Yes
Accuracy of the frequency measurement	No rec.	± 10 mHz recommended, ± 5 mHz desirable	Within ± 10 mHz	Within ± 10 mHz	No rec.	No rec.	No rec.	Within ± 10 mHz	No rec.
Controller insensitivity	T: ± 36 mHz in 2004; no rec. anymore NI: No rec. I: No rec.	T: ± 10 mHz NI: No rec. I: No rec.	T: ± 10 mHz NI: No rec. I: should be compensated within the zone	T: ± 10 mHz NI: No rec. I: ± 0 mHz	T: ± 10 mHz NI: No rec. I: should be compensated within the zone	T: ± 10 mHz NI: No rec. I: ± 0 mHz	5-60 MW: T: ± 150 mHz; NI: No rec.; I: No rec. > 60 MW: T: ± 10 mHz; NI: ± 10 mHz; I: ± 0 mHz	T: ± 10 mHz NI: ± 10 mHz I: No rec.	T: ± 15 mHz NI: No rec. I: No rec.
Full deployment for or before a deviation of:	No rec.	± 200 mHz	± 200 mHz	± 200 mHz	± 200 mHz	± 200 mHz	5-60 MW: 30 % for ± 150 -200 mHz > 60 MW: 70 % for ± 50 -100 mHz	± 200 mHz	Pri.: -800 mHz Sec.: -500 mHz Hi.: +500 mHz

2.3.4.3 Secondary frequency control

Secondary frequency control can actually be organized in three ways: centralised, pluralistic and hierarchical [UCTE (2004b)]. In a *centralised organisation*, the control is performed by a single controller for the whole control area. In a *pluralistic organisation*, the system is split into independent zones, each of which having its own controller and regulating capacity. In a *hierarchical organisation*, the organisation is similar to the pluralistic approach but a main controller coordinates the action of all the other controllers.

The *Area Control Error* (ACE) of a zone \mathfrak{z} which characterises the imbalance of the zone, is calculated as follows according to the UCTE ($ACE_{UCTE}^{\mathfrak{z}}$) or NERC ($ACE_{NERC}^{\mathfrak{z}}$):

$$ACE_{UCTE}^{\mathfrak{z}} = P_{interconnection\ m}^{\mathfrak{z}} - P_{interconnection\ 0}^{\mathfrak{z}} + K^{\mathfrak{z}}(f_m^{\mathfrak{z}} - f_t) \quad (2.1)$$

$$ACE_{NERC}^{\mathfrak{z}} = P_{interconnection\ m}^{\mathfrak{z}} - P_{interconnection\ 0}^{\mathfrak{z}} - 10B^{\mathfrak{z}}(f_m^{\mathfrak{z}} - f_t) - I_{ME}^{\mathfrak{z}} \quad (2.2)$$

where $P_{interconnection\ m}^{\mathfrak{z}}$ is the measured value of the total power exchanged by the zone with other zones (a positive value represents exports). Note that $P_{interconnection\ m}^{\mathfrak{z}}$ is slightly different from the actual exchanges $P_{interconnection}^{\mathfrak{z}}$ because of measurement errors. $f_m^{\mathfrak{z}}$ is the measured network frequency by the zone. f_t is the target frequency, which can differ from the nominal frequency when controlling the synchronous time (see section 2.3.3.1). The additional term $I_{ME}^{\mathfrak{z}}$ introduces a very small correction factor. This factor compensates the difference between the integration of the instantaneous power exchanged and the demand's energy measurements [NERC (2006)]. $K^{\mathfrak{z}}$ is the K-factor of the control area (in MW/Hz and positive) and $B^{\mathfrak{z}}$ the frequency bias setting (in W/0.1 Hz and negative). $K^{\mathfrak{z}}$ and $B^{\mathfrak{z}}$ are an overestimate of the frequency characteristic of the zone $\Lambda^{\mathfrak{z}}$ (see section 1.4.6). An underestimate would indeed lead to a conflict between the primary and secondary frequency controls. To illustrate this fact, Table 2.7 shows the impact of the K-factor on the secondary frequency control power when a disturbance appears outside the control area, i.e. when $P_{interconnection\ m}^{\mathfrak{z}} - P_{interconnection\ 0}^{\mathfrak{z}}$ is equal to $-\Lambda^{\mathfrak{z}}(f_m^{\mathfrak{z}} - f_t)$ (in other words, the imbalance of the area is only due to the action of the primary frequency control). Note that a positive term $K^{\mathfrak{z}} - \Lambda^{\mathfrak{z}}$ indicates that $K^{\mathfrak{z}}$ is an overestimate of the frequency characteristic $\Lambda^{\mathfrak{z}}$. Furthermore, when the term $f_m^{\mathfrak{z}} - f_t$ is negative, the primary frequency control power

increases and vice versa. Lastly, when ACE_{UCTE} is negative, the secondary frequency control power increases and vice versa. It is clear that conflicts appear only when K^{ξ} is inferior to Λ^{ξ} .

Table 2.7: Impact of the K-factor on secondary frequency control

$K^{\xi} - \Lambda^{\xi}$	$f_m^{\xi} - f_t$	$ACE_{UCTE} = (K^{\xi} - \Lambda^{\xi}) \times (f_m^{\xi} - f_t)$	Primary control power	Secondary control power	Conflict?
>0	<0	<0	Increases	Increases	No
>0	>0	>0	Decreases	Decreases	No
<0	<0	>0	Increases	Decreases	Yes
<0	>0	<0	Decreases	Increases	Yes

When the target frequency f_t of the power system is different from the nominal frequency f_n , a part of the primary frequency control reserve is undermined. In fact, primary frequency controllers are based on the nominal frequency (see section 1.4.4). Therefore, this use of primary frequency control has to be compensated. For example, requirements for primary frequency control reserves in France are changed as follows⁵⁰ [RTE (2004)]:

- ✓ If $f_t = 49.99$ Hz⁵¹, the reserves are *increased* by 150 MW;
- ✓ If $f_t = 50.00$ Hz, no change;
- ✓ If $f_t = 50.01$ Hz, the reserves are *decreased* by 150 MW.

Secondary frequency control usually relies on a Proportional Integral (PI) controller, filters and heuristics to bring the ACE back to zero. The exact configuration varies from a system to another [e.g., Jaggy and Longley (1991), Jaleeli *et al.* (1992), UCTE (2004b) or PJM (2007)].

Because of data management problems, the frequency and the power flows through interconnections are measured with discrete time steps. Therefore, the *time steps* of frequency and power exchanges measurements, as well as the *cycle time* of the controller, should be considered carefully. Shorter cycle times produce a more efficient secondary control, but also imply higher data management costs.

⁵⁰ The policy to change the requirement for primary frequency control reserves as a function of the target frequency is not adopted in all systems, which creates security breaches.

⁵¹ In Great Britain, time control is performed by changing the nominal frequency by ± 0.05 Hz or ± 0.10 Hz [National Grid (2008a)]. In North America, the target frequency is changed by ± 0.02 Hz [NERC (2006)].

The speed of the effective frequency correction by the secondary control depends on the error size. Nevertheless, the frequency normally should begin to come back to its target value (neglecting the frequency oscillations) no later than the full deployment of the primary frequency reserve. Indeed, at that time, the balance between consumption and production should have been re-established using the primary frequency control and the secondary frequency control should have started its action.

Table 2.8⁵² shows the parameters adopted for secondary frequency control in eight different systems. Great Britain is not included in this table because secondary frequency control is not used in that country.

Deployment times in European countries are generally smaller than what the UCTE recommends, probably to provide some additional margin or to remain consistent with former local policies. For its part, NERC does not provide any specific recommendation. However, it imposes some performance criteria through its Disturbance Control Standard (DCS) and its Control Performance Standard (CPS) [NERC (2006)]. To give an example of US practice, within PJM, the secondary frequency control power should be deployed within five minutes and for at least one hour (i.e., the duration of the regulation market) [PJM (2007)]. Lastly, UPS does not impose a deployment time but sets a minimum gradient that must be respected.

With a requirement of 0.8 mHz (coefficient of 50/60 applied), NERC recommends a more precise *frequency measurement* than the 1.5 mHz UCTE specification. The *cycle times* of German controllers are the smallest amongst the systems considered.

Unlike the UCTE, NERC does not make any particular recommendations regarding the *design of the secondary frequency controller*. Where this data is available, the proportional term is very small, while the integral term is about 100 s. Contrary to the frequency characteristic requirements given in Table 2.6, the K-factor (K^{ζ} or $-10B^{\zeta}$) cannot be estimated because it represents the actual frequency response of the system, which is not publicly available data. This parameter can be variable in real-time in North America, whereas it is constant in Europe. As guidelines for the K-factor, UCTE asks for a 10 % overestimation of the frequency characteristic while NERC recommends the exact value.

⁵² The following abbreviations and symbols are used: No rec.: no recommendation; ϵ : accuracy; T: cycle time; P, I or PI: proportional, integral and proportional-integral controller.

Table 2.8: Technical comparison of secondary frequency control parameters in various systems

	NERC	UPS	UCTE	DE	FR	ES	NL	BE
References	NERC (2006)	-	UCTE (2004b), TenneT (2006)	BDEW (2007a), BDEW (2007c)	RTE (2004)	Spanish industry and energy department (2006a)	TenneT (2003), DTe (2005)	Belgium economic department (2002)
Deployment start	No rec.	≤ 30 s	≤ 30 s	Immediate or ≤ 5 min	≤ 30 s	No rec.	30 s-1 min	≤ 10 s
Full availability	No rec.	As soon as possible (gradients imposed)	≤ 15 min	≤ 5 min	≤ 430 s or ≤ 97 s	≤ 300-500 s	≤ 15 min ≤ 5 min since 15 May 2008	≤ 10 min
Deployment end	No rec.	≥ 15 min	As long as required	As long as required	As long as required	≥ 15 min	≥ 15 min and as agreed	As long as required
Control organisation	No rec.	Hierarchical	No rec.	Pluralistic	Centralised	Hierarchical	Pluralistic	Centralised
Frequency measurement	$e \leq 1$ mHz T ≤ 6 s	$e \leq 1.00$ mHz T ≤ 1 s	$1.0 \leq e \leq 1.5$ mHz T: No rec.	$1.0 \leq e \leq 1.5$ mHz T = 1 s	$e \leq 1.0$ mHz T = 1 s	e: Unknown T = 2 s	$e \leq 1.0$ mHz T = 4 s	$e \leq 1.0$ mHz T: Variable
Exchanges measurement	$e \leq 1.3$ % T ≤ 6 s	$e \leq 1$ % T ≤ 1 s	$e \leq 1.5$ % T ≤ 5 s	$e \leq 1.5$ % T = 1 s	$e \leq 1.5$ % T = 10 s	e: Unknown T = 4 s	$e \leq 0.5$ % T = 4 s	$e \leq 0.5$ % T: Variable
Controller cycle time	≤ 6 s	7 s	1-5 s	1-2 s	5 s	4 s	4 s	5 s
Controller type	No rec.	I	I or PI	PI	I	I or PI, depending on the regulation zone	PI with additional heuristics	PI
Proportional term	No rec.	0	0-0.5	Unknown	0	Unknown	0.5	0-0.5
Integral term	No rec.	40-120 s	50-200 s	Unknown	115-180 s	100 s	100-160 s	50-200 s
K-factor for measuring the ACE	The frequency characteristic	Unknown	110 % of the frequency characteristic	Unknown	Unknown	Unknown	900 MW/Hz	≈ 660 MW/Hz

2.3.4.4 Voltage control

Contrary to the primary frequency control, the parameters of the primary voltage control cannot be compared between systems, and most of the time, even between units. In fact, the parameters of the voltage controller must take into account the configuration of the surrounding network. However, the *requirements in terms of reactive power capabilities* can be compared, as they measure the ability of the unit to control voltage and because one Mvar from a hydro unit is generally equivalent to one Mvar from a thermal unit. To allow a benchmarking between systems, the reactive power requirement given at the terminals Q_2 is converted to the Point Of Delivery (POD) Q_{POD} (see section 1.5.3).

Sometimes, reactive power requirements may be given for the dimensioning voltage U_{dim} instead of the nominal voltage of the network U_n . The dimensioning voltage is the actual average voltage at which the generating unit is connected, which may vary from U_n . The possible reactive power/voltage pairs are given by the U/Q diagram of the unit. To convert from the reactive power requirement at U_{dim} to the one at U_n , a typical U/Q diagram should be used on a case by case basis. In this survey, we assume that U_{dim} and U_n are equal.

Concerning *deployment times*, the primary voltage control is immediate and must operate continuously, as it maintains the voltage at its nominal value and insures stability.

From an accounting perspective, *cycle times* and *accuracy* are less important for the voltage control than for the frequency control, because the utilization cost of reactive power is generally considered to be too low to require a precise metering [Da Silva *et al.* (2001)]. However, for the stability of the system, the measurement accuracy and the parameters of the voltage controller should be considered carefully.

Most of the TSOs make recommendations regarding the *effectiveness of the control*, and in particular the stability margins [Spanish industry and energy department (2000), Belgium economic department (2002), French economic and industry department (2003) and BDEW (2007a)]. However, these requirements were not considered in this survey because it focuses on features of ancillary service controls.

Table 2.9⁵³ shows the reactive power requirements in eight different systems. While these requirements are often specified using a complete P/Q diagram, this table can only show the maximum requirements for P_n .

NERC and the UCTE do not give any recommendation on reactive power requirements because it is a local problem. UPS requirements are negotiated case by case. Spanish requirements are quite low in comparison to the other systems in the Table. Therefore, connecting conditions are less stringent on this point in Spain than in the other systems. However, reactive power connecting conditions do not imply that one system uses more or less reactive power than another one since TSOs can contract for additional reactive capabilities or use some of their own reactive power sources (see Chapter 4).

⁵³ The following abbreviations and symbols are used: No rec.: no recommendation; pf: power factor; P_n: nominal power; POD: Point Of Delivery; U_{dim}: dimensioning voltage; U_n: nominal voltage. Furthermore, note that the expressions lagging and leading refer to the stator voltage and the stator current (see section 1.5.3).

Table 2.9: Technical comparison of voltage control parameters in various systems

	NERC	UPS	UCTE	DE	FR	ES	NL	BE	GB
References	NERC (2006)	-	UCTE (2004b)	BDEW (2007a)	French economic and industry department (2003)	Spanish industry and energy department (2000)	DTe (2005)	Belgium economic department (2002)	National Grid (2008a)
Absorption capability requirement (leading)	No rec.	No rec.	No rec.	pf = 0.925, 1 or 1 at the POD for Pn and Un	-0.35·Pn at the POD for Pn and Udim	pf = 0.989 at the POD for Pn and Un	pf = 0.8 at the POD for Pn and Un	-0.10·Pn at the POD for Pn and Un	pf = -0.95 at the terminals for Pn
Production capability requirement (lagging)	No rec.	No rec.	No rec.	pf = 0.95, 0.925 or 0.9 at the POD for Pn and Un	0.32·Pn at the POD for Pn and Udim	pf = 0.989 at the POD for Pn and Un	pf = 0.8 at the POD for Pn and Un	0.45·Pn at the POD for Pn and Un	pf = 0.85 at the terminals for Pn
Estimated absorption requirement at the POD for Pn and Un	No rec.	No rec.	No rec.	-0.41·Pn or 0·Pn	-0.35·Pn	-0.15·Pn	-0.75·Pn	-0.10·Pn	-0.48·Pn
Estimated production requirement at the POD for Pn and Un	No rec.	No rec.	No rec.	0.33·Pn, 0.41·Pn or 0.48·Pn	0.32·Pn	0.15·Pn	0.75·Pn	0.45·Pn	0.47·Pn

2.3.5 Standardised specifications

As shown in section 2.3.4, actual specifications for ancillary services use time-related parameters (the deployment times). Since primary and secondary ancillary services rely on automatic controllers, *the time-related specifications make sense only for a given input signal* (e.g., a step function)⁵⁴. For example, as shown in Figure 2.5, the two deployment times $t_{deployment}^a$ and $t_{deployment}^b$ are totally different, whereas it is the same AS provider that is considered in both cases. Consequently, if two policy makers take different typical input signals, the capability of a provider cannot be translated directly to the other policy maker. Therefore, a standardised description may help the providers communicate their capabilities.

Second, actual specifications for ancillary services are with good reason focused on the quasi-steady state (e.g., frequency characteristic or full deployment for a given frequency deviation)⁵⁵. Therefore, *the dynamics of the providers are ignored*. Providers that react fast are more useful to the system⁵⁶ and have to respond more often, which increase their provision cost (see Chapter 3). Hence, these providers should be entitled to receive a premium for a provision of AS with an improved quality (see Chapter 4). In addition, the SO is eager to know the actual dynamics of the AS providers to better understand the reactions of the system. In particular, after collecting the data on dynamics from all the AS providers, the SO can run simulations to check whether its security criteria are fulfilled or not.

Lastly, the current frameworks define *their requirements for each type of providers* (e.g., conventional power plants, distributed generation, purposely-built devices or loads). In order to foster innovation, it would be useful for the policy maker to benefit from a framework that describes any provider.

⁵⁴ For manual ancillary services such as tertiary reserves, the input signal is managed by the provider itself (e.g., it can activate its fast units very close to the end of the deployment time).

⁵⁵ The short response (< 30 s) of a frequency control provider is linked to stability, whereas the longer-term response (beyond 30 s) is linked to the active power actually provided by the prime mover [Proctor (2001)].

⁵⁶ Dynamics that are too fast can also lead to an unstable system.

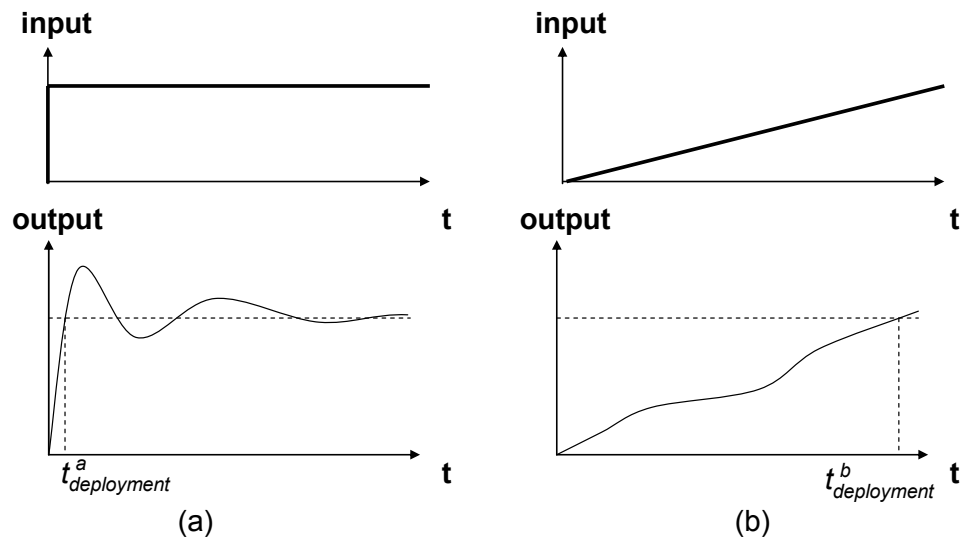

Figure 2.5: Representation of responses of an AS provider for two different inputs

Because of the limits of current specifications, Zhong (2003) and Doherty *et al.* (2005) have proposed specifications based on the actual dynamics of the control. Moreover, an innovative approach for classifying ancillary services has been proposed by a Cigré Task Force (2001). The idea is to convert the AS needs and responses from the time domain to the frequency domain by applying a Fourier transformation. Therefore, each AS is classified into different frequency categories in function of its response time, as shown in Figure 2.6.

Still, these innovative methods do not take into account all the specificities of an AS provider such as deadbands or delays. Therefore, an original specification of frequency and voltage control ancillary services is proposed here and illustrated in Figure 2.7. Primary, secondary and tertiary controls are only differentiated by the input signal, which is either computed locally, either sent by the SO or set by the device operator. Lastly, note that capacitor banks and generators do not provide the same reactive power capability because the actual reactive power supplied by a capacitor varies with the square of the voltage at its terminals [Fourment *et al.* (1995)]. This variation can be taken into account in this framework by using the terminals voltage as input.

In all the cases, the device responds to the input signal⁵⁷ with its own dynamics, characterised by five parameters. First, the equipments have a *delay of response*, generally associated with the transmission of data. This delay can also be very useful for providers

⁵⁷ AS providers may also respond to several input signals. For instance, the active power consumption of a load usually depends on both voltage and frequency of the electricity supply [Kundur (1994)].

that need a certain time before being able to react, such as disconnected gas turbines. Second, all equipments have a certain *insensitivity*, which is given by the deadband. In addition, this insensitivity can be used by all-or-nothing providers, such as loads fitted with a low-frequency relay. Third, *the response of the device* to the input signal is approximated by a first order system (see Figure 2.8). Obviously, a generating unit is not a first order system, but in most of cases, the approximation is sufficient to check whether the security may be guaranteed. This feature is important because slow and fast controllers have different values for the SO. If the provider agrees (and is able) to give a more precise description of its device (e.g. a second order system), this better description would be easily implemented in the model. Fourth, the process is limited by its *maximum and minimum outputs* (i.e., the negative and positive reserves) and by the *maximum slope*. The fifth and last parameter is the *maximum duration* of the control. This maximum duration may be expressed in terms of energy, which can be very useful for hydro units, storage devices or loads.

It is worth noting that classical control schemes for generators, FACTS and loads can fit this framework. In the particular case of generators, this structure may be used for different levels of active power production, since the dynamics of a unit are a function of its output. However, it is not clear whether this structure is appropriate for future forms of regulation such as adaptive commands, neural networks or fuzzy logic.

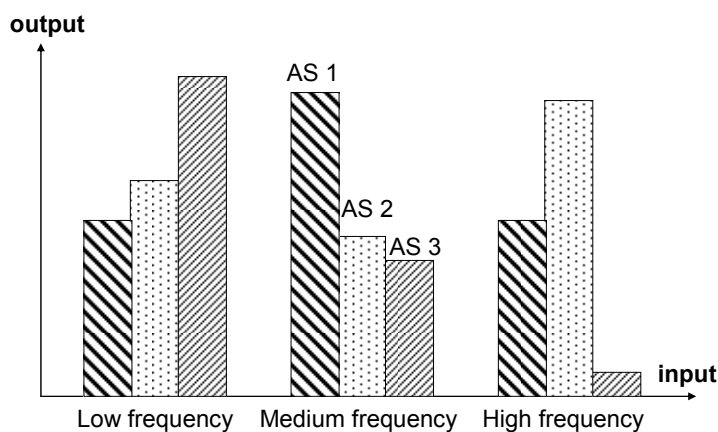

Figure 2.6: Classification of AS based on frequency-domain characterisation

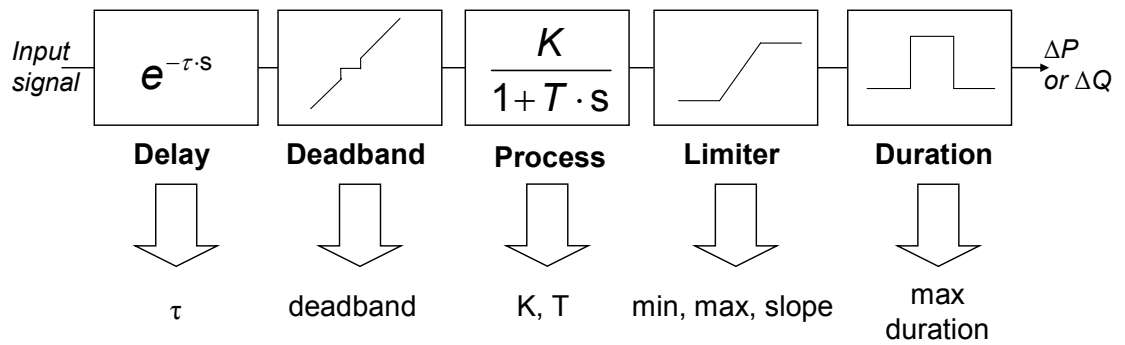

Figure 2.7: Proposed standardised definition of quality of a frequency or voltage control AS

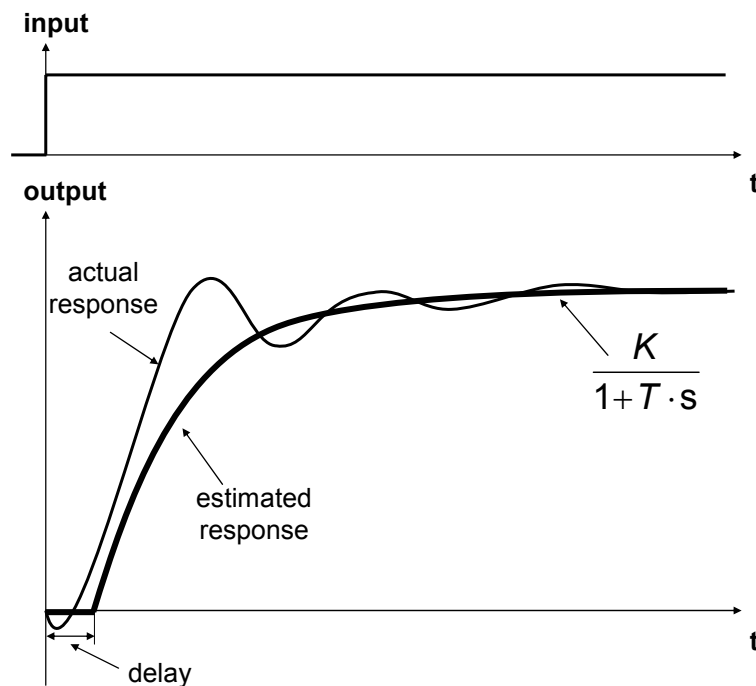

Figure 2.8: Representation of the actual response of the group versus its estimate

This standardised framework can be used to describe any AS provider. All the stakeholders would thus speak a common language. The particularities of providers would be recognized and the SO would have a better understanding of the system. In addition, to help identify types of AS providers that are either abundant or scarce, or to create a market⁵⁸, AS providers can be grouped in categories as a function of specific profiles, as shown in Figure 2.9. However, such profiles require an input signal, so it reduces the universality of the specification.

⁵⁸ Allowing product substitution between different qualities would be necessary in such a market.

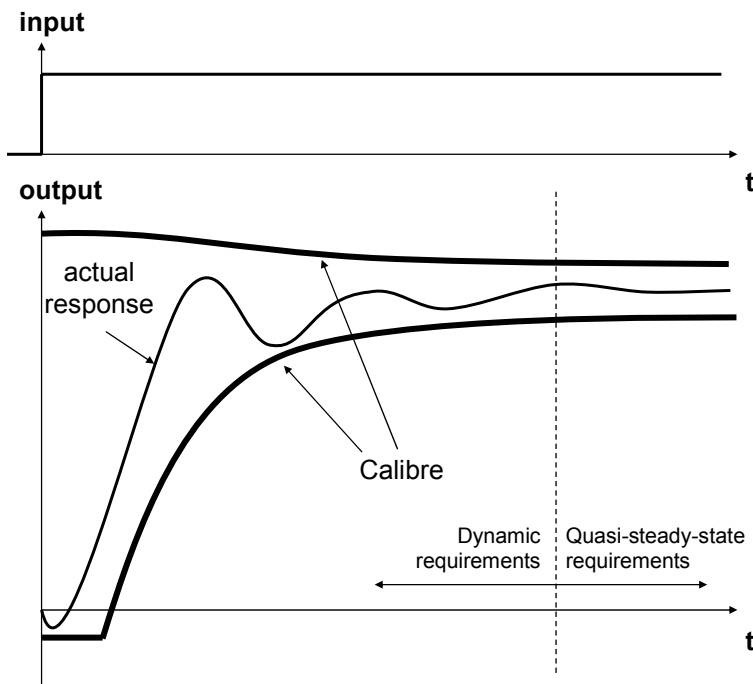

Figure 2.9: Utilisation of a profile to define a category of AS quality

2.4 Quantity of Ancillary Services

The previous section has provided various frameworks to specify the quality of a given ancillary service. None of the proposed frameworks stands out from the crowd. Therefore, the chosen specification depends on the constraints of the power system considered. Using these specifications, this section focuses on the quantity of system (and thus ancillary) services needed to meet the expectations of users in terms of reliability, power quality and utilisation. The optimal method is first presented (section 2.4.1), before reviewing and discussing the practical methods used within the UCTE (sections 2.4.2 and 2.4.3). The requirements in various systems are then given. Some original methods to define the appropriate quantity of system services are introduced (section 2.4.4). Lastly, actual requirements across systems are compared (section 2.4.5).

2.4.1 Optimal definition of the quantity of system services

As shown in section 2.2.4, the *optimum quantity* of system services is the one that maximizes the global welfare. However, this optimum is very difficult to reach because many parameters have to be considered. In particular, the value and cost of system services are

difficult to compute⁵⁹. Therefore, as illustrated in the following sections, the practical methods rely on heuristic (i.e., based on empirical past information) and deterministic (i.e., predefined) methods, because they are the easiest to handle while operating the system.

If the volume of SS can be computed depending on the operating conditions, the *frequency of review* of these requirements would have to be adequate. In practice, depending on the system service and the country considered, the requirements can be reviewed from every five minutes to once a year (see section 4.6.6). Obviously, an annual requirement does not provide a constant level of security throughout the year.

Moreover, it is probably more efficient to define *asymmetric* volumes for system services, i.e. the needs in quantity of up balance and down balance are likely to be different (see section 2.3.2).

Lastly, when the timeframe considered gets longer, the problem of volumes of system services moves from the security domain to the adequacy domain. The SO should give the *right signals to the investors* in order to obtain enough AS capacities in the long term. This issue remains open and is deeply linked to the investment in energy production capacities (see section 4.3.1).

2.4.2 Definitions used within the UCTE

The UCTE does not recommend any particular reactive power AS quantities [UCTE (2004b)]. Indeed, such reactive power reserves rely on the local structure of the system (e.g., strength of the power flows or rating of the lines). Therefore, the definition of these capabilities is not discussed in this section. On the other hand, frequency control reserves depend less on the local constraints of the system and have an impact on the whole system. Therefore, the policy on frequency control reserves across systems is defined by the UCTE.

The primary frequency control reserve within the UCTE is based on the largest power deviation to be handled, which is 3 000 MW, “assuming realistic characteristics concerning system reliability and size of loads and generation units” [UCTE (2004b)]. This reserve is linked to the frequency characteristic of the system and is thus shared by the

⁵⁹ Section 2.2 shows the difficulty to express the value of system services, while Chapter 3 demonstrates that it is impossible to calculate precisely the cost to provide ancillary services.

whole interconnected network, as explained in section 1.4.7. The burden of this reserve is then shared across the whole interconnected power system according to the generation of each system.

On the other hand, the secondary frequency control reserve is activated by a given zone to balance its own production and consumption. Therefore, the reserve of a zone varies in function of the size and portfolio considered. Within the UCTE, the calculation of secondary reserves originates from an empirical formula [UCPTE (1991)]. This formula was developed during the seventies from half-hourly measurements of production and consumption. The means used at that time were relatively limited, such as hand-calculation based on information given by phone by operators of generating units. The first formula has then evolved over time. Table 2.10 gives an overview of the evolution of the secondary reserve $R_{sec}^{\tilde{z}}$, by considering a few systems within the UCTE and depending on the available information. The current UCTE formula (i.e., since 2004) is a compromise based on all the previous formulas. However, TSOs prefer to take margins to increase the security of the system, especially during fast variations of the load. Lastly, note that the UCTE recommends that the loss of the largest unit in the zone be compensated by both secondary and fast (i.e., deployed in less than 15 min) tertiary frequency control reserves [UCTE (2004b)].

Table 2.10: Recommendations for secondary reserve in some systems within the UCTE

At least since	System	Formula	References
1991	Germany	$R_{sec}^{\tilde{z}} = \frac{1}{2} \sqrt{\frac{2\,500}{\hat{P}_{max\ generation}^{\tilde{z}}}} \times \hat{b}^{\tilde{z}} \times \hat{P}_{max\ generation}^{\tilde{z}}$ <p> $\hat{P}_{max\ generation}^{\tilde{z}}$ = estimate of the peak generation for the day (in MW) $\hat{b}^{\tilde{z}}$ = estimated power deviation in % related to $\hat{P}_{max\ generation}^{\tilde{z}}$. The average of b was around 3.5 %, and the maximal value 9 % during rapid load fluctuations (6-9 h) </p>	UCPTE (1991)
1991	France	$R_{sec}^{\tilde{z}} = 2.8 \times \sqrt{\hat{P}_{consumption}^{\tilde{z}}}$ <p> $R_{sec}^{\tilde{z}} = 0.02 \times \hat{P}_{consumption}^{\tilde{z}}$ during rapid load fluctuations $\hat{P}_{consumption}^{\tilde{z}}$ = estimate of the internal consumption (in MW) </p>	UCPTE (1991)
1991	Italy	$R_{sec}^{\tilde{z}} = 0.0125 \times \hat{P}_{consumption}^{\tilde{z}}$	UCPTE (1991)
1998	Spain	$R_{sec}^{\tilde{z}} = 3 \times \sqrt{\hat{P}_{max\ consumption}^{\tilde{z}}}$ <p> $R_{sec}^{\tilde{z}} = 6 \times \sqrt{\hat{P}_{max\ consumption}^{\tilde{z}}}$ during rapid load fluctuations $\hat{P}_{max\ consumption}^{\tilde{z}}$ = estimate of the maximal internal consumption (in MW) </p>	Spanish industry and energy department (1998)
2004	UCTE	$R_{sec}^{\tilde{z}} = \sqrt{10 \times \hat{P}_{max\ consumption}^{\tilde{z}} + 22\,500 - 150}$	UCTE (2004b)
2006	France	$R_{sec}^{\tilde{z}} = \min\left(500, \sqrt{10 \times \hat{P}_{max\ consumption}^{\tilde{z}} + 22\,500 - 150}\right)$ <p> $R_{sec}^{\tilde{z}} = \frac{\text{demand gradient}}{6}$ if the demand gradient is higher than 12 000 MW/h </p>	Texier-Pauton (2007)

2.4.3 Discussion of the UCTE recommendation

Clearly, the UCTE formula is a compromise between previous methods, which were developed during the seventies, when the portfolio and the measurement means were different than what is available today. This section thus attempts to put into perspective the current UCTE formula.

2.4.3.1 Link between secondary and tertiary controls

Tertiary and secondary frequency controls have the same objective: bringing back the exchanges of the area to their targets values (or the frequency to its target in a case of an area without any interconnection). A trade off is thus possible between secondary and fast tertiary reserves. Consequently, the definitions of the necessary secondary and fast tertiary frequency reserves have to be considered together. However, the current requirement of the UCTE ignores this possible trade-off.

Figure 2.10 represents the compensation of an imbalance with the help of both secondary and tertiary frequency controls. Despite having the same objective (i.e., compensate the imbalance of the zone), the tertiary frequency control is less flexible than the secondary frequency control. Indeed, tertiary frequency control offered by generating units or consumers usually include delays and minimum durations of use. However, some power systems can benefit more from flexible tertiary frequency control than other systems. Hence, each power system should have its own requirements for secondary reserves as a function of the available tertiary frequency control offers (which vary over time).

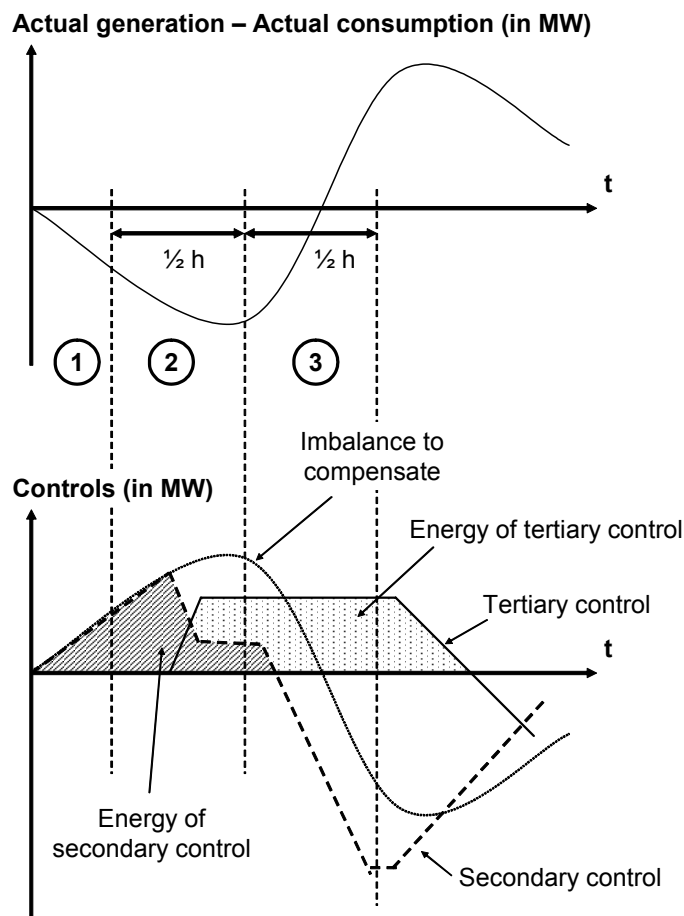

Figure 2.10: Deployment of secondary and tertiary controls

2.4.3.2 Normality

If the necessary secondary and tertiary frequency control powers can be determined to compensate a given imbalance, one can plot the probability density of the necessary frequency control powers⁶⁰ for any imbalance. Figure 2.11 gives a stylised representation of such a density. As it would be too expensive (and actually impossible) to have always enough frequency control power, policy makers have to accept that not all positive or negative imbalances will be covered. This is translated by two limits on the probability density (a limit for the negative tail and another for the positive tail, as shown in Figure 2.11).

The choice to cover 99 % of the cases is usual. For example, this criterion corresponds to the one chosen in France for the margin of the morning peak [RTE (2004)].

⁶⁰ When the regulation signal is equal to -1 (see section 2.3.3.1), the positive secondary frequency control power is equal to twice the secondary frequency control reserve.

Then, this criterion has to be distributed amongst positive and negative imbalances, according to the priority given and eventually the related cost (e.g., 0.5 % each tail).

The requirements within the UCTE during the nineties (see Table 2.10) made the assumption that the necessary secondary frequency control power follows a normal law. Hence, the necessary secondary frequency control power to be covered during 99 % of the cases can be easily deduced: it should be $\pm 2.576 \times \sigma$, where σ is the standard deviation of the normal law considered, as shown in Table 2.11 [Saporta (1990)].

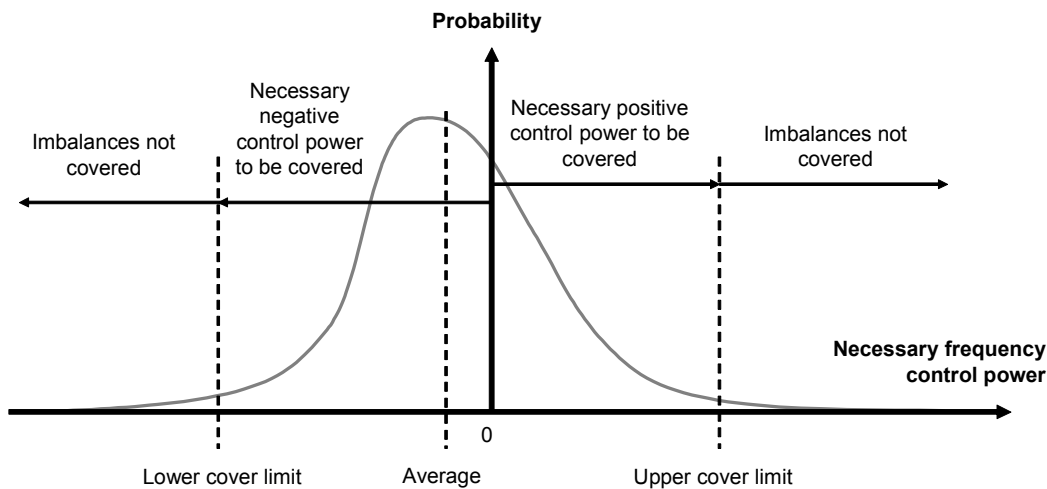

Figure 2.11: Probability density of the necessary frequency control power

Table 2.11: Repartition of a population for a normal distribution

Deviation from the mean	Probability to have a lower deviation
$\pm 1.645 \times \sigma$	90.00 %
$\pm 1.960 \times \sigma$	95.00 %
$\pm 2.576 \times \sigma$	99.00 %
$\pm 3.000 \times \sigma$	99.73 %
$\pm 3.291 \times \sigma$	99.90 %

The normality hypothesis was made when the available techniques were limited. However, because of the current computation capabilities, recent reserve requirement can now be based on more complex density functions. To give an example, Figure 2.12 shows the empirical cumulative distribution function of the activated French tertiary control power in 2006⁶¹, and the corresponding normal cumulative distribution function with an

⁶¹ The example is based on the tertiary frequency control because the data on the activated secondary frequency control power was not available.

average of -4.5 MW and a standard deviation of 893 MW. The activated tertiary control power is defined as twice the energy of tertiary frequency control deployed over half an hour (see Figure 2.10). In other words, it represents the average power needed to provide the activated energy⁶². The data are from RTE (2007a). Note that the transmission losses are included in these data, since RTE is treated as a consumer that uses active power to cover the network losses.

To test whether the two cumulative distribution functions are equivalent, the Kolmogorov test was performed. This test validates an empirical series $F^*(x)$ by comparison to another distribution $F(x)$ by calculating the maximal difference $D_{Kolmogorov}$ between the two functions, as shown in (2.3). If $D_{Kolmogorov}$ is inferior to a given value, the empirical series $F^*(x)$ can then be assimilated to the series $F(x)$ with a given confidence [Saporta (1990)].

$$D_{Kolmogorov} = \max |F^*(x) - F(x)| \quad (2.3)$$

In this case, $D_{Kolmogorov} = 0.055$ is obtained, whereas the threshold for the Kolmogorov test is 0.0081 for $17\,520$ elements⁶³ with a confidence of 80% ⁶⁴. Therefore, the series is far from following a normal distribution. This difference is explained by the threshold that can be seen around zero (see Figure 2.12). In other words, it is highly probable that the activated tertiary frequency control power is null over a half-hour. In fact, participants have incentives to reduce their imbalances, as the balancing mechanism charge users that are in imbalance.

It is difficult to extrapolate directly these results for the secondary frequency control. In addition, the UCTE recommendation is as function of the forecasted consumption of the zone $\hat{P}_{consumption}^x$, whereas our study has considered all the data. However, because of the link between secondary and tertiary frequency controls, secondary frequency control power may also not follow a normal distribution. Nevertheless, the same calculation

⁶² Therefore, up and down balancing can compensate each other over a half hour.

⁶³ The series has $17\,520$ elements because there are 365 days \times 48 half-hours/day.

⁶⁴ 0.0081 is obtained with the following formula: $\frac{1.073}{\sqrt{17\,520}}$ [Saporta (1990)].

should be performed to assess the foundation of the policy for the secondary frequency control reserves.

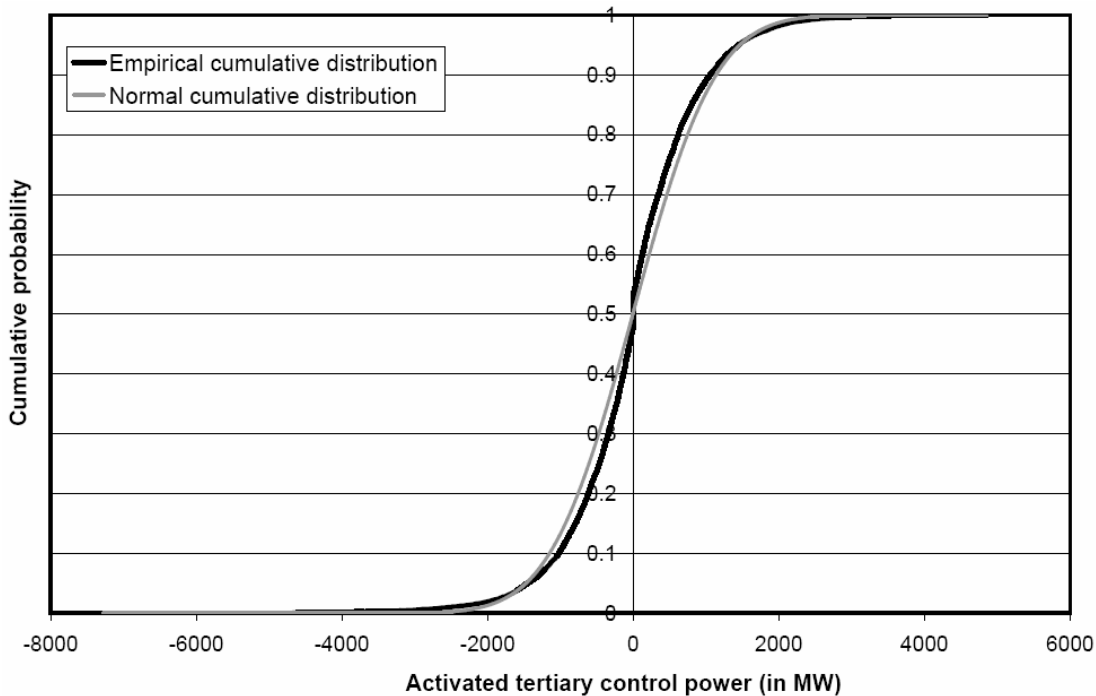

Figure 2.12: Empirical and normal cumulative distribution functions of the activated tertiary control power in 2006 in France

2.4.3.3 Stationnarity

Making assumptions on future imbalances relies on the hypothesis that the series considered is stationary, i.e. that its standard deviation and its average do not change over time (see Appendix A.1). However, since the portfolio of a system evolves in time, especially with the increase in distributed generation, it is possible that the necessary frequency control power not be stationary. Therefore, the reserve requirements should be updated frequently.

2.4.3.4 Symmetry of reserves

As shown in Figure 2.11, the necessary frequency control power can be on average different from zero. In other words, there may be an expected imbalance. This can happen when the participants have an incentive to under- or over-estimate their production or consumption. In practice, this happens when the balancing mechanism has asymmetric prices. Therefore, symmetrical reserves do not guarantee that sufficient reserves are available to hedge against imbalances. However, the secondary reserve is only dimensioned as a positive power within

the UCTE. Therefore, the current recommendation does not guarantee enough negative control power capacity.

2.4.3.5 Cost of outage and cost of provision

The probability density function discussed above does not take into account the cost of being short of system services (e.g., *the cost of the outage* resulting from by the lack of reserves). Indeed, as shown in section 2.2, this cost varies over time, so the risk cover factor (and the frequency control reserves) should also vary with time. For example, RTE's objective is to have a probability of using exceptional means (e.g., load disconnections) inferior to 1 % at the morning peak and 4 % at the evening peak [RTE (2004)]. However, the UCTE currently does not recommend such a differentiated requirement over time.

In addition, the method to calculate the frequency control reserves is marred by imprecision. Moreover, the cost to provide the necessary frequency control reserves by users (i.e., *the cost of provision*) varies with time. An inelastic demand (i.e., constant whatever is the cost of procurement) can thus be discussed (see section 4.3.2).

2.4.4 Innovative methods

The previous section has demonstrated the limits of a method based only on the probability of having insufficient resources. In particular, it has been shown that the needs of the users are not well reflected by such a method. Therefore, a few innovative methods are proposed here to contribute to this debate. As system services are public goods (see section 2.2), one might want to apply the relevant economic concepts in their procurement. A first possibility to procure a public good is to use *private provisions*. In this scheme, the users of the power system have to cooperate and truthfully reveal how much they value the system services. Then, each user would pay for the system services according to the value that it gives to each service. Such an approach is theoretically the best, but does not work in practice. In fact, users may not be willing to reveal the true value in order to try to pay as little as possible, hoping that others will pay. This phenomenon is called free riding. Therefore, incentives are generally too poor for providers when a voluntary equilibrium for a public good is sought [Varian (1999)].

Voting may also be an alternative. In such a system, users would vote for say three levels of system service A, B and C. When a level of system service is chosen, the cost is

split equitably amongst all the users. However, this system may lead to some difficulties. For example, let suppose that A is preferred after the vote. However, it is possible that a majority of users prefer B to A, a majority prefer C to B and that a majority prefer A to C! And even if such cycles can be avoided, the result may not be efficient because a vote is binary while the volume of system services is continuous. Lastly, voting does not necessarily provide a good incentive for users to honestly reveal their true preferences. For example, Varian (1999) illustrates these flaws using the case of a vote in the Congress of the United States in 1956.

In the case of a continuous public good, Varian (1999) shows that a Pareto-efficient amount of the good is obtained when the sum of the absolute *rates of substitution* between the private good and the public good for all consumers equals the marginal cost of providing an extra unit of the public good. However, it is not clear what private good can be substituted for security in a power system. For example, such a private good might be a generator close to the load, a private line, load-shedding or a small network with a DC link. A system can also be imagined in which a load or a distribution company gives instructions directly to an AS supplier in order to follow the consumption of the load or the distribution company [Tyagi and Srivastava (2006)]. Anyway, the marginal rate of substitution is unlikely to be useable directly since it is hard to compute.

Instead of the rates of substitution, a related idea could be used: the *cost of insecurity*⁶⁵. Indeed, the cost of insecurity is specific to every user of the power system. It can thus be proven very easily that the optimal quantity of system services is obtained when the marginal cost of insecurity equals in absolute the marginal cost of system services (see Figure 2.13). This optimisation problem seems therefore to be straightforward. However, even if the cost of system services as a function of the quantity can be calculated, computing the cost of insecurity is much harder for three reasons. First, determining the value that users put on electricity is not easy and this value varies with time. Second, supposing that the value of electricity is known for all the users, determining the related cost of insecurity for different quantities of system services requires huge amounts of computation. Lastly, the cost of insecurity is represented here by a smooth curve. In practice, it is very likely that this cost exhibits discontinuities. For example, if just one MW

⁶⁵ The security is a public good, while the damages of insecurity lead to private losses for a user. Therefore, the cost of insecurity can be seen as a private good that can be substituted for security.

of reserve is missing, the TSO may have to disconnect a whole feeder, which usually represents several MW. Despite these difficulties, this method is one of the main current research axes. Amongst others, see for example the recent contributions by Papadogiannis and Hatziargyriou (2004), Galiana *et al.* (2005), Abiri-Jahromi *et al.* (2007) or Ortega-Vazquez and Kirschen (2007). However, note that these papers do not consider the impact of system services on power quality and the utilisation of the power system (see section 2.2).

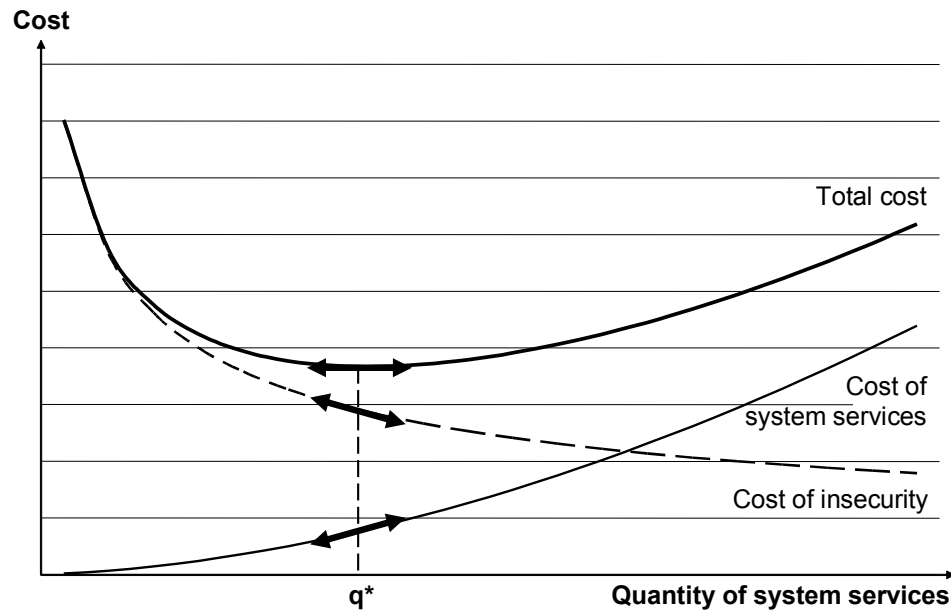

Figure 2.13: Cost curves of system services

Another possible solution relies on a tax, called the *Groves-Clarke tax*, described by Varian (1999). In this system, each user gives the value v_i of benefits it derives from the public good. In addition, if the public good is provided, everybody will have to pay a certain amount c_b , known in advance by all the users. The net value n_i can then be computed. This value is negative if the user loses money by buying the public good and positive if it benefits from the public good. Pivotal agents are the users that change the sign of the total net value, i.e. $\sum n_i$. In others words, pivotal agents are essential to the decision to procure the public good. The pivotal agents then pay the harm that they do to non-pivotal agents, i.e. the total net value without the participation of the pivotal agent. This tax disappears from the system: it is not given to a participant in order to avoid gaming. This scheme is really an incentive on participants to reveal the true value of the product. However, it works only when all the Pareto efficient allocations of the public good lead to the same amount of public good (a situation called quasi-linear indifference). In addition, the Groves-Clarke tax is not Pareto efficient since the tax disappears from the system. However, in the case of a

large number of participants, this tax may be rather small, because nobody would be pivotal. This method helps determine the efficient amount of public good, but does not help with the cost allocation⁶⁶. Lastly, note that the cost allocation scheme has an impact on the value of the tax, but does not affect the decision of buying or not the public good.

Table 2.12 illustrates the Groves-Clarke tax mechanism for a public good that costs 100 €. It can be seen that the proposed cost allocation c_i is different from the value v_i given by the participants. Therefore, this mechanism may be considered as unfair by some participants. On the other hand, participants have incentives to reveal the true value of the good. In fact, if they underestimate it, the good may not be bought at all and the participants may thus lose the benefit from the public good. But if the participants overestimate the value of the public good, they may be pivotal and pay a tax that will undermine any potential extra benefits.

Table 2.12: Example of a Groves-Clarke tax

	Cost (c_i)	Value (v_i)	Net value (n_i)	Pivotal?	Tax
Bidder 1	70 €	50 €	-20 €	No	0 €
Bidder 2	20 €	30 €	+10 €	No	0 €
Bidder 3	10 €	40 €	+30 €	Yes	10 €
Total	100 €	120 €	+20 €	-	10 €

Let us imagine a practical example for a given SS⁶⁷. First, the TSO determines the SS cost for a given period of time (e.g., one hour of the day) as a function of the quantity, and allocates it to, say, the four groups of system users A, B, C and D (see Figure 2.14). For example, these groups of users could be the balancing entities⁶⁸ in France.

⁶⁶ See section 4.8.2 for a discussion of cost allocation.

⁶⁷ The present example is an adaptation of the initial Groves-Clarke tax, which was initially designed for discrete public goods and not for continuous public goods like SS.

⁶⁸ A balancing entity acts on the balance between production and consumption within a specific perimeter of the market.

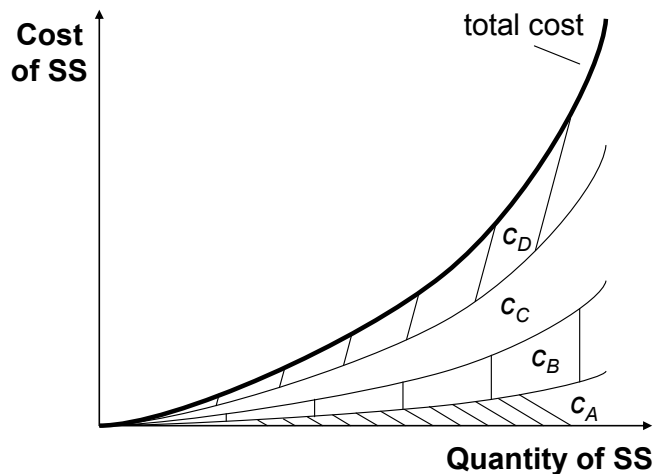

Figure 2.14: Allocation of SS costs between four groups of users

Then, each group of users reveals the value that it gives to the quantity of SS for the given period of time (see Figure 2.15 - note that a discontinuous curve could also be envisioned). To be able to let the value of SS be estimated by users, the TSO has to give them some system information. For example, for a given quantity of SS, the probability of level of quality of supply is estimated. All the values of SS are then added in order to obtain the total value expressed by all the users to the SS. Unfortunately, this step is likely to be very difficult to implement in practice because it may be very difficult for users to estimate the value of system services. In addition, the TSO may not be able to give sufficient information on the impact of a given quantity of system services.

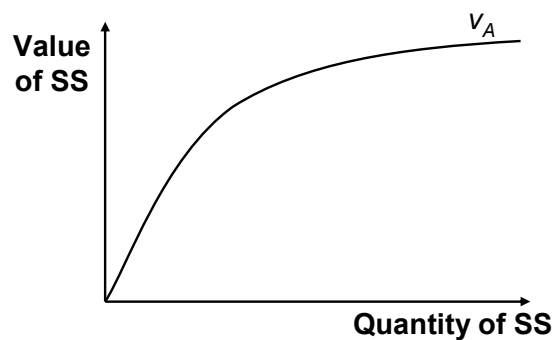

Figure 2.15: Value of SS for a group of user

With the cost and the value of the SS, the TSO can find the optimal quantity q^* of SS, which maximizes the difference between value and cost, i.e. the net benefit of SS (see Figure 2.16).

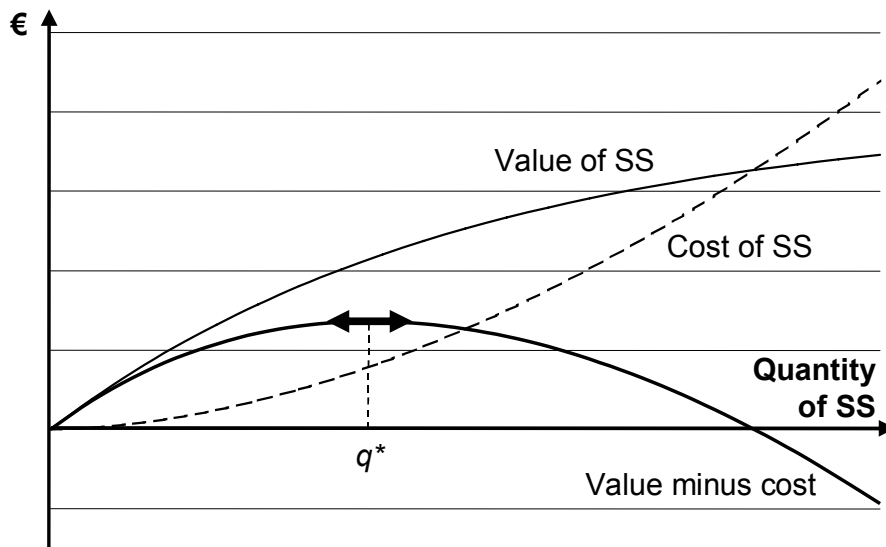

Figure 2.16: Representation of the optimal quantity q^* of SS

The last step consists in charging the tax to the pivotal agents as explained with the example of Table 2.12. The product of this tax can then be given to the regulator to help it to finance market audits or other related activities.

The advantage of the proposed method is that it switches the burden of calculating the cost of insecurity from the SO to the users of the system. In addition, it gives an incentive to the users to bid the real value of SS for them. On the other hand, the TSO has to be able to provide precise information on the impact of a given level of SS, which is likely to be very difficult to compute. Therefore, building the curve of the quantity of system services versus their value (see Figure 2.15) is the toughest point to solve to make this method practical.

2.4.5 Actual requirements across countries

Systems across the world have adopted different methods to calculate the needs for system services, which lead to different quantities of ancillary services. These quantities affect both the SOs and the providers. For example, with such data, SOs can figure out whether they could save money by reducing the volume of ancillary services that they purchase, while providers can check whether they could sell more ancillary services to their SO (see Chapter 4 for a discussion on the procurement of ancillary services).

To compare volumes, system specificities and especially the size of the power system need to be taken into account. Therefore, a specific indicator, called *Reserve Indicator*

(RI), is proposed in this thesis. It is calculated by dividing the amount of reserve in the system by the hourly average energy production or consumption (in MWh/h), depending on the type of reserve. Hence, the SO of a system with a high RI procures more reserves per unit of energy produced or consumed than one with a lower indicator. One advantage of this indicator is that it can be calculated easily on the basis of parameters that are easy to obtain. While the concept of reserve indicator could also be applied to reactive power services, not enough information is available on reactive power volumes to include a reactive reserve indicator in this work. Usually, the amount of primary control reserve is linked to the production. For example, the UCTE contribution coefficients for primary control are based on the annual production of each system [UCTE (2004b)]. Therefore, the reserve indicator used for the primary reserve RI_{pri}^{ζ} (in %) is obtained by dividing the average primary frequency control reserve R_{pri}^{ζ} (in MW) by the hourly energy production $E_{generation}^{\zeta}$ (in MWh/h), as shown in (2.4).

$$RI_{pri}^{\zeta} = \frac{R_{pri}^{\zeta}}{E_{generation}^{\zeta}} \quad (2.4)$$

In most systems, the secondary control reserve is linked to the estimated peak consumption during a given period. Therefore, the reserve indicator used for the secondary reserve RI_{sec}^{ζ} (in %) is obtained as shown in (2.5).

$$RI_{sec}^{\zeta} = \frac{R_{sec}^{\zeta}}{E_{consumption}^{\zeta}} \quad (2.5)$$

where R_{sec}^{ζ} (in MW) is the average secondary frequency control reserve and $E_{consumption}^{\zeta}$ (in MWh/h) the hourly energy consumption.

Figure 2.17 shows the primary and secondary frequency control reserve indicators calculated in 2004 or 2005, depending on data availability, for various systems⁶⁹. For the sake of clarity, primary and secondary RIs are not separated in this graph. However, in

⁶⁹ Australia and New Zealand have been included in order to have a different view from non-interconnected systems. For data on electricity production and consumption, see IEA (2005). For data on reserves, see the websites of TSOs and market operators of the systems.

order to explain differences, primary and secondary frequency control RI will be discussed separately.

Except in Australia, the primary reserve indicator is higher in small systems with no interconnections or limited interconnection capacity such as Great Britain⁷⁰, New Zealand and Sweden. Indeed, the primary frequency control reserve is sized to counteract the loss of the biggest unit, which is about the same in all the synchronous zones. Within the UCTE, Spain has a higher primary frequency control RI because of its compulsory provision (see section 4.4.2). The values of this indicator for Germany and France are similar. Finally, systems outside the UCTE have a non-symmetrical primary frequency control reserve (positive different from negative) and PJM's R_{pri} was not calculated because, contrary to the secondary frequency control, there is no specific requirement for the volume of primary frequency control reserve yet [NERC (2005)].

Germany has a high secondary frequency control RI because of the pluralistic structure that has been adopted (see section 2.3.4.3). Indeed, each of the four German TSOs must be able to compensate for any realistic imbalance within its control area. Therefore, the total of reserves represents a large amount for Germany as a whole. New Zealand, PJM and France seem to have similar policies in terms of secondary control volume. Spain has a higher RI_{sec} because the Spanish TSO uses an extended N-1 criterion (loss of the largest group *and* the largest line). Note that its reserves are not symmetrical, contrary to the two other countries of the UCTE (France and Germany) included in this comparison. Australia has relatively small amounts of secondary control reserves, because they are mainly used to control the synchronous time. Lastly, New Zealand is split into two islands connected by a DC link, so frequency control RIs have been calculated for each island separately.

⁷⁰ Note that for Great Britain, primary and secondary frequency responses have been added to obtain the total primary frequency control reserve.

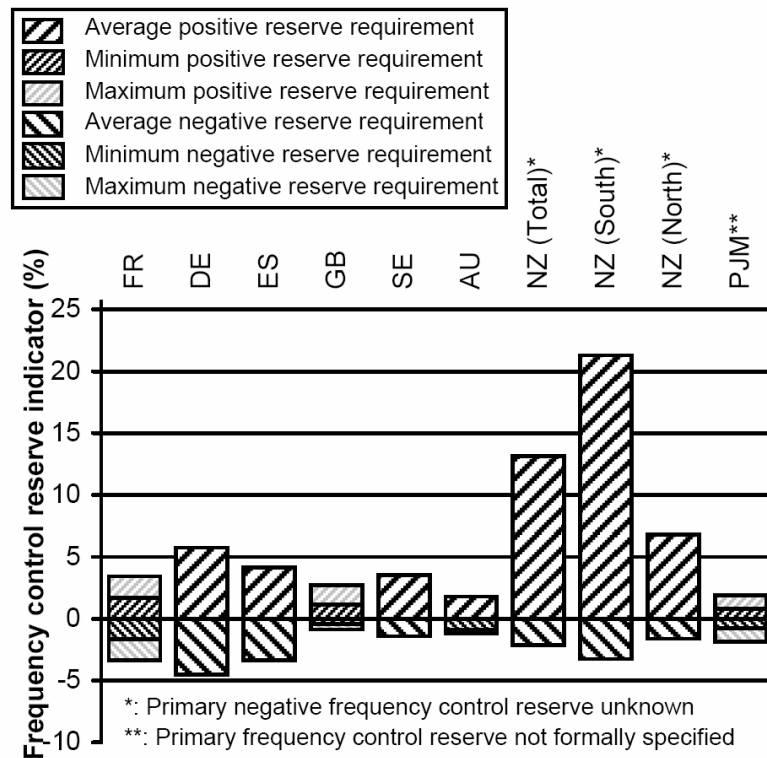

Figure 2.17: Frequency control reserve indicators in 2004-5 across systems surveyed

2.5 Location of Ancillary Services

In addition to the quality and the quantity of ancillary services, the location of the ancillary services has to be considered carefully.

2.5.1 Impact of the location of ancillary services

Frequency control ancillary services act on the global frequency (see section 1.4), so one can think that their location is not important. However, their physical locations should be considered while procuring ancillary services for various reasons. First, *congestions of transmission lines* can affect the reliable provision of frequency control AS⁷¹. Therefore, a part of the transmission capacity has to be allocated to frequency control AS, for example as proposed by the UCTE (2005). If enough transmission capacity is not available, the affected zone has to secure enough ancillary services from within its perimeter. More generally, as reserving transmission capacity may be too expensive, the contributions to frequency

⁷¹ The location issue is in this case relatively similar between active power AS and electrical energy-only products.

control are likely to be distributed across the whole interconnected network to reduce unplanned power transits following a large generation outage.

Second, in case of a *grid separation*, the separated parts of the network cannot stay stable without any frequency control system service. Therefore, a uniform distribution of frequency control services is desirable. In particular, distributed generation could be very useful to provide such a uniform distribution of reserve.

Third, balancing production and consumption is much more important *at the transmission level* than it is at the distribution level. Indeed, a distribution network with an imbalance can be disconnected easily from the rest of the system and therefore is not very threatening for security of the whole. However, an imbalance at the transmission level cannot be removed easily because of its meshed structure (see section 1.2). Therefore, an imbalance at the distribution level has generally local consequences while an imbalance at the transmission level has much greater global consequences. The French standards illustrate well the importance of transmission systems. In fact, the typical commitment of the French distributor against an unexpected loss of supply is six hours, whereas it is around three minutes at the transmission level⁷².

On the other hand, reactive power ancillary services are local products (see section 1.5), so the reactive sources have to be as electrically close as possible to the reactive loads. Therefore, the location of providers of reactive control AS is very important. In addition, like frequency control, voltage control AS impacts the transmission capacity. Indeed, (a) reactive power AS need a minimal available transmission capacity to be helpful; (b) flows of reactive power increase the active power losses; and (c) reactive power AS can increase or decrease active power flows.

In conclusion, an appropriate location of ancillary services is essential to meet the needs of users described in section 2.2. For example, Goel *et al.* (2004) or Galiana *et al.* (2005) propose methods to take into account the location of frequency control ancillary services while procuring them.

⁷² These values are only indicative. For complete information, refer to EDF (2004) for the distribution network and to RTE (2006) for the transmission network. Note that the actual average loss of supply is much lower than the commitment. Indeed, the average loss of supply was 60 minutes for the distribution network in 2004 [EDF (2006)] and 1 minute 42 for the transmission network in 2006 [RTE (2007c)].

2.5.2 Location in actual systems

As the location of ancillary services is important, systems have to develop policies to benefit from sufficient ancillary services at the appropriate places, as discussed in section 4.3.1. Moreover, systems have to define technical procedures to allow some ancillary services to be exchanged between participants. In fact, TSOs usually do not choose where the AS providers are.

In particular, an increased integration of the electricity markets across systems is on the way [e.g., see Meeus and Belmans (2008) for continental Europe]. Indeed, trading ancillary services across systems: (a) allows more efficient use of flexible resources; (b) reduces the potential exercise of market power; (c) diminishes imbalance exposure; and (d) makes better use of interconnection capabilities [Frontier Economics and Consentec (2005)]. On the other hand, a limited quantity can be traded for the reasons presented in section 2.5.1 (e.g., 33 % of the secondary frequency control within the UCTE [UCTE (2005)]). In addition, trading of ancillary services requires standardised definitions (see section 2.3) and may make the monitoring more difficult (see section 4.8.4).

2.5.2.1 Primary frequency control

Within the UCTE, the requirement for primary frequency control reserve is split amongst the various TSOs according to their electrical energy produced annually (see section 2.4.2). UCTE (2005) proposes to allow exchanges of primary frequency control reserves between TSOs. In this framework, the Reserve Receiving TSO (RRT) benefits from the contribution of one or several units connected in the area of the Reserve Connecting TSO (RCT). Two methods have been proposed:

- ✓ *An AS provider (in the area of the RCT) supplies primary frequency control for the RRT.* In this case, the RCT has to give its agreement;
- ✓ *The RCT provides primary frequency control for the RRT.* Therefore, the providers in the area of the RCT see an increase of their provision of primary frequency control.

Such a framework is relatively easy to put in place since no specific communication system has to be developed.

2.5.2.2 Secondary frequency control

In North America, regulation (i.e., secondary frequency control) can be traded between systems with the help of the following services [NERC (2006)]:

- ✓ *Overlap regulation service*: a control area incorporates some or all of another control area's tie lines, frequency response and schedules into its own ACE equation (see section 2.3.4.3);
- ✓ *Supplemental regulation service*: a control area takes into account all or a portion of the ACE of other control areas in order to provide more regulating power for these areas.

The UCTE (2005) has also proposed changes to allow generating units to provide secondary frequency control to another zone. Two architectures have been proposed, which do not directly use the ACE:

- ✓ *Direct control by the Reserve Receiving TSO* (see Figure 2.18): the generating unit in the reserve connecting area receives the regulation signal directly from the RRT. The participation of the unit is added to the balance of the RRT and subtracted from the balance of the RCT;
- ✓ *Control through the Reserve Connecting TSO* (see Figure 2.19): the RCT receives the regulation signal from the RRT. The RCT changes its ACE accordingly. Therefore, all the generating units providing regulation in the area of the RCT participate in the regulation effort. This service is thus somewhat similar to the North-American supplemental regulation service.

Lastly, note that such arrangements will have consequences on the current operating practices. In fact, contrary to the current organisation, the exchanges at the interconnections will not come back to their scheduled values after deployment of the secondary frequency control power.

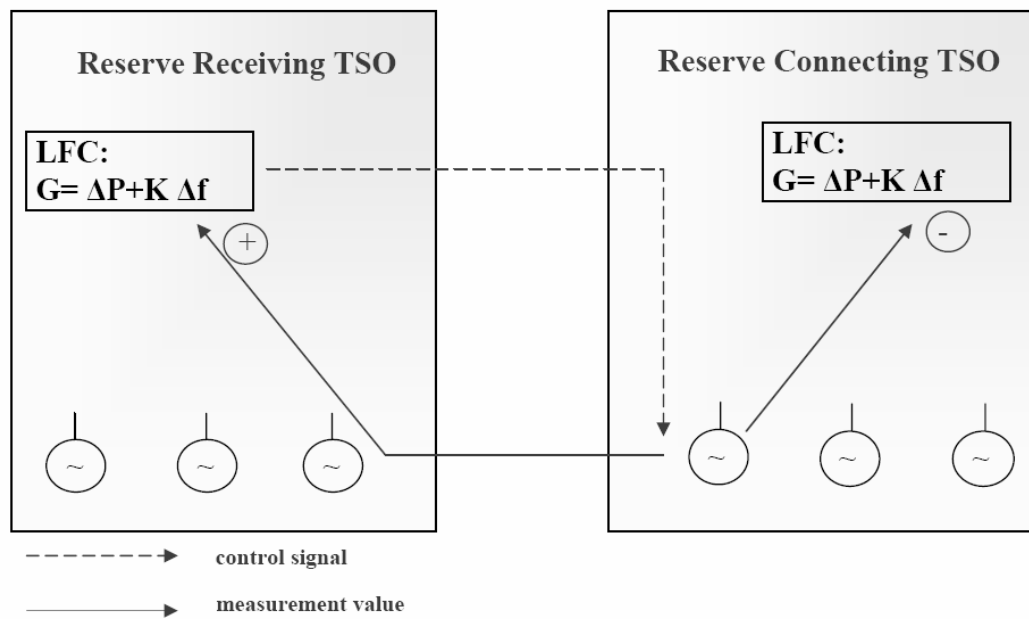

Figure 2.18: Direct control by the reserve receiving TSO [UCTE (2005)]

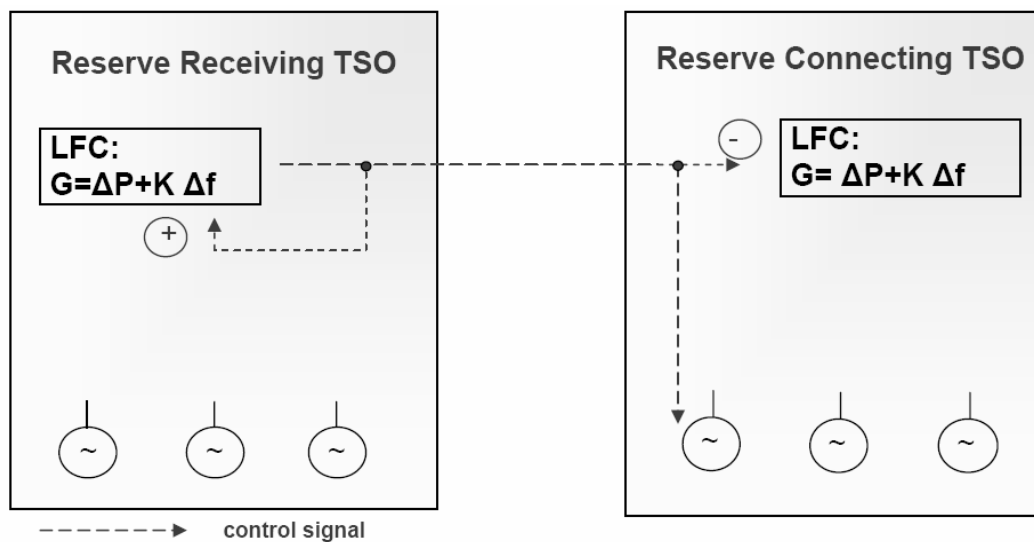

Figure 2.19: Control through the reserve connecting TSO [UCTE (2005)]

2.5.2.3 Voltage control

Because of the local characteristics of voltage control, this ancillary service cannot be easily traded over long distances (see section 1.5.4). Therefore, sufficient reactive power providers must be located across the system (see section 4.3.1). In addition, the voltage control management requires a strong cooperation at the connecting bus between two different entities; for example, between two TSOs of two neighbouring areas, a TSO and a DSO, or a TSO and a generating unit. Such cooperation has to be defined with the help of a specific contract or regulation rules.

2.6 Conclusion

This chapter has explored the issues related to the delivery of ancillary services, namely: the expression of the needs, the quality, the quantity and the location of ancillary services. Current policies can be improved by taking into account more accurately the value given by the users to system services and by refining some empirically-defined requirements. In particular, the following assessment list is proposed for the delivery of ancillary services:

- ✓ Needs for system services:
 - *Expression of the needs*: a cost-benefit optimisation is the best manner to define the needs in terms of system services. However, the value of system services is very difficult to estimate because system services affect at the same time the reliability, the power quality and the utilisation of the power system. Therefore, practical solutions tend to be based on very simplified methods, past experience or general recommendations. As a result, the users of a power system, who are represented by the regulator, may feel that the system services that are provided do not correspond to their needs, either because they are too expensive or insufficient;
 - *Reduction of the needs*: on the other hand, system operators have little incentive to change rules-of-thumb that have performed reasonably well for years, even if these rules are sometimes hard to justify. System operators may also consider that their approach within their own territory is the best, forgetting that system services affect the interconnected system as a whole;
 - *Review of the needs*: the needs of users and the system constraints evolve with time (e.g., with the introduction of new types of generations). Therefore, the needs for system services should be reviewed frequently by SOs.
- ✓ Quality of ancillary services: The description of AS quality is very important because AS are technical products.
 - *Differentiation of ancillary services*: it is not possible to find a perfect specification. A trade-off has to be found between too much or too low differentiation. Such differentiation may vary as a function of the time horizon considered. In particular, primary frequency control is more differentiated than secondary frequency control;
 - *Description of ancillary services*: a framework to compare ancillary services has been proposed and successfully applied to various power systems. In addition, a standardised description has been proposed based on five parameters: (a) a delay;

(b) a deadband; (c) dynamics of the process; (d) a limiter; and (e) a duration of service. Contrary to current specifications, this standardised description does not rely on the input signal, does take into account the dynamics and can be applied to any type of provider. Lastly, the term “spinning reserve” is defined in a standardised manner: the spinning reserve is the unused capacity which can be activated on decision of the system operator and which is provided by devices that are synchronized to the network and able to affect the active power;

- *Rationalisation of ancillary services*: in practice, specifications of ancillary services differ from one system to another. Therefore, efforts should be made to unify similar ancillary services in order to foster short-term exchanges of services.

✓ Quantity of ancillary services:

- *Responsibility for requirements*: because system services are public goods, only the system operator can define the requirements for ancillary services. In addition, the public good characteristic makes very difficult the design of new methods that define the requirements for ancillary services;
- *Definition of requirements for ancillary services*: the requirements should take into account (a) the possible trade-off between products; (b) the potential non-normality, (c) non-stationarity and (d) non-symetry of imbalances; (e) the time-dependent cost and value of ancillary services. However, current practices are usually opaque. Therefore, the system operator has to explain to all the participants how the requirements are calculated;
- *Elasticity of requirements*: the fixed demand for ancillary services currently used is inelastic and marred with large uncertainty. Therefore, the benefit of procuring more or less 10 MW of reserve is not assessed;
- *Synopsis of requirements*: an indicator has been developed to compare requirements for ancillary services and thus gives incentives to participants to improve their practices.

✓ Location of ancillary services:

- *Importance of location*: the location of reactive power providers is particularly important. For frequency control, the actions of providers are global but still may be hampered by a bad location (e.g., a congested area);
- *Incentives in the long run*: since AS providers cannot be moved easily, appropriate incentives should be given to have access to sufficient AS capabilities at the appropriate locations in the long run;

- *Exchanges in the short term:* technical mechanisms should exist to allow participants to exchange AS in the short run to help maximize the global welfare. In addition, standards should be developed to allow neighbouring participants to communicate (e.g., a TSO and a DSO). ■

CHAPTER 3

COST OF ANCILLARY SERVICES

A smile costs less money than electricity but gives as much light.

Henri Grouès (1912 - 2007)

3.1 Introduction

IT IS essential for a provider of ancillary services to understand the cost of its supply in order to take the appropriate decisions for its investments and its contracts. Furthermore, policy makers also need to appreciate the structure of the costs of ancillary services in order to design the most appropriate market. This chapter therefore reviews the main components of the cost of ancillary services (section 3.2). A practical methodology based on operational data is then proposed to estimate the cost incurred by a producer when it must reserve capacity on a day-ahead basis to provide frequency control (section 3.3). This methodology was successfully applied to EDF Producer's generation portfolio and gives interesting insights on the costs of frequency control ancillary services (sections 3.4 and 3.5). In addition, the cost of time control is assessed for France (section 3.6).

3.2 Main Cost Components of Ancillary Services

The reflection on the cost of ancillary services started in the mid-nineties, in particular with the work by Hirst and Kirby (1996)⁷³. At EDF, internal studies started at the same time in order to prepare the separation between activities of transmission (i.e., RTE) and generation (i.e., EDF Producer) of electricity (see section 1.2). After more than ten years of various studies, the cost of ancillary services is now much better understood than it was before the separation of transmission and generation activities. This section reviews the main cost components that frequency and voltage control ancillary services cause for an electricity producer. The additional costs for the system operators are not considered.

3.2.1 Fixed costs

Fixed costs are all the costs that do not depend on the quantity of services provided. The fixed costs due to frequency and voltage control ancillary services have two main components:

- ✓ An increased investment cost, such as:
 - Additional protections or regulators in the power plant;
 - The communication system between the system operator and the producer (e.g., to send the signal used for the secondary frequency control);
 - The measurement system that helps track the performances of the unit;
 - The over-investment in power generation capacity in comparison with what would be required to meet only the demand for energy. For example, frequency control reserves represent up to 20 % of the capacity needed for energy (see section 2.4.5). This over-investment cost is calculated by comparing the cost to develop a fictitious adapted portfolio to the actual portfolio;
 - The over-sizing some equipment such as step-up transformers or alternators (see Figure 3.1). Indeed, higher currents circulate through windings when voltage control is provided. To give an idea, three 360-MVA transformers are used in France for each 900-MW nuclear unit (instead of three 300-MVA transformers), and three 570-MVA transformers for each 1450-MW nuclear unit.

⁷³ In addition, various publications at that time were discussing the theoretical framework to unbundle prices for energy and ancillary services, such as Baughman *et al.* (1997a), Baughman *et al.* (1997b), Hao and Papalexopoulos (1997), Zobjan and Ilic (1997a), Zobjan and Ilic (1997b).

- ✓ The manpower required to provide ancillary services, for example for:
 - Controlling the performance of the ancillary services provided (tests and analysis of performance) and to operate the plant in a more complicated manner than it would have been without providing any ancillary services;
 - Implementing the contracts between the buyers and the suppliers of ancillary services. To give an order of magnitude, the transaction costs between the TSO, the DSO and the users represent 20 % of the transmission cost in France, i.e. 214 M€ in 2006 [French economic and industry department (2005)].

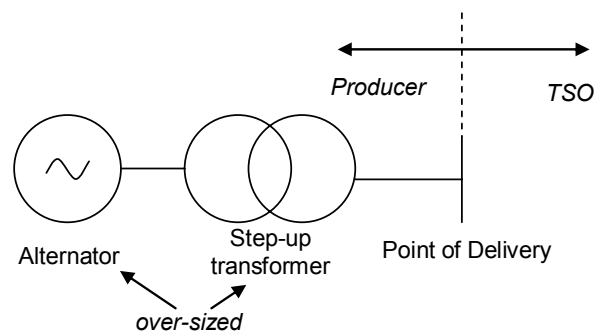

Figure 3.1: Representation of two over-sized elements because of voltage control

To show the complexity of determining the fixed costs due to ancillary services, let us briefly discuss the additional cost of a step-up transformer used for voltage control. Step-up transformers for large power plants are custom-built. The cost of this kind of transformer relies on various parameters related to their design such as the labour needed to design and build it, the materials used, its nominal power, its reactance⁷⁴, its number of poles⁷⁵ and its capability to withstand lightning surges (the protection level).

In addition, the transportation cost can vary a lot from one site to another because it is quite difficult to transport such a transformer. Typically, a site close to a large river or a railroad has cheaper transportation costs than a power plant on an isolated site. Moreover, if the oil tank or the magnetic circuit are reused, the cost may decrease drastically. Lastly,

⁷⁴ For nuclear power plants, the reactance of step-up transformers ranges from 12 to 14 %. To diminish this reactance, the winding length should be shortened. To do so, a smaller winding radius can be used, but the mechanical constraints are increased. Alternatively, a larger section may be used, but this method increases the space used, the weight and the cost. An optimum has thus to be found to satisfy the criteria of the generating company.

⁷⁵ Three single-phased transformers are 15 % more expensive than a stand-alone three-phased transformer.

the policies of the companies have also an important impact. Indeed, the generator may favour different manufacturers to spread risks, while manufacturers may reduce prices to increase their market shares.

Therefore, there is no catalogue price and it is very difficult to determine the standard investment cost of one MVA. Nevertheless, the order of magnitude of the cost is between 1 k€ and 6 k€/MVA.

Once the investment cost has been calculated, the actualised cost should be determined in order to spread the investment cost over the lifetime of the transformer. However, this lifetime varies between 30 and 40 years for nuclear power plants, and some step-up transformers for hydro units are still in use after 80 years of service⁷⁶. In addition, the investment cost is done in terms of apparent power (i.e., in MVA) and not in terms of reactive power (i.e., in Mvar). Appropriate amortisation and separation between active and reactive powers thus need to be performed. To do so, various techniques are possible. For more details, see for example Eurelectric (1997), Da Silva *et al.* (2001), Alvarado *et al.* (2003) or Elizondo *et al.* (2006), who all try to give the estimated total investment cost due to voltage control in various countries.

In conclusion, fixed costs are quite difficult to compute because costs are complex, assets used to provide ancillary services have usually other purposes than the sole provision of ancillary services and the lifetime to consider is not very clear. Therefore, it may be useless to try to determine a very precise fixed cost, because calculations are likely to be plagued by large uncertainties.

3.2.2 Variable costs

Variable costs are all the costs that depend on the quantity of services provided. The variable costs due to frequency and voltage control ancillary services have two main components:

- ✓ The capacity reservation produces additional costs, called *reservation costs*:
 - The de-optimisation cost: because of the provision of ancillary services, it costs more to the generation company to produce the same quantity of energy. For

⁷⁶ By comparison, transmission transformers have a lifetime of 40 to 60 years.

example, by providing ancillary services, a new generating unit may have to be started⁷⁷, the dispatch is not optimum (i.e., some cheap units provide ancillary services instead of energy) or the efficiency is lower⁷⁸. The de-optimisation cost is calculated by subtracting the dispatch cost of Figure 3.2.b from the dispatch cost of Figure 3.2.a. Note that this de-optimisation cost cannot be estimated easily by hand, because the dispatch of Figure 3.2.a is not straightforward. Indeed, the unit commitment is likely to be different. Lastly, note that the de-optimisation cost becomes linked to the increased investment cost when it is considered over a long period (see section 3.2.1);

- The opportunity cost: the net profit of the company would have been higher if it did not provide ancillary services (e.g., by selling additional energy on the spot market instead of withholding capacity to provide frequency control). The opportunity cost is calculated by subtracting the profit of Figure 3.2.a from the profit of Figure 3.2.b. The opportunity cost may sometimes not exist, i.e. the profit may not increase when ancillary services are not provided (profit of Figure 3.2.a < profit of Figure 3.2.b). However, in practice, the opportunity cost is actually calculated by subtracting the profit of Figure 3.2.c from the profit of Figure 3.2.b, where a larger amount of power is sold at the spot price in Figure 3.2.c than the optimal dispatch without ancillary services (quantity 2 > quantity 1). Even if the first calculation is more rigorous, the second one is preferred in practice (e.g., at PJM) because of its simplicity [PJM (2008)]. For voltage control, despite a large literature describing this phenomenon [Hirst and Kirby (1996), Da Silva *et al.* (2001), Gross *et al.* (2002)], the opportunity cost is actually quite theoretical because alternators have generally been designed to provide reactive power without reducing their active power generation. Indeed, the connection rules impose such capabilities (see section 2.3.4.4).

- ✓ The utilisation of the reserved capacity, called *utilisation cost*:

⁷⁷ For example, an expensive unit may be called to provide only voltage control to support a given area.

⁷⁸ The efficiency of thermal units is related to the main steam pressure and the throttling of the turbine control valves. Bakken and Faanes (1997) show that the efficiency can decrease by 2 % when the control valve is completely open, which can happen when a unit provides frequency control.

- Deployment cost: it is the direct extra-cost to actually provide the requested service. For example, more fuel may be used because the unit generates extra power or the active power losses may increase [Cigré Task Force (2001), Gross *et al.* (2002)];
- Additional maintenance cost: wear-and-tear is increased, so elements of the unit are aging faster than without providing any ancillary service. Note that this cost is particularly high when a generating unit is used as a synchronous compensator [Saluden (2006)].

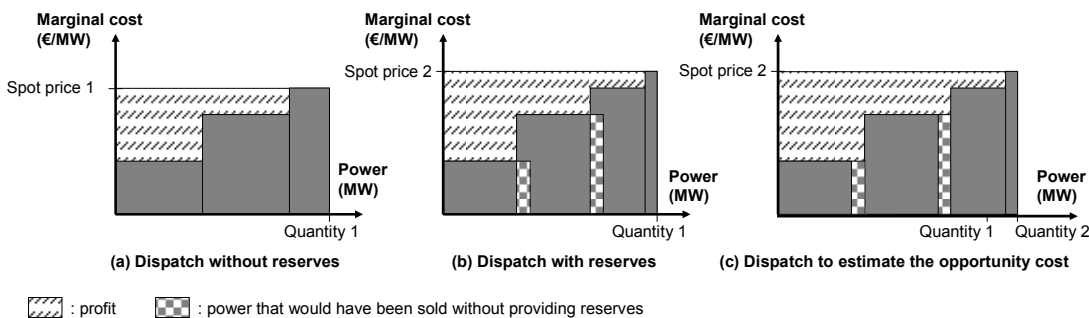

Figure 3.2: Schematic dispatches to understand de-optimisation and opportunity costs

To give an idea of the impacts of ancillary services on wear-and-tear costs:

- ✓ Voltage control implies:
 - Temperature fluctuations that damage mechanical parts;
 - Varying electromagnetic forces and thus vibrations that increase stress on alternators;
 - A faster aging of the step-up transformer because of increased currents⁷⁹ and because of the potential saturation of the magnetic core (a saturated magnetic core heats up quickly).
- ✓ Frequency control implies:
 - More stress on steam circuits. The list of components that are affected depends on the technology. Broadly, the mechanical parts that ensure a connection between two different parts (e.g., the boiler and its feeding pipe) are subject to higher constraints;
 - For a nuclear power plant, a reduction in the lifetime of the system that commands the control rods in the nuclear core.

⁷⁹ Windings of step-up transformers are wrapped in paper to avoid electrical contact between turns. When the current increases, the temperature in the transformer increases as well. This temperature increase extends the cellulose chains that are contained in the paper, which may possibly lead to a rupture. This rupture may cause a short circuit between two adjacent turns. In addition, the cellulose rupture releases water, which may react with the hot oil.

In conclusion, variable costs are somewhat easier to identify and quantify than fixed costs. The cost of capacity reservation is likely to be significant for frequency control, while it is close to zero for voltage control, except for synchronous compensator operation. As far as frequency control is concerned, the de-optimisation cost (i.e., the difference between the costs of dispatch with reserves and without reserves) represents the main capacity reservation cost. The direct utilisation cost due to voltage control is lower than the direct utilisation cost due to frequency control. However, voltage control produces higher stress in alternators and thus extra maintenance cost.

3.3 Methodology and Hypotheses to Estimate Cost

The previous section has presented the various components of the cost incurred by a generating company because of ancillary services. Determining this cost is difficult because (a) various time horizons have to be considered; (b) the cost has different origins; (c) the allocation of the cost amongst the different products is hard, so double-accounting is possible; (d) such a determination relies on simulations, because the system cannot be run again without AS provision, so assumptions have to be made, which lead to uncertainties and thus potential errors. Nevertheless, as discussed in this chapter, it is possible to estimate the de-optimisation cost, which is one of the most important components of the cost of AS. This section introduces the optimisation process at EDF Producer (sections 3.3.1 and 3.3.2), describes the methodology adopted to estimate the de-optimisation cost for EDF Producer (sections 3.3.3 and 3.3.6) and presents the main tools that have been used and the related hypotheses (sections 3.3.4 and 3.3.5).

3.3.1 Time horizon for a generating company

A generating company has to take decisions for various time horizons, such as [Ernu (2007)]:

- ✓ *More than five years ahead:* investments in generating capacities;
- ✓ *Several years ahead:* planning of shutdowns of nuclear power plants, as a nuclear power plant cycle lasts around 18 months;
- ✓ *Around one year ahead:* value of water, fuel provision, risk analysis;

- ✓ *Up to one week ahead*: adequacy analysis, timing of maintenance for thermal units, definition of the generation cost, option contracting;
- ✓ *Up to one day ahead*: dispatch of the production, trade-off with available options (e.g., option contracts or spot market, as presented in section 1.3.1);
- ✓ *Several hours ahead*: bidding/offering in the balancing mechanism and re-dispatch.

When the time horizon increases, the number of constraints diminishes but the uncertainty increases. Therefore, probabilistic approaches are adopted to deal with long-term issues: a large amount of computing power is used to run a large number of cases with a relatively low number of constraints. On the other hand, when the time horizon decreases, the uncertainty decreases but there are many more constraints. Deterministic methods are thus preferred: the computing power is used to take into account the maximum number of constraints, and the uncertainty is dealt with by taking margins (see Figure 3.4 in section 3.3.3).

Figure 3.3 shows the tools used by EDF Producer to optimise and take decisions over the different time horizons. ARRET, GLOBAL, LOCAL, OPHELIE and ARGOS are the names of the various software chains. ORION, MNR, COMPAS and APOGEE refer to the models used to optimise the decisions taken. Note that all the software chains are operated by humans. Indeed, the solutions proposed by the models need to be supervised and experts may decide to take different decisions by considering constraints not handled by the models.

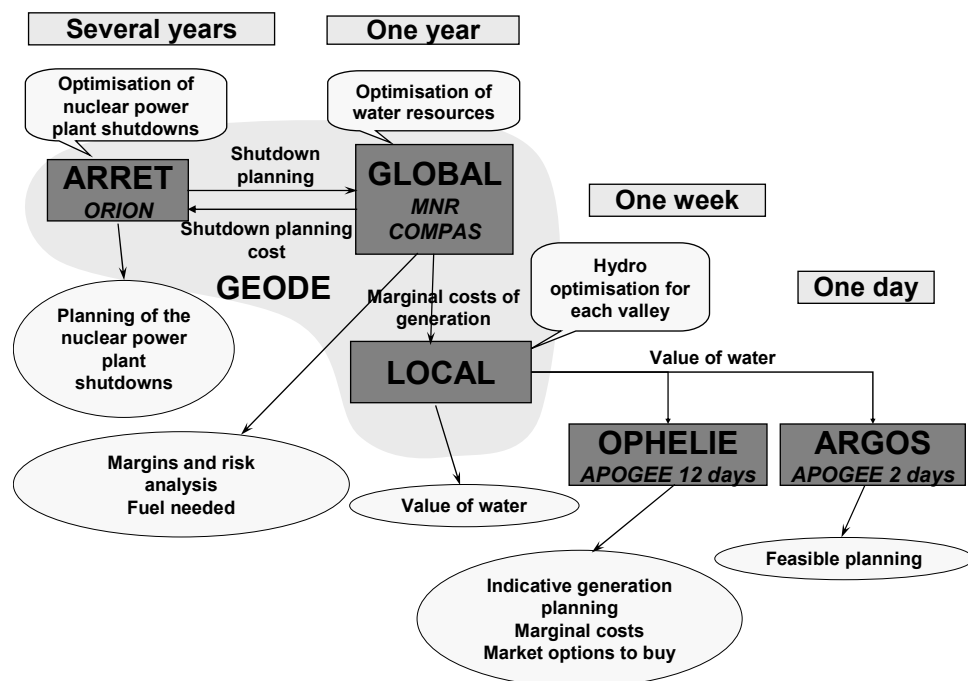

Figure 3.3: Overview of the optimisation process at EDF Producer [based on Ernu (2007)]

3.3.2 The daily optimisation process at EDF Producer

A software chain named ARGOS (see section 3.3.1) is the main tool that helps manage the daily generation optimisation process. This tool is divided into several modules, amongst which we need to describe a few:

- ✓ APOGEE, which optimises the generation of the 110 thermal units and the 50 hydro valleys⁸⁰. APOGEE two days optimises the portfolio with a resolution of half-hourly time steps over two days, i.e. 96 time steps⁸¹. As explained in section 3.3.1, decisions to start up or shut down nuclear power plants must be made well in advance. Therefore, once a nuclear unit is available, APOGEE usually commits it because the variable cost of a nuclear power plant is very low but the shutdown costs are high. However, APOGEE takes into account the maximum deep slow downs allowed per day and may sometimes ask to shut down a nuclear power plant⁸²;

⁸⁰ A hydro valley is a gathering of interdependent hydro units.

⁸¹ APOGEE can also be used to optimise the portfolio over 12 days (it is thus designated as APOGEE 12 days). The algorithm is the same as APOGEE 2 days, but the datasets are different. For the sake of simplicity, the term “APOGEE” is used in this thesis to designate APOGEE 2 days.

⁸² When APOGEE decides to shut down a nuclear power plant, it takes into account the tens of MW that the power plant consumes for its auxiliary systems. However, APOGEE ignores the transmission fees that will be incurred if all the nuclear units of a given site do not produce any power, which is very rare.

- ✓ CANYON, which optimises the 500 hydro units by taking into account much more hydro constraints than APOGEE does. This optimisation tries to meet the set points provided by APOGEE for the valleys;
- ✓ COCKPIT, the Human-Machine Interface (HMI) that helps co-ordinate the various modules of ARGOS. In particular, COCKPIT allows operators to change the dispatch provided by the models.

Table 3.1 presents the management of frequency control reserves throughout the short-term process adopted at EDF Producer.

Table 3.1: Daily management of frequency control reserves provided by EDF Producer

Day	Time	EDF Producer	RTE
$D-1$	11:00	RTE's demand is entered into ARGOS	RTE sends the demand for primary and secondary frequency control reserves to all the producers
$D-1$	13:00	APOGEE is run taking into account all the available constraints given by the operators from all the sites. Run-of-river hydro and special agreements are not considered	-
$D-1$	13:30	From the dispatch given by APOGEE, CANYON is launched to obtain a feasible hydro dispatch. The operators re-dispatch the generation and take into account the last constraints	-
$D-1$	16:00	EDF Producer sends its dispatch to RTE (<i>programme d'appel</i>)	-
$D-1$	-	-	RTE runs simulations for the French power system with the dispatches from all the producers. RTE validates these dispatches or makes modifications through the balancing mechanism to obtain the <i>programme de marche</i>
D	up to $H-2$ ⁸³	EDF Producer can modify its dispatch under some conditions	RTE uses the balancing mechanism to change the schedules. RTE sends the dispatch instructions to the units (this task will be performed by EDF Producer in the future)
D	H	EDF Producer provides the frequency control services in real-time	RTE controls in real-time the provision of the services (see section 4.8.4.1)

⁸³ Actually, producers cannot re-declare their production dispatch at any time. They can do it only at specific times every hour.

3.3.3 Principle of the de-optimisation cost calculation

The de-optimisation cost is one main component of the variable cost of frequency control ancillary services (see section 3.2.2). Since RTE requests frequency control reserves only one day ahead (see section 3.3.2), EDF Producer may wonder what the cost of this demand is going to be, compared to the cost of deciding on $D-1$ not to provide these reserves. In other words, this study proposes to estimate the de-optimisation cost due to the day-ahead request for reserves from RTE.

To calculate this cost, APOGEE is used to run two simulations: one with the reserve provision and a second one without any demand for frequency control reserves (see Figure 3.4). Both of these dispatches are fictitious because the dispatch proposed by APOGEE does not correspond to the ultimate dispatch. Indeed, CANYON and the operators change the dispatch of APOGEE (see section 3.3.2). The cost difference between the two dispatches gives the de-optimisation cost, as expressed in (3.1), where $C_{with\ reserves}^D$ and $C_{without\ reserves}^D$ are the dispatch costs for the day D with and without providing reserves, respectively; and $C_{de-optimisation}^D$ the de-optimisation cost for the day D .

$$C_{de-optimisation}^D = C_{with\ reserve}^D - C_{without\ reserve}^D \quad (3.1)$$

This de-optimisation cost is a short-term value because all the previous optimisations (from tens of years ahead to several days ahead) have considered the provision of frequency control ancillary services, so the day-ahead constraints would have been different without providing reserves in the long run. For example, it is probable that the start-up of nuclear power plants could be better optimised if no ancillary services are required. Moreover, in this study, the results obtained for one day do not modify the constraints of the following days. For example, more water is likely to be available after one day with the demand for reserves equal to zero than after a day with the initial demand for reserves. However, the water levels of the following days are not modified here as the initial operational constraints are kept for each day. Therefore, *the short-term de-optimisation cost calculated in this study is likely to give an underestimate of the actual de-optimisation cost.*

So far, such a study has never been conducted in the literature. Indeed, previous publications were either not focused on the de-optimisation cost or were considering a fictitious portfolio for a limited number of days and with a non-dedicated algorithm [e.g.,

Hirst and Kirby (1997), Proctor (2001), Wu *et al.* (2004), Galiana *et al.* (2005), Ortega-Vazquez and Kirschen (2007)]. On the other hand, the proposed method is practical because the computation burden is manageable and because it acknowledges that doing again the whole optimisation process without considering the reserve provision is practically impossible, since too many parameters are likely to change. This method is also realistic, because the constraints and the portfolio are actual data. Lastly, the optimisation algorithm used is complete and adapted to the problem, as it has been specifically developed by EDF over tens of years.

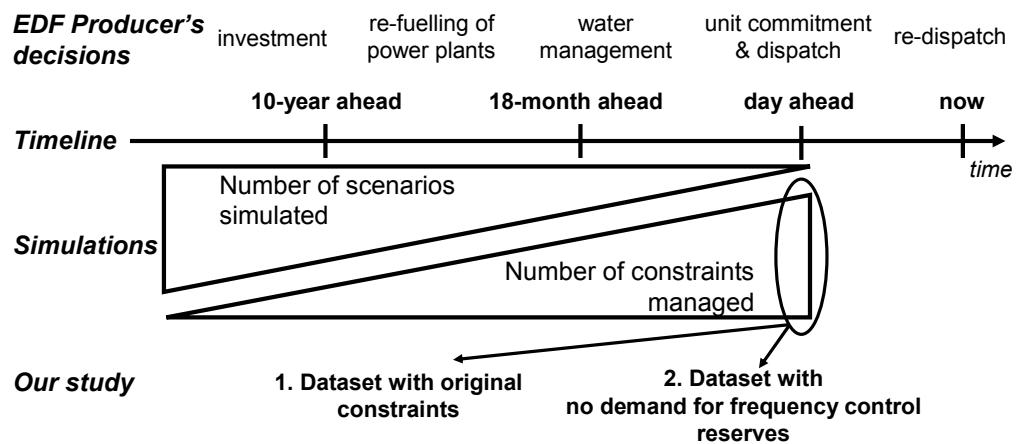

Figure 3.4: The two datasets considered to calculate the de-optimisation cost

3.3.4 Data considered

This section briefly presents the data used in this study.

3.3.4.1 Inputs of the model

All the input data considered in this study are those available to APOGEE at around 13h00 on $D-1$ (see Table 3.1). The first run of our study has the operational data as input, without any change. On the other hand, the second run uses as input the operational data with the reserve demand set to zero. However, even if the demand is zero, units can still provide reserves for this second run, because:

- ✓ Units that have been pre-scheduled with reserve prior to the APOGEE run are still providing reserves;
- ✓ APOGEE may estimate that it is cheaper to dispatch reserve than not to provide any.

3.3.4.2 Available datasets

APOGEE uses text files as inputs and outputs. To give an idea of the quantity of data to manipulate, a dataset for one day represents around 60 text files and 6 MB. Table 3.2 shows the periods studied and the available data. A non-valid day is a dataset for which APOGEE was not able to run, usually because of files lost during the process of archiving the operating data. In addition, the data from 01/01/2006 to 24/06/2006 were unfortunately not available. The present study is therefore based on 879 valid days, which is a sufficient large number to give significant results. In addition, note that each day represents 48 half-hourly time steps, so 42 192 valid half-hours are included in this study.

Table 3.2: Periods considered in the present study

From	To	Number of days	Number of valid days	Number of non-valid days	Percentage of non-valid days
08/09/2004	31/12/2005	480	460	20	4.2 %
25/06/2006	30/08/2007	432	419	13	3.0 %
Total		912	879	33	3.1 %

3.3.4.3 Hypotheses for missing data

As shown in Table 3.2, some datasets were not available. These missing data are simply ignored when frequency distributions⁸⁴ are calculated. However, it is important to complete this missing data to capture any seasonal effects (see section 3.4.2).

These missing data cannot be arbitrary set to zero because this will unbalance the series. Therefore, a moving average is used: the average of previous and next data is calculated to obtain the missing data $x_{extrapolated}$, as expressed in (3.2), where x is the series considered and $window$ the width of the extrapolation (an odd integer larger or equal to three). This approach is more accurate if the series has a strong autocorrelation. For the special case of time steps, time step 1 is completed by averaging all the time steps 1 from $D-i$ and $D+i$, where i varies from 1 to the half of the window, and so forth for the 47 remaining time steps. The size of the window actually does not matter too much since the number of non-valid data is low. However, this window was chosen as a function of the seasonality of the series. Lastly, note that this extrapolating method does not differentiate working and non-working days.

⁸⁴ See Appendix A.1 for an explanation of the basic statistics and methods used in this thesis.

$$x_{\text{extrapolated}}[D] = \frac{\sum_{k=D-\frac{\text{window}-1}{2}}^{D-1} x[k] + \sum_{k=D+1}^{D+\frac{\text{window}-1}{2}} x[k]}{\text{window} - 1} \quad (3.2)$$

3.3.4.4 Other data

The RTE's reserve demand for EDF Producer, as well as EDF Producer's *programme d'appel* (see Table 3.1), have been retrieved as spreadsheets from 01/01/2005 to 31/08/2007.

The target frequency of the secondary frequency control for each day during this period has also been provided (i.e., 49.99, 50.00 or 50.01 Hz, see section 2.3.4.3). These data are useful to calculate the cost of time control (see section 3.6), since the target frequency impacts the volume of frequency control reserve.

3.3.5 Hardware and software used

This section describes briefly the hardware and software used in this study.

3.3.5.1 APOGEE

As presented in section 3.3.2, APOGEE optimizes EDF Producer's thermal units and hydro valleys over two days (i.e., 96 half-hourly time steps). In an optimisation problem, the *primal problem* is to minimize the objective function $f(x_1, x_2, \dots, x_n)$ subject to the j constraint functions $\omega_j(x_1, x_2, \dots, x_n)$, where (x_1, x_2, \dots, x_n) are the *primal variables*, for which the values are in the feasible set:

$$f(x_1^*, x_2^*, \dots, x_n^*) = \min_{x_1, x_2, \dots, x_n} f(x_1, x_2, \dots, x_n) \text{ subject to } \omega_j(x_1, x_2, \dots, x_n) = 0 \quad (3.3)$$

The primal problem is often difficult to solve directly because the constraints create a coupling between the primal variables, so the *dual problem*, which leads to the same solution if the objective function $f(x_1, x_2, \dots, x_n)$ is strongly convex⁸⁵, is often used instead and is defined as:

$$L(x_1^*, x_2^*, \dots, x_n^*, \lambda_1^*, \dots, \lambda_j^*) = \max_{\lambda_1, \dots, \lambda_j} \min_{x_1, x_2, \dots, x_n} L(x_1, x_2, \dots, x_n, \lambda_1, \dots, \lambda_j) \quad (3.4)$$

⁸⁵ A *strongly convex two-dimension set* is a set for which the segment between any pair of its points is contained in the set, boundaries excluded. A *real function* is strongly convex if the set of points lying on or above its graph forms a strongly convex set.

where $(x_1^*, x_2^*, \dots, x_n^*, \lambda_1^*, \dots, \lambda_j^*)$ is the solution of the problem, $\min_{x_1, x_2, \dots, x_n} L(x_1, x_2, \dots, x_n, \lambda_1, \dots, \lambda_j)$ the Lagrange dual function and L the Lagrangian function defined as:

$$L(x_1, x_2, \dots, x_n, \lambda_1, \dots, \lambda_j) = f(x_1, x_2, \dots, x_n) + \lambda_1 \omega_1(x_1, x_2, \dots, x_n) + \dots \quad (3.5)$$

and where $(\lambda_1, \dots, \lambda_j)$ are called the *Lagrange multipliers*. They represent the worst penalty that can be applied to the violations of constraints (the worst constraints imply that the solution found is the best). Note that the dual problem is feasible only if it is separable (i.e., if the primal objective function and the constraints are additive, or in other words, if the minimum of the Lagrangian function can be found for a given set of Lagrange multipliers). This method consisting in putting the constraints into the objective function is often called dual optimisation technique or *Lagrangian relaxation* [e.g., Lasdon (1968), Wood and Wollenberg (1996), Bertsimas and Tsitsiklis (1997) or Kirschen and Strbac (2004a)].

To find the solution of the dual problem, APOGEE uses an algorithm based on the price decomposition (see Figure 3.5) [Lemaréchal (2004)]. The coordination algorithm increases or decreases the prices for power and reserves as a function of the mismatch between the target and the dispatch. These prices are the Lagrange multipliers. The sub-problems are then optimised individually, where each thermal sub-problem is solved using Dynamic Programming (DP)⁸⁶ and each hydro sub-problem is solved using Linear Programming (LP)⁸⁷. Each sub-problem maximizes the profits that would arise if the Lagrange multipliers were prices that could be turned into income. Note that the generation cost of hydro is equal to the value of water times the quantity of water released. In addition, every group has a penalty to switch from reserve provision to no reserve provision (and vice versa). This cost has no physical meaning, and is only a penalty to “encourage” APOGEE to propose a “smooth” program, i.e. that avoids erratic switchings.

Following this first optimisation, the dual variables (i.e., the prices for power and reserves) are obtained. A second optimisation is then performed to fine-tune the first solution. The augmented Lagrangian method is used in this case [Cohen (1978)]. To calculate the cost of the whole dispatch, APOGEE penalizes the gap between the target

⁸⁶ A DP problem is modelled as a set of various states. The optimisation algorithm then tries to maximize the gain to switch from different states.

⁸⁷ In a LP problem, the objective function to solve is a set of linear functions. In APOGEE, the simplex method is used to solve this problem.

and the dispatch for power and reserves. Penalties are the same for all the first 48 time steps of the day. They then decrease by 5 % per time step.

Concerning APOGEE's convergence performance, the same penalties and the same number of iterations are applied to the two dispatches of a given day (i.e., with and without reserves). However, note that these penalties and the number of iterations have actually evolved over the period studied, as a function of computing power and operational policies.

The reader should keep in mind the various limits of APOGEE:

- ✓ The modelling of hydro units simplifies the optimisation problem. Indeed, as soon as a hydro unit provides energy, the model dispatches it to provide reserves as well. This modelling brings a strong bias (see section 3.4.4);
- ✓ The tertiary reserve is not included in the calculated de-optimisation cost because it is currently not optimised by APOGEE two days (whereas it could do so). Indeed, EDF Producer and RTE agreed that specific units (some hydro units and gas turbines) provide this reserve;
- ✓ The re-dispatch by the operators is by definition not modelled;
- ✓ The costs considered in APOGEE are only the variable costs (e.g., the variable cost of nuclear units is very low in APOGEE, whereas their average cost is much higher);
- ✓ Some costs, such as the value of water, are not physical. Instead, they represent an evaluation of the use of a limited resource (e.g., the water that falls from the sky or nuclear fuel that cannot be refilled easily). Note that the hydro cost may be negative if reservoirs have higher levels of water at the end of the day than they had at the beginning;
- ✓ APOGEE manages some constraints by simply giving a cost to these constraints, whereas COCKPIT calculates the cost from the actual dispatch (e.g., APOGEE penalises a group that switches from frequency control provision to no provision, whereas this cost is not physical). Therefore, the dispatch cost calculated by APOGEE is less precise than the cost issued from COCKPIT and errors of some tens of k€ may affect the results;
- ✓ As shown previously, the marginal costs are actually the dual variables in the solution of the first optimisation problem;
- ✓ APOGEE does not converge exactly. Therefore, a financial penalty has to be attributed to the gap in order to compare the costs of dispatches. This penalty is obtained by

multiplying for each time step the gap with its corresponding marginal cost (see section 3.3.6).

From a practical point of view, APOGEE runs under Linux. An APOGEE simulation lasts on average between 15 and 20 minutes on a dedicated machine (bi-processor Intel® Xeon® 3.20 GHz, 1 MB of cache and 1 GB of RAM). APOGEE is stored as an executable file, and a Korn Shell (KSH) script has been developed in our study to automatically call APOGEE for a large number of datasets. The executable file used in this study was the APOGEE version from August 2007. Note that the original datasets (i.e., with the reserve constraint) have been run again with this executable in order to be able to compare the two dispatches. This takes care of the fact that the original datasets had been optimized with previous versions of APOGEE.

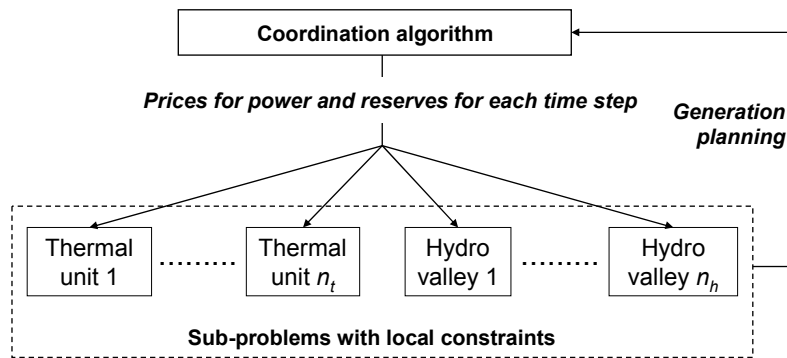

Figure 3.5: APOGEE algorithm

3.3.5.2 OTESS

APOGEE uses text files as inputs and outputs (around 6 MB/dataset). In order to manage such a large set of data (1 758 valid days and 10 GB of data), a specific tool has been developed in this study, named OTESS (*OuTil pour l'Etude des Services Système* - Tool for the study of ancillary services) and described in more details in Appendix A.2. The purpose of this tool is to modify the APOGEE input datasets, store the APOGEE output data in a relational database and then to study the data through a web-based interface (see Figure 3.6). The main features of OTESS are the following:

- ✓ Handle and modify inputs and outputs of EDF's dispatch algorithm;
- ✓ Extract the selected data from the APOGEE output files and store them into a relational database;

- ✓ Store any kind of additional data in its database, such as such as the target frequency, the balancing mechanism prices or the final dispatch planning (the *programme d'appel*);
- ✓ Easily modify data with user-defined scripts;
- ✓ Allow complex querying on cross-related tables;
- ✓ Display data with various graph types directly from queries (e.g., scatter plots or frequency distributions). Most of the graphs of this chapter are extracted from OTESS;
- ✓ Perform basic data mining techniques;
- ✓ Export data under various formats (e.g., CSV or XML⁸⁸);
- ✓ Share data between users since it is a server-based software with a web-based human-machine interface;
- ✓ Run on both Linux and Windows environment;
- ✓ Based on free software;
- ✓ Is strongly modular since it is object-oriented.

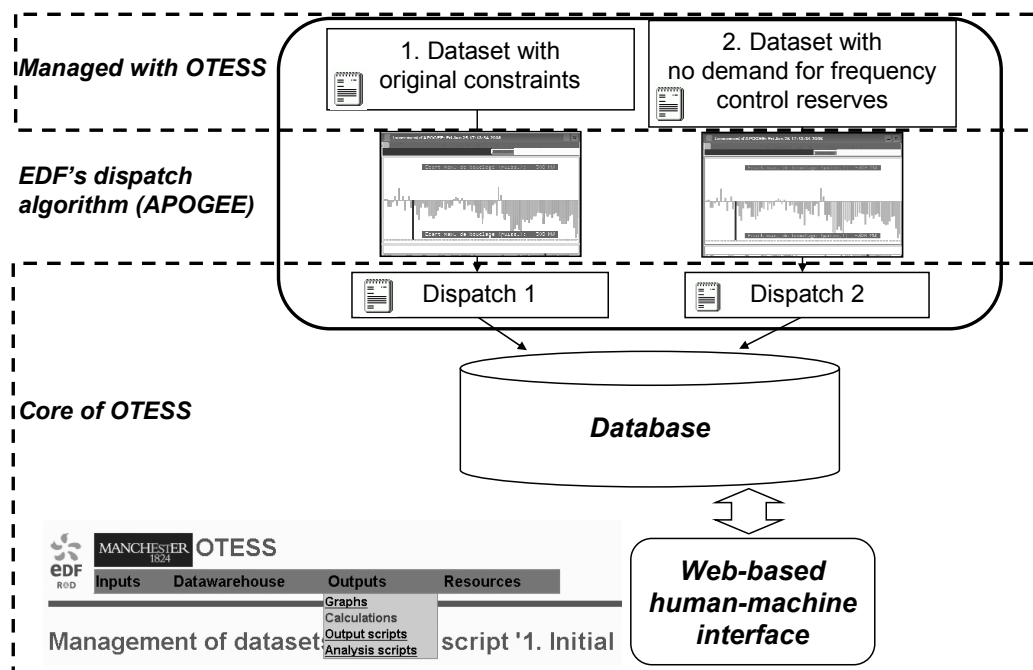

Figure 3.6: Principle of OTESS

3.3.5.3 NAG add-in for Excel

The partial autocorrelation function (PACF) is useful to identify seasonality components in a time series (see Appendix A.1). As the algorithm of the PACF is relatively complex, it has

⁸⁸ CSV stands for Comma-Separated Values and XML for Extensible Mark-up Language

not been implemented in OTESS yet. Instead, the Microsoft® Office Excel® statistical add-in from Numerical Algorithms Group (2007) has been used in this study after having exported the data under CSV format.

3.3.6 Cost calculation

In this study, the dispatch cost is directly extracted from APOGEE, and not from COCKPIT. Therefore, some errors of tens of k€ may mar the results because APOGEE does not exactly calculate the cost from the actual dispatch (see section 3.3.5.1).

In addition, APOGEE does not converge exactly, as shown by the frequency distributions of Figure 3.7, which represent the difference between the target value for a given time step and the value actually dispatched by APOGEE. Note that the convergence is better for reserves than for energy because the penalties are higher for the former than for the latter. Since APOGEE does not exactly converge to its target value, a money penalty has to be attributed to the gap to be able to compare costs of dispatches. This penalty is obtained here by multiplying for each time step the gap with the corresponding marginal cost. This calculation is shown in relations (3.6) and (3.7), where λ_P^i , $\lambda_{R_{sec}}^i$ and $\lambda_{R_{pri}}^i$ represent the different marginal costs, P the power dispatched during the time step (in MW), R_{sec} the secondary reserves (in MW), R_{pri} the primary reserves (in MW) and D the day of dispatch.

$$C^D = C_{tb}^D + C_b^D + \sum_{i=1}^{48} \left(\text{Penalty}_P^i + \text{Penalty}_{R_{sec}}^i + \text{Penalty}_{R_{pri}}^i \right) \quad (3.6)$$

With:

$$\begin{cases} \text{Penalty}_P^i = \lambda_P^i (P_{demand}^i - P_{dispatch}^i) \\ \text{Penalty}_{R_{sec}}^i = \max \left[0 ; \lambda_{R_{sec}}^i (R_{sec,demand}^i - R_{sec,dispatch}^i) \right] \\ \text{Penalty}_{R_{pri}}^i = \max \left[0 ; \lambda_{R_{pri}}^i (R_{pri,demand}^i - R_{pri,dispatch}^i) \right] \end{cases} \quad (3.7)$$

These relations are worth some comments and some remarks from section 3.3.5.1 have to be highlighted. First, these costs and penalties are calculated for the day D because uncertainty is too high for $D+1$ to consider gaps for $D+1$ as wrong. Second, tertiary reserve is not included in (3.6) because it is currently not optimized by APOGEE two days (whereas it could do so). Indeed, EDF Producers and RTE agreed that specific units (hydro

units and gas turbines) provide this reserve. Third, the penalty for reserves is zero when APOGEE provides more reserves than its target. Lastly, the hydro cost may be negative if reservoirs have higher levels of water at the end of the day than they had at the beginning. In addition, the hydro cost does not represent the actual cost (which is close to zero for hydro), but instead values the loss of water.

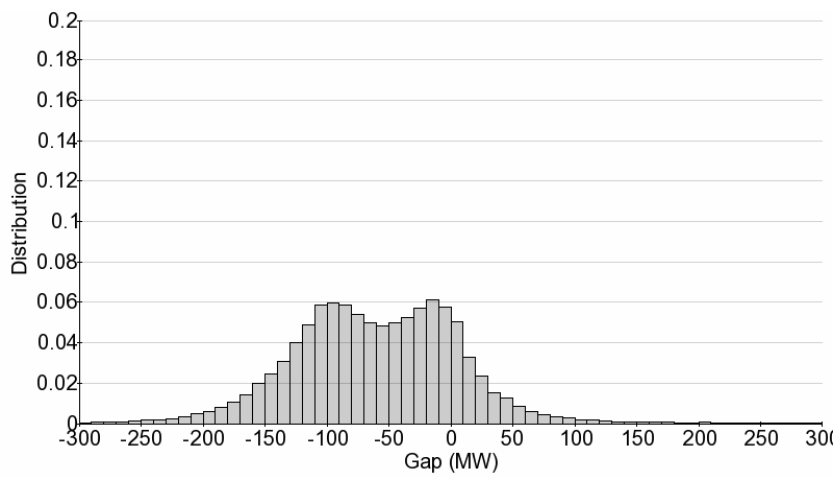

(a) Power

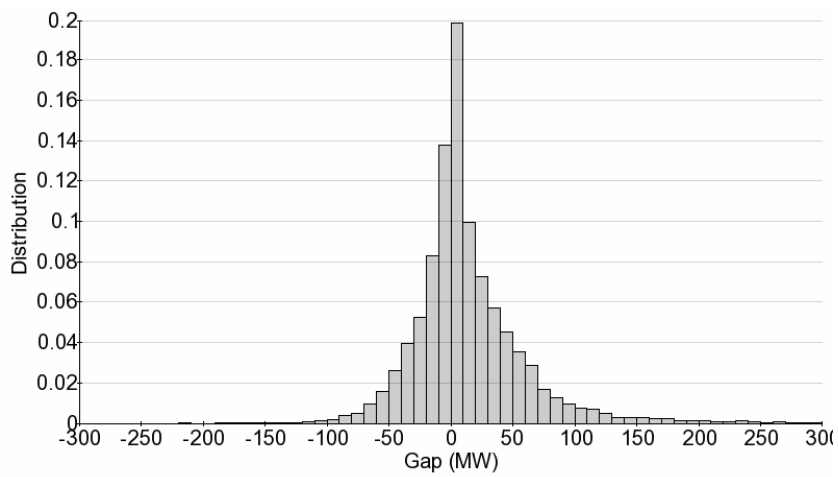

(b) Secondary reserves

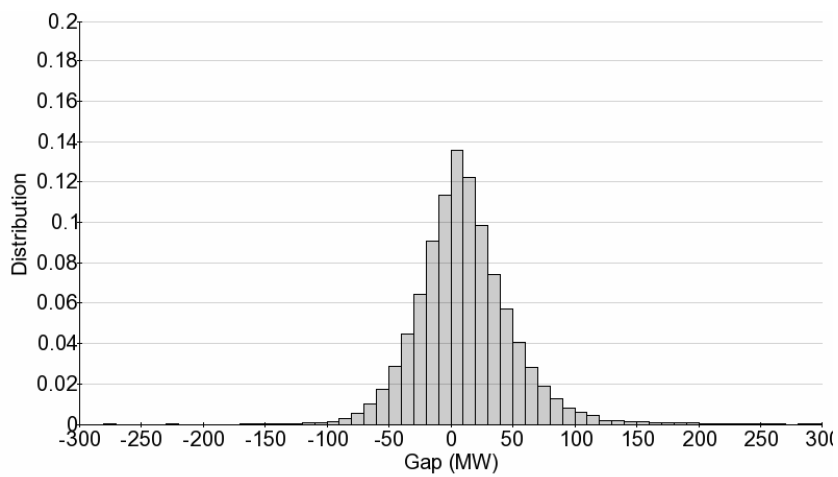

(c) Primary reserves

Figure 3.7: Frequency distributions of the gap between APOGEE dispatch and APOGEE demand for all the studied time steps between 1 and 48

3.4 Day-Ahead De-Optimisation Cost for a Producer

While the previous section presents the methodology adopted in this study, as well as the hypotheses made, this section gives the results obtained concerning the de-optimisation cost. For obvious confidentiality reasons, only data that do not reveal EDF costs, while providing essential results are given here. These results can be applied to some extent to other systems. However, the best would be to apply the same methodology with the actual portfolio and optimisation algorithm of each system.

3.4.1 De-optimisation cost over two and a half years

Figure 3.8 shows the evolution of the relative de-optimisation cost from 01/01/2005 to 30/08/2007 for all the studied days (day 1 represents the 1st of January, while day 365 is the 31st of December). The relative de-optimisation cost $C_{relative\ de-optimisation}^D$ is obtained by dividing the de-optimisation cost $C_{de-optimisation}^D$ by the dispatch cost with reserves $C_{with\ reserves}^D$, as shown in (3.8). The missing days have been extrapolated with a 7-day moving average (see section 3.3.4.3). Extrapolated points have been marked by crosses in Figure 3.8.

$$C_{relative\ de-optimisation}^D = \frac{C_{de-optimisation}^D}{C_{with\ reserves}^D} \quad (3.8)$$

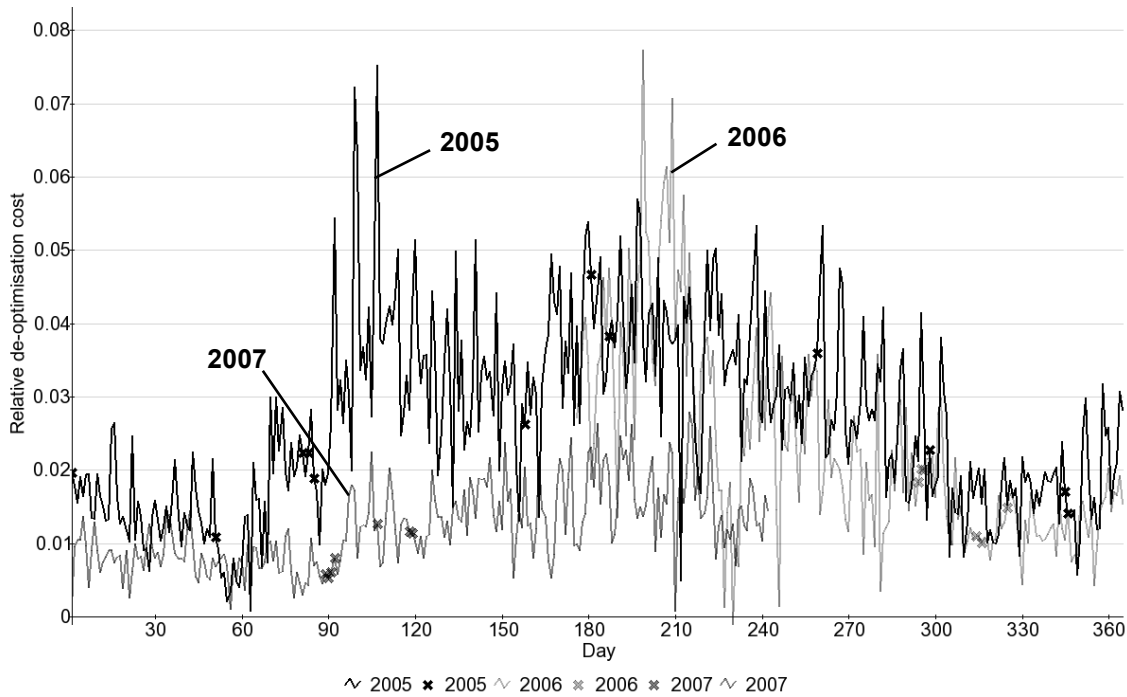

Figure 3.8: Evolution of the relative de-optimisation cost from 01/01/2005 to 30/08/2007

First, *the de-optimisation cost tends to be relatively high from the beginning of April (around day 90) to the end of October (around day 300)*, with the most expensive days in April 2005 and August 2006. The high de-optimisation cost during summer can be explained by the environmental constraints, which lead to less hydro power being available. Nevertheless, 2007 sees a low cost during the summer, which may be explained by both a better modelling of the capabilities of hydro units and a better water availability. Second, *the relatively low cost during the winter hides a high absolute de-optimisation cost*. Indeed, the dispatches are expensive during this period because the portfolio is constrained by the high demand for energy. The parameters influencing the costs will be discussed in more details in section 3.4.3.

Besides giving some hints on the parameters that may influence the de-optimisation cost, Figure 3.8 gives two important results. First, *the day-ahead de-optimisation cost is not negligible*, since it represents up to 7.8 % of the initial dispatch cost. In particular, Figure 3.9 shows the frequency distribution of the relative de-optimisation cost $C_{relative\ de-optimisation}^D$. The average of the relative de-optimisation cost calculated by APOGEE two days was equal to 2.2 % over the studied period. Therefore, this cost cannot be ignored, since it represents hundreds of millions of Euros every year. In addition, note that this result is in line with

Proctor (2001), who estimates the spinning reserve costs around 2 % of the total operating expenditure in a 16-unit system.

Second, *the day-ahead de-optimisation cost exhibits strong daily variations*. To evaluate the importance of these daily variations, we define $\Delta\%C_{de-optimisation}^D$ as in (3.9). This indicator gives the relative variation of the de-optimisation cost for D in comparison to $D-1$. The frequency distribution of this indicator is given in Figure 3.10. It is clear that the de-optimisation cost has a strong variation (greater than $\pm 20\%$ in more than 54 % of the days). The design of the market should therefore take this variation into account to help participants seize the opportunities (see Chapter 4).

$$\Delta\%C_{de-optimisation}^D = \frac{C_{de-optimisation}^D - C_{de-optimisation}^{D-1}}{C_{de-optimisation}^{D-1}} \quad (3.9)$$

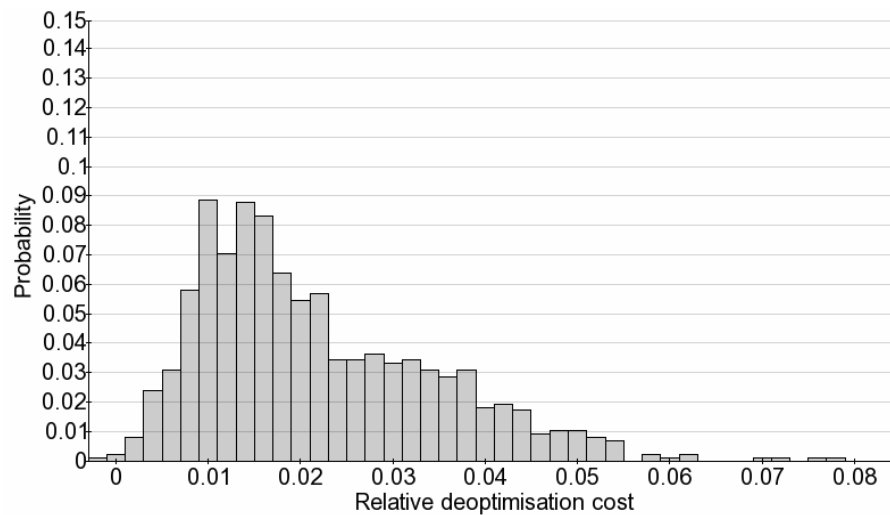

Figure 3.9: Frequency distribution of the relative de-optimisation cost for all the studied days⁸⁹

⁸⁹ The term “probability” is used here instead of “relative frequency” by misuse of language (see Appendix A.1.1).

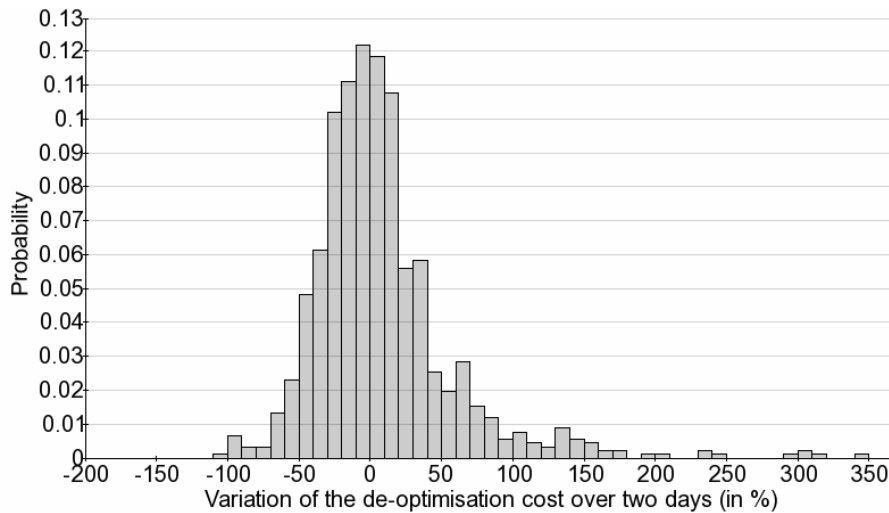

Figure 3.10: Frequency distribution of the variation of de-optimisation cost over two days for all the studied days

3.4.2 Seasonality of the de-optimisation cost

Producers are interested in any information that can help them to estimate their future costs. Therefore, a study of the seasonality of the de-optimisation cost has been performed. In addition to being useful for the producer, understanding the seasonality of the de-optimisation cost is also very useful for the policy makers (see Chapter 4). Lastly, spotting the seasonality can reduce considerably the need for further studies by concentrating calculation on specific periods. The absolute de-optimisation cost is used here instead of the relative de-optimisation cost, since this parameter is the most interesting for the producer. In addition, the seasonality results obtained with the relative de-optimisation cost turned out to be of little interest.

To investigate the seasonality of the de-optimisation cost, two complete one-year periods⁹⁰ are considered here. Figure 3.11 shows that the autocorrelation functions (ACF) for these two periods have relatively high correlation coefficients for lags of less than 30 days. In other words, the de-optimisation cost is somewhat correlated to the 30 previous days. To confirm this trend, the partial autocorrelation functions (PACF) have been drawn for various periods (see Figure 3.12 to Figure 3.15). Figure 3.12 exhibits a relatively low seasonality effect for periods greater than one week, except two peaks around 30 and 90

⁹⁰ From 01/01/2005 to 31/12/2005 and from 01/08/2006 to 31/07/2007 (see section 3.3.4.2). Missing data have been extrapolated with a 7-day window according to the method described in section 3.3.4.3. As the number of extrapolated points is low (around 3 %), it is admitted that the missing data do not bring a strong bias in this study.

days. Figure 3.15 shows a clear weekly seasonality, while Figure 3.13 and Figure 3.14 analyse in more details the two peaks around 30 and 90 days. The partial autocorrelation coefficients are however not large enough for these two peaks to be really significant. Lastly, there is no seasonality effect over longer periods, such as several months.

In conclusion, *the de-optimisation cost exhibits mainly a weekly seasonality*. Therefore, a week is likely to be the best timeframe to help estimate the future de-optimisation cost. However, it does not seem possible to select a particular period and then to generalise the result of this period over the whole timeframe. Nevertheless, the studied timeframe is probably too small to detect clear long-term seasonally effects. Hence, this study should be completed in the future by using data over a longer period.

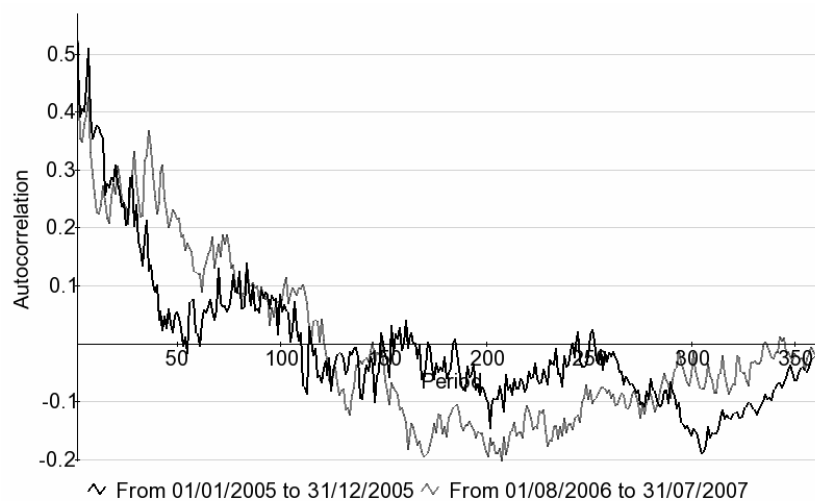

Figure 3.11: Autocorrelation function of the de-optimisation cost up to 1-year period

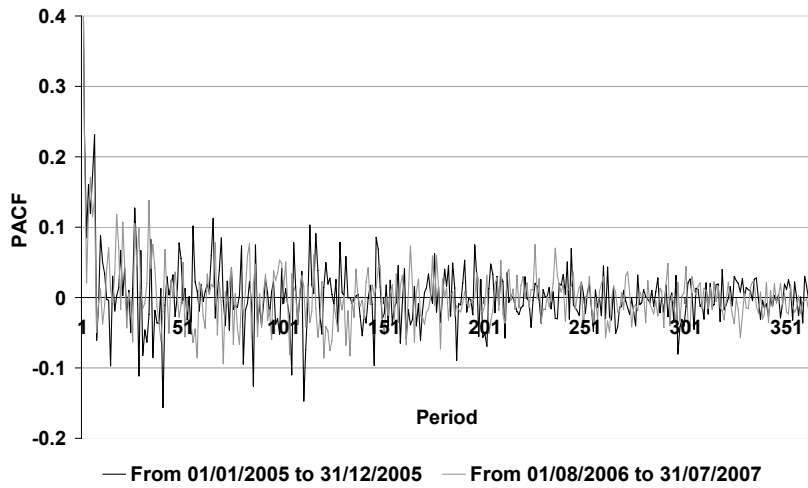

Figure 3.12: Partial autocorrelation function of the de-optimisation cost up to 1-year period

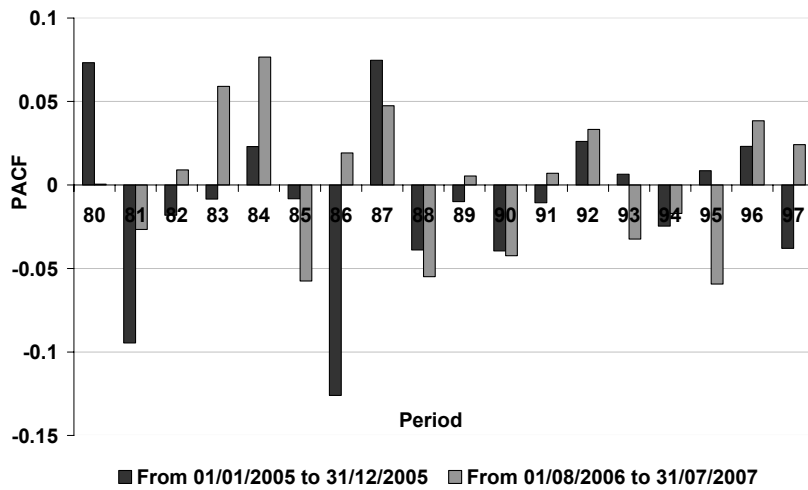

Figure 3.13: Partial autocorrelation function of the de-optimisation cost around a 3-month period

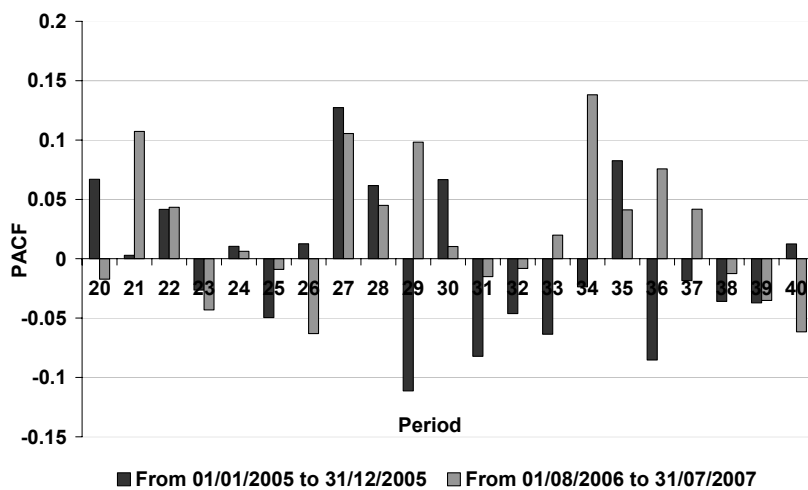

Figure 3.14: Partial autocorrelation function of the de-optimisation cost around a 1-month period

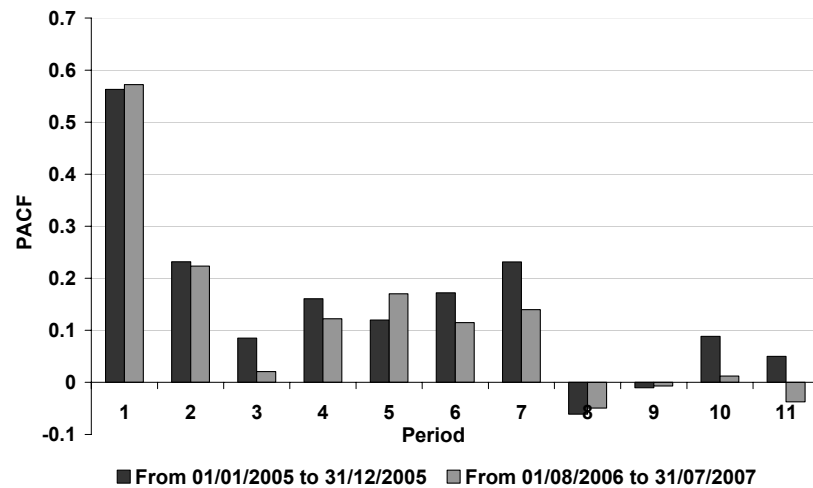

Figure 3.15: Partial autocorrelation function of the de-optimisation cost around a 1-week period

3.4.3 Parameters affecting the de-optimisation cost

From the method presented in section A.1.4, the following sections investigate the link between the de-optimisation cost series smoothed over a week according to (A.1.13) and other parameters, which have also been smoothed over a 7-day window and normalised according to (A.1.14). The 879 studied days are considered (see section 3.3.4.2). The three selected parameters amongst the parameters described in section A.2.4 are: (a) the marginal costs of reserves; (b) the demand for reserves; and (c) the thermal/hydro mix for the provision of reserve. These parameters have been selected because they influence most the de-optimisation cost according to the performed multidimensional data analysis, i.e. these parameters have high correlation coefficients with the de-optimisation cost (e.g., see the screenshot in Figure A.2.10). The results for the other parameters are thus of less interest.

3.4.3.1 Impact of the marginal costs

Figure 3.16 shows the normalized de-optimisation cost as a function of the weighted marginal cost of reserves λ_R^i , as defined in (3.10) and where the notations are similar to the ones used in section 3.3.6. Since λ_R^i is defined for each time step of the day, the data plotted here is the average over the 48 time steps of a day. It is clear that the de-optimisation cost and the weighted marginal cost of reserves exhibit a strong linear relation, confirmed by a correlation coefficient⁹¹ r_{xy} of 0.94. Figure 3.17 shows the de-optimisation cost as a function of the primary and secondary reserve marginal costs, and a similar linear

⁹¹ Values of basic statistics are defined in Appendix A.1.

relation is found. Therefore, *the expected de-optimisation cost clearly increases with the daily average marginal costs of reserves.*

$$\lambda_R^i = \frac{\lambda_{R_{pri}}^i \times R_{pri\ dispatch}^i + \lambda_{R_{sec}}^i \times R_{sec\ dispatch}^i}{R_{pri\ dispatch}^i + R_{sec\ dispatch}^i} \tag{3.10}$$

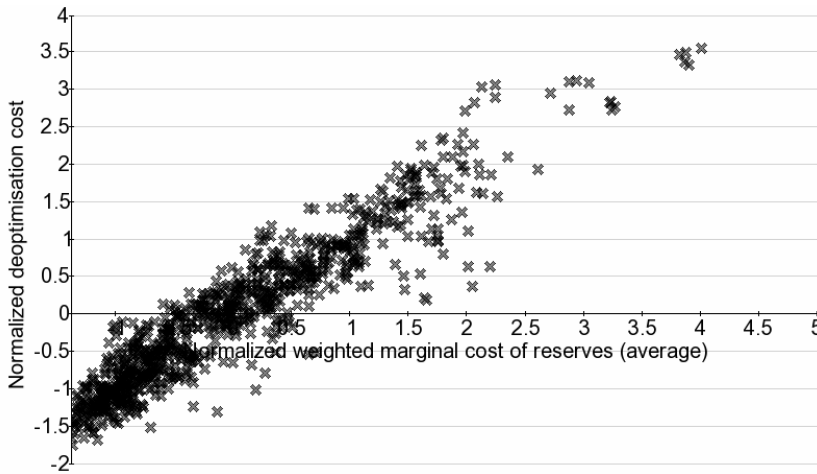
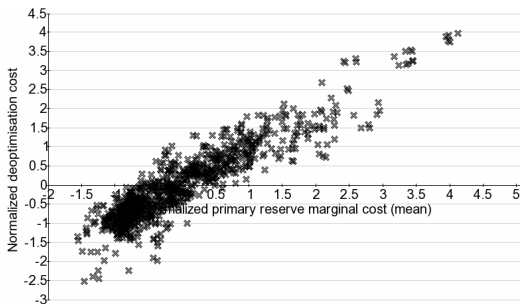
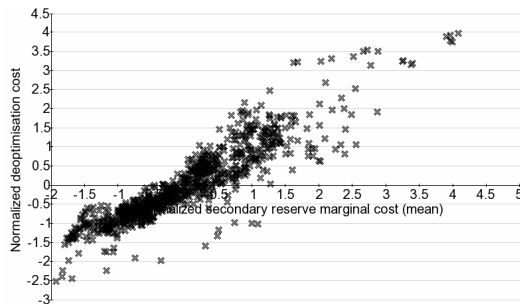

Figure 3.16: Normalized de-optimisation cost as a function of the average normalized weighted marginal cost of reserves for all the studied days ($r_{xy} = 0.94$)



(a) Primary reserve ($r_{xy} = 0.92$)



(b) Secondary reserve ($r_{xy} = 0.92$)

Figure 3.17: Normalized de-optimisation cost as a function of the average normalized marginal cost of reserves for all the studied days

3.4.3.2 Impact of the demand for reserves

Figure 3.18 shows the relation between the de-optimisation cost and the maximum primary reserve demand over the day (i.e., $\max(R_{pri\ demand}^i)$). The correlation between these two variables is not very clear, but the period spanning from 01/08/2006 to 31/07/2007 exhibits a more interesting relation (see Figure 3.19). Indeed, when the maximum demand increases, the de-optimisation cost becomes more spread with a trend for high expected values, whereas the expected de-optimisation cost is quite low when the maximum primary

reserve demand over the day is low. This relation is however not true for 2005, as shown in Figure 3.20, which explains the poor correlation over the whole study period (i.e., Figure 3.18). *The de-optimisation cost is dispersed for a given reserve amount* since the portfolio conditions may be very different for the same reserve demand. In addition, requiring high volume of reserve increases the constraints on the dispatch, so *the de-optimisation cost tends to increase for high reserve demands*.

The daily average of primary reserve demand shows a similar relation as the maximum demand for primary reserve, as shown in Figure 3.21. On the other hand, *the impact of secondary reserve on the de-optimisation cost seems to be low*, since the correlation coefficient is equal to -0.18 and since Figure 3.22 does not show any clear pattern. This is probably due to the fact that the French generating units' capabilities are twice as large for secondary reserves than they are for primary reserves (e.g., most of the French nuclear power plants allocate around 2 % of their nominal power to primary reserve and 5 % to secondary reserve⁹²). Therefore, dispatching primary reserve is more constraining than dispatching secondary reserve for the French portfolio.

In conclusion, primary reserve demand seems to have an impact on the de-optimisation cost, whereas the influence of secondary reserve has not been clearly identified. Therefore, increasing the primary reserve provision capabilities may be a good way to reduce the constraint due to primary reserve demand and thus to decrease the de-optimisation cost. In addition, *an accurate generic de-optimisation cost function depending on the demand for reserves cannot be built because the dispersion is high*. This latter subject will be investigated in more details in section 3.4.4.

⁹² Some nuclear power units, such as 900-MW plants, may be dispatched however with a 7-% provision of primary frequency control reserve.

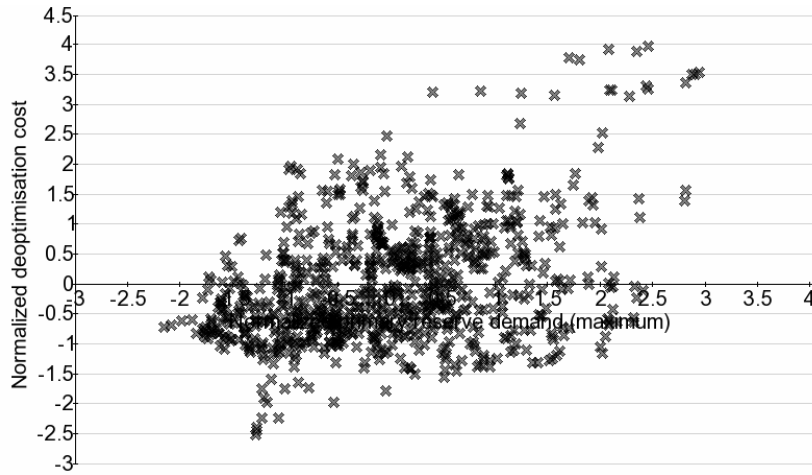

Figure 3.18: Normalized de-optimisation cost as a function of the maximum normalized primary reserve demand for all the studied days ($r_{xy} = 0.39$)

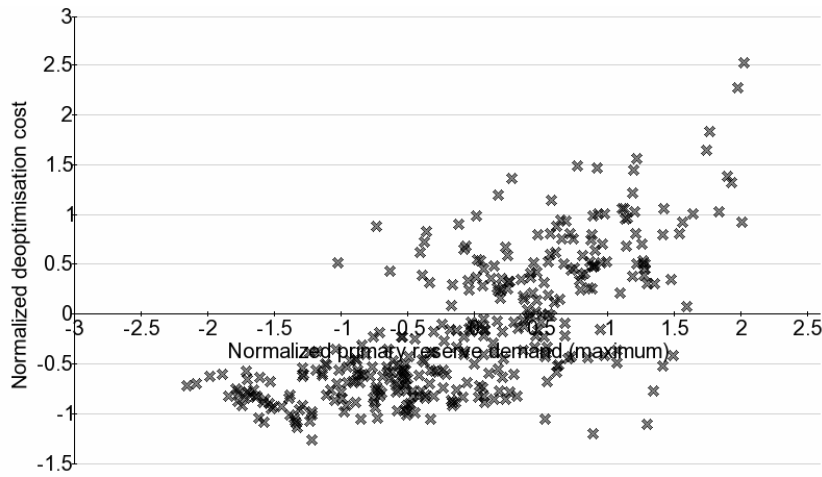

Figure 3.19: Normalized de-optimisation cost as a function of the maximum normalized primary reserve demand from 01/08/2006 to 31/07/2007 ($r_{xy} = 0.71$)

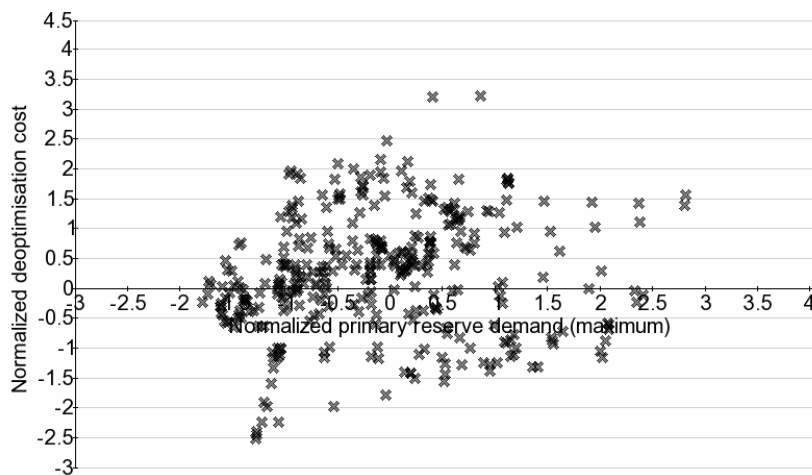

Figure 3.20: Normalized de-optimisation cost as a function of the maximum normalized primary reserve demand from 01/01/2005 to 31/12/2005 ($r_{xy} = 0.13$)

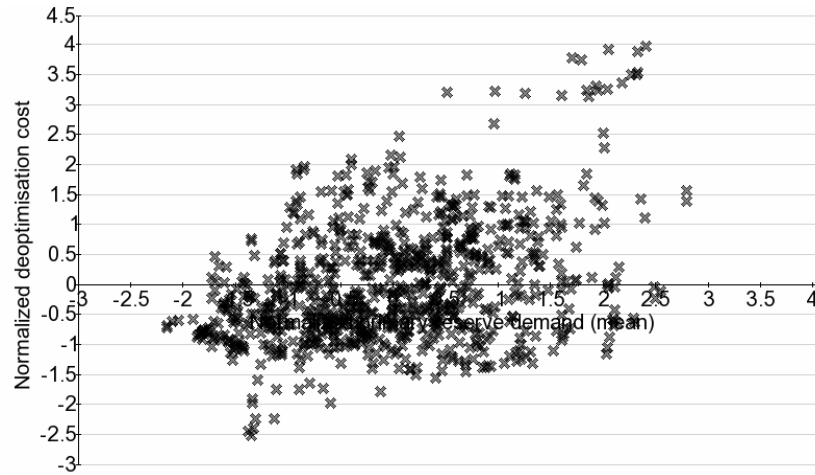

Figure 3.21: Normalized de-optimisation cost as a function of the mean normalized primary reserve demand for all the studied days ($r_{xy} = 0.38$)

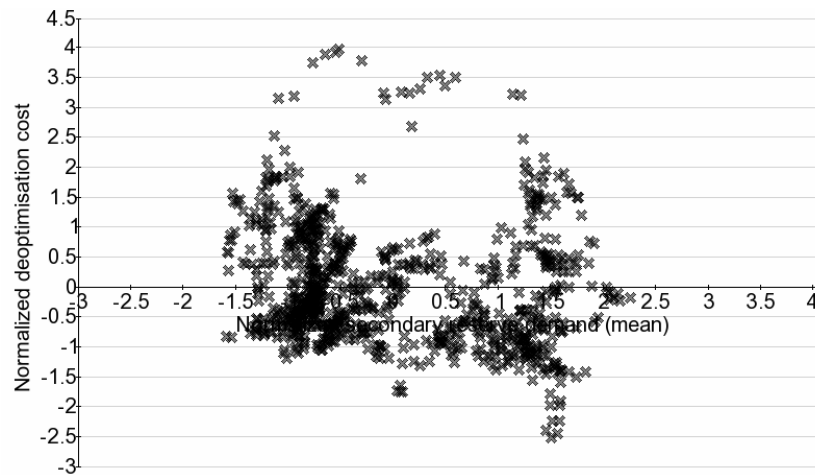

Figure 3.22: Normalized de-optimisation cost as a function of the mean normalized secondary reserve demand for all the studied days ($r_{xy} = -0.18$)

3.4.3.3 Impact of the thermal/hydro mix

Figure 3.23 shows the relation between the de-optimisation cost and the minimum thermal share for reserve $\min(\text{share}_{th}^i)$ over the day. The thermal reserve share share_{th}^i for a time step i is calculated as shown in (3.11). When the minimum thermal share is high, the de-optimisation cost tends to be high as well. In other words, *when hydro cannot be used extensively to provide reserves for some critical time steps, the de-optimisation cost tends to be high*. As a corollary, thermal participation to reserves tends to be expensive for some critical time steps. This link between hydro participation and de-optimisation cost is explained in section 3.4.4.

$$\text{share}_{th}^i = \frac{R_{pri\ dispatch\ th}^i + R_{sec\ dispatch\ th}^i}{R_{pri\ dispatch}^i + R_{sec\ dispatch}^i} \quad (3.11)$$

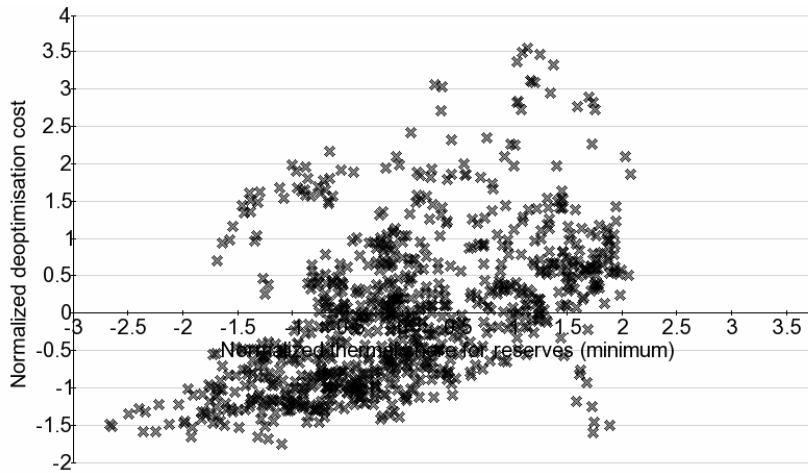

Figure 3.23: Normalized de-optimisation cost as a function of the minimum reserve share provided by thermal units for all the studied days ($r_{xy} = 0.44$)

3.4.4 De-optimisation cost and demand for reserves

As shown in section 3.4.3.2, the de-optimisation cost is linked to the daily average reserve demand, but the relation is not straightforward. Therefore, this section attempts to provide an insight on this relation by analysing the evolution of the de-optimisation cost for a given day as a function of the reserve demand. Thursday 24 May 2007 is considered here, because this is a recent day with an average de-optimisation cost. Indeed, the relative de-optimisation cost for this day is around 1.9 %, whereas the average is 2.2 % for all the studied days (see section 3.4.1). The initial demand for reserves has been multiplied by a coefficient ranging from 0 % to 100 %, with a step of 1 %. As 100 % correspond to the simulation with the initial demand and 0 % to the simulation without reserves, 98 additional simulations have been launched for this study.

Figure 3.24 shows the relative de-optimisation cost $C_{relative\ de-optimisation}^D(X)$ as a function of the average reserve demand over the day. This de-optimisation cost is redefined as shown in (3.12), where $C_{with\ X\ \%\ of\ initial\ reserve}^D(X)$ corresponds to the dispatch cost when the demand for reserves is equal to $X\%$ of the initial demand, with X ranging from 0 to 100. The average amount of reserves along the horizontal axis is obtained by summing the demand for primary and secondary reserves over the 48 steps of the day, and then by dividing this sum by 48. Below an average demand around 500 MW (i.e., one third of the total reserve demand), reserves do not cause any supplemental cost for APOGEE according to our hypotheses (see section 3.3.3) and the model's limits (see section 3.3.5.1).

In fact, the de-optimisation cost $C_{relative\ de-optimisation}^D(X)$ calculated by APOGEE is constant for an average demand of reserves between 0 and 500 MW. In other words, the dispatch cost $C_{with\ X\ \%\ of\ initial\ reserve}^D(X)$ is the same whatever is the provision of reserves below 500 MW. However, beyond this point, the de-optimisation cost depends almost linearly on the demand for reserves, with a slope around 2.7×10^{-3} %/MW/day, i.e. $C_{with\ X\ \%\ of\ initial\ reserve}^D(X)$ increases almost linearly beyond 500 MW of reserve. Figure 3.25 shows the schematic cost curve superimposed on the actual calculation.

$$C_{relative\ de-optimisation}^D(X) = \frac{C_{with\ reserve}^D - C_{with\ X\ \%\ of\ initial\ reserve}^D(X)}{C_{with\ reserve}^D} \quad (3.12)$$

$$C_{relative\ de-optimisation}^D(100) = 0 \quad (3.13)$$

$$C_{relative\ de-optimisation}^D(0) = C_{relative\ de-optimisation}^D \quad (3.14)$$

By analysing the dispatches proposed by APOGEE, it can be seen that a large amount of reserve is still provided despite a null demand. In other words, APOGEE considers that some reserve provided has no cost, and even may help to save money because this reserve may be useful to meet the dispatch constraints. This “no-cost reserve” is mainly provided by hydro units. In fact, 92 % of the primary reserve and 77 % of the secondary reserve initially dispatched on hydro units were still allocated by APOGEE when the demand for reserves was null (for the period from 01/08/2006 to 31/07/2007). The remainder is supplied by thermal units due to the initial constraints imposed by the operator⁹³. This choice by APOGEE in the allocation of reserves is due to the modelling and the operating constraints of hydro units. First, the participation in secondary frequency control is decided prior to APOGEE for several hydro units. Therefore, APOGEE cannot remove the reserve provision of these units, even if the demand for secondary frequency control reserves is zero⁹³. Second, since the maximum efficiency for hydro units is at 80 % of nominal power, it is usually more efficient to set a hydro group at such a level (the group thus provides reserves with the remaining capacity). Therefore, the operating procedures specify that a hydro unit should always provide reserve when producing energy. These

⁹³ Remember that the choice has been made in this study to keep all the initial operational constraints to evaluate the de-optimisation cost (see section 3.3.4.1).

procedures thus do not acknowledge that it may be more efficient to set hydro units at 100 % for some expensive time steps, though at degraded efficiency. As a consequence of these two operating procedures (i.e., pre-scheduled reserves and compulsory participation when providing energy)⁹⁴, providing reserves with hydro cause little de-optimisation cost for APOGEE, whereas there is an actual de-optimisation cost. It is important to note that the second part of the curve of Figure 3.25 is likely to give an order of magnitude of the actual constraints due to both hydro and thermal reserves. Therefore, the actual de-optimisation cost could be extrapolated by using the second part of the curve for the whole reserve demand. Furthermore, it is also important to quote that the “free hydro reserve” for the model (but which has a cost in the real world) is only available during the day, i.e. when hydro units are synchronised. At night, this is not true because French hydro units are not synchronised except some units that are able to pump water or those that cannot store water (run-of-water units). However, this type of units cannot provide reserves while pumping.

This threshold effect that leads to a non-linearity may thus explain the poor direct relation between the average reserve demand and the de-optimisation cost (see section 3.4.3.2). This relation is also in line with the conclusions of section 3.4.3.3, i.e. the de-optimisation cost calculated by APOGEE tends to increase when the hydro participation in reserve decreases.

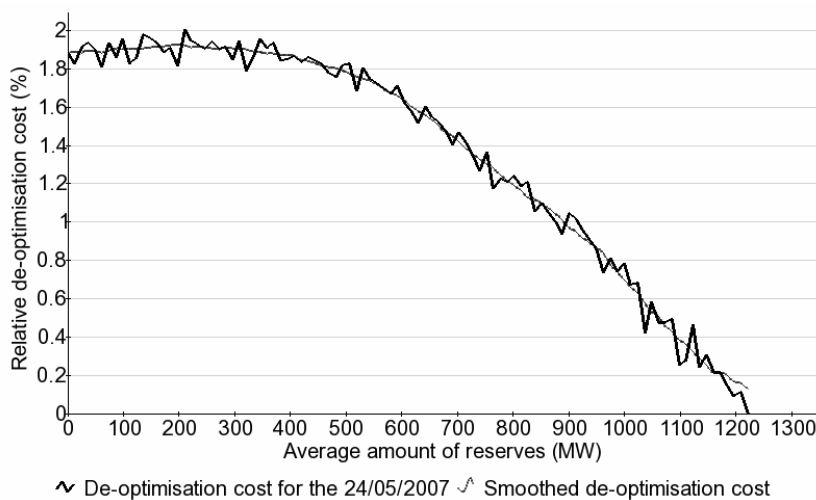

Figure 3.24: Relative de-optimisation cost as a function of the new demand for reserve for 24/05/2007

⁹⁴ These operational limitations will be removed in the short term, but will require a more complex optimisation algorithm.

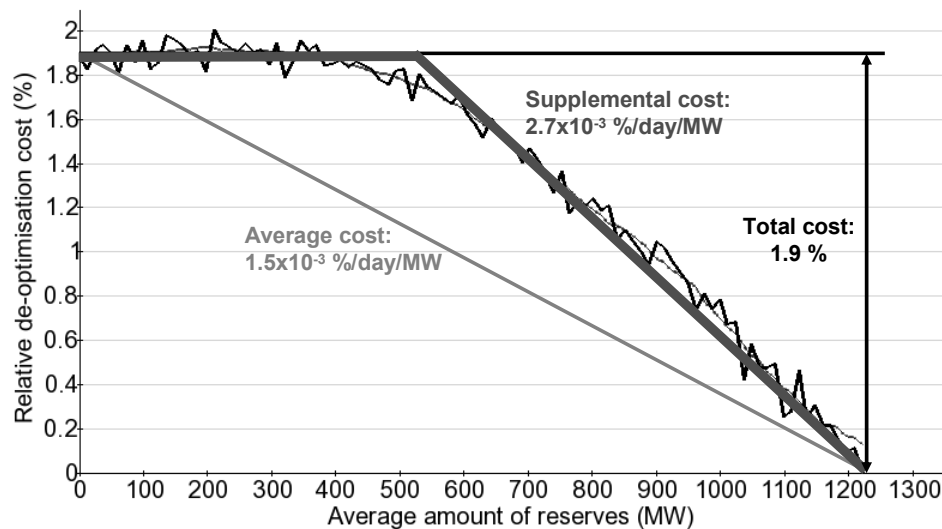

Figure 3.25: Simplified relative de-optimisation cost as a function of the new demand for reserve for 24/05/2007

3.5 Marginal Costs of Frequency Control for a Producer

Section 3.4.3.1 has shown that the marginal costs impacts the final de-optimisation cost. Indeed, the marginal costs of reserves reflect the constraints due to frequency control provided by a producer. Therefore, this section proposes to study these marginal costs. For confidentiality reasons, the absolute values are not given. Instead, comparisons between marginal costs are preferred in order to identify the binding and non-binding constraints.

3.5.1 Study of the binding constraints

The marginal costs help determine which parameter is binding in the dispatch. Indeed, the marginal cost of a product represents the cost to provide an additional unit of this product (e.g., a MW). Figure 3.26 gives the percentage of time when marginal costs of energy are higher than marginal costs of reserves as a function of the time for the 879 days studied (see section 3.3.4.2). Time step 1 spans from 00:00 to 00:30, while time step 48 spans from 23:30 to 24:00. It is clear that *the demand for energy is most of the time the most binding constraint in the dispatch*. Nevertheless, the reserves are the most binding constraint for some time steps (e.g., time step 44, i.e. from 21:30 to 22:00). Hence, the demand for one additional MW of reserve is likely to cost more than the demand for one additional MW for energy for these time steps. *It might therefore be cost effective to develop storage or load control strategies that could be used*

during critical time steps in order to allow a conversion of the cheaper energy into reserves. However, such arrangements would be profitable only if the difference between the marginal costs of reserves and energy is large enough. For confidentiality reasons, this data cannot be published here.

To assess the influence of the type of frequency control, Figure 3.27 shows the percentage of time when marginal costs for primary reserve are higher than marginal costs for secondary reserve as a function of the time of the day for all the studied time steps. It is clear that *primary reserves are usually more binding than secondary reserves*, which is in line with the results of section 3.4.3.2. Indeed, this section shows that the de-optimisation cost is more sensitive to the demand for primary reserve than the demand for secondary reserve.

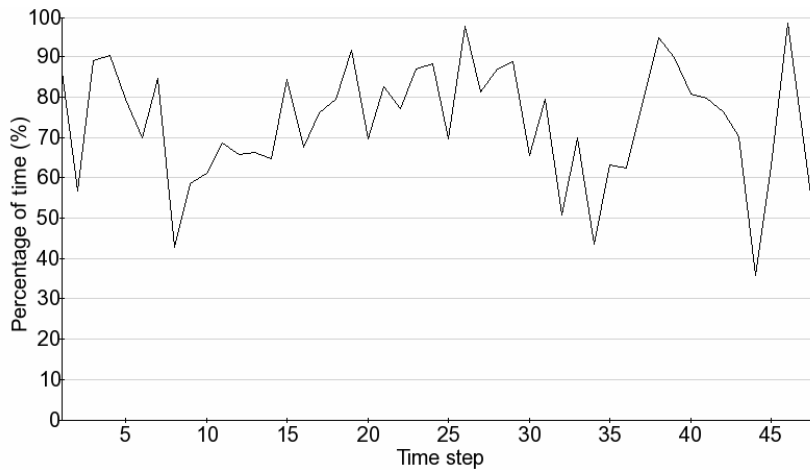

Figure 3.26: Percentage of time when marginal costs of energy are higher than marginal costs of reserves as a function of the time step for all the studied days

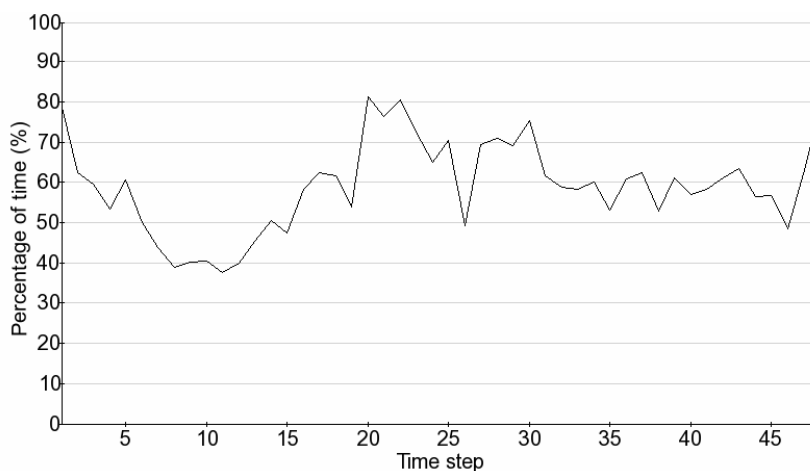

Figure 3.27: Percentage of time when marginal costs of primary reserve are higher than marginal costs of secondary reserve as a function of the time step for all the studied days

3.5.2 Study of the non-binding constraints

A null marginal cost for frequency control reserves implies that the demand for reserves is not a binding constraint. In other words, when the marginal cost for frequency control reserves is null, reserves do not de-optimize the dispatch of the producer. Figure 3.28 represents the percentage of time when the marginal costs of reserves are zero⁹⁵ as a function of the time of day for all the days in the study. In the middle of the night, i.e. between 02:00 and 06:30, the marginal costs of reserves are quite often equal to zero. Therefore, *it would be possible to increase the security of the system at least cost by increasing the demand for reserves during this period.*

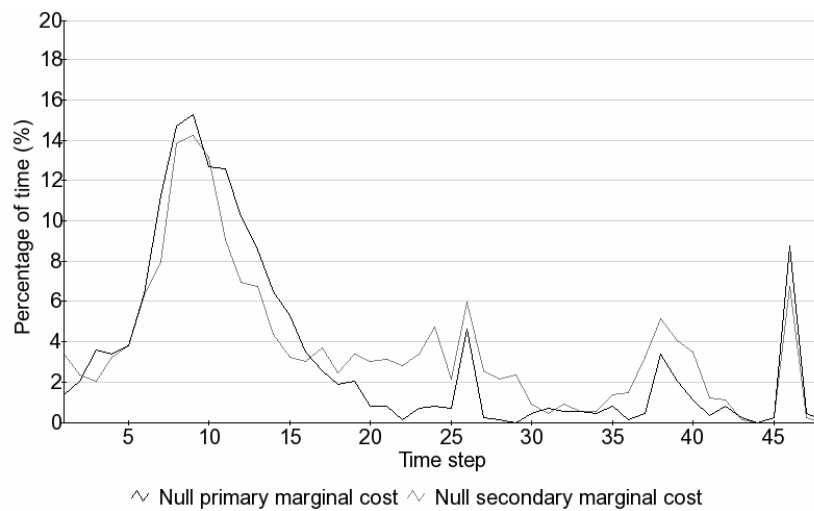

Figure 3.28: Percentage of time when marginal costs of reserves are null as a function of the time of the day for all the studied time steps

⁹⁵ More precisely, inferior to 1 (€/MW)/h.

3.6 Cost of Time Control in France

RTE modulates its demand for primary frequency reserves by ± 150 MW because of the time control. In fact, the time control modifies the system frequency, which leads to the deployment of primary frequency control power (see section 2.3.4.3). As the demand for reserves impacts the de-optimisation cost (see section 3.4.3.2), this section estimates the de-optimisation cost because of the modulation of the demand for reserves. Therefore, new simulations were launched with the following changes in the initial datasets:

- ✓ *Target frequency at 49.99 Hz*: the initial primary reserve demand is *decreased* by 150 MW for each time step of the day;
- ✓ *Target frequency at 50.01 Hz*: the initial primary reserve demand is *increased* by 150 MW for each time step of the day.

Note that these values correspond to the modulation of the demand for the whole of France. Therefore, by applying these values to EDF Producer's portfolio, the de-optimisation for the whole France can be estimated. It is thus assumed that the French cost structure is equivalent to the one of EDF Producer.

Figure 3.29 and Figure 3.30 give the frequency distribution of the relative de-optimisation cost due to frequency control for all the studied days from 01/01/2005⁹⁶. On average, the time control cost (because of an increased reserve demand) 0.46 % of the initial dispatch cost at 49.99 Hz, and saved (because of a decreased reserve demand) 0.57 % of the initial dispatch cost at 50.01 Hz. The average cost obtained with the target frequency set to 50.01 Hz has to be taken with caution, since the number of days is not sufficient to provide very significant results, and because the scattering of data is high (27 days at 50.01 Hz, whereas there were 175 days at 49.99 Hz). *The de-optimisation cost due to time control thus represents tens of millions of euros over one year.* One can thus wonder whether this cost is justified. Lastly, it is important to note that the de-optimisation cost due to time control is included in the de-optimisation cost calculated in section 3.4, since the initial demand for reserves takes into account the time control.

⁹⁶ The time control study is performed from 01/01/2005 because available data on target frequency span from 01/01/2005 to 31/08/2007 (see section 3.3.4.4).

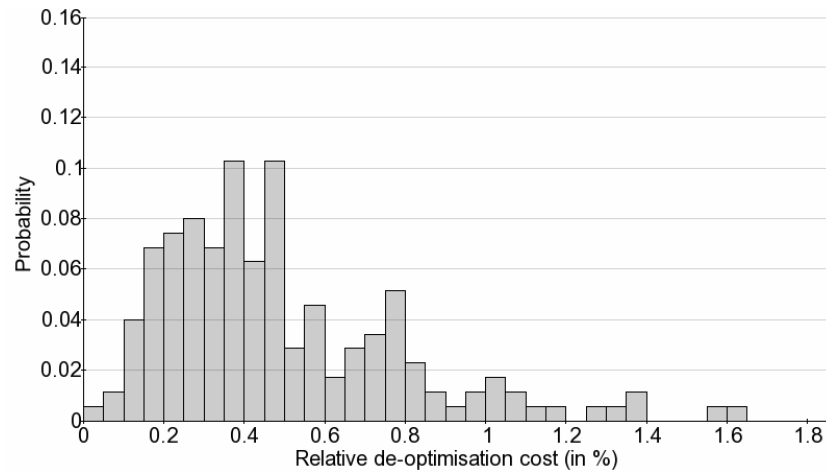

Figure 3.29: Frequency distribution of the relative de-optimisation cost due to time control with $\tilde{f}_t = 49.99$ Hz for all the studied days from 01/01/2005

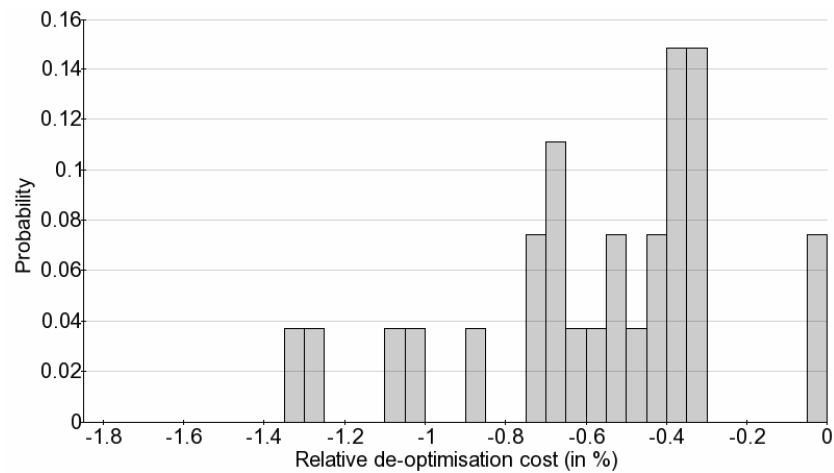

Figure 3.30: Frequency distribution of the relative de-optimisation cost due to time control with $\tilde{f}_t = 50.01$ Hz for all the studied days from 01/01/2005

3.7 Conclusion

This chapter has reviewed the main cost components of ancillary services and has proposed a methodology to estimate the day-ahead de-optimisation cost due to frequency control incurred by a producer. This methodology has been successfully applied to EDF Producer, and has provided several interesting results. Therefore, this methodology could be applied to other producers in order to perform a similar economic assessment. The main findings of this chapter are listed below. Policy makers could use these findings to assess their current policies.

✓ *Estimating the full real cost of ancillary services is impossible for a producer.*

- Ancillary services exhibit both fixed and variable costs that have each *several cost components* such as over-investment, capacity reservation or utilisation;
 - Different *inter-dependent time horizons* have to be considered, from tens of years ahead to real-time. For example, the day-ahead de-optimisation cost is linked to the over-investment that has been done several years before;
 - It may be *difficult to separate the cost due to ancillary services from the cost due to other products* such as the provision of energy. A classical example is the separation of the cost of reactive and active power provisions with an alternator;
 - The cost of ancillary services *depends on the portfolio considered* and it is *affected by many uncertainties*, especially for utilisation costs.
- ✓ One main cost component of frequency control is *the day-ahead de-optimisation cost* due to the reservation of the capacity to provide reserves. *A methodology has been proposed to estimate this cost and a specific tool, named OTESS, has been developed to apply this methodology to any producer;*
- ✓ *This methodology has been successfully applied to EDF Producer's portfolio (i.e., around 150 thermal units and 50 hydro valleys) over 879 days with actual operational data and EDF's actual optimisation algorithm;*
- ✓ The results obtained are *very helpful to assess the frequency control provision* in France. In addition, they give some hints to improve the system regarding both the technical aspects and the market design. In particular:
- *The de-optimisation cost is not negligible*, since it represents up to 7.8 % of the initial dispatch cost. In addition, this result is an underestimate because of the modelling limitations (numerous inflexible constraints for hydro units) and the methodology (short-term approach and unchanged initial constraints). Therefore, an efficient provision of frequency control reserve is essential to reduce this cost as much as possible;
 - *The de-optimisation cost exhibits strong variations* (greater than ± 20 % in more than 54 % of the days). Consequently, the market design should take this variation into account to help participants reap opportunities;
 - *The seasonality of the de-optimisation cost is relatively poor*, even if the auto-correlation of the de-optimisation cost is quite good over one week. Therefore, it does not seem possible from the timeframe considered to select a particular period and then to generalise the result of this period over the whole timeframe. In particular, results

cannot be generalized from one year to another. Hence, future studies on the de-optimisation costs have to consider a large number of days to be accurate. In addition, these further results may help to identify potential seasonalities;

- For EDF Producer, *the de-optimisation cost is sensitive to three major parameters*:
 - The *expected marginal costs*: there is a strong link between the marginal costs of reserves and the de-optimisation cost. Therefore, the marginal costs can be used as a proxy to estimate the de-optimisation cost;
 - The *primary reserve demand*: primary reserve demand has an impact on the de-optimisation cost, whereas the influence of secondary reserve has not been clearly identified. Therefore, increasing the primary reserve provision capabilities may be a good way to reduce the constraint due to primary reserve demand and thus to decrease the de-optimisation cost. Unfortunately, it is impossible to build a generic de-optimisation cost function depending on the demand for reserves because the dispersion is high;
 - The *quantity of reserves provided by hydro units*: when hydro cannot be used extensively to provide reserves for some critical time steps, the de-optimisation cost tends to be high. As a corollary, thermal participation to reserves tends to be expensive for some critical time steps. This trend is due to a somewhat simplistic modelling of hydro units in the optimisation algorithm and should be weakened in the future with more complex constraints taken into account.
- *The demand for reserves can be the most binding constraint*. Therefore, the demand for one additional MW of reserve can cost more than the demand for one additional MW of energy. It may thus be useful to develop storage or load control strategies for these critical time steps in order to allow a conversion of the cheaper energy into reserves;
- *The reserves may not be binding at all* (from the model's perspective), so the security of the system can be increased at very low cost by increasing the demand for reserves during periods when the marginal costs of reserves are low. This result is in line with the conclusion of Chapter 2 arguing the advantages of an elastic demand for reserve.
- *The de-optimisation cost due to time control represents tens of millions of euros per year in France*. The value of such an expenditure needs to be proven. ■

CHAPTER 4

PROCUREMENT OF SYSTEM SERVICES

It is often the solution directly set aside that would have been the right one.

Edouard Michelin (1859 - 1940)

4.1 Introduction

ANCILLARY services and energy are most of the time provided by the same generating units, and the provision of AS generally reduce the amount of energy that a generating unit can produce, and vice versa. Ancillary services can thus be viewed as an externality of the energy market. To manage externalities, economists recommend using property rights [Boucher *et al.* (2006)]. Property rights are the rights of an individual to own property and keep the income earned from it. If these property rights are well defined, trade between agents would result in an efficient allocation of the externality [Varian (1999)]. In other words, the externality becomes a constraint or a trade-off opportunity. In addition, Chapter 3 has shown that the cost of providing ancillary services is not negligible. These two reasons motivate the creation of a market for ancillary services to procure system services.

As capacities for energy and AS are physically linked and since AS often involve the production or consumption of energy, markets for energy and ancillary services present numerous similarities, while trying to take into account AS specificities described in Chapter 2. A lot of attention has thus been concentrated on defining pricing mechanisms to coordinate ancillary services with the markets for electrical energy in a centralised unit commitment structure. However, by focusing on centralised pricing and assuming that a spot market combined with bilateral contracts is the best model, one misses some aspects of the AS markets, which are not only crucial but also very different from what one finds in energy markets. Difficult issues that have not received enough attention include for example the procurement of AS in the long-term, a coordinated clearing of markets for energy and reserves with a decentralised unit commitment, or an allocation of the cost of AS that gives proper incentives.

This chapter identifies and discusses eight fundamental issues in the design of markets for ancillary services, namely: (1) choosing the entity responsible for AS procurement (section 4.2); (2) matching demand and supply (section 4.3); (3) choosing the relevant procurement methods (section 4.4); (4) defining the structures of offers and payments (section 4.5); (5) organizing the market clearing procedure (section 4.6); (6) avoiding price caps (section 4.7); (7) providing efficient incentives (section 4.8) and (8) assessing the procurement method (section 4.9). Addressing these eight issues is essential to the development of electricity markets that are not only efficient but also durable. This chapter does not pretend to propose a standard market design, since all market architectures should be tailor-made and evolve over time in relation to the market structure⁹⁷. Instead, it discusses current issues and proposes solutions for most of the features that a market has. In addition, it surveys actual practices in order to illustrate the discussion. This survey complements previous works by, amongst others, Kirby and Hirst (1996), Cali *et al.* (2001), Arnott *et al.* (2003), Zhong (2003), Eurelectric (2004) and Raineri *et al.* (2006).

It is assumed in this chapter that the required quantity and location of each quality of system services have been defined for the various time horizons. The discussion in this chapter is focused on the issues related to the procurement of the required system services.

⁹⁷ The market *architecture* describes how the market works (e.g., defining the auction process), while the market *structure* refers to what is traded and by whom (e.g., a lot of small companies).

Procurement is the act of ensuring the presence in the system of the necessary SS (provided in part with the help of some AS). As general rules, the procurement of system services should [Cali *et al.* (2001)]: (a) permit participants to recover the investments with enough return; (b) reduce the total cost to consumers of SS; (c) give an incentive to improve the service level; (d) find a price between the value and the cost of the service; (e) have a price setting mechanism with a reasonable transaction cost⁹⁸. The present chapter will mainly discuss the short-term procurement (say up to two or three years), even if most of the concepts are also applicable to long-term procurement.

4.2 Nominating the Entity Responsible of Procurement

The *definition* and the *deployment* of system services is a responsibility that falls naturally on the system operator, even if it does not always control directly some of these services, such as the primary frequency control ancillary service (see section 2.3.3.1). On the other hand, the Entity Responsible for Ancillary services Procurement (ERAP) can be either the system operator or some users of the system.

A tempting solution is *to put several users of the power system into competition* for the procurement of AS. For example, the load-serving entities (LSEs) of PJM must provide frequency control services such as regulation and synchronised reserve in pro rata of their load share [PJM (2008)]. This approach creates some competition between AS buyers and providers, which should result in lower prices. It also implicitly allocates the cost of ancillary services amongst LSEs. However, this approach has three weaknesses. First, the LSEs themselves are not users of AS and therefore do not know the true value of AS. Therefore, this results in an inelastic demand, which may jeopardise the match between supply and demand (see section 4.3). Second, the quantity, quality and location of system services are set by an entity that has no incentive to reduce the demand, because it does not pay for their procurement. Last, imposing such requirement on users can be a barrier to the entry of new competitors if the level of AS required from each participant is too high.

⁹⁸ This list is not exhaustive. For example, increase innovation may also be an objective of the procurement.

Another popular approach is *to designate the system operator as the single buyer*⁹⁹. This solution solves the problems mentioned above but raises others issues, common to most of regulated activities. First, the SO needs to recover somehow the costs incurred, which is an issue by itself addressed in section 4.8.2. Second, the management rules of the SO have to be transparent in order to ensure a fair treatment of all SS users, whatever their position in the industry (e.g., incumbent or new entrant). Third, as discussed in section 4.8.5, the SO should have enough incentives to optimise its procurement process. In particular, if the TO and the SO are the same entity, this entity should have enough incentives to choose the best procurement processes and not to select only the self-procurement (see section 4.4.1). In conclusion, designating the system operator as the ERAP is probably the most desirable solution if proper incentives are put in place by the regulator.

4.3 Matching Supply and Demand

If supply and demand do not match in the long run as well as in the short run, the market will fail. As shown in Chapter 1, the supply of ancillary services is mostly ensured by generating units. Marginally, other participants also provide ancillary services, such as means of storage that smooth either consumption or generation; consumers that can modulate their consumption upon request or automatically; or transmission owners that help to control voltage with purpose-built equipments. The demand for ancillary services is defined by the system operator and depends on the power system structure (see Chapter 2).

4.3.1 Long-term matching

Ideally, AS markets should provide sufficiently strong *signals to trigger investments* in new AS capacities and thus ensure in the long run: (a) enough AS to meet demand; (b) a liquid market; and (c) innovative AS resources that are competitive. However, because revenues from AS are highly uncertain and because of the long life of generating assets, no specific incentive scheme has been found yet to encourage efficient investments in AS capacity.

Therefore, the long-term supply of AS is currently ensured through the imposition of connecting conditions on generating units. Still, since AS capabilities deeply rely on the

⁹⁹ A single buyer can force the providers to supply AS (i.e., the compulsory procurement described in section 4.4).

adequacy of investments in energy generating capacity, which remains an open question in deregulated electricity markets [e.g., see Baldick *et al.* (2005) or Cramton and Stoft (2005)], the long-term procurement of AS remains an important issue. In addition, connecting conditions are likely to be non-optimal since they somewhat arbitrarily increase energy prices (because they raise the cost of building generating units) and decrease payments for ancillary services (because they artificially increase the supply of AS). Since SOs are generally responsible for both the definition of the connecting conditions¹⁰⁰ and the procurement of ancillary services, they are tempted to ask for strict requirements. Indeed, strict requirements are better for the security of the system and do not cost anything to the SO. Lastly, compulsory connecting conditions increase the barrier to entry of new competitors¹⁰¹.

Some solutions alternative to the compulsory connecting conditions have been developed to give specific signal for long-term supply. For example, in France, some geographical areas are declared as voltage-sensitive zones. If a reactive power AS provider supplies its service in one of these areas, it receives an additional remuneration [RTE (2007b)], which thus gives an incentive to invest in reactive power support. In addition, if a SO agrees on a long-term bilateral contract with an AS provider (e.g., following a tendering process), such an agreement gives the AS provider sufficient incentive to invest in new capacities.

It would also be worthwhile to explore the feasibility and desirability of incentives and connecting conditions that would *reduce the demand for AS*. For example, when intermittent generation such as wind farms represent a significant proportion of the energy mix, more stringent constraints on the output of intermittent generation could reduce the amount of frequency control that would be required otherwise.

4.3.2 Short-term matching

An adequate balance between supply and demand of AS in the long-term does not guarantee that the supply and demand of AS will match in the short-term. To cover this risk, the ERAP may rely on self-procurement or on long-term contracts. If hedging is not

¹⁰⁰ Most of the time, the legislator defines the connecting conditions. However, it usually follows the technical advice of the system operator.

¹⁰¹ See section 4.9.3 for a short discussion on barriers to competition.

possible, enough incentives should be given to AS providers to *offer their capacity in the short-term* to make enough AS available (e.g., compulsory minimum participation may be required for a market with an intrinsic concentration problem).

In addition, *an elastic AS demand*¹⁰² is essential (which is possible only when the ERAP is the SO). Indeed, Figure 4.1 illustrates the problem that appears when the supply is insufficient to meet the demand (e.g., when the system is stressed). This figure also shows that some responsiveness, even a small amount, can be enough to match supply and demand, especially when the system is constrained. In practice, demand for AS is usually very inelastic because the criteria used to define the amount of SS usually ignore the cost and the value of AS provision. However, all the system operators that buy AS have implicit non-vertical demand curves because, at some point, they will not accept to pay for additional AS¹⁰³, even if their explicit demand is most of the time totally inelastic (as shown in section 2.4). Anyway, some SOs have an explicit demand curve. For example, the New York Independent System Operator (NYISO) has a demand curve for secondary frequency control as shown in Figure 4.2 [NYISO (2008)]. In this case, if the supply is larger than the ISO's target, supply and demand will surely meet. However, this demand curve is very simple and does not reflect the true value of system services. In addition, one could argue that secondary frequency control reserve above its target is worth something (black-outs happen also at night, when frequency control reserves tend to be cheaper, as shown in section 3.5.2). Therefore, this curve could be refined.

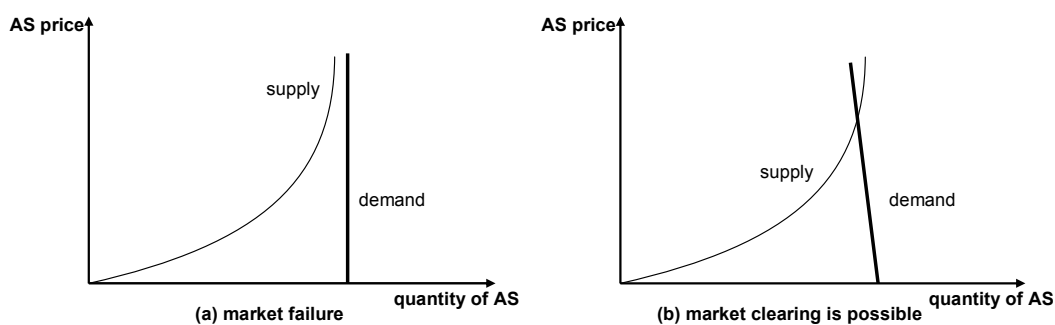

Figure 4.1: Impact of the demand responsiveness on market clearing

¹⁰² A demand is said to be elastic when it is sensitive to the price of the commodity. Note that there would probably be a cross-elasticity (which represents the link between the prices of two commodities) between active power AS and load reduction, supposing that load reduction can be priced through demand-side offers. See Kirschen and Strbac (2004a) for more details about elasticity.

¹⁰³ This limitation on demand is tightly related to the price caps discussed in section 4.7.

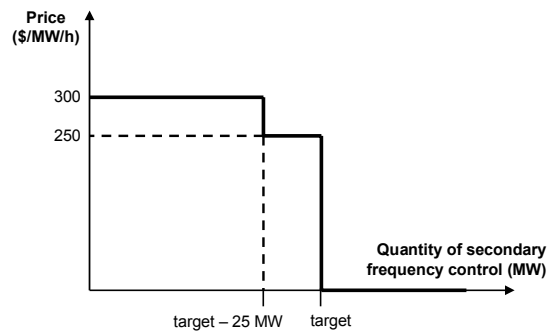

Figure 4.2: NYISO's demand curve for secondary frequency control. Data based on NYISO (2008)

4.4 Choosing the Relevant Procurement Methods

The entities responsible for AS procurement can use various methods to obtain ancillary services, namely: (a) compulsory provision, (b) self-procurement, (c) bilateral contracts, (d) tendering and (e) spot market. Various factors influence the choice of one of these methods over the others. These factors include risk aversion, market concentration, mode of energy and transmission rights trading, costs recovery method, centralised or decentralised AS control (see section 2.3.2), and the type of providers (e.g., loads are likely to prefer bilateral contracts).

4.4.1 Identified procurement methods

Compulsory provision refers to the obligation of a certain class of AS actuators connected to the network (typically large generators) to provide upon request from the TSO up to a certain amount of a given ancillary service. Compulsory provision is “fair” because all the users belonging to a certain class must provide the same absolute or relative amount of ancillary services. However, for the sake of fairness and transparency, the requirements for compulsory provision are often expressed in a manner that does not catch all the complexity of the issue. This simplification has two main consequences. First, the volume of ancillary services provided may exceed what is needed, imposing unnecessary costs on the providers. Second, compulsory provision does not necessarily minimize costs because potentially low-cost providers are treated on the same basis as more expensive ones. Lastly, note that this kind of procurement is possible only when the system operator is the unique ERAP.

Self-procurement makes reference to an ERAP that owns assets susceptible to provide AS. For example, a TSO can install static voltage compensators in its network to provide voltage control (see section 1.6.3).

When an ERAP procures an ancillary service using *bilateral contracts*, it negotiates with some providers the quantity, quality, price and delivery conditions of the service to be provided. Such negotiations could remove the two problems associated with compulsory provision because only the needed amount is procured and the ERAP can deal only with the cheaper providers. Bilateral contracts for AS are generally traded over-the-counter (OTC), which leads to forward contracts¹⁰⁴. However, bilateral contracts have disadvantages. First, since their terms are usually not disclosed to third parties, this form of procurement lacks the transparency that is desirable when one of the parties is a monopoly (e.g., if the SO is the unique ERAP). Second, bilateral negotiations can be long, complex and costly. Third, because of the high transaction cost of bilateral contracts, price and volume are often fixed for a long time, especially for OTC transactions. This will inevitably be detrimental to one of the parties if market conditions change, which is the case for AS. Section 3.4.1 shows that the cost of frequency control AS varies a lot over two successive days. However, bilateral contracts are very important in electricity markets because they allow participants to hedge against risk¹⁰⁵, especially with option contracts, and the cost of transaction may be offset by this mean. Nevertheless, if too large a part of the market is based on long-term bilateral contracts, it may be a barrier to the entry of new participants.

The fourth and fifth procurement methods involve the development of a *tendering process* or the creation of a *spot market*. Drawing a line between these two methods is not always easy. Here, the term spot market is used to denote a market where standardised products with a short delivery (i.e., one week or less) are exchanged (see section 1.3.1). A tendering process involves less standardised products with a longer duration. Both methods enhance transparency and foster competition. On the down side, they have high data management costs and may facilitate the manipulation of the market by some participants. Furthermore, a pure spot market for AS is unlikely to be implemented because markets respond too slowly. In other words, the ERAP will never be able to buy AS instantly.

¹⁰⁴ Bilateral contracts can also be traded in an organised market, where contracts are standardised and called future contracts. Note that a market trading short-delivery futures is close to the spot market (see section 1.3.1).

¹⁰⁵ Note that when risk diminishes, investments are eased.

Therefore, an AS spot market is in reality a future market with products with short deliveries and short durations. AS markets are thus incomplete¹⁰⁶, like electrical energy-only markets [Wilson (2002), Boucher *et al.* (2006)].

Table 4.1 summarizes for each procurement method some of the perceived advantages (+) and disadvantages (–). This grading is subjective and thus may change from a market participant to another. Moreover, advantages and disadvantages will be affected by the duration of the contracts. Table 4.1 shows that no method is superior to all the others. Furthermore, the importance of each parameter varies across jurisdictions (e.g., a market designer may give more importance to a procurement method that facilitates entrance of new participants, whereas another designer may prioritise market transparency). In particular, a market design relying on bilateral contracts associated with a spot market is not necessarily the best solution. As various methods are complementary, market designers are likely to choose a mix of methods, as shown in section 4.4.2.

Table 4.1: Parameters influencing the choice of AS-procurement method

	Compulsory provision	Self procurement	Bilateral contracts	Tendering process	Spot market
Mitigate the influence of dominant players	+++	+++	+	--	---
Facilitate entrance into the market of new AS providers	+	---	-/+	++	+++
Hedge against risk	++	++	+++	+	---
Lower transaction costs	++	+	-	-	-
Secure enough AS	+++	+++	+++	+++	+
Increase the global welfare	---	--	+	++	+++
Increase market transparency	+++	--	--	+	+++
Recognize the externality of AS	---	-	+++	+++	+++
Integrate demand response as an AS	--	+++	+++	++	+

¹⁰⁶ A *complete market* is a market in which every contingency can be negotiated. In other words, “there is a forward market for every commodity at every date”, as formulated by Mas-Colell *et al.* (1995), p. 745.

4.4.2 Procurement methods in practice

Table 4.2 summarizes the procurement methods chosen for the different types of ancillary services in various systems as of October 2006¹⁰⁷. As shown in section 2.3.4.1, the services used for tertiary control not related to the balancing mechanism are numerous and differ significantly from system to system. Useful comparisons are therefore not possible, so these ancillary services have not been included in Table 4.2. Primary frequency control is the ancillary service for which the widest choice of procurement methods exists. A compulsory provision for this service has the advantage of fulfilling an intrinsically homogeneous geographical repartition. Secondary frequency control is never compulsory and only France uses bilateral contracts. Sweden and Great Britain do not use this service, while other countries rely on more competitive procurement methods. By definition, the basic voltage control service is always compulsory. Bilateral contracts and tendering are the preferred trading methods for enhanced voltage control. No spot market for basic or enhanced voltage control has been put in place yet because these services are very local and therefore highly susceptible to the exercise of market power.

Table 4.2: Procurement methods chosen across various systems as of October 2006

	Compulsory provision	Bilateral contracts	Tendering process	Spot market
Primary frequency control	ES, PJM	AU, FR, NZ	DE, GB, NZ, SE	AU, NZ
Secondary frequency control	-	FR	DE, NZ	AU, ES, PJM
Basic voltage control	AU, ES, DE, FR, GB, NZ, PJM, SE	FR, NZ	GB	-
Enhanced voltage control	-	FR, DE	AU, ES, GB	-

¹⁰⁷ See Table 2.3 in section 2.3.4 for basic information on systems and the signification of the abbreviations. In addition to personal communications and the websites of the market and system operators, the following references were particularly used: AU: NEMMCO (2001), NEMMCO (2004); DE: E.ON (2005), BDEW (2007a); ES: Spanish industry and energy department (1998), Spanish industry and energy department (2000), OMEL (2005); FR: RTE (2004), French economic and industry department (2005), RTE (2007b); GB: National Grid (2008b), National Grid (2008c); NZ: Electricity Commission of New Zealand (2004), NZIER (2005), Electricity Commission of New Zealand (2005); PJM: PJM (2005a), PJM (2005b), PJM (2008); SE: SvK (2005).

4.5 Defining the Structures of Offers and Payments

The *structures of bids* are related to the scoring and clearing processes, while the *structures of payments* are related to the settlement process. A good price structure helps send correct price signals to the participants. It also ensures that costs are recovered efficiently. As guidelines, an efficient structure of payment should reflect as closely as possible the various costs that a provider of services may incur, while avoiding double accounting [Cali *et al.* (2001)], and staying simple enough to be practical. Indeed, if the structure of remuneration increases in complexity, recovery of cost would be a priori more efficient, but it would also be more difficult to choose the best offer because the theory of multi-dimensional auctions is complicated, even for two-part offers [Chao and Wilson (2002)]. As usual, the principal issue is to find the most appropriate balance. For example, paying separately the meals in a plane and the cost of the flight may be more efficient than paying an all-in-one flight ticket. Indeed, budget travellers may prefer to buy a cheaper ticket and to bring their own sandwich rather than to purchase a more expensive bundle ticket. On the other hand, separating the costs of the crew, the fuel and the plane does not bring a lot of advantages to consumers.

4.5.1 Identified structures of offers and payments

Ancillary services cannot be remunerated in the same manner as the classical electrical energy product (i.e., MWh). For example, a generator that is part-loaded in order to provide frequency control expects to get a payment for the service, even if it is not actually called during the period considered. In the scientific literature, most of the discussions on structures of offers and payment of AS are concentrated on three components, namely capacity, utilisation and opportunity cost [e.g., Hao and Papalexopoulos (1997), Singh (1999), Oren (2001), Chao and Wilson (2002), Chicco and Gross (2004) or Galiana *et al.* (2005)]. The literature also proposes innovative components [e.g., Doherty *et al.* (2005)]. In addition, some systems like Great Britain have adopted additional components, as shown in section 4.5.2. This section discusses six identified structures for offers and payments that are used in practice or have been proposed in the literature, namely: (a) a fixed allowance, (b) an availability price, (c) an utilisation payment, (d) a payment for the opportunity cost, (e) an utilisation frequency payment, and (f) a price for kinetic energy.

A *fixed allowance* is paid to the provider in every instance. For example, a synchronous condenser is generally remunerated even if it is not synchronised. An *availability price* is paid only when the unit is in a “ready-to-provide” state (e.g., a part-loaded generator that provides secondary frequency control). Therefore, the purpose of the fixed allowance is to compensate the provider for the fixed costs (e.g., investment in equipment), while the availability price compensates for the variable cost to maintain the unit in a “ready-to-provide” state (e.g., additional staff or energy costs). The separation between fixed allowance and availability payment may be blurred easily, so the fixed allowance is often included in the availability payment in the literature. However, the separation may be useful, especially for AS with a low operating cost. For example, the industry uses fixed allowance payments for voltage control service (see section 4.5.2). On the other hand, using both a fixed allowance and an availability payment introduces more easily a double accounting than a single payment does. Furthermore, it is sometimes complex to separate an availability price for two different ancillary services. For example, it is hard to split the cost of a generator exciter between active and reactive power AS, as shown in section 3.2.2.

An *utilisation payment* remunerates the actual delivery of the service. To use economic language, availability and utilisation payments can be considered as an option fee and a strike price, respectively. More specifically, an AS with this payment scheme is equivalent to a swing option because the SO can usually exercise it several times (see section 1.3.1). However, ancillary services with availability payments are different from standard financial options, because their goal is not to provide a financial hedge, but to fulfil preset standards for a “security hedge” [Singh (1999)]. Secondary frequency control is a very good example of AS with both availability (e.g., in €/MW/h) and utilisation payments (e.g., in €/MWh), because the TSO can exert or not its option on the available capacity through the regulation signal sent to the generating unit (see section 2.3.3.1). An utilisation payment should consider the amplitude of delivery of the service. For example, an utilisation spike has often a stronger impact on the provider than a continuous utilisation does. Figure 4.3 shows two different utilisations, which are however usually entitled to the same utilisation payment because both energy integrals are equal.

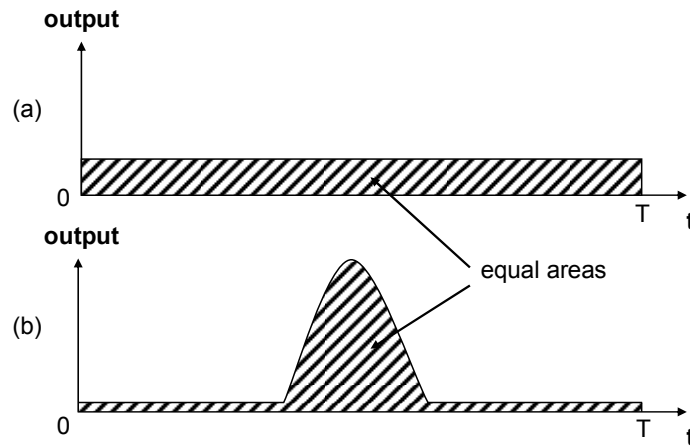

Figure 4.3: Same utilisation payments for two different utilisations

In addition to availability and utilisation payments, the *payment of the opportunity cost* has been identified for a long time by the community as an important allowance [Hirst and Kirby (1997)]. As presented in section 3.2.2, the opportunity cost represents the profit that the provider would have made if it had sold other products (e.g., energy) instead of supplying the service. Note that to compute the opportunity cost, the supply curves of units have to be provided, which is not popular in markets with decentralised unit commitment. In addition, it is usually assumed that the energy price would not change if the unit were economically dispatched without providing any AS. This assumption is a good approximation only when the liquidity of the market is sufficient.

An *utilisation frequency payment* is based on the number of calls to provide a service over a given period of time. It thus reflects the extra costs that may be incurred each time the service is called upon. For example, an event fee is used in New Zealand (in NZ\$/event). In case of a large disturbance, the user that triggers the disturbance pays an event fee, which is thus a penalty (see section 4.8.5). This fee is then split amongst the participants that need to be rewarded [Electricity Commission of New Zealand (2005)].

A *price for kinetic energy* (e.g., in €/MWs) remunerates the quantity of kinetic energy made available to the system [Doherty *et al.* (2005)]. This innovative approach recognizes that machines with high inertia (and thus with a high kinetic energy) reduce the rate of change of frequency¹⁰⁸ (but still cannot stabilize it durably). In fact, a power system must have a maximum rate of change of frequency (in Hz/s) following a contingency, so the participants reducing this rate of change of frequency should be remunerated. However,

¹⁰⁸ High inertia is characterised by a large J and thus a large $d^2\omega_m/dt^2$ in equation (1.2) of section 1.4.1.

although interesting, this approach is probably practical only in small interconnected systems that are much more sensitive to the stored kinetic energy (e.g., Ireland) than large interconnected systems are (e.g., the UCTE).

4.5.2 Structures of offers and payments in practice

In practice, only a few payment components are actually chosen, depending on the ancillary service considered, because the costs incurred are different (see Chapter 3). The timing of markets (see section 4.6.6) and the information available also enter into account (e.g., the opportunity cost is difficult to compute in a market with decentralised unit commitment). Table 4.3 shows the structures of payment chosen across various systems as of October 2006 (see ¹⁰⁷ p.195). For primary frequency control, an availability payment is in most cases the only type of remuneration because it operates continuously and the additional amount of energy it requires is considered negligible. The opportunity cost is not considered either, whereas the primary frequency control may cause such a cost. In three of the six systems that use secondary frequency control, both availability and utilization are remunerated. However, energy savings obtained when the output of a generator is reduced are subtracted from the additional energy used when this generator increases its output (see section 4.5.3).

Fixed and availability remunerations are favoured for basic and enhanced voltage controls. Except in Great Britain, New Zealand and Spain, the actual use of reactive power through the voltage control is not remunerated, so the utilisation cost of reactive power does not seem to be considered as significant. Voltage control is not remunerated at all in Sweden. The active power used when generators work in synchronous compensator mode is remunerated in Australia, France, PJM and Spain. Opportunity costs are not widely used, probably because they are more difficult to compute and they may be included in availability payments when a long period is considered (e.g., a week or more).

The structure of the offers is often identical to the structure of the payments, but some differences can appear. First, a payment component may be indexed on another market instead of being explicitly defined in the bidding process. For example, the utilisation payment of an active power AS can be based on the energy-only spot market. Second, the structure of an offer may be more complex than the structure of a payment. For example, it can be desirable to have different offer prices for different conditions of utilisation of an AS provider. However, the price of payment is unique for this provider. In

practice, providers often provide an offer curve. For example, Australian generators can offer up to ten frequency control AS price bands depending on the output of the given generator (see Figure 4.4) [NEMMCO (2001)]. In Great Britain, an equivalent system is used for reactive power AS, where up to six price bands are possible (see Figure 4.5) [National Grid (2008c)].

Table 4.3: Structures of payment chosen across various systems as of October 2006

	Fixed	Availability	Utilisation	Utilisation frequency	Opportunity cost
Primary frequency control	GB	AU, DE, FR, GB, NZ, SE	GB	GB, NZ	-
Secondary frequency control	-	AU, DE, FR, PJM, ES	DE, ES, FR	-	PJM
Basic voltage control	FR, GB, NZ, PJM	FR, GB, NZ	GB, NZ	-	PJM
Enhanced voltage control	FR, GB	AU, ES, FR, GB	ES, GB	-	AU, DE

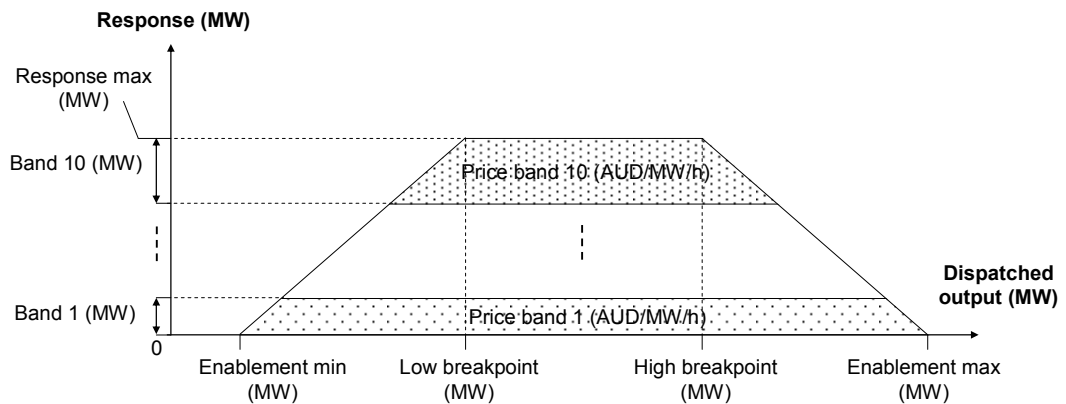

Figure 4.4: Representation of the generic frequency control ancillary service trapezium used in Australia. Based on NEMMCO (2001)

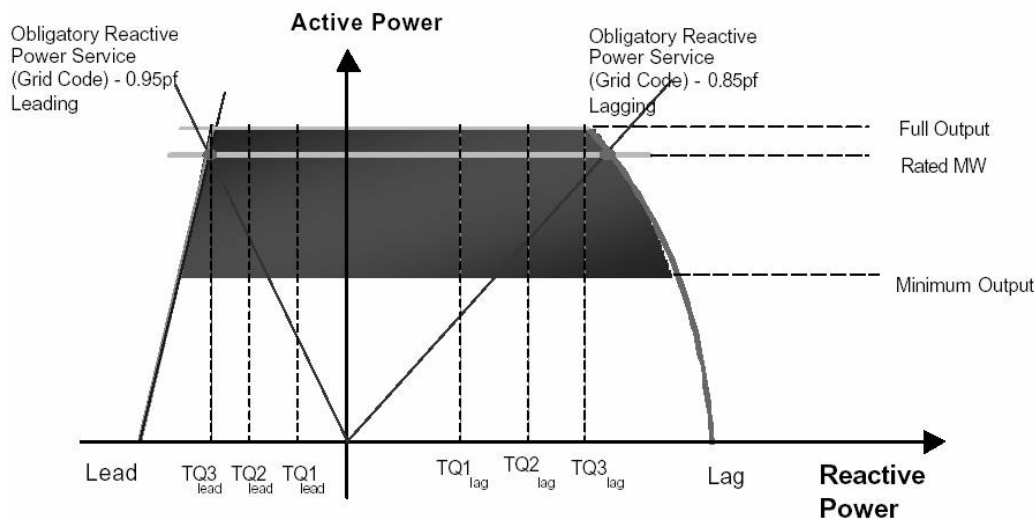

Figure 4.5: Reactive power capability curve in Great Britain [National Grid (2008c)]

4.5.3 Price sign and symmetry

Beyond the number of parameters to consider in the price structure, another interesting issue is the *price sign* (i.e., positive or negative price) and the *price symmetry* (i.e., down and up services with same prices). For example, if a unit provides secondary frequency control, shall it pay or be remunerated for reducing its output when the regulating signal requires it? Indeed, the SO may argue that in such cases this unit saves money by not producing power (so the unit should pay back), whereas the producer may argue that this reduction helps maintain the system in a secure state (so the unit should be paid). In the case of reactive power, the question is even harder, since both production and absorption can be paid or charged, depending on the state of the network (i.e., whether the voltage is higher or lower than desired). To achieve maximum flexibility in offers and hence enhance competition, it is probably best to avoid placing any constraint on the sign of the price or requiring pricing symmetry.

4.6 Organizing the Market Clearing Procedure

The market clearing process matches supply and demand by setting the prices and the amounts traded. Self-scheduled AS providers are not considered here, since they do not participate directly in the price discovery process resulting from the market clearing.

This section discusses the main features that a clearing procedure must have: (a) the *structure of the market* can be either centralised or decentralised (section 4.6.1); (b) various *types of auctions* are possible. Auctions define how the offers must be made (section 4.6.2); (c) *scoring*, i.e. ranking offers in a way that encourages truthful bidding and an efficient choice (section 4.6.3); (d) because the various AS are correlated with each other and with energy, *coordinating the various markets* is necessary (section 4.6.4); (e) there are still differences of opinion about the best *settlement rule*, in particular on the choice between discriminatory and uniform prices across AS products, and between the zonal and nodal approaches (section 4.6.5); lastly, (f) *timing of the market events* such as clearing, closure of demand and offers, as well as duration of contracts have to be chosen carefully (section 4.6.6).

4.6.1 Structural arrangement

With a *centralised unit commitment*, the market (usually called “pool”) is cleared by a unique entity. In pool energy-only markets, which are popular across the United States, participants provide bids and offers. Then, the system operator directly commits and dispatches the producers. Therefore, this approach favours links between AS and other products such as energy. For example, the opportunity cost can be calculated easily. However, markets with a centralised unit commitment are deemed to be opaque because the clearing process is quite complex. In addition, bidders have to provide a lot of information and this system hardly takes into account all the variables of the system.

On the other hand, a *decentralised unit commitment* may be adopted. In this system, which is popular across Europe, participants propose bids and select offers directly in the market. Therefore, a global co-optimisation is difficult since participants buy and sell independently from each other. Instead, each participant does its own co-optimisation with its assets. Therefore, the dispatching is *a priori* less efficient, but participants in the market are able to take more parameters into account. Note that the decentralised arrangement described here can use centralised markets (usually called “exchanges”) as described in section 1.3.1.

To probe further, CER (2003) discusses in more details advantages and drawbacks of pool and power-exchange markets.

4.6.2 Types of auction

By setting the rules for submitting and matching bids and offers, an auction helps determine the value of a commodity that has an undetermined or variable price. More precisely, in the case of ancillary services, the auctioneer wants to reveal the marginal cost of AS providers for each cost component. In economics, various auctions are available, depending on the problem considered. Section 4.6.2.1 discusses the general categories of auctions, while section 4.6.2.2 introduces the usual auctions and section 4.6.2.3 examines the most appropriate arrangement for AS procurement.

4.6.2.1 Principal categories of auctions

First, auctions can be *private-valued* or *common-valued*. In a private-value auction, the good (e.g., a painting) has a different value for every participant. In a common-value auction, the good (e.g., off-shore drilling rights to extract oil) has an identical value for all the participants, even if the estimate of each participant may vary. In this latter type of auctions, the optimal strategy for participants is to bid less than their estimate value in order to avoid an overvaluation that would lead to a financial loss. The difference between the amount that the winner paid and the next lower bid of an auctioned good is often referred as the Winner's curse [Varian (1999)]. Auctions for ancillary services can be either private-valued or common-valued depending on the size of the market considered. Indeed, the value of frequency control services would be higher in a part of the system with high AS requirements than in a less demanding part. However, a perimeter can be found where AS have a common value.

Second, an auction can be *single-sided* or *double-sided*. In the former type, only one buyer or one seller wants to acquire or sell the good. In the latter type of auction, several buyers and sellers participate in the auction. As highlighted in section 4.2, the AS buyer(s) for a given zone can be either unique (e.g., the SO) or several (e.g., users with AS requirements). Therefore, single-sided and double-sided auctions are both possible for AS. Even if solutions based on the unique buyer are popular, SOs may compete against each other to buy AS across interconnected systems, as discussed in section 2.5. Therefore, the procurement of ancillary services is likely to move towards a double-sided auction in the long-term.

Third, *single-unit* and *multiple-unit* auctions are possible. Single-unit auctions deal solely with identical goods (e.g., buying 1 000 iPods). This type of auctions is the simplest and benefits from a lot of analysis [Varian (1999)]. On the other hand, differentiate goods are traded in multiple-unit auctions (e.g., buying 100 second-hand cars). Unfortunately, properties of single-unit auctions cannot be extended to multiple-unit auctions [Staropoli and Jullien (2006)]. Therefore, multiple-unit auctions are much harder to deal with and no hasty conclusion should be drawn when dealing with such auctions. AS auctions can be either single- or multiple-unit, depending on the differentiation possible between AS providers (see section 2.3).

Lastly, auctions can also be categorised by their settlement rule. In particular, *discriminatory auction prices* and *uniform prices* are two important settlement rules that differentiate auctions. Section 4.6.5 discusses in details settlement rules.

4.6.2.2 Usual auction methods

Commenting on auction design, Klemperer (2002) states that “one size does not fit all”, because an auction helps to answer to a specific need. For example, an auction that is used to trade private-valued multiple-unit goods is not necessarily efficient for common-valued single-unit goods. In practice, some types of auction are often used. The usual types of auction presented in this section are English, Dutch, sealed-bid first-price and Vickrey. From these usual auctions, different variants are possible.

In an *English auction*, participants increase their price gradually from a minimum price, called the reserve price. The highest-price bidder takes the good. English auctions can be used for both single-unit and multiple-unit auctions, and are Pareto efficient as soon as the reserve price is below the clearing price. The *Japanese auction* is a variant of the English auction. In such a system, participants are able to enter or to leave the auction at any time, in a similar way as in a poker game. For a single-sided AS auction (e.g., the ERAP is unique), an English auction would not be practical, since this type of auction is designed for several buyers. However, this auction may be of interest in the case of a double-sided auction. For example, an AS provider would propose a given quality of service with a reserve price. The different ERAPs would then raise their biddings up to no more than the value that they attach to this service.

In a *Dutch auction*, a price is given by the auctioneer and then the price is decreased by steps until a buyer is interested. Dutch auctions have the advantage of being very fast¹⁰⁹. An AS auction based on a modified Dutch auction may be imagined as follows. The ERAP would propose to buy a given quality of ancillary service from AS providers. The ERAP would start with the highest price that it would be ready to pay for and then AS providers would manifest their interest. As long there would be an AS provider interested, the price of the contract would decrease by step. The last AS provider to accept would win the AS contract. However, such a system may not be Pareto efficient because it is not guaranteed that the latest accepted price be the lowest price that the AS provider was ready to accept.

In a *sealed-bid auction* (also called Yankee auction or sealed-bid first-price auction), all the participants make a bid (or an offer) at the same time. The best bid takes the good and pays as bid¹¹⁰. This type of auction is commonly used in tendering processes in the construction in industry. Lastly, this auction is applicable to both multiple-unit and single-unit procurements, but it is often not Pareto efficient. In fact, “no buyer knows other buyers’ valuations, so the highest valuation buyer may bid too low and lose to another bidder” [Bergstrom (1999)]. A system for ancillary services is easily imagined in which the ERAP would call to tender the AS providers. The AS providers would submit their offers, then the ERAP would select the best ones.

Lastly, a *Vickrey auction* (also called philatelist auction or sealed-bid second-price auction) is similar to a sealed-bid auction except that the winner pays the second highest bid. These auctions, which theoretically lead to the same result as English auctions but in a one-round auction [Varian (1999)], are related to single-unit auctions. In the case of multiple-unit auctions, the Vickrey-Clarke-Groves (VCG) auction may be used instead. In a *VCG auction*, each bidder divulges the value of each combination of items (in the particular case of products of the same quality, the bid is a demand curve). The bids are then selected by the auctioneer in order to maximize the global value. Then, the winner of each bid pays the value of its bid minus the added value of its bid. The added value of a bid is calculated by subtracting the maximized global value without the bidder from the actual maximized global value [Pekeč and Rothkopf (2004)].

¹⁰⁹ The Dutch auction holds its name from the Dutch markets where this auction is used to trade cheese and flowers [Varian (1999)].

¹¹⁰ A variant of this auction is possible with a uniform pricing, e.g., based on the last accepted offer or the first rejected offer.

An illustrative example of a VCG auction is given in Table 4.4. In this example, by granting the product {a} to bidder 1 and the product {b} to bidder 2, the global value is maximised (30 €). Table 4.5 gives a second example, where bidder 1 evaluates highly product {a} at 1 000 €. However, the product allocation and bidder 1's payment are the same as in example 1. On the other hand, bidder 2 will *receive* money in this case, whereas the seller is unlikely to pay for selling its good¹¹¹. In practice, such a case can happen if the two bidders collude and share the benefits of this strategy. This simple example thus shows the main flaw of VCG auctions: they are revenue deficient. Therefore, VCG auctions are rarely used in practice [Pekeč and Rothkopf (2004)]. Furthermore, Rothkopf (2007) lists thirteen reasons why VCG auctions are not practical. Note however that the VCG auction differs from the Groves-Clarke tax described in section 2.4.4¹¹².

Table 4.4: Example 1 of a Vickrey-Clarke-Groves auction

	Bids			Settlement	
	{a}	{b}	{a,b}	Gets	Pays
Bidder 1	12 €	6 €	20 €	{a}	12-(30-25) = 7 €
Bidder 2	3 €	18 €	25 €	{b}	18-(30-20) = 8 €

Table 4.5: Example 2 of a Vickrey-Clarke-Groves auction

	Bids			Settlement	
	{a}	{b}	{a,b}	Gets	Pays
Bidder 1	1 000 €	6 €	20 €	{a}	1 000-(1 018-25) = 7 €
Bidder 2	3 €	18 €	25 €	{b}	18-(1 018-20) = -980 €

4.6.2.3 Selecting the appropriate auction method

Table 4.6 summarizes some features of the described auction methods. English and Dutch auctions are multiple-round auctions, while sealed-bid first-price and Vickrey are single-round auctions. All auctions are Pareto efficient under particular conditions, but only the Vickrey auction gives incentives to buyers to reveal their true value for a good, even in an

¹¹¹ Note that sellers are sometimes ready to pay to get rid of their goods, especially when the goods cannot be stored anymore (e.g., electricity or perishable products).

¹¹² For example, a VCG auction helps determine the price of each product, whereas the cost allocation is pre-determined in the Clarke-Groves tax system.

imperfectly competitive market [Chao and Wilson (2002)]. However, all auctions are vulnerable to collusion or strategic behaviour [Varian (1999)]¹¹³.

The desirable features for an AS auction are highlighted in bold. In fact, AS auctions are multiple-unit, as explained in section 4.6.2.1. In addition, it is desirable to have an auction both Pareto- and revenue-efficient and that helps to reveal the true value of the good. Lastly, single-round auctions are easier to manage in real-time than multiple-round auctions, so they should be preferred. It is clear from Table 4.6 that none of the proposed auction methods fulfils all the requirements. In practice, sealed-bid auctions (first-price or uniform-price) are very popular across systems to procure ancillary services, because they are convenient for the procurement methods preferred by participants, i.e. tendering processes and spot markets (see section 4.4). However, despite their interesting features, the Vickrey and VCG auctions do not seem to be used because they are unpractical. Nevertheless, Chao and Wilson (2002) propose a market design for spinning reserves based on Vickrey and VCG auctions.

In conclusion, sealed-bid first-price auctions are probably the best trade-off so far. However, stakeholders have to keep in mind that such auctions do not guarantee the Pareto efficiency and do not reveal the true value of AS, so they are likely to send incorrect signals to the market. The possibility of non-efficient prices is even higher because markets for ancillary services usually involve an oligopoly and repetitive auctions. Participants have thus time to understand the market and the gaming possibilities [Staropoli and Jullien (2006)].

Table 4.6: Synopsis of the usual auction methods

Auction method	Single/ Multiple-unit	Single/Double-side	Pareto efficient	Revenue efficient	Help to reveal true value	Single/ multiple-round
English	Both	Both	Yes	Yes	No	Multiple
Dutch	Both	Both	Yes ¹¹⁴	Yes	No	Multiple
Sealed-bid first-price	Both	Both	Yes ¹¹⁴	Yes	No	Single
Vickrey	Single	Both	Yes	Yes	Yes	Single
VCG	Multiple	Both	Yes	No	Yes	Single

¹¹³ To probe further into auction theory, Varian (1999) gives a comprehensive introduction, while Klemperer (1999), Klemperer (2002), and Pekeč and Rothkopf (2004) discuss auctions in much more details. Lastly, Staropoli and Jullien (2006) show the interest of laboratory experiments, which help market designers to study and assess the performance of market rules in an environment simpler than reality.

¹¹⁴ Pareto efficiency can actually be hard to reach in practice.

4.6.3 The scoring problem

To select an offer over another, both have to be classified, e.g. by giving them a score¹¹⁵ (e.g., expressed in monetary value). This score should be calculated in a way that induces truthful bidding by participants [Bushnell and Oren (1994)] and, obviously, that leads to the appropriate result (i.e., the scoring should lead to the optimum solution according to the selected objective function¹¹⁶). The barriers to appropriately score ancillary services are namely: (a) the different technical qualities of products because it makes the products harder to compare (see Chapter 2); (b) the composite structures of offer and payment, which make offers dependent of the utilisation and also make offers harder to compare (see section 4.5); and (c) the strongly variable non-linear costs of ancillary services as function of time and demand, which makes the scoring of offers sensitive to time and demand (see Chapter 3). As usual, a trade-off has thus to be found between an overly simple solution, which can be totally inefficient [Wilson (2002)], and a non-practical mechanism.

To score offers while trying to *minimize its procurement cost*, the ERAP must take into account both the price and the probability of AS utilisation. This presents two difficulties. First, the optimisation problem introduces AS prices (i.e., the dual variables) into the primal problem, which makes the optimisation problem much harder to solve [O'Neill *et al.* (2006)]. Though, Luh *et al.* (2006) have proposed recently an optimisation algorithm that overcomes this difficulty by updating the Lagrangian multiplier in an iterative process, i.e. in a similar way as the price decomposition¹¹⁷. Second, taking into account the probability of AS utilisation may favour gaming. For example, some units may lower their utilisation offers and increase their availability payments to increase their profits [Singh (1999)]. To avoid such gaming, Chao and Wilson (2002) have proposed a new scoring method for active power AS. The idea is to force providers to reveal their true energy marginal cost through a Vickrey auction (see section 4.6.2.2). For the settlement, the opportunity cost of the various energy offers constitute the availability payment, and energy is paid at the lowest unused energy offer.

¹¹⁵ Note that the scoring should also include a tie-breaking feature that separates two bids with the same score. Defining this rule is a relatively easy task if bids can be split.

¹¹⁶ As explained in section 2.2.3, the ERAP can either minimize the procurement cost (method also known as the rational buyer approach) or maximize the global welfare. Both objective functions are dependent on the settlement method chosen. Various settlement methods are described in section 4.6.5.

¹¹⁷ See section 3.3.5.1 for an introduction to the primal and dual problems and to the price decomposition method.

The main down side of scoring AS in the perspective of minimizing the procurement cost is to ignore the value that AS (and thus SS) have for system users. If the perspective of *global welfare maximization* is adopted, the ERAP has to take into account the value of ancillary services in addition to their procurement cost. However, including the value in the scoring is complex, as shown in section 2.2.1. Therefore, most of the practical methods are limited to the procurement cost minimization.

4.6.4 Coordination of the different markets

Once a type of auction and a scoring method have been defined, it is possible to collect the AS offers, rank them and then to select the best offers. However, AS are an externality of the electrical energy-only market. For example, if a generator provides reserves for frequency control, it cannot sell all its capacity on the electrical energy-only market. On the other hand, if a generator is committed through energy dispatch, it is then able to provide reactive power support. A direct consequence of this feature is that AS prices and energy prices will interact. This statement can even go further concerning transmission: financial transmission rights and AS prices are likely to interact because active power ancillary services have similar geographic constraints as energy products do¹¹⁸. In fact, the ERAP may want to secure enough transmission capacity in order to have an efficient AS provisioning. More specifically, AS are a production externality of the energy-only market because the volume or the price of AS will not change the amount of electrical energy bought on the market [Varian (1999)].

Since AS are an externality of other products such as energy and because several AS products exist (see section 2.3), AS auctions have to be coordinated. In *independent merit-order auctions*, each ancillary service auction is cleared independently. However, because an AS provider can generally provide several AS products¹¹⁹, this approach may lead to infeasible solutions. Therefore, *sequential auctions* (also called cascading clearing) have been defended in the early designs of market for frequency control AS [Hirst and Kirby (1997), Singh (1999)]. With this method of coordination, AS are provided in a prioritised manner. Once an AS is bought, the capacity of the successful provider of this service for the following AS auction

¹¹⁸ However, because of their local effect, reactive power AS have stronger geographical constraints than active power AS do. See section 1.5 for more details.

¹¹⁹ See for example Baldick *et al.* (2005) about product substitution.

is reduced. However, this approach suffers from some flaws, in particular price reversals, illustrated by the infamous failure of the Californian AS market at the end of the 1990s [Brien (1999), Oren (2001)]¹²⁰. Since then, it has been recognised that *simultaneous auctions* have to be in place for AS and energy-only markets [e.g., Yan and Stern (2002), Ma *et al.* (2003), Baldick *et al.* (2005) or Galiana *et al.* (2005)].

To illustrate the flaws of independent and sequential clearing, consider a simple example. Two ancillary services called AS 1 and AS 2 are considered. The SO is the only ERAP and has to buy 100 units of each to meet its reliability criterion through a classical sealed-bid auction, as illustrated in Table 4.7 (i.e., inelastic demand). Two AS providers propose their capacities as shown in Table 4.8. In order to select the providers, the ERAP performs three auctions. The first auction is based on an independent merit-order, the second auction is sequential¹²¹ (starting with AS 1) and the last auction is simultaneous. In all auctions, the objective function of the ERAP is to minimize the procurement cost, subject to the constraint of meeting the demand (i.e., the rational buyer behaviour). The results of the three auctions are given in Table 4.9. It is clear that the simultaneous clearing gives the best results. Indeed, the sequential market clearing, although giving a feasible solution, depends on the clearing order. An optimal solution is thus not guaranteed.

However, simultaneous auctions between AS and energy-only markets raise some practical difficulties. First, the feasibility of AS simultaneous auctions depends on the choices for the electrical energy-only market design. In particular, the choice between a pool and a power exchange market is very important¹²². In fact, simultaneous auctions are easier to implement in pool systems than in exchanges, since a unique entity controls the whole system. Second, from a technical point of view, the optimisation problem has to be feasible. Simultaneous auctions require a large amount of data, which may be too large for an efficient clearing. For example, finding the optimum between AS offers and the active and reactive power losses in real-time is computationally demanding. Third, simultaneous

¹²⁰ A price reversal is said to appear when an ancillary service of lower quality is more expensive than another of higher quality. Further in this section, the example of Table 4.9 illustrates such a price reversal. As a practical example, during the Californian crisis, the price of non-spinning reserve was more expensive than the price of spinning reserve, whereas spinning reserve should be more expensive to provide than non-spinning (see section 2.3.4.1 for the vocabulary of reserves).

¹²¹ We consider here a supply (or product) substitution, i.e. the supply for a lower quality AS can be substituted by a higher quality AS. In the case of a demand substitution, the demand for a lower quality AS can be substituted by a higher quality AS [Oren (2001)].

¹²² See section 4.6.1 for a short discussion between pools and exchanges.

auctions are much less transparent than independent or sequential auctions, whereas participants usually prefer transparent processes. Fourth, it could be argued that it would be better to co-optimize the products over long periods of time to obtain better results. Indeed, transmission and generation capacity investments have an impact of the cost of ancillary services. However, such a long-term optimization is likely to be difficult to implement in a liberalized environment.

In practice, short-term simultaneous auctions are performed in PJM (secondary frequency control, synchronised reserves and energy together) and Australia (primary frequency control, secondary frequency control and energy together). The other surveyed systems have adopted independent or sequential auctions and each participant co-optimizes individually its portfolio.

Table 4.7: Parameters of the demand in the considered examples of market coordination

Product	Volume
AS 1	100 u
AS 2	100 u
Total	200 u

Table 4.8: Parameters of the offers in the considered examples of market coordination

Bidder	Capacity	Product	Volume	Price
Bidder 1	100 u	AS 1	100 u	5 €/u
		AS 2	100 u	15 €/u
Bidder 2	100 u	AS 1	100 u	100 €/u
		AS 2	100 u	300 €/u

Table 4.9: Result of the clearing processes in the examples of market coordination

Auction	Product	Provider	Volume	Price	Cost
Independent	AS 1	Bidder 1	100 u	5 €/u	500 €
	AS 2	Bidder 1	100 u	15 €/u	1 500 €
	Total	-			Infeasible solution
Sequential	AS 1	Bidder 1	100 u	5 €/u	500 €
	AS 2	Bidder 2	100 u	300 €/u	30 000 €
	Total	-	200 u	152.5 €/u	30 500 €
Simultaneous	AS 1	Bidder 2	100 u	100 €/u	10 000 €
	AS 2	Bidder 1	100 u	15 €/u	1 500 €
	Total	-	200 u	57.5 €/u	11 500 €

4.6.5 The settlement rule

The settlement rule organises the payment of the AS providers selected in the auction. Such a rule should give enough incentives to invest in AS capacities and to offer AS at their marginal costs if there is enough competition. A settlement can be either *ex-ante* (i.e., the price is discovered before the actual operating of the system) or *ex-post* (i.e., the price is discovered after the actual operation of the system). Ancillary services can be either non-remunerated, or paid according to one of three types of price: an administrative price, a discriminatory auction price or a uniform price.

While a *non-remunerated* system is very convenient for the ERAP, it is unlikely to be economically optimal because the costs that the providers incur end up bundled in the price of other products such as electrical energy. In addition, a non-remunerated policy is most of the time contrary to the concept of property rights, which is important for AS since they are an externality of the electrical energy-only market (see section 4.1).

An *administrative price* is set by the regulator or the SO and can be either nodal or zonal. This form of remuneration, also called regulated pricing, can take several forms: a reimbursement (i.e., an *ex-post* payment that compensates the AS providers for the cost of services), a value-based payment (i.e., a payment based on the estimated value of AS) or a tariff (i.e., an administrative rule of payment) [Cali *et al.* (2001)]. In practice, since the value of AS may be hard to calculate and tends to be high or very high (see section 2.2.1), reimbursements and tariff payment are preferred in practice. An administrative price is particularly justified when dominance of some participants is an issue. In general, however, a regulated price is not desirable as it reflects very imperfectly the actual cost of providing an ancillary service, particularly when this cost changes with time or circumstances, as it is the case of frequency control ancillary services (see section 3.4.1).

With *discriminatory auction prices*, winners of the auction pay/receive different prices for the same good. Discriminatory auction prices are suitable when the quality of the ancillary services offered is highly differentiated, so the offers are not easily comparable. However, a discriminatory auction price does not give providers an incentive to offer their marginal cost, except when market concentration is low [Stoft (2002)]. In the particular *pay-as-bid* discriminatory system, the supplier receives the price of its accepted offer. Variants of the pay-as-bid system are possible, as proposed by Bushnell and Oren (1994). However, Staropoli and Jullien (2006) argue that discriminatory auctions generally perform poorly in

electric power markets. Nevertheless, numerous systems have actually adopted discriminatory auction prices, as shown in Table 4.10.

In a *uniform price* system, all the winners of the auction pay/receive the same price. This form of pricing, defended for example by Chao and Wilson (2002) for frequency control AS, is deemed to give suppliers a real incentive to offer their marginal cost. On the other hand, it is not adapted to differentiated products because all the offers have to be comparable. Various settlement rules are possible in the case of a uniform price system and are described below [Oren (2001), Shahidehpour *et al.* (2002)]. We consider here only the settlement rules in case of a simultaneous auction because it has been shown in section 4.6.4 that sequential auctions do not guarantee efficiency, though being simpler than simultaneous auctions.

- ✓ Link between uniform prices of different AS of same nature (e.g., all frequency control ancillary services):
 - Common price between AS of same nature: this approach, defended by Galiana *et al.* (2005), is based on the fact that all the active power AS have an equal role in the security. In addition, the philosophy of common pricing between AS can be justified by the fact that some AS cost components may be common (e.g., an energy payment);
 - Separate prices between AS of same nature: the classical approach, in which each AS has its own market clearing price.
- ✓ Methods to calculate the market clearing price:
 - Marginal value pricing: the price is equal to the most expensive of all the accepted AS offers of equal or lower quality;
 - Last accepted bid: the price is equal to the highest accepted bid for the AS considered;
 - First rejected bid: the price is equal to the lowest rejected bid for the AS considered. Note that Bernard *et al.* (1998) and Staropoli and Jullien (2006) report that the last accepted offer auction performs slightly better in energy markets than the first rejected offer mechanism does. However, this conclusion cannot be directly extended to AS.
- ✓ Perimeter of the uniform pricing:
 - Zonal prices: they may be preferred for frequency control AS because the value of frequency control AS is usually not geographically dependent (see section 1.4).

However, defining the zone remains a problem because congestions may prevent the supply of the AS. In practice, the area of the TSO is often considered as the price zone [O'Neill et al. (2006)];

- Nodal prices: they may be favoured for voltage control services because their effect, and so their value, is local (see section 1.5). Some system operators, such as in Texas, argue that nodal payment of AS gives an incentive for relieving congestion similar to energy [Mickey (2006)]. In addition, Galiana et al. (2005) argue that it gives more signals to compute the marginal value of security in a nodal fashion than in a zonal manner. On the other hand, nodal pricing is expensive to implement, increase the complexity of bilateral contracts¹²³ and may increase the market power of some participants. More broadly, discussions on the relative advantages of nodal and zonal pricing are still ongoing in many countries [Sioshansi and Pfaffenberger (2006)].

Table 4.10 summarises the settlement rules chosen across various systems as of October 2006 (see ¹⁰⁷ p.195). PJM and Spain are the only systems where primary frequency control is not remunerated, so these systems do not recognize the property rights of generating units over their governor response. When this service is remunerated, a discriminatory auction price is preferred because primary frequency control is a differentiated product. Secondary frequency control services are remunerated in all the systems that use it. Since secondary frequency control is managed directly by the TSO and uses energy, it is obviously a service that providers deliver to the TSO and should therefore be remunerated. For basic voltage control there is as yet no consensus on whether this service should or should not be remunerated. Finally, discriminatory auction price is the preferred option for enhanced voltage control where this service is defined.

¹²³ Bilateral contracting is eased in energy-only market with the help of “hub prices” that reflect the average price in a given zone [O'Neill *et al.* (2006)].

Table 4.10: Settlement rules chosen across various systems as of October 2006

	None	Regulated price	Discriminatory auction price	Uniform price
Primary frequency control	PJM, ES	NZ	AU, FR, DE, GB, NZ, SE	AU
Secondary frequency control	-	-	PJM, AU, FR, ES, DE, GB, NZ, SE	AU, ES, PJM
Basic voltage control	AU, DE, ES, SE	GB, PJM	FR, GB, NZ	-
Enhanced voltage control	-	ES	FR, AU, DE, GB	-

4.6.6 The timing of markets

A market can be viewed as a game in which all the players try to maximize their benefits while respecting the rules. The timing of the various events (e.g., clearing, closure or review of the AS needs) is an important factor of the game. Indeed, the market events give information to the players that will then adapt their strategies in real-time until an equilibrium region is attained (see section 1.3.1). In addition, the timing impacts practical constraints. For example, scoring offers every 5 min is a different challenge from doing it on a day-ahead basis (see section 4.6.3).

One of the most obvious parameters in the market timing is the *frequency of market clearing*. The frequency of market clearing can vary from several years to a continuous quotation. The more often the market is cleared, the closer the market should be to the actual cost of supply and value of demand, the better are the signals given to the participants, and the more efficient the market should be. However, the feasibility and practicality of the market decreases when the frequency of clearing increases. It is not the purpose here to describe in details all the associated engineering issues (e.g., computing capacity, means of communication, data format, speed of transmission), but, as usual, a trade-off has to be found between the operational requirements and the possible economic benefits. In general, the lower the frequency of clearing is, the easier it is to use complex scoring methods. In addition, a high frequency market clearing helps players understand the behaviour of the market, and therefore to game it, as happened in California, where some capacities were withheld in order to raise prices [Brien (1999)]. Therefore, a low frequency market clearing has the advantage of reducing somewhat the influence of dominant players.

Table 4.11 gives the frequencies of market clearing across various systems as of October 2006 (see ¹⁰⁷ p.195). In practice, the active power AS can benefit from high frequency market clearing (e.g., every five minutes in Australia). However, even if real-time reactive power markets have been proposed, for example by Zhong *et al.* (2004), none has been implemented yet. In fact, the variable cost of reactive power is low [Hao and Papalexopoulos (1997)], so benefits from a high frequency clearing are likely to be low as well. In addition, reactive power is local, so gaming is increased, as illustrated by the simple example of Figure 4.6. By increasing the reactive power absorption of generator B, the value of reactive power production is increased as well. Therefore, load L is giving more money to generator A, even if load L's consumption has not changed. In conclusion, with a simple collusion between generators A and B, it is easy for them to make money from L.

Table 4.11: Frequencies of market clearing across various systems as of October 2006

	AU	DE	ES	FR	GB	PJM	NZ	SE
Primary frequency control	Every 5 minutes	Every six months	-	Every two or three years	Every month	-	Positive: Every 30 min Negative: every and every hour year	Every week
Secondary frequency control	Every 5 minutes	Every six months	Every day	Every two or three years	-	Every hour	Every year	-
Basic voltage control	-	-	-	Every two or three years	Every six months	Every year	No rec.	-
Enhanced voltage control	Every two years	No rec.	Every year	Every two or three years	Every six months	-	-	-

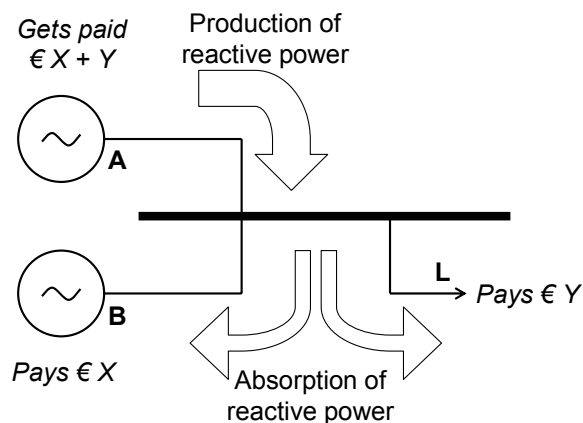

Figure 4.6: Illustration of a gaming possibility with a real-time reactive power market

A parameter related to the frequency of market clearing is the *opening duration of the market*. For example, a day-ahead market has typically an opening duration of less than one

day. In addition, note that the instant of the gate closure is important as it has to be coordinated with the other markets (see section 4.6.4).

The *frequency of offer submissions* (i.e., supply side) should not be confused with the frequency of market clearing. Indeed, it represents how often an AS provider can modify its offers. In order to reflect as closely as possible the actual conditions of the market, it may be desirable in general to have a high frequency offer submission system. However, close to the actual operation of the system, real-time offer submission may favour gaming and be unpractical as well. Therefore, most of the systems have adopted a market where AS offers are frozen on a day-ahead or longer basis before the actual operation of the system. For example, in PJM, secondary frequency control offers are partly frozen after 6 pm on the day ahead (new offers and price changes are not possible), whereas the market is actually cleared every hour of the operating day [PJM (2008)].

The *frequency of reviews of the needs* (i.e., demand side) in terms of ancillary services is also an important parameter of the market timing. By reviewing on a frequent basis the amount of ancillary services that it needs, an ERAP can ensure that it only purchases what it really needs to meet its objective function (see Chapter 2). Table 4.12 gives the frequencies of the reviews of the needs across various systems as of October 2006 (see ¹⁰⁷ p.195). Practices are thus very different from a system to another.

Table 4.12: Frequencies of reviews of the needs across various systems as of October 2006

	AU	DE	ES	FR	GB	PJM	NZ	SE
Primary frequency control	Every 5 minutes	Twice the year	-	Every day	Every month, or on the day, if applicable (revision contract)	-	Every half-hour	Every year
Secondary frequency control	Every 5 minutes	Every six months	Every day	Every day	-	Twice a day	Every year	-
Basic voltage control	-	-	-	As soon as the generating unit is connected	Every six months	Unknown	Every half-hour	-
Enhanced voltage control	Every half-hour (a trading interval)	Unknown	Every day	As soon the unit is connected	Every six months	-	-	-

The *date of settlement* is a minor factor, but has also to be taken into account, especially if complex calculations to estimate the AS utilisation are needed.

Lastly, the *duration of contracts* is also an important parameter in the market timing. Note that the duration of the opening of the market and the duration of the contracts are not necessarily linked, even if they are often the same in an energy-only spot market. As soon as a long-term contract (e.g., several years) is in place, there is no more competition until it comes up for renewal. This can be either a drawback or an advantage for the ERAP if the contract is respectively worse or better than the other offers on the market. In addition, the value of long-term contracts resides in the fact that the price is fixed over time [Kirschen and Strbac (2004a)] and allows suppliers to include maintenance and semi-fixed costs [DePillis (2006)]. Short-term contracts (e.g., five minutes) increase competition and opportunities, but also risks. It should be noted that even if the needs are constant, the available resources can vary during the day, which can bring some opportunities to the ERAP.

To illustrate some advantages and drawbacks from the various durations of contracts, let us consider the AS availability payments. In the short run, generators with some free AS capacity will propose their remaining capacity for almost nothing, since the unit is already committed. However, if the ERAP wants more capacity than is readily available, it would have to pay for the start-up costs, which would lead to a very high availability price. On the other hand, the generator can include in the long run its fixed and opportunity costs over the whole AS supply curve and can anticipate a potential high demand for AS. Figure 4.7 illustrates this discussion with supply curves for three different terms (short, medium and long). For the sake of simplicity, they are represented as continuous. However, they could have break points without changing the essence of the argument. The demand is represented in a schematic manner. Demand curve 1 cuts the short-term supply curve (i.e., representing only the short-term variable costs) at a very low price, whereas demand curve 2 and the short-term supply curve intersect only at a high price. On the other hand, the long-term supply curve includes all the costs and tends to have a more constant marginal cost. Therefore, prices obtained for the demand curves 1 or 2 are quite similar. In conclusion, it is clear from this curve that the short-term market is risky, but a large gain can be achieved, whereas the long-term market is less risky, but gains are likely to be smaller. In practice, small volumes are generally bought in short-term

markets, while long-term contracts are preferred for larger volumes, with the help of bilateral contracts¹²⁴.

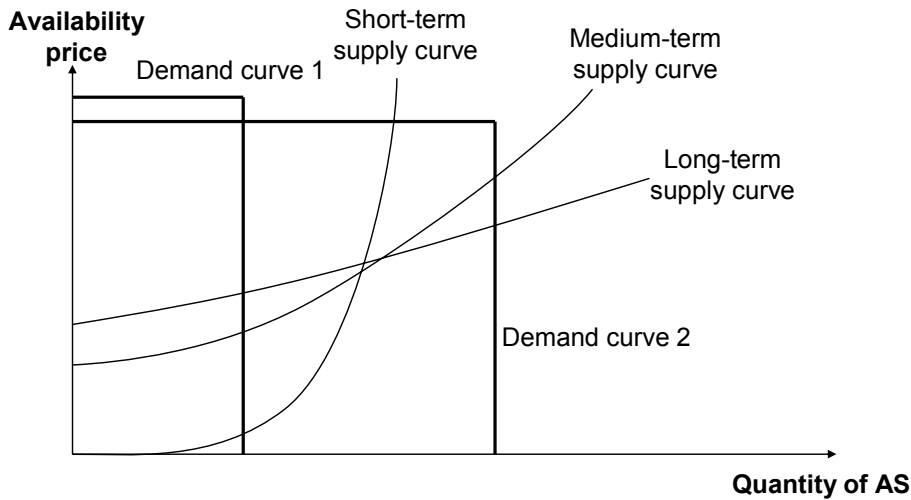

Figure 4.7: Supply curves for different due dates

4.7 Avoiding Price Caps

Price caps appear to be good remedies against abuses of market power. However, they should be avoided in markets for ancillary services. Figure 4.8 illustrates the effects of an offer cap (i.e., that specifies the maximum offer price that a supplier can propose) and a purchase cap (i.e., that limits the buyer’s demand price). A unique cost component is considered for each quantity of ancillary service (e.g., in €/MW), the demand curve is assumed to be vertical (inelastic demand, e.g. for a volume R_{sec}^z) and the supply to be sufficient to meet demand and supply. In both cases, the price cap PC is the same for the given period. Lastly, q^* represents the amount of AS finally bought.

The graph on the left shows that with an *offer cap* the initial demand will be met but will cause a revenue shortage for the AS providers and will discourage them from investing in new capacity. On the other hand, a *purchase cap* avoids this revenue shortage, but leads to a lower amount of AS ($q^* < R_{sec}^z$). In a sense, a purchase cap is only a simplistic demand curve. Unfortunately, the value of AS is not a linear function of the quantity of AS because one supplemental MW of AS may be enough to avoid a load-shedding of several MW.

¹²⁴ See section 4.4 for a discussion on procurement methods.

Therefore, an appropriate demand curve is much more desirable than price caps. In other words, AS have a value, but this value is difficult to determine because, as discussed in section 2.2, the needs of users are hard to define.

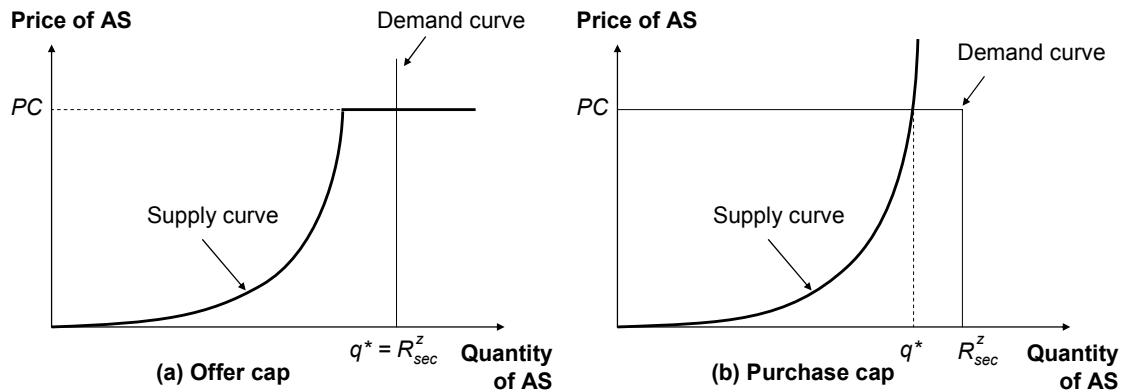

Figure 4.8: Effect of an offer cap (a) and a purchase cap (b)

Despite their drawbacks, if one of the two proposed price caps is adopted, finding the appropriate price is an issue. Theoretically, the value of AS has to be taken into account at some point. In practice, Table 4.13 shows the price caps adopted across various systems as of October 2006 (see ¹⁰⁷ p.195). Australia has implemented a purchase cap at the VOLL (i.e. AUD 10,000 in August 2001) for active power AS, whereas PJM has adopted offer caps at 100 \$/MW/h for its secondary frequency control AS market. Most of the European countries have not adopted any price cap yet for these products. In addition, price caps are constant over time, whereas it would be better to have a different value for each market clearing [Singh (1999)].

Table 4.13: Price caps across various systems as of October 2006

	AU	DE	ES	FR	GB	PJM	NZ	SE
Primary frequency control	Purchase cap at the VOLL ¹²⁵	None	-	None	None	-	None	None
Secondary frequency control	Purchase cap at the VOLL ¹²⁵	None	None	None	-	Offer cap at 100 \$/MW/h	Unknown	-
Basic voltage control	-	-	-	None	Fixed: offer cap at 999.999 £/Mvar/h Availability: offer cap at 999.999 £/Mvar/h Utilization: offer cap at 999.999 £/Mvarh	None	None	-
Enhanced voltage control	None	No rec.	None	None	Fixed and availability: offer cap at 999.999 £/Mvar/h Utilization: offer cap at 999.999 £/Mvarh	-	-	-

4.8 Providing Appropriate Incentives

Since system services are public goods, free riding is a strong temptation for participants in markets for AS. Therefore, participants should have enough incentives for behaving properly (section 4.8.1). Besides competition, several tools are available to the market designers to give incentives to participants. The typical solution is to introduce *penalties and rewards* (section 4.8.5), assuming that sufficient *AS monitoring* is in place (section 4.8.4). The *method chosen to allocate the costs* of system services has also a deep impact on the behaviour of the participants (section 4.8.2). Furthermore, an *appropriate information system* helps users respond to incentives (section 4.8.3). Finally, it is important to remember that *intangible incentives*, such as the fear of blackouts, also influence participants because they can damage a company's image even if it was not directly responsible.

4.8.1 Stakeholders that should have incentives

First, the *system operator* settles the security level and therefore the associated system services. The SO should thus have enough incentives in order to define appropriately the optimal quantity, quality and location of system services as described in section 2.2. These specifications should be in accordance with all the other interconnected systems. In

¹²⁵ The Value Of Lost Load (VOLL) is equal to AUD 10,000 in Australia (August 2001) [NEMMCO (2001)].

addition, in the case of AS trading across systems and with the SO as ERAP, the SO should not have a right of pre-emption over the cheap AS providers within its territory.

Second, the *entities responsible for AS procurement* should have a procurement cost in accordance with the objective function of the SS needs. If the ERAPs are users of the system (e.g., the PJM's LSE described in section 4.2), this pressure will come up naturally with the competition against other ERAPs, except in the case of the use of a dominant position. If the ERAP is the SO, the regulator should intervene to control the cost with the classical tool of regulated activities. For example, Weisman (2005) compares two types of regulated price: profit-share penalties and revenue-share penalties. Note that the profit-share penalties seem to be more efficient than the latter one. However, these regulated prices do not guarantee that AS expenses are optimal.

Third, the *AS providers* should not deviate from what they are contractually obliged to deliver and they should declare any deviation from such obligations. Indeed, not delivering the contracted AS when requested could jeopardize the security of the system. In addition, they should have enough incentive to offer their services at their marginal long-term cost.

Lastly, it is desirable to give some incentives to *all the users of the network* to improve their behaviour in order to reduce the need for system services.

4.8.2 Allocation of system services costs

Since system services are public goods, determining their cost is a joint cost allocation problem¹²⁶. The cost allocation has to be *fair* and *revenue-adequate* (i.e., that all the SS cost should be recovered). The Oxford Dictionary (2001) defines the adjective “fair” as: (a) “treating people equally” or (b) “just or appropriate in the circumstances”. Therefore, a “fair” cost allocation is likely to be subjective. In this section, it is considered that the allocation of SS costs should give incentives to maximise the benefit to users in the long run. However, such an allocation may go against the uniformity of some transmission tariffs (e.g., the postage stamp tariff, see section 1.3.3) in force in many European countries. The

¹²⁶ Because of the public good characteristic of system services, note that the allocation of SS costs is somewhat similar to the transmission pricing problem.

choice between socialisation and differentiation of some cost components of SS is a political decision and the legislator has thus an important role to play.

A first method to allocate the SS costs is to distribute the amount of AS to procure between users of the networks, who thus become ERAPs. However, section 4.2 has argued that such a solution should be avoided. Nevertheless, the SO has always some SS costs to recover, even if the procurement of AS is delegated to some users of the system. A second method is to have a unique ERAP (the system operator), which then allocates the cost of SS to users of the system. The cost allocation should depend on the type of cost considered, namely: (a) the fixed costs (section 4.8.2.1); (b) the potential SS utilisation cost (section 4.8.2.2); and (c) the SS actual utilisation cost (section 4.8.2.3).

4.8.2.1 Allocation of the fixed costs

To fairly allocate SS fixed costs¹²⁷ a first solution is to share them in proportion to the use of the system. Indeed, SS fixed costs, besides being sometimes difficult to quantify, are usually difficult to separate between users. For example, the cost can be split amongst different classes of users. Then, the cost for each class is divided amongst the users in the class on the basis of their energy consumption/production only. Obviously, this cost allocation can have different levels of complexity.

The easiest solution to implement is to include directly the SS fixed costs in the *transmission tariff*, as recommended by a Cigré Task Force (2001). This approach seems to be the fairest and most of the European systems have adopted it [ETSO tariffs task force (2006)]. Consequently, the SS fixed costs are allocated in function of the various parameters of the tariff (e.g., voltage level at the connection point, maximum power subscribed, or quantity of energy injected/withdrawn).

4.8.2.2 Allocation of the potential utilisation cost

Even if no user actually uses any SS, a quantity of SS is always reserved as a function of the particular configuration of the system, such as the type of users connected or the power transits (see section 2.4). Important parameters in the assessment of the SS needs are the reliability and the size of users connected. For example, Kirby and Hirst (2000) have shown that industrial consumers account for 93 % of secondary frequency control. On the other

¹²⁷ SS fixed costs are for example TO's capacitor banks, the information system or the staff necessary to provide the system services (see section 3.2.1).

hand, large generating units increase the requirement for tertiary frequency reserve. In addition, an unreliable large generator increases risks more than a small reliable one. Lastly, loads are the principal consumers of reactive power.

The tariff proposed in section 4.8.2.1 may be inefficient to allocate the SS potential utilisation cost, because such a tariff does not give any incentive to the entities that increase the SS potential utilisation cost to reduce it. Therefore, it would be interesting to *distinguish between classes of users* in order to allocate the cost of ancillary in a fairer manner. For example, in Australia, the cost of the “lower frequency control contingency” ancillary services is charged to loads, while generators pay for the “raise frequency control contingency” ancillary services [NEMMCO (2001)]. However, despite a better allocation, such an arrangement is not likely to give enough incentives to individual users of the network to improve their behaviour. Indeed, it still consists of only a single price for a whole category of users and therefore encourages free riding.

Strbac and Kirschen (2000) have proposed to allocate the cost of frequency control SS to producers *as a function of their size and their availability*. This method thus allocates the SS costs to generators that are likely to use them (i.e., differentiation between “bad” and “good” producers). The proposed method could be extended to consumers. However, three issues have to be addressed for such a cost allocation. First, no perverse incentive should be given to users. For example, an AS provider should not have any incentive to increase the SS needs in order to benefit from the sale of additional ancillary services. Second, the period considered to calculate the availability of generators has to be chosen carefully, since the availability of a unit may vary a lot, depending on the operating conditions and the maintenance. Last, the capacity of a unit can be hard to define, since a generator is unlikely to produce at its maximal output all the time. And if the payment is based on the declared capacity for, say, the next hour, generators may be tempted to under-schedule, as happened in the early designs of the Californian AS market [Singh (1999)].

4.8.2.3 Allocation of the actual utilisation cost

The method described in section 4.8.2.2 allocates only the potential SS utilisation cost. However, the SS actual utilisation cost varies in real-time, depending on the availability of cheap AS providers. Therefore, two users of the system can have the same potential utilisation, but one can use SS when they are expensive (e.g., during a consumption peak), while another can use them when there are cheap (e.g., at night, see section 3.5.2). Note that

only a fraction of the reserved SS capacity is actually used in real-time operation¹²⁸. Nevertheless, sufficient active and reactive power reserves are necessary at all times because system events are by nature unpredictable. Moreover, it is important to note that the utilisation of active power and reactive power SS differ. In fact, the arithmetic mean of frequency control utilisation is close to zero, while the arithmetic mean of voltage control utilisation is generally non-zero¹²⁹.

The Cigré Task Force (2001) proposed three methods to allocate the cost of actual SS utilisation, namely: (a) marginal cost allocation, (b) Shapley-value pricing; and (c) Aumann-Shapley pricing¹³⁰. It is assumed here that the SS cost function is known, which is not necessarily easy, as shown in Chapter 3. First, the *marginal cost allocation method* charges users in proportion to the marginal cost they induce because of their SS use. This method usually gives a higher amount recovered than the actual cost because the SS cost function is usually convex (the marginal cost is thus higher than the average cost). If a revenue adjustment is done, revenue and actual cost would match but the cost allocation would not be efficient.

Second, the *Shapley-value method* calculates the cost induced by each user as a function of their entrance order. All the entrance combinations are tried and then an average is performed. This scheme, in addition to its high computational requirements, is not neutral with respect to the size of similar users (two users with the same impact on the cost function but with different sizes would have different rates). This latter drawback can be resolved by splitting the users into equal sizes (agent splitting method). However, this increases the computational efforts required.

¹²⁸ For example, frequency variations are generally of low amplitude in large interconnected systems (e.g., the UCTE or the North-American systems), so solicitations for providers of primary frequency control are most of the time relatively low.

¹²⁹ The frequency of an interconnected system is kept centred around its nominal frequency, so the deployed quantities of “up active power balancing” and “down active power balancing” (see section 2.3.2) are relatively similar. On the other hand, users cannot easily procure reactive power by themselves and the network naturally uses reactive power. Therefore, the deployed quantities of “up reactive power balancing” and “down reactive power balancing” are generally very different.

¹³⁰ Young (1994) describes in more details and from an economic point of view these cost allocation methods.

Third, the *Aumann-Shapley method* is the limit case of the agent splitting method where the size of agents tends to zero. The price π_i charged to each user i is given by (4.1).

$$\pi_i = \int_0^1 \frac{\partial C(t \cdot \vec{q}^*)}{\partial q_i} dt \quad (4.1)$$

where \vec{q}^* represent the SS actually used (it is a vector that represents the SS utilisation at every bus of the network), $C(\vec{q})$ is the SS cost in function of the SS used and q_i is the SS used by the user i . The main drawback of the Aumann-Shapley pricing is that it requires the SS cost curve. This curve can only be calculated through a centralised algorithm and only if providers give a complete offer curve. For example, Lin *et al.* (2005) have applied this method to the reactive power SS in an eight-bus system. In this case, the price of voltage control SS is computed for each bus and only the opportunity cost of the reactive power AS is considered.

Another possibility is to charge the utilisation of SS through *other-related mechanisms* such as the balancing mechanism for frequency control ancillary services.

In conclusion, a cost allocation method based on the actual SS utilisation is theoretically possible and results in different prices for different users. However, a practical realisation may be easier for active power SS than for reactive power SS, since the former services already benefit from an information system.

4.8.3 Transmission of data

Transmission of data is crucial for a market, as sufficient and balanced information has to be provided to market participants in order to foster competition while avoiding collusion. First, signals may help to take the appropriate decisions. For example, high reactive power supply prices will provide incentive to: (a) reduce the demand for reactive power in this area; (b) increase cheaper supply; or (c) find alternative solutions (e.g., building new transmission lines). Second, if the signals sent are not symmetrical (i.e., they are not the same for every stakeholder), the participants who benefit from the most relevant information have a definite advantage over the others. Lastly, too much transparency is likely to remove competition by introducing tacit collusion. Therefore, the transmission of data has to be regulated carefully.

As highlighted by Hirst and Kirby (1997), three questions have to be answered concerning data publicity. First, *which data?* As a general rule, data should cover [Newbery *et al.* (2003)]: (a) the trading mechanism, (b) the needs in terms of SS, (c) factual data on the structure of the power system, such as generation capacity and reliability¹³¹, transmission grids and interconnections, reserves and imports and exports of electricity; and (d) the relevant economic signals. In the case of uniform pricing (see section 4.6.5), publishing the clearing price is the most natural choice, since it gives an incentive to AS providers to offer under this price in order for their offer to be accepted. However, the question is more difficult for a discriminatory auction pricing. For example, publishing the highest offer in a pay-as-bid system might encourage participants to raise the price of the lower offers in subsequent auctions. Therefore, weighted average prices for discriminatory auction pricing are more desirable, as it is done in Germany for the frequency control AS tendering processes. It is also desirable that some elements of penalties and rewards be communicated (see section 4.8.5).

Second, *who should have access to the data?* The same data should be available to all participants of a class (e.g., AS providers) to avoid any discrimination. However, because of their specific position, the SOs and the market monitoring entity should be allowed to gather more information than other participants (which thus creates asymmetrical information). In the case of AS trading across systems, the transmission of data between SOs is getting very sensitive.

Third, *when should be the data published?* They can be disclosed either *ex-ante* or *ex-post*, as discussed in section 4.6.5.

4.8.4 Monitoring

Monitoring of ancillary services covers both technical and economic aspects. Indeed, on the one hand, AS providers have to actually provide the contracted ancillary services. The goal of this *technical monitoring* is to detect non-complying AS providers that might endanger the security of the system. This technical monitoring is thus more important than the one for energy, because AS are directly related to the security of the network. On the other hand, participants should behave fairly by not abusing their dominant position. In addition,

¹³¹ However, generating companies are likely to be reticent about providing the reliability information on their units.

market flaws have to be detected as soon as possible. Note that such an *economic monitoring* is efficient only when it is associated with a system of penalties and rewards, which is discussed in section 4.8.5.

4.8.4.1 Technical monitoring

As shown in section 2.3, the definition of ancillary services includes numerous parameters. Therefore, AS monitoring requires specific equipments such as Phasor Measurement Units (PMU) to assess the efficiency of the AS provider¹³². Since the SO is in charge of the security of the system and is the only entity to have sufficient technical means to monitor the AS delivery, it should be in charge of the AS technical monitoring. Note that in case of cross-border trading (see section 2.5), monitoring may be difficult and does require a strong cooperation between the TSOs involved.

The SO's technical monitoring may be split into three components. First, the SO should carry out a *preliminary monitoring* in order to test the actual capability of the AS provider [e.g., Robert and Prestat (2004)]. Alternatively, the AS provider may give enough proof of its capability to fulfil the various criteria. In every case, this preliminary monitoring should be compulsory for any new provider in the market.

Second, the SO should enforce a *continuous monitoring* in normal operation. This monitoring may be costly, especially when the number of providers increases. To reduce the number of controls, the monitoring can be split into two levels. A global monitoring may help detect areas that do not behave as expected. A more precise monitoring of the AS providers within this area is then possible. Another solution to reduce the difficulty of collecting measurement from many sources is to choose only a few AS providers to supply AS for the whole system and to monitor them carefully, as is done in the Netherlands. Such a method allows an easy and low-cost monitoring, but may not favour security. Indeed, it is a priori better to have numerous small providers rather than a few large ones. A third solution to reduce the monitoring burden is to select randomly the AS providers being monitored carefully. Lastly, to monitor the contributions of distributed generation, a good solution is to delegate the task to DSOs and then to monitor the contribution of DSOs.

¹³² For detailed explanations on the actual implementation of the technical monitoring of AS, see for example Sterpu (2005) or Margotin *et al.* (2006).

Third, because AS are principally used when the system is stressed, AS monitoring is effective only during system events such as the sudden loss of a large generating unit. As such an event is unpredictable, a SO has to wait for an event of this kind to actually monitor an AS provider. Therefore, the SO may carry on instead an *extraordinary monitoring* by both stressing the AS provider (e.g., through the variation of the regulation signal sent to the units from the secondary frequency control) and monitoring its output. This type of monitoring should be exceptional because it stresses the system.

Lastly, since SOs cannot monitor everything, the proposed scheme should be complemented by incentives for self-improvement and transparency (*self-monitoring*). In fact, AS providers should be encouraged to declare any problem to the SO. However, AS providers would need sufficient means to monitor their service, which is not always the case, especially for small providers. Note that this lack of self-monitoring also means that the AS provider is not in a position to be able to argue against the SO's figures.

4.8.4.2 Economic monitoring

The economic monitoring is usually the task of the regulator or/and the anti-trust bodies (see section 1.2). The SO can also be involved, but obviously only if it is independent. The economic monitoring helps both give an incentive to participants and improve the procurement method. It can be split into four activities [Perrot and Molinier (2005)]: (a) detecting anti-competitive behaviours; (b) investigating in case of suspicion; (c) imposing sanctions against proven anti-competitive behaviours (e.g., by using penalties described in section 4.8.5); and (d) correcting the market design (see section 4.9).

Detecting an anti-competitive behaviour by a participant can be either done continuously in real-time (intensive method), as in the USA for energy spot markets, or upon *ex-post* request (non-intensive method), as in Europe. Discussing the advantages and the drawbacks of the available methods is not within the scope of this thesis. However, two comments should be highlighted. First, economic monitoring is intrinsically very difficult. Second, since monitoring rules are different across jurisdictions, economic monitoring of cross-border trading is likely to be even more difficult. Lastly, note that section 4.9.3 discusses in more details the assessment of the global economic efficiency of the procurement process.

4.8.5 Penalties and rewards

Monitoring without penalties or rewards does not give any incentive to participants to improve their behaviour. Penalizing AS providers should be the SO's task, since it is independent and has the means of control (see section 4.8.4). For example, the contract in France between the AS providers and RTE defines different levels of alert, with particular penalties [RTE (2007b)]. The penalties and rewards can then have different nature, intensity, structure and volatility.

First, the *nature* of the incentives has to be decided. In fact, penalties and rewards may be either financial or in other terms. For example, a unit which fails to provide a contracted service may have to provide free service (or receive a reduced payment) for a given period of time or until its next good response [Proctor (2001)]. In New Zealand, the party responsible for a disturbance pays some event charges determined annually by the TSO. Then, this fee is redistributed amongst the providers of the frequency control ancillary services during the two months prior the event [Electricity Commission of New Zealand (2005)]. Other schemes may be imagined, such as a redistribution of the fee amongst the “good” users during the event. Unfortunately, the literature does not seem to provide any discussion on this particular issue.

Second, an appropriate *structure* of the remuneration or the fee should be defined. Section 4.5 provides a discussion on the various structures possible.

Third, the *intensity* of the incentives varies with the measured performance. Keller and Franken (2006) have proposed four different incentive schemes, as shown in Figure 4.9.

Lastly, the *volatility* of the incentives should be determined. Indeed, penalties and rewards can be either fixed or variable over time. For example, they can be high when AS resources are scarce and low when the resources are abundant [DePillis (2006)], such as balancing mechanisms that provide volatile penalties (the price to pay for an imbalance depends on the market conditions).

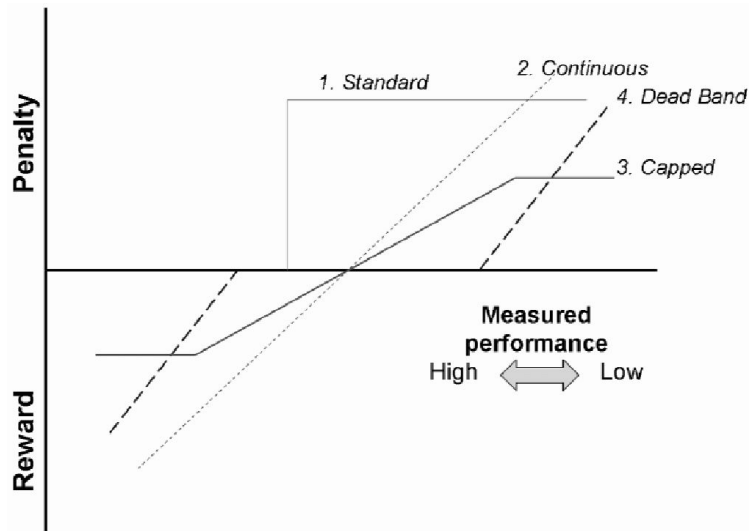

Figure 4.9: Four intensities of an incentive scheme [Keller and Franken (2006)]

4.9 Assessing the Procurement Method

Once a complete procurement method has been set up, it should be assessed against the following three goals: effectiveness (section 4.9.1), minimal running cost (section 4.9.2) and economic efficiency (section 4.9.3). It is important to perform this assessment regularly since the various parameters of the market evolve over time, such as power system operating conditions, the number and types of AS providers, or the behaviour of participants. This assessment should be followed by an improvement of the market design.

4.9.1 An effective procurement process

Effectiveness measures the extent to which all the system services that are needed are made available when required. So far, most of the systems in place are effective since ERAPs achieve to procure the required amount of ancillary services to fulfil the SS needs. Note that an effective procurement is not necessarily *efficient*, because the cost of SS procurement is not taken into account when assessing effectiveness.

4.9.2 Low running cost

The *cost of running the procurement system* should be minimized because it is subtracted from the global welfare. While this cost is sometimes forgotten in the liberalization process, setting up the metering, monitoring, billing and processes required can be expensive. The possible

gains from setting up a complex market for ancillary services rather than keeping a simple framework should therefore be considered carefully. To give an idea, the British balancing market is said to cost £80m/year to run [Thomas (2003)]

4.9.3 Economic efficiency

Economic efficiency depends on the behaviour of the participants. In theory, in a perfectly competitive market, all participants reveal the true value or true cost for a good. In practice, as shown in section 2.2, revealing the true value of system services is very difficult. Furthermore, markets for ancillary services suffer from high market concentration and poor liquidity because of the technical characteristics of ancillary services, as only a few providers are able to meet the technical criteria and there may be location constraints. Lastly, if the AS market is poorly designed and the demand is not very responsive, there is a strong chance that competition might be weak. Therefore, before moving towards the spot market paradigm for ancillary services, it may be wise to assess carefully and honestly the context and current markets and decide whether such a move is justified.

4.9.3.1 Measuring the economic efficiency

To measure the economic efficiency, the deviation from the simulated competitive price can be assessed, with, for example, the *Lerner index*. The Lerner index LI is calculated as in (4.2), where π^* is the actual price and $\tilde{\pi}$ the simulated competitive price [Liu *et al.* (2006)]. Sometimes, the competitive price may be hard to determine, so *benchmark prices* can be used instead. For instance, generator's reactive power offers in Australia are compared to benchmark prices based on the cost of SVCs [Cigré Task Force (2001)]. Deviations of the actual price from the simulated or benchmarked competitive price can be due to the abuse of a dominant position. However, some participants may have a dominant position but still can behave acceptably by helping to reach the competitive price. The parameters affecting a dominant position are discussed in section 4.9.3.2.

$$LI = \frac{\pi^* - \tilde{\pi}}{\pi^*} \quad (4.2)$$

It may be useful for SOs, regulators and AS providers to be able to benchmark their own markets for ancillary services against others and over time. By rising questions and thus initiating debates amongst participants, such a benchmark may improve the efficiency of

markets. The proposed *Cost Indicator* (CI or CI_{AS}^{\times}) for a given zone and a given ancillary service is calculated as in (2.4).

$$CI_{AS}^{\times} = \frac{C_{AS}^{\times}}{C_{energy}^{\times}} \quad (4.3)$$

where C_{AS}^{\times} (in €/year) is the annual ancillary service cost and C_{energy}^{\times} (in €/year) is the annual wholesale energy cost. CI_{energy}^{\times} is obtained by multiplying the average wholesale market price in the same year as CI_{AS}^{\times} by the energy consumption of the country in 2003¹³³ [IEA (2005)]. The wholesale energy cost is taken instead of the cost for end users in order to avoid price distortion due to taxes or specific agreements. C_{AS}^{\times} is either estimated by multiplying the average price by the average volume of ancillary services or obtained directly from reports.

Figure 4.10 shows the cost indicators in 2004-5 for primary frequency, secondary frequency and voltage control ancillary services for some systems considered in this thesis. The results are of the same magnitude as those reported in the study by Hirst and Kirby (1996) on the AS cost for twelve US utilities. The cost indicators for primary frequency control are fairly similar across all systems. This CI is comprised between 0.5 and 0.7 % of the energy cost, except in Australia where it is 0.35 %. This can be explained by a low price and a low negative reserve volume. Because of the lack of data on the new British market for ancillary services, the average cost of the pre-October 2005 system is used.

Secondary frequency control costs are rather high in Spain (more than 4 % of the energy cost). Indeed, the TSO bought large volumes at high prices in 2005. These high prices may be explained by the drought that affected Spain during that year. The French cost indicator is one of the lowest (0.5 %) mainly because of a volume that is more optimized than the average (see section 2.4.5). Cost incurred in Germany, PJM and New Zealand are equivalent (from 1 to 2 %). Lastly, the Australian cost indicator is the lowest because the amount of secondary frequency control reserve is very low.

Australia is the country with the highest voltage control cost. New Zealand cost is very low, even if the basic voltage control is remunerated, probably because of the large

¹³³ More recent data were not available at the time of the study.

proportion of cheap hydro units. PJM and France have a similar and intermediate position, while Great Britain is among the cheapest. Lastly, since the Swedish TSO does not remunerate voltage control, no cost indicator can be calculated.

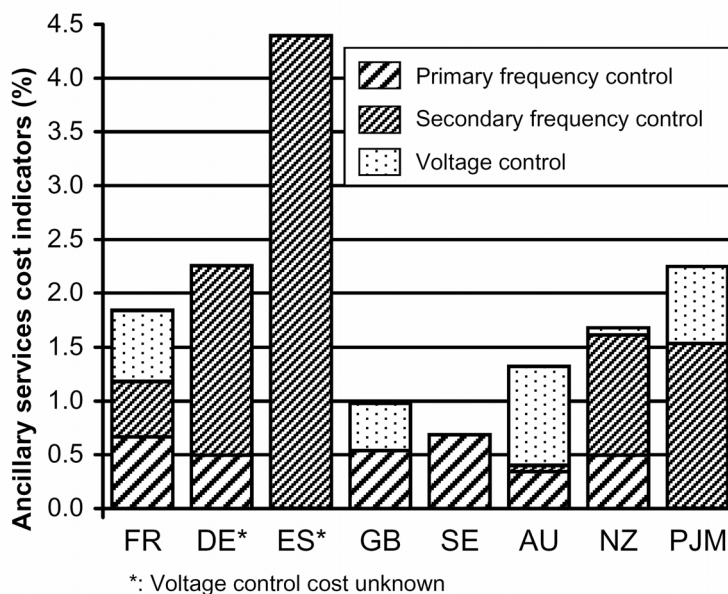

Figure 4.10: Ancillary services cost indicators across systems surveyed in 2004-5

4.9.3.2 Structural parameters influencing the economic efficiency

The parameters given in this section influence the dominance of some participants and are intrinsic to the market. First, the *market concentration* quantifies the diversity of possible AS providers and is usually measured using indicators such as the Herfindahl-Hirschman Index¹³⁴ (HHI) or the Residual Supply Index¹³⁵ (RSI). A high market concentration is often mentioned as the main reason of dominance. This lack of competitors is said to lead to an inefficient market.

Market concentration can be reduced by several means. First, large suppliers may be split into smaller ones. Besides having very strong political consequences, such a policy may be unfavourable for investments, which are often large in the electricity sector, rely economies of scales and depend on the control of technology. Second, less restrictive

¹³⁴ The Herfindahl-Hirschman Index of a market is calculated by summing the squares of the individual market shares (in %) of all participants. It is thus comprised between 0 and 10,000. The correspondance between values of the HHI and the generally agreed concentration of the market is as follows: 0-999: low; 1,000-1,800: moderate; 1,801-10,000: high [Newbery *et al.* (2004)].

¹³⁵ The Residual Supply Index of a company at a given time is calculated by subtracting the company's capacity (in MW) from the total capacity (imports included and in MW), and by dividing this difference by the total demand (in MW). Therefore, if the RSI is inferior to 1, the company is pivotal and has thus a strong impact on the market [Newbery *et al.* (2004)].

technical requirements may also decrease market concentration because they increase the number of potential AS providers. As explained in section 2.3.1, a trade-off has to be found between requirements that are too general or too restrictive. Third, barriers to entry (such as compulsory connecting conditions that are too complex or long-term bilateral contracts) decrease the number of potential AS providers. Therefore, removing these barriers may help decrease market concentration. Lastly, appropriate incentives, e.g. through a fair remuneration, have to be given in order to foster competition in the markets for AS.

In practice, Thomas (2003) and Haas *et al.* (2006) highlight that the electricity sector is strongly concentrated in Europe. The situation is worse in markets for ancillary services because fewer units are able to provide AS. However, demand for energy is much more important than for AS, which makes a comparison between markets for energy and AS difficult. Nevertheless, actual markets for voltage control suffer from intrinsic high market concentrations because of their local nature (see section 1.5). On the other hand, markets for primary and secondary frequency controls are generally less concentrated because participants located anywhere can provide this service as long as transmission capacities are sufficient. However, primary frequency control has to be uniformly spread around the network and technical requirements are more demanding for primary frequency control than for secondary frequency control (see Chapter 2), so more units are able to provide this latter service.

Second, the *liquidity of the market* also influences the dominance of participants. Indeed, even small agents can easily change clearing prices of a non-liquid market by selling or buying small quantities of AS. Good transmission and standardised products help increase the liquidity of the market. Note that a market can be both liquid and concentrated.

Third, the *topology of the network* is an important parameter because the dominance of an actor increases with network limitations (e.g., congestions). For instance, a non-meshed network is more easily subject to strategic behaviours because it is easier to create constraints in such a network. In addition, predictable network events such as the utilisation of large amount of secondary frequency control at a given hour of the day are also likely to increase the dominance of participants. Consequently, system operators have a key role to play in the mitigation of dominant positions through a network design and operation that foster competition. However, this mitigation of dominant positions has to be at any time in concordance with the system security.

Fourth, the *characteristics of the demand* are also very important. First, it is desirable to have a demand for AS much lower than the supply in order to increase competition [Cali *et al.* (2001)]¹³⁶. Second, an appropriate demand responsiveness reduces the incentives to deviate from the competitive price. However, the demand is often inelastic in practice (see section 2.4). Nevertheless, competition between ERAPs may help introduce more demand elasticity. For instance, section 2.5 discusses the procurement of AS across different areas, which implies a competition amongst TSOs. For a further discussion on demand curve for reserves, Hogan (2006) discusses the definition of such a curve for operating reserves.

Fifth, along with the restructuring of electricity markets, the *separation of responsibilities* is an important issue, in particular the unbundling of network and generation/supply activities (see section 1.2). In the particular case of ancillary services, trading AS across systems can raise similar questions. Indeed, the TSO usually manages the transmission capacities at its borders. It is also the natural buyer of AS within its territory. Therefore, it would be relatively easy for the TSO to have a right of pre-emption over the cheap AS providers within its territory because the TSO would be both deciding the rules and playing the game.

Lastly, the *market design* has an obvious impact on the influence of some actors. For instance, the repetitiveness of the auction in similar conditions may favour strategic behaviours (see section 4.6.6). As discussing the various issues related to the design of markets for AS is the principal motivation of the whole chapter, no details are given here. Broadly speaking, it is important that participants trust the market.

Consequently, it is very difficult to guarantee economic efficiency for AS markets. However, despite all these practical issues, a competitive market for frequency control AS is usually assumed in the literature. It is however generally recognized that markets for voltage control are difficult to implement. A competitive market implies that no participant uses its dominant position, which is hard to verify and may change over time. Therefore, it is desirable to find practical solutions to mitigate the potential abuse of dominance as described in section 4.8.

¹³⁶ See section 4.3 for a discussion on how foster the supply of AS.

4.10 Summary

This chapter has reviewed in a structured manner most of the issues and solutions related to the design of the procurement of system services. It is clear that an ideal market design does not exist, so the choice of one method over another one deeply relies on the history, the policy of the legislator, the design chosen for other related products (e.g., energy, transmission or balancing markets) and the particularities of the power system considered.

To improve current market designs, a fully independent body (e.g., the regulator) should describe and justify the methods adopted in its system area to solve every issue listed below. Flaws will then become obvious and thus stakeholders will have strong incentives to propose improvements.

- ✓ *Nominating the entity responsible of procurement (ERAP):* the SO is the best candidate since it is a natural buyer of AS;
- ✓ *Matching supply and demand:* long-term supply is achieved with compulsory connecting conditions. Though it is not the optimal solution, this policy is currently the most practical. However, reduction of the long-term demand is desirable but rarely implemented in practice. Concerning short-term procurement, demand response is compulsory if the ERAP has not covered its supply against risks. More generally, demand for AS does not reflect the true value of SS in all the surveyed systems;
- ✓ *Choosing the relevant procurement methods to contract AS provision:* various methods are possible for the ERAP, namely: (a) compulsory provision, (b) self procurement, (c) bilateral contract, (d) tendering and (e) spot market. None of these solutions is perfect, so it may be desirable to select a few of them and use them concurrently;
- ✓ *Defining the structures of offers and payments to remove price distortions:* six structures of offer and payment have been proposed, namely: (a) a fixed allowance, (b) an availability price, (c) an utilisation payment, (d) the opportunity cost, (e) an utilisation frequency payment and (f) a price for kinetic energy. The choice amongst these components depends on the cost structure of the ancillary services considered (e.g., high fixed costs or high variable costs).
- ✓ *Organizing the market clearing procedure to fix the prices and amounts of transactions between participants:* In conclusion, because of the number of possible methods that are still under debate, designing the most appropriate market clearing procedure is a complex task.

-
- Two *structural arrangements* are possible: centralised unit commitment (pool) or decentralised commitment (exchange). The choice is mainly a political matter, though centralised structures are theoretically more efficient because a global optimization can be performed;
 - The *auction* defines how the offer and the demand for AS are submitted and matched. The Vickrey and the VCG auctions have nice features but are not very practical. Therefore, classical sealed-bid auctions are preferred in practice, even if such auctions are not Pareto efficient;
 - *Scoring*, which classifies AS offers, is very difficult because of the multi-dimension feature of AS;
 - *Coordination between the clearings* of the various AS markets is essential. In particular, simultaneous clearing is the most efficient solution, but it is harder to implement in decentralised systems and is computationally very demanding;
 - The *settlement rule* organises the payment of the AS providers selected in the auction. Non-remunerated policies remove the property rights of AS providers and thus have to be avoided. Administrative prices are not efficient either, except in the presence of dominant players. The best settlement rule is still under debate (e.g., discriminatory or uniform price, zonal or nodal price, etc...);
 - The *timing* of the market has to be chosen carefully. Indeed, higher frequencies are likely to increase the efficiency of the market, but also the potential for abuse of dominance and the operating cost.
- ✓ *Price caps* of any kind should be avoided as much as possible. An appropriate demand curve is more desirable;
- ✓ *Providing proper incentives* to stimulate appropriate behaviours by participants, besides intangible incentives (e.g., the fear of blackouts) and competition:
- The *allocation of SS costs* should ideally be performed with three components: (a) the fixed cost of SS through the transmission tariff, (b) the variable AS reservation costs through an allocation based on the potential utilisation of the users and (c) the actual utilisation of SS through to the users that use them;
 - *Transmission of data*: sufficient and balanced information has to be given to the market participants to foster competition. This information should cover the trading mechanism, the needs in terms of SS, the structure of the power system and the relevant economic signals;

- *Monitoring* of the participants in markets for AS: the SO usually performs the technical monitoring, which is divided into a preliminary, a continuous and an extraordinary monitoring. Since it is very difficult to monitor all the AS providers, incentives have to be given to encourage self-monitoring. The regulator and the anti-trust body are usually in charge of the economic monitoring, which is split into four functions: detecting, investigating, imposing sanctions and correcting;
 - *Penalties and rewards*: to be effective, the monitoring should be complemented by penalties and rewards of various natures, structures, intensities and volatilities.
- ✓ *Assessing the procurement method* to improve it. The procurement method should fulfil three goals: effectiveness, minimisation of running cost and economic efficiency. The optimum between these three goals is currently searched through an iterative process. However, assessing these three indicators of the procurement method is actually very difficult and it is almost impossible to guarantee a competitive price for AS. Actual AS prices are thus often obtained with the help of acceptable behaviours of the participants or regulatory decision. ■

CHAPTER 5

CONCLUSIONS AND FUTURE RESEARCH

The future belongs to the one who has the longest memory.

Friedrich Nietzsche (1844 - 1900)

5.1 Rationale for the Thesis

From consumers to generating units, including system operators and transmission owners, *all users of an electrical power system expect an appropriate standard for frequency and voltage.* The global frequency and the local voltages can be controlled by acting on the balances between consumption and generation of active and reactive powers across the power system. The frequency and voltage control services are called system services (SS). In addition to expecting a certain standard, the power system users affect the balances of reactive and active powers. Therefore, *any user can both perturb and help control frequency and voltages.* When users help control frequency and voltage, they provide the so-called ancillary services (AS). While the responsibility of users to provide ancillary services was less clear twenty years ago, the development of information technologies, power electronics and electricity markets force now all users to face their double responsibilities as consumers of system services and

providers of ancillary services. However, *users need a consistent framework to manage ancillary services in order to fully grasp opportunities and hence maximize the global welfare.*

So far, academic and industrial research was concentrated on specific issues and sometimes ignored the relations between technique, cost and market design. A global framework was thus missing. To fill this gap, *this thesis provides a comprehensive assessment of markets for frequency and voltage control ancillary services* along three axes: (a) *defining the needs* for system services and the ancillary services that can fulfil these needs; (b) *assessing the cost* of ancillary services; and (c) *discussing the design* of an efficient market-based procurement of system services.

Such a framework exhibits several advantages: (a) stakeholders can *grasp quickly the issues* related to ancillary services; (b) stakeholders benefit from a standardised *method to assess their system*; (c) solutions are proposed to *improve current arrangements*; and (d) theoretical limitations that need *future work have been identified.*

5.2 Contributions to Knowledge

First, this thesis has formulated the problem of the needs of users. To meet these needs, given qualities and quantities ancillary services have to be provided at appropriate locations. The issues raised by these technical specifications have been discussed and compared with actual requirements across systems. In particular, the thesis has led to the following conclusions:

- ✓ *Needs for system services:*
 - *Expression of the needs:* a cost-benefit optimisation is the best manner to define the needs in terms of system services. Security, power quality and system utilisation should all be taken into account in the optimisation process. However, practical solutions tend to be based on obscure or simplified methods, past experience or general recommendations;
 - *Review of the needs:* the needs of users and the system constraints evolve with time. Therefore, the needs for system services should be reviewed frequently by system operators. However, system operators have little incentive to change rules-of-thumb that have performed reasonably well for years, even if these rules are sometimes hard to justify.

- ✓ *Quality of ancillary services:*
 - *Differentiation of ancillary services:* it is not possible to find a perfect specification between general and precise specifications of ancillary services;
 - *Description of ancillary services:* a framework to compare ancillary services has been proposed and successfully applied to various power systems. In addition, a standardised description has been proposed, as well as a standardised definition of the term “spinning reserve”;
 - *Standardisation of ancillary services:* in practice, specifications of ancillary services differ from one system to another. Therefore, efforts should be made to unify similar ancillary services in order to foster short-term exchanges of services between neighbouring systems.
- ✓ *Quantity of ancillary services:*
 - *Responsibility for quantity requirements:* because system services are public goods, only the system operator should define the requirements for ancillary services;
 - *Definition of quantity requirements for ancillary services:* the requirements should take into account various features. However, current practices are usually opaque;
 - *Elasticity of quantity requirements:* the demand for ancillary services should be elastic;
 - *Synopsis of quantity requirements:* an indicator has been developed to compare quantity requirements for ancillary services and thus gives incentives to system operators to improve their practices.
- ✓ *Location of ancillary services:*
 - *Importance of location:* the location of reactive power providers is particularly important. The actions of frequency control providers are global but still may be hampered by a bad location (e.g., a congested area);
 - *Mechanisms to exchange ancillary services between locations:* technical mechanisms should exist to allow participants exchange AS between neighbouring locations. However, these mechanisms usually do not exist between neighbouring systems.

Second, this thesis has reviewed the main cost components of ancillary services and has proposed a methodology to estimate the day-ahead de-optimisation cost incurred by a producer because of frequency control. This methodology has been successfully applied to EDF Producer, and has provided several interesting results. The main findings are:

- ✓ *Estimating accurately the total cost of ancillary services is extremely difficult for a producer because:*

- The cost of ancillary services has *several components*;
 - Different *inter-dependent time horizons* have to be considered, from tens of years ahead to real-time;
 - It is often *difficult to separate the cost* of ancillary services from the cost of other products;
 - The cost of ancillary services *depends on the portfolio considered* and it is *affected by many uncertainties*.
- ✓ One main cost component of frequency control is *the day-ahead de-optimisation cost* because of the need to set aside capacity to provide reserves. *A methodology has been proposed* to estimate this cost and *a specific tool, named OTESS, has been developed* to apply this methodology to any producer;
- ✓ *This methodology has been successfully applied to EDF Producer's portfolio* (i.e., around 150 thermal units and 50 hydro valleys) over 879 days with actual operational data and EDF's actual optimisation algorithm;
- ✓ The results obtained are *very helpful to assess the frequency control provision*. In particular:
- *The de-optimisation cost is not negligible*, since it represents up to 7.8 % of the initial dispatch cost as an underestimate. Therefore, an efficient provision of frequency control reserve is essential to reduce this cost as much as possible;
 - *The de-optimisation cost exhibits strong variations* (greater than ± 20 % for more than 54 % of the days). Therefore, the market design should take this variation into account to help participants reap opportunities (e.g., by allowing short-term exchanges);
 - *The seasonality of the de-optimisation cost is relatively poor over the studied timeframe*. Therefore, it does not seem possible to select a particular period and then to generalise the result of this period over the whole timeframe. Hence, future studies on the de-optimisation cost have to consider a large number of days to both give accurate results and help identify potential long-term seasonalities;
 - For EDF Producer, *the de-optimisation cost is sensitive to three major parameters*:
 - *The expected marginal costs of reserves*: there is a strong link between the marginal costs of reserves and the de-optimisation cost. Therefore, the marginal costs can be used as a proxy to estimate the de-optimisation cost;
 - *The primary reserve demand*: because of the capabilities of EDF Producer's portfolio, primary reserve demand clearly affects the de-optimisation cost, whereas the influence of secondary reserve is not as marked;

- *The quantity of reserves provided by hydro units:* when hydro cannot be used extensively to provide reserves for some critical time steps, the de-optimisation cost tends to be high. However, this trend is due to a somewhat simplistic modelling of hydro units in the optimisation algorithm that does not reflect the actual cost of hydro units.
- *The demand for reserves can be the most binding constraint.* It may thus be useful to develop storage or load control strategies in order to allow a conversion of the cheaper energy into reserves;
- *The reserve constraint may not be binding at all,* so the security of the system can be increased at very low cost by increasing the demand for reserves during periods when the marginal costs of reserves are low;
- *The de-optimisation cost due to time control represents tens of millions of euros per year in France.* The value of such an expenditure needs to be proven.

Third, this thesis has proposed a comprehensive and structured analysis of the features of a market for ancillary services. To improve current market designs and to balance the information sent to participants, a fully independent body (e.g., the regulator) should describe and justify the methods adopted to solve the design issues listed below:

- ✓ *Nominating the entity responsible of procurement (ERAP):* the system operator is the best candidate since it is a natural buyer of AS;
- ✓ *Matching supply and demand:* long-term supply should be ensured to have access in the long run to sufficient AS capabilities at the appropriate locations. In addition, reduction of demand for ancillary services should be pursued. Furthermore, an efficient short-term procurement mechanism is also essential;
- ✓ *Choosing the relevant procurement methods to contract AS provision:* five methods have been listed. Since none of them is perfect, it may be desirable that the ERAP selects a few of them and uses them concurrently;
- ✓ *Defining the structures of offers and payments to remove price distortions:* six possible structures of offer and payment have been proposed. The optimal choice amongst these components depends on the cost structure of the ancillary services considered;
- ✓ *Organizing the market clearing procedure to fix the prices and amounts of AS transactions between participants:* Several choices have to be made:

- Two *structural arrangements* are possible: centralised unit commitment (pool) or decentralised commitment (exchange);
 - The *auction* defines how the offer and the demand for AS are submitted and matched. Classical sealed-bid auctions are preferred in practice, even if such auctions are not Pareto efficient;
 - *Scoring*, which classifies AS offers, is very difficult because of the multi-dimension feature of AS;
 - *Coordination between the clearings* of the various AS markets is essential. In particular, simultaneous clearing is the most efficient solution, but it is harder to implement in decentralised systems and is computationally very demanding;
 - The *settlement rule* organises the payment of the AS providers selected in the auction. Non-remunerated procurement and administrative prices have to be avoided. The best settlement rule is still under debate (e.g., discriminatory or uniform price, zonal or nodal price, etc...);
 - The *timing* of the market has to be chosen carefully. Higher frequencies are likely to increase the efficiency of the market, but also the potential for abuse of dominance and the operating cost.
- ✓ *Price caps* of any kind should be avoided as much as possible. An appropriate demand curve is much more desirable;
- ✓ *Providing proper incentives* to stimulate appropriate behaviours by participants, besides intangible incentives (e.g., the fear of blackouts) and competition:
- The *allocation of SS costs* should ideally be performed with three components: (a) the fixed cost of SS through the transmission tariff, (b) the variable AS reservation costs through an allocation based on the potential utilisation of the users, and (c) the actual utilisation of SS through to the users that make the actual use of these services necessary;
 - *Transmission of data*: sufficient and balanced information has to be given to the market participants to foster competition;
 - *Monitoring* of the participants in markets for AS: the SO usually performs the technical monitoring and incentives have to be given to encourage self-monitoring and transparency. The regulator and the anti-trust body are usually in charge of the economic monitoring;

- *Penalties and rewards:* to be effective, the monitoring should be complemented by penalties and rewards of various natures, structures, intensities and volatilities.
- ✓ *Assessing the procurement method* to improve it. The procurement method should fulfil three goals: effectiveness, minimisation of running cost and economic efficiency. Note that current AS prices are often obtained with the help of acceptable behaviours of the participants or regulatory decisions, but not from incentive to compete.

5.3 Short-Term Evolutions Desirable in France

By applying the assessment framework to the French power system, various short-term evolutions become obvious candidates for improving current arrangements (the thesis discusses in more details the issues related to the following propositions):

- ✓ *Delivery of ancillary services:*
 - *Needs for system services:* more incentives should be developed to reduce the long-term needs for system services. Furthermore, the value of time control should be explored in further details;
 - *Quality of ancillary services:* technical AS requirements should facilitate the entrance of non-conventional participants, for example by allowing non-symmetrical capabilities, which would help wind farms or loads participate in the market;
 - *Quantity of ancillary services:* the French transmission system operator or the French regulator should explain in details the method used to calculate the requirements for frequency control reserves. In addition, an elastic demand would be desirable to buy more ancillary services when they are cheaper;
 - *Location of ancillary services:* exchanges between neighbouring countries should be implemented in order to increase the trade-off possibilities of participants. However, such a system requires a co-optimisation with energy and transmission, which can be complex in a decentralised trading mechanism such as the one used in continental Europe.
- ✓ *Cost of ancillary services:* work on this topic should be performed individually by AS providers;
- ✓ *Procurement of system services:*
 - *Procurement methods:* since it has been proven that the cost of ancillary services has a strong daily variation in France, short-term procurement methods are desirable to

complement the current system of long-term bilateral contracts. This would help increase the global welfare;

- *Structures of offers and payments*: symmetrical prices should be removed. The voltage control availability payment (i.e., in €/Mvar/h) should be a function of the distance from the unity power factor;
- *Settlement rule*: the energy utilisation of the secondary frequency control should be indexed on the price of balancing mechanism since the objectives of these two controls are similar.

5.4 Suggestions for Future Work

This thesis has left open various issues. First, this thesis focused on the description of an assessment method. Therefore, the developed framework will be particularly useful if it is applied to actual systems (the thesis applied the framework only partially to actual systems). Furthermore, the structures of systems vary over time. Therefore, *the proposed assessment should be applied regularly on power systems to improve current arrangements, balance information and share good practices*. Such an assessment would be particularly interesting for systems that are likely to benefit from a common market for AS in the future, such as Belgium, France, Germany, Luxembourg and The Netherlands. For example, a dedicated taskforce funded by regulators could be set up. Note that particular attention should be brought to the operating cost of markets, which is usually ignored in the restructuring process.

Second, defining appropriate needs for ancillary services is limited by a theoretical barrier well-known since the early age of power system: the value of a continuous supply of electricity. Furthermore, the value of ancillary services should also consider power quality and the power system utilisation. It is thus essential to *improve the knowledge of the value of system services* to enhance markets for ancillary services by introducing elasticity.

Third, long-term procurement of ancillary services is currently achieved through connecting conditions imposed on new generating units. A more efficient system could be developed to *send appropriate signals and trigger optimal investments in AS capabilities*. In particular, such signals are essential for AS providers to develop (or not) alternative means of AS provision.

Fourth, the limit between negotiable and non-negotiable products is not clear. For example, stability is not remunerated in some systems, whereas some units are useful for stability and others do not contribute to it. Therefore, it seems important to *draw the limit between negotiable and non-negotiable products* and to evaluate the price of potential new services.

Fifth, the *exchange of ancillary services across systems* is an important feature to help increase the global welfare. However, such an arrangement is challenging for several reasons: (a) it necessitates product standardisation across systems; (b) it needs market standardisation; and (c) it faces the strong engineering challenge to co-ordinate energy, transmission and ancillary services markets in a decentralised manner. In addition, the best organisation to tackle this issue is not clear. For example, should a dedicated entity or informal networks perform such studies?

Sixth, markets for ancillary services suffer from structural dominant positions. Therefore, economic research has to *develop methods that guarantee an efficient procurement of ancillary services* despite structural issues.

Seventh, *the cost of AS should be better understood*. In particular, OTESS could be used to determine the annual supplemental cost of frequency control reserves (i.e., the cost to provide one supplemental MW over one year). The study could also be completed with additional data since August 2007 and improved by better taking into account hydro constraints. Moreover, AS price forecasting should be improved to better negotiate long-term contracts.

Eight, to make the system as efficient as possible, it is essential to *investigate all the technical possibilities to control frequency and voltage*. In particular, research should be performed to increase contributions by intermittent generation, loads and storage.

Ninth, the thesis was concentrated on the markets for ancillary services. However, *other electricity markets, such as energy, transmission or CO₂ could benefit from similar comprehensive assessment frameworks*. ■

REFERENCES

- Abbott (2001) M. Abbott, "Is the Security of Electricity Supply a Public Good?" *The Electricity Journal*, vol. 14 (7), pp. 31-33, August-September 2001.
- Abiri-Jahromi *et al.* (2007) A. Abiri-Jahromi, M. Fotuhi-Firuzabad, and E. Abbasi, "Optimal Scheduling of Spinning Reserve Based on Well-Being Model", *IEEE Transactions on Power Systems*, vol. 22 (4), pp. 2048-2057, November 2007.
- Alvarado *et al.* (2003) F. Alvarado, B. Borissov, and L. Kirsch, "Reactive power as an identifiable ancillary service", Laurits R. Christensen Associates, Inc, Madison, WI, USA, 18 March 2003. Available: http://www.caenergy.com/downloads/Alvarado_Kirsch_IdentifiableAncillaryService.pdf
- Anderson (1999) P. M. Anderson, *Power System Protection*. New York, NY: Wiley-IEEE Press, 1999.
- Arnott *et al.* (2003) I. Arnott, G. Chown, K. Lindstrom, M. Power, A. Bose, O. Gjerde, R. Morfill, and N. Singh, "Frequency control practices in market environments", in *Proc. 2003 CIGRE/IEEE PES International Symposium. Quality and Security of Electric Power Delivery Systems*, pp. 143-148.

- Arroyo and Galiana (2005) J. M. Arroyo and F. D. Galiana, "Energy and reserve pricing in security and network-constrained electricity markets", *IEEE Transactions on Power Systems*, vol. 20 (2), pp. 634-643, May 2005.
- Bakken and Faanes (1997) B. Bakken and H. Faanes, "Technical and economic aspects of using a long submarine HVDC connection for frequency control", *IEEE Transactions on Power Systems*, vol. 12 (3), pp. 1252-1257, August 1997.
- Baldick *et al.* (2005) R. Baldick, U. Helman, B. F. Hobbs, and R. P. O'Neill, "Design of efficient generation markets", *Proceedings of the IEEE*, vol. 93 (11), pp. 1998-2012, November 2005.
- Bastard (1998) P. Bastard, "Fonctionnement et réglage des systèmes de transport et de distribution d'énergie électrique", Lecture handout 06923/50^a1998, Supélec, Gif-sur-Yvette, France, 1998.
- Baughman *et al.* (1997a) M. L. Baughman, S. N. Siddiqi, and J. W. Zarnikau, "Advanced pricing in electrical systems. I. Theory", *IEEE Transactions on Power Systems*, vol. 12 (1), pp. 489-495, February 1997.
- Baughman *et al.* (1997b) M. L. Baughman, S. N. Siddiqi, and J. W. Zarnikau, "Advanced pricing in electrical systems. II. Implications", *IEEE Transactions on Power Systems*, vol. 12 (1), pp. 496-502, February 1997.
- BDEW (2007a) "TransmissionCode 2007: Netz- und Systemregeln der deutschen Übertragungsnetzbetreiber", Bundesverband der Energie- und Wasserwirtschaft e.V., Berlin, Germany, 2007. Available: [http://www.bdew.de/bdew.nsf/id/DE_7B6ERD_NetzCodes_und_Richtlinien/\\$file/TransmissionCode2007.pdf](http://www.bdew.de/bdew.nsf/id/DE_7B6ERD_NetzCodes_und_Richtlinien/$file/TransmissionCode2007.pdf)
- BDEW (2007b) "TransmissionCode 2007 - Anhang D 1: Unterlagen zur Präqualifikation für die Erbringung von Primärregelleistung für die ÜNB", Bundesverband der

- Energie- und Wasserwirtschaft e.V, Berlin, Germany, 2007. Available: [http://www.bdew.de/bdew.nsf/id/DE_7B6ERD_NetzCodes_und_Richtlinien/\\$file/Anhang_D1_PRL.pdf](http://www.bdew.de/bdew.nsf/id/DE_7B6ERD_NetzCodes_und_Richtlinien/$file/Anhang_D1_PRL.pdf)
- BDEW (2007c) "TransmissionCode 2007 - Anhang D 2: Unterlagen zur Präqualifikation für die Erbringung von Sekundärregelleistung für die ÜNB", Bundesverband der Energie- und Wasserwirtschaft e.V, Berlin, Germany, 2007. Available: [http://www.bdew.de/bdew.nsf/id/DE_7B6ERD_NetzCodes_und_Richtlinien/\\$file/Anhang_D2_SRL.pdf](http://www.bdew.de/bdew.nsf/id/DE_7B6ERD_NetzCodes_und_Richtlinien/$file/Anhang_D2_SRL.pdf)
- Belgium economic department (2002) Ministère des affaires économiques, *Arrêté royal établissant un règlement technique pour la gestion du réseau de transport de l'électricité et l'accès à celui-ci*, Moniteur Belge, 2002, pp. 58471-58541. Available: <http://www.ejustice.just.fgov.be/>
- Bergstrom (1999) T. Bergstrom, "Lecture on Economics. Chapter 17: Auctions", Lecture slides, Department of Economics, University of California, Santa Barbara, CA, 1999. Available: <http://econ.ucsb.edu/~tedb/Courses/Ec100BS06/PPSlides/Ch17.ppt>
- Bernard *et al.* (1998) J. C. Bernard, T. Mount, and W. Schulze, "Alternative auction institutions for electric power markets", *Agricultural and Resources Economics Review*, vol. 27 (2), pp. 125-131, October 1998. Available: http://agecon.lib.umn.edu/cgi-bin/pdf_view.pl?paperid=5668&ftype=.pdf
- Berry and Lindgren (1990) D. A. Berry and B. W. Lindgren, *Statistics: theory and method*. Pacific Grove, Calif: Andover : Brooks/Cole ; International Thomson Pub. Services, 1990.
- Bertsimas and Tsitsiklis (1997) D. Bertsimas and J. N. Tsitsiklis, *Introduction to Linear Optimization*. Athena Scientific, 1997.

- Bhattacharya and Zhong (2001) K. Bhattacharya and J. Zhong, "Reactive power as an ancillary service", *IEEE Transactions on Power Systems*, vol. 16 (2), pp. 294-300, May 2001.
- Billinton and Allan (1996) R. Billinton and R. N. Allan, *Reliability evaluation of power systems*. New York; London: Plenum Press, 1996.
- Bosch (2006) "Lave-linge Logixx 5 - Notice d'utilisation et d'installation", 0206 fr G1411-01, Robert Bosch Hausgeräte GmbH, München, Germany, 2006.
- Boucher *et al.* (2006) J. Boucher, O. Daxhelet, and Y. Smeers, "An alternative benchmark of the Internal Electricity Market", in *Proceedings of the Journées de la section électrotechnique du club EEA 2006*, pp. 69-95.
- Brien (1999) L. Brien, "Why the Ancillary Services Markets in California Don't Work and What to Do About It", *The Electricity Journal*, vol. 12 (5), pp. 38-49, June 1999.
- British Electricity International (1991) British Electricity International, *Modern power station practice : incorporating modern power system practice*, 3rd ed. Oxford: Pergamon, 1991.
- Bushnell and Oren (1994) J. B. Bushnell and S. S. Oren, "Bidder cost revelation in electric power auctions", *Journal of Regulatory Economics*, vol. 6 (1), pp. 5-26, February 1994.
- CAISO (2005a) "Dispatch of Operating Reserves", Procedure No M-430, Version No 2.1, CAISO, Folsom, CA, USA, 30 September 2005. Available: <http://www.caiso.com/docs/2002/07/30/2002073015073820275.pdf>
- CAISO (2005b) "Ancillary Service Procurement", Procedure No M-402, Version No 6.1, CAISO, Folsom, CA, USA, 4 November 2005. Available: <http://www.caiso.com/docs/1998/12/02/1998120218202714536.pdf>

-
- Cali *et al.* (2001) A. Cali, S. Conti, and G. Tina, "Ancillary services in deregulated electricity power industry: a structured comparison", in *Proceeding of the Fifth LASTED International Conference on Power and Energy Systems 2001*, pp. 161-166.
- CER (2003) "Self-Commitment versus Centralised Commitment", Commission for Energy Regulation (CER), Dublin, Ireland, 22 December 2003. Available: <http://www.cer.ie/CERDocs/cer03299.pdf>
- Chao and Wilson (2002) H.-P. Chao and R. Wilson, "Multi-Dimensional Procurement Auctions for Power Reserves: Robust Incentive-Compatible Scoring and Settlement Rules", *Journal of Regulatory Economics*, vol. 22 (2), pp. 161-183, September 2002.
- Chicco and Gross (2004) G. Chicco and G. Gross, "Competitive acquisition of prioritizable capacity-based ancillary services", *IEEE Transactions on Power Systems*, vol. 19 (1), pp. 569-576, February 2004.
- Cigré Task Force (2001) Task Force 38.05.07, "Methods and tools for costing ancillary services", Report No 190, Conseil International des Grands Réseaux Electriques (Cigré), Paris, France, June 2001.
- Cohen (1978) G. Cohen, "Optimization by decomposition and coordination: A unified approach", *IEEE Transactions on Automatic Control*, vol. 23 (2), pp. 222-232, April 1978.
- Corsi *et al.* (1995) S. Corsi, P. Marannino, N. Losignore, G. Moreschini, and G. Piccini, "Coordination between the reactive power scheduling function and the hierarchical voltage control of the EHV ENEL system", *IEEE Transactions on Power Systems*, vol. 10 (2), pp. 686-694, May 1995.
- Cramton and Stoft (2005) P. Cramton and S. Stoft, "A Capacity Market that Makes Sense", *The Electricity Journal*, vol. 18 (7), pp. 43-54, August-September 2005.

- CRE (2008) "Observatoire des marchés de l'électricité et du gaz - 4ème trimestre 2007", Commission de Régulation de l'Energie (CRE), Paris, France, 29 February 2008. Available: <http://www.cre.fr/fr/content/download/5342/118109/file/dmspObsT407.pdf>
- Da Silva *et al.* (2001) E. Da Silva, J. Hedgecock, J. C. Mello, and J. C. F. Da Luz, "Practical Cost-Based Approach for the Voltage Ancillary Service", *IEEE Transactions on Power Systems*, vol. 16 (4), pp. 806-812, November 2001.
- DePillis (2006) M. S. DePillis, "The New Ancillary Services Markets of New England", presented at the Midwest ISO Ancillary Services Roundtable, Carmel, IN, USA, 26-27 April 2006. Available: http://www.midwestmarket.org/publish/Document/469a41_10a26fa6c1e_-74c30a48324a/7%20-%20Midwest%20ISO%20Ancillary%20Services%20Roundtable_ISO-NE.pdf?action=download&_property=Attachment
- DGEMP/DIDEME (2003) "Les coûts de référence de la production électrique", DGEMP/DIDEME/SD6, Ministère de l'Economie, des Finances et de l'Industrie, Paris, France 2003. Available: http://www.industrie.gouv.fr/energie/electric/se_ele_a10.htm
- Doherty *et al.* (2005) R. Doherty, G. Lalor, and M. O'Malley, "Frequency control in competitive electricity market dispatch", *IEEE Transactions on Power Systems*, vol. 20 (3), pp. 1588-1596, August 2005.
- DTe (2005) "Netcode", Directie Toezicht Energie, The Hague, The Netherlands, 1 July 2005. Available: http://www.dte.nl/images/NETCODE%20per%2001072005_tcm7-74895.pdf
- EDF (2004) "Conditions générales relatives à l'accès et à l'utilisation du réseau électrique ainsi qu'à la fourniture d'électricité pour les clients soumis au code des marchés

- publics ayant souscrit un contrat unique", Electricité de France (EDF), Paris, France, 10 November 2004.
- EDF (2006) (July). "Une électricité de qualité". [Online]. Available: <http://collectivite.edf.fr/>
- Electricity Commission of New Zealand (2004) "Recommended Approach Regarding Dispatch of Generators for Voltage Support", Electricity Commission, Wellington, New Zealand, December 2004. Available: <http://www.electricitycommission.govt.nz/pdfs/opdev/comqual/consultationpdfs/voltage-support-consultation.pdf>
- Electricity Commission of New Zealand (2005) (1 September). "Electricity Governance Rules". [Online]. Available: <http://www.electricitycommission.govt.nz/rulesandregs/rules/>
- Elizondo *et al.* (2006) M. Elizondo, M. Ilic, and P. Mercado, "Determining the cost of dynamic control capacity for improving system efficiency", presented at the IEEE PES General Meeting, Montreal, Canada, 2006.
- E.ON (2005) "Procurement of control power and energy in Germany", E.ON Netz GmbH, Bayreuth, Germany, 07 July 2005. Available: http://www.eon-netz.com/Ressources/downloads/procurement_controlpower_energy.pdf
- ETSO tariffs task force (2006) "ETSO Overview of transmission tariffs in Europe: Synthesis 2005", European Transmission System Operators (ETSO), Brussels, Belgium, June 2006. Available: <http://www.etsonet.org/upload/documents/benchmarking2005.pdf>
- Ernu (2007) X. Ernu, "Introduction à la gestion optimisée de la production", presented at EDF R&D seminar Gestion optimisée de la production, Clamart, France, 2007.

- Eurelectric (1997) Eurelectric, "Voltage control - Reactive energy", Report No 03005Ren9712, Union of the Electricity Industry - Eurelectric, Brussels, Belgium, March 1997. Available: <http://www.eurelectric.org/Download/Download.aspx?DocumentID=5622>
- Eurelectric (2000) "Connection rules for generation and management of ancillary services", Report No 2000-130-0003, Union of the Electricity Industry - Eurelectric, Brussels, Belgium, May 2000. Available: <http://www.eurelectric.org/Download/Download.aspx?DocumentFileID=4604>
- Eurelectric (2004) "Ancillary Services Unbundling Electricity Products – An Emerging Market", Report No 2003-150-0007, Union of the Electricity Industry - Eurelectric, Brussels, Belgium, February 2004. Available: <http://www.eurelectric.org/Download/Download.aspx?DocumentID=13934>
- Fourment *et al.* (1995) C. Fourment, H. Lefebvre, and J. M. Tesson, "Power system requirements and associated services at generator level in France", in *Proceedings of the IEE Colloquium on Frequency Control Capability of Generating Plant*, London, UK, 8 February 1995.
- French economic and industry department (2003) Ministère de l'économie, des finances et de l'industrie, *Arrêté du 4 juillet 2003 relatif aux prescriptions techniques de conception et de fonctionnement pour le raccordement au réseau public de transport d'une installation de production d'énergie électrique*, Journal Officiel de la République française n° 201, 2003, pp. 14896-14902. Available: <http://www.legifrance.gouv.fr/WAspad/UnTexteDeJorf?numjo=INDI0301719A>
- French economic and industry department (2005) Ministère de l'économie, des finances et de l'industrie, *Décision du 23 septembre 2005 approuvant les tarifs d'utilisation des réseaux publics de transport et de distribution d'électricité*, Journal Officiel de la République française n° 233, 2005, pp. 15888-15917. Available: <http://www.legifrance.gouv.fr/WAspad/UnTexteDeJorf?numjo=INDI0505749S>

- Frontier Economics and Consentec (2005) "Benefits and practical steps towards the integration of intraday electricity markets and balancing mechanisms", Frontier Economics Ltd, London, U.K., December 2005. Available: http://europa.eu.int/comm/energy/electricity/publications/doc/frontier_consentec_balancing_dec_2005.pdf
- Fuller (1976) W. A. Fuller, *Introduction to statistical time series*. New York ; London: Wiley, 1976.
- Galiana *et al.* (2005) F. D. Galiana, F. Bouffard, J. M. Arroyo, and J. F. Restrepo, "Scheduling and pricing of coupled energy and primary, secondary, and tertiary reserves", *Proceedings of the IEEE*, vol. 93 (11), pp. 1970-1983, November 2005.
- Garcia (2005) M. P. Garcia-Alajarin, "Forecasting system imbalance volumes and analysis of unusual events in competitive electricity markets", PhD thesis, School of Electrical and Electronic Engineering, The University of Manchester, Manchester, UK, 2005. Available: http://www.eee.manchester.ac.uk/research/groups/eeps/docs/garcia_PhD_2005.pdf
- Gautier (1990) A. Gautier, "Le fonctionnement des centrales à eau sous pression - Adaptation de la centrale aux besoins du réseau", Institut National des Sciences et Techniques Nucléaires (INSTN), Saclay, France, 1990 (approximate date).
- Goel *et al.* (2004) L. Goel, Z. Song, and P. Wang, "Impact of Transmission Line Failures on the Cost/Risk-Based Spinning Reserve Allocation", *International Journal of Emerging Electric Power Systems*, vol. 1 (1), May 2004.
- Grainger and Stevenson (1994) J. J. Grainger and W. D. Stevenson, *Power system analysis*. New York ; London: McGraw-Hill, 1994.

- Gross *et al.* (2002) G. Gross, S. Tao, E. Bompard, and G. Chicco, "Unbundled Reactive Support Service: Key Characteristics and Dominant Cost Component", *IEEE Transactions on Power Systems*, vol. 17 (2), pp. 283-289, May 2002.
- Haas *et al.* (2006) R. Haas, J.-M. Glachant, N. Keseric, and Y. Perez, "Competition in the Continental European Electricity Market: Despair or Work in Progress?" in *Electricity market reform: an international perspective*, Elsevier global energy policy and economics series, F. P. Sioshansi and W. Pfaffenberger, Amsterdam: Elsevier, 2006, pp. 265-315.
- Hamilton (1994) J. D. Hamilton, *Time series analysis*. Princeton, N.J.: Princeton University Press, 1994.
- Hao and Papalexopoulos (1997) S. Hao and A. Papalexopoulos, "Reactive power pricing and management", *IEEE Transactions on Power Systems*, vol. 12 (1), pp. 95-104, February 1997.
- Hingorani and Gyugyi (2000) N. G. Hingorani and L. Gyugyi, *Understanding FACTS: concepts and technology of flexible AC transmission systems*. New York, N.Y.: IEEE Press, 2000.
- Hirst and Kirby (1996) E. Hirst and B. Kirby, "Costs for electric-power ancillary services", *The Electricity Journal*, vol. 9 (10), pp. 26-30, December 1996.
- Hirst and Kirby (1997) E. Hirst and B. Kirby, "Creating competitive markets for ancillary services", ORNL/CON-448, Oak Ridge National Laboratory, Oak Ridge, TN, USA, October 1997. Available: <http://www.ornl.gov/sci/btc/apps/Restructuring/con448.pdf>
- Hirst and Kirby (1998) E. Hirst and B. Kirby, "Unbundling Generation and Transmission Services for Competitive Electricity Markets: Ancillary Services", ORNL/CON-454, National Regulatory Research Institute, Columbus, OH, USA,

- January 1998. Available:
<http://www.ornl.gov/sci/btc/apps/Restructuring/con454.pdf>
- Hogan (2006) W. W. Hogan, "Reliability and scarcity pricing: operating reserve demand curves (continued)", Harvard University, Cambridge, MA, USA, 3 March 2006. Available: http://www.hks.harvard.edu/hepg/Papers/Hogan_hepg_030206.pdf
- Hoinkis and Lindner (2007) J. Hoinkis and E. Lindner, *Chemie für Ingenieure*, 13 ed. Weinheim: Wiley-VCH, 2007.
- IEA (2005) (June). "IEA Energy Statistics". [Online]. Available: <http://www.iea.org/Textbase/stats/prodresult.asp?PRODUCT=Electricity/Heat>
- IEEE Std 1159-1995 (1995) IEEE Working Group on Monitoring Electric Power Quality, *IEEE Std 1159-1995 - IEEE Recommended Practice for Monitoring Electric Power Quality*. New York: The Institute of Electrical and Electronics Engineers, Inc., 1995.
- IMF (2006) "Financial Soundness Indicators: Compilation Guide", ISBN/ISSN 978-1-58906-385-3, International Monetary Fund (IMF), Washington, DC, USA, 4 April 2006. Available: <http://www.imf.org/external/pubs/ft/fsi/guide/2006/index.htm>
- Ingleson and Ellis (2005) J. W. Ingleson and D. M. Ellis, "Tracking the eastern interconnection frequency governing characteristic", in *Proceedings of the 2005 IEEE Power Engineering Society General Meeting*, pp. 2484 - 2489.
- Jaggy and Longley (1991) E. Jaggy and A. P. Longley, "Implementation of an AGC-algorithm in different power systems and on different control levels", in *Proceedings of the 1991 IEEE International Conference on Power System Monitoring and Control*, pp. 162-167.

- Jaleeli *et al.* (1992) N. Jaleeli, L. S. VanSlyck, D. N. Ewart, L. H. Fink, and A. G. Hoffmann, "Understanding automatic generation control", *IEEE Transactions on Power Systems*, vol. 7 (3), pp. 1106-1122, August 1992.
- Johannet (1997) P. Johannet, "Lignes aériennes : chutes de tension", *Techniques de l'Ingénieur* (D 4 438), February 1997.
- Joskow (2006) P. Joskow, "Introduction to Electricity Sector Liberalization: Lessons Learned from Cross-Country Studies", in *Electricity market reform: an international perspective*, *Elsevier global energy policy and economics series*, F. P. Sioshansi and W. Pfaffenberger, Amsterdam: Elsevier, 2006, pp. 1-32.
- Joskow and Tirole (2004) P. Joskow and J. Tirole, "Reliability and competitive electricity markets", Report No CSEM WP 129, University of California Energy Institute (UCEI), Berkeley, CA, USA, April 2004. Available: <http://repositories.cdlib.org/ucei/csem/CSEMWP-129/>
- Kariuki and Allan (1996) K. K. Kariuki and R. N. Allan, "Evaluation of reliability worth and value of lost load", *IEE Proceedings: Generation, Transmission and Distribution*, vol. 143 (2), pp. 171-180, March 1996.
- Keller and Franken (2006) K. Keller and B. F. C. Franken, "Quality of supply and market regulation; survey within Europe", 30630505-TDC 06-59095A, KEMA Consulting, Arnhem, The Netherlands, 7 December 2006. Available: <http://www.leonardo-energy.org/drupal/files/2006/06-59095A.pdf?download>
- Kirby and Hirst (1996) B. Kirby and E. Hirst, "Ancillary-Service Costs for 12 U.S. Electric Utilities", ORNL/CON-427, Oak Ridge National Laboratory, Oak Ridge, TN, USA, April 1996. Available: <http://www.ornl.gov/sci/btc/apps/Restructuring/con427.pdf>

-
- Kirby and Hirst (2000) B. Kirby and E. Hirst, "Customer-specific metrics for the regulation and load-following ancillary services", Report No ORNL/CON-474, Oak Ridge National Laboratory, Oak Ridge, TN, USA, January 2000. Available: <http://certs.lbl.gov/pdf/ornl-con-474.pdf>
- Kirby and Hirst (2003) B. Kirby and E. Hirst, "New England Demand Response Initiative: Technical issues related to retail-load provision of ancillary services", 10 February 2003. Available: <http://www.raponline.org/Pubs/NEDRI/AncillaryBackground.pdf>
- Kirschen (2002) D. S. Kirschen, "Power system security", *Power Engineering Journal*, vol. 16 (5), pp. 241-248, October 2002.
- Kirschen and Jayaweera (2007) D. S. Kirschen and D. Jayaweera, "A Comparison of Risk-Based and Deterministic Security Assessments", *IET Generation, Transmission & Distribution*, vol. 1 (4), pp. 527-533, July 2007.
- Kirschen and Strbac (2004a) D. S. Kirschen and G. Strbac, *Fundamentals of power system economics*, 1st ed., Chichester: Wiley, 2004.
- Kirschen and Strbac (2004b) D. S. Kirschen and G. Strbac, "Why Investments Do Not Prevent Blackouts", *The Electricity Journal*, vol. 17 (2), pp. 29-36, March 2004.
- Klemperer (1999) P. Klemperer, "Auction Theory: A Guide to the Literature", *Journal of Economic Surveys*, vol. 13, pp. 227-286, 1999.
- Klemperer (2002) P. Klemperer, "What really matters in auction design", *The Journal of Economic Perspectives*, vol. 16 (1), pp. 169-189, winter 2002.
- Kluge (2006) T. Kluge, "Pricing Swing Options and other Electricity Derivatives", PhD Thesis, Mathematical Institute, St Hugh's College, University of Oxford, Oxford, UK, 2006. Available: <http://eprints.maths.ox.ac.uk/246/01/kluge.pdf>

- Kundur (1994) P. Kundur, *Power system stability and control*. New York; London: McGraw-Hill, 1994.
- Lasdon (1968) L. S. Lasdon, "Duality and Decomposition in Mathematical Programming", *IEEE Transactions on Systems Science and Cybernetics*, vol. SSC-4 (2), pp. 86-100, July 1968.
- Lemaréchal (2004) C. Lemaréchal, "Saving Energy", in *ERCIM News*, vol. 56, January 2004, p. 43. Available: http://www.ercim.org/publication/Ercim_News/enw56/EN56.pdf
- Lin *et al.* (2005) X. J. Lin, C. W. Yu, and C. Y. Chung, "Pricing of reactive support ancillary services", *IEE Proceedings-Generation, Transmission and Distribution*, vol. 152 (5), pp. 616-622, September 2005.
- Liu *et al.* (2006) J. D. Liu, T. T. Lie, and K. L. Lo, "An empirical method of dynamic oligopoly behavior analysis in electricity markets", *IEEE Transactions on Power Systems*, vol. 21 (2), pp. 499-506, May 2006.
- Luh *et al.* (2006) P. B. Luh, W. E. Blankson, Y. Chen, J. H. Yan, G. A. Stern, S.-C. Chang, and F. Zhao, "Payment cost minimization auction for deregulated electricity markets using surrogate optimisation", *IEEE Transactions on Power Systems*, vol. 21 (2), pp. 568-578, May 2006.
- Ma *et al.* (2003) X. Ma, D. I. Sun, and K. W. Cheung, "Evolution toward standardised market design", *IEEE Transactions on Power Systems*, vol. 18 (2), pp. 460-469, May 2003.
- Margotin *et al.* (2006) T. Margotin, P. Juston, M. P. Houry, G. Morales, P. Bertolini, and D. Burnel, "Reactive power support on the French power system: generation units performance monitoring", *Proceedings of the 2006 IEEE Mediterranean Electrotechnical Conference (MELECON)*, pp. 906-909.

-
- Mas-Colell *et al.* (1995) A. Mas-Colell, M. D. Whinston, and J. R. Green, *Microeconomic Theory*. USA: Oxford University Press, 1995.
- Mathworks (2007) "Online documentation - Percentiles". [Online] Available: <http://www.mathworks.com/access/helpdesk/help/toolbox/stats/index.html?access/helpdesk/help/toolbox/stats/prctile.html>
- Meeus and Belmans (2008) L. Meeus and R. Belmans, "Electricity market integration in Europe", *Revue E tijdschrift*, vol. 124 (1), March 2008.
- Mickey (2006) J. Mickey, "Competitive Ancillary Services Market in ERCOT", presented at the Midwest ISO Ancillary Services Roundtable, Carmel, IN, USA, 26-27 April 2006.
- National Grid (2007) "Short-term operating reserve: general description of the service", National Grid, Warwick, U.K., 14 December 2007. Available: http://www.nationalgrid.com/NR/rdonlyres/72D4386B-2027-474C-B281-2384F5B21A5E/22123/STOR_Service_Description_Final.pdf
- National Grid (2008a) "The Grid Code", Issue 3, Revision 25, National Grid, Warwick, U.K., 1 February 2008. Available: <http://www.nationalgrid.com/NR/rdonlyres/1403354E-36F2-4010-A72C-F36862E1FF3E/23088/zFullGBGridCodeI3R25.pdf>
- National Grid (2008b) "Firm Frequency Response Market Information for Tenders for April 2008", National Grid, Warwick, U.K., 2008. Available: http://www.nationalgrid.com/NR/rdonlyres/F4649A84-1580-4E15-B411-0FAE9159608A/23984/FFR_Market_Info_Apr_2008_v1.pdf
- National Grid (2008c) "Reactive Power Market. Obligatory and Enhanced Reactive Power Services: Invitation to Tender and Guidance Notes for the Completion of Tenders for Reactive Power Market Agreements Commencing 1 October 2008",

National Grid, Warwick, U.K., March 2008. Available: http://www.nationalgrid.com/NR/rdonlyres/1EBD3C1C-02A1-4124-B705-FD7660650BD7/24227/Guidance_Notes.pdf

NEMMCO (2001) "Guide to Ancillary Services in the National Electricity Market", Version 1.0, National Electricity Market Management Company Limited, Australia, 24 August 2001. Available: http://www.nemmco.com.au/ancillary_services/160-0056.pdf

NEMMCO (2004) "Market Ancillary Service Specification", Version 1.5 Final, National Electricity Market Management Company Limited, Australia, 27 February 2004. Available: http://www.nemmco.com.au/ancillary_services/160-0163.pdf

NEMMCO (2005) "Operating procedure: glossary", SO_OP2000, National Electricity Market Management Company Limited, Australia, 20 October 2005. Available: http://www.nemmco.com.au/powersystemops/so_op2000v011.pdf

NERC (2004) "Operating manual", North American Electric Reliability Corporation, Princeton, NJ, USA, 15 June 2004.

NERC (2005) "Frequency Response Standard Whitepaper", North American Electric Reliability Corporation, Princeton, NJ, USA, 17 January 2005. Available: ftp://www.nerc.com/pub/sys/all_updl/oc/rs/Frequency_Response_White_Paper.pdf

NERC (2006) "Operating manual", North American Electric Reliability Corporation, Princeton, NJ, USA, 15 June 2006. Available: ftp://www.nerc.com/pub/sys/all_updl/oc/opman/opman_061506.pdf

Newbery *et al.* (2003) D. Newbery, N.-H. von der Fehr, and E. van Damme, "Transparency and monitoring of security and adequacy of supply", Directie

- Toezicht Energie (DTe), The Hague, The Netherlands, 25 August 2003. Available: http://www.dte.nl/images/12_12720_tcm7-3712.pdf
- Newbery *et al.* (2004) D. Newbery, R. Green, K. Neuhoff, and P. Twomey, "A Review of the Monitoring of Market Power: The Possible Roles of TSOs in Monitoring for Market Power Issues in Congested Transmission Systems", European Transmission System Operators (ETSO), Brussels, Belgium, November 2004. Available: <http://www.etso-net.org/upload/documents/ETSO%20Market%20Power%20final.pdf>
- Nobile *et al.* (2001) E. Nobile, A. Bose, and K. Tomsovic, "Feasibility of a Bilateral Market for Load Following", *IEEE Transactions on Power Systems*, vol. 16 (4), pp. 782-787, November 2001.
- Nordel (2004) "Nordisk Regelsamling (Nordic Grid Code)", Nordel, Helsinki, Finland, 18 June 2004. Available: <http://www.statnett.no/Resources/Filer/Dokumenter/Div.%202004/Nordisk%20regelsamling%20rev%20161104.pdf>
- Numerical Algorithms Group (2007) (October). "NAG Add-Ins for Excel". [Online] Available: <http://www.nag.co.uk/downloads/aedownloads.asp>
- NYISO (2008) NYISO Customer Technical Services, "Ancillary services manual", Manual 2, Version 3.10, New York Independent System Operator (NYISO), Schenectady, NY, USA, 6 March 2008. Available: <http://www.nyiso.com/public/webdocs/documents/manuals/operations/ancserv.pdf>
- NZIER (2005) "Market Design Report: Initial Stock-take Paper Report to the Electricity Commission", NZIER, Wellington, New Zealand, August 2005. Available: <http://www.electricitycommission.govt.nz/pdfs/opdev/wholesale/market-design/Initial-Stocktake.pdf>

- OMEL (2005) (September). "Market results". [Online]. Available: http://www.omel.es/frames/en/resultados/resultados_index.htm
- O'Neill *et al.* (2006) R. O'Neill, U. Helman, B. F. Hobbs, and R. Baldick, "Independent System Operators in the USA: History, Lessons Learned, and Prospects", in *Electricity market reform: an international perspective, Elsevier global energy policy and economics series*, F. P. Sioshansi and W. Pfaffenberger, Amsterdam: Elsevier, 2006, pp. 479-528.
- Open University (1988) Open University, Applications of Probability Course Team, *Applications of probability. Unit 15: Time series*. Milton Keynes: Open University Press, 1988.
- Oren (2001) S. Oren, "Design of ancillary service markets", presented at the 34th Annual Hawaii International Conference on System Sciences, Maui, HI, USA, 3-6 January 2001.
- Ortega-Vazquez and Kirschen (2007) M. A. Ortega-Vazquez and D. S. Kirschen, "Optimizing the Spinning Reserve Requirements Using a Cost/Benefit Analysis", *IEEE Transactions on Power Systems*, vol. 22 (1), pp. 24-33, February 2007.
- Oxford Dictionary (2001) *Oxford Paperback Dictionary, Thesaurus and Wordpower Guide*. New York: Oxford University Press Inc., 2001.
- Papadogiannis and Hatziargyriou (2004) K. A. Papadogiannis and N. D. Hatziargyriou, "Optimal allocation of primary reserve services in energy markets", *IEEE Transactions on Power Systems*, vol. 19 (1), pp. 652-659, February 2004.
- Paul *et al.* (1990) J. P. Paul, C. Corroyer, P. Jeannel, J. M. Tesson, F. Maury, and A. Torra, "Improvements in the organisation of secondary voltage control in France", *Proc. 33rd International Conference on Large High Voltage Electric Systems (CIGRE) Session*, Paper No 38/39-03, pp. 1-8, 26 August - 1 September 1990.

-
- Pekeč and Rothkopf (2004) A. Pekeč and M. H. Rothkopf, "Combinatorial Auction Design", *Management Science*, vol. 49 (11), pp. 1485-1503, November 2003.
- Peradotto (2001) A. Peradotto, "Data mining : état de l'art", Internal report No HE-72/2001/016/A, Electricité de France Research and Development (EDF R&D), Clamart, France, 24 July 2001.
- Perrot and Molinier (2005) D. Perrot and P. Molinier, "Surveillance des marchés de gros", Internal report No H-R16-2005-01546-FR, Electricité de France Research and Development (EDF R&D), Clamart, France, July 2005.
- Pignon (2003) V. Pignon, *L'harmonisation des méthodes de tarification du transport de l'électricité : une analyse économique du marché unique européen*, PhD Thesis, Sciences économiques, Paris I Pantheon-Sorbonne, Paris, France, 2003. Available: http://www.grjm.net/index.php?option=com_content&task=view&id=56&Itemid=65
- PJM (2005a) "PJM eMKT Users Guide", PJM Interconnection, Norristown, PA, USA, June 2005. Available: <http://www.pjm.com/etools/downloads/emkt/ts-userguide.pdf>
- PJM (2005b) "PJM Open Access Transmission Tariff", PJM Interconnection, Norristown, PA, USA, 22 July 2005. Available: <http://www.pjm.com/documents/downloads/agreements/tariff.pdf>
- PJM (2006) "Manual 35: Definitions and Acronyms", Revision 13, PJM Interconnection, Norristown, PA, USA, 1 November 2006. Available: <http://www.pjm.com/contributions/pjm-manuals/pdf/m35.pdf>
- PJM (2007) "Manual 12: Balancing Operations", Revision 16, PJM Interconnection, Norristown, PA, USA, 01 November 2007. Available: <http://www.pjm.com/contributions/pjm-manuals/pdf/m12.pdf>

- PJM (2008) "Manual 11: Scheduling Operations", Revision 34, PJM Interconnection, Norristown, PA, USA, 21 February 2008. Available: <http://www.pjm.com/contributions/pjm-manuals/pdf/m11.pdf>
- Powernext (2008) Powernext, "Powernext Futures - Monthly statistics", Powernext SA, Paris, France, 30 June 2008. Available: http://www.powernext.fr/modules/PwnDI/download/files/fra/Powernext_Futures06-2008.pdf
- Proctor (2001) R. L. Proctor, *Management of power system reserve in a competitive environment*, PhD Thesis, School of Electrical and Electronic Engineering, The Queen's University of Belfast, Belfast, U.K., 2001.
- Quintana and Bautista (2006) V. Quintana and G. Bautista, "Financial Transmission Rights in Electricity Markets (Invited Paper)", in *Proceedings of the 2006 IEEE Mediterranean Electrotechnical Conference (MELECON)*, pp. 931- 934.
- Raineri *et al.* (2006) R. Raineri, S. Rios, and D. Schiele, "Technical and economic aspects of ancillary services markets in the electric power industry: an international comparison", *Energy Policy*, vol. 34 (13), pp. 1540-1555, September 2006.
- Rious (2007) V. Rious, *Le développement du réseau de transport dans un système électrique libéralisé, un problème de coordination avec la production*, PhD Thesis, Faculté Jean Monnet, Paris-Sud XI and Supélec, Paris, France, 2007. Available: http://www.grjm.net/index.php?option=com_content&task=view&id=455&Itemid=65
- Robert and Prestat (2004) G. Robert and B. Prestat, "Conformity evaluation method of power plants performance for grid stability", in *Proceedings of the 2004 IEEE PES Power Systems Conference and Exposition (PSCE)*, vol. 2, pp. 1109-1112.

- Rothkopf (2007) M. H. Rothkopf, "Thirteen Reasons Why the Vickrey-Clarke-Groves Process Is Not Practical", *Operations Research*, vol. 55 (2), pp. 191–197, March–April 2007.
- RTE (2004) "Mémento de la sûreté du système électrique", Réseau de Transport d'Electricité (RTE), La Défense, France, 2004. Available: http://www.rte-france.com/htm/fr/mediatheque/telecharge/memento_surete_2004/memento_surete_2004_complet__.pdf
- RTE (2006) "Conditions générales relatives a l'accès au réseau public de transport. Consommateur", Réseau de Transport d'Electricité (RTE), La Défense, France, January 2006. Available: http://www.rte-france.com/htm/fr/offre/telecharge/Conditions_generales_consommateurs_10_01_06.pdf
- RTE (2007a) (February). "RTE - Clients & acteurs du marché - Vie du système". [Online]. Available: http://www.rte-france.com/htm/fr/vie/vie_mecanisme_historique.jsp
- RTE (2007b) RTE, "Contrat type de participation aux services système", Réseau de Transport d'Electricité (RTE), La Défense, France, 21 December 2007. Available: http://www.rte-france.com/htm/fr/offre/telecharge/Contrat_services_systeme_trame_type_2007_12_21.pdf
- RTE (2007c) "Dossier de presse : Le bilan électrique français 2006", Réseau de Transport de l'Electricité (RTE), La Défense, France, January 2007. Available: http://www.rte-france.com/htm/fr/journalistes/telecharge/dossiers/DP_bilanElec_2006.pdf
- Saluden (2006) Y. Saluden, "Etude des coûts de maintenance de la sous-fonction mécanique marche en compensateur pour les turbines Francis/Pelton", Internal

report No IH-SSYST-00024-ABPE, Electricité de France Direction Production et Ingénierie (EDF DPI), Le Bourget du Lac, France, 20 February 2006.

Saporta (1990) G. Saporta, *Probabilités, analyse des données et statistique*. Paris, France: Editions Technip, 1990.

Shahidehpour *et al.* (2002) M. Shahidehpour, H. Yamin, and Z. Li, *Market operations in electric power systems: forecasting, scheduling, and risk management*. New York: Institute of Electrical and Electronics Engineers (IEEE) Wiley-Interscience, 2002.

Singh (1999) H. Singh, "Auctions for ancillary services", *Decision Support Systems*, vol. 24 (3-4), pp. 183-191, January 1999.

Sioshansi and Pfaffenberger (2006) F. P. Sioshansi and W. Pfaffenberger, *Electricity market reform: an international perspective*. Amsterdam: Elsevier, 2006.

Spanish industry and energy department (1998) Ministerio de industria y energía, *Resolución de 30 de julio de 1998, de la Secretaria de Estado de Energía y Recursos Minerales, por la que se aprueba un conjunto de procedimientos de carácter técnico e instrumental necesarios para realizar la adecuada gestión técnica del sistema eléctrico*, vol. BOE n° 197, 20053, 1998. Available: http://www.ree.es/operacion/pdf/po/PO_resol_30jul1998_b.pdf

Spanish industry and energy department (2000) Ministerio de industria y energía, *Resolución de 10 de marzo de 2000, de la Secretaría de Estado de Industria y Energía, por la que se aprueba el procedimiento de operación del sistema (P.O. - 7.4) «Servicio complementario de control de tensión de la red de transporte»*, vol. BOE n° 67, 5204, 18 March 2000, pp. 11330-11346. Available: http://www.ree.es/operacion/pdf/po/PO_resol_10mar2000_correc.pdf

Spanish industry and energy department (2006a) Ministerio de industria y energía, *Resolución de 24 de mayo de 2006, de la Secretaria General de Energía, por la que se aprueban*

- diversos procedimientos de operación para su adaptación a la nueva normativa eléctrica*, vol. BOE n° 128, 9521, 2006. Available: http://www.ree.es/operacion/pdf/po/PO_resol_24may2006_7.2.pdf
- Spanish industry and energy department (2006b) Ministerio de industria y energía, *Resolución de 13 de julio 2006, de la Secretaria General de Energía, por la que se aprueba el procedimiento de operación 1.5 «Establecimiento de la reserva par la regulación frecuencia-potencia»*, BOE n° 173, 13170, 2006, pp. 27473-4. Available: http://www.ree.es/operacion/pdf/po/RES_PO_1.5.pdf
- Staropoli and Jullien (2006) C. Staropoli and C. Jullien, "Using Laboratory Experiments to Design Efficient Market Institutions. The case of wholesale markets", presented at the Journées de la section électrotechnique du club EEA 2006, Gif-sur-Yvette, France, 15-16 March 2006.
- Sterpu (2005) S. Sterpu, "Contrôle de performances de producteurs indépendants pour une meilleure sécurité des réseaux électriques", PhD Thesis, Laboratoire d'Electrotechnique de Grenoble (LEG), Institut National Polytechnique de Grenoble (INPG), Grenoble, France, 2005. Available: http://tel.archives-ouvertes.fr/docs/00/17/21/64/PDF/These_StefanSterpu_final.pdf
- Stoft (2002) S. Stoft, *Power system economics: designing markets for electricity*. Piscataway, N.J.; New York, N.Y.: IEEE Press: Wiley-Interscience, 2002.
- Strbac and Kirschen (2000) G. Strbac and D. S. Kirschen, "Who Should Pay for Reserve?" *The Electricity Journal*, vol. 13 (8), pp. 32-37, October 2000.
- SvK (2005) (December). "Svenska Kraftnät keeps the electricity system in balance". [Online]. Available: <http://www.svk.se/web/Page.aspx?id=5216>
- TenneT (2003) "Samenvatting uit "Summary of the current operating principles of the UCPTTE" met betrekking tot de primaire en secundaire regeling", TenneT,

- Arnhem, The Netherlands, December 2003. Available: http://www.tennet.nl/images/UCTE-regels_tcm41-12792.pdf
- TenneT (2006) (January). "Primary reserve". [Online]. Available: http://www.tennet.org/english/system_services/primary/
- Tesson (2008) J.-M. Tesson, "Mission : Sûreté - Lutter contre les blackouts", presented at the IEEE France General Meeting, Paris, France, 14 March 2008.
- Testud (1991) G. Testud, "Le réglage de la tension. Réglage primaire et domaine de fonctionnement de l'alternateur", Fiche Echos Système n°08, Electricité de France (EDF) R&D, Clamart, France, September 1991.
- Texier-Pauton (2007) R. Texier-Pauton, "Données et études nécessaires à la préparation de la négociation du contrat services système 2008-2010", Internal report No FC/FDO/COPMAM/2007/036, Electricité de France (EDF) Direction Optimisation Amont/Aval & Trading (DOAAT), Saint-Denis, France, 11 May 2007.
- Thomas (2003) S. Thomas, "The Seven Brothers", *Energy Policy*, vol. 31 (5), pp. 393-403, April 2003.
- Tirole (1988) J. Tirole, *The theory of industrial organisation*. Cambridge, Mass. ; London: MIT Press, 1988.
- Tyagi and Srivastava (2006) B. Tyagi and S. C. Srivastava, "A decentralised automatic generation control scheme for competitive electricity markets", *IEEE Transactions on Power Systems*, vol. 21 (1), pp. 312-320, February 2006.
- UCPTE (1991) "Active power control in the UCPTE system - Inventory", Union for the Co-ordination of Production and Transmission of Electricity (UCPTE), Brussels, Belgium, 1991.

-
- UCTE (2004a) "Final report of the Investigation Committee on the 28 September 2003 blackout in Italy", Union for the Co-ordination of Transmission of Electricity (UCTE), Brussels, Belgium, April 2004. Available: http://www.ucte.org/_library/otherreports/20040427_UCTE_IC_Final_report.pdf
- UCTE (2004b) "UCTE Operation Handbook", Version 2.5E, Union for the Co-ordination of Transmission of Electricity (UCTE), Brussels, Belgium, 20 July 2004. Available: http://www.ucte.org/_library/ohb/Operation_Handbook_20.07.2004.pdf
- UCTE (2005) "Geographical Distribution of Reserves", Version 1.0, Union for the Co-ordination of Transmission of Electricity (UCTE), Brussels, Belgium, July 2005. Available: http://www.ucte.org/_library/otherreports/Geographical_Distribution_of_Reserves.zip
- UCTE (2006) UCTE, "Geographical Distribution of Reserves", Version 1.0, Union for the Co-ordination of Transmission of Electricity (UCTE), Brussels, Belgium, July 2005 (available since June 2006). Available: http://www.ucte.org/_library/otherreports/Geographical_Distribution_of_Reserves.zip
- UCTE (2007) "Final Report - System Disturbance on 4 November 2006", Union for the Co-ordination of Transmission of Electricity (UCTE), Brussels, Belgium, January 2007. Available: http://www.ucte.org/_library/otherreports/Final-Report-20070130.pdf
- U.S.-Canada Power System Outage Task Force (2004) U.S.-Canada Power System Outage Task Force, "Final Report on the August 14, 2003 Blackout in the United States and Canada: Causes and Recommendations", April 2004. Available: <https://reports.energy.gov/BlackoutFinal-Web.pdf>

- Varian (1999) R. Varian Hal, *Intermediate microeconomics: a modern approach*, 5th edition, New York; London: W.W. Norton & Co, 1999.
- Vu *et al.* (1996) H. Vu, P. Pruvot, C. Launay, and Y. Harmand, "An improved voltage control on large-scale power system", *IEEE Transactions on Power Systems*, vol. 11 (3), pp. 1295-1303, August 1996.
- Weisman (2005) D. L. Weisman, "Price regulation and quality", *Information Economics and Policy*, vol. 17 (2), pp. 165-174, March 2005.
- Williams and Lane (2004) H. E. Williams and D. Lane, *Web Database Applications with PHP and MySQL*, 2nd ed. Sebastopol, CA, USA; Cambridge, MA, USA: O'Reilly, 2004.
- Wilson (2002) R. Wilson, "Architecture of power markets", *Econometrica*, vol. 70 (4), pp. 1299-1340, July 2002.
- Wood and Wollenberg (1996) A. J. Wood and B. F. Wollenberg, *Power Generation, Operation and Control*, 2nd ed. New York: Wiley Interscience, 1996.
- Wu *et al.* (2004) T. Wu, M. Rothleder, Z. Alaywan, and A. D. Papalexopoulos, "Pricing energy and ancillary services in integrated market systems by an optimal power flow", *IEEE Transactions on Power Systems*, vol. 19 (1), pp. 339-347, February 2004.
- Yan and Stern (2002) J. H. Yan and G. A. Stern, "Simultaneous Optimal Auction and Unit Commitment for Deregulated Electricity Markets", *The Electricity Journal*, vol. 15 (9), pp. 72-80, November 2002.
- Young (1994) H. P. Young, "Cost Allocation", in *Handbook of game theory with economic applications*, vol. 2. Amsterdam; Oxford: Elsevier, 1994, pp. 1193-1235.
- Zhong (2003) J. Zhong, "On some aspects of design of electric power ancillary service markets", PhD Thesis, Department of Electric Power Engineering, Chalmers

-
- University of Technology, Göteborg, Sweden, 2003. Available: <ftp://ftp.elteknik.chalmers.se/Publications/PhD/ZhongJinPhD.pdf>
- Zhong *et al.* (2004) J. Zhong, E. Nobile, A. Bose, and K. Bhattacharya, "Localized reactive power markets using the concept of voltage control areas", *IEEE Transactions on Power Systems*, vol. 19 (3), pp. 1555-1561, August 2004.
- Zhong *et al.* (2005) Z. Zhong, C. Xu, B. J. Billian, L. Zhang, S.-J. S. Tsai, R. W. Conners, V. A. Centeno, A. G. Phadke, and Y. Liu, "Power system frequency monitoring network (FNET) implementation", *IEEE Transactions on Power Systems*, vol. 20 (4), pp. 1914-1921, November 2005.
- Zhu *et al.* (2000) J. Zhu, G. Jordan, and S. Ihara, "The market for spinning reserve and its impacts on energy prices", presented at Power Engineering Society Winter Meeting, Singapore, 2000.
- Zobian and Ilic (1997a) A. Zobian and M. D. Ilic, "Unbundling of transmission and ancillary services. I. Technical issues", *IEEE Transactions on Power Systems*, vol. 12 (2), pp. 539-548, May 1997.
- Zobian and Ilic (1997b) A. Zobian and M. D. Ilic, "Unbundling of transmission and ancillary services. II. Cost-based pricing framework", *IEEE Transactions on Power Systems*, vol. 12 (2), pp. 549-558, May 1997. ■

REFERENCES BY CATEGORIES

General

Oxford Dictionary (2001)

Williams and Lane (2004)

IEA (2005)

Hoinkis and Lindner (2007)

Mathematics

Lasdon (1968)

Fuller (1976)

Cohen (1978)

Open University (1988)

Berry and Lindgren (1990)

Saporta (1990)

Hamilton (1994)

Bertsimas and Tsitsiklis (1997)

Peradotto (2001)

Lemaréchal (2004)

Mathworks (2007)

Numerical Algorithms Group (2007)

Power systems

Gautier (1990)

British Electricity International (1991)

Grainger and Stevenson (1994)

Kundur (1994)

IEEE Std 1159-1995 (1995)

Wood and Wollenberg (1996)

Johannet (1997)

Bastard (1998)

Anderson (1999)

Hingorani and Gyugyi (2000)

- DGEMP/DIDEME (2003) Robert and Prestat (2004)
U.S.-Canada Power System Outage Task
Force (2004)
Kirschen and Strbac (2004a)

Reliability of power systems

- Billinton and Allan (1996) Keller and Franken (2006)
Kariuki and Allan (1996) Abiri-Jahromi *et al.* (2007)
Abbott (2001) Kirschen and Jayaweera (2007)
Kirschen (2002) Ortega-Vazquez and Kirschen (2007)
Joskow and Tirole (2004) Tesson (2008)

Technical features of ancillary services

- Paul *et al.* (1990) Da Silva *et al.* (2001)
Jaggy and Longley (1991) Nobile *et al.* (2001)
Testud (1991) Proctor (2001)
Jaleeli *et al.* (1992) Gross *et al.* (2002)
Kundur (1994) Alvarado *et al.* (2003)
Corsi *et al.* (1995) RTE (2004)
Fourment *et al.* (1995) Ingleson and Ellis (2005)
Vu *et al.* (1996) Vu *et al.* (1996) Sterpu (2005)
Wood and Wollenberg (1996) Zhong *et al.* (2005)
Bakken and Faanes (1997) Elizondo *et al.* (2006)
Eurelectric (1997) Margotin *et al.* (2006)
Zobian and Ilic (1997a) Raineri *et al.* (2006)
Hirst and Kirby (1998) Saluden (2006)
Eurelectric (2000) Tyagi and Srivastava (2006)
Cali *et al.* (2001)

Economics

- Tirole (1988)
Young (1994)
Mas-Colell *et al.* (1995)
Bergstrom (1999)
Klemperer (1999)
Varian (1999)
Klemperer (2002)
Pekeč and Rothkopf (2004)
Weisman (2005)
IMF (2006)
Rothkopf (2007)

Power system economics

- Bushnell and Oren (1994)
Baughman *et al.* (1997a)
Baughman *et al.* (1997b)
Bernard *et al.* (1998)
Shahidehpour *et al.* (2002)
Stoft (2002)
Wilson (2002)
Yan and Stern (2002)
CER (2003)
Ma *et al.* (2003)
Newbery *et al.* (2003)
Thomas (2003)
Pignon (2003)
Kirschen and Strbac (2004a)
Kirschen and Strbac (2004b)
Newbery *et al.* (2004)
Baldick *et al.* (2005)
Cramton and Stoft (2005)
Frontier Economics and Consentec (2005)
Garcia (2005)
Perrot and Molinier (2005)
Boucher *et al.* (2006)
ETSO tariffs task force (2006)
Haas *et al.* (2006)
Joskow (2006)
Kluge (2006)
Liu *et al.* (2006)
Luh *et al.* (2006)
O'Neill *et al.* (2006)
Quintana and Bautista (2006)
Sioshansi and Pfaffenberger (2006)
Staropoli and Jullien (2006)
Rious (2007)

Markets for frequency control ancillary services

- Hirst and Kirby (1996)
Kirby and Hirst (1996)

- Hirst and Kirby (1997)
Zobian and Ilic (1997b)
Hirst and Kirby (1998)
Brien (1999)
Singh (1999)
Kirby and Hirst (2000)
Strbac and Kirschen (2000)
Zhu *et al.* (2000)
Cali *et al.* (2001)
Cigré Task Force (2001)
Nobile *et al.* (2001)
Oren (2001)
Proctor (2001)
Chao and Wilson (2002)
Arnott *et al.* (2003)
Kirby and Hirst (2003)
Zhong (2003)
Chicco and Gross (2004)
Eurelectric (2004)
Goel *et al.* (2004)
Papadogiannis and Hatziargyriou (2004)
Wu *et al.* (2004)
Arroyo and Galiana (2005)
Doherty *et al.* (2005)
E.ON (2005)
Frontier Economics and Consentec (2005)
Galiana *et al.* (2005)
DePillis (2006)
Hogan (2006)
Mickey (2006)
Raineri *et al.* (2006)
Tyagi and Srivastava (2006)
UCTE (2006)
Abiri-Jahromi *et al.* (2007)
Ortega-Vazquez and Kirschen (2007)

Markets for voltage control ancillary services

- Hirst and Kirby (1996)
Kirby and Hirst (1996)
Hao and Papalexopoulos (1997)
Hirst and Kirby (1997)
Zobian and Ilic (1997b)
Hirst and Kirby (1998)
Bhattacharya and Zhong (2001)
Cali *et al.* (2001)
Cigré Task Force (2001)
Da Silva *et al.* (2001)
Gross *et al.* (2002)
Zhong (2003)
Electricity Commission of New Zealand (2004)
Eurelectric (2004)
Zhong *et al.* (2004)
Lin *et al.* (2005)
Raineri *et al.* (2006)

Australia

NEMMCO (2001)

NEMMCO (2005)

NEMMCO (2004)

Belgium

Belgium economic department (2002)

California

Brien (1999)

CAISO (2005b)

CAISO (2005a)

France

Paul *et al.* (1990)

Margotin *et al.* (2006)

Fourment *et al.* (1995)

EDF (2006)

DGEMP/DIDEME (2003)

RTE (2006)

French economic and industry
department (2003)

Ernu (2007)

Robert and Prestat (2004)

RTE (2007a)

EDF (2004)

RTE (2007b)

Lemaréchal (2004)

RTE (2007c)

RTE (2004)

Texier-Pauton (2007)

French economic and industry
department (2005)

CRE (2008)

Tesseron (2008)

Germany

E.ON (2005)

BDEW (2007a)

BDEW (2007b)

BDEW (2007c)

Great Britain

National Grid (2007)

National Grid (2008b)

National Grid (2008a)

National Grid (2008c)

The Netherlands

DTe (2005)

TenneT (2006)

TenneT (2003)

New Zealand

Electricity Commission of New Zealand
(2004)

NZIER (2005)

Electricity Commission of New Zealand
(2005)

PJM

PJM (2005a)

PJM (2007)

PJM (2005b)

PJM (2008)

PJM (2006)

Spain

Spanish industry and energy department
(1998)

Spanish industry and energy department
(2006a)

Spanish industry and energy department
(2000)

Spanish industry and energy department
(2006b)

OMEL (2005)

Sweden

Nordel (2004)

SvK (2005)

Europe

UCPTE (1991)

Boucher *et al.* (2006)

UCTE (2004a)

ETSO tariffs task force (2006)

UCTE (2004b)

Haas *et al.* (2006)

Frontier Economics and Consentec
(2005)

UCTE (2006)

UCTE (2007)

UCTE (2005)

Meeus and Belmans (2008)

North America

Hirst and Kirby (1996)

Ingleson and Ellis (2005)

Kirby and Hirst (1996)

NERC (2005)

Ma *et al.* (2003)

DePillis (2006)

U.S.-Canada Power System Outage Task
Force (2004)

NERC (2006)

O'Neill *et al.* (2006)

NERC (2004)

NYISO (2008)



PUBLICATIONS

Journals

Y. Rebours, D. Kirschen, M. Trotignon, and S. Rossignol, "A Survey of Frequency and Voltage Control Ancillary Services—Part I: Technical Features", *IEEE Transactions on Power Systems*, vol. 22 (1), pp. 350-357, February 2007.

Y. Rebours, D. Kirschen, M. Trotignon, and S. Rossignol, "A Survey of Frequency and Voltage Control Ancillary Services—Part II: Economic Features", *IEEE Transactions on Power Systems*, vol. 22 (1), pp. 358-366, February 2007.

Y. Rebours, D. Kirschen, and M. Trotignon, "Fundamental design issues in markets for ancillary services", *The Electricity Journal*, vol. 20 (6), pp. 26-34, July 2007.

Conferences

Y. Rebours, "Some salient features of the management of frequency and voltage control ancillary services", presented at the IEEE Power Engineering Society General Meeting, Tampa, FL, USA, 2007.

Working papers

Y. Rebours and D. Kirschen, "What is spinning reserve?" Release 1, The University of Manchester, 16 September 2005. Available:

http://www.eee.manchester.ac.uk/research/groups/eeps/publications/reportstheses/aoe/rebours%20et%20al_tech%20rep_2005A.pdf

Y. Rebours and D. Kirschen, "A Survey of Definitions and Specifications of Reserve Services", Release 2, The University of Manchester, 12 October 2005. Available: http://www.eee.manchester.ac.uk/research/groups/eeps/publications/reportstheses/aoe/rebours%20et%20al_tech%20rep_2005B.pdf ■

THE AUTHOR

Yann Rebours received his Electrical Engineer's degree from the Ecole Supérieure d'Electricité, France and his Master's degree in electrical engineering from the University of Wollongong, Australia, in 2004. During his Master, he mainly worked on the voltage compensation of a 2-MW induction machine. He then started in March 2005 his PhD at the University of Manchester, U.K., in partnership with Electricité de France R&D at Clamart, France. ■

APPENDICES

A.1 Basics of Statistics

Since the definition of some statistic indicators may vary [Berry and Lindgren (1990)], the statistics and data analysis method used in this thesis, as well as their abbreviations and symbols are presented in this section. Note that we consider that all the existence conditions are met to calculate these various statistics (e.g., no division by zero, vectors have an appropriate size and sums do not tend toward the infinity).

A.1.1 Univariate data

- ✓ *Univariate data* refer to the observations made for only one *random variable* X . Let us consider a sample data defined by N elements, $x[1]$ to $x[N]$, sorted in an ascending order;
- ✓ The *sample mean* (\bar{x} or M), simply called mean or average in this thesis, is defined as follows:

$$\bar{x} = \frac{1}{N} \sum_{k=1}^N x[k] \tag{A.1.1}$$

- ✓ The sample mean tends to the *expected value* of the random variable X when the number of observation increases [Berry and Lindgren (1990)];
- ✓ The *sample variance* (σ^2) represents the weighted scattering of the data¹³⁷:

¹³⁷ Note that the sample variance is defined slightly differently in comparison to the variance of the random variable X (also called population variance). The variance of the random variable generally cannot be calculated because most of the time the complete population is unknown [Berry and Lindgren (1990)].

$$\sigma^2 = \frac{1}{N-1} \sum_{k=1}^N (x[k] - \bar{x})^2 \quad (\text{A.1.2})$$

- ✓ The *sample standard deviation* (σ) gives a friendlier picture of the dispersion than the variance because the standard deviation is homogeneous to X :

$$\sigma = \sqrt{\sigma^2} \quad (\text{A.1.3})$$

- ✓ The *sample median* (\tilde{x}), also called second quartile, is the value that splits a sample in two parts, with 50 % of the sample on each side. It is calculated as follows [Berry and Lindgren (1990)]:

$$\tilde{x} = \begin{cases} \text{if } N \text{ is odd} \Rightarrow x\left[\frac{N+1}{2}\right] \\ \text{if } N \text{ is even} \Rightarrow \frac{1}{2} \left(x\left[\frac{N}{2}\right] + x\left[\frac{N}{2} + 1\right] \right) \end{cases} \quad (\text{A.1.4})$$

- ✓ The *first quartile* (FQ) is the median of the samples below the median (the median excluded)¹³⁸. It thus represents the boundary that holds the 25 % first sample values;
- ✓ The *third quartile* (TQ) is the median of the samples above the median (the median excluded)¹³⁸. It thus represents the boundary that gathers the 75 % first sample values;
- ✓ More generally, the *nth-percentile* (p_n) is the boundary for the n % first values of the sample. It is calculated as follows in our study [Mathworks (2007)]:

We define:

$$y[k] = \frac{100}{N} \times \left(k - \frac{1}{2} \right) \quad (\text{A.1.5})$$

We find i such as:

$$y[i] \leq n < y[i+1] \quad (\text{A.1.6})$$

We can then calculate the n th-percentile:

$$p_n = x[i] + \frac{N}{100} \times (y[n] - y[i]) (x[i+1] - x[i]) \quad (\text{A.1.7})$$

¹³⁸ Note that Microsoft Excel does not use exactly the same algorithm to define the first and third quartiles.

- ✓ The *interquartile range* (IQR) represents how the majority of the data close to the centre are spread. It thus a good indicator of the dispersion of the “reasonable” data. The interquartile range may be used to find outliers, i.e. observations that are standing out of the crowd. The IQR is defined as follows:

$$IQR = TQ - FQ \quad (\text{A.1.8})$$

- ✓ The interquartile mean (IQM) is the average of the 50 % samples that are around the median and is defined as follows, where \mathbb{N}^* represents the set of the natural numbers except zero:

$$IQM = \begin{cases} \text{if } \frac{N}{4} \in \mathbb{N}^* \Rightarrow \frac{2}{N} \sum_{k=\frac{N}{4}+1}^{\frac{3N}{4}} x[k] \\ \text{if } \frac{N-1}{4} \in \mathbb{N}^* \Rightarrow \frac{2}{N+1} \sum_{k=\frac{N-1}{4}+1}^{\frac{3N+1}{4}} x[k] \\ \text{if } \frac{N-2}{4} \in \mathbb{N}^* \Rightarrow \frac{2}{N-2} \sum_{k=\frac{N+2}{4}+1}^{\frac{3N-2}{4}} x[k] \\ \text{if } \frac{N-3}{4} \in \mathbb{N}^* \Rightarrow \frac{2}{N-1} \sum_{k=\frac{N+1}{4}+1}^{\frac{3N-1}{4}} x[k] \end{cases} \quad (\text{A.1.9})$$

- ✓ A range of values is called a *class interval*. The number of samples in a given class interval gives the *frequency of this class*. When the frequencies are divided by the size of the sample, the relative frequencies are obtained, that are called probability in this report by misuse of language;
- ✓ The relative frequencies are plotted in many figures in this thesis. Such a figure gives a so-called *frequency distribution* and an example is given in Figure A.1.1. Note that several frequency distributions could be defined since different class intervals may be chosen. In addition, contrary to *histograms*, the areas in a frequency distribution do not mean anything. However, class intervals in this report have all the same size for a given frequency distribution to facilitate the reading. Lastly, the sum of the relative frequencies is obviously equal to one.

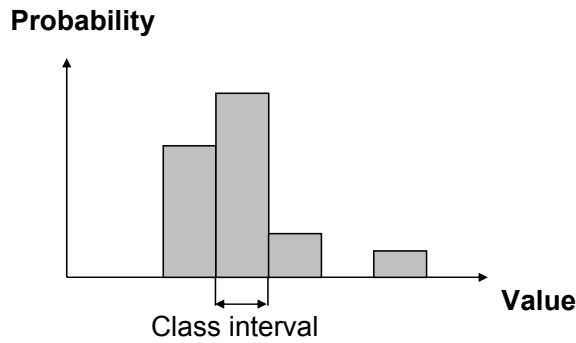

Figure A.1.1: Example of a frequency distribution

A.1.2 Bivariate data

- ✓ *Bivariate data* refer to the observations made for two random variables X and Y ¹³⁹. Let consider now a bivariate sample data defined by $2 \times N$ elements, noted from $x[1]$ to $x[N]$ and from $y[1]$ to $y[N]$, classified in any order, but each couple of data $x[k]$ and $y[k]$ represents one sample;
- ✓ The *sample covariance*¹⁴⁰ C_{xy} represents the linear relationship between x and y and is defined as [Berry and Lindgren (1990)]:

$$C_{xy} = \frac{1}{N-1} \sum_{k=1}^N (x[k] - \bar{x})(y[k] - \bar{y}) \quad (\text{A.1.10})$$

- ✓ The *sample correlation coefficient* r_{xy} , (sometimes called cross-correlation) gives a friendlier picture of the linear relationship between the two series of data than C_{xy} , is comprised between -1 and 1 , and is defined as:

$$r_{xy} = \frac{C_{xy}}{\sigma_x \sigma_y} \quad (\text{A.1.11})$$

- ✓ It is important to keep in mind that C_{xy} and r_{xy} can be equal to zero despite a clear non-linear relationship between the two variables;
- ✓ C_{xy} and r_{xy} represent *the strength of the linear relationship* between X and Y , but do not give information about the significance of the strength of the linear relationship. The significance can be estimated with for example a one-tailed test (t-test);

¹³⁹ The general term to designate data with observations on several variables is multivariate data.

¹⁴⁰ The sample covariance is sometimes called cross-covariance to make the distinction with the covariance matrix of a time series [Fuller (1976)]

- ✓ A significant strong linear relationship between X and Y does not mean that X causes Y or vice-versa;
- ✓ A *scatter plot* shows the relation between two variables by plotting each observation in a two-dimensional graph, where the horizontal axis represents one random variable and the vertical axis the second one. This kind of graph may be very helpful to detect specific patterns.

A.1.3 Time-dependent data

A *time series* is a sequence of observations made at regular interval of time [Open University (1988)]. When the observations of the random variables are made over time, the basic statistics presented in the previous sections can be misleading in some cases, although they can give a good insight of some particular data arrangements (e.g., see section 3.4.3).

- ✓ Let us consider a univariate time series defined by N elements, noted from $x[1]$ to $x[N]$, classified in chronological order;
- ✓ The *sample autocorrelation coefficient* r_{lag} , comprised between -1 and 1 , is somewhat similar to r_{xy} as r_{lag} gives the correlation of the process with the previous observations that were made during the lag. The autocorrelation coefficient is defined as follows for a given lag [Hamilton (1994)]:

$$r_{lag} = \frac{\sum_{k=1}^{N-lag} (x[k] - \bar{x})(x[k+lag] - \bar{x})}{\sum_{k=1}^N (x[k] - \bar{x})^2} \quad (\text{A.1.12})$$

- ✓ From the previous formula, the *autocorrelation function* (ACF) can be drawn with the lags on the horizontal axis and the corresponding autocorrelation coefficients on the vertical axis;
- ✓ The ACF shows the influence of all the observations from $x[k-lag]$ to $x[k-1]$ on $x[k]$. To estimate the specific influence of $x[k-lag]$ on $x[k]$, the *partial autocorrelation function* (PACF) should be used instead. Since its formulation is not straightforward [Hamilton (1994)], its mathematical formulation is not given here. To calculate the PACF in this thesis, the Microsoft Excel statistical add-in from Numerical Algorithms Group (2007) was used;

- ✓ An important concept for time-dependant data is *stationarity*, since a stationary time series can be studied as a classical random variable (see section A.1.1). A time series is said to be strictly stationary if the probability laws describing the shifted time series $x[k+l]$ are the same as those describing the original time series $x[k]$ [Open University (1988)]. Strictly stationary time series are rare. Practically, a time series is *weakly stationary* (or covariance-stationary) when [Hamilton (1994)]:
 - The expected values and variances are constant over time;
 - Each autocorrelation coefficient is constant over time.
- ✓ Generally speaking, a time series may be split into three components [Open University (1988)]:
 - A *trend component*, which represents a non-periodic long-term variation;
 - A *seasonal component*, which shows a periodic variation;
 - A *stationary irregular component*, which basically represents the short-term noise around the trend and the seasonal components.

A.1.4 Descriptive analysis

This thesis tries to understand the causes underlying the de-optimisation cost, but does not specifically attempt to predict the de-optimisation cost (see Chapter 3). The process of understanding the data is called *descriptive analysis*. In general, a descriptive analysis summarizes the characteristics (trend and dispersion) of the variable, estimates its density and detects atypical values (the *outliers*). Then, it may be necessary to transform data with for example a logarithmic transformation. Such transformations are useful to separate the different components of a time series, as introduced in section A.1.3. Lastly, descriptive analysis helps to understand the links between variables [Peradotto (2001)].

In this thesis, the following steps are performed to analyse the computed de-optimisation cost:

- ✓ *Data selection*: in this process, data are extracted from the OTESS database and some basic calculations are performed (e.g., subtraction between two costs). Most of the data are defined for each time step of the day whereas the de-optimisation cost has a meaning only over a day. Therefore, basic statistics for each parameter are taken, such as the minimum, the maximum, the mean, the standard deviation and the difference between the minimum and the maximum over the 48 first steps (the 48 following steps

are ignored, as explained in section 3.3.6). In total, around 100 variables have been defined;

- ✓ *Handling missing data*: the missing data are completed as explained in section 3.3.4.3;
- ✓ *Calculation of basic statistics*: the frequency distributions are plotted for the valid data and basic statistics are given to evaluate the quality of the series;
- ✓ *Seasonality*: the seasonality of the time series is analysed with the ACF and the PACF (see section 3.4.2);
- ✓ *Data smoothing (or filtering)*: in order to remove the noise around the main variation of the series, a smoothing is performed with a window-moving average according to (A.1.13). In other words, this technique tries to remove the stationary component from the original series. For example, Figure 4.4 represents the smoothing process with a 3-element window. Note that the new set of data is smaller than the window since the beginning and the end of the series cannot be smoothed. In this report, the window is chosen according to the seasonality period;

$$x_{smoothed}[t] = \frac{\sum_{k=t-\frac{window-1}{2}}^{t+\frac{window-1}{2}} x_{original}[k]}{window}, \text{ where window is odd} \quad (\text{A.1.13})$$

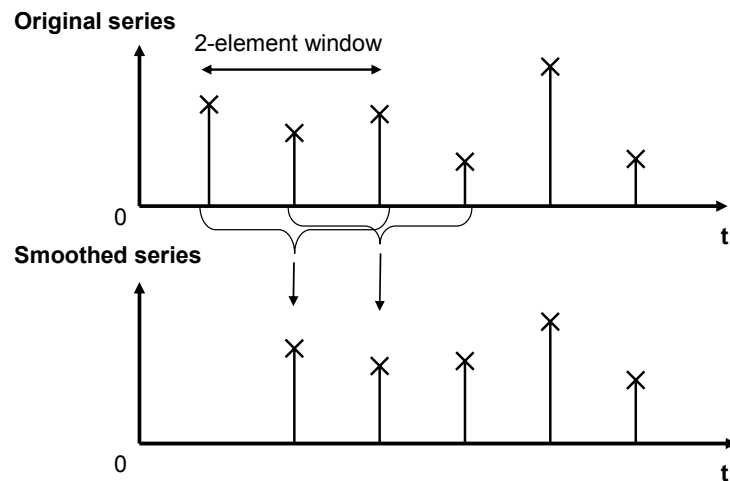

Figure A.1.2: Schematic representation of the smoothing process

- ✓ *Getting the stationary component*: this is done by removing the trend and seasonal components of each series over time and any correlation correction. Seasonal patterns can be detected by calculating the auto-correlation coefficients of the series or by performing a Fourier Transform or a caterpillar decomposition [Garcia (2005)]. In this

study, the trend and seasonal components are removed by simply subtracting the smoothed series from the original one;

- ✓ *Normalization*: this makes possible comparing data with different units or orders of magnitude. The normalization used in this report is shown in (A.1.14), where \bar{x} and σ are respectively the mean and the standard deviation of the series to be normalized [Garcia (2005)].

$$x_{\text{normalized}}[t] = \frac{x[t] - \bar{x}}{\sigma} \quad (\text{A.1.14})$$

- ✓ *Multidimensional analysis*: this report relies on a basic multidimensional analysis, for which correlation coefficients are calculated and scatter plots are drawn. More complex techniques such as clustering (e.g. with the help of Kohonen networks) could be performed for further studies [Garcia (2005)]. ■

A.2 Technical Description of OTESS

This section gives an overview of OTESS from a technical point of view. It is assumed here that the reader is familiar with the optimisation process described in section 3.3. OTESS stands for *OuTil pour l'Etude des Services Système* (Tool for the study of ancillary services). This software has been initially developed to manipulate the operating data of EDF Producer in order to estimate its de-optimisation cost because of frequency control reserves (see Chapter 3). However, because it is object-oriented architecture, this software could be quickly adapted to any information system. Furthermore, the studies possible with OTESS are not limited to ancillary services. In fact, any kind of research related to the generation optimisation algorithm can be performed, such as assessing the impact of a new portfolio or different market prices.

A.2.1 Basic functionalities

As presented in section 3.3.5.2, the main features of OTESS are the following:

- ✓ Handle and modify inputs and outputs of EDF's dispatch algorithm;
- ✓ Extract the selected data from the optimisation algorithm's output files and store them into a relational database;
- ✓ Store any kind of additional data in its database, such as such as the target frequency, the balancing mechanism prices or the final dispatch planning (the *programme d'appel*);
- ✓ Easily modify data of the database with user-defined scripts;
- ✓ Allow complex querying on cross-related tables;
- ✓ Display data with various graph types directly from queries (e.g., scatter plots or frequency distributions, as shown in Chapter 3);
- ✓ Perform basic data mining techniques;
- ✓ Export data under various formats (e.g., CSV or XML¹⁴¹);
- ✓ Share data between users since it is a server-based software with a web-based human-machine interface;
- ✓ Run on both Linux and Windows environment;
- ✓ Based on free software;

¹⁴¹ CSV stands for Comma-Separated Values and XML for Extensible Mark-up Language

- ✓ Strongly modular because object-oriented.

A.2.2 Hardware architecture

The architecture of OTESS is based on the famous LAMP architecture (Linux, Apache, MySQL and PHP) and is shown in Figure A.2.3 where the basic operations are as follows:

- ✓ *Operation 1*: the operational data are stored as zipped text files on a specific server. They are thus transferred via FTP to the main machine, where they are unzipped;
- ✓ *Operation 2*: the datasets are modified by OTESS according to a given script. For example, the demand for reserve can be set to zero (see section A.2.6);
- ✓ *Operation 3*: the modified datasets are sent via FTP to several simulation machines in order to reduce the computation time (see section 3.3.5.1 for more details on these machines);
- ✓ *Operation 4*: a KSH script launches automatically EDF's dispatch algorithm for the modified datasets. Following the optimisation process, new datasets are created as outputs;
- ✓ *Operation 5*: the results are sent back via FTP to the main machine;
- ✓ *Operation 6*: only a part of the dispatch results are used to feed in the relational database of OTESS (see section A.2.3 for more details on the database structure);
- ✓ *Operation 7*: the user makes use of the functionalities of OTESS in order to extract the data that are useful via tailored-made scripts and a generic web-based interface (see section A.2.5 for a few screenshots).

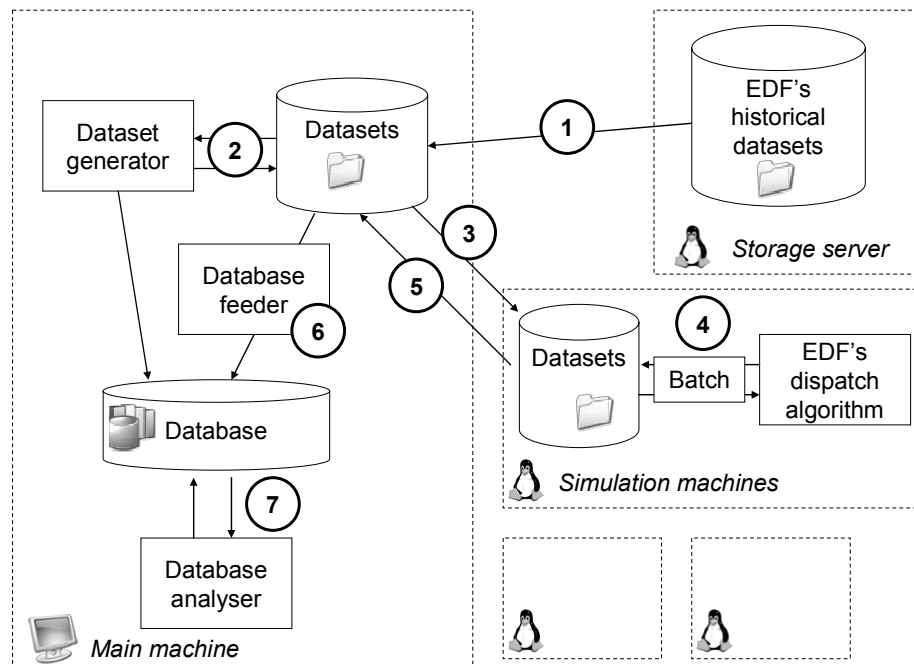

Figure A.2.3: Hardware architecture of OTESS

A.2.3 Software architecture

OTESS relies on a relational database. The entity relation modelling of the main tables of OTESS is given in Figure A.2.4¹⁴². To give an idea of data stored, Table A.2.1 to Table A.2.4 give the structures of four data tables. In fact, there are 27 tables, amongst which 15 are dedicated to OTESS management (e.g., relations between tables, user management, session, script locations, graphs...). Nevertheless, this relational database can be easily modified through a dedicated interface in OTESS.

¹⁴² For more information on entity relation modelling, see for example Williams and Lane (2004).

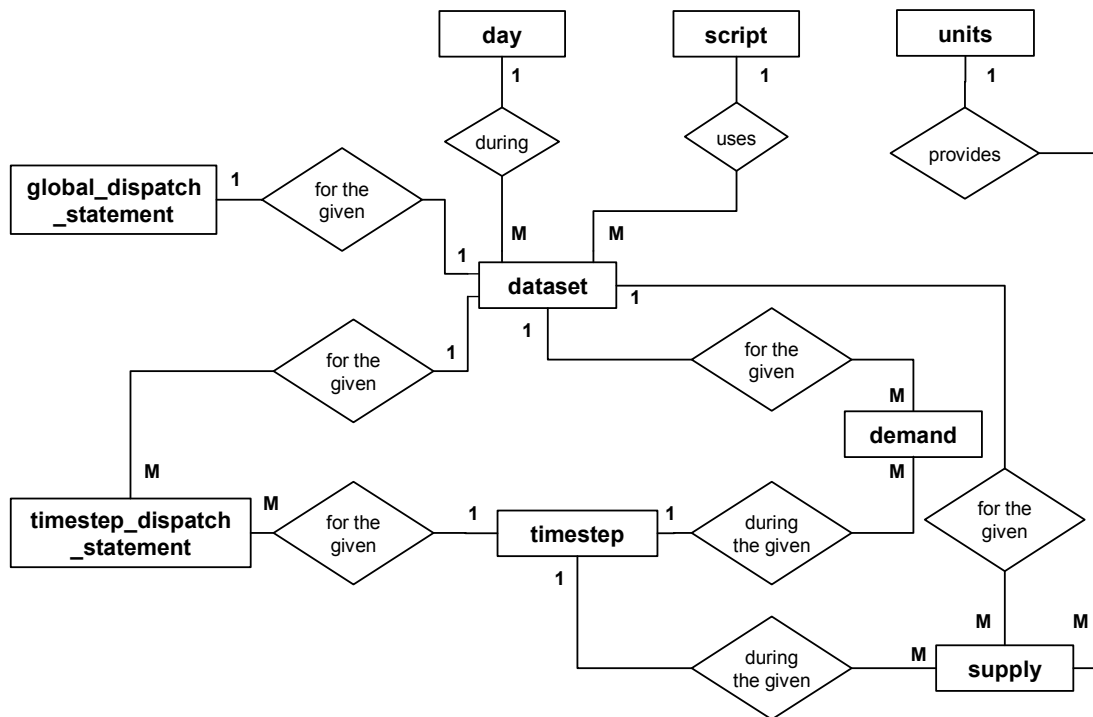

Figure A.2.4: Entity relation modelling of the main tables of OTESS

Table A.2.1: Structure of the table “unit”

Name	Data type	Unit	Description
UNIT_ID	INT(3) >0	-	Unit ID (unique primary key)
NAME	VAR(10)	-	Generating unit name, identical to the one used by EDF (e.g., ‘CHIN2T 1’)
MAIN_TYPE	(‘thermal’,‘hydro’)	-	Group main type: thermal or hydro
TYPE	CHAR(1)	-	For thermal : ‘N’ : nuclear, ‘H’ : bituminous coal, ‘C’ : coal, ‘F’ : fuel, ‘G’ : gas turbine, ‘B’ : bagasse, ‘E’ : exchange, ‘P’ : Phenix For hydro : ‘L’ : lake downstream, ‘E’ : lock downstream, ‘F’ : fatal downstream, ‘P’ : pumping, ‘D’ : floodgate, ‘R’ : restitution
CITY_NAME	VAR(255)	-	Name of the place
CITY_CODE	INT(5) >0	-	Zip code of the place

Table A.2.2: Structure of the table “demand”

Name	Data type	Unit	Description
DATASET_ID	INT(8) >0	-	See table “dataset” (co-primary key)
TIMESTEP_ID	INT(8) >0	-	See table “timestep” (co-primary key)
NRJ	SCI >0 or <0	MW	Forecasted power demand
SEC	SCI >0	MW	Secondary reserve demand
PRI	SCI >0	MW	Primary reserve demand

Table A.2.3: Structure of the table “supply”

Name	Data type	Unit	Description
DATASET_ID	INT(8) >0	-	See table “dataset” (co-primary key)
UNIT_ID	INT(3) >0	-	See table “unit” (co-primary key)
TIMESTEP_ID	INT(8) >0	-	See table “timestep” (co-primary key)
NRJ	SCI >0 or <0	MW	Dispatched power
SEC	SCI >0	MW	Dispatched secondary reserve
PRI	SCI >0	MW	Dispatched primary reserve

Table A.2.4: Structure of the table “global_dispatch_statement”

Name	Data type	Unit	Description
DATASET_ID	INT(8) >0	-	See table “dataset” (unique primary key)
NRJ_AVG_GAP	SCI >0 or <0	MW	Average gap between scheduled power supply and estimated power demand over the first 48 steps
SEC_AVG_GAP	SCI >0 or <0	MW	Average gap between scheduled secondary reserve and secondary reserve demand
PRI_AVG_GAP	SCI >0 or <0	MW	Average gap between scheduled primary reserve and primary reserve demand
THM_COST	SCI >0 or <0	k€	Cost of the thermal power supply dispatch for the first 48 steps
HYD_COST	SCI >0 or <0	k€	Cost of the de-stocked water for the first 48 steps
NRJ_PENALTY	SCI >0 or <0	k€	Cost of the power supply mismatch for the first 48 steps
SEC_PENALTY	SCI >0 or <0	k€	Cost of the secondary reserve mismatch for the first 48 steps
PRI_PENALTY	SCI >0 or <0	k€	Cost of the primary reserve mismatch for the first 48 steps
TOTAL_COST	SCI >0 or <0	k€	Total cost of dispatch, including penalties, for the first 48 steps

A.2.4 Parameters for data analysis

The following parameters have been computed and stored in two specific tables of OTESS in order to perform multidimensional data analysis (operation 7 in section A.2.2). Only a few of these parameters have exhibited a clear interest (see section 3.4.3). Note that the relations between the marginal costs of reserves and other parameters have not been included in this thesis for obvious confidentiality reasons.

- ✓ For the de-optimisation cost (table “descriptive_analysis_normalized_data_dates”):
 - VALID: indicates whether the data is original (1) or extrapolated (0). See section 3.3.4.3 for more information on extrapolated data;
 - DATE: date of the day;
 - DAY_NUMBER: number of the day (from 1 to 365);
 - DAY_NAME: name of the day;
 - SEASON: season of the day;
 - BANKHOLIDAY: indicates whether the day is a bank holiday (1) or not (0);
 - CHANGING_TIME: indicates whether the Summer/Winter time is triggered during this day (1) or not (0);
 - TARGET_FREQUENCY: UCTE target frequency for this day (49.99, 50.00 or 50.01);
 - WEEKDAY: indicates whether the day is a weekday (1) or a weekend (0);
 - INITIAL_COST (_TOT, _THM, _HYD, _PEN): cost of dispatch with reserves (total, thermal, hydro, APOGEE penalty) (in k€). See section 3.3.6 for more information on the cost calculation;
 - COST_DIFFERENCE (_TOT, _TOT_PERCENT): difference between the cost of dispatch without reserves and the cost of dispatch with reserve (absolute – in k€, relative);
 - NRJ_DEMAND (_MEAN, _MIN, _MAX, _DELTAMINMAX, _STDDEV): initial demand for energy for the day (mean, minimum, maximum, maximum minus minimum, standard deviation) (in MW/h). See Section A.1.1 for more details on the statistics used;
 - SEC_DEMAND (_MEAN, ...): initial demand for secondary reserve (in MW/h);
 - PRI_DEMAND (_MEAN, ...): initial demand for primary reserve (in MW/h);
 - SPIN_DEMAND (_MEAN, ...): initial demand for primary + secondary reserves (in MW/h);

- THM_SHARE_NRJ_DISPATCH (_MEAN, ...): the thermal generation divided by the total generation;
- THM_SHARE_SEC_DISPATCH (_MEAN, ...): the secondary reserves provided by thermal units divided by the total provided secondary reserves;
- THM_SHARE_PRI_DISPATCH (_MEAN, ...): same as above but with primary reserves;
- THM_SHARE_SPIN_DISPATCH (_MEAN, ...): same as above but with primary + secondary reserves;
- NRJ_DISPATCH (_MEAN, ...): dispatched generation (in MW/h);
- SEC_DISPATCH (_MEAN, ...): dispatched secondary reserves (in MW/h);
- PRI_DISPATCH (_MEAN, ...): dispatched primary reserves (in MW/h);
- SPIN_DISPATCH (_MEAN, ...): dispatched primary + secondary reserves (in MW/h);
- NRJ_NEGATIVE_MARGIN (_MEAN, ...): the dispatched generation minus the minimum available generation (in MW/h);
- NRJ_POSITIVE_MARGIN (_MEAN, ...): the maximum available generation minus the dispatched generation (in MW/h);
- SEC_MARGIN (_MEAN, ...): the maximum available secondary reserves minus the dispatched secondary reserves (in MW/h);
- PRI_MARGIN (_MEAN, ...): same as above with primary reserves (in MW/h);
- SPIN_MARGIN (_MEAN, ...): same as above with primary + secondary reserves (in MW/h);
- NRJ_MARGINAL_COST (_MEAN, ...): marginal cost of energy (in €/MW/h);
- SEC_MARGINAL_COST (_MEAN, ...): marginal cost of secondary reserves (in €/MW/h);
- PRI_MARGINAL_COST (_MEAN, ...): marginal cost of primary reserves (in €/MW/h);
- NRJ_GAP (_MEAN, ...): dispatched generation minus the initial demand for energy (in MW/h);
- SEC_GAP (_MEAN, ...): dispatched secondary reserves minus the initial demand for secondary reserves (in MW/h);
- PRI_GAP (_MEAN, ...): dispatched primary reserves minus the initial demand for primary reserves (in MW/h);

- SPIN_WEIGHTED_SUM_MARGINAL_COSTS (_MEAN, ...):

$$\lambda_{R^i} = \frac{\lambda_{R_{pri}^i} \times R_{pri\ dispatch}^i + \lambda_{R_{sec}^i} \times R_{sec\ dispatch}^i}{R_{pri\ dispatch}^i + R_{sec\ dispatch}^i} \quad (\text{in } \text{€}/\text{MW}/\text{h}). \quad \text{See section 3.4.3.1 for more}$$

explanation on this indicator;

- ALL_WEIGHTED_SUM_MARGINAL_COSTS (_MEAN, ...): same as above, but considering energy + secondary + primary instead of secondary + primary only (in €/MW/h).
- ✓ For the marginal costs of reserves (table “descriptive_analysis_normalized_data_timesteps”):
 - VALID: indicates whether the data is original (1) or extrapolated (0). See section 3.3.4.3 for more information on extrapolated data;
 - DATE: date of the day;
 - TIMESTEP: number of the time step (from 1 to 48);
 - DAY_NUMBER: number of the day (from 1 to 365);
 - DAY_NAME: name of the day;
 - SEASON: season of the day;
 - BANKHOLIDAY: indicates whether the day is a bank holiday (1) or not (0);
 - CHANGING_TIME: indicates whether the Summer/Winter time is triggered during this day (1) or not (0);
 - TARGET_FREQUENCY: UCTE target frequency for this day (49.99, 50.00 or 50.01);
 - WEEKDAY: indicates whether the day is a weekday (1) or a weekend (0);
 - NRJ_DEMAND: initial demand for energy for the time step (in MW/h);
 - SEC_DEMAND: initial demand for secondary reserve (in MW/h);
 - PRI_DEMAND: initial demand for primary reserve (in MW/h);
 - SPIN_DEMAND: initial demand for primary + secondary reserves (in MW/h);
 - THM_SHARE_NRJ_DISPATCH: the thermal generation divided by the total generation during the time step;
 - THM_SHARE_SEC_DISPATCH: the secondary reserves provided by thermal units divided by the total provided secondary reserves;
 - THM_SHARE_PRI_DISPATCH: same as above but with primary reserves;
 - THM_SHARE_SPIN_DISPATCH: same as above but with primary + secondary reserves;

- NRJ_DISPATCH: dispatched generation during the time step (in MW/h);
- SEC_DISPATCH: dispatched secondary reserves (in MW/h);
- PRI_DISPATCH: dispatched primary reserves (in MW/h);
- SPIN_DISPATCH: dispatched primary + secondary reserves (in MW/h);
- NRJ_NEGATIVE_MARGIN: the dispatched generation minus the minimum available generation (in MW/h);
- NRJ_POSITIVE_MARGIN: the maximum available generation minus the dispatched generation (in MW/h);
- SEC_MARGIN: the maximum available secondary reserves minus the dispatched secondary reserves (in MW/h);
- PRI_MARGIN: same as above with primary reserves (in MW/h);
- SPIN_MARGIN: same as above with primary + secondary reserves (in MW/h);
- NRJ_MARGINAL_COST: marginal cost of energy for the time step (in €/MW/h);
- SEC_MARGINAL_COST: marginal cost of secondary reserves (in €/MW/h);
- PRI_MARGINAL_COST: marginal cost of primary reserves (in €/MW/h);
- NRJ_GAP: dispatched generation minus the initial demand for energy (in MW/h);
- SEC_GAP: dispatched secondary reserves minus the initial demand for secondary reserves (in MW/h);
- PRI_GAP: dispatched primary reserves minus the initial demand for primary reserves (in MW/h);
- SPIN_WEIGHTED_SUM_MARGINAL_COSTS:

$$\lambda_R^i = \frac{\lambda_{R_{pri}}^i \times R_{pri\ dispatch}^i + \lambda_{R_{sec}}^i \times R_{sec\ dispatch}^i}{R_{pri\ dispatch}^i + R_{sec\ dispatch}^i} \quad (\text{in } \text{€/MW/h}). \quad \text{See section 3.4.3.1 for more}$$

explanation on this indicator.

- ALL_WEIGHTED_SUM_MARGINAL_COSTS: same as above, but considering energy + secondary + primary instead of secondary + primary only (in €/MW/h).

A.2.5 Screenshots

In order to illustrate some of the basic functionalities of OTESS mentioned in section A.2.1, Figure A.2.5 to Figure A.2.10 display a few screenshots from OTESS (note that OTESS is compatible with most of web browsers).

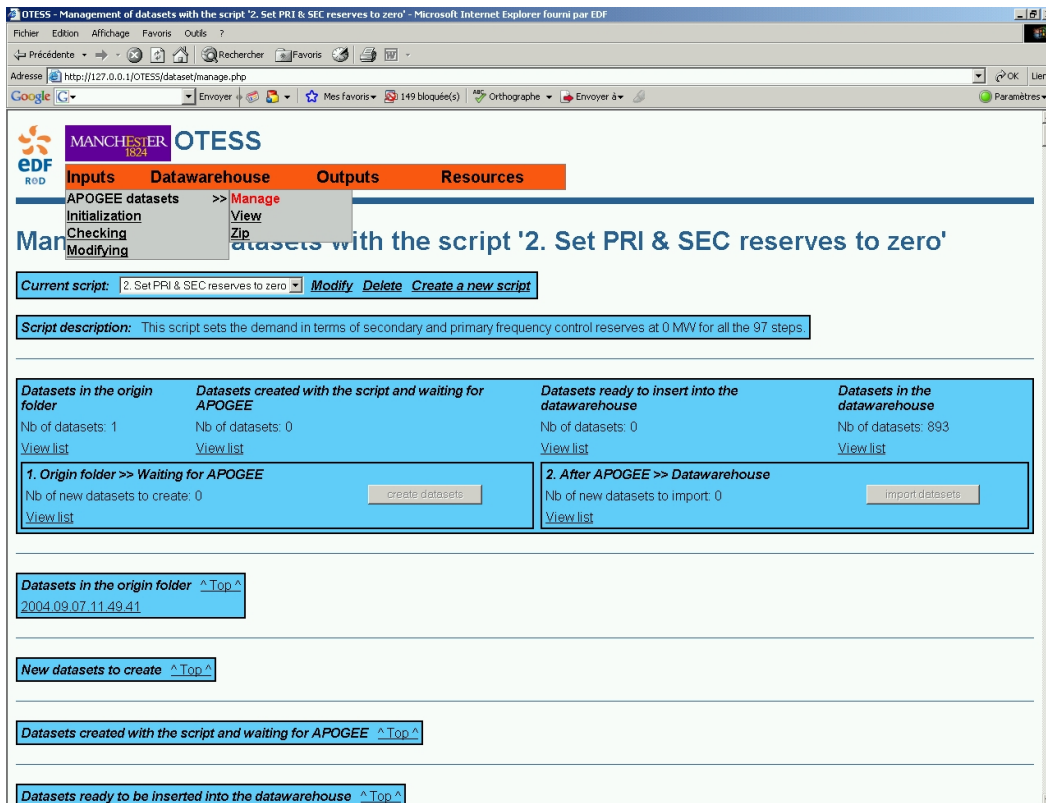

Figure A.2.5: Modification and import of datasets with OTESS (operations 2 and 6 in section A.2.2)

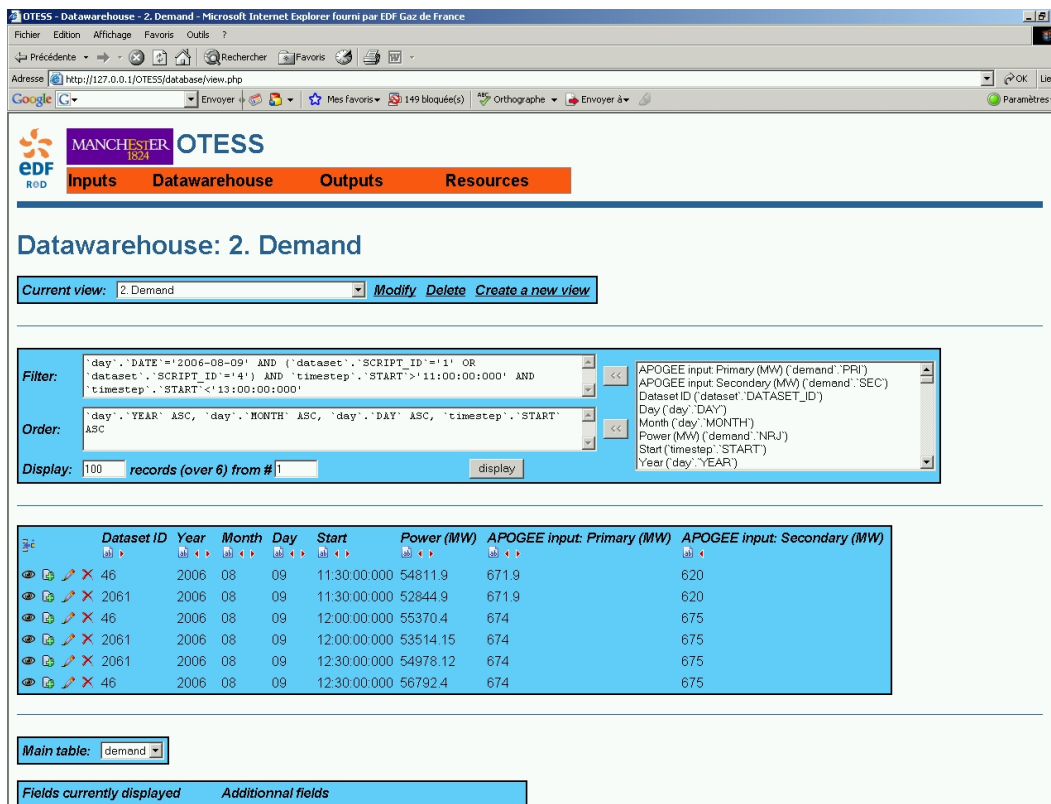

Figure A.2.6: Management of data in the database (operation 7 in section A.2.2)

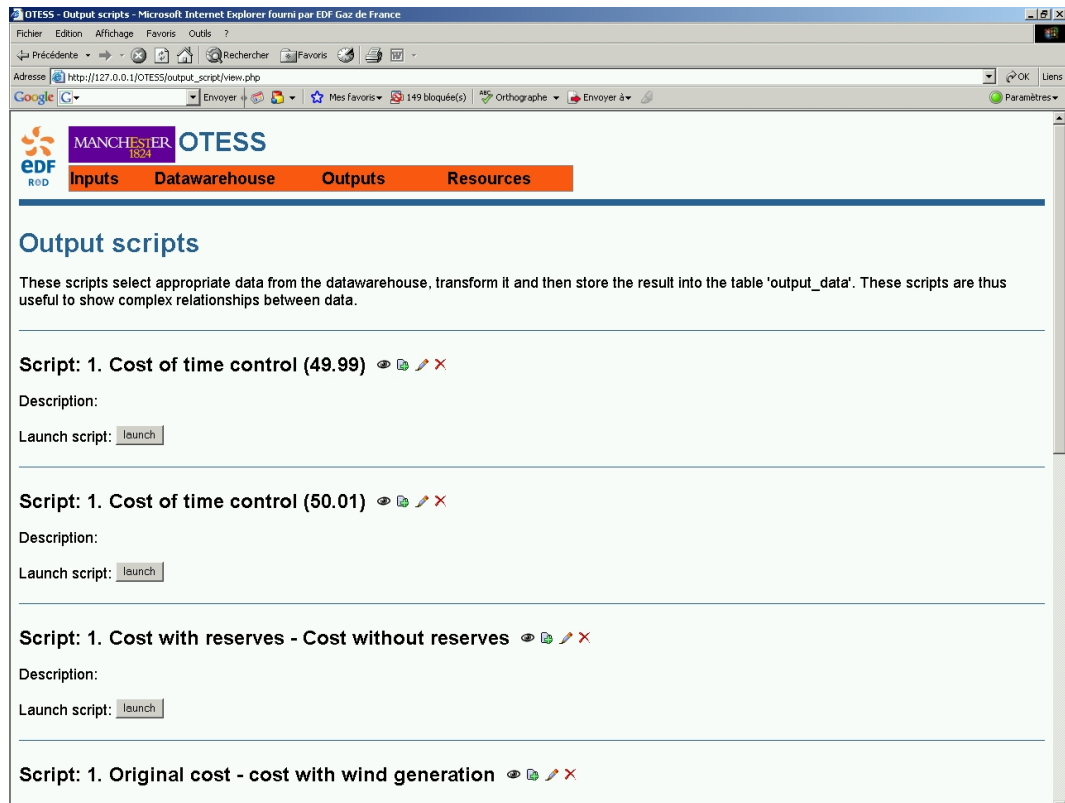

Figure A.2.7: Creation of new data in the database (operation 7 in section A.2.2)

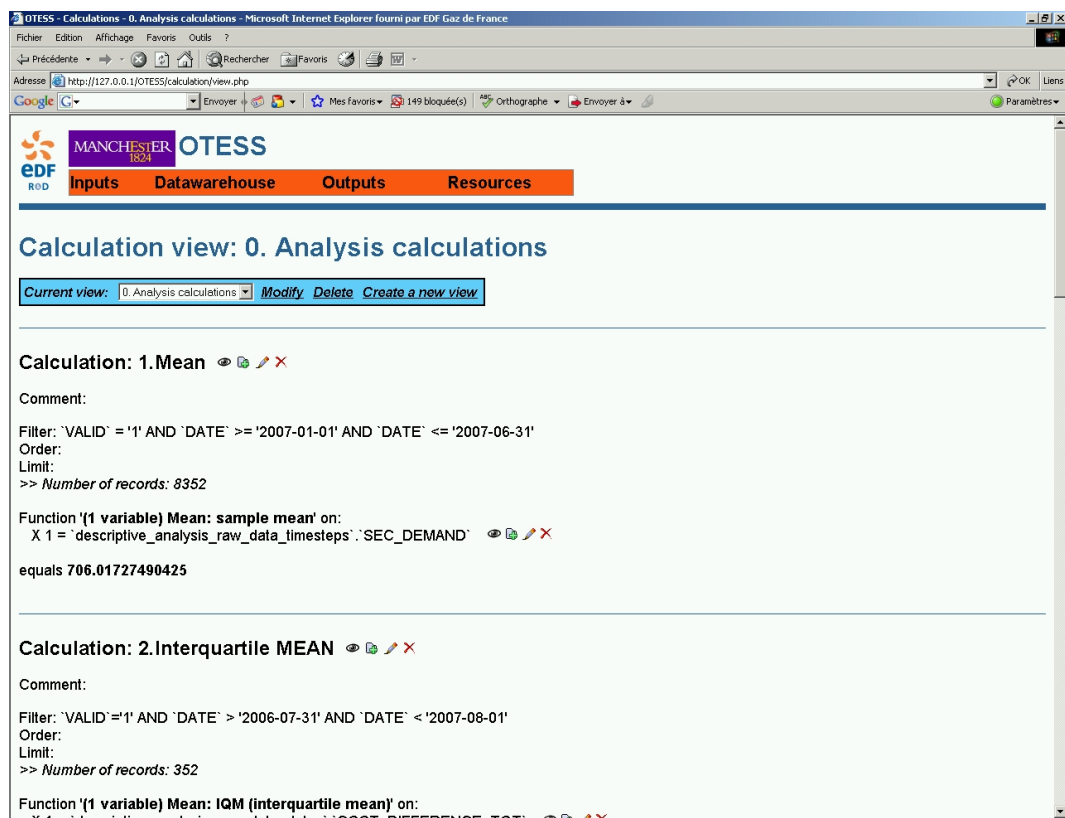

Figure A.2.8: Basic calculation on the data (operation 7 in section A.2.2)

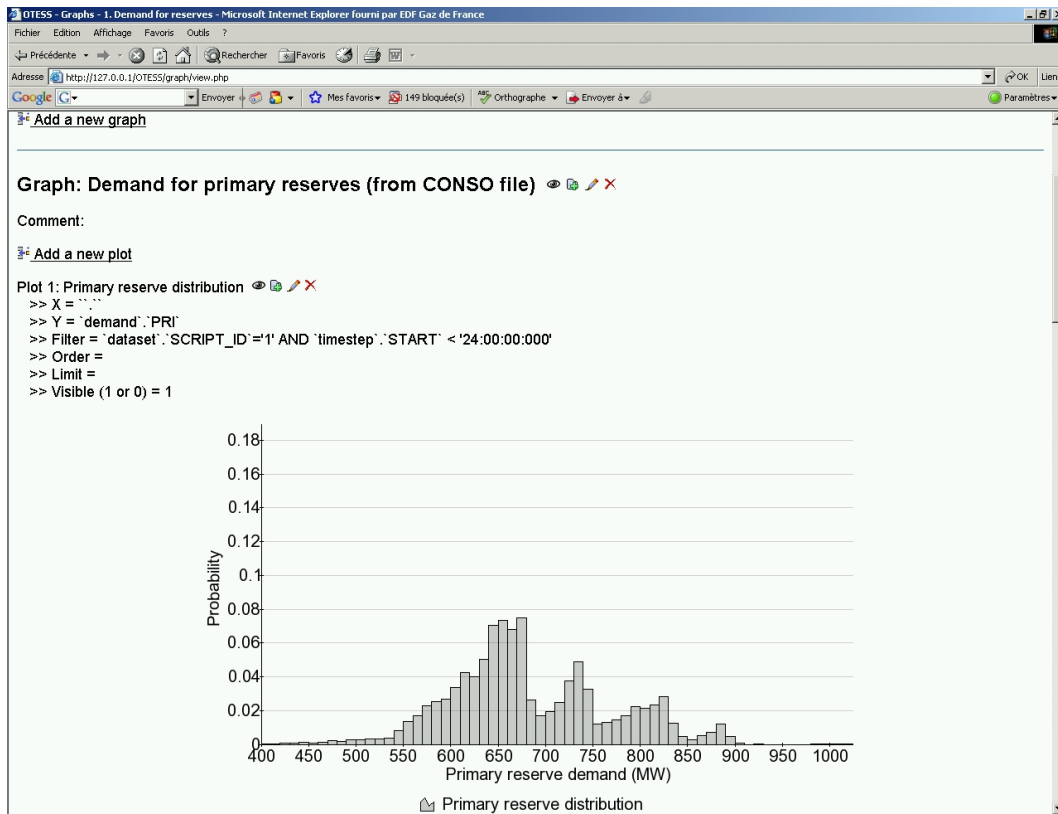

Figure A.2.9: Display of a graph with OTESS (operation 7 in section A.2.2)

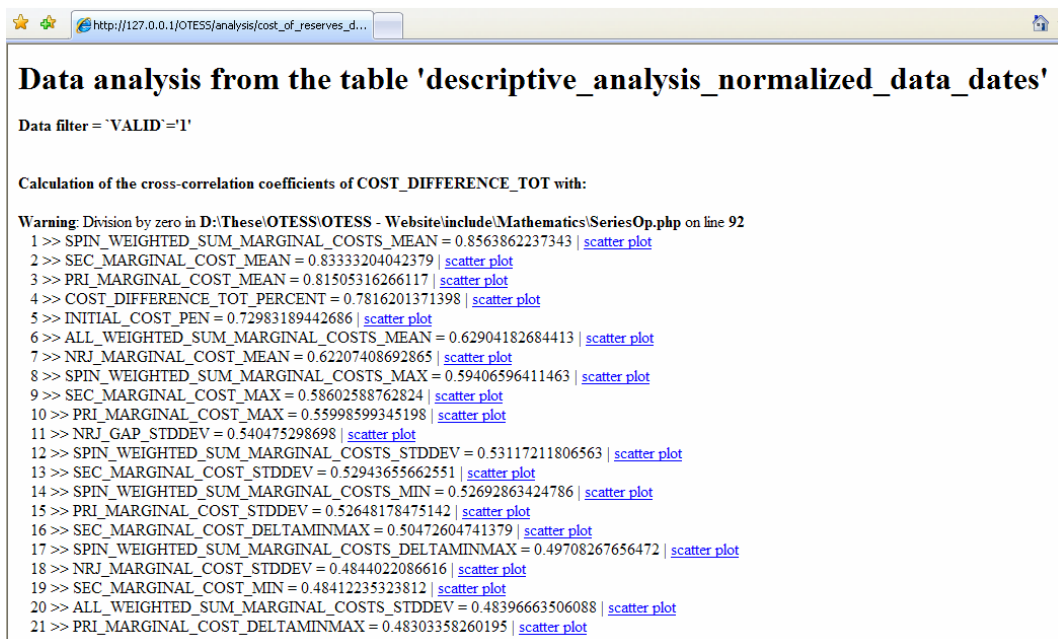

Figure A.2.10: Analysis of data with OTESS (operation 7 in section A.2.2)

A.2.6 Code example

To perform complex tasks such as creating new datasets or modifying data, OTESS allows users to define their own scripts. For example, the following script has been used to create

new datasets with the demand for reserves set to zero (note the object-oriented programming that allows any change in the structure of the dataset text files):

```
<?php
```

```
/*-----*\
dataset/script/reserve_demand_at_zero.php

Written by:    Yann REBOURS (yann.rebours@ieee.org)
Created:      2007.09.11
Last modified: 2007.10.12
Description:   Copy the datasets and set the demand for the primary and
               secondary reserves at zero
Utilisation:  uses the POST method for:
               - SCRIPT_ID: the id of script that we use
               - datasets: encoded list of the names of the datasets to copy

(C) The University of Manchester 2007
(C) Electricité de France 2007
*-----*/

////////////////
// MODULES //
////////////////
require_once 'parameters.inc';           // Parameters
require_once 'System/Folder.php';       // To manage folders and files
require_once 'HTTP/Input.php';         // To have access to the arguments
require_once 'Dataset/Script.php';     // Class that manages scripts
require_once 'Dataset/File_Conso.php';  // To have access to the CONSO file

////////////////
// PARAMETERS //
////////////////

// We get the ID of the script
$id_script = HTML_Input::getInputs("SCRIPT_ID", "POST");
// We get the list of datasets to copy
$array_datasets_to_copy = HTML_Input::decodeUrlVariable(HTML_Input::getInputs("datasets",
"POST"));
// We get the information on the script
$script = new Script($id_script);

// We define the initial and the destination folders
$path_initial_folder = $script->getInitialFolder();
$path_destination_folder = $script->getDestinationFolder();

// We create a folder object related to the destination folder
$destination_folder = new Folder($path_destination_folder);

////////////////
// CREATION OF THE DATASETS //
////////////////

// We define the empty reserve as an array of 97 elements
$empty_reserve = array_pad(array(),97,"0.000000000E+00");

// We go through the list of datasets to copy
foreach ( $array_datasets_to_copy as $current_dataset ) {
    // We check whether the dataset to copy is valid and whether the target dataset does
    not already exist
    if ( is_dir($path_initial_folder . $current_dataset) && !
is_dir($path_destination_folder . $current_dataset) ) {

        // We copy the dataset
        $destination_folder->copyFolder ( $path_initial_folder . $current_dataset ,
$path_destination_folder . $current_dataset);

        // We set the demand at 0 in the CONSO file
        $file_conso = new File_Conso($path_destination_folder . $current_dataset .
"/CONSO", "edit");
        $file_conso->setSecondaryDemand($empty_reserve);
        $file_conso->setPrimaryDemand($empty_reserve);

        // We free the memory
        // Note : this step is particularly important when there are hundreds of datasets
to manage
    }
}

```



```

        unset ($file_conso);
    }
}

//////////
// RETURN HEADER //
//////////

// We return to the page that helps to manage datasets
header("Location: " . OTESS_LOCATION_ROOT . "dataset/manage.php");
exit;

?>

```

To give an idea, the APOGEE text file that defines the demand for reserves and power for a given dataset looks as the following:

```

'CONSO' '28/03/2007' '13:16'
'29/03/2007'
'CONSOMMATION'
6.10609000E+04
5.79043000E+04 5.66327000E+04 5.68756000E+04 5.67770000E+04 5.61201000E+04 5.48171000E+04
5.47673000E+04 5.37623000E+04 5.55873000E+04 5.57700000E+04 5.57548000E+04 5.68733000E+04
5.86196000E+04 6.11816000E+04 6.52323000E+04 6.59297000E+04 6.67484000E+04 6.72475000E+04
6.81454000E+04 6.81704000E+04 6.89083000E+04 6.87611000E+04 6.93756000E+04 6.94626000E+04
6.78709000E+04 6.90679000E+04 6.77728000E+04 6.74430000E+04 6.66728000E+04 6.54041000E+04
6.46813000E+04 6.39915000E+04 6.36389000E+04 6.32568000E+04 6.28645000E+04 6.29857000E+04
6.32740000E+04 6.44215000E+04 6.51604000E+04 6.50362000E+04 6.62513000E+04 6.70456000E+04
6.50181000E+04 6.37341000E+04 6.32413000E+04 6.46282000E+04 6.26931000E+04 6.17510000E+04
5.89262000E+04 5.73462000E+04 5.79264000E+04 5.77593000E+04 5.65285000E+04 5.51436000E+04
5.47145000E+04 5.37294000E+04 5.45065000E+04 5.46943000E+04 5.60083000E+04 5.69993000E+04
5.99415000E+04 6.26598000E+04 6.54907000E+04 6.65409000E+04 6.67381000E+04 6.76150000E+04
6.84972000E+04 6.87932000E+04 6.95726000E+04 6.93596000E+04 6.98391000E+04 6.97841000E+04
6.80657000E+04 6.90857000E+04 6.80906000E+04 6.75953000E+04 6.62638000E+04 6.47184000E+04
6.36285000E+04 6.27277000E+04 6.21265000E+04 6.14530000E+04 6.08399000E+04 6.09224000E+04
6.13701000E+04 6.26496000E+04 6.31714000E+04 6.28654000E+04 6.55030000E+04 6.61970000E+04
6.44273000E+04 6.30994000E+04 6.28869000E+04 6.46170000E+04 6.23045000E+04 6.13917000E+04
'PRIMAIRE'
5.53256235E+02
5.55831191E+02 5.65831191E+02 5.66911208E+02 5.66911208E+02 5.66911208E+02 5.65831191E+02
5.66431191E+02 5.71131191E+02 5.70051235E+02 5.69451235E+02 5.70531191E+02 5.62531191E+02
5.51556691E+02 5.50521708E+02 5.53721708E+02 5.49621708E+02 5.47186236E+02 5.43436236E+02
5.44516253E+02 5.45116253E+02 5.44116253E+02 5.44116253E+02 5.44616253E+02 5.44616253E+02
5.49181254E+02 5.49181254E+02 5.51001267E+02 5.51471281E+02 5.56166267E+02 5.57946254E+02
5.58996254E+02 5.57916237E+02 5.54756691E+02 5.55081691E+02 5.54001735E+02 5.53301735E+02
5.48301735E+02 5.47706691E+02 5.46626734E+02 5.46076735E+02 5.41056691E+02 5.41056691E+02
5.47876735E+02 5.47876735E+02 5.48956691E+02 5.49256691E+02 5.51136708E+02 5.52786708E+02
5.83911208E+02 5.93911208E+02 5.93911208E+02 5.93911208E+02 5.97911208E+02 5.97911208E+02
5.95911208E+02 5.96611208E+02 5.92611208E+02 5.92611208E+02 5.90611208E+02 5.90611208E+02
5.80621708E+02 5.78746708E+02 5.69661708E+02 5.69111708E+02 5.73436253E+02 5.73436253E+02
5.68866253E+02 5.68866253E+02 5.67866253E+02 5.67866253E+02 5.67466253E+02 5.67466253E+02
5.71346254E+02 5.71346254E+02 5.71346254E+02 5.76826254E+02 5.77376254E+02 5.81196254E+02
5.81996254E+02 5.81996254E+02 5.80536708E+02 5.80951708E+02 5.81336708E+02 5.80636708E+02
5.79251708E+02 5.77761708E+02 5.77761708E+02 5.77761708E+02 5.68451708E+02 5.68451708E+02
5.74421708E+02 5.78136708E+02 5.78136708E+02 5.78136708E+02 5.78136708E+02 5.79401708E+02
'TELEREGLAGE'
8.38000000E+02
6.22000000E+02 6.62000000E+02 6.62000000E+02 6.62000000E+02 6.62000000E+02 6.62000000E+02
6.62000000E+02 6.62000000E+02 6.62000000E+02 6.62000000E+02 6.62000000E+02 6.62000000E+02
6.22000000E+02 7.70000000E+02 7.70000000E+02 7.70000000E+02 7.68919983E+02 7.68919983E+02
7.68919983E+02 7.68919983E+02 7.68919983E+02 7.68919983E+02 7.68919983E+02 7.68919983E+02
7.68919983E+02 7.68919983E+02 7.14919983E+02 7.14919983E+02 7.14919983E+02 7.16000000E+02
7.16000000E+02 7.16000000E+02 7.16000000E+02 7.16000000E+02 7.16000000E+02 7.16000000E+02
7.16000000E+02 7.16000000E+02 7.16000000E+02 7.16000000E+02 7.16000000E+02 7.16000000E+02
6.22000000E+02 6.62000000E+02 6.62000000E+02 6.62000000E+02 6.62000000E+02 6.62000000E+02
6.62000000E+02 6.62000000E+02 6.62000000E+02 6.62000000E+02 6.62000000E+02 6.62000000E+02
7.70000000E+02 7.70000000E+02 7.70000000E+02 7.70000000E+02 7.70000000E+02 7.70000000E+02
7.70000000E+02 7.70000000E+02 7.70000000E+02 7.70000000E+02 7.70000000E+02 7.70000000E+02
7.70000000E+02 7.70000000E+02 7.70000000E+02 7.70000000E+02 7.70000000E+02 7.70000000E+02
7.70000000E+02 7.70000000E+02 7.70000000E+02 7.70000000E+02 7.70000000E+02 7.70000000E+02
7.70000000E+02 7.70000000E+02 7.70000000E+02 7.70000000E+02 7.70000000E+02 7.70000000E+02

```

Lastly, to show how data from the database can be easily change, the following code was used to calculate the percentage of time when the marginal cost of energy was higher than the marginal costs of reserves (see section 3.5.1):

```
<?php
```

```

/*-----*
| user_scripts/output/constraint_energy_as_most_binding.php |

```

```

Written by:      Yann REBOURS (yann.rebours@ieee.org)
Created:        2008.04.07
Last modified:  2008.04.07
Description:    Get the percentage of time when NRJ is the most binding
Utilisation:   no input needed

(C) The University of Manchester 2008
(C) Electricité de France 2008
*-----*/

////////////////////////////////
// MODULES //
////////////////////////////////
require_once 'parameters.inc';           // Parameters
require_once 'Database/Database_Otess.php'; // To access to the Otess database
require_once '../..output_script/OutputData.php'; // To save the output

////////////////////////////////
// PARAMETERS //
////////////////////////////////

// We get connected to the database
$database = new Database_Otess();

// We define the tables to select
$array_tables_to_select =
Array("day","timestep_dispatch_statement","timestep","dataset");
// We define the fields to select
$array_fields_to_select = array (
    Array("Table" => "day", "Field" => "DATE"),
    Array("Table" => "timestep", "Field" => "START"),
    Array("Table" => "timestep_dispatch_statement", "Field" => "NRJ_MC" ),
    Array("Table" => "timestep_dispatch_statement", "Field" => "SEC_MC" ),
    Array("Table" => "timestep_dispatch_statement", "Field" => "PRI_MC" )
);

// We select the data on the marginal costs
$array_array_marginal_costs = $database-
>selectElements($array_tables_to_select,$array_fields_to_select,`SCRIPT_ID`=1' AND
`timestep`.`START`<'24:00:00'");

// Initialisation of the counters
$array_total = array();
$array_nrj_highest = array();

// We go through all the data (i.e., 48 x 879 days)
foreach ( $array_array_marginal_costs as $array_marginal_costs ) {

    // Initialisation of the arrays
    if ( empty($array_nrj_highest[$array_marginal_costs["START"]]) ) {
        $array_nrj_highest[$array_marginal_costs["START"]] = 0;
    }
    if ( empty($array_total[$array_marginal_costs["START"]]) ) {
        $array_total[$array_marginal_costs["START"]] = 0;
    }

    // Actualisation of the data
    $array_total[$array_marginal_costs["START"]] ++;
    if ( $array_marginal_costs["NRJ_MC"] > $array_marginal_costs["PRI_MC"] &&
        $array_marginal_costs["NRJ_MC"] > $array_marginal_costs["SEC_MC"] ) {
        $array_nrj_highest[$array_marginal_costs["START"]] ++;
    }
}

// We create the array with the result
$array_data_to_insert = array();
$timestep = 1;
foreach( array_keys($array_nrj_highest) as $start ) {
    array_push($array_data_to_insert , Array( "X"=>$timestep ,
"Y"=>100*$array_nrj_highest[$start]/$array_total[$start] ) );
    $timestep ++;
}

// We import the data into the database
$output_data = new OutputData();
// Note: we delete the previous results

```

```
$output_data->insertData($array_data_to_insert,true);
```

```
//////////
```

```
// RETURN //
```

```
//////////
```

```
echo '<BR /><A HREF="../../output_script/view.php">Return to the list of output  
scripts</A><BR />';
```



INDEX

—A—

ACE, 107, 108, 110, 138

ACF, 168

Adaptive deterministic security
 boundaries, 86

Adequacy, 84

ADSB *See* Adaptive deterministic security
 boundaries

Agent

 Pivotal, 129, 132

Auction

 Dutch, 206, 207

 English, 205, 206

 Japanese, 205

 Multiple-unit, 205, 206, 208

 Philatelist *See* Auction, Vickrey

 Sealed-bid, 206, 208, 211, 239, 246

 Sealed-bid second price *See* Auction,
 Vickrey

 Sequential, 210, 212, 214

 Simultaneous, 211, 212, 214

 Single-sided, 204, 205

 Single-unit, 205, 206

 VCG *See* Auction, Vickrey-Clarke-
 Groves

 Vickrey, 206, 209

 Vickrey-Clarke-Groves, 206, 207, 208,
 239

 AVR *See* Voltage control, Primary

—B—

Bid

 First rejected, 214

 Last accepted, 214

—C—

- Congestion, 215
- Contract
- Bilateral, 50, 52, 92, 188, 191, 193, 194, 195, 196, 215, 220, 236, 238, 248
 - Duration, 203, 219
 - Forward, 50, 194
 - Future, 194
- Control
- Speed, 58, 59, 60, 92
- Controller, 58, 92, 93, 104, 105, 106, 107, 108, 109, 110, 111, 116
- Correlation coefficient, 168, 171, 173
- Cost
- Allocation, 130, 131, 207, 223, 224, 225, 226, 227, 239, 246
 - Aumann-Shapley, 226, 227
 - Marginal, 226
- De-optimisation, 146, 149, 154, 155, 159, 165, 166, 167, 168, 169, 170, 171, 172, 173, 174, 175, 176, 177, 178, 179, 180, 182, 183, 184, 185, 243, 244, 245
- Deployment, 148
- Fixed, 144, 145, 146, 149, 198, 219, 224, 238, 239, 246
- Marginal, 50, 128, 159, 160, 162, 171, 172, 179, 180, 181, 185, 204, 209, 213, 214, 219, 226, 244, 245
- Opportunity, 72, 147, 148, 197, 199, 200, 201, 203, 209, 219, 227, 238
- Procurement, 88, 209, 210, 211, 223
- Reservation, 146, 149, 239, 246
- Running, 232, 240, 247
- Transaction, 90, 145, 189, 194, 195
- Utilisation, 147, 149, 184, 200, 224, 225
- Variable, 146, 149, 151, 154, 159, 184, 198, 217, 219, 238
- CRE, 100
- Cross-elasticity, 192
- Curve
- Demand, 50, 192, 193, 206, 219, 220, 239, 246
 - Offer, 201, 227
 - Supply, 50, 199, 219, 220
- Customer damage function, 85

—D—

Demand

- Curve, 50, 192, 193, 206, 219, 220, 239, 246
- Response, 192, 195, 237, 238
- Deployment end, 103, 106, 110
- Deployment start, 103, 104, 110
- Differentiation
- Horizontal, 89
- Vertical, 89
- Distributed generation, 47, 114, 126, 136, 229
- E—**
- Economic efficiency, 230, 232, 233, 235, 237, 240, 247
- EENS *See* Expected Energy Not Served
- Elasticity, 127, 141, 185, 189, 192, 211, 220, 237, 243, 247, 248
- ERAP, 189, 190, 191, 192, 193, 194, 205, 206, 209, 210, 211, 213, 218, 219, 223, 224, 238, 245
- Exchange *See* Market, Decentralized
- Expected Energy Not Served, 85
- Externality, 187, 195, 210, 213
- F—**
- FACTS, 80, 116
- Ferranti effect, 75
- Financial transmission rights, 53, 210
- Free riding, 127, 222, 225
- Frequency control
- Overlap regulation service, 138
- Primary, 93, 94, 97, 100, 101, 102, 103, 104, 105, 106, 108, 109, 111, 119, 133, 134, 137, 140, 173, 182, 189, 196, 200, 201, 212, 215, 216, 217, 218, 222, 226, 234, 236
- Secondary, 92, 94, 97, 101, 102, 107, 108, 109, 110, 120, 122, 123, 124, 125, 133, 134, 137, 138, 140, 144, 153, 157, 177, 192, 193, 196, 198, 200, 201, 202, 212, 215, 216, 217, 218, 221, 222, 224, 230, 234, 236, 248
- Supplemental regulation service, 138
- Tertiary, 94, 97, 101, 102, 120, 122, 123, 124, 125
- FTR *See* Financial transmission rights
- Full availability, 103, 106, 110
- G—**
- Gas
- Turbine, 78, 116, 159, 163

Generating unit, 43, 45, 46, 47, 51, 52, 54,
55, 56, 58, 59, 60, 63, 64, 68, 70, 71, 72,
77, 78, 79, 80, 81, 92, 93, 94, 95, 98, 99,
101, 103, 105, 111, 116, 120, 122, 138,
139, 147, 148, 173, 187, 190, 198, 215,
218, 225, 230, 241, 248

—H—

HHI *See* Index, Herfindahl-Hirschman

—I—

Incentives, 46, 125, 126, 127, 128, 129,
132, 140, 141, 188, 189, 190, 191, 192,
207, 213, 214, 215, 222, 223, 225, 227,
228, 230, 231, 232, 236, 237, 238, 239,
240, 242, 243, 246, 247

Penalties, 158, 159, 162, 199, 222, 223,
228, 229, 230, 231, 240, 247

Rewards, 222, 228, 229, 231, 240, 247

Index

Herfindahl-Hirschman, 235

Lerner, 233

Residual Supply, 235

Indicator

Cost, 234, 235

Reserve, 133, 134, 135

Insecurity *See* Security

—K—

Kolmogorov test, 125

—L—

Lagrange multiplier, 158

Lagrangian function, 158

Load-serving entity, 189, 223

LSE *See* Load-serving entity

—M—

Market

Centralised, 50, 52, 203, 211, 239, 246

Clearing, 46, 188, 192, 202, 211, 214,
216, 217, 218, 221, 238, 245

Concentration, 193, 213, 233, 235, 236

Coordination, 212

Decentralised, 49, 50, 52, 54, 64, 142,
203, 211, 239, 243, 246, 249

Liquidity, 50, 199, 233, 236

Monitoring, 48, 137, 222, 228, 229,
230, 231, 232, 240, 246, 247

Settlement, 203, 205, 213, 214, 215,
216, 239, 246, 248

Spot, 49, 52, 147, 150, 188, 193, 194,
195, 196, 200, 208, 219, 230, 233,
238

-
- Timing, 200, 216, 218, 219
- Transparency, 193, 194, 195, 227, 230, 246
- N—**
- Nash equilibrium, 51
- Net Surplus *See* Profit
- Normality, 123, 124, 141
- O—**
- Organisation
- Centralised, 107
 - Hierarchical, 107
 - Pluralistic, 107
- OTC *See* Over-the-Counter
- Over-the-counter, 50, 51, 52, 54, 194
- P—**
- PACF, 161, 168
- Pareto efficiency, 51, 88, 128, 129, 205, 206, 207, 208, 239, 246
- Payment
- Structure of, 197
- Pool *See* Market, Centralised
- Price
- Common, 214
 - Decomposition, 158, 209
 - Ex-ante, 53, 88, 213, 228
 - Ex-post, 53, 213, 228, 230
 - Nodal, 53, 203, 213, 215, 239, 246
 - Separate, 214
 - Sign, 197, 202
 - Symmetry, 202
 - Zonal, 203, 213, 214, 215, 239, 246
- Price cap, 46, 188, 192, 220, 221, 222, 239, 246
- Offer, 220, 221, 222
- Purchase, 220, 221, 222
- Prime mover, 55, 58, 69, 114
- Problem
- Dual, 157, 158, 209
 - Primal, 157, 209
- Product substitution, 117, 128, 210, 211
- Profit, 147, 199, 223
- Property rights, 187, 213, 215, 239
- Public good, 43, 84, 87, 127, 128, 129, 130, 141, 222, 223, 243

—Q—

Quality

Of supply, 131

Power, 84, 86, 87, 118, 129, 140, 242,
248Quasi-steady state, 57, 58, 59, 61, 77, 103,
114**—R—**

Rational buyer, 209, 211

Reliability, 84, 85, 86, 87, 99, 118, 119,
140, 211, 224, 228Risk, 50, 52, 86, 92, 127, 146, 149, 191,
193, 194, 195, 219, 225, 238RSI *See* Index, Residual supply**—S—**

Security, 242

Cost of, 86, 128, 132

Level of, 85, 86, 119

Smart grid, 92

Stability, 91, 92, 93, 97, 111, 114, 249

Stationarity, 141

Substitution

Rate of, 128

—T—

Tax

Groves-Clarke, 129, 130, 207

Tendering process, 105, 191, 194, 195,
196, 206, 208, 228Transformer, 47, 71, 72, 79, 86, 145, 146,
148Transmission tariff, 54, 152, 223, 224,
239, 246**—V—**

Value

Marginal, 214, 215

Of lost load, 85, 221, 222

VOLL *See* Value, Of lost load

Voltage control

Basic, 196, 201, 215, 216, 217, 218,
222, 234Enhanced, 196, 200, 201, 215, 216,
217, 218, 222

Primary, 71, 98, 111

Secondary, 98

Tertiary, 98

Voting, 127

—W—

Welfare

Global, 44, 88, 118, 142, 195, 209, 210,
232, 242, 248, 249