



HAL
open science

Conceptual Modelling of Life Cycle Design: a Modelling and Evaluation Method Based on Analogies and Dimensionless Numbers

Eric Coatanéa

► **To cite this version:**

Eric Coatanéa. Conceptual Modelling of Life Cycle Design: a Modelling and Evaluation Method Based on Analogies and Dimensionless Numbers. Engineering Sciences [physics]. Université de Bretagne occidentale - Brest, 2005. English. NNT: . tel-00393844

HAL Id: tel-00393844

<https://theses.hal.science/tel-00393844v1>

Submitted on 10 Jun 2009

HAL is a multi-disciplinary open access archive for the deposit and dissemination of scientific research documents, whether they are published or not. The documents may come from teaching and research institutions in France or abroad, or from public or private research centers.

L'archive ouverte pluridisciplinaire **HAL**, est destinée au dépôt et à la diffusion de documents scientifiques de niveau recherche, publiés ou non, émanant des établissements d'enseignement et de recherche français ou étrangers, des laboratoires publics ou privés.



HELSINKI UNIVERSITY OF TECHNOLOGY P.O. BOX 1000, FIN-02015 HUT http://www.hut.fi		ABSTRACT OF DOCTORAL DISSERTATION	
Author			
Name of the dissertation			
Date of manuscript		Date of the dissertation	
Monograph		Article dissertation (summary + original articles)	
Department			
Laboratory			
Field of research			
Opponent(s)			
Supervisor (Instructor)			
Abstract			
Keywords			
UDC		Number of pages	
ISBN (printed)		ISBN (pdf)	
ISBN (others)		ISSN	
Publisher			
Print distribution			
The dissertation can be read at http://lib.hut.fi/Diss/			

ABSTRACT

This thesis develops a paradigm for conceptual design based on the idea that dimensional analysis can improve the evaluation and comparison of concepts of solution during the conceptual design process. The conceptual design approach developed in this research is a combination of tasks which starts with the identification of the customer needs in a formalized manner, is followed by the generation of design concepts taking into account the different phases of the physical life cycle and ends by the evaluation and adequacy analysis of the concepts of solution with the formalized needs.

The General Design Theory (GDT) is used as the methodological basis of this work. Using the results of GDT, the research introduces a definition of the concept of function which is generic and not dedicated to a solution-based approach. Consequently the concept of function fulfils its intended objective of modelling the design problems at a general level. In addition to the concept of function, this thesis introduces a series of classifications based on generic concepts and rules aimed at generating concepts of solutions progressively. All these concepts are integrated into the developed metamodel framework. The metamodel provides a group of generic concepts associated with laws and mapped with a normalized functional vocabulary. The metamodel framework is an intermediate structure developed in order to provide guidance during the synthesis process and to meet the initial condition in order to transform the classification structure into a metric space. A metric space is a topological space with a unique metric. The transformation of the initial topological space into a metric space can be obtained when a series of conditions are verified. The first condition consists of clustering the concepts of solutions in order to underline the comparable aspects in each of them. This is done by using a set of dedicated rules. In addition three other fundamental conditions should be obtained. The metamodel framework ensures the first condition; an enhanced fundamental system of unit provides the second condition and a paradigm of separation of concept the third one. When all these three conditions are verified, it becomes possible to transform the design problems modelled by four types of generic variables into a series of dimensionless groups. This transformation process is achieved by using the Vashy-Buckingham theorem and the Butterfield's paradigm. The Butterfield's paradigm is used in order to select the minimum set of repeated variables which ensure the non-singularity of the metrization procedure. This transformation process ends with the creation of a machinery dedicated to the qualitative simulation of the concepts of solutions. The thesis ends with the study of practical cases.

PREFACE

First of all, I would like to dedicate this work to my wife Elina for her support and personal sacrifices she has made all over the past three years.

Pierre Dac a French humorist and writer has said: “It is while wanting to know always more than one realises not knowing a lot” *“C’est en voulant connaître toujours davantage qu’on se rend compte qu’on ne sait pas grand-chose.”*

I do agree and this is how I feel during this work and in this respect research is a school of humility.

The initial objective of my thesis starts from the intuition that a method derived from dimensional analysis could help designers in comparing functions of the concepts of solution by clustering attributes in an appropriate manner. The initial goal has been enriched all along the work by integrating this method in a more developed framework. Consequently some readers could consider that the final methodology presented in this book is in contradiction with the initial quotation of this preface. But this work is only the consequence of the complexity of the design process which cannot be described without taking into account the relationship existing between different phases of conceptual design.

The working context of this thesis has been a research cooperation between the laboratory of Machine Design of the Helsinki University of Technology and the University of West Brittany (Brest, France). I thank Kalevi Ekman and Markku Kuuva for their constant help over the course of this work and for there willingness to act as “promoters”, much more than the formal academic sense only. I would like to thank also Jean Vareille, Bernard Yannou and Petri Makkonen for the time they have spent analysing my work and giving interesting and fruitful comments.

A special thank for Professor Marcel Le Floch and Michelle Kerleroux from the doctorale school of the University of West Brittany (Brest, France) for their constant help related with the administrative aspects of this joint supervision.

I would like also to thank all my colleagues of the laboratory of Machine Design for their welcoming behaviour.

Albert Einstein has said “The secret to creativity is to know how to hide your sources.” On the contrary of this sentence, Jean Vareille and Bernard Yannou have been generous all over this work and have provided me extremely precious advice coming from their vast

scientific knowledge. They have contributed in many ways to this work.

My warmest thank to the reviewers of this thesis for their constructive comments. Many other people have influence this work in a direct sense by sharing analyse and scientific comments. Thanks to all of them.

Thank to my parents and my brother for their support and the practical help they have provided during the frequent moving between France and Finland.

Brest, France, May 2005

Eric Coatanéa

TABLE OF CONTENTS

ABSTRACT

NOMENCLATURE AND GENERIC DEFINITIONS

SYMBOLS AND DEFINITIONS RELATED TO TOPOLOGY

1	INTRODUCTION	18
1.1	BACKGROUND	18
1.2	RESEARCH PROBLEM.....	18
1.3	AIM OF THE RESEARCH	20
1.4	RESEARCH METHODS.....	20
1.5	SCOPE OF THE RESEARCH	22
1.6	AUTHOR'S CONTRIBUTION	23
1.7	OUTLINE OF THE THESIS.....	27
2	CLARIFICATION AND ANALYSIS OF THE TERMINOLOGY AND CONCEPTS USED IN THE THESIS	29
2.1	INTRODUCTION.....	29
2.2	NATURE OF THE DESIGN ACTIVITY	29
2.2.1	General terminology	30
2.2.2	Properties of design model and nature of the thinking in design.....	33
2.2.3	Classification of existing methodologies and theories from a conceptual perspective	37
2.2.4	Conclusion	43
2.3	PRESENTATION OF THE GDT CONCEPTS AND CONSEQUENCES FOR THE THESIS.....	44
2.3.1	Introduction.....	44
2.3.2	Main GDT definitions and axioms in the ideal knowledge.....	48
2.3.3	Main GDT definitions and axioms in the real knowledge	56
2.3.4	The central role of the classification in this thesis	60
2.3.5	Consequences of the Axiom of separation/recognition for the thesis	62
2.3.6	General classification structure of the metamodel framework.....	67
2.3.7	The three domains of design	75
2.3.8	The principle of conservation of the energy and its consequences: Presentation of the derived concepts and of the normal vocabulary associated with this principle.....	76
2.3.9	Presentation of the basic mechanisms used in the thesis	80

2.4	ANALYSIS OF THE CONCEPT OF FUNCTION USED IN THE THESIS	94
2.4.1	Introduction	94
2.4.2	Function as an interface between two situations	96
2.4.3	Standard vocabulary for functions and situations in the thesis	102
2.4.4	Similarities between the concept of function of this thesis, Su-Fields of TRIZ and simplified standard solutions.....	110
2.4.5	The different types of functions used in the thesis.....	115
2.4.6	Analysis of the transition between functions.....	122
2.4.7	Example of analysis of transition between functions using GRAFCET	124
2.5	SYNTHESIS OF THE METAMODEL STRUCTURE	125
3	SYNTHESIS OF THE CONCEPTUAL DESIGN APPROACH DEVELOPED IN THE THESIS	137
3.1	INTRODUCTION	137
3.2	THE CLARIFICATION/FORMULATION AND SYNTHESIS PROCESSES	139
3.2.1	Example of the clarification/formulation and synthesis of technical system (TS): a wiper system for rear-view mirrors of a car	139
3.2.2	Example of synthesis of a Technological Process (TP)	146
3.3	EVALUATION AND ADEQUACY ANALYSIS	162
3.3.1	Enhanced system of fundamental quantities required for the evaluation and adequacy analysis.....	162
3.3.2	Mathematical machinery made for obtaining a metric space and method for analysing and comparing concepts of solutions	171
3.3.3	Example of the use of the machinery for simple concepts of beam.....	186
4	CONCLUSION	194
	REFERENCES	

NOMENCLATURE AND GENERIC DEFINITIONS

AI (Artificial Intelligence): The branch of computer science concerned with making computers behave like humans. The term was created in 1956 by John McCarthy at the Massachusetts Institute of Technology [Webopedia].

AD (Axiomatic Design theory): This is a theory of design based on two fundamental axioms; the decoupling of the functions and the minimization of the informational content [Suh, 1990].

ADT (Abstract Design Theory): Abstract Design Theory [Kakuda and Kikuchi, 2001a] is a mathematical theory of design based on Channel Theory, a theory of information flow by Barwise and Seligman [Barwise and Seligman, 1997].

ARIZ (Inventive Problem Solving Algorithm): All the major TRIZ (see later) concepts are included in ARIZ, in which the various TRIZ heuristics are presented as a sequence of operations to resolve technical problems. According to Altshuller [Altshuller, 1984] the letter “T” means theory in TRIZ, and the “A” algorithm in ARIZ.

Auxiliary useful functions: Functions assuring the execution of the higher-level functions [Savransky, 2000].

Behaviour: A behaviour is a sequence of one or more changes of states. [Yoshioka et al., 2001]

Bond graph theory: A form of object-oriented tool for modelling engineering systems using uniform notations for all types of physical system based on energy flow [Shim, 2002].

Conceptual design: A combination of tasks starting with the product design definition and modelling by using precise and neutral concepts coming from needs or ideas. This is followed by the generation of design concepts taking the different phases of the physical life cycle into account and ended by the evaluation of proposed design concepts. The analysis of the adequacy of the design concepts with the formalized needs ends these tasks.

Concept selection: Process of selection of the design concept that best achieves the requirements.

Constraints: Limitations of the designer freedom considered necessary by the customer [NF EN 1325-1, 1996].

DAT (Dimensional Analysis Theory): A theory highlighting the similarities between full-size and small-scale models of a technical system by reducing the number of independent variables that specify the problem [Sonin, 2001].

Descriptive statements: Statements establishing certain facts as they appear. Every theory is a set of descriptive statements [Hubka and Eder, 1996].

Design theory: A collection of principles useful for explaining the design process and providing a foundation for methodologies [EVBuomvan, 1996].

Design methodology: A collection of procedures, tools and techniques for designers to use when designing [EVBuomvan, 1996].

Design concept: A design concept defines and describes the principles and engineering features of a system, machine or component which is feasible and which has the potential to fulfil all the essential design requirements [Thomson, 1999].

Domains: Domains represent the three fundamental areas of reasoning when analyzing the interactions of a technical system during its life cycle (e.g. physical, informational and economical area).

Fields: Energy type associated with the energy carrier,

Function: It is a pair of the using situation u and the outer system situation s and represents the possible states of the artefacts.

GRAFCET (French acronym « Graphe de l'Association Française de Cybernétique Economique et Technique » for Sequential Function Chart) : A discrete method of system modelling aimed at designing sequential system control [NF C 03-190 + R1, 1995].

GDТ (General Design Theory): A mathematical theory of design developed by Yoshikawa and Tomiyama [Yoshikawa, 1981] [Tomiyama et al., 1987].

Harmful functions: Functions not intended for or desired of the technical system and that have undesired results [Savransky, 2000].

Invariant concepts: Generic concepts that can be applied to the total field of design [Top, 1993].

Qualitative Physics: A formalization of human ordinary knowledge of the physical world [Top, 1993]

Life cycle phase models: Conceptualisations of the physical life cycle phases of an existing/desired product via the use of abstract and generic concepts.

Neutral functions: Functions which have not useful or harmful effects.

Open system: A thermodynamic ordered structure which is synthesized from disordered atoms and molecules found in atmosphere and soils. This kind of structure import necessary energy and exports entropy into their environment to stay far from the thermodynamic equilibrium of highest entropy. This equilibrium is only reached when structure dies or is broken [Glansdorff and Prigogine, 1971] [Odum, 1994].

Overall function: Abstract formulation of the overall task according to the inputs and outputs of all the quantities involved in the overall task using statements consisting of a verb and a noun.

Physical design life cycle: The physical life cycle viewed from a design-centred perspective.

Physical Life cycle: A set of life phases of an existing/desired product starting from the customer needs or an initial idea and finishing with the recycling, incineration and disposal process. The term does not take into account the marketing aspects of life-cycle.

Physical life cycle architecture: Defines the type of interaction between the phases of the life cycle.

Physical product life cycle: The physical life cycle viewed from a product-centred perspective.

Prescriptive statements: Instructions declared in order to act or to realize functions and structures by using appropriate means. A methodology can be considered as a set of prescriptive statements [Hubka and Eder, 1996].

Problem clarification and formulation: Initial phase of the conceptual design process of a product conclude by the creation of a synthetic document which should contain a description of the product and its market, the context of the project, the analysis of the need and a study of the product feasibility (adapted from NF X50-151 [NF X50-151]).

Product architecture: Defines the type of interaction between organs [Hubka, Andreasen and Eder, 1988] or chunks [Ullrich and Eppinger, 95].

Product environment: The set of factors which can influence the manner of a technical system (or service) to achieve a desired result [Hubka and Eder, 1996].

Product model: A conceptualisation of an existing/desired product analysed during its use phase via the use of abstract and generic concepts.

Service function: Expected actions of a product according to the need of a specified user [NF EN 1325-1, 1996].

SI system: International System of quantities and units

Situation: The state(s) of the elements in the environment within a volume of time and space. A state is described by material entities, attributes related to these entities, and relations between them.

Situation theory: A theory for semantics of natural language invented by Barwise and Perry [Barwise and Perry, 1999].

Secondary useful functions: Functions reflecting subsidiary goals of the technical system creators [Savransky, 2000].

Support useful functions: Functions assuring the execution of the primary function (services functions) [Savransky, 2000].

Synthesis (Concept generation): Sequence of processes intended to develop many alternatives of solutions for a product focused on innovation, function satisfaction and structural blueprint.

Technical systems (TS): Artificial objects [Savransky, 2000]

Technological process (TP): Artificial single action or consequences of procedures to perform activity with assistance of a technical system or a natural object [Savransky, 2000].

TRIZ (Russian acronym “Téoria Rechénia Izobréatelskikh Zadatch”): A Theory of Inventive Problem Solving created by Altshuller [Altshuller, 1984]

VAVE (Value engineering and analysis): A specific design approach acting on the functional, economic and multidisciplinary aspects of design in order to satisfy the customer needs [Dardy and Teixido, 2003].

SYMBOLS AND DEFINITIONS RELATED TO TOPOLOGY

\cap : Intersection

\cup : Union

\in : Belong to

\notin : Not belong to

$A \subseteq B$: A weaker than B or B stronger than A

$A \subset B$: A strictly weaker than B or B strictly stronger than A

\leq : Inferior or equal

\emptyset : Empty ensemble

\forall : For all

\bar{S} : Complementary set of the set S

\exists : It exists

iff: If and only if

Abstract concepts (T): Each class of a classification is called an abstract concept. The set is denoted by T [Yoshikawa, 1981].

Attribute (GDT version): In the ideal knowledge; physical, chemical, mechanical, or any other property that can be observed or measured, potentially through the use of an instrument and in real knowledge; physical quantity which is identifiable using a set of finite number of physical laws [Yoshikawa, 1981].

Attribute (in the thesis): In the real knowledge; physical, economical and informational quantities which are identifiable using a set of finite number of laws belonging to the physical, economical and informational domains (based on Yoshikawa [Yoshikawa, 1981]).

Attribute space (T_A): Set of all artefact descriptions. The set of all classes of all the classifications of attributes is denoted by T_A [Yoshikawa, 1981].

Classification: Division of the entities set into several classes [Yoshikawa, 1981].

Clopen: Subset of X which is open and closed [Bourbaki, 1966].

Closed set: The complement of an open set [Bourbaki, 1966].

Concept of entity (S) or Concept of solution: The representation of an object [Yoshikawa, 1981]. The set of all the representation of an object is denoted by S . In this thesis the term concept of solution is extensively used for concept of entity.

Concept of physical law (T_P): An abstract concept formed if entities are classified based on physical manifestations of physical laws (real knowledge). The set of all classes of all the classifications of the physical laws is denoted by T_P . [Yoshikawa, 1981]

Concept of law (T_L) (in the thesis): An abstract concept formed on classified entities based on manifestations of laws belonging to the three domains (e.g. physical, economical, informational). The set of all classes of all the classifications of the laws is denoted by T_L (this definition is based on Yoshikawa [Yoshikawa, 1981]).

Design solution: A concept of entity s that is included in its specification and contains its necessary manufacturing information [Yoshikawa, 1981]

Design solution (in the thesis): A solution that contains its own physical life cycle information presented in term of attributes belonging to T_A .

Design specification (T_s): Designates the functions of the required entity by using abstract concepts [Yoshikawa, 1981].

Entity: Real object that has existed, exists presently, or that will exist in the future [Yoshikawa, 1981].

Entity set: The set of all objects [Yoshikawa, 1981].

Feasible object: An object that does not contradict physical laws (real knowledge) [Yoshikawa, 1981].

Feasible object (s_F) (in the thesis): This is an object that does not contradict the laws. (based on Yoshikawa [Yoshikawa, 1981])

Feasible concepts of entity (S_F): This is the representation of a feasible object [Yoshikawa, 1981]. In this thesis a feasible concept of entity is also extensively called concept of solution.

Filter (F): The set of design specifications is a filter. A filter of S is a collection F of subsets of S that has the following properties:

(a) $\emptyset \notin F$, (b) if $A \in F$, and $A \subset B \subset S$, then $B \in F$, and (c) if $A, B \in F$ then $A \cap B \in F$ [Bourbaki, 1966].

Function space (T_F): Set of all the functions. The set of all the classes from all the classifications of the functions is denoted by T_F [Yoshikawa, 1981].

Functional property: Behaviour displayed by an entity which is subjected to a situation. The collection of functions observed in different situations is the functional description of the entity [Yoshikawa, 1981].

Fundamental system of entourages (B): B is fundamental system of entourages of a uniformity U iff $B \subseteq F$ (filter) and for any $V \in U$ there is $W \in B$ such that $W \subseteq V$. [Kakuda and Kikuchi, 2001]

Metamodel: Integrative model developed in order to combine multiple design objects models and to represent relationships among the concepts of these different models.

Metamodel (in the thesis): Integrative model developed in order to combine multiple models of design objects and to represent relationships among the concepts of these different models. The models are developed according to the three domains (physical, economical and informational) introduced in the thesis (definition based on Yoshioka [Yoshioka et al., 2001])

Metric space: Topological space having a unique metric [Bourbaki, 1966].

Neighbourhood: If (S, T) is a topological space then the neighbourhood of $s \in S$ is any of the sets $U \in T$ such that $s \in U$. [Bourbaki, 1966]

$P(X)$: Ensemble of the parts of X [Bourbaki, 1966],

T_0 [Bourbaki, 1966]: For each pair $a \neq b$ in S , there is $U \in T$ such that $a \in U$ and $b \notin U$ or vice versa.

T_1 [Bourbaki, 1966]: For each pair $a \neq b$ in S , there is $U, V \in T$ such that $a \in U$ and $b \notin U$ and $b \in V$ and $a \notin V$.

T_2 (Hausdorff space) [Bourbaki, 1966]: similar to T_1 but $U \cap V = \emptyset$.

T_3 [Bourbaki, 1966]: T_3 is a generalization of T_2 where A is a set instead of a single entity but still using b .

T_4 (Normal space) [Bourbaki, 1966]: Satisfies T_1 and for every pair of disjoint closed sets $A, B \in \bar{S}$ there exists a pair of disjoint open sets $U, V \in T$ such that $A \subset U$ and $B \subset V$.

T_5 [Bourbaki, 1966]: Satisfies T_1 and for every pair of closed sets $A, B \subset \bar{S}$ with $\bar{A} \cap B = A \cap \bar{B} = \emptyset$, there exists a pair of disjoint open sets $U, V \in T$ such that $A \subset U$ and $B \subset V$.

Open set of O : An element of O [Bourbaki, 1966],

Physical law: A description about the relationship between object properties and its environment [Yoshikawa, 1981].

Topology (O): A topological structure (or topology) on a set X is a set $O \in P(X)$ (with $P(X)$: the ensemble of the parts of X) having the following properties:

- (1) $\emptyset \in O$ and $X \in O$,
- (2) for any $U, V \in O$, $U \cap V \in O$,
- (3) for any set I and $U_i \in O$ ($i \in I$), $\bigcup_{i \in I} U_i \in O$.

Topological space: Pair $\mathbf{X} = \langle X, O \rangle$ of a set X and a topology O on X .

1 INTRODUCTION

1.1 Background

Many studies indicate that as much as 75% of the cost of a product is being committed during the design phase [Lotter, 1986] [Hsu et al., 1998]. Indeed, decisions made at the conceptual design stage have significant influence on factors such as cost, performance, reliability, safety and the environmental impact of a product.

This fact combined with the global tendency to see products' manufacturing flowing from industrialized countries to developing world and the necessity to promote sustainable development has revealed to companies, researchers and authorities that a fundamental benefit can be obtained by focusing more on innovation and conceptual design. This factor is associated with the duty to promote sustainable development in order to expect a future for our children.

Consequently, researchers have developed several tools and techniques that are able to support the various phases of design. Guidelines have been created to assist specific fields of design. Increasing attention is being directed to support conceptual-level design activity and methodologies have been developed in order to assist the conceptual design process. More importantly, it has been shown that a poorly conceived design concept can never be compensated for by a good detailed design.

Nevertheless, these attempts remain partially unsatisfactory because of the unquestionable fact that our knowledge is limited. Indeed, the knowledge about design requirements and constraints during this early phase of a product's life cycle is usually imprecise, approximate or unknown. Faced with such complexity, individual designers often restrict themselves to narrow, well-defined sub-tasks. As a result, the global design process remains in best cases sub-optimal. The trial and error approach in this type of situation remains common and for this reason a designer may never reveal a satisfactory solution to a design problem.

1.2 Research problem

Design has been performed continuously for centuries. However, it was only in the middle of the 20th century when design –an intense human activity– became a centre of interest for scientists towards the direction of its formalization and “scientification”. Since then, design philosophies, models, methods and techniques have been developed [Evbuomwan, 1996].

This introduction leads to three fundamental aspects which constitute the research problem of this thesis:

- 1- The first one is related to the analysis of the history of sciences. This analysis shows that for various young sciences, classification has been the starting point of a real breakthrough. It is particularly true in chemistry with the Lavoisier and Mendeleev classifications which have provided the basic concepts necessary for developing the chemistry. In zoology and botanic; taxonomies developed by Linné and Buffon have been an important foundation for Darwin's theory of evolution. In this respect, if the goal of design science is, as stated by Yoshikawa [Yoshikawa, 1981] to clarify "the human ability of designing in a scientific way and at the same time producing the practical knowledge about [...] design methodology.", then classification can be considered as an initial step in order to achieve this goal. Therefore, my first object is to promote the development of classifications in design. The question remains how to proceed scientifically to build this classification?
- 2- Another object of this thesis which is related to classification is that a powerful method consisting of recognizing and applying analogies in different context for supporting design process can be developed. If analogies are based on concepts and elementary processing blocks which are globally invariant then these analogies are a powerful tool in order to support design activity. Interesting view point about analogy is given both in DAT [Barenblatt, 1979] and bond graph theory [Paynter, 1961] [Karnopp et al., 1990].
- 3- Latest object of the thesis is that design activity is strongly involved with various type of comparison during the design process. Classification fails to provide help when comparing the various aspects of design. The fundamental role of a metric has to be investigated. The fundamental link between classification and the computation of a unique metric has also to be analysed.

In short, the research problem is expressed by three fundamental aspects:

- The need for the development of design classifications based on analogies and recognition of generic fundamental principles.
- The necessity of discovering the fundamental links existing between the structure of a classification and the final goal which is the computation of a metric.
- The practical selection of the attributes which describe a function and the computation based on these attributes of a metric.

1.3 Aim of the research

The aim of this research is to create a useful analytical tool to help designers during the conceptual design process. Consequently, the practical methodology developed in this thesis should remain simple. At the same time, the work should be established on unquestionable scientific principles.

This research will not follow the mythic scientific pattern of a) observing b) experimenting c) forming hypotheses and d) theorizing, because in reality most scientific experiments are performed after hypothesizing, and are conducted mainly with the view of confirming the hypothesis. Peter Medawar said: '*Scientists don't ask questions very loudly until they can see the beginnings of an answer*' [Eder, 1995]. In the case of this work context, many observation and experimentation had been already performed by several researchers. Consequently the aim is to use this existing knowledge in order to creating a synthesis by highlighting existing connections within theories and methodologies by creating a conceptual framework able to improve the clarification of the design process, the synthesis of design solutions and the scientific evaluation of design concepts.

1.4 Research methods

The scientific method of this research consists of a) forming hypotheses related to design b) searching for theoretical confirmation for the hypotheses based on analysis of existing theories c) creating a new coherent theoretical framework which associates the design theories and the exogenous theories which confirm the initial hypotheses d) experimenting the theoretical framework on practical cases.

This work focuses on the methodological research related to design activity and to the development of a new conceptual design method based on GDT, DAT, bond graph theory and development of classifications.

The methodological approach starts with a definition of the terminology and the concepts used in this thesis. The main terms, acronyms and notations are summarized in the part called *Nomenclature and generic definitions* and *Mathematical symbols and specific definitions*.

The research methodology is clustered in two parts corresponding to the chapters 2 and 3 of the thesis.

At first the approach consists of analysing the nature of design. The main characteristics of the design activity and the different ways of thinking in design are analysed at a theoretical level [Hubka and

Eder, 1996] [Evbuomwan, 1996]. This survey leads to a classification of the main conceptual design features.

After that, the design activity is analysed from the General Design theory (GDT) perspective [Yoshikawa, 1981] [Tomiyama et al., 1987]. The GDT constitutes the backbone of the work and is used because it is a notable exception among the design theories in the sense that the theory is using mathematical language in order to model design activity. An extensive analysis of the separation and recognition ability of different topological spaces is conducted. The practical consequences of such an analysis aim at confirming the intuition that Dimensional Analysis Theory (DAT) [Barenblatt, 1979] associated with qualitative physic concepts [Kuipers, 1984] [Karnopp et al., 1990] is an appropriate method for the selection and comparison of conceptual design solutions.

Then the thesis is studying the existing link between classification and metamodel. At first, the method consists of using GDT framework in order to show that classification is an intermediate and necessary structure. This structure constitutes a transitional step in obtaining concepts of solutions which can be analysed via the use of a single metric at the end of the conceptual design process. In the second phase, the classification structure is developed and a list of generic concepts is established in order to flow from a functional definition of a problem to concepts of solutions.

Following the analysis of conceptual design from a GDT perspective, the methodology consists of analysing and enhancing the concept of function in order to switch from the commonly used question “What is the object’s function?” to “How does it function?”. The aim of using an enhanced concept of function is to improve the ability to analyse the transition between functions and other generic concepts.

The method consists then of associating function with a normalized vocabulary coming from the taxonomy developed by Hirtz [Hirtz et al., 2002]. The ability of such vocabulary to model the different phases of the physical life cycle is investigated especially from the three perspectives which are considered in this thesis to be the domains of the design activity namely the physical domain, the economical domain and the information domain.

The concept of function introduced in the thesis is then compared with the Substance-fields concepts of the TRIZ methodology [Altshuller, 1984] and the concepts of useful and harmful functions. The study of the concept of function ends with the analysis of transition between functions from the perspective of a sequential chart structure.

All this methodological analysis will lead to the synthesis of a metamodel framework which combines the generic concepts, associates the concepts using laws and maps these concepts.

The last part of the research methodology consists of developing a synthesis of the metamodel framework developed in this thesis. The scientific approach consists of experimenting the framework resulting from the theoretical analysis and developing a strategy to use dimensional analysis theory as the tool for transforming a classification space into a metric space.

1.5 Scope of the research

The scope of this thesis includes four aspects of the conceptual design activity [Yannou, 2001] (Figure 1). In the first place this work deals with some aspects of the refinement of the initial definition of the needs into a functional definition of the problem, also called problem clarification and formulation [Ulrich and Eppinger, 2000] [Miled, 2003]. The thesis then proposes a synthesis approach of concepts of solutions. The third and fourth step of the conceptual design process treated in the thesis consists of evaluating and analysing the adequacy of the generated concepts of solution with the functional description. These two last steps constitute the central part of the research.

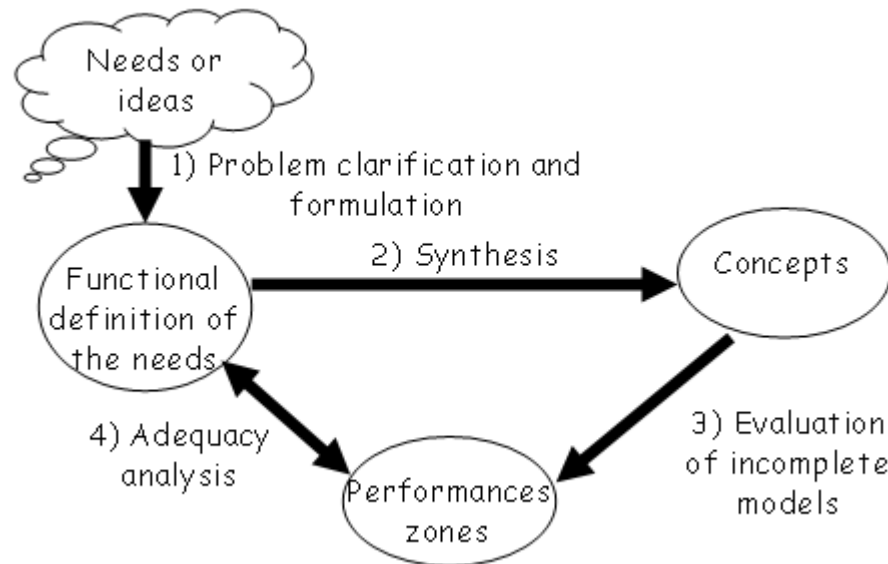

Figure 1: The Conceptual design process [Yannou, 2001]

1.6 Author's contribution

The contributions are described in the paragraph using Hubka's and Eder's [Hubka and Eder, 1996] classification about design science. According to their analysis, the design science exhibits seven major characteristics of statements. These statements can be hierarchically structured and two categories appear as the most important. The first category is constituted by the descriptive and the prescriptive statements. The *descriptive statements* establish certain facts as they appear. They answer to questions like what does exist?, how does it behave? And why does it appear as it does? Every theory is a set of descriptive statements. On the other hand, the *prescriptive statements* are instructions declared in order to act or to realize functions and structures by using appropriate means. A methodology can be considered as a set of prescriptive statements. The second category is called aspects of designing. This category of statements presents two visions of design. The first vision is the description of the *technical system* in its various states of existence (e.g. from specifications to concepts, plans ...). The second vision is the *design process* vision where the proposals for the technical system pass through stages or phases: generating a design specification, conceptual design, embodiment design, and detailed design.

According to these characteristics, the contributions of this work could be positioned according to Figure 2.

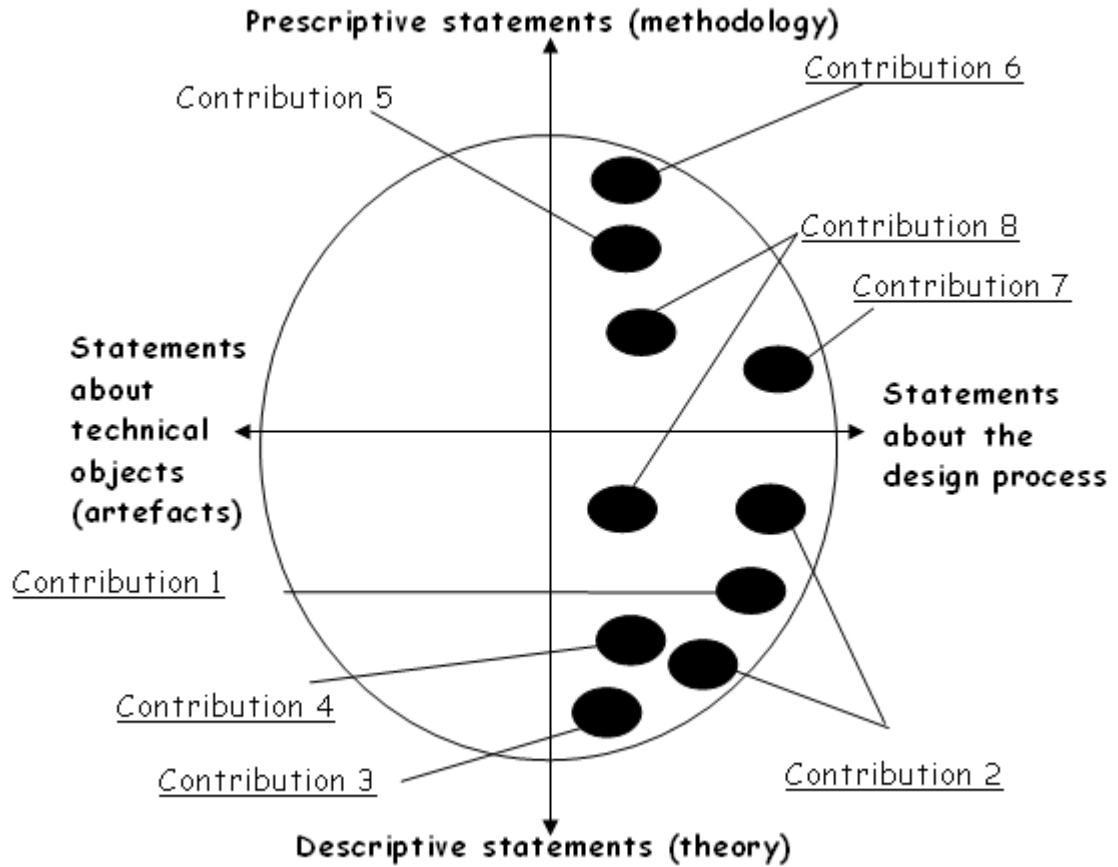

Figure 2: The positioning of the contributions in the [Hubka and Eder, 1992] graph

The approach selected in this thesis consists of using discursive methods in order to deal with the problem of searching solution. Discursive methods mean that we are using a stepwise procedure in order to build progressively the solutions or the set of solutions. This stepwise procedure is summarized in Figure 1.

All the contributions are related to the conceptual aspects of the design process. It is the reason why the contributions are also presented according to the Figure 3 which is used to describe the conceptual design process.

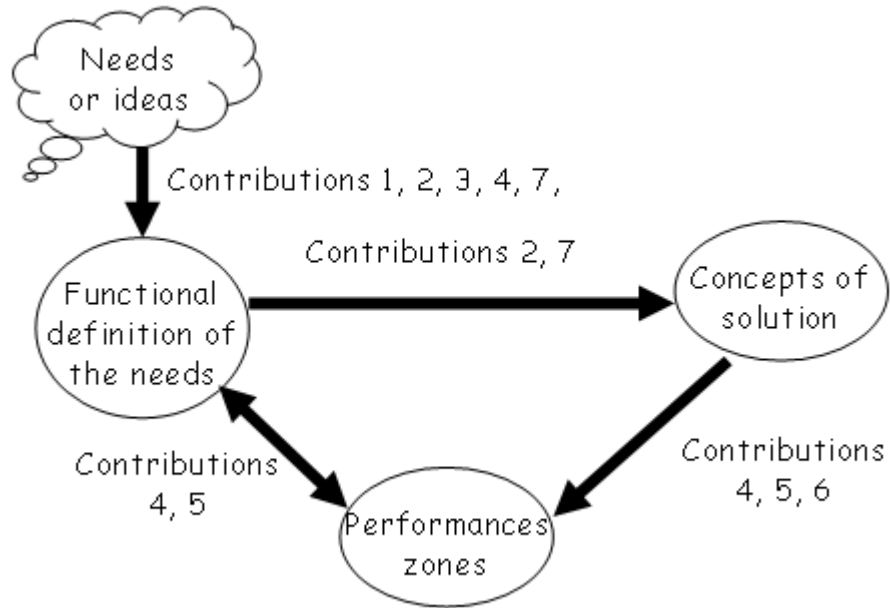

Figure 3: Positioning of the contributions on the [Yannou, 2001] graph

Contribution 1: A concept of function has been introduced by Kikuchi and Nagaska [Kikuchi and Nagaska, 2003]. According to them function is seen as an interface between an inner and an outer situation. This approach is developed and applied in a practical manner in this thesis. The concept is coming from Situation theory [Barwise and Perry, 1999] which is a mathematical semantic theory of language. The main interest of this concept is its generality. This concept is developed and analysed from the perspective of General Design Theory (GDT) and its compatibility with tools of Value Analysis and Value Engineering (VAVE) [Miles, 1961] also used in this thesis, are investigated.

Contribution 2: This research states that the design domain can be clustered in three domains named the physical, the informational and the economical domain. This thesis argues that when designing, the designers have to deal with all these three domains. These domains constitute the first level of classification developed in this thesis.

Contribution 3: It is shown that classification analysed as a topological structure has many good features of a metric space [Yoshikawa, 1981] [Tomiya et al., 1987] [Kakuda and Kikuchi, 2001ab]. Necessary conditions to obtain metrizable from a

classification space are discussed in a theoretical and practical manner [Reich, 1995] [Bourbaki, 1966] [Butterfield, 2001].

Contribution 4: An enhanced system of quantities and units is proposed by introducing two new fundamental quantities. This is a direct consequence of the division of the design activity in three domains and as well as a consequence of the contribution 3. The information and the cost are the two extra quantities in this thesis. The interest of this kind of modification of the International System of Units is discussed and justified. In addition a practical manner to compute information is proposed. This approach is based on the theory of information [Shannon, 1949] [Brillouin, 1964]. In addition, the general aspects of a method developed in order to compute information indicators related to geometrical parts of a technical system is also presented.

Contribution 5: Mathematical machinery built in order to construct dimensionless numbers associated to functions. In addition this machinery provides an analysis of the existing relations within the attributes of a dimensionless number by developing partials of intra-dimensionless numbers. The machinery provides also an analysis of the relation existing between functions which share attributes (inter-functions partials). Finally the machinery provides tools for reasoning about the ensemble (inter-ensemble partials). This machinery provides the necessary structure in order to compare concepts of solutions, to rank these concepts of solutions and to analyse the importance and relations of elementary functions which constitute a technical system.

Contribution 6: A ranking and comparison method of concepts of solution via dimensionless indicators is presented. The relative comparison of the importance of elementary functions of a technical system is discussed both from inter-functions partials and inter-ensemble partials' viewpoint.

Contribution 7: The development of a generic classification based on analogies related to physical, informational and economical domains is introduced. The thesis states that a general conservation law similar to the conservation of energy law can be applied to the physical, informational and economical domains. The key idea states that if this conservation law exists. Then the concepts developed in bond graph theory [Karnopp et al., 1990] can be extended to the three fundamental domains of the design activity by using the potential of the classification developed in this thesis. It becomes possible by following step by step the proposed classification scheme to flow progressively from the functional representation of the design problem to the synthesis of the concepts of solutions.

Contribution 8: All the previous elements are integrated into a practical tool made for the conceptual design activity and having the

fundamental features of the methodology developed by Dardy and Teixido [Dardy and Teixido, 2003].

According to Figure 2 [Hubka and Eder, 1996] all the contributions are related to the statements about the design process. This is in agreement with my vision of design as a phase-based model in which conceptual design process passes through fundamental stages as generating the functional description, making the synthesis of concepts of solutions, ranking and comparing the concepts of solution and analysing the adequacy between the concepts of solution and the functional description created during the first initial stage.

1.7 Outline of the thesis

The thesis is divided in four parts. The first part constitutes the introduction of the research problem. Chapter 2 constitutes the core of the analysis. Chapter 3 summarizes the results of the thesis as a new methodological approach of the conceptual design activity. Finally, chapter 4 concludes the work by making the synthesis of the main contributions in a critical manner and proposes ideas for future development related to the same topic.

Chapter 2 is divided in five parts. After a short introduction presenting the goal of the chapter, part 2.2 checks in which way major existing design theories and design methodologies answer to the objectives of the conceptual design process. Following this analysis it becomes possible to highlight existing lack in the actual state of art of the conceptual design process.

Part 2.3 analyses the design process from a GDT perspective. The goal is to underline the fundamental theoretical basis which proves that the initial intuition of this thesis is right. The importance of obtaining a metric space in design activity and the way to obtain it are discussed. The importance of an intermediate topological space called classification space is also discussed. The concept of metamodel is presented and compared with the classification space. Finally generic concepts are introduced and a classification structure is developed based on these concepts.

The part 2.4 analyses the concept of function by showing that most of the design theories study functions by focusing on the designers' or users' intentions. This duality of the concept of function makes the analysis difficult. This thesis argues that this vision of function is not satisfactory. Consequently, part 2.4 modifies the formulation of function in order to shift the question from "What is D's function?" to "How does it function?" As a result, the concept of function presented is not anymore something intrinsic to a machine. It represents what is the effect of the function. In addition, a

normalized vocabulary is introduced and a link will be established with the Su-field concept of TRIZ. This part ends with a study of the manner in which transitions between functions can be modelled.

Part 2.5 makes the synthesis of a metamodel framework based on the previous analysis.

Chapter 3 implements in a practical manner the theoretical results coming from chapter 2. After an introduction which summarizes the results of this chapter, two parts will be developed. The first one called *clarification/formulation and synthesis* is using the framework developed in the thesis in two examples. The first one dedicated to a technical process and the second one dedicated to the study of a technological process. This part is followed by part 3.3 which provides an enhanced fundamental system of quantities and develops a mathematical framework aimed at obtaining a metric space and at comparing concepts of solutions. These two parts implement in a practical manner the theoretical conclusions about metrizable made in 2.3.5. Chapter 3 ends with the development of a practical case verifying the developed approach by an experimental process.

The chapter 4 concludes the thesis by analysing in a critical manner the results and proposing ideas for further research.

2 CLARIFICATION AND ANALYSIS OF THE TERMINOLOGY AND CONCEPTS USED IN THE THESIS

2.1 Introduction

The aim of this chapter is at first to clarify the basic terms and concepts related to science and design activity. This vocabulary is used in this work and it seems necessary to define it clearly. The second objective consists of analysing some fundamental characteristics of well accepted design methodologies and theories in order to see in what extent they fulfil the conceptual design requirements. Then design process is described by using the approach of the General Design theory (GDT) [Yoshikawa, 1987] [Tomiyama et al., 1987]. The goal is to highlight some fundamental basis in order to confirm the initial intuition that design process can benefit greatly from analogies and from the computation of a unique dimensionless metric. The last part of the chapter introduces new elements in order to execute the theoretical conclusion of the analysis. The chapter provides the entire necessary theoretical and practical basis in order to implement the methodological framework in the chapter 3.

2.2 Nature of the design activity

Design activity has been performed for ages by humans but for a long time its structure and organisation did not have any unified formalism. The first attempt to create a unified formalism was made in the middle of the twentieth century. Starting from those times, design nature is a subject of debate between different schools of thought. Questions like: What is design? How to do it? Is it a science? have been discussed, and are still questioned. The goal is here to clarify and summarize the design procedure and to highlight its main characteristics in order to analyse in which way the existing theories and methodologies fulfil the model of conceptual design phases. This approach ends with a kind of classification of existing contributions according to the phases of the conceptual design process.

This viewpoint could be seen as mechanic and far too simplistic to take into account the complexity of the design process. Nevertheless it is important to notice that the phase-based model approach selected in this research obviously influences the scientific procedure followed in this work. This procedure also suits to the future analysis and development in the sense that phase-based approach is very coherent with the content of the thesis.

2.2.1 General terminology

In the course of this research words like theory, methodology, concept, design and other associated words will be used. In my opinion, the linguistic factors need to be discussed at first. These words can easily lead to confusion because of the variety of interpretation and sense they can produce. In order to avoid misunderstanding, it seems necessary at first to clarify the general sense of these words because of the central implication they have in this research work.

A *theory* is according to the definition of the dictionary Wordnet [WordNet ©] a well-substantiated explanation of some aspect of the natural world. It is an organised system of accepted knowledge that applies in a variety of circumstances to explain a specific set of phenomena.

A *concept* is an abstract or general idea inferred or derived from specific instances [WordNet ©].

A *methodology* is the system of methods followed in a particular discipline [WordNet ©].

The thesis is dealing with design. It is then necessary to define in a clear and simple manner the term design but also the terms design theory, design methodology and design concept. The viewpoint expressed by Evbuomwan [Evbuomwan, 1996] is adopted and enriched by life cycle and environmental considerations.

Design is the process of establishing requirements based on human needs, transforming them into functions and performance specification which are then mapped and converted (subject to constraints) into design solutions (using creativity, scientific and technical knowledge) that can be economically manufactured and produced with care for the life cycle and environmental aspects.

Now, if trying to define design theory and design methodology. Some definitions have been given to them. The American Society of Mechanical Engineers (ASME) [Goals and priorities for research in engineering design, ASME, 1986] defines the field of design theory and methodology as "... an engineering discipline concerned with process understanding and organised procedures for creating, restructuring and optimising artefacts and systems". This definition is far too general for the purpose of this thesis and did not define precisely the border between the two expressions. Because of its higher level of precision the viewpoint of Evbuomvan is taken in this work [Evbuomvan, 1996].

Design theory is a collection of principles that are useful for explaining the design process and providing a foundation for the

basic understanding required to propose useful methodologies. Design theory is descriptive as it indicates what design is or what is being done when designing.

Design methodology is a collection of procedures, tools and techniques for designers to use when designing. Design methodology is prescriptive as it indicates how to do design.

Design concept is an idea established by deduction from specific cases for more general cases or guessed from a specific item of information which is converted in a visual thinking model. For Thomson [Thomson, 1999], a design concept defines and describes the principles and engineering features of a system, machine or component which is feasible and which has the potential to fulfil all the essential design requirements. In order to produce a design concept, designers should at first take into account the product environment.

The *product environment* is according to [Hubka and Eder, 1996] the set of factors which can influence the manner of a technical system (or service) to achieve a desired result. In order to produce a design concept, the product environment and the product itself need to be modelled.

A *model* in conceptual design perspective is a conceptualisation of an existing/desired product or a conceptualisation of the phases of a product life cycle via abstract and generic concepts. It is of interest in this thesis to define also the product model and the life cycle phase models. A general picture of the *physical product life cycle* is given in Figure 4.

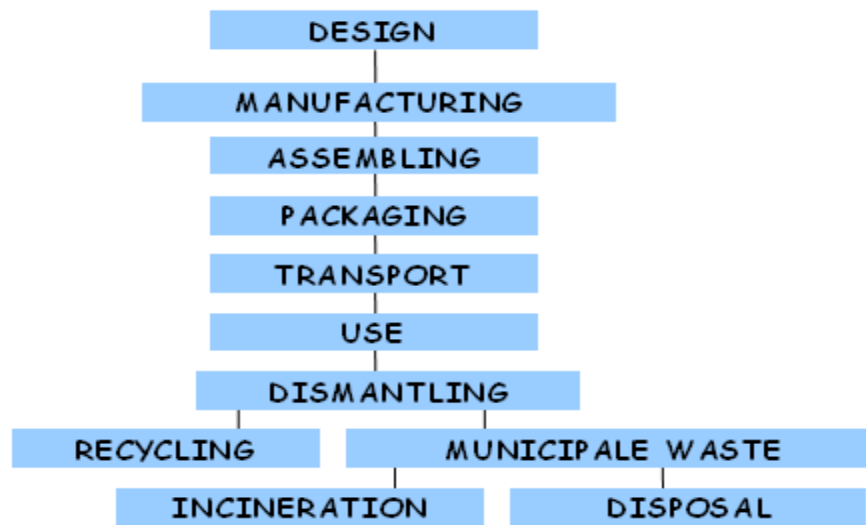

Figure 4: The physical product life cycle model [Pré consultants, 1999]

A *product model* is a conceptualisation of an existing/desired product viewed during its use phase via the use of abstract and generic concepts.

The *life cycle phase models* are the conceptualisations of the physical life cycle phases of an existing/desired product via the use of abstract and generic concepts.

The *physical life cycle* is the set of life phases of an existing/desired product starting from the customer needs or initial idea and finishing with the recycling, incineration and disposal process. The term does not take into account the market life-cycle aspects.

The *physical product life cycle* presented in Figure 4 views the physical life cycle from a product-centred point of view.

Another viewpoint is to look at the physical life cycle from a design-centred perspective. This point of view is called in this thesis *physical design life cycle* and this perspective is presented in Figure 5. Design in this perspective is the central element of the life cycle process. These two viewpoints of the physical life cycle require modelling. A model defines the type of interaction between parts constituting a product and the elements of the physical life cycle. Both viewpoints of the physical life cycle exhibit product architecture.

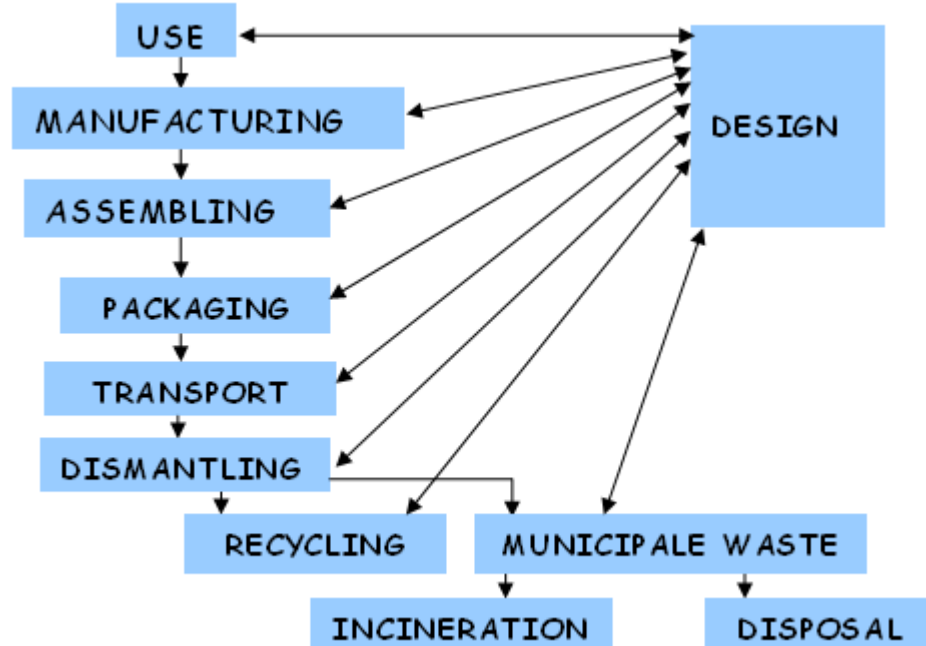

Figure 5: The physical design life cycle model

A *product architecture* defines the type of interaction between organs [Hubka, Andreasen and Eder, 1988] or chunks [Ullrich and Eppinger, 1995].

A *physical life cycle architecture* defines the type of interaction between the phases of the life cycle.

This thesis focuses on *conceptual design*. Usually, product design starts with the identification of a need, proceeds through a sequence of activities to seek an optimal solution to the problem, and ends with a detailed description of the product. According to Hsu [Hsu et al., 1998] a design process consists of three phases:

Phase 1 is the product design specification, where information about the product is collected and defined in precise but yet neutral terms. Examples of terms used in a typical product design specification are performance, quality, reliability, safety, product life span, aesthetics, and ergonomics.

Phase 2 is the conceptual design phase; its primary concern is the generation of physical solutions to meet the design specification.

Phase 3 is the detailed design. In this phase, final decisions on dimensions, arrangement and shapes of individual components and materials are made with due consideration given to the manufacturing function.

This research states that *conceptual design* has a broader scope.

Conceptual design according to this thesis is the combination of tasks starting with the product design definition and modelling by using precise and neutral concepts coming from needs or ideas. This is followed by the generation of design concepts taking the different phases of the physical life cycle into account and ended by the evaluation of proposed design concepts. The analysis of the adequacy of the design concepts with the formalized needs concludes these tasks.

When several design concepts are developed, the design concept that best achieves the requirements has to be selected. This process is called *concept selection*.

2.2.2 Properties of design model and nature of the thinking in design

Every design model usually exhibits certain properties which represent various viewpoints and processes that occur during the design procedure. These properties are discussed below according to Gero [Gero, 1973]:

1. Design is an opportunistic activity because both *top-down and bottom-up approaches* are used by the designer in an opportunistic manner.
2. Design is an incremental activity involving *an evolutionary process*, because changes (improvements or refinements) are proposed all over the design procedure in order to move to a better design.
3. Design is *an exploratory activity* [Smithers, 1989] involving an exploration-based model of design and describing the design process as *a knowledge-based exploration task*.
4. Design is *an investigating research process* involving a survey about the client's needs and expectations, available design techniques, previous similar design solutions, past failures and successes, etc.
5. Design is *a creative process* involving the creation of a design solution with the help of know-how, ingenuity, good memory, pattern recognition ability, search in the solution space, transversal thinking, analogies, etc.
6. Design is *a rational process* related to checking and testing of proposed solutions, using logical and mathematical analysis, computer simulation, test and experiment.
7. Design is *a decision-making process*,
8. Design is *an iterative process*,
9. Design is *an interactive process*.

A comprehensive design process must be able to deal with the various facets of design expressed above. It is interesting to analyse the different nature of thinking from a scientist's and from a designer's viewpoint in order to highlight the specificity of design activity and to underline some fundamental useful characteristics. This will clarify the scientific approach developed in this thesis.

When analysing the manner scientists and designers solve similar problems, Cross [Cross, 1991] states that: "The scientists tended to use a strategy of systematically exploring the problem, in order to look for underlying rules which would enable them to generate the correct or optimum solution. In contrast, the designers tended to suggest a variety of possible solutions until they found one that was good or satisfactory. The evidence from the experiments suggested that scientists problem-solve by analysis, whereas designers problem-solved by synthesis. Scientists use - problem-focused - strategies and designers use -solution-focused- strategies".

Yoshikawa [Yoshikawa, 1989] has classified the design philosophies in three schools, which also highlight the difference between problem and solution-focused strategies.

This classification is presented below and it will be used in the thesis to position the different theories and methodologies discussed in the course of the thesis.

1. The semantics school:

The central proposal of this school is that every machine which is the object of design can be seen as something that transforms three forms of inputs - *substance, energy, information*- into three outputs similar to each input, but having different states.

The difference between the inputs and the outputs is called functionality. The initial requirements are usually given in terms of functionality, which can be in turn decomposed into sub-functionalities. The resulting sub-functionalities are mapped with particular physical phenomena that realize the transformations.

2. The syntax school:

This school is associated with the effort made to give some formalism to the design process, and attention is paid to the procedural aspects of the design activity rather than on the design object itself. Here attempts are made to abstract the dynamical or temporary aspects from the design, neglecting the static aspects of design as emphasized in the semantics school. The process of abstraction is considered as the premise for improving the universality of design models belonging to this school. This emphasizes the dynamical aspects of design and it can be combined with the semantics one, which emphasizes the static aspects of design to achieve a more sophisticated design methodology.

3. Past experience school:

Adherents of this school suggest that the universality, which is the target of most design methodologies and theories is contradictory to practical usefulness and that the creativity of designers can be troubled and may deteriorate if design methodologies are adopted. Emphasis is placed on the significance of case histories of design, including all necessary knowledge to be learnt for improving design ability. This view is closely related with the idea that the ability to design cannot be acquired efficiently in a theoretical manner, but by the experience.

This thesis states that the scientific approach of searching for underlying rules is fruitful when applied to the design activity,. In addition this short summary of the thinking process in design shows that a similar concern already exists in the semantic and syntax schools of design. In my opinion an approach which mixes the synthesis of the semantic and syntax school is more likely to be able to deal with the actual design problems. Nevertheless the past experience school exhibits also some interesting characteristics in

the sense that it provides a kind of compass in order to flow in the direction of a good or appropriate design solution more quickly and efficiently. In this respect, the TRIZ methodology [Altshuller, 1984] is an ideal methodology because it grasps the positive aspects of the past experience school of design by integrating the past experience knowledge into a methodology which aims at describing the underlying rules of a collection of old successful patents. At the same time TRIZ combines the aspects of the syntax and semantic school by giving a certain type of formalism to the knowledge and by providing a tool called Su-field [Altshuller, 1984] [Savransky, 2000] which models the design problem according to the semantic school. In other words, the TRIZ approach can avoid or diminish the problems of the classical trial and error process.

The design of products is complex because the products are in general, multifaceted in order to describe a product; it is necessary to express its function, behaviour, and structure. A function is the perceived use of the device by the human being. Behaviour is the sequence of states in which the device goes through to achieve the function. Structure refers to the physical components or forms that are utilized to achieve the behaviour. Kuipers [Kuipers, 1984] illustrates this distinction with the example of a steam valve in a boiler.

“The function of the steam valve is to prevent an explosion, its behaviour is that it opens when a certain pressure difference is detected and its structure is the physical layout and connection between the various physical components.”

Having expressed the various aspects of a mechanical product, it is necessary to understand the interactions between these different facets so as to be able to generate and select some feasible solutions. Obviously, a conceptual framework is needed in order to present these concepts of functions, behaviours, sequence of states, interactions and structures in a formal manner. This conceptual framework clarifies the design process and initiates possible future progress in its understanding. According to this thesis there are two main aspects that require to be investigated. The first one is the lack of generic conceptualisation of the issues the designers are reasoning about. The second aspect is the necessary deeper understanding of the modelling process itself. Is it possible to define elementary, generic and invariant concepts which could be applied in all the contexts of the conceptual design activity?

In an ideal scientific process the designer's activity follows the methodology which consists first of all of modelling the problem by using a set of appropriate concepts, in order to transform the initial problem into a generic problem. The second step then consists of using a set of general design rules which have passed the

experimental test barrier. By using the set of rules it becomes then possible to synthesize concepts.

Many concepts and modelling processes have been presented in earlier researches. In order to underline useful concepts and possible gaps in the past researches, these existing theories and methodologies need to be investigated first. This is the goal of the following chapter.

2.2.3 Classification of existing methodologies and theories from a conceptual perspective

The purpose of this section is to classify existing theories and methodologies in order to analyse in which way they fulfil the requirements of conceptual design. The method consists of defining a list of criteria in order to separate design theories and design methodologies. It is then followed by a description of the main features used to process the design problem through each of the conceptual design phases.

An attempt to classify some existing theories and methods is developed in Table 1 and Table 2. This classification is based on criteria. The first one is that the conceptual design process presented in this thesis is described according to a Phase-based model [Yannou, 2001]. A *Phase-based model* is a sequential model of the design process which tend to emphasize the progression of the design in terms of phases (Planning and clarifying the task, conceptual design, embodiment design and detail design) [Pahl and Beitz, 1984]. This type of model fits with the classification approach developed in this thesis. The characteristics of the initial phase called clarification and formulation require according to this thesis:

- the existence of a standard vocabulary associated with concepts and defined without ambiguity,
- the existence of a framework for interaction analysis,

The design theories and design methodologies studied here are also classified according to criteria related to there ability of taking into account:

- the requirements of the manufacturing phase,
- the requirements of the assembling phase,
- the requirements of the environmental phase,
- the requirements of the use phase,
- the requirements of the recycling phase,
- the concept of function developed in this thesis,
- the generation of functional structure,
- the functional interactions,

The phase called synthesis requires some fundamental characteristics:

- the existence of invariable concepts providing a certain kind of mapping between the functional model and the physical implementation,
- the existence of explicit rules related to the design knowledge,
- the existence of explicit rules related to the resolution of design contradictions,

The last phases called evaluation and adequacy analysis require some fundamental characteristics related to the ability of design methodologies or design theories to provide:

- methods for evaluation of the product concepts,
- method for analysing the adequacy between the functional model and the performance of the product concepts,
- method for comparing product concepts,

The last criterion which is taken into account in this thesis is the distinction between the terms theory and methodology. A theory should be established on clear hypotheses. If these hypotheses are clearly presented the term theory is used in our classification nevertheless it is considered to be a methodology. This is in agreement with the scientific method described by Eder [Eder, 1995].

The Table 1 and Table 2 present the classifications of these theories and methodologies according to the criteria described above.

Table 1: Classification of theories and methodologies according to the clarification and formulation phase

	Other Theories	Design theories	Methodologies for functional refinements								
			Ability to take into accounts the manufacturing requirements	Ability to take into accounts the assembling requirements	Ability to take into accounts the environmental requirements	Ability to take into accounts the using requirements	Ability to take into accounts the recycling requirements	Function as an interface between situations	Ability to generate a functional model of concepts	Ability to model functional interaction	
Suh axiomatic theory		X	X								
GDT		X (mathematical framework)									
ADT		X (mathematical framework)									
Bond graph	X							X			
Qualitative physics (AI)	X							X			
Dimensional analysis	X										
Channel theory	X								X	X	
Situation theory	X							X	X	X	
Hubka & Eder		X									
Pahl and Beitz		X	X	X		X			X	X	
TRIZ		X	X	X	X	X	X	X	X	X	
Pugh			X	X							
Ulrich & Eppinger			X	X	X	X	X				
Hirtz functional reconciled taxonomy											
Open system theory	X				X						
Information theory	X		X	X	X	X	X				
VAVE			X	X	X	X	X		X	X	

Table 2: Classification of theories and methodologies according to the clarification, synthesis, evaluation and adequacy phases

Other Theories	Design theories	Design methodologies								
		Concept development					Concept selection			
		Methods for functional refinement			methods for synthesis		Rules related to resolution of contradiction	Methods for Evaluation	Methods for adequacy analysis	Methods for comparing concepts
		Standard concepts and vocabulary	Interactions analysis	Existence of invariant concepts helping the implementation	Rules related to the existing design knowledge					
Suh Axiomatic theory	X		X (independence of functions)					X (independence of functions) X (minimize information)		
GDT	X (mathematical framework)									
ADT	X (mathematical framework)									
Bond graph	X			X	X		X			
Qualitative physics (AI)	X			X					X	
Dimensional analysis	X						X (qualitative simulation)		X (dimensionless attri.)	
Channel theory	X		X							
Situation theory	X		X							
Hubka & Eder		X			X					
Pahl and Beitz		X	X	X	X	X	X (subjective)	X (subjective)		
TRIZ		X		X (Evolution laws)	X	X	X (contradiction method)			
Pugh							X (subjective)	X (subjective)	X (subjective)	
Ulrich & Eppinger							X (subjective)	X (subjective)	X (subjective)	
Hirtz functional reconciled taxonomy			X							
Open systems theory	X			X						
Information theory	X									
VAVE			X	X	X		X (Subjective)	X (subjective)	X (subjective)	

The Figure 6 below presented is synthesizing the information of Table 1 and Table 2 in a concise manner by presenting the scope of each theory and methodology according to the phase-based model selected in the thesis. Figure 6 clusters the theories and methodologies according to the phases of the conceptual design model namely: 1-clarification and formulation, 2- synthesis and 3- 4 evaluation, adequacy analysis. A significant number of tools are dedicated to the clarification and formulation of the problem. The number of tools dedicated to the two other phases is much smaller.

In addition the scientific approach of the evaluation and adequacy analysis phases is characterized by its poor level of repeatability and measurability.

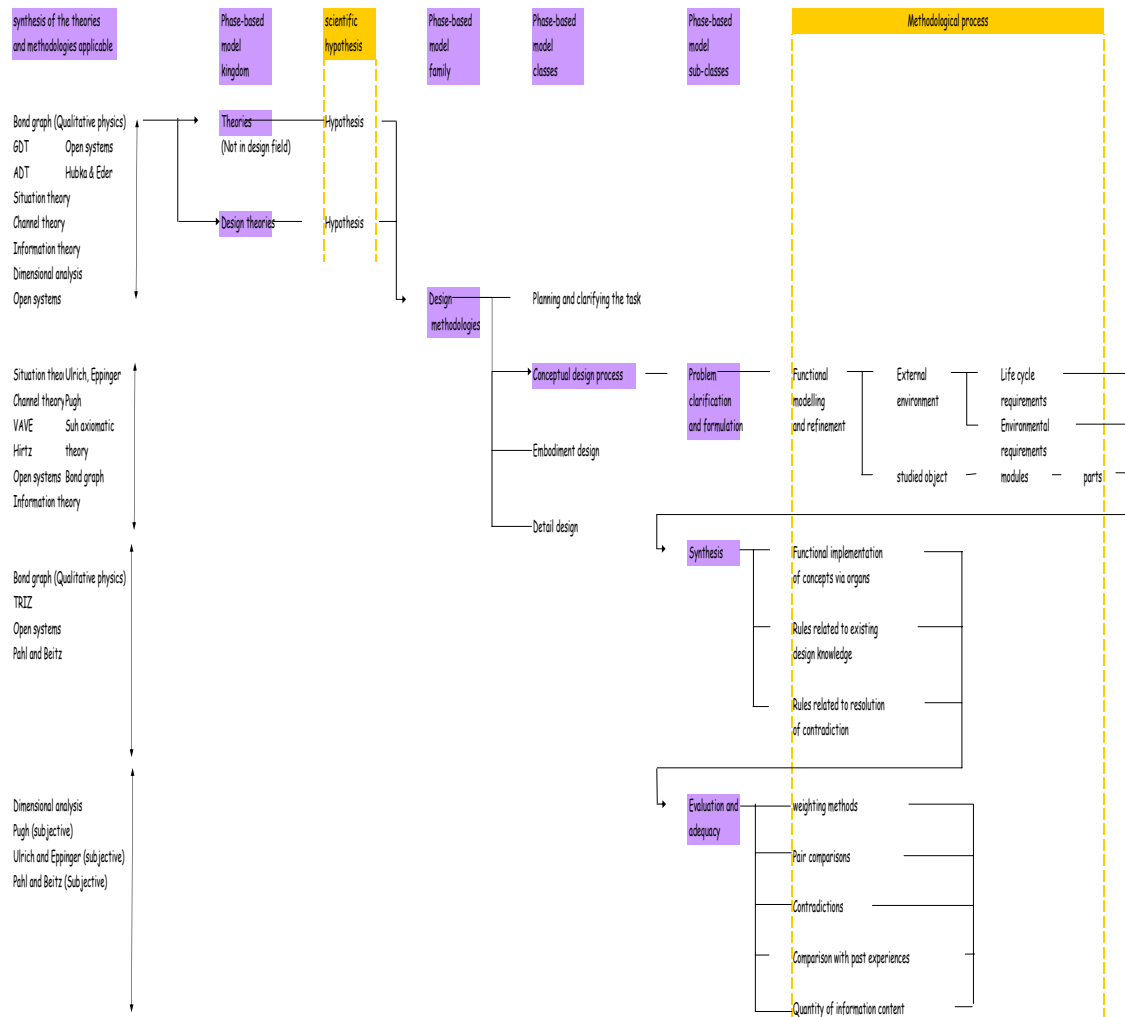

Figure 6: Summary of the design theories and methodologies review

This state of the art shows that some fundamental aspects are required for this thesis.

Clear definition of the fundamental standard and invariant concepts:

The concept of function is certainly a central element which needs to be investigated more precisely. Three design methodologies and design theories presented in this short review are defining this concept (namely Pahl and Beitz methodology, AD theory and GDT

theory [Pahl and Beitz, 1984] [Suh, 1990] [Yoshikawa, 1981] [Tomiya et al., 1987]).

In the Pahl and Beitz methodology [Pahl and Beitz, 1984], functions are used for describing three types of flows through a system: energy, material, and signals. A functional structure is defined as “a meaningful and compatible combination of sub-functions into an overall function”. The functions comprising the functional structure are classified as main or auxiliary functions. This definition of function exhibits interesting characteristics which need to be investigated deeply.

In AD [Suh, 1990], *functional requirements* are defined as “the minimum set of independent requirements that completely characterize the design objective for a specific need.” Here, the functional requirements correspond to the functions in the functional structure of Pahl and Beitz, while there is no distinction between main and auxiliary functions in AD. The definition of function in AD is largely subjective.

GDT proposed by Yoshikawa [Yoshikawa, 1981] [Tomiya et al., 1987] is another formal theory of design. It is noted in GDT that, “When an entity is exposed to a circumstance, a peculiar behaviour manifests corresponding to the circumstance. This behaviour is called a *visible function*. Different behaviours are observed for different circumstances. The total of these behaviours is called a *latent function*. Both are called *function* inclusively.”

In these design methodologies and theories, the arguments on functions are not intending to give a clear definition of function itself, but to show how desired overall functions are decomposed into identifiable sub-functions until they correspond to certain entities or design objects. Entities are composed according to the principles derived from the structure of functions to satisfy the overall function.

In most design theories and methodologies, functions have been studied by focusing on a specific machine. It is stated in this thesis that especially during the problem clarification and refinement, discussion about function should switch from “What is the machine function?” to “How does it function?”. The concept of function should participate to this change of paradigm.

Systematic use of generic concepts:

Generic concepts already exist in some design theories and methodologies [Karnopp et al., 1990] [Pahl and Beitz, 1984] [Altshuller, 1984] [Dardy and Teixeira, 2003] [VAI, 1993] [Glansdorff and Prigogine, 1971] [Odum, 1994].

Modern design is complex and requires also modelling of the economical and informational aspects related to the physical life cycle. An integrated approach of the design activity requires establishing generic principles and concepts. For example the principle of conservation of the energy used as a basis of the bond graph theory needs to be investigated. It is important in this work to analyse in to what extent this principle can be expanded to the economical and informational domains.

Investigating the evaluation and adequacy analysis of concepts of solution:

The short analysis made in this section shows that methodologies used to deal with concepts evaluation suffer from a lack of repeatability and measurability. Those two qualities are of fundamental importance in a scientific context. Most of the methodologies which cover the scope of concepts selection are based at some stages on subjective approaches (e.g. Pahl and Beitz method [Pahl and Beitz, 1984], Ulrich and Eppinger methodology [Ulrich and Eppinger, 2000], Pugh methodology [Pugh, 1990]). This approach is probably inevitable in some cases for example when ranking technical functions related to the same product. However, this thesis states that the harmful effects of such type of approach can be drastically limited using another kind of approach based on a combination of qualitative physics approach and dimensional analysis [Bashkar et al., 1990]. This approach can provide a finer analysis of the relation existing between the overall functions of a product and the technical functions which contribute to implement these overall functions. This approach could also analyse the manner technical functions and overall functions interact with each others.

More interesting viewpoints are provided both by the axiomatic design (AD) [Suh, 1990] and the TRIZ methodology [Altshuller, 1984] [Savransky, 2000] via the use of generic rules. The independence of functions and the minimum amount of information are examples of these rules in AD [Suh, 1990]. The technique of TRIZ which consists of overcoming contradictions can be considered as generic rule which can be integrated in the fundamental concepts.

2.2.4 Conclusion

This chapter has made a review of the state of the art of existing theories and methodologies according to a phase-based model. The theories and methodologies have been clustered according to the four phases (e.g. clarification and formulation, synthesis, evaluation and adequacy analysis) of the conceptual design process.

In addition, the central role of the concept of function has been highlighted. The concept of function used in this research should shift the question about functions from “What is D’s function?” to

“How does it function?”. Consequently, the first phase dedicated to the clarification and formulation should stay general enough as not to constrain the designers’ choices too early. This issue is treated in the chapter 2.4.

The importance of a conceptual design approach where generic rules relate to the elimination of unexpected or harmful characteristics of a product has been also highlighted. This aspect is investigated in the section 2.4.4.

The necessity to enlarge the scope of the generic invariant concepts existing in various theories and methodologies has also been underlined. The initial idea consists of showing that the principle of conservation of the energy can be extended to economical and informational aspects. This issue is analysed in the section 2.3.8.

A new approach applied to conceptual design process which combines the good features of qualitative physics and dimensional analysis needs to be investigated [Kuipers, 1984] [Matz, 1959]. This should be done in order to limit the use of a method which consists of weighting factors like functions or describing attributes when selecting concepts of solutions.

In addition, it should be investigated in which manner the AD principles [Suh, 1990] and the TRIZ principles [Altshuller, 1984] can be integrated in an elegant manner to the framework of the thesis. This is done respectively in the sections 2.4.4 and 3.3.2.

2.3 Presentation of the GDT concepts and consequences for the thesis

2.3.1 Introduction

In the previous section, I have been highlighting some fundamental characteristics of a conceptual design approach. The aim of this chapter is to analyse the design activity from the GDT perspective [Yoshikawa, 1981] [Tomyama et al., 1987] because as stated by Reich [Reich, 1995]: “GDT is a notable exception in the domain of design theory in the sense that it is a mathematical theory of design.”

In my opinion the rigorous framework integrated in the mathematical language is appropriated to the type of approach followed in this thesis. The major hypothesis of the GDT theory consists of stating that design has a topological structure.

Hypothesis 1: Design has a topological structure.

Usually people associate topology with geometrical considerations. Considering the design goals, it is clear that design is strongly related with geometry. Nevertheless, the scope of topological approach is much broader and it could be seen as an extension of the

concept of continuity [Reich, 1995] [Sutherland, 1975]. The major impact of this type of viewpoint is that the concept of continuity exhibits four major properties according to Reich [Reich, 1995] [Bourbaki, 1966]. These properties are: distance, continuity, convergence and transformation.

Distance: The distance between two functions or between two product concepts is interesting during the selection and evaluation process. Distance is a metric which can provide answer to questions like: How close are those two functions? Or How close are these two concepts of solutions? Or How far are the concepts of solutions from the expected functions?

Continuity: The continuity guarantees that a small change in the functional description will result in a small change in the product concepts and vice versa. This property ensures that the mapping is possible between functions and attributes which are describing the product concepts.

Convergence: The convergence guarantees that a sequence of small incremental changes on the product concepts attributes will cause only small incremental changes to the functionality and vice versa.

Transformation: This property guarantees that a transformation conserves the continuity and convergence. This allows for example clustering the descriptive attributes of a product concept in a different manner in order to create new viewpoint of design. This is the premise for connecting dimensional analysis theory (DAT) [Matz, 1959] [Barenblatt, 1979] [Sonin, 2001] with GDT principles.

An analysis of design from this viewpoint can be fruitful. In order to present the GDT concepts in a pedagogical manner, an example of an autonomous vacuum cleaner is used. In this example a certain amount of design concepts of the vacuum cleaner are presented. Vacuum cleaner concepts are compared according to a group of functions and physical attributes. The vacuum cleaner concepts are derived from a study made by Nicoud [Nicoud, 2003] about concepts of small mobile robots. This example is presented below and is only focusing on the architecture of the moving module of the vacuum cleaner. The reconciled functional taxonomy of Hirtz [Hirtz et al, 2002] has been used to establish the list of the functions of the group of robots.

Example of the autonomous vacuum cleaner concepts:

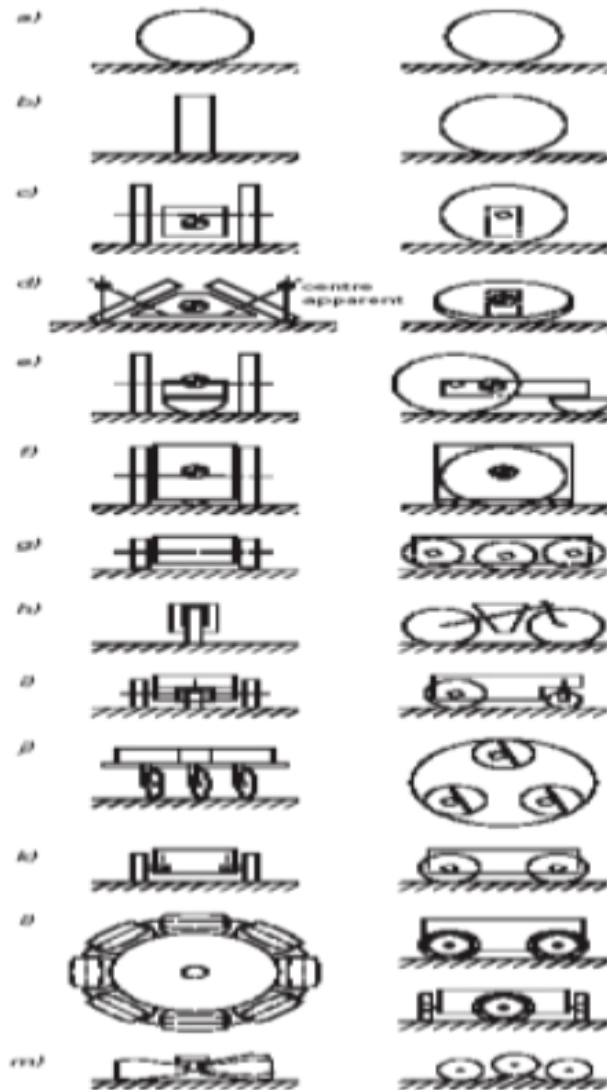

Figure 7: Autonomous vacuum cleaner concepts of solutions based on Nicoud [Nicoud, 2003]

A + in the Table 3 and Table 4 denotes that the robot named by a letter displays the function or the physical attribute. A – indicates on contrary that the function or physical attribute is not displayed by the structure.

Table 3: Functional expected properties list of the moving module of the robots

Functions of artefacts	Functional properties	A	B	C	D	E	F	G	H	I	J	K	L	M
1	The robot should Translate	+	+	+	+	+	+	+	+	+	+	+	+	+
2	The robot should Rotates	+	+	+	+	+	+	+	+	+	+	+	+	+
3	The robot should Contains energy	+	+	+	+	+	+	+	+	+	+	+	+	+
4	The robot should Collects energy	+	+	+	+	+	+	+	+	+	+	+	+	+
5	The robot should Senses the environment	+	+	+	+	+	+	+	+	+	+	+	+	+
6	The robot should be Stable	-	-	+	+	+	-	+	-	+	+	+	+	+

Presentation of the sections 2.3.2, 2.3.3 and 2.3.4:

The section 2.3.2 presents the GDT definitions and axioms from the Ideal knowledge perspective. Ideal knowledge is viewed as an infinite knowledge.

The section 2.3.3 modifies the ideal approach by taking into account that the real knowledge is limited. The manner designers are flowing progressively from a functional description of the product to a product concept solution is described.

The section 2.3.4 analyses the formal links existing between the GDT theory [Yoshikawa, 1981] [Tomiya et al., 1987] and the idea developed in this thesis. Design is seen as a topological structure based on classified generic concepts mapped with a functional language and at the end of the synthesis process transformed into a metric space.

Table 4: Physical attributes list of the moving module of the robots

	Physical attributes	A	B	C	D	E	F	G	H	I	J	K	L	M
1	has a spherical structure	+	-	-	-	-	-	-	-	-	-	-	-	-
2	has a cylindrical structure	-	+	-	-	-	-	-	-	-	-	-	-	-
3	has one point of contact	+	+	-	-	-	-	-	-	-	-	-	-	-
4	has two points of contact	-	-	+	+	-	-	-	+	-	-	-	-	-
5	has three points of contacts	-	-	-	-	+	-	-	-	+	+	-	-	-
6	has four points of contacts	-	-	-	-	-	+	+	-	-	-	+	-	-
7	has decoupled rotation and translation	-	-	-	-	-	-	-	+	+	-	+	+	-
8	has coupled rotation and translation	+	+	+	+	+	+	+	-	-	+	-	-	+
9	has wheels of wheels	-	-	-	-	-	-	-	-	-	-	-	+	-
10	has more than 4 points of contacts	-	-	-	-	-	-	-	-	-	-	-	+	+
11	has more than two driven points of contacts	-	-	-	-	-	-	+	-	-	+	-	+	+
12	has parallel axle of rotation for the motors	-	-	+	-	+	+	+	-	-	-	-	-	+
13	has contacts only realized by wheels	-	-	+	+	-	-	+	+	+	+	+	+	+

2.3.2 Main GDT definitions and axioms in the ideal knowledge

The ideal knowledge in GDT is defined as [Yoshikawa, 1981] [Tomiyama et al., 1987]:

“... the one that knows all the entities and can describe each of them by abstract concepts without ambiguity.” [Yoshikawa, 1981]

Definition 1: An *entity* is a real object that has existed, exists presently, or that will exist in the future.

Definition 2: The set of all objects is called the *entity set*.

The domain of robots of Figure 7 can be viewed as an entity set. It is a simplification because the entity set should be infinite in ideal knowledge.

Definition 3: An *attribute* is a physical, chemical, mechanical, or any other property that can be observed or measured, potentially through the use of an instrument. Each entity has values for its attributes.

The properties listed in Table 4 are the attributes of the robots. They all can be observed or measured by some instruments. The table specifies the qualitative property for each robot. The values of these

properties are a major issue in design, discovering a metric to measure the value of attributes is not an easy task.

Definition 4: When an entity is subjected to a *situation*, it displays a *behaviour* which is called a *functional property*. The collection of functions observed in different situations is *the functional description of the entity*.

The properties listed in Table 3 are all the functional properties of different robots. The table specifies the functional behaviour manifested by each robot. For example translating is a behaviour manifested when the motors are subjected to a situation in which the command unit send electrical impulsions.

This example shows that functional properties and situations are closely connected in GDT theory. Nevertheless the concepts of situation and function have not been emphasised so much in GDT.

Definition 5: The representation of an object is called *concept of entity (S)*.

In this thesis the concept of entity is also called concept of solution. Both terms have similar meaning in the work. The representation of a robot using the functional properties and properties of the attributes from Table 3 and Table 4 is a concept of entity. A drawing is also a concept of entity. Until now, the discussion has concentrated on single entities and their representation. The important concept of classification will now be introduced.

Definition 6: A classification over the entity set is a division of the entities into several classes. Each class is called an abstract concept. The set of all *abstract concepts* is denoted by T .

Robot C, D and A, B could form two classes and the remaining robots could form more classes. A more meaningful classification can be obtained by classifying the robots based on their attributes. For example, the property “*has coupled rotation and translation*” divides the set of robots into two classes, robots with “*coupled rotation and translation*” {A,B, C, D, E, F, G, J, M} and the other robots { H, I, K, L}. A classification can be based on more than just one property. For example, the properties “*has coupled rotation and translation*” and “*has more than two driven points of contacts*” divide the set into two classes {G, J, M} and {A, B, C, D, E, F, H, I, K, L}.

Definition 7: The set of all functions, called the *function space*, is the set of all the classes from all the classifications of the functions. It is denoted by T_F .

In principle, the function space for the domain of robots can contain 2^{13} functions (i.e.: the size of the power set of the set of robots).

Definition 8: The set of all artefact descriptions, called the *attribute space* is the set of all classes of all the classifications of attributes. It is denoted by T_A .

The attribute space for the domain of robots can contain 2^{13} potential descriptions of artefacts. For example, the attribute “*has two points of contacts and has coupled rotation and translation*” contain two robots {C, D} from the whole set of robots. The attribute space however is not accurate since some of the potential classifications do not contain any robots. For example the two classifications “*has a spherical structure and has wheel of wheel*” is empty, same for “*has three points of contacts and has wheels of wheels*”.

Nevertheless, in most of the cases it is easy to construct new robots having for example “*a spherical structure and wheels of wheels*”, same for “*three points of contacts and wheels of wheels*”.

Axioms:

The GDT’s axioms convey the hypotheses of the theory. These hypotheses are the foundation of the theory and they result later in theorems.

Axiom 1: Axiom of recognition

Any entity can be recognized or described by its attributes and, or other abstract concepts.

The fundamental meaning of this axiom is that GDT supports the extensional description of concepts.

Tomiyama and Yoshikawa [Tomiyama et al., 1987] described two kinds of description methods of entity concepts. One is called *extensional*, and the other is called *intentional*. The difference of these two can be regarded as the difference of the formulations of the relationship between *entity concept (S)* and *abstract concept (T)*. In the extensional description we have first the entity concept and the abstract concept is a result of this entity concept. The intentional description is the opposite. Both methods have advantages and disadvantages. For example, if focusing on the class attributes, the two types of descriptions are presented as:

Has coupled rotation and translation = {A, B, C, D, E, F, G, J, M} is an *extensional* description of the attributes has coupled rotation and translation.

A = (has a spherical structure, has coupled rotation and translation, has one point of contact) is an *intentional* description of the robot A.

It is obvious according to these two examples that the intentional description is more compact but on the other hand the extensional description is more flexible because concepts of entities can be added or removed freely from the description when changes appear in the concepts of entities.

If two robots have similar description according to our classifications by functions or attributes, the axiom fails to differentiate between the robots. The classifications are a manner to store our knowledge; when describing a product using abstract concepts our knowledge is limited and can explain that differentiation becomes impossible.

Axiom 2: Axiom of correspondence

The entity set and its representation have one-to-one correspondence.

Each robot in Figure 7 is an entity and their representation in Table 3 and Table 4 are the concept of entity (S). The axiom says that there is a one-to-one mapping between them.

Axiom 3: Axiom of operation

The set of all abstract concepts is a topology of the entity set.

The mathematical concept of topology is extensively used in GDT theory. I will use the definition of Nicolas Bourbaki [Bourbaki, 1966].

Topology [Bourbaki, 1966]: A *topological structure* (or *topology*) on a set X is a set $O \in P(X)$ (with $P(X)$:the ensemble of the parts of X) having the following properties:

- $\emptyset \in O$ and $X \in O$,
- For any $U, V \in O$, $U \cap V \in O$,
- For any set I and $U_i \in O$ ($i \in I$), $\bigcup_{i \in I} U_i \in O$.

A *topological space* is a pair $\mathbf{X} = \langle X, O \rangle$ of a set X and a topology O on X . An element of O is called an *open* set of O , and the complement of an open set is called a *closed* set. A subset of X is *clopen* if it is open and closed.

If considering S , the representation of the robots, called the *concept of entities* of the robots and T a classification over the entity set

called *abstract concepts* of the robots and denoted by T , then a topological space $S = \langle S, T \rangle$

A simple topology over the set of concept of entities S of the robots can be constructed including $\{\emptyset, \{A\}, \{B\}, \{D\}, \{C, E, F, G, H, I, K, L, M\}, S\} \subseteq T$. The purpose of creating these subsets can be to differentiate between entities. It is the classical goal of a classification. $\{A\}$ can be named the set of spherical robots, $\{B\}$ the set of cylindrical robots, $\{D\}$ the set of robots with inclined wheels, and $\{C, E, F, G, H, I, K, L, M\}$ the set of robots with parallel wheels. To be complete the topology should satisfy the properties listed in the definition above. Thus another topologies are $T = \{\emptyset, S\}$ and $T = \{\emptyset, 2^S\}$

Axiom 4: Hierarchy of separation/recognition

There exists a hierarchy in the ability of separation/recognition of the topological spaces (S, T) :

T_0 : For each pair $a \neq b$ in S , there is $U \in T$ such that $a \in U$ and $b \notin U$ or vice versa.

T_1 : For each pair $a \neq b$ in S , there is $U, V \in T$ such that $a \in U$ and $b \notin U$ and $b \in V$ and $a \notin V$.

T_2 (*Hausdorff space*): similar to T_1 but $U \cap V = \emptyset$.

T_3 : T_3 is a generalization of T_2 where A is a set instead of a single entity but still using b .

T_4 (*Normal space*): Satisfies T_1 and for every pair of disjoint closed sets $A, B \in \bar{S}$ there exists a pair of disjoint open sets $U, V \in T$ such that $A \subset U$ and $B \subset V$.

T_5 : Satisfies T_1 and for every pair of closed sets $A, B \subset \bar{S}$ with $\bar{A} \cap B = A \cap \bar{B} = \emptyset$, there exists a pair of disjoint open sets $U, V \in T$ such that $A \subset U$ and $B \subset V$.

Metric space: There exists a metric on the space such that a set S is called a metric space if with every pair of points $x, y \in S$, there exists a non-negative real number $d(x, y)$ that satisfies:

- If $d(x, y) = 0$ then $x = y$ and $d(x, x) = 0$.
- For any pair of points x, y , $d(x, y) = d(y, x)$
- For any three points x, y and z , $d(x, z) \leq d(x, y) + d(y, z)$

It can be shown that: $Metric\ space \Rightarrow T_5 \Rightarrow T_4 \Rightarrow T_3 \Rightarrow T_2 \Rightarrow T_1 \Rightarrow T_0$ and that none of these implications is reversible. Therefore, the type of separation defines an order on topological spaces.

This axiom can be a topological interpretation of the term “without ambiguity” used above to define the ideal knowledge.

According to the Figure 8 the classification of Table 5 has a certain ability to separate the concepts of entities of the robots. This ability is even better if using the entire list of physical attributes of the robot of the Table 4. It is clearly shown when analysing the Figure 9b that the separation and recognition ability is much better when using the entire Table 4. It should be noticed that the recognition and separation ability of the Figure 3 is worse in the example case when using the Table 3.

Table 5: Physical attributes U, V

Physical attributes		Sets of concepts of entities of the robots													
		A	B	A	B	A	B	A	B	A	B	A	B	A	
		single concepts of entities													
		a	b	c	d	e	f	g	h	i	j	k	l	m	
U	has a spherical structure	+	-	+	-	+	-	+	-	+	-	+	-	+	
V	has a cylindrical structure	-	+	-	+	-	+	-	+	-	+	-	+	-	
U'	has a plastic structure	-	+	-	+	-	+	-	+	-	+	-	-	-	
V'	has a metallic structure	+	-	+	-	+	-	+	-	+	-	+	-	+	

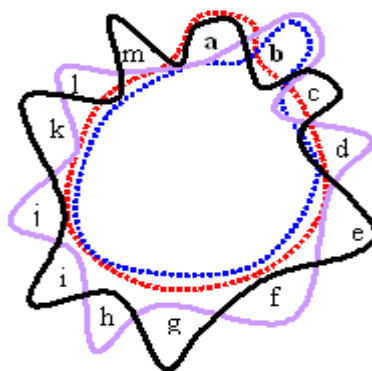

Figure 8: Representation of Physical attributes U, V

Nevertheless as noted later, it is difficult to draw conclusions about the recognition ability based on the example of the autonomous vacuum cleaner because the set of attributes is the double than the set of functions. It is shown later in this thesis that classification is a

particular type of topological space which has some of the good characteristics of the metric spaces.

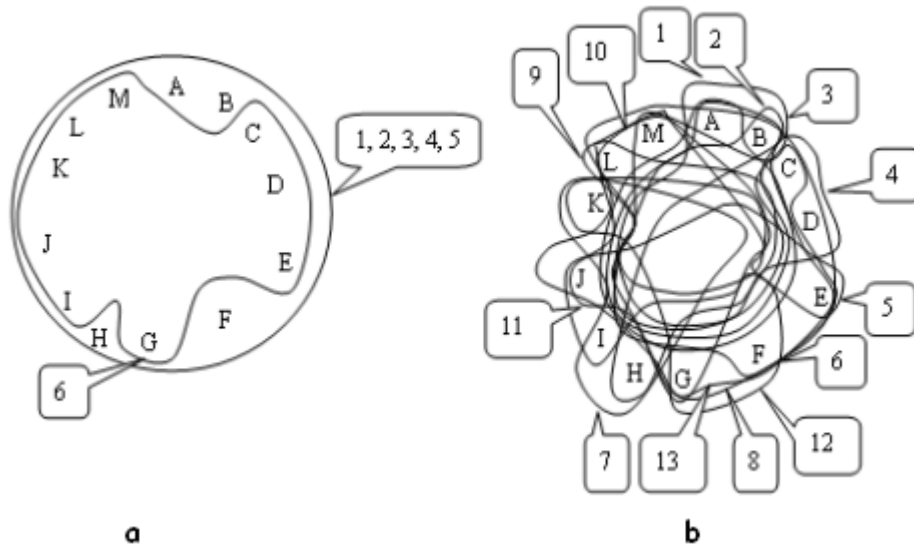

Figure 9: Functions and physical attributes ability to separate entities

Derived theorems and definitions:

When designing each concept of entity is considered as a *single* entity. A theorem follows the definition of the ideal knowledge and axiom 4:

Theorem 1: The ideal knowledge is a Hausdorff's space.

It means that the ideal knowledge is a T_2 -type structure.

Definition 9: The design specifications, T_s designates the functions of the required entity by using abstract concepts.

This definition states that design specification is expressed in a functional manner. It is in agreement with the table 2 of the robot example.

Theorem 2: The specification can be described by the intersection of abstract concepts.

In the general case the specification is described according to a list of functions. The intersections of these abstract concepts of functions constitute the specification. For example the Table 3 is presenting specification for the different concepts of entities of the autonomous vacuum cleaner robot.

Theorem 3: The set of design specifications is a filter.

Filter (F) [Bourbaki, 1966]: A filter of S is a collection F of subsets of S that has the following properties:

$\emptyset \notin F$, (b) if $A \in F$, and $A \subset B \subset S$, then $B \in F$, and (c) if $A, B \in F$ then $A \cap B \in F$.

A filter does not have a topological structure according to (a); it is understandable because an empty specification is useless in design.

Weaker topology [Bourbaki, 1966]: If (S, T_D) and (S, T_E) are two topological spaces T_D is said to be weaker than T_E if $T_D \subset T_E$. $T_D \subset T_E$ means that each element of T_D is strictly included in T_E .

Theorem 4: $T_F \subset T$ and $T_A \subset T$

The theorem 4 stands that the attribute space and the function space are both included in the set of all abstract concepts. In the case of an ideal knowledge where T_F and T_A are two topologies, then T_F and T_A are weaker than T . The set of all abstract concepts represents the ideal knowledge. The Figure 10 presents this theorem in a graphical manner by using the Euler graph.

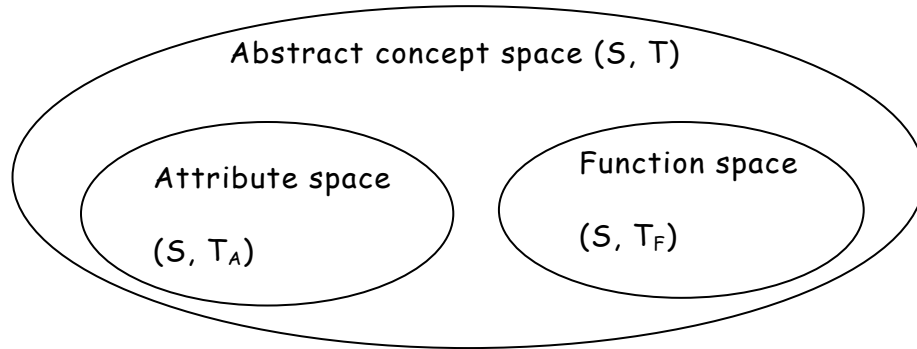

Figure 10: Topological structure of the abstract concept, attribute and function spaces

Definition 10: A design solution is a concept of entity s that is included in its specification and contains its necessary manufacturing information.

If considering one robot entity (robot D for example), a design solution is a representation of this robot in the form of a concept of entity (concept of entity D for example). This concept of entity should fulfil the design specification of the Table 3 and in addition to that the manufacturing information should also be described. This vision of a design solution does not take into account the other

aspects of the physical product life cycle, for example the transport, the dismantling and the recycling. In a physical life cycle perspective, these aspects should also be included.

Theorem 5: The concept of entity in the ideal knowledge is a design solution.

Theorem 6: The design solution is represented by the intersection of classes of S that belong to the attribute space T_A .

The Figure 9b exhibits this property. This is a consequence of the axiom 4 of separation and recognition.

Theorem 7: The identity mapping between the attribute space and the function space is continuous.

As explained earlier, the continuity guarantees that a small change in the functional description will result as a small change in the product concepts and vice versa. This property ensures that the mapping between functions and attributes describing the product concepts is possible.

2.3.3 Main GDT definitions and axioms in the real knowledge

In reality no one could pretend to be able to “... know all the entities and describe each of them by abstract concepts without ambiguity” [Yoshikawa, 1981]. Designers have to deal with limited and imperfect knowledge when designing. To explain the difference between ideal and imperfect knowledge, the concept of real knowledge has been introduced. The real knowledge constitutes a second hypothesis added to the first hypothesis stating that design has a topological structure.

It should be noticed that the topological structure is no more perfect in the real knowledge.

Hypothesis 2: The real knowledge is a set of feasible entity concepts (S_F) which are made compact by coverings selected from the physical law topology.

To be understood this hypothesis 2 needs to be followed by two extra definitions.

Compact: A topological space is compact if every open cover has a finite (not just countable) cover. [Bourbaki, 1966]

Cover: A cover of a set S is a collection of sets whose union is a superset of S . [Bourbaki, 1966]

Definition 11: A physical law is a description of the relationship between object properties and its environment.

Definition 12: An attribute is a physical quantity which is identifiable using a set of finite number of physical laws.

Definition 13: A concept of physical law is an abstract concept. It is formed if entities are classified based on physical manifestations of physical laws.

Definition 14: A feasible object is an object that does not contradict physical laws.

Theorem 8: The topology of physical law T_p on S_F is a subspace of T_A . S_F is the set of concept of entities which do not contradict the physical laws.

In the case of the set of abstract concept of a robot, a physical law could for example describe the friction existing between the robot's wheels and the ground. Using this description it is possible to define the best type of material for the robots wheels. This material could be described according to different attributes: -coefficient of friction, hardness, surface-.

A classification of the physical laws is an abstract concept. A feasible robot does not contradict the physical laws. In addition, in the real knowledge, the entities to be considered as feasible entity concepts should be properly surrounded and described by group of physical laws.

Theorem 9: In the real knowledge, it is possible to make a converging subsequence from any design specification and to find out the design solution for the specification.

This theorem states that the design process is a refinement process which starts from the design specification and ends with design solution(s). The model used to describe this refinement is a central question of this work. The formal definition of a metamodel follows this theorem.

Definition 15: A metamodel M_Λ is defined as $\bigcap_{\lambda \in \Lambda} M_\lambda$, where $M_\lambda \in T_A$ and Λ is finite.

In order to organize and move easily from one model of an object to another the metamodel concept have been introduced in the literature [Tomiyama et al., 1987] [Tomiyama et al. 1989].

Definition 16: The metamodel set M is the set of metamodels that are formed by finite intersections of abstract concepts from the attribute topology.

Theorem 10: The metamodel set is a topology of the real knowledge.

Theorem 11: In real knowledge, the metamodel set is a weaker topology than the attribute topology.

The term weaker means that the metamodel set is not as precise as the attribute topology and thus, can only approximate it.

Theorem 12: In real knowledge, the necessary condition for designing is that the topology of the metamodel set is stronger than the topology of the function space.

The theorems 11 and 12 state that $T_F \subset T_A$ because $M \subset T_A$ and $T_F \subset M$.

This group of definitions and theorems is central because it shows that there exist a hierarchy of topologies. The finest topology is the attribute topology, followed by the metamodel and function topology. These aspects are summarized in the Figure 11 by using the Euler's diagram.

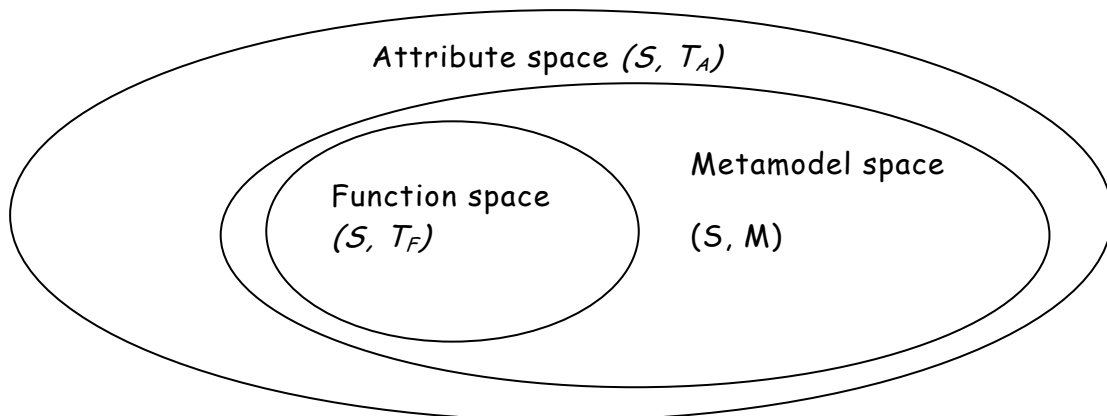

Figure 11: Hierarchy of topologies in the real knowledge

In the practical example of robot used in this thesis, it is clear that the attribute topology is finest than the function topology (see Figure 9). Nevertheless, the example of the autonomous vacuum cleaner is based on a set of 6 functions and 12 physical attributes and it cannot be considered as a proof.

The fact that these models exist and are finest than the function topology make the mapping between the function and the attribute topologies possible according to theorem 7.

Theorem 13: If we evolve a metamodel by way of intersection of abstract concepts, we get an entity concept as the end of the evolution process.

This theorem states that the design process is an evolutionary process. The everyday practice of the designers validates this fact. According to the theorem 13, the evolution of a metamodel based on a succession of generic interconnected concepts evolve in the direction of a concept of entity (also called in the thesis concept of solution).

Definition 17: A function of an entity is a physical phenomenon caused by the physical laws governing the situation.

This definition of a function is slightly different from definition 4 because it emphasizes on the behaviour of an object when exposed to a physical situation defined by attributes. The chapter 2.4 will discuss extensively the concept of function, because according to the two definitions of function given by the GDT theory (Definition 4 and 17), a function is seen from the behaviour perspective or in this case from a physical phenomenon perspective. These viewpoints emphasize a lot the physical aspects of the concept of function and its physical implementation in the entity. This is in agreement with the following definition of a *function element*. Nevertheless, this vision needs to be discussed in section 2.4.

Definition 18: A function element is a metamodel $\bigcap_{\lambda \in \Lambda} M_{\lambda}$, where $M_{\lambda} \in T_A$ and Λ is finite, such as $\forall M_{\lambda \in \Lambda}, M_{\lambda} \in T_P$.

In the definition 18, a specific function called *function element* is associated with a finite list of attributes. The attributes can be identified according to physical laws. This viewpoint which consists of associating the high level concept of function with a list of attributes which do not contradict the physical laws is discussed in the section 2.3.4 and it can constitute a theoretical confirmation of one of the initial intuition of this work which consists of describing an entity according to a list of attributes grouped in the form of dimensionless numbers and clustered by functions.

Theorem 14: If we choose function elements as the metamodel, design specification is described by the topology of the metamodel, and there exists a design solution that is an element of this metamodel.

Theorem 15: The real knowledge is a normal space.

This theorem states that the topology of real knowledge is T_4 type instead of T_2 as originally stated. This is a consequence of the hypothesis 2, which restricts the Hausdorff space to be compact.

Later in chapter 2.3.5, it is shown that a metamodel based on classifications exhibit a different topological structure which is called uniform space having many good features of the normal space structure. To be metrizable this type of space requires some necessary conditions which are discussed also in chapter 2.3.5.

Theorem 16: In the real knowledge there exists a distance between two different entities.

This theorem states that the topology of the real knowledge is precise enough to allow the calculation of a metric. This result is fundamental for this thesis because it shows that a transformation of the topological space is possible in order to calculate a unique metric. Nevertheless, as stated by Reich [Reich, 1995] the restriction imposed by the hypothesis 2 is quite strong and it can be possible according to Reich to obtain a metric also with less restrictive conditions.

Definition 19: When a design solution is identified and realized, it may have behaviours that are different from the specification. These behaviours are called unexpected functions.

Theorem 17: In the real knowledge, the design solution has unexpected functions.

Due to our limited knowledge and the limitation of the functional and attributes description precision, unexpected behaviours occur. This aspect of the design activity has been studied extensively in the TRIZ methodology [Altshuller, 1984]. The GDT concept of unexpected function requires to be compared and may be associated with the concept of Harmful function developed in the TRIZ approach [Altshuller, 1984] [Savransky, 2000].

2.3.4 The central role of the classification in this thesis

According to the GDT's axiom of separation and recognition, the feasible entities (real knowledge) called in this thesis *concepts of solution* can be best separated and recognized if the structure of the design can be expressed through a metric space. In order to obtain a metric space, an intermediate space called classification space can be used [Kakuda and Kikuchi, 2001]. In addition the analysis of the previous chapters has proved that classification is a fundamental element of the GDT approach. Classification plays a central role in this thesis too. The classifications which need to be developed are based on *abstract concepts* like in GDT. These abstract concepts constitute the classes of a classification framework made in order to separate entities. The set of abstract concepts T can be divided into several classes according to GDT:

- Classification of entities based on the concept of function. The set of all the functions is denoted by T_F ,
- Classification of entities based on the concept of attribute. The set of all the attributes is denoted by T_A ,
- The selection of a certain number of functions belonging to T_F is called a design specification T_S .
- The classification of entities according to the physical manifestation of physical laws is called a concept of physical law.
- The set of all the physical laws is denoted by T_P . T_P is a subspace of T_A .

This thesis modifies slightly this fundamental structure by viewing design from the perspective of a physical design life cycle. According to Figure 5 it is stated that during the design process; a designer needs to concentrate on three fundamental domains: the physical, the economical and the informational domains. The informational domain is added because a designer needs to exchange and to grasp information with the other phases of the physical design life cycle model. In the same way, the designer needs to take into considerations the economical aspects of the physical design life cycle model because of economical constraints. The nature of these domains needs to be discussed more extensively. This is the goal of the section 2.3.7.

On the opposite of the GDT's approach which states that the attributes and laws defined in the theory belong to the physical domain, it is argued in this thesis that a design process requires to take into account these three domains. Consequently, the adopted viewpoint requires the modification of some definitions of GDT. The set of abstract concepts T is still divided into several classes but there number of classes has been increased. No particular changes affect the definition of most of the classes initially existing classes. Nevertheless, the concept of law has also to be modified.

Concept of law (T_L): An abstract concept formed on classified entities based on manifestations of laws belonging to the three domains (e.g. physical, economical, informational). The set of all classes of all the classifications of the laws is denoted by T_L (this definition is based on Yoshikawa [Yoshikawa, 1981]).

It is also possible to refine other terms of the initial GDT definitions.

A design solution is a solution that contains its own physical life cycle information presented in term of attributes belonging to T_A .

Attribute: In the real knowledge; physical, economical and informational quantities which are identifiable by using a set of

finite number of laws belonging to the physical, economical and informational domains (derivate from Yoshikawa [Yoshikawa, 1981]).

A *feasible object* (s_F) is an object that does not contradict the laws.

Metamodel: Integrative model developed in order to combine multiple models of design objects and to represent relationships among the concepts of these different models. The models are developed according to the three domains (physical, economical and informational) introduced in the thesis.

In addition to the introduction of these three domains, the thesis modifies concepts like function (see section 2.4). The intermediate structure called metamodel which requires also classifications is developed in section 2.3.6. Consequently the classification framework which will be developed in this thesis is broader than the initial GDT one. A short overview of this classification framework is given below:

- Classification of domains,
- Classifications of functions,
- Classification of substances,
- Classification of variables (power variables, state variables, law variables),
- Classification of generic organs [Karnopp et al., 1990] [Hubka, Andreasen and Eder, 1988, 1988],

Classification plays a central role in this thesis; this concept is strongly connected to the ability to obtain a metric space at the end of the design process. The following sections use and develop its structure.

2.3.5 Consequences of the Axiom of separation/recognition for the thesis

The aim of this section consists of analysing the necessary conditions which authorize a transformation of classification spaces into a metric space. The metamodel developed in the thesis maps the functional space and the attribute space. The axiom 4 which is the axiom of separation/recognition stipulates that there is a hierarchy of the topological spaces (S , T) when ensuring the separation and recognition of the concepts of solutions. In simple terms, it means that when a designer is faced with the selection and ranking of concepts of solutions developed during the synthesis phase (see Figure 1). He should be able to separate and recognise each concept of solution in order to properly complete this task. The axiom 4 based on mathematical considerations states that a hierarchy of recognition/separation exists. According to this hierarchy the best

topological structure is the topological structure called metric space. This topological structure exhibits a unique metric which gives the possibility to compute distances between concepts of solutions.

At this stage of the analysis, several questions appear:

- If the abstract concepts used to design consist of several types of classifications, what is the nature of the topological structure of a classification?
- Is it possible to transform the topological structure of a classification in order to obtain a metric space?

In order to determine the topological structure of a classification, it is necessary to study both literature related to topology [Bourbaki, 1966] and the theoretical literature related to design [Kakuda and Kikuchi, 2001b]. The GDT states also in one of its theorems (not presented in the above sections 2.3.2 and 2.3.3) that the topology of the real knowledge can allow the calculation of metric. Nevertheless, the hypothesis 2 about the real knowledge is very restrictive (see section 2.3.3 p.56). According to Reich [Reich, 1995] the assumption about the compactness of the real knowledge can be relaxed. In other terms, the laws selected in order to cover a set of the concepts of solutions does not need to be perfectly bordered in their scope of use. Consequently according to Reich [Reich, 1995] there is least demanding theorem in order to obtain metrization [Nagata, 1950] [Smirnov, 1953]. The following analysis developed by Kikuchi and Kakuda [Kikuchi and Kakuda, 2001ab] gives answers to the nature of the topological structure of a classification and provides necessary conditions to obtain metrization.

It is necessary now to demonstrate how a metric space can be derived logically from a classification.

At first, it is necessary to restate the fundamental hypothesis 1 of GDT: Design has a topological structure. Kakuda and Kikuchi state that [Kakuda and Kikuchi, 2001b]:

Definition 3.7.: A classification is a topological structure called classification space.

This topological structure called classification space can be defined a little bit differently according to the channel theory [Barwise and Seligman, 1997] and to the Abstract Design Theory (ADT) [Kakuda and Kikuchi, 2001a].

According to this theory, a classification is a triple:

$A = \langle tok(A), typ(A), \models_A \rangle$ where $tok(A)$ is equivalent to a set of entities S , $typ(A)$ is equivalent to an abstract concept T and \models_A is a binary relation between the sets $tok(A)$ and $typ(A)$

For example, a classification over the set of the concepts of solutions (S) of the vacuum cleaner robot presented in Figure 7 by the set of functions (T_F) presented in Table 3 can be summarized according to the Figure 12:

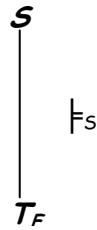

Figure 12: Representation of the classification of a set of robot's concepts of solutions by the set of functions

The binary relation represented by \models_A is relative to the + and – of the Table 3. The difference according to the topological representation of a classification by Yoshikawa [Yoshikawa, 1981] is that the nature of the relation is clearly integrated in the definition. Nevertheless this representation still exhibits the fundamental properties of a topological space. There is no fundamental contradiction between this definition and the topological definition and so it can be said that every classification induces a topological space.

Consequently, $top(A) = \langle tok(A), O^A \rangle$ is the topological space induced by the classification A . It is said that a topological space is a *classification space* if it is induced by a classification.

According to the Kakuda's and Kikuchi's [Kakuda and Kikuchi, 2001b] study, the logical sequence of transformation in order to obtain a metric space consists of first transforming the classification space into a structure called uniform space noted $Unif(A)$.

It is proved by Kakuda and Kikuchi [Kakuda and Kikuchi, 2001b] that:

Theorem 4.8: Every classification space is uniformizable.

Uniformity of a classification space is induced according to the choice of B which is called a *fundamental system of entourage*. The choice of B is not unique and B is defined according to Kakuda and Kikuchi [Kakuda and Kikuchi, 2001b] as:

Definition 4.3: B is a fundamental system of entourages of a uniformity U iff $B \subseteq F$ (filter) and for any $V \in U$ there is $W \in B$ such that $W \subseteq V$.

U^B is called the uniformity induced by B and consequently a uniform space is represented in the following manner:

$$Unif(A) = \langle tok(A), U^B \rangle$$

A fundamental system of entourage B can be visualized by using the practical case of an autonomous vacuum cleaner robot. The theorem 11 of GDT (see section 2.3.3) states that the metamodel topology is weaker than the attribute topology. The generic mechanisms and the generic variables which constitute the elementary elements of the metamodel structures are themselves weaker than the metamodel topology because the metamodel contain in addition laws which provide method in order to analyse the interconnection and the behaviour of the elements of the generic classes. Consequently a filter (F) is assimilated in this example to a metamodel, a uniformity U is assimilated to the set of attributes T_A and a fundamental system of entourages (B) is assimilated to the generic mechanisms and variables which constitute the metamodel structure.

This thesis states that the generic mechanisms and variables introduced in sections 2.3.6 and 2.3.9 constitute a fundamental system of entourage (B). This fundamental system of entourage induces uniformity of a classification space and consequently it constitutes with the creation of a metamodel framework a necessary intermediate process required in order to obtain a metric space.

The second step of the transformation which leads to a metric space consists of transforming the uniform space into a metric space. The necessary conditions for obtaining that type of topological structure can be summed up according to Kakuda and Kikuchi by the following proposition [Kakuda and Kikuchi, 2001b]:

Proposition: For a classification A , $Unif(A)$ is metrizable if A is separated and $typ(A)$ is countable.

A is separated if $typ A(a1) = typ A(a2)$ implies $a1 = a2$ for every $a1, a2 \in tok(A)$.

The first condition of metrization consists of having a fundamental system of entourage. A fundamental system of entourage is set of generic concepts.

The second condition of metrization consists of ensuring the property of separation. The property of separation is very important

and has been extensively studied in GDT [Yoshikawa, 1981] [Tomiyama et al., 1987] by introducing the axiom 4 of separation/recognition and followed by the theorems 15 and 16. Nevertheless at this stage of the thesis this property of separation can only be supposed for our generic abstract concepts. This property of separation is obtained if the uniform spaces induced from the fundamental system of entourage are precise enough to provide separation between all the concepts of solutions. This issue is analysed extensively in section 2.3.5 by presenting the necessary basic concepts and conditions in order to ensure the separation property. Nevertheless it should be noticed that the metamodel stage constitutes only an intermediate stage of the conceptual design process. The final concepts of solutions are described by using a set of attributes (T_A). According to theorems 11 and 12 of GDT, the topology of T_A is stronger than the topology of a metamodel (see section 2.3.3) and consequently T_A should ensure better this property of separation. The classification and metamodel structures are described in sections 2.3.6 to 2.3.9 and in chapter 2.5. The goal is to obtain a structure of the classification space precise enough in order to ensure the property of separation.

The third condition of metrization is related to the countable characteristic of a set of generic abstract concepts developed in section 3.3.1. To be countable the generic abstract concepts should be based on a fundamental system of quantity. The characteristics of this fundamental system of quantities are developed in section 3.2.1 by introducing new basic quantities to the International System of quantities and units (SI system) [Sonin, 2001]. The development of this type of enhanced system of unit should take into account the three domains of design. This is followed by the presentation of the machinery aimed at obtaining the metric space in section 3.3.2.

Summary of the necessary conditions to obtain a metric space from a classification space:

- Having a *fundamental system of entourages*,
- Having a *sufficiently detailed* fundamental system of entourage in order to ensure separation (condition analysed in section 3.3.2),
- Having a *countable* fundamental system of entourage,

It is necessary to present in a more practical manner the consequences of this theoretical analysis. This is the goal of the following sections and chapters.

2.3.6 General classification structure of the metamodel framework

The fundamental objective in this thesis is to be able to compute at the end of the evaluation process a unique metric. It has been shown in the section 2.3.5 that this objective can be achieved if a certain number of conditions are met. These conditions are summarized in the previous section. Nevertheless the one which is of interest here consist at first of creating uniform classification structures. To achieve this goal of uniformity, fundamental systems of entourages have to be created. In practice for functions it can be achieved by selecting a normal vocabulary. This is done in section 2.4.3.

For metamodel structure it can be achieved by underlying generic types of concepts and mechanisms present in technical systems and technological processes (a *technical system* is defined as an entity or an artificial object and the *technological process* is defined as an artificial single action or consequences of procedures to perform activity with assistance of a technical system or a natural object [Savransky, 2000]). The choice of the fundamental system of entourages is not unique. In this thesis it has been decided to use as a fundamental system of entourage for the metamodel, a collection of generic mechanisms adapted from bond graph theory [Paynter, 1961] [Karnopp et al., 1990].

The bond graph theory is based on the initial fundamental principle of inviolability of the principle of conservation of the energy. This concept is a high-level abstraction but it is still a physical abstraction which is understood by many people. Then it can be considered has an appropriate principle to elaborate a metamodel framework. The principle of conservation of the energy which is common to different sub domains of physic such as thermodynamic, electromagnetic, mechanic and hydrodynamic allows for integration between those domains. In bond graph theory energy can be opened into a pair of conjugated quantities. These conjugated quantities are *effort* and *flow*. Flows represent an extensive quantity that can be accumulated and distributed. The accumulation of such quantity is accompanied by an increase of the associated intensive quantity effort. A difference between efforts is the cause of a flow until equilibrium is reached. As noted by Top [Top, 1993] the concepts of effort and flow can be found in other domains than physics. For example in economy an effort can be named a cost, a flow is for example a monetary flow [Marty, 1991]. When talking about information, a flow of information is needed to flow from the designing stage to the manufacturing stage. In similar manner an information potential is probably required by the manufacturers. This is the analogy with the effort.

These two quantities are domain dependant when energy is not. Flow and effort are observable quantities. Effort and flow are influenced by organs [Hubka, Andreasen and Eder, 1988] or mechanisms [Roth,

1982] [Pahl and Beitz, 1984]. These mechanisms can be considered as elementary processes that interact together and determine the behaviour (see definition of behaviour in section 2.4.2 or in nomenclature and generic definitions) of a system. At a general level these mechanisms represents laws (physical laws, economical laws and information transfer laws).

According to the bong graph theory [Karnopp et al., 1990] [Top, 1993] the organs can be classified into six basic types:

Storage mechanisms: These organs accumulate and release efforts or flows. They are represented by the generalized capacitor C and the generalized inertia I. The Figure 13 and Figure 14 present a block diagram of this type of storage mechanism associated with the law organising the mechanism behaviour.

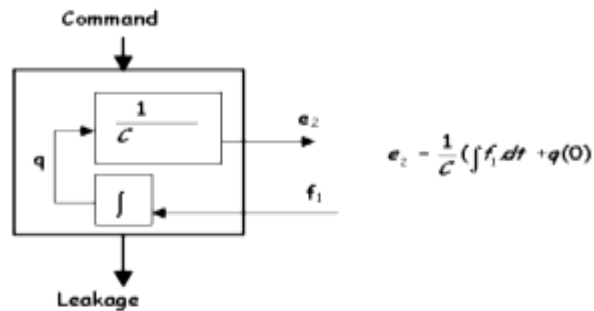

Figure 13: C-organ

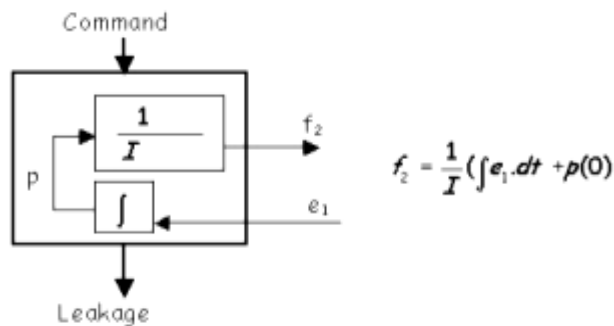

Figure 14: I-organ

A *C-organ* (for example a bank account in the economical domain) refers to the storage of monetary charge (Monetary unit, Quantity of time). In the electrical domain, it refers to a capacitor storing an electrical charge in Coulomb (Ampère, Quantity of time). In the mechanical domain (translation), it refers to a translational spring

which store displacement (Unit of displacement). An *I-organ* in the mechanical domain refers to the storage of momentum.

Dissipative mechanism: These organs convert free energy into heat inside of a system or heat is lost into the environment in the case of complex thermodynamic structures called open systems [Glansdorff and Prigogine, 1971] [Odum, 1994]. Complex technical structures like cars, planes and robots constitute cases of open systems in the same respect than living structures. R-organs belong to the dissipative mechanism family. The Ohm's law is generalized in the dissipative mechanism.

Source of effort and source of flow mechanisms: These organs directly impose effort or flow at some point of the system and at a certain level imposed by the internal characteristics of the source. The two organs *Se* and *Sf* belong to that class of mechanism.

Converting mechanisms: These organs amplify effort or flow or connect flow to effort or effort to flow. This is done respectively by the T-organ and by the gyrator organs (G-organ). Both of these organs are defined in term of mathematical laws.

Distribution mechanisms: These elements represent the distribution of energy. Paynter [Paynter, 1961] has introduced the 0-organ and the 1-organ. They generalize the Kirshoff's law commonly used in electrical networks. Other organs have been introduced in this thesis; these organs represent the basic mechanical link which can be used in a mechanical structure.

Calculation mechanisms: These organs are logical mechanisms. They have been added to the five families of mechanisms used in bond graph theory. The reasons of the decision are explained below.

Initially, Karnopp [Karnopp et al., 1990] [Top, 1993] has defined five elementary mechanisms in the bond graph theory. These five elementary mechanisms can not represent the action of *processing* defined by the normal vocabulary of function summarized by Hirtz and her colleagues [Hirtz et al., 2002]. The action of *processing* is presented in many technical systems (TS) or technological processes (TP) nowadays. Consequently it is argued in this thesis that another family of elementary mechanisms should be added to the five initial elementary families of mechanisms. This family is called calculation mechanisms. This family of mechanisms has been reduced in this thesis to three fundamental logical components namely the NO organ, OR organ and the AND organ. These logical components are sufficient in order to implement the more complex function levels like *store* and *process (compare, calculate and check)*.

In addition, this thesis has enlarged the number of elementary mechanisms which constitute the distribution mechanisms family by integrating into the distributive mechanisms the mechanical links (i.e. fasten link, rotational link, etc...) which are implemented in all systems.

An upper class of abstraction has been created in order to show how the elementary mechanisms families can be combined to form more complex structures. This class is constituted by three complex mechanisms. These complex systems are called respectively *Signal mechanisms*, *Command Unit mechanisms* and *Open systems mechanisms* [Glansdorff and Prigogine, 1971] [Odum, 1994] and they are built by the combination of basic mechanisms. The description of these super mechanisms is done below.

Signal Mechanisms:

The signal mechanism family is synthesized by a combination of *converting mechanisms* and/or *dissipative mechanisms* and/or *storage mechanisms* and/or *distributive mechanisms*. The reasons for all these possible combinations are that at first, the action of a signal mechanism is to *signal*. Consequently, the action of *signalling* can be decomposed according to the taxonomy of Hirtz (see Table 9) [Hirtz et al., 2002] into several secondary actions (i.e. *to sense*, *to indicate*, *to process*). The action of *sensing* implies in most of the cases to *convert* a signal and/or to *magnitute* this signal according to the normal vocabulary defined by Hirtz [Hirtz et al., 2002]. Consequently, these two basic actions are related to the *converting mechanisms* and to the *dissipative mechanisms*. *Indicating* implies in most of the cases the *branching-transferring-transmitting* and this can be done by *distributive mechanisms*. Processing implies calculation; consequently it can be embodied by using *calculation mechanisms*.

Command Unit mechanisms:

The command unit mechanisms can be identified in many practical living or technical systems. A brain and computers constitute a practical implementation of this type of mechanisms. Their goal is to represent by using an abstract concept the ability technical systems or living structures have to implement the primary function of the taxonomy of Hirtz called *Control* [Hirtz, 2002]. To achieve this goal these types of mechanisms should combine a number of basic mechanisms. These mechanisms can be analysed through the study of a command unit mechanism. The Figure 15, Figure 16 and Figure 17 present the analysis of the command unit mechanisms by at first taking the usual representation of a command unit. After this the representation is transformed in a functional structure and finally the functional structure is associated with basic mechanisms.

Therefore the four types of mechanisms necessary in order to synthesize a command unit mechanism are:

- The calculation mechanisms,
- The distributive mechanisms,
- The storage mechanisms,
- The signal mechanisms,

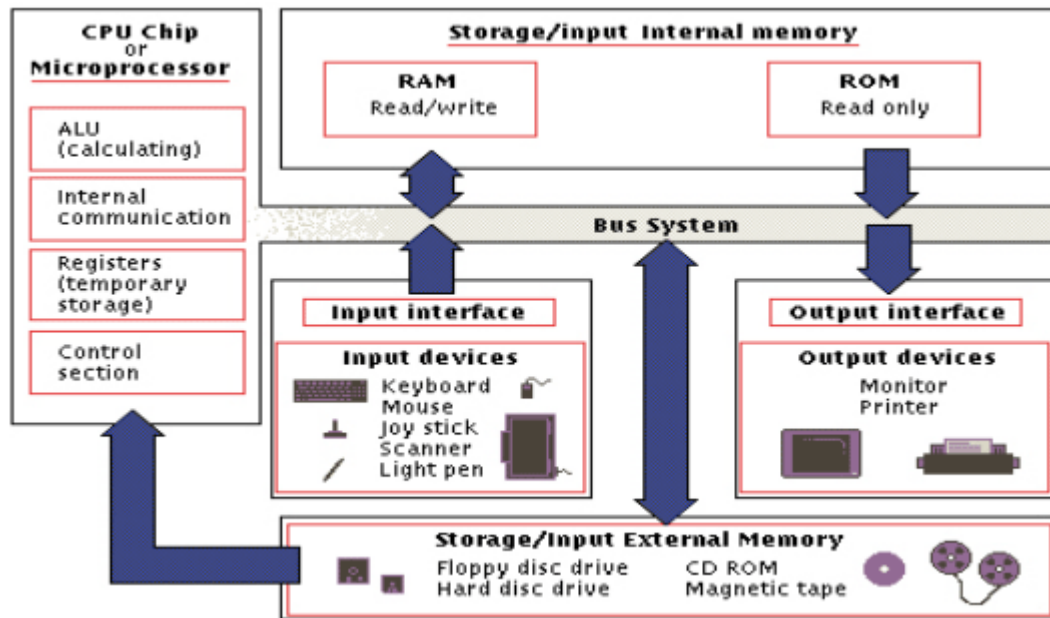

Figure 15: Structure of a command unit mechanism

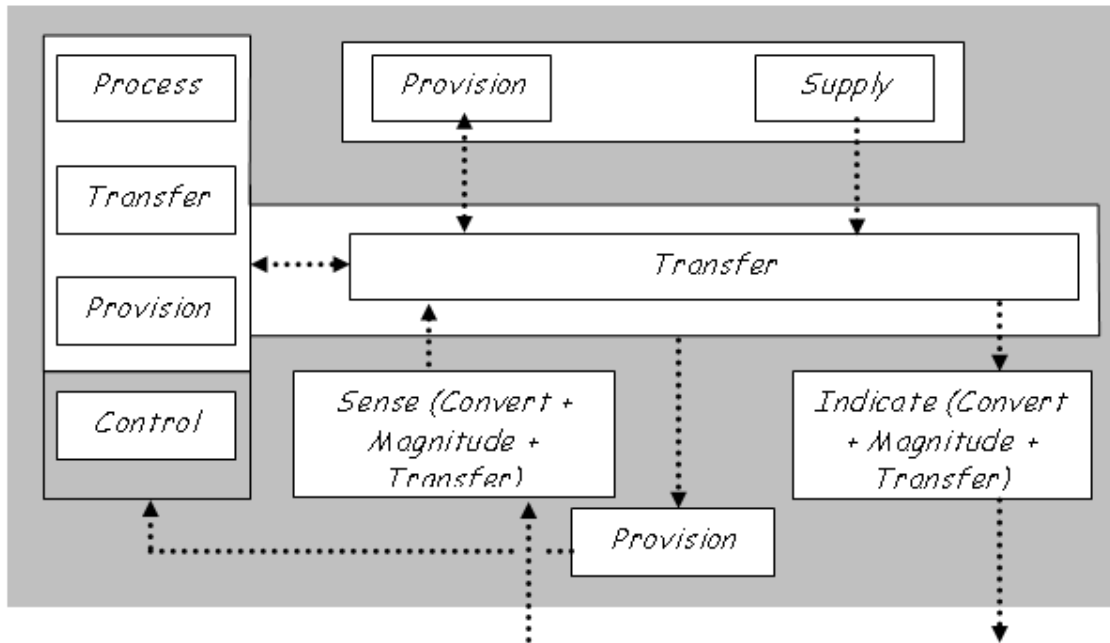

Figure 16: Simplified functional structure of a control unit mechanism

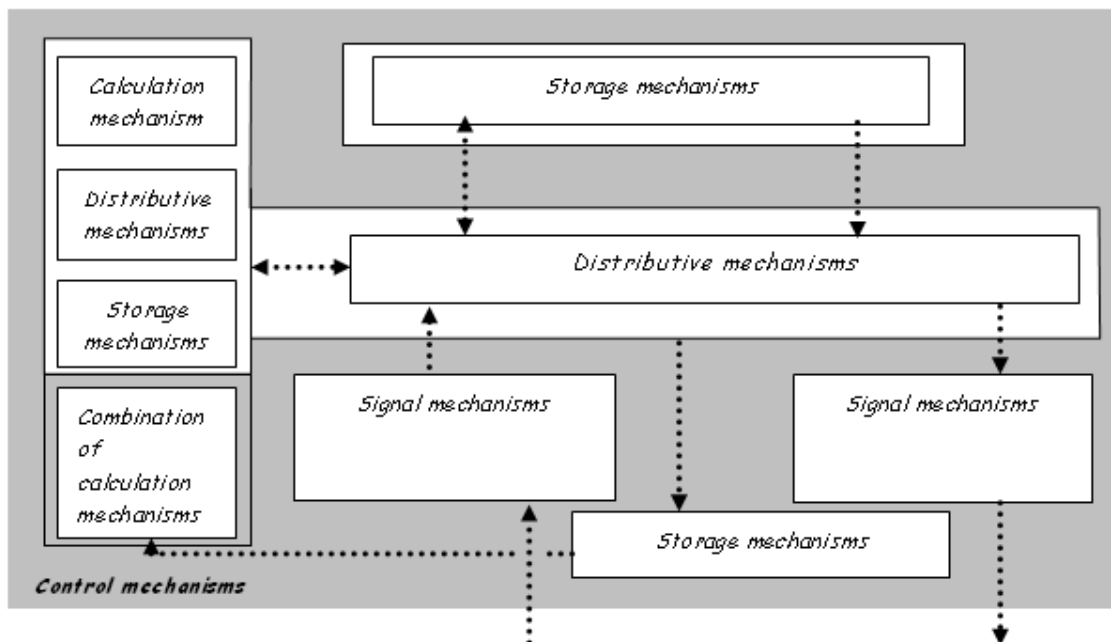

Figure 17: Different types of mechanisms involved in the implementation of control mechanisms

Open system family:

I state in this thesis that open system mechanisms are useful both for implementing complex structures able to grasp the complete functional structure exhibited in the taxonomy of Hirtz (see Table 9) and modelling the environmental effects of systems. This second statement is analysed below.

An Open system is defined according to Glansdorff and Prigogine [Glansdorff and Prigogine, 1971] and Odum [Odum, 1994] as a thermodynamic ordered structure which is synthesized from disordered atoms and molecules found in atmosphere and soils. This kind of structure imports the necessary energy and exports entropy into its environment in order to stay far from the thermodynamic equilibrium of highest entropy. This equilibrium is only reached when a structure dies or breaks.

Living structures and complex technical inventions like cars, and autonomous robots belong to this family of systems.

An open system does not necessary contain a command unit mechanism. An open system structure emphasizes on the energetic exchange with the external environment in terms of entropy. According to the theory of Open systems [Glansdorff and Prigogine, 1971], the total variation of entropy is presented in the form of two items:

$$\text{Eq. 1} \quad dS(t) = diS(t) + deS(t)$$

Where $d_iS(t) = \frac{dQ(t)}{T(t)}$, $dQ(t)$ is the heat production (in Joules) caused by irreversible processes within the system and $T(t)$ is the current temperature (in Kelvin) at a given point of the external environment of the system. The value $d_eS(t)$ corresponds to the entropy of exchange processes between the system and its environment. Based on the Eq. 1 Svirezhev [Svirezhev, 2000] has modelled the impact of the entropy of a system on the environment in the following manner:

$$\text{Eq. 2} \quad \sigma = \frac{W(t)}{T(t)} + \frac{P_1(t)}{T(t)} - \frac{P_0(t)}{T(t)}$$

Where σ is the environment degradation (degradation if $\sigma > 0$), $\frac{W(t)}{T(t)}$ is the entropy produced by the flow of energy into the

system, $\frac{P_1(t)}{T(t)}$ is the production entropy of the system in terms of direct effect on the system in the environment (e.g. chemical elimination into the environment, matter elimination into the environment, mechanical impact on the environment, etc..) and $\frac{P_0(t)}{T(t)}$ is the *entropy pump* of the environment, its ability to recycle a certain amount of entropy corresponding to the environment in a steady state. According to the fundamental law expressed in Eq. 2, it is possible to model the environmental impact of a system by using the concept of open system. This law can also be applied to basic mechanisms and super mechanisms for the same purpose.

This is the reason why I state that by using the abstract generic mechanism called open system and the associated concept of entropy it is possible to model the thermodynamic exchanges of a studied system with the environment. In addition, the concept of entropy is considered to be an appropriate metric in order to measure the environmental impact. Indeed, the concept of entropy can be used to measure both the flow of substance and the flow of energy between the system and its environment.

In opposite to traditional bond graph approach which derives the abstract model from the observed device or process; the approach developed in this thesis is using an enhanced bond graph semantic in order to flow from a description of abstract concepts into a form of a group of function to a physical implementation of the concept of entity via the use of the invariant semantic developed in this chapter.

Consequently, this analysis shows that it is necessary an sufficient to implement an Open system mechanism to use at least the five initial types of mechanisms of the bond graph method [Karnopp et al., 1990] namely *the storage mechanisms, the dissipative mechanisms, the sources mechanisms, the converting mechanisms, the distributive mechanisms*. In addition *the command unit mechanisms* and *the signal mechanisms* can also be integrated into an Open system mechanism.

2.3.7 The three domains of design

A generic functional vocabulary derived from Hirtz [Hirtz et al., 2002] has been presented in the Table 9 and Table 10. According to the vision developed in this thesis, the design process needs to be analysed from a physical design life cycle perspective. The physical design life cycle deals with three fundamental aspects according to the Figure 18. Consequently it is stated in this thesis that the physical design life cycle can be divided in three fundamental domains summarized in the Figure 18.

Analysing a design problem in the physical domain should provide information about the physical elements of a future product. The economical domain deals with the efficient use of resources during the design, production, distribution, consumption and recycling and more specifically it deals with the constraints of cost established during the definition of the product requirements. The informational domain deals with the commands (requests, desires, rules, normative statements) and data (verbal, graphical, symbolic and numerical). Nevertheless it should be noticed that information is not only present as an interface between the different parts of the physical design life cycle as shown in Figure 18 but information is also present in the physical domain and in the economical domain. However the informational domain deals specifically with transfer of information between the phases of the physical design life cycle.

Information is a central element in the design process and therefore I have decided to introduce information as a specific domain of design. A precise study of the concept of information is done in the section 3.3.1.

It is obvious that these three domains are linked together. The link is ensured by the transfer of information between the physical and the economical domains. Information is considered to be the connecting domain. The idea to introduce these three domains is mainly related with the objective to define a framework able to deal with the design activity in a structured manner. The choice of a domain is the first selection a designer has to do in this methodology. A design process is considered to be achieved if the physical life cycle of a product has been studied both in the physical and economical domains by using the informational domain as an interface.

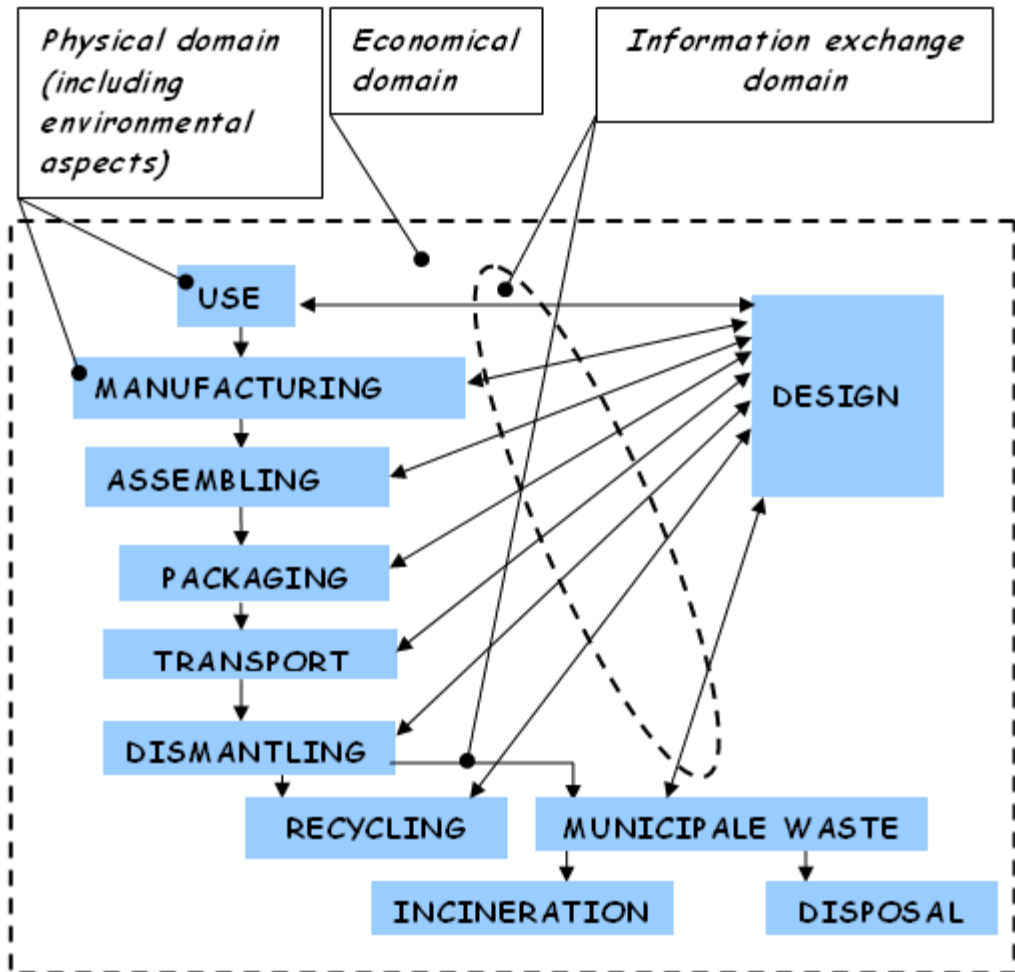

Figure 18: Representation of the three domains of design

2.3.8 The principle of conservation of the energy and its consequences: Presentation of the derived concepts and of the normal vocabulary associated with this principle

The principle of conservation of the energy constitutes the fundamental basis of the metamodel framework which is developed in the chapter 3. This principle rules the three fundamental domains and the entire physical life cycle. The concept of energy is interpreted in a broad sense by taking into account also the potential energy which can be generated by money or informational signals. The concept of energy itself can be divided into sub-classes called fields. A combines the type of energy and a carrier (i.e. a substance in the sense of the classification of Table 10). This concept of field is developed in section 2.4.4. The fields themselves can be measured by using laws. These laws are described through two types of fundamental variables [Karnopp et al., 1990]. The first types are the

energy variables called *states variables* which are formed by the *momentum* $p(t)$ and the *displacement* $q(t)$. The second types of variables are the *power variables* $P(t)$ which are formed by the *effort* $e(t)$ and the *flow* $f(t)$. These variables are connected to the *energy* $E(t)$ via following equations Eq. 3 and Eq. 4. The power variables can be derived from state variables via Eq. 5 and Eq. 6:

$$\text{Eq. 3} \quad E(t) = \int^t P(t)dt = \int^t e(t)f(t)dt$$

$$\text{Eq. 4} \quad E(t) = \int^t e(t)dq(t) = \int^t f(t)dp(t)$$

$$\text{Eq. 5} \quad \frac{dp(t)}{dt} = e(t)$$

$$\text{Eq. 6} \quad \frac{dq(t)}{dt} = f(t)$$

A standard vocabulary for the concepts of domain, energy, field, power and state variable is defined in Table 6 and Table 7. This vocabulary and the classification are used in chapter 2.5 to develop the metamodel structure. This structure is used in chapter 3 in order to provide guidance during the clarification/formulation and synthesis process but also during the metrization.

Table 6: Classifications of domains and related names for power variables (adapted from Hirtz [Hirtz, 2002])

DOMAINS	Energy	Primary fields	Secondary fields	Generalized effort (e)	Generalized flow (f)				
Physical	Energy	Acoustic Biological Chemical Electrical Hydraulic Magnetic Mechanical		Effort	Flow				
				Acoustic Pressure	Particle velocity				
				Biological Pressure	Volumetric flow				
				Chemical Affinity	Reaction rate				
				Electrical potential	Current				
				Hydraulic Pressure	Volumetric flow				
				Magnetomotive force	Magnetic flux rate				
				Mechanical Effort	Flow				
				Rotational	Angular velocity				
				Translational	Linear velocity				
		Pneumatic Electromagnetic			Pneumatic Pressure	Mass flow			
					Radiation potential	Number of particles			
					Gamma (Photon + $\Delta\lambda_1$)	Number of particles			
					X Ray (photon + 2 neutrons)	Number of particles			
					UV(Photon + $\Delta\lambda_2$)	Number of particles			
					Visible (Photon + $\Delta\lambda$)	Number of particles			
					Infra-Red (Photon + $\Delta\lambda_4$)	Number of particles			
					Radio (atoms, molecules + $\Delta\lambda$)	Number of particles			
					Radioactive/Nuclear			Decay rate	Number of particles
								Beta (Electron + antineutron) or (Positon + neutrino)	Number of particles
		Alpha (proton + 2 neutrons)	Number of particles						
		Thermodynamic/Environmental			Thermal Temperature	Heat flow			
					Heat transfer	Entropy per unit of time			
					Mass transfer	Mass per unit of time			
					Mechanical work	Volume flow (Q)			
		Information	Signal	Status	Auditory	Informational potential	Information flow		
					Olfactory	Informational potential	Information flow		
					Tactile	Informational potential	Information flow		
					Taste	Informational potential	Information flow		
					Visual	Informational potential	Information flow		
Control					Analog	Informational potential	Information flow		
					Discrete	Informational potential	Information flow		
Economical	Monetary	Control	Physical currency Digital currency Exchange	Cost	Monetary flow				

Table 7: Classifications of domains and related names for state variables (adapted from Hirtz [Hirtz, 2002])

Domain	Energy	Primary fields	Secondary fields	Generalized Displacement (q)	Generalized Momentum (p)			
Physical	Energy	Mechanical Translation		Displacement	Momentum			
			Mechanical	Angular	Angular			
			Rotational	Displacement	Momentum			
		Electrical		Electrical charge (q)	Flux			
					Linkage (OR)			
				magnetic flux				
		Pneumatic		Volume	Pressure momentum			
		Hydraulic		Volume	Pressure			
					Momentum			
		Thermodynamic	Heat exchange		Entropy (S)	Temperature		
						Momentum		
			Mass flow	Mass	Free Gibbs enthalpy			
		AND				Momentum		
		Environmental			Mechanical	Volume	Pressure	
					Work		Momentum	
			Magnetic			displacement	Magnetic momentum	
			Acoustic			volume	Particle pressure momentum	
			Biological			volume	Pressure momentum	
			Chemical			volume	Pressure momentum	
			Electromagnetic				Wave length (λ)	Momentum
					Gamma (Photon + $\Delta\lambda_1$)		Wave length (λ)	Momentum
					X Ray (photon + 2 neutrons)		Wave length (λ)	Momentum
					UV(Photon + $\Delta\lambda_2$)		Wave length (λ)	Momentum
				Visible (Photon + $\Delta\lambda$)		Wave length (λ)	Momentum	
				Infra-Red (Photon + $\Delta\lambda_4$)		Wave length (λ)	Momentum	
				Radio (atoms, molecules + $\Delta\lambda$)		Wave length (λ)	Momentum	
						Displacement	Momentum	
Radioactivity			Beta (Electron + antineutron) or (Positon + neutrino)	Displacement	Momentum			
			Alpha (proton + 2 neutrons)	Displacement	Momentum			
			Auditory	Informational Charge (Iq)	Informational flux			
			Olfactory		Linkage			
			Tactile					
		Taste						
		Visual						
Informational	Signal	Status						
Economical	Monetary	Control	Analog	Informational Charge (Iq)	Informational flux			
		Control	Discrete	Monetary Charge (Eq)	Linkage			
			Physical currency		Monetary flux			
			Digital currency					
			Exchange					

2.3.9 Presentation of the basic mechanisms used in the thesis

In order to provide guidance for the designer when proceeding from a functional description of a design problem to a synthesis of generic concepts of solutions, it is important to provide a detailed description of the basic generic mechanisms. The presentation of the generic basic mechanisms is done below. The basic mechanisms are divided in 6 subgroups. These 6 subgroups constitute the *secondary basic class of mechanisms*. The elements of this class can be combined into a super class called *primary basic class* which contain the command unit mechanisms. The secondary and the primary class can be in turn combined in order to form the *basic mechanism family* which is composed of the open system mechanisms.

At first, the 6 subgroups of the secondary basic class are presented below and associated with the generic laws which govern the behaviour of the mechanisms. A functional vocabulary is mapped with the mechanisms. A harmful function [Altshuller, 1984] of a mechanism consists of *Channelling* loss in term of substance and fields in the environment. A more precise description of the harmful functions can only be made when implementation of concepts of solutions is made.

The SADT representation [SADT®] has been selected in order to represent the basic mechanisms because it can be used to represent a design problem both in term of actions and data. The framework used in this thesis should be able to take into account both the physical aspects of a product but also the informational and economical aspects. These aspects are studied in section 2.3.7. The SADT approach is not normalized. It should be noticed that a normalized approach called IDEFO exists [IDEFO]. Nevertheless this approach concentrates on the activity aspects of a system when SADT deals also with data. Consequently the SADT model is more comprehensive and this is the reason why this representation has been selected for the representation of generic mechanisms. The SADT approach however is not taking into account the time in the modelling process. This aspect is added in the following SADT representation of this thesis.

The SADT representation distinguishes between the two types of flows respectively the flows of energy represented by the field type associated with the substance which carry the field and the substance(s) [Altshuller, 1984] which is processed by the technical system (TS) or the technological process (TP). The representation of these flows is given in the following figure.

Substance	—————
Energy field and carrying substance

Figure 19: Substance and energy representation in SADT representation

N.B.: The types of functions used in the thesis and the normalized vocabulary are defined in sections 2.4.5 and 2.4.3. Nevertheless this vocabulary is already necessary to present the family of mechanisms and there mapping with functions as presented below.

Secondary basic class of mechanisms:

Storage mechanisms family: This family is composed of two mechanisms called the C-organ and the I-organ. The verb used for the support useful function of these mechanisms is to *PROVISION* and the verb for the secondary useful function is to *CONVERT*.

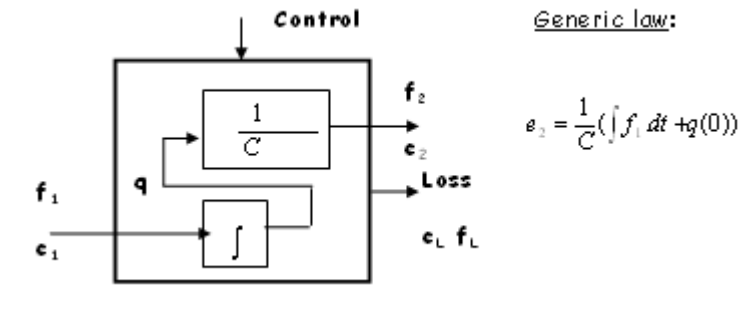

Figure 20: SADT representation of the C-organ

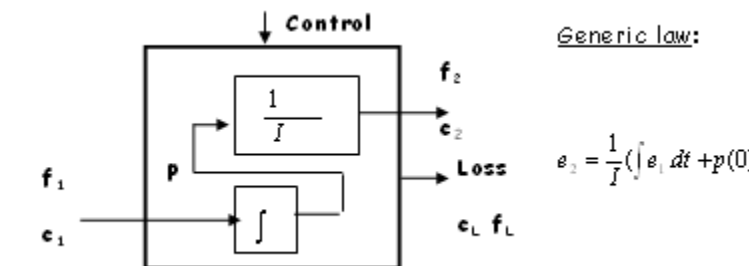

Figure 21: SADT representation of the I-organ

Dissipative mechanisms family: This family is composed of a single type of organ, the R-organ. The verbs for the support useful function of this mechanism are to *MAGNITUDE* and *CONVERT*.

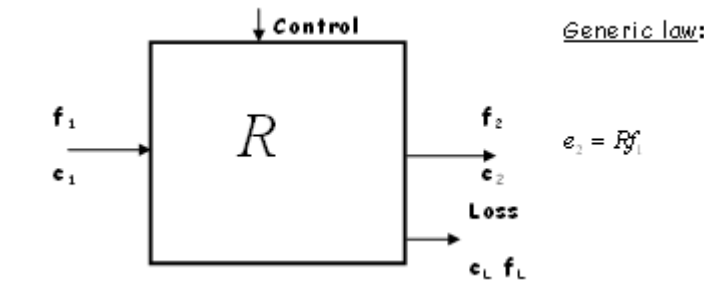

Figure 22: SADT representation 1 of the R-organ

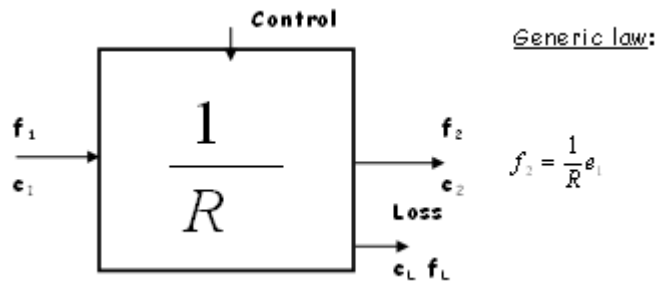

Figure 23: SADT representation 2 of the R-organ

Source of effort and source of flow mechanisms family: This family is composed of two organs called the Se-organ and Sf-organ. The verb used for the support useful function of these mechanisms is to *PROVISION*.

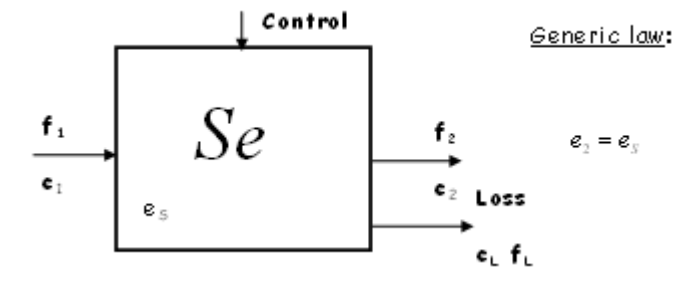

Figure 24: SADT representation of a Se-organ

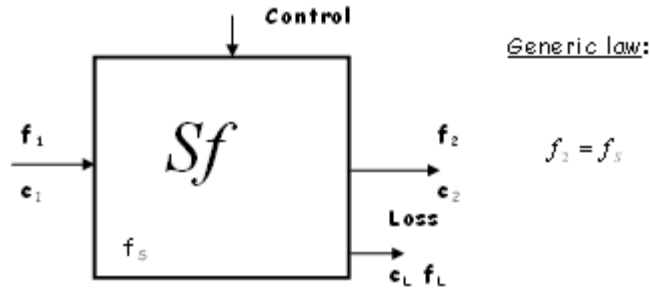

Figure 25: SADT representation of a *Sf*-organ

Converting mechanisms family: This family is composed of two organs called the T-organ and the G-organ. The verbs used for the support useful function of these mechanisms are to *CONVERT* and the verb for secondary useful function is to *MAGNITUDE*.

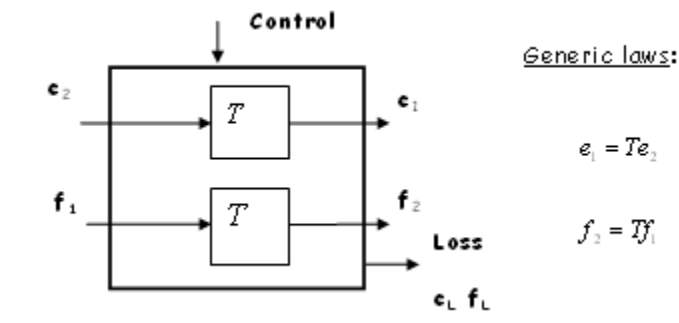

Figure 26: SADT representation 1 of the T-organ

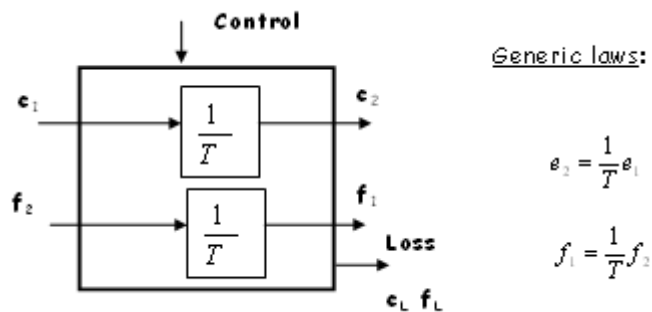

Figure 27: SADT representation 2 of the T-organ

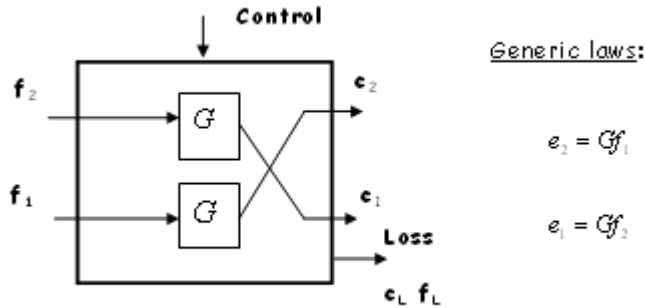

Figure 28: SADT representation 1 of the G-organ

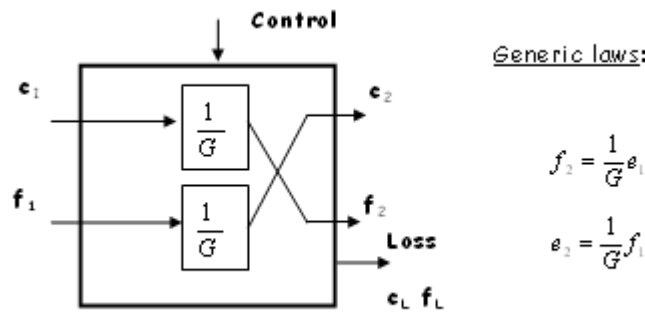

Figure 29: SADT representation 2 of the G-organ

Distributive mechanisms family: This family is composed of twelve organs divided into two groups. These two groups are using the principle of power conservation as a fundamental law. This law can be represented by the following equation:

$$Eq. 7 \quad \sum_{i=1}^n e_i f_i = 0$$

The subgroups are called respectively *Paynter's junctions subgroup* and *mechanical junctions' subgroup*.

The group of junctions called the *Paynter's junctions subgroup* has been invented by Paynter [Top, 1993] and they are used in bond graph theory [Paynter, 1959] [Karnopp et al., 1990] in order to analyse physical problems dealing with the electrical, hydraulic, pneumatic, mechanical translational and mechanical rotational fields. Nevertheless, these two types of junctions in the case of mechanical problems are used for modelling the junctions between elastic elements for the effort-organ and for modelling the junction

between rigid elements for the flow-organ. They are however useless for modelling other types of mechanical junctions which are almost all the time present in complex systems dealing with mechanical parts. Consequently it is argued in this thesis that some other distributive mechanisms should be added in order to ensure a complete modelling ability of the metamodel approach.

These mechanisms constitute the second subgroup called *mechanical junctions subgroup*. This subgroup is dedicated to the modelling of the mechanical systems. This group requires representing the power variables in order to take into account the six possible degrees of freedom of a mechanism in space. Consequently this family of mechanism can allow 3 degrees of freedom in mechanical translational field and 3 degrees of freedom in the mechanical rotational field. This family of mechanisms combines these two fields.

Paynter's junctions subgroup:

The verbs used for the support useful function of these mechanisms are to *BRANCH*, *CHANNEL* and *CONNECT*.

- *Effort-junction*

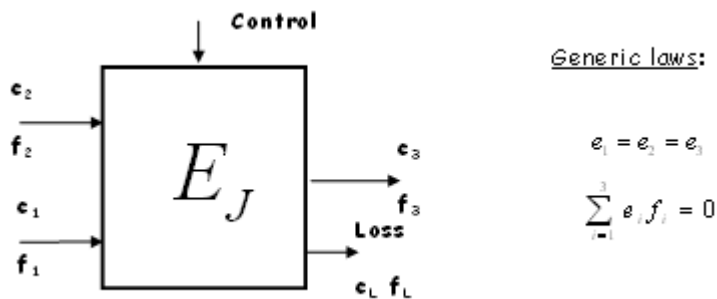

Figure 30: SADT representation of the Effort junction organ

- *Flow-junction*

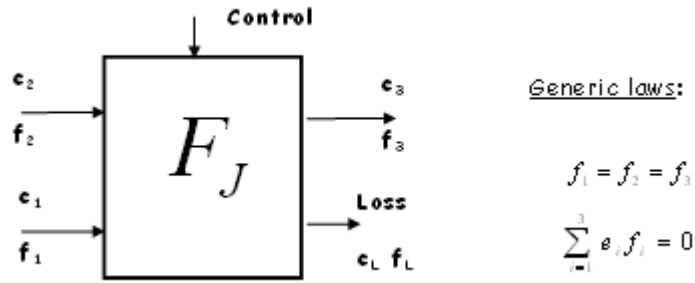

Figure 31: SADT representation of the Flow junction organ

Mechanical junctions subgroup:

The mechanical junctions' subgroups are mechanisms which combine the properties of the effort and flow junctions as it is shown by the generic laws. These types of mechanisms are ruled by the same generic law of power conservation. In addition the degrees of freedom of this type of mechanisms are taken into account. We can imagine a generic mechanical junction which can be controlled in order to switch from one type of link organ to another one. This generic mechanical junction can be defined as below.

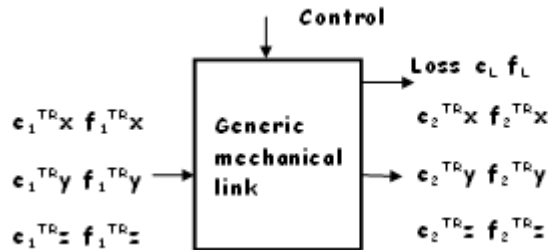

Figure 32: SADT representation of the generic mechanical organ with control

The general verb used for the support useful function of this family of mechanisms is to *COUPLE* or *GUIDE*. The specific mechanisms and their laws are presented below.

An important remark: All the following laws are related to the relative movement between the two parts of a link. This is of importance to have this aspect in mind when modelling mechanisms. The SADT modelling of the example of section 3.2.1 takes this aspect into account.

Lock link organ,

It should be noticed that a lock link in the mechanical field is a specific case of an effort junction. In the case of a synthesis in the mechanical field both organs can be selected for implementing the same function. The specific verbs used for the support useful function of this type of mechanism are to *COUPLE-JOIN* and *STOP*.

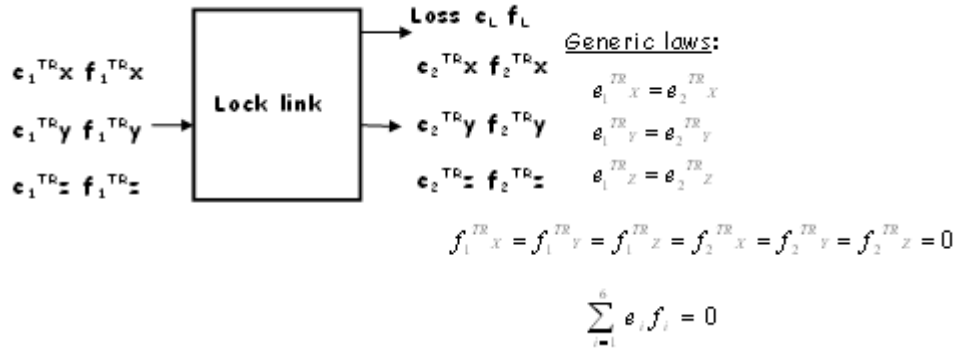

Figure 33: SADT representation of the Lock link organ

- *Rotational link-organ,*

The verbs used for the support useful function of this mechanism are to *GUIDE-ROTATE*.

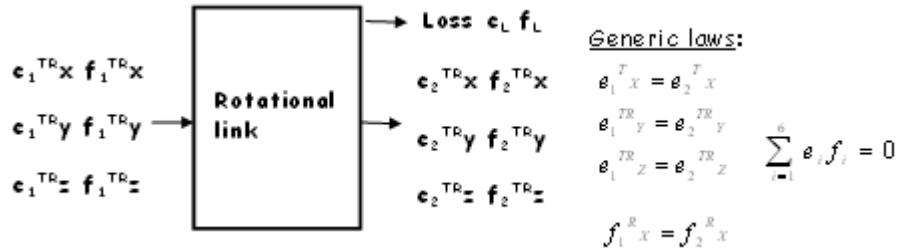

Figure 34: SADT representation of the Rotational link organ

- *Prismatic link-organ,*

The verbs used for the support useful function of this mechanism are to *GUIDE-TRANSLATE*.

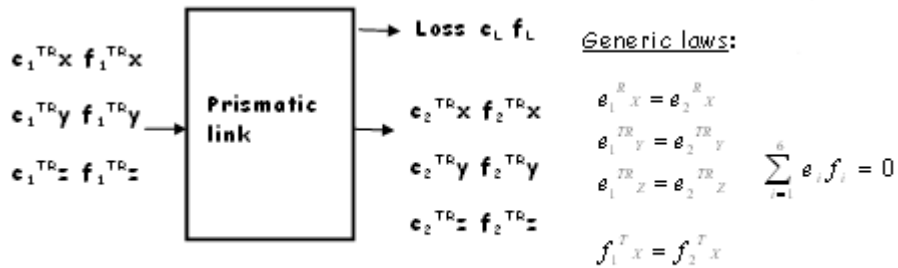

Figure 35: SADT representation of the Prismatic link organ

- *Helicoidal link-organ,*

It should be noticed that the helicoidal link-organ is a particular case of the converting mechanism T-organ.

The verb used for the support useful function of this mechanism is to *CONVERT*. This is in agreement with the practical rule of design stating that screws should not be used for guiding.

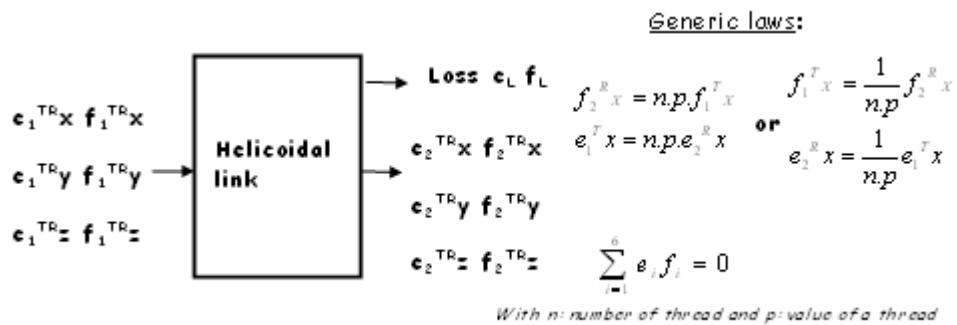

Figure 36: SADT representation of the Helicoidal link organ

- *Rotational and translational link-organ,*

The verbs used for the support useful function of this mechanism are to *GUIDE-ROTATE* and *TRANSLATE*.

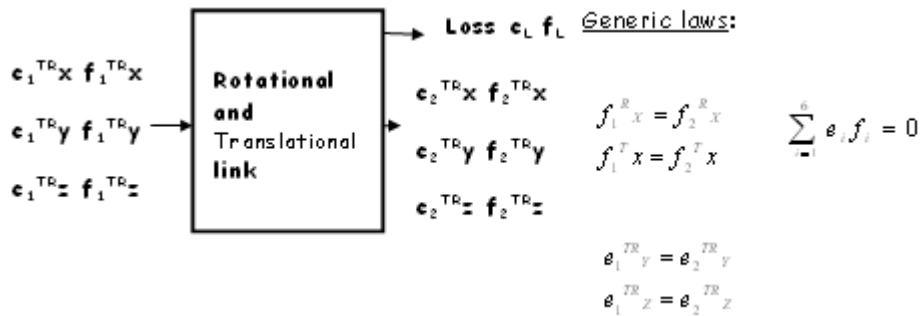

Figure 37: SADT representation of the Rotational-Translational link organ

- *Spherical link-organ,*

The verbs used for the support useful function of this mechanism are to *GUIDE-ROTATE*.

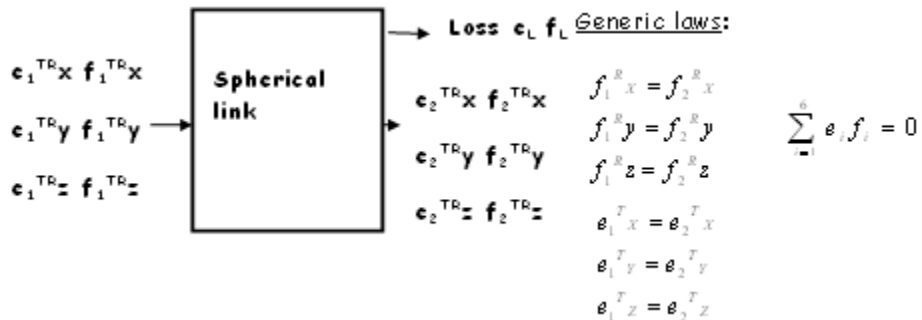

Figure 38: SADT representation of the Spherical link organ

- Spherical link with finger-organ,

The verbs used for the support useful function of this mechanism are to *GUIDE-ROTATE*.

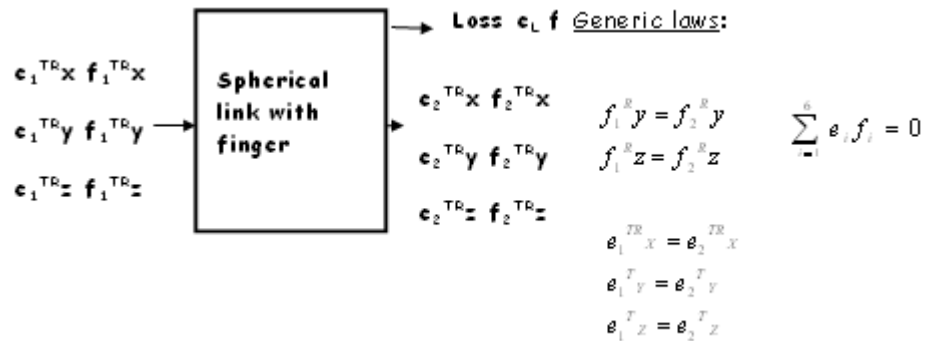

Figure 39: SADT representation of the Spherical link with finger organ

- Plan link-organ,

The verbs used for the support useful function of this mechanism are to *GUIDE-ROTATE* and *TRANSLATE*.

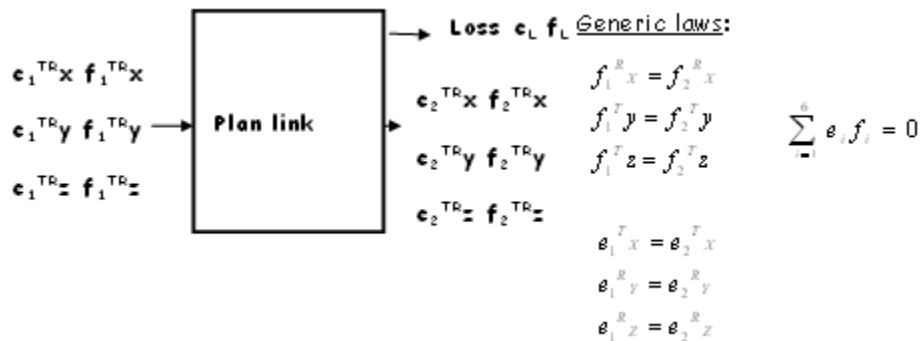

Figure 40: SADT representation of the Plan link organ

- *Linear annular link-organ,*

The verbs used for the support useful function of this mechanism are to *GUIDE-ROTATE* and *TRANSLATE*.

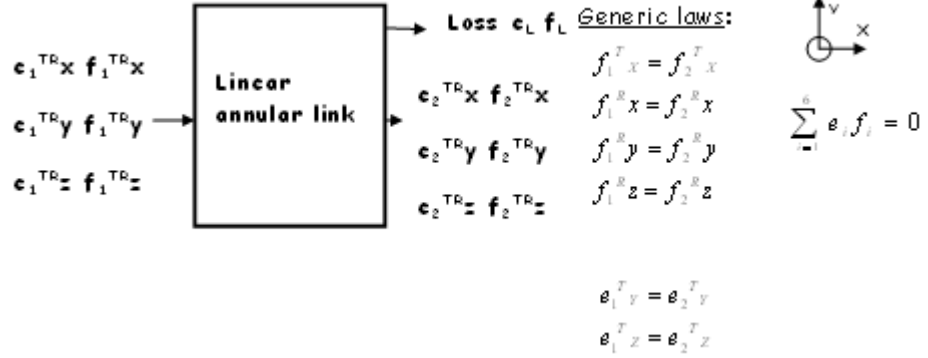

Figure 41: SADT representation of the Linear annular organ

- *Linear link-organ,*

The verbs used for the support useful function of this mechanism are to *GUIDE-ROTATE* and *TRANSLATE*.

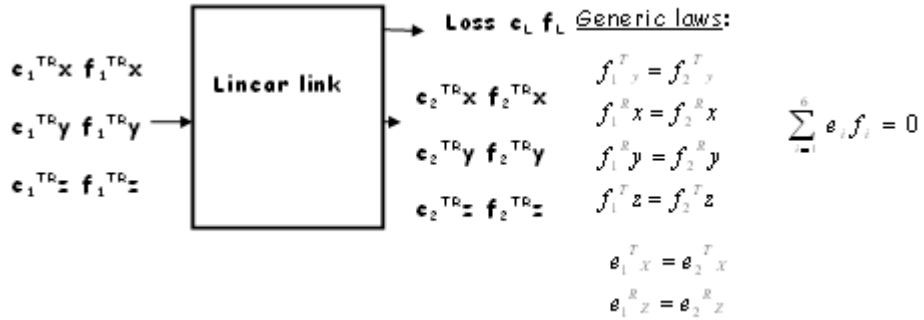

Figure 42: SADT representation of the Linear link organ

- Point link-organ,

The verbs used for the support useful function of this mechanism are to *GUIDE-ROTATE* and *TRANSLATE*.

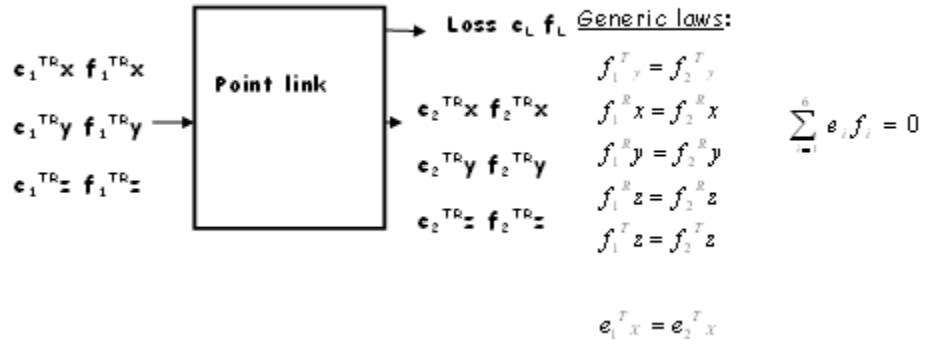

Figure 43: SADT representation of the Point link organ

Calculation mechanisms family:

In these mechanisms the laws are based on the Boolean algebra rules namely *the Commutative Law, the Associate Law, the Distributive Law, the Identity Law, the Redundance Law and the De Morgan's theorem*. An AND organ is denoted by (\cdot), an OR organ is denoted by ($+$) and the NO organ is denoted by the variable v and its complementary element \bar{v} . Like in the case of the mechanical junctions' subgroup, we can imagine a generic calculation mechanism which can be controlled and transformed alternatively in each of the three fundamental organs.

- NO-organ,

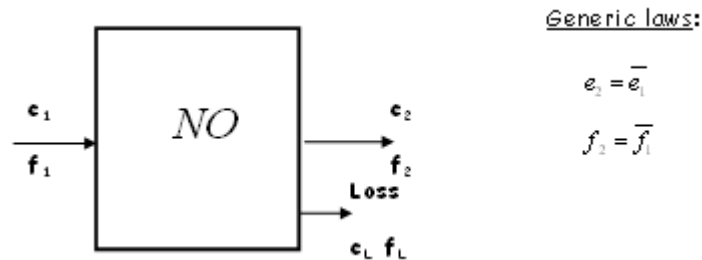
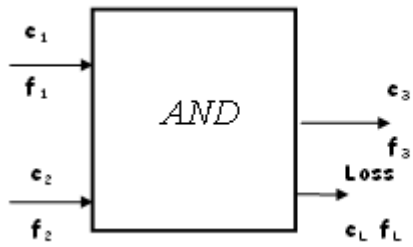

Figure 44: SADT representation of the No organ

- *AND-organ,*



Generic laws:

$$e_3 = e_1 e_2$$

$$f_3 = f_1 f_2$$

Figure 45: SADT representation of the AND organ

- *OR-organ,*

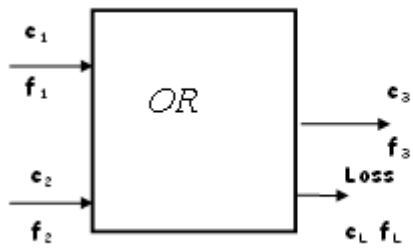

Generic laws:

$$e_3 = e_1 + e_2$$

$$f_3 = f_1 + f_2$$

Figure 46: SADT representation of the OR organ

2.4 Analysis of the concept of function used in the thesis

2.4.1 Introduction

Nature of function in different methodologies and theories:

In the Pahl and Beitz [Pahl and Beitz, 1984] methodology, a functional structure is defined as “a meaningful and compatible combination of sub-functions into an overall function”. The functions are classified as main or auxiliary functions. Main functions are those sub-functions that serve the overall function directly, and auxiliary functions are those that contribute to it indirectly. In this methodology, the definition of function and relations between functions and design parameters are general, and the final decision about the meaningful and compatible combination of the function depends uniquely on the designer’s personal preference.

In AD [Suh, 1990], *functional requirements* are defined as “the minimum set of independent requirements that completely characterize the design objective for a specific need.” Here, there is no more precise definition of a function and no distinction between main and auxiliary functions. The definition of function in AD is largely subjective.

The previous chapter has already given definitions of functions proposed by Yoshikawa in GDT, and modified in the Extended General Design Theory by Tomiyama and Yoshikawa [Yoshikawa, 1981] [Tomiyama et al., 1987]. For the readers, it is of interest to remind the initial definition of the first version of the GDT [Yoshikawa, 1981], “When an entity is exposed to a circumstance, a peculiar behaviour appear corresponding to the circumstance. This behaviour is called as *visible function*. Different behaviours are observed for different circumstances. The total of these behaviours is called as *latent function*. Both are called *function* inclusively.”

In the methodology developed by Dardy and Teixido [Dardy and Teixido, 2003], a function is described according to the norms FD X50-101 and NF X50-151 as “an action of a product or one of his component expressed in term of finality” [FD X50-101] [NF X50-151]. To express a function they propose to use a verb associated with one or several complement. They also distinguish two types of functions.

The first one is called *service function*. This type of function is defined as “the actions expected of the product in order to answer the user’s needs”. When needed the designer can distinguish between the *usability functions* and the *esteem function*. The usability function is directly related to the service given by the product to the user. The esteem function is more connected to the

value the user have for the product than to the real service the product gives to the user. For example in many cases having an expensive and powerful car does not provide any extra function in term of usability but more in term of esteem.

The second type of function is the *constraint* which is the “limitation of the designer’s freedom considered to be necessary for the applicant”.

Dardy and Teixido also present another type of function called *technical function* which is not directly related to the user’s need. This type of function describes the internal action of a product in order to achieve its service function.

In most of these design methodologies and theories (the Dardy and Teixido method is a notable exception in this respect) [Dardy and Teixido, 2003] [APTE ®] the arguments about functions are not intended to give a clear definition of function itself, but to show how desired overall functions are decomposed into identifiable sub-functions until they correspond to certain entities or design objects. Entities are composed according to the principles derived from the structure of functions to satisfy the overall function.

Behaviour and function:

The methodology of Pahl and Beitz, a function is fulfilled by the physical effect. In GDT, a function is a particular behaviour, which corresponds to a certain circumstance. But in my point of view physical effect or behaviour alone fails to give a complete picture of the concept of function. Furthermore, understanding how a composition of the entities contributes to overall function is not made explicit by its behavioural constraints.

The designer or user intentions:

In most of design theory, functions have been studied by focusing on either of two essential aspects: *What an object is for?* And *What an object is and what an object does?*. Those two approach are focusing on the ‘designers’ or users’ intentions, and on certain kinds of attributes or behaviours of artefacts. This duality of functions makes the analysis difficult. Very different events can be resulted from the very same behaviour of an object. The definition of function is not sufficiently clear and the analysis has to be pushed further to overtake this duality.

2.4.2 Function as an interface between two situations

Function:

One goal of this thesis is to provide a definition of function which gives to this concept a clear and precise definition. This definition should avoid taking into consideration too early the physical implementation of the product. The goal is to focus on “How does it function?” instead of “What is the object’s function?”. One initial approach which can be of interest is to check how the graphical tools used in the Dardy and Teixido [Dardy and Teixido, 2003] [APTE[®]] can visualize the relations between a product and its environment. The method consists of using a graphical tool called *interaction graph* in order to establish the service functions of a product and the constraints of the product in relation with its environment.

According to Figure 47, a service function is seen as a link between two elements of the external environment of a product and the product itself. A constraint is seen as a link between one element of the external environment and the product itself. The example of an autonomous vacuum cleaner used for cleaning a house is used to analyse present the service function (F1) and the constraints (C1 and C2).

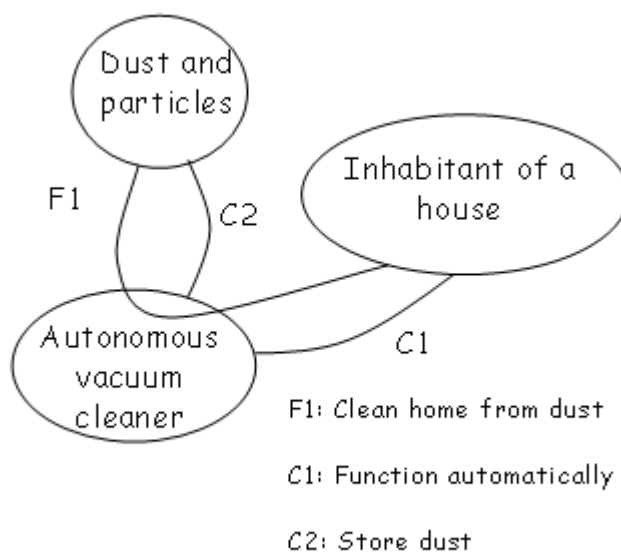

Figure 47: Functions according to the interaction graph [APTE[®]]

This vision of function exhibits interesting characteristics. Indeed, function is seen as an interface linking elements of the environment

together in the case of a service function. What comes to constraint, it is an interface linking an element of the environment and the future product itself. In this vision function is not seen as something having an intrinsic existence but as a concept which acts as an interface between elements. These elements can be implemented in a physical manner or not.

A similar approach which goes further in the analyzing process has been proposed by Kikuchi and Nagasaka [Kikuchi and Nagasaka, 2003] by referring to the formal theory of natural language semantics developed by Barwise and Perry [Barwise and Perry, 1999] and called Situation Semantics. This theory claims that:

“If considering a function of an artefact or machine, we consider also two kinds of situations. One is the situation u that a person is designing D , and the other is the situation s of its outer system. The intention of the person is embedded in u , and the attributes or behaviours of D are accounted in s . u and s are not unique even if considering the same event.”

This formulation of function shifts the question about functions from “What is D ’s function?” to “How does it function?” As a result, the function is not anymore something intrinsic to a machine. A pair of situations does not belong to any particular machine. It represents what is the effect of the function.

One good feature of this formulation is that it allows the discussion about functions themselves without mentioning any specific mechanism which have the functions. This characteristic of function requires being associated with a standard vocabulary in order to be manageable by many researchers or designers. This is the goal of section 2.4.3 which makes a proposal of a general taxonomy of functions and situations. In this thesis, a function is defined according to the Kikuchi and Nagasaka proposal (Figure 48) as:

“A *function* is a pair of the *using situation* u and the *outer system situation* s and represents the possible *states* of the artefacts.”

This definition also fits with the graphical model approach which will be used in this research.

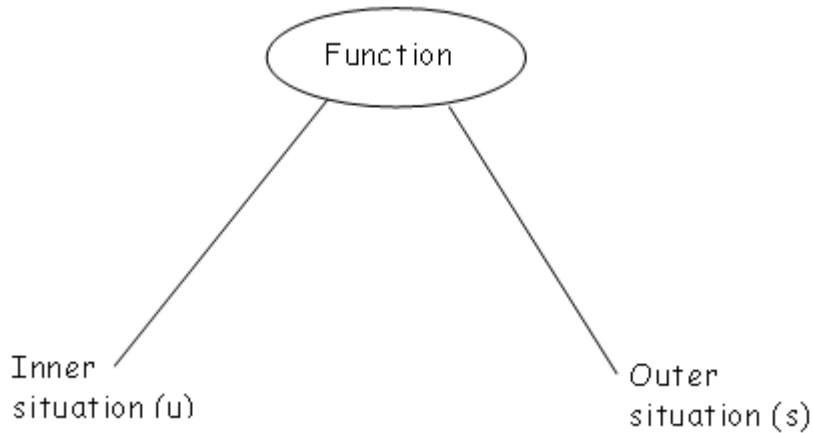

Figure 48: Function as an interface between an inner and an outer situation

If we now apply this type of definition to the example of the autonomous vacuum cleaner and the event of cleaning the house, u is the situation that there is dust on the floor, and s is the situation that the house is clean. The service function can be expressed like in Figure 49, $F1$: Clean inhabitant home from dust.

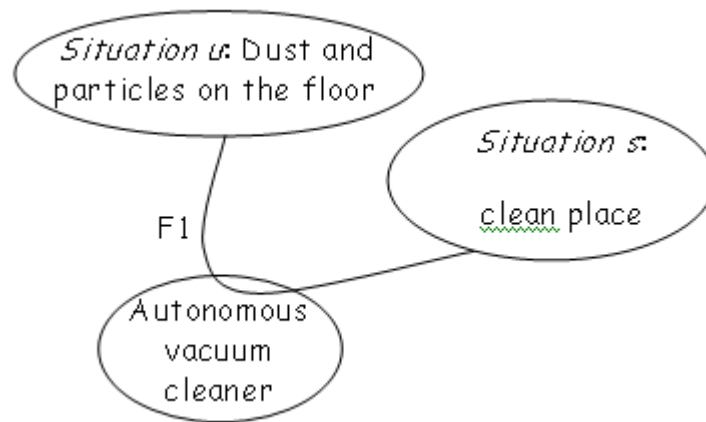

Figure 49: Interaction graph representing a service function using the Kikuchi and Nagasaka definition [Kikuchi and Nagasaka, 2003]

Another situation related to the inhabitant is, u the situation that he has no interaction with the device during the cleaning process, and s is the situation of the product that the device is autonomous. It is then according to the APTE method a constraint because an autonomous vacuum cleaner is not an interface between two situations of the environment. Figure 50 presents the constraint. The constraint is, $C1$: Function automatically. This constraint borders the description of the service function $F1$.

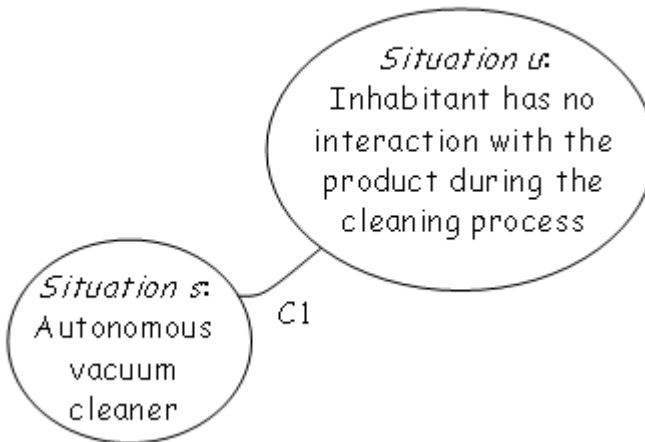

Figure 50: Interaction graph representing the constraint function using the Kikuchi and Nagasaka definition [Kikuchi and Nagasaka, 2003]

In order to benefit from this definition of function, it is necessary to investigate more thoroughly the concept of situation. This is the goal of the following part.

Situation:

A function, according to the definition selected in the research is intimately associated with the concept of situation and the association of function and situation constitutes the *concept of function*. In practice, we have not yet established a clear definition of the concept of situation.

According to the dictionary [hyperdictionnary.com] the noun *situation* can be defined as:

- A physical position in relation to the surroundings,
- A condition or position in which you find yourself,
- The general state of things; the combination of circumstances at a given time,

The definition highlights three important characteristics of a situation:

- Physical position,
- State of things,

- Combination of circumstances at a given time.

The definition of a situation is not yet formalized. Nevertheless we can analyse the characteristic of a situation representing the state of things, the physical position and circumstances by using the *interaction graph* [APTE®] (see Figure 51).

Figure 51 analyses the situation of dust and particles related to their interaction with elements in the environment of a house.

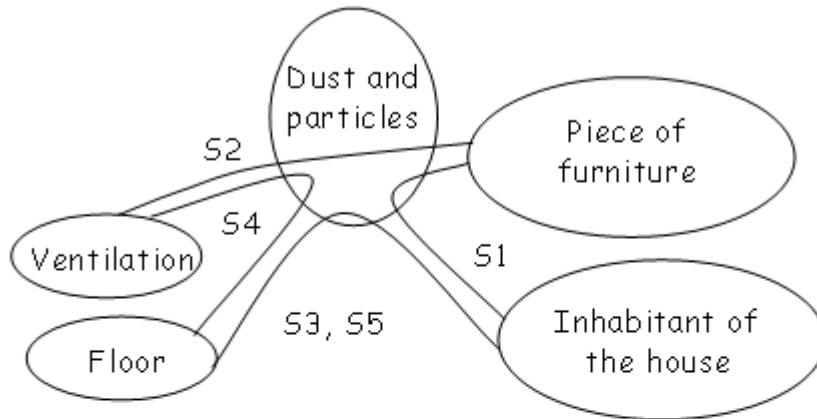

S1, S2: Light dust mainly in the form of fibers settles on furniture when a flow of air is created.

S3, S4: Heavy dust mainly in the form of aggregated fibres and light particles moves on the floor and stays in places on the floor where protected from air flow.

S5: Heavy particles move on the floor when pushed by the inhabitant

Figure 51: Analysis of the situations of dust and particles by using the interaction graph

According to this example, a situation is related:

- to the nature of a physical substance,
- to the localization in space at a given time,
- to the domain of the analysis,
- to the nature of the action applied on the physical substance,

It can be noticed that these aspects are quite familiar for a practitioner of the TRIZ methodology [Altshuller, 1984] [Savransky, 2000] in particular for the users of the Substance and Field approach. Considering these remarks, it is legitimate to consider that a situation exhibit two fundamental properties:

- the nature of the physical substance involved in the situation,
- the localization in space and time,

According to the definition of situation developed by Endsley [Endsley, 1995] and the definition of a state defined by Yoshioka [Yoshioka et al., 2001] a situation can be defined as:

Situation: The state(s) of the elements in the environment within a volume of time and space. A state is described by material entities, attributes related to these entities, and relations between them.

Consequently, a situation exhibits several fundamental characteristics which can be represented according to the classification of the Table 8. In addition, defining a state as a part of a situation gives the possibility to define behaviour. Behaviour is defined in this thesis as followed.

Behaviour: Behaviour is a sequence of one or more changes of states.

Table 8: The situation structure in this thesis

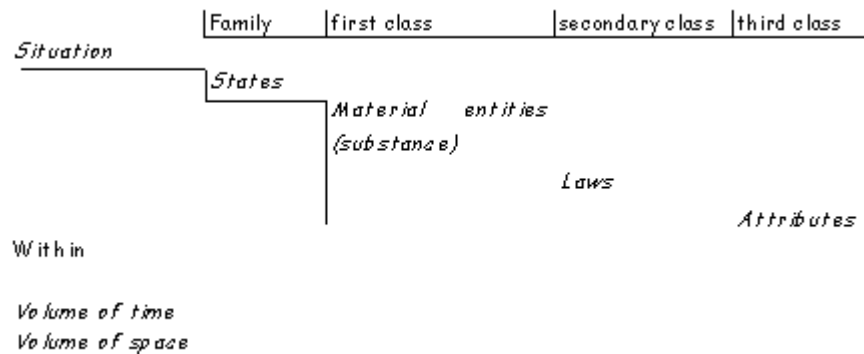

This chapter has presented the concept of function used in this research. As presented shortly, the concept of function selected in this thesis exhibits interesting similarities with a concept of TRIZ called Su-Field developed by Altshuller [Altshuller, 1984]. The section 2.4.4 investigates the similarities and analyses the importance of such a correspondence for this work. Moreover, usually a function is defined by an action verb. The approach selected in the thesis, the progressive transformation from functional description to physical embodiment of the solutions requires a standard vocabulary. This standard vocabulary is

necessary in order to map the functional description and the physical implementation which is used for representing the concepts of solutions. This vocabulary is important both for representing a function by a verb of action and a situation by describing the nature of the substance involved in the situation. This is the goal of the following chapter.

2.4.3 Standard vocabulary for functions and situations in the thesis

Functional classification and standard vocabulary:

The central objective of defining a standard vocabulary for describing the functional description of a design problem is that later in the conceptual design process, a normalized functional description of a design problem can facilitate the mapping of functions and generic mechanisms. The first level of functional classification is inspired from the reconciled functional taxonomy developed by Hirtz [Hirtz et al., 2002]. In the thesis an initial classification level has been inserted. This level is corresponding to the three fundamental domains of design. It is argued that a design problem should flow through these domains of design in order to be solved. The Table 9 presents the functional classification.

Table 9: Reconciled functional taxonomy adapted from Hirtz [Hirtz et al., 2002]

Taxonomy of the functions

Possible Domains	Primary function	Secondary function	Tertiary function	Correspondences
Physical, informational and economical domains	Branch	Separate		Isolate, sever, disjoin
			Divide	Detach, isolate, release, sort, split, disconnect, subtract
			Extract	Refine, filter, purify, percolate, strain, clear
			Remove	Cut, drill, lathe, polish, sand

	Distribute	Diffuse, dispel, disperse, dissipate, diverge, scatter
Channel	Import	Form entrance, allow, input, capture
	Export	Dispose, eject, emit, empty, remove, destroy, eliminate
	Transfer	Carry, deliver
	Transport	Advance, lift, move
	Transmit	Conduct, convey
	Guide	Direct, shift, steer, straighten, switch
	Translate	Move, relocate
	Rotate	Spin, turn
	Allow DOF	Constrain, unfasten, unlock
	Connect	Couple
Join		Assemble, fasten
Link		Attach
Control	Mix	Add, blend, coalesce, combine, pack
	Actuate	Enable, initiate, start, turn-on
	Regulate	Control, equalize, limit, maintain
	Increase	Allow, open
	Decrease	Close, delay, interrupt

Physical, informational and economical domains

Magnitude	Change	Adjust, modulate, clear, demodulate, invert, normalize, rectify, reset, scale, vary, modify
	Increment	Amplify, enhance, magnify, multiply
	Decrement	Attenuate, dampen, reduce
	Shape	Compact, compress, crush, pierce, deform, form, cast, turn, mill
	Condition	Prepare, adapt, treat
	Stop	End, halt, pause, interrupt, restrain
	Prevent	Disable, turn-off
	Inhibit	Shield, insulate, protect, resist
Convert	Convert	Condense, create, decode, differentiate, digitize, encode, evaporate, generate, integrate, liquefy, process, solidify, transform
Provision	Store	Accumulate
	Contain	Capture, enclose
	Collect	Absorb, consume, fill, reserve
	Supply	Provide, replenish, retrieve
Signal	Sense	Feel, determine

	Detect	Discern, perceive, recognize
	Measure	Identify, locate
Indicate		Announce, show, denote, record, register
	Track	Mark, time
	Display	Emit, expose, select
Process		Compare, calculate (Add, Subtract, Multiply, Divide), check,
Support	Stabilize	Steady
	Secure	Constrain, hold, place, fix
	Position	Align, locate, orient

Nevertheless this functional classification has been developed in order to properly describe the designer needs when analysing the use phase of the future product. Is the vocabulary really adapted when analysing the economical and informational domains and the phases of the physical life cycle other than the use phase?

This issue is partially investigated in the small example which follows the two next classifications tables.

Situation classification and standard vocabulary:

The standard vocabulary for the situation developed in this section is focusing on the nature of the substance which is a part of the situation framework as summarized in Table 8. Nevertheless, the previous analysis made in 2.4.2 has shown that a situation is defined according to the domain in which the situation is studied. In addition, it has been shown also in 2.4.2 that a field can be considered as a domain subclass. Consequently it is necessary to present the classification of domains and fields adapted from the taxonomy of Hirtz [Hirtz et al., 2002]. The concept of field [Altshuller, 1984] [Savransky, 2000] has been shortly described in 2.3.8 and is used in Table 11. This concept is described also in 2.4.4.

Table 10: Reconciled material taxonomy adapted from Hirtz [Hirtz et al., 2002]

Class (Primary)	Secondary	Tertiary	Molecule	Atom	Elementary particles	Correspondents	
Substance	Liquid					Hand, foot, head	
						Homogeneous Incompressible Compressible Homogeneous	
	Solid	Object					Rigid-body Elastic-body Widget
			Particulate Composite				
		Gas					
	Plasma						
	Mixture	Gas-gas					
		Liquid-liquid					
		Solid-solid					Aggregate
		Solid-liquid					
Liquid-gas							
Solid-gas							
		Solid- liquid-gas					
		Colloidal				Aerosol	
			molecule				
				atom			
					Fermion		
					Lepton	Electron Neutrino	
					Hadron	Neutron Proton	
					Baryon		
					Mesons		
Particles (other type)					Boson	Photon Gluon	

*Colloidal: a mixture with properties between those of a solution and fine suspension

Table 11: Classification of the domains and fields (adapted from Hirtz [Hirtz et al., 2002])

Domain	Primary fields	Secondary fields	Tertiary fields	
Physical	Energy	Mechanical	Translation	
			Rotational	
			Electrical	
			Pneumatic	
		Hydraulic	Thermodynamic	Heat exchange
				Mass flow
		AND Environmental	Mechanical Work	
		Magnetic		
		Acoustic		
		Biological		
Chemical				
Electromagnetic				
Informational	Signal	Radioactivity	Gamma (Photon + $\Delta\lambda_1$)	
			X Ray (photon + 2 neutrons)	
			UV(Photon + $\Delta\lambda_2$)	
			Visible (Photon + $\Delta\lambda$)	
			Infra-Red (Photon + $\Delta\lambda_4$)	
			Radio (atoms, molecules + $\Delta\lambda$)	
			Beta (Electron + antineutron) or (Positon + neutrino)	
			Alpha (proton + 2 neutrons)	
			Auditory	
			Olfactory	
Tactile				
Taste				
Visual				
Economical	monetary	Control	Analog	
		Control	Discrete	
			Physical currency	
			Digital currency	
			Barter	

Example of functional modelling related to the three domains of the design activity:

A functional study using the standard vocabulary developed in the current chapter is presented in this section. The example is a concept of solution of a steering part of an autonomous vacuum cleaner designed which will be studied from designer's, manufacturer's and economical perspective by using the interaction graph [APTE®]. The goal is to define the service function (FP) and the constraints (C).

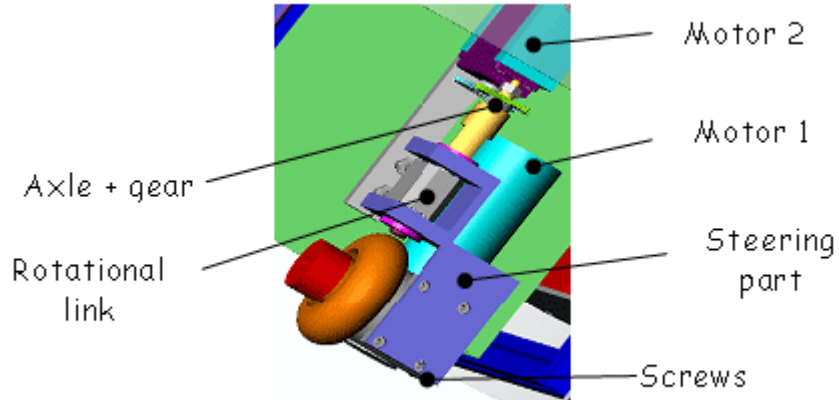

Figure 52: Steering and displacement concept of an autonomous vacuum cleaner

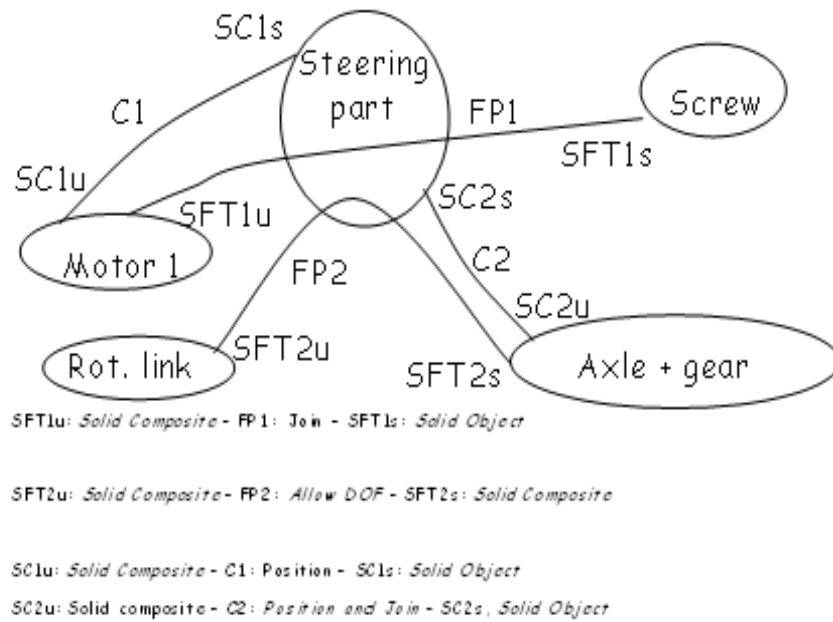

Figure 53: Interaction graph from a designer's perspective

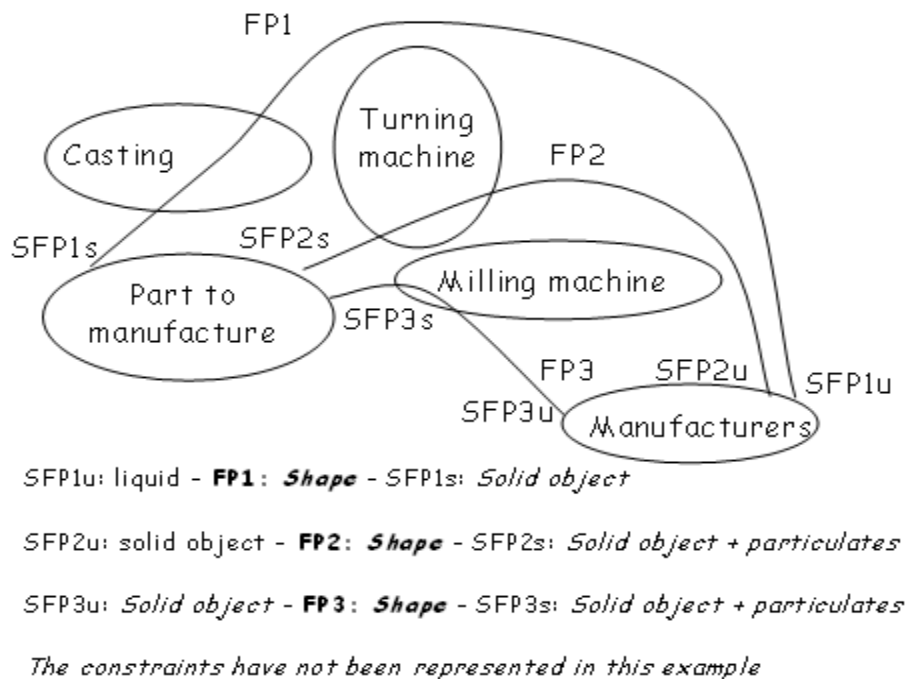
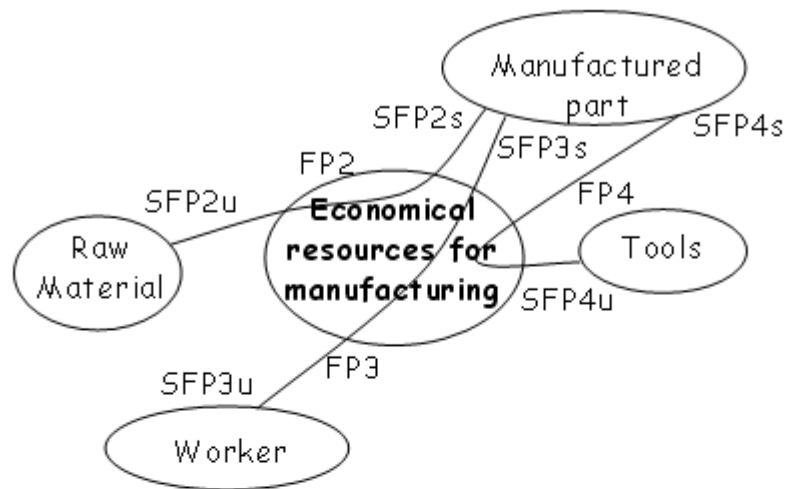

Figure 54: Interaction graph from manufacturer's perspective



SFP2u: solid material + volume + mass + Young modulus + Hardness + melting point + ... - **FP2: Transfer (Channel)** money in order to buy raw material for manufacturing - SFP2s: solid material + volume + dimensions + shape+...

SFP3u: Solid composite + force + ... - **FP3: Transfer (Channel)** money in order to pay workers for manufacturing the steering part - SFP3s: solid material + volume + dimensions + shape+...

SFP4u: solid material + Young modulus + Hardness +... - **FP4: Transfer (Channel)** money in order to buy tools for manufacturing the steering part - SFP4s: solid material + volume + dimensions + shape+...

The constraints have not been represented in this example but there are resource constraints for all the elements of the environment.

Figure 55: Interaction graph from an economical perspective

This example shows that the normalized vocabulary can be used to identify service function in the three domains. Nevertheless the vocabulary is not very rich for representing the manufacturing and economical aspects. In addition the analysis of a TP in 3.2.2 shows that the interaction graph has a limited interest when analysing the manufacturing interactions.

2.4.4 Similarities between the concept of function of this thesis, Su-Fields of TRIZ and simplified standard solutions

Su-Field is a tool developed by Altshuller and his team [Alshuller, 1984] [Savransky, 2000]. Su-Fields are an attempt to generate a systematic and universal language for the definition and solution of problems. The Su-Field method represents a way of classifying

different problem types both in terms of the number of interacting components (Substances) and the actions (Fields) which act upon them. TRIZ researchers have classified the different combinations of possible Substances and Fields and subsequently identified *Standard Inventive Solutions* which may be applied to solve any given Substance-Field combination.

As explained before the concept of function used in this thesis is viewed as an interface between two situations. This vision exhibits a representation of the concept of function in term of a triangle. A similar representation is used in the Su-Field representation. Two substances and a field are necessary and sufficient to define a working technical system in a Su-Field.

The analogy between the concept of function used in this thesis and the Su-Field can be viewed as the double analogy between *situation - substance* and *function* described by a verb of action and *field* which represents this action. This analogy is used in the following chapters.

The Su-Field analysis is based on qualitative descriptions of the relationship between the individual components of the overall system. Each function is classified in terms of usefulness, neutrality or harmfulness associated with the functions' levels which can be insufficient-satisfactory or excessive. In addition the direction (one-way, both ways), and time based function (continuous, periodic, etc) are taken into account. Consequently, the Su-Field structure is dedicated to the component level but it is used in this thesis also to analyse the technical systems at a higher level of description.

The definition of the concept of function used in this thesis states that a function (expressed in the form of a verb of action) is an interface between two situations. A situation is defined as the state of the elements in the environment within a volume of time and space. The state of an element is related to its substance, the laws which describe the state and the attributes of these laws. The different types of substance conveyed into a TS or a TP can constitute interesting information when developing the functional structure of a TS or a TP. In addition, energy is also conveyed in TS and TP and the concept of energy is a generic and useful concept not only in physic but also when developing the functional structure of a product [Pahl and Beitz, 1984] [Hubka, Andreasen and Eder, 1988]. According to the vision developed in the thesis energy is carried by a carrier (particles, solid, etc...). Therefore, in order to describe the concept of energy, it is necessary to describe both the nature of the energy and the carrier. This is in agreement with the fundamental principle of duality wave-particle which is one of the bases of the quantic mechanic theory. Indeed, a wave (for example an electromagnetic wave) is a form of energy and it is also a particle (for example a photon) (see Table 10 and Table 11).

As a result the concept of function can be implemented logically into a less abstract concept by using the concept of energy. The concept of energy has been used also to express a function in TRIZ [Altshuller, 1984]. This concept has been classified in classes called *fields*. The concept of fields is defined according to Savransky [Savransky, 2000] as:

Fields: Energy carriers regardless of their nature and mass [Savransky, 2000]

This is not in agreement with the previous analysis which views energy as the combination of its type and the carrier of this energy. Consequently, a field is defined in this thesis as:

Field: Energy type associated with the energy carrier,

The concept of field in the TRIZ methodology is associated with the concept of substances [Altsuller, 1984]. The meaning of a field is interpreted in a very broad sense. It can be the fields of physics (i.e. electromagnetism, gravity, strong and weak nuclear interactions) as well as other fields like olfactory, chemical, etc. A Su-field is constituted of a field and two substances in the case of a TS (one called tool and the other one Substance). The tool acts on the substance via the field. The tool and the substance constitute a more physical interpretation of a function seen as an interface between two situations in this thesis. The Substance in the TRIZ definition of a Su-field is a direct implementation of the substance as defined in the thesis which constitutes the inner and outer situation of the concept of function. This can be summarized according to the Figure 56.

The Su-field modelling has many similarities with the concept of function introduced in this thesis. Su-field is closer to the physical implementation of a product than the concept of function. The concepts of field introduced by TRIZ are used during the problem clarification and synthesis. In addition, it should be noticed that the Su-field modelling differentiates the modelling of TS and TP according to Figure 57.

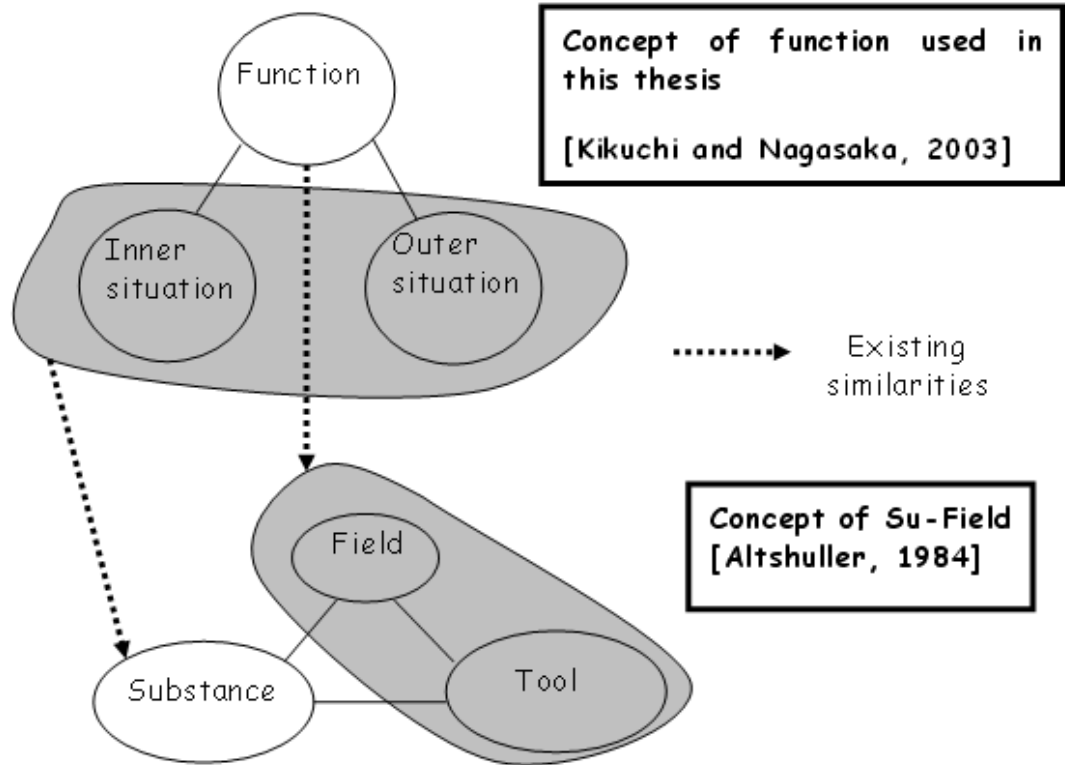

Figure 56: Transformation of the concept of function in Su-Field during the synthesis process

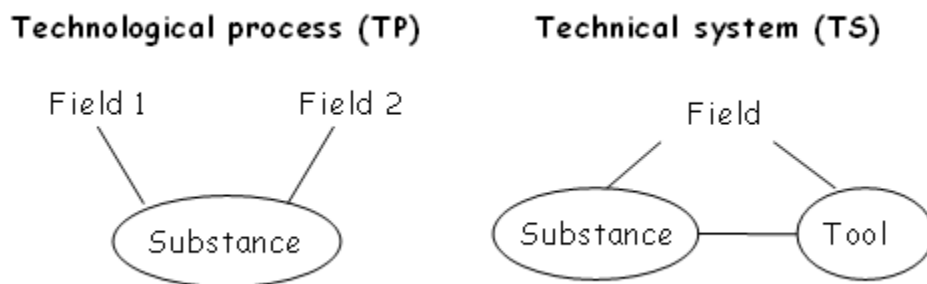

Figure 57: Su-field modelling of TP and TS

It should also be noticed that the concept of energy in this thesis is very broad. It integrates several different aspects. The physical perspective of energy is completed by considering that an informational signal constitutes a type of energy and money a potential energy. These aspects are summarized in Table 6 and Table 7.

Simplified standard solutions:

Based on the pioneer work of Altshuller [Altshuller, 1984] and enriched by a number of other researches especially in the former USSR, a large group of standard solutions have been established. According to Soderlin [Soderlin, 2003], these standards solutions can be simplified and if the Su-field modelling is done initially with respect to the pattern of Figure 57, then few rules can summarize most of the standard solutions of TRIZ. These rules are based on the approach developed by Soderlin [Soderlin, 2003]:

Standard solution with three elements (a field, a tool, a substance):

If in a system there are harmful fields or interactions between substances; inadequate fields or substances interactions, the solution is found according to the following rules:

Rule a: Add a new substance or field between the Tool and Substance.

Rule b: Add a new substance either to the Tool or Object. As its best the new substance is the variant of the Tool or the Object. The new addition can be either complex internal, external or environmental.

Rule c: Change the Field.

Rule d: Change the Field and the Tool.

Rule e: The Tool and the Object can be fragmented.

Rule f: Use ferromagnetic substances and magnetic or ferromagnetic fields.

Rule g: The Field and the Substances can be made dynamic (flexible, pulse).

Rule h: Match (mismatch) the rhythms in the system.

Rule i: Compensate the harmful action of the Field by an additional counteracting system or field.

Rule j: The Object can be converted to a new system, which is linked to the other elements.

Standard Solutions for Detection and Measurement:

Rule k: In measurement or detection type of problems, one should consider the substance in question as the Tool and the solution as an Object that reacts.

Standards for Applying the Standards Solutions:

Rule l: Introducing Substance

Rule m: If it is necessary to introduce a field, you should:

- First and foremost apply existing fields whose carriers are the substances involved,
- Secondly, introduce fields from the Environment,
- Thirdly utilize substances capable of originating fields.

Rule n: Phase Transitions

Make use of the various phase states of materials

1. Changing the phase
2. Using dynamic phase state
3. Utilizing associated phenomena
4. Using transition to a dual phase state
5. Using phase interaction

2.4.5 The different types of functions used in the thesis

The method used in this section consists at first of underlining some fundamental categories of functions by analysing the function types and structures defined in the literature. This analysis is summarized by a classification of the function types and levels. The chapter ends with the presentation of the function types and structures and the vocabulary selected in this thesis.

It is useful to remind first of all the goal of the functional formulation of a design problem. The goal of the functional formulation of a problem consists of using an abstract formulation of the task which should be accomplished by a technical system independent from any particular solution [Pahl and Beitz, 1984]. Nevertheless, the abstract concept called function is not uniform in its representation and it gathers several different levels of abstraction according to the characteristics of the phases of the conceptual design process when used.

For example during the first phase of the conceptual design process called refinement of the customer needs (see Figure 1), the concept of function should represent a high level of abstraction in order to describe in a general way the overall tasks of a technical system and

to model the different types of interactions of the future technical system with its own environment.

Short overview of the type of functions defined in literature:

In the literature, many terms have been introduced in order to describe this general level. Pahl and Beitz [Pahl and Beitz, 1984] call this type of function, the overall function of a mechanism. Savransky [Savransky, 2000] uses the same type of vocabulary in order to describe this type of general function representation aimed at describing the overall task of a system. According to Pahl and Beitz [Pahl and Beitz, 1984] an overall function can be defined as:

Overall function: Abstract formulation of the overall task according to the inputs and outputs of all the quantities involved in the overall task using statements consisting of a verb and a noun.

This definition shows that an overall function is the result of inputs and outputs. This view exhibits a technical point of view about a function. This vision about technical function extends the definition of the norm NF EN 1325-1 [NF EN 1325-1, 1996], because a technical function is defined as the internal action within a product required to ensure the service functions. According to this thesis an overall function is seen as a certain type of technical function called an *overall technical function* in the classification of the Table 12. As a remark and in order to justify this classification class, the required knowledge about input and output is often not available when the design process starts. The designer is more likely in a situation where he does not know what these inputs and outputs are. On the contrary he can know what the expected actions of the system are. Consequently the definition of a *service function* introduced by the European norm NF EN 1325-1 and the French norm NF X50-151 [NF EN 1325-1, 1996] [NF X50-151, 1991] used by Dardy and Teixido [Dardy and Teixido, 2003] [VAI, 1993] is probably a better approach in order to refine the formulation of the customer needs or ideas (see Figure 1) at the very beginning of the design process.

Service function: Expected actions of a product according to the need of a specified user.

Similarly when expressing the customer needs, it is necessary to limit the designer's freedom in term of time limit, cost, norm, security among many other aspects. This is done by defining constraints. A constraint is defined according to the norm NF EN 1325-1 [NF EN 1325-1, 1996] as:

Constraints: Limitations of the designer's freedom considered necessary by the customer.

The literature exhibits other types of *overall technical functions*. The TRIZ methodology in particular uses the term *primary function* [Savransky, 2000] and describes this function as “the working function, the aim of technique’s existence”. The *primary function* is similar to the *service function* described in the European norm NF EN 1325-1 [NF EN 1325-1, 1996]. According to TRIZ each technical system is designed to provide one or several *useful functions* and also unfortunately *harmful functions* which are undesirable and consequently which should be eliminated. For example in order to perform its service function, an autonomous vacuum cleaner also produces noise, heat and vibration which are considered in TRIZ as harmful functions.

A technical system might consist of subsystems arranged in some way in space (i.e. an autonomous vacuum cleaner) and/or of subsystems interconnected in time (i.e. a manufacturing process). The subsystems are themselves technical systems for their own subsystems and so on down to some granular level where the basic elements can be labelled. Furthermore a technical system is part of its environment (called super-system in TRIZ [Altshuller, 1984]). Therefore, a part, a subsystem, a technical system and its environment form a hierarchy. Any technical system can be divided into subsystems of various granularity degrees according to the following figure.

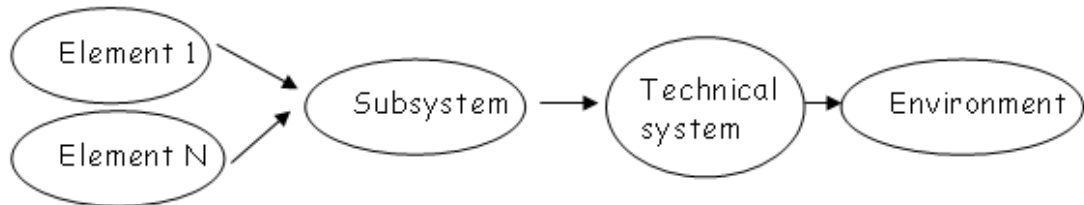

Figure 58: Hierarchy of composition in technical systems

This hierarchy also exists for functions. This hierarchy is presented in Table 12 by the creation of two classes called *overall technical functions* which represent the functions of a technical system and technical sub-functions which represent the functions of a subsystem. This second category exhibits various functions’ type.

According to the norms NF EN 1325-1 [NF EN 1325-1, 1996], NF X50-151 [NF X50-151, 1991] and the work of Dardy and Teixido [Dardy and Teixido, 2003], a technical function is defined as follows.

Technical function: Internal action of the product in order to ensure the service functions. The technical functions do not express the user’s needs.

Pahl and Beitz [Pahl and Beitz, 1984] defines two other type of functions called main and auxiliary function as:

Main function: Sub-functions that serve the overall function directly.

Auxiliary functions: Sub-functions that contribute to the overall function indirectly.

According to Savransky [Savransky, 2000], there are three other types of functions namely the *support useful function*, the *secondary useful function* and the *auxiliary useful function*. These functions are also called by other authors [Busov et al., 1999] respectively basic function, additional and auxiliary function. Nevertheless, the first formulation is retained in this thesis. These functions are defined according to the following definition.

Support useful functions: Functions assuring the execution of the primary function (services functions) [Savransky, 2000].

Secondary useful functions: Functions reflecting subsidiary goals of the technical system creators [Savransky, 2000].

Auxiliary useful functions: Functions assuring the execution of the higher-level functions [Savransky, 2000].

Neutral functions: Functions which have not useful or harmful effects.

In addition these functions exhibits levels classified as *normal*, *excessive* and *insufficient*.

The APTE approach [APTE®] [Dardy and Teixido, 2003] proposes the definition of a type of function called *elementary function* which is associated with the use of a tool called *block-diagram*. The goal of the tool is to analyse an existing product or concept of solution in order to underline the elementary functions which are just sufficient in order to answer the requirements. The approach distinguishes three types of functions.

Elementary contact functions: Represent the physical contact existing between elements and/or subsystems,

Elementary main flow functions: Represent the energetic flow within a technical system.

Elementary loop flow functions: Represent the existing loops between elements and/or subsystems and their contacts.

This approach is not directly dedicated to the refinement of the needs but instead to the analysis of the adequacy of the concepts of

solutions with the functional definition of the needs. Moreover, the elementary contact functions are directly related to the nature of the link existing within the technical system. The elementary main flow function is representing the links existing between the system and its environment. Consequently it gives a way to verify the overall technical functions class. The elementary loop flow function represents a manner to verify the technical sub-functions class.

Another interesting aspect of the functional structures developed in TRIZ literature [Altshuller, 1984] [Savransky, 2000] is the concept of Ideality. Ideality in TRIZ has been described for functions in the following way:

- A technical system performs only primary and secondary useful functions,
- A technical system consists only of what is necessary.
- A technical system does not have harmful or neutral functions nor support and auxiliary functions.

Unfortunately an ideal technical system can not be obtained in practice but the ideality principle is a goal in which the harmful functions have disappeared. The concept of ideality comes from the concept of harmful and neutral functions which are classified in the class of non-expected technical functions. The concept of harmful function is defined as:

Harmful functions: Functions not intended for or desired of the technical system and that have undesired results.

GDT [Yoshikawa, 1981] presents in the Definition 19 (see p.62) the definition of an unexpected function, where an unexpected function is seen as a deviation of the behaviour of the technical system with the initial specification.

All the described types of functions defined here are summarized in the Table 12.

Table 12: Summary of the functional structure in literature

Literature references	Function necessary to express the needs	Overall technical functions	Technical sub-functions		Non expected technical functions
			Level of the functions in TRIZ	types of sub functions in APTE	
NF EN 1325-1, NF X50-151	Services functions				
NF EN 1325-1, NF X50-151	Constraints				
Pahl and Beitz, TRIZ		Overall functions			
NF EN 1325-1, NF X50-151				Technical functions	
TRIZ	Primary functions				
TRIZ		Useful functions			
TRIZ			normal		
TRIZ			insuffisiant		
TRIZ			excessive		
TRIZ					Harmful functions
GDT					Unexpected functions
Pahl and Beitz				Main functions	
Pahl and Beitz & TRIZ				Auxiliary functions	
TRIZ				Support useful function	
TRIZ				Secondary useful function	
TRIZ					Neutral functions
APTE				Elementary functions	
APTE					Contact
APTE					Loop flow
APTE					main flow

Characteristics of the functions structure in this thesis:

The framework of the conceptual design process retained in this thesis is described according to the four phases of the conceptual design process as shown in Figure 1 (p.22) [Yannou, 2001] and summarized according to Figure 59. The function structure retained in this thesis is summarized in Figure 60. The idea of using at first the concept of service functions instead of the concept of useful function consists of analysing the goal of the design problem in terms of service instead of product. This approach is a source of new ideas. For example it has been the initial idea behind the reduction of the environmental impact of solvent in German industry. Indeed SAFECEM, a German company producing Chlorine solvent and leader in this market is now providing a service to the companies by helping them in using and recycling the solvent instead of only

selling the product. An effect of this strategy is a significant reduction of the quantity of solvent used in industry and of its environmental impact thanks to the recycling of these solvent. In addition the company has improved its economical results.

The functional framework retained in this thesis is based on the norms NF EN1325-1 and NF X50-151 [NF EN1351-1] [NF X50-151] and the concepts of the TRIZ approach [Altshuller, 1984] [Savransky, 2000].

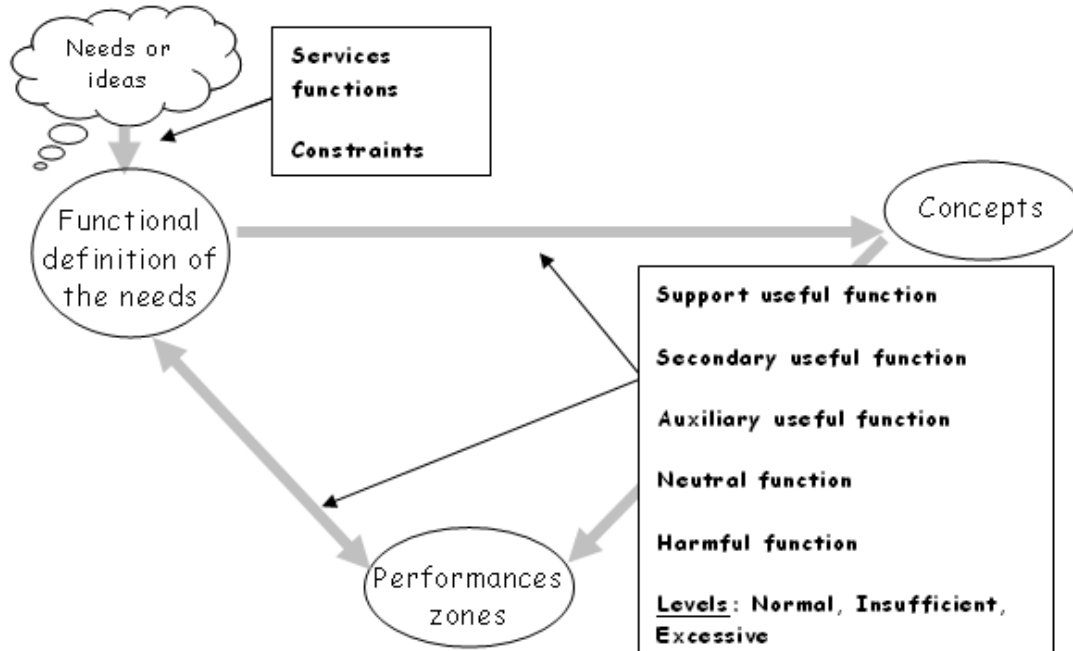

Figure 59: The functional framework used in the thesis

The graphical structure used in TRIZ [Altshuller, 1984] [Savransky, 2000] for representing connections between substances and fields is adapted in this thesis in order to represent the different types of functions. This language is described in Figure 60.

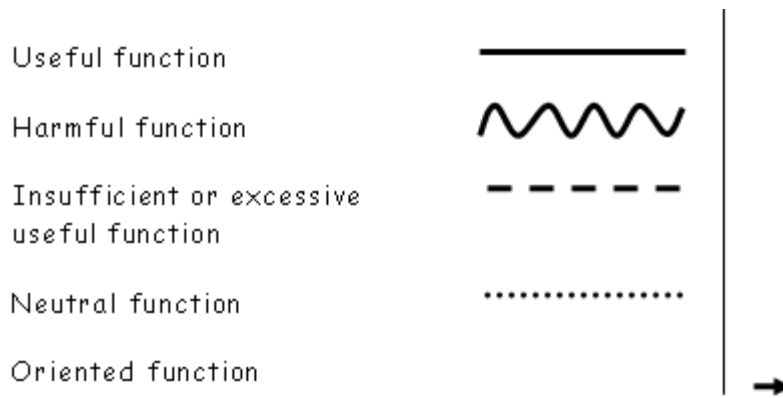

Figure 60: Graphical language used for functions and fields in Su-field representation (derived from Altshuller [Altshuller, 1984])

2.4.6 Analysis of the transition between functions

The goal of this section is to analyse in which manner this thesis can deal with the fact that the structure of the concept of function (i.e. a function and the situations linked to this function) can be affected by the modification of the situations associated to the function. It means that in certain situation a useful function can become neutral, insufficient, excessive or even harmful. It is necessary to introduce a tool in order to analyse these types of transitions. Nevertheless this problem is quite vast and my intention is only to show that a link exists between the concept of function of this thesis and an existing tool used in automation. This problem has been already studied in detail in the thesis of Miled [Miled, 2003], proposing a specific matrix in order to analyse transition changes, nevertheless it can be of interest to use a tool coming from automation in order to analyse this type of transition. A tool called GRAFCET [NF C 03-190 + R1, 1995] is a sequential function chart which has the advantage of investigating precisely the concept of function and transition. This tool is used both as a communication tool between the automation engineer and a customer and as a tool to define the functional list of requirement of a studied technical system. GRAFCET is intended for the representation of the automated system which could be reduced to system described via Boolean logic. It is the case of most of the technical systems (TS) and technological processes (TP). Indeed all continuous attribute describing a TS or a TP can be transformed in discontinuous variables corresponding to logical values if and only if the attributes are measurable (this should be the case for the framework developed in the thesis), and if a differential thresholds is attached to logical values in order to obtain discontinuous set.

The basic concepts of *GRAF CET* are:

- *Step*: A step represents a state of a system, in which an action is performed. A step can be *active* or *inactive*.
- *Action*: An associated *action* is performed when the step is active, and it remains asleep when the step is inactive. The *action* in our case is the interface function resulting from the concept of function discussed above.
- *Transition*: A *transition* is a link between steps. A transition represents the fact that the action(s) of the previous step(s) is followed by the action(s) of the following one(s) and indicates a possible decision for changing the system state.

According to these definitions, similarities can be highlighted between concept of function and *GRAF CET*.

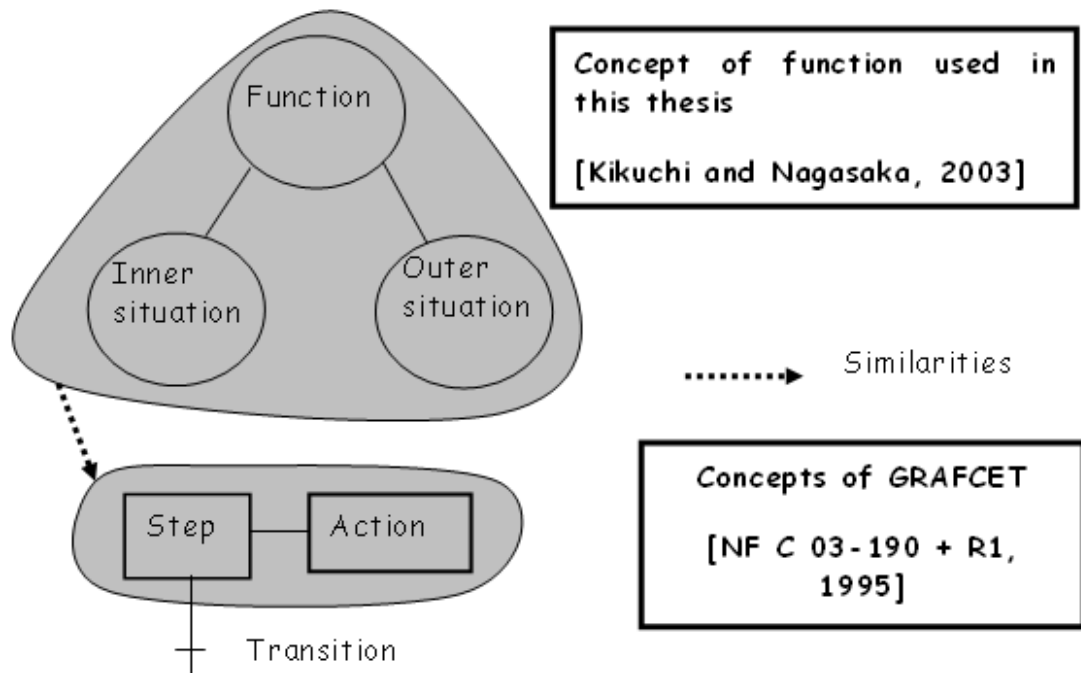

Figure 61: Comparison of the concept of function and the *GRAF CET* structure

The concept of function can be associated with steps and actions. A step represents the different states of a system in a more abstract manner and consequently, it is a less precise representation of the concept of situation. In addition the concept of transition does not exist in the concept of function and the *GRAF CET* tool is appropriate in order to represent the transformation between different situations of a system.

Conditions associated to transition:

The change of the system state is controlled by two conditions:

Condition 1: Every step before the concerned transition must be active.

Condition 2: A Boolean condition associated with the transition must be true.

The dynamic behaviour of the graph contains five evolutionary rules.

Rule 1: Initial situation

The initial situation is characterized by the initial steps which are by definition active at the beginning of the evolutionary process. At least one initial step should be active.

Rule 2: Clearing of a transition

A transition is either enabled or disabled. It is said to be enabled when all immediately preceding steps linked to its corresponding transition symbol are active, otherwise it is disabled. A transition cannot be cleared unless it is enabled, and its associated transition condition is true.

Rule 3: Evolution of active steps

The clearing of a transition simultaneously leads to the active state of the immediately following step(s) and to the inactive state of the immediately preceding step(s).

Rule 4: Simultaneous clearing of transitions

All simultaneous cleared transitions are simultaneously cleared.

Rule 5: Simultaneous activation and deactivation of a step

If during operation, a step is simultaneously activated and deactivated, priority is given to the activation. In addition two types of divergences are used in order to represent different types of evolutions according to the type of transition; the AND and the OR divergence (see Figure 62 for the OR divergence).

2.4.7 Example of analysis of transition between functions using GRAFCET

The example studied here is related to the changes in the useful function of a vacuum cleaner caused by an obstruction at the entry of the sucker of a vacuum cleaner.

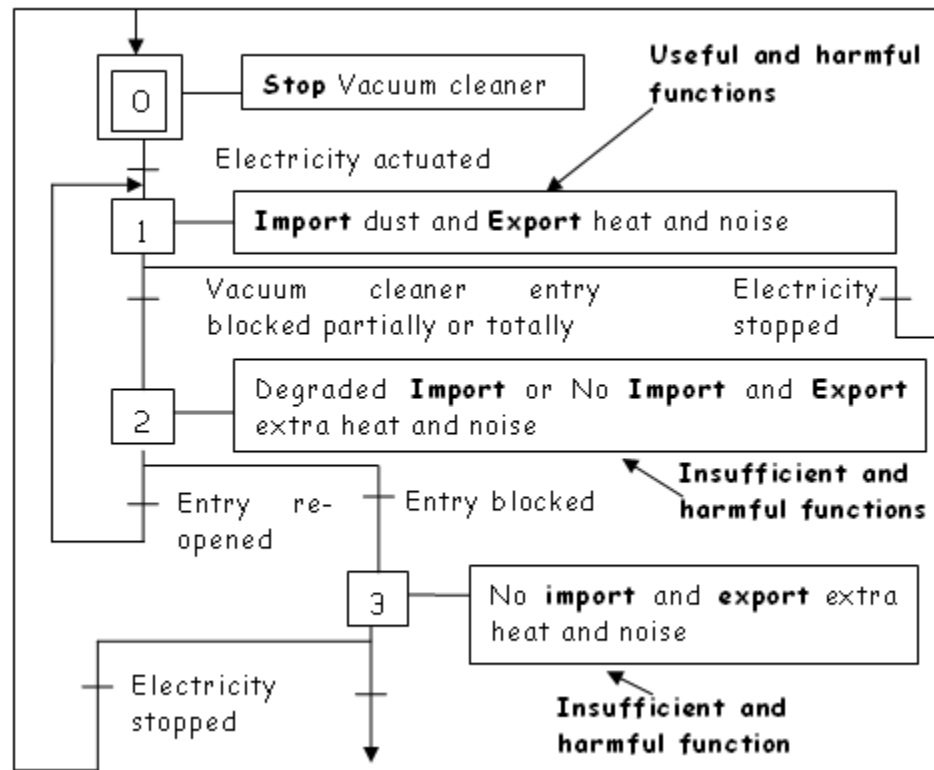

Figure 62: Example of transition analysis using GRAFCET

2.5 Synthesis of the metamodel structure

The goal of this section is to present the structure of the metamodel used for flowing from the functional definition of the problem to the end of the synthesis (i.e. the end of the concept generation process). In addition the generic concepts which constitute the metamodel structure ensure that the property of separation of the classification space is obtained.

The chapter is organised in the following manner. The hypotheses and laws which constitute the basis of the metamodel are first summarized. The classification structure introduced in 2.3.6 is also summarized. Finally the gradual mapping of the fundamental concepts is summarized.

Hypotheses:

Hypothesis 1: The imperfect and limited real knowledge has a topological structure.

Hypothesis 2: The design activity can be analysed via three domains named physical, informational and economical domains.

Hypothesis 3: The concept of energy derived from physics can be used and extended in order to represent the informational and economical aspects of the design activity.

Hypothesis 4: The principle of the conservation of energy can be extended to the informational and economical domains.

Generic type of variables:

The structure of metamodel variables is composed of different types of variables:

- Fundamental level of abstraction

- Domains,
- Energy,
 - Fields,

- Intermediate level of abstraction

- The power variables,
 - Effort,
 - Flow,
- The state variables,
 - Displacement,
 - Momentum,
- The connecting variables (which link effort and flow or displacement and momentum or power variables with state variables),

Fundamental laws:

Principle of the conservation of energy: This principle of the conservation of energy is valid in the physical, informational and economical domains.

Power conservation law: This principle is applied to the family of distributive mechanism.

Entropy impact on the environment law [Svirezhev, 2000]:

Eq. 2 $\sigma = \frac{W(t)}{T(t)} + \frac{P_1(t)}{T(t)} - \frac{P_0(t)}{T(t)}$ as presented in 2.3.6

Law of information content [Shannon et al., 1949]:

Eq. 9 $I = -\log_2 p_i$ $I = -\log_2 p_i$ as presented in 3.3.1

and

Eq. 10 $p_i = \frac{1}{2^n}$ as presented in 3.3.1

Generic laws for the basic mechanisms: See section 2.3.9

Connecting laws between organs: Organs can be interconnected if they share compatible types of:

- Domains,
- Energy,
 - o Fields
- Matters,
- Power variables,
- State variables,

Classification structure of the metamodel:

Domains:

Three domains introduced:

- the physical domain,
- economical domain,
- informational domain,

Functions:

A classification framework for standard functions vocabulary has been introduced in section 2.4.3.

First level of mechanism:

- Signal mechanisms,
- Command unit mechanisms,
- Open systems mechanisms,

Families of mechanisms and elementary mechanisms:

- Family of storage mechanisms
 - o C-organs,
 - o I-organs,
- Family of dissipative mechanisms
 - o R-organs,
- Family of source mechanisms
 - o Source of effort organs,
 - o Source of flow organs,
- Family of converting mechanisms
 - o T-organs,
 - o G-organs,
- Family of distributive mechanisms

- Paynter's junction subgroup
 - Effort junction organs,
 - Flow junction organs,
- Mechanical junction subgroup
 - Lock link organ,
 - Rotational link organ,
 - Prismatic link organ,
 - Helicoïdal link organ,
 - Rotational and translational link organ,
 - Spherical link,
 - Spherical link with finger,
 - Plan link,
 - Linear annular link,
 - Linear link,
 - Point link,
- Family of calculation mechanisms
 - NO-organ,
 - AND-organ,
 - OR-organ,

Generic standard solutions:

Generic standard solutions have been presented in 2.4.4 [Altsuller, 1984] [Savransky, 2000] [Soderlin, 2003]. These simplified standard solutions presented in the form of generic rules are applied in the metamodel structure in order to overcome or circumvent problems related to insufficient/excessive useful functions or harmful functions.

Mapping:

In order to achieve the goal of generating concepts of solutions, it is necessary to produce different levels of mapping between the generic

mechanisms and the functional classification. The mapping is done at two levels. The first level consists of mapping the functions and the families of basic mechanisms. The second level of mapping consists of associating the basic mechanisms, the functional vocabulary, the fields, the power variables and the state variables. This mapping is done respectively in the following Table 13 and Table 14 . In addition Figure 63 and Figure 64 summarize respectively the generic concepts and the metamodel framework which constitute the intermediate language used in this thesis.

Table 13: Mapping between functional vocabulary and mechanisms (level 1)

Classification of functions			Classification of mechanisms	
Primary function	Secondary function	Tertiary function	Basic mechanisms secondary class	Basic mechanism family
Magnitude	Change	Increase Decrement Shape Condition Stop Prevent Inhibit	Dissipative mechanisms Converting mechanisms	Open systems composed at least of Distributive mechanism Dissipative mechanisms Converting mechanisms Storage mechanisms Source of effort Source of flow
Support	Stabilize Secure Position		Storage mechanisms, Dissipative mechanisms Distributive mechanisms	
Control	Actuate Regulate	Increase Decrease	Command Unit mechanism	
Convert	Convert		Storage Converting and dissipative mechanisms	
Provision	Store	Contain Collect	Storage mechanisms Source of effort mechanisms Source of flow mechanisms	
Branch	Separate	Divide Extract Remove	Distributive mechanism	Signal mechanisms
Channel	Distribute Import Export Transfer	Transport Transmit		
Guide	Guide	Translate Rotate Allow DOF		
Connect	Couple	Join Link		
Mix	Mix			
Signal	Sense	Detect Measure	Functional implementation based on combination of Storage and/or Dissipative mechanisms and/or Converting mechanisms	
Indicate	Indicate	Track Display		
Process	Process		Calculation mechanisms	

Table 14: Mapping between mechanisms families, organs, functions, fields, power and state variables

Classification of mechanisms	Classification of functions		Fields	Power variables type		State variables type	
	Basic mechanisms tertiary class			Effort (e)	Flow (f)	Displacement (q)	momentum (p)
Basic mechanisms secondary class							
Storage mechanisms	C-organ	Provision-store Provision-supply Convert		X X (2) ←	X X (1)	X	
	I-organ	Provision-store Provision-supply Convert Convert		X X (1) X (2) ↓	X		X
Dissipative mechanisms	R-organ	Magnitude-Change Convert (1) Convert (2)		X X (1) → X (2) ←	X X (2) X (1)		
Converting mechanisms	T-organ	Convert Magnitude-Change		X(1) X(2) ↓	X(1) X(2) ↓		
	G-organ	Convert Magnitude-Change	X	X X(2) ↑ X(1) X	X X(1) X(2) X		
Source mechanisms	Source of effort Source of flow	Provision-supply Provision-supply		X	X		
Distributive mechanisms	Effort-junction	Branch Channel Connect		X X X			
	Flow-junction	Branch Channel Connect			X X X		
	Lock link	Couple-join Stop		X X	X X	X X	X X
	Rotational link	Guide-rotate		X	X		X
	Prismatic link	Guide-translate		X	X	X	
	Helicoidal link	Convert	X ↑ Mech. Trans. ↓ Mech. Rota.				
	Rotational and translational link	Guide-Rotate and Translate		X	X	X	X
	Spherical link	Guide-rotate		X	X		X
	Spherical link with finger	Guide-rotate		X	X		X
	Plan link	Guide -rotate and translate		X	X	X	X
	Linear annular link	Guide -rotate and translate		X	X	X	X
	Linear link	Guide -rotate and translate		X	X	X	X
	Point link	Guide -rotate and translate		X	X	X	X
	Calculation mechanisms	NO-organ	Process		X	X	
AND-organ		Process		X	X		
OR-organ		Process		X	X		

Graphical levels of representation:

The metamodel structure entails four levels of graphical representation. These levels are related to the advancement of the synthesis process:

- A first graphical representation is using the graph of interaction associated with the concept of function introduced in this thesis.
- A second graphical step is using Su-field representations aimed at:
 - o Highlighting potential harmful functions or Insufficient/excessive useful functions,
 - o Defining initial concepts of solutions by referring to the generic standard solutions,
- A third graphical step is using SADT representation in order to develop the initial solutions identified by the Su-field representations. The SADT representations are using the basic mechanisms, their laws, the connecting laws, the mapping tables and the generic standard solutions,
- A fourth level of representation is the blue print drawing of the solutions. These blue print drawings can be 2D or 3D drawings and the formalism used to establish these drawings can be selected according to the normalized symbols defined in the norms NF E 04-056 for hydraulic and pneumatic symbols, NFE E22-610 and NF E 04-013 and 015 [NF C 03-202 to 208] [NF E 04-056], [NFE E22-610] [NF E 04-013] [NF E 04-015].

Discussion:

The organs and mechanisms presented in 2.3.9 are abstract entities. The mapping between these abstract entities and the initial representation of the conceptual design model in the form of a functional design specification entails a step of abstraction. Mapping consists of linking the mechanisms and organs with functions. Nevertheless, the generic mechanisms and organs presented in 2.3.9 can be viewed as components of a physical system even if they are abstract processes. These components require some necessary features according to Artificial Intelligence (AI) [Forbus, 1984]:

- The models should be decomposable into more elementary units.
- The qualitative models should be generalizable into quantitative complements in a straightforward manner.
- The building blocks of physical models should be generic since qualitative reasoning must be possible across domains.

It is argued in this thesis that the generic structure presented in this chapter complies with these requirements. The proposed framework provides a powerful intermediate language between the functional representation of the design specifications and their implementation in the form of concept of solutions. Figure 64 summarizes details and positions the metamodel structure into the integrated framework of the thesis. The functional models are built using a standard vocabulary and a classification. The metamodel structure exhibits also standard generic concepts associated with laws as shown in Figure 64.

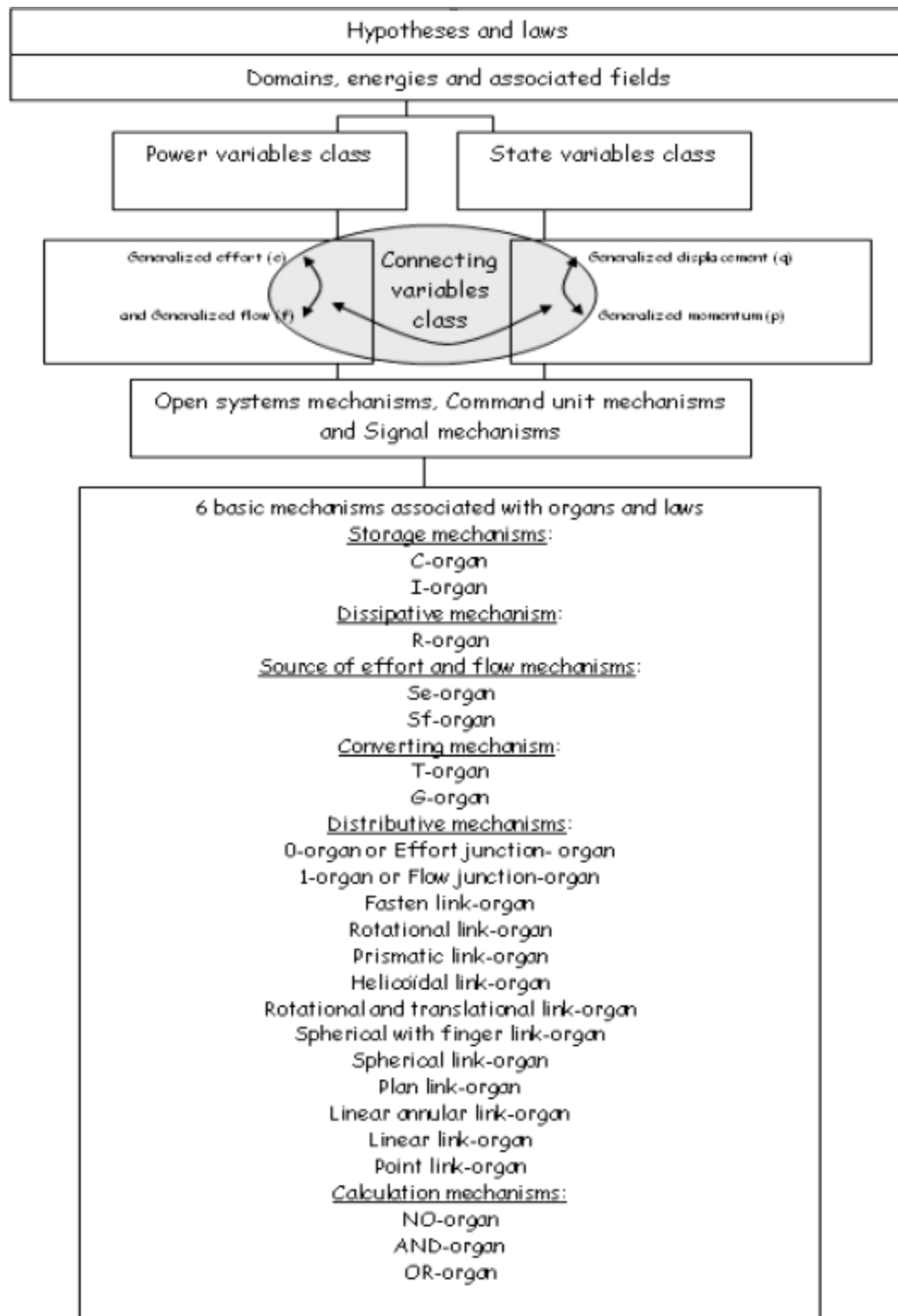

Figure 63: Intermediate language for design modelling derived from bond graphs

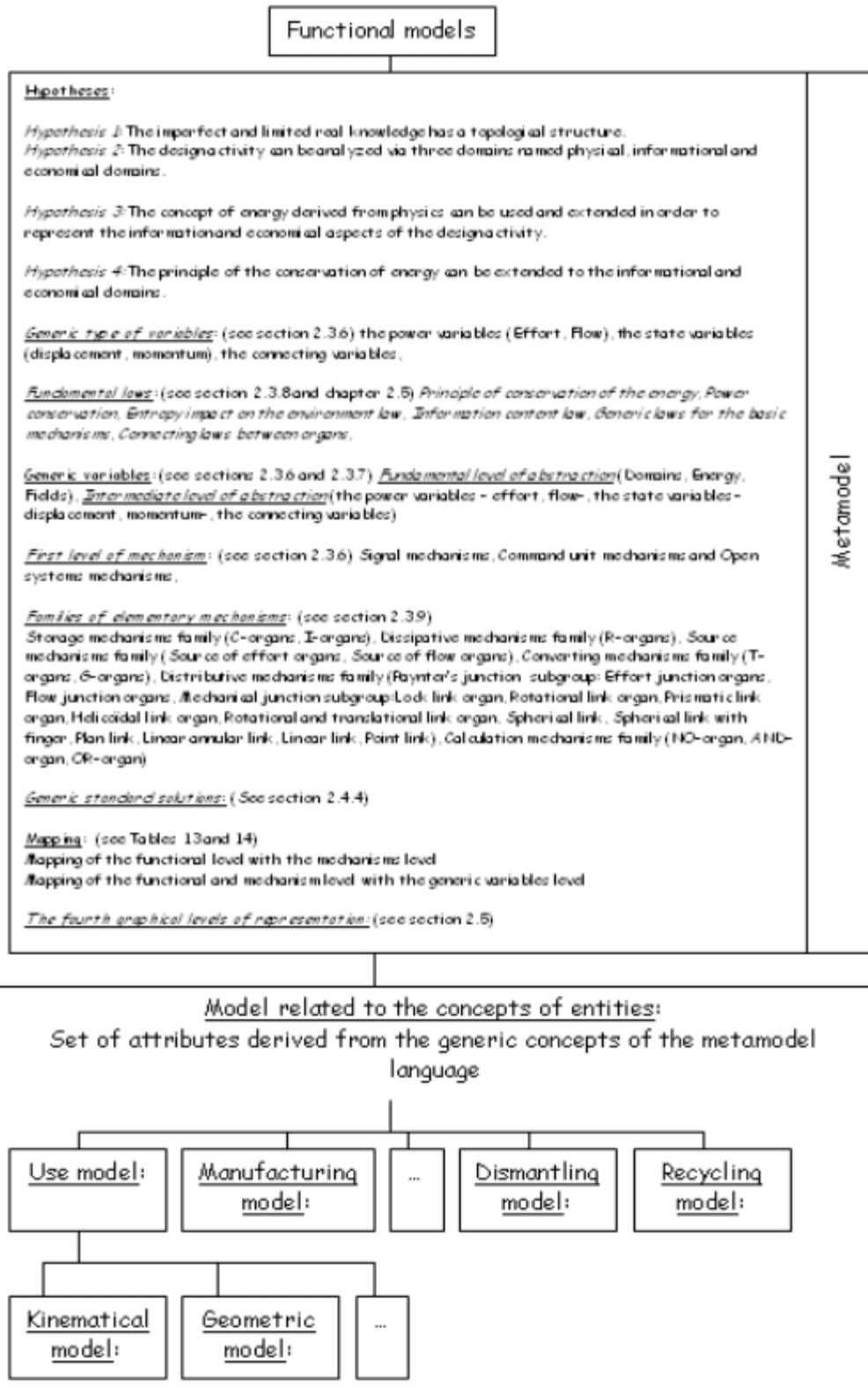

Figure 64: Position of the metamodel framework within the design process

3 SYNTHESIS OF THE CONCEPTUAL DESIGN APPROACH DEVELOPED IN THE THESIS

3.1 Introduction

The goal of this chapter is to summarize the approach developed in the thesis by using algorithms and practical examples. The systematisation of the use of classification, the transformation of the final attributes into a metric space and the use of this metric space in order to reason about design constitute the fundamental aspects introduced in this work. They aim at improving the evaluation and comparison of concepts of solutions and at verifying their adequacy with the functional definition of the needs.

The method presented for the problem clarification and synthesis can not be considered as novel as such. Indeed the clarification and formulation process presented in the thesis is partial. According to Pahl and Beitz [Pahl and Beitz, 1984] the clarification and formulation is divided in two steps:

- The clarification of the tasks and elaboration of the specifications,
- Abstracting in order to identify the essential problems,

Other authors [Otto and Wood, 2001] divide the clarification and formulation of the problem into three main steps:

- The actions a product should do,
- The market position of the product,
- The cost range of the product,

These three steps lead to the presentation of customer needs in a form of a *customer needs and engineering specifications document*. This document is divided according to Dardy and Teixido [Dardy and Teixido, 2003] [NF X50-151] into four parts named:

- The product and its market,
- The context of the project,
- The analysis of the needs,
- The study of the feasibility,

The creation of this kind of document is out of the scope of the present thesis.

Nevertheless the last part called the study of the feasibility contains the expression of the needs in term of service functions and constraints. The identification of this type of information is necessary in order to start the synthesis process and it constitutes the first part of this chapter.

This chapter is divided in two parts, the clarification/formulation/synthesis and the evaluation/adequacy analysis.

It has been decided to associate the problem clarification and formulation with the synthesis process in order to emphasize on the continuity of these two phases during the conceptual design process. The approach selected in order to synthesize concepts of solutions is a classifying approach. The goal is to guide the development of concepts by providing principles associated with the knowledge of physical effects and technologies.

Classification and mapping are systematically applied in order to provide the necessary topological structure for the final transformation process.

The structure of the classification is intended to form the concept of *fundamental system of entourages* and to ensure that the property of separation is obtained. These two conditions form two of the three characteristics required from a classification space in order to be transformed into a metric space. The structure of the classifications is described below:

- A domain classification,
- A functional classification,
- A substance (or matter) classification,
- A functional structure classification,
- A fields, power variables and state variable classification,
- A generic mechanisms classification,

The second part of the chapter dedicated to the evaluation and adequacy analysis proposes an enhancement of the international system of unit and the development of a mathematical machinery.

The enhancement of the international unit system (SI system) by introduction of new basic units is made in order to ensure that a

fundamental countable system of entourages is obtainable in this thesis. This is the third condition in order to be able to transform a classification space into a metric space.

The creation of machinery aimed at forming dimensionless numbers (i.e. a metric space). This machinery at first clusters the attributes by analysing the existing functional similarities between the concepts of solutions. Then the attributes are associated in order to form dimensionless groups. In addition the thesis presents machinery made for the qualitative simulation of the behaviour of the concepts of solutions [Bashkar and Nigam, 1990].

3.2 The clarification/formulation and synthesis processes

This chapter shows how a clarification/formulation and synthesis process can be conducted by using the metamodel and the classification framework develop in the thesis. It should be noticed that this chapter deals only with the last part of the clarification/formulation process (i.e. the identification of the service functions and constraints) but totally with the synthesis process. This introduction is followed by a practical analysis of the development of concepts of solutions related to the development of a technical system aimed at wiping water from the rear mirrors of a car. A second example related to the development of a technological process of manufacturing a part belonging to a pressure regulator will be studied.

3.2.1 Example of the clarification/formulation and synthesis of technical system (TS): a wiper system for rear-view mirrors of a car

The goal of this section consists of identifying the service functions and the constraints of the studied technical system. The relative ranking of these service functions and the definition of the qualitative, quantitative and subjective customer's requirements attached to these functions is out of the scope of this study.

The considered information available is the knowledge of the future product in its market and the context of the project. It is considered that this type of technical system is potentially interesting for customers. The main aspects related to the context of the project are that the technical system (TS) should be compact and cheap. The service functions are defined according to the following interaction graph.

This example has been selected in order to demonstrate that problems dealing with dynamic and cinematic aspects can be properly modelled by the generic mechanisms adapted from the bond graph theory [Karnopp et al., 1990]. The ability of bond graph theory to model problems related to transfer of energy and fluids

have been demonstrated by many studies, nevertheless the capability of bond graph to model mechanical links is open to discussion.

The approach developed in this example is using the metamodel structure developed in chapter 2.5 (Figure 63 and Figure 64).

a- The TS in its environment:

Initial choice: The study is made in the physical and informational domain.

The TS and the environment are analysed with the interaction graph representation [APTE®]. The normalized vocabulary is defined according to the Table 9 and Table 10.

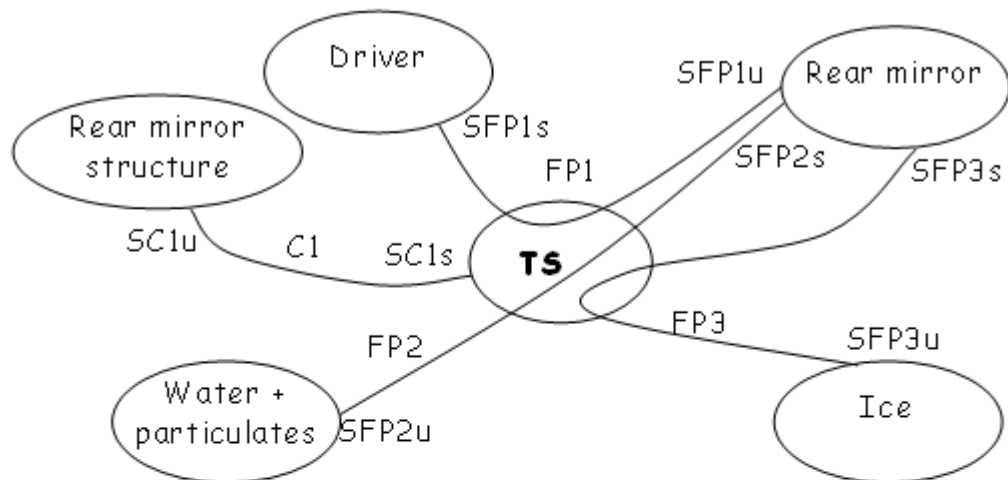

SFP1u: Photon + law of diffraction on mirror - **FP1: Stabilize** -
SFP1s: Photon + diffraction in the eyes.

SFP2u: Mixture Liquid + particulate on solid object +
diffraction on water, particulates and mirror - **FP2: Remove** -
SFP2s: solid object + diffraction on solid object

SFP3u: Solid particulate + diffraction on ice - **FP3: Convert
and remove** - SFP3s: solid object + diffraction on solid object

SC1u: Solid composite + internal volume V1 + mirror surface S1
- **C1: Couple** - SC1s: Solid composite + internal volume V1 +
mirror surface S1

Figure 65: Interaction graph [SADT®] of the TS environment

b- Su-Field analysis:

The initial analysis of Figure 65 clearly demonstrates that in order to stabilize the vision of the driver when using the rear mirror, the functions convert and/or remove should be implemented physically. The analysis can now change the point of view by using the Su- field approach. Section 2.4.4 has shown that a similarity can be established between the concept of function used in the previous figure and the Su-field representation. It should be noticed that the concept of function is still used in the Su-field representation of the thesis.

This approach combined with standard solutions provides elements of solutions. A TS can be modelled according to Su-fields in the following manner (see Figure 66) by using the standard rules presented in 2.4.4 and by the functional structure presented in section 2.4.5 (see Figure 59 and Figure 60).

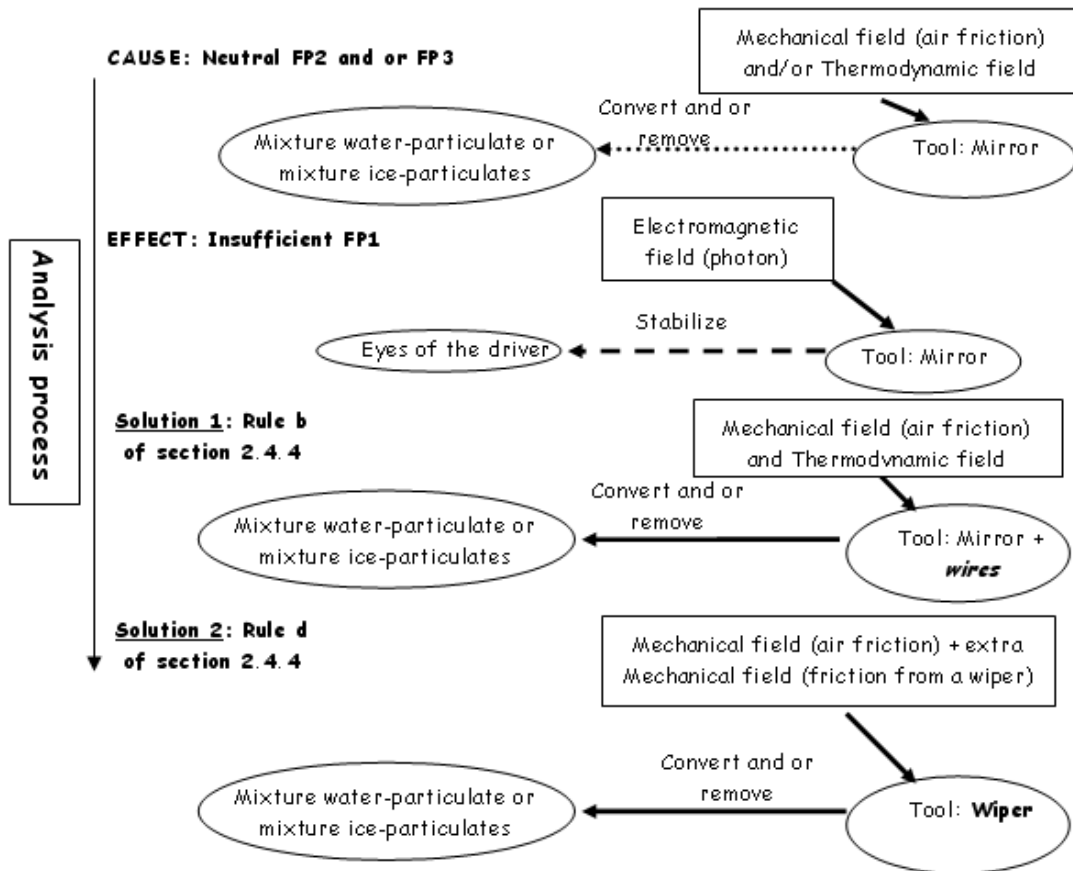

The arrows types are defined according to the graphical language defined in Figure 58

Figure 66: Su-field analysis of the TS

c- functional structure:

The goal of the functional structure approach is to identify the internal functions of the concepts of solution based on the initial Su-field approach. The functional structure developed is a normalized functional structure which takes into account the different concepts introduced in the metamodel. It should be noticed that there is no correlation between the graphical language used in the functional structure representation and the graphical language used in the Su-field representation (see Figure 60 p.122).

Indeed, the representation of a functional structure is using two types of arrows as presented in the Figure 67:

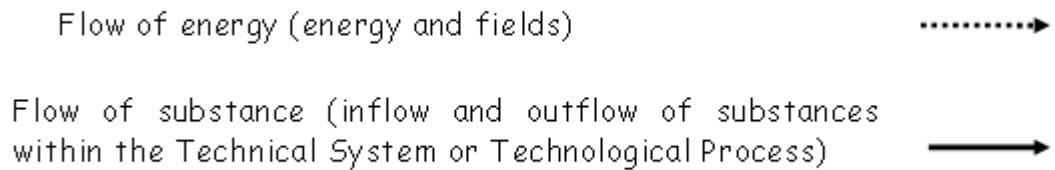

Figure 67: Graphical language used in the functional representation

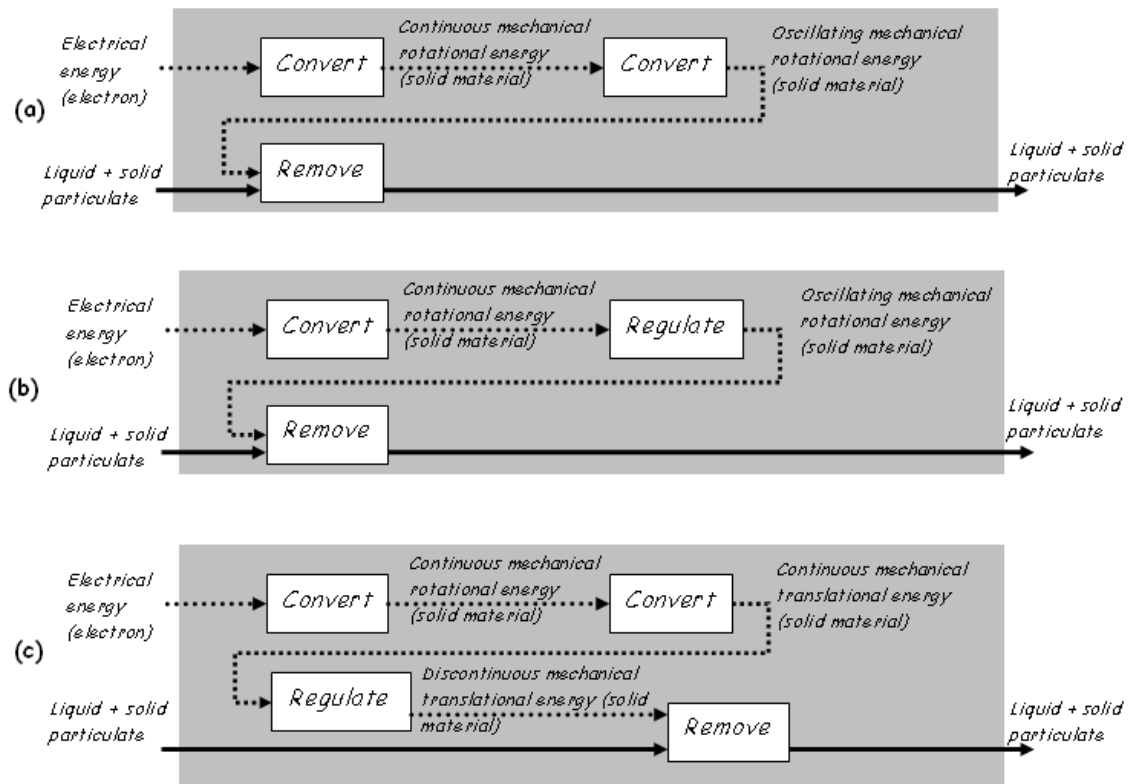

Figure 68: Functional structures of three possible concepts of solution for the solution 2

An important remark should be made at this stage of the synthesis process. The functional structure presented in Figure 68 does not support the entire synthesis process of concepts of solution as noticed in their study of Chakrabarti and Bligh [Chakrabarti et al., 2001]. Nevertheless the functional structure provides interesting additional information compared with Su-field about the structure of the product.

For example the concept of solution (a) of the Figure 68 shows that a continuous rotational mechanical field has to be transformed into an oscillating rotational mechanical field.

Nevertheless, in order to define a functional structure a designer should already have in mind existing solutions or technical principles or to be helped by a database of existing principles. After defining appropriate Su-fields and possible functional structures for the problem, it is required to implement the concepts of solutions in a more practical manner. The choice in this thesis has been made to use the SADT representation of generic mechanisms associated with the metamodel structure.

d- SADT representation:

The following figure presents one possible implementation of the solution 2a by using the SADT representation. It should be noticed that the creation of concepts of solutions have been voluntarily limited in this thesis. Nevertheless it can be said that the more concepts of solution are created the better it is [Otto and Wood, 2001].

The creation of the SADT representation is also using the generic standard solutions established in 2.4.4. In this example the author has only developed the SADT representation of the solution 2 by selecting specific domains and fields. The main idea is to show that the SADT method associated with the enhanced generic mechanisms can model mechanical problems related to cinematic and dynamic. The distinction between flow of energy and flow of material does not exist anymore in the SADT representation because according to the generic mechanism characteristics, consequently only plain line type is used to link mechanisms.

The SADT representation of the solution 2 has been developed in the physical and informational domains (the informational domain is the one which ensures a link with the other domains and the life cycle phases. Consequently this domain is always present). The study is related to the electrical and mechanical fields. Another SADT representation could have been developed for other kinds of fields. The arrows $\leftarrow\rightarrow$ mean that the actions of the fields are transmitted in the sense of the big arrow, and the counteractions which result from this action are represented by the small arrow. By using bond graph vocabulary, the big arrow represents the cause and the small arrow the effect [Karnopp et al., 1990]. In the SADT representation of the Figure 69, only the power and state variables related to the initial action are caused by the rotational torque (T) and the rotational speed (ω) that has been presented.

<p>Solution 2: Wiper</p> <p>Domains: physical and informational</p> <p>Fields involved: Electrical, mechanical</p>	<p>Solution 2a: Using rotational links</p>
---	---

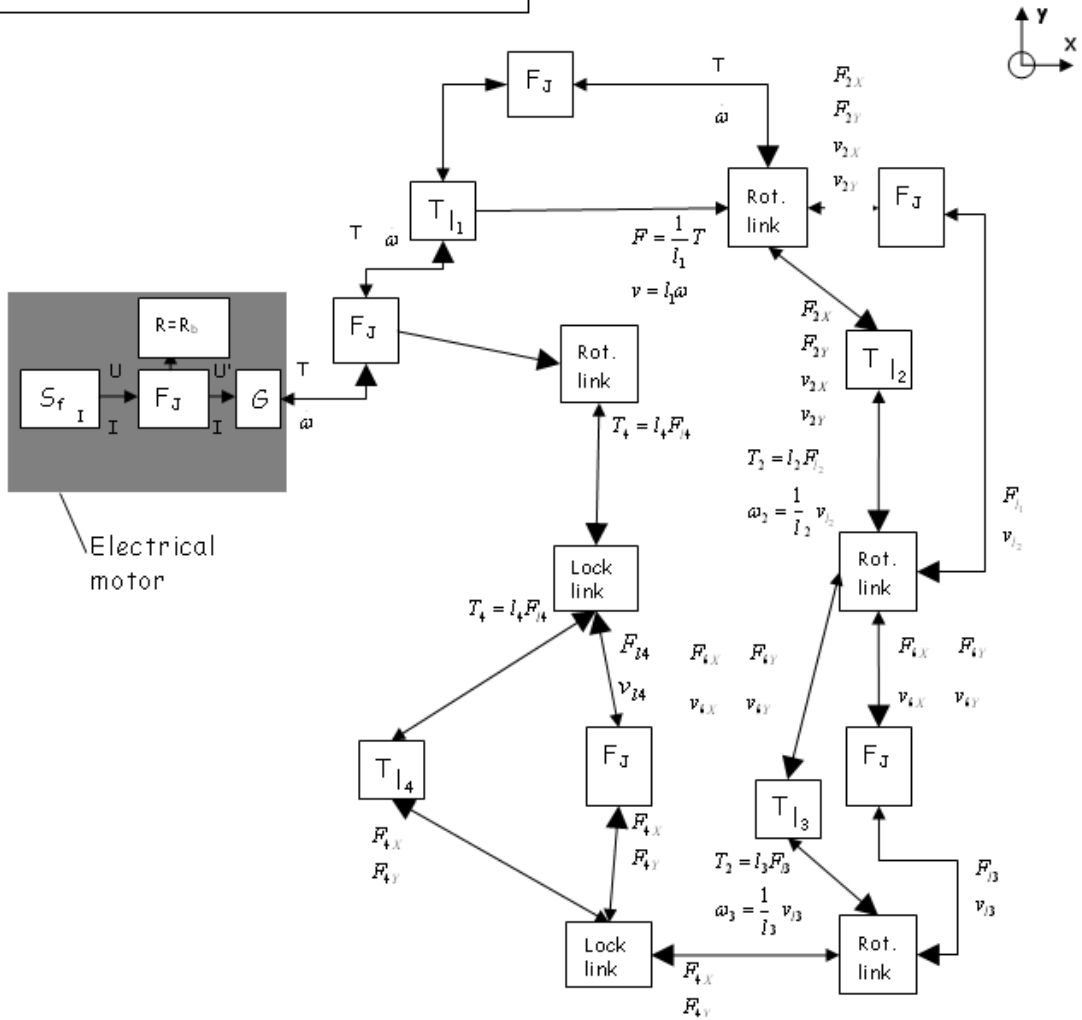

Figure 69: SADT representation of a wiper mechanism for a rear mirror of a car.

e- Graphical representation of the concept of solution:

The last step of the synthesis process consists of representing an appropriate graphical representation of the concept of solution. The selected graphical format is the one defined by the norm NFE 04-015 (ISO 3952) [NFE 04-015]. This is done in the following figure.

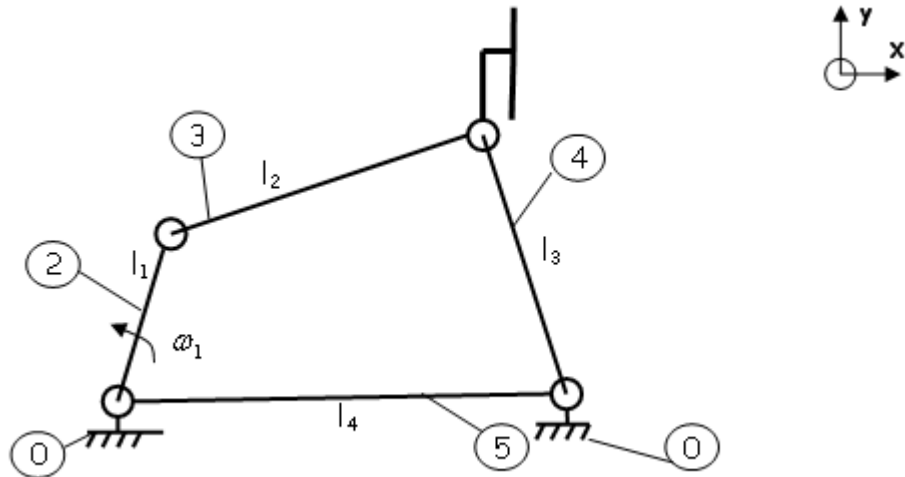

Figure 70: Synthesis representation of the bar linkage mechanism of a wiper for a rear mirror

f- Discussion:

The creation of functional structures, SADT diagram and final graphical representation for the solution 1 can be made by taking into account the *rule n* of 2.4.4 which suggests to take advantage of the phase transitions (for example in our case the transformation from ice into water, the sublimation of ice -direct transformation from ice into water vapour- or the transformation of water into vapour.

This example wanted to summarize the synthesis which results from the framework developed all along the thesis. It should be noted that a classification of technical solution types mapped with basic mechanisms will be of interest when synthesizing concepts of solutions. This is because the approach of synthesizing a concept of solution is based on the modification or the direct use of known solutions. The development of such a classification is the goal of a future research.

3.2.2 Example of synthesis of a Technological Process (TP)

The example studied in this section is related to the synthesis of the manufacturing process aimed at producing a piston belonging to a pressure regulator. This technical system is used in the hydraulic circuit of an autonomous robot. The goal is to present an approach flowing from the use phase perspective to the manufacturing phase perception.

At first the context of the study is given by presenting the synthesis of a pressure regulator starting from its functional structure. The

graph of interaction and the Su-field analysis are not included in this representation but they constitute obviously the two initial steps of the analysis process. The first part leads to a 3D drawing of the piston with a final list of attributes which is the result of the algorithm described in the section 3.3.2.

The second part of the analysing process consists of analysing two manufacturing process candidates by applying the pattern: - graph of interaction analysis, Su-field analysis, functional structure definition and SADT structure definition-.

At the end of the manufacturing synthesis process, the available information is divided into a list of attributes describing the piston, a list of attributes describing the turning process and a list of attributes describing the casting process. These lists need to be processed in order to select the appropriate manufacturing process by using the method developed in section 3.3.2.

a- Selection of the piston variables from a designer perspective:

The functional structure of the selected concept of pressure regulator is presented in the following figures. This representation is the final result of the clarification and formulation procedure described in section 3.2.1.

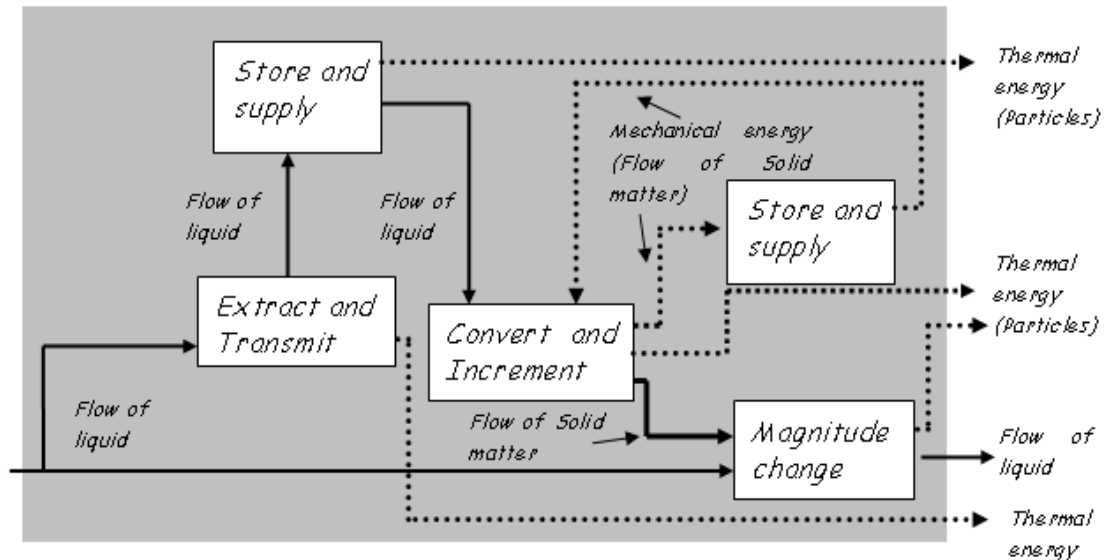

Figure 71: Functional structure of a pressure regulator

By using this functional structure, a SADT representation can be defined by means of the basic and complex mechanisms created in the chapter 2.3.9. The following figure presents the SADT

representation and the fundamental power, state and connecting variables. It should be noticed that the pressure regulator concept is modelled in order to take into account some imperfections. Internal and external leakages of fluid are important parameters in a pressure regulator. An important internal leak is associated with the clearance between the parts of the translational/rotational link inserted between the storage organ C_1 and the converter organ T .

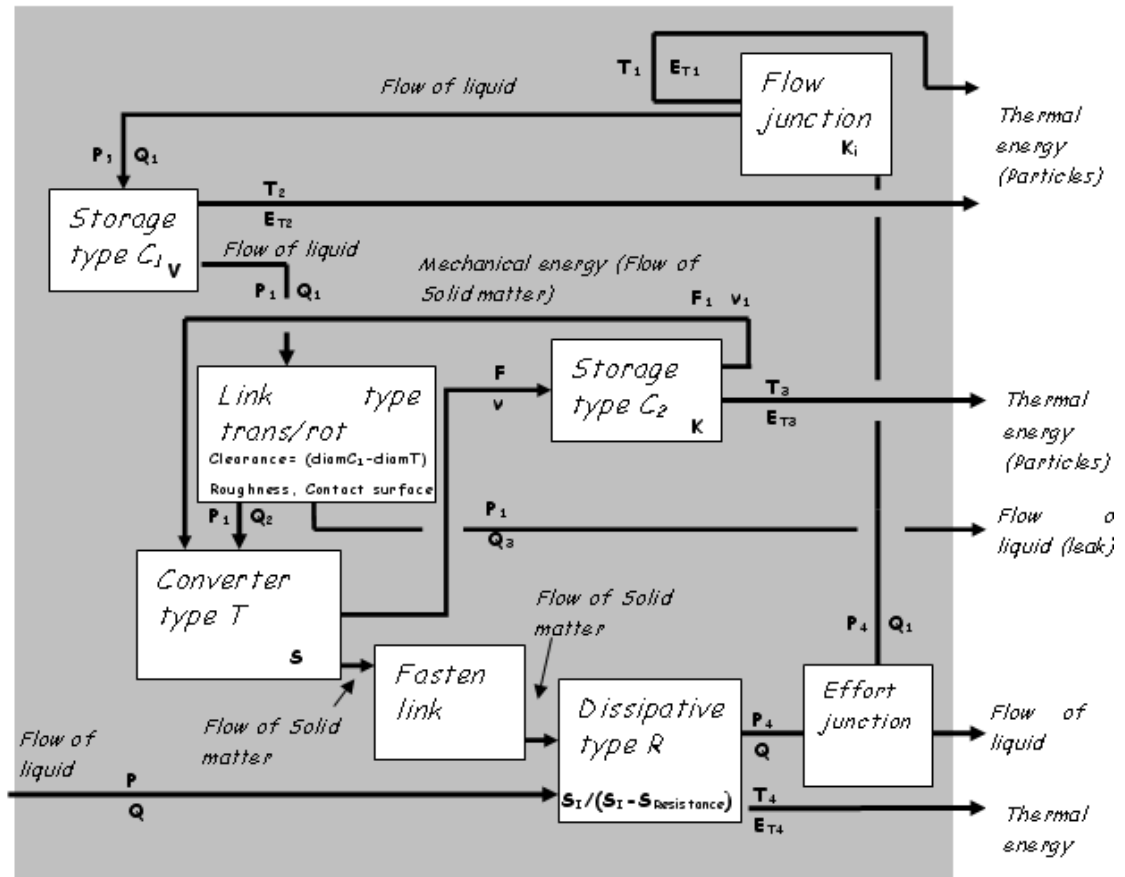

Figure 72: SADT representation of a concept of pressure regulator

Defining a SADT representation is only possible if a designer has already in mind a kind of graphical schematic representation of the pressure regulator concept. Consequently, the SADT representation provides more help in checking and analysing the feasibility of an idea than in conducting the synthesis process itself. The SADT tool is intended in this research rather for preparing the evaluation process than for making the synthesis of a concept of solution.

The next step of the conceptual design process consists of drawing a schematic representation of the selected concept of pressure

regulator and of clustering the SADT representation according to this drawing.

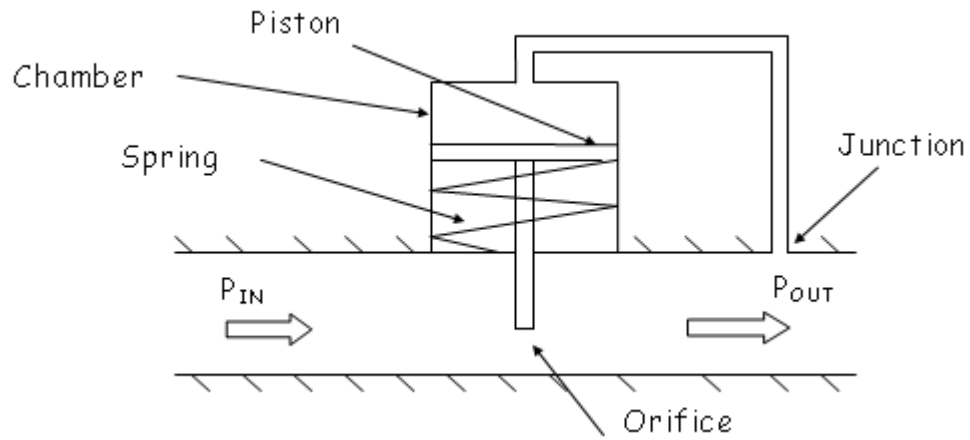

Figure 73: Pressure regulator schematic representation [Bashkar and Nigam, 1990]

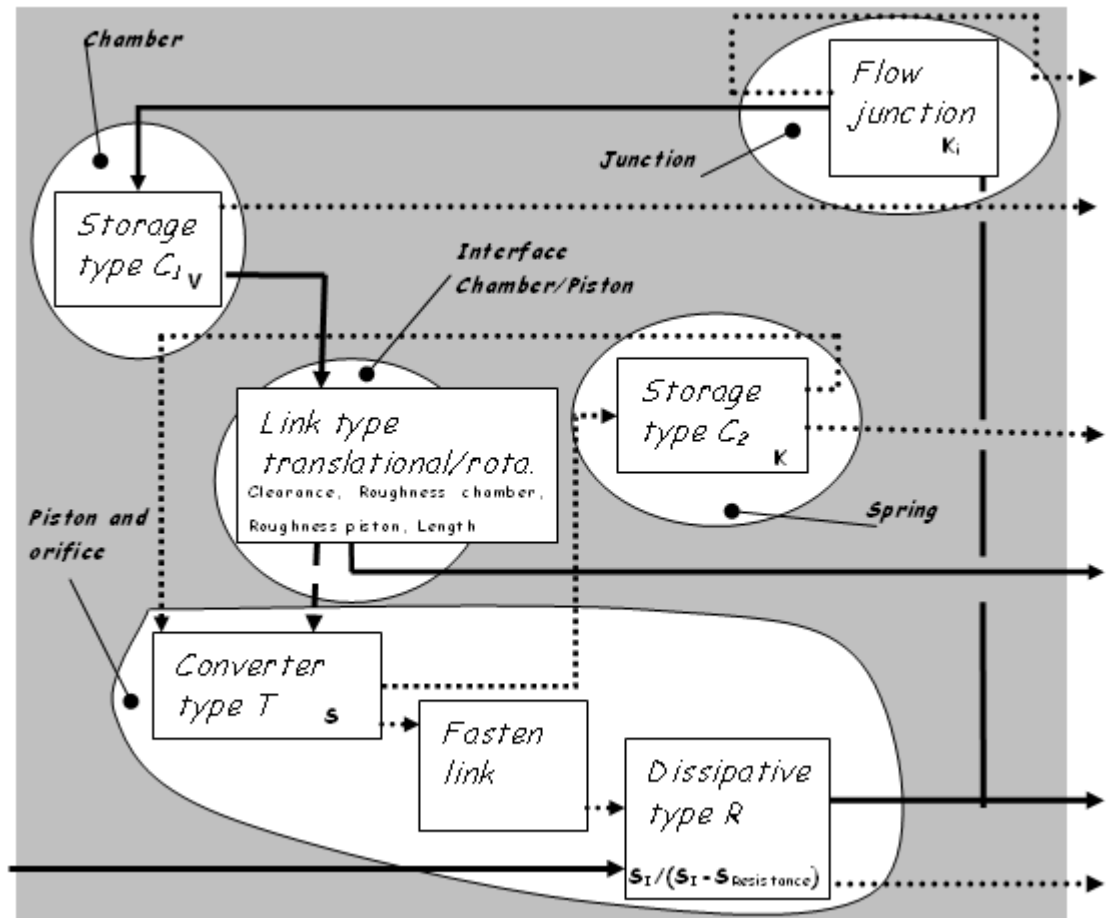

Figure 74: Clustered SADT diagram according to the schematic representation

According to the Figure 72, Figure 73 and Figure 74 the piston behaviour in the pressure regulator ensemble is defined according to a primary list of variables summarized in the following table. The connecting variables represent the characteristics of the basic organs. For example the clearance in the translational-rotational link can be expressed as:

$$\text{Eq. 8} \quad \text{Clearance} = (D_{\text{Chamber}} - D_{\text{Piston}})$$

Table 15: Primary list of variables related to the piston in the pressure regulator environment

Power variables		Connecting variables	State variables	
Effort (e)	Flow (f)		Displacement (q)	Momentum (p)
P_1	Q_1	Diameter of the piston, Roughness Length of the piston in contact with the chamber	/	/
P_1	Q_2		/	/
P_1	Q_2	Diameter of the piston	/	/
F	v		/	/
P	Q	Surface of the resistive part of the piston	/	/
P_4	Q		/	/
T_4	E_{T4}		/	/

The fundamental variables used for describing the concepts of piston are not necessary all summarized in the Table 15. Another type of variable is required; this type is called the comparing variable. These types of variables and the machinery aimed at discovering them are described in the section 3.3.2. Nevertheless at this stage of the design process, the general design approach consists of:

- creating various 3D concepts of a pressure regulator,
- selecting the best concept of pressure regulator according to the machinery of the section 3.3.2,
- creating concepts of solutions for the various parts of the selected concept of pressure regulator,
- applying the machinery of the section 3.3.2 to select them,

The Figure 75 presents a possible concept of solution for a pressure regulator.

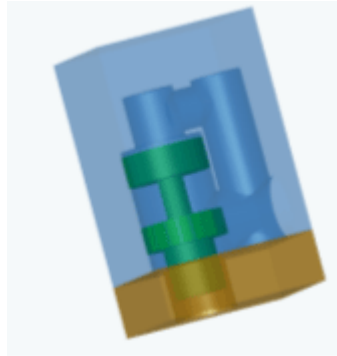

Figure 75: A concept of pressure regulator

Based on the approach described above, a concept of a piston is selected. The necessary attributes used to describe the piston combine the fundamental connecting variables of the Table 15 and the comparison variables which are necessary to ensure that the axiom of recognition/separation is true. The paradigm of identification of the comparison variables of the section 3.3.2 provides a tool in order to underline the comparison variables. According to the Table 23 of the section 3.3.2, if the concepts of the piston diverge by their shape, the comparison is only possible if all of them exhibit a similar volume and a similar mass. The drawing of the selected piston and its necessary variables are given in the following figure.

Material:
20 Mo 5

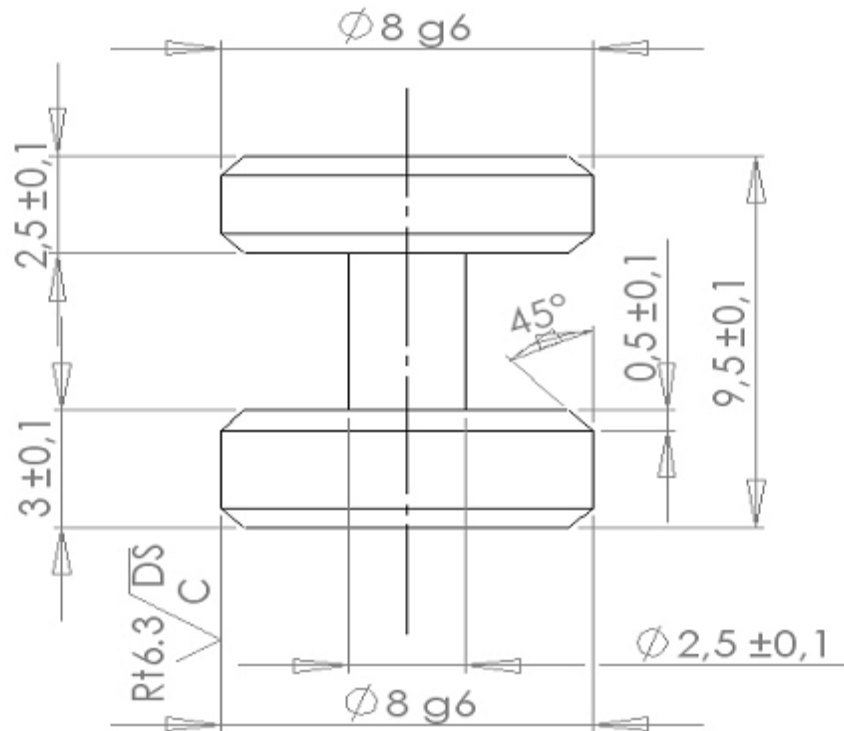
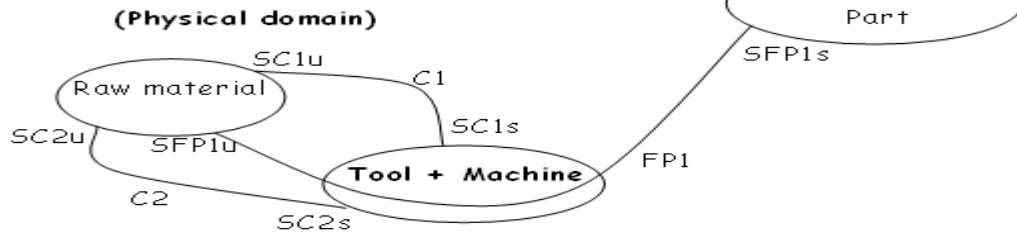

Figure 76: Drawing of the piston of a pressure regulator with the fundamental functional dimensions and the separation variables

b- Analysis of the TP in its environment:

Initial choice: The study is made in the informational, physical and economical domains. The informational domain constitutes the interface between the two other domains. The example is focusing on the overall level of the representation of the TP. The goal is to analyse the Technological Processes in their environment from a physical and economical perspective in order to underline the service functions and the constraints.

TP concept 1: NC lathe process



SFP1u: Solid material - **FP1: Shape + Sense + Process** - SFP1s: solid material + shape + dimensions

SC1u: solid material + Hardness- **C1: Remove** - SC1s: solid composite material + power

SC2u: solid material- **C2: Position + Secure** - SC2s: solid composite material

TP concept 2: Casting process

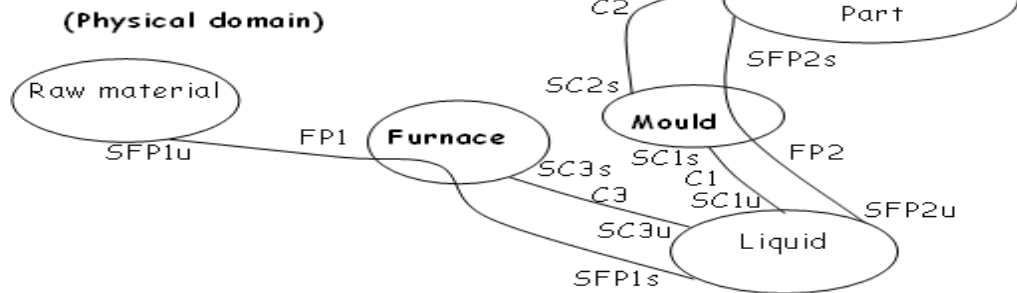

SFP1u: Solid material + volume v1 + Temperature T1- **FP1: Convert** - SFP1s: liquid material + volume v2 + Temperature T2

SFP2u: liquid material + volume v2+ Temperature T2 + melting point + chemical composition- **FP2: Shape + Convert** - SFP2s: solid material + volume v3 + dimensions + mass + Young modulus + Hardness + Chemical composition

SC1u: liquid material- **C1: Contain** - SC1s: solid composite material

SC2u: solid material- **C2: Separate** - SC2s: solid composite material

SC3u: Liquid material + Temperature + Chemical composition- **C3: Stabilize** - SC3s: solid composite material + Temperature + Atmosphere

Use phase/manufacturing phase interaction



SFP2u: solid material or/and atom (electron) + information amount + ... - **FP2: Convert** - SFP2s: solid material + volume + dimensions + shape+...

Figure 77: The TP in its environment from the perspective of the physical and informational domains

Economical study related to the manufacturing and design phases

(Economical domain)

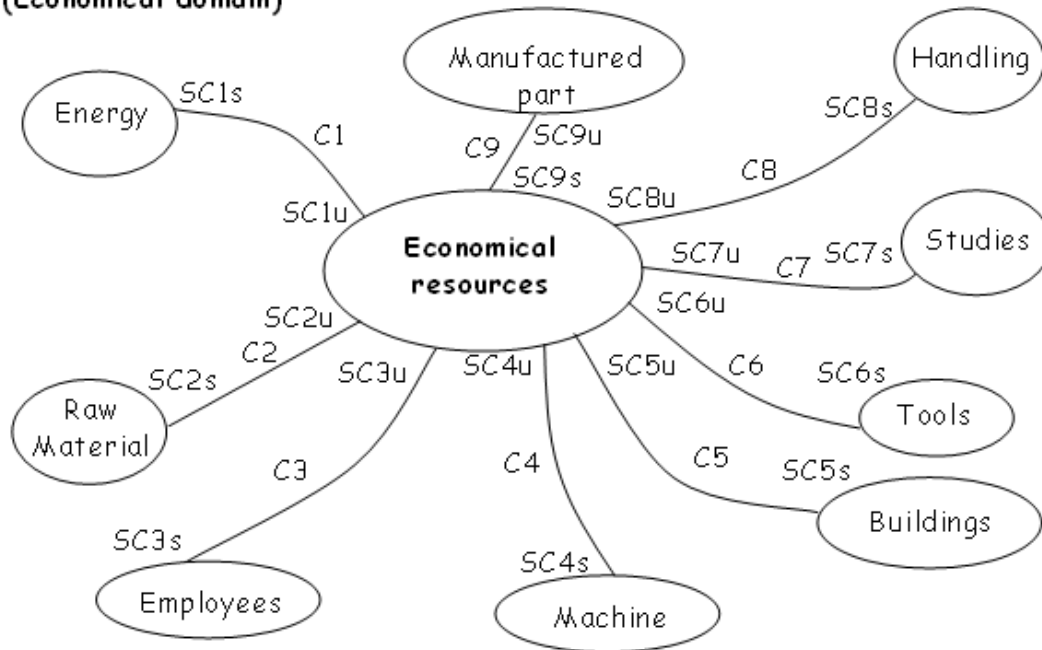

SC1u: Solid objects or electron (money) - C1: *Transfer* (energy costs) - SC1s: electron (electricity)

SC2u: Solid objects or electron (money) - C2: *Transfer* (Raw material costs) - SC2s: Solid material (raw material)

SC3u: Solid objects or electron (money) - C3: *Transfer* (salary costs + social costs) - SC3s: Solid composite material (employees)

SC4u: Solid objects or electron (money) - C4: *Transfer* (Depreciation costs + financial costs + maintenance and reparation costs) - SC4s: Solid composite material (machine)

SC5u: Solid objects or electron (money) - C5: *Transfer* (Storage costs) - SC5s: Solid composite material (building)

SC6u: Solid objects or electron (money) - C6: *Transfer* (Tool costs) - SC6s: Solid composite material (tools)

SC7u: Solid objects or electron (money) - C7: *Transfer* (Planning and manufacturing design costs) - SC7s: electrons or solid objects (studies)

SC8u: Solid objects or electron (money) - C8: *Transfer* (Handling costs) - SC8s: solid objects (handling equipments)

SC9s: Solid objects or electron (money) - C9: *Transfer* (Selling price) - SC9u: solid objects (manufactured part)

Figure 78: The TP in its environment from the perspective of the economical domain

c- Su-Field analysis of the TP:

In the presented case, the two manufacturing processes are meant to be capable. The Su-field analysis is not intended to solve a specific design problem in this case but instead to model, in a more synthetic and precise manner, the two possible manufacturing processes. All the fields and the actions are meant to be useful and the construction rules of the Su-field modelling are respected (see Figure 57 of section 2.4.4).

TP Concept 1: NC lathe process (physical domain)

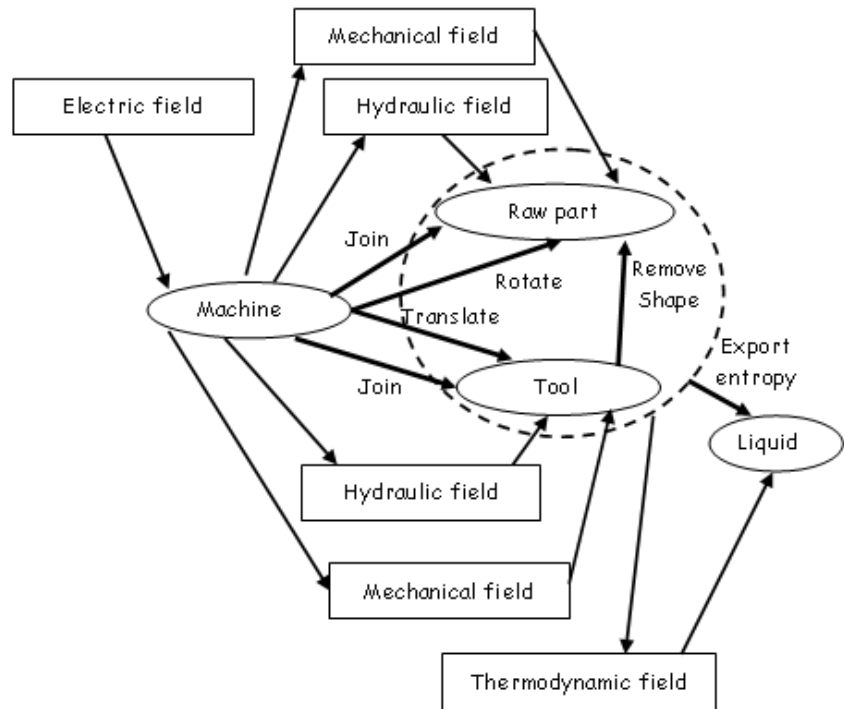

Figure 79: Su-field representation of the NC lathe process in the physical domain

TP Concept 2: Casting process (physical domain)

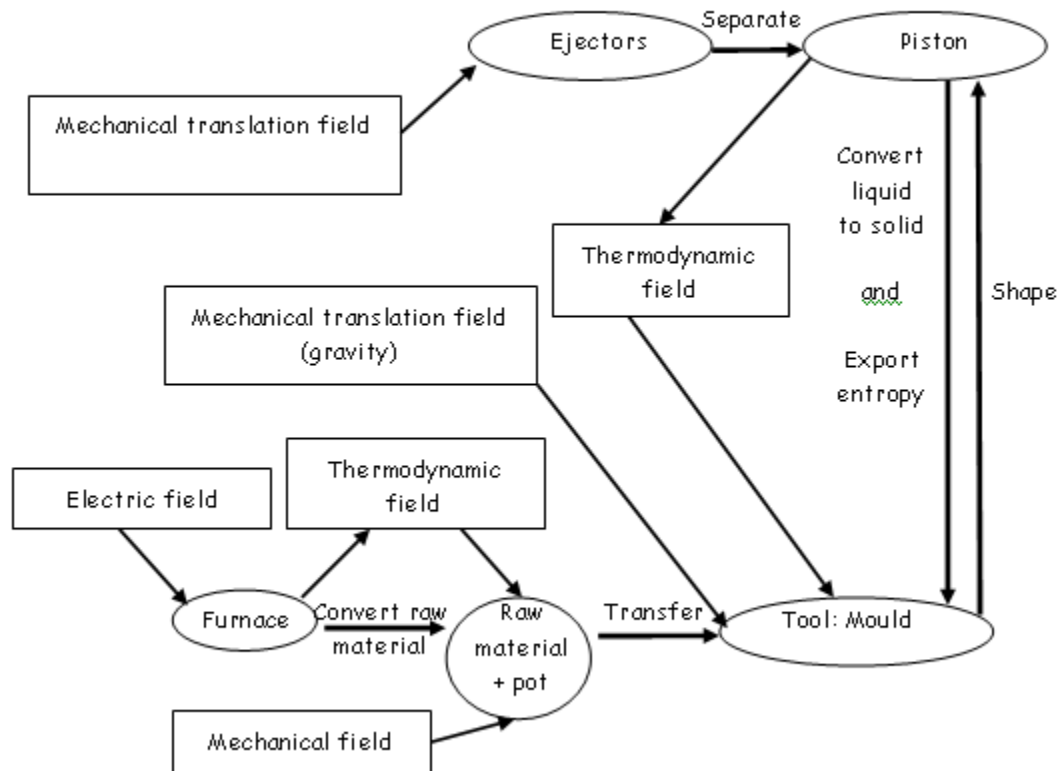

Figure 80: Su-field representation of the casting process in the physical domain

This analysis provides mainly information about the types of fields and functions involved in the two technological processes. It shows also that the two processes are intended to shape a piston. This is trivial and at this level the Su-field analysis is not providing any real insight. Nevertheless according to the paradigm developed later in section 3.3.2, the two TP can be compared at this level. Consequently it is of interest to focus from now on the functional structure of the shaping process.

a- Functional structure:

The functional structure of the two shaping processes is given in Figure 81 and Figure 82. The idea is to describe the sub-processes involved in the manufacturing processes. The sub-processes are related both to the physical and economical domains.

Shaping process - NC lathe

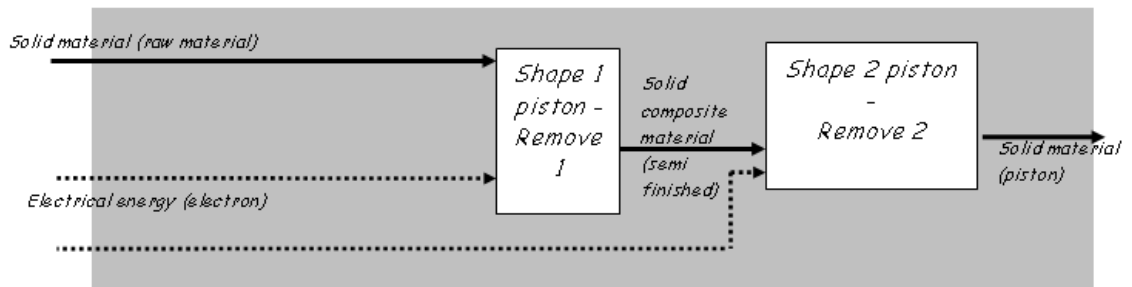

Figure 81: Functional structure of the NC lathe process

Shaping process - Casting

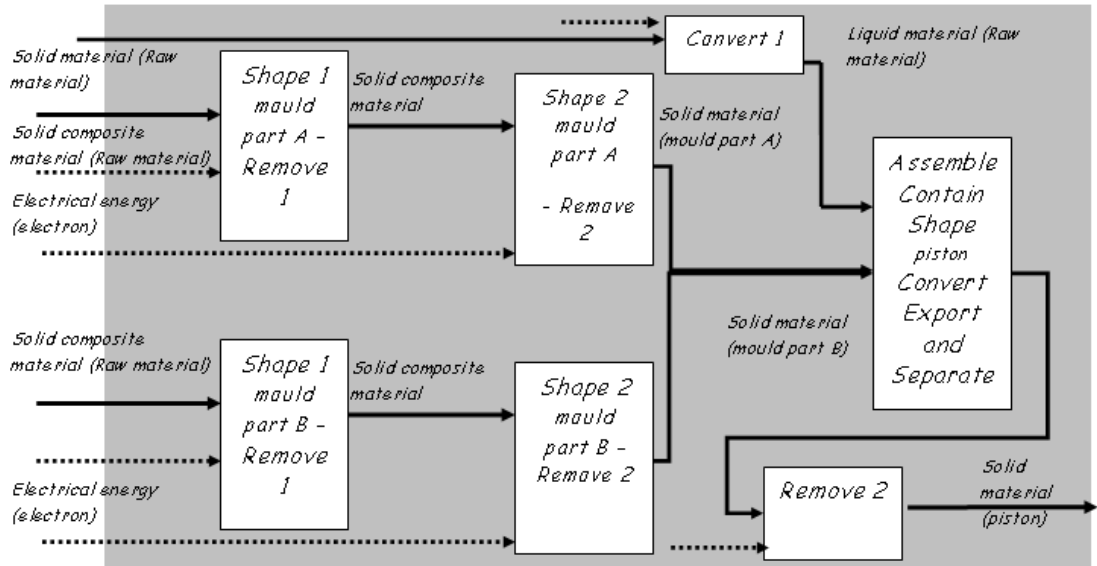

Figure 82: Functional structure of the casting process

e- SADT Representation:

Shaping process - NC lathe

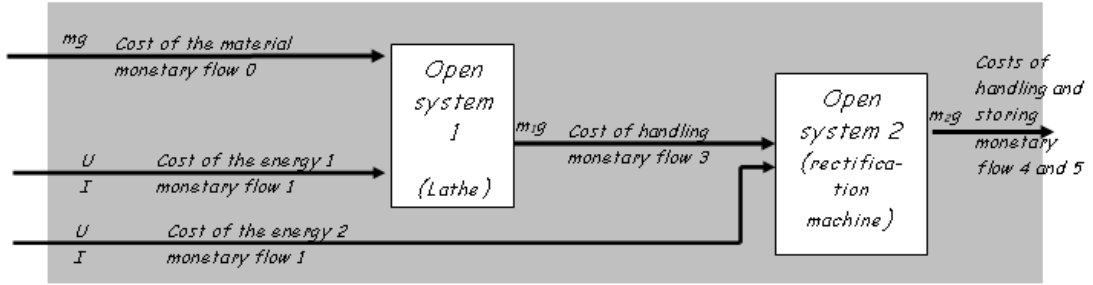

Figure 83: SADT representation of one concept of NC lathe process

The list of variables involved in the open system 1 of the NC lathe process is listed in the following table. The process is similar for the open system 2.

Table 16: Internal and external variables of the Open system 1

Open system 1						
		Power variables		Connecting variables	State variables	
		Effort (e)	Flow (f)		Displacement (q)	Momentum (p)
External variables	Cost of the energy 1	Monetary flows related to the cost of the energy 1		Np: Nominal power, fN: power factor, e: cost/kWh	/	/
	Cost of the material	Monetary flows related to the cost of the material			/	/
	Costs of handling	Monetary flows related to the costs of			/	/

		handling			
	Selling price	Monetary flows related to the selling price		/	/
Internal variables related to the economical domain	Salary costs + social costs	Monetary flows related to salary costs and social costs	Sw: Salary per hour of the worker, Sm: salary per hour of the management, f%: % of the general cost, fg%: % period of the management involvement in the open system 1	/	/
	Depreciation costs	Monetary flows related to depreciation costs	P: Actualized value of the machine, new with equipment, Na: number of years expected for the depreciation, H: number of use per year	/	/
	Financial costs	Monetary flows related to the financial costs	P: Actualized value of the machine, new with equipment, Ir: Interest rate of the loan, H: number of use per year	/	/
	Maintenance and reparation costs	Monetary flows related to the maintenance and reparation costs	P: Actualized value of the machine, new with equipment, q: reparation rate %, H: number of use per year	/	/
	Storage and room costs	Monetary flows related to the storage and room costs	I: Renting price per m ² , S: surface occupied by the , H: number of use per year	/	/

	Tools costs	Monetary flows related to the tools costs	Po: global cost of a new tool, nu: number of use, Cm: cost per hour of the machine, Tcha: Time to change a tool	/	/
	Planning and manufacturing design costs	Monetary flows related to the Planning and manufacturing design costs	Sm: salary per hour, fg%: % of the management involvement in the open system 1	/	/
Internal variables related to the physical domain and given by the design phase (see Figure 76)	/	/	Dimension piston, Roughness Length of the piston surfaces in contact with the chamber/	/	/
	/	/	Diameter of the piston	/	/
	/	/	Surface of the resistive part of the piston /	/	/
Internal variables related to the physical domain and given by the manufacturing phase	Fc: Cutting effort	Vc: Cutting speed	T: life time of the cutting edge, nozzle radius of the plate	a: depth of cutting, f: advance per revolution	/

Shaping process - Casting

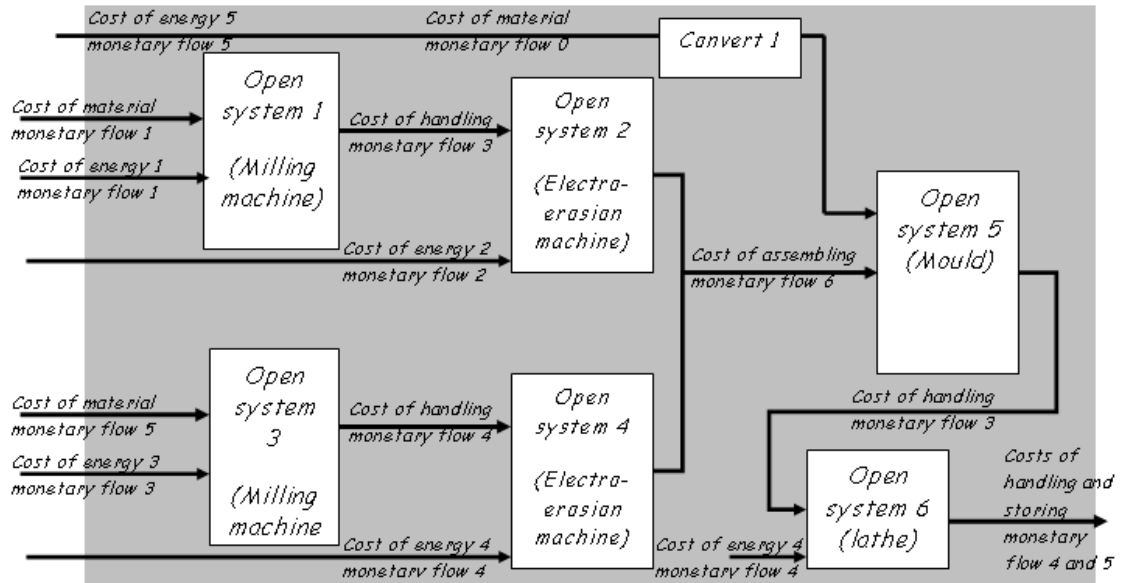

Figure 84: SADT representation of one concept of casting process

Following the same pattern than the Table 16, several lists of variables can be established for each open system related to the two manufacturing possibilities. The final number of variables is important. Consequently, it can be interesting to diminish them both by considering the concept of information as an approach to normalize the design metrics (see the presentation about the practical implementation of the concept of information in section 3.3.1) and by applying the method described in section 3.3.2 which clusters the variables by forming dimensionless groups.

3.3 Evaluation and adequacy analysis

The goal of this section is to present in a synthetic manner the process of the evaluation and adequacy analysis.

3.3.1 Enhanced system of fundamental quantities required for the evaluation and adequacy analysis

This section presents the *fundamental countable system of entourage* which is one of the third necessary conditions for the metrization of a classification space during the last phases of the conceptual design process, namely the comparison and evaluation phases. It has been presented several times that the design process is dealing with three domains. According to the physical life cycle vision of the design process, conceptual design should be able to

model the three domains of design as summarized in the Figure 18. Consequently, metrics should be associated with the quantities of the domains in order to ensure that the attributes used to describe the various model are countable and measurable. This is traditionally done for a set of physical attributes using the international system of quantity (SI system) composed of 7 base quantities -length, time, mass, temperature, current, number of elementary particles, and luminous intensity-. Nevertheless, this system does not have any fundamental quantity related to the economical and informational domains which constitute an important sector of the design activity. I argued that design activity requires two extra fundamental quantities in order to ensure that a *fundamental countable system of entourage* can be created. These two quantities are the quantity of information symbolized by *Sh* and the economical quantity symbolized by *C*. The units of these two quantities are respectively the Shannon (Sh) and the Euro or Dollar (€, \$ for example).

The fundamental quantities and units are summarized in the table below [Coatanéa, Vareille and Le Bolc'h, 2004].

Table 17: Fundamental quantities and units

The seven Base SI quantities and units		
Physical quantity (symbol)	Base unit	Unit Symbol
Length (L)	metre	m
Time (T)	second	s
Mass (M)	kilogram	kg
Electric current (A)	ampere	A
Thermodynamic temperature (K)	kelvin	K
Luminous intensity (Cd)	candela	cd
Amount of substance (Mol)	mole	mol
The two non physical quantities and units		
Quantity (symbol)	Base unit	Unit Symbol
Informational (Sh)	shannon	Sh
Economical (C)	cost	€ or \$ or others

Discussion about the concept of information:

The analysis of the connection between the different phases of the physical life cycle and within the phases themselves, for example in the use phase shows that information is present in many ways. For example the connection between design and manufacturing requires the exchange of information. Similarly many types of sub-systems which compose a technical system exchange information. The information takes different forms and it is useful to find a way to transform the various metric related to information during the

conceptual design phase in order to express them according to the fundamental quantity of information introduced in this thesis. To achieve this goal it is important to highlight the fundamental aspects of information in design.

At first, the quantity of information transmitted during the communication process is clearly correlating with the complexity of the designed technical system. Consequently, we can compute automatically specific attributes related to the nature and quantity of the information for elements of a TS. For example if considering the 3D concept of the piston presented in the Figure 85. The quantity of information related to the plan XY, XZ and YZ can be computed. This type of information attribute associated with other ones can then be compared with the range of information which can be treated by manufacturing equipments. This comparison gives information about the capability of technological processes to do the manufacturing tasks. Consequently the quantity of information can be the normalized type of information used in the conceptual design activity. The quantity of information is measured by the Shannon unit.

Practical implementation of the concept of information [Coatanéa and Vareille, 2004]:

The short analysis conducted above has shown that the quantity of information can be used as a unified metric of information. Information should now be defined for the purpose of this work a practical case of information transformation will also be presented.

In the theory of information [Shannon et al, 1949] [Brillouin, 1952] [Brillouin, 1964], information is presented as a probability. Probabilities distinguish possibilities according to the information they contain. But the inconvenience of this probabilistic presentation of information is that smaller probabilities signify more information, not less and probabilities are multiplicative rather than additive. Consequently Shannon [Shannon et al, 1949] has introduced a sign – and a binary logarithm in order to ensure additive property for the information and a correlation between the probability and the amount of information. The basic information presentation is then:

$$Eq. 9 \quad I = -\log_2 p_i$$

In this thesis, it has been decided to call the quantity of information Shannon (sh) instead of Bit, because Bit has nothing in common with the probabilistic nature of information defined in the theory of information [Clavier, 1998].

A 3D concept of the piston of a pressure regulator is drawn with 3D CAD software (Figure 85). A 3D concept gives more information than a 2D concept when the goal is to analyse the use the information in the other phases of the physical life cycle. The blue box of Figure 85 guarantees for each concept of the piston that they stay in a constrained volume, ensuring that later dimensional comparison is possible (see Paradigm for the verification of the separation property and identification of the comparison variables in section 3.3.2). Figure 86 is presenting the dimensions of the piston resulting from the 3D draft. Then it is possible to compute the flow of information (which can flow to the manufacturing phase, see Figure 18 p.76) by using the mathematical machinery described hereafter the Figure 85 and Figure 86 and Table 18, Table 19 and Table 19. In order to be usable for the manufacturers, information needs to be clustered according to different classes. These classes have been defined in this example according to three families:

- Information related to the *macro geometrical characteristics*,
- Information related to the *micro geometrical characteristics*,
- Information related to the *material characteristics*,

The type of information analyzed in our example is the macro geometrical information according to Figure 86. A beginning of a classification of information attributes is done in Table 18.



Figure 85: A 3D concept of piston

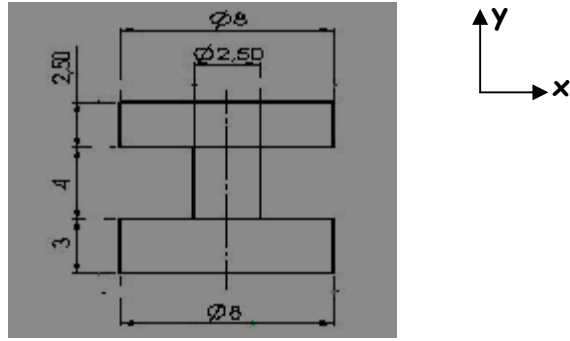

Figure 86: The dimensions of the piston

Table 18: A possible classification of the information attributes for the piston

Class (Primary)	Secondary	Tertiary	Units
Information	Macro geometrical		
		Total amount of information	Sh
		Information of plan XY	Sh
		Information of plan XZ	Sh
		Information of plan YZ	Sh
		Information of axle X	Sh
		Information of axle Y	Sh
		Information of axle Z	Sh
	Micro geometrical		
	Material		

Normalisation of the informational metric:

The symbol \emptyset (Figure 85) represents the diameter and this symbol is coded in ASCII code II using the decimal number 238. The binary code of this number is 11101101. The coding of such number requires 8 bits. If we consider that each numeral (e.g. 0, 1, 2, 3, 4, 5, 6, 7, 8, 9) has a similar probability to occur, we can write:

$$Eq. 10 \quad p_i = \frac{1}{2^n}$$

n being the number of bits necessary to code the decimal number 238, n should be a whole number such as $n = \lceil \log_2 238 \rceil = 8$.

Subsequently, the symbol representing the diameter has a probability $p_1 = \frac{1}{2^8} = \frac{1}{256}$. Consequently the information necessary to code such type of symbol is $I = -\log_2\left(\frac{1}{256}\right) = 8sh$. The total content of the macro geometrical information related to the piston is synthesized in the following table.

Table 19: The amount of information related to the piston

Dimension and symbols	Number of bits for coding the characters	Number of repetitions	Information (Shannon)
∅	8	3	24 sh
8	4	2	8 sh
2	2	2	4 sh
0,50	6	2	12 sh
4	3	1	3 sh
3	2	1	2 sh

Some aspects should be clarified at this point of the work: - The number of Shannon is equivalent to the number of Bit necessary for coding information. This explains why Bit is often assimilated to a unit of information. Brillouin and Clavier [Brillouin, 1952] [Brillouin, 1964] [Clavier, 1998] have noticed that information convey also sense, this characteristic is blurred by the computation of a quantity of information and is not taken into account in the theory of information [Shannon et al., 1949]. By classifying information according to different types of attributes a part of the sense can be conserved. This is the goal of the following table which summarizes the results of Table 19.

Table 20: Clustering of the information about the piston

Class (Primary)	Secondary	Tertiary	Information (Shannon)
Information	Macro geometrical	Total amount of information	105 sh
		Information of plan XY	0 sh
		Information of plan XZ	84 sh
		Information of plan YZ	0 sh
		Information of axle X	0 sh
		Information of axle Y	21 sh
		Information of axle Z	0 sh

The micro geometrical and material attributes of the information are out of the focus of this thesis. Nevertheless the general procedure remains similar for them too.

This short analysis of the normalization of the informational metric can be developed further by pursuing the analysis started in 3.2.2 according to the new elements introduced in the following section 3.3.2. The analysis will consist of comparing and matching the functional and SADT structure of *manufacturing concepts* with the functional and SADT structure of *3D modelling concepts*. The other possibility is to compare concepts of solution belonging to the same phase of the physical design life cycle. The important remark is that the informational domain and the informational metric can constitute the fundamental domain when dealing with transfer of information between two phases of the physical design life cycle. These two cases are summarized in the figure below.

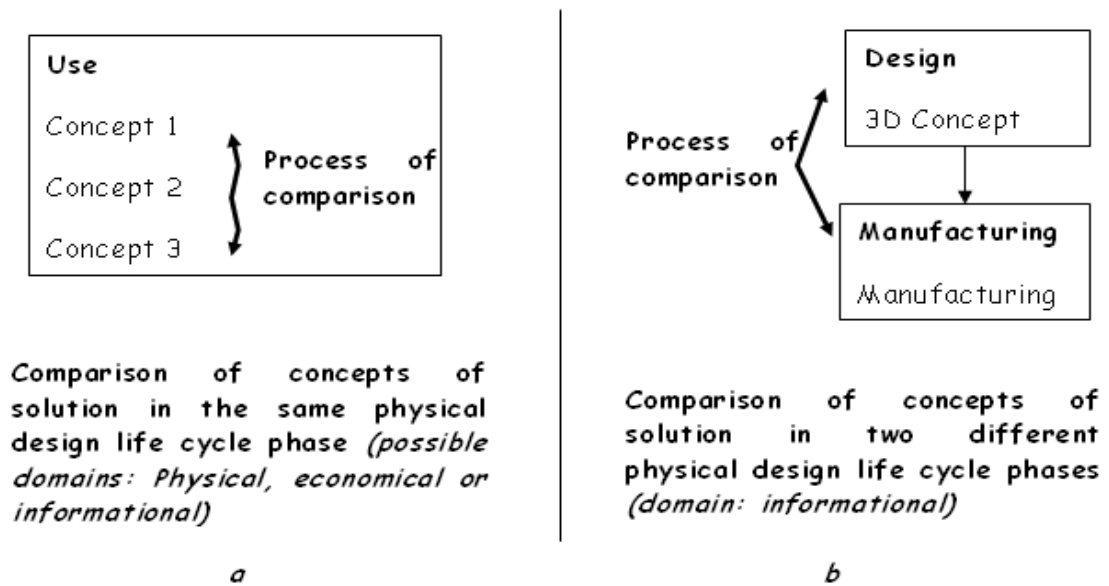

Figure 87: Comparison of the design domains for two types of process for the comparison of concepts of solutions in the physical design life cycle

Discussion about the environmental aspects:

In order to be able to measure the environmental impact, I argue that the concept of entropy is the unified metric which can be used. Svirezhev has modelled the environmental impact of a system by using entropy according to Eq. 2 (p.73) [Svirezhev, 2000]. He has modelled the environmental degradation by comparing the ability of the environment to recycle entropy in a steady state both with the exogenous exportation of entropy produced directly by a technical system or a technological process to the environment (for example by a mechanical degradation of soil in the case of a tractor) and with the exportation of a flow of degraded energy by a technical system or a technological process (for example heat and exhaust fumes of a tractor). The metric of entropy is a derived metric of the fundamental quantities which compose the enhanced fundamental system of unit. This metric has the form $ML^2T^{-2}K^{-1}$ (J/K) according to Table 17.

An extensive study focusing on the analysis of the environmental impacts using entropy is the goal of a future research project.

3.3.2 Mathematical machinery made for obtaining a metric space and method for analysing and comparing concepts of solutions

The consequences of the axiom of separation/recognition studied in the section 2.3.5 have been followed by practical implementations from sections 2.3.6 to 2.3.9 and in chapter 2.5 by creating a

metamodel structure based on generic concepts. The metamodel structure's aim is to create *fundamental systems of entourage* at different levels of the synthesis process. In addition this structure is made for ensuring the property of *separation*. The third consequence of the analysis of the section 2.3.5 was to provide a fundamental *countable* system of entourage. This system has been established in section 3.3.1. At this stage of the conceptual design process, the necessary bases are combined and it is now possible to establish the method aimed at obtaining a metrization of the classification space. This is the goal of this section. In addition this section is providing a method dedicated to analysing the interconnections between the variables within and across dimensionless numbers. Finally this machinery also provides a tool for analysing the interconnections between the ensembles formed by the functions. This analysing approach is based on the method developed by Bashkar and Nigam [Bashkar and Nigam, 1990].

Method for clustering functions and mechanisms dedicated to function's description:

Before transforming a classification space into a metric space, a method for clustering comparable attributes should be established. It should be noticed first that in the example of Figure 87b, the two concepts of solutions located in two different phases of the physical design life cycle are related to the respect of the same service function. These rules are described below:

Fundamental rules for the clustering of comparable functions and mechanisms:

Rule 1: Normalized functional structures of the concepts of solution should be established,

Rule 2: Concepts of solutions related to TS or TP can be compared by using dimensionless numbers if and only if they are related to same service functions,

Rule 3: Two groups of attributes can be compared if they are used for describing the same function,

Rule 4: The concepts of solution should be represented by using SADT diagrams (see Table 13 and Table 14) in which the black boxes are formed by the generic mechanisms structures of section 2.3.9. The boxes should be associated with the generic variables structure and the period of time studied should be defined,

Rule 5: Using the mapping Table 13 and Table 14 in order to cluster the generic mechanisms represented in the SADT diagrams. At the same time the correlation of the functional and SADT

representations should be verified in order to detect modeling mistakes.

For example, if considering two concepts of solutions namely the brush/dustpan and a vacuum cleaner; they can both be represented according to two types of representation:

- a normalized functional structure,
- a SADT representation using generic mechanisms (the SADT representation of the concepts of solution is using the generic organs and variables which constitute a part of the metamodel structure.)

The Figure 88 and Figure 89 present these two representations.

It is possible to compare the two concepts of solution a and b in Figure 88 using the rules 2 and 3. They are both related to the same service function. In addition dimensionless numbers can be formed for the attributes used for describing the following sub- functions:

- Import, Store, Export,
- And for the service functions Import and Store,

The function convert of the vacuum cleaner concept can not be compared with any other similar functions in the brush/dustpan concept.

This comparison is followed by the task of highlighting these functions in the SADT diagrams. This is done in the Figure 89 by using the metamodel structure. It is also possible to define general variables which are used to describe the TS.

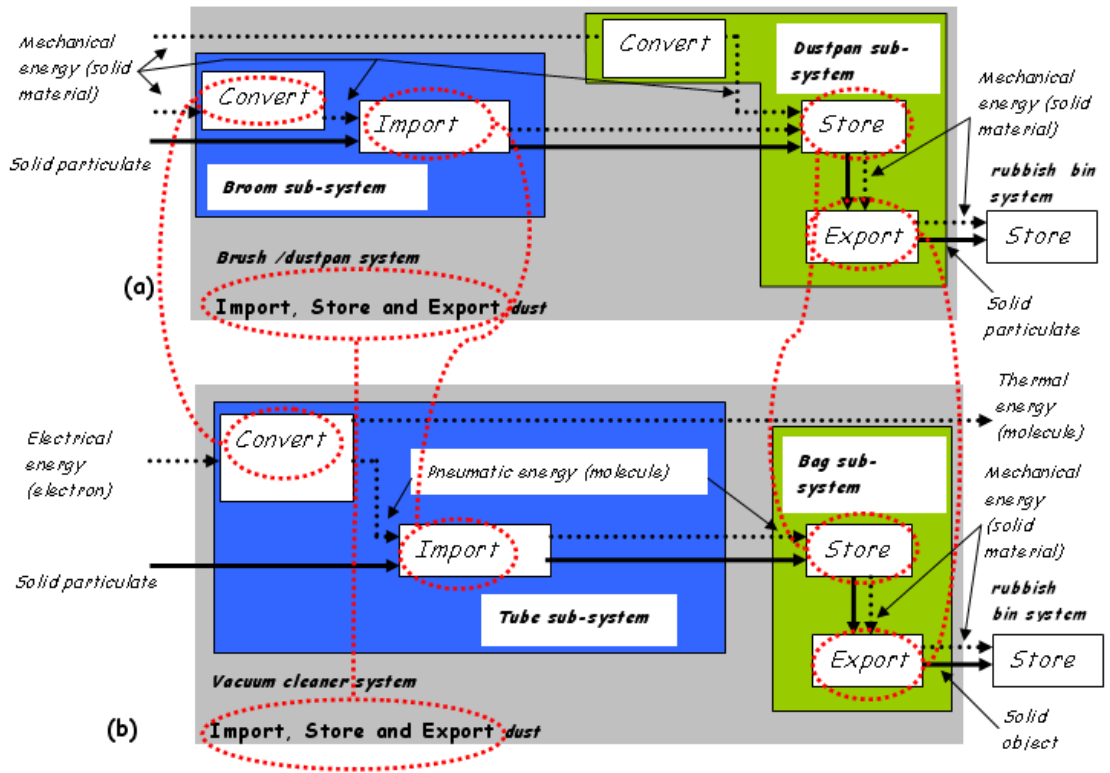
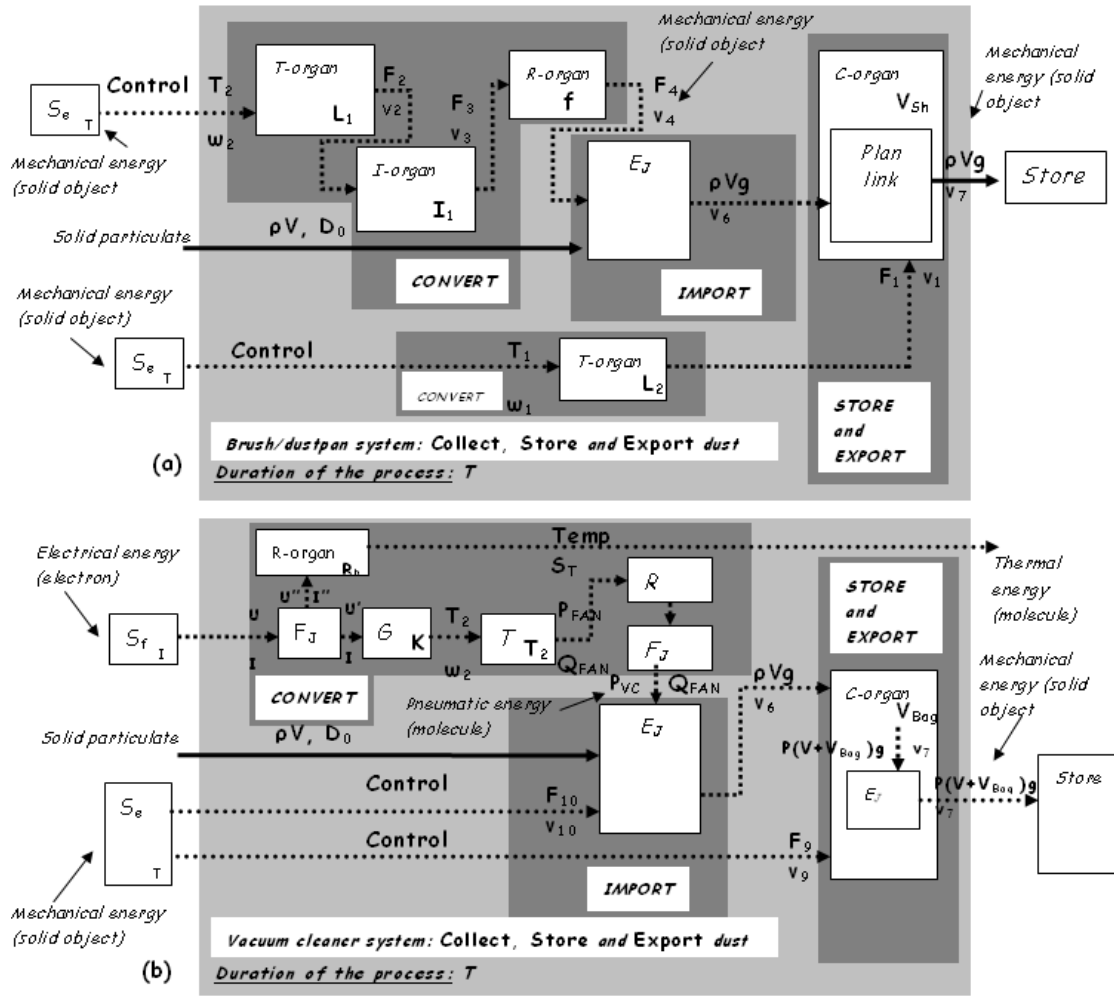

Figure 88 a-b: Normalized functional structure of two concepts of solutions dedicated to the service functions **Import, Store** and **Export dust**



N.B.: It should be noticed that the control of the generic mechanisms in a and b is made by the Source of effort (the user), not by the TS.

Figure 89: SADT representation of the concepts of solutions

Remark about the dissipative organ (R) and flow junction organ (F_J) in the CONVERT function of the Figure 89 b:

Both of these organs have been selected in order to constitute a Venturi. The dissipative organ (R) is related to the diminution of the section in the Figure 90. The Flow junction organ (F_J) is related to the junction between different tubes in B (see Figure 90).

This law of continuity between the flow of the two points A and B of the Figure 90 xvcc is expressed in Eq. 11.

$$\text{Eq. 11} \quad Q_A = Q_B$$

Then $v_A = \frac{S_B}{S_A} v_B$ with v_A, v_B linear velocity and S_A, S_B sections of the Venturi system. The value of the pressure in P_B is inferior to the one in P_A . In the case of a Venturi, it is expressed by using the Bernoulli's law expressed below:

$$\text{Eq. 12} \quad P_A - P_B = \frac{1}{2} \rho (v_B^2 - v_A^2)$$

According to the Bernoulli's law of Eq. 12 and the law of continuity of Eq. 11, if the diminution of the section is equivalent to a dissipative organ, the Eq. 14 gives the expression of the resistance R of the dissipative organ.

$$\text{Eq. 13} \quad P_A - P_B = \frac{Q \rho (S_B^2 - S_A^2)}{2 S_B^4} Q$$

$$\text{Eq. 14} \quad R = \frac{Q \rho (S_B^2 - S_A^2)}{2 S_B^4}$$

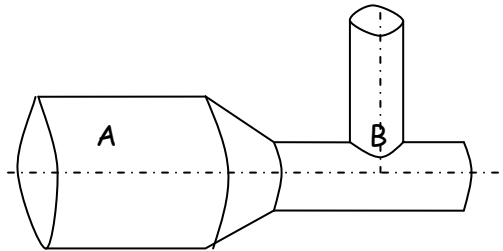

Figure 90: Venturi system

This short analysis shows that the synthesis of a system despite the use of generic organs requires that the engineer has in mind a specific solution.

List of attributes and dimensions for the two concepts of solutions of the example:

The following table is listing the different types of attributes and dimensions related to the two concepts of solutions described in Figure 89. This list can be later transformed by using the machinery made for developing dimensionless numbers.

Table 21: List of attributes and dimensions for the Brush/dustpan and Vacuum cleaner concepts

Functions	Comment	Brush/Dustpan concept			Functions	Comment	Vacuum cleaner concept		
		list of attributes and quantities					list of attributes and quantities		
		Power variables type	Connecting variables type	State variables type			Power variables type	Connecting variables type	State variables type
CONVERT	System input	Torque (T_2) in $ML^2 T^{-2}$ Angular velocity (ω_2) in T^{-1}			CONVERT	F ₂ -organ input	Elec. potential (U) in $ML^2 T^{-2} A^{-1}$ Current (I) in A		
	T-organ		Brush stem (L_1) in L			F ₂ -organ output and R-organ input	Elec. potential (U') in $ML^2 T^{-2} A^{-1}$ Current (I') in A		
	T-organ output and I-organ input	Effort (F_2) in $ML T^{-2}$ Linear velocity (v_2) in LT^{-1}				F ₂ -organ output and G-organ input	Elec. potential (U') in $ML^2 T^{-2} A^{-1}$ Current (I) in A		
	I-organ characteristics		Inertia of the brush brush (I_1) in L^4			G-organ characteristics		Factor K (K) in $ML^2 T^{-2} A^{-1}$	
	I-organ output and R-organ input	Effort (F_3) in $ML T^{-2}$ Linear velocity (v_3) in LT^{-1}		Bending momentum (M) in $ML^2 T^{-2}$		R-organ characteristics		Resistance (R) in $ML^2 T^{-3} A^{-2}$	
	R-organ characteristics		Friction of the Brush on floor (f) dimensionless			G-organ output and T-organ input	Torque (T_2) in $ML^2 T^{-2}$ Angular velocity (ω_2) in T^{-1}		
	R-organ output and E ₂ -organ input	Effort (F_4) in $ML T^{-2}$ Linear velocity (v_4) in LT^{-1}				T-organ characteristics		Surface of the fan wings (S^2) in L^2	
IMPORT	solid particulate input and E ₂ -organ input	Weight (ρVg) in MLT^2 Linear velocity ($v_{3=0}$) in LT^{-1}			IMPORT	T-organ output and F ₂ -organ input	Pressure (P_{FAN}) in $ML^{-1} T^{-2}$ Air flow (Q_{FAN}) in $L^3 T^{-1}$		
	Solid particulate characteristics		Diameter D_0 in L Mass (ρV) in M			F ₂ -organ characteristics		Pipes surfaces ratio (S_x/S_d) dimensionless	
	E ₂ -organ output and C-organ, Plan Link input	Effort (F_5) in $ML T^{-2}$ Linear velocity (v_5) in LT^{-1} Weight (ρVg) in MLT^2 Linear velocity (v_6) in LT^{-1}				F ₂ -organ output and E ₂ -organ input	Pressure (P_{in}) in $ML^{-1} T^{-2}$ Air flow (Q_{FAN}) in $L^3 T^{-1}$ Weight (ρVg) in MLT^2 Linear velocity ($v_{5=0}$) in LT^{-1}		
STORE EXPORT	C-organ characteristics		Volume of the Dustpan (V_{sh}) in L^3		Solid particulate characteristics		Diameter D_0 in L Mass (ρV) in M		
Sub function TRANSLATE	Plan Link				System input	Effort (F_{10}) in $ML T^{-2}$ Linear velocity (v_{10}) in LT^{-1}			
	C-organ output	Weight (ρVg) in MLT^2 Linear velocity (v_7) in LT^{-1}			E ₂ -organ characteristics		Pipes diameter D in L		
CONVERT	System input	Torque (T_1) in $ML^2 T^{-2}$ Angular velocity (ω_1) in T^{-1}			STORE EXPORT	E ₂ -organ output and C-organ input	Weight (ρVg) in MLT^2 Linear velocity (v_8) in LT^{-1}		
	T-organ		Dustpan stem (L_2) in L			C-organ characteristic		Volume of the Bag (V_{bag}) in L^3	
	T-organ output and C-organ input	Effort (F_1) in $ML T^{-2}$ Linear velocity (v_1) in LT^{-1}				Sub function LINK	E ₂ -organ		
					C-organ output	Weight ($\rho(V+V_{bag}g)$) in MLT^2 Linear velocity (v_{7+8}) in LT^{-1}			

The Vashy-Buckingham theorem used for the metrization of the classification space [Matz, 1959] [Barenblatt, 1979] [Sonin, 2001] :

Let $y = \sum_i a_i x_i$ be a law. Then all $a_i x_i$ must have the same dimensions as y . If a_i are dimensionless constants, then x_i must have the same dimension than y . This is the principle of dimensional homogeneity. If the system of fundamental quantities needed in this law is in the form of 3 basic quantities namely the length L , the mass M and the time T (see Table 17 p.164) and if $[y]$ the dimension of the

variables is a combination of the 3 basic dimensions then $[y]$ has the form:

$$\text{Eq. 15} \quad [y] = C_1 \cdot L^{\alpha_1} M^{\alpha_2} T^{\alpha_3}$$

This form is called the product theorem in which the constant C_1 and the exponents α_1 , α_2 and α_3 are dimensionless numbers.

It follows from the product theorem that every law which takes the form $y_0 = f(x_1, x_2, \dots, x_n)$ can take the alternative form

$$\text{Eq. 16} \quad \Pi_0 = f(\Pi_1, \Pi_2, \dots, \Pi_n)$$

Π_i are dimensionless products. This alternative form is the final result of the dimensional analysis and is the consequence of the *Vashy-Buckingham theorem*.

Algorithm for creating dimensionless numbers:

When having demonstrated that an alternative form of any law can be written by the combination of dimensionless numbers, it is now necessary to analyse how the dimensionless numbers are calculated.

A dimensionless number is a product which takes the following form:

$$\text{Eq. 17} \quad \Pi_i = y_i \cdot (x_1^{\alpha_{i1}} x_2^{\alpha_{i2}} x_3^{\alpha_{i3}})$$

where $\{x_1, x_2, x_3\}$ are called the *repeating variables*, $\{y_1, y_2, y_3\}$ are called the *performance variables* [Bashkar and Nigam, 1990] and $\{\alpha_{ij} | 1 \leq i \leq n - r, x_2, x_3\}$ are the exponents.

The Vashy-Buckingham theorem is universally accepted as the tool to be used for dimensional analysis. Nevertheless, it is not easy to select properly the *repeating variables* and the *performance variables* in practice, especially in the case of complex problems. This can lead to an impasse. The Vashy-Buckingham theorem does not provide any specific guidance related to the two following choices:

- the selection of the repeating and performance variables,
- the determination of the unique number of governing dimensions (D_{\min}),

An approach for making the appropriate choices can be summarized according to the following table [Butterfield, 2001]. In Table 22:

- V is the list of the independent variables which are assumed to govern the system,
- $R \in V$ contains the variables selected from V , which have distinct dimensions other than 0,
- P are variables not in R which have been placed in this group because the dimensions of some of these variables repeat the dimension of the variables in R .
- O are variables which have zero dimension,
- D is a possible set of m independent from basic or composed dimensions.
- Q is a set of variables selected from R , from which a dimensionless group cannot be formed. The Q list is the *repeated variable* list.

The array ($m \times m$) $[A]$ is the outcome of the process of selection of the variables. In order to be able to form dimensionless numbers, it should be checked that $[A]$ is non-singular ($\det(A) \neq 0$).

Then it is necessary that:

- No column of $[A]$ contains entirely zero elements,
- No column of $[A]$ is either repeated or a multiple of another one,
- The column of $[A]$ cannot be combined to form a zero column. This requirement is similar of selecting the variables of Q in order to avoid that they can form a *dimensionless group*.

All these conditions are similar to say that the rank of $[A]$ is m . This is the condition that defines the number of components of D to be D_{min} . The list Q is often not unique.

Table 22: Table for the selection of the repeating and performance variables (adapted from Butterfield [Butterfield, 2001])

		V							
		R				P	O		
		Q		S					
		v ₁		v _m		v ₀		v _p	
D	d ₁	A (m×m)				B(m×(n-m))			
	d _m								

Machinery aimed at providing intra-inter analysis of the dimensionless groups and inter-functions analysis: [Bashkar and Nigam, 1990]

Interactions can take place:

- within a dimensionless group between the attributes,
- across dimensionless groups, if they are connected through a *contact attribute*,
- across functions via a coupling dimensionless group,

Mathematical machinery has been developed by Bashkar and Nigam [Bashkar and Nigam, 1990] in order to analyse this type of interactions.

Intra-dimensionless group interactions:

A specific dimensionless group can be expressed in the following manner according to Eq. 12,:

$$y_i = \prod_k .x_j^{-\alpha_{ij}} .x_l^{-\alpha_{il}} .x_m^{-\alpha_{mi}}$$

This equation can be written:

$$Eq. 18: \quad \frac{y_i}{x_j} = \prod_k \frac{x_j^{-\alpha_{ij}}}{x_j} x \frac{x_l^{-\alpha_{il}} .x_m^{-\alpha_{mi}}}{x_j} .$$

The derivative of this dimensionless group has the form:

$$Eq. 19: \quad \frac{\partial y_i}{\partial x_j} = -\prod_k \alpha_{ij} \frac{x_j^{-\alpha_{ij}}}{x_j} x_l^{-\alpha_{il}} x_m^{-\alpha_{mi}}$$

Consequently the derivative can take the form:

$$Eq. 20: \quad \frac{\partial y_i}{\partial x_j} = -\alpha_{ij} \frac{y_i}{x_j}$$

Knowing the sign of the exponents, α_{ij} , the sign of the intra dimensionless group derivative can be determined by using the Eq. 20.

Inter-dimensionless group interactions:

The inter-dimensionless group interactions can only be defined if the dimensionless groups share variables. The share variables are called *contact variables* (x_p). The inter-dimensionless group derivative is defined according to the following equation.

$$Eq. 21: \quad \left[\frac{\partial y_i}{\partial y_j} \right]^{x_p} = \frac{\partial y_i / \partial x_p}{\partial y_j / \partial x_p} = \frac{-(\alpha_{ip} y_i) / x_p}{-(\alpha_{jp} y_j) / x_p} = \frac{\alpha_{ip}}{\alpha_{jp}} \cdot \frac{y_i}{y_j}$$

Inter-function interactions:

The inter-function interactions require the presence of coupling dimensionless groups Π_C . These dimensionless groups are ratio of quantities with identical dimensionality modulo exponents. They are constructed by coupling dimensionless groups Π_{Ai} and Π_{Bj} belonging to different functions by using the rule described below:

Rule: The coupling dimensionless groups Π_C are obtained by coupling a performance variable in Π_{Ai} with a repeating variable in Π_{Bj} or/and a performance variable in Π_{Bj} with a repeating variable in Π_{Ai} .

When a feedback exists between two functions at least two coupling dimensionless groups should appear. The inter-functions interaction framework can also be used to couple different level of functional descriptions.

In order to be applicable in practice the machinery described above need to be connected with a database of physical and economic attributes. Developing a software and a database is the goal of

future research for implementing the framework presented in this thesis.

Comparison of concepts of solutions and identification of the comparison variables:

Comparison and ranking of concepts of solutions:

The machinery aimed at comparing and ranking concepts of solutions and functions should be able to distinguish between some fundamental features of a design solution. A good concept should have some basic qualities. These qualities are:

- Meet the technical requirements and provide these technical requirements efficiently by minimizing the consumption of energy (physical and informational domains),
- They should be easy to manufacture, assemble, pack, transport, dismantle, recycle and treat in municipal waste. All the people who work in these domains need information about the product and have to match it with information about the specific processes. Consequently all these aspects can be considered to be related with the informational domain.
- They should have a low cost related to each step of the physical life cycle (economical and informational domain).

Four rules dedicated to the evaluation and ranking of concepts of solution can be established from the previous list. These rules are dedicated to the transfer of information between two phases of the physical design life cycle and to the evaluation of the environmental impact.

Rule of information: The best concepts of solutions in the informational domain are the ones which minimize the required exchange of information [Suh, 1990].

Rule of information correspondence in TP: The creation and designing of technological processes (TP) require that the informational content of the features of a TS matches with the amount of information which can be processed by the TPs.

Rule of environment impact: The best concepts of solutions in the environmental domain are the one which minimize the environmental degradation according to the Svirezhev's law of entropy exchange between systems and environment (see Eq. 2 p.73) [Svirezhev, 2000].

Paradigm for the verification of the separation property and identification of the comparison variables:

A practical problem appears when a designer has to check that the third condition of metrization is met (the principle of separation of different concepts of solutions). The designer has to find a procedure in order to verify this condition. He also has to find another procedure for highlighting a fourth type of generic variable used for making the concepts of solution comparable. This type of variable is called a *comparison variable* in this thesis.

The fundamental idea of the paradigm is that the metamodel structure flow progressively from a high level of granularity to a small level of granularity. At a certain level of description the concepts of solution diverge from each other. The idea is to reveal this level of description. The comparison variables belong to this level where concepts of solutions are diverging. These variables ensure that the axiom of separation/recognition described in sections 2.3.3 and 2.3.5 is true.

Table 23: Classification of the levels of granularity description

Finer level of granularity description →										
Domains	Physical domain	Energy	Primary fields	Secondary fields	Power variables	Effort				
	Informational domain				Flow					
	Economical domain				State variables	Displacement				
					Connecting variables	Laws variables	System or subsystem level			
							Volume			
							Mass			
							Inertia			
							Young modulus			
							<i>Etcetera</i>			
								Macro geometrical level		Micro geometrical level
								Shape description		Roughness
								<i>Etcetera</i>		molecular structure
										<i>Etcetera</i>

For example in the case of the two concepts of solution of Figure 89 *a* and *b*, the function *CONVERT* exhibits different types of efforts and flows. In the classification of the Table 23, the level of granularity located just before the effort and flow is the power variables. Flows and efforts belong to the power variables family. Consequently, in order to ensure comparability between the two concepts of Figure 89*a* and *b*. The power (i.e. effort x flow) related to the function *CONVERT* should be similar for both concepts. This type of variable is called *comparison variable* and should be integrated in the list of variables necessary for the metrization process if not yet identified by the SADT approach.

In conclusion, the use of this paradigm is fundamental for two reasons. At first, it ensures that the property of separation is obtained for the studied design problem and secondly, it provide guidance in order to highlight the comparison variables which are the variables which required to be similar in order to be able to compare two different concepts of solution.

Summarizing algorithm for creating the machinery aimed at comparing concepts of solution:

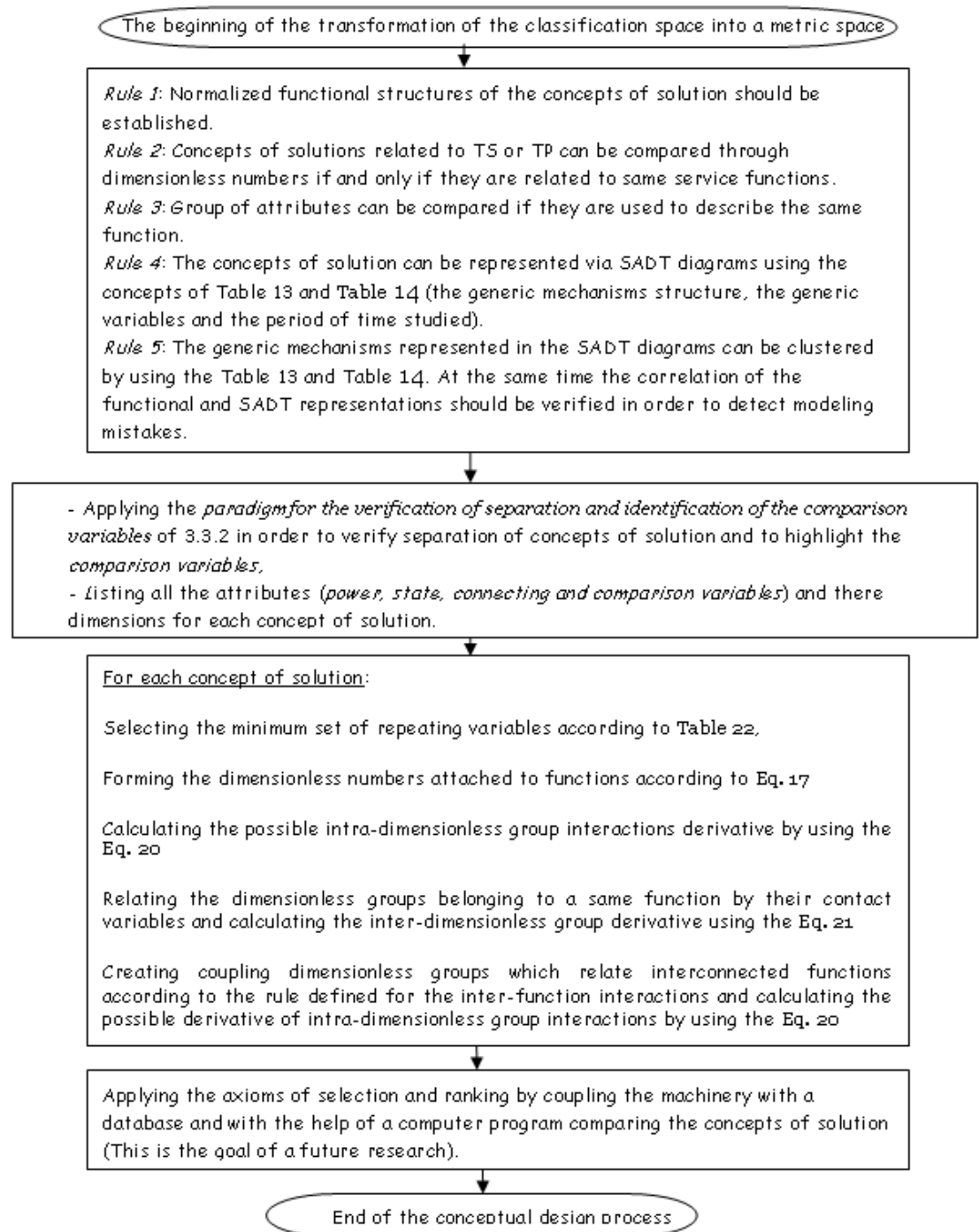

Figure 91: Algorithm for creating the machinery comparing concepts of solution

3.3.3 Example of the use of the machinery for simple concepts of beam

The goal of this small example studied in this section is to show how the machinery can be coupled with an existing database. The example is trivial but the interest is to present how the methodology can be used in practice when coupled with the material database CES4.

It is important to notice that the entire analysing process which follows can also be applied to compare more complex cases like whole systems' concepts consisting of groups of different components or concepts of manufacturing processes. This has not been done both because the treatment of these kinds of examples will exceed the format of this type of thesis and because quantitative data is needed at the final stage of the analysis. The development of that kind of database is out of the scope of this thesis.

The example analyses a beam loaded with effort that causes bending. For us the interesting function is the constraint function of the beam expressed in the following manner:

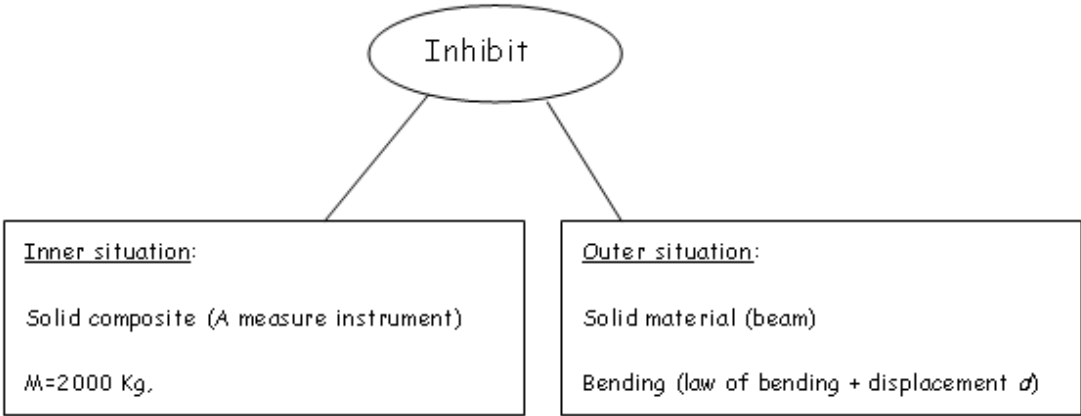

Figure 92: Constraint function of a beam loaded with a heavy measurement instrument

Identifying the functional structure, SADT diagram, concepts of solution, power variables, state variables and connecting variables:

The functional structure and the SADT representation of the beam are defined according to Table 7, Table 8 and Table 13:



Figure 93: Functional structure of a beam

These factors are represented by the connecting variables which are the variables of the equation which govern the physical phenomenon.

According to the generic law of a C-organ: $e_2 = \frac{1}{C}(\int f_1 \cdot dt + q(0))$ the

law ruling the beam bending is: $F = \frac{C_1 EI}{L^3} d$

The factor $\frac{C_1 EI}{L^3}$ is equivalent to the factor $\frac{1}{C}$ of the C-organ equation. Consequently, the variables which can be used in order to describe beams are the displacement d due to the bending effort which is a state variable, the Young modulus (E), the Inertia (I) and the length of the beam (L) which are connecting variables. The SADT diagram can be completed by using these 4 variables completed by the input power variables F_1 . The speed v_1 and the output power variables are out of the interest in this example because they are not modelled in the initial representation of the concept of function of the Figure 92.

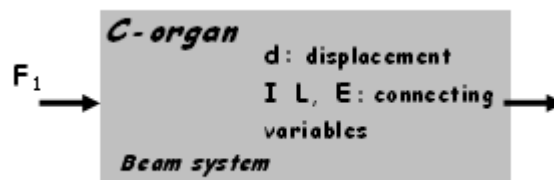

Figure 94: SADT representation of the beam

Following the SADT diagram it is possible to define concepts of solution. Three of them are presented in the following figure.

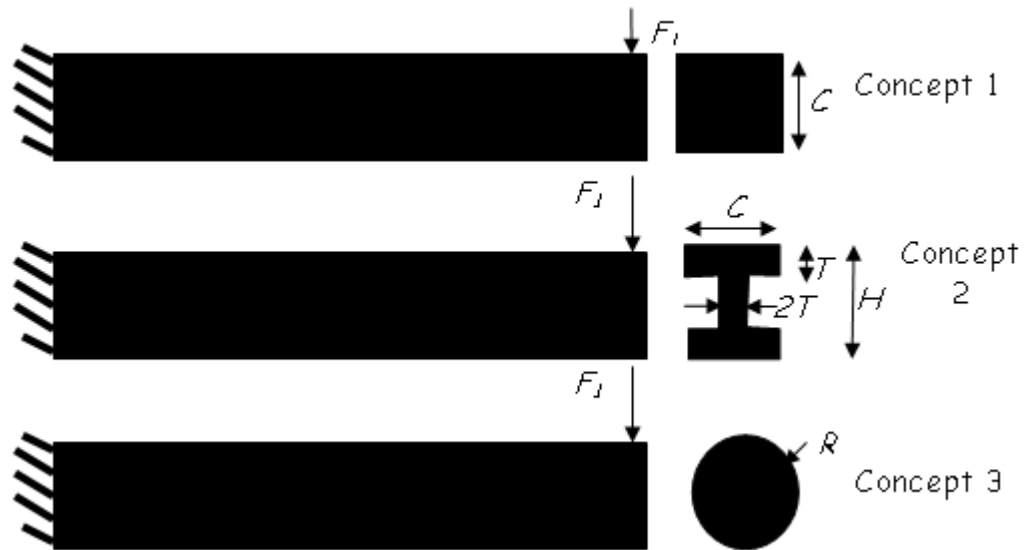

Figure 95: Concepts of solution for a beam loaded with effort which causes bending

Verifying the separation property and identifying the comparison variables:

At this stage of the study it is important to use the paradigm proposed for ensuring the comparability of concepts of solution and to verify that the property of separation is obtained. The fundamental idea is to check at what stage of the classification proposed in the part called *paradigm for verifying the separation of concepts of solution and identifying the comparison variables* presented in section 3.3.2, the development of the concepts of solution are diverging.

In the case of the beam, the concepts diverge during the *shaping process* of the beam. The shaping process is described by the macro geometrical level of description. This level is represented by the variables R , H , T and C in the Figure above. These variables separate the concepts of solution and consequently are different for each concept. The inertias $I_i=f(R, H, T, C)$ which have been identified in the SADT are then also different. In the classification of the Table 23, the other types of variables located before the *shape* level are the *volume, effort, flow, displacement, momentum* and *connecting variables*. Consequently, all the beams should exhibit similar properties of *volume, effort, flow, displacement, momentum* and *connecting variables*. These variables are the comparison variables of the design problem.

Then the volume $V=A.L$, the effort $F1$ and the displacement d of the beam under the effort $F1$ which are the variables of interest

according to the SADT diagram of Figure 94 should be similar in the definition of the problem. L , F_1 , V and d are the comparison variables, L , F_1 and d have already been introduced in the SADT diagram of the Figure 94 but A has not been introduced yet. Subsequently in order to ensure the comparison of concepts, A should be added as a variable of the problem in addition to the other variables described in the SADT diagram. The following table is summarizing the different variables used for describing the problem.

Table 24: List of attributes and quantities involved in the problem

Functions	Comment	Beam concept list of attributes and quantities		
		Power variables type	Connecting and comparison variable types	State variables type
STORE and CONVERT	System	Effort (F_1) in (MLT^{-2})		
	input	velocity (v_1) in (LT^{-1})		
	C-organ			d bending displacement in L
			A section of the beam (L^2)	
			I inertia of the beam (L^4)	
			L Length of the beam (L)	
			E Young modulus ($ML^{-1}T^{-2}$)	
	C-organ output and I-organ input	Effort (F_2) in (MLT^{-2}) Linear velocity (v_2) in (LT^{-1})		

The interesting variables in order to analyse how the beam's concepts can meet the requirement of inhibiting bending are according to the C-organ generic law defined above:

A , I , L , d , F_1 and E

The 3 basic quantities involved in the process:

L , T and M

Selection of the repeating and performance variables:

Table 25: The first step of the selection of the performance and repeating variables

		V									
		R				P				O	
		Q		S							
		E	I			F₁	d	A	L		
D	L	-1	4			1	1	2	1		
	T	-2	0			-2	0	0	0		
	M	1	0			1	0	0	0		

Q are the repeating variables and P are the performance variables. A quick check shows that the matrix formed by QxD is non singular. It is then possible according to Eq. 17 $\Pi_i = y_i \cdot (x_1^{\alpha_{i1}} x_2^{\alpha_{i2}} x_3^{\alpha_{i3}})$ to create 4 dimensionless numbers.

$\Pi_1 = dI^{1/4}$, $\Pi_2 = AI^{1/2}$, $\Pi_3 = LI^{1/4}$ using this set of performance variables, it is not possible to create the last dimensionless number. The dimensionless groups Π_2 and Π_3 have a physical sense because they are both related to the shape of the concepts of solutions but in the dimensionless group Π_1 an element is missing, the Young modulus E and the effort F_1 . Then using the bending law $F = \frac{C_1 EI}{l^3} d$, it is possible to combine two of the performance variables F and d in: $\frac{F}{d} = \frac{C_1 EI}{l^3}$

This ratio is called the stiffness of the beam, and the table above is transformed into the following table.

Table 26: The second step of the selection of the performance and repeating variables

		V									
		R				P				O	
		Q		S							
		E	I			F₁/d	A	L			
D	L	-1	4			0	2	1			
	T	-2	0			-2	0	0			
	M	1	0			1	0	0			

We have then 3 dimensionless groups:

$$\Pi_1 = \frac{F_1}{d} E^{-1} I^{-1/4}, \Pi_2 = A I^{1/2} \text{ and } \Pi_3 = L I^{1/4}$$

The first one is combining the effort applied on the beam, the material of the beam and the shape of the beam.

The second one is related to the shape of the beam. It should be noticed that this dimensionless group exhibit similarities with the shape factors introduced by Shanley [Shanley, 1960] and used by Ashby [Ashby, 1999]. The third one is related to the length combined with the shape of the beam.

The derivates of the intra-dimensionless groups are according to Eq. 20:

$$\frac{\partial(F_1/d)}{\partial E} = \frac{F_1/d}{E} \langle 0 \text{ and } \frac{\partial(F_1/d)}{\partial I} = \frac{1}{4} \frac{F_1/d}{I} \langle 0 \text{ for } \Pi_1 = \frac{F_1}{d} E^{-1} I^{-1/4}$$

$$\frac{\partial A}{\partial I} = -\frac{1}{2} \frac{A}{I} \langle 0 \text{ for } \Pi_2 = A I^{1/2}$$

$$\text{and } \frac{\partial L}{\partial I} = -\frac{1}{4} \frac{L}{I} \langle 0 \text{ for } \Pi_3 = L I^{1/4}$$

The derivates of the inter-dimensionless group are all defined according to the contact variable I , then according to Eq. 21:

$$\left[\frac{\partial(F_1/d)}{\partial A} \right]^I = -\frac{1}{2} \frac{(F_1/d)}{A} \langle 0 \text{ for the relation between } \Pi_1 \text{ and } \Pi_2$$

$$\left[\frac{\partial(F_1/d)}{\partial L} \right]^I = -\frac{(F_1/d)}{L} < 0 \text{ for the relation between } \Pi_1 \text{ and } \Pi_3$$

$$\left[\frac{\partial A}{\partial L} \right]^I = 2 \frac{A}{L} > 0 \text{ for the relation between } \Pi_2 \text{ and } \Pi_3$$

There is no *inter-function derivatives and coupling dimensionless groups* according to the functional structure described in Figure 93.

It is possible to simulate qualitatively the behaviour of the beam according to the machinery developed above. The cascading consequences of the variation of the variables can be analysed. Nevertheless, the interest is limited in a trivial example of that type. It is possible at this stage to represent the dimensionless structure framework of the beam according to the following figure.

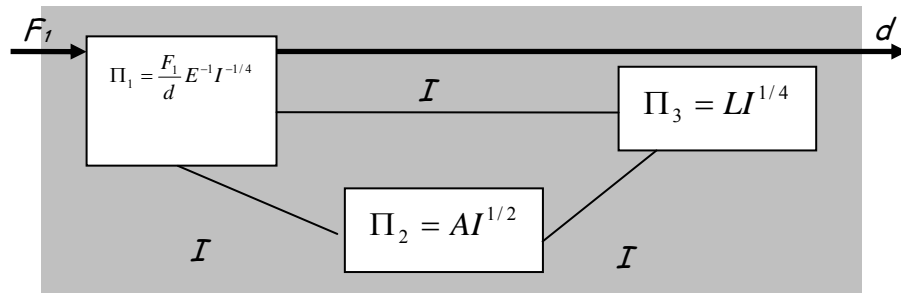

Figure 96: The synthesis figure of the dimensionless model of a beam

Practical analyse of the best concept of shape for the beam:

Some of the parameters are fixed and similar for all the concepts according to the analysis made by using the paradigm of verification of the concepts separation and identification of the comparison variables:

$$L = 3\text{m}, A = 0.2 \text{ m}^2 \text{ and } F_1 = 2000.9.81 = 19620 \text{ N}$$

There is no use to define the value of d at this stage because d is not represented in the dimensionless groups Π_2 and Π_3 which are the two dimensionless groups necessary in order to evaluate the shape of the concepts of solutions. Π_1 provides complementary information which is not required for the comparison of the concepts of solutions.

Consequently:

If the connecting variable T is selected to be $T=0.1\text{ m}$ in concept 2, it follows that $C=0.447\text{ m}$, $H = 0.753\text{ m}$ and $D=0.505\text{ m}$. These variables constitute the macro geometrical level of description of the concepts. The separation of the concepts of solutions is ensured by defining these variables. For each concept of solution, the dimensionless numbers are given in the following table.

Table 27: Value of the dimensionless groups Π_2 and Π_3 for the concepts of solution

Dimensionless groups	Concept 1	Concept 2 (best concept)	Concept 3
Π_2	0.011	0.028	0.011
Π_3	0.72	1.12	0.71

The analysis of these two dimensionless numbers shows that the concept 2 is the best followed by the concept 1 and the concept 3 is the third. It is possible to establish the direction in order to improve concepts of solutions. This direction is the one which is maximizing Π_2 and Π_3 . If the numerical value of the displacement d is chosen, then it is possible to have the following figure presenting a list of possible material for the beam by using the dimensionless group Π_1 associated with a data base of material from the CES4 software [CES4[©]]. Nevertheless this analysis of Π_1 has a limited interest because the best concept of solution has already been selected according to the shape which was the diverging aspect of the concepts of solution. The dimensionless group Π_1 will have been interesting in the case of concepts of solution which have diverged also according to their material composition.

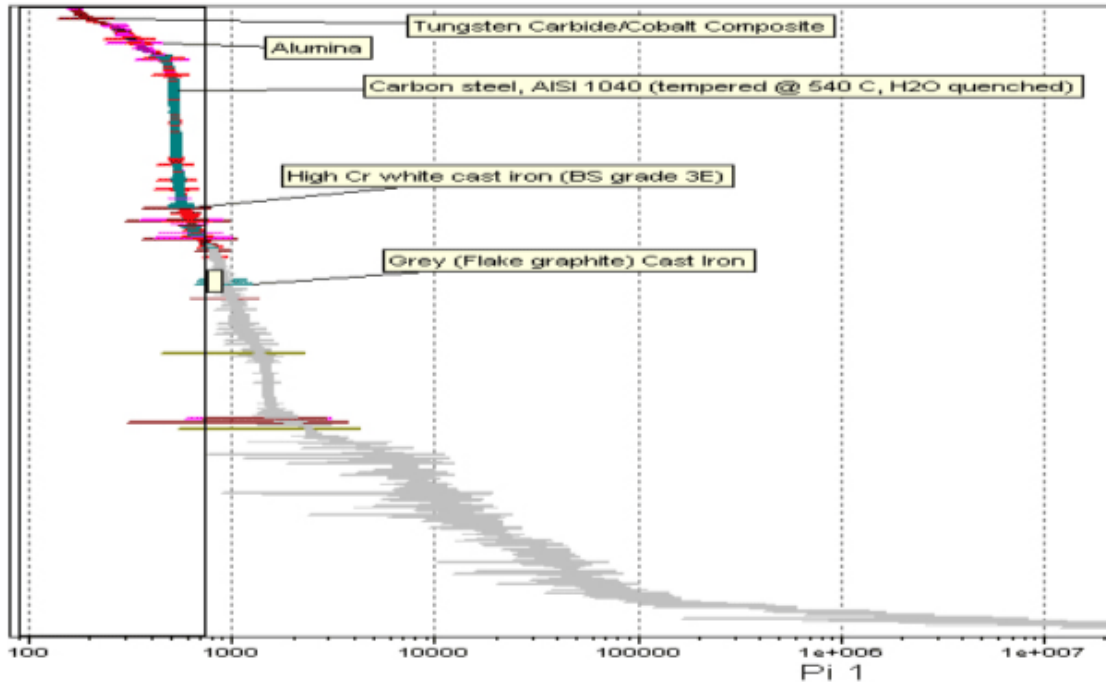

Figure 97: Material proposal for Π_1 using the software CES4 [CES4[©]]

This example is trivial and it has been treated in many ways in literature. Nevertheless this approach is very general and gives an overall vision of the metrization/comparison process. This example has been studied in the book of Ashby [Ashby, 1999] but in a less complete manner than the approach developed in this work.

I have also developed other examples related to the study of entire product concepts and manufacturing processes. Nevertheless, I have not presented them in this thesis both because grasping the quantitative data necessary to rank the concepts is out of the scope of this work and because the presentation of this type of example is long and can easily lead to confusion for the readers. These examples show however that the methodology is also applicable to these more complex cases.

4 CONCLUSION

This thesis was based on the intuition that dimensional analysis can be used to assist the comparison and selection process of the concepts of solution during the conceptual design process. Nevertheless, in order to verify the feasibility of this initial intuition, it was not sufficient to implement directly dimensional analysis in the conceptual design process. It was necessary to define at first a general scientific approach in order to identify the necessary

conditions which can lead to the use of dimensional analysis during the conceptual design process.

Because the dimensional analysis theory has a mathematical framework, it was logical to try embedding at first this framework inside a more general structure of design by using a mathematical language. This phase was achieved by investigating the General Design Theory (GDT) [Yoshikawa, 1981] [Tomiyama and Yoshikawa, 1987]. In order to integrate the framework of dimensional analysis into the framework of GDT, the approach consisted of highlighting the similarities of the two theories. The GDT's axiom of separation/recognition provided a fundamental analogy.

In addition the study of the GDT associated with the study of the Abstract Design Theory [Kakuda and Kikuchi, 2001a] enabled me to underline the necessary conditions which can lead to the application of the dimensional analysis theory in design activity. The three necessary conditions were:

- Having a fundamental system of entourage,
- Being sure that this system of entourage is countable,
- Respecting the property of separation between the concepts,

In order to verify the existence of these necessary conditions, it was needed to construct a structure of generic concepts starting from the concept of function and ending with the underlying structure of the attributes used to express a concept of solution. Consequently, a series of concepts were introduced guided by the idea of providing a group of generic concepts able to guide the designer both during the refinement of the customer's requirements and the synthesis process.

To provide guidance during the refinement process, the concept of function was extensively investigated and a concept of function coming from the situation theory was introduced [Barwise and Perry, 1999]. According to the vision developed in the thesis, a function is an abstract concept not particularly dedicated to a specific machine. At the same time this abstract concept should conserve a clear link with the real world. This was done by defining a function as an interface between two situations. In order to ensure the generality of the concept of function, a normalized vocabulary related to function and situation has been used [Hirtz et al., 2002]. Similarly a situation in the concept of function was described as the interaction of a substance, energy fields associated with the energy carrier and laws modelling the interaction of situations and functions. Normalized vocabulary and classifications were also introduced for expressing the substances and the energy fields [Hirtz

at al., 2002]. This vocabulary is meant to ensure homogeneity when describing design problems.

To provide guidance during the synthesis phase, two steps are required. First of all new concepts were needed in order to flow in the direction of concepts of solution. Secondly the mapping of these concepts with the concept of function was required.

These concepts were intended to classify the design space. The first and the most abstract concept was the concept of domain which split the design space into three parts namely, the physical, economical and informational domains. The concept of generic mechanisms was introduced by enhancing and combining previous researches [Pahl and Beitz, 1988] [Hubka, Andreasen and Eder, 1988] [Karnopp et al., 1990] [Top, 1993]. The generic mechanisms were classified in 6 elementary families. The families of mechanisms can themselves be combined in order to form three types of more complex mechanisms. The behaviour of the mechanisms is ruled by a set of elementary laws. These laws are expressed according to a set of variables.

In the thesis four families of variables were established namely the power, state, connecting and comparison variables. The family of power variables is itself composed of two variables called generalized effort and generalized flow. The family of state variables is composed of two variables called generalized displacement and generalized momentum. The connecting variables are the variables used in the laws to connect the variables of power type and state type. In addition, the comparison variables are extra variables not necessary directly expressing the laws of the generic mechanisms but essential for being able to compare different types of concepts of solution. The identification of these comparison variables is ruled by a paradigm developed in the thesis.

In order to map the functions and the generic concepts, a metamodel structure was introduced. This structure combines all the generic concepts, laws and the mapping rules. A metamodel is a generic model to be used as an intermediate between a functional definition of a problem and the final drawings of the concepts of solutions. This structure constitutes a fundamental system of entourage.

The fundamental system of entourage needs to be countable. This was ensured by introducing two new fundamental quantities to the international system of units. These quantities are the information and the economical quantities. A procedure for normalizing the unit of information was presented in the thesis by using the bases of the theory of information associated with a classification of the information as a procedure to unify the metric of information. The unification of the economical units was much easier and required only knowing the change rate between different types of currencies.

The property of separation was checked by using the *paradigm of separation and identification of comparison variables*.

When these three metrization requirement are obtained it is then possible to proceed to the metrization process using the Vashy-Buckingham theorem associated with the paradigm of Butterfield [Matz, 1956] [Barenblatt, 1979] [Sonin, 2001] [Butterfield, 2001]. A machinery dedicated to the reasoning about dimensionless groups was also introduced in order to provide the possibility of qualitative simulation [Bashkar and Nigam, 1990].

This work has created an integrated framework meant for improving the comparison of concepts of solutions. I argue that this framework can be applied to the entire physical life cycle of a product and to the entire domain of design.

Nevertheless, this thesis has tested the approach on a limited number of practical cases. A complete study of the applicability of the method is needed. This study should include testing complex concepts of whole products and during the different phases of the life cycle. The real interest of introducing the informational and economical domains can only then be analysed.

This will be done in the framework of a future research program called COMODE, financed by the European Commission. The approach developed in this thesis will be tested on an extended number of practical cases in close relation with the Finnish foundry industry. The final implementation of the approach as a software package will also be completed within the next two years.

REFERENCES

Altshuller G., *Creativity as an exact science*, Gordon & Breach, Luxembourg, 1984.

APTE® , *Cabinet de Conseil en Management, Spécialiste Analyse de la Valeur et Analyse Fonctionnelle*, 27 rue Lafayette 78000 Versailles, France.

Ashby M.F., *Materials Selection in Mechanical Design*, 2nd Edition, Butterworth Heinemann, 1999.

Barenblatt G. I., *Similarity, Self-similarity and Intermediate Asymptotics*, Consultant Bureau, Plenum, New York, 1979.

Barwise J. and Perry J., *Situation and Attitude*, Cambridge, MIT Press, 1983; Stanford, CSLI Publications, 1999.

Barwise J. and Seligman J., *Information Flow: The logic of distributed systems*, Cambridge University Press, 1997.

Bhashkar R., Nigam A., *Qualitative physics using dimensional analysis*, Artificial Intelligence, vol. 45, pp. 73-111, 1990.

Bourbaki N., *General Topology* (two volumes), Springer-Verlag (2nd printing 1989) Berlin, 1966.

Brillouin L., *La science et la théorie de l'information*, Masson, 1952.

Brillouin L., *Scientific uncertainty and information*, Academic Press, 1964.

Butterfield R., *Dimensional analysis revisited*, Proc Instn Mech Engrs Vol 215 Part C, ImechE, pp. 1365-1375, 2001.

CES Selector Version 4, Granta Design Limited 1999-2002.

Chakrabarti A., Bligh T. P., *A scheme for functional reasoning in conceptual design*, Design Studies, No. 22, pp. 493-517, 2001.

Clavier J., *Théorie de l'information*, Techniques de l'Ingénieur, traités électroniques E3080-E3082-E3084, 1998.

Coatanéa E. and Vareille J., *Applying dimensionless indicators for the analysis of multiple constraints and compound objectives in conceptual design*, Proceedings of Congrès Français de Mécanique – CFM2003, Nice, France, 2003.

Coatanéa E. and Vareille J., *A life cycle modelling for the conceptual design stage using dimensional analysis approach*, Proceedings of DETC'04, Salt lake City, USA, 2004.

Coatanéa E., Vareille J. and Le Bolc'h F., *Towards a life cycle model for the conceptual design process*, Proceedings of IDDME2004, Bath, UK, 2004.

Dardy F. and Teixido C., *Guide de compétitivité industrielle*, Delagrave, Paris, 2003.

Eder W. E., *Engineering design - art, science and relationships*, Design Studies, 16, pp.117-127, 1995.

Evbuomwan N.F.O., *A Survey of Design Philosophies, Models, Methods and Systems*, In Proceedings of Institution of Mechanical Engineers, Vol 210, pp301-321,1996.

FD X50-101, *Analyse fonctionnelle - L'analyse fonctionnelle outil interdisciplinaire de compétitivité*, AFNOR, Décembre 1995.

Forbus K.D., *Qualitative Process Theory*, Artificial Intelligence 24(3), North-Holland, pp. 85-168, 1984.

Gero J. S.. *A system for computer-aided design in architecture*, in J. Vlietstra and R. F. Wielinga (eds), *Principles of Computer-Aided Design*, North-Holland, Amsterdam, pp. 309-326, 1973.

Glansdorff P. and Prigogine I., *Thermodynamic theory of structure, stability and fluctuations*, Wiley-Interscience, 1971.

Hirtz, J. Stone R. B., McAdams D. A., Szykman S. and Wood K. L., *A functional basis for engineering design: Reconciling and evolving previous efforts*, Springer-Verlag 2002, Research in Engineering Design 13, pp. 65-82,2002.

Hsu W., Woon I.M.Y., *Current Research in the Conceptual Design of Mechanical Products*, Computer-Aided Design, Vol. 30, No. 5, pp. 377-389, 1998

Hubka, V., and Eder, W. E., *Design science: introduction to the needs, scope and organization of engineering design knowledge*, London, Springer-Verlag, 1996.

Hubka V. Eder W.E., *Engineering Design*, Heurista, Zürich, Switzerland, ISBN 3-85693-026-4, 1992.

Hubka V., Andreasen M., and Eder W., *Practical Studies in Systematic Design*, Butterworths, London, 1988.

IDEFo, *Integration Definition for Function Modeling (IDEFo)*, Processing Standards Publication 183, National Institute of Standards and Technology, USA, 1993.

Kakuda Y. and Kikuchi M., *Abstract Design Theory*, The Annals of the Japan Association for Philosophy of Science, Vol. 10, No. 3, 109–125, 2001a.

Kakuda Y. and Kikuchi M., *Topology on classifications in Abstract Design Theory*, Proceedings of IWES'01, 123–130, 2001b.

Karnopp, D.C, Margolis D.L. and Rosenberg R.C., *System Dynamics: A unified Approach*. John Wiley & Sons, New York, Second revised edition, 1990.

Kikuchi M. and Nagasaka I, *Situation Theoretic Analysis of Functions for a Formal Theory of Design*, in Proceedings of International Conference of Engineering Design '03, 2003.

Kuipers B., *Commonsense reasoning about causality: Deriving behavior from structure*, Artificial Intelligence, v 24, n 1-3, Dec, p 169-203, 1984.

Lotter B., *Manufacturing Assembly Handbook*. Butterworths, Boston, 1986.

Marty C., *Le mieux produire*, Lavoisier- Tec&Doc, Paris, 1991.

Matz W., *Le principe de similitude en Génie Chimique*, Dunod, Paris, 1959.

Miled F., *Contribution à une méthodologie de conception des systèmes dynamiques actifs*, PhD Thesis, University of Technology of Belfort-Montbéliard (UTBM), 2003.

Miles L. D., *Techniques of Value Analysis and Engineering*, McGraw-Hill Book Company, New York NY, 1961.

Nagata J., *On a necessary and sufficient condition of metrizable*, Journal of Polytechnics, 1:93-100, 1950.

NF C 03-190 + R1, *Norme Française , Diagramme fonctionnel "GRAF CET" pour la description des systèmes logiques de commande*, Union Technique de l'Electricité, Paris, UTE Editions, September 1995.

NF X50-151, *Analyse de la valeur, analyse fonctionnelle - Expression fonctionnelle du besoin et cahier des charges fonctionnel*, AFNOR, Décembre 1991.

NF E04-013 (NF E04-013), *Dessins techniques - Dessins d'opérations - Symbolisation des prises de pièces*, AFNOR, Août 1985.

NF E04-015 (NF EN ISO 3952-1/A1), *Schémas cinématiques - Symboles graphiques - Partie 1 : amendement 1*, AFNOR, Novembre 2004.

NF E04-056 (NF ISO 1219-1), *Transmissions hydrauliques et pneumatiques - Symboles graphiques et schémas de circuits - Partie 1 : symboles graphiques*, AFNOR, Mars 1992.

NF EN1325-1, *Vocabulaire du management de la valeur, de l'analyse de la valeur et de l'analyse fonctionnelle - Partie 1 : analyse de la valeur et analyse fonctionnelle*, AFNOR, Novembre 1996.

NF E22-610, *Transmissions mécaniques - Organes d'accouplements - Classification - Terminologie - Symboles graphiques*, AFNOR, Décembre 1986.

Nicoud J.D., *Robots mobiles miniatures*. Les techniques de l'ingénieur. S 7 854, p. 1-12.

Odum H.T., *Ecological and general systems. An introduction to systems ecology*. Univ. Press of Colorado: 644 p. ISBN 0-87081-320-x, 1994.

Otto K., Wood K., *Product Design: Techniques in reverse engineering and new product development*, Prentice Hall, 2001

Pahl G., Beitz W., *Engineering design: a systematic approach*, London: Springer, 1984.

Paynter H. M., *Analysis and design of engineering systems*. MIT Press, Cambridge, Mass., 1961.

Pré Consultants, *The Eco-Indicators 99- A damage oriented method for Life Cycle Impact Assessment, methodology Report*, Pré Consultants b.v., Amersfoort, The Netherlands, <http://www.pre.nl/>, 1999.

Pugh, S., *Total Design: Integrated Methods for Successful Product engineering*, Wokingham, Adison Wesley, 1990.

Reich, Y., *A critical review of General Design theory*, Research in Engineering, 7(1):1-18, 1995.

SADT®, registered brand from SofTech (USA) and IGL Technologie (France)

Savransky, S. D., *Engineering of creativity, Introduction to TRIZ Methodology of Inventive Problem Solving*, Boca Raton, CRC Press, 2000.

Shanley F.R., *Weight-Strength Analysis of Aircraft Structures*, 2nd edition, Dover Publications, New York, 1960.

Shannon C.E. and Weaver W., *The mathematical theory of communication*. Univ. of Illinois Press, Urbana, 1949.

Shim, T., *Introduction to physical system modelling using bond graphs*, University of Michigan-Dearborn, 2002.

Smirnov Y.M., *On metrization of topological spaces*, American Mathematical Society Translation, Series 1, 8:62-77, 1953.

Smithers T., *AI-based design versus geometry-based design, or why design cannot be supported by geometry alone*, Computer-Aided Design, 21(3):141-150, 1989.

Soderlin P., *Thoughts on Substance-Field Models and 76 Standards, Do we need all of the standards?*, TRIZ journal, 2003.

Sonin A.A., *The physical basis of dimensional analysis*, 2nd edition, Department of Mechanical Engineering MIT Cambridge, MA 02139, 2001.

Suh N.P. *The Principles of Design*, Oxford University Press, Oxford, 1990.

Sutherland W. A. *Introduction to Metric and Topological Spaces*, Oxford University Press, Oxford, UK, 1975.

Svirezhev Y. M., *Thermodynamics and ecology*, Ecological Modelling, 132: 11–22, 2000

Thomson, G., *Improving Maintainability and Reliability through Design*, Professional Engineering Publishing, UK, 1999.

Tomiyama T. and Yoshikawa H. , *Extended General Design Theory*, in H. Yoshikawa and E.A. Warman (eds.), Design Theory for CAD, pp. 95–130, North-Holland, Amsterdam, 1987.

Tomiyama T., Kiriya T., Takeda H. and Xue D., *Metamodel: A Key to Intelligent CAD Systems*, Research in Engineering Design, Springer International, Vol. 1, No. 1, pp.19-34, 1989.

Top J. L., *Conceptual modelling of physical systems*, University of Twente, PhD thesis, 1993.

Ulrich K.T. and Eppinger S. D., *Product Design and Development*, Mc Graw-Hill, 2edn, 2000.

VAI, *Value analysis, value engineering, and value management*, Value Analysis Inc., Clifton Park, New York, 1993.

Wordnet®, *WordNet2.0* Princeton University,
www.wordnet.princeton.edu.

Webopedia, *online dictionary and search engine*,
www.webopedia.com.

Yannou B., *Préconception de Produits, Mémoire d'habilitation à diriger des recherches*, Discipline :mécanique, Institut Nationale Polytechnique de Grenoble (INPG), 2000.

Yoshikawa H., *Design philosophy: the state of the art*. Ann. CIRP, 38(2), 579-586, 1989.

Yoshikawa H., *General design theory and a CAD system*, Man-machine Communication, in CAD/CAM, T. Sata, E. Warman (editors), 35-57, North-Holland, 1981.

Yoshioka, M., Sekiya, T., Tomiyama, T., *An Integrated Design-Object Modelling Environment - Pluggable Metamodel Mechanism-*, Turk J Elec Engin, vol.9, no.1, 2001.